

THE
**MECHANICAL ENGINEERS'
POCKET-BOOK.**

A *REFERENCE-BOOK* OF RULES, *TABLES*, DATA,
AND *FORMULÆ*, FOR THE USE OF
ENGINEERS, *MECHANICS*,
AND STUDENTS.

BY

WILLIAM KENT, M.E., Sc.D.,

Consulting Engineer.

Member *Amer. Soc'y Mechl. Engrs.* and *Amer. Inst. Mining Engrs.*

EIGHTH EDITION, REWRITTEN.
TOTAL ISSUE SEVENTY-ONE THOUSAND.

NEW YORK:
JOHN WILEY & SONS.

LONDON: CHAPMAN & HALL, LIMITED,

1910.

WORKS OF WILLIAM KENT

PUBLISHED BY

JOHN WILEY & SONS.

The Mechanical Engineers' Pocket-Book.

A Reference **Book of Rules, Tables, Data, and
Formulæ, for the Use of Engineers, Mechanics,
and Students,** xl + 1461 pages, 16mo, morocco,
\$5.00 net.

Steam-Boiler Economy.

A treatise on the **Theory and Practice of Fuel
Economy in the Operation of Steam-Boilers.**
xiv + 458 pages, 136 figures, 8vo, cloth, \$4.00.

WARNING: This is a **1910** edition. Some of the material may no longer be accurate.

COPYRIGHT, 1895, 1902, 1910,

BY

WILLIAM KENT.

Eighth Edition entered at Stationers' Hall

TYPOGRAPHY BY

Stanhope Press

F. H. GILSON COMPANY

BOSTON. U.S.A.

PRESS OF

BRAUNWORTH & CO.

BOOKBINDERS AND PRINTERS

BROOKLYN, N. Y.

PREFACE TO THE FIRST EDITION, 1895.

MORE than twenty years ago the author began to follow the advice given by Nystrom: "Every engineer should make his own pocket-book, as he proceeds in study and practice, to suit his particular business." The manuscript pocket-book thus begun, however, soon gave place to more modern means for disposing of the accumulation of engineering facts and figures, viz., the index rerum, the scrap-book, the collection of indexed envelopes, portfolios and boxes, the card catalogue, etc. Four years ago, at the request of the publishers, the labor was begun of selecting from this accumulated mass such matter as pertained to mechanical engineering, and of condensing, digesting, and arranging it in form for publication. In addition to this, a careful examination was made of the transactions of engineering societies; and of the most important recent works on mechanical engineering, in order to fill gaps that might be left in the original collection and insure that no important facts had been overlooked.

Some ideas have been kept in mind during the preparation of the Pocket-book that will, it is believed, cause it to differ from other works of its class. In the first place it was considered that the field of mechanical engineering was so great, and the literature of the subject so vast, that as little space as possible should be given to subjects which especially belong to civil engineering. While the mechanical engineer must continually deal with problems which belong properly to civil engineering, this latter branch is so well covered by Trautwine's "Civil Engineer's Pocket-book" that any attempt to treat it exhaustively would not only fill no "long-felt want," but would, occupy space which should be given to mechanical engineering.

Another idea, prominently kept in view by the author has been that he would not assume the position of an "authority" in giving rules and formulae for designing, but only that of compiler, giving not only the name of the originator of the rule, where it was known, but also the volume and page from which it was taken, so that its derivation may be traced when desired. When different formulae for the same problem have been found they have been given in contrast, and in many cases examples have been calculated by each to show the difference between them. In some cases these differences are quite remarkable, as will be seen under Safety-valves and Crank-pins. Occasionally the study of these differences has led to the author's devising a new formula, in which case the derivation of the formula is given.

Much attention has been paid to the abstracting of data of experiments from recent periodical literature, and numerous references to other data are given. In this respect the present work will be found to differ from other Pocket-books.

WARNING: This is a 1910 edition. Some of the material may no longer be accurate

The author desires to express his obligation to the many persons who have assisted him in the preparation of the work, to manufacturers who have furnished their catalogues and given permission for the use of their tables, and to many engineers who have contributed original data and tables. The names of these persons are mentioned in their proper places in the text, and in all cases it has been endeavored to give credit to whom credit is due. The thanks of the author are also due to the following gentlemen who have given assistance in revising manuscript or proofs of the sections named: Prof. De Volson Wood, mechanics and turbines; Mr. Frank Richards, compressed air; Mr. Alfred R. Weiff, windmills; Mr. Alex. C. Humphreys, illuminating gas; Mr. Albert E. Mitchell, locomotives; Prof. James E. Denton, refrigerating-machinery; Messrs. Joseph Wetzler and Thomas W. Varley, electrical engineering; and Mr. Walter S. Dix, for valuable contributions on several subjects, and suggestions as to their treatment.

WILLIAM KENT.

PREFACE TO THE EIGHTH EDITION.

SEPTEMBER, 1910.

DURING the first ten years following the issue of the first edition of this book, in 1895, the attempt was made to keep it up to date by the method of cutting out pages and paragraphs, inserting new ones in their places, by inserting new pages lettered a, b, c, etc., and by putting some new matter in an appendix. In this way the book passed to its 7th edition in October, 1904. After 50,000 copies had been printed it was found that the electrotyped plates were beginning to wear out, so that extensive resetting of type would soon be necessary. The advances in engineering practice also had been so great that it was evident that many chapters required to be entirely rewritten. It was therefore determined to make a thorough revision of the book, and to reset the type throughout. This has now been accomplished after four years of hard labor. The size of the book has increased over 300 pages, in spite of all efforts to save space by condensation and elision of much of the old matter and by resetting many of the tables and formulæ in shorter form. A new style of type for the tables has been designed for the book, which is believed to be much more easily read than the old.

The thanks of the author are due to many manufacturers who have furnished new tables of materials and machines, and to many engineers who have made valuable contributions and helpful suggestions. He is especially indebted to his son, Robert Thurston Kent, M.E., who has done the work of revising manufacturers' tables of materials and has done practically all of the revising of the subjects of Compressed Air, Fans and Blowers, Hoisting and Conveying, and Machine Shop.

CONTENTS.

(For Alphabetical Index see page 1417.)

MATHEMATICS.

Arithmetic.

	PAGE
Arithmetical and Algebraical Signs	1
Greatest Common Divisor	2
Least Common Multiple	2
Fractions	2
Decimals	3
Table. Decimal Equivalents of Fractions of One Inch	3
Table. Products of Fractions expressed in Decimals.	4
Compound or Denominate Numbers	5
Reduction, Descending and Ascending	5
Decimals of a Foot Equivalent to Fractions of an Inch	5
Ratio and Proportion	6
Involution, or Powers of Numbers	7
Table. First Nine Powers of the First Nine Numbers.	7
Table. First Forty Powers of 2	8
Evolution. Square Root	8
Cube Root	9
Alligation	9
Permutation	10
Combination	10
Arithmetical Progression	10
Geometrical Progression	11
Percentage, Profit and Loss, Efficiency	12
Interest	12
Discount	13
Compound Interest	13
Compound Interest Table, 3, 4, 5, and 6 per cent	14
Equation of Payments	14
Partial Payments	14
Annuities	15
Tables of Amount, Present Values, etc., of Annuities.	15

Weights and Measures.

Long Measure	17
Old Land Measure	17
Nautical Measure	17
Square Measure	18
Solid or Cubic Measure	18
Liquid Measure	18
The Miners' Inch	18
Apothecaries' Fluid Measure	18
Dry Measure	19
Shipping Measure	19
Avoirdupois Weight	19
Troy Weight	19
Apothecaries' Weight	20
To Weigh Correctly on an Incorrect Balance	20
Circular Measure	20
Measure of Time	20

WARNING: This is a 1910 edition. Some of the material may no-longer be accurate

	PAGE
Board and Timber Measure	20
Table. Contents in Feet of Joists, Scantings, and Timber	21
French or Metric Measures	22
British and French Equivalents	22
Metric Conversion Tables	23
Compound Units	
of Pressure and Weight	27
of Water, Weight, and Bulk	28
of Air, Weight and Volume	28
of Work, Power, and Duty	28
of Velocity	29
Wire and Sheet Metal Gauges	30
Twist-drill and Steel-wire Gauges	31
Circular-mil Wire Gauge	31
New U. S. Standard Wire and Sheet Gauge, 1893	31
Decimal Gauge	33

Algebra.

Addition, Multiplication, etc.	34
Powers of Numbers	34
Parentheses, *Division	35
Simple Equations and Problems	35
Equations containing two or more Unknown Quantities	36
Elimination	36
Quadratic Equations	36
Theory of Exponents	37
Binomial Theorem	38
Geometrical Problems of Construction	38
of Straight Lines	38
of Angles	39
of Circles	40
of Triangles	42
of Squares and Polygons	42
of the Ellipse	46
of the Parabola	49
of the Hyperbola	50
of the Cycloid	51
of the Tractrix or Schiele Anti-friction Curve	51
of the Spiral	52
of Rings inside a Circle	52
of Arc of a Large Circle	52
of the Catenary	53
of the Involute	53
of plotting Angles	54
Geometrical Propositions	54

Mensuration, Plane Surfaces.

Quadrilateral, Parallelogram, etc	55
Trapezium and Trapezoid	55
Triangles	55
Polygons. Table of Polygons	56
Irregular Figures	57
Properties of the Circle	58
Values of π and its Multiples, etc	58
Relations of arc, chord, etc	59
Relations of circle to inscribed square, etc	60
Formulas for a Circular Curve	60
Sectors and Segments	61
Circular Ring	61
The Ellipse	61
The Helix	62
The Spiral	62
Surfaces and Volumes of Similar Solids	62

Mensuration, Solid Bodies.

	PAGE
Prism	63
Pyramid	63
Wedge	63
Rectangular Prismoid	63
Cylinder	63
Cone	63
Sphere	63
Spherical Triangle	64
Spherical Polygon	64
The Prismoid	64
The Prismoidal Formula	64
Polyedron	64
Spherical Zone	65
Spherical Segment	65
Spheroid or Ellipsoid	65
Cylindrical Ring	65
Solids of Revolution	65
Spindles	65
Frustrum of a Spheroid	65
Parabolic Conoid	66
Volume of a Cask	66
Irregular Solids	66

Plane Trigonometry.

Solution of Plane Triangles	67
Sine, Tangent, Secant, etc	67
Signs of the Trigonometric Functions	68
Trigonometrical Formulæ	69
Solution of Plane Right-angled Triangle;	70
Solution of Oblique-angled Triangles	70

Analytical Geometry.

Ordinates and Abscissas	71
Equations of a Straight Line, Intersections, etc	71
Equations of the Circle	72
Equations of the Ellipse	72
Equations of the Parabola	73
Equations of the Hyperbola	73
Logarithmic Curves	74

Differential Calculus.

Definitions	74
Differentials of Algebraic Functions	75
Formulæ for Differentiating	75
Partial Differentials	76
Integrals	76
Formulæ for Integration	76
Integration between Limits	77
Quadrature of a Plane Surface	77
Quadrature of Surfaces of Revolution	78
Cubature of Volumes of Revolution	78
Second, Third, etc., Differentials	78
Maclaurin's and Taylor's Theorems	79
Maxima and Minima	79
Differential of an Exponential Function	80
Logarithms	80
Differential Forms which have Known Integrals	81
Exponential Functions	81
Circular Functions	82
The Cycloid	82
Integral Calculus	83

	PAGE
The Slide Rule.	
Examples solved by the Slide Rule	83
Logarithmic Ruled Paper.	
Plotting on Logarithmic Paper.....	85
Mathematical Tables.	
Formula for Interpolation.....	87
Reciprocals of Numbers 1 to 2000.....	88
Squares, Cubes, Square Roots, and Cube Roots from 0.1 to 1600 ..	94
Squares and Cubes of Decimals.....	109
Fifth Roots and Fifth Powers.....	110
Circumferences and Areas of Circles.....	111
Circumferences of Circles in Feet and Inches from 1 inch to 32 feet 11 inches in diameter.....	120
Areas of the Segments of a Circle.....	121
Lengths of Circular Arcs, Degrees Given.....	122
Lengths of Circular Arcs, Height of Arc Given.....	124
Spheres.....	125
Contents of Pipes and Cylinders, Cubic Feet and Gallons.....	127
Cylindrical Vessels, Tanks, Cisterns, etc.....	128
Gallons in a Number of Cubic Feet.....	129
Cubic Feet in a Number of Gallons.....	129
Square Feet in Plates 3 to 32 feet long and 1 inch wide.....	130
Capacities of Rectangular Tanks in Gallons.....	132
Number of Barrels in Cylindrical Cisterns and Tanks.....	133
Logarithms.....	134
Table of Logarithms.....	136
Hyperbolic Logarithms.....	163
Natural Trigonometrical Functions.....	166
Logarithmic Trigonometric Functions.....	169
Materials.	
Chemical Elements.....	170
Specific Gravity and Weight of Materials.....	171
The Hydrometer.....	172
Metals, Properties of.....	174
Aluminum.....	174
Antimony.....	175
Bismuth.....	175
Cadmium.....	175
Copper.....	175
Gold.....	175
Iridium.....	175
Iron.....	175
Lead.....	175
Magnesium.....	176
Manganese.....	176
Mercury.....	176
Nickel.....	176
Platinum.....	176
Silver.....	176
Tin.....	176
Zinc.....	177
Miscellaneous Materials.	
Order of Malleability, etc., of Metals.....	177
Measures and Weights of Various Materials.....	177
Formulae and Table for Calculating Weight of Rods, Plates, etc.....	178
Commercial Sizes of Iron and Steel Bars.....	179
Weights of Iron Bars.....	180
of Iron and Steel Sheets.....	181
of Flat Rolled Iron.....	182
of Plate Iron.....	184
of Steel Blooms.....	185

	PAGE
Sizes and Weights of Roofing Materials.....	186
“ “ Terra-cotta.....	186
“ “ Tiles.....	186
“ “ Tin Plates.....	187
“ “ Slates.....	189
“ “ Pine Shingles.....	189
“ “ Sky-light Glasses.....	190
Weights of Various Roof-coverings.....	190
“ Cast-iron Pipes or Columns.....	191
Weights and Thickness of Cast-iron Pipes.....	192
Safe Pressures on Cast-iron Pipe.....	194
Cast-iron Pipe Fittings.....	196
Standard Pipe Flanges.....	197
Straight-way Gate Valves.....	199
Forged Steel Flanges.....	200
Standard Hose Couplings.....	207
Standard Sizes of Welded Pipe.....	208
Wrought-iron Welded Tubes.....	209
Shelby Cold-drawn Tubing.....	210
Riveted Iron Pipes.....	211
Weight of Iron for Riveted Pipe.....	212
Spiral Riveted Pipe.....	212
Riveted Hydraulic Pipe.....	212
called Pipes.....	214
Forged Steel Flanges for Riveted Pipe.....	214
Seamless Brass Tubing.....	215, 216
Copper Tubing.....	216
Lead and Tin-lined Lead Pipe.....	217
Wooden Stave Pipe.....	218
Weight of Copper Rods.....	218
Weight of Copper and Brass Wire and Plates.....	219
“ “ Sheet and Bar Brass.....	220
“ “ Aluminium Sheets and Bars.....	220
Whitworth Screw-threads.....	220
Screw-thread, U. S. Standard.....	221
Automobile Screws and Nuts.....	222
International Screw-thread.....	222
Limit-gauges for Screw-threads.....	223
Size of Iron for Standard Bolts.....	223
Sizes of Screw-threads for Bolts and Taps.....	224
Set Screws and Tap Screws.....	225
Acme Screw-thread.....	226
Machine Screws, A.S.M.E. Standard.....	226
Standard Taps.....	227
Machine Screw Heads.....	228
Weight of Bolts with Hex-heads.....	229
Round Head Rivets.....	229
Track Bolts.....	230
Washers.....	230
Weights of Cone-head Rivets.....	231
Sizes of Turnbuckles.....	231
Tinners' Rivets.....	232
Material Required per Mile of Railroad Track.....	232
Railway Spikes.....	233
Boat Spikes.....	233
Wrought Spikes.....	233
Cut Nails.....	234
Wood Screws.....	234
Lag Screws.....	234
Wire Nails.....	235, 236
Steel Wire, Size, Strength, etc.....	237
Galvanized Iron Telegraph Wire.....	238
Tests of Telegraph Wire.....	238
Specifications for Galvanized Iron Wire.....	239
Strength of Piano Wire.....	239
Plough-steel Wire.....	239
Copper Wire Table, Edison or Circular-mil Gauge.....	240

	PAGE
Insulated Wire	241
Copper Telegraph Wire	241
Stranded Copper, Feed Wire	242
Rule for Resistance of Copper Wire	242
Wires of Different Metals	243
Specifications for Copper Wire	243
Wire Ropes	244
Transmission or Haulage Rope	245
Plough-steel Ropes	246
Lang Lay Rope	246
Galvanized Iron Wire Rope	247
Cable Traction Ropes	247
Flat Wire Ropes	248
Galvanized Steel Cables	248
Steel Hawsers	249
Galvanized Steel-wire Strand	249
Notes on use of Wire Rope	250
Locked Wire Rope	250
Chains and Chain Cables	251
Sizes of Fire Brick	253
Weights of Logs, Lumber, etc	254, 255
Fire Clay, in Analysis	255
Refractoriness of American Fire-brick	255
Slag Bricks and Slag Blocks	256
Magnesia Bricks	257
Asbestos	257
Strength of Materials.	
Stress and Strain	258
Elastic Limit	259
Yield Point	259
Modulus of Elasticity	260
Resilience	260
Elastic Limit and Ultimate Stress	261
Repeated Stresses	261
Repeated Shocks	262
Stresses due to Sudden Shocks	263
Increasing Tensile Strength of Bars by Twisting	264
Tensile Strength	265
Measurement of Elongation	265
Shapes of Test Specimens	266
Compressive Strength	267
Columns, Pillars, or Struts	269
Hodgkinson's Formula. Euler's Formula	269
Gordon's Formula. Rankine's Formula	270
Wrought-iron Columns	271
Built Columns	271
The Straight-line Formula	271
Working Strains in Bridge Members	272
Strength of Cast-iron Columns	274
Safe Load on Cast-iron Columns	276
Strength of Brackets on Cast-iron Columns	277
Eccentric Loading of Columns	278
Moment of Inertia	279
Radius of Gyration	279
Elements of Usual Sections	280
Transverse Strength	282
Formulae for Flexure of Beams	282
Safe Loads on Steel Beams	284
Beams of Uniform Strength	286
Properties of Rolled Structural Shapes	287
" " Steel I Beams	288
Spacing of Steel I Beams	291
Properties of Steel Channels	292
" " T Shapes	294
" " Angles	295
" " Z-bars	299

	PAGE
Dimensions of Z-bar Columns	300
Dimensions and Safe Load on Channel Columns	305
Bethlehem Special, Girder and H-beams	306
Torsional Strength	311
Elastic Resistance to Torsion	311
Combined Stresses	312
Stress due to Temperature	312
Strength of Flat Plates	313
Thickness of Flat Cast-iron Plates	313
Strength of Unstayed Flat Surfaces	314
Unbraced Heads of Boilers	314
Strength of Stayed Surfaces	315
Stresses in Steel Plating under Water Pressure	315
Spherical Surfaces and Domed Heads	316
Thick Hollow Cylinders under Tension	316
Thin Cylinders under Tension	317
Carrying Capacity of Steel Rollers and Balls	317
Resistance of Hollow Cylinders to Collapse	318
Collapsing Pressure of Tubes or Flues	319
Formula for Corrugated Furnaces	193
Hollow Copper Balls	322
Holding Power of Nails, Spikes, Bolts, and Screws	323
Cut versus Wire Nails	324
Strength of Wrought-iron Bolts	325, 326
Initial Strain on Bolts	325
Stand Pipes and their Design	327
Riveted Steel Water-pipes	329
Kirkaldy's Tests of Materials	330
Cast Iron	330
Castings	330
Bars, Forgings, etc	330
Steel Rails and Tires	331
Steel Axles, Shafts, Springs, Steel	332
Riveted Joints	333
Welds	333
Copper, Brass, Bronze, etc	334
Wire-rope	334
Wire	335
Ropes, Hemp, and Cotton	335
Belting-Canvas	335
Stones, Brick, Cement	335
Wood	336
Tensile Strength of Wire	336
Watertown Testing-machine Tests	337
Riveted Joints	337
Wrought-iron Bars. Compression Tests	337
Steel Eye-bars	338
Wrought-iron Columns	338
Cold Drawn Steel	339
Tests of Steel Angles	340
Shearing Strength	340
Relation of Shearing to Tensile Strength	340
Strength of Iron and Steel Pipe	341
Tilreading Tests of pipe	341
Old Tubes used as Columns	341
Methods of Testing Hardness of Metals	342
Holding Power of Boiler-tubes	342
Strength of Glass	343
Strength of Ice	344
Copper at High Temperatures	344
Strength of Timber	344
Expansion of Timber	345
Tests of American Woods	346
Shearing Strength of Woods	347
Strength of Brick, Stone, etc	347
" " Flagging	350
" " Lime and Cement Mortar	350

	PAGE
Moduli of Elasticity of Various Materials	351
Tests of Portland Cement	351
Factors of Safety	352
Properties of Cork	355
Vulcanized India-Rubber	356
Nickel	357
Aluminum, Properties and Uses	357
Alloys.	
Alloys of Copper and Tin, Bronze	360
Alloys of Copper and Zinc, Brass	362
Variation in Strength of Bronze	362
Copper-tin-zinc Alloys	363
Liquation, or Separation of Metals	364
Alloys used in Brass Foundries	366
Tobin Bronze	368
Copper-zinc-iron Alloys	369
Alloys of Copper, Tin and Lead	369
Phosphor Bronze	370
Aluminum Alloys	371
Alloys for Lasting under Pressure	371
The Thermit Process	372
Caution as to Strength of Alloys	373
Alloys of Aluminum, Silicon and Iron	374
Tungsten-aluminum Alloys	375
Aluminum-tin Alloys	375
Manganese Alloys	376
Manganese Bronze	377
German Silver	378
Copper-nickel Alloys	378
Alloys of Bismuth	379
Fusible Alloys	380
Bearing Metal Alloys	380
Bearing Metal Practice, 1907	382
White Metal for Engine Bearings	382
Alloys containing Antimony	383
White-metal Alloys	383
Type-metal	384
Babbitt metals	384
Solders	385
Ropes and Cables.	
Strength of Hemp, Iron, and Steel Ropes	386
Rope for Hoisting or Transmission	386
Flat Ropes	387
Cordage, Technical Terms of	388
Splicing of Ropes	388
Cargo Hoisting	390
Working Loads for Manila Rope	390
Knots	391
Life of Hoisting and Transmission Rope	391
Efficiency of Rope Tackles	391
Splicing Wire Ropes	393
Springs.	
Laminated Steel Springs	394
Helical Steel Springs	395
Carrying Capacity of Springs	396
Elliptical Springs	399
Springs to Resist Torsional Force	399
Helical Springs for Cars, etc.	400
Phosphor-bronze Springs	401
Chromium-Vanadium Spring Steel	401
Test of a Vanadium Steel Spring	401

	PAGE
Riveted Joints.	
Fairbairn's Experiments	401
Loss of Strength by Punching	401
Strength of Perforated Plates	402
Hand vs. Hydraulic Riveting	402
Formulae for Pitch of Rivets	404
Proportions of Joints	405
Efficiencies of Joints	405
Diameter of Rivets	406
Shearing Resistance of Rivet Iron and Steel	407
Strength of Riveted Joints	408
Riveting Pressures	412
Iron and Steel.	
Classification of Iron and Steel	413
Grading of Pig Iron	414
Manufacture of Cast Iron	414
Influence of Silicon Sulphur, Phos. and Mn on Cast Iron	415
Microscopic Constituents	416
Analyses of Cast Iron	416
Specifications for Pig Iron and Castings	418
Specifications for Cast-iron Pipe	419
Strength of Cast Iron	421
Strength in relation to Cross-section	422
Shrinkage of Cast Iron	423
White Iron Converted into Gray	424
Mobility of Molecules of Cast Iron	424
Castings from Blast-Furnace Metal	425
Effect of Cupola Melting	425
Additions of Titanium, etc., to Cast Iron	426
"Semi-steel"	428
Permanent Expansion of Cast Iron by Heating	429
Mixture of Cast Iron with Steel	429
Bessemerized Cast Iron	429
Bad, Cast Iron	429
Malleable Cast Iron	429
Design of Malleable Castings	433
Specifications for Malleable Iron	433
Strength of Malleable Cast Iron	434
Wrought Iron	435
Chemistry of Wrought Iron	436
Influence of Rolling on Wrought Iron	437
Specifications for Wrought Iron	437
Stay-bolt, Iron	438
Tenacity of Iron at High Temperatures	439
Effect of Cold on Strength of Iron	440
Expansion of Iron by Heat	441
Durability of Cast Iron	441
Corrosion of Iron and Steel	442
Corrosion of Iron and Steel Pipes	443
Electrolytic Theory, and Prevention of Corrosion	444
Chrome Paints, Anti-corrosive	445
Corrosion Caused by Stray Electric Currents	446
Electrolytic Corrosion due to Overstrain	446
Preservative Coatings; Paints, etc.	447
Inoxydation Processes, Bower-Barff, etc.	448
Aluminum Coatings	449
Galvanizing	449
Sherardizing, Galvanizing by Cementation	450
Lead Coatings	450
Manufacture of Steel	451
Crucible, Bessemer and Open Hearth Steel	451
Steel.	
Relation between Chemical and Physical Properties	452
Electric Conductivity	453
Variation in Strength	454

	PAGE
Bending Tests of Steel	454
Effect of Heat Treatment and of Work	454
Hardening Soft Steel	455
Effect of Cold Rolling	455
Comparison of Full-sized and Small Pieces	455
Recalescence of Steel	455
Critical Point	456
Metallography	456
Burning, Overheating, and Restoring Steel	457
Working Steel at a Blue Heat	458
Oil Tempering and Annealing	458
Brittleness due to Long-continued Heating	458
Influence of Annealing upon Magnetic Capacity	459
Treatment of Structural Steel	459
May Carbon be Burned out of Steel?	461
Effect of Nicking a Bar	461
Specific Gravity	461
Welding of Steel	461
Occasional Failures	462
Segregation in Ingots and Plates	462
Endurance of Steel under Repeated Stresses	463
The Thermit Welding Process	463
Oxy-acetylene Welding and Cutting of Metals	464
Hydraulic Forging	464
Fluid-compressed Steel	464
Steel castings	464
Crucible Steel	466
Effect of Heat on Grain	466
Heating and Forging	467
Tempering Steel	468
Rinds of Steel used for Different Purposes	469
High-speed Tool Steel	469
Manganese Steel	470
Chrome Steel	470
Nickel Steel	472
Aluminum Steel	472
Tungsten Steel	472
Copper Steel	475
Nickel-Vanadium Steel	475
Static and Dynamic Properties of Steel	476
Strength and Fatigue Resistance of Steels	477
Chromium-Vanadium Steel	478
Heat Treatment of Alloy Steels	479
Specifications for Steel	480
High-strength Steel for Shipbuilding	483
Fire-box Steel	484
Steel Rails	484

MECHANICS,

Matter, Weight, Mass	487
Force, Unit of Force	488
Inertia	488
Newton's Laws of Motion	488
Resolution of Forces	489
Parallelogram of Forces	489
Moment of a Force	490
Statical Moment, Stability	490
Stability of a Dam	491
Parallel Forces	491
Couples	491
Equilibrium of Forces	492
Center of Gravity	492
Moment of Inertia	493
Centers of Oscillation and Percussion	494
Center and Radius of Gyration	494
The Pendulum	496

	PAGE
Conical Pendulum	496
Centrifugal Force	497
Velocity, Acceleration, Falling Bodies	497
Value of g	498
Angular Velocity	498
Height due to Velocity	499
Parallelogram of Velocities	499
Velocity due to Falling a Given Height	500
Mass, Force of Acceleration	501
Formulae for Accelerated Motion	501
Motion on inclined Planes	502
Momentum, Vis-Viva	502
Work, Foot-pound	502
Fundamental Equations in Dynamics	502
Power, Horse-power	503
Energy	503
Work of Acceleration	504
Work of Accelerated Rotation	504
Force of a Blow	504
Impact of Bodies	505
Energy of Recoil of Guns	506
Conservation of Energy	506
Sources of Energy	506
Perpetual Motion	507
Efficiency of a Machine	507
Animal-power, Man-power	507
Man-wheel, Treat Mills	508
Work of a Horse	508
Horse-gin	509
Resistance of Vehicles	509

Elements of Mechanics.

The Lever	510
The Bent Lever	511
The Moving strut	511
The Toggle-joint	511
The Inclined Plane	512
The Wedge	512
The Screw	512
The Cam	512
The Pulley	513
Differential Pulley	513
Differential Windlass	514
Differential Screw	514
Wheel and Axle	514
Toothed-wheel Gearing	514
Endless Screw, Worm Gear	514

Stresses in Framed Structures.

Cranes and Derricks	515
Shear Poles and Guys	516
King Post Truss or Bridge	517
Queen Post Truss	517
Burr Truss	518
Pratt or Whipple Truss	518
Method of Moments	519
Howe Truss	620
Warren Girder	520
Roof Truss	521
The Economical Angle	522

HEAT.

Thermometers and Pyrometers	523
Centigrade and Fahrenheit degrees compared	524
Copper-ball Pyrometer	526
Thermo-electric Pyrometer	526
Temperatures in Furnaces	527

	PAGE
Seeger's Fire-clay Pyrometer	528
Wiborgh Air Pyrometer.....	528
Mesure and Nouel's Pyrometer.....	529
Uehling and Steinbart Pyrometer.....	530
Air-thermometer.....	530
High Temperatures judged by Color.....	531
Boiling-points of Substances.....	532
Melting-points.....	532
Unit of Heat.....	532
Mechanical Equivalent of Heat.....	533
Heat of Combustion.....	533
Heat Absorbed by Decomposition.....	534
Specific Heat.....	534
Thermal Capacity of Gases.....	537
Expansion by Heat.....	538
Absolute Temperature, Absolute Zero.....	540
Latent Heat of Fusion.....	541
Latent Heat of Evaporation.....	542
Total Heat of Evaporation.....	542
Evaporation and Drying.....	542
Evaporation from Reservoirs.....	543
Evaporation by the Multiple System.....	543
Resistance to Boiling.....	543
Manufacture of Salt.....	543
Solubility of Salt.....	544
Salt Contents of Brines.....	545
Concentration of Sugar Solutions.....	545
Evaporating by Exhaust Steam.....	545
Drying in Vacuum.....	546
Driers and Drying.....	547
Design of Drying Apparatus.....	550
Humidity Table.....	551
Radiation of Heat.....	551
Black-body Radiation.....	552
Conduction and Convection of Heat.....	553
Rate of External Conduction.....	554
Heat Conduction of Insulating Materials.....	555
Heat Resistance, Reciprocal of Heat Conductivity.....	556
Steam-pipe Coverings.....	558
Transmission through Plates.....	561
Transmission in Condenser Tubes.....	563
Transmission of Heat in Feed-water Heaters.....	564
Transmission through Cast-iron Plates.....	565
Heating Water by Steam Coils.....	565
Transmission from Air or Gases to Water.....	566
Transmission from Flame to Water.....	567
Cooling of Air.....	568
Transmission from Steam or Hot Water to Air.....	569
Thermodynamics.....	572
Entropy.....	573
Reversed Carnot Cycle, Refrigeration.....	574
Principal Equations of a Perfect Gas.....	575
Construction of the Curve $PV^n = C$	576
Temperature-Entropy Diagram of Water and Steam.....	576
PHYSICAL PROPERTIES OF GASES.	
Expansion of Gases.....	577
Boyle and Mariotte's Law.....	577
Law of Charles, Avogadro's Law.....	578
Saturation Point of Vapors.....	578
Law of Gaseous Pressure.....	578
Flow of Gases.....	579
Absorption by Liquids.....	579
Liquefaction of Gases, Liquid Air.....	579
AIR	
Properties of Air.....	580
Air-manometer.....	581

	PAGE
Barometric Pressures.....	581
Pressure at Different Altitudes.....	582
Leveling by the Barometer and by Boiling Water.....	582
To find Difference in Altitude.....	582
Moisture in Atmosphere.....	583
Weight of Air and Mixtures of Air and Vapor.....	584, 586
Specific Heat of Air.....	587
Flow of Air.	
Flow of Air through Orifices.....	588
Flow of Air in Pipes.....	591
Effects of Bends in Pipe.....	593
Flow of Compressed Air.....	593
Tables of Flow of Air.....	594
Loss of Pressure in Pipes.....	595
Anemometer Measurements.....	596
Equalization of Pipes.....	597
Wind.	
Force of the Wind.....	597
Wind Pressure in Storms.....	598
Windmills.....	599
Capacity of Windmills.....	601
Economy of Windmills.....	601
Electric Power from Windmills.....	603
Compressed Air.	
Heating of Air by Compression.....	604
Loss of Energy in Compressed Air.....	604
Volumes and Pressures.....	605
Loss due to Heating.....	606
Horse-power Required for Compression.....	606
Work of Adiabatic Compression of Air.....	607
Compressed-air Engines.....	608
Compound Air-compression.....	609
Table for Adiabatic Compression.....	610
Mean Effective Pressures.....	610
Mean and Terminal Pressures.....	611
Air-compression at Altitudes.....	611
Popp Compressed-air System.....	612
Small Compressed-air Motors.....	612
Efficiency of Air-heating Stoves.....	612
Efficiency of Compressed-air Transmission.....	613
Efficiency of Compressed-air Engines.....	613
Air-compressors.....	614
Requirements of Rock-drills.....	616
Steam Required to Compress 1 Cu. Ft. of Air.....	617
Compressed air for Pumping Plants.....	617
Compressed air for Hoisting Engines.....	618
Practical Results with Air Transmission.....	619
Effect of Intake Temperature.....	619
Compressed air Motors with Return Circuit.....	620
Intercoolers for Air-compressors.....	620
Centrifugal Air-compressors.....	620
High-pressure Centrifugal Fans.....	621
Test of a Hydraulic Air-compressor.....	622
Pneumatic Postal Transmission.....	624
Mekarski Compressed-air Tramways.....	624
Compressed Air Working Pumps in Mines.....	625
Compressed Air for Street Railways.....	625
Fans and Blowers.	
Centrifugal Fans.....	626
Best Proportions of Fans.....	626
Pressure due to Velocity.....	627
Experiments with Blowers.....	629

	PAGE
Blast Area or Capacity Area.....	629
Quantity of Air Delivered.....	630
Efficiency of Fans and Positive Blowers.....	631
Capacity of Fans and Blowers.....	632
Table of Centrifugal Fans.....	632
Steel Pressure Blowers for Cupolas.....	633
Sturtevant Steel Pressure-blower.....	635
Effect of Resistance on Capacity of Fans.....	636
Sirocco Fans.....	636
Multivane Fans.....	638
Methods of Testing Fans.....	639
Efficiency of Fans.....	641
Diameter of Blast-pipes.....	643
Centrifugal Ventilators for Mines.....	644
Experiments on Mine Ventilators.....	645
Disk Fans.....	647
Efficiency of Disk Fans.....	648
Positive Rotary Blowers.....	649
Steam-jet Blowers.....	651
Blowing Engines.....	652
Steam-jet for Ventilation.....	652

HEATING AND VENTILATION.

Ventilation.....	653
Quantity of Air Discharged through a Ventilating Duct.....	655
Heating and Ventilating of Large Buildings.....	656
Standards for Calculating Heating Problems.....	658
Heating Value of Coal.....	658
Heat Transmission through Walls, etc.....	659
Allowance for Exposure and Leakage.....	660
Heating by Hot-air Furnaces.....	661
Carrying Capacity of Air-pipes.....	662
Volume of Air at Different Temperatures.....	663
Sizes of Pipes Used in Furnace Heating.....	663
Furnace Heating with Forced Air Supply.....	664
Rated Capacity of Boilers for House Heating.....	664
Capacity of Grate Surface.....	665
Steam Heating, Rating of Boilers.....	665
Testing Cast-iron Heating Boilers.....	667
Proportioning House Heating Boilers.....	667
Coefficient of Transmission in Direct Radiation.....	668
Heat Transmitted in Indirect Radiation.....	669
Short Rules for Computing Radiating Surface.....	669
Carrying Capacity of Steam Pipes in Low Pressure Heating.....	669
Proportioning Pipes to Radiating Surface.....	671
Sizes of Pipes in Steam Heating Plants.....	672
Resistance of Fittings.....	672
Removal of Air, Vacuum Systems.....	673
Overhead Steam-pipes.....	673
Steam-consumption in Car-heating.....	673
Heating a Greenhouse by Steam.....	673
Heating a Greenhouse by Hot Water.....	674
Velocity of Flow in Hot-water Heating.....	674
Hot-water Heating.....	674
Sizes of Pipe for Hot-water Heating.....	675
Sizes of Flow and Return Pipes.....	678
Heating by Hot-water, with Forced Circulation.....	678
Blower System of Heating and Ventilating.....	678
Advantages and Disadvantages of the Plenum System.....	678
Heat Radiated from Coils in the Blower System.....	679
Test of Cast-iron Heaters for Hot-blast Work.....	680
Factory Heating by the Fan System.....	681
Artificial Cooling of Air.....	681
Capacities of Fans for Hot-blast Heating.....	682
Relative Efficiency of Fans and Heated Chimneys.....	683
Heating a Building to 70° F.....	683

	PAGE
Heating by Electricity.....	684
Mine-ventilation.....	685
Friction of Air in Underground Passages.....	685
Equivalent Orifices.....	686

WATER.

Expansion of Water.....	687
Weight of Water at Different Temperatures.....	687, 688
Pressure of Water due to its Weight.....	689, 690
Head Corresponding to Pressures.....	689
Buoyancy.....	690
Boiling-point.....	690
Freezing-point.....	690
Sea-water.....	690
Ice and Snow.....	691
Specific Heat of Water.....	691
Compressibility of Water.....	691
Impurities of Water.....	691
Causes of Incrustation.....	692
Means for Preventing Incrustation.....	692
Analyses of Boiler-scale.....	693
Hardness of Water.....	694
Purifying Feed-water.....	694
Softening Hard Water.....	695

Hydraulics. Flow of Water.

Formulae for Discharge through Orifices and Weirs.....	697
Flow of Water from Orifices.....	698
Flow in Open and Closed Channels.....	699
General Formulae for Flow.....	699
Chezy's Formula.....	699, 703
Values of the Coefficient c.....	700
Table, Fall in Feet per mile, etc.....	701
Values of \sqrt{r} for Circular Pipes.....	701
Kutter's Formula.....	701
D'Arcy's Formula.....	704
Velocity of Water in Open Channels.....	704
Mean Surface and Bottom Velocities.....	705
Safe Bottom and Mean Velocities.....	705
Resistance of Soil to Erosion.....	705
Abrading and Transporting Power of Water.....	706
Grade of Sewers.....	706
Flow of Water in a 20-inch Pipe.....	706
Table of Flow of Water in Circular Pipes.....	707-711
Short formulae.....	710
Flow of Water in House-service pipes.....	712
Flow of Water through Nozzles.....	713
Loss of Head.....	714
Values of the Coefficient of Friction.....	715
Resistance at the Inlet of a Pipe.....	715
Flow of Water in Riveted Pipes.....	716
Cox's Formula.....	717
Exponential formula.....	718
Friction Loss in Clean Cast-Iron Pipe.....	719
Approximate Hydraulic Formulae.....	720
Compound Pipes, and Pipes with Branches.....	720
Effect of Bend and Curves.....	721
Hydraulic Grade-line.....	721
Long Pipe Lines.....	721
Rifled Pipes for Conveying Oils.....	721
Loss of Pressure Caused by Valves, etc.....	722
Air-bound Pipes.....	722
Vertical Jets.....	722
Water Delivered through Meters.....	722
Fire Streams.....	722
Water Hammer.....	722

	PAGE
Price Charged for Water in Cities.....	722
Hydrant Pressures required with Different Lengths and Sizes of Hose.....	723
Friction Losses in Hose.....	725
Pump Inspection Table.....	725
Rated Capacity of Steam Fire-engines.....	725
The Siphon.....	726
Measurement of Flowing Water.....	727
Piezometer.....	727
Pitot Tube Gauge.....	727
Maximum and Mean Velocities in Pipes.....	727
The Venturi Meter.....	728
Measurement of Discharge by Means of Nozzles.....	728
Flow through, Rectangular Orifices.....	729
Measurement of an Open Stream.....	729
Miners' Inch Measurements.....	730
Flow of Water over Weirs.....	731
Francis's Formula for Weirs.....	731
Weir Table.....	732
Bazin's Experiments.....	733
The Cippoletti, or Trapezoidal Weir.....	733
Water-power.	
Power of a Fall of Water.....	734
Horse-power of a Running Stream.....*	734
Current Motors.....	734
Bernouilli's Theorem.....	734
Maximum Efficiency of a Long Conduit.....	735
Mill-power.....	735
Value of Water-power.....	735
Water Wheels; Turbine Wheels.	
Water Wheels.....	737
Proportions of Turbines.....	737
Tests of Turbines.....	742
Dimensions of Turbines.....	743
Rating and Efficiency of Turbines.....	743
Rating Table for Turbines.....	746
Turbines of 13,500 H.P. each.....	747
The Fall-increaser for Turbines.....	747
Tangential or Impulse Water Wheel.....	748
The Pelton Water Wheel.....	748
Considerations in the Choice of a Tangential Wheel.....	749
Control of Tangential Water Wheels.....	750
Tangential Water-wheel Table.....	751
Amount of Water Required to Develop a given Horse-Power.....	753
Efficiency of the Doble Nozzle.....	753
Water Plants Operating under High Pressure.....	754
Formulae for Calculating the Power of Jet Water Wheels.....	754
The Power of Ocean Waves.	
Utilization of Tidal Power.....	756
Pumps.	
Theoretical Capacity of a Pump.....	757
Depth of Suction.....	757
The Deane Pump.....	758
Amount of Water Raised by a Single-acting Lift-pump.....	759
Proportioning the Steam-cylinder of a Direct-acting Pump.....	759
Speed of Water through Pipes and Pump-passages.....	759
Sizes of Direct-acting Pumps.....	759
Efficiency of Small Pumps.....	759
The Worthington Duplex Pump.....	760
Speed of Piston.....	760
Speed of Water through Valves.....	761

	PAGE
Boiler-feed Pumps.....	761
Pump Valves.....	762
The Worthington High-duty Pumping Engine.....	762
The d'Auria Pumping Engine.....	762
A 72,000,000-Gallon Pumping Engine.....	762
The Screw Pumping Engine.....	763
Finance of Pumping Engine Economy.....	763
Cost of Pumping 1000 Gallons per minute.....	76-1
Centrifugal Pumps.....	764
Design of a Four-stage Turbine Pump.....	765
Relation of Peripheral Speed to Head.....	766
Tests of De Laval Centrifugal Pump.....	768
A High-duty Centrifugal Pump.....	770
Rotary Pumps.....	770
Tests of Centrifugal and Rotary Pumps.....	770
Duty Trials of Pumping Engines.....	771
Leakage Tests of Pumps.....	772
Notable High-duty Pump Records.....	774
Vacuum Pumps.....	775
The Pulsometer.....	775
Pumping by Compressed Air.....	776
The Jet Pump.....	776
The Injector.....	776
Air-lift Pump.....	776
Air-lifts for Deep Oil-wells.....	777
The Hydraulic Ram.....	778
Quantity of Water Delivered by the Hydraulic Ram.....	778
Hydraulic Pressure Transmission.	
Energy of Water under Pressure.....	779
Efficiency of Apparatus.....	780
Hydraulic Presses.....	781
Hydraulic Power in London.....	781
Hydraulic Riveting Machines.....	782
Hydraulic Forging.....	782
Hydraulic Engine.....	783
FUEL.	
Theory of Combustion.....	784
Analyses of the Gases of Combustion.....	785
Temperature of the Fire.....	785
Classification of Solid Fuels.....	786
Classification of Coals.....	786
Analyses of Coals.....	787
Caking and Non-caking Goals.....	788
Cannel Coals.....	788
Rhode Island Graphitic Anthracite.....	788
Analysis and Heating Value of Coals.....	789
Approximate Heating Values.....	791
Tests of the U. S.-Geological Survey.....	791
Lord and Haas's Tests.....	792
Sizes of Anthracite Coal.....	792
Space occupied by Anthracite.....	793
Bernice Basin Pa. Coal.....	793
Connellsville Coal and Coke.....	793
Bituminous Coals of the United States.....	794
Western Lignites.....	796
Analysis of Foreign Coals.....	796
Sampling Coal for Analyses.....	797
Relative Value of Steam Coals.....	797
Calorimetric Tests of Coals.....	797
Purchase of Coal Under Specifications.....	799
Evaporative Power of Bituminous Coals.....	799
Weathering of Coal.....	800
Pressed Fuel.....	801

	PAGE
Coke.....	801
Experiments in Coking.....	802
Coal Washing.....	802
Recovery of By-products in Coke Manufacture.....	802
Generation of Steam from the Waste Heat and Gases from Coke-ovens.....	803
Products of the Distillation of Coal.....	803
Wood as Fuel.....	804
Heating Value of Wood.....	804
Composition of Wood.....	805
Charcoal.....	805
Yield of Charcoal from a Cord of Wood.....	806
Consumption of Charcoal in Blast Furnaces.....	806
Absorption of Water and of Gases by Charcoal.....	806
Composition of Charcoals.....	807
Miscellaneous Solid Fuels.....	807
Dust-fuel — Dust Explosions.....	807
Peat or Turf.....	808
Sawdust as Fuel.....	808
Wet Tan-bark as Fuel.....	808
Straw as Fuel.....	808
Bagasse as Fuel in Sugar Manufacture.....	809
Liquid Fuel.	
Products of Distillation of Petroleum.....	810
Lima Petroleum..... I.....	810
Value of Petroleum as Fuel.....	811
Fuel Oil Burners.....	812
Oil vs. Coal as Fuel.....	812
Alcohol as Fuel.....	813
Specific Gravity of Ethyl Alcohol.....	813
Vapor Pressures of Saturation of Alcohol and other Liquids.....	814
Fuel Gas.	
Carbon Gas.....	814
Anthracite Gas.....	815
Bituminous Gas.....	816
Water Gas.....	817
Natural Gas in Ohio and Indiana.....	817
Natural Gas as a Fuel for Boilers.....	817
Producer-gas from One Ton of Coal.....	818
Proportions of Gas Producers and Scrubbers.....	819
Combustion of Producer-gas.....	819
Gas Producer Practice.....	820
Capacity of Producers.....	821
High Temperature Required for Production of CO ₂	822
The Mond Gas Producer.....	822
Relative Efficiency of Different Coals in Gas-engine Tests.....	823
Use of Steam in Producers and Boiler Furnaces.....	824
Gas Fuel for Small Furnaces.....	824
Gas Analyses by Volume and by Weight.....	824
Blast-furnace Gas.....	825
Acetylene and Calcium Carbide.	
Acetylene.....	825
Calcium Carbide.....	826
Acetylene Generators and Burners.....	826
The Acetylene Blowpipe.....	827
Illuminating Gas.	
Coal-gas.....	828
Water-gas.....	829
Analyses of Water-gas and Coal-gas.....	830
Caloric Equivalents of Constituents.....	830
Efficiency of a Water-gas Plant.....	830

	PAGE
Space Required for a Water-gas Plant.....	832
Fuel-value of Illuminating Gas.....	833
Flow of Gas in Pipes.....	834
Services for Lamps.....	834
STEAM.	
Temperature and Pressure.....	836
Total Heat.....	836
Latent Heat of Steam.....	836
Specific Heat of Saturated Steam.....	837
The Mechanical Equivalent of Heat.....	837
Pressure of Saturated Steam.....	837
Volume of Saturated Steam.....	837
Volume of Superheated Steam.....	837
Specific Density of Gaseous Steam.....	838
Specific Heat of Superheated Steam.....	838
Regnault's Experiments.....	838
Table of the Properties of Saturated Steam.....	839
Table of the Properties of Superheated Steam.....	843
Flow of Steam.	
Napier's Approximate Rule.....	844
Flow of Steam through a Nozzle.....	844
Flow of Steam in Pipes.....	845
Table of Flow of Steam in Pipes.....	846
Carrying Capacity of Extra Heavy Steam Pipes.....	847
Flow of Steam in Long Pipes, Leblond's Formula.....	847
Resistance to Flow by Bends, Valves, etc.....	848
Sizes of Steam-pipes for Stationary Engines.....	848
Sizes of Steam-pipes for Marine Engines.....	848
Proportioning Pipes for Minimum Loss by Radiation and Friction.....	849
Available Maximum Efficiency of Expanded Steam.....	850
Steam-pipes.	
Bursting-tests of Copper Steam-pipes.....	851
Failure of a Copper Steam-pipe.....	851
Wire-wound Steam-pipes.....	851
Materials for Pipes and Valves for Superheated Steam.....	851
Riveted Steel Steam-pipes.....	852
Valves in Steam-pipes.....	852
The Steam Loop.....	852
Loss from an Uncovered Steam-pipe.....	853
Condensation in an Underground Pipe Line.....	853
Steam Receivers in Pipe Lines.....	853
Equation of Pipes.....	853
Identification of Power House Piping by Colors.....	854
THE STEAM-BOILER.	
The Horse-power of a Steam-boiler.....	854
Measures for Comparing the Duty of Boilers.....	855
Steam-boiler Proportions.....	855
Unit of Evaporation.....	855
Heating-surface.....	856
Horse-power, Builders' Rating.....	857
Grate-surface.....	857
Areas of Flues.....	858
Air-passages-Through Grate-bars.....	858
Performance of Boilers.....	858
Conditions which Secure Economy.....	859
Air Leakage in Boiler Settings.....	859
Efficiency of a Boiler.....	860
Autographic CO ₂ Recorders.....	860
Relation of Efficiency to Rate of Driving, Air Supply, etc.....	862
Tests of Steam-boilers.....	864

	PAGE
Boilers at the Centennial Exhibition.....	864
High Rates of Evaporation.....	865
Economy Effected by Heating the Air.....	865
Maximum Boiler Efficiency with Cumberland Coal.....	865
Boilers Using Waste Gases.....	866
Rules for Conducting Boiler Tests.....	872
Heat Balance in Boiler Tests.....	874
Table of Factors of Evaporation.....	874
Strength of Steam-boilers.	
Rules for Construction.....	879
Shell-plate Formulæ.....	880
Rules for Flat Plates.....	880
Furnace Formulæ.....	881
Material for Stays.....	882
Loads allowed on Stays.....	882
Girders.....	882
Tube Plates.....	882
Material for Tubes.....	883
Holding Power of Boiler Tubes.....	883
Iron <i>versus</i> Steel Boiler Tubes.....	883
Rules for Construction of Boilers in Merchant Vessels in U. S.....	884
Safe-working Pressures.....	887
Flat-stayed Surfaces.....	888
Diameter of Stay-bolts.....	888
Strength of Stays.....	888
Boiler Attachments, Furnaces, etc.	
Fusible Plugs.....	889
Steam Domes.....	889
Height of Furnace.....	889
Mechanical Stokers.....	889
The Hawley Down-draught Furnace.....	890
Under-feed Stokers.....	890
Smoke Prevention.....	890
Burning Illinois Coal without Smoke.....	892
Conditions of Smoke Prevention.....	893
Forced Combustion.....	894
Fuel Economizers	894
Thermal Storage.....	897
Incrustation and Corrosion.....	897
Boiler-scale Compounds.....	898
Removal of Hard Scale.....	900
Corrosion in Marine Boilers.....	900
Use of Zinc.....	901
Effect of Deposit on Flues.....	901
Dangerous Boilers.....	901
Safety-valves.	
Rules for Area of Safety-valves.	902
Spring-loaded Safety-valves.....	904
The Injector.	
Equation of the Injector.....	908
Performance of Injectors.....	907
Boiler-feeding Pumps.....	908
Feed-water Heaters.	
Percentage of Saving Due to Use of Heaters.....	909
Strains Caused by Cold Feed-water.....	909
Calculation of Surface of Heaters and Condensers.....	910
Open <i>vs.</i> Closed Feed-water Heaters.....	911
Steam Separators.	
Efficiency of Steam Separators.....	911

	PAGE
Determination of Moisture in Steam.	
Steam Calorimeters.....	912
Coil Calorimeter.....	913
Throttling Calorimeters.....	918
Separating Calorimeters.....	914
Identification of Dry Steam.....	915
Usual Amount of Moisture in Steam.....	915
Chimneys.	
Chimney Draught Theory.....	915
Force or Intensity of Draught.....	916
Rate of Combustion Due to Height of Chimney.....	918
High Chimneys not Necessary.....	919
Height of Chimneys Required for Different Fuels.....	919
Protection of Chimney from Lightning.....	920
Table of Size of Chimneys.....	921
Some Tall Brick Chimneys.....	922
Stability of Chimneys.....	924
Steel Chimneys.....	925
Reinforced Concrete Chimneys.....	927
Sheet-iron Chimneys.....	928
THE STEAM ENGINE.	
Expansion of Steam.....	929
Mean and Terminal Absolute Pressures.....	930
Calculation of Mean Effective Pressure.....	931
Mechanical Energy of Steam Expanded Adiabatically.....	933
Measures for Comparing the Duty of Engines.....	933
Efficiency, Thermal Units per Minute.....	934
Real Ratio of Expansion.....	935
Effect of Compression.....	935
Clearance in Low- and High-speed Engines.....	936
Cylinder-condensation.....	936
Water-consumption of Automatic Cut-off Engines.....	937
Experiments on Cylinder-condensation.....	937
Indicator Diagrams.....	938
Errors of Indicators.....	939
Pendulum Indicator Rig.....	939
The Manograph.....	939
The Lea Continuous Recorder.....	940
Indicated Horse-power.....	940
Rules for Estimating Horse-power.....	940
Horse-power Constants.....	941
Table of Engine Constants.....	942
To Draw Clearance on Indicator-diagram.....	944
To Draw Hyperbola Curve on Indicator-diagram.....	944
Theoretical Water Consumption.....	945
Leakage of Steam.....	946
Compound Engines.	
Advantages of Compounding.....	946
Woolf and Receiver Types of Engines.....	947
Combined Diagrams.....	949
Proportions of Cylinders in Compound Engines.....	950
Receiver Space.....	950
Formula for Calculating Work of Steam.....	951
Calculation of Diameters of Cylinders.....	952
Triple-expansion Engines.....	953
Proportions of Cylinders.....	953
Formulæ for Proportioning Cylinders.....	953
Types of Three-stage Expansion Engines.....	956
Sequence of Cranks.....	956
Velocity of Steam through Passages.....	956
A Double-tandem Triple-expansion Engine.....	956
Quadruple-expansion Engines.....	956

Steam-engine Economy.		PAGE
Economic Performance of Steam-engines		957
Feed-water Consumption of Different Types		957
Sizes and Calculated Performances of Vertical High-speed Engine.		959
The Willans Law, Steam Consumption at Different Loads		962
Relative Economy of Engines under Variable Loads.		963
Steam consumption of Various Sizes		963
Steam Consumption in Small Engines.		964
Steam Consumption at Various Speeds.		964
Capacity and Economy of Steam fire Engines		964
Economy Tests of High-speed Engines		965
Limitation of Engine Speed		966
British High-speed Engines.		966
Advantage of High Initial and Low-back Pressure.		967
Comparison of Compound and Single-cylinder Engines.		968
Two-cylinder and Three-cylinder Engines.		968
The Lentz Compound Engine.		968
Steam Consumption of Different Types of Engine		969
Steam Consumption of Engines with Superheated Steam		969
Efficiency of Non-condensing Compound Engines.		971
Economy of Engines under Varying Loads.		971
Effect of Water in Steam on Efficiency		972
Influence of Vacuum and Superheat on Steam Consumption.		972
Practical Application of Superheated Steam		973
Performance of a Quadruple Engine.		974
Influence of the Steam-jacket		975
Best Economy of the Piston Steam Engine.		977
Highest Economy of Pumping-engines.		978
Sulphur-dioxide Addendum to Steam-engine		978
Standard Dimensions of Direct-connected Generator Sets		979
Dimensions of Parts of Large Engines.		979
Large Rolling-mill Engines.		950
Counterbalancing Engines.		980
Preventing Vibrations of Engines		980
Foundations Embedded in Air.		980
Most Economical Point of Cut-off		981
Type of Engine used when Exhaust-steam is used for Heating		981
Cost of Steam-power	981	982
Cost of Coal for Steam-power		983
Relative Commercial Economy of Compound and Triple-expansion Engines		984
Power-plant Economics.		984
Economy of Combination of Gas Engines and Turbines		986
Analysis of Operating Costs of Power-plants.		987
Storing Steam Heat in Hot Water.		987
Utilizing the Sun's Heat as a Source of Power		988
Rules for Conducting Steam-engine Tests		988

Dimensions of Parts of Engines.

Cylinder	996
Clearance of Piston	996
Thickness of Cylinder	997
Cylinder Heads	998
Cylinder-head Bolts	999
The Piston	999
Piston Packing-rings	1000
Fit of Piston-rod	1001
Diameter of Piston-rods	1002
Piston-rod Guides	1002
The Connecting-rod	1003
Connecting-rod Ends	1005
Tapered Connecting-rods	1005
The Crank-pin	1005
Crosshead-pin or Wrist-Din	1009
The Crank-arm	1009
The Shaft, Twisting Resistance.	1010

	PAGE
Resistance to Bending	1012
Equivalent Twisting Moment	1012
Fly-wheel Shafts	1013
Length of Shaft-bearings	1015
Crank-shafts with Center-crank and Double-crank Arms	1017
Crank-shaft with two Cranks Coupled at 90°	1018
Crank-shaft with three Cranks at 120°	1019
Valve-stem or Valve-rod	1019
Size of Slot-link	1020
The Eccentric	1020
The Eccentric-rod	1020
Reversing-gear	1020
Current Practice in Engine Proportions, 1897.	1021
Current Practice in Steam-engine Design, 1909	1022
Shafts and Bearings of Engines	1023
Calculating the Dimensions of Bearings.	1024
Engine-frames or Bed-plates.	1025

Fly-wheels.

Weight of Fly-wheels	1026
Weight of Fly-wheels for Alternating-current Units	1026
Centrifugal Force in Fly-wheels	1029
Diameters for Various Speeds	1030
Strains in the Rims	1031
Arms of Fly-wheels and Pulleys	1032
Thickness of Rims	1032
A Wooden Rim Fly-wheel	1033
Wire-wound Fly-wheels	1034

The Slide-valve.

Definitions, Lap, Lead, etc.	1034
The Zeuner Valve-diagram	1036
The Zeuner Valve-diagram	1036
Port Opening, Lead, and Inside Lead	1039
Crank Angles for Connecting-rods of Different Lengths	1040
Ratio of Lap and of Port-opening to Valve-travel.	1041
Relative Motions of Crosshead and Crank.	1042
Periods of Admission or Cut-off for Various Laps and Travels.	1042
Piston-valves	1043
Setting the Valves of an Engine	1043
To put an Engine on its Center	1043
Lint-motion	1044
The Walschaert Valve-gear	1046

Governors.

Pendulum or Fly-ball Governors	1047
To Change the Speed of an Engine.	1048
Ply-wheel or Shaft Governors	1048
The Rites Inertia Governor	1048
Calculation of Springs for Shaft-governors	1048

Condenser & Air-bumps, Circulating-pumps, etc.

The Jet Condenser	1050
Quantity of Cooling water	1050
Ejector Condensers	1051
The Barometric Condensers	1051
The Surface Condenser	1051
Coefficient of Heat Transference in Condensers	1052
The Power Used for Condensing Apparatus	1053
Vacuum, Inches of Mercury and Absolute Pressure	1053
Temperatures, Pressures and Volumes of Saturated Air	1054
Condenser Tubes	1054
Bimetallic Condenser Tubes	1055
Tube-plates	1055
Spacing of Tubes	1055

	PAGE
A. F. Nagle's Formula.....	1117
Width of Belt for Given Horse-power.....	1118
Belt Factors.....	1119
Taylor's Rules for Belting.....	1120
Barth's Studies on Belting.....	1123
Notes on Belting.....	1123
Lacing of Belts.....	1124
Setting a Belt on Quarter-twist.....	1124
To Find the Length of Belt.....	1125
To Find the Angle of the Arc of Contact.....	1125
To Find the Length of Belt when Closely Rolled.....	1125
To Find the Approximate Weight of Belts.....	1125
Relations of the Size and Speeds of Driving and Driven Pulleys.....	1125
Evils of Tight Belts.....	1126
Sag of Belts.....	1126
Arrangements of Belts and Pulleys.....	1126
Care of Belts.....	1127
Strength of Belting.....	1127
Adhesion, Independent of Diameter.....	1127
Endless Belts.....	1127
Belt Data.....	1127
Belt Dressing.....	1128
Cement for Cloth or Leather.....	1128
Rubber Belting.....	1128
Steel Belts.....	1129
Roller Chain and Sprocket Drives.....	1129
Belting <i>versus</i> Chain Drives.....	1132
A 350 H.P. Silent Chain Drive.....	1132

GEARING.

Pitch, Pitch-circle, etc.....	1133
Diametral and Circular Pitch.....	1133
Diameter of Pitch-line of Wheels from 10 to 100 Teeth.....	1134
Chordal Pitch.....	1135
Proportions of Teeth.....	1135
Gears with Short Teeth.....	1135
Formulae for Dimensions of Teeth.....	1136
Width of Teeth.....	1136
Proportion of Gear-wheels.....	1137
Rules for Calculating the Speed of Gears and Pulleys.....	1137
Milling Cutters for Interchangeable Gears.....	1138

Forms of the Teeth.

The Cycloidal Tooth.....	1138
The Involute Tooth.....	1140
Approximation by Circular Arcs.....	1142
Stepped Gears.....	1143
Twisted Teeth.....	1143
Spiral Gears.....	1143
Worm Gearing.....	1143
The Hindley Worm.....	1144
Teeth of Bevel-wheels.....	1144
Annular and Differential Gearing.....	1145
Efficiency of Gearing.....	1146
Efficiency of Worm Gearing.....	1147
Efficiency of Automobile Gears.....	1148

Strength of Gear Teeth.

Various Formulae for Strength..... I.....	1148
Comparison of Formulae.....	1150
Raw-hide Pinions.....	1153
Maximum Speed of Gearing.....	1153
A Heavy Machine-cut Spur-gear.....	1153
Frictional Gearing.....	1154
Frictional Grooved Gearing.....	1154

	PAGE
Power Transmitted by Friction Drives.....	1154
Friction Clutches.....	1155
Coil Friction Clutches.....	1156

HOISTING AND CONVEYING.

Working Strength of Blocks.....	1157
Chain-blocks.....	1157
Efficiency of Hoisting Tackle.....	1158
Proportions of Hooks.....	1159
Iron versus Steel Hooks.....	1159
Heavy Crane Hooks.....	1159
Strength of Hooks and Shackles.....	1161
Power of Hoisting Engines.....	1162
Effect of Slack Rope on Strain in Hoisting.....	1162
Limit of Depth for Hoisting.....	1162
Large Hoisting Records.....	1163
Pneumatic Hoisting.....	1163
Counterbalancing of Winding-engines.....	1163

Cranes.

Classification of Cranes.....	1165
Position of the Inclined Brace in a Jib Crane.....	1166
Electric Overhead Traveling Cranes.....	1166
Power Required to Drive Cranes.....	1166
Dimensions, Loads and Speeds of Electric Cranes.....	1167
Notable Crane Installations.....	1168
Electric <i>versus</i> Hydraulic Cranes.....	1168
A 150-ton Pillar Crane.....	1168
Compressed-air Traveling Cranes.....	1169
Power Required for Traveling Cranes and Hoists.....	1169
Lifting Magnets.....	1169
Telpherage.....	1171

Coal-handling Machinery.

Weight of Overhead Bins.....	1172
Supply-pipes from Bins.....	1172
Types of Coal Elevators.....	1172
Combined Elevators and Conveyors.....	1172
Coal Conveyors.....	1173
Horse-power of Conveyors.....	1173
Weight of Chain and of Flights.....	1174
Bucket, Screw, and Belt Conveyors.....	1175
Capacity of Belt Conveyors.....	1175
Belt Conveyor Construction.....	1176
Horse-power to Drive Belt Conveyors.....	1176
Relative Wearing Power of Conveyor Belts.....	1177

Wire-rope Haulage.

Self-acting Inclined Plane.....	1177
Simple Engine Plane.....	1178
Tail-rope System.....	1178
Endless Rope System.....	1179
Wire-rope Tramways.....	1179
Stress in Hoisting-ropes on Inclined Planes.....	1180
An Aerial Tramway 2.1 miles long.....	1180
Formulae for Deflection of a Wire Cable.....	1181
Suspension Cableways and Cable Hoists.....	1182
Tension Required to Prevent Wire Slipping on Drums.....	1183
Taper Ropes of Uniform Tensile Strength.....	1183

WIRE-ROPE TRANSMISSION.

Working Tension of Wire Ropes.....	1183
Breaking Strength of Wire Ropes.....	1184
Sheaves for Wire-rope Transmission.....	1184

	PAGE
Bending Stresses of Wire Ropes.....	1184
Horse-power Transmitted.....	1185
Diameters of Minimum Sheaves.....	1186
Deflections of the Rope.....	1187
Limits of Span.....	1187
Long-distance Transmission.....	1188
Inclined Transmissions.....	1188
Bending Curvature of Wire Ropes.....	1188

ROPE DRIVING.

Formulae for Rope Driving.....	1189
Horse-power of Transmission at Various Speeds.....	1191
Sag of the Rope between Pulleys.....	1191
Tension on the Slack Part of the Rope.....	1192
Data of Manila Transmission Rope.....	1193
Miscellaneous Notes on Rope-driving.....	1193
Cotton Ropes.....	1194

FRICITION AND LUBRICATION.

Coefficient of Friction.....	1194
Rolling Friction.....	1194
Friction of Solids.....	1195
Friction of Rest.....	1195
Laws of Unlubricated Friction.....	1195
Friction of Tires Sliding on Rails.....	1195
Coefficient of Rolling Friction.....	1195
Laws of Fluid Friction.....	1196
Angles of Repose of Building Materials.....	1196
Coefficient of Friction of Journals.....	1196
Friction of Motion.....	1197
Experiments on Friction of a Journal.....	1197
Coefficients of Friction of Journal with Oil Bath.....	1197, 1199
Coefficients of Friction of Motion and of Rest.....	1198
Value of Anti-friction Metals.....	1199
Cast-iron for Bearings.....	1199
Friction of Metal Under Steam-pressure.....	1200
Morin's Laws of Friction.....	1200
Laws of Friction of well-lubricated Journals.....	1201
Allowable Pressures on Bearing-surface.....	1203
Oil-pressure in a Bearing.....	1204
Friction of Car-journal Brasses.....	1204
Experiments on Overheating of Bearings.....	1205
Moment of Friction and Work of Friction.....	1205
Tests of Large Shaft Bearings.....	1206
Clearance between Journal and Bearing.....	1206
Allowable Pressures on Bearings.....	1206
Bearing Pressures for Heavy Intermittent Loads.....	1207
Bearings for Very High Rotative Speed.....	1208
Thrust Bearings in Marine Practice.....	1208
Bearings for Locomotives.....	1208
Bearings of Corliss Engines.....	1208
Temperature of Engine Bearings.....	1209
Pivot Bearings.....	1209
The Schiele Curve.....	1209
Friction of a Flat Pivot-bearing.....	1209
Mercury-bath Pivot.....	1209
Ball Bearings, Roller Bearings, etc.....	1210
Friction Rollers.....	1210
Conical Roller Thrust Bearings.....	1211
The Hyatt Roller Bearing.....	1211
Notes on Ball Bearings.....	1212
Saving of Power by use of Ball Bearings.....	1214
Knife-edge Bearings.....	1214
Friction of Steam-engines.....	1215
Distribution of the Friction of Engines.....	1215

Friction Brakes and Friction Clutches.

	PAGE
Friction Brakes.....	1216
Friction Clutches.....	1216
Magnetic and Electric Brakes.....	1217
Design of Band Brakes.....	1217
Friction of Hydraulic Plunger Packing.....	1217

Lubrication.

Durability of Lubricants.....	1218
Qualifications of Lubricants.....	1219
Examination of Oils.....	1219
Specifications for Petroleum Lubricants.....	1219
Penna. R. R. Specifications.....	1220
Grease Lubricants.....	1221
Testing Oil for Steam Turbines.....	1221
Quantity of Oil to run an Engine.....	1221
Cylinder Lubrication.....	1222
Soda Mixture for Machine Tools.....	1223
Water as a Lubricant.....	1223
Acheson's Deflocculated Graphite.....	1223
Solid Lubricants.....	1223
Graphite, Soapstone, Metaline.....	1223

THE FOUNDRY.

Cupola Practice.....	1224
Melting Capacity of Different Cupolas.....	1225
Charging a Cupola.....	1225
Improvement of Cupola Practice.....	1226
Charges in Stove Foundries.....	1227
Foundry Blower Practice.....	1227
Results of Increased Driving.....	1229
Power Required for a Cupola Fan.....	1230
Utilization of Cupola Gases.....	1230
Loss of Iron in Melting.....	1230
Use of Softeners.....	1230
Weakness of Large Castings.....	1230
Shrinkage of Castings.....	1231
Growth of Cast Iron by Heating.....	1231
Hard Iron due to Excessive Silicon.....	1231
Ferro Alloys for Foundry Use.....	1232
Dangerous Ferro-silicon.....	1232
Quality of Foundry Coke.....	1232
Castings made in Permanent Cast-iron Molds.....	1232
Weight of Castings from Weight of Pattern.....	1233
Molding Sand.....	1233
Foundry Ladles.....	1234

THE MACHINE SHOP.

Speed of Cutting Tools.....	1235
Table of Cutting Speeds.....	1235
Spindle Speeds of Lathes.....	1236
Rule for Gearing Lathes.....	1236
Change-gears for Lathes.....	1237
Quick Change Gears.....	1237
Metric Screw-threads.....	1238
Cold Chisels.....	1238
Setting the Taper in a Lathe.....	1238
Taylor's Experiments on Tool Steel.....	1238
Proper Shape of Lathe Tool.....	1239
Forging and Grinding Tools.....	1240
Best Grinding Wheel for Tools.....	1241
Chatter.....	1241
Use of Water on Tool.....	1241
Interval between Grindings.....	1241
Effect of Feed and Depth of Cut on Speed.....	1241

	PAGE
Best High Speed Tool Steel — Heat Treatment.....	1242
Best Method of Treating Tools, in Small Shops.....	1243
Quality of Different Tool Steels.....	1243
Parting and Thread Tools.....	1243
Durability of Cutting Tools.....	1243
Economical Cutting Speeds.....	1243-1245
New High Speed Steels, 1909.....	1246
Use of a Magnet to Determine Hardening Temperature.....	1246
Case-hardening, Cementation Harveyizing.....	1246
Change of Shape due to Hardening and Tempering.....	1247
Milling Cutters.....	1247
Teeth of Milling Cutters.....	1247
Keyways in Milling Cutters.....	1248
Power Required for Milling.....	1249
Extreme Results with Milling Machines.....	1249
Speed of Cutters.....	1250
Typical Milling Jobs.....	1251
Milling with or against Feed.....	1252
Modern Milling Practice.....	1252
Lubricant for Milling Cutters.....	1252
Milling-machine vs. Planer.....	1252
Drills, Speed of Drills.....	1253
High-speed Steel Drills.....	1253
Power Required to Drive High-speed Drills.....	1253
Extreme Results with Radial Drills.....	1254
Experiments on Twist, Drills.....	1254
Resistance Overcome in Cutting Metal.....	1256
Heavy Work on a Planer.....	1256
Horse-power to run Lathes.....	1256-1260
Power required for Machine Tools.....	1256-1260
Power used by Machine Tools.....	1258
Size of Motors for Machine Tools.....	1260
Horse-power Required to Drive Shafting.....	1261
Power used in Machine-shops.....	1261
Power Required to Drive Machines in Groups.....	1262

Abrasive Processes.

The Cold Saw.....I.	1262
Reese's Fusing-disk.....I.	1262
Cutting Stone with Wire.....	1262
The Sand-blast.....	1262
Emery-wheels.....	1263-1267
Grindstones.....	1264-1268

Various Tools and Processes.

Efficiency of a Screw.....*	1268
Tap Drills.....	1269
Efficiency of Screw Bolts.....	1270
Efficiency of a Differential Screw.....	1270
Taper Bolts, Pins, Reamers, etc.....	1270
Morse Tapers.....	1271
The Jarno Taper.....*	1271
Punches, Dies, Presses.....	1272
Clearance between Punch and Die.....	1272
Size of Blanks for Drawing-press.....	1272
Pressure of Drop-press.....	1273
Flow of Metals.....	1273
Forcing and Shrinking Fits.....	1273
Shaft Allowances for Electrical Machinery.....	1274
Running Fits.....	1274
Force Required to Start Force and Shrink Fits.....	1275
Proportioning Parts of Machines in Series.....	1276
Keys for Gearing, etc.....	1276
Holding-power of Set-screws.....I.	1278
Holding-power of Keys.....	1279

DYNAMOMETERS.

	PAGE
Traction Dynamometers.....	1280
The Prony Brake.....	1280
The Alden Dynamometer.....	1281
Capacity of Friction Brakes.....	1281
Transmission Dynamometers.....	1282

ICE MAKING, OR REFRIGERATING MACHINES.

Operations of a Refrigerating-Machine.....	1283
Pressures, etc., of Available Liquids.....	1284
Properties of Ammonia and Sulphur Dioxide Gas.....	1285
Solubility of Ammonia.....	1288
Properties of Saturated Vapors.....	1288
Heat Generated by Absorption of Ammonia.....	1288
Cooling Effect, Compressor Volume and Power Required, with different Cooling Agents.....	1289
Ratios of Condenser, Mean Effective, and Vaporizer Pressures.....	1289
Properties of Rine used to absorb Refrigerating Effect.....	1290
Chloride-of-calcium Solution.....	1290
Ice-melting Effect.....	1291
Ether-machines.....	1291
Air-machines.....	1291
Carbon Dioxide Machines.....	1292
Methyl Chloride Machines.....	1292
Sulphur Dioxide Machines.....	1292
Machines Using Vapor of Water.....	1292
Ammonia Compression-machines.....	1292
Dry, Wet and Flooded Systems.....	1292
Ammonia Absorption-machines.....	1293
Relative Performance of Compression and Absorption Machines.....	1294
Efficiency of a Refrigerating-machine.....	1295
Cylinder-heating.....	1296
Volumetric Efficiency.....	1296
Pounds of Ammonia per Ton of Refrigeration.....	1297, 1298
Mean Effective Pressure, and Horse-power.....	1297
The Voorhees Multiple Effect Compressor.....	1297
Size and Capacities of Ammonia Machines.....	1299
Piston Speeds and Revolutions per Minute.....	1300
Condensers for Refrigerating-machines.....	1300
Cooling Tower Practice in Refrigerating Plants.....	1301
Test Trials of Refrigerating-machines.....	1302
Comparison of Actual and Theoretical Capacity.....	1302
Performance of Ammonia Compression-machines.....	1303
Economy of Ammonia Compression-machines.....	1304
Form of Report of Test.....	1306
Temperature Range.....	1306
Metering the Ammonia.....	1307
Performance of Ice-making Machines.....	1307
Performance of a 75-ton Refrigerating-machine.....	1309, 1311
Ammonia Compression-machine, Result of Tests.....	1312
Performance of a Single-ton Ammonia Compressor.....	1312
Performance of Ammonia Absorption-machine.....	1312
Means for Applying the Cold.....	1314
Artificial Ice-manufacture.....	1314
Test of the New York Hygeia Ice-making Plant.....	1315
An Absorption Evaporator Ice-making System.....	1315
Ice-making with Exhaust Steam.....	1316
Tons of Ice per Ton of Coal.....	1316
Standard Ice Cans or Molds.....	1316

MARINE ENGINEERING

Rules for Measuring and Obtaining Tonnage of Vessels.....	1316
The Displacement of a Vessel.....	1317
Coefficient of Fineness.....	1317
Coefficient of Water-lines.....	1317

	PAGE
Best High Speed Tool Steel — Heat Treatment	1242
Best Method of Treating Tools, in Small Shops	1243
Quality of Different Tool Steels	1243
Parting and Thread Tools	1243
Durability of Cutting Tools	1243
Economical Cutting Speeds	1243-1245
New High Speed Steels, 1909	1246
Use of a Magnet to Determine Hardening Temperature	1246
Case-hardening, Cementation, Harveyzing	1246
Change of Shape due to Hardening and Tempering	1247
Milling Cutters	1247
Teeth of Milling Cutters	1247
Keyways in Milling Cutters	1248
Power Required for Milling	1248
Extreme Results with Milling Machines	1249
Speed of Cutters	1250
Typical Milling Jobs	1251
Milling with or against Feed ..	1252
Modern Milling Practice	1252
Lubricant for Milling Cutters	1252
milling-machine vs. Planer	1252
Drills, Speed of Drills	1253
High-speed Steel Drills	1253
Power Required to Drive High-speed Drills	1253
Extreme Results with Radial Drills	1254
Experiments on Twist Drills	1254
Resistance Overcome in Cutting Metal	1256
Heavy Work on a Planer	1256
Horse-power to run Lathes	1256-1260
Power required for Machine Tools	1256-1260
Power used by Machine Tools	1258
Size of Motors for Machine Tools	1260
Horse-Power Required to Drive Shafting	1261
Power used in Machine-shops	1261
Power Required to Drive Machines in Groups	1262

Abrasive Processes.

The Cold Saw	1262
Reese's Fusing-disk	1262
Cutting Stone with Wire	1262
The Sand-blast	1262
Emery-wheels	1263-1267
Grindstones	1264-1268

Various Tools and Processes.

Efficiency of a Screw	1268
Tap Drills	1269
Efficiency of Screw Bolts	1270
Efficiency of a Differential Screw	1270
Taper Bolts, Pins, Reamers, etc.	1270
Morse Tapers	1271
The Jarno Taper	1271
Punches, Dies, Presses	1272
Clearance between Punch and Die	1272
Size of Blanks for Drawing-press	1272
Pressure of Drop-press	1273
Flow of Metals	1273
Forcing and Shrinking Fits	1273
Shaft Allowances for Electrical Machinery	1274
Running Fits	1274
Force Required to Start Force and Shrink Fits	1275
Proportioning Parts of Machines in Series	1276
Keys for Gearing, etc.	1276
Holding-power of Set-screws	1278
Holding-power of Keys	1279

DYNAMOMETERS.

	PAGE
Traction Dynamometers	1280
The Prony Brake	1280
The Alden Dynamometer	1281
Capacity of Friction-brakes	1281
Transmission Dynamometers	1282

ICE MAKING, OR REFRIGERATING MACHINES.

Operations of a Refrigerating-Machine	1283
Pressures, etc., of Available Liquids	1284
Properties of Ammonia and Sulphur Dioxide Gas	1285
Solubility of Ammonia	1288
Properties of Saturated Vapors	1288
Heat Generated by Absorption of Ammonia	1288
Cooling Effect, Compressor Volume and Power Required, with different Cooling Agents	1289
Ratios of Condenser Mean Effective and Vaporizer Pressures ..	1289
Properties of Brine used to absorb Refrigerating Effect	1290
Chloride-of-calcium Solution	1290
Ice-melting effect	1291
Ether-machines	1291
Air-machines	1291
Carbon Dioxide Machines	1292
Methyl Chloride Machines	1292
Sulphur Dioxide Machines	1292
Machines Using Vapor of Water	1292
Ammonia Compression-machines	1292
Dry, Wet and Flooded Systems	1292
Ammonia Absorption-machines	1293
Relative Performance of Compression and Absorption Machines ..	1294
Efficiency of a Refrigerating-machine	1295
Cylinder-heating	1296
Volumetric Efficiency	1296
Pounds of Ammonia per Ton of Refrigeration	1297
Mean Effective Pressure, and Horse-power	1297
The Voorhees Multiple Test Compressor	1297
Size and Capacities of Ammonia Machines	1299
Piston Speeds and Revolutions per Minute	1300
Condensers for Refrigerating-machines	1300
Cooling Tower Practice in Refrigerating Plants	1301
Test Trials of Refrigerating-machines	1302
Comparison of Actual and Theoretical Capacity	1302
Performance of Ammonia Compression-machines	1303
Economy of Ammonia Compression-machines	1304
Form of Report of Test	1306
Temperature Range	1306
Metering the Ammonia	1307
Performance of Ice-making Machines	1307
Performance of a 75-ton Refrigerating-machine	1309, 1311
Ammonia Compression-machine, Results of Tests	1312
Performance of a Single-acting Ammonia Compressor	1312
Performance of Ammonia Absorption-machine	1312
Means for Applying the Cold	1314
Artificial Ice-manufacture	1314
Test of the New York Hygeia Ice-making Plant	1315
An Absorption Evaporator Ice-making System	1315
Ice-making with Exhaust Steam	1316
Tons of Ice per Ton of Coal	1316
Standard Ice Cans or Molds	1316

MARINE ENGINEERING

Rules for Measuring and Obtaining Tonnage of Vessels	1316
The Displacement of a Vessel	1317
Coefficient of Fineness	1317
Coefficient of Water-lines	1317

	PAGE
Resistance of Ships	1317
Coefficient of Performance of Vessels.....	1318
Defects of the Common Formula for Resistance	1318
Rankine's Formula.....	1319
E. R. Mumford's Method.....	1319
Dr. Kirk's Method.....	1329
To find the I.H.P. from the Wetted Surface.....	1320
Relative Horse-power required for Different Speeds of Vessels.....	1321
Resistance per Horse-power for Different Speeds.....	1321
Estimated Displacement, Horse-power,, etc.. of Steam-vessels.....	1322
Speed of Boats with Internal Combustion Engines.....	1322

The Screw-propeller

Pitch and Size of Screw	1324
Propeller Coefficients.....	1325
Efficiency of the Propeller.....	1326
Pitch-ratio and Slip for Screws of Standard Form	1326
Table for Calculating Dimensions of Screws.....	1327

Marine Practice

Dimensions and Performance of Notable Atlantic Steamers.....	1328
Relative Economy of Turbines and Reciprocating Engines.....	1328
Marine Practice, 1901.....	1329
Comparison of Marine Engines, 1872, 1881, 1891, 1901.....	1329
Turbines and Boilers of the "Lusitania".....	1330
Performance of the "Lusitania," 1908.....	1330
Relation of Horse-power to Speed.....	1331
Reciprocating Engines with a Low-pressure Turbine.....	1331

The Paddle-wheel

Paddle-wheels with Radial Floats.....	1331
Feathering Paddle-wheels.....	1331
Efficiency of Paddle-wheels.....	1332

Jet Propulsion

Reaction of a Jet	1332
-------------------------	------

CONSTRUCTION OF BUILDINGS

Foundations

Bearing Power of Soils.....	1333
Bearing Power of Piles.....	1334
Safe Strength of Brick Piers.....	1334
Thickness of Foundation Walls.....	1334

Masonry

Allowable Pressures on Masonry.....	1 3 3 4
Crushing Strength of Concrete.....	1334

Beams and Girders

Safe Loads on Beams.....	1335
Maximum Permissible Stresses in Structural Materials.....	1335
Safe Loads on Wooden Beams.....	1336

Walls

Thickness of Walls of Buildings.....	1336
Walls of Warehouse, Stores, Factories, and Stables.....	1337

Floors, Columns and Posts

Strength of Floors, Roofs, and Supports.....	1337
Columns and Posts.....	1 3 3 7
Fireproof Buildings.....	1338
Iron and Steel Columns.....	1338
Lintels, Bearings, and Supports.....	1338

	PAGE
Strains on Girders and Rivets.....	1338
Maximum Load on Floors.....	1339
Strength of Floors.....	1339
Mill Columns.....	1341
Safe Distributed Loads on Southern-pine Beams.....	1341
Maximum Spans for 1, 2 and 3 inch Plank.....	1342
Approximate Cost of Mill Buildings.....	1342

ELECTRICAL ENGINEERING.

C. G. S. System of Physical Measurement.....	1344
Practical Units used in Electrical Calculations.....	1345
Relations of Various Units.....	1346
Units of the Magnetic Circuit.....	1346
Equivalent Electrical and Mechanical Units.....	1347
Permeability.....	1348
Analogies between Flow of Water and Electricity.....	1348

Electrical Resistance

Laws of Electrical Resistance.....	1349
Electrical Conductivity of Different Metals and Alloys.....	1349
Conductors and Insulators.....	1350
Resistance Varies with Temperature.....	1350
Annealing.....	1351
Standard of Resistance of Copper Wire.....	1351

Direct Electric Currents

Ohm's Law.....	1351
Series and Parallel or Multiple Circuits.....	1352
Resistance of Conductors in Series and Parallel.....	1352
Internal Resistance.....	1353
Power of the Circuit.....	1353
Electrical, Indicated, and Brake Horse-power.....	1353
Heat Generated by a Current.....	1354
Heating of Conductors.....	1354
Heating of Coils.....	1355
Fusion of Wires.....	1355
Allowable Carrying Capacity of Copper Wires.....	1355
Underwriters' Insulation.....	1355
Drop of Voltage in Wires Carrying Allowed Currents.....	1356
Wiring Table for Motor Service.....	1356
Copper-wire Table.....	1357, 1358

Electric Transmission, Direct-Currents

Section of Wire Required for a Given Current.....	1359
Weight of Copper for a Given Power.....	1359
Short-circuiting.....	1360
Economy of Electric Transmission.....	1360
Wire Table for 110, 220, 500, 1600, and 2000 volt Circuits.....	1360
Efficiency of Electric Systems.....	1361
Resistances of Pure Aluminium Wire.....	1362
Systems of Electrical Distribution.....	1363
Table of Electrical Horse-powers.....	1364
Cost of Copper for Long-distance Transmission.....	1365

Electric Railways

Electric Railway Cars and Motors.....	1366
A 4000-H.P. Electric Locomotive.....	1366

Electric Lighting; — Illumination

Illumination.....	1367
Terms, Units, Definitions.....	1367
Relative Color Values of Illuminants.....	1367
Relation of Illumination to Vision.....	1367

	PAGE
Arc Lamps.....	1368
Illumination by Arc Lamps at Different Distances.....	1368
Data of Some Arc Lamps.....	1369
Watts per Square Foot Required for Arc Lighting.....	1369
The Mercury Vapor Lamp.....	1369
Incandescent Lamps.....	1370
Rating of Incandescent Lamps.....	1370
Incandescent Lamp Characteristics.....	1370
Variation in Candle-power Efficiency and Life.....	1371
Performance of Tantalum and Tungsten Lamps.....	1372
Specifications for Lamps.....	1372
Special Lamps.....	1372
Nernst Lamp.....	1372
Cost of Electric Lighting.....	1373
Electric Welding	1374
Electric Heaters	1375
Electric Furnaces.....	1376
Silundum.....	1377
Electric Batteries	
Description of Storage-batteries or Accumulators.....	1378
Sizes and Weights of Storage-batteries.....	1379
Efficiency of a Storage Cell.....	1380
Rules for Care of Storage-batteries.....	1380
Electrolysis	1381
Electro-chemical Equivalents	1382
The Magnetic Circuit	
Lines and Loops of Force.....	1383
Values of B and H	1384
Tractive or Lifting Force of a Magnet.....	1384
Determining the Polarity of Electro-magnets.....	1385
Determining the Direction of a Current.....	1385
Dynamo-electric Machines	
Kinds of Machines as regards Manner of Winding.....	1385
Moving Force of a Dynamo-electric Machine.....	1386
Torque of an Armature.....	1386
Torque, Horse-power and Revolutions.....	1386
Electro-motive Force of the Armature Circuit.....	1386
Strength of the Magnetic Field.....	1387
Alternating Currents	
Maximum, Average and Effective Values.....	1388
Frequency.....	1388
Inductance.....	1389
Capacity.....	1389
Power Factor.....	1389
Reactance, Impedance, Admittance.....	1390
Skin Effect.....	1390
Ohm's Law Applied to Alternating Current Circuits.....	1390
Impedance Polygons.....	1390
Self-inductance of Lines and Circuits.....	1393
Capacity of Conductors.....	1394
Single-phase and Polyphase Currents.....	1394
Measurement of Power in Polyphase Circuits.....	1395
Alternating Current Circuits	
Calculation of Alternating Current Circuits.....	1396
Relative Weight of Copper Required in Different Systems.....	1398
Rule for Size of Wires for Three-phase Transmission Lines.....	1398
Notes on High-tension Transmission.....	1398

	PAGE
Transformers, Converters, etc.	
Transformers.....	1400
Converters.....	1401
Mercury Arc Rectifiers.....	1401
Electric Motors	
Classification of Motors.....	1401
The Auxiliary-pole Type of Motors.....	1402
Speed of Electric Motors.....	1403
Speed Control of Motors. Rheostats.....	1404
Selection of Motors for Different Kinds of Service.....	1405
The Electric Drive in the Machine Shop.....	1407
Choice of Motors for Machine Tools.....	1407
Alternating Current Motors	
Synchronous Motors.....	1408
Induction Motors.....	1409
Induction Motor Applications.....	1409
Alternating Current Motors for Variable Speed.....	1412
Sizes of Electric Generators and Motors	
Direct-connected Engine-driven Generators.....	1412
Belt-driven Generators.....	1412
Belt-driven Motors.....	1413
Belt-driven Alternators.....	1413
Machines with Commutating Poles.....	1413
Small Engine-driven Alternators.....	1414
Railway Motors.....	1414
Small Polyphase, Single-phase, and Direct-current Motors.....	1415
Symbols Used in Electrical Diagrams	1416

NAMES AND ABBREVIATIONS OF PERIODICALS AND TEXT-BOOKS FREQUENTLY REFERRED TO IN THIS WORK.

Am. Mach. American Machinist.
 App. Cyl. Mech. Appleton's Cyclopædia of Mechanics, Vols. I and II.
 Bull. I. & S. A. Bulletin of the American Iron and Steel Association.
 Burr's Elasticity and Resistance of Materials.
 Clark, R. T. D. D. K. Clark's Rules, Tables, and Data for Mechanical Engineers.
 Clark, S. E. D. K. Clark's Treatise on the Steam-Engine.
 Col. Cotl. Qly. Columbia College Quarterly.
 El. Rev. Electrical Review.
 El. World. Electrical World and Engineer.
 Engg. Engineering (London).
 Eng. News. Engineering News.
 Eng. Rec. Engineering Record.
 Engr. The Engineer (London).
 Fairbairn's Useful Information for Engineers.
 Flynn's Irrigation Canals and Flow of Water.
 Indust. Eng. Industrial Engineering.
 Jour. A. C. I. W. Journal of American Charcoal Iron Workers' Association.
 Jour. Ass. Eng. Soc. Journal of the Association of Engineering Societies.
 Jour. F. I. Journal of the Franklin Institute.
 Kapp's Electric Transmission of Energy.
 Lanza's Applied Mechanics.
 Machy. Machinery.
 Merriman's Strength of Materials.
 Modern Mechanism. Supplementary volume of Appleton's Cyclopædia of Mechanics.
 Peabody's Thermodynamics.
 Proc. A. S. H. V. E. Proceedings Am. Soc'y of Heating and Ventilating Engineers.
 Proc. A. S. T. M. Proceedings Amer. Soc'y for Testing Materials.
 Proc. Inst. C. E. Proceedings Institution of Civil Engineers (London).
 Proc. Inst. M. E. Proceedings Institution of Mechanical Engineers (London).
 Proceedings Engineers' Club of Philadelphia.
 Rankine, S. E. Rankine's The Steam Engine and other Prime Movers.
 Rankine's Machinery and Millwork.
 Rankine, R. T. D. Rankine's Rules, Tables, and Data.
 Reports of U. S. Iron and Steel Test Board.
 Reports of U. S. Testing Machine at Watertown, Massachusetts.
 Rontgen's Thermodynamics.
 Seaton's Manual of Marine Engineering.
 Hamilton Smith, Jr.'s Hydraulics.
 Stevens Indicator. Stevens Institute Indicator.
 Thompson's Dynamo-electric Machinery.
 Thurston's Manual of the Steam Engine.
 Thurston's Materials of Engineering.
 Trans. A. I. E. E. Transactions American Institute of Electrical Engineers.
 Trans. A. I. M. E. Transactions American Institute of Mining Engineers.
 Trans. A. S. C. E. Transactions American Society of Civil Engineers.
 Trans. A. S. M. E. Transactions American Society of Mechanical Engineers.
 Trautwine's Civil Engineer's Pocket Book.
 The Locomotive (Hartford, Connecticut).
 Unwin's Elements of Machine Design.
 Weisbach's Mechanics of Engineering.
 Wood's Resistance of Materials.
 Wood's Thermodynamics.

MATHEMATICS.

Greek Letters.

A α Alpha	H η Eta	N ν Nu	T τ Tau
B β Beta	Θ θ Theta	Ξ ξ Xi	Υ υ Upsilon
Γ γ Gamma	Ι ι Iota	Ο ο Omicron	Φ φ Phi
Δ δ Delta	Κ κ Kappa	Π π Pi	Χ χ Chi
Ε ε Epsilon	Λ λ Lambda	Ρ ρ Rho	Ψ ψ Psi
Ζ ζ Zeta	Μ μ Mu	Σ σ Σigma	Ω ω Omega

Arithmetical and Algebraical Signs and Abbreviations.

+ plus (addition).
 + positive.
 - minus (subtraction).
 - negative.
 ± plus or minus.
 ∓ minus or plus.
 = equals.
 X multiplied by.
 ab or a.b = a X b.
 ÷ divided by.
 / divided by.
 $\frac{a}{b} = a/b = a \div b. \quad 15/16 = \frac{15}{16}$
 $0.2 = \frac{2}{10}; 0.002 = \frac{2}{1000}$
 $\sqrt{\quad}$ square root.
 $\sqrt[3]{\quad}$ cube root.
 $\sqrt[4]{\quad}$ 4th root.
 : is to, :: so is, . to (proportion).
 2 : 4 :: 3 : 6, 2 is to 4 as 3 is to 6.
 : ratio; divided by.
 2 : 4, ratio of 2 to 4 = 2/4.
 ∴ therefore.
 > greater than.
 < less than.
 □ square.
 ○ round.
 ° degrees, arc or thermometer.
 ' minutes or feet.
 " seconds or inches.
 ' ' ' accents to distinguish letters, as a', a", a'''.
 a₁, a₂, a₃, a_b, a_c, read a sub 1, a sub b, etc.
 () [] { } — parenthesis, brackets, braces, vinculum; denoting that the numbers enclosed are to be taken together: as.
 (a + b)c = 4 + 3 X 5 = 35.
 a², a³, a squared, a cubed.
 aⁿ, a raised to the nth power.
 $a^3 = \sqrt[3]{a^3}, a^{\frac{1}{2}} = \sqrt{a^2}$
 $a^{-1} = \frac{1}{a}, a^{-2} = \frac{1}{a^2}$
 10⁹ = 10 to the 9th power = 1,000,000,000.
 sin a = the sine of a.
 sin⁻¹ a = the arc whose sin is a.
 $\sin a^{-1} = \frac{1}{\sin a}$
 log = logarithm.
 loge or hyp log = hyperbolic logarithm.
 % per cent.
 ∠ angle.

⊥ right angle.
 ⊥ perpendicular to.
 sin, sine.
 cos, cosine.
 tan, tangent.
 sec, secant.
 versin, versed sine.
 cot, cotangent.
 cosec, cosecant.
 covers, co-versed sine.
 In Algebra, the first letters of the alphabet, a, b, c, d, etc., are generally used to denote known quantities, and the last letters, w, x, y, z, etc., unknown quantities.
 Abbreviations and Symbols commonly used.
 d, differential (in calculus).
 ∫, integral (in calculus).
 \int_a^b , integral between limits a and b.
 Δ, delta, difference.
 Σ, sigma, sign of summation.
 π, pi, ratio of circumference of circle to diameter = 3.14159.
 g, acceleration due to gravity = 32.16 ft. per second per second.
 Abbreviations frequently used in this Book.
 L., l., length in feet and inches.
 B., b., breadth in feet and inches.
 D., d., depth or diameter.
 H., h., height, feet and inches.
 T., t., thickness or temperature.
 V., v., velocity.
 F., force, or factor of safety.
 f, coefficient of friction.
 E., coefficient of elasticity.
 R., r., radius.
 W., w., weight.
 P., p., pressure or load.
 H.P., horse-power.
 I.H.P., indicated horse-power.
 B.H.P., brake horse-power.
 h. p., high pressure.
 i. p., intermediate pressure.
 l. p., low pressure.
 A.W.G., American Wire Gauge (Brown & Sharpe).
 B.W.G., Birmingham Wire Gauge.
 r. p. m., or revs. per min., revolutions per minute.
 Q. = quantity, or volume.

ARITHMETIC.

The user of this book is supposed to have had a training in arithmetic as well as in elementary algebra. Only those rules are given here which are apt to be easily forgotten.

GREATEST COMMON MEASURE, OR GREATEST COMMON DIVISOR OF TWO NUMBERS.

Rule. — Divide the greater number by the less; then divide the divisor by the remainder, and so on, dividing always the last divisor by the last remainder, until there is no remainder, and the last divisor is the greatest common measure required.

LEAST COMMON MULTIPLE OF TWO OR MORE NUMBERS.

Rule. — Divide the given numbers by any number that will divide the greatest number of them without a remainder, and set the quotients with the undivided numbers in a line beneath. Divide the second line as before, and so on, until there are no two numbers that can be divided: then the continued product, of the divisors, last quotients, and undivided numbers will give the multiple required.

FRACTIONS.

To reduce a common fraction to its lowest terms. — Divide both terms by their greatest common divisor: $\frac{39}{52} = \frac{3}{4}$.

To change an improper fraction to a mixed number. — Divide the numerator by the denominator: the quotient is the whole number, and the remainder placed over the denominator is the fraction: $\frac{39}{4} = 9\frac{3}{4}$.

To change a mixed number to an improper fraction. — Multiply the whole number by the denominator of the fraction; to the product add the numerator, place the sum over the denominator: $1\frac{7}{8} = \frac{15}{8}$.

To express a whole number in the form of a fraction with a given denominator. — Multiply the whole number by the given denominator, and place the product over that denominator: $13 = \frac{39}{3}$.

To reduce a compound to a simple fraction, also to multiply fractions. — Multiply the numerators together for a new numerator and the denominators together for a new denominator:

$$\frac{2}{3} \text{ of } \frac{4}{3} = \frac{8}{9}, \text{ also } \frac{2}{3} \times \frac{4}{3} = \frac{8}{9}$$

To reduce a complex to a simple fraction. — The numerator and denominator must each first be given the form of a simple fraction; then multiply the numerator of the upper fraction by the denominator of the lower for the new numerator, and the denominator of the upper by the numerator of the lower for the new denominator:

$$\frac{7/8}{13/4} = \frac{7/8}{7/4} = \frac{28}{56} = \frac{1}{2}$$

To divide fractions. — Reduce both to the form of simple fractions, invert the divisor, and proceed as in multiplication:

$$\frac{3}{4} \div 1\frac{1}{4} = \frac{3}{4} \div \frac{5}{4} = \frac{3}{4} \times \frac{4}{5} = \frac{12}{20} = \frac{3}{5}$$

Cancellation of fractions. — In compound or multiplied fractions, divide any numerator and any denominator by any number which will divide them both without remainder, striking out the numbers thus divided and setting down the quotients in their stead.

To reduce fractions to a common denominator. — Reduce each fraction to the form of a simple fraction; then multiply each

WARNING: This is a 1910 edition. Some of the material may no longer be accurate

by all the denominators except its own for the new numerator, and all the denominators together for the common denominator:

$$\frac{1}{2}, \frac{1}{3}, \frac{3}{7} = \frac{21}{42}, \frac{14}{42}, \frac{18}{42}$$

To add fractions. — Reduce them to a common denominator, then add the numerators and place their sum over the common denominator:

$$\frac{1}{2} + \frac{1}{3} + \frac{3}{7} = \frac{21 + 14 + 18}{42} = \frac{53}{42} = 1\frac{11}{42}$$

To subtract fractions. — Reduce them to a common denominator, subtract the numerators and place the difference over the common denominator:

$$\frac{1}{2} - \frac{3}{7} = \frac{7 - 6}{14} = \frac{1}{14}$$

DECIMALS.

To add decimals. — Set down the figures so that the decimal points are one above the other, then proceed as in simple addition: $18.75 + 0.012 = 18.762$.

To subtract decimals. — Set down the figures so that the decimal points are one above the other, then proceed as in simple subtraction: $18.75 - 0.012 = 18.738$.

To multiply decimals. — Multiply as in multiplication of whole numbers, then point off as many decimal places as there are in multiplicand taken together: $1.5 \times 0.02 = .030 = 0.03$.

To divide decimals. — Divide as in whole numbers, and point off in the quotient as many decimal places as those in the dividend exceed those in the divisor. Ciphers must be added to the dividend to make it as many places at least equal those in the divisor, and as many more as it is desired to have in the quotient: $1.5 \div 0.25 = 6$. $0.1 \div 0.3 = 0.3333 +$ $00 \div 0.3$

Decimal Equivalents of Fractions of One Inch

1-64	.015625	17-64	.265625	33-64	.515625	49-64	.765625
1-32	.03125	9-32	.28125	17-32	.53125	25-32	.78125
3-64	.046875	19-64	.296875	35-64	.546875	51-64	.796875
1-16	.0625	5-16	.3125	9-16	.5625	13-16	.8125
5-64	.078125	21-64	.328125	37-64	.578125	53-64	.828125
3-32	.09375	11-32	.34375	19-32	.59375	27-32	.84375
7-64	.109375	23-64	.359375	39-64	.609375	55-64	.859375
1-8	.125	3-8	.375	5-8	.625	7-8	.875
9-64	.140625	25-64	.390625	41-64	.640625	57-64	.890625
5-32	.15625	13-32	.40625	21-32	.65625	29-32	.90625
11-64	.171875	27-64	.421875	43-64	.671875	59-64	.921875
3-16	.1875	7-16	.4375	11-16	.6875	15-16	.9375
13-64	.203125	29-64	.453125	45-64	.703125	61-64	.953125
7-32	.21875	15-32	.46875	23-32	.71875	31-32	.96875
15-64	.234375	31-64	.484375	47-64	.734375	63-64	.984375
1-4	.25	1-2	.50	3-4	.75	1	1

To convert a common fraction into a decimal. — Divide the numerator by the denominator, adding to the numerator as many ciphers, prefixed by a decimal as are necessary to give the number of decimal places desired in the result: $\frac{1}{3} = 1.0000 \div 3 = 0.3333 +$.

To convert a decimal into a common fraction. — Set down the decimal as a numerator, and place as the denominator 1 with as many ciphers annexed as there are decimal places in the numerator; erase the

Product of Fractions Expressed in Decimals.

0	1	1/8	1/4	3/8	1/2	5/8	3/4	7/8	1
1/16	.0625	.0039	.0625	.0352	.0781	.1172	.1562	.1953	.2344
1/8	.1250	.0078	.1250	.0781	.1562	.2344	.3125	.3906	.4688
3/16	.1875	.0117	.1875	.1172	.2344	.3516	.4688	.5860	.7031
1/4	.2500	.0156	.2500	.1562	.3125	.4688	.6250	.7812	.9375
5/16	.3125	.0195	.3125	.2031	.4063	.6094	.8125	.1016	.2031
3/8	.3750	.0234	.3750	.2578	.5156	.7734	.1042	.2084	.3125
7/16	.4375	.0273	.4375	.3438	.6875	.1068	.2136	.3204	.4271
1/2	.5000	.0313	.5000	.4063	.8125	.1094	.2187	.3281	.4375
9/16	.5625	.0352	.5625	.4688	.9375	.1120	.2240	.3360	.4480
5/8	.6250	.0391	.6250	.5156	.1016	.2031	.3047	.4063	.5078
11/16	.6875	.0430	.6875	.5625	.1068	.2136	.3204	.4271	.5339
3/4	.7500	.0469	.7500	.6094	.1120	.2240	.3360	.4480	.5600
13/16	.8125	.0508	.8125	.6563	.1172	.2344	.3516	.4688	.5860
7/8	.8750	.0547	.8750	.7031	.1225	.2450	.3675	.4900	.6125
15/16	.9375	.0586	.9375	.7500	.1277	.2554	.3831	.5108	.6385
1	1.0000	.0625	1.0000	.8125	.1329	.2658	.3987	.5316	.6645

decimal point in the numerator, and reduce the fraction thus formed to its lowest terms:

$$0.25 = \frac{25}{100} = \frac{1}{4}; \quad 0.3333 = \frac{3333}{10000} = \frac{1}{3}, \text{ nearly.}$$

To reduce a recurring decimal to a common fraction. — Subtract the decimal figures that do not recur from the whole decimal including one set of recurring figures; set down the remainder as the numerator of the fraction, and as many nines as there are recurring figures followed by as many ciphers as there are non-recurring figures, in the denominator. Thus:

Subtract 0.79054054, the recurring figures being 054.

$$\frac{78975}{99900} = (\text{reduced to its lowest terms}) \frac{117}{148}$$

COMPOUND OR DENOMINATE NUMBERS.

Reduction descending. — To reduce a compound number to a lower denomination. Multiply the number by as many units of the lower denomination as makes one of the higher.

3 yards to inches: 3 X 36 = 108 inches.

0.04 square feet to square inches: .04 X 144 = 5.76 sq. in.

If the given number is in more than one denomination proceed in steps from the highest denomination to the next lower, and so on to the lowest, adding in the units of each denomination as the operation proceeds.

3 yds. 1 ft. 7 in. to inches: 3X 3 = 9, + 1 = 10, 10X 12 = 120, + 7 = 127 in.

Reduction ascending. — To express a number of a lower denomination in terms of a higher, divide the number by the number of units of the lower denomination contained in one of the next higher; the quotient is in the higher denomination, and the remainder, if any, in the lower.

127 inches to higher denomination.

127 ÷ 12 = 10 feet + 7 inches: 10 feet ÷ 3 = 3 yards + 1 foot.

Ans. 3 yds. 1 ft. 7 in.

To express the result in decimals of the higher denomination divide the given number by the number of units of the given denomination contained in one of the required denomination, carrying the result to as many places of decimals as may be desired.

127 inches to yards: 127 ÷ 36 = 3 19/36 = 3.5277 + yards.

Decimals of a Foot Equivalent to Inches and Fractions of an Inch.

Inches	0	1/8	1/4	3/8	1/2	5/8	3/4	7/8
0	0	.01042	.02083	.03125	.04167	.05208	.06250	.07292
1	.0833	.0938	.1042	.1146	.1250	.1354	.1458	.1563
2	.1667	.1771	.1875	.1979	.2083	.2188	.2292	.2396
3	.2500	.2604	.2708	.2813	.2917	.3021	.3125	.3229
4	.3333	.3438	.3542	.3646	.3750	.3854	.3958	.4063
5	.4167	.4271	.4375	.4479	.4583	.4688	.4792	.4896
6	.5000	.5104	.5208	.5313	.5417	.5521	.5625	.5729
7	.5833	.5938	.6042	.6146	.6250	.6354	.6458	.6563
8	.6667	.6771	.6875	.6979	.7083	.7188	.7292	.7396
9	.7500	.7604	.7708	.7813	.7917	.8021	.8125	.8229
10	.8333	.8438	.8542	.8646	.8750	.8854	.8958	.9063
11	.9167	.9271	.9375	.9479	.9583	.9688	.9792	.9896

RATIO AND PROPORTION.

Ratio is the relation of one number to another, as obtained by dividing the first number by the second. *Synonymous with quotient.*

Ratio of 2 to 4, or $2 : 4 = \frac{2}{4} = \frac{1}{2}$.

Ratio of 4 to 2, or $4 : 2 = 2$.

Proportion is the equality of two ratios. Ratio of 2 to 4 equals ratio of 3 to 6, $\frac{2}{4} = \frac{3}{6}$; expressed thus, $2 : 4 :: 3 : 6$; read, 2 is to 4 as 3 is to 6.

The first and fourth terms are called the extremes or outer terms, the second and third the means or inner terms.

The product of the means equals the product of the extremes:

$$2 : 4 :: 3 : 6; \quad 2 \times 6 = 12; \quad 3 \times 4 = 12.$$

Hence, given the first three terms to find the fourth, multiply the second and third terms together and divide by the first.

$$2 : 4 :: 3 : \text{what number?} \quad \text{Ans. } \frac{4 \times 3}{2} = 6.$$

Algebraic expression of proportion. — $a : b :: c : d; \frac{a}{b} = \frac{c}{d}; ad = bc$:

$$\text{from which } a = \frac{bc}{d}; \quad d = \frac{bc}{a}; \quad b = \frac{ad}{c}; \quad c = \frac{ad}{b}.$$

From the above equations may also be derived the following:

$$\begin{array}{lll} b : a :: d : c & a + b : a :: c + d : c & a + b : a - b :: c + d : c - d \\ a : c :: b : d & a + b : b :: c + d : d & a^n : b^n :: c^n : d^n \\ a : b = c : d & a - b : b :: c - d : d & \sqrt[n]{a} : \sqrt[n]{b} :: \sqrt[n]{c} : \sqrt[n]{d} \\ & a - b : a :: c - d : c & \end{array}$$

Mean proportional between two given numbers, 1st and 2d, is such a number that the ratio which the first bears to it equals the ratio which it bears to the second. Thus, $2 : 4 :: 4 : 8$; 4 is a mean proportional between 2 and 8. To find the mean proportional between two numbers, extract the square root of their product.

$$\text{Mean proportional of 2 and 8} = \sqrt{2 \times 8} = 4.$$

Single Rule of Three; or, finding the fourth term of a proportion when three terms are given. — Rule, as above, when the terms are stated in their proper order, multiply the second by the third and divide by the first. The difficulty is state the terms in their proper order. The term which is of the same kind as the required or fourth term is made the third; the first and second **must** be like each other in kind and denomination. To determine which is to be made second and which first requires a little reasoning. If an inspection of the problem shows that the answer should be greater than the third term, then the greater of the other two given terms should be made the second term — otherwise the first. Thus, 3 men remove 54 cubic feet of rock in a day; how many men will remove in the same time 10 cubic yards? The answer is to be men — make men third term: the answer is to be more than three men, therefore make the greater quantity, 10 cubic yards, the second term; but as it is not the same denomination as the other term it must be reduced, = 270 cubic feet. The proportion is then stated:

$$54 : 270 :: 3 : x \text{ (the required number); } x = \frac{3 \times 270}{54} = 15 \text{ men.}$$

The problem is more complicated if we increase the number of given terms. Thus, in the above question, substitute for the words "in the same time" the words "in 3 days." First solve it as above, as if the work were to be done in the same time; then make another proportion, stating it thus: If 15 men do it in the same time, it will take fewer men to do it in 3 days: make 1 day the second term and 3 days the first term. $3 : 1 :: 15 \text{ men} : 5 \text{ men.}$

Compound Proportion, or Double Rule of Three. — By this rule are solved questions like the one just given, in which two or more statings are required by the single rule of three. In it, as in the single rule, there is one third term, which is of the same kind and denomination as the fourth or required term, but there may be two or more first and second terms. Set down the third term, take each pair of terms of the same kind separately, and arrange them as first and second by the same reasoning as is done in the single rule of three, making the greater of the pair the second if this pair considered alone should require the answer to be greater.

Set down all the first terms one under the other, and likewise all the second terms. Multiply all the first terms together and all the second terms together. Multiply the product of all the second terms by the third term, and divide this product by the product of all the first terms. Example: If 3 men remove 4 cubic yards in one day working 12 hours a day, how many men working 10 hours a day will remove 20 cubic yards in 3 days?

$$\begin{array}{r} \text{Yards} \quad 4 : 20 \\ \text{Days} \quad 3 : 1 \\ \text{Hours} \quad 10 : 12 \end{array} :: 3 \text{ men.}$$

$$\text{Products } 120 : 240 :: 3 : 6 \text{ men.} \quad \text{Ans.}$$

To abbreviate by cancellation, any one of the first terms may cancel either the third or any of the second terms; thus, 3 in first cancels 3 in third, making it 1, 10 cancels into 20 making the latter 2, which into 4 makes it 2, which into 12 makes it 6, and the figures remaining are only $1 : 6 :: 1 : 6$.

INVOLUTION, OR POWERS OF NUMBERS.

Involution is the continued multiplication of a number by itself a given number of times. The number is called the root, or first power, and the products are called powers. The second power is called the square and the third power the cube. The operation may be indicated without being performed by writing a small figure called the *index* or *exponent* to the right of and a little above the root; thus, $3^3 = \text{cube of } 3 = 27$.

To multiply two or more powers of the same number, add their exponents; thus, $2^2 \times 2^3 = 2^5$, or $4 \times 8 = 32 = 2^5$.

To divide two powers of the same number, subtract their exponents; thus, $2^3 \div 2^2 = 2^1 = 2$; $2^2 \div 2^1 = 2 - 2 = \frac{1}{2} = \frac{1}{2}$. The exponent may

thus be negative. $2^3 \div 2^3 = 2^0 = 1$, whence the zero power of any number = 1. The first power of a number is the number itself. The exponent may be fractional, as $2^{\frac{1}{2}}$ which means that the root is to be raised to a power whose exponent is the numerator of the fraction and the root whose sign is the denominator is to be extracted (see Evolution). The exponent may be a decimal, as $2^{0.5}$, $2^{1.5}$; read two to the five-tenths power, two to the one and five-tenths power. These powers are solved by means of Logarithms (which see).

First Nine Powers of the First Nine Numbers.

1st Power.	2d Power.	3d Power.	4th Power.	5th Power.	6th Power.	7th Power.	8th Power.	9th Power.
1	1	1	1	1	1	1	1	1
2	4	8	16	32	64	128	256	512
3	9	27	81	243	729	2187	6561	19683
4	16	64	256	1024	4096	16384	65536	262144
5	25	125	625	3125	15625	38125	390625	1953125
6	36	216	1296	7776	46656	279936	1679616	10077696
7	49	343	2401	16807	117049	823543	5764801	40353607
8	64	512	4096	32768	262144	2097152	16777216	134217728
9	81	729	6561	59049	531441	4782969	43046721	387420489

The First Forty Powers of 2.

Power.	Value.	Power.	Value.	Power.	Value.	Power.	Value.	Power.	Value.
0	1	9	512	18	262144	27	134217728	36	68719476736
1	2	10	1024	19	524288	28	268435456	37	137436953472
2	4	11	2048	20	1048576	29	5368704	38	274877906944
3	8	12	4096	21	2097152	30	1073741824	39	549755813800
4	16	13	8192	22	4194304	31	2147483648	40	1099511627776
5	32	14	16384	23	8388608	32	4294967296		
6	64	15	32768	24	16777216	33	8589934592		
7	128	16	65536	25	33554432	34	17179069184		
8	256	17	131072	26	67108864	35	34399730358		

EVOLUTION.

Evolution is the finding of the root (or extracting the root) of any number the power of which is given.

The sign $\sqrt{\quad}$ indicates that the square root is to be extracted: $\sqrt[3]{\quad}$ $\sqrt[4]{\quad}$ $\sqrt[n]{\quad}$, the cube root, 4th root, nth root.

A fractional exponent with 1 for the numerator of the fraction is also used to indicate that the operation of extracting the root is to be performed; thus, $2^{\frac{1}{2}}$, $2^{\frac{1}{3}}$ = $\sqrt{2}$, $\sqrt[3]{2}$.

When the power of a number is indicated, the involution not being performed, the extraction of any root of that power may also be indicated by dividing the index of the power by the index of the root, indicating the division by a fraction. Thus, extract the square root of the 6th power of 2:

$$\sqrt{2^6} = 2^{\frac{6}{2}} = 2^3 = 2^3 = 8.$$

The 6th power of 2, as in the table above, is 64; $\sqrt{64} = 8$.

Difficult problems in evolution are performed by logarithms, but the square root and the cube root may be extracted directly according to the rules given below. The 4th root is the square root of the square root. The 6th root is the cube root of the square root, or the square root of the cube root; the 9th root is the cube root of the cube root; etc.

To Extract the Square Root. -Point off the given number into periods of two places each, beginning with units. If there are decimals, point these off likewise, beginning at the decimal point, and supplying as many ciphers as may be needed. Find the greatest number whose square is less than the first left-hand period, and place it as the first figure in the quotient. Subtract its square from the left-hand period, and to the remainder annex the two figures of the second period for a dividend. Double the first figure of the quotient for a partial divisor; find how many times the latter is contained in the dividend exclusive of the right-hand figure, and set the figure representing that number of times as the second figure in the quotient, and annex it to the right of the partial divisor, forming the complete divisor. Multiply this divisor by the second figure in the quotient and subtract the product from the dividend. To the remainder bring down the next period and proceed as before, in each case doubling the figures in the root already found to obtain the trial divisor; Should the product of the second figure in the root by the completed divisor be greater than the dividend, erase the second figure both from the quotient and from the divisor, and substitute the next smaller figure, or one small enough to make the product of the second figure by the divisor less than or equal to the dividend.

WARNING: This is a 1910 edition. Some of the material may no longer be accurate

SQUARE ROOT.

3.1415926536 | 1.77245 +

1	
27	214
	189
347	2515
	2429
3542	8692
	7084
35444	160865
	141776
354485	1908936
	1772425

CUBE ROOT.

1,881,365,963,625 | 12345

1	
	30 x 1
	300 x 1 ²
	x 2 = 60
	2 ² = 300
	364 728
	300 x 12 ²
	30 x 12
	= 43200
	2 x 3 = 1080
	3 ² = 9
	44289
	132867
300 X 123 ²	= 4538700
30 X 123 X 4	= 14760
	4 ² = 16
	45534761
	18213904
	2285059625
300 X 1234 ²	= 456826800
30 X 1234 X 5	= 185100
	5 ² = 25
	457011925
	2285059625

To extract the square root of a fraction, extract the root of a numerator and denominator separately, $\sqrt{\frac{4}{9}} = \frac{2}{3}$, or first convert the fraction into a decimal, $\sqrt{\frac{4}{9}} = \sqrt{.4444} = .6666 +$.

To Extract the Cube Root. - Point off the number into periods of 3 figures each, beginning at the right hand, or unit's place. Point off decimals in periods of 3 figures from the decimal point. Find the greatest cube that does not exceed the left-hand period; write its root as the first figure in the required root. Subtract the cube from the left-hand period, and to the remainder bring down the next period for a dividend.

Square the first figure of the root; multiply by 300, and divide the product into the dividend for a trial divisor; write the quotient after the first figure of the root as a trial second figure.

Complete the divisor by adding to 300 times the square of the first figure, 30 times the product of the first by the second figure, and the square of the second figure. Multiply this divisor by the second figure; subtract the product from the remainder. (Should the product be greater than the remainder, the last figure of the root and the complete divisor are too large; substitute for the last figure the next smaller number, and correct the trial divisor accordingly.)

To the remainder bring down the next period, and proceed as before to find the third figure of the root - that is, square the two figures of the root already found; multiply by 300 for a trial divisor, etc.

If at any time the trial divisor is greater than the dividend, bring down another period of 3 figures, and place 0 in the root and proceed.

The cube root of a number will contain as many figures as there are periods of 3 in the number.

To Extract a Higher Root than the Cube. - The fourth root is the square root of the square root; the sixth root is the cube root of the square root or the square root of the cube root. Other roots are most conveniently found by the use of logarithms.

ALLIGATION.

shows the value of a mixture of different ingredients when the quantity and value of each are known.

Let the ingredients be a, b, c, d, etc., and their respective values per unit w, x, y, z, etc.

A = the sum of the quantities = a + b + c + d, etc.
 P = mean value or price per unit of A.
 AP = aw + bx + cy + dz, etc.

$$P = \frac{aw + bx + cy + dz}{A}$$

PERMUTATION

shows in how many positions any number of things may be arranged in a row; thus, the letters a, b, c may be arranged in six positions, viz. abc, acb, cab, cba, bac, bca.

Rule. — Multiply together all the numbers used in counting the things; thus, permutations of 1, 2, and 3 = 1 X 2 X 3 = 6. In how many positions can 9 things in a row be placed?

$$1 \times 2 \times 3 \times 4 \times 5 \times 6 \times 7 \times 8 \times 9 = 362880.$$

COMBINATION

shows how many arrangements of a few things may be made out of a greater number. Rule: Set down that figure which indicates the greater number, and after it a series of figures diminishing by 1, until as many are set down as the number of the few things to be taken in each combination. Then beginning under the last one, set down said number of few things; then going backward set down a series diminishing by 1 until arriving under the first of the upper numbers. Multiply together all the upper numbers to form one product, and all the lower numbers to form another; divide the upper product by the lower one.

How many combinations of 9 things can be made, taking 3 in each combination?

$$\frac{9 \times 8 \times 7}{1 \times 2 \times 3} = \frac{504}{6} = 84.$$

ARITHMETICAL PROGRESSION,

in a series of numbers, is a progressive increase or decrease in each successive number by the addition or subtraction of the same amount at each step, as 1, 2, 3, 4, 5, etc., or 15, 12, 9, 6, etc. The numbers are called terms, and the equal increase or decrease the difference. Examples in arithmetical progression may be solved by the following formulæ:

Let a = first term, l = last term, d = common difference, n = number of terms, s = sum of the terms:

$$l = a + (n - 1)d, \quad = -\frac{1}{2}d \pm \sqrt{2ds + \left(a - \frac{1}{2}d\right)^2},$$

$$= \frac{2s}{n} - a, \quad = \frac{s}{n} + \frac{(n - 1)d}{2}.$$

$$s = \frac{1}{2}n[2a + (n - 1)d], \quad = \frac{l + a}{2} + \frac{l^2 - a^2}{2d},$$

$$= (l + a)\frac{n}{2}, \quad = \frac{1}{2}n[2l - (n - 1)d].$$

$$a = l - (n - 1)d, \quad = \frac{s}{n} - \frac{(n - 1)d}{2},$$

$$= \frac{1}{2}d \pm \sqrt{\left(l + \frac{1}{2}d\right)^2 - 2ds}, \quad = \frac{2s}{n} - l.$$

$$d = \frac{l - a}{n - 1}, \quad = \frac{2(s - an)}{n(n - 1)},$$

$$= \frac{l^2 - a^2}{2s - l - a}, \quad = \frac{2(nl - s)}{n(n - 1)},$$

$$r = \frac{l - a}{d} + 1, \quad = \frac{d - 2a \pm \sqrt{(2a - d)^2 + 8ds}}{2d},$$

$$= \frac{2s}{l + a}, \quad = \frac{2l + d \pm \sqrt{(2l + d)^2 - 8ds}}{2d}.$$

GEOMETRICAL PROGRESSION,

in a series of numbers, is a progressive increase or decrease in each successive number by the same multiplier or divisor at each step, as 1, 2, 4, 8, 16, etc., or 243, 81, 27, 9, etc. The common multiplier is called the ratio.

Let a = first term, l = last term, r = ratio or constant multiplier, n = number of terms, m = any term, as 1st, 2d, etc., s = sum of the terms:

$$l = ar^{n-1}, \quad = \frac{a + (r - 1)s}{r}, \quad = \frac{(r - 1)sr^{n-1}}{r^n - 1},$$

$$\log l = \log a + (n - 1) \log r, \quad l(s - l)^{n-1} - a(s - a)^{n-1} = 0.$$

$$m = ar^{m-1} \quad \log m = \log a + (m - 1) \log r.$$

$$s = \frac{a(r^n - 1)}{r - 1}, \quad = \frac{rl - a}{r - 1}, \quad = \frac{n^{-1}\sqrt[l]{n} - n^{-1}\sqrt[a]{a^n}}{n^{-1}\sqrt[l]{l} - n^{-1}\sqrt[a]{a}}, \quad = \frac{lr^n - 1}{r^n - r^{n-1}}.$$

$$a = \frac{l}{r^{n-1}}, \quad = \frac{(r - 1)s}{r^{n-1}}, \quad \log a = \log l - (n - 1) \log r.$$

$$r = \sqrt[n-1]{\frac{l}{a}}, \quad = \frac{s - a}{s - l}, \quad \log r = \frac{\log l - \log a}{n - 1}.$$

$$r^n - \frac{s}{a}r + \frac{s - a}{a} = 0. \quad r^n - \frac{s}{s - 1}r^{n-1} + \frac{l}{s - l} = 0.$$

$$n = \frac{\log l - \log a}{\log r} + 1, \quad = \frac{\log [a + (r - 1)s] - \log a}{\log r}.$$

$$= \frac{\log l - \log a}{\log (s - a) - \log (s - l)} + 1, \quad = \frac{\log l - \log [lr - (r - 1)s] + 1}{\log r}.$$

Population of the United States.

(A problem in geometrical progression.)

Year.	Population.	Increase in 10 Years, per cent.	Annual Increase, per cent.
1860	31,443,321		
1880	39,818,449*	26.63	2.39
1890	50,155,783	25.96 34.86	2.33
1900	62,622,250		2.25
1905	76,295,220	Est. 21.834	1.994
1910	Est. 91,554,000	Est. 20.0	Est. 1.840

Estimated Population in Each Year from 1870 to 1909.

(Based on the above rates of increase, in even thousands.)

1870....	39,818	1880...	50,156	1890....	62,622	1900...	76,295
1871....	40,748	1881....	51,281	1891....	63,871	1901....	77,699
1872....	41,699	1882....	52,433	1892....	65,145	1902....	79,129
1873....	42,673	1883....	53,610	1893....	66,444	1903....	80,585
1874....	43,670	1884....	54,813	1894....	67,770	1904....	82,067
1875....	44,690	1885....	56,043	1895....	69,122	1905....	83,577
1876....	45,373	1886....	57,301	1896....	70,500	1906....	85,115 86,681
1877....	46,800	1887....	58,588	1897....	71,906	1907....	
1878....	47,993 49,011	1888....	59,903	1898....	73,341	1908....	88,276
		1889....	61,247	1899....	74,803	1909....	89,900

* Corrected by addition of 1,260,078, estimated error of the census of 1870, Census Bulletin No. 16, Dec. 12, 1890.

The preceding table has been calculated by logarithms as follows:

$$\log r = \log l - \log a \div (n - 1), \quad \log m = \log a + (m - 1) \log r$$

Pop. 1900. . . 76,295,220	log = 7.8824988	= log <i>l</i>
" 1890. . . 62,622,250	log = 7.7967285	= log <i>a</i>
	diff. = .0857703	
$n = 11, n - 1 = 10$	$10 \times \text{diff.} = 0.857703$	= log <i>r</i> ,
	$7.7967285 + 0.857703 = 8.6544315$	= log <i>a</i>
log for 1891	= 7.80530553	No. = 63,871 . . .
add again	.00857703	
log for 1892	7.81388256	No. = 65,145. . .

Compound interest is a form of geometrical progression; the ratio being 1 plus the percentage.

PERCENTAGE: PROFIT AND LOSS: PER CENT OF EFFICIENCY.

Per cent means "by the hundred." A profit of 10 per cent means a gain of \$10 on every \$100 expended. If a thing is bought for \$1 and sold for \$2 the profit is 100 per cent; but if it is bought for \$2 and sold for \$1 the loss is not 100 per cent, but only 50 per cent.

Rule for percentage: Per cent gain or loss is the gain or loss divided by the original cost, and the quotient multiplied by 100.

Efficiency is defined in engineering as the quotient "output divided by input," that is, the energy utilized divided by the energy expended. The difference between the input and the output is the loss or waste of energy. Expressed as a fraction, efficiency is nearly always less than unity. Expressed as a per cent, it is this fraction multiplied by 100. Thus we may say that a motor has an efficiency of 0.9 or of 90 per cent.

The efficiency of a boiler is the ratio of the heat units absorbed by the boiler in heating water and making steam to the heating value of the coal burned. The saving in fuel due to increasing the efficiency of a boiler from 60 to 75% is not 25%, but only 20%. The rule is: Divide the gain in efficiency (15) by the greater figure (75). The amount of fuel used is inversely proportional to the efficiency; that is, 60 lbs. of fuel with 75% efficiency will do as much work as 75 lbs. with 60% efficiency. The saving of fuel is 15 lbs. which is 20% of 75 lbs.

INTEREST AND DISCOUNT.

Interest is money paid for the use of money for a given time: the factors are:

- p*, the sum loaned, or the principal;
- t*, the time in years;
- r*, the rate of interest;
- i*, the amount of interest for the given rate and time;
- $a = p + i$ = the amount of the principal with interest at the end of the time.

Formulae:

$$i = \text{interest} = \text{principal} \times \text{time} \times \text{rate per cent} = i = \frac{ptr}{100};$$

$$a = \text{amount} = \text{principal} + \text{interest} = p + \frac{ptr}{100};$$

$$r = \text{rate} = \frac{100i}{pt};$$

$$p = \text{principal} = \frac{100i}{tr} = a - \frac{ptr}{100};$$

$$t = \text{time} = \frac{100i}{pr}.$$

If the rate is expressed decimally as a per cent, — thus, 6 per cent = .06, — the formulæ become

$$i = prt; a = p(1 + rt); r = \frac{i}{pt}; t = \frac{i}{pr}; p = \frac{i}{tr} = \frac{i}{1 + rt}.$$

Rules for finding Interest. — Multiply the principal by the rate per annum divided by 100, and by the time in years and fractions of a year.

If the time is given in days, interest = $\frac{\text{principal} \times \text{rate} \times \text{no. of days}}{365 \times 100}$

In banks interest is sometimes calculatea on the basis of 360 days to a year, or 12 months of 30 days each.

Short rules for interest at 6 per cent, when 360 days are taken as 1 year: Multiply the principal by number of days and divide by 6000.

Multiply the principal by number of months and divide by 200. The interest of 1 dollar for one month is $\frac{1}{2}$ cent.

Interest of 100 Dollars for Different Times and Rates.

Time	2%	3%	4%	6%	6%	8%	10%	
1 year	\$2.00	\$3.00	\$4.00	\$ 5 . 0	0	\$6.00	\$8.00	\$10.00
1 month	.16 $\frac{2}{3}$.25	.33 $\frac{1}{3}$.41 $\frac{2}{3}$.50	.66 $\frac{2}{3}$.83 $\frac{1}{3}$	
1 day = & year	.0055 $\frac{5}{8}$.0083 $\frac{1}{4}$.0111 $\frac{1}{9}$.0138 $\frac{2}{3}$.0166 $\frac{2}{3}$.0222 $\frac{2}{9}$.0277 $\frac{7}{9}$	
1 day = & year	.005479	.008219	.010959	.013699	.016438	.0219178	.0273973	

Discount is interest deducted for payment of money before it is due.

True discount is the difference between the amount of a debt payable at a future date without interest and its present worth. The present worth is that sum which put at interest at the legal rate will amount to the debt when it is due.

To find the present worth of an amount due at a future, date, divide the amount by the amount of \$1 placed at interest for the given time. The discount equals the amount minus the present worth.

What discount should be allowed on \$103 paid six months before it is due, interest being 6 per cent per annum?

$$\frac{103}{1 + 1 \times .06 \times \frac{1}{2}} = \$100 \text{ present worth, discount} = 3.00.$$

Bank discount is the amount deducted by a bank as interest on money loaned on promissory notes. It is interest calculated not on the actual sum loaned but on the gross amount of the note, from which the discount is deducted in advance. It is also calculated on the basis of 360 days in the year, and for 3 (in some banks 4) days more than the time specified in the note. These are called days of grace, and the note is not payable till the last of these days. In some States days of grace have been abolished.

What discount will be deducted by a bank in discounting a note for \$103 payable 6 months hence? Six months = 182 days, add 3 days grace = 185 days. $\frac{103 \times 185}{6000} = \$3.176.$

Compound Interest. — In compound interest the interest is added to the principal at the end of each year, (or shorter period if agreed upon).

Let *p* = the principal, *r* = the rate expressed decimally, *n* = no. of Years, and *a* the amount:

$$a = \text{amount} = p(1 + r)^n; r = \text{rate} = \sqrt[n]{\frac{a}{p}} - 1;$$

$$p = \text{principal} = \frac{a}{(1 + r)^n}; \text{no. of years} = n = \frac{\log a - \log p}{\log (1 + r)}.$$

Compound Interest Table.

(Value of one dollar at compound interest, compounded yearly, at 3, 4, 5, and 6 per cent, from 1 to 50 years.)

Years.	Per cent				Years.	Per cent			
	3	4	5	6		3	4	5	6
1	1.03	1.04	1.05	1.06	16	1.6047	1.8730	2.1829	2.5403
2	1.0609	1.0816	1.1025	1.1236	17	1.6528	1.9479	2.2920	2.6928
3	1.0927	1.1249	1.1576	1.1910	18	1.7024	2.0258	2.4066	2.6543
4	1.1255	1.1699	1.2155	1.2625	19	1.7535	2.1068	2.5269	3.0256
5	1.1593	1.2166	1.2763	1.3382	20	1.8061	2.1911	2.6533	3.2071
6	1.1941	1.2653	1.3401	1.4185	21	1.8603	2.2787	2.7859	3.3995
7	1.2299	1.3159	1.4071	1.5036	22	1.9161	2.3699	2.9252	3.6035
8	1.2668	1.3686	1.4774	1.5938	23	1.9736	2.4647	3.0715	3.8197
9	1.3048	1.4233	1.5513	1.6895	24	2.0328	2.5633	3.225	4.0487
10	1.3439	1.4802	1.6289	1.7908	25	2.0937	2.6658	3.3863	4.2919
11	1.3842	1.5394	1.7103	1.8983	30	2.4272	3.2433	4.3219	5.7435
12	1.4258	1.6010	1.7958	2.0122	35	2.8138	3.9460	5.5159	7.6862
13	1.4685	1.6651	1.8856	2.1329	40	3.2620	4.8009	7.0398	10.2858
14	1.5126	1.7317	1.9799	2.2609	45	3.7815	5.8410	8.9847	13.7648
15	1.5550	1.8009	2.0789	2.3965	50	4.3838	7.1064	11.4670	18.4204

At compound interest at 3 per cent money will double itself in 23 1/2 years, at 4 per cent in 17 2/3 years, at 5 per cent in 14.2 years, and at 6 per cent in 11.9 years.

EQUATION OF PAYMENTS.

By equation of payments we find the equivalent or average time in which one payment should be made to cancel a number of obligations due at different dates; also the number of days upon which to calculate interest or discount upon a gross sum which is composed of several smaller sums payable at different dates.

Rule. — Multiply each item by the time of its maturity in days from a fixed date, taken as a standard, and divide the sum of the products by the sum of the items: the result is the average time in days from the standard date.

A owes B \$100 due in 30 days, \$200 due in 60 days, and \$300 due in 90 days. In how many days may the whole be paid in one sum of \$600?

$$100 \times 30 + 200 \times 60 + 300 \times 90 = 42,000; 42,000 \div 600 = 70 \text{ days, ans.}$$

A owes B 8100, 8200, and \$300, which amounts are overdue respectively 30, 60, and 90 days. If he now pays the whole amount, \$600, how many days' interest should he pay on that sum? Ans. 70 days.

PARTIAL PAYMENTS.

To compute interest on notes and bonds when partial payments have been made.

United States Rule. — Find the amount of the principal to the time of the first payment, and subtracting the payment from it, find the amount of the remainder as a new principal to the time of the next payment.

If the payment is less than the interest, find the amount of the Principal to the time when the sum of the payments equals or exceeds the interest due, and subtract the sum of the payments from this amount.

Proceed in this manner till the time of settlement.

Note. — The principles upon which the preceding rule is founded are:

- 1st. That payments must be applied first to discharge accrued interest, and then the remainder, if any, toward the discharge of the principal.
- 2d. That only unpaid principal can draw interest.

Mercantile Method. — When partial payments are made on short notes or interest accounts, business men commonly employ the following method:

Find the amount of the whole debt to the time of settlement; also find the amount of each payment from the time it was made to the time of settlement. Subtract the amount of payments from the amount of the debt: the remainder will be the balance due.

ANNUITIES.

An Annuity is a fixed sum of money paid yearly, or at other equal times agreed upon. The values of annuities are calculated by the principles of compound interest.

1. Let i denote interest on \$1 for a year, then at the end of a year the amount will be $1 + i$. At the end of n years it will be $(1 + i)^n$.

2. The sum which in n years will amount to 1 is $\frac{1}{(1 + i)^n}$ or $(1 + i)^{-n}$, or the present value of 1 due in n years.

3. The amount of an annuity of 1 in any number of years n is $\frac{(1 + i)^n - 1}{i}$.

4. The present value of an annuity of 1 for any number of years n is $\frac{1 - (1 + i)^{-n}}{i}$.

5. The annuity which 1 will purchase for any number of years n is $\frac{i}{1 - (1 + i)^{-n}}$.

6. The annuity which would amount to 1 in n years is $\frac{i}{(1 + i)^n - 1}$.

Amounts, Present Values, etc., at 5% Interest.

Years	(1)	(2)	(3)	(4)	(5)	(6)
	$(1 + i)^n$	$(1 + i)^{-n}$	$\frac{(1 + i)^n - 1}{i}$	$\frac{1 - (1 + i)^{-n}}{i}$	$\frac{i}{1 - (1 + i)^{-n}}$	$\frac{i}{(1 + i)^n - 1}$
1	1.05	.952381	1.00	.952381	1.05	1.00
2	1.1025	.907029	2.05	1.859410	.537805	.487805
3	1.16075	.863838	3.1525	2.723248	.367209	.317209
4	1.215506	.822702	4.310125	3.545951	.282012	.232012
5	1.276282	.783526	5.525631	4.329477	.230975	.180975
6	1.340096	.746215	6.801913	5.075692	.197017	.147018
7	1.407100	.710681	8.142008	5.786373	.172820	.122820
8	1.477455	.676839	9.549109	6.463213	.154722	.104722
9	1.551328	.644609	11.026564	7.107822	.140690	.090690
10	1.628895	.613913	12.577893	7.721735	.129505	.079505

Table I. — Annuity Required to Redeem \$1000 in from 1 to 50 Years.

Years to run	Rate of Interest, per cent.												
	2	2 1/4	2 1/2	2 3/4	3	3 1/4	3 1/2	3 3/4	4	4 1/2	5	5 1/2	6
2	495.05	494.43	493.83	493.22	492.61	492.00	491.40	490.80	490.20	489.60	487.80	486.62	485.43
3	326.72	325.94	325.14	324.35	323.56	322.75	321.94	321.13	320.36	318.77	317.21	315.63	314.10
4	242.63	241.74	240.84	239.93	239.03	238.14	237.26	236.38	235.50	233.74	232.01	230.29	228.60
5	192.16	191.18	190.24	189.30	188.35	187.42	186.49	185.56	184.63	182.79	180.98	179.13	177.39
6	158.53	157.53	156.56	155.58	154.61	153.64	152.67	151.73	150.79	148.88	147.02	145.18	143.36
7	134.52	133.51	132.49	131.50	130.51	129.54	128.57	127.59	126.61	124.67	122.82	120.96	119.13
8	116.51	115.48	114.47	113.46	112.46	111.47	110.48	109.50	108.53	106.60	104.72	102.86	101.03
9	102.52	101.48	100.46	99.45	98.44	97.44	96.44	95.46	94.49	92.57	90.69	88.83	87.02
10	91.33	90.29	89.25	88.24	87.24	86.24	85.24	84.26	83.29	81.38	79.50	77.67	75.87
11	82.18	81.14	80.11	79.09	78.07	77.08	76.09	75.12	74.15	72.25	70.39	68.57	66.79
12	74.56	73.52	72.49	71.47	70.46	69.47	68.48	67.51	66.55	64.67	62.83	61.03	59.28
13	68.12	67.08	66.05	65.04	64.03	63.05	62.06	61.10	60.14	58.27	56.45	54.68	52.96
14	62.60	61.56	60.54	59.53	58.53	57.55	56.57	55.62	54.67	52.82	51.02	49.28	47.58
15	57.83	56.79	55.77	54.77	53.77	52.79	51.82	50.88	49.94	48.11	46.34	44.62	42.96
16	53.65	52.62	51.60	50.60	49.61	48.64	47.68	46.75	45.82	44.01	42.27	40.58	38.95
17	49.97	48.94	47.93	46.94	45.95	44.99	44.04	43.12	42.20	40.42	38.70	37.04	35.44
18	46.70	45.67	44.67	43.69	42.71	41.76	40.82	39.90	38.99	37.24	35.54	33.92	32.36
19	43.78	42.76	41.76	40.78	39.81	38.87	37.94	37.04	36.14	34.40	32.75	31.15	29.62
20	41.15	40.14	39.14	38.18	37.22	36.29	35.36	34.47	33.58	31.87	30.24	28.68	27.18
25	31.22	30.24	29.27	28.35	27.43	26.55	25.67	24.84	24.01	22.44	20.95	19.55	18.23
30	24.65	23.70	22.78	21.90	21.02	20.19	19.37	18.60	17.83	16.39	15.05	13.80	12.65
35	20.00	19.09	18.20	17.37	16.54	15.77	15.00	14.29	13.58	12.27	11.07	9.97	8.97
40	16.55	15.68	14.84	14.05	13.26	12.54	11.83	11.17	10.52	9.34	8.28	7.32	6.46
45	13.91	13.07	12.27	11.52	10.78	10.12	9.45	8.85	8.26	7.20	6.26	5.43	4.70
50	11.82	11.02	10.26	9.56	8.87	8.25	7.63	7.09	6.55	5.60	4.75	4.06	3.44

TABLES FOR CALCULATING SINKING-FUNDS AND PRESENT VALUES.

Engineers and others connected with municipal work and industrial enterprises often find it necessary to calculate payments to sinking-funds which will provide a sum of money sufficient to pay off a bond issue or other debt at the end of a given period, or to determine the present value of certain annual charges. The accompanying tables were computed by Mr. John W. Hill, of Cincinnati, Eng'g News, Jan. 25, 189-L.

Table I (opposite page) shows the annual sum at various rates of interest required to net \$1000 in from 2 to 50 years, and Table II shows the present value at various rates of interest of an annual charge of \$1000 for from 5 to 50 years, at five-year intervals, and for 100 years.

Table II. — Capitalization of Annuity of \$1000 for from 6 to 100 Years.

Years.	Rate of Interest, per cent.								
	2 1/2	3	3 1/2	4	4 1/2	6	5 1/2	6	
5	4,645.88	4,579.60	4,514.92	4,451.68	4,389.91	4,329.45	4,268.09	4,212.40	
10	8,752.17	8,530.13	8,316.45	8,110.74	7,912.67	7,721.73	7,537.54	7,360.19	
15	12,381.41	11,937.80	11,517.23	11,118.06	10,739.42	10,379.53	10,037.48	9,712.30	
20	15,589.215	14,877.27	14,212.12	13,590.21	13,007.88	12,462.13	11,950.26	11,469.96	
25	18,424.67	17,413.01	16,481.28	15,621.93	14,828.12	14,093.86	13,413.82	12,783.38	
30	20,930.59	19,600.21	18,391.85	17,291.86	16,288.77	15,372.36	14,533.63	13,764.85	
35	23,145.31	21,487.04	20,000.43	18,664.37	17,460.89	16,374.36	15,390.48	14,488.65	
40	25,103.53	23,114.36	21,354.83	19,792.65	18,401.49	17,159.01	16,044.92	15,046.31	
45	26,833.15	24,518.49	22,495.23	20,719.89	19,156.24	17,773.99	16,547.65	15,458.85	
50	28,362.48	25,729.58	23,455.21	21,482.08	19,761.93	18,255.86	16,931.97	15,761.87	
100	36,614.21	31,598.81	27,165.36	24,504.96	21,949.21	19,847.90	18,095.83	16,612.64	

WEIGHTS AND MEASURES.

Lbng Measure. - Measures of Length.

- 12 inches = 1 foot.
- 3 feet = 1 yard.
- 1760 yards, or 5280 feet = 1 mile.

Additional measures of length in occasional use: 1000 mils = 1 inch; 4 inches = 1 hand; 9 inches = 1 span; 2 1/2 feet = 1 military pace; 2 yards = 1 fathom; 5 1/2 yards, or 16 1/2 feet = 1 rod (formerly also called pole or perch).

Old Land Measure. — 7.92 inches = 1 link; 100 links, or 66 feet, or 4 rods = 1 chain; 10 chains, or 220 yards = 1 furlong; 8 furlongs, or 80 chains = 1 mile; 10 square chains = 1 acre.

Nautical Measure.

- 6080.26 feet, or 1.15156 statute miles } = 1 nautical mile, or knot.*
- 3 nautical miles } = 1 league.
- 60 nautical miles, or 69.168 statute miles } = 1 degree (at the equator).
- 360 degrees } = circumference of the earth at the equator.

* The British Admiralty takes the round figure of 6080 ft. which is the length of the "measured mile" used in trials of vessels. The value varies from 6080.26 to 6088.44 ft. according to different measures of the earth's diameter. There is a difference of opinion among writers as to the use of the word "knot" to mean length or a distance — some holding that it should be used only to denote a rate of speed. The length between knots on the log line is 1/20 of a nautical mile, or 50.7 ft., when a half-minute glass is used; so that a speed of 10 knots is equal to 10 nautical miles per hour.

Square Measure. -Measures of Surface.

144 square inches, or 183.35 circular inches = 1 square foot.
 9 square feet = 1 square yard,
 30 1/4 square yards, or 272 1/4 square feet = 1 square rod.
 10 sq. chains, or 160 sq. rods, or 4840 sq. yards, or 43560 sq. feet } = 1 acre.
 640 acres = 1 square mile.

An acre equals a square whose side is 205.71 feet.

Circular Inch; Circular Mil. — A circular inch is the area of a circle 1 inch in diameter = 0.7854 square inch.
 1 square inch = 1.2732 circular inches.
 A circular mil is the area of a circle 1 mil or 0.001 inch in diameter.
 1000² or 1,000,000 circular mils = 1 circular inch.
 1 square inch = 1,273,239 circular mils.

The mil and circular mil are used in electrical calculations involving the diameter and area of wires.

Solid or Cubic Measure. -Measures of Volume.

1725 cubic inches = 1 cubic foot.
 27 cubic feet = 1 cubic yard.
 1 cord of wood = a pile, 4 X 4 X 8 feet = 128 cubic feet.
 1 perch of masonry = 16 1/2 X 1 1/2 X 1 foot = 24 3/4 cubic feet.

Liquid Measure.

4 gills = 1 pint.
 2 pints = 1 quart.
 4 quarts = 1 gallon { U. S. 231 cubic inches.
 Eng. 277.274 cubic inches.

Old Liquid Measures. — 31 1/2 gallons = 1 barrel; 42 gallons = 1 tierce; 2 barrels, or 63 gallons = 1 hogshead; 84 gallons, or 2 tierces = 1 puncheon; 2 hogsheads, or 126 gallons = 1 pipe or butt; 2 pipes, or 3 puncheons = 1 tun.

A gallon of water at 62° F. weighs 8.3356 lbs.

The U. S. gallon contains 231 cubic inches; 7.4805 gallons = 1 cubic foot. A cylinder 7 in. diam. and 6 in. high contains 1 gallon, very nearly, or 230.9 cubic inches. The British Imperial gallon contains 277.274 cubic inches = 1.20032 U. S. gallon, or 10 lbs. of water at 62° F.

The gallon is a very troublesome unit for engineers. Much labor might be saved if it were abandoned and the cubic foot used instead. The capacity of a tank or reservoir should be stated in cubic feet, and the delivery of a pump in cubic feet per second or in millions of cubic feet in 24 hours. One cubic foot per second = 86,400 cu. ft. in 24 hours. One million cu. ft. per 24 hours = 11,5741 cu. ft. per sec.

The Miner's Inch. — (Western U. S. for measuring flow of a stream of water.) An act of the California legislature, May 23, 1911, makes the standard miner's inch 1.5 cu. ft. per minute, measured through any aperture or orifice.

The term Miner's Inch is more or less indefinite, for the reason that California water companies do not all use the same head above the centre of the aperture, and the inch varies from 1.36 to 1.73 cu. ft. per min., but the most common measurement is through an aperture 2 ins. high and whatever length is required, and through a plank 1 1/4 ins. thick. The lower edge of the aperture should be 2 ins. above the bottom of the measuring-box, and the plank 5 ins. high above the aperture, thus making a 6-in. head above the centre of the stream. Each square inch of this opening represents a miner's inch, which is equal to a flow of 1 1/2 cu. ft. per min.

Apothecaries' Fluid Measure.

60 minims = 1 fluid drachm. 8 drachms = 1 fluid ounce.

In the U. S. a fluid ounce is the 128th part of a U. S. gallon, or 1.805 cu. ins. It contains 456.3 grains of water at 39° F. In Great Britain the fluid ounce is 1.732 cu. ins. and contains 1 ounce avoirdupois, or 437.5 grains of water at 62° F.

Dry Measure, U. S.

2 pints = 1 quart. 8 quarts = 1 peck. 4 pecks = 1 bushel.

The standard U. S. bushel is the Winchester bushel, which is in cylinder form, 18 1/2 inches diameter and 8 inches deep, and, contains 2150.42 cubic inches.

A struck bushel contains 2150.42 cubic inches = 1.2445 cu. ft.; 1 cubic foot = 0.80356 struck bushel. A heaped bushel is a cylinder 18 1/2 inches diameter and 8 inches deep, with a heaped cone not less than 6 inches high. It is equal to 1 1/4 struck bushels.

The British Imperial bushel is based on the Imperial gallon, and contains 8 such gallons, or 2218.192 cubic inches = 1.2837 cubic feet. The English quarter = 8 Imperial bushels.

Capacity of a cylinder in U. S. gallons = square of diameter, in inches X height in inches X .0034. (Accurate within 1 part in 100,000.)

Capacity of a cylinder in U. S. bushels = square of diameter in inches X height in inches X 0.0003652.

Shipping Measure.

Register Ton. — For register tonnage or for measurement of the entire internal capacity of a vessel:

100 cubic feet = 1 register ton.

This number is arbitrarily assumed to facilitate computation.

Shipping Ton. — For the measurement of cargo:

49 cubic feet = 1 U. S. shipping ton.
 = 31.16 Imp. bushels.
 = 32.143 U. S. " "
 42 cubic feet = 1 British shipping ton.
 = 32.719 Imp. bushels.
 = 33.75 U. S. " "

Carpenter's Rule. — Weight a vessel will carry = length of keel X breadth at main beam X depth of hold in feet ÷ 95 (the cubic feet allowed for a ton). The result will be the tonnage. For a double-decker instead of the depth of the hold take half the breadth of the beam.

Measures of Weight. — Avoirdupois, or Commercial Weight.

16 drachms, or 437.5 grains = 1 ounce, oz.
 16 ounces, or 7000 grains = 1 pound, lb.
 28 pounds = 1 quarter, qr.
 4 quarters = 1 hundredweight, cwt. = 112 lbs.
 20 hundred weight = 1 ton of 2240 lbs., gross or long ton.
 2000 pounds = 1 net, or short, ton.
 2204.6 pounds = 1 metric ton.
 1 stone = 14 pounds; 1 quintal = 100 pounds.

The drachm, quarter, hundredweight, stone, and quintal are now seldom used in the United States.

Troy Weight.

24 grains = 1 pennyweight, dwt.
 20 pennyweights = 1 ounce, oz. = 480 grains.
 12 ounces = 1 pound, lb. = 5760 grains.

Troy weight is used for weighing gold and silver. The grain is the same in Avoirdupois, Troy, and Apothecaries' weights. A carat, used in weighing diamonds = 3.168 grains = 0.205 gramme.

Apothecaries' Weight.

20 grains = 1 scruple, \mathfrak{z}
 3 scruples = 1 drachm, \mathfrak{ss} = 60 grains.
 8 drachms = 1 ounce, $\mathfrak{ʒ}$ = 480 grains.
 12 ounces = 1 pound, lb. = 5760 grains.

To determine whether a balance has unequal arms. — After weighing an article and obtaining equilibrium, transpose the article and the weights. If the balance is true, it will remain in equilibrium; if untrue, the pan suspended from the longer arm will descend.

To weigh correctly on an incorrect balance. — First, by substitution. Put the article to be weighed in one pan of the balance and counterpoise it by any convenient heavy articles placed on the other pan. Remove the article to be weighed and substitute for it standard weights until equipoise is again established. The amount of these weights is the weight of the article.

Second, by transposition. Determine the apparent weight of the article as usual, then its apparent weight after transposing the article and the weights. If the difference is small, add half the difference to the smaller of the apparent weights to obtain the true weight. If the difference is 2 per cent the error of this method is 1 part in 10,990. For larger differences, or to obtain a perfectly accurate result, multiply the two apparent weights together and extract the square root of the product.

Circular Measure.

60 seconds, " = 1 minute, '
 60 minutes, ' = 1 degree, °
 90 degrees = 1 quadrant.
 360 " = circumference.

Arc of angle of 57.3" or $360^\circ \div 6.2832 = 1$ radian = the arc whose length is equal to the radius.

Time.

60 seconds = 1 minute.
 60 minutes = 1 hour.
 24 hours = 1 day.
 7 days = 1 week.

365 days, 5 hours, 48 minutes, 48 seconds = 1 year.

By the Gregorian Calendar every year whose number is divisible by 4 is a leap year, and contains 366 days, the other years containing 365 days, except that the centesimal years are leap years only when the number of the year is divisible by 400.

The comparative values of mean solar and sidereal time are shown by the following relations according to Bessel:

365.24222 mean solar days = 366.24222 sidereal days, whence
 1 mean solar day = 1.00273791 sidereal days;
 1 sidereal day = 0.99726957 mean solar day;
 24 hours mean solar time = $23^h 56^m 55^s$ sidereal time;
 24 hours sidereal time = $23^h 56^m 4^s$ mean solar time,

whence 1 mean solar day is $3^m 55^s.91$ longer than a sidereal day, reckoned in mean solar time.

BOARD AND TIMBER MEASURE.

Board Measure.

In board measure boards are assumed to be one inch in thickness. To obtain the number of feet board measure (B. M.) of a board or stick of square timber, multiply together the length in feet, the breadth in feet, and the thickness in inches.

To compute the measure or surface in square feet. — When all dimensions are in feet, multiply the length by the breadth, and the product will give the surface required.

When either of the dimensions are in inches, multiply as above and divide the product by 12.

When all dimensions are in inches, multiply as before and divide product by 144.

Timber Measure.

To compute the volume of round timber. — When all dimensions are in feet, multiply the length by one quarter of the product of the mean girth and diameter, and the product will give the measurement in cubic feet. When length is given in feet, and girth and diameter in inches, divide the product by 144; when all the dimensions are in inches, divide by 1728.

To compute the volume of square timber. — When all dimensions are in feet, multiply together the length, breadth, and depth; the product will be the volume in cubic feet. When one dimension is given in inches, divide by 12; when two dimensions are in inches, divide by 144; when all three dimensions are in inches, divide by 1728.

Contents in Feet of Joists, Scantling, and Timber.

Length in Feet.

Size.	12	14	16	18	20	22	24	26	28	30
Feet Board Measure.										
2 X 4	8	9	11	12	13	15	16	17	19	20
2 X 6	12	14	16	18	20	22	24	26	28	30
2 X 8	16	19	21	24	27	29	32	35	37	40
2 X 10	20	23	27	30	33	37	40	43	47	50
2 X 12	24	26	32	36	40	44	48	52	56	60
2 X 14	28	33	37	42	47	51	56	61	65	70
3 X 8	24	28	32	36	40	44	48	52	56	60
3 X 10	30	35	40	45	50	55	60	65	70	75
3 X 12	36	42	48	54	60	66	72	78	84	90
3 X 14	42	49	56	63	70	77	84	91	98	105
4 X 4	16	19	21	24	27	29	32	35	37	40
4 X 6	24	28	32	36	40	44	48	52	56	60
4 X 8	32	37	43	48	53	59	64	69	75	80
4 X 10	40	47	53	60	67	73	80	87	93	100
4 X 12	48	56	64	72	80	88	96	104	112	120
4 X 14	56	65	75	84	93	103	112	121	131	140
6 X 6	36	42	48	54	60	66	72	78	84	90
6 X 8	48	56	64	72	80	88	96	104	112	120
6 X 10	60	70	80	90	100	110	120	130	140	150
6 X 12	72	84	96	108	120	132	144	156	168	180
6 X 14	84	98	112	126	140	154	168	182	196	210
8 X 8	64	75	85	96	107	117	128	139	149	160
8 X 10	80	93	107	120	133	147	160	173	187	200
8 X 12	96	112	128	144	160	176	192	208	224	240
8 X 14	112	131	149	168	187	205	224	243	261	280
10 X 10	100	117	133	150	167	183	200	217	233	250
10 X 12	120	140	160	180	200	220	240	260	280	300
10 X 14	140	163	187	210	233	257	280	303	327	350
12 X 12	144	168	192	216	240	264	288	312	336	360
12 X 14	168	196	224	252	280	308	336	364	392	420
14 X 14	196	229	261	294	327	359	392	425	457	490

FRENCH OR METRIC MEASURES.

The-metric unit of length is the metre = 39.37 inches.
 The metric unit of weight is the gram = 15.432 grains.
 The following prefixes are used for subdivisions and multiples: Milli = 1/1000, Centi = 1/100, Deci = 1/10, Deca = 10, Hecto = 100, Kilo = 1000, blyns = 10,000.

FRENCH AND BRITISH (AND AMERICAN) EQUIVALENT MEASURES.

Measures of Length.

FRENCH.	BRITISH and U. S.
1 metre	= 39.37 inches, or 3.25083 feet, or 1.09361 yards.
0.3048 metre	= 1 foot.
1 centimetre	= 0.3937 inch.
2.54 centimetres	= 1 inch.
1 millimetre	= 0.03937 inch, or 1/25 inch, nearly.
25.4 millimetres	= 1 inch.
1 kilometre	= 1093.61 yards, or 0.62137 mile.

Of Surface.

FRENCH.	BRITISH and U. S.
1 square metre	= { 10.764 square feet, 1.196 square yards.
0.836 square metre	= 1 square yard.
0.0929 square metre	= 1 square foot.
1 square centimetre	= 0.155 square inch.
6.452 square centimetres	= 1 square inch.
1 square millimetre	= 0.00155 sq. in. = 1973.5 circ. mils.
645.2 square millimetres	= 1 square inch.
1 centiare = 1 sq. metre	= 10.764 square feet.
1 are = 1 sq. decametre	= 1076.41 "
1 hectare = 100 ares	= 107641 " " = 2.4711 acres.
1 sq. kilometre	= 0.386109 sq. miles = 247.11 "
1 sq. myriametre	= 38.6109 " "

Of Volume.

FRENCH.	BRITISH and U. S.
1 cubic metre	= { 35.314 cubic feet, 1.308 cubic yards.
9.7645 cubic metre	= 1 cubic yard.
0.02832 cubic metre	= 1 cubic foot.
1 cubic decimetre	= { 61.023 cubic inches, 0.0353 cubic foot.
28.32 cubic decimetres	= 1 cubic foot.
1 cubic centimetre	= 0.061 cubic inch.
1 cubic centimetre	= 1 cubic inch.
1 ceatilitre	= 0.061 cubic inch.
1 decilitre	= 0.610 " "
1 hectolitre or decistere	= 6.102 " "
1 stere, kilolitre, or cubic metre	= 61.023 " " = 1.05671 quarts, U.S.
	= 3.5314 cubic feet = 2.8375 bushels, "
	= 1.308 cubic yards = 228.37 bushels, "

Of Capacity.

FRENCH.	BRITISH and U. S.
1 litre (= 1 cubic decimetre)	= { 61.023 cubic inches, 0.03531 cubic foot, 0.2642 gallon (American), 2.202 pounds of water at 62° F.
28.317 litres	= 1 cubic foot.
4.543 litres	= 1 gallon (British).
3.785 litres	= 1 gallon (American).

Of Weight.

FRENCH.	BRITISH and U. S.
1 gramme	= 15.432 grains.
0.0648 gramme	= 1 grain.
28.35 gramme	= 1 ounce avoirdupois.
1 kilogramme	= 2.2046 pounds.,
0.4536 kilogramme	= 1 pound.
1 tonne or metric ton	= 0.9842 ton of 2240 pounds,
1000 kilogrammes	= 19.68 cwts.,
1.016 metric tons	= 2204.6 pounds.
1016 kilogrammes	= } 1 ton of 2240 pounds.

Mr. O. H. Titmann, in Bulletin No. 9 of the U. S. Coast and Geodetic Survey, discusses the work of various authorities who have compared the yard and the metre, and by referring all the observations to a common standard has succeeded in reconciling the discrepancies within very narrow limits. The following are his results for the number of inches in a metre according to the comparisons of the authorities named: 1817. Hassler, 39.36994 in. 1818. Kater, 39.36990 in. 1835. Baily, 39.36973 in. 1866. Clarke, 39.36970 in. 1885. Comstock, 39.36984 in. The mean of these is 39.36982 in.

The value of the metre is now defined in the U. S. laws as 39.37 inches.

French and British Equivalents of Compound Units.

FRENCH.	BRITISH.
1 gramme per square millimetre	= 1.422 lbs. per sq. in.
1 kilogramme per square centimetre	= 1422.32 " " " "
1.0335 kg per sq. cm. = 1 atmosphere	= 14.7 " " " "
0.070308 kilogramme per square centimetre	= 1 lb. per square inch.
1 kilogramme	= 7.2330 foot-pounds.
1 gramme per litre = 0.062428 lb. per cu. ft. of Water at 62° F.	= 58.349 grains per U. S gal.
1 grain per gallon = 1 part in 58,349	= 1.7138 parts per 100,000
= 0.017138 grammes per litre.	

METRIC CONVERSION TABLES.

The following tables, with the subjoined memoranda, were published in 1890 by the United States Coast and Geodetic Survey, office of standard weights and measures, T. C. Mendenhall, Superintendent.

Tables for Converting U. S. Weights and Measures — Customary to Metric.

LINEAR.

	Inches to Milli- metres.	Feet to Metres.	Yards to Metres.	Miles to Kilo- metres.
1 =	25.4001	0.304801	0.914402	1.60935
2 =	50.8001	0.609601	1.828804	3.21869
3 =	76.2002	0.914402	2.743205	4.02804
4 =	101.6002	1.219202	3.657607	6.43739
5 =	127.0003	1.524003	4.572009	0.04674
6 =	152.4003	1.828804	5.486411	9.65608
7 =	177.8004	2.133604	6.400813	11.26543
8 =	203.2004	2.438405	7.315215	12.87470
9 =	228.6005	2.743205	8.229616	14.40412

SQUARE.

	Square Inches to Square Centimetres.	Square Feet to Square Decimetres.	Square Yards to Square Metres.	Acres to Hectares.
1 =	6.452	9.290	0.836	0.4047
2 =	12.903	18.581	1.672	0.8094
3 =	19.355	27.871	2.508	1.2141
4 =	25.807	37.161	3.344	1.6187
5 =	32.250	46.452	4.181	2.0234
6 =	38.710	55.742	5.017	2.4281
7 =	45.161	65.032	5.853	2.8328
8 =	51.613	74.323	6.689	3.2375
9 =	58.065	83.613	7.525	3.6422

CUBIC.

	Cubic Inches to Cubic Centimetres.	Cubic Feet to Cubic Metres.	Cubic Yards to Cubic Metres.	Bushels to Hectolitres.
1 =	16.387	0.02832	0.765	0.35242
2 =	32.774	0.05663	1.529	0.70485
3 =	49.161	0.08495	2.294	1.05727
4 =	65.548	0.11327	3.058	1.40969
5 =	81.936	0.14158	3.823	1.76211
6 =	98.323	0.16990	4.587	2.11454
7 =	114.710	0.19822	5.352	2.46696
8 =	131.097	0.22654	6.116	2.81938
9 =	147.484	0.25485	6.881	3.17181

CAPACITY.

	Fluid Drachms to Millilitres or Cubic Centimetres.	Fluid Ounces to Millilitres.	Quarts to Litres	Gallons to Litres.
1 =	3.70	29.57	0.94636	3.78544
2 =	7.39	59.15	1.89272	7.57088
3 =	11.09	80.72	2.83908	11.35632
4 =	14.79	118.30	3.78544	15.14176
5 =	18.48	147.87	4.73180	18.92720
6 =	22.18	177.44	5.67816	22.71264
7 =	25.88	207.02	6.62452	26.49800
8 =	29.57	236.59	7.57088	30.28352
9 =	33.28	266.16	8.5172;	34.06896

WEIGHT.

	Grains to Milligrammes.	Avoirdupois Ounces to Grammes.	Avoirdupois Pounds to Kilogrammes.	Troy Ounces to Grammes.
1 =	64.7909	28.3495	0.45359	31.10348
2 =	129.5978	56.6991	0.90719	62.20696
3 =	194.3968	85.0486	1.36078	93.31044
4 =	259.1957	113.3981	1.81437	124.41392
5 =	323.9946	141.7476	2.26796	155.51740
6 =	388.7935	170.0972	2.72156	186.62089
7 =	453.5924	198.4467	3.17515	217.72437
8 =	518.3914	226.7962	3.62874	248.82785
9 =	583.1903	255.1457	4.08233	279.93133

1 chain = 20.1169 metres.
 1 square mile = 259 hectares.
 1 fathom = 1.829 metres.
 1 nautical mile = 1853.27 metres.
 1 foot = 0.304801 metre.
 1 avoirdupois pound = 453.5924277 gram.
 15432.35639 grains = 1 kilogramme.

Tables for Converting U. S. Weights and Measures — Metric to Customary.

LINEAR.

	Metres to Inches.	Metres to Feet.	Metres to Yards.	Kilometres to Miles.
1 =	39.3700	3.28083	1.093611	0.62137
2 =	78.7400	6.56167	2.187222	1.24274
3 =	118.1100	9.84250	3.280833	1.86411
4 =	157.4800	13.12333	4.374444	2.48548
5 =	196.8500	16.40417	5.468056	3.10685
6 =	236.2200	19.68500	6.561667	3.72822
7 =	275.5900	22.96583	7.655270	4.34959
8 =	314.9600	26.24667	8.748809	4.97096
9 =	354.3300	29.52750	9.842500	5.59233

SQUARE.

	Square Centimetres to Square Inches.	Square Metres to Square Feet.	Square Metres to Square Yards.	Hectares to Acres.
1 =	0.1550	10.764	1.196	2.471
2 =	0.3100	21.528	2.392	4.942
3 =	0.4650	32.292	3.588	7.413
4 =	0.6200	43.055	4.784	9.884
5 =	0.7750	53.819	5.980	12.355
6 =	1.0850	71.76	7.176	14.826
7 =	1.2400	82.617	8.372	17.297
8 =	1.3950	93.474	9.568	19.768
9 =	1.5500	104.331	10.764	22.239

CUBIC.

	Cubic Centi- metres to Cubic Inches.	Cubic Deci- metres to Cubic Inches.	Cubic Metres Cubic Feet.	Cubic Metres to Cubic Yards.
1 =	0.0610	61.023	35.314	1.308
2 =	0.1220	122.047	70.629	2.616
3 =	0.1831	183.070	105.943	3.924
4 =	0.2441	244.093	141.258	5.232
5 =	0.3051	305.117	176.572	6.540
6 =	0.3661	366.140	211.887	7.048
7 =	0.4272	427.163	247.201	9.156
8 =	0.4882	488.187	282.516	10.464
9 =	0.5492	549.210	317.830	11.771

CAPACITY.

	Millilitres or Cubic Centi- litres to Fluid Drachms.	Centilitres to Fluid Ounces.	Litres to Quarts.	Dekalitres to Gallons.	Hektolitres to Bushels.
1 =	0.27	0.338	1.0567	2.6417	2.8375
2 =	0.54	0.676	2.1134	5.2834	5.6750
3 =	0.81	1.014	3.1700	7.9251	8.5125
4 =	1.08	1.352	4.2267	10.5668	11.3500
5 =	1.35	1.691	5.2834	13.2085	14.1875
6 =	1.62	2.029	6.3401	15.8502	17.0250
7 =	1.89	2.366	7.3968	18.4919	19.8625
8 =	2.16	2.706	8.4534	21.1336	22.7000
9 =	2.43	3.043	9.5101	23.7753	25.5375

WEIGHT.

	Milligrammes to Grains.	Kilogrammes to Grains.	Hectogrammes (100 grammes) to Ounces Av.	Kilogrammes to Pounds Avoirdupois.
1 =	0.01543	15432.36	3.5274	2.20462
2 =	0.03086	30864.71	7.0548	4.40924
3 =	0.04630	46297.07	10.5822	6.61386
4 =	0.06173	61729.43	14.1096	a. 81849
5 =	0.07716	77161.78	17.6370	II. 02311
6 =	0.09259	92594.14	21.1644	13.22773
7 =	0.10803	108026.49	24.6918	15.43235
8 =	0.12346	123458.85	20.2192	17.63697
9 =	0.13889	138891.21	31.7466	19.84159

WEIGHT — (Continued).

	Quintals to Pounds Av.	Milliers or Tonnes to Pounds Av.	Grammes to Ounces. Troy.
1 =	220.46	2204.6	0.03215
2 =	440.92	4409.2	0.06430
3 =	661.38	6613.8	0.09645
4 =	881.84	8818.4	0.12860
5 =	1102.30	11023.0	0.16075
6 =	1322.76	13227.6	0.19290
7 =	1543.22	15432.2	0.22505
8 =	1763.68	17636.8	0.25721
9 =	1984.14	19841.4	0.28936

The British Avoirdupois pound was derived from the British standard Troy pound of 1758 by direct comparison, and it contains 7000 grams Troy. The grain Troy is therefore the same as the gram Avoirdupois, and the pound Avoirdupois in use in the United States is equal to the British pound Avoirdupois.

By the concurrent action of the principal governments of the world an International Bureau of Weights and Measures has been established near Paris.

The International Standard Metre is derived from the *Mètre des Archives*, and its length is defined by the distance between two lines at 0° Centigrade, on a platinum-iridium bar deposited at the International Bureau.

The International Standard Kilogramme is a mass of platinum-iridium deposited at the same place, and its weight *in vacuo* is the same as that of the Kilogramme des Archives.

Copies of these international standards are deposited in the office of standard weights and measures of the U. S. Coast and Geodetic Survey.

The litre is equal to a cubic decimetre of water, and it is measured by the quantity of distilled water which, at its maximum density, will counterpoise the standard kilogramme in a vacuum: the volume of such a quantity of water being, as nearly as has been ascertained, equal to a cubic decimetre.

The metric system was legalized in the United States in 1866. Many attempts were made during the 40 years following to have the U. S. Congress pass laws to make the metric system the legal standard, but they have all failed. Similar attempts in Great Britain have also failed. For arguments for and against the metric system see the report of a committee of the American Society of Mechanical Engineers, 1903. Vol. 24.

COMPOUND UNITS.

Measures of Pressure and Weight.

1 lb. per square inch.	=	$\left\{ \begin{array}{l} 144 \text{ lbs. per square foot.} \\ 2.0355 \text{ ins. of mercury at } 32^\circ \text{ F.} \\ 2.0416 \text{ " " " " } 62^\circ \text{ F.} \\ 2.309 \text{ ft. of water at } 62^\circ \text{ F.} \\ 27.71 \text{ ins. " " " " } 62^\circ \text{ F.} \end{array} \right.$
1 ounce per sq. in.	=	$\left\{ \begin{array}{l} 0.1276 \text{ in. of mercury at } 62^\circ \text{ F.} \\ 1.732 \text{ ins. of water at } 62^\circ \text{ F.} \end{array} \right.$
1 atmosphere (14.7 lbs. per sq.in.)	=	$\left\{ \begin{array}{l} 2116.3 \text{ lbs. per square foot.} \\ 33.947 \text{ ft. of water at } 62^\circ \text{ F.} \\ 30 \text{ ins. of mercury at } 62^\circ \text{ F.} \\ 29.922 \text{ ins. of mercury at } 32^\circ \text{ F.} \\ 760 \text{ millimetres of mercury at } 32^\circ \text{ F.} \end{array} \right.$

COMPOUND UNITS — (Continued).

1 inch of water at 62° F.	=	{	0.03609 lb. or .5774 oz. per sq.in.
			5.196 lbs. per square foot.
1 inch of water at 32° F.	=	{	0.0736 in. of mercury at 62° F.
			5.2021 lbs. per square foot.
1 foot of water at 62° F.	=	{	0.036125 lb. " " inch.
			0.433 lb. per square inch.
1 inch of mercury at 62° F.	=	{	62.355 lbs. " " foot.
			0.491 lb. or 7.86 oz. per sq. in.
			1.132 ft. of water at 62° F.
			13.58 ins. " " 62° F.

Weight of One Cubic Foot of Pure Water.

At 32° F. (freezing-point).....	62.418 lbs.
" 39.1° F. (maximum density).....	62.425 "
" 62° F. (standard temperature).....	62.355 "
" 212° F. (boiling-point, under 1 atmosphere).....	59.76 "
American gallon = 231 cubic ins. of water at 62° F. =	8.3356 lbs.
British " = 277.274 " " " " " " " " =	10 lbs.

Weight and Volume of Air.

1 cubic ft. of air at 32° F. and atmospheric Pressure weighs	0.080728 lb.
1 ft. in height of air at 32° F. =	{
	0.0005606 lb. per sq. in.
	0.008970 ounces per sq. in.
	0.015534 inches of water at 62° F.
For air at any other temperature T° Fahr. multiply by	$\frac{460 + T}{460}$
1 lb. pressure per sq. ft. =	12.387 ft. of air at 32° F.
1 " " " sq. in. =	1784. " " " " "
1 ounce " " " " =	111.48 " " " " "
1 inch of water at 62° F. =	64.37 " " " " "
For air at any other temperature multiply by	$\frac{460 + T}{460}$
1 atmosphere = 14.696 lb. per sq. in. =	760 mm. or 29.921 in. of mercury.

Measures of Work, Power, and Duty.

Work. — The sustained exertion of pressure through space.
Unit of work. — One foot-pound, i.e., a pressure of one pound exerted through a space of one foot.
Horse-power. — The rate of work. Unit of horse-power = 33,000 ft.-lbs. per minute, or 550 ft.-lbs. per second = 1,980,000 ft.-lbs. per hour.
Heat unit = heat required to raise 1 lb. of water 1° F. (from 39° to 40°).
 Horse-power expressed in heat units = $\frac{33000}{778} = 42.416$ heat units per minute = 0.707 heat unit per second = 2545 heat units per hour.
 1 lb. of fuel per H. P. per hour = $\frac{1,980,000 \text{ ft.-lbs. per lb. of fuel.}}{2,045 \text{ heat units}} = 968.17$ heat units
 1,000,000 ft.-h. per lb. of fuel = 1.98 lbs. of fuel per H. P. per hour.
Velocity. — Feet per second = $\frac{5280}{3600} = \frac{22}{15}$ X miles per hour.
Gross tons per mile = $\frac{1760}{2240} = \frac{11}{14}$ lbs. per yard (single rail.)

WIRE AND SE&T-METAL GAUGES COMPARED.

Number of Gauge.	Birmingham (or Stubbs' Iron) Wire Gauge.	American or Brown and Sharpe Gauge.	Roebing's and Washburn & Moen's Gauge.	Stubbs' Steel Wire Gauge. (See also p. 30.)	British Imperial Standard Wire Gauge. (Legal Standard in Great Britain since March 1, 1884.)		U. S. Standard Gauge for Sheet and Plate Iron and Steel. 1893.	Number of Gauge.
					inch.	millim.		
0000000	inch.	inch.	inch.	inch.	inch.	millim.	inch.	7/0
000000			.49		.500	12.7	.5	6/0
000000			.46		.464	11.78	.469	5/0
000000			.43		.432	11.07	.438	4/0
0000	.454	.46	.393		.4	10.16	.406	3/0
000	.425	.40964	.362		.372	9.45	.375	2/0
00	.38	.3648	.331		.348	8.84	.344	0
0	.34	.32486	.307		.324	8.23	.313	1
1	.3	.2893	.283	.227	.3	7.62	.281	2
2	.284	.25763	.263	.219	.276	7.01	.266	3
3	.259	.22942	.244	.212	.252	6.4	.25	4
4	.238	.20431	.225	.207	.232	5.89	.234	5
5	.22	.18194	.207	.204	.212	5.38	.219	6
6	.203	.16202	.192	.201	.192	4.88	.203	7
7	.18	.14428	.177	.199	.176	4.47	.188	8
8	.165	.12849	.162	.197	.16	4.06	.172	9
9	.148	.11443	.148	.194	.144	3.66	.156	10
10	.134	.10189	.135	.191	.128	3.25	.141	11
11	.12	.09074	.12	.188	.116	2.95	.125	12
12	.109	.08081	.105	.185	.104	2.64	.109	13
13	.095	.07196	.092	.182	.092	2.34	.094	14
14	.083	.06408	.08	.180	.08	2.03	.078	15
15	.072	.05707	.072	.178	.072	1.83	.07	16
16	.065	.05082	.063	.175	.064	1.63	.0625	17
17	.058	.04526	.054	.172	.056	1.42	.0563	18
18	.049	.0403	.047	.168	.048	1.22	.05	19
19	.042	.03589	.041	.164	.04	1.02	.0438	20
20	.035	.03196	.035	.161	.036	.91	.0375	21
21	.032	.02846	.032	.157	.032	.81	.0344	22
22	.028	.02535	.028	.155	.028	.71	.0313	23
23	.025	.02257	.025	.153	.024	.61	.0281	24
24	.022	.0201	.023	.151	.022	.56	.025	25
25	.02	.0179	.02	.148	.02	.51	.0219	26
26	.018	.01594	.018	.146	.018	.46	.0188	27
27	.016	.01419	.017	.143	.0164	.42	.0172	28
28	.014	.01264	.016	.139	.0148	.38	.0156	29
29	.013	.01126	.015	.134	.0136	.35	.0141	30
30	.012	.01002	.014	.127	.0124	.31	.0125	31
		.00893	.013	.120	.0116	.29	.0109	32
32	.009	.00795	.013	.115	.0108	.27	.0101	33
3	.008	.00708	.011	.112	.01	.25	.0094	34
34	.007	.0063	.01	.110	.0092	.23	.0086	35
35	.005	.00561	.00	.108	.0084	.21	.0078	36
36	.004	.005	.009	.106	.0076	.19	.007	37
37		.00445	.0085	.103	.0068	.17	.0066	38
38		.00396	.008	.101	.006	.15	.0063	39
		.00353	.0075	.099	.0052	.13		40
40		.00314	.007	.097	.0048	.12		41
41				.095	.0044	.11		42
42				.092	.004	.10		43
43				.088	.0036	.09		44
44				.085	.0032	.08		45
45				.081	.0028	.07		46
46				.079	.0024	.06		47
47				.077	.002	.05		48
48				.075	.0016	.04		49
49				.092	.0012	.03		50
50				.069	.001	.025		50

EDISON, OR CIRCULAR MIL GAUGE, FOR ELECTRICAL WIRES.

Gauge Number.	Circular Mils.	Diameter in Mils.	Gauge Number.	Circular Mils.	Diameter in Mils.	Gauge Number.	Circular Mils.	Diameter in Mils.
3	3,000	54.78	70	70,000	264.58	190	190,000	435.89
5	5,000	70.72	75	75,000	273.87	200	200,000	447.22
8	8,000	89.45	80	80,000	282.85	220	220,000	469.05
12	12,000	109.55	85	85,000	291.55	240	240,000	489.90
15	15,000	122.48	90	90,000	300.00	260	260,000	509.91
20	20,000	141.43	95	95,000	308.23		280,000	529.16
25	25,000	158.12	100	100,000	316.23	300	300,000	547.73
30	30,000	173.21	110	110,000	331.67	320	320,000	565.69
35	35,000	187.09	120	120,000	344.42	340	340,000	583.10
40	40,000	200.00	130	130,000	360.56	360	360,000	600.00
45	45,000	212.14	140	140,000	374.17			
50	50,000	223.61	150	150,000	387.30			
55	55,000	234.53	160	160,000	400.00			
60	60,000	244.95	170	170,000	412.32			
65	65,000	254.96	180	180,000	424.27			

TWIST DRILL AND STEEL WIRE GAUGE.

(Morse Twist Drill and Machine Co.)

No.	Size.	No.	Size.	No.	Size.	No.	Size.	No.	Size.	No.	Size.
	inch.		inch.		inch.		inch.		inch.		inch.
1	.2280	11	.1910	21	.1590	31	.1200	41	.0960	51	.0670
2	.2210	12	.1890	22	.1570	32	.1160	42	.0935	52	.0635
3	.2130	13	.1850	23	.1540	33	.1130	43	.0890	53	.0595
4	.2090	14	.1820	24	.1520	34	.1110	44	.0860	54	.0550
5	.2055	15	.1800	25	.1495	35	.1100	45	.0820	55	.0520
6	.2040	16	.1770	26	.1470	36	.1065	46	.0810	56	.0465
7	.2010	17	.1730	27	.1440	37	.1040	47	.0785	57	.0430
8	.1990	18	.1695	28	.1405	38	.1015	48	.0760	58	.0420
9	.1960	19	.1660	29	.1360	39	.0995	49	.0730	59	.0410
10	.1935	20	.1610	30	.1285	40	.0980	50	.0700	60	.0400

STUBS' STEEL WIRE GAUGE.

(For Nos. 1 to 50 see table on page 29.)

No.	Size.	No.	Size.	No.	Size.	No.	Size.	No.	Size.	No.	Size.
	inch.		inch.		inch.		inch.		inch.		inch.
Z	.413	P	.323	F	.257	51	.066	61	.038	71	.026
Y	.404	O	.316	E	.250	52	.063	62	.037	72	.024
X	.397	N	.302	D	.246	53	.058	63	.036	73	.023
W	.386	M	.295	C	.242	54	.055	64	.035	74	.022
V	.377	L	.290	B	.238	55	.050	65	.033	75	.020
U	.368	K	.281	A	.234	56	.045	66	.032	76	.018
T	.358	J	.277	I	.272	57	.042	67	.031	77	.016
S	.348	I	.272	H	.266	58	.041	68	.030	78	.015
R	.339	H	.266	G	.261	59	.040	69	.029	79	.014
Q	.332	G	.261			60	.039	70	.027	80	.013

The Stub Steel Wire Gauge is used in measuring drawn steel wire or drill rods of stubs' make, and is also used by many makers of American drill rods.

THE EDISON OR CIRCULAR MIL WIRE GAUGE.

(For table of copper wires by this gauge, giving weights, electrical resistances, etc., see Copper Wire.)

Mr. C. J. Field (Stevens Indicator, July, 1887) thus describes the origin of the Edison gauge:

The Edison company experienced inconvenience and loss by not having a wide enough range nor sufficient number of sizes in the existing gauges. This was felt more particularly in the central-station work in making electrical determinations for the street system. They were compelled to make use of two of the existing gauges at least, thereby introducing a complication that was liable to lead to mistakes by the contractors and linemen.

In the incandescent system an even distribution throughout the entire system and a uniform pressure at the point of delivery are obtained by calculating for a given maximum percentage of loss from the potential as delivered from the dynamo. In carrying this out, on account of lack of regular sizes, it was often necessary to use larger sizes than the occasion demanded, and even to assume new sizes for large underground conductors. The engineering department of the Edison company, knowing the requirements, have designed a gauge that has the widest range obtainable and a large number of sizes which increase in a regular and uniform manner. The basis of the graduation is the sectional area, and the number of the wire corresponds. A wire of 100,000 circular mils area is No. 100; a wire of one half the size will be No. 50; twice the size No. 200.

In the older gauges, as the number increased the size decreased. With this gauge, however, the number increases with the wire, and the number multiplied by 1000 will give the circular mils.

The weight per mil-foot, 3.00000302705 pounds, agrees with a specific gravity of 8.899, which is the latest figure given for copper. The ampere capacity which is given was deduced from experiments made in the company's laboratory, and is based on a rise of temperature of 50 F. in the wire.

In 1893 Mr. Field writes, concerning gauges in use by electrical engineers: The B. and S. gauge seems to be in general use for the smaller sizes, up to 100,000 c.m., and in some cases a little larger. From between one and two hundred thousand circular mils upwards, the Edison gauge or its equivalent is practically in use, and there is a general tendency to designate all sizes above this in circular mils, specifying a wire as 200,000, 400,000, 500,000, or 1,000,000 c.m.

In the electrical business there is a large use of copper wire and rod and other materials of these large sizes, and in ordering them, speaking of them, specifying, and in every other use, the general method is to simply specify the circular milage. I think it is going to be the only system in the future for the designation of wires, and the attaining of it means practically the adoption of the Edison gauge or the method and basis of this gauge as the correct one for wire sizes.

THE U. S. STANDARD GAUGE FOR SHEET AND PLATE IRON AND STEEL, 1893.

There is in this country no uniform or standard gauge, and the same numbers in different gauges represent different thicknesses of sheets or plates. This has given rise to much misunderstanding and friction between employers and workmen and mistakes and fraud between dealers and consumers:

An Act of Congress in 1893 established the Standard Gauge for sheet iron and steel which is given on the next page. It is based on the fact that a cubic foot of iron weighs 480 pounds.

A sheet of iron 1 foot square and 1 inch thick weighs 40 pounds, or 640 ounces, and 1 ounce in weight should be 1/640 inch thick. The scale has been arranged so that each descriptive number represents a certain number of ounces in weight and an equal number of 640ths of an inch in thickness.

The law enacts that on and after July 1, 1893, the new gauge shall be used in determining duties and taxes levied on sheet and plate iron and

U. S. STANDARD GAUGE FOR SHEET AND PLATE IRON AND STEEL, 1893.

Number of Gauge.	Approximate Thickness in Fractions of an Inch.	Approximate Thickness in Decimal Parts of an Inch.	Approximate Thickness in Millimeters.	Weight per Square Foot in Ounces Avoirdupois.	Weight per Square Foot in Pounds Avoirdupois.	Weight per Square Foot in Kilograms.	Weight per Square Meter in Kilograms.	Weight per Sq. Meter in Pounds Avoirdupois.
000000	1-2	0.5	12.7	320	20.	9.072	97.65	215.28
000000	15-32	0.46875	11.90625	300	18.75	8.505	91.55	201.82
000000	7-16	0.4375	11.1125	280	17.50	7.938	85.44	188.37
000000	13-32	0.40625	10.31875	260	16.25	7.371	79.33	174.91
000000	3-8	0.375	9.525	240	15.	6.804	73.24	161.46
000000	1-32	0.34375	8.73125	220	13.75	6.237	67.13	148.00
000000	5-16	0.3125	7.9375	200	12.50	5.67	61.03	134.55
000000	9-32	0.28125	7.14375	180	11.25	5.103	54.93	121.09
000000	7-64	0.265625	6.746875	170	10.625	4.809	51.88	114.37
000000	1-4	0.25	6.35	160	10.	4.536	48.02	107.64
000000	5-64	0.234375	5.953125	150	9.375	4.252	45.77	100.91
000000	7-32	0.21875	5.55625	140	8.75	3.969	42.72	94.10
000000	3-64	0.203125	5.159375	130	8.125	3.686	39.67	87.45
000000	3-16	0.1875	4.7625	120	7.5	3.403	36.62	80.72
000000	1-64	0.171875	4.365625	110	6.875	3.118	33.57	74.00
000000	5-32	0.15625	3.96675	100	6.25	2.835	30.52	67.27
000000	9-64	0.140625	3.571875	90	5.625	2.552	27.46	60.55
000000	1-8	0.125	3.175	80	5.	2.268	24.41	53.82
000000	7-64	0.109375	2.778125	70	4.375	1.984	21.36	47.09
000000	3-32	0.09375	2.38125	60	3.75	1.701	18.31	40.36
000000	5-64	0.078125	1.984375	50	3.125	1.417	15.26	33.64
000000	9-128	0.0703125	1.7859375	45	2.8125	1.276	13.73	30.27
000000	1-16	0.0625	1.5875	40	2.5	1.133	12.21	26.91
000000	9-160	0.05625	1.42075	36	2.25	1.021	10.99	24.22
000000	1-20	0.05	1.27	32	2.	0.9072	9.765	21.53
000000	7-160	0.04375	1.11125	28	1.75	0.7938	8.544	18.84
000000	3-80	0.0375	0.9525	24	1.50	0.6804	7.324	16.15
000000	1-320	0.034375	0.873125	22	1.375	0.6237	6.713	14.80
000000	1-32	0.03125	0.793750	20	1.25	0.567	6.103	13.46
000000	9-320	0.028125	0.714375	18	1.125	0.5103	5.49	12.11
000000	1-40	0.025	0.635	16	1.	0.4536	4.882	10.76
000000	7-320	0.021875	0.555625	14	0.875	0.398	4.272	9.42
000000	3-160	0.01875	0.47625	12	0.75	0.362	3.662	8.07
000000	1-640	0.0171875	0.4365625	11	0.6875	0.3119	3.357	7.40
000000	1-64	0.015625	0.396875	10	0.625	0.2835	3.052	6.73
000000	9-800	0.0140625	0.3571875	9	0.5625	0.2551	2.746	6.05
000000	7-640	0.0125	0.3175	8	0.5	0.241	2.441	5.38
000000	13-3200	0.0109375	0.2778125	7	0.4375	0.1984	2.136	4.71
000000	1-1600	0.01015625	0.25796875	6 1/2	0.40625	0.1843	1.983	4.37
000000	1-1600	0.009375	0.238125	6	0.375	0.1701	1.831	4.04
000000	1516000	0.00859375	0.21828125	5 1/2	0.34375	0.1559	1.678	3.70
000000	3717-2560	0.0078125	0.1984375	5	0.3125	0.1417	1.526	3.36
000000	38	0.00703125	0.17859375	4 1/2	0.28125	0.1276	1.373	3.03
000000	I-160	0.00664062	0.16867187	4 1/4	0.26562	0.1205	1.297	2.87
000000		0.00625	0.15875	4	0.25	0.1134	1.221	2.69

WARNING: This is a 1910 edition. Some of the material may no longer be accurate

steel; and that in its application a variation of 2 1/2 per cent either way may be allowed.

The Decimal Gauge. -The legalization of the standard sheet-metal gauge of 1893 and its adoption by some manufacturers of sheet iron have only added to the existing confusion of gauges. A joint committee of the American Society of Mechanical Engineers and the American Railway Master Mechanics' Association in 1895 agreed to recommend the use of the decimal gauge, that is, a gauge whose number for each thickness is the number of thousandths of an inch in that thickness, and also to recommend "the abandonment and disuse of the various other gauges now in use, as tending to confusion and error." A notched gauge of oval form, shown in the cut below, has come into use as a standard form of the decimal gauge.

In 1904 The Westinghouse Electric & Mfg. Co. abandoned the use of gauge numbers in referring to wire, sheet metal, etc.

Weight of Sheet Iron and Steel. Thickness by Decimal Gauge.

Decimal Gauge.	Approx. Fractions of an Inch.	Approx. Millimeters.	Weight per Square Foot in Pounds.		Decimal Gauge.	Approx. Fractions of an Inch.	Appr. %	Weight per Square Foot in Pounds.	
			Iron, 480 Lbs. per Cu. Ft.	Steel, 489.6 Lbs. per Cu. Ft.				Iron, 480 Lbs. per Cu. Ft.	Steel, 489.6 Lbs. per Cu. Ft.
0.002	1/500	0.05	0.08	0.082	0.060	1/16	1.52	2.40	2.448
0.004	1/250	0.10	0.16	0.163	0.065	13/200	1.63	2.60	2.652
0.006	3/500	0.15	0.24	0.245	0.070	7/100	1.78	2.80	2.856
0.008	1/125	0.20	0.32	0.326	0.075	3/40	1.90	3.00	3.060
0.010	1/100	0.25	0.40	0.408	0.080	2/25	2.03	3.20	3.264
0.012	3/250	0.30	0.48	0.490	0.085	17/200	2.16	3.40	3.468
0.014	7/500	0.36	0.56	0.571	0.090	9/100	2.28	3.60	3.672
0.016	1/64 +	0.41	0.64	0.653	0.095	19/200	2.41	3.80	3.876
0.018	9/500	0.46	0.72	0.734	0.100	1/10	2.54	4.00	4.080
0.020	1/50	0.51	0.80	0.816	0.110	11/100	2.79	4.40	4.488
0.022	11/500	0.56	0.88	0.898	0.125	1/8	3.18	5.00	5.100
0.025	1/40	0.64	1.00	1.020	0.135	27/200	3.43	5.40	5.508
0.028	7/250	0.71	1.12	1.142	0.150	3/20	3.81	6.00	6.120
0.032	1/32 +	0.81	1.28	1.306	0.165	33/200	4.19	6.60	6.732
0.036	9/250	0.91	1.44	1.469	0.180	9/50	4.57	7.20	7.344
0.040	1/25	1.02	1.60	1.632	0.200	1/5	5.08	8.00	8.160
0.045	9/200	1.14	1.80	1.836	0.220	11/50	5.59	8.80	8.976
0.050	1/20	1.27	2.00	2.040	0.240	6/25	6.10	9.60	9.792
0.055	11/200	1.40	2.20	2.244	0.250	1/4	6.35	10.00	10.200

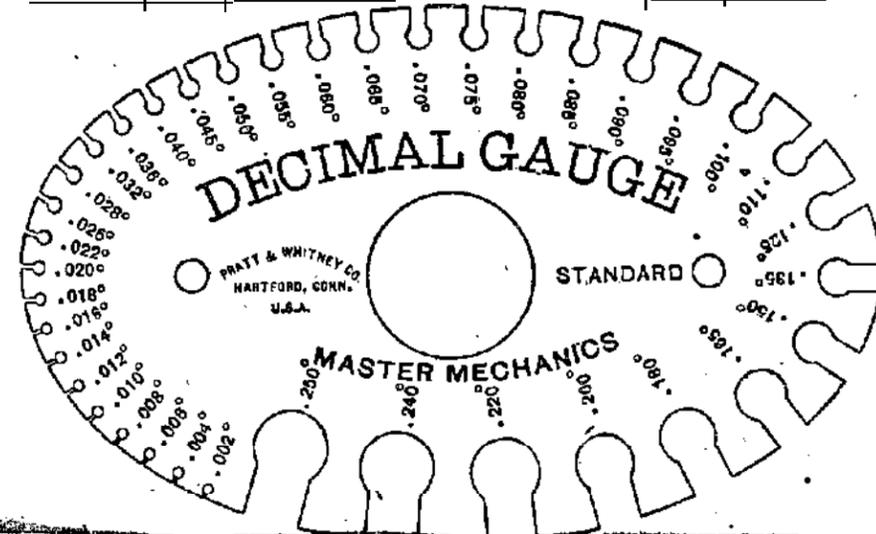

ALGEBRA.

Addition. — Add a , b , and $-c$. Ans. $a + b - c$.
Add $2a$ and $-3a$. Ans. $-a$. Add $2ab, -3ab, -c, -3c$. Ans. $-ab - 4c$. Add a^2 and $2a$. Ans. $a^2 + 2a$.

Subtraction. — Subtract a from b . Ans. $b - a$. Subtract $-a$ from $-b$. Ans. $-b + a$.
Subtract $b + c$ from a . Ans. $a - b - c$. Subtract $3a^2b - 9c$ from $4a^2b + c$. Ans. $a^2b + 10c$. RULE: Change the signs of the subtrahend and proceed as in addition.

Multiplication. — Multiply a by b . Ans. ab . Multiply ab by $a + b$. Ans. $a^2b + ab^2$.

Multiply $a + b$ by $a + b$. Ans. $(a + b)(a + b) = a^2 + 2ab + b^2$.
Multiply $-a$ by $-b$. Ans. ab . Multiply $-a$ by b . Ans. $-ab$.
Like signs give plus, unlike signs minus.

Powers of numbers. — The product of two or more powers of any number is the number with an exponent equal to the sum of the powers: $a^2 \times a^3 = a^5$; $a^2b^2 \times ab = a^3b^3$; $-7ab \times 2ac = -14a^2bc$.

To multiply a polynomial by a monomial, multiply each term of the polynomial by the monomial and add the partial products: $(6a - 3b) \times 3c = 18ac - 9bc$.

To multiply two polynomials, multiply each term of one factor by each term of the other and add the partial products: $(5a - 6b) \times (3a - 4b) = 15a^2 - 38ab + 24b^2$.

The square of the sum of two numbers = sum of their squares + twice their product.

The square of the difference of two numbers = the sum of their squares - twice their product.

The product of the sum and difference of two numbers = the difference of their squares:

$$(a + b)^2 = a^2 + 2ab + b^2; (a - b)^2 = a^2 - 2ab + b^2;$$

$$(a + b) \times (a - b) = a^2 - b^2.$$

The square of half the sums of two quantities is equal to their product plus the square of half their difference: $\left(\frac{a+b}{2}\right)^2 = ab + \left(\frac{a-b}{2}\right)^2$.

The square of the sum of two quantities is equal to four times their products, plus the square of their difference: $(a + b)^2 = 4ab + (a - b)^2$.

The sum of the squares of two quantities equals twice their product, plus the square of their difference: $a^2 + b^2 = 2ab + (a - b)^2$.

The square of a trinomial = square of each term + twice the product of each term by each of the terms that follow it: $(a + b + c)^2 = a^2 + b^2 + c^2 + 2ab + 2ac + 2bc$; $(a - b - c)^2 = a^2 + b^2 + c^2 - 2ab - 2ac + 2bc$.

The square of (any number + $\frac{1}{2}$) = square of the number + the number + $\frac{1}{4}$; = the number \times (the number + 1) + $\frac{1}{4}$; $(a + \frac{1}{2})^2 = a^2 + a + \frac{1}{4}$, $= a(a + 1) + \frac{1}{4}$. $(4\frac{1}{2})^2 = 4^2 + 4 + \frac{1}{4} = 4 \times 5 + \frac{1}{4} = 20\frac{1}{4}$.

The product of any number + $\frac{1}{2}$ by any other number + $\frac{1}{2}$ = product of the numbers + half their sum + $\frac{1}{4}$. $(a + \frac{1}{2}) \times (b + \frac{1}{2}) = ab + \frac{1}{2}(a + b) + \frac{1}{4}$. $4\frac{1}{2} \times 6\frac{1}{2} = 4 \times 6 + \frac{1}{2}(4 + 6) + \frac{1}{4} = 24 + 5 + \frac{1}{4} = 29\frac{1}{4}$.

Square, cube, 4th power, etc., of a binomial $a + b$.

$$(a + b)^2 = a^2 + 2ab + b^2; (a + b)^3 = a^3 + 3a^2b + 3ab^2 + b^3$$

$$(a + b)^4 = a^4 + 4a^3b + 6a^2b^2 + 4ab^3 + b^4.$$

In each case the number of terms is one greater than the exponent of the power to which the binomial is raised.

2. In the first term the exponent of a is the same as the exponent of the power to which the binomial is raised, and it decreases by 1 in each succeeding term.

3. b appears in the second term with the exponent 1, and its exponent increases by 1 in each succeeding term.

4. The coefficient of the first term is 1.

5. The coefficient of the second term is the exponent of the power to which the binomial is raised.

6. The coefficient of each succeeding term is found from the next preceding term by multiplying its coefficient by the exponent of a , and dividing the product by a number greater by 1 than the exponent of b . (See Binomial Theorem, below.)

Parentheses. — When a parenthesis is preceded by a plus sign it may be removed without changing the value of the expression: $a + b + (a + b) = 2a + 2b$. When a parenthesis is preceded by a minus sign it may be removed if we change the signs of all the terms within the parenthesis: $1 - (a - b - c) = 1 - a + b + c$. When a parenthesis is within a parenthesis remove the inner one first: $a - [b - \{c - (d - e)\}] = a - [b - \{c - d + e\}] = a - [b - c + d - e] = a - b + c - d + e$.

A multiplication sign \times has the effect of a parenthesis, in that the operation indicated by it must be performed before the operations of addition or subtraction. $a + b \times a + b = a + ab + b$; while $(a + b) \times (a + b) = a^2 + 2ab + b^2$, and $(a + b) \times a + b = a^2 + a^0 + 0$.

The absence of any sign between two parentheses, or between a quantity and a parenthesis, indicates that the parenthesis is to be multiplied by the quantity or parenthesis: $a(a + b + c) = a^2 + ab + ac$.

Division. — The quotient is positive when the dividend and divisor have like signs, and negative when they have unlike signs: $abc \div b = ac$; $abc \div -b = -ac$.

To divide a monomial by a monomial, write the dividend over the divisor with a line between them. If the expressions have common factors, remove the common factors:

$$a^2bx \div aby = \frac{a^2bx}{aby} = \frac{ax}{y}; \frac{a^4}{a^3} = a; \frac{a^3}{a^5} = \frac{1}{a^2} = a^{-2}.$$

To divide a polynomial by a monomial, divide each term of the polynomial by the monomial: $(8ab - 12ac) \div 4a = 2b - 3c$.

To divide a polynomial by a polynomial, arrange both dividend and divisor in the order of the ascending or descending powers of some common letter and **keep** this arrangement throughout the operation.

Divide the first term of the dividend by the first term of the divisor, and write the result as the first term of the quotient.

Multiply all the terms of the divisor by the first term of the quotient and subtract the product from the dividend. If there be a remainder, consider it as a new dividend and proceed as before: $(a^2 - b^2) \div (a + b)$.

$$\begin{array}{r} a^2 - b^2 \text{ I } a + b. \\ a^2 + ab \text{ I } a - b. \\ \hline - ab - b^2. \\ \hline - ab - b^2. \\ \hline \end{array}$$

The difference of two equal odd powers of any two numbers is divisible by their difference and also by their sum:

$$(a^3 - b^3) \div (a - b) = a^2 + ab + b^2; (a^3 - b^3) \div (a + b) = a^2 - ab + b^2.$$

The difference of two equal even powers of two numbers is divisible by their difference and also by their sum: $(a^2 - b^2) \div (a - b) = a + b$.

The sum of two equal even powers of two numbers is not divisible by either the difference or the sum of the numbers; but when the exponent of each of the two equal powers is composed of an odd and an even factor, the sum of the given power is divisible by the sum of the powers expressed by the even factor. Thus $x^6 + y^6$ is not divisible by $x + y$ or by $x - y$, but is divisible by $x^2 + y^2$.

Simple equations. — An equation is a statement of equality between two expressions; as $a + b = c + d$.

A simple equation, or equation of the first degree, is one which contains only the first power of the unknown quantity. If equal changes be made (by addition subtraction, multiplication, or division) in both sides of an equation, the results will be equal.

Any term may be changed from one side of an equation to another, provided its sign be changed: $a + b = c + d$; $a = c + d - b$. To solve

an equation having one unknown quantity, transpose all the terms involving the unknown quantity to one side of the equation, and all the other terms to the other side; combine like terms, and divide both sides by the coefficient of the unknown quantity.

Solve $8x - 29 = 26 - 3x$. $8x + 3x = 29 + 26$; $11x = 55$; $x = 5$, ans.

Simple algebraic problems containing one unknown quantity are solved by making x = the unknown quantity, and stating the conditions of the problem in the form of an algebraic equation, and then solving the equation. What two numbers are those whose sum is 48 and difference 14? Let x = the smaller number, $x + 14$ the greater. $x + x + 14 = 48$. $2x = 34$. $x = 17$; $x + 14 = 31$, ans.

Find a number whose treble exceeds 50 as much as its double falls short of 40. Let x = the number. $3x - 50 = 40 - 2x$; $5x = 90$; $x = 18$, ans. Proving, $54 - 50 = 40 - 36$.

Equations containing two unknown quantities. — If one equation contains two unknown quantities, x and y , an indefinite number of pairs of values of x and y may be found that will satisfy the equation, but if a second equation be given only one pair of values can be found that will satisfy both equations. Simultaneous equations, or those that may be satisfied by the same values of the unknown quantities, are solved by combining the equations so as to obtain a single equation containing only one unknown quantity. This process is called elimination.

Elimination by addition or subtraction. — Multiply the equation by such numbers as will make the coefficients of one of the unknown quantities equal in the resulting equation. Add or subtract the resulting equations according as they have unlike or like signs.

$$\text{Solve } \begin{cases} 2x + 3y = 7. \\ 4x - 5y = 3. \end{cases} \quad \begin{array}{l} \text{Multiply by 2:} \\ \text{Subtract:} \end{array} \quad \begin{array}{l} 4x + 6y = 14 \\ 4x - 5y = 3 \end{array} \quad \begin{array}{l} 11y = 11 \\ y = 1. \end{array}$$

Substituting value of y in first equation, $2x + 3 = 7$; $x = 2$.

Elimination by substitution. — From one of the equations obtain the value of one of the unknown quantities in terms of the other. Substitute for this unknown quantity its value in the other equation and reduce the resulting equations.

$$\text{Solve } \begin{cases} 2x + 3y = 8. \quad (1). \\ 3x + 7y = 7. \quad (2). \end{cases} \quad \text{From (1) we find } x = \frac{8 - 3y}{2}$$

$$\text{Substitute this value in (2): } 3\left(\frac{8 - 3y}{2}\right) + 7y = 7; = 24 - 9y + 14y = 14,$$

whence $y = -2$. Substitute this value in (1): $2x + 6 = 8$; $x = 1$.

Elimination by comparison. — From each equation obtain the value of one of the unknown quantities in terms of the other. Form an equation from these equal values, and reduce this equation.

$$\text{Solve } 2x - 9y = 21. \quad (1) \text{ and } 3x - 4y = 7. \quad (2). \text{ From (1) we find } x = \frac{11 + 9y}{2} \quad \text{From (2) we find } x = \frac{7 + 4y}{3}$$

$$\text{Equating these values of } x, \frac{11 + 9y}{2} = \frac{7 + 4y}{3}; 19y = -19; y = -1.$$

Substitute this value of y in (1): $2x + 9 = 11$; $x = 1$.

If three simultaneous equations are given containing three unknown quantities, one of the unknown quantities must be eliminated between two pairs of the equations; then a second between the two resulting equations.

Quadratic equations. — A quadratic equation contains the square of the unknown quantity, but no higher power. A pure quadratic contains the square only; an affected quadratic both the square and the first power.

To solve a pure quadratic. collect the unknown quantities on one side, and the known quantities on the other; divide by the coefficient of the unknown quantity and extract the square root of each side of the resulting equation.

$$\text{Solve } 3x^2 - 15 = 0. \quad 3x^2 = 15; x^2 = 5; x = \sqrt{5}.$$

A root like $\sqrt{5}$, which is indicated, but which can be found only approximately, is called a *surd*.

$$\text{Solve } 3x^2 + 15 = 0. \quad 3x^2 = -15; x^2 = -5; x = \sqrt{-5}.$$

The square root of -5 cannot be found even approximately, for the square of any number positive or negative is positive; therefore a root which is indicated, but cannot be found even approximately, is called *imaginary*.

To solve an affected quadratic, 1. Convert the equation into the form $ax^2 \pm 2abx = c$, multiplying or dividing the equation if necessary, so as to make the coefficient of x^2 a square number.

2. Complete the square of the first member of the equation, so as to convert it to the form of $ax^2 \pm 2abx + b^2$, which is the square of the binomial $ax \pm b$, as follows: add to each side of the equation the square of the quotient obtained by dividing the second term by twice the square root of the first term.

3. Extract the square root of each side of the resulting equation. Solve $3x^2 - 4x = 32$. To make the coefficient of x^2 a square number, multiply by 3: $9x^2 - 12x = 96$; $12x \div (2 \times 3x) = 2$; $2^2 = 4$.

Complete the square: $9x^2 - 12x + 4 = 100$. Extract the root: $3x - 2 = \pm 10$, whence $x = 4$ or $-2\frac{2}{3}$. The square root of 100 is either $+10$ or -10 , since the square of -10 as well as $+10^2 = 100$.

Every affected quadratic may be reduced to the form $ax^2 + bx + c = 0$.
The solution of this equation is $x = \frac{-b \pm \sqrt{b^2 - 4ac}}{2a}$.

Problems involving quadratic equations have apparently two solutions, as a quadratic has two roots. Sometimes both will be true solutions, but generally one only will be a solution and the other be inconsistent with the conditions of the problem.

The sum of the squares of two consecutive positive numbers is 481. Find the numbers.

Let x = one number. $x + 1$ the other. $x^2 + (x + 1)^2 = 481$. $2x^2 + 2x + 1 = 481$.

$x^2 + 5 = 240$. Completing the square, $x^2 + x + 0.25 = 240.25$. Extracting the root we obtain $x + 0.5 = \pm 15.5$; $x = 15$ or -16 . The negative root -16 is inconsistent with the conditions of the problem.

Quadratic equations containing two unknown quantities require different methods for their solution, according to the form of the equations. For these methods reference must be made to works on algebra.

Theory of exponents. — $\sqrt[n]{a}$ when n is a positive integer is one of n equal factors of a . $\sqrt[n]{a^m}$ means a is to be raised to the m th power and the n th root extracted.

$(\sqrt[n]{a})^m$ means that the n th root of a is to be taken and the result raised to the m th power.

$\sqrt[n]{a^m} = (\sqrt[n]{a})^m = a^{\frac{m}{n}}$. When the exponent is a fraction, the numerator indicates a power, and the denominator a root. $a^{6/2} = \sqrt{a^6} = a^3$; $a^{3/2} = \sqrt{a^3} = a^{1.5}$.

To extract the root of a quantity raised to an indicated power, divide the exponent by the index of the required root: as,

$$\sqrt[n]{a^m} = a^{\frac{m}{n}}; \quad \sqrt{a^6} = a^{6/3} = a^2.$$

Subtracting 1 from the exponent of a is equivalent to dividing by a :

$$a^{2-1} = a^1 = a; \quad a^{1-1} = a^0 = \frac{a}{a} = 1; \quad a^{0-1} = a^{-1} = \frac{1}{a}; \quad a^{-1-1} = a^{-2} = \frac{1}{a^2}$$

A number with a negative exponent denotes the reciprocal of the number with the corresponding positive exponent.

A factor under the radical sign whose root can be taken may, by having the root taken, be removed from under the radical sign:

$$\sqrt{a^2b} = \sqrt{a^2} \times \sqrt{b} = a\sqrt{b}.$$

A factor outside the radical sign may be raised to the corresponding power and placed under it:

$$\sqrt{\frac{a}{b}} = \sqrt{\frac{ab}{b^2}} = \sqrt{ab} \times \frac{1}{b} = \frac{1}{b} \sqrt{ab}; \quad \sqrt{\frac{a}{b^2}} = \frac{1}{b} \sqrt{a}.$$

Binomial Theorem. — To obtain any power, as the n th, of an expression of the form $x+a$

$$(a+x)^n = a^n + na^{n-1}x + \frac{n(n-1)a^{n-2}}{1.2}x^2 + \frac{n(n-1)(n-2)a^{n-3}}{1.2.3}x^3 + \text{etc.}$$

The following laws hold for any term in the expansion of $(a+x)^n$.

The exponent of x is less by one than the number of terms.

The exponent of a is n minus the exponent of x .

The last factor of the numerator is greater by one than the exponent of a .

The last factor of the denominator is the same as the exponent of x .

In the r th term the exponent of x will be $r-1$.

The exponent of a will be $n-(r-1)$, or $n-r+1$.

The last factor of the numerator will be $n-r+2$.

The last factor of the denominator will be $r-1$.

Hence the r th term = $\frac{n(n-1)(n-2) \dots (n-r+2)}{1.2.3 \dots (r-1)} a^{n-r+1} x^{r-1}$.

GEOMETRICAL PROBLEMS.

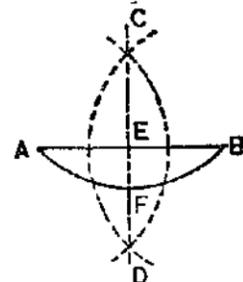

FIG. 1.

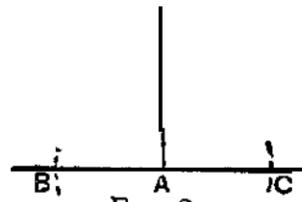

FIG. 2.

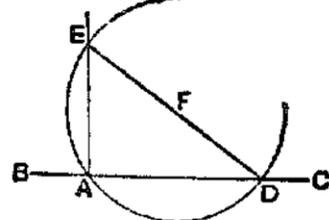

FIG. 3.

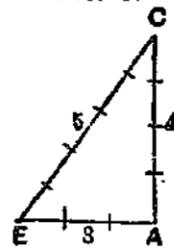

FIG. 4.

1. To bisect a straight line, or an arc of a circle (Fig. 1). — From the ends A, B , as centres, describe arcs intersecting at C and D , and draw a line through C and D which will bisect the line at E or the arc at F .

2. To draw a perpendicular to a straight line, or a radial line to a circular arc. — Same as in Problem 1. CD is perpendicular to the line AB , and also radial to the arc.

3. To draw a perpendicular to a straight line from a given point in that line (Fig. 2). — With any radius, from the given point A in the line BC , cut the line at B and C . With a longer radius describe arcs from B and C , cutting each other at D , and draw the perpendicular DA .

4. From the end A of a given line AD to erect a perpendicular AE (Fig. 3). — From any centre F above AD , describe a circle passing through the given point A , and cutting the given line at D . Draw DF and produce it to cut the circle at E , and draw the perpendicular AE .

Second Method (Fig. 4). — From the given point A set off a distance AE equal to three parts, by any scale; and on the centres A and E , with radii of four and five parts respectively, describe arcs intersecting at C . Draw the perpendicular AC .

NOTE. — This method is most useful on very large scales, where straight edges are inapplicable. Any multiples of the numbers 3, 4, 5 may be taken with the same effect, as 6, 8, 10, or 9, 12, 15.

5. To draw a perpendicular to a straight line from any point without it (Fig. 5). — From the point A , with a sufficient radius cut the given line at F and G , and, from these points describe arcs cutting at E . Draw the perpendicular AE .

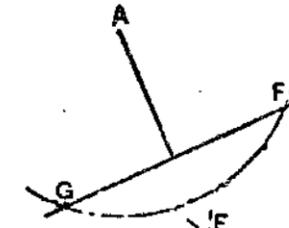

FIG. 5.

6. To draw a straight line parallel to a given line, at a given distance apart (Fig. 6). — From the centres A, B , in the given line, with the given distance as radius, describe arcs C, D , and draw the parallel lines CD touching the arcs.

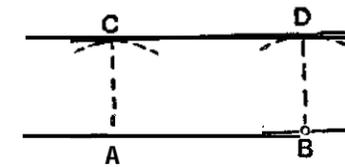

FIG. 6.

7. To divide a straight line into a number of equal parts (Fig. 7). — To divide the line AB into, say, five parts, draw the line AC at an angle from A ; set off five equal parts; draw $B5$ and draw parallels to it from the other points of division in AC . These parallels divide AB as required.

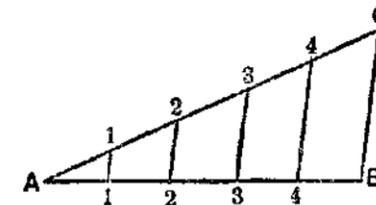

FIG. 7.

NOTE. — By a similar process a line may be divided into a number of unequal parts; setting off divisions on AC , proportional by a scale to the required divisions, and drawing parallels cutting AB . The triangles $A11, A22, A33$, etc., are similar triangles.

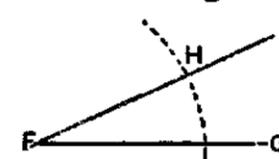
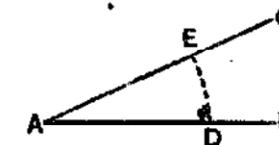

FIG. 8.

8. Upon a straight line to draw an angle equal to a given angle (Fig. 8). — Let A be the given angle and FG the line. From the point A with any radius describe the arc DE . From F with the same radius describe the arc IH . Set off the arc IH equal to DE , and draw FH . The angle F is equal to A , as required.

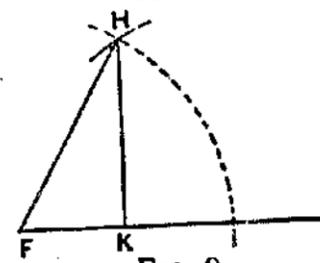

FIG. 9.

9. To draw angles of 60° and 30° (Fig. 9). — From F , with any radius FI , describe an arc IH ; and from I , with the same radius, cut the arc at H and draw FH to form the required angle IFH . Draw the perpendicular HK to the base line to form the angle of 30° FHK .

10. To draw an angle of 45° (Fig. 10). — Set off the distance FI ; draw the perpendicular IH equal to FI , and join HF to form the angle at F . The angle at H is also 45°.

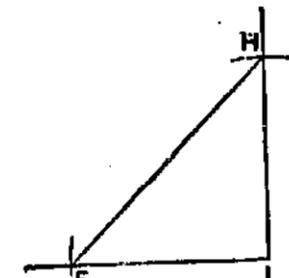

FIG. 10.

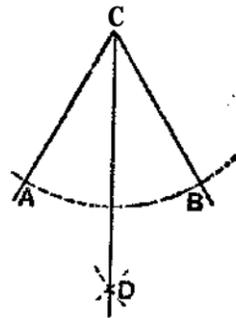

FIG. 11

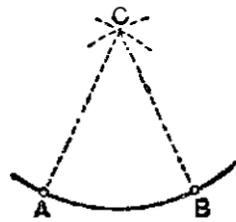

FIG. 12.

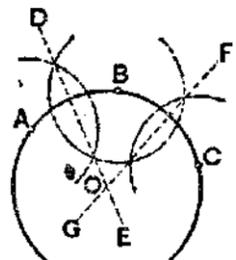

FIG. 13.

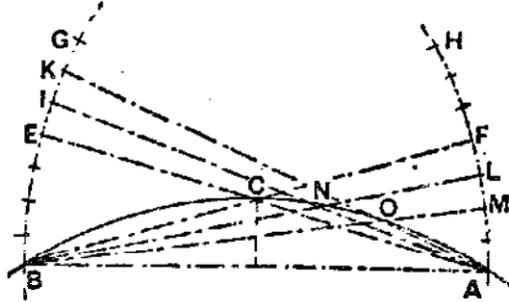

FIG. 14.

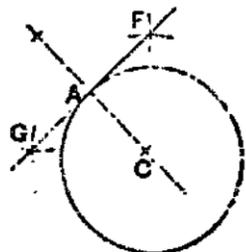

FIG. 15.

11. To bisect an angle (Fig. 11).—Let ACB be the angle; with C as a centre draw an arc cutting the sides at A, B . From A and B as centres, describe arcs cutting each other at D . Draw CD , dividing the angle into two equal parts.

12. Through two given points to describe an arc of a circle with a given radius (Fig. 12).—From the points A and B as centres, with the given radius, describe arcs cutting at C ; and from C with the same radius describe an arc $A B$.

13. To find the centre of a circle or of an arc of a circle (Fig. 13).—Select three points, A, B, C , in the circumference, well apart; with the same radius describe arcs from these three points, cutting each other, and draw the two lines, DE, FG through their intersections. The point O , where they cut, is the centre of the circle or arc.

To describe a circle passing through three given points.—Let A, B, C be the given points, and proceed as in last problem to find the centre O , from which the circle may be described.

14. To describe an arc of a circle passing through three given points when the centre is not available (Fig. 14).—From the extreme points A, B , as centres, describe arcs AH, BG . Through the third point C draw AE, BF , cutting the arcs. Divide AF and BE into any number of equal parts, and set off a series of equal parts of the same length on the upper portions of the arcs beyond the points EF . Draw straight lines, BL, BM , etc., to the divisions in AF , and AI, AK , etc., to the divisions in EG . The successive intersections N, O , etc., of these lines are points in the circle required between the given points A and C , which may be drawn in; similarly the remaining part of the curve BC may be described. (See also Problem 54.)

15. To draw a tangent to a circle from a given point in the circumference (Fig. 15).—Through the given point A , draw the radial line AC , and a perpendicular to it FG , which is the tangent required.

16. To draw tangents to a circle from a point without it (Fig. 16).—From A , with the radius AC describe an arc BCD , and from C , with a radius equal to the diameter of the circle, cut the arc at B, D . Join BC, CD , cutting the circle at E, F , and draw AE, AF , the tangents.

NOTE.—When a tangent is already drawn, the exact point of contact may be found by drawing a perpendicular to it from the centre.

17. Between two inclined lines to draw a series of circles touching these lines and touching each other (Fig. 17).—Bisect the inclination of the given lines AB, CD , by the line NO . From a point P in this line draw the perpendicular PB to the line AB , and on P describe the circle BD , touching the lines and cutting the centre line at E . From E draw EF perpendicular to the centre line, cutting AB at F , and from F describe an arc EG , cutting AB at G . Draw GH parallel to BP , giving H , the centre of the next circle, to be described with the radius HE , and so on for the next circle IN .

Inversely, the largest circle may be described first, and the smaller ones in succession. This problem is of frequent use in scroll-work.

18. Between two inclined lines to draw a circular segment tangent to the lines and passing through a point F on the line FC which bisects the angle of the lines (Fig. 18).—Through F draw DA at right angles to FC ; bisect the angles A and D , as in Problem 11, by lines cutting at C , and from C with radius CF draw the arc HFG required.

19. To draw a circular arc that will be tangent to two given lines AB and CD inclined to one another, one tangential point E being given (Fig. 19).—Draw the centre line GF . From E draw EF at right angles to AB ; then F is the centre of the circle required.

20. To describe a circular arc joining two circles, and touching one of them at a given point (Fig. 20).—To join the circles A, B, FG , by an arc touching one of them at F , draw the radius EF , and produce it both ways. Set off FH equal to the radius AC of the other circle; join CH and bisect it with the perpendicular LI , cutting EF at I . On the centre I , with radius IF , describe the arc FA as required.

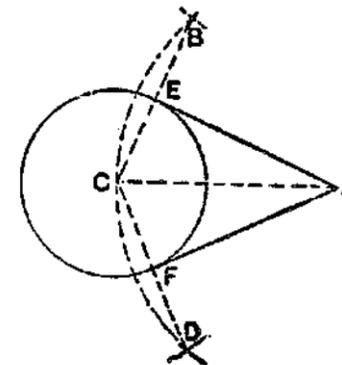

FIG. 16.

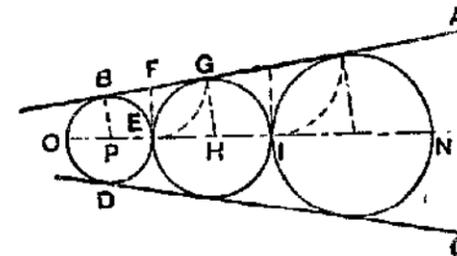

FIG. 17.

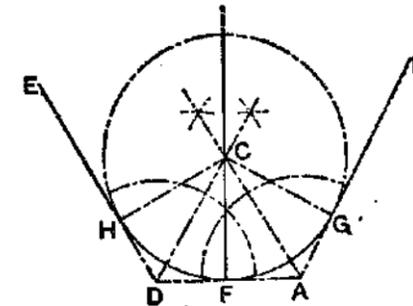

FIG. 18.

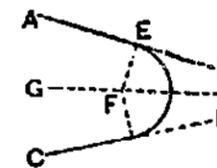

FIG. 19.

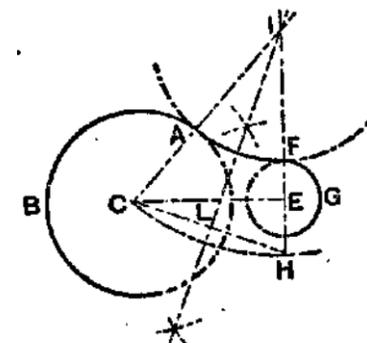

FIG. 20.

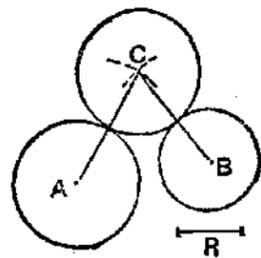

FIG. 21.

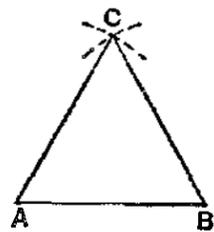

FIG. 22.

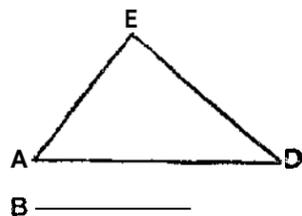

FIG. 23.

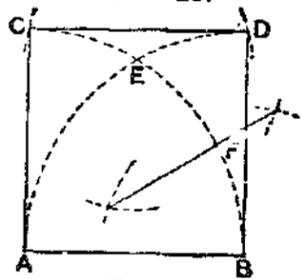

FIG. 24.

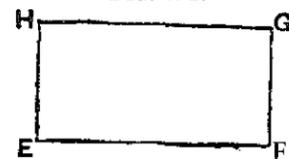

FIG. 25.

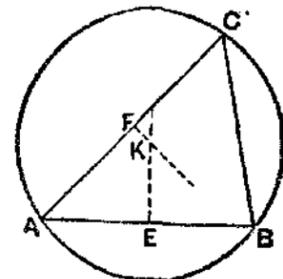

FIG. 26.

21. To draw a circle with a given radius R that will be tangent to two given circles A and B (Fig. 21). — From centre of circle A with radius equal R plus radius of A , and from centre of B with radius equal to R + radius of B , draw two arcs cutting each other at C , which will be the centre of the circle required.

22. To construct an equilateral triangle, the sides being given (Fig. 22). — On the ends of one side, A, B , with AB as radius, describe arcs cutting at C , and draw AC, CB .

23. To construct a triangle of unequal sides (Fig. 23). — On either end of the base AD , with the side B as radius, describe an arc; and with the side C as radius, on the other end of the base as a centre, cut the arc at E . Join AE, DE .

24. To construct a square on a given straight line AB (Fig. 24). — With AB as radius and A and B as centres, draw arcs AD and BC , intersecting at E . Bisect EB at F . With E as centre and EF as radius, cut the arcs AD and BC in D and C . Join AC, CD , and DB to form the square.

25. To construct a rectangle with given base EF and height EH (Fig. 25). — On the base EF draw the perpendiculars EH, FG equal to the height, and join GH .

26. To describe a circle about a triangle (Fig. 26). — Bisect two sides AB, AC of the triangle at E, F , and from these points draw perpendiculars cutting at K . On the centre K , with the radius KA , draw the circle ABC .

27. To inscribe a circle in a triangle (Fig. 27). — Bisect two of the angles A, C , of the triangle by

lines cutting at D ; from D draw a perpendicular DE to any side, and with DE as radius describe a circle. When the triangle is equilateral, draw a perpendicular from one of the angles to the opposite side, and from the side set off one third of the perpendicular.

28. To describe a circle about a square, and to inscribe a square in a circle (Fig. 28). — To describe the circle, draw the diagonals AC, BD of the square, cutting at E . On the centre E , with the radius AE , describe the circle.

To inscribe the square. — Draw the two diameters, AB, CD , at right angles, and join the points A, B, CD , to form the square.

NOTE. — In the same way a circle may be described about a rectangle.

29. To inscribe a circle in a square (Fig. 29). — To inscribe the circle, draw the diagonals AC, BD of the square, cutting at E ; draw the perpendicular EF to one side, and with the radius EF describe the circle.

30. To describe a square about a circle (Fig. 30). — Draw two diameters AB, CD at right angles. With the radius of the circle and A, B, C and D as centres, draw the four half circles which cross one another in the corners of the square.

31. To inscribe a pentagon in a circle (Fig. 31). — Draw diameters AC, BD at right angles, cutting at O . Bisect AO at E , and from E with radius EB , cut AC at F ; from B , with radius BF , cut the circumference at G, H , and with the same radius step round the circle to Z and K ; join the points SO found to form the pentagon.

32. To construct a pentagon on a given line AB (Fig. 32). — From B erect a perpendicular BC half the length of AB ; join AC and prolong it to D , making $CD = BC$. Then BD is the radius of the circle circumscribing the pentagon. From A and B as centres, with BD as radius, draw arcs cutting each other in O , which is the centre of the circle.

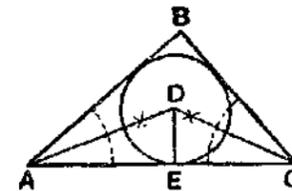

FIG. 27.

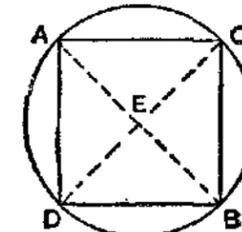

FIG. 28.

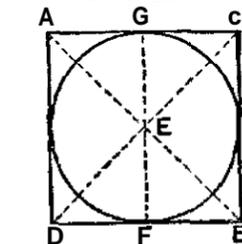

FIG. 29.

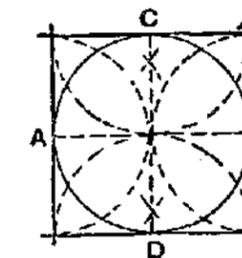

FIG. 30.

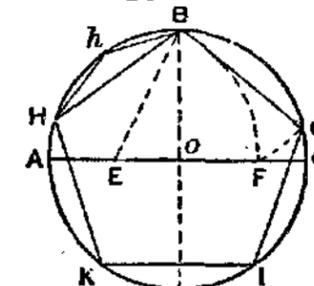

FIG. 31.

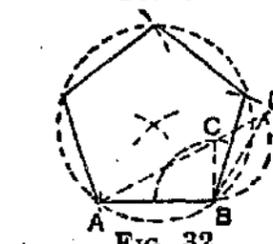

FIG. 32.

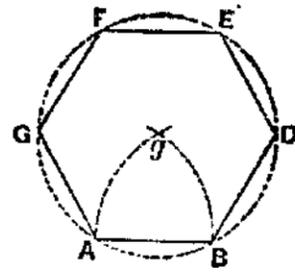

FIG. 33.

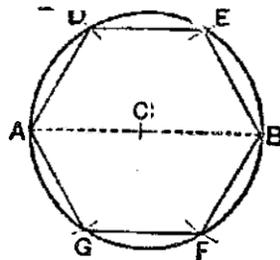

FIG. 34.

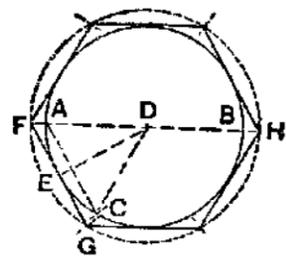

FIG. 35.

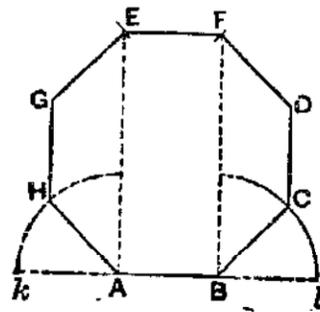

FIG. 36.

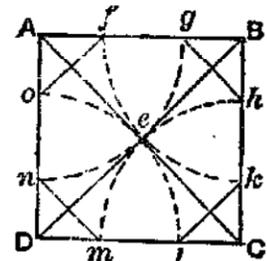

FIG. 37.

33. To construct a hexagon upon a given straight line (Fig. 33). — From A and B the ends of the given line, with radius A B, describe arcs cutting at g; from g, with the radius of A, describe a circle; with the same radius set off the arcs A G, G F, and B D, D E. Join the points so found to form the hexagon. The side of a hexagon = radius of its circumscribed circle.

34. To inscribe a hexagon in a circle (Fig. 34). — Draw a diameter A C B. From A and B as centres, with the radius of the circle A C, cut the circumference at D, E, F, G, and draw A D, D E, etc., to form the hexagon. The radius of the circle is equal to the side of the hexagon: therefore the points D, E, etc., may also be found by stepping the radius six times round the circle. The angle between the diameter and the sides of a hexagon and also the exterior angle between a side and an adjacent side prolonged is 60 degrees; therefore a hexagon may conveniently be drawn by the use of a 60-degree triangle.

35. To describe a hexagon about a circle (Fig. 35). — Draw a diameter A D B, and with the radius A D, on the centre A, cut the circumference at C; join A C, and bisect it with the radius D E; through E draw F G, parallel to A C, cutting the diameter at F, and with the radius D F describe the circumscribing circle F H. Within this circle describe a hexagon by the preceding problem. A more convenient method is by use of a 60-degree triangle. Four of the sides make angles of 60 degrees with the diameter, and the other two are parallel to the diameter.

36. To describe an octagon on a given straight line (Fig. 36). — Produce the given line A B both ways, and draw perpendiculars A E, B F; bisect the external angles A and B by the lines A H, B C, which make equal to A B. Draw C D and H G parallel to A E, and equal to A B; from the centres G, D, with the radius A B, cut the perpendiculars at E, F, and draw E F to complete the octagon.

37. To convert a square into an octagon (Fig. 37). — Draw the diagonals of the square cutting at e; from the corners A B C D, with A e as radius, describe arcs cutting the sides at g, h, i, j, and join the points so found to form the octagon. Adjacent sides of an octagon make an angle of 135 degrees.

38. To inscribe an octagon in a circle (Fig. 38). — Draw two diameters, A C, B D at right angles; bisect the arcs A B, B C, etc., at e, f, etc., and join A e, e B, etc., to form the octagon.

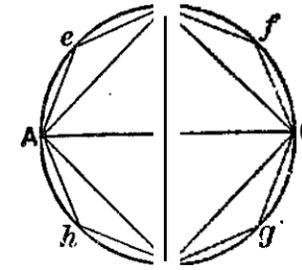

FIG. 38.

39. To describe an octagon about a circle (Fig. 39). — Describe a square about the given circle A B; draw perpendiculars h k, etc., to the diagonals, touching the circle to form the octagon.

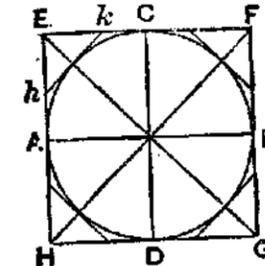

FIG. 39.

40. To describe a polygon of any number of sides upon a given straight line (Fig. 40). — Produce the given line A B, and on A, with the radius A B, describe a semicircle; divide the semi-circumference into as many equal parts as there are to be sides in the polygon — say, in this example, five sides. Draw lines from A through the divisional points D, h and c, omitting one point a; and on the centres B, D, with the radius A B, cut A b at E and A c at F. Draw D E, E F, F B to complete the polygon.

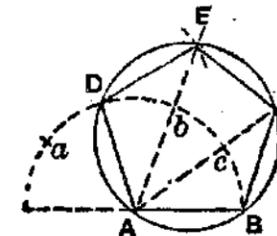

FIG. 40.

41. To inscribe a circle within a polygon (Figs. 41, 42). — When the polygon has an even number of sides (Fig. 41), bisect two opposite sides at A and B; draw A B, and bisect it at C by a diagonal D E, and with the radius C A describe the circle.

When the number of sides is odd (Fig. 42), bisect two of the sides at A and B and draw lines A E, B D to the opposite angles, intersecting at C; from C, with the radius C A, describe the circle.

42. To describe a circle without a polygon (Figs. 41, 42). — Find the centre C as before, and with the radius C D describe the circle.

43. To inscribe a polygon of any number of sides within a circle (Fig. 43). — Draw the diameter A B and through the centre E draw the

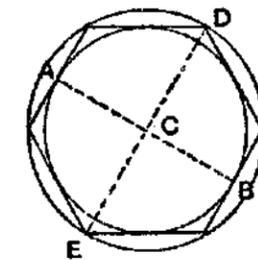

FIG. 41.

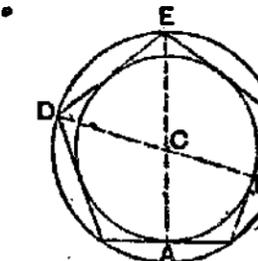

FIG. 42.

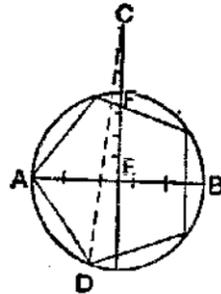

FIG. 43.

perpendicular EC , cutting the circle at F . Divide EF into four equal parts, and set off three parts equal to those from F to C . Divide the diameter AB into as many equal parts as the polygon is to have sides; and from C draw CD , through the second point of division, cutting the circle at D . Then AD is equal to one side of the polygon, and by stepping round the circumference with the length AD the polygon may be completed.

Table of Polygonal Angles.

Number of Sides.	Angle at Centre.	Number of Sides.	Angle at Centre.	Number of Sides.	Angle at Centre.
No.	Degrees.	No.	Degrees.	No.	Degrees.
3	120	9	40	15	24
4	90	10	36	16	22 1/2
5	72	11	32 8/11	17	21 3/17
6	60	12	30	18	20
7	51 3/7	13	27 9/13	19	19
8	45	14	25 5/7	20	18

In this table the angle at the centre is found by dividing 360 degrees the number of degrees in a circle, by the number of sides in the polygon; and by setting off round the centre of the circle a succession of angles by means of the protractor, equal to the angle in the table due to a given number of sides, the radii so drawn will divide the circumference into the same number of parts.

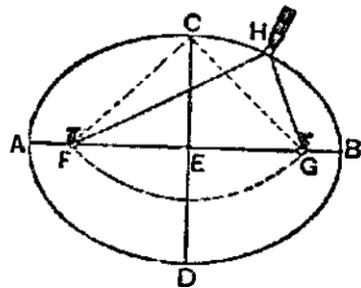

FIG. 44.

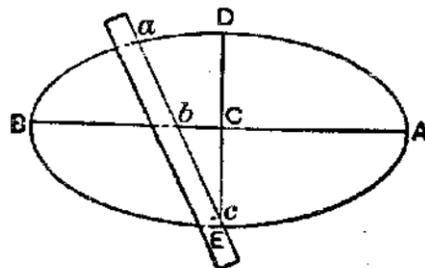

FIG. 45.

44. To describe an ellipse when the length and breadth are given (Fig. 44). - AB , transverse axis; CD , conjugate axis; FG , foci. The sum of the distances from C to F and G , also the sum of the distances from F and G to any other point in the curve, is equal to the transverse axis. From the centre C , with AE as radius, cut the axis AB at F and G , the foci; fix a couple of pins into the axis at F and G , and loop on a thread or cord upon them equal in length to the axis AB , so as when stretched to reach to the extremity C of the conjugate axis, as shown in dot-lining. Place a pencil inside the cord as at H , and guiding the pencil in this way, keeping the cord equally in tension, carry the pencil round the pins F, G , and so describe the ellipse.

NOTE. - This method is employed in setting off elliptical garden-plots, walks, etc.

2d Method (Fig. 45). - Along the straight edge of a slip of stiff paper mark off a distance a equal to AC half the transverse axis; and from the same point a distance b equal to CE half the conjugate axis.

Place the slip so as to bring the point b on the line AB of the transverse axis and the point c on the line DE ; and set off on the drawing the position of the point a . Shifting the slip so that the point b travels on the transverse axis, and the point c on the conjugate axis, any number of points in the curve may be found, through which the curve may be traced.

3d Method (Fig. 46). - The action of the preceding method may be embodied so as to afford the means of describing a large curve continuously by means of a bar m , with steel points m, l, k , riveted into brass slides adjusted to the length of the semi-axis and fixed with set-screws. Rectangular cross EG , with guiding-slots is placed, coinciding with the two axes of the ellipse AC and BH . By sliding the points k, l in the slots, and carrying round the point m , the curve may be continuously described. A pen or pencil may be used at m .

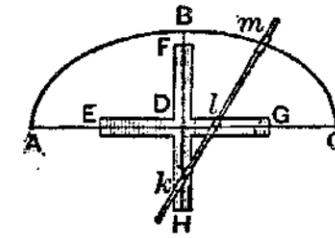

FIG. 46.

4th Method (Fig. 47). - Bisect the transverse axis at C , and through C draw the perpendicular DE , making CD and CE each equal to half the conjugate axis. From D or E , with the radius AC , cut the transverse axis at F, F' , for the foci. Divide AC into a number of parts at the points 1, 2, 3, etc. With the radius AI on F and F' as centres, describe arcs, and with the radius BI on the same centres cut these arcs as shown. Repeat the operation for the other divisions of the transverse axis. The series of intersections thus made are points in the curve, through which the curve may be traced.

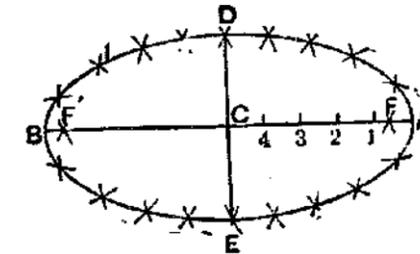

FIG. 47.

5th Method (Fig. 48). - On the two axes AB, DE as diameters, on centre C , describe circles; from a number of points a, b , etc., in the circumference AFB , draw radii cutting the inner circle at a', b' , etc. From a, b , etc., draw perpendiculars to AB ; and from a', b' , etc., draw parallels to AB , cutting the respective perpendiculars at n, o , etc. The intersections are points in the curve, through which the curve may be traced.

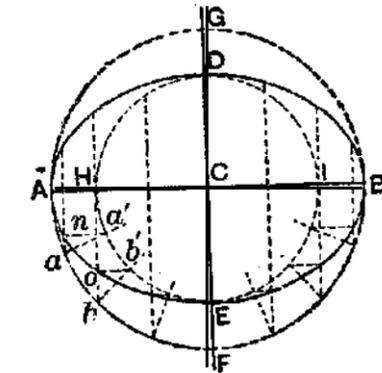

FIG. 48.

6th Method (Fig. 49). - When the transverse and conjugate diameters are given, AB, CD , draw the tangent EF parallel to AB . Produce CD , and on the centre G with the radius of half AB , describe a semicircle HDK ; from the centre G draw any number of straight lines to the points E, r , etc., in the line EF , cutting the circumference at l, m, n , etc.; from the centre O of the ellipse draw straight lines to the points E, r , etc.; and from the points l, m, n , etc., draw parallels to GC , cutting the lines OE, Or , etc., at L, M, N , etc.

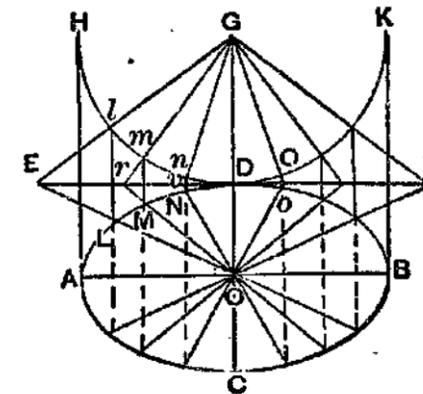

FIG. 49.

These are points in the circumference of the ellipse, and the curve may be traced through them. Points in the other half of the ellipse are formed by extending the intersecting lines as indicated in the figure.

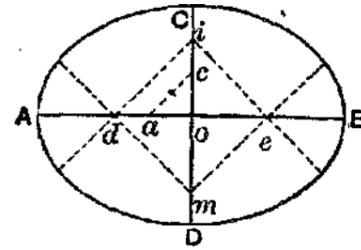

FIG. 50.

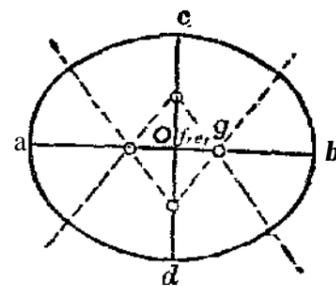

FIG. 51.

The method is not considered applicable for cases in which the minor axis is less than two thirds of the major.

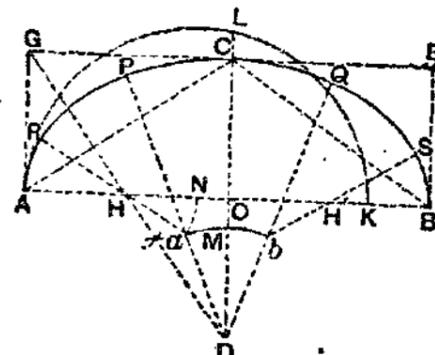

FIG. 52.

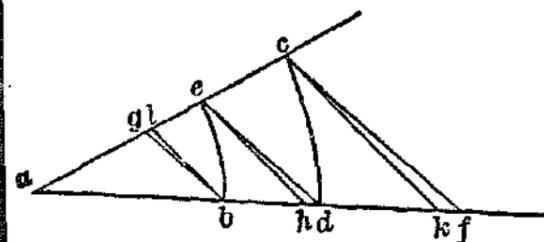

FIG. 53.

45. To describe an ellipse approximately by means of circular arcs. — *First.* — With arcs of two radii (Fig. 50). — Find the difference of the semi-axes and set it off from the centre o to a and c on OA and OC ; draw ac , and set off half ac to d ; draw di parallel to ac ; set off oe equal to od ; join ei and draw the parallels em , dm . From m , with radius mC , describe an arc through C ; and from i describe an arc through D ; from d and e describe arcs through A and B . The four arcs form the ellipse approximately.

Note. — This method does not apply satisfactorily when the conjugate axis is less than two thirds of the transverse axis.

2d Method (by Carl G. Barth, Fig. 51). — In Fig. 51 a bis the major and cd the minor axis of the ellipse to be approximated. Lay off be equal to the semi-minor axis co , and use ae as radius for the arc at each extremity of the minor axis. Bisect eo at f and lay off eg equal to ef , and use gb as radius for the arc at each extremity of the major axis.

3d Method. With arcs of three radii (Fig. 52). — On the transverse axis AB draw the rectangle BG on the height OC ; to the diagonal AC draw the perpendicular GH ; set off OK equal to OC , and describe a semicircle on AK , and produce OC to L ; set off OM equal to CL , and from D describe an arc with radius DM ; from A , with radius oA , cut AB at N ; from H , with radius HN , cut arc ab at a . Thus the five centres D, a, b, H, H' are found, from which the arcs are described to form the ellipse.

This process works well for nearly all proportions of ellipses. It is used in striking out vaults and stone bridges.

4th Method (by F. R. Honey, Figs. 53 and 54). — Three radii are employed. With the shortest radius describe the two arcs which pass through the vertices of the major axis, with the longest the two arcs which pass through the vertices of the minor axis, and with the third radius the four arcs which connect the former.

A simple method of determining the radii of curvature is illustrated in Fig. 53. Draw the straight lines af and ac , forming any angle at a . With a as a centre, and with radii $a b$ and $a c$, respectively, equal to the semi-minor and semi-major axes, draw the arcs $b e$ and $c d$. Join $e d$, and through b and c respectively, draw $b g$ and $c f$ parallel to $e d$, intersecting ac at g , and af at f ; $a f$ is the radius of curvature at the vertex of the minor axis; and $a g$ the radius of curvature at the vertex of the major axis.

Lay off $d h$ (Fig. 53) equal to one eighth of $b d$. Join $e k$, and draw ck and bl parallel to $e h$. Take k for the longest radius ($= R$), $a l$ for the shortest radius ($= r$), and the arithmetical mean, or one half the sum of the semi-axes, for the third radius ($= p$), and employ these radii for the eight-centred oval as follows:

Let $a b$ and $c d$ (Fig. 54) be the major and minor axes. Lay off $a e$ equal to r , and $a f$ equal to p ; also lay off $c g$ equal to R , and $c k$ equal to p . With g as a centre and gh as a radius, draw the arc $h k$; with the centre e and radius $e f$ draw the arc $f k$, intersecting $k k$ at k . Draw the line $g k$ and produce it, making $g l$ equal to R . Draw $k e$ and produce it, making $k m$ equal to p . With the centre g and radius $g c$ ($= R$) draw the arc $c l$; with the centre k and radius $k l$ ($= p$) draw the arc $l m$, and with the centre e and radius $e m$ ($= r$) draw the arc $m a$.

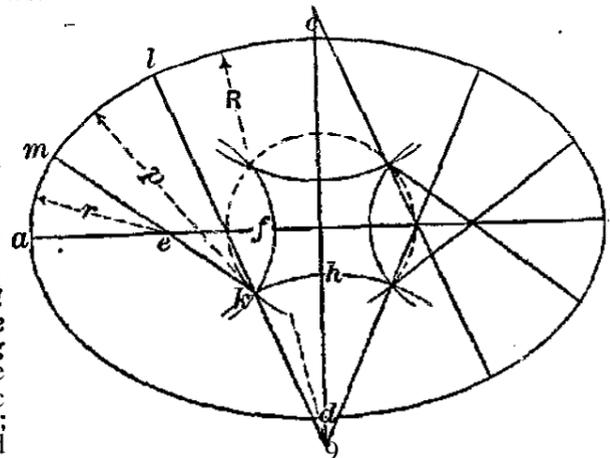

FIG. 54.

The remainder of the work is symmetrical with respect to the axes.

46. The Parabola. — A parabola (Fig. 55) is a curve such that every point in the curve is equally distant from the directrix KL and the focus F . The focus lies in the axis AB drawn from the vertex or head of the curve a , so as to divide the figure into two equal parts. The vertex A is equidistant from the directrix and the focus, or $A e = A F$. Any line parallel to the axis is a diameter. A straight line, as $E G$ or $D C$, drawn across the figure at right angles to the axis is a double ordinate, and either half of it is an ordinate. The ordinate to the axis $E F G$, drawn through the focus, is called the parameter of the axis. A segment of the axis, reckoned from the vertex, is an abscissa of the axis, and it is an abscissa of the ordinate drawn from the base of the abscissa. Thus, $A B$ is an abscissa of the ordinate $B C$.

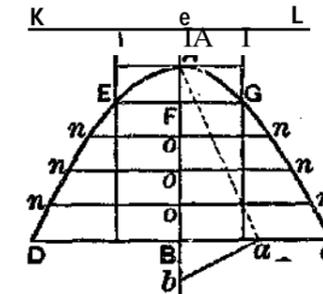

FIG. 55.

Abscissae of a parabola are as the squares of their ordinates.

To describe a parabola when an abscissa and its ordinate are given (Fig. 55). — Bisect the given ordinate $B C$ at a , draw $A a$, and then $a b$ perpendicular to it, meeting the axis at b . Set off $A e, A F$, each equal to $B b$; and draw $K e L$ perpendicular to the axis. Then $K L$ is the directrix and F is the focus. Through F and any number of points $o, o, etc.$ in the axis draw double ordinates, $n o n, etc.$, and from the centre F with the radii $F e o e, etc.$, cut the respective ordinates at $E, G, n, n, etc.$ The curve may be traced through these points as shown. (Fig. 56). — Place a

2d Method. By means of a square and a cord (Fig. 56). — Place a

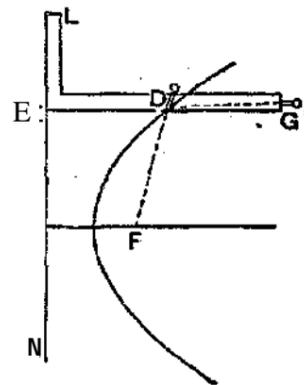

FIG. 56.

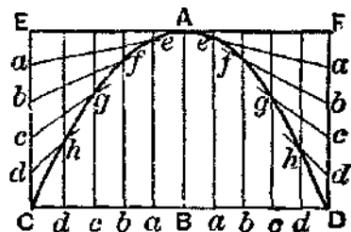

FIG. 57.

47. **The Hyperbola** (Fig. 58). — A hyperbola is a plane curve such that the difference of the distances from any point of it to two fixed points is equal to a given distance, e . The fixed points are called the foci.

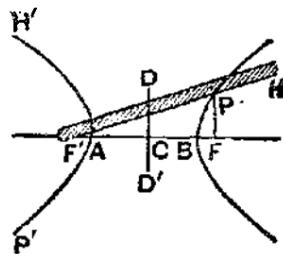

FIG. 58.

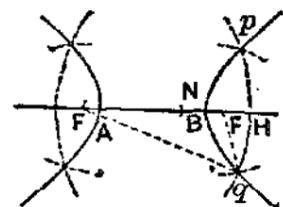

FIG. 59

Then with F' as a centre and NH as a radius describe an arc intersecting the arc before described at p and q . These will be points of the hyperbola, for $F'q - Fq$ is equal to the transverse axis A, B .

If, with F as a centre and $F'H$ as a radius, an arc be described and a second arc be described with F' as a centre and NH as a radius two points in the other branch of the curve will be determined. Hence, by changing the centres, each pair of radii will determine two points in each branch.

The Equilateral Hyperbola. — The transverse axis of a hyperbola is

straight-edge to the directrix EN , and apply to it a square LEG . Fasten to the end G one end of a thread, or cord equal in length to the edge EG , and attach the other end to the focus F ; slide the square along the straight-edge, holding the cord taut against the edge of the square by a pencil D , by which the curve is described.

3d Method: When the height and the base are given (Fig. 57). — Let AB be the given axis, and CD a double ordinate or base; to describe a parabola of which the vertex is at A . Through A draw EF parallel to CD , and through C and D draw CE and DF parallel to the axis. Divide BC and BD into any number of equal parts, say five, at a, b , etc., and divide CE and DF into the same number of parts. Through the points a, b, c, d in the base CD on each side of the axis draw perpendiculars, and through a, b, c draw CE and DF draw lines to the vertex A , cutting the perpendiculars at e, f, g, h . These are points in the parabola, and the curve CAD may be traced as shown, passing through them.

To construct a hyperbola. — Let F' and F be the foci, and $F'F$ the distance between them. Take a ruler longer than the distance $F'F$, and fasten one of its extremities at the focus F' . At the other extremity, H , attach a thread of such a length that the length of the ruler shall exceed the length of the thread by a given distance AB . Attach the other extremity of the thread at the focus F .

Press a pencil, P , against the ruler, and keep the thread constantly taut, while the ruler is turned around F' as a centre. The point of the pencil will describe one branch of the curve.

2d Method: By points (Fig. 59). — From the focus F' lay off a distance $F'N$ equal to the transverse axis, or distance between the two branches of the curve, and take any other distance, as $F'H$, greater than $F'N$.

With F' as a centre and $F'H$ as a radius describe the arc of a circle.

Then with F as a centre and NH as a radius describe an arc intersecting the arc before described at p and q . These will be points of the hyperbola, for $F'q - Fq$ is equal to the transverse axis A, B .

If, with F as a centre and $F'H$ as a radius, an arc be described and a second arc be described with F' as a centre and NH as a radius two points in the other branch of the curve will be determined. Hence, by changing the centres, each pair of radii will determine two points in each branch.

The Equilateral Hyperbola. — The transverse axis of a hyperbola is

the distance, on a line joining the foci, between the two branches of the curve. The conjugate axis is a line perpendicular to the transverse axis, drawn from its centre, and of such a length that the diagonal of the rectangle of the transverse and conjugate axes is equal to the distance between the foci. The diagonals of this rectangle, indefinitely prolonged, are the asymptotes of the hyperbola, lines which the curve continually approaches, but touches only at an infinite distance. If these asymptotes are perpendicular to each other, the hyperbola is called a *rectangular* or *equilateral hyperbola*. It is a property of this hyperbola that if the asymptotes are taken as axes of a rectangular system of coordinates (see Analytical Geometry), the product of the abscissa and ordinate of any point in the curve is equal to the product of the abscissa and ordinate of any other point; or, if p is the ordinate of any point and v its abscissa, and p_1 , and v_1 are the ordinate and abscissa of any other point, $pv = p_1v_1$; or $PV = a$ constant.

48. **The Cycloid** (Fig. 60).

— If a circle Adb be rolled along a straight line $A6$, any point of the circumference as A will describe a curve, which is called a cycloid. The circle is called the generating circle, and A the generating point.

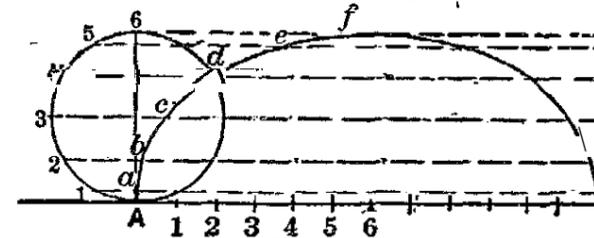

FIG. 60.

To draw a cycloid. — Divide the circumference of the generating circle into an even number of equal parts, as $A, 1, 2$, etc., and set off these distances on the base. Through the points $1, 2, 3$, etc., on the circle draw horizontal lines, and on them set off distances $1a = A1, 2b = A2, 3c = A3$, etc. The points A, a, b, c , etc., will be points in the cycloid, through which draw the curve.

49. **The Epicycloid** (Fig. 61) is generated by a point D in one circle DC rolling upon the circumference of another circle ACB , instead of on a flat surface or line; the former being the generating circle, and the latter the fundamental circle. The generating circle is shown in four positions, in which the generating point is successively marked D, D', D'', D''' . $AD'''B$ is the epicycloid.

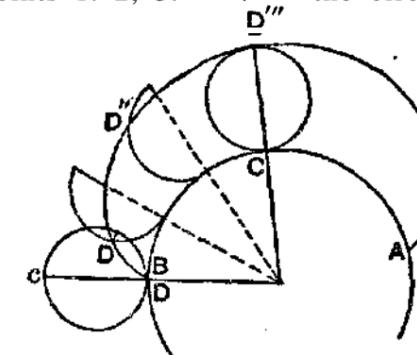

FIG. 61.

50. **The Hypocycloid** (Fig. 62) is generated by a point in the generating circle rolling on the inside of the fundamental circle.

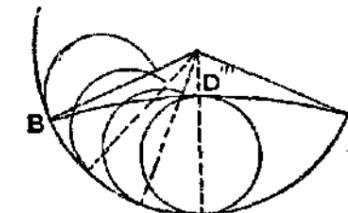

FIG. 62.

When the generating circle = radius of the other circle, the hypocycloid becomes a straight line.

51. **The Tractrix or Schiele's anti-friction curve** (Fig. 63). — R is the radius of the shaft, $C, 1, 2$, etc., the axis. From O set off on R a small distance, oa ; with radius R and centre a cut the axis at 1 , join $a, 1$, and set off a like small distance ab ; from b with radius R cut axis at 2 , join $b, 2$, and so on, thus finding points o, a, b, c , etc., through which the curve is to be drawn.

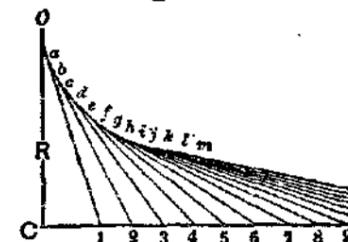

FIG. 63.

62. The Spiral. — The spiral is a curve described by a point which moves along a straight line according to any given law, the line at the same time having a uniform angular motion. The line is called the radius vector.

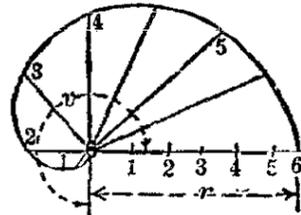

FIG. 64.

the distances 1, 2, 3, 4, etc., corresponding to the scale upon which the curve is drawn, as shown in Fig. 64.

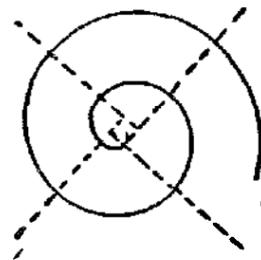

FIG. 65.

63. To find the diameter of a circle into which a certain number of rings will fit. At on its inside (Fig. 66). — For instance, what is the diameter of a circle into which twelve 1/2-inch rings will fit, as per sketch? Assume that we have found the diameter of the required circle and have drawn the rings inside of it. Join the centres of the rings by straight lines, as shown: we then obtain a regular polygon with 12 sides, each side being equal to the diameter of a given ring. We have now to find the diameter of a circle circumscribed about this polygon, and add the diameter of one ring to it; the sum will be the diameter of the circle into which the rings will fit.

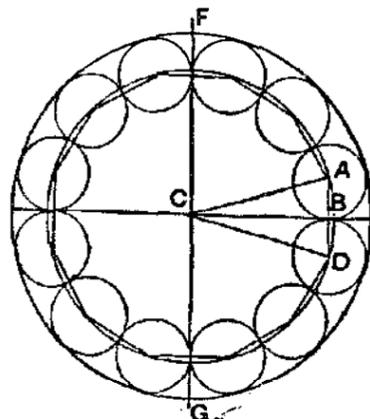

FIG. 66.

Through the centres A and D of two adjacent rings draw the radii CA and CD; since the polygon has twelve sides the angle ACD = 30° and a CB = 15°. One half of the side AD is equal to AB. We now give the following proportion: The sine of the angle ACB is to AB as 1 is to the required radius. From this we get the following rule: Divide AB by the sine of the angle ACB; the quotient will be the radius of the circumscribed circle; add to the corresponding diameter the diameter of one ring; the sum will be the required diameter FG.

54. To describe an arc of a circle which is too large to be drawn by a beam compass, by means of points in the arc radius being given. — Suppose the radius is 20 feet and it is desired to obtain five points in an arc whose half chord is 4 feet. Draw a line equal to the half chord, full size, or on a smaller scale if more convenient, and erect a perpendicular at one end, thus making rectangular axes of coordinates. Erect perpendiculars at points 1, 2, 3, and 4 feet from the first perpendicular. Find values of y in the formula of the circle, $x^2 + y^2 = R^2$, by substituting for

If the radius vector increases directly as the measuring angle, the spires, or parts described in each revolution, thus gradually increasing their distance from each other. The curve is known as the spiral of Archimedes (Fig. 64).

This curve is commonly used for cams. To describe it draw the radius vector in several different directions around the centre with equal angles between them, set off

In the common spiral (Fig. 64) the pitch is uniform; that is, the spires are equidistant. Such a spiral is made by rolling up a belt of uniform thickness.

To construct a spiral with four centres (Fig. 65). — Given the pitch of the spiral, construct a square about the centre, with the sum of the four sides equal to the pitch. Prolong the sides in one direction as shown; the corners are the centres for each arc of the external angles, forming a quadrant of a spire.

the values will be $y = \sqrt{R^2 - x^2} = \sqrt{400 - 1} = \sqrt{399}$, $\sqrt{396}$, the radius, or $\sqrt{391}$, $\sqrt{384} = 20$, 19.975, 19.90, 19.774, 19.596.

Subtract the smallest, 0.404. 0.379. 0.304, 9.178. 0 feet. or 19.596, leaving Lay off these distances on the five perpendiculars, as ordinates from the half chord, and the positions of five points on the arc will be found. Through these the curve may be drawn. (See also Problem 14.)

55. The Catenary is the curve assumed by a perfectly flexible cord when its ends are fastened at two points, the weight of a unit length being constant.

The equation of the catenary is $y = \frac{a}{2} \left(e^{\frac{x}{a}} + e^{-\frac{x}{a}} \right)$, in which e is the base of the Napierian system of logarithms.

To plot the catenary. — Let O (Fig. 67) be the origin of coördinates. Assigning to a any value as 3, the equation becomes

$$y = \frac{3}{2} \left(e^{\frac{x}{3}} + e^{-\frac{x}{3}} \right).$$

To find the lowest Point of the curve.

$$\text{Put } x = 0; \therefore y = \frac{3}{2} (e^0 + e^{-0}) = \frac{3}{2} (1 + 1) = 3.$$

$$\text{Then put } x = 1; \therefore y = \frac{3}{2} (e^{\frac{1}{3}} + e^{-\frac{1}{3}}) = \frac{3}{2} (1.396 + 0.717) = 3.17.$$

$$\text{Put } x = 2; \therefore y = \frac{3}{2} (e^{\frac{2}{3}} + e^{-\frac{2}{3}}) = \frac{3}{2} (1.948 + 0.513) = 3.69.$$

Put $x = 3, 4, 5, \text{ etc.}$ and find the corresponding values of y. For each value of y we obtain two symmetrical points, as for example p and p'. In this way, by making a successively equal to 2, 3, 4, 5, 6, 7, and 8, the curves of Fig. 67 were plotted.

In each case the distance from the origin to the lowest point of the curve is equal to a; for putting $x = 0$, the general equation reduces to $y = a$.

For values of a = 6, 7, and 8 the catenary closely approaches the parabola. For derivation of the equation of the catenary see Bowser's Analytic Mechanics.

66. The involute is a name given to the curve which is formed by the end of a string which is unwound from a cylinder and kept taut, consequently the string as it is unwound will always lie in the direction of a tangent to the cylinder. To describe the involute of any given circle, Fig. 68, take any point A on its circumference, draw a diameter AB, and from B draw Bb perpendicular to AB. Make Bb equal in length to half the circumference of the circle. Divide Bb and the semi-circumference into the same number of equal parts, say six.

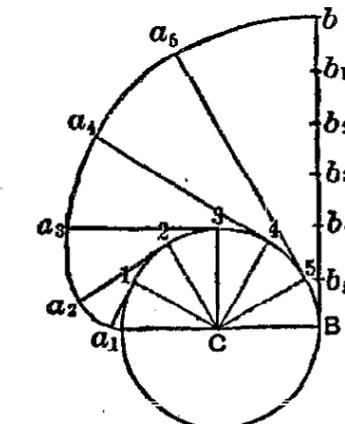

FIG. 66.

From each point of division 1, 2, 3, etc. on the circumference draw lines to the centre C of the circle. Then draw $1a_1$ perpendicular to $C1$; $2a_2$ perpendicular to $C2$; and so on. Make $1a_1$ equal to b_1b_1 ; $2a_2$ equal to b_2b_2 ; $3a_3$ equal to b_3b_3 ; and so on. Join the points A, $a_1, a_2, \text{ as etc.}$, by a curve: this curve will be the required involute.

6.7. Method of plotting angles without using a protractor. — The radius of a circle whose circumference is 360 is 57.3 (more accurately 57.296). Striking a semicircle with a radius 57.3 by any scale, spacers set to 10 by the same scale will divide the arc into 18 spaces of 10° each, and intermediates can be measured indirectly at the rate of 1 by scale for each 1°, or interpolated by eye according to the degree of accuracy required. The following table shows the chords to the above-mentioned radius for every 10 degrees from 0° up to 110°. By means of one of these a 10° point is fixed upon the paper next less than the required angle, and the remainder is laid off at the rate of 1 by scale for each degree.

Angle.	Chord.	Angle.	Chord.	Angle.	Chord.
1°	0.999	40°	39.192	80°	73.658
10°	9.985	50°	48.429	90°	81.029
20°	19.899	60°	57.996	100°	87.782
30°	29.658	70°	65.727	110°	93.869

GEOMETRICAL PROPOSITIONS.

In a right-angled triangle the square on the hypotenuse is equal to the sum of the squares on the other two sides.

If a triangle is equilateral, it is equiangular, and vice versa.

If a straight line from the vertex of an isosceles triangle bisects the base, it bisects the vertical angle and is perpendicular to the base.

If one side of a triangle is produced, the exterior angle is equal to the sum of the two interior and opposite angles.

If two triangles are mutually equiangular, they are similar and their corresponding sides are proportional.

If the sides of a polygon are produced in the same order, the sum of the exterior angles equals four right angles. (Not true if the polygon has re-entering angles.)

In a quadrilateral, the sum of the interior angles equals four right angles.

In a parallelogram, the opposite sides are equal; the opposite angles are equal; it is bisected by its diagonal, and its diagonals bisect each other.

If three points are not in the same straight line, a circle may be passed through them.

If two arcs are intercepted on the same circle, they are proportional to the corresponding angles at the centre.

If two arcs are similar, they are proportional to their radii.

The areas of two circles are proportional to the squares of their radii.

If a radius is perpendicular to a chord, it bisects the chord and it bisects the arc subtended by the chord.

A straight line tangent to a circle meets it in only one point, and it is perpendicular to the radius drawn to that point.

If from a point without a circle tangents are drawn to touch the circle, there are but two; they are equal, and they make equal angles with the chord joining the tangent points.

If two lines are parallel chords or a tangent and parallel chord, they intercept equal arcs of a circle.

If an angle at the circumference of a circle, between two chords, is subtended by the same arc as an angle at the centre, between two radii, the angle at the circumference is equal to half the angle at the centre.

If a triangle is inscribed in a semicircle, it is right-angled.

If two chords intersect each other in a circle, the rectangle of the segments of the one equals the rectangle of the segments of the other.

And if one chord is a diameter and the other perpendicular to it, the rectangle of the segments of the diameter is equal to the square on the half the other chord, and the half chord is a mean proportional between the segments of the diameter.

If an angle is formed by a tangent and a chord, it is measured by one half of the arc intercepted by the chord; that is, it is equal to half the angle at the centre subtended by the chord.

Degree of a Railway Curve. — This last proposition is useful in staking out railway curves. A curve is designated as one of so many degree% and the degree is the angle at the centre subtended by a chord of 100 ft. To lay out a curve of *n* degrees the transit is set at its beginning or "point of curve," pointed in the direction of the tangent, and turned through $1/2n$ degrees, a point 100 ft. distant in the line of sight will be a point in the curve. The transit is then swung $1/2n$ degrees further and a 100 ft. chord is measured from the point already found to a point in the new line of sight, which is a second point or "station" in the curve.

The radius of a 1° curve is 5729.65 ft., and the radius of a Curve of any degree is 5729.65 ft. divided by the number of degrees.

MENSURATION.

PLANE SURFACES.

Quadrilateral. — A four-sided figure.

Parallelogram. — A quadrilateral with opposite sides parallel. **Rectangles.** — Square: four sides equal, all angles right angles. **Rhombus.** — four sides equal, opposite angles equal, angles not right angles. **Rhomboid:** opposite sides equal, opposite angles equal, angles not right angles.

Trapezium. — A quadrilateral with unequal sides.

Trapezoid. — A quadrilateral with only one pair of opposite sides parallel.

Diagonal of a square = $\sqrt{2} \times \text{side} = 1.4142 \times \text{side}$

Diag. of a rectangle = $\sqrt{\text{sum of squares of two adjacent sides}}$

Area of any parallelogram = base X altitude.

Area of rhombus or rhomboid = product of two adjacent sides X sine of angle included between them.

Area of a trapezoid = product of half the sum of the two parallel sides by the perpendicular distance between them.

To find the area of any quadrilateral figure. — Divide the quadrilateral into two triangles; the sum of the areas of the triangles is the area.

Or, multiply half the product of the two diagonals by the sine of the angle at their intersection.

To find the area of a quadrilateral which may be inscribed in a circle. — From half the sum of the four sides subtract each side severally; multiply the four remainders together; the square root of the product is the area.

Triangle. — A three-sided plane figure.

Varieties. — Right-angled, having one right angle; obtuse-angled, having one obtuse angle; isosceles, having two equal angles and two equal sides; equilateral, having three equal sides and equal angles.

The sum of the three angles of every triangle = 180°.

The sum of the two acute angles of a right-angled triangle = 90°.

Hypotenuse of a right-angled triangle, the side opposite the right angle, = $\sqrt{\text{sum of the squares of the other two sides}}$ or $a = \sqrt{c^2 - b^2} = \sqrt{(c+b)(c-b)}$.

If the two sides are equal, side = hyp ÷ 1.4142; or hyp X .7071.

To find the area of a triangle:

RULE 1. Multiply the base by half the altitude.

RULE 2. Multiply half the product of two sides by the sine of the included angle.

RULE 3. From half the sum of the three sides subtract each side severally, multiply together the half sum and the three remainders, and extract the square root of the product.

The area of an equilateral triangle is equal to one fourth the square of one of its sides multiplied by the square root of 3, = $\frac{1}{4} a^2 \sqrt{3}$, a being the side; or $a^2 \times 0.433013$.

Area of a triangle given, to find base: Base = twice area ÷ perpendicular height.

Area of a triangle given, to find height: Height = twice area ÷ base. Two sides and base given, to find perpendicular height (In a triangle in which both of the angles at the base are acute).

RULE. — As the base is to the sum of the sides, so is the difference of the sides to the difference of the divisions of the base made by drawing the perpendicular. Half this difference being added to or subtracted from half the base will give the two divisions thereof. As each side and its opposite division of the base constitutes a right-angled triangle, the perpendicular is ascertained by the rule: Perpendicular = $\sqrt{\text{hyp}^2 - \text{base}^2}$.

Areas of similar figures are to each other as the squares of their respective linear dimensions. If the area of an equilateral triangle of side = 1 is 0.433013 and its height 0.86603, what is the area of a similar triangle whose height = 1? $0.86603^2 : 1^2 :: 0.433013 : 0.57735$. Ans.

Polygon. — A plane figure having three or more sides. Regular or irregular, according as the sides or angles are equal or unequal. Polygons are named from the number of their sides and angles.

To find the area of an irregular polygon. — Draw diagonals dividing the polygon into triangles, and find the sum of the areas of these triangles.

To find the area of a regular polygon:

RULE. — Multiply the length of a side by the perpendicular distance to the centre: multiply the product by the number of sides and divide it by 2. Or, multiply the perimeter by the perpendicular let fall from the centre on one of the sides.

The perpendicular from the centre is equal to half of one of the sides of the polygon multiplied by the cotangent of the angle subtended by the half side.

The angle at the centre = 360° divided by the number of sides.

Table of Regular Polygons.

No. of Sides.	Name of Polygon.	Area, Side = 1.	Area, Short diam.* = 1.	Radius of Circumscribed Circle.		Radius of Inscribed Circle, Side = 1.	Length of Side, Radius of Circumscribed Circle = 1.	Angle at Centre.	Angle between Adjacent Sides.
				Perpen. from Centre = 1.	Side = 1.				
3	Triangle	0.4330	0.5773	2.414	0.5078	0.2887	1.732	120°	
4	Square	1.0000	1.0000	1.238	0.8506	0.5000	1.414	90°	60°
5	Pentagon	1.7205	0.7265	1.151	1.5241	0.666	1.0000	72°	108°
6	Hexagon	2.5981	0.8660	1.1551	1.5241	0.666	1.0000	60°	120°
7	Heptagon	3.6399	0.7572	1.1551	1.5241	1.0383	0.8677	51° 26'	128° 47'
8	Octagon	4.8284	0.8284	1.064	1.3066	1.2071	0.8408	45°	135°
9	Nonagon	6.1818	0.7688	1.051	1.618	1.3270	0.618	40°	140°
10	Decagon	7.6942	0.8123	1.044	1.7747	1.5388	0.618	36°	144°
11	Undecagon	9.3656	0.7744	1.037	1.9319	1.7028	0.5634	32° 43'	147° 11'
12	Dodecagon	11.1962	0.8038	1.037	1.9319	1.866	0.5176	30°	150°

* Short diameter, even number of sides = diam. of inscribed circle; short diam., odd number of sides, = rad. of inscribed circle + rad. of circumscribed circle.

To find the area of a regular polygon, when the length of a side only is given:

RULE. — Multiply the square of the side by the multiplier opposite to the name of the polygon in the table.

Length of a side of a regular polygon inscribed in a circle = diam. × sin (180° ÷ no. of sides).

No. of sides	sin (180°/n)	No. of sides	sin (180°/n)	No. of sides	sin (180°/n)
3	0.86603	9	0.34202	15	0.20791
4	.70711	10		16	
5	.61803	11	.30902	17	.19509
6	.58778	12	.25882		
7	.43388	13	.23931	18	.17365
8	.38268	14	.22252	20	.15643

To find the area of an irregular figure, (Fig. 69). — Draw ordinates across its breadth at equal distances apart, the first and the last ordinate each being one half space from the ends of the figure. Find the average breadth by adding together the lengths of these lines included between the boundaries of the figure, and divide by the number of the lines added; multiply this mean breadth by the length. The greater the number of lines the nearer the approximation.

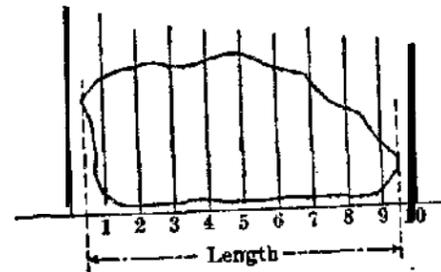

FIG. 69.

In a figure of very irregular outline, as an indicator-diagram from a high-speed steam-engine, mean lines may be substituted for the actual lines of the figure, being so traced as to intersect the undulations, so that the total area of the spaces cut off may be compensated by that of the extra spaces inclosed.

2d Method. THE TRAPEZOIDAL RULE. — Divide the figure into any sufficient number of equal parts: add half the sum of the two end ordinates to the sum of all the other ordinates: divide by the number of spaces (that is, one less than the number of ordinates) to obtain the mean ordinate, and multiply this by the length to obtain the area.

3d Method: SIMPSON'S RULE. — Divide the length of the figure into any even number of equal parts, at the common distance *D* apart, and draw ordinates through the points of division to touch the boundary lines. Add together the first and last ordinates and call the sum *A*; add together the even ordinates and call the sum *B*; add together the odd ordinates, except the first and last, and call the sum *C*. Then,

$$\text{area of the figure} = \frac{A + 4B + 2C}{3} \times D.$$

4th Method: DURAND'S RULE. — Add together $\frac{1}{10}$ the sum of the first and last ordinates, $\frac{1}{10}$ the sum of the second and the next to the last (or the penultimates), and the sum of all the intermediate ordinates. Multiply the sum thus gained by the common distance between the ordinates to obtain the area, or divide this sum by the number of spaces to obtain the mean ordinate.

Prof. Durand describes the method of obtaining his rule in *Engineering News*, Jan. 15, 1894. He claims that it is more accurate than Simpson's rule and practically as simple as the trapezoidal rule. He thus describes its application for approximate integration of differential equations. Any definite integral may be represented graphically by an area. Thus, let

$$Q = \int u \, dx$$

be an integral in which *u* is some function of *x*, either known or admitting of computation or measurement. Any curve plotted with *x* as abscissa and *u* as ordinate will then represent the variation of *u* with *x*, and the

area between such curve and the axis X will represent the integral in question, no matter how simple or complex may be the real nature of the function u.

Substituting in the rule as above given the word "volume" for "area" and the word "section" for "ordinate," it becomes applicable to the determination of volumes from equidistant sections as well as of areas from equidistant ordinates.

Having approximately obtained an area by the trapezoidal rule the area by Durand's rule may be found by adding algebraically to the sum of the ordinates used in the trapezoidal rule (that is, half the sum of the end ordinates + sum of the other ordinates) 1/10 of (sum of penultimates - sum of first and last) and multiplying by the common distance between the ordinates.

5th Method. — Draw the figure on cross-section paper. Count the number of squares that are entirely included within the boundary. then estimate the fractional parts of squares that are cut by the boundary. add together these fractions and add the sum to the number of whole squares. The result is the area in units of the dimensions of the squares. The finer the rule of the cross-section paper the more accurate the result.

6th Method. — Use a planimeter.
7th Method. — With a chemical balance; sensitive to one milligram draw the figure on paper of uniform thickness and cut it out carefully; weigh the piece cut out, and compare its weight with the weight per square inch of the paper as tested by weighing a piece of rectangular shape.

THE CIRCLE.

Circumference = diameter X 3.1416, nearly; more accurately, 3.14159265359.

Approximations, $\frac{22}{7} = 3.143$; $\frac{355}{113} = 3.1415929$.

The ratio of circum. to diam. is represented by the symbol π (called Pi).
 Area = 0.7854 X square of the diameter.

Multiples of π .		Multiples of $\frac{\pi}{4}$.	
$1\pi = 3.14159265359$		$1/4\pi = 0.7853982$	
$2\pi = 6.28318530718$		$\times 2 = 1.5707963$	
$3\pi = 9.42477796077$		$\times 3 = 2.3561945$	
$4\pi = 12.56637061436$		$\times 4 = 3.1415927$	
$5\pi = 15.70796326795$		$\times 5 = 3.9269908$	
$6\pi = 18.84955592154$		$\times 6 = 4.7123890$	
$7\pi = 21.99114857513$		$\times 7 = 5.4977871$	
$8\pi = 25.13274122872$		$\times 8 = 6.2831853$	
$9\pi = 28.27433388231$		$\times 9 = 7.0685835$	

Ratio of diam. to circumference = reciprocal of $\pi = 0.3183099$.

Reciprocal of $1/4\pi = 1.27324$	$7/\pi = 2.22817$	$\pi/12 = 0.261799$
Multiples of $1/\pi$.	$8/\pi = 2.54645$	$a/360 = 0.0087266$
$1/x = 0.31831$	$9/\pi = 2.86479$	$360/n = 114.5915$
$2/\pi = 0.63662$	$10/\pi = 3.18310$	$\pi^2 = 9.86960$
$3/\pi = 0.95493$	$12/\pi = 3.81972$	$1/\pi^2 = 0.101321$
$4/\pi = 1.27324$	$\pi/2 = 1.570796$	$\sqrt{\pi} = 1.772453$
$5/\pi = 1.59155$	$\pi/3 = 1.047197$	$\sqrt{1/\pi} = 0.564189$
$6/\pi = 1.90986$	$\pi/6 = 0.523599$	$\text{Log } \pi = 0.49714987$
		$\text{Log } n/4 = 1.895090$

Diam. in ins. = 13.5405 $\sqrt{\text{area in sq. ft.}}$

Area in sq. ft. = (diam. in inches)² x .0054542.

D = diameter, R = radius, C = circumference, A = area.

$$C = \pi D; = 2\pi R; = \frac{4A}{D}; = 2\sqrt{\pi A}; = 3.545\sqrt{A};$$

$$A = D^2 \times .7854; = \frac{CR}{2}; = 4R^2 \times .7854; = \pi R^2; = \frac{1}{4}\pi D^2; = \frac{C^2}{4\pi}; = .07958C^2; = \frac{CD}{4}$$

$$D = \frac{C}{\pi}; = 0.31831C; = 2\sqrt{\frac{A}{\pi}}; = 1.12838\sqrt{A};$$

$$R = \frac{C}{2\pi}; = 0.159155C; = \sqrt{\frac{A}{\pi}}; = 0.564189\sqrt{A}.$$

Areas of circles are to each other as the squares of their diameters.
To find the length of an arc of a circle:
RULE 1. As 360 is to the number of degrees in the arc, so is the circumference of the circle to the length of the arc.
RULE 2. Multiply the diameter of the circle by the number of degrees in the arc, and this product by 0.0087266.

Relations of Arc, Chord, Chord of Half the Arc, etc.

Let R = radius, D = diameter, L = length of arc,
 C = chord of the arc, c = chord of half the arc,
 V = rise, or height of the arc,
 Length of the arc = $L = \frac{8c - C}{3}$ (very nearly). = $\frac{2c \times 10V}{60D - 27V} + 2c$, nearly,
 $= \frac{\sqrt{C^2 + 4V^2} \times 10V^2}{15C^2 + 33V^2} + 2c$ nearly

$$\text{Chord of the arc } C, = 2\sqrt{c^2 - V^2}; = \sqrt{D^2 - (D - 2V)^2}; = 8c - 3L$$

$$= 2\sqrt{R^2 - (R - V)^2}; = 2\sqrt{(D - V) \times V}.$$

$$\text{Chord of half the arc, } c = 1/2\sqrt{C^2 + 4V^2}; = \sqrt{D \times V}; = (3L + C) \div 8.$$

$$\text{Diameter of the circle, } D = \frac{c^2}{V}; = \frac{1/4 C^2 + V^2}{V};$$

$$\text{Rise of the arc, } V = \frac{c^2}{D}; = 1/2 (D - \sqrt{D^2 - C^2}).$$

$$\text{(or if } V \text{ is greater than radius } 1/2 (D + \sqrt{D^2 - C^2});$$

$$= \sqrt{c^2 - 1/4 C^2}.$$

Half the chord of the arc is a mean proportional between the rise and the diameter minus the rise: $1/2 C = \sqrt{V \times (D - V)}$.
Length of the Chord subtending an angle α at the centre = twice the sine of half the angle. (See Table of Sines).
Ordinates to Circular Arcs. — C = chord, V = height of the arc, or middle ordinate, x = abscissa, or distance measured on the chord from its central point, y = ordinate, or distance from the arc to the chord at the point x, $V = R - \sqrt{R^2 - 1/4 C^2}$; $y = \sqrt{R^2 - x^2} - (R - V)$.

Length of a Circular Arc. — Huyghens's Approximation.

Length of the arc. $L = (8c - C) \div 3$. Professor Williamson shows that when the arc subtends an angle of 30°, the radius being 100,000 feet (nearly 19 miles), the error by this formula is about two inches, or 1/600,000 part of the radius. When the length of the arc is equal to the radius, i.e., when it subtends an angle of 57°.3, the error is less than 1/7680 part of the radius. Therefore, if the radius is 100,000 feet, the error is less than 100,000/7680 = 13 feet. The error increases rapidly with the increase of the angle subtended. For an arc of 120° the error is 1 part in 400; for an arc of 180° the error is 1.18%.

In the measurement of an arc which is described with a short radius the error is so small that it may be neglected. Describing an arc with a radius of 12 inches subtending an angle of 30°, the error is 1/50000 of an inch.

To measure an arc when it subtends a large angle, bisect it and measure each half as before—in this casemaking B = length of the chord of half the arc, and b = length of the chord of one-fourth the arc; then $L = (16b - 2B) \div 3$.

Formulas for a Circular Curve.

J. C. Locke, *Eng. News*, March 16, 1908.

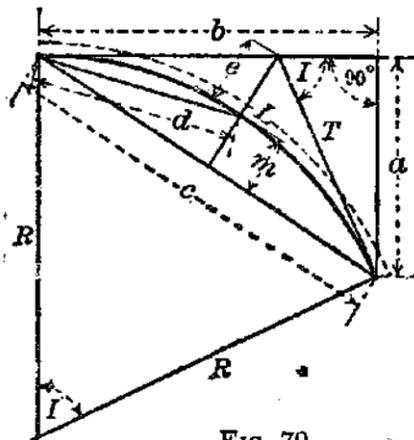

$$c = \sqrt{2Ra}, = \sqrt{a^2 + b^2},$$

$$= \sqrt{2R(R - \sqrt{(R + b)(R - b)})}$$

$$= 2\sqrt{m(2R - m)}, = 2R \sin \frac{1}{2}I,$$

$$= 2T \cos \frac{1}{2}I.$$

$$e = R \operatorname{exsec} \frac{1}{2}I, = R \tan \frac{1}{2}I \tan \frac{1}{4}I,$$

$$= T \tan \frac{1}{4}I.$$

$$b = \sqrt{a(2R - a)}, = \sqrt{\left(c + \frac{c^2}{2R}\right)\left(c - \frac{c^2}{2R}\right)},$$

$$= R \sin I, = a \cot \frac{1}{2}I.$$

$$R = \frac{a^2 + b^2}{2a}, = \frac{c^2}{2a}, = \frac{d^2}{2m}, = \frac{c^2 + 4m}{8m}.$$

FIG. 70.

$$d = \sqrt{2Rm}, = \sqrt{R(2R - \sqrt{(2R + c)(2R - c)})}, = 2R \sin \frac{1}{4}I.$$

$$m = \frac{d^2}{2R}, = R \mp \sqrt{\left(R + \frac{c}{2}\right)\left(R - \frac{c}{2}\right)}, = R \operatorname{vers} \frac{1}{2}I,$$

$$= R \sin \frac{1}{2}I \tan \frac{1}{4}I, = \frac{1}{2}c \tan \frac{1}{4}I.$$

$$a = \frac{c^2}{2R}, = R - \sqrt{(R + b)(R - b)}, = 2R (\sin \frac{1}{2}I)^2, = R \operatorname{vers} I,$$

$$= R \sin I \tan \frac{1}{2}I, = b \tan \frac{1}{2}I, = T \sin I.$$

$$T = R \tan \frac{1}{2}I. \quad I = \frac{L}{R} \times 57.295780^\circ. \quad R = \frac{L}{I} \times 57.295750''.$$

$$L = IR \times 0.01745329, = \frac{8d - c}{3}.$$

$$\text{Area of Segment} = \frac{LR}{2} - \frac{R^2 \sin I}{2}, = \frac{LR}{2} - \frac{Rb}{2}.$$

Relation of the Circle to its Equal, Inscribed, and Circumscribed Squares.

Diameter of circle	x 0.88623)	= side of equal square.
Circumference of circle	x 0.28209	= perimeter of equal square.
Diameter of circle	x 0.7071	= side of inscribed square.
Circumference of circle	x 0.22508	= side of inscribed square.
Area of circle x diameter	x 0.90031	= area of circumscribed square.
Area of circle	x 1.2732	= area of inscribed square.
Area of circle	x 0.63662	= diam. of circumscribed circle.
Side of square	x 1.4142	= circum.
" " x	x 4.4428	= diam. of equal circle.
" " x	x 1.1284	= circum. " "
" " x	x 3.5449	= circum. " "
Perimeter of square	x 0.88623	= circular inches.
Square inches	x 1.2732	= circular inches.

Sectors and Segments. — To find the area of a sector of a circle.

RULE 1. Multiply the arc of the sector by half its radius.

RULE 2. As 360 is to the number of degrees in the arc, so is the area of the circle to the area of the sector.

RULE 3. Multiply the number of degrees in the arc by the square of the radius and by 0.005727.

To find the area of a segment of a circle: Find the area of the sector which has the same arc, and also the area of the triangle formed by the chord of the segment and the radii of the sector.

Then take the sum of these areas, if the segment is greater than a semi-circle, but take their difference if it is less. (See Table of Segments.)

Another Method: Area of segment = $\frac{1}{2}R^2$ (arc-sin A), in which A is the central angle, R the radius, and arc the length of arc to radius 1.

To find the area of a segment of a circle when its chord and height only are given. First, find radius, as follows:

$$\text{radius} = \frac{1}{2} \left[\frac{\text{square of half the chord} + \text{height}}{\text{height}} \right].$$

2. Find the angle subtended by the arc, as follows: half chord ÷ radius = sine of half the angle. Take the corresponding angle from a table of sines, and double it to get the angle of the arc.

3. Find area of the sector of which the segment is a part:

$$\text{area of sector} = \text{area of circle} \times \text{degrees of arc} \div 360.$$

4. Subtract area of triangle under the segment:

$$\text{Area of triangle} = \text{half chord} \times (\text{radius} - \text{height of segment}).$$

The remainder is the area of the segment.

When the chord, arc, and diameter are given, to find the area, From the length of the arc subtract the length of the chord. Multiply the remainder by the radius or one-half diameter: to the product add the chord multiplied by the height, and divide the sum by 2.

Given diameter, d , and height of segment, h .

$$\text{When } h \text{ is from } 0 \text{ to } \frac{1}{4}d, \text{ area} = h\sqrt{1.766dh - h^2};$$

$$\text{" " " " } \frac{1}{4}d \text{ to } \frac{1}{2}d, \text{ area} = h\sqrt{0.017d^2 + 1.7dh - h^2}$$

(approx.). Greatest error 0.23%, when $h = \frac{1}{4}d$.

To find the chord: From the diameter subtract the height; multiply the remainder by four times the height and extract the square root.

When the chords of the arc and of half the arc and the rise are given: To the chord of the arc add four thirds of the chord of half the arc; multiply the sum by the rise and the product by 0.40426 (approximate).

Circular Ring. — To find the area of a ring included between the circumferences of two concentric circles: Take the difference between the areas of the two circles; or, subtract the square of the less radius from the square of the greater, and multiply their difference by 3.14159.

$$\text{The area of the greater circle is equal to } \pi R^2;$$

$$\text{and the area of the smaller, } \pi r^2.$$

Their difference, or the area of the ring, is $\pi(R^2 - r^2)$.

The Ellipse. — Area of an ellipse = product of its semi-axes X 3.14159 = product of its axes X 0.785398.

$$\text{The Ellipse. — Circumference (approximate) = } 3.1416 \sqrt{\frac{D^2 + d^2}{2}}.$$

and d being the two axes.

Trautwine gives the following as more accurate: When the longer axis D is not more than five times the length of the shorter axis, d ,

$$\text{Circumference} = 3.1416 \sqrt{\frac{D^2 + d^2}{2} - \frac{(D - d)^2}{8.8}}$$

When D is more than $5d$, the divisor 8.8 is to be replaced by the following:

For $D/d = 6$	7	8	9	10	12	14	16	18	20	30	40	50
Divisor = 9	9.2	9.3	9.35	9.4	9.5	9.6	9.68	9.75	9.8	9.92	9.98	10

An accurate formula is $C = \pi(a+b) \left(1 + \frac{A^2}{4} + \frac{A^4}{64} + \frac{A^6}{256} + \frac{25A^8}{16384} + \dots \right)$,
in which $A = \frac{a-b}{a+b}$ *Ingenieurs Taschenbuch*, 1896. (a and b , semi-axes.)

Carl G. Barth (*Machinery*, Sept., 1900) gives as a very close approximation to this formula

$$C = \pi(a+b) \frac{64 - 3A^4}{64 - 16A^2}$$

Area of a segment of an ellipse the base of which is parallel to one of the axes of the ellipse. Divide the height of the segment by the axis of which it is part, and find the area of a circular segment, in a table of circular segments, of which the height is equal to the quotient: multiply the area thus found by the product of the two axes of the ellipse.

Cycloid. — A curve generated by the rolling of a circle on a plane.

Length of a cycloidal curve = 4 X diameter of the generating circle
Length of the base-circumference of the generating circle:
Area of a cycloid = 3 X area of generating circle.

Helix (Screw). — A line generated by the progressive rotation of a point around an axis and equidistant from its center.

Length of a helix. — To the square of the circumference described by the generating point add the square of the distance advanced in one revolution, and take the square root of their sum multiplied by the number of revolutions of the generating point. Or,

$$\sqrt{(c^2 + h^2)n} = \text{length, } n \text{ being number of revolutions.}$$

Spirals. — Lines generated by the progressive rotation of a point around a fixed axis, with a constantly increasing distance from the axis.

A **plane spiral** is made when the point rotates in one plane.

A **conical spiral** is made when the point rotates around an axis at a progressing distance from its center, and advancing in the direction of the axis, as around a cone.

Length of a plane spiral line. — When the distance between the coils is uniform

RULE. — Add together the greater and less diameters, divide their sum by 2; multiply the quotient by 3.1416, and again by the number of revolutions. Or, take the mean of the length of the greater and less circumferences and multiply it by the number of revolutions. Or,

$$\text{length} = \pi n \frac{d+d'}{2}, \text{ } d \text{ and } d' \text{ being the inner and outer diameters.}$$

Length of a conical spiral line. — Add together the greater and less diameters; divide their sum by 2 and multiply the quotient by 3.1416. To the square of the product of this circumference and the number of revolutions of the spiral add the square of the height of its axis and take the square root of the sum.

$$\text{Or, length} = \sqrt{\left(\pi n \frac{d+d'}{2}\right)^2 + h^2}$$

SOLID BODIES.

Surfaces and Volumes of Similar Solids. — The surfaces of two similar solids are to each other as the squares of their linear dimensions. The volumes are as the cubes of their linear dimensions. If L = the side

of a cube or other solid, and l the side of a similar body of different size, S, s , the surfaces and V, v , the volumes respectively, $S : s :: L^2 : l^2$; $V : v :: L^3 : l^3$.

The Prism. — To find the surface of a right prism: Multiply the perimeter of the base by the altitude for the convex surface. To this add the areas of the two ends when the entire surface is required.

Volume of a prism = area of its base X its altitude.

The pyramid. — Convex surface of a regular pyramid = perimeter of its base X half the slant height. To this add area of the base if the whole surface is required.

Volume of a pyramid = area of base X one third of the altitude.

To find the surface of a frustum of a regular pyramid: Multiply half the slant height by the sum of the perimeters of the two bases for the convex surface. To this add the areas of the two bases when the entire surface is required.

To find the volume of a frustum of a pyramid: Add together the areas of the two bases and a mean proportional between them, and multiply the sum by one third of the altitude. (Mean proportional between two numbers = square root of their product.)

Wedge. — A wedge is a solid bounded by five planes, viz.: a rectangular base, two trapezoids, or two rectangles, meeting in an edge, and two triangular ends. The altitude is the perpendicular drawn from any point in the edge to the plane of the base.

To find the volume of a wedge: Add the length of the edge to twice the length of the base, and multiply the sum by one sixth of the product of the height of the wedge and the breadth of the base.

Rectangular prismoid. — A rectangular prismoid is a solid bounded by six planes, of which the two bases are rectangles, having their corresponding sides parallel, and the four upright sides of the solid are trapezoids.

To find the volume of a rectangular prismoid: Add together the areas of the two bases and four times the area of a parallel section equally distant from the bases, and multiply the sum by one sixth of the altitude.

Cylinder. — Convex surface of a cylinder = perimeter of base X altitude. To this add the areas of the two ends when the entire surface is required.

Volume of a cylinder = area of base X altitude.

Cone. — Convex surface of a cone = circumference of base X half the slant height. To this add the area of the base when the entire surface is required.

Volume of a cone = area of base X one third of the altitude.

To find the surface of a frustum of a cone: Multiply half the side by the sum of the circumferences of the two bases for the convex surface; to this add the areas of the two bases when the entire surface is required.

To find the volume of a frustum of a cone: Add together the areas of the two bases and a mean proportional between them, and multiply the sum by one third of the altitude. Or, Vol. = $0.2618a(b^2 + c^2 + bc)$; a = altitude; b and c , diams. of the two bases.

Sphere. — To find the surface of a sphere: Multiply the diameter by the circumference of a great circle; or, multiply the square of the diameter by 3.14159.

Surface of sphere = 4 X area of its great circle.
" " " = convex surface of its circumscribing cylinder.

Surfaces of spheres are to each other as the squares of their diameters.

To find the volume of a sphere: Multiply the surface by one third of the radius, or multiply the cube of the diameter by $\pi/6$; that is, by 0.5236.

Value of $\pi/6$ to 10 decimal places = 0.5235987756.
The volume of a sphere = $2/3$ the volume of its circumscribing cylinder.
Volumes of spheres are to each other as the cubes of their diameters.

Spherical triangle. — To find the area of a *spherical triangle*: Compute the surface of the *quadrantal triangle*, or one eighth of the surface of the *sphere*. From the sum of the three angles subtract two right angles; divide the remainder by 90, and multiply the quotient by the area of the *quadrantal triangle*.

Spherical polygon. — To find the area of a *spherical polygon*: Compute the surface of the *quadrantal triangle*. From the sum of all the angles subtract the product of two right angles by the number of sides less two; divide the remainder by 90 and multiply the quotient by the area of the *quadrantal triangle*.

The prismoid. — The prismoid is a solid having parallel end areas, and may be composed of any combination of prisms, cylinders, wedges, pyramids, or cones or frustums of the same, whose bases and apices lie in the end areas.

Inasmuch as cylinders and cones are but special forms of prisms and pyramids, and warped surface solids may be divided into elementary forms of them, and since frustums may also be subdivided into the elementary forms, it is sufficient to say that all prismoids may be decomposed into prisms, wedges, and pyramids. If a formula can be found which is equally applicable to all of these forms, then it will apply to any combination of them. Such a formula is called

The Prismoidal Formula.

Let *A* = area of the base of a prism, wedge, or pyramid:

Al. *A*₂, *A*₁ = the two end and the middle areas of a prismoid, or of any of its elementary solids; *h* = altitude of the prismoid or elementary solid; *V* = its volume:

$$V = \frac{h}{6} (A_1 + 4A_m + A_2).$$

For a prism, Al. *A*₁ and *A*₂ are equal. = *A*; $V = \frac{h}{6} \times 6A = hA$.

For a wedge with parallel ends, *A*₂ = 0, $A_m = \frac{1}{2} A_1$; $V = \frac{h}{6} (A_1 + 2A_1) = \frac{hA}{2}$.

For a cone or pyramid, *A*₂ = 0, $A_m = \frac{1}{4} A_1$; $V = \frac{h}{6} (A_1 + A_1) = \frac{hA}{3}$.

The prismoidal formula is a rigid formula for all prismoids. The only approximation involved in its use is in the assumption that the given solid may be generated by a right line moving over the boundaries of the end areas.

The area of the middle section is never the mean of the two end areas if the prismoid contains any pyramids or cones among its elementary forms. When the three sections are similar in form the *dimensions* of the middle area are always the means of the corresponding end dimensions. This fact often enables the dimensions, and hence the area of the middle section, to be computed from the end areas.

Polyedrons. — A polyedron is a solid bounded by plane polygons. A regular polyedron is one whose sides are all equal regular polygons.

To find the surface of a regular polyedron. — Multiply the area of one of the faces by the number of faces; or, multiply the square of one of the edges by the surface of a similar solid whose edge is unity.

A TABLE OF THE REGULAR POLYEDRONS WHOSE EDGES ARE UNITY.

Names.	No. of Faces.	Surface.	Volume.
Tetraedron.....	4	1.7320508	0.1178513
Hexaedron.....	6	6.0000000	1.0000000
Octaedron.....	8	3.4641016	0.4714045
Dodecaedron.....	12	20.6457288	7.6631189
Icosaedron.....	20	8.6602540	2.1816950

To find the volume of a regular polyedron. — Multiply the surface by one third of the perpendicular let fall from the centre, on one of the faces; or, multiply the cube of one of the edges by the solidity of a similar polyedron whose edge is unity.

Solid of revolution. — The volume of any solid of revolution is equal to the product of the area of its generating surface by the length of the path of the centre of gravity of that surface.

The convex surface of any solid of revolution is equal to the product of the perimeter of its generating surface by the length of path of its centre of gravity.

Cylindrical ring. — Let *d* = outer diameter; *d'* = inner diameter; $\frac{1}{2}(d - d')$ = thickness = *t*; $\frac{1}{4}\pi t^2$ = sectional area; $\frac{1}{2}(d + d')$ = mean diameter = *M*; πt = circumference of section; πM = mean circumference of ring; surface = $\pi t \times \pi M$; = $\frac{1}{4}\pi^2 (d^2 - d'^2)$; = 9.86965 *tM*; = 2.46741 (*d*² - *d'*²); volume = $\frac{1}{4}\pi t^2 M \pi$; = 2.467241 *t*² *M*.

Spherical zone. — Surface of a spherical zone or segment of a sphere = its altitude X the circumference of a great circle of the sphere, A great circle is one whose plane passes through the centre of the sphere.

Volume of a zone of a sphere. — To the sum of the squares of the radii of the ends add one third of the square of the height; multiply the sum by the height and by 1.5708.

Spherical segment. — Volume of a spherical segment with one base. — Multiply half the height of the segment by the area of the base, and the cube of the height by 6.5236 and add the two products. Or, from three times the diameter of the sphere subtract twice the height of the segment; multiply the difference by the square of the height and by 0.5236. Or, to three times the square of the radius of the base of the segment add the square of its height, and multiply the sum by the height and by 0.5236.

Spheroid or ellipsoid. — When the revolution of the generating surface of the spheroid is about the transverse diameter the spheroid is prolate, and when about the conjugate it is oblate.

Convex surface of a segment of a spheroid. — Square the diameters of the spheroid, and take the square root of half their sum; then, as the diameter from which the segment is cut is to this root so is the height of the segment to the proportionate height of the segment to the mean diameter. Multiply the product of the other diameter and 3.1416 by the proportionate height.

Convex surface of a frustum or zone of a spheroid. — Proceed as by previous rule for the surface of a segment, and obtain the proportionate height of the frustum. Multiply the product of the diameter parallel to the base of the frustum and 3.1416 by the proportionate height of the frustum.

Volume of a spheroid is equal to the product of the square of the revolving axis by the fixed axis and by 0.5236. The volume of a spheroid is two thirds of that of the circumscribing cylinder.

Volume of a segment of a spheroid. — 1. When the base is parallel to the revolving axis, multiply the difference between three times the fixed axis and twice the height of the segment, by the square of the height and by 0.5236. Multiply the product by the square of the revolving axis, and divide by the square of the fixed axis.

2. When the base is perpendicular to the revolving axis, multiply the difference between three times the revolving axis and twice the height of the segment by the square of the height and by 0.5236. Multiply the product by the length of the fixed axis, and divide by the length of the revolving axis.

Volume of the middle frustum of a spheroid. — 1. When the ends are Circular, or parallel to the revolving axis: To twice the square of the middle diameter add the square of the diameter of one end: multiply the sum by the length of the frustum and by 0.2618.

2. When the ends are elliptical, or perpendicular to the revolving axis: To twice the product of the transverse and conjugate diameters of the middle section add the product of the transverse and conjugate diameters of one end: multiply the sum by the length of the frustum and by 0.2618.

Spindles. — Figures generated by the revolution of a Plane area, bounded by a curve other than a circle, when the curve is revolved about a chord perpendicular to its axis or about its double ordinate. They are designated by the name of the arc or curve from which they are generated, as Circular, Elliptic, Parabolic, etc., etc.

Convex surface of a circular spindle, zone, or segment of it. — **Rule:** Multiply the length by the radius of the revolving arc; multiply this arc by the central distance, or distance between the centre of the spindle and centre of the revolving arc; subtract this product from the former, double the remainder, and multiply it by 3.1416.

Volume of a circular spindle. — Multiply the central distance by half the area of the revolving segment; subtract the product from one third of the cube of half the length, and multiply the remainder by 12.5664.

Volume of frustum or zone of a circular spindle. — From the square of half the length of the whole spindle take one third of the square of half the length of the frustum, and multiply the remainder by the said half length of the frustum; multiply the central distance by the revolving area which generates the frustum; subtract this product from the former, and multiply the remainder by 6.2832.

Volume of a segment of a circular spindle. — Subtract the length of the segment from the half length of the spindle; double the remainder and ascertain the volume of a middle frustum of this length; subtract the result from the volume of the whole spindle and halve the remainder.

Volume of a cycloidal spindle = five eighths of the volume of the circumscribing cylinder. — Multiply the product of the square of twice the diameter of the generating circle and 3.927 by its circumference, and divide this product by 8.

Parabolic conoid. — **Volume Of a parabolic conoid** (generated by the revolution of a parabola on its axis). — Multiply the area of the base by half the height.

Or multiply the square of the diameter of the base by the height and by 0.3927.

Volume of a frustum of a parabolic conoid. — Multiply half the sum of the areas of the two ends by the height.

Volume of a parabolic spindle (generated by the revolution of a parabola on its base). — Multiply the square of the middle diameter by the length and by 0.4189. The volume of a parabolic spindle is to that of a cylinder of the same height and diameter as 8 to 15.

Volume of the middle frustum of a parabolic spindle. — Add together 8 times the square of the maximum diameter, 3 times the square of the end diameter, and 4 times the product of the diameters. Multiply the sum by the length of the frustum and by 0.05236. This rule is applicable for calculating the content of casks of parabolic form.

Casks. — To find the volume of a cask of any form. — Add together 39 times the square of the bung diameter, 25 times the square of the head diameter, and 26 times the product of the diameters. Multiply the sum by the length, and divide by 31,773 for the content in Imperial gallons, or by 26,470 for U. S. gallons.

This rule was framed by Dr. Hutton, on the supposition that the middle third of the length of the cask was a frustum of a parabolic spindle, and each outer third was a frustum of a cone.

To **find the ullage of a cask**, the quantity of liquor in it when it is not full.
1. For a **lying cask:** Divide the number of wet or dry inches by the bung diameter in inches. If the quotient is less than 0.5, deduct from it one fourth part of what it wants of 0.5. If it exceeds 0.5, add to it one fourth part of the excess above 0.5. Multiply the remainder or the sum by the whole content of the cask. The product is the quantity of liquor in the cask, in gallons, when the dividend is wet inches; or the empty space, if dry inches.

2. For a **standing cask:** Divide the number of wet or dry inches by the length of the cask. If the quotient exceeds 0.5, add to it one tenth of its excess above 0.5; if less than 0.5, subtract from it one tenth of what it wants of 0.5. Multiply the sum or the remainder by the whole content of the cask. The product is the quantity of liquor in the cask, when the dividend is wet inches; or the empty space, if dry inches.

Volume of cask (approximate) U. S. gallons = square of mean diam. X length in inches X 0.0034. Mean diameter = half the sum of the bung and head diameters.

Volume of an irregular solid. — Suppose it divided into parts resembling pins or other bodies measurable by preceding rules. Find the content of each part; the sum of the contents is the cubic contents of the solid.

The content of a small part is found nearly by multiplying half the sum of the areas of each end by the perpendicular distance between them.

The contents of small irregular solids may sometimes be found by immersing them under water in a prismatic or cylindrical vessel, and observing the amount by which the level of the water descends when the solid is withdrawn. The sectional area of the vessel being multiplied by the descent of the level gives the cubic contents.

Or weigh the solid in air and in water: the difference is the weight of water it displaces. Divide the weight in pounds by 62.4 to obtain volume in cubic feet, or multiply it by 27.7 to obtain the volume in Cubic inches.

When the solid is very large and a great degree of accuracy is not requisite, measure its length, breadth, and depth in several different places, and take the mean of the measurement for each dimension, and multiply the three means together.

When the surface of the solid is very extensive it is better to divide it into triangles, to find the area of each triangle, and to multiply it by the mean depth of the triangle for the contents of each triangular portion; the contents of the triangular sections are to be added together.

The mean depth of a triangular section is obtained by measuring the depth at each angle, adding together the three measurements, and taking one third of the sum.

PLANE TRIGONOMETRY.

Trigonometrical Functions.

Every triangle has six parts — three angles and three sides. When any three of these parts are given, provided one of them is a side, the other parts may be determined. By the *solution of a triangle* is meant the determination of the unknown parts of a triangle when certain parts are given.

The complement of an angle or arc is what remains after subtracting the angle or arc from 90° .

In general, if we represent any arc by A , its complement is $90^\circ - A$. Hence the complement of an arc that exceeds 90° is negative.

The supplement of an angle or arc is what remains after subtracting; angle or arc from 180° . If A is an arc its supplement is $180^\circ - A$. supplement of an arc that exceeds 180° is negative.

The sum of the three angles of a triangle is equal to 180° . Either angle is the supplement of the other two. In a right-angled triangle, the right angle being equal to 90° , each of the acute angles is the complement of the other.

In all right-angled triangles having the same acute angle, the sides have to each other the same ratio. These ratios have received special names, as follows:

If A is one of the acute angles, a the opposite side, b the adjacent side; and c the hypotenuse.

The sine of the angle A is the quotient of the opposite side divided by the hypotenuse. $\text{Sin } A = \frac{a}{c}$.

The tangent of the angle A is the quotient of the opposite side divided by the adjacent side. $\text{Tan } A = \frac{a}{b}$.

The secant of the angle A is the quotient of the hypotenuse divided by the adjacent side. $\text{Sec } A = \frac{c}{b}$.

The cosine (cos), cotangent (cot), and cosecant (cosec) of an angle are respectively the sine, tangent, and secant of the complement of that angle. The terms sine, cosine, etc., are called trigonometrical functions.

In a circle whose radius is unity, the sine of an arc, or of the angle at the centre measured by that arc, is the perpendicular let fall from one extremity of the arc upon the diameter passing through the other extremity.

The tangent of an arc is the line which touches the circle at one extremity

$$\frac{\sin(A+B)}{\cos A \cos B} = \tan A + \tan B; \quad \tan(A+B) = \frac{\tan A + \tan B}{1 - \tan A \tan B};$$

$$\frac{\sin(A-B)}{\cos A \cos B} = \tan A - \tan B; \quad \tan(A-B) = \frac{\tan A - \tan B}{1 + \tan A \tan B};$$

$$\frac{\cos(A+B)}{\cos A \cos B} = 1 - \tan A \tan B; \quad \cot(A+B) = \frac{\cot A \cot B - 1}{\cot B + \cot A};$$

$$\frac{\cos(A-B)}{\cos A \cos B} = 1 + \tan A \tan B; \quad \cot(A-B) = \frac{\cot A \cot B + 1}{\cot B - \cot A}.$$

Functions of twice an angle:

$$\sin 2A = 2 \sin A \cos A; \quad \cos 2A = \cos^2 A - \sin^2 A;$$

$$\tan 2A = \frac{2 \tan A}{1 - \tan^2 A}; \quad \cot 2A = \frac{\cot^2 A - 1}{2 \cot A}.$$

Functions of half an angle:

$$\sin \frac{1}{2}A = \pm \sqrt{\frac{1 - \cos A}{2}}; \quad \cos \frac{1}{2}A = \pm \sqrt{\frac{1 + \cos A}{2}};$$

$$\tan \frac{1}{2}A = \pm \sqrt{\frac{1 - \cos A}{1 + \cos A}}; \quad \cot \frac{1}{2}A = \pm \sqrt{\frac{1 + \cos A}{1 - \cos A}}.$$

For tables of Trigonometric Functions, see Mathematical Tables.

Solution of Plane Right-angled Triangles.

Let A and B be the two acute angles and C the right angle and a , b , and c the sides opposite these angles, respectively, then we have

$$1. \sin A = \cos B = \frac{a}{c}; \quad 3. \tan A = \cot B = \frac{a}{b};$$

$$2. \cos A = \sin B = \frac{b}{c}; \quad 4. \cot A = \tan B = \frac{b}{a}.$$

1. In any plane right-angled triangle the sine of either of the acute angles is equal to the quotient of the opposite leg divided by the hypotenuse.
2. The cosine of either of the acute angles is equal to the quotient of the adjacent leg divided by the hypotenuse.
3. The tangent of either of the acute angles is equal to the quotient of the opposite leg divided by the adjacent leg.
4. The cotangent of either of the acute angles is equal to the quotient of the adjacent leg divided by the opposite leg.
5. The square of the hypotenuse equals the sum of the squares of the other two sides.

Solution of Oblique-angled Triangles.

The following propositions are proved in works on plane trigonometry. In any plane triangle —

Theorem 1. The sines of the angles are proportional to the opposite sides.

Theorem 2. The sum of any two sides is to their difference as the tangent of half the sum of the opposite angles is to the tangent of half their difference.

Theorem 3. If from any angle of a triangle a perpendicular be drawn to the opposite side or base, the whole base will be to the sum of the other two sides as the difference of those two sides is to the difference of the segments of the base.

- CASE I.** Given two angles and a side, to find the third angle and the other two sides. 1. The third angle = $180^\circ -$ sum of the two angles. 2. The sides may be found by the following proportion:

The **sine** of the angle opposite the given side is to the sine of the angle opposite the required side as the given side is to the required side.

CASE II. Given two sides and an angle opposite one of them, to find the third side and the remaining angles.

The side opposite the given angle is to the side opposite the required angle as the sine of the given angle is to the sine of the required angle.

The third angle is found by subtracting the sum of the other two from 180° , and the third side is found as in Case I.

CASE III. Given two sides and the included angle, to find the third side and the remaining angles.

The sum of the required angles is found by subtracting the given angle from 180° . The difference of the required angles is then found by Theorem II. Half the difference added to half the sum gives the greater angle, and half the difference subtracted from half the sum gives the less angle. The third side is then found by Theorem I.

Another method:

Given the sides c , b , and the included angle A , to find the remaining side a and the remaining angles B and C .

From either of the unknown angles, as B , draw a perpendicular Be to the opposite side.

Then

$$Ae = c \cos A, \quad Be = c \sin A, \quad eC = b - Ae, \quad Be \div eC = \tan C.$$

Or, in other words, solve Be , Ae and BeC as right-angled triangles.

CASE IV. Given the three sides, to find the angles.

Let fall a perpendicular upon the longest side from the opposite angle, dividing the given triangle into two right-angled triangles. The two segments of the base may be found by Theorem III. There will then be given the hypotenuse and one side of a right-angled triangle to find the angles.

For areas of triangles, see Mensuration.

ANALYTICAL GEOMETRY.

Analytical geometry is that branch of Mathematics which has for its object the determination of the forms and magnitudes of geometrical magnitudes by means of analysis.

Ordinates and abscissas. — In analytical geometry two intersecting lines YY' , XX' are used as *coördinate axes*, XX' being the axis of abscissas or axis of X , and YY' the axis of ordinates or axis of Y .

A , the intersection, is called the origin of coördinates. The distance of any point P from the axis of Y measured parallel to the axis of X is called the *abscissa* of the point, as AD or CP , Fig. 72. Its distance from the axis of X , measured parallel to the axis of Y , is called the *ordinate*, as AC or PD . The abscissa and ordinate taken together are called the *coordinates* of the point P . The angle of intersection is usually taken as a right angle, in which case the axes of X and Y are called *rectangular coördinates*.

The abscissa of a point is designated by the letter x and the ordinate by y .

The *equations* of a point are the equations which express the distances of the point from the axis. Thus $x = a$, $y = b$ are the equations of the Point P .

Equations referred to rectangular coördinates. — The equation of a line expresses the relation which exists between the coordinates of every Point of the line.

Equation of a straight line, $y = ax \pm b$, in which a is the tangent of the angle the line makes with the axis of X , and b the distance above A in which the line cuts the axis of Y .

Every equation of the first degree between two variables is the equation

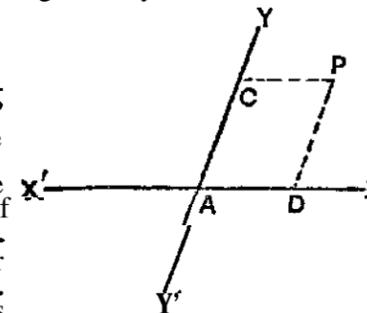

FIG. 72.

of a straight line. as $Ay + Bx + C = 0$, which can be reduced to the form $y = ax \pm b$.

Equation of the distance between two points:

$$D = \sqrt{(x'' - x')^2 + (y'' - y')^2},$$

in which $x'y', x''y''$ are the coördinates of the two points.

Equation of a line passing through a given point:

$$y - y' = a(x - x'),$$

in which $x'y'$ are the coördinates of the given point, a , the tangent of the angle the line makes with the axis of x , being undetermined, since any number of lines may be drawn through a given point

Equation of a line passing through two given points:

$$y - y' = \frac{y'' - y'}{x'' - x'}(x - x').$$

Equation of a line parallel to a given line and through a given point:

$$y - y' = a(x - x').$$

Equation of an angle V included between two given lines:

$$\text{tang } V = \frac{a' - a}{1 + a'a},$$

in which a and a' are the tangents of the angles the lines make with the axis of abscissas.

If the lines are at right angles to each other $\text{tang } V = \infty$, and

$$1 + a'a = 0.$$

Equation of an intersection of two lines, whose equations are

$$y = ax + b \quad \text{and} \quad y = a'x + b',$$

$$x = -\frac{b - b'}{a - a'}, \quad \text{and} \quad y = \frac{ab' - a'b}{a - a'}$$

Equation of a perpendicular from a given point to a given line:

$$y - y' = -\frac{1}{a}(x - x').$$

Equation of the length of the perpendicular P :

$$P = \frac{y' - ax' - b}{\sqrt{1 + a^2}}$$

The **circle**.—Equation of a circle, the origin of coördinates being at the centre. and radius $=R$:

$$x^2 + y^2 = R^2.$$

If the origin is at the left extremity of the diameter, on the axis of x :

$$y^2 = 2Rx - x^2.$$

If the origin is at any point, and the coordinates of the centre are $x'y'$

$$(x - x')^2 + (y - y')^2 = R^2.$$

Equation of a tangent to a circle, the coördinates of the point of tangency being $x''y''$ and the origin at the centre,

$$yy'' + xx'' = R^2.$$

The **ellipse**.—Equation of an ellipse, referred to rectangular coördinates with axis at the centre:

$$A^2y^2 + B^2x^2 = A^2B^2,$$

in which A is half the transverse axis and B half the conjugate axis.

Equation of the ellipse when the origin is at the vertex of the transverse axis:

$$y^2 = \frac{B^2}{A^2}(2Ax - x^2).$$

The eccentricity of an ellipse is the distance from the centre to either focus, divided by the semi-transverse axis, or

$$e = \frac{\sqrt{A^2 - B^2}}{A}.$$

The parameter of an ellipse is the double ordinate passing through the focus. It is a third proportional to the transverse axis and its conjugate. or

$$2A : 2B :: 2B : \text{parameter}; \quad \text{or} \quad \text{parameter} = \frac{2B^2}{A}.$$

Any ordinate of a circle circumscribing an ellipse is to the corresponding ordinate of the ellipse as the semi-transverse axis to the semi-conjugate. Any ordinate of a circle inscribed in an ellipse is to the corresponding ordinate of the ellipse as the semi-conjugate axis to the semi-transverse.

Equation of the tangent to an ellipse, origin of axes at the centre:

$$A^2yy'' + B^2xx'' = A^2B^2,$$

$y''x''$ being the coordinates of the point of tangency.

Equation of the normal, passing through the point of tangency, and perpendicular to the tangent:

$$y - y'' = \frac{A^2y''}{B^2x''}(x - x'').$$

The normal bisects the angle of the two lines drawn from the Point of tangency to the foci.

The lines drawn from the foci make equal angles with the tangent.

The **parabola**.—Equation of the parabola referred to rectangular coordinates, the origin being at the vertex of its axis, $y^2 = 2px$, in which $2p$ is the parameter or double ordinate through the focus.

The parameter is a third proportional to any abscissa and its corresponding ordinate, or

$$x : y :: y : 2p.$$

Equation of the tangent:

$$yy'' = p(x + x''),$$

$y''x''$ being coordinates of the point of tangency.

Equation of the normal:

$$y - y'' = -\frac{y''}{p}(x - x'').$$

The sub-normal, or projection of the normal on the axis, is constant, and equal to half the parameter.

The tangent at any point makes equal angles with the axis and with the line drawn from the point of tangency to the focus.

The **hyperbola**.—Equation of the hyperbola referred to rectangular Coordinates, origin at the centre:

$$A^2y^2 - B^2x^2 = -A^2B^2,$$

in which A is the semi-transverse axis and B the semi-conjugate axis.

Equation when the origin is at the right vertex of the transverse axis:

$$y^2 = \frac{B^2}{A^2}(2Ax + x^2).$$

Conjugate and equilateral hyperbolas.—If on the Conjugate axis,

as a transverse, and a focal distance equal to $\sqrt{A^2 + B^2}$, we construct the two branches of a hyperbola., the two hyperbolas thus constructed are called conjugate hyperbolas. If the transverse and conjugate axes are equal, the hyperbolas are called equilateral, in which case $y^2 - x^2 = -A^2$ when A is the transverse axis, and $x^2 - y^2 = -B^2$ when B is the transverse axis.

The parameter of the transverse axis is a third proportional to the transverse axis and its conjugate.

$$2A : 2B :: 2B : \text{parameter.}$$

The tangent to a hyperbola bisects the angle of the two lines drawn from the point of tangency to the foci.

The asymptotes of a hyperbola are the diagonals of the rectangle, described on the axes, indefinitely produced in both directions.

The asymptotes continually approach the hyperbola, and become tangent to it at an infinite distance from the centre.

Equilateral hyperbola. — In an equilateral hyperbola the asymptotes make equal angles with the transverse axis, and are at right angles to each other. With the asymptotes as axes, and P = ordinate V = abscissa PV = a constant. This equation is that of the expansion of a perfect gas, in which P = absolute pressure, V = volume.

Curve of Expansion of Gases. — PV^n = a constant, or $P_1V_1^n = P_2V_2^n$, in which V_1 and V_2 are the volumes at the pressures P_1 and P_2 . When these are given, the exponent n may be found from the formula

$$n = \frac{\log P_1 - \log P_2}{\log V_2 - \log V_1}.$$

Conic sections. — Every equation of the second degree between two variables will represent either a circle, an ellipse, a parabola or a hyperbola. These curves are those which are obtained by intersecting the surface of a cone by planes, and for this reason they are called conic sections.

Logarithmic curve. — A logarithmic curve is one in which one of the coordinates of any point is the logarithm of the other.

The coordinate axis, to which the lines denoting the logarithms are parallel is called the *axis of logarithms*, and the other the axis of numbers. If Y is the axis of logarithms and x the axis of numbers, the equation of the curve is $y = \log x$.

If the base of a system of logarithms is a , we have $a^y = x$, in which y is the logarithm of x .

Each system of logarithms will give a different logarithmic curve. $y = 0, x = 1$. Hence every logarithmic curve will intersect the axis of numbers at a distance from the origin equal to 1.

DIFFERENTIAL CALCULUS.

The differential of a variable quantity is the difference between any two of its consecutive values, hence it is indefinitely small. It is expressed by writing d before the quantity, as dx , which is read *differential of x*.

The term $\frac{dy}{dx}$ is called the differential coefficient of y regarded as a function of x . It is also called the first derived function or the derivative.

The differential of a function is equal to its differential coefficient multiplied by the differential of the independent variable; thus, $\frac{dy}{dx} dx = dy$.

The limit of a variable quantity is that value to which it continually approaches, so as at last to differ from it by less than any assignable quantity.

The differential coefficient is the limit of the ratio of the increment of the independent variable to the increment of the function.

The differential of a constant quantity is equal to 0.
The differential of a product of a constant by a variable is equal to the constant multiplied by the differential of the variable.

$$\text{If } u = Av, \quad du = A dv.$$

In any curve whose equation is $y = f(z)$, the differential coefficient $\frac{dy}{dx} = \tan a$; hence, the rate of increase of the function, or the ascension of the curve at any point, is equal to the tangent of the angle which the tangent line makes with the axis of abscissas.

All the operations of the Differential Calculus comprise but two objects:

1. To find the rate of change in a function when it passes from one state of value to another, consecutive with it.
2. To find the actual change in the function: The rate of change is the differential coefficient, and the actual change the differential.

Differentials of algebraic functions. — The differential of the sum, or difference of any number of functions, dependent on the same variable, is equal to the sum or difference of their differentials taken separately:

$$\text{If } u = y + z - w, \quad du = dy + dz - dw.$$

The differential of a product of two functions dependent on the same variable is equal to the sum of the products of each by the differential of the other:

$$d(uv) = v du + u dv. \quad \frac{d(uv)}{uv} = \frac{du}{u} + \frac{dv}{v}$$

The differential of the product of any number of functions is equal to the sum of the products which arise by multiplying the differential of each function by the product of all the others:

$$d(uls) = ts du + us dt + ut ds.$$

The differential of a fraction equals the denominator into the differential of the numerator minus the numerator into the differential of the denominator, divided by the square of the denominator:

$$d\left(\frac{u}{v}\right) = \frac{v du - u dv}{v^2}.$$

If the denominator is constant, $dv = 0$, and $dt = \frac{v du}{v^2} = \frac{du}{v}$.

If the numerator is constant, $du = 0$, and $dt = -\frac{u dv}{v^2}$.

The differential of the square root of a quantity is equal to the differential of the quantity divided by twice the square root of the quantity:

$$\text{If } v = u^{1/2}, \text{ or } v = \sqrt{u}, \quad dv = \frac{du}{2\sqrt{u}} = \frac{1}{2} u^{-1/2} du.$$

The differential of any power of a function is equal to the exponent multiplied by the function raised to a powerless one, multiplied by the differential of the function, $d(u^n) = nu^{n-1} du$.

Formulas for differentiating algebraic functions.

- | | |
|---------------------------|---|
| 1. $d(a) = 0.$ | 6. $d\left(\frac{x}{y}\right) = \frac{y dx - x dy}{y^2}.$ |
| 2. $d(ax) = adx.$ | 7. $d(x^m) = mx^{m-1} dx.$ |
| 3. $d(x + y) = dx + dy.$ | 8. $d(\sqrt{x}) = \frac{dx}{2\sqrt{x}}.$ |
| 4. $d(x - y) = dx - dy.$ | 9. $d\left(x^{-\frac{r}{s}}\right) = -\frac{r}{s} x^{-\frac{r}{s}-1} dx.$ |
| 5. $d(xy) = x dy + y dx.$ | |

To find the differential of the form $u = (a + bx^n)^m$:
Multiply the exponent of the parenthesis into the exponent of the variable within the parenthesis, into the coefficient of the variable, into

binomial raised to a power less 1, into the variable within the parenthesis raised to a power less 1, into the differential of the variable.

$$du = d(a + bx^n)^m = mnb(a + bx^n)^{m-1} x^{n-1} dx.$$

To find the rate of change for a given value of the variable:

Find the differential coefficient, and substitute the value of the variable in the second member of the equation.

EXAMPLE. — If x is the side of a cube and u its volume, $u = x^3$, $\frac{du}{dx} = 3x^2$. Hence the rate of change in the volume is three times the square of the edge. If the edge is denoted by 1, the rate of change is 3.

Application. The coefficient of expansion by heat of the volume of a body is three times the linear coefficient of expansion. Thus if the side of a cube expands 0.001 inch, its volume expands 0.003 cubic inch. $1.001^3 = 1.003003001$.

A partial differential coefficient is the differential coefficient of a function of two or more variables under the supposition that only one of them has changed its value.

A partial differential is the differential of a function of two or more variables under the supposition that only one of them has changed its value.

The total differential of a function of any number of variables is equal to the sum of the partial differentials.

If $u = f(xy)$, the partial differentials are $\frac{du}{dx} dx$, $\frac{du}{dy} dy$.

$$\text{If } u = x^2 + y^3 - z, du = \frac{du}{dx} dx + \frac{du}{dy} dy + \frac{du}{dz} dz; = 2x dx + 3y^2 dy - dz.$$

Integrals. — An integral is a functional expression derived from a differential. Integration is the operation of finding the primitive function from the differential function. It is indicated by the sign \int , which is read "the integral of." Thus $\int 2x dx = x^2$ and the integral of $2x dx$ equals x^2 .

To integrate an expression of the form $mx^{m-1} dx$ or $x^m dx$ add 1 to the exponent of the variable, and divide by the new exponent and by the differential of the variable: $\int 3x^2 dx = x^3$. (Applicable in all cases except when $m = -1$. For $\int x^{-1} dx$ see formula 2, page 81.)

The integral of the product of a constant by the differential of a variable is equal to the constant multiplied by the integral of the differential:

$$\int ax^m dx = a \int x^m dx = a \frac{1}{m+1} x^{m+1}.$$

The integral of the algebraic sum of any number of differentials is equal to the algebraic sum of their integrals:

$$du = 2ax^2 dx - by dy - z^2 dz; \int du = \frac{2}{3} ax^3 - \frac{b}{2} y^2 - \frac{z^3}{3}.$$

Since the differential of a constant is 0, a constant connected with a variable by the sign + or - disappears in the differentiation, thus $d(a + x^m) = dx^m = mx^{m-1} dx$. Hence in integrations, a differential expression we must annex to the integral obtained a constant represented by C to compensate for the term which may have been lost in differentiation. Thus if we have $dy = a dx$, integrating,

$$y = ax \pm c.$$

The constant C , which is added to the first integral, must have such a value as to render the functional equation true for every possible value that may be attributed to the variable. Hence, after having found the first integral equation and added the constant C , if we then make the variable equal to zero, the value which the function assumes will be the true value of C .

An indefinite integral is the first integral obtained before the value of the constant C is determined.

A particular integral is the integral after the value of C has been found.

A definite integral is the integral corresponding to a given value of the variable.

Integration between limits. — Having found the indefinite integral and the particular integral, the next step is to find the definite integral, and then the definite integral between given limits of the variable.

The integral of a function, taken between two limits, indicated by given values of x , is equal to the difference of the definite integrals corresponding to those limits. The expression

$$\int_{x'}^{x''} dy = a \int dx$$

is read: Integral of the differential of y , taken between the limits x' and x'' ; the least limit, or the limit corresponding to the subtractive integral, being placed below.

Integrate $du = 9x^2 dx$ between the limits $x = 1$ and $x = 3$, u being equal to 81 when $x = 0$. $\int du = \int 9x^2 dx = 3x^3 + C$; $C = 81$ when $x = 0$, then

$$\int_{x=1}^{x=3} du = 3(3)^3 + 81, \text{ minus } 3(1)^3 + 81 = 78.$$

Integration of particular forms.

To integrate a differential of the form $du = (a + bx^n)^m x^{n-1} dx$.

1. If there is a constant factor, place it without the sign of the integral, and omit the power of the variable without the parenthesis and the differential;

2. Augment the exponent of the parenthesis by 1 and then divide this quantity, with the exponent so increased, by the exponent of the parenthesis, into the exponent of the variable within the parenthesis, into the coefficient of the variable. Whence

$$\int du = \frac{(a + bx^n)^{m+1}}{(m+1)nb} + C.$$

The differential of an arc is the hypotenuse of a right-angle triangle of which the base is dx and the perpendicular dy .

$$\text{If } z \text{ is an arc, } dz = \sqrt{dx^2 + dy^2} \quad z = \int \sqrt{dx^2 + dy^2}.$$

Quadrature of a plane figure.

The differential of the area of a plane surface is equal to the ordinate into the differential of the abscissa. $ds = y dx$.

To apply the principle enunciated in the last equation, in finding the area of any particular plane surface:

Find the value of y in terms of x , from the equation of the bounding line; substitute this value in the differential equation, and then integrate between the required limits of x .

Area of the parabola. — Find the area of any portion of the common parabola whose equation is

$$y^2 = 2px; \text{ whence } y = \sqrt{2px}.$$

Substituting this value of y in the differential equation $ds = y dx$ gives

$$\int ds = \int \sqrt{2px} dx = \sqrt{2p} \int x^{1/2} dx = \frac{2\sqrt{2p}}{3} x^{3/2} + C;$$

or, $s = \frac{2\sqrt{2px}}{3} \times x = \frac{2}{3} xy + C.$

If we estimate the area from the principal vertex, $x = 0, y = 0,$ and $C = 0;$ and denoting the particular integral by $s', s' = \frac{2}{3} xy.$

That is, the area of any portion of the parabola, estimated from the vertex, is equal to $\frac{2}{3}$ of the rectangle of the abscissa and ordinate of the extreme point. The curve is therefore quadrable.

Quadrature of surfaces of revolution. — The differential of a surface of revolution is equal to the circumference of a circle perpendicular to the axis into the differential of the arc of the meridian curve.

$$ds = 2\pi y \sqrt{dx^2 + dy^2};$$

in which y is the radius of a circle of the bounding surface in a plane perpendicular to the axis of revolution, and x is the abscissa, or distance of the plane from the origin of coordinate axes.

Therefore, to find the volume of any surface of revolution: Find the value of y and dy from the equation of the meridian curve in terms of x and $dx,$ then substitute these values in the differential equation, and integrate between the proper limits of $x.$

By application of this rule we may find:
The curved surface of a cylinder equals the product of the circumference of the base into the altitude.

The convex surface of a cone equals the product of the circumference of the base into half the ~~surface~~ height.

The surface of a sphere is equal to the area of four great circles, or equal to the curved surface of the ~~circumscribing~~ cylinder.

Cubature of volumes of revolution. — A volume of revolution is a volume generated by the revolution of a plane figure about a fixed line called the axis.

If we denote the volume by $V dV = \pi y^2 dx.$
The area of a circle described by any ordinate y is $\pi y^2;$ hence the differential of a volume of revolution is equal to the area of a circle perpendicular to the axis into the differential of the axis.

The differential of a volume generated by the revolution of a plane figure about the axis of Y is $\pi x^2 dy.$

To find the value of V for any given volume of revolution. Find the value of y^2 in terms of x from the equation of the meridian curve, substitute this value in the differential equation, and then integrate between the required limits of $x.$

By application of this rule we may find:
The volume of a cylinder is equal to the area of the base multiplied by the altitude.

The volume of a cone is equal to the area of the base into one third the altitude.

The volume of a Prolate spheroid and of an oblate spheroid (formed by the revolution of an ellipse around its transverse and its conjugate axes respectively) are each equal to two thirds of the circumscribing cylinder.

If the axes are equal, the spheroid becomes a sphere and its volume = $\frac{2}{3} \pi R^2 \times D = \frac{1}{6} \pi D^3;$ R being radius and D diameter.

The volume of a paraboloid is equal to half the cylinder having the same base and altitude.

The volume of a pyramid equals the area of the base multiplied by one third the altitude.

Second, third, etc., differentials. — The differential coefficient being a function of the independent variable, it may be differentiated, and we thus obtain the second differential coefficient:

$d\left(\frac{du}{dx}\right) = \frac{d^2u}{dx^2}.$ Dividing by $dx,$ we have for the second differential coefficient $\frac{d^2u}{dx^2},$ which is read: second differential of u divided by the square of the differential of x (or dx squared).

The third differential Coefficient $\frac{d^3u}{dx^3}$ is read: third differential of u divided by dx cubed.

The differentials of the different orders are obtained by multiplying the differential coefficient by the corresponding powers of $dx;$ thus $\frac{d^3u}{dx^3} dx^3 =$ third differential of $U.$

Sign of the first differential coefficient. — If we have a curve whose equation is $y = f(x),$ referred to rectangular coordinates, the curve will recede from the axis of X when $\frac{dy}{dx}$ is positive, and approach the axis when it is negative, when the curve lies within the first angle of the coordinate axes. For all angles and every relation of y and x the curve will recede from the axis of X when the ordinate and first differential coefficient have the same sign, and approach it when they have different signs. If the tangent of the curve becomes parallel to the axis of X at any point $\frac{dy}{dx} = 0.$ If the tangent becomes perpendicular to the axis of X at any point $\frac{dy}{dx} = \infty.$

Sign of the second differential coefficient. — The second differential coefficient has the same sign as the ordinate when the curve is convex toward the axis of abscissa and a contrary sign when it is concave.

Maclaurin's Theorem. — For developing into a series any function of a single variable as $u = A + Bx + Cx^2 + Dx^3 + Ex^4,$ etc., in which $A, B, C,$ etc., are independent of $x:$

$$u = (u)_{x=0} + \left(\frac{du}{dx}\right)_{x=0} x + \frac{1}{1.2} \left(\frac{d^2u}{dx^2}\right)_{x=0} x^2 + \frac{1}{1.2.3} \left(\frac{d^3u}{dx^3}\right)_{x=0} x^3 + \text{etc.}$$

In applying the formula, omit the expression $x = 0,$ although the coefficients are always found under this hypothesis.

EXAMPLES :

$$(a + x)^m = a^m + ma^{m-1}x + \frac{m(m-1)}{1.2} a^{m-2}x^2 + \frac{m(m-1)(m-2)}{1.2.3} a^{m-3}x^3 + \text{etc.}$$

$$\frac{1}{a+x} = \frac{1}{a} - \frac{x}{a^2} + \frac{x^2}{a^3} - \frac{x^3}{a^4} + \dots \frac{x^n}{a^{n+1}}, \text{ etc.}$$

Taylor's Theorem. — For developing into a series any function of the sum or difference of two independent variables, as $u = f(x \pm y):$

$$u' = u + \frac{du}{dx} y + \frac{d^2u}{dx^2} \frac{y^2}{1.2} + \frac{d^3u}{dx^3} \frac{y^3}{1.2.3} + \text{etc.},$$

in which u is what u' becomes when $y = 0,$ $\frac{du}{dx}$ is what $\frac{du'}{dx}$ becomes when $y = 0,$ etc.

Maxima and minima. — To find the maximum or minimum value of a function of a single variable:

1. Find the first differential coefficient of the function, place it equal to 0, and determine the roots of the equation.
2. Find the second differential coefficient, and substitute each real root.

in succession, for the variable in the second member of the equation. Each root which gives a negative result will correspond to a maximum value of the function, and each which gives a positive result will correspond to a minimum value.

EXAMPLE.— To find the value of x which will render the function y a maximum or minimum in the equation of the circle, $y^2 + x^2 = R^2$;

$$\frac{dy}{dx} = -\frac{x}{y}; \text{ making } -\frac{x}{y} = 0 \text{ gives } x = 0.$$

The second differential coefficient is: $\frac{d^2y}{dx^2} = -\frac{x^2 + y^2}{y^3}$

When $x = 0, y = R$; hence $\frac{d^2y}{dx^2} = -\frac{1}{R}$, which being negative, y is a maximum for R positive.

In applying the rule to practical examples we first find an expression for the function which is to be made a maximum or minimum.

2. If in such expression a constant quantity is found as a factor it may be omitted in the operation; for the product will be a maximum or a minimum when the variable factor is a maximum or a minimum.

3. Any value of the independent variable which renders a function a maximum or a minimum will render any power or root of that function a maximum or minimum; hence we may square both members of an equation to free it of radicals before differentiating.

By these rules we may find:

The maximum rectangle which can be inscribed in a triangle is one whose altitude is half the altitude of the triangle.

The altitude of the maximum cylinder which can be inscribed in a cone is one third the altitude of the cone.

The surface of a cylindrical vessel of a given volume open at the top, is a minimum when the altitude equals half the diameter.

The altitude of a cylinder inscribed in a sphere when its convex surface is a maximum is $r\sqrt{2}$, r = radius.

The altitude of a cylinder inscribed in a sphere when the volume is a maximum is $2r \div \sqrt{3}$.

Maxima and Minima without the Calculus.— In the equation $y = a + bx + cx^2$, in which $a, b,$ and c are constants, either positive or negative, if c be positive y is a minimum when $x = -b \div 2c$; if c be negative y is a maximum when $x = -b \div 2c$. In the equation $y = a + bx + c/x, y$ is a minimum when $bx = c/x$.

APPLICATION.—The cost of electrical transmission is made up (1) of fixed charges, such as superintendence, repairs, cost of poles etc., which may be represented by a ; (2) of interest on cost of the wire which varies with the sectional area, and may be represented by bx ; and (3) of cost of the energy wasted in transmission, which varies inversely with the area of the wire, or c/x . The total cost, $y = a + bx + c/x$, is a minimum when item 2 = item 3, or $bx = c/x$.

Differential of an exponential function.

$$\text{If } u = a^x \text{ then } du = da^x = a^x k dx \quad (1)$$

in which k is a constant dependent on a .

The relation between a and k is $a^k = e$: whence $a = e^k$ in which $e = 2.7182818 \dots$ the base of the Naperian system of logarithms. (3)

Logarithms.—The logarithms in the Naperian system are denoted by l , Nap. log or hyperbolic log, hyp. log. or log.; and in the common system always by log.

$$k = \text{Nap. log } a, \text{ log } a = k \text{ log } \dots \dots (4)$$

The common logarithm of $e, = \log 2.7182815 \dots = 0.4342945 \dots$ is called the modulus of the common system, and is denoted by M . Hence, if we have the Naperian logarithm of a number we can find the common logarithm of the same number by multiplying by the modulus. Reciprocally, Nap. log = com. log $\times 2.3025851$.

If in equation (4) we make $a = 10$, we have

$$1 = k \text{ log } e, \text{ or } \frac{1}{k} = \text{log } e = M.$$

That is, the modulus of the common system is equal to 1, divided by the Naperian logarithm of the common base.

From equation (2) we have

$$\frac{du}{u} = \frac{da^x}{a^x} = k dx.$$

If we make $a = 10$, the base of the common system, $x = \text{log } u$, and

$$d(\text{log } u) = dx = \frac{du}{u} \times \frac{1}{k} = \frac{du}{u} \times M.$$

That is, the differential of a common logarithm of a quantity is equal to the differential of the quantity divided by the quantity, into the modulus.

If we make $a = e$, the base of the Naperian system, x becomes the Naperian logarithm of u , and k becomes 1 (see equation (3)); hence $M = 1$, and

$$d(\text{Nap. log } u) = dx = \frac{du}{a^x} = \frac{du}{u}.$$

That is, the differential of a Naperian logarithm of a quantity is equal to the differential of the quantity divided by the quantity; and in the Naperian system the modulus is 1.

Since k is the Naperian logarithm of $a, du = a^x l a dx$. That is, the differential of a function of the form a^x is equal to the function, into the Naperian logarithm of the base a , into the differential of the exponent.

If we have a differential in a fractional form, in which the numerator is the differential of the denominator, the integral is the Naperian logarithm of the denominator. Integrals of fractional differentials of other forms are given below:

Differential forms which have known integrals; exponential functions. (l = Nap. log.).

1. $\int a^x l a dx = a^x + C;$
2. $\int \frac{dx}{x} = \int dx x^{-1} = lx + C;$
3. $\int (xy^{x-1} dy + y^x ly \times dx) = y^x + C;$
4. $\int \frac{dx}{\sqrt{x^2 \pm a^2}} = l(x + \sqrt{x^2 \pm a^2}) + C;$
5. $\int \frac{dx}{\sqrt{x^2 \pm 2ax}} = l(x \pm a + \sqrt{x^2 \pm 2ax}) + C;$
6. $\int \frac{2a dx}{a^2 - x^2} = l \left(\frac{a+x}{a-x} \right) + C;$

$$7. \int \frac{2a dx}{x^2 - a^2} = l \left(\frac{x-a}{x+a} \right) + C;$$

$$8. \int \frac{2a dx}{x \sqrt{a^2 + x^2}} = l \left(\frac{\sqrt{a^2 + x^2} - a}{\sqrt{a^2 + x^2} + a} \right) + C;$$

$$9. \int \frac{2a dx}{x \sqrt{a^2 - x^2}} = l \left(\frac{a - \sqrt{a^2 - x^2}}{a + \sqrt{a^2 - x^2}} \right) + C;$$

$$10. \int \frac{x^{-2} dx}{\sqrt{x + x^{-2}}} = -l \left(\frac{1 + \sqrt{1 + a^2 x^2}}{x} \right) + C.$$

Circular functions. --Let z denote an arc in the first quadrant, y its sine, x its cosine, v its versed sine, and t its tangent; and the following notation be employed to designate an arc by any one of its functions, viz..

$\sin^{-1} y$ denotes an arc of which y is the sine,
 $\cos^{-1} x$ " " " " " x is the cosine,
 $\tan^{-1} t$ " " " " " t is the tangent,

(read "arc whose sine is y ," etc.). -- we have the following differential forms which have known integrals (r = radius):

$\int \cos z dz = \sin z + C;$	$\int \sin z dz = \text{versin } z + C;$
$\int -\sin z dz = \cos z + C;$	$\int \frac{dz}{\cos^2 z} = \tan z + C;$
$\int \frac{dy}{\sqrt{1-y^2}} = \sin^{-1} y + C;$	$\int \frac{r dv}{\sqrt{2rv+v^2}} = \text{versin}^{-1} v + C;$
$\int \frac{-dx}{\sqrt{1-x^2}} = \cos^{-1} x + C;$	$\int \frac{r^2 dt}{r^2+t^2} = \tan^{-1} t + C;$
$\int \frac{dv}{\sqrt{2v-v^2}} = \text{versin}^{-1} v + C;$	$\int \frac{du}{\sqrt{a^2-u^2}} = \sin^{-1} \frac{u}{a} + C;$
$\int \frac{dt}{1+t^2} = \tan^{-1} t + C;$	$\int \frac{-du}{\sqrt{a^2-u^2}} = \cos^{-1} \frac{u}{a} + C;$
$\int \frac{r du}{\sqrt{r^2-u^2}} = \sin^{-1} \frac{u}{r} + C;$	$\int \frac{du}{\sqrt{2au-u^2}} = \text{versin}^{-1} \frac{u}{a} + C;$
$\int \frac{-r dx}{\sqrt{r^2-x^2}} = \cos^{-1} \frac{x}{r} + C;$	$\int \frac{a du}{a^2+u^2} = \tan^{-1} \frac{u}{a} + C.$

The cycloid. -- If a circle be rolled along a straight line, any point of the circumference, as P , will describe a curve which is called a cycloid. The circle is called the generating circle, and P the generating point.

The transcendental equation of the cycloid is

$$x = \text{versin}^{-1} \frac{y}{r} - \sqrt{2ry - y^2},$$

and the differential equation is $dx = \frac{y dx}{\sqrt{2ry - y^2}}$

The area of the cycloid is equal to three times the area of the generating circle.

The surface described by the arc of a cycloid when revolved about its base is equal to 64 thirds of the generating circle.

The volume of the solid generated by revolving a cycloid about its base is equal to five eighths of the circumscribing cylinder.

Integral calculus. --In the integral calculus we have to return from the differential to the function from which it was derived. A number of differential expressions are given above, each of which has a known integral corresponding to it, which, being differentiated, will produce the given differential.

In all classes of functions any differential expression may be integrated when it is reduced to one of the known forms; and the operations of the integral calculus consist mainly in making such transformations of given differential expressions as shall reduce them to equivalent ones whose integrals are known.

For methods of making these transformations reference must be made to the text-books on differential and integral calculus.

THE SLIDE. RULE.

The slide rule is based on the principles that the addition of logarithms multiplies the numbers which they represent, and subtracting logarithms divides the numbers. By its use the operations of multiplication, division, the finding of powers and the extraction of roots, may be performed rapidly and with an approximation to accuracy which is sufficient for many purposes. With a good 10-inch Mannheim rule the results obtained are usually accurate to 1/4 of 1 per cent. Much greater accuracy is obtained with cylindrical rules like the Thacher.

The rule (see Fig. 73) consists of a fixed and a sliding part both of which are ruled with logarithmic scales; that is, with consecutive divisions spaced not equally as in an ordinary scale, but in proportion to the logarithms of a series of numbers from 1 to 10. By moving the slide to the right or left the logarithms are added or subtracted, and multiplication or division of the numbers thereby effected. The scales on the fixed part of the rule are known as the **A** and **D** scales and those on the slide as the **B** and **C** scales. **A** and **B** are the upper and **C** and **D** are the lower scales. The **A** and **B** scales are each divided into two left hand and right hand, each being a reproduction, one half the size, of the **C** and **D** scales. A "runner," consisting of a transparent strip of celluloid with a vertical line on it, is used to facilitate some of the operations. The numbering on each scale begins with the figure 1, which is called

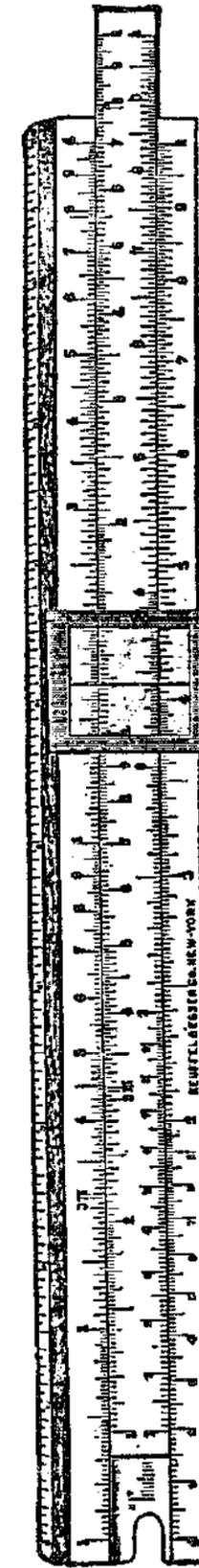

FIG. 73.

the "index" of the scale. In using the scale the figures 1, 2, 3, etc., are to be taken either as representing these numbers, or as 10, 20, 30, etc., 100, 200, 300, etc., 0.1, 0.2, 0.3, etc., that is, the numbers multiplied or divided by 10, 100, etc., as may be most convenient for the solution of a given problem.

The following examples will give an idea of the method of using the slide rule.

Proportion.— Set the first term of a proportion on the *C* scale opposite the **second** term on the *D* scale, then opposite the third term on the *C* scale read the fourth term on the *D* scale.

EXAMPLE.— Find the fourth term in the proportion $12 : 21 :: 30 : x$. Move the slide to the right until 12 on *C* coincides with 21 on *D*, then opposite 30 on *C* read x on *D* = 52.5. The *A* and *B* scales may be used instead of *C* and *D*.

Multiplication.— Set the index or figure 1 of the *C* scale to one of the factors on *D*.

EXAMPLE.— 25×3 . Move the slide to the right until the left index of *C* coincides with 25 on the *D* scale. Under 3 on the *C* scale will be found the product on the *D* scale, = 75.

Division.— Place the divisor on *C* opposite the dividend on *D*, and the quotient will be found on *D* under the index of *C*.

EXAMPLE.— $750 \div 25$. Move the slide to the left until 25 on *C* coincides with 750 on *D*. Under the left index of *C* is found the quotient on *D*, = 30.

Combined Multiplication and Division.— Arrange the factors to be multiplied and divided in the form of a fraction with one more factor in the numerator than in the denominator, supplying the factor 1 if necessary. Then perform alternate division and multiplication, using the runner to indicate the several partial results.

EXAMPLE.— $\frac{4 \times 5 \times 8}{3 \times 6} = 8.9$ nearly. Set 3 on *C* over 4 on *D*, set runner to 5 on *C*, then set 6 on *C* under the runner, and read under 8 on *C* the result 8.9 — on *D*.

Involution and Evolution.— The numbers on scales *A* and *B* are the squares of their coinciding numbers on the scales *C* and *D* and also the numbers on scales *C* and *D* are the square roots of their coinciding numbers on scales *A* and *B*.

EXAMPLE.— $4^2 = 16$. Set the runner over 4 on scale *D* and read 16 on *A*.

$\sqrt{16} = 4$. Set the runner over 16 on *A* and read 4 on *D*. In extracting square roots, if the number of digits is odd, take the number on the left-hand scale of *A*; if the number of digits is even, take the number on the right-hand scale of *A*.

To cube a number, perform the operations of squaring and multiplication.

EXAMPLE.— $2^3 = 8$. Set the index of *C* over 2 on *D*, and above 2 on *B* read the result 8 on *A*.

Extraction of the Cube Root.— Set the runner over the number on *A*, then move the slide until there is found under the runner on *B* the same number which is found under the index of *C* on *D*; this number is the cube root desired.

EXAMPLE.— $\sqrt[3]{8} = 2$. Set the runner over 8 on *A*, move the slide along until the same number appears under the runner on *B* and under the index of *C* on *D*; this will be the number 2.

Trigonometrical Computations.— On the under side of the slide (which is reversible) are placed three scales, a scale of natural sines marked *S*, a scale of natural tangents marked *T*, and between these a scale of equal parts. To use these scales, reverse the slide bringing its under side to the top. Coinciding with an angle on *S* its sine will be found on *A* and coinciding with an angle on *T* will be found the tangent on *D*. Sines and tangents can be multiplied or divided like numbers.

LOGARITHMIC RULED PAPER.

W. F. Durand (*Eng. News*, Sept. 28, 1893.)

As plotted on ordinary cross-section paper the lines which express relations between two variables are usually curved, and must be plotted point by point from a table previously computed. It is only where the exponents involved in the relationship are unity that the line becomes straight and may be drawn immediately on the determination of two of its points. It is the peculiar property of logarithmic section paper that for all relationships which involve multiplication, division, raising to powers, or extraction of roots, the lines representing them are straight. Any such relationship may be represented by an equation of the form: $y = Bx^n$. Taking logarithms we have: $\log y = \log B + n \log x$.

Logarithmic section paper is a short and ready means of plotting such logarithmic equations. The scales on each side are logarithmic instead of uniform, as in ordinary cross-section paper. The numbers and divisions marked are placed at such points that their distances from the origin are proportional to the logarithms of such numbers instead of to the numbers themselves. If we take any point, as 3, for example, on such a scale, the real distance we are dealing with is $\log 3$ to some particular base, and not 3 itself. The number at the origin of such a scale is always 1 and not 0, because 1 is the number whose logarithm is 0. This 1 may, however, represent a unit of any order, so that quantities of any size whatever may be dealt with.

If we have a series of values of x and of Bx^n , and plot on logarithmic section paper x horizontally and Bx^n vertically, the actual distances involved will be $\log x$ and $\log(Bx^n)$, or $\log B + n \log x$. But these distances will give a straight line as the locus. Hence all relationships expressible in this form are represented on logarithmic section paper by straight lines. It follows that the entire locus may be determined from any two points; that is, from any two values of Bx^n ; or, again, by any one point and the angle of inclination: that is, by one value of Bx^n and the value of n , remembering that n is the tangent of the angle of inclination to the horizontal.

A single square plotted on each edge with a logarithmic scale from 1 to 10 may be made to serve for any number whatever from 0 to ∞ . Thus to express graphically the locus of the equation: $y = x^{3/2}$. Let Fig. 74 denote a square cross-sectioned with logarithmic scales, as described. Suppose that there were joined to it, and to each other on the right and above, an indefinite series of such squares similarly divided. Then, considering, in passing from one square to an adjacent one to the right or above, that the unit becomes of next higher order, such a series of squares would, with the proper variation of the unit, represent all values of either x or y between 0 and ∞ .

Suppose the original square divided on the horizontal edge into 3 parts, and on the vertical edge into 2 parts, the points of division being at A, B, D, E, G, I. Then lines joining these points, as shown, will be at an inclination to the horizontal whose tangent is $3/2$. Now, beginning at O, OF will give the value of $x^{3/2}$ for values of x from 1 to that denoted by HF, or OB, or about 4.6. For greater values of x the line would run into the adjacent square above, but the location of this line, if continued, would be exactly similar to that of BD in the square before us. Therefore the line BD will give values of $x^{3/2}$ for x between B and C, or 4.6 and 10, the corresponding values of y being of the order of tens, and ranging from 10 to 31.3. For larger values of x the unit of x is of the higher order, and we run into an adjacent square to the right without change of unit for y . In this square we should traverse a line similar to IG. Therefore, by a proper choice of units we may make use of IG for the determination of values of $x^{3/2}$ where x lies between 10 and the value at G, or about 21.5. We should then run into an adjacent square above, requiring the unit on y to be of the next higher order, and traverse a line similar to AE, which

takes us finally to the opposite corner and completes the cycle. Following this, the same series of lines would result for numbers of succeeding orders.

The value of $x^{3/2}$ for any value of x between 1 and 10 may thus be read from one or another of these lines, and likewise for any value between 0 and 1. The location of the decimal point is readily found by a little attention to the numbers involved. The limiting values of x for any given line may be marked on it, thus enabling a proper choice to be readily made. Thus, in Fig. 2 we mark OF as 0 - 4.6, BD as 1.6 - 10, IG as

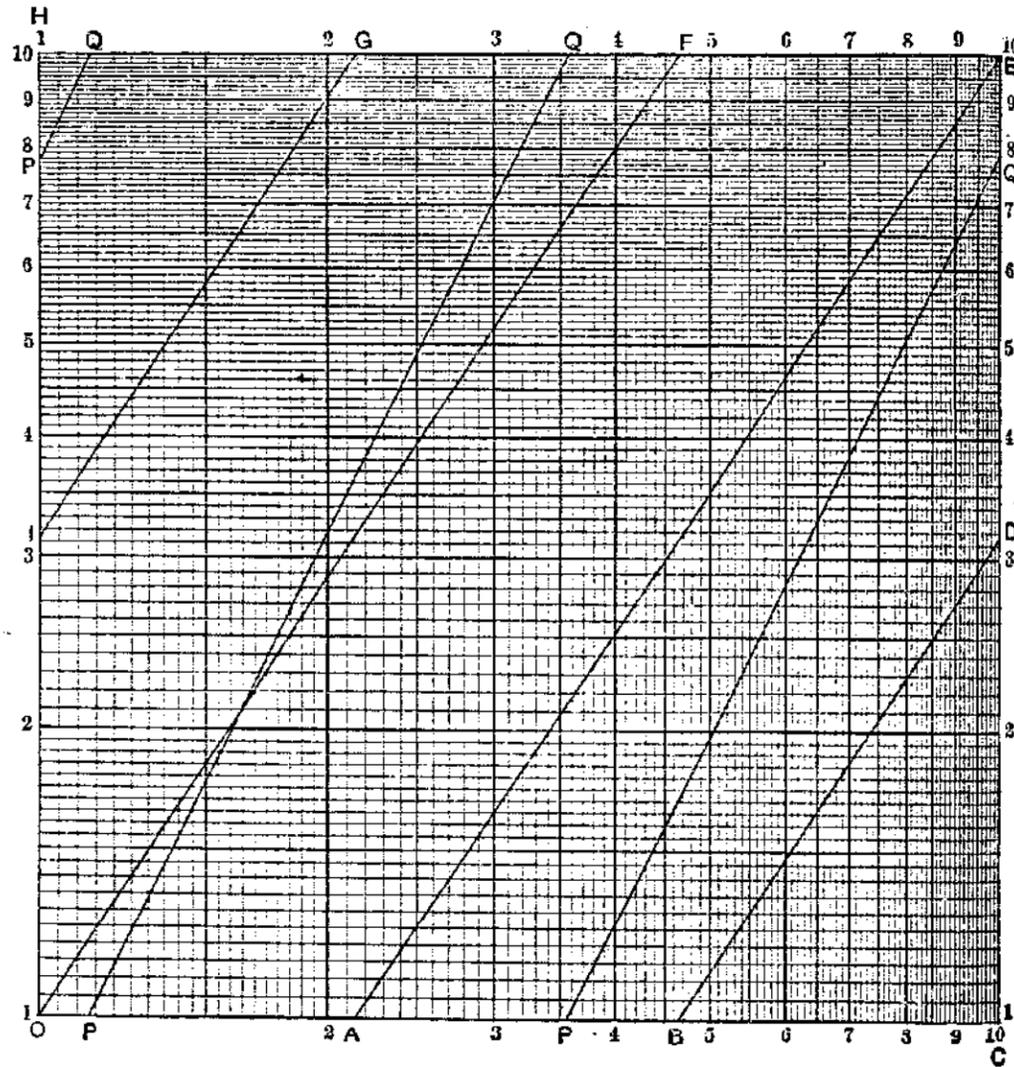

FIG. 74.

10 - 21.5, and AE as 21.5 - 100. If values of x less than 1 are to be dealt with, AAE will serve for values of x between 1 and 0.215, IG for values between 0.215 and 0.1, BD for values between 0.1 and 0.046, and OF for values between 0.046 and 0.001.

The principles involved in this case may be readily extended to any other, and in general if the exponent be represented by m/n , the complete set of lines may be drawn by dividing on a side of the square into m and the other into n parts, and joining the points of division as in Fig. 74. In all there will be $(m+n-1)$ lines, and opposite to any point on X there will be n lines corresponding to the n different beginnings of the n th root

of the m th power, while opposite to any point on Y will be m lines corresponding to the different beginnings of the m th root of the n th power. Where the complete number of lines would be quite large, it is usually unnecessary to draw them all, and the number may be limited to those necessary to cover the needed range in the values of x .

If, instead of the equation $y = x^n$, we have a constant term as a multiplier, giving an equation in the more general form $y = Bx^n$, or $Bx^{m/n}$, there will be the same number of lines and at the same inclination, but all shifted vertically through a distance equal to $\log B$. If, therefore, we start on the axis of Y at the point B , we may draw in the same series of lines and in a similar manner. In this way PQ represents the locus giving the values of the areas of circles in terms of their diameters, being the locus of the equation $A = 1/4 \pi d^2$ or $y = 1/4 \pi x^2$.

If in any case we have x in the denominator such that the equation is in the form $y = B/x^n$, this is equal to $y = Bx^{-n}$, and the same general rules hold. The lines in such case slant downward to the right instead of upward. Logarithmic ruled paper, with directions for the use, may be obtained from Keuffel & Esser Co., 127 Fulton St., New York.

MATHEMATICAL TABLES.

Formula for Interpolation.

$$a_n = a_1 + (n-1)d_1 + \frac{(n-1)(n-2)}{1 \cdot 2} d_2 + \frac{(n-1)(n-2)(n-3)}{1 \cdot 2 \cdot 3} d_3 + \dots$$

a_1 = the first term of the series; n , number of the required term; a_n , the required term; d_1, d_2, d_3 , first terms of successive orders of differences between a_1, a_2, a_3, a_4 , successive terms.

EXAMPLE. - Required the log of 40.7, logs of 40, 41, 42, 43 being given as below.

Terms a_1, a_2, a_3, a_4 : 1.6021 1.6128 1.6232 1.6335

1st differences: 0.0107 0.0104 0.0103
 2d " - 0.0003 + - 0.0002 0.0001
 3d " " " " " " " "

For log 40, $n = 1$; log 41, $n = 2$; for log 40.7, $n = 1.7$; $n - 1 = 0.7$; $n - 2 = -0.3$; $n - 3 = -1.3$.

$$a_n = 1.6021 + 0.7(0.0107) + \frac{(0.7)(-0.3)(-0.0003)}{2} + \frac{(0.7)(-0.3)(-1.3)(0.0002)}{6}$$

$$= 1.6021 + 0.00749 + 0.000031 + 0.000009 = 1.6096 +$$

RECIPROCAL OF NUMBERS.

No.	Reciprocal.	No.	Reciprocal.	No.	Reciprocal.	No.	Reciprocal.	No.	Reciprocal.
1	1.0000000	64	.01562500	127	.00787402	190	.00526316	253	.00395257
2	.5000000	5	.01538461	8	.00781250	5	.00523560	4	.00397301
3	.3333333	6	.01515151	9	.00775194	2	.00520833	5	.00392157
4	.2500000	7	.01492537	130	.00769231	3	.00518135	6	.00390625
5	.2000000	8	.01470588	1	.00763359	4	.00515464	7	.00389105
6	.1666667	9	.01449275	2	.00757575	5	.00512820	8	.00387597
7	.1428571	70	.01428571	3	.00751885	6	.00510204	9	.00386100
8	.1250000	1	.01408451	4	.00746269	7	.00507614	260	.00384615
9	.1111111	2	.01388889	5	.00740741	8	.00505053	1	.00383142
10	.1000000	3	.01369863	6	.00735294	9	.00502510	23	.00381679
11	.0909090	4	.01351351	7	.00729927	200	.00500000		.00380228
12	.0833333	5	.01333333	8	.00724633	1	.00497512		
13	.0769230	6	.01315789	9	.00719424	2	.00495049	43	.00378786
14	.0714285	7	.01298701	140	.00714285	3	.00492616	6	.00375940
15	.0666667	8	.01282051	1	.00709222	4	.00490195	7	.00374532
16	.0625000	9	.01265823	2	.00704222	5	.00487800		
17	.0588235	80	.01250000	3	.00699300	6	.00485437	8	.00373134
18	.0555556	1	.01234568	4	.00694444	7	.00483092	270	.00370370
19	.0526315	2	.01219512	5	.00689653	8	.00480763		.00369004
20	.0500000	3	.01204819	6	.00684931	9	.00478462	2	.00367647
1	.04761905	4	.01190476	7	.00680272	210	.00476190	3	.00366300
2	.0454545	5	.01176471	8	.00675673	1	.00473934		
3	.0434782	6	.01162791	9	.00671114	12	.00471698	4	.00364935
4	.0416667	7	.01149425	150	.00666666	13	.00469484	6	.00362319
5	.0400000	8	.01136364	1	.00662252	14	.00467290	7	.00361011
6	.0384615	9	.01123595	2	.00657892	15	.00465116	8	.00359712
7	.0370370	90	.01111111	3	.00653592	16	.00462969	280	.00358423
8	.0357142	1	.01098901	4	.00649351	17	.00460825		.00357143
9	.0344827	2	.01086953	5	.00645161	18	.00458716	1	.00355872
30	.0333333	3	.01075262	6	.00641026	19	.00456623	2	.00354610
1	.0322580	4	.01063831	7	.00636943	20	.00454549	3	.00353357
2	.0312500	5	.01052632	8	.00632911	1	.00452480		.00352113
3	.0303030	6	.01041667	9	.00628931	2	.00450450		
4	.0294117	7	.01030928	160	.00625000	3	.00448439	65	.00350877
5	.0285714	8	.01020498	1	.00621111	4	.00446424	8	.00348432
6	.0277778	9	.01010101	2	.00617228	5	.00444444		.00347222
7	.0270270	100	.01000000	3	.00613497	6	.00442471	9	.00346021
8	.0263157	1	.00990099	4	.00609753	7	.00440525	290	.00344828
9	.0256410	2	.00980392	5	.00606060	8	.00438591	2	.00343643
40	.0250000	3	.00970874	6	.00602411	9	.00436683		.00342466
1	.0243902	4	.00961531	7	.00598800	230	.00434783	43	.00340136
2	.0238095	5	.00952381	8	.00595232	1	.00432900		.00338983
3	.0232558	6	.00943395	9	.00591716	2	.00431031	5	.00337838
4	.0227272	7	.00934573	170	.00588232	3	.00429181	6	.00336700
5	.0222222	8	.00925925	1	.00584792	4	.00427350	7	.00335570
6	.0217391	9	.00917431	2	.00581392	5	.00425532	8	.00334448
7	.0212766	110	.00909091	3	.00578035	6	.00423725	9	.00333333
8	.0208333	11	.00900901	4	.00574713	7	.00421941	300	.00333333
9	.0204081	12	.00892857	5	.00571425	8	.00420168	1	.00332276
50	.0200000	13	.00884956	6	.00568182	9	.00418410	2	.00331126
1	.0196078	14	.00877193	7	.00564972	20	.00416667	3	.00330033
2	.0192307	15	.00869565	8	.00561798	1	.00414938	4	.00328947
3	.0188679	16	.00862069	9	.00558659	2	.00413223	5	.00327869
4	.0185185	17	.00854701	180	.00555556	3	.00411523	6	.00326797
5	.0181818	18	.00847458	1	.00552486	4	.00409836	7	.00325733
6	.0178571	19	.00840336	2	.00549451	5	.00408163	8	.00324675
7	.0175438	120	.00833333	3	.00546448	6	.00406504	9	.00323625
8	.0172413	1	.00826446	4	.00543478	7	.00404858	310	.00322581
9	.0169491	2	.00819672	5	.00540540	8	.00403226	11	.00321543
60	.0166667	3	.00813008	6	.00537634	9	.00401606	12	.00320513
1	.0163934	4	.00806452	7	.00534759	25	.00400000	13	.00319489
2	.0161290	5	.00800000	8	.00531914	1	.00398406	14	.00318471
3	.0158730	6	.00793651	9	.00529100	2	.00396825	15	.00317460

No.	Reciprocal.	No.	Reciprocal.	No.	Reciprocal.	No.	Reciprocal.	No.	Reciprocal.
316	.00316456	381	.00262467	446	.00224215	511	.00195695	575	.00173611
17	.00315457	2	.00261780	7	.00223714	12	.00195312	577	.00173310
18	.00314465	3	.00261097	8	.00223214	13	.00194932	8	.00173010
19	.00313480	4	.00260417	9	.00222717	141	.00194552	9	.00172712
320	.00312500	5	.00259740	450	.00222222	15	.00194175	0	.00172414
1	.00311526	6	.00259067	11	.00221729	16	.00193798	58	.00172117
2	.00310559	7	.00258398	2	.00221239	17	.00193424	2	.00171821
3	.00309597	8	.00257732	3	.00220751	18	.00193050	3	.00171527
4	.00308642	9	.00257069	4	.00220264	19	.00192678	4	.00171233
5	.00307692	390	.00256410	5	.00219780	520	.00192308	5	.00170940
6	.00306748	1	.00255754	6	.00219298	1	.00191939	6	.00170648
7	.00305810	2	.00255102	7	.00218818	2	.00191571	7	.00170358
8	.00304878	3	.00254453	8	.00218341	3	.00191205	8	.00170068
9	.00303951	4	.00253807	9	.00217865	4	.00190840	9	.00169779
330	.00303030	5	.00253165	460	.00217391	5	.00190476	0	.00169491
1	.00302115	6	.00252525	1	.00216920	6	.00190114	59	.00169205
2	.00301205	7	.00251889	2	.00216450	7	.00189753	2	.00168919
3	.00300300	8	.00251256	3	.00215983	8	.00189394	3	.00168634
4	.00299401	9	.00250627	4	.00215517	9	.00189036	4	.00168350
5	.00298507	400	.00250000	5	.00215054	530	.00188679	5	.00168067
6	.00297619	1	.00249377	6	.00214592	1	.00188324	6	.00167785
7	.00296736	2	.00248756	7	.00214133	2	.00187970	7	.00167504
8	.00295858	3	.00248139	8	.00213675	3	.00187617	8	.00167224
9	.00294985	4	.00247525	9	.00213220	4	.00187266	9	.00166945
340	.00294118	5	.00246914	470	.00212766	5	.00186916	0	.00166667
1	.00293255	6	.00246305	1	.00212314	6	.00186567	60	.00166389
2	.00292398	7	.00245700	2	.00211864	7	.00186220	2	.00166113
3	.00291545	8	.00245098	3	.00211416	8	.00185874	3	.00165837
4	.00290698	9	.00244499	4	.00210970	9	.00185528	4	.00165563
5	.00289855	410	.00243902	5	.00210526	5	.00185185	5	.00165289
6	.00289017	11	.00243309	6	.00210084	6	.00184843	6	.00165016
7	.00288184	12	.00242718	7	.00209644	7	.00184502	7	.00164745
8	.00287356	13	.00242131	8	.00209205	8	.00184162	8	.00164474
9	.00286533	14	.00241546	9	.00208768	9	.00183823	9	.00164204
350	.00285714	15	.00240964	480	.00208333	5	.00183486	10	.00163934
1	.00284900	16	.00240385	1	.00207900	6	.00183151	11	.00163666
2	.00284091	17	.00239808	2	.00207469	7	.00182812	12	.00163399
3	.00283286	18	.00239234	3	.00207039	8	.00182481	13	.00163132
4	.00282486	19	.00238663	4	.00206612	9	.00182146	14	.00162866
5	.00281690	420	.00238095	5	.00206186	5	.00181811	15	.00162602
6	.00280899	1	.00237530	6	.00205761	6	.00181481	16	.00162338
7	.00280112	2	.00236967	7	.00205339	7	.00181151	17	.00162075
8	.00279330	3	.00236407	8	.00204918	8	.00180831	18	.00161812
9	.00278551	4	.00235849	9	.00204499	9	.00180510	19	.00161551
360	.00277778	5	.00235294	490	.00204082	5	.00180181	20	.00161290
1	.00277008	6	.00234742	1	.00203666	6	.00179851	1	.00161031
2	.00276243	7	.00234192	2	.00203252	7	.00179531	2	.00160772
3	.00275482	8	.00233645	3	.00202840	8	.00179211	3	.00160514
4	.00274725	9	.00233100	4	.00202429	9	.00178891	4	.00160256
5	.00273973	430	.00232558	5	.00202020	560	.00178571	5	.00160000
6	.00273224	1	.00232019	6	.00201613	1	.00178251	6	.00159744
7	.00272480	2	.00231481	7	.00201207	2	.00177931	7	.00159490
8	.00271739	3	.00230947	8	.00200803	3	.00177611	8	.00159236
9	.00271003	4	.00230415	9	.00200401	4	.00177291	9	.00158982
370	.00270270	5	.00229885	500	.00200000	5	.00176971	530	.00158730
1	.00269542	6	.00229358	6	.00199601	6	.00176651	1</	

No.	Reciprocal.	No.	Reciprocal.	No.	Reciprocal.	No.	Reciprocal.	No.	Reciprocal.
641	.00156006	706	.00141643	771	.00129702	836	.00119617	901	.00110988
2	.00155763	7	.00141443	2	.00129534	7	.00119474	2	.00110865
3	.00155521	8	.00141243	3	.00129366	8	.00119332	3	.00110742
4	.00155279	9	.00141044	4	.00129199	9	.00119189	4	.00110619
5	.00155039	7101	.00140845	5	.00129032	840	.00119048	5	.00110497
6	.00154799	11	.00140647	6	.00128866	1	.00118906	6	.00110375
7	.00154559	12	.00140449	7	.00128700	2	.00118765	7	.00110254
8	.00154321	13	.00140252	8	.00128535	3	.00118624	8	.00110132
9	.00154083	14	.00140056	9	.00128370	4	.00118483	9	.00110011
650	.00153846	15	.00139860	780	.00128205	5	.00118343	910	.00109890
1	.00153610	16	.00139665	1	.00128041	6	.00118203	11	.00109769
2	.00153374	17	.00139470	2	.00127877	7	.00118064	12	.00109649
3	.00153140	18	.00139276	3	.00127714	8	.00117924	13	.00109529
4	.00152905	19	.00139082	4	.00127551	9	.00117786	14	.00109409
5	.00152672	20	.00138889	5	.00127388	850	.00117647	15	.00109290
6	.00152439	1	.00138696	6	.00127226	1	.00117509	16	.00109170
7	.00152207	2	.00138504	7	.00127065	2	.00117371	17	.00109051
8	.00151975	3	.00138313	8	.00126904	3	.00117233	18	.00108932
9	.00151745	4	.00138121	9	.00126743	4	.00117096	19	.00108814
660	.00151515	5	.00137931	790	.00126582	5	.00116959	920	.00108696
1	.00151286	6	.00137741	1	.00126422	6	.00116822	1	.00108578
2	.00151057	7	.00137552	2	.00126263	7	.00116686	2	.00108460
3	.00150830	8	.00137363	3	.00126103	8	.00116550	3	.00108342
4	.00150602	9	.00137174	4	.00125945	9	.00116414	4	.00108225
5	.00150376	7301	.00136986	5	.00125786	860	.00116279	5	.00108108
6	.00150150	1	.00136799	6	.00125628	1	.00116144	6	.00107991
7	.00149925	2	.00136612	7	.00125470	2	.00116009	7	.00107875
8	.00149701	3	.00136425	8	.00125313	3	.00115875	8	.00107759
9	.00149477	4	.00136240	9	.00125156	4	.00115741	9	.00107643
670	.00149254	5	.00136054	800	.00125000	5	.00115607	930	.00107527
1	.00149031	6	.00135870	1	.00124844	6	.00115473	1	.00107411
2	.00148809	7	.00135685	2	.00124688	7	.00115340	2	.00107296
3	.00148588	8	.00135501	3	.00124533	8	.00115207	3	.00107181
4	.00148368	9	.00135318	4	.00124378	9	.00115075	4	.00107066
5	.00148148	740	.00135135	5	.00124224	870	.00114942	5	.00106952
6	.00147929	1	.00134953	6	.00124069	1	.00114811	6	.00106838
7	.00147710	2	.00134771	7	.00123916	2	.00114679	7	.00106724
8	.00147493	3	.00134589	8	.00123762	3	.00114547	8	.00106610
9	.00147275	4	.00134409	9	.00123609	4	.00114416	9	.00106496
680	.00147059	5	.00134228	810	.00123457	5	.00114286	940	.00106383
1	.00146843	6	.00134048	11	.00123305	6	.00114155	1	.00106270
2	.00146628	7	.00133869	12	.00123153	7	.00114025	2	.00106157
3	.00146413	8	.00133690	13	.00123001	8	.00113895	3	.00106044
4	.00146199	9	.00133511	14	.00122850	9	.00113766	4	.00105932
5	.00145985	750	.00133333	15	.00122699	880	.00113636	5	.00105820
6	.00145773	1	.00133156	16	.00122549	1	.00113507	6	.00105708
7	.00145560	2	.00132979	17	.00122399	2	.00113379	7	.00105597
8	.00145349	3	.00132802	18	.00122249	3	.00113250	8	.00105485
9	.00145137	4	.00132626	19	.00122100	4	.00113122	9	.00105374
690	.00144927	5	.00132450	820	.00121951	5	.00112994	950	.00105263
1	.00144718	6	.00132275	1	.00121803	6	.00112867	1	.00105152
2	.00144509	7	.00132100	2	.00121654	7	.00112740	2	.00105042
3	.00144300	8	.00131926	3	.00121507	8	.00112613	3	.00104932
4	.00144092	9	.00131752	4	.00121359	9	.00112486	4	.00104822
5	.00143885	760	.00131579	5	.00121212	890	.00112360	5	.00104712
6	.00143678	1	.00131406	6	.00121065	1	.00112233	6	.00104602
7	.00143472	2	.00131234	7	.00120919	2	.00112108	7	.00104493
8	.00143266	3	.00131062	8	.00120773	3	.00111982	8	.00104384
9	.00143061	4	.00130890	9	.00120627	4	.00111857	9	.00104275
700	.00142857	5	.00130719	830	.00120482	5	.00111732	960	.00104167
1	.00142653	6	.00130548	1	.00120337	6	.00111607	1	.00104058
2	.00142450	7	.00130378	2	.00120192	7	.00111483	2	.00103950
3	.00142247	8	.00130208	3	.00120048	8	.00111359	3	.00103842
4	.00142045	9	.00130039	4	.00119904	9	.00111235	4	.00103734
5	.00141844	70	.00129870	5	.00119760	900	.00111111	5	.00103627

No.	Reciprocal.	No.	Reciprocal.	No.	Reciprocal.	No.	Reciprocal.	No.	Reciprocal.
966	.00103520	031	.000969932	1096	.000912409	1161	.000861326	1226	.000815661
7	.00103413	2	.000968992	7	.000911577	2	.000860585	7	.000814996
8	.00103306	3	.000968054	8	.000910747	3	.000859845	8	.000814332
9	.00103199	4	.000967118	9	.000909918	4	.000859106	9	.000813670
970	.00103093	5	.000966184	1100	.000909091	5	.000858369	1230	.000813008
1	.00102987	6	.000965251	1	.000908265	6	.000857633	1	.000812348
2	.00102881	7	.000964320	2	.000907441	7	.000856898	2	.000811688
3	.00102775	8	.000963391	3	.000906618	8	.000856164	3	.000811030
4	.00102669	9	.000962464	4	.000905797	9	.000855432	4	.000810373
5	.00102564	040	.000961538	5	.000904977	1170	.000854701	5	.000809717
6	.00102459	1	.000960615	6	.000904159	1	.000853971	6	.000809061
7	.00102354	2	.000959693	7	.000903342	2	.000853242	7	.000808407
8	.00102250	3	.000958774	8	.000902527	3	.000852515	8	.000807754
9	.00102145	4	.000957854	9	.000901713	4	.000851789	9	.000807102
980	.00102041	5	.000956938	1110	.000900901	5	.000851064	1240	.000806452
1	.00101937	6	.000956023	11	.000900090	6	.000850340	1	.000805802
2	.00101833	7	.000955110	12	.000899281	7	.000849618	2	.000805153
3	.00101729	8	.000954198	13	.000898473	8	.000848896	3	.000804505
4	.00101626	9	.000953289	14	.000897666	9	.000848176	4	.000803858
5	.00101523	050	.000952381	15	.000896861	1180	.000847457	5	.000803213
6	.00101420	1	.000951475	16	.000896057	1	.000846740	6	.000802568
7	.00101317	2	.000950570	17	.000895255	2	.000846024	7	.000801925
8	.00101215	3	.000949668	18	.000894454	3	.000845308	8	.000801282
9	.00101112	4	.000948767	19	.000893655	4	.000844595	9	.000800640
990	.00101010	5	.000947867	1120	.000892857	5	.000843882	1250	.000800000
1	.00100908	6	.000946970	1	.000892061	6	.000843170	1	.000799360
2	.00100806	7	.000946074	2	.000891266	7	.000842460	2	.000798722
3	.00100705	8	.000945180	3	.000890472	8	.000841751	3	.000798085
4	.00100604	9	.000944287	4	.000889680	9	.000841043	4	.000797448
5	.00100502	060	.000943396	5	.000888889	1190	.000840336	5	.000796813
6	.00100402	1	.000942507	6	.000888099	1	.000839631	6	.000796178
7	.00100301	2	.000941620	7	.000887311	2	.000838926	7	.000795545
8	.00100200	3	.000940734	8	.000886525	3	.000838222	8	.000794913
9	.00100100	4	.000939850	9	.000885740	4	.000837521	9	.000794281
1000	.00100000	5	.000938967	1130	.000884956	5	.000836820	1260	.000793651
1	.000999001	6	.000938086	1	.000884173	6	.000836120	1	.000793021
2	.000998004	7	.000937207	2	.000883392	7	.000835422	2	.000792393
3	.000997009	8	.000936330	3	.000882612	8	.000834724	3	.000791766
4	.000996016	9	.000935454	4	.000881834	9	.000834028	4	.000791139
5	.000995025	070	.000934579	5	.000881057	1200	.000833333	5	.000790514
6	.000994036	1	.000933707	6	.000880282	1	.000832639	6	.000789889
7	.000993049	2	.000932836	7	.000879508	2	.000831947	7	.000789266
8	.000992063	3	.000931966	8	.000878735	3	.000831255	8	.000788643
9	.000991080	4	.000931099	9	.000877963	4	.000830565	9	.000788022
1010	.000990099	5	.000930233	1140	.000877193	5	.000829875	1270	.000787402
11	.000989120	6	.000929368	1	.000876424	6	.000829187	1	.000786782
12	.000988142	7	.000928505	2	.000875657	7	.000828500	2	.000786163
13	.000987167	8	.000927644	3	.000874891	8	.000827815	3	.000785546
14	.000986193	9	.000926784	4	.000874126	9	.000827130	4	.000784929
15	.000985222	1080	.000925926	5	.000873362	1210	.000826446	5	.000784314
16	.000984252	1	.000925069	6	.000872600	11	.000825		

No.	Reciprocal.	No.	Reciprocal.	No.	Reciprocal.	No.	Reciprocal.	No.	Reciprocal.
1291	.000774593	1356	.000737463	1421	.000703730	1486	.000672948	1551	.000644745
2	.000773994	7	.000736920	21	.000703235	7	.000672495	2	.000644330
3	.000773395	8	.000736377	31	.000702741	8	.000672043	3	.000643915
4	.000772797	9	.000735835	41	.000702247	9	.000671592	4	.000643501
5	.000772201	1360	.000735294	51	.000701754	1490	.000671141	5	.000643087
6	.000771605	1	.000734754	61	.000701262	1	.000670691	6	.000642673
7	.000771010	2	.000734214	71	.000700771	2	.000670241	7	.000642261
8	.000770416	3	.000733676	81	.000700280	3	.000669792	8	.000641848
9	.000769823	4	.000733138	91	.000699790	4	.000669344	9	.000641437
1300	.000769231	5	.000732601	1430	.000699301	5	.000668896	1560	.000641026
1	.000768639	6	.000732064	1	.000698812	6	.000668449	1	.000640615
2	.000768049	71	.000731529	2	.000698324	7	.000668003	2	.000640205
3	.000767459	81	.000730994	3	.000697837	8	.000667557	3	.000639795
4	.000766871	91	.000730460	4	.000697350	9	.000667111	4	.000639386
5	.000766283	1370	.000729927	5	.000696864	1500	.000666667	5	.000638978
6	.000765697	1	.000729395	6	.000696379	1	.000666223	6	.000638570
7	.000765111	2	.000728863	7	.000695894	2	.000665779	7	.000638162
8	.000764526	3	.000728332	8	.000695410	3	.000665336	8	.000637755
9	.000763942	4	.000727802	9	.000694927	4	.000664894	9	.000637349
1310	.000763359	5	.000727273	1440	.000694444	5	.000664452	1570	.000636943
11	.000762776	6	.000726744	1	.000693962	6	.000664011	1	.000636537
12	.000762195	7	.000726216	2	.000693481	7	.000663570	2	.000636132
13	.000761615	8	.000725689	3	.000693001	8	.000663130	3	.000635728
14	.000761035	91	.000725163	4	.000692521	9	.000662691	4	.000635324
15	.000760456	1380	.000724638	5	.000692041	1510	.000662252	5	.000634921
16	.000759878	1	.000724113	6	.000691563	11	.000661813	6	.000634518
17	.000759301	2	.000723589	7	.000691085	12	.000661376	7	.000634115
18	.000758725	3	.000723066	8	.000690608	13	.000660939	8	.000633714
19	.000758150	4	.000722543	9	.000690131	14	.000660502	9	.000633312
1320	.000757576	5	.000722022	1450	.000689655	15	.000660066	1580	.000632911
1	.000757002	6	.000721501	1	.000689180	16	.000659631	1	.000632511
2	.000756430	7	.000720980	2	.000688705	17	.000659196	2	.000632111
3	.000755858	8	.000720461	3	.000688231	18	.000658761	3	.000631712
4	.000755287	9	.000719942	4	.000687758	19	.000658328	4	.000631313
5	.000754717	1390	.000719424	5	.000687285	1520	.000657895	5	.000630915
6	.000754148	1	.000718907	6	.000686813	1	.000657462	6	.000630517
7	.000753579	2	.000718391	7	.000686341	2	.000657030	7	.000630120
8	.000753012	3	.000717875	8	.000685871	3	.000656598	8	.000629723
9	.000752445	4	.000717360	9	.000685401	4	.000656168	9	.000629327
1330	.000751880	5	.000716846	1460	.000684932	5	.000655738	1590	.000628931
1	.000751315	6	.000716332	1	.000684463	6	.000655308	1	.000628536
2	.000750750	7	.000715820	2	.000683994	7	.000654879	2	.000628141
3	.000750187	8	.000715308	3	.000683527	8	.000654450	3	.000627746
4	.000749625	9	.000714796	4	.000683060	9	.000654022	4	.000627353
5	.000749064	1400	.000714286	5	.000682594	1530	.000653595	5	.000626959
6	.000748503	1	.000713776	6	.000682128	1	.000653168	6	.000626566
7	.000747943	2	.000713267	7	.000681663	2	.000652742	7	.000626174
8	.000747384	3	.000712758	8	.000681199	3	.000652316	8	.000625782
9	.000746826	4	.000712251	9	.000680735	4	.000651890	9	.000625391
1340	.000746269	5	.000711744	1470	.000680272	5	.000651466	1600	.000625000
1	.000745712	6	.000711238	1	.000679810	6	.000651042	2	.000624619
2	.000745156	7	.000710732	2	.000679348	7	.000650618	4	.000624241
3	.000744602	8	.000710227	3	.000678887	8	.000650195	6	.000623865
4	.000744048	9	.000709723	4	.000678426	9	.000649773	8	.000623491
5	.000743494	1410	.000709220	5	.000677966	1540	.000649351	1610	.000623118
6	.000742942	11	.000708717	6	.000677507	1	.000648929	12	.000622747
7	.000742390	12	.000708215	7	.000677048	2	.000648508	14	.000622378
8	.000741840	13	.000707714	8	.000676590	3	.000648088	16	.000622011
9	.000741290	14	.000707214	9	.000676132	4	.000647668	18	.000621647
1350	.000740741	15	.000706714	1480	.000675676	5	.000647249	1620	.000621284
1	.000740192	16	.000706215	1	.000675219	6	.000646830	2	.000620923
2	.000739645	17	.000705716	2	.000674764	7	.000646412	4	.000620563
3	.000739098	18	.000705219	3	.000674309	8	.000645995	6	.000620206
4	.000738552	19	.000704722	4	.000673854	9	.000645578	8	.000619850
5	.000738007	1420	.000704225	5	.000673401	1550	.000645161	1630	.000619497

No.	Reciprocal.	No.	Reciprocal.	No.	Reciprocal.	No.	Reciprocal.	No.	Reciprocal.
1632	.000612745	1706	.000586166	1780	.000561798	1854	.000539374	1928	.000518672
4	.000611995	8	.000585480	2	.000561167	6	.000538793	1930	.000518135
6	.000611247	1710	.000584795	4	.000560538	8	.000538213	2	.000517599
8	.000610500	12	.000584112	6	.000559910	1860	.000537634	4	.000517063
1640	.000609756	14	.000583430	8	.000559284	2	.000537057	6	.000516528
2	.000609013	16	.000582750	1790	.000558659	4	.000536480	8	.000515996
4	.000608272	18	.000582072	2	.000558035	6	.000535905	1940	.000515464
6	.000607533	1720	.000581395	4	.000557413	8	.000535332	2	.000514933
8	.000606796	2	.000580720	6	.000556793	1870	.000534759	4	.000514403
1650	.000606061	4	.000580046	8	.000556174	2	.000534188	6	.000513874
2	.000605327	6	.000579374	1800	.000555556	4	.000533618	8	.000513347
4	.000604595	8	.000578704	2	.000554939	6	.000533049	1950	.000512820
6	.000603865	1730	.000578035	4	.000554324	8	.000532481	2	.000512295
8	.000603136	2	.000577367	6	.000553710	1880	.000531915	4	.000511770
1660	.000602410	4	.000576701	8	.000553097	2	.000531350	6	.000511247
2	.000601685	6	.000576037	1810	.000552486	4	.000530785	8	.000510725
4	.000600962	8	.000575374	12	.000551876	6	.000530222	1960	.000510204
6	.000600240	1740	.000574713	14	.000551268	8	.000529661	2	.000509684
8	.000599520	2	.000574053	16	.000550661	1890	.000529100	4	.000509165
1670	.000598802	4	.000573394	18	.000550055	2	.000528541	6	.000508647
2	.000598086	6	.000572737	1820	.000549451	4	.000527983	8	.000508130
4	.000597371	8	.000572082	2	.000548848	6	.000527426	1970	.000507614
6	.000596658	1750	.000571429	4	.000548246	8	.000526870	2	.000507099
8	.000595947	2	.000570776	6	.000547645	1900	.000526316	4	.000506585
1680	.000595238	4	.000570125	8	.000547046	2	.000525762	6	.000506073
2	.000594530	6	.000569476	1830	.000546448	4	.000525210	8	.000505561
4	.000593824	8	.000568828	2	.000545851	6	.000524659	1980	.000505051
6	.000593120	1760	.000568182	4	.000545256	8	.000524109	2	.000504541
8	.000592417	2	.000567537	6	.000544662	1910	.000523560	4	.000504032
1690	.000591716	4	.000566893	8	.000544069	12	.000523012	6	.000503524
2	.000591017	6	.000566251	1840	.000543478	14	.000522466	8	.000503018
4	.000590319	8	.000565611	2	.000542888	16	.000521920	1990	.000502513
6	.000589622	1770	.000564972	4	.000542299	18	.000521376	2	.000502008
8	.000588928	2	.000564334	6	.000541711	1920	.000520833	4	.000501504
1700	.000588235	4	.000563698	8	.000541125	2	.000520291	6	.000501002
2	.000587544	6	.000563063	1850	.000540540	4	.000519750	8	.000500501
4	.000586854	8	.000562430	2	.000539957	6	.000519211	2000	.000500000

Use of reciprocals. — Reciprocals may be conveniently used to facilitate computations in long division. Instead of dividing as usual, multiply the dividend by the reciprocal of the divisor. The method is especially useful when many different dividends are required to be divided by the same divisor. In this case find the reciprocal of the divisor, and make a small table of its multiples up to 9 times, and use this as a multiplication-table instead of actually performing the multiplication in each case.

EXAMPLE. — 9871 and several other numbers are to be divided by 1638. The reciprocal of 1638 is .000610500. Multiples of the reciprocal:

1.	.0006105
2.	.0012210
3.	.0018315
4.	.0024420
5.	.0030525
6.	.0036630
7.	.0042735
8.	.0048840
9.	.0054945
10.	.0061050

The table of multiples is made by continuous addition of 6105. The tenth line is written to check the accuracy of the addition, but it is not afterwards used.

Operation:

Dividend	9871	
Take from table 1.....		.0006105
7.....		0.042735
8.....		00.48840
9.....		005.4945

Quotient. 6.0262455
Correct quotient by direct division. 6.0262515

The result will generally be correct to as many figures as there are significant figures in the reciprocal, less one, and the error of the next figure will in general not exceed one. In the above example the reciprocal has six significant figures, 610500, and the result is correct to five places of figures.

No.	Sq.	Cube.	Sq. Root.	Cube Root.	No.	Square.	Cube.	Sq. Root.	Cube Root.
100	100201	1000000	10.0499	4.6416	155	24025	3723875	12.4499	5.3717
101	10404	1061208	10.0995	4.6723	156	24336	3796416	12.4900	5.3832
102		1092727	10.1489	4.6875	157	24649	3869893	12.5300	5.3947
103	10609	10816	10.1980	4.7027	158	24964	3944312	12.5698	5.4061
104		1124864			159	25281	4019679	12.6095	5.4175
105	11236	1191626	10.2030	4.7177	160	25600	4096000	12.6491	5.4288
106	11449	1225043	10.3441	4.7326	161	25921	4173281	12.6886	5.4401
107	11664	1259712	10.3923	4.7475	162	26244	4251528	12.7279	5.4514
108	11881	1295029	10.4403	4.7622	163	26569	4330747	12.7671	5.4626
109				4.7769	164	26896	4410944	12.8062	5.4737
110	12320	1367631	10.4887	4.7914	165	27225	4492125	12.8452	5.4848
111	12544	1404928		4.8059	166	27556	4574296	12.8841	5.4959
112	12769	1442897	10.6320	4.8203	167	27889	4657463	12.9228	5.5069
113	12996	1481544		4.8346	168	28224	4741632	12.9615	5.5178
114			10.6771	4.8488	169	28561	4826809	13.0005	5.5288
115	13236	1580896	10.7238	4.8629	170	28900	4913000	13.0384	5.5397
116	13639	1601613	10.7703	4.8770	171	29241	5000211	13.0767	5.5505
117	13924	1643032	10.8688	4.8910	172	29584	5088448	13.1149	5.5613
118	14161	1685159			173	29929	5177717	13.1529	5.5721
119			10.9087	4.9187	174	30276	5268024	13.1909	5.5828
120	14640	1771560	10.9545	4.9324	175	30625	5359375	13.2288	5.5934
121	14884	1815848	11.0000	4.9461	176	30976	5451776	13.2665	5.6041
122	15129	1860867	II. 0454	4.9597	177	31329	5545233	13.3041	5.6147
123	15376	1906624	II. 0905	4.9732	178	31684	5639752	13.3417	5.6252
124			II. 1355	4.9866	179	32041	5735339	13.3791	5.6357
125	15825	1966326	II. 1803	5.0000	180	32400	5832000	13.4164	5.6462
126	16129	2048383	II. 2694	5.0133	181	32761	5929741	13.4536	5.6567
127	16384	2097152		5.0265	182	33124	6028568	13.4907	5.6671
128	16641	2146689	II. 3137	5.0397	183	33489	6128487	13.5277	5.6774
129			II. 3578	5.0528	184	33856	6229504	13.5647	5.6877
130	17160	2248000	II. 4019	5.0658	185	34225	6331625	13.6015	5.6980
131	17424	2299963		5.0788	186	34596	6434856	13.6382	5.7083
132	17689	2352637	II. 4891	5.0916	187	34969	6539203	13.6748	5.7185
133	17956	2406104	II. 5326	5.1045	188	35344	6644672	13.7113	5.7287
134			II. 5758	5.1172	189	35721	6751269	13.7477	5.7388
135	18496	2460336	II. 6190	5.1299	190	36100	6859000	13.7840	5.7489
136	18769	2511353	II. 6619	5.1426	191	36481	6967871	13.8203	5.7590
137	19044	2628072	II. 7047	5.1551	192	36864	7077888	13.8564	5.7690
138	19321	2685619	II. 7473	5.1676	193	37249	7189057	13.8924	5.7790
139			II. 7898	5.1801	194	37636	7301384	13.9284	5.7890
140	19880	2864000	II. 8322	5.1925	195	38025	7414875	13.9642	5.7989
141	20164	2863288	II. 8743	5.2048	196	38416	7529536	14.0000	5.8088
142	20449	2924207	II. 9164	5.2171	197	38809	7645373	14.0357	5.8186
143	20736	2985984	II. 9583	5.2293	198	39204	7762392	14.0712	5.8285
144			II. 10000	5.2415	199	39601	7880599	14.1067	5.8383
145	21316	3048625	12.0416	5.2536	200	40000	8000000	14.1421	5.8480
146	21609	3178188	12.0830	5.2656	201	40401	8120601	14.1774	5.8578
147	21904						8242408	14.2127	5.8675
148	22201	3241792	12.1655	5.2896	203	41209	8365427	14.2478	5.8771
149		3307949	12.2066	4.3015	204	41616	8489664	14.2829	5.8868
150	22800	3373000	12.2474	5.3133	205	42025	8619125	14.3178	5.8964
151	23104	3511808	12.2882	5.3251	206	42436	8741816	14.3527	5.9059
152	23409	3581577	12.3288	5.3368	207	42849	8869743	14.3875	5.9155
153	23716	3652264	12.3693	5.3485	208	43264	8998912	14.4222	5.9250
154			12.4097	5.3601	209	43681	9129329	14.4568	5.9345

No.	Sq.	Cube.	Sq. Root.	Cube Root.	No.	Square.	Cube.	Sq. Root.	Cube Root.
210	44100	9261000	14.4914	5.9439	265	70225	18609625	16.2788	6.4232
211	414521	9393931	14.5258	5.9533	266	70756	18821096	16.3095	6.4312
212	414944	9528120	14.5602	5.9627	267	71289	19034163	16.3401	6.4393
213	45369	9663597	14.5945	5.9721	268	71824	19248832	16.3707	6.4473
214	45796	9800344	14.6288	5.9814	269	72361	19465109	16.4012	6.4553
215	46225	9938375	14.6629	5.9907	270	72900	19683000	16.4317	6.4633
216	46656	10077696	14.6969	6.0000	271	73441	19902511	16.4621	6.4713
217	47089	10218313	14.7309	6.0092	272	73984	20123648	16.4924	6.4792
218	47524	10360232	14.7648	6.0185	273	74529	20346417	16.5227	6.4872
219	47961	10503459	14.7986	6.0277	274	75076	20570824	16.5529	6.4951
220	48400	10648000	14.8324	6.0368	275	75625	20796875	16.5831	6.5030
221	48841	10793861	14.8661	6.0459	276	76176	21024576	16.6132	6.5108
222	49284	10941048	14.8997	6.0550	277	76729	21253933	16.6433	6.5187
223	49729	11089567	14.9332	6.0641	278	77284	21484952	16.6733	6.5265
224	50176	11239424	14.9666	6.0732	279	77841	21717639	16.7033	6.5343
225	50625	11390625	15.0000	6.0822	280	78400	21952000	16.7332	6.5421
226	51076	11543176	15.0333	6.0912	281	78961	22188041	16.7631	6.5499
227	51529	11697083	15.0665	6.1002	282	79524	22425768	16.7929	6.5577
228	51984	11852352	15.0997	6.1091	283	80089	22665187	16.8226	6.5654
229	52441	12008989	15.1327	6.1180	284	80656	22906304	16.8523	6.5731
230	52900	12167000	15.1658	6.1269	285	81225	23149125	16.8819	6.5808
231	53361	12326391	15.1987	6.1358	286	81796	23393656	16.9115	6.5885
232	53824	12487168	15.2315	6.1446	287	82369	23639903	16.9411	6.5962
233	54289	12649337	15.2643	6.1534	288	82944	23887872	16.9706	6.6039
234	54756	12812904	15.2971	6.1622	289	83521	24137569	17.0000	6.6115
235	55225	12977875	15.3297	6.1710	290	84100	24389000	17.0294	6.6191
236	55696	13144256	15.3622	6.1797	291	84681	24642171	17.0587	6.6267
237	56169	13312053	15.3948	6.1885	292	85264	24897088	17.0880	6.6343
238	56644	13481272	15.4272	6.1972	293	85849	25153757	17.1172	6.6419
239	57121	13651919	15.4596	6.2058	294	86436	25412184	17.1464	6.6494
240	57600	13824000	15.4919	6.2145	295	87025	25672375	17.1756	6.6569
241	58081	13997521	15.5242	6.2231	296	87616	25934336	17.2047	6.6644
242	58564	14172488	15.5563	6.2317	297	88209	26198073	17.2337	6.6719
243	59049	14348907	15.5885	6.2403	298	88804	26463592	17.2627	6.6794
244	59536	14526784	15.6205	6.2488	299	89401	26730899	17.2916	6.6869
245	60025	14706125	15.6525	6.2573	300	90000	27000000	17.3205	6.6943
246	60516	14886936	15.6844	6.2658	301	90601	27270901	17.3494	6.7018
247	61009	15069223	15.7162	6.2743	302	91204	27543608	17.3781	6.7092
248	61504	15252992	15.7480	6.2828	303	91809	27818127	17.4069	6.7166
249	62001	15438249	15.7797	6.2912	304	92416	28094464	17.4356	6.7240
250	62500	15625000	15.8114	6.2996	305	93025	28372625	17.4642	6.7313
251	63001	15813251	15.8430	6.3080	306	93636	28652616	17.4929	6.7387
252	63504	16003008	15.8745	6.3164	307	94249	28934443	17.5214	6.7460
253	64009	16194277	15.9060	6.3247	308	94864	29218112	17.5499	6.7533
254	64516	16387064	15.9374	6.3330	309	95481	29503629	17.5784	6.7606
255	65025	16581375	15.9687	6.3413	310	96100	29791000	17.6068	6.7679
256	65536	16777216	16.0000	6.3496	311	96721	30080231	17.6352	6.7752
257	66049	16974593	16.0312	6.3579	312	97344	30371328	17.6635	6.7824
258	66564	17173512	16.0624	6.3661	313	97969	30664297	17.6918	6.7897
259	67081	17373979	16.0935	6.3743	314	98596	30959144	17.7200	6.7969
260	67600	17576000	16.1245	6.3825	315	99225	31255875	17.7482	6.8041
261	68121	17779581	16.1555	6.3907	316	99856	31554496	17.7764	6.8113
262	68644	17984728	16.1864	6.3988	317	100489	31855013	17.8045	6.8185
263									6.8256
264	69600	18399744	16.2478	6.4070	318	101104	32167439	17.83	

No.	Square.	Cube.	Sq. Root.	Cube Root.	No.	Square	Cube.	Sq. Root.	Cube Root.
320	102400	32768000	17.8885	6.8399	375	140625	52734375	19.3649	7.2112
321	103041	33076161	17.9165	6.8470	376	141376	53157376	19.3907	7.2177
322	103684	33386248	17.9444	6.8541	377	142129	53582633	19.4165	7.2240
323	104329	33698267	17.9722	6.8612	378	142884	54010152	19.4422	7.2304
324	104976	34012224	18.0000	6.8683	379	143641	54439939	19.4679	7.2368
325	105625	34328125	18.0278	6.8753	380	144400	54872000	19.4936	7.2432
326	106276	34645976	18.0555	6.8824	381	145161	55306341	19.5192	7.2495
327	106929	34965783	18.0831	6.8894	382	145924	55742968	19.5448	7.2558
328	107584	35287552	18.1108	6.8964	383	146689	56181887	19.5704	7.2622
329	108241	35611289	18.1384	6.9034	384	147456	56623104	19.5959	7.2685
330	108900	35937000	18.1659	6.9104	385	148225	57066625	19.6214	7.2748
331	109561	36264691	18.1934	6.9174	386	148996	57512456	19.6469	7.2811
332	110224	36594368	18.2209	6.9244	387	149769	57960603	19.6723	7.2874
333	110889	36926037	18.2483	6.9313	388	150544	58411072	19.6977	7.2936
334	111556	37259704	18.2757	6.9382	389	151321	58863869	19.7231	7.2999
335	112225	37595375	18.3030	6.9451	390	152100	59319000	19.7484	7.3061
336	112896	37933056	18.3303	6.9521	391	152881	59776471	19.7737	7.3124
337	113569	38272753	18.3576	6.9589	392	153664	60236288	19.7990	7.3186
338	114244	38614472	18.3848	6.9658	393	154449	60698457	19.8242	7.3248
339	114921	38958219	18.4120	6.9727	394	155236	61162984	19.8494	7.3310
340	115600	39304000	18.4391	6.9795	395	156025	61629875	19.8746	7.3372
341	116281	39651821	18.4662	6.9864	396	156816	62099136	19.8997	7.3434
342	116964	40001688	18.4932	6.9932	397	157609	62570773	19.9249	7.3495
343	117649	40353607	18.5203	7.0000	398	158404	63044792	19.9499	7.3556
344	118336	40707584	18.5472	7.0068	399	159201	63521199	19.9750	7.3617
345	119025	41063625	18.5742	7.0136	400	160000	64000000	20.0000	7.3678
346	119716	41421736	18.6011	7.0203	401	160801	64481201	20.0250	7.3739
347	120409	41781923	18.6279	7.0271	402	161604	64964808	20.0499	7.3800
348	121104	42144192	18.6548	7.0338	403	162409	65450827	20.0749	7.3861
349	121801				404	163216	65939264	20.0998	7.3922
350	122500	42508549	18.6815	7.0406	405	164025	66430125	20.1246	7.3983
351	123201	43243551	18.7350	7.0540	406	164836	66923416	20.1494	7.4044
352	123904	43614208	18.7617	7.0607	407	165649	67419143	20.1742	7.4105
353	124609	43986977	18.7883	7.0674	408	166464	67917312	20.1990	7.4166
354	125316	44361864	18.8149	7.0740	409	167281	68417929	20.2237	7.4227
355	126025	44738875	18.8414	7.0807	410	168100	68921000	20.2485	7.4288
356	126736	45118016	18.8680	7.0873	411	168921	69426531	20.2731	7.4349
357	127449	45499293	18.8944	7.0940	412	169744	69934528	20.2978	7.4410
358	128164	45882712	18.9209	7.1006	413	170569	70444997	20.3224	7.4471
359	128881	46268279	18.9473	7.1072	414	171396	7095794420	20.3470	7.4532
360	129600	46656000	18.9737	7.1138	415	172225	71473375	20.3715	7.4593
361	130321	47045881	19.0000	7.1204	416	173056	71991296	20.3961	7.4654
362	131044	47437928	19.0263	7.1269	417	173889	72511713	20.4206	7.4715
363	131769	47832147	19.0526	7.1335	418	174724	7303463220	20.4450	7.4776
364	132496	48228544	19.0788	7.1400		75561		20.4695	7.4837
365	133225	48627125	19.1050	7.1466	420	176400	74088000	20.4939	7.4898
366	133956	49027896	19.1311	7.1531	421	177241	74618461	20.5183	7.4959
367	134689	49430863	19.1572	7.1596		420-176400	75151448	20.5426	7.5020
368	135424	49836032	19.1833	7.1661	422	178084	75686967	20.5670	7.5081
369	136161	50243409	19.2094	7.1726	423	178929	76225024120	20.5913	7.5142
370	136900	50653000	19.2354	7.1791	424	179776	76765625	20.6155	7.5203
371	137641	51064811	19.2614	7.1855	425	180625	77308776	20.6398	7.5264
372	138384	51478848	19.2873	7.1920	426	181476	77854483	20.6640	7.5325
373	139129	51895117	19.3132	7.1984			78402752	20.6882	7.5386
374	139876	52313624	19.3391	7.2048	428	183184	78953589	20.7123	7.5447

No.	Square	Cube.	Sq. Root.	Cube Root.	No.	Square	Cube.	Sq. Root.	Cube Root.
430	184900	79507000	20.7364	7.5478	485	235225	114084125	22.0227	7.8568
431	185761	80062991	20.7605	7.5537	486	236086	114791256	22.0454	7.8622
432	186624	80621568	20.7846	7.5595	487	236949	115501303	22.0681	7.8676
433	187489	81182737	20.8087	7.5654	488	237814	116214272	22.0907	7.8730
434	188356	81746504	20.8327	7.5712	489	238681	116930169	22.1133	7.8784
435	189225	82312875	20.8567	7.5770	490	239549	117649000	22.1359	7.8837
436	190096	82881856	20.8806	7.5828	491	240418	118370771	22.1585	7.8891
437	190969	83453453	20.9045	7.5886	492	241289	119095488	22.1811	7.8944
438	191844	84027672	20.9284	7.5944	493	242161	119823157	22.2036	7.8999
439	192721	84604519	20.9623	7.6001	494	243034	120553784	22.2261	7.9051
440	193600	85184000	20.9762	7.6059	495	243909	121286375	22.2486	7.9105
441	194481	85766121	21.0000	7.6117	496	244786	122021936	22.2711	7.9158
442	195364	86350888	21.0238	7.6174	497	245665	122763473	22.2935	7.9211
443	196249	86938307	21.0476	7.6232	498	246546	123505992	22.3159	7.9264
444	197136	87528384	21.0713	7.6289	499	247429	124251499	22.3383	7.9317
445	198025	88121125	21.0950	7.6346	500	250000	125000000	22.3607	7.9370
446	198916	88716536	21.1187	7.6403	501	251001	125751501	22.3830	7.9423
447	199809	89314623	21.1424	7.6460	502	252004	126506008	22.4054	7.9476
448	200704	89915392	21.1660	7.6517	503	253009	127263527	22.4277	7.9529
449	201601	90518849	21.1896	7.6574	504	254016	128024064	22.4499	7.9581
450	202500	91125000	21.2132	7.6631	505	255025	128787625	22.4721	7.9634
451	203401	91733851	21.2368	7.6688	506	256036	129554216	22.4944	7.9686
452	204304	92345408	21.2603	7.6744	507	257049	130323843	22.5167	7.9739
453	205209	92959677	21.2838	7.6800	508	258064	131096512	22.5389	7.9791
454	206116	93576664	21.3073	7.6857	509	259081	131872229	22.5610	7.9843
455	207025	94196375	21.3307	7.6914	510	260100	132651000	22.5832	7.9896
456	207936	94818816	21.3542	7.6970	511	261121	133432831	22.6053	7.9948
457	208849	95443993	21.3776	7.7026	512	262144	134217728	22.6274	8.0000
458	209764	96071912	21.4009	7.7082	513	263169	135005697	22.6495	8.0052
459	210681	96702579	21.4243	7.7138	514	264196	135796744	22.6716	8.0104
460	211600	97336000	21.4476	7.7194	515	265225	136590875	22.6936	8.0156
461	212521	97972181	21.4709	7.7250	516	266256	137388096	22.7156	8.0208
462	213444	98611128	21.4942	7.7306	517	267289	138188413	22.7376	8.0260
463	214369	99252847	21.5174	7.7362	518	268324	138991832	22.7596	8.0311
464	215296	99897344	21.5407	7.7418	519	269361	139798359	22.7816	8.0363
465	216225	100544625	21.5639	7.7473	520	270400	140608000	22.8035	8.0415
466	217156	101194696	21.5870	7.7529	521	271441	141420761	22.8254	8.0466
467	218089	101847563	21.6102	7.7584	522	272484	142236648	22.8473	8.0517
468	219024	102503232	21.6333	7.7639	523	273529	143055667	22.8692	8.0569
469	219961	103161709	21.6564	7.7695	524	274576	143877824	22.8910	8.0620
470	220900	103823000	21.6795	7.7750	525	275625	144703125	22.9129	8.0671
471	221841	104487111	21.7025	7.7805	526	276676	145531576	22.9347	8.0723
472	222784	105154048	21.7256	7.7860	527	277729	146363183	22.9565	8.0774
473	223729	105823817	21.7486	7.7915	528	278784	147197952	22.9783	8.0825
474	224676	106496424	21.7715	7.7970	529	279841	148035889	23.0000	8.0876
475	225625	107171875	21.7945	7.8025	530	280900	148877000	23.0217	8.0927
476	226576	107850176	21.8174	7.8079	531	281961	149721291	23.0434	8.0978
477	227529	108531333	21.8403	7.8134	532	283024	150568766	23.0651	8.1028
478	228484			7.8188	533	284089	151419437	23.0868	8.1079
479	229441	109902239	21.8861	7.824					

No.	Square.	Cube.	Sq. Root.	Cube Root.	No.	Square.	Cube.	Sq. Root.	Cube Root.
540	291600	157464000	23.2379	8.1433	595	354025	210644875	24.3926	8.4108
541	292681	158340421	23.2594	8.1483	596	355216	211708736	24.4131	8.4155
542	293764	159220088	23.2809	8.1533	597	356409	212776773	24.4336	8.4202
543	294849	160103007	23.3024	8.1583	598	357604	213847192	24.4540	8.4249
544	295936	160989184	23.3238	8.1633	599	358801	214921799	24.4745	8.4296
545	297025	161878625	23.3452	8.1683	600	360000	216000000	24.4949	8.4343
546	298116	162771336	23.3666	8.1733	601	361201	217081801	24.5153	8.4390
547	299209	163669323	23.3880	8.1783	602	362404	218167208	24.5359	8.4439
548	300304	164566592	23.4094	8.1833	603	363609	219256227	24.5561	8.4484
549	301401	165469149	23.4307	8.1892	604	364816	220348864	24.5764	8.4530
550	302500	166375000	23.4521	8.1932	605	366025	221445125	24.5969	8.4577
551	303601	167284151	23.4734	8.1982	606	367236	222545016	24.6171	8.4623
552	304904	168196608	23.4947	8.2031	609	368449	223648543	24.6394	8.4690
553	305809	169112377	23.5160	8.2081	608	369664	224755712	24.6599	8.4916
554	306916	170031464	23.5372	8.2130	609	370881	225866529	24.6779	8.4763
555	308025	170953875	23.5584	8.2180	610	372100	226981000	24.6982	a. 4809
556	309136	171899616	23.5797	8.2229	611	373321	228099131	24.7184	8.4856
559	310249	192808693	23.6008	8.2278	612	374544	229220928	24.9386	8.4902
560	311364	173741112	23.6220	8.2329	613	375769	230346397	24.7588	8.4948
561	312481	174676000	23.6432	8.2377	614	376996	2314755424	24.7790	8.4994
562	313600	175613440	23.6643	8.2426	615	378225	232608375	24.7992	8.5040
563	314721	176553441	23.6854	8.2475	616	379456	233744856	24.8193	8.5086
564	315844	177495984	23.7065	8.2524	617	380689	234885113	24.8395	a. 5132
565	316969	178441089	23.7276	8.2573	618	381924	236029032	24.8596	8.5178
566	318096	179387744	23.7487	8.2621	619	383161	237176659	24.8797	8.5224
567	319225	180336925	23.7697	8.2690	620	384400	238328000	24.8998	8.5270
568	320356	181288624	23.7908	8.2719	621	385641	239483061	24.9199	8.5316
569	321489	182242843	23.8118	8.2768	622	386884	240641848	24.9399	a. 5362
570	322624	183200482	23.8328	8.2816	623	388129	241804367	24.9600	8.5408
571	323761	184161641	23.8537	8.2865	624	389376	242970624	24.9800	8.5453
572	324900	185126320	23.8747	8.2913	625	390625	244140625	25.0000	8.5499
573	326041	186094521	23.8956	8.2962	626	391876	245314376	25.0200	8.5544
574	327184	187066244	23.9165	8.3010	627	393129	246492883	25.0400	8.5590
575	328329	188041489	23.9374	8.3059	628	394384	247676152	25.0599	8.5635
576	329476	189019224	23.9583	8.3107	629	395641	248864189	25.0799	8.5681
577	330625	190000445	23.9792	8.3155	630	396900	250057000	25.0998	8.5726
578	331776	190984156	24.0000	8.3203	631	398161	251259591	25.1197	8.5772
579	332929	191970353	24.0208	8.3251	632	399424	252472968	25.1396	8.5817
580	334084	192959132	24.0416	8.3300	633	400689	253697137	25.1595	8.5862
581	335241	193950489	24.0624	8.3348	634	401956	254932104	25.1794	8.5907
582	336400	194944424	24.0832	8.3396	635	403225	256177785	25.1992	8.5952
583	337561	195940933	24.1039	8.3443	636	404496	257434184	25.2190	8.5997
584	338724	196940024	24.1247	a. 3491	637	405769	258691283	25.2389	8.6043
585	339891	197941701	24.1454	3 5 3 9	638	407044	259949092	25.2589	8.6089
586	341060	198945960	24.1661	a. 3587	639	408321	260917119	25.2784	8.6132
587	342225	200000000	24.1868	8.3634	640	409600	262144000	25.2982	8.6177
588	343396	201060000	24.2074	8.3682	641	410881	263374721	25.3180	8.6222
589	344569	202126000	24.2281	8.3730	642	412164	264609288	25.3379	8.6267
590	345744	203200000	24.2487	8.3777	643	413449	265847707	25.3574	8.6312
591	346921	204280000	24.2693	8.3825	644	414736	267089984	25.3772	8.6357
592	348100	205379000	24.2899	8.3872	645	416025	268336125	25.3969	8.6401
593	349281	206487000	24.3105	8.3919	646	417316	269586136	25.4165	8.6446
594	350464	207494000	24.3311	8.3967	647	418609	270840023	25.4362	8.6490
595	351649	208527857	24.3516	8.4014	648	419904	272097792	25.4558	8.6535
596	352836	209584584	24.3721	8.4061	649	421201	273359449	25.4755	8.6579

No.	Square.	Cube.	Sq. Root.	Cube Root.	No.	Square.	Cube.	Sq. Root.	Cube Root.
650	422500	74625000	25.4951	8.6624	705	497025	350402625	26.5518	8.9001
651	423801	74984451	25.51478	8.6668	706	498436	351895816	26.5707	8.9043
652	425104	75344808	25.5343	a. 6713	707	499849	353393243	26.5895	8.9085
653	426409	75704507	25.5539	8.6757	708	501264	354894912	26.6083	8.9127
654	427716	759726425	25.5734	8.6801	709	502681	356400829	26.6271	8.9169
655	429025	762402125	25.5930	8.6845	710	504100	357911000	26.6458	8.9211
656	430336	765082256	25.6125	8.6890	711	505521	359425431	26.6646	8.9253
657	431649	767766927	25.63208	8.6934	712	506944	360944128	26.6833	8.9295
658	432964	770456048	25.6515	8.6978	713	508369	362467097	26.7021	8.9337
659	434281	773149719	25.6710	8.7022	714	509796	363994344	26.7208	8.9378
660	435600	775848000	25.6905	a. 7066	715	511225	365525875	26.7395	8.9420
661	436921	778550881	25.7099	8.7110	716	512656	367061696	26.7582	8.9462
662	438244	781258352	25.7294	a. 7154	717	514089	368601813	26.9969	8.9533
663	439569	783970409	25.7488	8.7198	718	515524	370146232	26.7955	8.9545
664	440896	786687040	25.7682	8.7241	719	516961	371694959	26.8142	8.9587
665	442225	789408225	25.7876	8.7285	720	518400	393248000	26.8328	G.3628
666	443556	792133964	25.8070	8.7329	721	519841	374805361	26.8514	8.9690
667	444889	794864253	25.8263	8.7373	722	521284	376369048	26.8701	a. 9711
668	446224	797600088	25.8457	a. 7416	723	522729	377933067	26.8889	8.9952
669	447561	799341479	25.8650	8.7460	724	524176	379503424	26.9092	8.9794
670	448900	801088400	25.88448	8.7503	725	525625	381078125	26.9258	8.9835
671	450241	802840851	25.9037	8.7549	726	527076	392659176	26.9444	8.9876
672	451584	804598832	25.92308	8.7590	727	528529	384240583	26.9629	8.9918
673	452929	806362343	25.9422	8.7634	728	529984	385820352	26.9815	8.9959
674	454276	808131384	25.9615	a. 7677	729	531441	387420489	29.0000	9.0000
675	455625	809905965	25.9808	8.7721	730	532900	389040700	29.0185	9.0041
676	456976	811686088	26.0000	0.9964	731	534361	390681981	27.0370	9.0082
677	458329	813471753	26.0192	8.7807	732	535824	392223168	29.0555	9.0123
678	459684	815262968	26.0384	8.7850	733	537289	393832839	29.0940	9.0164
679	461041	817069733	26.0576	8.7893	734	538756	395446904	27.0924	9.0205
680	462400	818882000	26.0768	8.7937	735	540225	399065395	27.1109	9.0246
681	463761	820700761	26.0960	8.7980	736	541696	398680256	27.1293	9.0287
682	465124	822525016	26.1151	8.8023	737	543169	400315553	29.1497	9.0328
683	466489	824354769	26.1343	8.8066	738	544644	401949292	27.1662	9.0369
684	467856	826190024	26.1534	8.8109	739	546121	403583419	27.1846	9.0410
685	469225	828030785	26.1725	8.8152	740	547600	405224000	27.2029	9.0450
686	470596	829877056	26.19168	8.8194	741	549081	406869021	27.2213	9.0491
687	471969	831728833	26.2107	8.8237	742	550564	408518488	29.2397	9.0532
688	473344	833586112	26.2298	8.8280	743	552049	410172407	27.2580	9.0572
689	474721	835448901	26.2488	8.8323	744	553536	411030784	292764	9.0613
690	496100	328509000	26.2679	8.8366	745	555025	413493625	29.2949	9.0654
691	477481	837319371	26.2869	8.8406	746	556516	415160936	29.3130	9.0694
692	478864	839134888	26.3059	8.8451	747	558009	416832723	29.3313	9.0735
693	480249	840951453	26.3249	8.8493	748	559504	418508992	27.3496	9.0775
694	481636	842769064	26.3439	8.8536	749	561001	420189749	29.3679	9.0816
695	483025	844587725	26.3629	8.8578	750	562500	421895000	27.3861	9.0856
696	484416	846407436	26.3818	8.8621	751	564001	423564751	27.4044	9.0896
697	485809	848228193	26.4008	8.8663	752	565504	4		

No.	Square.	Cube.	Sq. Root.	Cube Root.	No.	Square	Cube.	Sq. Root.	Cube Root.
760	577600	438976000	27.5681	9.1258	815	664225	541343375	28.5482	9.3408
761	579121	440711081	27.5862	9.1298	816	665856	54338496	28.5657	9.3447
762	580644	442450728	27.6043	9.1338	817	667489	545338513	28.5832	9.3485
763	582169	444190375	27.6224	9.1378	818	669124	547343432	28.6007	9.3523
764	583696	445930022	27.6405	9.1418	819	670761	549353259	28.6182	9.3561
765	585225	447697125	27.6586	9.1458	820	672400	551368000	28.6356	9.3599
766	586756	449455096	27.6767	9.1498	821	674041	553387661	28.6531	9.3637
767	588289	451217663	27.6948	9.1537	822	675684	555412248	28.6705	9.3675
768	589824	452984832	27.7128	9.1577	823	677329	557441767	28.6880	9.3713
769	591361	454756609	27.7308	9.1617	824	678976	559476224	28.7054	9.3751
770	592900	456533000	27.7489	9.1657	825	680625	561515625	28.7228	9.3789
771	594441	458314011	27.7669	9.1696	826	682276	563559976	28.7402	9.3827
772	595984	460099648	27.7849	9.1736	827	683929	565509283	28.7576	9.3865
773	597529	461889917	27.8029	9.1775	828	685584	567463552	28.7750	9.3902
774	599076	463684824	27.8209	9.1815	829	687241	569422789	28.7924	9.3940
775	600625	465484375	27.8388	9.1855	830	688900	571387000	28.8097	9.3978
776	602176	467288576	27.8568	9.1894	831	690561	573356191	28.8271	9.4016
777	603729	469097433	27.8747	9.1933	832	692224	575330368	28.8444	9.4053
778	605284	470910952	27.8927	9.1973	833	693889	577309537	28.8617	9.4091
779	606841	472729139	27.9106	9.2012	834	695556	579293704	28.8791	9.4129
780	608400	474552000	27.9285	9.2052	835	697225	581282875	28.8964	9.4166
781	609961	476379541	27.9464	9.2091	836	698896	583277056	28.9137	9.4204
782	611524	478211768	27.9643	9.2130	837	700569	585276253	28.9310	9.4241
783	613089	480048687	27.9821	9.2170	838	702244	587280464	28.9482	9.4279
784	614656	481890304	28.0000	9.2209	839	703921	589289699	28.9655	9.4316
785	616225	483736625	28.0179	9.2248	840	705600	591304000	28.9828	9.4354
786	617796	485587656	28.0357	9.2287	841	707281	593323321	29.0000	9.4391
787	619369	487443403	28.0535	9.2326	842	708964	595347688	29.0172	9.4429
788	620944	489303872	28.0713	9.2365	843	710649	597377107	29.0345	9.4466
789	622521	491169069	28.0891	9.2404	844	712336	601211584	29.0517	9.4503
790	624100	493039000	28.1069	9.2443	845	714025	603251125	29.0689	9.4541
791	625681	494913671	28.1247	9.2482	846	715716	605295736	29.0861	9.4578
792	627264	496793088	28.1425	9.2521	847	717409	607345423	29.1033	9.4615
793	628849	498677257	28.1603	9.2560	848	719104	609399192	29.1204	9.4652
794	630436	500566184	28.1780	9.2599	849	720801	611458049	29.1376	9.4690
795	632025	502459875	28.1957	9.2638	850	722500	613521900	29.1548	9.4727
796	633616	504359326	28.2135	9.2677	851	724201	615590851	29.1719	9.4764
797	635209	506264533	28.2312	9.2716	852	725904	617664804	29.1890	9.4801
798	636804	508175592	28.2489	9.2754	853	727609	619743767	29.2062	9.4838
799	638401	510092409	28.2666	9.2793	854	729316	621827732	29.2233	9.4875
800	640000	512015000	28.2843	9.2832	855	731025	623917705	29.2404	9.4912
801	641601	513942201	28.3019	9.2870	856	732736	626013688	29.2575	9.4949
802	643204	515874968	28.3196	9.2909	857	734449	628115683	29.2746	9.4986
803	644809	517813227	28.3373	9.2947	858	736164	630223688	29.2916	9.5023
804	646416	519757004	28.3549	9.2986	859	737881	632337709	29.3087	9.5060
805	648025	521706225	28.3725	9.3025	860	739600	634457744	29.3258	9.5097
806	649636	523660906	28.3901	9.3063	861	741321	636583791	29.3428	9.5134
807	651249	525621043	28.4077	9.3102	862	743044	638715848	29.3598	9.5171
808	652864	527586632	28.4253	9.3140	863	744769	640853923	29.3768	9.5207
809	654481	529557677	28.4429	9.3179	864	746496	642998016	29.3939	9.5244
810	656100	531534180	28.4605	9.3217	865	748225	645148125	29.4109	9.5281
811	657721	533516141	28.4781	9.3255	866	749956	647304248	29.4279	9.5317
812	659344	535503568	28.4956	9.3294	867	751689	649466383	29.4449	9.5354
813	660969	537496467	28.5132	9.3332	868	753424	651634528	29.4618	9.5391
814	662596	539494832	28.5307	9.3370	869	755161	653808683	29.4788	9.5427

No.	Square.	Cube.	Sq. Root.	Cube Root.	No.	Square.	Cube.	Sq. Root.	Cube Root.
870	756900	658503000	29.4958	9.5464	925	855625	791453125	30.4138	9.7435
871	758441	660776311	29.5127	9.5501	926	857176	794022776	30.4302	9.7470
872	760384	663054848	29.5296	9.5537	927	858729	796597983	30.4467	9.7505
873	762129	665338617	29.5466	9.5574	928	861184	799178752	30.4631	9.7540
874	763876	667627624	29.5635	9.5610	929	863041	801765089	30.4795	9.7575
875	765625	669921875	29.5804	9.5647	930	864900	804357000	30.4959	9.7610
876	767376	672221376	29.5973	9.5683	931	866761	806954491	30.5123	9.7645
877	769129	674526133	29.6142	9.5717	932	868624	809557568	30.5287	9.7680
878	770884	676836152	29.6311	9.5756	933	870489	812166237	30.5450	9.7715
879	772641	679151439	29.6479	9.5792	934	872356	814780504	30.5614	9.7750
880	774400	681472000	29.6648	9.5828	935	874225	817400375	30.5777	9.7785
881	776161	683797841	29.6816	9.5865	936	876096	820025856	30.5941	9.7819
882	777924	686128968	29.6985	9.5901	937	877969	822656953	30.6105	9.7854
883	779689	688465387	29.7153	9.5937	938	879844	825293672	30.6269	9.7889
884	781456	690807104	29.7321	9.5973	939	881721	827936019	30.6431	9.7924
885	783225	693154125	29.7489	9.6010	940	883600	830584000	30.6594	9.7959
886	784996	695506456	29.7658	9.6046	941	885481	833237621	30.6757	9.7993
887	786769	697864103	29.7825	9.6082	942	887364	835896888	30.6920	9.8028
888	788544	700227072	29.7993	9.6118	943	889249	838561807	30.7083	9.8063
889	790321	702595369	29.8161	9.6154	944	891136	841232384	30.7246	9.8097
890	792100	704969000	29.8329	9.6190	945	893025	843908625	30.7409	9.8132
891	793881	707347971	29.8496	9.6226	946	894916	846590536	30.7571	9.8167
892	795664	709732288	29.8664	9.6262	947	896803	849278123	30.7734	9.8201
893	797449	712121957	29.8831	9.6298	948	898704	851971392	30.7896	9.8236
894	799236	714516984	29.8998	9.6334	949	900601	854670549	30.8058	9.8270
895	801025	716917375	29.9166	9.6370	950	902500	857375000	30.8221	9.8305
896	802816	719323136	29.9333	9.6406	951	904401	860085551	30.8383	9.8339
897	804609	721734273	29.9500	9.6442	952	906304	862801408	30.8545	9.8374
898	806404	724150792	29.9666	9.6477	953	908209	865523177	30.8707	9.8408
899	808201	726572699	29.9833	9.6513	954	910116	868250664	30.8869	9.8443
900	810000	729000000	30.0000	9.6549	955	912025	870983875	30.9031	9.8477
901	811801	731432701	30.0167	9.6585	956	913936	873722816	30.9192	9.8511
902	813604	733870808	30.0333	9.6620	957	915849	876467493	30.9354	9.8546
903	815409	736314327	30.0500	9.6656	958	917764	879217912	30.9516	9.8580
904	817216	738763264	30.0666	9.6692	959	919681	881974079	30.9677	9.8614
905	819025	741217625	30.0832	9.6727	960	921600	884736000	30.9839	9.8648
906	820836	743677416	30.0998	9.6763	961	923521	887503681	31.0005	9.8683
907	822649	746142643	30.1164	9.6799	962	925444	890277128	31.0161	9.8717
908	824464	748613312	30.1330	9.6834	963	927369	893056347	31.0322	9.8751
909	826281	751089429	30.1496	9.6870	964	929296	895841344	31.0483	9.8785
910	828100	753571000	30.1662	9.6905	965	931225	898632125	31.0644	9.8819
911	829921	756058031	30.1828	9.6941	966	933156	901428696	31.0805	9.8854
912	831744	758550528	30.1993	9.6976	967	935089	904231063	31.0966	9.8888
913	833569	761048497	30.2159	9.7012	968	937024	907039232	31.1127	9.8922
914	835396	763551944	30.2324	9.7047	969	938961	909853209	31.1288	9.8956
915	837225	766060875	30.2490	9.7082	970	940900	912673000	31.1448	9.8990
916	839056	768575296	30.2655	9.7118	971	942841	915498611	31.1609	9.9024
917	840889	771095213	30.2820	9.7153	972	944784	918		

No.	Square.	Cube.	Sq. Root.	Cube Root.	No.	Square.	Cube.	Sq. Root.	Cube Root.
980	960400	941192000	31.3050	9.9329	1035	1071225	1105717875	32.1714	10.1153
981	962361	944076141	31.3209	9.9363	1036	1073236	110934656	32.1870	10.1186
982	964324	946966168	31.3369	9.9396	1037	1075269	1113157653	32.2025	10.1218
983	966289	949862087	31.3528	9.9430	1038	1077444	11171836872	32.2180	10.1251
984	968256	952763904	31.3688	9.9464	1039	1079521	1121222319	32.2335	10.1283
985	970225	955671625	31.3847	9.9497	1040	1081600	1125384000	32.2490	10.1316
986	972196	958585256	31.4007	9.9531	1041	1083681	112956881	32.2645	10.1348
987	974169	961504303	31.4166	9.9565	1042	1085764	1133866088	32.2800	10.1381
988	976144	964430272	31.4325	9.9598	1043	1087849	113826507	32.2955	10.1413
989	978121	967361569	31.4484	9.9632	1044	1089936	1142783184	32.3110	10.1446
990	980100	970299000	31.4643	9.9666	1045	1092025	11474166125	32.3265	10.1478
991	982081	9732427131	31.4802	9.9699	1046	1094116	1152065336	32.3419	10.1510
992	984064	9761914381	31.4960	9.9733	1047	1096209	1156829383	32.3573	10.1543
993	986049	9791461731	31.5119	9.9766	1048	1098304	1161608736	32.3728	10.1575
994	988036	982107784	31.5278	9.9800	1049	1100401	1166404001	32.3883	10.1607
995	990025	985074955	31.5436	9.9833	1050	1102500	1171215250	32.4037	10.1640
996	992016	988047686	31.5595	9.9866	1051	1104601	1176042551	32.4191	10.1672
997	994009	991025977	31.5753	9.9900	1052	1106704	1180885904	32.4345	10.1704
998	996004	994010928	31.5911	9.9933	1053	1108809	1185845319	32.4500	10.1736
999	998001	997002999	31.6070	9.9967	1054	1110916	1190920796	32.4654	10.1769
1000	1000000	1000000000	31.6228	10.0000	1055	1113025	1196012335	32.4808	10.1801
1001	1002001	1003003001	31.6386	10.0033	1056	1115136	1201120936	32.4962	10.1833
1002	1004004	1006012008	31.6544	10.0067	1057	1117249	1206245603	32.5115	10.1865
1003	1006009	1009027027	31.6702	10.0100	1058	1119364	1211387336	32.5269	10.1897
1004	1008016	1012048064	31.6860	10.0133	1059	1121481	1216546135	32.5423	10.1929
1005	1010025	1015075125	31.7017	10.0166	1060	1123600	1221722000	32.5576	10.1961
1006	1012036	1018108216	31.7175	10.0200	1061	1125721	1226915031	32.5730	10.1993
1007	1014049	10211925731	31.7333	10.0233	1062	1127844	1232125136	32.5883	10.2025
1008	1016064	10241925731	31.7490	10.0266	1063	1129969	1237352303	32.6036	10.2057
1009	1018081	1027243727	31.7648	10.0299	1064	1132096	1242596536	32.6190	10.2089
1010	1020100	1030301000	31.7805	10.0332	1065	1134225	1247857835	32.6343	10.2121
1011	1022121	1033364331	31.7962	10.0365	1066	1136356	1253136200	32.6496	10.2153
1012	1024144	1036433728	31.8119	10.0400	1067	1138489	1258431631	32.6649	10.2185
1013	1026169	1039509197	31.8277	10.0435	1068	1140624	1263744136	32.6803	10.2217
1014	1028196	1042590744	31.8434	10.0470	1069	1142761	1269073703	32.6956	10.2249
1015	1030225	1045678375	31.8591	10.0498	1070	1144900	1274420300	32.7109	10.2281
1016	1032256	1048772096	31.8748	10.0531	1071	1147041	1279783921	32.7262	10.2313
1017	1034289	1051871913	31.8904	10.0563	1072	1149184	1285164564	32.7415	10.2345
1018	1036324	1054977832	31.9061	10.0596	1073	1151329	1290562329	32.7568	10.2377
1019	1038361	1058089859	31.9218	10.0629	1074	1153476	1295977216	32.7721	10.2409
1020	1040400	1061208000	31.9374	10.0662	1075	1155625	1301409265	32.7874	10.2441
1021	1042441	1064332261	31.9531	10.0695	1076	1157776	1306858486	32.8027	10.2473
1022	1044484	1067462648	31.9687	10.0728	1077	1159929	1312324779	32.8180	10.2505
1023	1046529	1070599167	31.9844	10.0761	1078	1162084	1317808088	32.8333	10.2537
1024	1048576	1073741824	32.0000	10.0794	1079	1164241	1323308413	32.8486	10.2569
1025	1050625	10768890625	32.0156	10.0826	1080	1166400	1328825764	32.8639	10.2601
1026	1052676	1080045576	32.0312	10.0859	1081	1168561	1334350135	32.8792	10.2633
1027	1054729	1083206683	32.0468	10.0892	1082	1170724	1339891528	32.8945	10.2665
1028	1056784	1086373952	32.0624	10.0925	1083	1172889	1345449943	32.9098	10.2697
1029	1058841	1089547389	32.0780	10.0957	1084	1175056	1351025396	32.9251	10.2729
1030	1060900	1092727000	32.0936	10.0990	1085	1177225	1356617895	32.9404	10.2761
1031	1062961	1095912791	32.1092	10.1023	1086	1179396	1362227448	32.9557	10.2793
1032	1065024	1099104768	32.1248	10.1055	1087	1181569	1367854063	32.9710	10.2825
1033	1067089	1102302937	32.1403	10.1088	1088	1183744	1373497740	32.9863	10.2857
1034	1069156	1105507304	32.1559	10.1121	1089	1185921	1379158479	33.0016	10.2889

No.	Square.	Cube.	Sq. Root.	Cube Root.	No.	Square.	Cube.	Sq. Root.	Cube Root.
1090	1188100	295029000	33.0151	10.2914	1145	1311025	1501123625	33.8378	10.4617
1091	1190281	1298596571	33.0303	10.2946	1146	1313316	1505060136	33.8526	10.4647
1092	1132464	1302170688	33.0454	10.2977	1147	1315609	1509003523	33.8674	10.4678
1093	1194649	1305751357	33.0606	10.3009	1148	1317904	1512953792	33.8821	10.4708
1094	1196836	1309338584	33.0757	10.3040	1149	1322500	1516910949	33.8969	10.4739
1095	1199025	1312932375	33.0908	10.3071	1150	1324801	1520875000	33.9116	10.4769
1096	1201216	1316532736	33.1059	10.3103	1151	1327104	1524845951	33.9264	10.4799
1097	1203409	1320139673	33.1210	10.3134	1152	1329409	1528823808	33.9411	10.4830
1098	1205604	1323753192	33.1361	10.3165	1153	1331716	1532808577	33.9559	10.4860
1099	1207801	1327373299	33.1511	10.3197	1154	1334025	1536800264	33.9706	10.4890
1100	1210000	1331000000	33.1662	10.3228	1155	1336336	1540800000	33.9853	10.4921
1101	1212201	1334633301	33.1813	10.3259	1156	1338649	1544804416	34.0000	10.4951
1102	1214404	1338273208	33.1964	10.3290	1157	1340964	1548816893	34.0147	10.4981
1103	1216609	1341919727	33.2114	10.3322	1158	1343281	1552836312	34.0294	10.5011
1104	1218816	1345572864	33.2264	10.3353	1159	1345600	1556862679	34.0441	10.5042
1105	1221025	1349232625	33.2415	10.3384	1160	1347921	1560896000	34.0588	10.5072
1106	1223236	1352899016	33.2566	10.3415	1161	1350244	1564936281	34.0735	10.5102
1107	1225449	1356572043	33.2716	10.3447	1162	1352569	1568983523	34.0881	10.5132
1108	1227664	1360251712	33.2866	10.3478	1163	1354896	1573037747	34.1028	10.5162
1109	1229881	1363938029	33.3017	10.3509	1164	1357225	1577098944	34.1174	10.5192
1110	1232100	1367631000	33.3167	10.3540	1165	1359556	1581167125	34.1321	10.5223
1111	1234321	1371330631	33.3317	10.3571	1166	1361889	1585242308	34.1467	10.5253
1112	1236544	1375031728	33.3467	10.3602	1167	1364224	1589324503	34.1614	10.5283
1113	1238769	1378734249	33.3617	10.3633	1168	1366561	1593413632	34.1760	10.5313
1114	1240996	1382438296	33.3766	10.3664	1169	1368900	1597509807	34.1906	10.5343
1115	1243225	1386195875	33.3916	10.3695	1170	1371241	1601613000	34.2053	10.5373
1116	1245456	1389928896	33.4066	10.3726	1171	1373584	1605723211	34.2199	10.5403
1117	1247689	1393668613	33.4215	10.3757	1172	1375929	1609840448	34.2345	10.5433
1118	1249924	1397415032	33.4365	10.3788	1173	1378276	1613964717	34.2491	10.5463
1119	1252161	1401168159	33.4515	10.3819	1174	1380625	1618096024	34.2637	10.5493
1120	1254400	1404928000	33.4664	10.3850	1175	1382976	1622234375	34.2783	10.5523
1121	1256641	1408694561	33.4813	10.3881	1176	1385329	1626379776	34.2929	10.5553
1122	1258884	1412467848	33.4963	10.3912	1177	1387684	1630532233	34.3074	10.5583
1123	1261129	1416247867	33.5112	10.3943	1178	1390041	1634691752	34.3220	10.5612
1124	1263376	1420034624	33.5261	10.3973	1179	1392400	1638858339	34.3366	10.5642
1125	1265625	1423828125	33.5410	10.4004	1180	1394761	1643032000	34.3511	10.5672
1126	1267876	1427628376	33.5559	10.4035	1181	1397124	1647222741	34.3657	10.5702
1127	1270129	1431435383	33.5708	10.4066	1182	1399489	1651420568	34.3802	10.5732
1128	1272384	1435249152	33.5857	10.4097	1183	1401856	1655625517	34.3948	10.5762
1129	1274641	1439069689	33.6006	10.4127	1184	1404225	1659837584	34.4093	10.5791
1130	1276900	1442897000	33.6155	10.4158	1185	1406596	1664056625	34.4238	10.5821
1131	1279161	1446731091	33.6303	10.4189	1186	1408969	16682		

No.	Square.	Cube.	Sq. Root.	Cube Root.	No.	Square.	Cube.	Sq. Root.	Cube Root.
1200	1440000	1728000000	34.6410	10.6266	1255	1575025	1976656375	35.4260	10.7865
1201	1442401	1732323601	34.6554	10.6295	1256	1577536	198085216	35.4400	10.7894
1202	1444804	1736654408	34.6699	10.6325	1257	1580049	1986121593	35.4542	10.7922
1203	1447209	1740992427	34.6843	10.6354	1258	1582564	1990865512	35.4683	10.7951
1204	1449616	1745337664	34.6987	10.6384	1259	1585081	1995616979	35.4824	10.7980
1206	1454086	1754049816	34.7275	10.6413	1261	1587600	2000376000	35.4965	10.8008
1207	1456349	1758416743	34.7419	10.6443	1262	1590121	2005142581	35.5106	10.8037
1208	1459264	1762790912	34.7563	10.6472	1263	1592644	2009916728	35.5246	10.8065
1209	1461681	1767172329	34.7707	10.6501	1264	1595169	2014698447	35.5387	10.8094
1210	1464100	1771561000	34.7851	10.6530	1265	1597696	2019487744	35.5528	10.8122
1211	1466521	1775956931	34.7994	10.6560	1266	1600225	2024284625	35.5668	10.8150
1212	1468944	1780360128	34.8138	10.6590	1267	1602756	2029089096	35.5809	10.8179
1213	1471369	1784770597	34.8281	10.6619	1268	1605289	2033901163	35.5949	10.8208
1214	1473796	1789188344	34.8425	10.6648	1269	1607824	2038720832	35.6090	10.8236
1215	1476225	1793613375	34.8569	10.6678	1270	1610361	2043548109	35.6230	10.8265
1216	1478656	1798045696	34.8712	10.6707	1271	1612900	2048383000	35.6371	10.8293
1217	1481089	1802485313	34.8855	10.6736	1272	1615441	2053224501	35.6511	10.8322
1218	1483524	1806932232	34.8999	10.6765	1273	1617984	2058072604	35.6651	10.8350
1219	1485961	1811386459	34.9142	10.6794	1274	1620529	2062927317	35.6791	10.8378
1220	1488400	1815848000	34.9285	10.6824	1275	1623076	2067798824	35.6931	10.8407
1221	1490841	1820316861	34.9428	10.6853	1276	1625625	2072677301	35.7071	10.8435
1222	1493284	1824793048	34.9571	10.6882	1277	1628176	2077562576	35.7211	10.8463
1223	1495729	1829276567	34.9714	10.6911	1278	1630729	2082454933	35.7351	10.8492
1224	1498176	1833767424	34.9857	10.6940	1279	1633284	2087354392	35.7491	10.8520
1225	1500625	1838265625	35.0000	10.6970	1280	1635841	2092260961	35.7631	10.8548
1226	1503076	1842771176	35.0143	10.7000	1281	1638400	2097174700	35.7771	10.8577
1227	1505529	1847284083	35.0286	10.7028	1282	1640961	2102094601	35.7911	10.8605
1228	1507984	1851804352	35.0428	10.7057	1283	1643524	2107020604	35.8051	10.8633
1229	1510441	1856331989	35.0571	10.7086	1284	1646089	2111952709	35.8191	10.8661
1230	1512900	1860867000	35.0714	10.7115	1285	1648656	2116890924	35.8331	10.8689
1231	1515361	1865409391	35.0856	10.7144	1286	1651225	2121835241	35.8471	10.8717
1232	1517824	1869959168	35.0999	10.7173	1287	1653796	2126785664	35.8611	10.8745
1233	1520289	1874516337	35.1141	10.7202	1288	1656369	2131742193	35.8751	10.8773
1234	1522756	1879080904	35.1283	10.7231	1289	1658944	2136704928	35.8891	10.8801
1235	1525225	1883652825	35.1425	10.7260	1290	1661521	2141673869	35.9031	10.8829
1236	1527696	1888232064	35.1566	10.7289	1291	1664100	2146648916	35.9171	10.8857
1237	1530169	1892818609	35.1707	10.7318	1292	1666681	2151630069	35.9311	10.8885
1238	1532644	1897412664	35.1848	10.7347	1293	1669264	2156617328	35.9451	10.8913
1239	1535121	1902014129	35.1989	10.7376	1294	1671849	2161610693	35.9591	10.8941
1240	1537600	1906623000	35.2130	10.7405	1295	1674436	2166610164	35.9731	10.8969
1241	1540081	1911239281	35.2271	10.7434	1296	1677025	2171615741	35.9871	10.8997
1242	1542564	1915862484	35.2412	10.7463	1297	1679616	2176627524	36.0011	10.9025
1243	1545049	1920492609	35.2553	10.7492	1298	1682209	2181645513	36.0151	10.9053
1244	1547536	1925130656	35.2694	10.7520	1299	1684804	2186669568	36.0291	10.9081
1245	1550025	1929778625	35.2835	10.7549	1300	1687401	2191700729	36.0431	10.9109
1246	1552516	1934436516	35.2976	10.7578	1301	1690000	2196738000	36.0571	10.9137
1247	1555009	1939105229	35.3117	10.7607	1302	1692601	2201781281	36.0711	10.9165
1248	1557504	1943784764	35.3258	10.7635	1303	1695204	2206830664	36.0851	10.9193
1249	1560001	1948475021	35.3399	10.7664	1304	1697809	2211886153	36.0991	10.9221
1250	1562500	1953176000	35.3540	10.7693	1305	1700416	2216947856	36.1131	10.9249
1251	1565001	1957887801	35.3681	10.7722	1306	1703025	2222015785	36.1271	10.9277
1252	1567504	1962600224	35.3822	10.7750	1307	1705636	2227089944	36.1411	10.9305
1253	1570009	1967323249	35.3963	10.7779	1308	1708249	2232170333	36.1551	10.9333
1254	1572516	1972046884	35.4104	10.7808	1309	1710864	2237256952	36.1691	10.9361
1255	1575025	1976771125	35.4245	10.7837	1310	1713481	2242349801	36.1831	10.9389

No.	Square.	Cube.	Sq. Root.	Cube Root.	No.	Square.	Cube.	Sq. Root.	Cube Root.
1310	1716100	2248091000	36.1939	10.9418	1365	1892225	2542298125	36.9450	11.0020
1311	1718721	225243231	36.2077	10.9446	1366	1894856	2546639536	36.9590	11.0048
1312	1721344	2256773664	36.2215	10.9474	1367	1897489	2550981049	36.9730	11.0076
1313	1723969	2261115077	36.2353	10.9502	1368	1899924	2555322724	36.9870	11.0104
1314	1726596	2265456544	36.2491	10.9530	1369	1902361	2559664569	37.0010	11.0132
1315	1729225	2269798065	36.2629	10.9557	1370	1904800	2564006700	37.0150	11.0160
1316	1731856	2274140646	36.2767	10.9585	1371	1907241	2568249021	37.0288	11.0188
1317	1734489	2278483289	36.2905	10.9613	1372	1909684	2572491536	37.0426	11.0216
1318	1737124	2282825992	36.3043	10.9641	1373	1912129	2576734249	37.0564	11.0244
1319	1739761	2287168755	36.3180	10.9668	1374	1914576	2580977064	37.0702	11.0272
1320	1742400	2291511568	36.3318	10.9696	1375	1917025	2585219935	37.0840	11.0300
1321	1745041	2295854441	36.3456	10.9724	1376	1919476	2589462864	37.0978	11.0328
1322	1747684	2300197324	36.3593	10.9752	1377	1921929	2593705859	37.1116	11.0356
1323	1750329	2304540217	36.3731	10.9779	1378	1924384	2597948920	37.1254	11.0384
1324	1752976	2308883120	36.3868	10.9807	1379	1926841	2602192041	37.1392	11.0412
1325	1755625	2313226033	36.4005	10.9834	1380	1929296	2606435224	37.1530	11.0440
1326	1758276	2317568956	36.4143	10.9862	1381	1931753	2610678469	37.1668	11.0468
1327	1760929	2321911889	36.4281	10.9890	1382	1934212	2614921776	37.1806	11.0496
1328	1763584	2326254832	36.4419	10.9917	1383	1936673	2619165145	37.1944	11.0524
1329	1766241	2330597785	36.4557	10.9945	1384	1939136	2623408576	37.2082	11.0552
1330	1768900	2334940748	36.4695	10.9972	1385	1941601	2627652079	37.2220	11.0580
1331	1771561	2339283731	36.4833	10.0000	1386	1944068	2631895656	37.2358	11.0608
1332	1774224	2343626734	36.4971	10.0028	1387	1946537	2636139309	37.2496	11.0636
1333	1776889	2347969757	36.5109	10.0056	1388	1949008	2640383040	37.2634	11.0664
1334	1779556	2352312796	36.5247	10.0083	1389	1951481	2644626841	37.2772	11.0692
1335	1782225	2356655855	36.5385	10.0110	1390	1953956	2648870712	37.2910	11.0720
1336	1784896	2360998936	36.5523	10.0138	1391	1956433	2653114653	37.3048	11.0748
1337	1787569	2365342039	36.5661	10.0165	1392	1958912	2657358664	37.3186	11.0776
1338	1790244	2369685164	36.5799	10.0193	1393	1961393	2661602735	37.3324	11.0804
1339	1792921	2374028311	36.5937	10.0220	1394	1963876	2665846866	37.3462	11.0832
1340	1795600	2378371480	36.6075	10.0247	1395	1966361	2670091057	37.3600	11.0860
1341	1798281	2382714671	36.6213	10.0275	1396	1968848	2674335312	37.3738	11.0888
1342	1800964	2387057884	36.6351	10.0302	1397	1971337	2678579631	37.3876	11.0916
1343	1803649	2391401119	36.6489	10.0330	1398	1973828	2682824016	37.4014	11.0944
1344	1806336	2395744376	36.6627	10.0357	1399	1976321	2687068467	37.4152	11.0972
1345	1809025	2400087655	36.6765	10.0384	1400	1978816	2691313084	37.4290	11.1000
1346	1811716	2404430956	36.6903	10.0412	1401	1981313	2695557767	37.4428	11.1028
1347	1814409	2408774281	36.7041	10.0439	1402	1983812	2699802516	37.4566	11.1056
1348	1817104	2413117632	36.7179	10.0466	1403	1986313	2704047331	37.4704	11.1084
1349	1819801	2417461003	36.7317	10.0494	1404	1988816	2708292212	37.4842	11.1112
1350	1822500	2421804396	36.7455	10.0521	1405	1991321	2712537159	37.4980	11.1140
1351	1825								

No.	Square	Sq. Root.	Cube	Cube Root.	No.	Square	Cube	Sq. Root.	Cube Root.
1420	2016400	286328000	37.6829	I. 2399	1475	2175625	3209046875	38.4057	11.3832
1421	2019241	2869341461	37.6962	II. 2425	1476	2178576	3215578176	38.4187	11.3838
1422	2022084	2875403448	37.7094	II. 2452	1477	2181529	3222118333	38.4318	11.3845
1423	2024929	2881473967	37.7227	I. 2478	1478	2184484	3228667382	38.4448	11.3852
1424	2027776	2887553024	37.7359	I. 2505	1479	2187441	3235225239	38.4578	11.3859
1426	2032497	2900737781	37.7624	II. 2531	1481	2190400	3241792000	38.4708	11.3960
1427	2036329	2905841483	37.7757	II. 2583	1482	2193361	3248360801	38.4838	11.3986
1428	2040164	2910945188	37.7889	II. 2610	1483	2196324	3254930704	38.4968	11.4012
		37.8021	II. 2636		1484	2202256	3268147904	38.5227	11.4063
1430	2044900	2924207000	37.8153			2205225	3274759125	38.5357	
1431	2047761	2930345991	37.8286	II. 2663	1485	2208196	3281370256	38.5487	11.4114
1433	2053489	294264973	37.8550	II. 2715	1487	2211169	3288008303	38.5616	11.4140
1434	2056356	2948814504	37.8682	II. 2741	1488	2214144	3294646224	38.5746	11.4191
			II. 2767		1489	2217121	3301294151	38.5876	11.4191
1436	2062096	2961169856	37.8946	II. 2793	1490	2220100	3307944000	38.6005	11.4216
1437	2064969	2967360453	37.9078	II. 2820	1491	2223081	3314604001	38.6135	11.4242
1439	2070724	2979767519	37.9342	II. 2872	1492	2226064	3321284888	38.6264	11.4268
			II. 2898		1493	2229049	3327975777	38.6394	11.4293
1440	2073600	2985984000	37.9473	II. 2924	1494	2232036	3334666784	38.6523	11.4319
1441	2076481	2992209121	37.9605	II. 2950	1495	2235025	3341367825	38.6652	11.4344
1442	2079364	2998442888	37.9737	II. 2977	1497	2241009	3354790473	38.6782	11.4370
1443	2082249	3004685307	37.9868	II. 3003	1498			38.6911	II. 4395
1444	2085136	3010936384	38.0000	II. 3029	1499	2244004	3361517992	38.7040	11.4446
1445	2088025	3017196125	38.0132	II. 3055	1500	2250000	3375000000	38.7298	11.4471
1446	2090916	3023464536	38.0263	II. 3081	1501	2253001	3381754501	38.7427	11.4497
1447	2093809	3029741623	38.0395	II. 3107	1502	2256004	3388518008	38.7556	11.4522
1448	2096704	3036027392	38.0526	II. 3133	1503	2259009	3395290527	38.7685	11.4548
1449	2099601	3042321849	38.0657	II. 3159	1504	2262016	3402072064	38.7814	11.4573
1450	2102500	3048625000	38.0789	II. 3185	1505	2265025	3408862625	38.7943	11.4598
1451	2105401	3054936851	38.0920	II. 3211	1506	2268036	3415662216	38.8072	11.4624
1452	2108304	3061257408	38.1051	II. 3237	1507	2271049	3422470843	38.8201	11.4649
1453	2111209	3067586677	38.1182	II. 3263	1508	2274064	3429288512	38.8330	11.4675
1454	2114116	3073924664	38.1314	II. 3289	1509	2277081	3436115229	38.8458	11.4700
1455	2117025	3080271375	38.1445	II. 3315	1510	2280100	3442951000	38.8587	11.4725
1456	2119936	3086626816	38.1576	II. 3341	1511	2283121	3449795831	38.8716	11.4751
1457	2122849	3092990993	38.1707	II. 3367	1512	2286144	3456649728	38.8844	11.4776
1458	2125764	3099363912	38.1838	II. 3393	1513	2289169	3463512697	38.8973	11.4801
1459	2128681	3105745579	38.1969	II. 3419	1514	2292196	3470384744	38.9102	11.4826
1460	2131600	3112136000	38.2099	II. 3445	1515	2295225	3477265875	38.9230	11.4852
1461	2134521	3118535181	38.2230	II. 3471	1516	2298256	3484166096	38.9358	11.4877
1462	2137444	3124943128	38.2361	II. 3496	1517	2301289	3491085413	38.9487	11.4902
1463	2140369	3131359847	38.2492	II. 3522	1518	2304324	3497963832	38.9615	11.4927
1464	2143296	3137785344	38.2623	II. 3548	1519	2307361	3504881359	38.9744	11.4953
1465	2146225	3144219625	38.2753	II. 3574	1520	2310400	3511808000	38.9872	11.4978
1466	2149156	3150662696	38.2884	II. 3600	1521	2313441	3518743761	39.0000	11.5003
1467	2152089	3157114563	38.3014	II. 3626	1522	2316484	3525688648	39.0128	11.5028
1468	2155024	3163575232	38.3145	II. 3652	1523	2319529	3532642667	39.0256	11.5054
1469	2157961	3170044709	38.3275	II. 3677	1524	2322576	3539605824	39.0384	11.5079
1470	2160900	3176523000	38.3406	II. 3703	1525	2325625	3546578125	39.0512	11.5104
1471	2163841	3183010111	38.3536	II. 3729	1526	2328676	3553559576	39.0640	11.5129
1472	2166784	3189506048	38.3667	II. 3755	1527	2331729	3560550183	39.0768	11.5154
1473	2169729	3196010817	38.3797	II. 3780	1528	2334784	3567549952	39.0896	11.5179
1474	2172676	3202524424	38.3927	II. 3806	1529	2337841	3574558889	39.1024	11.5204

No.	Square	Cube	Sq. Root.	Cube Root.	No.	Square	Cube	Sq. Root.	Cube Root.
1530	2340900	3581577000	39.1152	11.5230	1565	2449225	3833037125	39.5601	11.6102
1531	2343961	3588604291	39.1280	11.5255	1566	2452356	3840389496	39.5727	11.6126
1532	2347024	3595640768	39.1408	11.5280	1567	2455489	3847751263	39.5854	11.6151
1533	2350089	3602686437	39.1535	11.5305	1568	2458624	3855123432	39.5980	11.6176
1534	2353156	3609741304	39.1663	11.5330	1569	2461761	3862503009	39.6106	11.6200
1535	2356225	3616805375	39.1791	11.5355	1570	2464900	3869893000	39.6232	11.6225
1536	2359296	3623878656	39.1918	11.5380	1571	2468041	3877292411	39.6358	11.6250
1537	2362369	3630961153	39.2046	11.5405	1572	2471184	3884701248	39.6485	11.6274
1538	2365444	3638052872	39.2173	11.5430	1573	2474329	3892119517	39.6611	11.6299
1539	2368521	3645153819	39.2301	11.5455	1574	2477476	3899547224	39.6737	11.6324
1540	2371600	3652264000	39.2428	11.5480	1575	2480625	3906984375	39.6863	II. 6348
1541	2374681	3659383421	39.2556	11.5505	1576	2483776	3914430976	39.6989	I. 6373
1542	2377764	3666512088	39.2683	11.5530	1577	2486929	3921637033	39.7115	11.6398
1543	2380849	3673650007	39.2810	11.5555	1578	2490084	3929352552	39.7240	I. 6422
1544	2383936	3680797184	39.2938	11.5580	1579	2493241	3936827539	39.7366	II. 6447
1545	2387025	3687953625	39.3065	I. 1.5605	1580	2496400	3944312000	39.7492	11.647
1546	2390116	3695119336	39.3192	11.5630	1581	2499561	3951805941	39.7618	I. 6520
1547	2393209	3702294323	39.3319	11.5655	1582	2502724	3959309368	I. 6545	
1549	2399401	3710672140	39.3448	11.5680	1583	2505889	3966821270	39.6693	11.6570
									11.6594
1550	2402509	3723875000	39.3700	11.5729	1585	2512225	3981876625	39.8121	39.8246
1551	2405601	3731087151	39.3827	11.5754	1586	2515396	3989418056		11.6643
1552	2408704	3738308608	39.3954	11.5779	1587	2518569	3996969003	39.8372	39.8497
1553	2411809	3745539377	39.4082	11.5804	1589	2524840	4012099469	39.8623	11.6692
1555	2418025	3760028875	39.4335	11.5854	1590	2528100	4019679000	39.8749	11.6717
1556	2421136	3767292936	39.4462	11.5879	1591	2531281	4027268071	39.8873	11.6741
1557	2424249	3774555693	39.4588	11.5903	1592	2534464	4034866688	39.8999	11.6765
1558	2427364	3781833112	39.4715	11.5928	1593	2537649	4042474857	39.9124	11.6790
1559	2430481	3789119879	39.4842	11.5953	1594	2540836	4050092584	39.9249	11.6814
1560	2433600	3796416000	39.4968	11.5978	1595	2544025	4057719875	39.9375	11.6839
1561	2436721	3803721481	39.5095	11.6003	1596	2547216	4065356736	39.9500	11.6863
1562	2439844	3811036328	39.5221	11.6027	1597	2550409	4073003173	39.9625	11.6888
1563	2442969	3818360547	39.5348	11.6052	1598	2553604	4080659192	39.9750	11.6912
1564	2446096	3825694144	39.5474	11.6077	1599	2556801	4088324799	39.9875	11.6936
					1600	2560000	4096000000	40.0000	11.6961

SQUARES AND CUBES OF DECIMALS.

No.	Square	Cube	No.	Square	Cube	No.	Square</
-----	--------	------	-----	--------	------	-----	----------

FIFTH ROOTS AND FIFTH POWERS. (Abridged from TRAUTWINE.)

Table with 9 columns: No. of Root, Power, No. of Root, Power, No. of Root, Power, No. of Root, Power, No. of Root, Power. It lists fifth roots and their corresponding powers for values from 1.0 to 3.60.

CIRCUMFERENCES AND AREAS OF CIRCLES.

Table with 8 columns: Diam., Circum., Area, Diam., Circum., Area, Diam., Circum., Area. It provides data for circles with diameters from 1/64 to 2, listing their circumferences and areas.

WARNING: This is a 1910 edition. Some of the material may no longer be accurate.

Diam.	Circum.	Area.	Diam.	Circum.	Area.	Diam.	Circum.	Area.
1 5/8	42.804	145.80	21 7/8	68.722	375.83	30 1/8	94.640	712.76
3/4	43.197	148.40	22.	69.115	380.15	1/4	95.033	718.69
7/8	43.590	151.	1/8	69.108	384.46	3/8	95.426	724.64
14.	43.982	153.	1/4	69.900	388.82	1/2	95.819	730.62
1/8	44.375	156.	3/8	70.293	393.20	5/8	96.211	736.62
1/4	44.768	159.	1/2	70.686	397.61	3/4	96.604	742.64
3/8	45.160	162.	5/8	71.079	402.04	7/8	96.997	748.69
1/2	45.553	165.	3/4	71.471	406.49	31.	97.389	754.77
5/8	45.946	167.	7/8	71.864	410.97	1/8	97.782	760.07
3/4	46.338	170.	23.	72.257	415.48	1/4	98.175	766.39
7/8	46.731	173.	1/8	72.649	420.00	3/8	98.567	773.14
15.	47.124	176.	1/4	73.042	424.56	1/2	98.960	779.31
1/8	47.517	179.	3/8	73.435	429.13	5/8	99.353	785.51
1/4	47.909	182.	1/2	73.827	433.74	3/4	99.746	791.93
3/8	48.302	185.	5/8	74.220	438.36	7/8	100.138	797.98
1/2	48.695	188.	3/4	74.613	443.01	32.	100.531	804.25
5/8	49.087	191.	7/8	75.006	447.69	1/8	100.924	810.54
3/4	49.480	194.1	24.	75.398	452.39	1/4	101.316	816.86
7/8	49.873	197.	1/8	75.791	457.11	3/8	101.709	823.21
1 6.	50.265	201.0	1/4	76.184	461.86	1/2	102.102	829.58
1/8	50.658	204.	3/8	76.576	466.64	5/8	102.494	835.97
1/4	51.051	207.	1/2	76.969	471.44	3/4	102.887	842.39
3/8	51.444	210.	5/8	77.362	476.26	7/8	103.280	848.83
1/2	51.836	213.	3/4	77.754	481.11	33.	103.673	855.30
5/8	52.229	217.0	7/8	78.147	485.98	1/8	104.065	861.79
3/4	52.622	220.3	25.	78.540	490.87	1/4	104.458	868.31
7/8	53.014	223.6	1/8	78.933	495.79	3/8	104.851	874.85
17.	53.407	226.9	1/4	79.325	500.74	1/2	105.243	881.41
1/8	53.800	230.3	3/8	79.718	505.71	5/8	105.636	888.00
1/4	54.192	233.7	1/2	80.111	510.71	3/4	106.029	894.62
3/8	54.585	237.1	5/8	80.503	515.72	7/8	106.421	901.26
1/2	54.978	240.5	3/4	80.896	520.77	34.	106.814	907.92
5/8	55.371	243.9	7/8	81.289	525.84	1/8	107.207	914.61
3/4	55.763	247.4	26.	81.681	530.93	1/4	107.600	921.32
7/8	56.156	250.9	1/8	82.074	536.05	3/8	107.992	928.06
18.	56.549	254.4	1/4	82.467	541.19	1/2	108.385	934.82
1/8	56.941	258.0	3/8	82.860	546.35	5/8	108.778	941.61
1/4	57.334	261.5	1/2	83.252	551.55	3/4	109.170	948.42
3/8	57.727	265.1	5/8	83.645	556.76	7/8	109.563	955.25
1/2	58.119	268.8	3/4	84.038	562.00	35.	109.956	962.11
5/8	58.512	272.4	7/8	84.430	567.27	1/8	110.348	969.00
3/4	58.905	276.1	27.	84.823	572.56	1/4	110.741	975.91
7/8	59.298	279.8	1/8	85.216	577.87	3/8	111.134	982.84
19.	59.690	283.5	1/4	85.608	583.21	1/2	111.527	989.80
1/8	60.083	287.2	3/8	86.001	588.57	5/8	111.919	996.78
1/4	60.476	291.0	1/2	86.394	593.96	3/4	112.312	1003.8
3/8	60.868	294.8	5/8	86.786	599.37	7/8	112.705	1010.8
1/2	61.261	298.6	3/4	87.179	604.81	36.	113.097	1017.9
5/8	61.654	302.4	7/8	87.572	610.27	1/8	113.490	1025.0
3/4	62.046	306.3	28.	87.965	615.75	1/4	113.883	1032.1
7/8	62.438	310.2	1/8	88.357	621.26	3/8	114.275	1039.2
20.	62.832	314.1	1/4	88.750	626.80	1/2	114.668	1046.3
1/8	63.225	318.10	3/8	89.143	632.36	5/8	115.061	1053.5
1/4	63.617	322.06	1/2	89.535	637.94	3/4	115.454	1060.7
3/8	64.010	326.05	5/8	89.928	643.55	7/8	115.846	1068.0
1/2	64.403	330.06	3/4	90.321	649.18	37.	116.239	1075.2
5/8	64.795	334.10	7/8	90.713	654.84	1/8	116.632	1082.5
3/4	65.188	338.16	29.	91.106	660.52	1/4	117.024	1089.8
7/8	65.581	342.25	1/8	91.499	666.23	3/8	117.417	1097.1
19.	65.973	346.36	1/4	91.892	671.96	1/2	117.810	1104.5
1/8	66.366	350.50	3/8	92.284	677.71	5/8	118.202	1111.8
1/4	66.759	354.66	1/2	92.677	683.49	3/4	118.596	1119.2
3/8	67.152	358.84	5/8	93.070	689.30	7/8	118.988	1126.7
1/2	67.544	363.05	3/4	93.462	695.13	38.	119.381	1134.1
5/8	67.937	367.28	7/8	93.855	700.98	1/8	119.773	1141.6
3/4	68.330	371.54	0.	94.248	706.86	1/4	120.166	1149.1

Diam.	Circum.	Area.	Diam.	Circum.	Area.	Diam.	Circum.	Area.
38 3/8	120.559	1156.6	46 5/8	146.477	1707.4	54 1/8	172.395	2365.0
1/2	120.951	1164.2	3/4	146.869	1716.5	55.	172.788	2375.8
5/8	121.344	1171.7	7/8	147.262	1725.7	1/8	173.180	2386.6
3/4	121.737	1179.3	47.	147.655	1734.9	1/4	173.573	2397.5
7/8	122.129	1186.9	1/8	148.048	1744.2	3/8	173.966	2408.3
39.	122.522	1194.6	1/4	148.440	1753.5	1/2	174.358	2419.2
1/8	122.915	1202.3	3/8	148.833	1762.7	5/8	174.751	2430.1
1/4	123.308	1210.0	1/2	149.226	1772.1	3/4	175.144	2441.1
3/8	123.700	1217.7	5/8	149.618	1781.4	7/8	175.536	2452.0
1/2	124.093	1225.4	3/4	150.011	1790.8	56.	175.929	2463.0
5/8	124.486	1233.2	7/8	150.404	1800.1	1/8	176.322	2474.0
3/4	124.878	1241.0	48.	150.796	1809.6	1/4	176.715	2485.0
7/8	125.271	1248.8	1/8	151.189	1819.0	3/8	177.107	2496.1
40.	125.664	1256.6	1/4	151.582	1828.5	1/2	177.500	2507.2
1/8	126.056	1264.5	3/8	151.975	1837.9	5/8	177.893	2518.3
1/4	126.448	1272.3	1/2	152.367	1847.5	3/4	178.285	2529.4
3/8	126.840	1280.3	5/8	152.760	1857.0	7/8	178.678	2540.6
1/2	127.232	1288.2	3/4	153.153	1866.5	57.	179.071	2551.8
5/8	127.624	1296.2	7/8	153.545	1876.1	1/8	179.463	2563.0
3/4	128.016	1304.2	49.	153.938	1885.7	1/4	179.856	2574.2
7/8	128.408	1312.2	1/8	154.331	1895.4	3/8	180.249	2585.4
41.	128.800	1320.3	1/4	154.723	1905.0	1/2	180.642	2596.7
1/8	129.192	1328.3	3/8	155.115	1914.7	5/8	181.034	2608.0
1/4	129.584	1336.4	1/2	155.509	1924.4	3/4	181.427	2619.4
3/8	129.976	1344.5	5/8	155.902	1934.2	7/8	181.820	2630.7
1/2	130.368	1352.7	3/4	156.294	1943.9	58.	182.212	2642.1
5/8	130.760	1360.8	7/8	156.687	1953.7	1/8	182.605	2653.5
3/4	131.152	1369.0	50.	157.080	1963.5	1/4	182.998	2664.9
7/8	131.544	1377.2	1/8	157.472	1973.3	3/8	183.390	2676.4
42.	131.936	1385.4	1/4	157.865	1983.2	1/2	183.783	2687.8
1/8	132.328	1393.7	3/8	158.258	1993.1	5/8	184.176	2699.3
1/4	132.720	1402.0	1/2	158.650	2003.0	3/4	184.569	2710.9
3/8	133.112	1410.3	5/8	159.043	2012.9	7/8	184.961	2722.4
1/2	133.504	1418.6	3/4	159.436	2022.8	59.	185.354	2734.0
5/8	133.896	1427.0	7/8	159.829	2032.8	1/8	185.747	2745.6
3/4	134.288	1435.4	43.	160.221	2042.8	1/4	186.139	2757.2
7/8	134.680	1443.8	1/8	160.614	2052.8	3/8	186.532	2768.8
43.	135.072	1452.2	1/4	161.007	2062.9	1/2	186.925	2780.5
1/8	135.464	1460.7	3/8	161.399	2073.0	5/8	187.317	2792.2
1/4	135.856	1469.1	1/2	161.792	2083.1	3/4	187.710	2803.9
3/8	136.248	1477.6	5/8	162.185	2093.2	7/8	188.103	2815.7
1/2	136.640	1486.2	3/4	162.577	2103.3	60.	188.496	2827.4
5/8	137.032	1494.7	7/8	162.970	2113.5	1/8	188.888	2839.2
3/4	137.424	1503.3	44.	163.363	2123.7	1/4	189.281	2851.0
7/8	137.816	1511.9	1/8	163.756	2133.9	3/8	189.674	2862.9
44.	138.208	1520.5	1/4	164.148	2144.2	1/2	190.066	2874.8
1/8	138.600	1529.2	3/8	164.541	2154.5	5/8	190.459	2886.6
1/4	138.992	1537.9	1/2	164.934	2164.8	3/4	190.852	2898.5
3/8	139.384	1546.6	5/8	165.326	2175.1	7/8	191.244	2910.5
1/2	139.776	1555.3	3/4	165.719	2185.4	61.	191.637	2922.5
5/8	140.168	1564.0	7/8	166.112	2195.8	1/8	192.030	2934.5
3/4	140.560	1572.8	45.	166.504	2206.2	1/4	192.423	2946.5
7/8	140.952	1581.6	1/8	166.897	2216.6	3/8	192.815	2958.5
45.	141.344	1590.4	1/4	167.290	2227.0	1/2	193.208	2970.6
1/8	141.736	1599.3	3/8	167.683	2237.5	5/8	193.601	2982.7
1/4	142.128	1608.2	1/2	168.075	2248.0	3/4	193.993	2994.8
3/8	142.520	1617.0	5/8	168.468	2258.5	7/8	194.386	3006.9
1/2	142.912	1626.0	3/4	168.861	2269.1	62.	194.779	3019.1
5/8	143.304	1634.9	7/8	169.253	2279.6	1/8	195.171	3031.3
3/4								

Diam.	Circum.	Area.	Diam.	Circum.	Area.	Diam.	Circum.	Area.
63 1/8	198.313	3129.6	71 3/8	224.231	4001.1	79 5/8	250.149	4979.5
1/4	198.706	3142.0	1/2	224.624	4015.2	3/4	250.542	4995.2
3/8	199.098	3154.5	5/8	225.017	4029.2	7/8	250.935	5010.9
1/2	199.491	3166.9	3/4	225.409	4043.3	80.	251.327	5026.5
5/8	199.884	3179.4	7/8	225.802	4057.4	1/8	251.720	5042.3
3/4	200.277	3191.9	72.	226.195	4071.5	1/4	252.113	5058.0
7/8	200.669	3204.4	1/8	226.587	4085.7	3/8	252.506	5073.8
64.	201.062	3217.0	1/4	226.980	4099.8	1/2	252.898	5089.6
1/8	201.455	3229.6	3/8	227.373	4114.0	5/8	253.291	5105.4
1/4	201.847	3242.2	1/2	227.765	4128.2	3/4	253.684	5121.2
3/8	202.240	3254.8	5/8	228.158	4142.5	7/8	254.076	5137.1
1/2	202.633	3267.5	3/4	228.551	4156.8	81.	254.469	5153.0
5/8	203.025	3280.1	7/8	228.944	4171.1	1/8	254.862	5168.9
3/4	203.418	3292.8	73.	229.336	4185.4	1/4	255.254	5184.9
7/8	203.811	3305.6	1/8	229.729	4199.7	3/8	255.647	5200.8
65.	204.204	3318.3	1/4	230.122	4214.1	1/2	256.040	5216.8
1/8	204.596	3331.1	3/8	230.514	4228.5	5/8	256.433	5232.8
1/4	204.989	3343.9	1/2	230.907	4242.9	3/4	256.825	5248.9
3/8	205.382	3356.7	5/8	231.300	4257.4	7/8	257.218	5264.9
1/2	205.774	3369.6	3/4	231.692	4271.8	82.	257.611	5281.0
5/8	206.167	3382.4	7/8	232.085	4286.3	1/8	258.003	5297.1
3/4	206.560	3395.3	74.	232.478	4300.8	1/4	258.396	5313.3
7/8	206.952	3408.2	1/8	232.871	4315.4	3/8	258.789	5329.4
66.	207.345	3421.2	1/4	233.263	4329.9	1/2	259.181	5345.6
1/8	207.738	3434.2	3/8	233.656	4344.5	5/8	259.574	5361.8
1/4	208.131	3447.2	1/2	234.049	4359.2	3/4	259.967	5378.1
3/8	208.523	3460.2	5/8	234.441	4373.8	7/8	260.359	5394.3
1/2	208.916	3473.2	3/4	234.834	4388.5	83.	260.752	5410.6
5/8	209.309	3486.3	7/8	235.227	4403.1	1/8	261.145	5426.9
3/4	209.701	3499.4	75.	235.619	4417.9	1/4	261.538	5443.3
7/8	210.094	3512.5	1/8	236.012	4432.6	3/8	261.930	5459.6
67.	210.487	3525.7	1/4	236.405	4447.4	1/2	262.323	5476.0
1/8	210.879	3538.8	3/8	236.798	4462.2	5/8	262.716	5492.4
1/4	211.272	3552.0	1/2	237.190	4477.0	3/4	263.108	5508.8
3/8	211.665	3565.2	5/8	237.583	4491.8	7/8	263.501	5525.3
1/2	212.058	3578.5	3/4	237.976	4506.7	84.	263.894	5541.8
5/8	212.450	3591.7	7/8	238.368	4521.5	1/8	264.286	5558.3
3/4	212.843	3605.0	76.	238.761	4536.5	1/4	264.679	5574.8
7/8	213.236	3618.3	1/8	239.154	4551.4	3/8	265.072	5591.4
68.	213.628	3631.7	1/4	239.546	4566.4	1/2	265.465	5607.9
1/8	214.021	3645.0	3/8	239.939	4581.3	5/8	265.857	5624.5
3/8	214.414	3658.4	1/2	240.332	4596.3	3/4	266.250	5641.2
1/2	214.806	3671.8	5/8	240.725	4611.4	7/8	266.643	5657.8
3/4	215.199	3685.3	3/4	241.117	4626.4	85.	267.035	5674.5
5/8	215.592	3698.7	7/8	241.510	4641.5	1/8	267.428	5691.2
1/2	215.984	3712.2	77.	241.903	4656.6	1/4	267.821	5707.9
5/8	216.377	3725.7	1/8	242.295	4671.8	3/8	268.213	5724.7
69.	216.770	3739.3	1/4	242.688	4686.9	1/2	268.606	5741.5
1/8	217.163	3752.8	3/8	243.081	4702.1	5/8	268.999	5758.3
1/4	217.555	3766.4	1/2	243.473	4717.3	3/4	269.392	5775.1
3/8	217.948	3780.0	5/8	243.866	4732.5	7/8	269.784	5791.9
1/2	218.341	3793.7	3/4	244.259	4747.8	86.	270.177	5808.8
3/4	218.733	3807.3	7/8	244.652	4763.1	1/8	270.570	5825.7
5/8	219.126	3821.0	78.	245.044	4778.4	1/4	270.962	5842.6
7/8	219.519	3834.7	1/8	245.437	4793.7	3/8	271.355	5859.6
69.	219.911	3848.5	1/4	245.830	4809.0	1/2	271.748	5876.5
1/8	220.304	3862.2	3/8	246.222	4824.4	5/8	272.140	5893.5
1/4	220.697	3876.0	1/2	246.615	4839.8	3/4	272.533	5910.6
3/8	221.090	3889.8	5/8	247.008	4855.2	7/8	272.926	5927.6
1/2	221.482	3903.6	3/4	247.400	4870.7	87.	273.319	5944.7
5/8	221.875	3917.5	7/8	247.793	4886.2	1/8	273.711	5961.8
3/4	222.268	3931.4	79.	248.186	4901.7	1/4	274.104	5978.9
7/8	222.660	3945.3	1/8	248.579	4917.2	3/8	274.497	5996.0
69.	223.053	3959.2	1/4	248.971	4932.7	1/2	274.889	6013.2
1/8	223.446	3973	3/8	249.364	4948.3	5/8	275.282	6030.4
1/4	223.838	3987.1	1/2	249.757	4963.9	3/4	275.675	6047.6

Diam.	Circum.	Area.	Diam.	Circum.	Area.	Diam.	Circum.	Area.
87 7/8	276.067	6064.9	95 7/8	301.200	7219.4	130	408.41	13273.23
88.	276.460	6082.1	96.	301.593	7238.2	131	411.55	13478.22
1/8	276.853	6099.4	1/8	301.986	7257.1	132	414.69	13684.78
1/4	277.246	6116.7	1/4	302.378	7276.0	133	417.83	13892.91
3/8	277.639	6134.1	3/8	302.771	7294.9	134	420.97	14102.61
1/2	278.031	6151.4	1/2	303.164	7313.8	135	424.12	14313.88
5/8	278.424	6168.8	5/8	303.556	7332.8	136	427.26	14526.72
3/4	278.816	6186.2	3/4	303.949	7351.8	137	430.40	14741.14
7/8	279.209	6203.7	7/8	304.342	7370.8	138	433.54	14957.12
89.	279.602	6221.1	97.	304.734	7389.8	139	436.68	15174.68
1/8	279.994	6238.6	1/8	305.127	7408.9	140	439.82	15393.80
1/4	280.387	6256.1	1/4	305.520	7428.0	141	442.96	15614.50
3/8	280.780	6273.7	3/8	305.913	7447.1	142	446.11	15836.77
1/2	281.173	6291.2	1/2	306.305	7466.2	143	449.25	16060.61
5/8	281.565	6308.8	5/8	306.698	7485.3	144	452.39	16286.02
3/4	281.958	6326.4	3/4	307.091	7504.5	145	455.53	16513.00
7/8	282.351	6344.1	7/8	307.483	7523.7	146	458.67	16741.55
90.	282.743	6361.7	98.	307.876	7543.0	147	461.81	16971.67
1/8	283.136	6379.4	1/8	308.269	7562.2	148	464.96	17203.36
1/4	283.529	6397.1	1/4	308.661	7581.5	149	468.10	17436.62
3/8	283.921	6414.9	3/8	309.054	7600.8	150	471.24	17671.46
1/2	284.314	6432.6	1/2	309.447	7620.1	151	474.38	17907.86
5/8	284.707	6450.4	5/8	309.840	7639.5	152	477.52	18145.84
3/4	285.100	6468.2	3/4	310.232	7658.9	153	480.66	18385.39
7/8	285.492	6486.0	7/8	310.625	7678.3	154	483.81	18626.50
91.	285.885	6503.9	99.	311.018	7697.7	155	486.95	18869.19
1/8	286.278	6521.6	1/8	311.410	7717.1	156	490.09	19113.45
1/4	286.670	6539.7	1/4	311.803	7736.6	157	493.23	19359.28
3/8	287.063	6557.6	3/8	312.196	7756.1	158	496.37	19606.68
1/2	287.456	6575.5	1/2	312.588	7775.6	159	499.51	19855.65
5/8	287.848	6593.5	5/8	312.981	7795.2	160	502.65	20106.19
3/4	288.241	6611.5	3/4	313.374	7814.8	161	505.80	20358.31
7/8	288.634	6629.6	7/8	313.767	7834.4	162	508.94	20611.99
92.	289.027	6647.6	100	314.159	7854.0	163	512.08	20867.24
1/8	289.419	6665.7	101	317.30	8011.85	164	515.22	21124.07
1/4	289.812	6683.8	102	320.44	8171.28	165	518.36	21382.46
3/8	290.205	6701.9	103	323.58	8332.29	166	521.50	21642.43
1/2	290.597	6720.1	104	326.73	8494.87	167	524.65	21903.97
5/8	290.990	6738.2	105	329.87	8659.01	168	527.79	22167.08
3/4	291.383	6756.4	106	333.01	8824.73	169	530.93	22431.76
7/8	291.775	6774.7	107	336.15	8992.02	170	534.07	22698.01
93.	292.168	6792.5	108	339.29	9160.88	171	537.21	22965.83
1/8	292.561	6810.2	109	342.43	9331.32	172	540.35	23235.22
1/4	292.954	6828.5	110	345.58	9503.32	173	543.50	23506.18
3/8	293.346	6847.3	111	348.72	9676.89	174	546.64	23778.71
1/2	293.739	6866.1	112	351.86	9852.03	175	549.78	24052.82
5/8	294.132	6884.5	113	355.00	10028.75	176	552.92	24328.49
3/4	294.524	6902.9	114	358.14	10207.03	177	556.06	24605.74
7/8	294.917	6921.3	115	361.28	10386.89	178	559.20	24884.56
94.	295.310	6939.8	116	364.42	10568.32	179	562.35	25164.94
1/8	295.702	6958.2	117	367.57	10751.32	180	565.49	25446.90
1/4	296.095	6976.7	118	370.71	10935.88	181	568.63	25730.43
3/8	296.488	6995.5	119	373.85	11122.02	182	571.77	26015.53
1/2	296.881	7013.8	120	376.99	11309.73	183	574.91	26302.20
5/8	297.273	7032.4	121	380.13	11499.01	184	578.05	26590.44
3/4	297.666	7051.0	122	383.27	11689.87	185	581.19	26880.25
7/8	298.059							

Diam.	Circum.	Area.	Diam.	Circum.	Area.	Diam.	Circum.	Area.
193	606.35	29255.30	260	816.81	53092.92	327	1027.30	83981.84
194	609.47	29559.25	261	819.96	53502.11	328	1030.44	84496.28
195	612.61	29864.77	262	823.10	53912.87	329	1033.58	85012.25
196	615.75	30171.86	263	826.24	54325.21	330	1036.73	85529.86
197	618.89	30480.52	264	829.38	54739.11	331	1039.87	86049.01
198	622.04	30790.75	265	832.52	55154.59	332	1043.01	86569.73
199	625.18	31102.55	266	835.66	55571.63	333	1046.15	87092.02
200	628.32	31415.93	267	838.81	55990.25	334	1049.29	87615.88
201	631.46	31730.87	268	841.95	56410.44	335	1052.43	88141.31
202	634.60	32047.39	269	845.09	56832.20	336	1055.58	88668.31
203	637.74	32365.47	270	848.23	57255.53	337	1058.72	89196.88
204	640.88	32685.13	271	851.37	57680.43	338	1061.86	89727.03
205	644.03	33006.36	272	854.51	58106.90	339	1065.00	90258.74
206	647.17	33329.16	273	857.65	58534.94	340	1068.14	90792.03
207	650.31	33653.53	274	860.80	58964.55	341	1071.28	91326.88
208	653.45	33979.47	275	863.94	59395.74	342	1074.42	91863.31
209	656.59	34306.98	276	867.08	59828.49	343	1077.57	92401.31
210	659.73	34636.06	277	870.22	60262.82	344	1080.71	92940.88
211	662.88	34966.71	278	873.36	60698.71	345	1083.85	93482.02
212	666.02	35298.94	279	876.50	61136.18	346	1086.99	94024.73
213	669.16	35632.73	280	879.65	61575.22	347	1090.13	94569.01
214	672.30	35968.09	281	882.79	62015.82	348	1093.27	95114.86
215	675.44	36305.03	282	885.93	62458.00	349	1096.42	95662.28
216	678.58	36643.54	283	889.07	62901.75	350	1099.56	96211.28
217	681.73	36983.61	284	892.21	63347.07	351	1102.70	96761.84
218	684.87	37325.26	285	895.35	63793.97	352	1105.84	97313.47
219	688.01	37668.48	286	898.50	64242.43	353	1108.98	97867.60
220	691.15	38013.27	287	901.64	64692.46	354	1112.12	98422.96
221	694.29	38359.63	288	904.78	65144.07	355	1115.27	98979.80
222	697.43	38707.56	289	907.92	65597.24	356	1118.41	99538.22
223	700.58	39057.07	290	911.06	66051.99	357	1121.55	100098.21
224	703.72	39408.14	291	914.20	66508.30	358	1124.69	100659.77
225	706.86	39760.78	292	917.35	66966.19	359	1127.83	101222.91
226	710.00	40115.00	293	920.49	67425.65	360	1130.97	101787.60
227	713.14	40470.78	294	923.63	67886.68	361	1134.11	102353.87
228	716.28	40828.14	295	926.77	68349.28	362	1137.26	102921.72
229	719.42	41187.07	296	929.91	68813.45	363	1140.40	103491.13
230	722.57	41547.56	297	933.05	69279.19	364	1143.54	104062.12
231	725.71	41909.63	298	936.19	69746.50	365	1146.68	104634.67
232	728.86	42273.27	299	939.34	70215.38	366	1149.82	105208.80
233	731.99	42638.48	300	942.48	70685.83	367	1152.96	105784.49
234	735.13	43005.26	301	945.62	71157.86	368	1156.11	106361.76
235	738.27	43373.61	302	948.76	71631.45	369	1159.25	106940.60
236	741.42	43743.54	303	951.90	72106.62	370	1162.39	107521.01
237	744.56	44115.03	304	955.04	72583.36	371	1165.53	108102.99
238	747.70	44488.09	305	958.19	73061.66	372	1168.67	108686.51
239	750.84	44862.73	306	961.33	73541.54	373	1171.81	109271.66
240	753.98	45238.93	307	964.47	74022.99	374	1174.96	109858.35
241	757.12	45616.71	308	967.61	74506.01	375	1178.10	110446.62
242	760.27	45996.06	309	970.75	74990.60	376	1181.24	111036.45
243	763.41	46376.98	310	973.89	75476.76	377	1184.38	111627.86
244	766.55	46759.47	311	977.04	75964.50	378	1187.52	112220.83
245	769.69	47143.52	312	980.18	76453.80	379	1190.66	112815.38
246	772.83	47529.16	313	983.32	76944.67	380	1193.81	113411.49
247	775.97	47916.36	314	986.46	77437.12	381	1196.95	114009.18
248	779.11	48305.13	315	989.60	77931.13	382	1200.09	114608.44
249	782.26	48695.47	316	992.74	78426.72	383	1203.23	115209.27
250	785.40	49087.39	317	995.88	78923.88	384	1206.37	115811.67
251	788.54	49480.87	318	999.03	79422.60	385	1209.51	116415.64
252	791.68	49875.92	319	1002.17	79922.90	386	1212.65	117021.18
253	794.82	50272.55	320	1005.31	80424.77	387	1215.80	117628.30
254	797.96	50670.75	321	1008.45	80928.21	388	1218.94	118236.98
255	801.11	51070.52	322	1011.59	81433.22	389	1222.08	118847.24
256	804.25	51471.85	323	1014.73	81939.80	390	1225.22	119459.06
257	807.39	51874.76	324	1017.87	82447.96	391	1228.36	120072.46
258	810.53	52279.24	325	1021.02	82957.68	392	1231.50	120687.46
259	813.67	52685.29	326	1024.16	83468.98	393	1234.65	121303.96

Diam.	Circum.	Area.	Diam.	Circum.	Area.	Diam.	Circum.	Area.
394	1237.79	121922.07	461	1448.27	166913.60	528	1658.76	218956.44
395	1240.93	122541.75	462	1451.42	167638.53	529	1661.90	219786.61
396	1244.07	123163.09	463	1454.56	168365.02	530	1665.04	220618.34
397	1247.21	123785.82	464	1457.70	169093.08	531	1668.19	221451.65
398	1250.35	124410.21	465	1460.84	169822.72	532	1671.33	222286.53
399	1253.50	125036.17	466	1463.98	170553.92	533	1674.47	223122.98
400	1256.64	125663.71	467	1467.12	171286.70	534	1677.61	223961.00
401	1259.78	126292.81	468	1470.27	172021.05	535	1680.75	224800.59
402	1262.92	126923.48	469	1473.41	172756.97	536	1683.89	225641.75
403	1266.06	127555.73	470	1476.55	173494.45	537	1687.04	226484.48
404	1269.20	128189.55	471	1479.69	174233.51	538	1690.18	227328.79
405	1272.35	128824.93	472	1482.83	174974.14	539	1693.32	228174.66
406	1275.49	129461.89	473	1485.97	175716.35	540	1696.46	229022.10
407	1278.63	130100.42	474	1489.11	176460.12	541	1699.60	229871.12
408	1281.77	130740.52	475	1492.26	177205.46	542	1702.74	230721.71
409	1284.91	131382.19	476	1495.40	177952.37	543	1705.88	231573.86
410	1288.05	132025.43	477	1498.54	178700.86	544	1709.03	232427.59
411	1291.19	132670.24	478	1501.68	179450.91	545	1712.17	233282.89
412	1294.34	133316.63	479	1504.82	180202.54	546	1715.31	234139.76
413	1297.48	133964.58	480	1507.96	180955.74	547	1718.45	234998.20
414	1300.62	134614.10	481	1511.11	181710.50	548	1721.59	235858.21
415	1303.76	135265.20	482	1514.25	182466.84	549	1724.73	236719.79
416	1306.90	135917.86	483	1517.39	183224.75	550	1727.88	237582.94
417	1310.04	136572.10	484	1520.53	183984.23	551	1731.02	238447.67
418	1313.19	137227.91	485	1523.67	184745.28	552	1734.16	239313.96
419	1316.33	137885.29	486	1526.81	185507.90	553	1737.30	240181.83
420	1319.47	138544.24	487	1529.96	186272.10	554	1740.44	241051.26
421	1322.61	139204.76	488	1533.10	187037.86	555	1743.58	241922.27
422	1325.75	139866.85	489	1536.24	187805.19	556	1746.73	242794.85
423	1328.89	140530.51	490	1539.38	188574.10	557	1749.87	243668.99
424	1332.04	141195.74	491	1542.52	189344.57	558	1753.01	244544.71
425	1335.18	141862.54	492	1545.66	190116.62	559	1756.15	245422.00
426	1338.32	142530.92	493	1548.81	190890.24	560	1759.29	246300.86
427	1341.46	143200.86	494	1551.95	191665.43	561	1762.43	247181.30
428	1344.60	143872.38	495	1555.09	192442.18	562	1765.58	248063.30
429	1347.74	144545.46	496	1558.23	193220.51	563	1768.72	248946.87
430	1350.88	145220.12	497	1561.37	194000.41	564	1771.86	249832.01
431	1354.03	145896.35	498	1564.51	194781.89	565	1775.00	250718.73
432	1357.17	146574.15	499	1567.65	195564.93	566	1778.14	251607.01
433	1360.31	147253.52	500	1570.80	196349.54	567	1781.28	252496.87
434	1363.45	147934.46	501	1573.94	197135.72	568	1784.42	253388.30
435	1366.59	148616.97	502	1577.08	197923.48	569	1787.57	254281.29
436	1369.73	149301.05	503	1580.22	198712.80	570	1790.71	255175.86
437	1372.88	149986.70	504	1583.36	199503.70	571	1793.85	256072.00
438	1376.02	150673.93	505	1586.50	200296.17	572	1796.99	256969.71
439	1379.16	151362.72	506	1589.65	201090.20	573	1800.13	257868.99
440	1382.30	152053.08	507	1592.79	201885.81	574	1803.27	258769.85
441	1385.44	152745.02	508	1595.93	202682.99	575	1806.42	259672.27
442	1388							

Diam.	Circum.	Area.	Diam.	Circum.	Area.	Diam.	Circum.	Area.	Diam.	Circum.	Area.	Diam.	Circum.	Area.			
595	1869.25	278050.58	663	2082.88	345236.69	731	2296.50	419686.15	799	2510.13	501398.97	867	2723.76	590375.16	935	2937.39	686614.71
596	1872.39	278985.99	664	2086.02	346278.91	732	2299.65	420835.19	800	2513.27	502654.82	868	2726.90	591737.83	936	2940.53	688084.19
597	1875.53	279922.97	665	2089.16	347322.70	733	2302.79	421985.79	801	2516.42	503912.25	869	2730.04	593102.06	937	2943.67	689555.24
598	1878.67	280861.52	666	2092.30	348368.07	734	2305.93	423137.97	802	2519.56	505171.24	870	2733.19	594467.87	938	2946.81	691027.86
599	1881.81	281801.65	667	2095.44	349415.00	735	2309.07	424291.72	803	2522.70	506431.80	871	2736.33	595835.25	939	2949.96	692502.05
600	1884.96	282743.34	668	2098.58	350463.51	736	2312.21	425447.04	804	2525.84	507693.94	872	2739.47	597204.20	940	2953.10	693977.82
601	1888.10	283686.60	669	2101.73	351513.59	737	2315.35	426603.94	805	2528.98	508957.64	873	2742.61	598574.72	941	2956.24	695455.15
602	1891.24	284631.44	670	2104.87	352565.24	738	2318.50	427762.40	806	2532.12	510222.92	874	2745.75	599946.81	942	2959.38	696934.06
603	1894.38	285577.84	671	2108.01	353618.45	739	2321.64	428922.43	807	2535.27	511489.77	875	2748.89	601320.47	943	2962.52	698414.53
604	1897.52	286525.82	672	2111.15	354673.24	740	2324.78	430084.03	808	2538.41	512758.19	876	2752.04	602695.70	944	2965.66	699896.58
605	1900.66	287475.36	673	2114.29	355729.60	741	2327.92	431247.21	809	2541.55	514028.18	877	2755.18	604072.50	945	2968.81	701380.19
606	1903.81	288426.48	674	2117.43	356787.54	742	2331.06	432411.95	810	2544.69	515299.74	878	2758.32	605450.88	946	2971.95	702865.38
607	1906.95	289379.17	675	2120.58	357847.04	743	2334.20	433578.27	811	2547.83	516572.87	879	2761.46	606830.82	947	2975.09	704352.14
608	1910.09	290333.43	676	2123.72	358908.11	744	2337.34	434746.16	812	2550.97	517847.57	880	2764.60	608212.34	948	2978.23	705840.47
609	1913.23	291289.26	677	2126.86	359970.75	745	2340.49	435915.62	813	2554.11	519123.84	881	2767.74	609595.42	949	2981.37	707330.37
610	1916.37	292246.66	678	2130.00	361034.97	746	2343.63	437086.64	814	2557.26	520401.68	882	2770.88	610980.08	950	2984.51	708821.84
611	1919.51	293205.63	679	2133.14	362100.75	747	2346.77	438259.24	815	2560.40	521681.10	883	2774.03	612366.31	951	2987.65	710314.88
612	1922.65	294166.17	680	2136.28	363168.11	748	2349.91	439433.41	816	2563.54	522962.08	884	2777.17	613754.11	952	2990.80	711809.50
613	1925.80	295128.28	681	2139.42	364237.04	749	2353.05	440609.16	817	2566.68	524244.63	885	2780.31	615143.48	953	2993.94	713305.68
614	1928.94	296091.97	682	2142.57	365307.54	750	2356.19	441786.47	818	2569.82	525528.76	886	2783.45	616534.42	954	2997.08	714803.43
615	1932.08	297057.22	683	2145.71	366379.60	751	2359.34	442965.35	819	2572.96	526814.46	887	2786.59	617926.93	955	3000.22	716302.76
616	1935.22	298024.05	684	2148.85	367453.24	752	2362.48	444145.80	820	2576.11	528101.73	888	2789.73	619321.01	956	3003.36	717803.66
617	1938.36	298992.44	685	2151.99	368528.45	753	2365.62	445327.83	821	2579.25	529390.96	889	2792.88	620716.66	957	3006.50	719306.12
618	1941.50	299962.41	686	2155.13	369605.23	754	2368.76	446511.42	822	2582.39	530680.97	890	2796.02	622113.89	958	3009.65	720810.16
619	1944.65	300933.95	687	2158.27	370683.59	755	2371.90	447696.59	823	2585.53	531972.95	891	2799.16	623512.68	959	3012.79	722315.77
620	1947.79	301907.05	688	2161.42	371763.51	756	2375.04	448883.32	824	2588.67	533266.50	892	2802.30	624913.04	960	3015.93	723822.95
621	1950.93	302881.73	689	2164.56	372845.00	757	2378.19	450071.63	825	2591.81	534561.62	893	2805.44	626314.98	961	3019.07	725331.70
622	1954.07	303857.98	690	2167.70	373928.07	758	2381.33	451261.51	826	2594.96	535858.32	894	2808.58	627718.49	962	3022.21	726842.02
623	1957.21	304835.80	691	2170.84	375012.70	759	2384.47	452452.96	827	2598.10	537156.58	895	2811.73	629123.56	963	3025.35	728353.91
624	1960.35	305815.20	692	2173.98	376098.91	760	2387.61	453645.98	828	2601.24	538456.41	896	2814.87	630530.21	964	3028.50	729867.37
625	1963.50	306796.16	693	2177.12	377186.68	761	2390.75	454840.57	829	2604.38	539757.82	897	2818.01	631938.43	965	3031.64	731382.40
626	1966.64	307778.69	694	2180.27	378276.03	762	2393.89	456036.73	830	2607.52	541060.79	898	2821.15	633348.22	966	3034.78	732899.01
627	1969.78	308762.79	695	2183.41	379366.95	763	2397.04	457234.46	831	2610.66	542365.34	899	2824.29	634759.58	967	3037.92	734417.18
628	1972.92	309748.47	696	2186.55	380459.44	764	2400.18	458433.77	832	2613.81	543671.46	900	2827.43	636172.51	968	3041.06	735936.93
629	1976.06	310735.71	697	2189.69	381553.50	765	2403.32	459634.64	833	2616.95	544979.15	901	2830.58	637587.01	969	3044.20	737458.24
630	1979.20	311724.53	698	2192.83	382649.13	766	2406.46	460837.08	834	2620.09	546288.40	902	2833.72	639003.09	970	3047.34	738981.13
631	1982.35	312714.92	699	2195.97	383746.33	767	2409.60	462041.10	835	2623.23	547599.23	903	2836.86	640420.73	971	3050.49	740505.59
632	1985.49	313706.88	700	2199.11	384845.10	768	2412.74	463246.69	836	2626.37	548911.63	904	2840.00	641839.95	972	3053.63	742031.62
633	1988.63	314700.40	701	2202.26	385945.44	769	2415.88	464453.84	837	2629.51	550225.61	905	2843.14	643260.73	973	3056.77	743559.22
634	1991.77	315695.50	702	2205.40	387047.36	770	2419.03	465662.57	838	2632.65	551541.15	906	2846.28	644683.09	974	3059.91	745088.39
635	1994.91	316692.17	703	2208.54	388150.84	771	2422.17	466872.87	839	2635.80	552858.26	907	2849.42	646107.01	975	3063.05	746619.13
636	1998.05	317690.42	704	2211.68	389255.90	772	2425.31	468084.74	840	2638.94	554176.94	908	2852.57	647532.51	976	3066.19	748151.44
637	2001.19	318690.23	705	2214.82	390362.52	773	2428.45	469298.18	841	2642.08	555497.20	909	2855.71	648959.58	977	3069.34	749685.32
638	2004.34	319691.61	706	2217.96	391470.72	774	2431.59	470513.19	842	2645.22	556819.02	910	2858.85	650388.22	978	3072.48	751220.78
639	2007.48	320694.56	707	2221.11	392580.49	775	2434.73	471729.77	843	2648.36	558142.42	911	2861.99	651818.43	979	3075.62	752757.80
640	2010.62	321699.09	708	2224.25	393691.82	776	2437.88	472947.92	844	2651.50	559467.39	912	2865.13	653250.21	980	3078.76	754296.40
641	2013.76	322705.18	709	2227.39	394804.73	777	2441.02	474167.65	845	2654.65	560793.92	913	2868.27	654683.56	981	3081.90	755836.56
642	2016.90	323712.85	710	2230.53	395919.21	778	2444.16	475388.94	846	2657.79	562122.03	914	2871.42	656118.48	982	3085.04	757378.30
643	2020.04	324722.09	711	2233.67	397035.26	779	2447.30	476611.81	847	2660.93	563451.71	915	2874.56	657554.98	983	3088.19	758921.61
644	2023.19	325732.89	712	2236.81	398152.89	780	2450.44	477836.24	848	2664.07	564782.96	916	2877.70	658993.04	984	3091.33	760466.48
645	2026.33	326745.27	713	2239.96	399272.08	781	2453.58	479062.25	849	2667.21	566115.78	917	2880.84	660432.68	985	3094.47	762012.93
646	2029.47	327759.22	714	2243.10	400392.84	782	2456.73	480289.83	850	2670.35	567450.17	918	2883.98	661873.88	986	3097.61	763560.95
647	2032.61	328774.74	715	2246.24	401515.18	783	2459.87	481518.97	851	2673.50	568786.14	919	2887.12	663316.66	987	3100.75	765110.54
648	2035.75	329791.83	716	2249.38	402639.08	784	2463.01	482749.69	852	2676.64	570123.67	920	2890.27	664761.01	988	3103.89	766661.70
649	2038.89	330810.49	717	2252.52	403764.56	785	2466.15	483981.98	853	2679.78	571462.77	921	2893.41	666206.92	989	3107.04	768214.44
650	2042.04	331830.72	718	2255.66	404891.60	786	2469.29	485215.84	854	2682.92	572803.45	922	2896.55	667654.41	990	3110.18	769768.74
651	2045.18	332852.53	719	2258.81	406020.22	787	2472.43	486451.28	855	2686.06	574145.69	923	2899.69	669103.47	991	3113.32	771324.61
652	2048.32	333875.90	720	2261.95	407150.41	788	2475.58	487688.28	856	2689.20	575489.51	924	2902.83	670554.10	992	3116.46	772882.06
653	2051.46	334900.85	721	2265.09	408282.												

CIRCUMFERENCE OF CIRCLES FROM 1 INCH TO 32 FT. 11 IN. DIAMETER.

Diam. Feet.	0 In.		1 Inch.		2 In.		3 In.		4 In.		5 In.		6 In.		7 In.		8 In.		9 In.		10 In.		11 In.		Diam. Feet.
	Ft.	In.	Ft.	In.	Ft.	In.	Ft.	In.	Ft.	In.	Ft.	In.	Ft.	In.	Ft.	In.	Ft.	In.	Ft.	In.	Ft.	In.	Ft.	In.	
0																								0	
1	3	13/8	3	47/8	3	6 1/4	3	8 1/8	3	11 1/8	4	2 1/4	4	5 3/8	4	8 1/2	4	11 5/8	5	6 1/8	5	9 1/8	5	12 1/8	1
2	6	33/8	6	6 1/8	6	9 5/8	6	13 1/8	7	3 7/8	7	7 3/8	7	10 7/8	7	14 1/8	8	8 1/8	8	11 5/8	8	15 1/8	8	18 5/8	2
3	9	51/8	9	8 1/4	9	11 7/8	9	15 1/4	10	4 1/4	10	8 1/4	10	11 7/8	10	15 1/4	11	9 1/4	11	12 7/8	11	16 1/4	11	19 7/8	3
4	12	69/8	12	9 7/8	12	13 1/2	12	17 1/4	13	5 1/4	13	9 1/4	13	12 7/8	13	16 1/4	14	10 1/4	14	13 7/8	14	17 1/4	14	20 7/8	4
5	15	87/8	15	11 5/8	15	15 3/4	15	19 1/2	16	6 1/4	16	10 1/4	16	13 7/8	16	17 1/4	17	11 1/4	17	14 7/8	17	18 1/4	17	21 7/8	5
6	18	105/8	18	13 3/8	18	17 1/2	18	21 1/4	19	7 1/4	19	11 1/4	19	14 7/8	19	18 1/4	20	12 1/4	20	15 7/8	20	19 1/4	20	23 7/8	6
7	21	123/8	21	15 1/8	21	19 1/4	21	23 1/2	22	8 1/4	22	12 1/4	22	15 7/8	22	19 1/4	23	13 1/4	23	16 7/8	23	20 1/4	23	24 7/8	7
8	25	141/8	25	17 3/8	25	21 1/2	25	25 1/4	26	9 1/4	26	13 1/4	26	16 7/8	26	20 1/4	27	14 1/4	27	17 7/8	27	21 1/4	27	25 7/8	8
9	28	159/8	28	19 5/8	28	23 3/4	28	27 1/2	29	10 1/4	29	14 1/4	29	17 7/8	29	21 1/4	30	15 1/4	30	18 7/8	30	22 1/4	30	27 7/8	9
10	31	177/8	31	21 3/8	31	25 1/2	31	29 1/4	32	11 1/4	32	15 1/4	32	18 7/8	32	22 1/4	33	16 1/4	33	19 7/8	33	23 1/4	33	29 7/8	10
11	34	195/8	34	23 1/8	34	27 1/4	34	31 1/2	35	12 1/4	35	16 1/4	35	19 7/8	35	23 1/4	36	17 1/4	36	20 7/8	36	24 1/4	36	31 7/8	11
12	37	213/8	37	24 3/8	37	28 3/4	37	32 1/2	38	13 1/4	38	17 1/4	38	20 7/8	38	24 1/4	39	18 1/4	39	21 7/8	39	25 1/4	39	33 7/8	12
13	40	231/8	40	25 5/8	40	29 1/2	40	33 1/4	41	14 1/4	41	18 1/4	41	21 7/8	41	25 1/4	42	19 1/4	42	22 7/8	42	26 1/4	42	35 7/8	13
14	43	249/8	43	26 7/8	43	30 3/4	43	34 1/2	44	15 1/4	44	19 1/4	44	22 7/8	44	26 1/4	45	20 1/4	45	23 7/8	45	27 1/4	45	37 7/8	14
15	47	267/8	47	28 1/8	47	32 1/2	47	36 1/4	48	16 1/4	48	20 1/4	48	23 7/8	48	27 1/4	49	21 1/4	49	24 7/8	49	28 1/4	49	39 7/8	15
16	50	285/8	50	29 3/8	50	33 3/4	50	37 1/2	51	17 1/4	51	21 1/4	51	24 7/8	51	28 1/4	52	22 1/4	52	25 7/8	52	29 1/4	52	41 7/8	16
17	53	303/8	53	30 5/8	53	34 1/2	53	38 1/4	54	18 1/4	54	22 1/4	54	25 7/8	54	29 1/4	55	23 1/4	55	26 7/8	55	30 1/4	55	43 7/8	17
18	56	321/8	56	31 7/8	56	35 3/4	56	39 1/2	57	19 1/4	57	23 1/4	57	26 7/8	57	30 1/4	58	24 1/4	58	27 7/8	58	31 1/4	58	45 7/8	18
19	59	339/8	59	32 5/8	59	36 1/2	59	40 1/4	60	20 1/4	60	24 1/4	60	27 7/8	60	31 1/4	61	25 1/4	61	28 7/8	61	32 1/4	61	47 7/8	19
20	62	357/8	62	33 3/8	62	37 1/2	62	41 1/4	63	21 1/4	63	25 1/4	63	28 7/8	63	32 1/4	64	26 1/4	64	29 7/8	64	33 1/4	64	49 7/8	20
21	65	375/8	65	34 1/8	65	38 3/4	65	42 1/2	66	22 1/4	66	26 1/4	66	29 7/8	66	33 1/4	67	27 1/4	67	30 7/8	67	34 1/4	67	51 7/8	21
22	69	393/8	69	34 3/4	69	39 1/2	69	43 1/4	70	23 1/4	70	27 1/4	70	30 7/8	70	34 1/4	71	28 1/4	71	31 7/8	71	35 1/4	71	53 7/8	22
23	72	411/8	72	35 1/8	72	40 3/4	72	44 1/2	73	24 1/4	73	28 1/4	73	31 7/8	73	35 1/4	74	29 1/4	74	32 7/8	74	36 1/4	74	55 7/8	23
24	75	429/8	75	35 3/4	75	41 1/2	75	45 1/4	76	25 1/4	76	29 1/4	76	32 7/8	76	36 1/4	77	30 1/4	77	33 7/8	77	37 1/4	77	57 7/8	24
25	78	447/8	78	36 1/8	78	42 1/2	78	46 1/4	79	26 1/4	79	30 1/4	79	33 7/8	79	37 1/4	80	31 1/4	80	34 7/8	80	38 1/4	80	59 7/8	25
26	81	465/8	81	36 3/4	81	43 1/2	81	47 1/4	82	27 1/4	82	31 1/4	82	34 7/8	82	38 1/4	83	32 1/4	83	35 7/8	83	39 1/4	83	61 7/8	26
27	84	483/8	84	37 1/8	84	44 1/2	84	48 1/4	85	28 1/4	85	32 1/4	85	35 7/8	85	39 1/4	86	33 1/4	86	36 7/8	86	40 1/4	86	63 7/8	27
28	87	501/8	87	37 3/4	87	45 1/2	87	49 1/4	88	29 1/4	88	33 1/4	88	36 7/8	88	40 1/4	89	34 1/4	89	37 7/8	89	41 1/4	89	65 7/8	28
29	91	519/8	91	38 1/8	91	46 1/2	91	50 1/4	92	30 1/4	92	34 1/4	92	37 7/8	92	41 1/4	93	35 1/4	93	38 7/8	93	42 1/4	93	67 7/8	29
30	94	537/8	94	38 3/4	94	47 1/2	94	51 1/4	95	31 1/4	95	35 1/4	95	38 7/8	95	42 1/4	96	36 1/4	96	39 7/8	96	43 1/4	96	69 7/8	30
31	97	555/8	97	39 1/8	97	48 1/2	97	52 1/4	98	32 1/4	98	36 1/4	98	39 7/8	98	43 1/4	99	37 1/4	99	40 7/8	99	44 1/4	99	71 7/8	31
32	100	573/8	100	39 3/4	100	49 1/2	100	53 1/4	101	33 1/4	101	37 1/4	101	40 7/8	101	44 1/4	102	38 1/4	102	41 7/8	102	45 1/4	102	73 7/8	32

WARNING: This is a 1910 edition. Some of the material may no longer be accurate

(Diameter = 1; Rise or Height in parts of Diameter being given.)

Rule for Use of the Table.—Divide the rise or height of the segment by the diameter. Multiply the area in the table corresponding to the quotient thus found by the square of the diameter.

If the segment exceeds a semicircle its area is area of circle — area of segment whose rise is (diam. of circle — rise of given segment).

Given chord and rise, to find diameter. Diam. = (square of half chord + rise) + rise. The half chord is a mean proportional between the two parts into which the chord divides the diameter which is perpendicular to it.

Rise + Diam.	Area.	Rise + Diam.	Area.	Rise + Diam.	Area.	Rise + Diam.	Area.	Rise + Diam.	Area.	Rise + Diam.	Area.
.001	.00004	.054	.01646	.107	.04514	.16	.08111	.213	.12235		
.002	.00012	.055	.01691	.108	.04576	.161	.08185	.214	.12317		
.003	.00022	.056	.01737	.109	.04638	.162	.08258	.215	.12399		
.004	.00034	.057	.01783	.11	.04701	.163	.08332	.216	.12481		
.005	.00047	.058	.01830	.111	.04763	.164	.08406	.217	.12563		
.006	.00062	.059	.01877	.112	.04826	.165	.08480	.218	.12646		
.007	.00078	.06	.01924	.113	.04889	.166	.08554	.219	.12729		
.008	.00095	.061	.01972	.114	.04953	.167	.08629	.22	.12811		
.009	.00113	.062	.02020	.115	.05016	.168	.08704	.221	.12894		
.01	.00133	.063	.02068	.116	.05080	.169	.08779	.222	.12977		
.011	.00153	.064	.02117	.117	.05145	.17	.08854	.223	.13060		
.012	.00175	.065	.02166	.118	.05209	.171	.08929	.224	.13144		
.013	.00197	.066	.02215	.119	.05274	.172	.09004	.225	.13227		
.014	.00222	.067	.02265	.12	.05338	.173	.09079	.226	.13311		
.015	.00244	.068	.02315	.121	.05404	.174	.09155	.227	.13395		
.016	.00268	.069	.02366	.122	.05469	.175	.09231	.228	.13478		
.017	.00294	.07	.02417	.123	.05535	.176	.09307	.229	.13562		
.018	.0032	.071	.02468	.124	.05600	.177	.09384	.23	.13646		
.019	.00347	.072	.02520	.125	.05666	.178	.09460	.231	.13731		
.02	.00375	.073	.02571	.126	.05733	.179	.09537	.232	.13815		
.021	.00403	.074	.02624	.127	.05799	.18	.09613	.233	.13900		
.022	.00432	.075	.02676	.128	.05866	.181	.09690	.234	.13984		
.023	.00462	.076	.02729	.129	.05933	.182	.09767	.235	.14069		
.024	.00492	.077	.02782	.13	.06000	.183	.09845	.236	.14154		
.025	.00523	.078	.02836	.131	.06067	.184	.09922	.237	.14239		
.026	.00555	.079	.02889	.132	.06135	.185	.10000	.238	.14324		
.027	.00587	.08	.02943	.133	.06203	.185	.10077	.239	.14409		
.028	.00619	.081	.02998	.134	.06271	.187	.10155	.24	.14494		
.029	.00653	.082	.03053	.135	.06339	.188	.10233	.241	.14580		
.03	.00687	.083	.03108	.136	.06407	.189	.10312	.242	.14666		
.031	.00721	.084	.03163	.137	.06476	.19	.10390	.243	.14751		
.032	.00756	.085	.03219	.138	.06545	.191	.10469	.244	.14837		
.033	.00791	.086	.03275	.139	.06614	.192	.10547	.245	.14923		
.034	.00827	.087	.03331	.14	.06683	.193	.10626	.246	.15009		
.035	.00864	.088	.03387	.141	.06753	.194	.10705	.247	.15095		
.036	.00901	.089	.03444	.142	.06822	.195	.10784	.248	.15182		
.037	.00938	.09	.03501	.143	.06892	.196	.10864	.249	.15268		
.038	.00976	.091	.03559	.144	.06963	.197	.10943	.25	.15355		
.039	.01015	.092	.03616	.145	.07033	.198	.11023	.251	.15441		
.04	.01054	.093	.03674	.146	.07103	.199	.11102	.252	.15528		
.041	.01093	.094	.03732	.147	.07174	.2	.11182	.253	.15615		
.042	.01133	.095	.03791	.148	.07245	.					

Rise ÷ Diam.	Area.	Rise ÷ Diam.	Area.	Rise ÷ Diam.	Area.	Rise ÷ Diam.	Area.	Rise ÷ Diam.	Area.
.266	.16755	.313	.21015	.36	.25457	.407	.30024	.454	.34676
.267	.16843	.314	.21108	.361	.25557	.408	.30122	.455	.34776
.268	.16932	.315	.21201	.362	.25643	.409	.30220	.456	.34876
.269	.17020	.316	.21294	.363	.25740	.411	.30319	.457	.34975
.27	.17109	.317	.21387	.364	.25839	.412	.30417	.458	.35075
.271	.17198	.318	.21480	.365	.25939	.413	.30516	.459	.35175
.272	.17287	.319	.21573	.366	.26032	.414	.30614	.46	.35274
.273	.17376	.32	.21667	.367	.26128	.415	.30712	.461	.35374
.274	.17465	.321	.21760	.368	.26229	.416	.30811	.462	.35474
.275	.17554	.322	.21853	.369	.26321	.417	.30910	.463	.35573
.276	.17644	.323	.21947	.37	.26418	.418	.31008	.464	.35673
.277	.17733	.324	.22040	.371	.26514	.419	.31107	.465	.35773
.278	.17823	.325	.22134	.372	.26611	.42	.31205	.466	.35873
.279	.17912	.326	.22228	.373	.26708	.421	.31304	.467	.35972
.28	.18002	.327	.22322	.374	.26805	.422	.31403	.468	.36072
.281	.18092	.328	.22415	.375	.26901	.423	.31502	.469	.36172
.282	.18182	.329	.22509	.376	.27095	.424	.31600	.47	.36272
.283	.18272	.33	.22603	.377	.27192	.425	.31798	.472	.36372
.284	.18362	.331	.22697	.378	.27289	.426	.31897	.473	.36471
.285	.18452	.332	.22792	.379	.27386	.427	.31996	.474	.36571
.286	.18542	.333	.22886	.38	.27483	.428	.32095	.475	.36671
.287	.18633	.334	.22980	.381	.27580	.429	.32194	.476	.36771
.288	.18723	.335	.23074	.382	.27678	.43	.32293	.477	.36871
.289	.18814	.336	.23169	.383	.27775	.431	.32392	.478	.36971
.29	.18905	.337	.23263	.384	.27872	.432	.32491	.479	.37071
.291	.18996	.338	.23358	.385	.27969	.433	.32590	.48	.37171
.292	.19086	.339	.23453	.386	.28067	.434	.32689	.481	.37270
.293	.19177	.34	.23547	.387	.28164	.435	.32788	.482	.37370
.294	.19268	.341	.23642	.388	.28262	.436	.32887	.483	.37470
.295	.19360	.342	.23737	.389	.28359	.437	.32987	.484	.37570
.296	.19451	.343	.23832	.39	.28457	.438	.33086	.485	.37670
.297	.19542	.344	.23927	.391	.28554	.439	.33185	.486	.37770
.298	.19634	.345	.24022	.392	.28652	.44	.33284	.487	.37870
.299	.19725	.346	.24117	.393	.28750	.441	.33384	.488	.37970
.3	.19817	.347	.24212	.394	.28848	.442	.33483	.489	.38070
.301	.19908	.348	.24307	.395	.28945	.443	.33582	.49	.38170
.302	.20000	.349	.24403	.396	.29043	.444	.33682	.491	.38270
.303	.20092	.35	.24498	.397	.29141	.445	.33781	.492	.38370
.304	.20184	.351	.24593	.398	.29239	.446	.33880	.493	.38470
.305	.20276	.352	.24689	.399	.29337	.447	.33980	.494	.38570
.306	.20368	.353	.24784	.4	.29435	.448	.34079	.495	.38670
.307	.20460	.354	.24880	.401	.29533	.449	.34179	.496	.38770
.308	.20553	.355	.24976	.402	.29631	.45	.34278	.497	.38870
.309	.20645	.356	.25071	.403	.29729	.451	.34378	.498	.38970
.31	.20738	.357	.25167	.404	.29827	.452	.34477	.499	.39070
.311	.20830	.358	.25263	.405	.29926	.453	.34577	.5	.39170
.312	.20923	.359	.25359	.406	.30024	.454	.34676	.5	.39270

For rules for finding the area of a segment see Mensuration, page 61.

LENGTHS OF CIRCULAR ARCS.

(Degrees being given. Radius of Circle = 1.)

FORMULA. - Length of arc = $\frac{3.1415927}{180} \times$ radius \times number of degrees.
 RULE. - Multiply the factor in the table (see next page) for any given number of degrees by the radius.
 EXAMPLE. - Given a curve of a radius of 55 feet and an angle of 78° 20'.
 Factor from table for 78° 1.3613568
 Factor from table for 20'0058178
 Factor 1.3671746
 1.3671746 \times 55 = 75.19 feet.

FACTORS FOR LENGTHS OF CIRCULAR ARCS.

Degrees.		Minutes.	
1	.0174533	61	1.0646508
2	.0349066	62	1.0821041
3	.0523599	63	1.0995574
4	.0698132	64	1.1170107
5	.0872665	65	1.1344640
6	.1047198	66	1.1519173
7	.1221730	67	1.1693706
8	.1396263	68	1.1868239
9	.1570796	69	1.2042772
10	.1745329	70	1.2217305
11	.1919862	71	1.2391838
12	.2094395	72	1.2566371
13	.2268928	73	1.2740904
14	.2443461	74	1.2915436
15	.2617994	75	1.3089969
16	.2792527	76	1.3264502
17	.2967060	77	1.3439035
18	.3141593	78	1.3613568
19	.3316126	79	1.3788101
20	.3490659	80	1.3962634
21	.3665191	81	1.4137167
22	.3839724	82	1.4311700
23	.4014257	83	1.4486233
24	.4188790	84	1.4660766
25	.4363323	85	1.4835299
26	.4537856	86	1.5009832
27	.4712389	87	1.5184364
28	.4886922	88	1.5358897
29	.5061455	89	1.5533430
30	.5235988	90	1.5707963
31	.5410521	91	1.5882496
32	.5585054	92	1.6057029
33	.5759587	93	1.6231562
34	.5934119	94	1.6406095
35	.6108652	95	1.6580628
36	.6283185	96	1.6755161
37	.6457718	97	1.6929694
38	.6632251	98	1.7104227
39	.6806784	99	1.7278760
40	.6981317	100	1.7453293
41	.7155850	101	1.7627826
42	.7330383	102	1.7802359
43	.7504916	103	1.7976892
44	.7679449	104	1.8151424
45	.7853982	105	1.8325957
46	.8028515	106	1.8500490
47	.8203047	107	1.8675023
48	.8377580	108	1.8849556
49	.8552113	109	1.9024089
50	.8726646	110	1.9198622
51	.8901179	111	1.9373155
52	.9075712	112	1.9547688
53	.9250245	113	1.9722221
54	.9424778	114	1.9896754
55	.9599311	115	2.0071287
56	.9773844	116	2.0245820
57	.9948377	117	2.0420353
58	1.0122910	118	2.0594886
59	1.0297443	119	2.0769419
60	1.0471976	120	2.0943952
121	2.1118484	1	.0002909
122	2.1293017	2	.0005818
123	2.1467550	3	.0008727
124	2.1642083	4	.0011636
125	2.1816616	5	.0014544
126	2.1991149	6	.0017453
127	2.2165682	7	.0020362
128	2.2340214	8	.0023271
129	2.2514747	9	.0026180
130	2.2689280	10	.0029089
131	2.2863813	11	.0031998
132	2.3038346	12	.0034907
133	2.3212879	13	.0037815
134	2.3387412	14	.0040724
135	2.3561945	15	.0043633
136	2.3736478	16	.0046542
137	2.3911011	17	.0049451
138	2.4085544	18	.0052360
139	2.4260077	19	.0055269
140	2.4434610	20	.0058178
141	2.4609142	21	.0061087
142	2.4783675	22	.0063995
143	2.4958208	23	.0066904
144	2.5132741	24	.0069813
145	2.5307274	25	.0072722
146	2.5481807	26	.0075631
147	2.5656340	27	.0078540
148	2.5830873	28	.0081449
149	2.6005406	29	.0084358
150	2.6179939	30	.0087266
151	2.6354472	31	.0090175
152	2.6529005	32	.0093084
153	2.6703538	33	.0095993
154	2.6878070	34	.0098902
155	2.7052603	35	.0101811
156	2.7227136	36	.0104720
157	2.7401669	37	.0107629
158	2.7576202	38	.0110538
159	2.7750735	39	.0113446
160	2.7925268	40	.0116355
161	2.8099801	41	.0119264
162	2.8274334	42	.0122173
163	2.8448867	43	.0125082
164	2.8623400	44	.0127991
165	2.8797933	45	.0130900
166	2.8972466	46	.0133809
167	2.9146999	47	.0136717
168	2.9321531	48	.0139626
169	2.9496064	49	.0142535
170	2.9670597	50	.0145444
171	2.9845130	51	.0148353
172	3.0019663	52	.0151262
173	3.0194196	53	.0154171
174	3.0368729	54	.0157080
175	3.0543262	55	.0159989
176	3.0717795	56	.0162897
177	3.0892328	57	.0165806
178	3.1066861	58	.0168715
179	3.1241394	59	.0171624
180	3.1415927	60	.0174533

LENGTHS OF CIRCULAR ARCS,

(Diameter = 1. Given the Chord and Height of the Arc.)

RULE FOR USE OF THE TABLE. — Divide the height by the chord. Find in the column of heights the number equal to this quotient. Take out the corresponding number from the column of lengths. Multiply this last number by the length of the given chord; the product will be length of the arc.

If the arc is greater than a semicircle, first find the diameter from the formula, Diam. = (square of half chord ÷ rise) + rise; the formula is true whether the arc exceeds a semicircle or not. Then find the circumference. From the diameter subtract the given height of arc, the remainder will be height of the smaller arc of the circle; find its length according to the rule, and subtract it from the circumference.

Table with 10 columns: Hgts., Lgths., Hgts., Lgths., Hgts., Lgths., Hgts., Lgths., Hgts., Lgths. It lists chord lengths and arc lengths for various heights from 0.00 to 1.00.

SPHERES.

(Some errors of 1 in the last figure only. From TRAUTWINE.)

Table with 9 columns: Diam., Surface, Volume, Diam., Surface, Volume, Diam., Surface, Volume. It lists surface areas and volumes for spheres of various diameters from 1/32 to 22.

SPHERES — Continued.

Diam.	Sur- face.	Vol- ume.	Diam.	Sur- face.	Vol- ume.	Diam.	Sur- face.	Vol- ume.
22 1/2	1590.4	5964.1	40 1/2	5153.1	34783	70 1/2	15615	183471
3/4	1626.0	6165.2	41.	5281.1	36087	71.	15837	187402
23.	1661.9	6370.6	42.	5410.7	37423	72.	16061	191389
1/4	1698.2	6580.6	43.	5541.9	38792	73.	16286	195433
1/2	1735.0	6795.2	44.	5674.5	40194	74.	16513	199532
3/4	1772.1	7014.3	45.	5808.8	41630	75.	16742	203689
24.	1809.6	7238.2	46.	5944.7	43099	76.	16972	207903
1/4	1847.5	7466.7	47.	6082.1	44602	77.	17204	212175
1/2	1885.8	7700.1	48.	6221.2	46141	78.	17437	216505
3/4	1924.4	7938.3	49.	6361.7	47713	79.	17672	220894
25.	1963.5	8181.3	50.	6503.9	49321	80.	17908	225341
1/4	2002.9	8429.2	51.	6647.6	50965	81.	18146	229840
1/2	2042.8	8682.0	52.	6792.9	52645	82.	18386	234414
3/4	2083.0	8939.9	53.	6939.9	54362	83.	18626	239041
26.	2123.7	9202.8	54.	7088.3	56115	84.	18869	243728
1/4	2164.7	9470.8	55.	7238.3	57906	85.	19114	248475
1/2	2206.2	9744.0	56.	7389.9	59734	86.	19360	253284
3/4	2248.0	10022	57.	7543.1	61601	87.	19607	258155
27.	2290.2	10306	58.	7697.7	63506	88.	19856	263088
1/4	2332.8	10595	59.	7854.0	65450	89.	20106	268083
1/2	2375.8	10889	60.	8011.8	67433	90.	20358	273141
3/4	2419.2	11189	61.	8171.2	69456	91.	20612	278263
28.	2463.0	11494	62.	8332.3	71519	92.	20867	283447
1/4	2507.2	11805	63.	8494.8	73622	93.	21124	288696
1/2	2551.8	12121	64.	8658.9	75767	94.	21382	294010
3/4	2596.7	12443	65.	8824.8	77952	95.	21642	299388
29.	2642.1	12770	66.	8992.0	80178	96.	21904	304831
1/4	2687.8	13103	67.	9160.8	82448	97.	22167	310340
1/2	2734.0	13442	68.	9331.2	84760	98.	22432	315915
3/4	2780.5	13787	69.	9503.2	87114	99.	22698	321556
30.	2827.4	14137	70.	9676.8	89511	100.	22966	327264
1/4	2874.8	14494		9852.0	91953		23235	333039
1/2	2922.5	14856		10029	94438		23506	338882
3/4	2970.6	15224		10207	96967		23779	344792
31.	3019.1	15599		10387	99541		24053	350771
1/4	3068.0	15979		10568	102161		24328	356811
1/2	3117.3	16366		10751	104826		24606	362935
3/4	3166.9	16758		10936	107536		24885	369122
32.	3217.0	17157		11122	110294		25165	375376
1/4	3267.4	17563		11310	113098		25447	381704
1/2	3318.3	17974		11499	115949		25730	388102
3/4	3369.6	18392		11690	118847		26016	394570
33.	3421.2	18817		11882	121794		26302	401109
1/4	3473.3	19248		12076	124789		26590	407721
1/2	3525.7	19685		12272	127832		26880	414405
3/4	3578.5	20129		12469	130925		27172	421161
34.	3631.7	20580		12668	134067		27464	427991
1/4	3685.3	21037		12868	137259		27759	434894
1/2	3739.3	21501		13070	140501		28055	441871
35.	3848.5	22449		13273	143794		28353	448920
1/2	3959.2	23425		13478	147138		28652	456047
36.	4071.5	24429		13685	150533		28953	463248
1/2	4185.5	25461		13893	153980		29253	470524
37.	4300.9	26522		14103	157480		29559	477874
1/2	4417.9	27612		14314	161032		29865	485302
38.	4536.5	28731		14527	164637		30172	492808
1/2	4656.7	29880		14741	168295		30481	500388
39.	4778.4	31059		14957	172007		30791	508047
1/2	4901.7	32270		15175	175774		31103	515785
40.	5026.5	33510		15394	179595		31416	523598

CONTENTS IN CUBIC FEET AND U. S. GALLONS OF PIPES AND CYLINDERS OF VARIOUS DIAMETERS AND ONE FOOT IN LENGTH.

1 gallon = 231 cubic inches. 1 cubic foot = 7.4805 gallons.

Diameter in Inches.	For 1 Foot in Length.		Diameter in Inches.	For 1 Foot in Length.		Diameter in Inches.	For 1 Foot in Length.	
	Cu. Ft. also Area in Sq. Ft.	U.S. Gals., 231 Cu. In.		Cu. Ft. also Area in Sq. Ft.	U.S. Gals., 231 Cu. In.		Cu. Ft. also Area in Sq. Ft.	U.S. Gals., 231 Cu. In.
1/4	.0003	.0025	6 3/4	.2485	1.859	19	1.969	14.73
5/16	.0005	.004	7	.2673	1.999	19 1/2	2.074	15.51
3/8	.0008	.0057	7 1/4	.2867	2.145	20	2.182	16.32
7/16	.001	.0078	7 1/2	.3068	2.295	20 1/2	2.292	17.15
1/2	.0014	.0102	7 3/4	.3276	2.45	21	2.405	17.99
9/16	.0017	.0129	8	.3491	2.611	21 1/2	2.521	18.86
5/8	.0021	.0159	8 1/4	.3712	2.777	22	2.640	19.75
11/16	.0026	.0193	8 1/2	.3941	2.948	22 1/2	2.761	20.66
3/4	.0031	.0230	8 3/4	.4176	3.125	23	2.885	21.58
13/16	.0036	.0269	9	.4418	3.305	23 1/2	3.012	22.53
7/8	.0042	.0312	9 1/4	.4667	3.491	24	3.142	23.50
15/16	.0048	.0359	9 1/2	.4922	3.682	25	3.409	25.50
1	.0055	.0408	9 3/4	.5185	3.879	26	3.687	27.58
1 1/4	.0085	.0638	10	.5454	4.08	27	3.976	29.74
1 1/2	.0123	.0918	10 1/4	.5730	4.286	28	4.276	31.99
1 3/4	.0167	.1249	10 1/2	.6013	4.498	29	4.587	34.31
2	.0218	.1632	10 3/4	.6303	4.715	30	4.909	36.72
2 1/4	.0276	.2066	11	.66	4.937	31	5.241	39.21
2 1/2	.0341	.2550	11 1/4	.6903	5.164	32	5.585	41.78
2 3/4	.0412	.3085	11 1/2	.7213	5.396	33	5.940	44.43
3	.0491	.3672	11 3/4	.7530	5.633	34	6.305	47.16
3 1/4	.0576	.4309	12	.7854	5.875	35	6.681	49.98
3 1/2	.0668	.4998	12 1/2	.8222	6.375	36	7.069	52.88
3 3/4	.0767	.5738	13	.8621	6.895	37	7.461	55.86
4	.0873	.6528	13 1/2	.904	7.436	38	7.876	58.92
4 1/4	.0985	.7369	14	1.069	7.997	39	8.296	62.06
4 1/2	.1104	.8263	14 1/2	1.147	8.578	40	8.727	65.28
4 3/4	.1231	.9206	15	1.227	9.180	41	9.168	68.58
5	.1364	1.020	15 1/2	1.310	9.801	42	9.621	71.97
5 1/4	.1503	1.125	16	1.396	10.44	43	10.085	75.44
5 1/2	.1650	1.234	16 1/2	1.485	11.11	44	10.559	78.99
5 3/4	.1803	1.349	17	1.576	11.79	45	11.045	82.62
6	.1963	1.469	17 1/2	1.670	12.49	46	11.541	86.33
6 1/4	.2131	1.594	18	1.768	13.22	47	12.048	90.10
6 1/2	.2304	1.724	18 1/2	1.867	13.96	48	12.566	94.00

To find the capacity of pipes greater than the largest given in the table, look in the table for a pipe of one-half the given size, and multiply its capacity by 4 or one of one-third its size, and multiply its capacity by 9, etc. To find the weight of water in any of the given sizes, multiply the capacity in cubic feet by 62 1/4 or the gallons by 8 1/3, or, if a closer approximation is required, by the weight of a cubic foot of water at the actual temperature in the pipe.

Given the dimensions of a cylinder in inches, to find its capacity in U.S. gallons: Square the diameter, multiply by the length and by 0.0034. If d = diameter, l = length, gallons = $\frac{d^2 \times 0.7854 \times l}{231} = 0.0034 d^2 l$. If D and L are in feet, gallons = $5.875 D^2 L$.

CYLINDRICAL VESSELS, TANKS, CISTERNS, ETC.

Diameter in Feet and Inches, Area In Square Feet, and U. S. Gallons Capacity for One Foot in Depth.

1 gallon = 231 cubic inches = $\frac{1 \text{ cubic foot}}{7.4805}$ = 0.13365 cubic feet.

Diam.	Area.	Gals.	Diam.	Area.	Gals.	Diam.	Area.	Gals.
Ft. In.	Sq. ft.	1 foot depth.	Ft. In.	Sq. ft.	1 foot depth.	Ft. In.	Sq. ft.	1 foot depth.
1	.785	5.87	5 8	25.22	188.66	19	283.53	2120.9
1 1	.922	6.89	5 9	25.97	194.25	19 3	291.04	2177.1
1 2	1.069	8.00	5 10	26.73	199.92	19 6	298.65	2234.0
1 3	1.227	9.18	5 11	27.49	205.67	19 9	306.35	2291.7
1 4	1.396	10.44	6	28.27	211.51	20	314.16	2350.1
1 5	1.576	11.79	6 3	30.68	229.50	20 3	322.06	2409.2
1 6	1.767	13.22	6 6	33.18	248.23	20 6	330.06	2469.1
1 7	1.969	14.73	6 9	35.78	267.69	20 9	338.16	2529.6
1 8	2.182	16.32	7	38.48	287.88	21	346.36	2591.0
1 9	2.405	17.99	7 3	41.28	308.81	21 3	354.66	2653.0
1 10	2.640	19.75	7 6	44.18	330.48	21 6	363.05	2715.8
1 11	2.885	21.53	7 9	47.17	352.88	21 9	371.54	2779.3
2	3.142	23.50	8	50.27	376.01	22	380.13	2843.6
2 1	3.409	25.50	8 3	53.46	399.88	22 3	388.82	2908.6
2 2	3.687	27.58	8 6	56.75	424.48	22 6	397.61	2974.3
2 3	3.976	29.74	8 9	60.13	449.82	22 9	406.49	3040.8
2 4	4.276	31.99	9	63.62	475.89	23	415.48	3108.0
2 5	4.587	34.31	9 3	67.20	502.70	23 3	424.56	3175.9
2 6	4.909	36.72	9 6	70.88	530.24	23 6	433.74	3244.6
2 7	5.241	39.21	9 9	74.66	558.51	23 9	443.01	3314.0
2 8	5.585	41.78	10	78.54	587.52	24	452.39	3384.1
2 9	5.940	44.43	10 3	82.52	617.26	24 3	461.86	3455.0
2 10	6.305	47.16	10 6	86.59	647.74	24 6	471.44	3526.6
2 11	6.681	49.98	10 9	90.76	678.95	24 9	481.11	3598.9
3	7.069	52.88	11	95.03	710.90	25	490.87	3672.0
3 1	7.467	55.86	11 3	99.40	743.58	25 3	500.74	3745.8
3 2	7.876	58.92	11 6	103.87	776.99	25 6	510.71	3820.3
3 3	8.296	62.06	11 9	108.43	811.14	25 9	520.77	3895.6
3 4	8.727	65.28	12	113.10	846.03	26	530.93	3971.6
3 5	9.168	68.58	12 3	117.86	881.65	26 3	541.19	4048.4
3 6	9.621	71.97	12 6	122.72	918.00	26 6	551.55	4125.9
3 7	10.085	75.44	12 9	127.68	955.09	26 9	562.00	4204.1
3 8	10.559	78.99	13	132.73	992.91	27	572.56	4283.0
3 9	11.045	82.62	13 3	137.89	1031.5	27 3	583.21	4362.7
3 10	11.541	86.33	13 6	143.14	1070.8	27 6	593.96	4443.1
3 11	12.048	90.13	13 9	148.49	1110.8	27 9	604.81	4524.3
4	12.566	94.00	14	153.94	1151.5	28	615.75	4606.2
4 1	13.095	97.96	14 3	159.48	1193.0	28 3	626.80	4688.8
4 2	13.635	102.00	14 6	165.13	1235.3	28 6	637.94	4772.1
4 3	14.186	106.12	14 9	170.87	1278.2	28 9	649.18	4856.2
4 4	14.748	110.32	15	176.71	1321.9	29	660.52	4941.0
4 5	15.321	114.61	15 3	182.65	1366.4	29 3	671.96	5026.6
4 6	15.90	118.97	15 6	188.69	1411.5	29 6	683.49	5112.9
4 7	16.50	123.42	15 9	194.83	1457.4	29 9	695.13	5199.9
4 8	17.10	127.95	16	201.06	1504.1	30	706.86	5287.7
4 9	17.72	132.56	16 3	207.39	1551.4	30 3	718.69	5376.2
4 10	18.35	137.25	16 6	213.82	1599.5	30 6	730.62	5465.4
4 11	18.99	142.02	16 9	220.35	1648.4	30 9	742.64	5555.4
5	19.63	146.88	17	226.98	1697.9	31	754.77	5646.1
5 1	20.29	151.82	17 3	233.71	1748.2	31 3	766.99	5737.5
5 2	20.97	156.83	17 6	240.53	1799.3	31 6	779.31	5829.7
5 3	21.65	161.93	17 9	247.45	1851.1	31 9	791.73	5922.6
5 4	22.34	167.12	18	254.47	1903.6	32	804.25	6016.2
5 5	3.04	172.38	18 3	261.59	1956.8	32 3	816.86	6110.6
5 6	3.76	177.72	18 6	268.80	2010.8	32 6	829.58	6205.7
5 7	54.48	183.15	18 9	276.12	2065.5	32 9	842.39	6301.5

GALLONS AND CUBIC FEET.

United States Gallons in a given Number of Cubic Feet.

1 cubic foot = 7.480519 U.S. gallons; 1 gallon = 331 cu. in. = 0.13368056 cu. ft.

Cubic Ft.	Gallons.	Cubic Ft.	Gallons.	Cubic Ft.	Gallons.
0.1	0.75	50	374.0	8,000	59,844.2
0.2	1.50	60	448.8	9,000	67,324.7
0.3	2.24	70	523.6	10,000	74,805.2
0.4	2.99	80	598.4	20,000	149,610.4
0.5	3.74	90	673.2	30,000	224,415.6
0.6	4.49	100	748.0	40,000	299,220.8
0.7	5.24	200	1,496.1	50,000	374,025.9
0.8	5.98	300	2,244.2	60,000	448,831.1
0.9	6.73	400	2,992.2	70,000	523,636.3
1	7.45	500	3,740.3	80,000	598,441.5
2	14.96	600	4,488.3	90,000	673,246.
3	22.44	700	5,236.4	100,000	748,051.9
4	29.92	800	5,984.4	200,000	1,496,103.8
5	37.40	900	6,732.5	300,000	2,244,155.7
6	44.88	1,000	7,480.5	400,000	2,992,207.6
7	52.36	2,000	14,961.0	500,000	3,740,259.5
8	59.84	3,000	22,441.6	600,000	4,488,311.4
9	67.32	4,000	29,922.1	700,000	5,236,363.3
10	74.80	5,000	37,402.6	800,000	5,984,415.2
20	149.6	6,000	44,883.1	900,000	6,732,467.1
30	224.4	7,000	52,363.6	1,000,000	7,480,519.0
40	299.2				

Cubic Feet in a given Number of Gallons.

Gallons.	Cubic Ft.	Gallons.	Cubic Ft.	Gallons	Cubic Ft.
1	.134	1,000	133.681	1,000,000	133,680.6
2	.267	2,000	267.361	2,000,000	267,361.1
3	.401	3,000	401.042	3,000,000	401,041.7
4	.535	4,000	534.722	4,000,000	534,722.2
5	.668	5,000	668.403	5,000,000	668,402.8
6	.802	6,000	802.083	6,000,000	802,083.3
7	1.069	7,000	935.764	7,000,000	935,763.9
8	1.203	8,000	1,069.444	8,000,000	1,069,444.4
9		9,000	1,203.125	9,000,000	1,203,125.0
10	1.337	10,000	1,336.806	10,000,000	1,336,805.6

Cubic Feet per Second, Gallons in 24 hours, etc.

Cu. ft. per sec.	$\frac{1}{60}$	1	1.5472	2.2801
Cu. ft. per min.	$\frac{1}{60}$	60	92.334	133.681
U. S. Gals. per min.	7.480519	448.31	694.444	1,000.
" " 24 hrs.	10,771.95	646,317	1,000,000	1,440,000
Pounds of water (at 62° F.) per min.	62.355	3741.3	5788.66	8335.65

The gallon is a troublesome and unnecessary measure. If hydraulic engineers and pump manufacturers would stop using it, and use cubic feet instead, many tedious calculations would be saved.

WARNING: This is a 1910 edition. Some of the material may no longer be accurate

NUMBER OF SQUARE FEET IN PLATES 3 TO 32 FEET LONG, AND 1 INCH WIDE.

For other widths, multiply by the width in inches. 1 sq. in. = 0.00694/sq. ft.

Ft. and In. Long.	In. Long.	Square Feet.	Ft. and In. Long.	In. Long.	Square Feet.	Ft. and In. Long.	In. Long.	Square Feet.
3.	0	.36	7.	10	.94	12.	8	1.056
	1	.37		11	.95		9	1.063
	2	.38	8.	0	.96		10	1.069
	3	.39		1	.97		11	1.076
	4	.40		2	.98	13.	0	1.083
	5	.41		3	.99		1	1.09
	6	.42		4	1.00		2	1.097
	7	.43		5	1.01		3	1.104
	8	.44		6	1.02		4	1.114
	9	.45		7	1.03		5	1.118
	10	.46		8	1.04		6	1.125
	11	.47		9	1.05		7	1.132
4.	0	.48		10	1.06		8	1.139
	1	.49		11	1.07		9	1.146
	2	.50	9.	0	1.08		10	1.153
	3	.51		1	1.09		11	1.159
	4	.52		2	1.10	14.	0	1.167
	5	.53		3	1.11		1	1.174
	6	.54		4	1.12		2	1.181
	7	.55		5	1.13		3	1.188
	8	.56		6	1.14		4	1.194
	9	.57		7	1.15		5	1.201
	10	.58		8	1.16		6	1.208
	11	.59		9	1.17		7	1.215
5.	0	.60		10	1.18		8	1.222
	1	.61		11	1.19		9	1.229
	2	.62	10.	0	1.20		10	1.236
	3	.63		1	1.21		11	1.243
	4	.64		2	1.22	15.	0	1.25
	5	.65		3	1.23		1	1.257
	6	.66		4	1.24		2	1.264
	7	.67		5	1.25		3	1.271
	8	.68		6	1.26		4	1.278
	9	.69		7	1.27		5	1.285
	10	.70		8	1.28		6	1.292
	11	.71		9	1.29		7	1.299
6.	0	.72		10	1.30		8	1.306
	1	.73		11	1.31		9	1.313
	2	.74	11.	0	1.32		10	1.319
	3	.75		1	1.33		11	1.326
	4	.76		2	1.34	16.	0	1.333
	5	.77		3	1.35		1	1.34
	6	.78		4	1.36		2	1.347
	7	.79		5	1.37		3	1.354
	8	.80		6	1.38		4	1.361
	9	.81		7	1.39		5	1.368
	10	.82		8	1.40		6	1.375
	11	.83		9	1.41		7	1.382
7.	0	.84		10	1.42		8	1.389
	1	.85		11	1.43		9	1.396
	2	.86	12.	0	1.44		10	1.403
	3	.87		1	1.45		11	1.41
	4	.88		2	1.46	17.	0	1.417
	5	.89		3	1.47		1	1.424
	6	.90		4	1.48		2	1.431
	7	.91		5	1.49		3	1.438
	8	.92		6	1.50		4	1.444
	9	.93		7	1.51		5	1.451

SQUARE FEET IN PLATES. —Continued.

Ft. and In. Long.	In. Long.	Square Feet.	Ft. and In. Long.	In. Long.	Square Feet.	Ft. and In. Long.	In. Long.	Square Feet.
17.	6	210	22.	5	269	27.	4	328
	7	211		6	270		5	329
	8	212		7	271		6	330
	9	213		8	272		7	331
	10	214		9	273		8	332
	11	215		10	274		9	333
		216		11	275		10	334
18.	0	217	23.	0	276		11	335
	1	218		1	277	28.	0	336
	2	219		2	278		1	337
	3	220		3	279		2	338
	4	221		4	280		3	339
	5	222		5	281		4	340
	6	223		6	282		5	341
	7	224		7	283		6	342
	8	225		8	284		7	343
	9	226		9	285		8	344
	10	227		10	286		9	345
	11	228		11	287		10	346
19.	0	229	24.	0	288		11	347
	1	230		1	289	29.	0	348
	2	231		2	290		1	349
	3	232		3	291		2	350
	4	233		4	292		3	351
	5	234		5	293		4	352
	6	235		6	294		5	353
	7	236		7	295		6	354
	8	237		8	296		7	355
	9	238		9	297		8	356
	10	239		10	298		9	357
	11	240		11	299		10	358
20.	0	241	25.	0	300		11	359
	1	242		1	301	30.	0	360
	2	243		2	302		1	361
	3	244		3	303		2	362
	4	245		4	304		3	363
	5	246		5	305		4	364
	6	247		6	306		5	365
	7	248		7	307		6	366
	8	249		8	308		7	367
	9	250		9	309		8	368
	10	251		10	310		9	369
	11	252		11	311		10	370
21.	0	253	26.	0	312		11	371
	1	254		1	313	31.	0	372
	2	255		2	314		1	373
	3	256		3	315		2	374
	4	257		4	316		3	375
	5	258		5	317		4	376
	6	259		6	318		5	377
	7	260		7	319		6	378
	8	261		8	320		7	379
	9	262		9	321		8	380
	10	263		10	322		9	381
	11	264		11	323		10	382
22.	0	265	27.	0	324		11	383
	1	266		1	325	32.	0	384
	2	267		2	326		1	385
	3	268		3	327		2	386
	4	269		4	328		3	387

CAPACITIES OF RECTANGULAR TANKS IN U. S. GALLONS, FOR EACH FOOT IN DEPTH.

1 cubic foot = 7.4805 U. S. gallons.

Width of Tank.	Length of Tank.										
	feet. 2	ft. in. 2 6	feet. 3	ft. in. 3 6	feet. 4	ft. in. 4 6	feet. 5	ft. in. 5 6	feet. 6	ft. in. 6 6	feet. 7
ft. in. 2	29.92	37.40	44.88	52.36	59.84	67.32	74.80	82.28	89.77	97.25	104.73
2 6	..	46.75	54.23	61.71	69.19	76.67	84.15	91.63	99.11	106.59	114.07
3 6	57.32	64.80	72.28	79.76	87.24	94.72	102.20	109.68	117.16
4	91.64	99.12	106.60	114.08	121.56	129.04	136.52	144.00
4 6	119.69	127.17	134.65	142.13	149.61	157.09	164.57
5 6	151.48	158.96	166.44	173.92	181.40	188.88
6 6	187.01	194.49	201.97	209.45	216.93
6 6	226.28	233.76	241.24	248.72
6 6	269.30	276.78	284.26
7	316.05	323.53
											1366.54

Width of Tank.	Length of Tank.									
	ft. in. 7 6	feet. 8	ft. in. 8 6	feet. 9	ft. in. 9 6	feet. 10	ft. in. 10 6	feet. 11	ft. in. 11 6	feet. 12
ft. in. 2	112.21	119.69	127.17	134.65	142.13	149.61	157.09	164.57	172.05	179.53
2 6	140.26	149.61	158.96	168.31	177.66	187.01	196.36	205.71	215.06	224.41
3 6	168.31	179.53	190.75	201.97	213.19	224.41	235.63	246.86	258.07	269.30
3 6	196.36	209.45	222.54	235.63	248.73	261.82	274.90	288.00	301.09	314.18
4	224.41	239.37	254.34	269.30	284.26	299.22	314.18	329.14	344.10	359.06
4 6	252.47	269.30	286.13	302.96	319.79	336.62	353.45	370.28	387.11	403.94
5	280.52	299.22	317.92	336.62	355.32	374.02	392.72	411.42	430.12	448.82
5 6	308.57	329.14	349.71	370.28	390.85	411.43	432.00	452.57	473.14	493.71
6 6	336.62	359.06	381.50	403.94	426.39	448.83	471.27	493.71	516.15	538.59
6 6	364.67	388.98	413.30	437.61	461.92	486.23	510.54	534.85	559.16	583.47
7	392.72	418.91	445.09	471.27	497.45	523.64	549.81	575.99	602.18	628.36
7 6	420.78	448.83	476.88	504.93	532.98	561.04	589.08	617.14	645.19	673.24
8	..	478.75	508.67	538.59	568.51	598.44	628.36	658.28	688.20	718.12
8 6	540.46	572.25	604.05	635.84	667.63	699.42	731.21	763.00
9	605.92	639.58	673.25	706.90	740.56	774.23	807.89
9 6	675.11	710.65	746.17	781.71	817.24	852.77
10 6	748.05	785.45	822.86	860.26	897.66
11	824.73	864.00	903.26	942.56
11 6	905.14	946.27	987.43
12	989.29	1032.3
										11077.2

NUMBER OF BARRELS (31 1-2 GALLONS) IN CISTERNS AND TANKS.

1 barrel = 3 1/2 gallons = $\frac{31.5 \times 231}{1728}$ = 4.21094 cu. ft. Reciprocal = 0.237477

Depth in Feet.	Diameter in Feet.									
	5	6	7	8	9	10	11	12	13	14
1	4.663	6.714	9.139	11.937	15.108	18.652	22.569	26.859	31.522	36.557
5	23.3	33.6	45.7	59.7	75.5	93.3	113.1	134.3	157.6	182.8
6	28.0	40.3	54.8	71.6	90.6	111.9	135.4	161.2	189.1	219.3
7	32.6	47.0	64.0	83.6	105.8	130.6	158.0	188.0	220.7	255.9
8	37.3	53.7	73.1	95.5	120.9	149.2	180.6	214.9	252.2	292.5
9	42.0	60.4	82.3	107.4	136.0	167.9	203.1	241.7	283.7	329.0
10	46.6	67.1	91.4	119.4	151.1	186.5	225.7	268.6	315.2	365.6
11	51.3	73.9	100.5	131.3	166.2	205.2	248.3	295.4	346.7	402.1
12	56.0	80.6	109.7	143.2	181.3	223.8	270.8	322.3	378.3	438.7
13	60.6	87.3	118.8	155.2	196.4	242.5	293.4	349.2	409.8	475.2
14	65.3	94.0	127.9	167.1	211.5	261.1	316.0	376.0	441.3	511.8
15	69.9	100.7	137.1	179.1	226.6	279.8	338.5	402.9	472.8	540.4
16	74.6	107.4	146.2	191.0	241.7	298.4	361.1	429.7	504.4	584.9
17	79.3	114.1	155.4	202.9	256.8	317.1	383.7	456.6	535.9	621.5
18	83.9	120.9	164.5	214.9	271.9	335.7	406.2	483.5	567.4	658.0
19	88.6	127.6	173.4	226.8	287.1	354.4	428.8	510.3	598.9	694.6
20	93.3	134.3	182.8	238.7	302.2	373.0	451.4	537.2	630.4	731.1

Depth in Feet.	Diameter in Feet.									
	15	16	17	18	19	20	21	22		
1	41.966	47.743	53.903	60.431	67.332	74.606	82.253	90.273		
5	209.8	238.7	269.5	302.2	336.7	373.0	411.3	451.4		
6	251.8	286.5	323.4	362.6	404.0	447.6	493.5	541.6		
7	293.8	334.2	377.3	423.0	471.3	522.2	575.8	631.9		
8	335.7	382.0	431.2	483.4	538.7	596.8	657.8	722.2		
9	377.7	429.7	485.1	543.9	606.0	671.5	740.3	812.5		
10	419.7	477.5	539.0	604.3	673.3	746.7	822.5	902.7		
11	461.6	525.2	592.9	664.7	740.7	820.7	904.8	993.0		
12	503.6	573.0	646.8	725.2	808.0	895.3	987.0	1083.3		
13	545.6	620.7	700.7	785.6	875.3	969.9	1069.3	1173.5		
14	587.5	660.5	754.6	846.0	942.6	1044.5	1151.5	1263.8		
15	629.5	716.2	808.5	906.5	1010.0	1119.1	1233.8	1354.1		
16	671.5	764.0	862.4	966.9	1077.3	1193.7	1316.0	1444.4		
17	713.4	811.7	916.4	1027.3	1144.6	1268.3	1398.3	1534.5		
18	755.4	859.5	970.3	1087.8	1212.0	1342.9	1480.6	1624.9		
19	797.4	907.2	1024.2	1148.2	1279.3	1417.5	1562.8	1715.2		
20	839.3	955.0	1078.1	1208.6	1346.6	1492.1	1645.1	1805.5		

NUMBER OF BARRELS (31 1-2 GALLONS) IN CISTERNS AND TANKS. — *Continued.*

Depth in Feet.	Diameter in Feet.							
	23	24	25	26	27	28	29	30
5	493.3	98.666 107.432 493.3	537.2	116.571	126.083	135.968	146.226	157.858 167.863
6				582.9	630.4	679.8	731.1	784.3
7		690.7	592.0	644.6	752.0	816.0	882.6	951.8
8		789.3	859.5	932.6	1008.7	1087.7	1169.8	1254.9
10	888.0	966.9		1049.1	1134.7	1223.7	1316.0	1411.7
11	1085.3	986.7	1074.3	1165.7	1260.8	1359.7	1462.2	1568.6
12			1181.8	1282.3	1386.9	1495.6	1608.5	1725.4
13	1282.7	1184.0	1289.2	1398.8	1513.0	1631.6	1754.7	1882.3
			1396.6	1515.4	1639.1	1767.6	1900.9	2039.2
15	1381.3	1504.0	1632.0	1765.2	1903.6	2047.2	2196.0	2350.1
16	1578.7	1480.0	1611.5	1748.6	1891.2	2039.5	2193.4	2352.9
			1718.9	1865.1	2017.3	2175.5	2339.6	2509.7
17	1677.3	1826.3	1981.7	2143.4	2311.5	2485.8	2666.6	2853.7
18	1776.0	1933.8	2098.3	2269.5	2447.4	2632.0	2823.4	3021.5
19	1874.7	2041.2	2214.8	2395.6	2583.4	2778.3	2980.3	3189.4
20	1973.3	2148.6	2321.4	2521.7	2719.4	2924.5	3137.2	3357.3

LOGARITHMS.

Logarithms (abbreviation *log*). — The log of a number is the exponent of the power to which it is necessary to raise a fixed number to produce the given number. The fixed number is called the base. Thus if the base is 10, the log of 1000 is 3, for $10^3 = 1000$. There are two systems of logs in general use, the common, in which the base is 10, and the Naperian, or hyperbolic, in which the base is 2.718281828. . . . The Naperian base is commonly denoted by *e*, as in the equation $e^y = x$, in which *y* is the Nap. log of *x*. The abbreviation *log*, is commonly used to denote the Nap log.

In any system of logs, the log of 1 is 0; the log of the base, taken in that system, is 1. In any system the base of which is greater than 1, the logs of all numbers greater than 1 are positive and the logs of all numbers less than 1 are negative.

The modulus of any system is equal to the reciprocal of the Naperian log of the base of that system. The modulus of the Naperian system is 1, that of the common system is 0.4342945.

The log of a number in any system equals the modulus of that system \times the Naperian log of the number.

The hyperbolic or Naperian log of any number equals the common log \times 2.3025851.

Every log consists of two parts, an entire part called the characteristic, or index, and the decimal part, or mantissa. The mantissa only is given in the usual tables of common logs, with the decimal point omitted. The characteristic is found by a simple rule, viz., it is one less than the number of figures to the left of the decimal point in the number whose log is to be found. Thus the characteristic of numbers from 1 to 9.99, + is 0, from 10 to 99.99 + is 1, from 100 to 999 + is 2, from 0.1 to 0.99 + is -1, from 0.01 to 0.099 + is -2, etc. Thus

log of 2000	is 3.30103	log of 0.2	is -1.30103	or 9.30103 - 10
" " 20	" " 1.30103	" " 0.02	" " -2.30103	" " 8.30103 - 10
" " 2	" " 0.30103	" " 0.002	" " -3.30103	" " 7.30103 - 10
		" " 0.0002	" " -4.30103	" " 6.30103 - 10

The minus sign is frequently written above the characteristic thus: $\log 0.002 = \bar{3}.30103$. The characteristic only is negative, the decimal part, or mantissa, being always positive.

When a log consists of a negative index and a positive mantissa, it is usual to write the negative sign over the index, or else to add 10 to the index, and to indicate the subtraction of 10 from the resulting logarithm.

Thus $\log 0.2 = \bar{1}.30103$, and this may be written $9.30103 - 10$. In tables of logarithmic sines, etc., the - 10 is generally omitted, as being understood.

Rules for use of the table of logarithms. — To find the log of any whole number. — For 1 to 100 inclusive the log is given complete in the small table on page 136.

For 100 to 999 inclusive the decimal part of the log is given opposite the given number in the column headed 0 in the table (including the two figures to the left, making six figures). Prefix the characteristic, or index, 2.

For 1000 to 9999 inclusive: The last four figures of the log are found opposite the first three figures of the given number and in the vertical column headed with the fourth figure of the given number; prefix the two figures under column 0, and the index, which is 3.

For numbers over 10,000 having five or more digits: Find the decimal part of the log for the first four digits as above, multiply the difference figure in the last column by the remaining digit or digits, and divide by 10 if there be one digit, more by 100 if there be two more, and so on; add the quotient to the log of the first four digits and prefix the index, which is 4 if there are five digits, 5 if there are six digits, and so on. The table of proportional parts may be used, as shown below.

To find the log of a decimal fraction or of a whole number and a decimal. — First find the log of the quantity as if there were no decimal point, then prefix the index according to rule: the index is one less than the number of figures to the left of the decimal point.

Required log of 3.141593.

	log of 3.141	= 0.497068.	Diff. = 138
From proportional parts	5	=	690
" " " "	09	=	1242
" " " "	003	=	041
	log 3.141593		0.4971498

To find the number corresponding to a given log. — Find in the table the log nearest to the decimal part of the given log and take the first four digits of the required number from the column *N* and the top or foot of the column containing the log which is the next less than the given log. To find the 5th and 6th digits subtract the log in the table from the given log, multiply the difference by 100, and divide by the figure in the Diff. column opposite the log; annex the quotient to the four digits already found, and place the decimal point according to the rule: the number of figures to the left of the decimal point is one greater than the index. The number corresponding to a log is called the anti-logarithm.

Find the anti-log of 0.497150 Diff. = 82
Next lowest log in table corresponds to 3141 0.497068
Tabular diff. = 138; $82 \div 138 = 0.59 +$
The index being 0, the number is therefore 3.14159 +.

To multiply two numbers by the use of logarithms. — Add together the logs of the two numbers, and find the number whose log is the sum.

To divide two numbers. — Subtract the log of the divisor from the log of the dividend, and find the number whose log is the difference.
Log of a fraction. $\log a/b = \log a - \log b$.

To raise a number to any given power. — Multiply the log of the number by the exponent of the power, and find the number whose log is the product.

To find any root of a given number. — Divide the log of the number by the index of the root. The quotient is the log of the root.

No. 110 L. 041.]

[No. 119 L. 078.]

Table with columns N, 0, 1, 2, 3, 4, 5, 6, 7, 8, 9, Diff. containing logarithmic values for numbers 110-119.

PROPORTIONAL PARTS.

Table with columns Diff., 1, 2, 3, 4, 5, 6, 7, 8, 9 showing proportional parts for numbers 395-350.

No. 120 L. 079.]

[No. 134 L. 130.]

Table with columns N, 0, 1, 2, 3, 4, 5, 6, 7, 8, 9, Diff. containing logarithmic values for numbers 120-134.

PROPORTIONAL PARTS.

Table with columns Diff., 1, 2, 3, 4, 5, 6, 7, 8, 9 showing proportional parts for numbers 355-322.

WARNING: This is a 1910 edition. Some of the material may no longer be accurate

NO. 135 [130.] [No. 149 L. 175.]

N.		1	2	3	4	5	6	7	8	9	Diff.
135	130334	0655	0977	1298	1619	1939	2260	2580	2900	3219	321
6	3539	3858	4177	4496	4814	5133	5451	5769	6086	6403	318
7	6721	7037	7354	7671	7987	8303	8618	8934	9249	9564	316
8	9874										
9	143015	0194	0508	0822	1136	1450	1763	2076	2389	2702	314
140	6128	3327	3639	3951	4263	4574	4885	5196	5507	5818	311
1	9219	6438	6748	7058	7367	7676	7985	8294	8603	8911	309
2				0142	0449	0756	1063	1370	1676	1982	307
3		2594	2900	3205	3510	3815	4120	4424	4728	5032	305
4	8362	5640	5943	6246	6549	6852	7154	7457	7759	8061	303
5						0168	0469	0769	1068	1367	301
6	161368	1667	1967	2266	2564	2863	3161	3460	3758	4055	299
7	4353	4650	4947	5244	5541	5838	6134	6430	6726	7022	297
8	7317	7613	7908	8203	8497	8792	9086	9380	9674	9968	295
9	170262	0555	0848	1141	1434	1726	2019	2311	2603	2895	293
	3186	3478	3769	4060	4351	4641	4932	5222	5512	5802	291

PROPORTIONAL PARTS.

Diff.	1	2	3	4	5	6	7	8	9
321	32.1	64.2	96.3	128.4	160.5	192.6	224.7	256.8	288.9
320	32.0	64.0	96.0	128.0	160.0	192.0	224.0	256.0	288.0
319	31.9	63.8	95.7	127.6	159.5	191.4	223.3	255.2	287.1
318	31.8	63.6	95.4	127.2	159.0	191.0	222.9	254.8	286.7
317	31.7	63.4	95.1	126.8	158.5	190.2	221.9	253.6	285.3
316	31.6	63.2	94.8	126.4	158.0	189.6	221.2	252.8	284.4
315	31.5	63.0	94.5	126.0	157.5	189.0	220.5	252.0	283.5
314	31.4	62.8	94.2	125.6	157.0	188.4	219.8	251.2	282.6
313	31.3	62.6	93.9	125.2	156.5	187.8	219.1	250.4	281.7
312	31.2	62.4	93.6	124.8	156.0	187.2	218.4	249.6	280.8
311	31.1	62.2	93.3	124.4	155.5	186.6	217.7	248.8	279.9
310	31.0	62.0	93.0	124.0	155.0	186.0	217.0	248.0	279.0
309	30.9	61.8	92.7	123.6	154.5	185.4	216.3	247.2	278.1
308	30.8	61.6	92.4	123.2	154.0	184.8	215.6	246.4	277.2
307	30.7	61.4	92.1	122.8	153.5	184.2	214.9	245.6	276.3
306	30.6	61.2	91.8	122.4	153.0	183.6	214.2	244.8	275.4
305	30.5	61.0	91.5	122.0	152.5	183.0	213.5	244.0	274.5
304	30.4	60.8	91.2	121.6	152.0	182.4	212.8	243.2	273.6
303	30.3	60.6	90.9	121.2	151.5	181.8	212.1	242.4	272.7
302	30.2	60.4	90.6	120.8	151.0	181.2	211.4	241.6	271.8
301	30.1	60.2	90.3	120.4	150.5	180.6	210.7	240.8	270.9
300	30.0	60.0	90.0	120.0	150.0	180.0	210.0	240.0	270.0
299	29.9	59.8	89.7	119.6	149.5	179.4	209.3	239.2	269.1
298	29.8	59.6	89.4	119.2	149.0	178.8	208.6	238.4	268.2
297	29.7	59.4	89.1	118.8	148.5	178.2	207.9	237.6	267.3
296	29.6	59.2	88.8	118.4	148.0	177.6	207.2	236.8	266.4
295	29.5	59.0	88.5	118.0	147.5	177.0	206.5	236.0	265.5
294	29.4	58.8	88.2	117.6	147.0	176.4	205.8	235.2	264.6
293	29.3	58.6	87.9	117.2	146.5	175.8	205.1	234.4	263.7
292	29.2	58.4	87.6	116.8	146.0	175.2	204.4	233.6	262.8
291	29.1	58.2	87.3	116.4	145.5	174.6	203.7	232.8	261.9
290	29.0	58.0	87.0	116.0	145.0	174.0	203.0	232.0	261.0
289	28.9	57.8	86.7	115.6	144.5	173.4	202.3	231.2	260.1
288	28.8	57.6	86.4	115.2	144.0	172.8	201.6	230.4	259.2
287	28.7	57.4	86.1	114.8	143.5	172.2	200.9	229.6	258.3
286	28.6	57.2	85.8	114.4	143.0	171.6	200.2	228.8	257.4

No. 150 L. 176.1 [No. 169 L. 230.]

N.	0	1	2	3	4	5	6	7	8	9	Diff.
150	176091	6381	6670	6959	7248	7536	7825	8113	8401	8689	289
1	8977	9264	9552	9839	0126	0413	0699	0986	1272	1558	287
2	181844	2129	2415	2700	2985	3270	3555	3839	4123	4407	285
3	4691	4975	5259	5542	5825	6108	6391	6674	6956	7239	283
4	7521	7803	8084	8366	8647	8928	9209	9490	9771	0051	281
5	190332	0612	0892	1171	1451	1730	2010	2289	2567	2846	279
6	3125	3403	3681	3959	4237	4514	4792	5069	5346	5623	278
7	5900	6176	6453	6729	7005	7281	7556	7832	8107	8382	276
8	8657	8932	9206	9481	9755	0029	0303	0577	0850	1124	274
9	201397	1670	1943	2216	2488	2761	3033	3305	3577	3848	272
160	4120	4391	4663	4934	5204	5475	5746	6016	6286	6556	271
1	6826	7096	7365	7634	7904	8173	8441	8710	8979	9247	269
2	9515	9784	0051	0319	0586	0853	1121	1388	1654	1921	267
3	21218	2389	2656	2923	3190	3457	3724	3991	4258	4525	266
4	4844	5111	5378	5645	5912	6179	6446	6713	6980	7247	264
5	7484	7751	8018	8285	8552	8819	9086	9353	9620	9887	262
6	220108	0370	0631	0892	1153	1414	1675	1936	2196	2456	261
7	2716	2976	3236	3496	3755	4015	4274	4533	4792	5051	259
8	5309	5568	5826	6084	6342	6600	6858	7115	7372	7630	258
9	7887	8144	8400	8657	8913	9170	9426	9682	9938	0193	256
23											

PROPORTIONAL PARTS.

Diff.	1	2	3	4	5	6	7	8	9
285	28.5	57.0	85.5	114.0	142.5	171.0	199.5	228.0	256.5
284	28.4	56.8	85.2	113.6	142.0	170.4	198.8	227.2	255.6
283	28.3	56.6	84.9	113.2	141.5	169.8	198.1	226.4	254.7
282	28.2	56.4	84.6	112.8	141.0	169.2	197.4	225.6	253.8
281	28.1	56.2	84.3	112.4	140.5	168.6	196.7	224.8	252.9
280	28.0	56.0	84.0	112.0	140.0	168.0	196.0	224.0	252.0
279	27.9	55.8	83.7	111.6	139.5	167.4	195.3	223.2	251.1
278	27.8	55.6	83.4	111.2	139.0	166.8	194.6	222.4	250.2
277	27.7	55.4	83.1	110.8	138.5	166.2	193.9	221.6	249.3
276	27.6	55.2	82.8	110.4	138.0	165.6	193.2	220.8	248.4
275	27.5	55.0	82.5	110.0	137.5	165.0	192.5	220.0	247.5
274	27.4	54.8	82.2	109.6	137.0	164.4	191.8	219.2	246.6
273	27.3	54.6	81.9	109.2	136.5	163.8	191.1	218.4	245.7
272	27.2	54.4	81.6	108.8	136.0	163.2	190.4	217.6	244.8
271	27.1	54.2	81.3	108.4	135.5	162.6	189.7	216.8	243.9
270	27.0	54.0	81.0	108.0	135.0	162.0	189.0	216.0	243.0
269	26.9	53.8	80.7	107.6	134.5	161.4	188.3	215.2	242.1
268	26.8	53.6	80.4	107.2	134.0	160.8	187.6	214.4	241.2
267	26.7	53.4	80.1	106.8	133.5	160.2	186.9	213.6	240.3
266	26.6	53.2	79.8	106.4	133.0	159.6	186.2	212.8	239.4
265	26.5	53.0	79.5	106.0	132.5	159.0	185.5	212.0	238.5
264	26.4	52.8	79.2	105.6	132.0	158.4	184.8	211.2	237.6
263	26.3	52.6	78.9	105.2	131.5	157.8	184.1	210.4	236.7
262	26.2	52.4	78.6	104.8	131.0	157.2	183.4	209.6	235.8
261	26.1	52.2	78.3	104.4	130.5	156.6	182.7	208.8	234.9
260	26.0	52.0	78.0	104.0	130.0	156.0	182.0	208.0	234.0
259	25.9	51.8	77.7	103.6	129.5	155.4	181.3	207.2	233.1
258	25.8	51.6	77.4	103.2	129.0	154.8	180.6	206.4	232.2
257	25.7	51.4	77.1	102.8	128.5	154.2	179.9	205.6	231.3
256	25.6	51.2	76.8	102.4	128.0	153.6	179.2	204.8	230.4
255	25.5	51.0	76.5	102.0	127.5	153.0	178.5	204.0	229.5

No. 170 L. 230.]

[No. 189 L. 278

Table of logarithms for numbers 170-189. Columns include N., 0-9, and Diff. Values range from 230449 to 852529.

PROPORTIONAL PARTS

Table of proportional parts for numbers 170-189. Columns include Diff., 1-9. Values range from 25.5 to 203.4.

No. 190 L. 278.]

[No. 211 L. 332.

Table of logarithms for numbers 190-210. Columns include N., 0-9, and Diff. Values range from 278754 to 330414.

PROPORTIONAL PARTS

Table of proportional parts for numbers 190-210. Columns include Diff., 1-9. Values range from 22.5 to 203.4.

No. 215 L. 332.]

[No. 239 L. 380.

N.	0	1	2	3	4	5	6	7	8	9	Diff.
215	332438	2640	2842	3044	3246	3447	3649	3850	4051	4253	202
6	445.4	4635	4856	5057	5257	5458	5658	5859	6059	6260	201
7	6460	6660	6860	7060	7260	7459	7659	7858	8058	8257	200
8	8456	8656	8855	9054	9253	9451	9650	9849			
9	340444	0642	0841	1039	1237	1435	1632	1830	2028	2225	199
220	2423	2620	2817	3014	3212	3409	3606	3802	3999	4196	197
1	4392	4589	4785	4981	5178	5374	5570	5766	5962	6157	196
2	6353	6549	6744	6939	7135	7330	7525	7720	7915	8110	195
3	8305	8500	8694	8889	9083	9278	9472	9666	9860		
4	350248	0442	0636	0829	1023	1216	1410	1603	1796	1989	194
5	2188	2375	2568	2761	2954	3147	3339	3532	3724	3916	193
6	4108	4301	4493	4685	4876	5068	5260	5452	5643	5834	192
7	6026	6217	6408	6599	6790	6981	7172	7363	7554	7744	191
8	7935	8125	8316	8506	8696	8886	9076	9266	9456	9646	190
9	9835	0025	0215	0404	0593	0783	0972	1161	1350	1539	189
230	361728	1917	2105	2294	2482	2671	2859	3048	3232	3424	188
1	3612	3800	3988	4176	4363	4551	4739	4927	5113	5301	188
2	5488	5675	5862	6049	6236	6423	6610	6796	6983	7169	187
3	7356	7542	7729	7915	8101	8287	8473	8659	8845	9030	186
4	9216	9401	9587	9772	9958						
5	371068	1253	1437	1622	1806	0143	0328	0513	0698	0883	185
6	2912	3096	3280	3464	3647	3831	4015	4198	4382	4565	184
7	4748	4932	5115	5298	5481	5664	5846	6029	6212	6394	183
8	6577	6759	6942	7124	7306	7488	7670	7852	8034	8216	182
9	8398	8580	8761	8943	9124	9306	9487	9668	9849		

PROPORTIONAL PARTS.

Diff.	1	2	3	4	5	6	7	8	9
202	20.2	40.4	60.6	80.8	101.0	121.2	141.4	161.6	181.8
201	20.1	40.2	60.3	80.4	100.5	120.6	140.7	160.8	180.9
200	20.0	40.0	60.0	80.0	100.0	120.0	140.0	160.0	180.0
199	19.9	39.8	59.7	79.6	99.5	119.4	139.3	159.2	179.1
198	19.8	39.6	59.4	79.2	99.0	118.8	138.6	158.4	178.2
197	19.7	39.4	59.1	78.8	98.5	118.5	138.2	157.9	177.9
196	19.6	39.2	58.8	78.4	98.0	118.0	137.5	157.4	177.3
195	19.5	39.0	58.5	78.0	97.5	117.5	137.0	156.9	176.4
194	19.4	38.8	58.2	77.6	97.0	117.0	136.5	156.4	175.5
193	19.3	38.6	57.9	77.2	96.5	116.5	136.0	155.9	174.6
192	19.2	38.4	57.6	76.8	96.0	116.0	135.5	155.4	173.7
191	19.1	38.2	57.3	76.4	95.5	115.5	135.0	154.9	172.8
190	19.0	38.0	57.0	76.0	95.0	115.0	134.5	154.4	171.9
189	18.9	37.8	56.7	75.6	94.5	114.5	134.0	153.9	171.0
188	18.8	37.6	56.4	75.2	94.0	114.0	133.5	153.4	170.1
187	18.7	37.4	56.1	74.8	93.5	113.5	133.0	152.9	169.2
186	18.6	37.2	55.8	74.4	93.0	113.0	132.5	152.4	168.3
185	18.5	37.0	55.5	74.0	92.5	112.5	132.0	151.9	167.4
184	18.4	36.8	55.2	73.6	92.0	112.0	131.5	151.4	166.5
183	18.3	36.6	54.9	73.2	91.5	111.5	131.0	150.9	165.6
182	18.2	36.4	54.6	72.8	91.0	111.0	130.5	150.4	164.7
181	18.1	36.2	54.3	72.4	90.5	110.5	130.0	149.9	163.8
180	18.0	36.0	54.0	72.0	90.0	110.0	129.5	149.4	162.9
179	17.9	35.8	53.7	71.6	89.5	109.5	129.0	148.9	162.0

No. 240 L. 380.1

[No. 269 L. 431.

N.	0	1	2	3	4	5	6	7	8	9	Diff.
240	380211	0392	0573	0754	0934	1115	1296	1476	1656	1837	181
1	2017	2197	2377	2557	2737	2917	3097	3277	3456	3636	180
2	3815	3995	4174	4353	4533	4712	4891	5070	5249	5428	179
3	5606	5785	5964	6142	6321	6499	6677	6856	7034	7212	178
4	7390	7568	7746	7924	8101	8279	8456	8634	8811	8989	178
5	9166	9343	9520	9698	9875						
6	390935	1112	1288	1464	1641	1817	1993	2169	2345	2521	177
7	2697	2873	3048	3224	3400	3575	3751	3926	4101	4277	176
8	4452	4627	4802	4977	5152	5326	5501	5676	5850	6025	175
9	6199	6374	6548	6722	6896	7071	7245	7419	7592	7766	174
250	7940	8114	8287	8461	8634	8808	8981	9154	9328	9501	173
1	9674	9847									
2	401401	1573	1745	1917	2089	2261	2433	2605	2777	2949	173
3	3121	3292	3464	3635	3807	3978	4149	4320	4492	4663	172
4	4834	5005	5176	5346	5517	5688	5858	6029	6199	6370	171
5	6540	6710	6881	7051	7221	7391	7561	7731	7901	8070	170
6	8240	8410	8579	8749	8918	9087	9257	9426	9595	9764	169
7	9933										
8	411620	1788	1956	2124	2293	2461	2629	2796	2964	3132	169
9	3300	3467	3635	3803	3970	4137	4305	4472	4639	4806	167
260	4973	5140	5307	5474	5641	5808	5974	6141	6308	6474	167
1	6641	6807	6973	7139	7305	7471	7637	7803	7969	8135	166
2	8301	8467	8633	8798	8964	9129	9295	9460	9625	9791	165
3	9956	0121	0286	0451	0616	0781	0945	1110	1275	1439	165
4	42888	5045	5208	5371	5534	5697	5860	6023	6186	6349	164
5	4882	5045	5208	5371	5534	5697	5860	6023	6186	6349	163
6	6511	6674	6836	6999	7161	7324	7486	7648	7811	7973	162
7	8135	8297	8459	8621	8783	8944	9106	9268	9429	9591	162
8	9752	9914									
9											

PROPORTIONAL PARTS.

Diff.	1	2	3	4	5	6	7	8	9
178	17.8	35.6	53.4	71.2	89.0	106.8	124.6	142.4	160.2
177	17.7	35.4	53.1	70.8	88.5	106.2	123.9	141.6	159.3
176	17.6	35.2	52.8	70.4	88.0	105.6	122.5	140.0	157.5
175	17.5	35.0	52.5	70.0	87.5	105.0	121.8	139.2	156.6
174	17.4	34.8	52.2	69.6	87.0	104.4	121.1	138.4	155.7
173	17.3	34.6	51.9	69.2	86.5	103.8	120.4	137.6	154.8
172	17.2	34.4	51.6	68.8	86.0	103.2	119.7	136.8	153.9
171	17.1	34.2	51.3	68.4	85.5	102.6	119.0	136.0	153.0
170	17.0	34.0	51.0	68.0	85.0	102.0			
169	16.9	33.8	50.7	67.6	84.5	101.4	118.3	135.2	152.1
168	16.8	33.6	50.4	67.2	84.0	100.8	117.6	134.4	151.2
167	16.7	33.4	50.1	66.8	83.5	100.2	116.9	133.6	150.3
166	16.6	33.2	49.8	66.4	83.0	99.6	116.2	132.8	149.4
165	16.5	33.0	49.5	66.0	82.5	99.0	115.5	132.0	148.5
164	16.4	32.8	49.2	65.6	82.0	98.4	114.8	131.2	147.6
163	16.3	32.6	48.9	65.2	81.5	97.8	114.1	130.4	146.7
162	16.2	32.4	48.5	64.8	81.0	97.2	113.4	129.6	145.8
161	16.1	32.2	48.3	64.4	80.5	96.6	112.7	128.8	144.9

WARNING: This is a 1910 edition. Some of the material may no longer be accurate

No. 270 L. 431.]

[No. 299 L. 476.

Table of logarithms for numbers 270-299. Columns include N., 0-9 digits, and Diff. values.

PROPORTIONAL PARTS.

Table of proportional parts for numbers 140-161. Columns include Diff., 1-9, and corresponding values.

No. 300 L. 477.]

[No. 339 L. 531.

Table of logarithms for numbers 300-339. Columns include N., 0-9 digits, and Diff. values.

PROPORTIONAL PARTS.

Table of proportional parts for numbers 127-139. Columns include Diff., 1-9, and corresponding values.

WARNING: This is a 1910 edition. Some of the material may no longer be accurate

No. 340 L. 531.]

[No. 379 L. 570.

N.	0	1	2	3	4	5	6	7	8	9	Diff.
340	531479	1607	1734	1862	1990	2117	2245	2372	2500	2627	128
1	2754	2882	3009	3136	3264	3391	3518	3645	3772	3899	127
2	4026	4153	4280	4407	4534	4661	4787	4914	5041	5167	127
3	5294	5421	5547	5674	5800	5927	6053	6180	6306	6432	126
4	6558	6685	6811	6937	7063	7189	7315	7441	7567	7693	126
5	7819	7945	8071	8197	8322	8448	8574	8699	8825	8951	126
6	9076	9202	9327	9452	9578	9703	9829	9954	0079	0204	125
7	540329	0455	0580	0705	0830	0955	1080	1205	1330	1454	125
8	1579	1704	1829	1953	2078	2203	2327	2452	2576	2701	125
9	2825	2950	3074	3199	3323	3447	3571	3696	3820	3944	124
350	4068	4192	4316	4440	4564	4688	4812	4936	5060	5183	124
1	5307	5431	5555	5678	5802	5925	6049	6172	6296	6419	124
2	6543	6666	6789	6913	7036	7159	7282	7405	7529	7652	123
3	7775	7898	8021	8144	8267	8389	8512	8635	8758	8881	123
4	9003	9126	9249	9371	9494	9616	9739	9861	9984	0106	123
5	550228	0351	0473	0595	0717	0840	0962	1084	1206	1328	122
6	1450	1572	1694	1816	1938	2060	2181	2303	2425	2547	122
7	2660	2790	2911	3033	3155	3276	3398	3519	3640	3762	121
8	3883	4004	4126	4247	4368	4489	4610	4731	4852	4973	121
9	5094	5215	5336	5457	5578	5699	5820	5940	6061	6182	121
360	6303	6423	6544	6664	6785	6905	7026	7146	7267	7387	120
1	7507	7627	7748	7868	7988	8108	8228	8349	8469	8589	120
2	8709	8829	8948	9068	9188	9308	9428	9548	9667	9787	120
3	9907	0026	0146	0265	0385	0504	0624	0743	0863	0982	119
4	561101	1221	1340	1459	1578	1698	1817	1936	2055	2174	119
5	2293	2412	2531	2650	2769	2887	3006	3125	3244	3362	119
6	3481	3600	3718	3837	3955	4074	4192	4311	4429	4548	119
7	4666	4784	4903	5021	5139	5257	5376	5494	5612	5730	118
8	5848	5966	6084	6202	6320	6437	6555	6673	6791	6909	118
9	7026	7144	7262	7379	7497	7614	7732	7849	7967	8084	118
370	8202	8319	8436	8554	8671	8788	8905	9023	9140	9257	117
1	9374	9491	9608	9725	9842	9959	0076	0193	0309	0426	117
2	570543	0660	0776	0893	1010	1126	1243	1359	1476	1592	117
3	1709	1825	1942	2058	2174	2291	2407	2523	2639	2755	116
4	2872	2988	3104	3220	3336	3452	3568	3684	3800	3915	116
5	4031	4147	4263	4379	4494	4610	4726	4841	4957	5072	116
6	5188	5303	5419	5534	5650	5765	5880	5996	6111	6226	115
7	6341	6457	6572	6687	6802	6917	7032	7147	7262	7377	115
8	7492	7607	7722	7836	7951	8066	8181	8295	8410	8525	115
9	8639	8754	8868	8983	9097	9212	9326	9441	9555	9669	114

PROPORTIONAL PARTS.

Diff.	1	2	3	4	5	6	7	8	9
128	12.8	25.6	38.4	51.2	64.0	76.8	89.6	102.4	115.2
127	12.7	25.4	38.1	50.8	63.5	76.2	88.9	101.6	114.3
126	12.6	25.2	37.8	50.4	63.0	75.6	88.2	100.8	113.4
125	12.5	25.0	37.5	50.0	62.5	75.0	87.5	100.0	112.5
124	12.4	24.8	37.2	49.6	62.0	74.4	86.8	99.2	111.6
123	12.3	24.6	36.9	49.2	61.5	73.8	86.1	98.4	110.7
122	12.2	24.4	36.6	48.8	61.0	73.2	85.4	97.6	109.8
121	12.1	24.2	36.3	48.4	60.5	72.6	84.7	96.8	108.9
120	12.0	24.0	36.0	48.0	60.0	72.0	84.0	96.0	108.0
119	11.9	23.8	35.7	47.6	59.5	71.4	83.3	95.2	107.1

No. 380 L. 579.1

[No. 414 L. 617.

N.	0	1	2	3	4	5	6	7	8	9	Diff.
380	579784	9898				0355	0469	0583	0697	0811	114
1	580925	103900	11250	12660	1381	1495	1608	1722	1836	1950	114
2	2063	2177	2291	2404	2518	2631	2745	2858	2972	3085	113
3	3199	3312	3426	3539	3652	3765	3879	3992	4105	4218	113
4	4331	4444	4557	4670	4783	4896	5009	5122	5235	5348	113
5	5461	5574	5686	5799	5912	6024	6137	6250	6362	6475	112
6	6587	6700	6812	6925	7037	7149	7262	7374	7486	7599	112
7	7711	7823	7935	8047	8160	8272	8384	8496	8608	8720	112
8	8832	8944	9056	9167	9279	9391	9503	9615	9726	9838	112
9	9950	0061	0173	0284	0396	0507	0619	0730	0842	0953	111
390	591065	1176	1287	1399	1510	1621	1732	1843	1955	2066	111
1	2177	2288	2399	2510	2621	2732	2843	2954	3064	3175	111
2	3286	3397	3508	3618	3729	3840	3950	4061	4171	4282	110
3	4393	4503	4614	4724	4834	4945	5055	5165	5276	5386	110
4	5496	5606	5717	5827	5937	6047	6157	6267	6377	6487	110
5	6597	6707	6817	6927	7037	7146	7256	7366	7476	7586	109
6	7695	7805	7914	8024	8134	8243	8353	8462	8572	8681	109
7	8791	8900	9009	9119	9228	9337	9446	9556	9665	9774	109
8	98839	9	0101	0210	0319	0428	0537	0646	0755	0864	108
9	600973	1082	1191	1299	1408	1517	1625	1734	1843	1951	108
400	2066	2169	2277	2386	2494	2603	2711	2819	2928	3036	108
1	3144	3253	3361	3469	3577	3686	3794	3902	4010	4118	107
2	4226	4334	4442	4550	4658	4766	4874	4982	5089	5197	107
3	5303	5413	5521	5628	5736	5844	5951	6059	6166	6274	107
4	6381	6489	6596	6704	6811	6919	7026	7133	7241	7348	107
5	7459	7562	7669	7777	7884	7991	8098	8205	8312	8419	106
6	8526	8633	8740	8847	8954	9061	9167	9274	9381	9488	106
7	9594	9701	9808	9914	0021	0128	0234	0341	0447	0554	106
8	610660	0767	0873	0979	1086	1192	1298	1405	1511	1617	106
9	1723	1829	1936	2042	2148	2254	2360	2466	2572	2678	105
410	2784	2890	2996	3102	3207	3313	3419	3525	3630	3736	105
1	3842	3947	4053	4159	4264	4370	4475	4581	4686	4792	105
2	4897	5003	5108	5213	5319	5424	5529	5634	5740	5845	105
3	5950	6055	6160	6265	6370	6476	6581	6686	6790	6895	105
4	7000	7102	7210	7315	7420	7525	7629	7734	7839	7943	105

PROPORTIONAL PARTS.

Diff.	1	2	3	4	5	6	7	8	9
118	11.8	23.6	35.4	47.2	59.0	70.8	82.6	94.4	106.2
117	11.7	23.4	35.1	46.8	58.5	70.2	81.9	93.6	105.3
116	11.6	23.2	34.8	46.4	58.0	69.6	81.2	92.8	104.4
115	11.5	23.0	34.5	46.0	57.5	69.0	80.5	92.0	103.5
114	11.4	22.8	34.2	45.6	57.0	68.4	79.8	91.2	102.6
113	11.3	22.6	33.9	45.2	56.5	67.8	79.1	90.4	101.7
112	11.2	22.4	33.6	44.8	56.0	67.2	78.4	89.6	100.8
111	11.1	22.2	33.3	44.4	55.5	66.6	77.7	88.8	99.9
110	11.0	22.0	33.0	44.0	55.0	66.0	77.0	88.0	99.0
109	10.9	21.8	32.7	43.6	54.5	65.4	76.3	87.2	98.1
108	10.8	21.6	32.4	43.2	54.0	64.8	75.6	86.4	97.2
107	10.7	21.4	32.1	42.8	53.5	64.2	74.9	85.6	96.3
106	10.6	21.2	31.8	42.4	53.0	63.6	74.2	84.8	95.4
105	10.5	21.0	31.5	42.0	52.5	63.0	73.5	84.0	94.5
104	10.4	20.8	31.2	41.6	52.0	62.4	72.8	83.2	93.6

No. 415 L. 618.]

[No. 459 L. 662

N.	0	1	2	3	4	5	6	7	8	9	Diff.
415	618048	8153	8257	8362	8466	8571	8676	8780	8884	8989	105
6	9093	9198	9302	9406	9511	9615	9719	9824	9928	0032	
7	620136	0240	0344	0448	0552	0656	0760	0864	0968	1072	104
8	1176	1280	1384	1488	1592	1695	1799	1903	2007	2110	
9	2214	2318	2421	2525	2628	2732	2835	2939	3042	3146	
420	3249	3353	3456	3559	3663	3766	3869	3973	4076	4179	
1	4282	4385	4488	4591	4695	4798	4901	5004	5107	5210	103
2	5312	5415	5518	5621	5724	5827	5929	6032	6135	6238	
3	6340	6443	6546	6648	6751	6853	6956	7058	7161	7263	
4	7366	7468	7571	7673	7775	7878	7980	8082	8185	8287	
5	8389	8491	8593	8695	8797	8900	9002	9104	9206	9308	102
6	9410	9512	9613	9715	9817	9919	0021	0123	0224	0326	
7	6304213	0530	0631	0733	0835	0936	1038	1139	1241	1342	
8	1444	1545	1647	1748	1849	1951	2052	2153	2255	2356	
9	2457	2559	2660	2761	2862	2963	3064	3165	3266	3367	
430	3469	3569	3670	3771	3872	3973	4074	4175	4276	4376	101
1	4477	4578	4679	4779	4880	4981	5081	5182	5283	5383	
2	5484	5584	5685	5785	5886	5986	6087	6187	6287	6388	
3	6488	6588	6688	6789	6889	6989	7089	7189	7290	7390	
4	7491	7590	7690	7790	7890	7990	8090	8190	8290	8389	100
5	8489	8589	8689	8789	8888	8988	9088	9188	9287	9387	
6	9486	9586	9686	9785	9885	9984	0084	0183	0283	0382	
7	640481	0581	0680	0779	0879	0978	1077	1177	1276	1375	
8	1474	1573	1672	1771	1871	1970	2069	2168	2267	2366	
9	2465	2563	2662	2761	2860	2959	3058	3156	3255	3354	99
440	3453	3551	3650	3749	3847	3946	4044	4143	4242	4340	
1	4439	4537	4636	4734	4832	4931	5029	5127	5226	5324	
2	5422	5521	5619	5717	5815	5913	6011	6110	6208	6306	
3	6404	6502	6600	6698	6796	6894	6992	7089	7187	7285	98
4	7383	7481	7579	7676	7774	7872	7969	8067	8165	8262	
5	8360	8458	8555	8653	8750	8848	8945	9043	9140	9237	
6	9335	9432	9530	9627	9724	9821	9919	0016	0113	0210	
7	650303	0405	0502	0599	0696	0793	0890	0987	1084	1181	
8	1278	1375	1472	1569	1666	1762	1859	1956	2053	2150	97
9	2246	2343	2440	2536	2633	2730	2826	2923	3019	3116	
450	3213	3309	3405	3502	3598	3695	3791	3888	3984	4080	
1	4177	4273	4369	4465	4562	4658	4754	4850	4946	5042	
2	5138	5235	5331	5427	5523	5619	5715	5810	5906	6002	96
3	6098	6194	6290	6386	6482	6577	6673	6769	6864	6960	
4	7056	7152	7247	7343	7438	7534	7629	7725	7820	7916	
5	8011	8107	8202	8298	8393	8488	8584	8679	8774	8870	
6	8965	9060	9155	9250	9346	9441	9536	9631	9726	9821	
7	9916	0011	0106	0201	0296	0391	0486	0581	0676	0771	95
a	660865	0960	1055	1150	1245	1339	1434	1529	1623	1718	
9	1813	1907	2002	2096	2191	2286	2380	2475	2569	2663	

PROPORTIONAL PARTS.

Diff.	1	2	3	4	5	6	7	8	9
105	10.5	21.0	31.5	42.0	52.5	63.0	73.5	84.0	94.5
104	10.4	20.8	31.2	41.6	52.0	62.4	72.8	83.2	93.6
103	10.3	20.6	30.9	41.3	51.5	61.8	72.1	82.4	92.7
102	10.2	20.4	30.6	40.8	50.9	61.2	71.4	81.6	91.8
101	10.1	20.2	30.3	40.4	50.5	60.7	70.9	81.0	91.1
100	10.0	20.0	30.0	40.0	50.0	60.0	70.0	80.0	90.0
99	9.9	19.8	29.7	39.6	49.5	59.4	69.3	79.2	89.1

No. 460 L. 862.]

[No. 499 L. 698.

N.	0	1	2	3	4	5	6	7	8	9	Diff.
460	662758	2852	2947	3041	3135	3230	3324	3418	3512	3607	
1	3701	3795	3889	3983	4078	4172	4266	4360	4454	4548	
2	4642	4736	4830	4924	5018	5112	5206	5299	5393	5487	94
3	5581	5675	5769	5862	5956	6050	6143	6237	6331	6424	
4	6518	6612	6705	6799	6892	6986	7079	7173	7266	7360	
5	7453	7546	7640	7733	7826	7920	8013	8106	8199	8293	
6	8386	8479	8572	8665	8759	8852	8945	9038	9131	9224	
7	9317	9410	9503	9596	9689	9782	9875	9967	0060	0153	93
8	670246	0339	0431	0524	0617	0710	0802	0895	0988	1080	
9	1173	1266	1358	1451	1543	1636	1728	1821	1913	2005	
470	2098	2190	2283	2375	2467	2560	2652	2744	2836	2929	
1	3021	3113	3205	3297	3390	3482	3574	3666	3758	3850	92
2	3942	4034	4126	4218	4310	4402	4494	4586	4677	4769	
3	4861	4953	5045	5137	5228	5320	5412	5503	5595	5687	
4	5778	5870	5962	6053	6145	6236	6328	6419	6511	6602	
5	6694	6785	6876	6968	7059	7151	7242	7333	7424	7516	91
6	7607	7698	7789	7881	7972	8063	8154	8245	8336	8427	
7	8518	8609	8700	8791	8882	8973	9064	9155	9246	9337	
8	9428	9519	9610	9700	9791	9882	9973	0063	0154	0245	
9	680336	0426	0517	0607	0698	0789	0879	0970	1060	1151	
480	1241	1332	1422	1513	1603	1693	1784	1874	1964	2055	
1	2145	2235	2326	2416	2506	2596	2686	2777	2867	2957	
2	3047	3137	3227	3317	3407	3497	3587	3677	3767	3857	90
3	3947	4037	4127	4217	4307	4397	4486	4576	4666	4756	
4	4845	4935	5025	5114	5204	5294	5383	5473	5563	5652	
5	5742	5831	5921	6010	6100	6189	6279	6368	6458	6547	89
6	6636	6726	6815	6904	6994	7083	7172	7261	7351	7440	
7	7529	7618	7707	7796	7886	7975	8064	8153	8242	8331	
8	8420	8509	8598	8687	8776	8865	8954	9043	9132	9221	
9	9309	9398	9486	9575	9664	9753	9841	9930	0019	0107	
490	690196	0285	0373	0462	0550	0639	0728	0816	0905	0993	
1	1081	1170	1258	1347	1435	1524	1612	1700	1789	1877	
2	1965	2053	2142	2230	2318	2406	2494	2583	2671	2759	
3	2847	2935	3023	3111	3199	3287	3375	3463	3551	3639	88
4	3727	3815	3903	3991	4078	4166	4254	4342	4430	4518	
5	4605	4693	4781	4868	4956	5044	5131	5219	5307	5394	
6	5482	5569	5657	5744	5832	5919	6007	6094	6182	6269	
7	6356	6444	6531	6618	6706	6793	6880	6968	7055	7142	87
8	7229	7317	7404	7491	7578	7665	7752	7839	7926	8014	
9	8100	8188	8275	8362	8449	8535	8622	8709	8796	8883	

PROPORTIONAL PARTS.

Diff.	1	2	3	4	5	6	7	8	9
98	9.8	19.6	29.4	39.2	49.0	58.8	68.6	78.4	88.2
97	9.7	19.4	29.1	38.8	48.5	58.2	67.9	77.6	87.3
96	9.6	19.2	28.8	38.4	47.9	57.6	67.2	76.8	86.4
95	9.5	19.0	28.5	38.0	47.5	57.0	66.5	76.0	85.5
94	9.4	18.8	28.2	37.6	47.0	56.4	65.8	75.2	84.6
93	9.3	18.6	27.9	37.2	46.5	55.8	65.1	74.4	83.7
92	9.2	18.4	27.6	36.8	46.0	55.3	64.4	73.6	82.8
91	9.1	18.2	27.3	36.4	45.5	54.8	63.7	72.8	81.9
90	9.0	18.0	27.0	36.0	45.0	54.0	63.0	72.0	81.0
89	8.9	17.8	26.7	35.6	44.5	53.4	62.3	71.2	80.1
88	8.8	17.6	26.4	35.2	44.0	52.8	61.6	70.4	79.2
87	8.7	17.4	26.1	34.8	43.5	52.2	60.9	69.6	78.3
86	8.6	17.2	25.8	34.4	43.0	51.6	60.2	68.8	77.4

WARNING: This is a 1910 edition. Some of the material may no longer be accurate

No. 500 L. 638.]

[No. 544 L. 736.

N.	0	1	2	3	4	5	6	7	8	9	Diff.
500	698970	9057	9144	9231	9317	9404	9491	9578	9664	9751	
1	9838	9924									
2	700704	0790	0877	0963	1050	1136	1222	1309	1395	1482	
3	1568	1654	1741	1827	1913	1999	2086	2172	2258	2344	
4	2431	2517	2603	2689	2775	2861	2947	3033	3119	3205	
5	3291	3378	3464	3550	3635	3721	3807	3893	3979	4065	86
6	4151	5094	5179		4494	4579	4665	4751	4837	4922	
7	5008	5949	6035	5265	5350	5436	5522	5607	5693	5778	
8	5864	6803	6888	6120	6206	6291	6376	6462	6547	6632	
9	6718		6974	7059	7144	7229	7315	7400	7485		
510	7570	8566	8650	7826	7911	7996	8081	8166	8251	8336	
1	8421	9355	9440	8674	8761	8846	8931	9015	9100	9185	85
2	9270			9609	9694	9779	9863	9948			
3	710117	1048	1132	0371	0456	0540	0625	0710	0794	0033	
4	0963	1892	1976	1217	1301	1385	1470	1554	1639	0879	
5	1807	2734	2818	2062	2146	2230	2314	2397	2481	1723	
6	2650	3575	3659	2902	2984	3067	3150	3233	3316	2566	
7	3491	4414	4497	3742	3826	3910	3994	4078	4162	3407	
8	4330	5251		4497	4581	4665	4749	4833	4916	4246	84
9	5167		5418	5502	5586	5669	5753	5836	5920	5084	
520	6003	6087	6170	6254	6337	6421	6504	6588	6671	6754	
1	6833	6921	7004	7088	7171	7254	7338	7421	7504	7587	
2	7671	7754	7837	7920	8003	8086	8169	8253	8336	8419	
3	8502	8585	8668	8751	8834	8917	9000	9083	9165	9248	83
4	9331	9414	9497	9580	9663	9745	9828	9911	9994		
5	720154	0242	0325	0407	0490	0573	0655	0738	0821	0077	
6	0986	1068	1151	1233	1316	1398	1481	1563	1646	0903	
7	1811	1893	1975	2058	2140	2222	2305	2387	2469	1728	
8	2634	2716	2798	2881	2963	3045	3127	3209	3291	2552	
9	3456	3538	3620	3702	3784	3866	3948	4030	4112	3374	82
530	4276	4358	4440	4522	4604	4685	4767	4849	4931	4194	
1	5095	5176	5258	5340	5422	5503	5585	5667	5748	5013	
2	5912	5993	6075	6156	6238	6320	6401	6483	6564	5830	
3	6727	6809	6890	6972	7053	7134	7216	7297	7379	6646	
4	7541	7623	7704	7785	7866	7948	8029	8110	8191	7460	
5	8354	8435	8516	8597	8678	8759	8841	8922	9003	8273	
6	9165	9246	9327	9408	9489	9570	9651	9732	9813	9084	
7	9974									9893	81
8	730782	0055	0136	0217	0298	0378	0459	0540	0621	0702	
9	1589	0863	0944	1024	1105	1186	1266	1347	1428	1508	
540	2394	2474	2555	2635	2715	2796	2876	2956	3037	3117	
1	3197	3278	3358	3438	3518	3598	3679	3759	3839	3919	
2	3999	4079	4160	4240	4320	4400	4480	4560	4640	4720	80
3	4800	4880	4960	5040	5120	5200	5279	5359	5439	5519	
4	5599	5679	5759	5838	5918	5998	6078	6157	6237	6317	

PROPORTIONAL PARTS.

Diff.	1	2	3	4	5	6	7	8	9
87	8.7	17.4	26.1	34.8	43.5	52.2	60.9	69.6	78.3
86	8.6	17.2	25.8	34.0	42.5	51.0	59.5	68.0	76.5
85	8.5	17.0	25.5	33.6	42.0	50.4	58.8	67.2	75.6
84	8.4	16.8	25.2						

No. 545 L. 736.1

[No. 584 L. 767.

N.	0	1	2	3	4	5	6	7	8	9	Diff.
545	736397	6476	6556	6635	6715	6795	6874	6954	7034	7113	
6	7193	7272	7352	7431	7511	7590	7670	7749	7829	7908	
7	7987	8067	8146	8225	8305	8384	8463	8543	8622	8701	
8	8781	8860	8939	9018	9099	9177	9256	9335	9414	9493	
9	9572	9651	9731	9810	9889	9968					
550	7410363	0442	0521	0600	0678	0757	0836	0915	0994	1073	
1	1152	1230	1309	1388	1467	1546	1624	1703	1782	1860	
2	1939	2018	2096	2175	2254	2332	2411	2489	2568	2647	
3	2725	2804	2882	2961	3039	3118	3196	3275	3353	3431	
4	3510	3588	3667	3745	3823	3902	3980	4058	4136	4215	
5	4293	4371	4449	4528	4606	4684	4762	4840	4919	4997	79
6	5075	5153	5231	5309	5387	5465	5543	5621	5699	5777	
7	5855	5933	6011	6089	6167	6245	6323	6401	6479	6556	78
8	6634	6712	6790	6868	6945	7023	7101	7179	7256	7334	
9	7412	7489	7567	7645	7722	7800	7878	7955	8033	8110	
560	8188	8266	8343	8421	8498	8576	8653	8731	8808	8885	
1	8963	9040	9118	9195	9272	9350	9427	9504	9582	9659	
2	9736	9814	9891	9968							
3	750508	0586	0663	0740	0817	0894	0971	1048	1125	1202	
4	1279	1356	1433	1510	1587	1664	1741	1818	1895	1972	77
5	2048	2125	2202	2279	2356	2433	2509	2586	2663	2740	
6	2816	2893	2970	3047	3123	3200	3277	3353	3430	3506	
7	3583	3660	3736	3813	3889	3966	4042	4119	4195	4272	
8	4348	4425	4501	4578	4654	4730	4807	4883	4960	5036	
9	5112	5189	5265	5341	5417	5494	5570	5646	5722	5799	
570	5875	5951	6027	6103	6180	6256	6332	6408	6484	6560	
1	6636	6712	6788	6864	6940	7016	7092	7168	7244	7320	76
2	7396	7472	7548	7624	7700	7775	7851	7927	8003	8079	
3	8155	8230	8306	8382	8458	8533	8609	8685	8761	8836	
4	8912	8988	9063	9139	9214	9290	9366	9441	9517	9592	
5	9668	9743	9819	9894	9970						
6	760422	0498	0573	0649	0724	0799	0875	0950	1025	1101	
7	1176	1251	1326	1402	1477	1552	1627	1702	1778	1853	
8	1928	2003	2078	2153	2228	2303	2378	2453	2529	2604	75
9	2679	2754	2829	2904	2978	3053	3128	3203	3278	3353	
580	3428	3503	3578	3653	3727	3802	3877	3952	4027	4101	
1	4176	4251	4326	4400	4475	4550	4624	4699	4774	4848	
2	4923	4998	5072	5147	5221	5296	5370	5445	5520	5594	
3	5669	5743	5818	5892	5966	6041	6115	6190	6264	6338	
4	6413	6487	6562	6636	6710	6785	6859	6933	7007	7082	

PROPORTIONAL PARTS.

Diff.	1	2	3	4	5	6	7	8	9
83	8.3	16.6	24.9	33.2	41.5	49.8	58.1	66.4	74.7
82	8.2	16.4	24.6	32.0	41.0	49.2	57.4	65.6	73.0
81	8.1	16.2	24.3	32.4	40.5	48.6	56.7	64.8	72.9
80	8.0	16.0	24.0	32.0	40.0	48.0	56.0	64.0	72.0
79	7.9	15.8	23.7	31.6	39.5	47.4	55.3	63.2	71.1
78	7.8	15.6	23.4	31.2	39.0	46.8	54.6	62.4	70.2
77	7.7	15.4	23.1	30.8	38.5	46.2	53.9	61.6	69.3
76	7.6	15.2	22.8	30.4	38.0	45.6	53.2	60.8	68.4
75	7.5	15.0	22.5	30.0	37.5	45.0	52.5	60.0	67.5
74	7.4	14.8	22.2	29.6	37.0	44.4	51.8		

No. 585 L. 767.]

[No. 629 L. 799.]

N.	0	1	2	3	4	5	6	7	8	9	Diff.
585	767156	7230	7304	7379	7453	7527	7601	7675	7749	7823	
6	7898	7972	8046	8120	8194	8268	8342	8416	8490	8564	74
7	8638	8712	8786	8860	8934	9008	9082	9156	9230	9303	
8	9377	9451	9525	9599	9673	9746	9820	9894	9968		
9	770115	0189	0263	0336	0410	0484	0557	0631	0705	0778	
590	0852	0926	0999	1073	1146	1220	1293	1367	1440	1514	
1	1587	1661	1734	1808	1881	1955	2028	2102	2175	2248	
2	2322	2395	2468	2542	2615	2688	2762	2835	2908	2981	
3	3051	3128	3201	3274	3348	3421	3494	3567	3640	3713	
4	3786	3860	3933	4006	4079	4152	4225	4298	4371	4444	73
5	4517	4590	4663	4736	4809	4882	4955	5028	5100	5173	
6	5246	5319	5392	5465	5538	5610	5683	5756	5829	5902	
7	5973	6047	6120	6193	6266	6338	6411	6483	6556	6629	
8	6701	6774	6846	6919	6992	7064	7137	7209	7282	7354	
9	7427	7499	7572	7644	7717	7789	7862	7934	8006	8079	
600	8151	8224	8296	8368	8441	8513	8585	8658	8730	8802	
1	8874	8947	9019	9091	9163	9236	9308	9380	9452	9524	
2	9593	9669	9741	9813	9885	9957	0029	0101	0173	0245	
3	780317	0389	0461	0533	0605	0677	0749	0821	0893	0965	72
4	1037	1109	1181	1253	1324	1396	1468	1540	1612	1684	
5	1755	1827	1899	1971	2042	2114	2186	2258	2329	2401	
6	2473	2544	2616	2688	2759	2831	2902	2974	3046	3117	
7	3189	3260	3332	3403	3475	3546	3618	3689	3761	3832	
8	3904	3975	4046	4118	4189	4261	4332	4403	4475	4546	
9	4617	4689	4760	4831	4902	4974	5045	5116	5187	5259	
610	5330	5401	5472	5543	5615	5686	5757	5828	5899	5910	
1	6041	6112	6183	6254	6325	6396	6467	6538	6609	6680	71
2	6751	6822	6893	6964	7035	7106	7177	7248	7319	7390	
3	7460	7531	7602	7673	7744	7815	7885	7956	8027	8098	
4	8168	8239	8310	8381	8451	8522	8593	8663	8734	8804	
5	8875	8946	9016	9087	9157	9228	9299	9369	9440	9510	
6	9581	9651	9722	9792	9863	9933	0004	0074	0144	0215	
7	790285	0356	0426	0496	0567	0637	0707	0778	0848	0918	
8	0988	1059	1129	1199	1269	1339	1410	1480	1550	1620	
9	1691	1761	1831	1901	1971	2041	2111	2181	2252	2322	
620	2392	2462	2532	2602	2672	2742	2812	2882	2952	3022	70
1	3092	3162	3231	3301	3371	3441	3511	3581	3651	3721	
2	3790	3860	3930	4000	4070	4139	4209	4279	4349	4418	
3	4488	4558	4627	4697	4767	4836	4906	4976	5045	5115	
4	5185	5254	5324	5393	5463	5532	5602	5672	5741	5811	
5	5880	5949	6019	6088	6158	6227	6297	6366	6436	6505	
6	6574	6644	6713	6782	6852	6921	6990	7060	7129	7198	
7	7268	7337	7406	7475	7545	7614	7683	7752	7821	7890	
8	7960	8029	8098	8167	8236	8305	8374	8443	8513	8582	
9	8651	8720	8789	8858	8927	8996	9065	9134	9203	9272	69

PROPORTIONAL PARTS.

Diff.	1	2	3	4	5	6	7	8	9
75	7.5	15.0	22.5	30.0	37.5	45.0	52.5	60.0	67.5
74	7.4	14.8	22.2	29.6	37.0	44.4	51.8	59.2	66.6
73	7.3	14.6	21.9	29.2	36.5	43.8	51.1	58.4	65.7
72	7.2	14.4	21.6	28.8	36.0	43.2	50.4	57.6	64.8
71	7.1	14.2	21.3	28.4	35.5	42.6	49.7	56.8	63.9
70	7.0	14.0	21.0	28.0	35.0	42.0	49.0	56.0	63.0
69	6.9	13.8	20.7	27.6	34.5	41.4	48.3	55.2	62.1

No. 630 L. 799.]

[No. 674 L. 829.]

N.	0	1	2	3	4	5	6	7	8	9	Diff.
630	799341	9409	9478	9547	9616	9685	9754	9823	9892	9961	
1	800029	0098	0167	0236	0305	0373	0442	0511	0580	0648	
2	0717	079	0854	0923	0992	1061	1129	1198	1266	1335	
3	1404	1472	1541	1609	1677	1747	1815	1884	1952	2021	
4	2089	2158	2226	2295	2363	2432	2500	2568	2637	2705	
5	2774	2842	2910	2979	3047	3116	3184	3252	3321	3389	
6	3457	3525	3594	3662	3730	3798	3867	3935	4003	4071	
7	4139	4208	4276	4344	4412	4480	4548	4616	4685	4753	
8	4821	4889	4957	5025	5093	5161	5229	5297	5365	5433	68
9	5501	5569	5637	5705	5773	5841	5908	5976	6044	6112	
6408	06180	6248	6316	6384	6451	6519	6587	6655	6723	6790	
1	6858	6926	6994	7061	7129	7197	7264	7332	7400	7467	
2	7535	7603	7670	7738	7806	7873	7941	8008	8076	8143	
3	8211	8279	8346	8414	8481	8549	8616	8684	8751	8818	
4	8886	8953	9021	9088	9156	9223	9290	9358	9425	9492	
5	9560	9627	9694	9762	9829	9896	9964	0031	0098	0165	
6	810233	0100	0367	0434	0501	0569	0636	0703	0770	0837	
7	0904	0971	1039	1106	1173	1240	1307	1374	1441	1508	67
8	1575	1642	1709	1776	1843	1910	1977	2044	2111	2178	
9	2245	2312	2379	2445	2512	2579	2646	2713	2780	2847	
650	2913	2960	3047	3114	3181	3247	3314	3381	3448	3514	
1	3581	3648	3714	3781	3848	3914	3981	4048	4114	4181	
2	4243	4314	4381	4447	4514	4581	4647	4714	4780	4847	
3	4913	4980	5046	5113	5179	5246	5312	5378	5445	5511	
4	5578	5644	5711	5777	5843	5910	5976	6042	6109	6175	
5	6241	6307	6374	6440	6506	6573	6639	6705	6771	6838	
6	6904	6971	7036	7102	7169	7235	7301	7367	7433	7499	
7	7565	7631	7698	7764	7830	7896	7962	8028	8094	8160	66
8	8226	8292	8358	8424	8490	8556	8622	8688	8754	8820	
9	8885	8951	9017	9083	9149	9215	9281	9346	9412	9478	
660	9544	9610	9676	9741	9807	9873	9939	0004	0070	0136	
1	820201	01267	0333	0399	0464	0530	0595	0661	0727	0792	
2	0858	0924	0989	1055	1120	1186	1251	1317	1382	1448	
3	1514	1579	1644	1710	1775	1841	1906	1972	2037	2103	
4	2168	2233	2298	2364	2430	2495	2560	2626	2691	2756	
5	2822	2887	2952	3018	3083	3148	3213	3279	3344	3409	
6	3474	3539	3604	3670	3735	3800	3865	3930	3996	4061	
7	4126	4191	4256	4321	4386	4451	4516	4581	4646	4711	
8	4776	4841	4906	4971	5036	5101	5166	5231	5296	5361	65
9	5416	5491	5556	5621	5686	5751	5815	5880	5945	6010	
670	607	6140	6204	6269	6334	6399	6464	6528	6593	6658	
1	6723	6787	6917	6981	7046	7111	7175	7240	7305	7369	
2	7369	7434	7499	7563	7628	7692	7757	7821	7886	7951	
3	8015	8080	8144	8209	8273	8338	8402	8467	8531	8595	
4	8660	8724	8789	8853	8918	8982	9046	9111	9175	9239	

PROPORTIONAL PARTS.

Diff.	1	2	3	4	5	6	7	8	9
68	6.8	13.6	20.4	26.8	33.5	40.2	46.9	53.6	60.3
67	6.7	13.4	20.1	26.6	33.0	39.6	46.2	52.8	59.4
66	6.6	13.2	19.8	26.0	32.5	39.0	45.5	52.0	58.5
65	6.5	13.0	19.5	25.6	32.0	38.4	44.8	51.2	57.6
64	6.4	12.8	19.2	25.2	31.6	38.0	44.4	50.8	57.2

WARNING: This is a 1910 edition. Some of the material may no longer be accurate

No. 675 L. 829.]

[No. 719 L. 857.

N.	0	1	2	3	4	5	6	7	8	9	Diff.
675	829304	9368	9432	9497	9561	9625	9690	9754	9818	9882	
6	9947	0011	0075	0139	0204	0268	0332	0396	0460	0525	
7	830589	0653	0717	0781	0845	0909	0973	1037	1102	1166	
8	1230	1294	1358	1422	1486	1550	1614	1678	1742	1806	64
9	1870	1934	1998	2062	2126	2189	2253	2317	2381	2445	
680	2509	2573	2637	2700	2764	2828	2892	2956	3020	3083	
1	3147	3211	3275	3338	3402	3466	3530	3593	3657	3721	
2	3784	3848	3912	3975	4039	4103	4166	4230	4294	4357	
3	4421	4484	4548	4611	4675	4739	4802	4866	4929	4993	
4	5056	5120	5183	5247	5310	5373	5437	5500	5564	5627	
5	5691	5754	5817	5881	5944	6007	6071	6134	6197	6261	
6	6324	6387	6451	6514	6577	6641	6704	6767	6830	6894	
7	6957	7020	7083	7146	7210	7273	7336	7399	7462	7525	
8	7588	7652	7715	7778	7841	7904	7967	8030	8093	8156	63
9	8219	8282	8345	8408	8471	8534	8597	8660	8723	8786	
690	8849	8912	8975	9038	9101	9164	9227	9289	9352	9415	
1	9478	9541	9604	9667	9729	9792	9855	9918	9981	0043	
2	840106	0169	0232	0294	0357	0420	0482	0545	0608	0671	
3	0733	0796	0859	0921	0984	1046	1109	1172	1234	1297	
4	1359	1422	1485	1547	1610	1672	1735	1797	1860	1922	
5	1985	2047	2110	2172	2235	2297	2360	2422	2484	2547	
6	2609	2672	2734	2796	2859	2921	2983	3046	3108	3170	
7	3233	3295	3357	3420	3482	3544	3606	3669	3731	3793	
8	3855	3918	3980	4042	4104	4166	4229	4291	4353	4415	
9	4477	4539	4601	4664	4726	4788	4850	4912	4974	5036	
700	5098	5160	5222	5284	5346	5408	5470	5532	5594	5656	
1	5718	5780	5842	5904	5966	6028	6090	6151	6213	6275	
2	6337	6399	6461	6523	6585	6646	6708	6770	6832	6894	
3	6955	7017	7079	7141	7202	7264	7326	7388	7449	7511	
4	7573	7634	7696	7758	7819	7881	7943	8004	8066	8128	
5	8189	8251	8312	8374	8435	8497	8559	8620	8682	8743	
6	8805	8866	8928	8989	9051	9112	9174	9235	9297	9358	
7	9419	9481	9542	9604	9665	9726	9788	9849	9911	9972	
8	850033	0095	0156	0217	0279	0340	0401	0462	0524	0585	
9	0646	0707	0769	0830	0891	0952	1014	1075	1136	1197	
710	1258	1320	1381	1442	1503	1564	1625	1686	1747	1809	
1	1870	1931	1992	2053	2114	2175	2236	2297	2358	2419	
2	2480	2541	2602	2663	2724	2785	2846	2907	2968	3029	
3	3090	3150	3211	3272	3333	3394	3455	3516	3577	3637	
4	3698	3759	3820	3881	3941	4002	4063	4124	4185	4245	
5	4306	4367	4428	4488	4549	4610	4670	4731	4792	4852	
6	4913	4974	5034	5095	5156	5216	5277	5337	5398	5459	
7	5519	5580	5640	5701	5761	5822	5882	5943	6003	6064	
8	6124	6185	6245	6306	6366	6427	6487	6548	6608	6668	
9	6729	6789	6850	6910	6970	7031	7091	7152	7212	7272	

PROPORTIONAL PARTS.

Diff.	1	2	3	4	5	6	7	8	9
65	6.5	13.0	19.5	26.0	32.5	39.0	45.5	52.0	58.5
64	6.4	12.8	19.2	25.6	32.0	38.4	44.8	51.2	57.6
63	6.3	12.6	18.9	25.2	31.5	37.8	44.1	50.4	56.7
62	6.2	12.4	18.6	24.8	31.0	37.2	43.4	49.6	55.8
61	6.1	12.2	18.3	24.4	30.5	36.6	42.7	48.8	54.9
60	6.0	12.0	18.0	24.0	30.0	36.0	42.0	48.0	54.0

No. 720 L. 857.]

[No. 564 L. 883.

N.	0	1	2	3	4	5	6	7	8	9	Diff.
720	857332	7393	7453	7513	7574	7634	7694	7755	7815	7875	
1	7935	7995	8056	8116	8176	8236	8297	8357	8417	8477	
2	8537	8597	8657	8718	8778	8838	8898	8958	9018	9078	
3	9138	9198	9258	9318	9379	9439	9499	9559	9619	9679	60
4	9739	9799	9859	9918	9978	0038	0098	0158	0218	0278	
5	860338	0398	0458	0518	0578	0637	0697	0757	0817	0877	
6	0937	0996	1056	1116	1176	1236	1295	1355	1415	1475	
7	1534	1594	1654	1714	1773	1833	1893	1952	2012	2072	
8	2131	2191	2251	2310	2370	2430	2489	2549	2608	2668	
9	2723	2787	2847	2906	2966	3025	3085	3144	3204	3263	
730	3323	3382	3442	3501	3561	3620	3680	3739	3799	3858	
1	3917	3977	4036	4096	4155	4214	4274	4333	4392	4452	
2	4511	4570	4630	4689	4748	4808	4867	4926	4985	5045	
3	5104	5163	5222	5282	5341	5400	5459	5519	5578	5637	
4	5696	5755	5814	5874	5933	5992	6051	6110	6169	6228	
5	6287	6346	6405	6465	6524	6583	6642	6701	6760	6819	
6	68786	937	6996	7055	7114	7173	7232	7291	7350	7409	59
7	7467	7526	7585	7644	7703	7762	7821	7880	7939	7998	
8	8056	8115	8174	8233	8292	8350	8409	8468	8527	8586	
9	86448	703	8762	8821	8879	8938	8997	9056	9114	9173	
740	9232	9290	9349	9408	9466	9525	9584	9642	9701	9760	
1	9818	9877	9935	9994	0053	0111	0170	0228	0287	0345	
2	870404	0462	0521	0579	0638	0696	0755	0813	0872	0930	
3	0989	1047	1106	1164	1223	1281	1339	1398	1456	1515	
4	1573	1631	1690	1748	1806	1865	1923	1981	2040	2098	
5	2156	2215	2273	2331	2389	2448	2506	2564	2622	2681	
6	2739	2797	2855	2913	2972	3030	3088	3146	3204	3262	
7	3321	3379	3437	3495	3553	3611	3669	3727	3785	3844	
8	3907	3960	4018	4076	4134	4192	4250	4308	4366	4424	5.3
9	4482	4540	4598	4656	4714	4772	4830	4888	4945	5003	
750	5061	5119	5177	5235	5293	5351	5409	5466	5524	5582	
1	5640	5698	5756	5813	5871	5929	5987	6045	6102	6160	
2	6218	6276	6333	6391	6449	6507	6564	6622	6680	6737	
3	6795	6853	6910	6968	7026	7083	7141	7199	7256	7314	
4	7371	7429	7487	7544	7602	7659	7717	7774	7832	7889	
5	7947	8004	8062	8119	8177	8234	8292	8349	8407	8464	
6	8522	8579	8637	8694	8752	8809	8866	8924	8981	9039	
7	9095	9153	9211	9268	9325	9383	9440	9497	9555	9612	
8	9669	9726	9784	9841	9899	9956	0013	0070	0127	0185	
9	880242	0299	0356	0413	0471	0528	0585	0642	0699	0756	
760	0814	0871	0928	0985	1042	1099	1156	1213	1271	1328	
1	1385	1442	1499	1556	1613	1670	1727	1784	1841	1898	
2	1955	2012	2069	2126	2183	2240	2297	2354	2411	2468	57
3	2525	2581	2638	2695	2752	2809	2866	2923	2980	3037	
4	3093	3150	3207	3264	3321	3377	3434	3491	3548	3605	

PROPORTIONAL PARTS.

Diff.	1	2	3	4	5	6	7	8	9
59	5.9	11.8							

No. 765 L. 883.]

[No. 809 L. 908.

N.	0	1	2	3	4	5	6	7	8	9	Diff.
76	003661	3718	3775	3832	3000	3945	4002	4059	4115	4172	
	4229	4285	4342	4399	4455	4512	4569	4625	4682	4739	
	4795	4852	4909	4965	5022	5078	5135	5192	5248	5305	
	5361	5418	5474	5531	5587	5644	5700	5757	5813	5870	
	5926	5983	6039	6096	6152	6209	6265	6321	6375	6434	
77	6491	6547	6604	6660	6716	6773	6829	6885	6942	6998	
	7054	7111	7167	7223	7280	7336	7392	7449	7505	7561	
	7617	7674	7730	7786	7842	7898	7955	8011	8067	8123	
	8179	8236	8292	8348	8404	8460	8516	8573	8629	8685	
	8741	8797	8853	8909	8965	9021	9077	9134	9190	9246	
	9302	9358	9414	9470	9526	9582	9638	9694	9750	9806	56
	9862	9918	9974								
			0030	0086	0141	0197	0253	0309	0365		
	190421	0477	0533	0589	0645	0700	0756	0812	0868	0924	
	0980	1035	1091	1147	1203	1259	1314	1370	1426	1482	
	1537	1593	1649	1705	1760	1816	1872	1928	1983	2039	9
78	2095	2150	2206	2262	2317	2373	2429	2484	2540	2595	
	2651	2707	2762	2818	2873	2929	2985	3040	3096	3151	
	3207	3262	3318	3373	3429	3484	3540	3595	3651	3706	
	3762	3817	3873	3928	3984	4039	4094	4150	4205	4261	
	4316	4371	4427	4482	4538	4593	4648	4704	4759	4814	
	4870	4925	4980	5036	5091	5146	5201	5257	5312	5367	
	5423	5478	5533	5588	5643	5698	5754	5809	5864	5920	
	5975	6030	6085	6140	6195	6250	6306	6361	6416	6471	
	6526	6581	6636	6691	6747	6802	6857	6912	6967	7022	
	7077	7132	7187	7242	7297	7352	7407	7462	7517	7572	
79	7627	7682	7737	7792	7847	7902	7957	8012	8067	8122	55
	8176	8231	8286	8341	8396	8451	8506	8561	8616	8670	
	8725	8780	8835	8890	8944	8999	9054	9109	9164	9218	
	9273	9328	9383	9437	9492	9547	9601	9656	9711	9766	
	9821	9875	9930	9985							
			0039	0094	0149	0203	0258	0312	0367	0421	
	00367	0422	0476	0531	0586	0640	0695	0749	0804	0859	
	0913	0968	1022	1077	1131	1186	1240	1295	1349	1404	
	1458	1513	1567	1622	1676	1731	1785	1840	1894	1948	
	2003	2057	2112	2166	2221	2275	2329	2384	2438	2492	
	2547	2601	2655	2710	2764	2818	2873	2927	2981	3036	
80	3090	3144	3199	3253	3307	3361	3416	3470	3524	3578	
	3633	3687	3741	3795	3849	3904	3958	4012	4066	4120	
	4174	4229	4283	4337	4391	4445	4499	4553	4607	4661	
	4716	4770	4824	4878	4932	4986	5040	5094	5148	5202	
	5256	5310	5364	5418	5472	5526	5580	5634	5688	5742	54
	5796	5850	5904	5958	6012	6066	6119	6173	6227	6281	
	6335	6389	6443	6497	6551	6604	6658	6712	6766	6820	
	6874	6927	6981	7035	7089	7143	7196	7250	7304	7358	
	7411	7464	7519	7573	7626	7680	7734	7787	7841	7895	
	7949	8002	8056	8109	8163	8217	8270	8324	8378	8431	

PROPORTIONAL PARTS.

Diff.	1	2	3	4	5	6	7	8	9
57	5.7								
56	5.6		17.1			34.2	39.9	45.6	
55		11.4		22.8	28.5		39.2		51.3
54	5.5	11.2	16.5	22.4	28.0	33.6	38.5	44.0	50.4
	5.4	10.8	16.2	21.6	27.0	32.4	37.8	43.2	49.5
									40.6

No. 810 L. 908.1

[No. 854 L. 931.

N.	0	1	2	3	4	5	6	7	8	9	Diff.
810	908485	8539	0592	0646	8699	8753	8807	0060	8914	0967	
	9021	9374	9125	9181	9235	9289	9342	9396	9449	9503	
	9556	9610	9663	9716	9770	9823	9877	9930	9984		
										0037	
81	910091	0144	0197	0251	0304	0358	0411	0464	0518	0571	
	0624	0578	0731	0704	0838	0891	0944	0998	1051	1104	
	1158	1211	264	1317	1371	1424	1477	1530	1584	1637	
	1690	1743	3179	1850	1903	1956	2009	2063	2116	2169	
	2222	2275	2320	2381	2435	2488	2541	2594	2647	2700	
	2753	2806	2859	2913	2966	3019	3072	3125	3178	3231	
	3284	3337	3390	3443	3496	3549	3602	3655	3708	3761	53
820	3814	3067	3920	3973	4026	4079	4132	4184	4237	4290	
	4343	4396	4449	4502	4555	4608	4660	4713	4766	4819	
	4872	4925	4977	5030	5083	5136	5189	5241	5294	5347	
	5400	5453	5505	5558	5611	5664	5716	5769	5821	5875	
	5927	5980	6033	6085	6138	6191	6243	6296	6349	6401	
	6454	6507	6559	6612	6664	6717	6770	6822	6875	6927	
	6980	7033	7085	7138	7190	7243	7295	7348	7400	7453	
	7506	7558	7611	7663	7716	7768	7820	7873	7925	7977	
	8030	8082	8135	8188	8240	8293	8345	8397	8450	8502	
	8555	8607	8659	8712	8764	8816	8869	8921	8973	9026	
830	9078	9130	9183	9235	9287	9340	9392	9444	9496	9549	
	9601	9653	9706	9758	9810	9862	9914	9967	0019		
	920123	0176	0228	0280	0332	0384	0436	0489	0541	0593	52
	0645	0697	0749	0801	0853	0906	0958	1010	1062	1114	
	1166	1218	1270	1322	1374	1426	1478	1530	1582	1634	
	1686	1738	1790	1842	1894	1946	1998	2050	2102	2154	
	2206	2258	2310	2362	2414	2466	2518	2570	2622	2674	
	2725	2777	2829	2881	2933	2985	3037	3089	3140	3192	
	3244	3296	3348	3399	3451	3503	3555	3606	3658	3710	
	3762	3814	3865	3917	3969	4021	4072	4124	4176	4228	
840	4279	4331	4383	4434	4486	4538	4589	4641	4693	4744	
	4796	4848	4899	4951	5003	5054	5106	5157	5209	5261	
	5312	5364	5415	5467	5518	5570	5621	5673	5725	5776	
	5828	5879	5931	5982	6034	6085	6137	6188	6240	6291	
	6342	6394	6445	6497	6548	6600	6651	6702	6754	6805	
	6857	6908	6959	7011	7062	7114	7165	7216	7267	7319	
	7370	7422	7473	7524	7576	7627	7678	7730	7781	7832	
	7883	7935	7986	8037	8088	8140	8191	8242	8293	8345	
	8396	8447	8498	8549	8601	8652	8703	8754	8805	8857	
	8908	8959	9010	9061	9112	9163	9215	9266	9317	9368	
850	9419	9470	9521	9572	9623	9674	9725	9776	9827	9879	51
	9930	9981									
			0032	0083	0134	0185	0236	0287	0338	0389	
	930440	0491	0542	0592	0643	0694	0745	0796	0847	0898	
	0949	1000	1051	1102	1153	1204	1254	1305	1356	1407	
	1458	1509	1560	1610	1661	1712	1763	1814	1865	1915	

PROPORTIONAL PARTS.

Diff.	1	2	3	4	5	6	7	8
-------	---	---	---	---	---	---	---	---

No. 855 L. 931.]

[No. 899 L. 954.

Table of logarithms for numbers 855-899. Columns include N., 0, 1, 2, 3, 4, 6, 6, 7, 8, 9, and Diff. Values range from 931966 to 3760.

PROPORTIONAL PARTS.

Table of proportional parts for page 160. Columns include Diff., 1, 2, 3, 4, 5, 6, 7, 8, 9. Values range from 5.1 to 43.2.

No. 900 L. 954.1

[No. 944 L. 975.

Table of logarithms for numbers 900-940. Columns include N., 0, 1, 2, 3, 4, 5, 6, 7, 8, 9, and Diff. Values range from 954243 to 4972.

PROPORTIONAL PARTS.

Table of proportional parts for page 161. Columns include Diff., 1, 2, 3, 4, 6, 6, 7, 8, 9. Values range from 4.7 to 41.4.

[No. 045 L. 975.]

[No. 989 L. 995.]

N.	0	1	2	3	4	5	6	7	8	9	Diff.
945	975432	547%	55241	5570	5616	5662	5707	5753	5799	5845	
6	5891	5937	5983	6029	6075	6121	6167	6212	6258	6304	
7	6350	6396	6442	6488	6533	6579	6625	6671	6717	6763	
8	6808	6854	6900	6946	6992	7037	7083	7129	7175	7220	
9	7266	7312	7358	7403	7449	7495	7541	7586	7632	7677	
950	7724	7769	7815	7861	7906	7952	7999	8043	8089	8135	
1	8181	8226	8272	8317	8363	8409	8454	8500	8546	8591	
2	8637	8683	8728	8774	8819	8865	8911	8956	9002	9047	
3	9093	9138	9184	9230	9275	9321	9366	9412	9457	9503	
4	9548	9594	9639	9685	9730	9776	9821	9867	9912	9958	
5	980003	0049	0094	0140	0185	0231	0276	0322	0367	0412	
6	045%	0503	0549	0594	0640	0685	0730	0776	0821	0867	
7	0912	0957	1003	1048	1093	1139	1184	1229	1275	1320	
8	1366	1411	1456	1501	1547	1592	1637	1683	1728	1773	
9	1819	1864	1909	1954	2000	2045	2090	2135	2181	2226	
960	2271	2316	2362	2407	2452	2497	2543	2588	2633	2678	
1	2723	2769	2814	2859	2904	2949	2994	3040	3085	3130	
2	3175	3220	3265	3310	3356	3401	3446	3491	3536	3581	
3	3626	3671	3716	3762	3807	3852	3897	3942	3987	4032	
4	4077	4122	4167	4212	4257	4302	4347	4392	4437	4482	
5	4527	4572	4617	4662	4707	4752	4797	4842	4887	4932	45
6	4977	5022	5067	5112	5157	5202	5247	5292	5337	5382	
7	5426	5471	5516	5561	5606	5651	5696	5741	5786	5831	
8	5875	5920	5965	6010	6055	6100	6144	6189	6234	6279	
9	6324	6369	6413	6458	6503	6548	6593	6637	6682	6727	
970	6772	6817	6861	6906	6951	6996	7040	7085	7130	7175	
1	7219	7264	7309	7353	7398	7443	7488	7532	7577	7622	
2	7666	7711	7756	7800	7845	7890	7934	7979	8024	8068	
3	8113	8157	8202	8247	8291	8336	8381	8425	8470	8514	
4	8559	8604	8648	8693	8737	8782	8826	8871	8916	8960	
5	9005	9049	9094	9138	9183	9227	9272	9316	9361	9405	
6	9450	9494	9539	9583	9628	9672	9717	9761	9806	9850	
7	9895	9939	9983	0028	0072	0117	0161	0206	0250	0294	
8	990339	0383	0428	0472	0516	0561	0605	0650	0694	0738	
9	0783	0827	0871	0916	0960	1004	1049	1093	1137	1182	
980	1226	1270	1315	1359	1403	1448	1492	1536	1580	1625	
1	1669	1713	1758	1802	1846	1890	1935	1979	2023	2067	
2	2111	2155	2200	2244	2288	2332	2376	2420	2464	2509	
3	2554	3039	3083	3127	3172	3216	2819	2863	2907	2951	
4	2995	3480	3524	3568	3613	3657	3260	3304	3348	3392	
5	3436	3921	3965	4009	4053	4097	3701	3745	3789	3833	
6	3877	4361	4405	4449	4493	4537	4141	4185	4229	4273	
7	4317	4801	4845	4889	4933	4537	4581	4625	4669	4713	44
8	4757	5240	5284	5328	5372	5416	5021	5065	5108	5152	
9	5196					5460	5504	5547	5591		

PROPORTIONAL PARTS.

Diff.	1	2	3	4	5	6	7	8	9
			13.8		23.0				
46	4.6	9.2	13.5	18.4 18.0	22.5	27.6	32.2	36.8	41.4
45	4.5	9.0	13.2	17.6	22.0	27.0	31.5	36.0	40.5
44	4.4	8.8	12.9	17.2	21.5	26.8	30.8	35.2	39.6
43	4.3	8.6					34.4		38.7

[No. 990 L. 995.]

[No. 999 L. 999.]

N.	0	1	2	3	4	5	6	7	8	9	Diff.
990	995635	5679	5723	5767	5811	5854	5898	5942	5986	6030	
1	6074	6117	6161	6205	6249	6293	6337	6380	6424	6468	44
2	6512	6555	6599	6643	6687	6731	6774	6818	6862	6906	
3	6949	6993	7037	7080	7124	7168	7212	7255	7299	7343	
4	7386	7430	7474	7517	7561	7605	7648	7692	7736	7779	
5	7823	7867	7910	7954	7999	8041	8085	8129	8172	8216	
6	8259	8303	8347	8390	8434	8477	8521	8564	8608	8652	
7	8695	8739	8782	8826	8869	8913	8956	9000	9043	9087	
8	9131	9174	9217	9261	9305	9348	9392	9435	9479	9522	
9	9565	9609	9652	9696	9739	9783	9826	9870	9913	9957	43

HYPERBOLIC LOGARITHMS.

No.	Log.	No.	Log.	No.	Log.	No.	Log.	No.	Log.
1.01	.0099	1.45	.3716	1.89	.6366	2.33	.945%	2.77	1.0188
1.02	.0198	1.46	.3784	1.90	.6419	2.34	.9502	2.78	1.0225
1.03	.0296	1.47	.3853	1.91	.6471	2.35	.9544	2.79	1.0260
1.04	.0392	1.48	.3920	1.92	.6523	2.36	.9587	2.80	1.0296
1.05	.0488	1.49	.3988	1.93	.6575	2.37	.9629	2.81	1.0332
1.06	.0583	1.50	.4055	1.94	.6627	2.38	.9671	2.82	1.0367
1.07	.0677	1.51	.4121	1.95	.6678	2.39	.9713	2.83	1.0403
1.08	.0770	1.52	.4187	1.96	.6729	2.40	.9755	2.84	1.0438
1.09	.0862	1.53	.4253	1.97	.6780	2.41	.9796	2.85	1.0473
1.10	.0953	1.54	.4318	1.98	.6831	2.42	.9838	2.86	1.0508
1.11	.1044	1.55	.4383	1.99	.6881	2.43	.9879	2.87	1.0543
1.12	.1133	1.56	.4447	2.00	.6931	2.44	.9920	2.88	1.0578
1.13	.1222	1.57	.4511	2.01	.6981	2.45	.9961	2.89	1.0613
1.14	.1310	1.58	.4574	2.02	.7031	2.46	.9999	2.90	1.0647
1.15	.1398	1.59	.4637	2.03	.7080	2.47	1.0042	2.91	1.0682
1.16	.1484	1.60	.4700	2.04	.7129	2.48	1.0083	2.92	1.0716
1.17	.1570	1.61	.4762	2.05	.7178	2.49	1.0123	2.93	1.0750
1.18	.1655	1.62	.4824	2.06	.7227	2.50	1.0163	2.94	1.0784
1.19	.1740	1.63	.4886	2.07	.7275	2.51	1.0203	2.95	1.0818
1.20	.1823	1.64	.4947	2.08	.7324	2.52	1.0243	2.96	1.0852
1.21	.1906	1.65	.5008	2.09	.7372	2.53	1.0282	2.97	1.0886
1.22	.1988	1.66	.5068	2.10	.7419	2.54	1.0321	2.98	1.0919
1.23	.2070	1.67	.5128	2.11	.7467	2.55	1.0360	2.99	1.0953
1.24	.2151	1.68	.5188	2.12	.7514	2.56	1.0398	3.00	1.0986
1.25	.2231	1.69	.5247	2.13	.7561	2.57	1.0436	3.01	1.1019
1.26	.2311	1.70	.5306	2.14	.7608	2.58	1.0473	3.02	1.1056
1.27	.2390	1.71	.5365	2.15	.7655	2.59	1.0510	3.03	1.1081
1.28	.2469	1.72	.5423	2.16	.7701	2.60	1.0547	3.04	1.1113
1.29	.2548	1.73	.5481	2.17	.7747	2.61	1.0583	3.05	1.1144
1.30	.2627	1.74	.5539	2.18	.7793	2.62	1.0619	3.06	1.1175
1.31	.2705	1.75	.5596	2.19	.7839	2.63	1.0654	3.07	1.1206
1.32	.2783	1.76	.5653	2.20	.7885	2.64	1.0689	3.08	1.1236
1.33	.2861	1.77	.5710	2.21	.7930	2.65	1.0724	3.09	1.1266
1.34	.2939	1.78	.5766	2.22	.7975	2.66	1.0759	3.10	1.1296
1.35	.3017	1.79	.5822	2.23	.8020	2.67	1.0793	3.11	1.1326
1.36	.3095	1.80	.5878	2.24	.8065	2.68	1.0827	3.12	1.1356
1.37	.3173	1.81	.5933	2.25	.8109	2.69	1.0861	3.13	1.1386
1.38	.3251	1.82	.5988	2.26	.8154	2.70	1.0895	3.14	1.1416
1.39	.3329	1.83	.6043	2.27	.8198	2.71	1.0929	3.15	1.1446
1.40	.3407	1.84	.6098	2.28	.8242	2.72			

No.	Log.	No.	Log.	No.	Log.	No.	Log.	No.	Log.
3.21	1.1668	3.87	1.3533	4.53		1.6467	5.85	1.7664	
3.22	1.1699	3.88	1.3558	4.54		1.6487	5.86	1.7681	
3.23	1.1725	3.89	1.3584	4.55	1.5129 1.5151 1.5177 5.19 5.20 5.21	1.6506	5.87	1.7699	
3.24	1.1756	3.90	1.3610	4.56		1.6525	5.88	1.7716	
3.25	1.1787	3.91	1.3635	4.57		1.6544	5.89	1.7733	
3.26	1.1811	3.92	1.3661	4.58		1.6563	5.90	1.7750	
3.27	1.1848	3.93	1.3686	4.59		1.6582	5.91	1.7766	
3.28	1.1878	3.94	1.3712	4.60		1.6601	5.92	1.7783	
3.29	1.1909	3.95	1.3737	4.61		1.6620	5.93	1.7800	
3.30	1.1939	3.96	1.3762	4.62		1.6639	5.94	1.7817	
3.31	1.1969	3.97	1.3788	4.63		1.6658	5.95	1.7834	
3.32	1.1999	3.98	1.3813	4.64		1.6677	5.96	1.7851	
3.33	1.2030	3.99	1.3838	4.65		1.6696	5.97	1.7867	
3.34	1.2060	4.00	1.3863	4.66		1.6715	5.98	1.7884	
3.35	1.2090	4.01	1.3888	4.67		1.6734	5.99	1.7901	
3.36	1.2119	4.02	1.3913	4.68		1.6752	6.00	1.7918	
3.37	1.2149	4.03	1.3938	4.69		1.6771	6.01	1.7934	
3.38	1.2179	4.04	1.3962	4.70		1.6790	6.02	1.7951	
3.39	1.2208	4.05	1.3987	4.71		1.6808	6.03	1.7967	
3.40	1.2238	4.06	1.4012	4.72		1.6827	6.04	1.7984	
3.41	1.2267	4.07	1.4036	4.73		1.6845	6.05	1.8001	
3.42	1.2296	4.08	1.4061	4.74		1.6864	6.06	1.8017	
3.43	1.2325	4.09	1.4085	4.75		1.6882	6.07	1.8034	
3.44	1.2354	4.10	1.4110	4.76		1.6901	6.08	1.8050	
3.45	1.2384	4.11	1.4134	4.77		1.6919	6.09	1.8066	
3.46	1.2413	4.12	1.4159	4.78		1.6938	6.10	1.8083	
3.47	1.2442	4.13	1.4183	4.79		1.6956	6.11	1.8099	
3.48	1.2470	4.14	1.4207	4.80		1.6974	6.12	1.8116	
3.49	1.2499	4.15	1.4231	4.81		1.6993	6.13	1.8132	
3.50	1.2528	4.16	1.4255	4.82		1.7011	6.14	1.8148	
3.51	1.2556	4.17	1.4279	4.83		1.7029	6.15	1.8165	
3.52	1.2585	4.18	1.4303	4.84		1.7047	6.16	1.8181	
3.53	1.2613	4.19	1.4327	4.85		1.7066	6.17	1.8197	
3.54	1.2641	4.20	1.4351	4.86		1.7084	6.18	1.8213	
3.55	1.2669	4.21	1.4375	4.87		1.7102	6.19	1.8229	
3.56	1.2698	4.22	1.4398	4.88		1.7120	6.20	1.8245	
3.57	1.2726	4.23	1.4422	4.89		1.7138	6.21	1.8262	
3.58	1.2754	4.24	1.4446	4.90		1.7156	6.22	1.8278	
3.59	1.2782	4.25	1.4469	4.91		1.7174	6.23	1.8294	
3.60	1.2809	4.26	1.4493	4.92		1.7192	6.24	1.8310	
3.61	1.2837	4.27	1.4516	4.93		1.7210	6.25	1.8326	
3.62	1.2865	4.28	1.4540	4.94		1.7228	6.26	1.8342	
3.63	1.2892	4.29	1.4563	4.95		1.7246	6.27	1.8358	
3.64	1.2920	4.30	1.4586	4.96		1.7263	6.28	1.8374	
3.65	1.2947	4.31	1.4609	4.97		1.7281	6.29	1.8390	
3.66	1.2975	4.32	1.4633	4.98		1.7299	6.30	1.8405	
3.67	1.3002	4.33	1.4656	4.99		1.7317	6.31	1.8421	
3.68	1.3029	4.34	1.4679	5.00		1.7334	6.32	1.8437	
3.69	1.3056	4.35	1.4702	5.01		1.7352	6.33	1.8453	
3.70	1.3083	4.36	1.4725	5.02		1.7370	6.34	1.8469	
3.71	1.3110	4.37	1.4748	5.03		1.7387	6.35	1.8485	
3.72	1.3137	4.38	1.4770	5.04		1.7405	6.36	1.8500	
3.73	1.3164	4.39	1.4793	5.05		1.7422	6.37	1.8516	
3.74	1.3191	4.40	1.4816	5.06		1.7440	6.38	1.8532	
3.75	1.3218	4.41	1.4839	5.07		1.7457	6.39	1.8547	
3.76	1.3244	4.42	1.4861	5.08		1.7475	6.40	1.8563	
3.77	1.3271	4.43	1.4884	5.09		1.7492	6.41	1.8579	
3.78	1.3297	4.44	1.4907	5.10		1.7509	6.42	1.8594	
3.79	1.3324	4.45	1.4929	5.11		1.7527	6.43	1.8610	
3.80	1.3350	4.46	1.4951	5.12		1.7544	6.44	1.8625	
3.81	1.3376	4.47	1.4974	5.13		1.7561	6.45	1.8641	
3.82	1.3403	4.48	1.4996	5.14		1.7579	6.46	1.8656	
3.83	1.3429	4.49	1.5019	5.15		1.7596	6.47	1.8672	
3.84	1.3455	4.50	1.5041	5.16		1.7613	6.48	1.8687	
3.85	1.3481	4.51	1.5063	5.17		1.7630	6.49	1.8703	
3.86	1.3507	4.52	1.5085	5.18		1.7647	6.50	1.8718	

No.	Log.	No.	Log.	No.	Log.	No.	Log.		
6.51	1.8733	7.15	1.9671	7.79	2.0528	8.66	2.1587	9.94	2.2966
6.52	1.8749	7.16	1.9685	7.80	2.0541	8.68	2.1610	9.96	2.2986
6.53	1.8764	7.17	1.9699	7.81	2.0554	8.70	2.1633	9.98	2.3006
6.54	1.8779	7.18	1.9713	7.82	2.0567	8.72	2.1656	10.00	2.3026
6.55	1.8795	7.19	1.9727	7.83	2.0580	8.74	2.1679	10.25	2.3279
6.56	1.8810	7.20	1.9741	7.84	2.0592	8.76	2.1702	10.50	2.3513
6.57	1.8825	7.21	1.9754	7.85	2.0605	8.78	2.1725	10.75	2.3749
6.58	1.8840	7.22	1.9769	7.86	2.0618	8.80	2.1748	11.00	2.3979
6.59	1.8856	7.23	1.9782	7.87	2.0631	8.82	2.1770	11.25	2.4201
6.60	1.8871	7.24	1.9796	7.88	2.0643	8.84	2.1793	11.50	2.4430
6.61	1.8886	7.25	1.9810	7.89	2.0656	8.86	2.1815	11.75	2.4636
6.62	1.8901	7.26	1.9824	7.90	2.0669	8.88	2.1838	12.00	2.4849
6.63	1.8916	7.27	1.9838	7.91	2.0681	8.90	2.1861	12.25	2.5052
6.64	1.8931	7.28	1.9851	7.92	2.0694	8.92	2.1883	12.50	2.5262
6.65	1.8946	7.29	1.9865	7.93	2.0707	8.94	2.1905	12.75	2.5455
6.66	1.8961	7.30	1.9879	7.94	2.0719	8.96	2.1928	13.00	2.5649
6.67	1.8976	7.31	1.9892	7.95	2.0732	8.98	2.1950	13.25	2.5840
6.68	1.8991	7.32	1.9906	7.96	2.0744	9.00	2.1972	13.50	2.6027
6.69	1.9006	7.33	1.9920	7.97	2.0757	9.02	2.1994	13.75	2.6211
6.70	1.9021	7.34	1.9933	7.98	2.0769	9.04	2.2017	14.00	2.6391
6.71	1.9036	7.35	1.9947	7.99	2.0782	9.06	2.2039	14.25	2.6567
6.72	1.9051	7.36	1.9961	8.00	2.0794	9.08	2.2061	14.50	2.6740
6.73	1.9066	7.37	1.9974	8.01	2.0807	9.10	2.2083	14.75	2.6913
6.74	1.9081	7.38	1.9988	8.02	2.0819	9.12	2.2105	15.00	2.7081
6.75	1.9095	7.39	2.0001	8.03	2.0832	9.14	2.2127	15.25	2.7248
6.76	1.9110	7.40	2.0015	8.04	2.0844	9.16	2.2148	15.50	2.7408
6.77	1.9125	7.41	2.0028	8.05	2.0857	9.18	2.2170	15.75	2.7567
6.78	1.9140	7.42	2.0041	8.06	2.0869	9.20	2.2192	16.00	2.7726
6.79	1.9155	7.43	2.0055	8.07	2.0882	9.22	2.2214	16.25	2.7883
6.80	1.9169	7.44	2.0069	8.08	2.0894	9.24	2.2235	16.50	2.8034
6.81	1.9184	7.45	2.0082	8.09	2.0906	9.26	2.2257	16.75	2.8183
6.82	1.9199	7.46	2.0096	8.10	2.0919	9.28	2.2279	17.00	2.8332
6.83	1.9213	7.47	2.0108	8.11	2.0931	9.30	2.2300	17.25	2.8481
6.84	1.9228	7.48	2.0122	8.12	2.0943	9.32	2.2322	17.50	2.8621
6.85	1.9242	7.49	2.0136	8.13	2.0956	9.34	2.2343	17.75	2.8761
6.86	1.9257	7.50	2.0149	8.14	2.0968	9.36	2.2364	18.00	2.8904
6.87	1.9272	7.51	2.0162	8.15	2.0980	9.38	2.2386	18.25	2.9044
6.88	1.9286	7.52	2.0176	8.16	2.0992	9.40	2.2407	18.50	2.9178
6.89	1.9301	7.53	2.0189	8.17	2.1005	9.42	2.2428	18.75	2.9307
6.90	1.9315	7.54	2.0202	8.18	2.1017	9.44	2.2449	19.00	2.9434
6.91	1.9330	7.55	2.0215	8.19	2.1029	9.46	2.2470	19.25	2.9557
6.92	1.9344	7.56	2.0229	8.20	2.1041	9.48	2.2491	19.50	2.9677
6.93	1.9359	7.57	2.0242	8.21	2.1053	9.50	2.2512	19.75	2.9794
6.94	1.9373	7.58	2.0255	8.22	2.1066	9.52	2.2533	20.00	2.9907
6.95	1.9387	7.59	2.0268	8.23	2.1078	9.54	2.2554	20.25	3.0017
6.96	1.9402	7.60	2.0281	8.24	2.1090	9.56	2.2575	20.50	3.0124
6.97	1.9416	7.61	2.0295	8.25	2.1103	9.58	2.2596	20.75	3.0228
6.98	1.9430	7.62	2.0308	8.26	2.1115	9.60	2.2617	21.00	3.0329
6.99	1.9444	7.63	2.0321	8.27	2.1127	9.62	2.2638	21.25	3.0427
7.00	1.9459	7.64	2.0334	8.28	2.1139	9.64	2.2659	21.50	3.0522
7.01	1.9473	7.65	2.0347	8.29	2.1151	9.66	2.2680	21.75	3.0614
7.02	1.9487	7.66	2.0360	8.30	2.1163	9.68	2.2701	22.00	3.0703
7.03	1.9502	7.67	2.0373	8.31	2.1175	9.70	2.2722	22.25	3.0789
7.04	1.9516	7.68	2.0386	8.32	2.1187	9.72	2.2742	22.50	3.0872
7.05	1.9530	7.69	2.0399	8.33	2.1199	9.74	2.2763	22.75	3.0952
7.06	1.								

NATURAL TRIGONOMETRICAL FUNCTIONS.

°	M.	Sine.	Co-Vers.	Cosec.	Tang.	Cotan.	Secant.	Ver. Sin.	Cosine.	°	M.
0	0	.00000	1.0000	Infinite	.00000	Infinite	1.0000	.00000	1.0000	90	0
	15	.00436	.99564	229.18	.00436	229.18	1.0000	.00001	.99999		45
	30	.00873	.99127	114.59	.00873	114.59	1.0000	.00004	.99996		30
	45	.01309	.98691	76.397	.01309	76.390	1.0001	.00009	.99991		15
1	0	.01745	.98255	57.299	.01745	57.290	1.0001	.00015	.99985	89	0
	15	.02181	.97819	45.840	.02182	45.829	1.0002	.00024	.99976		45
	30	.02618	.97382	38.202	.02618	38.188	1.0003	.00034	.99966		30
	45	.03054	.96946	32.746	.03055	32.730	1.0005	.00047	.99953		15
2	0	.03490	.96510	28.654	.03492	28.636	1.0006	.00061	.99939	88	0
	15	.03926	.96074	25.471	.03929	25.452	1.0008	.00077	.99923		45
	30	.04362	.95638	22.926	.04366	22.904	1.0009	.00095	.99905		30
	45	.04798	.95202	20.843	.04803	20.819	1.0011	.00115	.99885		15
3	0	.05234	.94766	19.107	.05241	19.081	1.0014	.00137	.99863	87	0
	15	.05669	.94331	17.639	.05678	17.611	1.0016	.00161	.99839		45
	30	.06105	.93895	16.380	.06116	16.350	1.0019	.00187	.99813		30
	45	.06540	.93460	15.290	.06554	15.257	1.0021	.00214	.99786		15
4	0	.06976	.93024	14.336	.06993	14.301	1.0024	.00244	.99756	86	0
	15	.07411	.92589	13.494	.07431	13.457	1.0028	.00275	.99725		45
	30	.07846	.92154	12.745	.07870	12.706	1.0031	.00308	.99692		30
	45	.08281	.91719	12.076	.08309	12.035	1.0034	.00343	.99656		15
5	0	.08716	.91284	11.474	.08749	11.430	1.0038	.00381	.99619	85	0
	15	.09150	.90850	10.929	.09189	10.883	1.0042	.00420	.99580		45
	30	.09585	.90415	10.433	.09629	10.385	1.0046	.00460	.99540		30
	45	.10019	.89981	9.9812	.10069	9.9310	1.0051	.00503	.99497		15
6	0	.10453	.89547	9.5668	.10510	9.5144	1.0055	.00548	.99452	84	0
	15	.10887	.89113	9.1855	.10952	9.1309	1.0060	.00594	.99406		45
	30	.11320	.88680	8.8337	.11393	8.7769	1.0065	.00643	.99357		30
	45	.11754	.88246	8.5079	.11836	8.4490	1.0070	.00693	.99307		15
7	0	.12187	.87813	8.2055	.12278	8.1443	1.0075	.00745	.99255	83	0
	15	.12620	.87380	7.9240	.12722	7.8606	1.0081	.00800	.99200		45
	30	.13053	.86947	7.6613	.13165	7.5958	1.0086	.00856	.99144		30
	45	.13485	.86515	7.4156	.13609	7.3479	1.0092	.00913	.99086		15
8	0	.13917	.86083	7.1853	.14054	7.1154	1.0098	.00973	.99027	82	0
	15	.14349	.85651	6.9690	.14499	6.8969	1.0105	.01035	.98965		45
	30	.14781	.85219	6.7655	.14945	6.6912	1.0111	.01098	.98902		30
	45	.15212	.84788	6.5736	.15391	6.4971	1.0118	.01164	.98836		15
9	0	.15643	.84357	6.3924	.15838	6.3138	1.0125	.01231	.98769	81	0
	15	.16074	.83926	6.2211	.16286	6.1402	1.0132	.01300	.98700		45
	30	.16505	.83495	6.0589	.16734	5.9758	1.0139	.01371	.98629		30
	45	.16935	.83065	5.9049	.17183	5.8197	1.0147	.01444	.98556		15
10	0	.17365	.82635	5.7588	.17633	5.6713	1.0154	.01519	.98481	80	0
	15	.17794	.82206	5.6198	.18083	5.5301	1.0162	.01596	.98404		45
	30	.18224	.81776	5.4874	.18534	5.3955	1.0170	.01675	.98325		30
	45	.18652	.81348	5.3612	.18986	5.2672	1.0179	.01755	.98245		15
11	0	.19081	.80919	5.2408	.19438	5.1446	1.0187	.01837	.98163	79	0
	15	.19509	.80491	5.1258	.19891	5.0273	1.0196	.01921	.98079		45
	30	.19937	.80063	5.0158	.20345	4.9152	1.0205	.02008	.97992		30
	45	.20364	.79636	4.9106	.20800	4.8077	1.0214	.02095	.97905		15
12	0	.20791	.79209	4.8097	.21256	4.7046	1.0223	.02185	.97815	78	0
	15	.21218	.78782	4.7130	.21712	4.6057	1.0233	.02277	.97723		45
	30	.21644	.78356	4.6202	.22169	4.5107	1.0243	.02370	.97630		30
	45	.22070	.77930	4.5311	.22628	4.4194	1.0253	.02466	.97534		15
13	0	.22495	.77505	4.4454	.23087	4.3315	1.0263	.02563	.97437	77	0
	15	.22920	.77080	4.3630	.23547	4.2468	1.0273	.02662	.97338		45
	30	.23345	.76655	4.2837	.24008	4.1653	1.0284	.02763	.97237		30
	45	.23769	.76231	4.2072	.24470	4.0867	1.0295	.02866	.97134		15
14	0	.24192	.75808	4.1336	.24933	4.0108	1.0306	.02970	.97030	76	0
	15	.24615	.75385	4.0625	.25397	3.9375	1.0317	.03077	.96923		45
	30	.25038	.74962	3.9939	.25862	3.8667	1.0329	.03185	.96815		30
	45	.25460	.74540	3.9277	.26328	3.7983	1.0341	.03295	.96705		15
15	0	.25882	.74118	3.8637	.26795	3.7320	1.0353	.03407	.96593	75	0

From 75° to 90° read from bottom of table upwards.

°	M.	Sine.	Co-Vers.	Cosec.	Tang.	Cotan.	Secant.	Ver. Sin.	Cosine.	°	M.
15	0	.25882	.74118	3.8637	.26795	3.7320	1.0353	.03407	.96593	75	0
	15	.26303	.73697	3.8018	.27263	3.6680	1.0365	.03521	.96479		45
	30	.26724	.73276	3.7420	.27732	3.6059	1.0377	.03637	.96363		30
	45	.27144	.72856	3.6840	.28203	3.5457	1.0390	.03754	.96246	74	15
16	0	.27564	.72436	3.6280	.28674	3.4874	1.0403	.03874	.96126		0
	15	.27983	.72017	3.5736	.29147	3.4308	1.0416	.03995	.96005		45
	30	.28402	.71598	3.5209	.29621	3.3759	1.0429	.04118	.95882		30
	45	.28820	.71180	3.4699	.30096	3.3226	1.0443	.04243	.95757		15
17	0	.29237	.70763	3.4203	.30573	3.2709	1.0457	.04370	.95630	73	0
	15	.29654	.70346	3.3722	.31051	3.2205	1.0471	.04498	.95502		45
	30	.30070	.69929	3.3255	.31530	3.1716	1.0485	.04628	.95372		30
	45	.30486	.69514	3.2801	.32010	3.1240	1.0500	.04760	.95240		15
18	0	.30902	.69098	3.2361	.32492	3.0777	1.0515	.04894	.95106	72	0
	15	.31316	.68684	3.1932	.32975	3.0326	1.0530	.05030	.94970		45
	30	.31730	.68270	3.1515	.33459	2.9887	1.0545	.05168	.94832		30
	45	.32144	.67856	3.1110	.33945	2.9459	1.0560	.05307	.94693		15
19	0	.32557	.67443	3.0715	.34433	2.9042	1.0576	.05448	.94552	71	0
	15	.32969	.67031	3.0331	.34921	2.8636	1.0592	.05591	.94409		45
	30	.33381	.66619	2.9957	.35412	2.8239	1.0608	.05736	.94264		30
	45	.33792	.66208	2.9593	.35904	2.7852	1.0625	.05882	.94118		15
20	0	.34202	.65798	2.9238	.36397	2.7475	1.0642	.06031	.93969	70	0
	15	.34612	.65388	2.8892	.36892	2.7106	1.0659	.06181	.93819		45
	30	.35021	.64979	2.8554	.37388	2.6746	1.0676	.06333	.93667		30
	45	.35429	.64571	2.8225	.37887	2.6395	1.0694	.06486	.93514		15
21	0	.35837	.64163	2.7904	.38386	2.6051	1.0711	.06642	.93358	69	0
	15	.36244	.63756	2.7591	.38888	2.5715	1.0729	.06799	.93201		45
	30	.36650	.63350	2.7285	.39391	2.5386	1.0748	.06958	.93042		30
	45	.37056	.62944	2.6986	.39896	2.5065	1.0766	.07119	.92881		15
22	0	.37461	.62539	2.6695	.40403	2.4751	1.0785	.07282	.92718	68	0
	15	.37865	.62135	2.6410	.40911	2.4443	1.0804	.07446	.92554		45
	30	.38268	.61732	2.6131	.41421	2.4142	1.0824	.07612	.92388		30
	45	.38671	.61329	2.5859	.41933	2.3847	1.0844	.07780	.92220		15
23	0	.39073	.60927	2.5593	.42447	2.3559	1.0864	.07950	.92050	67	0
	15	.39474	.60526	2.5333	.42963	2.3276	1.0884				

°	M.	Sine.	Co-Vers.	Cosec.	Tang.	Cotan.	Secant.	Ver. Sin.	Cosine		
30	0	50000	50000	2.0000	57735	1.7320	1.1547	13397	86603	60	0
	15	50377	49623	1.9850	58318	1.7147	1.1576	13616	86384		45
	30	50754	49246	1.9703	58904	1.6977	1.1606	13837	86163		30
	45	51129	48871	1.9558	59494	1.6808	1.1636	14059	85941		15
31	0	51504	48496	1.9416	60086	1.6643	1.1666	14283	85717	59	0
	15	51877	48123	1.9276	60681	1.6479	1.1697	14509	85491		45
	30	52250	47750	1.9139	61280	1.6319	1.1728	14736	85264		30
	45	52621	47379	1.9004	61882	1.6160	1.1760	14965	85035		15
32	0	52992	47008	1.8871	62487	1.6003	1.1792	15195	84805	58	0
	15	53361	46639	1.8740	63095	1.5849	1.1824	15427	84573		45
	30	53730	46270	1.8612	63707	1.5697	1.1857	15661	84339		30
	45	54097	45903	1.8485	64322	1.5547	1.1890	15896	84104		15
33	0	54464	45536	1.8361	64941	1.5399	1.1924	16133	83867	57	0
	15	54829	45171	1.8238	65563	1.5253	1.1958	16371	83629		45
	30	55194	44806	1.8118	66188	1.5108	1.1992	16611	83389		30
	45	55557	44443	1.7999	66818	1.4966	1.2027	16853	83147		15
34	0	55919	44081	1.7883	67451	1.4826	1.2062	17096	82904	56	0
	15	56280	43720	1.7768	68087	1.4687	1.2098	17341	82659		45
	30	56641	43359	1.7655	68728	1.4550	1.2134	17587	82413		30
	45	57000	43000	1.7544	69372	1.4415	1.2171	17835	82165		15
35	0	57358	42642	1.7434	70021	1.4281	1.2208	18085	81915	55	0
	15	57715	42285	1.7327	70673	1.4150	1.2245	18336	81664		45
	30	58070	41930	1.7220	71329	1.4019	1.2283	18588	81412		30
	45	58425	41575	1.7116	71990	1.3891	1.2322	18843	81157		15
36	0	58779	41221	1.7013	72654	1.3764	1.2361	19098	80902	54	0
	15	59131	40869	1.6912	73323	1.3638	1.2400	19356	80644		45
	30	59482	40518	1.6812	73996	1.3514	1.2440	19614	80386		30
	45	59832	40168	1.6713	74673	1.3392	1.2480	19875	80125		15
37	0	60181	39819	1.6616	75355	1.3270	1.2521	20136	79864	53	0
	15	60529	39471	1.6521	76042	1.3151	1.2563	20400	79600		45
	30	60876	39124	1.6427	76733	1.3032	1.2605	20665	79335		30
	45	61222	38778	1.6334	77428	1.2915	1.2647	20931	79069		15
38	0	61566	38434	1.6243	78129	1.2799	1.2690	21199	78801	52	0
	15	61909	38091	1.6153	78834	1.2685	1.2734	21468	78532		45
	30	62251	37749	1.6064	79543	1.2572	1.2778	21739	78261		30
	45	62592	37408	1.5976	80258	1.2460	1.2822	22012	77988		15
39	0	62932	37068	1.5890	80978	1.2349	1.2868	22285	77715	51	0
	15	63271	36729	1.5805	81703	1.2239	1.2913	22561	77439		45
	30	63608	36392	1.5721	82434	1.2131	1.2960	22838	77162		30
	45	63944	36056	1.5639	83169	1.2024	1.3007	23116	76884		15
40	0	64279	35721	1.5557	83910	1.1918	1.3054	23396	76604	50	0
	15	64612	35388	1.5477	84656	1.1812	1.3102	23677	76323		45
	30	64945	35055	1.5398	85408	1.1708	1.3151	23959	76041		30
	45	65276	34724	1.5320	86165	1.1606	1.3200	24244	75756		15
41	0	65606	34394	1.5242	86929	1.1504	1.3250	24529	75471	49	0
	15	65935	34065	1.5166	87698	1.1403	1.3301	24816	75184		45
	30	66262	33738	1.5092	88472	1.1303	1.3352	25104	74896		30
	45	66588	33412	1.5018	89253	1.1204	1.3404	25394	74606		15
42	0	66913	33087	1.4945	90040	1.1106	1.3456	25686	74314	48	0
	15	67237	32763	1.4873	90834	1.1009	1.3509	25978	74022		45
	30	67559	32441	1.4802	91633	1.0913	1.3563	26272	73728		30
	45	67880	32120	1.4732	92439	1.0818	1.3618	26568	73432		15
43	0	68200	31800	1.4663	93251	1.0724	1.3673	26865	73135	47	0
	15	68518	31482	1.4595	94071	1.0630	1.3729	27163	72837		45
	30	68835	31165	1.4527	94896	1.0538	1.3786	27463	72537		30
	45	69151	30849	1.4461	95729	1.0446	1.3843	27764	72236		15
44	0	69466	30534	1.4396	96569	1.0355	1.3902	28066	71934	46	0
	15	69779	30221	1.4331	97416	1.0265	1.3961	28370	71630		45
	30	70091	29909	1.4267	98270	1.0176	1.4020	28675	71325		30
	45	70401	29599	1.4204	99131	1.0088	1.4081	28981	71019		15
45	0	70711	29289	1.4142	1.0000	1.0000	1.4142	29289	70711	45	0
		Cosine	Ver. Sin.	Secant.	Cotan.	Tang.	Cosec.	Co-Vers.	Sine.	°	M.

Prom 45° to 60° read from bottom of table upwards.

LOGARITHMIC SINES, ETC.

Deg.	Sine.	Cosec.	Versin.	Tangent	Cotan.	Covers.	Secant.	Cosine.	Deg.
0	In.Neg.	Infinite.	In.Neg.	In.Neg.	Infinite.	10.00000	10.00000	10.00000	90
1	8.24186	11.75814	6.18271	8.24192	11.75808	9.99235	10.00007	9.99993	89
2	8.54282	11.45718	6.78474	8.54308	11.45692	9.90457	10.00026	9.99974	88
3	8.7'880	11.28120	7.13687	8.71940	11.28060	9.97665	10.00060	9.99940	87
4	8.84358	11.15642	7.38667	8.84464	11.15536	9.96860	10.00106	9.99894	86
5	8.94030	11.05970	7.58039	8.94195	11.05805	9.96040	10.00166	9.99834	85
6	9.01923	10.98077	7.73863	9.02'62	10.97838	9.95205	10.00239	9.99761	84
7	9.08589	10.91411	7.87238	9.08914	10.91086	9.94356	10.00325	9.99675	83
8	9.14356	10.85644	7.98820	9.14780	10.85220	9.93492	10.00425	9.99575	82
9	9.19433	10.80567	8.09032	9.19971	10.80029	9.92612	10.00538	9.99462	81
10	9.23967	10.76033	8.18'62	9.24632	10.75368	9.91717	10.00655	9.99335	80
11	9.28060	10.7'940	8.264'8	9.28865	10.7'135	9.90805	10.00805	9.99195	79
12	9.31788	10.682'2	8.33950	9.32747	10.67253	9.09877	10.00960	9.99040	78
13	9.35209	10.64791	8.40875	9.36336	10.63664	9.88933	10.01128	9.98872	77
14	9.38368	10.61632	8.47282	9.39677	10.60323	9.87971	10.013'0	9.98690	76
15	9.41300	10.58700	8.53243	9.42805	10.57195	9.86992	10.01506	9.98494	75
16	9.44034	10.55966	8.588'4	9.45750	10.54250	9.85996	10.017'6	9.98284	74
17	9.46594	10.53406	8.64043	9.48534	10.5'466	9.84981	10.01940	9.98060	73
18	9.48998	10.51002	8.68969	9.51'78	10.48822	9.83947	10.02179	9.97821	72
19	9.5'264	10.48736	8.73625	9.53697	10.46303	9.82894	10.02433	9.97567	71
20	9.53405	10.46595	8.78037	9.56107	10.43893	9.81821	10.02701	9.97299	70
21	9.55433	10.44567	8.82230	9.58418	10.4'582	9.80729	10.02985	9.97015	69
22	9.57358	10.42642	8.86223	9.60641	10.39359	9.79615	10.03283	9.96717	68
23	9.59188	10.40812	8.90034	9.62785	10.37215	9.78481	10.03597	9.96403	67
24	9.60931	10.39069	8.93679	9.64858	10.35142	9.77325	10.03927	9.96073	66
25	9.62595	10.37405	8.97'70	9.66867	10.33'33	9.76'46	10.04272	9.95728	65
26	9.64184	10.35816	9.00521	9.68818	10.3'182	9.74945	10.04634	9.95366	64
27	9.65705	10.34295	9.03740	9.70717	10.29283	9.73720	10.050'2	9.94988	63
28	9.67161	10.32839	9.06838	9.72567	10.27433	9.72471	10.05407	9.94593	62
29	9.68557	10.31443	9.09823	9.74375	10.25625	9.71197	10.058'8	9.94182	61
30	9.69897	10.30103	9.12702	9.76'44	10.23856	9.69897	10.06247	9.93753	60
31	9.71184	10.28816	9.15483	9.77877	10.22'23	9.68571	10.06693	9.93307	59
32	9.72421	10.27579	9.18171	9.79579	10.20421	9.67217	10.07158	9.92842	58
33	9.73611	10.26389	9.20771	9.81252	10.18748	9.65836	10.07641	9.92359	57
34	9.74756	10.25244	9.23290	9.82899	10.17101	9.64425	10.08143	9.91857	56
35	9.75859	10.24141	9.25731	9.84523	10.15477	9.62984	10.08664	9.91336	55
36	9.76922	10.23078	9.28099	9.86126	10.13874	9.61512	10.09204	9.90796	54
37	9.77946	10.22054	9.30398	9.87711	10.12289	9.60008	10.09765	9.90235	53
38	9.78934	10.21066	9.32631	9.89281	10.10719	9.58471	10.10347	9.89653	52
39	9.79887	10.20'13	9.34802	9.90837	10.09163	9.56900	10.10950	9.89050	51
40	9.80807	10.19193	9.36913	9.92381	10.07619	9.55293	10.11575	9.88425	50
41	9.81694	10.18306	9.38968	9.93916	10.06084	9.53648	10.12222	9.87778	49
42	9.82551	10.17449	9.40969	9.95444	10.04556	9.51966	10		

MATERIALS.

THE **CHEMICAL ELEMENTS.**

Common Elements (42).

Chemical Symbol.	Name.	Atomic Weight.	Chemical Symbol.	Name.	Atomic Weight.	Chemical Symbol.	Name.	Atomic Weight.
Al	Aluminum	27.1	F	Fluorine	19.	Pd	Palladium	106.5
Sb	Antimony	120.2	Au	Gold	197.2	P	Phosphorus	31.
As	Arsenic	75.0	H	Hydroge	1.01	Pt	Platinum	194.8
Ba	Barium	137.4	I	Iodine	127.0	K	Potassium	39.1
Bi	Bismuth	208.5	Ir	Iridium	193.0	Si	Silicon	28.4
B	Boron	11.0	Fe	Iron	55.9	Ag	Silver	107.9
Br	Bromine	80.0	Pb	Lead	206.9	Na	Sodium	23.
Cd	Cadmium	112.4	Li	Lithium	7.03	Sr	Strontium	87.6
Ca	Calcium	40.1	Mg	Magnesium	24.36	S	Sulphur	32.1
C	Carbon	12.	Mn	Manganese	55.	Sn	Tin	119.
Cl	Chlorine	35.4	Hg	Mercury	200.	Ti	Titanium	48.1
Cr	Chromium	52.1	Ni	Nickel	58.7	W	Tungsten	184.0
Co	Cobalt	59.	N	Nitrogen	14.04	Va	Vanadium	51.2
Cu	Copper	63.6	O	Oxygen	16.	Zn	Zinc	65.4

The atomic weights of many of the elements vary in the decimal place as given by different authorities. The above are the most recent values referred to O = 16 and H = 1.008. When H is taken as 1, O = 15.879 and the other figures are diminished proportionately. (See *Jour. Am Chem Soc.*, March, 1896.)

Rare Elements (27).

Beryllium, Be.	Iridium, Ir.	Ruthenium, Ru.	Thallium, Tl.
Cæsium, Cs.	Lanthanum, La.	Samarium, Sm.	Thorium, Th.
Cerium, Ce.	Molybdenum, Mo.	Scandium, Sc.	Uranium, U.
Erbium, Er.	Niobium, Nb.	Selenium, Se.	Ytterbium, Yr.
Gallium, Ga.	Osmium, Os.	Tantalum, Ta.	Yttrium, Y.
Germanium, Ge.	Rhodium, R.	Tellurium, Te.	Zirconium, Zr.
Glucinum, G.	Rubidium, Rb.	Terbium, Tb.	

Elements recently discovered (1900-1905): Argon A 39.9. Krypton, Kr, 81.8; Neon, Ne, 20.0; Xenon, X, 125.0; constituents of the atmosphere, which contains about 1 per cent by volume of Argon and very small quantities of the others. Helium, He, 4.0. Radium, R, 226.0; Gadolinium, Gd, 156.0; Neodymium, Nd, 143.6; Præsodymium, Pr, 140.5; Thulium, Tm, 171.0.

SPECIFIC GRAVITY.

The specific gravity of a substance is its weight as compared with the weight of an equal bulk of pure water.

To find the specific gravity of a substance.
 W = weight of body in air; w = weight of body submerged in water.

$$\text{Specific gravity} = \frac{W}{w - w}$$

If the substance be lighter than the water, sink it by means of a heavier substance and deduct the weight of the heavier substance.

Specific gravity determinations are usually referred to the standard of the weight of water at 62° F., 62.355 lbs. per cubic foot. Some experimenters have used 60° F. as the standard, and others 32° and 39.1° F. There is no general agreement.

Given sp. gr. referred to water at 39.1° F., to reduce it to the standard of 62° F. multiply it by 1.00112.

Given sp. gr. referred to water at 62° F., to find weight per cubic foot multiply by 62.355. Given weight per cubic foot, to find sp. gr. multiply by 0.016037. Given Sp. gr., to find weight per cubic inch multiply by 0.036085.

Weight and Specific Gravity of Metals.

	Specific Gravity. Range according to several Authorities.	Specific Gravity. Approx. Mean Value, used in Calculation of Weight.	Weight per Cubic Foot, lbs.	Weight per Cubic Inch, lbs.
Aluminum	2.56 to 2.71	2.67	166.5	0.0963
Antimony	6.66 to 6.86	6.76	421.6	0.2439
Bismuth	9.74 to 9.90	9.82	612.4	0.3544
Brass: Copper + Zinc				
80 20	7.8 to 8.6	8.60	536.3	0.3103
70 30		8.40	523.8	0.3031
60 40		8.36	521.3	0.3017
50 50		8.20	511.4	0.2959
Bronze {Cop., 95 to 80; Tin, 5 to 20}		8.52 to 6.96	a.053	552.
Cadmium	8.6 to 8.7	6.65	539.0	0.3121
Calcium	1.58	1.58	98.5	0.0570
Chromium	5.0	5.0	311.8	0.1804
Cobalt	-0.5 to 8.6	a.55	533.1	0.3085
Gold, pure	19.245 to 19.361	19.258	1200.9	0.6949
Copper	8.69 to 8.92	8.853	552.0	0.3195
Iridium	22.38 to 23.	22.30	1396.	0.8076
Iron, Cast	6.85 to 7.48	7.218	450.	0.2604
Iron, Wrought	7.4 to 7.9	7.70	480.	0.2779
Lead	11.07 to 11.44	11.38	709.7	0.4106
Manganese	7. to 8.	8.	499.	0.2887
Magnesium	1.69 to 1.75	1.75	109.	0.0641
Mercury	13.60 to 13.62	13.62	849.3	0.4915
	32° 13.58	13.58	846.8	0.4900
	60° 13.37 to 13.38	13.38	834.4	0.4828
	212° 8.279 to 6.93	8.8	548.7	0.3175
Nickel	20.33 to 22.07	21.5	1347.0	0.7758
Platinum	0.865	0.865	53.9	0.0312
Potassium	10.474 to 10.511	10.505	655.1	0.3791
Silver	0.97	0.97	60.5	0.0350
Sodium	7.69* to 7.932†	7.854	489.6	0.2834
Steel	7.291 to 7.409	7.350	458.3	0.2652
Tin	5.3	5.3	330.5	0.1913
Titanium	17. to 17.6	17.3	1078.7	0.6243*
Tungsten	6.86 to 7.20	7.00	436.5	0.2526
Zinc				

* Hid and burned.
 † Very pure and soft. The sp. gr. decreases as the carbon is increased. In the first column of figures the lowest are usually those of cast metals, which are more or less porous; the highest are of metals finely rolled or drawn into wire.

Specific Gravity of Liquids at 60°F.

Acid, Muriatic.....	1.200	Oil, Olive.....	0.92
" Nitric.....	1.217	" Palm.....	0.97
" Sulphuric.....	1.49	" Petroleum.....	0.78 to 0.88
Alcohol, pure.....	0.794	" Rape.....	0.92
" 95 per cent.....	0.816	" Turpentine.....	0.87
" 50 per cent.....	0.934	" Whale.....	0.92
Ammonia, 27.9 per cent.....	0.891	Tar.....	1.
Bromine.....	2.97	Vinegar.....	1.08
Carbon disulphide.....	1.26	Water.....	1.
Ether, Sulphuric.....	0.72	Water, Sea.....	1.026 to 1.03
Oil, Linseed.....	0.94		

Compression of the following Fluids under a Pressure of 15 lbs. per Square Inch.

Water.....	0.00004663	Ether.....	0.00006158
Alcohol.....	0.0000216	Mercury.....	0.00000265

The Hydrometer.

The hydrometer is an instrument for determining the density of liquids. It is usually made of glass, and consists of three parts: (1) the upper part, a graduated stem or fine tube of uniform diameter, (2) a bulb, or enlargement of the tube, containing air; and (3) a small bulb at the bottom, containing shot or mercury which causes the instrument to float in a vertical position. The graduations are figures representing either specific gravities, or the numbers of an arbitrary scale, as in Baumé's Twaddell's, Beck's, and other hydrometers.

There is a tendency to discard all hydrometers with arbitrary scales and to use only those which read in terms of the specific gravity directly.

Baumé's Hydrometer and Specific Gravities Compared.

Formulae { Heavy liquids, Sp. gr. = 145 ÷ (145 - deg. Be.)
 { Light liquids, Sp. gr. = 140 ÷ (130 + deg. Be.)

Degrees Baumé	Liquids Heavier than Water Sp. Gr.	Liquids Lighter than Water, Sp. Gr.	Degree Baumé	Liquids Heavier than Water, Sp. Gr.	Liquids Lighter than Water, Sp. Gr.	Degree Baumé	Liquids Heavier than Water, Sp. Gr.	Liquids Lighter than Water, Sp. Gr.
0.0	1.000		19.0	1.151	0.940	38.0	1.355	0.833
1.0	1.007		20.0	1.160	0.933	39.0	1.368	0.828
2.0	1.014		21.0	1.169	0.927	40.0	1.381	0.824
3.0	1.021		22.0	1.179	0.921	41.0	1.394	0.819
4.0	1.028		23.0	1.189	0.915	42.0	1.408	0.814
5.0	1.036		24.0	1.198	0.909	44.0	1.436	0.805
6.0	1.043		25.0	1.208	0.903	46.0	1.465	0.796
7.0	1.051		26.0	1.219	0.897	48.0	1.495	0.787
8.0	1.058		27.0	1.229	0.892	50.0	1.526	0.778
9.0	1.066		28.0	1.239	0.886	52.0	1.559	0.769
10.0	1.074	1.000	29.0	1.250	0.881	54.0	1.593	0.761
11.0	1.082	0.993	30.0	1.261	0.875	56.0	1.629	0.753
12.0	1.090	0.986	31.0	1.272	0.870	58.0	1.667	0.745
13.0	1.099	0.979	32.0	1.283	0.864	60.0	1.706	0.737
14.0	1.107	0.972	33.0	1.295	0.859	65.0	1.813	0.718
15.0	1.115	0.966	34.0	1.306	0.854	70.0	1.933	0.700
16.0	1.124	0.959	35.0	1.318	0.849	75.0	2.071	0.683
17.0	1.133	0.952	36.0	1.330	0.843			
18.0	1.142	0.946	37.0	1.343	0.838			

Specific Gravity and Weight of Gases at Atmospheric Pressure and 32° F.

(For other temperatures and pressures see Physical Properties of Gases.)

	Density, Air = 1.	Density, H = 1.	Grammes per Litre	Lbs. per Cu. Ft.	Cubic Ft. per Lb.
Air.....	1.0000	14.444	1.2931	0.080728	12.388 1.209
oxygen, O.....	1.1052	15.963	1.4291	0.08921	
Hydrogen, H.....	0.0692	1.000	0.0895	0.00559	
Nitrogen, N.....	0.9701	14.012	1.2544	0.07831	178.931 12.770
Carbon monoxide, CO.....	0.9671	13.968	1.2505	0.07807	12.810
Carbon dioxide, CO ₂	1.5197	21.950	1.9650	0.12287	8.152
Methane, marsh-gas, CH ₄	0.5530	7.987	0.7150	0.04464	22.429
Ethylene, C ₂ H ₄	0.9674	13.973	1.2510	0.07809	12.805
Acetylene, C ₂ H ₂	0.8982	12.973	1.1614	0.07251	13.792
Ammonia, NH ₃	0.5889	8.506	0.7615	0.04820	21.036
Water vapor, H ₂ O.....	0.6218	8.981	0.8041	0.05020	19.922

Specific Gravity and Weight of Wood.

	Specific Gravity.	Weight per Cubic Foot, Pounds.		Specific Gravity.	Weight per Cubic Foot, Pounds.		
	Avge.			Avge.			
Alder.....	0.56 to 0.80	0.68	42	Hornbeam..	0.76	0.76	47
Alder.....	0.30 to 0.84	0.79	47	Juniper....	0.56	0.56	35
Bamboo.....	0.31 to 0.62	0.40	22	Larch.....	0.56	0.56	35
Beech.....	0.40 to 0.85	0.35	22	Lignum vitæ	0.65 to 1.33	1.00	62
Birch.....	0.56 to 0.74	1.33	46	Linden....	0.604		37
Boxar.....	0.49 to 0.75	0.62	49	Locust.....	0.728		46
Cherry.....	0.61 to 0.72	0.66	41	Mahogany..	0.56 to 1.06	0.81	51
Chestnut....	0.46 to 0.66	0.56	35	Maple.....	0.57 to 0.79	0.68	42
Cork.....	0.24	0.24	15	Mulberry...	0.56 to 0.90	0.73	46
Cypress.....	0.41 to 0.66	0.53	33	Oak, Live..	0.96 to 1.26	1.11	69
Dogwood....	0.76	0.76	47	Oak, White.	0.69 to 0.86	0.77	48
Ebony.....	1.13 to 1.33	1.23	76	Oak, Red..	0.73 to 0.75	0.74	46
Elm.....	0.55 to 0.78	0.61	38	Pine, White	0.35 to 0.55	0.45	28
Fir.....	0.48 to 0.70	0.59	37	" Yellow	0.46 to 0.76	0.61	38
Hackmatack	0.84 to 0.59	0.59	37	Poplar.....	0.38 to 0.58	0.48	30
Hemlock....	0.36 to 0.41	0.38	24	Spruce.....	0.40 to 0.50	0.45	28
Hickory.....	0.69 to 0.94	0.77	48	Sycamore...	0.59 to 0.62	0.60	37
Holly.....	0.76	0.76	47	Teak.....	0.66 to 0.98	0.82	51
				Walnut....	0.50 to 0.67	0.58	36
				Willow....	0.49 to 0.59	0.54	34

Weight and Specific Gravity of Stones, Brick, Cement, etc. (Pure Water = 1.00.)

	Lb. per Cu. Ft.	Sp. Cr.
Asphaltum	87	1.39
Brick, Soft	100	1.6
" Common	112	1.79
" Hard	125	2.0
" Pressed	135	2.16
" Fire	140 to 150	2.24 to 2.4
Sand-lime	136	2.18
Brickwork in mortar	100	1.6
" cement	112	1.79
Cement, American, natural	...	2.8 to 3.2
" Portland	...	3.05 to 3.15
" loose	92	...
" in barrel	115	...
Clay	120 to 150	1.92 to 2.4
Concrete	120 to 155	1.92 to 2.48
Earth, loose	72 to 80	1.15 to 1.28
" rammed	90 to 110	1.44 to 1.76
Emery	250	4.
Glass	156 to 172	2.5 to 2.75
" flint	180 to 196	2.88 to 3.14
Gneiss	160 to 170	2.56 to 2.72
Granite	100 to 120	1.6 to 1.92
Gravel	130 to 150	2.08 to 2.4
Gypsum	200 to 220	3.2 to 3.52
Hornblende	55 to 57	0.88 to 0.92
Ice	50 to 60	0.8 to 0.96
Lime, quick, in bulk	140 to 185	2.30 to 2.90
Limestone	150	2.4
Magnesia, Carbonate	160 to 180	2.56 to 2.88
Marble	140 to 160	2.24 to 2.56
Masonry, dry rubble	140 to 180	2.24 to 2.88
" dressed	175	2.80
Mica	90 to 100	1.44 to 1.6
Mortar	104 to 120	1.67 to 1.92
Mud, soft flowing	72	1.15
Pitch	93 to 113	1.50 to 1.81
Plaster of Paris	165	2.64
Quartz	90 to 110	1.44 to 1.76
Sand	118 to 129	1.89 to 2.07
Sand, wet	140 to 150	2.24 to 2.4
Sandstone	170 to 180	2.72 to 2.88
Slate	166 to 175	2.65 to 2.8
Soapstone	135 to 200	2.16 to 3.4
Stone, various	170 to 200	2.72 to 3.4
Tran	110 to 120	1.76 to 1.92
Tile		

PROPERTIES OF THE USEFUL METALS.

Aluminum, Al. — Atomic weight 27.1. Specific gravity 2.6 to 2.7. The lightest of all the useful metals except magnesium. A soft, ductile, malleable metal, of a white color, approaching silver, but with a bluish cast. Very non-corrosive. Tenacity about one third that of wrought iron. Formerly a rare metal, but since 1890 its production and use have greatly increased on account of the discovery of cheap processes for reducing it from the ore. Melts at 1215° F. For further description see Aluminum, under Strength of Materials, page 357.

Antimony (Stibium), Sb. — At. wt. 120.2. Sp. gr. 6.7 to 6.8. A brittle metal of a bluish-white color and highly crystalline or laminated structure. Melts at 842° F. Heated in the open air it burns with a bluish-white flame. Its chief use is for the manufacture of certain alloys, as type-metal (antimony 1, lead 4), britannia (antimony 1, tin 9), and various anti-friction metals (see Alloys). Cubical expansion by heat from 32° to 212° F., 0.0070. Specific heat 0.059.

Bismuth, Bi. — At. wt. 208.5. Bismuth is of a peculiar light reddish color, highly crystalline, and so brittle that it can readily be pulverized. It melts at 510° F., and boils at about 2300° F. Sp. gr. 9.823 at 54° F., and 10.055 just above the melting-point. Specific heat about 0.0301 at ordinary temperatures. Coefficient of cubical expansion from 32° to 212°, 0.0040. Conductivity for heat about 1/50 and for electricity only about 1/50 of that of silver. Its tensile strength is about 6400 lbs. per square inch. Bismuth expands in cooling, and Tribe has shown that this expansion does not take place until after solidification. Bismuth is the most diamagnetic element known, a sphere of it being repelled by a magnet.

Cadmium, Cd. — At. wt. 112.4. Sp. gr. 8.6 to 8.7. A bluish-white metal, lustrous, with a fibrous fracture. Melts below 500° F. and volatilizes at about 680° F. It is used as an ingredient in some fusible alloys with lead, tin, and bismuth. Cubical expansion from 32° to 212° F., 0.0094.

Copper, Cu. — At. wt. 63.6. Sp. gr. 5.81 to 8.95. Fuses at about 1930° F. Distinguished from all other metals by its reddish color. Very ductile and malleable, and its tenacity is next to iron. Tensile strength 20,000 to 30,000 lbs. per square inch. Heat conductivity 73.6% of that of silver, and superior to that of other metals. Electric conductivity equal to that of gold and silver. Expansion by heat from 32° to 212° F. 0.0051 of its volume. Specific heat 0.093. (See Copper under Strength of Materials; also Alloys.)

Gold (Aurum), Au. — At. wt. 197.2. Sp. gr. when pure and pressed in a die, 19.34. Melts at about 1915° F. The most malleable and ductile of all metals. One ounce Troy may be beaten so as to cover 160 sq. ft. of surface. The average thickness of gold-leaf is 1/282000 of an inch, or 100 sq. ft. per ounce. One grain may be drawn into a wire 500 ft. in length. The ductility is destroyed by the presence of 1/2000 part of lead, bismuth, or antimony. Gold is hardened by the addition of silver or of copper. U. S. gold coin is 90 parts gold and 10 parts alloy which is chiefly copper with 5 little silver. By jewelers the fineness of gold is expressed in carats, pure gold being 24 carats, three-fourths fine 18 carats, etc.

Iridium, Ir. — Iridium is one of the rarer metals. It has a white lustre, resembling that of steel; its hardness is about equal to that of the ruby; in the cold it is quite brittle, but at white heat it is somewhat malleable. It is one of the heaviest of metals, having a specific gravity of 22.38. It is extremely infusible and almost absolutely inoxidizable.

For uses of iridium, methods of manufacturing it, etc., see paper by W. L. Dudley on the "Iridium Industry," Trans. A. I. M. E., 1884.

Iron (Ferrum), Fe. — At. wt. 55.9. Sp. gr.: Cast, 6.85 to 7.48; Wrought, 7.4 to 7.9. Pure iron is extremely infusible, its melting point being above 3000° F., but its fusibility increases with the addition of carbon, cast iron fusing about 2500° F. Conductivity for heat 11.9, and for electricity 12 to 14.8, silver being 100. Expansion in bulk by heat: cast iron 0.0033 and wrought iron 0.0035, from 32° to 212° F. Specific heat, cast iron 0.1298, wrought iron 0.1138, steel 0.1165. Cast iron exposed to continued heat becomes permanently expanded 1 1/2 to 3 per cent of its length. Grate-bars should therefore be allowed about 4 per cent play. (For other properties see Iron and Steel under Strength of Materials.)

Lead (Plumbum), Pb. — At. wt. 206.9. Sp. gr. 11.07 to 11.44 by different authorities. Melts at about 625° F., softens and becomes pasty at about 617° F. If broken by a sudden blow when just below the melting-point it is quite brittle and the fracture appears crystalline. Lead is very malleable and ductile, but its tenacity is such that it can be drawn into wire with great difficulty. Tensile strength, 1600 to 2400 lbs. per square inch. Its elasticity is very low, and the metal

flows under very slight strain. Lead dissolves to some extent in pure water, but water containing carbonates or sulphates forms over it a film of insoluble salt which prevents further action.

Magnesium, Mg. — At. wt. 24.36. Sp. gr. 1.69 to 1.75. Silver-white, brilliant, malleable, and ductile. It is one of the lightest of metals, weighing only about two thirds as much as aluminum. In the form of filings, wire, or thin ribbons it is highly combustible, burning with a light of dazzling brilliancy, useful for signal-lights and for flash-lights for photographers. It is nearly non-corrosive, a thin film of carbonate of magnesia forming on exposure to damp air, which protects it from further corrosion. It may be alloyed with aluminum, 5 per cent Mg added to Al giving about as much increase of strength and hardness as 10 per cent of copper. Cubical expansion by heat 0.0083, from 32° to 212° F. Melts at 1200° F. Specific heat 0.25.

Manganese, Mn. — At. wt. 55. Sp. gr. 7 to 8. The pure metal is not used in the arts, but alloys of manganese and iron, called spiegeleisen when containing below 25 per cent of manganese, and ferro-manganese when containing from 25 to 90 per cent, are used in the manufacture of steel. Metallic manganese, when alloyed with iron, oxidizes rapidly in the air, and its function in steel manufacture is to remove the oxygen from the bath of steel whether it exists as oxide of iron or as occluded gas.

Mercury (Hydrargyrum), Hg. — At. wt. 199.5. A silver-white metal, liquid at temperatures above -39° F., and boils at 680° F. Unchangeable as gold, silver, and platinum in the atmosphere at ordinary temperatures, but oxidizes to the red oxide when near its boiling-point. Sp. gr.: when liquid 13.58 to 13.59, when frozen 14.4 to 14.5. Easily tarnished by sulphur fumes, also by dust, from which it may be freed by straining through a cloth. No metal except iron or platinum should be allowed to touch mercury. The smallest portions of iron, lead, zinc, and even copper to a less extent, cause it to tarnish and lose its perfect liquidity. Coefficient of cubical expansion from 32° to 212° F. 0.0182; per deg. 0.000101.

Nickel, Ni. — At. wt. 58.7. Sp. gr. 8.27 to 8.93. A silvery-white metal with a strong lustre, not tarnishing on exposure to the air. Ductile, hard, and as tenacious as iron. It is attracted to the magnet and may be made magnetic like iron. Nickel is very difficult of fusion, melting at about 3000° F. Chiefly used in alloys with copper, as german-silver, nickel-silver, etc., and also in the manufacture of steel to increase its hardness and strength, also for nickel-plating. Cubical expansion from 32° to 212° F. 0.0035. Specific heat 0.109.

Platinum, Pt. — At. wt. 194.8. A whitish steel-gray metal, malleable, very ductile, and as unalterable by ordinary agencies as gold. When fused and refined it is as soft as copper. Sp. gr. 21.15. It is fusible only by the oxyhydrogen blowpipe or in strong electric currents. When combined with iridium it forms an alloy of great hardness which has been used for gun-vents and for standard weights and m&es. The most important uses of platinum in the arts are for vessels for chemical laboratories and manufactories, and for the connecting wires in incandescent electric lamps and for electrical contact points. Cubical expansion from 32° to 212° F. 0.002; less than that of any other metal except the rare metals, and almost the same as glass.

Silver (Argentum), Ag. — At. wt. 107.9. Sp. gr. 10.1 to 11.1 according to condition and purity. It is the whitest of the metals, very malleable and ductile, and in hardness intermediate between gold and copper. Melts at about 1750° F. Specific heat 0.056. Cubical expansion from 32° to 212° F. 0.0058. As a conductor of electricity it is equal to copper. As a conductor of heat it is superior to all other metals.

Tin (Stannum), Sn. — At. wt. 119. Sp. gr. 7.293. White, lustrous, soft, malleable, of little strength; tenacity about 3500 lbs. per square inch. Fuses at 442° F. Not sensibly volatile when melted at ordinary heats. Heat conductivity 14.5; electric conductivity 12.4; silver being 100 in each case. Expansion of volume by heat 0.0069 from 32° to 212° F. Specific heat 0.055. Its chief uses are for coating of sheet-iron (called tin plate) and for making alloys with copper and other metals.

Zinc, Zn. — At. wt. 65.4. Sp. gr. 7.14. Melts at 780° F. Volatilizes and burns in the air when melted, with bluish-white fumes of zinc oxide. It is ductile and malleable, but to a much less extent than copper, and its tenacity about 5000 to 6000 lbs. per square inch, is about one tenth that of wrought iron. It is practically non-corrosive in the atmosphere, a thin film of carbonate of zinc forming upon it. Cubical expansion between 32° and 212° F. 0.0088. Specific heat 0.096. Electric conductivity 29, heat conductivity 32, silver being 100. Its principal uses are for coating iron surfaces, called "galvanizing," and for making brass and other alloys.

Table Showing the Order of

Malleability.	Ductility:	Tenacity.	Infusibility..
Gold	Platinum	Iron	Platinum
Silver	Silver	Copper	Iron
Aluminum	Iron	Aluminum	Copper
Copper	Copper	Platinum	Gold
Tin	Gold	Silver	Silver
Lead	Aluminum	Zinc	Aluminum
Zinc	Zinc	Gold	Zinc
Platinum	Tin	Tin	Lead
Iron	Lead	Lead	Tin

MEASURES AND WEIGHTS OF VARIOUS MATERIALS (APPROXIMATE).

Brickwork. — Brickwork is estimated by the thousand, and for various thicknesses of wall runs as follows:

Thickness	Bricks per superficial foot.
8 1/4-in. wall, or 1 brick in thickness	14
12 3/4 " " " 1 1/2 " " "	21
17 " " " 2 " " "	28
21 1/2 " " " 2 1/2 " " "	35

An ordinary brick measures about 8 1/4 x 4 x 2 inches, which is equal to 66 cubic inches, or 26.2 bricks to a cubic foot. The average weight is 4 1/2 lbs.

Fuel. — A bushel of bituminous coal weighs 76 pounds and contains 2688 cubic inches = 1.504 cubic feet. 29.47 bushels = 1 gross ton. One acre of bituminous coal contains 1600 tons of 2240 pounds per ton of bituminous coal worked. 15 to 25 per cent must be deducted for waste in mining.

41 to 45 cubic feet	bituminous coal when broken down	= 1 ton, 2240 lbs.
34 to 41 " "	anthracite prepared for market	= 1 ton, 2240 lbs.
23 " "	of charcoal	= 1 ton, 2240 lbs.
70.9 " "	coke	= 55 to 66 lbs.
1 cubic foot of anthracite coal		= 50 to 55 lbs.
1 " " "	bituminous coal	= 53 lbs.
1 " " "	Cumberland (semi-bituminous) coal	= 50.3 lbs.
1 " " "	Cannel coal (hardwood)	= 18.5 lbs.
1 " " "	Charcoal (pine)	= 18 lbs.

A bushel of coke weighs 40 pounds (35 to 42 pounds). A bushel of charcoal. — In 1881 the American Charcoal-Iron Workers' Association adopted for use in its official publications a standard bushel of charcoal 2748 cubic inches. This figure of 20 pounds to the coal is to be taken at 2000 pounds. bushel was taken as a fair average of different bushels used throughout the country, and it has since been established by law in some States.

Ores, Earths, etc.

13 cubic feet of ordinary gold or silver ore, in mine	= 1 ton = 2000 lbs.
20 " " " broken quartz.	= 1 ton = 2000 lbs.
18 feet of gravel in bank	= 1 ton
27 cubic feet of gravel when dry	= 1 ton
25 " " " sand	= 1 ton
18 " " " earth in bank	= 1 ton
27 " " " earth when dry	= 1 ton
17 " " " clay	= 1 ton

Cement. -Portland, per bbl. net, 376 lbs., per bag net 94 lbs.
 Natural, per bbl. net, 282 lbs., per bag net 84 lbs.

Lime. — A struck bushel 72 to 75 lbs.

Grain. — 4 struck bushel of wheat = 60 lbs.; of corn = 56 lbs.; of oats = 30 lbs.

Salt. -A struck bushel of salt, coarse, Syracuse, N. Y. = 56 lbs.; Turk's Island = 76 to 80 lbs.

WEIGHT OF RODS, BARS, PLATES, TUBES, AND SPHERES OF DIFFERENT MATERIALS.

Notation: *b* = breadth, *t* = thickness, *s* = side of square, *D* = external diameter, *d* = internal diameter, all in inches.

Sectional areas: of square bars = s^2 ; of flat bars = bt ; of round rods = $0.7854 D^2$; of tubes = $0.7854 (D^2 - d^2) = 3.1416 (Dt - t^2)$.

Volume of 1 foot in length: of square bars = $12s^2$; of flat bars = $12bt$; of round rods = $9.4248D^2$; of tubes = $9.4248 (D^2 - d^2) = 37.699 (Dt - t^2)$, in cu. in.

Weight per foot length = volume X weight per cubic inch of material. Weight of a sphere = $\text{diam.}^3 \times 0.5236 \times \text{weight per cubic inch}$.

Material.	Specific Gravity.	Weight per Cubic Foot, Lbs.	Weight of Plates 1 Inch Thick per Sq. Ft., Lbs.	Weight of Square Bars per Foot Length, Lbs.	Weight of Flat Bars per Foot Length, Lbs.	Weight per Cubic Inch, Lbs.	Relative Weights. Wrought Iron = 1	Weight of Round Rod per Foot Length, Lbs.	Weight of Spheres or Balls, Lbs.
Cast iron	7.211	450.	37.5	$s^2 \times 31/8$	$bt \times 31/8$.260	15-16	$D^2 \times 2.454$	$D^3 \times .1363$
Wrought iron	7.7	480.	40.	$s^2 \times 31/8$	$bt \times 31/8$.277	1	$D^2 \times 2.618$	$D^3 \times .1455$
Steel	7.85	469.6	40.8	$s^2 \times 3.4$	$bt \times 3.4$.283	1.02	$D^2 \times 2.670$	$D^3 \times .1484$
Copper & Bronze (copper and tin)	8.85	552	46.	$s^2 \times 3.833$	$bt \times 3.833$.319	1.15	$D^2 \times 3.011$	$D^3 \times .1673$
Brass { 65 copper 35 Zinc. . I	8.39	523.2	43.6	$s^2 \times 3.633$	$bt \times 3.633$.302	1.09	$D^2 \times 2.854$	$D^3 \times .1586$
Lead	11.38	709.6	59.1	$s^2 \times 4.93$	$bt \times 4.93$.410	1.48	$D^2 \times 3.870$	$D^3 \times .2150$
Aluminum	2.67	166.5	13.9	$s^2 \times 1.16$	$bt \times 1.16$.096	D.347	$D^2 \times 0.908$	$D^3 \times .0504$
Glass	2.62	163.4	13.6	$s^2 \times 1.13$	$bt \times 1.13$.094	0.34	$D^2 \times 0.891$	$D^3 \times .0495$
Pine wood, dry	0.481	30.0	2.5	$s^2 \times 0.21$	$bt \times 0.21$.017	1-16	$D^2 \times 0.164$	$D^3 \times .0091$

Weight per cylindrical in., 1 in. long, = coefficient of D^2 in next to last col. + 12.

For tubes use the coefficient of D^2 in next to last column, as for rods, and multiply it into $(D^2 - d^2)$; or multiply it by 4 $(Dt - t^2)$.

For hollow squares use the coefficient of D^3 in the last column, and multiply it into $(D^3 - d^3)$.

For hexagons multiply the weight of square bars by 0.866 (short diam. of hexagon = side of square). For octagons multiply by 0.8284.

COMMERCIAL SIZES OF IRON AND STEEL BARS.

Flats.

Width.	Thickness.	Width.	Thickness.	Width.	Thickness.
3/4	1/8 to 5/8	1 7/8	1/2 to 1 1/2	4	1/4 to 2
7/8	1/8 to 3/4	2	1/8 to 1 3/4	4 1/2	1/4 to 2
1	1/8 to 1	2 1/4	1/4 to 1 3/4	5	1/4 to 2
1 1/8	1/8 to 1 1/8	2 3/8	1/4 to 1 1/8	5 1/2	1/4 to 2
1 1/4	1/8 to 1 1/8	2 1/2	3/16 to 1 3/4	6	1/4 to 2
1 3/8	1/8 to 1 1/8	2 5/8	1/4 to 1 1/8	6 1/2	1/4 to 2
1 1/2	1/8 to 1 1/4	2 3/4	1/4 to 1 1/8	7	1/4 to 2
1 5/8	1/4 to 1 1/4	3	1/4 to 2	7 1/2	1/4 to 2
1 3/4	3/16 to 1 1/2	3 1/2	1/4 to 2		

Commercial Sizes of Iron and Steel Bars.

Rounds: Iron. 1/4 to 1 3/8 in., advancing by 1/16 in.; 1 3/8 in. to 5 in., advancing by 1/8 in. **Steel.** 1/4 in. to 1 1/8 in., advancing by 1/32 in.; 1 1/8 in. to 2 in., advancing by 1/16 in.; 2 in. to 4 in., advancing by 1/8 in.; 4 to 6 3/4 in., advancing by 1/4 in. Also the following intermediate sizes: 23/64, 25/64, 29/64, 31/64, 33/64, 35/64, 39/64, 47/64, 53/64, 55/64, 63/64, 17/64 and 115/32 in.

Squares: Iron. 5/16 to 1 1/4 in., advancing by 1/16 in.; 1 1/4 to 3 in., advancing by 1/8 in. **Steel.** 1/4 to 2 in., advancing by 1/16 in.; 2 1/8 in.; 2 1/4 to 4 in., advancing by 1/4 in.; 4 1/2 in.; 5 in.

Half rounds: Iron. 7/16, 1/2, 5/8, 11/16, 3/4, 1, 1 1/8, 1 1/4, 1 1/2, 1 3/4, and 2 in. **Steel.** 3/8, 25/64, 13/32, 7/16, 29/64, 15/32, 1/2, 33/64, 17/32, 9/16, 19/32, 5/8, 21/32, 11/16, 23/32, 3/4, 25/32, 13/16, 27/32, 7/8, 29/32, 15/16, 1, 1 1/32, 1 1/8, 1 1/4, 1 3/8, 1 1/2, 1 3/4, 2, 2 1/2, and 3 in. Weights of half rounds, one half of corresponding rounds. See table, page 180.

Ovals: Iron. 1/2 x 1/4, 5/8 x 5/16, 3/4 x 3/8, and 7/8 x 7/16 in. **Steel.** 5/8 x 5/16, 1/2 x 3/8, 17/32 x 9/32, 9/16 x 3/8, 19/32 x 9/32, 3/4 x 5/16, 3/4 x 3/8, 7/8 x 5/16, 7/8 x 7/16, 1 x 1/2, and 1 1/8 x 9/16 in.

Half Ovals: Iron. 1/2 x 1/8, 5/8 x 5/32, 3/4 x 3/16, 7/8 x 7/32, 1 1/2 x 1/2, 1 3/4 x 5/8, 1 7/8 x 5/8 in.

Round Edge Flats: Iron. 1 1/2 x 1/2, 1 3/4 x 5/8, 1 7/8 x 5/8 in. **Steel.** 1 x 3/16, 1 x 1/4, 1 x 5/16, 1 x 3/8, 1 x 7/16, 1 1/4 x 3/16, 1 1/4 x 1/4, 1 1/4 x 5/16, 1 1/4 x 3/8, 1 1/4 x 7/16 in.; 1 1/2 x 1/4 to 1 1/2 x 1 in., advancing by 1/16 in.; 1 3/4 x 1/4 to 1 3/4 x 1 in., advancing by 1/16 in.; 2 x 1/4 to 2 x 1 in., advancing by 1/16 in.; 2 1/4 x 1/4 to 2 1/4 x 1 in., advancing by 1/16 in.; 2 1/2 x 1/4 to 2 1/2 x 1 in., advancing by 1/16 in.; 2 3/4 x 1/4 to 2 3/4 x 1 in., advancing by 1/16 in.; 3 x 1/4 to 3 x 1 in., advancing by 1/16 in.

Bands: Iron. 1/2 to 1 1/8 in., advancing by 1/8 in., 7 to 16 B. W. G.; 1 1/4 to 5 in.; advancing by 1/4 in., 7 to 16 gauge up to 3 in., 4 to 14 gauge, 3 1/4 to 5 in.

WEIGHTS OF SQUARE AND ROUND BARS OF WROUGHT IRON IN POUNDS PER LINEAL FOOT.

Iron weighing 480 lb. per cubic foot. For steel add 2 per cent.

Thickness of Diameter in Inches.	Weight of Square Bar 1 Ft. Long.	Weight of Round Bar 1 Ft. Long.	Thickness of Diameter in Inches.	Weight of Square Bar 1 Ft. Long.	Weight of Round Bar 1 Ft. Long.	Thickness of Diameter in Inches.	Weight of Square Bar 1 Ft. Long.	Weight of Round Bar 1 Ft. Long.
0			11/16	24.08	18.91	3/8	96.30	75.64
1/16	0.013	0.010	3/4	25.21	19.80	7/16	98.55	77.40
1/8	.052	.041	13/16	26.37	20.71	1/2	100.8	79.19
3/16	.117	.092	7/8	27.55	21.64	5/8	103.1	81.00
1/4	.208	.164	15/16	28.76	22.59	3/4	105.5	82.83
5/16	.326	.256	1	30.00	23.56	7/8	107.8	84.69
3/8	.469	.368	1 1/16	31.26	24.55	15/16	110.2	86.56
7/16	.638	.501	1/8	32.55	25.57	1	112.6	88.45
1/2	.833	.654	3/16	33.87	26.60	1/8	115.1	90.36
9/16	1.055	.828	1/4	35.21	27.65	3/8	117.5	92.29
5/8	1.302	1.023	5/16	36.58	28.73	1/2	120.0	94.25
11/16	1.576	1.237	3/8	37.97	29.82	5/8	125.1	98.22
3/4	1.875	1.473	7/16	39.39	30.94	1	130.2	102.3
13/16	2.201	1.728	1/2	40.83	32.07	1/8	135.5	106.4
7/8	2.552	2.004	9/16	42.30	33.23	3/8	140.8	106.4
15/16	2.930	2.301	5/8	43.80	34.40	1/2	146.3	110.6
1	3.333	2.618	11/16	45.33	35.60	5/8	151.9	114.9
1 1/16	3.763	2.955	3/4	46.88	36.82	3/4	157.6	119.3
1/8	4.219	3.313	13/16	48.45	38.05	7/8	163.3	123.7
3/16	4.701	3.692	7/8	50.05	39.31	1	169.2	128.3
1/4	5.208	4.091	15/16	51.68	40.59	1/8	175.2	132.9
5/16	5.742	4.510	1	53.33	41.89	1/4	181.3	137.6
3/8	6.302	4.950	1 1/16	55.01	43.21	3/8	187.5	142.4
7/16	6.888	5.410	1/8	56.72	44.55	1/2	193.8	147.3
1/2	7.500	5.890	3/16	58.45	45.91	5/8	200.2	152.2
9/16	8.138	6.391	1/4	60.21	47.29	3/4	206.7	157.2
5/8	8.802	6.913	5/16	61.99	48.69	7/8	213.3	162.4
11/16	9.492	7.455	3/8	63.80	50.11	1	220.0	167.6
3/4	10.21	8.018	7/16	65.64	51.55	1/4	226.9	172.2
13/16	10.95	8.601	1/2	67.50	53.01	1/2	234.0	178.2
7/8	11.72	9.204	9/16	69.39	54.50	3/4	241.2	184.3
15/16	12.51	9.828	5/8	71.30	56.00	1	248.5	190.4
2	13.33	10.47	11/16	73.24	57.52	1/4	255.9	196.4
1 1/16	14.18	11.14	3/4	75.21	59.07	1/2	263.4	202.4
1/8	15.05	11.82	13/16	77.20	60.63	3/4	270.9	208.4
3/16	15.95	12.53	7/8	79.22	62.22	1	278.5	214.4
1/4	16.88	13.25	15/16	81.26	63.82	1/8	286.2	220.4
5/16	17.83	14.00	1	83.33	65.45	1/4	294.0	226.4
3/8	18.80	14.77	5	85.43	67.10	1/2	301.8	232.3
7/16	19.80	15.55	1 1/16	87.55	68.76	3/4	309.7	238.3
1/2	20.83	16.36	1/8	89.70	70.45	1	317.7	244.3
9/16	21.89	17.19	3/16	91.88	72.16	1 1/2	325.8	250.3
5/8	22.97	18.04	1/4	94.08	73.89	3/4	334.0	256.3
			5/16			1	342.3	262.3
						1 1/4	350.7	268.3
						1 1/2	359.2	274.3
						1 3/4	367.7	280.3
						2	376.3	286.3
						2 1/4	384.9	292.3
						2 1/2	393.6	298.3
						2 3/4	402.3	304.3
						3	411.1	310.3
						3 1/4	419.9	316.3
						3 1/2	428.8	322.3
						3 3/4	437.7	328.3
						4	446.7	334.3
						4 1/4	455.7	340.3
						4 1/2	464.8	346.3
						4 3/4	473.9	352.3
						5	483.1	358.3
						5 1/4	492.3	364.3
						5 1/2	501.6	370.3
						5 3/4	510.9	376.3
						6	520.3	382.3
						6 1/4	529.7	388.3
						6 1/2	539.2	394.3
						6 3/4	548.7	400.3
						7	558.3	406.3
						7 1/4	567.9	412.3
						7 1/2	577.6	418.3
						7 3/4	587.3	424.3
						8	597.1	430.3
						8 1/4	606.9	436.3
						8 1/2	616.8	442.3
						8 3/4	626.7	448.3
						9	636.7	454.3
						9 1/4	646.7	460.3
						9 1/2	656.8	466.3
						9 3/4	666.9	472.3
						10	677.1	478.3
						10 1/4	687.3	484.3
						10 1/2	697.6	490.3
						10 3/4	707.9	496.3
						11	718.3	502.3
						11 1/4	728.7	508.3
						11 1/2	739.2	514.3
						11 3/4	749.7	520.3
						12	760.3	526.3

WEIGHT OF IRON AND STEEL SHEETS.

Weights in Pounds per Square Foot.

(For weights by the Decimal Gauge, see page 33.)

Thickness by Birmingham Gauge.				U. S. Standard Gauge, 1893. (See p. 32.)			
No. of Gauge.	Thickness in Inches.	Iron.	Steel.	No. of Gauge.	Thickness, In. (Approx.)	Iron.	Steel.
0000	.454	18.16	18.52	000000	0.5	20.	20.40
000	.425	17.00	17.34	000000	0.4688	18.75	19.125
00	.38	15.20	15.50	00000	0.4375	17.50	17.85
0	.34	13.60	13.87	0000	0.4063	16.25	16.575
1	.3	12.00	12.24	000	0.375	15.	15.30
2	.284	11.36	11.59	00	0.3438	13.75	14.025
3	.259	10.36	10.57	0	0.3125	12.50	12.75
4	.238	9.52	9.71	1	0.2813	11.25	11.475
5	.22	8.80	8.98	2	0.2656	10.625	10.837
6	.203	8.12	8.28	3	0.25	10.	10.20
7	.18	7.20	7.34	4	0.2344	9.375	9.562
8	.165	6.60	6.73	5	0.2188	8.75	8.925
9	.148	5.92	6.04	6	0.2031	8.125	8.287
10	.134	5.36	5.47	7	0.1875	7.5	7.65
11	.12	4.80	4.90	8	0.1719	6.875	7.012
12	.109	4.36	4.45	9	0.1563	6.25	6.375
13	.095	3.80	3.88	10	0.1406	5.625	5.737
14	.083	3.32	3.39	11	0.125	5.	5.10
15	.072	2.88	2.94	12	0.1094	4.375	4.462
16	.065	2.60	2.65	13	0.0938	3.75	3.825
17	.058	2.32	2.37	14	0.0781	3.125	3.187
18	.049	1.96	2.00	15	0.0703	2.8125	2.869
19	.042	1.68	1.71	16	0.0625	2.5	2.55
20	.035	1.40	1.43	17	0.0563	2.25	2.295
21	.032	1.28	1.31	18	0.05	2.	2.04
22	.028	1.12	1.14	19	0.0438	1.75	1.785
23	.025	1.00	1.02	20	0.0375	1.50	1.53
24	.022	.88	.898	21	0.0344	1.375	1.402
25	.02	.80	.816	22	0.0312	1.25	1.275
26	.018	.72	.734	23	0.0281	1.125	1.147
27	.016	.64	.653	24	0.025	1.	1.02
28	.014	.56	.571	25	0.0219	0.875	0.892
29	.013	.52	.530	26	0.0188	0.75	0.765
30	.012	.48	.487	27	0.0172	0.6875	0.701
31	.01	.40	.407	28	0.0156	0.625	0.637
32	.009	.36	.366	29	0.0141	0.5625	
33	.008	.32	.326	30	0.0125	0.5	0.514
34	.007	.28	.283	31	0.0109	.4375	0.451
35	.005	.20	.203	32	0.0102	0.40625	0.414
36	.004	.16	.161	33	0.0094	0.375	0.382
				34	0.0086	0.34375	0.351
				35	0.0078	0.3125	0.319
				36	0.0070	0.28125	0.287
				37	0.0065	.26562	0.271
				38	0.0063	0.25	0.255

Specific gravity.....	7.7	7.854
Weight per cubic foot.....	480.	489.6
	0.2778	0.2833

As there are many gauges in use differing from each other, and even the thicknesses of a certain specified gauge, as the Birmingham, are not assumed the same by all manufacturers, orders for sheets and wires should always state the weight per square foot., or the thickness in thousandths of an inch.

WARNING: This is a 1910 edition. Some of the material may no longer be accurate

WEIGHTS OF FLAT ROLLED IRON IN POUNDS PER LINEAL FOOT.
WIDTHS from 1 In. to 12 In.

Iron weighing 480 lbs. per cubic foot. For steel add 2 per cent.

Thick-ness in Inches	Widths															
	1".	1 1/4".	1 1/2".	1 3/4".	2".	2 1/4".	2 1/2".	2 3/4".	3".	3 1/4".	3 1/2".	3 3/4".	4".	4 1/4".	4 1/2".	4 3/4".
1/16	0.208	0.260	0.313	0.365	0.417	0.469	0.521	0.573	0.625	0.677	0.729	0.781	0.833	0.885	0.938	0.990
1/8	.417	.521	.625	.729	.833	.938	1.04	1.15	1.25	1.35	1.46	1.56	1.67	1.77	1.88	1.98
3/16	.625	.781	.938	1.09	1.25	1.41	1.56	1.72	1.88	2.03	2.19	2.34	2.50	2.66	2.81	2.97
1/4	.833	1.04	1.25	1.46	1.67	1.88	2.09	2.29	2.50	2.71	2.92	3.13	3.33	3.54	3.75	3.96
5/16	1.04	1.30	1.56	1.82	2.08	2.34	2.60	2.86	3.13	3.35	3.65	3.91	4.17	4.43	4.69	4.95
3/8	1.25	1.56	1.88	2.19	2.50	2.81	3.13	3.44	3.75	4.06	4.38	4.69	5.00	5.31	5.63	5.94
7/16	1.46	1.82	2.19	2.55	2.92	3.28	3.65	4.01	4.38	4.74	5.10	5.47	5.83	6.20	6.56	6.93
1/2	1.67	2.08	2.50	2.92	3.33	3.75	4.17	4.58	5.00	5.42	5.83	6.25	6.67	7.08	7.50	7.92
9/16	1.88	2.34	2.81	3.28	3.75	4.22	4.69	5.16	5.63	6.09	6.56	7.03	7.50	7.97	8.44	8.91
5/8	2.08	2.60	3.13	3.65	4.17	4.69	5.21	5.73	6.25	6.77	7.29	7.81	8.33	8.85	9.38	9.90
11/16	2.29	2.86	3.44	4.01	4.58	5.16	5.73	6.30	6.88	7.45	8.02	8.59	9.17	9.74	10.31	10.89
3/4	2.50	3.13	3.75	4.38	5.00	5.63	6.25	6.88	7.50	8.13	8.75	9.38	10.00	10.63	11.25	11.88
13/16	2.71	3.39	4.06	4.74	5.42	6.09	6.77	7.45	8.13	8.81	9.48	10.16	10.83	11.51	12.19	12.86
7/8	2.92	3.65	4.38	5.10	5.83	6.56	7.29	8.02	8.75	9.48	10.21	10.94	11.67	12.40	13.13	13.85
15/16	3.13	3.91	4.69	5.47	6.25	7.03	7.81	8.59	9.38	10.16	10.94	11.72	12.50	13.28	14.06	14.84
1 1/16	3.33	4.17	5.00	5.83	6.67	7.50	8.33	9.17	10.00	10.83	11.67	12.50	13.33	14.17	15.00	15.83
1 1/8	3.54	4.43	5.31	6.20	7.08	7.97	8.85	9.74	10.63	11.51	12.40	13.28	14.17	15.05	15.94	16.82
1 1/4	3.75	4.69	5.63	6.56	7.50	8.44	9.38	10.31	11.25	12.19	13.13	14.06	15.00	15.94	16.88	17.81
1 3/8	3.96	4.95	5.94	6.93	7.92	8.91	9.90	10.89	11.88	12.86	13.85	14.84	15.83	16.82	17.81	18.80
1 1/2	4.17	5.21	6.25	7.29	8.33	9.38	10.42	11.46	12.50	13.54	14.58	15.63	16.67	17.71	18.75	19.79
1 5/8	4.37	5.47	6.56	7.66	8.75	9.84	10.94	12.03	13.13	14.22	15.31	16.41	17.50	18.59	19.69	20.78
1 3/4	4.58	5.73	6.88	8.02	9.17	10.31	11.46	12.60	13.75	14.90	16.04	17.19	18.33	19.48	20.63	21.77
1 7/8	4.79	5.99	7.19	8.39	9.58	10.78	11.98	13.18	14.38	15.57	16.77	17.97	19.17	20.36	21.56	22.76
2	5.00	6.25	7.50	8.75	10.00	11.25	12.50	13.75	15.00	16.25	17.50	18.75	20.00	21.25	22.50	23.75
2 1/16	5.21	6.51	7.81	9.11	10.42	11.72	13.02	14.32	15.63	16.93	18.23	19.53	20.83	22.14	23.44	24.74
2 1/8	5.42	6.77	8.13	9.48	10.83	12.19	13.54	14.90	16.25	17.60	18.96	20.31	21.67	23.02	24.38	25.73
2 1/4	5.63	7.03	8.44	9.84	11.25	12.66	14.06	15.47	16.88	18.28	19.69	21.09	22.50	23.91	25.31	26.72
2 3/8	5.83	7.29	8.75	10.21	11.67	13.13	14.58	16.04	17.50	18.96	20.42	21.88	23.33	24.79	26.25	27.71
2 1/2	6.04	7.55	9.06	10.57	12.08	13.59	15.10	16.61	18.13	19.64	21.15	22.66	24.17	25.68	27.19	28.70
2 5/8	6.25	7.81	9.38	10.94	12.50	14.06	15.63	17.19	18.75	20.31	21.88	23.44	25.00	26.56	28.13	29.69
2 3/4	6.46	8.07	9.69	11.30	12.92	14.53	16.15	17.76	19.38	20.99	22.60	24.22	25.83	27.45	29.06	30.68
2 7/8	6.67	8.33	10.00	11.67	13.33	15.00	16.67	18.33	20.00	21.67	23.33	25.00	26.67	28.33	30.00	31.67

182 MATERIALS

Widths.

Thick-ness in Inches	Widths															
	6".	6 1/4".	6 1/2".	6 3/4".	7".	7 1/4".	7 1/2".	7 3/4".	8".	8 1/2".	9".	10".	11".	12".		
1/16	1.04	1.09	1.15	1.20	1.25	1.30	1.35	1.41	1.46	1.56	1.67	1.77	1.88	2.08	2.29	2.50
1/8	2.08	2.19	2.29	2.40	2.50	2.60	2.71	2.81	2.92	3.13	3.33	3.54	3.75	4.17	4.58	5.00
3/16	3.13	3.24	3.34	3.59	3.75	3.91	4.06	4.22	4.38	4.69	5.00	5.31	5.63	6.25	6.88	7.50
1/4	4.17	4.38	4.58	4.79	5.00	5.21	5.42	5.63	5.83	6.25	6.67	7.08	7.50	8.33	9.17	10.00
5/16	5.21	5.47	5.73	5.99	6.25	6.51	6.77	7.03	7.29	7.81	8.33	8.85	9.38	10.42	11.46	12.50
3/8	6.25	6.56	6.88	7.19	7.50	7.81	8.13	8.44	8.75	9.38	10.00	10.63	11.25	12.40	13.54	14.69
7/16	7.29	7.66	8.02	8.39	8.75	9.11	9.48	9.84	10.21	10.94	11.67	12.40	13.13	14.58	16.04	17.50
1/2	8.33	8.75	9.17	9.58	10.00	10.42	10.83	11.25	11.67	12.50	13.33	14.17	15.00	16.67	18.33	20.00
9/16	9.38	9.84	10.31	10.78	11.25	11.72	12.19	12.66	13.13	14.06	15.00	15.94	16.88	18.75	20.63	22.50
5/8	10.42	10.94	11.46	11.98	12.50	13.02	13.54	14.06	14.58	15.63	16.67	17.71	18.75	20.83	22.92	25.00
11/16	11.46	12.03	12.60	13.18	13.75	14.32	14.90	15.47	16.04	17.19	18.33	19.48	20.63	22.92	25.21	27.50
3/4	12.50	13.13	13.75	14.38	15.00	15.63	16.25	16.88	17.50	18.75	20.00	21.25	22.50	25.00	27.50	30.00
13/16	13.54	14.22	14.90	15.57	16.25	16.93	17.60	18.28	18.96	20.31	21.67	23.02	24.38	27.08	29.79	32.50
7/8	14.58	15.31	16.04	16.77	17.50	18.23	18.96	19.69	20.42	21.88	23.33	24.79	26.25	29.17	32.08	35.00
15/16	15.63	16.41	17.19	17.97	18.75	19.53	20.31	21.09	21.88	23.44	25.00	26.56	28.13	31.25	34.38	37.50
1 1/16	16.67	17.50	18.33	19.17	20.00	20.83	21.67	22.50	23.33	25.00	26.67	28.33	30.00	33.33	36.67	40.00
1 1/8	17.71	18.64	19.57	20.50	21.43	22.36	23.29	24.22	25.15	27.00	28.85	30.70	32.55	36.40	40.25	44.10
1 1/4	18.75	19.74	20.73	21.72	22.71	23.70	24.69	25.68	26.67	28.62	30.57	32.52	34.47	39.42	43.37	47.32
1 3/8	19.79	20.83	21.87	22.91	23.95	24.99	26.03	27.07	28.11	30.16	32.21	34.26	36.31	41.26	45.21	49.16
1 1/2	20.83	21.92	23.01	24.10	25.19	26.28	27.37	28.46	29.55	31.64	33.73	35.82	37.91	42.86	46.81	50.76
1 5/8	21.88	23.01	24.14	25.27	26.40	27.53	28.66	29.79	30.92	33.01	35.10	37.19	39.28	44.23	48.18	52.13
1 3/4	22.92	24.10	25.28	26.46	27.64	28.82	29.99	31.17	32.35	34.44	36.53	38.62	40.71	45.66	49.61	53.56
1 7/8	23.96	25.19	26.42	27.65	28.88	30.11	31.34	32.57	33.80	35.89	37.98	39.97	41.96	46.91	50.86	54.81
2	25.00	26.25	27.50	28.75	30.00	31.25	32.50	33.75	35.00	37.00	39.00	41.00	43.00	47.91	51.82	55.73

WEIGHTS OF FLAT WROUGHT IRON.

Other sizes. — Weight of other sizes can easily be obtained from the above table by means of combinations or divisions. Thus, for example,
 Weight of 12 x 1 1/4 equals weight of 12 x 1 plus weight of 12 x 1/4 50.00
 Or, twice weight of 12 x 5/8, as it is twice as thick 50.00
 Weight of 6 x 1 15/16 equals midway weight between 6 x 1 7/8 and 6 x 2 75.00
 Weight of 24 x 15/16, being twice as wide as 12 x 15/16, weighs.....

183

WEIGHT OF PLATE IRON, PER LINEAL FOOT, IN POUNDS.
(Based on 480 lbs. per Cubic Foot. For Steel add 2 per cent.)

Width in Inches	Thickness in Inches.															I
	1/16	1/8	3/16	1/4	5/16	3/8	7/16	1/2	9/16	5/8	11/16	3/4	13/16	7/8	15/16	
12	2.50	5.00	7.50	10.00	12.50	15.00	17.50	20.00	22.50	25.00	27.50	30.00	32.50	35.00	37.50	40.00
13	2.71	5.42	8.13	10.83	13.54	16.25	18.96	21.67	24.38	27.08	29.79	32.50	35.21	37.92	40.63	43.33
14	2.92	5.83	8.75	11.67	14.58	17.50	20.42	23.33	26.25	29.17	32.08	35.00	37.92	40.83	43.75	46.67
15	3.13	6.25	9.38	12.50	15.63	18.75	21.88	25.00	28.13	31.25	34.38	37.50	40.63	43.75	46.88	50.00
16	3.33	6.67	10.00	13.33	16.67	20.00	23.33	26.67	30.00	33.33	36.67	40.00	43.33	46.67	50.00	53.33
17	3.54	7.08	10.63	14.17	17.71	21.25	24.79	28.33	31.88	35.42	38.96	42.50	46.05	49.50	53.00	56.67
18	3.75	7.50	11.25	15.00	18.75	22.50	26.25	30.00	33.75	37.50	41.25	45.00	48.75	52.50	56.25	60.00
19	3.96	7.92	11.87	15.83	19.79	23.75	27.71	31.67	35.67	39.58	43.54	47.50	51.45	55.41	59.37	63.33
20	4.17	8.33	12.50	16.67	20.83	25.00	29.17	33.33	37.50	41.67	45.83	50.00	54.17	58.33	62.50	66.67
21	4.38	8.75	13.13	17.50	21.88	26.25	30.63	35.00	39.38	43.75	48.13	52.50	56.88	61.25	65.63	70.00
22	4.58	9.17	13.75	18.33	22.92	27.50	32.08	36.67	41.25	45.83	50.42	55.00	59.58	64.17	68.75	73.33
23	4.79	9.58	14.38	19.17	23.96	28.75	33.54	38.33	43.13	47.92	52.71	57.50	62.30	67.09	71.88	76.67
24	5.00	10.00	15.00	20.00	25.00	30.00	35.00	40.00	45.00	50.00	55.00	60.00	65.00	70.00	75.00	80.00
25	5.21	10.42	15.62	20.83	26.04	31.25	36.46	41.67	46.88	52.08	57.29	62.50	67.70	72.91	78.13	83.33
26	5.42	10.83	16.25	21.67	27.08	32.50	37.92	43.33	48.75	54.17	59.58	65.00	70.42	75.83	81.25	86.67
27	5.63	11.25	16.88	22.50	28.13	33.75	39.38	45.00	50.63	56.25	61.88	67.50	73.13	78.75	84.38	90.00
28	5.83	11.67	17.50	23.33	29.17	35.00	40.83	46.67	52.50	58.33	64.17	70.00	75.84	81.67	87.50	93.33
29	6.04	12.08	18.13	24.17	30.21	36.25	42.29	48.33	54.38	60.42	66.46	72.50	78.55	84.59	90.63	96.67
30	6.25	12.50	18.75	25.00	31.25	37.50	43.75	50.00	56.25	62.50	68.75	75.00	81.25	87.50	93.75	100.00
32	6.67	13.33	20.00	26.67	33.33	40.00	46.67	53.33	60.00	66.67	73.33	80.00	86.67	93.33	100.00	106.7
34	7.08	14.17	21.25	28.33	35.42	42.50	49.58	56.67	63.75	70.83	77.91	85.00	92.08	99.17	106.3	113.3
36	7.50	15.00	22.50	30.00	37.50	45.00	52.50	60.00	67.50	75.00	82.50	90.00	97.50	105.0	112.5	120.0
38	7.92	15.83	23.75	31.67	39.59	47.50	55.42	63.33	71.25	79.17	87.09	95.00	102.9	110.8	118.8	126.7
40	8.33	16.67	25.00	33.33	41.67	50.00	58.33	66.67	75.00	83.33	91.67	100.0	108.3	116.7	125.0	133.3
42	8.75	17.50	26.25	35.00	43.75	52.50	61.25	70.00	78.75	87.50	96.25	105.0	113.7	122.5	131.3	140.0
44	9.17	18.33	27.50	36.67	45.84	55.00	64.17	73.33	82.50	91.67	100.8	110.0	119.2	128.3	137.5	146.7
46	9.58	19.17	28.75	38.33	47.92	57.50	67.08	76.67	86.25	95.83	105.4	115.0	124.6	134.2	143.8	153.3
48	10.00	20.00	30.00	40.00	50.00	60.00	70.00	80.00	90.00	100.0	110.0	120.0	130.0	140.0	150.0	160.0
50	10.42	20.83	31.25	41.67	52.08	62.50	72.91	83.33	93.75	104.2	114.6	125.0	135.4	145.8	156.3	166.7
52	10.83	21.67	32.50	43.33	54.17	65.00	75.83	86.67	97.50	108.3	119.2	130.0	140.8	151.7	162.5	173.3
54	11.25	22.50	33.75	45.00	56.25	67.50	78.75	90.00	101.3	112.5	123.8	135.0	146.3	157.5	168.8	180.0
56	11.67	23.33	35.00	46.67	58.33	70.00	81.66	93.33	105.0	116.7	128.3	140.0	151.7	163.3	175.0	186.7
58	12.08	24.17	36.25	48.33	60.42	72.50	84.58	96.67	108.8	120.8	132.9	145.0	157.1	169.2	181.3	193.3
60	12.50	25.00	37.50	50.00	62.50	75.00	87.50	100.00	112.5	125.0	137.5	150.0	162.5	175.0	187.5	200.0

WARNING: This is a 1910 edition. Some of the material may no longer be accurate

WEIGHTS OF STEEL BLOOMS.

Soft steel. 1 cubic inch = 0.284 lb. 1 cubic foot = 490.75 lbs.

Size, Inches	Lengths.										
	1"	6"	12"	18"	24"	30"	36"	42"	48"	54"	60"
3	2.56	15	31	48	63	78	92	107	125	143	161
3 1/2	2.98	18	36	54	72	89	104	125	146	167	188
4	3.40	20	41	61	81	101	121	143	165	188	209
4 1/2	3.97	24	48	72	96	119	143	167	191	215	238
5	4.54	27	55	82	109	136	164	191	218	246	272
5 1/2	5.11	31	63	92	123	153	184	214	245	276	307
6	5.68	34	68	102	133	164	204	239	286	327	368
6 1/2	6.25	37	75	112	144	177	221	266	310	354	399
7	6.82	41	82	123	155	190	233	286	334	382	429
7 1/2	7.38	44	89	133	166	204	247	307	368	429	490
8	7.95	48	96	143	177	219	263	327	391	460	521
8 1/2	8.52	51	102	153	188	230	277	341	409	477	545
9	9.09	55	109	164	199	244	293	357	422	490	558
9 1/2	9.66	58	116	175	210	259	311	377	441	511	574
10	10.22	61	123	184	221	273	327	382	452	522	582
10 1/2	10.79	64	130	195	232	288	344	409	477	545	600
11	11.36	68	136	205	244	300	357	422	490	552	613
11 1/2	11.93	71	143	215	255	311	368	433	500	562	625
12	12.50	75	150	225	266	322	379	444	511	574	638
12 1/2	13.07	78	157	235	277	333	391	455	522	582	650
13	13.64	82	164	245	288	344	402	466	533	594	662
13 1/2	14.21	85	171	255	299	355	413	477	544	605	674
14	14.78	89	178	265	309	366	424	488	555	616	686
14 1/2	15.35	92	185	275	319	377	435	499	566	627	698
15	15.92	96	192	285	329	388	446	509	577	638	710
15 1/2	16.49	99	199	295	339	399	457	519	588	649	722
16	17.06	103	206	305	349	409	468	529	599	660	734
16 1/2	17.63	106	213	315	359	419	479	539	609	671	746
17	18.20	110	220	325	369	429	489	549	619	682	758
17 1/2	18.77	113	227	335	379	439	499	559	629	693	770
18	19.34	117	234	345	389	449	509	569	639	704	782
18 1/2	19.91	120	241	355	399	459	519	579	649	715	794
19	20.48	124	248	365	409	469	529	589	659	726	806
19 1/2	21.05	127	255	375	419	479	539	599	669	737	818
20	21.62	131	262	385	429	489	549	609	679	748	830
20 1/2	22.19	134	269	395	439	499	559	619	689	759	842
21	22.76	138	276	405	449	509	569	629	699	770	854
21 1/2	23.33	141	283	415	459	519	579	639	709	781	866
22	23.90	145	290	425	469	529	589	649	719	792	878
22 1/2	24.47	148	297	435	479	539	599	659	729	803	890
23	25.04	152	304	445	489	549	609	669	739	814	902
23 1/2	25.61	155	311	455	499	559	619	679	749	825	914
24	26.18	159	318	465	509	569	629	689	759	836	926
24 1/2	26.75	162	325	475	519	579	639	699	769	847	938
25	27.32	166	332	485	529	589	649	709	779	858	950
25 1/2	27.89	169	339	495	539	599	659	719	789	869	962
26	28.46	173	346	505	549	609	669	729	799	880	974
26 1/2	29.03	176	353	515	559	619	679	739	809	891	986
27	29.60	180	360	525	569	629	689	749	819	902	998
27 1/2	30.17	183	367	535	579	639	699	759	829	913	1010
28	30.74	187	374	545	589	649	709	769	839	924	1022
28 1/2	31.31	190	381	555	599	659	719	779	849	935	1034
29	31.88	194	388	565	609	669	729	789	859	946	1046
29 1/2	32.45	197	395	575	619	679	739	799	869	957	1058
30	33.02	201	402	585	629	689	749	809	879	968	1070
30 1/2	33.59	204	409	595	639	699	759	819	889	979	1082
3											

SIZES AND WEIGHTS OF ROOFING MATERIALS.

Corrugated Iron or Steel Plates. — **Weight** per 100 Sq. Ft., Lb.
(American Sheet and Tin Plate Co., 190.5.)

SCHEDULE OF WEIGHTS.

Corrugations.	5/8 in.		1 1/4 x 3/8 in.		2 x 1/2 in.		2 1/2 x 1/2 in.		3 x 3/4 in.		5 x 7/8 in.	
	Painted.	Galvanized.	Painted.	Galvanized.	Painted.	Galvanized.	Painted.	Galvanized.	Painted.	Galvanized.	Painted.	Galvanized.
U. S. Std Sheet Metal Gauge.												
28	72	87	72	87	68	85	68	85	68	85	68	85
27	79	94	79	94	76	91	76	91	76	91	76	91
26	86	101	86	101	83	98	83	98	83	98	83	98
25	100	115	100	115	96	111	96	111	96	111	96	111
24	114	129	114	129	110	124	110	124	110	124	110	124
23			128	143	123	138	123	138	123	138	123	138
22			142	157	136	151	136	151	136	151	136	151
21			156	171	150	165	150	165	150	165	150	165
20			170	185	163	178	163	178	163	178	163	178
18					217	232	217	232	217	232	217	232
16					271	286	271	286	271	286	271	286

Covering width of plates, lapped one corrugation 24 in. Standard lengths, 5, 6, 7, 8, 9, and 10 ft.; maximum length, 12 ft.

Ordinary corrugated sheets should have a lap of 1 1/2 or 2 corrugations side-lap for roofing in order to secure water-tight side seams: if the roof is rather steep 1 1/2 corrugations will answer. Some manufacturers make a special high-edge corrugation on sides of sheets, and thereby are enabled to secure a water-proof side-lap with one corrugation only; thus saving from 6% to 12% of material to cover a given area.

No. 28 gauge corrugated iron is generally used for applying to wooden buildings; but for applying to iron framework No. 24 gauge or heavier should be adopted.

Galvanizing sheet iron adds about 2 1/2 oz. to its weight per square foot.

Corrugated Arches.

For corrugated curved sheets for floor and ceiling construction in fire-proof buildings, No. 16, 18, or 20 gauge iron is commonly used, and sheets may be curved from 4 to 10 in. rise — the higher the rise the stronger the arch. By a series of tests it has been demonstrated that corrugated arches give the most satisfactory results with a base length not exceeding 6 ft., and 5 ft. or even less is preferable where great strength is required. These corrugated arches are made with 1 1/4 X 3/8, 2 1/2 X 1/2, 3 X 3/4 and 5 X 7/8 in. corrugations, and in the same width of sheet as above mentioned.

Terra-Cotta.

Porous terra-cotta roofing 3 in. thick weighs 16 lb. Per square foot and 2 in. thick, 12 lb. per square foot.

Ceiling made of the same material 2 in. thick weighs 11 lb. per square foot.

Tiles.

Flat tiles 6 1/4 X 10 1/2 X 5/8 in. weigh from 1480 to 1850 lb. per square of roof (100 square feet), the lap being one-half the length of the tile.

Tiles with grooves and fillets weigh from 740 to 925 lb. per square of roof.

Pan-tiles 14 1/2 X 10 1/2 laid 10 in. to the weather weigh 850 lb. per square.

Standard Weights and Gauges of Tin Plates.
American Sheet and Tin Plate Co., Pittsburg, Pa.

Trade term.	56 lb.	60 lb.	65 lb.	70 lb.	75 lb.	80 lb.	85 lb.	90 lb.	95 lb.	100 lb.
Nearest wire gauge No.	38	37	35	35	34	33	32	31	31	30 1/2
Weight per sq. ft., lb.	0.257	0.275	0.298	0.322	0.345	0.367	0.390	0.413	0.436	0.459
Weight, box, 14x20 in., 1 b.	56	60	65	70	75	80	85	90	95	100

Trade term	IC	IXL	IX	IXX	IXXX	IXXXX	IXXXXX
Nearest wire gauge No.	30	28	28	27	26	25	24
Weight per sq. ft., lb.	0.491	0.588	0.619	0.712	0.803	0.895	0.987
Weight, box, 14x20 in., 1 b.	107	128	135	155	175	195	215

Trade term	DC	DX	DXX	DXXX	DXXXX
Weight, per sq. ft., lb.	0.637	0.826	0.962	1.10	1.23
Nearest equivalent in I plates	IX	IXXX	IXXXX	I-6X	I-7X
12 1/2 x 17 in. 100 sheets, per box, lbs.	94	122	142	162	182
17 x 25 in. 50 sheets, per box, lbs.	94	122	142	162	182
15 x 21 in. 100 sheets, per box, lbs.	40	181	211	241	271

Sizes and Net Weight per Box of 100-lb. (0.459 lb. Per sq. ft.) Tin Plates.

Size of Sheets	Sheets per Box.	Weight per Box.	Size of Sheets.	Sheets per Box.	Weight per Box.	Size of Sheets.	Sheets per Box.	Weight per Box.
10 x 14	225	100	15 x 15	225	161	14 x 31	112	155
14 x 20	112	100	16 x 16	225	183	11 1/4 x 22 3/4	112	91
20 x 28	112	200	17 x 17	225	206	13 1/4 x 17 3/4	112	84
10 x 20	225	143	18 x 18	112	116	13 1/4 x 19 1/4	112	91
11 x 22	225	172	19 x 19	112	129	13 1/2 x 19 1/2	112	95
11 1/2 x 23	225	189	20 x 20	112	143	13 1/2 x 19 3/4	112	95
12 x 12	225	103	21 x 21	112	158	14 x 18 3/4	124	103
12 x 24	112	103	22 x 22	112	172	14 x 19 1/4	120	103
17 x 13	225	121	23 x 23	112	189	14 x 21	112	105
13 x 26	112	121	24 x 24	112	204	14 x 22	112	110
14 x 14	225	140	26 x 26	112	241	14 x 22 1/4	112	111
14 x 28	112	140	16 x 20	112	114	15 1/2 x 23	112	127

For weight per box of other than 100-lb. plates, multiply by the figures in the fourth line of the two upper tables and divide by 100.

Thus for IX plates 20 X 28 in., 200 X 135 ÷ 100 = 270.

Tin Plates are made of soft sheet steel coated with tin. The words "charcoal" and "coke" plates are trade terms retained from the time

when high-grade tin plates were made from charcoal iron and lower grade from coke iron (sheet iron made with coke as fuel). The terms are now used to distinguish the percentage of tin coating and the finish. Coke plates, with light coating, are used for cans. Charcoal plates are designated by letters A to A.A.A.A., the latter having the heaviest coating and the highest polish. Plates lighter than 65-lb. per base box (14 X 20 in., 112 plates) are called taggers tin.

Terne Plates, or Roofing Tin, are coated with an alloy of tin and lead. In the "U. S. Eagle, N.M." brand the alloy is 30% tin and 70% lead. The weight per 112 sheets of this brand before and after coating is as follows:

	IC 14 x 20	IC 20 x 28	IX 14 x 20	IX 20 x 28
Black plates	95 to 100 lb.	190 to 200 lb.	125 to 130 lb.	250 to 260 lb.
After coating	115 to 120	230 to 240	145 to 150	290 to 300

Long terne sheet? are made in gauges. Nos. 20 to 30 from 20 to 40 in wide and up to 120 in. long. Continuous roofs are made in 20 and 28 in wide. Is made from terne coated sheets 72, 84 and 96 in. long, single lock seam and soldered.

A box of 112 sheets 14 X 20 in. will cover approximately 192 sq. ft. of roof flat seam, or 583 sheets 1000 sq. ft. For standing seam roofing a sheet 20 X 28 in. will cover 475 sq. in., or 363 sheets 1000 sq. ft. A box of 112 sheets 20 X 28 in. will cover approximately 370 sq. ft.

The common sizes of tin plates are 10 x 14 in. and multiples of that measure. The sizes most generally used are 14 x 20 and 20 x 28 in.

Specifications for Tin and Terne Plate. (Penna. R.R. Co., 1903.)

	Material Desired.		
	Tin Plate.	No. 1 Terne.	No. 2 Terne.
Kind of coating.....	Pure tin	26 tin, 74 lead	16 tin, 84 lead
Amount of coating per sq. ft.	0.023 lb.	0.46 lb.	0.023 lb.
Weight per sq. ft. of —			
Grade IC.....	0.496 "	0.519 "	0.496 "
Grade IX.....	0.625 "	0.640 "	0.625 "
Grade IXX.....	0.716 "	0.739 "	0.716 "
Grade IXXX.....	0.808 "	0.831 "	0.808 "
	0.900 "	0.923 "	0.900 "
Will be rejected if less than			
Amount of coating per sq. ft.	0.0183 lb.	0.0413 lb.	0.0183 lb.
Weight per sq. ft. of —			
Grade IC.....	0.468 "	0.490 "	0.468 "
Grade IX.....	0.590 "	0.612 "	0.590 "
Grade IXX.....	0.676 "	0.699 "	0.676 "
Grade IXXX.....	0.763 "	0.787 "	0.763 "
Grade IXXXX.....	0.850 "	0.874 "	0.850 "

Each sheet in a shipment of tin or terne plate must (1) be cut as nearly exact to size ordered as possible; (2) must be rectangular and flat and free from flaws; (3) must double seam successfully under reasonable treatment; (4) must show a smooth edge with no sign of fracture when bent through an angle of 180 degrees and flattened down with a wooden mallet. (5) must be so nearly like every other sheet in the shipment, and in uniformity and amount of coating, that no difficulty will arise in the shops, due to varying thickness of sheets.

Slate.

Number and superficial area of slate required for One Square of roof. (1 square = 100 square feet.)

Size, Inches.	Number per Square.	Area in Sq. Ft.	Size, Inches.	Number per Square.	Area in Sq. Ft.	Size, Inches.	Number per Square.	Area in Sq. Ft.
6x12	533	267	9x16	246	240	16x20	137	231
7x12	457		10x16	221		12x22	126	
8x12	400	254	9x18	213	235	14x22	108	228
9x12	355		10x18	192		12x24	114	
7x14	374		12x18	160		14x24	90	225
8x14	327		10x20	169		16x24	86	
9x14	291		11x20	154		14x26	89	
10x14	261		12x20	141		16x26	70	
8x16	277	246	14x20	212				

As slate is usually laid, the number of square feet of roof covered by one square can be obtained from the following formula:
width X (length - 3 inches) = the number of square feet of roof covered.

Weight of slate of various lengths and thicknesses required for one square of roof: based on the number of slate required for one square of roof taking the weight of a cubic-foot of slate at 175 pounds.

Length in Inches.	Weight in Pounds per Square for the Thickness.							
	1/8 In.	3/16 In.	1/4 In.	3/8 In.	1/2 In.	5/8 In.	3/4 In.	1 In.
12	403	724	967	1450	1936	2419	2902	3872
14	460	688	920	1379	1842	2301	2760	3683
16	445	667	890	1336	1784	2229	2670	3567
18	434	667	869	1309	1704	2129	2553	3408
20	425	630	836	1254	1653	2093	2478	3350
22	412	626	836	1254	1653	2066	2478	3306
24	407	617	810	1222	1631	2039	2445	3263
26								

pine Shingles.

Number and weight of shingles required to cover one square of roof:

Inches exposed to weather.....	4	4 1/2	5	5 1/2	6
Number of shingles per square of roof..	900	800	720	655	600
Weight of shingles on one square, pound..	216	192	173	157	144

The number of shingles per square is for common gable-roofs. For hip-roofs add five per cent to these figures.

Skylight Glass.

The weights of various sizes and thicknesses of fluted or rough plate glass required for one square of roof.

Dimensions in Inches.	Thickness in Inches.	Area in Square Feet.	Weight in Lbs. per Square of Roof.
12x 48	3/16	3.997	250
15x 60	1/4	6.246	350
20x 100	3/8	13.880	500
94x 156	1/2	101.768	700

In the above table no allowance is made for lap.

If ordinary window-glass is used, single thick glass (about 1/16 inch) will weigh about 82 lb. per square, and double thick glass (about 1/8 inch) will weigh about 164 lb. per square, no allowance being made for lap. A box of ordinary window-glass contains as nearly 50 square feet as the size of the panes will admit of. Panes of any size are made to order by the manufacturers, but a great variety of sizes are usually kept in stock, ranging from 6 X 8 inches to 36 X 60 inches.

APPROXIMATE WEIGHT OF MATERIALS FOR ROOFS.

American Sheet and Tin Plate Co.

Material.	Average Weight, Lb. per Sq. Ft.
Corrugated galvanized iron, No. 20, unboarded	2 1/4
Copper, 16 oa. standing seam	1 1/4
Felt and asphalt, without sheathing	2
Glass, 1/8 in. thick	13/4
Hemlock sheathing, 1 in. thick	2
Lead, about 1/2 in. thick	6 to 8
Lath and plaster ceiling (ordinary)	6 to 8
Mackite, 1 in. thick, with plaster	10
Neponset roofing, felt 2 layers	1 1/2
Spruce sheathing 1 in. thick	2 1/2
Slate, 3/16 in. thick, 3 in. double lap	63/4
Slate, 1/8 in. thick, 3 in. double lap	4 1/2
Shingles, 6 in. X 18 in., 1/3 to weather	2
Skylight of glass, 3/16 to 1/2 in., inc. frame	4 to 10
Slag roof, 4-ply	4
Terne plate, IC, without sheathing	1 1/2
Terne plate, IX, without sheathing	5/8
Tiles (Spanish) 1 1/2 in. x 6 1/4 in. x 5/8 - 5 1/4 in. to weather	18
Tiles (Spanish) 1 1/2 in. x 10 1/2 in. - 7 1/4 in. to weather	8 1/2
White pine sheathing, 1 in. thick	2 1/2
Yellow pine sheathing, 1 in. thick	4

WEIGHT OF CAST-IRON PIPES OR COLUMNS.

In Pounds per Lineal Foot:

Cast iron = 450 lbs. per cubic foot.

Bore.	Thick. of Metal.	Weight per Foot.	Bore.	Thick. of Metal.	Weight per Foot.	Bore.	Thick. of Metal.	Weight per Foot.
3	3/8	12.4	10	3/4	79.2	22	3/4	167.5
	1/2	17.2	10 1/2	1/2	54.0	23	3/4	174.9
	5/8	22.2		5/8	60.2		7/8	205.1
3 1/2	3/8	14.3		3/4	82.8		7/8	255.6
	1/2	19.6	11	1/2	56.5	24	3/4	182.2
	5/8	25.3		5/8	71.3		7/8	213.7
4	3/8	16.1		3/4	86.5		7/8	245.4
	1/2	22.1	11 1/2	1/2	58.9	25	3/4	189.6
	5/8	28.4		5/8	74.4		7/8	222.3
4 1/2	3/8	18.0		3/4	90.2		7/8	255.3
	1/2	24.5	12	1/2	61.4	26	3/4	197.0
	5/8	31.5		5/8	77.5		7/8	213.9
5	3/8	19.8		3/4	93.9		7/8	265.1
	1/2	27.0	12 1/2	1/2	63.8	27	3/4	204.3
	5/8	34.4		5/8	80.5		7/8	239.4
5 1/2	3/8	21.6		3/4	97.6		7/8	274.9
	1/2	29.4	13	1/2	66.3	28	3/4	211.7
	5/8	37.6		5/8	83.6		7/8	248.1
6	3/8	23.5		3/4	101.2		7/8	284.7
	1/2	31.9	14	1/2	71.2	29	3/4	219.1
	5/8	40.7		5/8	89.7		7/8	256.6
6 1/2	3/8	25.3		3/4	108.6		7/8	294.5
	1/2	34.4	15	5/8	95.9	30	7/8	265.2
	5/8	43.7		3/4	116.0		7/8	304.3
7	3/8	27.2		7/8	136.4		7/8	343.7
	1/2	36.8	16	5/8	102.0	31	1 1/8	273.0
	5/8	46.8		3/4	123.3		7/8	314.2
7 1/2	3/8	29.0		7/8	145.0		7/8	354.8
	1/2	39.3	17	5/8	108.2	32	1 1/8	202.4
	5/8	49.9		3/4	130.7		7/8	324.0
8	3/8	30.8		7/8	153.6		7/8	365.0
	1/2	41.7	18	5/8	114.3	33	1 1/8	291.0
	5/8	52.9		3/4	138.1		7/8	333.9
8 1/2	3/8	34.2		7/8	162.1		7/8	376.9
	1/2	44.2	19	5/8	120.4	34	1 1/8	299.6
	5/8	55.0		3/4	145.4		7/8	343.7
9	3/8	36.1		7/8	170.7		7/8	388.0
	1/2	46.6	20	5/8	126.6	35	1 1/8	308.1
	5/8	59.1		3/4	152.8		7/8	353.4
9 1/2	3/8	41.8		7/8	179.3		7/8	399.0
	1/2	49.1	21	5/8	132.7	36	1 1/8	316.6
	5/8	62.1		3/4	160.1		7/8	363.1
10	3/8	47.5		7/8	187.9		7/8	410.0
	1/2	51.5	22	5/8	138.8		7/8	363.1
	5/8	65.2		7/8	198.8		7/8	410.0

The weight of the two Ranges may be reckoned = weight Of one foot.

STANDARD THICKNESSES AND WEIGHTS OF CAST-IRON PIPES.

(U. S. Cast-Iron Pipe & Fd'y Co., 1908.)

Nominal Inside Diam. Ins.	Class A. 100 ft. Head. 43 lb. Pressure.			Class B. 200 ft. Head. 86 lb. Pressure.		
	Thick-ness, Ins.	Wt. per		Thick-ness, Ins.	Wt. per	
		Ft.	L'gth.		Ft.	L'gth.
3	0.39	14.5	175	0.42	16.2	194
4	.42	20.0	240	.45	21.7	260
6	.44	30.8	370	.48	33.3	400
8	.46	42.9	515	.51	47.5	570
10	.50	57.1	685	.57	63.8	765
12	.54	72.5	870	.62	82.1	985
14	.57	89.6	1075	.66	102.5	1230
16	.60	108.3	1300	.70	125.0	1500
18	.64	129.2	1550	.75	150.0	1800
20	.67	150.0	1800	.80	175.0	2100
24	.76	204.2	2450	.89	233.3	2800
30	.88	291.7	3500	1.03	333.3	4000
36	.99	391.7	4700	1.15	454.2	5450
42	1.10	512.5	6150	1.28	591.7	7100
48	1.26	666.7	8000	1.42	750.0	9000
54	1.35	800.0	9600	1.55	933.3	11200
60	1.39	916.7	11000	1.67	1104.2	13250
72	1.67	1283.4	15400	1.95	1545.8	18550
84	1.72	1633.4	19600	2.22	2104.2	25250

Nominal Inside Diam. Ins.	Class C. 300 ft. Head. 130 lb. Pressure.			Class D. 400 ft. Head. 173 lb. Pressure.		
	Thick-ness, Ins.	Wt. per		Thick-ness, Ins.	Wt. per	
		Ft.	L'gth.		Ft.	L'gth.
3	0.45	17.1	205	0.48	18.0	216
4	.48	23.3	280	.52	25.0	300
6	.51	35.8	430	.55	38.3	460
8	.56	52.1	625	.60	55.8	670
10	.62	70.8	850	.68	76.7	920
12	.68	91.7	1100	.75	100.0	1200
14	.74	116.7	1400	.82	129.2	1550
16	.80	143.8	1725	.89	158.3	1900
18	.87	175.0	2100	.96	191.7	2300
20	.92	208.3	2500	1.03	229.2	2750
24	1.04	279.2	3350	1.16	306.7	3680
30	1.20	400.0	4800	1.37	450.0	5400
36	1.36	545.8	6550	1.58	625.0	7500
42	1.54	716.7	8600	1.78	825.0	9900
48	1.71	908.3	10900	1.96	1050.0	12600
54	1.90	1141.7	13700	2.23	1341.7	16100
60	2.00	1341.7	16100	2.38	1583.3	19000
72	2.39	1904.2	22850
84

The above weights are per length to lay 12 feet including standard sockets; proportionate allowance to be made for any variation.

Standard Thicknesses and Weights of Cast-Iron Pipe.

FOR FIRE-LINES AND OTHER HIGH-PRESSURE SERVICE.

(U. S. Cast-Iron Pipe & Fd'y Co., 1908.)

Nominal Inside Diam. In.	Class E. 500 ft. Head. 217 lb.			Class F. 600 ft. Head. 260 lb.			Class G. 700 ft. Head. 304 lb.			Class H. 800 ft. Head. 347 lb.		
	Thick-ness, Ins.	Wt. per		Thick-ness, Ins.	Wt. per		Thick-ness, Ins.	Wt. per		Thick-ness, Ins.	Wt. per	
		Ft.	L'gth.		Ft.	L'gth.		Ft.	L'gth.		Ft.	L'gth.
6	0.58	41.7	500	0.61	43.3	520	0.65	47.1	565	0.69	49.6	595
8	.66	61.7	740	.71	65.7	790	.75	70.8	850	.80	75.0	900
10	.74	86.3	1035	.80	92.1	1105	.86	100.9	1210	.92	106.7	1280
12	.82	113.8	1365	.89	122.1	1465	.97	135.4	1625	1.04	143.8	1725
14	.90	145.0	1740	.99	157.5	1890	1.07	174.2	2090	1.16	186.7	2240
16	.98	179.6	2155	1.08	195.4	2345	1.18	219.2	2620	1.27	232.5	2790
18	1.07	220.4	2645	1.17	238.4	2860	1.28	267.1	3205	1.39	286.7	3440
20	1.15	263.0	3155	1.27	286.3	3435	1.39	320.8	3850	1.51	344.6	4135
24	1.31	359.6	4315	1.45	392.9	4715
30	1.55	521.7	6260	1.73	585.4	7025
36	1.80	725.0	8700	2.02	820.0	9840

The above weights are per length to lay 12 feet, including standard sockets; proportionate allowance to be made for any variation.

Weight of Underground Pipes. (Adopted by the Natl. Fire Protection Association, 1905). Weights are not to be less than those specified when the normal pressures do not exceed 125 lbs. per sq. in. When the normal pressures are in excess of 125 lbs. heavier pipes should be used. The weights given include sockets.

Pipe, ins.	4	6	8	10	12	14	16
Weights per foot, lbs.	19	32	48	67	87	109	133

THICKNESS OF CAST-IRON WATER-PIPES.

P. H. Baermann, in a paper read before the Engineers' Club of Philadelphia in 1882, gave twenty different formulas for determining the thickness of cast-iron pipes under pressure. The formulas are of three classes:

1. Depending upon the diameter only.
 2. Those depending upon the diameter and head, and which add a constant.
 3. Those depending upon the diameter and head, contain an additive or subtractive term depending upon the diameter, and add a constant.
- The more modern formulas are of the third class, and are as follow:

$t = 0.00008hd + 0.1d + 0.36$	Shedd,	No. 1.
$t = 0.00006hd + 0.0133d + 0.296$	Warren Foundry,	No. 2.
$t = 0.000058hd + 0.0152d + 0.312$	Francis,	No. 3.
$t = 0.000048hd + 0.013d + 0.32$	Dupuit,	No. 4.
$t = 0.00004bd + 0.1\sqrt{d} + 0.15$	Box,	No. 5.
$t = 0.000135hd + 0.4 - 0.0011d$	Whitman,	No. 6.
$t = 0.00006(h + 230)d + 0.333 - 0.0033d$	Fanning,	No. 7.
$t = 0.00015hd + 0.25 - 0.0052d$	Meggs,	No. 8.

In which t = thickness in inches, R = head in feet, d = diameter in inches. For $R = 100$ ft., and $d = 10$ in., formula? Nos. 1 to 7 inclusive give to from 0.49 to 0.54 in., but No. 8 gives only 0.35 in. Fanning's formula, now (1908) in most common use, gives 0.50 in.

Rankine (*Civil Engineering*, p. 721) says: "Cast-iron pipes should be made of a soft and tough quality of iron. Great attention should be paid to molding them correctly, so that the thickness may be exactly uniform all round. Each pipe should be tested for air-bubbles and flaws by ringing it with a hammer, and for strength by exposing it to double the intended greatest working pressure." The rule for computing the thickness of a pipe to resist a given working pressure is $t = rp/f$, where r is the radius in inches, p the pressure in pounds per square inch, and f the tensile strength of the iron per square inch. When $f = 18,000$, and a factor of safety of 5 is used, the above expressed in terms of d and h becomes $t = 0.5d \times 0.433h \div 3600 = 0.00006dh$.

There are limitations, however, arising from difficulties in casting, and by the strain produced by shocks, which cause the thickness to be made greater than that given by the above formula." (See also Bursting Strength of Cast-iron Cylinders, under "Cast Iron.")

The most common defect of cast-iron pipes is due to the "shifting of the core," which causes one side of the pipe to be thinner than the other. Unless the pipe is made of very soft iron the thin side is apt to be chilled in casting, causing it to become brittle and it may contain blow-holes and "cold-shots." This defect should be guarded against by inspection of every pipe for uniformity of thickness.

Safe Pressures and Equivalent Heads of Water for Cast-iron Pipe of Different Sizes and Thicknesses.

(Calculated by F. H. Lewis, from Fanning's Formula.)

Thickness.	Size of Pipe.																		
	4"		6"		8"		10"		12"		14"		16"		18"		20"		
	Pressure in Lbs.	Head in Ft.	Pressure in Lbs.	Head in Ft.	Pressure in Lbs.	Head in Ft.	Pressure in Lbs.	Head in Ft.	Pressure in Lbs.	Head in Ft.	Pressure in Lbs.	Head in Ft.	Pressure in Lbs.	Head in Ft.	Pressure in Lbs.	Head in Ft.	Pressure in Lbs.	Head in Ft.	
7/16.....	112	258	49	112	18	42													
1/2.....	224	516	124	286	74	171	44	101	24	55									
9/16.....	336	774	199	458	130	300	89	205	62	143	42	97							
5/8.....			274	631	186	429	132	304	99	228	74	170	56	129	41	95			
11/16.....							177	408	137	316	106	244	84	194	66	152	51	118	
3/4.....							224	516	174	401	138	316	112	258	91	210	74	170	
13/16.....									212	488	170	392	140	323	116	267	96	221	
7/8.....									249	574	202	465	168	387	141	325	119	274	
15/16.....											234	538	196	452	166	382	141	325	
1.....											266	612	224	516	191	440	164	378	
1 1/8.....															216	497	209	481	
1 1/4.....																	256	589	

Safe Pressures, etc., for Cast-iron Pipe. — (Continued.)

Thickness.	Size of Pipe.																		
	22"		24"		27"		30"		33"		36"		42"		48"		60"		
	Pressure in Lbs.	Head in Ft.	Pressure in Lbs.	Head in Ft.	Pressure in Lbs.	Head in Ft.	Pressure in Lbs.	Head in Ft.	Pressure in Lbs.	Head in Ft.	Pressure in Lbs.	Head in Ft.	Pressure in Lbs.	Head in Ft.	Pressure in Lbs.	Head in Ft.	Pressure in Lbs.	Head in Ft.	
11/16.....	4	92	30	69	19	64													
3/4.....	6	138	49	113	36	83	24	55											
13/16.....	8	184	68	157	52	120	39	90											
7/8.....	10	233	86	198	69	159	54	124	42	97	3	74							
15/16.....	12	279	105	242	85	196	69	159	55	127	4	81							
1.....	14	327	124	286	102	235	84	194	69	159	5	91	38	88	24	55			
1 1/8.....	18	419	161	371	135	311	114	263	96	221	8	107	59	136	43	99			
1 1/4.....	22	516	199	458	169	389	144	332	124	286	10	127	81	187	62	143	34	78	
1 3/8.....			237	546	202	465	174	401	151	348	13	154	103	237	81	187	49	113	
1 1/2.....					236	544	204	470	178	410	15	162	124	286	99	228	64	147	
1 5/8.....							234	538	205	472	18	179	145	334	116	272	79	182	
1 3/4.....									233	537	20	177	167	385	136	313	94	217	
1 7/8.....													188	433	155	357	109	251	
2.....														210	484	174	401	124	286
2 1/8.....															193	445	139	320	
2 1/4.....															212	488	154	355	
2 1/2.....																	184	424	
2 3/4.....																		214	482

NOTE. — The absolute safe static pressure which may be put upon pipe is given by the formula $P = 2TS/5D$, in which formula P is the pressure per square inch; T , the thickness of the shell; S , the ultimate strength per square inch of the metal in tension; and D , the inside diameter of the pipe. In the tables S is taken as 18,000 pounds per square inch, with a working strain of one-fifth this amount or 3600 pounds per square inch. The formula for the absolute safe static pressure then is: $P = 7200/D$.

It is, however, usual to allow for "water-ram" by increasing the thickness enough to provide for 100 pounds additional static pressure, and, to insure sufficient metal for good casting and for wear and tear, a further increase equal to $0.333(1 - 0.01D)$.

The expression for the thickness then becomes

$$T = \frac{(P + 100)D}{7200} + 0.333 \left(1 - \frac{D}{100}\right),$$

and for safe working pressure

$$P = \frac{7200}{D} \left(T - 0.333 \left(1 - \frac{D}{100}\right)\right) - 100.$$

The additional section provided as above represents an increased value under static pressure for the different sizes of pipe as follows (see table in margin). So that to test the pipes up to one-fifth of the ultimate strength of the material, the pressures in the marginal table should be added to the pressure-values given in the table above.

Size of Pipe.	Lbs.
4"	676
6	476
8	346
10	316
12	276
14	248
16	226
18	209
20	196
22	185
24	176
27	165
30	156
33	149
36	143
42	133
48	126
60	116

CAST-IRON PIPE-FITTINGS.

Approximate Weights (The Massillon Iron & Steel Co.).

Inches.	Crosses.	Tees.	Inches.	Crosses.	Tees.	Inches.	Crosses.	Tees.	Inches.	Crosses.	Tees.
3x3	85	65	14x14	665	525	20x12	900	800	36x36	4160	3490
4x4	115	90	14x10	530	445	20x8	665	665	36x30	3475	3010
4x3	105	85	14x6	390	350	20x3	565	545	36x24	2920	2585
6x6	165	130	14x3	330	310	24x24	1800	1565	36x20	2550	2315
6x3	125	105	16x16	810	735	24x18	1480	1280	36x18	2370	2175
8x8	290	230	16x12	715	615	24x14	1215	1085	36x16	2240	2070
8x6	230	195	16x8	585	520	24x10	1035	945	36x14	2060	1930
8x4	205	175	16x3	415	395	24x6	840	800	36x12	1940	1835
8x3	185	165	18x18	1055	860	24x3	725	705	36x10	1810	1730
10x10	380	300	18x14	865	735	30x30	2850	2415	36x8	1700	1635
10x6	280	240	18x10	695	610	30x20	2020	1790	36x6	1555	1515
10x3	225	205	18x3	550	510	30x16	1755	1585	36x4	1445	1415
12x12	495	395	20x20	1335	1100	30x8	1255	1190	36x3	1380	1360
12x8	405	345	20x16	1100	935	30x4	1030	1005			
12x3	275	255									

These tables are greatly abridged from the original, many intermediate sizes being omitted.

Inches.	Branches.			Inches.	Branches.			Inches.	Branches.		
	30°	45°	60°		30°	45°	60°		30°	45°	60°
3x3	70	70	60	14x3	360	295	305	24x16	1865	1520	1345
4x4	115	95	85	16x16	1185	910	815	24x12	1500	1235	1100
4x3	100	80	75	16x12	885	710	635	24x8	1175	1055	915
6x6	180	145	130	16x8	670	560	520	24x3	825	770	695
6x3	135	105	100	16x3	460	385	385	30x30	4445	3390	2905
8x8	310	250	230	18x18	1415	1080	935	30x20	3005	2365	2220
8x6	240	205	190	18x14	1105	865	770	30x16	2475	2025	1770
8x3	185	160	150	18x10	850	670	635	30x12	1990	1695	1495
10x10	450	370	320	18x6	630	510	500	30x8	1630	1400	1250
10x6	300	255	235	18x3	510	435	410	30x3	1180	1125	960
10x3	235	195	190	20x20	1935	1455	1400	36x36	6595	4565	4115
12x12	650	545	445	20x16	1550	1190	1045	36x24	4405	3335	2990
12x8	470	385	345	20x12	1195	935	860	36x18	3370	2695	2360
12x3	300	255	240	20x8	930	750	690	36x14	2805	2340	2050
14x14	830	650	565	20x3	635	550	520	36x10	2295	2040	1760
14x10	625	505	455	24x24	2795	2140	1840	36x6	1860	1610	1415
14x6	450	365	355	24x18	2035	1675	1450	36x3	1505	1360	1245

Split Tees.

3x3	65	8x8	165	12x8	275	16x8	380	20x8	595	30x3	1090
4x4	85	8x3	125	12x3	325	18x8	340	20x3	555	36x8	1460
6x6	115	10x8	220	14x8	285	18x3	465	24x8 30x8	1130 780	36x3	1420
4x3	100	10x3	180	14x3							

Split Sleeves.

Inches.	Branches.			Inches.	Branches.			Inches.	Branches.		
	30°	45°	60°		30°	45°	60°		30°	45°	60°
3	50	8	110	12	220	16	325	20	540	30	1075
4	60	10	165	14	270	18	430	24	725	36	1405
6	85										

Taper Plugs.

3	7	8	25	12	60	16	95	20	170	30	430
4	10	10	40	14	80	18	135	260		36	600
6	20										

Reducers.

6x4	50	10x8		14x12	295	16x6	220	20x14	430	30x24	865
6x3	70	10x3	175	14x8	220	18x16 18x12	435 345	24x20 20x10	380 645	30x18 36x30	1455 825
8x6	60	12x10	225	14x4	165	20x18 18x8	355 290	24x16 24x12	485 555	36x18	950
8x3	100	12x6	165	16x14 16x10	140						
8x3	55	12x3	165								

Increases.

3x4	55	4x14	210	8x14	235	12x14	300	16x18	455	20x36	1310
3x8	95	6x8	115	8x18	320	12x18	385	16x30	965	24x30	940
4x6	165	6x12	195	10x12	245	12x24	510	18x20	485	24x36	1380
4x10	150 75	6x16 8x10	275 190	10x16 10x20	335 410	14x16 14x24	375 600	20x24 18x36	1220 700	30x38	1475

Size.	Elbows.	45° bends.	22 1/2° bends.	Shoe elbows.	S. pieces.	Drp boxes.	90° Y pipes.	60° Y pipes.	45° Y pipes.	30° Y pipes.	Caps.	Sleeves.
3	50	40	35	75	50	355	50	55	65	70	20	35
4	60	50	45	105	70	370	70	75	85	95	25	45
6	95	70	60	145	115	395	95	105	120	125	40	60
8	155	115	100	210	190	450	160	175	205	210	60	75
10	215	160	130	360	295	485	200	235	270	290	85	100
12	290	210	170	450	420	575	265	300	380	425	110	125
14	355	260	210	595	500	690	320	360	480	520	145	150
16	495	355	280	640	775	890	415	500	615	755	165	175
18	575	405	320	880	910	1080	475	565	735	875	235	200
20	745	515	410	1160	1195	1190	580	725	950	1135	290	240
24	1040	715	555	1590	1680	1785	830	1000	1330	1600	435	345
30	1580	1060	800	2450	2345	2410	1145	1470	20435	2270	680	475
36	2230	1490	1120	3540	3495	3225	1600	2070	2720	3315	1015	630

STANDARD PIPE FLANGES (CAST IRON).

Adopted August, 1894, at a conference of committees of the American Society of Mechanical Engineers, and the Master Steam and Hot Water Fitters' Association with representatives of leading manufacturers and users of pipe. — *Trans. A. S. M. E.*, xxi, 29.

The list is divided into two groups: for medium and high pressures, the first ranging up to 75 lbs. per square inch, and the second up to 200 lbs.

Pipe Size, Inches.	Pipe Thickness, $P + \frac{0.333}{0.46} d + 0.333 (1 - \frac{d}{100})$	Thickness, Nearest Fraction, Inches.	Stress on Pipe per Square Inch at 200 Lbs.	Radius of Fillet, Inches.	Flange Diameters, Inches.	Flange Thicknesses at Edge, Inches.	Width Flange Face, Inches.	Bolt Circle Diameter, Inches.	Number of Bolts.	Bolt Diameter, Inches.	Bolt Length, Inches.	Stress on Each Bolt, per Square Inch, at Bottom of Thread at 200 Lbs.
2	0.409	7/16	460	1/8	6	5/8	2	4 3/4	4	5/8	2	825
2 1/2	.429	7/16	550	1/8	7	11/16	2 1/4	5 1/2	4	5/8	2 1/4	1050
3	.448	7/16	690	1/8	7 1/2	3/4	2 1/4	6	4	5/8	2 1/2	1330
3 1/2	.466	1/2	700	1/8	8 1/2	13/16	2 1/2	7	4	5/8	2 1/2	2530
4	.486	1/2	800	1/8	9	15/16	2 1/2	7 1/2	4	3/4	2 3/4	2100
4 1/2	.498	1/2	900	1/8	9 1/4	15/16	2 3/8	7 3/4	8	3/4	3	1430
5	.525	1/2	1000	1/8	10	15/16	2 3/8	8 1/2	8	3/4	3	1630
6	.563	9/16	1060	1/8	11	1	2 1/2	9 1/2	8	3/4	3	2360
7	.60	5/8	1120	1/8	12 1/2	1 1/16	2 3/4	10 3/4	8	3/4	3 1/4	3200
8	.639	5/8	1280	1/8	13 1/2	1 1/8	2 3/4	11 3/4	8	3/4	3 1/2	4190
9	.678	11/16	1310	3/16	15	1 1/8	3	13 1/4	12	3/4	3 1/2	3610
10	.713	3/4	1330	3/16	16	1 3/16	3	14 1/4	12	7/8	3 5/8	2970
12	.79	13/16	1470	3/16	19	1 1/4	3 1/2	17	12	7/8	3 3/4	4280
14	.864	7/8	1600	3/16	21	1 3/8	3 1/2	18 3/4	12	1	4 1/4	4280
15	.904	15/16	1600	3/16	22 1/4	1 3/8	3 5/8	20	16	1	4 1/4	3660
16	.946	1	1600	3/16	23 1/2	1 7/16	3 3/4	21 1/4	6	1	4 1/4	4210
18	1.02	1 1/16	1690	3/16	25	1 9/16	3 1/2	22 3/4	6	1 1/8	4 3/4	4540
20	1.09	1 1/8	1780	3/16	27 1/2	1 11/16	3 3/4	25	20	1 1/8	5	4490
22	1.18	1 3/16	1850	1/4	29 1/2	1 13/16	3 3/4	27 1/4	20	1 1/4	5 1/2	4320
24	1.25	1 1/4	1920	1/4	31 1/2	1 7/8	3 3/4	29 1/4	20	1 1/4	5 1/2	5130
26	1.30	1 5/16	1980	1/4	33 3/4	1 3/4	3 7/8	31 1/4	24	1 1/4	5 3/4	5030
28	1.38	1 3/8	2040	1/4	36	1 7/8	4	33 1/2	28	1 1/4	6	5000
30	1.48	1 1/2	2000	1/4	38	2 1/8	4	35 1/2	28	1 3/8	6 1/4	4590
36	1.71	1 3/4	1920	1/4	44 1/2	2 3/8	4 1/4	42 3/4	32	1 3/8	6 1/2	5790
42	1.87	2	2100	1/4	51	2 5/8	4 1/2	49 1/2	36	1 1/2	7 1/4	5700
48	2.17	2 1/4	2130	1/4	57 1/2	3 3/4	4 3/4	54 3/4	44	1 1/2	7 3/4	6090

NOTES. — Sizes up to 24 inches are designed for 200 lbs. or less. Sizes from 24 to 48 inches are divided into two scales, one for 200 lbs. the other for less.

The sizes of bolts given are for high pressure. For medium pressures the diameters are 1/8 in. less for pipes 2 to 20 in. diameter inclusive, and 1/4 in. less for larger sizes, except 48-in. pipe, for which the size of bolt is 1 3/8 in.

When two lines of figures occur under one heading, the single columns are for both medium and high pressures. Beginning with 24 inches, the left-hand columns are for medium and the right-hand lines are for high pressures.

The sudden increase in diameters at 16 inches is due to the possible insertion of wrought-iron pipe, making with a nearly constant width of gasket a greater diameter desirable.

When wrought-iron pipe is used, if thinner flanges than those given are sufficient, it is proposed that bosses be used, to bring the nuts up to the standard length. This avoids the use of a reinforcement around the pipe.

Figures in the 3d, 4th, 5th, and last columns refer only to pipe for high pressure.

In drilling valve flanges a vertical line parallel to the spindles should be midway between two holes on the inner side of the flanges.

FLANGE DIMENSIONS, ETC., FOR EXTRA HEAVY PIPE FITTINGS (UP TO 250 LBS. PRESSURE).

Adopted by a Conference of Manufacturers, June 28, 1901.

Size of Pipe, Inches.	Diam. of Flange, Inches.	Thickness of Flange, Inches.	Diameter of Bolt Circle, Inches.	Number of Bolts.	Size of Bolts, Inches.
2	6 1/2	7/8	5	4	5/8
2 1/2	7 1/2	1	5 7/8	4	3/4
3	8 1/4	1 1/8	6 5/8	8	5/8
3 1/2	9	1 3/16	7 1/4	8	5/8
4	10	1 1/4	7 7/8	8	3/4
4 1/2	10 1/2	1 5/16	8 1/2	8	3/4
5	11	1 3/8	9 1/4	8	3/4
6	12 1/2	1 7/16	10 5/8	12	3/4
7	14	1 1/2	11 7/8	12	7/8
8	15	1 5/8	13	12	7/8
9	16	1 3/4	14	12	7/8
10	17 1/2	1 7/8	15 1/4	16	7/8
12	20	2	17 3/4	16	7/8
14	22 1/2	2 1/8	20	20	7/8
15	23 1/2	2 3/16	21	20	1
16	25	2 1/4	22 1/2	20	1
18	27	2 3/8	24 1/2	24	1
20	29 1/2	2 1/2	26 3/4	24	1 1/8
22	31 1/2	2 5/8	28 3/4	28	1 1/8
24	34	2 3/4	31 1/4	28	1 1/8

STANDARD STRAIGHT-WAY GATE VALVES.

(Crane Co.)

Iron Body. Brass Trimmings. Wedge Gate.

Dimensions in Inches: A, nominal size; B, face to face, flanged; C, diam. of flanges; D, thickness of flanges; K, end to end, screwed; N, center to top of non-rising stem; O, diam. of wheel; S, center to top of rising stem, open; P, size of by-pass; F, end to end, hub; T, diam. of hub; X, number of turns to open.

A	B	C	D	K	N	O	S	Y	P	X
1 1/2	6 1/2	5 1/4	9/16	5	10 1/2	5 1/2				6
2	7	6	5/8	5 7/16	11 3/4	5 1/2	14			7
2 1/2	7 1/2	7	11/16	5 7/8	12 3/4	5 1/2	15 3/4			8
3	8	7 1/2	3/4	6 1/8	14 1/4	6 1/2	18 1/2			10 1/4
3 1/2	8 1/2	8 1/2	13/16	6 1/2	15 1/4	7 1/2	20 3/4			10 1/8
4	9	9	15/16	6 7/8	16 1/4	9	23 1/2			8 3/4
4 1/2	9 1/2	9 1/4	15/16	7 1/4	17 5/8	9	24 3/4			9
5	10	10	15/16	7 5/16	19	10	28			11
6	10 1/2	11	1	7 3/4	20 3/4	10	31 3/4			12 5/8
7	11	12 1/2	1 1/16	8 1/4	23	12	37 1/4			15 1/4
8	11 1/2	13 1/2	1 1/8	8 11/16	26	14	41			16
9	12	15	1 1/8	9 1/4	28	14	44 1/4			18 3/4
10	13	16	1 3/16	9 7/8	30 1/4	16	49 1/2			20 1/2
12	14	19	1 1/4	11 5/8	35 1/4	18	57 1/4			24 1/8
14	15	21	1 3/8	13 1/4	39 1/4	20	66 1/2	19 1/2	2	28 1/4
15	15	22 1/4	1 3/8	14 1/8	41 1/8	20	69 3/4	21	2	31 1/2
16	16	23 1/2	1 7/16	14 3/4	42 3/4	22	74 3/4	23 3/4	3	33 1/4
18	17	25	1 9/16	15 1/8	48 3/4	24	86	24 3/4	3	35 1/2
20	18	27 1/2	1 11/16	15 7/8	52 1/2	24	91	27 3/4	4	42 1/4
22	19	29 1/2	1 13/16	16 1/2	55 1/2	27	100	29	4	46
24	20	32	1 7/8	17	62	30	109	30 1/2	4	50
26	23	34 1/4	2	17 3/8	65 7/8	33	117 1/2	32	4	65
28	26	36 1/2	2 1/16	18 1/8	70	36	125	33	4	80
30	30	38 3/4	2 1/8	19 1/4	75 1/2	36	133	34	4	92 1/2
36	36	45 3/4	2 3/8	23 1/8	83	39	158 1/2	39	6	108

WARNING: This is a 1910 edition. Some of the material may no longer be accurate

EXTRA HEAVY STRAIGHT-WAX GATE VALVES.
Ferrosteel. Hard Metal Seats. Wedge Gate.

A	B	K	C	D	N	S	O	P	Y	X
1 1/4	6 1/2	5 1/2	5	3/4	83/4	10 5/8	5			12
1 1/2	7 1/2	6 1/4	6	13/16	95/8	12 1/4	5 1/2			11
2	8 1/2	7	6 1/2	7/8	10 1/2	13 3/4	6 1/2			14
2 1/2	9 1/2	8	7 1/2	1	127/8	16	7 1/2			15
3	11 1/8	9	8 1/4	1 1/8	145/8	19 1/2	9			14
3 1/2	11 7/8	10	9	13/16	15 1/2	22	10			16
4	12	11	10	1 1/4	173/4	24 1/2	12			18
4 1/2	13 1/4	12 1/4	10 1/2	1 5/16	183/4	27	12			21
5	15	13 1/2	11	1 3/8	20 1/4	29 3/4	14			23
6	15 7/8	15 7/8	12 1/2	1 7/16	23	34 1/8	16	1 1/4	13	28
7	16 1/4	16 1/4	14	1 1/2	24 3/4	38	18	1 1/4	14 1/8	30
8	16 1/2	16 1/2	15	1 5/8	28 3/4	42 3/4	20	1 1/2	15 7/8	34
9	17	17	16	1 3/4	30 1/2	47	20	1 1/2	16 3/8	40
10	18	18	17 1/2	1 7/8	33 3/4	52 3/4	22	1 1/2	16 7/8	39
12	19 3/4		20	2	37 1/4	60	24	2	19 7/8	46
14	22 1/2		22 1/2	2 1/8	42 3/4	67 3/4	24	2	20 5/8	52
15	22 1/2		23 1/2	2 3/16	42 3/4	67 3/4	24	2	20 5/8	52
16	24		25	2 1/4		75 1/4	27	3	25 1/4	60
18	26		27	2 3/8		82 1/4	30	3	26 1/2	67
20	28		29 1/2	2 1/2		91 1/2	30	4	30 1/2	74
22	29 1/2		31 1/2	2 5/8		101	36	4	32 1/4	82
24	31		34	2 3/4		109	36	4	33	88

For dimensions of Medium Valves and Extra Heavy Hydraulic Valves, See Crane Company's Catalogue

FORGED AND ROLLED STEEL FLANGES.

Dimensions in Inches. (American Spiral Pipe Works, 1908.)

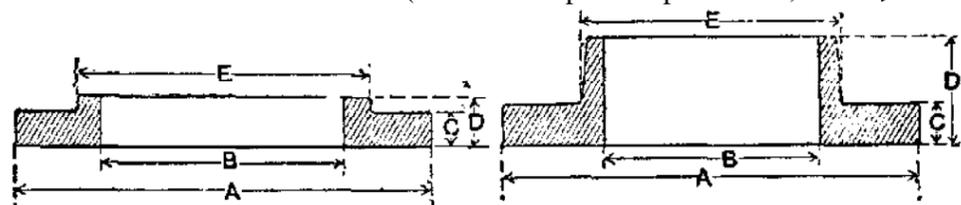

Standard Companion Flanges.					Standard Shrink Flanges.						
Nominal Size, Inches.	Outside Diam.	Actual Bore	Thick-ness.	Depth of Hub.	Diam. of Hub.	Nominal Size, Inches.	Outside Diam.	Bore Diam.	Thick-ness.	Depth of Hub.	Diam. of Hub.
	A	B	C	D	E		A	B	C	D	E
2	6	2 1/8	5/8	1	3 1/8	4	9	4 3/8	1 5/16	2 3/16	5 3/4
2 1/2	7	2 1/2	1 1/16	1 1/16	3 5/8	4 1/2	9 1/4	4 7/8	1 5/16	2 1/4	6 1/8
3	7 1/2	3 1/8	3/4	1 1/8	4 5/8	5	10	5 7/16	1 5/16	2 5/16	6 7/8
3 1/2	8 1/2	3 5/8	13/16	1 3/16	4 7/8	5	10	6 1/2	1	2 7/16	7 7/8
4	9	4 1/8	1 3/16	1 3/16	5 3/8	6	11	7 1/2	1 1/16	3	9
4 1/2	9 1/4	4 5/8	1 5/16	1 1/4	5 13/16	6	11	8 1/2	1 1/8	2 5/8	10 1
5	10	5 1/8	1 5/16	1 5/16	6 7/16	7	12	9 1/2	1 1/8	2 3/4	11 1/8
6	11	6 3/16	1 1/16	1 1/2	7 9/16	8	13	10 5/8	1 3/8	3	12 1/8
7	12 1/2	7 3/16	1 1/16	1 1/2	8 5/8	9	14	11 7/8	1 3/8	3 3/8	13 1/8
8	13 1/2	8 3/16	1 1/8	1 5/8	9 11/16	10	15	12 5/8	1 1/4	3 3/8	14 7/8
9	15	9 3/16	1 1/8	1 3/4	10 5/8	11	16	13 7/8	1 3/8	3 1/2	16
10	16	10 5/16	1 3/16	1 7/8	11 15/16	12	17	14 7/8	1 3/8	3 5/8	17 1/2
12	19	12 5/16	1 1/4	2 1/16	14 1/8	14	21	17 7/8	1 9/16	3 7/8	20 1/8
14	21	13 1/2	1 3/8	2 3/16	15 7/16	16	23 1/2	19 7/8	1 11/16	4 1/8	22 1/4

FORGED AND ROLLED STEEL FLANGES. — Continued

Extra Heavy Companion Flanges. Extra Heavy High Hub Flanges.

Nominal Size, Inches.	Extra Heavy Companion Flanges.					Extra Heavy High Hub Flanges.					
	Outside Diam.	Bore Diam.	Thick-ness.	Depth of Hub.	Diam. of Hub.	Nominal Size, Inches.	Outside Diam.	Bore.	Thick-ness.	Depth of Hub.	Diam. of Hub.
	A	B	C	D	E		A	B	C	D	E
2	6 1/2	2 1/8	7/8	1 3/8	3 3/8	4	10	4 3/8	1 1/8	3 1/8	5 3/4
2 1/2	7 1/2	2 1/2	1	1 7/16	4 1/16	4 1/2	10 1/2	4 7/8	1 1/4	3 1/4	6 1/4
3	8 1/4	3 1/8	1	1 9/16	4 11/16	5	11	5 7/16	1 1/4	3 1/4	7
3 1/2	9	3 5/8	1 1/8	1 5/8	5 5/16	5	12 1/2	6 1/2	1 1/4	3 1/4	7 15/16
4	10	4 1/8	1 1/8	1 3/4	5 13/16	6	14	7 1/2	1 5/16	3 3/8	9 1/8
4 1/2	10 1/2	4 5/8	1 1/4	1 13/16	6 1/4	6	15	8 1/2	1 3/8	3 1/2	10 5/16
5	11	5 1/8	1 1/4	1 7/8	6 13/16	7	16	9 1/2	1 7/16	3 5/8	11 3/8
6	12 1/2	6 3/16	1 1/4	2	7 7/8	8	17 1/2	10 5/8	1 1/2	3 3/4	12 5/8
7	14	7 3/16	1 5/16	2 1/16	9 1/8	9	18 3/4	11 5/8	1 9/16	3 7/8	13 5/8
8	15	8 3/16	1 3/8	2 3/16	10 1/8	10	20	12 5/8	1 5/8	4	14 3/4
9	16	9 3/16	1 7/16	2 1/4	11 3/16	11	22 1/2	13 7/8	1 3/4	4 3/8	16 3/16
10	17 1/2	10 5/16	1 1/2	2 3/8	12 9/16	12	23 1/2	14 7/8	1 13/16	4 1/2	17 1/4
12	20	12 5/16	1 5/8	2 9/16	14 5/8	14	25	15 7/8	1 7/8	4 3/4	18 1/2
14	22 1/2	13 1/2	1 3/4	2 11/16	15 13/16	16	27	17 7/8	2	5	20 3/4
15	23 1/2	14 1/2	1 13/16	2 13/16	17 3/16	18	29 1/2	19 7/8	2 1/4	5 1/2	22 1/2
16	25	15 1/2	1 7/8	3 1/16	18 1/4	20					

Forged Steel Flanges for Riveted Pipe.

Riveted Pipe Manufacturers' Standard.*

Nominal Size, Ins.	Outside Diam.	Thick-ness of Flange.*	No. of Bolts.	Size of Bolts.	Diam. of Bolt Circle.	Nominal Size, Ins.	Outside Diam.	Thick-ness of Flange.*	No. of Bolts	Size of Bolts.	Diam. of Bolt Circle.
3	6	5/16	4	7/16	4 3/4	16	21 1/4	5/8	12	1 1/2	19 1/4
4	7	5/16	8	7/16	5 5/16	18	23 1/4	5/8	16	5/8	21 1/4
5	8	5/16	8	7/16	6 5/16	20	25 1/4	5/8	16	5/8	23 1/8
6	9	3/8	8	1/2	7 7/8	22	28 1/4	11/16	16	5/8	26
7	10	3/8	8	1/2	9	24	30	11/16	16	5/8	27 3/4
8	11	3/8	8	1/2	10	26	32	1 3/8	24	3/4	29 3/4
9	13	3/8	8	1/2	11 1/4	28	34	1 3/8	28	3/4	31 3/4
10	14	3/8	12	1/2	12 1/4	30	36	1 3/8	28	3/4	33 3/4
11	15	7/16	12	1/2	13 3/8	32	38	1 3/8	28	3/4	35 3/4
12	16	7/16	12	1/2	14 1/4	34	40	1 1/2	28	3/4	37 3/4
13	17	7/16	12	1/2	15 1/4	36	42	1 1/2	32	3/4	39 3/4
14	18	7/16	12	1/2	16 1/4	40	46	1 1/2	32	3/4	43 3/4
15	19	9/16	12	1/2	17 7/16						

* Flanges for riveted pipe are also made with the outside diameter and the drilling dimensions the same as those of, the A. S. M. E. standard (page 198), and with the thickness as given in the second column of figures under "Thickness of Flange" in the above table.

Curved Forged Steel Flanges are also made for boilers and tanks. See catalogue of American Spiral Pipe Works, Chicago.

The Rockwood Pipe Joint. -The system of flanged joints now in common use for high pressures, made by slipping a Hange over the pipe, expanding the end of the pipe by rolling or peening, and then facing it in a athe, so that when the flanges of two pipes are bolted together the bearing of the joint is on the ends of the pipe's themselves and not on the Ranges, was patented by George I. Rockwood, April 5, 1897, No. 580,058, and first described in *Eng. Rec.*, July 20, 1895. The joint as made by different manufacturers is known by various trade names, as Walmanco, Van Stone, etc.

WROUGHT-IRON (OR STEEL) WELDED PIPE.

For discussion of the Briggs Standard of Wrought-iron Pipe Dimensions, see Report of the Committee of the A. S. M. E. in "Standard Pipe and Pipe Threads," 1886. *Trans.*, Vol. VIII, p. 29. The diameter of the bottom of the thread is derived from the formula $D - (0.05D + 1.9) \times \frac{1}{n}$, in which D = outside diameter of the tubes, and n the number of threads to the inch. The diameter of the top of the thread is derived from the formula $0.8 \frac{1}{n} \times 2 + d$, or $1.6 \frac{1}{n} + d$, in which d is the diameter at the bottom of the thread at the end of the pipe.
(Continued on page 207).

FORMS OF CAST-IRON FLANGES. (See tables on pages 203 to 206:)

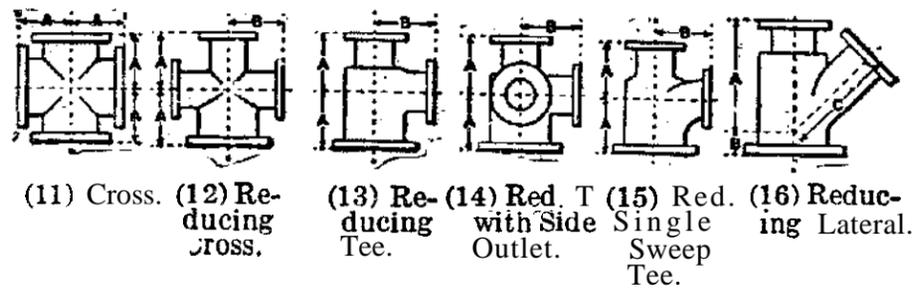
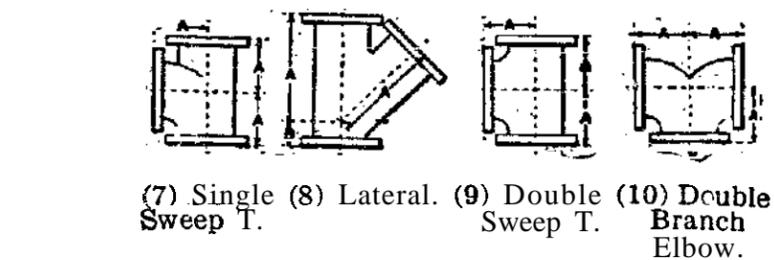
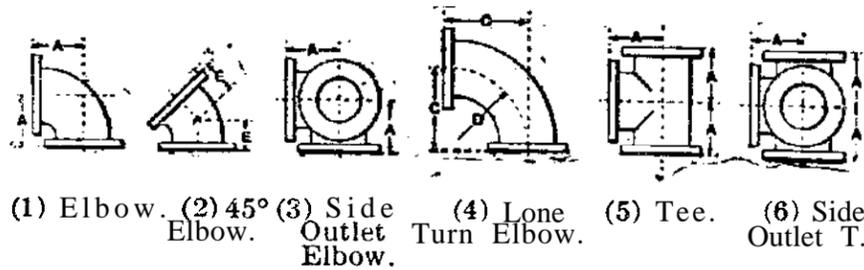

DIMENSIONS OF STANDARD CAST-IRON FLANGED FITTINGS.

For Steam Working Pressures up to 125 Pounds. (Crane Company, 1908.)

Size.....	1/4	1/2	3/4	1	1 1/2	2	2 1/2	3	4	5	6	7	8	9	10	12	14	15	16	
AA-Face to Face.....	1 1/2	2	2 1/2	3	4	5	6	7	8	9	10	11	12	13	14	15	16	17 1/2	18 1/2	19 1/2
A-Center to Face.....	1 1/4	1 3/4	2 1/4	3 1/4	4 1/4	5 1/4	6 1/4	7 1/4	8 1/4	9 1/4	10 1/4	11 1/4	12 1/4	13 1/4	14 1/4	15 1/4	16 1/4	17 1/4	18 1/4	19 1/4
B-Center to Face.....	1 1/2	2 1/4	3 1/4	4 1/4	5 1/4	6 1/4	7 1/4	8 1/4	9 1/4	10 1/4	11 1/4	12 1/4	13 1/4	14 1/4	15 1/4	16 1/4	17 1/4	18 1/4	19 1/4	20 1/4
C-Center to Face.....	1 1/2	2 1/4	3 1/4	4 1/4	5 1/4	6 1/4	7 1/4	8 1/4	9 1/4	10 1/4	11 1/4	12 1/4	13 1/4	14 1/4	15 1/4	16 1/4	17 1/4	18 1/4	19 1/4	20 1/4
D-Radius, Long Radius Ells.....	1 1/2	2 1/4	3 1/4	4 1/4	5 1/4	6 1/4	7 1/4	8 1/4	9 1/4	10 1/4	11 1/4	12 1/4	13 1/4	14 1/4	15 1/4	16 1/4	17 1/4	18 1/4	19 1/4	20 1/4
E-Radius, Long Radius Ells.....	1 1/2	2 1/4	3 1/4	4 1/4	5 1/4	6 1/4	7 1/4	8 1/4	9 1/4	10 1/4	11 1/4	12 1/4	13 1/4	14 1/4	15 1/4	16 1/4	17 1/4	18 1/4	19 1/4	20 1/4
Diameter of Flange.....	1 1/2	2 1/4	3 1/4	4 1/4	5 1/4	6 1/4	7 1/4	8 1/4	9 1/4	10 1/4	11 1/4	12 1/4	13 1/4	14 1/4	15 1/4	16 1/4	17 1/4	18 1/4	19 1/4	20 1/4
Thickness of Flange.....	1 1/2	2 1/4	3 1/4	4 1/4	5 1/4	6 1/4	7 1/4	8 1/4	9 1/4	10 1/4	11 1/4	12 1/4	13 1/4	14 1/4	15 1/4	16 1/4	17 1/4	18 1/4	19 1/4	20 1/4
Number of Bolts.....	1 1/2	2 1/4	3 1/4	4 1/4	5 1/4	6 1/4	7 1/4	8 1/4	9 1/4	10 1/4	11 1/4	12 1/4	13 1/4	14 1/4	15 1/4	16 1/4	17 1/4	18 1/4	19 1/4	20 1/4
Size of Bolts.....	1 1/2	2 1/4	3 1/4	4 1/4	5 1/4	6 1/4	7 1/4	8 1/4	9 1/4	10 1/4	11 1/4	12 1/4	13 1/4	14 1/4	15 1/4	16 1/4	17 1/4	18 1/4	19 1/4	20 1/4
Length of Bolts.....	1 1/2	2 1/4	3 1/4	4 1/4	5 1/4	6 1/4	7 1/4	8 1/4	9 1/4	10 1/4	11 1/4	12 1/4	13 1/4	14 1/4	15 1/4	16 1/4	17 1/4	18 1/4	19 1/4	20 1/4
Bolt Circle.....	1 1/2	2 1/4	3 1/4	4 1/4	5 1/4	6 1/4	7 1/4	8 1/4	9 1/4	10 1/4	11 1/4	12 1/4	13 1/4	14 1/4	15 1/4	16 1/4	17 1/4	18 1/4	19 1/4	20 1/4

Reducing Fittings, sizes 1 1/4 to 9 inch, inclusive, the dimensions do not change from above table by any reductions in the size of run or outlet except Double Sweep Tees, in which the reduced end is longer than the regular fitting.

VARIATIONS FROM THE ABOVE GENERAL DIMENSIONS OF STANDARD FLANGED FITTINGS, SIZES 10 TO 16 INCH WITH SMALL OUTLET, SHORT BODY PATTERN.

Size.....	10	12	14	15	16
Outlets.....	8 and smaller	8 and smaller	9 and smaller	9 and smaller	10 and smaller
AA-Face to Face.....	18	20	22	23	24
A-Center to Face.....	9	10	11	11 1/2	12
B-Center to Face of Outlets.....	9 1/2	11	13	13 1/2	14

If the outlet is larger than given in this lower table, use the upper table of Long Body Pattern.

DIMENSIONS OF EXTRA HEAVY FLANGED FITTINGS, CAST-IRON, FERROSTEEL OR CAST STEEL 204
For Steam Working Pressures up to 250 Pounds.

Size.....In.	1 1/4	1 1/2	2	2 1/2	3	3 1/2	4	4 1/2	5	6	6	7	8	9	10	12	14	15	16	18	20	22	24
A-Face to Face.....In.	8 1/2	9	10	11	12	13	14	15	16	17	18	19	20	21	23	26	29	30	32	34	37	40	44
A-Center to Face.....In.	4 1/4	4 1/2	5	5 1/2	6	6 1/2	7	7 1/2	8	8 1/2	9	10	10 1/2	11 1/2	13	14 1/2	15	16	17	18 1/2	20	22	
B-Center to Face.....In.	4 1/4	4 1/2	5	5 1/2	6	6 1/2	7	7 1/2	8	8 1/2	9	10	10 1/2	11 1/2	13	14 1/2	15	16	17	18 1/2	20	22	
C-Center to Face of Long Radius Ells.....In.		6 1/2	7	7 3/4	8 1/2	9	9 1/2	10 1/4	11 1/2	12 3/4	14	15 1/4	16 1/2	19	21 1/2	22 3/4	24	26 1/2	29	31 1/2	34		
D-Radius of Long Radius Ells.....In.	5 1/4	5 5/8	6 1/4	6 7/8	7 3/8	7 3/4	8 1/2	9 5/8	10 7/8	12	13	14 1/8	16 1/2	18 7/8	20	21 1/4	23 5/8	26	28 3/8	30 3/4			
E-Center to Face of 45° Ells.....In.	2 1/2	2 3/4	3	3 1/2	3 1/2	4	4 1/2	4 1/2	5	5 1/2	6	6	6 1/2	7	8	8	8 1/2	9	9 1/2	10	10 1/2	11 1/2	
Diameter of Flange.....In.	5	6	6 1/2	7 1/2	8 1/4	9	10	10 1/2	11	12 1/2	14	15	16	17 1/2	20	22 1/2	23 1/2	25	27	29 1/2	31 1/2	34	
Thickness of Flange.....In.	3/4	13/16	7/8	1	1 1/8	1 3/16	1 1/4	1 5/16	1 3/8	1 7/16	1 1/2	1 5/8	1 3/4	1 7/8	2	2 1/8	2 3/16	2 1/4	2 5/8	2 1/2	2 5/8	2 3/4	
Number of Bolts.....	4	4	4	4	8	8	8	8	8	12	12	12	12	12	16	16	20	20	20	24	24	28	
Size of Bolts.....In.	1 1/2	5/8	5/8	3/4	5/8	5/8	3/4	5/8	3/4	7/8	7/8	7/8	7/8	7/8	7/8	7/8	1	1	1	1 1/8	1 1/8	1 1/8	
Length of Bolts.....In.	2 1/4	2 1/2	2 1/2	3	3	3 1/4	3 1/2	3 1/2	3 3/4	3 3/4	4	4 1/4	4 1/2	4 3/4	5	5 1/4	5 1/2	5 3/4	6	6 1/2	6 3/4	7	
Bolt Circle.....In.	3 3/4	4 1/2	5	5 7/8	6 5/8	7 1/4	7 7/8	8 1/2	9 1/4	10 5/8	11 7/8	13	14	15 1/4	17 3/4	20	21	22 1/2	24 1/2	26 3/4	28 3/4	31 1/4	

Reducing Fittings, sizes 1 1/4 to 9 inch, inclusive, the dimensions do not change from above by any reductions in the size of run or outlet, except Double Sweep Tees, in which the reduced end is always longer than the regular fitting.

VARIATIONS FROM THE ABOVE GENERAL DIMENSIONS OF EXTRA HEAVY REDUCING FLANGED FITTINGS, SIZES 10 TO 24 INCH WITH SMALL OUTLET, SHORT BODY PATTERN.

Size.....In.	10	12	14	15	16	18	20	22	24
Size of Outlets.....In.	6 and smaller	8 and smaller	9 and smaller	9 and smaller	10 and smaller	12 and smaller	14 and smaller	15 and smaller	15 and smaller
AA-Face to Face of Run.....In.	18	21	22	23	24	27	30	30	30
A-Center to Face of Run.....In.	9	10 1/2	11	11 1/2	12	13 1/2	15	15	15
B-Center to Face of Outlet.....In.	11	12 1/2	13 1/2	13 1/2	15	16 1/2	17 1/2	18 1/2	19 1/2

If the outlet is larger than given in this lower table, use the upper table of Long Body Pattern.

LOW PRESSURE CAST-IRON FLANGED FITTINGS
For Steam Working Pressures up to 25 Pounds.

Size.....In.	12	14	15	16	18	20	22	24	26	28	30	32	34	36	38	40	42	44	46	48
AA-Face to Face.....In.	24	28	29	30	35	40	44	46	48	50	52	54	56	58	60	62	64	66	68	
A-Center to Face.....In.	12	14	14 1/2	15	16 1/2	18	20	22	23	24	25	26	27	28	29	30	31	32	33	
B-Center to Face.....In.	12	14	14 1/2	15	16 1/2	18	20	22	23	24	25	26	27	28	29	30	31	32	33	
E-Center to Face of 45° Ells.....In.	7 1/2	7 1/2	8	8	8 1/2	9 1/2	10	11	13	14	15	16	17	18	19	20	21	22	23	
Diameter of Flange.....In.	19	21	22 1/4	23 1/2	25	27 1/2	29 1/2	32	34 1/4	36 1/2	38 3/4	41 1/2	43 1/2	45 3/4	48 1/2	50 1/2	52 3/4	55 1/4	57 1/4	
Thickness of Flange.....In.	1	1 1/16	1 1/8	1 3/16	1 1/4	1 3/8	1 1/2	1 5/8	1 11/16	1 3/4	1 13/16	1 15/16	1 7/8	1 15/16	2	2 1/16	2 1/8	2 1/4	2 3/8	
Number of Bolts.....	12	12	16	16	20	20	20	24	28	28	28	32	32	32	36	36	40	40	44	
Size of Bolts.....In.	7/8	1	1	1	1 1/8	1 1/8	1 1/4	1 1/4	1 1/4	1 1/4	1 3/8	1 3/8	1 3/8	1 3/8	1 1/2	1 1/2	1 1/2	1 1/2	1 1/2	
Length of Bolts.....In.	3 1/2	4	4	4	4 1/2	4 3/4	5	5 1/4	5 1/4	5 1/2	5 3/4	6	6	6	6 1/4	6 1/2	6 3/4	6 3/4	7	
Bolt Circle.....In.	17	18 3/4	20	21 1/4	22 3/4	25	27 1/4	29 1/2	31 3/4	34	36	38 1/2	40 1/2	42 3/4	45 1/4	47 1/4	49 1/2	51 3/4	53 3/4	

VARIATIONS FROM THE ABOVE GENERAL DIMENSIONS OF REDUCING FITTINGS WITH SMALL OUTLET - SHORT BODY PATTERN.

Size.....In.	12	14	15	16	18	20	22	24	26	28	30	32	34	36	38	40	42	44	46	48
Size of Outlets, In., and smaller..	8	9	9	10	12	12	13	14	15	16	18	20	22	24	26	28	30	32	34	36
AA-Face to Face of Run.....In.	20	22	23	23 1/2	24	26	28	30	32	34	36	38	40	42	44	46	48	5	54	56
B-Center to Face of Outlet.....In.	11	13	13 1/2	14	15 1/2	17	18	19	20	21	23	24	25	27	28	29	30	31	32	33 1/2

If the outlet is larger than given in this lower table, use the upper table of Long Body Pattern.

EXTRA HEAVY HYDRAULIC FERROSTEEL FLANGED FITTINGS
For Water Working Pressures up to 800 Pounds.
Tested to 2000 Pounds Pressure per Square Inch.

Size.....In.	1 1/2	2	2 1/2	3	3 1/2	4	4 1/2	5	6	7	8	9	10	12
Diameter of Flanges.....In.	6 1/2	7 1/2	8 3/4	10	10 3/4	11 1/2	12 1/2	13 1/2	15	16	17	18 1/2	21	23 1/2
Center to Face of Run or Outlet Straight or Reducing Sizes, Tees and Crosses.....In.	5 1/2	6	6 1/2	7 1/2	8	8 1/2	9 1/2	10	11	11 1/2	12 1/2	13 1/2	15	16 1/2
Center to Face of Elbows.....In.	7 1/4	8	8 3/4	9 1/2	10	10 3/4	12 1/2	13 3/4	15	16 1/2	17 3/4	20 3/4	22 3/4	24 3/4
Radius of Sweep of Elbows.....In.	5 5/8	6 1/4	6 7/8	7 3/8	8	8 1/2	9 5/8	10 3/8	12	13	14 1/8	16 1/2	18 1/2	20
Center to Face of 45° Elbows.....In.	3 1/4	3 1/2	4	4 1/2	5	5 1/4	5 1/2	6	6 1/2	7	7 1/4	8 1/4	9 1/4	10 1/4

WARNING: This is a 1910 edition. Some of the material may no longer be accurate

HYDRAULIC FERROSTEEL FLANGED FITTINGS

DIMENSIONS OF STRAIGHT LATERALS.

Size.....In.	2	2 1/2	3	3 1/2	4	4 1/2	5	6	7	8	9	10	12	14	15	16	18	20	22	24
Face to Face of Run...In.	10 1/2	12	13	14 1/2	15	15 1/2	17	18	20 1/2	22	24	25 1/2	30	33	34 1/2	36 1/2	39	43	46	49 1/2
A-Center to Face...In.	8 1/2	10 1/2	11 1/2	12 1/2	13	13 1/2	15 1/2	16 1/2	18 1/2	20 1/2	22 1/2	23 1/2	28 1/2	31 1/2	32 1/2	34 1/2	37 1/2	41 1/2	44 1/2	47 1/2
B-Center to Face...In.	21 1/2	21 1/2	3	3	3	3 1/2	3 1/2	4	4 1/2	5	5	5 1/2	6	6 1/2	6 1/2	7 1/2	8	8 1/2	9 1/2	10
Face to Face of Run...In.	11 1/2	13	14	15 1/2	16 1/2	18	18 1/2	20 1/2	21 1/2	23	24	25 1/2	30	33	34 1/2	36 1/2	39	43	46	49 1/2
A-Center to Face...In.	9	10 1/2	11	12 1/2	13 1/2	14 1/2	15	16 1/2	17 1/2	19	20	21 1/2	26 1/2	29	30 1/2	32 1/2	35	38 1/2	41 1/2	44 1/2
B-Center to Face...In.	21 1/2	21 1/2	3	3	3	3 1/2	3 1/2	4	4 1/2	5	5	5 1/2	6	6 1/2	6 1/2	7 1/2	8	8 1/2	9 1/2	10

DIMENSIONS OF REDUCING LATERALS.

Size.....In.	4	4 1/2	5	6	7	8	9	10	12	14	15	16	18	20	22	24
Size of Branch.....In.	2 1/2	2 1/2	3	3	3 1/2	4	4 1/2	5	6	7	7	8	9	10	10	12
Face to Face of Run...In.	13	13	14	15	16	16	17	18	20	22	23	24	26	28	29	32
A-Center to Face...In.	11	11	12	13 1/2	14 1/2	14 1/2	15 1/2	16 1/2	18 1/2	20 1/2	21	22	24	25	27	29 1/2
B-Center to Face...In.	2	2	2	1 1/2	1 1/2	1 1/2	1 1/2	1 1/2	1	1	1	1	1	1	1 1/2	1 1/2
C-Center to Face...In.	11	11	12	13 1/2	15	15 1/2	16 1/2	18 1/2	20 1/2	21 1/2	21 1/2	23	24	25 1/2	27 1/2	29 1/2
Face to Face of Run...In.	4	15	16	17	18	20	21	23	26	29	30	32	34	37	40	44
A-Center to Face...In.	12	12 1/2	13 1/2	14 1/2	15 1/2	17 1/2	18 1/2	20 1/2	21 1/2	23 1/2	26 1/2	27 1/2	29	31	33	37
B-Center to Face...In.	2	2 1/2	2 1/2	2 1/2	2 1/2	2 1/2	2 1/2	2 1/2	2 1/2	2 1/2	2 1/2	3	3	3	3	3
C-Center to Face...In.	13	13 1/2	14 1/2	15 1/2	16 1/2	18 1/2	19 1/2	21 1/2	24 1/2	27 1/2	28 1/2	30 1/2	32 1/2	36	39	43

If the Branch is larger than given in this lower table, use the upper table.
 The dimensions of Reducing Flanged Fittings are always regulated by the reduction of the outlet.
 Fittings reducing on the run only, the long body pattern (upper table) will always be used.
 For general dimensions and templates for drilling, see page 203.

NATIONAL STANDARD HOSE COUPLINGS.

(Continued from page 202.) The sizes for the diameters at the bottom and top of the thread at the end of the pipe are as follows:

Diam. of Pipe at Bottom of Thread.	Diam. of Pipe at Top of Thread.	Diam. of Pipe at Bottom of Thread.	Diam. of Pipe at Top of Thread.	Diam. of Pipe at Bottom of Thread.	Diam. of Pipe at Top of Thread.
1/8	0.334	0.393	2.620	2.820	8.334
1/4	0.433	0.522	3.241	3.441	9.327
3/8	0.568	0.658	3.738	3.938	10.645
1/2	0.701	0.815	4.234	4.434	11.639
3/4	0.911	1.025	4.731	4.931	12.633
1	1.144	1.283	5.290	5.490	13.627
1 1/4	1.488	1.627	6.346	6.546	14.669
1 1/2	1.727	1.866	7.340	7.540	14.869
2	2.223	2.339	7.340	7.540	15.863

Having the taper, length of full-threaded portion, and the sizes at bottom and top of thread at the end of the pipe, as given in the table, taps and dies can be made to secure these points correctly, the length of the imperfect threaded portions on the pipe, and the length the tap is run into the fittings beyond the point at which the size is as given, or, in other words, beyond the end of the pipe, having no effect upon the standard. The angle of the thread is 60° and it is slightly rounded off at top and bottom, so that, instead of its depth being 0.866 its pitch, as is the case with a full V-thread, it is 4/5 the pitch, or equal to 0.8 + n, n being the number of threads per inch.
 Taper of conical tube ends, 1 in 32 to axis of tube = 3/4 inch to the foot total taper.

NATIONAL STANDARD HOSE COUPLINGS.
 Dimensions in Inches.

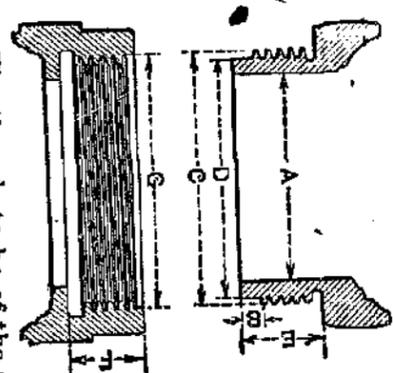

A.....	2 1/2	3	3 1/2	4 1/2
B.....	1/4	1/4	1/4	1/4
C.....	3 1/8	3 5/8	4 1/4	5 3/4
D.....	2.875	3.375	4.00	5.3970
E.....	1	1 1/8	1 1/8	1 3/8
F.....	7/8	6	6	4
G.....	3.0925	3.6550	4.28	5.80

The threads to be of the 60° V. pattern with 0.01 in. cut off the top of thread and 0.01 in. left in the bottom of the 2 1/2-in., 3-in., and 3 1/2-in. couplings, and 0.02 in. in like manner for the 4 1/2 in. couplings.
 A = inside diameter of hose couplings, N = number of threads per inch.

DIMENSIONS OF STANDARD WELDED PIPE.

Referring to the table on the next page, the weights per foot are based upon steel weighing 0.2833 lb. per cu. in. and up to and including 15 ins. on an average length of 20 ft., 0 in. including the coupling, although slipping lengths of small sizes will usually average less than 20 ft. long. Above 15 ins. the weights given are for plain end pipe. All dimensions and weights are nominal. The limits of variation in weight are 5 per cent above and 5 per cent below. Taper of threads is 3/4 in. in the diameter per ft. length. Weight of contained water is based on a temperature of 62° F. and 0.036085 lb. to the cubic inch.

WARNING: This is a 1910 edition. Some of the material may no longer be accurate.

Dimensions of Standard Welded Pipe.
Briggs' Standard to 10 in. National Tube Company Standard above 10 in. (National Tube Co., Feb., 1910.)

Size.	Diameter.		Thickness of Metal.	No. of Threads per inch.	Weight of Pipe per Lin. ft.	Circumference.		L'gth of Pipe per sq. ft. of		Sectional Areas.		Length of pipe containing 1 cubic foot.	U. S. gallons contained in 1 lin. ft. of pipe.	Water contained in 1 lin. ft. of pipe.		
	External.	Internal.				External.	Internal.	External surface.	Internal surface.	External.	Internal.					
1/8	0.405	0.269	0.068	27	0.246	1.272	0.845	9.431	14.200	0.127	6.0009	0.057	0.0004	2533.8	0.0030	0.0246
1/4	0.540	0.364	0.088	18	0.426	1.696	1.144	7.074	10.494	0.229	0.0016	0.104	0.0007	1383.8	0.0054	0.0451
3/8	0.675	0.493	0.091	18	0.570	2.121	1.549	5.659	10.494	0.351	0.0025	0.191	0.0013	754.36	0.0099	0.0827
1/2	0.840	0.622	0.109	14	0.855	2.639	1.954	4.547	10.494	0.554	0.0038	0.304	0.0021	473.91	0.0158	0.1316
3/4	1.050	0.824	0.113	14	1.140	3.299	2.589	3.638	10.494	0.866	0.0060	0.533	0.0037	270.03	0.0277	0.2309
1 1/4	1.315	1.049	0.133	11 1/2	1.690	4.131	3.296	2.905	10.494	1.358	0.0094	0.864	0.0060	166.62	0.0449	0.3742
1 1/2	1.660	1.380	0.154	11 1/2	2.290	5.215	4.335	2.810	10.494	2.164	0.0150	1.496	0.0104	96.275	0.0777	0.6477
2	1.900	1.610	0.154	11 1/2	2.740	5.969	5.058	1.608	10.494	2.831	0.0197	2.036	0.0141	70.733	0.1058	0.8816
2 1/2	2.375	2.067	0.203	8	3.690	7.461	6.494	1.329	10.494	4.430	0.0308	3.336	0.0233	42.913	0.1743	1.4530
3	2.075	2.469	0.216	8	5.850	9.032	7.757	1.091	10.494	6.492	0.0451	4.783	0.0332	30.077	0.2487	2.0732
3 1/2	3.500	3.068	0.226	8	7.660	10.996	9.638	1.091	10.494	8.821	0.0668	7.393	0.0513	19.479	0.3840	3.2012
4	4.000	3.548	0.237	8	9.240	12.566	11.146	0.955	10.494	12.566	0.0873	9.887	0.0687	14.565	0.5136	4.2812
4 1/2	4.500	4.026	0.247	8	10.900	14.137	12.648	0.849	10.494	15.904	0.1104	12.730	0.0884	11.312	0.6613	5.5125
5	5.000	4.506	0.258	8	12.700	15.708	14.156	0.764	10.494	19.635	0.1364	15.947	0.1107	9.0301	0.8284	6.9053
5 1/2	5.563	5.047	0.280	8	14.900	17.477	15.856	0.687	10.494	24.306	0.1688	20.006	0.1389	7.1979	1.0393	8.6629
6	6.625	6.065	0.301	8	19.200	20.813	19.054	0.577	10.494	34.472	0.2394	28.890	0.2006	4.9844	1.5008	12.5101
7	7.625	7.023	0.322	8	23.800	23.955	22.063	0.501	10.494	45.664	0.3171	38.738	0.2690	3.7173	2.0124	16.7743
8	8.625	7.981	0.342	8	28.900	27.096	25.073	0.443	10.494	50.426	0.4057	50.027	0.3474	2.8784	2.5988	21.6627
9	9.625	8.941	0.365	8	34.300	30.230	28.089	0.397	10.494	72.760	0.5053	62.786	0.4360	2.2935	3.2616	27.1876
10	10.750	10.020	0.375	8	41.200	33.772	31.479	0.355	10.494	90.763	0.6303	78.854	0.5476	1.8262	4.0963	34.1456
11	12.750	12.000	0.375	8	46.400	36.914	34.558	0.300	10.494	108.434	0.7530	95.033	0.6600	1.5153	4.9368	41.1513
12	14.000	13.250	0.375	8	50.900	40.055	37.609	0.273	10.494	128.318	0.8866	113.097	0.7854	1.2732	5.8752	48.9735
13	15.000	14.250	0.375	8	56.100	43.982	41.626	0.255	10.494	148.715	1.0690	137.886	0.91075	1.0443	7.1629	59.7077
14	16.000	15.250	0.375	8	64.900	50.265	47.909	0.239	10.494	176.715	1.2272	159.485	1.0684	0.82849	8.2849	69.0603
15	18.000	17.250	0.375	8	70.600	56.549	54.192	0.212	10.494	201.062	1.3963	182.654	1.2111	0.94885	9.4885	79.0931
16	20.000	19.250	0.375	8	78.600	62.832	60.476	0.191	10.494	254.469	1.7671	233.705	1.6230	0.61616	12.1405	101.1992
17	22.000	21.250	0.375	8	86.600	69.115	66.759	0.174	10.494	319.159	2.1817	291.039	2.0211	0.49478	15.1189	125.0270
18	24.000	23.250	0.375	8	94.600	75.398	73.042	0.159	10.494	452.389	2.6398	354.656	2.4629	0.40603	18.4237	153.5736
19																
20																
21																
22																

WROUGHT-IRON WELDED TUBES, EXTRA STRONG.
Standard Dimensions.
(National Tube Co., 1902.)

Nominal Diameter.	Actual Outside Diameter.	Thickness, Extra Strong.	Thickness, Double Extra Strong.	Actual Inside Diameter, Extra Strong.	Actual Inside Diameter, Double Extra Strong.	Length of Tube		Weight per Lineal Foot.
						per Sq. Ft. of Inside Surface.	per Sq. Ft. of Outside Surface.	
1/8	0.405	0.100	0.100	0.205	0.205	3.820	4.149	0.90
1/4	0.54	0.123	0.123	0.294	0.294	3.056	3.330	1.15
3/8	0.675	0.127	0.127	0.421	0.421	2.547	2.732	1.40
1/2	0.84	0.149	0.149	0.542	0.542	2.185	2.316	1.65
3/4	1.05	0.157	0.157	0.736	0.736	1.998	2.010	1.91
1 1/4	1.315	0.182	0.182	0.951	0.951	1.698	1.776	2.16
1 1/2	1.66	0.194	0.194	1.272	1.272	1.528	1.601	2.75
2	2.375	0.203	0.203	1.494	1.494	1.389	1.449	3.04
2 1/2	2.875	0.221	0.221	1.933	1.933	1.273	1.322	3.33
3	3.5	0.280	0.280	2.315	2.315	1.175	1.222	3.96
3 1/2	4.0	0.304	0.304	2.892	2.892	1.019	1.054	4.60
4	4.5	0.321	0.321	3.358	3.358	0.995	0.990	5.47
4 1/2	4.5	0.341	0.341	3.819	3.819	0.849	0.876	6.17

STANDARD SIZES, ETC., OF LAP-WELDED CHARCOAL-IRON BOILER-TUBES.
(National Tube Co.)

External Diameter.	Internal Diameter.	Standard Thickness.	Internal Circumference.	External Circumference.	Internal Area.	External Area.	Length of Tube per Sq. Ft. of Inside Surface.	Length of Tube per Sq. Ft. of Outside Surface.	Length of Tube per Sq. Ft. of Mean Surface.	Weight per Lineal Foot.
1/8	0.810	0.095	2.545	3.142	0.515	0.785	4.479	3.820	4.149	0.90
1/4	1.060	0.095	3.330	3.927	0.882	1.227	3.604	3.056	3.330	1.15
3/8	1.310	0.095	4.115	4.712	1.348	1.767	2.916	2.547	2.732	1.40
1/2	1.560	0.095	4.901	5.498	1.911	2.405	2.448	2.185	2.316	1.65
3/4	1.810	0.095	5.686	6.283	2.573	3.142	2.110	1.910	2.010	1.91
1	2.060	0.095	6.472	7.069	3.333	3.976	1.854	1.698	1.776	2.16
1 1/4	2.310	0.095	7.257	7.854	4.090	4.810	1.674	1.528	1.601	2.75
1 1/2	2.560	0.095	8.042	8.640	4.935	5.740	1.508	1.389	1.449	3.04
2	2.810	0.095	8.827	9.425	5.845	6.669	1.373	1.273	1.322	3.33
2 1/2	3.060	0.095	9.612	10.196	6.816	7.609	1.269	1.175	1.222	3.96
3	3.310	0.095	10.397	10.967	7.847	8.548	1.172	1.091	1.132	4.28
3 1/2	3.560	0.095	11.182	11.738	8.939	9.487	1.088	1.019	1.054	4.60
4	3.810	0.095	11.967	12.493	10.099	10.426	1.024	0.955	0.990	5.47
4 1/2	4.060	0.095	12.752	13.248	11.244	11.365	0.963	0.849	0.876	6.17
5	4.310	0.095	13.537	14.003	12.415	12.304	0.903	0.764	0.788	7.58
6	4.810	0.095	14.912	15.478	14.137	14.274	0.812	0.637	0.656	10.16
7	5.310	0.095	16.287	16.953	15.959	15.904	0.744	0.546	0.560	11.90
8	5.810	0.095	17.662	18.428	17.780	17.725	0.676	0.477	0.488	13.65
9	6.310	0.095	19.037	19.903	19.601	19.546	0.608	0.424	0.433	16.76
10	6.810	0.095	20.412	21.378	21.422	21.367	0.540	0.382	0.390	21.00
11	7.310	0.095	21.787	22.853	23.243	23.188	0.472	0.340	0.348	25.00
12	7.810	0.095	23.162	24.328	25.064	25.009	0.404	0.308	0.316	29.00
13	8.310	0.095	24.537	25.803	26.885	26.830	0.336	0.276	0.284	33.00
14	8.810	0.095	25.912	27.278	28.706	28.651	0.268	0.244	0.252	37.00
15	9.310	0.095	27.287	28.753	30.527	30.472	0.200	0.212	0.220	41.00
16	9.810	0.095	28.662	30.228	32.348	32.293	0.132	0.180	0.188	45.00
17	10.310	0.095	30.037	31.703	34.169	34.114	0.064	0.148	0.156	49.00
18	10.810	0.095	31.412	33.178	35.990	35.935	0.006	0.114	0.122	53.00
19	11.310	0.095	32.787	34.653	37.811	37.756	0.006	0.080	0.088	57.00
20	11.810	0.095	34.162	36.128	39.632	39.577	0.006	0.046	0.054	61.00
21	12.310	0.095	35.537	37.603	41.453	41.398	0.006	0.012	0.020	65.00
22	12.810	0.095	36.912	39.078	43.274</					

Weight Per Foot of Shelby Standard Cold Drawn Mechanical Tubing.

Based on 1 cu. in. Steel = 0.2833 lb. This table is copyrighted by the National Tube Company, Pittsburgh, Pa., and is published in this edition only by their permission

Thickness in B.W. Gauge and Fractions of an Inch.

Outside Diam. Inches.	22 0.028	20 0.035	18 0.049	1 1/8	3/32	1/8	5/32	3/10	7/32	1/4	5/16	3/8	1/2	5/8	3/4	7/8	1
1/2	0.141	0.174	0.240	0.292	0.407	0.501	0.991	1.13	1.53	2.00	3.13	3.50	5.34	9.16	18.02	19.86	21.36
5/8	.179	.221	.301	.375	.532	.668	1.20	1.38	1.83	2.67	3.55	4.01	6.68	12.52	20.03	22.19	24.03
3/4	.216	.267	.367	.459	.657	.834	1.41	1.63	2.12	3.00	3.96	4.51	8.01	14.18	22.03	24.53	26.70
7/8	.253	.314	.432	.542	.762	1.00	1.83	2.13	2.41	3.34	4.31	5.51	10.68	17.52	26.03	29.29	32.04
1	.291	.361	.498	.626	.907	1.17	2.03	2.38	2.70	3.68	4.67	6.51	12.02	19.19	28.04	31.54	34.71
1 1/8	.328	.407	.529	.679	1.03	1.34	2.24	2.63	2.99	3.94	4.96	7.51	13.35	20.86	29.04	33.88	37.38
1 1/4	.365	.454	.579	.733	1.16	1.50	2.66	3.13	3.58	4.01	5.01	8.51	14.69	22.53	30.04	36.21	40.05
1 3/8	.401	.501	.629	.796	1.28	1.67	3.08	3.63	4.16	4.67	5.63	9.51	16.02	24.20	32.04	38.55	42.72
1 1/2	.438	.548	.681	.860	1.41	1.84	3.49	4.13	4.75	5.34	6.31	10.51	17.36	25.87	33.04	39.55	43.86
1 3/4	.475	.594	.733	.924	1.66	2.17	3.91	4.63	5.33	6.01	7.30	12.31	18.69	27.53	35.04	41.55	45.96
2	.512	.641	.791	1.00	1.91	2.50	4.33	5.13	5.91	6.68	8.14	13.52	20.03	29.20	36.04	42.55	46.96
2 1/4	.549	.688	.848	1.07	2.16	2.84	4.75	5.63	6.50	7.34	8.97	14.52	21.36	30.53	37.04	43.55	48.06
2 1/2	.586	.735	.896	1.13	2.41	3.17	5.16	6.13	7.08	8.01	9.80	15.52	22.70	32.04	38.55	44.55	48.96
2 3/4	.623	.782	.945	1.29	2.66	3.50	5.58	6.63	7.67	8.68	10.64	16.52	24.03	33.04	39.55	45.55	49.96
3	.660	.829	1.00	1.46	2.91	3.84	6.00	7.13	8.25	9.35	11.47	17.52	25.36	34.04	40.55	46.55	50.96
3 1/4	.697	.876	1.06	1.63	3.16	4.17	6.41	7.63	8.83	10.01	12.31	18.69	26.69	35.04	41.55	47.55	51.96
3 1/2	.734	.923	1.12	1.79	3.41	4.51	6.83	8.14	9.42	10.68	13.14	19.52	28.04	36.04	42.55	48.55	52.96
3 3/4	.771	.970	1.18	1.96	3.66	4.84	7.25	8.64	10.00	11.35	13.98	20.52	29.04	37.04	43.55	49.55	53.96
4	.808	1.017	1.23	2.13	3.91	5.17	7.67	9.14	10.59	12.02	14.81	21.52	30.04	38.04	44.55	50.55	54.96
4 1/4	.845	1.064	1.29	2.31	4.17	5.50	8.08	9.64	11.17	12.68	15.64	22.52	31.04	39.04	45.55	51.55	55.96
4 1/2	.882	1.101	1.35	2.49	4.42	5.83	8.49	10.14	11.71	13.22	16.64	23.52	32.04	40.04	46.55	52.55	56.96
4 3/4	.919	1.140	1.41	2.67	4.67	6.17	8.90	10.64	12.34	14.02	17.64	24.52	33.04	41.04	47.55	53.55	57.96
5	.956	1.181	1.47	2.85	4.92	6.50	9.31	11.14	13.00	14.81	18.64	25.52	34.04	42.04	48.55	54.55	58.96
5 1/2	.993	1.222	1.53	3.03	5.17	6.84	9.72	11.64	13.84	15.64	19.64	26.52	35.04	43.04	49.55	55.55	59.96

In estimating the effective steam-heating or boiler surface of tubes, the surface in contact with air or gases of combustion (whether internal or external to the tubes) is to be taken.

For heating liquids by steam, superheating steam, or transferring heat from one liquid or gas to another, the mean surface of the tubes is to be taken.

Outside Area of Tubes.

To find the square feet of surface, S , in a tube of a given length, L , in feet, and diameter, d , in inches, multiply the length in feet by the diameter in inches and by 0.2618. Or, $S = \frac{3.1416 dL}{12} = 0.2618 dL$. For the diameters in the table below, multiply the length in feet by the figures given opposite the diameter.

Inches, Diameter.	Square Feet per Foot Length.	Inches, Diameter.	Square Feet per Foot Length.	Inches, Diameter.	Square Feet per Foot Length.
1/4	0.0654	2 1/4	0.5890	5	1.3090
1/2	.1309	2 1/2	.6545	6	1.5708
3/4	.1963	2 3/4	.7199	7	1.8326
1	.2618	3	.7854	8	2.0944
1 1/4	.3272	3 1/4	.8508	9	2.3562
1 1/2	.3927	3 1/2	.9163	10	2.6180
1 3/4	.4581	3 3/4	.9817	11	2.8798
2	.5236	4	1.0472	12	3.1416

RIVETED IRON PIPE.

(Abendroth & Root Mfg. Co.)

Sheets punched and rolled, ready for riveting, are packed in convenient form for shipment. The following table shows the iron and rivets required for punched and formed sheets.

Diam-eter in Inches.	Width of Lap in Inches.	Square Feet.	Approximate No. of Rivets 1 Inch apart Required for 100 Lineal Feet Punched and Formed Sheets.	Diam-eter in Inches.	Width of Lap in Inches.	Square Feet.	Approximate No. of Rivets 1 Inch apart Required for 100 Lineal Feet Punched and Formed Sheets.
4	1	116	1700	15	1 1/2	423	2900
5	1 1/2	150	1800	16	1 1/2	452	3000
6	1 1/2	178	1900	18	1 1/2	506	3200
7	1 1/2	206	2000	20	1 1/2	562	3500
8	1 1/2	234	2200	22	1 1/2	617	3700
9	1 1/2	258	2300	24	1 1/2	670	3900
10	1 1/2	289	2400	26	1 1/2	725	4100
11	1 1/2	314	2500	28	1 1/2	779	4400
12	1 1/2	343	2600	30	1 1/2	836	4600
13	1 1/2	369	2700	36	1 1/2	998	5200

Weight and Strength of Riveted Hydraulic Pipe.

(Abner Doble Co., San Francisco, 1906.)

S = Safe head in feet. W = Weight in pounds.

Thickness.		4-in.		5-in.		6-in.		7-in.		8-in.	
Gauge.	In.	S	W	S	W	S	W	S	W	S	W
18	0.050	555	2.8	444	3.5	370	4.1	317	4.7	277	5.3
16	.062	693	3.7	555	4.4	462	5.2	396	5.9	346	6.7
14	.078	866	4.4	693	5.5	578	6.4	495	7.3	433	8.2
12	.109					808	8.8	693	10.0	606	11.5
10	.140									777	14.5
		9-in.		10-in.		11-in.		12-in.		14-in.	
14	0.062	308	7.5	277	8.3	252	9.0	231	9.9	198	11.4
12	.078	385	9.2	346	10.2	314	11.0	289	12.2	248	14.0
	.109	539	12.6	485	14.2	439	15.2	404	16.7	346	19.2
10	.140	693	16.4	623	18.0	565	19.3	519	21.0	445	24.2
8	.171			761	21.5	693	23.5	635	25.6	543	29.5
	3/16			832	23.5	757	25.5	693	27.7	594	31.9
		15-in.		16-in.		18-in.		20-in.		22-in.	
16	0.062	185	12.0	173	12.8	154	14.5	139	16.0	126	17.7
14	.078	231	14.0	217	16.0	193	17.8	173	19.6	157	21.2
12	.109	323	20.3	303	21.5	270	24.4	242	27.3	220	29.2
10	.140	415	25.7	388	27.3	346	30.7	311	34.5	283	37.1
8	.171	507	30.4	475	33.3	422	38.4	380	41.5	346	45.2
	3/16	555	34.0	520	36.0	462	40.5	416	45.0	378	49.0
	1/4	739	45.5	693	48.2	616	54.1	555	59.6	505	65.5
	5/16			866	60.6	770	67.7	693	74.6	631	81.5
	3/8					924	81.3	831	89.5	757	98.0
	7/16							970	105.0	883	114.5
		24-in.		26-in.		30-in.		36-in.		42-in.	
14	0.078	144	23.7	133	25.5						
12	.109	202	32.5	186	34.5	162	39.5	134	47.7	148	69.5
10	.140	259	40.5	239	43.7	208	50.3	173	60.0	181	84.7
8	.171	317	49.2	293	53.0	254	60.5	211	75.0	198	91.5
	3/16	346	53.0	320	57.5	277	65.5	231	79.0	198	91.5
	1/4	462	71.0	427	76.5	370	87.5	308	105.5	264	122.0
	5/16	578	88.5	533	95.5	462	109.0	385	130.0	330	151.0
	3/8	693	106.0	640	114.5	555	130.5	462	156.0	396	180.5
	7/16	808	124.5	747	134.0	647	151.5	539	182.5	462	211.0
	1/2	924	142.0	854	153.0	739	174.5	616	207.0	528	240.5
	5/8			1066	191.0	924	220.0	770	260.0	660	302.0
	3/4					1108	264.0	924	312.5	792	361.5
	7/8							1078	366.0	924	424.0
		48-in.		54-in.		60-in.		66-in.		72-in.	
8	0.171	158	98.0	141	110.0	127	121.0			115	158.0
	3/16	173	106.0	154	119.0	139	131.0	127	144.5	115	158.0
	1/4	231	142.0	205	159.0	185	175.0	168	193.0	154	211.0
	5/16	289	177.0	256	198.0	231	218.0	210	239.0	193	260.0
	3/8	346	212.0	308	237.0	277	261.0	252	286.5	231	312.0
	7/16	404	249.0	359	277.5	323	303.0	294	334.0	270	365.0
	1/2	462	284.0	411	316.5	370	349.0	336	382.0	308	414.0
	5/8	578	334.0	513	399.5	462	440.0	420	480.0	385	520.0
	3/4	693	430.0	616	479.5	555	528.0	504	577.5	462	624.0
	7/8	808	505.0	719	563.5	647	620.0	588	677.0	539	732.0
		924	582.0	822	647.5	739	712.0	672	777.5	616	840.0

Pipe made of sheet steel plate, ultimate tensile strength 55,000 lbs. per sq. in., double-riveted longitudinal joints and single-riveted circular joints. Strength of longitudinal joints, 70%. Strain by safe pressure, 1/4 of ultimate strength.

WARNING: This is a 1910 edition. Some of the material may no longer be accurate

WEIGHT OF ONE SQUARE FOOT OF SHEET-IRON FOR RIVETED PIPE.

Thickness by the Birmingham Wire-Gauge.

No. of Gauge.	Thick-ness, In.	Weight in Lbs., Black.	Weight in Lbs., Galvan-ized.	No. of Gauge.	Thick-ness, In.	Weight in Lbs., Black.	Weight in Lbs., Galvan-ized.
26	0.018	0.80	0.91	18	0.049	1.82	2.16
24	.022	1.00	1.15	16	.065	2.50	2.67
22	.028	1.25	1.40	14	.083	3.12	3.34
20	.035	1.56	1.67	12	.109	4.37	4.73

SPIRAL RIVETED PIPE.

Approximate Bursting Strength. Pounds per Square Inch.

(American Spiral Pipe Works.)

Inside Diam. Inches.	Thickness. — U. S. Standard Gauge.							
	No. 20.	No. 18.	No. 16.	No. 14.	No. 12.	No. 10.	No. 8.	No. 6. No. 3 (1/4").
3	1500	2000						
4	1125	1500	1875					
5	900	1200	1500					
6		1000	1290	1560	2170			
7		860	1070	1340	1860			
8		750	935	1170	1640			
9			835	1045	1460			
10			750	935	1310			
11			680	890	1200			
12			629	780	1080	1 4 1 0		
13			575	720	1010	1295		
14			535	670	940	1210		
15				625	875	1125		
16				989	820	1050	1290	1520 1880
18				920	730	940	1140	1360 1660
20				470	660	840	1030	1220 1500
22				429	599	765	940	1108 1364
24				390	540	705	820	1015 1250
26					505	650	795	935 1154
28					470	605	735	870 1071
30					439	560	685	819 1000
32					410	525	645	760 940
34					380	490	600	715 880
36					365	470	570	680 830
40					330	420	515	610 750

FORGED STEEL FIANGES FOR RIVETED PIPE.

(American Spiral Pipe Works.)

Nominal Size, Inches.	Outside Diameter, Inches.	Bore, Inches.	Bolt Circle, Inches.	Number of Bolts.	Size of Bolts.	Nominal Size, Inches.	Outside Diameter, Inches.	Bore, Inches.	Bolt Circle, Inches.	Number of Bolts.	Size of Bolts.
3	6	33/16	4 3/4	4	7/16	16	21 1/4	16 1/4	19 1/4	12	1/2
4	7	43/16	5 1/2	8	7/16	18	23 1/4	18 5/16	21 1/4	16	5/8
5	8	53/16	6 1/2	8	7/16	20	28 1/4	22 3/8	26 23/16	16	5/8
6	9	73/16	9 7/8	8	1/2	22				16	5/8
7	10	83/16	10	8	1/2	24	30	24 3/8	27 3/4	16	5/8
8	11			8	1/2	26	34	2 6%		24	3/4
9	13	9 1/4	11 1/4	8	1/2	28	36	28 3/8	31 3/4	28	3/4
10	14	10 1/4	12 1/4	8	1/2	30	38	32 3/8	33 3/4	28	3/4
11	15	11 1/4	13 3/8	12	1/2	32	40	34 3/8	37 3/4	28	3/4
12	16	12 1/4	14 1/4	12	1/2	34				28	3/4
13	17	13 1/4	15 1/4	12	1/2	36	42	35 3/8	39 3/4	32	3/4
14	18	14 1/4	16 1/4	12	1/2	40	46	40 3/8	43 3/4	32	3/4
15	19	15 1/4	17 7/16	12	1/2						

BENT AND COILED PIPES.

(National Pipe Bending Co., New Haven, Conn.)

Coils and Bends of Iron and Steel Pipe.

Least outside diameter of coil, Inches	1/4	3/8	1/2	3/4	1	1 1/4	1 1/2	2	2 1/2	3
Size of pipe, Inches	2	2 1/2	3 1/2	4 1/2	6	8	12	16	24	32
Size of pipe, Least outside diameter of coil, Inches	3 1/2	4	4 1/2	5	6	7	8	9	10	12
Least outside diameter of coil, Inches	40	48	52	58	66	80	92	105	130	156

Lengths continuous welded up to 3-in. pipe or coupled as desired.

Coils and Bends of Drawn Brass and Copper Tubing.

Size of tube, outside diameter, Least outside diameter of coil, Inches	1 1/4	3/8	1/2	5/8	3/4	1	1 1/4	1 3/8
Least outside diameter of coil, Inches	1 1/2	11	5	11 3/4	2	2 1/4	23/8	2 1/2
Size of tube, diameter of coil, Inches	8	9	10	12	14	16	18	20

Lengths continuous brazed, soldered, or coupled as desired.

90° Bends in Iron or Steel Pipe.

(Whitlock Coil Pipe Co., Hartford, Conn.)

Size pipe, I.D.	3	3 1/2	4	4 1/2	5	6	7	8	9	10	12
Radius of bend	12	13	15	17	20	23	26	30	36	42	48
End	3	3 1/2	3 1/2	4	4	4	5	5	5	6	6
Center to face	15	16 1/2	18 1/2	21	24	27	31	35	41	48	54

Size pipe, O.D.	14	16	18	20	22	24	26	28	30
Radius of bend	60	70	80	90	100	110	120	140	160
End	7	7	7	8	8	8	10	10	10
Center to face	67	77	87	98	108	118	130	150	170

The radii given are for the center of the pipe. "End" means the length of straight pipe, in addition to the 90° bend, at each end of the pipe. "Center to face" means the perpendicular distance from the center of one end of the bent pipe to a plane passing across the other end.

Flexibility of Pipe Bends. (*Valve World*, Feb., 1906.)—So far as can be ascertained, no thorough attempt has ever been made to determine the maximum amount of expansion which a U-loop, or quarter bend, would take up in a straight run of pipe having both ends anchored. The Crane Company have adopted five diameters of the pipe as a standard radius, which come nearer than any other to suiting average requirements, and at the same time produce a symmetrical article. Bends shorter than this can be made, but they are extremely stiff, tend to buckle in bending, and the metal in the outer wall is stretched beyond a desirable point.

In 1905 the Crane Company made a few experiments with 8-inch U and quarter bends to ascertain the amount of expansion they would take up. The U-bend was made of steel pipe 0.32 inch thick, weighing 28 lbs. per foot, with extra heavy cast-iron flanges screwed on and refaced. It was connected by elbows to two straight pipes, N, 67 ft., S, 82 ft., which were firmly anchored at their outer ends. Steam was then let into the pipes with results as follows:

80 lbs. Expansion, Total 17/8 in. Flange broke.
 50 lbs. Expansion, N, 7/8, S, 11/8. Total 2 in.
 100 lbs. Expansion, N, 13/16, S, 1 1/2. Total 2 11/16 in.
 150 lbs. Expansion, N, 11/8, S, 1 7/8. Total 3 in.
 200 lbs. Expansion, N, 1 1/2, S, 1 7/8. Total 3 3/8 in. Flange broke at 208 lbs.

Quarter bend, full weight pipe. Straight pipe 148 ft., one end. 50 lbs. Total expansion 1 3/8. Flange leaked.

Quarter bend, extra heavy pipe. Expanded 7/8 in. when a flange broke. Replaced with a new flange, which broke when the expansion was 1 1/8 in.

SEAMLESS BRASS TUBE, IRON-PIPE SIZES.

(For actual dimensions see tables of Wrought-iron Pipe.)

Nominal Size.	Weight per Foot.	Nom. Size.	Weight per Foot.	Nom. Size.	Weight per Foot.	Nom. Size.	Weight per Foot.
ins. 1/8	lbs. .25	ins. 3/4	1.25	ins. 2	4.0	ins. 4	12.70
1/4	.43	1	1.70	2 1/2	5.75	4 1/2	13.90
3/8			2.50	3	8.30	5	15.75
1/2	.62 .90	1 1/4 1 1/2	3.	3 1/4	10.90	6	18.31

WEIGHT PER FOOT OF SEAMLESS BRASS TUBES.

(Waterbury Brass Co., 1908.)

A. W. G.	4	6	8	10	12	14	16	18	20	22	24	26
In. †	.2043†	.16202	.12849	.10189	.080808	.064084	.05082	.040303	.031961	.025347	.0201	.01594
1/8	0.043	0.039	0.034	0.028	0.024	0.020
3/16	0.090	.08	.068	.057	.047	.038	.032
1/4	0.174	0.16	.14	.12	.097	.080	.065	.053	.043
5/1625	.22	.18	.15	.13	.104	.084	.067	.054
3/8	0.36	.32	.27	.23	.19	.15	.126	.102	.082	.066
1/2	...	0.63	.55	.47	.39	.32	.26	.21	.17	.139	.111	.089
5/8	0.99	.87	.74	.61	.51	.42	.34	.27	.22	.174	.140	.112
3/4	1.29	1.10	.92	.76	.62	.51	.41	.33	.26	.211	.169	.135
7/8	1.58	1.33	1.11	.91	.74	.60	.48	.39	.31	.248	.198	.158
1	1.88	1.57	1.29	1.06	.86	.69	.56	.45	.36	.285	.227	.181
1 1/8	2.17	1.80	1.48	1.20	.97	.79	.63	.50	.40	.321	.256	...
1 1/4	2.47	2.03	1.66	1.35	1.09	.88	.70	.56	.45	.358	.285	...
1 3/8	2.76	2.27	1.85	1.50	1.21	.97	.78	.62	.50	.395	.314	...
1 1/2	3.05	2.59	2.03	1.64	1.32	1.06	.85	.68	.54	.43	.343	...
1 3/4	3.64	2.97	2.40	1.94	1.56	1.25	1.00	.79	.63	.50	.401	...
2	4.23	3.44	2.77	2.23	1.79	1.43	1.14	.91	.73	.58	.459	...

A.W.G.	2	4	6	8	10	12	14	16	18	20	22	24
In. †	.25763	.2043†	.16202	.12849	.10189	.080808	.064084	.05082	.040303	.031961	.025347	.01594
2 1/4	5.92	4.82	3.90	3.15	2.53	2.02	1.62	1.29	1.03	0.82	0.65	...
2 1/2	6.67	5.41	4.37	3.52	2.82	2.26	1.80	1.44	1.14	.91	.73	...
2 3/4	7.41	6.00	4.84	3.89	3.11	2.49	1.99	1.58	1.26	1.00	.80	...
3	8.16	6.59	5.31	4.26	3.41	2.72	2.17	1.73	1.38	1.09	.87	...
3 1/4	8.90	7.18	5.77	4.63	3.70	2.96	2.36	1.88	1.49	1.19	.94	...
3 1/2	9.64	7.77	6.24	5.00	4.00	3.19	2.54	2.02	1.61	1.28	1.02	...
3 3/4	10.39	8.36	6.71	5.37	4.29	3.42	2.73	2.17	1.72	1.37	1.09	...
4	11.13	8.95	7.18	5.74	4.58	3.66	2.91	2.32	1.84	1.46	1.16	...
4 1/4	11.87	9.54	7.64	6.11	4.88	3.89	3.10	2.46	1.96	1.55
4 1/2	12.62	10.13	8.11	6.48	5.17	4.12	3.28	2.61	2.07	1.64
4 3/4	13.36	10.72	8.58	6.85	5.47	4.36	3.47	2.76	2.19	1.74
5	14.10	11.31	9.05	7.22	5.76	4.59	3.65	2.90	2.31	1.83
5 1/4	14.85	11.90	9.51	7.59	6.05	4.82	3.84	3.05	2.42
5 1/2	15.59	12.49	9.98	7.97	6.35	5.06	4.02	3.20	2.54
5 3/4	16.33	13.08	10.45	8.34	6.64	5.29	4.21	3.34	2.65
6	17.08	13.67	10.92	8.71	6.94	5.52	4.39	3.49	2.77
6 1/4	17.82	14.26	11.38	9.08	7.23	5.76	4.58	3.64
6 1/2	18.56	14.84	11.85	9.45	7.52	5.99	4.76	3.78
6 3/4	19.31	15.43	12.32	9.82	7.82	6.22	4.95	3.93
7	20.05	16.02	12.79	10.19	8.11	6.46	5.13	4.08
7 1/4	20.79	16.61	13.25	10.56	8.41	6.69	5.32
7 1/2	21.54	17.20	13.72	10.93	8.70	6.92	5.50
7 3/4	22.28	17.79	14.19	11.30	8.99	7.15	5.69
8	23.03	18.48	14.66	11.67	9.29	7.39	5.87

* Thickness of Wall. † Outside diameter.

Seamless brass tubes are made from 1/8 in. to 1 in. outside diameter, varying by 1/16 in., and from 1 1/8 in. to 8 in. outside diameter, varying by 1/8 in., and in all gauges from No. 2 to No. 26 A. W. G. within the limits of the above table. To determine the weight per foot of a tube of a given inside diameter, add to the weights given above the weights given below, under the corresponding gauge numbers.

For copper tubing add 5% to the weights given above.

A.W.G.	2	4	6	8	10	12	14	16	18	20	22	24	26
Lb. per ft.	1.532	.9637	.6061	.3811	.2397	.1507	.0948	.0596	.0375	.0236	.0148	.0093	.0059

LEAD AND TIN LINED LEAD PIPE.

(United Lead Co., New York, 1908.)

Caliber.	Letter.	Weight per Foot, and Rod.	Thickness in 1/100 In.	Caliber.	Letter.	Weight per Foot.	Thickness in 1/100 In.
3/8 in.	E	7 lbs. per rod	5	1 in.	E	11 1/2 lbs. per foot	10
	D	9 oz. per foot	6	"	D	2 "	11
	C	"	8	"	C	2 1/2 "	14
	B	"	12	"	B	3 1/4 "	17
	A	"	16	"	A	4 "	21
	AAA	"	19	"	AAA	4 3/4 "	24
7/16 in.	AAA	1 1/2 "	27	1 1/4 in.	E	6 "	30
	E	3 oz. "	1		D	2 "	10
	D	1 lb. "	1		C	2 1/2 "	12
	C	"	7		B	3 "	14
	B	9 lbs. per rod	9		A	3 3/4 "	16
	A	3 1/4 lb. per foot	11		AAA	4 3/4 "	19
1/2 in.	C	"	11	1 1/2 in.	E	5 3/4 "	25
	B	"	13		D	6 3/4 "	28
	A	"	14		AAA	6 3/4 "	28
	Spcl	1 1/4 "	16		E	3 1/2 "	14
	A	1 1/2 "	19		D	4 1/4 "	17
	AAA	2 1/2 "	23		C	5 1/4 "	19
5/8 in.	AAA	3 "	25	1 3/4 in.	B	5 "	23
	E	12 " per rod	8		A	6 1/2 "	23
	D	1 " per foot	9		AAA	7 1/2 "	25
	C	1 1/2 "	13		Spcl	8 "	27
	B	2 "	16		AAA	8 1/2 "	28
	A	2 1/2 "	20		D	4 "	13
3/4 in.	AAA	2 3/4 "	22	2 in.	E	5 "	17
	E	3 1/2 "	25		C	6 "	19
	D	"	8		B	6 1/2 "	21
	C	1 1/4 "	10		Spcl	7 "	23
	B	1 3/4 "	12		A	7 1/2 "	27
	A	2 "	14		AAA	8 1/2 "	30
8/4 in.	Spcl	2 "	14	2 in.	D	4 3/4 "	15
	B	2 1/4 "	16		C	6 "	18
	A	3 "	20		B	7 "	22
	AAA	3 1/2 "	23		A	8 "	25
	E	4 3/4 "	30		AAA	9 "	27
	D	"	30		AAA	11 3/4 "	30

WEIGHT OF LEAD PIPE WHICH SHOULD BE USED FOR A GIVEN HEAD OF WATER.

(United Lead Co., New York, 1908.)

Head or Number of Feet Fall.	Pressure per sq. inch.	Caliber and Weight per Foot.						
		Letter.	3/8 in.	1/2 in.	5/8 in.	3/4 in.	1 in.	1 1/4 in.
30 ft.	15 lb.	D	10 oz.	3/4 lb.	1 lb.	1 1/4 lb.	2 lb.	2 1/2 lb.
50 ft.	25 lb.	C	12 oz.	1 lb.	1 1/2 lb.	1 3/4 lb.	2 1/2 lb.	3 lb.
75 ft.	38 lb.	B	1 lb.	1 1/4 lb.	2 lb.	2 1/4 lb.	3 1/4 lb.	3 3/4 lb.
100 ft.	50 lb.	A	1 1/4 lb.	1 3/4 lb.	2 1/2 lb.	3 lb.	4 lb.	4 3/4 lb.
150 ft.	75 lb.	AA	1 1/2 lb.	2 lb.	2 3/4 lb.	3 1/2 lb.	4 3/4 lb.	5 3/4 lb.
200 ft.	100 lb.	AAA	1 3/4 lb.	3 lb.	3 1/2 lb.	4 3/4 lb.	6 lb.	6 3/4 lb.

WARNING: This is a 1910 edition. Some of the material may no longer be accurate

To find the thickness of lead pipe required when the head of water is given. (Chadwick Lead Works.)
 Rule:—Multiply the head in feet by size of pipe wanted, expressed decimally, and divide by 750; the quotient will be the thickness required, in one-hundredths of an inch.
 Example:—Required thickness of half-inch pipe for a head of 25 feet.

$$25 \times 0.50 \div 750 = 0.16 \text{ inch.}$$

LEAD WASTE-PIPE.

1 1/2 in., 2 and 3 pounds per foot.	4 in., 5, 6, and 8 pounds per foot.
2 " " 3 and 4 pounds per foot.	4 1/2 " " 6 and 8 pounds per foot.
3 " " 3 1/2, 5, and 6 pounds per foot.	5 " " 8, 10, and 12 pounds per foot.
3 1/2 " " 4 pounds per foot.	6 " " 12 pounds per foot.

COMMERCIAL SIZES OF LEAD AND TIN TUBING.

1/8 inch. 1/4 inch.

SHEET LEAD.

Weight per square foot, 2 1/2, 3, 3 1/2, 4, 4 1/2, 5, 6, 8, 9, 10 lb. and upwards.
 Other weights rolled to order.

BLOCK-TIN PIPE.

3/8 in., 4, 5, 6 and 8 oz. per foot.	1 in., 15 and 18 oz. per foot.
1/2 " " 6, 7 1/2 and 10 " " "	1 1/4 " " 11/4 and 1 1/2 lb. " " "
5/8 " " 8 and 10 " " "	1 1/2 " " 2 and 2 1/2 lb. " " "
3/4 " " 10 and 12 " " "	2 " " 2 1/2 and 3 lb. " " "

TIN-LINED AND LEAD-LINED IRON PIPE.

Iron and steel pipes are frequently lined with tin or lead for use as water service pipes, ventilation pipes, and for carrying corrosive liquids. See catalogue of Lead Lined Iron Pipe Co., Wakefield, Mass.

WOODEN STAVE PIPE.

Pipes made of wooden staves, banded with steel hoops, are made by the Excelsior Wooden Pipe Co., San Francisco, in sizes from 10 inches to 10 feet in diameter, and are extensively used for long-distance piping, especially in the Western States. The hoops are made of steel rods with upset and threaded ends. When buried below the hydraulic grade line and kept full of water, these pipes are practically indestructible. For the economic design and use of stave pipe see paper by A. L. Adams, *Trans. A.S.C.E.*, vol. XII.

WEIGHT PER FT. OF COPPER RODS, LB.
 (Waterbury Brass Co., 1908.)

In.	Round.	Square.	In.	Round.	Square.	In.	Round.	Square.
1/8	0.047	0.060	1 1/8	3.831	4.88	2 1/8	13.668	17.42
1/4	.189	.241	1 1/4	4.723	6.01	2 1/4	15.325	19.51
3/8	.426	.542	1 3/8	5.723	7.24	2 3/8	17.075	21.74
1/2	.757	.964	1 1/2	6.811	8.67	2 1/2	18.916	24.09
5/8	1.182	1.51	1 5/8	7.993	10.18	2 5/8	20.856	26.56
3/4	1.703	2.17	1 3/4	9.27	11.80	2 3/4	22.891	29.05
7/8	2.318	2.95	1 7/8	10.642	13.55	2 7/8	25.019	31.86
1	3.03	3.86	2	12.108	15.42	3	27.243	34.69

To find the weight of octagon rod, multiply the weight of round rod by 1.084.
 To find the weight of hexagon rod, multiply the weight of round rod by 1.12.

WARNING: This is a 1910 edition. Some of the material may no longer be accurate

WEIGHT OF COPPER AND BRASS WIRE AND PLATES.

Brown & Sharpe Gauge.
 (From tables of leading manufacturers.)

No. of Gauge.	Thickness or Diameter.	Weight of Wire per 1000 Lineal Feet.		Weight of Plates per Square Foot.		No. of Gauge.	Thickness or Diameter.	Weight of Wire per 1000 Lineal Feet.		Weight of Plates per Square Foot.	
		Copper.	Brass.	Copper.	Brass.			Copper.	Brass.	Copper.	Brass.
	Inch.	Lbs.	Lbs.	Lbs.	Lbs.		Inch.	Lbs.	Lbs.	Lbs.	Lbs.
0000	0.46000	640.5	605.18	20.84	19.69	21	0.028462	2.45	2.317	1.29	1.22
0000	.40964	508.0	479.91	18.56	17.53	22	.025347	1.95	1.838	1.15	1.08
00	.36480	402.8	380.67	16.53	15.61	23	.022571	1.54	1.457	1.02	0.966
0	.32486	319.5	301.82	14.72	13.90	24	.020100	1.22	1.155	0.911	.860
1	.28930	253.3	239.35	13.11	12.38	25	.017900	0.970	0.916	.811	.766
2	.25763	200.9	189.82	11.67	11.03	26	.01594	.769	.727	.722	.682
3	.22942	159.3	150.52	10.39	9.82	27	.014195	.610	.576	.643	.608
4	.20431	126.4	119.38	9.26	8.74	28	.012641	.484	.457	.573	.541
5	.18194	100.2	94.67	8.24	7.79	29	.011257	.384	.362	.510	.482
6	.16202	79.46	75.08	7.34	6.93	30	.010025	.304	.287	.454	.429
7	.14428	63.01	59.55	6.54	6.18	31	.008928	.241	.228	.404	.382
8	.12849	49.98	47.22	5.82	5.50	32	.007950	.191	.181	.360	.340
9	.11443	39.64	37.44	5.18	4.90	33	.007080	.152	.143	.321	.303
10	.10189	31.43	29.69	4.62	4.36	34	.006304	.120	.114	.286	.270
11	.090742	24.92	23.55	4.11	3.80	35	.005614	.0956	.0902	.254	.240
12	.080808	19.77	18.68	3.66	3.46	36	.005000	.0757	.0715	.226	.214
13	.071961	15.61	14.81	3.26	3.08	37	.004453	.0600	.0567	.202	.191
14	.064084	12.44	11.75	2.90	2.74	38	.003965	.0476	.0450	.180	.170
15	.057068	9.81	9.32	2.59	2.44	39	.003531	.0376	.0357	.160	.151
16	.050820	7.82	7.59	2.30	2.18	40	.003144	.0299	.0283	.142	.135
17	.045257	6.20	5.86	2.05	1.94						
18	.040303	4.92	4.65	1.83	1.73						
19	.035890	3.90	3.68	1.63	1.54						
20	.031961	3.09	2.92	1.45	1.38						
							Specific gravity.....	8.880	8.386	8.698	8.218
							Weight per cubic ft...	555.	524.16	5,436	513.6

WEIGHT OF SHEET AND BAR BRASS.

Thickness, Side or Diam., Inches.	Sheets per sq. ft., Lbs.	Square Bars 1 ft. long, Lbs.	Round Bars 1 ft. long, Lbs.	Thickness, Side or Diam., Inches.	Sheets per sq. ft., Lbs.	Square Bars 1 ft. long, Lbs.	Round Bars 1 ft. long, Lbs.
1/16	2.72	0.014	0.011	1 1/16	46.32	4.10	3.22
1/8	5.45	.056	.045	1 1/8	49.05	4.59	3.61
3/16	8.17	.128	.100	1 3/16	51.77	5.12	4.02
1/4	10.90	.227	.178	1 1/4	54.50	5.67	4.45
5/16	13.62	.355	.278	1 5/16	57.22	6.26	4.91
3/8	16.35	.510	.401	1 3/8	59.95	6.86	5.39
7/16	19.07	.695	.545	1 7/16	62.67	7.50	5.89
1/2	21.80	.907	.712	1 1/2	65.40	8.16	6.41
5/8	24.52	1.15	.902	1 9/16	68.12	8.86	6.95
3/4	27.25	1.42	1.11	1 5/8	70.85	9.59	7.53
7/8	29.97	1.72	1.35	1 11/16	73.57	10.34	8.12
1 1/16	32.70	2.04	1.60	1 3/4	76.30	11.12	8.73
1 1/8	35.42	2.40	1.88	1 13/16	79.02	11.93	9.36
1 1/4	38.15	2.78	2.18	1 7/8	81.75	12.76	10.01
1 1/2	40.87	3.19	2.50	1 15/16	84.47	13.63	10.70
1 3/4	43.60	3.63	2.85	2	87.20	14.52	11.40

WEIGHT OF ALUMINUM SHEETS, SQUARE AND ROUND BARS.
(Specific Gravity 2.68: 1 cu. in. = 0.0973 lb.)

Thickness or Diameter, Inches.	Sheets per Sq. Ft., Lbs.	Round Bars per Ft., Lbs.	Square Bars per Ft., Lbs.	Thickness or Diameter, Inches.	Sheets per Sq. Ft., Lbs.	Round Bars per Ft., Lbs.	Square Bars per Ft., Lbs.
1/16	0.876	0.004	0.005	3/4	0.508	0.516	0.657
1/8	1.75	.014	.018	7/8	12.260	.702	.894
3/8	5.893	.129	.073	1	14.011	.917	1.168
			.164	1 1/2	17.514	1.433	1.824
1/2	7.006	.229	.292	2	21.017	2.063	2.627
5/8	a. 757	.358	.456		25.022	3.668	4.671

For further particulars regarding aluminum, see pp. 174,357.

SCREW-THREADS, WHITWORTH (ENGLISH) STANDARD.

a	Pitch.	Diam.	Pitch.	Diam.	Pitch.	Diam.	Pitch.	Diam.	Pitch.
1/4	20	5/8	11	1	8	1 3/4	5	3	3 1/2
5/16	18	11/16	11	1 1/8	7	1 7/8	5	3 1/4	3 1/4
3/8	16	3/4	10	1 1/4	7	2	4 1/2	3 1/2	3 1/4
7/16	14	13/16	10	1 3/8	6	2 1/4	4	3 3/4	3
1/2	12	7/8	9	1 1/2	6	2 1/2	4	4	3
9/16	12	15/16	9	1 5/8	5	2 3/4	3 1/2		

In the Whitworth or English system the angle of the thread is 55 degrees, and the point and root of the thread are rounded to a radius of 0.1373 X pitch. The depth of the thread is 0.6403 X pitch.

SCREW-THREADS, SELLERS OR U. S. STANDARD.

BOLTS AND THREADS.					HEX. NUTS AND HEADS.					Long Diam. Sq. Nuts Rough.	
Diam. of Bolt.	Threads per Inch.	Diam. of Root of Thread.	Width of Flat.	Area of Bolt Body in Sq. Inches.	Area of Root of Thread in Sq. Inches.	Short Diam., Rough.	Short Diam., Finish.	Long Diam., Rough.	Thickness, Rough.		Thickness, Finish.
1/4	20	0.185	0.0062	0.049	0.027	1/2	7/16	37/64	1/4	3/16	7/10
5/16	18	.240	.0074	.077	.045	19/32	17/32	11/16	5/16	5/16	10/12
3/8	16	.294	.0078	.110	.068	11/16	5/8	51/64	3/8	3/8	63/64
7/16	14	.344	.0089	.150	.093	25/32	23/32	9/10	7/16	3/8	17/64
1/2	13	.400	.0096	.196	.126	7/8	13/16	1	1/2	7/16	15/64
9/16	12	.454	.0104	.249	.162	31/32	29/32	11/8	9/16	1/2	123/64
5/8	11	.507	.0113	.307	.202	11/16	1	17/32	5/8	9/16	11/2
3/4	10	.620	.0125	.442	.302	11/4	13/16	17/16	3/4	11/16	1 49/64
7/8	9	.731	.0138	.601	.420	17/16	13/8	121/32	7/8	13/16	21/32
1	8	.837	.0156	.785	.550	15/8	19/16	17/8	1	15/16	219/64
1 1/8	7	.940	.0178	.994	.694	113/16	13/4	23/32	1 1/8	11/16	29/16
1 1/4	7	1.065	.0178	1.227	.893	2	15/16	25/16	1 1/4	13/16	253/64
1 3/8	6	1.160	.0208	1.485	1.057	23/16	21/8	217/32	1 3/8	15/16	33/32
1 1/2	6	1.284	.0208	1.767	1.295	23/8	25/16	23/4	1 1/2	17/16	323/64
1 5/8	5 1/2	1.389	.0227	2.074	1.515	29/16	21/2	231/32	1 5/8	19/16	35/8
1 3/4	5	1.491	.0250	2.405	1.746	23/4	211/16	33/16	1 3/4	111/16	357/64
1 7/8	5	1.616	.0250	2.761	2.051	25/16	27/8	313/32	1 7/8	113/16	45/32
2	4 1/2	1.712	.0277	3.142	2.302	31/8	31/8	35/8	2	115/16	427/64
2 1/4	4 1/2	1.962	.0277	3.976	3.023	31/2	37/16	41/16	2 1/4	23/16	461/64
2 1/2	4	2.176	.0312	4.909	3.719	37/8	313/16	41/2	2 1/2	27/16	531/64
2 3/4	4	2.426	.0312	5.940	4.620	4 1/4	43/16	429/32	2 3/4	211/16	6
3	3 1/2	2.629	.0357	7.069	5.428	45/8	89/16	53/8	3	215/16	617/32
3 1/4	3 1/2	2.879	.0357	8.296	6.510	5	415/16	513/16	3 1/4	33/16	71/16
3 1/2	3 1/2	3.100	.0384	9.621	7.548	53/8	55/16	67/64	3 1/2	37/16	799/64
3 3/4	3	3.317	.0413	11.045	8.641	53/4	511/16	621/32	3 3/4	311/16	81/8
4	3	3.567	.0413	12.566	9.993	61/8	61/16	73/32	4	315/16	841/64
4 1/4	27/8	3.798	.0435	14.186	11.329	61/2	67/16	79/16	4 1/4	43/16	93/16
4 1/2	23/4	4.028	.0454	15.904	12.743	67/8	613/16	731/32	4 1/2	47/16	93/4
4 3/4	25/8	4.256	.0476	17.721	14.226	71/4	73/16	813/32	4 3/4	411/16	101/4
5	21/2	4.480	.0500	19.635	15.763	75/8	79/16	827/32	5	415/16	1049/64
5 1/4	21/2	4.730	.0500	21.648	17.572	8	715/16	99/32	5 1/4	53/16	1123/64
5 1/2	23/8	4.953	.0526	23.758	19.267	83/8	85/16	923/32	5 1/2	57/16	117/8
5 3/4	23/8	5.203	.0526	25.957	21.262	83/4	811/16	105/32	5 3/4	511/16	123/8
6	21/4	5.423	.0555	28.274	23.098	91/8	91/16	1019/32	6	515/16	1215/16

In 1864 a committee of the Franklin Institute recommended the adoption of the system of screw-threads and bolts which was devised by Mr. William Sellers of Philadelphia. This system is now in general use in the United States and it is commonly called the United States Standard.

The rule for proportioning the thread is as follows: Divide the pitch, or what is the same thing, the side of the thread, into eight equal parts; take off one part from the top and fill in one part in the bottom of the thread, then the flat top and bottom will equal one-eighth of the pitch, the wearing surface will be three-quarters of the pitch, and the diameter of screw at bottom of the thread will be expressed by the formula,

diam. of bolt - (1.299 ÷ no. of threads per inch).

For a sharp V-thread with angle of 60 degrees the formula is, diam. of bolt - (1.733 ÷ no. of threads per inch).

The angle of the thread in the Sellers system is 60 degrees.

Thickness of Nuts and Bolt Heads.—In the above table the thickness of nuts and heads (rough) is given as equal to the diameter of the bolt. Many manufacturers make the thickness of nuts about 7/8, and of bolt heads 3/4, of the diam. of the bolt.

Automobile Screws and Nuts.—The Association of Licensed Automobile Mfrs (1906) adopted standard specifications for hexagon head screws, castle and plain nuts known as the A.L.A.M. standard. Material to be steel, elastic limit not less than 60,000 lbs. per sq. in., tensile strength not less than 100,000 lbs. per sq. in. U. S. Standard thread is used the threaded portion of screws being 1 1/2 times the diameter. The castle nut has a boss on the upper surface with six slots for a locking pin through the bolt.

Standard Automobile Screws, Castle and Plain Nuts.

All dimensions in inches. $P =$ pitch, or number of threads per inch. $d =$ diam. of cotter pin. $P \div 8 =$ flat top.

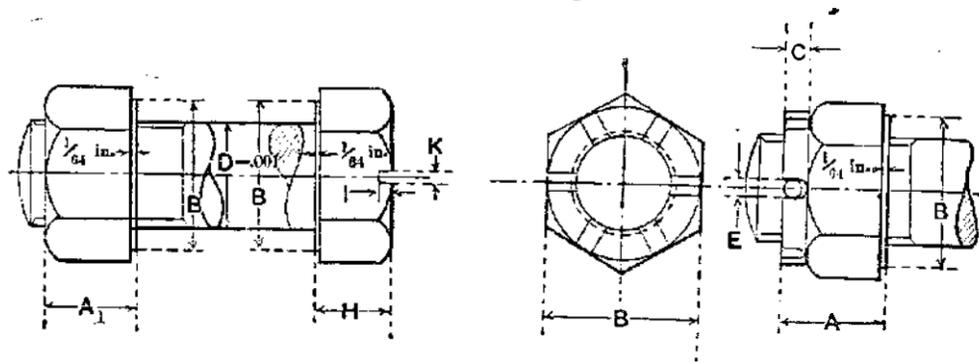

D	P	B	A ₁	H	K	I	A	C	E	d
1/4	28	3/8	7/32	3/16	1/16	3/32	9/32	3/32	5/64	1/16
5/16	24	1/2	17/64	15/64	1/16	7/64	21/64	3/32	5/64	1/16
3/8	24	9/16	21/64	9/32	3/32	1/8	13/32	1/8	1/8	3/32
7/16	20	11/16	3/8	21/64	3/32	1/8	29/64	1/8	1/8	3/32
1/2	20	3/4	7/16	3/8	3/32	1/8	9/16	3/16	1/8	3/32
9/16	18	7/8	31/64	27/64	3/32	1/8	39/64	3/16	5/32	1/8
5/8	18	15/16	35/64	15/32	3/32	1/8	23/32	1/4	5/32	1/8
11/16	16	1	19/32	33/64	3/32	1/8	49/64	1/4	5/32	1/8
3/4	16	1 1/8	21/32	9/16	3/32	1/8	13/16	1/4	5/32	1/8
7/8	14	1 1/4	49/64	21/32	3/32	1/8	29/32	1/4	5/32	1/8
1	14	1 7/8	7/8	3/4	3/32	1/8	1	1/4	5/32	1/8

INTERNATIONAL STANDARD THREAD (METRIC SYSTEM).

$P =$ pitch, = 1 - no. of threads per millimeter.

Depth of thread = $0.6495 P$.

Flat top and bottom of thread = one-eighth pitch.

Diam. at bottom of thread = diam. of bolt - $1.299 P$.

Pitch, mm.	1.0	1.25	1.5	2.0	2.5	3.0	4.0	5.0	6.0	8.0	10	12	16	20	25	30
Diam., mm.	3.3	3.5	4.0	4.5	5.0	5.5	6.0	6.5	7.0	7.5	8.0	9.0	10.0	11.0	12.0	13.0
Pitch, mm.	3.3	3.5	4.0	4.5	5.0	5.5	6.0	6.5	7.0	7.5	8.0	9.0	10.0	11.0	12.0	13.0

BRITISH ASSOCIATION STANDARD THREAD.

The angle between the threads is $47\frac{1}{2}^\circ$. The depth of the thread is $0.6 \times$ the pitch. The tops and bottoms of the threads are rounded with a radius of $\frac{2}{11}$ of the pitch.

Number.....	0	1	2	3	4	5	6	7	8	9
Diameter, mm.:	6.0	5.3	4.7	4.1	3.5	3.0	2.5	2.0	1.5	1.0
Pitch, mm.....	1.00	0.90	0.81	0.73	0.66	0.60	0.55	0.50	0.45	0.40

WARNING: This is a 1910 edition. Some of the material may no longer be accurate

Number.....	8	9	10	12	14	19	
Diameter, mm.....	275	282	1.9	1.7	1.3	1.0	.79
Pitch, mm.....	0.48	0.43	0.39	0.35	0.38	0.23	0.19

LIMIT GAUGES FOR IRON FOR SCREW-THREADS.

In adopting the Seders, or Franklin Institute, or United States Standard, as it is variously called, a difficulty arose from the fact that it is the habit of iron manufacturers to make iron over-size, and as there are no over-size screws in the Sellers system, if iron is too large it is necessary to cut it away with the dies. So great is this difficulty, that the practice of making taps and dies over-size has become very general. If the Sellers system is adopted it is essential that iron should be obtained of the correct size, or very nearly so. Of course no high degree of precision is possible in rolling iron, and when exact sizes were demanded, the question arose how much allowable variation there should be from the true size. It was proposed to make limit-gauges for inspecting iron with two openings one larger and the other smaller than the standard size, and then specify that the iron should enter the large end and not enter the small one. The following table of dimensions for the limit-gauges was adopted by the Master Car-Builders' Association in 1883.

Size of Iron, In.	Large End of Gauge.	Small End of Gauge.	Difference.	Size of Iron, In.	Large End of Gauge.	Small End of Gauge.	Difference.
1/4	0.2550	0.2450	0.010	5/8	0.6330	0.6170	0.016
5/16	0.3180	0.3070	0.011	3/4	0.7585	0.7415	0.017
3/8	0.3810	0.3690	0.012	7/8	0.8840	0.8660	0.018
7/16	0.4440	0.4310	0.013	1	1.0095	0.9905	0.019
1/2	0.5070	0.4930	0.014	1 1/8	1.1350	1.1150	0.020
9/16	0.5700	0.5550	0.015	1 1/4	1.2605	1.2395	0.021

Caliper gauges with the above dimensions, and standard reference gauges for testing them, are made by the Pratt & Whitney CO.

THE MAXIMUM VARIATION IN SIZE OF ROUGH IRON FOR U. S. STANDARD BOLTS.

Am. Mach., May 12, 1892.

By the adoption of the Sellers or U.S. Standard, thread taps and dies keep their size much longer in use, when Hatted in accordance with this system than when made sharp "V", though it has been found advisable in practice in most cases to make the taps of somewhat larger outside diameter than the nominal size, thus carrying the threads further towards the V-shape and giving corresponding clearance to the tops of the threads when in the nuts or tapped holes.

Makers of taps and dies often have calls for taps and dies, U. S. Standard "for rough iron."

An examination of rough iron will show that much of it is rolled out of round to an amount exceeding the limit of variation in size allowed.

In view of this it may be desirable to know what the extreme variation in iron may be consistent with the maintenance of U. S. Standard threads, i.e. threads which are standard when measured upon the angle, the only place where it seems advisable to have them fit closely. Mr. Chas. A. Bauer, the general manager of the Warder, Bushnell & Glessner Co. at Springfield, Ohio, in 1884 adopted a plan which may be stated as follows: All bolts, whether cut from rough or finished stock, are standard size at the bottom and at the sides or angles of the threads, the variation for fit of the nut and allowance for wear of taps being made in the machine taps. Nuts are punched with holes of such size as to give 85 per cent of a full thread, experience showing that the metal of wrought nuts will then crowd into the threads of the taps sufficiently to give practically a full thread, while if punched smaller some of the metal will be cut out by the tap at the bottom of the threads, which is of course undesirable. Machine taps are made enough larger than the nominal

to bring the tops of the threads up sharp, plus the amount allowed for Et and wear of taps. This allows the iron to be enough above the nominal diameter to bring the threads up full (sharp) at top, while if it is small the only effect is to give a flat at top of threads: neither condition affecting the actual size of the thread at the point at which it is intended to bear. Limit gauges are furnished to the mills, by which the iron is rolled, the maximum size being shown in the third column of the table. The minimum diameter is not given, the tendency in rolling being nearly always to exceed the nominal diameter.

In making the taps the threaded portion is turned to the size given in the eighth column of the table, which gives 6 to 7 thousandths of an inch allowance for fit and wear of tap. Just above the threaded portion of the tap a place is turned to the size given in the ninth column, these sizes being the same as those of the regular U. S. Standard bolt, at the bottom of the thread, plus the amount allowed for fit and wear of tap: or, in other words, $d' = U. S. Standard d + (D' - D)$. Gauges like the one in the cut, Fig. 75, are furnished for this sizing. In finishing the threads of the

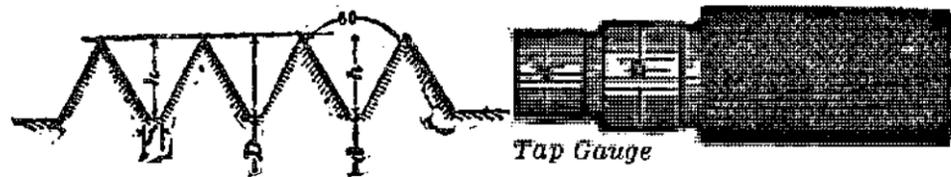

FIG. 75.

tap a tool is used which has a removable cutter finished accurately to gauge by grinding, this tool being correct U. S. Standard as to angle, and flat at the point. It is fed in and the threads chased until the flat point just touches the portion of the tap which has been turned to size d' . Care having been taken with the form of the tool, with its grinding on the top face (a fixture being provided for this to insure its being ground properly), and also with the setting of the tool properly in the lathe, the result is that the threads of the tap are correctly sized without further attention.

STANDARD SIZES OF SCREW-THREADS FOR BOLTS AND TAPS.

(CHAS. A. BAUER.)

A	n	D	d	h	f	D' - D	D	d'	H
		Inches	Inches	Inches	Inches	Inches	Inches	Inches	Inches
1/4	20	0.2608	0.1855	0.0379	0.0062	0.006	0.2668	0.1915	0.2024
5/16	18	0.3245	0.2403	0.0421	0.0070	0.006	0.3305	0.2463	0.2589
3/8	16	0.3885	0.2938	0.0474	0.0078	0.006	0.3945	0.2998	0.3139
7/16	14	0.4530	0.3447	0.0541	0.0089	0.006	0.4590	0.3507	0.3670
1/2	13	0.5166	0.4000	0.0582	0.0096	0.006	0.5226	0.4060	0.4236
9/16	12	0.5805	0.4543	0.0631	0.0104	0.007	0.5875	0.4613	0.4802
5/8	11	0.6445	0.5069	0.0689	0.0114	0.007	0.6517	0.5139	0.5346
3/4	10	0.7117	0.6201	0.0758	0.0125	0.007	0.7187	0.6271	0.6499
7/8	9	0.8991	0.7307	0.0842	0.0139	0.007	0.9061	0.7377	0.7630
1	8	1.0271	0.8376	0.0947	0.0156	0.007	1.0341	0.8446	0.8731
1 1/8	7	1.1559	0.9394	0.1083	0.0179	0.007	1.1629	0.9464	0.9789
1 1/4	7	1.2809	1.0644	0.1083	0.0179	0.007	1.2879	1.0714	1.1039

A = nominal diameter of bolt.

D = actual diameter of bolt.

d = diameter of bolt at bottom of thread.

n = number of threads per inch.

f = flat of bottom of thread.

h = depth of thread.

D' and d' = diameters of tap.

H = hole in nut before tapping.

$D = A + 0.2165/n$.

$d = A - 1.29904/n$.

$h = 0.7577/n = (D - d)/2$.

$f = 0.125/n$.

$H = D' - \frac{1.288}{n} = D' - 0.85(2h)$.

STANDARD SET-SCREWS AND CAP-SCREWS.

American, Hartford, and Worcester Machine-Screw Companies.

(Compiled by W. S. Dix, 1895.)

(See tables below)	(A)	(B)	(C)	(D)	(E)	(F)	(G)
Diameter of screw..	1/8	3/16	1/4	5/16	3/8	7/16	1/2
Threads per inch..	40	24	20	18	16	14	12
Size of tap drill *.	No. 43	No. 30	No. 5	17/64	21/64	3/8	27/64
Diameter of screw..	(H) 9/16	(I) 5/8	(J) 3/4	(K) 7/8	(L) 1	(M) 1	(N) 1 1/8
Threads per inch..	12	11	10	9	8	7	7
Size of tap drill *.	31/64	17/32	21/32	49/64	7/8	63/64	11/8

* For cast iron. For numbers of twist-drills, see page 30.

Set-screws.			Hex. Head Cap-screws.			Sq. Head Cap-screws.		
Short Diam. of Head.	Long Diam. of H'd	Lengths (under Head)	Short Diam. of Head.	Long Diam. of Head.	Lengths (under Head)	Short Diam. of Head.	Long Diam. of Head.	Lengths (under Head)
(C) 1/4	0.35	3/4 to 3	7/16	0.51	3/4 to 3	5/8	0.53	3/4 to 3
(D) 5/16	.44	3/4 to 3 1/4	1/2	.58	3/4 to 3 1/4	7/16		
(E) 3/8	.53	3/4 to 3 1/2	9/16	.65	3/4 to 3 1/2	1/2	.62	3/4 to 3 1/2
(F) 7/16	.62	3/4 to 3 3/4	5/8	.72	3/4 to 3 3/4	9/16	.80	3/4 to 3 3/4
(G) 1/2	.71	3/4 to 4	3/4	.87	3/4 to 4	5/8	.89	3/4 to 4
(H) 9/16	.80	3/4 to 4 1/4	13/16	.94	3/4 to 4 1/4	11/16	.98	3/4 to 4 1/4
(I) 5/8	.89	3/4 to 4 1/2	7/8	1.01	1 to 4 1/2	3/4	1.06	1 to 4 1/2
(J) 3/4	1.06	1 to 4 3/4	1	1.15	1 1/4 to 4 3/4	7/8	1.24	1 1/4 to 4 3/4
(K) 7/8	1.24	1 1/4 to 5	1 1/8	1.30	1 1/2 to 5	1 1/8	1.60	1 1/2 to 5
(L) 1	1.42	1 1/2 to 5	1 1/4	1.45	1 3/4 to 5	1 1/4	1.77	1 3/4 to 5
(M) 1 1/8	1.60	1 3/4 to 5	1 3/8	1.59	2 to 5	1 3/8	1.95	2 to 5
(N) 1 1/4	1.77	2 to 5	1 1/2	1.73	2 to 5	1 1/2	2.13	2 1/4 to 5

Round and Fillister Head Cap-screws.		Flat Head Cap-screws.		Button-head Cap-screws.	
Diam. of Head.	Lengths (under Head)	Diam. of Head.	Lengths (including Head)	Diam. of Head.	Lengths (under Head)
(A) 3/16	3/4 to 2 1/2	1/4	3/4 to 1 3/4	7/32 (.225)	3/4 to 1 3/4
(B) 1/4	3/4 to 2 3/4	3/8	3/4 to 2	5/16	3/4 to 2
(C) 3/8	3/4 to 3	15/32	3/4 to 2 1/4	7/16	3/4 to 2 1/4
(D) 7/16	3/4 to 3 1/4	5/8	3/4 to 2 3/4	9/16	3/4 to 2 1/2
(E) 9/16	3/4 to 3 1/2	3/4	3/4 to 3	5/8	3/4 to 2 3/4
(F) 5/8	3/4 to 3 3/4	13/16	1 to 3	3/4	3/4 to 3
(G) 3/4	3/4 to 4	7/8	1 1/4 to 3	13/16	1 to 3
(H) 13/16	1 to 4 1/4	1	1 1/2 to 3	15/16	1 1/4 to 3
(I) 7/8	1 1/4 to 4 1/2	1 1/8	1 3/4 to 3	1	1 1/2 to 3
(J) 1	1 1/2 to 4 3/4	1 3/8	2 to 3	1 1/4	1 3/4 to 3
(K) 1 1/8	1 3/4 to 5				
(L) 1 1/4	2 to 5				

Threads are U. S. Standard. Cap-screws are threaded 3/4 length up and including 1 inch diameter x 4 inches long, and 1/2 length above. Lengths increase by 1/4 inch each regular size between the limits given. Lengths of heads, except Rat and button, equal diameter of screw. The angle of the cone of the flat-head screw is 76 degrees, the sides making angles of 52 degrees with the top.

THE ACME SCREW THREAD.

The Acme Thread is an adaptation of the commonly used style of worm thread and is intended to take the place of the square thread. It is a little shallower than the worm thread, but the same depth as the square thread and much stronger than the latter. The angle of the thread is 29°.

The various parts of the Acme Thread are obtained as follows:
 Width of point of tool for screw or tap thread =
 $(0.3707 \div \text{No. of Threads per in.}) - 0.0052$.
 Width of screw or nut thread = $0.3707 \div \text{No. of Threads per in.}$
 Dism. of Tap = Diam. of Screw + 0.020.

$$\text{Diam. of Tap or } \left. \begin{array}{l} \text{Screw at Root} \end{array} \right\} = \text{Diam. of Screw} - \frac{1}{\text{No. of Threads per in.}} + 0.020.$$

$$\text{Depth of Thread} = (1 \div 2 \times \text{No. of Threads per in.}) + 0.010.$$

MACHINE SCREWS. - A.S.M.E. Standard.

The American Society of Mechanical Engineers (1907) received a report on standard machine screws from its committee on that subject. The included angle of the thread is 60 degrees and a flats made at the top and bottom of the thread of one-eighth the basic diameter. A uniform increment of 0.013 inch exists between all sizes from 0 to 10 and 0.026 inch in the remaining sizes. The pitches are a function of the diameter as expressed by the formula

$$\text{Threads per inch} = \frac{6.5}{D + 0.02}$$

The minimum tap conforms to the basic standard in all respects except diameter. The difference between the minimum tap and the maximum screw provides an allowance for error in pitch and for wear of the tap in service.

A. S. M. E. STANDARD MACHINE SCREWS.
 (Corbin Screw Corporation.)

No.	Size.	Outside Diameters.			Pitch Diameters.			Root Diameters.		
		Out. Dia. and Thds. per In.	Minimum.	Maximum.	Difference.	Minimum.	Maximum.	Difference.	Minimum.	Maximum.
0	0.060-80	0.0572	0.060	0.0028	0.0505	0.0519	0.0014	0.0410	0.438	0.0028
1	.073-72	.070	.073	.003	.0625	.064	.0015	.052	.055	.0030
2	.086-64	.0828	.086	.0032	.0743	.0759	.0016	.0624	.0657	.0033
3	.099-56	.0955	.099	.0035	.0857	.0874	.0017	.0721	.0758	.0037
4	.112-48	.1082	.112	.0038	.0966	.0985	.0019	.0807	.0849	.0042
5	.125-44	.1210	.125	.0040	.1082	.1102	.0020	.0910	.0955	.0045
6	.138-40	.1338	.138	.0042	.1197	.1218	.0021	.1007	.1055	.0048
7	.151-36	.1466	.151	.0044	.1308	.1330	.0022	.1097	.1149	.0052
8	.164-36	.1596	.164	.0044	.1438	.146	.0022	.1227	.1279	.0052
9	.177-32	.1723	.177	.0047	.1544	.1567	.0023	.1307	.1364	.0057
10	.190-30	.1852	.190	.0048	.166	.1684	.0024	.1467	.1467	.0060
12	.216-28	.2111	.216	.0049	.1904	.1928	.0024	.1696	.1696	.0063
14	.242-24	.2363	.242	.0052	.2123	.2149	.0026	.1808	.1879	.0071
16	.268-22	.2626	.268	.0054	.2358	.2385	.0027	.2014	.209	.0076
18	.294-20	.2884	.294	.0056	.2587	.2615	.0028	.2208	.229	.0082
20	.320-20	.3144	.320	.0056	.2847	.2875	.0028	.2468	.255	.0082
22	.346-18	.3402	.346	.0058	.3070	.3099	.0029	.2649	.2738	.0089
24	.372-16	.366	.372	.0060	.3284	.3314	.0030	.281	.2908	.0098
26	.398-16	.392	.398	.0060	.3544	.3574	.0030	.307	.3168	.0098
28	.424-14	.4178	.424	.0062	.3745	.3776	.0031	.3312	.3312	.0108
30	.450-14	.4438	.450	.0062	.4005	.4036	.0031	.3572	.3572	.0108

A. S. M. E. STANDARD TAPS.
 (Corbin Screw Corporation.)

No.	Size.	Outside Diameters.			Pitch Diameters.			Root Diameters.			Tap Drill Diameters.
		Out. Dia. and Thds. per Inch.	Minimum.	Maximum.	Difference.	Minimum.	Maximum.	Difference.	Minimum.	Maximum.	
0	0.060-80	0.0609	0.0632	0.0023	0.0528	0.0538	0.001	0.0447	0.0466	0.0019	0.0465
1	.073-72	.074	.0765	.0025	.065	.066	.001	.056	.058	.002	.0595
2	.086-64	.0871	.0898	.0027	.0770	.0781	.0011	.0668	.0689	.0021	.070
3	.099-56	.1002	.1033	.0031	.0886	.0897	.0011	.077	.0793	.0023	.0785
4	.112-48	.1133	.1168	.0035	.0998	.101	.0012	.0852	.0887	.0025	.089
5	.125-44	.1263	.1301	.0038	.1116			.0968	.0995	.0027	.0995
6	.138-40	.1394	.1435	.0041	.1232	.1129 .1246	.0013 .0014	.1069	.1097	.0028	.110
7	.151-36	.1525	.1569	.0044	.1345	.1359	.0014	.1164	.1193	.0029	.120
8	.164-36	.1655	.1699	.0044	.1475	.1489	.0014	.1294	.1323	.0029	.136
9	.177-32	.1786	.1835	.0049	.1583	.1598	.0015	.138	.1411	.0031	.1405
10	.190-30	.1916	.1968	.0052	.170	.1716	.0016	.1483	.1515	.0032	.152
12	.216-28	.2176	.2232	.0056	.1944	.1961	.0017	.1712	.1745	.0033	.173
14	.242-24	.2438	.250	.0062	.2167	.2184	.0017	.1897	.1932	.0035	.1935
16	.268-22	.2698	.2765	.0067	.2403	.2421	.0018	.2108	.2144	.0036	.213
18	.294-20	.2959	.3031	.0072	.2634	.2652	.0018	.2309	.2346	.0037	.234
20	.320-20	.3219	.3291	.0072	.2894	.2912	.0018	.2569	.2606	.0037	.261
22	.346-18	.3479	.3559	.0080	.3118	.3138	.0020	.2757	.2796	.0039	.281
24	.372-16	.374	.3828	.0088	.3334	.3354	.0020	.2928	.2968	.0040	.2968
26	.398-16	.400	.4088	.0088	.3594	.3614	.0020	.3188	.3228	.0040	.323
28	.424-14	.4261	.4359	.0098	.3797	.3818	.0021	.3333	.3374	.0041	.339
30	.450-14	.4521	.4619	.0098	.4057	.4078	.0021	.3593	.3634	.0041	.368

SPECIAL TAPS.

1	0.07364	0.0741	0.0768	0.0027	0.064	0.0651	0.001	0.0538	0.0559	0.0021	0.055
2	.086-56	.0872	.0903	.0031	.0756	.0767	.0011	.064	.0663	.0023	.067
3	.099-48	.1003	.1038	.0035	.0868	.088	.0012	.0732	.0757	.0025	.076
4	.112-40	.1134	.1175	.0041	.0972	.0986	.0014	.0809	.0837	.0028	.082
	36	.1135	.1179	.0044	.0955	.0969	.0014	.0774	.0803	.0029	.081
5	.125-40	.1264	.1305	.0041	.1102	.1116	.0014	.0939	.0967	.0028	.098
	36	.1255	.1309	.0044	.1085	.1099	.0014	.0904	.0933	.0029	.0935
6	.138-36	.1395	.1439	.0044	.1215	.1229	.0014	.1034	.1063	.0029	.1065
	32	.1396	.1445	.0049	.1193	.1208	.0015	.099	.1021	.0031	.1015
7	.151-32	.1526	.1575	.0049	.1323	.1338	.0015	.112	.1151	.0031	.116
	30	.1526	.1578	.0052	.131	.1326	.0016	.1093	.1125	.0032	.113
8	.164-32	.1656	.1705	.0049	.1453	.1468	.0015	.125	.1281	.0031	.1285
		.1656	.1708	.0052	.144	.1456	.0016	.1223	.1255	.0032	.1285
9	.177-z	.1786	.1838	.0052	.1569	.1585	.0016	.1353	.1385	.0032	.1405
	24	.1788	.185	.0062	.1517	.1534	.0017	.1247	.1282	.0035	.1285
10	.190-32	.1916	.1965	.0049	.1713	.1728	.0015	.151	.1541	.0031	.154
	24	.1918	.198	.0062	.1647	.1664	.0017	.1377	.1412	.0035	.1405
12	.216-24	.2178	.224	.0062	.1907	.1924	.0017	.1637	.1672	.0035	.166
14	.242-20	.2439	.2511	.0072	.2114	.2132	.0018	.1789	.1826	.0037	.182
16	.268-20	.2699	.2771	.0072	.2374	.2392	.0018	.2049	.2086	.0037	.209
18	.294-18	.2959	.3039	.0080	.2598	.2618	.0020	.2237	.2276	.0039	.228
20	.320-18	.3219	.3299	.0080	.2858	.2878	.0020	.2497	.2536	.0039	.257
22	.346-16	.348	.3568	.0088	.3074	.3094	.0020	.2668	.2708	.0040	.272
24	.372-18	.3739	.3819	.0080	.3378	.3398	.0020	.3017	.3056	.0039	.3125
26	.398-14	.4001	.4099	.0098	.3537	.3558	.0021	.3073	.3114	.0041	.316
28	.424-16	.426	.4348	.0088	.3854	.3874	.0020	.3448	.3488	.0040	.348
30	.450-16	.452	.4608	.0088	.4114	.4134	.0020	.3708	.3748	.0040	.377

WARNING: This is a 1910 edition. Some of the material may no longer be accurate

SQUARES, CUBES, SQUARE ROOTS AND CUBE ROOTS OF NUMBERS FROM 0.1 TO 1000.

No.	Square.	Cube.	Sq. Root.	Cube Root.	No.	Square.	Cube.	Sq. Root.	Cube Root.
0.1	.01	.001	.1000	.4642	1	1	1	1.0000	1.0000
0.15	.0225	.0034	.3873	.5315	2	4	8	2.0000	1.2600
0.2	.04	.008	.4472	.5848	3	9	27	3.0000	1.7100
0.25	.0625	.0156	.5000	.6300	4	16	64	4.0000	2.1533
0.3	.09	.027	.5477	.6694	5	25	125	5.0000	2.6207
0.35	.1225	.0429	.5910	.7047	6	36	216	6.0000	3.1067
0.4	.16	.064	.6325	.7368	7	49	343	7.0000	3.6089
0.45	.2025	.0911	.6708	.7663	8	64	512	8.0000	4.1213
0.5	.25	.125	.7071	.7937	9	81	729	9.0000	4.6416
0.55	.3025	.1666	.7416	.8195	10	100	1000	10.0000	5.1798
0.6	.36	.216	.7746	.8434	11	121	1331	11.0000	5.7344
0.65	.4225	.2746	.8062	.8662	12	144	1728	12.0000	6.3000
0.7	.49	.343	.8367	.8879	13	169	2197	13.0000	6.8763
0.75	.5625	.4219	.8660	.9086	14	196	2744	14.0000	7.4638
0.8	.64	.512	.8944	.9283	15	225	3375	15.0000	8.0625
0.85	.7225	.6141	.9219	.9473	16	256	4096	16.0000	8.6824
0.9	.81	.729	.9487	.9655	17	289	4913	17.0000	9.3234
0.95	.9025	.8574	.9747	.9830	18	324	5832	18.0000	9.9849
1.05	1.1025	1.158	1.025	1.016	19	361	6859	19.0000	10.6673
1.1	1.21	1.331	1.049	1.032	20	400	8000	20.0000	11.3603
1.15	1.3225	1.521	1.072	1.048	21	441	9261	21.0000	12.0639
1.2	1.44	1.728	1.095	1.065	22	484	10648	22.0000	12.7782
1.25	1.5625	1.953	1.118	1.077	23	529	12167	23.0000	13.5033
1.3	1.69	2.197	1.140	1.091	24	576	13824	24.0000	14.2391
1.35	1.8225	2.460	1.162	1.105	25	625	15625	25.0000	15.0
1.4	1.96	2.744	1.183	1.119	26	676	17566	26.0000	15.8262
1.45	2.1025	3.049	1.204	1.132	27	729	19659	27.0000	16.6633
1.5	2.25	3.375	1.224	1.147	28	784	21904	28.0000	17.5111
1.55	2.4025	3.724	1.245	1.161	29	841	24309	29.0000	18.3694
1.6	2.56	4.096	1.265	1.176	30	900	27000	30.0000	19.2381
1.65	2.7225	4.492	1.285	1.182	31	961	29911	31.0000	20.1171
1.7	2.89	4.913	1.304	1.195	32	1024	33032	32.0000	21.0062
1.75	3.0625	5.359	1.323	1.208	33	1089	36363	33.0000	21.9053
1.8	3.24	5.832	1.342	1.216	34	1156	40004	34.0000	22.8144
1.85	3.4225	6.332	1.360	1.228	35	1225	43855	35.0000	23.7335
1.9	3.61	6.859	1.378	1.238	36	1296	47916	36.0000	24.6626
1.95	3.8025	7.415	1.396	1.249	37	1369	52187	37.0000	25.6017
2	4	8	1.4142	1.259	38	1444	56668	38.0000	26.5508
2.05	4.2025	8.261	1.449	1.281	39	1521	61369	39.0000	27.5099
2.1	4.41	9.261	1.469	1.281	40	1600	66000	40.0000	28.4690
2.15	4.6225	10.046	1.483	1.301	41	1681	70881	41.0000	29.4281
2.2	4.84	10.648	1.493	1.320	42	1764	75902	42.0000	30.3872
2.25	5.0625	11.167	1.517	1.339	43	1849	81063	43.0000	31.3463
2.3	5.29	11.824	1.549	1.357	44	1936	86364	44.0000	32.3054
2.35	5.5225	12.625	1.581	1.375	45	2025	91805	45.0000	33.2645
2.4	5.76	13.574	1.612	1.375	46	2116	97386	46.0000	34.2236
2.45	6.0025	14.683	1.643	1.392	47	2209	103107	47.0000	35.1827
2.5	6.25	15.937	1.573	1.409	48	2304	108968	48.0000	36.1418
2.55	6.4925	17.352	1.603	1.426	49	2401	114969	49.0000	37.1009
2.6	6.76	17.874	1.632	1.442	50	2500	121100	50.0000	38.0600

No.	Square.	Cube.	Sq. Root.	Cube Root.	No.	Square.	Cube.	Sq. Root.	Cube Root.
45	2025	91125	45.0000	3.5200	45	2025	91125	45.0000	3.5200
46	2116	97336	46.0000	3.5791	46	2116	97336	46.0000	3.5791
47	2209	103823	47.0000	3.6382	47	2209	103823	47.0000	3.6382
48	2304	110592	48.0000	3.6973	48	2304	110592	48.0000	3.6973
49	2401	117649	49.0000	3.7564	49	2401	117649	49.0000	3.7564
50	2500	125000	50.0000	3.8155	50	2500	125000	50.0000	3.8155
51	2601	132651	51.0000	3.8746	51	2601	132651	51.0000	3.8746
52	2704	140608	52.0000	3.9337	52	2704	140608	52.0000	3.9337
53	2809	148877	53.0000	3.9928	53	2809	148877	53.0000	3.9928
54	2916	157462	54.0000	4.0519	54	2916	157462	54.0000	4.0519
55	3025	166367	55.0000	4.1110	55	3025	166367	55.0000	4.1110
56	3136	175596	56.0000	4.1701	56	3136	175596	56.0000	4.1701
57	3249	185153	57.0000	4.2292	57	3249	185153	57.0000	4.2292
58	3364	195042	58.0000	4.2883	58	3364	195042	58.0000	4.2883
59	3481	205267	59.0000	4.3474	59	3481	205267	59.0000	4.3474
60	3600	215832	60.0000	4.4065	60	3600	215832	60.0000	4.4065
61	3721	226741	61.0000	4.4656	61	3721	226741	61.0000	4.4656
62	3844	237998	62.0000	4.5247	62	3844	237998	62.0000	4.5247
63	3969	249607	63.0000	4.5838	63	3969	249607	63.0000	4.5838
64	4096	261572	64.0000	4.6429	64	4096	261572	64.0000	4.6429
65	4225	273905	65.0000	4.7020	65	4225	273905	65.0000	4.7020
66	4356	286610	66.0000	4.7611	66	4356	286610	66.0000	4.7611
67	4489	299691	67.0000	4.8202	67	4489	299691	67.0000	4.8202
68	4624	313152	68.0000	4.8793	68	4624	313152	68.0000	4.8793
69	4761	327007	69.0000	4.9384	69	4761	327007	69.0000	4.9384
70	4900	341260	70.0000	5.0000	70	4900	341260	70.0000	5.0000
71	5041	355925	71.0000	5.0611	71	5041	355925	71.0000	5.0611
72	5184	371006	72.0000	5.1222	72	5184	371006	72.0000	5.1222
73	5329	386507	73.0000	5.1833	73	5329	386507	73.0000	5.1833
74	5476	402432	74.0000	5.2444	74	5476	402432	74.0000	5.2444
75	5625	418785	75.0000	5.3055	75	5625	418785	75.0000	5.3055
76	5776	435570	76.0000	5.3666	76	5776	435570	76.0000	5.3666
77	5929	452791	77.0000	5.4277	77	5929	452791	77.0000	5.4277
78	6084	470452	78.0000	5.4888	78	6084	470452	78.0000	5.4888
79	6241	488557	79.0000	5.5499	79	6241	488557	79.0000	5.5499
80	6400	507110	80.0000	5.6110	80	6400	507110	80.0000	5.6110
81	6561	526125	81.0000	5.6721	81	6561	526125	81.0000	5.6721
82	6724	545606	82.0000	5.7332	82	6724	545606	82.0000	5.7332
83	6889	565557	83.0000	5.7943	83	6889	565557	83.0000	5.7943
84	7056	586082	84.0000	5.8554	84	7056	586082	84.0000	5.8554
85	7225	607185	85.0000	5.9165	85	7225	607185	85.0000	5.9165
86	7396	628870	86.0000	5.9776	86	7396	628870	86.0000	5.9776
87	7569	651141	87.0000	6.0387	87	7569	651141	87.0000	6.0387
88	7744	674002	88.0000	6.1000	88	7744	674002	88.0000	6.1000
89	7921	697557	89.0000	6.1611	89	7921	697557	89.0000	6.1611
90	8100	721810	90.0000	6.2222	90	8100	721810	90.0000	6.2222
91	8281	746775	91.0000	6.2833	91	8281	746775	91.0000	6.2833
92	8464	772456	92.0000	6.3444	92	8464	772456	92.0000	6.3444
93	8649	798867	93.0000	6.4055	93	8649	798867	93.0000	6.4055
94	8836	826012	94.0000	6.4666	94	8836	826012	94.0000	6.4666
95	9025	853905	95.0000	6.5277	95	9025	853905	95.0000	6.5277
96	9216	882550	96.0000	6.5888	96	9216	882550	96.0000	6.5888
97	9409	911951	97.0000	6.6499	97	9409	911951	97.0000	6.6499
98	9604	942112	98.0000	6.7110	98	9604	942112	98.0000	6.7110
99	9801	973037	99.0000	6.7721	99	9801	973037	99.0000	6.7721
100	10000	1000000	100.0000	6.8332	100	10000	1000000	100.0000	6.8332

WARNING: This is a 1910 edition. Some of the material may no longer be accurate

DIMENSIONS OF MACHINE SCREW HEADS, A. S. M. E. STANDARD.

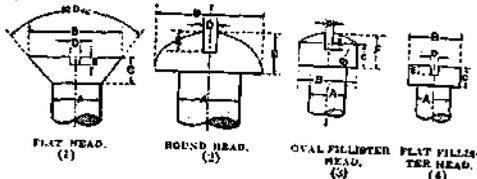

Dimensions.

A = Diam. of Body D = Width of Slot = 0.173 A + 0.015.
 B = Diameter of Head, and rad. of oval (3). (1) (2) (3) (4)
 C = Height of Head or Side of Head (3). A - 0.008 1.85A - 0.005 1.64A - 0.009 1.64A - 0.009
 E = Width of Slot. 1.75B 0.7A 0.56A - 0.002 0.66A - 0.002
 F = Height of Head (3). 1/2C + 0.01 1/2F 1/2C

A	B (1)	B (2)	B (3,4)	C (1)	C (2)	C (3,4)	D	E (1)	E (2)	E (3)	E (4)	F (3)
0.060	0.112	0.105	0.094	0.029	0.042	0.037	0.025	0.010	0.031	0.025	0.019	0.046
0.075	0.138	0.130	0.107	0.037	0.051	0.046	0.028	0.012	0.031	0.025	0.023	0.059
0.088	0.164	0.154	0.122	0.045	0.060	0.054	0.030	0.015	0.040	0.034	0.027	0.072
0.099	0.190	0.178	0.143	0.052	0.069	0.063	0.032	0.017	0.044	0.042	0.032	0.086
0.112	0.216	0.202	0.164	0.060	0.078	0.071	0.034	0.020	0.049	0.048	0.036	0.099
0.125	0.242	0.226	0.186	0.067	0.087	0.080	0.037	0.022	0.053	0.051	0.040	0.110
0.138	0.268	0.250	0.217	0.075	0.096	0.089	0.039	0.021	0.058	0.056	0.044	0.120
0.151	0.294	0.274	0.238	0.082	0.105	0.097	0.041	0.027	0.063	0.061	0.049	0.130
0.164	0.320	0.298	0.259	0.090	0.114	0.106	0.043	0.030	0.067	0.065	0.052	0.140
0.177	0.346	0.322	0.281	0.097	0.123	0.114	0.046	0.032	0.071	0.069	0.057	0.150
0.190	0.372	0.346	0.302	0.105	0.133	0.124	0.048	0.035	0.076	0.074	0.062	0.160
0.203	0.398	0.369	0.325	0.113	0.142	0.132	0.051	0.038	0.081	0.079	0.066	0.170
0.216	0.424	0.403	0.350	0.121	0.151	0.141	0.053	0.040	0.085	0.083	0.070	0.180
0.229	0.450	0.427	0.371	0.129	0.160	0.149	0.055	0.043	0.090	0.088	0.074	0.190
0.242	0.476	0.451	0.392	0.137	0.169	0.158	0.058	0.045	0.094	0.092	0.077	0.200
0.255	0.502	0.475	0.413	0.145	0.178	0.166	0.060	0.048	0.099	0.097	0.081	0.210
0.268	0.528	0.499	0.434	0.153	0.187	0.174	0.063	0.050	0.103	0.101	0.084	0.220
0.281	0.554	0.523	0.455	0.161	0.196	0.183	0.065	0.053	0.108	0.106	0.088	0.230
0.294	0.580	0.550	0.476	0.169	0.205	0.192	0.068	0.055	0.112	0.110	0.091	0.240
0.307	0.606	0.575	0.497	0.177	0.214	0.200	0.070	0.058	0.117	0.115	0.093	0.250
0.320	0.632	0.601	0.518	0.185	0.223	0.209	0.073	0.060	0.122	0.120	0.095	0.260
0.333	0.658	0.626	0.539	0.193	0.232	0.218	0.075	0.063	0.127	0.125	0.097	0.270
0.346	0.684	0.651	0.560	0.201	0.241	0.227	0.078	0.065	0.132	0.130	0.099	0.280
0.359	0.710	0.672	0.581	0.209	0.250	0.236	0.080	0.068	0.137	0.135	0.101	0.290
0.372	0.736	0.693	0.602	0.217	0.259	0.245	0.083	0.070	0.142	0.140	0.103	0.300
0.385	0.762	0.714	0.623	0.225	0.268	0.254	0.085	0.073	0.147	0.145	0.105	0.310
0.398	0.788	0.735	0.644	0.233	0.277	0.263	0.088	0.075	0.152	0.150	0.107	0.320
0.411	0.814	0.756	0.665	0.241	0.286	0.272	0.090	0.078	0.157	0.155	0.109	0.330
0.424	0.840	0.777	0.686	0.249	0.295	0.281	0.093	0.080	0.162	0.160	0.111	0.340
0.437	0.866	0.798	0.707	0.257	0.304	0.290	0.095	0.083	0.167	0.165	0.113	0.350
0.450	0.892	0.819	0.728	0.265	0.313	0.299	0.098	0.085	0.172	0.170	0.115	0.360

WARNING: This is a 1910 edition. Some of the material may no longer be accurate

WEIGHT OF 100 BOLTS WITH SQUARE HEADS. (Hoopes & Townsend.)

Diam. in.	Weight of 100 Bolts (lbs.)															
	1/4	5/16	3/8	7/16	1/2	9/16	5/8	3/4	7/8	1	1 1/8	1 1/4	1 3/8	1 1/2	1 3/4	2
1/16	3.8	4.2	4.6	5.0	5.4	5.8	6.2	6.6	7.0	7.4	7.8	8.2	8.6	9.0	9.4	9.8
1/8	4.8	5.2	5.6	6.0	6.4	6.8	7.2	7.6	8.0	8.4	8.8	9.2	9.6	10.0	10.4	10.8
3/16	5.8	6.2	6.6	7.0	7.4	7.8	8.2	8.6	9.0	9.4	9.8	10.2	10.6	11.0	11.4	11.8
1/4	6.8	7.2	7.6	8.0	8.4	8.8	9.2	9.6	10.0	10.4	10.8	11.2	11.6	12.0	12.4	12.8
5/16	7.8	8.2	8.6	9.0	9.4	9.8	10.2	10.6	11.0	11.4	11.8	12.2	12.6	13.0	13.4	13.8
3/8	8.8	9.2	9.6	10.0	10.4	10.8	11.2	11.6	12.0	12.4	12.8	13.2	13.6	14.0	14.4	14.8
7/16	9.8	10.2	10.6	11.0	11.4	11.8	12.2	12.6	13.0	13.4	13.8	14.2	14.6	15.0	15.4	15.8
1/2	10.8	11.2	11.6	12.0	12.4	12.8	13.2	13.6	14.0	14.4	14.8	15.2	15.6	16.0	16.4	16.8
9/16	11.8	12.2	12.6	13.0	13.4	13.8	14.2	14.6	15.0	15.4	15.8	16.2	16.6	17.0	17.4	17.8
5/8	12.8	13.2	13.6	14.0	14.4	14.8	15.2	15.6	16.0	16.4	16.8	17.2	17.6	18.0	18.4	18.8
3/4	13.8	14.2	14.6	15.0	15.4	15.8	16.2	16.6	17.0	17.4	17.8	18.2	18.6	19.0	19.4	19.8
7/8	14.8	15.2	15.6	16.0	16.4	16.8	17.2	17.6	18.0	18.4	18.8	19.2	19.6	20.0	20.4	20.8
1	15.8	16.2	16.6	17.0	17.4	17.8	18.2	18.6	19.0	19.4	19.8	20.2	20.6	21.0	21.4	21.8
1 1/8	16.8	17.2	17.6	18.0	18.4	18.8	19.2	19.6	20.0	20.4	20.8	21.2	21.6	22.0	22.4	22.8
1 1/4	17.8	18.2	18.6	19.0	19.4	19.8	20.2	20.6	21.0	21.4	21.8	22.2	22.6	23.0	23.4	23.8
1 3/8	18.8	19.2	19.6	20.0	20.4	20.8	21.2	21.6	22.0	22.4	22.8	23.2	23.6	24.0	24.4	24.8
1 1/2	19.8	20.2	20.6	21.0	21.4	21.8	22.2	22.6	23.0	23.4	23.8	24.2	24.6	25.0	25.4	25.8
1 3/4	20.8	21.2	21.6	22.0	22.4	22.8	23.2	23.6	24.0	24.4	24.8	25.2	25.6	26.0	26.4	26.8
2	21.8	22.2	22.6	23.0	23.4	23.8	24.2	24.6	25.0	25.4	25.8	26.2	26.6	27.0	27.4	27.8

ROUND HEAD RIVETS.

Approximate Number in One Pound. (Garland Nut & Rivet Co.)

Diam. in.	Approximate Number in One Pound															
	1/16	1/8	3/16	1/4	5/16	3/8	7/16	1/2	5/8	3/4	7/8	1	1 1/8	1 1/4	1 3/8	1 1/2
1/16	103	145	184	194	204	214	224	234	244	254	264	274	284	294	304	314
1/8	31	41	51	56	61	66	71	76	81	86	91	96	101	106	111	116
3/16	21	26	31	36	41	46	51	56	61	66	71	76	81	86	91	96
1/4	14	19	24	29	34	39	44	49	54	59	64	69	74	79	84	89
5/16	10	14	18	22	26	30	34	38	42	46	50	54	58	62	66	70
3/8	7	10	13	16	19	22	25	28	31	34	37	40	43	46	49	52
7/16	5	7	9	11	13	15	17	19	21	23	25	27	29	31	33	35
1/2	4	5	6	7	8	9	10	11	12	13	14	15	16	17	18	19
5/8	3	4	5	6	7	8	9	10	11	12	13	14	15	16	17	18
3/4	2	3	4	5	6	7	8	9	10	11	12	13	14	15	16	17
7/8	1	2	3	4	5	6	7	8	9	10	11	12	13	14	15	16
1	1	2	3	4	5	6	7	8	9	10	11	12	13	14	15	16

Small rivets are made to fit holes of their rated size; the actual diameter may vary slightly from the decimals given below:
 Diam. 1/16 1/8 3/16 1/4 5/16 3/8 7/16 1/2 5/8 3/4 7/8 1 1 1/8 1 1/4 1 3/8 1 1/2
 Approx. diam. .094 .106 .125 .146 .165 .187 .210 .236 .262 .289 .315 .342 .369 .396 .423
 Approx. diam. .215 .245 .275 .305 .365 .425

TRACK BOLTS.
With United States Standard Hexagon Nuts.

Wt. of Rail. Lb. per Yard.	Bolts.	Nuts.	No. in Keg. 200 Lb.	Kegs per Mile.	Wt. of Rail. Lbs. per Yard.	Bolts.	Nuts.	No. in Keg. 200 Lb.	Kegs per Mile.
45 to 85	3/4 x 4 1/4	1 1/4	230	6.3	30 to 40	5/8 x 3 1/2	1 1/8	375	4.
			240	6.		5/8 x 3	1 1/8	410	3.7
			254	5.7		5/8 x 2 3/4	1 1/8	435	3.3
			260	5.5		5/8 x 2 1/2	1 1/8	465	3.1
			266	5.4		1/2 x 3	7/8	715	2.
			283	5.1		1/2 x 2 1/2	7/8	760	2.
					20 to 30				
						1/2 x 2	7/8	820	2.

WROUGHT WASHERS. MANUFACTURERS' STANDARD.
(Upson Nut Co., Cleveland, 1906.)

Diam.	Hole.	Thick-ness B.W.G.	Bolt.	No. in 200 Lb.	Diam.	Hole.	Thick-ness B.W.G.	Bolt.	No. in 200 Lb.
In.	In.	No.	In.		In.	In.	No.	In.	
9/16	1/4	18	3/16	85200	2 1/2	1 1/8	9	1	1200
3/4	5/16	16	1/4	34800	2 3/4	1 1/4	9	1 1/8	888
7/8	3/8	16	5/16	26200	3	1 3/8	9	1 1/4	900
1	7/16	14	3/8	14400	3 1/4	1 1/2	8	1 3/8	600
1 1/4	1/2	14	7/16	8400	3 1/2	1 5/8	8	1 1/2	570
1 3/8	9/16	12	1/2	5800	3 3/4	1 3/4	8	1 3/8	460
1 1/2	5/8	12	9/16	4600	4	1 7/8	8	1 3/4	432
1 3/4	1 1/8	10	5/8	2600	4 1/4	2	8	1 7/8	366
2	1 3/8	10	3/4	2200	4 1/2	2 1/8	8	2	356
2 1/4	1 5/8	9	7/8	1600					

SIZES OF CAST WASHERS.
(Upson Nut Co., Cleveland, 1906.)

Diam.	Hole.	Thick.	Bolt.	Weight. Lbs.	Diam.	Hole.	Thick.	Bolt.	Weight. Lbs.
In.	In.	In.	In.		In.	In.	In.	In.	
2 1/4	5/8	1 1/8	1/2	1/2	4	1 1/8	1 5/16	1	1 5/8
2 3/4	3/4	3/4	5/8	5/8	4 1/2	1 1/4	1	1 1/8	2 1/4
3	7/8	1 3/16	3/4	3/4	5	1 3/8	1 1/8	1 1/4	3
3 1/2	1	7/8	7/8	1 1/4	6	1 3/4	1 1/4	1 1/2	5

CONE-READ BOILER RIVETS, WEIGHT PER 100.
(Hoopes & Townsend.)

Diam., in., Scant.	1/2	9/16	5/8	1 1/8	3/4	13/16	7/8	1	1 1/8*	1 1/4*
Length.	lbs.	lbs.	lbs.	lbs.	lbs.	lbs.	lbs.	lbs.	lbs.	lbs.
3/4 inch	8.75	13.7	16.20							
7/8 "	9.35	14.4	17.22							
1 "	10.00	15.2	18.25	21.70	26.55					
1 1/8 "	10.70	16.0	19.28	23.10	28.00					
1 1/4 "	11.40	16.8	20.31	24.50	29.45	37.0	46	60		
1 3/8 "	12.10	17.6	21.34	25.90	30.90	38.6	48	63	95	
1 1/2 "	12.80	18.4	22.37	27.30	32.35	40.2	50	65	98	133
1 5/8 "	13.50	19.2	23.40	28.70	33.80	41.9	52	67	101	137
1 3/4 "	14.20	20.0	24.43	30.10	35.25	43.5	54	69	104	141
1 7/8 "	14.90	20.8	25.46	31.50	36.70	45.2	56	71	110	145
2 "	15.60	21.6	26.49	32.90	38.15	47.0	58	74		149
2 1/8 "	16.30	22.4	27.52	34.30	39.60	48.7	60	77	114	153
2 1/4 "	17.00	23.2	28.55	35.70	41.05	50.3	62	80	118	157
2 3/8 "	17.70	24.0	29.58	37.10	42.50	51.9	64	83	121	161
2 1/2 "	18.40	24.8	30.61	38.50	43.95	53.5	66	86	124	165
2 5/8 "	19.10	25.6	31.64	39.90	45.40	55.1	68	89	127	169
2 3/4 "	19.80	26.4	32.67	41.30	46.85	56.8	70	92	130	173
2 7/8 "	20.50	27.2	33.70	42.70	48.30	58.4	72	95	133	177
3 "	21.20	28.0	34.73	44.10	49.75	60.0	74	98	137	181
3 1/4 "	22.60	29.7	36.79	46.90	52.65	63.3	78	103	144	189
3 1/2 "	24.00	31.5	38.85	49.70	55.51	66.5	82	108	151	197
3 3/4 "	25.40	33.3	40.91	52.50	58.45	69.5	86	113	158	205
4 "	26.80	35.2	42.97	55.30	61.35	73.0	90	118	165	213
4 1/4 "	28.20	36.9	45.03	58.10	64.25	76.3	94	124	172	221
4 1/2 "	29.60	38.6	47.09	60.90	67.15	79.5	98	130	179	229
4 3/4 "	31.00	40.3	49.15	63.70	70.05	82.8	102	136	186	237
5 "	32.40	42.0	51.27	66.50	72.95	86.0	106	142	193	245
5 1/4 "	33.80	43.7	53.27	69.20	75.85	89.3	110	148	200	254
5 1/2 "	35.20	45.4	55.33	72.00	78.75	92.5	114	154	206	263
5 3/4 "	36.60	47.1	57.39	74.80	81.65	95.7	118	160	212	272
6 "	38.00	48.8	59.45	77.60	84.55	99.0	122	166	218	281
6 1/2 "	40.80	52.0	63.57	83.30	90.35	105.5	130	177	231	297
7 "	43.60	55.2	67.69	88.90	95.15	112.0	138	188	245	314
Heads.....	5.50	8.40	11.50	13.20	18.00	23.0	29.0	38.0	55.0	77.5

* These two sizes are calculated for exact diameter.

TURNBUCKLES.

(Cleveland City Forge and Iron Co.)

Standard sizes made with right and left threads. D = outside diameter

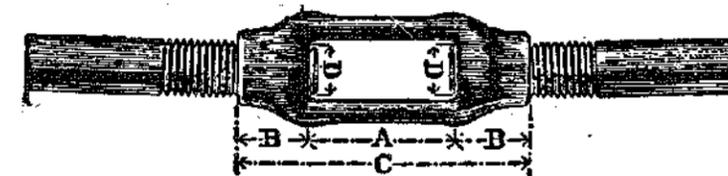

FIG. 76.

of screw. A = length in clear between heads = 6 ins. for all sizes. B = length of tapped heads = 1 1/2 D nearly. C = 6 ins. + 3 D nearly.

TINNERS' RIVETS. FLAT HEADS.

Garland Nut & Rivet. Cr.

Diam., in.	Length, in.	Wt. per 1000.	Diam., in.	Length, in.	Wt. per 1000.	Diam., in.	Length, in.	Wt. per 1000.	Diam., in.	Length, in.	Wt. per 1000.
0.070	1/8	4 oz.	0.115	13/64	1 lb.	0.160	5/16	3 lbs.	0.225	7/16	8
.080	9/64	6	.120	7/32	1 1/4	.163	21/64	3 1/2	.230	29/64	9
.090	5/32	8	.125	15/64	1 1/2	.173	11/32	4	.233	15/32	10
.094	11/64	10	.133	1/4	1 3/4	.185	3/8	5	.253	1/2	12
.101	3/16	12	.140	17/64	2	.200	25/64	6	.275	33/64	14
.109	3/16	14	.147	9/32	2 1/2	.215	13/32	7	.293	17/32	16

MATERIAL REQUIRED FOR ONE MILE OF SINGLE TRACK RAILROAD.

(American Bureau of Inspection and Tests, 1908.)

Cross Ties.

33-Foot Rail.		30-Foot Rail.		Spacing of Ties, Center to Center.
Ties per Rail.	Ties per Mile.	Ties per Rail.	Ties per Mile.	
20	3200	18	3168	1 ft. 6 in.
18	2880	16	2816	1 " 9 "
16	2560	14	2464	2 " 0 "

Rails.

Weight per Yard, Lb.	Gross Tons Per Mile.	Weight per Yard, Lb.	Gross Tons Per Mile.	Weight per Yard, Lb.	Gross Tons per Mile.
100	157 1/7	67	105 2/7	40	62 6/7
90		65	102 1/7	35	55
85	141 3/7	60	94 2/7	30	47 1/7
75	125 5/7	56	88	25	39 2/7
72	117 6/7	52	81 5/7	20	31 3/7
70	113 1/7	50	78 4/7	16	25 1/7
	110	45	70 5/7	12	18 6/7

Decimal Equivalent for 1/7 = 0.143. 2/7 = 0.286. 3/7 = 0.429. 4/7 = 0.571. 5/7 = 0.714. 6/7 = 0.857.

To find gross tons per mile of track multiply weight, of rail (pounds per yard) by 7 and divide by 7. To find feet of rail per gross ton divide 6720 by weight of rail per yard.

Splices and Bolts.

Length of Rails Used.	Number of Joints or Rails.	Number of Bolts Using Four-Hole Splices.	Number of Bolts Using Six-Hole Splices.
33 ft.	320	1280	1920
30 "	352	1408	2112

Spikes.

Kegs per Mile (4 Spikes to a Tie).

Size Measured Under Head.	Av. No. per Keg of 200 Lbs.	Using 33-Ft. Rails.			Using 30-Ft. Rails.			Ties 2 Ft. C. to C.	In ordering spikes allow for extras, waste, etc.
		20	18	16	18	16	14		
6 x 5/8	260	49.2	44.3	39.4	48.7	43.3	37.9	40.6	
6 x 9/16	350	36.6	32.9	29.3	36.2	32.2	29.2	30.2	
5 1/2 x 5/8	290	44.1	39.7	35.3	43.7	38.0	34.0	36.4	
5 1/2 x 9/16	375	34.1	30.7	27.3	33.8	30.0	26.3	28.2	
5 x 9/16	460	38.0	28.8	25.6	31.7	28.2	24.6	26.4	
5 x 1/2			25.6	22.8	28.2	23.0	21.9	23.5	
4 1/2 x 1/2					23.9	21.3	18.6	19.9	
4 1/2 x 7/16	530	24.2	21.8	17.0	18.6	16.6	14.5	15.5	
Spikes per mile.:	680	12800	11520	10240	2672	11264	9856	10560	

WROUGHT SPIKES.

Number of Nails in Keg of 150 Pounds.

Length, Inches.	1/4 in.	5/16 in.	3/8 in.	Length, Inches.	1/4 in.	5/16 in.	3/8 in.	7/16 in.	1/2 in.
3	2250		7	1161	662	662	482	384	306
3 1/2	1890			1208		635	455		256
4									240
4 1/2	1650	1464	1135	1064	1090	573	424	391	300
5							249		270
6	1380	1292	930	868	742	570	236	200	180

For sizes and weights of wire spikes see Steel Wire Nails, page 235.

BOAT SPIKES.

Number in Keg of 200 Pounds.

Length.	1/4	5/16	3/8	1/2
4 inch	2375			
5 "	2050	1220		
6 "	1825	1175	940	450
7 "		990	800	375
8 "		880	650	335
9 "			525	300
10 "			425	275

WARNING: This is a 1910 edition. Some of the material may no longer be accurate

LENGTH AND NUMBER OF CUT NAILS TO THE POUND.

Size.	Length.	Common.	Clinch.	Fence.	Finishing.	Fine.	Barrel.	Casing.	Brads.	Tobacco	Out Spikes
3/4	3/4 in.						800				
7/8	7/8						500				
2d	1	800			1100	1000	376				
3d	1 1/4	480			720	760	224				
4d	1 1/2	288			523	368	180	398			
5d	1 3/4	200			410					130	
6d	2	168	95	84	268			224	126	96	
7d	2 1/4	124	74	64	188				98	82	
8d	2 1/2	as	62	52	146			128	75	68	
9d	2 3/4	70	53	30	130			110	65		
10d	3	58	46	30	102			91	55		28
12d	3 1/4	44	42	24	76				40		
16d	3 1/2	34	38	20	62			54	27		
20d	4	23	33	16	54			40			22
30d	4 1/2	18	20					33			14 1/2
40d	5	14						27			12 1/2
50d	5 1/2	10									8 1/2
60d	6	8									6

DIMENSIONS OF WOOD SCREWS.

No.	Threads per In.	Diam. of Body.	Lengths.	No.	Threads per In.	Diam. of Body.	Lengths.
2	56	In. 0.0842	In. 3/16-1/2	12	20, 24	In. 0.2158	In. 3/8-13/4
3	48	.0975	3/16-5/8	14	20, 24	.2421	3/8-2
4	32, 36, 40	.1105	3/16-3/4	16	16, 18, 20	.2684	3/8-2 1/4
5	32, 36, 40	.1236	3/16-7/8	18	16, 18	.2947	1/2-2 1/2
6	30, 32	.1368	3/16-1	20	16, 18	.3210	1/2-2 3/4
7	30, 32	.1500	1/4-1 1/8	22	16, 18	.3474	1/2-3
8	30, 32	.1631	1/4-1 1/4	24	14, 16	.3737	1/2-3
9	24, 30, 32	.1763	1/4-1 3/4	26	14, 16	.4000	3/4-3
10	24, 30, 32	.1894	1/4-1 1/2	28	14, 16	.4263	8-13/7
				30	14, 16	.4520	13-

WEIGHTS AND DIMENSIONS OF LAG SCREWS.

Length in Inches.	Diameter in Inches.				
	3/8	7/16	1/2	5/8	3/4
	Lb. per 100.	Lb. per 100.	Lb. per 100.	Lb. per 100.	Lb. per 100.
1 1/2	6.88				
1 3/4	7.50	11.75			
2	8.25	12.62	16.88		
2 1/4	9.25	12.88	18.07		
2 1/2	9.62	13.28	19.18		
3	10.82	16.62	22.00	34.07	
3 1/2	11.50	18.18	24.00	35.88	
4	13.31	18.88	26.82	39.25	64.00
4 1/2	14.82	19.50	28.25	42.62	67.88
5	16.50	21.25	30.37	47.75	71.37
5 1/2	17.37	23.56	33.88	51.62	79.37
6	18.82	25.31	35.37	55.12	86.62
7			38.94	61.88	92.75
8			44.37	68.75	97.50
9				77.00	108.75
10				90.00	124.75

WARNING: This is a 1910 edition. Some of the material may no longer be accurate

SIZES, LENGTH, AND NUMBER TO THE POUND OF STANDARD STEEL WIRE NAILS. (American Steel and Wire Co., 1908.)

Sizes.	Length, Inches.	Wire Spikes.	Lining.	Tobacco.	Shingle.	Barbed Roofing.	Slatting.	Barbed Car Nail.		Boat Nails.		Flooring Brads.	Casing, and Smooth and Barbed Box.	Barrel.	Fine.	Smooth and Barbed Finishing.	Fence.	Clinch.	Common Nails and Brads.	Length, Inches.
								Light.	Heavy.	Light.	Heavy.									
2d	3/4	2077	2077			714								1346	2077					3/4
3d fine	7/8	1781	1781			469								906	1781					7/8
3d common	1	155	155			411								775	1551					1
4d	1 1/8					411	225	187	165	274	44			700	807	584	142	274	316	1 1/8
5d	1 1/4					230	187	176	118	142	82			568	500	500	157	235	271	1 1/4
6d	1 3/8					230	142	151	103	124	32			400	309	309	124	157	181	1 3/8
7d	1 1/2					103	103	103	76	92	26			357	238	189	139	139	161	1 1/2
8d	1 3/4					99	99	99	69	82	14			400	189	172	99	99	106	1 3/4
9d	2					90	90	90	54	62	13			568	121	121	69	69	96	2
10d	2 1/4					83	83	83	50	57	10			760	90	90	62	62	96	2 1/4
12d	2 1/2								42	50	13				113	113	40	40	63	2 1/2
16d	3								35	43	12				90	90	30	30	49	3
20d	3 1/4								26	31	10				62	62	23	23	31	3 1/4
30d	4								18	28	8								24	4
40d	4 1/2								15	21	7								18	4 1/2
50d	5								13	17	6								14	5
60d	5 1/2								11	15	5								11	5 1/2
	6								8	11	4								8	6

3 3/8 lb. of 4d Common, or 2 3/8 lb. of 3d Common, will lay 1000 shingles.
3 1/4 lb. of 3d Fine will put on 1000 laths — 4 nails to the lath.

APPROXIMATE NUMBER OF WIRE NAILS PER POUND.
(American Steel and Wire Co., 1908.)

Wire Gauge. B.W.G.	Length, Inches.																								
	3/16	1/4	3/8	1/2	5/8	3/4	1	1 1/4	1 1/2	1 3/4	2	2 1/2	3	3 1/2	4	4 1/2	5	6	7	8	9	10	11	12	
3/8 in.																									
0																									
1																									
2																									
3																									
4																									
5																									
6																									
7																									
8																									
9																									
10																									
11																									
12																									
13																									
14																									
15																									
16																									
17																									
18																									
19																									
20																									
21																									
22																									

These approximate numbers are an average only, and the figures given may be varied either way by changes in the dimensions of the heads or points. Brads and no-head nails will run more to the pound than the table shows, and large or thick-headed nails will run less.

PROPERTIES OF STEEL WIRE.

(John A. Roebling's Sons Co., 1908.)

No. of Roebling Gauge.	Diam., in.	Area, square inches.	Breaking strain, 100, per sq. inch.	Weight in pounds.		Feet in 2000 lb.
				Per 1000 ft.	Per mile.	
000000	0.460	0.166191	16,619	558.4	2,948	3,582
000000	0.430	0.145221	14,522	487.9	2,576	4,099
000000	0.395	0.121304	12,130	407.6	2,152	4,907
000000	0.362	0.102922	10,292	345.8	1,826	5,783
000000	0.331	0.086049	8,605	289.1	1,527	6,917
0	0.307	0.074023	7,402	248.7	1,313	8,041
1	0.283	0.062902	6,290	211.4	1,116	9,463
2	0.263	0.054325	5,433	182.5	964	10,957
3	0.244	0.047660	4,766	157.1	830	12,730
4	0.225	0.039761	3,976	133.6	705	14,970
5	0.207	0.033654	3,365	113.1	597	17,687
6	0.192	0.028953	2,895	97.3	514	20,559
7	0.177	0.024606	2,461	82.7	437	24,191
8	0.162	0.020612	2,061	69.3	366	28,878
9	0.148	0.017203	1,720	57.8	305	34,600
10	0.135	0.014314	1,431	48.1	254	41,584
11	0.120	0.011310	1,131	38.0	201	52,631
12	0.105	0.008659	866	29.1	154	68,752
13	0.092	0.006648	665	22.3	118	89,525
14	0.080	0.005027	503	16.9	89.2	118,413
15	0.072	0.004071	407	13.7	72.2	146,198
16	0.063	0.003117	312	10.5	55.3	191,022
17	0.054	0.002290	229	7.70	40.6	259,909
18	0.047	0.001735	174	5.83	30.8	343,112
19	0.041	0.001320	132	4.44	23.4	450,856
20	0.035	0.000962	96	3.23	17.1	618,620
21	0.032	0.000804	80	2.70	14.3	740,193
22	0.028	0.000616	62	2.07	10.9	966,651
23	0.025	0.000491	49	1.65	8.71	1,237,377
24	0.023	0.000415	42	1.40	7.37	1,500,000
25	0.020	0.000314	31	1.06	5.58	1,966,651
26	0.018	0.000254	25	0.855	4.51	2,500,000
27	0.017	0.000227	23	0.763	4.03	2,750,000
28	0.016	0.000201	20	0.676	3.57	3,000,000
29	0.015	0.000177	18	0.594	3.14	3,250,000
30	0.014	0.000154	15	0.517	2.73	3,500,000
31	0.0135	0.000143	14	0.481	2.54	3,750,000
32	0.013	0.000133	13	0.446	2.36	4,000,000
33	0.011	0.000095	9	0.319	1.69	5,000,000
34	0.010	0.000079	7	0.264	1.39	6,000,000
35	0.0095	0.000071	6	0.238	1.26	7,000,000
36	0.009	0.000064	6	0.214	1.13	8,000,000

The above table was calculated on a basis of 483.84 lb. per cu. ft. for steel wire. Iron wire is a trifle lighter. The breaking strains are calculated for 100,000 lb. per sq. in. throughout, simply for convenience, so that the breaking strains of wires of any strength per sq. in. may be quickly determined by multiplying the values given in the tables by the ratio between the strength per square inch and 100,000. Thus, a No. 15 wire, with a strength per sq. in. of 150,000 lb., has a breaking strain of $407 \times \frac{150,000}{100,000} = 610.5$ lb.

WARNING: This is a 1910 edition. Some of the material may no longer be accurate

GALVAXIZED IRON WIRE FOR TELEGRAPH AND TELEPHONE LINES.

(Trenton Iron Co.)

WEIGHT PER MILE-OHM. -This term is to be understood as distinguishing the *resistance* of material only, and means the weight of such material required per mile to give the resistance of one ohm. To ascertain the mileage resistance of any wire, divide the "weight per mile-ohm" by the weight of the wire per mile. Thus in a grade of Extra Best Best, of which the weight per mile-ohm is 5090, the mileage resistance of No. 6 (weight per mile 525 lbs.) would be about 9 1/2 ohms; and No. 14 steel wire, 6500 lbs. weight per mile-ohm (95 lbs. weight per mile), would show about 69 ohms.

Sizes of Wire used in Telegraph and Telephone Lines.

No. 4. Has not been much used until recently; is now used on important lines where the multiplex systems are applied.

No. 5. Little used in the United States.

No. 6. Used for important circuits between cities.

No. 8. Medium size for circuits of 400 miles or less.

No. 9. For similar locations to No. 8, but on somewhat shorter circuits; until lately was the size most largely used in this country.

Nos. 10, 11. For shorter circuits, railway telegraphs, private lines, police and fire-alarm lines, etc.

No. 12. For telephone lines, police and fire-alarm lines, etc.

Nos. 13, 1-I. For telephone lines and short private lines: steel wire is used most generally in these sizes.

The coating of telegraph wire with zinc as a protection against oxidation is now generally admitted to be the most efficacious method.

The grades of line wire are generally known to the trade as "Extra Best Best" (E. B. B.), "Best Best" (B. B.), and "Steel."

"Extra Best Best" is made of the very best iron, as nearly pure as any commercial iron, soft, tough, uniform, and of very high conductivity, its weight per mile-ohm being about 5000 lbs.

The "Best Best" is of iron, showing in mechanical tests almost as good results as the E. B. B., but is not quite as soft and somewhat lower in conductivity; weight per mile-ohm about 5700 lbs.

The "Steel" wire is well suited for telephone or short telegraph lines, and the weight per mile-ohm is about 6500 lbs.

The following are (approximately) the weights per mile of various sizes of galvanized telegraph wire, drawn by Trenton Iron Co.'s gauge:

NO.	4.	5.	6.	7.	8.	9.	10.	11.	12.	13.	14.
Lbs	720,	610,	525,	450.	375,	310,	250,	200,	160,	125,	95.

TESTS OF TELEGRAPH WIRE.

The following data are taken from a table given by Mr. Prescott relating to tests of E. B. B. galvanized wire furnished the Western Union Telegraph Co.

Size of Wire	Diam., Inch.	Weight.		Length, Feet per pound.	Resistance, Temp. 75.8° Fahr.		Ratio of Breaking Weight to Weight per mile.
		Grains per foot.	Pounds per mile.		Feet per ohm	ohms per mile.	
5	.220	891.3	673.0	7.85	727	7.26	
6	.203	758.9	572.2	9.20	618	a. 54	3.05
7	.180	596.7	449.9	11.70	578	10.86	3.40
8	.165	501.4	378.1	14.00	409	12.92	3.07
9	.148	403.4	304.2	17.4	328	16.10	3.38
10	.134	330.7	249.4	21.2	269	19.60	3.37
11	.120	265.2	200.0	26.4	216	24.42	2.97
12	.109	218.8	165.0	32.0	179	29.60	3.43
14	.083	126.9	95.7	55.2	104	51.00	3.05

WARNING: This is a 1910 edition. Some of the material may no longer be accurate

JOINTS IN TELEGRAPH WIRES. -The fewer the joints in a line the better. All joints should be carefully made and well soldered over. for a bad joint may cause as much resistance to the electric current as several miles of wire.

SPECIFICATIONS FOR GALVANIZED IROS WIRE.
Issued by the British Postal Telegraph Authorities.

Required Standard.	Weight per Mile		Diameter.		Tests for Strength and Ductility.							Resistance per mile at 60° F.	Constant = Standard Weight x Resistance.
	Allowed.	Required Standard.	Allowed.	Required Standard.	Breaking Weight.	No. of Twists in 6 in.	Least Breaking Weight for	Min. Twists in 6 in.	Least Breaking Weight for	Min. Twists in 6 in.	Max.		
lb.	lb.	lb.	mils.	mils.	mils.	lb.		lb.		lb.		ohms.	
800	767	833	242	237	247	2480	15	2550	14	2620	13	6.75	5400
600	571	629	209	204	214	1860	17	1910	16	1960	15	9.00	5400
450	424	477	181	176	186	1390	19	1425	18	1460	17	12.00	5400
400	377	424	171	166	176	1240	21	1270	20	1300	19	13.50	5400
200	190	213	121	118	125	620	30	638	28	655	26	27.00	5400

STRENGTH OF PIANO-WIRE.

The average strength of English piano-wire is given as follows by Webster, Horsfals & Lean:

Size, Music-wire Gauge.	Equivalent Diameters, Inch.	Ultimate Tensile Strength, Pounds.	Size, Music-wire Gauge.	Equivalent Diameters, Inch.	Ultimate Tensile Strength, Pounds.
12	0.029	225	18	0.041	395
13	.031	250	19	.043	425
14	.033	285	20	.045	500
15	.035	305	21	.047	540
16	.037	340	22	.052	650
17	.039	360			

These strengths range from 360,000 to 349,096 lbs. per sq. in. The composition of this wire is as follows: Carbon, 0.570; silicon, 0.090; sulphur, 6.611; phosphorus, 0.018; manganese, 0.425.

"PLOUGH"-STEEL WIRE.

The term "plough," given in England to steel wire of high quality was derived from the fact that such wire is used for the construction of ropes used for ploughing purposes. It is to be hoped that the term will not be used in this country as it tends to confusion of terms. Plough-steel is known here in some steel-works as the quality of plate steel used for the mold-boards of ploughs, for which a very ordinary grade is good enough.

Experiments by Dr. Percy on the English plough-steel (so-called) gave the following results: Specific gravity, 7.814; carbon, 0.828 per cent., manganese, 0.587 per cent; silicon, 6.143 per cent; sulphur, 0.009 per cent; phosphorus, 0.011; copper, 0.030 Per cent. No trace of chromium, titanium, or tungsten were found. The breaking strains of the wire were as follows:

Diameter, inch.	0.093	0.132	0.159	0.191
Pounds per sq. inch	344,966	257,600	224,000	201,600

The elongation was only from 0.75 to 1.1 percent.

DIMENSIONS, WEIGHT, AND RESISTANCE OF PURE COPPER WIRE. (Edison or Circular Mil Gauge.) (See page 31.)

E. W. G. Gauge Number.	Circular Mils.	Maximum Amperes. $\sqrt{\frac{C.M.}{104}}$	Diameter in Mils. Mil = 0.001 in.	Weight. Sp. gr. 8.889		Length.		Resistance at 75° Fahr.		E. W. G. Gauge Number.
				Lbs. per Foot.	Lbs. per Ohm.	Feet per Lb.	Feet per Ohm.	Ohms per Lb.	Ohms per Ft.	
3	3000	12.5	54.78	0.009084	2.597		285.9	0.3850405	0.003497600	3
5	5000	18.3	70.72	0.015139	7.214		476.5	0.1386225	0.002098640	5
8	8000	26.0	89.45	0.024220	18.464		762.3	0.051602	0.001311780	8
12	12000	35.2	109.55	0.036328	41.538		1143.4	0.0240743	0.000874578	12
15	15000	41.6	122.48	0.045410	64.902		1429.2	0.0154178	0.000699663	15
20	20000	51.6	141.43	0.060548	115.372		1905.7	0.0086664	0.000524745	20
25	25000	61.0	158.12	0.075682	180.278		2382.0	0.005470	0.000419807	25
30	30000	70.0	173.21	0.090817	259.722		2859.9	0.0038522	0.000349846	30
35	35000	78.6	187.09	0.105955	353.340		3334.9	0.0028301	0.000299863	35
40	40000	86.8	200.00	0.121092	461.440		3811.0	0.0021671	0.000262400	40
45	45000	94.9	212.14	0.136227	584.098		4287.7	0.0017120	0.000233227	45
50	50000	102.7	223.61	0.151357	721.026		4763.8	0.0013868	0.000209914	50
55	55000	110.3	234.53	0.166501	872.547		5240.5	0.0011467	0.000190821	55
60	60000	117.7	244.95	0.181625	1038.258		5716.5	0.00096315	0.000174931	60
65	65000	125.0	254.96	0.196772	1218.586		6192.9	0.00082057	0.000161465	65
70	70000	132.1	264.58	0.211901	1413.264		6669.4	0.00070758	0.000149937	70
75	75000	139.1	273.87	0.227043	1622.457		7146.0	0.00061635	0.000139938	75
80	80000	146.0	282.85	0.242176	1845.952		7622.3	0.00054172	0.000131193	80
85	85000	152.8	291.55	0.257303	2083.759		8098.4	0.00047990	0.000123480	85
90	90000	159.5	300.00	0.272434	2336.405		8574.7	0.00042807	0.000116622	90
95	95000	166.1	308.23	0.287567	2603.046		9051.6	0.00038415	0.000110477	95
100	100000	172.6	316.23	0.302709	2884.082		9527.6	0.00034673	0.000104960	100
110	110000	185.4	331.67	0.332991	3489.958		10480.6	0.00028656	0.000095410	110
120	120000	198.0	346.42	0.363267	4153.433		11433.6	0.00024070	0.000084460	120
130	130000	210.2	360.56	0.393527	4874.226		12386.0	0.00020514	0.000073730	130
140	140000	222.2	374.17	0.423797	5652.899		13338.7	0.00017690	0.000064970	140
150	150000	234.0	387.30	0.454061	6484.573		14291.3	0.00015409	0.000057997	150
160	160000	245.6	400.00	0.484328	7383.042		15243.9	0.00013544	0.000052422	160
170	170000	257.0	412.32	0.514622	8335.525		16197.4	0.00011995	0.000047335	170
180	180000	268.3	424.27	0.544884	9344.686		17149.9	0.00010701	0.000043109	180
189	180000	268.3	424.27	0.575140	10411.241		18102.1	0.00009604	0.000039886	189
196	190000	279.4	435.89	0.605427	11536.681		19055.4	0.00008667	0.000036600	196
200	200000	290.4	447.22	0.635975	12729.567		20010.0	0.00007863	0.000033733	200
220	220000	312.0	469.05	0.726498	16612.114		22866.0	0.00006019	0.000026368	220
240	240000	333.0	489.90	0.817058	19496.997		24772.1	0.00004422	0.000020486	240
260	260000	353.5	509.91	0.847605	22597.464		26677.8	0.00003852	0.000015986	260
280	280000	393.0	529.16	0.968672	29533.696		30488.3	0.00003386	0.000012799	280
300	300000	413.1	547.73	1.029214	33340.181		34298.7	0.00002999	0.000010870	300
320	320000	432.3	565.69	1.089738	37376.652		39177	0.00002675	0.000009155	320
340	340000	451.3	583.10							340
360	360000		600.00							360

1 Mil Foot = 9.758 B A. Units at 0° C. (Dr. Matthiessen.)

Sizes, Weights and Strengths of Hard-Copper Telegraph and Telephone Wire.

(J. A. Roebling's Sons Co., 1908.)

Size B. & S. Gauge.	Diam., in.	Wt., lbs. per mile.	Breaking strain, lbs.	Resistance, International ohms per mile at 75° F.	Approx. size, Roebing gauge of E. B. B. iron wire of equal resistance.	Size B. & S. Gauge.	Diam., in.	Wt., lbs. per mile.	Breaking strain, lbs.	Resistance, International ohms per mile at 75° F.	Approx. size, Roebing gauge of E. B. B. iron wire of equal resistance.
9	0.114	208	653	4.39	2	13	0.072	83	274	11.01	6 1/2
10	0.102	166	546	5.49	3	14	0.064	65	220	13.94	8
11	0.091	132	426	6.90	4	15	0.057	52	174	17.57	9
12	0.081	105	334	8.70	6	16	0.051	42	139	21.95	10

In handling this wire the greatest care should be observed to avoid kinks, bends, scratches, or cuts. Joints should be made only with McIntire connectors. On account of its conductivity being five times that of E. B. B. iron wire, and its breaking strength over three times its weight per mile, copper may be used for which the section is smaller and the weight less than an equivalent iron wire, allowing a greater number of wires to be strung on the poles. Besides this advantage, the reduction of section materially decreases the electrostatic capacity, while its non-magnetic character lessens the self-induction of the line, both of which features tend to increase the possible speed of signaling in telegraphing, and to give greater clearness of enunciation over telephone lines, especially those of great length.

Weight of Bare and Insulated Copper Wire, Pounds. (John A. Roebling's Sons Co., 1908.)

Size B. & S. Gauge.	Weight per 1000 Feet, Solid.					Weight per Mile, Solid.				
	Bare.	Double Braid.	Triple Braid.	Fire and Weather Proof.	Slow Burning.	Bare.	Double Braid.	Triple Braid.	Fire and Weather Proof.	Slow Burning.
0000	641	723	767	862	925	3384	3817	4050	4550	4890
000	509	587	629	710	760	2687	3098	3320	3750	4020
00	403	467	502	562	600	2127	2467	2650	2970	3170
0	320	377	407	462	495	1689	1989	2150	2440	2610
1	253	294	316	340	365	1335	1553	1670	1930	2085
2	202	239	260	280	300	1066	1264	1370	1480	1585
3	159	185	199	210	220	840	977	1050	1220	1325
4	126	151	164	190	200	655	795	865	1000	1080
5	100	122	135	155	160	528	646	710	820	880
6	79	100	112	127	130	417	529	590	670	720
8	50	66	75	85	110	264	349	395	450	480
9	39	54	62	72	80	206	283	325	375	400
10	32	46	53	60	66	169	241	280	320	340
12	20	30	35	42	45	106	158	185	220	240
14	12.4	20	25	30	30	66	107	130	160	170
16	7.9	16	20	20	24	42	83	105	130	140
18	4.8	12	16	16	24	25	64	85	100	110
20	3.1	9	12	12	16	16	48	65	80	90

WARNING: This is a 1910 edition. Some of the material may no longer be accurate

Stranded Copper Feed Wire, Weight in Founds.

(John A. Roebling's Sons Co., 1908.)

Size, Circular Mils.	Weight per 1000 Feet.					Weight per Mile.				
	Bare.	Weather-proof		Fire and Weather Proof.	Slow Burning.	Bare.	Weather-proof		Fire and Weather Proof.	Slow Burning.
		Double Braid.	Triple Braid.				Double Braid.	Triple Braid.		
2,000,000	6100	5690	7008	.	7540	32208	5323	37006	...	39800
1,750,000	5338	3894	6193	..	6700	23184	1119	32700	...	35400
1,500,000	4575	5098	5380	...	5830	24156	6915	28400	...	30800
1,250,000	3813	4264	4508	...	4940	20132	2516	23800	...	26000
1,000,000	3050	3456	31674	3860	3980	15104	8246	19400	20400	26100
900,000	2745	3127	31332	3520	3640	14493	6513	17600	18600	11000
800,000	2440	2799	2992	3180	3280	12883	4779	15800	16800	19200
750,000	2288	2635	2822	3000	3100	12080	3913	14900	15850	17300
700,000	2135	2471	2650	2820	2920	11272	3045	14000	14900	16300
600,000	1830	2093	2235	2350	2460	9666	1052	11800	12400	15400
500,000	1525	1765	1894	1990	2080	8552	9318	10000	10500	13100
450,000	1373	1601	1724	1820	1900	7249	8452	9100	9600	10000
400,000	1220	1436	1553	1650	1700	6441	7584	8200	8700	9000
350,000	1068	1248	1345	1440	1500	5639	6589	7100	7600	7900
300,000	915	1083	1174	1270	1310	4831	5721	6200	6700	6900
250,000	762	907	985	1060	1120	4023	4785	5200	5600	5900
3. & S. Gauge.										
0000	645	745	800	900	960	3405	3935	4220	4750	5070
000	513	604	653	735	785	2708	3190	3450	3880	4150
00	406	482	522	583	625	2143	2544	2760	3080	3360
0	322	388	424	480	510	1700	2051	2240	2530	2700
1	255	303	328	355	380	1346	1599	1735	1870	2000
2	203	246	270	290	335	1071	1301	1425	1540	1770
3	160	190	206	240	280	844	1004	1090	1270	1480
4	127	155	170	195	230	670	820	900	1030	1220
5	101	125	140	160	195	533	668	740	845	1030
6	80	103	115	132	165	422	544	610	695	870
8	50	68	78	87	105	264	359	410	460	555

Approximate Rules for the Resistance of Copper Wire.—The resistance of any copper wire at 20°C or 68°F., according to Matthiessen's standard, is $R = \frac{10.35l}{d^2}$, in which R is the resistance in international ohms, l the length of the wire in feet, and d its diameter in mils. (1 mil = 1/1000 inch.)

A No. 10 Wire, A.W.G., 0.1019 in. diameter (practically 0.1 in.), 1000 ft. in length, has a resistance of 1 ohm at 68° F. and weighs 31.4 lbs.

If a wire of a given length and size by the American or Brown & Sharpe gauge has a certain resistance, a wire of the same length and three numbers higher has twice the resistance, six numbers higher four times the resistance, etc.

Wire gauge, A.W.G. No.	000	1	4	7	10	13	16	19	22
Relative resistance	16	8	4	2	1	1/2	1/4	1/8	1/16
section or weight.	1/16	1/8	1/4	1/2	1	2	4	8	16

See wire table, A.W.G., under Electrical Engineering.

SPECIFICATIONS FOR HARD-DRAWN COPPER WIRE.

The British Post Office authorities require that hard-drawn copper wire supplied to them shall be of the lengths, sizes, weights, strengths, and conductivities as set forth in the annexed table.

Required Standard.	Weight per Statute Mile, lb.		Approximate Equivalent Diameter, mils.			Minimum Breaking Weight, lb.	Minimum No. of Twists in 3 Inches.	Maximum Resistance per Mile of Wire (when hard) at 60° F., ohms.	Minimum Weight of each Piece of Wire, lbs.
	Minimum.	Maximum.	Standard.	Minimum.	Maximum.				
100	97 1/2	121 1/2	79	78	80	330	36	9.10	50
150	146 1/4	153 3/4	97	95 1/2	98	498	25	6.05	50
200	195	205	112	110 1/2	113 1/4	650	20	4.53	50
400	390	410	158	155 1/2	160 1/4	1300	10	2.27	50

WIRES OF DIFFERENT METALS AND ALLOYS.

(J. Bucknall Smith, Treatise on Wire.)

Brass Wire is commonly composed of an alloy of 1 3/4 to 2 parts of copper to one part of zinc. The tensile strength ranges from 20 to 40 tons per square inch, increasing with the percentage of zinc in the alloy.

German or Nickel Silver, an alloy of copper, zinc, and nickel, is practically brass whitened by the addition of nickel. It has been drawn into wire as fine as 0.002 inch diameter.

Platinum wire may be drawn into the finest sizes. On account of its high price its use is practically confined to special scientific instruments and electrical appliances in which resistances to high temperature, oxygen, and acids are essential. It expands less than other metals when heated. Its coefficient of expansion being almost the same as that of glass permits its being sealed in glass without fear of cracking the latter. It is therefore used in incandescent electric lamps.

Phosphor-bronze Wire contains from 2 to 6 per cent of tin and from 1/20 to 1/8 per cent of phosphorus. The presence of phosphorus is detrimental to electric conductivity.

"Delta-metal" wire is made from an alloy of copper, iron, and zinc. Its strength ranges from 45 to 62 tons per square inch. It is used for some kinds of wire rope, also for wire gauze. It is not subject to deposits of verdigris. It has great toughness, even when its tensile strength is over 60 tons per square inch.

Aluminum Wire.—Specific gravity 0.268. Tensile strength only about 10 tons per square inch. It has been drawn as fine as 11.400 yards to the ounce, or 0.042 grain per yard.

Aluminum Bronze, 90 copper, 10 aluminum, has high strength and ductility; is inoxidizable, sonorous. Its electric conductivity is 12.6 per cent.

Silicon Bronze, patented in 1882 by L. Weiler of Paris, is made as follows: Fluosilicate of potash, pounded glass, chloride of sodium and calcium, carbonate of soda and lime, are heated in a plumbago crucible, and after the reaction takes place the contents are thrown into the molten bronze to be treated. Silicon-bronze wire has a conductivity of from 40 to 98 per cent of that of copper wire and four times more than that of iron, while its tensile strength is nearly that of steel, or 28 to 55 tons per square inch of section. The conductivity decreases as the tensile strength increases. Wire whose conductivity equals 95 per cent of that of pure copper gives a tensile strength of 28 tons per square inch, but when its conductivity is 34 per cent of pure copper, its strength is 50 tons per square inch. It is especially used for telegraph wires. It has great resistance to oxidation.

Ordinary Drawn and Annealed Copper Wire has a strength of from 15 to 20 tons per square inch.

WARNING: This is a 1910 edition. Some of the material may no longer be accurate

PLOUGH-STEEL ROPE.

Composed of 6 Strands and a Hemp Center.

19 WIRES TO THE STRAND.

Trade Number.	Diameter, in.	Approx. circum., in.	Wt. per ft., lb.	Approx. Breaking Strain, tons (2000 lb.).	Allowable Working Strain, tons (2000 lb.).	Min. Size of Drum or Sheave, ft.	Trade Number.	Diameter, in.	Approx. circum., in.	Wt. per ft., lb.	Approx. Breaking Strain, tons (2000 lb.).	Allowable Working Strain, tons (2000 lb.).	Min. Size of Drum or Sheave, ft.
1	23/4	85/8	11.95	305	61.0	11	8	1	3	1.58	44	6.80	41/4
2	21/2	77/8	9.85	254	50.8	10	9	7/8	23/4	1.20	34	6.80	33/4
3	21/4	71/8	8.00	208	41.6	9	10	3/4	21/4	0.89	25	5.00	31/2
4	2	61/4	6.30	165	33.0	8	10 1/4	5/8	2	0.62	18	3.60	3
5	13/4	51/2	4.85	128	25.6	7 1/2	10 1/2	9/16	13/4	0.50	14.5	2.90	21/2
6	15/8	5	4.15	111	22.2	6	10 3/4	1/2	11/2	0.39	11.4	2.28	2
7	11/2	43/4	3.55	96	19.2	5 1/2	10a	7/16	11/4	0.30	8.85	1.77	1 1/2
8	13/8	41/4	3.00	82	16.4	5 1/4	10b	3/8	11/8	0.22	6.55	1.31	1
9	11/4	4	2.45	67	13.4	5	10c	5/16	1	0.15	4.50	0.90	7/8
10	11/8	3 1/2	2.00	56	11.2	4 1/2	10d	1/4	3/4	0.10	3.00	0.60	2/3

7 WIRES TO THE STRAND.

11	11/2	43/4	3.55	91	18.2	8 1/2	19	5/8	2	0.62	17	3.40	3
12	13/8	41/4	3.00	78	15.6	8	20	9/16	13/4	0.50	14	2.80	23/4
13	11/4	4	2.45	64	12.8	7 1/4	21	1/2	11/2	0.39	11	2.20	2
14	11/8	3 1/2	2.00	53	10.6	6 1/4	22	7/16	11/4	0.30	8.55	1.71	2 1/2
15	3	3	1.58	42	8.40	5 1/2	23	3/8	11/8	0.22	6.35	1.27	1 1/2
16	7/8	23/4	1.20	32	6.40	5	24	5/16	1	0.15	4.35	0.87	1 1/4
17	3/4	21/4	0.89	24	4.80	4	25	9/32	7/8	0.125	3.65	0.73	1
18	11/16	21/8	0.75	21	4.20	3 1/2							

Plough-steel wire is made of high grade of crucible steel, and will stand a strain of from 95 to 175 tons per sq. in. Plough-steel ropes are used instead of cast-steel or iron where it is necessary to reduce the dead weight, as, for instance, with heavy or extremely long ropes when the weight of the rope is a large item. They are also employed when the load on the rope of an existing plant has been materially increased and the sheaves and drums cannot be altered to meet the new requirements. In this case a plough-steel rope of the same size can be used with an increase in strength of 50 to 100 per cent. Plough-steel is, therefore, applicable to conditions involving great wear and rough usage. It is advisable to reduce all bends to a minimum and to use somewhat larger drums and sheaves than are suitable for the ordinary cast-steel rope, having a strength of 60 to 80 tons per sq. in. It is well to obtain advice upon the adaptability of plough-steel ropes before using them.

"LANG LAY" ROPE.

In wire rope, as ordinarily made, the component strands are laid up into rope in a direction opposite to that in which the wires are laid into strands: that is, if the wires in the strands are laid from right to left, the strands are laid into rope from left to right. In the "Lang Lay," sometimes known as "Universal Lay," the wires are laid into strands and the strands into rope in the same direction: that is, if the wire is laid in the strands from right to left, the strands are also laid into rope from right to left. Its use has been found desirable under certain conditions

and for certain purposes, mostly for haulage plants, inclined planes, and street railway cables, although it has also been used for vertical hoists in mines, etc. Its advantages are that it is somewhat more flexible than rope of the same diameter and composed of the same number of wires laid up in the ordinary manner; and (especially) that owing to the fact that the wires are laid more axially in the rope, longer surfaces of the wire are exposed to wear, and the endurance of the rope is thereby increased. (Trenton Iron Co.)

CABLE-TRACTION ROPES.

According to English practice, cable-traction ropes, of about 3 1/2 in' circumference, are commonly constructed with six strands of 7 or 15 wires, the lays in the strands varying from, say, 3 in. to 3 1/2 in., and the lays in the ropes from, say, 7 1/2 in. to 9 in. In the United States, however strands of 19 wires are generally preferred, as being more flexible; but on the other hand, the smaller external wires wear out, more rapidly. The Market Street Railway Company, San Francisco, has used ropes 1 1/8 in. diam., composed of six strands of 19 steel wires, weighing 2 1/2 lb. per foot; the longest continuous length being 24,125 ft. The Chicago City Railroad Co. has employed cables of identical construction, the longest length being 27,700 ft. On the New York and Brooklyn Bridge cable-railway steel ropes 11,500 ft. long, containing 114 wires, have been used.

GALVANIZED IRON WIRE ROPE.

For Ships' Rigging and Derrick Guys.

Composed of 6 Strands and a Hemp Center. 7 or 12 Wires to the Strand:

Approx. diam., in.	Circum., in.	Wt. per ft., lb.	Approx. Breaking Strain, tons (2000 lb.).	Circum., in., of New Manila Rope of Equal Strength.	Approx. diam., in.	Circum., in.	Wt. per ft., lb.	Approx. Breaking Strain, tons (2000 lb.).	Circum., in., of New Manila Rope of Equal Strength.
1 3/4	5 1/2	4.815	44	11	1	3	1.44	13	5 1/4
1 11/16	5 1/4	4.40	36	10 1/2	7/8	23/4	1.21	19.0	5
1 5/8	5	4.00	32	10	13/16	21/2	1.00	7.3	4 3/4
1 1/2	4 3/4	3.60	29	9 1/2	3/4	21/4	0.81	5.8	4 1/2
1 7/16	4 1/2	3.25	26	9	5/8	2	0.64	4.4	4 1/8
1 3/8	4 1/4	2.90	23	8 1/2	9/16	13/4	0.49	3.2	3
1 1/4	4	2.55	20	8	1/2	11/2	0.36	2.3	2 1/2
1 3/16	3 3/4	2.25	18	7 1/2	7/16	11/4	0.25	1.8	2 1/4
1 1/8	3 1/2	1.95	15	6 1/2	3/8	11/8	0.20	1.4	2
1 1/16	3 1/4	1.70	15	6	5/16	1	0.16		

5 STRANDS, 7 WIRES EACH.

9/32	7/8	0.123	1.1	13/4	7/32	5/8	0.063	0.56	1 1/4
1/4	3/4	0.090	0.81	1 1/2	3/16	1/2	0.040	0.36	1 1/8

Galvanized wire rope has almost entirely superseded manila rope for shrouds and stays aboard ship. It is cheaper in first cost, is not affected by weather, and does not stretch and contract with changes in atmospheric conditions: on the other hand, it is quite as elastic as manila rope. It is only 1/5 or 1/6 as large by hull as a manila rope of equal strength, and offers only half as much surface, to the wind, and weighs much less. It is much less liable to accidents by cutting or chafing.

If galvanized rope of greater strength than that shown in the table is desired, galvanized open hearth, cast-steel or plough-steel wire rope can be obtained.

WARNING: This is a 1910 edition. Some of the material may no longer be accurate

STEEL FLAT ROPES.

(J. A. Roebling's Sons Co.)

Steel-wire Flat Ropes are composed of a number of strands, alternately twisted to the right and left, laid alongside of each other, and sewed together with soft iron wires. These ropes are used at times in place of round ropes in the shafts of mines. They wind upon themselves on a narrow winding-drum, which takes up less room than one necessary for a round rope. The soft-iron sewing-wires wear out sooner than the steel strands, and then it becomes necessary to sew the rope with new iron wires.

Width and Thickness, in.	Weight per ft., lb.	Approx. Breaking Strain, tons (2000 lb.)	Allowable Working Strain, tons (2000 lb.)	Width and Thickness, in.	Weight per ft., lb.	Approx. Breaking Strain, tons (2000 lb.)	Allowable Working Strain, tons (2000 lb.)
3/8 x 2	1.19	18	3.6	1/2 x 3	2.38	36	7.2
3/8 x 2 1/2	1.86	28	5.6	1/2 x 3 1/2	2.97	45	9.0
3/8 x 3	2.00	30	6.0	1/2 x 4	3.30	50	10.0
3/8 x 3 1/2		38	7.6	1/2 x 4 1/2	4.00	60	12.0
3/8 x 4	2.80	43	8.6	1/2 x 5	4.27	64	12.8
3/8 x 4 1/2	3.12	47	9.4	1/2 x 5 1/2	4.82	72	14.4
3/8 x 5	3.40	50	10.0	1/2 x 6	5.10	77	15.4
3/8 x 5 1/2	3.90	55	11.0	1/2 x 7	5.96	89	17.8

GALVANIZED STEEL CABLES.

For Suspension Bridges. (Roebling's.)

Composed of 6 Strands — With Wire Center.

Diam., in.	Wt. per foot, lb.	Approx. Breaking Strain, tons (2000 lb.)	Diam., in.	Wt. per foot, lb.	Approx. Breaking Strain, tons.	Diam., in.	Wt. per foot, lb.	Approx. Breaking Strain, tons.
2 3/4	12.7	310	2 1/4	8.52	208	1 3/4	5.16	124
2 5/8	11.6	283	2 1/8	7.60	185	1 5/8	4.34	106
2 1/2	10.5	256	2	6.73	164	1 1/2	3.70	90
2 3/8	9.50	232	1 7/8	5.90	144	1 3/8	3.10	75

GALVANIZED CAST-STEEL YACHT RIGGING

6 Strands and a Hemp Cater, 7 or 19 Wires to the Strand.

Approx. Diam., in.	Circum., in.	Wt. per ft., lb.	Approx. Breaking Strain, tons (2000 lb.)	Circum. of New Manila Rope of Equal Strength	Approx. Diam., in.	Circum., in.	Wt. per ft., lb.	Approx. Breaking Strain, tons (2000 lb.)	Circum. of New Manila Rope of Equal Strength
1 1/4	4	2.55	53	13	5/8	1 3/4	0.64	14.0	5
1 3/16	3 3/4	2.25	47	12	9/16	1 3/4	0.49	10.8	5 1/4
1 1/8	3 1/2	1.95	41	11	1/2	1 1/2	1.36	8.1	4 3/4
1 1/16	3 1/4	1.70	36	10	15/32	1 3/8	0.30	6.8	4 1/2
1	3	1.44	31	9	7/16	1 1/4	0.25	5.7	4 1/4
7/8	2 3/4	1.21	26	8 1/2	3/8	1 1/8	0.20	4.5	3 3/4
13/16	2 1/2	1.00	22	8	5/16	1	0.16	3.7	3
3/4	2 1/4	0.81	17.6	7					

GALVANIZED STEEL-WIRE STRAND.

For Smokestack Guys, Signal Strand, etc.

(J. A. Roebling's Sons Co., 1908.)

This strand is composed of 7 wires, twisted together into a single strand.

Diam., in.	Wt. per 1000 ft., lb.	Approx. Breaking Strain, lb.	Diam., in.	Wt. per 1000 ft.	Approx. Breaking Strain, lb.
1/2	510	8500	7/32	95	1800
7/16	415	6500	3/16	75	1400
3/8	295	5000	5/32	55	900
5/16	210	3800	1/8	32	500
1/4	125	2300	3/32	20	400

Galvanized strand is made on application of wire of any strength from 60,000 lb. to 350,000 lb. per sq. in. When used to run over sheaves or pulleys the use of soft-iron stock is advisable.

FLEXIBLE STEEL-WIRE HAWSERS.

These hawsers are extensively used. They are made with six strands of twelve wires each, hemp centers being inserted in the individual strands as well as in the completed rope. The material employed is crucible cast steel, galvanized, and guaranteed to fulfill Lloyd's requirements. They are only one-third the weight of hempen hawsers, and are sufficiently pliable to work round any bits to which hempen rope of equivalent strength can be applied.

1 1/2-inch tarred Russian hem., hawser weighs about 39 lbs. per fathom.

10-inch white manila hawser weighs about 20 lbs. per fathom.

1 1/8-inch stud chain weighs about 68 lbs. per fathom.

4-inch galvanized steel hawser weighs about 12 lbs. per fathom.

Each of the above named has about the same tensile strength.

GALVANIZED STEEL HAWSERS.

For Mooring, Sea or Lake Towing.

Composed of 6 Strands and a Hemp Center, each Strand consisting of 13 Wires and a Hemp Core or of 37 Wires.

Approx. Diam., in.	Circum., in.	Wt. per ft., lb.		Approx. Breaking Strain, tons (2000 lb.)	
		12-Wire Strand.	37-Wire Strand.	12-Wire Strand.	37-Wire Strand.
2 1/16	61 1/2	4.56	6.76	83	179
2	61 1/4	4.20	6.25	77	166
1 15/16	6	3.88	5.76	71	155
1 13/16	5 3/4	3.56	5.29	66	142
1 3/4	5 1/2	3.25	4.85	61	131
1 11/16	5 1/4	2.95	4.41	57	120
1 5/8	5	2.70	4.00	53	109
1 1/2	4 3/4	2.42	3.60	45	99
1 7/16	4 1/2	2.18	3.24	42	90
1 3/8	4 1/4	1.94	2.90	39	81
1 1/4	4	1.72	2.55	32	72
1 3/16	3 3/4	1.51	2.25	29	62
1 1/8	3 1/2	1.32	1.95	27	55
1 1/16	3 1/4	1.14	1.69	24	46
1	3	.97	1.44	21.5	40
7/8	2 3/4	.81	1.21	16.4	34
13/16	2 1/2	.67	1.00	14.4	28
3/4	2 1/4	.54	.81	12.3	23

WARNING: This is a 1910 edition. Some of the material may no longer be accurate

Notes on the Use of **Wire Rope.** (J. A. Roebling's Sons Co.)

(See also notes under various tables of wire ropes.)

Several kinds of wire rope are manufactured. The most pliable variety contains nineteen wires to the strand. The ropes with twelve wires and seven wires in the strand are stiffer, and are better adapted for standing rope, etc., and rigging. Orders should state the use of the rope, and advice will be given.

Wire rope is as pliable as new hemp rope of the same strength: the former will therefore run over the same-sized sheaves and pulleys as the latter. But the greater the diameter of the sheaves, pulleys, or drums, the longer wire rope will last. The minimum size of drum is given in the table. Experience has demonstrated that the wear increases with the speed. It is, therefore, better to increase the load than the speed.

Wire rope must not be coiled or uncoiled like hemp rope. — When mounted on a reel, the latter should be mounted on a spindle or flat turn-table to pay off the rope. When forwarded in a small coil, without reel, roll it over the ground like a wheel, and run off the rope in that way. All untwisting or kinking must be avoided.

To preserve wire rope, apply raw linseed-oil with a piece of sheepskin, wool inside; or mix the oil with equal parts of Spanish brown or lamp black.

To Preserve wire rope under water or under ground, take mineral or vegetable tar, and add one bushel of fresh-slacked lime to one barrel of tar, which will neutralize the acid. Boil it well, and saturate the rope with the hot tar. To give the mixture body, add some sawdust.

The grooves of cast-iron pulleys and sheaves should be filled with well-seasoned blocks of hard wood, set on end, to be renewed when worn out. This end-moed will save wear and increase adhesion. The smaller pulleys or rollers which support the ropes on inclined planes should be constructed on the same plan. When large sheaves run at high velocity, the grooves should be lined with leather, set on end, or with India rubber. This is done in the case of sheaves used in the transmission of power between distant points by means of rope, which frequently runs at the rate of 4000 feet per minute.

Locked Wire Rope.

Fig. 77 shows what is known as the Patent Locked Steel Wire Rope made by the Trenton Iron Co. It is claimed to wear two to three times



FIG. 77.

as long as an ordinary wire rope of equal diameter and of like material, with an increased life for sheaves and rollers. Sizes made are from 1/2 to 2 inches diameter, with a minimum diameter of sheave of 4 and 12 feet respectively.

CHAINS.

Weight per Foot, Proof Test and Breaking Weight.
(Pennsylvania Railroad Specifications, 1903.)

Nominal Diameter of Wire, Inches.	Description.	Maximum Length of 100 Links, Inches.	Weight per Foot, Lbs.	Proof Test, Lbs.	Breaking Weight, Lbs.
5/32	Twisted chain	103 1/8	0.20		
3/16	Perfection twisted chain	96 1/4	0.35		
3/16	Straight-link chain	151 1/2	0.27		
1/4	" " "	102	0.70	600	3,200
5/16	" " "	114 3/4	1.10	2,500	5,000
3/8	" " "	114 3/4	1.60	3,600	7,200
3/8	Crane chain	113 5/8	1.60	4,140	8,280
7/16	Straight-link chain	127 1/2	2.07	4,900	9,800
7/16	Crane chain	126 1/4	2.07	5,635	11,270
1/2	Straight-link chain	153	2.50	6,400	12,800
1/2	Crane chain	151 1/2	2.60	7,360	14,720
5/8	Straight-link chain	178 1/2	4.08	10,000	20,000
5/8	Crane chain	176 3/4	4.18	11,500	23,000
3/4	Straight-link chain	204	5.65	14,400	28,800
3/4	Crane chain	202	5.75	16,560	33,120
7/8	" " "	252 1/2	7.70	22,540	45,080
1	" " "	277 3/4	9.80	29,440	58,880
1	Straight-link chain	280 1/2	9.80	25,600	51,200
1 1/8	Crane chain	303	12.65	38,260	76,520
1 1/4	" " "	353 1/2	15.50	46,000	92,000
1 1/2	" " "	416 5/8	22.50	66,140	132,480
1 3/4	" " "	479 3/4	30.00	90,160	180,320
2	" " "	555 1/2	39.00	117,760	235,520

Elongation of all sizes, 10 per cent. All chain must stand the proof test without deformation. A piece 2 ft. long out of each 200 ft. is tested to destruction.

British Admiralty Proving Tests of Chain Cables. — Stud-links.
Minimum size in inches and 16ths. Proving test in tons of 2240 lbs.

Min. Size:	1 1/8	1 1/4	1 3/8	1 1/2	1 5/8	1 3/4	1 7/8	2	2 1/8	2 1/4
Test, tons:	8 1/2	10.1	11.9	13 1/2	15 1/2	18	20.3	22 1/2	25 1/2	28.1
Min. Size:	1 7/8	2	2 1/8	2 1/4	2 3/8	2 1/2	2 5/8	2 3/4	3	3 1/8
Test, tons:	37 1/2	40 1/2	43.9	47 1/2	51 1/2	55.1	59.1	63 1/2	67 1/2	72

Wrought-iron Chain Cables. — The strength of a chain link is less than twice that of a straight bar of a sectional area equal to that of one side of the link. A weld exists at one end and a bend at the other, each requiring at least one heat, which produces a decrease in the strength. The report of the committee of the U. S. Testing Board (1879), on tests of wrought-iron and chain cables, contains the following conclusions. That beyond doubt, when made of American bar iron, with cast-iron studs, the studded link is inferior in strength to the unstudded one.

"That when proper care is exercised in the selection of material, a variation of 5 to 17 per cent of the strongest may be expected in the resistance of cables. Without this care, the variation may rise to 25 per cent.

"That with proper material and construction the ultimate resistance of the chain may be expected to vary from 155 to 170 per cent of that of the bar used in making the links, and show an average of about 163 per cent.

"That the proof test of a chain cable should be about 50 per cent of the ultimate resistance of the weakest link."

The decrease of the resistance of the studded below the unstudded cable is probably due to the fact that in the former the sides of the link do not remain parallel to each other up to failure, as they do in the latter. The result is an increase of stress in the studded link over the unstudded in the proportion of unity, to the secant of half the inclination of the sides of the former to each other.

From a great number of tests of bars and unfinished cables, the committee considered that the average ultimate resistance, and Proof tests of chain cables made of the bars, whose diameters are given, should be such as are shown in the accompanying table.

ULTIMATE RESISTANCE AND PROOF TESTS OF CHAIN CABLES.

Diam. of Bar.	Average resist. = 163% of Bar.	Proof Test.	Diam. of Bar.	Average resist. = 163% of Bar.	Proof Test.
Inches.	Pounds.	Pounds.	Inches.	Pounds.	Pounds.
1	172	33,840	1 9/16	162,283	77,159
1 1/16	79,544	37,820	1 5/8	174,475	82,956
1 1/8	88,445	42,053	1 11/16	187,075	88,947
1 3/16	97,731	46,460	1 3/4	200,074	95,128
1 1/4	107,440	51,084	1 13/16	213,475	101,499
1 5/16	117,577	55,903	1 7/8	227,271	108,058
1 3/8	128,129	60,920	1 15/16	241,463	114,806
1 7/16	139,103	66,138	2	256,040	121,737
1 1/2	150,485	71,550			

Pitch, Breaking, Proof and Working Strains of Chains. (Bradlee & Co., Philadelphia.)

Size of Chain, in.	Pitch, in.	Approx. Wt. per ft. lb.	Outside Width, in.	D. B. G. Special Crane.			Crane.		
				Proof Test, lb.	Average Breaking Strain, lb.	Ordinary Safe Load, General Use, lb.	Proof Test, lb.	Average Breaking Strain, lb.	Ordinary Safe Load, General Use, lb.
1/4	25/32	3/4	15/16	1,932	3,864	1,288	1,680	3,360	1,12
5/16	27/32	1	1 1/8	2,898	5,796	1,932	2,520	5,040	1,68
3/8	31/32	1 1/2	1 5/16	4,186	8,372	2,790	3,640	7,280	2,420
7/16	15/32	2	1 1/2	5,796	11,592	3,864	5,040	10,080	3,360
1/2	1 11/32	2 1/2	1 13/16	7,728	15,456	5,152	6,720	13,440	4,487
9/16	1 15/32	3 3/10	2	9,660	19,320	6,440	8,400	16,800	5,600
5/8	1 23/32	4 1/10	2 3/16	11,914	23,828	7,942	10,360	20,720	6,900
11/16	1 13/16	5	2 3/8	14,490	28,980	9,660	12,600	25,200	8,400
3/4	1 15/16	6 2/10	2 9/16	17,388	34,776	11,592	15,120	30,240	10,087
13/16	2 1/16	6 7/10	2 3/4	20,286	40,572	13,524	17,640	35,280	11,760
7/8	2 3/16	8 3/8	2 15/16	22,484	44,968	14,989	20,440	40,880	13,620
15/16	2 7/16	9	3 3/16	25,872	51,744	17,248	23,520	47,040	15,680
1	2 1/2	10 1/2	3 3/8	29,568	59,136	19,712	26,880	53,760	17,927
1 1/16	2 5/8	12	3 9/16	33,264	66,528	22,176	30,240	60,480	20,160
1 1/8	2 3/4	13 5/8	3 13/16	37,576	75,152	25,050	34,160	68,320	22,770
1 3/16	3 1/16	13 7/10	4	41,888	83,776	27,925	38,080	76,160	25,380
1 1/4	3 1/8	16	4 3/16	46,200	92,400	30,800	42,000	84,000	28,003
1 5/16	3 3/8	16 1/2	4 3/8	50,512	101,024	33,674	45,920	91,840	30,617
1 3/8	3 9/16	19 1/4	4 9/16	55,748	111,496	37,165	50,680	101,360	33,780
1 7/16	3 11/16	19 7/10	4 3/4	60,368	120,736	40,245	54,880	109,760	36,583
1 1/2	3 7/8	23	5 1/8	66,528	133,056	44,352	60,480	120,960	40,327
1 9/16	4	25	5 5/16	70,762	141,524	47,174	65,520	131,040	43,187
1 3/4	4 3/4	31	5 7/8	82,320	164,640	54,880			
2	5 3/4	40	6 3/4	107,520	215,040	71,680			
2 1/4	6 3/4	52 3/4	7 5/8	136,080	272,160	90,720			
2 1/2	7	64 1/2	8 3/8	168,000	336,000	112,000			
2 3/4	7 1/4	73	9 1/8	193,088	386,176	128,725			
3	7 3/4	86	9 7/8	217,728	435,456	145,152			

The distance from center of one link to center of next is equal to the inside length of link, but in practice 1/32 in is allowed for weld. This is approximate, and where exactness is required, chain should be made so.
FOR CHAIN SHEAVES. — The diameter, if possible, should be not less than thirty times the diameter of chain used.
EXAMPLE. — For 1-inch chain use 30-inch sheaves.

SIZES OF FIRE-BRICK.

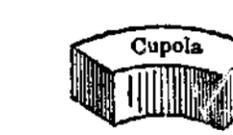
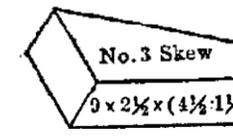
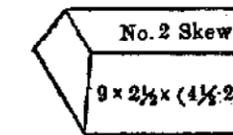
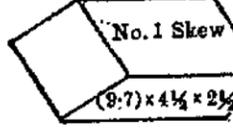
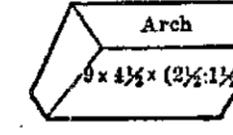
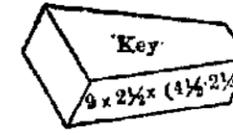
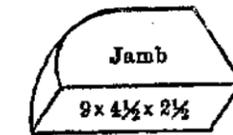

9-inch straight 9 X 4 1/2 X 2 1/2 inches.
 Soap. 9 x 2 1/4 X 2 1/2
 Checker. 9 X 3 X 3
 No. 1 Split 9 X 4 1/2 X 1 1/4
 No. 2 Split 9 X 4 1/2 X 2
 Jamb 9 X 4 1/2 X 2 1/2
 No. 1 key 9 X 2 1/2 thick X 4 1/2 to 4 inches wide. 112 bricks to circle 12 feet inside diam.
 No. 2 key 9 X 2 1/2 thick X 4 1/2 to 3 1/2 inches wide. 65 bricks to circle 6 ft. inside diam.
 No. 3 key 9 X 2 1/2 thick X 4 1/2 to 3 inches wide. 41 bricks to circle 3 ft. inside diam.
 No. 4 key 9 X 2 1/2 thick X 4 1/2 to 2 1/4 inches wide. 26 bricks to circle 1 1/2 ft. inside diam.
 No. 1 wedge (or bullhead) 9 X 4 1/2 wide X 2 1/2 to 2 in. thick, tapering lengthwise. 102 bricks to circle 5 ft. inside diam.
 No. 2 wedge 9 X 4 1/2 X 2 1/2 to 1 1/2 in. thick. 63 bricks to circle 2 1/2 ft. inside diam.
 No. 1 arch 9 X 4 1/2 X 2 1/2 to 2 in. thick, tapering breadthwise. 72 bricks to circle 4 ft. inside diam.
 No. 2 arch 9 X 4 1/2 X 2 1/2 to 1 1/2. 42 bricks to circle 2 ft. inside diam.
 No. 1 skew 9 to 5 X 4 1/2 to 2 1/2. Bevel on one end.
 No. 2 skew 9 X 2 1/2 X 4 1/2 to 2 1/2. Equal bevel on both edges.
 No. 3 skew 9 X 2 1/2 X 4 1/2 to 1 1/2. Taper on one edge.
 24-inch circle. 8 1/4 to 5 1/8 X 4 1/2 X 2 1/2. Edges curved, 9 bricks line a 24-inch circle.
 36-inch circle. 8 3/4 to 6 1/2 X 4 1/2 X 2 1/2. 13 bricks line a 36-inch circle.
 48-inch circle. 8 3/4 to 7 1/4 X 4 1/2 X 2 1/2. 17 bricks line a 48-inch circle.
 13 1/2-inch straight. 13 1/2 X 2 1/2 X 6.
 13 1/2-inch key No. 1. 13 1/2 X 2 1/2 X 6 to 5 inch. 90 bricks turn a 12-ft. circle.
 3 1/2-inch key No. 2. 13 1/2 X 2 1/2 X 6 to 4 3/4 inch. 52 bricks turn a 6-ft. circle.
 Bridge wall, No. 1. 13 X 6 1/2 X 6.
 Bridge wall, No. 2. 13 X 6 1/2 X 3.
 Mill tile 18, 20, or 24 X 6 X 3.
 Stock-hole tiles 18, 20, or 24 X 9 X 4.
 18-inch block 18 X 9 X 6.
 Flat back 9 X 6 X 2 1/2.
 Flat back arch 9 X 6 X 3 1/2 to 2 1/2. 22-inch radius, 56 bricks to circle.
 Locomotive tile 32 X 10 X 3. | 36 X 8 X 3.
 34 X 10 X 3. | 40 X 10 X 3.
 34 X 8 X 3.
 Tiles, slabs, and blocks, various sizes 12 to 30 in. long, 8 to 30 in. wide, 2 to 6 in. thick.
 Cupola brick, 4 and 6 in. high, 4 and 6 in. radial width, to lineshells 23 to 66 in. diameter.
 A 9-inch straight brick weighs 7 lb. and contains 100 cubic inches. (= 120 lb. per cubic foot. Specific gravity 1.93.)
 One cubic foot of wall requires 17 9-inch bricks, one cubic Yard requires 460. Where keys, wedges, and other "shapes" are used, add 10 per cent in estimating the number required.
 One ton of fire-clay should be sufficient to lay 3000 ordinary bricks. To secure the best results, fire-bricks should be laid in the same clay

from which they are manufactured. It should be used as a thin paste, and not as mortar. The thinner the joint the better the furnace wall. In ordering bricks, the service for which they are required should be stated.

NUMBER OF FIRE-BRICK REQUIRED FOR VARIOUS CIRCLES.

Diam. of Circle.	Key Bricks.				Arch Brick;				Wedge Bricks.				
	No. 4.	No. 3.	No. 2.	No. 1.	Total.	No. 2.	No. 1.	9-in.	Total.	No. 2.	No. 1.	9-in.	Total.
1 6	25				25								
2 0	17	13			30	42			42				
2 6	9	25			34	31	18		49	60			60
3 0		38			38	21	36		57	48	20		68
3 6		32	10		42	10	54		64	36	40		76
4 0		25	21		46		72		72	24	59		83
4 6		19	32		51		72	8	80	11	79		91
5 0		I 13	42		55		72	15	87	9	8		98
5 6		6	53		59		72	23	95	9	8	8	106
6 0			63		63		72	30	102	9	8	15	113
6 6			58	9	67		72	38	110	9	8	23	121
7 0			52	19	71		72	45	117	9	8	30	128
7 6			47	29	76		72	53	125		98	38	136
8 0			42	38	80		72	60	132		98	46	144
8 6			37	47	84		72	68	140		98		151
9 0			31	57	88		72	75	147		98	a:	159
9 6			26	66	92		72	83	155		98	6'	166
10 0			21	76	97		72	90	162		98	76	174
10 6			16	85	101	7	2	98	170		98	83	181
11 0			11	94	105		72	105	177		98	91	189
11 6			5	104	109		72	113	185	9	8	98	196
12 0				113	113		72	121	193		98	136	204
12 6				113	117								

For larger circles than 12 feet use 113 No. 1 Key, and as many Y-inch brick as may be needed in addition.

WEIGHTS OF LOGS, LUMBER, ETC.

Weight of Green Logs to Scale 1000 Feet, Board Measure.

Yellow pine (southern).....	8,000 to 10,000	1 lb.
Norway pine (Michigan).....	7,000 to 8,000	"
White pine (Michigan) } off of stump.....	7,000 to 7,000	"
White pine (Michigan) } cut of water.....	7,000 to 8,000	"
White pine (Pennsylvania), bark off.....	5,000 to 6,000	"
Hemlock (Pennsylvania), bark off.....	6,000 to 7,000	"

Four acres of water are required to store 1,000,000 feet of logs.

Weight of 1000 Feet of Lumber, Board Measure.

Yellow or Norway pine.....	Dry, 3,000 lb.	Green, 5,000 lb.
White pine.....	3,500 "	4,000 "

WARNING: This is a 1910 edition. Some of the material may no longer be accurate

Weight of 1 Cord of Seasoned Wood, 128 Cu. Ft. per Cord.

Hickory or sugar maple.....	4,500 lb.
White oak.....	3,850 "
Beech, red oak or black oak.....	3,250 "
Poplar, chestnut or elm.....	2,350 "
Pine (white or Norway).....	2,000 "
Hemlock bark, dry.....	2,200 "

ANALYSES OF FIRE CLAYS.

Brand.	Titanic Acid, TiO ₂	Silica, SiO ₂	Alumina, Al ₂ O ₃	Moisture, H ₂ O	Iron, Fe ₂ O ₃	Lime, CaO	Magnesia, MgO	Potash, K ₂ O	Soda, Na ₂ O	Total Impurities.	Loss.
Mt. Savage ¹		50.46	55.90	12.744	1.50	0.13	0.02	Trace		1.65	
Mt. Savage ²		56.80	30.08	10.50	1.12			0.80		1.92	
Mt. Savage ³	1.53	44.40	33.56	14.575	1.08	Tr.	0.11	0.247		1.47	
Mt. Savage ⁴		56.15	33.30	9.68	0.59	0.17	0.12			0.88	
Strasburg, O.....	0.45	55.87	41.39		1.60	0.40	0.30	0.29	0.20	2.79	
Cumberland, Md.....	1.15	56.80	30.08	7.69	1.67			2.30		3.97	
Woodbridge, N. J.....		67.84	21.83	5.98	1.57	0.28	0.24	2.24		4.33	
Carter Co., Ky.....		68.01	24.09	3.03	1.01	3.01				4.02	
Clearfield Co., Pa.....		48.35	36.37	10.56	2.00	0.07	0.12	2.54		4.73	
Clearfield ⁵ and Cambria Cos., Pa. ⁶		44.80	39.00	14.70	0.30	0.20	1.09				
Clinton Co., Pa.....	1.46	63.18	23.70	6.87	1.20	0.17	0.47	2.52		4.55	SO ₂ 0.19
Clarion Co., Pa.....	1.02	44.61	38.01	13.63	1.25	0.08	0.41	1.74		3.47	
Farrandville, Pa.....		45.26	37.85	13.30	2.03	0.08	0.02	1.26		3.59	0.20
St. Louis Co., Mo.....		67.47	19.33	10.45	2.56	0.41	0.07	1.07		5.14	
Stourbridge, Eng.....		73.82	15.88	6.45	2.95	Tr.	Tr.	0.90		3.85	

¹ Mass. Inst of Technology 1871. ² Report on Clays of New Jersey. Prof. G. H. Cook, 1877. ³ Second Geological Survey of Penna., 1878. ⁴ Dr. Otto Wuth (2 samples), 1885. ⁵ Flint clay from Clearfield and Cambria counties, Pa., average of hundreds of analyses by Harbison-Walker Refractories Co., Pittsburg, Pa. ⁶ Same material calcined. All other analyses from, catalogue of Stowe-Fuller Co., 1907.

Refractoriness of Some American Fire-Brick. -- (R. F. Weber, A. I. M. E. 1904.) Prof. Heinrich Ries notes that the fusibility of New Jersey brick is influenced largely by its percentage of silica, but also in part by the texture of the clay. It was found that the fusion-point of almost any of the New Jersey fire-bricks could be reduced four or five cones by grinding the brick sufficiently fine to pass through a 100-mesh sieve.

Mr. Weber draws the conclusion from his tests of 44 bricks that it is evident that the refractoriness of a fire-brick depends on the total quantity of fluxes present, the silica percentage and the coarseness of grain; moreover chemical analysis alone cannot be used as an index of the refractoriness except within rather wide limits. The following table shows the composition, fusion-point, and physical properties of six most refractory and of five least refractory of the 44 bricks.

Number of Sample.	Locality.	SiO ₂ .	Al ₂ O ₃ .	Fe ₂ O ₃ .	TiO ₂ .	Alkaline Earths and Alkalies	Sun of Fluxes.	Cone of Fusion.
		Per cent	Per cent	Per cent.	Per cent	Per cent	Per cent.	No.
1...	Missouri	51.59	31.26	1.84	1.97	6.34	10.25	32 to 33
2	Kentucky	54.90	38.19	2.18	1.55	3.18	6.91	32 to 33
3	Pennsylvania...	53.07	41.16	2.65	1.80	1.34	5.79	32 to 33
4...	Colorado	93.51	2.53	0.62	0.27	3.01	3.90	32 to 33
5	Kentucky	44.77	43.08	2.78	2.54	6.83	12.15	31 to 32
6.	New York...	68.70	20.75	1.20	5.54	3.81	10.55	31 to 32
40...	Pennsylvania	61.28	27.13	2.90	1.37	7.31	11.58	26
41...	Pennsylvania..	74.81	16.40	3.26	0.77	4.74	8.77	26
42...	Alabama...	67.11	25.05	2.83	0.71	4.22	7.76	26
43...	Indiana...	60.76	31.66	5.67	1.58	0.33	7.58	26
44.	Kentucky.	60.58	32.49	2.25	1.69	2.99	6.93	26

¹Fairly uniform, angular flint-clay particles, constituting body of brick. Largest pieces 5 to 6 mm. in diameter. White.

²Coarse-grained; angular pieces of flint-clay as large as 9 mm. Average 4 to 5 mm. Light buff.

³Coarse, angular flint-clay particles, varying from 1 to 5 mm. in diameter. Average 4 to 5 mm. Buff.

⁴Fine-grained quartz particles. Largest 2 to 3 mm. in diameter. White.

⁵Medium grain; flint-clay particles, fairly uniform in size. 3 to 4 mm. Light buff.

⁶Coarse grain; quartz particles, 4 to 5 mm. in diameter, forming about 50 per cent of brick. White.

⁴⁰Fine grain; small, white flint-clay particles, not over 2 mm. in diameter and not abundant. Buff.

⁴¹Medium grain; pieces of quartz with pinkish color and angular flint-clay particles. About 3 mm. in diameter. Buff.

⁴²Fine grain; even texture. Few coarse particles. Brown.

⁴³Fine grain; some particles as large as 1 to 2 mm. in diameter. Buff.

⁴⁴Angular, dark-colored, flinty-clay particles. Maximum size 5 mm. Throughout a reddish-brown matrix.

SLAG BRICKS AND SLAG BLOCKS.

Slag bricks are made by mixing granulated basic slag and slaked lime, molding the mixture in a brick press or by hand, and drying. The silica in the slag ranges from 22.5% to 35%; the alumina and iron oxide together from 16.1% to 21%; the lime, from 40% to 51.5%. The granulated slag is dried and pulverized. Powdered slaked lime is added in sufficient quantity to bring the total calcium oxide in the mixture up to about 55%. Usually a small amount of water is added. The mixture is then molded into shape, and the bricks are then dried for six to ten days in the open air. Slag bricks weigh less than clay bricks of equal size, require less mortar in laying up, and are at least equal to them in crushing strength.

Slag blocks are made by running molten slag direct from the furnaces into molds. If properly made, they are stronger than slug bricks. They are, however, impervious to air and moisture; and on that account dwellings constructed of them are apt to be damp. Their chief uses are for foundations or for paving blocks. The properties required in a slag paving block, viz: density, resistance to abrasion, toughness, and roughness of surface, vary with the chemical composition of the slag, the rapidity of cooling, and the character of the molds used. Blocks cast in sand molds, and heavily covered with loose sand, cool slowly and give much better results than those cast in iron molds. -E. C. Eckel, *Eng. News*, April 30, 1903.

WARNING: This is a 1910 edition. Some of the material may no longer be accurate

MAGNESIA BRICKS.

"Foreign Abstracts" of the Institution of Civil Engineers, 1893, gives a paper by C. Bischof on the production of magnesia bricks. The material most in favor at present is the magnesite of Styria, which, although less pure considered as a source of magnesia than the Greek, has the property of fritting at a high temperature without melting.

At a red heat magnesium carbonate is decomposed into carbonic acid and caustic magnesia, which resembles lime in becoming hydrated and recarbonated when exposed to the air, and possesses a certain plasticity, so that it can be moulded when subjected to a heavy pressure. By long-continued or stronger heating the material becomes dead-burnt, giving a form of magnesia of high density, sp. gr. 3.8, as compared with 3.0 in the plastic form, which is unalterable in the air but devoid of plasticity. A mixture of two volumes of dead-burnt with one of plastic magnesia can be moulded into bricks which contract but little in firing. Other binding materials that have been used are: clay up to 10 or 15 per cent; gas-tar, perfectly freed from water. soda, silica, vinegar as a solution of magnesium acetate which is readily decomposed by heat, and carbonates of alkalies or lime. Among magnesium compounds a weak solution of magnesium chloride may also be used. For setting the bricks lightly burnt, caustic magnesia, with a small proportion of silica to render it less refractory? is recommended. The strength of the bricks may be increased by adding iron, either as oxide or silicate. If a porous product is required, sawdust or starch may be added to the mixture. When dead-burnt magnesia is used alone, soda is said to be the best binding material. See also papers by A. E. Hunt, *Trans. A. I. M. E.*, xvi, 720, and by T. Egleston, *Trans. A. I. M. E.*, xiv, 458.

The average composition of magnesite, crude and calcined, is given as follows by the Harbison-Walker Refractories Co., Pittsburg (1907).

	Grecian.		Styrian.	
	Crude.	Calcined.	Crude.	Calcined.
Carbonate of magnesia	97.00%	94.00%	92.50%	85.50%
Magnesia.
Silica	1.25	2.75	1.50	3.00
Alumina	0.40	0.70	0.50	1.00
Iron Oxide.	0.40	0.80	3.90	8.00
Lime	0.75	1.50	1.25	2.50
Loss	0.40	0.50
	100.05	100.15	99.65	100.50

With the calcined Styrian magnesite of the above analysis it is not necessary to use a binder either for making brick or for forming the bottom of an open-hearth furnace.

ASBESTOS.

The following analyses of asbestos are given by J. T. Donald, *Eng. and M. Jour.*, June 27, 1891.

	Italian.	Canadian.	
		Broughton.	Templeton.
Silica	40.30%	40.57%	40.52%
Magnesia	43.37	41.50	42.05
Ferrous oxide	.87	1.97
Alumina	2.27	2.90	2.10
Water	13.72	13.55	13.46
	100.53	99.33	100.10

Chemical analysis throws light upon an important point in connection with asbestos, i.e., the cause of the harshness of the fibre of some varieties. Asbestos is principally a hydrous silicate of magnesia, i.e., silicate of magnesia combined with water. When harsh fibre is analyzed it is found to contain less water than the soft fibre. In fibre of very fine quality from Black Lake analysis showed 14.38% of water, while a harsh and red sample gave only 11.70%. If soft fibre be heated to a temperature that will drive off a portion of the combined water there results a substance so brittle that it may be crumbled between thumb and finger. There is evidently some connection between the consistency of the fibre and the amount of water in its composition.

STRENGTH OF MATERIALS.

Stress and Strain. - There is much confusion among writers on strength of materials as to the definition of these terms. An external force applied to a body, so as to pull it apart, is resisted by an internal force, or resistance, and the action of these forces causes a displacement of the molecules, or deformation. By some writers the external force is called a Stress, and the internal force a strain; others call the external force a strain and the internal force a stress; this confusion of terms is not of importance, as the words stress and strain are quite commonly used synonymously, but the use of the word strain to mean molecular displacement, deformation, or distortion, as is the custom of some, is a corruption of the language. See *Engineering News*, June 23, 1892. Some authors in order to avoid confusion never use the word strain in their writings. Definitions by leading authorities are given below.

Stress. - A stress is a force which acts in the interior of a body, and resists the external forces which tend to change its shape. A deformation is the amount of change of shape of a body caused by the stress. The word strain is often used as synonymous with stress, and sometimes it is also used to designate the deformation. (Merriman.)

The force by which the molecules of a body resist a strain at any point is called the stress at that point.

The summation of the displacements of the molecules of a body for a given point is called the distortion or strain at the point considered. (Burr.)

Stresses are the forces which are applied to bodies to bring into action their elastic and cohesive properties. These forces cause alterations of the forms of the bodies upon which they act. *Strain* is a name given to the kind of alteration produced by the stresses. The distinction between stress and strain is not always observed, one being used for the other. (Wood.)

The use of the word stress as synonymous with "stress per square inch," or with "strength per square inch," should be condemned as tacking in precision.

Stresses are of different kinds, viz.: *tensile, compressive, transverse, torsional, and shearing* stresses.

A *tensile stress*, or pull, is a force tending to elongate a piece. A *compressive stress*, or push, is a force tending to shorten it. A *transverse stress* tends to bend it. A *torsional stress* tends to twist it. A *shearing stress* tends to force one part of it to slide over the adjacent part.

Tensile, compressive, and shearing stresses are called simple stresses. Transverse stress is compounded of tensile and compressive stresses, and torsional of tensile and shearing stresses.

To these five varieties of stresses might be added tearing stress, which is either tensile or shearing, but in which the resistance of different portions of the material are brought into play in detail, or one after the other, instead of simultaneously, as in the simple stresses.

Effects of Stresses. - The following general laws for cases of simple tension or compression have been established by experiment (Merriman):

1. When a small stress is applied to a body, a small deformation is produced and on the removal of the stress the body springs back to its original form. For small stresses, then, materials may be regarded as perfectly elastic.

2. Under small stresses the deformations are approximately proportional to the forces or stresses which produce them, and also approximately proportional to the length of the bar or body.

3. When the stress is great enough a deformation is produced which is partly permanent, that is, the body does not spring back entirely to its original form on removal of the stress. This permanent part is termed a set. In such cases the deformations are not proportional to the stress.

4. When the stress is greater still the deformation rapidly increases and the body finally ruptures.

5. A sudden stress, or shock, is more injurious than a steady stress or than a stress gradually applied.

Elastic Limit. - The elastic limit is defined as that load at which the deformations cease to be proportional to the stresses, or at which the rate of stretch (or other deformation) begins to increase. It is also defined as the load at which a permanent set first becomes visible. The last definition is not considered as good as the first, as it is found that with some materials a set occurs with any load, no matter how small, and that with others a set which might be called permanent vanishes with lapse of time, and as it is impossible to get the point of first set without removing the whole load after each increase of load, which is frequently inconvenient. The elastic limit, defined, however, as that stress at which the extensions begin to increase at a higher rate than the applied stresses, usually corresponds very nearly with the point of first measurable permanent set.

Apparent Elastic Limit. - Prof. J. B. Johnson (*Materials of Construction*, p. 19) defines the "apparent elastic limit" as "the point on the stress diagram [a plotted diagram in which the ordinates represent loads and the abscissas the corresponding elongations] at which the rate of deformation is 50% greater than it is at the origin." [the minimum rate] An equivalent definition, proposed by the author, is that point at which the modulus of extension (length X increment of load per unit of section ÷ increment of elongation) is two thirds of the maximum. For steel, with a modulus of elasticity of 30,000,000, this is equivalent to that point at which the increase of elongation in an 8-inch specimen for 1000 lbs. per sq. in. increase of load is 0.0004 in.

Yield-point. - The term yield-point has recently been introduced into the literature of the strength of materials. It is defined as that point at which the rate of stretch suddenly increases rapidly with no increase of the load. The difference between the elastic limit, strictly defined as the point at which the rate of stretch begins to increase, and the yield-point, may in some cases be considerable. This difference, however, will not be discovered in short, test-pieces unless the readings of elongations are made by an exceedingly fine instrument, as 5 micrometer reading to 0.0001 inch. In using a coarser instrument, such as calipers reading to 1/100 of an inch, the elastic limit and the yield-point will appear to be simultaneous. Unfortunately for precision of language, the term yield-point was not introduced until long after the term elastic limit had been, almost universally adopted to signify the same physical fact which is now defined by the term yield-point, that is, not the point at which the first change in rate, observable only by a microscope, occurs, but that later point (more or less indefinite as to its precise position) at which the increase is great enough to be seen by the naked eye. A most convenient method of determining the point at which a sudden increase of rate of stretch occurs in short specimens, when a testing-machine in which the Pulling is done by screws is used, is to note the weight on the beam at the instant that the beam "drops." During the earlier portion of the test, as the extension is steadily increased by the uniform but slow rotation of the screws, the poise is moved steadily along the beam to keep it in equipoise; suddenly a point is reached at which the beam drops, and will not rise until the elongation has been considerably increased by the further rotation of the screws, the advancing of the poise meanwhile being suspended. This point corresponds practically to the point at which the rate of elongation suddenly increases, and to the point at which an appreciable permanent set is first found. It is also the point which has hitherto been called in practice and in test-books the elastic limit, and it will probably continue to be so called, although the use of the newer term "yield-point" for it, and the restriction of the term elastic limit to mean the earlier point at which the rate of stretch begins to increase, as determinable only by micrometric measurements, is more precise and scientific. In order to obtain the yield-point by the drop of the beam with approximate accuracy, the screws of the testing machine must be run very slowly as the yield-point is approached, so as to cause an elongation of not more than, say, 0.005 in. per minute.

In tables of strength of materials hereafter given, the term elastic limit is used in its customary meaning, the point at which the rate of stress has begun to increase as observable by ordinary instruments or by the drop of the beam. With this definition it is practically synonymous with yield-point.

Coefficient (or Modulus) of Elasticity. — This is a term expressing the relation between the amount of extension or compression of a material and the load producing that extension or compression.

It is defined as the load per unit of section divided by the extension per unit of length.

Let P be the applied load, k the sectional area of the piece, l the length of the part extended, λ the amount of the extension, and E the coefficient of elasticity. Then $P \div k =$ the load on a unit of section: $\lambda \div l =$ the elongation of a unit of length.

$$E = \frac{P}{k} \div \frac{\lambda}{l} = \frac{Pl}{k\lambda}$$

The coefficient of elasticity is sometimes defined as the figure expressing the load which would be necessary to elongate a piece of one square inch section to double its original length, provided the piece would not break, and the ratio of extension to the force producing it remained constant. This definition follows from the formula above given, thus: If $k =$ one square inch, $l =$ one inch, $E = P$.

Within the elastic limit, when the deformations are proportional to the stresses, the coefficient of elasticity is constant, but beyond the elastic limit it decreases rapidly.

In cast iron there is generally no apparent limit of elasticity, the deformations increasing at a faster rate than the stresses, and a permanent set being produced by small loads. The coefficient of elasticity therefore is not constant during any portion of a test, but grows smaller as the load increases. The same is true in the case of timber. In wrought iron and steel, however, there is a well-defined elastic limit, and the coefficient of elasticity within that limit is nearly constant.

Resilience or Work of Resistance of a Material. — Within the elastic limit the resistance increases uniformly from zero stress to the stress at the elastic limit, the work done by a load applied gradually is equal to one half the product of the final stress by the extension or other deformation. Beyond the elastic limit, the extensions increase more rapidly than the loads, and the strain diagram (a plotted diagram showing the relation of extensions to stresses) approximating a parabolic form, the work is approximately equal to two thirds the product of the maximum stress by the extension.

The amount of work required to break a bar, measured usually in inch-pounds, is called its resilience; the work required to strain it to the elastic limit is called its elastic resilience. (See below.)

Under a load applied suddenly the momentary elastic distortion is equal to twice that caused by the same load applied gradually.

When a solid material is exposed to percussive stress, as when a weight falls upon a beam transversely, the work of resistance is measured by the product of the weight into the total fall.

Elastic Resilience. — In a rectangular beam tested by transverse stress, supported at the ends and loaded in the middle,

$$P = \frac{2}{3} \frac{Rbd^2}{l}; \quad (1) \quad \Delta = \frac{1}{4} \frac{Pl^3}{Ebd^3}; \quad (2)$$

in which, if P is the load in pounds at the elastic limit, R = the modulus of transverse strength, or the stress on the extreme fibre, at the elastic limit, E = modulus of elasticity, Δ = deflection, l , b , and d = length, breadth, and depth in inches. Substituting for P in (2) its value in (1), $A = \frac{1}{6} \frac{Rl}{E} \div Ed$.

The elastic resilience = half the product of the load and deflection = $\frac{1}{2} P \Delta$, and the elastic resilience per cubic inch = $\frac{1}{2} P \Delta \div lbd$.

Substituting the values of P and Δ , this reduces to elastic resilience Per cubic inch = $\frac{1}{18} \frac{R^2}{E}$, which is independent of the dimensions; and therefore the elastic resilience per cubic inch for transverse strain may be used as a modulus expressing one valuable quality of a material.

Similarly for tension: Let P = tensile stress in pounds per square inch at the elastic limit; e = elongation per unit of length at the elastic limit; E = modulus of elasticity = $P \div e$ whence $e = P \div E$.

Then elastic resilience per cubic inch = $\frac{1}{2} Pe = \frac{1}{2} \frac{P^2}{E}$.

Elevation of Ultimate Resistance and Elastic Limit. — It was first observed, by Prof. R. H. Thurston, and Commander J. A. Beardslee, U.S.N., independently, in 1873, that if wrought iron be subjected to a stress beyond its elastic limit, but not beyond its ultimate resistance, and then allowed to "rest" for a definite interval of time, a considerable increase of elastic limit and ultimate resistance may be experienced. In other words, the application of stress and subsequent "rest" increases the resistance of wrought iron. This "rest" may be an entire release from stress or a simple holding the test-piece at a given intensity of stress.

Commander Beardslee prepared twelve specimens and subjected them to a stress equal to the ultimate resistance of the material without breaking the specimens. These were then allowed to rest, entirely free from stress, from 24 to 30 hours, after which they were again stressed until broken. The gain in ultimate resistance by the rest was found to vary from 4.4 to 17 per cent.

This elevation of elastic and ultimate resistance appears to be peculiar to iron and steel; it has not been found in other metals.

Relation of the Elastic Limit to Endurance under Repeated Stresses (condensed from Engineering, August 7, 1891). — When engineers first began to test materials, it was soon recognized that if a specimen was loaded beyond a certain point it did not recover its original dimensions on removing the load, but took a permanent set: this point was called the elastic limit. Since below this point a bar appeared to recover completely its original form and dimensions on removing the load, it appeared obvious that it had not been injured by the load, and hence the working load might be deduced from the elastic limit by using a small factor of safety.

Experience showed, however, that in many cases a bar would not carry safely a stress anywhere near the elastic limit of the material as determined by these experiments, and the whole theory of any connection between the elastic limit of a bar and its working load became almost discredited, and engineers employed the ultimate strength only in deducing the safe working load to which their structures might be subjected. Still, as experience accumulated it was observed that a higher factor of safety was required for a live load than for a dead one.

In 1871 Wöhler published the results of a number of experiments on bars of iron and steel subjected to live loads. In these experiments the stresses were put on and removed from the specimens without impact but it was, nevertheless, found that the breaking stress of the materials was in every case much below the statical breaking load. Thus, a bar of Krupp's axle steel having a tenacity of 49 tons per square inch broke with a stress of 28.6 tons per square inch, when the load was completely removed and replaced without impact 170,000 times. These experiments were made on a large number of different brands of iron and steel, and the results were concordant in showing that a bar would break with an alternating stress of only, say, one third the statical breaking strength of the material, if the repetitions of stress were sufficiently numerous. At the same time, however, it appeared from the general trend of the experiments that a bar would stand an indefinite number of alternations of stress, provided the stress was kept below the limit.

Prof. Bauschinger defines the elastic limit as the point at which stress ceases to be sensibly proportional to extension, the latter being measured with a mirror apparatus reading to $\frac{1}{5000}$ of a millimetre, or about $\frac{1}{100000}$ in. This limit is always below the yield-point, and may on occasion be zero. On loading a bar above the yield-point, this point rises with the stress, and the rise continues for weeks, months, and possibly for years if the bar is left at rest under its load. On the other hand, when a bar is loaded beyond its true elastic limit, but below its yield-point, this limit rises, but reaches a maximum as the yield-point is approached, and then falls rapidly, reaching even to zero. On leaving the bar at rest under a stress exceeding that of its primitive breaking-

down point the elastic limit begins to rise again, and may, if left a sufficient time, rise to a point much exceeding its previous value.

A bar has two limits of elasticity, one for tension and one for compression. Bauschinger loaded a number of bars in tension until stress ceased to be sensibly proportional to deformation. The load was then removed and the bar tested in compression until the elastic limit in this direction had been exceeded. This process raises the elastic limit in compression, as would be found on testing the bar in compression a second time. In place of this, however, it was now again tested in tension, when it was found that the artificial raising of the limit in compression had lowered that in tension below its previous value. By repeating the process of alternately testing in tension and compression, the two limits took up points at equal distances from the line of no load, both in tension and compression. These limits Bauschinger calls natural elastic limits of the bar, which for wrought iron correspond to a stress of about 8 1/2 tons per square inch, but this is practically the limiting load to which a bar of the same material can be strained alternately in tension and compression, without breaking when the loading is repeated sufficiently often, as determined by Wöhler's method.

As received from the rolls the elastic limit of the bar in tension is above the natural elastic limit of the bar as defined by Bauschinger, having been artificially raised by the deformations to which it has been subjected in the process of manufacture. Hence, when subjected to alternating stresses, the limit in tension is immediately lowered, while that in compression is raised until they both correspond to equal loads. Hence, in Wöhler's experiments, in which the bars broke at loads nominally below the elastic limits of the material, there is every reason for concluding that the loads were really greater than true elastic limits of the material. This is confirmed by tests on the connecting-rods of engines, which work under alternating stresses of equal intensity. Careful experiments on old rods show that the elastic limit in compression is the same as that in tension, and that both are far below the tension elastic limit of the material as received from the rolls.

The common opinion that straining a metal beyond its elastic limit injures it appears to be untrue. It is not the mere straining of a metal beyond one elastic limit that injures it, but the straining, many times repeated, beyond its two elastic limits. Sir Benjamin Baker has shown that in bending a shell plate for a boiler the metal is of necessity strained beyond its elastic limit, so that stresses of as much as 7 tons to 15 tons per square inch may obtain in it as it comes from the rolls, and unless the plate is annealed, these stresses will still exist after it has been built into the boiler. In such a case, however, when exposed to the additional stress due to the pressure inside the boiler, the overstrained portions of the plate will relieve themselves by stretching and taking a permanent set, so that probably after a year's working very little difference could be detected in the stresses in a plate built into the boiler as it came from the bending rolls, and in one which had been annealed, before riveting into place and the first, in spite of its having been strained beyond its elastic limits, and not subsequently annealed, would be as strong as the other.

Resistance of Metals to Repeated Shocks.

More than twelve years were spent by Wöhler at the instance of the Prussian Government in experimenting upon the resistance of iron and steel to repeated stresses. The results of his experiments are expressed in what is known as Wöhler's law, which is given in the following words in Dubois's translation of Weyrauch:

"Rupture may be caused not only by a steady load which exceeds the carrying strength, but also by repeated applications of stresses, none of which are equal to the carrying strength. The differences of these stresses are measures of the disturbance of continuity, in so far as by their increase the minimum stress which is still necessary for rupture diminishes."

A practical illustration of the meaning of the first portion of this law may be given thus: If 50,000 pounds once applied will just break a bar of iron or steel, a stress very much less than 50,000 pounds will break it if repeated sufficiently often.

This is fully confirmed by the experiments of Fairbairn and Spangenberg, as well as those of Wöhler; and, as is remarked by Weyrauch, it may be considered as a long-known result of common experience. It partially accounts for what Mr. Holley has called the "intrinsically ridiculous factor of safety of six."

Another "long-known result of experience" is the fact that rupture may be caused by a succession of *shocks* or *impacts*, none of which alone would be sufficient to cause it. Iron axles, the piston-rods of steam hammers, and other pieces of metal subject to continuously repeated shocks, invariably break after a certain length of service. They have a "life" which is limited.

Several years ago Fairbairn wrote: "We know that in some cases wrought iron subjected to continuous vibration assumes a crystalline structure, and that the cohesive powers are much deteriorated, but we are ignorant of the causes of this change." We are still ignorant, not only of the causes of this change, but of the conditions under which it takes place. Who knows whether wrought iron subjected to very slight continuous vibration will endure forever? or whether to insure final rupture each of the continuous small shocks must amount at least to a certain percentage of single heavy shock (both measured in foot-pounds), which would cause rupture with one application? Wöhler found in testing iron by repeated stresses (not impacts) that in one case 400,000 applications of a stress of 500 centners to the square inch caused rupture, while a similar bar remained sound after 48,000,000 applications of a stress of 300 centners to the square inch (1 centner = 110.2 lbs.).

Who knows whether or not a similar law holds true in regard to repeated shocks? Suppose that a bar of iron would break under a single impact of 1000 foot-pounds, how many times would it be likely to bear the repetition of 100 foot-pounds, or would it be safe to allow it to remain for fifty years subjected to a continual succession of blows of even 10 foot-pounds each?

Mr. William Metcalf published in the *Metallurgical Review*, Dec. 1877, the results of some tests of the life of steel of different percentages of carbon under impact. Some small steel pitmans were made, the specifications for which required that the unloaded machine should run 4 1/2 hours at the rate of 1200 revolutions per minute before breaking.

The steel was all of uniform quality, except as to carbon. Here are the results. The

0.30 C.	ran 1 h. 21 m.	Heated and bent before breaking.
0.49 c.	" 1 h. 28 m.	
0.53 C.	" 4 h. 57 m.	Broke without heating.
0.65 C.	" 3 h. 50 m.	Broke at weld where imperfect.
0.80 C.	" 5 h. 40 m.	
0.84 C.	" 18 h.	
0.87 C.	Broke in weld near the end.	
0.96 C.	Ran 4.55 m., and the machine broke down.	

Some other experiments by Mr. Metcalf confirmed his conclusion, viz. that high-carbon steel was better adapted to resist repeated shocks and vibrations than low-carbon steel.

These results, however, would scarcely be sufficient to induce any engineer to use 0.54 carbon steel in a car-axle or a bridge-rod. Further experiments are needed to confirm or overthrow them.

(See description of proposed apparatus for such an investigation in the author's paper in *Trans. A. I. M. E.*, vol. viii, p. 76, from which the above extract is taken.)

Stresses Produced by Suddenly Applied Forces and Shocks-

(Mansfield Merriman, *R. R. & Eng. Jour.*, Dec., 1889.)

Let P be the weight which is dropped from a height h upon the end of a bar, and let y be the maximum elongation which is produced. The work performed by the falling weight, then, is $W = P(h + y)$, and this must equal the internal work of the resisting molecular stresses. The stress in the bar which is at first 0, increases up to a certain limit Q , which is greater than P ; and if the elastic limit be not exceeded the elongation increases uniformly with the stress, so that the internal work is equal to

WARNING: This is a 1910 edition. Some of the material may no longer be accurate

Mark on the specimen divisions of $\frac{1}{2}$ inch each. After fracture measure from the point of fracture the length of 8 of the marked spaces on each fractured portion (or 7 + on one side and 8 + on the other if the fracture is not at one of the marks). The sum of these measurements, less 8 inches, is the elongation of 8 inches of the original length. If the fracture is so near one end of the specimen that 7 + spaces are not left on the shorter portion, then take the measurement of as many spaces (with the fractional part next to the fracture) as are left, and for the spaces lacking add the measurement of as many corresponding spaces of the longer portion as are necessary to make the 7 + spaces.

Shapes of Specimens for Tensile Tests.—The shapes shown in Fig. 75 were recommended by the author in 1882 when he was connected with the Pittsburgh Testing Laboratory. They are now in most general use; the earlier forms, with 5 inches or less in length between shoulders, being almost entirely abandoned.

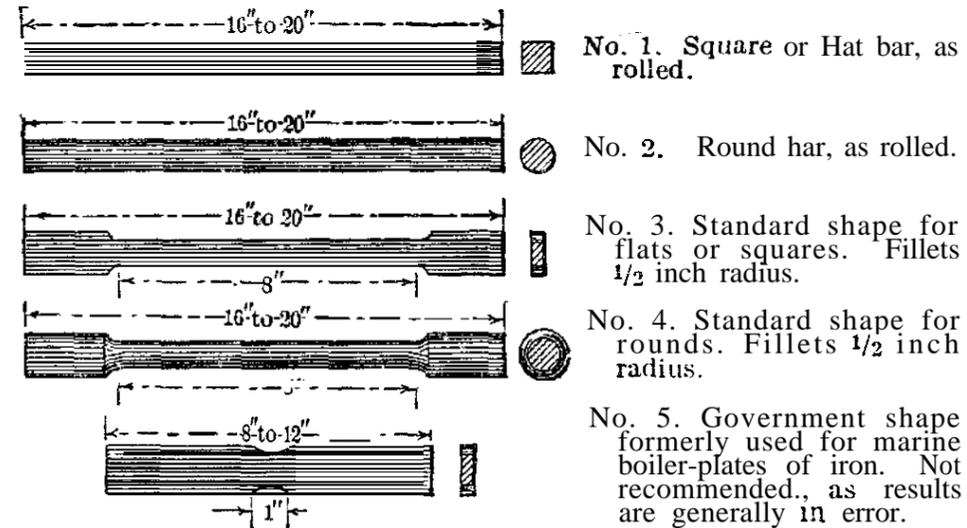

FIG. 78.

Precautions Required in making Tensile Tests.—The testing-machine itself should be tested, to determine whether its weighing apparatus is accurate, and whether it is so made and adjusted that in the test of a properly made specimen the line of strain of the testing-machine is absolutely in line with the axis of the specimen.

The specimen should be so shaped that it will not give an incorrect record of strength.

It should be of uniform minimum section for not less than eight inches of its length. Eight inches is the standard length for bars. For forgings and castings and in special cases shorter lengths are used; these show greater percentages of elongation, and the length between gauge marks should therefore always be stated in the record.

Regard must be had to the time occupied in making tests of certain materials. Wrought iron and soft steel can be made to show a higher than their actual apparent strength by keeping them under strain for a great length of time.

In testing soft alloys, copper, tin, zinc, and the like, which flow under constant strain, their highest apparent strength is obtained by testing them rapidly. In recording tests of such materials the length of time occupied in the test should be stated.

For very accurate measurements of elongation, corresponding to increments of load during the tests, the electric contact micrometer, described in Trans. A. S. M. E., vol. vi. p. 479, will be found convenient. When readings of elongation are then taken during the test; a strain diagram may be plotted from the reading, which is useful in comparing the qualities of different specimens. Such strain diagrams are made automatically by the new Olsen testing-machine, described in Jour. Frank. Inst. 1891.

The coefficient of elasticity should be deduced from measurement

observed between fixed increments of load per unit section, say between 2000 and 12,000 pounds per square inch or between 1000 and 11,000 pounds instead of between 0 and 10,000 pounds.

COMPRESSIVE STRENGTH.

What is meant by the term "compressive strength" has not yet been settled by the authorities, and there exists more confusion in regard to this term than in regard to any other used by writers on strength of materials. The reason of this may be easily explained. The effect of a compressive stress upon a material varies with the nature of the material, and with the shape and size of the specimen tested. While the effect of a tensile stress is to produce rupture or separation of particles in the direction of the line of strain, the effect of a compressive stress on a piece of material may be either to cause it to fly into splinters, to separate into two or more wedge-shaped pieces and fly apart, to bulge, buckle, or bend, or to flatten out and utterly resist rupture or separation of particles. A piece of speculum metal (copper 2, tin 1) under compressive stress will exhibit no change of appearance until rupture takes place, and then it will fly to pieces as suddenly as if blown apart by gunpowder. A piece of cast iron or of stone will generally split into wedge-shaped fragments. A piece of wrought iron will buckle or bend. A piece of wood or zinc may bulge, but its action will depend upon its shape and size. A piece of lead will flatten out and resist compression till the last degree; that is, the more it is compressed the greater becomes its resistance.

Air and other gaseous bodies are compressible to any extent as long as they retain the gaseous condition. Water not confined in a vessel is compressed by its own weight to the thickness of a mere film, while when confined in a vessel it is almost incompressible.

It is probable, although it has not been determined experimentally, that solid bodies when confined are at least as incompressible as water. When they are not confined, the effect of a compressive stress is not only to shorten them, but also to increase their lateral dimensions or bulge them. Lateral stresses are therefore induced by compressive stresses.

The weight per square inch of original section required to produce any given amount or percentage of shortening of any material is not a constant quantity, but varies with both the length and the sectional area, with the shape of the sectional area, and with the relation of the area to the length. The "compressive strength" of a material, if this term be supposed to mean the weight in pounds per square inch necessary to cause rupture, may vary with every size and shape of specimen experimented upon. Still more difficult would it be to state what is the "compressive strength" of a material which does not rupture at all, but flattens out. Suppose we are testing a cylinder of a soft metal like lead, two inches in length and one inch in diameter, a certain weight will shorten it one per cent, another weight ten per cent, another fifty per cent, but no weight that we can place upon it will rupture it, for it will flatten out to a thin sheet. What, then, is its compressive strength? Again, a similar cylinder of soft wrought iron would probably compress a few per cent, bulging evenly all around; it would then commence to bend, but at first the bend would be imperceptible to the eye and too small to be measured. Soon this bend would be great enough to be noticed, and finally the piece might be bent nearly double, or otherwise distorted. What is the "compressive strength" of this piece of iron? Is it the weight per square inch which compresses the piece one per cent or five per cent, that which causes the first bending (impossible to be discovered), or that which causes a perceptible bend?

As showing the confusion concerning the definitions of compressive strength, the following statements from different authorities on the strength of wrought iron are of interest.

Wood's Resistance of Materials states, "Comparatively few experiments have been made to determine how much wrought iron will sustain at the point of crushing. Hodgkinson gives 65,000, Rondulet 70,800, Weisbach 72,000, Rankine 30,000 to 40,000. It is generally assumed that wrought

WARNING: This is a 1910 edition. Some of the material may no longer be accurate

The following table gives the average results.

Ratio l/r Length to Least Ra- dius of Gyration.	Ultimate Load, P/a , in Pounds per Square Inch.			
	Fixed Ends.	Fiat Ends.	Hinged Ends.	Round Ends.
20	46,000	46,000	46,000	44,000
40	40,000	40,000	40,000	36,500
60	36,000	36,000	36,000	30,500
80	32,000	32,000	31,500	25,000
100	30,000	29,800	28,000	20,500
120	28,000	26,300	24,300	16,500
140	25,500	23,500	21,000	12,800
160	23,000	20,000	16,500	9,500
180	20,000	16,800	12,800	7,500
200	17,500	14,500	10,800	6,000
220	15,000	12,700	8,800	5,000
240	13,000	11,200	7,500	4,300
260	11,000	9,800	6,500	3,800
280	10,000	8,500	5,700	3,200
300	9,000	7,200	5,000	2,800
320	8,000	6,000	4,500	2,500
360	6,500	4,300	3,500	1,900
400	5,200	3,000	2,500	1,500

The results of Christie's tests agree with those computed by Euler's formula for round-end columns with l/r between 150 and 400, but differ widely from them in shorter columns, and still more widely in columns with fixed ends.

Rankine's Formula (sometimes called Gordon's), $S = \frac{P}{a} \left(1 + \phi \left(\frac{l}{r} \right)^2 \right)$ or $\frac{P}{a} = \frac{S}{1 + \phi (l/r)^2}$. Applying Rankine's formula to the results of experiments, wide variations are found in the values of the empirical coefficient ϕ . Merriman gives the following values, which are extensively employed in practice.

VALUES OF ϕ FOR RANKINE'S FORMULA.

Material.	Both Ends Fixed.	Fixed and Round.	Both Ends Round.
Timber.....	1/3,000	1.78/3,000	4/3,000
Cast Iron.....	1/5,000	1.78/5,000	4/5,000
Wrought Iron.....	1/36,000	1.78/36,000	4/36,000
Steel.....	1/25,000	1.78/25,000	4/25,000

The value to be taken for S is the ultimate compressive strength of the material for cases of rupture, and the allowable compressive unit stress for cases of design.

Burr gives the following values as commonly taken for S and ϕ . For solid wrought-iron columns, $S = 36,000$ to $40,000$. $\phi = 1/36,000$ to $1/40,000$.

For solid cast-iron columns, $S = 80,000$, $\phi = 1/6,400$.

For hollow cast-iron columns, $P/a = 80,000 \div \left(1 + \frac{1}{800} \frac{l^2}{d^2} \right)$ ($d =$ outside diam. in inches).

WARNING: This is a 1910 edition. Some of the material may no longer be accurate

The coefficient of l^2/d^2 is given by different writers as $1/400$, $1/500$, $1/600$ and $1/800$. (See Strength of Cast-iron Columns, below.)

Sir Benjamin Baker gives for mild steel, $S = 67,000$ lbs., $\phi = 1/22,400$; for strong steel, $S = 114,000$ lbs., $\phi = 1/14,400$. Prof. Burr considers these only loose approximations. (See Straight-line Formula, below).

For dry timber, Rankine gives $S = 7200$ lbs., $\phi = 1/3000$.

The Straight-line Formula.—The results of computations by Euler's or Rankine's formulas give a curved line when plotted on a diagram with values of l/r as abscissas and value of P/a as ordinates. The average results of experiments on columns within the limits of l/r commonly used in practice, say from 50 to 200, can be represented by a straight line about as accurately as by a curve. Formulas derived from such plotted lines, of the general form $P/a = S - Cl/r$, in which C is an experimental coefficient, are in common use, but Merriman says it is advisable that the use of this formula should be limited to cases in which the specifications require it to be employed, and for rough approximate computations. Values of S and C given by T. H. Johnson are as follows:

	F	H	R	F	H	R
Wrought Iron:						
	$S = 42,000$ lbs., $C = 128, 157, 203$; limit of $l/r = 218, 178, 138$					
Structural Steel:						
	$S = 52,500$ " $C = 179, 220, 284$; " " " 195, 159, 123					
Cast Iron:						
	$S = 80,000$ " $C = 438, 537, 693$; " " " 122, 99, 77					
Oak, flat ends:						
	$S = 5,400$ " $C = 28$; " " " 128					

F, flat ends; H, hinged ends; R, round ends.

Merriman says: "The straight-line formula is not suitable for investigating a column, that is for determining values of S due to given loads, because S enters the formula in such a manner as to lead to a cubic equation when it is the only unknown quantity. It may be used to find the safe load for a given column to withstand a given unit stress, or to design a column for a given load and unit stress. When so used, it is customary to divide the values of S and C given in the table by an assumed factor of safety. For example, Cooper's specifications require that the sectional area for a medium-steel post of a through railroad bridge shall be found from $P = 17,000 A$ or l/r the first eq. in... in which P is the direct deadload compression on the post plus twice the live-load compression; the values of S and C here used, are a little less than one-third of those given in the table for round ends."

Working Formulae for Wrought-iron and Steel Struts of Various Forms.—Burr gives the following practical formulæ:

Kind of Strut.	$p =$ Ultimate Strength, lbs. per sq. in. of Section.	$p_1 =$ Working Strength = $1/5$ Ultimate, lbs. per sq. in. of Section.
Flat and fixed end iron angles and tees	$44000 - 140 \frac{l}{r}$ (1)	$8800 - 28 \frac{l}{r}$ (2)
Hinged-end iron angles and tees,	$46000 - 175 \frac{l}{r}$ (3)	$9200 - 35 \frac{l}{r}$ (4)
Flat-end iron channels and I-beams,	$40000 - 110 \frac{l}{r}$ (5)	$8000 - 22 \frac{l}{r}$ (6)
Flat-end mild-steel angles	$52000 - 180 \frac{l}{r}$ (7)	$10460 - 36 \frac{l}{r}$ (8)
Flat-end high-steel angles,	$76000 - 290 \frac{l}{r}$ (9)	$15200 - 58 \frac{l}{r}$ (10)
Pin-end solid wrought-iron columns	$32000 - 50 \frac{l}{r}$ (11)	$6400 - 16 \frac{l}{r}$ (12)
	$32000 - 277 \frac{l}{d}$	$6400 - 55 \frac{l}{d}$

Equations (1) to (4) are to be used only between $\frac{l}{r} = 40$ and $\frac{l}{r} = 206$
 " (5) and (8) " " " " " " " " " = 20 " " = 200
 " (7) to (10) " " " " " " " " " = 40 " " = 200
 " (11) and (12) " " " " " " " " " = 20 " " = 200
 or $\frac{l}{d} = 6$ and $\frac{l}{d} = 65$

Built Columns (Burr).—Steel columns, properly made, of steel ranging in specimens from 65,000 to 73,000 lbs. per square inch, should give a resistance 25 to 33 per cent in excess of that of wrought-iron columns with the same value of $l \div r$, provided that ratio does not exceed 140.

The unsupported width of a plate in a compression member should not exceed 30 times its thickness.

In built columns the transverse distance between centre lines of rivets securing plates to angles or channels, etc., should not exceed 35 times the plate thickness. If this width is exceeded, longitudinal buckling of the plate takes place, and the column ceases to fail as a whole, but yields in detail.

The thickness of the leg of an angle to which latticing is riveted should not be less than $\frac{1}{9}$ of the length of that leg or side if the column is purely a compression member. The above limit may be passed somewhat in stiff ties and compression members designed to carry transverse loads.

The panel points of latticing should not be separated by a greater distance than 60 times the thickness of the angle-leg to which the latticing is riveted, if the column is wholly a compression member.

The rivet pitch should never exceed 16 times the thickness of the thinnest metal pierced by the rivet, and if the plates are very thick it should never nearly equal that value.

Burr gives the following general principles which govern the resistance of built columns:

The material should be disposed as far as possible from the neutral axis of the cross-section, thereby increasing r ;

There should be no initial internal stress;

The individual portions of the column should be mutually supporting;

The individual portions of the column should be so firmly secured to each other that no relative motion can take place, in order that the column may fail as a whole, thus maintaining the original value of r .

Stoney says: "When the length of a rectangular wrought-iron tubular column does not exceed 30 times its least breadth, it fails by the bulging or buckling of a short portion of the plates, not by the flexure of the pillar as a whole."

WORKING STRAITS ALLOWED IN BRIDGE MEMBERS.

Theodore Cooper gives the following in his Bridge Specifications: Compression members shall be so proportioned that the maximum load shall in no case cause a greater strain than that determined by the following formula:

$$P = \frac{8000}{1 + \frac{l^2}{40,000 r^2}}$$

for square-end compression members;

$$P = \frac{8000}{1 + \frac{l^2}{30,000 r^2}}$$

for compression members with one pin and one square end;

$$P = \frac{8000}{1 + \frac{l^2}{20,000 r^2}}$$

for compression members with pin-bearings;

WARNING: This is a 1910 edition. Some of the material may no longer be accurate

(These values may be increased in bridges over 150 ft. span. See Cooper's Specifications.)

P = the-allowed compression per square inch of cross-section;

l = the length of compression member, in inches;

r = the least radius of gyration of the section in inches.

No compression member, however, shall have a length exceeding 25 times its least width.

Tension Members.— All parts of the structure shall be so proportioned that the maximum loads shall in no case cause a greater tension than the following (except in spans exceeding 150 feet):

	Pounds per sq. in.
On lateral bracing..	15,000
On solid rolled beams, used as cross floor-beams and stringers	9,000
On bottom chords and main diagonals (forged eye-bars).	10,000
On bottom chords and main diagonals (plates or shapes), net section	8,000
On counter rods and long verticals (forged eye-bars)	8,000
On counter and long verticals (plates or shapes), net section	8,500
On bottom flange of riveted cross-girders, net section	8,000
On bottom flange of riveted longitudinal plate girders over 20 ft. long, net section	8,000
On bottom flange of riveted longitudinal plate girders under 20 ft. long, net section	7,000
On floor-beam hangers, and other similar members liable to sudden loading (bar iron with forged ends)	6,000
On floor-beam hangers and other similar members liable to sudden loading (plates or shapes), net section	5,000

Members subject to alternate strains of tension and compression shall be proportioned to resist each kind of strain. Both of the strains shall, however, be considered as increased by an amount equal to $\frac{8}{10}$ of the least of the two strains, for determining the sectional area by the above allowed strains.

The Phoenix Bridge Co. (Standard Specifications, 1895) gives the following: The greatest working stresses in pounds per square inch shall be as follows:

Tension.	
Steel.	Iron.
$P = 9,000 \left[1 + \frac{\text{Min. stress}}{\text{Max. stress}} \right]$ For bars, forged ends.	$P = 7,500 \left[1 + \frac{\text{Min. stress}}{\text{Max. stress}} \right]$
$P = 8,500 \left[1 + \frac{\text{Min. stress}}{\text{Max. stress}} \right]$ Plates or shapes net.	$P = 7,000 \left[1 + \frac{\text{Min. stress}}{\text{Max. stress}} \right]$
8,500 pounds.	Floor-beam hangers, forged ends. 7,000 pounds.
7,500 " "	Floor-beam hangers, plates or shapes, net section 6,000 " "
10,000 " "	Lower flanges of rolled beams. 8,000 " "
20,000 " "	Outside fibres of pins. 15,000 " "
30,000 " "	Pins for wind-bracing. 22,500 " "
20,000 " "	Lateral bracing. 15,000 " "

Shearing.

9,000 pounds.	Pins and rivets. 7,500 pounds.
	Hand-driven rivets 20% less unit stresses.
6,000 pounds.	For bracing increase unit stresses 50%. Webs of plate girders. 5,000 pounds.

Bearing.

16,000 pounds.	Projection semi-intrados pins and rivets. 12,000 pounds.
	Hand-driven rivets 20% less unit stresses. For bracing increase unit stresses 50%.

Compression.

Lengths less than forty times the least radius of gyration, P previously found. See Tension.

Lengths more than forty times the least radius of gyration, P reduced by following formulae:

$$\text{For both ends fixed, } b = \frac{P}{1 + \frac{P}{36,000 r^2}}$$

$$\text{For one end hinged, } b = \frac{P}{1 + \frac{P}{24,000 r^2}}$$

$$\text{For both ends hinged, } b = \frac{P}{1 + \frac{P}{18,000 r^2}}$$

P = permissible stress previously found (see Tension); b = allowable working stress per square inch; l = length of member in inches; r = least radius of gyration of section in inches. No compression member, however, shall have a length exceeding 45 times its least width.

	Pounds per sq. in.
In counter web members.	10,500
In long verticals.	10,000
In all main-web and lower-chord eye-bars.	13,200
In plate hangers (net section).	9,000
In tension members of lateral and transverse bracing.	19,000
In steel-angle lateral ties (net section).	15,000
For spans over 200 feet in length the greatest allowed working stresses per square inch, in lower-chord and end main-web eye-bars, shall be taken at	

$$10,000 \left(1 + \frac{\text{min. total stress}}{\text{max. total stress}} \right)$$

whenever this quantity exceeds 13,200.

The greatest allowable stress in the main-web eye-bars nearest the centre of such spans shall be taken at 13,200 pounds per square inch; and those for the intermediate eye-bars shall be found by direct interpolation between the preceding values.

The greatest allowable working stresses in steel plate and lattice girders and rolled beams shall be taken as follows:

	Pounds per sq. in.
Upper Range of plate girders (gross section).	10,000
Lower flange of plate girders (net section).	10,000
In counters and long verticals of lattice girders (net section).	9,000
In lower chords and main diagonals of lattice girders (net section).	10,000
In bottom flanges of rolled beams.	10,000
In top Ranges of rolled beams.	10,030

THE STRENGTH OF CAST-IRON COLUMNS.

Hodgkinson's experiments (first published in Phil. Trans. Royal Socy., 1840, and condensed in Tredgold on Cast Iron, 4th ed., 1846), and Gordon's formula, based upon them, are still used (1898) in designing cast-iron columns. They are entirely inadequate as a basis of a practical formula suitable to the present methods of casting columns.

Hodgkinson's experiments were made on nine "long" pillars, about 7 1/2 ft. long, whose external diameters ranged from 1.74 to 2.23 in., and average thickness from 0.29 to 0.35 in., the thickness of each column also varying, and on 13 "short" pillars, 0.733 ft. to 2.251 ft. long, with exter-

nal diameters from 1.08 to 1.26 in., all of them less than 1/4 in. thick. The iron used was Low-Moor, Yorkshire, No. 3, said to be a good iron, not very hard, earlier experiments on which had given a tensile strength of 14,535 and a crushing strength of 109,801 lbs. per sq. in. Modern cast-iron columns, such as are used in the construction of buildings, are very different in size, proportions, and quality of iron from the slender "long" pillars used in Hodgkinson's experiments. There is usually no check, by actual tests or by disinterested inspection, upon the quality of the material. The tensile, compressive, and transverse strength of cast iron varies through a great range (the tensile strength ranging from less than 10,000 to over 40,000 lbs. per sq. in.), with variations in the chemical composition of the iron, according to laws which are as yet very imperfectly understood, and with variations in the method of melting and of casting. There is also a wide variation in the strength of iron of the same melt when cast into bars of different thicknesses.

Another difficulty in obtaining a practical formula for the strength of cast-iron columns is due to the uncertainty of the quality of the casting, and the danger of hidden defects, such as internal stresses due to unequal cooling, cinder or dirt, blow-holes, "cold-shuts," and cracks on the inner surface, which cannot be discovered by external inspection. Variation in thickness, due to rising of the core during casting, is also a common defect.

In addition to these objections to the use of Gordon's formula, for cast-iron columns, we have the data of experiments on full-sized columns, made by the Building Department of New York City (*Eng'g News*, Jan. 13 and 20, 1898). Ten columns in all were tested, six 15-inch, 190 1/4 inches long, two 8-inch, 160 inches long, and two 6-inch, 120 inches long. The tests were made on the large hydraulic machine of the Phoenix Bldg Co., of 2,000,000 pounds capacity, which was calibrated for frictional error by the repeated testing within the elastic limit of a large Phoenix column, and the comparison of these tests with others made on the government machine at the Watertown Arsenal. The average frictional error was calculated to be 15.4 per cent, but *Engineering News*, revising the data, makes it 17.1 per cent, with a variation of 3 per cent either way from the average with different loads. The results of the tests of the columns are given below.

TESTS OF CAST-IRON COLUMNS.

Num-ber.	Diam Inches.	Thickness.			Breaking Load.	
		Max.	Min.	Average.	Pounds.	Pounds er Sq. In.
1	15	1	1	1	1,356,000	30,830
2	15	1 5/16	1	1 1/8	1,330,000	27,700
3	15	1 1/4	1	1 1/8	1,198,000	24,900
4	15 1/8	1 7/32	1	1 1/8	1,246,000	25,200
5	15	1 11/16	1	1 11/64	1,632,000	32,100
6	15	1 1/4	1 1/8	1 3/16	2,082,000 +	40,400 +
7	7 3/4 to 8 1/8	1 1/4	5/8	1	651,000	31,900
8	8	3/32	1	1 3/64	612,800	26,800
9	6 1/16	5/32	1 1/8	1 9/64	400,000	22,700
10	6 3/32	1 1/8	1 1/16	1 7/64	455,200	26,300

Column No. 6 was not broken at the highest load of the testing machine.

Columns Nos. 3 and 4 were taken from the Ireland Building, which collapsed on August 8, 1895; the other four 15-inch columns were made from drawings prepared by the Building Department, as nearly as possible duplicates of Nos. 3 and 4. Nos. 1 and 2 were made by a foundry in New York with no knowledge of their ultimate use. Nos. 5 and 6 were made

WARNING: This is a 1910 edition. Some of the material may no longer be accurate

by a foundry in Brooklyn with the knowledge that they were to be tested. Nos. 7 to 10 were made from drawings furnished by the Department.

Applying Gordon's formula, as used by the Building Department, $S = \frac{50000 a}{1 + \frac{l^2}{400 d^2}}$, to these columns gives for the breaking strength per square

inch of the 15-inch columns 57,143 pounds, for the 8-inch columns 46,096 pounds, and for the 6-inch columns 40,000. The strength of columns Nos. 3 and 4 as calculated is 128 per cent more than their actual strength; their actual strength is less than 44 per cent of their calculated strength; and the factor of safety, supposed to be 5 in the Building Law, is only 2.2 for central loading, no account being taken of the likelihood of eccentric loading.

Prof. Lanza, *Applied Mechanics*, p. 372, quotes the records of 14 tests of cast-iron mill columns, made on the Watertown testing-machine in 1887-88, the breaking strength per square inch ranging from 23,100 to 63,310 pounds, and showing no relation between the breaking strength per square inch and the dimensions of the columns. Only 3 of the 14 columns had a strength exceeding 33,506 pounds per square inch. The average strength of the other 11 was 29,600 pounds per square inch. Prof. Lanza says that it is evident that in the case of such columns we cannot rely upon a crushing strength of greater than, 25,000 or 30,000 pounds per square inch of area of section.

He recommends a factor of safety of 5 or 6 with these figures for crushing strength, or 5000 pounds per square inch of area of section as the highest allowable safe load, and in addition makes the conditions that the length of the column shall not be greatly in excess of 20 times the diameter, that the thickness of the metal shall be such as to insure a good strong casting, and that the sectional area should be increased if necessary to insure that the extreme fibre stress due to probable eccentric loading shall not be greater than 5000 pounds per square inch.

Prof. W. H. Burr (*Eng'g News*, June 30, 1898) gives a formula derived from plotting the results of the Watertown and Phoenixville tests, above described, which represents the average strength of the columns in pounds per square inch. It is $p = 30,500 - 160 l/d$. It is to be noted that this is an average value, and that the actual strength of many of the columns was much lower. Prof. Burr says: "If cast-iron columns are designed with anything like a reasonable and real margin of safety, the amount of metal required dissipates any supposed economy over columns of mild steel."

Square Columns.— Square cast-iron columns should be abandoned. They are liable to have serious internal strains from difference in contraction on two adjacent sides. John F. Ward, *Eng. News*, Apr. 16, 1896.

Safe Load, in Tons of 2000 Lbs., for Round Cast-iron Columns, with Turned Capitals and Bases.

Loads being not eccentric, and length of column not exceeding 20 times the diameter. Based on ultimate crushing strength of 25,000 lbs. per sq. in. and a factor of safety of 5.

Thick- ness, Inches.	Diameter, Inches.											
	6	7	8	9	10	11	12	13	14	15	16	18
5/8	26.4	31.3										
3/4	30.9	36.8										
7/8	35.2	42.1	48.9	55.8	62.7	69.6	76.5					
1	39.2	47.1	55.0	62.8	70.7	78.5	86.4	94.2	102.1	110.0		
1 1/8			60.8	69.6	78.4	87.2	96.0	104.9	113.8	122.6	131.4	
1 1/4				76.1	85.9	95.7	105.5	115.3	125.2	135.0	144.8	164.4
1 3/8					93.1	103.9	114.7	125.5	136.3	147.1	157.9	179.5
1 1/2							123.7	135.5	147.3	159.0	170.8	194.4
1 3/4								168.4	182.1	195.8	223.3	
2									204.2	219.9	251.3	

For lengths greater than 20 diameters the allowable loads should be decreased. How much they should be decreased is uncertain, since sufficient data of experiments on full-sized very long columns, from which a formula for the strength of such columns might be derived, are as yet lacking. There is, however, rarely, if ever, any need of proportioning cast-iron columns with a length exceeding 20 diameters.

Safe Loads in Tons of 2000 Pounds for Cast-iron Columns.

(By the Building Laws of New York City, Boston, and Chicago, 1897.)

	New York.	Boston.	Chicago.
Square columns.	$\frac{8a}{1 + \frac{l^2}{500d^2}}$	$\frac{5a}{1 + \frac{l^2}{1067d^2}}$	$\frac{5a}{1 + \frac{l^2}{800d^2}}$
Round columns . . .	$\frac{8a}{1 + \frac{l^2}{400d^2}}$	$\frac{5a}{1 + \frac{l^2}{800d^2}}$	$\frac{5a}{1 + \frac{l^2}{800d^2}}$

a = sectional area in square inches; l = unsupported length of column in inches; d = side of square column or thickness of round column in inches.

The safe load of a 15-inch round column 1 1/2 inches diameter, 16 feet long, according to the laws of these cities would be, in New York, 36 1/2 tons; in Boston, 26 1/2 tons; in Chicago, 25 tons.

The allowable stress per square inch of area of such a column would be, in New York, 11,350 pounds; in Boston, 8300 pounds; in Chicago, 7850 pounds. A safe stress of 5000 pounds per square inch would give for the safe load on the column 159 tons.

Strength of Brackets on Cast-iron Columns.—The columns tested by the New York Building Department referred to above had brackets cast upon them, each bracket consisting of a rectangular shelf supported by one or two triangular ribs. These were tested after the columns had been broken in the principal tests. In 17 out of 22 cases the brackets broke by tearing a hole in the body of the column, instead of by shearing or transverse breaking of the bracket itself. The results were surprisingly low and very irregular. Reducing them to strength per square inch of the total vertical section through the shelf and rib or ribs, they ranged from 2450 to 5600 lbs., averaging 4200 lbs., for a load concentrated at the end of the shelf, and 4100 to 10,900 lbs., averaging 8000 lbs., for a distributed load. (*Eng'g News*, Jan. 20, 1898.)

Maximum Permissible Stresses in columns used in buildings. (Building Ordinances of City of Chicago, 1893.)

For riveted or other forms of wrought-iron columns:

$$S = \frac{12006 a}{1 + \frac{l^2}{36000 r^2}}$$

l = length of column in inches;
r = least radius of gyration in inches;
a = area of column in square inches.

For riveted or other steel columns, if more than 60 r in length:

$$S = 17,600 - \frac{60 l}{r}$$

If less than 60 r in length: S = 13,500 a.

For wooden posts:

$$S = \frac{ac}{1 + \frac{l^2}{250 d^2}}$$

a = area of post in square inches;
d = least side of rectangular post in inches;
l = length of post in inches;
c = { 600 for white or Norway pine;
800 for oak;
900 for long-leaf yellow pine.

WARNING: This is a 1910 edition. Some of the material may no longer be accurate

ECCENTRIC LOADING OF COLUMNS.

In a given rectangular cross-section, such as a masonry joint under pressure, the stress will be distributed uniformly over the section only when the resultant passes through the centre of the section: any deviation from such a central position will bring a maximum unit pressure to one edge and a minimum to the other; when the distance of the resultant from one edge is one third of the entire width of the joint, the pressure at the nearer edge is twice the mean pressure, while that at the farther edge is zero, and that when the resultant approaches still nearer to the edge the pressure at the farther edge becomes less than zero: in fact, becomes a tension, if the material (mortar, etc.) there is capable of resisting tension. Or, if, as usual in masonry joints, the material is practically incapable of resisting tension, the pressure at the nearer edge, when the resultant approaches it nearer than one third of the width, increases very rapidly and dangerously, becoming theoretically infinite when the resultant reaches the edge.

With a given position of the resultant relatively to one edge of the joint or section, a similar redistribution of the pressures throughout the section may be brought about by simply adding to or diminishing the width of the section.

Let P = the total pressure on any section of a bar of uniform thickness.
 w = the width of that section = area of the section, when thickness = 1.
 $p = P/w$ = the mean unit pressure on the section.
 M = the maximum unit pressure on the section.
 m = the minimum unit pressure on the section.
 d = the eccentricity of the resultant = its distance from the centre of the section.

$$\text{Then } M = p \left(1 + \frac{6d}{w} \right) \text{ and } m = p \left(1 - \frac{6d}{w} \right)$$

$$\text{When } d = \frac{1}{6} w \text{ then } M = 2p \text{ and } m = 0.$$

When d is greater than $1/6 w$, the resultant in that case being less than one third of the width from one edge, p becomes negative. (J. C. Trautwine, Jr., *Engineering News*, Nov. 23, 1893.)

Eccentric Loading of Cast-iron Columns. — Prof. Lanza writes the author as follows: The table on page 276 applies when the resultant of the loads upon the column acts along its central axis, i. e., passes through the centre of gravity of every section. In buildings and other constructions, however, cases frequently occur when the resultant load does not pass through the centre of gravity of the section: and then the pressure is not evenly distributed over the section, but is greatest on the side where the resultant acts. (Examples occur when the loads on the floors are not uniformly distributed.) In these cases the outside fibre stresses of the column should be computed as follows, viz.:

Let P = total pressure on the section:

d = eccentricity of resultant = its distance from the centre of gravity of the section.

A = area of the section, and I its moment of inertia about an axis in its plane, passing through its centre of gravity, and perpendicular to d ;

c_1 = distance of most compressed and c_2 = that of least compressed fibre from above stated axis;

s_1 = maximum and s_2 = minimum pressure per unit of area. Then

$$s_1 = \frac{P}{A} + \frac{(Pd)c_1}{I} \quad \text{and} \quad s_2 = \frac{P}{A} - \frac{(Pd)c_2}{I}$$

Having assumed a certain trial section for the column to be designed s_1 should be computed, and, if it exceed the proper safe value, a different section should be used for which s_1 does not exceed this value.

The proper safe value, in the case of cast-iron columns whose ratio of length to diameter does not greatly exceed 20, is 5000 pounds per square inch when the eccentricity used in the computation of s_1 is liable to occur frequently in the ordinary uses of the structure; but when it is one which can only occur in rare cases the value 8000 lbs. per sq. in. may be used.

Along cap on a column is more conducive to the production of eccentricity of loading than a short one, hence a long cap is a source of weakness.

MOMENT OF INERTIA AND RADIUS OF GYRATION.

The moment of inertia of a section is the sum of the products of each elementary area of the section into the square of its distance from an assumed axis of rotation, as the neutral axis.

Assume the section to be divided into a great many equal small areas, a , and that each such area has its own radius, r , or distance from the assumed axis of rotation, then the sum of all the products derived by multiplying each a by the square of its r is the moment of inertia, I , or $I = \sum ar^2$, in which \sum is the sign of summation.

For moment of inertia of the weight or mass of a body see Mechanics. The radius of gyration of the section equals the square root of the quotient of the moment of inertia divided by the area of the section. If R = radius of gyration, I = moment of inertia and A = area

$$R = \sqrt{I/A}, \quad I/A = R^2.$$

The center of gyration is the point where the entire area might be concentrated and have the same moment of inertia as the actual area. The distance of this center from the axis of rotation is the radius of gyration.

The moments of inertia of various sections are as follows:

d = diameter, or outside diameter; d_1 = inside diameter; b = breadth; h = depth; b_1, h_1 , inside breadth and depth;

Solid rectangle $I = 1/12 bh^3$; Hollow rectangle $I = 1/12 (bh^3 - b_1h_1^3)$;
 Solid square $I = 1/12 b^4$; Hollow square $I = 1/12 (b^4 - b_1^4)$;
 Solid cylinder $I = 1/64 \pi d^4$; Hollow cylinder $I = 1/64 \pi (d^4 - d_1^4)$.

Moment of Inertia about any Axis. — If b = breadth and h = depth of a rectangular section its moment of inertia about its central axis (parallel to the breadth) is $1/12 bh^3$; and about one side is $1/3 bh^3$. If a parallel axis exterior to the section is taken, and d = distance of this axis from the farthest side and d_1 = its distance from the nearest side, ($d - d_1 = h$), the moment of inertia about this axis is $1/3 b (d^3 - d_1^3)$.

The moment of inertia of a compound shape about any axis is equal to the sum of the moments of inertia, with reference to the same axis, of all the rectangular portions composing it.

Moment of Inertia of Compound Shapes. (Pencoyd Iron Works.) — The moment of inertia of any section about any axis is equal to the I about a parallel axis passing through its centre of gravity + (the area of the section \times the square of the distance between the axes).

By this rule the moments of inertia or radii of gyration of any single sections being known, corresponding values may be obtained for any combination of these sections.

E. 4. Dixon (*Am. Mach.*, Dec. 15, 1898) gives the following formula for the moment of inertia of any rectangular element of a built up beam: $I = 1/3 (h^3 - h_1^3) b$, I = moment of inertia about any axis parallel to the neutral axis; h = distance from the assumed axis to the farthest fiber; h_1 = distance to nearest fiber; b = breadth of element. The sum of the moments of inertia of all the elements, taken about the center of gravity or neutral axis of the section, is the moment of inertia of the section.

The polar moment of inertia of a surface is the sum of the products obtained by multiplying each elementary area by the square of its distance from the center of gravity of the surface: it is equal to the sum of the moments of inertia taken with respect to two axes at right angles to each other passing through the center of gravity. It is represented by J . For a solid shaft $J = 1/32 \pi d^4$; for a hollow shaft, $J = 1/32 \pi (d^4 - d_1^4)$, in which d is the outside and d_1 the inside diameter.

The polar radius of gyration, $R_p = \sqrt{J/A}$, is defined as the radius of a circumference along which the entire area might be concentrated and have the same polar moment of inertia as the actual area.

For a solid circular section $R_p^2 = 1/8 D^2$; for a hollow circular section $R_p^2 = 1/8 (d^2 + d_1^2)$.

Moments of Inertia and Radius of Gyration for Various Sections, and their Use in the Formulas for Strength of Girders and Columns. — The strength of sections to resist strains, either as girders or as columns depends not only on the area but also on the form of the section, and the property of the section which forms the

WARNING: This is a 1910 edition. Some of the material may no longer be accurate

basis of the constants used in the formulas for strength of girders and columns to express the effect of the form, is its moment of inertia about its neutral axis. The modulus of resistance of any section to transverse bending is its moment of inertia divided by the distance from the neutral axis to the fibres farthest removed from that axis; or

$$\text{Section modulus} = \frac{\text{Moment of inertia}}{\text{Distance of extreme fibre from axis}} \quad Z = \frac{I}{c}$$

Moment of resistance = section modulus × unit stress on extreme fibre.

Radius of Gyration of Compound Shapes. -- In the case of a pair of any shape without a web the value of *R* can always be found without considering the moment of inertia.

The radius of gyration for any section around an axis parallel to another axis passing through its centre of gravity is found as follows:

Let *r* = radius of gyration around axis through centre of gravity; *R* = radius of gyration around another axis parallel to above; *d* = distance between axes: $R = \sqrt{d^2 + r^2}$.

When *r* is small; *R* may be taken as equal to *d* without material error.

Graphical Method for Finding Radius of Gyration. -- Benj. F. La Rue. *Eng. News*, Feb. 2, 1893, gives a short graphical method for finding the radius of gyration of hollow, cylindrical, and rectangular columns, as follows:

For cylindrical columns:

Lay off to a scale of 4 (or 40) a right-angled triangle, in which the base equals the outer diameter, and the altitude equals the inner diameter of the column, or *vice versa*. The hypotenuse, measured to a scale of unity (or 10), will be the radius of gyration sought.

This depends upon the formula

$$G = \sqrt{\text{Mom. of inertia} \div \text{Area}} = \frac{1}{4} \sqrt{D^2 + d^2}$$

in which *A* = area and *D* = diameter of outer circle. *a* = area and *d* = diameter of inner circle, and *G* = radius of gyration. $\sqrt{D^2 + d^2}$ is the expression for the hypotenuse of a right-angled triangle, in which *D* and *d* are the base and altitude.

The sectional area of a hollow round column is $0.7854(D^2 - d^2)$. By constructing a right-angled triangle in which *D* equals the hypotenuse and *d* equals the altitude, the base will equal $\sqrt{D^2 - d^2}$. Calling the value of this expression for the base *B*, the area will equal $0.7854B^2$.

Value of *G* for square columns:

Lay off as before, but using a scale of 10, a right-angled triangle of which the base equals *D* or the side of the outer square, and the altitude equals *d*, the side of the inner square. With a scale of 3 measure the hypotenuse, which will be, approximately, the radius of gyration.

This process for square columns gives an excess of slightly more than 4%. By deducting 4% from the result, a close approximation will be obtained.

A very close result is also obtained by measuring the hypotenuse with the same scale by which the base and altitude were laid off, and multiplying by the decimal 0.29; more exactly, the decimal is 0.28867.

The formula is

$$G = \sqrt{\frac{\text{Mom. of inertia}}{\text{Area}}} = \frac{1}{\sqrt{12}} \sqrt{D^2 + d^2} = 0.28867 \sqrt{D^2 + d^2}$$

This may also be applied to any rectangular column by using the lesser diameters of an unsupported column, and the greater diameters if the column is supported in the direction of its least dimensions.

ELEMENTS OF USUAL SECTIONS.

Moments refer to horizontal axis through centre of gravity. This table is intended for convenient application where extreme accuracy is not important. Some of the terms are only approximate; those marked * are correct. Values for radius of gyration in flanged beams apply to standard minimum sections only. *A* = area of section; *b* = breadth; *h* = depth; *D* = diameter.

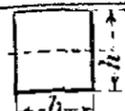
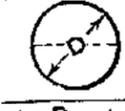
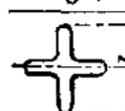
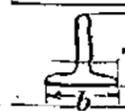
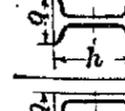
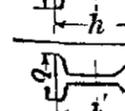
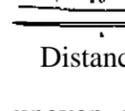
Shape of Section.	Moment of Inertia.	Section Modulus.	Square of Least Radius of Gyration.	Least Radius of Gyration.
 Solid Rect-angle.	$\frac{bh^3}{12}$ *	$\frac{bh^2}{6}$ *	Least side) ² * 1 2	Least side.* 3.46
 Hollow Rect-angle.	$\frac{bh^3 - b_1h_1^3}{12}$ *	$\frac{h^3 - b_1h_1^3}{6h}$ *	$\frac{h^2 + h_1^2}{12}$ *	$\frac{h + h_1}{4}$ *
 Solid Circle.	$\frac{1}{64} \pi D^4$ = 0.0491 <i>D</i> ⁴	$\frac{1}{32} \pi D^3$ = 0.0982 <i>D</i> ³	$\frac{D^2}{16}$ *	$\frac{D}{4}$ *
 Hollow Circle. <i>A</i> , area of large section <i>a</i> , area of small section	$\frac{AD^2 - ad^2}{16}$	$\frac{AD^2 - ad^2}{8D}$	$\frac{D^2 + d^2}{16}$ *	$\frac{D + d}{4}$ *
 Solid Triangle	$\frac{bh^3}{36}$	$\frac{bh^2}{24}$	The least of the two; $\frac{h^2}{18}$ or $\frac{b^2}{24}$	The least of the two; $\frac{h}{4.24}$ or $\frac{b}{4.9}$
 Even Angle.	$\frac{Ah^2}{10.2}$	$\frac{Ah}{7.2}$	$\frac{b^2}{25}$	$\frac{b}{5}$
 Uneven Angle.	$\frac{Ah^2}{9.5}$	$\frac{Ah}{6.5}$	$\frac{(hb)^2}{13(h^2 + b^2)}$	$\frac{kb}{2.6(h + b)}$
 Even Cross.	$\frac{Ah^2}{19}$	$\frac{Ah}{9.5}$	$\frac{h^2}{22.5}$	$\frac{h}{4.74}$
 Even Tee.	$\frac{Ah'}{11.1}$	$\frac{Ah}{8}$	22.5	$\frac{b}{4.74}$
 I Beam.	$\frac{Ah'}{6.66}$	$\frac{Ah}{3.2}$	$\frac{b^2}{21}$	$\frac{b}{4.58}$
 Channel.	$\frac{Ah^2}{7.34}$	$\frac{Ah}{3.67}$	$\frac{b^2}{12.5}$	$\frac{b}{3.54}$
 Deck Beam.	$\frac{Ah^2}{6.9}$	$\frac{Ah}{4}$	$\frac{b^2}{36.5}$	$\frac{b}{a}$

Distance of base from centre of gravity, solid triangle, $\frac{h}{3}$; even angle, $\frac{h}{3.3}$; uneven angle, $\frac{h}{3.5}$; even tee, $\frac{h}{3.3}$; deck beam, $\frac{h}{2.3}$; all other shapes given in the table, $\frac{h}{2}$ or $\frac{D}{2}$.

WARNING: This- is a 1910 edition. Some of the material may no longer be accurate

TRANSVERSE STRENGTH.

In transverse tests the strength of bars of rectangular section is found to vary directly as the breadth of the specimen tested, as the square of its depth, and **inversely** as its length. The deflection under any load varies as the cube of the length, and inversely as the breadth and as the cube of the depth. Represented algebraically, if S = the strength and D the deflection, l the length, b the breadth, and d the depth.

$$S \text{ varies as } \frac{bd^2}{l} \text{ and } D \text{ varies as } \frac{l^3}{bd^3}$$

For the purpose of reducing the strength of pieces of Various sizes to a common standard, the **term modulus of rupture** (represented by R) is used. Its value is obtained by experiment on a bar of rectangular section supported at the ends and **loaded** in the middle and substituting numerical values in the following formula:

$$R = \frac{3Pl}{2bd^2}$$

in which P = the breaking load in pounds, l = the length in inches, b the breadth, and d the depth.

The *modulus of rupture* is sometimes defined as the strain at the instant of rupture upon a unit of the section which is most remote from the neutral axis on the side which first ruptures. This definition, however, is based upon a theory which is yet in dispute among authorities, and it is better to define it as a numerical value, or experimental constant, found by the application of the formula above given.

From the **above** formula, making l 12 inches, and b and d each 1 inch, it follows that the modulus of rupture is 18 times the **load** required to break a bar one inch square, supported at two points one foot apart, the load being applied in the middle.

$$\begin{aligned} \text{Coefficient of transverse strength} &= \frac{\text{span in feet X load at middle in lbs.}}{\text{breadth in inches} \times (\text{depth in inches})^2} \\ &= \frac{1}{18} \text{th of the modulus of rupture.} \end{aligned}$$

Fundamental Formula? for **Flexure** of Beams (Merriman).

Resisting shear = vertical shear;

Resisting moment = bending moment;

Sum of tensile stresses = sum of compressive stresses;

Resisting shear = algebraic sum of all the vertical components of the internal stresses at any section of the beam.

If A be the area of the section and S_s the shearing unit stress, then resisting shear = AS_s ; and if the vertical shear = V , then $V = AS_s$.

The *vertical shear* is the algebraic sum of all the external vertical forces on one **side** of the section considered. It is equal to the reaction of one support, considered as a force acting upward, minus the sum of all the vertical downward forces acting between the support and the section.

The *resisting moment* = algebraic sum of all the moments of the internal horizontal stresses at any section with reference to a point in that section. = $\frac{SI}{c}$, in which S = the horizontal uni: stress, tensile or compressive as the case may be upon the fibre most remote from the neutral axis. c = the shortest distance from that fibre to said axis, and I = the moment of inertia of the cross-section with reference to that axis.

The *bending moment* M is the algebraic sum of the moment of the external forces on one side of the section with reference to a point in that section = moment of the reaction of one support minus sum of moments of loads between the support and the section considered.

$$M = \frac{SI}{c}$$

The bending moment is a compound quantity = product of a force by the distance of its point of application from the section considered, the distance being measured on a line drawn from the section perpendicular to the direction of the action of the force.

GENERAL FORMULÆ FOR TRANSVERSE STRENGTH OF BEAMS OF UNIFORM CROSS-SECTION.

Beam.	Rectangular Beam.		Beam of any Section.		
	Breaking Load.	Deflection for Load P or W .	Maximum Moment of Stress.	Moment of Rupture.	Deflection.
(For notation see page 285.)					
Fixed at one end, load at the other	$P = \frac{1}{6} \frac{Rbd^2}{l}$	$\frac{4Pl^3}{Ebd^3}$	P	$\frac{Rl}{c}$	$\frac{1}{3} \frac{Pl^3}{EI}$
Same with load distributed uniformly	$W = \frac{1}{3} \frac{Rbd^2}{l}$	$\frac{3}{2} \frac{Wl^3}{Ebd^3}$	$\frac{1}{2} W$	$\frac{Rl}{c}$	$\frac{1}{8} \frac{Wl^3}{EI}$
Supported at ends, loaded in middle	$P = \frac{2}{3} \frac{Rbd^2}{l}$	$\frac{Pl^3}{4Ebd^3}$	$\frac{1}{4} P$	$\frac{Rl}{c}$	$\frac{1}{48} \frac{Pl^3}{EI}$
Same, loaded uniformly	$W = \frac{4}{3} \frac{Rbd^2}{l}$	$\frac{5}{32} \frac{Wl^3}{Ebd^3}$	$\frac{1}{8} W$	$\frac{Rl}{c}$	$\frac{5}{384} \frac{Wl^3}{EI}$
Same, loaded at middle, and also with uniform load.	$2P + W = \frac{4}{3} \frac{Rbd^2}{l}$	$\frac{1}{4} \left(P + \frac{1}{8} W \right) \frac{l^3}{Ebd^3}$	$\left(\frac{1}{4} P + \frac{1}{8} W \right) l$	$\frac{Rl}{c}$	$\frac{1}{48} \left(P + \frac{5}{8} W \right) \frac{l^3}{EI}$
Fixed at both ends, loaded in middle	$P = \frac{4}{3} \frac{Rbd^2}{l}$	$\frac{1}{16} \frac{Pl^3}{Ebd^3}$	$\frac{1}{8} P$	$\frac{Rl}{c}$	$\frac{Pl^3}{192 EI}$
Same, Barlow's Experiments	$P = \frac{Rbd^2}{l}$		$\frac{1}{6} P$	$\frac{Rl}{c}$	
Same, uniformly loaded	$W = \frac{2Rbd^2}{l}$	$\frac{1}{32} \frac{Wl^3}{Ebd^3}$	$\frac{1}{12} W$	$\frac{Rl}{c}$	$\frac{Wl^3}{384 EI}$
Fixed at one end, supported at the other, loaded at 0.634l from fixed end.		$\frac{0.1148Pl^3}{Ebd^3}$	$\frac{3}{8} \left(2\sqrt{3} - 3 \right) Pl$	$\frac{Rl}{c}$	$\frac{Pl^3}{105 EI}$ (nearly)
Same, uniformly loaded	$W = \frac{4}{3} \frac{Rbd^2}{l}$	$\frac{0.0648Wl^3}{Ebd^3}$	$\frac{1}{8} W$	$\frac{Rl}{c}$	$\frac{Wl^3}{187 EI}$ (nearly)

Concerning the formula, $M = SI/c$, p. 282, Prof. Merriman, Eng. News, July 21, 1894, says: The formula quoted is true when the unit-stress S on the part of the beam farthest from the neutral axis is within the elastic limit of the material. It is not true when this limit is exceeded, because then the neutral axis does not pass through the center of gravity of the cross-section, and because also the different longitudinal stresses are not proportional to their distances from that axis, these two requirements being involved in the deduction of the formula. But in all cases of design the permissible unit-stresses should not exceed the elastic limit, and hence the formula applies rationally, without regarding the ultimate strength of the material or any of the circumstances regarding rupture. Indeed, so great reliance is placed upon this formula that the practice of testing beams by rupture has been almost entirely abandoned, and the allowable unit-stresses are mainly derived from tensile and compressive tests.

APPROXIMATE GREATEST SAFE LOADS IN LBS. ON STEEL BEAMS. (Pencoyd Iron Works.)

Based on fiber strains of 16,000 lbs. for steel. (For iron the loads should be one-eighth less, corresponding to a fibre strain of 14,000 lbs. per square inch.) Beams supported at the ends and uniformly loaded.

L = length in feet between supports; a = interior area in square inches;
 A = sectional area of beam in square inches; d = interior depth in inches.
 D = depth of beam in inches. w = working load in net tons.

Shape of Section.	Greatest Safe Load in Pounds.		Deflection in Inches.	
	Load in Middle.	Load Distributed.	Load in Middle.	Load Distributed.
Solid Rect-angle.	$\frac{890AD}{L}$	$\frac{1780AD}{L}$	$\frac{wL^3}{32.4D^2}$	$\frac{wL^3}{52AD^2}$
Hollow Rectangle.	$\frac{890(AD-ad)}{L}$	$\frac{1780(AD-ad)}{L}$	$\frac{wL^3}{32(AD^2-ad^2)}$	$\frac{wL^3}{52(AD^2-ad^2)}$
Solid Cylinder.	$\frac{667AD}{L}$	$\frac{1333.40}{L}$	$\frac{wL^3}{24.40'}$	$\frac{wL^3}{38AD^2}$
Hollow Cylinder.	$\frac{667(AD-ad)}{L}$	$\frac{1333(AD-ad)}{L}$	$\frac{wL^3}{24(AD^2-ad^2)}$	$\frac{wL^3}{38(AD^2-ad^2)}$
Even-legged Angle or Tee.	$\frac{885AD}{L}$	$\frac{1770AD}{L}$	$\frac{wL^3}{32AD^2}$	$\frac{wL^3}{52AD^2}$
Channel or Z bar	$\frac{1525AD}{L}$	$\frac{3050AD}{L}$	$\frac{wL^3}{53AD^2}$	$\frac{wL^3}{85AD^2}$
Deck Beam.	$\frac{1380AD}{L}$	$\frac{2760AD}{L}$	$\frac{wL^3}{50AD^2}$	$\frac{wL^3}{80AD^2}$
I Beam.	$\frac{1695AD}{L}$	$\frac{3390AD}{L}$	$\frac{wL^3}{58AD^2}$	$\frac{wL^3}{95AD^2}$
I	II	III	I \	V

The above formulæ for the strength and stiffness of rolled beams of various sections are intended for convenient application in cases where strict accuracy is not required.

WARNING: This is a 1910 edition. Some of the material may no longer be accurate

The rules for rectangular and circular sections are correct, while those for the flanged sections are approximate, and limited in their application to the standard shapes as given in the Pencoyd tables. When the section of any beam is increased above the standard minimum dimensions, the flanges remaining unaltered, and the web alone being thickened, the tendency will be for the load as found by the rules to be in excess of the actual, but within the limits that it is possible to vary any section in the rolling, the rules will apply without any serious inaccuracy.

The calculated safe loads will be approximately one half of loads that would injure the elasticity of the materials.

The rules for deflection apply to any load below the elastic limit, or less than double the greatest safe load by the rules.

If the beams are long without lateral support, reduce the loads for the ratios of width to span as follows:

Length of Beam, times flange width.	Proportion of Calculated Load forming Greatest Safe Load.
20	Whole calculated load.
30	9-10
40	8-10
50	7-10
60	6-10
70	5-10

These rules apply to beams supported at each end. For beams supported otherwise, alter the coefficients of the table as described below, referring to the respective columns indicated by number.

Changes of Coefficients for Special Forms of Beams.

Kind of Beam.	Coefficient for Safe Load.	Coefficient for Deflection
Fixed at one end, loaded at the other.	One fourth of the coefficient, col. II.	One sixteenth of the coefficient of col. IV.
Fixed at one end, load evenly distributed.	One fourth of the coefficient of col. III.	Five forty-eighths of the coefficient of col. V.
Both ends rigidly fixed, or a continuous beam, with a load in middle.	Twice the coefficient of col. II.	Four times the coefficient of col. IV.
Both ends rigidly fixed, or a continuous beam, with load evenly distributed.	One and one-half times the coefficient of col. III.	Five times the coefficient of col. V.

Formulæ for Transverse Strength of Beams. — Referring to table

W = load at middle;
 W = total load, distributed uniformly;
 l = length, b = breadth, d = depth, in inches;
 E = modulus of elasticity;
 R = modulus of rupture, or stress per square inch of extreme fiber;
 I = moment of inertia;
 c = distance between neutral axis and extreme fibre.
 For breaking load of circular section, replace bd^2 by $0.59d^3$.

The value of R at rupture, or the modulus of rupture (see page 268), is about 60,000 for structural steel, and about 110,000 for strong steel. (Merriman.)

For cast iron the value of R varies greatly according to quality. Thus, for No. 2 and No. 4 cast iron, respectively, the values are 45,740 and 67,980.

For beams fixed at both ends and loaded in the middle, Barlow, by experiment, found the maximum moment of stress = $1/6 Pl$ instead of $1/8 Pl$, the result given by theory. Prof. Wood (Resist. Matls. p.155) says of this case: The phenomena are of too complex a character to admit of a thorough and exact analysis, and it is probably safer to accept the results of Mr. Barlow in practice than to depend upon theoretical results.

BEAMS OF UNIFORM STRENGTH THROUGHOUT THEIR LENGTH.

The section is supposed in all cases to be rectangular throughout. The beams shown in plan are of uniform depth throughout. Those shown in elevation are of uniform breadth throughout.

B = breadth of beam. D = depth of beam.

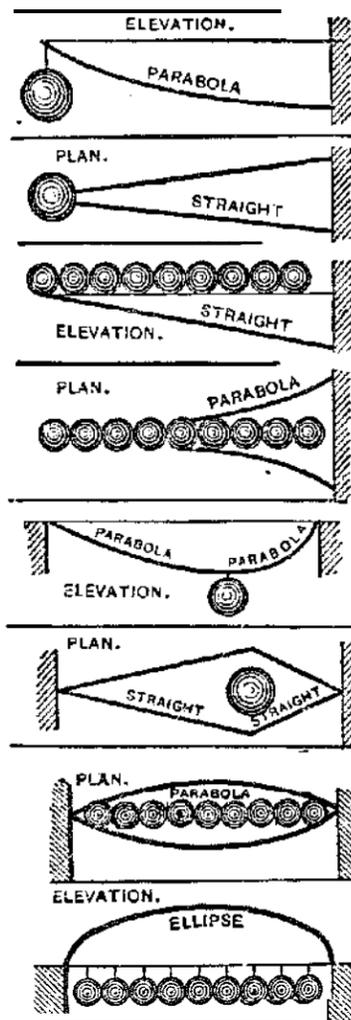

Fixed at one end, loaded at the other: curve parabola, vertex at loaded end: BD^2 proportional to distance from loaded end. The beam may be reversed, so that the upper edge is parabolic, or both edges may be parabolic.

Fixed at one end, loaded at the other: triangle, apices at loaded end: BD^2 proportional to the distance from the loaded end.

Fixed at one end: load distributed: triangle, apices at unsupported end: BD^2 proportional to square of distance from unsupported end.

Fixed at one end; load distributed: curves two parabolas, vertices touching each other at unsupported end: BD^2 proportional to distance from unsupported end.

Supported at both ends; load at any one point; two parabolas, vertices at the points of support, bases at point loaded: BD^2 proportional to distance from nearest point of support. The upper edge or both edges may also be parabolic.

Supported at both ends; load at any one point; two triangles, apices at points of support, bases at point loaded: BD^2 proportional to distance from the nearest point of support.

Supported at both ends; load distributed: curves two parabolas, vertices at the middle of the beam: bases centre line of beam: BD^2 proportional to product of distances from points of support.

Supported at both ends; load distributed: curve semi-ellipse: BD^2 proportional to the product of the distances from the points of support.

PROPERTIES OF ROLLED STRUCTURAL STEEL.

Explanation of Tables of the Properties of I-Beams, Channels, Angles, Z-Bars, Tees, Trough and Corrugated Plates.

(The Carnegie Steel Co.)

The tables for I-beams and channels are calculated for all standard weights to which each pattern is rolled. The tables for angles are calculated for the minimum intermediate and maximum weights of the various shapes, while the properties of Z-bars are given for thicknesses differing by $1/16$ inch. For tees, each shape can be rolled to one weight only.

Columns headed C in the tables for I-beams and channels give coefficients by the help of which the safe uniformly distributed load may be readily determined. To do this, divide the coefficient given by the span or distance between supports in feet.

If a section is to be selected (as will usually be the case), intended to carry a certain load for a length of span already determined on, ascertain the coefficient which this load and span will require, and refer to the table for a section having a coefficient of this value. The coefficient is obtained by multiplying the load, in pounds uniformly distributed, by the span length in feet.

In case the load is not uniformly distributed, but is concentrated at the middle of the span, multiply the load by 2, and then consider it as uniformly distributed. The deflection will be $8/10$ of the deflection for the latter load.

For other cases of loading obtain the bending moment in foot-pounds; this multiplied by 8 will give the coefficient required.

If the loads are quiescent, the coefficients for a fiber stress of 16,000 pounds per square inch for steel may be used; but if moving loads are to be provided for, a coefficient of 12,500 pounds should be taken. Inasmuch as the effects of impact may be very considerable (the stresses produced in an unyielding inelastic material by a load suddenly applied being double those produced by the same load in a quiescent state), it will sometimes be advisable to use still smaller fiber stresses than those given in the tables. In such cases the coefficients may be determined by proportion. Thus, if a fiber stress of 8000 pounds per square inch the coefficient will equal the coefficient for 16,000 pounds fiber stress, from the table, divided by 2.

The section moduli are used to determine the fiber stress per square inch in a beam, or other shape, subjected to bending or transverse stresses, by simply dividing the bending moment expressed in inch-pounds by the section modulus.

In the case of T-shapes with the neutral axis parallel to the flange, there will be two section moduli, and the smaller is given. The fiber stress calculated from it will, therefore, give the larger of the two stresses in the extreme fibers since these stresses are equal to the bending moment divided by the section modulus of the section.

For Z-bars the coefficient (C) may be applied for cases where the bars are subjected to transverse loading, as in the case of roof-purlins.

For angles there will be two section moduli for each position of the neutral axis, since the distance between the neutral axis and the extreme fibers has a different value on one side of the axis from what it has on the other. The section modulus given in the table is the smaller of these two values.

Column headed X, in the table of the properties of standard channels, giving the distance of the center of gravity of channel from the outside of web, is used to obtain the radius of gyration for columns or struts consisting of two channels latticed, for the case of the neutral axis passing through the center of the cross-section parallel to the webs of the channels. This radius of gyration is equal to the distance between the center of gravity of the channel and the center of the section, i.e., neglecting the moments of inertia of the channels around their own axes, thereby introducing a slight error on the side of safety.

(For much other important information concerning rolled structural shapes, see the "Pocket Companion" of The Carnegie Steel Co., Pittsburgh, Pa., price \$2.)

Safe Loads, Uniformly Distributed, for Carnegie Standard Steel I-Beams:
In Tons of 2000 Lb.

Distance between Supports in Feet.	24" I.				20" I.				18" I.				15" I.				Distance between Supports in Feet.	12" I.			10" I.	9" I.	Distance between Supports in Feet.	8" I.		7" I.	6" I.	5" I.	4" I.	3" I.
	80 lb.		60 lb.		65 lb.		55 lb.		80 lb.		60 lb.		42 lb.		40 lb.	31.5 lb.		25 lb.	21 lb.	18 lb.	15 lb.	12.25 lb.		9.75 lb.	7.5 lb.	5.5 lb.				
	80 lb.	60 lb.	65 lb.	55 lb.	80 lb.	60 lb.	42 lb.	40 lb.	31.5 lb.	25 lb.	21 lb.	18 lb.	15 lb.	12.25 lb.	9.75 lb.	7.5 lb.		5.5 lb.												
12	77.33	65.18	51.98	39.29	47.14	36.09	26.18	12	19.92	15.99	10.85	8.39	5	15.17	11.04	7.75	5.16	3.18	1.76											
13	71.38	60.16	47.98	36.27	43.51	33.31	24.17	13	18.39	14.76	10.02	7.74	6	14.64	9.20	6.46	4.30	2.65	1.47											
14	66.28	55.87	44.56	33.68	40.40	30.93	22.44	14	17.08	13.70	9.30	7.19	7	10.84	7.89	5.54	3.69	2.27	1.26											
15	61.86	52.14	41.59	31.43	37.71	28.87	20.94	15	15.94	12.79	8.68	6.71	8	5.48	6.90	4.84	3.23	1.99	1.10											
16	58.00	48.88	38.99	29.47	35.35	27.07	19.63	16	14.94	11.99	8.14	6.29	9	8.43	6.13	4.31	2.87	1.77	0.98											
17	54.58	46.01	36.69	27.74	33.27	25.47	18.48	17	14.06	11.29	7.66	5.92	10	7.59	5.52	3.88	2.58	1.59	0.88											
18	51.56	43.45	34.66	26.19	31.42	24.06	17.45	18	13.28	10.66	7.24	5.59	11	6.90	5.02	3.52	2.35	1.45	0.80											
19	48.84	41.17	32.83	24.82	29.77	22.79	16.53	19	12.58	10.10	6.86	5.30	12	6.32	4.60	3.23	2.15	1.33	0.73											
20	46.40	39.11	31.19	23.58	28.28	21.65	15.71	20	11.95	9.59	6.51	5.03	13	5.83	4.25	2.98	1.98	1.22	0.68											
21	44.19	37.24	29.70	22.45	26.94	20.62	14.96	21	11.38	9.14	6.20	4.79	14	5.42	3.94	2.77	1.84	1.14	0.63											
22	42.18	35.55	28.35	21.43	25.71	19.68	14.28	22	10.87	8.72	5.92	4.58	15	5.06	3.68	2.50	1.72	1.06	0.59											
23	40.35	34.01	27.12	20.50	24.59	18.83	13.66	23	10.39	8.34	5.66	4.38	16	4.74	3.45	2.42	1.61	0.99	0.55											
24	38.67	32.59	25.99	19.65	23.57	18.04	13.09	24	9.96	7.99	5.43	4.19	17	4.46	3.25	2.28	1.52	0.94	0.52											
25	37.12	31.29	24.95	18.86	22.63	17.32	12.57	25	9.56	7.67	5.21	4.03	18	4.21	3.07	2.15	1.43	0.88	0.49											
26	35.69	30.08	23.99	18.14	21.76	16.66	12.08	26	9.19	7.38	5.01	3.87	19	3.99	2.91	2.04	1.36	0.84	0.46											
27	34.37	28.97	23.10	17.46	20.95	16.04	11.64	27	8.85	7.11	4.82	3.73	20	3.79	2.76	1.94	1.29	0.80	0.44											
28	33.14	27.93	22.28	16.84	20.20	15.47	11.22	28	8.54	6.85	4.65	3.59	21	3.61	2.63	1.88	1.23	0.76	0.42											
29	32.00	26.97	21.51	16.26	19.51	14.93	10.83	29	8.24	6.62	4.49	3.47																		
30	30.93	26.07	20.79	15.72	18.86	14.43	10.47	30	7.97	6.40	4.34	3.36																		
31	29.94	25.23	20.12	15.21	18.25	13.97	10.13																							
32	29.00	24.44	19.49	14.73	17.68	13.53	9.82																							
33	28.12	23.70	18.90	14.29	17.14	13.12	9.52																							
34	27.29	23.00	18.35	13.87	16.64	12.74	9.24																							
35	26.51	22.35	17.82	13.47	16.16	12.37	8.98																							
36	25.78	21.73	17.33	13.10	15.71	12.03	8.73																							

Only figures above the cross-lines should be used with plastered ceilings, so that the deflection will not cause cracking of the plaster.

Safe loads given include weight of beam. Maximum fiber stress, 16,000 pounds per square inch.

Spacing of Carnegie I-Beams for Uniform Load of 100 Lb. per Square Foot. STEEL.

(Proper distance in feet, center to center of beams.)

Distance between Supports in Feet.	24" I.				20" I.				18" I.				15" I.				12" I.		10" I.	Distance between Supports in Feet.	9" I.	8" I.	7" I.	6" I.	5" I.	4" I.	3" I.
	80 lb.	60 lb.	65 lb.	55 lb.	80 lb.	60 lb.	42 lb.	40 lb.	31.5 lb.	25 lb.	21 lb.	18 lb.	15 lb.	12.25 lb.	9.75 lb.	7.5 lb.	5.5 lb.										
12	12.6	9.1	10.8	6.8	6.6	6.5	5 x 6	0.1	4.3	3.6	3.2	2.6	6	18.1	5	80.5	60.7	44.2	31.0	20.6	12.7	7.0					
13	109.8	92.6	73.8	55.8	67.0	51.3	37.2	28.3	22.7	15.4	6	55.9	42.1	30.7	21.5	14.3	8.8	4.9									
14	94.7	79.8	63.7	48.1	57.7	44.2	32.1	24.4	19.6	13.1	7	41.1	31.0	22.5	15.8	10.5	6.5	3.6									
15	82.5	69.5	55.5	41.5	50.3	38.5	27.9	21.3	17.1	11.6	8	31.5	23.7	17.3	12.1	8.1	5.0	2.8									
16	72.5	61.1	48.7	36.8	44.2	33.8	24.5	18.7	15.0	10.2	9	24.9	18.7	13.6	9.6	6.4	3.9	2.2									
17	64.2	54.1	43.2	32.6	39.2	30.0	21.7	16.5	13.3	9.0	10	20.1	15.2	11.1	7.8	5.2	3.2	1.8									
18	57.3	48.3	38.5	29.1	34.9	26.7	19.4	14.8	11.8	8.0	11	16.6	12.5	9.1	6.4	4.3	2.6	1.5									
19	51.41	43.3	34.6	26.1	31.3	24.0	17.4	13.2	10.6	7.2	12	14.0	10.5	7.7	5.4	3.6	2.2	1.2									
20	46.4	39.1	31.2	23.6	28.3	21.7	15.7	12.0	9.5	6.5	13	11.9	9.0	6.5	4.6	3.1	1.9	1.0									
21	42.1	35.5	28.3	21.4	25.7	19.6	14.2	10.8	8.7	5.9	14	10.3	7.7	5.6	4.0	2.6	1.6	0.9									
22	38.4	32.3	25.8	19.5	23.4	17.9	13.0	9.9	7.9	5.4	15	9.0	6.7	4.9	3.4	2.3	1.4	...									
23	35.1	29.6	23.6	17.8	21.4	16.4	11.9	9.0	7.3	4.9	16	7.9	5.9	4.3	3.0	2.0	1.2	...									
24	32.2	27.2	21.7	16.4	19.6	15.0	10.9	8.3	6.7	4.5	17	7.0	5.3	3.8	2.7	1.8	1.1	...									
25	29.7	25.0	20.0	15.1	18.1	13.9	10.1	7.7	6.1	4.2	18	6.2	4.7	3.4	2.4	1.6	0.9, 8	...									
26	27.5	23.1	18.5	13.9	16.7	12.8	9.3	7.1	5.7	3.9	19	5.6	4.2	3.1	2.2	1.4	...										
27	25.5	21.5	17.1	12.9	15.5	11.9	8.6	6.6	5.3	3.6	20	5.0	3.8	2.8	1.9	1.3	...										
28	23.7	20.0	15.9	12.0	14.4	11.0	8.0	6.1	4.9	3.3	21	4.6	3.4	2.5	1.8	1.2	...										
29	22.1	18.6	14.8	11.2	13.5	10.3	7.5	5.7	4.6	3.1	22	3.8	3.1	2.3	1.6	1.1	...										
30	20.6	17.41	13.91	10.51	12.6	9.61	7.01	5.31	4.3	2.91								...									

For any other load than 100 lb. per square foot, divide the spacing given by the ratio the given load per square foot bears to 100. Thus for a load of 150 lb. per square foot divide by 1.5. Maximum fiber stress, 16,000 lb. per square inch. Only figures above the cross-lines should be used for plastered ceilings, so that the deflection will not cause cracking of the plaster.

WARNING: This is a 1910 edition. Some of the material may be on gear beam crate

Properties of Carnegie Standard Channels — Steel.

Depth of Channel.	Weight per Foot.	Area of Section	Thickness of Web.	Width of Flange.	Moment of Inertia, Neutral Axis Perpendicular to Web at Center.	Moment of Inertia, Neutral Axis Parallel with Center Line of Web.	Radius of Gyration, Neutral Axis Perpendicular to Web at Center.	Radius of Gyration, Neutral Axis Parallel with Center Line of Web.	Section Modulus, Neutral Axis Perpendicular to Web at Center.	Coefficient of Strength for Fiber Stress of 16,000 lbs. per sq. in.	Distance of Center of Gravity from Outside of Web.
in.	lbs.	sq. in.	in.	in.	I	I'	r	r'	S	C*	e
15	55	16.18	0.82	3.82	430.2	12.19	5.16	0.868	57.4	611900	0.823
50	14.71	0.72	3.72	402.7	11.22	5.23	0.873	53.7	572700	0.803	
45	13.24	0.62	3.62	375.1	10.29	5.32	0.882	50.0	533500	0.788	
40	11.76	0.52	3.52	347.5	9.39	5.43	0.893	46.3	494200	0.783	
35	10.29	0.43	3.43	320.0	8.48	5.58	0.908	42.7	455000	0.789	
33	9.90	0.40	3.40	312.6	8.23	5.62	0.912	41.7	444500	0.794	
40	11.76	0.76	3.42	197.0	6.63	4.09	0.751	32.8	350200	0.722	
35	10.29	0.64	3.30	179.3	5.90	4.17	0.757	29.9	318800	0.694	
30	8.81	0.51	3.17	161.7	5.21	4.28	0.768	26.9	287400	0.677	
25	7.35	0.39	3.05	144.0	4.53	4.43	0.785	24.0	256100	0.678	
20.5	6.03	0.28	2.94	128.1	3.91	4.61	0.805	21.4	227800	0.704	
35	10.29	0.82	3.18	115.5	4.66	3.35	0.672	23.1	246400	0.695	
30	8.82	0.68	3.04	103.2	3.90	3.42	0.672	20.6	220300	0.651	
25	7.35	0.53	2.89	91.0	3.40	3.52	0.680	18.2	194100	0.620	
20	5.88	0.38	2.74	78.7	2.85	3.66	0.696	15.7	168000	0.609	
15	4.46	0.24	2.60	66.9	2.30	3.87	0.718	13.4	142700	0.639	
25	7.35	0.62	2.82	70.7	2.98	3.10	0.637	15.7	167600	0.615	
20	5.88	0.45	2.65	60.8	2.45	3.21	0.646	13.5	144100	0.585	
15	4.41	0.29	2.49	50.9	1.95	3.40	0.665	11.3	120500	0.590	
13 1/4	3.89	0.23	2.43	47.3	1.77	3.49	0.674	10.5	112200	0.607	
21 1/4	6.25	0.58	2.62	47.8	2.25	2.77	0.600	11.9	127400	0.587	
18 3/4	5.51	0.49	2.53	43.8	2.01	2.82	0.603	11.0	116900	0.567	
16 1/4	4.78	0.40	2.44	39.9	1.78	2.89	0.610	10.0	106400	0.556	
13 3/4	4.04	0.31	2.35	36.0	1.55	2.98	0.619	9.0	96000	0.557	
11 1/4	3.35	0.22	2.26	32.3	1.33	3.11	0.630	8.1	86100	0.576	
19 3/4	5.81	0.63	2.51	33.2	1.85	2.39	0.565	9.5	101100	0.583	
17 1/4	5.07	0.53	2.41	30.2	1.62	2.44	0.564	8.6	92000	0.555	
14 3/4	4.34	0.42	2.30	27.2	1.40	2.50	0.568	7.8	82800	0.535	
12 1/4	3.60	0.32	2.20	24.2	1.19	2.59	0.575	6.9	73700	0.528	
9 3/4	2.85	0.21	2.09	21.1	0.98	2.72	0.586	6.0	66800	0.546	
15.5	4.56	0.56	2.28	19.5	1.25	2.07	0.529	6.5	69500	0.546	
13	3.82	0.44	2.16	17.3	1.07	2.13	0.529	5.8	61600	0.517	
10.5	3.09	0.32	2.04	15.1	0.88	2.21	0.534	5.0	53800	0.503	
8	2.38	0.20	1.92	13.0	0.70	2.34	0.542	4.3	46200	0.517	
11.5	3.38	0.48	2.04	10.4	0.82	1.75	0.493	4.2	44100	0.508	
9	2.65	0.33	1.89	8.9	0.64	1.83	0.493	3.5	37900	0.481	
6.5	1.95	0.19	1.75	7.4	0.48	1.95	0.498	3.0	31600	0.487	
7 1/4	2.13	0.33	1.73	4.6	0.44	1.46	0.455	2.3	24500	0.463	
6 1/4	1.84	0.25	1.65	4.2	0.38	1.51	0.454	2.1	22300	0.458	
5 1/4	1.55	0.18	1.58	3.8	0.32	1.56	0.453	1.9	20200	0.464	
6	1.76	0.36	1.60	2.1	0.31	1.013	0.421	1.4	14700	0.459	
5	1.47	0.26	1.50	1.8	0.25	1.12	0.415	1.2	13100	0.443	
4	1.19	0.17	1.41	1.6	0.20	1.17	0.409	1.1	11600	0.443	

* Used for buildings; for bridges use 12,500 pounds, or multiply coefficient in this column by 0.73125.

L = safe load in pounds, uniformly distributed; l = span in feet.
 M = moment of forces in foot-pounds; C = coefficient given above.
 $L = \frac{C}{l}$; $M = \frac{C}{8}$; $C = Ll = 8M = \frac{8fS}{12}$; f = fiber stress.

Distance between Supports in Feet.	3" E	4" E	5" E	6" E	7" E	8" E	9" E	10" E	12" E	15" E
5	1.16	2.02	3.16	4.62	6.68	8.61	10.35	11.39	13.89	22.23
6	0.97	1.68	2.63	3.85	5.57	7.18	8.61	10.35	13.07	18.52
7	0.83	1.44	2.26	3.30	4.77	6.15	7.35	8.82	11.10	15.87
8	0.73	1.26	1.98	2.89	4.18	5.38	6.48	7.81	9.87	14.82
9	0.64	1.12	1.76	2.57	3.71	4.78	5.61	6.74	8.59	13.89
10	0.58	1.01	1.58	2.31	3.34	4.31	5.10	6.14	7.76	13.07
11	0.53	0.92	1.44	2.10	3.04	3.91	4.68	5.61	7.07	12.35
12	0.48	0.84	1.32	1.93	2.78	3.59	4.32	5.19	6.50	11.70
13	0.45	0.78	1.22	1.78	2.57	3.31	4.01	4.76	6.00	11.11
14	0.41	0.72	1.13	1.65	2.39	3.08	3.74	4.46	5.61	10.58
15	0.39	0.67	1.05	1.54	2.23	2.87	3.51	4.20	5.24	10.10
16	0.36	0.63	0.99	1.44	2.09	2.69	3.30	4.00	4.92	9.66
17	0.34	0.59	0.93	1.36	1.96	2.53	3.12	3.76	4.66	9.26
18	0.32	0.56	0.88	1.28	1.86	2.39	2.95	3.57	4.45	8.89
19	0.30	0.53	0.83	1.22	1.76	2.27	2.81	3.40	4.28	8.55
20	0.29	0.51	0.79	1.16	1.67	2.15	2.67	3.24	4.12	8.23
21	0.28	0.48	0.75	1.10	1.59	2.05	2.55	3.10	3.98	7.94
22	0.26	0.46	0.72	1.05	1.52	1.96	2.44	2.97	3.83	7.66
23	0.25	0.44	0.69	1.00	1.45	1.87	2.34	2.85	3.69	7.41
24	0.24	0.42	0.66	0.96	1.39	1.79	2.24	2.74	3.56	7.17
25	0.23	0.40	0.63	0.92	1.34	1.72	2.16	2.64	3.43	6.94
26	0.23	0.40	0.63	0.92	1.34	1.72	2.16	2.64	3.43	6.71
27	0.23	0.40	0.63	0.92	1.34	1.72	2.16	2.64	3.43	6.49
28	0.23	0.40	0.63	0.92	1.34	1.72	2.16	2.64	3.43	6.27
29	0.23	0.40	0.63	0.92	1.34	1.72	2.16	2.64	3.43	6.05
30	0.23	0.40	0.63	0.92	1.34	1.72	2.16	2.64	3.43	5.83

Safe loads given include weight of channel. Maximum fiber stress, 16,000 lbs. per square inch.

WARNING: This is a 1910 edition. Some of the material may no longer be accurate

Properties of Carnegie T-Shapes. — Steel.

Size: Flange by Stem.	Weight per Foot.	Area of Section	Distance of Center of Gravity from outside of Flange.	Mom. of Inertia, Neutral Axis through Center of Gravity Parallel to Flange.	Axis through Center of Gravity Parallel to Flange.	through Center of Gravity Parallel to Flange.	Mom. of Inertia, Neut. Axis through C. of G. Coincident with Center Line of Stem.	Section Modulus, Neut. Axis through C. of G. Coincident with Center Line of Stem.	Radius of Gyration, Neut. Axis through C. of G. Coincident with Center Line of Stem.	Stress of 12,000 lb. per sq. in., Neut. Axis thro C. of G. Parallel to Flange.
in.	lbs.	sq. in.	in.	I	S	r	I'	S'	r'	C
5 x3	13.6	3.99	0.75	2.6	1.18	1.82	5.6	2.22	1.19	9410
5 x2 1/2	11.0	3.24	0.65	1.6	0.86	1.71	4.3	1.70	1.16	6900
4 1/2 x3 1/2	15.9	4.65	1.11	5.1	2.13	1.04	3.7	1.65	0.90	17020
4 1/2 x3	8.6	2.55	0.73	1.8	0.81	0.87	2.6	1.16	1.03	6490
4 1/2 x3	10.0	3.00	0.75	2.1	0.94	0.86	3.1	1.38	1.04	7540
4 1/2 x2 1/2	9.0	2.40	0.58	1.1	0.56	0.69	2.6	1.16	1.07	4520
4 1/2 x2 1/2	9.3	2.79	0.60	1.2	0.65	0.68	3.1	1.38	1.08	5220
4 x5	15.7	4.56	1.56	10.7	3.10	1.54	2.8	1.41	0.79	24800
4 x5	12.3	3.54	1.51	8.5	2.43	1.56	2.1	1.06	0.78	19410
4 x4 1/2	14.8	4.29	1.37	8.0	2.55	1.37	2.8	1.41	0.81	20400
4 x4 1/2	11.6	3.36	1.31	6.3	1.98	1.38	2.1	1.06	0.80	15840
4 x4	13.9	4.02	1.18	5.7	2.02	1.20	2.8	1.40	0.84	16170
4 x4	10.9	3.21	1.15	4.7	1.64	1.23	2.2	1.09	0.84	13100
4 x3	9.3	2.73	0.78	2.0	0.88	0.86	2.1	1.05	0.88	7070
4 x2 1/2	8.7	2.52	0.63	1.2	0.62	0.69	2.1	1.05	0.92	4980
4 x2 1/2	7.4	2.16	0.60	1.0	0.55	0.70	1.8	0.88	0.91	4380
4 x2	7.9	2.31	0.48	0.60	0.40	0.52	2.1	1.05	0.96	3180
4 x2	6.7	1.95	0.51	0.54	0.34	0.51	1.8	0.88	0.95	2700
3 1/2 x4	12.8	3.75	1.25	5.5	1.98	1.21	1.89	1.08	0.72	15870
3 1/2 x4	10.0	2.91	1.19	4.3	1.55	1.22	1.42	0.81	0.70	12380
3 1/2 x3 1/2	11.9	3.45	1.06	3.7	1.52	1.04	1.89	1.08	0.74	12160
3 1/2 x3 1/2	9.3	2.70	1.01	3.0	1.19	1.05	1.42	0.81	0.73	9530
3 1/2 x3	11.0	3.21	0.88	2.4	1.13	0.87	1.88	1.08	0.77	9050
3 1/2 x3	8.1	2.49	0.83	1.9	0.88	0.88	1.41	0.81	0.75	7040
3 1/2 x3	7.7	2.28	0.78	1.6	0.72	0.89	1.18	0.68	0.76	5790
3 x4	11.9	3.48	1.32	5.2	1.94	1.23	1.21	0.81	0.59	15480
3 x4	10.6	3.12	1.32	4.8	1.78	1.25	1.09	0.72	0.60	14270
3 x4	9.3	2.73	1.29	4.3	1.57	1.26	0.93	0.62	0.59	12540
3 x3 1/2	11.0	3.21	1.12	3.5	1.49	1.06	1.20	0.80	0.62	11910
3 x3 1/2	9.8	2.88	1.11	3.3	1.37	1.08	1.31	0.88	0.68	10990
3 x3	10.1	2.94	0.93	2.3	1.10	0.88	1.20	0.80	0.64	8780
3 x3	9.0	2.67	0.92	2.1	1.01	0.90	1.08	0.72	0.64	8110
3 x3	7.7	2.28	0.88	1.8	0.86	0.90	0.90	0.60	0.63	6900
3 x2 1/2	7.7	2.10	0.71	1.1	0.60	0.72	0.89	0.60	0.66	4800
2 3/4 x2	7.4	2.16	0.53	1.1	0.75	0.71	0.62	0.45	0.54	6000
2 1/2 x3	7.2	2.10	0.97	1.8	0.87	0.92	0.54	0.43	0.51	6960
2 1/2 x2 3/4	6.8	1.98	0.87	1.4	0.73	0.84	0.66	0.53	0.58	5860
2 1/2 x2 1/2	6.5	1.89	0.76	1.0	0.55	0.74	0.52	0.42	0.53	4700
2 1/2 x1 1/4	3.0	0.84	0.29	0.05	0.05	0.31	0.29	0.23	0.58	710
2 1/4 x2 1/4	5.0	1.44	0.69	0.66	0.42	0.68	0.33	0.30	0.48	3360
2 x2	4.1	1.26	0.63	0.45	0.33	0.60	0.23	0.23	0.43	2610
2 x1 1/2	3.2	0.90	0.42	0.16	0.15	0.42	0.18	0.18	0.45	1200
1 3/4 x1 3/4	3.2	0.90	0.54	0.23	0.15	0.51	0.12	0.14	0.37	1540
1 1/2 x1 1/2	2.1	0.75	0.42	0.1	0.14	0.49	0.08	0.10	0.34	1150
1 1/4 x1 1/4	2.1	0.60	0.40	0.01	0.10	0.36	0.05	0.07	0.27	760
1 x1	1.1	0.36	0.32	0.02	0.05	0.29	0.02	0.04	0.21	370

Some light weight T's of the smaller sizes are omitted.

WARNING: This is a 1910 edition. Some of the material may no longer be accurate;

Properties of Carnegie Standard and Special Angles with Equal Legs. Minimum, Intermediate, and Maximum Thicknesses and Weights.

Dimensions. — Inches.	Thickness. — Inches.	Weight per Foot. — Lbs.	Area of Section. — Square Inches.	Distance of Center of Gravity from Back of Flange. — Inches.	Moment of Inertia, Neutral Axis through Center of Gravity Parallel to Flange. — I.	Section Modulus, Neutral Axis through Center of Gravity Parallel to Flange. — S.	Radius of Gyration, Neutral Axis through Center of Gravity Parallel to Flange. — r.	Least Radius of Gyration, Neut. Axis thro Center of Gravity at Angle of 45° to Flanges. — r'.
∞ x8	1 1/8	56.9	16.73	2.41	97.97	17.53	2.42	1.55
8 x8	13/16	42.0	12.34	2.30	74.71	13.11	2.46	1.57
8 x8	1/2	26.4	7.75	2.19	48.63	8.37	2.50	1.58
6 x6	1	37.4	11.00	1.86	35.46	8.57	1.80	1.16
6 x6	11/16	26.5	7.78	1.75	26.19	6.17	1.83	1.17
6 x6	3/8	14.9	4.36	1.64	15.39	3.53	1.88	1.19
*5 x5	1	30.6	9.00	1.61	19.64	5.80	1.48	0.96
*5 x5	11/16	21.8	6.42	1.50	14.68	4.20	1.51	0.97
*5 x5	3/8	12.3	3.61	1.39	8.74	2.42	1.56	0.99
4 x4	13/16	19.9	5.84	1.29	8.14	3.01	1.18	0.77
4 x4	9/16	14.3	4.18	1.21	6.12	2.19	1.21	0.78
4 x4	5/16	8.2	2.40	1.12	3.71	1.29	1.24	0.79
3 1/2 x3 1/2	13/16	17.1	5.03	1.17	5.25	2.25	1.02	0.67
3 1/2 x3 1/2	9/16	12.4	3.62	1.08	3.99	1.65	1.05	0.68
3 1/2 x3 1/2	5/16	7.2	2.09	0.99	2.45	0.98	1.08	0.69
3 x3	5/8	11.5	3.36	0.98	2.62	1.30	0.88	0.57
3 x3	7/16	8.3	2.43	0.91	1.99	0.95	0.91	0.58
3 x3	1/4	4.9	1.44	0.84	1.24	0.58	0.93	0.59
*2 3/4 x2 3/4	1/2	8.5	2.50	0.87	1.67	0.89	0.82	0.52
*2 3/4 x2 3/4	3/8	6.6	1.92	0.82	1.33	0.69	0.83	0.53
*2 3/4 x2 3/4	1/4	4.5	1.31	0.78	0.93	0.48	0.85	0.55
2 1/2 x2 1/2	1/2	7.7	2.25	0.81	1.23	0.73	0.74	0.47
2 1/2 x2 1/2	3/8	5.9	1.73	0.76	0.98	0.57	0.75	0.48
2 1/2 x2 1/2	3/16	3.1	0.90	0.69	0.55	0.30	0.78	0.49
*2 1/4 x2 1/4	1/2	6.8	2.00	0.74	0.87	0.58	0.66	0.48
*2 1/4 x2 1/4	3/8	5.3	1.55	0.70	0.70	0.45	0.67	0.43
*2 1/4 x2 1/4	3/16	2.8	0.81	0.63	0.39	0.24	0.70	0.44
2 x2	7/16	5.3	1.56	0.66	0.54	0.40	0.59	0.39
2 x2	5/16	4.0	1.15	0.61	0.42	0.30	0.60	0.39
2 x2	3/16	2.5	0.72	0.57	0.28	0.19	0.62	0.40
1 3/4 x1 3/4	7/16	4.6	1.30	0.59	0.35	0.30	0.51	0.33
1 3/4 x1 3/4	5/16	3.4	1.00	0.55	0.27	0.23	0.52	0.34
1 3/4 x1 3/4	3/16	2.2	0.62	0.51	0.18	0.14	0.54	0.35
1 1/2 x1 1/2	3/8	3.4	0.99	0.19	0.19	0.19	0.44	0.29
1 1/2 x1 1/2	1/4	2.4	0.69	0.14	0.14	0.134	0.45	0.29
1 1/2 x1 1/2	1/8	1.3	0.36	0.42	0.08	0.070	0.46	0.30
1 1/4 x1 1/4	5/16	2.4	0.69	0.42	0.09	0.109	0.36	0.23
1 1/4 x1 1/4	1/4	2.0	0.56	0.40	0.077	0.091	0.37	0.24
1 1/4 x1 1/4	1/8	1.1	0.30	0.35	0.044	0.049	0.38	0.25
1 x1	1/4	1.5	0.44	0.34	0.037	0.056	0.29	0.19
1 x1	3/16	1.2	0.34	0.32	0.030	0.044	0.30	0.19
1 x1	1/8	0.8	0.24	0.30	0.022	0.031	0.31	0.20
*7/8 x7/8	3/16	1.0	0.29	0.29	0.019	0.033	0.26	0.18
*7/8 x7/8	1/8	0.7	0.21	0.26	0.014	0.023	0.26	0.19
3/4 x3/4	3/16	0.9	0.25	0.26	0.012	0.024	0.22	0.16
3/4 x3/4	1/8	0.6	0.17	0.23	0.009	0.017	0.23	0.17

Angles marked * are special.

Properties of Carnegie Standard and Special Angles with Unequal Legs; Minimum, Intermediate, and Maximum Thicknesses, and Weights.

Dimensions. — Inches.	Thickness. — Inches.	Weight per Foot. — Pounds.	Area of Section. — Square Inches.	Moment of Inertia. — I.		Section Modulus. — S.		Radius of Gyration. — r.		Least Radius. — Axis Diagonal.
				Neutral Axis Parallel to Longer Flange.	Neutral Axis Parallel to Shorter Flange.	Neutral Axis Parallel to Longer Flange.	Neutral Axis Parallel to Shorter Flange.	Neutral Axis Parallel to Longer Flange.	Neutral Axis Parallel to Shorter Flange.	
8 X 3 1/2	1 1/20	20.5	6.02	4.92	39.96	1.79	7.99	0.90	2.58	0.74
*7 X 3 1/2	1	32.3	9.50	7.53	45.37	2.96	10.58	0.89	2.19	0.88
*7 X 3 1/2	3/4	24.9	7.31	6.08	35.99	2.31	8.22	0.91	2.22	0.88
*7 X 3 1/2	7/16	15.0	4.40	3.95	22.56	1.47	5.01	0.95	2.26	0.89
6 X 4	1	30.6	9.00	10.75	30.75	3.79	8.02	1.09	1.85	0.85
6 X 4	11/16	21.8	6.41	8.11	22.02	2.76	5.78	1.13	1.89	0.86
6 X 4	3/8	12.3	3.61	4.90	12.3	3.32	3.32	1.17	1.93	0.88
6 X 3 1/2	1	28.9	8.50	7.21	29.24	2.90	7.83	0.92	1.85	0.74
6 X 3 1/2	11/16	20.0	6.06	5.47	21.74	2.11	5.65	0.95	1.89	0.75
6 X 3 1/2	3/8	11.7	3.42	3.34	12.86	1.23	3.25	0.99	1.94	0.77
*5 X 4	7/8	24.2	7.11	9.23	4.99	1.14	4.99	1.14	1.52	0.84
*5 X 4	5/8	17.8	5.23	7.14	10.61	3.38	3.73	1.17	1.55	0.84
*5 X 4	3/8	11.0	3.23	4.67	8.14	1.57	2.34	1.20	1.59	0.86
5 X 3 1/2	7/8	22.7	6.67	6.21	15.67	2.52	4.88	0.96	1.53	0.75
5 X 3 1/2	5/8	16.8	4.92	4.83	12.03	1.90	3.65	0.99	1.56	0.75
5 X 3 1/2	3/8	8.7	2.56	2.72	6.60	1.02	1.94	1.03	1.61	0.76
5 X 3	13/16	19.9	5.04	3.71	13.96	1.74	4.45	0.60	1.55	0.64
5 X 3	9/16	14.3	4.18	2.83	3.23	0.82	3.23	0.82	1.58	0.65
5 X 3	5/16	8.2	2.40	1.75	10.48	0.25	1.89	0.85	1.61	0.66
*4 1/2 X 3	13/16	18.5	5.43	3.60	10.33	1.71	3.62	0.81	1.38	0.64
*4 1/2 X 3	9/16	13.3	3.90	2.75	7.75	1.25	2.64	0.85	1.41	0.64
*4 1/2 X 3	5/16	7.7	2.25	1.73	4.69	0.76	1.54	0.88	1.44	0.66
*4 X 3 1/2	13/16	18.5	5.43	5.49	7.77	2.30	2.92	1.01	1.19	0.72
*4 X 3 1/2	9/16	13.3	3.90	4.17	5.86	1.68	2.15	1.03	1.23	0.72
*4 X 3 1/2	5/16	7.7	2.25	2.59	3.56	1.01	1.26	1.07	1.26	0.73
4 X 3	13/16	17.1	5.03	3.47	7.34	1.68	2.87	0.83	1.21	0.64
4 X 3	9/16	12.4	3.62	2.66	5.55	1.23	2.09	0.86	1.24	0.64
4 X 3	5/16	7.2	2.09	1.65	3.38	0.74	1.23	0.89	1.27	0.65
3 1/2 X 3	13/16	15.4	4.62	3.33	4.98	1.65	2.20	0.85	1.04	0.62
3 1/2 X 3	5/16	6.6	1.93	1.58	2.33	0.72	0.96	0.90	1.10	0.63
3 1/2 X 2 1/2	11/16	12.5	3.65	1.72	4.13	0.99	1.85	0.67	1.06	0.53
3 1/2 X 2 1/2	1/4	4.9	1.44	0.78	1.80	0.41	0.75	0.74	1.12	0.54
*3 1/4 X 2	9/16	9.0	2.64	0.75	2.64	0.53	1.30	0.53	1.00	0.44
*3 1/4 X 2	1/4	4.3	1.25	0.40	1.36	0.26	0.63	0.57	1.04	0.45
3 X 2 1/2	9/16	9.5	2.78	1.42	2.28	0.82	1.15	0.72	0.91	0.52
3 X 2 1/2	1/4	4.5	1.31	0.74	1.17	0.40	0.56	0.71	0.95	0.53
*3 X 2	1/2	7.7	2.25	0.67	1.92	0.47	1.00	0.55	0.92	0.43
*3 X 2	1/4	4.1	1.19	0.39	1.54	0.27	0.54	0.57	0.95	0.43
2 1/2 X 2	1/2	6.8	2.00	0.64	1.99	0.20	0.70	0.56	0.74	0.42
2 1/2 X 2	3/16	2.8	0.81	0.29	0.51	0.20	0.29	0.60	0.79	0.43
*2 1/4 X 1 1/2	1/2	5.6	1.63	0.26	0.75	0.26	0.54	0.40	0.68	0.39
*2 1/4 X 1 1/2	3/8	4.4	1.27	0.21	0.61	0.20	0.42	0.41	0.69	0.39
*2 1/4 X 1 1/2	3/16	2.3	0.67	0.12	0.34	0.11	0.23	0.43	0.72	0.40
*2 X 1 3/8	1/4	2.70	0.78	0.12	0.37	0.12	0.23	0.39	0.63	0.30
*2 X 1 3/8	3/16	2.10	0.60	0.09	0.24	0.09	0.18	0.40	0.63	0.31
*1 3/8 X 1	1/4	1.9	0.53	0.04	0.09	0.05	0.09	0.27	0.41	0.22
*1 3/8 X 1	1/8	1.0	0.28	0.02	0.05	0.03	0.06	0.23	0.44	0.22

Angles marked * are special. A few of the smaller intermediate sizes are omitted.

WARNING: This is a 1910 edition. Some of the material may no longer be accurate

Safe Loads (Tons, 2000 Lb.) Uniformly Distributed for Carnegie Standard and Special Angles With Equal Legs.

Size of Angle.	Distance between Supports in Feet.									
	1	2	3	4	5	6	7	8	9	10
8 X 8 X 1 1/8	93.49	46.74	1.16	23.37	8.70	5.58	13.36	1.69	0.39	9.35
8 X 8 X 1/2	44.64	22.32	4.88	11.16	8.93	7.44	6.38	5.58	4.96	4.46
6 X 6 X 1	45.72	22.86	5.24	11.43	9.14	7.62	6.53	5.72	5.08	4.57
6 X 6 X 3/8	18.82	9.41	6.27	4.70	3.76	3.14	2.69	2.35	2.09	1.88
*5 X 5 X 1	30.91	15.45	0.30	7.73	6.18	5.15	4.42	3.86	3.43	3.09
*5 X 5 X 3/8	12.91	6.45	4.30	3.23	2.58	2.15	1.84	1.61	1.43	1.29
4 X 4 X 13/16	16.05	8.03	5.35	4.01	3.21	2.68	2.29	2.01	1.78	1.61
4 X 4 X 5/16	6.88	3.44	2.29	1.72	1.38	1.15	0.98	0.86	0.76	0.69
3 1/2 X 3 1/2 X 13/16	12.00	6.00	4.00	3.00	2.40	2.00	1.71	1.50	1.33	1.20
3 1/2 X 3 1/2 X 5/16	5.20	2.60	1.73	1.30	1.04	0.87	0.74	0.65	0.58	0.52
3 X 3 X 5/8	6.93	3.47	2.31	1.73	1.39	1.16	0.99	0.87	0.77	0.69
3 X 3 X 1/4	3.09	1.55	1.03	0.77	0.62	0.52	0.44	0.39	0.34	0.31
*2 3/4 X 2 3/4 X 1/2	4.75	2.37	1.58	1.19	0.95	0.79	0.68	0.59	0.53	0.47
*2 3/4 X 2 3/4 X 1/4	2.56	1.28	0.85	0.64	0.51	0.43	0.37	0.32	0.28	0.26
2 1/2 X 2 1/2 X 1/2	3.89	1.95	1.29	0.97	0.78	0.65	0.56	0.49	0.43	0.39
2 1/2 X 2 1/2 X 3/16	1.61	0.81	0.54	0.40	0.32	0.27	0.23	0.20	0.18	0.16
*2 1/4 X 2 1/4 X 1/2	3.09	1.55	1.03	0.77	0.62	0.52	0.44	0.39	0.34	0.31
*2 1/4 X 2 1/4 X 3/16	1.30	0.65	0.43	0.32	0.26	0.22	0.19	0.16	0.14	0.13
2 X 2 X 7/16	2.13	1.07	0.71	0.53	0.43	0.36	0.30	0.27	0.24	0.21
2 X 2 X 3/16	1.01	0.51	0.34	0.25	0.20	0.17	0.14	0.13	0.11	0.10
1 3/4 X 1 3/4 X 7/16	1.60	0.80	0.53	0.40	0.32	0.27	0.23	0.20	0.18	0.16
1 3/4 X 1 3/4 X 3/16	0.75	0.37	0.25	0.19	0.15	0.12	0.11	0.09	0.083	0.075
1 1/2 X 1 1/2 X 3/8	1.01	0.51	0.34	0.25	0.20	0.17	0.14	0.13	0.110	0.100
1 1/2 X 1 1/2 X 1/8	0.38	0.19	0.13	0.09	0.07	0.064	0.055	0.04	0.043	0.038
1 1/4 X 1 1/4 X 5/16	0.58	0.29	0.19	0.15	0.12	0.097	0.083	0.07	0.065	0.058
1 1/4 X 1 1/4 X 1/8	0.26	0.13	0.087	0.06	0.05	0.044	0.037	0.03	0.029	0.026
1 X 1 X 1/4	0.30	0.15	0.100	0.075	0.06	0.050	0.043	0.03	0.033	0.030
1 X 1 X 1/8	0.17	0.08	0.055	0.041	0.03	0.028	0.024	0.02	0.018	0.017
* 7/8 X 7/8 X 3/16	0.18	0.08	0.059	0.044	0.03	0.029	0.025	0.02	0.020	0.018
* 7/8 X 7/8 X 1/8	0.12	0.06	0.041	0.031	0.02	0.020	0.018	0.01	0.014	0.012
3/4 X 3/4 X 3/16	0.13	0.06	0.043	0.032	0.02	0.021	0.018	0.01	0.014	0.013
3/4 X 3/4 X 1/8	0.091	0.04	0.030	0.023	0.01	0.015	0.013	0.01	0.010	0.009

Safe loads given include weight of angle. Maximum fiber stress, 16,000 pounds per square inch. Neutral axis through center of gravity parallel to one leg. Angles marked * are special.

Safe Loads in Tons (2000 Lb.) Uniformly Distributed for Standard Carnegie Angles with Unequal Legs.
(Short Leg Vertical.)

Size of Angle.	Distance between Supports in Feet.									
	1	2	3	4	5	6	7	8	9	10
6 x 4 x 1	20.21	10.11	6.74	5.05	4.04	3.37	2.89	2.53	2.25	2.02
6 x 4 x 3/8	8.53	4.27	2.84	2.13	1.71	1.42	1.22	1.07	0.95	0.85
6 x 3 1/2 x 1	15.47	7.74	5.16	3.87	3.09	2.58	2.21	1.93	1.72	1.55
6 x 3 1/2 x 3/8	6.56	3.28	2.19	1.64	1.31	1.09	0.94	0.82	0.73	0.66
5 x 3 1/2 x 7/8	13.44	6.72	4.48	3.36	2.69	2.24	1.92	1.68	1.49	1.34
5 x 3 1/2 x 5/16	5.44	2.72	1.81	1.36	1.09	0.91	0.78	0.68	0.60	0.54
5 x 3 x 13/16	9.28	4.64	3.09	2.32	1.86	1.55	1.33	1.16	1.03	0.93
5 x 3 x 5/16	4.00	2.00	1.33	1.00	0.80	0.67	0.57	0.50	0.44	0.40
4 x 3 x 13/16	4.96	2.48	1.65	1.24	1.00	0.84	0.72	0.63	0.55	0.50
4 x 3 x 5/16	3.95	1.97	1.32	0.99	0.79	0.66	0.56	0.49	0.44	0.39
3 1/2 x 3 x 13/16	8.80	4.40	2.93	2.20	1.76	1.47	1.26	1.10	0.98	0.88
3 1/2 x 3 x 5/16	3.64	1.82	1.28	0.96	0.77	0.64	0.55	0.48	0.43	0.38
3 1/2 x 2 1/2 x 11/16	5.28	2.64	1.76	1.32	1.06	0.88	0.75	0.66	0.59	0.53
3 1/2 x 2 1/2 x 1/4	2.19	1.09	0.73	0.55	0.44	0.36	0.31	0.27	0.24	0.22
3 x 2 1/2 x 9/16	4.37	2.19	1.46	1.09	0.87	0.73	0.62	0.55	0.49	0.44
3 x 2 1/2 x 1/4	2.13	1.07	0.71	0.53	0.43	0.36	0.30	0.27	0.24	0.21
2 1/2 x 2 x 1/2	2.45	1.23	0.82	0.61	0.49	0.41	0.35	0.31	0.27	0.25
2 1/2 x 2 x 3/16	1.07	0.53	0.36	0.27	0.21	0.18	0.15	0.13	0.12	0.11

Safe loads given include weight of angle. Maximum fiber stress, 16,000 lb. per sq. in. Neutral axis through center of gravity parallel to long leg.

Safe Loads in Tons (2000 Lb.) Uniformly Distributed for Standard Carnegie Angles with Unequal Legs.
(Long Leg Vertical.)

Size of Angle.	Distance between Supports in Feet.									
	1	2	3	4	5	6	7	8	9	10
6 x 4 x 1	42.77	21.39	14.26	10.69	8.55	7.13	6.11	5.35	4.75	4.28
6 x 4 x 3/8	17.71	8.85	5.90	4.43	3.54	2.95	2.53	2.21	1.97	1.77
6 x 3 1/2 x 1	41.76	20.88	13.92	10.44	8.35	6.96	5.97	5.22	4.64	4.18
6 x 3 1/2 x 3/8	17.33	8.67	5.78	4.33	3.47	2.89	2.48	2.17	1.93	1.73
5 x 3 1/2 x 7/8	26.03	13.01	8.68	6.51	5.21	4.34	3.72	3.25	2.89	2.60
5 x 3 1/2 x 5/16	10.35	5.18	3.45	2.59	2.07	1.73	1.48	1.29	1.15	1.04
5 x 3 x 13/16	23.73	11.87	7.91	5.93	4.75	3.96	3.39	2.97	2.64	2.37
5 x 3 x 5/16	10.08	5.04	3.36	2.52	2.02	1.68	1.44	1.26	1.12	1.01
4 x 3 x 13/16	15.31	7.65	5.10	3.83	3.06	2.55	2.19	1.91	1.70	1.53
4 x 3 x 5/16	6.56	3.28	2.19	1.64	1.31	1.10	0.94	0.82	0.73	0.66
3 1/2 x 3 x 13/16	11.73	5.87	3.91	2.93	2.35	1.96	1.68	1.47	1.30	1.17
3 1/2 x 3 x 5/16	5.12	2.56	1.71	1.28	1.02	0.85	0.73	0.64	0.57	0.51
3 1/2 x 2 1/2 x 11/16	9.87	4.93	3.29	2.47	1.97	1.64	1.41	1.23	1.10	0.99
3 1/2 x 2 1/2 x 1/4	4.00	2.00	1.33	1.00	0.80	0.67	0.57	0.50	0.44	0.40
3 x 2 1/2 x 9/16	6.13	3.07	2.04	1.53	1.23	1.02	0.88	0.77	0.68	0.61
3 x 2 1/2 x 1/4	2.99	1.50	1.00	0.75	0.60	0.50	0.43	0.37	0.33	0.30
2 1/2 x 2 x 1/2	3.73	1.87	1.24	0.93	0.75	0.62	0.53	0.47	0.41	0.37
2 1/2 x 2 x 3/16	1.55	0.77	0.52	0.39	0.31	0.26	0.22	0.19	0.17	0.16

Safe loads given include weight of angle. Maximum fiber stress, 16,000 lb. per sq. in. Neutral axis through center of gravity parallel to short leg.

Properties of Carnegie Z-Bars.

Depth of Web.	Width of Flange.	Thickness of Metal.	Weight per Foot.	Area of Section.	Mom. of Inertia, thro' C. of Gr. Perpendicular to Web.	Mom. of Inertia, thro' C. of Gr. Coincident with Web.	Section Modulus, thro' C. of Gr. Perpendicular to Web.	Section Modulus, thro' C. of Gr. Coincident with Web.	Radius of Gyration, Axis thro' C. of Gr. Perpendicular to Web.	Radius of Gyration, Axis thro' C. of Gr. Coincident with Web.	Least Radius, Axis Ding.	Coeff. of Strength for Fiber Stress of 12,000 lb. per sq. in., Axis Perpendicular to Web at Center.
in.	in.	n.	lb.	sq. in.	I	I	S	S	r	r	r	C
6	3 1/2	3/8	15.6	4.59	25.32	9.11	8.44	2.75	2.35	1.41	0.83	67,500
6 1/8	3 9/16	7/16	18.3	5.89	29.80	10.95	9.83	3.27	2.35	1.43	0.84	78,600
6 1/8	3 5/8	1/2	21.0	6.19	34.36	12.87	11.22	3.81	2.36	1.44	0.84	89,800
6	3 1/2	3/16	22.7	6.68	34.64	12.59	11.52	3.91	2.28	1.37	0.81	92,400
6 1/8	3 9/16	5/8	25.4	7.46	38.86	14.42	12.82	4.43	2.28	1.39	0.82	102,600
6 1/8	3 5/8	11/16	28.0	8.25	43.11	16.34	14.10	4.98	2.29	1.41	0.84	112,800
6	3 1/2	3/4	29.3	8.63	42.12	15.44	14.04	4.94	2.21	1.34	0.81	112,300
6 1/8	3 9/16	13/16	31.9	9.40	46.13	17.27	15.22	5.47	2.22	1.36	0.82	121,800
6 1/8	3 5/8	7/8	34.6	10.17	50.22	19.18	16.40	6.02	2.22	1.37	0.83	131,200
5	3 1/4	5/16	11.6	3.40	13.36	6.18	5.34	2.00	1.98	1.35	0.75	42,700
5 1/8	3 5/16	3/8	13.9	4.10	16.18	7.65	6.39	2.45	1.99	1.37	0.76	51,100
5 1/8	3 3/8	7/8	16.4	4.81	19.07	9.20	7.44	2.92	1.99	1.38	0.77	59,500
5	3 1/4	1/2	17.9	5.25	19.19	9.05	7.68	3.02	1.91	1.31	0.74	61,400
5 1/8	3 5/16	9/16	20.2	5.94	21.83	10.51	8.62	3.47	1.91	1.33	0.75	69,000
5 1/8	3 3/8	5/8	22.6	6.64	24.53	12.06	9.57	3.94	1.92	1.35	0.76	76,600
5	3 1/4	11/16	23.7	6.96	23.68	11.37	9.47	3.91	1.84	1.28	0.73	75,800
5 1/8	3 5/16	3/4	26.0	7.64	26.16	12.83	10.34	4.37	1.85	1.30	0.75	82,700
5 1/8	3 3/8	13/16	28.9	8.33	28.70	14.36	11.20	4.84	1.86	1.31	0.76	89,600
4	3 1/8	1/4	8.2	2.41	6.28	4.23	3.14	1.44	1.62	1.33	0.67	25,100
4 1/8	3 1/8	5/8	10.3	3.03	7.94	5.46	3.91	1.84	1.62	1.34	0.68	31,300
4 1/8	3 3/8	3/4	12.4	3.66	9.63	6.77	4.67	2.26	1.62	1.36	0.69	37,400
4	3 1/8	7/16	13.8	4.05	9.66	6.73	4.83	2.37	1.55	1.29	0.66	38,600
4 1/8	3 1/8	1/2	15.8	4.66	11.18	7.96	5.50	2.77	1.55	1.31	0.67	44,000
4 1/8	3 3/8	9/16	17.9	5.27	12.74	9.26	6.18	3.19	1.55	1.33	0.69	49,400
4	3 1/8	5/8	18.9	5.55	12.11	8.73	6.05	3.18	1.48	1.25	0.66	48,400
4 1/8	3 1/8	11/16	20.9	6.14	13.52	9.95	6.65	3.58	1.48	1.27	0.67	53,200
4 1/8	3 3/8	3/4	23.0	6.75	14.97	11.24	7.26	4.00	1.49	1.29	0.69	58,100
3	2 1/16	1/4	6.7	1.97	2.87	2.81	1.92	1.10	1.21	1.19	0.55	15,400
3 1/8	2 3/4	5/16	8.4	2.48	3.64	3.64	2.38	1.40	1.21	1.21	0.56	19,000
3	2 1/16	7/16	11.7	3.86	4.85	4.93	2.98	1.57	1.16	1.17	0.55	2,6000
3 1/8	2 3/4	3/4	14.2	4.18	5.26	5.70	3.43	1.88	1.17	1.19	0.56	23,800
3	2 1/16	1/2	12.5	3.69	4.59	4.85	3.06	1.99	1.12	1.15	0.56	24,500
3 1/8	2 3/4	9/16	14.2	4.18	5.26	5.70	3.43	2.31	1.12	1.17	0.56	27,400

WARNING: This is a 1910 edition. Some of the material may no longer be accurate.

Dimensions of 6, 8, and 10-Inch Carnegie Z-Bar Columns.

Thickness of Metal.	A.			B.			C.			D.		
	6 in.	8 in.	10 in.	6 in.	8 in.	10 in.	6 in.	8 in.	10 in.	6 in.	8 in.	10 in.
1/4	12 3/4	15 5/16	...	3 1/8	4 1/8	...	5 9/16	6 7/16	...	3 1/8	3 5/8	...
5/16	12 7/8	15 3/8	16 11/16	3 7/32	4 7/32	5 5/32	5 9/16	6 7/16	6 9/16	3 1/8	3 5/8	3 5/8
3/8	12 5/8	15 1/2	16 13/16	3 3/16	4 5/16	5 1/4	5 7/16	6 7/16	6 9/16	3 1/8	3 5/8	3 5/8
7/16	12 11/16	15 1/16	16 15/16	3 9/32	4 7/32	5 11/32	5 7/16	6 1/4	6 9/16	3 1/8	3 5/8	3 5/8
1/2	12 7/16	15 3/16	16 1/2	3 1/4	4 5/16	5 1/4	5 5/16	6 1/4	6 3/8	3 1/8	3 5/8	3 5/8
9/16	12 9/16	15 5/16	16 5/8	3 11/32	4 13/32	5 11/32	5 5/16	6 1/4	6 3/8	3 1/8	3 5/8	3 5/8
5/8	...	14 7/8	16 3/4	...	4 5/16	5 7/16	...	6 1/16	6 3/8	...	3 5/8	3 5/8
11/16	...	15	16 3/8	...	4 13/32	5 11/32	...	6 1/16	6 3/16	...	3 5/8	3 5/8
3/4	...	15 1/8	16 1/2	...	4 1/2	5 7/16	...	6 1/16	6 3/16	...	3 5/8	3 5/8
13/16	16 5/8	5 17/32	6 3/16	3 5/8

6-in. col. { 4 Z-bars, 3-3 1/16 in. deep,
1 web plate 6 in. X thick. of Z-bars.

8-in. col. { 4 Z-bars, 4-4 1/8 in. deep,
1 web plate 7 in. X thick. of Z-bars.

10-in. col. { 4 Z-bars, 5-5 1/8 in. deep,
1 web plate 7 in. X thick. of Z-bars.

All rivets or bolts 3/4 inch diameter.

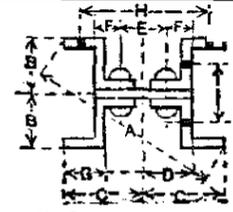

Dimensions of 14-Inch Carnegie Z-Bar Columns.

Thickness of Side Plates.	A. Inches.				B. Inches.				All sizes of Z-bars. C = 1 1/2 in. D = 1 1/2 in.
	6 1/8 X 11/16 in. Z-bars.	6 X 3/4 in. Z-bars.	6 1/16 X 13/16 in. Z-bars.	6 1/8 X 7/8 in. Z-bars.	6 1/8 X 11/16 in. Z-bars.	6 X 3/4 in. Z-bars.	6 1/16 X 19/16 in. Z-bars.	6 1/8 X 7/8 in. Z-bars.	
3/8	19 9/16	19 7/16	19 9/16	19 3/4	6 27/32	6 3/4	6 27/32	6 15/16	
7/16	19 11/16	19 1/2	19 5/8	19 13/16	6 29/32	6 13/16	6 29/32	7	
1/2	19 3/4	19 5/8	19 3/4	19 7/8	6 31/32	6 7/8	6 31/32	7 1/16	
9/16	19 7/8	19 3/4	19 7/8	20	7 1/32	6 15/16	7 1/32	7 1/8	
5/8	19 15/16	19 13/16	19 15/16	20 1/16	7 3/32	7	7 3/32	7 3/16	
11/16	20 1/16	19 7/8	20 1/16	20 1/8	7 5/32	7 1/16	7 5/32	7 1/4	
3/4	20 1/8	20	20 1/8	20 1/4	7 7/32	7 1/8	7 7/32	7 5/16	
13/16	20 1/4	20 1/16	20 3/16	20 5/16	7 9/32	7 3/16	7 9/32	7 3/8	
7/8	20 5/16	20 1/8	20 1/4	20 7/16	7 11/32	7 1/4	7 11/32	7 7/16	

1 Web Plate, 8 in. X thick. of Z-bars.
2 Side Plates 14 in. wide 4 Z-bars.

Notes on Tables of Z-Bar and Channel Columns.

(Carnegie Steel Co., 1903.)

The tables of safe loads for steel Z-bar and channel columns are compiled on the basis of an allowable stress per square inch of 13,000 pounds, with a factor of safety of 4 for lengths of 90 radii and under and an allowable stress deduced from the formula $17,100 - 57l \div r$ for lengths greater than 90 radii: l = length in feet; r = radius of gyration in inches. Calculations are made by means of Gordon's formula, modified for steel. The values used in these tables should be used only where the loads are mostly statical and equal or nearly so on opposite sides of the column. If the eccentricity is great or the load subject to sudden changes the values should be reduced according to circumstances. The safe loads given in the tables on channel columns range in value from $l \div r = 90$ to about $l \div r = 125$. The size and spacing of lattice bars of channel columns should be proportioned to the sections composing the column. They should not be less than 1 1/2 inch X 5/16 inch for 6-inch channels; 1 3/4 X 5/16 inch for 7- and 8-inch channels; 2 X 5/16 inch for 9- and 10-inch channels; 2 X 3/8 inch for 12-inch channels.

Sale Loads in Tons (2000 Lb.) on Carnegie Z-Bar Columns (Square Ends).

Dimensions and form of columns given in tables, p. 300.

6-INCH Z-BAR COLUMN.

Length of Col. Feet.	Thickness of Metal, Inch.									
	1/4	5/16	3/8	7/16	1/2	9/16	5/8	11/16	3/4	13/16
r (min)	1.86	1.90	1.88	1.93	1.90	1.95				
12 and under	55.9	70.3	81.61	95.8	105.7	119.8				
14	55.7	70.3	81.6	95.8	105.7	119.8				
16	52.3	66.5	76.6	91.3	99.9	114.8				
18	48.8	62.3	71.7	85.6	93.6	107.8				
20	45.4	58.1	66.7	79.9	87.2	100.8				
22	42.0	53.9	61.8	74.3	80.9	93.8				
24	38.6	49.7	56.9	68.6	74.6	86.8				
26	35.2	45.5	51.9	63.0	68.2	79.8				
28	31.7	41.3	47.0	57.3	61.9	72.0				
30	28.3	37.1	42.0	51.7	55.5	65.8				

S-INCH Z-BAR COLUMN.

r (min)	2.47	2.52	2.57	2.49	2.55	2.60	2.52	2 5/8	2.63
18 and under	67.5	84.8	102.4	114.2	131.2	148.5	157.5	174.3	191.2
20	65.0	82.5	100.5	110.5	128.2	146.4	153.3	171.3	189.6
22	61.9	78.7	95.9	105.3	122.4	139.9	146.2	163.5	181.3
24	58.8	74.8	91.3	100.1	116.5	133.4	139.1	155.8	173.0
26	55.7	71.0	86.8	94.8	110.6	126.9	132.0	148.1	164.7
28	52.6	67.1	82.3	89.6	104.7	120.3	124.8	140.4	156.4
30	49.4	63.3	77.7	84.4	98.8	113.8	117.7	132.7	148.2
32	46.3	59.5	73.2	79.2	93.0	107.3	110.6	125.0	139.9
34	43.2	55.6	68.7	74.0	87.1	100.8	103.5	117.3	131.6
36	40.1	51.8	64.1	68.7	81.2	94.3	96.4	109.6	123.3
38	37.0	48.0	59.6	63.5	75.3	87.8	89.4	101.9	115.0
40	33.9	44.1	55.0	58.3	69.5	81.3	82.2	94.2	106.7

WARNING: This is a 1910 edition. Some of the material may no longer be accurate

Safe Loads in Tons (2000 Lb.) on Carnegie Z-Bar Columns (Square Ends). (Continued)

10-INCH Z-BAR COLUMN.

r (min.) =	3.08	3.13	3.18	3.10	3.15	3.21	3.13	3.18	3.25
22 and under	94.7	114.2	133.9	147.0	166.2	185.6	196.0	214.9	234.0
24	92.8	112.6	133.1	144.6	164.8	185.3	193.6	213.9	234.0
26	89.3	108.6	128.3	139.2	158.7	178.7	186.5	206.2	226.6
28	85.8	104.4	123.5	133.8	152.7	172.1	179.3	198.5	218.4
30	82.3	100.2	118.7	128.4	146.7	165.5	172.2	190.8	210.2
32	78.8	96.1	113.8	123.0	140.7	158.9	165.0	183.1	202.0
34	75.3	91.9	109.1	117.6	134.7	152.3	157.9	175.4	193.8
36	71.8	87.8	104.3	112.2	128.7	145.7	150.7	167.8	185.6
38	68.3	83.6	99.5	106.8	122.7	139.1	143.6	160.0	177.4
40	64.8	79.4	94.7	101.4	116.7	132.5	136.5	152.3	169.1
42	61.3	75.3	89.9	96.0	110.6	125.9	129.4	144.6	160.9
44	57.7	71.1	85.1	90.6	104.6	119.3	122.2	136.9	152.7
46	54.2	67.0	80.3	85.2	98.6	112.7	115.1	129.2	144.5
48	50.7	62.8	75.5	79.8	92.6	106.1	107.9	121.5	136.3
50	47.2	58.6	70.7	74.4	86.6	99.5	100.8	113.8	128.1

Safe Load in Tons (2000 Lb.) on 14-Inch Carnegie Z-Bar Columns (Square Ends).

Dimensions and form of column given in table. p. 300.

Section: 4 Z-bar $6\frac{1}{8} \times 11\frac{1}{16}$ in. 1 Web Plate $8 \times 11\frac{1}{16}$ in. 2 Side Plate 14 in. wide.

Length of Column in Feet.	$14 \times 3/8$ Plates = 166.6 lb. = 49.0 sq. in.	$14 \times 7/16$ Plates = 172.6 lb. = 50.8 sq. in.	$14 \times 1/2$ Plates = 178.5 lb. = 52.5 sq. in.	$14 \times 9/16$ Plates = 184.5 lb. = 54.3 sq. in.	$14 \times 5/8$ Plates = 190.4 lb. = 56.0 sq. in.	$14 \times 11/16$ Plates = 196.4 lb. = 57.8 sq. in.	$14 \times 3/4$ Plates = 202.3 lb. = 59.5 sq. in.	$14 \times 13/16$ Plates = 208.4 lb. = 61.3 sq. in.	$14 \times 7/8$ Plates = 214.2 lb. = 63.0 sq. in.
r (min.) =	3.80	3.81	3.82	3.82	3.63	3.84	3.85	3.85	3.85
28 and under	294.0	304.5	315.0	325.5	336.0	346.5	357.0	367.5	378.0
30	286.6	297.2	307.7	318.3	328.9	339.5	350.0	360.4	370.9
32	277.8	288.1	298.3	308.6	318.9	329.2	339.4	349.5	359.7
34	269.0	278.9	288.9	298.9	308.9	318.9	328.8	338.6	348.6
36	260.1	269.8	279.5	289.2	298.9	308.6	318.2	327.7	337.4
38	251.3	260.7	270.1	279.5	289.0	298.3	307.6	316.8	326.2
40	242.5	251.6	260.7	269.7	278.9	288.0	297.0	306.0	315.0
42	233.7	242.5	251.3	260.1	269.0	277.8	286.4	295.1	303.8
44	224.9	233.3	241.9	250.4	258.9	267.4	275.8	284.2	292.3
46	216.0	224.3	232.4	240.7	249.0	257.2	265.2	273.3	281.6
48	207.2	215.1	223.0	230.9	238.9	246.9	254.6	262.4	270.5
50	198.4	206.0	213.6	221.3	229.0	236.5	244.0	251.5	259.1

Safe Load in Tons (2000 Lb.) on 14-Inch Carnegie Z-Bar Columns (Square Ends). (Continued)

Section: 4 Z-bars $6 \times 3/4$ in. 1 Web Plate $8 \times 3/4$ in. 2 Side Plates 14 in. wide.

Length of Column in Feet.	$14 \times 3/8$ Plates = 173.4 lb. = 51.0 sq. in.	$14 \times 7/16$ Plates = 179.4 lb. = 52.8 sq. in.	$14 \times 1/2$ Plates = 185.3 lb. = 54.5 sq. in.	$14 \times 9/16$ Plates = 191.4 lb. = 56.3 sq. in.	$14 \times 5/8$ Plates = 197.2 lb. = 58.0 sq. in.	$14 \times 11/16$ Plates = 203.2 lb. = 59.8 sq. in.	$14 \times 3/4$ Plates = 209.1 lb. = 61.5 sq. in.	$14 \times 13/16$ Plates = 215.1 lb. = 63.3 sq. in.	$14 \times 7/8$ Plates = 221.0 lb. = 65.0 sq. in.
r (min.) =	3.75	3.76	3.77	3.78	3.79	3.80	3.80	3.81	3.82
28 and under	306.0	316.5	327.0	337.5	348.0	358.5	369.0	379.5	390.0
30	296.7	307.2	317.8	328.3	338.9	349.4	359.9	370.5	381.1
32	287.4	297.6	307.9	318.2	328.4	338.7	348.9	359.1	369.4
34	278.1	288.0	298.0	308.0	318.0	327.9	337.8	347.8	357.8
36	268.8	278.4	288.2	297.9	307.4	317.2	326.8	336.4	346.1
38	259.5	268.8	278.3	287.7	297.0	306.4	315.7	325.1	334.5
40	250.2	259.3	268.4	277.5	286.5	295.6	304.7	313.7	322.8
42	240.9	249.7	258.5	267.3	276.1	284.8	293.6	302.4	311.2
44	231.6	240.1	248.6	257.1	265.6	274.1	282.5	291.0	299.6
46	222.4	230.5	238.7	246.9	255.1	263.4	271.5	279.7	287.9
48	213.0	220.9	228.13	236.6	244.7	252.6	260.4	268.3	276.2
50	203.7	211.3	219.0	226.6	234.2	241.8	249.4	257.0	264.6

Section: 4 Z-bars $6\frac{1}{16} \times 13\frac{1}{16}$ in. 1 Web Plate $8 \times 13\frac{1}{16}$ in. 2 Side Plates 14 in. wide.

Length of Column in Feet.	$14 \times 1/8$ Plates = 185.6 lb. = 54.6 sq. in.	$14 \times 7/16$ Plates = 191.5 lb. = 56.3 sq. in.	$14 \times 1/2$ Plates = 197.5 lb. = 58.1 sq. in.	$14 \times 9/16$ Plates = 203.4 lb. = 59.8 sq. in.	$14 \times 5/8$ Plates = 209.4 lb. = 61.6 sq. in.	$14 \times 11/16$ Plates = 215.3 lb. = 63.3 sq. in.	$14 \times 3/4$ Plates = 221.3 lb. = 65.1 sq. in.	$14 \times 13/16$ Plates = 227.2 lb. = 66.8 sq. in.	$14 \times 7/8$ Plate = 233.2 lb. = 68.6 sq. in.
(min.) =	3.73	3.74	3.75	3.76	3.77	3.78	3.78	3.79	3.80
26 and under	327.5	338.0	348.5	359.0	369.5	380.0	390.5	401.0	411.5
28	326.7	337.2	347.7	358.2	368.7	379.2	389.7	400.2	410.7
30	316.7	327.2	337.7	348.2	358.7	369.2	379.7	390.2	400.7
32	306.6	317.1	327.6	338.1	348.6	359.1	369.6	380.1	390.6
34	296.6	307.1	317.6	328.1	338.6	349.1	359.6	370.1	380.6
36	286.7	297.2	307.7	318.2	328.7	339.2	349.7	360.2	370.7
38	276.7	287.2	297.7	308.2	318.7	329.2	339.7	350.2	360.7
40	266.6	277.1	287.6	298.1	308.6	319.1	329.6	340.1	350.6
42	256.6	267.1	277.6	288.1	298.6	309.1	319.6	330.1	340.6
44	246.6	257.1	267.6	278.1	288.6	299.1	309.6	320.1	330.6
46	236.6	247.1	257.6	268.1	278.6	289.1	299.6	310.1	320.6
48	226.7	237.2	247.7	258.2	268.7	279.2	289.7	300.2	310.7
50	216.6	227.1	237.6	248.1	258.6	269.1	279.6	290.1	300.6

WARNING: This is a 1910 edition. Some of the material may no longer be accurate

Safe Load in Tons (2000 Lb.) on 14-Inch Carnegie Z-Bar Columns (Square Ends). (Continued)

Section: 4 Z-bars 6 1/8 x 7/8 in. 1 Web Plate 8 x 7/8 in. 2 Side Plates 14 in. wide.

Length of Column in Feet.	14 x 3/8 Plates = 197.8 lb. = 58.2 sq. in.		14 x 7/16 Plates = 203.8 lb. = 59.9 sq. in.		14 x 1/2 Plates = 209.7 lb. = 61.7 sq. in.		14 x 9/16 Plates = 215.7 lb. = 63.4 sq. in.		14 x 5/8 Plates = 221.6 lb. = 65.2 sq. in.		14 x 11/16 Plates = 227.6 lb. = 66.9 sq. in.		14 x 3/4 Plates = 233.5 lb. = 68.7 sq. in.		14 x 13/16 Plates = 239.5 lb. = 70.4 sq. in.		14 x 7/8 Plates = 245.4 lb. = 72.2 sq. in.	
	r (min.) =																	
26 and under	349.1	359.1	370.1	380.6	391.1	401.1	412.1	422.6	433.1									
28	347.4	358.1	369.1	380.0	390.5	401.1	412.1	422.6	433.1									
30	336.7	347.1	357.9	368.4	378.5	389.1	400.1	410.7	421.2									
32	326.0	336.1	346.6	356.8	367.1	377.1	387.1	397.1	408.2									
34	315.3	325.1	335.2	345.2	355.1	365.1	375.2	385.1	395.1									
36	304.5	314.1	324.1	333.6	343.1	353.1	362.7	372.4	382.0									
38	293.8	303.1	312.6	322.0	331.1	340.1	350.2	359.1	369.0									
40	283.1	292.1	301.3	310.4	319.1	328.1	337.7	346.8	355.9									
42	272.3	281.1	290.0	298.8	307.1	316.1	325.2	334.0	342.8									
44	261.6	270.1	278.7	287.2	295.1	304.1	312.7	321.2	329.8									
46	250.9	259.1	267.4	275.6	283.1	292.1	300.3	308.5	316.7									
48	240.2	248.1	256.1	264.0	272.1	279.1	287.8	295.7	303.6									
50	229.5	237.1	244.8	252.4	260.1	267.1	275.3	283.0	290.6									

Dimensions of and Safe Loads on Carnegie Channel Columns, Tons (2000 Lb.).

Column comprises 2 Channels Latticed or with 2 Side Plates. (Square Ends.)

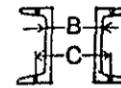

Depth of Channel, inches.	Wt. of Channel, lb. per ft.	Width of Side Pl., inches.	B-inches.	C-inches.	Length of Col., Feet.	Safe Load in Tons (2000 Lb.)																
						Latticed.	1/4 Plates.	5/16 Plates.	3/8 Plates.	7/16 Plates.	1/2 Plates.	9/16 Plates.	5/8 Plates.	11/16 Plates.	3/4 Plates.							
8	8	37/8	53/4	r =	2.33	2.32	2.32	2.32	2.32	2.32	2.32	2.32	2.32	2.32	2.32	2.32	2.32	2.32				
					16	28.6	52.6	50.6	64.6	70.6	76.6	82.6	88.6	94.6		
					18	25.1	51.7	57.5	63.4	69.3	75.2	81.1	87.0	92.9	
					20	26.7	49.1	54.7	60.3	65.0	71.4	77.0	82.6	88.2	
					22	25.3	46.5	51.8	57.1	62.4	67.7	73.0	78.3	83.5	
					24	23.9	43.9	48.9	53.9	58.9	63.9	68.9	73.9	78.9
					15.5	8	37/8	53/4	r =	2.00	2.12	2.13	2.14	2.15	2.16	2.17	2.18	2.18
					14	54.7	84.7	90.7
					16	53.0	84.2	90.4	96.7	102.7	108.7	114.7	120.7	126.7
					18	49.9	79.7	85.6	91.5	97.4	103.3	109.2	115.1	121.0
20	46.8	75.1	80.7	86.4	92.0	97.6	103.2	108.8	114.4					
22	43.7	70.5	75.9	81.2	86.5	91.8	97.1	102.5	107.8					
10	10	51/2	71/2	r =	3.11	3.03	3.02	3.01	3.00	2.99	2.96	2.98	2.97				
					22	40.2	70.2	77.8	85.2	92.7	100.2	107.7	115.2	122.7	
					24	39.6	68.4	75.5	82.7	89.8	97.0	104.1	111.2	118.4	
					26	38.1	65.7	72.6	79.4	86.3	93.1	100.1	106.8	113.7	
					28	36.6	63.1	69.7	76.2	82.8	89.3	95.9	102.4	109.0	
					30	35.2	60.5	66.7	73.0	79.2	85.5	91.8	98.0	104.2	
					21 1/4	10	51/2	71/2	r =	2.77	2.83	2.84	2.84	2.84	2.84	2.84	2.85	2.85
					20	75.0	135.0	142.5	150.0	157.5	165.0	172.5	180.0	187.5
					22	72.9	132.6	140.0	147.5	154.9	162.3	169.8	177.2	184.7
					24	69.8	127.2	134.3	141.5	148.6	155.7	162.9	170.0	177.1
26	66.7	121.7	128.6	135.4	142.3	149.1	155.9	162.8	169.6					
28	63.7	116.3	122.9	129.4	136.0	142.5	149.0	155.6	162.1					
15	15	7	9 1/2	r =	3.87	3.74	3.72	3.70	3.68	3.67	3.65	3.64	3.63				
					26	...	107.5	116.5	125.5	134.5	143.5	152.5	161.5		
					28	53.5	98.5	107.0	115.7	124.4	133.1	141.8	150.5	159.2		
					30	52.6	95.3	103.7	112.2	120.5	128.9	137.3	145.7	154.2		
					32	51.0	92.3	100.4	108.6	116.7	124.8	132.9	141.0	149.1		
					34	49.5	89.3	97.1	105.0	112.8	120.6	128.4	136.2	144.0		
					36	47.9	86.3	93.8	101.4	108.9	116.4	123.9	131.4	139.0		
					38	46.3	83.3	90.5	97.8	105.0	112.2	119.4	126.7	133.9		
					35	12	7	9 1/2	r =	3.35	3.45	3.45	3.45	3.45	3.45	3.45	3.45	3.45
					24	123.5	240.5	249.5	258.5	267.5	276.5	285.5	294.5	303.5	312.5	321.5	330.5	
26	121.8	239.3	248.2	257.2	266.2	275.2	284.1	293.1	302.1	311.1	320.1	329.1						
28	117.1	231.3	240.0	248.7	257.3	265.9	274.7	283.5	292.3	301.1	310.0	318.9						
30	112.9	223.3	231.7	240.1	248.5	256.9	265.3	273.7	282.1	290.5	298.9	307.3						
32	108.7	215.4	223.5	231.6	239.6	247.6	255.6	263.6	271.6	279.6	287.6	295.6						
34	104.5	207.4	215.2	223.0	230.8	238.6	246.4	254.2	262.0	269.8	277.6	285.4						
36	100.3	199.5	207.0	214.5	222.0	229.5	237.0	244.5	252.0	259.5	267.0	274.5						

To above weights of column shaft add weights of rivets and lattice bars.

Dimensions of and Safe Loads on Carnegie Channel Columns, Tons (2000 Lb.).

Column comprises 2 Channels Latticed or with 2 Side Plates. (Square Ends.)

Depth of Channel, Inches.	Wt. of Channel, lb. per ft.	Width of Side Pl., Inches.	B-inches.	C-inches.	Length of Col., Feet.	Plates.													
						Latticed.	1/4	5/16	3/8	7/16	1/2	9/16	5/8	11/16	3/4				
12	20 1/2	14	8 1/4	11 1/4	r =	4.61		4.40	4.38	4.35	4.33	4.32	4.30	4.29	4.27				
					32			124.9	135.4	145.9	156.4	166.9	177.4	187.9	198.4				
					34	72.4	...	123.0	133.0	142.9	152.9	162.8	172.8	182.8	192.7				
					36	70.9	...	119.7	129.4	139.1	148.8	158.4	168.1	177.8	187.4				
					38	69.1	...	116.5	125.9	135.3	144.6	154.0	163.4	172.8	182.1				
					40	67.3	...	113.3	122.4	131.5	140.5	149.6	158.7	167.8	176.0				
					42	65.5	...	110.0	118.8	127.6	136.4	145.2	154.0	162.8	171.5				
					44	63.7	...	106.8	115.3	123.8	132.3	140.8	149.3	157.8	166.2				
					12	40	14	8 1/4	11 1/4	r =	4.09	4.12	4.11	4.11	4.11	4.10	4.10	4.10	4.09
										30	141.1	277.6	288.1	298.6	309.1	330.1	351.1	372.1	393.1
32	138.2	272.6	282.8	293.0						303.2	323.7	344.1	364.6	385.0					
34	134.2	264.9	274.8	284.8						294.7	314.15	334.4	354.2	374.1					
36	130.3	257.2	266.8	276.5						286.1	305.4	324.6	343.9	363.1					
38	126.3	249.5	258.8	268.2						277.5	296.2	314.9	333.5	352.2					
40	122.4	241.8	250.9	259.9						268.9	287.0	305.1	323.2	341.3					
42	118.5	234.1	242.9	251.5						259.3	277.1	295.3	312.8	330.3					

To above weights of column shaft, add weights of rivets and lattice bars.

Bethlehem "Special," "Girder" and "H" Steel Beams. These beams are rolled on the Grey universal beam mill, and have wider flanges than the standard American forms of I-beams, which are rolled in grooved rolls. The special I-beams from 8 to 24 in. in depth have the same section modulus or coefficient of strength as the standard forms, but on account of putting a larger proportion of metal in the flanges they are 10% lighter. For equal weights of sections they have a coefficient of strength about 5% greater than the standard shapes. The 26, 28 and 30-in. beams are respectively equal in coefficient of strength to two 20-in. 6.5 lb., two 20-in. 80 lb., and two 24-in. 80 lb. standard beams.

The girder beams from 8 to 24 in. in depth have a coefficient of strength equal to that of two standard I-beams of minimum weight of the same depth, but weigh 12 1/2% less than the two combined.

The rolled H, or column sections are designed especially for columns of buildings. All shapes having the same section number are rolled from the same main rolls without change. Thus the 12-in. H column is rolled in 3.5 different weights, the sectional areas ranging from 11.76 to 79.06 sq. in.

The flanges of the special and girder beams have a uniform slope of 12 1/2%, and the flanges of the H sections a uniform slope of 2%.

The tables of special and girder beams give the sections and weights usually rolled. Intermediate and heavier weights may be obtained by special arrangement. The table of H columns gives only the minimum and maximum weights for each section number. Many intermediate weights are regularly made.

The coefficients of strength given in the tables are based on a maximum fiber stress of 16,000 lb. per sq. in., which is allowable for quiet loads, as in buildings. For moving loads the fiber stress of 12,500 lb. per sq. in. should be used, and the coefficients reduced proportionately. For suddenly applied loads, as in railroad bridges, they should be still further reduced. For a fiber stress of 8000 lb. per sq. in. the coefficients would be one half those given in the tables.

For further information see handbook of Structural Steel Shapes, Bethlehem Steel Co., South Bethlehem, Pa., 1907.

PROPERTIES OF BETHLEHEM GIRDER BEAMS.

Depth of Beam, Inches.	Weight per Foot, Pounds.	Area of Section, Square Inches.	Thickness of Web, Inch.	Width of Flange, Inches.	Neutral Axis Perpendicular to Web at Center.			Coefficients of Strength for Fiber Stress of 16,000 Lbs. per Sq. In. for Buildings.	Maximum Safe Shear on Web, in Tons of 2000 Lbs.	Neutral Axis Coincident with Center Line of Web.	
					Moment of Inertia, I	Radius of Gyration, r	Section Modulus, S			Moment of Inertia, I'	Radius of Gyration, r'
30	200.	58.85	.75	15.00	9154.7	12.47	610.3	6,510,000	95.2	599.7	3.19
30	175. a	51.35	.68	12.00	7851.81	12.37	523.5	5,583,500	81.1	346.4	2.60
28	180.0	52.98	.69	14.35	7269.0	11.72	519.2	5,538,200	81.3	507.6	3.09
28	162.5	47.81	.65	12.00	6465.1	11.63	461.8	4,925,800	73.8	320.2	2.62
26	160.0	47.00	.63	13.60	5618.7	10.93	432.2	4,610,200	68.3	414.5	2.97
26	150.0	44.13	.62	12.00	5200.4	10.86	400.0	4,267,000	66.6	306.5	2.63
24	140.0	41.03	.56	13.00	4241.9	10.17	353.5	3,770,700	54.9	338.3	2.87
24	120.0	35.31	.51	12.00	3630.7	10.14	302.6	3,227,200	44.5	240.0	2.61
20	140.0	41.28	.64	12.50	2938.3	8.44	293.8	3,134,200	62.4	334.3	2.05
20	112.0	32.88	.52	12.00	2368.9	8.49	236.9	2,526,700	45.6	232.0	2.66
18	92.0	27.09	.47	11.50	1595.3	7.67	177.3	1,890,800	37.1	172.4	2.52
15	140.0	41.28	.80	11.75	1591.5	6.21	212.2	2,263,500	67.3	319.2	2.70
15	104.0	30.58	.60	11.25	1219.7	6.32	162.6	1,734,700	47.4	203.3	2.58
15	73.0	21.52	.42	10.50	886.5	6.42	118.2	1,260,900	28.8	116.6	2.33
12	70.0	20.60	.445	10.00	540.9	5.12	90.2	961,600	28.0	109.5	2.31
12	55.0	16.12	.35	9.75	452.0	5.18	72.0	768,000	19.7	76.1	2.17
10	44.0	12.95	.30	9.00	244.3	4.34	48.9	521,200	14.3	53.6	2.03
9	38.0	11.18	.29	8.50	169.8	3.90	37.7	402,500	12.8	40.7	1.91
8	32.5	9.52	.28	8.00	113.9	3.46	28.5	303,800	11.4	30.3	1.78

W = Safe load in pounds uniformly distributed including weight of beam
 L = Span in feet. M = Moment of forces in foot-pounds. f = fiber stress.
 W = C/L; M = C/8; C = WL = 8M = 2/3 fS.

WARNING: This is a 1910 edition. Some of the material may no longer be accurate

Properties of Bethlehem Special I Beams.

Depth of Beam, Inches.	Weight per Foot, Pounds.	Area of Section, Square Inches.	Thickness of Web, Inch.	Width of Flange, Inches.	Neutral Axis Perpendicular to Web at center.			Coefficients of Strength for Fiber Stress of 16,000 Lbs. per Sq. In. for Buildings.	Maximum Safe Shear on Web, in Tons of 2000 Lbs.	Neutral Axis Coincident with Center Line of Web.	
					Moment of Inertia, I	Radius of Gyration, r	Section Modulus, S			Moment of Inertia, I	Radius of Gyration, r
30	120.0	35.25	.52	10.00	5271	12.23	351.4	3,748,200	48.7	149.7	2.11
28	105.0	31.04	.48	9.60	4089	11.43	292.1	3,115,700	41.5	122.6	1.98
26	90.0	26.63	.44	9.15	3043	10.71	234.1	2,496,900	34.9	93.4	1.87
24	84.0	24.79	.45	8.85	2392	9.82	199.3	2,125,900	36.3	82.0	1.82
24	82.0	24.33	.50	8.83	2240	9.60	186.7	1,991,600	43.8	71.1	1.71
24	72.0	21.21	.37	8.70	2091	9.93	174.2	1,858,100	24.4	67.7	1.79
20	82.0	24.23	.57	8.51	1561	8.03	156.1	1,665,400	51.5	71.5	1.72
20	72.0	21.43	.43	8.37	1468	8.28	144.8	1,565,800	32.7	67.6	1.78
20	68.0	19.95	.49	7.69	1270	7.98	127.0	1,354,600	40.4	45.7	1.51
20	63.0	18.55	.42	7.62	1223	8.12	122.3	1,304,500	31.1	44.3	1.54
20	60.0	17.65	.37	7.58	1193	8.22	119.3	1,272,600	25.3	43.4	1.57
20	58.5	17.15	.35	7.55	1176	8.28	117.6	1,254,800	22.2	43.0	1.58
18	58.5	17.29	.48	7.47	883	7.15	98.2	1,047,500	37.4	35.9	1.44
18	52.5	15.40	.37	7.37	832	7.35	92.5	987,200	24.8	34.4	1.49
18	48.5	14.23	.31	7.30	801	7.50	89.0	949,800	17.4	33.4	1.53
15	72.0	21.27	.54	7.15	797	6.13	106.4	1,134,800	41.2	55.11	1.61
15	64.0	18.85	.60	7.20	666	5.95	88.9	948,100	46.6	40.8	1.47
15	54.0	15.85	.40	7.00	610	6.21	81.4	868,100	26.5	37.2	1.53
15	46.0	13.46	.43	6.81	484	5.99	64.6	689,200	29.1	24.2	1.34
15	42.0	12.4	.36	6.74	464	6.12	62.0	661,200	22.1	23.4	1.37
15	38.0	11.21	.28	6.66	442	6.28	59.0	629,200	14.2	22.5	1.42
12	36.0	10.6	.31	6.30	270	5.04	45.0	480,300	16.2	20.41	1.38
12	31.0	9.13	.31	6.16	225	4.97	37.5	400,300	16.0	14.7	1.27
12	28.5	8.4	.25	6.10	216	5.07	36.1	385,000	11.2	14.2	1.30
10	27.5	8.05	.34	5.94	134	4.09	26.9	287,300	16.7	11.7	1.20
10	24.5	7.15	.25	5.85	127	4.22	25.4	271,300	10.6	11.1	1.24
10	22.5	6.65	.20	5.80	122	4.27	24.6	262,000	7.3	10.8	1.27
9	23.0	6.75	.31	5.50	92	3.70	20.5	219,100	13.8	a.5	1.12
9	21.0	6.2	.25	5.44	88	3.78	19.7	210,300	10.0	a.2	1.15
9	19.0	5.6	.19	5.38	85	3.87	18.9	201,800	6.5	7.9	1.18
8	21.25	6.25	.36	5.37	64	3.22	16.2	172,500	15.3	6.8	1.05
8	18.00	5.37	.25	5.26	60	3.34	15.0	160,000	9.5	6.4	1.09
8	16.25	4.81	.18	5.19	57	3.44	14.3	152,000	5.7	6.1	1.12

W = Safe load in pounds uniformly distributed including weight of beam.
 L = Span in feet. M = Moment of forces in foot-pounds. f = fiber stress.
 C = Coefficients given in the table.
 W = C/L; M = C/Y; C = WL = 8M = 2/3 fS.

WARNING: -This is a 1910 edition. Some of the material may no longer be accurate

Dimensions and Properties of Bethlehem Rolled Steel.
 14-Inch H Columns.

Table greatly condensed from original.*

Section Number.	Weight of Section, Lbs. per Foot.	Dimensions in Inches.				Area of Section, Square Inches.	Axis Perpen. to Web.			Axis Center of Web.		
		Depth.	Mean Thickness of Flange.	Breadth of Flange.	Thickness of Web.		Moment of Inertia.	Section Modulus.	Radius of Gyration.	Moment of Inertia.	Section Modulus.	Radius of Gyration.
H14s	42.6	13 3/8	1/2	8.00	0.33	12.5	400.8	59.9	5.66	43.6	10.9	1.87
	93.7	14	13/16	13.00	.51	27.5	1004.7	143.5	6.04	288.5	44.4	3.24
H14	98.8	14	13/16	14.00	.51	29.01	1070.6	153.0	6.07	355.9	50.8	3.50
	162.2	15	1 5/16	14.31	.82	47.7	1894.0	252.5	6.31	625.1	87.4	3.62
H14a	164.4	15	1 5/16	14.57	.82	48.3	1924.7	256.6	6.32	659.8	90.5	3.69
	222.3	15 7/8	1 3/4	14.84	1.09	65.3	2774.5	349.5	6.51	936.6	126.2	3.78
H14b	230.8	16	1 13/16	14.88	1.13	67.8	2905.9	363.2	6.55	978.7	131.1	3.80
	291.2	16 7/8	2 1/4	15.16	1.41	85.6	3897.7	462.0	6.75	1290.7	170.3	3.88

13-Inch H Columns.

H13s	41.2	12 3/8	1/2	8.00	0.33	12.12	334.5	54.1	5.25	43.2	10.8	1.89
	86.6	13	13/16	12.04	.51	25.48	793.6	122.1	5.58	229.9	38.2	3.00
H13	91.5	13	13/16	13.00	.51	26.93	847.4	130.5	5.61	286.7	44.1	3.26
	150.5	14	1 5/16	13.31	.82	44.27	1511.4	215.9	5.84	504.9	75.9	3.38
H13a	156.4	14	1 5/16	14.00	.82	45.99	1581.6	225.9	5.86	585.1	83.6	3.57
	219.8	15	1 13/16	14.31	1.13	64.64	2404.9	320.7	6.10	870.2	121.6	3.67
H13b	226.5	15	1 13/16	14.88	1.13	66.62	2492.7	332.4	6.12	975.8	131.2	3.83
	285.9	15 7/8	1 3/4	15.16	1.41	84.99	3361.9	423.6	6.32	1287.6	169.9	3.91

12-Inch H Columns.

H12s	40.0	11 1/2	1/2	8.00	0.33	11.76	282.1	41.9	4.90	42.8	10.7	1.91
	73.4	12	3/4	11.04	.47	21.60	572.8	95.5	5.15	163.7	29.7	2.75
H12	78.0	12	3/4	12.00	.47	22.94	614.3	102.6	5.18	208.1	30.7	3.01
	132.5	13	1 1/4	12.31	.78	38.97	1141.3	175.6	5.41	402.6	61.9	3.13
H12a	138.1	13	1 1/4	13.00	.78	40.61	1198.8	184.4	5.43	446.4	68.7	3.32
	197.1	14	1 3/4	13.31	1.09	57.96	1862.2	266.0	5.67	676.6	101.7	3.42
H12b	204.9	14	1 3/4	14.00	1.09	60.27	1950.8	278.7	5.69	784.8	112.1	3.61
	268.8	15	2 1/4	14.32	1.41	79.06	2777.0	370.3	5.93	1086.2	151.7	3.71

* Only the minimum and maximum weights of each section number are given here. The original table gives many intermediate weights.

Dimensions and Properties of Bethlehem Rolled Steel.

11-Inch H Columns.

Section Number.	Weight of Section, Lbs. per Foot.	Dimensions in Inches.			Area of Section, Square Inches.	Axis Perpen. to Web.			Axis Center of Web.			
		Depth.	Mean Thickness of Flange.	Breadth of Flange.		Thickness of Web.	Moment of Inertia.	Section Modulus.	Radius of Gyration.	Moment of Inertia.	Section Modulus.	Radius of Gyration.
H11 s	38.4	10 5/8	1/2	8.00	0.32	11.30	234.1	44.1	4.55	42.4	10.6	1.94
	61.3	11	11/16	10.03	.43	18.02	401.2	73.0	4.72	112.6	22.4	2.50
H11	65.5	11	11/16	11.00	.43	19.26	434.6	79.0	4.75	147.0	26.7	2.76
	115.5	12	1 3/16	11.31	.74	33.98	843.1	140.5	4.98	280.7	49.6	2.87
H11 a	120.9	12	1 3/16	12.00	.74	35.54	889.4	148.2	5.00	333.5	55.6	3.06
	175.8	13	1 1/2	12.32	1.06	51.70	1417.0	218.0	5.24	517.9	64.1	3.17

10-Inch H Columns.

H10 s	37.2	9 3/4	1/2	8.00	.32	10.95	192.0	39.4	4.19	41.9	10.5	1.96
	50.6	10	5/8	9.04	.40	14.88	272.5	54.5	4.28	75.1	16.6	2.25
H10	54.1	10	5/8	10.00	.39	15.91	296.8	40.4	4.32	100.4	20.1	2.51
	99.7	11	11/8	10.31	.70	29.32	607.0	110.4	4.55	201.7	39.1	2.62
H10 a	104.7	11	11/8	11.00	.70	10.80	643.6	117.0	4.57	243.7	44.3	2.81
	155.2	12	1 5/8	11.32	1.02	45.64	1053.6	175.6	4.80	387.2	60.4	2.91

9-Inch H Columns.

H9 s	28.8	8 3/4	7/16	7.00	0.28	8.46	119.3	27.3	3.76	24.7	7.0	1.71
	40.6	9	9/16	8.04	.36	11.95	177.0	39.3	3.85	47.6	11.8	2.00
H9	43.8	9	9/16	9.00	.35	12.88	194.7	43.3	3.09	65.9	14.6	2.26
	85.3	10	11/16	9.32	.67	25.00	424.6	84.9	4.11	140.9	30.2	2.37
H9 a	90.0	10	11/16	10.00	.67	26.46	452.6	90.5	4.14	173.1	34.6	2.56
	135.6	11	1 1/8	10.31	.98	39.87	762.8	138.7	4.38	281.6	54.6	2.66

8-Inch H Columns.

H8 s	27.7	7 7/8	7/16	7.00	0.28	8.15	93.6	23.8	3.39	24.4	7.0	1.73
	31.8	8	1/2	7.04	.32	9.35	109.1	27.3	3.42	28.5	8.1	1.74
H8	34.6	8	1/2	8.00	.31	10.17	121.5	30.4	3.46	41.1	10.3	2.01
	71.6	9	1	8.32	.63	21.05	235.6	63.5	3.68	94.4	22.7	2.12
H8 a	76.0	9	1	9.00	.65	22.35	306.8	68.2	3.70	118.9	26.4	2.31
	117.1	10	1 1/2	9.31	.94	34.45	535.9	107.2	3.94	199.3	42.8	2.41

WARNING: This is a 1910 edition. Some of the material may no longer be accurate

TORSIONAL STRENGTH.

Let a horizontal shaft of diameter = d be fixed at one end, and at the other or free end, at a distance = l from the fixed end, let there be fixed a horizontal lever arm with weight = P acting at a distance = a from the axis of the shaft; twist it; then Pa = moment of the applied force.

Resisting moment = twisting moment = SJ/c , in which S = unit shearing resistance, J = polar moment of inertia of the section with respect to the axis, and c = distance of the most remote fiber from the axis, in a cross-section. For a circle with diameter d

$$J = 1/32 \pi d^4; \quad c = 1/2 d;$$

$$Pa = \frac{SJ}{c} = \frac{\pi d^3 S}{16} = \frac{d^3 S}{5.1} = 0.1963 d^3 S; \quad d = \sqrt[3]{\frac{5.1 Pa}{S}}$$

For hollow shafts of external diameter d and internal diameter d_1 ,

$$Pa = 0.1963 \frac{d^4 - d_1^4}{d} S; \quad d = \sqrt[3]{\frac{5.1 Pa}{(1 - \frac{d_1^4}{d^4}) S}}$$

For a rectangular bar in which b and d are the long and short sides of the rectangle, $Pa = 0.2222 bd^2 S$; and for a square bar with side d , $Pa = 0.2222 d^3 S$. (Merriman, "Mechanics of Materials," 10th ed.)

The above formulæ are based on the supposition that the shearing resistance at any point of the cross-section is proportional to its distance from the axis; but this is true only within the elastic limit. In materials capable of flow, while the particles near the axis are strained within the elastic limit those at some distance within the circumference may be strained nearly to the ultimate resistance, so that the total resistance is something greater than that calculated by the formulæ. For working strength, however, the formulæ may be used, with S taken at the safe working unit resistance.

The ultimate torsional shearing resistance S is about the same as the direct shearing resistance, and may be taken at 20,000 to 25,000 lbs. per square inch for cast iron, 45,000 lbs. for wrought iron, and 50,000 to 150,000 lbs. for steel, according to its carbon and temper. Large factors of safety should be taken, especially when the direction of stress is reversed, as in reversing engines, and when the torsional stress is combined with other stresses, as is usual in shafting. (See "Shafting.")

Elastic Resistance to Torsion. — Let l = length of bar being twisted, d = diameter, P = force applied at the extremity of a lever arm of length = a , Pa = twisting moment, G = torsional modulus of elasticity, θ = angle through which the free end of the shaft is twisted, measured in arc of radius = 1.

For a cylindrical shaft,

$$Pa = \frac{\pi \theta G d^4}{32 l}; \quad \theta = \frac{32 Pa l}{\pi d^4 G}; \quad G = \frac{3232 Pa l}{\theta \pi d^4}; \quad \pi = 10.186.$$

If a = angle of torsion in degrees,

$$\theta = \frac{a \pi}{180}; \quad a = \frac{180 \theta}{\pi} = \frac{180 \times 32 Pa l}{\pi^2 d^4 G} = \frac{5bR.6 Pa l}{d^4 G}$$

The value of G is given by different authorities as from 1/3 to 2/5 of E , the modulus of elasticity for tension. For steel it is generally taken as 12,000,000 lbs. per sq. in.

COMBINED STRESSES.

Combined Tension and Flexure. — Let A = the area of a bar subjected to both tension and flexure, P = tensile stress applied at the ends. $P \div A$ = unit tensile stress. S = unit stress at the fiber on the tensile side most remote from the neutral axis, due to flexure alone; then maximum tensile unit stress = $(P \div A) + S$. A beam to resist combined tension and flexure should be designed so that $(P \div A) + S$ shall not exceed the proper allowable working unit stress.

Combined Compression and Flexure. — If $P \div A$ = unit stress due to compression alone, and S = unit compressive stress at fiber most remote from neutral axis, due to flexure alone, then maximum compressive unit stress = $(P \div A) + S$.

Combined Tension (or Compression) and Shear. — If applied tension (or compression) unit stress = p , applied shearing unit stress = v , then from the combined action of the two forces

$$\text{Max. } S = \pm \sqrt{v^2 + 1/4p^2}, \text{ Maximum shearing unit stress:}$$

$$\text{Max. } t = 1/2 p + \sqrt{v^2 + 1/4p^2}, \text{ Maximum tensile (or compressive) unit stress.}$$

Combined Flexure and Torsion. — If S = greatest unit stress due to flexure alone, and S_s = greatest torsional shearing unit stress due to torsion alone, then for the combined stresses

$$\text{Max. tension or compression unit stress } t = 1/2 S + \sqrt{S_s^2 + 1/4 S^2};$$

$$\text{Max. shear } s = \pm \sqrt{S_s^2 + 1/4 S^2}.$$

Equivalent bending moment = $1/2 M + 1/2 \sqrt{M^2 + T^2}$, where M = bending moment and T = torsional moment.

Formula for diameter of a round shaft subjected to transverse load while transmitting a given horse-power (see also Shafts of Engines):

$$d^3 = \frac{1}{\pi t} \frac{6 M}{n} + \frac{16}{t} \sqrt{\frac{M^2}{\pi^2} + \frac{402,500,000 H^2}{n^2}},$$

where M = maximum bending moment of the transverse forces in pound-inches, H = horse-power transmitted, n = No. of revs. per minute, and t = the safe allowable tensile or compressive working strength of the material.

Guest's Formula for maximum tension or compression unit stress is $t = \sqrt{S_s^2 + S^2}$ (*Phil. Mag.*, July, 1900). It is claimed by many writers to be more accurate than Rankine's formula, given above. Equivalent bending moment = $\sqrt{M^2 + T^2}$. (*Eng'g.*, Sept. 13 and 27, 1907; July 10, 1908; April 23, 1909.)

Combined Compression and Torsion. — For a vertical round shaft carrying a load and also transmitting a given horse-power, the resultant maximum compressive unit stress

$$t = \frac{4 P}{\pi d^2} + \sqrt{321,000 \frac{H^2}{n^2 d^2} + \frac{16 P^2}{\pi^2 d^4}},$$

in which P is the load. From this the diameter d may be found when t and the other data are given.

Stress due to Temperature. — Let l = length of a bar. A = its sectional area, c = coefficient of linear expansion for one degree, t = rise or fall in temperature in degrees, E = modulus of elasticity, λ the change of length due to the rise or fall t ; if the bar is free to expand or contract, $\lambda = c t l$.

If the bar is held so as to prevent its expansion or contraction the stress produced by the change of temperature = $S = A c t E$. The following are average values of the coefficients of linear expansion for a change in temperature of one degree Fahrenheit:

For brick and stone. $a=0.000050$,
 For cast iron $a=0.000056$,
 For wrought iron and steel. $a=0.000065$.

The stress due to temperature should be added to or subtracted from the stress caused by other external forces according as it acts to increase or to relieve the existing stress.

What stress will be caused in a steel bar 1 inch square in area by a change of temperature of 100° F.? $S = A c t E = 1 \times 0.000065 \times 100 \times 30,000,000 = 19,500$ lbs. Suppose the bar is under tension of 19,500 lbs. between rigid abutments before the change in temperature takes place, a cooling of 100° F. will double the tension, and a heating of 100° will reduce the tension to zero.

STRENGTH OF FLAT PLATES.

For a circular plate supported at the edge, uniformly loaded, according to Grashof,

$$f = \frac{5 r^2}{8 l^2} p; \quad t = \sqrt{\frac{5 r^2 p}{6 f}}; \quad p = \frac{6 f t^2}{5 r^2}.$$

For a circular plate fixed at the edge, uniformly loaded,

$$f = \frac{2 r^2}{3 l^2} p; \quad t = \sqrt{\frac{2 r^2 p}{3 f}}; \quad p = \frac{3 f t^2}{2 r^2};$$

in which f denotes the working stress, r , the radius in inches; l , the thickness in inches; and p , the pressure in pounds per square inch.

For mathematical discussion, see Lanza. "Applied Mechanics."

Lanza gives the following table, using a factor of safety of 8, with tensile strength of cast iron 20,000, of wrought iron 40,000, and of steel 80,000:

	Supported.	Fixed.
Cast iron..	$t = 0.0182570 r \sqrt{p}$	$t = 0.0163300 r \sqrt{p}$
Wrought iron.	$t = 0.0117850 r \sqrt{p}$	$t = 0.0105410 r \sqrt{p}$
Steel	$t = 0.0091287 r \sqrt{p}$	$t = 0.0081649 r \sqrt{p}$

For a circular plate supported at the edge, and loaded with a concentrated load P applied at a circumference the radius of which is r_0 :

$$f = \left(\frac{4}{3} \log \frac{r}{r_0} + 1 \right) \frac{P}{\pi l^2} = c \frac{P}{\pi l^2};$$

for $\frac{r}{r_0} = 10 \quad 20 \quad 30 \quad 40 \quad 50;$

$$c = 4.07 \quad 5.00 \quad 5.53 \quad 5.92 \quad 6.22;$$

$$t = \sqrt{\frac{c P}{\pi f}}; \quad P = \frac{\pi l^2 f}{c}.$$

The above formulae are deduced from theoretical considerations, and give thicknesses much greater than are generally used in steam-engine cylinder-heads. (See empirical formulae under Dimensions of Parts of Engines.) The theoretical formulae seem to be based on incorrect or incomplete hypotheses, but they err in the direction of safety.

Thickness of Flat Cast-iron Plates to resist Bursting Pressures. — Capt. John Ericsson (Church's Life of Ericsson), gave the following rules: The proper thickness of a square cast-iron plate will be obtained by the following: Multiply the side in feet (or decimals of a foot) by 1/4 of the pressure in pounds and divide by 850 times the side in inches; the quotient is the square of the thickness in inches.

For a circular plate, multiply 11-14 of the diameter in feet by 1/4 of the pressure on the plate in pounds. Divide by 850 times 11-14 of the diameter in inches. [Extract the square root.]

Prof. Wm. Harkness, *Eng'g News*, Sept. 5, 1893. shows that these rules can be put in a more convenient form, thus: For square plates $T = 0.00495 S \sqrt{p}$, and for circular plates $T = 0.00439 D \sqrt{p}$, where T = thickness of plate. S = side of the square. D = diameter of the circle and p = pressure in lbs. per sq. in. Professor Harkness, however, doubts the value of the rules, and says that no satisfactory theoretical solution has yet been obtained.

The Strength of Unstayed Flat Surfaces. — Robert Wilson (*Eng'g*, Sept. 24, 1877) draws attention to the apparent discrepancy between the results of theoretical investigations and of actual experiments on the strength of unstayed flat surfaces of boiler-plate, such as the unstayed flat crowns of domes and of vertical boilers.

On trying to make the rules given by the authorities agree with the results of his experience of the strength of unstayed flat ends of cylindrical boilers and domes that had given way after long use. Mr. Wilson was led to believe that the rules give the breaking strength much lower than it actually is. He describes a number of experiments made by Mr. Nichols of Kirkstall, which gave results varying widely from each other, as the method of supporting the edges of the plate was varied, and also varying widely from the calculated bursting pressures, the actual results being in all cases very much the higher. Some conclusions drawn from these results are:

1. Although the bursting pressure has been found to be so high, boiler-makers must be warned against attaching any importance to this, since the plates deflected almost as soon as any pressure was put upon them and sprang back again on the pressure being taken off. This springing of the plate in the course of time inevitably results in grooving or channeling, which, especially when aided by the action of the corrosive acids in the water or steam, will in time reduce the thickness of the plate, and bring about the destruction of an unstayed surface at a very low pressure.

2. Since flat plates commence to deflect at very low pressures, they should never be used without stays; but it is better to dish the plates when they are not stayed by flues, tubes, etc.

3. Against the commonly accepted opinion that the limit of elasticity should never be reached in testing a boiler or other structure, these experiments show that an exception should be made in the case of an unstayed flat end-plate of a boiler, which will be safer when it has assumed a permanent set that will prevent its becoming grooved by the continual variation of pressure in working. The hydraulic pressure in this case simply does what should have been done before the plate was fixed, that is, dishes it.

4. These experiments appear to show that the mode of attaching by flange or by an inside or outside angle-iron exerts an important influence on the manner in which the plate is strained by the pressure.

When the plate is secured to an angle-iron, "the stretching under pressure is, to a certain extent, concentrated at the line of rivet-holes, and the plate partakes rather of a beam supported than fixed round the edge. Instead of, the strength increasing as the square of the thickness, when the plate is attached by an angle-iron, it is probable that the strength does not increase even directly as the thickness, since the plate gives way simply by stretching at the rivet-holes, and the thicker the plate, the less uniformly is the strain borne by the different layers of which the plate may be considered to be made up. When the plate is flanged, the Range becomes compressed by the pressure against the hord of the plate, and near the rim, as shown by the contrary flexure, the inside of the plate is stretched more than the outside, and it may be by a kind of shearing action that the plate gives way along the line where the crushing and stretching meet.

5. These tests appear to show that the rules deduced from the theoretical investigations of Lamé, Rankine, and Grashof are not, confirmed by experiment, and are therefore not, trustworthy.

The rules of Lamé, etc., apply only within the elastic limit. (*Eng'g*, Dec. 13, 1895.)

Unbraced Wrought-iron Heads of Boilers, etc. (*The Locomotive*, Feb., 1890). — Few experiments have been made on the strength of flat heads, and our knowledge of them comes largely from theory. Experiments have been made on small plates $1/16$ of an inch thick,

yet the data so obtained cannot be considered satisfactory when we consider the far thicker heads that are used in practice, although the results agreed well with Rankine's formula. Mr. Nichols has made experiments on larger heads, and from them he has deduced the following rule: "To find the proper thickness for a flat unstayed head, multiply the area of the head by the pressure per square inch that it is to bear safely, and multiply this by the desired factor of safety (say 8): then divide the product by ten times the tensile strength of the material used for the head." His rule for finding the bursting pressure when the dimensions of the head are given is: "Multiply the thickness of the end-plate in inches by ten times the tensile strength of the material used, and divide the product by the area of the head in inches."

In Mr. Nichols's experiments the average tensile strength of the iron used for the heads was 44,500 pounds. The results he obtained are given below, with the calculated pressure, by his rule, for comparison.

1. An unstayed flat boiler-head is $34\frac{1}{2}$ inches in diameter and $9/16$ inch thick. What, is its bursting pressure? The area of a circle $34\frac{1}{2}$ inches in diameter is 935 square inches; then $9/16 \times 44,500 \times 10 = 252,000$, and $252,000 \div 935 = 270$ pounds, the calculated bursting pressure. The head actually burst at 280 pounds.

2. Head $34\frac{1}{2}$ inches in diameter and $3/8$ inch thick. The area = 935 square inches; then, $3/8 \times 44,800 \times 10 = 168,000$, and $168,000 \div 935 = 180$ pounds, calculated bursting pressure. This head actually burst at 200 pounds.

3. Head $26\frac{1}{4}$ inches in diameter, and $3/8$ inch thick. The area 541 square inches; then, $3/8 \times 44,800 \times 10 = 168,000$, and $168,000 \div 541 = 311$ pounds. This head burst at 370 pounds.

4. Head $28\frac{1}{2}$ inches in diameter and $3/8$ inch thick. The area = 638 square inches; then, $3/8 \times 44,800 \times 10 = 165,000$, and $168,000 \div 638 = 263$ pounds. The actual bursting pressure was 300 pounds.

In the third experiment, the amount the plate bulged under different pressures was as follows:

At pounds per sq. in.	10	20	40	80	120	140	170	200
Plate bulged	$1/32$	$1/16$	$1/8$	$1/4$	$3/8$	$1/2$	$5/8$	$3/4$

The pressure was now reduced to zero, and the end sprang back $3/16$ inch leaving it with a permanent set of $9/16$ inch. The pressure of 200 lbs. was again applied on 36 separate occasions during an interval of five days the bulging and permanent set being noted on each occasion, but without any appreciable difference from that noted above.

The experiments described were confined to plates not widely different in their dimensions, so that Mr. Nichols's rule cannot be relied upon for heads that depart much from the proportions given in the examples.

Strength of Stayed Surfaces. — A flat plate of thickness t is supported uniformly by stays whose distance from center to center is a , uniform load p lbs. per square inch. Each stay supports pa^2 lbs. The greatest stress on the plate is

$$f = \frac{2a^2}{9t^2} p. \quad (\text{Unwin.})$$

For additional matter on this subject see strength of Steam Boilers.

Stresses in Steel Plating due to Water-pressure, as in plating of vessels and bulkheads (*Engineering*, May 22, 1891, page 629)

Mr. J. A. Yates has made calculations of the stresses to which steel plates are subjected by external water-pressure, and arrives at the following conclusions:

Assume d inches to be the distance between the frames or other rigid supports, and let d represent the depth in feet, below the surface of the water of the plate under consideration, t = thickness of plate in inches, D the deflection from a straight line under pressure in inches, and P = stress per square inch of section.

For outer bottom and ballast-tank plating, $a = 420 t/d$, D should not be greater than $0.05 \times 2 a/12$, and $P/2$ not greater than 2 to 3 tons; while for bulkheads, etc., $a = 2352 t/d$, D should not be greater than

9.1 $\times 2a/12$, and $P/2$ not greater than 7 tons. To illustrate the application of these formulæ the following cases have been taken:

For Outer Bottom, etc.			For Bulkheads, etc.		
Thick-ness of Plating.	Depth below Water.	Spacing of Frames should not exceed	Thick-ness of Plating.	Depth of Water.	Maximum Spacing of Rigid Stiffeners.
in.	ft.	in.	in.	ft.	ft. in.
1/2	20	About 21	1/2	20	9 10
1/2	10	42	3/8	20	7 4
3/8	18	18	3/8	10	14 8
3/8	9	36	1/4	20	4 10
1/4	10	20	1/4	10	9 8
1/4	5	40	1/8	10	4 10

It would appear that the course which should be followed in stiffening bulkheads is to fit substantially rigid stiffening frames at comparatively wide intervals, and only work such light angles between as are necessary for making a fair job of the bulkhead.

SPHERICAL SHELLS AND DOMED BOILER-HEADS.

To And the Thickness of a Spherical Shell to resist a given Pressure. — Let d = diameter in inches, and p the internal pressure per square inch. The total pressure which tends to produce rupture around the great circle will be $\frac{1}{4}\pi d^2 p$. Let S = safe tensile stress per square inch, and t the thickness of metal in inches; then the resistance to the pressure will be $\pi dt S$. Since the resistance must be equal to the pressure,

$$\frac{1}{4}\pi d^2 p = \pi dt S. \quad \text{Whence } t = \frac{pd}{4s}$$

The same rule is used for finding the thickness of a hemispherical head to a cylinder, as of a cylindrical boiler.

Thickness of a Domed Head of a Boiler. — If S = safe tensile stress per square inch, d = diameter of the shell in inches, and t = thickness of the shell, $t = pd \div 2S$; but the thickness of a hemispherical head of the same diameter is $t = pd \div 4S$. Hence if we make the radius of curvature of a domed head equal to the diameter of the boiler, we shall have $t = \frac{2pd}{4S} = \frac{pd}{2S}$, or the thickness of such a domed head will be equal to the thickness of the shell.

THICK HOLLOW CYLINDERS UNDER TENSION.

Lame's formula, which is generally used, gives

$$t = r_1 \left\{ \left(\frac{h+p}{h-p} \right)^{\frac{1}{2}} - 1 \right\}$$

t = thickness; r_1 = inside and r_2 = outside radius;
 h = maximum allowable hoop tension at the interior of the cylinder;
 p = intensity of interior pressure;
 s = tension at the exterior of the cylinder.

$$h = p \frac{r_2^2 + r_1^2}{r_2^2 - r_1^2}; \quad s = p \frac{2r_1^2}{r_2^2 - r_1^2}; \quad r_2 = r_1 \left(\frac{h+p}{h-p} \right)^{\frac{1}{2}}$$

EXAMPLE: Let maximum unit stress at the inner edge of the annulus = 8000 lbs. per square inch, radius of cylinder = 4 inches, interior pressure = 4000 lbs. per square inch. Required the thickness and the tension at the exterior surface.

$$t = 4 \left\{ \left(\frac{8000 + 4000}{8000 - 4000} \right)^{\frac{1}{2}} - 1 \right\} = 4 (\sqrt{3} - 1) = 2.928 \text{ inches.}$$

$$s = p \frac{2r_1^2}{r_2^2 - r_1^2} = 4000 \times \frac{2 \times 16}{48 - 16} = 4000 \text{ lbs. per sq. in.}$$

For short cast-iron cylinders, such as are used in hydraulic presses, it is doubtful if the above formulæ hold true, since the strength of the cylindrical portion is reinforced by the end. In that case the strength would be higher than that calculated by the formula. A rule used in practice for such presses is to make the thickness = $\frac{1}{10}$ of the inner circumference, for pressures of 3000 to 4000 lbs. per square inch.

Hooped Cylinders. — For very high pressures, as in large guns, hoops or outer tubes of forged steel are shrunk on inner tubes, thus bringing a compressive stress on the latter which assists in resisting the tension due to the internal pressure. For discussion of Lamé's, and other formulæ for built-up guns, see Merriman's "Mechanics of Materials."

THIN CYLINDERS UNDER TENSION.

Let p = safe working pressure in lbs. per sq. in.:

d = diameter in inches:

T = tensile strength of the material, lbs. per sq. in.:

t = thickness in inches;

f = factor of safety:

c = ratio of strength of riveted joint to strength of solid plate.

$$fpd = 2Ttc; \quad p = \frac{2Ttc}{df}; \quad t = \frac{fpd}{2Tc}$$

If $T = 50,000$, $f = 5$, and $c = 0.7$; then

$$p = \frac{14,000t}{d}; \quad t = \frac{dp}{14,000}$$

The above represents the strength resisting rupture along a longitudinal seam. For resistance to rupture in a circumferential seam, due to pressure on the ends of the cylinder, we have $\frac{p\pi d^2}{4} = \frac{Tt\pi d c}{t}$,

$$\text{whence } p = \frac{4Ttc}{df}$$

Or the strength to resist rupture around a circumference is twice as great as that to resist rupture longitudinally; hence boilers are commonly single-riveted in the circumferential seams and double-riveted in the longitudinal seams.

CARRYING CAPACITY OF STEEL ROLLERS AND BALLS.

Carrying Capacity of a Steel Roller between Flat Plates. — (Merriman, *Mech. of Matls.*) Let S = maximum safe unit stress of the material, l = length of the roller in inches, d = diameter, E = modulus of elasticity, W = load, then $W = \frac{2}{3}ldS(2S/E)^{\frac{1}{2}}$. Taking $w = W/l$, and $S = 15,000$ and $E = 30,000,000$ lbs. per sq. in. for steel the formula reduces to $w = 316d$. Cooper's specifications for bridges, 1901, gives $w = 300d$. (The rule given in some earlier specifications, $w = 1200\sqrt{d}$, is erroneous.) The formula assumes that only the roller is deformed by the load, but experiments show that the plates also, are deformed, and that the formula errs on the side of safety. Experiments by Crandall

and Marston on steel rollers, of diameters from 1 to 16 in. show that their crushing loads are closely given by the formula $W = 880 ld$. (See Roller Bearings.)

Spherical Rollers. -With the same notation as above, d being the diameter of the sphere. $S = \sqrt{WE/1/4 \pi d^2}$; $W = 1/4 \pi d^2 S^2 / E$. The diameter of a sphere to carry a given load with an allowable unit-stress S is $d = 2 \sqrt{WE/\pi S^2}$. This rule assumes that there is no deformation of the plates between which the sphere acts, hence it errs on the side of safety. (See Ball Bearings.)

RESISTANCE OF HOLLOW CYLINDERS TO COLLAPSE.

Fairbairn's empirical formula (*Phil. Trans.*, 1858) is

$$p = 9,675,600 \frac{t^{2.19}}{ld} \dots \dots \dots (1)$$

where p = Pressure in lbs. per square inch, t = thickness of cylinder, d = diameter, and l = length, all in inches; or,

$$p = 806,300 \frac{t^{2.19}}{Ld}, \text{ if } L \text{ is in feet } \dots \dots \dots (2)$$

He recommends the simpler formula

$$p = 9,675,600 \frac{t^2}{ld} \dots \dots \dots (3)$$

as sufficiently accurate for practical purposes, for tubes of considerable diameter and length.

The diameters of Fairbairn's experimental tubes were 4, 6, 8, 10, and 12 inches, and their lengths ranged between 19 and 60 inches.

His formula (3) was until about 1908 generally accepted as the basis of rules for strength of boiler-tubes. In some cases, however, limits were fixed to its application by a supplementary formula.

Lloyd's Register contains the following formula for the strength of circular boiler-tubes, viz.,

$$P = \frac{89,600 t^2}{Ld} \dots \dots \dots (4)$$

The English Board of Trade prescribes the following formula for circular tubes, when the longitudinal joints are welded, or made with riveted butt-joints, viz.,

$$P = \frac{90,000 t^2}{(L + 1) d} \dots \dots \dots (5)$$

For lap-joints and for inferior workmanship the numerical factor may be reduced as low as 60,000.

The rules of Lloyd's Register, and those of the Board of Trade, prescribe further, that in no case the value of P must exceed $800 t/d$. (6)

In formulae (4), (5), (6) P is the highest working pressure in pounds per square inch, t and d are the thickness and diameter in inches, L is the length of the flue in feet measured between the strengthening rings, in case it is fitted with such. Formula (4) is the same as formula (3), with a factor of safety of 9. In formula (5) the length L is increased by 1: the influence which this addition has on the value of P is, of course, greater for short tubes than for long ones.

Nystrom has deduced from Fairbairn's experiments the following formula for the collapsing strength of tubes:

$$p = \frac{4 T t^2}{d \sqrt{L}} \dots \dots \dots (7)$$

where p , t , and d have the same meaning as in formula (1). L is the length in feet, and T is the tensile strength of the metal in pounds per square inch.

If we assign to T the value 50,000, and express the length of the flue in inches, equation (7) assumes the following form, viz.,

$$p = \frac{692,800 t^2}{d \sqrt{l}} \dots \dots \dots (8)$$

Nystrom considers a factor of safety of 4 sufficient in applying his formula. (See "A New Treatise on Steam Engineering," by J. W. Nystrom. P. 106.)

Formulae (1), (4), and (8) have the common defect that they make the collapsing pressure decrease indefinitely with increase of length, and vice versa.

D. K. Clark, in his "Manual of Rules," etc., p. 696, gives the dimensions of six flues, selected from the reports of the Manchester Steam-Users Association, 1862-69, which collapsed while in actual use in boilers. These flues varied from 24 to 60 inches in diameter, and from 3/16 to 3/8 inch in thickness. They consisted of rings of plates riveted together, with one or two longitudinal seams, but all of them unfortified by intermediate flanges or strengthening rings. At the collapsing pressures the flues experienced compressions ranging from 1.53 to 2.17 tons, or a mean compression of 1.82 tons per square inch of section. From these data Clark deduced the following formula "for the average resisting force of common boiler-flues," viz.,

$$p = t^2 \left(\frac{50,000}{d} - 500 \right) \dots \dots \dots (9)$$

where p is the collapsing pressure in pounds per square inch, and d and t are the diameter and thickness expressed in inches.

Clark (*S. E.*, vol. i. P. 643) says: The resistance to collapse of plain-riveted flues is directly as the square of the thickness of the plate, and inversely as the square of the diameter. The support of the two ends of the flue does not practically extend over a length of tube greater than twice or three times the diameter. The collapsing pressure of long tubes is therefore practically independent of the length. Instances of collapsed flues of Cornish and Lancashire boilers collated by Clark, showed that the resistance to collapse of flues of 3/8-inch plates, 18 to 43 feet long, and 30 to 50 inches diameter, varied as the 1.75 power of the diameter. Thus,-

for diameters of.	30	35	40	45	50	inches.
the collapsing pressures were.	76	58	45	37	30	lbs. per sq. in.
for 7/16-inch plates the collapsing pressures were..			60	49	42	lbs. per sq. in.

C. R. Roelker, in *Van Nostrand's Magazine*, March, 1881, says that Nystrom's formula, (8), gives a closer agreement of the calculated with the actual collapsing pressures in experiments on flues of every description than any of the other formulæ.

For collapsing pressures of plain iron flue-tubes of Cornish and Lancashire steam-boilers, Clark gives:

$$p = \frac{200,000 t^2}{d^{1.75}}$$

For short lengths the longitudinal tensile resistance may be effective in augmenting the resistance to collapse. Flues efficiently fortified by flange-joints or hoops at intervals of 3 feet may be enabled to resist from 50 lbs. to 60 bl. or 70 lbs. pressure per square inch more than plain tubes, according to the thickness of the plates.

(For strength of Segmental Crowns of Furnaces and Cylinders see Clark, *S. E.*, vol. i. pp. 649-651 and pp. 627, 628.)

Formula for Corrugated Furnaces (*Eng'g*, July 24, 1891, p.102). — As the result of a series of experiments on the resistance to collapse of Fox's corrugated furnaces, the Board of Trade and Lloyd's Register altered their formulæ for these furnaces in 1891 as follows:

Board of Trade formula is altered from

$$\frac{12,500 \times T}{D} = WP \text{ to } \frac{14,000 \times T}{D} = WP.$$

T = thickness in inches;
 D = mean diameter of furnace;
 WP = working pressure in pounds per square inch.

Lloyd's formula is altered from

$$\frac{1000 \times (T - 2)}{D} = WP \text{ to } \frac{1234 \times (T - 2)}{D} = WP.$$

T = thickness in sixteenths of an inch;
 D = greatest diameter of furnace;
 WP = working pressure in pounds per square inch.

Stewart's Experiments. — Prof. Reid T. Stewart (*Trans. A.S.M.E.*, xxvii, 730) made two series of tests on Bessemer steel lap-welded tubes 3 to 10 ins. diam. One series was made on tubes 8 5/8 in. outside diam. with the different commercial thicknesses of wall, and in lengths of 2 1/2, 5, 10, 15 and 20 ft. between transverse joints tending to hold the tube in a circular form. A second series was made on single lengths of 20 ft. Seven sizes, from 3 to 10 in. outside diam., in all the commercial thicknesses obtainable were tested. The tests showed that all the old formulæ were inapplicable to the wide range of conditions found in modern practice. The principal conclusions drawn from the research are as follows:

1. The length of tube, between transverse joints tending to hold it in circular form, has no practical influence upon the collapsing pressure of a commercial lap-welded tube so long as this length is not less than about six diameters of tube.
2. The formulæ, based upon this research, for the collapsing pressures of modern lap-welded Bessemer steel tubes, for all lengths greater than six diameters, are as follows:

$$P = 1,000 \left(1 - \sqrt{1 - 1600 \frac{t^2}{d^2}} \right) \dots \dots \dots (A)$$

$$P = 86,670 \frac{t}{d} - 1386 \dots \dots \dots (B)$$

Where P = collapsing pressure, pounds per sq. inch, d = outside diameter of tube in inches, t = thickness of wall in inches.

Formula A is for values of P less than 581 pounds, or for values of t/d less than 0.023, while formula B is for values greater than these. When applying these formulæ, to practice, a suitable factor of safety must be applied.

3. The apparent fibre stress under which the different tubes failed varied from about 7000 lbs. for the relatively thinnest to 33,000 lbs. per sq. in. for the relatively thickest walls. Since the average yield point of the material was 37,000 and the tensile strength 55,000 lbs. per sq. in., it would appear that the strength of a tube subjected to a fluid collapsing pressure is not dependent alone upon either the elastic limit or ultimate strength of the material constituting it. The element of greatest weakness in a tube is its departure from roundness, even when this departure is relatively small.

The table on the following page is a condensed statement of the principal results of the tests.

Rational Formulæ for Collapse of Tubes. (S. E. Slocum, *Eng'g.*, Jan. 8, 1909.)

Heretofore designers have been forced to rely either upon the antiquated experiments of Fairbairn, which were known to be in error by as much as 100% in many cases, or else to apply the theoretical formulæ of Love and others, without knowing how far the assumptions on which these formulæ are based are actually realized.

A rational formula for thin tubes under external pressure, due to A. E. H. Love, is

$$P = [2E/(1 - m^2)] (t/D)^3, \dots \dots \dots (1)$$

in which P = collapsing pressure in lbs. per sq. in.
 E = modulus of elasticity in lbs. per sq. in.
 m = Poisson's ratio of lateral to transverse deformation.
 t = thickness of tube wall in ins.
 D = external tube diameter in ins.

COLLAPSING PRESSURE OF LAP-WELDED STEEL TUBES.

Outside Diameter, 8 5/8 In.; Length of Pipe, 20 Ft.

Thickness, In.	Length Ft.	Bursting Pressure, Lbs. per Sq. In.	Average.	Outside Diam. In.	Thickness.	Bursting Pressure.	Average.
0.176	2.21	815-1085	977	3	0.112	1550-2175	1 8 6 0
0.180	4.70	525-705	792	3	0.143	2575-3350	2962
0.181	10.08	455-650	565	3	0.188	3700-4200	4095
0.184	14.71	425-610	548	4	0.119	860-1030	964
0.185	19.72	450-625	536	4	0.175	2050-2540	2280
0.212	2.21	1240-1353	1314	4	0.212	3075-3375	3170
0.212	4.70	805-975	907	4	0.327	5425-5625	5560
0.217	10.50	700-960	841	6	0.130	450-640	524
0.219	12.79	750-1115	905	6	0.167	715-1110	920
0.268	2.14	1475-2200	1872	6	0.222	1200-2075	1791
0.274	4.64	1345-2030	1684	6	0.266	1750-289	2441
0.272	9.64	1150-1908	1583	7	0.160	515-675	592
0.273	14.64	1250-1725	1485	7	0.242	1525-1850	1680
0.268	19.64	1250-1520	1419	7	0.279	1835-2445	2147
0.311	2.16	2290-2490	2397	8.64	0.185	450-625	536
0.306	4.64	1795-2325	2073	8.66	0.268	1250-1520	1419
0.306	9.64	1585-2055	1807	8.67	0.354	1830-2180	2028
0.309	14.64	1520-2025	1781	10	0.165	210-240	225
0.302	19.75	1575-1960	1762	10	0.194	305-425	383
				10	0.316	1275-1385	1319

COLLAPSING PRESSURE OF LAP-WELDED STEEL TUBES (LBS. PER SQ. IN.) Calculated by Stewart's Formulæ.

Thickness.	Outside Diameters. Inches.									
	2 1/2 In.	3 In.	4 In.	5 In.	6 In.	7 In.	8 In.	9 In.	10 In.	11 In.
0.10	2947	2081	1503	781						
0.12	3814	2774	2081	1214	694	400				
0.14	4671	3468	2659	1647	1041	636	400	286	217	
0.16	5548	4161	3236	2081	1387	925	595	400	297	232
0.18	6414	4854	3814	3514	1734	1214	843	564	400	306
0.20	7281	5548	4392	2947	2081	1503	1090	781	542	400
0.22	8148	6241	4970	3381	2427	1792	1338	997	733	525
0.24	9014	6934	5548	3814	2774	2081	1586	1214	935	694
0.26	9881	7628	6125	4248	3121	2370	1833	1431	1118	867
0.28		8321	6703	4681	3468	2669	2081	1647	1310	1041
0.30		9014	7281	5114	3814	2947	2328	1664	1503	1214
0.32			7859	5548	4161	3236	2576	2081	1696	1387
0.34			8437	5981	4508	3525	2824	2297	1888	1561
0.36			9014	6414	4854	3814	3071	2514	2081	1734
0.38			9592	6848	5201	4103	3319	2731	2273	1907
0.40				7281	5548	4392	3567	2947	2466	2081
0.42				7714	5894	4681	3814	3164	2659	2254
0.44				8148	6241	4970	4062	3381	2851	2427
0.46				8581	6588	5259	4309	3598	3044	2601
0.48				9014	6934	5548	4557	3814	3236	2774
0.50				9448	7281	5887	4805	4031	3429	2947

For thick tubes a special case of Lamé's general formula is

$$P = 2u[(t/D) - (t/D)^2] \dots \dots \dots (2)$$

in which u = ultimate compressive strength in lbs. per sq. in.
The average values of the elastic constants are for Steel, $E = 30,000,000$, $m = 0.295$, $u = 40,000$; and for brass, $E = 14,000,000$, $m = 0.357$, $u = 11,000$.

Hence, for thin steel tubes, $P = 65,720,000 (t/D)^3$ (3)
For thick steel tubes, $P = 80,000 [(t/D) - (t/D)^2]$ (4)
For thin brass tubes, $P = 32,090,000 (t/D)^3$ (5)
For thick brass tubes, $P = 22,000 [(t/D) - (t/D)^2]$ (6)

It is desirable to introduce a correction factor C in (1) which shall allow for the average ellipticity and variation in thickness. The correction for ellipticity = $C_1 = (D_{min}/D_{max})^3$, and that for variation in thickness = $C_2 = (t_{min}/t_{aver.})^3$. From Stewart's twenty-five experiments $C_1 = 0.967$ and $C_2 = 0.712$. The correction factor $C = C_1 C_2 = 0.69$; and (1) becomes

$$P = C [2E/(1 - m^2)] (t/D)^3 \dots \dots \dots (7)$$

in which $C = 0.69$ for Stewart's lap-welded steel flues, t = average thickness in ins., and D = maximum diameter in ins.

The empirical formulas obtained by Carman (Univ. of Illinois, Bull. No 17. 1906). are for thin cold-drawn seamless steel tubes,

$$P = 50,200,000 (t/D)^3,$$

and for thin seamless brass tubes,

$$P = 25,150,000 (t/D)^3.$$

Carman assigns 0.025 as the upper limit of t/D for thin tubes and 0.03 as the lower limit of t/D for thick tubes. Stewart assigns 0.023 as the limit of t/D between thin and thick tubes.

Comparing these with (3) and (5), it is evident that they correspond to a correction factor of 0.76 for the steel tubes and 0.78 for the brass tubes. Since Carman's experiments were performed on seamless drawn tubes, while Stewart used lap-welded tubes, it might have been anticipated that the latter would develop a smaller percentage of the theoretical strength for perfect tubes than the former.

Formula (2) for thick tubes when corrected for ellipticity and variation in thickness reads

$$P = 2u_c C (t/D) [1 - C (t/D)] \dots \dots \dots (8)$$

in which t = average thickness, and $C = C_1, C_2, C_1$ being equal to D_{min}/D_{max} ; $C_2 = t_{average}/t_{min}$.

From Stewart's experiments, average ellipticity $C_1 = 0.9874$, and average variation in thickness $C_2 = 0.9022$; $\therefore C = 0.9874 \times 0.9022 = 0.89$.

We have then, for thick lap-welded steel flues,

$$P = 2u_c 0.89 (t/D) [1 - 0.89 (t/D)]$$

and for thin lap-welded steel flues,

$$P = 0.69 [2E/(1 - m^2)] (t/D)^3$$

in which $E = 30,000,000$, $m = 0.295$, and $u_c = 38,500$ lbs. per sq. in.

The experimental data of Stewart and Carman have made it possible to correct the rational formulas of Love and Lamé to actual conditions, and the result is a pair of supplementary formulas (7) and (8), which cover the entire range of materials, diameters, and thicknesses for long tubes of circular section. All that now remains to be done is the experimental determination of the correction constants for other types of commercial tubes than those already tested.

HOLLOW COPPER BALLS.

Hollow copper balls are used as floats in boilers or tanks, to control feed and discharge valves and regulate the water-level.

They are spun up in halves from sheet copper, and a rib is formed on one half. Into this rib the other half fits and the two are then soldered or brazed together. In order to facilitate the brazing, a hole is left on one side of the ball, to allow air to pass freely in or out; and this hole

made use of afterwards to secure the float to its stem. The original thickness of the metal may be anything up to about 1/16 of an inch if the spinning is done on a hand lathe, though thicker metal may be used when special machinery is provided for forming it. In the process of spinning, the metal, is thinned down in places by stretching; but the thinnest place is neither at the equator of the ball (i.e., along the rib) nor at the poles. The thinnest points lie along two circles, passing around the ball parallel to the rib, one on each side of it, from a third to a half of the way to the poles. Along these lines the thickness may be 10, 15, or 20 per cent less than elsewhere, the reduction depending somewhat on the skill of the workman.

The Locomotive for October, 1891, gives two empirical rules for determining the thickness of a copper balk which is to work under an external pressure, as follows:

- 1 Thickness = $\frac{\text{diameter in inches} \times \text{pressure in pounds per sq. in.}}{16,000}$
2. Thickness = $\frac{\text{diameter} \times \sqrt{\text{pressure}}}{1240}$

These rules give the same result for a pressure of 166 lbs. only. EXAMPLE: Required the thickness of a 5-inch copper ball to sustain Pressures of. 50 100 .0469 166 .0625 250 lbs. per sq. in. Answer by first rule .0156 .0312 .0519 .0781 inch. Answer by second rule .0285 .0403 .0494 .0518 .0570 .0637 "

HOLDING-POWER OF NAILS, SPIKES, AND SCREWS.

(A. W. Wright, Western Society of Engineers, 1881.)

Spiques. — Spiques driven into dry cedar (cut 18 months):

Size of spikes.	.5 X 1/4 in. sq.	6 X 1/4	6 X 1/2	5 X 3/8
Length driven in.	4 1/4 in.	5 in.	5 in.	4 1/4 in.
Pounds resistance to drawing.	Av'ge. lbs. 857	831	1691	1202
From 6 to 9 tests each.	Max. " 1159	923	2129	1556
	Min. " 766	766	1120	687

A. M. Wellington found the force required to draw spikes 9/16 X 9/16 in., driven 4 1/4 inches into seasoned oak, to be 4281 lbs.; same spikes, etc., in unseasoned Oak, 6523 lbs.

Professor W. R. Johnson found that a plain spike 3/8 inch square driven 3 3/8 inches into seasoned Jersey yellow pine or unseasoned chestnut required about 2000 lbs. force to extract it; from seasoned white oak about 4000, and from well-seasoned locust 6000 lbs.

Experiments in Germany, by Funk, give from 2465 to 3940 lbs. (mean of many experiments about 3000 lbs.) as the force necessary to extract a plain 1/2-inch square iron spike 6 inches long wedge-pointed for one inch and driven 4 1/2 inches into white or yellow pine. When driven 5 inches the force required was about 1/10 part greater. Similar spikes 9/16 inches square, 7 inches long, driven 6 inches deep, required from 3700 to 6745 lbs. to extract them from pine; the mean of the results being 4873 lbs. In all cases about twice as much force was required to extract them from oak. The spikes were all driven across the grain of the wood. When driven with the grain, spikes or nails do not hold with more than half as much force.

Boards of oak or pine nailed together by from 4 to 16 tenpenny common cut nails and then pulled apart in a direction lengthwise of the boards, and across the nails, tending to break the latter in two by a shearing action, averaged about 300 to 400 lbs. per nail to separate them, as the result of many trials.

Resistance of Drift-bolts in Timber. -Tests made by Rust and Coolidge, in 1878.

			White Pine.	Norway Pine.
1 in. square iron drove	30 in in is/is-in. hole,	tbs.	26,400	19,200
1 in. round " "	34 " " 13/16-in. " "	" "	16,800	18,720
1 in. square " "	18 " " 15/16-in. " "	" "	14,600	15,600
1 in. round " "	23 " " 13/16-in. " "	" "	13,200	14,400

Holding-power of Bolts in White Pine. (Eng'g News, Sept. 26, 1891.)

	Round.	Square.
	Lbs.	Lbs.
Average of all plain 1-in. bolts	8224	8200
Average of all plain bolts, 5/8 to 1 1/8 in.	7805	8110
Average of all bolts	8383	8598

Round drift-bolts should be driven in holes 13/16 of their diameter, and square drift-bolts in holes whose diameter is 14/16 of the side of the square.

Force required to draw Screws out of Norway Pine.

1/2" diam. drive screw 4 in. in. wood.	Power required, average	2424 lbs.
" " 4 threads per in. 5 in. in wood.	" "	2743 "
" " D'ble thr'd. 3 per in., 4 in. in "	" "	2730 "
" " Lag-screw, 7 per in., 1 1/2 " " "	" "	1465 "
" " " 6 " " 2 1/2 " " "	" "	2026 "
1/2 inch R.R. spike.....5 " " "	" "	2191 "

Force required to draw Wood Screws out of Dry Wood. -Test, s made by Mr. Bevan. The screws were about two inches in length, 0.22 diameter at the exterior of the threads, 0.15 diameter at the bottom, the depth of the worm or thread being 0.035 and the number of threads in one inch equal 12. They were passed through pieces of wood half an inch in thickness and drawn out by the weights stated: Beech, 460 lbs.; ash, 790 lbs.; oak, 760 lbs.; mahogany, 770 lbs.; elm, 665 lbs.; sycamore, 830 lbs.

Tests of Lag-screws in Various Woods were made by A. J. Cor. University of Iowa, 1891:

Kind of Wood.	Size Screw.	Size Hole bored.	Length in Tie.	Max. Resist. lbs.	No. Tests.
Seasoned white oak	5/8 in.	1/2 in.	4 1/2 in.	8037	3
" " "	9/16 "	7/16 "	3 "	6480	1
" " "	1/2 "	3/8 "	4 1/2 "	8780	2
Yellow-pine stick	5/8 "	1/2 "	4 "	3800	2
White cedar, unseasoned.	5/8 "	1/2 "	4 "	3405	2

Cut versus Wire Nails. — Experiments were made at the Watertown Arsenal in 1893 on the comparative direct tensile adhesion, in pine and spruce, of cut and wire nails. The results are stated by Prof. W. H. Burr as follows:

There were 58 series of tests, ten pairs of nails (a cut and a wire nail in each) being used. The tests were made in spruce wood in most instances. The nails were of all sizes, from 1 1/8 to 6 in. in length. In every case the cut nails showed the superior holding strength by a large percentage. In spruce, in nine different sizes of nails, both standard and light weight the ratio of tenacity of cut to wire nail was about 3 to 2. With the "finish" nails the ratio was roughly 3.5 to 2. With box nails (1/2 to 4 inches long) the ratio was roughly 3 to 2. The mean superiority in spruce wood was 61%. In white pine, cut nails, driven with taper along the grain, showed a superiority of 100%, and with taper across the grain of 135%. Also when the nails were driven in the end of the stick, i.e., along the grain, the superiority of cut nails was 100%, or the ratio of cut to wire was 2 to 1. The total of the results showed the ratio of tenacity to be about 3.2 to 2 for the harder wood, and about 2 to 1 for the softer, and for the whole taken together the ratio was 3.5 to 2.

Nail-holding Power of Various Woods. -Tests at the Watertown Arsenal on different sizes of nails from 8d. to 60d., reduced to holding power per sq. in. of surface in wood, gave average results, in pounds, as follows: white pine, wire, 167; cut, 405. Yellow pine, wire, 318; cut, 662. White oak, wire, 940; cut, 1216. Chestnut, cut, 683. Laurel, wire, 651; cut, 1200.

Experiments by F. W. Clay. (Eng'g News, Jan. 11, 1894.)

Wood.	Tenacity of 6d nails-			
	Plain.	Barbed.	Flued.	Mean.
White pine	106	94	270.35	111
Yellow pine	190	130	219	196
Basswood	78	x32		143
White oak	226	300	555	360
Hemlock	141	201	319	220

STRENGTH OF WROUGHT IRON BOLTS.

(Computed by A. F. Nagle.)

Dia.	No. Thr.	Dia. of Root.	Area at Root.	Stress upon Bolt upon Basis of					Probable Breaking Load.
				1,000 lbs. per Sq. In.	4,000 lb.	5,000 lb.	7,500 lb.	10,000 lb.	
1/2	13	0.400	0.126	3781	5041	630	9451	1,260	6,400
9/16	12	0.454	0.162	486	640	810	1,215	1,620	8,200
5/8	11	0.507	0.202	606	808	1,010	1,515	2,020	10,200
3/4	10	0.620	0.302	906	1,208	1,510	2,265	3,020	15,200
7/8	9	0.731	0.420	1,260	1,680	2,100	3,150	4,200	21,100
1	8	0.837	0.550	1,650	2,260	2,750	4,125	5,500	27,500
1 1/8	7	0.940	0.694	2,082	2,776	3,470	5,205	6,940	34,500
1 1/4	7	1.065	0.893	2,679	3,572	4,465	6,698	8,930	44,000
1 3/8	6	1.160	1.057	3,171	4,228	5,285	7,927	10,570	52,000
1 1/2	6	1.284	1.295	3,885	5,180	6,475	9,712	12,950	63,000
1 5/8	5 1/2	1.389	1.515	4,545	6,060	7,575	11,362	15,150	74,000
1 3/4	5	1.491	1.746	5,238	6,984	8,730	13,095	17,460	84,000
1 7/8	5	1.616	2.051	6,153	8,204	10,255	15,382	20,510	99,000
2	4 1/2	1.712	2.302	6,906	9,208	11,510	17,265	23,020	110,000
2 1/4	4 1/2	1.962	3.023	9,069	12,092	15,165	22,672	30,230	143,000
2 1/2	4	2.176	3.719	11,157	14,676	16,595	27,892	37,190	174,000
2 3/4	4	2.426	4.620	13,860	18,480	23,100	34,650	46,200	214,000
3	3 1/2	2.629	5.428	16,284	21,712	27,140	40,710	54,280	248,000
3 1/2	3 1/4	3.100	7.548	22,644	30,192	37,740	56,610	75,480	337,000
4	3	3.567	9.963	29,889	39,852	49,815	74,722	99,630	433,000

The U. S. or Sellers System of Screw Threads is used in the above table. The "Probable Breaking Load" is based upon wrought iron running from 51,000 lbs. per sq. in. for 1/2 inch diam. down to 43,500 lbs. for 4 in. diam.

For soft steel bolts add 20% to this column. When it is known what load is to be put upon a bolt, and the judgment of the engineer has determined what stress is safe to put upon the iron, look down in the proper column of said stress until the required load is found. The area at the bottom of the thread will give the equivalent area of a flat bar to that of the bolt.

Effect of Initial Strain in Bolts. — Suppose that bolts are used to connect two parts of a machine and that they are screwed up tightly before the effective load comes on the connected parts. Let P₁ = the initial tension on a bolt due to screwing up, and P₂ = the load afterwards added. The greatest load may vary but little from P₁ or P₂, according as the former or the latter is greater or it may approach the value P₁ + P₂, depending upon the relative rigidity of the bolts and of the parts connected. Where rigid flanges are bolted together, metal to metal, it is probable that the extension of the bolts with any additional tension relieves the initial tension and that the total tension is P₁ or P₂, but in cases where elastic packing, as india rubber, is interposed, the extension of the bolts may very little affect the initial tension, and the total strain may be nearly P₁ + P₂. Since the latter assumption is more unfavorable to the resistance of the bolt this contingency should usually be provided for. (See Unwin, "Elements of Machine Design," for demonstration.)

Forrest E. Cardullo (*Machinery's Reference Series No. 22, 1908*) states the effect of initial stress in bolts due to screwing them tight as follows:
 1. When the bolt is more elastic than the material it compresses, the stress in the bolt is either the initial stress or the force applied, whichever is greater.
 2. When the material compressed is more elastic than the bolt, the stress in the bolt is the sum of the initial stress and the force applied.
 Experiments on screwing up 1/2, 3/4, 1 and 1 1/4 in. bolts showed that the stress produced is often sufficient to break a 1/2-in. bolt, and that the stress varies about as the square of the diameter. From these experiments Prof. Cardullo calculates what he calls the "working section" of a bolt as equal to its area, at the root of the thread, less the area of a 1/2-in. bolt at the root of the thread times twice the diameter of the bolt, and gives the following table based on this rule.

Working Strength of Bolts. U. S. Standard Threads.

Diameter of Bolt, inches.	Area at Root of Thread, square inches.	Working Section, square inches.	Strength of Bolt, 5000 pounds Stress.	Strength of Bolt, 6000 pounds Stress.	Strength of Bolt, 7000 pounds Stress.	Strength of Bolt, 8000 pounds Stress.	Strength of Bolt, 10,000 pounds Stress.	Strength of Bolt, 12,000 pounds Stress.
1/2	0.126	0	0	0	0	0	0	0
5/8	0.202	0.044	220	264	308	352	440	528
3/4	0.302	0.113	565	678	791	904	1,130	1,356
7/8	0.420	0.200	1,000	1,200	1,400	1,600	2,000	2,400
1	0.550	0.298	1,490	1,788	2,086	2,384	2,980	3,476
1 1/8	0.694	0.411	2,055	2,466	2,877	3,288	4,110	4,932
1 1/4	0.893	0.578	2,890	3,468	4,046	4,624	5,780	6,936
1 3/8	1.057	0.710	3,550	4,260	4,970	5,680	7,100	8,520
1 1/2	1.295	0.917	4,585	5,502	6,419	7,336	9,170	10,504
1 5/8	1.515	1.105	5,525	6,630	7,735	8,840	11,050	13,260
1 3/4	1.746	1.305	6,525	7,830	9,135	10,440	13,050	15,660
1 7/8	2.051	1.578	7,890	9,468	11,046	12,624	15,780	18,936
2	2.302	1.798	8,990	10,788	12,586	14,384	17,980	21,576
2 1/4	3.023	2.456	12,280	14,736	17,192	19,648	24,560	29,472
2 1/2	3.719	3.089	15,445	18,534	21,623	24,712	30,890	37,068
2 3/4	4.620	3.927	19,635	23,562	27,489	31,416	39,270	47,124
3	5.428	4.672	23,360	28,032	32,704	37,376	46,720	56,064
3 1/4	6.510	5.690	28,450	34,140	39,830	45,520	56,900	68,280
3 1/2	7.548	6.666	33,330	39,996	46,664	53,328	66,660	79,992

The stresses on bolts caused by tightening the nuts by a wrench may be calculated as follows: Let L = the effective length of the wrench in inches, P = the force in pounds applied at the distance L , n = no. of threads per inch of the bolt, T = total tension on the bolt, if there were no friction then $T = 2 \pi nLP$. Wilfred Lewis. Trans. A. S. M. E., give for the efficiency of a bolt $E = 1 \div (1 + nd)$, where d = external diameter of the screw. $T \times E = 2 \pi nLP \div (1 + nd)$ is the tension corrected for friction. It also expresses the load that can be lifted by screwing a nut on a bolt or a bolt into a nut.

STRENGTH OF CHAINS.

Formulas for Safe Load on Chains.-Writing the formula for the safe load on chains $P = Kd^2$, P in pounds, d in inches, the following figures for K are given by the authorities named.

	Open link	Stud link
Unwin	13,440; 11,200*	20,160
Weisbach	13,350	17,800
Bach	13,750; 11,000*	16,500; 13,200*

* The lower figures are for much used chain, subject frequently to the maximum load, G. A. Goodenough and L. E. Moore. *Univ. of Illinois*

WARNING: This is a 1910 edition. Some of the material may no longer be accurate

STAND-PIPES AND THEIR DESIGN.

(Freeman C. Coffin, New England Water Works Assoc., *Eng. News*, March 16, 1893.) See also papers by A. H. Howland, Eng. Club of Phil., 1887; B. F. Strepens, Amer. Water Works Assoc., *Eng. News*, Oct. 6 and 13, 1888; W. Kiersted, Rensselaer Soc. of Civil Eng., *Eng. Record*, April 25 and May 2, 1891, and W. D. Pence, *Eng. News*, April and May, 1894; also, J. N. Hazlehurst's "Towers and Tanks for Water Works."

The question of diameter is almost entirely independent of that of height. The efficient capacity must be measured by the length from the high-water line to a point below which it is undesirable to draw the water on account of loss of pressure for fire-supply, whether that point is the actual bottom of the stand-pipe or above it. This allowable fluctuation ought not to exceed 50 ft., in most cases. This makes the diameter dependent upon two conditions, the first of which is the amount of the consumption during the ordinary interval between the stopping and starting of the pumps. This should never draw the water below a point that will give a good fire stream and leave a margin for still further draught for fires. The second condition is the maximum number of fire streams and their size which it is considered necessary to provide for, and the maximum length of time which they are liable to have to run before the pumps can be relied upon to reinforce them.

Another reason for making the diameter large is to provide for stability against wind-pressure when empty.

The following table gives the height of stand-pipes beyond which they are not safe against wind-pressures of 40 and 50 lbs. per square foot. The area of surface taken is the height multiplied by one half the diameter.

Diameter, feet...	20	25	30	35
Max. height, wind 40 lbs	.45	70	150	...
50	.35	55	80	160

Any form of anchorage that depends upon connections with the side plates near the bottom is unsafe. By suitable guys, the wind-pressure is resisted by tension in the guys, and the stand-pipe is relieved from wind strains that tend to overthrow it. The guys should be attached to a band of angle or other shaped iron that completely encircles the tank, and rests upon some sort of bracket or projection, and not be riveted to the tank. They should be anchored at a distance from the base equal to the height of the point at which they are attached, if possible.

The best plan is to build the stand-pipe of such diameter that it will resist the wind by its own stability.

Thickness of the Side Plates.

The pressure on the sides tending to rupture the plates by tension, due to the weight of the water, increases in direct ratio to the height, and also to the diameter. The strain upon a section 1 inch in height at any point is the total strain at that point divided by two — for each side is supposed to bear the strain equally. The total pressure at any point is equal to the diameter in inches, multiplied by the pressure per square inch, due to the height at that point. It may be expressed as follows:

- H = height in feet, and f = factor of safety;
- d = diameter in inches;
- p = pressure in lbs. per square inch;
- $0.434 = p$ for 1 ft. in height;
- s = tensile strength of material per square inch;
- T = thickness of plate.

Bulletin, No. 18, 1907 after an extensive theoretical and experimental investigation, find that these values give maximum stresses in the external fibers of from 26,400 to 40,320 lbs. per sq. in., which they consider much too high for safety. Taking 20,000 as a permissible maximum stress, they give the formulæ for safe load $P = 8000 d^2$ for "pen links and $P = 10,000 d^2$ for stud links. They say that the stud link will within the elastic limit bear from 20 to 25% more load than the open link, but that the ultimate strength of the stud link is probably less than that of the open link. See also tables of Size and Strength of Chains, page 251.

Then the total strain on each side per vertical inch

$$= \frac{0.434 Hd}{2} = \frac{pd}{2}; \quad T = \frac{0.434 Hdf}{2s} = \frac{pdf}{2s}.$$

Mr. Coffin takes $f = 5$, not counting reduction of strength of joint, equivalent to an actual factor of safety of 3 if the strength of the riveted joint is taken as 60 Per cent of that of the plate.

The amount of the wind strain per square inch of metal at any joint can be found by the following formula, in which

- H = height of stand-pipe in feet above joint;
- T = thickness of plate in inches;
- p = wind-pressure per square foot;
- W = wind-pressure per foot in height above joint;
- $W = Dp$ where D is the diameter in feet;
- m = average leverage or movement about neutral axis or central points in the circumference: or.
- m = sine of 45° , or 0.707 times the radius in feet.

Then the strain per square inch of plate

$$= \frac{(Hw) \frac{H}{2}}{\text{circ. in ft.} \times mT}$$

Mr. Coffin gives a number of diagrams useful in the design of stand-pipes, together with a number of instances of failures, with discussion of their probable causes.

Mr. Kiersted's paper contains the following: Among the most prominent strains a stand-pipe has to bear are: that due to the static pressure of the water, that due to the overturning effect of the wind on an empty stand-pipe, and that due to the collapsing effect, on the upper rings, of violent wind storms.

For the thickness of metal to withstand safely the static pressure of water, let t = thickness of the plate iron in inches; H = height of stand-pipe in feet; D = diameter of stand-pipe in feet.

Then, assuming a tensile strength of 48,000 lbs. per square inch, a factor of safety of 4, and efficiency of double-riveted lap-joint equaling 0.6 of the strength of the solid plate, $t = 0.00036 H \times D$; $H = 10,000 t - 3.6 D$; which will give safe heights for thicknesses up to $5/8$ to $3/4$ of an inch. The same formula may also apply for greater heights and thicknesses within practical limits, if the joint efficiency be increased by triple riveting.

The conditions for the severest overturning wind strains exist when the stand-pipe is empty.

Formula for wind-pressure of 50 pounds per square foot, when d = diameter of stand-pipe in inches; x = any unknown height of stand-pipe; $x = \sqrt{80\pi dl} = 15.85 \sqrt{dl}$.

Failures of Stand-pipes. — A list showing 23 important failures inside of nine years is given in a paper by Prof. W. D. Pence, *Eng'g News*, April 5, 12, 19 and 26, May 3, 10 and 24, and June 7, 1894. His discussion of the probable causes of the failures is most valuable.

Water Tower at Yonkers, N.Y. — This tower, with a pipe 122 feet high and 20 feet diameter, is described in *Engineering News*, May 18, 1892.

The thickness of the lower rings is $11/16$ of an inch, based on a tensile strength of 60,000 lbs. per square inch of metal, allowing 65% for the strength of riveted joints, using a factor of safety of $3 1/2$ and adding a constant of $1/8$ inch. The plates diminish in thickness by $1/16$ inch to the last four plates at the top, which are $1/4$ inch thick.

The contract for steel requires an elastic limit of at least 33,000 lbs. per square inch; an ultimate tensile strength of from 56,000 to 66,000 lbs. per square inch; an elongation in 8 inches of at least 20%, and a reduction of area of at least 45%. The inspection of the work was made by the Pittsburgh Testing Laboratory. According to their report the actual conditions developed were as follows: Elastic limit from 34,020 to 39,420;

the tensile strength from 58,330 to 65,390; the elongation in 8 inches from $22 1/2$ to 32%; reduction in area from 52.72 to 71.32%; 17 plates out of 141 were rejected in the inspection.

The following table is calculated by Mr. Kiersted's formulae. The stand-pipe is intended to be self-sustaining: that is, without guys or stiffeners.

Heights of Stand-pipes for Various Diameters and Thicknesses of Plates.

Thickness of Plate in Fractions of an Inch.	Diameters in Feet.												
	5	6	7	8	9	10	12	14	15	16	18	20	25
3/16	50	55	60	65	55	50	35						
7/32	55				65	60	50	40	40				
1/4	60	65	70	75	75	70	55	50	45	40	35	35	25
5/16	70	75	80	85	90	85	70	60	55	50	45	40	35
3/8	75	80	90	95	100	100	85	75	70	65	55	50	40
7/16	80	90	95	100	110	115	100	85	80	75	65	60	45
1/2	85	95	100	110	115	120	115	100	90	85	75	70	55
9/16				115	125	130	130	110	100	95	85	80	60
5/8					130	135	145	120	115	105	95	85	65
11/16						145	155	135	125	120	105	95	75
3/4						150	165	145	135	130	115	105	80
13/16								160	150	140	125	110	90
17/16									160	150	135	120	95
5/4										160	145	130	105
1											155	140	110

~ Heights to nearest 5 feet. Rings are to build 5 feet vertically.

WROUGHT-IRON AND STEEL WATER-PIPES.

Riveted Steel Water-pipes (Engineering News, Oct. 11, 1890, and Aug. 1, 1891). — The use of riveted wrought-iron pipe has been common in the Pacific States for many years, the largest being a 44-inch conduit in connection with the works of the Spring Valley Water Co., which supplies San Francisco. The use of wrought iron and steel pipe has been necessary in the West! owing to the extremely high pressures to be withstood and the difficulties of transportation. As an example; In connection with the water supply of Virginia City and Gold Hill, Nev., there was laid in 1872 an 11 1/2-inch riveted wrought-iron pipe, a part of which is under a head of 1720 feet.

In the East, an important example of the use of riveted steel water pipe is that of the East Jersey Water Co., which supplies the city of Newark. The contract provided for a maximum high service supply of 25,000,000 gallons daily. In this case 21 miles of 48-inch pipe was laid, some of it under 340 feet head. The plates from which the pipe is made are about 13 feet long by 7 feet wide, open-hearth steel. Four plates are used to make one section of pipe about 27 feet long. The pipe is riveted longitudinally with a double row, and at the end joints with a single row of rivets. Before being rolled into the trench, two of the 27-foot lengths are riveted together, thus diminishing the number of joints to be made in the trench and the extra excavation to give room for joining.

The thickness of the plates varies with the pressure, but only three thicknesses are used, $1/4$, $5/16$, and $3/8$ inches, the pipe made of these thicknesses having a weight of 160, 185, and 225 lbs. per foot, respectively. At the works all the pipe was tested to pressure $1 1/2$ times that which it is to be subjected when in place.

An important discussion of the design of large riveted steel pipes to

resist not only the internal pressure but also the external pressure from moist earth in which they are laid, together with notes on the design of a pipe 1X ft diam. 6000 ft. long for the Ontario Water Power Co., Niagara Falls, by Joseph Mayer, will be found in *Eng. News*, April 26, 1906.

STRENGTH OF VARIOUS MATERIALS. EXTRACTS FROM KIRKALDY'S TESTS.

The publication, in a book by W. G. Kirkaldy, of the results of many thousand tests made during a quarter of a century by his father, David Kirkaldy has made an important contribution to our knowledge concerning the range of variation in strength of numerous materials. A condensed abstract of these results was published in the *American Machinist*, May 11 and 18, 1893, from which the following still further condensed extracts are taken:

The figures for tensile and compressive strength, or, as Kirkaldy calls them, pulling and thrusting stress, are given in pounds per square inch of original section, and for bending strength in pounds of actual stress or pounds Per BD^2 (breadth X square of depth) for length of 36 inches between supports. The contraction of area is given as a percentage of the original area, and the extension as a percentage in a length of 10 inches, except when otherwise stated. The abbreviations T. S., E. L., Contr., and Est. are used for the sake of brevity, to represent tensile strength, elastic limit, and percentages of contraction of area, and elongation, respectively.

Cast Iron. -44 tests: T. S. 15,468 to 25,740 pounds: 17 of these were unsound, the strength ranging from 15,468 to 24,357 pounds. Average of all, 23,805 pounds.

Thrusting stress, specimens 2 inches long, 1.34 to 1.5 in. diameter: 43 tests, all sound, 94,352 to 131,912: one, unsound, 93,759: average of all, 113,825.

Bending stress, bars about 1 in. wide by 2 in. deep, cast on edge. Ultimate stress 2876 to 3854: stress per $BD^2 = 725$ to 892: average, 820. Average modulus of rupture, $R = \frac{3}{2}$ stress per BD^2 X length, = 44,280. Ultimate deflection, 0.29 to 0.40 in.: average, 0.34 inch.

Other tests of cast iron, 460 tests, 16 lots from various sources, gave results with total range as follows: Pulling stress, 12,688 to 33,618 pounds: thrusting stress, 66,363 to 175,950 pounds: bending stress, Per BD^2 , 505 to 1128 pounds: modulus of rupture, R , 27,270 to 61,912. Ultimate deflection, 0.2: to 0.45 inch.

The specimen which was the highest in thrusting stress was also the highest in bending, and showed the greatest deflection, but its tensile strength was only 26,502.

The specimen with the highest tensile strength had a thrusting stress of 143,939 and a bending strength, Per BD^2 , of 979 pounds with 0.41 deflection. The specimen lowest in T. S. was also lowest in thrusting and bending, but gave 0.38 deflection. The specimen which gave 0.21 deflection had T. S., 19,185: thrusting, 104,281; and bending, 561.

Iron Castings. - 69 tests: tensile strength, 10,416 to 31,652; thrusting stress, ultimate per square inch, 53,502 to 132,031.

Channel Irons. - Tests of 18 pieces cut from channel irons. T. S. 40,693 to 53,141 pounds per square inch: contr. of area from 3.9 to 32.5%. Est. in 10 in. from 2.1 to 22.5%. The fractures ran all the way from 100% fibrous to 100% crystalline. The highest T. S. 53,141, with 8.1% contr. and 5.3% ext., was 100% crystalline; the low T. S., 40,693, with 3.9 contr. and 2.1% ext., was 75% crystalline. All the fibrous irons showed from 12.2 to 22.5% ext., 17.3 to 32.5 contr. and T. S. from 43,426 to 49,615. The fibrous irons are therefore of medium tensile strength and high ductility. The crystalline irons are of variable T. S., highest to lowest, and low ductility.

Lowmoor Iron Bars. - Three rolled bars 2 1/2 inches diameter: tensile tests: elastic, 23,200 to 24,200; ultimate, 50,875 to 51,905; contraction, 44.4 to 42.5: extension, 29.2 to 24.3. Three hammered bars, 4 1/2 inches diameter, elastic 25,100 to 24,200: ultimate, 46,810 to 49,223: contraction, 20.7 to 46.5: extension, 10.8 to 31.6. Fractures of all, 100 per cent fibrous. In the hammered bars the lowest T. S. was accompanied by lowest ductility.

Iron Bars, Various. - Of a lot of 80 bars of various sizes, some rolled and some hammered (the above Lowmoor bars included), the lowest T. S. (except one) 40,808 pounds per square inch, was shown by the Swedish "hoop L" bar 3 1/4 inches diameter, rolled. Its elastic limit was 19,150 pounds; contraction 68.7% and extension 37.7% in 10 inches. It was also the most ductile of all the bars tested, and was 100% fibrous. The highest T. S., 60,780 pounds, with elastic limit, 29,400; contr., 36.6: and ext., 24.3%, was shown by a "Farnley" 2-inch bar, rolled. It was also 100% fibrous. The lowest ductility 2.6% contr., and 4.1% ext., was shown by a 3 3/4-inch hammered bar, without brand. It also had the lowest T. S., 40,278 pounds, but rather high elastic limit, 25,700 pounds. Its fracture was 95% crystalline. Thus of the two bars showing the lowest T. S., one was the most ductile and the other the least ductile in the whole series of SO bars.

Generally, high ductility is accompanied by low tensile strength, as in the Swedish bars, but the Farnley bars showed a combination of high ductility and high tensile strength.

Locomotive Forgings, Iron. - 17 tests, average, E. L., 30,420; T. S., 50,521; contr., 36.5; est. in 10 inches, 23.8.

Broken Anchor Forgings, Iron. - 4 tests: average, E. L., 23,525; T. S., 40,083; contr., 3.0; est. in 10 inches, 3.8.

Kirkaldy places these two irons in contrast to show the difference between good and bad work. The broken anchor material, he says, is of a most treacherous character, and a disgrace to any manufacturer.

Iron Plate Girder. - Tensile tests of pieces cut from a riveted iron girder after twenty years' service in a railway bridge. Top plate, average of 3 tests, E. L., 26,600; T. S., 40,806; contr., 16.1; est. in 10 inches, 7.8. Bottom plate, average of 3 tests, E. L., 31,200; T. S., 44,288; contr., 13.3; ext. in 10 inches, 6.3. Web-plate, average of 3 tests, E. L., 28,000; T. S., 45,902; contr., 15.9; est. in 10 inches, 8.9. Fractures all fibrous. The results of 30 tests from different parts of the girder prove that the iron has undergone no change during twenty years of use.

Steel Plates. - Six plates 100 inches long, 2 inches wide, thickness various, 0.36 to 0.97 inch. T. S., 53,485 to 60,805; E. L., 29,600 to 33,200; contr., 52.9 to 59.5; ext., 17.05 to 18.57.

Steel Bridge Links. - 40 links from Hammersmith Bridge, 1886.

	T. S.	E. L.	Contr.	Ext. in 100 in.	Fracture.	
					Silky.	Granular.
Average of all.	67,294	38,294	34.5%	14.1%		
Lowest T. S.	69,753	36,030	30.1	15.51	30%	70%
Highest T. S. and E. L.	75,936	44,166	31.2	12.42	15	85
Lowest E. L.	64,044	32,441	34.7	13.43	30	70
Greatest Contraction.	63,745	38,118	52.8	15.46	100	0
Greatest Extension.	65,980	36,792	40.8	17.78	35	65
Least Contr. and Ext.	63,980	39,017	6.0	6.62	0	100

The ratio of elastic to ultimate strength ranged from 50.6 to 65.2 Per cent; average, 56.9 Per cent.

Extension in lengths of 100 inches. At 10,000 lbs. per sq. in., 0.018 to 0.024; mean, 0.020 inch; at 20,000 lbs. per sq. in., 0.049 to 0.063; mean, 0.056 inch; at 30,000 lbs. per sq. in., 0.083 to 0.100; mean, 0.090; set at 30,000 pounds, per sq. in., 0 to 0.002; mean, 0.

The mean extension between 10,000 to 30,000 lbs. per sq. in. increased regularly at the rate of 0.007 inch for each 2000 lbs. per sq. in. increment of strain. This corresponds to a modulus of elasticity of 28,571,429.

The least increase of extension for an increase of load of 20,000 lbs. per sq. in., 0.065 inch, corresponds to a modulus of elasticity of 30,769,231, and the greatest, 0.076 inch, to a modulus of 26,315,789.

Steel Rails. - Bending tests, 5 feet between supports, 11 tests of flange rails 72 Pounds per yard, 4.63 inches high.

WARNING: This is a 1910 edition. Some of the material may no longer be accurate

	Elastic stress. Pounds.	Ultimate stress. Pounds.	Deflection at 50,000 Pounds.	Ultimate Deflection.
Hardest	34,200	60,960	3.24 ins.	8 ins.
Softest	32,000	56,740	3.76 "	8 "
Mean	32,763	59,209	3.53 "	8 "

All uncracked at 8 inches deflection.
Pulling tests of pieces cut from same rails. Mean results.

	Elastic Stress, per sq. in.	Ultimate Pounds. per sq. in.	Contraction of area of frac- ture.	Extension in 10 ins.
Top of rails	44,200	83,110	19.9%	13.5%
Bottom of rails	40,900	77,820	30.9%	22.8%

Steel Tires. — Tensile tests of specimens cut from steel tires.

KRUPP STEEL. — 262 Tests.

	E. L.	T. S.	Contr.	Ext. in 5 inches.
Highest	69,250	119,079	31.9	18.1
Mean	52,869	104,112	29.5	19.7
Lowest	41,700	90,523	45.5	23.7

VICKERS, SONS & Co. — 70 Tests.

	E. L.	T. S.	Contr.	Ext. in 5 inches.
Highest	58,600	120,789	11.8	8.4
Mean	51,066	101,264	17.6	12.4
Lowest	43,700	87,697	24.7	16.0

Note the correspondence between Krupp's and Vickers' steels as to tensile strength and elastic limit, and their great difference in contraction and elongation. The fractures of the Krupp steel averaged 22 per cent silky, 78 per cent granular; of the Vicker steel, 7 per cent silky, 93 per cent granular.

Steel Axles. — Tensile tests of specimens cut from steel axles.

PATENT SHAFT AND AXLE TREE Co. — 157 Tests.

	E. L.	T. S.	Contr.	Ext. in 5 inches.
Highest	49,800	99,009	21.1	16.0
Mean	36,267	72,099	33.0	23.6
Lowest	31,800	61,382	34.8	25.3

VICKERS, SONS & Co. — 125 Tests.

	E. L.	T. S.	Contr.	Ext. in 5 inches.
Highest	42,600	83,701	18.9	13.2
Mean	37,618	70,572	41.6	27.5
Lowest	30,250	56,388	49.0	37.2

The average fracture of Patent Shaft and Axle Tree Co. steel was 33 per cent silky, 67 per cent granular.
The average fracture of Vickers' steel was 88 per cent silky, 12 per cent granular.

Steel Propeller Shafts. — Tensile tests of pieces cut from two shafts, mean of four tests each. Hollow shaft, Whitworth, T. S., 61,290; E. L., 30,575; contr., 52.8; ext. in 10 inches, 28.6. Solid shaft, Vickers', T. S., 46,870; E. L., 20,425; contr., 44.4; ext. in 10 inches, 30.7.

Thrusting tests, Whitworth, ultimate, 56,201; elastic, 29,300; set at 30,000 lbs., 0.18 per cent; set at 40,000 lbs., 2.04 per cent; set at 50,000 lbs., 3.82 per cent.
Thrusting tests, Vickers', ultimate, 44,602; elastic, 22,250; set at 30,000 lbs., 2.29 per cent; set at 40,000 lbs., 4.69 per cent.

Shearing strength of the Whitworth shaft, mean of four tests, 40,654 lbs. per square inch, or 66.3 per cent of the pulling stress. Specific gravity of the Whitworth steel, 7.867; of the Vickers', 7.856.

Spring Steel. — Untempered, 6 tests, average, E. L., 67,916; T. S., 115,668; contr., 37.8; ext. in 10 inches, 16.6. Spring steel untempered, 15 tests, average, E. L., 38,785; T. S., 69,496; contr., 19.1; ext. in 10 inches, 29.8. These two lots were shipped for the same purpose, viz., railway carriage leaf springs.

Steel Castings. — 44 tests, E. L., 31,816 to 35,567; T. S., 54,928 to 63,840; contr., 1.67 to 15.8; ext., 1.45 to 15.1. Note the great variation in ductility. The steel of the highest strength was also the most ductile.

Riveted Joints, Pulling Tests of Riveted Steel Plates, Triple Riveted Lap Joints, Machine Riveted, Holes Drilled.

Plates, width and thickness, inches:	13.50 × 0.25	13.00 × 0.51	11.75 × 0.78	12.25 × 1.01	14.00 × 0.77
Plates, gross sectional area square inches:	3.375	6.63	9.165	12.372	10.780
Stress, total, pounds:	199,320	332,640	423,180	528,000	455,210
Stress per square inch of gross area, joint:	59,058	50,172	46,173	42,696	42,227
Stress per square inch of plates, solid:	70,765	65,300	64,050	62,280	68,045
Ratio of strength of joint to solid plate:	83.46	76.83	72.09	68.55	62.06
Ratio net area of plate to gross:	73.4	65.5	62.7	64.7	72.9
Where fractured:	plate at holes.	plate at holes.	plate at holes.	plate at holes.	rivets sheared
Rivets, diameter, area and number:	0.45, 0.159, 24	0.64, 0.321, 21	0.95, 0.708, 12	1.08, 0.916, 12	0.95, 0.708, 12
Rivets, total area:	3.816	6.741	8.496	10.992	8.496

Strength of Welds. — Tensile tests to determine ratio of strength of weld to solid bar.

IRON TIE BARS. — 28 Tests.

Strength of solid bars varied from	43,201 to 57,065 lbs.
Strength of welded bars varied from	17,816 to 44,586 lbs.
Ratio of weld to solid varied from	37.0 to 79.1%

IRON PLATES. — 7 Tests.

Strength of solid plate from	44,851 to 47,481 lbs.
Strength of welded plate from	26,442 to 38,931 lbs.
Ratio of weld to solid	57.7 to 83.9%

CHAIN LINKS. — 216 Tests.

Strength of solid bar from	49,122 to 57,875 lbs.
Strength of welded bar from	39,575 to 48,824 lbs.
Ratio of weld to solid	72.1 to 95.4%

IRON BARS. — Hand and Electric Machine Welded.

32 tests, solid iron, average	52,444
17 " electric welded, average	46,836 ratio 89.1%
19 " hand "	46,899 " 89.3%

STEEL BARS AND PLATES. — 14 Tests.

Strength of solid	54,226 to 64,580
Strength of weld	28,553 to 46,019
Ratio weld to solid	52.6 to 82.1%

The ratio of weld to solid in all the tests ranging from 37.0 to 95.4 is proof of the great variation of workmanship in welding.

Cast Copper. — 4 tests, average, E. L. 5900; T. S., 24,781; contr., 24.5; ext., 21.8.

Copper Plates. — As rolled, 22 tests, 0.26 to 0.75 in. thick; E. L., 9766 to 18,650; T. S., 30,993 to 34,281; contr., 31.1 to 57.6; ext., 39.9 to 52.2. The variation in elastic limit is due to difference in the heat at which the plates were finished. Annealing reduces the T. S. only about 1000 pounds, but the E. L. from 3000 to 7000 pounds.

Another series, 0.38 to 0.52 in. thick; 148 tests, T. S., 29,099 to 31,924; contr., 28.7 to 56.7; ext. in 10 inches, 28.1 to 41.8. Note the uniformity in tensile strength.

Drawn Copper. — 74 tests (0.88 to 1.08 inch diameter); T. S., 31,634 to 40,557; contr., 37.5 to 64.1; ext. in 10 inches, 5.8 to 48.2.

Bronze from a Propeller Blade. — Means of two tests each from center and edge. Central portion (sp. gr. 8.320), E. L., 7550; T. S., 26,312; contr., 25.4; ext. in 10 inches, 32.8. Edge portion (sp. gr. 8.550), E. L., 8950; T. S., 35,960; contr., 37.8; ext. in 10 inches, 47.9.

Cast German Silver. — 10 tests: E. L., 13,400 to 29,100; T. S., 23,714 to 46,540; contr., 3.2 to 21.5; ext. in 10 inches, 0.6 to 10.2.

Thin Sheet Metal. — Tensile Strength.

German silver, 2 lots.....	75,816 to 87,129
Bronze, 4 lots.....	73,380 to 92,086
Brass, 2 lots.....	44,398 to 58,188
Copper, 9 lots.....	30,470 to 48,450
Iron, 13 lots, lengthway.....	44,331 to 59,484
Iron, 13 lots, crossway.....	39,838 to 57,350
Steel, 6 lots.....	49,253 to 78,251
Steel, 6 lots, crossway.....	55,948 to 80,799

Wire Ropes.

Selected Tests Showing Range of Variation.

Description.	Circumference, inches.	Weight per Fathom.	Strands.		Diameter of Wires, inches.	Hemp Core.	Ultimate Strength, lbs.
			No. of Strands.	No. of Wires.			
Galvanized.....	7.70	53.00	6	19	0.1563	Main	339,780
Ungalvanized.....	7.00	53.10	7	19	0.1495	Main and Strands	314,860
Ungalvanized.....	6.38	42.50	7	19	0.1347	Wire Core	295,920
Galvanized.....	7.10	37.57	6	30	0.1004	Main and Strands	272,750
Ungalvanized.....	6.18	40.46	7	19	0.1302	Wire Core	268,470
Ungalvanized.....	6.19	40.33	7	19	0.1316	Wire Core	221,820
Galvanized.....	4.92	20.86	6	30	0.0728	Main and Strands	190,890
Galvanized.....	5.36	18.94	6	12	0.1104	Main and Strands	136,550
Galvanized.....	4.82	21.50	6	7	0.1693	Main	129,710
Ungalvanized.....	3.65	12.21	6	19	0.0755	Main	110,180
Ungalvanized.....	3.50	12.65	7	7	0.122	Wire Core	101,440
Ungalvanized.....	3.82	14.12	6	7	0.135	Main	98,670
Galvanized.....	4.11	11.35	6	12	0.080	Main and Strands	75,110
Galvanized.....	3.31	7.27	6	12	0.068	Main and Strands	55,095
Ungalvanized.....	3.02	8.62	6	7	0.105	Main	49,555
Ungalvanized.....	2.68	6.26	6	6	0.0963	Main and Strands	41,205
Galvanized.....	2.87	5.43	6	12	0.0560	Main and Strands	38,555
Galvanized.....	2.46	3.85	6	12	0.0472	Main and Strands	28,075
Ungalvanized.....	1.75	2.80	6	7	0.0619	Main	24,552
Galvanized.....	2.04	2.72	6	12	0.0378	Main and Strands	20,415
Galvanized.....	1.76	1.85	6	12	0.0305	Main	14,634

Wire. — Tensile Strength.

German silver, 5 lots.....	81,735 to 92,224
Bronze, 1 lot.....	78,049
Brass, as drawn, 4 lots.....	81,114 to 98,578
Copper, as drawn, 3 lots.....	37,607 to 46,494
Copper annealed, 3 lots.....	34,936 to 45,210
Copper (another lot), 4 lots.....	35,052 to 62,190
Copper (extension 36.4 to 0.6%) Iron, 8 lots.....	59,246 to 97,908
Iron (extension 15.1 to 0.7%) Steel, 8 lots.....	103,272 to 318,823

The steel of 318,823 T. S. was 0.047 inch diam., and had an extension of only 0.3 per cent; that of 103,272 T. S. was 0.107 inch diam., and had an extension of 2.2 per cent. One lot of 0.044 inch diam. had 267,114 T. S., and 5.2 per cent extension.

Hemp Ropes, Untarred. — 15 tests of ropes from 1.53 to 6.90 inches circumference, weighing 0.42 to 7.77 pounds per fathom, showed an ultimate strength of from 1670 to 33,808 pounds, the strength per fathom weight varying from 2872 to 5534 pounds.

Hemp Ropes, Tarred. — 15 tests of ropes from 1.44 to 7.12 inches circumference, weighing from 0.38 to 10.39 pounds per fathom, showed an ultimate strength of from 1046 to 31,549 pounds, the strength per fathom weight varying from 1767 to 5149 pounds.

Cotton Ropes. — 5 ropes, 2.48 to 6.51 inches circumference, 1.08 to 8.17 pounds per fathom. Strength 3089 to 23,258 pounds, or 2474 to 3346 pounds per fathom weight.

Manila Ropes. — 35 tests: 1.19 to 8.90 inches circumference, 0.20 to 11.40 pounds per fathom. Strength 1280 to 65,550 pounds, or 3003 to 7394 pounds per fathom weight.

Belting.

No. of lots.	Tensile strength per square inch.
11 Leather, single, ordinary tanned.....	3248 to 4824
4 Leather, single, Helvetia.....	5631 to 5944
7 Leather, double, ordinary tanned.....	2180 to 3572
8 Leather, double Helvetia.....	4078 to 5412
6 Cotton, solid woven.....	5648 to 8869
14 Cotton, folded, stitched.....	4570 to 7750
1 Flax, solid, woven.....	9946
1 Flax, folded, stitched.....	6389
6 Hair, solid, woven.....	3852 to 5159
2 Rubber, solid, woven.....	4271 to 4343

Canvas. — 35 lots: Strength, lengthwise, 113 to 408 pounds per inch; crossways, 191 to 468 pounds per inch. The grades are numbered 1 to 6, but the weights are not given. The strengths vary considerably, even in the same number.

Marbles. — Crushing strength of various marbles. 38 tests, 8 kinds. Specimens were 6-inch cubes, or columns 4 to 6 inches diameter, and 6 and 12 inches high. Range 7542 to 13,720 pounds per square inch.

Granite. — Crushing strength, 17 tests: square columns 4 X 4 and 6 X 4, 4 to 24 inches high, 3 kinds. Crushing strength ranges 10,026 to 13,271 pounds per square inch. (Very uniform.)

Stones. — (Probably sandstone, local names only given.) 11 kinds, 42 tests, 6 X 6, columns 12, 18 and 24 inches high. Crushing strength ranges from 2105 to 12,122. The strength of the column 24 inches long is generally from 10 to 20 per cent less than that of the 6-inch cube.

Stones. — (Probably sandstone) tested for London & Northwestern Railway. 16 lots, 3 to 6 tests in a lot. Mean results of each lot ranged from 3785 to 11,956 pounds. The variation is chiefly due to the stones being from different lots. The different specimens in each lot gave results which generally agreed within 30 per cent.

Tests of Steel Angles with Riveted End Connections. (F. P. McKibbin, *Proc. A.S.T.M.*, 1907.) — The angles broke through the rivet holes in all cases. The strength developed ranged from 62.5 to 79.1% of the ultimate strength of the gross area, or from 73.9 to 92% of the calculated strength of the net section at the rivet holes.

SHEARING STRENGTH.

H. V. Loss in *American Engineer and Railroad Journal*, March and April, 1893, describes an extensive series of experiments on the shearing of iron and steel bars in shearing machines. Some of his results are:

Depth of penetration at point of maximum resistance for soft steel bars is independent of the width, but varies with the thickness. If d = depth of penetration and t = thickness, $d = 0.3t$ for a flat knife, $d = 0.25t$ for a 4° bevel knife, and $d = 0.16\sqrt{t}$ for an 8° bevel knife. The ultimate pressure per inch of width in flat steel bars is approximately 0.000 lbs. $\times t$. The energy consumed in foot-pounds per inch width of steel bars is, approximately: 1" thick, 1300 ft.-lbs.; 1 1/2", 2500; 1 3/4", 3700; 1 7/8", 4500; the energy increasing at a slower rate than the square of the thickness. Iron angles require more energy than steel angles of the same size: steel breaks while iron has to be cut off. For hot-rolled steel the resistance per square inch for rectangular sections varies from 4400 lbs. to 20,500 lbs., depending partly upon its hardness and partly upon the size of its cross-area, which latter element indirectly but greatly indicates the temperature, as the smaller dimensions require a considerably longer time to reduce them down to size, which time again means loss of heat.

It is not probable that the resistance in practice can be brought very much below the lowest figures here given — viz., 4400 lbs. per square inch — as a decrease of 1000 lbs. will henceforth mean a considerable increase in cross-section and temperature.

Relation of Shearing to Tensile Strength of Different Metals. E. G. Izod, in a paper presented to the Institution of Mech. Engrs. (*Am. Mach.*, Jan. 18, 1906), describes a series of tests on bars and plates of different metals. The specimens were firmly clamped on two steel plates with opposed shearing edges 4 ins. apart, and a shearing block, which was a sliding fit between these edges, was brought down upon the specimen, so as to cut it in double shear, by a testing machine.

	a	b	c		a	b	c
Cast iron. A.....	9.7	152	Rolled phosphor-bronze.....	39.5	11.7	61
Cast iron. B.....	13.4	111	Aluminum.....	6.4	25.5	70
Cast iron. C.....	11.3	122	Aluminum alloy.....	12.7	9.6	59
Cast aluminum-bronze.....	33.1	12.5	60	Wrought-iron bar.....	26.0	22.5	75
Cast phosphor-bronze.....	13.4	2.2	128	Mild-steel, 0.14 carbon.....	26.9	34.7	76
Cast phosphor-bronze.....	19.7	8.0	93	Crucible steel, 0.12 C.....	24.9	43.0	74
Gun metal.....	12.1	7.8	103	0.48 C.....	42.1	26.0	68
Yellow brass.....	7.5	6.5	126	0.71 C.....	56.3	15.0	65
Yellow brass.....	16.0	35.0	74	0.77 C.....	61.3	11.0	62

a. Tensile strength of the metal, gross tons per sq. in.; b. elongation in 2 in.%; c. ratio shearing + tensile strength. The results seem to point to the fact that there is no common law connecting the ultimate shearing stress with the ultimate tensile stress, the ratio varying greatly with different materials. The test figures from crystalline materials, such as cast iron or those with very little or no elongation, seem to indicate that the ultimate shear stress exceeds the ultimate tensile stress by as much as 20 or 25%, while from those with a fairly high measure of ductility, the ultimate shear stress may be anything from 0 to 50% less than the ultimate tensile stress.

For shearing strength of rivets, see pages 407 and 412.

STRENGTH OF IRON AND STEEL PIPE.

Tests of Strength and Threading of Wrought-Iron and Steel Pipe. T. N. Thomson, in *Proc. Am. Soc. Heat and Vent. Engineers*, vol. xii., p. 80, describes some experiments on welded wrought iron and steel pipes. Short rings of 6-in. pipe were pulled in the direction of a diameter so as to elongate the ring. Four wrought iron rings broke at 2400, 3000, 3100 and 4100 lbs., and four steel rings at 5300 (defective weld) 18,000, 29,000 and 35,000 lbs. Another series of 9 tests each were tested so as to show the tensile strength of the metal and of the weld. The average strength of the metal was, iron, 34,520, steel, 61,850 lbs. The strength of the weld in iron ranged from 49 to 84, averaging 71 per cent of the strength of the metal, and in steel from 50 to 93, averaging 72%.

A large number of iron and steel pipes of different sizes were tested by twisting, the force being applied at the end of a three-foot lever. The average pull on the steel pipes was: 1/2 in. pipe, 109 lbs.; 1 in., 172 lbs.; 1 1/2 in., 300 lbs.; number of turns in 6 ft. length, respectively, 15, 8 and 5 1/2. Per cent failed in weld, 0, 13 and 13 respectively. For different lots of iron pipe the average pull was: 1/2 in., 68, 81 and 65 lbs.; 1 in., 151, 136, 107 lbs.; 1 1/2 in., 256, 250, 258 lbs. The number of turns in 6 feet for the nine lots were respectively, 4 1/2, 5 3/4, 2 1/2, 6 1/4, 3 1/2, 2 1/2, 4 1/2, 3 1/2, 2 1/4. The failures in the weld ranged from 33 to 100% in the different lots.

The force required to thread 1 1/4-in. pipe with two forms of die was tested by pulling on a lever 21 ins. long. The results were as follows:

Old form of die, iron pipe... 83 to 87 lbs. pull, steel pipe 100 to 111 lbs.
Improved die iron pipe.... 58 to 62 lbs. pull, steel pipe, 60 to 65 lbs.

Mr. Thomson gives the following table showing approximately the steady pull in pounds required at the end of a 16-in. lever to thread twist and split iron and steel pipe of small sizes:

	To Thread with Oiled Dies.			To Twist Lbs.	To Split Lbs.	Safety Margin Lbs.
	New Rake Dies.	New Common Dies.	Old Common Dies.			
1/2 in. steel.....	34	56	60	122	152	74
1/2 in. iron.....	27	33	49	102	110	46
3/4 in. steel.....	44	60	91	150	240	112
3/4 in. iron.....	44	51	73	140	176	81
1 in. steel.....	69	111	124	286	420	259
1 in. iron.....	62	106	116	273	327	173

The margin of safety is computed by adding 30% to the pull required to thread with the old dies and subtracting the sum from the pull required to split the pipe. If the mechanic pulls on the dies beyond the limit, due to imperfect dies, or to a hard spot in the pipe, he will split the pipe.

Old Boiler Tubes used as Columns. (*Tech. Quar.* XIII, No. 3, 1900, p. 225.) Thirteen tests were made of old 4-in. tubes taken from worn-out boilers. The lengths were from 6 to 8 ft., ratio l/r 53 to 71, and thickness of metal 0.13 to 0.18 in. It is not stated whether the tubes were iron or steel. The maximum load ranged from 34,600 to 50,090 lbs., and the maximum load per sq. in. from 17,100 to 27,500 lbs. Six new tubes also were tested, with maximum loads 55,600 to 64,800 lbs., and maximum loads per sq. in. 31,600 to 38,100 lbs. The relation of the strength per sq. in. of the old tubes to the ratio l/r was very variable, being expressed approximately by the formula $S = 41,000 - 300 l/r \pm 5000$. That of the new tubes is approximately $S = 52,000 - 300 l/r \pm 2000$.

HOLDING-POWER OF BOILER-TUBES EXPANDED INTO TUBE-SHEETS.

Experiments by Chief Engineer W. H. Shock, U. S. N., on brass tubes, 2 1/2 inches diameter, expanded into plates 3/4 inch thick, gave results ranging from 5850 to 46,000 lbs. Out of 48 tests 5 gave figures under 10,000 lbs., 12 between 10,000 and 20,000 lbs., 18 between 20,000 and 30,000 lbs., 10 between 30,000 and 40,000 lbs., and 3 over 40,000 lbs.

Experiments by Yarrow & Co., on steel tubes, 2 to 2 1/4 inches diameter, gave results similarly varying, ranging from 7900 to 41,715 lbs., the majority ranging from 20,000 to 30,000 lbs. In 15 experiments on 4 and 5 inch tubes the strain ranged from 20,720 to 68,040 lbs. Beading the tube does not necessarily give increased resistance, as some of the lower figures were obtained with beaded tubes. (See paper on Rules Governing the Construction of Steam Boilers, Trans. Engineering Congress, Section G, Chicago, 1893.)

The Slipping Point of Rolled Boiler-Tube Joints.

(O. P. Hood and G. L. Christensen, *Trans. A. S. M. E.*, 1908).

When a tube has started from its original seat, the fit may be no longer continuous at all points and a leak may result, although the ultimate holding power of the tube may not be impaired. A small movement of the tube under stress is then the preliminary to a possible leak, and it is of interest to know at what stress this slipping begins.

As results of a series of experiments with tube sheets of from 1/2 in. to 1 in. in thickness and with straight and tapered tube seats, the authors found that the slipping point of a 3-in. 12-gage Shelby cold-drawn tube rolled into a straight, smooth machined hole in a 1-in. sheet occurs with a pull of about 7,000 lbs. The frictional resistance of such tubes is about 750 lbs. per sq. in. of tube-bearing area in sheets 5/8 in. and 1 in. thick.

Various degrees of rolling do not greatly affect the point of initial slip, and for higher resistances to initial slip other resistance than friction must be depended upon. Cutting a 10-pitch square thread in the seat, about 0.01 in. deep will raise the slipping point to three or four times that in a smooth hole. In one test this thread was made 0.015 in. deep in a sheet 1 in. thick, giving an abutting area of about 1.4 sq. in., and a resistance to initial slip of 45,000 lbs. The elastic limit of the tube was reached at about 34,000 lbs.

Where tubes give trouble from slipping and are required to carry an unusual load, the slipping point can be easily raised by serrating the tube seat by rolling with an ordinary flue expander, the rolls of which are grooved about 0.007 in. deep and 10 grooves to the inch. One tube thus serrated had its slipping point raised between three and four times its usual value.

METHODS OF TESTING THE HARDNESS OF METALS.

Brinell's Method. J. A. Brinell, a Swedish engineer, in 1900 published a method for determining the relative hardness of steel which has come into somewhat extensive use. A hardened steel ball, 10 mm. (0.3937 in.), is forced with a pressure of 3000 kg. (6614 lbs.) into a flat surface on the sample to be tested, so as to make a slight spherical indentation, the diameter of which may be measured by a microscope or the depth by a micrometer. The hardness is defined as the quotient of the pressure by the area of the indentation. From the measurement the "hardness number" is calculated by one of the following formulæ:

$$H = K \left(r + \sqrt{r^2 - R^2} \right) \div 2 \pi r R^2, \text{ or } H = K \div 2 \pi r d.$$

K = load, = 3000 kg., r = radius of ball, = 5 mm., R = radius and d = depth of indentation.

The following table gives the hardness number corresponding to different values of R and d.

WARNING: This is a 1910 edition. Some of the material may no longer be accurate

R	H	R	H	R	H	d	H	d	H	d	H
1.00	955	2.40	398	3.80	251	2.00	946	3.20	364	4.60	170
1.20	796	2.60	367	4.00	239	2.10	857	3.40	321	4.80	156
1.40	682	2.80	341	4.20	227	2.20	782	3.60	286	5.00	143
1.60	597	3.00	318	4.40	217	2.40	652	3.80	255	5.50	116
1.80	531	3.20	298	4.60	208	2.60	555	4.00	228	6.00	95
2.00	477	3.40	281	4.80	199	2.80	477	4.20	207	6.50	80
2.20	434	3.60	265	4.95	193	3.00	418	4.40	187	6.95	68

The hardness of steel, as determined by the Brinell method, has a direct relation to the tensile strength, and is equal to the product of a coefficient, C, into the hardness number. Experiments made in Sweden with annealed steel showed that when the impression was made transversely to the rolling direction, with H below 175, C = 0.362; with H above 175, C = 0.344. When the impression was made in the rolling direction, with H below 175, C = 0.354; with H above 175, C = 0.324. The product, C x H, or the tensile strength, is expressed in kilograms per square millimeter.

Electro-magnetic Method.—Several instruments have been devised for testing the hardness of steel by electrical methods. According to Prof. D. E. Hughes (*Cass. Mag.*, Sept., 1908), the magnetic capacity of iron and steel is directly proportional to the softness, and the resistance to a feeble external magnetic force is directly as the hardness. The electric conductivity of steel decreases with the increase of hardness. (See *Electric Conductivity of Steel*, p. .)

The Scleroscope.—This is the name of an instrument invented by A. F. Shore for determining the hardness of metals. It consists chiefly of a vertical glass tube in which slides freely a small cylinder of very hard steel, pointed on the lower end, called the hammer. This hammer is allowed to fall about 10 inches on to the sample to be tested, and the distance it rebounds is taken as a measure of the hardness of the sample. A scale on the tube is divided into 140 equal parts, and the hardness is expressed as the number on the scale to which the hammer rebounds. Measured in this way the hardness of different substances is as follows: Glass, 130; porcelain, 120; hardest steel, 110; tool steel, 1% C., may be as low as 31; mild steel, 0.5 C, 26 to 30; gray castings, 39; wrought iron, 18; babbitt metal, 4 to 10; soft brass, 12; zinc, 8; copper, 6; lead, 2. (*Cass. Mag.*, Sept., 1908.)

STRENGTH OF GLASS.

(Fairbairn's "Useful Information for Engineers," Second Series.)

	Best Flint Glass.	Common Green Glass.	Extra White Crown Glass.
Mean specific gravity	3.078	2.528	2.450
Mean tensile strength, lbs. per sq. in., bars	2,413	2,896	2,546
do. thin plates	4,200	4,800	6,000
Mean crushing strength, lbs. p. sq. in., cyl'drs	27,582	39,876	31,003
do. cubes	13,130	20,206	21,867

The bars in tensile tests were about 1/2 inch diameter. The crushing tests were made on cylinders about 3/4 inch diameter and from 1 to 2 inches high, and on cubes approximately 1 inch on a side. The mean transverse strength of glass, as calculated by Fairbairn from a mean tensile strength of 2560 lbs. and a mean compressive strength of 30,150 lbs. per sq in., is, for a bar supported at the ends and loaded in the middle, $w = 3140 bd^2/l$, in which w = breaking weight in lbs., b = breadth, d = depth, and l = length, in inches. Actual tests will probably show wide variations in both directions from the mean calculated strength.

STRENGTH OF ICE.

Experiments at the University of Illinois in 1895 (*The Technograph*, vol. ix) gave 620 lbs. per sq. in. as the average crushing strength of cubes of manufactured ice tested at 23° F., and 906 lbs. for cubes tested at 14° F. Natural ice, at 12° F., tested with the direction of pressure parallel to the original water surface, gave a mean of 1070 lbs., and tested with the pressure perpendicular to this surface 1845 lbs. The range of variation in strength of individual pieces is about 50% above and below the mean figures, the lowest and highest figures being respectively 318 and 2818 lbs. per sq. in. The tensile strength of 34 samples tested at 19 to 23° F. was from 102 to 256 lbs. per sq. in.

STRENGTH OF COPPER AT HIGH TEMPERATURES.

The British Admiralty conducted some experiments at Portsmouth Dockyard in 1877, on the effect of increase of temperature on the tensile strength of copper and various bronzes. The copper experimented upon was in rods 0.72 in. diameter.

The following table shows some of the results:

Temperature, Fahr.	Tensile Strength in lbs. per sq. in.	Temperature, Fahr.	Tensile Strength in lbs. per sq. in.
Atmospheric	23,115	300°	21,607
100°	23,366	400°	21,105
200°	22,110	500°	19,597

Up to a temperature of 400° F. the loss of strength was only about 10 per cent, and at 500° F. the loss was 16 per cent. The temperature of steam at 200 lbs. pressure is 382° F., so that according to these experiments the loss of strength at this point would not be a serious matter. Above a temperature of 500° the strength is seriously affected.

STRENGTH OF TIMBER.

Strength of Long-leaf Pine (Yellow Pine, *Pinus Palustris*) from Alabama (Bulletin No. 8, Forestry Div., Dept. of Agriculture, 1893. Tests by Prof. J. B. Johnson).

The following is a condensed table of the range of results of mechanical tests of over 2000 specimens, from 25 trees from four different sites in Alabama; reduced to 15 per cent moisture:

	Butt Logs.	Middle Logs.	Top Logs.	Av'g of all Butt Logs.
Specific gravity	0.449 to 1.039	0.575 to 0.859	0.484 to 0.907	0.767
Transverse strength, $\frac{3WL}{2bh^2}$	4,762 to 16,200	7,640 to 17,128	4,268 to 15,554	12,614
do. do. at elast. limit	4,930 to 13,110	5,540 to 11,790	2,553 to 11,950	9,460
Mod. of elast., thous. lbs.	1,119 to 3,117	1,136 to 2,982	842 to 2,697	1,926
Relative elast. resilience, inch-pounds per cub. in.	0.23 to 4.69	1.34 to 4.21	0.09 to 4.65	2.98
Crushing endwise, str. per sq. in.-lbs.	4,781 to 9,850	5,030 to 9,300	4,587 to 9,100	7,452
Crushing across grain, strength per sq. in., lbs.	675 to 2,094	656 to 1,445	584 to 1,766	1,598
Tensile strength per sq. in.	8,600 to 31,890	6,330 to 29,500	4,170 to 23,280	17,359
Shearing strength (with grain), mean per sq. in.	464 to 1,299	539 to 1,230	484 to 1,156	866

Some of the deductions from the tests were as follows:

1. With the exception of tensile strength a reduction of moisture is accompanied by an increase in strength, stiffness, and toughness.
2. Variation in strength goes generally hand-in-hand with specific gravity.

WARNING: This is a 1910 edition. Some of the material may no longer be accurate

3. In the first 20 or 30 feet in height the values remain constant; then occurs a decrease of strength which amounts at 70 feet to 20 to 40 per cent of that of the butt-log.

4. In shearing parallel with the grain and crushing across and parallel with the grain, practically no difference was found.

5. Large beams appear 10 to 20 per cent weaker than small pieces.

6. Compression tests endwise seem to furnish the best average statement of the value of wood, and if one test only can be made, this is the safest, as was also recognized by Bauschinger.

7. Bled timber is in no respect inferior to unbled timber.

The figures for crushing across the grain represent the load required to cause a compression of 15 per cent. The relative elastic resilience, in inch-pounds per cubic inch of the material, is obtained by measuring the area of the plotted strain-diagram of the transverse test from the origin to the point in the curve at which the rate of deflection is 50 per cent greater than the rate in the earlier part of the test where the diagram is a straight line. This point is arbitrarily chosen since there is no definite "elastic limit" in timber as there is in iron. The "strength at the elastic limit" is the strength taken at this same point. Timber is not perfectly elastic for any load if left on any great length of time.

The long-leaf pine is found in all the Southern coast states from North Carolina to Texas. Prof. Johnson says it is probably the strongest timber in large sizes to be had in the United States. In small selected specimens, other species, as oak and hickory, may exceed it in strength and toughness. The other Southern yellow pines, viz., the Cuban, short-leaf and the loblolly pines are inferior to the long-leaf about in the ratios of their specific gravities; the long-leaf being the heaviest of all the pines. It averages (kiln-dried) 48 pounds per cubic foot, the Cuban 47, the short-leaf 40, and the loblolly 34 pounds.

Strength of Spruce Timber. — The modulus of rupture of spruce is given as follows by different authors: Hatfield, 9900 lbs. per square inch; Rankine, 11,100; Laslett, 9045; Trautwine, 8100; Rodman, 6168. Trautwine advises for use to deduct one-third in the case of knotty and poor timber.

Prof. Lanza, in 25 tests of large spruce beams, found a modulus of rupture from 2995 to 5666 lbs.; the average being 4613 lbs. These were average beams, ordered from dealers of good repute. Two beams of selected stock, seasoned four years, gave 7562 and 8748 lbs. The modulus of elasticity ranged from 897,000 to 1,588,000, averaging 1,294,000.

Time tests show much smaller values for both modulus of rupture and modulus of elasticity. A beam tested to 5800 lbs. in a screw machine was left over night, and the resistance was found next morning to have dropped to about 3000, and it broke at 3500.

Prof. Lanza remarks that while it was necessary to use larger factors of safety, when the moduli of rupture were determined from tests with smaller pieces, it will be sufficient for most timber constructions, except in factories, to use a factor of four. For breaking strains of beams, he states that it is better engineering to determine as the safe load of a timber beam the load that will not deflect it more than a certain fraction of its span, say about 1/300 to 1/400 of its length.

Expansion of Timber Due to the Absorption of Water.

(De Volson Wood, A. S. M. E., vol. x.)

Pieces 36 × 5 in., of pine, oak, and chestnut, were dried thoroughly, and then immersed in water for 37 days.

The mean per cent of elongation and lateral expansion were:

	Pine.	Oak.	Chestnut.
Elongation, per cent	0.065	0.085	0.165
Lateral expansion, per cent	2.6	3.5	3.65

Expansion of Wood by Heat. — Trautwine gives for the expansion, of white pine for 1 degree Fahr. 1 part in 440,530, or for 180 degrees 1 part in 2447, or about one-third of the expansion of iron.

TESTS OF AMERICAN WOODS. (Watertown Arsenal Tests, 1883.)

In all cases a large number of tests were made of each wood. Minimum and maximum results only are given. All of the test specimens had a sectional area of 1.575 X 1.575 inches. The transverse test specimens were 39.37 inches between supports, and the compressive test specimens were 12.60 inches long. Modulus of rupture calculated from formula $R = \frac{3 Pl}{2 bd^2}$; P = load in pounds at the middle, l = length, in inches, b = breadth, d = depth:

Name of Wood.	Transverse Tests. Modulus of Rupture.		Compression Parallel to Grain, pounds per square inch.	
	Min.	Max.	Min.	Max.
Cucumber tree (<i>Magnolia acuminata</i>)	7,440	12,050	4,560	7,410
Yellow poplar white wood (<i>Liriodendron tulipifera</i>)	6,560	11,756	4,150	5,790
White wood, Basswood (<i>Tilia Americana</i>)	6,720	11,530	3,810	6,480
Sugar-maple, Rock-maple (<i>Acer saccharinum</i>)	9,680	20,130	7,460	9,940
Red maple (<i>Acer rubrum</i>)	8,610	13,450	6,010	7,500
Locust (<i>Robinia pseudacacia</i>)	12,200	21,730	8,330	11,940
Wild cherry (<i>Prunus serotina</i>)	8,310	16,800	5,830	9,120
Sweet gum (<i>Liquidambar styraciflua</i>)	7,470	11,130	5,630	7,620
Dogwood (<i>Cornus florida</i>)	10,190	14,560	6,250	9,400
Sour gum, Pepperidge (<i>Nyssa sylvatica</i>)	9,830	14,300	6,240	7,480
Persimmon (<i>Diospyros Virginiana</i>)	10,290	18,500	6,650	8,080
White ash (<i>Fraxinus Americana</i>)	5,950	15,800	4,520	8,830
Sassafras (<i>Sassafras officinale</i>)	5,180	10,150	4,050	5,970
Slippery elm (<i>Ulmus fulva</i>)	10,220	13,952	6,980	8,790
White elm (<i>Ulmus Americana</i>)	8,250	15,070	4,960	8,040
Sycamore; Buttonwood (<i>Platanus occidentalis</i>)	6,720	11,360	4,960	7,340
Butternut; white walnut (<i>Juglans cinerea</i>)	4,700	11,740	5,480	6,810
Black walnut (<i>Juglans nigra</i>)	8,400	16,320	6,940	8,850
Shellbark hickory (<i>Carya alba</i>)	14,870	20,710	7,650	10,280
Pignut (<i>Carya porcina</i>)	11,560	19,430	7,460	8,470
White oak (<i>Quercus alba</i>)	7,010	18,360	5,810	9,070
Red oak (<i>Quercus rubra</i>)	9,760	18,370	4,960	8,970
Black oak (<i>Quercus tinctoria</i>)	7,900	18,420	4,540	8,550
Chestnut (<i>Castanea vulgaris</i>)	5,950	12,870	3,680	6,650
Beech (<i>Fagus ferruginea</i>)	13,850	18,840	5,770	7,840
Canoe-birch, paper-birch (<i>Betula papyracea</i>)	11,710	17,610	5,770	8,590
Cottonwood (<i>Populus monilifera</i>)	8,390	13,430	3,790	6,510
White cedar (<i>Thuja occidentalis</i>)	6,310	9,530	2,660	5,810
Red cedar (<i>Juniperus Virginiana</i>)	5,640	15,100	4,400	7,040
Cypress (<i>Saxodium Distichum</i>)	9,530	10,030	5,060	7,140
White pine (<i>Pinus strobus</i>)	5,610	11,530	3,750	5,600
Spruce pine (<i>Pinus glabra</i>)	3,780	10,980	2,580	4,680
Long-leaved pine, Southern pine (<i>Pinus palustris</i>)	9,220	21,060	4,010	10,600
White spruce (<i>Picea alba</i>)	9,900	11,650	4,150	5,300
Hemlock (<i>Tsuga Canadensis</i>)	7,590	14,680	4,500	7,420
Red fir, yellow fir (<i>Pseudotsuga Douglasii</i>)	8,220	17,920	4,880	9,800
Tamarack (<i>Larix Americana</i>)	10,080	16,770	6,810	10,700

Shearing Strength of American Woods, adapted for Pins or Tree-nails.

J. C. Trautwine (*Jour. Franklin Inst.*). (Shearing across the grain.)

	per sq. in.		per sq. in.
Ash	6280	Hickory	6045
Beech	5223	Hickory	7285
Birch	5595	Maple	6355
Cedar (white)	1372	Oak	4425
Cedar (white)	1519	Oak (live)	8480
Cedar (Central American)	3410	Pine (white)	2480
Cherry	2945	Pine (Northern yellow)	4340
Chestnut	1536	Pine (Southern yellow)	5735
Dogwood	6510	Pine (very resinous yellow)	5053
Ebony	7750	Poplar	4418
Gum	5890	Spruce	3255
Hemlock	2750	Walnut (black)	4728
Locust	7176	Walnut (common)	2830

Transverse Tests of Pine and Spruce Beams. (*Tech. Quar. XIII, No. 3, 1900, p. 226.*)—Tests of 37 hard pine beams, 4 to 10 ins. wide, 6 to 12 ins. deep, and 8 to 16 ft. length between supports, showed great variations in strength. The modulus of rupture of different beams was as follows: 1, 2970; 4, 4000 to 5000; 1, 5510; 1, 6220; 9, 7000 to 8000; 8, 8000 to 9000; 4, 9000 to 10,000; 5, 10,000 to 11,000; 3, 11,000 to 12,000; 1, 13,800.

Six tests of white pine beams gave moduli of rupture ranging from 1840 to 7810; and eighteen tests of spruce beams from 2750 to 7970 lbs. per sq. in.

Drying of Wood.—Circular 111, U. S. Forest Service, 1907. Sticks of Southern loblolly pine 11 to 13 inches diameter, 9 to 10 ft. long, were weighed every two weeks until seasoned, to find the weight of water evaporated. The loss, per cent of weight, was as follows:

Weeks	2	4	6	8	10	12	14	16
Loss per cent of green wood	16	21	26	31	32	34	35	35

Preservation of Timber.—U. S. Forest Service, Circular 111, 1907, discusses preservative treatment of timber by different methods, namely, brush treatment with creosote and with carbolinium; open tank treatment with salt solution, zinc chloride solution; and cylinder treatment with zinc chloride solution and creosote.

The increased life necessary to pay the cost of these several preservative treatments is respectively: 6, 16, 7, 13, 41, 27, and 55%. The results of the experiments prove that it will pay mining companies to peel their timber, to season it for several months and to treat it with a good preservative. Loblolly and pitch pine have been most successfully preserved by treatment with creosote in an open tank.

Circular No. 151 of the Forest Service describes experiments on the best method of treating loblolly pine cross-arms of telegraph poles. The arms after being seasoned in air are placed in a closed air-tight cylinder, a vacuum is applied sufficient to draw the oil (creosote, dead oil of coal tar) from the storage tank into the treating cylinder. Sufficient pressure is then applied to force the oil into the heartwood portion of the timber, and continued until the desired amount of oil is absorbed, then a vacuum is maintained until the surplus oil is drawn from the sapwood. It is recommended that heartwood should finally contain about 6 lbs. of oil per cubic foot, and sapwood about 10 lbs. The preliminary bath of live steam, formerly used, has been found unnecessary. Much valuable information concerning timber treatment and its benefits is contained in the several circulars on the subject issued by the Forest Service.

THE STRENGTH OF BRICK, STONE, ETC.

A great advance has recently (1895) been made in the manufacture of brick, in the direction of increasing their strength. Chas. P. Chase, in *Engineering News*, says: "Taking the tests as given in standard engineering books eight or ten years ago, we find in Trautwine the strength of brick given as 500 to 4200 lbs. per sq. in. Now, taking recent tests in

WARNING: This is a 1910 edition. Some of the material may no longer be accurate

experiments made at Watertown Arsenal, the strength ran from 5000 to 22,000 lbs. per sq. in. In the tests on Illinois paving-brick, by Prof. I. O. Baker, we find an average strength in hard paving brick of over 5000 lbs. per square inch. The average crushing strength of ten varieties of paving-brick much used in the West, I find to be 7150 lbs. to the square inch.

A test of brick made by the dry-clay process at Watertown Arsenal, according to *Paving*, showed an average compressive strength of 3972 lbs. per sq. in. In one instance it reached 4973 lbs. per sq. in. A test was made at the same place on a "fancy pressed brick." The first crack developed at a pressure of 305,000 lbs., and the brick crushed at 364,300 lbs., or 11,130 lbs. per sq. in. This indicates almost as great compressive strength as granite paving-blocks, which is from 12,000 to 20,000 lbs. per sq. in.

The three following notes on bricks are from Trautwine's *Engineer's Pocket-book*:

Strength of Brick. — 40 to 300 tons per sq. ft., 622 to 4668 lbs. per sq. in. A soft brick will crush under 450 to 600 lbs. per sq. in., or 30 to 40 tons per square foot, but a first-rate machine-pressed brick will stand 200 to 400 tons per sq. ft. (6112 to 6224 lbs. per sq. in.).

Weight of Bricks. — Per cubic foot, best pressed brick, 150 lbs.; good pressed brick, 131 lbs.; common hard brick, 125 lbs.; good common brick, 118 lbs.; soft inferior brick, 100 lbs.

Absorption of Water. — A brick will in a few minutes absorb 1/2 to 3/4 lb. of water, the last being 1/7 of the weight of a hand-molded one, or 1/3 of its bulk.

Tests of Bricks, full size, on flat side. (Tests made at Watertown Arsenal in 1883.) — The bricks were tested between flat steel buttresses. Compressed surfaces (the largest surface) ground approximately flat. The bricks were all about 2 to 2.1 inches thick, 7.5 to 8.1 inches long, and 3.5 to 3.76 inches wide. Crushing strength per square inch: One lot ranged from 11,056 to 16,734 lbs.; a second, 12,995 to 22,351; a third, 10,390 to 12,709. Other tests gave results from 5960 to 10,250 lbs. per sq. in.

Tests of Brick. (*Tech. Quar.*, 1900.) — Different brands of brick tested on the broad surfaces, and on edge, gave results as follows, lbs. per sq. in.

(*Tech. Quar.* XII, No. 3, 1899.) 38 tests.

	No. Test.	Average.	Maximum.	Minimum.	Per cent Water Absorbed.
On broad surface					
Bay State, light hard	71	7039	11,200	3587	15.15 to 19.3 av. 7.5
Same, tested on edge	67	6241	10,300	3325	13.67 to 18.2 " 7.4
On broad surface					
Dover River, soft burned	38	5350	8630	3930	14.0 to 18.6 " 11.6
Dover River, hard burned	36	8070	10,940	5850	4.7 to 10.1 " 7.0
Central N. Y., soft burned	36	2190	3060	1370	17.8 to 22.0 " 19.9
Central N. Y., medium burned	36	3600	4950	2080	16.6 to 23.4 " 18.6
Central N. Y., hard burned	36	5360	8810	3310	8.3 to 16.7 " 12.5
Another lot,* hard burned	16	7940	9770	6570	7.6 to 12.9 " 10.6
Same,* tested on edge	16	6430	10,230	3830	6.2 to 18.7 " 11.4

* Brand not named.

The per cent water absorbed in general seemed to have a relation to the strength, the greatest absorption corresponding to the lowest strength, and *vice versa*, but there were many exceptions to the rule.

Strength of Common Red Brick. — Tests of 67 samples of Hudson River machine-molded brick were made by I. H. Woolson, *Eng. News*, April 13, 1905. The crushing strength, in lbs. per sq. in., of 15 pale brick ranged from 1607 to 4546, average 3010; 44 medium, 2080 to 8944, av. 4080; 8 hard brick, 2396 to 6420, av. 4960. Five Philadelphia pressed brick gave from 3524 to 9425, av. 6361. The absorption ranged from 8.7 to 21.4% by weight. The relation of absorption to strength varied greatly, but on the average there was an increase of absorption up to 3000 lbs. per sq. in. crushing strength, and beyond that a decrease.

The **Strongest Brick** ever tested at the Watertown Arsenal was a paving brick from St. Louis, Mo., which showed a compressive strength of 38,446 lbs. per sq. in. The absorption was 0.21% by weight and 0.5% by volume. The sample was set on end, and measured 2.45 x 3.06 ins. in cross section. — *Eng. News*, Mar. 14, 1907.

Crushing Strength of Masonry Materials. (From Howe's "Retaining-Walls.") —

	tons per sq. ft.	tons per sq. ft.	
Brick, best pressed	40 to 300	Limestones and marbles 250 to 1000	
Chalk	20 to 30	Sandstone	150 to 550
Granite	300 to 1200	Soapstone	400 to 800

Strength of Granite. — The crushing strength of granite is commonly rated at 12,000 to 15,000 lbs. per sq. in. when tested in two-inch cubes, and only the hardest and toughest of the commonly used varieties reach a strength above 20,000 lbs. Samples of granite from a quarry on the Connecticut River, tested at the Watertown Arsenal, have shown a strength of 35,965 lbs. per sq. in. (*Engineering News*, Jan. 12, 1893).

Ordinary granite ranges from 20,000 to 30,000 lbs. compressive strength per sq. in. A granite from Asheville, N.C., tested at the Watertown Arsenal, gave 51,900 lbs. — *Eng. News*, Mar. 14, 1907.

Strength of Avondale, Pa., Limestone. (*Engineering News*, Feb. 9, 1893.) — Crushing strength of 2-in. cubes: light stone 12,112, gray stone 18,040, lbs. per sq. in.

Transverse test of lintels, tool-dressed, 42 in. between knife-edge bearings, load with knife-edge brought upon the middle between bearings:

Gray stone, section 6 in. wide x 10 in. high, broke under a load of 20,950 lbs.	
Modulus of rupture	2,200 "
Light stone, section 8 1/4 in. wide x 10 in. high, broke under...	14,720 "
Modulus of rupture	1,170 "
Absorption. — Gray stone	0.051 of 1%
Light stone	0.052 of 1%

Tests of Sand-lime Brick. (I. H. Woolson, *Eng. News*, June 14, 1906.) — Eight varieties of brick in lots of 300 to 800 were received from different manufacturers. They were tested for transverse strength, on supports 7 in. apart, loaded in the middle; and half bricks were tested by compression, sheets of heavy fibrous paper being inserted between the specimen and the plates of the testing machine to insure an even bearing. Tests were made on the brick as received, and on other samples after drying at about 150° F. to constant weight, requiring from four to six days. The moisture in two bricks of each series was determined, and found to range from 1 to 10%, average 5.9%. The figures of results given below are the averages of 10 tests in each case. Other bricks of each lot were tested for absorption by being immersed 1/2 in. in water for 48 hours, for resistance to 20 repeated freezings and thawings, and for resistance to fire by heating them in a fire testing room, the bricks being built in as 8-in. walls, to 1700° F. and maintaining that temperature three hours, then cooling them with a 1 1/8-in. stream of cold water from a hydrant. Transverse and compressive tests were made after these treatments. The results given below are averages of five tests, except in the case of the bricks tested after firing, in which two samples are averaged.

EFFECT OF THE FIRE TEST. — Several large cracks developed in both the sand-lime and the clay brick walls during the test. These were no worse in one wall than in the other. With the exception of surface deterioration the walls were solid and in good condition. After they

were cooled the inside course of each wall was cut through and specimens of each series secured for examination and test. It was difficult to secure whole bricks, owing to the extreme brittleness.

In general the bricks were affected by fire about half way through. They were all brittle and many of them tender when removed from the wall. With the sand-lime brick, if a brick broke the remainder had to be chiseled out like concrete, whereas a clay brick under like conditions would chip out easily. The clay brick were so brittle and full of cracks that the wall could be broken down without trouble. The sand-lime bricks adhered to the mortar better, were cracked less, and were not so brittle.

Designation of Brick.		A	B	C	D	E	F	G
Modulus of Rupture	As received	272	424	377	262	190	301	365
	Dried	320	505	406	334	197	570	494
	Increase, %	15.0	16.0	7.1	21.5	3.5	47.2	26.2
	Wet	248	349	345	241	243	250	485
	After fire	17	57	20	32	24	27	37
Compressive Strength, lbs. per sq. in.	As received	1875	2300	2871	1923	1610	2460	2669
	Dried	2604	2772	3240	2476	1870	3273	3190
	Increase, %	30.2	17.1	20.7	22.3	13.5	24.8	16.3
	Wet	1611	2174	2097	1923	1108	2063	2183
	After freezing	1596	1619	2265	1174	1167	1851	1739
After fire	1807	2814	2573	2069	1089	2051	4885	
% of lime in brick	6	10	5	4 1/2	4 1/2	5	8	
Pressure for hardening, lbs.	120	135	150	125	120	150	125	
Hours in hardening, hrs.	10	8	7	10	10	7	10	

Transverse Strength of Flagging.

(N. J. Steel & Iron Co.'s Book.)

EXPERIMENTS MADE BY R. G. HATFIELD AND OTHERS.

b = width of the stone in inches; *d* = its thickness in inches; *l* = distance between bearings in inches.

The breaking loads in tons of 2000 lbs., for a weight placed at the center of the space, will be as follows:

	$\frac{bd^2}{l} \times$		$\frac{bd^2}{l} \times$
Bluestone flagging	0.744	Dorchester freestone	0.264
Quincy granite	0.624	Aubigny freestone	0.216
Little Falls freestone	0.576	Caen freestone	0.144
Belleville, N. J., freestone	0.480	Glass	1.000
Granite (another quarry)	0.432	Slate	1.2 to 2.7
Connecticut freestone	0.312		

Thus a block of Quincy granite 80 inches wide and 6 inches thick, resting on beams 36 inches in the clear, would be broken by a load resting midway between the beams = $\frac{80 \times 36}{36} \times 0.624 = 49.92$ tons.

STRENGTH OF LIME AND CEMENT MORTAR.

(Engineering, October 2, 1891.)

Tests made at the University of Illinois on the effects of adding cement to lime mortar. In all the tests a good quality of ordinary fat lime was used, slaked for two days in an earthenware jar, adding two parts by weight of water to one of lime, the loss by evaporation being made up

by fresh additions of water. The cements used were a German Portland, Black Diamond (Louisville), and Rosendale. As regards fineness of grinding, 85 per cent of the Portland passed through a No. 100 sieve, as did 72 per cent of the Rosendale. A fairly sharp sand, thoroughly washed and dried, passing through a No. 18 sieve and caught on a No. 30, was used. The mortar in all cases consisted of two volumes of sand to one of lime paste. The following results were obtained on adding various percentages of cement to the mortar:

Tensile Strength, pounds per square inch.

Age	4 Days.	7 Days.	14 Days.	21 Days.	28 Days.	50 Days.	84 Days.
Lime mortar	4	8	10	13	18	21	26
20 per cent Rosendale	5	8 1/2	9 1/2	12	17	17	18
20 " " Portland	5	8 1/2	14	20	25	24	26
30 " " Rosendale	7	11	13	18 1/2	21	22 1/2	23
30 " " Portland	8	16	18	22	25	28	27
40 " " Rosendale	10	12	16 1/2	21 1/2	22 1/2	24	36
40 " " Portland	27	39	38	43	47	59	57
60 " " Rosendale	9	13	20	16	22	22 1/2	23
60 " " Portland	45	58	55	68	67	102	78
80 " " Rosendale	12	18 1/2	22 1/2	27	29	31 1/2	33
80 " " Portland	87	91	103	124	94	210	145
100 " " Rosendale	18	23	26	31	34	46	48
100 " " Portland	90	120	146	152	181	205	202

Tests of Portland Cement.

(Tech. Quar. XIII. No. 3, 1900, p. 236.)

	1 Day.	2 Days.	14 Days.	1 Mo.	2 Mos.	6 Mos.	1 Year.
Neat cement:							
Tension, lbs. per sq. in.	268-312	454-532	780-820	915-920	950-1100	1036-1190	996-1248
Compression, lbs. per sq. in.	8650 to 10,250	13,080 to 14,860	23,640 to 34,820	34,000 to 38,500	36,150 to 50,000
3 sand, 1 cem. Tens.	56-75	79-92	185-211	211-230	217-240	300-362	280-383
3 sand, 1 cem. Comp.	1200 to 1585	1750 to 1885	3780 to 4420	7850 to 8250	8000 to 10,000

MODULI OF ELASTICITY OF VARIOUS MATERIALS.

The modulus of elasticity determined from a tensile test of a bar of any material is the quotient obtained by dividing the tensile stress in pounds per square inch at any point of the test by the elongation per inch of length produced by that stress; or if *P* = pounds of stress applied, *K* = the sectional area, *l* = length of the portion of the bar in which the measurement is made, and λ = the elongation in that length, the modulus of elasticity $E = \frac{P}{K} \div \frac{\lambda}{l} = \frac{Pl}{K\lambda}$. The modulus is generally measured within the elastic limit only, in materials that have a well-defined elastic limit, such as iron and steel, and when not otherwise stated the modulus is understood to be the modulus within the elastic limit. Within this limit, for such materials the modulus is practically constant for any given bar, the elongation being directly proportional to the stress. In

other materials, such as cast iron, which have no well-defined elastic limit, the elongations from the beginning of a test increase in a greater ratio than the stresses, and the modulus is therefore at its maximum near the beginning of the test, and continually decreases. The moduli of elasticity of various materials have already been given above in treating of these materials, but the following table gives some additional values selected from different sources:

Brass, cast.....	9,170,000	
Brass wire.....	14,230,000	
Copper.....	15,000,000 to 18,000,000	
Lead.....	1,000,000	
Tin, cast.....	4,600,000	
Iron, cast.....	12,000,000 to 27,000,000 (?)	
Iron, wrought.....	22,000,000 to 29,000,000 (?)	
Steel.....	28,000,000 to 32,000,000 (see below)	
Marble.....	25,000,000	
Slate.....	14,500,000	
Glass.....	8,000,000	
Ash.....	1,600,000	
Beech.....	1,300,000	
Birch.....	1,250,000 to 1,500,000	
Fir.....	869,000 to 2,191,000	
Oak.....	974,000 to 2,283,000	
Teak.....	2,414,000	
Walnut.....	306,000	
Pine, long-leaf (butt-logs).....	1,119,000 to 3,117,000	Avg. 1,926,000

The maximum figures given by some early writers for iron and steel, viz., 40,000,000 and 42,000,000, are undoubtedly erroneous. The modulus of elasticity of steel (within the elastic limit) is remarkably constant, notwithstanding great variations in chemical analysis, temper, etc. It rarely is found below 29,000,000 or above 31,000,000. It is generally taken at 30,000,000 in engineering calculations. Prof. J. B. Johnson, in his report on Long-leaf Pine, 1893, says: "The modulus of elasticity is the most constant and reliable property of all engineering materials. The wide range of value of the modulus of elasticity of the various metals found in public records must be explained by erroneous methods of testing."

In a tensile test of cast iron by the author (Van Nostrand's Science Series, No. 41, page 45), in which the ultimate strength was 23,285 lbs. per sq. in., the measurements of elongation were made to 0.0001 inch, and the modulus of elasticity was found to decrease from the beginning of the test, as follows: At 1000 lbs. per sq. in., 25,000,000; at 2000 lbs., 16,866,000; at 4000 lbs., 15,384,000; at 6000 lbs., 13,636,000; at 8000 lbs., 12,500,000; at 12,000 lbs., 11,250,000; at 15,000 lbs., 10,000,000; at 20,000 lbs., 8,000,000; at 23,000 lbs., 6,140,000.

FACTORS OF SAFETY.

A factor of safety is the ratio in which the load that is just sufficient to overcome instantly the strength of a piece of material is greater than the greatest safe ordinary working load. (Rankine.)

Rankine gives the following "examples of the values of those factors which occur in machines":

	Dead Load.	Live Load, Greatest.	Live Load, Mean.
Iron and steel.....	3	6	from 6 to 40
Timber.....	4 to 5	8 to 10
Masonry.....	4	8

The great factor of safety, 40, is for shafts in millwork which transmit very variable efforts.

Unwin gives the following "factors of safety which have been adopted in certain cases for different materials." They "include an allowance for ordinary contingencies."

	Live Load.		
	Dead Load.	In Temporary Structures.	In Permanent Structures subj. to Shocks.
Wrought iron and steel	3	4	4 to 5
Cast iron.....	3	4	5
Timber.....	4	10
Brickwork.....	6
Masonry.....	20	20 to 30

Unwin says that "these numbers fairly represent practice based on experience in many actual cases, but they are not very trustworthy."

Prof. Wood in his "Resistance of Materials" says: "In regard to the margin that should be left for safety, much depends upon the character of the loading. If the load is simply a dead weight, the margin may be comparatively small; but if the structure is to be subjected to percussive forces or shocks, the margin should be comparatively large on account of the indeterminate effect produced by the force. In machines which are subjected to a constant jar while in use, it is very difficult to determine the proper margin which is consistent with economy and safety. Indeed, in such cases, economy as well as safety generally consists in making them *excessively* strong, as a single breakage may cost much more than the extra material necessary to fully insure safety."

For discussion of the resistance of materials to repeated stresses and shocks, see pages 261 to 264.

Instead of using factors of safety, it is becoming customary in designing to fix a certain number of pounds per square inch as the maximum stress which will be allowed on a piece. Thus, in designing a boiler, instead of naming a factor of safety of 6 for the plates and 10 for the stay-bolts, the ultimate tensile strength of the steel being from 50,000 to 60,000 lbs. per sq. in., an allowable working stress of 10,000 lbs. per sq. in. on the plates and 6000 lbs. per sq. in. on the stay-bolts may be specified instead. So also in the use of formulae for columns (see page 271) the dimensions of a column are calculated after assuming a maximum allowable compressive stress per square inch on the concave side of the column.

The factors for masonry under dead load as given by Rankine and by Unwin, viz., 4 and 20, show a remarkable difference, which may possibly be explained as follows: If the actual crushing strength of a pier of masonry is known from direct experiment, then a factor of safety of 4 is sufficient for a pier of the same size and quality under a steady load; but if the crushing strength is merely assumed from figures given by the authorities (such as the crushing strength of pressed brick, quoted above from Howe's Retaining Walls, 40 to 300 tons per square foot, average 170 tons), then a factor of safety of 20 may be none too great. In this case the factor of safety is really a "factor of ignorance."

The selection of the proper factor of safety or the proper maximum unit stress for any given case is a matter to be largely determined by the judgment of the engineer and by experience. No definite rules can be given. The customary or advisable factors in many particular cases will be found where these cases are considered throughout this book. In general the following circumstances are to be taken into account in the selection of a factor:

1. When the ultimate strength of the material is known within narrow limits, as in the case of structural steel when tests of samples have been made, when the load is entirely a steady one of a known amount, and there is no reason to fear the deterioration of the metal by corrosion, the lowest factor that should be adopted is 3.
2. When the circumstances of 1 are modified by a portion of the load being variable, as in floors of warehouses, the factor should be not less than 4.
3. When the whole load, or nearly the whole, is apt to be alternately put on and taken off, as in suspension rods of floors of bridges, the factor should be 5 or 6.
4. When the stresses are reversed in direction from tension to compression, as in some bridge diagonals and parts of machines, the factor should be not less than 6.

5. When the piece is subjected to repeated shocks, the factor should be not less than 10.

6. When the piece is subject to deterioration from corrosion the section should be sufficiently increased to allow for a definite amount of corrosion before the piece be so far weakened by it as to require removal.

7. When the strength of the material, or the amount of the load, or both are uncertain, the factor should be increased by an allowance sufficient to cover the amount of the uncertainty.

8. When the strains are of a complex character and of uncertain amount, such as those in the crank-shaft of a reversing engine, a very high factor is necessary, possibly even as high as 40, the figure given by Rankine for shafts in millwork.

Formulas for Factor of Safety. — (F. E. Cardullo, *Mach'y*, Jan., 1906.) The apparent factor of safety is the product of four factors, or,

$$F = a \times b \times c \times d.$$

a is the ratio of the ultimate strength of the material to its elastic limit, not the yield point, but the true elastic limit within which the material is, in so far as we can discover, perfectly elastic, and takes no permanent set. Two reasons for keeping the working stress within this limit are: (1) that the material will rupture if strained repeatedly beyond this limit; and (2) that the form and dimensions of the piece would be destroyed under the same circumstances.

The second factor, *b*, is one depending upon the character of the stress produced within the material. The experiments of Wohler proved that the repeated application of a stress less than the ultimate strength of a material would rupture it. Prof. J. B. Johnson's formula for the relation between the ultimate strength and the "carrying strength" under conditions of variable loads is as follows:

$$f = U + (2 - p_1/p),$$

where *f* is the "carrying strength" when the load varies repeatedly between a maximum value, *p*, and a minimum value, *p*₁, and *U* is the ultimate strength of the material. The quantities *p* and *p*₁ have plus signs when they represent loads producing tension, and minus signs when they represent loads producing compression.

If the load is variable the factor *b* must then have a value,

$$b = U/f = 2 - p_1/p.$$

Taking a load varying between zero and a maximum,

$$p_1/p = 0, \text{ and } b = 2 - p_1/p = 2.$$

Taking a load that produces alternately a tension and a compression equal in amount,

$$p_1 = -p \text{ and } p_1/p = -1, \text{ and } b = 2 - p_1/p = 2 - (-1) = 3.$$

The third factor, *c*, depends upon the manner in which the load is applied to the piece. When the load is suddenly applied *c* = 2. When not all of the load is applied suddenly, the factor 2 is reduced accordingly. If a certain fraction of the load, *n/m*, is suddenly applied, the factor is 1 + *n/m*.

The last factor, *d*, we may call the "factor of ignorance." All the other factors have provided against known contingencies; this provides against the unknown. It commonly varies in value between 1 1/2 and 3, although occasionally it becomes as great as 10. It provides against excessive or accidental overload, unexpectedly severe service, unreliable or imperfect materials, and all unforeseen contingencies of manufacture or operation. When we know that the load will not be likely to be increased, that the material is reliable, that failure will not result disastrously, or even that the piece for some reason must be small or light, this factor will be reduced to its lowest limit, 1 1/2. When life or property would be endangered by the failure of the piece, this factor must be made larger. Thus, while it is 1 1/2 to 2 in most ordinary steel constructions, it is rarely less than 2 1/2 for steel in a boiler.

The reliability of the material in a great measure determines the value of this factor. For instance, in all cases where it would be 1 1/2 for mild steel, it is made 2 for cast iron. It will be larger for those materials subject to internal strains, for instance for complicated castings, heavy

forgings, hardened steel, and the like, also for materials subject to hidden defects, such as internal flaws in forgings, spongy places in castings, etc. It will be smaller for ductile and larger for brittle materials. It will be smaller as we are sure that the piece has received uniform treatment, and as the tests we have give more uniform results and more accurate indications of the real strength and quality of the piece itself. In fixing the factor *d*, the designer must depend on his judgment, guided by the general rules laid down.

Table of Factors of Safety.

The following table may assist in a proper choice of the factor of safety. It shows the value of the four factors for various materials and conditions of service.

CLASS OF SERVICE OR MATERIALS.	Factor				F
	a	b	c	d	
Boilers..	2	1	1	2 1/4-3	4 1/2- 6
Piston and connecting rods for double-acting engines.....	1 1/2-2	3	2	1 1/2	13 1/2-18
Piston and connecting rod for single-acting engines.....	1 1/2-2	2	2	1 1/2	9 -12
Shaft carrying bandwheel, fly-wheel, or armature.....	1 1/2-2	3	1	1 1/2	6 3/4- 9
Lathe spindles.....	2	2	2	1 1/2	12
Mill shafting.....	2	3	2	2	24
Steel work in buildings.....	2	1	1	2	4
Steel work in bridges.....	2	1	1	2 1/2	5
Steel work for small work.....	2	1	2	1 1/2	6
Cast iron wheel rims.....	2	1	1	10	20
Steel wheel rims.....	2	1	1	4	8.
MATERIALS.					
	Minimum Values.				
Cast iron and other castings.....	2	1	1	2	4
Wrought iron or mild steel.....	2	1	1	1 1/2	3
Oil tempered or nickel steel.....	1 1/2	1	1	1 1/2	2 1/4
Hardened steel.....	1 1/2	1	1	2	3
Bronze and brass, rolled or forged.....	2	1	1	1 1/2	3

THE MECHANICAL PROPERTIES OF CORK.

Cork possesses qualities which distinguish it from all other solid or liquid bodies, namely, its power of altering its volume in a very marked degree in consequence of change of pressure. It consists, practically, of an aggregation of minute air-vessels, having thin, water-tight, and very strong walls, and hence, if compressed, the resistance to compression rises in a manner more like the resistance of gases than the resistance of an elastic solid such as a spring. In a spring the pressure increases in proportion to the distance to which the spring is compressed, but with gases the pressure increases in a much more rapid manner; that is, inversely as the volume which the gas is made to occupy. But from the permeability of cork to air, it is evident that, if subjected to pressure in one direction only, it will gradually part with its occluded air by effusion, that is, by its passage through the porous walls of the cells in which it is contained. The gaseous part of cork constitutes 53% of its bulk. Its elasticity has not only a very considerable range, but it is very persistent. Thus in the better kind of corks used in bottling the corks expand the instant they escape from the bottles. This expansion may amount to an increase of volume of 75%, even after the corks have been kept in a state of compression in the bottles for ten years. If the cork be steeped in hot water, the volume continues to increase till it attains nearly three times that which it occupied in the neck of the bottle.

When cork is subjected to pressure a certain amount of permanent deformation or "permanent set" takes place very quickly. This property is common to all solid elastic substances when strained beyond their elastic limits, but with cork the limits are comparatively low. Besides the permanent set, there is a certain amount of sluggish elasticity — that is, cork on being released from pressure springs back a certain amount at once, but the complete recovery takes an appreciable time,

Cork which had been compressed and released in water many thousand times had not changed its molecular structure in the least, and had continued perfectly serviceable. Cork which has been kept under a pressure of three atmospheres for many weeks appears to have shrunk to from 80% to 85% of its original volume. — *Van Nostrand's Eng'g Mag.*, 1886, xxxv. 307.

VULCANIZED INDIA-RUBBER.

The specific gravity of a rubber compound, or the number of cubic inches to the pound, is generally taken by buyers as a correct index of the value, though in reality such is often very far from being the case. In the rubber works the qualities of the rubber made vary from floating, the best quality, to densities corresponding to 11 or 12 cu. in. to the pound, the latter densities being in demand by consumers with whom price appears to be the main consideration. Such densities as these can only be obtained by utilizing to the utmost the quality that rubber exhibits of taking up a large bulk of added matters. — *Eng'g.* 1897.

Lieutenant L. Vladomiroff, a Russian naval officer, has recently carried out a series of tests at the St. Petersburg Technical Institute with view to establishing rules for estimating the quality of vulcanized india-rubber. The following, in brief, are the conclusions arrived at, recourse being had to physical properties, since chemical analysis did not give any reliable result: 1. India-rubber should not give the least sign of superficial cracking when bent to an angle of 180 degrees after five hours of exposure in a closed air-bath to a temperature of 125° C. The test-pieces should be 2.4 inches thick. 2. Rubber that does not contain more than half its weight of metallic oxides should stretch to five times its length without breaking. 3. Rubber free from all foreign matter, except the sulphur used in vulcanizing it, should stretch to at least seven times its length without rupture. 4. The extension measured immediately after rupture should not exceed 12% of the original length, with given dimensions. 5. Suppleness may be determined by measuring the percentage of ash formed in incineration. This may form the basis for deciding between different grades of rubber for certain purposes. 6. Vulcanized rubber should not harden under cold. These rules have been adopted for the Russian navy. — *Iron Age*, June 15, 1893.

Singular Action of India Rubber under Tension. — R. H. Thurston. *Am. Mach.*, Mar. 17, 1898, gives a diagram showing the stretch at different loads of a piece of partially vulcanized rubber. The results translated into figures are:

Load, lbs.	30	50	80	120	150	200	320	430
Stretch per in. of length, in.	0.5	1.	2.2	4	5	6	7	7.5
Stretch per 10 lbs. increase of load	0.17	0.25	0.4	0.45	0.33	0.20	0.08	0.04

Up to about 30% of the breaking load the rubber behaves like a soft metal in showing an increasing rate of stretch with increase of load, then the rate of stretch becomes constant for a while and later decreases steadily until before rupture it is less than one-tenth of the maximum. Even when stretched almost to rupture it restores itself very nearly to its original dimensions on removing the load, and gradually recovers a part of the loss of form at that instant observable. So far as known, no other substance shows this curious relation of stretch to load.

Rubber Goods Analysis. Randolph Bolling. (*Iron Age*, Jan. 28, 1909.) The loading of rubber goods used in manufacturing establishments with zinc oxide, lead sulphate, calcium sulphate, etc., and the employment of the so-called "rubber substitutes" mixed with good rubber call for close inspection of the works chemist in order to determine the value of the samples and materials received. The following method of analysis is recommended:

Thin strips of the rubber must be cut into small bits about the size of No. 7 shot. A half gram is heated in a 200 c.c. flask with red fuming nitric acid on the hot plate until all organic matter has been decomposed, and the total sulphur is determined by precipitation as barium sulphate. The difference between the total and combined sulphur gives the per cent that has been used for vulcanization. Free sulphur indicates either that improper methods were used in vulcanizing or that an excessive

per cent of substitutes was employed. Following is a scheme for the analysis of india-rubber articles:

1. Extraction with acetone: A. Solution: Resinous constituents of india-rubber, fatty oils, mineral oils, resin oils, solid hydrocarbons, resins free sulphur. B. Residue.
2. Extraction with pyridine: C. Extract: Tar, pitch, bituminous bodies, sulphur in above. D. Residue.
3. Extraction with alcoholic potash: E. Extract: Chlorosulphide substitutes, sulphide substitutes, oxidized (blown) oils, sulphur in substitutes, chlorine in substitutes. F. Residue.
4. Extraction with nitro-naphthalene: G. Extract: India-rubber, sulphur in india-rubber, chlorine in india-rubber, the total of the above three estimated by loss. H. Residue.
5. Extraction with boiling water: I. Extract: Starch (farina), dextrine. K. Residue: Mineral matter, free carbon, fibrous materials, sulphur in inorganic compounds.
6. Separate estimations: Total sulphur, chlorine in rubber.

NICKEL.

Properties of Nickel. — (F. L. Sperry, *Tran. A. I. M. E.*, 1895.) Nickel has similar physical properties to those of iron and copper. It is less malleable and ductile than iron, and less malleable and more ductile than copper. It alloys with these metals in all proportions. It has nearly the same specific gravity as copper, and is slightly heavier than iron. It melts at a temperature of about 2900° to 3200° F. A small percentage of carbon in metallic nickel lowers its melting-point perceptibly. Nickel is harder than either iron or copper; is magnetic, but will not take a temper. It has a grayish-white color, takes a fine polish, and may be rolled easily into thin plates or drawn into wire. It is unappreciably affected by atmospheric action, or by salt water. Commercial nickel is from 98 to 99 per cent pure. The impurities are iron, copper, silicon, sulphur, arsenic, carbon, and (in some nickel) a kernel of unreduced oxide. It is not difficult to cast, and acts like some iron in being cold-short. Cast bars are likely to be porous or spongy, but, after hammering or rolling, are compact and tough.

The average results of several tests are as follows: Castings, tensile strength, 80,000 lbs. per sq. in., elongation, 12%; wrought nickel, T. S., 96,000, El., 14%; wrought nickel, annealed, T. S., 95,000, El., 23%; hard rolled, T. S., 78,000, El., 10%. (See also page 473.)

Nickel readily takes up carbon, and the porous nature of the metal is undoubtedly due to occluded gases. According to Dr. Wedding, nickel may take up as much as 9% of carbon, which may exist either as amorphous or as graphitic carbon.

Dr. Fleitmann, of Germany, discovered that a small quantity of pure magnesium would free nickel from occluded gases and give a metal capable of being drawn or rolled perfectly free from blow-holes, to such an extent that the metal may be rolled into thin sheets 3 feet in width. Aluminum or manganese may be used equally as well as a purifying agent; but either, if used in excess, serves to make the nickel very much harder. Nickel will alloy with most of the useful metals, and generally adds the qualities of hardness, toughness, and ductility.

ALUMINUM — ITS PROPERTIES AND USES.

(By Alfred E. Hunt, Pres't of the Pittsburgh Reduction Co.)

The specific gravity of pure aluminum in a cast state is 2.58; in rolled bars of large section it is 2.6; in very thin sheets subjected to high compression under chilled rolls, it is as much as 2.7. Taking the weight of a given bulk of cast aluminum as 1, wrought iron is 2.90 times heavier; structural steel, 2.95 times; copper, 3.60; ordinary high brass, 3.45. Most wood suitable for use in structures has about one third the weight of aluminum, which weighs 0.092 lb. to the cubic inch.

Pure aluminum is practically not acted upon by boiling water or steam. Carbonic oxide or hydrogen sulphide does not act upon it at any temperature under 600° F. It is not acted upon by most organic secretions.

Hydrochloric acid is the best solvent for aluminum, and strong solutions of caustic alkalis readily dissolve it. Ammonia has a slight solvent action, and concentrated sulphuric acid dissolves aluminum upon heating, with evolution of sulphurous acid gas. Dilute sulphuric acid acts but slowly on

the metal, though the presence of any chlorides in the solution allows rapid decomposition. Nitric acid, either concentrated or dilute, has very little action upon the metal, and sulphur has no action unless the metal is at a red heat. Sea-water has very little effect on aluminum. Strips of the metal placed on the sides of a wooden ship corroded less than 1/1000 inch after six months' exposure to sea-water, corroding less than copper sheets similarly placed.

In malleability pure aluminum is only exceeded by gold and silver. In ductility it stands seventh in the series, being exceeded by gold, silver, platinum, iron, very soft steel, and copper. Sheets of aluminum have been rolled down to a thickness of 0.0005 inch, and beaten into leaf nearly as thin as gold leaf. The metal is most malleable at a temperature of between 400° and 600° F., and at this temperature it can be drawn down between rolls with nearly as much draught upon it as with heated steel. It has also been drawn down into the very finest wire. By the Mannesmann process aluminum tubes have been made in Germany.

Aluminum stands very high in the series as an electro-positive metal, and contact with other metals should be avoided, as it would establish a galvanic couple.

The electrical conductivity of aluminum is only surpassed by pure copper, silver, and gold. With silver taken at 100 the electrical conductivity of aluminum is 54.20; that of gold on the same scale is 78; zinc is 29.90; iron is only 16, and platinum 10.60. Pure aluminum has no polarity, and the metal in the market is absolutely non-magnetic.

Sound castings can be made of aluminum in either dry or "green" sand moulds, or in metal "chills." It must not be heated much beyond its melting-point, and must be poured with care, owing to the ready absorption of occluded gases and air. The shrinkage in cooling is 17/64 inch per foot, or a little more than ordinary brass. It should be melted in plumbago crucibles, and the metal becomes molten at a temperature of 1215° F.

The coefficient of linear expansion, as tested on 3/8-inch round aluminum rods, is 0.00002295 per degree centigrade between the freezing and boiling point of water. The mean specific heat of aluminum is higher than that of any other metal, excepting only magnesium and the alkali metals. From zero to the melting-point it is 0.2185; water being taken as 1, and the latent heat of fusion at 28.5 heat units. The coefficient of thermal conductivity of unannealed aluminum is 37.96; of annealed aluminum, 38.37. As a conductor of heat aluminum ranks fourth, being exceeded only by silver, copper, and gold.

Aluminum, under tension, and section for section, is about as strong as cast iron. The tensile strength of aluminum is increased by cold rolling or cold forging, and there are alloys which add considerably to the tensile strength without increasing the specific gravity to over 3 or 3.25.

The strength of commercial aluminum is given in the following table as the result of many tests:

Form.	Elastic Limit per sq. in. in Tension, lbs.	Ultimate Strength per sq. in. in Tension, lbs.	Percentage of Reduct'n of Area in Tension.
Castings.....	6,500	15,000	15
Sheet.....	12,000	24,000	35
Wire.....	16,000-30,000	30,000-65,000	60
Bars.....	14,000	28,000	40

The elastic limit per square inch under compression in cylinders, with length twice the diameter, is 3500. The ultimate strength per square inch under compression in cylinders of same form is 12,000. The modulus of elasticity of cast aluminum is about 11,000,000. It is rather an open metal in its texture, and for cylinders to stand pressure an increase in thickness must be given to allow for this porosity. Its maximum shearing stress in castings is about 12,000, and in forgings about 16,000, or about that of pure copper.

Pure aluminum is too soft and lacking in tensile strength and rigidity for many purposes. Valuable alloys are now being made which seem to give great promise for the future. They are alloys containing from 2% to 7% or 8% of copper, manganese, iron, and nickel.

Plates and bars of these alloys have a tensile strength of from 40,000 to

50,000 pounds per square inch, an elastic limit of 55% to 60% of the ultimate tensile strength, an elongation of 20% in 2 inches, and a reduction of area of 25%.

This metal is especially capable of withstanding the punishment and distortion to which structural material is ordinarily subjected. Some aluminum alloys have as much resilience and spring as the hardest of hard-drawn brass.

Their specific gravity is about 2.80 to 2.85, where pure aluminum has a specific gravity of 2.72.

In castings, more of the hardening elements are necessary in order to give the maximum stiffness and rigidity, together with the strength and ductility of the metal; the favorite alloy material being zinc, iron, manganese, and copper. Tin added to the alloy reduces the shrinkage, and alloys of aluminum and tin can be made which have less shrinkage than cast iron.

The tensile strength of hardened aluminum-alloy castings is from 20,000 to 25,000 pounds per square inch.

Alloys of aluminum and copper form two series, both valuable. The first is aluminum bronze, containing from 5% to 11 1/2% of aluminum; and the second is copper-hardened aluminum, containing from 2% to 15% of copper. Aluminum-bronze is a very dense, fine-grained, and strong alloy, having good ductility as compared with tensile strength. The 10% bronze in forged bars will give 100,000 lbs. tensile strength per square inch, with 60,000 lbs. elastic limit per square inch, and 10% elongation in 8 inches. The 5% to 7 1/2% bronze has a specific gravity of 8 to 8.30, as compared with 7.50 for the 10% to 11 1/2% bronze, a tensile strength of 70,000 to 80,000 lbs., an elastic limit of 40,000 lbs. per square inch, and an elongation of 30% in 8 inches.

Aluminum is used by steel manufacturers to prevent the retention of the occluded gases in the steel, and thereby produce a solid ingot. The proportions of the dose range from 1/2 lb. to several pounds of aluminum per ton of steel. Aluminum is also used in giving extra fluidity to steel used in castings, making them sharper and sounder. Added to cast iron, aluminum causes the iron to be softer, free from shrinkage, and lessens the tendency to "chill."

With the exception of lead and mercury, aluminum unites with all metals, though it unites with antimony with great difficulty. A small percentage of silver whitens and hardens the metal, and gives it added strength; and this alloy is especially applicable to the manufacture of fine instruments and apparatus. The following alloys have been found recently to be useful in the arts: Nickel-aluminum, composed of 20 parts nickel to 80 of aluminum; rosine, made of 40 parts nickel, 10 parts silver, 30 parts aluminum, and 20 parts tin, for jewellers' work; mettaline, made of 35 parts cobalt, 25 parts aluminum, 10 parts iron, and 30 parts copper. The aluminum-bourbouze metal, shown at the Paris Exposition of 1889, has a specific gravity of 2.9 to 2.96, and can be cast in very solid shapes, as it has very little shrinkage. From analysis the following composition is deduced: Aluminum, 85.74%; tin, 12.94%; silicon, 1.32%; iron, none.

The metal can be readily electrically welded, but soldering is still not satisfactory. The high heat conductivity of the aluminum withdraws the heat of the molten solder so rapidly that it "freezes" before it can flow sufficiently. A German solder said to give good results is made of 80% tin to 20% zinc, using a flux composed of 80 parts stearic acid, 10 parts chloride of zinc, and 10 parts of chloride of tin. Pure tin, fusing at 250° C., has also been used as a solder. The use of chloride of silver as a flux has been patented, and used with ordinary soft solder has given some success. A pure nickel soldering-bit should be used, as it does not discolor aluminum as copper bits do.

Aluminum Wire. — Tension tests. Diam. 0.128 in. 14 tests. E.L. 12,500 to 19,100; T. S. 25,800 to 26,900 lbs. per sq. in.; el. 0.30 to 1.02% in 48 ins.; Red. of area, 75.0 to 83.4%. Mod. of el. 8,800,000 to 10,700,000. — *Tech. Quar.*, xii, 1899.

Aluminum Rod. — Torsion tests. 10 samples, 0.257 in. diam. Apparent outside fiber stress, lbs. per sq. in. 15,900 to 18,300 lbs. per sq. in. 11 samples, 0.367 in. diam. Apparent outside fiber stress, 18,400 to 19,200. 10 samples, 0.459 in. diam. Apparent outside fiber stress, 20,700 to 21,500 lbs. per sq. in. The average number of turns per inch for the three series were respectively, 1.58 to 3.65; 1.20 to 2.64; 0.87 to 1.06.

ALLOYS.

ALLOYS OF COPPER AND TIN.

(Extract from Report of U. S. Test Board.*)

Number.	Mean Com- position by Analysis.		Tensile Strength. lbs. per sq. in.	Elastic Limit. lbs. per sq. in.	Elongation, per cent in 5 inches.	Transverse Test, Modulus of Rupture.	Deflection, 1" sq Bar 22 in. long, inches.	Crushing Strength, lbs. per sq. in.	Torsion Tests.	
	Cop- per.	Tin.							Maximum Tor. Mo- ment, ft.-lbs.	Angle of Torsion, degrees.
1	100.	...	27,800	14,000	6.47	29,848	bent.	42,000	143	153
1a	100.	...	12,760	11,000	0.47	21,251	2.31	39,000	65	40
2	97.89	1.90	24,580	10,000	13.33	34,000	150	317
3	96.06	3.76	32,000	16,000	14.29	33,232	bent.	42,048	157	247
4	94.11	5.43	38,659
5	92.11	7.80	28,540	19,000	5.53	43,731	..	42,000	160	126
6	90.27	9.58	26,860	15,750	3.66	49,400	..	38,000	175	114
7	88.41	11.59	60,403
8	87.15	12.73	29,430	20,000	3.33	34,531	4.00	53,000	182	100
9	82.70	17.34	67,930	0.63
10	80.95	18.84	32,980	...	0.04	56,715	0.49	78,000	190	16
11	77.56	22.25	0.	29,926	0.16
12	76.63	23.24	22,010	22,010	0.	32,210	0.19	114,000	122	3.4
13	72.89	26.85	0.	9,512	0.05
14	69.84	29.88	5,585	5,585	0.	12,076	0.06	147,000	18	1.5
15	68.58	31.26	0.	9,152	0.04
16	67.87	32.10	0.	9,477	0.05
17	65.34	34.47	2,201	2,201	0.	4,776	0.02	84,700	16	1
18	56.70	43.17	1,455	1,455	0.	2,126	0.02
19	44.52	55.28	3,010	3,010	0.	4,776	0.03	35,800	23	1
20	34.22	65.80	3,371	3,371	0.	5,384	0.04	19,600	17	2
21	23.35	76.29	6,775	6,775	0.	12,408	0.27
22	15.08	84.62	9,063	0.86	6,500	23	25
23	11.49	88.47	6,380	3,500	4.10	10,706	5.85	10,100	23	62
24	8.57	91.39	6,450	3,500	6.87	5,305	bent.	9,800	23	132
25	3.72	96.31	4,780	2,750	12.32	6,925	..	9,800	23	220
26	0.	100.	3,505	...	35.51	3,740	..	6,400	12	557

* The tests of the alloys of copper and tin and of copper and zinc, the results of which are published in the Report of the U. S. Board appointed to test Iron Steel, and other Metals, Vols. I and II, 1879 and 1881, were made by the author under direction of Prof. R. H. Thurston, chairman of the Committee on Alloys. See preface to the report of the Committee, in Vol. I.

Nos. 1a and 2 were full of blow-holes.

Tests Nos. 1 and 1a show the variation in cast copper due to varying conditions of casting. In the crushing tests Nos. 12 to 20, inclusive, crushed and broke under the strain, but all the others bulged and flattened out. In these cases the crushing strength is taken to be that which caused a decrease of 10% in the length. The test-pieces were 2 in. long and 5/8 in. diameter. The torsional tests were made in Thurston's torsion-machine, on pieces 5/8 in. diameter and 1 in. long between heads.

Specific Gravity of the Copper-tin Alloys.—The specific gravity of copper, as found in these tests, is 8.874 (tested in turnings from the ingot, and reduced to 39.1° F.). The alloy of maximum sp. gr. 8.956 contained 62.42 copper, 37.48 tin, and all the alloys containing less than

37% tin varied irregularly in sp. gr. between 8.65 and 8.93, the density depending not on the composition, but on the porosity of the casting. It is probable that the actual sp. gr. of all these alloys containing less than 37% tin is about 8.95, and any smaller figure indicates porosity in the specimen.

From 37% to 100% tin, the sp. gr. decreases regularly from the maximum of 8.956 to that of pure tin, 7.293.

Note on the Strength of the Copper-tin Alloys.

The bars containing from 2% to 24% tin, inclusive, have considerable strength, and all the rest are practically worthless for purposes in which strength is required. The dividing line between the strong and brittle alloys is precisely that at which the color changes from golden yellow to silver-white, viz., at a composition containing between 24% and 30% of tin.

It appears that the tensile and compressive strengths of these alloys are in no way related to each other, that the torsional strength is closely proportional to the tensile strength, and that the transverse strength may depend in some degree upon the compressive strength, but it is much more nearly related to the tensile strength. The modulus of rupture, as obtained by the transverse tests, is, in general, a figure between those of tensile and compressive strengths per square inch, but there are a few exceptions in which it is larger than either.

The strengths of the alloys at the copper end of the series increase rapidly with the addition of tin till about 4% of tin is reached. The transverse strength continues regularly to increase to the maximum, till the alloy containing about 17 1/2% of tin is reached, while the tensile and torsional strengths also increase, but irregularly, to the same point. This irregularity is probably due to porosity of the metal, and might possibly be removed by any means which would make the castings more compact. The maximum is reached at the alloy containing 82.70 copper, 17.34 tin, the transverse strength, however, being very much greater at this point than the tensile or torsional strength. From the point of maximum strength the figures drop rapidly to the alloys containing about 27.5% of tin, and then more slowly to 37.5%, at which point the minimum (or nearly the minimum) strength, by all three methods of test, is reached. The alloys of minimum strength are found from 37.5% tin to 52.5% tin. The absolute minimum is probably about 45% of tin.

From 52.5% of tin to about 77.5% tin there is a rather slow and irregular increase in strength. From 77.5% tin to the end of the series, or all tin, the strengths slowly and somewhat irregularly decrease.

The results of these tests do not seem to corroborate the theory given by some writers, that peculiar properties are possessed by the alloys which are compounded of simple multiples of their atomic weights or chemical equivalents, and that these properties are lost as the compositions vary more or less from this definite constitution. It does appear that a certain percentage composition gives a maximum strength and another certain percentage a minimum, but neither of these compositions is represented by simple multiples of the atomic weights.

There appears to be a regular law of decrease from the maximum to the minimum strength which does not seem to have any relation to the atomic proportions, but only to the percentage compositions.

Hardness.—The pieces containing less than 24% of tin were turned in the lathe without difficulty, a gradually increasing hardness being noticed, the last named giving a very short chip, and requiring frequent sharpening of the tool.

With the most brittle alloys it was found impossible to turn the test-pieces in the lathe to a smooth surface. No. 13 to No. 17 (26.85 to 34.47 tin) could not be cut with a tool at all. Chips would fly off in advance of the tool and beneath it, leaving a rough surface; or the tool would sometimes, apparently, crush off portions of the metal, grinding it to powder. Beyond 40% tin the hardness decreased so that the bars could easily be turned.

WARNING: This is a 1910 edition. Some of the material may no longer be accurate

ALLOYS OF COPPER AND ZINC. (U. S. Test Board.)

No.	Mean Com- position by Analysis.		Tensile Str'gth, lbs. per sq. in.	Elastic Limit % of Break- ing Load, lbs. per sq. in.	Elongation % in 5 inches.	Trans- verse Test Modu- lus of Rup- ture.	Deflection 1" sq. bar 22" long, in.	Crush- ing Str'gth per sq. in., lbs.	Torsional Tests.	
	Cop- per.	Zinc.							Max. Tors. Moment ft.-lbs.	Angle of Tors. deg.
1	97.83	1.88	27,240	26.1	26.7	23,197	Bent	...	130	357
2	82.93	16.98	32,600	30.6	31.4	21,193	155	329
3	81.91	17.99	32,670	30.6	31.4	21,193	166	345
4	77.39	22.45	35,630	20.0	35.5	25,374	169	311
5	76.65	23.08	30,520	24.6	35.8	22,325	...	42,000	165	267
6	73.20	26.47	31,580	23.7	38.5	25,994	168	293
7	71.20	28.54	30,510	29.5	29.2	24,468	164	269
8	69.74	30.06	28,120	28.7	20.7	26,930	143	202
9	66.27	33.50	37,800	25.1	37.7	28,459	176	257
10	63.44	36.36	48,300	32.8	31.7	43,216	202	230
11	60.94	38.65	41,065	40.1	20.7	38,968	...	75,000	194	202
12	58.49	41.10	50,450	54.4	10.1	63,304	227	93
13	55.15	44.44	44,280	44.0	15.3	42,463	...	78,000	209	109
14	54.86	44.78	46,400	53.9	8.0	47,955	223	72
15	49.66	50.14	30,990	54.5	5.0	33,467	1.26	117,400	172	38
16	48.93	50.82	26,050	100	0.8	40,189	0.61	...	176	16
17	47.56	52.28	24,150	100	0.8	48,471	1.17	121,000	155	13
18	43.56	55.22	9,170	100	...	17,691	0.10	...	88	2
19	41.30	58.12	5,727	100	...	7,761	0.04	...	18	2
20	32.94	66.23	1,774	100	...	8,296	0.04	...	29	1
21	29.29	70.17	6,414	100	...	16,579	0.04	...	40	2
22	20.81	77.63	9,000	100	0.2	22,972	0.13	52,152	65	1
23	12.12	86.67	12,413	100	0.4	35,026	0.31	...	82	3
24	4.35	94.59	18,065	100	0.5	26,162	0.46	...	81	22
25	Cast.	Zinc.	5,400	75	0.7	7,539	0.12	22,000	37	142

Variation in Strength of Gun-bronze, and Means of Improving the Strength. — The figures obtained for alloys of from 7.8% to 12.7% tin, viz., from 26,860 to 29,430 pounds, are much less than are usually given as the strength of gun-metal. Bronze guns are usually cast under the pressure of a head of metal, which tends to increase the strength and density. The strength of the upper part of a gun casting, or sinking head, is not greater than that of the small bars which have been tested in these experiments. The following is an extract from the report of Major Wade concerning the strength and density of gun-bronze (1850): — Extreme variation of six samples from different parts of the same gun (a 32-pounder howitzer): Specific gravity, 8.487 to 8.835; tenacity, 26,428 to 52,192. Extreme variation of all the samples tested: Specific gravity, 8.308 to 8.850; tenacity, 23,108 to 54,531. Extreme variation of all the samples from the gun heads: Specific gravity, 8.308 to 8.756; tenacity, 23,529 to 35,484.

Major Wade says: The general results on the quality of bronze as it is found in guns are mostly of a negative character. They expose defects in density and strength, develop the heterogeneous texture of the metal in different parts of the same gun, and show the irregularity and uncertainty of quality which attend the casting of all guns, although made from similar materials, treated in like manner.

Navy ordnance bronze containing 9 parts copper and 1 part tin, tested at Washington, D.C., in 1875-6, showed a variation in tensile strength from 29,800 to 51,400 lbs. per square inch, in elongation from 3% to 58%, and in specific gravity from 8.39 to 8.88.

That a great improvement may be made in the density and tenacity of gun-bronze by compression has been shown by the experiments of Mr. S. B. Dean in Boston, Mass., in 1869, and by those of General Uchatius in Austria in 1873. The former increased the density of the

WARNING: This is a 1910 edition. Some of the material may no longer be accurate

metal next the bore of the gun from 8.321 to 8.875, and the tenacity from 27,238 to 41,471 pounds per square inch. The latter, by a similar process, obtained the following figures for tenacity:

	Pounds per sq. in.
Bronze with 10% tin.....	72,053
Bronze with 8% tin.....	73,958
Bronze with 6% tin.....	77,656

ALLOYS OF COPPER, TIN, AND ZINC.

(Report of U. S. Test Board, Vol. II, 1881.)

No. in Report.	Analysis, Original Mixture.			Transverse Strength.		Tensile Strength per square inch.		Elongation per cent in 5 inches.	
	Cu.	Sn.	Zn.	Modulus of Rupture.	Deflection, ins.	A.	B.	A.	B.
72	90	5	5	41,334	2.63	23,660	30,740	2.34	9.68
5	88.14	1.86	10	31,986	3.67	32,000	33,000	17.6	19.5
70	85	5	10	44,457	2.85	28,840	28,560	6.80	5.28
71	85	10	5	62,470	2.56	35,680	36,000	2.51	2.25
89	85	12.5	2.5	62,405	2.83	34,500	32,800	1.29	2.79
88	82.5	12.5	5	69,960	1.61	36,000	34,000	0.86	0.92
77	82.5	15	2.5	69,045	1.09	33,600	33,800	...	0.68
67	80	5	15	42,618	3.88	37,560	32,300	11.6	3.59
68	80	10	10	67,117	2.45	32,830	31,950	1.57	1.67
69	80	15	5	54,476	0.44	32,350	30,760	0.55	0.44
86	77.5	10	12.5	63,849	1.19	35,500	36,000	1.00	1.00
87	77.5	12.5	10	61,705	0.71	36,000	32,500	0.72	0.59
63	75	5	20	55,355	2.91	33,140	34,960	2.50	3.19
85	75	7.5	17.5	62,607	1.39	33,700	39,300	1.56	1.33
64	75	10	15	58,345	0.73	35,320	34,000	1.13	1.25
65	75	15	10	51,109	0.31	35,440	28,000	0.59	0.54
66	75	20	5	40,235	0.21	23,140	27,660	0.43	...
83	72.5	7.5	20	51,839	2.86	32,700	34,800	3.73	3.78
84	72.5	10	17.5	53,230	0.74	30,000	30,000	0.48	0.49
59	70	5	25	57,349	1.37	38,000	32,940	2.06	0.99
82	70	7.5	22.5	48,836	0.36	38,000	32,400	0.84	0.40
60	70	10	20	36,520	0.18	33,140	26,300	0.31	...
61	70	15	15	37,924	0.20	33,440	27,800	0.25	...
62	70	20	10	15,126	0.08	17,000	12,900	0.03	...
81	67.5	2.5	30	58,343	2.91	34,720	45,850	7.27	3.09
74	67.5	5	27.5	55,976	0.49	34,000	34,460	1.06	0.43
75	67.5	7.5	25	46,875	0.32	29,500	30,000	0.36	0.26
80	65	2.5	32.5	56,949	2.36	41,350	38,300	3.26	3.02
55	65	5	30	51,369	0.56	37,140	36,000	1.21	0.61
56	65	10	25	27,075	0.14	25,720	22,500	0.15	0.19
57	65	15	20	13,591	0.07	6,820	7,231
58	65	20	15	11,932	0.05	3,765	2,665
79	62.5	2.5	35	69,255	2.34	44,400	45,000	2.15	2.19
78	60	2.5	37.5	69,508	1.46	57,400	52,900	4.87	3.02
52	60	5	35	46,076	0.28	41,160	38,330	0.39	0.40
53	60	10	30	24,699	0.13	21,780	21,240	0.15	...
54	60	15	25	18,248	0.09	18,020	12,400
12	58.22	2.30	39.48	95,623	1.99	66,500	67,600	3.13	3.15
3	58.75	8.75	32.5	35,752	0.18	Broke	before test;	very	brittle
4	57.5	21.25	21.25	2,752	0.02	725	1,300
73	55	0.5	44.5	72,308	3.05	68,900	68,900	9.43	2.88
50	55	5	40	38,174	0.22	27,400	30,500	0.46	0.43
51	55	10	35	28,258	0.14	25,460	18,500	0.29	0.10
49	50	5	45	20,814	0.11	23,000	31,300	0.66	0.45

The transverse tests were made in bars 1 in. square, 22 in. between supports. The tensile tests were made on bars 0.798 in. diam. turned from the two halves of the transverse-test bar, one half being marked A and the other B.

Ancient Bronzes. — The usual composition of ancient bronze was the same as that of modern gun-metal — 90 copper, 10 tin; but the proportion of tin varies from 5% to 15%, and in some cases lead has been found. Some ancient Egyptian tools contained 88 copper, 12 tin.

Strength of the Copper-zinc Alloys. — The alloys containing less than 15% of zinc by original mixture were generally defective. The bars were full of blow-holes, and the metal showed signs of oxidation. To insure good castings it appears that copper-zinc alloys should contain more than 15% of zinc.

From No. 2 to No. 8 inclusive, 16.98 to 30.06% zinc the bars show a remarkable similarity in all their properties. They have all nearly the same strength and ductility, the latter decreasing slightly as zinc increases, and are nearly alike in color and appearance. Between Nos. 8 and 10, 30.06 and 36.36% zinc, the strength by all methods of test rapidly increases. Between No. 10 and No. 15, 36.36 and 50.14% zinc, there is another group, distinguished by high strength and diminished ductility. The alloy of maximum tensile, transverse and torsional strength contains about 41% of zinc.

The alloys containing less than 55% of zinc are all yellow metals. Beyond 55% the color changes to white, and the alloy becomes weak and brittle. Between 70% and pure zinc the color is bluish gray, the brittleness decreases and the strength increases, but not to such a degree as to make them useful for constructive purposes.

Difference between Composition by Mixture and by Analysis. — There is in every case a smaller percentage of zinc in the average analysis than in the original mixture, and a larger percentage of copper. The loss of zinc is variable, but in general averages from 1 to 2%.

Liquation or Separation of the Metals. — In several of the bars a considerable amount of liquation took place, analysis showing a difference in composition of the two ends of the bar. In such cases the change in composition was gradual from one end of the bar to the other, the upper end in general containing the higher percentage of copper. A notable instance was bar No. 13, in the above table, turnings from the upper end containing 40.36% of zinc, and from the lower end 48.52%.

Specific Gravity. — The specific gravity follows a definite law, varying with the composition, and decreasing with the addition of zinc. From the plotted curve of specific gravities the following mean values are taken:

Per cent zinc	0	10	20	30	40	50	60	70	80	90	100
Specific gravity	8.80	8.72	8.60	8.40	8.36	8.20	8.00	7.72	7.40	7.20	7.14

Graphic Representation of the Law of Variation of Strength of Copper-Tin-Zinc Alloys. — In an equilateral triangle the sum of the perpendicular distances from any point within it to the three sides is equal to the altitude. Such a triangle can therefore be used to show graphically the percentage composition of any compound of three parts, such as a triple alloy. Let one side represent 0 copper, a second 0 tin, and the third 0 zinc, the vertex opposite each of these sides representing 100 of each element respectively. On points in a triangle of wood representing different alloys tested, wires were erected of lengths proportional to the tensile strengths, and the triangle then built up with plaster to the height of the wires. The surface thus formed has a characteristic topography representing the variations of strength with variations of composition. The cut shows the surface thus made. The vertical section to the left represents the law of tensile strength of the copper-tin alloys, the one to the right that of tin-zinc alloys, and the one at the rear that of the copper-zinc alloys. The high point represents the strongest possible alloys of the three metals. Its composition is copper 55, zinc 43, tin 2, and its strength about 70,000 lbs. The high ridge from this point to the point of maximum height of the section on the left is the line of the strongest alloys, represented by the formula $\text{zinc} + (3 \times \text{tin}) = 55$.

All alloys lying to the rear of the ridge, containing more copper and less tin or zinc are alloys of greater ductility than those on the line of

maximum strength, and are the valuable commercial alloys; those in front on the declivity toward the central valley are brittle, and those in the valley are both brittle and weak. Passing from the valley toward the section at the right the alloys lose their brittleness and become soft, the maximum softness being at tin=100, but they remain weak, as is shown by the low elevation of the surface. This model was planned and constructed by Prof. Thurston in 1877. (See *Trans. A. S. C. E.*, 1881. Report of the U. S. Board appointed to test Iron, Steel, etc., vol. ii, Washington, 1881, and Thurston's *Materials of Engineering*, vol. iii.)

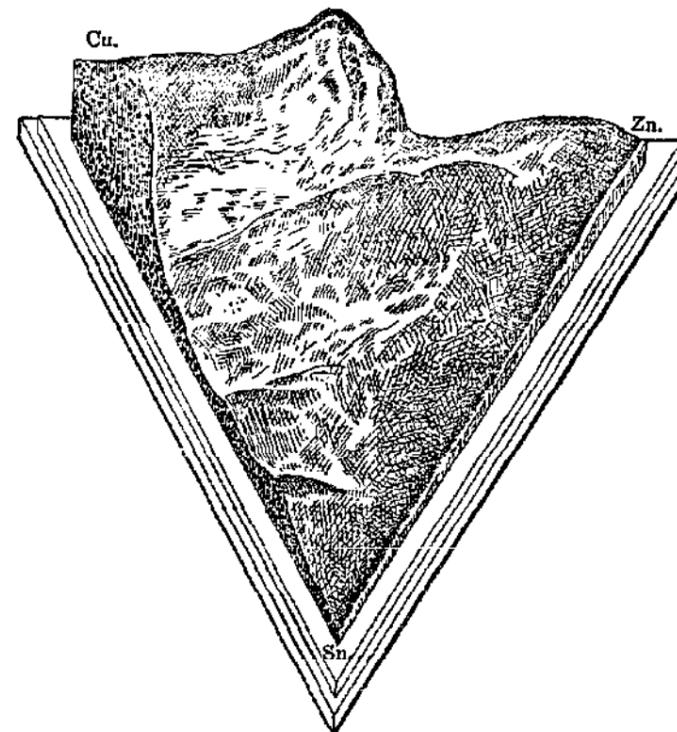

FIG. 79.

The best alloy obtained in Thurston's research for the U. S. Testing Board has the composition, copper 55, tin 0.5, zinc 44.5. The tensile strength in a cast bar was 68,900 lbs. per sq. in., two specimens giving the same result; the elongation was 47 to 51 per cent in 5 inches. Thurston's formula for copper-tin-zinc alloys of maximum strength (*Trans. A. S. C. E.*, 1881) is $z + 3t = 55$, in which z is the percentage of zinc and t that of tin. Alloys proportioned according to this formula should have a strength of about 40,000 lbs. per sq. in. + 500 z . The formula fails with alloys containing less than 1 per cent of tin.

The following would be the percentage composition of a number of alloys made according to this formula, and their corresponding tensile strength in castings:

Tin.	Zinc.	Copper.	Tensile Strength, lbs. per sq. in.	Tin.	Zinc.	Copper.	Tensile Strength lbs. per sq. in.
1	52	47	66,000	8	31	61	55,500
2	49	49	64,500	9	28	63	54,000
3	46	51	63,000	10	25	65	52,500
4	43	53	61,500	12	19	69	49,500
5	40	55	60,000	14	13	73	46,500
6	37	57	58,500	16	7	77	43,500
7	34	59	57,000	18	1	81	40,500

These alloys, while possessing maximum tensile strength, would in general be too hard for easy working by machine tools. Another series made on the formula $z + 4t = 50$ would have greater ductility, together with considerable strength, as follows, the strength being calculated as before, tensile strength in lbs. per sq. in. = $40,000 + 500z$.

Tin.	Zinc.	Copper.	Tensile Strength, lbs. per sq. in.	Tin.	Zinc.	Copper.	Tensile Strength, lbs. per sq. in.
1	46	53	63,000	7	22	71	51,000
2	42	56	61,000	8	18	74	49,000
3	38	59	59,000	9	14	77	47,000
4	34	62	57,000	10	10	80	45,000
5	30	65	55,000	11	6	83	43,000
6	26	68	53,000	12	2	86	41,000

Composition of Alloys in Every-day Use in Brass Foundries.

(American Machinist.)

	Cop- per.	Zinc.	Tin.	Lead.	
	lbs.	lbs.	lbs.	lbs.	
Admiralty metal...	87	5	8	For parts of engines on board naval vessels.
Bell metal.....	16	4	Bells for ships and factories.
Brass (yellow).....	16	8	1/2	For plumbers, ship and house brass work.
Bush metal.....	64	8	4	4	For bearing bushes for shafting.
Gun metal.....	32	1	3	For pumps and other hydraulic purposes.
Steam metal.....	20	1	1 1/2	1	Castings subjected to steam pressure.
Hard gun metal...	16	2 1/2	For heavy bearings.
Muntz metal.....	60	40	Metal from which bolts and nuts are forged, valve spindles, etc.
Phosphor bronze...	92	8 phos. tin	For valves, pumps and general work.
" " ..	90	10	" "	For cog and worm wheels, bushes, axle bearings, slide valves, etc.
Brazing metal.....	16	3	Flanges for copper pipes.
" solder.....	50	50	Solder for the above flanges.

Admiralty Metal, for surface condenser tubes where sea water is used for cooling, Cu, 70; Zn, 29; Sn, 1. *Power*, June 1, 1909.

Gurley's Bronze. — 16 parts copper, 1 tin, 1 zinc, 1/2 lead, used by W & L. E. Gurley of Troy for the framework of their engineer's transits. Tensile strength 41,114 lbs. per sq. in., elongation 27% in 1 inch, sp. gr. 8.696. (W. J. Keep, *Trans. A. I. M. E.*, 1890.)

Composition of Various Grades of Rolled Brass, Etc.

Trade Name.	Copper.	Zinc.	Tin.	Lead.	Nickel.
Common high brass.....	61.5	38.5
Yellow metal.....	60	40
Cartridge brass.....	66 2/3	33 1/3
Low brass.....	80	20
Clock brass.....	60	40	...	1 1/2	...
Drill rod.....	60	40	...	1 1/2 to 2	...
Spring brass.....	66 2/3	33 1/3	1 1/2
18 per cent German silver.....	61 1/2	20 1/2	18

The above table was furnished by the superintendent of a mill in Connecticut in 1894. He says: While each mill has its own proportions for various mixtures, depending upon the purposes for which the product is intended, the figures given are about the average standard. Thus, between cartridge brass with 33 1/3 per cent zinc and common high brass with 38 1/2 per cent zinc, there are any number of different mixtures known generally as "high brass," or specifically as "spinning brass," "drawing brass," etc., wherein the amount of zinc is dependent upon the amount of scrap used in the mixture, the degree of working to which the metal is to be subjected, etc.

Useful Alloys of Copper, Tin, and Zinc.

(Selected from numerous sources.)

	Copper.	Tin.	Zinc.
U. S. Navy Dept. journal boxes } and guide-gibs.....	{ 6 82.8	1 13.8	1/4 parts. 3.4 per cent.
Tobin bronze.....	58.22	2.30	39.48 " "
Naval brass.....	62	1	37 " "
Composition, U. S. Navy.....	88	10	2 " "
Brass bearings (J. Rose).....	{ 64 87.7	8 11.0	1 parts. 1.3 per cent
Gun metal.....	92.5	5	2.5 " "
" " ..	91	7	2 " "
" " ..	87.75	9.75	2.5 " "
" " ..	85	5	10 " "
" " ..	83	2	15 " "
Tough brass for engines.....	{ 13 76.5	2 11.8	2 parts. 11.7 per cent.
Bronze for rod-boxes (Lafond).....	82	16	2 slightly malleable.
" " pieces subject to shock.....	83	15	1.50 0.50 lead.
Red brass.....	20	1	1 1 " "
" " .. per cent.....	87	4.4	4.3 4.3 " "
Bronze for pump casings (Lafond).....	88	10	2
" " eccentric straps.....	84	14	2
" " shrill whistles.....	80	18 2.0 antimony.
" " low-toned whistles.....	81	17 2.0 " "
Art bronze, dull red fracture.....	97	2	1
Gold bronze.....	89.5	2.1	5.6 2.8 lead.
Bearing metal.....	89	8	3
" " ..	89	2 1/2	8 1/2
" " ..	86	14
" " ..	85 1/4	12 3/4	2
" " ..	80	18	2
" " ..	79	18	2 1/2 1/2 lead.
" " ..	74	9 1/2	9 1/2 7 lead.
English brass of A. D. 1504.....	64	3	29 1/2 31 1/2 lead.

"Steam-metal." Alloys of copper and zinc are unsuitable for steam valves and other like purposes, since their strength is greatly reduced at high temperatures, and they appear to undergo a deterioration by continued heating. Alloys of copper with from 10 to 12% of tin, when cast without oxidation are good steam metals, and a favorite alloy is what is known as "government mixture," 88 Cu, 10 Sn, 2 Zn. It has a tensile strength of about 33,000 lbs. per sq. in., when cold, and about 30,600 lbs. when heated to 407° F., corresponding to steam of 250 lbs. pressure.

Tobin Bronze. — This alloy is practically a sterro or delta metal with the addition of a small amount of lead, which tends to render copper softer and more ductile. (F. L. Garrison, *J. F. I.*, 1891.)

The following analyses of Tobin bronze were made by Dr. Chas. B. Dudley:

	Pig Metal, per cent.	Test Bar (Rolled), per cent.
Copper.....	59.00	61.20
Zinc.....	38.40	37.14
Tin.....	2.16	0.90
Iron.....	0.11	0.18
Lead.....	0.31	0.35

Dr. Dudley writes, "We tested the test bars and found 78,500 tensile strength with 40½% elongation in two inches, and 15% in eight inches. This high tensile strength can only be obtained when the metal is manipulated. Such high results could hardly be expected with cast metal."

The original Tobin bronze in 1875, as described by Thurston, *Trans. A. S. C. E.*, 1881, had copper 58.22, tin 2.30, zinc 39.48. As cast it had a tenacity of 66,000 lbs. per sq. in., and as rolled 79,000 lbs.; cold rolled it gave 104,000 lbs.

A circular of Ansonia Brass & Copper Co. gives the following: — The tensile strength of six Tobin bronze one-inch round rolled rods, turned down to a diameter of 5/8 of an inch, tested by Fairbanks, averaged 79,600 lbs. per sq. in., and the elastic limit obtained on three specimens averaged 54,257 lbs. per sq. in.

At a cherry-red heat Tobin bronze can be forged and stamped as readily as steel. Bolts and nuts can be forged from it, either by hand or by machinery. Its great tensile strength, and resistance to the corrosive action of sea-water, render it a most suitable metal for condenser plates, steam-launch shafting, ship sheathing and fastenings, nails, hull plates for steam yachts, torpedo and life boats, and ship deck fittings.

The Navy Department has specified its use for certain purposes in the machinery of the new cruisers. Its specific gravity is 8.071. The weight of a cubic inch is 0.291 lb.

Special Alloys. (*Engineering*, March 24, 1893.)

JAPANESE ALLOYS for art work:

	Copper.	Silver.	Gold.	Lead.	Zinc.	Iron.
Shaku-do.....	94.50	1.55	3.73	0.11	trace.	trace.
Shibu-ichi.....	67.31	32.07	traces.	0.52		

GILBERT'S ALLOY for *cera-perduta* process, for casting in plaster-of-paris.

Copper 91.4 Tin 5.7 Lead 2.9 Very fusible.

COPPER-ZINC-IRON ALLOYS.

(F. L. Garrison, *Jour. Frank. Inst.*, June and July, 1891.)

Delta Metal. — This alloy, which was formerly known as *sterro-metal*, is composed of about 60 copper, from 34 to 44 zinc, 2 to 4 iron, and 1 to 2 tin.

The peculiarity of all these alloys is the content of iron, which appears to have the property of increasing their strength to an unusual degree. In making delta metal the iron is previously alloyed with zinc in known and definite proportions. When ordinary wrought-iron is introduced into molten zinc, the latter readily dissolves or absorbs the former, and will take it up to the extent of about 5% or more. By adding the zinc-iron alloy thus obtained to the requisite amount of copper, it is possible to introduce any definite quantity of iron up to 5% into the copper alloy. Garrison gives the following as the range of composition of copper-zinc-iron, and copper-zinc-tin-iron alloys:

I.		II.	
	Per cent.		Per cent.
Iron.....	0.1 to 5	Iron.....	0.1 to 5
Copper.....	50 to 65	Tin.....	0.1 to 10
Zinc.....	49.9 to 30	Zinc.....	1.8 to 45
		Copper.....	98 to 40

The advantages claimed for delta metal are great strength and toughness. It produces sound castings of close grain. It can be rolled and forged hot, and can stand a certain amount of drawing and hammering when cold. It takes a high polish, and when exposed to the atmosphere tarnishes less than brass.

When cast in sand delta metal has a tensile strength of about 45,000 pounds per square inch, and about 10% elongation; when rolled, tensile strength of 60,000 to 75,000 pounds per square inch, elongation from 9% to 17% on bars 1.128 inch in diameter and 1 inch area.

Wallace gives the ultimate tensile strength 33,600 to 51,520 pounds per square inch, with from 10% to 20% elongation.

Delta metal can be forged, stamped and rolled hot. It must be forged at a dark cherry-red heat, and care taken to avoid striking when at a black heat.

According to Lloyd's Proving House tests, made at Cardiff, December 20, 1887, a half-inch delta metal-rolled bar gave a tensile strength of 88,400 pounds per square inch, with an elongation of 30% in three inches.

ALLOYS OF COPPER, TIN, AND LEAD.

G. H. Clamer, in *Castings*, July, 1908, describes some experiments on the use of lead in copper alloys. A copper and lead alloy does not make what would be called good castings; by the introduction of tin a more homogeneous product is secured. By the addition of nickel it was found that more than 15% of lead could be used, while maintaining tin at 8 to 10%, and also that the tin could be dispensed with. A good alloy for bearings was then made without nickel, containing Cu 65, Sn 5, Pb 30. This alloy is largely sold under the name of "plastic bronze." If the matrix of tin and copper were so proportioned that the tin remained below 9% then more than 20% of lead could be added with satisfactory results. As the tin is decreased more lead may be added. (See *Bearing Metal Alloys*, below.)

The Influence of Lead on Brass. — E. S. Sperry, *Trans. A.I.M.E.*, 1897. As a rule, the lower the brass (that is, the lower in zinc) the more difficult it is to cut. If the alloy is made from pure copper and zinc, the chips are long and tenacious, and a slow speed must be employed in cutting. For some classes of work, such as spinning or cartridge brass, these qualities are essential, but for others, such as clock brass or screw rod, they are almost prohibitory. To make an alloy which will cut easily, giving short chips, the best method is the addition of a small percentage of lead. Experiments were made on alloys con-

taining different percentages of lead. The following is a condensed statement of the chief results:

Cu, 60; Zn, 30; Pb, 10. Difficult to obtain a homogeneous alloy. Cracked badly on rolling.
 Cu, 60; Zn, 35; Pb, 5. Good cutting qualities but cracked on rolling.
 Cu, 60; Zn, 37.5; Pb, 2.5. Cutting qualities excellent, but could only be hot-rolled or forged with difficulty.
 Cu, 60; Zn, 38.75; Pb, 1.25. Cutting qualities inferior to those of the alloy containing 2.5% of lead, but superior to those of pure brass.
 Cu, 60; Zn, 40. Perfectly homogeneous. Rolls easily at a cherry red heat, and cracks but slightly in cold rolling. Chips long and tenacious, necessitating a slow speed in cutting.

Tensile tests of these alloys gave the following results:

Copper, %	60.0			60.0			60.0			60.0		
	C	A	H	C	A	H	C	A	H	C	A	H
Zinc, %	40.0			37.5			35.0			30.0		
Lead, %	None.			2.5			5.0			10.0		
T. S. per sq. in.*	16	60	107	39	51	88	33	42	61	36	35	63
Elonga. in 1 in., %	48	51	1	28	27	0	28	26	1	36	20	2
Elonga. in 8 in., %	27	33	0	27	23	0	27	22	0	30	16	3
Red. of area, %	61	44	13	30	33	0	26	33	0	29	25	4
P. R.	92%			65%			61%			38%		

* Thousands of pounds. C, casting; A, annealed sheet; H, hard rolled sheet; P. R., possible reduction in rolling.

The use of tin, even in small amounts, hardens and increases the tensile strength of brass, which is detrimental to free turning. Mr. Sperry gives analyses of several brasses which have given excellent results in turning, all included within the following range: Cu, 60 to 66%, Zn, 38 to 32%, Pb, 1.5 to 2.5%. For cartridge-brass sheet, anything over 0.10% of lead increases the liability of cracking in drawing.

PHOSPHOR-BRONZE AND OTHER SPECIAL BRONZES.

Phosphor-bronze. — In the year 1868, Montefiore & Kunzel of Liege, Belgium, found by adding small proportions of phosphorus or "phosphoret of tin or copper" to copper that the oxides of that metal, nearly always present as an impurity, more or less, were deoxidized and the copper much improved in strength and ductility, the grain of the fracture became finer, the color brighter, and a greater fluidity was attained. Three samples of phosphor-bronze tested by Kirkaldy gave:

Elastic limit, lbs. per sq. in.	23,800	24,700	16,100
Tensile strength, lbs. per sq. in.	52,625	46,100	44,448
Elongation, per cent.	8.40	1.50	33.40

The strength of phosphor-bronze varies like that of ordinary bronze according to the percentages of copper, tin, zinc, lead, etc., in the alloy.

Phosphor-bronze Rod. — Torsion tests of 20 samples, 1/4 in. diam. Apparent outside fiber stress, 77,500 to 86,700 lbs. per sq. in.; average number of turns per inch of length, 0.76 to 1.50. — *Tech. Quar.*, vol. xii, Sept., 1899.

Penn. R. R. Co.'s Specifications for Phosphor-bronze (1902). — The metal desired is a homogeneous alloy of copper, 79.70; tin, 10.00; lead, 9.50; phosphorus, 0.80. Lots will not be accepted if samples do not show tin, between 9 and 11%; lead, between 8 and 11%; phosphorus, between 0.7 and 1%; nor if the metal contains a sum total of other substances than copper, tin, lead, and phosphorus in greater quantity than 0.50 per cent. (See also p. 381.)

Deoxidized Bronze. — This alloy resembles phosphor bronze somewhat in composition and also delta metal, in containing zinc and iron. The following analysis gives its average composition: Cu, 82.67; Sn, 12.40; Zn, 3.23; Pb, 2.14; Fe, 0.10; Ag, 0.07; P, 0.005.

Comparison of Copper, Silicon-bronze, and Phosphor-bronze Wires. (*Engineering*, Nov. 23, 1883.)

Description of Wire.	Tensile Strength.	Relative Conductivity.
Pure copper	39,827 lbs. per sq. in.	100 per cent.
Silicon bronze (telegraph)	41,696 " " " "	96 " "
" " (telephone)	108,080 " " " "	34 " "
Phosphor bronze (telephone)	102,390 " " " "	26 " "

Silicon Bronze. (*Aluminum World*, May, 1897.)

The most useful of the silicon bronzes are the 3% (97% copper, 3% silicon) and the 5% (95% copper, 5% silicon), although the hardness and strength of the alloy can be increased or decreased at will by increasing or decreasing silicon. A 3% silicon bronze has a tensile strength, in a casting, of about 55,000 lbs. per sq. in., and from 50% to 60% elongation. The 5% bronze has a tensile strength of about 75,000 lbs. and about 8% elongation. More than 5% or 5 1/2% of silicon in copper makes a brittle alloy. In using silicon, either as a flux or for making silicon bronze, the rich alloy of silicon and copper which is now on the market should be used. It should be free from iron and other metals if the best results are to be obtained. Ferro-silicon is not suitable for use in copper or bronze mixtures.

Copper and Vanadium Alloys. The Vanadium Sales Co. of America reports (1908) that the addition of vanadium to copper has given a tensile strength of 83,000 lbs. per sq. in.; with an elongation of over 60%.

ALLOYS FOR CASTING UNDER PRESSURE IN METAL MOLDS. E. L. Lake, *Am. Mach.*, Feb. 13, 1908.

No.	Tin.	Copper.	Aluminum.	Zinc.	Lead.	Antimony.	Iron
1	14.75	5.25	6.25	73.75			
2	19	5	1	72.7	2	0.3	
3	12	10.6	3.4	73.8			0.2
4	30.8	20.4	2.6	46.2			

Nos. 1 and 2 suitable for ordinary work, such as could be performed by average brass castings. No. 3 and 4 are harder.

ALUMINUM ALLOYS.

The useful alloys of aluminum so far found have been chiefly in two groups, the one of aluminum with not more than 35% of other metals, and the other of metals containing not over 15% of aluminum; in the one case the metals impart hardness and other useful qualities to the aluminum, and in the other the aluminum gives useful qualities to the metal with which it is alloyed.

Aluminum-Copper Alloys. — The useful aluminum-copper alloys can be divided into two classes. — the one containing less than 11% of aluminum, and the other containing less than 15% of copper. The first class is best known as Aluminum Bronze.

Aluminum Bronze. (Cowles Electric Smelting and Al. Co.'s circular.) The standard A No. 2 grade of aluminum bronze, containing 10% of aluminum and 90% of copper, has many remarkable characteristics which distinguish it from all other metals.

The tenacity of castings of A No. 2 grade metal varies between 75,000 and 90,000 lbs. to the square inch, with from 4% to 14% elongation.

Increasing the proportion of aluminum in bronze beyond 11% produces a brittle alloy; therefore nothing higher than the A No. 1, which contains 11%, is made.

The B, C, D, and E grades, containing 7 1/2%, 5%, 2 1/2%, and 1 1/4% of aluminum, respectively, decrease in tenacity in the order named, that of the former being about 65,000 pounds, while the latter is 25,000 pounds. While there is also a proportionate decrease in transverse and torsional strengths, elastic limit, and resistance to compression as the percentage of aluminum is lowered and that of copper raised, the ductility on the other hand increases in the same proportion. The specific gravity of the A No. 1 grade is 7.56.

Bell Bros., Newcastle, gave the specific gravity of the aluminum bronzes as follows:

3%, 8.691; 4%, 8.621; 5%, 8.369; 10%, 7.689.

The Thermit Process. — When finely divided aluminum is mixed with a metallic oxide and ignited the aluminum burns with great rapidity and intense heat, the chemical reaction being $Al + Fe_2O_3 = Al_2O_3 + Fe$. The heat thus generated may be used to fuse or weld iron and other metals. See the Thermit Process, under Welding of Steel, page 463.

Tests of Aluminum Bronzes.

(John H. J. Dagger, British Association, 1889.)

Per cent of Aluminum.	Tensile Strength.		Elongation, per cent.	Specific Gravity.
	Tons per square inch.	Pounds per square inch.		
11	40 to 45	89,600 to 100,800	8	7.23
10	33 " 40	73,920 " 89,600	14	7.69
7 1/2	25 " 30	56,000 " 67,200	40	8.00
5-2 1/2	15 " 18	33,600 " 40,320	40	8.37
2 1/2	13 " 15	29,120 " 33,600	50	8.69
1 1/4	11 " 13	24,640 " 29,120	55	

Both physical and chemical tests made of samples cut from various sections of 2 1/2%, 5%, 7 1/2%, or 10% aluminized copper castings tend to prove that the aluminum unites itself with each particle of copper with uniform proportion in each case, so that we have a product that is free from liquation and highly homogeneous. (R. C. Cole, *Iron Age*, Jan. 16, 1890.)

Casting. — The melting point of aluminum bronze varies slightly with the amount of aluminum contained, the higher grades melting at a somewhat lower temperature than the lower grades. The A No. 1 grades melt at about 1700° F., a little higher than ordinary bronze or brass.

Aluminum bronze shrinks more than ordinary brass. As the metal solidifies rapidly it is necessary to pour it quickly and to make the feeders amply large, so that there will be no "freezing" in them before the casting is properly fed. Baked-sand molds are preferable to green sand, except for small castings, and when fine skin colors are desired in the castings. (Thos. D. West, *Trans. A. S. M. E.*, 1886, vol. viii.)

All grades of aluminum bronze can be rolled, swedged, spun, or drawn cold except A 1 and A 2. They can all be worked at a bright red heat.

In rolling, swedging, or spinning cold, it should be annealed very often, and at a brighter red heat than is used for annealing brass.

Seamless Tubes. — Leonard Waldo, *Trans. A. S. M. E.*, vol. xviii, describes the manufacture of aluminum bronze seamless tubing. Many difficulties were met in all stages of the process. A cold drawn bar, 1.40 ins. outside diameter, 0.05 in. thick, showed a yield point of 68,700, and a tensile strength of 96,000 lbs. per sq. in. with an elongation of 4.9% in 10 in.; heated to bright red and plunged in water, the Y. P. reduced to 24,200 and the T. S. to 47,600 lbs. per sq. in., and the elongation in 10 ins. increased to 64.9%.

Brazing. — Aluminum bronze will braze as well as any other metal, using one-quarter brass solder (zinc 500, copper 500) and three-quarters borax, or, better, three-quarters cryolite.

Soldering. — To solder aluminum bronze with ordinary soft (pewter) solder: Cleanse well the parts to be joined free from grease and dirt. Then place the parts to be soldered in a strong solution of sulphate of copper and place in the bath a rod of soft iron touching the parts to be joined. After a while a coppery-like surface will be seen on the metal. Remove from bath, rinse quite clean, and brighten the surfaces. These surfaces can then be tinned by using a fluid consisting of zinc dissolved in hydrochloric acid, in the ordinary way, with common soft solder.

Mierzinski recommends ordinary hard solder, and says that Hulot uses an alloy of the usual half-and-half lead-tin solder, with 12.5%, 25% or 50% of zinc amalgam.

Aluminum Brass. (E. H. Cowles, *Trans. A. I. M. E.*, vol. xviii.) — Cowles aluminum brass is made by fusing together equal weights of A 1 aluminum bronze, copper, and zinc. The copper and bronze are first thoroughly melted and mixed, and the zinc is finally added. The material is left in the furnace until small test-bars are taken from it and broken. When these bars show a tensile strength of 80,000 pounds or over, with 2 or 3 per cent ductility, the metal is ready to be poured. Tests of this brass, on small bars, have at times shown as high as 100,000 pounds tensile strength.

The screw of the United States gunboat Petrel is cast from this brass mixed with a trifle less zinc in order to increase its ductility.

Tests of Aluminum Brass.

(Cowles E. S. & Al. Co.)

Specimen (Castings)	Diameter of Piece, Inch.	Area, sq. in.	Tensile Strength, lbs. per sq. in.	Elastic Limit, lbs. per sq. in.	Elongation, per ct.	Remarks.				
15% A grade Bronze } 17% Zinc..... } 68% Copper..... }	0.465	0.1698	41,225	17,668	41 1/2	These test pieces were all 6" long between the shoulders.				
1 part A Bronze... } 1 part Zinc..... } 1 part Copper..... }							0.465	0.1698	78,327	21 1/2
1 part A Bronze... } 1 part Zinc..... } 1 part Copper..... }										

The first brass on the above list is an extremely tough metal with low elastic limit, made purposely so as to "upset" easily. The other, which is called Aluminum brass No. 2, is very hard.

We have not in this country or in England any official standard by which to judge of the physical characteristics of cast metals. There are two conditions that are absolutely necessary to be known before we can make a fair comparison of different materials; namely, whether the casting was made in dry or green sand or in a chill, and whether it was attached to a larger casting or cast by itself. It has also been found that chill-castings give higher results than sand-castings, and that bars cast by themselves purposely for testing almost invariably run higher than test-bars attached to castings. It is also a fact that bars cut out from castings are generally weaker than bars cast alone. (E. H. Cowles.)

Caution as to Reported Strength of Alloys. — The same variation in strength which has been found in tests of gun-metal (copper and tin) noted above, must be expected in tests of aluminum bronze and in fact of all alloys. They are exceedingly subject to variation in density and in grain, caused by differences in method of moulding and casting, temperature of pouring, size and shape of casting, depth of "sinking head," etc.

Aluminum Hardened by Addition of Copper.

Tests of rolled sheets 0.04 inch thick. (*The Engineer*, Jan. 2, 1891.)

Al. Per cent.	Cu. Per cent.	Sp. Gr. Calculated.	Sp. Gr. Determined.	Tensile Strength lbs. per sq. in.
100			2.67	26,535
98	2	2.78	2.71	43,563
96	4	2.90	2.77	44,130
94	6	3.02	2.82	54,773
92	8	3.14	2.85	50,374

Tests of Aluminum Alloys.

(Engineer Harris, U. S. N., *Trans. A. I. M. E.*, vol. xviii.)

Composition.					Tensile Strength per sq. in., lbs.	Elastic Limit, lbs. per sq. in.	Elongation, per ct.	Reduction of Area, per ct.
Copper.	Aluminum.	Silicon.	Zinc.	Iron.				
91.50%	6.50%	1.75%	0.25%	60,700	18,000	23.2	30.7
88.50	9.33	1.66	0.50	66,000	27,000	3.8	7.8
81.50	6.50	1.75	0.25	67,600	24,000	13	21.62
90.00	9.00	1.00	72,830	33,000	2.40	5.78
63.00	3.33	0.33	33.33%	82,200	60,000	2.33	9.88
63.00	3.33	0.33	33.33	70,400	55,000	0.4	4.33
91.50	6.50	1.75	0.25	59,100	19,000	15.1	23.59
93.00	6.50	0.50	53,000	19,000	6.2	15.5
88.50	9.33	1.66	0.50	69,930	33,000	1.33	3.30
92.00	6.50	0.50	46,530	17,000	7.8	19.19

For comparison with the above 6 tests of "Navy Yard Bronze," Cu 88, Sn 10, Zn 2, are given in which the T. S. ranges from 18,000 to 24,590, E. L. from 10,000 to 13,000, El. 2.5 to 5.8%, Red. 4.7 to 10.89.

Alloys of Aluminum, Silicon and Iron.

M. and E. Bernard have succeeded in obtaining through electrolysis, by treating directly and without previous purification, the aluminum earths (red and white bauxites), the following:

Alloys such as ferro-aluminum, ferro-silicon-aluminum and silicon-aluminum, where the proportion of silicon may exceed 10%, which are employed in the metallurgy of iron for refining steel and cast-iron.

Also silicon-aluminum, where the proportion of silicon does not exceed 10%, which may be employed in mechanical constructions in a rolled or hammered condition, in place of steel, on account of their great resistance, especially where the lightness of the piece in construction constitutes one of the main conditions of success.

The following analyses are given:

1. Alloys applied to the metallurgy of iron, the refining of steel and cast iron: No. 1. Al, 70%; Fe, 25%; Si, 5%. No. 2. Al, 70; Fe, 20; Si, 10. No. 3. Al, 70; Fe, 15; Si, 15. No. 4. Al, 70; Fe, 10; Si, 20. No. 5. Al, 70; Fe, 10; Si, 10; Mn, 10. No. 6. Al, 70; Fe, trace; Si, 20; Mn, 10.

2. Mechanical alloys: No. 1. Al, 92; Si, 6.75; Fe, 1.25. No. 2. Al, 90; Si, 9.25; Fe, 0.75. No. 3. Al, 90; Si, 10; Fe, trace. The best results were with alloys where the proportion of iron was very low, and the proportion of silicon in the neighborhood of 10%. Above that proportion the alloy becomes crystalline and can no longer be employed. The density of the alloys of silicon is approximately the same as that of aluminum. — *La Metallurgie*, 1892.

Tungsten and Aluminum. — Mr. Leinhardt Mannesmann says that the addition of a little tungsten to pure aluminum or its alloys communicates a remarkable resistance to the action of cold and hot water, salt water and other reagents. When the proportion of tungsten is sufficient the alloys offer great resistance to tensile strains. An alloy of aluminum and tungsten called partinium, from the name of its inventor, M. Partin, has been used in France since 1898 for motor-car bodies. Its properties are stated as follows: Cast, sp. gr., 2.86; T. S., 17,000 to 24,000; elong., 12 to 6%. Rolled, sp. gr., 3.09; T. S., 45,500 to 53,600; elong., 8 to 6%.

Aluminum, Copper, and Tin. — Prof. R. C. Carpenter, *Trans. A. S. M. E.*, vol. xix., finds the following alloys of maximum strength in a series in which two of the three metals are in equal proportions:

Al, 85; Cu, 7.5; Sn, 7.5; tensile strength, 30,000 lbs. per sq. in.; elongation in 6 in., 4%; sp. gr., 3.02. Al, 6.25; Cu, 87.5; Sn, 6.25; T. S., 63,000; El., 3.8; sp. gr., 7.35. Al, 5; Cu, 5; Sn, 90; T. S., 11,000; El. 10.1; sp. gr., 6.82.

From 85 to 95% Cu the bars have considerable strength, are close grained and of a golden color. Between 78 and 80% the color changes to silver white and the bars become brittle. From 78 to 20% Cu the alloys are very hard and brittle, and worthless for practical purposes. Aluminum is strengthened by the addition of equal parts of copper and tin up to 7.5% of each, beyond which the strength decreases. All the alloys that contain between 20 and 60% of either one of the three metals are very weak.

Aluminum and Zinc. — Like the copper alloys, the zinc alloys can be divided into two classes, (1) those containing a relatively small amount of aluminum, and (2) those containing less than 35% of zinc. The first class is used largely in galvanizing baths to produce greater fluidity, while the second class embraces the zinc casting alloys. Prof. Carpenter finds that the strongest alloy of these metals consists of two parts of aluminum and one part of zinc. Its tensile strength is 24,000 to 26,000 lbs. per sq. in.; has but little ductility, is readily cut with machine-tools, and is a good substitute for hard cast brass.

Aluminum and Tin. — M. Bourbouze has compounded an alloy of aluminum and tin, by fusing together 100 parts of the former with 10 parts of the latter. This alloy is paler than aluminum, and has a specific gravity of 2.85. The alloy is not as easily attacked by several reagents as aluminum is, and it can also be worked more readily. Another advantage is that it can be soldered as easily as bronze, without further preliminary preparations. Prof. Carpenter found that aluminum-tin alloys with from 2 to 10% Al are as a rule weaker than pure aluminum and of little practical value.

Aluminum with Nickel, German Silver or Titanium. — J. W. Richards, *Jour. Frank. Inst.*, 1895, says that an addition of 5% of nickel or German silver, or 2% of titanium to aluminum increases the tensile strength to 20,000-30,000 lbs. per sq. in. in castings and to 40,000-50,000 lbs. in sheet. For purposes where the requirements are fine color, strength, hardness and springiness the German-silver alloy is recommended.

Aluminum-Antimony Alloys. — Dr. C. R. Alder Wright describes some aluminum-antimony alloys in a communication read before the Society of Chemical Industry. The results of his researches do not disclose the existence of a commercially useful alloy of these two metals, and have greater scientific than practical interest. A remarkable point is that the alloy with the chemical composition Al Sb has a higher melting-point than either aluminum or antimony alone, and that when aluminum is added to pure antimony the melting-point goes up from that of antimony (450° C.) to a certain temperature rather above that of silver (1000° C.).

Aluminum and Cast Iron. — Aluminum alloys readily with cast iron, up to 14 to 15% Al, but the metal decreases in strength as the Al is increased. Mixtures with greater percentages of Al are granular, and have practically no coherence. — *Trans. A. I. M. E.*, vol. xviii., *A. S. M. E.*, vol. xix.

Other Aluminum Alloys. — Al 75.7, Cu 3, Zn 20, Mn 1.3 is an excellent casting metal, having a tensile strength of over 35,000 lbs. per sq. in., and a sp. gr. slightly above 3. It has very little ductility.

Al 96.5, Cu 2, and chromium 1.5 is a little heavier than pure aluminum and has a tensile strength of 26,300 lbs. per sq. in. — *A. S. M. E.*, vol. xix.

Aluminum and Magnesium. — Magnalium. — An alloy containing 90 to 98% of aluminum, the balance being mainly magnesium, has been patented under the trade name of "magnalium." Its specific gravity is only 2.5; it is whiter, harder and stronger than aluminum, and can be forged, rolled, drawn, machined and filed. It takes a high polish and resists oxidation better than any other light metals or alloys. The tensile strength of cast magnalium, class X, is reported at 18,400 to 21,300 lbs. per sq. in., with a reduction of area of 3.75%; hard rolled plates, class Z, 52,200 lbs. per sq. in., with 3.7% reduction; annealed plates, 42,200 lbs. per sq. in., 17.8% reduction. Made by the Magnalium Syndicate of Berlin. The price is said to be about twice that of aluminum. — (*Mach'y*, July, 1908.)

Prof. Carpenter (*A. S. M. E.*, vol. xix) found that additions of Mn increased the strength of Al up to 10% Mn. Larger additions made brittle alloys.

Resistance of Aluminum Alloys to Corrosion. — J. W. Richards, *Jour. Frank. Inst.*, 1895, gives the following table showing the relative resistance to corrosion of aluminum (99% pure) and alloys of aluminum with different metals, when immersed in the liquids named. The figures are losses per day in milligrams per square centimeter of surface:

	3% Caustic potash. Cold.	3% Hydrochloric Acid. Cold.	Strong Nitric Acid. Cold.	Strong Salt Solution. 150° F.	Strong Acetic Acid. 140° F.	Carbonic Acid. Water. 77° F.
3 per cent copper	265.0	53.3	36.1	0.1	0.4	0.0
3 per cent German silver	1534.4	130.6	97.7	0.05	0.6	0.01
3 per cent nickel	580.3	180.0	83.0	0.13	0.75	0.04
2 per cent titanium	73.4	4.3	18.6	0.06	0.20	0.0
99 per cent aluminum	34.6	5.8	9.6	0.04	0.15	0.01

Aluminum Alloys used in Automobile Construction (*Am. Mach.*, Aug. 22, 1907.)

- (1) Al 2, Zn, 1, T.S. 35,000; Sp. gr. 3.1
- (2) Al 92, Cu, 8, T.S. 18,000; Sp. gr. 2.84 Ni, trace
- (3) Al 83, Zn, 15, Cu, 2, T.S. 23,000; Sp. gr. 3.1

(1) Unsatisfactory on account of failures under repeated vibration.
 (2) Generally used. Resists vibrations well. (3) Used to some extent. Many motor-car makers decline to use it because of uncertainty of its behavior under vibration.

ALLOYS OF MANGANESE AND COPPER.

Various Manganese Alloys. — E. H. Cowles, in *Trans. A. I. M. E.* vol. xviii, p. 495, states that as the result of numerous experiments on mixtures of the several metals, copper, zinc, tin, lead, aluminum, iron, and manganese, and the metalloid silicon, and experiments upon the same in ascertaining tensile strength, ductility, color, etc., the most important determinations appear to be about as follows:

1. That pure metallic manganese exerts a bleaching effect upon copper more radical in its action even than nickel. In other words, it was found that 18 1/2% of manganese present in copper produces as white a color in the resulting alloy as 25% of nickel would do, this being the amount of each required to remove the last trace of red.
2. That upwards of 20% or 25% of manganese may be added to copper without reducing its ductility, although doubling its tensile strength and changing its color.
3. That manganese, copper, and zinc when melted together and poured into molds behave very much like the most "yeasty" German

silver, producing an ingot which is a mass of blow-holes, and which swells up above the mold before cooling.

4. That the alloy of manganese and copper by itself is very easily oxidized.

5. That the addition of 1.25% of aluminum to a manganese-copper alloy converts it from one of the most refractory of metals in the casting process into a metal of superior casting qualities, and the non-corrodibility of which is in many instances greater than that of either German or nickel silver.

A "silver-bronze" alloy especially designed for rods, sheets, and wire has the following composition: Mn, 18; Al, 1.20; Si, 0.5; Zn, 13; and Cu, 67.5%. It has a tensile strength of about 57,000 lbs. on small bars, and 20% elongation. It has been rolled into thin plate and drawn into wire 0.008 inch in diameter. A test of the electrical conductivity of this wire (of size No. 32) shows its resistance to be 41.44 times that of pure copper. This is far lower conductivity than that of German silver.

Manganese Bronze. (F. L. Garrison, *Jour. F. I.*, 1891.) — This alloy has been used extensively for casting propeller-blades. Tests of some made by B. H. Cramp & Co., of Philadelphia, gave an average elastic limit of 30,000 lbs. per sq. in., tensile strength of about 60,000 lbs. per sq. in. with an elongation of 8% to 10% in sand castings. When rolled, the E. L. is about 80,000 lbs. per sq. in., tensile strength 95,000 to 106,000 lbs. per sq. in., with an elongation of 12% to 15%.

Compression tests made at United States Navy Department from the metal in the pouring-gate of propeller-hub of U. S. S. Maine gave in two tests a crushing stress of 126,450 and 135,750 lb. per sq. in. The specimens were 1 inch high by 0.7 x 0.7 inch in cross-section = 0.49 square inch. Both specimens gave way by shearing, on a plane making an angle of nearly 45° with the direction of stress.

A test on a specimen 1 x 1 x 1 inch was made from a piece of the same pouring-gate. Under stress of 150,000 pounds it was flattened to 0.72 inch high by about 1 1/4 x 1 1/4 inches, but without rupture or any sign of distress.

One of the great objections to the use of manganese bronze, or in fact any alloy except iron or steel, for the propellers of iron ships is on account of the galvanic action set up between the propeller and the stern-posts. This difficulty has in great measure been overcome by putting strips of rolled zinc around the propeller apertures in the stern-frames.

The following analysis of Parsons' manganese bronze No. 2 was made from a chip from the propeller of Mr. W. K. Vanderbilt's yacht *Alva*.

Cu, 88.64; Zn, 1.57; Sn, 3.70; Fe, 0.72; Pb, 0.30; P, trace.

It will be observed there is no manganese present and the amount of zinc is very small.

E. H. Cowles, *Trans. A. I. M. E.*, vol. xviii, says: Manganese bronze, so called, is in reality a manganese brass, for zinc instead of tin is the chief element added to the copper. Mr. P. M. Parsons, the proprietor of this brand of metal, has claimed for it a tensile strength of from 24 to 28 tons per sq. in. in small bars when cast in sand.

E. S. Sperry, *Am. Mach.*, Feb. 1, 1906, gives the following analyses of manganese bronze:

	Cu.	Zn.	Fe.	Sn.	Al.	Mn.	Pb.
No. 1	60.27	37.52	1.41	0.75	0.01	0.01
" 2	56.11	41.34	1.30	0.75	0.47	0.01	0.02
" 3	60.00	38.00	1.25	0.65	0.10
" 4	56.00	42.38	1.25	0.75	0.50	0.12

No. 1 is Parsons' alloy for sheet, No. 2 for sand casting. No. 3 is Mr. Sperry's formula for sheet, and No. 4 his formula for sand castings. The mixture for No. 3, allowing for volatilization of some zinc is: copper, 60 lbs.; zinc, 39 lbs.; "steel alloy," 2 lbs. That for No. 4 is: copper, 56 lbs.; zinc, 43 lbs.; "steel alloy," 2 lbs.; aluminum, 0.5 lb. The steel alloy is made by melting wrought iron, 18 lbs.; ferro-manganese (80 Fe, 20 Mn), 4 lbs.; tin, 10 lbs. The iron and ferro-manganese are first melted and then the tin is added. In making the bronzes about 15 lbs. of the copper is first melted under charcoal, the steel alloy is

added, melted and stirred, then the aluminum is added, melted and stirred, then the rest of the copper is added, and finally the zinc. The only function of the manganese is to act as a carrier to the iron, which is difficult to alloy with copper without such carrier. The iron is needed to give a high elastic limit. Green sand castings of No. 4 frequently give results as high as the following: T. S., 70,000; E. L., 30,000 lbs. per sq. in.; elongation in 6 ins., 18%; reduction of area, 26%.

Magnetic Alloys of Non-Magnetic Metals. (*El. World*, April 15, 1905; *Electrot.-Zeit.*, Mar. 2, 1905.)—Dr. Heusler has discovered that alloys of manganese, aluminum, and copper are strongly magnetic. The best results have been obtained when the Mn and Al are in the proportions of their respective atomic weights, 55 and 27.1. Two such alloys are described (1) Mn, 26.8; Al, 13.2; Cu, 60. (2) Mn, 20.1; Al, 9.9; Cu, 70, with 1% Pb added. The first was too brittle to be workable. The second was machined without difficulty. These alloys have as yet no commercial importance, as they are far inferior magnetically (at most 1 to 4) to iron.

GERMAN-SILVER AND OTHER NICKEL ALLOYS.

German Silver.—The composition of German silver is a very uncertain thing and depends largely on the honesty of the manufacturer and the price the purchaser is willing to pay. It is composed of copper, zinc, and nickel in varying proportions. The best varieties contain from 18% to 25% of nickel and from 20% to 30% of zinc, the remainder being copper. The more expensive nickel silver contains from 25% to 33% of nickel and from 75% to 66% of copper. The nickel is used as a whitening element; it also strengthens the alloy and renders it harder and more non-corrodible than the brass made without it, of copper and zinc. Of all troublesome alloys to handle in the foundry or rolling-mill, German silver is the worst. It is unmanageable and refractory at every step in its transition from the crude elements into rods, sheets, or wire. (E. H. Cowles, *Trans. A. I. M. E.*, xviii, p. 494.)

The following list of copper-nickel alloys is from various sources:

	Copper.	Nickel.	Tin.	Zinc.
German silver.....	51.6	25.8	22.6	
" ".....	50.2	14.8	3.1	31.9
" ".....	51.1	13.8	3.2	31.9
" ".....	52 to 55	18 to 25		20 to 30
Nickel ".....	75 to 66	25 to 33		
Chinese packfong.....	40.4	31.6		6.5 parts
" tutenag.....	8	3		6.5 "
German silver.....	2	1		1 "
" " (cheaper).....	8	2		3.5 "
" " (resembles silver).....	8	3		3.5 "

Nickel-copper Alloys.—(F. L. Sperry, *A. I. M. E.*, 1895.)

	Copper.	Nickel.	Zinc.	Iron.	Cobalt.
Berlin.....	52 to 63	22 to 6	26 to 31		
French, tableware.....	50	18.7 to 20	31.3 to 30		
Maillechort.....	65.4	16.8	13.4	3.4	
Christofle.....	50	50			
Austrian, tableware.....	50 to 60	25 to 20	25 to 20		
English, Sheffield.....	45.7 to 60	31.6 to 15	25.4 to 17	0 to 2.6	0 to 3.4
American, castings.....	52.5	17.7	28.8		
" bearings.....	50	25	25		
" one-cent coin.....	88	12			
Nickel coins.....	75	25			

A refined copper-nickel alloy containing 50% copper and 49% nickel, with very small amounts of iron, silicon and carbon, is produced direct from Bessemer matte in the Sudbury (Canada) Nickel Works. German-silver manufacturers purchase a ready-made alloy, which melts at a low heat and requires only the addition of zinc, instead of buying the nickel and copper separately. This alloy, "50-50" as it is called, is almost indistinguishable from pure nickel. Its cost is less than nickel, its melting-point much lower, it can be cast solid in any form desired, and furnishes a casting which works easily in the lathe or planer, yielding a silvery-white surface unchanged by air or moisture. For bullet casings now used in various British and Continental rifles, a special alloy of 80% copper and 20% nickel is made.

Monel Metal.—An alloy of about 72% Ni, 1.5 Fe, 26.5 Cu, made from the Canadian copper-nickel ores, is described in the *Metal Worker*, Oct. 10, 1908. It has many valuable properties when rolled into sheets, making it especially suitable for roofing. It is ductile and flexible, is easily soldered, has a high resistance to corrosion, and a relatively small expansion and contraction under temperature changes. The tensile strength in castings is from 70,000 to 80,000 lbs. per sq. in., and in rolled sheets as high as 108,000 lbs.

Constantan is an alloy containing about 60% copper and 40% nickel, which is much used for resistance wire in electrical instruments. Its electrical resistance is about twenty-eight to thirty times that of copper, and it possesses a very low temperature coefficient, — approximately .00003. This same material is also much used to form one element of base-metal thermo-couples.

ALLOYS OF BISMUTH.

By adding a small amount of bismuth to lead the latter may be hardened and toughened. An alloy consisting of three parts of lead and two of bismuth has ten times the hardness and twenty times the tenacity of lead. The alloys of bismuth with both tin and lead are extremely fusible, and take fine impressions of casts and molds. An alloy of one part Bi, two parts Sn, and one part Pb is used by pewter-workers as a soft solder, and by soap-makers for molds. An alloy of five parts Bi, two parts Sn, and three parts Pb melts at 199° F., and is somewhat used for stereotyping, and for metallic writing-pencils. Thorpe gives the following proportions for the better-known fusible metals:

Name of Alloy.	Bis-muth.	Lead.	Tin.	Cad-mium.	Mer-cury.	Melting-point.
Newton's.....	50	31.25	18.75			202° F.
Rose's.....	50	28.10	24.10			203° "
D'Arcet's.....	50	25.00	25.00			201° "
D'Arcet's with mercury.....	50	25.00	25.00		250.0	113° "
Wood's.....	50	25.00	12.50	12.50		149° "
Lipowitz's.....	50	26.90	12.78	10.40		149° "
Guthrie's "Eutectic".....	50	20.55	21.10	14.03		"Very low."

The action of heat upon some of these alloys is remarkable. Thus, Lipowitz's alloy, which solidifies at 149° F., contracts very rapidly at first, as it cools from this point. As the cooling goes on the contraction becomes slower and slower, until the temperature falls to 101.3° F. From this point the alloy expands as it cools, until the temperature falls to about 77° F., after which it again contracts, so that at 32° F. a bar of the alloy has the same length as at 115° F.

Alloys of bismuth have been used for making fusible plugs for boilers, but it is found that they are altered by the continued action of heat, so that one cannot rely upon them to melt at the proper temperature. Pure Banca tin is used by the U. S. Government for fusible plugs.

FUSIBLE ALLOYS.

(From various sources. Many of the figures are probably very inaccurate.)

Sir Isaac Newton's, bismuth 5, lead 3, tin 2, melts at	212° F.
Rose's, bismuth 2, lead 1, tin 1, melts at	200 "
Wood's, cadmium 1, bismuth 4, lead 2, tin 1, melts at	165 "
Gutrie's, cadmium 13.29, bismuth 47.38, lead 19.36, tin 19.97, melts at	160 "
Lead 1, tin 1, bismuth 1, cadmium 1, melts at	155 "
Lead 3, tin 5, bismuth 8, melts at	208 "
Lead 1, tin 3, bismuth 5, melts at	212 "
Lead 1, tin 4, bismuth 5, melts at	240 "
Tin 1, bismuth 1, melts at	286 "
Lead 2, tin 3, melts at	334 to 367 "
Tin 2, bismuth 1, melts at	336 "
Lead 1, tin 2, melts at	340 to 360 "
Tin 8, bismuth 1, melts at	392 "
Lead 2, tin 1, melts at	440 to 475 "
Lead 1, tin 1, melts at	370 to 400 "
Lead 1, tin 3, melts at	356 to 383 "
Tin 3, bismuth 1, melts at	392 "
Lead 1, bismuth 1, melts at	257 "
Lead 1, tin 1, bismuth 4, melts at	201 "
Lead 5, tin 3, bismuth 8, melts at	202 "
Tin 3, bismuth 5 melts at	202 "

BEARING-METAL ALLOYS.

(C. B. Dudley, *Jour. F. I.*, Feb. and March, 1892.)

Alloys are used as bearings in place of wrought iron, cast iron, or steel, partly because wear and friction are believed to be more rapid when two metals of the same kind work together, partly because the soft metals are more easily worked and got into proper shape, and partly because it is desirable to use a soft metal which will take the wear rather than a hard metal, which will wear the journal more rapidly.

A good bearing-metal must have five characteristics: (1) It must be strong enough to carry the load without distortion. Pressures on car-journals are frequently as high as 350 to 400 lb. per square inch.

(2) A good bearing-metal should not heat readily. The old copper-tin bearing, made of seven parts copper to one part tin, is more apt to heat than some other alloys. In general, research seems to show that the harder the bearing-metal, the more likely it is to heat.

(3) Good bearing-metal should work well in the foundry. Oxidation while melting causes spongy castings. It can be prevented by a liberal use of powdered charcoal while melting. The addition of 1% to 2% of zinc or a small amount of phosphorus greatly aids in the production of sound castings. This is a principal element of value in phosphor-bronze.

(4) Good bearing-metals should show small friction. It is true that friction is almost wholly a question of the lubricant used; but the metal of the bearing has certainly some influence.

(5) Other things being equal, the best bearing-metal is that which wears slowest.

The principal constituents of bearing-metal alloys are copper, tin, lead, zinc, antimony, iron, and aluminum. The following table gives the constituents of most of the prominent bearing-metals as analyzed at the Pennsylvania Railroad laboratory at Altoona.

Analyses of Bearing-metal Alloys.

Metal.	Copper.	Tin.	Lead.	Zinc.	Anti-mony.	Iron.
Camelia metal	70.20	4.25	14.75	10.20		0.55
Anti-friction metal	1.60	98.13				trace
White metal			87.92		12.08	
Car-brass lining		trace	84.87		15.10	
Salgee anti-friction	4.01	9.91	1.15	85.57		
Graphite bearing-metal		14.38	67.73		16.73	? (1)
Antimonial lead			80.69		18.83	
Carbon bronze	75.47	9.72	14.57			(2)
Cornish bronze	77.83	9.60	12.40	trace		trace(3)
Delta metal	92.39	2.37	5.10			0.07
* Magnolia metal	trace		83.55	trace	16.45	trace(4)
American anti-friction metal			78.44	0.98	19.60	0.65
Tobin bronze	59.30	2.16	0.31	38.40		0.11
Graney bronze	75.8	9.20	15.06			
Damascus bronze	76.41	10.60	12.52			
Manganese bronze	90.52	9.58				(5)
Ajax metal	81.24	10.98	7.27			(6)
Anti-friction metal			88.32		11.93	
Harrington bronze	55.73	0.97		42.67		0.68
Car-box metal			84.33	trace	14.38	0.61
Hard lead			94.40		6.03	
Phosphor-bronze	79.17	10.22	9.61			(7)
Ex. B. metal	76.80	8.00	15.00			(8)

Other constituents:

- (1) No graphite.
- (2) Possible trace of carbon.
- (3) Trace of phosphorus.
- (4) Possible trace of bismuth.
- (5) No manganese.
- (6) Phosphorus or arsenic, 0.37.
- (7) Phosphorus, 0.94.
- (8) Phosphorus, 0.20.

* Dr. H. C. Torrey says this analysis is erroneous and that Magnolia metal always contains tin.

As an example of the influence of minute changes in an alloy, the Harrington bronze, which consists of a minute proportion of iron in a copper-zinc alloy, showed after rolling a tensile strength of 75,000 lb. and 20% elongation in 2 inches.

In experimenting on this subject on the Pennsylvania Railroad, a certain number of the bearings were made of a standard bearing-metal, and the same number were made of the metal to be tested. These bearings were placed on opposite ends of the same axle, one side of the car having the standard bearings, the other the experimental. Before going into service the bearings were carefully weighed, and after a sufficient time they were again weighed. The standard bearing-metal used is the "S bearing-metal" of the Phosphor-Bronze Smelting Co. It contains about 79.70% copper, 9.50% lead, 10% tin, and 0.80% phosphorus. A large number of experiments have shown that the loss of weight of a bearing of this metal is 1 lb. to each 18,000 to 25,000 miles traveled. Besides the measurement of wear, observations were made on the frequency of "hot boxes" with the different metals.

The results of the tests for wear, so far as given, are condensed into the following table:

Metal.	Composition.					Rate of Wear.
	Copper.	Tin.	Lead.	Phos.	Arsenic.	
Standard	79.70	10.00	9.50	0.80	100
Copper-tin	87.50	12.50	148
Same, second experiment	153
Same, third experiment	147
Arsenic-bronze	89.20	10.00	0.80	142
Arsenic-bronze	79.20	10.00	7.00	0.80	115
Arsenic-bronze	79.70	10.00	9.50	0.80	101
"K" bronze	77.00	10.50	12.50	92
Same, second experiment	92.7
Alloy "B"	77.00	8.00	15.00	86.5

WARNING: This is a 1910 edition. Some of the material may no longer be accurate

The old copper-tin alloy of 7 to 1 has repeatedly proved its inferiority to the phosphor-bronze metal. Many more of the copper-tin bearings heated than of the phosphor-bronze. The showing of these tests was so satisfactory that phosphor-bronze was adopted as the standard bearing-metal of the Pennsylvania R.R., and was used for a long time.

The experiments, however, were continued. It was found that arsenic practically takes the place of phosphorus in a copper-tin alloy, and three tests were made with arsenic-bronzes as noted above. As the proportion to lead is increased to correspond with the standard, the durability increases as well. In view of these results the "K" bronze was tried, in which neither phosphorus nor arsenic were used, and in which the lead was increased above the proportion in the standard phosphor-bronze. The result was that the metal wore 7.30% slower than the phosphor-bronze. No trouble from heating was experienced with the "K" bronze more than with the standard. Dr. Dudley continues:

At about this time we began to find evidences that wear of bearing-metal alloys varied in accordance with the following law: "That alloy which has the greatest power of distortion without rupture (resilience), will best resist wear." It was now attempted to design an alloy in accordance with this law, taking first the proportions of copper and tin. 9 1/2 parts copper to 1 of tin was settled on by experiment as the standard, although some evidence since that time tends to show that 12 or possibly 15 parts copper to 1 of tin might have been better. The influence of lead on this copper-tin alloy seems to be much the same as a still further diminution of tin. However, the tendency of the metal to yield under pressure increases as the amount of tin is diminished, and the amount of the lead increased, so a limit is set to the use of lead. A certain amount of tin is also necessary to keep the lead alloyed with the copper.

Bearings were cast of the metal noted in the table as alloy "B," and it wore 13.5% slower than the standard phosphor-bronze. This metal is now the standard bearing-metal of the Pennsylvania Railroad, being slightly changed in composition to allow the use of phosphor-bronze scrap. The formula adopted is: Copper, 105 lbs.; phosphor-bronze, 80 lbs.; tin, 9 3/4 lbs.; lead, 25 1/4 lbs. By using ordinary care in the foundry, keeping the metal well covered with charcoal during the melting, no trouble is found in casting good bearings with this metal. The copper and the phosphor-bronze can be put in the pot before putting it in the melting-hole. The tin and lead should be added after the pot is taken from the fire.

It is not known whether the use of a little zinc, or possibly some other combination, might not give still better results. For the present, however, this alloy is considered to fulfill the various conditions required for good bearing-metal better than any other alloy. The phosphor-bronze had an ultimate tensile strength of 30,000 lb., with 6% elongation, whereas the alloy "B" had 24,000 lb. T. S. and 11% elongation.

Bearing Metal Practice, 1907. (G. H. Clamer, *Proc. A. S. T. M.*, vii, 302, discusses the history of bearing metal practice since the date of Dr. Dudley's paper quoted above. It was found that tin could be diminished and lead increased far beyond the figures formerly used, and a satisfactory bearing metal was made with 65% copper, 5% tin and 30% lead. This alloy is largely sold under the name of "plastic bronze." It has a compressive strength of about 15,000 lbs. per sq. in., and is found to operate without distortion in the bearings of the heaviest locomotives, not only for driving brasses, but also for rod brasses and bushings, and for bearings of cars of 100,000 lbs. capacity, the heaviest cars now in service. Specifications of different railroads cover bearing alloys with tin from 8 to 10% and lead from 10 to 15%. There is also used a vast quantity of bearings made from scrap. These contain copper, 65 to 75%, tin, 2 to 8%, lead, 10 to 18%, zinc, 5 to 20%, and they constitute from 50 to 75 per cent of the car bearings now in use.

White Metal for Engine Bearings. (Report of a British Naval Committee, *Eng'g.* July 18, 1902.) — For lining bearings, crankpin bushes, and other parts exclusive of cross-head bushes: Tin 12, copper 1, antimony 1. Melt 6 tin 1 copper, and 6 tin 1 antimony separately and mix the two together. For cross-head bushes a harder alloy, viz., 85% tin, 5% copper, 10% antimony, has given good results.

(For other bearing-metals, see "Alloys containing Antimony," below.)

WARNING: This is a 1910 edition. Some of the material may no longer be accurate

ALLOYS CONTAINING ANTIMONY.

VARIOUS ANALYSES OF BABBITT METAL AND OTHER ALLOYS CONTAINING ANTIMONY.

Tin.	Copper.	Antimony.	Zinc.	Lead.	Bismuth.
Babbitt metal } 50	1	5 parts			
for light duty } =89.3	1.8	8.9 per ct.			
Harder Babbitt } 96	4	8 parts			
for bearings* } =88.9	3.7	7.4 per ct.			
Britannia 85.7	1.0	10.1	2.9		
" 81.9		16.2	1.9		
" 81.0	2	16	1		
" 70.5	4	25.5			
" 22	10	62	6		
"Babbitt" 45.5	1.5	13		40.0	
Plate pewter 89.3	1.8	7.1			1.8
White metal 85	5	10			

Bearings on Ger. locomotives.

* It is mixed as follows: Twelve parts of copper are first melted and then 36 parts of tin are added; 24 parts of antimony are put in, and then 36 parts of tin, the temperature being lowered as soon as the copper is melted in order not to oxidize the tin and antimony, the surface of the bath being protected from contact with the air. The alloy thus made is subsequently remelted in the proportion of 50 parts of alloy to 100 tin. (Joshua Rose.)

White-metal Alloys. — The following alloys are used as lining metals by the Eastern Railroad of France (1890):

Number.	Lead.	Antimony.	Tin.	Copper.
1.....	65	25	0	10
2.....	0	11.12	83.33	5.55
3.....	70	20	10	0
4.....	50	8	12	0

No 1 is used for lining cross-head slides, rod-brasses and axle-bearings; No. 2 for lining axle-bearings and connecting-rod brasses of heavy engines; No. 3 for lining eccentric straps and for bronze slide-valves; and No. 4 for metallic rod-packing.

Some of the best-known white-metal alloys are the following (Circular of Hoveler & Dieckhaus, London, 1893):

	Tin.	Anti- mony.	Lead.	Copper.	Zinc.
1. Parsons'.....	86	1	2	2	27
2. Richards'.....	70	15	10 1/2	4 1/2	0
3. Babbitt's.....	55	18	23 1/2	3 1/2	0
4. Fenton's.....	16	0	0	5	79
5. French Navy.....	7 1/2	0	7	7	87 1/2
6. German Navy.....	85	7 1/2	0	7 1/2	0

"There are engineers who object to white metal containing lead or zinc. This is, however, a prejudice quite unfounded, inasmuch as lead and zinc often have properties of great use in white alloys.

It is a further fact that an "easy liquid" alloy must not contain more than 18% of antimony, which is an invaluable ingredient of white metal

for improving its hardness; but in no case must it exceed that margin, as this would reduce the plasticity of the compound and make it brittle.

Hardest tin-lead alloy: 6 tin, 4 lead. Hardest of all tin alloys (?) : 74 tin, 18 antimony, 8 copper.

Alloy for thin open-work, ornamental castings: Lead 2, antimony 1. White metal for patterns: Lead 10, bismuth 6, antimony 2, common brass 8, tin 10.

Type-metal is made of various proportions of lead and antimony, from 17% to 20% antimony according to the hardness desired.

Babbitt Metals. (C. R. Tompkins, *Mechanical News*, Jan., 1891.)

The practice of lining journal-boxes with a metal that is sufficiently fusible to be melted in a common ladle is not always so much for the purpose of securing anti-friction properties as for the convenience and cheapness of forming a perfect bearing in line with the shaft without the necessity of boring them. Boxes that are bored, no matter how accurate, require great care in fitting and attaching them to the frame or other parts of a machine.

It is not good practice, however, to use the shaft for the purpose of casting the bearings, especially if the shaft be steel, for the reason that the hot metal is apt to spring it; the better plan is to use a mandrel of the same size or a trifle larger for this purpose. For slow-running journals, where the load is moderate, almost any metal that may be conveniently melted and will run free will answer the purpose. For wearing properties, with a moderate speed, there is probably nothing superior to pure zinc, but when not combined with some other metal it shrinks so much in cooling that it cannot be held firmly in the recess, and soon works loose; and it lacks those anti-friction properties which are necessary in order to stand high speed.

For line-shafting, and all work where the speed is not over 300 or 400 r. p. m., an alloy of 8 parts zinc and 2 parts block-tin will not only wear longer than any composition of this class, but will successfully resist a heavy load. The tin counteracts the shrinkage, so that the metal, if not overheated, will firmly adhere to the box until it is worn out. But this mixture does not possess sufficient anti-friction properties to warrant its use in fast-running journals.

Among all the soft metals in use there are none that possess greater anti-friction properties than pure lead; but lead alone is impracticable, for it is so soft that it cannot be retained in the recess. But when by any process lead can be sufficiently hardened to be retained in the boxes without materially injuring its anti-friction properties, there is no metal that will wear longer in light fast-running journals. With most of the best and most popular anti-friction metals in use and sold under the name of the Babbitt metal, the basis is lead.

Lead and antimony have the property of combining with each other in all proportions without impairing the anti-friction properties of either. The antimony hardens the lead, and when mixed in the proportion of 80 parts lead by weight with 20 parts antimony, no other known composition of metals possesses greater anti-friction or wearing properties, or will stand a higher speed without heat or abrasion. It runs free in its melted state, has no shrinkage, and is better adapted to light high-speed machinery than any other known metal. Care, however, should be manifested in using it, and it should never be heated beyond a temperature that will scorch a dry pine stick.

Many different compositions are sold under the name of Babbitt metal. Some are good, but more are worthless; while but very little genuine Babbitt metal is sold that is made strictly according to the original formula. Most of the metals sold under that name are the refuse of type-foundries and other smelting-works, melted and cast into fancy ingots with special brands, and sold under the name of Babbitt metal.

It is difficult at the present time to determine the exact formulas used by the original Babbitt, the inventor of the recessed box, as a number of different formulas are given for that composition. Tin, copper,

and antimony were the ingredients, and from the best sources of information the original proportions were as follows:

50 parts tin.....	= 89.3%	Another writer gives:	82.3%
2 parts copper.....	= 3.6%		8.3%
4 parts antimony.....	= 7.1%		8.3%

The copper was first melted, and the antimony added first and then about ten or fifteen pounds of tin, the whole kept at a dull-red heat and constantly stirred until the metals were thoroughly incorporated, after which the balance of the tin was added, and after being thoroughly stirred again it was then cast into ingots. When the copper is thoroughly melted, and before the antimony is added, a handful of powdered charcoal should be thrown into the crucible to form a flux, in order to exclude the air and prevent the antimony from vaporizing; otherwise much of it will escape in the form of a vapor and consequently be wasted. This metal, when carefully prepared, is probably one of the best metals in use for lining boxes that are subjected to a heavy weight and wear; but for light fast-running journals the copper renders it more susceptible to friction, and it is more liable to heat than the metal composed of lead and antimony in the proportions just given.

SOLDERS.

Common solders, equal parts tin and lead; fine solder, 2 tin to 1 lead; cheap solder, 2 lead, 1 tin.

Fusing-point of tin-lead alloys (many figures probably inaccurate).

Tin 1 to lead 25.....	538° F.	Tin 1 1/2 to lead 1.....	334° F.
" 1 " " 10.....	541	" 2 " " 1.....	340
" 1 " " 5.....	511	" 3 " " 1.....	356
" 1 " " 3.....	482	" 4 " " 1.....	365
" 1 " " 2.....	441	" 5 " " 1.....	378
" 1 " " 1.....	370	" 6 " " 1.....	381

The melting point of the tin-lead alloys decreases almost proportionately to the increase of tin, from 619°F, the melting point of pure lead, to 356°F when the alloy contains 68% of tin, and then increases to 448°F, the melting point of pure tin. Alloys on either side of the 68% mixture begin to soften materially at 356°F, because at that temperature the eutectic alloy melts and permits the whole alloy to soften. (Dr. J. A. Mathews.)

Common pewter contains 4 lead to 1 tin.

The relative hardness of the various tin and lead solders has been determined by Brinell's method. The results are as follows:

% Tin	0	10	20	30	40	50	60
Hardness	3.90	10.10	12.16	14.46	15.76	14.90	14.58
% Tin	66	67	68	70	80	90	100
Hardness	16.66	15.40	14.58	15.84	15.20	13.25	4.14

The hardest solder is the one composed of 2 parts of tin and 1 part of lead. It is the eutectic alloy, or the one with the lowest melting point of all the mixtures. — *Mechanical World*.

Gold solder: 14 parts gold, 6 silver, 4 copper. Gold solder for 14-carat gold: 25 parts gold, 25 silver, 12 1/2 brass, 1 zinc.

Silver solder: Yellow brass 70 parts, zinc 7, tin 1 1/2. Another: Silver 145 parts, brass (3 copper, 1 zinc) 73, zinc 4.

German-silver solder: Copper 38, zinc 54, nickel 8.

Novel's solders for aluminum:

Tin 100 parts, lead 5;	melts at 536° to 572° F.
100 " zinc 5;	" 536 to 612
" 1000 " copper 10 to 15;	" 662 to 842
" 1000 " nickel 10 to 15;	" 662 to 842

Novel's solder for aluminum bronze: Tin, 900 parts, copper 100, bismuth 2 to 3. It is claimed that this solder is also suitable for joining aluminum to copper, brass, zinc, iron, or nickel.

ROPES AND CABLES.

STRENGTH OF ROPES.

(A. S. Newell & Co., Birkenhead. Klein's Translation of Weisbach, vol. iii, part 1, sec. 2.)

Hemp.		Iron.		Steel.		Tensile Strength, Gross tons.
Girth. Inches.	Weight per Fathom. Pounds.	Girth. Inches.	Weight per Fathom. Pounds.	Girth. Inches.	Weight per Fathom. Pounds.	
2 3/4	2	1	1			2
		1 1/2	1 1/2	1	1	3
3 3/4	4	1 5/8	2			4
		1 3/4	2 1/2	1 1/2	1 1/2	5
4 1/2	5	1 7/8	3			6
		2	3 1/2	1 5/8	2	7
5 1/2	7	2 1/8	4	1 3/4	2 1/2	8
		2 1/4	4 1/2			9
6	9	2 3/8	5	1 7/8	3	10
		2 1/2	5 1/2			11
6 1/2	10	2 5/8	6	2	3 1/2	12
		2 3/4	6 1/2	2 1/8	4	13
7	12	2 7/8	7	2 1/4	4 1/2	14
		3	7 1/2			15
7 1/2	14	3 1/8	8	2 3/8	5	16
		3 1/4	8 1/2			17
8	16	3 3/8	9	2 1/2	5 1/2	18
		3 1/2	10	2 5/8	6	20
8 1/2	18	3 5/8	11	2 3/4	6 1/2	22
		3 3/4	12			24
9 1/2	22	3 7/8	13	3 1/4	8	26
10	26	4	14			28
11	30	4 1/4	15	3 3/8	9	30
		4 3/8	16			32
		4 1/2	18	3 1/2	10	36
12	34	4 5/8	20	3 3/4	12	40

Length Sufficient to Cause the Maximum Working Stress. (Weisbach.)

Hemp rope, dry and untarred	2855 feet.
Hemp rope, wet or tarred	1975 "
Wire rope	4590 "
Open-link chain	1360 "
Stud chain	1660 "

Sometimes, when the depths are very great, ropes are given approximately the form of a body of uniform strength, by making them of separate pieces, whose diameters diminish towards the lower end. It is evident that by this means the tensions in the fibres caused by the rope's own weight can be considerably diminished:

Rope for Hoisting or Transmission. Manila Rope. (C. W. Hunt Company, New York.) — Rope used for hoisting or for transmission of power is subjected to a very severe test. Ordinary rope chafes and grinds to powder in the center, while the exterior may look as though it was little worn.

In bending a rope over a sheave, the strands and the yarns of these strands slide a small distance upon each other, causing friction, and wear the rope internally.

The "Stevedore" rope used by the C. W. Hunt Company is made by lubricating the fibres with plumbago, mixed with sufficient tallow to hold it in position. This lubricates the yarns of the rope, and prevents internal chafing and wear. After running a short time the exterior of the rope gets compressed and coated with the lubricant.

In manufacturing rope, the fibres are first spun into a yarn, this yarn being twisted in a direction called "right hand." From 20 to 80 of these yarns, depending on the size of the rope, are then put together and twisted in the opposite direction, or "left hand," into a strand. Three of these strands, for a 3-strand, or four for a 4-strand rope, are then twisted together, the twist being again in the "right hand" direction. When the strand is twisted, it untwists each of the threads, and when the three strands are twisted together into rope, it untwists the strands, but again twists up the threads. It is this opposite twist that keeps the rope in its proper form. When a weight is hung on the end of a rope, the tendency is for the rope to untwist, and become longer. In untwisting the rope, it would twist the threads up, and the weight will revolve until the strain of the untwisting strands just equals the strain of the threads being twisted tighter. In making a rope it is impossible to make these strains exactly balance each other. It is this fact that makes it necessary to take out the "turns" in a new rope, that is, untwist it when it is put at work. The proper twist that should be put in the threads has been ascertained approximately by experience.

The amount of work that the rope will do varies greatly. It depends not only on the quality of the fibre and the method of laying up the rope, but also on the kind of weather when the rope is used, the blocks or sheaves over which it is run, and the strain in proportion to the strain put upon the rope. The principal wear comes in practice from defective or badly set sheaves, from excess of load and exposure to storms.

The loads put upon the rope should not exceed those given in the tables, for the most economical wear. The indications of excessive load will be the twist coming out of the rope, or one of the strands slipping out of its proper position. A certain amount of twist comes out in using it the first day or two, but after that the rope should remain substantially the same. If it does not, the load is too great for the durability of the rope. If the rope wears on the outside, and is good on the inside, it shows that it has been chafed in running over the pulleys or sheaves. If the blocks are very small, it will increase the sliding of the strands and threads, and result in a more rapid internal wear. Rope made for hoisting and for rope transmission is usually made with four strands, as experience has shown this to be the most serviceable.

The strength and weight of "Stevedore" rope is estimated as follows:

Breaking strength in pounds = 720 (circumference in inches)²;
Weight in pounds per foot = 0.032 (circumference in inches)².

Flat Ropes. (Weisbach.)

Iron.		Steel.		Tensile Strength, Gross tons.	Iron.		Steel.		Tensile Strength, Gross tons.
Girth. In.	Weight per Fathom. Lbs.	Girth. In.	Weight per Fathom. Lbs.		Girth. In.	Weight per Fathom. Lbs.	Girth. In.	Weight per Fathom. Lbs.	
2 1/4 x 1/2	11			20	3 3/4 x 11/16	22	2 1/2 x 1/2	13	40
2 1/2 x 1/2	13			23	4 x 11/10	25	2 3/4 x 3/8	15	45
2 3/4 x 5/8	15			27	4 1/4 x 3/4	28	3 x 3/4	16	50
3 x 5/8	16	2 x 1/2	10	28	4 1/2 x 3/4	32	3 1/4 x 3/8	18	56
3 1/4 x 5/8	18	2 1/4 x 1/2	11	32	4 5/8 x 3/4	34	3 1/2 x 3/8	20	60
3 1/2 x 5/8	20	2 1/4 x 1/2	12	36					

WARNING: This is a 1910 edition. Some of the material may no longer be accurate

The Technical Words relating to Cordage most frequently heard are:

YARN. — Fibres twisted together.
THREAD. — Two or more *small yarns* twisted together.
STRING. — The same as a thread but a little larger *yarns*.
STRAND. — Two or more *large yarns* twisted together.
CORD. — Several threads twisted together.
ROPE. — Several *strands* twisted together.
HAWSER. — A rope of three *strands*.
SHROUD-LAID. — A rope of four *strands*.
CABLE. — Three *hawsers* twisted together.
YARNS are laid up left-handed into *strands*.
STRANDS are laid up right-handed into rope.
HAWSEERS are laid up left-handed into a cable.

A rope is:

LAId by twisting strands together in making the rope.
SPliced by joining to another rope by interweaving the strands.
WHipped. — By winding a string around the end to prevent untwisting.
Served. — When covered by winding a yarn continuously and tightly around it.
PARceled. — By wrapping with canvas.
Seized. — When two parts are bound together by a yarn, thread or string.
Payed. — When painted, tarred or greased to resist wet.
Haul. — To pull on a rope.
Taut. — Drawn tight or strained.

Splicing of Ropes. — The splice in a transmission rope is not only the weakest part of the rope but is the first part to fail when the rope is worn out. If the rope is larger at the splice, the projecting part will wear on the pulleys and the rope fail from the cutting off of the strands. The following directions are given for splicing a 4-strand rope.

The engravings show each successive operation in splicing a 1 3/4-inch manila rope. Each engraving was made from a full-size specimen.

Tie a piece of twine, 9 and 10, around the rope to be spliced, about 6 feet from each end. Then unlay the strands of each end back to the twine.

Butt the ropes together and twist each corresponding pair of strands loosely, to keep them from being tangled, as shown in Fig. 80.

The twine 10 is now cut, and the strand 8 unlaied and strand 7 carefully laid in its place for a distance of four and a half feet from the junction.

The strand 6 is next unlaied about one and a half feet and strand 5 laid in its place.

The ends of the cores are now cut off so they just meet.

Unlay strand 1 four and a half feet, laying strand 2 in its place.

Unlay strand 3 one and a half feet, laying in strand 4.

Cut all the strands off to a length of about twenty inches for convenience in manipulation.

The rope now assumes the form shown in Fig. 81 with the meeting points of the strands three feet apart.

Each pair of strands is successively subjected to the following operation:

From the point of meeting of the strands 8 and 7, unlay each one three turns; split both the strand 8 and the strand 7 in halves as far back as they are now unlaied and "whip" the end of each half strand with a small piece of twine.

The half of the strand 7 is now laid in three turns and the half of 8 also laid in three turns. The half strands now meet and are tied in a simple knot, 11, Fig. 82, making the rope at this point its original size.

The rope is now opened with a marlin spike and the half strand of 7 worked around the half strand of 8 by passing the end of the half strand 7 through the rope, as shown in the engraving, drawn taut, and again worked around this half strand until it reaches the half strand 13 that was not laid in. This half strand 13 is now split, and the half strand 7 drawn through the opening thus made, and then tucked under the two adjacent strands, as shown in Fig. 83. The other half of the strand 8 is now wound around the other half strand 7 in the same manner. After each pair of strands has been treated in this manner, the ends are cut off at 12, leaving them about four inches long. After a few days' wear they will

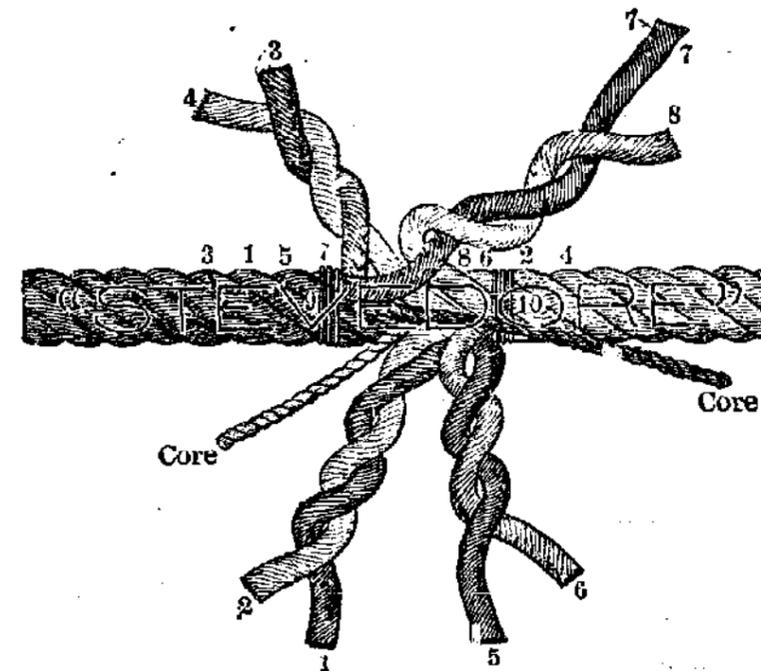

FIG. 80.

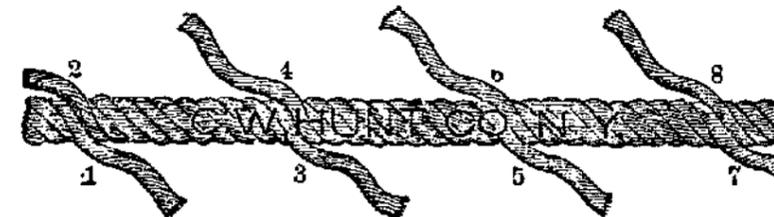

FIG. 81.

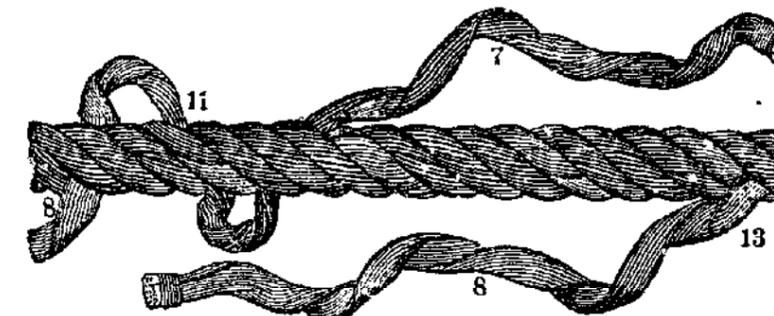

FIG. 82.

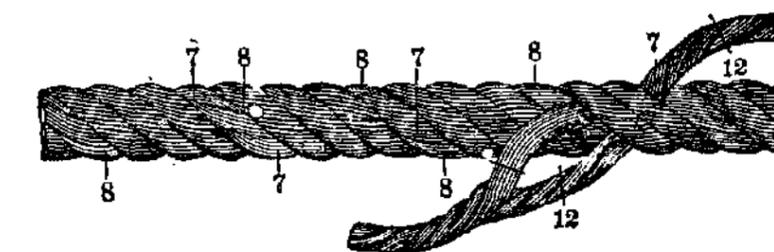

FIG. 83.

SPlicing OF ROPES.

draw into the body of the rope or wear off, so that the locality of the splice can scarcely be detected.

Cargo Hoisting. (C. W. Hunt Company.) — The amount of coal that can be hoisted with a rope varies greatly. Under the ordinary conditions of use a rope hoists from 5000 to 8000 tons. Where the circumstances are more favorable, the amounts run up frequently to 12,000 or 15,000 tons, occasionally to 20,000 and in one case 32,400 tons to a single fall.

When a hoisting rope is first put in use, it is likely from the strain put upon it to twist up when the block is loosened from the load. This occurs in the first day or two only. The rope should then be taken down and the "turns" taken out of the rope. When put up again the rope should give no further trouble until worn out.

It is necessary that the rope should be much larger than is needed to bear the strain from the load.

Practical experience for many years has substantially settled the most economical size of rope to be used which is given in the table below.

Hoisting ropes are not spliced, as it is difficult to make a splice that will not pull out while running over the sheaves, and the increased wear to be obtained in this way is very small.

Coal is usually hoisted with what is commonly called a "double whip;" that is, with a running block that is attached to the tub which reduces the strain on the rope to approximately one-half the weight of the load hoisted.

Hoisting rope is ordered by circumference, transmission rope by diameter.

Working Loads for Manila Rope (C. W. Hunt, *Trans. A. S. M. E.*, xxiii, 125.)

Diameter of Rope, Inches.	Ultimate Strength, Pounds.	Working Load in Pounds.			Minimum Diameter of Sheaves in Inches.		
		Rapid.	Medium.	Slow.	Rapid.	Medium.	Slow.
1	7,100	200	400	1000	40	12	5
1 1/8	9,000	250	500	1250	45	13	9
1 1/4	11,000	300	600	1500	50	14	10
1 3/8	13,400	380	750	1900	55	15	11
1 1/2	15,800	450	900	2200	60	16	12
1 5/8	18,800	530	1100	2600	65	17	13
1 3/4	21,800	620	1250	3000	70	18	14

In this table the work required of the rope is, for convenience, divided into three classes — "rapid," "medium," and "slow," these terms being used in the following sense: "Slow" — Derrick, crane and quarry work; speed from 50 to 100 feet per minute. "Medium" — Wharf and cargo, hoisting 150 to 300 feet per minute. "Rapid" — 400 to 800 feet per minute.

The ultimate strength given in the table is materially affected by the age and condition of a rope in active service, and also it is said to be weaker when it is wet. Trautwine states that a few months of exposed work weakens rope 26 to 50 per cent. The ultimate strength of a new rope given in the table is the result of tests of full sized specimens of manila rope, purchased in the open market, and made by three independent rope walks.

The proper diameter of pulley-block sheaves for different classes of work given in the table is a compromise of the various factors affecting the case. An increase in the diameter of sheave will materially increase the life of a rope. The advantage, however, is gained by increased difficulty of installation, a clumsiness in handling, and an increase in first cost. The best size is one that considers the advantages and the drawbacks as they are found in practical use, and makes a fair balance between the conflicting elements of the problem.

Records covering many years have been kept by various coal dealers, of the diameter and cost of their rope per ton of coal hoisted from vessels, using sheaves of from 12 to 16 inches in diameter. These records show conclusively that, in hoisting a bucket that produces 900 pounds stress upon the rope, a 1 1/4-inch diameter rope is too small and a 1 3/4-inch rope is too large for economy. The Pennsylvania Railroad Company

uses 1 1/2-inch rope, running over 14-inch diameter sheaves for hoisting freight on lighters in New York harbor, and handle on a single part of the rope loads up to 3,000 pounds as a maximum. Greater weights are handled on a 6-part tackle.

Life of Hoisting and Transmission Rope. A rope 1 1/2-in. diam, usually hoists from a vessel from 7000 to 10,000 tons of coal, running with a working stress of 850 to 950 lbs. over three sheaves, one 12 in., and two 16-in. diam. In hoisting 10,000 tons it makes 20,000 trips, bending in that time from a straight line to the curve of the sheave 120,000 times, when it is worn out. A 1000 ft. transmission in a tin-plate mill, with 1 1/2 in. rope, sheaves 5 ft., 17 ft., and 36 ft. apart, center to center, runs 5000 ft. per minute making 13,900 bends per hour, or more bends in 9 hours than the hoisting rope made in its entire life, yet the life of a transmission rope is measured in years, not hours. This enormous difference in the life of ropes of the same size and quality is wholly gained by reducing the stresses on the rope and increasing the diameter of the sheaves.

Efficiency of Knots as a percentage of the full strength of the rope, and the factor of safety when used with the stresses given in the 5th column of the table of working loads.

Kind of Knot.	Effy.	Fact. S
Eye splice over an iron thimble.....	90	6.3
Short splice in the rope.....	80	5.6
Timber hitch, round turn, half-hitch.....	65	4.5
Bowline slip knot, clove hitch.....	60	4.2
Square knot, weaver's knot sheet bend.....	50	3.5
Flemish loop, overhand knot.....	45	3.1
Full strength of dry rope, average of four tests.....	100	7.0

Efficiency of Rope Tackles. Robert Grimshaw in 1893 tested a 3 3/4-in., 3-strand ordinary dry manila rope on a "cat and fish" tackle with a 6-fold purchase. The sheaves were 8-in. diam., the three upper ones having roller bearings and the three lower ones solid bushings. The results were as below:

Net load on tackle, weight raised, lbs.....	600	800	1000	1200
Theoretical force required to raise the weight	100	1333.3	166.7	200
Actual force required.....	158	198	243	288
Percentage above the theoretical.....	58	48	45.8	44

Weight and Strength of Manila Rope. Spencer Miller (*Eng'g News*, Dec. 6, 1890) gives a table of breaking strength of manila rope, which he considers more reliable than the strength computed by Mr. Hunt's formula: Breaking strength = 720 × (circumference in inches)². Mr. Miller's formula is: Breaking weight lbs. = circumference² × a coefficient which varies from 900 for 1/2" to 700 for 2" diameter rope, as below:

Circumference ..	1 1/2	2	2 1/2	2 3/4	3	3 1/2	3 3/4	4 1/4	4 1/2	5	5 1/2	6
Coefficient.....	900	845	820	790	765	760	745	735	725	712	700	

Knots. The principle of a knot is that no two parts, which would move in the same direction if the rope were to slip, should lay along side of and touching each other. (See illustrations on the next page.)

The bowline is one of the most useful knots, it will not slip, and after being strained is easily untied. Commenced by making a bight in the rope, then put the end through the bight and under the standing part as shown in G, then pass the end again through the bight, and haul tight.

The square or reef knot must not be mistaken for the "granny" knot that slips under a strain. Knots H, K and M are easily untied after being under strain. The knot M is useful when the rope passes through an eye and is held by the knot, as it will not slip and is easily untied after being strained.

The timber hitch S looks as though it would give way, but it will not; the greater the strain the tighter it will hold. The wall knot looks complicated, but is easily made by proceeding as follows: Form a bight with strand 1 and pass the strand 2 around the end of it, and the strand 3 round the end of 2 and then through the bight of 1 as shown in the cut Z. Haul the ends taut when the appearance is as shown in AA. The end of the strand 1 is now laid over the center of the knot, strand 2 laid over 1 and 3 over 2, when the end of 3 is passed through the bight of 1 as shown in BB. Haul all the strands taut as shown in CC.

Varieties of Knots. — A great number of knots have been devised of which a few only are illustrated, but those selected are the most frequently used. In the cut, Fig. 84, they are shown open, or before being drawn taut, in order to show the position of the parts. The names usually given to them are:

- | | |
|---------------------------------|---------------------------------|
| A. Bight of a rope. | P. Flemish loop. |
| B. Simple or Overhand knot. | Q. Chain knot with toggle. |
| C. Figure 8 knot. | R. Half-hitch. |
| D. Double knot. | S. Timber-hitch. |
| E. Boat knot. | T. Clove-hitch. |
| F. Bowline, first step. | U. Rolling-hitch. |
| G. Bowline, second step. | V. Timber-hitch and half-hitch. |
| H. Bowline completed. | W. Blackwall-hitch. |
| I. Square or reef knot. | X. Fisherman's bend. |
| J. Sheet bend or weaver's knot. | Y. Round turn and half-hitch. |
| K. Sheet bend with a toggle. | Z. Wall knot commenced. |
| L. Carrick bend. | AA. Wall knot completed. |
| M. Stevedore knot completed. | BB. Wall knot crown commenced. |
| N. Stevedore knot commenced. | CC. Wall knot crown completed. |
| O. Slip knot. | |

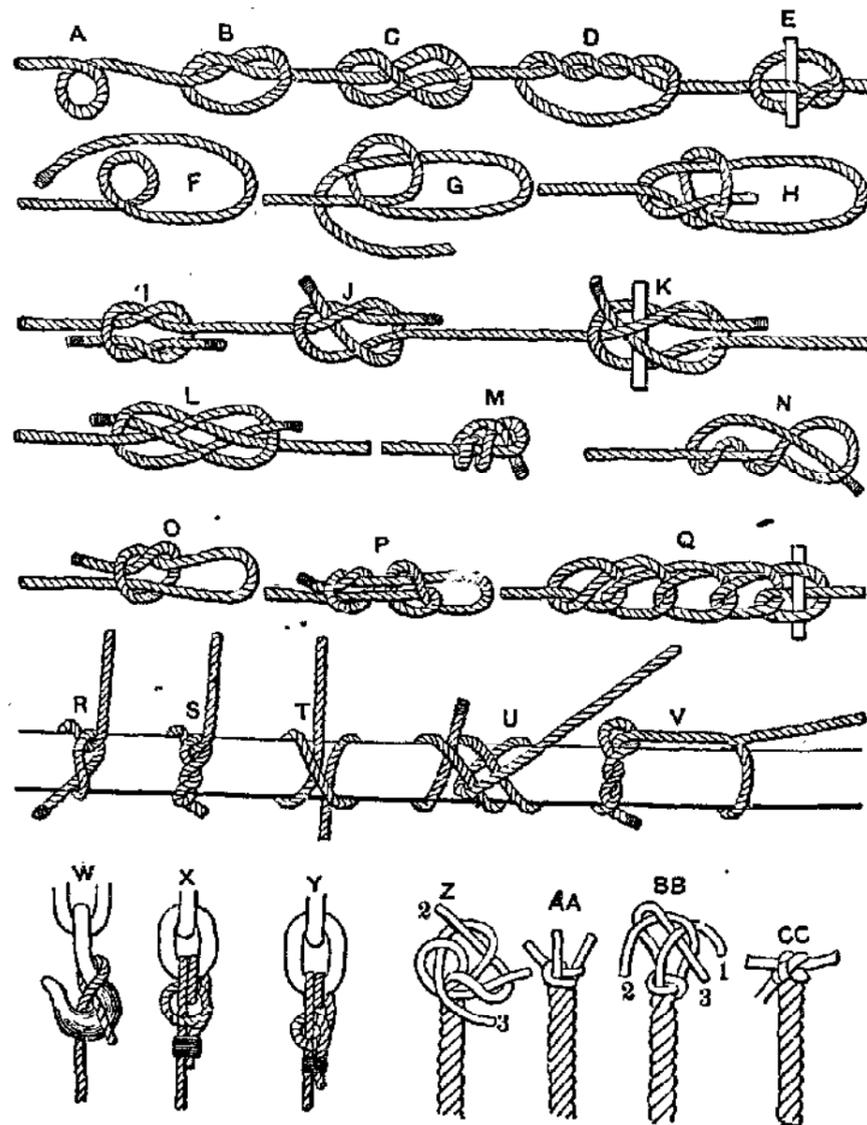

FIG. 84. — KNOTS.

To Splice a Wire Rope. — The tools required will be a small marline spike, nipping cutters, and either clamps or a small hemp-rope sling with which to wrap around and untwist the rope. If a bench-vise is accessible it will be found convenient.

In splicing rope, a certain length is used up in making the splice. An allowance of not less than 16 feet for 1/2-inch rope, and proportionately longer for larger sizes, must be added to the length of an endless rope in ordering.

Having measured, carefully, the length the rope should be after splicing, and marked the points *M* and *M'*, Fig. 85, unlay the strands from each end *E* and *E'* to *M* and *M'* and cut off the center at *M* and *M'*, and then:

(1). Interlock the six unlayed strands of each end alternately and draw them together so that the points *M* and *M'* meet, as in Fig. 86.

(2). Unlay a strand from one end, and following the unlay closely, lay into the seam or groove it opens, the strand opposite it belonging to the other end of the rope, until within a length equal to three or four times the length of one lay of the rope, and cut the other strand to about the same length from the point of meeting as at *A*, Fig. 87.

(3). Unlay the adjacent strand in the opposite direction, and following the unlay closely, lay in its place the corresponding opposite strand, cutting the ends as described before at *B*, Fig. 87.

There are now four strands laid in place terminating at *A* and *B*, with the eight remaining at *MM'*, as in Fig. 87.

It will be well after laying each pair of strands to tie them temporarily at the points *A* and *B*.

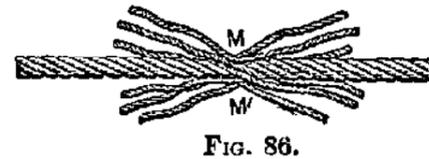
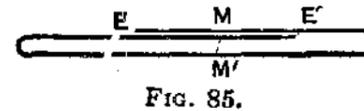

FIG. 88. SPLICING WIRE ROPE. FIG. 89.

Pursue the same course with the remaining four pairs of opposite strands, stopping each pair about eight or ten turns of the rope short of the preceding pair, and cutting the ends as before.

We now have all the strands laid in their proper places with their respective ends passing each other, as in Fig. 88.

All methods of rope-splicing are identical to this point: their variety consists in the method of tucking the ends. The one given below is the one most generally practiced.

Clamp the rope either in a vise at a point to the left of *A*, Fig. 88, and by a hand-clamp applied near *A*, open up the rope by untwisting sufficiently to cut the core at *A*, and seizing it with the nippers, let an assistant draw it out slowly, you following it closely, crowding the strand in its place until it is all laid in. Cut the core where the strand ends, and push the end back into its place. Remove the clamps and let the rope close together around it. Draw out the core in the opposite direction and lay the other strand in the center of the rope, in the same manner. Repeat the operation at the five remaining points, and hammer the rope lightly at the points where the ends pass each other at *A*, *A*, *B*, *B*, etc., with small wooden mallets, and the splice is complete, as shown in Fig. 89.

If a clamp and vise are not obtainable, two rope slings and short wooden levers may be used to untwist and open up the rope.

A rope spliced as above will be nearly as strong as the original rope and smooth everywhere. After running a few days, the splice, if well made, cannot be found except by close examination.

The above instructions have been adopted by the leading rope manufacturers of America.

WARNING: This is a 1910 edition. Some of the material may no longer be accurate

SPRINGS.

Definitions.—A spiral spring is one which is wound around a fixed point or center, and continually receding from it, like a watch spring. A helical spring is one which is wound around an arbor, and at the same time advancing like the thread of a screw. An elliptical or laminated spring is made of flat bars, plates, or "leaves," of regularly varying lengths, superposed one upon the other.

Laminated Steel Springs.—Clark (Rules, Tables and Data) gives the following from his work on *Railway Machinery*, 1855:

$$\Delta = \frac{1.66 L^3}{bt^3n}; \quad s = \frac{bt^2n}{11.3 L}; \quad n = \frac{1.66 L^3}{\Delta bt^3}$$

Δ = elasticity, or deflection, in sixteenths of an inch per ton of load;
 s = working strength, or load, in tons (2240 lbs.);
 L = span, when loaded in inches;
 b = breadth of plates, in inches, taken as uniform;
 t = thickness of plates, in sixteenths of an inch;
 n = number of plates.

NOTE.—1. The span and the elasticity are those due to the spring when weighted.

2. When extra thick back and short plates are used, they must be replaced by an equivalent number of plates of the ruling thickness, prior to the employment of the first two formulæ. This is found by multiplying the number of extra thick plates by the cube of their thickness, and dividing by the cube of the ruling thickness. Conversely, the number of plates of the ruling thickness given by the third formula, required to be deducted and replaced by a given number of extra thick plates, are found by the same calculation.

3. It is assumed that the plates are similarly and regularly formed, and that they are of uniform breadth, and but slightly taper at the ends. Reuleaux's Constructor gives for semi-elliptic springs:

$$P = \frac{Snbh^2}{6l} \quad \text{and} \quad f = \frac{6Pl^3}{Enbh^3}$$

S = max. direct fiber-strain in plate; b = width of plates;
 n = number of plates in spring; h = thickness of plates;
 l = one-half length of spring; f = deflection of end of spring;
 P = load on one end of spring; E = modulus of direct elasticity

The above formula for deflection can be relied upon where all the plates of the spring are regularly shortened; but in semi-elliptic springs, as used, there are generally several plates extending the full length of the spring, and the proportion of these long plates to the whole number is usually about one-fourth. In such cases $f = \frac{5.5 Pl^3}{Enbh^3}$. (G. R. Henderson,

Trans. A. S. M. E., vol. xvi.)

In order to compare the formulæ of Reuleaux and Clark we may make the following substitutions in the latter: s in tons = P in lbs. \div 1120; $\Delta s = 16 f$; $L = 2l$; $t = 16h$; then

$$\Delta s = 16 f = \frac{1.66 \times 8 l^3 \times P}{4096 \times 1120 \times nbh^3}, \quad \text{whence} \quad f = \frac{Pl^3}{5,527,133}$$

which corresponds with Reuleaux's formula for deflection if in the latter we take $E = 33,162,800$.

$$\text{Also} \quad s = \frac{P}{1120} = \frac{256 nbh^2}{11.3 \times 2l}, \quad \text{whence} \quad P = \frac{12,687 nbh^2}{l}$$

which corresponds with Reuleaux's formula for working load when S in the latter is taken at 76,120.

The value of E is usually taken at 30,000,000 and S at 80,000, in which case Reuleaux's formulæ become

$$P = \frac{13,533 nbh^2}{l} \quad \text{and} \quad f = \frac{Pl^3}{5,000,000nbh^3}$$

G. R. Henderson, in *Trans. A. S. M. E.*, vol. xvii, gives a series of tables for use in designing both elliptical and helical springs.

Helical Steel Springs.

NOTATION. Let d = diam. of wire or rod of which the spring is made.
 D = outside diameter of coil, inches.
 R = mean radius of coil, = $1/2(D - d)$.
 n = number of coils.
 P = load applied to the spring, lbs.
 G = modulus of torsional elasticity.
 S = stress on extreme fiber caused by load P .
 F = extension or compression of one coil, in., for load P .
 F_n = total extension or compression, for load P .
 W = safe carrying capacity of spring, lbs.

$$F = \frac{64 PR^3}{Gd^4}; \quad F_n = \frac{64 PE^3n}{Gd^4}; \quad W = \frac{0.1963 Sd^3}{R} = \frac{\pi Sd^3}{16 R}$$

Values of G according to different authorities range from 10,000,000 to 14,000,000.

The safe working value commonly taken for $S = 60,000$ lbs. per sq. in. Taking G at 12,000,000 and S at 60,000 the above formulæ become

$$F = \frac{PR^3}{187,500 d^4}, \quad W = 11,781 \frac{d^3}{R} \quad \text{If } P = W, \text{ then } F = 0.06285 \frac{R^2}{d}$$

For square steel the values found for F and W are to be multiplied by 0.59 and 1.2 respectively, d being the side of the square.

The stress in a helical spring is almost wholly one of torsion. For method of deriving the formulæ for springs from torsional formulæ see paper by J. W. Cloud, *Trans. A. S. M. E.*, vol. 173. Mr. Cloud takes $S = 80,000$ and $G = 12,600,000$.

Taking from the Pennsylvania Railroad Specifications (1891) the capacity when closed, W_1 , of the following springs, and the total compression when closed $H - h$, in which H = height when free and h when closed, and assuming $n = h \div d$, we have the following comparison of the specified values of capacity and compression with those obtained from the formulæ.

No.	d , in.	D	$D - d$	W_1	W	H	h	$H - h$	F_n	n
T.	1/4	1 1/2	1 1/4	400	295	9	6	3	3.20	24
S.	1/2	3	2 1/2	1900	1178	8	5	3	3.16	10
K.	3/4	5 3/4	5	2100	1988	7	4 1/4	2 3/4	3.15	5 2/3
D.	1	5	4	8100	5890	10 1/2	8	2 1/2	2.76	8
I.	1 1/4	8	6 3/4	10000	6788	9	5 3/4	3 1/4	3.86	4 3/5
C.	1 1/8	4 7/8	3 3/8	16000	8946	4 3/8	3 3/8	1	1.05	3

The value of F_n in the table is calculated from the formula with $P = W$. Wilson Hartnell (*Proc. Inst. M. E.*, 1882, p. 426), says: "The size of a spiral spring may be calculated from the formula on page 304 of 'Rankine's Useful Rules and Tables;' but the experience with Salter's springs has shown that the safe limit of stress is more than twice as great as there given, namely 60,000 to 70,000 lbs. per square inch of section with 3/8-inch wire, and about 50,000 with 1/2-inch wire. Hence the work that can be done by springs of wire is four or five times as great as Rankine allows."

For 3/8-inch wire and under,

$$\text{Maximum load in lbs.} = \frac{12,000 \times (\text{diam. of wire})^3}{\text{Mean radius of springs}}$$

$$\text{Weight in lbs. to deflect spring 1 in.} = \frac{180,000 \times (\text{diam.})^4}{\text{Number of coils} \times (\text{rad.})^3}$$

The work in foot-pounds that can be stored up in a spiral spring would lift it above 50 ft.

In a few rough experiments made with Salter's springs the coefficient of rigidity was noticed to be 12,600,000 to 13,700,000 with 1/4-inch wire; 11,000,000 for 11/32 inch; and 10,600,000 to 10,900,000 for 3/8-inch wire.

Helical Springs. — J. Begtrup, in the *American Machinist* of Aug. 18, 1892, gives formulas for the deflection and carrying capacity of helical springs of round and square steel, as follow:

$$W = 0.3927 \frac{Sd^3}{D-d}, \quad F = 8 \frac{P(D-d)^3}{Ed^4}, \text{ for round steel.}$$

$$W = 0.471 \frac{Sd^3}{D-d}, \quad F = 4.712 \frac{P(D-d)^3}{Ed^4}, \text{ for square steel.}$$

- W = carrying capacity in pounds,
- S = greatest shearing stress per square inch of material,
- d = diameter of steel,
- D = outside diameter of coil,
- F = deflection of one coil,
- E = torsional modulus of elasticity,
- P = load in pounds.

From these formulas the following table has been calculated by Mr. Begtrup. A spring being made of an elastic material, and of such shape as to allow a great amount of deflection, will not be affected by sudden shocks or blows to the same extent as a rigid body, and a factor of safety very much less than for rigid constructions may be used.

HOW TO USE THE TABLE.

When designing a spring for continuous work, as a car spring, use a greater factor of safety than in the table; for intermittent working, as in a steam-engine governor or safety valve, use figures given in table; for square steel multiply line W by 1.2 and line F by 0.59.

Example 1. — How much will a spring of 3/8" round steel and 3" outside diameter carry with safety? In the line headed D we find 3, and right underneath 473, which is the weight it will carry with safety. How many coils must this spring have so as to deflect 3" with a load of 400 pounds? Assuming a modulus of elasticity of 12 millions we find in the line headed F the figure 0.0610; this is deflection of one coil for a load of 100 pounds; therefore 0.0610 x 4 = 0.244" is deflection of one coil for 400 pounds load, and 3 ÷ 0.244 = 12 1/2 is the number of coils wanted. This spring will therefore be 4 3/4" long when closed, counting working coils only, and stretch to 7 3/4".

Example 2. — A spring 3 1/4" outside diameter of 7/16" steel is wound close; how much can it be extended without exceeding the limit of safety? We find maximum safe load for this spring to be 702 pounds, and deflection of one coil for 100 pounds load 0.0405 inches; therefore 7.02 x 0.0405 = 0.284" is the greatest admissible opening between coils. We may thus, without knowing the load, ascertain whether a spring is overloaded or not.

Carrying Capacity and Deflection of Helical Springs of Round Steel.

d = diameter of steel. D = outside diameter of coil. W = safe working load in pounds — tensile stress not exceeding 60,000 pounds per square inch. F = deflection by a load of 100 pounds of one coil, with a modulus of elasticity of 12 millions. The ultimate carrying capacity will be about twice the safe load. (The original table gives three values

of F, corresponding respectively to a modulus of elasticity of 10, 12 and 14 millions. To find values of F for 10 million modulus increase the figures here given by one-sixth; for 14 million subtract one-sixth.)

d in.	D	0.25	0.50	0.75	1.00	1.25	1.50	1.75	2.00				
	W	35	15	9	7	5	4.5	3.8	3.3				
.065	F	0.0236	0.3075	1.228	3.053	6.214	11.04	17.87	27.06				
	D	0.50	0.75	1.00	1.25	1.50	1.75	2.00	2.25	2.50			
.120	W	107	65	46	36	29	25	22	19	17			
	F	0.0176	0.0804	0.2191	0.4639	0.8448	1.392	2.136	3.107	4.334			
	D	0.75	1.00	1.25	1.50	1.75	2.00	2.25	2.50	2.75	3.00		
.180	W	241	157	128	104	88	75	66	59	53	49		
	F	0.0118	0.0350	0.0778	0.1460	0.2457	0.3828	0.5632	0.7928	1.077	1.423		
	D	1.25	1.50	1.75	2.00	2.25	2.50	2.75	3.00	3.25	3.50		
1/4	W	368	294	245	210	184	164	147	134	123	113		
	F	0.0171	0.0333	0.0576	0.0914	0.1365	0.1944	0.2665	0.3548	0.4607	0.5859		
	D	1.50	1.75	2.00	2.25	2.50	2.75	3.00	3.25	3.50	3.75	4.00	
5/16	W	605	500	426	371	329	295	267	245	226	209	195	
	F	0.0117	0.0207	0.0336	0.0508	0.0732	0.1012	0.1357	0.1771	0.2263	0.2839	0.3503	
	D	2.00	2.25	2.50	2.75	3.00	3.25	3.50	3.75	4.00	4.25	4.50	
3/8	W	765	663	589	523	473	433	398	368	343	321	301	
	F	0.0145	0.0222	0.0323	0.0452	0.0610	0.0801	0.1029	0.1297	0.1606	0.1963	0.2367	
	D	2.00	2.25	2.50	2.75	3.00	3.25	3.50	3.75	4.00	4.50	5.00	
7/16	W	1263	1089	957	853	770	702	644	596	544	486	432	
	F	0.0069	0.0108	0.0160	0.0225	0.0306	0.0405	0.0529	0.0661	0.0823	0.10220	0.12728	
	D	2.00	2.25	2.50	2.75	3.00	3.25	3.50	3.75	4.00	4.50	5.00	
1/2	W	1963	1683	1472	1309	1178	1071	982	906	841	736	654	
	F	0.0036	0.0057	0.0085	0.0121	0.0167	0.0222	0.0288	0.0366	0.0457	0.0563	0.0692	
	D	2.50	2.75	3.00	3.25	3.50	3.75	4.00	4.25	4.50	5.00	5.50	
9/16	W	2163	1916	1720	1560	1427	1315	1220	1137	1065	945	849	
	F	0.0048	0.0070	0.0096	0.0129	0.0169	0.0216	0.0271	0.0334	0.0406	0.0582	0.0801	
	D	2.50	2.75	3.00	3.25	3.50	3.75	4.00	4.25	4.50	5.00	5.50	
5/8	W	3068	2707	2422	2191	2001	1841	1704	1587	1484	1315	1180	
	F	0.0029	0.0042	0.0058	0.0079	0.0104	0.0133	0.0168	0.0208	0.0254	0.0366	0.0506	
	D	3.00	3.25	3.50	3.75	4.00	4.25	4.50	4.75	5.00	5.50	6.00	
11/16	W	3311	2988	2723	2500	2311	2151	2009	1885	1776	1591	1441	
	F	0.0037	0.0050	0.0066	0.0086	0.0108	0.0135	0.0165	0.0200	0.0239	0.0333	0.0447	
	D	3.00	3.25	3.50	3.75	4.00	4.25	4.50	4.75	5.00	5.50	6.00	
3/4	W	4418	3976	3615	3313	3058	2840	2651	2485	2339	2093	1893	
	F	0.0024	0.0033	0.0044	0.0057	0.0072	0.0090	0.0111	0.0135	0.0162	0.0226	0.0305	
	D	3.50	3.75	4.00	4.25	4.50	4.75	5.00	5.25	5.50	6.00	6.50	
7/8	W	6013	5490	5051	4676	4354	4073	3826	3607	3413	3080	2806	
	F	0.0018	0.0024	0.0030	0.0038	0.0047	0.0058	0.0070	0.0083	0.0098	0.0134	0.0177	
	D	3.50	3.75	4.00	4.25	4.50	4.75	5.00	5.25	5.50	6.00	6.50	
1	W	9425	8568	7854	7250	6732	6283	5890	5544	5236	4712	4284	
	F	0.0010	0.0014	0.0018	0.0023	0.0028	0.0035	0.0043	0.0051	0.0061	0.0083	0.0111	

J. D. Howe, *Am. Mach.*, Dec. 20, 1906, using Begtrup's formulæ, computes a table for springs made from wire of Roebling's or Washburn and Moen gauges, Nos. 28 to 000. It is here given somewhat abridged, values of F corresponding to a torsional modulus of elasticity of 12,000,000 only being used.

WARNING: This is a 1910 edition. Some of the material may no longer be accurate

No. 28 0.016"	D	0.20	0.25	0.3125	0.375	0.4375	0.500	0.5625	0.625	0.75	0.875
	W	0.524	0.41	0.31	0.27	0.23	0.20	0.175	0.16	0.13	0.11
	F	6.32	13.02	30.2	47.0	76.0	115	166	230	402	695
No. 24 0.0225"	D	0.25	0.3125	0.375	0.4375	0.500	0.5625	0.625	0.75	0.875	1.00
	W	1.18	0.92	0.76	0.45	0.56	0.50	0.45	0.37	0.31	0.28
	F	2.78	6.31	11.35	18.57	28.2	40.8	56.9	97.5	166	242
No. 22 0.028"	D	0.25	0.3125	0.375	0.4375	0.50	0.5625	0.625	0.75	0.875	1.00
	W	2.35	1.84	1.49	1.26	1.095	0.96	0.865	0.715	0.61	0.53
	F	1.19	2.50	4.53	7.42	11.40	16.5	23.1	40.8	66.0	99.5
No. 20 0.035"	D	0.25	0.3125	0.375	0.4375	0.50	0.5625	0.625	0.75	0.875	1.00
	W	4.7	3.64	2.97	2.5	2.18	1.92	1.72	1.42	1.20	1.05
	F	0.451	0.952	1.75	2.90	4.47	6.51	9.14	16.3	26.4	40.0
No. 18 0.047"	D	0.25	0.3125	0.375	0.4375	0.50	0.625	0.75	0.875	1.00	1.125
	W	12.05	9.2	74.5	6.57	5.40	4.23	3.48	2.95	2.85	2.27
	F	0.1158	0.294	0.488	0.824	1.320	1.870	3.96	7.85	12.60	17.5
No. 14 0.08"	D	0.375	0.5	0.625	0.75	0.875	1.00	1.125	1.25	1.50	1.75
	W	41	28.8	22.2	18.1	15.2	13.15	11.6	10.35	8.52	7.25
	F	0.0418	0.128	0.342	0.572	0.82	1.27	1.86	2.60	5.48	7.57
No. 12 0.105"	D	0.625	0.75	0.875	1.00	1.25	1.50	1.75	2.00	2.25	2.50
	W	52.5	42.25	35.4	30.4	23.8	19.5	16.6	14.4	12.7	11.4
	F	0.069	0.1480	0.262	0.395	0.830	1.49	2.45	3.74	5.45	7.34
No. 10 0.135"	D	0.875	1.00	1.25	1.50	1.75	2.00	2.25	2.50	2.75	3.00
	W	77	67	52	42.5	36	31	27	24	22	20
	F	0.081	0.135	0.276	0.512	0.846	1.295	1.910	2.660	3.58	4.75
No. 8 0.162"	D	1.00	1.25	1.50	1.75	2.00	2.25	2.50	2.75	3.00	3.25
	W	120	98.5	76	64	55.5	48.8	43.5	39	36	33
	F	0.0570	0.124	0.199	0.554	0.597	0.880	1.26	1.68	2.20	2.85
No. 7 0.177"	D	1.00	1.25	1.50	1.75	2.00	2.25	2.50	2.75	3.00	3.25
	W	159	122	99	83.5	72	63	56.4	51	46.5	42.5
	F	0.0382	0.0828	0.156	0.265	0.416	0.603	0.830	1.15	1.54	1.96
No. 6 0.192"	D	1.25	1.50	1.75	2.00	2.25	2.50	2.75	3.00	3.25	3.50
	W	158	128	107	92.5	81	72	65	59.5	55.5	50
	F	0.0572	0.108	0.185	0.284	0.420	0.590	0.802	1.07	1.38	1.74
No. 5 0.205"	D	1.50	1.75	2.00	2.25	2.50	2.75	3.00	3.25	3.50	4.00
	W	155	131	113	99	88.5	80	70	67	61.5	53.5
	F	0.0820	0.139	0.218	0.321	0.412	0.6175	0.82	1.60	1.34	2.22
No. 4 0.225"	D	1.50	1.75	2.00	2.25	2.50	2.75	3.00	3.25	3.50	4.00
	W	210	175	150	132	118	106	97	89	82	71
	F	0.0536	0.093	0.147	0.220	0.303	0.412	0.652	0.715	0.91	1.30
No. 2 0.263"	D	1.50	1.75	2.00	2.25	2.50	2.75	3.00	3.25	3.50	4.00
	W	345	290	250	215	192	175	156	146	134	115
	F	0.0264	0.0458	0.0730	0.109	0.154	0.214	0.274	0.371	0.469	0.720
No. 1 0.283"	D	1.75	2.00	2.25	2.50	2.75	3.00	3.25	3.50	4.00	4.50
	W	360	310	270	240	215	195	180	165	145	127
	F	0.0328	0.0550	0.0778	0.112	0.155	0.208	0.270	0.344	0.530	0.775
No. 0 0.307"	D	1.75	2.00	2.25	2.50	2.75	3.00	3.25	3.50	4.00	4.50
	W	470	400	350	310	280	250	230	212	185	162
	F	0.0308	0.0380	0.0548	0.0788	0.109	0.149	0.199	0.244	0.327	0.550
No. 00 0.331"	D	2.00	2.25	2.50	2.75	3.00	3.25	3.50	4.00	4.50	5.00
	W	510	445	390	350	320	290	270	230	205	183
	F	0.0289	0.0388	0.0564	0.0780	0.105	0.137	0.176	0.273	0.414	0.562

To find deflection of one coil by one pound, divide the values of F by 100.

ELLIPTICAL SPRINGS, SIZES, AND PROOF TESTS.

Pennsylvania Railroad Specifications, 1896.

Class.	Length between Centers, Ins.	Width over all, Inches.	Plates, No. Size, In	Tests.					
				Ins. high. (a)	(b)	lbs.	Ins. (a)	lbs. (a)	a. p. t. (a) ins.
E 1, Triple.....	40	1 13/4	5 3 x 11/32	3 3/4	9 3/8	4,800	3	5,500	2
E 2, Quadruple...	40	1 5/4	5 3 x 3/8	3 3/4	9 3/4	6,650	3	8,000	2
E 3, Triple.....	36	1 13/4	6 3 x 11/32	4	9 3/8	6,000	3	8,000	
E 4, Single †.....	40		8 3 x 11/32	5*		free	3	2,350	
E 5, " †.....	40		7 3 x 3/8	1 5/16*		3,000	0	4,970	
E 6, " †.....	42		8 3 1/2 x 3/8	1 1/8*		4,375	0	6,350	
E 7, Triple.....	36	1 13/4	8 3 x 11/32	2 1/2	9 1/2	11,800			
E 8, Double.....	32	7 1/2	6 3 x 3/8	3	9	8,000			
E 9, ".....	36	9 1/2	5 4 x 11/32	3 1/2	8 7/16	5,400	3	6,000	
E 10, Quadruple..	40	1 5 1/2	5 3 x 3/8	4	10	8,000	3	10,000	2
E 11, ".....	40	1 5 1/2	5 3 x 3/8	3 3/4	9 3/4	10,600	3	12,200	2
E 12, ".....	34	1 5 1/2	5 3 x 3/8	3 3/4	9 3/4	13,100	3	15,780	2
E 13, Double.....	30	9 1/2	5 4 x 3/8	3 3/4	9	5,600	2	10,600	
E 14, ".....	40	9 1/2	6 4 x 11/32	3 3/8	9	6,840	2	8,600	
E 15, Quadruple..	36	1 5 1/2	6 3 x 11/32	3 7/16	9 3/4	11,820	2 1/2	14,370	2
E 16, ".....	30	1 5 1/2	6 3 x 11/32	4 1/2	10 1/8	8,000	2 3/4	15,500	
E 17, Double.....	36	9 1/2	5 4 x 3/8	2 3/4	8	8,070	2	9,540	
E 18, Single †.....	42		9 3 1/2 x 3/8	1*		5,250	0	7,300	
E 19, Double.....	22	10 1/2	6 4 1/2 x 11/32	13/16	6 7/16	13,800			
E 20, ".....	22	10 1/2	7 4 1/2 x 11/32	13/16	7 1/8	15,600			
E 21, ".....	24	10 1/2	7 4 1/2 x 3/8	1	7 1/4	15,750	0	28,800	
E 22, ".....	24	10 1/2	8 4 1/2 x 3/8	1	8 1/2	18,000	0	30,930	
E 23, ".....	36	10	5 4 x 3/8	2 1/4	8	8,750	1 1/4	10,750	
E 24, ".....	36	10	5 4 x 3/8	2 1/4	8	7,500	1 1/4	9,500	

(a) Between bands; (b) over all; a.p.t., auxiliary plates touching.
* Between bottom of eye and top of leaf. † Semi-elliptical.
Tracings are furnished for each class of spring.

SPRINGS TO RESIST TORSIONAL FORCE.

(Reuleaux's Constructor.)

Flat spiral or helical spring $P = \frac{S bh^2}{6 R}$; $f = R\theta = 12 \frac{PIR^2}{Ebh^3}$

Round helical spring..... $P = \frac{S\pi d^3}{32 R}$; $f = R\theta = \frac{64 PI R^2}{\pi E d^4}$

Round bar, in torsion..... $P = \frac{S\pi d^3}{16 R}$; $f = R\theta = \frac{32 P R^2}{\pi G d^4}$

Flat bar, in torsion..... $P = \frac{S bh^2}{3R \sqrt{b^2 + h^2}}$; $f = R\theta = \frac{3PR^2}{G} \frac{b^2 + h^2}{b^3h^3}$

P = force applied at end of radius or lever-arm; R; θ = angular motion at end of radius R; S = permissible maximum stress, = 4/5 of permissible stress in flexure; E = modulus of elasticity in tension; G = torsional modulus, = 2/5 E; l = developed length of spiral, or length of bar; d = diameter of wire; b = breadth of flat bar; h = thickness.

Compare Elastic Resistance to Torsion, p. 311.

HELICAL SPRINGS—SIZES AND CAPACITIES.
(Selected from Specifications of Penna. R. R. Co., 1899.)

P. R. R. Co.'s Class.	Diam. of Bar, ins.	Length of Bar, ins.	Tapered to ins.	Normal Weight.		Outside Diam. of Coil, ins.	Test. Height and Loads.				Capacity of Single Coil, lbs.
				lbs.	oz.		Free, ins.	Solid, ins.	Ins. with	Load of lbs.	
H 26	9/64	571/2	59	0	4	1	53/4	3	31/4	110	130
H 18	11/64	75	761/4	0	8	1	8	5	6	170	270
H 55	3/16	451/8	465/16	0	55/8	1	41/2	35/16	4	103	245
H 73	3/16	426	4273/4	3	51/2	15/16	39	221/2	35	45	185
H 29	7/32	201/2	227/10	0	31/2	115/32	111/16	19/64	13/8	110	200
H 1	1/4	451/2	47	0	10	11/4	51/8	35/8	43/8	250	500
H 5	1/4	251/4	281/4	0	6	21/4	21/4	11/8	11/2	164	240
H 58	5/16	2531/2	2561/2	5	7	21/4	23	13	18	248	495
H 74	5/16	180	1821/8	3	141/2	111/16	191/8	13	141/8	587	700
H 68*	3/8	991/2	1031/4	3	11/2	23/4	9	5	7	350	700
H 79	3/8	88	903/4	2	12	21/8	85/8	6	63/4	676	946
H 80	13/32	1923/8	1953/4	7	11/2	29/16	18	119/16	151/2	380	975
H 43	7/16	96	1025/16	4	1	47/16	815/16	33/8	51/8	450	660
H 64	7/16	755/8	781/2	3	3	29/32	75/8	55/8	53/4	1350	1440
H 53	15/32	1695/16	1729/16	8	4	217/32	161/2	121/4	151/2	330	1410
H 27	1/2	903/4	951/8	5	0	31/4	81/2	51/4	63/4	810	1500
H 61	1/2	151/2	213/8	0	133/4	41/4	13/8	05/8	1	532	1050
H 19	17/32	811/2	851/2	5	2	31/32	8	59/16	67/16	1200	1900
H 86	17/32	1535/8	159	9	10	4	133/4	71/2	87/16	1156	1360
H 6	9/16	98	103	6	15	33/4	91/8	51/2	7	1050	1800
H 33	9/16	801/4	847/8	5	101/2	31/4	8	53/8	613/16	1000	2200
H 59	5/8	741/4	773/4	6	7	27/8	81/4	69/16	71/4	2100	3500
H 80	5/8	1921/2	1973/4	15	11	315/16	18	119/16	151/2	900	2315
H 72	21/32	601/8	631/2	5	117/8	23/4	75/16	6	63/8	3260	4240
H 15	11/16	557/8	593/4	5	14	31/2	53/4	45/16	53/16	1400	3500
H 41	11/16	1171/2	1231/2	12	10	41/2	107/8	63/4	85/8	1500	2720
H 40	3/4	1771/2	1865/8	22	21/2	61/2	16	73/8	87/8	1900	2300
H 70	3/4	62	66	7	12	33/8	7	55/8	61/4	2750	5050
H 17	13/16	100	1063/4	14	12	51/8	91/8	6	75/8	1700	3700
H 66	13/16	1051/4	1103/8	15	7	45/32	107/8	81/8	87/8	3670	5040
H 37	27/32	77	817/8	12	21/2	315/16	81/2	611/16	71/2	3300	6250
H 87	27/32	13013/10	13715/16	20	9	53/8	121/4	73/4	87/16	3540	4165
H 12	7/8	85	911/2	14	7	5	81/2	53/4	73/8	2000	5200
H 33	7/8	32	8811/16	13	15	51/8	8	53/8	613/16	2250	5000
H 2	15/16	46	523/8	8	151/4	5	45/8	33/8	4	3250	7000
H 16	15/16	85	927/8	16	10	6	8	5	6	3600	5100
H 10	1	85	92	18	14	51/2	81/2	6	7	4500	7000
H 42	1	36	427/8	8	0	53/8	75/8	25/8	33/8	1795	7180
H 4	11/16	967/8	105	24	12	5	107/8	81/2	93/8	6000	9570
H 86	11/16	1535/8	1641/2	38	9	8	133/4	71/2	87/16	4624	5440
H 3	11/8	353/8	411/4	9	15	47/8	41/8	33/8	33/4	6000	12000
H 14	11/8	51	587/8	14	4	61/8	51/8	311/16	43/16	5000	8950
H 61	13/16	991/8	1093/4	31	1	8	91/8	51/2	7	4550	7750
H 47	13/16	731/2	791/2	23	0	57/16	81/4	69/16	71/4	7400	12500
H 9	11/4	971/2	108	33	12	8	9	53/4	71/2	4000	9100
H 72	11/4	621/8	683/4	21	81/2	53/8	75/16	6	63/8	10700	14875
H 8	15/16	96	1061/2	36	12	8	91/8	6	71/4	6350	10600
H 62	15/16	70	771/16	26	12	513/16	8	61/2	71/4	7900	15800
H 12	13/8	87	973/8	36	7	8	81/2	53/4	73/8	5000	12200
H 39	13/8	755/8	831/2	31	11	63/8	83/8	65/8	71/2	8150	16300
H 28	113/32	8411/16	95	37	3	8	81/4	53/4	67/8	7325	13250

* The subscript 1 means the outside coil of a concentric group or cluster; 2 and 3 are inner coils.

WARNING: This is a 1910 edition. Some of the material may no longer be accurate

Phosphor-Bronze Springs. Wilfred Lewis (Engs' Club, Phila., 1887) made some tests of a helical spring of phosphor-bronze wire, 0.12 in. diameter, 1 1/4 in. diameter from center to center, making 52 coils.

Such a spring of steel, according to the practice of the P. R. R., might be used for 40 lbs. A load of 30 lbs. gradually applied gave a permanent set. With a load of 21 lbs. in 30 hours the spring lengthened from 20 3/8 inches to 21 1/8 inches, and in 200 hours to 21 1/4 inches. It was concluded that 21 lbs. was too great for durability. For a given load the extension of the bronze spring was just double the extension of a similar steel spring, that is, for the same extension the steel spring is twice as strong.

Chromium-Vanadium Spring Steel. (Proc. Inst. M. E., 1904, pp 1263, 1305.)—A spring steel containing C, 0.44; Si, 0.173; Mn, 0.837; Cr, 1.044; Va, 0.188 was made into a spring with dimensions as follows: length unstretched 9.6 in., mean diam. of coils (D) 5.22; No. of coils (n) 4; diam. of wire, (d) 0.561. It was tempered in the usual way. When stretched it showed signs of permanent set at about 1900 lbs. Compared with two springs of ordinary steels the following formulæ are obtained:

Load at which Permanent Set begins. Extension for a load W.
 Chrome-Vanadium Spring... 56,300 d³/D lbs. $WnD^3 + 1,468,000 d^4$
 West Bromwich Spring..... 28,400 d³/D " $WnD^3 + 1,575,000 d^4$
 Turton & Platt Spring..... 44,200 d³/D " $WnD^3 + 1,331,600 d^4$

Test of a Vanadium-steel Spring. (Circular of the American Vanadium Co., 1908).—Comparative tests of an ordinary carbon-steel locomotive flat spring and of a vanadium-steel spring, made by the American Locomotive Co., showed the following: The vanadium spring, on 36-in. centers tested to 94,000 lbs., reached its elastic limit at 85,000 lbs., or 234,000 lbs. per sq. in. fiber stress, and a permanent set of 0.48 in. The test was repeated three times without change in the deflection. The carbon spring was tested to 89,280 lbs. and reached an elastic limit at 85,000 lbs., or 180,000 lbs. fiber stress, with a permanent set of 1.12 in. On repeating the test it took an additional set of 0.25 in., and on the next test several of the plates failed.

RIVETED JOINTS.

Fairbairn's Experiments.—The earliest published experiments on riveted joints are contained in the memoir by Sir W. Fairbairn in the Transactions of the Royal Society. Making certain empirical allowances, he adopted the following ratios as expressing the relative strength of riveted joints:

Solid plate.....	100
Double-riveted joint.....	70
Single-riveted joint.....	56

These celebrated ratios appear to rest on a very unsatisfactory analysis of the experiments on which they were based.

Loss of Strength in Punched Plates. (Proc. Inst. M. E., 1881.)—A report by Mr. W. Parker and Mr. John, made in 1878 to Lloyd's Committee, on the effect of punching and drilling, showed that thin steel plates lost comparatively little from punching, but that in thick plates the loss was very considerable. The following table gives the results for plates punched and not annealed or reamed:

Thickness of plates.....	1/4	3/8	1/2	3/4
Loss of tenacity, per cent.....	8	18	26	33

When 7/8-in. punched holes were reamed out to 1 1/8 in. diameter, the loss of tenacity disappeared, and the plates carried as high a stress as drilled plates. Annealing also restores to punched plates their original tenacity.

The Report of the Research Committee of the Institution of Mechanical Engineers, on Riveted Joints (1881), and records of investigations by Prof. A. B. W. Kennedy (1881, 1882, and 1885), summarize the existing information regarding the comparative effects of punching and drilling upon iron and steel plates. An examination of the voluminous tables given in Professor Unwin's Report, of the experiments made on iron and steel plates, leads to the general conclusion that, while thin plates, even of steel, do not suffer very much from punching, yet in those of 1/2 inch thickness and upwards the loss of tenacity due to punching ranges from 10% to 23% in iron plates, and from 11% to 33% in the case of mild steel. In drilled plates there is no appreciable loss of strength. It is

possible to remove the bad effects of punching by subsequent reaming or annealing. The introduction of a practicable method of drilling the plating of ships and other structures, after it has been bent and shaped, is a matter of great importance. In the modern English practice (1887) of the construction of steam-boilers with steel plates punching is almost entirely abolished, and all rivet-holes are drilled after the plates have been bent to the desired form.

Strength of Perforated Plates. (P. D. Bennett, *Eng'g*, Feb. 12, 1886, p. 155.) — Tests were made to determine the relative effect produced upon tensile strength of a flat bar of iron or steel: 1. By a 3/4-inch hole drilled to the required size; 2. By a hole punched 1/8 inch smaller and then drilled to the size of the first hole; and, 3. By a hole punched in the bar to the size of the drilled hole. The relative results in strength per square inch of original area were as follows:

	1.	2.	3.	4.
	Iron.	Iron.	Steel.	Steel.
Unperforated bar.....	1.000	1.000	1.000	1.000
Perforated by drilling.....	1.029	1.012	1.068	1.103
Perforated by punching and drilling	1.030	1.008	1.059	1.110
Perforated by punching only.....	0.795	0.894	0.935	0.927

In tests 2 and 4 the holes were filled with rivets driven by hydraulic pressure. The increase of strength per square inch caused by drilling is a phenomenon of similar nature to that of the increased strength of a grooved bar over that of a straight bar of sectional area equal to the smallest section of the grooved bar. Mr. Bennett's tests on an iron bar 0.84 in. diameter, 10 in. long, and a similar bar turned to 0.84 in. diameter at one point only, showed that the relative strength of the latter to the former was 1.323 to 1.000.

Comparative Efficiency of Riveting done by Different Methods.

The Reports of Professors Unwin and Kennedy to the Institution of Mechanical Engineers (*Proc.* 1881, 1882, and 1885) tend to establish the four following points:

1. That the shearing resistance of rivets is not highest in joints riveted by means of the greatest pressure;
2. That the ultimate strength of joints is not affected to an appreciable extent by the mode of riveting; and, therefore,
3. That very great pressure upon the rivets in riveting is not the indispensable requirement that it has been sometimes supposed to be;
4. That the most serious defect of hand-riveted as compared with machine-riveted work consists in the fact that in hand-riveted joints visible slip commences at a comparatively small load, thus giving such joints a low value as regards tightness, and possibly also rendering them liable to failure under sudden strains after slip has once commenced.

The following figures of mean results give a comparative view of hand and hydraulic riveting, as regards their ultimate strengths in joints, and the periods at which in both cases visible slip commenced.

Total breaking load. Tons.....	Hand.....	86.01	82.16	149.2	193.6
	Hydraulic.....	85.75	82.70	145.5	183.1
Load at which visible slip began	Hand.....	21.7	25.0	31.7	25.0
	Hydraulic.....	47.5	53.7	49.7	56.0

Some of the Conclusions of the Committee of Research on Riveted Joints.

(*Proc. Inst. M. E.*, April, 1885.)

The conclusions refer to joints made in soft steel plate with steel rivets, the holes drilled, and the plates in their natural state (unannealed). The rivet or shearing area has been assumed to be that of the holes, not the area of the rivets themselves. The strength of the metal in the joint has been compared with that of strips cut from the same plates.

The metal between the rivet-holes has a considerably greater tensile resistance per square inch than the unperforated metal. This excess tenacity amounted to more than 20%, both in 3/3-inch and 3/4-inch plates, when the pitch of the rivet was about 1.9 diameters. In other cases 3/8-inch plate gave an excess of 15% at fracture with a pitch of 2 diameters, of 10% with a pitch of 3.6 diameters, and of 6.6%, with a pitch of 3.9 diameters; and 3/4-inch plate gave 7.8% excess with a pitch of 2.8 diameters.

In single-riveted joints it may be taken that about 22 tons per square inch is the shearing resistance of rivet steel, when the pressure on the rivets does not exceed about 40 tons per square inch. In double-riveted joints, with rivets of about 3/4-inch diameter, most of the experiments gave about 24 tons per square inch as the shearing resistance, out the joints in one series went at 22 tons. [Tons of 2240 lbs.]

The ratio of shearing resistance to tenacity is not constant, but diminishes very markedly and not very irregularly as the tenacity increases.

The size of the rivet heads and ends plays a most important part in the strength of the joints — at any rate in the case of single-riveted joints. An increase of about one-third in the weight of the rivets (all this increase, of course, going to the heads and ends) was found to add about 8 1/2% to the resistance of the joint; the plates remaining unbroken at the full shearing resistance of 22 tons per square inch, instead of tearing at a shearing stress of only a little over 20 tons. The additional strength is probably due to the prevention of the distortion of the plates by the great tensile stress in the rivets.

The intensity of bearing pressure on the rivet exercises, with joints proportioned in the ordinary way, a very important influence on their strength. So long as it does not exceed 40 tons per square inch (measured on the projected area of the rivets), it does not seem to affect their strength; but pressures of 50 to 55 tons per square inch seem to cause the rivets to shear in most cases at stresses varying from 16 to 18 tons per square inch. For ordinary joints, which are to be made equally strong in plate and in rivets, the bearing pressure should therefore probably not exceed 42 or 43 tons per square inch. For double-riveted butt-joints perhaps, as will be noted later, a higher pressure may be allowed, as the shearing stress may probably not be more than 16 or 18 tons per square inch when the plate tears.

A margin (or net distance from outside of holes to edge of plate) equal to the diameter of the drilled hole has been found sufficient in all cases hitherto tried.

To attain the maximum strength of a joint, the breadth of lap must be such as to prevent it from breaking zigzag. It has been found that the net metal measured zigzag should be from 30% to 35% in excess of that measured straight across, in order to insure a straight fracture. This corresponds to a diagonal pitch of 2/3 p + d/3, if p be the straight pitch and d the diameter of the rivet-hole.

Visible slip or "give" occurs always in a riveted joint at a point very much below its breaking load, and by no means proportional to that load. A collation of the results obtained in measuring the slip indicates that it depends upon the number and size of the rivets in the joint, rather than upon anything else; and that it is tolerably constant for a given size of rivet in a given type of joint. The loads per rivet at which a joint will commence to slip visibly are approximately as follows:

Diameter of Rivet.	Type of Joint.	Riveting.	Slipping Load per Rivet.
3/4 inch	Single-riveted	Hand	2.5 tons
3/4 "	Double-riveted	Hand	3.0 to 3.5 tons
3/4 "	Double-riveted	Machine	7 tons
1 inch	Single-riveted	Hand	3.2 tons
1 "	Double-riveted	Hand	4.3 tons
1 "	Double-riveted	Machine	8 to 10 tons

To find the probable load at which a joint of any breadth will commence to slip, multiply the number of rivets in the given breadth by the proper figure taken from the last column of the table above. The above figures are not given as exact; but they represent the results of the experiments.

The experiments point to simple rules for the proportioning of joints of maximum strength. Assuming that a bearing pressure of 43 tons per square inch may be allowed on the rivet, and that the excess tenacity of the plate is 10% of its original strength, the following table gives the values of the ratios of diameter d of hole to thickness t of plate ($d + t$), and of pitch p to diameter of hole ($p \div d$) in joints of maximum strength in $3/8$ -inch plate.

For Single-riveted Plates.

Original Tenacity of Plate.		Shearing Resistance of Rivets.		Ratio. $d \div t$	Ratio. $p \div d$	Ratio. $\frac{\text{Plate Area}}{\text{Rivet Area}}$
Tons per Sq. In.	Lbs. per Sq. In.	Tons per Sq. In.	Lbs. per Sq. In.			
30	67,200	22	49,200	2.48	2.30	0.667
28	62,720	22	49,200	2.48	2.40	0.785
30	67,200	24	53,760	2.28	2.27	0.713
28	62,720	24	53,760	2.28	2.36	0.690

This table shows that the diameter of the hole should be $2\frac{1}{3}$ times the thickness of the plate, and the pitch of the rivets $2\frac{3}{8}$ times the diameter of the hole. Also, it makes the mean plate area 71% of the rivet area. If a smaller rivet be used than that here specified, the joint will not be of uniform, and therefore not of maximum, strength; but with any other size of rivet the best result will be got by use of the pitch obtained from the simple formula $p = ad^2/t + d$, where, as before, d is the diameter of the hole.

The value of the constant a in this equation is as follows:

For 30-ton plate and 22-ton rivets, $a = 0.524$
" 28 " " " 22 " " " 0.558
" 30 " " " 24 " " " 0.570
" 28 " " " 24 " " " 0.606

Or, in the mean, the pitch $p = 0.56 \frac{d^2}{t} + d$. With too small rivets this gives pitches often considerably smaller in proportion than $2\frac{3}{8}$ times the diameter.

For double-riveted lap-joints a similar calculation to that given above, but with a somewhat smaller allowance for excess tenacity, on account of the large distance between the rivet-holes, shows that for joints of maximum strength the ratio of diameter to thickness should remain precisely as in single-riveted joints; while the ratio of pitch to diameter of hole should be 3.64 for 30-ton plates and 22 or 24 ton rivets, and 3.82 for 28-ton plates with the same rivets.

Here, still more than in the former case, it is likely that the prescribed size of rivet may often be inconveniently large. In this case the diameter of rivet should be taken as large as possible; and the strongest joint for a given thickness of plate and diameter of hole can then be obtained by using the pitch given by the equation $p = ad^2/t + d$, where the values of the constant a for different strengths of plates and rivets may be taken as follows, for any thickness of plate from $3/8$ to $3/4$ -inch:

For 30-ton plate and 24-ton rivets } $p = 1.16 \frac{d^2}{t} + d$;
" 28 " " " 22 " " " } $p = 1.06 \frac{d^2}{t} + d$;
" 30 " " " 22 " " " } $p = 1.06 \frac{d^2}{t} + d$;
" 28 " " " 24 " " " } $p = 1.24 \frac{d^2}{t} + d$.

WARNING: This is a 1910 edition. Some of the material may no longer be accurate

In double-riveted butt-joints it is impossible to develop the full shearing resistance of the joint without getting excessive bearing pressure, because the shearing area is doubled without increasing the area on which the pressure acts. Considering only the plate resistance and the bearing pressure, and taking this latter as 45 tons per square inch, the best pitch would be about 4 times the diameter of the hole. We may probably say with some certainty that a pressure of from 45 to 50 tons per square inch on the rivets will cause shearing to take place at from 16 to 18 tons per square inch. Working out the equations as before, but allowing excess strength of only 5% on account of the large pitch, we find that the proportions of double-riveted butt-joints of maximum strength, under given conditions, are those of the following table:

Double-riveted Butt-joints.

Original Tenacity of Plate, Tons per Sq. In.	Shearing Resistance of Rivets, Tons per Sq. In.	Bearing Pressure, Tons per Sq. In.	Ratio $\frac{d}{t}$	Ratio $\frac{p}{d}$
30	16	45	1.80	3.85
28	16	45	1.80	4.06
30	18	48	1.70	4.03
28	18	48	1.70	4.27
30	16	50	2.00	4.20
28	16	50	2.00	4.42

Practically, therefore, it may be said that we get a double-riveted butt-joint of maximum strength by making the diameter of hole about 1.8 times the thickness of the plate, and making the pitch 4.1 times the diameter of the hole.

The proportions just given belong to joints of maximum strength. But in a boiler the one part of the joint, the plate, is much more affected by time than the other part, the rivets. It is therefore not unreasonable to estimate the percentage by which the plates might be weakened by corrosion, etc., before the boiler would be unfit for use at its proper steam-pressure, and to add correspondingly to the plate area. Probably the best thing to do in this case is to proportion the joint, not for the actual thickness of plate, but for a nominal thickness less than the actual by the assumed percentage. In this case the joint will be approximately one of uniform strength by the time it has reached its final workable condition; up to which time the joint as a whole will not really have been weakened, the corrosion only gradually bringing the strength of the plates down to that of rivets.

Efficiencies of Joints.

The average results of experiments by the committee gave: For double-riveted lap-joints in $3/8$ -inch plates, efficiencies ranging from 67.1% to 81.2%. For double-riveted butt-joints (in double shear) 61.4% to 71.3%. These low results were probably due to the use of very soft steel in the rivets. For single-riveted lap-joints of various dimensions the efficiencies varied from 54.8% to 60.8%. The shearing resistance of steel did not increase nearly so fast as its tensile resistance. With very soft steel, for instance, of only 26 tons tenacity, the shearing resistance was about 80% of the tensile resistance, whereas with very hard steel of 52 tons tenacity the shearing resistance was only somewhere about 65% of the tensile resistance.

Proportions of Pitch and Overlap of Plates to Diameter of Rivet-Hole and Thickness of Plate.

(Prof. A. B. W. Kennedy, *Proc. Inst. M. E.*, April, 1885.)

- t = thickness of plate;
- d = diameter of rivet (actual) in parallel hole;
- p = pitch of rivets, center to center;
- s = space between lines of rivets;
- l = overlap of plate.

The pitch is as wide as is allowable without impairing the tightness of the joint under steam.

For single-riveted lap-joints in the circular seams of boilers which have double-riveted longitudinal lap-joints,

$$d = t \times 2.25; p = d \times 2.25 = t \times 5 \text{ (nearly); } l = t \times 6.$$

For double-riveted lap-joints:

$$d = 2.25t; p = 8t; s = 4.5t; l = 10.5t.$$

Single-riveted Joints.				Double-riveted Joints.				
t	d	p	l	t	d	p	s	l
3/16	7/16	15/16	11/8	3/16	7/16	11/2	7/8	2
1/4	9/16	1 1/4	1 1/2	1/4	9/16	2	1 3/16	2 3/4
5/16	11/16	1 9/16	1 7/8	5/16	11/16	2 1/2	1 1/2	3 3/8
3/8	13/16	1 7/8	2 1/4	3/8	13/16	3	1 3/4	4
7/16	1	2 3/16	2 5/8	7/16	1	3 1/2	2	4 5/8
1/2	1 1/8	2 1/2	3	1/2	1 1/8	4	2 1/4	5 1/4
9/16	1 1/4	2 13/16	3 3/8	9/16	1 1/4	4 1/2	2 1/2	5 7/8

With these proportions and good workmanship there need be no fear of leakage of steam through the riveted joint.

The net diagonal area, or area of plate, along a zigzag line of fracture should not be less than 30% in excess of the net area straight across the joint, and 35% is better.

Mr. Theodore Cooper (*R. R. Gazette*, Aug. 22, 1890), referring to Prof. Kennedy's statement quoted above, gives as a sufficiently approximate rule for the proper pitch between the rows in staggered riveting, one-half of the pitch of the rivets in a row plus one-quarter the diameter of a rivet-hole.

Test of Double-riveted Lap and Butt Joints.

(*Proc. Inst. M. E.*, October, 1888.)

Steel plates of 25 to 26 tons per square inch T. S., steel rivets of 24.8 tons shearing strength per square inch.

Kind of Joint.	Thickness of Plate.	Diameter of Rivet-holes.	Ratio of Pitch to Diameter.	Comparative Efficiency of Joint.
Lap.....	3/8"	0.8"	3.62	75.2
Butt.....	3/8	0.7	3.93	76.5
Lap.....	3/4	1.1	2.82	68.0
Lap.....	3/4	1.6	3.41	73.6
Butt.....	3/4	1.1	4.00	72.4
Butt.....	3/4	1.6	3.94	76.1
Lap.....	1	1.3	2.42	63.0
Lap.....	1	1.75	3.00	70.2
Butt.....	1	1.3	3.92	76.1

Diameter of Rivets for Different Thicknesses of Plates.

Thickness of Plate.	5/16	3/8	7/16	1/2	9/16	5/8	11/16	3/4	13/16	7/8	15/16	1
Diam. (1) ..	5/8	5/8	5/8	3/4	3/4	3/4	3/8	7/8	7/8	1	1	1
Diam. (2) ..	5/8	5/8	3/4	13/16	13/16	7/8	7/8	15/16	1	1 1/8	1 3/16	1 1/4
Diam. (3) ..	1/2	5/8	3/4	3/4	7/8	7/8	7/8	1	1	1 1/8	1 1/8	1 1/8
Diam. (4) ..		5/8	5/8		3/4		13/16	7/8		1		1 1/16
Diam. (5) ..	3/4	7/8	15/16	1								
Diam. (6) ..	11/16	3/4	7/8	15/16	1							
Diam. (7) ..	3/8	1/2	9/16	11/16	3/4	13/16						

WARNING: This is a 1910 edition. Some of the material may no longer be accurate

- (1) Lloyd's Rules. (2) Liverpool Rules. (3) English Dock-yards.
- (4) French Veritas. (5) Hartford Steam Boiler Inspection and Insurance Co., double-riveted lap-joints. (6) Ditto, triple-riveted butt-joints.
- (7) F. E. Cardullo. (1/16 less than diam. of hole.)

Calculated Efficiencies — Steel Plates and Steel Rivets. — The following table has been calculated by the author on the assumptions that the excess strength of the perforated plate is 10%, and that the shearing strength of the rivets per square inch is four-fifths of the tensile strength of the plate (or, if no allowance is made for excess strength of the perforated plate that the shearing strength is 72.7% of the tensile strength). If t = thickness of plate, d = diameter of rivet-hole, p = pitch, and T = tensile strength per square inch, then for single-riveted plates

$$(p - d)t \times 1.10T = \frac{\pi}{4} d^2 \times \frac{4}{5} T, \text{ whence } p = 0.571 \frac{d^2}{t} + d.$$

$$\text{For double-riveted lap-joints, } p = 1.142 \frac{d^2}{t} + d.$$

The coefficients 0.571 and 1.142 agree closely with the averages of those given in the report of the committee of the Institution of Mechanical Engineers, quoted on page 404, ante.

Thickness.	Diam. of Rivet-hole.	Pitch.		Efficiency.		Thickness.	Diam. of Rivet-hole.	Pitch.		Efficiency.	
		Single Riveting.	Double Riveting.	Single Riveting.	Double Riveting.			Single Riveting.	Double Riveting.		
in.	in.	in.	in.	%	%	in.	in.	in.	in.	%	%
3/16	7/16	1.020	1.603	57.1	72.7	1/2	3/4	1.392	2.035	45.1	63.1
3/16	1/2	1.261	2.023	60.5	75.3	1/2	7/8	1.749	2.624	50.0	66.6
1/4	1/2	1.071	1.642	53.3	69.6	1/2	1	2.142	3.284	53.3	70.0
1/4	9/16	1.285	2.008	56.2	72.0	1/2	1 1/8	2.570	4.016	56.2	72.0
5/16	9/16	1.137	1.712	50.5	67.1	9/16	3/4	1.321	1.892	43.2	60.3
5/16	5/8	1.339	2.053	53.3	69.5	9/16	7/8	1.652	2.429	47.0	64.0
5/16	11/16	1.551	2.415	55.7	71.5	9/16	1	2.015	3.030	50.4	67.0
3/8	5/8	1.218	1.810	48.7	65.5	9/16	1 1/8	2.410	3.694	53.3	69.5
3/8	3/4	1.607	2.463	53.3	69.5	9/16	1 1/4	2.836	4.422	55.9	71.5
3/8	7/8	2.041	3.206	57.1	72.7	5/8	3/4	1.264	1.778	40.7	57.8
7/16	5/8	1.136	1.647	45.7	62.0	5/8	7/8	1.575	2.274	44.4	61.5
7/16	3/4	1.484	2.218	49.5	66.2	5/8	1	1.914	2.827	47.7	64.6
7/16	7/8	1.869	2.864	53.2	69.4	5/8	1 1/8	2.281	3.438	50.7	67.3
7/16	1	2.305	3.610	56.6	72.3	5/8	1 1/4	2.678	4.105	53.3	69.5

Apparent Shearing Resistance of Rivet Iron and Steel.

(*Proc. Inst. M. E.*, 1879, *Engineering*, Feb. 20, 1880.)

The true shearing resistance of the rivets cannot be ascertained from experiments on riveted joints (1) because the uniform distribution of the load to all the rivets cannot be insured; (2) because of the friction of the plates, which has the effect of increasing the apparent resistance to shearing in an element uncertain in amount. Probably in the case of single-riveted joints the shearing resistance is not much affected by the friction.

Fairbairn's experiments show that a rivet is 6 1/2% weaker in a drilled than in a punched hole. By rounding the edge of the rivet-hole, the apparent shearing resistance is increased 12%. Messrs. Greig and Eyth's experiments indicate a greater resistance of the rivets in punched holes than in drilled holes.

If the apparent shearing resistance is less for double than for single shear, it is probably due to unequal distribution of the stress on the two rivet sections.

The shearing resistance of a bar, when sheared in circumstances which prevent friction, is usually less than the tenacity of the bar. The following results show the decrease:

Harkort, iron.....	Tenacity, 26.4	Shearing, 16.5	Ratio, 0.62
Lavalley, iron.....	" 25.4	" 20.2	" 0.79
Greig and Eyth, iron.	" 22.2	" 19.0	" 0.85
Greig and Eyth, steel	" 28.8	" 22.1	" 0.77

In Wöhler's researches (in 1870) the shearing strength of iron was found to be four-fifths of the tenacity. Later researches of Bauschinger confirm this result generally, but they show that for iron the ratio of the shearing resistance and tenacity depends on the direction of the stress relatively to the direction of rolling. The above ratio is valid only if the shear is in a plane perpendicular to the direction of rolling, and if the tension is applied parallel to the direction of rolling. If the plane of shear is parallel to the breadth of the bar, the resistance is only half as great as in a plane perpendicular to the fibers.

THE STRENGTH OF RIVETED JOINTS.

Joint of Maximum Efficiency. — (F. E. Cardullo.) If a riveted joint is made with sufficient lap, and a proper distance between the rows of rivets, it will break in one of the three following ways:

1. By tearing the plate along a line, through the outer row of rivets.
2. By shearing the rivets.
3. By crushing the plate or the rivets.

Let t = the thickness of the main plates.
 d = the diameter of the rivet-holes.
 f = the tensile strength of the plate in pounds per sq. in.
 s = the shearing strength of the rivets in pounds per sq. in. when in single shear.
 p = the distance between the centers of rivets of the outer row (see Figs. 90 and 91) = the pitch in single and double lap riveting = twice

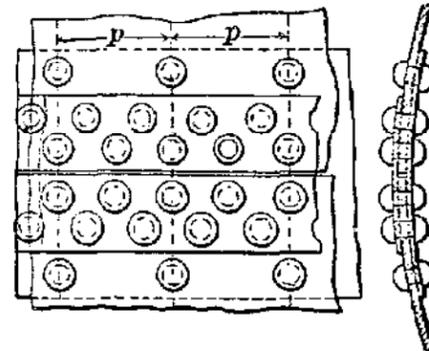

FIG. 90.
TRIPLE RIVETING.

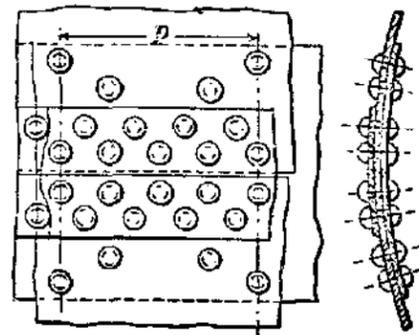

FIG. 91.
QUADRUPLE RIVETING.

the pitch of the inner rows in triple butt strap riveting, in which alternate rivets in the outer row are omitted, = four times the pitch in quadruple butt strap riveting, in which the outer row has one-fourth of the number of rivets of the two inner rows.

c = the crushing strength of the rivets or plates in pounds per sq. in.
 n = the number of rivets in each group in single shear. (A group is the number of rivets on one side of a joint corresponding to the distance p : = 1 rivet in single riveting, 2 in double riveting, 5 in triple butt strap riveting, and 11 in quadruple butt strap riveting.)
 m = the number of rivets in each group in double shear.
 s' = the shearing strength of rivets in double shear, in pounds per sq. in., the rivet section being counted once.
 T = the strength of the plate at the weakest section. = $ft(p - d)$.
 S = the strength of the rivets against shearing, = $0.7854 d^2 (ns + ms')$.
 C = the strength of the rivets or the plates against crushing, = $dtc(n + m)$.

In order that the joint shall have the greatest strength possible, the tearing, shearing, and crushing strength must all be equal. In order to make it so,

1. Substitute the known numerical values, equate the expressions for shearing and crushing strength, and find the value of d , taking it to the nearest $1/16$ in.
2. Next find the value of S in the second equation, and substitute it for T in the first equation. Substitute numerical values for the other factors in the first equation, and solve for p .

The efficiency of a riveted joint in tearing, shearing and crushing, is equal to the tearing, shearing or crushing strength, divided by the quantity ftp , or the strength of the solid plate.

The efficiency in tearing is also equal to $(p - d) \div p$.
 The maximum possible efficiency for a well-designed joint is

$$E = \frac{m + n}{m + n + (f \div c)}$$

Empirical formula for the diameter of the rivet-hole when the crushing strength is unknown. Assuming that $c = 1.4f$, and $s' = 1.75s$, we have by equating C and S , and substituting,

$$d = 1.782t \frac{f(n + m)}{s(n + 1.75m)}$$

Margin. The distance from the center of any rivet-hole to the edge of the plate should be not less than $1\frac{1}{2}d$. The distance between two adjacent rivet centers should be not less than $2d$. It is better to increase each of these dimensions by $1/8$ in.

The distance between the rows of rivets should be such that the net section of plate material along any broken diagonal through the rivet-holes should be not less than 30 per cent greater than the plate section along the outer line of rivets.

The thickness of the inner cover strap of a butt joint should be $3/4$ of the thickness of the main plate or more. The thickness of the outer strap should be $5/8$ of the thickness of the main plate or more.

Steam Tightness. It is of great importance in boiler riveting that the joint be steam tight. It is therefore necessary that the pitch of the rivets nearest to the calked edge be limited to a certain function of the thickness of the plate. The Board of Trade rule for steam tightness is

$$p = Ct + 1\frac{5}{8} \text{ in.}$$

where p = the maximum allowable pitch in inches.
 t = the thickness of main plate in inches.
 C = a constant from the following table.

No. of Rivets per Group...	1	2	3	4	5
Lap Joints.....	$C = 1.31$	2.62	3.47	4.14	...
Double-straped Joints....	$C = 1.75$	3.50	4.63	5.52	6.00

The pitch should not exceed ten inches under any circumstances. When the joint has been designed for strength, it should be checked by the above formula. Should the pitch for strength exceed the pitch for steam tightness, take the latter, substitute it in the formula

$$ft(p - d) = 0.7854 d^2 (ns + ms')$$

and solve for d . If the value of d so obtained is not the diameter of some standard size rivet, take the next larger $1/16$ in.

Calculation of Triple-riveted Butt and Strap Joints. — Formulæ:
 $T = ft(p - d)$, $S = 0.7854 d^2 (ns + ms')$, $C = dtc(m + n)$ (notation on preceding page), $n = 1$, $m = 4$.
 Take $f = 55,000$; $s = 0.8f$, = 44,000; $s' = 1.75s = 77,000$, $c = 1.4f = 77,000$.
 Then $T = 55,000t(p - d)$, $S = 276,460 d^2$, $C = 385,000 dt$.

For maximum strength, $T = S = C$; dividing by $55,000t$, $(p - d) = 5.027d^2 = 7dt$; whence $d = 1.3925t$; $p = 8d$.

Thickness of plate, $t = 5/16$	$3/8$	$7/16$	$1/2$	$9/16$	$5/8$	
Diam. rivet hole, $d = 1.3925t$	0.4353	0.5222	0.6092	0.6962	0.7833	0.8703
Pitch of outer row, $p = 8d$	3.4816	4.1776	4.8736	5.5696	6.2664	6.9624
$T = 55,000t(p - d)$	52,360	75,390	102,610	134,020	169,630	209,420
$S = 276,460d^2$	52,330	75,360	102,570	133,970	169,560	209,330
$C = 385,000dt$	52,350	75,390	102,620	134,030	169,630	209,420

Calculations by logarithms, to nearest 10 pounds.

Efficiency of all joints $(p - d) \div p = 87.5$ per cent.

Maximum efficiency by Cardullo's formula, $\frac{n + m}{n + m + f/c} = \frac{5}{5 + 1/1.4} = 87.5$ per cent.

Diameter of rivet-hole, next largest 16th. $7/16$ $9/16$ $5/8$ $3/4$ $13/16$ $7/8$
 For the same thickness of plates the Hartford Steam Boiler Inspection and Insurance Co. gives the following proportions:

Thickness, t	$5/16$	$3/8$	$7/16$	$1/2$	$9/16$	$5/8$
Diam. rivet-hole, d	$3/4$	$13/16$	$15/16$	1	$1 1/16$	$1 1/16$
Pitch of outer row, p	$6 1/4$	$6 1/2$	$6 3/4$	$7 1/2$	$7 3/4$	$7 3/4$

Using the same values for f , s , s'' and c , we obtain:

$T =$	94,530	117,300	139,860	178,750	207,850	229,880
$S =$	155,400	168,400	194,300	207,300	220,200	220,200
$C =$	90,030	117,300	157,900	192,500	230,000	255,500

Strength of solid plate, $fpt =$ 107,360 134,060 162,420 206,250 239,770 266,400

Efficiency T, S or C , lowest $\div fpt$, per cent	83.9	87.5	86.1	86.7	86.7	82.6
---	------	------	------	------	------	------

The $5/16$ in. plate fails by crushing, the $5/8$ by shearing, the others by tearing.

Calculation of Quadruple Riveting. — In this case there are 11 rivets in the group. If the upper strap plate contains all the rivets except the outer row, then $n = 1$, $m = 10$. Using the same values for f , s , s'' and c as above, we have $ns + ms'' = 814,000$; $T = 55,000t(p - d)$; $S = 639,315d^2$; $C = 847,000dt$.

For maximum strength, $t(p - d) = 11.624d^2 = 15.4dt$; whence $d = 1.32485t$, $p = 16.4d$. Efficiency $(p - d) \div p = 93.9$ per cent. Check by

Cardullo's formula $\frac{n + m}{n + m + f/c} = \frac{11}{11 + 10/1.4} = 93.9$ per cent.

British Board of Trade and Lloyd's Rules for Riveted Joints. — *Board of Trade.* — Tensile strength of rivet bars between 26 and 30 tons, el. in 10" not less than 25%, and contr. of area not less than 50%.

The shearing resistance of the rivet steel to be taken at 23 tons per square inch, 5 to be used for the factor of safety independently of any addition to this factor for the plating. Rivets in double shear to have only 1.75 times the single section taken in the calculation instead of 2. The diameter must not be less than the thickness of the plate, and the pitch never greater than $8 1/2"$. The thickness of double butt-straps (each) not to be less than $5/8$ the thickness of the plate; single butt-straps not less than $9/8$.

Distance from center of rivet to edge of hole = diameter of rivet $\times 1 1/2$.
 Distance between rows of rivets

= $2 \times$ diam. of rivet or = $[(\text{diam.} \times 4) + 1] \div 2$, if chain, and

= $\frac{\sqrt{[(\text{pitch} \times 11) + (\text{diam.} \times 4)] \times (\text{pitch} + \text{diam.} \times 4)}}{10}$ if zigzag.

Diagonal pitch = $(\text{pitch} \times 6 + \text{diam.} \times 4) \div 10$.

Lloyd's. — T. S. of rivet bars, 26 to 30 tons; el. not less than 20% in 8". The material must stand bending to a curve, the inner radius of which is

WARNING: This is a 1910 edition. Some of the material may no longer be accurate

not greater than $1 1/2$ times the thickness of the plate, after having been uniformly heated to a low cherry-red, and quenched in water at 82° F.

Rivets in double shear to have only 1.75 times the single section taken in the calculation instead of 2. The shearing strength of rivet steel to be taken at 85% of the T. S. of the material of shell plates. In any case where the strength of the longitudinal joint is satisfactorily shown by experiment to be greater than given by the formula, the actual strength may be taken in the calculation.

Proportions of Riveted Joints. (Hartford S. B. Insp. and Ins. Co.)

Single-riveted Girth Secms of Boilers.

Thickness.	$1/4$	$5/16$	$3/8$	$7/16$	$1/2$
Diam. rivet-hole.	$3/4$ $11/16$	$13/16$ $3/4$	$15/16$ $13/16$	1 $15/16$	$1 1/16$ 1
Pitch	$2 1/16$ $2 1/16$	$2 1/8$ $2 1/8$	$2 3/8$ $2 1/8$	$2 7/16$ $2 3/8$	$2 1/2$ $2 1/2$
Center to edge . .	$1 1/8$ $1 1/32$	$1 7/32$ $1 1/8$	$1 13/32$ $1 7/32$	$1 1/2$ $1 13/32$	$1 9/32$ $1 1/2$

Double-riveted Lap Joints.

Thickness of plate	$1/4$	$5/16$	$3/8$	$7/16$	$1/2$
Diam. rivet-hole	$3/4$	$13/16$	$15/16$	1	$1 1/16$
Pitch	$2 7/8$	$2 7/8$	$3 1/4$	$3 1/4$	3.32
Dist. bet. rows	$1 15/16$	$1 15/16$	$2 3/16$	$2 3/16$	2.2
Dist. inner row to edge	$1 1/8$	$1 7/32$	$1 13/32$	$1 1/2$	$1 19/32$
Efficiency	0.74	0.72	0.70	0.70	0.68

Triple-riveted Lap Joints.

Thickness	$1/4$	$5/16$	$3/8$	$7/16$	$1/2$
Diam. rivet-hole	$1 1/16$	$3/4$	$13/16$	$15/16$	1
Pitch	3	$3 1/8$	$3 1/4$	$3 3/4$	$3 15/16$
Dist. bet. rows	2	$2 1/16$	$2 3/16$	$2 1/2$	$2 5/8$
Inner row to edge	$1 1/32$	$1 1/8$	$1 7/32$	$1 13/32$	$1 1/2$
Efficiency	0.77	0.76	0.75	0.75	0.75

Triple-riveted Bull-strap Joints.

Thickness	$5/16$	$3/8$	$7/16$	$1/2$	$9/16$	$5/8$
Diam. rivet-hole	$3/4$	$13/16$	$15/16$	1	$1 1/16$	$1 1/16$
Pitch, inner rows	$3 1/8$	$3 1/4$	$3 3/8$	$3 3/4$	$3 7/8$	$3 7/8$
Dist. bet. inner rows	$2 1/8$	$2 3/16$	$2 1/4$	$2 3/8$	$2 5/8$	$2 5/8$
Dist. outer to 2d row	$2 3/8$	$2 1/2$	$2 3/4$	3	$3 3/16$	$3 3/16$
Edge to nearest row	$1 1/4$	$1 7/32$	$1 13/32$	$1 1/2$	$1 19/32$	$1 19/32$
Efficiency %	88 (?)	87.5	86	86.6	85.4	84 (?)

The distance to the edge of the plate is from the center of rivet-holes.

Pressure Required to Drive Hot Rivets. — R. D. Wood & Co. Philadelphia, give the following table (1897):

POWER TO DRIVE RIVETS HOT.

Size.	Girder-work.	Tank-work.	Boiler-work.	Size.	Girder-work.	Tank-work.	Boiler-work.
in.	tons.	tons.	tons.	in.	tons.	tons.	tons.
1/2	9	15	20	1 1/8	38	60	75
5/8	12	18	25	1 1/4	45	70	100
3/4	15	22	33	1 1/2	60	85	125
7/8	22	30	45	1 3/4	75	100	150
1	30	45	60				

The above is based on the rivet passing through only two thicknesses of plate which together exceed the diameter of the rivet but little, if any.

As the plate thickness increases the power required increases approximately in proportion to the square root of the increase of thickness. Thus, if the total thickness of plate is four times the diameter of the rivet, we should require twice the power given above in order to thoroughly fill the rivet-holes and do good work. Double the thickness of plate would increase the necessary power about 40%.

It takes about four or five times as much power to drive rivets cold as to drive them hot. Thus, a machine that will drive 3/4-in. rivets hot will usually drive 3/8-in. rivets cold (steel). Baldwin Locomotive Works drive 1/2-in. soft-iron rivets cold with 15 tons.

Riveting Pressure Required for Bridge and Boiler Work.

(Wilfred Lewis, Engineers' Club of Philadelphia, Nov., 1893.)

A number of 3/8-inch rivets were subjected to pressures between 10,000 and 60,000 lbs. At 10,000 lbs. the rivet swelled and filled the hole without forming a head. At 20,000 lbs. the head was formed and the plates were slightly pinched. At 30,000 lbs. the rivet was well set. At 40,000 lbs. the metal in the plate surrounding the rivet began to stretch, and the stretching became more and more apparent as the pressure was increased to 50,000 and 60,000 lbs. From these experiments the conclusion might be drawn that the pressure required for cold riveting was about 300,000 lbs. per square inch of rivet section. In hot riveting, until recently there was never any call for a pressure exceeding 60,000 lbs., but now pressures as high as 150,000 lbs. are not uncommon, and even 300,000 lbs. have been contemplated as desirable.

Pressure Required for Heading Cold Rivets. — Experiments made by the author in 1906 on 1/2 and 5/8 in. soft steel rivets showed that the pressure required to head a rivet cold, with a hemispherical heading die, was a function of the final or maximum diameter of the head. The metal began to flow and fill the hole at about 50,000 lbs. per sq. in. pressure, but it hardened and increased its resistance as it flowed until it reached a maximum of about 100,000 lbs. per sq. in. of the maximum area of the head.

Chemical and Physical Tests of Soft Steel Rivets. — Ten rivet bars and ten rivets selected from stock of the Champion Rivet Co., Cleveland, O., were analyzed by Oscar Textor, with results as follows:

P, 0.008 to 0.027, av. 0.015; Mn, 0.31 to 0.69, av. 0.46; S, 0.023 to 0.044, av. 0.033; Si, 0.001 to 0.008, av. 0.005; C, 0.06 to 0.19, av. 0.11. Only four of the 20 samples were over 0.14 C, and these were made for high strength. Ten bars and two rivets gave tensile strength, 46,735 to 55,380, av. 52,195 lbs. per sq. in.; elastic limit, 31,350 to 43,150, av. 35,954; elongation, bars only, 28 to 35, av. 31.9% in 8 ins.; reduction of area, 65.6%. Eight bars in single shear gave shearing strength 35,660 to 50,190, av. 44,478 lbs. per sq. in.; seven bars in double shear gave 39,170 to 53,900, av. 45,720 lbs. The shearing strength averaged 86.3% of the tensile strength.

IRON AND STEEL.

CLASSIFICATION OF IRON AND STEEL.

(W. Kent, Railroad and Engineering Journal, April, 1887.)

Generic Term.	IRON.		Or welded from a pasty mass.	Will Harden.	(8) WROUGHT STEEL.	Obtained by direct or indirect process, as German, shear, blister, and puddled steels.
	Or obtained from a fluid mass.	Or wrought.				
How Obtained.	Non-malleable.	Malleable.	Will Not Harden.			
Distinguishing Quality.						
Species.	CAST IRON.	CAST STEEL.	(7) WROUGHT IRON.			
Varieties.	(1) Ordinary cast-ings.	(2) Malleable cast iron obtained from No. 1 by annealing in oxides.	a. Obtained by direct process from ores, as Catalan, Chenot, and other process irons.			
		(3) Crucible, (4) Bessemer, and (5) Open-hearth steels.	b. Obtained by indirect process from cast iron, as finery-hearth and puddled irons.			
		(6) Mitis.*				

* No. 6. Mitis is the name given to a new product (having the same general properties and produced by the same processes as soft cast steels) made by adding an alloy of aluminum to melted wrought iron or soft steel before pouring.
 † No. 8. Wrought steel is almost an obsolete product, having been replaced in commerce by cast steel. Blister steel, however, is still made as an intermediate product for remelting in the crucible.
 Sub-varieties of Nos. 3, 4, and 5, soft, mild, medium, and hard steels, according to percentage of carbon, the divisions between them not being well defined.
 Cast iron usually contains over 3% of carbon; cast steel anywhere from 0.06% to 1.50%, according to the purpose for which it is used; wrought iron from 0.02% to 0.10%. The quality of hardening and tempering which formerly distinguished steel from wrought iron is now no longer the dividing line between them, since soft steels are now produced which, by the ordinary blacksmith's tests, will not harden. All products of the crucible, Bessemer, and open-hearth processes are now commercially known as steel.

CAST IRON.

The Manufacture of Cast Iron. — Pig iron is the name given to the crude form of iron as it is produced in the blast furnace. This furnace is a tall shaft, lined with fire brick, often as large as 100 ft. high and 20 ft. in diameter at its widest part, called the "bosh." The furnace is kept filled with alternate layers of fuel (coke, anthracite or charcoal), while a melting temperature is maintained at the bottom by a strong blast. The iron ore as it travels down the furnace is decarbonized by the carbon monoxide gas produced by the incomplete combustion of the fuel, and as it travels farther, into a zone of higher temperature, it absorbs carbon and silicon. The phosphorus originally in the ore remains in the iron. The sulphur present in the ore and in the fuel may go into combination with the lime in the slag, or into the iron, depending on the constitution of the slag and on the temperature. The silica and alumina in the ore unite with the lime to form a fusible slag, which rests on the melted iron in the hearth. The iron is tapped from the furnace several times a day, while in large furnaces the slag is usually run off continuously.

Grading of Pig Iron. — Pig iron is approximately graded according to its fracture, the number of grades varying in different districts. In Eastern Pennsylvania the principal grades recognized are known as No. 1 and 2 foundry, gray forge or No. 3, mottled or No. 4, and white or No. 5. Intermediate grades are sometimes made, as No. 2 X, between No. 1 and No. 2, and special names are given to irons more highly silicized than No. 1, as No. 1 X, silver-gray, and soft. Charcoal foundry pig iron is graded by numbers 1 to 5, but the quality is very different from the corresponding numbers in anthracite and coke pig. Southern coke pig iron is graded into ten or more grades. Grading by fracture is a fairly satisfactory method of grading irons made from uniform ore mixtures and fuel, but is unreliable as a means of determining quality of irons produced in different sections or from different ores. Grading by chemical analysis, in the latter case, is the only satisfactory method. The following analyses of the five standard grades of northern foundry and mill pig irons are given by J. M. Hartman (*Bull. I. & S. A.*, Feb., 1892):

	No. 1.	No. 2.	No. 3.	No. 4.	No. 4 B.	No. 5.
Iron.....	92.37	92.31	94.66	94.48	94.08	94.68
Graphitic carbon.....	3.52	2.99	2.50	2.02	2.02
Combined carbon.....	0.13	0.37	1.52	1.98	1.43	3.83
Silicon.....	2.44	2.52	0.72	0.56	0.92	0.41
Phosphorus.....	1.25	1.08	0.26	0.19	0.04	0.04
Sulphur.....	0.02	0.02	trace	0.08	0.04	0.02
Manganese.....	0.28	0.72	0.34	0.67	2.02	0.98

CHARACTERISTICS OF THESE IRONS.

No. 1. *Gray.* — A large, dark, open-grain iron, softest of all the numbers and used exclusively in the foundry. Tensile strength low. Elastic limit low. Fracture rough. Turns soft and tough.

No. 2. *Gray.* — A mixed large and small dark grain, harder than No. 1 iron, and used exclusively in the foundry. Tensile strength and elastic limit higher than No. 1. Fracture less rough than No. 1. Turns harder, less tough, and more brittle than No. 1.

No. 3. *Gray.* — Small, gray, close grain, harder than No. 2 iron, used either in the rolling-mill or foundry. Tensile strength and elastic limit higher than No. 2. Turns hard, less tough, and more brittle than No. 2.

No. 4. *Mottled.* — White background, dotted closely with small black spots of graphitic carbon: little or no grain. Used exclusively in the rolling-mill. Tensile strength and elastic limit lower than No. 3. Turns with difficulty; less tough and more brittle than No. 3. The manganese in the B pig iron replaces part of the combined carbon, making the iron harder and closing the grain. Notwithstanding the lower combined carbon,

No. 5. *White.* — Smooth, white fracture, no grain, used exclusively in the rolling mill. Tensile strength and elastic limit much lower than No. 4. Too hard to turn and more brittle than No. 4.

Southern pig irons are graded as follows, beginning with the highest in silicon: Nos. 1 and 2 silvery, Nos. 1 and 2 soft, all containing over 3% of silicon; Nos. 1, 2, and 3 foundry, respectively about 2.75%, 2.5% and 2% silicon; No. 1 mill, or "foundry forge;" No. 2 mill, or gray forge; mottled; white.

Chemistry of Cast Iron. — Abbreviations, TC, total carbon; GC, graphitic carbon; CC, combined carbon. Numerous researches have been made and many papers written, especially between the years 1895 and 1908, on the relation of the physical properties to the chemical constitution of cast iron. Much remains to be learned on the subject, but the following is a brief summary of prevailing opinions.

CARBON. — Carbon exists in three states in cast iron: 1, Combined carbon, which has the property of making iron white and hard; 2, Graphitic carbon or graphite, which is not alloyed with the iron, but exists in it as a separate body, since it may be removed from the fractured surface of pig iron by a brush; 3, a third form, called by Ledebur "tempering graphite carbon," into which combined carbon may be changed by prolonged heating. The relative percentages in which GC and CC may be found in cast iron differ with the rate of cooling from the liquid state, so that in a large casting, cooled slowly, nearly all the C may be GC, while in a small casting from the same ladle cooled quickly, it may be nearly all CC. The total C in cast iron usually is between 3 and 4%.

COMBINED CARBON. — CC increases hardness, brittleness and shrinkage. Up to about 1% it increases strength, then decreases it. The presence of S tends to increase the CC in a casting, while Si tends to change CC to GC.

GRAPHITE. — GC in a casting causes softness and weakness when above 3%; softness and strength when added to irons low in GC and over 1% in CC. It increases with the size of the casting, with slow cooling, or rather with holding a long time in the mold at a high temperature.

SILICON. — Si acts as a softener by counteracting the hardening effect of S, and by changing CC into GC, changes white iron to gray, increases fluidity and lessens shrinkage. When added to hard brittle iron, high in CC, it may increase strength by removing hard brittleness, but when it reduces the CC to 1% and less it weakens the iron. Above 3.5 or 4% it changes the fracture to silvery gray, and the iron becomes brittle and weak. The softening effect of Si is modified by S and Mn.

SULPHUR. — S causes the C to take the form of CC, increases hardness, brittleness, and shrinkage, and also has a weakening effect of its own. Above about 0.1% it makes iron very weak and brittle. When Si is below 1%, even 0.06 S makes the iron dangerously brittle.

MANGANESE. — Mn in small amount, less than 0.5%, counteracts the hardening influence of S; in larger amounts it changes GC into CC, and acts as a hardener. Above 2% it makes the iron very hard. Mn combines with iron in almost all proportions. When it is from 10 to 30% the alloy is called spiegeleisen, from the German word for mirror, and has large, bright crystalline faces. Above 50% it is known as ferro-manganese. Mn has the property of increasing the solubility of iron for carbon; ordinary pig iron containing rarely over 4.2% C, while spiegeleisen may have 5%, and ferro-manganese as high as 6%. Cast iron with 1% Mn is used in making chilled rolls, in which a hard chill is desired. When softness is required in castings, Mn over 0.4% has to be avoided. Mn increases shrinkage. It also decreases the magnetism of iron. Iron with 25% Mn loses all its magnetism. It therefore has to be avoided in castings for dynamo fields and other pieces of electrical machinery.

PHOSPHORUS. — P increases fluidity, and is therefore valuable for thin and ornamental castings in which strength is not needed. It increases softness and decreases shrinkage. Below 0.7% it does not appear to decrease strength, but above 1% it is a weakener.

COPPER. — Cu is found in pig irons made from ores containing Cu. From 0.1 to 1% it closes the grain of cast iron, but does not appreciably cause brittleness.

ALUMINUM. — Al from 0.2 to 1.0% (added to the ladle in the form of a FeAl alloy) increases the softness and strength of white iron; added to gray iron it softens and weakens it.

TITANIUM. — An addition of 2 to 3% of a TiFe alloy containing 10% Ti caused an increase of 20 to 30% in strength of cast iron. A. J. Rossi, *A.I.M.E.*, xxxiii, 194. Ti reacts with any O or N present in the metal and thus purifies it, and does not remain in the metal. After enough Ti for deoxidation has been added, further additions have no effect. R. Moldenke, *A.I.M.E.*, xxxv, 153.

VANADIUM. — Va to the extent of 0.15% added to the ladle in the form of a ground FeVa alloy greatly increases the strength of cast iron. It acts as a deoxidizer and also by alloying.

OXIDE OF IRON. — The cause of the difference in strength of charcoal and coke irons of identical composition is believed by Dr. Moldenke (*A.I.M.E.*, xxxi, 988) to be the degree of oxidation to which they have been subjected in making or remelting. Since Mn, Ti, and Va all act as deoxidizers, it should be possible by additions to the ladle of alloys of FeMn, FeVa, or FeTi, to make the two irons of equal strength.

Temper Carbon. The main part of the C in white cast iron is the carbide Fe₃C. This breaks down under annealing to what Ledebur calls "temper carbon," and in annealing in oxides, as in making malleable iron, it is oxidized to CO. The C remaining in the casting at the end of the process is nearly all GC, since the latter is very slowly oxidized.

Influence of Various Elements on Cast Iron. — W. S. Anderson, *Castings*, Sept., 1908, gives the following:

Fluidity, increased by	Si, P, G.C.	Reduced by	S, C.C.
Shrinkage, increased by	S, Mn, C.C.	Reduced by	Si, P, G.C.
Strength, increased by	Mn, C.C.	Reduced by	Si, S, P, G.C.
Hardness, increased by	S, Mn, C.C.	Reduced by	Si, G.C.
Chill, increased by	S, Mn, C.C.	Reduced by	Si, P, G.C.

Microscopic Constituents. (See also Metallography, under Steel.)

Ferrite, iron free from carbon. It is found in mild steel in small amounts in gray cast iron, and in malleable cast iron.

Cementite, Fe₃C. Fe with 6.67% C. Harder than hardened steel. Hardness U on the mineralogical scale. Found in high C steel, and in white and mottled pig.

Pearlite, a compound made up of alternate laminae of ferrite and cementite, in the ratio of 7 ferrite to 1 cementite, and containing therefore 0.83% C. Found in iron and steel cooled very slowly from a high temperature. In steel of 0.83 C it composes the entire mass. Steels lower or higher than 0.83 C contain pearlite mixed with ferrite or with cementite respectively.

Martensite, the hardening component of steel. Found in iron and steel quenched above the recalescence point, and in tempered steel. It forms the entire structure of 0.83 C steel quenched.

Analyses of Cast Iron. (Notes of the table on page 417.)

1 to 7, R. Moldenke, Pittsburg. F'drymen's Assn., 1898; 1 to 5, pig irons; 6, white iron cast in chills; 7, gray iron cast in sand from the same ladle. The temperatures were taken with a Le Chatelier pyrometer. For comparison, steel, 1.18 C, melted at 2450° F.; silico-spiegel, 12.30 Si, 16.98 Mn, at 2190°; ferro-silicon, 12.01 Si, 2.17 CC, at 2040°; ferro-tungsten, 39.02 W, at 2280°; ferro-manganese, 81.4 Mn, at 2255°; ferro-chrome, 62.7 Cr, at 2400°; ditto, 5.4 Cr., at 2180°.

8. Gray foundry Swedish pig, very strong. 9. Pig to be used in mixtures of gray pig and scrap, for castings requiring a hard close grain, machining to a fine surface, and resisting wear. 8 to 15, from paper by F. M. Thomas, *Castings*, July, 1908.

16. Specification by J. E. Johnston, Jr., *Am. Mach.*, Oct. 15, 1903. The results were excellent. Si might have been 0.75 to 1.25 if S had been kept below 0.035.

17 to 22. G. R. Henderson, *Trans. A.S.M.E.*, vol. xx. The chill is to be measured in a test bar 2 X 2 X 24 in., the chill piece being so placed as to form part of one side of the mold. The actual depth of white iron will be measured.

Analyses of Cast Iron.

(Abbreviations, TC, total carbon; GC, graphitic carbon; CC, combined carbon.)

No.	TC	GC	CC	Silicon.	Man-ganese.	Phos-phorus.	Sul-phur.	
1	3.98	0.39	3.59	0.38	0.13	0.20	0.038	Melts at 2048° F.
2	3.78	1.76	2.01	0.69	0.44	0.53	0.031	Melts at 2156° F.
3	3.88	2.60	1.28	1.52	0.49	0.46	0.035	Melts at 2211° F.
4	4.03	3.47	0.56	2.01	0.49	0.39	0.034	Melts at 2248° F.
5	3.56	3.43	0.13	2.40	0.90	0.08	0.032	Melts at 2280° F.
6	4.39	0.13	4.26	0.65	0.40	0.25	0.038	Melts at 2000° F.
7	4.45	2.99	1.46	0.67	0.41	0.26	0.039	Melts at 2237° F.
8	3.30	2.80	0.50	2.00	0.60	0.08	0.03	Swedish char-coal pig.
9	2.25-2.5	0.6-0.8	0.8-1.2	0.4-0.8	0.15-0.4	For engine cylinders.
10	3.40	3.40	trace	2.90	0.50	1.65	0.04	English, high P. No. 1.
11	3.40	3.20	0.20	2.60	0.50	1.58	0.04	English, high P. No. 3.
12	3.2-3.6	0.1-0.15	2.5-2.8	up to 1.0	1.3-1.5	.03-.04	For thin ornamental work.
13	3.0-3.2	0.4-0.5	2-2.3	up to 1.0	1-1.3	.06-.08	For medium size castings.
14	2.8-3.0	0.4-0.6	1.2-1.5	0.6-0.9	0.4-0.6	.06-.08	Heavy machinery castings.
15	2.5-2.8	0.6-0.8	1.0-1.3	0.5-0.7	0.4-0.7	.08-.12	Cylinders and hydraulic work.
16	1.2-1.8	0.4-1.0	0.4-0.7	to .06	For hydraulic cylinders.
17	2.7-3.0	0.5-0.8	0.5-0.7	0.3-0.5	0.3-0.5	.05-.07	For car wheels.
18	2.6-3.1	0.6-1.0	0.6-0.7	0.1-0.3	0.3-0.5	.05-.08	For car wheels.
19	2.5-3.0	0.4-0.9	1.3-1.7	0.5-1.0	0.3-0.4	.03 max	Charcoal pig. 1/4 in. chill.
20	2.3-2.7	0.5-1.0	1.0-1.5	0.5-1.0	0.3-0.4	.03	" Ditto 1/2 in. chill.
21	2.0-2.5	0.8-1.2	0.8-1.2	0.5-1.0	0.3-0.4	.035	" Ditto 3/4 in. chill.
22	1.8-2.2	0.9-1.4	0.5-1.0	0.3-0.7	0.3-0.4	.035	" Ditto 1 in. chill.
23	3.87	3.44	0.43	1.67	0.29	0.095	0.032	Series A. Am. F'dmen's Assn.
24	3.82	3.23	0.59	1.95	0.39	0.405	0.042	Series B. ditto.
25	3.84	3.52	0.32	2.04	0.39	0.578	0.044	Series C. ditto.
26	2.8-3.2	0.5-0.7	1.3-1.5	0.3-0.6	0.5-0.8	.06-.10	For locomotive cylinders.
27	2.3-2.4	0.8-1.0	1.8-2.0	0.8-1.0	0.6-0.8	.06-.10	" Semi-steel."
28	2.4-2.6	0.8-1.0	0.9-1.0	0.6-0.7	0.1-0.3	.04-.06	" Semi-steel."
29	4.33	3.08	1.25	0.73	0.44	0.43	0.08	A strong car wheel, Cu, 0.03.
30	3.17	2.72	0.45	1.99	0.39	0.65	0.13	Automobile cylinders.
31	3.34	2.57	0.77	1.89	0.39	0.70	0.09	Ditto.
32	3.5	2.9	0.6	0.7	0.4	0.5	0.08	Good car wheel.
33	3.55	3.0	0.55	2.75	2.39	0.86	0.014	Scotch irons.
34	3.10	1.80	0.90	" Am. Scotch " Ohio irons.
35	0.75-1.5	to 0.6	to 0.22	to 0.04	Pig for malleable castings.
36	2-25	to 0.7	to 0.7	to 0.15	Brake-shoes.
37	1.2-1.5	0.5-0.8	0.35-0.6	to 0.09	Hard iron for heavy work.
38	1.5-2	0.5-0.8	0.35-0.6	to 0.08	Medium iron for general work.
39	2.2-2.8	to 0.7	to 0.7	to 0.085	Soft iron cast'gs

23 to 25. Series of bars tested by a committee of the association. See results of tests on page 419. Series A, soft Bessemer mixture; B, dynamo-frame iron; C, light machinery iron. Samples for analysis were taken from the 1-in. square dry sand bars.

26. Specifications by a committee of the Am. Ry. Mast. Mechs. Assn., 1906. T.S., 25,000; transverse test, 3000 lb. on 1 1/4-in. round bar, 12 in. between supports; deflection, 0.1 in. minimum; shrinkage, 1/8 in. max. 27, soft "semi-steel;" 28, harder do. They approach air-furnace iron in most respects, and excel it in strength; test bars 2 X 1 X 24 in. of the low Si semi-steel showing 2800 to 3000 lb. transverse strength, with 7/16 in. deflection. M. B. Smith, *Eng. Digest*, Aug., 1908. 29. J. M. Hartman, *Bull. I. & S. Assn.*, Feb., 1892. The chill was very hard, 1/4 in. deep at root of flange, 1/2 in. deep on tread. 30, 31. Strong and shock-resisting. T.S., 38,000. *Castings*, June, 1908. 32. Com. of A.S.T.M., 1905, *Proc.*, v. 65. Successful wheels varying quite considerably from these figures may be made. 33, 34. C. A. Meissner, *Iron Age*, 1890. Average of several. 35. R. Moldenke, *A.S.M.E.*, 1908. 36-39. J. W. Keep, *A.S.M.E.*, 1907.

A *Chilling Iron* is one which when cooled slowly has a gray fracture, but when cast in a mold one side of which is a thick mass of cast-iron, called a chill, the fractured surface shows white iron for some depth on the side that was rapidly cooled by the chill. See Table Nos. 19-22.

Specifications for Castings, recommended by a committee of the A.S.T.M., 1908. S in gray iron castings, light, not over 0.08; medium, not over 0.10; heavy, not over 0.12. A light casting is one having no section over 1/2 in. thick, a heavy casting one having no section less than 2 in. thick, and a medium casting one not included in the classification of light or heavy. The transverse strength of the arbitration bar shall not be under 2500 lb. for light, 2900 lb. for medium, and 3300 lb. for heavy castings; in no case shall the deflection be under 0.10 in. When a tensile test is specified this shall run not less than 18,000 lb. per sq. in. for light, 21,000 lb. for medium, and 24,000 lb. for heavy castings.

The "arbitration bar" is 1 1/4 in. diam., 15 in. long, cast in a thoroughly dried and cold sand mold. The transverse test is made with supports 12 in. apart. The moduli of rupture corresponding to the figures for transverse strength are respectively 39115, 45373, and 51632, being the product of the figures given and the constant 15.646, the factor for R/P for a 1 1/4-in. round bar 12 in. between supports.* The standard form of tensile test piece is 0.8 in. diam., 1 in. long between shoulders, with a fillet 7/32 in. radius, and ends 1 in. long, 1 1/4 in. diam., cut with standard thread, to fit the holders of the testing machine.

Specifications by J. W. Keep, *A.S.M.E.*, 1907. See Table of Analyses, Nos. 37-39, page 417. Transverse test, 1 x 1 x 12-in. bar, hard iron castings. No. 37, 2400 to 2600 lb.; tensile test of same bar, 22,000 to 25,000 lb. No. 38, medium, transverse, 2200 to 2400; tensile, 20,000 to 23,000. No. 39, soft, transverse, 2000 to 2200; tensile, 18,000 to 20,000.

Standard Specifications for Foundry Pig Iron.

(American Foundrymen's Association, May, 1909.)

ANALYSIS. — It is recommended that foundry pig be bought by analysis.

SAMPLING. — Each carload or its equivalent shall be considered as a unit. One pig of machine-cast, or one-half pig of sand-cast iron shall be taken to every four tons in the car, and shall be so chosen from different parts of the car as to represent as nearly as possible the average quality of the iron. Drillings shall be taken so as to fairly represent the composition of the pig as cast. An equal quantity of the drillings from each pig shall be thoroughly mixed to make up the sample for analysis.

PERCENTAGE OF ELEMENTS. — When the elements are specified the following percentages and variations shall be used. Opposite each percentage of the different elements a syllable has been affixed so that buyers, by combining these syllables, can form a code word to be used in telegraphing.

* Formula, $1/4 Pl = RI/c$; see page 283. $I = 1/64 \pi c^4$; $c = 1/2 d$; $d = 1 1/4$ in.; $l = 12$ in.

SILICON		SULPHUR		TOTAL CARBON		MANGANESE		PHOSPHORUS	
%	Code	(max.)	Code	(min.)	Code	%	Code	%	Code
1.00	La	0.04	Sa	3.00	Ca	0.20	Ma	0.20	Pa
1.50	Le	0.05	Se	3.20	Ce	0.40	Me	0.40	Pe
2.00	Li	0.06	Si	3.40	Ci	0.60	Mi	0.60	Pi
2.50	Lo	0.07	So	3.60	Co	0.80	Mo	0.80	Po
3.00	Lu	0.08	Su	3.80	Cu	1.00	Mu	1.00	Pu
		0.09	Sy			1.25	My	1.25	Py
		0.10	Sh			1.50	Mh	1.50	Ph

Percentages of any element specified one-half way between the above shall be designated by the addition of the letter *x* to the next lower symbol, thus Lex means 1.75 Si.

Allowed variation: Si, 0.25; P, 0.20; Mn, 0.20. The percentages of P and Mn may be used as maximum or minimum figures when so specified.

Example: — Le-sa-pl-me represents 1.50 Si, 0.04 S, 0.60 P, 0.40 Mn.

BASE OR QUOTING PRICE. — For market quotations an iron of 2.00 Si (with variation 0.25 either way) and S 0.05 (max.) shall be taken as the base. The following table may be filled out, and become a part of a contract; "B," or base, represents the price agreed upon for a pig of 2.00 Si and under 0.05 S. "C" is a constant differential to be determined at the time the contract is made.

Sul-	Silicon									
phur	3.25	3.00	2.75	2.50	2.25	2.00	1.75	1.50	1.25	1.00
0.04	B+6C	B+5C	B+4C	B+3C	B+2C	B+C	B	B-1C	B-2C	B-3C
0.05	B+5C	B+4C	B+3C	B+2C	B+1C	B	B-1C	B-2C	B-3C	B-4C
0.06	B+4C	B+3C	B+2C	B+1C	B	B-1C	B-2C	B-3C	B-4C	B-5C
0.07	B+3C	B+2C	B+1C	B	B-1C	B-2C	B-3C	B-4C	B-5C	B-6C
0.08	B+2C	B+1C	B	B-1C	B-2C	B-3C	B-4C	B-5C	B-6C	B-7C
0.09	B+1C	B	B-1C	B-2C	B-3C	B-4C	B-5C	B-6C	B-7C	B-8C
0.10	B	B-1C	B-2C	B-3C	B-4C	B-5C	B-6C	B-7C	B-8C	B-9C

Specifications for Metal for Cast-iron Pipe. — *Proc. A.S.T.M.*, 1905, *A.I.M.E.*, xxxv, 166. Specimen bars 2 in. wide x 1 in. thick x 24 in. between supports, loaded in the center, for pipes 12 in. or less in diam. shall support 1900 lb. and show a deflection of not less than 0.30 in. before breaking. For pipes larger than 12 in., 2000 lb. and 0.32 in. The corresponding moduli of rupture are respectively 34,200 and 36,000 lb. Four grades of pig are specified: No. 1, Si, 2.75; S, 0.035. No. 2, Si, 2.25; S, 0.045. No. 3, Si, 1.75; S, 0.055. No. 4, Si, 1.25; S, 0.065. A variation of 10% of the Si either way, and of 0.01 in the S above the standard, is allowed.

Tensile Tests of Cast-iron Bars.

(American Foundrymen's Association, 1899.)

Size, in...	Square Bars.				Round Bars.			
	0.5 x 0.5	1 x 1	1.5 x 1.5	2 x 2	0.56	1.13	1.69	2.15
(A) g. c.	15,900	13,900	12,100	10,600	16,000	13,800	12,000	11,000
" g. m.	15,400	12,900	10,900	10,900	13,800	13,500	12,200	12,200
" d. s.	14,600	12,900	12,300	9,800	14,300	13,700	11,700	10,500
" d. m.	13,800	13,800	13,400	12,100	13,600	13,200	10,600	10,600
(B) g. c.	17,100	15,200	12,900	11,500	16,500	15,900	13,100	11,400
" g. m.	17,600	15,000	11,800	11,800	19,000	15,400	12,500	12,500
" d. c.	16,300	15,100	13,300	11,100	16,700	16,200	13,200	11,000
" d. m.	18,400	15,000	12,100	12,100	16,900	15,100	13,100	13,100
(C) g. c.	17,700	16,000	12,500	11,100	17,800	15,900	14,200	12,000
" g. m.	18,500	15,100	11,700	11,700	17,400	15,000	11,600	11,600
" d. c.	16,400	16,000	12,200	11,300	16,400	15,900	14,000	11,600
" d. m.	17,100	14,100	9,800	9,800	17,700	15,900	10,400	10,400
av. g. c.	13,600	16,100	13,400	11,300	13,400	16,000	13,900	11,600
av. d. c.	15,800	15,500	13,400	11,000	15,800	15,700	13,800	11,200
av. c. c.	14,700	14,800	12,500	10,900	16,300	15,200	13,000	11,200
av. m. c.	16,800	14,200	11,400	11,400	16,400	14,600	11,700	11,700

Transverse Tests of Cast-Iron Bars. Modulus of Rupture.

Size *	0.5x0.5	1x1	1.5x1.5	2x2	2.5x2.5	3x3	3.5x3.5	4x4
Diam. †	0.56	1.13	1.69	2.15	2.82	3.38	3.95	4.51
(A) r. d. c.	31,100	33,400	33,900	31,700	27,000	26,600	23,400	22,600
" r. d. m.		27,800	38,000	32,300	28,000	28,600	22,400	22,900
(B) s. g. c.	44,400	39,100	39,500	33,900	31,900	29,700	27,200	27,600
" s. g. m.		37,400	40,300	34,700	35,800	33,500	30,100	27,100
" s. d. c.	35,500	38,300	34,000	32,900	31,900	30,200	29,300	25,900
" s. d. m.		30,200	36,200	33,300	35,200	30,900	28,100	25,800
" r. g. c.	36,400	46,200	41,200	41,400	41,300	36,300	34,800	31,000
" r. g. m.		40,000	44,800	38,800	37,100	32,900	32,700	32,300
" r. d. c.	37,800	49,000	44,300	39,200	40,700	31,800	35,300	31,100
" r. d. m.		39,100	37,800	37,700	33,900	32,800	32,000	31,200
(C) s. g. c.	51,800	39,200	33,600	37,900	32,200	31,100	31,300	29,200
" s. g. m.			40,200	37,000	33,700	33,300	32,300	27,900
" s. d. c.	48,000	39,100	38,800	35,100	31,200	29,300	29,300	27,800
" s. d. m.			38,900	35,400	33,500	32,700	29,100	25,500
" r. g. c.	62,800	48,500	39,000	44,500	41,400	41,200	35,000	32,300
" r. g. m.		55,700	49,200	42,900	41,500	36,500	34,100	36,000
" r. d. c.	53,000	50,400	44,000	40,200	39,500	37,800	35,200	32,100
" r. d. m.		47,900	51,300	38,000	38,900	36,300	32,200	33,500
Av. (B) s.	39,900	36,200	37,500	33,700	33,700	31,100	28,700	26,600
" r.	37,100	43,600	42,000	39,300	38,200	33,400	33,700	31,400
(C) s.	49,900	39,100	37,900	36,300	32,600	31,600	30,500	27,600
" r.	57,900	50,600	45,900	41,400	40,400	37,900	34,100	33,200
" (B) & (C) g.	43,800	43,100	41,000	38,800	36,800	33,900	32,200	30,400
" " d.	43,300	41,600	40,700	36,500	35,600	32,700	31,300	30,400
Gen'l av.	46,100	42,400	40,800	37,700	36,200	33,400	31,700	29,900
Equiv. load.	320	2356	7650	16,756	31,424	50,109	75,516	106,311

* Size of square bars as cast, in. † Diam. of round bars as cast, in.

Compression Tests of Cast-iron Bars.

Size, in.	0.5x0.5	1x1	1.5x1.5	2x2	2.5x2.5	3x3	3.5x3.5	4x4
(A) (1)	29,570	20,010	17,180	13,810	10,950	9,830	9,350	9,100
" (2)		21,990	17,920	13,750	12,040	11,200	10,770	10,340
" (3)			17,180	13,880	11,430	10,270	9,830	9,950
" (4)					10,950	10,430	9,540	9,570
(B) (1)	38,360	23,000	20,980	18,130	15,060	13,790	13,160	12,430
" (2)		12,440	24,820	21,640	18,270	17,000	15,970	16,140
" (3)			20,980	18,740	15,940	14,410	15,200	13,950
" (4)				15,060		13,900	13,560	13,750
(C) (1)	38,360	24,890	20,750	18,010	15,840	15,950	15,880	14,220
" (2)		27,900	22,060	21,750	19,800	18,170	17,100	16,410
" (3)			20,750	19,340	18,050	16,850	16,510	15,250
" (4)				17,840		16,040	16,080	14,880

NOTES ON THE TABLES OF TESTS. — The machined bars were cut to the next size smaller than the size they were cast. The transverse bars were 12 in. long between supports. (A), (B), (C), three qualities of iron; for analyses see page 417; r, round bars; s, square bars; d, cast in dry sand; g, cast in green sand; c, bar tested as cast; m, bar machined to size. The general average (next to last line of the first table) is the average of the six lines preceding. The equivalent load (last line) is the calculated total load that would break a square bar whose modulus of rupture is that of the general average.

COMPRESSION TESTS. — The figures given are the crushing strengths, in pounds, of 1/4 in. cubes cut from the bars. Multiply by 4 to obtain lbs. per sq. in. (1) Cube cut from the middle of the bar; (2) first 1/4 in. from edge; (3) second 1/4 in. from edge; (4) third 1/4 in. from edge.

SOME TESTS OF CAST IRON. (G. Lanza, *Trans. A.S.M.E.*, x, 187.) — The chemical analyses were as follows: Gun iron: TC, 3.51; GC, 2.80; S, 0.133; P, 0.155; Si, 1.140. Common iron: S, 0.173; P, 0.413; Si, 1.89.

The test specimens were 26 in. long; those tested with the skin on being very nearly 1 in. square, and those tested with the skin removed being cast nearly 1 1/4 in. square, and afterwards planed down to 1 in. square.

Tensile Strength. Elastic Limit. Modulus of Elasticity.

Unplaned common	20,200 to 23,000 T.S. Av. = 22,066	6,500	13,194,233
Planed common	20,300 to 20,800 " " = 20,520	5,833	11,943,953
Unplaned gun	27,000 to 28,775 " " = 28,175	11,000	16,130,300
Planed gun	29,500 to 31,000 " " = 30,500	8,500	15,932,880

The elastic limit is not clearly defined in cast iron, the elongations increasing faster than the increase of the loads from the beginning of the test. The modulus of elasticity is therefore variable, decreasing as the loads increase.

The Strength of Cast Iron depends on many other things besides its chemical composition. Among them are the size and shape of the casting, the temperature at which the metal is poured, and the rapidity of cooling. Internal stresses are apt to be induced by rapid cooling, and slow cooling tends to cause segregation of the chemical constituents and opening of the grain of the metal, making it weak. The author recommends that in making experiments on the strength of cast iron, bars of several different sizes, such as 1/2, 1, 1 1/2, and 2 in. square (or round), should be taken, and the results compared. Tests of bars of one size only do not furnish a satisfactory criterion of the quality of the iron of which they are made. *Trans. A.I.M.E.*, xxvi, 1017.

Theory of the Relation of Strength to Chemical Constitution. — J. E. Johnston, Jr. (*Am. Mach.*, April 5 and 12, 1900), and H. M. Howe (*Trans. A.I.M.E.*, 1901) have presented a theory to explain the variation in strength of cast iron with the variation in combined carbon. It is that cast iron is steel of CC ranging from 0 to 4%, with particles of graphite, which have no strength, enmeshed with it. The strength of the cast iron therefore is that of the steel or graphiteless iron containing the same percentage of CC, weakened in some proportion to the percentage of GC. The tensile strength of steel ranges approximately from 40,000 lb. per sq. in. with 0 C to 125,000 lb. with 1.20 C. With higher C it rapidly becomes weak and brittle. White cast iron with 3% CC is about 30,000 T.S., and with 4% about 18,000. The amount of weakening due to GC is not known, but by making a few assumptions we may construct a table of hypothetical strengths of different compositions, with which results of actual tests may be compared. Suppose the strength of the steel-white cast-iron series is as given below for different percentages of CC, that 6.25% GC entirely destroys the strength, and that the weakening effect of other percentages is proportional to the ratio of the square root of that percentage to the square root of 6.25, that the TC in two irons is respectively 3% and 4%, then we have the following:

Per cent CC.	0	0.2	0.4	0.6	0.8	1.0	1.2	1.5	2.0	2.5	3	3.5	4
Steel, T.S.	40	60	80	100	110	120	125	110	60	40	30	22	18
Cast iron, 4%													
TC	8	13.2	19.2	26	31.2	37	41.5	40.5	26	20.7	18	15.8	18
Cast iron, 3%													
TC	15.4	19.9	28.5	38	42.9	52.1	58	56.1	36	28.7	30		

The figures for strength are in thousands of pounds per sq. in. The table is calculated as follows: Take 0.6 CC; with 4% TC, this leaves 3.4 GC, and with 3% TC, 2.4 GC. The sq. root of 3.4 is 1.9, and of 2.4 is 1.55. The ratio of these to √6.25 is respectively 74 and 62%, which subtracted from 100 leave 26 and 38% as the percentage of strength of the 0.6 C steel remaining after the effect of the GC is deducted. The table indicates that strength is increased as total C is diminished, and this agrees with general experience.

Relation of Strength to Size of Bar as Cast. — If it is desired that a test bar shall fairly represent a casting made from the same iron, then the dimensions of the bar as cast should correspond to the dimensions of the casting, so as to have about the same ratio of cooling surface to volume that the casting has. If the test bar is to represent the strength of a plate, it should be cut from the plate itself if possible or else cut from a cylindrical shell made of considerable diameter and of a thickness equal to that of the casting. If the test is for distinguishing the quality of the iron, then at least two test bars should be cast, one say 1/2 or 5/8 in. and one say 2 or 2 1/2 in. diameter, in order to show the effect of rapid and slow cooling.

In 1904 the author made some tests of four bars of "semi-steel" advertised to have a strength of over 30,000 lb. per sq. in. The bars were cast 1/2, 1, 2, and 3 in. diam., and turned to 0.46, 0.69, 1.6, and 1.85 in. respectively. The results of transverse and tensile tests were:

Mod. of rupture... 1/2 in., 100,000; 1 in., 61,613; 2 in., 67,619; 3 in., 58,543
T.S. per sq. in. 38,510; " 37,005; " 25,685; " 20,375

The 1/2-in. piece was so hard that it could not be turned in a lathe and had to be ground.

Influence of Length of Bar upon the Modulus of Rupture.—(R. Moldenke, *Jour. Am. Foundrymen's Assn.*, Sept., 1899.) Seven sets, each of five 2-in. square bars, made of a heavy machinery mixture, and cast on end, were broken transversely, the distance between supports ranging from 6 to 16 ins. The average results were:

Dist. bet. supports, ins. 6 8 10 12 14 16
Modulus of rupture 40,000 39,000 35,600 37,000 36,000 34,400

The 10-in. bar in six out of seven cases gave a lower result than the 12-in. It appears that the ordinary formulas used in calculating the cross breaking strength of beams are not only incorrect for cast iron, on account of the chemical differences in the iron itself when in different cross sections, but that with the cross sections identical the distance between the supports must be specially provided for by suitable constants in whatever formulæ may be developed. As seen from the above results, the doubling of the distance between supports means a drop in the modulus of rupture in the same sized bar of nearly 10 per cent.

Strength in Relation to Silicon and Cross-section.—In castings one half-inch square in section the strength increases as silicon increases from 1.00 to 3.50; in castings 1 in. square in section the strength is practically independent of silicon, while in larger castings the strength decreases as silicon increases.

The following table shows values taken from Mr. Keep's curves of the approximate transverse strength of cast bars of different sizes reduced to the equivalent strength of a 1/2-in. x 12-in. bar.

Silicon, Per cent.	Size of Square Cast Bars.					Silicon, Per cent.	Size of Square Cast Bars.				
	1/2 in.	1 in.	2 in.	3 in.	4 in.		1/2 in.	1 in.	2 in.	3 in.	4 in.
	Strength of a 1/2-in. x 12-in. Section, lb.						Strength of a 1/2-in. x 12-in. Section, lb.				
1.00	290	260	232	222	220	2.50	392	278	212	190	184
1.50	324	272	228	212	208	3.00	426	276	202	180	172
2.00	358	278	220	202	196	3.50	446	264	192	168	160

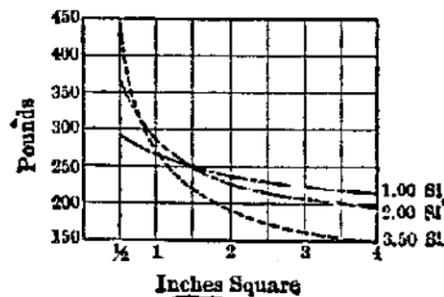

FIG. 92.

Fig. 92 shows the relation of the strength to the size of the cast-iron bar and to Si, according to the figures in the above table. Comparing the 2-in. bars with the 1/2-in. bars, we find

Si, per cent. 1 1.5 2 2.5 3 3.5
2-in. weaker than 1/2-in., per cent. 20 30 35 46 53 57

The fact that with the 1-in. bar the strength is nearly independent of Si, shows that it is the worst size of bar to use to distinguish the quality of the metal. If two bars were used, say 1/2-in. and 2-in., the drop in strength would be a better index to the quality than the test of any single bar could be.

Shrinkage of Cast Iron.—W. J. Keep (*A. S. M. E.* xvi., 1082) gives a series of curves showing that shrinkage depends on silicon and on the cross-section of the casting, decreasing as the silicon and the section increase. The following figures are obtained by inspection of the curves:

Silicon, Per cent.	Size of Square Bars.					Silicon, Per cent.	Size of Square Bars.				
	1/2 in.	1 in.	2 in.	3 in.	4 in.		1/2 in.	1 in.	2 in.	3 in.	4 in.
	Shrinkage, In. per Foot.						Shrinkage, In. per Foot.				
1.00	0.178	0.158	0.129	0.112	0.102	2.50	0.142	0.121	0.091	0.072	0.060
1.50	.166	.145	.116	.099	.088	3.00	.130	.109	.078	.058	.046
2.00	.154	.133	.104	.086	.074	3.50	.118	.097	.065	.045	.032

Mr. Keep says: "The measure of shrinkage is practically equivalent to a chemical analysis of silicon. It tells whether more or less silicon is needed to bring the quality of the casting to an accepted standard of excellence."

A shrinkage of 1/8 in. per ft. is commonly allowed by pattern makers. According to the table, this shrinkage will be obtained by varying the Si in relation to the size of the bar as follows: 1/2 in., 3.25 Si; 1 in., 2.4 Si; 2 in., 1.1 Si; 3 and 4, less than 1.0 Si.

Shrinkage and Expansion of Cast Iron in Cooling. (T. Turner, *Proc. I. & S. I.*, 1906.)—Some irons show the phenomenon of expanding immediately after pouring, and then contracting. Four irons were tested, analyzing as follows: (1) "Washed" white iron, CC 2.73; Si, 0.01; P, 0.01; Mn and S, traces. (2) Gray hematite, GC, 2.53; CC, 0.86; Si, 3.47; Mn, 0.55; P, 0.04; S, 0.03. (3) Northampton, GC, 2.60; CC, 0.15; Si, 3.98; Mn, 0.50; P, 1.25; S, 0.03. (4) Cast iron, GC, 2.73; CC, 0.79; Si, 1.41; Mn, 0.43; P, 0.96; S, 0.07. No. 1 was stationary for 5 seconds after pouring, shrunk 125 sec., stationary 10 sec., then shrunk till cold. No. 2 expanded 15 sec., shrunk 20 sec. to original size, continued shrinking 90 sec. longer, stationary 10 sec., expanded 30 sec., then shrunk till cold. No. 3 expanded irregularly with three expansions and two shrinkages, until 125 sec. after pouring the total expansion was 0.019 in. in 12 in., then shrunk till cold. No. 4 expanded 0.08 in. in 50 sec., then shrunk till cold.

Shrinkage Strains Relieved by Uniform Cooling. (F. Schumann, *A.S.M.E.*, xvii., 433.)—Mr. Jackson in 1873 cast a flywheel with a very large rim and extremely small straight arms. Cast in the ordinary way, the arms broke either at the rim or at the hub. Then the same pattern was molded so that large chunks of iron were cast between the arms, a thickness of sand separating them. Cast in this way, all the arms remained unbroken.

Deformation of Castings from Unequal Shrinkage.—(F. Schumann, *A. S. M. E.*, vol. xvii.) A prism cast in a sand mold will maintain its alignment, after cooling in the mold, provided all parts around its center of gravity of cross section cool at the same rate as to time and temperature. Deformation is due to unequal contraction, and this is due chiefly to unequal cooling.

Modifying causes that effect contraction are: Imperfect alloying of two or more different irons having different rates of contraction; variations in the thickness of sand forming the mold; unequal dissipation of heat, the upper surface dissipating the greater amount of heat; position and form of cores, which tend to resist the action of contraction, also the difference in conducting power between moist sand and dry-baked cores; differences in the degree of moisture of the sand; unequal expos-

ure by the removal of the sand while yet in the act of contracting; flanges, ribs, or gussets that project from the side of the prism, of sufficient area to cause the sand to act as a buttress, and thus prevent the natural longitudinal adjustment due to contraction; in light castings of sufficient length the unyielding sand between the flanges, etc., may cause rupture.

Irregular Distribution of Silicon in Pig Iron.—J. W. Thomas (*Iron Age*, Nov. 12, 1891) finds in analyzing samples taken from every other bed of a cast of pig iron that the silicon varies considerably, the iron coming first from the furnace having generally the highest percentage. In one series of tests the silicon decreased from 2.040 to 1.713 from the first bed to the eleventh. In another case the third bed had 1.280 Si, the seventh 1.718, and the eleventh 1.101. He also finds that the silicon varies in each pig, being higher at the point than at the butt. Some of his figures are: Point of pig, 2.328 Si; butt of same, 2.157; point of pig, 1.834; butt of same, 1.787.

White Iron Converted into Gray by Heating. (A. E. Outerbridge, Jr., *Proc. Am. Socy. for Testing Mat'ls*, 1902, p. 229.)—When white chilled iron containing a considerable amount of Si and low in GC is heated to about 1850° F. from 3½ to 10 hours the CC is changed into C, which differs materially from graphite, and a metal is formed which has properties midway between those of steel and cast iron. The specific gravity is raised from 7.2 to about 7.8; the fracture is of finer grain than normal gray iron; and the metal is capable of being forged, hardened, and taking a sharp cutting edge, so that it may be used for axes, hatchets, etc. It differs from malleable cast iron, since the latter has its carbon removed by oxidation, while the converted cast iron retains its original total carbon, although in a changed form. The tensile strength of the new metal is high, 40,000 to 50,000 lb. per sq. in., with very small elongation. The peculiar change from white to gray iron does not take place if Si is low. The analysis of the original castings should be about TC, 3.4 to 3.8; Si, 0.9 to 1.2; Mn, 0.35 to 0.20; S, 0.05 to 0.04; P, 0.04 to 0.03. The following shows the change effected by the heat treatment:

Before annealing, GC, 0.72; CC, 2.60; Si, 0.71; Mn, 0.11; S, 0.045; P, 0.04
After annealing, GC, 2.75; CC, 0.82; Si, 0.73; Mn, 0.11; S, 0.040; P, 0.04

The GC after annealing is, however, not ordinary graphite, but an allotropic form, evidently identical with what Ledebur calls "tempering graphite carbon."

Change of Combined to Graphitic Carbon by Heating.—(H. M. Howe, *Trans. A. I. M. E.*, 1908, p. 483.) On heating white cast iron to different temperatures for some hours, the carbon changes from the combined to the graphitic state to a degree which increases in general with the temperature and with the silicon-content. With 0.05 Si, a little graphite formed at 1832° F.; with 0.13 Si, at 1652° F.; with 2.12 Si, graphite formed at a moderate rate at 1112°, and with 3.15 Si, it formed rapidly at 1112° F. In iron free from Si, with 4.271 comb. C. and 0.255 graphitic, none of the C. was changed to graphite on long heating to from 1680° to 2040° F., but in iron with 0.75 Si the graphite, originally 0.938%, rose to 1.69% on heating to 1787°, and to 2.795% on heating to 2057° F. On the other hand, when carbon enters iron, as in the cementation process in making blister-steel, it appears chiefly as cementite (combined carbon). Also on heating iron containing graphite to high temperatures and cooling quickly, some of the graphite is changed to cementite.

Mobility of Molecules of Cast Iron. (A. E. Outerbridge, Jr., *A. I. M. E.*, xxvi, 176; xxxv, 223.)—Within limits, cast iron is materially strengthened by being subjected to repeated shocks or blows. Six bars 1 in. sq., 15 in. long, subjected for about 4 hours to incessant blows in a tumbling barrel, were 10 to 15% stronger than companion bars not thus treated. Six bars were struck 1000 blows on one end only with a hand hammer, and they showed a like gain in strength. The increase is greater in hard mixtures, or strong iron, than in soft mixtures, or weak iron; greater in 1-in. bars than in ½-in., and somewhat greater in 2-in. than in 1-in. bars. Bars were treated in a machine by dropping a 14-lb. weight on the middle of a 1-in. bar, supports 12 in. apart. Six bars

were first broken by having the weight fall a sufficient distance to break them at the first blow, then six companion bars were subjected to from 10 to 50 blows of the same weight falling one-half the former distance, and then the weight was allowed to fall from the height at which the first bars broke. Not one of the bars broke at the first blow; and from 2 to 10, and in one case 15 blows from the extreme height were required to break them. Mr. Outerbridge believes that every casting when first made is under a condition of strain, due to the difference in the rate of cooling at the surface and near the center, and that it is practicable to relieve these strains by repeatedly tapping the casting, allowing the particles to rearrange themselves and assume a new condition of molecular equilibrium. The results, first reported in 1896, were corroborated by other experimenters. A report in *Jour. Frank. Inst.*, 1898, gave tests of 82 bars, in which the maximum gain in strength compared with untreated bars was 40%, and the maximum increase in deflection was 41%.

In his second paper, 1904, Mr. Outerbridge describes another series of tests which showed that 1-in. sq. bars 15 in. long subjected to repeated heating and cooling grew longer and thicker with each successive operation. One bar heated about an hour each day to about 1450° F. in a gas furnace for 27 times increased its length 1 11/16 in. and its cross-section 1/8 in. Soft iron expands more rapidly than hard iron. White iron does not expand sufficiently to cover the original shrinkage. Wrought iron and steel bars similarly treated in a closed tube all contracted slightly, the average contraction after 60 heatings being 1/8 in. per foot. The strength and deflection of the cast-iron bars was greatly decreased by the treatment, 1250 as compared with 2150 lb., and 0.1 in. deflection as compared with 0.15 in. The specific gravity of the expanded bars was 5.49 to 6.01, as compared with 7.13 for the untreated bars.

Grate-bars of boiler furnaces grow longer in use, as do also cast-iron pipes in ovens for heating air.

Castings from Blast Furnace Metal. Castings are frequently made from iron run directly from the blast furnace, or from a ladle filled with furnace metal. Such metal, if high in Si, is more apt to throw out "kish" or loose particles of graphite than cupola metal. With the same percentage of Si, it is softer than cupola metal, which is due to two causes: 1, lower S; 2, higher temperature. T. D. West, *A. I. M. E.*, xxxv, 211, reports an example of furnace metal containing Si, 0.51; S, 0.045; Mn, 0.75; P, 0.094; which was easily planed, whereas if it had been cupola metal it would have been quite hard. J. E. Johnson, Jr., *ibid.*, p. 213, says that furnace metal with S, 0.03, and Si, 0.7, makes good castings, not too hard to be machined. Should the metal contain over 0.9 Si, difficulty is experienced in preventing holes and soft places in the castings, caused by the deposition of kish or graphite during or after pouring. The best way to prevent this is to pour the iron very hot when making castings of small or moderate size.

Effect of Cupola Melting. (G. R. Henderson, *A. S. M. E.*, xx, 621.)—27 car-wheels were analyzed in the pig and also after remelting. The P remains constant, as does Si when under 1%. Some of the Mn always disappears. The total C remains the same, but the GC and CC vary in an erratic manner. The metal charged into the cupola should contain more GC, Si and Mn than are desired in the castings. Fairbairn (*Manufacture of Iron*, 1865) found that remelting up to 12 times increased the strength and the deflection, but after 18 remeltings the strength was only 5/8 and the deflection 1/3 of the original. The increase of strength in the first remeltings was probably due to the change of GC into CC, and the subsequent weakening to the increase of S absorbed from the fuel.

Hard Castings from Soft Pig. (B. F. Fackenthal, Jr., *A. I. M. E.*, xxxv, 993.)—Samples from a car load of pig gave Si, 2.61; S, 0.023. Castings from the same iron gave 2.33 and 2.26 Si, and 0.26 and 0.25 S, or 12 times the S in the original pig; probably due to fuel too high in S, but more probably to the use of too little fuel in remelting.

The loss of Si in remelting, and the consequent hardening, is affected by the amount of Mn, as shown below:

Mn, per cent.	0.04	0.20	0.43	0.53
Si lost in remelting, per cent.	34	23	12	4

Difficult Drilling due to Low Mn.—H. Souther, *A.S.T.M.*, v, 219, reports a case where thin castings drilled easily while thick parts on the same castings rapidly dulled 1/2 and 3/4-in. drills. The chemical constitution was normal except Mn; Si, 2.5; P, 0.7; S about 0.08; C, 3.5; Mn, 0.16. When the Mn was raised to 0.5 the trouble disappeared.

Addition of Ferro-silicon in the Ladle. (A. E. Outerbridge, *Proc. A.S.T.M.*, vi, 263.)—Half a pound of FeSi, containing 50% Si, added to a 200-lb. ladle of soft cast iron used for making pulleys with rims 1/4 in. thick, prevented the chilling of the surface of the casting, and enabled the pulleys to be turned more rapidly. Analysis showed that the actual increase of the Si in the casting was less than the calculated increase. Tests of the metal treated with FeSi as compared with untreated metal showed a gain in strength of from 2 to 26%, and a gain in deflection of 2 to 3%. The reason assigned for the increase of strength with increase of softness is that cupola iron contains a small amount of iron oxide, which reacts with the Si added in the ladle, forming SiO₂, which goes into the slag.

Experiments with Titanium added to cast iron in the ladle are reported by R. Moldenke, *Proc. Am. Fdrymen's Assn.*, 1908. Two irons were used: gray, with 2.58 Si, 0.042 S, 0.54 P, 0.74 Mn; and white, with 0.85 Si, 0.07 S, 0.42 P, 0.6 Mn. Two Fe Ti alloys with 10% Ti were used, one containing no C, and the other 5% C. The latter has the lower melting point. The results were as below:

		Gray Iron.		White Iron. Lbs.		
Original iron.....	9 tests	1720-2260 av.	2020	8 tests	1920-2110 av.	2050
Plus 0.05 Ti.....	4 tests	2750-3140 "	3100	11 tests	2210-2660 "	2400
Plus 0.10 Ti.....	3 tests	2880-3150 "	3030			
Plus 0.05 Ti and C	6 tests	2850-3230 "	3070	9 tests	2230-2720 "	2420
Plus 0.10 Ti and C	6 tests	2850-3150 "	2990	10 tests	2320-2460 "	2400
Plus 0.15 Ti and C	4 tests	3030-3270 "	3190	10 tests	2280-2620 "	2520
Average of treated iron.....		3070		2430		
Increase over original.....		52%		18%		
Modulus of rupture, treated iron, ...				48,030		38,020

The test bars were 1 1/4 in. diam. 12 in. between supports. The improvement is as marked whether 0.05, 0.10, or 0.15% Ti is used, which indicates that if sufficient Ti is used for deoxidation of the iron, any additional Ti is practically wasted.

Ti lessens the chilling action, yet whatever chill remains shows much harder iron. Test pieces made with iron which chilled 1 1/2 in. deep gave but 1 in. chill when the iron was treated in the ladle. The original iron crushed at 173,000 lbs. per sq. in. and stood 445 in Brinel's test for hardness, soft steel running about 105. The treated piece ran 298,000 lbs. per sq. in. and showed a hardness of 557. Testing the soft metal below the chilled portion for hardness gave 332 for the original and 322 for the treated piece.

Additions of Vanadium and Manganese.—R. Moldenke, *Am. Fdrymen's Assn.*, 1908, *Am. Mach.*, Feb. 20, '08. Experiments were made by adding to melted cast iron in the ladle a ground alloy of ferro-vanadium, containing 14.67 Va, 6.36 C, and 0.18 Si. In other experiments ferro-manganese (80% Mn) was added, together with the vanadium. Four kinds of iron were used: burnt gray iron (gratebars, stove iron, etc.), burnt white iron, gray machinery iron (Si, 2.72, S, 0.065, P, 0.068, Mn, 0.54) and remelted car wheels (white, two samples analyzed: Si, 0.60 and 0.53, S, 0.122, 0.138; P, 0.399, 0.374; Mn, 0.38, 0.44). The following are average results:

WARNING: This is a 1910 edition. Some of the material may no longer be accurate

Gray Machinery Iron.				Remelted Car Wheels.				
Added Per cent.		Breaking Strength, lbs.	Deflection, In.	Added Per cent.		Breaking Strength, lbs.	Deflection, In.	
Va.	Mn.			Va.	Mn.			
0.0	0.0	1980	0.105	0.0	0.0	1470	0.050	
0.0	0.50	1970	0.100	0.05	0.50	2790	0.070	
0.05	1980	0.100	0.05	3020	0.060	
0.05	0.50	2130	0.100	0.05	0.50	2970	0.090	
0.10	2372	0.090	0.10	2800	0.055	
0.10	0.50	2530	0.120	0.10	0.50	3030	0.090	
0.15	2360	0.100	0.15	2950	0.070	
	bars	0.15	0.50	3920	0.095	
Average treated		2224				3069		
Mod. of rupture.....				35,800				48,020

The bars were 1 1/4 in. diam. 12 in. between supports.

The burnt gray iron was increased in breaking strength from 1310 to 2220 lbs. by the addition of 0.05% Va, and the burnt white iron from 1440 to 1910 lbs. by the addition of 0.05 Va and 0.50 Mn.

Strength of Cast-Iron Beams.—C. H. Benjamin, *Mach'y*, May, 1906. Numerous tests were made of beams of different sections, including hollow rectangles and cylinders, I and T-shapes, etc. All the sections were made approximately the same area, about 4.4 sq. in., and all were tested by transverse loading, with supports 18 in. apart. The results, when reduced by the ordinary formula for stress on the extreme fiber, $S = My/I$, showed an extraordinary variation, some of the values being as follows: Square bar, 23,300; Round bar, 25,000. Hollow round, 3.4 in. outside and 2.5 in. inside diam., 26,450, and 35,800. Hollow ellipse, 3 in. wide, 3.9 in. high, 0.9 in. thick, 36,000. I-beam, 4 in. high, web 0.44 in. thick, 17,700. The hollow cylindrical and elliptical sections are much stronger than the solid sections. This is due to the thinner metal, the greater surface of hard skin, and freedom from shrinkage strains. Professor Benjamin's conclusions from these tests are:

- (1) The commonly accepted formulas for the strength and stiffness of beams do not apply well to cored and ribbed sections of cast iron.
- (2) Neither the strength nor the stiffness of a section increases in proportion to the increase in the section modulus or the moment of inertia.
- (3) The best way to determine these qualities for a cast-iron beam is by experiment with the particular section desired and not by reasoning from any other section.

Bursting Strength of Cast-Iron Cylinders.—C. H. Benjamin, *A. S. M. E.*, XIX, 597; *Mach'y*, Nov., 1905. Four cylinders, 20 in. long, 10 1/8 in. int. diam., 3/4 in. thick, with flanged ends and bolted covers, burst at 1350, 1400, 1350, and 1200 lbs. per sq. in. hydraulic pressure, the corresponding fiber stress, from the formula $S = pd/2t$, being 9040, 10,200, 9735 and 9080. Pieces cut from the shell had an average tensile strength of 14,000 lbs. per sq. in., and a modulus of rupture in transverse tests of 30,000.

Transverse Strength of Cast-iron Water-pipe. (*Technology Quarterly*, Sept., 1897.)—Tests of 31 cast-iron pipes by transverse stress gave a maximum outside fibre stress, calculated from maximum load, assuming each half of pipe as a beam fixed at the ends, ranging from 12,800 lbs. to 25,300 lbs. per sq. in.

Bars 2 in. wide cut from the pipes gave moduli of rupture ranging from 28,400 to 51,400 lbs. per sq. in. Four of the tests, bars and pipes:

Moduli of rupture of bar.....	28,400	34,400	40,000	51,400
Fiber stress of pipe.....	18,300	12,800	14,500	26,300

These figures show a great variation in the strength of both bars and pipes, and also that the strength of the bar does not bear any definite relation to the strength of the pipe.

Bursting Strength of Flanged Fittings. — *Power*, Feb. 4, 1908. The Crane Company, Chicago, published in the *Valve World* records of tests of tees and ells, standard and extra heavy, which show that the bursting strength of such fittings is far less than is given by the standard formulæ for thick cylinders. As a result of the tests they give the following empirical formula: $B = TS/D$, in which B = bursting pressures, lbs. per sq. in., T = thickness of metal, D = inside diam., and S = 85% of the tensile strength of the metal for pipes up to 12 in. diam., for larger sizes use 60%. The pipes were made of "ferro-steel" of 33,000 lbs. T. S., and of cast iron of 22,000 lbs. as tested in bars. The following are the principal results of tests of extra heavy tees and ells compared with results of calculation by the Crane Company's formula:

BURSTING STRENGTH OF PIPE-FITTINGS. POUNDS PER SQUARE INCH.

Inside Diam. Thickness.	6 3/4	8 13/16	10 15/16	12 1	14 1 1/8	16 1 3/16	18 1 1/4	20 1 5/16	24 1 1/2
B, Ferro-steel.....	2733	2250	2160	2033	1825	1700	1450	1275	1300
calculated.....	2680	2180	2010	1870	1570	1450	1350	1280	1220
B, Cast iron.....	1687	1350	1306	1380	1100	1025	600	750	700
calculated.....	1790	1450	1340	1190	1060	980	920	870	820
Ells. ferro steel....	3266	2725	2350	2133					
" cast-iron.....	2275	1625	1541	1275	1075	1250			

Specific Gravity and Strength. (Major Wade, 1856.)

Third-class guns: Sp. Gr. 7.087, T. S. 20,148. Another lot: least Sp. Gr. 7.163, T. S. 22,402.

Second-class guns: Sp. Gr. 7.154, T. S. 24,767. Another lot: mean Sp. Gr. 7.302, T. S. 27,232.

First-class guns: Sp. Gr. 7.204, T. S. 28,805. Another lot: greatest Sp. Gr. 7.402, T. S. 31,027.

Strength of Charcoal Pig Iron. — Pig iron made from Salisbury ores, in furnaces at Wassaic and Millerton, N. Y., has shown over 40,000 lbs. T. S. per square inch, one sample giving 42,281 lbs. Murkirk, Md., iron tested at the Washington Navy Yard showed: average for No. 2 iron, 21,601 lbs.; No. 3, 23,959 lbs.; No. 4, 41,329 lbs.; average density of No. 4, 7.336 (*J. C. I. W.*, v, p. 44).

Nos. 3 and 4 charcoal pig iron from Chapinville, Conn., showed a tensile strength per square inch of from 34,761 lbs. to 41,882 lbs. Charcoal pig iron from Shelby, Ala. (tests made in August, 1891), showed a strength of 34,800 lbs. for No. 3; No. 4, 39,675 lbs.; No. 5, 46,450 lbs.; and a mixture of equal parts of Nos. 2, 3, 4, and 5, 41,470 lbs. (*Bull. I. & S. A.*)

Variation of Density and Tenacity of Gun-Irons. — An increase of density invariably follows the rapid cooling of cast iron, and as a general rule the tenacity is increased by the same means. The tenacity generally increases quite uniformly with the density, until the latter ascends to some given point; after which an increased density is accompanied by a diminished tenacity.

The turning-point of density at which the best qualities of gun-iron attain their maximum tenacity appears to be about 7.30. At this point of density, or near it, whether in proof-bars or gun-heads, the tenacity is greatest.

As the density of iron is increased its liquidity when melted is diminished. This causes it to congeal quickly, and to form cavities in the interior of the casting. (Pamphlet of Builders' Iron Foundry, 1893.)

"Semi-steel" is a trade name given by some founders to castings made from pig iron melted in the cupola with additions of from 20 to 30 per cent of steel scrap. Ferro-manganese is also added either in the cupola or in the ladle. The addition of the steel dilutes the Si of the pig iron, and changes some of the C from GC to CC, but the TC is unchanged, for any reduction made by the steel is balanced by absorption of C from the fuel.

Semi-steel therefore is nothing more than a strong cast iron, low in Si and containing some Mn, and the name given it is a misnomer.

Mixture of Cast Iron with Steel. — Car wheels are sometimes made from a mixture of charcoal iron, anthracite iron, and Bessemer steel. The following shows the tensile strength of a number of tests of wheel mixtures, the average tensile strength of the charcoal iron used being 22,000 lbs. (*Jour. C. I. W.*, iii, p. 184):

	lbs. per sq. in.
Charcoal iron with 2 1/2% steel	22,467
" " " 3 3/4% steel	26,733
" " " 6 1/4% steel and 6 1/4% anthracite	24,400
" " " 7 1/3% steel and 7 1/2% anthracite	28,150
" " " 2 1/2% steel, 2 1/2% wro't iron, and 6 1/4% anth.	25,550
" " " 5 % steel, 5% wro't iron, and 10% anth.....	26,500

Cast Iron Partially Bessemerized. — Car wheels made of partially Bessemerized iron (blown in a Bessemer converter for 3 1/2 minutes), chilled in a chill test mold over an inch deep, just as a test of cold blast charcoal iron for car wheels would chill. Car wheels made of this blown iron have run 250,000 miles. (*Jour. C. I. W.*, vi, p. 77.)

Bad Cast Iron. — On October 15, 1891, the cast-iron fly-wheel of a large pair of Corliss engines belonging to the Amoskeag Mfg. Co., of Manchester, N.H., exploded from centrifugal force. The fly-wheel was 30 feet diameter and 110 inches face, with one set of 12 arms, and weighed 116,000 lbs. After the accident, the rim castings, as well as the ends of the arms, were found to be full of flaws, caused chiefly by the drawing and shrinking of the metal. Specimens of the metal were tested for tensile strength, and varied from 15,000 lbs. per square inch in sound pieces to 1000 lbs. in spongy ones. None of these flaws showed on the surface, and a rigid examination of the parts before they were erected failed to give any cause to suspect their true nature. Experiments were carried on for some time after the accident in the Amoskeag Company's foundry in attempting to duplicate the flaws, but with no success in approaching the badness of these castings.

Permanent Expansion of Cast Iron by Heating. (*Valve World*, Sept., 1908.) — Cast iron subjected to continued temperatures of approximately 500° to 600° took a permanent expansion and did not return to its original volume when cooled.

As steam is being superheated quite commonly to temperatures above 575°, this fact is of great interest inasmuch as it modifies our ideas about the proper material to be used in the construction of valves and fittings for service under high temperatures. A permanent volumetric expansion is followed by a loss of strength, the loss in cast iron being fully 40 per cent in four years.

Crane Co. made an attempt to determine whether cast steel was affected in the same manner as cast iron. Three flanges were taken, one of cast iron, one of ferrosteel, and the third of cast steel. These flanges were exposed for a total period of 130 hours to temperatures ranging as follows:

Less than 500°, 18 hours; 500° to 700°, 97 hours; 710° to 800°, 12 hours; over 800°, 3 hours. Average temp., 583°.

The outside diameter in each case was 12 1/2 in. and the bore 6 29/64 in. The results were: Cast-steel flange, no change. Cast-iron flange, outside diam. increased 0.019 in., inside diam. increased 0.007 in. Ferro-steel flange, outside diam. increased 0.033 in., inside diam. increased 0.017 in.

If the permanent expansion of cast iron stopped at the figures given above, it would not be a serious matter; but all evidence points toward a steady increase as time goes on, as was shown by one of Crane Co.'s 14-in. valves, which originally was 22 1/2 in. face to face, and increased 5/16 in. in length in four years under an average temperature of about 590°.

MALLEABLE CAST IRON.*

There are four great classes of work for whose requirements malleable cast iron (commonly called "malleable iron" in America) is especially

* References. — R. Moldenke, *Cass. Mag.*, 1907, and *Iron Trade Review*, 1908; E. C. Wheeler, *Iron Age*, Nov. 9, 1899; C. H. Gale, *Incust. World*, April 13, 1908; W. H. Hatfield, *ibid.*; G. A. Akerlund, *Iron Tr. Rev.*, Aug. 23, 1906; C. H. Day, *Am. Mach.*, April 5, 1906.

adapted. These are agricultural implements, railway supplies, carriage and harness castings and pipe fittings. Besides these main classes there are innumerable other unclassified uses. The malleable casting is seldom over 175 lbs. in weight, or 3 ft. in length, or 3/4 in. in thickness. The great majority of even the heavier castings do not exceed 10 lbs.

When properly made, malleable cast iron should have a tensile strength of 42,000 to 48,000 lbs. per sq. in., with an elongation of 5% in 2 in. Bars 1 in. square and on supports 12 in. apart should show a transverse strength of 2500 to 3500 lbs., with a deflection of at least 1/2 in.

While the strength of malleable iron should be as stated, much of it will fall as low as 35,000 lbs. per sq. in., and this will still be good for such work as pipe fittings, hardware castings and the like. On the other hand, even 63,000 lbs. per sq. in. has been reached, with a load of 5000 lbs. and a deflection of 2 1/2 in. in the transverse test. This high strength is not desirable, as the softness of the casting is sacrificed, and its resistance to continued shock is lessened. For the repeated stresses of severe service the malleable casting ranks ahead of steel, and only where a high tensile strength is essential must it be replaced by that material.

The process of making malleable iron may be summarized as follows: The proper cast irons are melted in either the crucible, the air furnace, the open-hearth furnace or the cupola. The metal when cast into the sand molds must chill white or not more than just a little mottled. After removing the sand from the hard castings they are packed in iron scale, or other materials containing iron oxide, and subjected to a red heat (1250 to 1350° F.) for over 60 hours. They are then cooled slowly, cleaned from scale, chipped or ground, and straightened.

When hard, or just from the sand, the composition of the iron should be about as follows: Si, from 0.35 up to 1.00, depending upon the thickness and the purpose the casting is to be used for; P not over 0.225, Mn not over 0.20, S not over 0.05. The total carbon can be from 2.75 upward, 4.15 being about the highest that can be carried. The lower the carbon the stronger the casting subsequently. Below 2.75 there is apt to be trouble in the anneal, the black-heart structure may not appear, and the castings remain weak. A casting 1 in. thick would necessitate silicon at 0.35, and the use of chills in the mold in addition, to get the iron white. For a casting 1/2 in. thick, Si about 0.60 is the proper limit, except where great strength is desired, when it can be dropped to 0.45. Above 0.60 there is danger of getting heavily-mottled if not gray iron from the sand molds, and this material, when annealed the long time required for the white castings, would be ruined. For very thin castings, Si can run up to 1.00 and still leave the metal white in fracture.

Pig Iron for Malleable Castings. — The specifications run as follows: Si, 0.75, 1.00, 1.25, 1.50, 1.75, 2.00%, as required; Mn, not over 0.60; P, not over 0.225; S, not over 0.05.

Works making heavy castings almost exclusively, specify Si to include 0.75 up to 1.50%. Makers of very light work take 1.25 to 2.00%.

The Melting Furnace. — Malleable iron is melted in the reverberatory furnace, the open-hearth furnace and the cupola: the reverberatory being the most extensively used, about 85 per cent. of the entire output of the United States being melted by this process. Prior to about 1885, the standard furnace was one of 5 tons capacity. At present (1908) we have furnaces of 25 and 30 tons capacity, though furnaces of from 10 to 15 tons are the most popular and give more uniform results than those of larger capacity.

The adoption of the open-hearth furnace for malleable iron dates back to about 1893. It is used largely in the Pittsburgh district.

Cupola melted iron does not possess the tensile strength nor ductility of iron melted in the reverberatory or open-hearth furnace, due partly to the higher carbon and sulphur caused by the metal being in contact with the fuel. This feature is rather an advantage than otherwise, as most of the product of cupola melted iron consists of pipe fittings; castings that are not subjected to any great stress or shock. The castings are threaded, and a strong, tough malleable iron does not cut a clean, smooth thread, but rather will rough up under the cutting tool.

In the reverberatory and open-hearth furnaces the metal may be partly desiliconized at will, by an oxidizing flame or by additions of scrap or other low-silicon material. Manganese is also oxidized in the furnace.

The composition of good castings in American practice is: Si, from 0.45 to 1.00%; Mn, up to 0.30%; P, up to 0.225%; S, up to 0.07%; total carbon in the hard casting, above 2.75%.

In special cases, especially for very small castings, the silicon may go up as high as 1.25%, while for very heavy work it may drop down to 0.35% with very good results. In the case of charcoal iron this figure gives the strongest castings. With coke irons, however, especially when steel scrap additions are the rule, 0.45 should be the lower limit, and 0.65 is the best silicon for all-around medium and heavy work, such as railroad castings.

In American practice phosphorus is required not to exceed 0.225%, and is preferred lower. In European practice it is required as low as 0.10%, but castings have been made successfully with P as high as 0.40%.

The heat treatment of metal during melting has an important bearing upon its tensile strength, elongation, etc. Excessive temperatures promote the chances of burning. Iron is burnt mainly through the generation in melting furnaces of higher temperatures than those prevailing during the initial casting at blast furnaces and an excess of air in the flame. The choicest irons may thus turn out poor material.

Shrinkage of the Casting. — The shrinkage of the hard casting is about 1/4 in. to the foot, or double that of gray iron. In annealing about half of this is recovered, and hence the net result is the same as in ordinary foundry pattern practice. The effect of this great shrinkage is to cause shrinkage cracks or sponginess in the interior of the casting. As soon as the liquid metal sets against the surface of the mold and the source of supply is cut off, the contraction of the metal in the interior as it cools causes the particles to be torn apart and to form minute cracks or cavities. "Every test bar, and for that matter every casting may be regarded as a shell of fairly continuous metal with an interior of slight planes of separation at right angles to the surface. This characteristic of malleable iron forms the basis of many a mysterious failure." (Moldenke.)

Packing for Annealing. — After the castings have been chipped and sorted they are packed in iron annealing pots, holding about 800 pounds of iron, together with a packing composed of iron ore, hammer and rolling mill scale, turnings, borings, etc. The turnings, etc., were formerly treated with a solution of salammoniac or muriatic acid to form a heavy coating of oxide, but such treatment is now considered unnecessary. Blast furnace slag, coke, sand, and fire clay have also been used for packing. The changes in chemical composition of the castings when annealed in slag and in coke are given as follows by C. H. Gale:

	Si.	S.	P.	Mn.	C. C.	G. C.
Hard iron.....	0.63	0.043	0.147	0.21	2.54	Trace
Annealed in slag.....	0.61	0.049	0.145	0.21	0.24	1.65
Annealed in coke.....	0.61	0.065	0.150	0.21	0.25	2.00

The Annealing Process. — The effect of the annealing is to oxidize and remove the carbon from the surface of the casting, to remove it to a greater or less degree below the surface, and to convert the remaining carbon from the combined form into the amorphous form called a "temper carbon" by Professor Ledebur, the German metallurgist. It differs from the graphite found in pig iron, but is usually reported as graphitic carbon by the chemists. In the original malleable process, invented by Reaumur, in 1722, the castings were packed in iron ore and annealed thoroughly, so that most of the carbon was probably oxidized, but in American practice the annealing process is rather a heat treatment than an oxidizing process, and its effect is to precipitate the carbon rather than to eliminate it. According to the analysis quoted above, the metal annealed in slag lost 0.65% of its total C, while that annealed in the coke lost only 0.29%. In the former, S increased 0.006% and in the latter 0.022%. The Si decreased 0.02% in both cases, while the P and Mn remained constant.

As to the distribution of carbon in an annealed casting, Dr. Moldenke says: "Take a flat piece of malleable and plane off the skin, say $\frac{1}{16}$ in. deep and gather the chips for analysis. The carbon will be found, say, 0.15% perhaps even less. Cut in another $\frac{1}{16}$ in. and the total C will be nearer 0.60%. Now go down successively by sixteenths and the total C will range from, say, 1.70 to 3.65% and will then remain constant until the center is reached." "The malleable casting is for practical purposes a poor steel casting with a lot of graphite, not crystallized, between the crystals or groups of crystals of the steel."

The heat in the annealing process must be maintained for from two to four days, depending upon the thickness of sections of the castings and the compactness with which the castings or annealing boxes are placed in the furnace. An annealing temperature 1550° to 1600° Fahr. is often used, but it is not essential, as the annealing can be accomplished at 1300°, but the time required will be longer than that at the higher temperature. Burnt iron in the anneal is no uncommon feature, and, generally speaking, it is the result of carelessness. The most carefully prepared metal from melting furnaces can here be turned into worthless castings by some slight inattention of detail. The highest temperature for annealing should be registered in each foundry, and kept there by the daily and frequent use of a thermometer constructed for that sole purpose. Steady, continued heat insures soft castings, while unequal temperatures destroy all chances for successful work, although the initial metal was of the most excellent quality.

After annealing, the castings are cleaned by tumblers or the sand blast; they are carefully examined for cracks or other defects, and if sprung out of shape are hammered or forced by hydraulic power to the correct shape. Such parts as are produced in great quantities are placed in a drop hammer and one or two blows will insure a correct form. They may be drop-forged or even welded when the iron has been made for that purpose. Castings are sometimes dipped into asphaltum diluted with benzine to give them a better finish.

Malleable castings must never be straightened hot, especially when thick. In the case of very thin castings there is some latitude, as the material is so decarbonized that it is nearer a steel than genuine malleable cast iron. In heating portions of castings that were badly warped, it seems that the amorphous carbon in them was combined again, and while the balance of the casting remained black and sound, the heated parts became white and brittle, as in the original hard casting. Hence the advice to straighten the castings cold, preferably with a drop hammer and suitable dies, or still better in the hydraulic press. (R. Moldenke, *Proc. A. S. T. M.*, vi, 244.)

Physical Characteristics. — The characteristic that gives malleable iron its greatest value as compared with gray iron is its ability to resist shocks. Malleability in a light casting $\frac{1}{4}$ in. thick and less means a soft, pliable condition and the ability to withstand considerable distortion without fracture, while in the heavy sections, $\frac{1}{2}$ in. and over, it means the ability to resist shocks without bending or breaking.

For general purposes it is not altogether desirable to have a metal very high in tensile strength, but rather one which has a high transverse strength, and especially a good deflection. It is not always that a strong and at the same time soft material can be produced in a foundry operating on the lighter grades of castings. The purchaser, therefore, unless he requires very stiff material, should rather look upon the deflection of the metal coupled with the weight it took to do this bending before failure, than for a high tensile strength.

The ductility of the malleable casting permits the driving of rivets, which cannot so readily be done with gray cast iron; and for certain parts of cars, like the journal boxes, malleable cast iron may be considered supreme, leaving cast iron and "semi-steel" far behind.

It was formerly the general belief that the strength of malleable iron was largely in the white skin always found on this material, but it has been demonstrated that the removal of the skin does not proportionately lessen the strength of the casting.

Test Bars. — The rectangular shape is used for test bars in preference to the round section, because the latter is more apt to have serious cracks in the center, due to shrinkage, especially if the diameter is large. A round section, unless in very light hardware, is to be avoided, as the

shrinkage crack in the center may have an outlet to the skin, and cause failure in service.

It is customary to provide for two sizes of test bars, the heavy and the light. Thus the 1-in. square bar represents work $\frac{1}{2}$ an inch thick and over, and a $1 \times \frac{1}{2}$ -in. section bar cares for the lighter castings. Both are 14 inches long. They should be cast at the beginning and at the end of each heat.

Design of Malleable Castings. — As white cast iron shrinks a great deal more than gray iron, and as the sections of malleable castings are lighter than those of similar castings of gray iron, fractures are very common. It is therefore the designer's aim to distribute the metal so as to meet these conditions. In long pieces the stiffening ribs should extend lengthways so as to produce as little resistance as possible to the contraction of the metal at the time of solidification. If this be not possible, the molder provides a "crush core" whose interior is filled with crushed coke. When the metal solidifies in the flask the core is crushed by the casting and thus prevents shrinkage cracks. At other times a certain corner or juncture of ribs in the casting will be found cracked. In order to prevent this a small piece of cast iron (chill) is embedded in the sand at this critical point, and the metal will cool here more quickly than elsewhere, and thus fortify this point, although it may happen that some other part of the casting will be found fractured instead, and in many cases the locations and the shape of strengthening ribs in the casting must be altered until a casting is procured free from shrinkage cracks. In designing of malleable cast-iron details the following rules should be observed:

(1) Endeavor to keep the metal in different parts of the casting at a uniform thickness. In a small casting, of, say, 10 lbs. weight, $\frac{1}{4}$ -in. metal is about the practical thickness, $\frac{5}{16}$ in. for a casting of 15 to 20 lbs., and $\frac{3}{8}$ to $\frac{1}{2}$ in. for castings of 40 lbs. and over. (2) Endeavor to avoid sharp junctions of ribs or parts, and if the casting is long, say 24 inches or more, the ends should be made of such shape as to offer as little resistance as possible to the contraction of metal when cooling in the mold.

Specifications for Malleable Iron. — The tensile strength of malleable iron varies with the thickness of the metal, the lighter sections having a greater strength per square inch than the heavier sections. An Eastern railroad designates the tensile strength desired as follows: Sections $\frac{3}{8}$ in. thick or less should have a tensile strength of not less than 40,000 lbs. per sq. in.; $\frac{3}{8}$ to $\frac{3}{4}$ in. thick, not less than 38,000; and over $\frac{3}{4}$ in., not less than 36,000 lbs. per sq. in. Test bars $\frac{5}{8}$ and $\frac{7}{8}$ in. diam. were made in the same mold and poured from the same ladle, and annealed together. The average tensile strength of five pairs of bars so treated, representing five heats, was, $\frac{5}{8}$ -in. bars, 45,095; $\frac{7}{8}$ -in. bars, 41,316 lbs. per sq. in. Average elongation in 6 in.: $\frac{5}{8}$ -in. bars 5.3%; $\frac{7}{8}$ -in. bars 4.2%.

A very high tensile strength can be obtained approaching that of cast steel but at the expense of the malleability of the product. Malleable test bars have been made with a tensile strength of between 60,000 and 70,000 lbs. per sq. in., but the ductility and ability to resist shocks of these bars was not equal to that of bars breaking at 40,000 to 45,000 pounds per sq. in.

The British Admiralty specification is 18 tons (40,320 lbs.) per square inch, a minimum elongation of $4\frac{1}{2}\%$ in three inches and a bending angle of at least 90° over a 1-in. radius, the bar being $1 \times \frac{3}{8}$ in. in section.

The specifications of the American Society for Testing Materials include the following:

Cupola iron is not recommended for heavy or important castings. Castings for which physical requirements are specified shall not contain over 0.06 sulphur or over 0.225 phosphorus.

The Standard Test Bar is 1 in. square and 14 in. long, cast without chills and left perfectly free in the mold. Three bars shall be cast in one mold, heavy risers insuring sound bars. Where the full heat goes into castings which are subject to specification, one mold shall be poured two minutes after tapping into the first ladle, and another mold from the last iron of the heat.

The tensile strength of a standard test bar shall not be less than 40,000 lbs. per sq. in. The elongation in 2 in. shall not be less than $2\frac{1}{2}\%$.

WARNING: This is a 1910 edition. Some of the material may no longer be accurate

The transverse strength of a standard test bar on supports 12 inches apart shall not be less than 3000 lbs., deflection being at least 1/2 in.

Improvement in Quality of Castings. (Moldenke.)—The history of improvement in the malleable casting is admirably reflected in the test records of any works that has them. Going back to the early 90's, the average tensile strength of malleable cast iron was about 35,000 lbs. per sq. in., with an elongation of about 2% in 2 in. The transverse strength was perhaps 2800 lbs., with a deflection of 1/2 in. Toward the close of the 90's a fair average of the castings then made would run about 44,000 lbs. per sq. in., with an elongation of 5% in 2 in., and the transverse strength, about 3500 lbs., with a deflection of 1/2 inch. These average figures were greatly exceeded in establishments where special attention was given to the niceties of the process. The tensile strength here would run 52,000 lbs. per sq. in. regularly, with 7% elongation in 2 in., and the transverse strength, 5000 and over, with 1 1/2 in. deflection.

Further Progress Desirable. (Moldenke.)—We do not know at the present time why cupola malleables require an annealing heat several hundred degrees higher than air or open-hearth furnace iron. The underlying principles of the oxidation of the bath, which is a frequent cause of defective iron, is practically unknown to the majority of those engaged in this industry. Heats are frequently made that will not pour nor anneal properly, but the causes are still being sought. To produce castings from successive heats, so that with the same composition they will have the same physical strength regardless of how they are tested, is a problem partially solved for steel, but not yet approached for malleable cast iron.

Sufficient progress in the study of iron with the microscope has been made to warrant the belief that in the not distant future we may be able to distinguish the constituents of the material by means of etching with various chemicals. When the sulphides and phosphides of iron, or the manganese-sulphur compounds, can be seen directly under the microscope, it is probable that a method may be found by which the dangerous ingredients may be so scattered or arranged that they will do the least harm.

The high sulphur in European malleable accounts to some extent for the comparatively low strength when contrasted with our product. Their castings being all very light, so long as they bend and twist properly, the purpose is served, and hence until heavier castings become the rule instead of the exception, "white heart" and steely-looking fractures will remain the characteristic feature of European work.

Strength of Malleable Cast Iron.

Bars cast by Buhl Malleable Co., Detroit, Mich. Reported by Chas. H. Day, *Am. Mach.*, April 5, 1906. The castings were all made at the same time. The figures here given are the maximum and minimum results from three bars of each section.

Section.	TENSILE TESTS.				COMPRESSION TESTS.			
	Area, sq. in.	Tensile St'gth, lbs. per sq. in.	Elong. in 8 in., %.	Red. of Area, %.	Area, sq. in.	L'gth, in.	Comp. Str., lbs. per sq. in.	Final Area, sq. in.
Round	0.817	43,000	5.87	4.76	0.847	15	31,700	0.901
"	0.801	43,400	6.21	3.98	0.801	15	33,240	0.886
"	0.219	41,130	7.70	3.40	0.209	7.5	32,600	0.221
"	0.202	44,700	13.00	3.63	0.204	7.5	34,600	0.215
Square	0.277	36,700	4.70	2.20	0.263	7.5	33,200	0.272
"	0.277	38,100	3.72	3.00	0.254	7.5	31,870	0.278
"	1.040	38,460	4.10	3.30	1.051	15	29,650	1.070
"	1.050	37,860	2.38	2.94	1.040	15	30,450	1.066
Rect.	0.239	31,200*	5.19	1.50	0.436	15	32,200	0.448
"	0.244	37,600	3.87	3.80	0.457	15	30,400	0.467
Star	0.584	34,600	4.20	3.10				
"	0.575	37,200	4.80	3.50				

* Broke in flaw.

WARNING: This is a 1910 edition. Some of the material may no longer be accurate

The rectangular sections were approximately 1/4 x 3/4 in. The star sections were square crosses, 1 inch wide, with arms about 1/4 in. thick.

Tests of Rectangular Cast Bars, made by a committee of the Master Car-builders' Assn. in 1891 and 1892, gave the following results (selected to show range of variation):

Size of Section, in.	Tensile St'gth, lbs. per sq. in.	Elastic Limit, lbs. per sq. in.	Elongation, % in 4 in.	Size of Section, in.	Tensile St'gth, lbs. per sq. in.	Elastic Limit, lbs. per sq. in.	Elong. in 8 in., %.
0.25 x 1.52	34,700	21,100	2	0.29 x 2.78	28,160	22,650	0.6
0.5 x 1.53	32,800	17,000	2	0.39 x 2.82	32,060	20,595	1.5
0.78 x 2	25,100	15,400	1.5	0.53 x 2.76	27,875	19,520	1.1
0.88 x 1.54	33,600	19,300	1.5	0.8 x 2.76	25,120	18,390	1.1
1.52 x 1.54	28,200	1.5	1.03 x 2.82	28,720	18,220	1.5

Tests of Square Bars, 1/2 in. and 1 in., by tension, compression and transverse stress, by M. H. Miner and F. E. Blake (*Railway Age*, Jan. 25, 1901).

TENSION. Six 1/2-in. and six 1-in. round bars, also two 1-in. bars turned to remove the skin, from each of four makers. Average results:

T. S., 1/2-in. bars, 37,470-42,950, av. 40,960; E. L., 16,500-21,100, av. 19,176.

T. S., 1-in. bars, 35,750-40,530, av. 38,300; E. L., 14,860-19,900, av. 17,181.

Tensile strength, turned bars, av. 35,090; Elastic limit, av. 15,660. Elong. in 8 in., 1/2-in. bars, 4.75%; 1-in. bars, 4.32%; turned bars, 3.73%.

Modulus of elasticity, 1/2-in. bars, 22,289,000; 1-in. bars, 21,677,000.

COMPRESSION. 16 short blocks, 2 in. long, 1 in. and 1/2 in. square respectively.

8 long columns, 15 in. long, 1 in. sq., and 7.5 in. long, 1/2 in. sq. respectively.

Averages of blocks from each of four makers: Short blocks, 1/2-in. sq., 93,000 to 114,500 lbs. per sq. in. Mean, 101,900 lbs. per sq. in.

Short blocks, 1 in. sq., 137,600 to 165,300 lbs. per sq. in. Mean, 152,800 lbs. per sq. in.

Ratio of final to original length, 1/2 in., 61.7%; 1 in., 52.6%. A small part of the shortening was due to sliding on the 45° plane of fracture.

Long columns: 1/2 in. x 7.5 in. Mean, 29,400 lbs. per sq. in.; 1 in. x 15 in., 27,500 lbs. per sq. in. Ratio of final to original length, 1/2 in., 98.5%; 1 in., 98.8%. The long columns did not rupture, but reached the maximum stress after bending into a permanent curve.

TRANSVERSE TESTS. Maximum fiber stress, mean of 8 tests, 1/2-in. bars, 34,163 lbs. per sq. in. 1-in. bars, 36,125 lbs. per sq. in. Length between supports, 20 in. The bars did not break, but failed by bending. The 1/2-in. bars could be bent nearly double.

WROUGHT IRON.

The Manufacture of Wrought Iron.—When iron ore, which is an oxide of iron, Fe₂O₃ or Fe₃O₄, containing silica, phosphorus, sulphur, etc., as impurities, is heated to a yellow heat in contact with charcoal or other fuel, the oxygen of the ore combines with the carbon of the fuel, part of the iron combines with silica to form a fusible cinder or slag, and the remainder of the iron agglutinates into a pasty mass which is intermingled with the cinder. Depending upon the time and the temperature of the operation, and on the kind and quality of the impurities present in the ore and the fuel, more or less of the sulphur and phosphorus may remain in the iron or may pass into the slag; a small amount of carbon may also be absorbed by the iron. By squeezing, hammering, or rolling the lump of iron while it is highly heated, the cinder may be

nearly all expelled from it, but generally enough remains to give a bar after being rolled, cooled and broken across, the appearance of a fibrous structure. The quality of the finished bar depends upon the extent to which the chemical impurities and the intermingled slag have been removed from the iron.

The process above described is known as the direct process. It is now but little used, having been replaced by the indirect process known as puddling or boiling. In this process pig iron which has been melted in a reverberatory furnace is desilicized and decarbonized by the oxygen derived from iron ore or iron scale in the bottom of the furnace, and from the oxidizing flame of the furnace. The temperature being too low to maintain the iron, when low in carbon, in a melted condition, it gradually "comes to nature" by the formation of pasty particles in the bath, which adhere to each other, until at length all the iron is decarbonized and becomes of a pasty condition, and the lumps so formed when gathered together make the "puddle-ball" which is consolidated into a bloom by the squeezer and then rolled into "muck-bar." By cutting the muck-bar into short lengths and making a "pile" of them, heating the pile to a welding heat and rerolling, a bar is made which is freer from cinder and more homogeneous than the original bar, and it may be further "refined" by another piling and rerolling. The quality of the iron depends on the quality of the pig-iron, on the extent of the decarbonization, on the extent of dephosphorization which has been effected in the furnace, on the greater or less contamination of the iron by sulphur derived from the fuel, and on the amount of work done on the piles to free the iron from slag. Iron insufficiently decarbonized is irregular, and hard or "steely." Iron thoroughly freed from impurities is soft and of low tensile strength. Iron high in sulphur is "hot-short," liable to break when being forged. Iron high in phosphorus is "cold-short," of low ductility when cold, and breaking with an apparently crystalline fracture.

See papers on Manufacture and Characteristics of Wrought Iron, by J. P. Roe, *Trans. A. I. M. E.*, xxxiii, p. 551; xxxvi, pp. 203, 807.

Influence of Chemical Composition on the Properties of Wrought Iron. (Beardslee on Wrought Iron and Chain Cables. Abridgment by W. Kent. Wiley & Sons, 1879.) — A series of 2000 tests of specimens from 14 brands of wrought iron, most of them of high repute, was made in 1877 by Capt. L. A. Beardslee, U.S.N., of the United States Testing Board. Forty-two chemical analyses were made of these irons, with a view to determine what influence the chemical composition had upon the strength, ductility, and welding power. From the report of these tests by A. L. Holley the following figures are taken:

Brand.	Average Tensile Strength.	Chemical Composition.					
		S.	P.	Si.	C.	Mn.	Slag.
L	66,598	trace	{ 0.065 0.084	0.080 0.105	0.212 0.512	0.005 0.029	0.192 0.452
P	54,363	{ 0.009 0.001	0.250 0.095	0.182 0.028	0.033 0.066	0.033 0.009	0.848 1.214
B	52,764	0.008	0.231	0.156	0.015	0.017
J	51,754	{ 0.003 0.005	0.140 0.291	0.182 0.321	0.027 0.051	trace 0.053	0.678 1.724
O	51,134	{ 0.004 0.005	0.067 0.078	0.065 0.073	0.045 0.042	0.007 0.005	1.168 0.974
C	50,765	0.007	0.169	0.154	0.042	0.021

Where two analyses are given, they are the extremes of two or more analyses of the brand. Where one is given, it is the only analysis. Brand L should be classed as a puddled steel.

ORDER OF QUALITIES GRADED FROM NO. 1 TO NO. 19.

Brand.	Tensile Strength.	Reduction of Area.	Elongation.	Welding Power.
L	1	18	19	most imperfect.
P	6	6	3	badly.
B	12	16	15	best.
J	16	19	18	rather badly.
O	18	1	4	very good.
C	19	12	16

The reduction of area varied from 54.2 to 25.9 per cent, and the elongation from 29.9 to 8.3 per cent.

Brand O, the purest iron of the series, ranked No. 18 in tensile strength, but was one of the most ductile; brand B, quite impure, was below the average both in strength and ductility, but was the best in welding power. P, also quite impure, was one of the best in every respect except welding, while L, the highest in strength, was not the most pure, it had the least ductility, and its welding power was most imperfect. The evidence of the influence of chemical composition upon quality, therefore, is quite contradictory and confusing. The irons differing remarkably in their mechanical properties, it was found that a much more marked influence upon their qualities was caused by different treatment in rolling than by differences in composition.

In regard to slag Mr. Hooley says: "It appears that the smallest and most worked iron often has the most slag. It is hence reasonable to conclude that an iron may be dirty and yet thoroughly condensed."

In his summary of "What is learned from chemical analysis," he says: "So far, it may appear that little of use to the makers or users of wrought iron has been learned. . . . The character of steel can be surely predicated on the analyses of the materials; that of wrought iron is altered by subtle and unobserved causes."

Influence of Reduction in Rolling from Pile to Bar on the Strength of Wrought Iron. — The tensile strength of the irons used in Beardslee's tests ranged from 46,000 to 62,700 lbs. per sq. in., brand L, which was really a steel, not being considered. Some specimens of L gave figures as high as 70,000 lbs. The amount of reduction of sectional area in rolling the bars has a notable influence on the strength and elastic limit; the greater the reduction from pile to bar, the higher the strength. The following are a few figures from tests of one of the brands:

Size of bar, in. diam.:	4	3	2	1	1/2	1/4
Area of pile, sq. in.:	80	80	72	25	9	3
Bar per cent of pile:	15.7	8.83	4.36	3.14	2.17	1.6
Tensile strength, lb.:	46,322	47,761	48,280	51,128	52,275	59,585
Elastic limit, lb.:	23,430	26,400	31,892	36,467	39,126

Specifications for Wrought Iron. (F. H. Lewis, Engineers' Club of Philadelphia, 1891.) — 1. All wrought iron must be tough, ductile, fibrous, and of uniform quality for each class, straight, smooth, free from cinder-pockets, flaws, buckles, blisters, and injurious cracks along the edges, and must have a workmanlike finish. No specific process or provision of manufacture will be demanded, provided the material fulfills the requirements of these specifications.

2. The tensile strength, limit of elasticity, and ductility shall be determined from a standard test-piece not less than 1/4 inch thick, cut from the full-sized bar, and planed or turned parallel. The area of cross-section shall not be less than 1/2 square inch. The elongation shall be measured after breaking on an original length of 8 inches.

3. The tests shall show not less than the following results:

	T. S.	E. L.	E. L.,	In 8 in.
For bar iron in tension. . . .	= 50,000;	= 26,000;	= 18%	18%
For shape iron in tension. . .	= 48,000;	= 26,000;	= 15%	15%
For plates under 36 in. wide . .	= 48,000;	= 26,000;	= 12%	12%
For plates over 36 in. wide . .	= 46,000;	= 25,000;	= 10%	10%

included tests of the tensile strength of iron and steel at temperatures ranging between 70° and 2000° F. Three kinds of metal were tested, viz., fibrous iron of 52,464 lbs. T. S., 38,280 lbs. E. L., and 17.5% elong.; fine-grained iron of 56,892 lbs. T. S., 30,113 lbs. E. L., and 20% elong.; and Bessemer steel of 84,826 lbs. T. S., 55,029 lbs. E. L., and 14.5% elong. The mean ultimate tensile strength of each material expressed in per cent of that at ordinary atmospheric temperature is given in the following table, the fifth column of which exhibits, for purposes of comparison, the results of experiments by a committee of the Franklin Institute in the years 1832-36.

Temperature Degrees F.	Fibrous Iron, %.	Fine-grained Iron, %.	Bessemer Steel, %.	Franklin Institute, %.
0	100.0	100.0	100.0	96.0
100	100.0	100.0	100.0	102.0
200	100.0	100.0	100.0	105.0
300	97.0	100.0	100.0	106.0
400	95.5	100.0	100.0	106.0
500	92.5	98.5	98.5	104.0
600	88.5	95.5	92.0	99.5
700	81.5	90.0	68.0	92.5
800	67.5	77.5	44.0	75.5
900	44.5	51.5	36.5	53.5
1000	26.0	36.0	31.0	36.0
1100	20.0	30.5	26.5
1200	18.0	28.0	22.0
1400	13.5	19.0	15.0
1600	7.0	12.5	10.0
1800	4.5	8.5	7.5
2000	3.5	5.0	5.0

Effect of Cold on the Strength of Iron and Steel. — The following conclusions were arrived at by Mr. Styffe in 1865:

- (1) The absolute strength of iron and steel is not diminished by cold, even at the lowest temperature which ever occurs in Sweden.
- (2) Neither in steel nor in iron is the extensibility less in severe cold than at the ordinary temperature.
- (3) The limit of elasticity in both steel and iron lies higher in severe cold.
- (4) The modulus of elasticity in both steel and iron is increased on reduction of temperature, and diminished on elevation of temperature; but that these variations never exceed 0.05% for a change of 1.8° F.

W. H. Barlow (*Proc. Inst. C. E.*) made experiments on bars of wrought iron, cast iron, malleable cast iron, Bessemer steel, and tool steel. The bars were tested with tensile and transverse strains, and also by impact: one-half of them at a temperature of 50° F., and the other half at 5° F.

The results of the experiments were summarized as follows:

1. When bars of wrought iron or steel were submitted to a tensile strain and broken, their strength was not affected by severe cold (5° F.), but their ductility was increased about 1% in iron and 3% in steel.
2. When bars of cast iron were submitted to a transverse strain at a low temperature, their strength was diminished about 3% and their flexibility about 16%.
3. When bars of wrought iron, malleable cast iron, steel, and ordinary cast iron were subjected to impact at 5° F., the force required to break them, and their flexibility, were reduced as follows:

	Reduction of Force of Impact, %.	Reduction of Flexibility, %.
Wrought iron, about.....	3	18
Steel (best cast tool), about.....	3 1/2	17
Malleable cast iron, about.....	4 1/2	15
Cast iron, about.....	21	not taken

The experience of railways in Russia, Canada, and other countries where the winter is severe, is that the breakages of rails and tires are far more numerous in the cold weather than in the summer. On this account a softer class of steel is employed in Russia for rails than is usual in more temperate climates.

The evidence extant in relation to this matter leaves no doubt that the capability of wrought iron or steel to resist impact is reduced by cold. On the other hand, its static strength is not impaired by low temperatures.

Increased Strength of Steel at very Low Temperature. — Steel of 72,300 lb. T. S. and 52,800 lb. elastic limit when tested at 76° F. gave 97,600 T. S. and 80,000 E. L. when tested at the temperature of liquid air. — Watertown Arsenal Tests, *Eng. Rec.*, July 21, 1906.

Prof. R. C. Carpenter (*Proc. A. A. S.* 1897) found that the strength of wrought iron at - 70° F. was 20% greater than at 70° F.

Effect of Low Temperatures on Strength of Railroad Axles. (Thos. Andrews, *Proc. Inst. C. E.*, 1891.) — Axles 6 ft. 6 in. long between centers of journals, total length 7 ft. 3 1/2 in., diameter at middle 4 1/2 in., at wheel-sets 5 1/8 in., journals 3 3/4 x 7 in., were tested by impact at temperatures of 0° and 100° F. Between the blows each axle was half turned over, and was also replaced for 15 minutes in the water-bath.

The mean force of concussion resulting from each impact was ascertained as follows:

Let h = height of free fall in feet, w = weight of test ball, $hw = W$ = "energy," or work in foot-tons, x = extent of deflections between bearings

$$\text{then } F \text{ (mean force)} = W/x = hw/x.$$

The results of these experiments show that whereas at 0° F. a total average mean force of 179 tons was sufficient to cause the breaking of the axles, at 100° F. a total average mean force of 428 tons was required. In other words, the resistance to concussion of the axles at 0° F. was only about 42% of what it was at 100° F.

The average total deflection at 0° F. was 6.48 in., as against 15.06 in. with the axles at 100° F. under the conditions stated; this represents an ultimate reduction of flexibility, under the test of impact, of about 57% for the cold axles at 0° F., compared with the warm axles at 100° F.

EXPANSION OF IRON AND STEEL BY HEAT.

James E. Howard, engineer in charge of the U. S. testing-machine at Watertown, Mass., gives the following results of tests made on bars 35 inches long (*Iron Age*, April 10, 1890):

	C.	Mn.	Si.	Coeff. of Expansion per degree F.		C.	Mn.	Si.	Coeff. of Expansion per degree F.
Wrought iron.....				0.000067302	Steel.....	0.57	0.93	.07	0.000063891
Steel.....	0.09	0.11		.000067561	".....	.71	.58	.08	.000064716
".....	.20	.45		.000066259	".....	.81	.56	.17	.000062167
".....	.31	.57		.000065149	".....	.89	.57	.19	.000062335
".....	.37	.70		.000066597	".....	.97	.30	.28	.000061700
".....	.51	.58	.02	.000066202	Cast (gun) iron.....				.000059261

DURABILITY OF IRON, CORROSION, ETC.

Crystallization of Iron by Fatigue. — Wrought iron of the best quality is very tough, and breaks, on being pulled in a testing machine or bent after nicking, with a fibrous fracture. Cold-short iron, however, is more brittle, and breaks square across the fibers with a fracture which is commonly called crystalline although no real crystals are present. Iron which has been repeatedly overstrained, and especially iron subjected to repeated vibrations and shocks, also becomes brittle, and breaks with an apparently crystalline fracture. See "Resistance of Metals to Repeated Shocks," p. 262.

Walter H. Finley (*Am. Mach.*, April 27, 1905) relates a case of failures of $1\frac{1}{8}$ -in. wrought-iron coupling pins on a train of 1-ton mine cars, apparently due to crystallization. After two pins were broken after a year's hard service, "several hitchings were laid on an anvil and the pin broken by a single blow from a sledge. Pieces of the broken pins were then heated to a bright red, and, after cooling slowly, were again put under the hammer, which failed entirely to break them. After cutting with a cleaver, the pins were broken, and the fracture showed a complete restoration of the fibrous structure. This annealing process was then applied to the whole supply of hitchings. Piles of twenty-five or thirty were covered by a hot wood fire, which was allowed to die down and go out, leaving the hitchings in a bed of ashes to cool off slowly. By repeating this every six months the danger from brittle pins was entirely avoided."

Durability of Cast Iron. — Frederick Graff, in an article on the Philadelphia water-supply, says that the first cast-iron pipe used there was laid in 1820. These pipes were made of charcoal iron, and were in constant use for 53 years. They were uncoated, and the inside was well filled with tubercles. In salt water good cast iron, even uncoated, will last for a century at least; but it often becomes soft enough to be cut by a knife, as is shown in iron cannon taken up from the bottom of harbors after long submersion. Close-grained, hard white metal lasts the longest in sea water. (*Eng'g News*, April 23, 1887, and March 26, 1892.)

Tests of Iron after Forty Years' Service. — A square link 12 inches broad, 1 inch thick and about 12 feet long was taken from the Kieff bridge, then 40 years old, and tested in comparison with a similar link which had been preserved in the stock-house since the bridge was built. The following is the record of a mean of four longitudinal test-pieces, $1 \times 1\frac{1}{8} \times 8$ inches, taken from each link (*Stah' und Eisen*, 1890):

Old Link	T. S., 21.8 tons;	E. L., 11.1 tons;	Elong., 14.05%
New Link	" 22.2 "	" 11.9 "	" 13.42%

Durability of Iron in Bridges. (G. Lindenthal, *Eng'g*, May 2, 1884, p. 139.) — The Old Monongahela suspension bridge in Pittsburg, built in 1845, was taken down in 1882. The wires of the cables were frequently strained to half of their ultimate strength, yet on testing them after 37 years' use they showed a tensile strength of from 72,700 to 100,000 lbs. per sq. in. The elastic limit was from 67,100 to 78,600 lbs. per sq. in. Reduction at point of fracture, 35% to 75%. Their diameter was 0.13 in.

A new ordinary telegraph wire of same gauge tested for comparison showed: T. S., of 100,000 lbs.; E. L., 81,550 lbs.; reduction, 57%. Iron rods used as stays or suspenders showed: T. S., 43,770 to 49,720 lbs. E. L., 26,380 to 29,200. Mr. Lindenthal draws these conclusions:

"The above tests indicate that iron highly strained for a long number of years, but still within the elastic limit, and exposed to slight vibration, will not deteriorate in quality.

"That if subjected to only one kind of strain it will not change its texture, even if strained beyond its elastic limit, for many years. It will stretch and behave much as in a testing-machine during a long test.

"That iron will change its texture only when exposed to alternate severe straining, as in bending in different directions. If the bending is slight but very rapid, as in violent vibrations, the effect is the same."

Durability of Iron in Concrete. — In Paris a sewer of reinforced concrete 40 years old was removed and the metal was found in a perfect state of preservation. In excavating for the foundations of the new General Post Office in London some old Roman brickwork had to be removed, and the hoop-iron bonds were still perfectly bright and good. (*Eng'g*, Aug. 16, 1907, p. 227.)

Corrosion of Iron Bolts. — On bridges over the Thames in London, bolts exposed to the action of the atmosphere and rain-water were eaten away in 25 years from a diameter of $\frac{7}{8}$ in. to $\frac{1}{2}$ in., and from $\frac{5}{8}$ in. diameter to $\frac{5}{16}$ inch.

Wire ropes exposed to drip in colliery shafts are very liable to corrosion. **Corrosive Agents in the Atmosphere.** — The experiments of F. Crace Calvert (*Chemical News*, March 3, 1871) show that carbonic acid, in the presence of moisture, is the agent which determines the oxidation of iron in the atmosphere. He subjected perfectly cleaned blades of iron

and steel to the action of different gases for a period of four months, with results as follows:

Dry oxygen, dry carbonic acid, a mixture of both gases, dry and damp oxygen and ammonia: no oxidation. Damp oxygen: in three experiments one blade only was slightly oxidized.

Damp carbonic acid: slight appearance of a white precipitate upon the iron, found to be carbonate of iron. Damp carbonic acid and oxygen: oxidation very rapid. Iron immersed in water containing carbonic acid oxidized rapidly.

Iron immersed in distilled water deprived of its gases by boiling rusted the iron in spots that were found to contain impurities.

Sulphurous acid (the product of the combustion of the sulphur in coal) is an exceedingly active corrosive agent, especially when the exposed iron is coated with soot. This accounts for the rapid corrosion of iron in railway bridges exposed to the smoke from locomotives. (See account of experiments by the author on action of sulphurous acid in *Jour. Frank. Inst.*, June, 1875, p. 437.) An analysis of sooty iron rust from a railway bridge showed the presence of sulphurous, sulphuric, and carbonic acids, chlorine, and ammonia. Bloxam states that ammonia is formed from the nitrogen of the air during the process of rusting.

Galvanic Action is a most active agent of corrosion. It takes place when two metals, one electro-negative to the other, are placed in contact and exposed to dampness.

Corrosion in Steam-boilers. — Internal corrosion may be due either to the use of water containing free acid, or water containing sulphate or chloride of magnesium, which decompose when heated, liberating the acid, or to water containing air or carbonic acid in solution. External corrosion rarely takes place when a boiler is kept hot, but when cold it is apt to corrode rapidly in those portions where it adjoins the brick-work or where it may be covered by dust or ashes, or wherever dampness may lodge. (See Impurities of Water, p. 691, and Incrustation and Corrosion, p. 897.)

Corrosion of Iron and Steel. — Experiments made at the Riverside Iron Works, Wheeling, W. Va., on the comparative liability to rust of iron and soft Bessemer steel: A piece of iron plate and a similar piece of steel, both clean and bright, were placed in a mixture of yellow loam and sand, with which had been thoroughly incorporated some carbonate of soda, nitrate of soda, ammonium chloride, and chloride of magnesium. The earth as prepared was kept moist. At the end of 33 days the pieces of metal were taken out, cleaned, and weighed, when the iron was found to have lost 0.84% of its weight and the steel 0.72%. The pieces were replaced and after 28 days weighed again, when the iron was found to have lost 2.06% of its original weight and the steel 1.79%. (*Eng'g*, June 28, 1891.)

Internal Corrosion of Iron and Steel Pipes by Warm Water. (T. N. Thomson, *Proc. A. S. H. V. E.*, 1908.) — Three short pieces of iron and three of steel pipes, 2 in. diam., were connected together by nipples and made part of a pipe line conveying water at a temperature varying from 160° to 212° F. In one year $9\frac{13}{32}$ lbs. of wrought iron lost $20\frac{3}{4}$ oz., and $9\frac{13}{32}$ lbs. of steel $24\frac{7}{8}$ oz. The pipes were sawed in two lengthwise, and the deepest pittings were measured by a micrometer. Assuming that the pitting would have continued at a uniform rate the wrought-iron pipes would have been corroded through in from 686 to 780 days, and the steel pipes from 760 to 850 days, the average being 742 days for iron and 797 days for steel. Two samples each of galvanized iron and steel pipe were also included in the pipe line, and their calculated life was: iron 770 and 1163 days; steel 619 and 1163 days. Of numerous samples of corroded pipe received from heating engineers ten had given out within four years of service, and of these six were steel and four were iron.

To ascertain whether pipe is made of wrought iron or steel, cut off a short piece of the pipe and suspend it in a solution of 9 parts of water, 3 of sulphuric acid, and 1 of hydrochloric acid in a porcelain or glass dish in such a way that the end will not touch the bottom of the dish. After 2 to 3 hours' immersion remove the pipe and wash off the acid. If the pipe is steel the end will present a bright, solid, unbroken surface, while if made of iron it will show faint ridges or rings, like the year rings in a tree, showing the different layers of iron and streaks of cinder. In order that the scratches made by the cutting-off tool may not be mistaken for

the cinder marks, file the end of the pipe straight across or grind on an emery wheel until the marks of the cutting-off tool have disappeared before putting it in the acid.

Relative Corrosion of Wrought Iron and Steel. (H. M. Howe, *Proc. A. S. T. M.*, 1906.) — On one hand we have the very general opinion that steel corrodes very much faster than wrought iron, an opinion held so widely and so strongly that it cannot be ignored. On the other hand we have the results of direct experiments by a great many observers, in different countries and under widely differing conditions; and these results tend to show that there is no very great difference between the corrosion of steel and wrought iron. Under certain conditions steel seems to rust a little faster than wrought iron, and under others wrought iron seems to rust a little faster than steel. Taking the tests in unconfined sea water as a whole wrought iron does constantly a little better than steel, and its advantage seems to be still greater in the case of boiling sea water. In the few tests in alkaline water wrought iron seems to have the advantage over steel, whereas in acidulated water steel seems to rust more slowly than wrought iron.

Steel which in the first few months may rust faster than wrought iron may, on greatly prolonging the experiments, or pushing them to destruction, actually rust more slowly, and *vice versa*.

Carelessly made steel, containing blowholes, may rust faster than wrought iron, yet carefully made steel, free from blowholes, may rust more slowly. Any difference between the two may be due not to the inherent and intrinsic nature of the material, but to defects to which it is subject if carelessly made. Care in manufacture, and special steps to lessen the tendency to rust, might well make steel less corrodible than wrought iron, even if steel carelessly made should really prove more corrodible than wrought iron.

For extensive discussions on this subject see *Trans. A. I. M. E.*, 1905, and *Proc. A. S. T. M.*, 1906.

Corrosion of Fence Wire. (A. S. Cushman, *Farmers' Bulletin*, No. 239, U. S. Dept. of Agriculture, 1905.) — "A large number of letters were received from all over the country in response to official inquiry, and all pointed in the same direction. As far as human testimony is capable of establishing a fact, there need be not the slightest question that modern steel does not serve the purpose as well as the older metal manufactured twenty or more years ago."

Electrolytic Theory, and Prevention of Corrosion. (A. S. Cushman, *Bulletin* No. 30, U. S. Dept. of Agriculture, Office of Public Roads, 1907. *The Corrosion of Iron*.) — The various kinds of merchantable iron and steel differ, within wide limits, in their resistance, not only to the ordinary processes of oxidation known as rusting, but also in other corrosive influences. Different specimens of one and the same kind of iron or steel will show great variability in resistance to corrosion under the conditions of use and service. The causes of this variability are numerous and complex, and the subject is not nearly so well understood at the present time as it should be. All investigators are agreed that iron cannot rust in air or oxygen unless water is present, and on the other hand it cannot rust in water unless oxygen is present.

From the standpoint of the modern theory of solutions, all reactions which take place in the wet way are attended with certain readjustments of the electrical states of the reacting ions. The electrolytic theory of rusting assumes that before iron can oxidize in the wet way it must first pass into solution as a ferrous ion.

Dr. Cushman then gives an account of his experiments which he considers demonstrate that iron goes into solution up to a certain maximum concentration in pure water, without the aid of oxygen, carbonic acid or other reacting substances. It is apparent that the rusting of iron is primarily due, not to attack by oxygen, but by hydrogen ions.

Solutions of chromic acid and potassium bichromate inhibit the rusting of iron. If a rod or strip of bright iron or steel is immersed for a few hours in a 5 to 10 per cent solution of potassium bichromate, and is then removed and thoroughly washed, a certain change has been produced on the surface of the metal. The surface may be thoroughly washed and wiped with a clean cloth without disturbing this new surface condition. No visible change has been effected, for the polished surfaces

examined under the microscope appear to be untouched. If, however, the polished strips are immersed in water it will be found that rusting is inhibited. An ordinary untreated polished specimen of steel will show rusting in a few minutes when immersed in the ordinary distilled water of the laboratory. Chromated specimens will stand immersion for varying lengths of time before rust appears. In some cases it is a matter of hours, in others of days or even weeks before the inhibiting effect is overcome.

It would follow from the electrolytic theory that in order to have the highest resistance to corrosion a metal should either be as free as possible from certain impurities, such as manganese, or should be so homogeneous as not to retain localized positive and negative nodes for a long time without change. Under the first condition iron would seem to have the advantage over steel, but under the second much would depend upon care exercised in manufacture, whatever process was used.

There are two lines of advance by which we may hope to meet the difficulties attendant upon rapid corrosion. One is by the manufacture of better metal, and the other is by the use of inhibitors and protective coverings. Although it is true that laboratory tests are frequently unsuccessful in imitating the conditions in service, it nevertheless appears that chromic acid and its salts should under certain circumstances come into use to inhibit extremely rapid corrosion by electrolysis.

Chrome Paints. — G. B. Heckel (*Jour. F. I., Eng. Dig.*, Sept., 1908) quotes a letter from Mr. Cushman as follows: "My observation that chromic acid and certain of its compounds act as inhibitors has led to many experiments by other workers along the same line. I have found that the chrome compounds on the market vary very much in their action. Some of them show up as strong inhibitors, while others go to the opposite extreme and stimulate corrosion. Referring only to the labeled names of the pigments, I find among the good ones, in the order cited: Zinc chromate, American vermilion, chrome yellow orange, chrome yellow dd. Among the bad ones, also in the order given, I find: Chrome yellow medium, chrome green, chrome red. Much the worst of all is chrome yellow lemon. I presume that the difference is due to impurities that are present in the bad pigments."

Mr. Heckel suggests the following formula for a protective paint: 40 lbs. American vermilion, 10 lbs. red lead, 5 lbs. Venetian red. Zinc oxide and lamp-black to produce the required tint or shade. Grind in $1\frac{1}{3}$ gal. of raw linseed oil — increasing the quantity as required for added zinc oxide or lamp-black — and $\frac{1}{8}$ gal. crusher's drier. For use, thin with raw oil and very little turpentine or benzine.

He states that the substitution of zinc chrome for the American vermilion; of any high-grade finely ground iron oxide for the Venetian red; and of American vermilion for the red lead, would probably improve the protective value of the formula; that the addition of a very little kauri gum varnish, if zinc oxide is used, might be found advantageous; and that the substitution of a certain proportion of China wood oil for some of the linseed oil might improve the wearing qualities of the paint.

Dr. Cushman points out two dangers confronting us when we attempt to base an inhibitive formula on commercial products. The first is that all carbon pigments, excepting pure graphite, may contain sulphur compounds easily oxidizable to sulphuric acid when spread out as in a paint film. The second is the probability of variation in the composition of basic lead chromate or American vermilion. Because of these facts, it is necessary, before selecting any particular pigment for its inhibitive quality, to ascertain that it is free from acids or acid-forming impurities. As a result of his experiments he recommends the substitution of Prussian blue for the lamp-black in Mr. Heckel's formula, and lays down as a safe rule in the formulation of inhibitive paints, a careful avoidance of all potential stimulators of the hydrogen ions and consequently of any substance which might develop acid; preference being given to chromate pigments which are to some extent soluble in water, and to other pigments which in undergoing change tend to develop an alkaline rather than an acid reaction. Calcium sulphate, for example, in any form (as a constituent of Venetian red, for example), he deems dangerous to use because of the possibility of its developing acid. Barium sulphate, on the other hand, he regards as practically safe, because of its well-known chemical stability.

Corrosion caused by Stray Electric Currents. (W. W. Churchill, *Science*, Sept. 28, 1906). — Surface condensers in electric lighting and other plants were abandoned on account of electrolytic corrosion. The voltage of the rails in the freight yard of the Long Island railroad at the peak of the load was 9 volts above the potential of the river, decreasing to 2 volts or less at light loads. This caused a destruction of water pipes and other things in the railroad yards. Experiments with various metal plates immersed in samples of East River water showed that it gave a more violent action than ordinary sea water. It was further observed that there was a local galvanic action going on, and that the amount of stray currents had something to do with the polarization of the surfaces, making the galvanic action exceedingly violent and destroying thin copper tubes at a very rapid rate. There was a violent local action between the zinc and the copper of the brass tubes which were in contact with the electrolyte, and this increased in the reaction as it progressed in stagnant conditions. By interposing a counter electromotive force against the galvanic couple which should exceed in pressure the voltage of the couple, the actions of the electrolytic corrosion ceased. When unconnected, or electrically separated, plates were placed in the electrolyte, if they were of composite construction and had sharp projections into the fluid, raised by cutting and prying up with a knife, they would have these projections promptly destroyed, and if an electric battery having a pressure exceeding that of the couple in the East River water was caused to act to produce a counter current, and having a pressure exceeding that of the galvanic couple (0.12 volt), the capacity of this electrolyte to drive off atoms of the mechanically combined metals in the alloys used was overcome and corrosion was arrested.

It, therefore, became desirable not only to carefully provide the balancing quantity of current to equal the stray traction currents arising from the ground returns of railway and other service, but to add to this the necessary voltage through a cathode placed in the circulating water in such a way as to bring to bear electrolytic action which would prevent the galvanic action due to this current coming into contact with alloys of mechanically combined metals such as the brass tubes (60% copper, 40% zinc).

In order to accomplish these two things, it was first necessary to so install the condensers as to prevent undue amounts of stray currents flowing through them, thus tending to reduce the amount of power required to prevent injurious action of these currents and otherwise to neutralize them. This was done by insulating the joints in the piping and from ground connections, and even lining the large water connections with glass melted on to the surface.

To furnish electromotive force, a 3-K.W. motor generator was provided. By means of a system of wiring, with ammeters and voltmeters, and a connection to an outlying anode in the condensing supply intake at its harbor end, this generator was planned to provide current to neutralize the stray currents in the condenser structure to any extent that they had passed the insulated joints in the supports and connections, as well as through the columns of water in the pipe connections, and then to adjust the additional voltage needed to counteract and prevent the galvanic action. All connections were made in a manner to insure a uniform voltage of the various parts of the condenser to prevent local action, each connection being so made and provided with such measuring instruments as to insure ready adjustment to effect this. The apparatus was designed in accordance with the above statements. Its operation has extended over fourteen months (to date, 1906), and with the exception of about ten tubes which have become pitted, the results have been satisfactory. The efficiency of the apparatus amply justifies the expense of its installation, while its operation is not expensive, and the plant described will be followed by other protecting plants of the same character.

Electrolytic Corrosion due to Overstrain. (C. F. Burgess, *El. Rev.*, Sept. 19, 1908.) — Mild steel bars overstrained in their middle portion were subjected to corrosion by suspension in dilute hydrochloric acid solutions, and others by making them the anode in neutral solutions of ammonium chloride and causing current to flow under low current density. In all cases a marked difference was noted in the rate at which the strained portions corroded as compared with the unstrained.

Differences of potential of from five to nine millivolts were noted between two electrodes, one of which constituted the strained portion and one the unstrained.

The more rapid electrolytic corrosion of the strained portion appears to be due to the fact that the strained metal is electropositive to the unstrained, the current finding the easier path through the surface of the electropositive metal. That the strained metal is the more electropositive is also shown by a liberation of hydrogen bubbles on the unstrained portion.

PRESERVATIVE COATINGS.

The following notes have been furnished to the author by Prof. A. H. Sabin. (Revised, 1908.)

Cement. — Iron-work is often bedded in concrete; if free from cracks and voids it is an efficient protection. The metal should be cleaned and then washed with neat cement before embedding.

Asphaltum. — This is applied either by dipping (as water-pipe) or by pouring it on (as bridge floors). The asphalt should be slightly elastic when cold, with a high melting-point, not softening much at 100° F., applied at 300° to 400°; the surface must be dry and should be hot; the coating should be of considerable thickness.

Paint. — Composed of a vehicle or binder, usually linseed oil or some inferior substitute, or varnish (enamel paints); and a pigment, which is a more or less inert solid in the form of a powder, either mixed or ground together. Nearly all paint contains paint drier or japan, which is a lead or (and) manganese compound soluble in oil, and acts as a carrier of oxygen; as little should be used as possible. Boiled oil contains drier; no additional drier is needed. None should be used with varnish paints, nor with "ready-mixed paints" in general.

The principal pigments are white lead (carbonate or oxy-sulphate) and white zinc (oxide), red lead (peroxide), oxides of iron, hydrated and anhydrous, graphite, lampblack, bone black, chrome yellow, chrome green, ultramarine and Prussian blue, and various tinting colors. White lead has the greatest body or opacity of white pigments; three coats of it equal five of white zinc; zinc is more brilliant and permanent, but it is liable to peel, and it is customary to mix the two. These are the standard white paints for all uses, and the basis of all light-colored paints. Anhydrous iron oxides are brown and purplish brown, hydrated oxides are yellowish red to reddish yellow, with more or less brown; most iron oxides are mixtures of both sorts, and often contain a little manganese and much clay. They are cheap, and are serviceable paints on wood and are often used on iron, but for the latter use are falling into disrepute. Graphite used for painting iron contains from 10 to 90% foreign matter, usually silicates. It is very opaque, hence has great covering power and may be applied in a very thin coat, which is to be avoided. The best graphite paints give very good results. There are many grades of lampblack; the cheaper sorts contain oily matter and are especially hard to dry; all lampblack is slow to dry in oil. In a less degree this is true of all paints containing carbon, including graphite. Lampblack is used with advantage with red lead; it is also an ingredient of many "carbon" paints, the base of which is either bone black or artificial graphite. Red lead dries by uniting chemically with the oil to form a cement; it is heavy, and makes an expensive paint, and is often highly adulterated. Pure red lead has long had a high reputation as a paint for iron and steel, and is still used extensively, especially as a first coat; but of late years some of the new paints and varnish-like preparations have displaced it to a considerable extent even, on the most important work.

Varnishes. — These are made by melting fossil resin, to which is then added from half its weight to three times its weight of refined linseed oil, and the compound is thinned with turpentine; they usually contain a little drier. They are chiefly used on wood, being more durable and more brilliant than oil, and are often used over paint to preserve it. Asphaltum is sometimes substituted in part or in whole for the fossil resin, and in this way are made black varnishes which have been used on iron and steel with good results. Asphaltum and substances like it have

also been simply dissolved in solvents, as benzine or carbon disulphide, and used for the same purpose.

All these preservative coatings are supposed to form impervious films, keeping out air and moisture; but in fact all are somewhat porous. On this account it is necessary to have a film of appreciable thickness, best formed by successive coats, so that the pores of one will be closed by the next. The pigment is used to give an agreeable color, to help fill the pores of the oil film, to make the paint harder, so that it will resist abrasion, and to make a thicker film. In varnishes these results are sought to be attained by the resin which is dissolved in the oil. There is no sort of agreement among practical men as to which coating is best for any particular case; this is probably because so much depends on the preparation of the surface and the care with which the coating is applied, and also because the conditions of exposure vary so greatly.

Methods of Application. — From the surface of the metal mud and dirt must be first removed, then any rusty spots must be cleaned thoroughly; loose scale may be removed with wire brushes, but thick and closely adherent rust must be removed with steel scrapers, or with hammer and chisel if necessary. The sand-blast is used largely and increasingly to clean before painting, and is the best method known. Pickling is usually done with 10% sulphuric acid; the solution is made more active by heating. All traces of acid must be removed by washing, and the metal must be immediately dried and painted. Less than two coats of paint should never be used, and three or four are better. The first painting of metal is the most important. Paint is always thin on angles and edges, also on bolt and rivet heads; after the first full coat apply a partial or striping coat, covering the angles and edges for at least an inch back from the edge, also all bolt and rivet heads. After this is dry apply the second full coat. At least a week should elapse between coats.

Cast-iron water pipes are usually coated by dipping in a hot mixture of coal-tar and coal-tar pitch; riveted steel pipes by dipping in hot asphalt or by a japan enamel which is baked on at about 400° F. Ships' bottoms are coated with a varnish paint to prevent rusting, over which is a similar paint containing a poison, as mercury chloride, or a copper compound, or else for this second coat a greasy copper soap is applied hot; this prevents the accumulation of marine growths. Galvanized iron and tin surfaces should be thoroughly cleaned with benzine and scrubbed before painting. When new they are partly covered with grease and chemicals used in coating the plates, and these must be removed or the paint will not adhere.

Quantity of Paint for a Given Surface. — One gallon of paint will cover 250 to 400 sq. ft. as a first coat, depending on the character of the surface, and from 350 to 500 sq. ft. as a second coat.

Qualities of Paints. — *The Railroad and Engineering Journal*, vols. liv. and lv., 1890 and 1891, has a series of articles on paint as applied to wooden structures, its chemical nature, application, adulteration, etc., by Dr. C. B. Dudley, chemist, and F. N. Pease, assistant chemist, of the Penna. R. R. They give the results of a long series of experiments on paints as applied to railway purposes.

Inoxydation Processes. (Contributed by Alfred Sang, Pittsburg, Pa., 1908.) — The black oxide of iron (Fe_3O_4) as a continuous coating affords excellent protection against corrosion. Lavoisier (1781) noted its artificial production and its stable qualities. Faraday (1858) observed the protective properties of the coating formed by the action of steam in superheating tubes. Berthier discovered its formation by the action of highly heated air.

Bower-Barff Process. — Dr. Barff's method was to heat articles to be coated to about 1800° F. and inject steam heated to 1000° F. into the muffle. George and A. S. Bower used air instead of steam, then carbon monoxide (producer gas) to reduce the red oxide. In the combined process, the articles are heated to 1600° F. in a closed retort; superheated steam is injected for 20 min., then producer gas for 15 to 25 min.; the treatment can be repeated to increase the depth of oxidation. Less heat is required for wrought than for cast iron or steel. By a later improvement, steam heated above the temperature of the articles was injected during the last 1 to 2 hours. By a further improvement known as the "Wells Process," the work is finished in one operation, the steam

and producer-gas being injected together. Articles are slightly increased in size by the treatment. The surface is gray, changing to black when oiled; it will chip off if too thin; it will take paint or enamel and may be polished, but cannot be either bent or machined; the coating itself is incorrodible and resists sea-water, mine-water and acid fumes; the strength of the metal is slightly reduced. The process is extensively used for small hardware. (See F. S. Barff, *Jour. I. & S. Inst.*, 1877, p. 356; A. S. Bower, *Trans. A. I. M. E.* 1882, p. 329; B. H. Thwaite, *Proc. Inst. C. E.* 1883, p. 255; George W. Maynard, *Trans. A. S. M. E.* iv, 351.)

Gesner Process. — Dr. George W. Gesner's process is in commercial operation since 1890. The coating retort is kept at 1200° F. for 20 minutes after charging, then steam, partially decomposed by passing through a red-hot pipe, is allowed to act at intervals during 35 min.; finally, a small quantity of naphtha, or other hydrocarbon, is introduced and allowed to act for 15 min. The work is withdrawn when the heat has fallen to 800° F. The articles are neither increased in size nor distorted; the loss of strength and reduction of elongation are only slight. Large pieces can be treated. (See *Jour. I. & S. Inst.*, 1890 (ii), p. 850; *Iron Age*, 1890, p. 544.)

Hydraesfer Process. — An improvement of the Gesner process patented by J. J. Bradley and in commercial operation. As its name implies, the coating is thought to be an alloy of hydrogen, copper and iron. The sulphides and phosphides are claimed to be burned out of the surface of the metal by the action of hydrogen at a high temperature, giving additional rust-proof qualities. The appearance of the finished work is that of genuine Bower Barffing.

Russia and Planished Iron. — Russia iron is made by cementation and slight oxidation. W. Dewees Wood (U. S. Pat. No. 252,166 of 1882) treated planished sheets with hydrocarbon vapors or gas and superheated steam within an air-tight and heated chamber.

Niter Process. — An old process improved by Col. A. R. Buffington in 1884. The articles are stirred about in a mixture of fused potassium nitrate (saltpeter) and manganese dioxide, then suspended in the vapors and finally dipped and washed in boiling water. Pure chemicals are essential. Used for small arms and pieces which cannot stand the high heat of other processes. (*Trans. A. I. M. E.*, vol. vi, p. 628.)

Electric Process. — A. de Meritens connected polished articles as anodes in a bath of warm distilled water and used a current as weak as would be conducted. A black film of oxide was formed; too strong a current produced rust. It being essential that hydrogen be occluded in the surface of the metal, it was found necessary, as a rule, to connect the articles as cathodes for a short time previous to inoxidation. (*Bull. Soc. Intle. des Electr.*, 1886, p. 230.)

Aluminum Coatings. — Aluminum can be deposited electrically, the main difficulties being the high voltage required and the readiness of the coating to redissolve. The metal-work of the tower of City Hall, Philadelphia, was coated by the Tacony Iron & Metal Co., Tacony, Pa., with 14 oz. per sq. ft. of copper on which was deposited 2 1/2 oz. of an alloy of tin and aluminum. The Reeves Mfg. Co., Canal Dover, Ohio, makes aluminum-coated conductor pipes, etc., said to be as durable as copper and as rust-proof as aluminum. The Aluminum Co. of America makes "bi-metallic" tubing composed of aluminum and other metal tubes placed one inside the other and drawn down together to the required size.

Galvanizing is a method of coating articles, usually of iron or steel, with zinc. Galvanized iron resists ordinary corroding agencies, the zinc becoming covered with a film of zinc carbonate, which protects the metal from further chemical action. The coating is, however, quickly destroyed by mine-water, tunnel gases, sea water and conditions that commonly exist in tropical countries. If the work is badly done and the coating does not adhere properly, and if any acid from the pickle or any chloride from the flux remains on the iron, corrosion takes place under the zinc coating. (See M. P. Wood: *Trans. A. S. M. E.* xvi, 350. Alfred Sang: *Trans. Am. Foundrymen's Assoc.*, 1907, *Iron Age*, May 23d and 30th, 1907, and *Proc. Eng. Soc. of W. Penna.*, Nov., 1907.)

The Penna. R. R. Specifications for galvanized sheets for car roofs

(1907) prescribe that the black sheets before galvanizing should weigh 16 oz. per sq. ft., the galvanized sheet 18 oz. Sheets will not be accepted if a chemical determination shows less than 1.5 oz. of zinc per sq. ft.

Hot Galvanizing. — The articles to be galvanized are first cleaned by pickling and then dipped in a solution of hydrochloric acid and immersed in a bath of molten zinc at a temperature of from 800 to 900° F.; when they have reached the temperature of the bath, they are withdrawn and the coating is set in water; sal-ammoniac is used on the pot as a flux, either alone or as an emulsion with glycerine or some other fatty medium. Wire, bands and similar articles are drawn continuously through the bath, and may be passed through asbestos wipers to remove the surplus metal; in this case it is advisable to use a very soft spelter free from iron. If wire is treated slowly and passed through charcoal dust instead of wipers the product is known as "double-galvanized." Tin can be added to the bath to help bring out the spangles, but it gives a less durable coating. Aluminum is added as a Zn-Al alloy, with about 20% Al, to give fluidity. Sheets are galvanized continuously, and except in the case of so-called "flux sheets," are put through rolls as they emerge from the bath, to squeeze off the excess of zinc and improve the adherence.

Test for Galvanized Wire. — Sir W. Preece devised the following standard test for the British Post Office: dip for one minute in a saturated neutral solution of sulphate of copper, wash and wipe; to pass, the material must stand 3 dips.

The American standard test is as follows: prepare a neutral solution of sulphate of copper of sp. gr. 1.185, dip for one minute, wash and wipe dry; the wire must stand 4 dips without a permanent coating of copper showing on any part of the wire.

Galvanizing by Cementation; Sherardizing. — The alloying of metals at temperatures below their melting points has been known since 1820 or earlier. Berry (1838) invented a process of depositing zinc, in which the objects to be coated were placed in a closed retort and covered with a mixture of charcoal and powder of zinc; the retort was heated to cherry-red for a longer or shorter period, according to the bulk of the article and to the desired thickness of the coating. Demas gave iron articles a slight coating of copper by dipping them in a solution of sulphate of copper and then heated them in a closed retort with oxide of zinc and charcoal dust. Sheet steel cowbells are coated with brass by placing them in a mixture of finely divided brass and charcoal dust and heating them to redness in an air-tight crucible.

S. Cowper-Coles's process, known as Sherardizing, patented in 1902, consists in packing the objects which are to be coated in zinc dust or pulverized zinc to which zinc oxide with a small percentage of charcoal dust is added, and heating in a closed retort to a temperature below the melting point of zinc. A large proportion of sand can be used to reduce the amount of zinc dust carried in the retort, to prevent caking and give a brighter finish; motion of the retort is in most cases necessary to obtain an even coating. The operation lasts from 30 minutes to several hours, depending on the size of the drum. Tempered steel is not affected by the process, but surfaces are hardened, there being a zinc-iron alloy formed to a depth varying with the time of treatment. This process is suitable for small work, giving a superior quality of zinc coating. (See Cowper-Coles, "Preservation and Ornamentation of Iron and Steel Surfaces," *Trans. Soc. Engrs.* 1905, p. 183; "Sherardizing," *Iron Age*, 1904, p. 12. Alfred Sang, "Theory and Practice of Sherardizing," *El. Chem. and Metall. Ind.*, May, 1907.)

Lead Coatings. — Lead is a good protection for iron and steel provided it is perfectly gas-tight. Electrically deposited lead does not bond well and the coating is porous. Sheets having a light coating of lead, produced by dipping in the molten metal, are known as terne plates; they have no lasting qualities. Lead-lined wrought pipe, fittings and valves are made for conveying acids and other corroding liquids.

STEEL.

The Manufacture of Steel. (See Classification of Iron and Steel, p. 413.) Cast steel is a malleable alloy of iron, cast from a fluid mass. It is distinguished from cast iron, which is not malleable, by being much lower in carbon, and from wrought iron, which is welded from a pasty mass, by being free from intermingled slag. Blister steel is a highly carbonized wrought iron, made by the "cementation" process, which consists in keeping wrought-iron bars at a red heat for some days in contact with charcoal. Not over 2% of C is usually absorbed. The surface of the iron is covered with small blisters, supposedly due to the action of carbon on slag. Other wrought steels were formerly made by direct processes from iron ore, and by the puddling process from wrought iron, but these steels are now replaced by cast steels. Blister steel is, however, still used as a raw material in the manufacture of crucible steel. Case-hardening is a process of surface cementation.

Crucible Steel is commonly made in pots or crucibles holding about 80 pounds of metal. The raw material may be steel scrap; blister steel bars; wrought iron with charcoal; cast iron with wrought iron or with iron ore; or any mixture that will produce a metal having the desired chemical constitution. Manganese in some form is usually added to prevent oxidation of the iron. Some silicon is usually absorbed from the crucible, and carbon also if the crucible is made of graphite and clay. The crucible being covered, the steel is not affected by the oxygen or sulphur in the flame. The quality of crucible steel depends on the freedom from objectionable elements, such as phosphorus, in the mixture, on the complete removal of oxide, slag and blowholes by "dead-melting" or "killing" before pouring, and on the kind and quantity of different elements which are added in the mixture, or after melting, to give particular qualities to the steel, such as carbon, manganese, chromium, tungsten and vanadium.

Bessemer Steel is made by blowing air through a bath of melted pig iron. The oxygen of the air first burns away the silicon, then the carbon, and before the carbon is entirely burned away, begins to burn the iron. Spiegeleisen or ferro-manganese is then added to deoxidize the metal and to give it the amount of carbon desired in the finished steel. In the ordinary or "acid" Bessemer process the lining of the converter is a silicious material, which has no effect on phosphorus, and all the phosphorus in the pig iron remains in the steel. In the "basic" or Thomas and Gilchrist process the lining is of magnesian limestone, and limestone additions are made to the bath, so as to keep the slag basic, and the phosphorus enters the slag. By this process ores that were formerly unsuited to the manufacture of steel have been made available.

Open-hearth Steel. — Any mixture that may be used for making steel in a crucible may also be melted on the open hearth of a Siemens regenerative furnace, and may be desiliconized and decarbonized by the action of the flame and by additions of iron ore, deoxidized by the addition of spiegeleisen or ferro-manganese, and recarbonized by the same additions or by pig iron. In the most common form of the process pig iron and scrap steel are melted together on the hearth, and after the manganese has been added to the bath it is tapped into the ladle. In the Talbot process a large bath of melted material is kept in the furnace, melted pig iron, taken from a blast furnace, is added to it, and iron ore is added which contributes its iron to the melted metal while its oxygen decarbonizes the pig iron. When the decarbonization has proceeded far enough, ferro-manganese is added to destroy iron oxide, and a portion of the metal is tapped out, leaving the remainder to receive another charge of pig iron, and thus the process is continued indefinitely. In the Duplex Process melted cast iron is desiliconized in a Bessemer converter, and then run into an open hearth, where the steel-making operation is finished.

The open-hearth process, like the Bessemer, may be either acid or basic, according to the character of the lining. The basic process is a dephosphorizing one, and is the one most generally available, as it can use pig irons that are either low or high in phosphorus.

Relation between the Chemical Composition and Physical Character of Steel.

W. R. Webster (*Trans. A. I. M. E.*, vols. xxi and xxii, 1893-4) gives results of several hundred analyses and tensile tests of basic Bessemer steel plates, and from a study of them draws conclusions as to the relation of chemical composition to strength, the chief of which are condensed as follows:

The indications are that a pure iron, without carbon, phosphorus, manganese, silicon, or sulphur, if it could be obtained, would have a tensile strength of 34,750 lbs. per sq. in., if tested in a 3/8-in. plate. With this as a base, a table is constructed by adding the following hardening effects, as shown by increase of tensile strength, for the several elements named.

Carbon, a constant effect of 800 lbs. for each 0.01%.

Sulphur, " " " " 500 " " " " 0.01%.

Phosphorus, the effect is higher in high-carbon than in low-carbon steels.

With carbon hundredths %..... 9 10 11 12 13 14 15 16 17

Each 0.01% P has an effect of lbs. 900 1000 1100 1200 1300 1400 1500 1500 1500

Manganese, the effect decreases as the per cent of manganese increases.

Mn being per cent.....	.00	.15	.20	.25	.30	.35	.40	.45	.50	.55
to	to	to	to	to	to	to	to	to	to	to
Strength incr. for 0.01%...	240	240	220	200	180	160	140	120	100	100 lbs.
Total increase from 0 Mn...	3600	4800	5900	6900	7800	8600	9300	9900	10,400	11,400

Silicon is so low in this steel that its hardening effect has not been considered.

With the above additions for carbon and phosphorus the following table has been constructed (abridged from the original by Mr. Webster). To the figures given the additions for sulphur and manganese should be made as above.

Estimated Ultimate Strengths of Basic Bessemer-steel Plates.

For Carbon, 0.06 to 0.24; Phosphorus, .00 to .10; Manganese and Sulphur, .00 in all cases.

Carbon.	0.06	.08	.10	.12	.14	.16	.18	.20	.22	.24
Phos. .005	39,950	41,550	43,250	44,950	46,650	48,300	49,900	51,500	53,100	54,700
" .01	40,350	41,950	43,750	45,550	47,350	49,050	50,650	52,250	53,850	55,450
" .02	41,150	42,750	44,750	46,750	48,750	50,550	52,150	53,750	55,350	56,950
" .03	41,950	43,550	45,750	47,950	50,150	52,050	53,650	55,250	56,850	58,450
" .04	42,750	44,350	46,750	49,150	51,550	53,550	55,150	56,750	58,350	59,950
" .05	43,550	45,150	47,750	50,350	52,950	55,050	56,650	58,250	59,850	61,450
" .06	44,350	45,950	48,750	51,550	54,350	56,550	58,150	59,750	61,350	62,950
" .07	45,150	46,750	49,750	52,750	55,750	58,050	59,650	61,250	62,850	64,450
" .08	45,950	47,550	50,750	53,950	57,150	59,550	61,150	62,750	64,350	65,950
" .09	46,750	48,350	51,750	55,150	58,550	61,050	62,650	64,250	65,850	67,450
" .10	47,550	49,150	52,750	56,350	59,950	62,550	64,150	65,750	67,350	68,950
0.001 P =	80 lbs.	80 lbs.	100 lb.	120 lb.	140 lb.	150 lb.	150 lb.	150 lb.	150 lb.	150 lb.

In all rolled steel the quality depends on the size of the bloom or ingot from which it is rolled, the work put on it, and the temperature at which it is finished, as well as the chemical composition.

The above table is based on tests of plates 3/8 inch thick and under 70 inches wide; for other plates Mr. Webster gives the following corrections for thickness and width. They are made necessary only by the effect of thickness and width on the finishing temperature in ordinary practice. Steel is frequently spoiled by being finished at too high a temperature.

Thickness, in.....	3/4*	11/16	5/8	9/16	1/2	7/16	3/8	5/16
Correction (1).....	-2000	-1750	-1500	-1250	-1000	-750	0	+3000
Correction (2).....	-1000	-750	-500	-250	0	+500	+1000	+5000

* And over. (1) Plates up to 70 in. wide. (2) Over 70 in. wide.

Comparing the actual result of tests of 408 plates with the calculated results, Mr. Webster found the variation to range as below.

Within lbs. 1000	2000	3000	4000	5000	
Per cent.	23.4	55.1	74.7	89.9	94.9

The last figure would indicate that if specifications were drawn calling for steel plates not to vary more than 5000 lbs. T. S. from a specified figure (equal to a total range of 10,000 lbs.), there would be a probability of the rejection of 5% of the blooms rolled, even if the whole lot was made from steel of identical chemical analysis.

Campbell's Formulæ. (H. H. Campbell, *The Manufacture and Properties of Iron and Steel*, p. 387.) —

- Acid steel, 40,000 + 1000 C + 1000 P + xMn = Ultimate strength.
Basic steel, 41,500 + 770 C + 1000 P + yMn = Ultimate strength.

The values of xMn and yMn are given by Mr. Campbell in a table, but they may be found from the formulæ xMn = 8 CMn - 320 C and yMn = 90 Mn + 4 CMn - 2700 - 120 C, or, combining the formulæ we have:

Ult. strength, acid steel, 40,000 + 680 C + 1000 P + 8 CMn.
" basic " 38,800 + 650 C + 1000 P + 90 Mn + 4 CMn.

In these formulæ the unit of each chemical element is 0.01%.
Examples. Required the tensile strength of two steels containing respectively C, 0.10, P, 0.10, Mn, 0.30, and C, 0.20, P, 0.10, Mn, 0.65.

Answers, by Webster, 59,650 and 77,150; by Campbell, 57,700 and 72,850.

Low Tensile Strength of Very Pure Steel. — Swedish nail-rod open-hearth steel, tested by the author in 1881, showed a tensile strength of only 42,591 lbs. per sq. in. A piece of American nail-rod steel showed 45,021 lbs. per sq. in. Both steels contained about 0.10 C and 0.015 P, and were very low in S, Mn, and Si. The pieces tested were bars about 2 x 3/8 in. section.

R. A. Hadfield (*Jour. Iron and Steel Inst.*, 1894) gives the strength of very pure Swedish iron, remelted and tested as cast, 45,024 lbs. per sq. in.; remelted and forged, 47,040 lbs. The analysis of the cast bar was: C, 0.08; Si, 0.04; S, 0.02; P, 0.02; Mn, 0.01; Fe, 99.82.

Effect of Oxygen upon Strength of Steel. — A. Lantz, of the Peine works, Germany, in a letter to Mr. Webster, says that oxygen plays an important rôle — such that, given a like content of C, P, and Mn, a blow with greater oxygen content gives a greater hardness and less ductility than a blow with less oxygen content. The method used for determining oxygen is that of Prof. Ledebur, given in *Stahl und Eisen*, May, 1892, p. 193. The variation in O may make a difference in strength of nearly 1/2 ton per sq. in. (*Jour. I. and S. I.*, 1894.)

Electric Conductivity of Steel. — Louis Campredon reports in *Le Genie Civil* [prior to 1895] the results of experiments on the electric resistance of steel wires of different composition, ranging from 0.09 to 0.14 C; 0.21 to 0.54 Mn; Si, S, and P low. The figures show that the purer and softer the steel the better is its electric conductivity, and, furthermore, that manganese is the element which most influences the conductivity. The results may be expressed by the formula $R = 5.2 + 6.2S \pm 0.3$; in which R = relative resistance, copper being taken as 1, and S = the sum of the percentages of C, P, S, Si, and Mn. The conclusions are confirmed by J. A. Capp, in 1903, *Trans. A. I. M. E.*, vol. xxxiv, who made forty-five experiments on steel of a wide range of composition. His results may be expressed by the formula $R = 5.5 + 4S \pm 1$. High manganese increases the resistance at an increasing rate. Mr. Capp proposes the following specification for steel to make a satisfactory third rail, having a resistance eight times that of copper: C, 0.15; Mn, 0.30; P, 0.06; S, 0.06; Si, 0.05; none of these figures to be exceeded.

Range of Variation in Strength of Bessemer and Open-Hearth Steels.

The Carnegie Steel Co. in 1888 published a list of 1057 tests of Bessemer and open-hearth steel, from which the following figures are selected:

Kind of Steel.	No. of Tests.	Elastic Limit.		Ultimate Strength.		Elongation per cent in 8 Inches.	
		High't.	Lowest.	High't.	Lowest.	High't.	Lowest.
		(a) Bess. structural.	100	46,570	39,230	71,300	61,450
(b) " "	170	47,690	39,970	73,540	65,200	30.25	23.15
(c) Bess. angles.....	72	41,890	32,630	63,450	56,130	34.30	26.25
(d) O. H. fire-box....	25	62,790	50,350	36.00	25.62
(e) O. H. bridge.....	20	69,940	63,970	30.00	22.75

REQUIREMENTS OF SPECIFICATIONS.

- (a) E. L., 35,000; T. S., 62,000 to 70,000; elong., 22% in 8 in.
- (b) E. L., 40,000; T. S., 67,000 to 75,000.
- (c) E. L., 30,000; T. S., 56,000 to 64,000; elong., 20% in 8 in.
- (d) T. S., 50,000 to 62,000; elong., 26% in 4 in.
- (e) T. S., 64,000 to 70,000; elong., 20% in 8 in.

Bending Tests of Steel. (Pencoyd Iron Works.) — Steel below 0.10 C should be capable of doubling flat without fracture, after being chilled from a red heat in cold water. Steel of 0.15 C will occasionally submit to the same treatment, but will usually bend around a curve whose radius is equal to the thickness of the specimen; about 90% of specimens stand the latter bending test without fracture. As the steel becomes harder its ability to endure this bending test becomes more exceptional, and when the carbon becomes 0.20 little over 25% of specimens will stand the last-described bending test. Steel having about 0.40% C will usually harden sufficiently to cut soft iron and maintain an edge.

EFFECT OF HEAT TREATMENT AND OF WORK ON STEEL.

Low Strength Due to Insufficient Work. (A. E. Hunt, *Trans. A. I. M. E.*, 1886.) — Soft steel ingots, made in the ordinary way for boiler plates, have only from 10,000 to 20,000 lbs. tensile strength per sq. in., an elongation of only about 10% in 8 in., and a reduction of area of less than 20%. Such ingots, properly heated and rolled down from 19 in. to 1/2 in. thickness, will give from 55,000 to 65,000 lbs. tensile strength, an elongation in 8 in. of from 23% to 33%, and a reduction of area of from 55% to 70%. Any work stopping short of the above reduction in thickness ordinarily yields intermediate results in tensile tests.

Effect of Finishing Temperature in Rolling. — The strength and ductility of steel depend to a high degree upon fineness of grain, and this may be obtained by having the temperature of the steel rather low, say at a dull red heat, 1300° to 1400° F., during the finishing stage of rolling. In the manufacture of steel rails a great improvement in quality has been obtained by finishing at a low temperature. An indication of the finishing temperature is the amount of shrinkage by cooling after leaving the rolls. The Phila. & Reading Railway Co.'s specification for rails (1902) says, "The temperature of the ingot or bloom shall be such that with rapid rolling and without holding before or in the finishing passes or subsequently, and without artificial cooling after leaving the last pass, the distance between the hot saws shall not exceed 30 ft. 3 in. for a 30-ft. rail."

Finishing the Grain by Annealing. — Steel which is coarse-grained on account of leaving the rolls at too high a temperature may be made fine-grained and have its ductility greatly increased without lowering its tensile strength by reheating to a cherry-red and cooling at once in air. (See paper on "Steel Rails," by Robert Job, *Trans. A. I. M. E.*, 1902.)

Effect of Cold Rolling. — Cold rolling of iron and steel increases the elastic limit and the ultimate strength, and decreases the ductility. Major Wade's experiments on bars rolled and polished cold by Lauth's process showed an average increase of load required to give a slight permanent set as follows: Transverse, 162%; torsion, 130%; compression, 161% on short columns 1 1/2 in. long, and 64% on columns 8 in. long; tension, 95%. The hardness, as measured by the weight required to produce equal indentations, was increased 50%; and it was found that the hardness was as great in the center of the bars as elsewhere. Sir W. Fairbairn's experiments showed an increase in ultimate tensile strength of 50%, and a reduction in the elongation in 10 in. from 2 in. or 20% to 0.79 in. or 7.9%.

Hardening of Soft Steel. — A. E. Hunt (*Trans. A. I. M. E.*, 1885, vol. xii) says that soft steel, no matter how low in carbon, will harden to a certain extent upon being heated red-hot and plunged into water, and that it hardens more when plunged into brine and less when quenched in oil.

A heat of open-hearth steel of 0.15% C and 0.29% Mn gave the following results upon test-pieces from the same 1/4 in. thick plate.

Unhardened.....	T. S. 55,000	El. in 8 in. 27%	Red. of Area 62%
Hardened in water.....	" 74,000	" 25%	" 50%
Hardened in brine.....	" 84,000	" 22%	" 43%
Hardened in oil.....	" 67,000	" 26%	" 49%

The greatly increased tenacity after hardening indicates that there must be a considerable molecular change in the steel thus hardened, and that if such a hardening should be created locally in a steel plate, there must be very dangerous internal strains caused thereby.

Comparative Tests of Full-sized Eye-bars and Small Samples. (G. S. Morison, *A. S. C. E.*, 1893.) — 17 full-sized eye-bars, of the steel used in the Memphis bridge, sections 10 in. wide x 1 to 2 3/16 in. thick, and sample bars from the same melts. Average results:

Eye-bars: E. L., 32,350; T. S., 63,330; El. in full length, 13.7%; Red. of area, 36.3%.

Small bars: E. L., 40,650; T. S., 71,640; El. in 8 ins., 26.2%; Red. of area, 46.7%.

Effect of Annealing on Rolled Bars. (Campbell, *Mfr. of Iron and Steel*, p. 275.) —

	Ultimate Strength.		Elastic Limit.		Elong. in 8 in., %.		Red. Area, %.		Elas. Ratio.	
	Natural.	Annealed.	Natural.	Annealed.	Natural.	Annealed.	Natural.	Annealed.	Natural.	Annealed.
9/4 in. rounds.	58,568	54,098	40,300	31,823	29.7	28.8	60.8	62.7	68.8	58.8
	62,187	58,364	42,606	35,120	28.0	28.6	62.2	63.5	68.5	60.2
	70,530	65,500	49,000	37,685	26.9	23.4	61.1	55.3	69.5	57.5
	76,616	69,402	51,108	40,505	24.5	23.0	53.7	56.5	66.7	58.4
2 x 3/8 in. flats.	58,130	51,418	40,400	30,393	30.1	31.1	61.8	60.5	69.5	59.1
	62,089	55,021	42,441	31,576	30.1	30.4	60.9	60.0	68.4	57.4
	69,420	60,850	45,090	34,000	25.6	26.5	59.3	52.1	65.0	55.9
	75,865	67,618	49,691	39,403	24.7	26.3	54.4	51.4	65.5	58.3

The bars were rolled from 4 x 4-in. billets of open-hearth steel. The figures are averages of from 2 to 12 tests of each heat. In annealing the bars were heated in a muffle and withdrawn when they had reached a dull yellow heat.

"Recalescence" of Steel. — If we heat a bar of copper by a flame of constant strength, and note carefully the interval of time occupied in passing from each degree to the next higher degree, we find that these intervals increase regularly, i.e., that the bar heats more and more slowly, as its temperature approaches that of the flame. If we substitute a bar of steel for one of copper, we find that these intervals increase regularly up to a certain point, when the rise of temperature is suddenly and in most

cases greatly retarded or even completely arrested. After this the regular rise of temperature is resumed, though other like retardations may recur as the temperature rises farther. So if we cool a bar of steel slowly the fall of temperature is greatly retarded when it reaches a certain point in dull redness. If the steel contains much carbon, and if certain favoring conditions be maintained, the temperature, after descending regularly, suddenly rises spontaneously very abruptly, remains stationary a while and then redescends. This spontaneous reheating is known as "recalescence."

These retardations indicate that some change which absorbs or evolves heat occurs within the metal. A retardation while the temperature is rising points to a change which absorbs heat; a retardation during cooling points to some change which evolves heat. (Henry M. Howe, on "Heat Treatment of Steel," *Trans. A. I. M. E.*, vol. xxii.)

Critical Point. (Campbell, p. 287.)—If a piece of steel containing over 0.50 C be allowed to cool slowly from a high temperature the cooling at first proceeds at a uniformly retarded rate, but when about 700° C. is reached there is an interruption of this regularity. In some cases the rate of cooling may be very slow, in other cases the bar may not decrease in temperature at all, while in still other cases the bar may actually grow hotter for a moment. When this "critical point" is passed, the bar cools as before until it reaches the temperature of the atmosphere.

In metallography such a critical point is denoted by the letter A, and the particular one just described is known as Ar. In heating a piece of steel an opposite phenomenon is observed, there being an absorption of heat by internal molecular action, with a consequent retardation in the rise of temperature, and this point, which is some 30° C. higher than Ar, is called Ac.

In soft steels, below 0.30 C, three critical points are found in cooling a bar from a high temperature, called Ar₃, Ar₂, Ar₁, Ar₁ being the lowest, and in heating the bar there are also three points, Ac₁, Ac₂, Ac₃, the first named being the lowest. At each of the points there is a change in the micro-structure of the steel.

Metallography.—This is a name given to a study of the micro-structure of metals. The steel metallographist designates the different structures that are found in a polished and etched section by the names austenite, martensite, pearlite, cementite, ferrite, troostite, and sorbite. Austenite is produced by quenching steel of over 1.40 C in ice water from above 1350° C. Martensite is produced by quenching this steel from temperatures between 1050° C. and Ar₁. It is also found together with cementite or ferrite in carbon steels below 1.30 C quenched at any point above Ar₁. It is the constituent which confers hardness on steel. In steels cooled slowly to below Ar₁ the structure is composed entirely of ferrite, or entirely of pearlite, or of pearlite mixed with ferrite or cementite. Ferrite is iron free from carbon and forms almost the whole of a low-carbon steel, while cementite is considered to be a compound of iron and carbon, Fe₃C, the C of this form being known as cement carbon. Pearlite is an intimate mixture of definite proportions of ferrite and cementite, corresponding to a pure steel of about 0.80 C, which, unhardened, consists of pearlite alone. Steels lower in C contain pearlite with ferrite, and steels higher in C contain pearlite and cementite. Troostite is a structure found when steel is quenched while cooling through the critical range, and sorbite when it is quenched at the end of the critical range. Quenching in lead or reheating quenched steel to a purple tint may also produce sorbite. (Campbell, p. 296.)

Effect of Work on the Structure of Soft and Medium Steel.—Steel as usually cast, cooling slowly, forms in crystals or grains. Rolling tends to break up this grain, but immediately after the cessation of work the formation of grains begins and continues until the metal has cooled to the lower critical point. Hence the lower the temperature to which the steel is worked, the more broken up the structure will be, but on the other hand if the rolling be continued below the critical point, the effect of cold work will be shown and strains will be set up which will make the piece unfit for use without annealing.

Effect of Heat Treatment.—In heating steel through the lowest critical point the crystalline structure is obliterated, the metal assuming the finest condition of which it is capable. Above this point the size of grain increases with the temperature.

Effect of Heating on Crucible Steel. (W. Campbell, *Proc. A. S. T. M.*, vi, 213.)—Six steels, containing carbon as follows: (1) 2.04, (2) 1.94, (3) 1.72, (4) 1.61, (5) 1.04, and (6) 0.70, were heated in a small gas furnace to the temperatures given in the table and allowed to cool slowly in the furnace, and were then tested, with results as below.

	As Rolled.	650° C	715° C	760° C	800° C	855° C	905° C	950° C	1070° C	1200° C
(1) T. S.	144000	115400	114500	98800	95650	93800	95250	95200	99000	57400
E. L.	104200	84600	83900	57700	57800	55500	55350	49350	49600	56000
El. in 2 in.	4.0	6.0	7.0	11.5	12.5	12.0	11.5	6.0	4.5	1.0
(2) T. S.	146400	115200	104100	95000	92000	89000	95350	91800	97000	61350
E. L.	91000	91500	72600	68650	50500	51000	49450	49800	41750	47000
El. in 2 in.	6.3	8.0	9.5	15.0	17.0	12.5	7.0	9.5	8.5	2.0
(3) T. S.	153100	126000	111000	100300	98000	94000	94350	95000	92350	65300
E. L.	98100	78300	71000	50500	48750	47900	48600	45200	43100	50600
El. in 2 in.	7.2	8.0	11.5	16.5	10.0	13.5	11.0	7.5	6.0	2.0
(4) T. S.	157700	128100	117000	98650	97700	95000	97350	96350	94400	69800
E. L.	105200	85300	81300	52300	53350	51350	51350	48500	51400
El. in 2 in.	6.5	14.5	18.5	15.0	11.5	7.5	3.5	3.0
(5) T. S.	141100	105400	97800	86800	96600	111800	115900	111500	106100	112600
E. L.	75800	57700	55200	44850	46600	47200	50600	46800	56500	89600
El. in 2 in.	12.8	18.0	22.0	26.5	19.0	13.0	13.0	10.5	11.0	11.5
(6) T. S.	117000	95200	88700	85600	94300	91350	90300	90500	89500	90000
E. L.	64700	53250	49700	40200	42150	42100	41400	39700	57350	58500
El. in 2 in.	17.0	23.0	27.5	27.0	19.0	18.5	18.0	16.5	18.0	16.0

The critical points Ar₁ and Ac₁ were determined, and the six steels gave practically identical results; thus Ar₁ ranged from 896 to 708, averaging 704° C., and Ac₁ ranged from 730 to 737, averaging 733° C.

The temperatures at which the finest-grained and a very coarse-grained fracture were found are as follows:

Steel No.	1	2	3	4	5	6
Finest fracture	800	760	715-760	760	715	715° C
Very coarse fracture	1070	1070	1070	1070	855	800° C

Mr. Campbell's paper gives a list of fourteen papers by different authorities on the micro-structure and the heat treatment of steel.

Burning, Overheating, and Restoring Steel. (G. B. Waterhouse, *A. S. T. M.*, vi, 247.)—Burnt metal is defined as coarsely crystalline and exceedingly brittle iron or steel, in consequence of excessive heating, often with some layers of oxide of iron. It cannot be effectively restored by heat treatment or mechanical work. Overheated metal is coarsely crystalline from excessive heating, but with no inter-crystalline spaces. It can be restored by heat treatment or mechanical work. Seven lots of nickel steel bars, containing 3.8% Ni, and C as in the table, were heated to various temperatures in a muffle furnace, with results as below.

% C.	Heated to	1000a	1000b	1100b	1200b	1300b	1200c	1200d
0.41	T. S.	90246	71800	71700	74000	71320	71487	74989
	El. % in 2 in.	26.0	26.0	25.5	11.0	7.0	10.5	25.0
0.51	T. S.	99109	78600	78800	84900	79600	81487	80795
	El. % in 2 in.	21.0	25.0	24.0	11.5	5.0	15.5	22.5
0.63	T. S.	115421	89000	89400	99600	85200	96040	89842
	El. % in 2 in.	16.5	20.5	19.0	7.0	2.0	10.0	21.0
0.79	T. S.	135194	108960	111840	109600	66800	102705	90214
	El. % in 2 in.	14.0	15.0	14.0	3.0	0.5	6.0	21.0
0.97	T. S.	156827	130336	138112	83117	46648	114107	103476
	El. % in 2 in.	7.5	3.5	0.5	0.0	5.5	18.0
1.24	T. S.	168697	97510	98183	90729	60600	95103	106304
	El. in 2 in.	3.5	15.0	1.0	0.5	0.0	1.5	3.5
1.48	T. S.	145642	63950	66640	97894	35480	89045	74592
	El. in 2 in.	10.5	23.6	25.0	8.0	1.0	17.5	24.0

a. Heated to 1000 C., which took 1 hr. 25 min., held there 25 min., and cooled in air. b. The time required to heat to the temperatures named was respectively 1 h. 10 m., 1 h. 45 m., 2 h. 35 m., and 2 h. 35 m. The bars were kept at the desired temperature for an hour and then cooled slowly in place. c. Reheated to 700 C. d. Reheated to 775 C.

In the steels below 1% C heating to 1200° is accompanied by an increase in ultimate strength and a drop in ductility. Heating above 1200° produces a very coarse crystallization and a great loss in strength and ductility. Reheating the overheated bars to 700° does not materially affect their structure, but reheating to 775° restores the structure nearly to that found before overheating, and completely restores the ductility. Similar results are found with carbon steel.

Working Steel at a Blue Heat. — Not only are wrought iron and steel much more brittle at a blue heat (i.e., the heat that would produce an oxide coating ranging from light straw to blue on bright steel, 430° to 600° F.), but while they are probably not seriously affected by simple exposure to blueness, even if prolonged, yet if they be worked in this range of temperature they remain extremely brittle after cooling, and may indeed be more brittle than when at blueness; this last point, however, is not certain. (Howe, *Metallurgy of Steel*, p. 534.)

Tests by Prof. Krohn, for the German State Railways, show that working at blue heat has a decided influence on all materials tested, the injury done being greater on wrought iron and harder steel than on the softer steel. The fact that wrought iron is injured by working at a blue heat was reported by Stromeyer. (*Engineering News*, Jan. 9, 1892.)

A practice among boiler-makers for guarding against failures due to working at a blue heat consists in the cessation of work as soon as a plate which had been red-hot becomes so cool that the mark produced by rubbing a hammer-handle or other piece of wood will not glow. A plate which is not hot enough to produce this effect, yet too hot to be touched by the hand, is most probably blue hot, and should under no circumstances be hammered or bent. (C. E. Stromeyer, *Proc. Inst. C. E.*, 1886.)

Oil-tempering and Annealing of Steel Forgings. — H. F. J. Porter says (1897) that all steel forgings above 0.1% carbon should be annealed, to relieve them of forging and annealing strains, and that the process of annealing reduces the elastic limit to 47% of the ultimate strength. Oil-tempering should only be practiced on thin sections, and large forgings should be hollow for the purpose. This process raises the elastic limit above 50% of the ultimate tensile strength, and in some alloys of steel, notably nickel steel, will bring it up to 60% of the ultimate.

Heat Treatment of Armor Plates. (Hadfield Process, *Iron Tr. Rev.*, Dec. 7, 1905.) — A cast armor plate of nickel-chromium steel is heated to from 950° C. to 1100° C., then cooled, preferably in air, then reheated to about 700° and cooled slowly, preferably in the furnace in which the heating was previously effected, again heated to about 700° and allowed to cool slowly to 640° C., whereupon it is suddenly cooled by spraying with water or by an air blast, but preferably in water. It is then reheated to about 600° and again suddenly cooled, preferably by quenching in water. Steel treated as described is suitable for armor plates and other articles, including parts of safes. Satisfactory results have been obtained by thus treating cast 6-in. armor plates containing about 0.3 to 0.4 C, 0.25 Mn, 1.8 Cr, and 3.3 Ni cast in a sand mold. Such a 6-in. plate attacked by armor-piercing projectiles of 4.7-in. and 6-in. calibers, stood over 15,000 foot-tons of energy without showing a crack. Also a 4-in. plate treated as described and having a carbonized or cemented face has withstood the attack of a 5.7-in. armor-piercing shell.

Brittleness Due to Long-continued Heating. If low-carbon steel, (say under 0.15%) is held for a very long time at temperatures between 500 and 750° C. (930 and 1380° F.), the crystals become enormous and the steel loses a large part of its strength and ductility. It takes a long time, in fact days, to produce this effect to any alarming degree, so that it is not liable to occur during manufacture or mechanical treatment, but steel is sometimes placed in positions where it may suffer this injury, for example, in the case of the tie-rods of furnaces, supports of boilers, etc., so that the danger should be borne in mind by all engineers and users of steel. A wrought-iron chain that supported one side of a 50-ton open-hearth ladle, which was heated many times to a temperature above 500° C., finally reached a condition of coarse crystallization, so that it was unable

to bear the strain upon it. This phenomenon of coarse crystallization in low-carbon steel is known as "Stead's Brittleness," after J. E. Stead, who has explained its cause. The effect seems to begin at a temperature of about 500° C. and proceeds more rapidly with an increase in temperature until we reach 750° C. The damage may be repaired completely by heating the steel to a temperature between 800 and 900° C. The remedy is the same as that for coarse crystallization, due to overheating, and all steel which is placed in positions where it is liable to reach these temperatures frequently should be restored at intervals of a week or a month, or as often as may be necessary. (Stoughton.)

Influence of Annealing upon Magnetic Capacity.

Prof. D. E. Hughes (*Eng'g*, Feb. 8, 1884, p. 130) has invented a "Magnetic Balance," for testing the condition of iron and steel, which consists chiefly of a delicate magnetic needle suspended over a graduated circular index, and a magnet coil for magnetizing the bar to be tested. He finds that the following laws hold with every variety of iron and steel:

1. The magnetic capacity is directly proportional to the softness, or molecular freedom.
2. The resistance to a feeble external magnetizing force is directly as the hardness, or molecular rigidity.

The magnetic balance shows that annealing not only produces softness in iron, and consequent molecular freedom, but it entirely frees it from all strains previously introduced by drawing or hammering. Thus a bar of iron drawn or hammered has a peculiar structure, say a fibrous one, which gives a greater mechanical strength in one direction than another. This bar, if thoroughly annealed at high temperatures, becomes homogeneous in all directions, and has no longer even traces of its previous strains, provided that there has been no actual separation into a distinct series of fibers.

TREATMENT OF STRUCTURAL STEEL.

(James Christie, *Trans. A. S. C. E.*, 1893.)

Effect of Punching and Shearing. — The physical effects of punching and shearing as denoted by tensile test are for iron or steel:

Reduction of ductility; elevation of tensile strength at elastic limit; reduction of ultimate tensile strength.

In very thin material the disturbance described is less than in thick; in fact, a degree of thinness is reached where this disturbance practically ceases. On the contrary, as thickness is increased the injury becomes more evident.

The effects described do not invariably ensue; for unknown reasons there are sometimes marked deviations from what seems to be a general result.

By thoroughly annealing snared or punched steels the ductility is to a large extent restored and the exaggerated elastic limit reduced, the change being modified by the temperature of reheating and the method of cooling.

It is probable that the best results combined with least expenditure can be obtained by punching all holes where vital strains are not transferred by the rivets, and by reaming for important joints where strains on riveted joints are vital, or wherever perforation may reduce sections to a minimum. The reaming should be sufficient to thoroughly remove the material disturbed by punching; to accomplish this it is best to enlarge punched holes at least 1/8 in. diameter with the reamer.

Riveting. — It is the current practice to perforate holes 1/16 in. larger than the rivet diameter. For work to be reamed it is also a usual requirement to punch the holes from 1/8 to 3/16 in. less than the finished diameter, the holes being reamed to the proper size after the various parts are assembled.

It is also excellent practice to remove the sharp corner at both ends of the reamed holes, so that a fillet will be formed at the junction of the body and head of the finished rivets.

The rivets of either iron or mild steel should be heated to a bright red or yellow heat and subjected to a pressure of not less than 50 tons per square inch of sectional area.

For rivets of ordinary length this pressure has been found sufficient to completely fill the hole. If, however, the holes and the rivets are excep-

tionally long, a greater pressure and a slower movement of the closing tool than is used for shorter rivets has been found advantageous.

Welding. — No welding should be allowed on any steel that enters into structures. [See page 463.]

Upsetting. — Enlarged ends on tension bars for screw-threads, eye-bars, etc., are formed by upsetting the material. With proper treatment and a sufficient increment of enlarged sectional area over the body of the bar the result is entirely satisfactory. The upsetting process should be performed so that the properly heated metal is compelled to flow without folding or lapping.

Annealing. — The object of annealing structural steel is for the purpose of securing homogeneity of structure that is supposed to be impaired by unequal heating, or by the manipulation necessarily attendant on certain processes. The objects to be annealed should be heated throughout to a uniform temperature and uniformly cooled.

The physical effects of annealing, as indicated by tensile tests, depend on the grade of steel, or the amount of hardening elements associated with it; also on the temperature to which the steel is raised, and the method or rate of cooling the heated material.

The physical effects of annealing medium-grade steel, as indicated by tensile test, are reported very differently by different observers, some claiming directly opposite results from others. It is evident, when all the attendant conditions are considered, that the obtained results must vary both in kind and degree.

The temperatures employed will vary from 1000° to 1500° F. In some cases the heated steel is withdrawn at full temperature from the furnace and allowed to cool in the atmosphere; in others the mass is removed from the furnace, but covered under a muffle, to lessen the free radiation; or, again, the charge is retained in the furnace, and the whole mass cooled with the furnace, and more slowly than by either of the other methods.

The best general results from annealing will probably be obtained by introducing the material into a uniformly heated oven in which the temperature is not so high as to cause a possibility of cracking by sudden and unequal changing of temperature, then gradually raising the temperature of the material until it is uniformly about 1200° F., then withdrawing the material after the temperature is somewhat reduced and cooling under shelter of a muffle sufficiently to prevent too free and unequal cooling on the one hand or excessively slow cooling on the other.

G. G. Mehlertens, *Trans. A. S. C. E.*, 1893, says: "Annealing is of advantage to all steel above 64,000 lbs. strength per square inch, but it is questionable whether it is necessary in softer steels. The distortions due to heating cause trouble in subsequent straightening, especially of thin plates.

"In a general way all unannealed mild steel for a strength of 56,000 to 64,000 lbs. may be worked in the same way as wrought iron. Rough treatment or working at a blue heat must, however, be prohibited. Shearing is to be avoided, except to prepare rough plates, which should afterwards be smoothed by machine tools or files before using. Drifting is also to be avoided, because the edges of the holes are thereby strained beyond the yield-point. Reaming drilled holes is not necessary, particularly when sharp drills are used and neat work is done. A slight counter-sinking of the edges of drilled holes is all that is necessary. Working the material while heated should be avoided as far as possible, and the engineer should bear this in mind when designing structures. Upsetting, cranking, and bending ought to be avoided, but when necessary the material should be annealed after completion.

"The riveting of a mild-steel rivet should be finished as quickly as possible, before it cools to the dangerous heat. For this reason machine work is the best. There is a special advantage in machine work from the fact that the pressure can be retained upon the rivet until it has cooled sufficiently to prevent elongation and the consequent loosening of the rivet."

Punching and Drilling of Steel Plates. (*Proc. Inst. M. E.*, Aug., 1887, p. 326.) — In Prof. Unwin's report the results of the greater number of the experiments made on iron and steel plates lead to the general conclusion that while thin plates, even of steel, do not suffer very much from punching, yet in those of 1/2 in. thickness and upwards the loss of tenacity due to punching ranges from 10% to 23% in iron plates and from 11% to 33% in the case of mild steel.

MISCELLANEOUS NOTES ON STEEL.

May Carbon be Burned Out of Steel? — Experiments made at the Laboratory of the Penna. Railroad Co. (Specifications for Springs, 1888) with the steel of spiral springs, show that the place from which the borings are taken for analysis has a very important influence on the amount of carbon found. If the sample is a piece of the round bar, and the borings are taken from the end of this piece, the carbon is always higher than if the borings are taken from the side of the piece. It is common to find a difference of 0.10% between the center and side of the bar, and in some cases the difference is as high as 0.23%. Apparently during the process of reducing the metal from the ingots to the round bar, with successive heatings, the carbon in the outside of the bar is burned out.

Effect of Nicking a Steel Bar. — The statement is sometimes made that, owing to the homogeneity of steel, a bar with a surface crack or nick in one of its edges is liable to fail by the gradual spreading of the nick, and thus break under a very much smaller load than a sound bar. With iron it is contended this does not occur, as this metal has a fibrous structure. Sir Benjamin Baker has, however, shown that this theory, at least so far as statical stress is concerned, is opposed to the facts, as he purposely made nicks in specimens of the mild steel used at the Forth Bridge, but found that the tensile strength of the whole was thus reduced by only about one ton per square inch of section. In an experiment by the Union Bridge Company a full-sized steel counter-bar, with a screw-turned buckle connection, was tested under a heavy statical stress, and at the same time a weight weighing 1040 lbs. was allowed to drop on it from various heights. The bar was first broken by ordinary statical strain, and showed a breaking stress of 66,800 lbs. per square inch. The longer of the broken parts was then placed in the machine and put under the following loads, whilst a weight, as already mentioned, was dropped on it from various heights at a distance of five feet from the sleeve-nut of the turn-buckle, as shown below:

Stress in pounds per sq. in.	50,000	55,000	60,000	63,000	65,000
	ft. in.	ft. in.	ft. in.	ft. in.	ft. in.
Height of fall	2 1	2 6	3 0	4 0	5 0

The weight was then shifted so as to fall directly on the sleeve-nut, and the test proceeded as follows:

Stress on specimen in lbs. per square inch	65,350	65,350	68,800
Height of fall, feet	3	6	6

It will be seen that under this trial the bar carried more than when originally tested statically, showing that the nicking of the bar by screwing had not appreciably weakened its power of resisting shocks. — *Eng'g News*.

Specific Gravity of Soft Steel. (W. Kent, *Trans. A. I. M. E.*, xiv, 585.) — Five specimens of boiler-plate of C 0.14, P 0.03 gave an average sp. gr. of 7.932, maximum variation 0.008. The pieces were first planed to remove all possible scale indentations, then filed smooth, then cleaned in dilute sulphuric acid, and then boiled in distilled water, to remove all traces of air from the surface.

The figures of specific gravity thus obtained by careful experiment on bright, smooth pieces of steel are, however, too high for use in determining the weights of rolled plates for commercial purposes. The actual average thickness of these plates is always a little less than is shown by the calipers, on account of the oxide of iron on the surface, and because the surface is not perfectly smooth and regular. A number of experiments on commercial plates, and comparison of other authorities, led to the figure 7.854 as the average specific gravity of open-hearth boiler-plate steel. This figure is easily remembered as being the same figure with change of position of the decimal point (.7854) which expresses the relation of the area of a circle to that of its circumscribed square. Taking the weight of a cubic foot of water at 62° F. as 62.36 lbs. (average of several authorities), this figure gives 489.775 lbs. as the weight of a cubic foot of steel, or the even figure, 490 lbs., may be taken as a convenient figure, and accurate within the limits of the error of observation.

A common method of approximating the weight of iron plates is to consider them to weigh 40 lbs. per square foot one inch thick. Taking this

weight and adding 2% gives almost exactly the weight of steel boiler-plate given above ($40 \times 12 \times 1.02 = 489.6$ lbs. per cubic foot).

Occasional Failures of Bessemer Steel.—G. H. Clapp and A. E. Hunt, in their paper on "The Inspection of Materials of Construction in the United States" (*Trans. A. I. M. E.*, vol. xix), say: Numerous instances could be cited to show the unreliability of Bessemer steel for structural purposes. One of the most marked, however, was the following: A 12-in. I-beam weighing 30 lbs. to the foot, 20 feet long, on being unloaded from a car broke in two about 6 feet from one end.

The analyses and tensile tests made do not show any cause for the failure. The cold and quench bending tests of both the original $\frac{3}{4}$ -in. round test-pieces, and of pieces cut from the finished material, gave satisfactory results; the cold-bending tests closing down on themselves without sign of fracture.

Numerous other cases of angles and plates that were so hard in places as to break off short in punching, or, what was worse, to break the punches, have come under our observation, and although makers of Bessemer steel claim that this is just as likely to occur in open-hearth as in Bessemer steel, we have as yet never seen an instance of failure of this kind in open-hearth steel having a composition such as C 0.25%, Mn 0.70%, P 0.08%.

J. W. Wailles, in a paper read before the Chemical Section of the British Association for the Advancement of Science, in speaking of mysterious failures of steel, states that investigation shows that "these failures occur in steel of one class, viz., soft steel made by the Bessemer process."

Segregation in Steel Ingots. (A. Pourcel, *Trans. A. I. M. E.*, 1893.)—H. M. Howe, in his "Metallurgy of Steel," gives a *résumé* of observations, with the results of numerous analyses, bearing upon the phenomena of segregation.

A test-piece taken 24 inches from the head of an ingot 7.5 feet in length gave by analysis very different results from those of a test-piece taken 30 inches from the bottom.

	C.	Mn.	Si.	S.	P.
Top.....	0.92	0.535	0.043	0.161	0.261
Bottom.....	0.37	0.498	0.006	0.025	0.096

Segregation is less marked in ingots of extra-soft metal cast in cast-iron molds of considerable thickness. It is, however, still important, and explains the difference often shown by the results of tests on pieces taken from different portions of a plate. Two samples, taken from the sound part of a flat ingot, one on the outside and the other in the center, 7.9 inches from the upper edge, gave:

	C.	S.	P.	Mn.
Center.....	0.14	0.053	0.072	0.576
Exterior.....	0.11	0.036	0.027	0.610

Manganese is the element most uniformly disseminated in hard or soft steel.

For cannon of large caliber, if we reject, in addition to the part cast in sand and called the *masselotte* (sinking-head), one-third of the upper part of the ingot, we can obtain a tube practically homogeneous in composition, because the central part is naturally removed by the boring of the tube. With extra-soft steels, destined for ship- or boiler-plates, the solution for practically perfect homogeneity lies in the obtaining of a metal more closely deserving its name of extra-soft metal.

The injurious consequences of segregation must be suppressed by reducing, as far as possible, the elements subject to liquation.

Segregation in Steel Plates. (C. L. Huston, *Proc. A. S. T. M.*, vi, 182.) A plate $370 \times 76 \times \frac{5}{16}$ in. was rolled from a 16×18 -in. ingot, weighing

2800 lbs., the ladle test of which showed 0.18 C. Test pieces from the plate gave the following:

Top of Ingot:					
Tensile Strength.....	56,730	67,420	67,050	66,980	56,140
Carbon.....	0.13	0.25	0.27	0.25	0.13
Bottom of Ingot:					
Tensile Strength.....	56,120	57,720	58,400	58,140	56,900
Carbon.....	0.13	0.13	0.16	0.16	0.14
	1	2	3	4	5

Columns 1 and 5, edge of plate; 3, middle; 2 and 4, half way between middle and edge.

Other tests of low-carbon steel showed a lower degree of segregation. A plate from an ingot of 0.23 C gave minimum 0.18 C T. S., 64,580; maximum 0.38 C, T. S., 70,340. One from an ingot of 0.26 C gave maximum 0.20 C, T. S., 59,600; maximum 0.50 C, T. S., 78,600. (See also paper on this subject by H. M. Howe in vol. vii, p. 75.)

Endurance of Steel under Repeated Alternate Stresses. (J. E. Howard, *A. S. T. M.*, 1907, p. 252.)—Small bars were rapidly rotated in a machine while being subjected to a transverse strain. Two steels gave results as follows: (1) 0.55 C, T. S., 111,200; E. L., 59,000; Elong., 12%; Red. of area, 33.5%. (2) 0.82 C, T. S., 142,000; E. L., 64,000; Elong., 7%; Red. of area, 11.8%.

Fiber stress.....	60,000	50,000	45,000	40,000	35,000	30,000
No. of rotations before rupture.	{(1) 12,490 (2) 37,250	33,160 213,150	166,240 605,640	455,000 202,000,000	900,720	76,326,240 Not broken.

Welding of Steel.—H. H. Campbell (*Manuf. of Iron and Steel*, p. 402) had numerous bars of steel welded by different skilled blacksmiths. The record of results, he says, "is extremely unsatisfactory." The worst weld by each of four workmen showed respectively 70, 54, 58, and 44% of the strength of the original bar. Forging steel showed one weld with only 48%, common soft steel 44%, and pure basic steel 59%. In a series of tests by the Royal Prussian Testing Institute, the average strength of welded bars of medium steel was 58% of the natural, the poorest bar showing only 23%. In softer steel the average was 71%, and the poorest 33%, while in puddled iron the average was 81% and the poorest 62%. Mr. Campbell concludes: "A weld as performed by ordinary blacksmiths, whether on iron or steel, is not nearly as good as the rest of the bar; and it is still more certain that welds of large rods of common forging steel are unreliable and should not be employed in structural work. Electric methods do not offer a solution of the problem, for the metal is heated beyond the critical temperature of crystallization, and only by heavy reductions under the hammer or press can much be done towards restoring the ductility of the piece."

Welding of Steel.—A. E. Hunt (*A. I. M. E.*, 1892) says: "I have never seen so-called 'welded' pieces of steel pulled apart in a testing-machine or otherwise broken at the joint which have not shown a smooth cleavage plane, as it were, such as in iron would be condemned as an imperfect weld. My experience in this matter leads me to agree with the position taken by Mr. William Metcalf in his paper upon Steel in the *Trans. A. S. C. E.*, vol. xvi, p. 301. Mr. Metcalf says, 'I do not believe steel can be welded.'"

The Thermit Welding Process. (Goldschmidt Thermit Co., New York.)—When powdered or finely divided aluminum is mixed with a metallic oxide and ignited, the aluminum burns with great rapidity and intense heat, reducing the oxide to a metal and fusing it. It is said that iron oxide and aluminum will make a temperature of 5400° F., producing iron which will melt any iron or steel with which it comes in contact. The process is largely used for repairing breaks of large castings or forgings, such as the stern post of a steamship, a locomotive frame, etc. In the operation of welding a large fractured piece, the fracture is drilled out with a series of $\frac{3}{4}$ -in. holes close together, making a clear opening. A mold of fire-clay and sand is then made to fit all around the fracture, leaving a collar or ring surrounding it, baked in a furnace

and then placed in position. The fractured section is then heated by a blow-torch inserted in the riser of the mold. A conical sheet iron crucible, lined with magnesia tar, is then inserted in the riser, and thermit (the mixture of aluminum and oxide of iron) poured into it. An ignition powder is placed on top of the thermit, and lighted with a storm match. The mixture begins to burn with great agitation; when this ceases the crucible is tapped, and white-hot fused iron or steel runs into the mold and thoroughly fuses with the pieces to be joined.

Oxy-acetylene Welding and Cutting of Metals. — Autogenous Welding. — By means of acetylene gas and oxygen, stored in tanks under pressure, and a properly constructed nozzle or torch in which the two gases are united and fired, an intense temperature said to be 6000° F. is generated, and it may be used to weld or fuse together iron, steel, aluminum, brass, copper, or other metals. The process of uniting metals by heat without using either flux or compression is called autogenous welding. The oxy-acetylene torch may also be used for cutting metals, such as steel plates, beams and large forgings, and for repairing flaws or defects, or filling cavities by melting a strip of metal and flowing it into place. The apparatus, with instruction in its use, is furnished by the Davis-Bournonville Co., Jersey City, N. J.

Electric Welding. — For description see Electrical Engineering.

Hydraulic Forging. — In the production of heavy forgings from cast ingots of mild steel it is essential that the mass of metal should be operated on as equally as possible throughout its entire thickness. When employing a steam-hammer for this purpose it has been found that the external surface of the ingot absorbs a large proportion of the sudden impact of the blow, and that a comparatively small effect only is produced on the central portions of the ingot, owing to the resistance offered by the inertia of the mass to the rapid motion of the falling hammer — a disadvantage that is entirely overcome by the slow, though powerful, compression of the hydraulic forging-press, which appears destined to supersede the steam-hammer for the production of massive steel forgings.

Fluid-compressed Steel by the "Whitworth Process." (*Proc. Inst. M. E.*, May, 1887, p. 167.) — In this system a gradually increasing pressure up to 6 or 8 tons per square inch is applied to the fluid ingot, and within half an hour or less after the application of the pressure the column of fluid steel is shortened 1 1/2 inches per foot or one-eighth of its length; the pressure is then kept on for several hours, the result being that the metal is compressed into a perfectly solid and homogeneous material, free from blow-holes.

In large gun-ring ingots during cooling the carbon is driven to the center, the center containing 0.8 carbon and the outer ring 0.3. The center is bored out until a test shows that the inside of the ring contains the same percentage of carbon as the outside.

Fluid-compressed steel is made by the Bethlehem Steel Co. for gun and other heavy forgings.

Putting sufficient pressure upon the outside of the ingot when the walls are solid but the interior is still liquid will prevent the formation of a pipe. In Whitworth's system the ingot is raised and compressed lengthwise against a solid ram situated above it, during and shortly after solidification. In Harmet's method the ingot is forced upward during solidification into its tapered mold. This causes a large radial pressure on its sides. In Lilienberg's method the ingots are stripped and then run on their cars between a solid and movable wall. The movable wall is then pressed against one side of the ingots. (*Stoughton's Metallurgy of Iron and Steel.*)

For other methods of compressing ingots see paper by A. J. Capron in *Jour. I. & S. I.*, 1906, *Iron Tr. Rev.*, May 24, 1906.

STEEL CASTINGS.

(E. S. Cramp, Proc. Eng'g Congress, Dept. of Marine Eng'g, Chicago, 1893.)

In 1891 American steel-founders had successfully produced a considerable variety of heavy and difficult castings, of which the following are the most noteworthy specimens:

Bed-plates up to 24,000 lbs.; stern-posts up to 54,000 lbs.; stems up to 21,000 lbs.; hydraulic cylinders up to 11,000 lbs.; shaft-struts up to 32,000 lbs.; hawse-pipes up to 7500 lbs.; stern-pipes up to 8000 lbs.

The percentage of success in these classes of castings since 1890 has ranged from 65% in the more difficult forms to 90% in the simpler ones; the tensile strength has been from 62,000 to 78,000 lbs., elongation from 15% to 25%.

The first steel castings of which anything is generally known were crossing-frogs made for the Philadelphia & Reading R. R. in July, 1867, by the William Butcher Steel Works, now the Midvale Steel Co. The molds were made of a mixture of ground fire-brick, black-lead crucible-pots ground fine, and fire-clay, and washed with a black-lead wash. The steel was melted in crucibles, and was about as hard as tool steel. The surface of these castings was very smooth, but the interior was very much honey-combed. This was before the days when the use of silicon was known for solidifying steel. The sponginess, which was almost universal, was a great obstacle to their general adoption.

The next step was to leave the ground pots out of the molding mixture and to wash the mold with finely ground fire-brick. This was a great improvement, especially in very heavy castings; but this mixture still clung so strongly to the casting that only comparatively simple shapes could be made with certainty. A mold made of such a mixture became almost as hard as fire-brick, and was such an obstacle to the proper shrinkage of castings that, when at all complicated in shape, they had so great a tendency to crack as to make their successful manufacture almost impossible. By this time the use of silicon had been discovered, and the only obstacle in the way of making good castings was a suitable molding mixture. This was ultimately found in mixtures having the various kinds of silica sand as the principal constituent.

One of the most fertile sources of defects in castings is a bad design. Very intricate shapes can be cast successfully if they are so designed as to cool uniformly. Mr. Cramp says while he is not yet prepared to state that anything that can be cast successfully in iron can be cast in steel, indications seem to point that way in all cases where it is possible to put on suitable sinking-heads for feeding the casting.

H. L. Gantt (*Trans. A. S. M. E.*, xii, 710) says: Steel castings not only shrink much more than iron ones, but with less regularity. The amount of shrinkage varies with the composition and the heat of the metal: the hotter the metal the greater the shrinkage; and, as we get smoother castings from hot metal, it is better to make allowance for large shrinkage and pour the metal as hot as possible. Allow 3/16 or 1/4 in. per ft. in length for shrinkage, and 1/4 in. for finish on machined surfaces, except such as are cast "up." Cope surfaces which are to be machined should, in large or hard castings, have an allowance of from 3/8 to 1/2 in. for finish, as a large mass of metal slowly rising in a mold is apt to become crusty on the surface, and such a crust is sure to be full of imperfections. On small, soft castings 1/8 in. on drag side and 1/4 in. on cope side will be sufficient. No core should have less than 1/4 in. finish on a side and very large ones should have as much as 1/2 in. on a side. Blow-holes can be entirely prevented in castings by the addition of manganese and silicon in sufficient quantities; but both of these cause brittleness, and it is the object of the conscientious steel-maker to put no more manganese and silicon in his steel than is just sufficient to make it solid. The best results are arrived at when all portions of the castings are of a uniform thickness, or very nearly so.

The following table will illustrate the effect of annealing on tensile strength and elongation of steel castings:

Carbon.	Tensile Strength.		Elongation.	
	Unannealed.	Annealed.	Unannealed.	Annealed.
0.23%	68,738	67,210	22.40%	31.40%
0.37	85,540	82,228	8.20	21.80
0.53	90,121	106,415	2.35	9.80

The proper annealing of large castings takes nearly a week.

The proper steel for roll pinions, hammer dies, etc., seems to be that containing about 0.60% of carbon. Such castings, properly annealed, have worn well and seldom broken. Miscellaneous gearing should contain

WARNING: This is a 1910 edition. Some of the material may no longer be accurate

carbon 0.40% to 0.60%, gears larger in diameter being softest. General machinery castings should, as a rule, contain less than 0.40% of carbon, those exposed to great shocks containing as low as 0.20% of carbon. Such castings will give a tensile strength of from 60,000 to 80,000 lbs. per sq. in. and at least 15% extension in 2 in. Machinery and hull castings for war-vessels for the United States Navy, as well as carriages for naval guns, contain from 0.20% to 0.30% of carbon.

For description of methods of manufacture of steel castings by the Bessemer, open-hearth, and crucible processes, see paper by P. G. Salom, *Trans. A. I. M. E.*, xiv, 118.

CRUCIBLE STEEL.

Selection of Grades by the Eye, and Effect of Heat Treatment. (J. W. Langley, *Amer. Chemist*, Nov., 1876.) — In the early days of steel making the grades were determined by inspection of the fractured surfaces of the cast ingots. The method of selection is described as follows:

The steel when thoroughly fluid is poured into cast-iron molds, and when cold the top of the ingot is broken off, exposing a freshly fractured surface. The appearance presented is that of confused groups of crystals, all appearing to have started from the outside and to have met in the center; this general form is common to all ingots of whatever composition, but to the trained eye, and only to one long and critically exercised, a minute but indescribable difference is perceived between varying samples of steel, and this difference is now known to be owing almost wholly to variations in the amount of combined carbon, as the following table will show. Twelve samples selected by the eye alone, and analyses of drillings taken direct from the ingot before it had been heated or hammered, gave results as below:

Ingot Nos.	1	2	3	4	5	6	7	8	9	10	11	12
C	0.302	.490	.529	.649	.801	.841	.867	.871	.955	1.005	1.058	1.079
Diff. of C		0.188	.039	.120	.152	.040	.026	.004	.084	.050	.053	.021

The C is seen to increase in quantity in the order of the numbers. The other elements, with the exception of total iron, bear no relation to the number on the samples. The mean difference of C is 0.071.

In mild steels the discrimination is less perfect.

The appearance of the fracture by which the above twelve selections were made can only be seen in the cold ingot before any operation, except the original one of casting, has been performed upon it. As soon as it is hammered, the structure changes, so that all trace of the primitive condition appears to be lost.

The specific gravity of steel is influenced not only by its chemical analysis but by the heat to which it is subjected.

The sp. gr. of the ingots in the above list ranged from 7.855 for No. 1 down to 7.803 for No. 12. Rolling into bars produced a very slight difference, — 0.005 in Nos. 5 and 6 and +0.020 in No. 12, but overheating reduced the sp. gr. of the bar 0.023 in No. 3 to 0.135 in No. 12, the sp. gr. of the burnt sample of No. 12 being only 7.690.

Effect of Heat on the Grain of Steel. (W. Metcalf, — *Jeans on Steel*, p. 642.) — A simple experiment will show the alteration produced in a high-carbon steel by different methods of hardening. If a bar of such steel be nicked at about 9 or 10 places, and about half an inch apart, a suitable specimen is obtained for the experiment. Place one end of the bar in a good fire, so that the first nicked piece is heated to whiteness, while the rest of the bar, being out of the fire, is heated up less and less as we approach the other end. As soon as the first piece is at a good white heat, which of course burns a high-carbon steel, and the temperature of the rest of the bar gradually passes down to a very dull red, the metal should be taken out of the fire and suddenly plunged in cold water, in which it should be left till quite cold. It should then be taken out and carefully dried. An examination with a file will show that the first piece has the greatest hardness, while the last piece is the softest, the intermediate pieces gradually passing from one condition to the other. On now breaking off the pieces at each nick it will be seen that very considerable and characteristic changes have been produced in the appearance of the metal. The first burnt piece is very open or crystalline in fracture; the succeeding pieces become closer and closer in the grain until one piece is found to possess that perfectly even grain and velvet-like appearance

which is so much prized by experienced steel users. The first pieces also, which have been too much hardened, will probably be cracked; those at the other end will not be hardened through. Hence if it be desired to make the steel hard and strong, the temperature used must be high enough to harden the metal through, but not sufficient to open the grain.

Heating Tool Steel. (Crescent Steel Co., Pittsburg, Pa.) — There are three distinct stages or times of heating: First, for forging; second, for hardening; third, for tempering.

The first requisite for a good heat for forging is a clean fire and plenty of fuel, so that jets of hot air will not strike the corners of the piece; next, the fire should be regular, and give a good uniform heat to the whole part to be forged. It should be keen enough to heat the piece as rapidly as may be, and allow it to be thoroughly heated through, without being so fierce as to overheat the corners.

Steel should not be left in the fire any longer than is necessary to heat it clear through, as "soaking" in fire is very injurious; and, on the other hand, it is necessary that it should be hot through, to prevent surface cracks.

By observing these precautions a piece of steel may always be heated safely, up to even a bright yellow heat, when there is much forging to be done on it.

The best and most economical of welding fluxes is clean, crude borax, which should be first thoroughly melted and then ground to fine powder.

After the steel is properly heated, it should be forged to shape as quickly as possible; and just as the red heat is leaving the parts intended for cutting edges, these parts should be refined by rapid, light blows, continued until the red disappears.

For the second stage of heating, for hardening, great care should be used; first, to protect the cutting edges and working parts from heating more rapidly than the body of the piece; next, that the whole part to be hardened be heated uniformly through, without any part becoming visibly hotter than the other. A uniform heat, as low as will give the required hardness, is the best for hardening.

For every variation of heat which is great enough to be seen there will result a variation in grain, which may be seen by breaking the piece; and for every such variation in temperature there is a very good chance for a crack to be seen. Many a costly tool is ruined by inattention to this point.

The effect of too high heat is to open the grain; to make the steel coarse. The effect of an irregular heat is to cause irregular grain, irregular strains, and cracks.

As soon as the piece is properly heated for hardening, it should be promptly and thoroughly quenched in plenty of the cooling medium, water, brine, or oil, as the case may be.

An abundance of the cooling bath, to do the work quickly and uniformly all over, is very necessary to good and safe work.

To harden a large piece safely a running stream should be used.

Much uneven hardening is caused by the use of too small baths.

For the third stage of heating, to temper, the first important requisite is again uniformity. The next is time; the more slowly a piece is brought down to its temper, the better and safer is the operation.

When expensive tools are to be made it is a wise precaution to try small pieces of the steel at different temperatures, so as to find out how low a heat will give the necessary hardness. The lowest heat is the best for any steel. [This is true of carbon steel but not of "high speed" alloy steels.]

Heating in a Lead Bath. — A good method of heating steel to a uniform temperature is by means of a bath of lead kept at a red heat by a gas furnace. See *Heat Treatment by the Taylor-White Process*, under *Machine Shop*.

Heating Steel in Melted Salts by Electric Current. — L. M. Cohn (*Electrot. Z.*, Aug., 1906, *Mach'g.*, Dec., 1906) describes a furnace patented by Gebr. Körting, Berlin, in which steel may be heated uniformly to any desired temperature up to 1300° C. (2372° F.) without danger of oxidizing.

The furnace consists mainly of a cast-iron box, lined inside with fire-clay, a second lining of fire-bricks, lined again with asbestos, and inclosing the crucible made of one piece of fireproof material. Two electrodes lead into the crucible, through which alternating current is sent. The crucible is filled with metal salts. For temperatures above

1000° C. pure chloride of barium is used, the melting-point of which is at about 950° C. (1742 F.); for lower temperatures a mixture of chloride of barium and chloride of potassium, 2 to 1, is used, melting at about 670° C. (1238 F.). Any other suitable salts may be used. A special regulating transformer serves to regulate the current, and thus also the temperature.

A test was made with a furnace, the bath of which was 6 1/2 X 6 1/2 X 7 in. A 50-period alternating current of 190-volt primary tension was used. This tension had to be reduced to from 50 to 55 volts by the regulating transformer for starting the furnace, and lowered later on. The heating lasted about half an hour. For temperatures from 750 to 1300° C., the secondary tension amounted to from 13 to 18 volts. The consumption of energy was as follows: 880° C., 5.4 Kw.; 1140° C., 8.5 Kw.; 1300° C., 12.25 Kw.

A milling cutter 5 in. diameter, 1 1/4 in. bore, 1 in. thick, was heated in 62 seconds to 1300° C. A bushing of tool steel 2 3/4 in. diam., 2 3/4 in. long, 5/8 in. bore, was heated in 243 seconds to 850° C.

Heating to Forge. (Crescent Steel Co.) — The trouble in the forge fire is usually uneven heat, and not too high heat. Suppose the piece to be forged has been put into a very hot fire, and forced as quickly as possible to a high yellow heat, so that it is almost up to the scintillating point. If this be done, in a few minutes the outside will be quite soft and in a nice condition for forging, while the middle parts will not be more than red-hot. Now let the piece be placed under the hammer and forged, and the soft outside will yield so much more readily than the hard inside, that the outer particles will be torn asunder, while the inside will remain sound.

Suppose the case to be reversed and the inside to be much hotter than the outside; that is, that the inside shall be in a state of semi-fusion, while the outside is hard and firm. Now let the piece be forged, and the outside will be all sound and the whole piece will appear perfectly good until it is cropped, and then it is found to be hollow inside.

In either case, if the piece had been heated soft all through, or if it had been only red-hot all through, it would have forged perfectly sound.

In some cases a high heat is more desirable to save heavy labor, but in every case where a fine steel is to be used for cutting purposes it must be borne in mind that very heavy forging refines the bars as they slowly cool, and if the smith heats such refined bars until they are soft, he raises the grain, makes them coarse, and he cannot get them fine again unless he has a very heavy steam-hammer at command and knows how to use it well.

Annealing. (Crescent Steel Co.) — Annealing or softening is accomplished by heating steel to a red heat and then cooling it very slowly, to prevent it from getting hard again.

The higher the degree of heat, the more will steel be softened, until the limit of softness is reached, when the steel is melted.

It does not follow that the higher a piece of steel is heated the softer it will be when cooled, no matter how slowly it may be cooled; this is proved by the fact that an ingot is always harder than a rolled or hammered bar made from it.

Therefore there is nothing gained by heating a piece of steel hotter than a good, bright, cherry-red; on the contrary, a higher heat has several disadvantages: First. If carried too far, it may leave the steel actually harder than a good red heat would leave it. Second. If a scale is raised on the steel, this scale will be harsh, granular oxide of iron, and will spoil the tools used to cut it. Third. A high scaling heat continued for a little time changes the structure of the steel, makes it brittle, liable to crack in hardening, and impossible to refine.

To anneal any piece of steel, heat it red-hot; heat it uniformly and heat it through, taking care not to let the ends and corners get too hot.

As soon as it is hot, take it out of the fire, the sooner the better, and cool it as slowly as possible. A good rule for heating is to heat it at so low a red that when the piece is cold it will still show the blue gloss of the oxide that was put there by the hammer or the rolls.

Steel annealed in this way will cut very soft; it will harden very hard, without cracking; and when tempered it will be very strong, nicely refined, and will hold a keen, strong edge.

Tempering. — Tempering steel is the act of giving it, after it has been shaped, the hardness necessary for the work it has to do. This is done by

first hardening the piece, generally a good deal harder than is necessary, and then toughening it by slow heating and gradual softening until it is just right for work.

A piece of steel properly tempered should always be finer in grain than the bar from which it is made. If it is necessary, in order to make the piece as hard as is required, to heat it so hot that after being hardened the grain will be as coarse as or coarser than the grain in the original bar, then the steel itself is of too low carbon for the desired work.

If a great degree of hardness is not desired, as in the case of taps and most tools of complicated form, and it is found that at a moderate heat the tools are too hard and are liable to crack, the smith should first use a lower heat in order to save the tools already made, and then notify the steel-maker that his steel is too high, so as to prevent a recurrence of the trouble.

For descriptions of various methods of tempering steel, see "Tempering of Metals," by Joshua Rose, in App. Cyc. Mech., vol. ii, p. 863; also, "Wrinkles and Recipes," from the *Scientific American*. In both of these works Mr. Rose gives a "color scale," lithographed in colors, by which the following is a list of the tools in their order on the color scale, together with the approximate color and the temperature at which the color appears on brightened steel when heated in the air:

Scrapers for brass; <i>very pale yellow</i> , 430° F.	Hand-plane irons.
Steel-engraving tools.	Twist-drills.
Slight turning tools.	Flat drills for brass.
Hammer faces.	Wood-boring cutters.
Planer tools for steel.	Drifts.
Ivory-cutting tools.	Coopers' tools.
Planer tools for iron.	Edging cutters; <i>light purple</i> , 530° F.
Paper-cutters.	Augers.
Wood-engraving tools.	Dental and surgical instruments.
Bone-cutting tools.	Cold chisels for steel.
Milling-cutters; <i>straw yellow</i> , 460° F.	Axes; <i>dark purple</i> , 550° F.
Wire-drawing dies.	Gimlets.
Boring-cutters.	Cold chisels for cast iron.
Leather-cutting dies.	Saws for bone and ivory.
Screw-cutting dies.	Needles.
Inserted saw-teeth.	Firmer-chisels.
Taps.	Hack-saws.
Rock-drills.	Framing-chisels.
Chasers.	Cold chisels for wrought iron.
Punches and dies.	Molding and planing cutters to be filed.
Penknives.	Circular saws for metal.
Reamers.	Screw-drivers.
Half-round bits.	Springs.
Planing and molding cutters.	Saws for wood.
Stone-cutting tools; <i>brown yellow</i> , 500° F.	<i>Dark blue</i> , 570° F.
Gauges.	<i>Pale blue</i> , 610°
	<i>Blue tinged with green</i> , 630°.

Uses of Crucible Steel of Different Carbons. (Metcalf on Steel.) —

- 0.50 to 0.60 C, for hot work and for battering tools.
- 0.60 to 0.70 C, ditto, and for tools of dull edge.
- 0.70 to 0.80 C, battering tools, cold-sets, and some forms of reamers and taps.
- 0.80 to 0.90 C, cold-sets, hand-chisels, drills, taps, reamers and dies.
- 0.90 to 1.00 C, chisels, drills, dies, axes, knives, etc.
- 1.00 to 1.10 C, axes, hatchets, knives, large lathe-tools, and many kinds of dies and drills if care be used in tempering them.
- 1.10 to 1.50 C, lathe-tools, graving tools, scribes, scrapers, little drills, and many similar purposes.

The best all-around tool steel is found between 0.90 and 1.10 C; steel that can be adapted safely and successfully to more uses than any other.

High-speed Tool Steel. (A. L. Valentine, *Am. Mach.*, July 2, 1908.) — Eight brands of high-speed steel were analyzed with the following results:

Steel.	C.	W.	Cr.	Mn.	Si.	Mo.	P.	S.
a	0.70	14.91	2.95	0.01			0.013	0.008
b	0.25	17.27	2.69	Trace	0.179		0.035	Trace
c	0.75	14.83	2.90	0.08		5.19	0.02	0.01
d	0.49	17.60	5.11				0.01	0.007
e	0.65			0.19	0.039	9.60	0.016	0.005
f	0.60	13.00	2.88				0.019	0.01
g	0.55	17.81	2.48	0.11	0.090			
h	0.66	19.03			0.036		0.015	

W, Wolfram, symbol for tungsten.

Where blanks appear in the table, the steel was not analyzed for these ingredients.

Many different brands of high-speed steel are being made. Some that have been marketed are almost worthless. From some of these steels a tool can be made from one end of a bar that is easily forged, machined and hardened, while the other end of the bar would resist almost any cutting tool and would invariably crack in hardening. Different bars of the same make also give very different results. These faults are sometimes caused by non-uniform annealing in the steels which are sent out as thoroughly annealed, and in many cases they are caused by the use of impure ingredients. A good high-speed steel will stand a temperature as high as 1200° F., or over double that of carbon steel, without losing its hardness, and experience has proven that the higher the temperature is raised over the white-heat point, the higher a temperature caused by friction the tool will withstand, before losing its intense hardness. The higher the percentage of carbon is, the more brittle and hard to work the steel will be, especially to forge. The steel which has given the best all-around results has contained about 0.40 C. The analysis of this same steel showed nearly 3% of chromium. The higher the percentage of tungsten in the steel, the better has been its cutting qualities. (See Best High-Speed Tool Steel, and description of the Taylor-White process of heat treatment, under "The Machine-Shop.")

MANGANESE, NICKEL, AND OTHER "ALLOY" STEELS.

Manganese Steel. (H. M. Howe, *Trans. A. S. M. E.*, vol. xii.) — Manganese steel is an alloy of iron and manganese, incidentally, and probably unavoidably, containing a considerable proportion of carbon.

The effect of small proportions of manganese on the hardness, strength, and ductility of iron is probably slight. The point at which manganese begins to have a predominant effect is not known; it may be somewhere about 2.5%.

Manganese steel is very free from blow-holes; it welds with great difficulty; its toughness is increased by quenching from a yellow heat; its electric resistance is enormous, and very constant with changing temperature; it is low in thermal conductivity. Its remarkable combination of great hardness, which cannot be materially lessened by annealing, and great tensile strength, with astonishing toughness and ductility, at once creates and limits its usefulness.

The hardness of manganese steel seems to be of an anomalous kind. The alloy is hard, but under some conditions not rigid. It is very hard in its resistance to abrasion; it is not always hard in its resistance to impact.

Manganese steel forges readily at a yellow heat, though at a bright white heat it crumbles under the hammer. But it offers greater resistance to deformation, i.e., it is harder when hot, than carbon steel.

The most important single use for manganese steel is for the pins which hold the buckets of elevator dredges. Here abrasion chiefly is to be resisted. Another important use is for the links of common chain-elevators. As a material for stamp-shoes, for horse-shoes, for the knuckles of an automatic car-coupler, it has not met expectations.

Manganese steel has been regularly adopted for the blades of the Cyclone pulverizer. Some manganese-steel wheels are reported to have run over 300,000 miles each without turning, on a New England railroad.

Manganese Steel and its Uses. (E. F. Lake, *Am. Mach.*, May 16, 1907.) — When more than 2% and less than 6% of Mn is added, with C less than 0.5%, it makes steel very brittle, so that it can be powdered under a hand hammer. From 6% Mn up, this brittleness gradually disappears until 12% is reached, when the former strength returns and reaches its maximum at 15%. After this, a decrease in toughness, but not in transverse strength, takes place until 20% is reached, after which a rapid decrease in strength again takes place.

Steel with from 12 to 15% Mn and less than 0.5% of C is very hard and cannot be machined or drilled in the ordinary way; yet it is so tough that it can be twisted and bent into peculiar shapes without breaking. It is malleable enough to be used for rivets that are to be headed cold.

This hardness, toughness and malleability make manganese steel the most durable metal known, in its ability to resist wear, for such parts as the teeth on steam-shovel dippers, where they will outwear about three teeth made of the best tool steel; for plow points on road-building work; for frogs, switches and crossings in railroad construction; for fluted or toothed crushing rolls used on ore, coal and stone crushers; for screen shells to screen these crushings; gears, sprockets, link belts, etc., when used in the vicinity of ore, stone and coal crushers or other places where they are subjected to the hard, grinding wear of the gritty particles of dust with which they are usually covered.

The higher the percentage of C in the steel, the less percentage of Mn will be required to produce brittleness. Si, however, neutralizes the injurious tendencies of Mn, and in Europe the Si-Mn alloy is used for automobile springs and gears. This steel is not high in Mn and can be rolled, while the peculiar properties given to steel by the addition of from 12 to 15% of manganese make such steel impossible to roll; therefore all parts made of this steel have to be cast, after which it can be forged and rendered tougher by quenching from a white heat.

One of its peculiarities is that it is softened by rapid cooling and can be restored to its former hardness by heating to a bright red.

It is more difficult to mold in the foundry than the ordinary cast steel, as it must be poured at a very high temperature, and in cooling it shrinks nearly twice as much. The shrinkage allowed for patterns to be cast of the ordinary cast steel is 3/16 in. per foot, and for manganese-steel castings 5/16 in. per foot.

This enormous shrinkage makes it impossible to cast in any intricate or delicate shapes, and as it is too hard to machine or drill successfully, all holes must be cored in the casting. If a close fit is desired in these they must be ground out with an emery wheel. These properties limit its use to a large extent.

The composition that seems to give the best results is:

Mn, from 12 to 15%; C, not over 0.5%; P, not over 0.04%; S, not over 0.04%.

Manganese-steel castings should be annealed in order to remove any internal strains which may be caused by its high shrinkage and the fact that the outer surface cools so much quicker than the core, which leaves the center of the casting strained. This can be done by heating to 1500° F. and quenching in water, after which it can be hardened by heating to 900° and allowed to cool slowly.

Manganese-steel castings, when tested in a 7/8-inch round bar, should show:

T. S. per sq. in., not less than 140,000 lbs.; E. L., not less than 90,000 lbs.; Red. of area, not less than 50%; Elong. in 2 in., not less than 20%.

Chrome Steel. (F. L. Garrison, *Jour. F. I.*, Sept., 1891.) — Chromium increases the hardness of iron, perhaps also the tensile strength and elastic limit, but it lessens its weldability.

Chromium does not appear to give steel the power of becoming harder when quenched or chilled. Howe states that chrome steels forge more readily than tungsten steels, and when not containing over 0.5 of chromium nearly as well as ordinary carbon steels of like percentage of carbon. On the whole the status of chrome steel is not satisfactory. There are other steel alloys coming into use, which are so much better, that it would seem to be only a question of time when it will drop entirely out of the race. Howe states that many experienced chemists have found no chromium, or but the merest traces, in chrome steel sold in the markets.

(J. W. Langley) *Trans. A. S. C. E.*, 1892) says: Chromium, like manganese,

WARNING: This is a 1910 edition. Some of the material may no longer be accurate

is a true hardener of iron even in the absence of carbon. The addition of 1% or 2% of chromium to a carbon steel will make a metal which gets excessively hard. Hitherto its principal employment has been in the production of chilled shot and shell. Powerful molecular stresses result during cooling, and the shells frequently break spontaneously months after they are made.

Tungsten Steel — Mushet Steel. (J. B. Nau, *Iron Age*, Feb. 11, 1892.) — By incorporating simultaneously carbon and tungsten in iron, it is possible to obtain a much harder steel than with carbon alone, without danger of an extraordinary brittleness in the cold metal or an increased difficulty in the working of the heated metal.

When a special grade of hardness is required, it is frequently the custom to use a high tungsten steel, known in England as special steel. A specimen from Sheffield, used for chisels, contained 9.3% of tungsten, 0.7% of silver, and 0.6% of carbon. This steel, though used with advantage in its untempered state to turn chilled rolls, was not brittle; nevertheless it was hard enough to scratch glass.

A sample of Mushet's special steel contained 8.3% of tungsten and 1.73% of manganese.

According to analyses made by the Duc de Luynes of ten specimens of the celebrated Oriental damasked steel, eight contained tungsten, two of them in notable quantities (0.518% to 1%), while in all of the samples analyzed nickel was discovered ranging from traces to nearly 4%.

Stein & Schwartz, of Philadelphia, in a circular say: It is stated that tungsten steel is suitable for the manufacture of steel magnets, since it retains its magnetism longer than ordinary steel. Cast steel to which tungsten has been added needs a higher temperature for tempering than ordinary steel, and should be hardened only between yellow, red, and white. Chisels made of tungsten steel should be drawn between cherry-red and blue, and stand well on iron and steel. Tempering is best done in a mixture of 5 parts of yellow rosin, 3 parts of tar, and 2 parts of tallow, and then the article is once more heated and then tempered as usual in water of about 15° C.

Aluminum Steel. — R. A. Hadfield (*Trans. A. I. M. E.*, 1890) says: Aluminum appears to be of service as an addition to baths of molten iron or steel unduly saturated with oxides, and these in properly regulated steel manufacture should not often occur. Speaking generally, its rôle appears to be similar to that of silicon. The statement that aluminum lowers the melting-point of iron seems to have no foundation in fact. If any increase of heat or fluidity takes place by the addition of small amounts of aluminum, it may be due to evolution of heat from oxidation of the aluminum, as the calorific value of this metal is very high — in fact, higher than silicon. According to Berthollet, the conversion of aluminum to Al₂O₃ equals 7900 cal.; silicon to SiO₂ is stated as 7800.

The action of aluminum may be classed along with that of silicon, sulphur, phosphorus, arsenic, and copper, as giving no increase of hardness to iron, in contradistinction to carbon, manganese, chromium, tungsten, and nickel. Its special advantage seems to be that it combines in itself the advantages of both silicon and manganese; but so long as alloys containing these metals are so cheap and aluminum dear, its extensive use seems hardly probable.

J. E. Stead, in discussion of Mr. Hadfield's paper, said: Every one of our trials has indicated that aluminum can kill the most fiery steel, providing, of course, that it is added in sufficient quantity to combine with all the oxygen which the steel contains. The metal will then be absolutely dead, and will pour like dead-melted silicon steel. If the aluminum is added as metallic aluminum, and not as a compound, and if the addition is made just before the steel is cast, 0.1% is ample to obtain perfect solidity in the steel.

Nickel Steel. — The remarkable tensile strength and ductility of nickel steel, as shown by the test-bars and the behavior of nickel-steel armor-plate under shot tests, are witness of the valuable qualities conferred upon steel by the addition of a few per cent of nickel.

Nickel steel has shown itself to be possessed of some exceedingly valuable properties; these are, resistance to cracking, high elastic limit, and homogeneity. Resistance to cracking, a property to which the name of non-fissibility has been given, is shown more remarkably as the percentage of nickel increases. Bars of 27% nickel illustrate this property. A 1 1/4-in. square

bar was nicked 1/4 in. deep and bent double on itself without further fracture than the splintering off, as it were, of the nicked portion. Sudden failure or rupture of this steel would be impossible; it seems to possess the toughness of rawhide with the strength of steel. With this percentage of nickel the steel is practically non-corrodible and non-magnetic. The resistance to cracking shown by the lower percentages of nickel is best illustrated in the many trials of nickel-steel armor.

In such places (shafts, axles, etc.) where failure is the result of the fatigue of the metal this higher elastic limit of nickel steel will tend to prolong indefinitely the life of the piece, and at the same time, through its superior toughness, offer greater resistance to the sudden strains of shock.

Howe states that the hardness of nickel steel depends on the proportion of nickel and carbon jointly, nickel up to a certain percentage increasing the hardness, beyond this lessening it. Thus while steel with 2% of nickel and 0.90% of carbon cannot be machined, with less than 5% nickel it can be worked cold readily, provided the proportion of carbon be low. As the proportion of nickel rises higher, cold-working becomes less easy. It forges easily whether it contain much or little nickel.

The presence of manganese in nickel steel is most important, as it appears that without the aid of manganese in proper proportions the conditions of treatment would not be successful.

Properties of Nickel Steel. — D. H. Browne, in *Proc. A. I. M. E.*, 1899, gives a paper of 79 pages, entitled "Nickel Steel: a synopsis of experiment and opinion," including a bibliography containing 50 titles. Some extracts from this paper are here given.

Commercially pure nickel, containing 98.13 Ni, 1.15 Co, 0.43 Fe, 0.08 Si, 0.11 Mn, showed the following physical properties:

	L. P.*	E. L.	T. S.	M. E.†	El. % in 2 in.	
Cast bars.....	5,119	12,557	40,669	23,989,140	18.2	
Rolled	Raw.....	9,243	21,045	72,522	29,506,500	43.9
	Annealed.....	17,064	18,059	72,806	26,870,800	48.6
	Quenched.....		16,921	71,860		45.0

* Limit of Proportionality. † Modulus of Elasticity.

ANNEALED CAST BARS OF NICKEL STEEL WITH C 0.15 TO 0.20. (Hadfield.) — The proportion of Ni used in soft steels for armor and for engine-forgings is from 3 to 3.5%. With 0.25 C this produces an E. L. and T. S. equal to open-hearth steel of 0.45 C without Ni, with a ductility equal to that of the lower-carbon steel.

NICKEL STEEL, 3.25 NI, AND SIMPLE STEEL FORGINGS COMPARED. (Bethlehem Steel Co.)

C.	Ni.	T. S.	E. L.	El. %.	Red. Area, %.	C.	Ni.	T. S.	E. L.	El. %.	Red. Area, %.
0.20	0	55000	28000	34	60	0.20	3.5	85000	48000	26	55
0.30	0	75000	37000	30	50	0.30	3.5	95000	60000	22	48
0.40	0	85000	43000	25	45	0.40	3.5	110000	72000	18	40
0.50	0	95000	48000	21	40	0.50	3.5	125000	85000	13	32

As compared with simple steels of the same tensile strength, a 3% nickel steel will have from 10 to 20% higher E. L. and from 20 to 30% greater elongation, while as compared with simple steels of the same carbon, the nickel steel, up to 5% Ni, will have about 40% greater tensile strength, with practically the same elongation and reduction of area.

Cholat and Harmet found with 0.30 C and 15% Ni a T. S. of 213,400 lbs. per sq. in.; when oil-tempered a T. S. of 277,290 and an E. L. of 166,300.

Riley states that steel of 25% Ni and 0.27 C gave a T. S. of 102,600 and elong. 29%, while steel of 25% Ni gave 94,300 T. S. and 40% elong. Steels high in Ni are entirely different in physical properties from low-nickel steels.

WARNING: This is a 1910 edition. Some of the material may no longer be accurate

EFFECT OF NI ON HARDNESS.—Gun barrels with 4.5% Ni and 0.30 C are soft and very ductile; T. S. 80,000, elong. 25%, red. of area 45%. Rolls with 5% Ni and 1% C turned easier than simple steel of 1% C. If a steel contains less than 6% Ni the influence of the C present on the hardness produced by water quenching is strongly marked. Above 8% Ni the effect of the C seems to be masked by the Ni; steel with 18% Ni is as hard and elastic with 0.30 as with 0.75 C. If steel with 18% Ni and 0.60 C be heated and plunged in water it will be perceptibly softened, and if the Ni is raised to 25% this softening is very noticeable.

COMPRESSION TESTS OF LOW-CARBON NICKEL STEELS. (Hadfield.)

Carbon.....	0.13	0.14	0.19	0.18	0.17	0.16	0.18	0.23	0.19	0.16	0.14
Nickel.....	0.95	1.92	3.82	5.81	7.65	9.51	11.39	13.48	19.64	24.51	29.07
E. L., tons.....	27	28	40	40	70	100	80	80	50	50	24
Shortening*....	49	47	41	37	33	3	1	1	3	16	41

* Shortening by 100-ton load, %.

SPECIFIC GRAVITY.—The sp. gr. of low-carbon nickel steels containing up to 15% Ni is about the same as that of carbon steel, from 7.86 to 7.90; from 19 to 39% Ni it is from 7.91 to 8.08; one sample of wire of 29% Ni, however, being reported at 8.4. A 44% Ni steel, according to Guillaume, has a sp. gr. of 8.12.

THE RESISTANCE OF CORROSION of nickel steel increases with the percentage of Ni up to 18. "This alloy is practically non-corrodible." "Tico" resistance wire, 27.5% Ni, was very slightly rusted after a year's exposure in a wet cellar; iron wire under the same conditions was entirely changed to oxide. With the ordinary nickel steels, 3 to 3.5% Ni, corrosion is slightly less than in simple steels.

ELECTRICAL RESISTANCE.—All nickel steels have a high electrical resistance which does not seem to vary much with the percentage of Ni. The resistance wires, "Tico," "Superior," and "Climax," containing from 25 to 30% Ni, have about 48 times, while German silver has about 18 times the resistance of copper.

MAGNETIC PROPERTIES.—According to Guillaume all nickel steels below 25.7% Ni can be, at the same temperature, either magnetic or non-magnetic, according to their previous heat-treatment, and they show different properties at ascending and at descending temperatures. The low-nickel steels, 3 to 5% Ni, possess a magnetic permeability greater than that of wrought iron.

Nickel Steel for Bridges.—J. A. L. Waddell, *Trans. A. S. C. E.*, 1908, presents at length an argument in favor of the use of nickel steel in long-span bridges.

Some Uses of Nickel Steel. (F. L. Sperry, *A. I. M. E.*, xxv, 51.)—The propeller shaft of the U. S. cruiser Brooklyn was made of hollow-forged, oil-tempered nickel steel, 17 in. outside, 11 in. inside diam., length 38 ft. 11 in., weight per foot, 449 lbs. Test bars cut from the tube gave T. S., 90,350 to 94,245; E. L., 56,470 to 60,770; El. in 2 in., 25.5 to 28.0%; Red. of area, 59.8 to 61.3%. A solid shaft of the same elastic strength of simple steel, having an E. L. of $\frac{3}{5}$ of that of the nickel steel, would be 18.9 in. diam., and would have weighed 920 lbs. per foot.

The rotating field of the 5000 H.P. electric generators of the Niagara Falls Power Co. is inclosed in a ring of forged nickel steel, outside diam. 139 $\frac{3}{8}$ in.; inside, 130 in.; width, 50 $\frac{3}{4}$ in.; weight, 28,840 lbs. It travels at the rate of nearly two miles per minute.

Nickel steel wire with 27.7% Ni and 0.40 C used for torpedo defense netting, 0.116 in. diam., gave a T. S. of 198,700; El. in 2 in., 6.25%; Red. of area, 16.5%.

Flange plate of soft nickel steel Ni, 2.69; C, 0.08; Mn, 0.36; P, 0.045; S, 0.038, gave, average of 6 tests, T. S., 65,760; E. L., 47,080; El. in 8 in., 24.8%; Red. of area, 52.0%. For comparison: Soft carbon steel, C, 0.10; Mn, 0.27; P, 0.048; S, 0.039; T. S., 54,450; E. L., 35,240; El., 27.4%; Red. of area, 55.3%.

Coefficients of Expansion of Nickel Steel. (D. H. Browne, *A. I. M. E.*, 1899.)—Per degree C. (Prefix 0.0000 to the figures here given.)

% Ni.	26.	28.	28.7	30.4	31.4	34.6	35.6	37.3	39.4	44.4
Coeff.	1312	1131	1041	0458	0349	0137	0087	0356	0537	0856

For comparison: Brass, 1878; Hard steel, 1239; Soft steel, 1078; Platinum, 0884; Glass, 0861; Nickel, 1252. Ordinary commercial nickel steels, containing 3 to 4% Ni, have coefficients about the same as carbon steel. See also page 540.

Invar is a nickel-iron alloy, which is characterized by an extraordinarily low coefficient of expansion at ordinary temperatures. The analysis is about as follows:—carbon, 0.18; nickel, 35.5%; manganese, 0.42, — the other elements being low. Guillaume gives the mean coefficient of expansion for an alloy containing 35.6% nickel as $(0.877 + 0.00117 t)^{10-6}$ between temperatures 0° C. and t° C. where t does not exceed 200° C. This material is used in measuring instruments and for standards of length, chronometers, etc. Its expansion as compared with ordinary steel is about as 1:11.5; with brass, as 1:17.2; with glass, as 1:8.5. Alloys either richer or poorer in nickel show much greater expansion, and the alloy containing 47.5% nickel, known as "Platinite," has the same coefficient of expansion as platinum and glass. See also page 540.

Copper Steels.—Pierre Breuil (*Jour. I. and S. I.*, 1907) gives an account of experiments on four series of copper steels containing respectively 0.15, 0.40, 0.65, and 1% of C with Cu in each ranging from 0 to 34%. An abstract of his principal conclusions is as follows:

Copper steel does not yield a metal capable of being rolled in practice, if Cu exceeds 4%.

When in the ingot state copper hardens steel in proportion as there is less C present.

Copper steels as rolled appear to be stronger in proportion as they contain more Cu. This difference is the more manifest in proportion as the C is lower.

Annealing leaves the steels with the same characteristics, but greatly reduces the differences observed in the case of the untreated steels. Quenching restores the differences encountered in the case of the steels as cast.

Copper steels equal nickel steels in tensile strength and would be less costly than the latter. They are no more brittle than nickel steels containing equivalent percentages of Ni. The steel containing 0.16% C and 4% Cu is remarkable in this respect.

The presence of copper makes the constituents of the steel finer, approximating them to classes containing higher percentages of C. While hardening the steel the presence of Cu does not render it brittle. It confers upon it a very fair degree of elasticity, while leaving the elongation good, thus conducing to the production of a most valuable metal.

Cutting tests were carried on with steels containing C about 1% and Cu 0%, 1%, and 3% respectively. The presence of Cu in no wise altered the cutting properties.

The presence of Cu was found to increase the electrical resistance, and a well-defined maximum was shown, coinciding with 2% Cu in 0.15 C, with 1.7% in 0.35% C, and with 0.5% Cu in 0.7 to 1% carbon steels.

Nickel-Vanadium Steels. (*Eng. Mag.*, April, 1906.)—M. Leon Guillet has investigated the influence of Ni and Va when used jointly.

In steels containing 0.20 C and from 2 to 12% of Ni, the tensile strength and the elastic limit are both materially increased by the addition of small percentages of Va. In no case should the Va exceed 1%, the best results being secured by the use of 0.7 to 1%. A steel containing 0.20 C, 2% of Ni, and 0.7% Va showed a tensile strength of 91,000 lbs., an elastic limit of 70,000 lbs., and an elongation of 23.5%. With 1% Va, the T. S. increased to 119,500 lbs., and the E. L. to 91,000 lbs., the elong. falling to 22%. A nickel steel of 0.20% C and 12% Ni gave, with 0.7 Va, a T. S. of over 200,000 lbs. and an E. L. of 172,000 lbs. per sq. in., the elong. being 6%, while with 1% Va the T. S. rose to 220,000 lbs. and the E. L. to 176,000 lbs., the elongation remaining unchanged. When the Va is increased above 1% the tensile strength falls off, and the material begins to show evidence of brittleness.

Similar effects are produced for steels of the higher carbon, but in a lesser degree.

When the nickel-vanadium steels are subjected to a tempering process the beneficial effects of the Va are still further emphasized. The tempering experiments of M. Guillet were conducted by heating the steel to a temperature of 350° C., and cooling in water at 20° C. The T. S. and

the E. L. were increased, being nearly doubled for the low nickel content. Thus while the 0.20 C steel with 2% of Ni, untempered, and containing 0.7% of Va, gave a T. S. of 91,000 lbs., with an E. L. of 70,000 lbs., the same steel, tempered from 850° C., showed a T. S. of 168,000 lbs. and an E. L. of 150,000 lbs., the resistance to shock and the hardness being also increased.

Static and Dynamic Properties of Steels. (W. L. Turner, *Iron Age*, July 2, 1908.)—The term "crystallization" is a name given to designate phenomena due to the influences of shock and alternating stresses, whether pure or combined. The name has been advantageously altered to "intermolecular disintegration," but, whatever we choose to call it, there remains the evidence that some modification takes place in the structure of steel when the above-named forces are to be dealt with. Resistance to fatigue is not a function of static strength.

An example of our knowledge of the "life" properties of ordinary steel is the case of the staying of a locomotive fire-box. Something is required which will possess considerable strength combined with the power to withstand a moderate degree of flexure in all directions. Experience has shown that the use of anything but the mildest steel for this work is prohibitive, and that wrought iron, or even copper, is still more satisfactory.

The writer has completed a preliminary investigation into the relative dynamic properties of iron and the various ordinary and alloy steels, the results being given in the accompanying table. The conditions of the "dynamic" tests were as follows:

A cylindrical test-piece, 6 in. long, 3/8 in. diam., finished with emery to remove all tool marks, is clamped at one end in a vise. A tool-steel head, in which there is cut a slot, is placed over the other end, the distance from the striking center of this head to the vise line being 4 in. A crank and connecting rod furnished the reciprocating motion for this head, thereby causing the test-piece to be deflected 3/8 in. each side of the neutral position. In addition to this alternating flexure, the test-piece is also subjected, at each reversal, to an impact, due to the slot on the reciprocating head. The sample undergoes 650 alternations per minute. A deflection of 3/8 in. on each side has the effect of imparting a permanent set to the test-piece.

On each class of steel a large number of dynamic tests were made, an average being taken of the results after elimination of those figures which were apparently abnormal.

It is apparent that the action of nickel is twofold: 1. It statically intensifies. 2. It dynamically "poisons." As an instance of this, take tests Nos. 13 and 15, the former being a 3.7% nickel steel and the latter a chrome-vanadium steel. In the annealed condition, the elastic limits of the two are almost identical, but at the same time the alternations of stress endured by the latter are 2 1/4 times the number sustained by the nickel steel. Take again Nos. 17 and 18. The dynamic figures are more than three to one in favor of the chrome-vanadium product, whereas the difference in elastic limit is only about 3%.

It is manifest that the static action of vanadium is similar to that of nickel, but that its dynamic effects are the exact converse. The differences are markedly brought out in the quality figures, which invite attention as to comparison with those of ordinary carbon steel. Taking the latter as standard, the chrome-vanadium steels are as much above it as the nickel steels are below it.

Chromium, *per se*, does not appear to exert appreciable influence other than statically, but it is possible that the effect of this metal in a ternary steel might be very marked.

The dynamic attributes of plain carbon steel reach a maximum with about 0.25% C, falling away on both sides of this amount.

The quality figure in the case of the chrome-vanadium steel does not appear to undergo much alteration in the process of oil tempering, but there are considerable variations in other cases. The dynamic test may eventually act as a reliable guide to the correct methods for the heat treatment of individual steels.

Strength for strength, the chrome-vanadium steels also have the advantage over all others as regards machining properties. Chrome-vanadium steel may be forged with the same ease as ordinary steel of similar contents, no special precaution being necessary as to temperatures.

WARNING: This is a 1910 edition. Some of the material may no longer be accurate

No.	Material.	Heat Treatment.	C.	Approximate Analysis.				Elastic Limit. (E.)	Tensile Str'gth	Elong. in 2 in. %.	Red. of Area. (%).	Alterations. (A.)	Quality. E x R x A + 10 ⁶
				Mn.	Cr.	Ni	V.						
Elastic Limits, 30,000 to 60,000.													
1	Wrought iron.....	R.	0.05	0.05				32,020	49,450	42.5	53.8	583	1004
2	Mild Va steel.....	A.	0.11	0.31			0.19	32,120	54,400	44.0	60.1	1111	2143
3	Old plate.....	R.	0.24	0.42				58,160	70,840	25.5	53.4	612	1901
4	Mild steel.....	A.	0.18	0.40				39,460	60,650	35.0	62.6	871	2152
5	Mild steel.....	O. T.	0.18	0.40				45,390	70,630	33.0	64.0	777	2258
6	Forging steel.....	A.	0.26	0.28				43,010	61,850	34.0	63.4	1415	3858
7	Forging steel.....	O. T.	0.26	0.28				52,230	77,310	28.0	65.3	1175	4008
8	Va case hardening.....	A.	0.15	0.25	0.30		0.12	44,790	55,990	45.0	69.0	1958	6051
9	Cr-Ni steel.....	A.	0.36	0.34	0.95	1.70		56,520	81,370	32.0	68.5	978	3787
10	Steel casting.....	A.	0.18	0.65				34,690	58,800	28.0	44.9	269	419
11	Va steel casting.....	A.	0.19	0.60			0.076	44,340	70,250	25.5	44.9	850	1671
12	Cr-Va casting.....	A.	0.57	0.68	0.75		0.16	52,330	92,900	16.0	20.5	656	704
Elastic Limits, 60,000 to 100,000.													
13	Ni forging steel.....	A.	0.21	0.45		3.70		61,140	79,700	30.0	62.5	746	2851
14	Ni forging steel.....	O. T.	0.21	0.45		3.70		77,140	98,470	25.0	65.3	664	3345
15	Cr-Va forging.....	A.	0.26	0.50	1.00		0.16	61,920	92,900	25.0	57.3	1508	5706
16	Spring steel.....	A.	1.00	0.30				63,800	125,000	8.5	15.2	1260	1222
17	Cr-Va spring.....	A.	0.40	0.77	1.22		0.19	67,520	100,600	26.0	61.7	1406	5858
18	Cr-Ni-Va steel.....	A.	0.30	0.27	1.51	3.45	0.085	69,140	96,880	28.5	68.5	507	2402
19	Ni-Va steel.....	A.	0.24	0.72		3.40	0.15	79,260	99,700	25.0	64.0	798	4048
20	Cr-Ni-Va steel.....	A.	0.57	0.27	0.93	2.04	0.07	95,150	129,100	21.0	49.8	983	4659
21	Cr-Ni steel.....	T.	0.37	0.34	0.89	1.70		86,080	162,700	22.0	63.8	702	3855
Elastic Limits, 100,000 and Over.													
22	Spring steel.....	O. T.	1.00	0.30				101,630	186,300	9.5	16.1	561	912
23	Cr-Va spring.....	O. T.	0.40	0.77	1.22		0.19	195,300	208,500	10.0	36.3	480	3403
24	Cr-Va forging.....	O. T.	0.30	0.50	1.00		0.16	141,600	151,750	16.0	56.2	717	5705
25	Ni-Va steel.....	O. T.	0.24	0.72		3.40	0.15	129,900	134,600	18.0	64.8	626	5270
26	Cr-Ni-Va steel.....	O. T.	0.30	0.27	1.51	3.45	0.085	152,300	159,900	17.0	58.9	487	4369
27	Cr-Va spring.....	O. T.	0.40	0.77	1.22		0.19	183,400	187,600	14.0	50.6	634	5883
28	Cr-Ni steel.....	T.	0.36	0.34	0.95	1.70		134,500	150,300	15.5	53.5	579	4166

NOTES.—Static tests made on samples 1/2 in. diam. x 2 in. long. Dynamic tests made on the Landgraf-Turner alternating impact machine (old form). The quality figure is the product of: Elastic limit, representing useful strength; reduction of area, representing static ductility; dynamic figure, representing fatigue-resisting property—divided by 1,000,000 = E x R x A + 10⁶. Heat treatment, R., raw; A., annealed; O. T., oil tempered; T., tempered. Nos. 9, 17, 18, 20, 21, 26, 27, 28 were crucible steels, the others open-hearth.

Comparative Effects of Cr and Va. Sankey and J. Kent Smith, Proc. Inst. M. E., 1904.

Cr. Va.	T.S.*	E.L.*	El. in 2 in.	Red. A.	Cr. Va.	T.S.*	E.L.*	El. in 2 in.	Red. A.
0.5	34.0	22.9	33%	60.6%	1.0 0.15	48.6	36.2	24.	56.6
1.0	38.2	25.0	30	57.3	1.0 0.15	†52.6	34.4	25.0	55.5
... 0.1	34.8	28.5	31	60.0	1.0 0.25	60.4	49.4	18.5	46.3
... 0.15	36.5	30.4	26	59.0	C-Mn	27.0	16.0	35.	60.0
... 0.25	39.3	34.1	24	59.0	C-Mn	†32.2	17.7	34.	52.6

* Tons, of 2240 lbs., per sq. in. † Open-hearth steels; all the others are crucible. The last two steels in the table are ordinary carbon steels.

Effect of Heat Treatment on Cr-Va Steel. (H. R. Sankey and J. Kent Smith, Proc. Inst. M. E., 1904, p. 1235.) — Various kinds of heat treatment were given to several Cr-Va steels, the results of which are recorded at length. The following is selected as a sample of the results obtained. Steel with C, 0.297; Si, 0.086; Mn, 0.29; Cr, 1.02; Va, 0.17, gave:

	Tens. Str.	Yield Point.	El. in 2 in.	Red. Area.	Impact.	Alter-nations.
As rolled	121,200	82,650	24.0%	44.9%	3.1	1936
Annealed 1/2 hr. at 800° C.	87,360	47,260	34.5	53.1	15.6	2237
Soaked 12 hours at 800° C.	86,020	68,100	33.7	51.5	11.2
Water quenched at 800° C.	167,100	135,070	7.5	16.6	1.2	174
Oil quenched at 800° C.	122,080	82,880	22.0	35.2	2.4	296
Oil quenched at 800°, reheated to 350°	132,830	111,550	23.0	50.8	9.0	1314
Water quenched at 1200° C.	209,440	191,520	1.2	1.5	*	*
Oil quenched at 1200° C.	140,220	118,500	8.5	21.5	3.0

* Too hard to machine.

The impact tests were made on a machine described in Eng'g, Sept. 25, 1903, p. 431. The test-piece was 3/4 in. broad, notched so that 0.137 in. in depth remained to be broken through. The figures represent ft.-lbs. of energy absorbed. The piece was broken in one blow. The alternations-of-stress tests were made on Prof. Arnold's machine, described in The Engineer, Sept. 2, 1904, p. 227. The pieces were 3/8 in. square, one end was gripped in the machine and the free end, 4 in. long, was bent forwards and backwards about 710 times a minute, the motion of the free end being 3/4 in. on each side of the center line.

Tests by torsion of the same steel were made. The test-piece was 6 in. long, 3/4 in. diam. The results were:

	Shearing Stress.		Twist Angle.	No. of Twists.
	Elastic.	Ulti-mate.		
As rolled	45,700	99,900	1410°	3.92
Annealed 1/2 hr. at 800° C.	38,528	90,272	1628°	4.52

Heat-treatment of Alloy Steels. (E. F. Lake, Am. Mach., Aug. 1, 1907.) — In working the high-grade alloy steels it is very important that they be properly heat treated, as poor workmanship in this regard will produce working parts that are no better than ordinary steel, although the stock used be the highest grade procurable. By improperly heat-treating them it is possible to make these high-grade steels more brittle than ordinary carbon steels.

The theory of heat treatment rests upon the influence of the rate of cooling on certain molecular changes in structure occurring at different temperatures. These changes are of two classes, critical and progressive; the former occur periodically between certain narrow temperature limits, while the latter proceed gradually with the rise in temperature, each change producing alterations in the physical characteristics. By controlling the rate of cooling, these changes can be given a permanent set, and the characteristics can thus be made different from those in the metal in its normal state.

The results obtained are influenced by certain factors: 1. The original chemical and physical properties of the metal; 2. The composition of the gases and other substances which come in contact with the metal in heating and cooling. 3. The time in which the temperature is raised between certain degrees. 4. The highest temperature attained. 5. The length of time the metal is maintained at the highest temperature. 6. The time consumed in allowing the temperature to fall to atmospheric.

The highest temperature that it is safe to submit a steel to for heat-treating is governed by the chemical composition of the steel. Thus pure carbon steel should be raised to about 1300° F., while some of the high-grade alloy steels may safely be raised to 1750°. The alloy steels must be handled very carefully in the processes of annealing, hardening, and tempering; for this reason special apparatus has been installed to aid in performing these operations with definite results.

The baths for quenching are composed of a large variety of materials. Some of the more commonly used are as follows, being arranged according to their intensity on 0.85% carbon steel: Mercury; water with sulphuric acid added; nitrate of potassium; sal ammoniac; common salt; carbonate of lime; carbonate of magnesia; pure water; water containing soap, sugar, dextrine or alcohol; sweet milk; various oils; beef suet; tallow; wax.

With many of these alloy steels a dual quenching gives the best results, that is, the metal is quenched to a certain temperature in one bath and then immersed in the second one until completely cooled, or it may be cooled in the air after being quenched in the first bath. For this a lead bath, heated to the proper temperature, is sometimes used for the first quenching.

With the exception of the oils and some of the greases, the quenching effect increases as the temperature of the bath lowers. Sperm and linseed oils, however, at all temperatures between 32° and 250°, act about the same as distilled water at 160°.

The more common materials used for annealing are powdered charcoal, charred bone, charred leather, fire clay, magnesia or refractory earth. The piece to be annealed is usually packed in a cast-iron box in some of these materials or combinations of them, the whole heated to the proper temperature and then set aside, with the cover left on, to cool gradually to the atmospheric temperature. For certain grades of steel these materials give good results; but for all kinds of steels and for all grades of annealing, the slow-cooling furnace no doubt gives the best satisfaction, as the temperature can be easily raised to the right point, kept there as long as necessary, and then regulated to cool down as slowly as is desired. The gas furnace is the easiest to handle and regulate.

A high-grade alloy steel should be annealed after every process in manufacturing which tends to throw it out of its equilibrium, such as forging, rolling and rough machining, so as to return it to its natural state of repose. It should also be annealed before quenching, case-hardening or carbonizing.

The wide range of strength given to some of the alloy steels by heat

treatment is shown by the table below. The composition of the alloy was: Ni, 2.43; Cr, 0.42; Si, 0.26; C, 0.23; Mn, 0.43; P, 0.025; S, 0.022.

	Quenched at 1550° F.	Tempered at 575° F.	Tempered at 600° F.	Tempered at 925° F.	Tempered at 1025° F.	Tempered at 1125° F.	Tempered at 1550° F.
Tensile Strength	227,000	219,000	195,500	172,000	156,500	141,000	109,500
E. L.	208,000	203,500	150,000	148,500	125,000	102,000	70,500
Elong., % in 2 in.	4	6	8	11	13	15	22

VARIOUS SPECIFICATIONS FOR STEEL.

Structural Steel. — There has been a change during the ten years from 1880 to 1890, in the opinions of engineers, as to the requirements in specifications for structural steel, in the direction of a preference for metal of low tensile strength and great ductility. The following specifications for tension members at different dates are given by A. E. Hunt and G. H. Clapp, *Trans. A. I. M. E.*, xix, 926:

	1879.	1881.	1882.	1885.	1887.	1888.
Elastic limit...	50,000	40 @ 45,000	40,000	40,000	40,000	38,000
Tensile strength	80,000	70 @ 80,000	70,000	70,000	67 @ 75,000	63 @ 70,000
Elongation in 8 in.	12%	18%	18%	18%	20%	22%
Reduction of area	20%	30%	45%	42%	42%	45%

F. H. Lewis (*Iron Age*, Nov. 3, 1892) says: Regarding steel to be used under the same conditions as wrought iron, that is, to be punched without reaming, there seems to be a decided opinion (and a growing one) among engineers, that it is not safe to use steel in this way, when the ultimate tensile strength is above 65,000 lbs. The reason for this is not so much because there is any marked change in the material of this grade, but because all steel, especially Bessemer steel, has a tendency to segregations of carbon and phosphorus, producing places in the metal which are harder than they normally should be. As long as the percentages of carbon and phosphorus are kept low, the effect of these segregations is inconsiderable; but when these percentages are increased, the existence of these hard spots in the metal becomes more marked, and it is therefore less adapted to the treatment to which wrought iron is subjected.

There is a wide consensus of opinion that at an ultimate of 64,000 to 65,000 lbs. the percentages of carbon and phosphorus reach a point where the steel has a tendency to crack when subjected to rough treatment.

A grade of steel, therefore, running in ultimate strength from 54,000 to 62,000 lbs., or in some cases to 64,000 lbs., is now generally considered a proper material for this class of work.

A. E. Hunt, *Trans. A. I. M. E.*, 1892, says: Why should the tests for steel be so much more rigid than for iron destined for the same purpose? Some of the reasons are as follows: Experience shows that the acceptable qualities of one melt of steel offer no absolute guarantee that the next melt to it, even though made of the same stock, will be equally satisfactory.

It is now almost universally recognized that soft steel, if properly made and of good quality, is for many purposes a safe and satisfactory substitute for wrought iron, being capable of standing the same shop-treatment as wrought iron. But the conviction is equally general, that poor steel, or an unsuitable grade of steel, is a very dangerous substitute for wrought iron even under the same unit strains.

For this reason it is advisable to make more rigid requirements in selecting material which may range between the brittleness of glass and a ductility greater than that of wrought iron.

Specifications for Structural Steel for Bridges. (*Proc. A. S. T. M.*, 1905.)—Steel shall be made by the open-hearth process. The chemical and physical properties shall conform to the following limits:

Elements Considered.	Structural Steel.	Rivet Steel.	Steel Castings.
Phosphorus. { Basic... Max. { Acid... Sulphur, Max.	0.04% 0.08% 0.05%	0.04% 0.04% 0.04%	0.05% 0.08% 0.05%
Tensile strength, lbs. per sq. in.....	{ Desired 60,000 1,500,000*	Desired 50,000 1,500,000 tens. str.	Not less than 65,000
Elong.: Min. % in 8 in.	{ 22 tens. str.	tens. str.	18
Elong.: Min. % in 2 in.	22	22	18
Fracture.....	Silky	Silky	Silky or fine granular
Cold bend without fracture.....	180° flat†	180° flat†	90°, d = 3t

* The following modifications will be allowed in the requirements for elongation for structural steel: For each 1/16 inch in thickness below 5/16 inch, a deduction of 2 1/2 will be allowed from the specified percentage. For each 1/8 inch in thickness above 3/4 inch, a deduction of 1 will be allowed from the specified percentage.

† Plates, shapes and bars less than 1 in. thick shall bend as called for. Full-sized material for eye-bars and other steel 1 in. thick and over, tested as rolled, shall bend cold 180° around a pin of a diameter twice the thickness of the bar, without fracture on the outside of bend. When required by the inspector, angles 3/4 in. and less in thickness shall open flat, and angles 1/2 in. and less in thickness shall bend shut, cold, under blows of a hammer, without sign of fracture.

‡ Rivet steel, when nicked and bent around a bar of the same diameter as the rivet, shall give a gradual break and a fine, silky, uniform fracture.

If the ultimate strength varies more than 4000 lbs. from that desired, a retest may be made, at the discretion of the inspector, on the same gauge, which, to be acceptable, shall be within 5000 lbs. of the desired strength.

Chemical determinations of C, P, S, and Mn shall be made from a test ingot taken at the time of the pouring of each melt of steel. Check analyses shall be made from finished material, if called for by the purchaser, in which case an excess of 25% above the required limits will be allowed.

Specimens for tensile and bending tests for plates, shapes and bars shall be made by cutting coupons from the finished product, which shall have both faces rolled and both edges milled with edges parallel for at least 9 in.; or they may be turned 3/4 in. diam. for a length of at least 9 in., with enlarged ends. Rivet rods shall be tested as rolled. Specimens shall be cut from the finished rolled or forged bar in such manner that the center of the specimen shall be 1 in. from the surface of the bar. The specimen for tensile test shall be turned with a uniform section 2 in. long, with enlarged ends. The specimen for bending test shall be 1 x 1/2 in. in section.

Specifications for Steel for the Manhattan Bridge. (*Eng. News*, Aug. 3, 1905.)—

MATERIAL FOR CABLES, SUSPENDERS AND HAND ROPES. Open-hearth steel. (The wire for serving the cables shall be made of Norway iron of approved quality.) The ladle tests of the steel shall contain not more than: C, 0.85; Mn, 0.55; Si, 0.20; P, 0.04; S, 0.04; Cu, 0.02%. The wire shall have an ultimate strength of not less than 215,000 lbs. per sq. in. before galvanizing, and an elongation of not less than 2% in 12 in. The bright wire shall be capable of bending cold around a rod 1 1/2 times its own diam. without sign of fracture. The cable wire before galvanizing shall be 0.192 in. ± 0.003 in. in diam.; after galvanizing, the wire shall have an ultimate strength of not less than 200,000 lbs. per sq. in. of gross section.

WARNING: This is a 1910 edition. Some of the material may no longer be accurate

CARBON STEEL. The ladle tests as usually taken shall contain not more than: P, 0.04; S, 0.04; Mn, 0.60; Si, 0.10%. The ladle tests of the carbon rivet steel shall contain not more than: P, 0.035; S, 0.03. Rivet steel shall be used for all bolts and threaded rods.

NICKEL STEEL. The ladle test shall contain not less than 3.25 Ni, and not more than: P, 0.04; S, 0.04; Mn, 0.60; Si, 0.10; nickel rivet steel not more than: P, 0.035; S, 0.03%.

Nickel steel for plates and shapes in the finished material must show: T. S., 85,000 to 95,000 lbs. per sq. in.; E. L., 55,000 lbs. min.; elong. in 8 ins., min. = $1,600,000 \div T. S.$; min. red. of area, 40%.

Specimens cut from the finished material shall show the following physical properties:

Material.	T. S., lbs. per sq. in.	Min. E. L., lbs. per sq. in.	Min. Elong., % in 8 in.	Min. Red. of Area, %.
Shapes and universal mill plates.....	60,000 to 68,000	33,000	1,500,000 ultimate	44
Eye-bars, pins and rollers.....	64,000 to 72,000	35,000		40
Sheared plates.....	60,000 to 68,000	33,000		44
Rivet rods.....	50,000 to 58,000	30,000		50
High-carbon steel for trusses.....	85,000 to 95,000	45,000		35

Nickel rivet steel: T. S., 70,000 to 80,000; E. L., min., 45,000; elong., min., $1,600,000 \div T. S.$; % in 8 ins.

STEEL CASTINGS. The ladle test of steel for castings shall contain not more than: P, 0.05; S, 0.05; Mn, 0.80; Si, 0.35%. Test-pieces taken from coupons on the annealed castings shall show T. S., 65,000; E. L., 35,000; elong. 20% in 8 ins. They shall bend without cracking around a rod three times the thickness of the test-piece.

Specifications for Steel. (Proc. A. S. T. M., 1905.)

Steel Forgings	Kind of Steel.	Tensile Strength.	Elast. Limit.	El. in 2 in., %.	Red Area, %.
Solid or hollow forgings, no diam. or thickness of section to exceed 10 in.	S.	58,000	29,000*	28	35 (a)
	C.	75,000	37,500*	18	30 (c)
	C. A.	80,000	40,000	22	35 (b)
	N. A.	80,000	50,000	25	45 (a)
Solid or hollow forgings, diam. not to exceed 20 in. or thickness of section 15 in.	C. A.	75,000	37,500	23	35 (b)
	N. A.	80,000	45,000	25	45 (a)
Solid forgings, over 20 in.....	C. A.	70,000	35,000	24	30 (c)
Solid forgings.....	N. A.	80,000	45,000	24	40 (a)
Solid or hollow forgings, diam. or thickness not over 3 in.	C. O.	90,000	55,000	20	45 (b)
	N. O.	95,000	65,000	21	50 (b)
Solid rectangular sections, thickness not over 6 in., or hollow with walls not over 6 in. thick.	C. O.	85,000	50,000	22	45 (b)
	N. O.	90,000	60,000	22	50 (b)
Solid rect. sections, thickness not over 10 in., or hollow with walls not over 10 in. thick.	C. O.	80,000	45,000	23	40 (b)
	N. O.	85,000	55,000	24	45 (b)
Locomotive forgings.....		80,000	40,000	20	25 (d)

* The yield point, instead of the elastic limit, is specified for soft steel and carbon steel not annealed. It is determined by the drop of the beam or halt in the gauge of the testing machine. The elastic limit, specified for all other steels, is determined by an extensometer, and is defined as that point where the proportionality changes. The standard test specimen is 1/2 in. turned diam. with a gauged length of 2 inches.

Kind of steel: S., soft or low carbon. C., carbon steel, not annealed. C. A., carbon steel, annealed. C. O., carbon steel, oil tempered. N. A., nickel steel, annealed. N. O., nickel steel, oil tempered. Bending tests: A specimen 1 x 1/2 in. shall bend cold 180° without fracture on outside of bent portion, as follows: (a) around a diam. of 1/2 in.; (b) around a diam. of 1 in.; (c) around a diam. of 1/2 in.; (d) no bending test required.

Chemical composition: P and S not to exceed 0.10 in low-carbon steel, 0.06 in carbon steel not annealed, 0.04 in carbon or nickel steel oil tempered or annealed, 0.05 in locomotive forgings. Mn not to exceed 0.60 in locomotive forgings. Ni 3 to 4% in nickel steel.

Specifications for Steel Ship Material. (Amer. Bureau of Shipping, 1900. Proc. A. S. T. M., 1906, p. 175.) —

For Hull Construction.	Tens. Strength.	E. L.	El. in 8 in., %.
Plates, angles and shapes.....	58,000 to 60,000	1/2 T. S.	22*, 18†
Castings.....	60,000 to 75,000		15
Forgings.....	55,000 to 65,000		20

* In plates 18 lbs. per sq. ft. and over. † In plates under 18 lbs.

FOR MARINE BOILERS: Open-hearth steel; Shell: P and S, each not over 0.04%. Fire-box, not over 0.035%. Tensile Strength: Rivet steel, 45,000 to 55,000; Fire-box, 52,000 to 62,000; Shell, 55,000 to 65,000; Braces and stays, 55,000 to 65,000; Tubes and all other steel, 52,000 to 62,000 lbs. per sq. in.

Elongation in 8 in.: Rivet steel, 28%; Plates 3/8 in. and under, 20%; 3/8 to 3/4 in., 22%; 3/4 in. and over, 25%.

COLD BENDING AND QUENCHING TESTS. Rivet steel and all steel of 52,000 to 62,000 lbs. T. S., 1/2 in. thick and under, must bend 180° flat on itself without fracture on outside of bent portion; over 1/2 in. thick, 180° around a mandrel 1 1/2 times the thickness of the test-piece. For hull construction a specimen must stand bending on a radius of half its thickness, without fracture on the convex side, either cold or after being heated to cherry-red and quenched in water at 70° F.

High-strength Steel for Shipbuilding. (Eng'g. Aug. 2, 1907, p. 137.)—The average tensile strength of the material selected for the Lusitania was 82,432 lbs. per sq. in. for normal high-tensile steel, and 81,984 lbs. for the same annealed, as compared with 66,304 lbs. for ordinary mild steel. The material was subjected to tug tests as well as to other severe punishments, including the explosion of heavy charges of dynamite against the plates, and in every instance the results were satisfactory. It was not deemed prudent to adopt the high-tensile steel for the rivets, a point upon which there seems some difference of opinion.

Penna. R. R. Specifications for Steel.

	Note	Date	C.	Mn.	Si.	P.	S.	Cu.
Plates for steel cars.....	(1)	1899	0.12	0.35	0.05	0.04	0.03
Bar spring steel.....		1901	1.00	0.25	0.15	0.03	0.03	0.03
Steel for axles.....	(2)	1899	0.40	0.50	0.05	0.05	0.04
Steel for crank pins.....	(3)	1904	0.45	0.60	0.05	0.03	0.04
Billets or blooms for forging.....	(4)	1902	0.45	0.50	0.05	0.03	0.02	0.03
Boiler-shell sheets.....	(5)	1906	0.18	0.40	0.05	0.04	0.03	0.03
Fire-box sheets.....	(6)	1906	0.18	0.40	0.02	0.03	0.02	0.03

WARNING: This is a 1910 edition. Some of the material may no longer be accurate

The minus sign after a figure means "or less." The figures without the minus sign represent the composition desired.

Steel castings. Desired T. S., 70,000 lbs. per sq. in.; elong. in 2 in., 15%. Will be rejected if T. S. is below 60,000, or elong. below 12%, or if the castings show blow-holes or shrinkage cracks on machining.

NOTES. (1) Tensile strength, 52,000 lbs. per sq. in.; elong. in 8 ins. = 1,500,000 ÷ T. S. (2) Axles are also subjected to a drop test, similar to that of the A. S. T. M. specifications. Axles will be rejected if they contain C below 0.35 or above 0.50, Mn above 0.60, P above 0.07%. (3) T. S. desired, 85,000 lbs. per sq. in.; elong. in 8 ins., 18%. Pins will be rejected if the T. S. is below 80,000 or above 95,000, if the elongation is less than 12%, or if the P is above 0.05%. (4) The steel will be rejected if the C is below 0.35 or above 0.50, Si above 0.25, S above 0.05, P above 0.05, or Mn above 0.60%. (5) T. S. desired, 60,000; elong. in 8 ins., 26%. Sheets will be rejected if the T. S. is less than 55,000 or over 65,000, or if the elongation is less than the quotient of 1,400,000 divided by the T. S., or if P is over 0.05%. (6) T. S. desired, 60,000, with elong. of 28% in 8 in. Sheets will be rejected if the T. S. is less than 55,000 or above 65,000 (but if the elong. is 30% or over plates will not be rejected for high T. S.), if the elongation is less than 1,450,000 ÷ T. S., if a single seam or cavity more than 1/4 in. long is shown in either one of the three fractures obtained in the test for homogeneity, described below, or if on analysis C is found below 0.15 or over 0.25, P over 0.035, Mn over 0.45, Si over 0.33, S over 0.045, or Cu over 0.05%.

Homogeneity Test for Fire-box Steel. — This test is made on one of the broken tensile-test specimens, as follows:

A portion of the test-piece is nicked with a chisel, or grooved on a machine, transversely about a sixteenth of an inch deep, in three places about 2 in. apart. The first groove should be made on one side, 2 in. from the square end of the piece; the second, 2 in. from it on the opposite side; and the third 2 in. from the last, and on the opposite side from it. The test-piece is then put in a vise, with the first groove about 1/4 in. above the jaws, care being taken to hold it firmly. The projecting end of the test-piece is then broken off by means of a hammer, a number of light blows being used, and the bending being away from the groove. The piece is broken at the other two grooves in the same way. The object of this treatment is to open and render visible to the eye any seams due to failure to weld up, or to foreign interposed matter, or cavities due to gas bubbles in the ingot. After rupture, one side of each fracture is examined, a pocket lens being used if necessary, and the length of the seams and cavities is determined. The sample shall not show any single seam or cavity more than 1/4 in. long in either of the three fractures.

Dr. Chas. B. Dudley, chemist of the P. R. R. (*Trans. A. I. M. E.*, 1892), referring to tests of crank-pins, says: In testing a recent shipment, the piece from one side of the pin showed 88,000 lbs. strength and 22% elongation, and the piece from the opposite side showed 106,000 lbs. strength and 14% elongation. Each piece was above the specified strength and ductility, but the lack of uniformity between the two sides of the pin was so marked that it was finally determined not to put the lot of 50 pins in use. To guard against trouble of this sort in future, the specifications are to be amended to require that the difference in ultimate strength of the two specimens shall not be more than 3000 lbs.

Specifications for Steel Rails. (Adopted by the manufacturers of the U. S. and Canada. In effect Jan. 1, 1909.) — Bessemer rails:

Wt. per yard, lbs.	50 to 60	61 to 70	71 to 80	81 to 90	91 to 100
Carbon, %	0.35-0.45	0.35-0.45	0.40-0.50	0.43-0.53	0.45-0.55
Manganese, %	0.70-1.00	0.70-1.00	0.75-1.05	0.80-1.10	0.84-1.14

Phosphorus not over 0.10%; silicon not over 0.20%. Drop Test: A piece of rail 4 to 6 ft. long, selected from each blow, is placed head upwards on supports 3 ft. apart. The anvil weighs at least 20,000 lbs., and the tup, or falling weight, 2000 lbs. The rail should not break when the drop is as follows:

Weight per yard, lbs.	71 to 80	81 to 90	91 to 100
Height of drop, feet	16	17	18

If any rail breaks when subjected to the drop test, two additional tests will be made of other rails from the same blow of steel, and if either of

these latter tests fail, all the rails of the blow which they represent will be rejected; but if both of these additional test-pieces meet the requirements; all the rails of the blow which they represent will be accepted.

Shrinkage: The number of passes and the speed of the roll train shall be so regulated that for sections 75 lbs. per yard and heavier the temperature on leaving the rolls will not exceed that which requires a shrinkage allowance at the hot saws of 6 1/16 inches for a 33-ft. 75-lb. rail, with an increase of 1/16 in. for each increase of 5 lbs. in the weight of the section.

Open-hearth rails: chemical specifications:

Weight per yard, lbs.	50 to 60	61 to 70	71 to 80	81 to 90	90 to 100
Carbon, %	0.46-0.59	0.46-0.59	0.52-0.65	0.59-0.72	0.62-0.75

Manganese, 0.60 to 0.90; Phosphorus, not over 0.04; Silicon, not over 0.20. Drop Tests: 50 to 60-lb., 15 ft.; 61 to 70-lb., 16 ft.; heavier sections same as Bessemer.

Specifications for Steel Axles. (*Proc. A. S. T. M.*, 1905 p. 56.) —

	P. & S. †	Tens. Str.	Yield Pt.	El. in 2 in.	Red. Area.
Car and tender truck	0.06				
Driving and engine truck, C. S.*	0.06	80,000	40,000	20%	25%
Driving and engine truck, N. S.†	0.04	80,000	50,000	25%	45%

* Carbon steel.

† Nickel steel, 3 to 4% Ni.

‡ Each not to exceed. Mn in carbon steel not over 0.60%.

Drop Tests. — One drop test to be made from each melt. The axle rests on supports 3 ft. apart, the tup weighs 1640 lbs., the anvil supported on springs, 17,500 lbs.; the radius of the striking face of the tup is 5 in. The axle is turned over after the first, third and fifth blows. It must stand the number of blows named below without rupture and without exceeding, as the result of the first blow, the deflection given.

Diam. axle at center, in.	4 1/4	4 3/8	4 7/8	4 5/8	4 3/4	5 3/8	5 7/8
Number of blows	5	5	5	5	5	5	7
Height of drop, ft.	24	26	28 1/2	31	34	43	43
Deflection, in.	8 1/4	8 1/4	8 1/4	8	8	7	5 1/2

Specifications for Tires. (*A. S. T. M.*, 1901.) — Physical requirements of test-piece 1/2 in. diam. Tires for passenger engines: T. S., 100,000; El. in 2 in., 12%. Tires for freight engines and car wheels: T. S., 110,000; El., 10%. Tires for switching engines: T. S., 120,000; El., 8%.

Drop Test. — If a drop test is called for, a selected tire shall be placed vertically under the drop on a foundation at least 10 tons in weight and subjected to successive blows from a tup weighing 2240 lbs. falling from increasing heights until the required deflection is obtained, without breaking or cracking. The minimum deflection must equal $D^2 + (40T^2 + 2D)$, D being internal diameter and T thickness of tire at center of tread.

Splice-bars. (*A. S. T. M.*, 1901.) — Tensile strength of a specimen cut from the head of the bar, 54,000 to 64,000 lbs.; yield point, 32,000 lbs. Elongation in 8 in., not less than 25 per cent. A test specimen cut from the head of the bar shall bend 180° flat on itself without fracture on the outside of the bent portion. If preferred, the bending test may be made on an unpunched splice-bar, which shall be first flattened and then bent. One tensile test and one bending test to be made from each blow or melt of steel.

Specifications for Steel Used in Automobile Construction.
(E. F. Lake, *Am. Mach.*, March 14, 1907.) —

	C.	Mn.	Cr.	Ni	P.	S.	T. S.	E. L.	El. in 2 in.	R. of A.
(1)	0.40-0.55	0.40-	0.80+	1.50+	0.04-	0.04-	{ 90000+ 180000+ 85000+	{ 65000+ 140000+ 65000+	{ 18+ 8+ 20+	{ 35+a 20+b 50+a
(2)	0.20-0.35	0.40-	0.80+	1.50+	0.04-	0.04-	{ 130000+ 120000	{ 100000+ 105000	{ 12+ 20	{ 30+b 58c
(3)	0.25	0.40	1.50	3.50	0.015	0.025	{ 85000+ 100000+	{ 60000+ 70000+	{ 25+ 20+	{ 50+a 50+b
(4)	0.25-0.35	0.60	1.50+	0.03	0.04	{ 85000+ 100000+	{ 60000+ 70000+	{ 25+ 20+	{ 50+a 50+b
(5)	0.45-0.55	1.1-1.3	0.065-	0.06-	85000+	55000+	15+	45+c
(6)	0.28-0.36	0.3-0.6	0.05-	0.06-	75000+	40000+	25+	40+c
(7)	0.85-1.00	0.25-0.5	0.03-	0.03-
(8)	0.50	1.50-	30.0	0.04-	0.06-

- The plus sign means "or over"; the minus sign "or less."
a, fully annealed; b, heat-treated, that is oil-quenched and partly annealed; c, as rolled.
- (1) 45% carbon chrome-nickel steel, for gears of high-grade cars. When annealed this steel can be machined with a high-speed tool at the rate of 35 ft. per min., with a 1/16-in. feed and a 3/16-in. cut. It is annealed at 1400° F. 4 or 5 hours, and cooled slowly. In heat-treating it is heated to 1500°, quenched in oil or water and drawn at 500° F.
 - (2) 25% carbon chrome-nickel steel, for shafts, axles, pivots, etc. This steel may be machined at the same rate as (1), and it forges more easily.
 - (3) A foreign steel used for forgings that have to withstand severe alternating shocks, such as differential shafts, transmission parts, universal joints, axles, etc.
 - (4) Nickel steel, used instead of (1) in medium and low-priced cars.
 - (5) "Gun-barrel" steel, used extensively for rifle barrels, also in low-priced automobiles, for shafts, axles, etc. It is used as it comes from the maker, without heat-treating.
 - (6) Machine steel. Used for parts that do not require any special strength.
 - (7) Spring steel used in automobiles.
 - (8) Nickel steel for valves. Used for its heat-resisting qualities in valves of internal-combustion engines.

Carbonizing or Case-hardening. — Some makers carbonize the surface of gears made from steel (1) above. They are packed in cast-iron boxes with a mixture of bone and powdered charcoal and heated four hours at nearly the melting-point of the boxes, then cooled slowly in the boxes. They are then taken out, heated to 1400° F. for four hours to break up the coarse grain produced by the carbonizing temperature. After this the work is heat-treated as above described.

The machine steel (6) case-hardens well by the use of this process.
Specifications for Steel Castings. (*Proc. A. S. T. M.*, 1905, p. 53.) — Open-hearth, Bessemer, or crucible. Castings to be annealed unless otherwise specified. Ordinary castings, in which no physical requirements are specified, shall contain not over 0.04 C and not over 0.08 P. Castings subject to physical test shall contain not over 0.05 P and not over 0.05 S. The minimum requirements are:

	T. S.	Y. P.	El. in 2 in.	Red. Area.
Hard castings.....	85,000	38,250	15 %	20 %
Medium castings.....	70,000	31,500	18 %	25 %
Soft castings.....	60,000	27,000	22 %	30 %

WARNING: This is a 1910 edition. Some of the material may no longer be accurate

For small or unimportant castings a test to destruction may be substituted. Three samples are selected from each melt or blow, annealed in the same furnace charge, and shall show the material to be ductile and free from injurious defects, and suitable for the purpose intended. Large castings are to be suspended and hammered all over. No cracks, flaws, defects nor weakness shall appear after such treatment. A specimen 1 x 1/2 in. shall bend cold around a diam. of 1 in. without fracture on outside of bent portion, through an angle of 120° for soft and 90° for medium castings.

Specifications for steel castings issued by the U. S. Navy Department, 1889 (abridged): Steel for castings must be made by either the open-hearth or the crucible process, and must not show more than 0.06% of phosphorus. All castings must be annealed, unless otherwise directed. The tensile strength of steel castings shall be at least 60,000 lbs., with an elongation of at least 15% in 8 in. for all castings for moving parts of machinery, and at least 10% in 8 in. for other castings. Bars 1 in. sq. shall be capable of bending cold, without fracture, through an angle of 90°, over a radius not greater than 1 1/2 in. All castings must be sound, free from injurious roughness, sponginess, pitting, shrinkage, or other cracks, cavities, etc.

Pennsylvania Railroad specifications, 1888: Steel castings should have a tensile strength of 70,000 lbs. per sq. in. and an elongation of 15% in section originally 2 in. long. Steel castings will not be accepted if tensile strength falls below 60,000 lbs., nor if the elongation is less than 12%, nor if castings have blow-holes and shrinkage cracks. Castings weighing 80 lbs. or more must have cast with them a strip to be used as a test-piece. The dimensions of this strip must be 3/4 in. sq. by 12 in. long.

MECHANICS.

FORCE, STATICAL MOMENT, EQUILIBRIUM, ETC.

MECHANICS is the science that treats of the action of force upon bodies. Statics is the mechanics of bodies at rest relatively to the earth's surface. Dynamics is the mechanics of bodies in motion. Hydrostatics and hydrodynamics are the mechanics of liquids, and Pneumatics the mechanics of air and other gases. These are treated in other chapters.

There are four elementary quantities considered in Mechanics: *Matter, Force, Space, Time.*

Matter. — Any substance or material that can be weighed or measured. It exists in three forms: solid, liquid, and gaseous. A definite portion of matter is called a body.

The Quantity of Matter in a body may be determined either by measuring its bulk or by weighing it, but as the bulk varies with temperature, with porosity, with size, shape and method of piling its particles, etc., weighing is generally the more accurate method of determining its quantity.

Weight. Mass. — The word "weight" is commonly used in two senses: 1. As the measure of quantity of matter in a body, as determined by weighing it in an even balance scale or on a lever or platform scale, and thus comparing its quantity with that of certain pieces of metal called standard weights, such as the pound avoirdupois. 2. As the measure of the force which the attraction of gravitation of the earth exerts on the body, as determined by measuring that force with a spring balance. As the force of gravity varies with the latitude and elevation above sea level of different parts of the earth's surface, the weight determined in this second method is a variable, while that determined by the first method is a constant. For this reason, and also because spring balances are generally not as accurate instruments as even balances, or lever or platform scales, the word "weight," in engineering, unless otherwise specified, means the quantity of matter as determined by weighing it by the first method. The standard unit of weight is the pound.

The word "mass" is used in three senses by writers on physics and engineering: 1. As a general expression of an indefinite quantity, synonymous with lump, piece, portion, etc., as in the expression "a mass whose weight is one pound." 2. As the quotient of the weight, as

determined by the first method of weighing given above, by 32.2, the value of g , the acceleration due to gravity, at London, expressed by the formula $M = W/g$. This value is merely the arithmetical ratio of the weight in pounds to the acceleration in feet per second per second, and it has no unit. 3. As a measure of the quantity of matter, exactly synonymous with the first meaning of the word "weight," given above. In this sense the word is used in many books on physics and theoretical mechanics, but it is not so used by engineers. The statement in such books that the engineers' unit of mass is 32.2 lbs. is an error. There is no such unit. Whenever the term "mass" is represented by M in engineering calculations it is equivalent to W/g , in which W is the quantity of matter in pounds, and $g = 32.2$.

A Force is anything that tends to change the state of a body with respect to rest or motion. If a body is at rest, anything that tends to put it in motion is a force; if a body is in motion, anything that tends to change either its direction or its rate of motion is a force.

A force should always mean the pull, pressure, rub, attraction (or repulsion) of one body upon another, and always implies the existence of a simultaneous equal and opposite force exerted by that other body on the first body, i.e., the reaction. In no case should we call anything a force unless we can conceive of it as capable of measurement by a spring balance, and are able to say from what other body it comes. (I. P. Church.)

Forces may be divided into two classes, extraneous and molecular; extraneous forces act on bodies from without; molecular forces are exerted between the neighboring particles of bodies.

Extraneous forces are of two kinds, pressures and moving forces: pressures simply tend to produce motion; moving forces actually produce motion. Thus, if gravity act on a fixed body, it creates pressure; if on a free body, it produces motion.

Molecular forces are of two kinds, attractive and repellent: attractive forces tend to bind the particles of a body together; repellent forces tend to thrust them asunder. Both kinds of molecular forces are continually exerted between the molecules of bodies, and on the predominance of one or the other depends the physical state of a body, as solid, liquid, or gaseous.

The Unit of Force used in engineering, by English writers, is the pound avoirdupois. For some scientific purposes, as in electro-dynamics, forces are sometimes expressed in "absolute units." The absolute unit of force is that force which acting on a unit of mass during a unit of time produces a unit of velocity. In the French C. G. S., or centimeter-gram-second system, it is the force which acting on the mass whose weight is one gram at Paris will produce in one second a velocity of one centimeter per second. This unit is called a "dyne" = $1/981$ gram at Paris.

An attempt has been made by some writers on physics to introduce the so-called "absolute system" into English weights and measures, and to define the "absolute unit" of force as that force which acting on the mass whose weight is one pound at London will in one second produce a velocity of one foot per second, and they have given this unit the name "poundal." The use of this unit only makes confusion for students, and it is to be hoped that it will soon be abandoned in high-school textbooks. Professor Perry in his "Calculus for Engineers," p. 26, says, "One might as well talk Choctaw in the shops as to speak about . . . so many poundals of force and so many foot-poundals of work." *

Inertia is that property of a body by virtue of which it tends to continue in the state of rest or motion in which it may be placed, until acted on by some force.

Newton's Laws of Motion. — 1st Law. If a body be at rest, it will remain at rest; or if in motion, it will move uniformly in a straight line till acted on by some force.

* Professor Perry himself, however, makes a slip on the same page in saying: "Force in pounds is the space-rate at which work in foot-pounds is done; it is also the time-rate at which momentum is produced or destroyed." He gets this idea, no doubt, from the equations $FT = MV$, $F = MV/T$, $F = 1/2 MV^2 \div S$. Force is not these things; it is merely numerically equivalent, when certain units are chosen, to these last two quotients. We might as well say, since $T = MV/F$, that time is the force-rate of momentum.

2d Law. If a body be acted on by several forces, it will obey each as though the others did not exist, and this whether the body be at rest or in motion.

3d Law. If a force act to change the state of a body with respect to rest or motion, the body will offer a resistance equal and directly opposed to the force. Or, to every action there is opposed an equal and opposite reaction.

Graphic Representation of a Force. — Forces may be represented geometrically by straight lines, proportional to the forces. A force is given when we know its intensity, its point of application, and the direction in which it acts. When a force is represented by a line, the length of the line represents its intensity; one extremity represents the point of application; and an arrow-head at the other extremity shows the direction of the force.

Composition of Forces is the operation of finding a single force whose effect is the same as that of two or more given forces. The required force is called the resultant of the given forces.

Resolution of Forces is the operation of finding two or more forces whose combined effect is equivalent to that of a given force. The required forces are called components of the given force.

The resultant of two forces applied at a point, and acting in the same direction, is equal to the sum of the forces. If two forces act in opposite directions, their resultant is equal to their difference, and it acts in the direction of the greater.

If any number of forces be applied at a point, some in one direction and others in a contrary direction, their resultant is equal to the sum of those that act in one direction, diminished by the sum of those that act in the opposite direction; or, the resultant is equal to the algebraic sum of the components.

Parallelogram of Forces. — If two forces acting on a point be represented in direction and intensity by adjacent sides of a parallelogram, their resultant will be represented by that diagonal of the parallelogram which passes through the point. Thus OR , Fig. 93, is the resultant of OQ and OP .

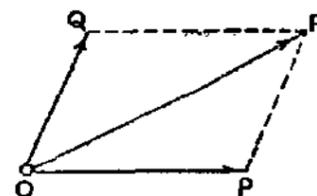

FIG. 93.

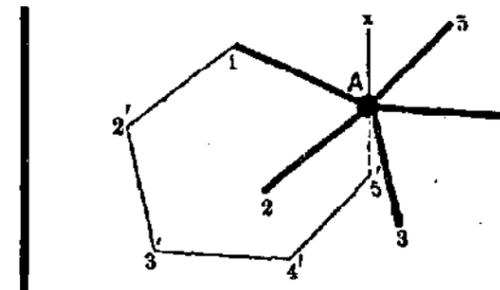

FIG. 94.

Polygon of Forces. — If several forces are applied at a point and act in a single plane, their resultant is found as follows:

Through the point draw a line representing the first force; through the extremity of this draw a line representing the second force; and so on, throughout the system; finally, draw a line from the starting-point to the extremity of the last line drawn, and this will be the resultant required.

Suppose the body A , Fig. 94, to be urged in the directions A_1 , A_2 , A_3 , A_4 , and A_5 by forces which are to each other as the lengths of those lines. Suppose these forces to act successively and the body to first move from A to 1; the second force A_2 then acts and finding the body at 1 would take it to 2'; the third force would then carry it to 3', the fourth to 4', and the fifth to 5'. The line A_5' represents in magnitude and direction the resultant of all the forces considered. If there had been an additional force, A_x , in the group, the body would be returned by that force to its original position, supposing the forces to act successively, but if they had acted simultaneously the body would never have moved at all; the tendencies to motion balancing each other.

It follows, therefore, that if the several forces which tend to move a body can be represented in magnitude and direction by the sides of a closed polygon taken in order, the body will remain at rest; but if the forces are represented by the sides of an open polygon, the body will move

and the direction will be represented by the straight line which closes the polygon.

Twisted Polygon. — The rule of the polygon of forces holds true even when the forces are not in one plane. In this case the lines $A1, 1-2', 2'-3',$ etc., form a twisted polygon, that is, one whose sides are not in one plane.

Parallelepipedon of Forces. — If three forces acting on a point be represented by three edges of a parallelepipedon which meet in a common point, their resultant will be represented by the diagonal of the parallelepipedon that passes through their common point.

Thus $OR,$ Fig. 95, is the resultant of OQ, OS and $OP.$ OM is the resultant of OP and $OQ,$ and OR is the resultant of OM and $OS.$

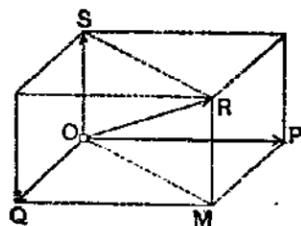

FIG. 95.

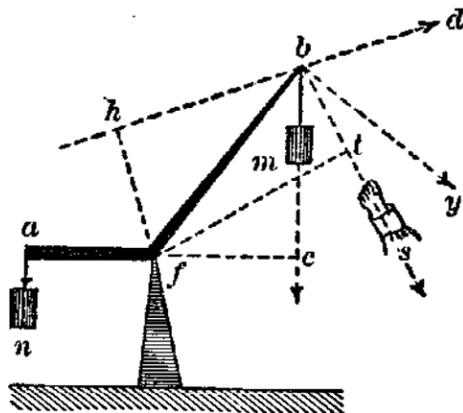

FIG. 96.

Moment of a Force. — The moment of a force (sometimes called statical moment), with respect to a point, is the product of the force by the perpendicular distance from the point to the direction of the force. The fixed point is called the center of moments; the perpendicular distance is the lever-arm of the force; and the moment itself measures the tendency of the force to produce rotation about the center of moments.

If the force is expressed in pounds and the distance in feet, the moment is expressed in foot-pounds. It is necessary to observe the distinction between foot-pounds of statical moment and foot-pounds of work or energy. (See Work.)

In the bent lever, Fig. 96 (from Trautwine), if the weights n and m represent forces, their moments about the point f are respectively $n \times af$ and $m \times fc.$ If instead of the weight m a pulling force to balance the weight n is applied in the direction $bs,$ or by or $bd,$ $s, y,$ and d being the amounts of these forces, their respective moments are $s \times ft, y \times fb,$ and $d \times fh.$

If the forces acting on the lever are in equilibrium it remains at rest, and the moments on each side of f are equal, that is, $n \times af = m \times fc,$ or $s \times ft, or y \times fb, or d \times hf.$

The moment of the resultant of any number of forces acting together in the same plane is equal to the algebraic sum of the moments of the forces taken separately.

Statical Moment. Stability. — The statical moment of a body is the product of its weight by the distance of its line of gravity from some assumed line of rotation. The line of gravity is a vertical line drawn from its center of gravity through the body. The stability of a body is that resistance which its weight alone enables it to oppose against forces tending to overturn it or to slide it along its foundation.

To be safe against turning on an edge the moment of the forces tending to overturn it, taken with reference to that edge, must be less than the statical moment. When a body rests on an inclined plane, the line of gravity, being vertical, falls toward the lower edge of the body, and the condition of its not being overturned by its own weight is that the line of gravity must fall within this edge. In the case of an inclined tower resting on a plane the same condition holds — the line of gravity must fall within the base. The condition of stability against sliding along a horizontal plane is that the horizontal component of the force exerted tending to cause it to slide shall be less than the product of the weight of

the body into the coefficient of friction between the base of the body and its supporting plane. This coefficient of friction is the tangent of the angle of repose, or the maximum angle at which the supporting plane might be raised from the horizontal before the body would begin to slide. (See Friction.)

The Stability of a Dam against overturning about its lower edge is calculated by comparing its statical moment referred to that edge with the resultant pressure of the water against its upper side. The horizontal pressure on a square foot at the bottom of the dam is equal to the weight of a column of water of one square foot in section, and of a height equal to the distance of the bottom below water-level; or, if H is the height, the pressure at the bottom per square foot = $62.4 \times H$ lbs. At the water-level the pressure is zero, and it increases uniformly to the bottom, so that the sum of the pressures on a vertical strip one foot in breadth may be represented by the area of a triangle whose base is $62.4 \times H$ and whose altitude is $H,$ or $62.4 H^2 \div 2.$ The center of gravity of a triangle being $1/3$ of its altitude, the resultant of all the horizontal pressures may be taken as equivalent to the sum of the pressures acting at $1/3 H,$ and the moment of the sum of the pressures is therefore $62.4 \times H^3 \div 6.$

Parallel Forces. — If two forces are parallel and act in the same direction, their resultant is parallel to both, and lies between them, and the intensity of the resultant is equal to the sum of the intensities of the two forces. Thus in Fig. 96 the resultant of the forces n and m acts vertically downward at $f,$ and is equal to $n + m.$

If two parallel forces act at the extremities of a straight line and in the same direction, the resultant divides the line joining the points of appli-

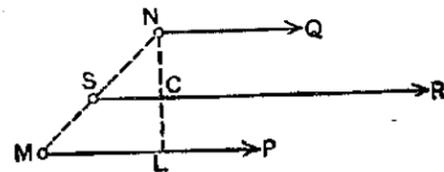

FIG. 97.

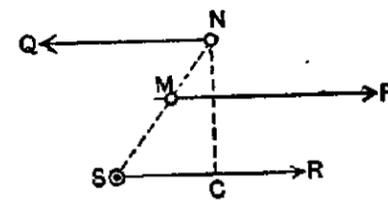

FIG. 98.

cation of the components, inversely as the components. Thus in Fig. 96, $m : n :: af : fc;$ and in Fig. 97, $P : Q :: SN : SM.$

The resultant of two parallel forces acting in opposite directions is parallel to both, lies without both, on the side and in the direction of the greater, and its intensity is equal to the difference of the intensities of the two forces.

Thus the resultant of the two forces Q and $P,$ Fig. 98, is equal to $Q - P = R.$ Of any two parallel forces and their resultant each is proportional to the distance between the other two; thus in both Figs. 97 and 98, $P : Q : R :: SN : SM : MN.$

Couples. — If P and Q be equal and act in opposite directions, $R = 0;$ that is, they have no resultant. Two such forces constitute what is called a couple.

The tendency of a couple is to produce rotation; the measure of this tendency, called the *moment of the couple,* is the product of one of the forces by the distance between the two.

Since a couple has no single resultant, no single force can balance a couple. To prevent the rotation of a body acted on by a couple the application of two other forces is required, forming a second couple. Thus in Fig. 99, P and $Q,$ forming a couple, may be balanced by a second couple formed by R and $S.$ The point of application of either R or S may be a fixed pivot or axis.

Moment of the couple $PQ = P(c + b + a) =$ moment of $RS = Rb.$ Also, $P + R = Q + S.$

The forces R and S need not be parallel to P and $Q,$ but if not, then their components parallel to PQ are to be taken instead of the forces themselves.

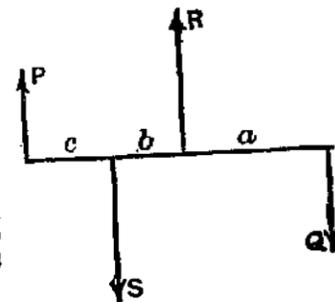

FIG. 99.

Equilibrium of Forces. — A system of forces applied at points of a solid body will be in equilibrium when they have no tendency to produce motion, either of translation or of rotation.

The conditions of equilibrium are: 1. The algebraic sum of the components of the forces in the direction of any three rectangular axes must be separately equal to 0.

2. The algebraic sum of the moments of the forces, with respect to any three rectangular axes, must be separately equal to 0.

If the forces lie in a plane: 1. The algebraic sum of the components of the forces, in the direction of any two rectangular axes, must be separately equal to 0.

2. The algebraic sum of the moments of the forces, with respect to any point in the plane, must be equal to 0.

If a body is restrained by a fixed axis, as in case of a pulley, or wheel and axle, the forces will be in equilibrium when the algebraic sum of the moments of the forces with respect to the axis is equal to 0.

CENTER OF GRAVITY.

The center of gravity of a body, or of a system of bodies rigidly connected together, is that point about which, if suspended, all the parts will be in equilibrium, that is, there will be no tendency to rotation. It is the point through which passes the resultant of the efforts of gravitation on each of the elementary particles of a body. In bodies of equal heaviness throughout, the center of gravity is the center of magnitude.

(The center of magnitude of a figure is a point such that if the figure be divided into equal parts the distance of the center of magnitude of the whole figure from any given plane is the mean of the distances of the centers of magnitude of the several equal parts from that plane.)

If a body be suspended at its center of gravity, it will be in equilibrium in all positions. If it be suspended at a point out of its center of gravity, it will swing into a position such that its center of gravity is vertically beneath its point of suspension.

To find the center of gravity of any plane figure mechanically, suspend the figure by any point near its edge, and mark on it the direction of a plumb-line hung from that point; then suspend it from some other point, and again mark the direction of the plumb-line in like manner. Then the center of gravity of the surface will be at the point of intersection of the two marks of the plumb-line.

The Center of Gravity of Regular Figures, whether plane or solid, is the same as their geometrical center; for instance, a straight line, parallelogram, regular polygon, circle, circular ring, prism, cylinder, sphere, spheroid, middle frustums of spheroid, etc.

Of a triangle: On a line drawn from any angle to the middle of the opposite side, at a distance of one-third of the line from the side; or at the intersection of such lines drawn from any two angles.

Of a trapezium or trapezoid: Draw a diagonal, dividing it into two triangles. Draw a line joining their centers of gravity. Draw the other diagonal, making two other triangles, and a line joining their centers of gravity. The intersection of the two lines is the center of gravity required.

Of a sector of a circle: On the radius which bisects the arc, $2cr \div 3l$ from the center, c being the chord, r the radius, and l the arc.

Of a semicircle: On the middle radius, $0.4244r$ from the center.

Of a quadrant: On the middle radius, $0.6002r$ from the center.

Of a segment of a circle: $c \div 12a$ from the center. c = chord, a = area.

Of a parabolic surface: In the axis, $3/5$ of its length from the vertex.

Of a semi-parabola (surface): $3/5$ length of the axis from the vertex, and $3/8$ of the semi-base from the axis.

Of a cone or pyramid: In the axis, $1/4$ of its length from the base.

Of a paraboloid: In the axis, $2/3$ of its length from the vertex.

Of a cylinder, or regular prism: In the middle point of the axis.

Of a frustum of a cone or pyramid: Let a = length of a line drawn from the vertex of the cone when complete to the center of gravity of the base, and a' that portion of it between the vertex and the top of the frustum; then distance of center of gravity of the frustum from center of gravity of its base = $\frac{a}{4} - \frac{3a'^3}{4(a^2 + aa' + a'^2)}$

its base = $\frac{a}{4} - \frac{3a'^3}{4(a^2 + aa' + a'^2)}$

For two bodies, fixed one at each end of a straight bar, the common center of gravity is in the bar, at that point which divides the distance between their respective centers of gravity in the inverse ratio of the weights. In this solution the weight of the bar is neglected. But it may be taken as a third body, and allowed for as in the following directions:

For more than two bodies connected in one system: Find the common center of gravity of two of them; and find the common center of these two jointly with a third body, and so on to the last body of the group.

Another method, by the principle of moments: To find the center of gravity of a system of bodies, or a body consisting of several parts, whose several centers are known. If the bodies are in a plane, refer their several centers to two rectangular coordinate axes. Multiply each weight by its distance from one of the axes, add the products, and divide the sum by the sum of the weights; the result is the distance of the center of gravity from that axis. Do the same with regard to the other axis. If the bodies are not in a plane, refer them to three planes at right angles to each other, and determine the mean distance of the sum of the weights from each of the three planes.

MOMENT OF INERTIA.

The moment of inertia of the weight of a body with respect to an axis is the algebraic sum of the products obtained by multiplying the weight of each elementary particle by the square of its distance from the axis. If the moment of inertia with respect to any axis = I , the weight of any element of the body = w , and its distance from the axis = r , we have $I = \sum (wr^2)$.

The moment of inertia varies, in the same body, according to the position of the axis. It is the least possible when the axis passes through the center of gravity. To find the moment of inertia of a body, referred to a given axis, divide the body into small parts of regular figure. Multiply the weight of each part by the square of the distance of its center of gravity from the axis. The sum of the products is the moment of inertia. The value of the moment of inertia thus obtained will be more nearly exact, the smaller and more numerous the parts into which the body is divided.

MOMENTS OF INERTIA OF REGULAR SOLIDS. — Rod, or bar, of uniform thickness, with respect to an axis perpendicular to the length of the rod,

$I = W \left(\frac{l^2}{3} + d^2 \right)$ (1)

W = weight of rod, $2l$ = length, d = distance of center of gravity from axis.

Thin circular plate, axis in its own plane, } $I = W \left(\frac{r^2}{4} + d^2 \right)$ (2)

r = radius of plate.

Circular plate, axis perpendicular to the plate, } $I = W \left(\frac{r^2}{2} + d^2 \right)$ (3)

Circular ring, axis perpendicular to its own plane, } $I = W \left(\frac{r^2 + r'^2}{2} + d^2 \right)$ (4)

r and r' are the exterior and interior radii of the ring.

Cylinder, axis perpendicular to the axis of the cylinder, } $I = W \left(\frac{r^2}{4} + \frac{l^2}{3} + d^2 \right)$ (5)

r = radius of base, $2l$ = length of the cylinder.

By making $d = 0$ in any of the above formulæ, we find the moment of inertia for a parallel axis through the center of gravity.

The moment of inertia, $\sum wr^2$, numerically equals the weight of a body which, if concentrated at the distance unity from the axis of rotation, would require the same work to produce a given increase of angular velocity that the actual body requires. It bears the same relation to angular acceleration which weight does to linear acceleration (Rankine). The term moment of inertia is also used in regard to areas, as the cross-sections of beams under strain. In this case $I = \sum ar^2$, in which a is any elementary area, and r its distance from the center. (See under Strength of Materials, p. 279.) Some writers call $\sum mr^2 = \sum wr^2 + g$ the moment of inertia.

CENTERS OF OSCILLATION AND OF PERCUSSION.

Center of Oscillation. — If a body oscillate about a fixed horizontal axis, not passing through its center of gravity, there is a point in the line drawn from the center of gravity perpendicular to the axis whose motion is the same as it would be if the whole mass were collected at that point and allowed to vibrate as a pendulum about the fixed axis. This point is called the center of oscillation.

The Radius of Oscillation, or distance of the center of oscillation from the point of suspension = the square of the radius of gyration + distance of the center of gravity from the point of suspension or axis. The centers of oscillation and suspension are convertible.

If a straight line, or uniform thin bar or cylinder, be suspended at one end, oscillating about it as an axis, the center of oscillation is at $\frac{2}{3}$ the length of the rod from the axis. If the point of suspension is at $\frac{1}{3}$ the length from the end, the center of oscillation is also at $\frac{2}{3}$ the length from the axis, that is, it is at the other end. In both cases the oscillation will be performed in the same time. If the point of suspension is at the center of gravity, the length of the equivalent simple pendulum is infinite, and therefore the time of vibration is infinite.

For a sphere suspended by a cord, r = radius, h = distance of axis of motion from the center of the sphere, h' = distance of center of oscillation from center of the sphere, l = radius of oscillation = $h + h' = h + \frac{2r^2}{5h}$.

If the sphere vibrate about an axis tangent to its surface, $h = r$, and $l = r + \frac{2r}{5} = \frac{7r}{5}$. If $h = 10r$, $l = 10r + \frac{r}{25}$.

Lengths of the radius of oscillation of a few regular plane figures or thin plates, suspended by the vertex or uppermost point.

1st. When the vibrations are flatwise, or perpendicular to the plane of the figure:

In an isosceles triangle the radius of oscillation is equal to $\frac{3}{4}$ of the height of the triangle.

In a circle, $\frac{5}{8}$ of the diameter.

In a parabola, $\frac{5}{7}$ of the height.

2d. When the vibrations are edgewise, or in the plane of the figure:

In a circle the radius of oscillation is $\frac{3}{4}$ of the diameter.

In a rectangle suspended by one angle, $\frac{2}{3}$ of the diagonal.

In a parabola, suspended by the vertex, $\frac{5}{7}$ of the height plus $\frac{1}{3}$ of the parameter.

In a parabola, suspended by the middle of the base, $\frac{4}{7}$ of the height plus $\frac{1}{2}$ the parameter.

Center of Percussion. — The center of percussion of a body oscillating about a fixed axis is the point at which, if a blow is struck by the body, the percussive action is the same as if the whole mass of the body were concentrated at the point. This point is identical with the center of oscillation.

CENTER AND RADIUS OF GYRATION.

The center of gyration, with reference to an axis, is a point at which, if the entire weight of a body be concentrated, its moment of inertia will remain unchanged; or, in a revolving body, the point in which the whole weight of the body may be conceived to be concentrated, as if a pound of platinum were substituted for a pound of revolving feathers, the angular velocity and the accumulated work remaining the same. The distance of this point from the axis is the radius of gyration. If W = the weight of a body, $I = \sum wr^2$ = its moment of inertia, and k = its radius of gyration,

$$I = Wk^2 = \sum wr^2; \quad k = \sqrt{\frac{\sum wr^2}{W}}$$

The moment of inertia = the weight \times the square of the radius of gyration. To find the radius of gyration divide the body into a considerable number of equal small parts, — the more numerous the more nearly exact is the result, — then take the mean of all the squares of the distances of the parts from the axis of revolution, and find the square root of the mean square. Or, if the moment of inertia is known, divide it by the weight and extract the square root. For radius of gyration of an area, as a cross-section of a beam, divide the moment of inertia of the area by the area and extract the square root.

The radius of gyration is the least possible when the axis passes through the center of gravity. This minimum radius is called the principal radius of gyration. If we denote it by k and any other radius of gyration by k' , we have for the five cases given under the head of moment of inertia above the following values:

- (1) Rod, axis perpen. to length, $k = l \sqrt{\frac{1}{3}}$; $k' = \sqrt{\frac{l^2}{3} + d^2}$.
- (2) Circular plate, axis in its plane, $k = \frac{r}{2}$; $k' = \sqrt{\frac{r^2}{4} + d^2}$.
- (3) Circular plate, axis perpen. to plane, $k = r \sqrt{\frac{1}{2}}$; $k' = \sqrt{\frac{r^2}{2} + d^2}$.
- (4) Circular ring, axis perpen. to plane, $k = \sqrt{\frac{r^2 + r'^2}{2}}$; $k' = \sqrt{\frac{r^2 + r'^2}{2} + d^2}$.
- (5) Cylinder, axis perpen. to length, $k = \sqrt{\frac{r^2}{4} + \frac{l^2}{3}}$; $k' = \sqrt{\frac{r^2}{4} + \frac{l^2}{3} + d^2}$.

Principal Radii of Gyration and Squares of Radii of Gyration.
(For radii of gyration of sections of columns, see page 281.)

Surface or Solid.	Rad. of Gyration.	Square of R. of Gyration.
Parallelogram: } axis at its base.....	0.5773 h	$\frac{1}{3} h^2$
height h } " mid-height.....	0.2886 h	$\frac{1}{12} h^2$
Straight rod: } axis at end.....	0.5773 l	$\frac{1}{3} l^2$
length l , or thin } " mid-length.....	0.2886 l	$\frac{1}{12} l^2$
rectang. plate		
Rectangular prism: axes $2a, 2b, 2c$, referred to axis $2a$	$0.577 \sqrt{b^2 + c^2}$	$\frac{(b^2 + c^2) \div 3}{4l^2 + b^2}$
Parallelepiped: length l , base b , axis at one end, at mid-breadth.....	$0.289 \sqrt{4l^2 + b^2}$	$\frac{12}{12}$
Hollow square tube: out. side h , inner h' , axis mid-length.....	$0.289 \sqrt{h^2 + h'^2}$	$\frac{(h^2 + h'^2) \div 12}{h^2 \div 6}$
very thin, side = h , axis mid-length.....	$\frac{408 h}{12}$	$\frac{h^2 \cdot h + 3b}{12 \cdot h + b}$
Thin rectangular tube: sides b, h , axis mid-length.....	$0.289 h \sqrt{\frac{h + 3b}{h + b}}$	$\frac{1}{4} r^2 = \frac{h^2 + 16}{(h^2 + h'^2) \div 16}$
Thin circ. plate: rad. r , diam. h , ax. diam.	$\frac{1}{2} r$	$\frac{r^2}{12} + \frac{r^2}{4}$
Flat circ. ring: diam. h, h' , axis diam.	$\frac{1}{4} \sqrt{h^2 + h'^2}$	$\frac{1}{12} + \frac{4}{R^2 + r^2}$
Solid circular cylinder: length l , axis diameter at mid-length.....	$0.289 \sqrt{l^2 + 3r^2}$	$\frac{l^2}{12} + \frac{R^2}{2}$
Circular plate: solid wheel of uniform thickness, or cylinder of any length, referred to axis of cyl.....	0.7071 r	$\frac{1}{2} r^2$
Hollow circ. cylinder, or flat ring: l , length; R, r , outer and inner radii. Axis, 1, longitudinal axis; 2, diam. at mid-length.....	$0.7071 \sqrt{R^2 + r^2}$ $0.289 \sqrt{l^2 + 3(R^2 + r^2)}$	$\frac{(R^2 + r^2) \div 2}{12} + \frac{4}{R^2 + r^2}$
Same: very thin, axis its diameter.....	$0.289 \sqrt{l^2 + 6R^2}$	$\frac{l^2}{12} + \frac{R^2}{2}$
" radius r ; axis, longitudinal axis.....	r	r^2
Circumf. of circle, axis its center.....	$\frac{r}{2}$	$\frac{1}{2} r^2$
Sphere: radius r , axis its diam.....	0.7071 r	$\frac{2}{5} r^2$
Spheroid: equatorial radius r , revolving } polar axis a	0.6325 r	$\frac{2}{5} r^2$
Paraboloid: r = rad. of base, rev. on axis.....	0.5773 r	$\frac{1}{3} r^2$
Ellipsoid: semi-axes a, b, c ; revolving on } axis $2a$	$0.4472 \sqrt{b^2 + c^2}$	$\frac{b^2 + c^2}{5}$
Spherical shell: radii R, r , revolving on } its diam.....	$0.6325 \sqrt{\frac{R^5 - r^5}{R^3 - r^3}}$	$\frac{2R^5 - r^5}{5R^3 - r^3}$
Same: very thin, radius r	0.8165 r	$\frac{2}{3} r^2$
Solid cone: r = rad. of base, rev. on axis.....	0.5477 r	$0.3 r^2$

THE PENDULUM.

A body of any form suspended from a fixed axis about which it oscillates by the force of gravity is called a compound pendulum. The ideal body concentrated at the center of oscillation, suspended from the center of suspension by a string without weight, is called a simple pendulum. This equivalent simple pendulum has the same weight as the given body, and also the same moment of inertia, referred to an axis passing through the point of suspension, and it oscillates in the same time.

The ordinary pendulum of a given length vibrates in equal times when the angle of the vibrations does not exceed 4 or 5 degrees, that is, 2° or 2 1/2° each side of the vertical. This property of a pendulum is called its isochronism.

The time of vibration of a pendulum varies directly as the square root of the length, and inversely as the square root of the acceleration due to gravity at the given latitude and elevation above the earth's surface.

If T = the time of vibration, l = length of the simple pendulum, g = acceleration = 32.16, T = π √(l/g); since π is constant, T ∝ √(l/g). At a given location g is constant and T ∝ √(l). If l be constant, then for any location T ∝ 1/√(g). If T be constant, gT² = π²l; l ∝ g; g = π²l/T². From this equation

the force of gravity at any place may be determined if the length of the simple pendulum, vibrating seconds, at that place is known. At New York this length is 39.1017 inches = 3.2585 ft., whence g = 32.16 ft. At London the length is 39.1393 inches. At the equator 39.0152 or 39.0168 inches, according to different authorities.

Time of vibration of a pendulum of a given length at New York

= t = √(l/39.1017) = √(l)/6.253.

l being in seconds and l in inches. Length of a pendulum having a given time of vibration, l = t² × 39.1017 inches.

The time of vibration of a pendulum may be varied by the addition of a weight at a point above the center of suspension, which counteracts the lower weight, and lengthens the period of vibration. By varying the height of the upper weight the time is varied.

To find the weight of the upper bob of a compound pendulum, vibrating seconds, when the weight of the lower bob and the distances of the weights from the point of suspension are given:

w = W (39.1 × D) - D² / (39.1 × d) + d²

W = the weight of the lower bob, w = the weight of the upper bob; D = the distance of the lower bob and d = the distance of the upper bob from the point of suspension, in inches.

Thus, by means of a second bob, short pendulums may be constructed to vibrate as slowly as longer pendulums.

By increasing w or d until the lower weight is entirely counterbalanced, the time of vibration may be made infinite.

Conical Pendulum. — A weight suspended by a cord and revolving at a uniform speed in the circumference of a circular horizontal plane whose radius is r, the distance of the plane below the point of suspension being h, is held in equilibrium by three forces — the tension in the cord, the centrifugal force, which tends to increase the radius r, and the force of gravity acting downward. If v = the velocity in feet per second of the center of gravity of the weight, as it describes the circumference, g = 32.16, and r and h are taken in feet, the time in seconds of performing one revolution is

t = 2πr/v = 2π√(h/g); h = gt²/4π² = 0.8146 t².

If t = 1 second, h = 0.8146 foot = 9.775 inches. The principle of the conical pendulum is used in the ordinary fly-ball governor for steam-engines. (See Governors.)

CENTRIFUGAL FORCE.

A body revolving in a curved path of radius = R in feet exerts a force, called centrifugal force, F, upon the arm or cord which restrains it from moving in a straight line, or "flying off at a tangent." If W = weight of the body in pounds, N = number of revolutions per minute, v = linear velocity of the center of gravity of the body, in feet per second, g = 32.16, then

v = 2πRN/60; F = Wv²/gl = Wv²/32.16R = W4π²RN²/3600g = WRN²/2933 = .0003410 WRN² lbs.

If n = number of revolutions per second, F = 1.2276 WRn². (For centrifugal force in fly-wheels, see Fly-wheels.)

VELOCITY, ACCELERATION, FALLING BODIES.

Velocity is the rate of motion, or the speed of a body at any instant. If s = space in feet passed over in t seconds, and v = velocity in feet per second, if the velocity is uniform,

v = s/t; s = vt; t = s/v.

If the velocity varies uniformly, the mean velocity v_m = 1/2(v_1 + v_2), in which v_1 is the velocity at the beginning and v_2 the velocity at the end of the time t.

s = 1/2(v_1 + v_2)t. (1)

If v_1 = 0, then s = 1/2 v_2 t. v_2 = 2 s/t.

If the velocity varies, but not uniformly, v for an exceedingly short interval of time = s/t, or in calculus v = ds/dt.

Acceleration is the change in velocity which takes place in a unit of time. Unit of acceleration = a = 1 foot per second in one second. For uniformly varying velocity, the acceleration is a constant quantity, and

a = (v_2 - v_1)/t; v_2 = v_1 + at; v_1 = v_2 - at. t = (v_2 - v_1)/a. (2)

If the body start from rest, v_1 = 0; then if v_m = mean velocity

v_m = v_2/2; v_2 = 2 v_m; a = v_2/t; v_2 = at; v_2 - at = 0; t = v_2/a.

Combining (1) and (2), we have

s = (v_2² - v_1²)/2a; s = v_1 t + at²/2; s = v_2 t - at²/2.

If v_1 = 0, s = 1/2 v_2 t.

Retarded Motion. — If the body start with a velocity v, and come to rest, v_2 = 0; then s = 1/2 v_1 t.

In any case, if the change in velocity is v,

s = v/2 t; s = v²/2a; s = a/2 t²

For a body starting from or ending at rest, we have the equations

v = at; s = v/2 t; s = at²/2; v² = 2as.

Falling Bodies. — In the case of falling bodies the acceleration due to gravity, at 40° latitude, is 32.16 feet per second in one second, = g. Then if v = velocity acquired at the end of t seconds, or final velocity, and h = height or space in feet passed over in the same time,

v = gt = 32.16 t = √2gh = 8.02√h = 2h/t;

h = gt²/2 = 16.08 t² = v²/2g = v²/64.32 = vt/2.

$$t = \frac{v}{g} = \frac{v}{32.16} = \sqrt{\frac{2h}{g}} = \frac{\sqrt{h}}{4.01} = \frac{2h}{v}$$

$$u = \text{space fallen through in the } T\text{th second} = g(T - 1/2)$$

From the above formulæ for falling bodies we obtain the following:

During the first second the body starting from a state of rest (resistance of the air neglected) falls $g \div 2 = 16.08$ feet; the acquired velocity is $g = 32.16$ ft. per sec.; the distance fallen in two seconds is $h = \frac{gt^2}{2} = 16.08 \times 4 = 64.32$ ft.; and the acquired velocity is $v = gt = 64.32$ ft. The acceleration, or increase of velocity in each second, is constant, and is 32.16 ft. per second. Solving the equations for different times, we find for

Seconds, t		1	2	3	4	5	6
Acceleration, g	32.16	\times	1	1	1	1	1
Velocity acquired at end of time, v	32.16	\times	1	2	3	4	5
Height of fall in each second, u	$\frac{32.16}{2}$	\times	1	3	5	7	9
Total height of fall, h	$\frac{32.16}{2}$	\times	1	4	9	16	25

Value of g . — The value of g increases with the latitude, and decreases with the elevation. At the latitude of Philadelphia, 40° , its value is 32.16. At the sea-level, Everett gives $g = 32.173 - .082 \cos^2 \text{ lat.} - .000003$ height in feet. At Paris, lat. $48^\circ 50'$ N., $g = 980.87$ cm. = 32.181 ft.

Values of $\sqrt{2g}$, calculated by an equation given by C. S. Pierce, are given in a table in Smith's Hydraulics, from which we take the following:

Latitude	0°	10°	20°	30°	40°	50°	60°
Value of $\sqrt{2g}$	8.0112	8.0118	8.0137	8.0165	8.0199	8.0235	8.0269
Value of g	32.090	32.094	32.105	32.132	32.160	32.189	32.216

The value of $\sqrt{2g}$ decreases about .0004 for every 1000 feet increase in elevation above the sea-level.

For all ordinary calculations for the United States, g is generally taken at 32.16, and $\sqrt{2g}$ at 8.02. In England $g = 32.2$, $\sqrt{2g} = 8.025$. Practical limiting values of g for the United States, according to Pierce, are:

Latitude 49° at sea-level	$g = 32.186$
" 25° 10,000 feet above the sea	$g = 32.089$

Fig. 100 represents graphically the velocity, space, etc., of a body falling for six seconds. The vertical line at the left is the time in seconds, the horizontal lines represent the acquired velocities at the end of each second = $32.16t$. The area of the small triangle at the top represents the height fallen through in the first second = $\frac{1}{2}gt = 16.08$ feet, and each of the other triangles is an equal space. The number of triangles between each pair of horizontal lines represents the height of fall in each second, and the number of triangles between any horizontal line and the top is the total height fallen during the time. The figures under h , u and v adjoining the cut are to be multiplied by 16.08 to obtain the actual velocities and heights for the given times.

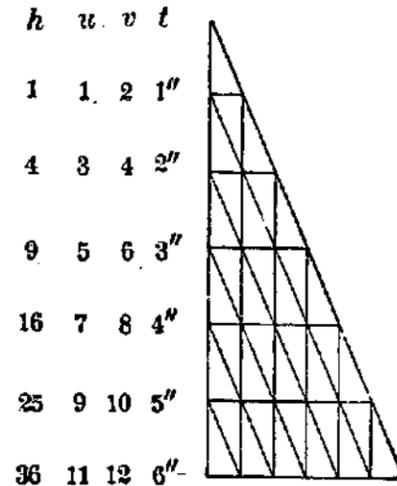

FIG. 100.

$$v = \frac{2\pi rn}{60}; 60v = 2\pi rn$$

WARNING: This is a 1910 edition. Some of the material may no longer be accurate

Angular velocity is a term used to denote the angle through which any radius of a body turns in a second, or the rate at which any point in it having a radius equal to unity is moving, expressed in feet per second. The unit of angular velocity is the angle which at a distance = radius from the center is subtended by an arc equal to the radius. This unit angle = $\frac{180}{\pi}$ degrees = 57.3° . $2\pi \times 57.3^\circ = 360^\circ$, or the circumference.

If A = angular velocity, $v = Ar$, $A = \frac{v}{r} = \frac{2\pi n}{60}$. The unit angle $\frac{180}{\pi}$ is called a *radian*.

Height Corresponding to a Given Acquired Velocity.

Velocity.	Height.	Velocity.	Height.	Velocity.	Height.	Velocity.	Height.	Velocity.	Height.	Velocity.	Height.
feet per sec.	feet.	feet per sec.	feet.	feet per sec.	feet.	feet per sec.	feet.	feet per sec.	feet.	feet per sec.	feet.
.25	0.0010	13	2.62	34	17.9	55	47.0	76	89.8	97	146
.50	0.0039	14	3.04	35	19.0	56	48.8	77	92.2	98	149
.75	0.0087	15	3.49	36	20.1	57	50.5	78	94.6	99	155
1.00	0.016	16	3.98	37	21.3	58	52.3	79	97.0	100	152
1.25	0.024	17	4.49	38	22.4	59	54.1	80	99.5	105	171
1.50	0.035	18	5.03	39	23.6	60	56.0	81	102.0	110	188
1.75	0.048	19	5.61	40	24.9	61	57.9	82	104.5	115	205
2	0.062	20	6.22	41	26.1	62	59.8	83	107.1	120	222
2.5	0.097	21	6.85	42	27.4	63	61.7	84	109.7	130	263
3	0.140	22	7.52	43	28.7	64	63.7	85	112.3	140	304
3.5	0.190	23	8.21	44	30.1	65	65.7	86	115.0	150	350
4	0.248	24	8.94	45	31.4	66	67.7	87	117.7	175	476
4.5	0.314	25	9.71	46	32.9	67	69.8	88	120.4	200	622
5	0.388	26	10.5	47	34.3	68	71.9	89	123.2	300	1390
6	0.559	27	11.3	48	35.8	69	74.0	90	125.9	400	2488
7	0.761	28	12.2	49	37.3	70	76.2	91	128.7	500	3887
8	0.994	29	13.1	50	38.9	71	78.4	92	131.6	600	5597
9	1.26	30	14.0	51	40.4	72	80.6	93	134.5	700	7618
10	1.55	31	14.9	52	42.0	73	82.9	94	137.4	800	9952
11	1.88	32	15.9	53	43.7	74	85.1	95	140.3	900	12,593
12	2.24	33	16.9	54	45.3	75	87.5	96	143.3	1000	15,547

Parallelogram of Velocities. — The principle of the composition and resolution of forces may also be applied to velocities or to distances moved in given intervals of time. Referring to Fig. 93, page 489, if a body at O has a force applied to it which acting alone would give it a velocity represented by OQ per second, and at the same time it is acted on by another force which acting alone would give it a velocity OP per second, the result of the two forces acting together for one second will carry it to R , OR being the diagonal of the parallelogram of OQ and OP , and the resultant velocity. If the two component velocities are uniform, the resultant will be uniform and the line OR will be a straight line; but if either velocity is a varying one, the line will be a curve. Fig. 101 shows the resultant velocities, also the path traversed by a body acted on by two forces, one of which would carry it at a uniform velocity over the intervals 1, 2, 3, B and the other of which would carry it by an accelerated motion over the intervals a , b , c , D in the same times. At

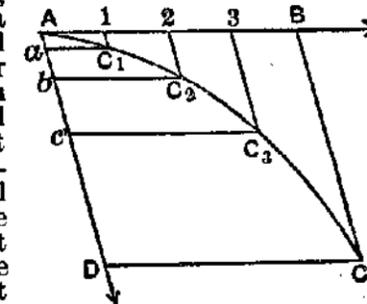

FIG. 101.

Falling Bodies: Velocity Acquired by a Body Falling a Given Height.

Height.	Velocity.	Height.	Velocity.	Height.	Velocity.	Height.	Velocity.	Height.	Velocity.	Height.	Velocity.
feet.	feet p.sec.	feet.	feet p.sec.	feet.	feet p.sec.	feet.	feet p.sec.	feet.	feet p.sec.	feet.	feet p.sec.
0.005	.57	0.39	5.01	1.20	8.79	5.	17.9	23.	38.5	72	68.1
0.010	.80	0.40	5.07	1.22	8.87	.2	18.3	.5	38.9	73	68.5
0.015	.98	0.41	5.14	1.24	8.94	.4	18.7	.5	39.3	74	69.0
0.020	1.13	0.42	5.20	1.26	9.01	.6	19.0	.5	39.7	75	69.5
0.025	1.27	0.43	5.26	1.28	9.08	.8	19.3	.5	40.1	76	69.9
0.030	1.39	0.44	5.32	1.30	9.15	.6	19.7	.5	40.9	77	70.4
0.035	1.50	0.45	5.38	1.32	9.21	.2	20.0	.5	41.7	78	70.9
0.040	1.60	0.46	5.44	1.34	9.29	.4	20.3	.5	42.5	79	71.3
0.045	1.70	0.47	5.50	1.36	9.36	.5	20.6	.5	43.2	80	71.8
0.050	1.79	0.48	5.56	1.38	9.43	.8	20.9	.5	43.9	81	72.2
0.055	1.88	0.49	5.61	1.40	9.49	.7	21.2	.5	44.7	82	72.6
0.060	1.97	0.50	5.67	1.42	9.57	.2	21.5	.5	45.4	83	73.1
0.065	2.04	0.51	5.73	1.44	9.62	.4	21.8	.5	46.1	84	73.5
0.070	2.12	0.52	5.78	1.46	9.70	.6	22.1	.5	46.8	85	74.0
0.075	2.20	0.53	5.84	1.48	9.77	.8	22.4	.5	47.4	86	74.4
0.080	2.27	0.54	5.90	1.50	9.82	.8	22.7	.5	48.1	87	74.8
0.085	2.34	0.55	5.95	1.52	9.90	.2	23.0	.5	48.8	88	75.3
0.090	2.41	0.56	6.00	1.54	9.96	.4	23.3	.5	49.4	89	75.7
0.095	2.47	0.57	6.06	1.56	10.0	.6	23.5	.5	50.1	90	76.1
0.100	2.54	0.58	6.11	1.58	10.1	.8	23.8	.5	50.7	91	76.5
0.105	2.60	0.59	6.16	1.60	10.2	.9	24.1	.5	51.4	92	76.9
0.110	2.66	0.60	6.21	1.65	10.3	.2	24.3	.5	52.0	93	77.4
0.115	2.72	0.62	6.32	1.70	10.5	.4	24.6	.5	52.6	94	77.8
0.120	2.78	0.64	6.42	1.75	10.6	.6	24.8	.5	53.2	95	78.2
0.125	2.84	0.66	6.52	1.80	10.8	.8	25.1	.5	53.8	96	78.6
0.130	2.89	0.68	6.61	1.90	11.1	10.	25.4	.5	54.4	97	79.0
0.14	3.00	0.70	6.71	2.	11.4	.5	26.0	.5	55.0	98	79.4
0.15	3.11	0.72	6.81	2.1	11.7	11.	26.6	.5	55.6	99	79.8
0.16	3.21	0.74	6.90	2.2	11.9	.5	27.2	.5	56.1	100	80.2
0.17	3.31	0.76	6.99	2.3	12.2	12.	27.8	.5	56.7	125	89.7
0.18	3.40	0.78	7.09	2.4	12.4	.5	28.4	.5	57.3	150	98.3
0.19	3.50	0.80	7.18	2.5	12.6	13.	28.9	.5	57.8	175	106
0.20	3.59	0.82	7.26	2.6	12.0	.5	29.5	.5	58.4	200	114
0.21	3.68	0.84	7.35	2.7	13.2	14.	30.0	.5	59.0	225	120
0.22	3.76	0.86	7.44	2.8	13.4	.5	30.5	.5	59.5	250	126
0.23	3.85	0.88	7.53	2.9	13.7	15.	31.1	.5	60.0	275	133
0.24	3.93	0.90	7.61	3.	13.9	.5	31.6	.5	60.6	300	139
0.25	4.01	0.92	7.69	3.1	14.1	16.	32.1	.5	61.1	350	150
0.26	4.09	0.94	7.78	3.2	14.3	.5	32.6	.5	61.6	400	160
0.27	4.17	0.96	7.86	3.3	14.5	17.	33.1	.5	62.1	450	170
0.28	4.25	0.98	7.94	3.4	14.8	.5	33.6	.5	62.7	500	179
0.29	4.32	1.00	8.02	3.5	15.0	18.	34.0	.5	63.2	550	188
0.30	4.39	1.02	8.10	3.6	15.2	.5	34.5	.5	63.7	600	197
0.31	4.47	1.04	8.18	3.7	15.4	19.	35.0	.5	64.2	700	212
0.32	4.54	1.06	8.26	3.8	15.6	.5	35.4	.5	64.7	800	227
0.33	4.61	1.08	8.34	3.9	15.8	20.	35.9	.5	65.2	900	241
0.34	4.68	1.10	8.41	4.	16.0	.5	36.3	.5	65.7	1000	254
0.35	4.74	1.12	8.49	.2	16.4	21.	36.8	.5	66.1	2000	359
0.36	4.81	1.14	8.57	.4	16.8	.5	37.2	.5	66.6	3000	439
0.37	4.88	1.16	8.64	.6	17.2	22.	37.6	.5	67.1	4000	507
0.38	4.94	1.18	8.72	.8	17.6	.5	38.1	.5	67.6	5000	567

WARNING: This is a 1910 edition. Some of the material may no longer be accurate

the end of the respective intervals the body will be found at C_1, C_2, C_3, C_4 , and the mean velocity during each interval is represented by the distances between these points. Such a curved path is traversed by a shot, the impelling force from the gun giving it a uniform velocity in the direction the gun is aimed, and gravity giving it an accelerated velocity downward. *The path of a projectile is a parabola.* The distance it will travel is greatest when its initial direction is at an angle 45° above the horizontal.

Mass — Force of Acceleration. — The mass of a body, $m = w/g$, is a constant quantity. If g = the acceleration due to gravity, and w = weight, then the mass $m = \frac{w}{g}$; $w = mg$. If the weight w is taken to be the

resultant of the force of gravity on the particles of a body, such as may be measured by a spring balance, or by the extension or deflection of a rod of metal loaded with the given weight, then the weight varies according to the variation in the force of gravity at different places, and the value of g is that at the place where the body is weighed; but if w is the weight as weighed on a platform scale, then $g = 32.2$, the English value. In either case $m = w/g$ is a constant.

Force has been defined as that which causes, or tends to cause, or to destroy, motion. It may also be defined as the cause of acceleration; and the unit of force, the pound, as the force required to produce an acceleration of 32.2 ft. per second per second in a pound of free mass.

Force equals the product of the mass by the acceleration, or $f = ma$. Also, if v = the velocity acquired in the time t , $ft = mv$; $f = mv \div t$; the acceleration being uniform.

The force required to produce an acceleration of g (that is, 32.16 ft. per sec. in one second) is $f = mg = \frac{w}{g} g = w$, or the weight of the body. Also,

$f = ma = m \frac{v_2 - v_1}{t}$, in which v_2 is the velocity at the end, and v_1 the velocity at the beginning of the time t , and $f = mg = \frac{w (v_2 - v_1)}{g t} = \frac{w}{g} a$;

$\frac{f}{w} = \frac{a}{g}$; or, the force required to give any acceleration to a body is to the weight of the body as that acceleration is to the acceleration produced by gravity. (The weight w is the weight where g is measured.)

EXAMPLE. — Tension in a cord lifting a weight. A weight of 100 lbs. is lifted vertically by a cord a distance of 80 feet in 4 seconds, the velocity uniformly increasing from 0 to the end of the time. What tension must be maintained in the cord? Mean velocity = $v_m = 20$ ft. per sec.; final

velocity = $v_2 = 2 v_m = 40$; acceleration $a = \frac{v_2}{t} = \frac{40}{4} = 10$. Force $f =$

$ma = \frac{wa}{g} = \frac{100}{32.16} \times 10 = 31.1$ lbs. This is the force required to produce the acceleration only; to it must be added the force required to lift the weight without acceleration, or 100 lbs., making a total of 131.1 lbs.

The Resistance to Acceleration is the same as the force required to produce the acceleration = $\frac{w (v_2 - v_1)}{g t}$.

Formulae for Accelerated Motion. — For cases of uniformly accelerated motion other than those of falling bodies, we have the formulae

already given, $f = \frac{w}{g} a$, = $\frac{w v_2 - v_1}{g t}$. If the body starts from rest, $v_1 = 0$.

$v_1 = v$, and $f = \frac{w v}{g t}$; $fgt = wv$. We also have $s = \frac{vt}{2}$. Transforming and substituting for g its value 32.16, we obtain

$$f = \frac{wv^2}{64.32 s} = \frac{wv}{32.16 t} = \frac{ws}{16.08 t^2}; \quad w = \frac{32.16 ft}{v} = \frac{64.32 fs}{v^2}$$

$$s = \frac{wv^2}{64.32 f} = \frac{16.08 ft^2}{w} = \frac{vt}{2}; \quad v = 8.02 \sqrt{\frac{fs}{w}} = \frac{32.16 ft}{w}$$

$$t = \frac{wv}{32.16 f} = \frac{1}{4.01} \sqrt{\frac{ws}{f}}$$

For any change in velocity, $f = w \left(\frac{v_2^2 - v_1^2}{64.32 s} \right)$.

(See also Work of Acceleration, under Work.)

Motion on Inclined Planes. — The velocity acquired by a body descending an inclined plane by the force of gravity (friction neglected) is equal to that acquired by a body falling freely from the height of the plane.

The times of descent down different inclined planes of the same height vary as the length of the planes.

The rules for uniformly accelerated motion apply to inclined planes. If a is the angle of the plane with the horizontal, $\sin a =$ the ratio of the height to the length $= \frac{h}{l}$, and the constant accelerating force is $g \sin a$.

The final velocity at the end of t seconds is $v = gt \sin a$. The distance passed over in t seconds is $l = \frac{1}{2} gt^2 \sin a$. The time of descent is

$$t = \sqrt{\frac{2l}{g \sin a}} = \frac{l}{4.01 \sqrt{h}}$$

FUNDAMENTAL EQUATIONS IN DYNAMICS.

(1) $FS = \frac{1}{2} MV^2 = WH$. Force into space equals energy, or work.

(2) $FT = MV$. Force into time equals momentum.

(3) $F = MA = MV/T$. Force equals mass into acceleration.

(4) $V = \sqrt{2gH}$. Falling bodies.

The sign $=$ here means "numerically equivalent to," the proper units of each elementary quantity being chosen.

M = mass = W/g ; W = weight in pounds, $g = 32.2$; F = force in pounds, exerted on a mass free to move; S = space, or distance in feet through which F is exerted; T = time in seconds; H = height in feet through which a body falls, or in eq. (1) is lifted; A = acceleration in feet per second per second, $= V/T$; V = velocity in feet per second acquired at the end of the time T , the space S , or the height of fall H .

By these four equations and their algebraic transformations practically all problems in dynamics (except those relating to impact) may be solved.

MOMENTUM, VIS-VIVA.

Momentum, in many books erroneously defined as the quantity of motion in a body, is the product of the mass by the velocity at any instant.

$$= mv = \frac{w}{g} v.$$

Since the moving force = product of mass by acceleration, $f = ma$; and if the velocity acquired in t seconds = v , or $a = \frac{v}{t}$, $f = \frac{mv}{t}$; $ft = mv$; that is, the product of a constant force into the time in which it acts equals numerically the momentum.

Since $ft = mv$, if $t = 1$ second $mv = f$, whence momentum might be defined as numerically equivalent to the number of pounds of force that will stop a moving body in 1 second, or the number of pounds of force which acting during 1 second will give it the given velocity.

Vis-viva, or living force, is a term used by early writers on Mechanics to denote the energy stored in a moving body. Some defined it as the product of the mass into the square of the velocity, $mv^2 = \frac{w}{g} v^2$; others as one-half of this quantity, or $\frac{1}{2} mv^2$, or the same as what is now known as energy. The term is now obsolete, its place being taken by the word energy.

WORK, ENERGY, POWER.

Work is the overcoming of resistance through a certain distance. It is measured by the product of the resistance into the space through which it is overcome. It is also measured by the product of the moving force into the distance through which the force acts in overcoming the resistance. Thus in lifting a body from the earth against the attraction of gravity,

the resistance is the weight of the body, and the product of this weight into the height the body is lifted is the work done.

The **Unit of Work**, in British measures, is the *foot-pound*, or the amount of work done in overcoming a pressure or weight equal to one pound through one foot of space.

The work performed by a piston in driving a fluid before it, or by a fluid in driving a piston before it, may be expressed in either of the following ways:

$$\begin{aligned} &= \text{Resistance} \times \text{distance traversed} \\ &= \text{intensity of pressure} \times \text{area} \times \text{distance traversed;} \\ &= \text{intensity of pressure} \times \text{volume traversed.} \end{aligned}$$

By intensity of pressure is meant pressure per unit of area, as lbs. persq. in. The work performed in lifting a body is the product of the weight of the body into the height through which its center of gravity is lifted.

If a machine lifts the centers of gravity of several bodies at once to heights either the same or different, the whole quantity of work performed in so doing is the sum of the several products of the weights and heights; but that quantity can also be computed by multiplying the sum of all the weights into the height through which their common center of gravity is lifted. (Rankine.)

Power is the rate at which work is done, and is expressed by the quotient of the work divided by the time in which it is done, or by units of work per second, per minute, etc., as foot-pounds per second. The most common unit of power is the *horse-power*, established by James Watt as the power of a strong London draught-horse to do work during a short interval, and used by him to measure the power of his steam-engines. This unit is 33,000 foot-pounds per minute = 550 foot-pounds per second = 1,980,000 foot-pounds per hour.

Expressions for Force, Work, Power, etc.

The fundamental conceptions in Dynamics are:

Mass, Force, Time, Space, represented by the letters M, F, T, S .

Mass = weight $\div g$. If the weight of a body is determined by a spring balance standardized at London it will vary with the latitude, and the value of g to be taken in order to find the mass is that of the latitude where the weighing is done. If the weight is determined by a balance or by a platform scale, as is customary in engineering and in commerce, the London value of g , = 32.2, is to be taken.

Velocity = space divided by time, $V = S \div T$, if V be uniform, $V = 2S \div T$ if V be uniformly accelerated.

Work = force multiplied by space = $FS = \frac{1}{2} MV^2 = FVT$ (V uniform).

Power = rate of work = work divided by time = $FS \div T = P =$ product of force into uniform velocity = FV .

Power exerted for a certain time produces work; $PT = FS = FVT$.

Effort is a force which acts on a body in the direction of its motion.

Resistance is that which is opposed to an acting force. It is equal and opposite to the force.

Horse-power Hours, an expression for work measured as the product of a power into the time during which it acts, = PT . Sometimes it is the summation of a variable power for a given time, or the average power multiplied by the time.

Energy, or stored work, is the capacity for performing work. It is measured by the same unit as work, that is, in foot-pounds. It may be either *potential*, as in the case of a body of water stored in a reservoir, capable of doing work by means of a water-wheel, or *actual*, sometimes called *kinetic*, which is the energy of a moving body. Potential energy is measured by the product of the weight of the stored body into the distance through which it is capable of acting, or by the product of the pressure it exerts into the distance through which that pressure is capable of acting. Potential energy may also exist as stored heat, or as stored chemical energy, as in fuel, gunpowder, etc., or as electrical energy, the measure of these energies being the amount of work that they are capable of performing. Actual energy of a moving body is the work which it is capable of performing against a retarding resistance before being brought to rest, and is equal to the work which must be done upon it to bring it from a state of rest to its actual velocity.

WARNING: This is a 1910 edition. Some of the material may no longer be accurate

The measure of actual energy is the product of the weight of the body into the height from which it must fall to acquire its actual velocity. If v = the velocity in feet per second, according to the principle of falling bodies, h , the height due to the velocity, $= \frac{v^2}{2g}$; and if w = the weight, the energy $= \frac{1}{2} mv^2 = wv^2 + 2g = wh$. Since energy is the capacity for performing work, the units of work and energy are equivalent, or $F'S = \frac{1}{2} mv^2 = wh$. Energy exerted = work done.

The actual energy of a rotating body whose angular velocity is A and moment of inertia $\Sigma wr^2 = I$ is $\frac{A^2 I}{2g}$, that is, the product of the moment of inertia into the height due to the velocity, A , of a point whose distance from the axis of rotation is unity; or it is equal to $\frac{wv^2}{2g}$, in which w is the weight of the body and v is the velocity of the center of gyration.

Work of Acceleration. — The work done in giving acceleration to a body is equal to the product of the force producing the acceleration, or of the resistance to acceleration, into the distance moved in a given time. This force, as already stated, equals product of the mass into the acceleration, or $f = ma = \frac{w}{g} \frac{v_2 - v_1}{t}$. If the distance traversed in the time $t = s$,

$$\text{then work} = fs = \frac{w}{g} \frac{v_2 - v_1}{t} s.$$

EXAMPLE. — What work is required to move a body weighing 100 lbs. horizontally a distance of 80 ft. in 4 seconds, the velocity uniformly increasing, friction neglected?

Mean velocity $v_m = 20$ ft. per second; final velocity $= v_2 = 2v_m = 40$; initial velocity $v_1 = 0$; acceleration, $a = \frac{v_2 - v_1}{t} = \frac{40}{4} = 10$; force $= \frac{w}{g} a = \frac{100}{32.16} \times 10 = 31.1$ lbs.; distance 80 ft.; work $= fs = 31.1 \times 80 = 2488$ foot-pounds.

The energy stored in the body moving at the final velocity, of 40 ft. per second is

$$\frac{1}{2} mv^2 = \frac{1}{2} \frac{w}{g} v^2 = \frac{100 \times 40^2}{2 \times 32.16} = 2488 \text{ foot-pounds,}$$

which equals the work of acceleration,

$$fs = \frac{w}{g} \frac{v_2}{t} s = \frac{w}{g} \frac{v_2}{t} \frac{v_2}{2} t = \frac{1}{2} \frac{w}{g} v_2^2.$$

If a body of the weight W falls from a height H , the work of acceleration is simply WH , or the same as the work required to raise the body to the same height.

Work of Accelerated Rotation. — Let A = angular velocity of a solid body rotating about an axis, that is, the velocity of a particle whose radius is unity. Then the velocity of a particle whose radius is r is $v = Ar$. If the angular velocity is accelerated from A_1 to A_2 , the increase of the velocity of the particle is $v_2 - v_1 = r(A_2 - A_1)$, and the work of accelerating it is

$$\frac{w}{g} \times \frac{v_2^2 - v_1^2}{2} = \frac{wr^2}{g} \frac{A_2^2 - A_1^2}{2}.$$

In which w is the weight of the particle. A is measured in radians. The work of acceleration of the whole body is

$$\Sigma \left\{ \frac{w}{g} \times \frac{v_2^2 - v_1^2}{2} \right\} = \frac{A_2^2 - A_1^2}{2g} \times \Sigma wr^2.$$

The term Σwr^2 is the moment of inertia of the body.

"Force of the Blow" of a Steam Hammer or Other Falling Weight. — The question is often asked: "With what force does a falling hammer strike?" The question cannot be answered directly, and it is based upon a misconception or ignorance of fundamental mechanical

laws. The energy, or capacity of doing work, of a body raised to a given height and let fall cannot be expressed in pounds, simply, but only in foot-pounds, which is the product of the weight into the height through which it falls, or the product of its weight + 64.32 into the square of the velocity, in feet per second, which it acquires after falling through the given height. If F = weight of the body, M its mass, g the acceleration due to gravity, S the height of fall, and v the velocity at the end of the fall, the energy in the body just before striking is $F'S = \frac{1}{2} Mv^2 = Wv^2 + 2g = Wv^2 + 64.32$, which is the general equation of energy of a moving body. Just as the energy of the body is a product of a force into a distance, so the work it does when it strikes is not the manifestation of a force, which can be expressed simply in pounds, but it is the overcoming of a resistance through a certain distance, which is expressed as the product of the average resistance into the distance through which it is exerted. If a hammer weighing 100 lbs. falls 10 ft., its energy is 1000 foot-pounds. Before being brought to rest it must do 1000 foot-pounds of work against one or more resistances. These are of various kinds, such as that due to motion imparted to the body struck, penetration against friction, or against resistance to shearing or other deformation, and crushing and heating of both the falling body and the body struck. The distance through which these resisting forces act is generally indeterminate, and therefore the average of the resisting forces, which themselves generally vary with the distance, is also indeterminate.

Impact of Bodies. — If two inelastic bodies collide, they will move on together as one mass, with a common velocity. The momentum of the combined mass is equal to the sum of the momenta of the two bodies before impact. If m_1 and m_2 are the masses of the two bodies and v_1 and v_2 their respective velocities before impact, and v their common velocity after impact, $(m_1 + m_2)v = m_1v_1 + m_2v_2$.

$$v = \frac{m_1v_1 + m_2v_2}{m_1 + m_2}.$$

If the bodies move in opposite directions, $v = \frac{m_1v_1 - m_2v_2}{m_1 + m_2}$, or the velocity of two inelastic bodies after impact is equal to the algebraic sum of their momenta before impact, divided by the sum of their masses.

If two inelastic bodies of equal momenta impinge directly upon one another from opposite directions they will be brought to rest.

Impact of Inelastic Bodies Causes a Loss of Energy, and this loss is equal to the sum of the energies due to the velocities lost and gained by the bodies, respectively.

$\frac{1}{2} m_1v_1^2 + \frac{1}{2} m_2v_2^2 - \frac{1}{2} (m_1 + m_2)v^2 = \frac{1}{2} m_1(v_1 - v)^2 + \frac{1}{2} m_2(v_2 - v)^2$; in which $v_1 - v$ is the velocity lost by m_1 and $v - v_2$ the velocity gained by m_2 .

EXAMPLE. — Let $m_1 = 10$, $m_2 = 8$, $v_1 = 12$, $v_2 = 15$.

If the bodies collide they will come to rest, for $v = \frac{10 \times 12 - 8 \times 15}{10 + 8} = 0$.

The energy loss is

$$\frac{1}{2} 10 \times 144 + \frac{1}{2} 8 \times 225 - \frac{1}{2} 18 \times 0 = \frac{1}{2} 10 (12 - 0)^2 + \frac{1}{2} 8 (15 - 0)^2 = 1620 \text{ ft.-lbs.}$$

What becomes of the energy lost? Ans. It is used doing internal work on the bodies themselves, changing their shape and heating them.

For *imperfectly elastic bodies*, let e = the elasticity, that is, the ratio which the force of restitution, or the internal force tending to restore the shape of a body after it has been compressed, bears to the force of compression; and let m_1 and m_2 be the masses, v_1 and v_2 their velocities before impact, and v_1' , v_2' their velocities after impact; then

$$v_1' = \frac{m_1v_1 + m_2v_2}{m_1 + m_2} - \frac{m_2e(v_1 - v_2)}{m_1 + m_2};$$

$$v_2' = \frac{m_1v_1 + m_2v_2}{m_1 + m_2} + \frac{m_1e(v_1 - v_2)}{m_1 + m_2}.$$

If the bodies are perfectly elastic, their relative velocities before and after impact are the same. That is, $v_1' - v_2' = v_2 - v_1$.

In the impact of bodies, the sum of their momenta after impact is the same as the sum of their momenta before impact.

$$m_1v_1' + m_2v_2' = m_1v_1 + m_2v_2.$$

For demonstration of these and other laws of impact, see Smith's Mechanics; also, Weisbach's Mechanics.

Energy of Recoil of Guns. (*Eng'g*, Jan. 25, 1884, p. 72.) —

- Let W = the weight of the gun and carriage;
- V = the maximum velocity of recoil;
- w = the weight of the projectile;
- v = the muzzle velocity of the projectile.

Then, since the momentum of the gun and carriage is equal to the momentum of the projectile (because both are acted on by equal force, the pressure of the gases in the gun, for equal time), we have $WV = wv$, or $V = wv \div W$.

Taking the case of a 10-inch gun firing a 400-lb. projectile with a muzzle velocity of 2000 feet per second, the weight of the gun and carriage being 22 tons = 50,000 lbs., we find the velocity of recoil =

$$V = \frac{2000 \times 400}{50,000} = 16 \text{ feet per second.}$$

Now the energy of a body in motion is $WV^2 \div 2g$.

Therefore the energy of recoil = $\frac{50,000 \times 16^2}{2 \times 32.2} = 198,800$ foot-pounds.

The energy of the projectile is $\frac{400 \times 2000^2}{2 \times 32.2} = 24,844,000$ foot-pounds.

Conservation of Energy. — No form of energy can ever be produced except by the expenditure of some other form, nor annihilated except by being reproduced in another form. Consequently the sum total of energy in the universe, like the sum total of matter, must always remain the same. (S. Newcomb.) Energy can never be destroyed or lost; it can be transformed, can be transferred from one body to another, but no matter what transformations are undergone, when the total effects of the exertion of a given amount of energy are summed up the result will be exactly equal to the amount originally expended from the source. This law is called the Conservation of Energy. (Cotterill and Slade.)

A heavy body sustained at an elevated position has potential energy. When it falls, just before it reaches the earth's surface it has actual or kinetic energy, due to its velocity. When it strikes, it may penetrate the earth a certain distance or may be crushed. In either case friction results by which the energy is converted into heat, which is gradually radiated into the earth or into the atmosphere, or both. Mechanical energy and heat are mutually convertible. Electric energy is also convertible into heat or mechanical energy, and either kind of energy may be converted into the other.

Sources of Energy. — The principal sources of energy on the earth's surface are the muscular energy of men and animals, the energy of the wind, of flowing water, and of fuel. These sources derive their energy from the rays of the sun. Under the influence of the sun's rays vegetation grows and wood is formed. The wood may be used as fuel under a steam-boiler, its carbon being burned to carbon dioxide. Three-tenths of its heat energy escapes in the chimney and by radiation, and seven-tenths appears as potential energy in the steam. In the steam-engine, of this seven-tenths six parts are dissipated in heating the condensing water and are wasted; the remaining one-tenth of the original heat energy of the wood is converted into mechanical work in the steam-engine, which may be used to drive machinery. This work is finally, by friction of various kinds, or possibly after transformation into electric currents, transformed into heat which is radiated into the atmosphere, increasing its temperature. Thus

all the potential heat energy of the wood is, after various transformations, converted into heat, which, mingling with the store of heat in the atmosphere, apparently is lost. But the carbon dioxide generated by the combustion of the wood is, again, under the influence of the sun's rays, absorbed by vegetation, and more wood may thus be formed having potential energy equal to the original.

Perpetual Motion. — The law of the conservation of energy, than which no law of mechanics is more firmly established, is an absolute barrier to all schemes for obtaining by mechanical means what is called "perpetual motion," or a machine which will do an amount of work greater than the equivalent of the energy, whether of heat, of chemical combination, of electricity, or mechanical energy, that is put into it. Such a result would be the creation of an additional store of energy in the universe, which is not possible by any human agency.

The Efficiency of a Machine is a fraction expressing the ratio of the useful work to the whole work performed, which is equal to the energy expended. The limit to the efficiency of a machine is unity, denoting the efficiency of a perfect machine in which no work is lost. The difference between the energy expended and the useful work done, or the loss, is usually expended either in overcoming friction or in doing work on bodies surrounding the machine from which no useful work is received. Thus in an engine propelling a vessel part of the energy exerted in the cylinder does the useful work of giving motion to the vessel, and the remainder is spent in overcoming the friction of the machinery and in making currents and eddies in the surrounding water.

A common and useful definition of efficiency is "output divided by input."

ANIMAL POWER.

Work of a Man against Known Resistances. (Rankine.)

Kind of Exertion.	R. lbs.	V. ft. per sec.	T" 3600 (hours per day).	RV, ft.-lbs. per sec.	RVT, ft.-lbs. per day.
1. Raising his own weight up stair or ladder.....	143	0.5	8	71.5	2,059,200
2. Hauling up weights with rope, and lowering the rope unloaded.....	40	0.75	6	30	648,000
3. Lifting weights by hand.....	44	0.55	6	24.2	522,720
4. Carrying weights up-stairs and returning unloaded....	143	0.13	6	18.5	399,600
5. Shoveling up earth to a height of 5 ft. 3 in.....	6	1.3	10	7.8	280,800
6. Wheeling earth in barrow up slope of 1 in 12, 1/2 horiz. veloc. 0.9 ft. per sec., and returning unloaded.....	132	0.075	10	9.9	356,400
7. Pushing or pulling horizontally (capstan or oar).....	26.5	2.0	8	53	1,526,400
8. Turning a crank or winch....	12.5	5.0	?	62.5
	18.0	2.5	8	45	1,296,000
	20.0	14.4	2 min.	288
9. Working pump.....	13.2	2.5	10	33	1,188,000
10. Hammering.....	15	?	8?	?	480,000

EXPLANATION. — R, resistance; V, effective velocity = distance through which R is overcome ÷ total time occupied, including the time of moving unloaded, if any; T", time of working, in seconds per day; T" ÷ 3600, same time, in hours per day; RV, effective power, in foot-pounds per second; RVT, daily work.

Performance of a Man in Transporting Loads Horizontally.
(Rankine.)

Kind of Exertion.	L, lbs.	V, ft.-sec.	$\frac{T''}{3600}$ (hours per day).	LV, lbs. conveyed 1 foot.	LVT, lbs. conveyed 1 foot.
11. Walking unloaded, transporting his own weight.	140	5	10	700	25,200,000
12. Wheeling load <i>L</i> in 2-whld. barrow, return unloaded.	224	12/3	10	373	13,428,000
13. Ditto in 1-wh. barrow, ditto.	132	12/3	10	220	7,920,000
14. Traveling with burden.	90	21/2	7	225	5,670,000
15. Carrying burden, returning unloaded.	140	12/3	6	233	5,032,800
16. Carrying burden, for 30 seconds only.	252	0	0
	126	11.7	1474.2
	0	23.1	0

EXPLANATION. — *L*, load; *V*, effective velocity, computed as before; *T''*, time of working, in seconds per day; $\frac{T''}{3600}$, same time in hours per day; *LV*, transport per second, in lbs. conveyed one foot; *LVT*, daily transport.

In the first line only of each of the two tables above is the weight of the man taken into account in computing the work done.

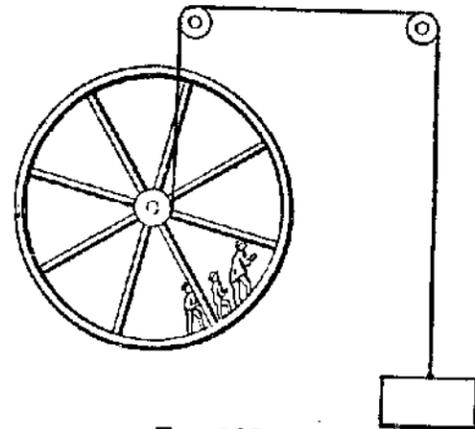

FIG. 102.

Clark says that the average net daily work of an ordinary laborer at a pump, a winch, or a crane may be taken at 3300 foot-pounds per minute, or one-tenth of a horse-power, for 8 hours a day; but for shorter periods from four to five times this rate may be exerted.

Mr. Glynn says that a man may exert a force of 25 lbs. at the handle of a crane for short periods; but that for continuous work a force of 15 lbs. is all that should be assumed, moving through 220 feet per minute.

Man-wheel.—Fig. 102 is a sketch of a very efficient man-power hoisting-machine which the author saw in Berne, Switzerland, in 1889. The face of the wheel was wide

Work of a Horse against a Known Resistance. (Rankine.)

Kind of Exertion.	<i>R</i> .	<i>V</i> .	$\frac{T''}{3600}$	<i>RV</i> .	<i>RVT</i> .
1. Canter and trotting, drawing a light railway carriage (thoroughbred).	{ min. 221/2 mean 301/2 max. 50 }	142/3	4	4471/2	6,441,000
2. Horse drawing cart or boat, walking (draught-horse).	120	3.6	8	432	12,441,600
3. Horse drawing a gin or mill, walking.	100	3.0	8	300	8,640,000
4. Ditto, trotting.	66	6.5	4 1/2	429	6,950,000

WARNING: This is a 1910 edition. Some of the material may no longer be accurate

EXPLANATION. — *R*, resistance, in lbs.; *V*, velocity, in feet per second; $\frac{T''}{3600}$, hours work per day; *RV*, work per second; *RVT*, work per day.

The average power of a draught-horse, as given in line 2 of the above table, being 432 foot-pounds per second, is $\frac{432}{550} = 0.785$ of the conventional value assigned by Watt to the ordinary unit of the rate of work of prime movers. It is the mean of several results of experiments, and may be considered the average of ordinary performance under favorable circumstances.

Performance of a Horse in Transporting Loads Horizontally.
(Rankine.)

Kind of Exertion.	L.	V.	T.	LV.	LVT.
5. Walking with cart, always loaded.	1500	3.6	10	5400	194,400,000
6. Trotting, ditto.	750	7.2	4 1/2	5400	87,480,000
7. Walking with cart, going loaded, returning empty; <i>V</i> , mean velocity.	1500	2.0	10	3000	108,000,000
8. Carrying burden, walking.	270	3.6	10	972	34,992,000
9. Ditto, trotting.	180	7.2	7	1296	32,659,200

EXPLANATION. — *L*, load in lbs.; *V*, velocity in feet per second; *T*, working hours per day; *LV*, transport per second; *LVT*, transport per day.

This table has reference to conveyance on common roads only, and those evidently in bad order as respects the resistance to traction upon them.

Horse-Gin.—In this machine a horse works less advantageously than in drawing a carriage along a straight track. In order that the best possible results may be realized with a horse-gin, the diameter of the circular track in which the horse walks should not be less than about forty feet.

Oxen, Mules, Asses.—Authorities differ considerably as to the power of these animals. The following may be taken as an approximative comparison between them and draught-horses (Rankine):

Ox.—Load, the same as that of average draught-horse; best velocity and work, two-thirds of horse.

Mule.—Load, one-half of that of average draught-horse; best velocity, the same as horse; work, one-half.

Ass.—Load, one-quarter that of average draught-horse; best velocity, the same; work, one-quarter.

Reduction of Draught of Horses by Increase of Grade of Roads. (*Engineering Record*, Prize Essays on Roads, 1892.)—Experiments on English roads by Gayffier & Parnell:

Calling load that can be drawn on a level 100:

On a rise of..... 1 in 100. 1 in 50. 1 in 40. 1 in 30. 1 in 26. 1 in 20. 1 in 10.
A horse can draw only 90 81 72 64 54 40 25

The Resistance of Carriages on Roads is (according to Gen. Morin) given approximately by the following empirical formula:

$$R = \frac{W}{r} [a + b(u - 3.28)].$$

In this formula *R* = total resistance; *r* = radius of wheel in inches; *W* = gross load; *u* = velocity in feet per second; while *a* and *b* are constants, whose values are: For good broken-stone road, *a* = 0.4 to 0.55, *b* = 0.024 to 0.026; for paved roads, *a* = 0.27, *b* = 0.0684.

Rankine states that on gravel the resistance is about double, and on sand five times, the resistance on good broken-stone roads.

ELEMENTS OF MACHINES.

The object of a machine is usually to transform the work or mechanical energy exerted at the point where the machine receives its motion into work at the point where the final resistance is overcome. The specific result may be to change the character or direction of motion, as from circular to rectilinear, or *vice versa*, to change the velocity, or to overcome a great resistance by the application of a moderate force. In all cases the total energy exerted equals the total work done, the latter including the overcoming of all the frictional resistances of the machine as well as the useful work performed. No increase of power can be obtained from any machine, since this is impossible according to the law of conservation of energy. In a frictionless machine the product of the force exerted at the driving-point into the velocity of the driving-point, or the distance it moves in a given interval of time, equals the product of the resistance into the distance through which the resistance is overcome in the same time.

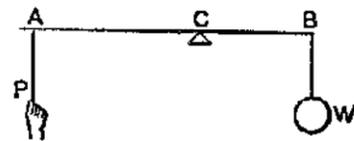

FIG. 103.

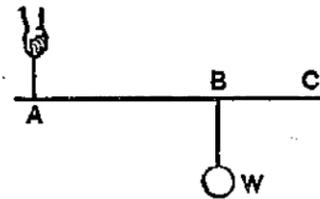

FIG. 104.

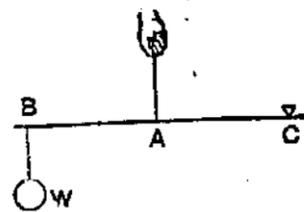

FIG. 105.

The most simple machines, or elementary machines, are reducible to three classes, viz., the Lever, the Cord, and the Inclined Plane.

The first class includes every machine consisting of a solid body capable of revolving on an axis, as the Wheel and Axle.

The second class includes every machine in which force is transmitted by means of flexible threads, ropes, etc., as the Pulley.

The third class includes every machine in which a hard surface inclined to the direction of motion is introduced, as the Wedge and the Screw.

A Lever is an inflexible rod capable of motion about a fixed point, called a fulcrum. The rod may be straight or bent at any angle, or curved.

It is generally regarded, at first, as without weight, but its weight may be considered as another force applied in a vertical direction at its center of gravity.

The arms of a lever are the portions of it intercepted between the force, *P*, and fulcrum, *C*, and between the weight or load, *W*, and fulcrum.

Levers are divided into three kinds or orders, according to the relative positions of the applied force, load, and fulcrum.

In a lever of the first order, the fulcrum lies between the points at which the force and load act. (Fig. 103.)

In a lever of the second order, the load acts at a point between the fulcrum and the point of action of the force. (Fig. 104.)

In a lever of the third order, the point of action of the force is between that of the load and the fulcrum. (Fig. 105.)

In all cases of levers the relation between the force exerted or the pull, *P*, and the load lifted, or resistance overcome, *W*, is expressed by the equation $P \times AC = W \times BC$, in which *AC* is the lever-arm of *P*, and *BC* is the lever-arm of *W*, or moment of the force = the moment of the resistance. (See Moment.)

In cases in which the direction of the force (or of the resistance) is not at right angles to the arm of the lever on which it acts, the "lever-arm" is the length of a perpendicular from the fulcrum to the line of direction of the force (or of the resistance). $W : P :: AC : BC$, or, the ratio of the resistance to the applied force is the inverse ratio of their lever-arms. Also, if *V_w* is the velocity of *W*, and *V_p* is the velocity of *P*, $W : P :: V_p : V_w$, and $P \times V_p = W \times V_w$.

If *S_p* is the distance through which the applied force acts, and *S_w* is the distance the load is lifted or through which the resistance is overcome, $W : P :: S_p : S_w$; $W \times S_w = P \times S_p$, or the load into the dis-

tance it is lifted equals the force into the distance through which it is exerted.

These equations are general for all classes of machines as well as for levers, it being understood that friction, which in actual machines increases the resistance, is not at present considered.

The Bent Lever. — In the bent lever (see Fig. 96, p. 490), the lever-arm of the weight *m* is *cf* instead of *bf*. The lever is in equilibrium when $n \times af = m \times cf$, but it is to be observed that the action of a bent lever may be very different from that of a straight lever. In the latter, so long as the force and the resistance act in lines parallel to each other, the ratio of the lever-arms remains constant, although the lever itself changes its inclination with the horizontal. In the bent lever, however, this ratio changes: thus, in the cut, if the arm *bf* is depressed to a horizontal direction, the distance *cf* lengthens while the horizontal projection of *af* shortens, the latter becoming zero when the direction of *af* becomes vertical. As the arm *af* approaches the vertical, the weight *m* which may be lifted with a given force *s* is very great, but the distance through which it may be lifted is very small. In all cases the ratio of the weight *m* to the weight *n* is the inverse ratio of the horizontal projection of their respective lever-arms.

The Moving Strut (Fig. 106) is similar to the bent lever, except that one of the arms is missing, and that the force and the resistance to be overcome act at the same end of the single arm.

The resistance in the case shown in the cut is not the load *W*, but its resistance to being moved, *R*, which may be simply that due to its friction on the horizontal plane, or some other opposing force. When the angle between the strut and the horizontal plane changes, the ratio of the resistance to the applied force changes. When the angle becomes very small, a moderate force will overcome a very great resistance, which tends to become infinite as the angle approaches zero. If *a* = the angle, $P \times \cos a = R \times \sin a$. If *a* = 5 degrees, $\cos a = 0.99619$, $\sin a = 0.08716$, $R = 11.44 P$.

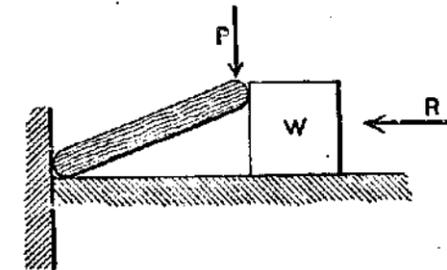

FIG. 106.

The stone-crusher (Fig. 107) shows a practical example of the use of two moving struts.

The Toggle-joint is an elbow or knee-joint consisting of two bars so connected that they may be brought into a straight line and made to produce great endwise pressure when a force is applied to bring them into this position. It is a case of two moving struts placed end to end,

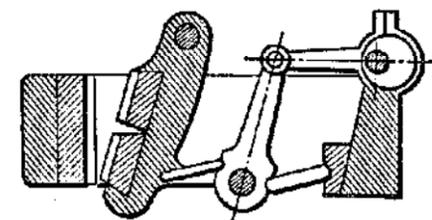

FIG. 107.

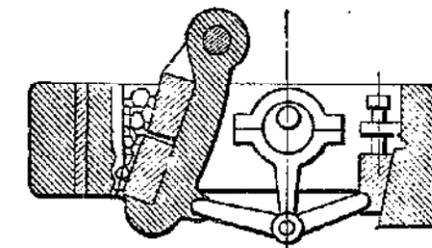

FIG. 108.

the moving force being applied at their point of junction, in a direction at right angles to the direction of the resistance, the other end of one of the struts resting against a fixed abutment, and that of the other against the body to be moved. If *a* = the angle each strut makes with the straight line joining the points about which their outer ends rotate, the ratio of the resistance to the applied force is $R : P :: \cos a : 2 \sin a$; $2 R \sin a = P \cos a$. The ratio varies when the angle varies, becoming infinite when the angle becomes zero.

The toggle-joint is used where great resistances are to be overcome through very small distances, as in stone-crushers (Fig. 108).

The Inclined Plane, as a mechanical element, is supposed perfectly hard and smooth, unless friction be considered. It assists in sustaining a heavy body by its reaction. This reaction, however, being normal to the plane, cannot entirely counteract the weight of the body, which acts vertically downward. Some other force must therefore be made to act upon the body, in order that it may be sustained.

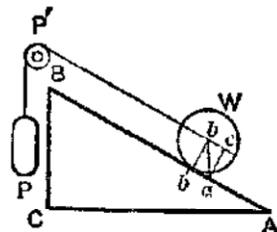

FIG. 109.

If the sustaining force act parallel to the plane (Fig. 109), the force is to the weight as the height of the plane is to its length, measured on the incline.

If the force act parallel to the base of the plane, the force is to the weight as the height is to the base.

If the force act at any other angle, let i = the angle of the plane with the horizon, and e = the angle of the direction of the applied force with the angle of the plane.

$P : W :: \sin i : \cos e$; $P \times \cos e = W \sin i$. Problems of the inclined plane may be solved by the parallelogram of forces thus: Let the weight W be kept at rest on the incline by the force P , acting in the line bP' , parallel to the plane. Draw the vertical line ba to represent the weight; also bb' perpendicular to the plane, and complete the parallelogram $b'c$. Then the vertical weight ba is the resultant of bb' , the measure of support given by the plane to the weight, and bc , the force of gravity tending to draw the weight down the plane. The force required to maintain the weight in equilibrium is represented by this force bc . Thus the force and the weight are in the ratio of bc to ba . Since the triangle of forces abc is similar to the triangle of the incline ABC , the latter may be substituted for the former in determining the relative magnitude of the forces, and

$$P : W :: bc : ab :: BC : AB.$$

The Wedge is a pair of inclined planes united by their bases. In the application of pressure to the head or butt end of the wedge, to cause it to penetrate a resisting body, the applied force is to the resistance as the thickness of the wedge is to its length. Let t be the thickness, l the length, W the resistance, and P the applied force or pressure on the head of the wedge. Then, friction neglected, $P : W :: t : l$; $P = \frac{Wt}{l}$; $W = \frac{Pl}{t}$.

The Screw is an inclined plane wrapped around a cylinder in such a way that the height of the plane is parallel to the axis of the cylinder. If the screw is formed upon the internal surface of a hollow cylinder, it is usually called a nut. When force is applied to raise a weight or overcome a resistance by means of a screw and nut, either the screw or the nut may be fixed, the other being movable. The force is generally applied at the end of a wrench or lever-arm, or at the circumference of a wheel. If r = radius of the wheel or lever-arm, and p = pitch of the screw, or distance between threads, that is, the height of the inclined plane for one revolution of the screw, P = the applied force, and W = the resistance overcome, then, neglecting resistance due to friction, $2\pi r \times P = Wp$; $W = 6.283 Pr \div p$. The ratio of P to W is thus independent of the diameter of the screw. In actual screws, much of the power transmitted is lost through friction.

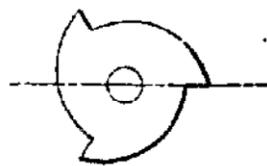

FIG. 110.

The **Cam** is a revolving inclined plane. It may be either an inclined plane wrapped around a cylinder in such a way that the height of the plane is radial to the cylinder, such as the ordinary lifting-cam, used in stamp-mills (Fig. 110),

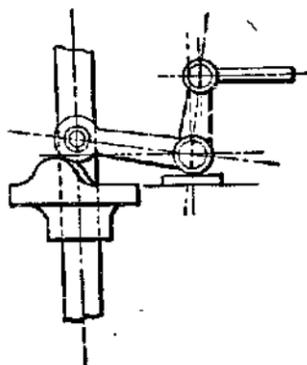

FIG. 111.

or it may be an inclined plane curved edgewise, and rotating in a plane parallel to its base (Fig. 111). The relation of the weight to the applied force is calculated in the same manner as in the case of the screw.

Pulleys or Blocks. — P = force applied, or pull; W = load lifted, or resistance. In the simple pulley A (Fig. 112) the point P on the pulling rope descends the same amount that the load is lifted, therefore $P = W$. In B and C the point P moves twice as far as the load is lifted, therefore $W = 2P$. In B and C there is one movable block, and two plies of the rope engage with it. In D there are three sheaves in the movable block, each with two plies engaged, or six in all. Six plies of the rope are therefore shortened by the same amount that the load is lifted, and the point P moves six times as far as the load, consequently

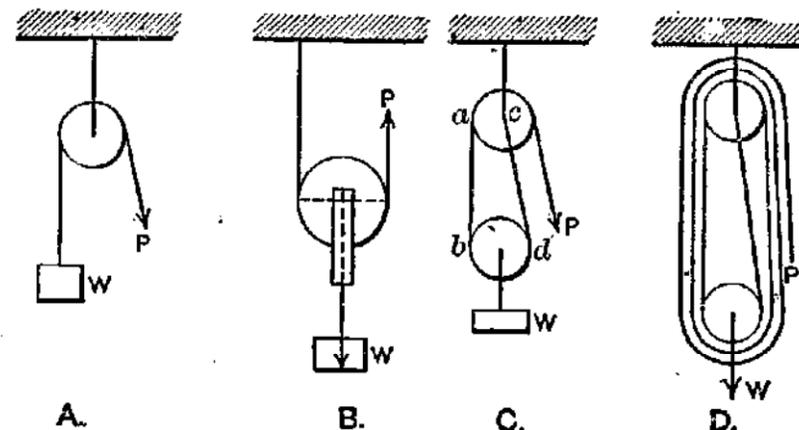

FIG. 112.

$W = 6P$. In general, the ratio of W to P is equal to the number of plies of the rope that are shortened, and also is equal to the number of plies that engage the lower block. If the lower block has 2 sheaves and the upper 3, the end of the rope is fastened to a hook in the top of the lower block, and then there are 6 plies shortened instead of 5, and $W = 6P$. If V = velocity of W , and v = velocity of P , then in all cases $VW = vP$, whatever the number of sheaves or their arrangement. If the hauling rope, at the pulling end, passes first around a sheave in the upper or stationary block, it makes no difference in what direction the rope is led from this block to the point at which the pull on the rope is applied; but if it first passes around the movable block, it is necessary that the pull be exerted in a direction parallel to the line of action of the resistance, or a line joining the centers of the two blocks, in order to obtain the maximum effect. If the rope pulls on the lower block at an angle, the block will be pulled out of the line drawn between the load and the upper block, and the effective pull will be less than the actual pull on the rope in the ratio of the cosine of the angle the pulling rope makes with the vertical, or line of action of the resistance, to unity.

Differential Pulley. (Fig. 113.) — Two pulleys, B and C , of different radii, rotate as one piece about a fixed axis, A . An endless chain, $BDECLKH$, passes over both pulleys. The rims of the pulleys are shaped so as to hold the chain and prevent it from slipping. One of the bights or loops in which the chain hangs, DE , passes under and supports the running block F . The other loop or bight, HKL , hangs freely, and is called the hauling part. It is evident that the velocity of the hauling part is equal to that of the pitch-circle of the pulley B .

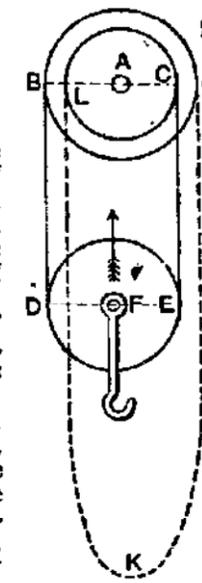

FIG. 113.

In order that the velocity-ratio may be exactly uniform, the radius of the sheave F should be an exact mean between the radii of B and C . Consider that the point B of the cord BD moves through an arc whose length = AB , during the same time the point C or the cord CE will

move downward a distance = AC . The length of the bight or loop $BDEC$ will be shortened by $AB - AC$, which will cause the pulley F to be raised half of this amount. If P = the pulling force on the cord HK , and W the weight lifted at F , then $P \times AB = W \times \frac{1}{2}(AB - AC)$.

To calculate the length of chain required for a differential pulley, take the following sum: Half the circumference of A + half the circumference of B + half the circumference of F + twice the greatest distance of F from A + the least length of loop HKL . The last quantity is fixed according to convenience.

The Differential Windlass (Fig. 114) is identical in principle with the differential pulley, the difference in construction being that in the differential windlass the running block hangs in the bight of a rope whose two parts are wound round, and have their ends respectively made fast to two barrels of different radii, which rotate as one piece about the axis A . The differential windlass is little used in practice, because of the great length of rope which it requires.

The Differential Screw (Fig. 115) is a compound screw of different pitches, in which the threads wind the same way. N_1 and N_2 are the two nuts; S_1S_1 , the longer-pitched thread; S_2S_2 , the shorter-pitched thread: in the figure both these threads are left-handed. At



FIG. 115.

each turn of the screw the nut N_2 advances relatively to N_1 through a distance equal to the difference of the pitches. The use of the differential screw is to combine the slowness of advance due to a fine pitch with the strength of thread which can be obtained by means of a coarse pitch only.

A Wheel and Axle, or Windlass, resembles two pulleys on one axis, having different diameters. If a weight be lifted by means of a rope wound over the axle, the force being applied at the rim of the wheel, the action is like that of a lever of which the shorter arm is equal to the radius of the axle plus half the thickness of the rope, and the longer arm is equal to the radius of the wheel. A wheel and axle is therefore sometimes classed as a perpetual lever. If P = the applied force, D = diameter of the wheel, W = the weight lifted, and d the diameter of the axle + the diameter of the rope, $PD = Wd$.

Toothed-wheel Gearing is a combination of two or more wheels and axles (Fig. 116). If a series of wheels and pinions gear into each other, as in the cut, friction neglected, the weight lifted, or resistance overcome, is to the force applied inversely as the distances through which they act in a given time. If R, R_1, R_2 be the radii of the successive wheels, measured to the pitch-line of the teeth, and r, r_1, r_2 the radii of the corresponding pinions, P the applied force, and W the weight lifted, $P \times R \times R_1 \times R_2 = W \times r \times r_1 \times r_2$, or the applied force is to the weight as the product of the radii of the pinions is to the product of the radii of the wheels; or, as the product of the numbers expressing the teeth in each pinion is to the product of the numbers expressing the teeth in each wheel.

Endless Screw, or Worm-gear. (Fig. 117.) — This gear is commonly used to convert motion at high speed into motion at very slow speed. When the handle P describes a complete circumference, the pitch-line of the cog-wheel moves through a distance equal to the pitch of the screw, and the weight W is lifted a distance equal to the pitch multiplied by the ratio of the diameter of the axle to the diameter of the pitch-circle of the wheel. The ratio of the applied force to the weight lifted is inversely as their velocities, friction not being considered; but the friction in the worm-gear is usually very great, amounting sometimes to three or four times the useful work done.

If v = the distance through which the force P acts in a given time, say 1 second, and V = distance the weight W is lifted in the same time, r = radius of the crank or wheel through which P acts, t = pitch of the screw,

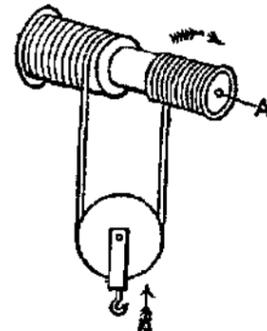

FIG. 114.

and also of the teeth on the cog-wheel, d = diameter of the axle, and D = diameter of the pitch-line of the cog-wheel, $v = \frac{6.283 r D}{t} \times V$; $V = v \times td + 6.283 r D$. $Pv = WV + \text{friction}$.

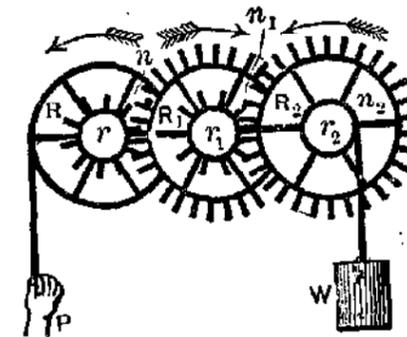

FIG. 116.

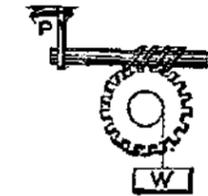

FIG. 117.

STRESSES IN FRAMED STRUCTURES.

Framed structures in general consist of one or more triangles, for the reason that the triangle is the one polygonal form whose shape cannot be changed without distorting one of its sides. Problems in stresses of simple framed structures may generally be solved either by the application of the triangle, parallelogram, or polygon of forces, by the principle of the lever, or by the method of moments. We shall give a few examples, referring the student to the works of Burr, Dubois, Johnson, and others for more elaborate treatment of the subject.

1. A Simple Crane. (Figs. 118 and 119.) — A is a fixed mast, B a brace or boom, T a tie, and P the load. Required the strains in B and T . The weight P , considered as acting at the end of the boom, is held in equilibrium by three forces: first, gravity acting downwards; second, the tension in T ; and third, the thrust of B . Let the length of the line p represent the magnitude of the downward force exerted by the load, and draw a parallelogram with sides bt parallel, respectively, to B and T , such that p is the diagonal of the parallelogram. Then b and t are the components drawn to the same scale as p , p being the resultant. Then if the length p represents the load, t is the tension in the tie, and b is the compression in the brace.

Or, more simply, T, B , and that portion of the mast included between them or A' may represent a triangle of forces, and the forces are proportional to the length of the sides of the triangle; that is, if the height of the

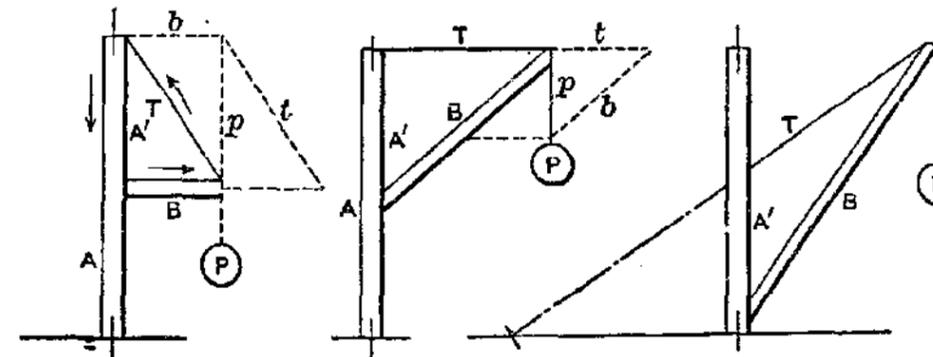

FIG. 118.

FIG. 119.

FIG. 120

triangle A' = the load, then B = the compression in the brace, and T = the tension in the tie; or if P = the load in pounds, the tension in $T = P \times \frac{T}{A'}$, and the compression in $B = P \times \frac{B}{A'}$. Also, if a = the angle the inclined member makes with the mast, the other member being

horizontal, and the triangle being right-angled, then the length of the inclined member = height of the triangle \times secant a , and the strain in the inclined member = P secant a . Also, the strain in the horizontal member = $P \tan a$.

The solution by the triangle or parallelogram of forces, and the equations Tension in $T = P \times T/A'$, and Compression in $B = P \times B/A'$, hold true even if the triangle is not right-angled, as in Fig. 120; but the geometrical relations above given do not hold, except in the case of a right-angled triangle. It is evident that as A' decreases, the strain in both T and B increases, tending to become infinite as A' approaches zero. If the tie T is not attached to the mast, but is extended to the ground, as shown in the dotted line, the tension in it remains the same.

2. A Guyed Crane or Derrick. (Fig. 121.) — The strain in B is, as before, $P \times B/A'$, A' being that portion of the vertical included between B and T , wherever T may be attached to A . If, however, the tie T is attached to B beneath its extremity, there may be in addition a bending strain in B due to a tendency to turn about the point of attachment of T as a fulcrum.

The strain in T may be calculated by the principle of moments. The moment of P is Pc , that is, its weight \times its perpendicular distance from the point of rotation of B on the mast. The moment of the strain on T is the product of the strain into the perpendicular distance from the line

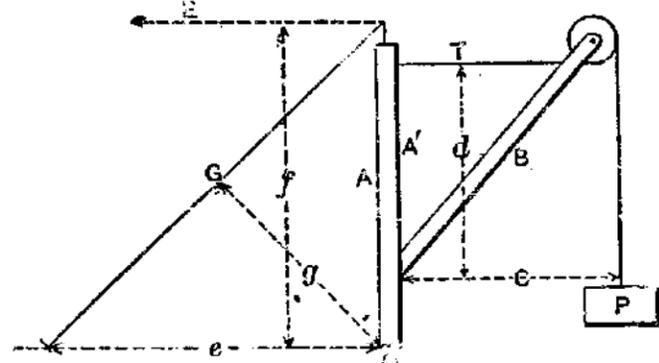

FIG. 121.

of its direction to the same point of rotation of B , or, Td . The strain in T therefore = $Pc \div d$. As d decreases, the strain on T increases, tending to infinity as d approaches zero.

The strain on the guy-rope is also calculated by the method of moments. The moment of the load about the bottom of the mast O is, as before, Pc . If the guy is horizontal, the strain in it is F and its moment is Ff , and $F = Pc \div f$. If it is inclined, the moment is the strain $G \times$ the perpendicular distance of the line of its direction from O , or Gg , and $G = Pc \div g$.

The guy-rope having the least strain is the horizontal one F , and the strain in $G =$ the strain in $F \times$ the secant of the angle between F and G . As G is made more nearly vertical g decreases, and the strain increases, becoming infinite when $g = 0$.

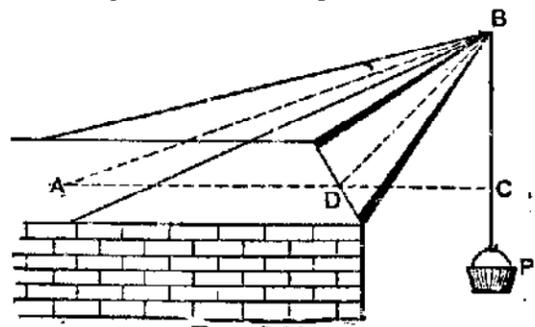

FIG. 122.

sustain a single load P . Compressive stress on $AD = \frac{1}{2} P \times AD \div AB$; on $CA = \frac{1}{2} P \times CA \div AB$. This is true only if CB and BD

3. Shear-poles with Guys. (Fig. 122.) — First assume that the two masts act as one placed at BD , and the two guys as one at AB . Calculate the strain in BD and AB as in Fig. 120. Multiply half the strain in BD (or AB) by the secant of half the angle the two masts (or guys) make with each other to find the strain in each mast (or guy).

Two Diagonal Braces and a Tie-rod. (Fig. 123.) — Suppose the braces are used to

are of equal length, in which case $\frac{1}{2}$ of P is supported by each abutment C and D . If they are unequal in length (Fig. 124), then, by the principle of the lever, find the reactions of the abutments R_1 and R_2 . If P is the load applied at the point B on the lever CD , the fulcrum being D , then $R_1 \times CD = P \times BD$ and $R_2 \times CD = P \times BC$; $R_1 = P \times BD \div CD$; $R_2 = P \times BC \div CD$.

The strain on $AC = R_1 \times AC \div AB$, and on $AD = R_2 \times AD \div AB$. The strain on the tie = $R_1 \times CB \div AB = R_2 \times BD \div AB$.

When $CB = BD$, $R_1 = R_2$. The strain on CB and BD is the same, whether the braces are of equal length or not, and is equal to $\frac{1}{2} P \times \frac{1}{2} CD \div AB$.

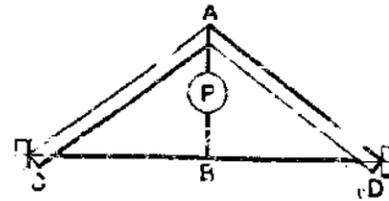

FIG. 123.

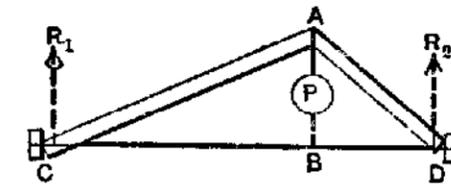

FIG. 124.

If the braces support a uniform load, as a pair of rafters, the strains caused by such a load are equivalent to that caused by one-half of the load applied at the center. The horizontal thrust of the braces against each other at the apex equals the tensile strain in the tie.

King-post Truss or Bridge. (Fig. 125.) — If the load is distributed over the whole length of the truss, the effect is the same as if half the load were placed at the center, the other half being carried by the abutments. Let $P =$ one-half the load on the truss, then tension in the vertical tie $AB = P$. Compression in each of the inclined braces = $\frac{1}{2} P \times AD \div AB$. Tension in the tie $CD = \frac{1}{2} P \times BD \div AB$. Horizontal thrust of inclined brace AD at $D =$ the tension in the tie. If $W =$ the total load on one truss uniformly distributed, $l =$ its length and $d =$ its depth, then the tension on the horizontal tie = $Wl \div 8d$.

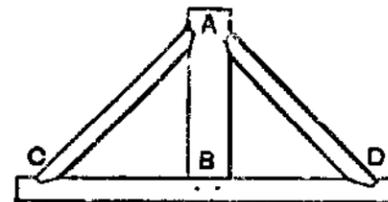

FIG. 125.

Inverted King-post Truss. (Fig. 126.) — If $P =$ a load applied at B , or one-half of a uniformly distributed load, then compression on $AB = P$ (the floor-beam CD not being considered to have any resistance to a slight bending). Tension on AC or $AD = \frac{1}{2} P \times AD \div AB$. Compression on $CD = \frac{1}{2} P \times BD \div AB$.

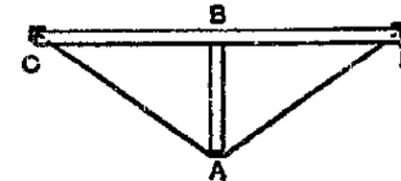

FIG. 126.

Queen-post Truss. (Fig. 127.) — If uniformly loaded, and the queen-posts divide the length into three equal bays, the load may be considered to be divided into three equal parts, two parts of which, P_1 and P_2 , are concentrated at the panel joints and the remainder

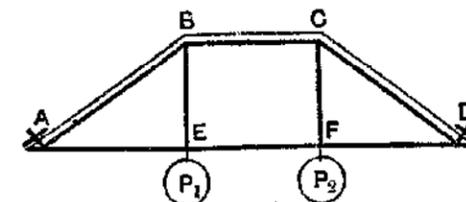

FIG. 127.

is equally divided between the abutments and supported by them directly. The two parts P_1 and P_2 only are considered to affect the members of the truss. Strain in the vertical ties BE and CF each equals P_1 or P_2 . Strain on AB and CD each = $P_1 \times CD \div CF$. Strain on the tie AE or EF or $ED = P_1 \times FD \div CF$. Thrust on $BC =$ tension on EF .

For stability to resist heavy unequal loads the queen-post truss should have diagonal braces from B to F and from C to E .

Inverted Queen-post Truss. (Fig. 128.) — Compression on *EB* and *FC* each = P_1 or P_2 . Compression on *AB* or *BC* or *CD* = $P_1 \times AB \div EB$. Tension on *AE* or *FD* = $P_1 \times AE \div EB$. Tension on *EF* = compression on *BC*. For stability to resist unequal loads, ties should be run from *C* to *E* and from *B* to *F*.

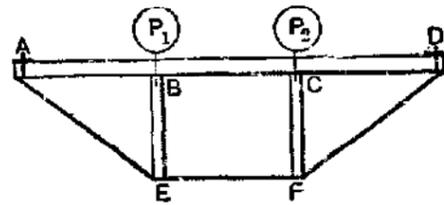

FIG. 128.

and *CD* the truss may be considered as a queen-post truss, with the loads P_1, P_2 concentrated at *E*, and the loads P_3, P_4 concentrated at *F*. Then compressive strain on *AB* = $(P_1 + P_2) \times AB \div BE$. The strain on *CD* is the same if the loads and panel lengths are equal. The tensile

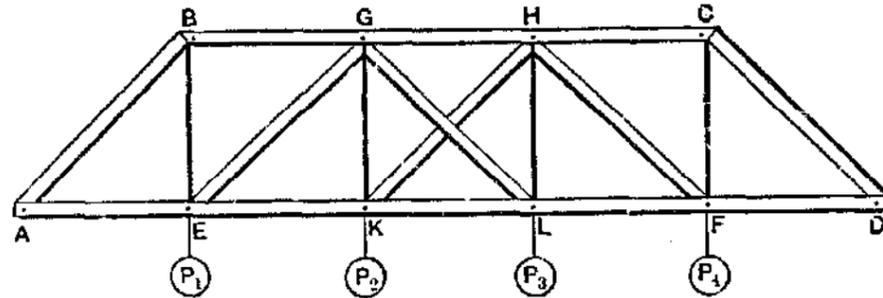

FIG. 129.

strain on *BE* or *CF* = $P_1 + P_2$. That portion of the truss between *E* and *F* may be considered as a smaller queen-post truss, supporting the loads P_2, P_3 at *K* and *L*. The strain on *EG* or *HF* = $P_2 \times EG \div GK$. The diagonals *GL* and *KH* receive no strain unless the truss is unequally loaded. The verticals *GK* and *HL* each receive a tensile strain equal to P_2 or P_3 .

For the strain in the horizontal members: *BG* and *CH* receive a thrust equal to the horizontal component of the thrust in *AB* or *CD*, = $(P_1 + P_2) \times \tan$ angle *ABE*, or $(P_1 + P_2) \times AE \div BE$. *GH* receives this thrust, and also, in addition, a thrust equal to the horizontal component of the thrust in *EG* or *HF*, or, in all, $(P_1 + P_2 + P_3) \times AE \div BE$.

The tension in *AE* or *FD* equals the thrust in *BG* or *HC*, and the tension in *EK*, *KL*, and *LF* equals the thrust in *GH*.

Pratt or Whipple Truss. (Fig. 130.) — In this truss the diagonals are ties, and the verticals are struts or columns.

Calculation by the method of distribution of strains: Consider first the load P_1 . The truss having six bays or panels, $5/8$ of the load is transmitted to the abutment *H*, and $1/8$ to the abutment *O*, on the principle of the lever. As the five-sixths must be transmitted through *JA* and *AH*, write on these members the figure 5. The one-sixth is transmitted successively through *JC*, *CK*, *KD*, *DL*, etc., passing alternately through a tie and a strut. Write on these members, up to the strut *GO* inclusive, the figure 1. Then consider the load P_2 , of which $4/8$ goes to *AH* and $2/8$ to *GO*. Write on *KB*, *BJ*, *JA*, and *AH* the figure 4, and on *KD*, *DL*, *LE*, etc., the figure 2. The load P_2 transmits $3/8$ in each direction; write 3 on each of the members through which this stress passes, and so on for all the loads, when the figures on the several members will appear as on the cut. Adding them up, we have the following totals:

Tension on diagonals	{	<i>AJ</i>	<i>BH</i>	<i>BK</i>	<i>CJ</i>	<i>CL</i>	<i>DK</i>	<i>DM</i>	<i>EL</i>	<i>EN</i>	<i>FM</i>	<i>FO</i>	<i>GN</i>
		15	0	10	1	6	3	3	5	1	10	0	15
Compression on verticals	{	<i>AH</i>	<i>BJ</i>	<i>CK</i>	<i>DL</i>	<i>EM</i>	<i>FN</i>	<i>GO</i>					
		15	10	7	6	7	10	15					

Each of the figures in the first line is to be multiplied by $1/8 P \times \secant$ of angle *H AJ*, or $1/8 P \times AJ \div AH$, to obtain the tension, and each

WARNING: This is a 1910 edition. Some of the material may no longer be accurate

figure in the lower line is to be multiplied by $1/8 P$ to obtain the compression. The diagonals *HB* and *FO* receive no strain.

It is common to build this truss with a diagonal strut at *HB* instead of the post *HA* and the diagonal *AJ*; in which case $5/8$ of the load P is carried through *JB* and the strut *BH*, which latter then receives a strain = $15/8 P \times \secant$ of *HBJ*.

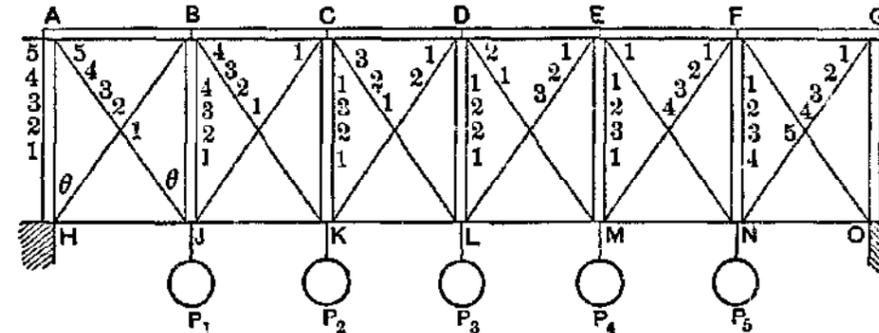

FIG. 130.

The strains in the upper and lower horizontal members or chords increase from the ends to the center, as shown in the case of the Burr truss. *AB* receives a thrust equal to the horizontal component of the tension in *AJ*, or $15/8 P \times \tan$ *AJB*. *BC* receives the same thrust + the horizontal component of the tension in *BK*, and so on. The tension in the lower chord of each panel is the same as the thrust in the upper chord of the same panel. (For calculation of the chord strains by the method of moments, see below.)

The maximum thrust or tension is at the center of the chords and is equal to $WL/8D$, in which W is the total load supported by the truss, L is the length, and D the depth. This is the formula for maximum stress in the chords of a truss of any form whatever.

The above calculation is based on the assumption that all the loads P_1, P_2 , etc., are equal. If they are unequal, the value of each has to be taken into account in distributing the strains. Thus the tension in *AJ*, with unequal loads, instead of being $15 \times 1/8 P \secant \theta$ would be $\sec \theta \times (5/8 P_1 + 4/8 P_2 + 3/8 P_3 + 2/8 P_4 + 1/8 P_5)$. Each panel load, P_1 , etc., includes its fraction of the weight of the truss.

General Formula for Strains in Diagonals and Verticals. — Let n = total number of panels, x = number of any vertical considered from the nearest end, counting the end as 1, r = rolling load for each panel, P = total load for each panel.

$$\text{Strain on verticals} = \frac{[(n-x) + (n-x)^2 - (x-1) + (x-1)^2] P}{2n} + \frac{r(x-1) + (x-1)^2}{2n}$$

For a uniformly distributed load, leave out the last term,

$$[r(x-1) + (x-1)^2] \div 2n$$

Strain on principal diagonals (*AJ*, *GN*, etc.) = strain on verticals $\times \secant \theta$, that is secant of the angle the diagonal makes with the vertical.

Strain on the counterbraces (*BH*, *CJ*, *FO*, etc.): The strain on the counterbrace in the first panel is 0, if the load is uniform. On the 2d, 3d, 4th, etc., it is $P \secant \theta \times \frac{1}{n}, \frac{1+2}{n}, \frac{1+2+3}{n}$, etc., P being the total load in one panel.

Strain in the Chords — Method of Moments. — Let the truss be uniformly loaded, the total load acting on it = W . Weight supported at each end, or reaction of the abutment = $W/2$. Length of the truss = L . Weight on a unit of length = W/L . Horizontal distance from the nearest abutment to the point (say *M* in Fig. 130) in the chord where the strain is to be determined = x . Horizontal strain at that point (tension on the lower chord, compression in the upper) = H . Depth of the truss = D .

By the method of moments we take the difference of the moments, about the point M , of the reaction of the abutment and of the load between M and the abutments, and equate that difference with the moment of the resistance, or of the strain in the horizontal chord, considered with reference to a point in the opposite chord, about which the truss would turn if the first chord were severed at M .

The moment of the reaction of the abutment is $Wx/2$. The moment of the load from the abutment to M is $(W/Lx) \times$ the distance of its center of gravity from M , which is $x/2$, or moment $-Wx^2/2L$. Moment of the stress in the chord $= HD = \frac{Wx}{2} - \frac{Wx^2}{2L}$, whence $H = \frac{W}{2D} \left(x - \frac{x^2}{L}\right)$.

If $x = 0$ or L , $H = 0$. If $x = L/2$, $H = \frac{WL}{8D}$, which is the horizontal strain at the middle of the chords, as before given.

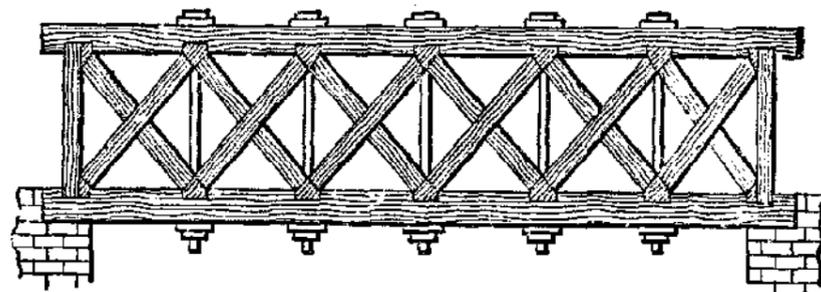

FIG. 131.

The Howe Truss. (Fig. 131.) — In the Howe truss the diagonals are struts, and the verticals are ties. The calculation of strains may be made in the same method as described above for the Pratt truss.

The Warren Girder. (Fig. 132.) — In the Warren girder, or triangular truss, there are no vertical struts, and the diagonals may transmit either tension or compression. The strains in the diagonals may be calculated by the method of distribution of strains as in the case of the rectangular truss.

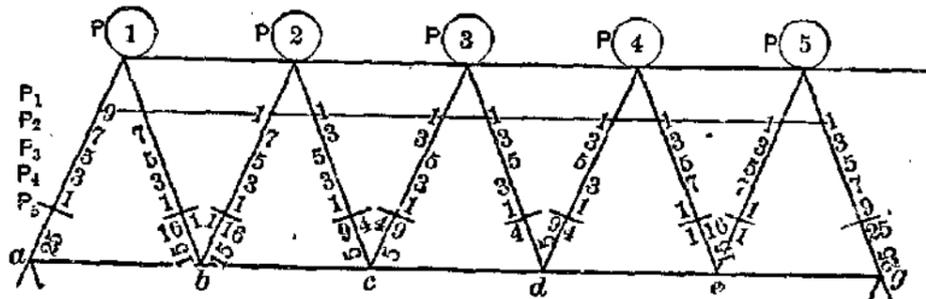

FIG. 132.

On the principle of the lever, the load P_1 being $1/10$ of the length of the span from the line of the nearest support a , transmits $9/10$ of its weight to a and $1/10$ to g . Write 9 on the right hand of the strut $1a$, to represent the compression, and 1 on the right hand of $1b$, $2c$, $3d$, etc., to represent compression, and on the left hand of $b2$, $c3$, etc., to represent tension. The load P_2 transmits $7/10$ of its weight to a and $3/10$ to g . Write 7 on each member from 2 to a , and 3 on each member from 2 to g , placing the figures representing compression on the right hand of the member, and those representing tension on the left. Proceed in the same manner with all the loads, then sum up the figures on each side of each diagonal, and write the difference of each sum beneath, and on the side of the greater sum, to show whether the difference represents tension or compression. The results are as follows: Compression, $1a$, 25; $2b$, 15; $3c$, 5; $3d$, 5; $4e$, 15; $5g$, 25. Tension, $1b$, 15; $2c$, 5; $4d$, 5; $5e$, 15. Each of these figures is to

be multiplied by $1/10$ of one of the loads as P_1 , and by the secant of the angle the diagonals make with a vertical line.

The strains in the horizontal chords may be determined by the method of moments as in the case of rectangular trusses.

Roof-truss. — *Solution by Method of Moments.* — The calculation of strains in structures by the method of statical moments consists in taking a cross-section of the structure at a point where there are not more than three members (struts, braces, or chords).

To find the strain in either one of these members take the moment about the intersection of the other two as an axis of rotation. The sum of the moments of these members must be 0 if the structure is in equilibrium. But the moments of the two members that pass through the point of reference or axis are both 0, hence one equation containing one unknown quantity can be found for each cross-section.

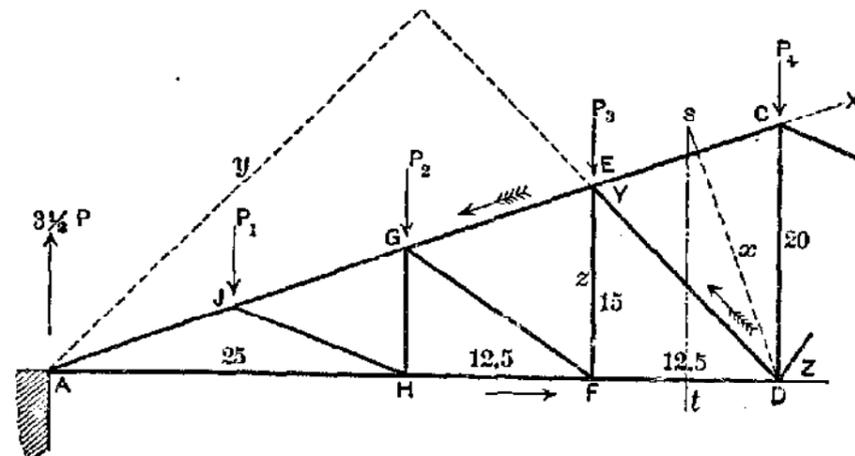

FIG. 133.

In the truss shown in Fig. 133 take a cross-section at ts , and determine the strain in the three members cut by it, viz., CE , ED and DF . Let X = force exerted in direction CE , Y = force exerted in direction DE , Z = force exerted in direction FD .

For X take its moment about the intersection of Y and Z at $D = Xx$. For Y take its moment about the intersection of X and Z at $A = Yy$. For Z take its moment about the intersection of X and Y at $E = Zz$. Let $z = 15$, $x = 18.6$, $y = 38.4$, $AD = 50$, $CD = 20$ ft. Let P_1, P_2, P_3, P_4 be equal loads, as shown, and $3\frac{1}{2}P$ the reaction of the abutment A .

The sum of all the moments taken about D or A or E will be 0 when the structure is at rest. Then $-Xx + 3.5P \times 50 - P_3 \times 12.5 - P_2 \times 25 - P_1 \times 37.5 = 0$.

The + signs are for moments in the direction of the hands of a watch or "clockwise" and - signs for the reverse direction or anti-clockwise. Since $P = P_1 = P_2 = P_3 = P_4 = 18.8$ $X + 175P - 75P = 0$; $-18.6X = -100P$;

$X = 100P \div 18.6 = 5.376P$.
 $-Yy + P_3 \times 37.5 + P_2 \times 25 \div P_1 \times 12.5 = 0$; $38.4Y = 75$; $Y = 75P \div 38.4 = 1.953P$.

$-Zz + 3.5P \times 37.5 - P_1 \times 25 - P_2 \times 12.5 - P_3 \times 0 = 0$; $15Z = 93.75P$; $Z = 6.25P$.

In the same manner the forces exerted in the other members have been found as follows: $EG = 6.73P$; $GJ = 8.07P$; $JA = 9.42P$; $JH = 1.35P$; $GF = 1.59P$; $AH = 8.75P$; $HF = 7.50P$.

The Fink Roof-truss. (Fig. 134.) — An analysis by Prof. P. H. Hilbrich (*Van N., Mag., Aug., 1880*) gives the following results:

- W = total load on roof;
- N = No. of panels on both rafters;
- $W/N = P$ = load at each joint b, d, f , etc.;
- Y = reaction at $A = \frac{1}{2}W = \frac{1}{2}NP = 4P$;
- $AD = S$; $AC = L$; $CD = D$;
- t_1, t_2, t_3 = tension on De, eg, gA , respectively;
- c_1, c_2, c_3, c_4 = compression on Cb, bd, df , and fA .

- Strains in
1. $De = h = 2PS + D;$
 2. $ce = g = 2PS + D;$
 3. $g1 = h = 2PS + D;$
 4. $Af = c_1 = \frac{1}{2} PL + D;$
 5. $fd = c_2 = \frac{1}{2} PL + D;$
 6. $de = c_3 = \frac{1}{2} PL + D;$
 7. $dc = c_4 = \frac{1}{2} PL + D;$
 8. $bc = c_5 = \frac{1}{2} PL + D;$
 9. $de = c_6 = \frac{1}{2} PL + D;$
 10. $cd = c_7 = \frac{1}{2} PL + D;$
 11. $ec = c_8 = \frac{1}{2} PL + D;$
 12. $cc = c_9 = \frac{1}{2} PL + D;$

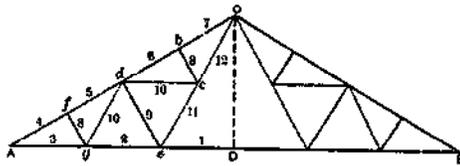

FIG. 134.

EXAMPLE. — Given a Fink roof-truss of span 64 ft., depth 16 ft., with four panels on each side, as in figure; total load 32 tons, or 4 tons each at the points *f, d, b, c, etc.* (and 2 tons each at *A* and *B*, which transmit no strain to the truss members). Here $W = 32$ tons, $P = 4$ tons, $S = 32$ ft., $D = 16$ ft., $L = \sqrt{S^2 + D^2} = 2.236 \times D$, $L + D = 2.236D + D = 0.4472S + D = 2$, $S + D = 2$, $S + L = 0.8944S$. The strains on the numbered members then are as follows:

1.	$2 \times 4 \times 2 = 16$	tons.	7.	$31.3 - 12 \times 0.447 = 25.94$	tons.
2.	$3 \times 4 \times 2 = 24$	"	8.	$4 \times 0.8944 = 3.58$	"
3.	$\frac{1}{2} \times 4 \times 2 = 4$	"	9.	$8 \times 0.8944 = 7.16$	"
4.	$\frac{1}{2} \times 4 \times 2.236 = 4.472$	"	10.	$2 \times 2 = 4$	"
5.	$31.3 - 4 \times 0.447 = 27.52$	"	11.	$4 \times 2 = 8$	"
6.	$31.3 - 8 \times 0.447 = 27.72$	"	12.	$8 \times 2 = 16$	"

The Economical Angle. — A structure of triangular form, Fig. 135, is supported at *a* and *b*. It sustains any load *L*, the elements *cc* being in compression and *t* in tension. Required the angle θ so that the total weight of the structure shall be a minimum. F. R. Hoxey (Sci. Am. Supp., Jan. 17, 1893) gives a solution of this problem, with the

result $\tan \theta = \sqrt{\frac{C+T}{C}}$. In which *C* and *T* represent

the crushing and the tensile strength respectively of the material employed. It is applicable to any material. For *C* = 7, $\theta = 34\frac{1}{2}^\circ$. For *C* = 0.4 *T* (yellow pine), $\theta = 49\frac{3}{4}^\circ$. For *C* = 0.8 *T* (soft steel), $\theta = 53\frac{1}{2}^\circ$. For *C* = 6 *T* (cast iron), $\theta = 60\frac{1}{2}^\circ$.

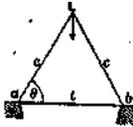

FIG. 135.

HEAT.

THERMOMETERS.

The Fahrenheit thermometer is generally used in English-speaking countries, and the Centigrade, or Celsius, thermometer in countries that use the metric system. In many scientific treatises in English, however, the Centigrade temperatures are also used, either with or without their Fahrenheit equivalents. The Réaumur thermometer is used to some extent on the Continent of Europe.

In the Fahrenheit thermometer the freezing-point of water is taken at 32°, and the boiling-point of water at mean atmospheric pressure at the sea-level, 14.7 lbs. per sq. in., is taken at 212°. The distance between these two points being divided into 180°. In the Centigrade, and Réaumur thermometers the freezing-point is taken at 0°. The boiling-point is 100° in the Centigrade scale, and 80° in the Réaumur.

1 Fahrenheit degree	= $\frac{5}{9}$ deg. Centigrade	= $\frac{4}{9}$ deg. Réaumur.
1 Centigrade degree	= $\frac{9}{5}$ deg. Fahrenheit	= $\frac{8}{9}$ deg. Réaumur.
1 Réaumur degree	= $\frac{9}{4}$ deg. Fahrenheit	= $\frac{5}{4}$ deg. Centigrade.
Temperature Fahrenheit	= $\frac{5}{9} \times \text{temp. C.} + 32^\circ$	= $\frac{4}{9} \text{ R.} + 32^\circ$.
Temperature Centigrade	= $\frac{5}{9} (\text{temp. F.} - 32^\circ)$	= $\frac{4}{9} \text{ F.} - 32^\circ$.
Temperature Réaumur	= $\frac{4}{9} \text{ temp. C.}$	= $\frac{4}{9} (\text{F.} - 32^\circ)$.

HANDY RULE FOR CONVERTING CENTIGRADE TEMPERATURE TO FAHRENHEIT. — Multiply by 2, subtract a tenth, add 32.

EXAMPLE. — $100^\circ \text{ C.} \times 2 = 200$, $- 20 = 180$, $+ 32 = 212^\circ \text{ F.}$

Mercurial Thermometer. (Rankine, S. E., p. 234). — The rate of expansion of mercury with rise of temperature increases as the temperature becomes higher; from which it follows, that if a thermometer showing the dilatation of mercury simply were made to agree with an air thermometer at 32° and 212°, the mercurial thermometer would show lower temperatures than the air thermometer between those standard points, and higher temperatures beyond them.

For example, according to Regnault, when the air thermometer marked 350° C. (= 662° F.), the mercurial thermometer would mark 352.16° C. (= 663.89° F.), the error of the latter being in excess 1.16° C. (= 21.89° F.).

Actual mercurial thermometers indicate intervals of temperature proportional to the difference between the expansion of mercury and that of glass.

The inequalities in the rate of expansion of the glass (which are very different for different kinds of glass) correct, to a greater or less extent, the errors arising from the inequalities in the rate of expansion of the mercury.

For practical purposes connected with heat engines, the mercurial thermometer made of common glass may be considered as sensibly coinciding with the air-thermometer at all temperatures not exceeding 500° F.

If the mercury is not throughout its whole length at the same temperature as that being measured, a correction, *k*, must be added to the temperature *t* in Fahrenheit degrees; $k = 0.6 D (t - t')$ = 1,000,000, where *D* is the length of the mercury column exposed, measured in Fahrenheit degrees, and *t* is the temperature of the exposed part of the thermometer. When long thermometers are used in shallow wells in high-pressure steam pipes this correction is often 5° to 10° F. (Meyer on Steam Turbines.)

PYROMETRY.

Principles Used in Various Pyrometers.

Pyrometers may be classified according to the principles upon which they operate, as follows:

1. Expansion of mercury in a glass tube. When the space above the mercury is filled with compressed nitrogen, and a specially hard glass is used for the tube, mercury thermometers may be made to indicate temperatures as high as 1000° F.

WARNING: This is a 1910 edition. Some of the material may no longer be accurate

TEMPERATURES, CENTIGRADE AND FAHRENHEIT.

C.	F.	C.	F.	C.	F.	C.	F.	C.	F.	C.	F.	C.	F.
-40	-40.	26	78.8	92	197.6	158	316.4	224	435.2	290	554.	950	1742
-39	-38.2	27	80.6	93	199.4	159	318.2	225	437.	300	572.	960	1760
-38	-36.4	28	82.4	94	201.2	160	320.	226	438.8	310	590.	970	1778
-37	-34.6	29	84.2	95	203.	161	321.8	227	440.6	320	608.	980	1796
-36	-32.8	30	86.	96	204.8	162	323.6	228	442.4	330	626.	990	1814
-35	-31.	31	87.8	97	206.6	163	325.4	229	444.2	340	644.	1000	1832
-34	-29.2	32	89.6	98	208.4	164	327.2	230	446.	350	662.	1010	1850
-33	-27.4	33	91.4	99	210.2	165	329.	231	447.8	360	680.	1020	1868
-32	-25.6	34	93.2	100	212.	166	330.8	232	449.6	370	698.	1030	1886
-31	-23.8	35	95.	101	213.8	167	332.6	233	451.4	380	716.	1040	1904
-30	-22.	36	96.8	102	215.6	168	334.4	234	453.2	390	734.	1050	1922
-29	-20.2	37	98.6	103	217.4	169	336.2	235	455.	400	752.	1060	1940
-28	-18.4	38	100.4	104	219.2	170	338.	236	456.8	410	770.	1070	1958
-27	-16.6	39	102.2	105	221.	171	339.8	237	458.6	420	788.	1080	1976
-26	-14.8	40	104.	106	222.8	172	341.6	238	460.4	430	806.	1090	1994
-25	-13.	41	105.8	107	224.6	173	343.4	239	462.2	440	824.	1100	2012
-24	-11.2	42	107.6	108	226.4	174	345.2	240	464.	450	842.	1110	2030
-23	-9.4	43	109.4	109	228.2	175	347.	241	465.8	460	860.	1120	2048
-22	-7.6	44	111.2	110	230.	176	348.8	242	467.6	470	878.	1130	2066
-21	-5.8	45	113.	111	231.8	177	350.6	243	469.4	480	896.	1140	2084
-20	-4.	46	114.8	112	233.6	178	352.4	244	471.2	490	914.	1150	2102
-19	-2.2	47	116.6	113	235.4	179	354.2	245	473.	500	932.	1160	2120
-18	-0.4	48	118.4	114	237.2	180	356.	246	474.8	510	950.	1170	2138
-17	+ 1.4	49	120.2	115	239.	181	357.8	247	476.6	520	968.	1180	2156
-16	+ 3.2	50	122.	116	240.8	182	359.6	248	478.4	530	986.	1190	2174
-15	+ 5.	51	123.8	117	242.6	183	361.4	249	480.2	540	1004.	1200	2192
-14	+ 6.8	52	125.6	118	244.4	184	363.2	250	482.	550	1022.	1210	2210
-13	+ 8.6	53	127.4	119	246.2	185	365.	251	483.8	560	1040.	1220	2228
-12	+ 10.4	54	129.2	120	248.	186	366.8	252	485.6	570	1058.	1230	2246
-11	+ 12.2	55	131.	121	249.8	187	368.6	253	487.4	580	1076.	1240	2264
-10	+ 14.	56	132.8	122	251.6	188	370.4	254	489.2	590	1094.	1250	2282
-9	+ 15.8	57	134.6	123	253.4	189	372.2	255	491.	600	1112.	1260	2300
-8	+ 17.6	58	136.4	124	255.2	190	374.	256	492.8	610	1130.	1270	2318
-7	+ 19.4	59	138.2	125	257.	191	375.8	257	494.6	620	1148.	1280	2336
-6	+ 21.2	60	140.	126	258.8	192	377.6	258	496.4	630	1166.	1290	2354
-5	+ 23.	61	141.8	127	260.6	193	379.4	259	498.2	640	1184.	1300	2372
-4	+ 24.8	62	143.6	128	262.4	194	381.2	260	500.	650	1202.	1310	2390
-3	+ 26.6	63	145.4	129	264.2	195	383.	261	501.8	660	1220.	1320	2408
-2	+ 28.4	64	147.2	130	266.	196	384.8	262	503.6	670	1238.	1330	2426
-1	+ 30.2	65	149.	131	267.8	197	386.6	263	505.4	680	1256.	1340	2444
0	+ 32.	66	150.8	132	269.6	198	388.4	264	507.2	690	1274.	1350	2462
+ 1	+ 33.8	67	152.6	133	271.4	199	390.2	265	509.	700	1292.	1360	2480
+ 2	+ 35.6	68	154.4	134	273.2	200	392.	266	510.8	710	1310.	1370	2498
+ 3	+ 37.4	69	156.2	135	275.	201	393.8	267	512.6	720	1328.	1380	2516
+ 4	+ 39.2	70	158.	136	276.8	202	395.6	268	514.4	730	1346.	1390	2534
+ 5	+ 41.	71	159.8	137	278.6	203	397.4	269	516.2	740	1364.	1400	2552
+ 6	+ 42.8	72	161.6	138	280.4	204	399.2	270	518.	750	1382.	1410	2570
+ 7	+ 44.6	73	163.4	139	282.2	205	401.	271	519.8	760	1400.	1420	2588
+ 8	+ 46.4	74	165.2	140	284.	206	402.8	272	521.6	770	1418.	1430	2606
+ 9	+ 48.2	75	167.	141	285.8	207	404.6	273	523.4	780	1436.	1440	2624
+ 10	+ 50.	76	168.8	142	287.6	208	406.4	274	525.2	790	1454.	1450	2642
+ 11	+ 51.8	77	170.6	143	289.4	209	408.2	275	527.	800	1472.	1460	2660
+ 12	+ 53.6	78	172.4	144	291.2	210	410.	276	528.8	810	1490.	1470	2678
+ 13	+ 55.4	79	174.2	145	293.	211	411.8	277	530.6	820	1508.	1480	2696
+ 14	+ 57.2	80	176.	146	294.8	212	413.6	278	532.4	830	1526.	1490	2714
+ 15	+ 59.	81	177.8	147	296.6	213	415.4	279	534.2	840	1544.	1500	2732
+ 16	+ 60.8	82	179.6	148	298.4	214	417.2	280	536.	850	1562.	1510	2750
+ 17	+ 62.6	83	181.4	149	300.2	215	419.	281	537.8	860	1580.	1520	2768
+ 18	+ 64.4	84	183.2	150	302.	216	420.8	282	539.6	870	1598.	1530	2786
+ 19	+ 66.2	85	185.	151	303.8	217	422.6	283	541.4	880	1616.	1540	2804
+ 20	+ 68.	86	186.8	152	305.6	218	424.4	284	543.2	890	1634.	1550	2822
+ 21	+ 69.8	87	188.6	153	307.4	219	426.2	285	545.	900	1652.	1600	2912
+ 22	+ 71.6	88	190.4	154	309.2	220	428.	286	546.8	910	1670.	1650	3002
+ 23	+ 73.4	89	192.2	155	311.	221	429.8	287	548.6	920	1688.	1700	3092
+ 24	+ 75.2	90	194.	156	312.8	222	431.6	288	550.4	930	1706.	1750	3182
+ 25	+ 77.	91	195.8	157	314.6	223	433.4	289	552.2	940	1724.	1800	3272

TEMPERATURES, FAHRENHEIT AND CENTIGRADE.

F.	C.	F.	C.	F.	C.	F.	C.	F.	C.	F.	C.	F.	C.
-40	-40.	26	-3.3	92	33.3	158	70.	224	106.7	290	143.3	360	182.2
-39	-39.4	27	-2.8	93	33.9	159	70.6	225	107.2	291	143.9	370	187.8
-38	-38.9	28	-2.2	94	34.4	160	71.1	226	107.8	292	144.4	380	193.3
-37	-38.3	29	-1.7	95	35.	161	71.7	227	108.3	293	145.	390	198.9
-36	-37.8	30	-1.1	96	35.6	162	72.2	228	108.9	294	145.6	400	204.4
-35	-37.2	31	-0.6	97	36.1	163	72.8	229	109.4	295	146.1	410	210.
-34	-36.7	32	0.	98	36.7	164	73.3	230	110.	296	146.7	420	215.6
-33	-36.1	33	+0.6	99	37.2	165	73.9	231	110.6	297	147.2	430	221.1
-32	-35.6	34	1.1	100	37.8	166	74.4	232	111.1	298	147.8	440	226.7
-31	-35.	35	1.7	101	38.3	167	75.	233	111.7	299	148.3	450	232.2
-30	-34.4	36	2.2	102	38.9	168	75.6	234	112.2	300	148.9	460	237.8
-29	-33.9	37	2.8	103	39.4	169	76.1	235	112.8	301	149.4	470	243.3
-28	-33.3	38	3.3	104	40.	170	76.7	236	113.3	302	150.	480	248.9
-27	-32.8	39	3.9	105	40.6	171	77.2	237	113.9	303	150.6	490	254.4
-26	-32.2	40	4.4	106	41.1	172	77.8	238	114.4	304	151.1	500	260.
-25	-31.7	41	5.	107	41.7	173	78.3	239	115.	305	151.7	510	265.6
-24	-31.1	42	5.6	108	42.2	174	78.9	240	115.6	306	152.2	520	271.1
-23	-30.6	43	6.1	109	42.8	175	79.4	241	116.1	307	152.8	530	276.7
-22	-30.	44	6.7	110	43.3	176	80.	242	116.7	308	153.3	540	282.2
-21	-29.4	45	7.2	111	43.9	177	80.6	243	117.2	309	153.9	550	287.8
-20	-28.9	46	7.8	112	44.4	178	81.1	244	117.8	310	154.4	560	293.3
-19	-28.3	47	8.3	113	45.	179	81.7	245	118.3	311	155.	570	298.9
-18	-27.8	48	8.9	114	45.6	180	82.2	246	118.9	312	155.6	580	304.4
-17	-27.2	49	9.4	115	46.1	181	82.8	247	119.4	313	156.1	590	310.
-16	-26.7	50	10.	116	46.7	182	83.3	248	120.	314	156.7	600	315.6
-15	-26.1	51	10.6	117	47.2	183	83.9	249	120.6	315	157.2	610	321.1
-14	-25.6	52	11.1	118	47.8	184	84.4	250	121.1	316	157.8	620	326.7
-13	-25.	53	11.7	119	48.3	185	85.	251	121.7	317	158.3	630	332.2
-12	-24.4	54	12.2	120	48.9	186	85.6	252	122.2	318	158.9	640	337.8
-11	-23.9	55	12.8	121	49.4	187	86.1	253	122.8	319	159.4	650	343.3
-10	-23.3	56	13.3	122	50.	188	86.7	254	123.3	320	160.	660	348.

2. Contraction of clay, as in the old Wedgwood pyrometer, at one time used by potters. This instrument was very inaccurate, as the contraction of clay varied with its nature.
3. Expansion of air, as in the air-thermometer, Wiborgh's pyrometer, Uehling and Steinbart's pyrometer, etc.
4. Pressure of vapors, as in some forms of Bristol's recording pyrometer.
5. Relative expansion of two metals or other substances, as in Brown's, Bulkley's and other metallic pyrometers, consisting of a copper rod or tube inside of an iron tube, or *vice versa*, with the difference of expansion multiplied by gearing and indicated on a dial.
6. Specific heat of solids, as in the copper-ball and platinum-ball pyrometers.
7. Melting-points of metals, alloys, or other substances, as in approximate determination of temperature by melting pieces of zinc, lead, etc., or as in Seger's fire-clay pyrometer.
8. Time required to heat a weighed quantity of water inclosed in a vessel, as in one form of water pyrometer.
9. Increase in temperature of a stream of water or other liquid flowing at a given rate through a tube inserted into the heated chamber.
10. Changes in the electric resistance of platinum or other metal, as in the Siemens pyrometer.
11. Measurement of an electric current produced by heating the junction of two metals, as in the Le Chatelier pyrometer.
12. Dilution by cold air of a stream of hot air or gas flowing from a heated chamber and determination of the temperature of the mixture by a mercury thermometer, as in Hobson's hot-blast pyrometer.
13. Polarization and refraction by prisms and plates of light radiated from heated surfaces, as in Mesuré and Nouel's pyrometric telescope or optical pyrometer, and Wanner's pyrometer.
14. Heating the filament of an electric lamp to the same color as that of an incandescent body, so that when the latter is observed through a telescope containing the lamp the filament becomes invisible, as in Holborn and Kuribaum's and Morse's optical pyrometers. The current required to heat the filament is a measure of the temperature.
15. The radiation pyrometer. The radiation from an incandescent surface is received in a telescope containing a thermo-couple, and the electric current generated therein is measured, as in Féry's radiation pyrometer.

(See "Optical Pyrometry" by C. W. W. Waidner and G. K. Burgess, Bulletin No. 2, Bureau of Standards, Department of Commerce and Labor; also *Eng'g*, Mar. 1, 1907.)

Platinum or Copper Ball Pyrometer. — A weighed piece of platinum, copper, or iron is allowed to remain in the furnace or heated chamber till it has attained the temperature of its surroundings. It is then suddenly taken out and dropped into a vessel containing water of a known weight and temperature. The water is stirred rapidly and its maximum temperature taken. Let W = weight of the water, w the weight of the ball, t = the original and T the final heat of the water, and S the specific heat of the metal; then the temperature x of the fire may be found from the formula

$$x = \frac{W(T - t)}{wS} + T.$$

The mean specific heat of platinum between 32° and 446° F. is 0.03333 or $\frac{1}{30}$ that of water, and it increases with the temperature about 0.000305 for each 100° F. For a fuller description, by J. C. Hoadley, see *Trans. A. S. M. E.*, vi, 702. Compare also Henry M. Howe, *Trans. A. I. M. E.*, xviii, 728.

For accuracy corrections are required for variations in the specific heat of the water and of the metal at different temperatures, for loss of heat by radiation from the metal during the transfer from the furnace to the water, and from the apparatus during the heating of the water; also for the heat-absorbing capacity of the vessel containing the water.

Fire-clay or fire-brick may be used instead of the metal ball.
Le Chatelier's Thermo-electric Pyrometer. — For a very full description, see paper by Joseph Struthers, *School of Mines Quarterly*, vol. xii, 1891; also, paper read by Prof. Roberts-Austen before the Iron and Steel Institute, May 7, 1891.

The principle upon which this pyrometer is constructed is the measurement of a current of electricity produced by heating a couple composed of two wires, one platinum and the other platinum with 10% rhodium — the current produced being measured by a galvanometer.

The composition of the gas which surrounds the couple has no influence on the indications.

When temperatures above 2500° F. are to be studied, the wires must have an isolating support and must be of good length, so that all parts of a furnace can be reached. The wires are supported in an iron tube $\frac{1}{2}$ inch interior diameter and held in place by a cylinder of refractory clay having two holes bored through, in which the wires are placed. The shortness of time (five seconds) allows the temperature to be taken without deteriorating the tube.

Tests made by this pyrometer in measuring furnace temperatures under a great variety of conditions show that the readings of the scale uncorrected are always within 45° F. of the correct temperature, and in the majority of industrial measurements this is sufficiently accurate.

Graduation of Le Chatelier's Pyrometer. — W. C. Roberts-Austen in his *Researches on the Properties of Alloys*, *Proc. Inst. M. E.*, 1892, says: The electromotive force produced by heating the thermo-junction to any given temperature is measured by the movement of the spot of light on the scale graduated in millimeters. The scale is calibrated by heating the thermo-junction to temperatures which have been carefully determined by the aid of the air-thermometer, and plotting the curve from the data so obtained. Many fusion and boiling-points have been established by concurrent evidence of various kinds, and are now generally accepted. The following table contains certain of these:

Deg. F.	Deg. C.		Deg. F.	Deg. C.	
212	100	Water boils.	1733	945	Silver melts.
618	326	Lead melts.	1859	1015	Potassium sulphate melts.
676	358	Mercury boils.			
779	415	Zinc melts.	1913	1045	Gold melts.
838	448	Sulphur boils.	1929	1054	Copper melts.
1157	625	Aluminum melts.	2732	1500	Palladium melts.
1229	665	Selenium boils.	3227	1775	Platinum melts.

The Temperatures Developed in Industrial Furnaces. — M. Le Chatelier states that by means of his pyrometer he has discovered that the temperatures which occur in melting steel and in other industrial operations have been hitherto overestimated. He finds the melting heat of white cast iron 1135° (2075° F.), and that of gray cast iron 1220° (2228° F.). Mild steel melts at 1475° (2687° F.), and hard steel at 1410° (2570° F.). The furnace for hard porcelain at the end of the baking has a heat of 1370° (2498° F.). The heat of a normal incandescent lamp is 1800° (3272° F.), but it may be pushed to beyond 2100° (3812° F.).

Prof. Roberts-Austen (*Recent Advances in Pyrometry*, *Trans. A. I. M. E.*, Chicago Meeting, 1893) gives an excellent description of modern forms of pyrometers. The following are some of his temperature determinations.

TEN-TON OPEN-HEARTH FURNACE, WOOLWICH ARSENAL.

	Degrees Centigrade.	Degrees Fahr.
Temperature of steel, 0.3% carbon, pouring into ladle...	1645	2993
Steel, 0.3% carbon, pouring into large mold.....	1580	2876
Reheating furnace, interior.....	930	1706
Cupola furnace, No. 2 cast iron, pouring into ladle.....	1600	2912

The following determinations have been effected by M. Le Chatelier:

BESSEMER PROCESS. SIX-TON CONVERTER.

A. Bath of slag.....	1580	2876
B. Metal in ladle.....	1640	2984
C. Metal in ingot mold.....	1580	2876
D. Ingot in reheating furnace.....	1200	2192
E. Ingot under the hammer.....	1080	1976

OPEN-HEARTH FURNACE (Semi-mild Steel). Deg. C. Deg. F.

A. Fuel gas near gas generator.....	720	1328
B. Fuel gas entering into bottom of regenerator chamber..	400	752
C. Fuel gas issuing from regenerator chamber.....	1200	2192
Air issuing from regenerator chamber.....	1000	1832
Chimney gases. Furnace in perfect condition.....	300	590
End of the melting of pig charge.....	1420	2588
Completion of conversion.....	1500	2732
Molten steel. In the ladle — Commencement of casting...	1580	2876
End of casting.....	1490	2714
In the molds.....	1520	2768

For very mild (soft) steel the temperatures are higher by 50° C.

BLAST-FURNACE (Gray-Bessemer Pig).

Opening in face of tuyere.....	1930	3506
Molten metal — Commencement of fusion.....	1400	2552
End, or prior to tapping.....	1570	2858

HOFFMAN RED-BRICK KILN.

Burning temperatures.....	1100	2012
---------------------------	------	------

R. Moldenke (*The Foundry*, Nov., 1898) determined with a Le Chatelier pyrometer the melting-point of 42 samples of pig iron of different grades. The range was from 2030° F. for pig containing 3.98% combined carbon to 2280 for pig containing 0.13 combined carbon and 3.43% graphite. The results of the whole series may be expressed within 30° F. by the formula $Temp. = 2300° - 70 \times \% \text{ of combined carbon}$.

Hobson's Hot-blast Pyrometer consists of a brass chamber having three hollow arms and a handle. The hot blast enters one of the arms and induces a current of atmospheric air to flow into the second arm. The two currents mix in the chamber and flow out through the third arm, in which the temperature of the mixture is taken by a mercury thermometer. The openings in the arms are adjusted so that the proportion of hot blast to the atmospheric air remains the same.

The Wiborgh Air-pyrometer. (E. Trotz, *Trans. A.I.M.E.*, 1892.) — The inventor using the expansion-coefficient of air, as determined by Gay-Lussac, Dulong, Rudberg, and Regnault, bases his construction on the following theory: If an air-volume, V , inclosed in a porcelain globe and connected through a capillary pipe with the outside air, be heated to the temperature T (which is to be determined) and thereupon the connection be discontinued, and there be then forced into the globe containing V another volume of air V' of known temperature t , which was previously under atmospheric pressure H , the additional pressure h , due to the addition of the air-volume V' to the air-volume V , can be measured by a manometer. But this pressure is of course a function of the temperature T . Before the introduction of V' we have the two separate air-volumes, V at the temperature T , and V' at the temperature t , both under the atmospheric pressure H . After the forcing in of V' into the globe, we have, on the contrary, only the volume V of the temperature T , but under the pressure $H + h$.

Seeger Cones. (Catalog, Stowe-Fuller Co., 1907.) — Seeger cones were developed in Germany by Dr. Herman A. Seeger. They comprise a series of triangular pyramids about 3 in. high and 5/8 in. wide at the base, each a trifle less fusible than the next. When the series is placed in a furnace whose temperature is gradually raised, one cone after another will bend as its temperature of plasticity is reached. The temperature at which it bends so far that its apex touches the surface supporting it, determines a point on Seeger's scale. Seeger used as his standard, Zettlitz kaolin and Rackonitz shale clay of the following analyses:

	Silica.	Alu- mina.	Lime.	Iron Oxide.	Mag- nesia.	{ Potash Soda. }	Loss on Ig- nition.
Zettlitz kaolin...	46.87	38.56	trace	0.83	trace	1.06	12.73
Rackonitz clay..	52.50	45.22	0.50	0.81	0.54	trace	0.78

Rackonitz shale clay consists of 99.27% clay substance and 0.73% sand. The melting-point of a cone depends on the ratio of alumina to silica and the amount of fluxes contained. The following table shows the chemical formulæ, mixtures and melting-points of Seger cones from 1 to 38. The temperatures corresponding to the melting-points of cones 21 to 26 are attained in the iron and steel industries. Cones 26 to 36 serve to determine the refractoriness of clays.

Cone.	Chemical Composition.					Mixture.					Melting-Point.	
	K ₂ O.	CaO.	Fe ₂ O ₃ .	Al ₂ O ₃ .	SiO ₂ .	Feldspar.	Marble.	Quartz.	Iron Oxide.	Zettlitz Kaolin.	Fahr.	Cent.
1	0.3	0.7	0.2	0.3	4	83.55	35	66	16.0	...	2102	1150
2	0.3	0.7	0.1	0.4	4	83.55	35	60	8.0	12.95	2138	1170
3	0.3	0.7	0.05	0.45	4	83.55	35	57	4.0	19.43	2174	1190
4	0.3	0.7	0.5	4	83.55	35	54	25.90	2210	1210
5	0.3	0.7	0.5	5	83.55	35	84	25.90	2246	1230
6	0.3	0.7	0.6	6	83.55	35	108	38.85	2282	1250
7	0.3	0.7	0.7	7	83.55	35	132	51.80	2318	1270
8	0.3	0.7	0.8	8	83.55	35	156	64.75	2354	1290
9	0.3	0.7	0.9	9	83.55	35	180	77.70	2390	1310
10	0.3	0.7	1.0	10	83.55	35	204	90.65	2426	1330
11	0.3	0.7	1.2	12	83.55	35	252	116.55	2462	1350
12	0.3	0.7	1.4	14	83.55	35	300	142.45	2498	1370
13	0.3	0.7	1.6	16	83.55	35	348	168.35	2534	1390
14	0.3	0.7	1.8	18	83.55	35	396	194.25	2570	1410
15	0.3	0.7	2.1	21	83.55	35	468	233.10	2606	1430
16	0.3	0.7	2.4	24	83.55	35	540	271.95	2642	1450
17	0.3	0.7	2.7	27	83.55	35	612	310.80	2678	1470
18	0.3	0.7	3.1	31	83.55	35	708	362.60	2714	1490
19	0.3	0.7	3.5	35	83.55	35	804	414.40	2750	1510
20	0.3	0.7	3.9	39	83.55	35	900	466.20	2786	1530
21	0.3	0.7	4.4	44	83.55	35	1020	530.95	2822	1550
22	0.3	0.7	4.9	49	83.55	35	1140	595.70	2858	1570
23	0.3	0.7	5.4	54	83.55	35	1260	660.45	2894	1590
24	0.3	0.7	6.0	60	83.55	35	1404	738.15	2930	1610
25	0.3	0.7	6.6	66	83.55	35	1548	815.85	2966	1630
26	0.3	0.7	7.2	72	83.55	35	1692	893.55	3002	1650
27	0.3	0.7	20.0	200	83.55	35	4764	2551.13	3038	1670
28	1.0	10	240	129.50	3074	1690
29	1.0	8	180	129.5	3110	1710
30	1.0	6	120	129.5	3146	1730
31	1.0	5	90	129.5	3182	1750
32	1.0	4	60	129.5	3218	1770
33	1.0	3	30	129.5	3254	1790
34	1.0	2.5	15	129.5	3290	1810
35	1.0	2	3326	1830
36	3362	1850

Mesuré and Nouel's Pyrometric Telescope. (H. M. Howe, *E. and M. J.*, June 7, 1890.) — Mesuré and Nouel's telescope gives an immediate determination of the temperature of incandescent bodies, and is therefore better adapted to cases where a great number of observations are to be made, and at short intervals, than Seeger's. The little telescope, carried in the pocket or hung from the neck, can be used by foreman or heater at any moment.

It is based on the fact that a plate of quartz, cut at right angles to the axis, rotates the plane of polarization of polarized light to a degree nearly inversely proportional to the square of the length of the waves; and, further, on the fact that while a body at dull redness merely emits red

light, as the temperature rises, the orange, yellow, green, and blue waves successively appear.

If, now, such a plate of quartz is placed between two Nicol prisms at right angles, a ray of monochromatic light which passes the first, or polarizer, and is watched through the second, or analyzer, is not extinguished as it was before interposing the quartz. Part of the light passes the analyzer, and, to again extinguish it, we must turn one of the Nicols a certain angle, depending on the length of the waves of light, and hence on the temperature of the incandescent object which emits this light. Hence the angle through which we must turn the analyzer to extinguish the light is a measure of the temperature of the object observed.

The Uehling and Steinbart Pyrometer. (For illustrated description see *Engineering*, Aug. 24, 1894.)—The action of the pyrometer is based on a principle which involves the law of the flow of gas through minute apertures in the following manner: If a closed tube or chamber be supplied with a minute inlet and a minute outlet aperture, and air be caused by a constant suction to flow in through one and out through the other of these apertures, the tension in the chamber between the apertures will vary with the difference of temperature between the inflowing and outflowing air. If the inflowing air be made to vary with the temperature to be measured, and the outflowing air be kept at a certain constant temperature, then the tension in the space or chamber between the two apertures will be an exact measure of the temperature of the inflowing air, and hence of the temperature to be measured.

In operation it is necessary that the air be sucked into it through the first minute aperture at the temperature to be measured, through the second aperture at a lower but constant temperature, and that the suction be of a constant tension. The first aperture is therefore located in the end of a platinum tube in the bulb of a porcelain tube over which the hot blast sweeps, or inserted into the pipe or chamber containing the gas whose temperature is to be ascertained.

The second aperture is located in a coupling, surrounded by boiling water, and the suction is obtained by an aspirator and regulated by a column of water of constant height.

The tension in the chamber between the apertures is indicated by a manometer.

The Air-thermometer. (Prof. R. C. Carpenter, *Eng'g News*, Jan. 5, 1893.)—Air is a perfect thermometric substance, and if a given mass of air be considered, the product of its pressure and volume divided by its absolute temperature is in every case constant. If the volume of air remain constant, the temperature will vary with the pressure; if the pressure remain constant, the temperature will vary with the volume. As the former condition is more easily attained, air-thermometers are usually constructed of constant volume, in which case the absolute temperature will vary with the pressure.

If we denote pressures by p and p' , and the corresponding absolute temperatures by T and T' , we should have

$$p : p' :: T : T' \text{ and } T' = p' \frac{T}{p}$$

The absolute temperature T is to be considered in every case 460 higher than the thermometer-reading expressed in Fahrenheit degrees. From the form of the above equation, if the pressure p corresponding to a known absolute temperature T be known, T' can be found. The quotient T/p is a constant which may be used in all determinations with the instrument. The pressure on the instrument can be expressed in inches of mercury, and is evidently the atmospheric pressure b as shown by a barometer, plus or minus an additional amount h shown by a manometer attached to the air-thermometer. That is, in general, $p = b \pm h$.

The temperature of 32° F. is fixed as the point of melting ice, in which case $T = 460 + 32 = 492^\circ$ F. This temperature can be produced by surrounding the bulb in melting ice and leaving it several minutes, so that the temperature of the confined air shall acquire that of the surrounding ice. When the air is at that temperature, note the reading of the attached manometer h , and that of a barometer; the sum will be the value of p corresponding to the absolute temperature of 492° F. The constant of the instrument, $K = 492 \div p$, once obtained, can be used in all future determinations.

High Temperatures judged by Color.—The temperature of a body can be approximately judged by the experienced eye unaided. M. Pouillet in 1836 constructed a table, which has been generally quoted in the text-books, giving the colors and their corresponding temperature, but which is now replaced by the tables of H. M. Howe and of Maunsel White and F. W. Taylor (*Trans. A. S. M. E.*, 1899), which are given below.

Howe.	° C.	° F.	White and Taylor.	° C.	° F.
Lowest red visible in dark..	470	878	Dark blood-red, black-red	990
Lowest red visible in day-light.....	475	887	Dark red, blood-red, low red	556	1050
Dull red.....	550 to 625	1022 to 1157	Dark cherry-red.....	635	1175
Full cherry.....	700	1292	Medium cherry-red.....	1250
Light red.....	850	1562	Cherry, full red.....	746	1375
Full yellow.....	950 to 1000	1742 to 1832	Light cherry, light red*.	843	1550
Light yellow.....	1050	1922	Orange, free scaling heat	899	1650
White.....	1150	2102	Light orange.....	941	1725
			Yellow	996	1825
			Light yellow.....	1079	1975
			White.....	1205	2200

* Heat at which scale forms and adheres on iron and steel, i.e., does not fall away from the piece when allowed to cool in air.

Skilled observers may vary 100° F. or more in their estimation of relatively low temperatures by color, and beyond 2200° F. it is practically impossible to make estimations with any certainty whatever. (Bulletin No. 2, Bureau of Standards, 1905.)

In confirmation of the above paragraph we have the following, in a booklet published by the Halcomb Steel Co., 1908.

° C.	° F.	Colors.	° C.	° F.	Colors.
400	752	Red, visible in the dark.	1000	1832	Bright cherry-red.
474	885	Red, visible in the twilight.	1100	2012	Orange-red.
525	975	Red, visible in the day-light.	1200	2192	Orange-yellow.
			1300	2372	Yellow-white.
581	1077	Red, visible in the sun-light.	1400	2552	White welding heat.
			1500	2732	Brilliant white.
700	1292	Dark red.	1600	2912	Dazzling white (bluish white).
800	1472	Dull cherry-red.			
900	1652	Cherry-red.			

Different substances heated to the same temperature give out the same color tints. Objects which emit the same tint and intensity of light cannot be distinguished from each other, no matter how different their texture, surface, or shape may be. When the temperature at all parts of a furnace at a low yellow heat is the same, different objects inside the furnace (firebrick, sand, platinum, iron) become absolutely invisible. (H. M. Howe.)

A bright bar of iron, slowly heated in contact with air, assumes the following tints at annexed temperatures (Claudel):

	Cent.	Fahr.		Cent.	Fahr.
Yellow at.....	225	437	Indigo at.....	288	550
Orange at.....	243	473	Blue at.....	293	559
Red at.....	265	509	Green at.....	332	630
Violet at.....	277	531	"Oxide-gray"....	400	752

The Halcomb Steel Co. (1908) gives the following heats and temper colors of steel:

Cent.	Fahr.	Colors.	Cent.	Fahr.	Colors.
221.1	430	Very pale yellow.	265.6	510	Spotted red-brown.
226.7	440	Light yellow.	271.1	520	Brown-purple.
232.2	450	Pale straw-yellow.	276.7	530	Light purple.
237.8	460	Straw-yellow.	282.2	540	Full purple.
243.3	470	Deep straw-yellow.	287.8	550	Dark purple.
248.9	480	Dark yellow.	293.3	560	Full blue.
254.4	490	Yellow-brown.	298.9	570	Dark blue.
260.0	500	Brown-yellow.	315.6	600	Very dark blue.

BOILING-POINTS AT ATMOSPHERIC PRESSURE.

14.7 lbs. per square inch.

Ether, sulphuric.....	100° F.	Saturated brine.....	226° F.
Carbon bisulphide.....	118	Nitric acid.....	248
Ammonia.....	140	Oil of turpentine.....	315
Chloroform.....	140	Aniline.....	363
Bromine.....	145	Naphthaline.....	428
Wood spirit.....	150	Phosphorus.....	554
Alcohol.....	173	Sulphur.....	833
Benzine.....	176	Sulphuric acid.....	590
Water.....	212	Linseed oil.....	597
Average sea-water.....	213.2	Mercury.....	676

The boiling-points of liquids increase as the pressure increases.

MELTING-POINTS OF VARIOUS SUBSTANCES.

The following figures are given by Clark (on the authority of Pouillet, Claudel, and Wilson), except those marked *, which are given by Prof. Roberts-Austen, and those marked †, which are given by Dr. J. A. Harker. These latter are probably the most reliable figures.

Sulphurous acid.....	- 148° F.	Cadmium.....	442° F.
Carbonic acid.....	- 108	Bismuth.....	504 to 507
Mercury.....	- 39, - 38†	Lead.....	618*, 620†
Bromine.....	+ 9.5	Zinc.....	779*, 786†
Turpentine.....	14	Antimony.....	1150, 1169†
Hyponitric acid.....	16	Aluminum.....	1157*, 1214†
Ice.....	32	Magnesium.....	1200
Nitro-glycerine.....	45	NaCl, common salt.....	1472†
Tallow.....	92	Calcium.....	Full red heat.
Phosphorus.....	112	Bronze.....	1692
Acetic acid.....	113	Silver.....	1733*, 1751†
Stearine.....	109 to 120	Potassium sulphate.....	1859*, 1958†
Spermaceti.....	120	Gold.....	1913*, 1947†
Margaric acid.....	131 to 140	Copper.....	1929*, 1943†
Potassium.....	136 to 144	Nickel.....	2600†
Wax.....	142 to 154	Cast iron, white.....	1922, 2075†
Stearic acid.....	158	" gray.....	2012 to 2786, 2228*
Sodium.....	194 to 208	Steel.....	2372 to 2532*
Iodine.....	225	" hard.....	2570*; mild, 2687
Sulphur.....	239	Wrought iron.....	2732 to 2912, 2737*
Alloy, 1½ tin, 1 lead.....	334, 367†	Palladium.....	2732*
Tin.....	446, 449†	Platinum.....	3227*, 3110†

Cobalt and manganese, fusible in highest heat of a forge. Tungsten and chromium, not fusible in forge, but soften and agglomerate. Platinum and iridium, fusible only before the oxyhydrogen blowpipe, or in an electrical furnace. For melting-point of fusible alloys see Alloys. For boiling and freezing points of air and other gases see p. 580.

QUANTITATIVE MEASUREMENT OF HEAT.

Unit of Heat. — The British thermal unit, or heat unit (B.T.U.), is the quantity of heat required to raise the temperature of 1 lb. of pure water from 62° to 63° F. (Peabody), or $\frac{1}{180}$ of the heat required to raise the temperature of 1 lb. of water from 32° to 212° F. (Marks and Davis, see Steam, p. 840).

The French thermal unit, or *calorie*, is the quantity of heat required to raise the temperature of 1 kilogram of pure water from 15° C. to 16° C.

1 French calorie = 3.968 British thermal units; 1 B.T.U. = 0.252 calorie. The "pound calorie" is sometimes used by English writers; it is the quantity of heat required to raise the temperature of 1 lb. of water 1° C. 1 lb. calorie = $\frac{1}{5}$ B.T.U. = 0.4536 calorie. The heat of combustion of carbon, to CO₂, is said to be 8080 calories. This figure is used either for French calories or for pound calories, as it is the number of pounds of water that can be raised 1° C. by the complete combustion of 1 lb. of carbon, or the number of kilograms of water that can be raised 1° C. by the combustion of 1 kilo. of carbon; assuming in each case that all the heat generated is transferred to the water.

The Mechanical Equivalent of Heat is the number of foot-pounds of mechanical energy equivalent to one British thermal unit, heat and

mechanical energy being mutually convertible. Joule's experiments, 1843-50, gave the figure 772, which is known as Joule's equivalent. More recent experiments by Prof. Rowland (*Proc. Am. Acad. Arts and Sciences*, 1880; see also Wood's *Thermodynamics*) give higher figures, and the most probable average is now considered to be 778.

1 heat-unit is equivalent to 778 ft.-lbs. of energy. 1 ft.-lb. = $\frac{1}{778}$ = 0.0012852 heat-unit. 1 horse-power = 33,000 ft.-lbs. per minute = 2545 heat-units per hour = 42.416 + per minute = 0.70694 per second. 1 lb. carbon burned to CO₂ = 14,600 heat-units. 1 lb. C per H.P. per hour = $2545 \div 14,600$ = 17.43% efficiency.

Heat of Combustion of Various Substances in Oxygen.

	Heat-units.		Authority.
	Cent.	Fahr.	
Hydrogen to liquid water at 0° C..	34,462	62,032	Favre and Silbermann.
	33,808	60,854	Andrews.
" to steam at 100° C.....	34,342	61,816	Thomsen.
	28,732	51,717	Favre and Silbermann.
Carbon (wood charcoal) to carbonic acid, CO ₂ ; ordinary temperatures.....	8,080	14,544	Andrews.
	7,960	14,220	
Carbon, diamond to CO ₂	8,137	14,647	Berthelot.
	7,859	14,146	
" black diamond to CO ₂	7,861	14,150	"
	7,901	14,272	
Carbon to carbonic oxide, CO.....	2,473	4,451	Favre and Silbermann.
	2,403	4,325	
Carbonic oxide to CO ₂ per unit of CO.....	2,431	4,376	Andrews.
	2,385	4,293	
CO to CO ₂ per unit of C = $\frac{21}{3} \times 2403$	5,607	10,093	Favre and Silbermann.
	13,120	23,616	
Marsh-gas, Methane, CH ₄ , to water and CO ₂	13,108	23,594	Andrews.
	13,063	23,513	
Olefiant gas, Ethylene, C ₂ H ₄ , to water and CO ₂	11,858	21,344	Favre and Silbermann.
	11,942	21,496	
Benzole gas, C ₆ H ₆ , to water and CO ₂	11,957	21,523	Andrews.
	10,102	18,184	
	9,915	17,847	Favre and Silbermann.

In calculations of the heating value of mixed fuels the value for carbon is commonly taken at 14,600 B.T.U., and that of hydrogen at 62,000. Taking the heating value of C burned to CO₂ at 14,000, and that of C to CO at 4450, the difference, 10,150 B.T.U., is the heat lost by the imperfect combustion of each lb. of C burned to CO instead of to CO₂. If the CO formed by this imperfect combustion is afterwards burned to CO₂ the lost heat is regained.

In burning 1 pound of hydrogen with 8 pounds of oxygen to form 9 pounds of water, the units of heat evolved are 62,000; but if the resulting product is not cooled to the initial temperature of the gases, part of the heat is rendered latent in the steam. The total heat of 1 lb. of steam at 212° F. is 1150.0 heat-units above that of water at 32°, and 9×1150 = 10,350 heat-units, which deducted from 62,000 gives 51,650 as the heat evolved by the combustion of 1 lb. of hydrogen and 8 lbs. of oxygen at 32° F. to form steam at 212° F.

Some writers subtract from the total heating value of hydrogen only the latent heat of the 9 lbs. of steam, or 9×969.7 = 8727 B.T.U., leaving as the "low" heating value 53,273 B.T.U.

The use of heating values of hydrogen "burned to steam," in computations relating to combustion of fuel, is inconvenient, since it necessitates a statement of the conditions upon which the figures are based; and it is, moreover, misleading, if not inaccurate, since hydrogen in fuel is not often burned in pure oxygen, but in air; the temperature of the gases before burning is not often the assumed standard temperature, and the products of combustion are not often discharged at 212°. In steam-

boiler practice the chimney gases are usually discharged above 300°; but if economizers are used, and the water supplied to them is cold, the gases may be cooled to below 212°, in which case the steam in the gases is condensed and its latent heat of evaporation is utilized. If there is any need at all of using figures of the "available" heating value of hydrogen, or its heating value when "burned to steam," the fact that the gas is burned in air and not in pure oxygen should be taken into consideration. The resulting figures will then be much lower than those above given, and they will vary with different conditions. (Kent, "Steam Boiler Economy," p. 23.)

Suppose that 1 lb. of H is burned in twice the quantity of air required for complete combustion, or $2 \times (8 \text{ O} + 26.56 \text{ N}) = 69.12$ lbs. air supplied at 62° F., and that the products of combustion escape at 562° F. The heat lost in the products of combustion will be

9 lbs. water heated from 62° to 212°.....	1352	B.T.U.
Latent heat of 9 lbs. H ₂ O at 212°, 9×969.7	8727	"
Superheated steam, 9 lbs. $\times (562^\circ - 212^\circ) \times 0.48$ (sp. ht.)	1512	"
Nitrogen, $26.56 \times (562^\circ - 62^\circ) \times 0.2438$	3238	"
Excess air, $34.56 \times (562^\circ - 62^\circ) \times 0.2375$	4104	"
Total.....	18,933	"

which subtracted from 62,000 gives 43,067 B.T.U. as the net available heating value under the conditions named.

Heating Value of Compound or Mixed Fuels. — The heating value of a solid compound or mixed fuel is the sum of its elementary constituents, and is calculated as follows by Dulong's formula:

$$\text{B.T.U.} = \frac{1}{100} \left[14,600 \text{ C} + 62,000 \left(\text{H} - \frac{\text{O}}{8} \right) + 4500 \text{ S} \right];$$

in which C, H, O, and S are respectively the percentages of the several elements. The term $\text{H} - \frac{1}{8} \text{O}$ is called the "available" or "disposable" hydrogen, or that which is not combined with oxygen in the fuel. For all the common varieties of coal, cannel coal and some lignites excepted, the formula is accurate within the limits of error of chemical analyses and calorimetric determinations.

Heat Absorbed by Decomposition. — By the decomposition of a chemical compound as much heat is absorbed or rendered latent as was evolved when the compound was formed. If 1 lb. of carbon is burned to CO₂, generating 14,600 B.T.U., and the CO₂ thus formed is immediately reduced to CO in the presence of glowing carbon, by the reaction $\text{CO}_2 + \text{C} = 2 \text{CO}$, the result is the same as if the 2 lbs. C had been burned directly to 2 CO, generating $2 \times 4450 = 8900$ B.T.U. The 2 lbs. C burned to CO₂ would generate $2 \times 14,600 = 29,200$ B.T.U., the difference, $29,200 - 8900 = 20,300$ B.T.U., being absorbed or rendered latent in the 2 CO, or 10,150 B.T.U. for each pound of carbon.

In like manner if 9 lbs. of water be injected into a large bed of glowing coal, it will be decomposed into 1 lb. H and 8 lbs. O. The decomposition will absorb 62,000 B.T.U., cooling the bed of coal this amount, and the same quantity of heat will again be evolved if the H is subsequently burned with a fresh supply of O. The 8 lbs. of O will combine with 6 lbs. C, forming 14 lbs. CO (since CO is composed of 12 parts C to 16 parts O), generating $6 \times 4450 = 26,700$ B.T.U., and $6 \times 10,150 = 60,900$ B.T.U. will be latent in this 14 lbs. CO, to be evolved later if it is burned to CO₂ with an additional supply of 8 lbs. O.

SPECIFIC HEAT.

Thermal Capacity. — The thermal capacity of a body between two temperatures T_0 and T_1 is the quantity of heat required to raise the temperature from T_0 to T_1 . The ratio of the heat required to raise the temperature of a certain weight of a given substance one degree to that required to raise the temperature of the same weight of water from 62° to 63° F. is commonly called the *specific heat* of the substance. Some writers object to the term as being an inaccurate use of the words "specific" and "heat." A more correct name would be "coefficient of thermal capacity."

Determination of Specific Heat.—Method by Mixture.—The body whose specific heat is to be determined is raised to a known temperature, and is then immersed in a mass of liquid of which the weight, specific

heat, and temperature are known. When both the body and the liquid have attained the same temperature, this is carefully ascertained.

Now the quantity of heat lost by the body is the same as the quantity of heat absorbed by the liquid.

Let $c, w,$ and t be the specific heat, weight, and temperature of the hot body, and $c', w',$ and t' of the liquid. Let T be the temperature the mixture assumes.

Then, by the definition of specific heat, $c \times w \times (t - T) =$ heat-units lost by the hot body, and $c' \times w' \times (T - t') =$ heat-units gained by the cold liquid. If there is no heat lost by radiation or conduction, these must be equal, and

$$cw(t - T) = c'w'(T - t') \text{ or } c = \frac{c'w'(T - t')}{w(t - T)}$$

Electrical Method. This method is believed to be more accurate in many cases than the method by mixture. It consists in measuring the quantity of current in watts required to heat a unit weight of a substance one degree in one minute, and translating the result into heat-units. 1 Watt = 0.0569 B.T.U. per minute.

Specific Heats of Various Substances.

The specific heats of substances, as given by different authorities show considerable lack of agreement, especially in the case of gases.

The following tables give the mean specific heats of the substances named according to Regnault. (From Röntgen's Thermodynamics, p. 134.) These specific heats are average values, taken at temperatures which usually come under observation in technical application. The actual specific heats of all substances, in the solid or liquid state, increase slowly as the body expands or as the temperature rises. It is probable that the specific heat of a body when liquid is greater than when solid. For many bodies this has been verified by experiment.

SOLIDS.

Antimony.....	0.0508	Steel (soft).....	0.1165
Copper.....	0.0951	Steel (hard).....	0.1175
Gold.....	0.0324	Zinc.....	0.0956
Wrought iron.....	0.1138	Brass.....	0.0939
Glass.....	0.1937	Ice.....	0.5040
Cast iron.....	0.1298	Sulphur.....	0.2026
Lead.....	0.0314	Charcoal.....	0.2410
Platinum.....	0.0324	Alumina.....	0.1970
Silver.....	0.0570	Phosphorus.....	0.1987
Tin.....	0.0562		

LIQUIDS.

Water.....	1.0000	Mercury.....	0.0333
Lead (melted).....	0.0402	Alcohol (absolute).....	0.7000
Sulphur ".....	0.2340	Fusel oil.....	0.5640
Bismuth ".....	0.0308	Benzine.....	0.4500
Tin ".....	0.0637	Ether.....	0.5034
Sulphuric acid.....	0.3350		

GASES.

	Constant Pressure.	Constant Volume.
Air.....	0.23751	0.16847
Oxygen.....	0.21751	0.15507
Hydrogen.....	3.40900	2.41226
Nitrogen.....	0.24380	0.17273
Superheated steam*.....	0.4805	0.346
Carbonic acid.....	0.217	0.1535
Olefiant gas (CH ₂).....	0.404	0.173
Carbonic oxide.....	0.2479	0.1758
Ammonia.....	0.508	0.299
Ether.....	0.4797	0.3411
Alcohol.....	0.4534	0.3200
Acetic acid.....	0.4125
Chloroform.....	0.1567

* See Superheated Steam, page 838.

In addition to the above, the following are given by other authorities. (Selected from various sources.)

METALS.

Platinum, 32° to 446° F.... 0.0333 (increased .000305 for each 100° F.)	Wrought iron (Petit & Dulong). 32° to 212° .. 0.1098
Cadmium..... 0.0567	" 32° to 392° .. 0.115
Brass..... 0.0939	" 32° to 572° .. 0.1218
Copper, 32° to 212° F..... 0.094	" 32° to 662° .. 0.1253
" 32° to 572° F..... 0.1013	Iron at high temperatures. (Pionchon, <i>Comptes Rendus</i> , 1887.)
Zinc, 32° to 212° F..... 0.0927	1382° to 1832° F..... 0.213
" 32° to 572° F..... 0.1015	1749° to 1843° F..... 0.218
Nickel..... 0.1086	1922° to 2192° F..... 0.199
Aluminum, 0° F. to melting-point (A. E. Hunt)..... 0.2185	

Dr.-Ing. P. Oberhoffer, in *Zeit. des Vereines Deutscher Ingenieure (Eng. Digest*, Sept., 1908), describes some experiments on the specific heat of nearly pure iron. The following mean specific heats were obtained:

Temp. F.	500	600	800	1000	1200	1300
Sp. Ht.	0.1228	0.1266	0.1324	0.1338	0.1462	0.1601
Temp. F.	1500	1800	2100	2400	2700	
Sp. Ht.	0.1698	0.1682	0.1667	0.1662	0.1666	

The specific heat increases steadily between 500 and 1200 F. Then it increases rapidly to 1400, after which it remains nearly constant.

OTHER SOLIDS.

Brickwork and masonry, about 0.20	Coal 0.20 to 0.241
Marble..... 0.210	Coke..... 0.203
Chalk..... 0.215	Graphite..... 0.202
Quicklime..... 0.217	Sulphate of lime..... 0.197
Magnesian limestone..... 0.217	Magnesia..... 0.222
Silica..... 0.191	Soda..... 0.231
Corundum..... 0.198	Quartz..... 0.188
Stones generally 0.2 to 0.22	River sand..... 0.195

WOODS.

Pine (turpentine)..... 0.467	Oak..... 0.570
Fir..... 0.650	Pear..... 0.500

LIQUIDS.

Alcohol, density 0.793..... 0.622	Olive oil..... 0.310
Sulphuric acid, density 1.87... 0.335	Benzine..... 0.393
" 1.30... 0.661	Turpentine, density 0.872... 0.472
Hydrochloric acid..... 0.600	Bromine..... 1.111

GASES.

		At Constant Pressure.	At Constant Volume.
Sulphurous acid.....		0.1553	0.1246
Light carbureted hydrogen, marsh gas (CH ₄) ..		0.5929	0.4683
Blast-furnace gases.....		0.2277	

Specific Heat of Water. (Peabody's Steam Tables, from Barnes and Regnault.)

°C.	°F.	Sp. Ht.	°C.	°F.	Sp. Ht.	°C.	°F.	Sp. Ht.	°C.	°F.	Sp. Ht.
0	32	1.0094	35	95	0.99735	70	158	1.00150	120	248	1.01670
5	41	1.00530	40	104	0.99735	75	167	1.00275	140	284	1.02230
10	50	1.00730	45	113	0.99760	80	176	1.00415	160	320	1.02850
15	59	1.00030	50	122	0.99800	85	188	1.00557	180	356	1.03475
20	68	0.99895	55	131	0.99850	90	194	1.00705	200	392	1.04100
25	77	0.99806	60	140	0.99940	95	203	1.00855	220	428	1.04760
30	86	0.99759	65	149	1.00040	100	212	1.01010			

Specific Heat of Salt Solution. (Schuller.)

Per cent salt in solution ...	5	10	15	20	25
Specific heat.....	0.9306	0.8909	0.8606	0.8490	0.8073

Specific Heat of Air.—Regnault gives for the mean value at constant pressure

Between - 30° C. and + 10° C.....	0.23771
" 0° C. " 100° C.....	0.23741
" 0° C. " 200° C.....	0.23751

Hanssen uses 0.1686 for the specific heat of air at constant volume. The value of this constant has never been found to any degree of accuracy by direct experiment. Prof. Wood gives $0.2375 \div 1.406 = 0.1689$. The ratio of the specific heat of a fixed gas at constant pressure to the sp. ht. at constant volume is given as follows by different writers (*Eng'g*, July 12, 1889): Regnault, 1.3953; Moll and Beck, 1.4085; Szathmari, 1.4027; J. Macfarlane Gray, 1.4. The first three are obtained from the velocity of sound in air. The fourth is derived from theory. Prof. Wood says: The value of the ratio for air, as found in the days of La Place, was 1.41, and we have $0.2377 \div 1.41 = 0.1686$, the value used by Clausius, Hanssen, and many others. But this ratio is not definitely known. Rankine in his later writings used 1.408, and Tait in a recent work gives 1.404, while some experiments give less than 1.4, and others more than 1.41. Prof. Wood uses 1.406.

Specific Heat of Gases. — Experiments by Mallard and Le Chatelier indicate a continuous increase in the specific heat at constant volume of steam, CO₂, and even of the perfect gases, with rise of temperature. The variation is inappreciable at 100° C., but increases rapidly at the high temperatures of the gas-engine cylinder. (Robinson's Gas and Petroleum Engines.)

Thermal Capacity and Specific Heat of Gases. (From Damour's "Industrial Furnaces.")—The specific heat of a gas at any temperature is the first derivative of the function expressing the thermal capacity. It is not possible to derive from the specific heat of a gas at a given temperature, or even from the mean specific heat between 0° and 100° C., the thermal capacity at a temperature above 100° C. The specific heats of gases under constant pressure between 0° and 100° C., given by Regnault, are not sufficient to calculate the quantity of heat absorbed by a gas in heating or radiated in cooling, hence all calculations based on these figures are subject to a more or less grave error.

The thermal capacities of a molecular volume (22.32 liters) of gases from absolute 0° (- 273° C.) to a temperature T ($= 273° + t$) may be expressed by the formula $Q = 0.001 aT + 0.000,001 bT^2$, in which a is a constant, 3.5, for all gases, and b has the following values for different gases: O₂, N₂, H₂, CO, 0.6; H₂O vapor, 2.9; CO₂, 3.7; CH₄, 6.0.

SPECIFIC HEATS OF GASES PER KILOGRAM.

Gases.	Under Constant Pressure.	Under Constant Volume.
Oxygen.....	$0.213 + 38 \times 10^{-6}t$	$0.150 + 38 \times 10^{-6}t$
Nitrogen and Carbon Monoxide.....	$0.243 + 42 \times 10^{-6}t$	$0.171 + 42 \times 10^{-6}t$
Hydrogen.....	$3.400 + 600 \times 10^{-6}t$	$2.400 + 600 \times 10^{-6}t$
Water Vapor.....	$0.447 + 324 \times 10^{-6}t$	$0.335 + 324 \times 10^{-6}t$
Carbon Dioxide.....	$0.193 + 168 \times 10^{-6}t$	$0.150 + 168 \times 10^{-6}t$
Methane.....	$0.608 + 748 \times 10^{-6}t$	$0.491 + 748 \times 10^{-6}t$

THERMAL CAPACITIES OF GASES PER KILOGRAM IN CENTIGRADE DEGREES.

Gases.	Under Constant Pressure.	Under Constant Volume.
Oxygen.....	0.213 t + 19 × 10 ⁻⁶ t ²	0.150 t + 19 × 10 ⁻⁶ t ²
Nitrogen and Carbon Monoxide.....	0.243 t + 21 × 10 ⁻⁶ t ²	0.243 t + 21 × 10 ⁻⁶ t ²
Hydrogen.....	3.400 t + 300 × 10 ⁻⁶ t ²	2.400 t + 300 × 10 ⁻⁶ t ²
Water Vapor.....	0.447 t + 162 × 10 ⁻⁶ t ²	0.335 t + 162 × 10 ⁻⁶ t ²
Carbon Dioxide.....	0.193 t + 84 × 10 ⁻⁶ t ²	0.150 t + 84 × 10 ⁻⁶ t ²
Methane or Marsh Gas.....	0.608 t + 374 × 10 ⁻⁶ t ²	0.491 t + 374 × 10 ⁻⁶ t ²

THERMAL CAPACITIES OF GASES PER KILOGRAM.

Temperatures.	THERMAL CAPACITIES OF GASES PER KILOGRAM.					
	O ₂	N ₂ , CO	H ₂	H ₂ O	CO ₂	CH ₄
Degrees Centigrade.	0	0	0	0	0	0
200.....	47.3	50	700	100	43.1	136.6
400.....	88.0	100	1400	203	91.0	303.0
600.....	134.0	154	2150	326	145.0	499.0
800.....	181.0	207	2900	461	208.0	726.0
1000.....	232.0	264	3700	609	277.0	982.0
1200.....	284.0	325	4550	770	354.0	1269.0
1400.....	334.0	383	5350	943	435.0	1584.0
1600.....	391.0	445	6250	1130	523.0	1931.0
1800.....	444.0	508	7100	1330	618.0	2307.0
2000.....	503.0	575	8050	1547	728.0	2712.0
2200.....	558.0	637	8950	1751	840.0	3148.0
2400.....	610.0	708	9900	1985	950.0	3614.0
2600.....	681.0	777	10900	2241	1070.0	4109.0
2800.....	735.0	850	11900	2520	1200.0	4635.0
3000.....	810.0	921	12950	2799	1355.0	5190.0

EXPANSION BY HEAT.

In the centigrade scale the coefficient of expansion of air per degree is 0.003665 = 1/273; that is, the pressure being constant, the volume of a perfect gas increases 1/273 of its volume at 0° C. for every increase in temperature of 1° C. In Fahrenheit units it increases 1/491.2 = 0.003620 of its volume at 32° F. for every increase of 1° F.

Expansion of Gases by Heat from 32° to 212° F. (Regnault.)

	Increase in Volume, Pressure Constant. Volume at 32° Fahr. = 1.0, for		Increase in Pressure, Volume Constant. Pressure at 32° Fahr. = 1.0, for	
	100° C.	1° F.	100° C.	1° F.
	Hydrogen.....	0.3661	0.002034	0.3667
Atmospheric air.....	0.3670	0.002039	0.3665	0.002036
Nitrogen.....	0.3670	0.002039	0.3668	0.002036
Carbon monoxide.....	0.3659	0.002038	0.3667	0.002037
Carbon dioxide.....	0.3710	0.002061	0.3688	0.002039
Sulphur dioxide.....	0.3903	0.002168	0.3845	0.002136

If the volume is kept constant, the pressure varies directly as the absolute temperature.

Lineal Expansion of Solids at Ordinary Temperatures.

(Mostly British Board of Trade; from Clark.)

	For 1° Fahr. Length = 1.	For 1° Cent. Length = 1.	Expansion from 32° to 212° F.	According to Other Authorities.
Aluminum (cast).....	0.00001234	0.00002221	0.002221	
Antimony (cryst.).....	0.00000627	0.00001129	0.001129	0.001083
Brass, cast.....	0.00000957	0.00001722	0.001722	0.001868
Brass, plate.....	0.00001052	0.00001894	0.001894	
Brick.....	0.00000306	0.00000550	0.000550	
Brick (fire).....	0.00000300	0.00000540	0.005400	
Bronze (Copper, 17; Tin, 2 1/2; Zinc, 1).....	0.00000986	0.00001774	0.001774	
Bismuth.....	0.00000975	0.00001755	0.001755	0.001392
Cement, Portland (mixed), pure.....	0.00000594	0.00001070	0.001070	
Concrete: cement-mortar and pebbles.....	0.00000795	0.00001430	0.001430	
Copper.....	0.00000887	0.00001596	0.001596	0.001718
Ebonite.....	0.00004278	0.00007700	0.007700	
Glass, English flint.....	0.00000451	0.00000812	0.000812	
Glass, thermometer.....	0.00000499	0.00000897	0.000897	
Glass, hard.....	0.00000397	0.00000714	0.000714	
Granite, gray, dry.....	0.00000438	0.00000789	0.000789	
Granite, red, dry.....	0.00000498	0.00000897	0.000897	
Gold, pure.....	0.00000786	0.00001415	0.001415	
Iridium, pure.....	0.00000356	0.00000641	0.000641	
Iron, wrought.....	0.00000648	0.00001166	0.001166	0.001235
Iron, cast.....	0.00000556	0.00001001	0.001001	0.001110
Lead.....	0.00001571	0.00002828	0.002828	
Magnesium.....				0.002694
Marbles, various { from.....	0.00000308	0.00000554	0.000554	
{ to.....	0.00000786	0.00001415	0.001415	
Masonry, brick { from.....	0.00000256	0.00000460	0.000460	
{ to.....	0.00000494	0.00000890	0.000890	
Mercury (cubic expansion).....	0.00009984	0.00017971	0.017971	0.018018
Nickel.....	0.00000695	0.00001251	0.001251	0.001279
Pewter.....	0.00001129	0.00002033	0.002033	
Plaster, white.....	0.00000922	0.00001660	0.001660	
Platinum.....	0.00000479	0.00000863	0.000863	
Platinum, 85 %, Iridium, 15 %.....	0.00000453	0.00000815	0.000815	0.000884
Porcelain.....	0.00000200	0.00000360	0.000360	
Quartz, parallel to maj. axis, 0° to 40° C.....	0.00000434	0.00000781	0.000781	
Quartz, perpend. to maj. axis, 0° to 40° C.....	0.00000788	0.00001419	0.001419	
Silver, pure.....	0.00001079	0.00001943	0.001943	0.001908
Slate.....	0.00000577	0.00001038	0.001038	
Steel, cast.....	0.00000636	0.00001144	0.001144	0.001079
Steel, tempered.....	0.00000689	0.00001240	0.001240	
Stone (sandstone), dry.....	0.00000652	0.00001174	0.001174	
Stone (sandstone), Rauville.....	0.00000417	0.00000750	0.000750	
Tin.....	0.00001163	0.00002094	0.002094	0.001938
Wedgwood ware.....	0.00000489	0.00000881	0.000881	
Wood, pine.....	0.00000276	0.00000496	0.000496	
Zinc.....	0.00001407	0.00002532	0.002532	0.002942
Zinc, 8, Tin, 1.....	0.00001496	0.00002692	0.002692	

Invar (see next page), 0.000,000,374 to 0.000,000,44 for 1° C.

Cubical expansion, or expansion of volume = linear expansion × 3.

Expansion of Steel at High Temperatures. (Charpy and Grenet, *Comptes Rendus*, 1902.) — Coefficients of expansion (for 1° C.) of annealed carbon and nickel steels at temperatures at which there is no transforma-

tion of the steel. The results seem to show that iron and carbide of iron have appreciably the same coefficient of expansion. [See also p. 474.]

Composition of Steels.				Mean Coefficients of Expansion from			Coeffs. between	
C	Mn	Si	P	1.5° to 200°	200° to 500°	500° to 650°		
0.03	0.01	0.03	0.013	11.8×10^{-6}	14.3×10^{-6}	17.0×10^{-6}	24.5×10^{-6}	880° & 950°
0.25	0.04	0.05	0.010	11.5	14.5	17.5	23.3	800° & 950°
0.64	0.12	0.14	0.009	12.1	14.1	16.5	23.3	720° & 950°
0.93	0.10	0.05	0.005	11.6	14.9	16.0	27.5	" "
1.23	0.10	0.08	0.005	11.9	14.3	16.5	33.8	" "
1.50	0.04	0.09	0.010	11.5	14.9	16.5	36.7	" "
3.50	0.03	0.07	0.005	11.2	14.2	18.0	33.3	" "

Nickel Steels.			Mean Coefficients of Expansion from				
Ni	C	Mn	15° to 100°	100° to 200°	200° to 400°	400° to 600°	600° to 900°
26.9	0.35	0.30	11.0×10^{-6}	18.0×10^{-6}	18.7×10^{-6}	22.0×10^{-6}	23.0×10^{-6}
28.9	0.35	0.36	10.0	21.5	19.0	20.0	22.7
30.1	0.35	0.34	9.5	14.0	19.5	19.0	21.3
34.7	0.36	0.36	2.0	2.5	11.75	19.5	20.7
36.1	0.39	0.39	1.5	1.5	11.75	17.0	20.3
32.8	0.29	0.66	8.0	14.0	18.0	21.5	22.3
35.8	0.31	0.69	2.5	2.5	12.5	18.75	19.3
37.4	0.30	0.69	2.5	1.5	8.5	19.75	18.3
25.4	1.01	0.79	12.5	18.5	19.75	21.0	35.0
29.4	0.99	0.89	11.0	12.5	19.0	20.5	31.7
34.5	0.97	0.84	3.0	3.5	13.0	18.75	26.7

Invar, an alloy of iron with 36 per cent of nickel, has a smaller coefficient of expansion with the ordinary atmospheric changes of temperature than any other metal or alloy known. This alloy is sold under the name of "Invar," and is used for scientific instruments, pendulums of clocks, steel tape-measures for accurate survey work, etc. The Bureau of Standards found its coefficient of expansion to range from 0.000,000,374 to 0.000,000,44 for 1° C., or about 1/28 of that of steel. For all surveys except in the most precise geodetic work a tape of invar may be used without correction for temperature. (*Eng. News*, Aug. 13, 1908.)

Platinite, an alloy of iron with 42 per cent of nickel, has the same coefficient of expansion and contraction at atmospheric temperatures as has glass. It can, therefore, be used for the manufacture of armored glass, that is, a plate of glass into which a network of steel wire has been rolled, and which is used for fire-proofing, etc. It can also be used instead of platinum for the electric connections passing through the glass plugs in the base of incandescent electric lights. (Stoughton's "Metallurgy of Steel.")

Expansion of Liquids from 32° to 212° F. — Apparent expansion in glass (Clark). Volume at 212°, volume at 32° being 1:

Water.....	1.0466	Nitric acid.....	1.11
Water saturated with salt.	1.05	Olive and linseed oils.....	1.08
Mercury.....	1.0182	Turpentine and ether.....	1.07
Alcohol.....	1.11	Hydrochloric and sulphuric acids.....	1.06

For water at various temperatures, see Water.
For air at various temperatures, see Air.

ABSOLUTE TEMPERATURE — ABSOLUTE ZERO.

The absolute zero of a gas is a theoretical consequence of the law of expansion by heat, assuming that it is possible to continue the cooling of a perfect gas until its volume is diminished to nothing.

If the volume of a perfect gas increases 1/273 of its volume at 0° C. for every increase of temperature of 1° C., and decreases 1/273 of its volume for every decrease of temperature of 1° C., then at -273° C. the volume of the imaginary gas would be reduced to nothing. This point -273° C., or 491.2° F. below the melting-point of ice on the air-thermometer, or 492.66° F. below on a perfect gas-thermometer = -459.2° F. (or -460.66°), is called the absolute zero; and absolute temperatures are temperatures measured, on either the Fahrenheit or Centigrade scale, from this zero. The freezing-point, 32° F., corresponds to 491.2° F. absolute. If p_0 be the pressure and v_0 the volume of a gas at the temperature of 32° F. = 491.2° on the absolute scale = T_0 , and p the pressure, and v the volume of the same quantity of gas at any other absolute temperature T , then

$$\frac{pv}{p_0v_0} = \frac{T}{T_0} = \frac{t + 459.2}{491.2}; \quad \frac{pv}{T} = \frac{p_0v_0}{T_0}$$

The value of $p_0v_0 \div T_0$ for air is 53.37, and $pv = 53.37T$, calculated as follows by Prof. Wood:

A cubic foot of dry air at 32° F. at the sea-level weighs 0.080728 lb. The volume of one pound is $v_0 = \frac{1}{.080728} = 12.387$ cubic feet. The pressure per square foot is 2116.2 lbs.

$$\frac{p_0v_0}{T_0} = \frac{2116.2 \times 12.387}{491.13} = \frac{26214}{491.13} = 53.37.$$

The figure 491.13 is the number of degrees that the absolute zero is below the melting-point of ice, by the air-thermometer. On the absolute scale, whose divisions would be indicated by a perfect gas-thermometer, the calculated value approximately is 492.66, which would make $pv = 53.21T$. Prof. Thomson considers that -273.1° C., = -459.4° F., is the most probable value of the absolute zero. See *Heat in Ency. Brit.*

LATENT HEATS OF FUSION AND EVAPORATION.

Latent Heat means a quantity of heat which has disappeared, having been employed to produce some change other than elevation of temperature. By exactly reversing that change, the quantity of heat which has disappeared is reproduced. Maxwell defines it as the quantity of heat which must be communicated to a body in a given state in order to convert it into another state without changing its temperature.

Latent Heat of Fusion. — When a body passes from the solid to the liquid state, its temperature remains stationary, or nearly stationary, at a certain melting-point during the whole operation of melting; and in order to make that operation go on, a quantity of heat must be transferred to the substance melted, being a certain amount for each unit of weight of the substance. This quantity is called the latent heat of fusion.

When a body passes from the liquid to the solid state, its temperature remains stationary or nearly stationary during the whole operation of freezing; a quantity of heat equal to the latent heat of fusion is produced in the body and rejected into the atmosphere or other surrounding bodies.

The following are examples in British thermal units per pound, as given in Landolt and Bornstein's *Physikalische-Chemische Tabellen* (Berlin, 1894).

Substances.	Latent Heat of Fusion.	Substances.	Latent Heat of Fusion.
Bismuth.....	22.75	Silver.....	37.93
Cast iron, gray...	41.4	Beeswax.....	76.14
Cast iron, white..	59.4	Paraffine.....	63.27
Lead.....	9.66	Spermaceti.....	66.56
Tin.....	25.65	Phosphorus.....	9.06
Zinc.....	50.63	Sulphur.....	16.86

Prof. Wood considers 144 heat-units as the most reliable value for the latent heat of fusion of ice. Person gives 142.65.

WARNING: This is a 1910 edition. Some of the material may no longer be accurate

Latent Heat of Evaporation. — When a body passes from the solid or liquid to the gaseous state, its temperature during the operation remains stationary at a certain boiling-point, depending on the pressure of the vapor produced; and in order to make the evaporation go on, a quantity of heat must be transferred to the substance evaporated, whose amount for each unit of weight of the substance evaporated depends on the temperature. That heat does not raise the temperature of the substance, but disappears in causing it to assume the gaseous state, and it is called the latent heat of evaporation.

When a body passes from the gaseous state to the liquid or solid state, its temperature remains stationary, during that operation, at the boiling-point corresponding to the pressure of the vapor: a quantity of heat equal to the latent heat of evaporation at that temperature is produced in the body; and in order that the operation of condensation may go on, that heat must be transferred from the body condensed to some other body.

The following are examples of the latent heat of evaporation in British thermal units, of one pound of certain substances, when the pressure of the vapor is one atmosphere of 14.7 lbs. on the square inch:

Substance.	Boiling-point under one atm. Fahr.	Latent Heat in British units.
Water.....	212.0	965.7 (Regnault).
Alcohol.....	172.2	364.3 (Andrews).
Ether.....	95.0	162.8 "
Bisulphide of carbon.....	114.8	158.0 "

The latent heat of evaporation of water at a series of boiling-points extending from a few degrees below its freezing-point up to about 375 degrees Fahrenheit has been determined experimentally by M. Regnault. The results of those experiments are represented approximately by the formula, in British thermal units per pound,

$$l \text{ nearly} = 1091.7 - 0.7(t - 32^\circ) = 965.7 - 0.7(t - 212^\circ).$$

Henning (*Ann. der Physik*, 1906) gives for l from 0° to 100° C.

For 1 kg., $l = 94.210(365 - t^\circ \text{C.}) + 0.31249$.

For 1 lb., $l = 141.124(689 - t^\circ \text{F.}) + 0.31249$.

The last formula gives for the latent heat at 212° F., 969.7 B.T.U.

The Total Heat of Evaporation is the sum of the heat which disappears in evaporating one pound of a given substance at a given temperature (or latent heat of evaporation) and of the heat required to raise its temperature, before evaporation, from some fixed temperature up to the temperature of evaporation. The latter part of the total heat is called the sensible heat.

In the case of water, the experiments of M. Regnault show that the total heat of steam from the temperature of melting ice increases at a uniform rate as the temperature of evaporation rises. The following is the formula in British thermal units per pound:

$$h = 1091.7 + 0.305(t - 32^\circ).$$

H. N. Davis (*Trans. A. S. M. E.*, 1908) gives, in British units, $h = 1150 + 0.3745(t - 212) - 0.000550(t - 212)^2$.

For the total heat, latent heat, etc., of steam at different pressures, see table of the Properties of Saturated Steam. For tables of total heat, latent heat, and other properties of steams of ether, alcohol, acetone, chloroform, chloride of carbon, and bisulphide of carbon, see Röntgen's *Thermodynamics* (Dubois's translation). For ammonia and sulphur dioxide, see Wood's *Thermodynamics*; also, tables under Refrigerating Machinery, in this book.

EVAPORATION AND DRYING.

In evaporation, the formation of vapor takes place on the surface; in boiling, within the liquid: the former is a slow, the latter a quick, method of evaporation.

If we bring an open vessel with water under the receiver of an air-pump and exhaust the air, the water in the vessel will commence to boil, and if we keep up the vacuum the water will actually boil near its freezing-point. The formation of steam in this case is due to the heat which the water takes out of the surroundings.

Steam formed under pressure has the same temperature as the liquid in which it was formed, provided the steam is kept under the same pressure.

By properly cooling the rising steam from boiling water, as in the multiple-effect evaporating systems, we can regulate the pressure so that the water boils at low temperatures.

Evaporation of Water in Reservoirs. — Experiments at the Mount Hope Reservoir, Rochester, N. Y., in 1891, gave the following results:

	July.	Aug.	Sept.	Oct.
Mean temperature of air in shade.....	70.5	70.3	68.7	53.3
" " " water in reservoir....	68.2	70.2	66.1	54.4
" humidity of air, per cent.....	67.0	74.6	75.2	74.7
Evaporation in inches during month.....	5.59	4.93	4.05	3.23
Rainfall in inches during month.....	3.44	2.95	1.44	2.16

Evaporation of Water from Open Channels. (Flynn's Irrigation Canals and Flow of Water.) — Experiments from 1881 to 1885 in Tulare County, California, showed an evaporation from a pan in the river equal to an average depth of $\frac{1}{8}$ in. per day throughout the year.

When the pan was in the air the average evaporation was less than $\frac{3}{16}$ in. per day. The average for the month of August was $\frac{1}{3}$ in. per day, and for March and April $\frac{1}{12}$ in. per day. Experiments in Colorado show that evaporation ranges from 0.088 to 0.16 in. per day during the irrigating season.

In Northern Italy the evaporation was from $\frac{1}{12}$ to $\frac{1}{9}$ inch per day, while in the south, under the influence of hot winds, it was from $\frac{1}{6}$ to $\frac{1}{5}$ inch per day.

In the hot season in Northern India, with a decidedly hot wind blowing, the average evaporation was $\frac{1}{2}$ inch per day. The evaporation increases with the temperature of the water.

Evaporation by the Multiple System. — A multiple effect is a series of evaporating vessels each having a steam chamber, so connected that the heat of the steam or vapor produced in the first vessel heats the second, the vapor or steam produced in the second heats the third, and so on. The vapor from the last vessel is condensed in a condenser. Three vessels are generally used; in which case the apparatus is called a *Triple Effect*. In evaporating in a triple effect the vacuum is graduated so that the liquid is boiled at a constant and low temperature.

A series distilling apparatus of high efficiency is described by W. F. M. Goss in *Trans. A. S. M. E.*, 1903. It has seven chambers in series, and is designed to distill 500 gallons of water per hour with an efficiency of approximately 60 lbs. of water per pound of coal.

Tests of Yaryan six-effect machines have shown as high as 44 lbs. of water evaporated per pound of fuel consumed. — *Mach'y.*, April, 1905. A description of a large distilling apparatus, using three 125-H.P. boilers and a Lillie triple effect, with record of tests, is given in *Eng. News*, Mar. 29, 1900, and in *Jour. Am. Soc'y of Naval Engineers*, Feb., 1900.

Resistance to Boiling. — **Brine.** (Rankine.) — The presence in a liquid of a substance dissolved in it (as salt in water) resists ebullition, and raises the temperature at which the liquid boils, under a given pressure; but unless the dissolved substance enters into the composition of the vapor, the relation between the temperature and pressure of saturation of the vapor remains unchanged. A resistance to ebullition is also offered by a vessel of a material which attracts the liquid (as when water boils in a glass vessel), and the boiling takes place by starts. To avoid the errors which causes of this kind produce in the measurement of boiling-points, it is advisable to place the thermometer, not in the liquid, but in the vapor, which shows the true boiling-point, freed from the disturbing effect of the attractive nature of the vessel. The boiling-point of saturated brine under one atmosphere is 226° F., and that of weaker brine is higher than the boiling-point of pure water by 1.2° F., for each $\frac{1}{32}$ of salt that the water contains. Average sea-water contains $\frac{1}{32}$; and the brine in marine boilers is not suffered to contain more than from $\frac{2}{32}$ to $\frac{3}{32}$.

Methods of Evaporation Employed in the Manufacture of Salt. (F. E. Engelhardt, Chemist Onondaga Salt Springs; Report for 1889.) — 1. Solar heat — solar evaporation. 2. Direct fire, applied to the heating surface of the vessels containing brine — kettle and pan methods. 3. The steam-grainer system — steam-pans, steam-kettles, etc. 4. Use

of steam and a reduction of the atmospheric pressure over the boiling brine — vacuum system.

When a saturated salt solution boils, it is immaterial whether it is done under ordinary atmospheric pressure at 228° F., or under four atmospheres with a temperature of 320° F., or in a vacuum under 1/10 atmosphere, the result will always be a fine-grained salt.

The fuel consumption is stated to be as follows: By the kettle method, 40 to 45 bu. of salt evaporated per ton of fuel, anthracite dust burned on perforated grates; evaporation, 5.53 lbs. of water per pound of coal. By the pan method, 70 to 75 bu. per ton of fuel. By vacuum pans, single effect, 86 bu. per ton of anthracite dust (2000 lbs.). With a double effect nearly double that amount can be produced.

Solubility of Common Salt in Pure Water. (Andrae.)

Temp. of brine, F.....	32	50	86	104	140	176
100 parts water dissolve parts..	35.63	35.69	36.03	36.32	37.06	38.00
100 parts brine contain salt....	26.27	26.30	26.49	26.64	27.04	27.54

According to Poggial, 100 parts of water dissolve at 229.66° F., 40.35 parts of salt, or in per cent of brine, 28.749. Gay-Lussac found that at 229.72° F., 100 parts of pure water would dissolve 40.38 parts of salt, in per cent of brine, 28.764 parts.

The solubility of salt at 229° F. is only 2.5% greater than at 32°. Hence we cannot, as in the case of alum, separate the salt from the water by allowing a saturated solution at the boiling-point to cool to a lower temperature.

Strength of Salt Brines. — The following table is condensed from one given in U. S. Mineral Resources for 1888, on the authority of Dr. Engelhardt.

Relations between Salinometer Strength, Specific Gravity, Solid Contents, etc., of Brines of Different Strengths.

Salinometer, degrees.	Baumé, degrees.	Specific gravity.	Per cent of salt.	Weight of a gallon of this brine in pounds.	Pounds of salt in a gallon of brine of 231 cubic inches.	Gallons of brine required for a bushel of salt.	Pounds of water to be evaporated to produce a bushel of salt.	Lbs. of coal required to produce a bushel of salt, 1 lb. coal evaporating 6 lbs. of water.	Bushels of salt that can be made with a ton of coal of 2000 pounds.
1.....	0.26	1.002	0.265	8.347	0.022	2,531	21,076	3,513	0.569
2.....	0.52	1.003	0.530	8.356	0.044	1,264	10,538	1,752	1.141
4.....	1.04	1.007	1.060	8.389	0.088	629.7	5,227	871.2	2.295
6.....	1.56	1.010	1.590	8.414	0.133	418.6	3,466	577.7	3.462
8.....	2.08	1.014	2.120	8.447	0.179	312.7	2,585	430.9	4.641
10.....	2.60	1.017	2.650	8.472	0.224	249.4	2,057	342.9	5.833
12.....	3.12	1.021	3.180	8.506	0.270	207.0	1,705	284.2	7.038
14.....	3.64	1.025	3.710	8.539	0.316	176.8	1,453	242.2	8.256
16.....	4.16	1.028	4.240	8.564	0.364	154.2	1,265	210.8	9.488
18.....	4.68	1.032	4.770	8.597	0.410	136.5	1,118	186.3	10.73
20.....	5.20	1.035	5.300	8.622	0.457	122.5	1,001	176.8	11.99
30.....	7.80	1.054	7.950	8.781	0.698	80.21	648.4	108.1	18.51
40.....	10.40	1.073	10.600	8.939	0.947	59.09	472.3	78.71	25.41
50.....	13.00	1.093	13.250	9.105	1.206	46.41	366.6	61.10	32.73
60.....	15.60	1.114	15.900	9.280	1.475	37.94	276.2	49.36	40.51
70.....	18.20	1.136	18.550	9.464	1.755	31.89	245.9	40.98	48.80
80.....	20.80	1.158	21.200	9.647	2.045	27.38	208.1	34.69	57.65
90.....	23.40	1.182	23.850	9.847	2.348	23.84	178.8	29.80	67.11
100.....	26.00	1.205	26.500	10.039	2.660	21.04	155.3	25.88	77.26

WARNING: This is a 1910 edition. Some of the material may no longer be accurate

Solubility of Sulphate of Lime in Pure Water. (Maignac.)

Temperature F. degrees..	32	64.5	89.6	100.4	105.8	127.4	186.8	212
Parts water to dissolve } 1 part gypsum	115	386	371	368	370	375	417	452
Parts water to dissolve } part anhydrous CaSO ₄	525	488	470	466	468	474	528	572

In salt brine sulphate of lime is much more soluble than in pure water. In the evaporation of salt brine the accumulation of sulphate of lime tends to stop the operation, and it must be removed from the pans to avoid waste of fuel.

The average strength of brine in the New York salt districts in 1889 was 69.38 degrees of the salinometer.

Concentration of Sugar Solutions.* (From "Heating and Concentrating Liquids by Steam," by John G. Hudson; *The Engineer*, June 13, 1890.) — In the early stages of the process, when the liquor is of low density, the evaporative duty will be high, say two to three (British) gallons per square foot of heating surface with 10 lbs. steam pressure, but will gradually fall to an almost nominal amount as the final stage is approached. As a generally safe basis for designing, Mr. Hudson takes an evaporation of one gallon per hour for each square foot of gross heating surface, with steam of the pressure of about 10 lbs.

As examples of the evaporative duty of a vacuum pan when performing the earlier stages of concentration, during which all the heating surface can be employed, he gives the following:

COIL VACUUM PAN. — 4 3/4 in. copper coils, 528 square feet of surface; steam in coils, 15 lbs.; temperature in pan, 141° to 148°; density of feed, 25° Baumé, and concentrated to 31° Baumé.

First Trial. — Evaporation at the rate of 2000 gallons per hour = 3.8 gallons per square foot; transmission, 376 units per degree of difference of temperature.

Second Trial. — Evaporation at the rate of 1503 gallons per hour = 2.8 gallons per square foot; transmission, 265 units per degree.

As regards the total time needed to work up a charge of massecuite from liquor of a given density, the following figures, obtained by plotting the results from a large number of pans, form a guide to practical working. The pans were all of the coil type, some with and some without jackets, the gross heating surface probably averaging, and not greatly differing from, 0.25 square foot per gallon capacity, and the steam pressure 10 lbs. per square inch. Both plantation and refining pans are included, making various grades of sugar:

Density of feed (degs. Baumé).....	10°	15°	20°	25°	30°
Evaporation required per gallon massecuite discharged.....	0.123	3.6	2.26	1.5	.97
Average working hours required per charge .	12.	9.	6.5	5.	4.
Equivalent average evaporation per hour per square foot of gross surface, assuming 0.25 sq. ft. per gallon capacity.....	2.04	1.6	1.39	1.2	0.97
Fastest working hours required per charge .	3.5	5.5	3.8	2.75	2.0
Equivalent average evaporation per hour per square foot.....	2.88	2.6	2.38	2.18	1.9

The quantity of heating steam needed is practically the same in vacuum as in open pans. The advantages proper to the vacuum system are primarily the reduced temperature of boiling, and incidentally the possibility of using heating steam of low pressure.

In a solution of sugar in water, each pound of sugar adds to the volume of the water to the extent of 0.061 gallon at a low density to 0.0638 gallon at high densities.

A Method of Evaporating by Exhaust Steam is described by Albert Stearns in *Trans. A. S. M. E.*, vol. viii. A pan 17' 6" X 11' X 1' 6",

* For other sugar data, see Bagasse as Fuel, under *Fuel*.

fitted with cast-iron condensing pipes of about 250 sq. ft. of surface, evaporated 120 gallons per hour from clear water, condensing only about one-half of the steam supplied by a plain slide-valve engine of 14" X 32" cylinder, making 65 revs. per min., cutting off about two-thirds stroke, with steam at 75 lbs. boiler pressure.

It was found that keeping the pan-room warm and letting only sufficient air in to carry the vapor up out of a ventilator adds to its efficiency, as the average temperature of the water in the pan was only about 165° F.

Experiments were made with coils of pipe in a small pan, first with no agitator, then with one having straight blades, and lastly with troughed blades; the evaporative results being about the proportions of one, two, and three respectively.

In evaporating liquors whose boiling-point is 220° F., or much above that of water, it is found that exhaust steam can do but little more than bring them up to saturation strength, but on weak liquors, sirups, glues, etc., it should be very useful.

Drying in Vacuum.—An apparatus for drying grain and other substances in vacuum is described by Mr. Emil Passburg in *Proc. Inst. Mech. Engrs.*, 1889. The three essential requirements for a successful and economical process of drying are: 1. Cheap evaporation of the moisture; 2. Quick drying at a low temperature; 3. Large capacity of the apparatus.

The removal of the moisture can be effected in either of two ways: either by slow evaporation, or by quick evaporation—that is, by boiling.

Slow Evaporation.—The principal idea carried into practice in machines acting by slow evaporation is to bring the wet substance repeatedly into contact with the inner surfaces of the apparatus, which are heated by steam, while at the same time a current of hot air is also passing through the substances for carrying off the moisture. This method requires much heat, because the hot-air current has to move at a considerable speed in order to shorten the drying process as much as possible; consequently a great quantity of heated air passes through and escapes unused. As a carrier of moisture hot air cannot in practice be charged beyond half its full saturation; and it is in fact considered a satisfactory result if even this proportion be attained. A great amount of heat is here produced which is not used; while, with scarcely half the cost for fuel, a much quicker removal of the water is obtained by heating it to the boiling-point.

Quick Evaporation by Boiling.—This does not take place until the water is brought up to the boiling-point and kept there, namely, 212° F., under atmospheric pressure. The vapor generated then escapes freely. Liquids are easily evaporated in this way, because by their motion consequent on boiling the heat is continuously conveyed from the heating surfaces through the liquid, but it is different with solid substances, and many more difficulties have to be overcome, because convection of the heat ceases entirely in solids. The substance remains motionless, and consequently a much greater quantity of heat is required than with liquids for obtaining the same results.

Evaporation in Vacuum.—All the foregoing disadvantages are avoided if the boiling-point of water is lowered, that is, if the evaporation is carried out under vacuum.

This plan has been successfully applied in Mr. Passburg's vacuum drying apparatus, which is designed to evaporate large quantities of water contained in solid substances.

The drying apparatus consists of a top horizontal cylinder, surmounted by a charging vessel at one end, and a bottom horizontal cylinder with a discharging vessel beneath it at the same end. Both cylinders are incased in steam-jackets heated by exhaust steam. In the top cylinder works a revolving cast-iron screw with hollow blades, which is also heated by exhaust steam. The bottom cylinder contains a revolving drum of tubes, consisting of one large central tube surrounded by 24 smaller ones, all fixed in tube-plates at both ends; this drum is heated by live steam direct from the boiler. The substance to be dried is fed into the charging vessel through two manholes, and is carried along the top cylinder by the screw creeper to the back end, where it drops through a valve into the bottom cylinder, in which it is lifted by blades attached to the drum and travels forward in the reverse direction; from the front end of the bottom cylinder it falls into a discharging vessel through another

valve, having by this time become dried. The vapor arising during the process is carried off by an air-pump, through a dome and air-valve on the top of the upper cylinder, and also through a throttle-valve on the top of the lower cylinder; both of these valves are supplied with strainers.

As soon as the discharging vessel is filled with dried material the valve connecting it with the bottom cylinder is shut, and the dried charge taken out without impairing the vacuum in the apparatus. When the charging vessel requires replenishing, the intermediate valve between the two cylinders is shut, and the charging vessel filled with a fresh supply of wet material; the vacuum still remains unimpaired in the bottom cylinder, and has to be restored only in the top cylinder after the charging vessel has been closed again.

In this vacuum the boiling-point of the water contained in the wet material is brought down as low as 110° F. The difference between this temperature and that of the heating surfaces is amply sufficient for obtaining good results from the employment of exhaust steam for heating all the surfaces except the revolving drum of tubes. The water contained in the solid substance to be dried evaporates as soon as the latter is heated to about 110° F., and as long as there is any moisture to be removed the solid substance is not heated above this temperature.

Wet grains from a brewery or distillery, containing from 75% to 78% of water, have by this drying process been converted from a worthless incumbrance into a valuable food-stuff. The water is removed by evaporation only, no previous mechanical pressing being resorted to.

At Guinness's brewery in Dublin two of these machines are employed. In each of these the top cylinder is 20 ft. 4 in. long and 2 ft. 8 in. diam., and the screw working inside it makes 7 revs. per min.; the bottom cylinder is 19 ft. 2 in. long and 5 ft. 4 in. diam., and the drum of the tubes inside it makes 5 revs. per min. The drying surfaces of the two cylinders amount together to a total area of about 1000 sq. ft., of which about 40% is heated by exhaust steam direct from the boiler. There is only one air-pump, which is made large enough for three machines; it is horizontal, and has only one air-cylinder, which is double-acting, 17 3/4 in. diam. and 17 3/4 in. stroke; and it is driven at about 45 revs. per min. As the result of about eight months' experience, the two machines have been drying the wet grains from about 500 cwt. of malt per day of 24 hours.

Roughly speaking, 3 cwt. of malt gave 4 cwt. of wet grains, and the latter yield 1 cwt. of dried grains; 500 cwt. of malt will therefore yield about 670 cwt. of wet grains, or 335 cwt. per machine. The quantity of water to be evaporated from the wet grains is from 75% to 78% of their total weight, or, say, about 512 cwt. altogether, being 256 cwt. per machine.

Driers and Drying.

(Contributed by W. B. Ruggles, 1909.)

Materials of different physical and chemical properties require different types of drying apparatus. It is therefore necessary to classify materials into groups, as below, and design different machines for each group.

Group A: Materials which may be heated to a high temperature and are not injured by being in contact with products of combustion. These include cement rock, sand, gravel, granulated slag, clay, marl, chalk, ore, graphite, asbestos, phosphate rock, slacked lime, etc.

The most simple machine for drying these materials is a single revolving shell with lifting flights on the inside, the shell resting on bearing wheels and having a furnace at one end and a stack or fan at the other. The advantage of this style of machine is its low cost of installation and the small number of parts. The disadvantages are great cost of repairs and excessive fuel consumption, due to radiation and high temperature of the stack gases. If the material is fed from the stack and towards the furnace end, the shell near the furnace gets red-hot, causing excessive radiation and frequent repairs. Should the feed be reversed the exhaust temperature

WARNING: This is a 1910 edition. Some of the material may no longer be accurate

must be kept above 212° F., or recondensation will take place, wetting the material.

In order to economize fuel the shell is sometimes supported at the ends and brickwork is erected around the shell, the hot gases passing under the shell and back through it. Although this method is more economical in the use of fuel, the cost of installation and the cost of repairs are greater.

Group B: Materials such as will not be injured by the products of combustion but cannot be raised to a high temperature on account of driving off water or crystallization, breaking up chemical combinations, or on account of danger from ignition. Included in these are gypsum, fluor-spar, iron pyrites, coal, coke, lignite, sawdust, leather scraps, cork chips, tobacco stems, fish scraps, tankage, peat, etc. Some of these materials may be dried in a single-shell drier and some in a bricked-in machine, but none of them in a satisfactory way on account of the difficulty of regulating the temperature and, in some cases, the danger of explosion of dust.

Group C: Materials which are not injured by a high temperature but which cannot be allowed to come into contact with products of combustion. These are kaolin, ocher and other pigments, fuller's earth, which is to be used in filtering vegetable or animal oils, whitening and similar earthy materials, a large proportion of which would be lost as dust in direct-heat drying. These may be dried by passing through a single-shell drier incased in brickwork and allowing heat to come into contact with the shell only, but this is an uneconomical machine to operate, due to the high temperature of the escaping gases.

Group D: Organic materials which are used for food either by man or the lower animals, such as grain which has been wet, cotton seed, starch feed, corn germs, brewers' grains, and breakfast foods, which must be dried after cooking. These, of course, cannot be brought into contact with furnace gases and must be kept at a low temperature. For these materials a drier using either exhaust or live steam is the only practical one. This is generally a revolving shell in which are arranged steam pipes. Care should be exercised in selecting a steam drier which has perfect and automatic drainage of the pipes. The condensed steam always amounts to more than the water evaporated from the material.

Group E: Materials which are composed wholly or contain a large proportion of soluble salts, such as nitrate of soda, nitrate of potash, carbonates of soda or potash, chlorates of soda or potash, etc. These in drying form a hard scale which adheres to the shell, and a rotary drier cannot be profitably used on account of frequent stops for cleaning. The only practical machine for such materials is a semicircular cast-iron trough having a shaft through the center carrying paddles that constantly stir up the material and feed it through the drier. This machine has brick side walls and an exterior furnace; the heat from the furnace passing under the shell and back through the drying material or out through a stack or fan without passing through the material, as may be desired. Should the material also require a low temperature, the same type of drier can be used by substituting steam-jacketed steel sections instead of cast iron.

The efficiency of a drier is the ratio of the theoretical heat required to do the drying to the total heat supplied. The greatest loss is the heat carried out by the exhaust or waste gases; this may be as great as 40% of the total heat from the fuel, or with a properly designed drier may be as small as 8%. The radiation from the shell or walls may be as high as 25% or as low as 4%. The heat carried away by the dried material may amount under conditions of careless operation to as much as 25% or may be as low as nothing.

A properly designed drier of the direct-heat type for either group "A" or "B" will give an efficiency of from 75% to 85%; a bricked-in return-draught single-shell drier, from 60% to 70%; and a single-shell straight-draught dryer, from 45% to 55%. A properly designed indirect-heat drier for group "C" will give an efficiency of 50% to 60%, and a poorly designed one may not give more than 30%; The best designed steam drier for group "D," in which the losses in the boiler producing the steam must be considered, will not often give an efficiency of more than

42%; and, while a poorly designed one may have an equal efficiency, its capacity may be not more than one-half of a good drier of equal size. The drier described for group "E" will not give an efficiency of more than 55%.

Performance of Different Types of Driers.

(W. B. Ruggles.)

Type of drier	Double shell; direct heat.	Indirect heat; 705 sq. ft.	Single shell, bricked in; direct heat.	Single shell; direct heat.	Stationary, with paddles; direct heat.
Material.....	Sand.	Coal.	Cement slurry.	Lime stone.	Nitrate of soda.
Moisture, initial, per cent.....	4.58	10.2	61.2	3.6	7.2
Moisture, final, per cent.....	0	0	40.7	0.5	0.3
Calorific value of fuel, B.T.U.	12100	12290	13200	13180	13600
Fuel consumed per hour, lbs.....	398	213.6	667	460	87
Water evaporated per hour, lbs..	2196	924.2	4057	1325	349
Water evap. per pound fuel, lbs..	5.3	4.3	6.1	2.3	4.0
Material dried per hour, lbs.....	36460	8300	7680	41400	4581
Fuel per ton dried material, lbs. ...	21.8	51.3	17.3	22.2	38.0
Heat lost in exhaust air, per cent	11.3	42.8	38.4	38.2	40.7
Heat lost by radiation, etc., per cent.....	7.6	7.7	12.5	15.6	13.8
Heat used to evaporate water, per cent.....	52.5	30.4	52.0	24.4	33.1
Heat used to raise temperature of material, per cent.....	28.6	10.	7.1	21.8	12.4
Total efficiency, per cent.....	81.1	49.5	59.1	46.2	45.5

PERFORMANCE OF A STEAM DRIER.

Material: Starch feed. Moisture, initial 39.8%, final 0.22%. Dried material per hour, 831 lbs. Water evaporated per hour, 548 lbs. Steam consumed per hour, 793 lbs. Water evaporated per pound steam, 0.691 lb. Temperature of material, moist, 58°, dry, 212°. Steam pressure, 98 lbs. gauge.

Total heat to evaporate 548 lbs. water at 58° into steam,

$$548 \times (154.2 + 969.7) = 615,897 \text{ B.T.U.}$$

Heat supplied by 793 lbs. steam condensed to water at 212°,

$$793 \times (1188.2 - 180.3) = 799,265 \text{ B.T.U.}$$

Heat used to evaporate water,

$$(615,897 + 799,265) = 77.1\%$$

Heat used to raise temp. of material,

$$(831 \times 154 \times 0.492) = 62,963 = 7.9\%$$

Loss by radiation . . . 100 - (77.1 + 7.9) = 15%.
Total efficiency 85.0%.

WARNING: This is a 1910 edition. Some of the material may no longer be accurate

WATER EVAPORATED AND HEAT REQUIRED FOR DRYING.

M = percentage of moisture in material to be dried.
 Q = lbs. water evaporated per ton (2000 lbs.) of dry material.
 H = British thermal units required for drying, per ton of dry material.

M	Q	H	M	Q	H	M	Q	H
1	20.2	85,624	14	325.6	424,884	35	1,077	1,269,240
2	40.8	108,696	15	352.9	458,248	40	1,333	1,555,960
3	61.9	130,424	16	381.0	489,720	45	1,636	1,895,320
4	83.3	156,296	17	409.6	521,752	50	2,000	2,303,000
5	105.3	180,936	18	439.0	554,680	55	2,444	2,800,280
6	127.7	206,024	19	469.1	588,392	60	3,000	3,423,000
7	150.5	231,560	20	500.0	623,000	65	3,714	4,222,680
8	173.9	257,768	21	531.6	658,392	70	4,667	5,290,040
9	197.8	284,536	22	564.1	694,792	75	6,000	6,783,000
10	222.2	311,864	23	597.4	732,088	80	8,000	9,023,000
11	247.2	339,864	24	631.6	770,392	85	11,333	12,755,960
12	272.7	368,424	25	666.7	809,704	90	18,000	20,223,000
13	298.9	397,768	30	857.0	1,022,840	95	38,000	42,623,000

Formulae: $Q = \frac{2000 M}{100 - M}$; $H = 1120 Q + 63,000$.

The value of H is found on the assumption that the moisture is heated from 62° to 212° and evaporated at that temperature, and that the specific heat of the material is 0.21. $[2000 \times (212 - 62) \times 0.21] = 63,000$.

Calculations for Design of Drying Apparatus. — A most efficient system of drying of moist materials consists in a continuous circulation of a volume of warm dry air over or through the moist material, then passing the air charged with moisture over the cold surfaces of condenser coils to remove the moisture, then heating the same air by steam-heating coils or other means, and again passing it over the material. In the design of apparatus to work on this system it is necessary to know the amount of moisture to be removed in a given time, and to calculate the volume of air that will carry that moisture at the temperature at which it leaves the material, making allowance for the fact that the moist, warm air on leaving the material may not be fully saturated, and for the fact that the cooled air is nearly or fully saturated at the temperature at which it leaves the cooling coils. A paper by Wm. M. Grosvenor, read before the Am. Inst. of Chemical Engineers (*Heating and Ventilating Mag.*, May, 1909) contains a "humidity table" and a "humidity chart" which greatly facilitate the calculations required. The table is given in a condensed form below. It is based on the following data: Density of air + 0.04% CO₂ = 0.001293052

(in Kg. per cu. m.). Density of water vapor = $1 + 0.00367 \times \text{Temp. C.}$
 = $0.62186 \times \text{density of air}$. Density at partial pressure ÷ density at 760 m.m. = partial pressure ÷ 760 m.m. Specific heat of water vapor = 0.475; sp. ht. of air = 0.2373. Kg. per cu. meter $\times 0.062428$ = lbs. per cu. ft. The results given in the table agree within 1/4% with the figures of the U. S. Weather Bureau. (Compare also the tables of H. M. Prevost Murphy, given under "Air," page 586.) The term "humid heat" in the heading of the table is defined as the B.T.U. required to raise 1° F. one pound of air plus the vapor it may carry when saturated at the given temperature and pressure; and "humid volume" is the volume of one pound of air when saturated at the given temperature and pressure.

WARNING: This is a 1910 edition. Some of the material may no longer be accurate.

Humidity Table.

Temp. F.	Vapor Tension, Millimeters of Mercury.	Lbs. Water Vapor per lb. Air.	Humid Heat, B.T.U.	Humid Volume cu. ft.	Density, lbs. per cu. ft. at 760 Millimeters.		Volume in cu. ft. per lb. of	
					Dry Air.	Sat'd Mix.	Dry Air.	Sat'd Mix.
32	4.569	.003761	.2391	12.462	.080726	.080556	12.388	12.414
35	5.152	.0042435	.2393	12.549	.080231	.080085	12.464	12.496
40	6.264	.0050463	.2398	12.695	.079420	.079181	12.590	12.629
45	7.582	.0062670	.2403	12.843	.078641	.078348	12.718	12.763
50	9.140	.0075697	.2409	12.999	.077867	.077511	12.842	12.901
55	10.980	.0091163	.2416	13.159	.077109	.076685	12.968	13.041
60	13.138	.010939	.2425	13.326	.076363	.075865	13.095	13.180
65	15.660	.013081	.2435	13.501	.075635	.075039	13.222	13.325
70	18.595	.015597	.2447	13.683	.074921	.074219	13.348	13.471
75	22.008	.018545	.2461	13.876	.074218	.073471	13.474	13.624
80	25.965	.021998	.2478	14.081	.073531	.072644	13.600	13.777
85	30.573	.026026	.2497	14.301	.072852	.071744	13.726	13.938
90	35.774	.030718	.2519	14.539	.072189	.070894	13.852	14.106
95	41.784	.036174	.2545	14.793	.071535	.070051	13.979	14.275
100	48.679	.042116	.2575	15.071	.070894	.069179	14.106	14.455
105	56.534	.049973	.2610	15.376	.070264	.068288	14.232	14.643
110	65.459	.058613	.2651	15.711	.069647	.067383	14.358	14.840
115	75.591	.068662	.2699	16.084	.069040	.066447	14.484	15.050
120	87.010	.080402	.2755	16.499	.068443	.065477	14.611	15.272
125	99.024	.094147	.2820	16.968	.067857	.064480	14.736	15.509
130	114.437	.11022	.2896	17.499	.067380	.063449	14.863	15.761
135	130.702	.12927	.2987	18.103	.066713	.062374	14.989	16.032
140	148.885	.15150	.3093	18.800	.066156	.061255	15.116	16.325
145	169.227	.17816	.3219	19.609	.065601	.060104	15.242	16.643
150	191.860	.21005	.3371	20.559	.065154	.058865	15.368	16.993
155	216.983	.24534	.3553	21.687	.064539	.057570	15.494	17.370
160	244.803	.29553	.3776	23.045	.064016	.056218	15.621	17.788
165	275.592	.35286	.4054	24.708	.063502	.054795	15.748	18.250
170	309.593	.42756	.4405	26.790	.062997	.053305	15.874	18.761
175	347.015	.52285	.4856	29.454	.062500	.051708	16.000	19.339
180	388.121	.64942	.5458	32.967	.062015	.050035	16.126	19.987
185	433.194	.82430	.6288	37.796	.061529	.048265	16.253	20.719
190	482.668	1.00805	.7519	44.918	.061053	.046391	16.379	21.557
195	536.744	1.4994	.9494	56.302	.060588	.044405	16.505	22.521
200	595.771	2.2680	1.3147	77.504	.060127	.042308	16.631	23.638
205	660.116	4.2272	2.1562	131.028	.059674	.040075	16.758	24.954
210	730.267	15.8174	15.9148	562.054	.059228	.037323	16.884	26.796

RADIATION OF HEAT.

Radiation of heat takes place between bodies at all distances apart, and follows the laws for the radiation of light.

The heat rays proceed in straight lines, and the intensity of the rays radiated from any one source varies inversely as the square of their distance from the source.

This statement has been erroneously interpreted by some writers, who have assumed from it that a boiler placed two feet above a fire would receive by radiation only one-fourth as much heat as if it were only one foot above. In the case of boiler furnaces the side walls reflect those rays that are received at an angle, — following the law of optics, that the angle of incidence is equal to the angle of reflection, — with the result that the intensity of heat two feet above the fire is practically the same as at one foot above, instead of only one-fourth as much.

The rate at which a hotter body radiates heat, and a colder body absorbs heat, depends upon the state of the surfaces of the bodies as well as on their temperatures. The rate of radiation and of absorption are increased by darkness and roughness of the surfaces of the bodies, and diminished by smoothness and polish. For this reason the covering

of steam pipes and boilers should be smooth and of a light color: uncovered pipes and steam-cylinder covers should be polished.

The quantity of heat radiated by a body is also a measure of its heat-absorbing power under the same circumstances. When a polished body is struck by a ray of heat, it absorbs part of the heat and reflects the rest. The reflecting power of a body is therefore the complement of its absorbing power, which latter is the same as its radiating power.

The relative radiating and reflecting power of different bodies has been determined by experiment, as shown in the table below, but as far as quantities of heat are concerned, says Prof. Trowbridge (Johnson's Cyclopaedia, art. Heat), it is doubtful whether anything further than the said relative determinations can, in the present state of our knowledge, be depended upon, the actual or absolute quantities for different temperatures being still uncertain. The authorities do not even agree on the relative radiating powers. Thus, Leslie gives for tin plate, gold, silver, and copper the figure 12, which differs considerably from the figures in the table below, given by Clark, stated to be on the authority of Leslie, De La Provostaye and Desains, and Melloni.

Relative Radiating and Reflecting Power of Different Substances.

	Radiating or Absorbing Power.	Reflecting Power.		Radiating or Absorbing Power.	Reflecting Power.
Lampblack.....	100	0	Zinc, polished.....	19	81
Water.....	100	0	Steel, polished.....	17	83
Carbonate of lead.....	100	0	Platinum, polished.....	24	76
Writing-paper.....	98	2	Platinum in sheet.....	17	83
Ivory, jet, marble.....	93 to 98	7 to 2	Tin.....	15	85
Ordinary glass.....	90	10	Brass, cast, dead polished.....	11	89
Ice.....	85	15	Brass, bright polished.....	7	93
Gum lac.....	72	28	Copper, varnished.....	14	86
Silver-leaf on glass.....	27	73	Copper, hammered.....	7	93
Cast iron, bright polished.....	25	75	Gold, plated.....	5	95
Mercury, about.....	23	77	Gold on polished steel.....	3	97
Wrought iron, polished.....	23	77	Silver, polished bright.....	3	97

Experiments of Dr. A. M. Mayer give the following: The relative radiations from a cube of cast iron, having faces rough, as from the foundry, planed, "drawfiled," and polished, and from the same surfaces oiled, are as below (Prof. Thurston, in *Trans. A. S. M. E.*, vol. xvi):

	Rough.	Planed.	Drawfiled.	Polished.
Surface oiled.....	100	60	49	45
Surface dry.....	100	32	20	18

It here appears that the oiling of smoothly polished castings, as of cylinder-heads of steam-engines, more than doubles the loss of heat by radiation, while it does not seriously affect rough castings.

"Black Body" Radiation. Stefan and Boltzman's Law. (*Eng'g*, March 1, 1907.) — Kirchhoff defined a black body as one that would absorb all radiations falling on it, and would neither reflect nor transmit any. The radiation from such a body is a function of the temperature alone,

and is identical with the radiation inside an inclosure all parts of which have the same temperature. By heating the walls of an inclosure as uniformly as possible, and observing the radiation through a very small opening, a practical realization of a black body is obtained. Stefan and Boltzman's law is: The energy radiated by a black body is proportional to the fourth power of the absolute temperature, or $E = K(T^4 - T_0^4)$, where E = total energy radiated by the body at T to the body at T_0 , and K is a constant. The total radiation from other than black bodies increases more rapidly than the fourth power of the absolute temperature, so that as the temperature is raised the radiation of all bodies approaches that of the black body. A confirmation of the Stefan and Boltzman law is given in the results of experiments by Lummer and Kurlbaum, as below ($T_0 = 290$ degrees C., abs. in all cases).

	$T = 492$.	654.	795.	1108.	1481.	1761.
$\frac{E}{T^4 - T_0^4}$ (Black body.....)	109.1	108.4	109.9	109.0	110.7
Polished platinum..	4.28	6.56	8.14	12.18	16.69	19.64
Iron oxide.....	33.1	33.1	36.6	46.9	65.3

CONDUCTION AND CONVECTION OF HEAT.

Conduction is the transfer of heat between two bodies or parts of a body which touch each other. Internal conduction takes place between the parts of one continuous body, and external conduction through the surface of contact of a pair of distinct bodies.

The rate at which conduction, whether internal or external, goes on, being proportional to the area of the section or surface through which it takes place, may be expressed in thermal units per square foot of area per hour.

Internal Conduction varies with the heat conductivity, which depends upon the nature of the substance, and is directly proportional to the difference between the temperatures of the two faces of a layer, and inversely as its thickness. The reciprocal of the conductivity is called the internal thermal resistance of the substance. If r represents this resistance, x the thickness of the layer in inches, T' and T the temperatures on the two faces, and q the quantity in thermal units transmitted per

hour per square foot of area, $q = \frac{T' - T}{rx}$ (Rankine.)

Péclet gives the following values of r :

Gold, platinum, silver.....	0.0016	Lead.....	0.0090
Copper.....	0.0018	Marble.....	0.0718
Iron.....	0.0043	Brick.....	0.1500
Zinc.....	0.0045		

Relative Heat-conducting Power of Metals.

Metals.	*C.&J.	†W.&F.	Metals.	*C.&J.	†W.&F.
Silver.....	1000	1000	Cadmium.....	577	...
Gold.....	981	532	Wrought iron.....	436	119
Gold, with 1% of silver.	840	...	Tin.....	422	145
Copper, rolled.....	845	736	Steel.....	397	116
Copper, cast.....	811	...	Platinum.....	380	84
Mercury.....	677	...	Sodium.....	365	...
Mercury, with 1.25% of tin.....	412	...	Cast iron.....	359	...
Aluminum.....	665	...	Lead.....	287	85
Zinc:			Antimony:		
cast vertically.....	628	...	cast horizontally..	215	...
cast horizontally... 608	cast vertically....	192	...
rolled.....	641	...	Bismuth.....	61	18

* Calvert & Johnson.

† Weidemann & Franz.

INFLUENCE OF A NON-METALLIC SUBSTANCE IN COMBINATION ON THE CONDUCTING POWER OF A METAL.

Influence of carbon on iron:		Cast copper.....	811
Wrought iron.....	436	Copper with 1% of arsenic....	570
Steel.....	397	with 0.5% of arsenic..	669
Cast iron.....	359	with 0.25% of arsenic.	771

WARNING: This is a 1910 edition. Some of the material may no longer be accurate

The Rate of External Conduction through the bounding surface between a solid body and a fluid is approximately proportional to the difference of temperature, when that is small; but when that difference is considerable, the rate of conduction increases faster than the simple ratio of that difference. (Rankine.)

If r , as before, is the coefficient of internal thermal resistance, e and e' the coefficient of external resistance of the two surfaces, x the thickness of the plate, and T' and T the temperatures of the two fluids in contact with the two surfaces, the rate of conduction is $q = \frac{T' - T}{e + e' + rx}$. Accord-

ing to Péclet, $e + e' = \frac{1}{A [1 + B (T' - T)]}$, in which the constants A and B have the following values:

- B for polished metallic surfaces..... 0.0028
- B for rough metallic surfaces and for non-metallic surfaces.. 0.0037
- A for polished metals, about..... 0.90
- A for glassy and varnished surfaces..... 1.34
- A for dull metallic surfaces..... 1.58
- A for lampblack..... 1.78

When a metal plate has a liquid at each side of it, it appears from experiments by Péclet that $B = 0.058$, $A = 8.8$.

The results of experiments on the evaporative power of boilers agree very well with the following approximate formula for the thermal resistance of boiler plates and tubes:

$$e + e' = \frac{a}{(T' - T)}$$

which gives for the rate of conduction, per square foot of surface per hour,

$$q = \frac{(T' - T)^2}{a}$$

This formula is proposed by Rankine as a rough approximation, near enough to the truth for its purpose. The value of a lies between 150 and 200. Experiments on modern boilers usually give higher values.

Convection, or carrying of heat, means the transfer and diffusion of the heat in a fluid mass by means of the motion of the particles of that mass.

The conduction, properly so called, of heat through a stagnant mass of fluid is very slow in liquids, and almost, if not wholly, inappreciable in gases. It is only by the continual circulation and mixture of the particles of the fluid that uniformity of temperature can be maintained in the fluid mass, or heat transferred between the fluid mass and a solid body.

The free circulation of each of the fluids which touch the side of a solid plate is a necessary condition of the correctness of Rankine's formulae for the conduction of heat through that plate; and in these formulae it is implied that the circulation of each of the fluids by currents and eddies is such as to prevent any considerable difference of temperature between the fluid particles in contact with one side of the solid plate and those at considerable distances from it.

When heat is to be transferred by convection from one fluid to another, through an intervening layer of metal, the motions of the two fluid masses should, if possible, be in opposite directions, in order that the hottest particles of each fluid may be in communication with the hottest particles of the other, and that the minimum difference of temperature between the adjacent particles of the two fluids may be the greatest possible.

Thus, in the surface condensation of steam, by passing it through metal tubes immersed in a current of cold water or air, the cooling fluid should be made to move in the opposite direction to the condensing steam.

Coefficients of Heat Conduction of Different Materials. (W. Nusselt, *Zeit. des Ver. Deut. Ing.*, June, 1908. *Eng. Digest*, Aug., 1908.)—The materials were inclosed between two concentric metal vessels, the inner of which contained an electric heating device.

It was found that the materials tested all followed Fourier's law, the quantity of heat transmitted being directly proportional to the extent of surface, the duration of flow and the temperature difference between the inner and outer surfaces; and inversely proportional to the thickness of the mass of material. It was also found that the coefficient of conduction increased as the temperature increased. The table gives the British equivalents of the average coefficients obtained.

COEFFICIENTS OF HEAT CONDUCTION AT DIFFERENT TEMPERATURES FOR VARIOUS INSULATING MATERIALS.

(B.T.U. per hour = Area of surface in square feet \times coefficient \div thickness in inches.)

Lb. per cu. ft.	Materials.	32° F.	212° F.	392° F.	572° F.	752° F.
10.	Ground cork.....	0.250	0.387	0.443		
8.5	Sheep's wool*.....	0.266	0.403			
6.3	Silk waste.....	0.306	0.411			
9.18	Silk, tufted.....	0.314	0.419			
5.06	Cotton wool.....	0.379	0.476			
11.86	Charcoal (carbonized cabbage leaves).....	0.403	0.508			
113.42	Sawdust (0.443 at 112° F.).....					
10.	Peat refuse† (0.443 at 77° F.).....					
21.85	Kieselguhr (infusorial earth), loose.....	0.419	0.532	0.596	0.629	
12.49	Asphalt-cork composition (0.492 at 65° F.).....					
25.28	Composition,‡ loose.....	0.484	0.613	0.653		
12.49	Kieselguhr stone§.....	0.516	0.629	0.742	0.854	0.961
12.17	Peat refuse† (0.564 at 68° F.).....					
36.2	Kieselguhr, dry and compacted (0.669 at 302° F.; 0.991 at 662° F.).....					
43.67	Composition,§§ compacted (0.806 at 302° F.; 0.967 at 428° F.).....					
22.47	Porous blast-furnace slag (0.766 at 112° F.).....					
35.96	Asbestos (1.644 at 1112° F.).....	1.048	1.346	1.451	1.499	1.548
34.33	Slag concrete (1.532 at 112° F.).....					
18.23	Pumice stone gravel (1.612 at 112° F.).....					
128.5	Portland cement, neat (6.287 at 95° F.).....					

* Tufted, oily, and containing foreign matter. Used in Linde's apparatus. † Hygroscopic; measurements made in moist zones. ‡ Cork, asbestos, kieselguhr and chopped straw, mixed with a binder and made in sheets for application to steam pipes in successive layers, the whole being wrapped in canvas and painted. § Kieselguhr, mixed with a binder and burned; very porous and hygroscopic. §§ Ingredients of (‡) mixed with water and compacted. || 1 part cement, 9 parts porous blast-furnace slag, by volume.

Heat Resistance, the Reciprocal of Heat Conductivity. (W. Kent, *Trans. A. S. M. E.*, xxiv, 278.)—The resistance to the passage of heat through a plate consists of three separate resistances: viz., the resistances of the two surfaces and the resistance of the body of the plate, which latter is proportional to the thickness of the plate. It is probable also that the resistance of the surface differs with the nature of the body or medium with which it is in contact.

A complete set of experiments on the heat-resisting power of heat-insulating substances should include an investigation into the difference in surface resistance when a surface is in contact with air and when it is in contact with another solid body. Suppose we find that the total resistance of a certain non-conductor may be represented by the figure 10, and that similar pieces all give the same figure. Two pieces in contact give 16. One piece of half the thickness of the others gives 8. What is the resistance of the surface exposed to the air in either piece, of the surface in contact with another surface, and of the interior of the body itself? Let the resistance of the material itself, of the regular thickness, be represented by A , that of the surface exposed to the air by a , and that of the surface in contact with another surface by c .

We then have for the three cases,

$$\begin{aligned} \text{Resistance of one piece} & \dots\dots\dots A + 2a = 10 \\ \text{of two pieces in contact} & \dots\dots 2A + 2c + 2a = 16 \\ \text{of the thin piece} & \dots\dots\dots \frac{1}{2}A + 2a = 8 \end{aligned}$$

These three equations contain three unknown quantities. Solving the equations we find $A = 4$, $a = 3$, and $c = 1$. Suppose that another experiment be made with the two pieces separated by an air space, and that the total resistance is then 22. If the resistance of the air space be represented by s we have the two equations: Resistance of one piece, $A + 2a = 10$; resistance of two pieces and air space, $2A + 4a + s = 22$, from which we find $s = 2$. Having these results we can easily estimate what will be the resistance to heat transfer of any number of layers of the material, whether in contact or separated by air spaces.

The writer has computed the figures for heat resistance of several insulating substances from the figures of conducting power given in a table published by John E. Starr, in *Ice and Refrigeration*, Nov., 1901. Mr. Starr's figures are given in terms of the B.T.U. transmitted per sq. ft. of surface per day per degree of difference of temperatures of the air adjacent to each surface. The writer's figures, those in the last column of the table given herewith, are calculated by dividing Mr. Starr's figures by 24, to obtain the hourly rate, and then taking their reciprocals. They may be called "coefficients of heat resistance" and defined as the reciprocals of the B.T.U. per sq. ft. per hour per degree of difference of temperature.

HEAT CONDUCTING AND RESISTING VALUES OF DIFFERENT INSULATING MATERIALS.

Insulating Material.	Conductance, B.T.U. per sq. ft. per Day per Degree of Difference of Temperature.	Coefficient of Heat Resistance, C.
1. 5/8-in. oak board, 1 in. lampblack, 7/8-in. pine board (ordinary family refrigerator).....	5.7	4.21
2. 7/8-in. board, 1 in. pitch, 7/8-in. board.....	4.89	4.91
3. 7/8-in. board, 2 in. pitch, 7/8-in. board.....	4.25	5.65
4. 7/8-in. board, paper, 1 in. mineral wool, paper, 7/8-in. board.....	4.6	5.22
5. 7/8-in. board, paper, 2 1/2 in. mineral wool, paper, 7/8-in. board.....	3.62	6.65
6. 7/8-in. board, paper, 2 1/2 in. calcined pumice, 7/8-in. board.....	3.38	7.10
7. Same as above, when wet.....	3.90	6.15
8. 7/8-in. board, paper, 3 in. sheet cork, 7/8-in. board.....	2.10	11.43
9. Two 7/8-in. boards, paper, solid, no air space, paper, two 7/8-in. boards.....	4.28	5.61
10. Two 7/8-in. boards, paper, 1 in. air space, paper, two 7/8-in. boards.....	3.71	6.47
11. Two 7/8-in. boards, paper, 1 in. hair felt, paper, two 7/8-in. boards.....	3.32	7.23
12. Two 7/8-in. boards, paper, 8 in. mill shavings, paper, two 7/8-in. boards.....	1.35	17.78
13. The same, slightly moist.....	1.80	13.33
14. The same, damp.....	2.10	11.43
15. Two 7/8-in. boards, paper, 3 in. air, 4 in. sheet cork, paper, two 7/8-in. boards.....	1.20	20.00
16. Same, with 5 in. sheet cork.....	0.90	26.67
17. Same, with 4 in. granulated cork.....	1.70	14.12
18. Same, with 1 in. sheet cork.....	3.30	7.27
19. Four double 7/8-in. boards (8 boards), with paper between, three 8-in. air spaces.....	2.70	8.89
20. Four 7/8-in. boards, with three quilts of 1/4-in. hair between, papers separating boards.....	2.52	9.52
21. 7/8-in. board, 6 in. patented silicated straw-board, finished inside with thin cement.....	2.48	9.68

Analyzing some of the results given in the last column of the table, we observe that, comparing Nos. 2 and 3, 1 in. added thickness of pitch increased the coefficient 0.74; comparing Nos. 4 and 5, 1 1/2 in. of mineral wool increased the coefficient 1.11. If we assume that the 1 in. of mineral wool in No. 4 was equal in heat resistance to the additional 1 1/2 in. added in No. 5, or 1.11 reciprocal units, and subtract this from 5.22, we get 4.11 as the resistance of two 7/8-in. boards and two sheets of paper. This would indicate that one 7/8-in. board and one sheet of paper give nearly twice as much resistance as 1 in. of mineral wool. In like manner any number of deductions may be drawn from the table, and some of them will be rather questionable, such as the comparison of No. 15 and No. 16, showing that 1 in. additional sheet cork increased the resistance given by four sheets 6.67 reciprocal units, or one-third the total resistance of No. 15. This result is extraordinary, and indicates that there must have been considerable differences of conditions during the two tests.

For comparison with the coefficients of heat resistance computed from Mr. Starr's results we may take the reciprocals of the figures given by Mr. Alfred R. Wolff as the result of German experiments on the heat transmitted through various building materials, as below:

K = B.T.U. transmitted per hour per sq. ft. of surface, per degree F. difference of temperature.
 C = coefficient of heat resistance = reciprocal of K .

The irregularity of the differences of C computed from the original values of K for each increase of 4 inches in thickness of the brick walls indicates a difference in the conditions of the experiments. The average difference of C for each 4 inches of thickness is about 0.80. Using this average difference to even up the figures we find the value of C is expressed by the approximate formula $C = 0.70 + 0.20 t$, in which t is the thickness in inches. The revised values of C , computed by this formula, and the corresponding revised values of K , are as follows:

Thickness, in.	4	8	12	16	20	24	28	32	36	40
C	1.50	2.30	3.10	3.90	4.70	5.50	6.30	7.10	7.90	8.70
K , revised.	0.667	0.435	0.323	0.256	0.213	0.182	0.159	0.141	0.127	0.115
K , original.	0.68	0.46	0.32	0.26	0.23	0.20	0.174	0.15	0.129	0.115
Difference..	0.013	0.025	0.003	0.004	0.017	0.018	0.015	0.009	0.002	0.0

The following additional values of C are computed from Mr. Wolff's figures for K :

	K	C
Wooden beam construction, planked over or ceiled:		
As flooring.....	0.083	12.05
As ceiling.....	0.104	9.71
Fireproof construction, floored over:		
As flooring.....	0.124	8.06
As ceiling.....	0.145	6.90
Single window.....	1.030	0.97
Single skylight.....	1.118	0.89
Double window.....	0.518	1.93
Double skylight.....	0.621	1.61
Door.....	0.414	2.42

It should be noted that the coefficient of resistance thus defined will be approximately a constant quantity for a given substance under certain fixed conditions, only when the difference of temperature of the air on its two sides is small — say less than 100° F. When the range of temperature is great, experiments on heat transmission indicate that the quantity of heat transmitted varies, not directly as the difference of temperature, but as the square of that difference. In this case a coefficient

of resistance with a different definition may be found — viz., that obtained from the formula $a = (T - t)^2 \div q$, in which a is the coefficient, $T - t$ the range of temperature, and q the quantity of heat transmitted, in British thermal units per square foot per hour.

Steam-pipe Coverings.

Experiments by Prof. Ordway, *Trans. A. S. M. E.*, vi, 168; also Circular No. 27 of Boston Mfrs. Mutual Fire Ins. Co., 1890.

Substance 1 inch thick, Heat applied, 310° F.	Pounds of Water heated 10° F., per hour, through 1 sq. ft.	British Thermal Units per sq. ft. per minute.	Solid Matter in 1 sq. ft., 1 inch thick, parts in 1000.	Air included, parts in 100.
1. Loose wool.....	8.1	1.35	56	944
2. Live-geese feathers.....	9.6	1.60	50	950
3. Carded cotton wool.....	10.4	1.73	20	980
4. Hair felt.....	10.3	1.72	185	815
5. Loose lampblack.....	9.8	1.63	56	944
6. Compressed lampblack.....	10.6	1.77	244	756
7. Cork charcoal.....	11.9	1.98	53	947
8. White-pine charcoal.....	13.9	2.32	119	881
9. Anthracite-coal powder.....	35.7	5.95	506	494
10. Loose calcined magnesia.....	12.4	2.07	23	977
11. Compressed calcined magnesia.....	42.6	7.10	285	715
12. Light carbonate of magnesia.....	13.7	2.28	60	940
13. Compressed carb. of magnesia.....	15.4	2.57	150	850
14. Loose fossil-meal.....	14.5	2.42	60	940
15. Crowded fossil-meal.....	15.7	2.62	112	888
16. Ground chalk (Paris white).....	20.6	3.43	253	747
17. Dry plaster of Paris.....	30.9	5.15	368	632
18. Fine asbestos.....	49.0	8.17	81	919
19. Air alone.....	48.0	8.00	0	1000
20. Sand.....	62.1	10.35	529	471
21. Best slag-wool.....	13.	2.17
22. Paper.....	14.	2.33
23. Blotting-paper wound tight.....	21.	3.50
24. Asbestos paper wound tight.....	21.7	3.62
25. Cork strips bound on.....	14.6	2.43
26. Straw rope wound spirally.....	18.	3.
27. Loose rice chaff.....	18.7	3.12
28. Paste of fossil-meal with hair.....	16.7	2.78
29. Paste of fossil-meal with asbestos.....	22.	3.67
30. Loose bituminous-coal ashes.....	21.	3.50
31. Loose anthracite-coal ashes.....	27.	4.50
32. Paste of clay and vegetable fiber.....	30.9	5.15

It will be observed that several of the incombustible materials are nearly as efficient as wool, cotton, and feathers, with which they may be compared in the preceding table. The materials which may be considered wholly free from the danger of being carbonized or ignited by slow contact with pipes or boilers are printed in Roman type. Those which are more or less liable to be carbonized are printed in italics.

The results Nos. 1 to 20 inclusive were from experiments with the various non-conductors each used in a mass one inch thick, placed on a flat surface of iron kept heated by steam to 310° F. The substances Nos. 21 to 32 were tried as coverings for two-inch steam-pipe; the results being reduced to the same terms as the others for convenience of comparison.

Experiments on still air gave results which differ little from those of Nos. 3, 4, and 6. The bulk of matter in the best non-conductors is relatively too small to have any specific effect except to trap the air and keep it stagnant. These substances keep the air still by virtue of the roughness of their fibers or particles. The asbestos, No. 18, had smooth fibers. Asbestos with exceedingly fine fiber made a somewhat better showing, but asbestos is really one of the poorest non-conductors. It may be used advantageously to hold together other incombustible substances, but the less of it the better. A "magnesia" covering, made of carbonate of magnesia with a small percentage of good asbestos fiber and containing 0.25 of solid matter, transmitted 2.5 B.T.U. per square foot per minute, and one containing 0.396 of solid matter transmitted 3.33 B.T.U.

Any suitable substance which is used to prevent the escape of steam heat should not be less than one inch thick.

Any covering should be kept perfectly dry, for not only is water a good carrier of heat, but it has been found that still water conducts heat about eight times as rapidly as still air.

Tests of Commercial Coverings were made by Mr. Geo. M. Brill and reported in *Trans. A. S. M. E.*, xvi, 827. A length of 60 feet of 8-inch steam-pipe was used in the tests, and the heat loss was determined by the condensation. The steam pressure was from 109 to 117 lbs. gauge, and the temperature of the air from 58° to 81° F. The difference between the temperature of steam and air ranged from 263° to 286°, averaging 272°.

The following are the principal results:

Kind of Covering.	Thickness of Covering, inches.	Lbs. Steam condensed per sq. ft. per hour.	B.T.U. per sq. ft. per minute.	B.T.U. per sq. ft. per hour per degree of average difference of temperature.	Saving due to covering, lbs. steam per hour per sq. ft.	Ratio of Heat lost, Bare to Covered Pipe, %.	H.P. lost per 100 sq. ft. of pipe (30 lbs. per hour = 1 H.P.).
Bare pipe.....	0.846	12.27	2.706	100.	2.819
Magnesia.....	1.25	0.120	1.74	0.384	0.726	14.2	0.400
Rock wool.....	1.60	0.080	1.16	0.256	0.766	9.5	0.267
Mineral wool.....	1.30	0.089	1.29	0.285	0.757	10.5	0.297
Fire-felt.....	1.30	0.157	2.28	0.502	0.689	18.6	0.523
Manville sectional.....	1.70	0.109	1.59	0.350	0.737	12.9	0.564
Manv. sect and hair-felt.....	2.40	0.066	0.96	0.212	0.780	7.8	0.221
Manville wool-cement.....	2.20	0.108	1.56	0.345	0.738	12.7	0.359
Champion mineral wool.....	1.44	0.099	1.44	0.317	0.747	11.7	0.330
Hair-felt.....	0.82	0.132	1.91	0.422	0.714	15.6	0.439
Riley cement.....	0.75	0.298	4.32	0.953	0.548	35.2	0.993
Fossil-meal.....	0.75	0.275	3.99	0.879	0.571	32.5	0.919

Tests of Pipe Coverings by an Electrical Method. (H. G. Stott, *Power*, 1902.) — A length of about 200 ft. of 2-in. pipe was heated to a known temperature by an electrical current. The pipe was covered with different materials, and the heat radiated by each covering was determined by measuring the current required to keep the pipe at a constant temperature. A brief description of the various coverings is given below.

No. 2. Solid sectional covering, 1½ in. thick, of granulated cork molded under pressure and then baked at a temperature of 500° F.; ⅛ in. asbestos paper next to pipe.

No. 3. Solid 1-in. molded sectional, 85% carbonate of magnesia.

No. 4. Solid 1-in. sectional, granulated cork molded under pressure and baked at 500° F.; 1/8 in. asbestos next to pipe.

No. 5. Solid 1-in. molded sectional, 85% carbonate of magnesia; outside of sections covered with canvas pasted on.

No. 6. Laminated 1-in. sectional, nine layers of asbestos paper with granulated cork between; outside of sections covered with canvas, 1/8 in. asbestos paper next to pipe.

No. 7. Solid 1-in. molded sectional, of 85% carbonate of magnesia; outside of sections covered with light canvas.

No. 8. Laminated 1-in. sectional, seven layers of asbestos paper indented with 1/4-in. square indentations, which serve to keep the asbestos layers from coming in close contact with one another; 1/8 in. asbestos paper next to pipe.

No. 9. Laminated 1-in. sectional, 64 layers of asbestos paper, in which were embedded small pieces of sponge; outside covered with canvas.

No. 10. Laminated 1 1/2-in. sectional, 12 plain layers of asbestos paper with corrugated layers between, forming longitudinal air cells; 1/8 in. asbestos paper next to pipe; sections wired on.

No. 11. Laminated 1-in. sectional, 8 layers of asbestos paper with corrugated layers between, forming small air ducts radially around the covering.

No. 12. Laminated 1 1/4-in. sectional, 6 layers of asbestos paper with corrugated layers; outside of sections covered with two layers of canvas.

No. 15. "Remanit," composed of 2 layers wound in reverse direction with ropes of carbonized silk. Inner layer 2 1/2 in. wide and 1/2 in. thick; outer layer 2 in. wide and 3/4 in. thick, over which was wound a network of fine wire; 1/8 in. asbestos next to pipe. Made in Germany.

No. 16. 2 1/2-in. covering, 85% carbonate of magnesia, 1/2-in. blocks about 3 in. wide and 18 in. long next to pipe and wired on; over these blocks were placed solid 2-in. molded sectional covering.

No. 17. 2 1/2-in. covering, 85% magnesia. Put on in a 2-in. molded section wired on; next to the pipe and over this a 1/2-in. layer of magnesia plaster.

No. 18. 2 1/2-in. covering, 85% carbonate of magnesia. Put on in two solid 1-in. molded sections with 1/2-in. layer of magnesia plaster between; two 1-in. coverings wired on and placed so as to break joints.

No. 19. 2-in. covering, of 85% carbonate of magnesia, put on in two 1-in. layers so as to break joints.

No. 20. Solid 2-in. molded sectional, 85% magnesia.

No. 21. Solid 2-in. molded sectional, 85% magnesia.

Two samples covered with the same thickness of similar material give different results; for example, Nos. 3 and 5, and also Nos. 20 and 21. The cause of this difference was found to be in the care with which the joints between sections were made. A comparison between Nos. 19 and 20, having the same total thickness, but one applied in a solid 2-in. section, and the other in two 1-in. sections, proved the desirability of breaking joints.

An attempt was made to determine the law governing the effect of increasing the thickness of the insulating material, and for all the 85% magnesia coverings the efficiency varied directly as the square root of the thickness, but the other materials tested did not follow this simple law closely, each one involving a different constant.

To determine which covering is the most economical the following quantities must be considered: (1) Investment in covering. (2) Cost of coal required to supply lost heat. (3) Five per cent interest on capital invested in boilers and stokers rendered idle through having to supply lost heat. (4) Guaranteed life of covering. (5) Thickness of covering.

The coverings Nos. 2 to 15 were finished on the outside with resin paper and 8-ounce canvas; the others had canvas pasted on outside of the sections, and an 8-oz. canvas finish. The following is a condensed statement of the results with the temperature of the pipe corresponding to 160 lb. steam pressure.

ELECTRICAL TEST OF STEAM-PIPE COVERINGS.

No.	Covering.	Aver. Thick-ness.	B.T.U. Loss per sq. ft. at 160 lb. Pres.	B.T.U. per sq. ft. per Hr. per Deg. Diff. of Temp.	Per cent Heat Saved by Covering.
2	Solid cork.....	1.63	1.672	0.348	87.1
3	85% magnesia.....	1.18	2.008	0.418	84.5
4	Solid cork.....	1.20	2.048	0.427	84.2
5	85% magnesia.....	1.19	2.130	0.444	83.6
6	Laminated asbestos cork.....	1.48	2.123	0.442	83.7
7	85% magnesia.....	1.12	2.190	0.456	83.2
8	Asbestos air cell [indent].....	1.26	2.333	0.486	83.1
9	Asbestos sponge felted.....	1.24	2.552	0.532	80.3
10	Asbestos air cell [long].....	1.70	2.750	0.573	78.8
11	"Asbestoscel" [radial].....	1.22	2.801	0.584	78.5
12	Asbestos air cell [long].....	1.29	2.812	0.586	78.4
15	"Remanit" [silk] wrapped.....	1.51	1.452	0.302	88.8
16	85% magnesia, 2" sectional and 1/2" block.....	2.71	1.381	0.288	89.4
17	85% magnesia, 2" sectional and 1/2" plaster.....	2.45	1.387	0.289	88.7
18	85% magnesia, two 1" sectional.....	2.50	1.412	-0.294	89.0
19	85% magnesia, two 1" sectional.....	2.24	1.465	0.305	88.7
20	85% magnesia, 2" sectional.....	2.34	1.555	0.324	88.0
21	85% magnesia, 2" sectional.....	2.20	1.568	0.314	87.9
	Bare pipe [from outside tests].....		13.	2.708

Transmission of Heat, through Solid Plates, from Water to Water. (Clark, S. E.) — M. Péclét found, from experiments made with plates of wrought iron, cast iron, copper, lead, zinc, and tin, that when the fluid in contact with the surface of the plate was not circulated by artificial means, the rate of conduction was the same for different metals and for plates of the same metal of different thicknesses. But when the water was thoroughly circulated over the surfaces, and when these were perfectly clean, the quantity of transmitted heat was inversely proportional to the thickness, and directly as the difference in temperature of the two faces of the plate. When the metal surface became dull, the rate of transmission of heat through all the metals was very nearly the same.

It follows, says Clark, that the absorption of heat through metal plates is more active whilst evaporation is in progress — when the circulation of the water is more active — than while the water is being heated up to the boiling-point.

Transmission from Steam to Water. — M. Péclét's principle is supported by the results of experiments made in 1867 by Mr. Isherwood on the conductivity of different metals. Cylindrical pots, 10 inches in diameter, 21 1/4 inches deep inside, and 1/8 inch, 1/4 inch, and 3/8 inch thick, turned and bored, were formed of pure copper, brass (60 copper and 40 zinc), rolled wrought iron, and remelted cast iron. They were immersed in a steam bath, which was varied from 220° to 320° F. Water at 212° was supplied to the pots, which were kept filled. It was ascertained that the rate of evaporation was in the direct ratio of the difference of the temperatures inside and outside of the pots; that is, that the rate of evaporation per degree of difference of temperatures was the same for all temperatures; and that the rate of evaporation was exactly the same for different thicknesses of the metal. The respective rates of conductivity of the several metals were as follows, expressed in weight of water evaporated from and at 212° F. per square foot of the interior surface of the pots per degree of difference of temperature per hour, together with the equivalent quantities of heat-units:

	Water at 212°.	Heat-units.	Ratio.
Copper.....	0.665 lb.	642.5	1.00
Brass.....	.577 "	556.8	0.87
Wrought iron.....	.387 "	373.6	.58
Cast iron.....	.327 "	315.7	.49

Whitham, "Steam Engine Design," p. 283, also *Trans. A. S. M. E.*, ix, 425, in using these data in deriving a formula for surface condensers, calls these figures those of perfect conductivity, and multiplies them by a coefficient *C*, which he takes at 0.323, to obtain the efficiency of condenser surface in ordinary use, i.e., coated with saline and greasy deposits.

Transmission of Heat from Steam to Water through Coils of Iron Pipe. — H. G. C. Kopp and F. J. Meystre (*Stevens Indicator*, Jan., 1894) give an account of some experiments on transmission of heat through coils of pipe. They collate the results of earlier experiments as follows, for comparison:

Experimenter.	Character of Surface.	Steam condensed per square foot per degree difference of temperature per hour.		Heat transmitted per square foot per degree difference of temperature per hour.		Remarks.
		Heating, pounds.	Evaporation, pounds.	Heating, B.T.U.	Evaporation, B.T.U.	
Laurens.	Copper coils	0.292	0.981	315	974	} Steam pressure = 100. } Steam pressure = 10.
"	2 Copper coils		1.20	1120		
Havrez..	Copper coil	0.268	1.26	280	1200	
Perkins..	Iron coil		0.24		215	
"	" "		0.22		208.2	
Box.....	Iron tube	0.235		230		
"	" "	0.196		207		
"	" "	0.206		210		
Havrez..	Cast-iron boiler	0.077	0.105	82	100	

From the above it would appear that the efficiency of iron surfaces is less than that of copper coils, plate surfaces being far inferior.

In all experiments made up to the present time, it appears that the temperature of the condensing water was allowed to rise, a mean between the initial and final temperatures being accepted as the effective temperature. But as water becomes warmer it circulates more rapidly, thereby causing the water surrounding the coil to become agitated and replaced by cooler water, which allows more heat to be transmitted.

Again, in accepting the mean temperature as that of the condensing medium, the assumption is made that the rate of condensation is in direct proportion to the temperature of the condensing water.

In order to correct and avoid any error arising from these assumptions and approximations, experiments were undertaken, in which all the conditions were constant during each test.

The pressure was maintained uniform throughout the coil, and provision was made for the free outflow of the condensed steam, in order to obtain at all times the full efficiency of the condensing surface. The condensing water was continually stirred to secure uniformity of temperature, which was regulated by means of a steam-pipe and a cold-water pipe entering the tank in which the coil was placed.

WARNING: This is a 1910 edition. Some of the material may no longer be accurate

The following is a condensed statement of the results.

HEAT TRANSMITTED PER SQUARE FOOT OF COOLING SURFACE, PER HOUR, PER DEGREE OF DIFFERENCE OF TEMPERATURE. (British Thermal Units.)

Temperature of Condensing Water.	1-in. Iron Pipe: Steam inside, 60 lbs. Gauge Pressure.	1 1/2-in. Pipe: Steam inside, 10 lbs. Pressure.	1 1/2-in. Pipe: Steam outside, 10 lbs. Pressure.	1 1/2-in. Pipe: Steam inside, 60 lbs. Pressure.
80	265	128	200	
100	269	130	230	239
120	272	137	260	247
140	277	145	267	276
160	281	158	271	306
180	299	174	270	349
200	313			419

The results indicate that the heat transmitted per degree of difference of temperature in general increases as the temperature of the condensing water is increased.

The amount transmitted is much larger with the steam on the outside of the coil than with the steam inside the coil. This may be explained in part by the fact that the condensing water when inside the coil flows over the surface of conduction very rapidly, and is more efficient for cooling than when contained in a tank outside of the coil.

This result is in accordance with that found by Mr. Thomas Craddock, which indicated that the rate of cooling by transmission of heat through metallic surfaces was almost wholly dependent on the rate of circulation of the cooling medium over the surface to be cooled.

Transmission of Heat in Condenser Tubes. (*Eng'g*, Dec. 10, 1875, p. 449.) — In 1874 B. C. Nichol made experiments for determining the rate at which heat was transmitted through a condenser tube. The results went to show that the amount of heat transmitted through the walls of the tube per estimated degree of mean difference of temperature increased considerably with this difference. For example:

Estimated mean difference of temperature between inside and outside of tube, degrees Fahr....	Vertical Tube.			Horizontal Tube.		
	128	151.9	152.9	111.6	146.2	150.4
Heat-units transmitted per hour per square foot of surface per degree of mean diff. of temp....	422	531	561	610	737	823

These results seem to throw doubt upon Mr. Isherwood's statement that the rate of evaporation per degree of difference of temperature is the same for all temperatures.

Mr. Thomas Craddock found that water was enormously more efficient than air for the abstraction of heat through metallic surfaces in the process of cooling. He proved that the rate of cooling by transmission of heat through metallic surfaces depends upon the rate of circulation of the cooling medium over the surface to be cooled. A tube filled with hot water, moved by rapid rotation at the rate of 59 ft. per second, through air, lost as much heat in one minute as it did in still air in 12 minutes. In water, at a velocity of 3 ft. per second, as much heat was abstracted in half a minute as was abstracted in one minute when it was at rest in the water. Mr. Craddock concluded, further, that the circulation of the cooling fluid became of greater importance as the difference of temperature on the two sides of the plate became less. (Clark, *R. T. D.*, p. 461.)

G. A. Orrok (*Power*, Aug. 11, 1908) gives a diagram showing the relation of the B.T.U. transmitted per hour per sq. ft. of surface per degree of difference of temperature to the velocity of the water in the condenser tubes, in feet per second, as obtained by different experimenters. Approximate figures taken from the several curves are given below.

Authority.	Tubes.	Velocity of Water, Feet per Second.						
		0.5	1	2	3	4	5	6
		B.T.U. per sq. ft. per hr. per deg. diff.						
1. Stanton.....	1/2-in. vert. copper.....	325	400	465	520	550	...	
2. Stanton.....	1/2-in. vert. copper.....	420	470	525	560	585	...	
3. Nichols.....	3/4-in. vert. brass.....	340	370	405	435	460	470	
4. Nichols.....	3/4-in. horiz. brass.....	500	530	560	585	615	650	
5. Hepburn.....	1 1/4-in. horiz. copper.....	250	365	590				
6. Hepburn.....	1 1/4-in. horiz. corrugated	360	560					
7. Richter.....	1 1/2-in. horiz. corrugated	460						
8. Weighton.....	5/8-in. plain tubes.....	380	615	760	865	940		
9. Allen.....	5/8-in. horizontal.....	225	290	365				

No. 1, water flowing up. Nos. 2 and 3, water flowing down.
Transmission of Heat in Feed-water Heaters. (W. R. Billings, *The National Engineer*, June, 1907.) — Experiments show that the rate of transmission of heat through metal surfaces from steam to water increases rapidly with the increased rate of flow of the water. Mr. Billings therefore recommends the use of small tubes in heaters in which the water is inside of the tubes. He says: A high velocity through the tubes causes friction between the water and the walls of the tubes; this friction is not the same as the friction between the particles of water themselves, and it tends to break up the column of water and bring fresh and cooler particles against the hot walls of the tubes.

The following results were obtained in tests:
 1 1/4-in. smooth tubes { V = 22.5 111 137 ...
 { U = 185 570 670 ...
 1 1/2-in. corrugated tubes { V = 24 34 43 82
 { U = 318 444 465 735

V = velocity of the water, ft. per min. U = B.T.U. transmitted per sq. ft. per hour per degree difference of temperature. (See Condensers.)
 In calculations of heat transmission in heaters it is customary to take as the mean difference of temperature the difference between the temperature of the steam and the arithmetical mean of the initial and final temperatures of the water; thus if S = steam temperature, I = initial and F = final temperature of the water, and D = mean difference, then $D = S - \frac{1}{2}(I + F)$. Mr. Billings shows that this is incorrect, and on the assumption that the rate of transmission through any portion of the surface is directly proportional to the difference he finds the true mean to be $D = \frac{F - I}{\text{hyp. log} [(S - I) \div (S - F)]}$. (This formula was derived by Cecil P. Poole in 1899, *Power*, Dec., 1906.)

The following table is calculated from the formula:
DEGREES OF DIFFERENCE BETWEEN STEAM TEMPERATURE AND ACTUAL AVERAGE TEMPERATURE OF WATER.

Initial Temperature of Water.	Vacuum Heaters Between Engine and Condenser.									
	26" Vac. Temp. 126° F.				24" Vac. Temp. 141° F.					
	Final Temp. of Water.				Final Temp. of Water.					
	105	110	115	120	105	110	115	120	125	130
40.....	46.1	41.6	36.9	30.1	62.9	60.2	55.3	50.9	46.1	40.6
50.....	42.8	38.4	33.6	27.6	59.2	56.6	51.8	47.7	43.2	37.9
60.....	39.3	35.3	30.7	25.0	55.5	52.1	48.4	44.4	40.1	35.0
70.....	35.6	31.9	27.6	22.4	51.6	48.2	45.0	41.0	36.9	32.2
80.....	31.8	28.3	24.5	19.6	47.6	44.2	41.2	37.5	33.6	29.2

WARNING: This is a 1910 edition. Some of the material may no longer be accurate

Initial Temp. of Water.	Atmospheric Heaters.												
	Atmos. Press. 212° F. Temp.						Initial Temp. of Water.	Atmos. Press. 212° F. Temp.					
	Final Temp. of Water.							Final Temp. of Water.					
	192	196	200	204	208	210	192	196	200	204	208	210	
40.....	70.6	65.7	60.1	53.5	44.8	38.0	105	51.9	47.9	43.4	38.2	31.4	26.4
50.....	67.9	63.1	57.6	51.2	42.8	36.4	110	50.3	46.4	42.1	36.9	30.2	25.5
60.....	65.1	60.4	55.2	48.9	40.7	34.7	115	48.8	45.0	40.6	35.7	29.2	24.5
70.....	62.2	57.7	52.6	46.6	38.7	32.9	120	47.2	43.5	39.2	34.4	28.0	23.5
80.....	59.4	54.9	50.0	44.2	36.6	31.0	125	45.6	41.9	37.8	33.1	26.9	22.5

The error in using the arithmetic mean for the value of D is not important if F is very much lower than S, but if it is within 10° of S then the error may be a large one. With S = 212, I = 40, F = 110, the arithmetic mean difference is 137, and the value by the logarithmic formula 131, an error of less than 5%; but if F is 204, the arithmetic mean is 90, and the value by the formula 53.5.

It should be observed, however, that the formula is based on an assumption that is probably greatly in error for high temperature differences, i.e., that the transmission of heat is directly proportional to the temperature difference. It may be more nearly proportional to the square of the difference, as stated by Rankine. This seems to be indicated by the results of heating water by steam coils, given below.

Heating Water by Steam Coils. — A catalogue of the American Radiator Co. (1908) gives a chart showing the pounds of steam condensed per hour per sq. ft. of iron, brass and copper pipe surface, for different mean or average differences of temperature between the steam and the water. Taking the latent heat of the steam at 966 B.T.U. per lb., the following figures are derived from the table.

Mean Temp. Diff.	Lb. Steam Condensed per Hour per Sq. Ft. of Pipe.			Lb. Steam Condensed per Hour per Sq. Ft. per Deg. Diff.			B.T.U. per Sq. Ft. per Hour per Deg. Diff.		
	Iron.	Brass.	Copper	Iron.	Brass.	Copper	Iron.	Brass.	Cop.
50	7.5	12.5	14.5	0.150	0.250	0.290	101	198	280
100	18.5	38	43.5	0.185	0.380	0.435	179	367	415
150	32.2	76.5	87.8	0.215	0.510	0.585	208	493	565
200	48	128	144	0.240	0.640	0.720	232	618	695

The chart is said to be plotted from a large number of tests with pipes placed vertically in a tank of water, about 20 per cent being deducted from the actual results as a margin of safety.

W. R. Billings (*Eng. Rec.*, Feb., 1898) gives as the results of one set of experiments with a closed feed-water heater:

Mean temp. diff., deg. F.....	5	6	8	11	15	18
B.T.U. per sq. ft. per hr. per deg. diff.	67	79	89	114	129	139

Heat Transmission through Cast-iron Plates Pickled in Nitric Acid. — Experiments by R. C. Carpenter (*Trans. A. S. M. E.*, xii, 179) show a marked change in the conducting power of the plates (from steam to water), due to prolonged treatment with dilute nitric acid.

in four successive operations, by machining to 0.125 in. Another, B, was tested in four thicknesses. The other plates were tested in one or two thicknesses. Each plate was found to have a law of transmission of its own. For plate A the value of a is represented closely by the formula $a = 40 + 20t$, in which t is the thickness in inches. The formula $a = 40 + 20t \pm 10$ covers the whole range of the experiments. The whole range of values is 38.6 to 71.9, which are very low when compared with values of a computed from the results of boiler tests, which are usually from 200 to 400, the low values obtained by Blechynden no doubt being due to the exceptionally favorable conditions of his tests as compared with those of boiler tests. Rankine says the value of a lies between 160 and 200, but values below 200 are rarely found in tests of modern types of boilers. (See Steam-Boilers.)

Cooling of Air. — H. F. Benson (*Am. Mach.*, Aug. 31, 1905) derives the following formula for transmission of heat from air to water through copper tubes. It is assumed that the rate of transmission at any point of the surface is directly proportional to the difference of temperature between the air and water.

Let A = cooling surface, sq. ft.; K = lb. of air per hour; S_a = specific heat of air; T_{a_1} = temp. of hot inlet air; T_{a_2} = temp. of cooled outlet air; d = actual average diff. of temp. between the air and the water; U = B.T.U. absorbed by the water per degree of diff. of temp. per sq. ft. per hour. W = lb. of water per hour; T_{w_1} = temp. of inlet water; T_{w_2} = temp. of outlet water. Then

$$AdU = KS_a(T_{a_1} - T_{a_2}); \quad A = KS_a(T_{a_1} - T_{a_2}) \div dU.$$

$$d = [(T_{a_1} - T_{a_2}) - (T_{w_2} - T_{w_1})] \div \log [(T_{a_1} - T_{w_2}) \div (T_{a_2} - T_{w_1})].$$

$$AU = \frac{KS_a W}{W - KS_a} \log_e \frac{T_{a_1} - T_{w_2}}{T_{a_2} - T_{w_1}}.$$

$$T_{w_2} = (S_a K + W)(T_{a_1} - T_{a_2}) \div W + T_{w_1}.$$

The more cooling water used, the lower is the temperature T_{w_2} . Also the less T_{w_1} is, the larger d becomes and the less surface is needed. About 10 is the largest value of V/K that it is economical to use, as there is a saving of less than 0.5% in increasing it from 10 to 15. When desirable to save water it will be advisable to make $W/K = 5$. Values of U obtained by experiment with a Wainwright cooler made with corrugated copper tubes are given in the following table. K and W are in lb. per minute, B_a = B.T.U. from air per min., B_w = B.T.U. from water per min., Vw = velocity of water, ft. per min.

T_{a_1}	T_{a_2}	T_{w_1}	T_{w_2}	K	W	B_a	B_w	Vw	U
221.0	76.3	50.0	169.0	125.2	28.50	4303	3392	2.20	6.75
217.0	64.3	45.8	146.4	122.8	36.73	4452	3695	2.84	7.12
224.0	63.3	45.7	149.2	126.3	40.30	4819	4171	3.11	7.91
209.6	54.0	43.8	125.9	122.1	50.00	4511	4105	3.86	8.81
214.5	46.3	43.0	106.2	124.6	68.95	4976	4357	5.32	10.55
234.6	63.6	52.6	120.2	124.4	73.25	5051	4552	5.65	8.41
214.2	43.5	43.0	94.7	117.3	79.84	4753	4128	6.16	14.32
242.9	61.7	55.3	114.0	133.6	92.72	5649	5443	7.15	10.01
223.0	46.0	40.1	79.1	131.5	114.80	5484	4477	8.86	7.86
239.3	57.5	51.0	95.2	130.0	125.70	5612	5556	9.70	9.38
246.0	58.0	52.3	95.1	133.5	145.90	5977	6244	11.26	10.57

Sixteen other tests were made besides those given above, and their plotted results all come within the field covered by those in the table.

WARNING: This is a 1910 edition. Some of the material may no longer be accurate

There is apparently an error in the last line of the table, for the heat gained by the water could not be greater than that lost by the air. The excess lost by the air may be due to radiation, but it shows a great irregularity. It appears that for velocities of water between 2.2 and 5.3 ft. per min. the value of U increases with the velocity, but for higher velocities the value of U is very irregular, and the cause of the irregularity is not explained.

Chas. L. Hubbard (*The Engineer*, Chicago, May 18, 1902) made some tests by blowing air through a tight wooden box which contained a nest of 30 1 1/2-in. tin tubes, of a total surface of about 20 sq. ft., through which cold water flowed. The results were as follows:

Cu. ft. of air per minute.....	268	268	469	469	636	636
Velocity over cooling surface.....	638	638	1116	1116	1514	1514
Initial temperature of air.....	72°	72°	72°	74°	74°	74°
Drop in temperature.....	8°	12°	8°	10°	8°	10°
Average temp. of water.....	50°	43°	48°	48°	50°	44°
Average temp. of air.....	68°	66°	68°	69°	70°	68°
Difference.....	18°	23°	20°	21°	20°	24°
B.T.U. per hour per sq. ft. per degree difference.....	6.5	7.6	10.2	12.1	13.8	14.4

Transmission of Heat through Plates and Tubes from Steam or Hot Water to Air. — The transfer of heat from steam or water through a plate or tube into the surrounding air is a complex operation, in which the internal and external conductivity of the metal, the radiating power of the surface, and the convection of heat in the surrounding air, are all concerned. Since the quantity of heat radiated from a surface varies with the condition of the surface and with the surroundings, according to laws not yet determined, and since the heat carried away by convection varies with the rate of the flow of the air over the surface, it is evident that no general law can be laid down for the total quantity of heat emitted.

The following is condensed from an article on "Loss of Heat from Steam-pipes," in *The Locomotive*, Sept. and Oct., 1892.

A hot steam-pipe is radiating heat constantly off into space, but at the same time it is cooling also by convection. Experimental data on which to base calculations of the heat radiated and otherwise lost by steam-pipes are neither numerous nor satisfactory.

In Box's "Practical Treatise on Heat" a number of results are given for the amount of heat radiated by different substances when the temperature of the air is 1° Fahr. lower than the temperature of the radiating body. A portion of this table is given below. It is said to be based on Péclet's experiments.

HEAT UNITS RADIATED PER HOUR, PER SQUARE FOOT OF SURFACE, FOR 1° FAHRENHEIT EXCESS IN TEMPERATURE.

Copper, polished.....	0.0327	Glass.....	0.5948
Tin, polished.....	0.0440	Cast iron, new.....	0.6480
Zinc and brass, polished... ..	0.0491	Common steam-pipe, in-ferred.....	0.6400
Tinned iron, polished.....	0.0858	Cast and sheet iron, rusted... ..	0.6868
Sheet iron, polished.....	0.0920	Wood, building stone, and brick.....	0.7358
Sheet lead.....	0.1329		
Sheet iron, ordinary.....	0.5662		

When the temperature of the air is about 50° or 60° Fahr., and the radiating body is not more than about 30° hotter than the air, we may calculate the radiation of a given surface by assuming the amount of heat given off by it in a given time to be proportional to the difference in temperature between the radiating body and the air. This is "Newton's law of cooling." But when the difference in temperature is great, Newton's law does not hold good; the radiation is no longer proportional to the difference in temperature, but must be calculated by a complex formula established experimentally by Dulong and Petit. Box has computed a table from this

formula, which greatly facilitates its application, and which is given below:

FACTORS FOR REDUCTION TO DULONG'S LAW OF RADIATION.

Differences in Temperature between Radiating Body and the Air. Deg. Fahr.	Temperature of the Air on the Fahrenheit Scale.											
	32°	50°	59°	68°	86°	104°	122°	140°	158°	176°	194°	212°
18	1.00	1.07	1.12	1.16	1.25	1.36	1.47	1.58	1.70	1.85	1.99	2.15
36	1.03	1.11	1.16	1.21	1.30	1.40	1.52	1.68	1.76	1.91	2.06	2.23
54	1.07	1.16	1.20	1.25	1.35	1.45	1.58	1.70	1.83	1.99	2.14	2.31
72	1.12	1.20	1.25	1.30	1.40	1.52	1.64	1.76	1.90	2.07	2.23	2.40
90	1.16	1.25	1.31	1.36	1.46	1.58	1.71	1.84	1.98	2.15	2.33	2.51
108	1.21	1.31	1.36	1.42	1.52	1.65	1.78	1.92	2.07	2.28	2.42	2.62
126	1.26	1.36	1.42	1.48	1.60	1.72	1.86	2.00	2.16	2.34	2.52	2.72
144	1.32	1.42	1.48	1.54	1.65	1.79	1.94	2.08	2.24	2.44	2.64	2.83
162	1.37	1.48	1.54	1.60	1.73	1.86	2.02	2.17	2.34	2.54	2.74	2.96
180	1.44	1.55	1.61	1.68	1.81	1.95	2.11	2.27	2.46	2.66	2.87	3.10
198	1.50	1.62	1.69	1.75	1.89	2.04	2.21	2.38	2.56	2.78	3.00	3.24
216	1.58	1.69	1.76	1.83	1.97	2.13	2.32	2.48	2.68	2.91	3.13	3.38
234	1.64	1.77	1.84	1.90	2.06	2.23	2.43	2.52	2.80	3.03	3.28	3.46
252	1.71	1.85	1.92	2.00	2.15	2.33	2.52	2.71	2.92	3.18	3.43	3.70
270	1.79	1.93	2.01	2.09	2.26	2.44	2.64	2.84	3.06	3.32	3.58	3.87
288	1.89	2.03	2.12	2.20	2.37	2.56	2.78	2.99	3.22	3.50	3.77	4.07
306	1.98	2.13	2.22	2.31	2.49	2.69	2.90	3.12	3.37	3.66	3.95	4.26
324	2.07	2.23	2.33	2.42	2.62	2.81	3.04	3.28	3.53	3.84	4.14	4.46
342	2.17	2.34	2.44	2.54	2.73	2.95	3.19	3.44	3.70	4.02	4.34	4.68
360	2.27	2.45	2.56	2.66	2.86	3.09	3.35	3.60	3.88	4.22	4.55	4.91
378	2.39	2.57	2.68	2.79	3.00	3.24	3.51	3.78	4.08	4.42	4.77	5.15
396	2.50	2.70	2.81	2.93	3.15	3.40	3.68	3.97	4.28	4.64	5.01	5.40
414	2.63	2.84	2.95	3.07	3.31	3.56	3.87	4.12	4.48	4.87	5.26	5.67
432	2.76	2.98	3.10	3.23	3.47	3.76	4.10	4.32	4.61	5.12	5.53	6.04

The loss of heat by convection appears to be independent of the nature of the surface, that is, it is the same for iron, stone, wood, and other materials. It is different for bodies of different shape, however, and it varies with the position of the body. Thus a vertical steam-pipe will not lose so much heat by convection as a horizontal one will: for the air heated at the lower part of the vertical pipe will rise along the surface of the pipe, protecting it to some extent from the chilling action of the surrounding cooler air. For a similar reason the shape of a body has an important influence on the result, those bodies losing most heat whose forms are such as to allow the cool air free access to every part of their surface. The following table from Box gives the number of heat units that horizontal cylinders or pipes lose by convection per square foot of surface per hour, for one degree difference in temperature between the pipe and the air.

HEAT UNITS LOST BY CONVECTION FROM HORIZONTAL PIPES, PER SQUARE FOOT OF SURFACE PER HOUR, FOR A TEMPERATURE DIFFERENCE OF 1° FAHR.

External Diameter of Pipe in Inches.	Heat Units Lost.	External Diameter of Pipe in Inches.	Heat Units Lost.	External Diameter of Pipe in Inches.	Heat Units Lost.
2	0.728	7	0.509	18	0.455
3	0.626	8	0.498	24	0.447
4	0.574	9	0.489	36	0.436
5	0.544	10	0.482	48	0.434
6	0.523	12	0.472		

WARNING: This is a 1910 edition. Some of the material may no longer be accurate

The loss of heat by convection is nearly proportional to the difference in temperature between the hot body and the air, but the experiments of Dulong and Péclet show that this is not exactly true, and we may here also resort to a table of factors for correcting the results obtained by simple proportion.

FACTORS FOR REDUCTION TO DULONG'S LAW OF CONVECTION.

Difference in Temp. between Hot Body and Air.	Factor.	Difference in Temp. between Hot Body and Air.	Factor.	Difference in Temp. between Hot Body and Air.	Factor.
18° F.	0.94	180° F.	1.62	360° F.	1.87
36°	1.11	198°	1.65	366°	1.90
54°	1.22	216°	1.68	378°	1.92
72°	1.30	234°	1.72	396°	1.94
90°	1.37	252°	1.74	414°	1.96
108°	1.43	270°	1.77	432°	1.98
126°	1.49	288°	1.80	450°	2.00
144°	1.53	306°	1.83	468°	2.02
162°	1.58	324°	1.85		

EXAMPLE IN THE USE OF THE TABLES. — Required the total loss of heat by both radiation and convection, per foot of length of a steam-pipe 2 11/32 in. external diameter, steam pressure 60 lbs., temperature of the air in the room 68° Fahr.

Temperature corresponding to 60 lbs. equals 307°; temperature difference = 307 - 68 = 239°.

Area of one foot length of steam-pipe = 2 11/32 × 3.1416 ÷ 12 = 0.614 sq. ft.

Heat radiated per hour per square foot per degree of difference, from table, 0.64.

Radiation loss per hour by Newton's law = 239° × 0.614 ft. × 0.64 = 93.9 heat units. Same reduced to conform with Dulong's law of radiation: factor from table for temperature difference of 239° and temperature of air 68° = 1.93. 93.9 × 1.93 = 181.2 heat units, total loss by radiation.

Convection loss per square foot per hour from a 2 11/32-inch pipe. by interpolation from table, 2" = 0.728, 3" = 0.626, 2 11/32" = 0.693.

Area, 0.614 × 0.693 × 239° = 101.7 heat units. Same reduced to conform with Dulong's law of convection: 101.7 × 1.73 (from table) = 175.9 heat units per hour. Total loss by radiation and convection = 181.2 + 175.9 = 357.1 heat units per hour. Loss per degree of difference of temperature per linear foot of pipe per hour = 357.1 ÷ 239 = 1.494 heat units = 2.433 per sq. ft.

It is not claimed, says *The Locomotive*, that the results obtained by this method of calculation are strictly accurate. The experimental data are not sufficient to allow us to compute the heat-loss from steam-pipes with any great degree of refinement; yet it is believed that the results obtained as indicated above will be sufficiently near the truth for most purposes. An experiment by Prof. Ordway, in a pipe 2 11/32 in. diam. under the above conditions (*Trans. A. S. M. E.*, v. 73), showed a condensation of steam of 181 grams per hour, which is equivalent to a loss of heat of 358.7 heat units per hour, or within half of one per cent of that given by the above calculation.

The quantity of heat given off by steam and hot-water radiators in ordinary practice of heating buildings by direct radiation varies from 1.25 to about 3.25 heat units per hour per square foot per degree of difference of temperature. (See Heating and Ventilation.)

THERMODYNAMICS.

Thermodynamics, the science of heat considered as a form of energy, is useful in advanced studies of the theory of steam, gas, and air engines, refrigerating machines, compressed air, etc. The method of treatment adopted by the standard writers is severely mathematical, involving constant application of the calculus. The student will find the subject

thoroughly treated in the works by Rontgen (Dubois's translation), Wood, Peabody, and Zeuner.

First Law of Thermodynamics. — Heat and mechanical energy are mutually convertible in the ratio of about 778 foot-pounds for the British thermal unit. (Wood.)

Second Law of Thermodynamics. — The second law has by different writers been stated in a variety of ways, and apparently with ideas so diverse as not to cover a common principle. (Wood, Therm., p. 389.)

It is impossible for a self-acting machine, unaided by any external agency, to convert heat from one body to another at a higher temperature. (Clausius.)

If all the heat absorbed be at one temperature, and that rejected be at one lower temperature, then will the heat which is transmuted into work be to the entire heat absorbed in the same ratio as the difference between the absolute temperature of the source and refrigerator is to the absolute temperature of the source. In other words, the second law is an expression for the efficiency of the perfect elementary engine. (Wood.)

The expression $\frac{Q_1 - Q_2}{Q_1} = \frac{T_1 - T_2}{T_1}$ may be called the symbolical or algebraic enunciation of the second law, — the law which limits the efficiency of heat engines, and which does not depend on the nature of the working medium employed. (Trowbridge.) Q_1 and T_1 = quantity and absolute temperature of the heat received; Q_2 and T_2 = quantity and absolute temperature of the heat rejected.

The expression $\frac{T_1 - T_2}{T_1}$ represents the efficiency of a perfect heat engine which receives all its heat at the absolute temperature T_1 , and rejects heat at the temperature T_2 , converting into work the difference between the quantity received and rejected.

EXAMPLE. — What is the efficiency of a perfect heat engine which receives heat at 388° F. (the temperature of steam of 200 lbs. gauge pressure) and rejects heat at 100° F. (temperature of a condenser, pressure 1 lb. above vacuum)?

$$\frac{388 + 459.2 - (100 + 459.2)}{388 + 459.2} = 34\%, \text{ nearly.}$$

In the actual engine this efficiency can never be attained, for the difference between the quantity of heat received into the cylinder and that rejected into the condenser is not all converted into work, much of it being lost by radiation, leakage, etc. In the steam engine the phenomenon of cylinder condensation also tends to reduce the efficiency.

The Carnot Cycle.—Let one pound of gas of a pressure p_1 , volume v_1 and absolute temperature T_1 be enclosed in an ideal cylinder, having non-conducting walls but the bottom a perfect conductor, and having a moving non-conducting frictionless piston. Let the pressure and volume of the gas be represented by the point A on the pv or pressure-volume diagram, Fig. 136, and let it pass through four operations, as follows:

1. Apply heat at a temperature of T_1 to the bottom of the cylinder and let the gas expand, doing work against the piston, at the constant temperature T_1 , or isothermally, to p_2v_2 , or B.
2. Remove the source of heat and put a non-conducting cover on the bottom, and let the gas expand adiabatically, or without transmission of heat, to p_3v_3 , or C, while its temperature is being reduced to T_2 .
3. Apply to the bottom of the cylinder a cold body, or refrigerator, of the temperature T_2 , and let the gas be compressed by the piston isothermally to the point D, or p_4v_4 , rejecting heat into the cold body.
4. Remove the cold body, restore the non-conducting bottom, and compress the gas adiabatically to A, or the original p_1v_1 , while its temperature is being raised to the original T_1 . The point D on the isothermal line CD is chosen so that an adiabatic line passing through it will also pass through A, and so that $v_4/v_1 = v_3/v_2$.

The area $aABCc$ represents the work done by the gas on the piston;

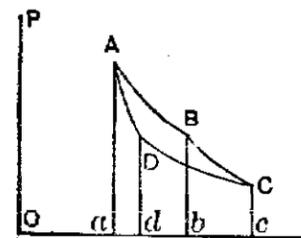

FIG. 136.

the area $CDAac$ the negative work, or the work done by the piston on the gas; the difference, $ABCD$, is the net work.

1a. The area $aABb$ represents the work done during isothermal expansion. It is equal in foot-pounds to $W_1 = p_1v_1 \log_e (v_2/v_1)$, where p_1 = the initial absolute pressure in lbs. per sq. ft. and v_1 = the initial volume in cubic feet. It is also equal to the quantity of heat supplied to the gas, $= U_1 = RT_1 \log_e (v_2/v_1)$. R is a constant for a given gas, = 53.35 for air.

2a. The area $bBCc$ is the work done during adiabatic expansion, $= W_2 = \frac{p_2v_2}{\gamma - 1} \left\{ 1 - \left(\frac{v_2}{v_3} \right)^{\gamma - 1} \right\}$, γ being the ratio of the specific heat at constant pressure to the specific heat at constant volume. For air $\gamma = 1.406$. The loss of intrinsic energy $= K_v(T_1 - T_2)$ ft.-lbs. K_v = specific heat at constant volume $\times 778$.

3a. $CDdc$ is the work of isothermal compression, $= W_3 = p_4v_4 \log_e (v_3/v_4) =$ heat rejected $= U_2 = RT_2 \log_e (v_3/v_4)$.

4a. $DAad$ is the work of adiabatic compression

$$= W_4 = \frac{p_1v_1}{\gamma - 1} \left\{ 1 - \left(\frac{v_1}{v_4} \right)^{\gamma - 1} \right\},$$

which is the same as W_2 and therefore, being negative, cancels it, and the net work $ABCD = W_1 - W_3$. The gain of intrinsic energy is $K_v(T_1 - T_2)$.

Comparing 1a and 3a, we have $p_1v_1 = p_2v_2$; $p_3v_3 = p_4v_4$; $v_2/v_3 = v_1/v_4 = r$.

$$W_1 = p_1v_1 \log_e r = RT_1 \log_e r; \quad W_3 = p_4v_4 \log_e r = RT_2 \log_e r.$$

$$\text{Efficiency } \frac{W_1 - W_3}{W_1} = \frac{R(T_1 - T_2) \log_e r}{RT_1 \log_e r} = \frac{T_1 - T_2}{T_1} = 1 - \frac{T_2}{T_1}$$

$$= 1 - \left(\frac{v_2}{v_3} \right)^{\gamma - 1} = \frac{U_1 - U_2}{U_1}.$$

Entropy.—In the pv or pressure-volume diagram, energy exerted or expended is represented by an area the lines of which show the changes of the values of p and v . In the Carnot cycle these changes are shown by curved lines. If a given quantity of heat Q is added to a substance at a constant temperature, we may represent it by a rectangular area in which the temperature is represented by a vertical line, and the base is the quotient of the area divided by the length of the vertical line. To this quotient is given the name entropy. When the temperature at which the heat is added is not constant a more general definition is needed, viz.: *Entropy is length on a diagram the area of which represents a quantity of heat, and the height at any point represents absolute temperature.* The value of the increase of entropy is given in the language of

calculus, $E = \int_{T_2}^{T_1} \frac{dQ}{T}$, which may be interpreted thus: increase of entropy

between the temperatures T_2 and T_1 equals the summation of all the quotients arising by dividing each small quantity of heat added by the absolute temperature at which it is added. It is evident that if the several small quantities of heat added are equal, while the values of T constantly increase, the quotients are not equal, but are constantly decreasing. The diagram, called the temperature-entropy diagram, or the $\theta\phi$, theta-phi, diagram, is one in which the abscissas, or horizontal distances, represent entropy, and vertical distances absolute temperature. The horizontal distances are measured from an arbitrary vertical line representing entropy at 32° F., and values of entropy are given as values beyond that point, while the temperatures are measured above absolute zero. Horizontal lines are isothermals, vertical lines adiabatics. The usefulness of entropy in thermodynamic studies is due to the fact that in many cases it simplifies calculations and makes it possible to use algebraic or graphical methods instead of the more difficult methods of the calculus.

The Carnot Cycle in the Temperature-Entropy Diagram.—Let a pound of gas having a temperature T_1 and entropy E be subjected to the four operations described above. (1) T_1 being constant, heat (area $aABc$, Fig. 137) is added and the entropy increases from A to B ; isothermal expansion. (2) No heat is transferred, as heat, but the temperature is reduced from T_1 to T_2 ; entropy constant; adiabatic expansion. (3) Heat is rejected at the constant temperature T_2 , the area $CcaD$ being subtracted; entropy decreases from C to D ; isothermal compression. (4) Entropy constant, temperature increases from D to A , or from T_2 to T_1 ; no heat transferred as heat; adiabatic compression. The area $aABc$ represents the total heat added during the cycle, the area $cCda$ the heat rejected; the difference, or the area $ABCD$, is the heat utilized or converted into work. The ratio of this area to the whole area

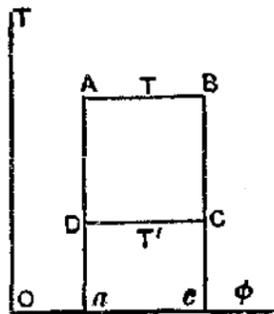

FIG. 137.

$aABc$ is the efficiency; it is the same as the ratio $(T_1 - T_2) \div T_1$. It appears from this diagram that the efficiency may be increased by increasing T_1 or by decreasing T_2 ; also that since T_2 cannot be lowered by any self-acting engine below the temperature of the surrounding atmosphere, say $460^\circ + 62^\circ \text{ F.} = 522^\circ \text{ F.}$, it is not possible even in a perfect engine to obtain an efficiency of 50 per cent unless the temperature of the source of heat is above 1000° F. It is shown also by this diagram that the Carnot cycle gives the highest possible efficiency of a heat engine working between any given temperatures T_1 and T_2 , and that the admission and rejection of heat each at a constant temperature gives a higher efficiency than the admission or rejection at any variable temperatures within the range $T_1 - T_2$.

The Reversed Carnot Cycle—Refrigeration.—Let a pound of cool gas whose temperature and entropy are represented by the "state-point" D on the diagram (1) receive heat at a constant temperature T_2 (the temperature of a refrigerating room) until its entropy is C ; (2) then let it be compressed adiabatically (no heat transmission, CB) to a high temperature T_1 ; (3) then let it reject heat into the atmosphere at this temperature T_1 (isothermal compression); (4) then let it expand adiabatically, doing work, as through a throttled expansion cock, or by pushing a piston, it will then cool to a temperature which may be far below that of the atmosphere and be used to absorb heat from the atmosphere. (See Refrigeration.)

Principal Equations of a Perfect Gas.—Notation: P = pressure in lbs. per sq. ft. V = volume in cu. ft. P_0V_0 , pressure and volume at 32° F. T , absolute temperature = $t^\circ \text{ F.} + 459.4$. C_p , specific heat at constant pressure. C_v , specific heat at constant volume. $K_p = C_p \times 778$; $K_v = C_v \times 778$; specific heats taken in foot-pounds of energy. R , a constant, = $K_p - K_v$. $\gamma = C_p/C_v$. r = ratio of isothermal expansion or compression = P_2/P_1 or V_1/V_2 .

For air: $C_p = 0.2375$; $C_v = 0.1689$; $K_p = 184.8$; $K_v = 131.4$; $R = 53.35$; $\gamma = 1.406$.

Boyle's Law, $PV = \text{constant}$ when T is constant. $P_1V_1 = P_2V_2$. For 1 lb. air $P_0V_0 = 2116.2 \times 12.387 = 26,224 \text{ ft.-lbs.}$

Charles's Law, $P_1V_1/T_1 = P_2V_2/T_2$; $P_1V_1 = P_0V_0 \times T_1/T_0$; $T_0 = 32 + 459.4 = 491.4$; P_1V_1 for air = $26,224 \div 491.4 = 53.35$.

General Equation, $PV = RT$. R is a constant which is different for different gases.

Internal or Intrinsic Energy $K_v(T_1 - T_0) = R(T_1 - T_0) \div (\gamma - 1) = P_1V_1 \div (\gamma - 1)$ = amount of heat in a body, measured above absolute zero. For air at 32° F. , $K_v(T_1 - T_0) = 131.4 \times 491.4 = 64,570 \text{ ft.-lbs.}$ When air is expanded or compressed isothermally, $PV = \text{constant}$, and the internal energy remains constant, the work done in expansion = the heat added, and the work done in compression = the heat rejected.

WARNING: This is a 1910 edition. Some of the material may no longer be accurate

Work done by Adiabatic Expansion, no transmission of heat, from P_1V_1 to $P_2V_2 = P_1V_1 \left\{ 1 - (V_1/V_2)^{\gamma-1} \right\} \div (\gamma - 1)$, = $(P_1V_1 - P_2V_2) \div (\gamma - 1)$

$$= P_1V_1 \left\{ 1 - (P_2/P_1)^{\frac{\gamma-1}{\gamma}} \right\} \div (\gamma - 1).$$

Work of Adiabatic Compression from P_1V_1 to P_2V_2 (P_2 here being the higher pressure) = $P_1V_1 \left\{ (V_1/V_2)^{\gamma-1} - 1 \right\} \div (\gamma - 1) = (P_2V_2 - P_1V_1) \div \gamma - 1$

$$= P_1V_1 \left\{ (P_2/P_1)^{\frac{\gamma-1}{\gamma}} - 1 \right\} \div (\gamma - 1).$$

Loss of Intrinsic Energy in adiabatic expansion, or gain in compression = $K_v(T_1 - T_2)$, T_1 being the higher temperature.

Work of Isothermal Expansion, temperature constant, = heat expended = $P_1V_1 \log_e V_2/V_1 = P_1V_1 \log_e r = RT \log_e r$.

Work of Isothermal Compression from P_1 to $P_2 = P_1V_1 \log_e P_1/P_2 = RT \log_e r = \text{heat discharged.}$

Relation between Pressure, Volume and Temperature:

$$P_2 = P_1 \left(\frac{V_1}{V_2} \right)^\gamma = P_1 \left(\frac{T_1}{T_2} \right)^{\frac{\gamma}{\gamma-1}}, \quad V_2 = V_1 \left(\frac{P_1}{P_2} \right)^{\frac{1}{\gamma}} = V_1 \left(\frac{T_1}{T_2} \right)^{\frac{1}{\gamma-1}}.$$

$$T_2 = T_1 \left(\frac{P_2}{P_1} \right)^{\frac{\gamma-1}{\gamma}} = T_1 \left(\frac{V_1}{V_2} \right)^{\gamma-1}, \quad P_1V_1^\gamma = P_2V_2^\gamma.$$

For air, $\gamma = 1.406$; $\gamma - 1 = 0.406$; $1/\gamma = 0.711$; $1/(\gamma - 1) = 2.463$; $\gamma/(\gamma - 1) = 3.463$; $(\gamma - 1)/\gamma = 0.289$.

Differential Equations of a Perfect Gas. Q = quantity of heat. ϕ = entropy.

$$dQ = C_v dT + (C_p - C_v) \frac{T}{V} dV, \quad d\phi = C_v \frac{dT}{T} + (C_p - C_v) \frac{dV}{V}.$$

$$dQ = C_p dT + (C_v - C_p) \frac{T}{P} dP, \quad d\phi = C_p \frac{dT}{T} + (C_v - C_p) \frac{dP}{P}.$$

$$dQ = C_v \frac{T}{P} dP + C_p \frac{T}{P} dV, \quad d\phi = C_v \frac{dP}{P} + C_p \frac{dV}{V}.$$

$$\phi_2 - \phi_1 = C_p \log_e \frac{T_2}{T_1} + (C_p - C_v) \log_e \frac{V_2}{V_1}.$$

$$\phi_2 - \phi_1 = C_p \log_e \frac{T_2}{T_1} + (C_v - C_p) \log_e \frac{P_1}{P_2}.$$

$$\phi_2 - \phi_1 = C_v \log_e \frac{P_2}{P_1} + C_p \log_e \frac{V_2}{V_1}.$$

Work of Isothermal Expansion, $W = P_1V_1 \int_{V_1}^{V_2} \frac{dV}{V} = P_1V_1 \log_e \frac{V_2}{V_1}$.

Heat supplied during isothermal expansion,

$$Q = (C_p - C_v) T_1 \int_{V_1}^{V_2} \frac{dV}{V} = (C_p - C_v) T_1 \log_e \frac{V_2}{V_1}.$$

Heat added = work done = $ART_1 \log_e V_2/V_1 = AP_1V_1 \log_e V_2/V_1$; ($A = 1/778$).

Work of adiabatic expansion,

$$W = \int_{V_1}^{V_2} PdV = V_1^\gamma P_1 \int_{V_1}^{V_2} \frac{dV}{V^\gamma} = \frac{P_1V_1}{\gamma-1} \left\{ 1 - \left(\frac{V_1}{V_2} \right)^{\gamma-1} \right\}.$$

Construction of the Curve $pV^n = C$. (*Am. Mach.*, June 21, 1900.) — Referring to Fig. 138, on a system of rectangular coordinates YOX lay off $OB = p_1$ and $BA = v_1$. Draw OJ , extended, at any convenient angle α , say 15° , with OX , and OC at an angle β with OY . β is found from the equation $1 + \tan \beta = [1 + \tan \alpha]^n$. Draw AJ parallel to YO . From B draw BC at 45° with BO , and draw CE parallel to OX . From J draw JH at 45° with AJ , and draw HE and HJ_1 parallel to YO . The intersection of CE and HE is the second point on the curve, or $p_2 v_2$. From J_1 draw $J_1 H_1$ at 45° to HJ_1 and draw the vertical $J_2 H_1 R$. Draw DK at 45° to DO_1 and KR parallel to OX . R is the third point on the curve, and so on.

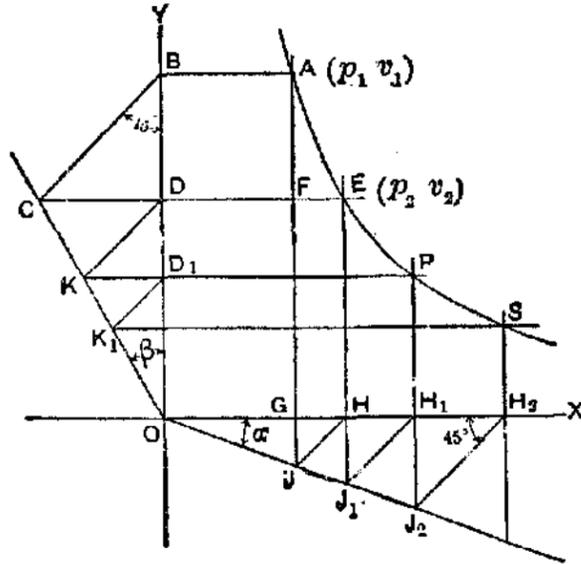

FIG. 138.

to derive an exponent, we can, by working backward, locate the lines OC and OJ , measure the angles α and β , and solve for n .

The smaller the angle α is taken the more closely the points of the curve may be located. If $\alpha = \beta$ the curve is the isothermal curve, $pV = \text{constant}$. If $\alpha = 15^\circ$ and $\beta = 21^\circ 30'$ the curve is the adiabatic for air, $n = 1.41$. (See Index of the Curve of an Air Diagram, p. 611).

Temperature-Entropy Diagram of Water and Steam. — The line OA , Fig. 139, is the origin from which entropy is measured on horizontal lines, and the line Og is the line of zero temperature, absolute. The diagram represents the changes in the state of one pound of water due to the addition or subtraction of heat or to changes in temperature. Any point on the diagram is called a "state point." A is the state of 1 lb. of water at 32° F. or 492° abs., B the state at 212° , and C at 392° F., corresponding to about 226 lbs. absolute pressure. At 212° F. the area $OABb$ is the heat added, and Ob is the increase of entropy. At 392° F., $bBcC$ is the further addition of heat, and the entropy, measured from OA , is Oc . The two quantities added are nearly the same, but the second increase of entropy is the smaller, since the mean temperature at which it is added is higher. If Q = the quantity of heat added, and T_1 and T_2 are respectively the lower and the higher temperatures, the addition of entropy, ϕ , is approximately $Q \div \frac{1}{2}(T_2 + T_1) = 180 \div \frac{1}{2}(672 + 492) = 0.3093$. More accurately it is $\phi = \log_e (T_2/T_1) = 0.3119$. In both of these expressions it is assumed that the specific heat of water = 1 at all temperatures, which is not strictly true. Accurate values of the entropy of water, taking into account the variation in specific heat, will be found in Peabody's Steam Tables.

Let the 1 lb. of water at the state B have heat added to it at the con-

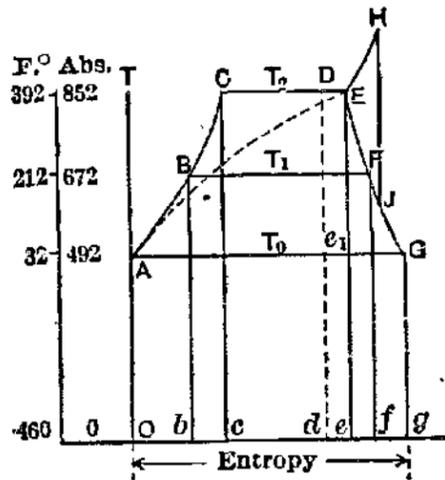

FIG. 139.

stant temperature of 212° F. until it is evaporated. The quantity of heat added will be the latent heat of evaporation at 212° (see Steam Table) or $L = 969.7$ B.T.U., and it will be represented on the diagram by the rectangle $bBff$. Dividing by $T_2 = 672$, the absolute temperature, gives $\phi_2 - \phi_1 = 1.443 = BF$. Adding $\phi_1 = 0.312$ gives $\phi_2 = 1.755$, the entropy of 1 lb. steam at 212° F. measured from water at 32° F.

In like manner if we take $L = 835$ for steam at 852° abs., $\phi_2 - \phi_1 = 0.980 = CE$, and $\phi_1 =$ entropy of water at $852^\circ = 0.558$, the sum $\phi_2 = 1.538 = Oe$ on the diagram.

E is the state point of dry saturated steam at 852° abs. and F the state point at 672° . The line EFG is the line of saturated steam and the line ABC the water line. The line CE represents the increase of entropy in the evaporation of water at 852° abs. If entropy CD only is added, or $cCDD$ of heat, then a part of the water will remain unevaporated, viz.: the fraction DE/CE of 1 lb. The state point D thus represents wet steam having a dryness fraction of CD/DE .

If steam having a state point E is expanded adiabatically to 672° abs. its state point is then e_1 , having the same entropy as at E , a total heat less by the amount represented by the area $FCEe_1$, and a dryness fraction Be/BF . If it is expanded while remaining saturated, heat must be added equal to $eEFf$, and the entropy increases by cf .

If heat is added to the steam at E , the temperature and the entropy both increase, the line EH representing the superheating, and the area EH , down to the line Og , is the heat added. If from the state point H the steam is expanded adiabatically, the state point follows the line FJ until it cuts the line EFG_1 , when the steam is dry saturated, and if it crosses this line the steam becomes wet.

If the state point follows a horizontal line to the left, it represents condensation at a constant temperature, the amount of heat rejected being shown by the area under the horizontal line. If heat is rejected at a decreasing temperature, corresponding with the decreasing pressure at release in a steam engine, or condensation in a cylinder at a decreasing pressure, the state point follows a curved line to the left, as shown in the dotted curved line on the diagram.

In practical calculations with the entropy-temperature diagram it is necessary to have at hand tables or charts of entropy, total heat, etc., such as are given in Peabody's Steam Tables, Ripper's Steam Engine, and other works. The diagram is of especial service in the study of steam turbines, and an excellent chart for this purpose will be found in Moyer's Steam Turbine. It gives for all pressures of steam from 0.5 to 300 lbs. absolute, and for different degrees of dryness up to 300° of superheating, the total heat contents in B.T.U. per pound, the entropy, and the velocity of steam through nozzles.

PHYSICAL PROPERTIES OF GASES.

(Additional matter on this subject will be found under Heat, Air, Gas and Steam.)

When a mass of gas is inclosed in a vessel it exerts a pressure against the walls. This pressure is uniform on every square inch of the surface of the vessel; also, at any point in the fluid mass the pressure is the same in every direction.

In small vessels containing gases the increase of pressure due to weight may be neglected, since all gases are very light; but where liquids are concerned, the increase in pressure due to their weight must always be taken into account.

Expansion of Gases, Mariotte's Law. — The volume of a gas diminishes in the same ratio as the pressure upon it is increased, if the temperature is unchanged.

This law is by experiment found to be very nearly true for all gases, and is known as Boyle's or Mariotte's law.

If p = pressure at a volume v , and p_1 = pressure at a volume v_1 , $p_1 v_1 = pv$; $p_1 = \frac{v}{v_1} p$; $pv = \text{a constant}$.

The constant, C , varies with the temperature, everything else remaining the same.

Air compressed by a pressure of seventy-five atmospheres has a volume about 2% less than that computed from Boyle's law, but this is the greatest divergence that is found below 160 atmospheres pressure.

Law of Charles. — The volume of a perfect gas at a constant pressure is proportional to its absolute temperature. If v_0 be the volume of a gas at 32° F., and v_1 the volume at any other temperature, t_1 , then

$$v_1 = v_0 \left(\frac{t_1 + 459.2}{491.2} \right); \quad v_1 = \left(1 + \frac{t_1 - 32^\circ}{491.2} \right) v_0,$$

$$\text{or } v_1 = [1 + 0.002036 (t_1 - 32^\circ)] v_0.$$

If the pressure also change from p_0 to p_1 ,

$$v_1 = v_0 \frac{p_0}{p_1} \left(\frac{t_1 + 459.2}{491.2} \right).$$

The Densities of the elementary gases are simply proportional to their atomic weights. The density of a compound gas, referred to hydrogen as 1, is one-half its molecular weight; thus the relative density of CO_2 is $1/2 (12 + 32) = 22$.

Avogadro's Law. — Equal volumes of all gases, under the same conditions of temperature and pressure, contain the same number of molecules.

To find the weight of a gas in pounds per cubic foot at 32° F., multiply half the molecular weight of the gas by 0.00559. Thus, 1 cu. ft. marsh-gas, CH_4 ,

$$= 1/2 (12 + 4) \times 0.00559 = 0.0447 \text{ lb.}$$

When a certain volume of hydrogen combines with one-half its volume of oxygen, there is produced an amount of water vapor which will occupy the same volume as that which was occupied by the hydrogen gas when at the same temperature and pressure.

Saturation Point of Vapors. — A vapor that is not near the saturation point behaves like a gas under changes of temperature and pressure; but if it is sufficiently compressed or cooled, it reaches a point where it begins to condense: it then no longer obeys the same laws as a gas, but its pressure cannot be increased by diminishing the size of the vessel containing it, but remains constant, except when the temperature is changed. The only gas that can prevent a liquid evaporating seems to be its own vapor.

Dalton's Law of Gaseous Pressures. — Every portion of a mass of gas inclosed in a vessel contributes to the pressure against the sides of the vessel the same amount that it would have exerted by itself had no other gas been present.

Mixtures of Vapors and Gases. — The pressure exerted against the interior of a vessel by a given quantity of a perfect gas inclosed in it is the sum of the pressures which any number of parts into which such quantity might be divided would exert separately, if each were inclosed in a vessel of the same bulk alone, at the same temperature. Although this law is not exactly true for any actual gas, it is very nearly true for many. Thus if 0.080728 lb. of air at 32° F., being inclosed in a vessel of one cubic foot capacity, exerts a pressure of one atmosphere, or 14.7 pounds, on each square inch of the interior of the vessel, then will each additional 0.080728 lb. of air which is inclosed, at 32° , in the same vessel, produce very nearly an additional atmosphere of pressure. The same law is applicable to mixtures of gases of different kinds. For example, 0.12344 lb. of carbonic-acid gas, at 32° , being inclosed in a vessel of one cubic foot in capacity, exerts a pressure of one atmosphere; consequently, if 0.080728 lb. of air and 0.12344 lb. of carbonic acid, mixed, be inclosed at the temperature of 32° , in a vessel of one cubic foot of capacity, the mixture will exert a

pressure of two atmospheres. Let 0.080728 lb.

of air, at 212° , be inclosed in a vessel of one cubic foot; it will exert a pressure of

$$\frac{212 + 459.2}{32 + 459.2} = 1.366 \text{ atmospheres.}$$

Let 0.03797 lb. of steam, at 212° , be inclosed in a vessel of one cubic foot; it will exert a pressure of one atmosphere. Consequently, if 0.080728 lb. of air and 0.03797 lb. of steam be mixed and inclosed together, at 212° , in a vessel of one cubic foot, the mixture will exert a pressure of 2.366 atmospheres. It is a common but erroneous practice, in elementary books on physics, to describe this law as constituting a difference between mixed and homogeneous gases; whereas it is obvious that for mixed and homogeneous gases the law of pressure is exactly the same, viz., that the pressure of the whole of a gaseous mass is the sum of the pressures of all its parts. This is one of the laws of mixture of gases and vapors.

A second law is that the presence of a foreign gaseous substance in contact with the surface of a solid or liquid does not affect the density of the vapor of that solid or liquid unless there is a tendency to chemical combination between the two substances, in which case the density of the vapor is slightly increased. (Rankine, S. E., p. 239.)

If 0.591 lb. of air, = 1 cu. ft. at 212° and atmospheric pressure, is contained in a vessel of 1 cu. ft. capacity, and water at 212° is introduced, heat at 212° being furnished by a steam jacket, the pressure will rise to two atmospheres.

If air is present in a condenser along with water vapor, the pressure is that due to the temperature of the vapor plus that due to the quantity of air present.

Flow of Gases. — By the principle of the conservation of energy, it may be shown that the velocity with which a gas under pressure will escape into a vacuum is inversely proportional to the square root of its density; that is, oxygen, which is sixteen times as heavy as hydrogen, would, under exactly the same circumstances, escape through an opening only one fourth as fast as the latter gas.

Absorption of Gases by Liquids. — Many gases are readily absorbed by water. Other liquids also possess this power in a greater or less degree. Water will, for example, absorb its own volume of carbonic-acid gas, 430 times its volume of ammonia, $2\frac{1}{3}$ times its volume of chlorine, and only about $1/20$ of its volume of oxygen.

The weight of gas that is absorbed by a given volume of liquid is proportional to the pressure. But as the volume of a mass of gas is less as the pressure is greater, the volume which a given amount of liquid can absorb at a certain temperature will be constant, whatever the pressure. Water, for example, can absorb its own volume of carbonic-acid gas at atmospheric pressure; it will also dissolve its own volume if the pressure is twice as great, but in that case the gas will be twice as dense, and consequently twice the weight of gas is dissolved.

Liquefaction of Gases.—Liquid Air. (A. L. Rice, *Trans. A. S. M. E.*, xxi, 156.)—Oxygen was first liquefied in 1877 by Cailletet and Pictet, working independently. In 1884 Dewar liquefied air, and in 1898 he liquefied hydrogen at a temperature of -396.4° F., or only 65° above the absolute zero. The method of obtaining the low temperatures required for liquefying gases was suggested by Sir W. Siemens, in 1857. It consists in expanding a compressed gas in a cylinder doing work, or through a small orifice, to a lower pressure, and using the cold gas thereby produced to cool, before expansion, the gas coming to the apparatus. Hampson claims to have condensed about 1.2 quarts of liquid air per hour at an expenditure of 3.5 H.P. for compression, using a pressure of 120 atmospheres expanded to 1, and getting 6.6 per cent of the air handled as liquid.

The following table gives some physical constants of the principal gases that have been liquefied. The critical temperature is that at which the properties of a liquid and its vapor are indistinguishable, and above which the vapor cannot be liquefied by compression. The critical pressure is the pressure of the vapor at the critical temperature.

WARNING: This is a 1910 edition. Some of the material may no longer be accurate

		Critical Temp. Deg. F.	Critical Pressure in Atmospheres	Temp. of Saturated Vapor at Atmos. Pressure Deg. F.	Freezing Point. Deg. F.	Density of Liquid at Temperature Given.
Water.....	H ₂ O	689	200	212	32	1 at 39° F.
Ammonia.....	NH ₃	266	115	-27	-107	0.6364 at 32° F.
Acetylene.....	C ₂ H ₂	98.6	-121	-113.8
Carbon Dioxide.....	CO ₂	88	75	-112	-69	0.83 at 32° F.
Ethylene.....	C ₂ H ₄	50	51.7	-150	-272
Methane.....	CH ₄	-115.2	54.9	-263.4	-302.4	0.415 at -263° F.
Oxygen.....	O ₂	-182	50.8	-294.5	1.124 at -294° F.
Argon.....	A	-185.8	50.6	-304.6	-309.3	about 1.5 at -305° F.
Carbon Monoxide.....	CO	-219.1	35.5	-310	-340.6
Air.....	-220	39	-312.6	0.933 at -313° F.
Nitrogen.....	N ₂	-231	35	-318	-353.2	0.885 at -318° F.
Hydrogen.....	H ₂	-389	20	-405

AIR.

Properties of Air. — Air is a mechanical mixture of the gases oxygen and nitrogen, with about 1% by volume of argon. Atmospheric air of ordinary purity contains about 0.04% of carbon dioxide. The composition of air is variously given as follows:

	By Volume.			By Weight.		
	N	O	Ar	N	O	Ar
1.....	79.3	23.7	77	23
2.....	79.09	20.91	76.85	23.15
3.....	78.122	20.941	0.937	75.539	23.024	1.437
4.....	78.06	21.	0.94	75.5	23.2	1.3

(1) Values formerly given in works on physics. (2) Average results of several determinations, Hempel's Gas Analysis. (3) Sir Wm. Ramsay, *Bull. U. S. Geol. Survey*, No. 330. (4) A. Leduc, *Comptes Rendus*, 1896, *Jour. F. I.*, Jan., 1898. Leduc gives for the density of oxygen relatively to air 1.10523; for nitrogen 0.9671; for argon, 1.376.

The weight of pure air at 32° F. and a barometric pressure of 29.92 inches of mercury, or 14.6963 lbs. per sq. in., or 2116.3 lbs. per sq. ft., is 0.080728 lb. per cubic foot. Volume of 1 lb. = 12.387 cu. ft. At any other temperature and barometric pressure its weight in lbs. per cubic

WARNING: This is a 1910 edition. Some of the material may no longer be accurate

foot is $W = \frac{1.3253 \times B}{459.2 + T}$, where B = height of the barometer, T = temperature Fahr., and 1.3253 = weight in lbs. of 459.2 cu. ft. of air at 0° F. and one inch barometric pressure. Air expands 1/491.2 of its volume at 32° F. for every increase of 1° F., and its volume varies inversely as the pressure.

The **Air-manometer** consists of a long, vertical glass tube, closed at the upper end, open at the lower end, containing air, provided with a scale, and immersed, along with a thermometer, in a transparent liquid, such as water or oil, contained in a strong cylinder of glass, which communicates with the vessel in which the pressure is to be ascertained. The scale shows the volume occupied by the air in the tube.

Let v_0 be that volume, at the temperature of 32° Fahrenheit, and mean pressure of the atmosphere, p_0 ; let v_1 be the volume of the air at the temperature t , and under the absolute pressure to be measured p_1 ; then

$$p_1 = \frac{(t + 459.2^\circ) p_0 v_0}{491.2^\circ v_1}$$

Pressure of the Atmosphere at Different Altitudes.

At the sea level the pressure of the air is 14.7 pounds per square inch; at 1/4 of a mile above the sea level it is 14.02 pounds; at 1/2 mile, 13.33; at 3/4 mile, 12.66; at 1 mile, 12.02; at 1 1/4 mile, 11.42; at 1 1/2 mile, 10.88; and at 2 miles, 9.80 pounds per square inch. For a rough approximation we may assume that the pressure decreases 1/2 pound per square inch for every 1000 feet of ascent.

It is calculated that at a height of about 3 1/2 miles above the sea level the weight of a cubic foot of air is only one-half what it is at the surface of the earth, at seven miles only one-fourth, at fourteen miles only one-sixteenth, at twenty-one miles only one sixty-fourth, and at a height of over forty-five miles it becomes so attenuated as to have no appreciable weight.

The pressure of the atmosphere increases with the depth of shafts, equal to about one inch rise in the barometer for each 900 feet increase in depth; this may be taken as a rough-and-ready rule for ascertaining the depth of shafts.

Pressure of the Atmosphere per Square Inch and per Square Foot at Various Readings of the Barometer.

RULE. — Barometer in inches \times 0.4908 = pressure per square inch; pressure per square inch \times 144 = pressure per square foot.

Barometer.	Pressure per Sq. In.	Pressure per Sq. Ft.	Barometer.	Pressure per Sq. In.	Pressure per Sq. Ft.
in.	lbs.	lbs.*	in.	lbs.	lbs.*
28.00	13.74	1978	29.75	14.60	2102
28.25	13.86	1995	30.00	14.72	2119
28.50	13.98	2013	30.25	14.84	2136
28.75	14.11	2031	30.50	14.96	2154
29.00	14.23	2049	30.75	15.09	2172
29.25	14.35	2066	31.00	15.21	2190
29.50	14.47	2083			

* Decimals omitted.

For lower pressures see table of the Properties of Steam.

Barometric Readings corresponding with Different Altitudes, in French and English Measures.

Altitude.	Reading of Barometer.	Altitude.	Reading of Barometer.	Altitude.	Reading of Barometer.	Altitude.	Reading of Barometer.
meters	mm.	feet.	inches.	meters.	mm.	feet.	inches.
0	762	0	30.	1147	660	3763.2	25.98
21	760	68.9	29.92	1269	650	4163.3	25.59
127	750	416.7	29.52	1393	640	4568.3	25.19
234	740	767.7	29.13	1519	630	4983.1	24.80
342	730	1122.1	28.74	1647	620	5403.2	24.41
453	720	1486.2	28.35	1777	610	5830.2	24.01
564	710	1850.4	27.95	1909	600	6243.	23.62
678	700	2224.5	27.55	2043	590	6702.9	23.22
793	690	2599.7	27.16	2180	580	7152.4	22.83
909	680	2962.1	26.77	2318	570	7605.1	22.44
1027	670	3369.5	26.38	2460	560	8071.	22.04

Boiling Point of Water.—[Temperature in degrees F., barometer in in. of mercury.

In.	.0	.1	.2	.3	.4	.5	.6	.7	.8	.9
28	208.7	208.9	209.1	209.2	209.4	209.5	209.7	209.9	210.1	210.3
29	210.5	210.6	210.8	210.9	211.1	211.3	211.4	211.6	211.8	212.0
30	212.1	212.3	212.4	212.6	212.8	212.9	213.1	213.3	213.5	213.6

Leveling by the Barometer and by Boiling Water. (Trautwine.)
 — Many circumstances combine to render the results of this kind of leveling unreliable where great accuracy is required. It is difficult to read off from an aneroid (the kind of barometer usually employed for engineering purposes) to within from two to five or six feet, depending on its size. The moisture or dryness of the air affects the results; also winds, the vicinity of mountains, and the daily atmospheric tides, which cause incessant and irregular fluctuations in the barometer. A barometer hanging quietly in a room will often vary 1/4 of an inch within a few hours, corresponding to a difference of elevation of nearly 100 feet. No formula can possibly be devised that shall embrace these sources of error.

To Find the Difference in Altitude of Two Places. — Take from the table the altitudes opposite to the two boiling temperatures, or to the two barometer readings. Subtract the one opposite the lower reading from that opposite the upper reading. The remainder will be the required height, as a rough approximation. To correct this, add together the two thermometer readings, and divide the sum by 2, for their mean. From table of corrections for temperature, take out the number under this mean. Multiply the approximate height just found by this number.

At 70° F. pure water will boil at 1° less of temperature for an average of about 550 feet of elevation above sea level, up to a height of 1/2 mile. At the height of 1 mile, 1° of boiling temperature will correspond to about 560 feet of elevation. In the table the mean of the temperatures at the two stations is assumed to be 32° F., at which no correction for temperature is necessary in using the table.

Boiling-point in Deg. Fahr.	Barom. In.	Altitude above Sea level, Feet.	Boiling-point in Deg. Fahr.	Barom. In.	Altitude above Sea level, Feet.	Boiling-point in Deg. Fahr.	Barom. In.	Altitude above Sea level, Feet.
184°	16.79	15,221	196	21.71	8,471	208	27.73	2,063
185	17.16	14,649	197	22.17	7,932	208.5	28.00	1,809
186	17.54	14,075	198	22.64	7,381	209	28.29	1,539
187	17.93	13,498	199	23.11	6,843	209.5	28.56	1,290
188	18.32	12,934	200	23.59	6,304	210	28.85	1,025
189	18.72	12,367	201	24.08	5,764	210.5	29.15	754
190	19.13	11,799	202	24.58	5,225	211	29.42	512
191	19.54	11,243	203	25.08	4,697	211.5	29.71	255
192	19.96	10,685	204	25.59	4,169	212	30.00	S.L. = 0
193	20.39	10,127	205	26.11	3,642	212.5	30.30	-261
194	20.82	9,579	206	26.64	3,115	213	30.59	-511
195	21.26	9,031	207	27.18	2,589			

CORRECTIONS FOR TEMPERATURE.

Mean temp. F. in shade.	0	10°	20°	30°	40°	50°	60°	70°	80°	90°	100°
Multiply by	.933	.954	.975	.996	1.016	1.036	1.058	1.079	1.100	1.121	1.142

Moisture in the Atmosphere. — Atmospheric air always contains a small quantity of carbonic acid (see Ventilation), and a varying quantity of aqueous vapor or moisture. The relative humidity of the air at any time is the percentage of moisture contained in it as compared with the amount it is capable of holding at the same temperature.

The degree of saturation or relative humidity of the air is determined by the use of the dry and wet bulb thermometer. The degree of saturation for a number of different readings of the thermometer is given in the following table, condensed from the Hygrometric Tables of the U. S. Weather Bureau:

RELATIVE HUMIDITY, PER CENT.

Dry Ther- mometer, Deg. F.	Difference between the Dry and Wet Thermometers, Deg. F.																													
	1	2	3	4	5	6	7	8	9	10	11	12	13	14	15	16	17	18	19	20	21	22	23	24	26	28	30			
32	89	79	69	59	49	39	30	20	11	2																				
40	92	83	75	68	60	52	45	37	29	23	15	7	0																	
50	93	87	80	74	67	61	55	49	43	38	32	27	21	16	11	5	0													
60	94	89	83	78	73	68	63	58	53	48	43	39	34	30	26	21	17	13	9	5	1									
70	95	90	86	81	77	72	68	64	59	55	51	48	44	40	36	33	29	25	22	19	15	12	9	6						
80	96	91	87	83	79	75	72	68	64	61	57	54	50	47	44	41	38	35	32	29	26	23	20	18	12	7				
90	96	92	89	85	81	78	74	71	68	65	61	58	55	52	49	47	44	41	39	36	34	31	29	26	22	17	13			
100	96	93	89	86	83	80	77	73	70	68	65	62	59	56	54	51	49	46	44	41	39	37	35	33	28	24	21			
110	97	93	90	87	84	81	78	75	73	70	67	65	62	60	57	55	52	50	48	46	44	42	40	38	34	30	26			
120	97	94	91	88	85	82	80	77	74	72	69	67	65	62	60	58	55	53	51	49	47	45	43	41	38	34	31			
140	97	95	92	89	87	84	82	79	77	75	73	70	68	66	64	62	60	58	56	54	53	51	49	47	44	41	38			

Moisture in Air at Different Pressures and Temperatures. (H. M. Prevost Murphy, *Eng. News*, June 18, 1908.) — 1. The maximum amount of moisture that pure air can contain depends only on its temperature and pressure, and has an unvarying value for each condition.

2. The higher the temperature of the air, the greater is the amount of moisture that it can contain.

3. The higher the pressure of the air, the smaller is the amount of moisture that it can contain.

4. When air is compressed, the rise of temperature due to the compression, in all cases found in practice, far more than offsets the opposite effect of the rise of pressure on the moisture-carrying capacity of the air. Water is deposited, therefore, by compressed air as it passes from the compressor to the various portions of the system.

Suppose that a certain amount of atmospheric air enters a compressor and that it contains all the moisture possible at the existing outside temperature and pressure. As this air is compressed its moisture-carrying capacity rapidly increases, consequently all the moisture is retained by the air and passes with it into the main or storage reservoir. Now if this air is permitted to pass from the reservoir into the various parts of the system before being cooled to the outside temperature, it will carry more moisture than it is capable of holding when the temperature finally drops to the normal point, and this excess quantity will be deposited, because, the pressure being high, the air cannot hold as much moisture as it did at the same temperature and only atmospheric pressure.

In order to reduce the moisture to a minimum, it is desirable to cool the air to the outside temperature before it leaves the reservoir, thereby causing it to deposit all of its excess moisture, which may be easily removed by drain cocks.

Although compressed air may be properly dried before leaving the main reservoirs, some moisture may be temporarily deposited when the air is subsequently expanded to lower pressures, as its moisture-carrying capacity is usually affected more by the drop in temperature, resulting from the expansion, than by the drop in pressure, but when the air again attains the outside temperature, the moisture thus deposited will be re-absorbed if it is freely exposed to the compressed air.

In order to determine what percentage of moisture pure air can contain at various pressures and temperatures, to ascertain how low the "relative humidity" of the atmosphere must be in order that no water will be deposited in any part of a compressed-air system and also to find to what temperature air drawn from a saturated atmosphere must be cooled in order to cause the deposition of moisture to commence, the following formulæ and tables are used, based on Dalton's law of gaseous pressures, which may be stated as follows:

The total pressure exerted against the interior of a vessel by a given quantity of a mixed gas enclosed in it is the sum of the pressures which each of the component gases, or vapors, would exert separately if it were enclosed alone in a vessel of the same bulk, at the same temperature. [The derivation of the formulæ is given at length in the original paper.]

Formulæ for the Weight, in Lbs., of 1 Cu. Ft. of Dry Air, of 1 Cu. Ft. of Saturated Steam or Water Vapor and the Maximum Weight of Water Vapor that 1 Lb. of Pure Air Can Carry at Any Pressure and Temperature. (Copyright, 1908, by H. M. Prevost Murphy.)

The values *K* and *H* being given in the table for various temperatures, *t*, in Fahrenheit degrees, the formulæ are:

$$\text{Weight of 1 cu. ft. saturated steam} = \frac{1.325271 KH}{459.2 + t}$$

H = elastic force or tension of water vapor or saturated steam, in in. of mercury corresponding to the temperature *t* (Fahr.) = 2.036 × (gauge pressure + atmospheric pressure, in pounds per square inch).

K = the ratio of the weight of a volume of saturated steam to an equal volume of pure dry air at the same temperature and pressure,

$$= 0.6113 + \frac{0.092 t}{850 - t}$$

Values of *K* and *H* corresponding to the various temperatures *t* are given in the table below.

$$\text{Weight of 1 cu. ft. pure dry air} = \frac{1.325271 M}{459.2 + t} = \frac{2.698192 P}{459.2 + t}$$

M = absolute pressure in inch of mercury.
P = absolute pressure in pounds per square inch.

W = maximum weight, in lbs., of water vapor, that 1 lb. of pure air can contain, when the temperature of the mixture is *t*, and the total, or observed, absolute pressure in pounds per square inch is *P*.

$$= \frac{KH}{2.036 P - H}$$

NOTE. — The results obtained by the use of any of the above formulæ agree exactly with the average data for air and steam weights as given by the most reliable authorities and careful experiments, for all pressures and temperatures; the value of *K* being correct for all temperatures up to the critical steam temperature of 689° F.

VALUES OF "K" AND "H" CORRESPONDING TO TEMPERATURES *t* FROM -30° TO 434° F.

<i>t</i>	<i>K</i>	<i>H</i>	<i>t</i>	<i>K</i>	<i>H</i>	<i>t</i>	<i>K</i>	<i>H</i>	<i>t</i>	<i>K</i>	<i>H</i>	<i>t</i>	<i>K</i>	<i>H</i>
-30	.6082	.0099	64	.6188	.5962	158	.6323	9.177	252	.6501	62.97	344	.6739	254.2
-28	.6084	.0111	66	.6190	.6393	160	.6326	9.628	254	.6505	65.21	346	.6745	261.0
-26	.6086	.0123	68	.6193	.6848	162	.6330	10.10	256	.6510	67.49	348	.6751	268.0
-24	.6088	.0137	70	.6196	.7332	164	.6333	10.59	258	.6514	69.85	350	.6757	275.0
-22	.6090	.0152	72	.6198	.7846	166	.6336	11.10	260	.6518	72.26	352	.6763	282.2
-20	.6092	.0168	74	.6201	.8391	168	.6340	11.63	262	.6523	74.75	354	.6770	289.6
-18	.6094	.0186	76	.6203	.8969	170	.6343	12.18	264	.6528	77.30	356	.6776	297.1
-16	.6096	.0206	78	.6206	.9585	172	.6346	12.75	266	.6532	79.93	358	.6783	304.8
-14	.6098	.0227	80	.6209	1.024	174	.6350	13.34	268	.6537	82.62	360	.6789	312.6
-12	.6100	.0250	82	.6211	1.092	176	.6353	13.96	270	.6541	85.39	362	.6795	320.6
-10	.6102	.0275	84	.6214	1.165	178	.6357	14.60	272	.6546	88.26	364	.6803	328.7
-8	.6104	.0303	86	.6217	1.242	180	.6360	15.27	274	.6551	91.18	366	.6809	337.0
-6	.6107	.0332	88	.6219	1.324	182	.6364	15.97	276	.6555	94.18	368	.6816	345.4
-4	.6109	.0365	90	.6222	1.410	184	.6367	16.68	278	.6560	97.26	370	.6822	354.0
-2	.6111	.0400	92	.6225	1.501	186	.6371	17.43	280	.6565	100.4	372	.6829	362.8
0	.6113	.0439	94	.6227	1.597	188	.6374	18.20	282	.6570	103.7	374	.6836	371.8
2	.6115	.0481	96	.6230	1.698	190	.6377	19.00	284	.6575	107.0	376	.6843	380.9
4	.6117	.0526	98	.6233	1.805	192	.6381	19.83	286	.6580	110.4	378	.6850	390.2
6	.6120	.0576	100	.6236	1.918	194	.6385	20.69	288	.6584	113.9	380	.6857	399.6
8	.6122	.0630	102	.6238	2.036	196	.6389	21.58	290	.6590	117.5	382	.6865	409.3
10	.6124	.0690	104	.6241	2.161	198	.6393	22.50	292	.6594	121.2	384	.6871	419.1
12	.6126	.0754	106	.6244	2.294	200	.6396	23.46	294	.6600	125.0	386	.6879	429.1
14	.6128	.0824	108	.6247	2.432	202	.6400	24.44	296	.6604	128.8	388	.6886	439.3
16	.6131	.0900	110	.6250	2.578	204	.6404	25.47	298	.6610	132.8	390	.6893	449.6
18	.6133	.0983	112	.6253	2.731	206	.6407	26.53	300	.6615	136.8	392	.6901	460.2
20	.6135	.1074	114	.6256	2.892	208	.6411	27.62	302	.6620	141.0	394	.6908	470.9
22	.6137	.1172	116	.6258	3.061	210	.6415	28.75	304	.6625	145.3	396	.6915	481.9
24	.6140	.1279	118	.6261	3.239	212	.6419	29.92	306	.6631	149.6	398	.6923	493.0
26	.6142	.1396	120	.6264	3.425	214	.6423	31.14	308	.6636	154.1	400	.6931	504.4
28	.6144	.1523	122	.6267	3.621	216	.6426	32.38	310	.6641	158.7	402	.6939	515.9
30	.6147	.1661	124	.6270	3.826	218	.6430	33.67	312	.6647	163.3	404	.6947	527.6
32	.6149	.1811	126	.6273	4.042	220	.6434	35.01	314	.6652	168.1	406	.6955	539.5
34	.6151	.1960	128	.6276	4.267	222	.6438	36.38	316	.6658	173.0	408	.6962	551.6
36	.6154	.2120	130	.6279	4.503	224	.6442	37.80	318	.6663	178.0	410	.6970	564.0
38	.6156	.2292	132	.6282	4.750	226	.6446	39.27	320	.6669	183.1	412	.6979	576.5
40	.6158	.2476	134	.6285	5.008	228	.6451	40.78	322	.6674	188.3	414	.6987	589.3
42	.6161	.2673	136	.6288	5.280	230	.6455	42.34	324	.6680	193.7	416	.6995	602.2
44	.6163	.2883	138	.6291	5.563	232	.6458	43.95	326	.6686	199.2	418	.7003	615.4
46	.6166	.3109	140	.6294	5.859	234	.6463	45.61	328	.6691	204.8	420	.7012	628.8
48	.6168	.3350	142	.6298	6.167	236	.6467	47.32	330	.6697	210.5	422	.7021	642.5
50	.6170	.3608	144	.6301	6.490	238	.6471	49.08	332	.6703	216.4	424	.7029	656.3
52	.6173	.3883	146	.6304	6.827	240	.6475	50.89	334	.6709	222.4	426	.7037	670.4
54	.6175	.4176	148	.6307	7.178	242	.6479	52.77	336	.6715	228.5	428	.7046	684.7
56	.6178	.4490	150	.6310	7.545	244	.6484	54.69	338	.6721	234.7	430	.7055	699.2
58	.6180	.4824	152	.6313	7.929	246	.6488	56.67	340	.6727	241.1	432	.7064	713.9
60	.6183	.5180	154	.6317	8.328	248	.6492	58.71	342	.6733	247.6	434	.7073	728.9
62	.6185	.5559	156	.6320	8.744	250	.6496	60.81						

Applications of the Formulæ and Tables.

EXAMPLE 1. — How low must the relative humidity be, when the atmospheric pressure is 14.7 lb. per sq. in. and the outside temperature is 60°, in order that no moisture may be deposited in any part of a compressed air system carrying a constant gauge pressure of 90 lb. per sq. in.?

Ans. — The maximum amount of moisture that 1 lb. of pure air can contain at 90 lb. gauge, = 104.7 lb. (absolute pressure) and 60° F., is

$$W = \frac{KH}{2.036 P - H} = \frac{0.6183 \times 0.5180}{2.036 \times 104.7 - 0.5180} = 0.001506 \text{ lb.}$$

The maximum weight of moisture that 1 lb. of air can contain at 60° F. and 14.7 lb. (absolute pressure) is

$$W \text{ (at 14.7)} = \frac{0.6183 \times 0.5180}{2.036 \times 14.7 - 0.5180} = 0.01089 \text{ lb.}$$

In order that no moisture may be deposited, the relative humidity must not be above

$$(0.001506 \div 0.01089) \times 100 = 13.83\%.$$

Weights in Pounds, of Pure Dry Air, Water Vapor and Saturated Mixtures of Air and Water Vapor at Various Temperatures, at Atmospheric Pressure, 29.921 In. of Mercury or 14.6963 Lb. Per Sq. In. Also the Elastic Force or Pressure of the Air and Vapor Present in Saturated Mixtures.

(Copyright, 1908, by H. M. Prevost Murphy.)

Temperatures in Fahrenheit Degrees.	Weight of One Cubic Foot of Pure Dry Air, Lb.	Saturated Mixtures of Air and Water Vapor.					
		Elastic Force of the Vapor, In. of Mercury.	Elastic Force of the Air alone, when Saturated, Ins. of Mercury.	Weight of the Vapor in 1 Cu. Ft. of the Mixture, or Wt. of 1 Cu. Ft. of Saturated Steam.	Weight of the Air in 1 Cu. Ft. of the Mixture.	Total Weight of 1 Cu. Ft. of the Mixture.	Weight of Water Vapor Mixed with 1 lb. of Air.
0	0.086354	0.0439	29.877	0.000077	0.086226	0.086303	0.000898
12	0.084154	0.0754	29.846	0.000130	0.083943	0.084073	0.001548
22	0.082405	0.1172	29.804	0.000198	0.082083	0.082281	0.002413
32	0.080728	0.1811	29.740	0.000300	0.080239	0.080539	0.003744
42	0.079117	0.2673	29.654	0.000435	0.078411	0.078846	0.005554
52	0.077569	0.3883	29.533	0.000621	0.076563	0.077184	0.008116
62	0.076081	0.5559	29.365	0.000874	0.074667	0.075541	0.011709
72	0.074649	0.7846	29.136	0.001213	0.072690	0.073903	0.016691
82	0.073270	1.092	28.829	0.001661	0.070595	0.072256	0.023526
92	0.071940	1.501	28.420	0.002247	0.068331	0.070578	0.032877
102	0.070658	2.036	27.885	0.002999	0.065850	0.068849	0.045546
112	0.069421	2.731	27.190	0.003962	0.063085	0.067047	0.062806
122	0.068227	3.621	26.300	0.005175	0.059970	0.065145	0.086285
132	0.067073	4.750	25.171	0.006689	0.056425	0.063114	0.118548
142	0.065957	6.167	23.754	0.008562	0.052363	0.060925	0.163508
152	0.064878	7.929	21.992	0.010854	0.047686	0.058540	0.227609
162	0.063834	10.097	19.824	0.013636	0.042293	0.055929	0.322407
172	0.062822	12.749	17.172	0.016987	0.036055	0.053042	0.471146
182	0.061843	15.965	13.956	0.021000	0.028845	0.049845	0.728012
192	0.060893	19.826	10.095	0.025746	0.020545	0.046291	1.25319
202	0.059972	24.442	5.479	0.031354	0.010982	0.042336	2.85507
212	0.059079	29.921	0.000	0.037922	0.000000	0.037922	Infinite.

WARNING: This is a 1910 edition. Some of the material may no longer be accurate

NOTE. — Air is said to be saturated with water vapor when it contains the maximum amount possible at the existing temperature and pressure.

EXAMPLE 2. — When compressing air into a reservoir carrying a constant gauge pressure of 75 lb., from a saturated atmosphere of 14.7 lb. abs. press. and 70° F., to what temperature must the air be cooled after compression in order to cause the deposition of moisture to commence?

Ans. — First find the maximum weight of moisture contained in 1 lb. of pure air at 14.7 lb. pressure and 70° F.

$$W = \frac{KH}{2.036 P - H} = \frac{0.6196 \times 0.7332}{2.036 \times 14.7 - 0.7332} = 0.01556 \text{ lb.}$$

The temperature to which the air must be cooled in order to cause the deposition of moisture may be found by placing this value of 0.01556 together with P equal to 75 + 14.7 in the equation thus:

$$0.01556 = \frac{KH}{2.036 \times 89.7 - H} = \frac{KH}{182.63 - H}$$

or $H = \frac{2.842}{0.01556 + K}$, and the temperature which satisfies this equation is found by aid of the table [by trial and error] to be approximately 129° F.

EXAMPLE 3. — When the outside temperature is 82° F., and the pressure of the atmosphere is 14.6963 lb. per sq. in., the relative humidity being 100%, how many cu. ft. of free air must be compressed and delivered into a reservoir at 100 lb. gauge in order to cause 1 lb. of water to be deposited when the air is cooled to 82° F.?

Ans. — Weight of moisture mixed with 1 lb. of air at 82° F., and atmospheric pressure = 0.023526 lb. For 100 lb. gauge pressure,

$$W = \frac{KH}{2.036 P - H} = \frac{0.6211 \times 1.092}{2.036 \times 114.6963 - 1.092} = 0.002918 \text{ lb.}$$

Weight of moisture deposited by each lb. of compressed air = 0.023526 - 0.002918 = 0.020608 lb. Each cu. ft. of the moist atmosphere contains 0.070595 lb. of pure air, therefore the number of cu. ft. that must be delivered to cause 1 lb. of water to be deposited is

$$\frac{1}{0.070595} \times \frac{1}{0.020608} = 687.37 \text{ cu. ft.}$$

EXAMPLE 4. — Under the same conditions as stated in Example 3, what is the loss in volumetric efficiency of the plant when the excess moisture is properly trapped in the main reservoirs?

Ans. — Before compression, each pound of air is mixed with 0.023526 lb. of water vapor, and the weight of 1 cu. ft. of the mixture is 0.072256 lb., consequently the volume of the mixture is

$$1.023526 \div 0.072256 = 14.165 \text{ cu. ft.}$$

For 100 lb. gauge pressure and 82° F. as shown in Example 3, 1 lb. of air can hold 0.002918 lb. of water in suspension, having deposited 0.020608 lb. in the reservoir. The weight of 1 cu. ft. of water vapor at 82° is 0.001661 lb., consequently by Dalton's law the volume of the mixture of 1 lb. of air and 0.002918 lb. of water vapor at 100 lb. gauge pressure is the same as that of the vapor or saturated steam alone; that is,

$$0.002918 \div 0.001661 = 1.757 \text{ cu. ft.}$$

By Mariotte's law, the volume of the 1.757 cu. ft. of mixed gas at 114.6963 lb. absolute when expanded to atmospheric pressure will be

$$(114.6963 \div 14.6963) \times 1.757 = 13.712 \text{ cu. ft.};$$

consequently the decrease of volume, that is, the loss of volumetric efficiency, is

$$14.165 - 13.712 = 0.453 \text{ cu. ft., or } (0.453 \div 14.165) \times 100 = 3.2\%.$$

This example shows that, particularly in warm, moist climates, there is a very appreciable loss in the efficiency of compressors, due to the condensation of water vapor.

Specific Heat of Air at Constant Volume and at Constant Pressure. — Volume of 1 lb. of air at 32° F. and pressure of 14.7 lbs. per sq. in. = 12.387 cu. ft. = a column 1 sq. ft. area \times 12.387 ft. high. Raising tem-

perature 1° F. expands it 1/492, or to 12.4122 ft. high — a rise of 0.02522 foot.

Work done = 2116 lbs. per sq. ft. × .02522 = 53.37 foot-pounds, or 53.37 ÷ 778 = 0.0686 heat units.

The specific heat of air at constant pressure, according to Regnault, is 0.2375; but this includes the work of expansion, or 0.0686 heat units; hence the specific heat at constant volume = 0.2375 - 0.0686 = 0.1689.

Ratio of specific heat at constant pressure to specific heat at constant volume = 0.2375 ÷ 0.1689 = 1.406. (See Specific Heat, p. 534.)

Flow of Air through Orifices. — The theoretical velocity in feet per second of flow of any fluid, liquid, or gas through an orifice is $v = \sqrt{2gh}$ = 8.02 \sqrt{h} , in which h = the "head" or height of the fluid in feet required to produce the pressure of the fluid at the level of the orifice. (For gases the formula holds good only for small differences of pressure on the two sides of the orifice.) The quantity of flow in cubic feet per second is equal to the product of this velocity by the area of the orifice, in square feet, multiplied by a "coefficient of flow," which takes into account the contraction of the vein or flowing stream, the friction of the orifice, etc.

For air flowing through an orifice or short tube, from a reservoir of the pressure p_1 into a reservoir of the pressure p_2 , Weisbach gives the following values for the coefficient of flow, obtained from his experiments.

FLOW OF AIR THROUGH AN ORIFICE.

Coefficient c in formula $v = c \sqrt{2gh}$.

Diam. 1 cm. = 0.394 in.:						
Ratio of pressures...	1.05	1.09	1.43	1.65	1.89	2.15
Coefficient.....	.555	.589	.692	.724	.754	.788
Diam. 2.14 cm. = 0.843 in.:						
Ratio of pressures...	1.05	1.09	1.36	1.67	2.01
Coefficient.....	.558	.573	.634	.678	.723

FLOW OF AIR THROUGH A SHORT TUBE.

Diam. 1 cm., = 0.394 in., length 3 cm. = 1.181 in.						
Ratio of pressures $p_1 \div p_2$...	1.05	1.10	1.30
Coefficient.....	.730	.771	.830
Diam. 1.414 cm. = 0.557 in., length 4.242 cm. = 1.670 in.:						
Ratio of pressures.....	1.41	1.69
Coefficient.....	.813	.822
Diam. 1 cm. = 0.394 in., length 1.6 cm. = 0.630 in. Orifice rounded:						
Ratio of pressures.....	1.24	1.38	1.59	1.85	2.14
Coefficient.....	.979	.986	.965	.971	.978

Clark (Rules, Tables, and Data, p. 891) gives, for the velocity of flow of air through an orifice due to small differences of pressure,

$$V = C \sqrt{\frac{2gh}{12}} \times 773.2 \times \left(1 + \frac{t - 32}{493}\right) \times \frac{29.92}{p}$$

or, simplified,

$$V = 352 C \sqrt{(1 + .00203(t - 32)) \frac{h}{p}}$$

in which V = velocity in feet per second; $2g = 64.4$; h = height of the column of water in inches, measuring the difference of pressure; t = the temperature Fahr.; and p = barometric pressure in inches of mercury. 773.2 is the volume of air at 32° under a pressure of 29.92 inches of mercury when that of an equal weight of water is taken as 1.

For 62° F., the formula becomes $V = 363 C \sqrt{h/p}$, and if $p = 29.92$ inches, $V = 66.35 C \sqrt{h}$.

The coefficient of efflux C , according to Weisbach, is:

For conoidal mouthpiece, of form of the contracted vein.	
with pressures of from 0.23 to 1.1 atmospheres....	$C = 0.97$ to 0.99
Circular orifices in thin plates.....	$C = 0.56$ to 0.79
Short cylindrical mouthpieces.....	$C = 0.81$ to 0.84
The same rounded at the inner end.....	$C = 0.92$ to 0.93
Conical converging mouthpieces.....	$C = 0.90$ to 0.99

WARNING: This is a 1910 edition. Some of the material may no longer be accurate

R. J. Durlley, *Trans. A. S. M. E.*, xxvii, 193, gives the following: The consideration of the adiabatic flow of a perfect gas through a frictionless orifice leads to the equation

$$W = A \sqrt{2g \frac{\gamma}{\gamma - 1} \cdot \frac{P_1}{V_1} \left[\left(\frac{P_2}{P_1}\right)^{\frac{2}{\gamma}} - \left(\frac{P_2}{P_1}\right)^{\frac{\gamma+1}{\gamma}} \right]} \dots (1)$$

- W = weight of gas discharged per second in pounds.
- A = area of cross section of jet in square feet.
- P_1 = pressure inside orifice in pounds per square foot.
- P_2 = pressure outside orifice.
- V_1 = specific volume of gas inside orifice in cu. ft. per lb.
- γ = ratio of the specific heat at constant pressure to that at constant volume.

For air, where $\gamma = 1.404$, we have for a circular orifice of diameter d inches, the initial temperature of the air being 60° Fahr. (or 521° abs.),

$$W = 0.000491 d^2 P_1 \sqrt{\left(\frac{P_2}{P_1}\right)^{1.425} - \left(\frac{P_2}{P_1}\right)^{1.712}} \dots (2)$$

In practice the flow is not frictionless, nor is it perfectly adiabatic, and the amount of heat entering or leaving the gas is not known. Hence the weight actually discharged is to be found from the formulas by introducing a coefficient of discharge (generally less than unity) depending on the conditions of the experiment and on the construction of the particular form of orifice employed.

If we neglect the changes of density and temperature occurring as the air passes through the orifice, we may obtain a simpler though approximate formula for the ideal discharge:

$$W = 0.01369 d^2 \sqrt{\frac{iP}{T}} \dots (3)$$

in which d = diam. in inches, i = difference of pressures measured in inches of water, P = mean absolute pressure in lbs. per sq. ft., and T = absolute temperature on the Fahrenheit scale = degrees F. + 461. In the usual case, in which the discharge takes place into the atmosphere, P is approximately 2117 pounds per square foot and

$$W = 0.6299 d^2 \sqrt{\frac{i}{T}} \dots (4)$$

To obtain the actual discharge the values found by the formula are to be multiplied by an experimental coefficient C , values of which are given in the table below.

Up to a pressure of about 20 ins. of water (or 0.722 lbs. per sq. in.) above the atmospheric pressure, the results of formulæ (2) and (4) agree very closely. At higher differences of pressure divergence becomes noticeable.

They hold good only for orifices of the particular form experimented with, and bored in plates of the same thickness, viz.: iron plates 0.057 in. thick.

The experiments and curves plotted from them indicate that: —

- (1) The coefficient for small orifices increases as the head increases, but at a lesser rate the larger the orifices, till for the 2-in. orifice it is almost constant. For orifices larger than 2 ins. it decreases as the head increases, and at a greater rate the larger the orifice.
- (2) The coefficient decreases as the diameter of the orifice increases, and at a greater rate the higher the head.
- (3) The coefficient does not change appreciably with temperature (between 40° and 100° F.).
- (4) The coefficient (at heads under 6 ins.) is not appreciably affected by the size of the box in which the orifice is placed if the ratio of the areas of the box and orifice is at least 20 : 1.

MEAN DISCHARGE IN POUNDS PER SQUARE FOOT OF ORIFICE PER SECOND AS FOUND FROM EXPERIMENTS.

Diameter Orifice, Inches.	1-inch Head Discharge per Sq. Ft.	2-inch Head Discharge per Sq. Ft.	3-inch Head Discharge per Sq. Ft.	4-inch Head Discharge per Sq. Ft.	5-inch Head Discharge per Sq. Ft.
0.3125	3.060	4.336	5.395	6.188	7.024
0.3005	3.012	4.297	5.242	6.129	6.821
1.002	3.058	4.341	5.348	6.214	6.838
1.505	3.050	4.257	5.222	6.071	6.775
2.002	2.983	4.286	5.284	6.107	6.788
2.502	3.041	4.303	5.224	5.991	6.762
3.001	3.078	4.297	5.219	6.033	6.802
3.497	3.051	4.258	5.202	5.966	6.814
4.002	3.046	4.325	5.264	5.951	6.774
4.506	3.075	4.383	5.508	6.260	7.028

COEFFICIENTS OF DISCHARGE FOR VARIOUS HEADS AND DIAMETERS OF ORIFICE.

Diameter of Orifice, Inches.	1-inch Head.	2-inch Head.	3-inch Head.	4-inch Head.	5-inch Head.
5/16	0.603	0.606	0.610	0.613	0.616
1/2	0.602	0.605	0.608	0.610	0.613
1	0.601	0.603	0.605	0.606	0.607
1 1/2	0.601	0.601	0.602	0.603	0.603
2	0.600	0.600	0.600	0.600	0.600
2 1/2	0.599	0.599	0.599	0.598	0.598
3	0.599	0.598	0.597	0.596	0.596
3 1/2	0.599	0.597	0.596	0.595	0.594
4	0.598	0.597	0.595	0.594	0.593
4 1/2	0.598	0.596	0.594	0.593	0.592

CORRECTED ACTUAL DISCHARGE IN POUNDS PER SECOND AT 60° F. AND 14.7 LBS. BAROMETRIC PRESSURE FOR CIRCULAR ORIFICES IN PLATE 0.057 IN. THICK.

Head, In. of Water.	Diameter of Orifice in Inches.										
	0.3125	0.500	1.000	1.500	2.000	2.500	3.000	3.500	4.000	4.500	5.000
1/2	0.00114	0.00293	0.0117	0.0263	0.0468	0.0732	0.105	0.143	0.187	0.237	0.292
1	0.00162	0.00416	0.0166	0.0373	0.0663	0.103	0.149	0.202	0.264	0.334	0.413
1 1/2	0.00199	0.00510	0.0203	0.0457	0.0811	0.127	0.182	0.248	0.323	0.409	0.505
2	0.00231	0.00590	0.0235	0.0528	0.0937	0.146	0.210	0.285	0.373	0.471	0.582
2 1/2	0.00259	0.00662	0.0263	0.0591	0.105	0.163	0.235	0.319	0.416	0.526	0.649
3	0.00285	0.00726	0.0289	0.0648	0.115	0.179	0.257	0.349	0.455	0.575	0.710
3 1/2	0.00308	0.00786	0.0312	0.0700	0.124	0.193	0.277	0.377	0.491	0.621	0.766
4	0.00330	0.00842	0.0334	0.0749	0.133	0.206	0.296	0.402	0.525	0.663	0.817
4 1/2	0.00351	0.00895	0.0355	0.0794	0.141	0.219	0.314	0.426	0.556	0.702	0.865
5	0.00371	0.00945	0.0375	0.0838	0.148	0.231	0.331	0.449	0.586	0.739	0.912
5 1/2	0.00390	0.00993	0.0393	0.0879	0.155	0.242	0.347	0.471	0.613	0.774	0.953
6	0.00408	0.01049	0.0411	0.0918	0.162	0.252	0.362	0.492	0.640	0.808	0.995

Flow of Air in Pipes. — Hawksley (*Proc. Inst. C. E.*, xxxiii, 55) states that his formula for flow of water in pipes, $v = 48 \sqrt{\frac{HD}{L}}$, may also be employed for flow of air. In this case H = height in feet of a column of air required to produce the pressure causing the flow, or the loss of head for a given flow; v = velocity in feet per second, D = diameter in feet, L = length in feet.

If the head is expressed in inches of water, h , the air being taken at 62° F., its weight per cubic foot at atmospheric pressure = 0.0761 lb. Then $H = \frac{62.36}{0.0761 \times 12} = 68.3 h$. If d = diameter in inches, $D = \frac{d}{12}$, and

the formula becomes $v = 114.5 \sqrt{\frac{hd}{L}}$, in which h = inches of water column,

d = diameter in inches, and L = length in feet; $h = \frac{Lv^2}{13110 d}$; $d = \frac{Lv^2}{13110 h}$.

The quantity in cubic feet per second s

$$Q = 0.7854 \frac{d^2}{144}; v = 0.6245 \sqrt{\frac{hd^5}{L}}; d = \sqrt{\frac{Q^2 L}{0.39 h}}; h = \frac{Q^2 L}{0.39 d^5}$$

The horse-power required to drive air through a pipe is the volume Q in cubic feet per second multiplied by the pressure in pounds per square foot and divided by 550. Pressure in pounds per square foot = P = inches of water column $\times 5.196$, whence horse-power =

$$H.P. = \frac{QP}{550} = \frac{Qh}{105.9} = \frac{Q^2 L}{41.3 d^5}$$

Volume of Air Transmitted in Cubic Feet per Minute in Pipes of Various Diameters.

$$\text{Formula } Q = \frac{0.7854}{144} d^2 v \times 60.$$

Veloc'y of Flow, Ft. per Sec.	Actual Diameter of Pipe in Inches.											
	1	2	3	4	5	6	8	10	12	16	20	24
1	0.327	1.31	2.95	5.24	8.18	11.78	20.94	32.73	47.12	83.77	130.9	188.5
2	0.655	2.62	5.89	10.47	16.36	23.56	41.89	65.45	94.25	167.5	261.8	377.0
3	0.982	3.93	8.84	15.7	24.5	35.3	62.8	98.2	141.4	251.3	392.7	565.5
4	1.31	5.24	11.78	20.9	32.7	47.1	83.8	131	188	335	523	754
5	1.64	6.54	14.7	26.2	41.0	59.0	104	163	235	419	654	942
6	1.96	7.85	17.7	31.4	49.1	70.7	125	196	283	502	785	1131
7	2.29	9.16	20.6	36.6	57.2	82.4	146	229	330	586	916	1319
8	2.62	10.5	23.5	41.9	65.4	94	167	262	377	670	1047	1508
9	2.95	11.78	26.5	47	73	106	188	294	424	754	1178	1696
10	3.27	13.1	29.4	52	82	118	209	327	471	838	1309	1885
12	3.93	15.7	35.3	63	98	141	251	393	565	1005	1571	2262
15	4.91	19.6	44.2	78	122	177	314	491	707	1256	1963	2827
18	5.89	23.5	53	94	147	212	377	589	848	1508	2356	3393
20	6.54	26.2	59	105	164	235	419	654	942	1675	2618	3770
24	7.85	31.4	71	125	196	283	502	785	1131	2010	3141	4524
25	8.18	32.7	73	131	204	294	523	818	1178	2094	3272	4712
28	9.16	36.6	82	146	229	330	586	916	1319	2346	3665	5278
30	9.8	39.3	88	157	245	353	628	982	1414	2513	3927	5655

In Hawksley's formula and its derivatives the numerical coefficients are constant. It is scarcely possible, however, that they can be accurate except within a limited range of conditions. In the case of water it is found that the coefficient of friction, on which the loss of head depends, varies with the length and diameter of the pipe, and with the velocity, as well as with the condition of the interior surface. In the case of air and other gases we have, in addition, the decrease in density and consequent increase in volume and in velocity due to the progressive loss of head from one end of the pipe to the other.

Clark states that according to the experiments of D'Aubuisson and those of a Sardinian commission on the resistance of air through long conduits or pipes, the diminution of pressure is very nearly directly as the length, and as the square of the velocity and inversely as the diameter. The resistance is not varied by the density.

If these statements are correct, then the formulæ $h = \frac{Lv^2}{cd}$ and $h = \frac{Q^2L}{c'd^5}$ and their derivatives are correct in form, and they may be used when the numerical coefficients c and c' are obtained by experiment.

If we take the forms of the above formulæ as correct, and let C be a variable coefficient, depending upon the length, diameter, and condition of surface of the pipe, and possibly also upon the velocity, the temperature and the density, to be determined by future experiments, then for $h =$ head in inches of water, $d =$ diameter in inches, $L =$ length in feet, $v =$ velocity in feet per second, and $Q =$ quantity in cubic feet per second:

$$v = C \sqrt{\frac{hd}{L}}; \quad d = \frac{Lv^2}{C^2h}; \quad h = \frac{Lv^2}{C^2d};$$

$$Q = 0.005454 C \sqrt{\frac{hd^5}{L}}; \quad d = \sqrt[5]{\frac{33683 Q^2L}{C^2h}}; \quad h = \frac{33683 Q^2L}{C^2d^5}.$$

For difference or loss of pressure p in pounds per square inch,

$$h = 27.71 p; \quad \sqrt{h} = 5.264 \sqrt{p};$$

$$v = 5.264 C \sqrt{\frac{pd}{L}}; \quad d = \frac{Lv^2}{27.71 C^2 p}; \quad p = \frac{Lv^2}{27.71 C^2 d};$$

$$Q = 0.02871 C \sqrt{\frac{pd^5}{L}}; \quad d = \sqrt[5]{\frac{1213 Q^2L}{C^2 p}}; \quad p = \frac{1213 Q^2L}{C^2 d^5}.$$

(For other formulæ for flow of air, see Mine Ventilation.)

Loss of Pressure in Ounces per Square Inch. — B. F. Sturtevant Company uses the following formulæ:

$$p_1 = \frac{Lv^2}{25000 d}; \quad v = \sqrt{\frac{25000 dp_1}{L}}; \quad d = \frac{Lv^2}{25000 p_1};$$

in which $p_1 =$ loss of pressure in ounces per square inch, $v =$ velocity of air in feet per second, and $L =$ length of pipe in feet. If p is taken in pounds per square inch, these formulæ reduce to

$$p = 0.0000025 \frac{Lv^2}{d}; \quad v = 632.5 \sqrt{\frac{dp_1}{L}}; \quad d = \frac{0.0000025 Lv^2}{p}.$$

These are deduced from the common formula (Weisbach's), $p = f \frac{l v^2}{d 2g}$, in which $f = 0.0001608$. They correspond to the formulæ given above when C is taken at 120.15, Hawksley's formula for the same notation giving 114.5. Using the notation given in the formulæ for compressed air, where Q is taken in cu. ft. per minute, Sturtevant's formula gives a value of $C = 57.1$, Hawksley's 54.4. The figure 60 is commonly used, assuming a density of air of 0.761 lb. per cu. ft.

The following table is condensed from one given in the catalogue of B. F. Sturtevant Company.

LOSS OF PRESSURE IN PIPES 100 FT. LONG,* IN OUNCES PER SQ. IN.

Velocity ft. per min.	Diameter of Pipe in Inches.											
	1	2	3	4	5	6	7	8	9	10	11	12
600	0.400	0.200	0.133	0.100	0.080	0.067	0.057	0.050	0.044	0.040	0.036	0.033
1200	1.600	0.800	0.533	0.400	0.320	0.267	0.229	0.200	0.178	0.160	0.145	0.133
1800	3.600	1.800	1.200	0.900	0.720	0.600	0.514	0.450	0.400	0.360	0.327	0.300
2400	6.400	3.200	2.133	1.600	1.280	1.067	0.914	0.800	0.711	0.640	0.582	0.533
3000	10.0	5.0	3.333	2.5	2.0	1.667	1.429	1.250	1.111	1.000	0.909	0.833
3600	14.4	7.2	4.8	3.6	2.88	2.4	2.057	1.8	1.6	1.44	1.309	1.200
4200	19.8	9.8	6.553	4.9	3.92	3.267	2.8	2.45	2.178	1.96	1.782	1.633
4800	26.4	12.8	8.533	6.4	5.12	4.267	3.657	3.2	2.844	2.56	2.327	2.133
6000	40.0	20.	13.333	10.0	8.0	6.667	5.714	5.0	4.444	4.0	3.636	3.333
	14	16	18	20	22	24	28	32	36	40	44	48
600	.029	.026	.022	.020	.018	.017	.014	.012	.011	.010	.009	.008
1200	.114	.100	.089	.080	.073	.067	.057	.050	.044	.040	.036	.033
1800	.257	.225	.200	.180	.164	.156	.129	.112	.100	.090	.082	.075
2400	.457	.400	.356	.320	.291	.267	.239	.200	.178	.160	.145	.133
3600	1.029	.900	.800	.720	.655	.600	.514	.450	.400	.360	.327	.300
4200	1.400	1.225	1.089	.980	.891	.817	.700	.612	.544	.490	.445	.408
4800	1.829	1.600	1.422	1.280	1.164	1.067	.914	.800	.711	.640	.582	.533
6000	2.857	2.500	2.222	2.000	1.818	1.667	1.429	1.250	1.111	1.000	.909	.833

* For any other length the loss is proportional to the length.

Effect of Bends in Pipes. (Norwalk Iron Works Co.)

Radius of elbow, in diameter of pipe =	5	3	2	1 1/2	1 1/4	1	3/4	1/2
Equivalent lengths of straight pipe, diams.	7.85	8.24	9.03	10.36	12.72	17.51	35.09	121.2

Friction of Air in Passing through Valves and Elbows. W. L. Saunders, *Compressed Air*, Dec., 1902. — The following figures give the length in feet of straight pipe which will cause a reduction in pressure equal to that caused by globe valves, elbows, and tees in different diameters of pipe.

Diam. of pipe, in..	1	1 1/2	2	2 1/2	3	3 1/2	4	5	6	7	8	10
Globe Valves	2	4	7	10	13	16	20	28	36	44	53	70
Elbows and Tees	2	3	5	7	9	11	13	19	24	30	35	47

Compressed-air Transmission. (Frank Richards, *Am. Mach.*, March 8, 1894.) — The volume of free air transmitted may be assumed to be directly as the number of atmospheres to which the air is compressed. Thus, if the air transmitted be at 75 pounds gauge-pressure, or six atmospheres, the volume of free air will be six times the amount given in the table (page 591). It is generally considered that for economical transmission the velocity in main pipes should not exceed 20 feet per second. In the smaller distributing pipes the velocity should be decidedly less than this.

The loss of power in the transmission of compressed air in general is not a serious one, or at all to be compared with the losses of power in the operation of compression and in the re-expansion or final application of the air.

The formulas for loss by friction are all unsatisfactory. The statements of observed facts in this line are in a more or less chaotic state, and self-evidently unreliable.

A statement of the friction of air flowing through a pipe involves at least all the following factors: Unit of time, volume of air, pressure of air, diam-

eter of pipe, length of pipe, and the difference or pressure at the ends of the pipe or the head required to maintain the flow. Neither of these factors can be allowed its independent and absolute value, but is subject to modifications in deference to its associates. The flow of air being assumed to be uniform at the entrance to the pipe, the volume and flow are not uniform after that. The air is constantly losing some of its pressure and its volume is constantly increasing. The velocity of flow is therefore also somewhat accelerated continually. This also modifies the use of the length of the pipe as a constant factor.

Then, besides the fluctuating values of these factors, there is the condition of the pipe itself. The actual diameter of the pipe, especially in the smaller sizes, is different from the nominal diameter. The pipe may be straight, or it may be crooked and have numerous elbows.

Formulae for Flow of Compressed Air in Pipes.—The formulæ on pages 591 and 592 are for air at or near atmospheric pressure. For compressed air the density has to be taken into account. A common formula for the flow of air, gas, or steam in pipes is

$$Q = c \sqrt{\frac{pd^5}{wL}}$$

in which Q = volume in cubic feet per minute, p = difference of pressure in lbs. per sq. in. causing the flow, d = diameter of pipe in in., L = length of pipe in ft., w = density of the entering gas or steam in lbs. per cu. ft., and c = a coefficient found by experiment. Mr. F. A. Halsey in calculating a table for the Rand Drill Co.'s Catalogue takes the value of c at 58, basing it upon the experiments made by order of the Italian government preliminary to boring the Mt. Cenis tunnel. These experiments were made with pipes of 3281 feet in length and of approximately 4, 8, and 14 in. diameter. The volumes of compressed air passed ranged between 16.64 and 1200 cu. ft. per minute. The value of c is quite constant throughout the range and shows little disposition to change with the varying diameter of the pipe. It is of course probable, says Mr. Halsey, that c would be smaller if determined for smaller sizes of pipe, but to offset that the actual sizes of small commercial pipe are considerably larger than the nominal sizes, and as these calculations are commonly made for the nominal diameters it is probable that in those small sizes the loss would really be less than shown by the table. The formula is of course strictly applicable to fluids which do not change their density, but within the change of density admissible in the transmission of air for power purposes it is probable that the errors introduced by this change are less than those due to errors of observation in the present state of knowledge of the subject. Mr. Halsey's table is condensed below.

Diameter of Pipe, in inches.	Cubic feet of free air compressed to a gauge-pressure of 80 lbs. and passing through the pipe each minute.										
	50	100	200	400	800	1000	1500	2000	3000	4000	5000
	Loss of pressure in lbs. per square inch for each 1000 ft. of straight pipe.										
1 1/4	3.61										
1 1/2	1.45	5.8									
2	0.20	1.05	4.30								
2 1/2	0.12	0.35	1.41	5.80							
3		0.14	0.57	2.28							
3 1/2			0.26	1.05	4.16	6.4					
4			0.14	0.54	2.12	3.27	7.60				
5				0.18	0.68	1.08	2.43	4.32	9.6		
6					0.28	0.43	1.00	1.75	3.91	7.10	10.7
8						0.07	0.10	0.24	0.42	0.93	1.68
10								0.08	0.14	0.30	0.55
12										0.12	0.22
14											0.10

To apply the formula given above to air of different pressures it may be given other forms, as follows:

Let Q = the volume in cubic feet per minute of the compressed air; Q_1 = the volume before compression, or "free air," both being taken at mean atmospheric temperature of 62° F.; w_1 = weight per cubic foot of Q_1 = 0.0761 lb.; r = atmospheres, or ratio of absolute pressures, = (gauge-pressure + 14.7) ÷ 14.7; w = weight per cu. ft. of Q ; p = difference of pressure, in lbs. per sq. in., causing the flow; d = diam. of pipe in in.; L = length of pipe in ft.; c = experimental constant. Then

$$Q = c \sqrt{\frac{pd^5}{wL}}; \quad Q_1 = rQ; \quad w = rw_1 = 0.0761 r;$$

$$Q = 3.625 c \sqrt{\frac{pd^5}{rL}}; \quad Q_1 = 3.625 c \sqrt{\frac{pd^5 r}{L}};$$

$$d = \sqrt[5]{0.0761 \frac{LQ^2 r}{c^2 p}} = 0.597 \sqrt[5]{\frac{LQ^2 r}{c^2 p}} = \sqrt[5]{0.0761 \frac{LQ_1^2}{c^2 p r}} = 0.597 \sqrt[5]{\frac{LQ_1^2}{c^2 p r}};$$

$$p = 0.0761 \frac{LQ^2 r}{c^2 d^5} = 0.0761 \frac{LQ_1^2}{c^2 d^5 r}.$$

The value of c according to the Mt. Cenis experiments is about 58 for pipes 4, 8, and 14 in. diameter, 3281 ft. long. In the St. Gothard experiments it ranged from 62.8 to 73.2 (see table below) for pipes 5.91 and 7.87 in. diameter, 1713 and 15,092 ft. long. Values derived from Darcy's formula for flow of water in pipes, ranging from 45.3 for 1 in. diameter to 63.2 for 24 in., are given under "Flow of Steam," p. 845. For approximate calculations the value 60 may be used for all pipes of 4 in. diameter and upwards. Using $c = 60$, the above formulæ become

$$Q = 217.5 \sqrt{\frac{pd^5}{rL}}; \quad Q_1 = 217.5 \sqrt{\frac{pd^5 r}{L}};$$

$$d = 0.1161 \sqrt[5]{\frac{LQ^2 r}{p}} = 0.1161 \sqrt[5]{\frac{LQ_1^2}{p r}};$$

$$p = 0.00002114 \frac{LQ^2 r}{d^5} = 0.00002114 \frac{LQ_1^2}{d^5 r}.$$

Loss of Pressure in Compressed Air Pipe-main, at St. Gothard Tunnel. (E. Stockalper.)

Experiment No.	Air Main Diameter, in.	Volume per second of free air, or equivalent volume at atmospheric pressure and 32° F., cu. ft.	Volume per second of compressed air at mean density, cu. ft.	Mean density of compressed air, (Water = 1), den.	Weight of air flowing per second, lbs.	Mean velocity in feet per second, feet.	Observed Pressures.		Loss of Pressure.		Value of c in formula $Q = c \sqrt{\frac{pd^5}{wL}}$.
							Pressure at beginning of pipe, at.	Pressure at end of pipe, at.	lbs. per sq. in.	%	
1	7.87	33.056	6.534	.00650	2.669	19.32	5.60	5.24	5.292	6.4	73.2
	5.91		7.063	.00603	2.669	37.14	5.24	5.00	3.528	4.6	63.9
2	7.87	22.002	5.509	.00514	1.776	16.30	4.35	4.13	3.234	5.1	70.7
	5.91		5.863	.00482	1.776	4.13
3	7.87	18.364	5.262	.00449	1.483	15.58	3.84	3.65	2.793	5.0	67.6
	5.91		5.580	.00423	1.483	29.34	3.65	3.54	1.617	3.0	62.8

The length of the pipe 7.87 in. in diameter was 15,092 ft., and of the smaller pipe 1712.6 ft. The mean temperature of the air in the large pipe was 70° F. and in the small pipe 80° F.

Flow of Air in Long Pipes with Large Differences of Pressure.—The formulæ given above are applicable strictly only to cases in which the

difference of pressure at the two ends of the pipe is small, and the density of the air, therefore, nearly constant. For long pipes with considerable difference of pressure the density decreases and the velocity increases during the flow from one end of the pipe to the other. Church (*Mechs. of Eng'g*, p. 790) develops a formula for flow in long pipes under the assumptions of uniform decrease of density and of constant temperature, the loss of heat by adiabatic expansion being in great part made up by the heat generated by friction. Using the same notation as above Church's formula is $\frac{1}{2}(p_1^2 - p_2^2) = \frac{4}{2} \frac{fl}{gd} \frac{W^2}{A^2} \frac{p_1}{w_1}$, f being the coefficient of friction,

A the area of the pipe in square inches, and w the density of air at the entrance. The value of f is given at 0.004 to 0.005.

J. E. Johnson, Jr. (*Am. Mach.*, July 27, 1899) gives Church's formula in a simpler form as follows: $p_1^2 - p_2^2 = KQ^2L \div d^5$, in which p_1 and p_2 are the initial and final pressures in lbs. per sq. in., Q the volume of free air (that is the volume reduced to atmospheric pressure) in cubic feet per minute, d the diameter of the pipe in inches, L the length in feet, and K a numerical coefficient, which from the Mt. Cenis and St. Gothard experiments has a value of about 0.0006. E. A. Rix, in a paper on the Compression and Transmission of Illuminating Gas, read before the Pacific Coast Gas Ass'n, 1905, says he uses Johnson's formula, with a coefficient of 0.0005, which he considers more nearly correct than 0.0006. For gas the velocity varies inversely as the square root of the density, and for gas of a density G , relative to air as 1, Rix gives the formula $p_1^2 - p_2^2 = 0.0005 \sqrt{G} \times Q^2L \div d^5$.

Measurement of the Velocity of Air in Pipes by an Anemometer.
— Tests were made by B. Donkin, Jr. (*Inst. Civil Engrs.*, 1892), to compare the velocity of air in pipes from 8 in. to 24 in. diam., as shown by an anemometer $2\frac{3}{4}$ in. diam. with the true velocity as measured by the time of descent of a gas-holder holding 1622 cubic feet. A table of the results with discussion is given in *Eng'g News*, Dec. 22, 1892. In pipes from 8 in. to 20 in. diam. with air velocities of from 140 to 690 feet per minute the anemometer showed errors varying from 14.5% fast to 10% slow. With a 24-inch pipe and a velocity of 73 ft. per minute, the anemometer gave from 44 to 53 feet, or from 13.6 to 39.6% slow. The practical conclusion drawn from these experiments is that anemometers for the measurement of velocities of air in pipes of these diameters should be used with great caution. The percentage of error is not constant, and varies considerably with the diameter of the pipes and the speeds of air. The use of a baffle consisting of a perforated plate, which tended to equalize the velocity in the center and at the sides in some cases diminished the error.

The impossibility of measuring the true quantity of air by an anemometer held stationary in one position is shown by the following figures, given by Wm. Daniel (*Proc. Inst. M. E.*, 1875), of the velocities of air found at different points in the cross-sections of two different airways in a mine.

DIFFERENCES OF ANEMOMETER READINGS IN AIRWAYS.
8 ft. square.

1712	1795	1859	1329
1622	1685	1782	1091
1477	1344	1524	1049
1262	1356	1293	1333

Average 1469.

5 x 8 ft.

1170	1209	1288
948	1104	1177
1134	1049	1106

Average 1132.

Equalization of Pipes.— It is frequently desired to know what number of pipes of a given size are equal in carrying capacity to one pipe of a larger size. At the same velocity of flow the volume delivered by two pipes of different sizes is proportional to the squares of their diameters;

thus, one 4-inch pipe will deliver the same volume as four 2-inch pipes. With the same head, however, the velocity is less in the smaller pipe, and the volume delivered varies about as the square root of the fifth power (i.e., as the 2.5 power). The following table has been calculated on this basis. The figures opposite the intersection of any two sizes is the number of the smaller-sized pipes required to equal one of the larger. Thus one 4-inch pipe is equal to 5.7 two-inch pipes.

Diam. In.	1	2	3	4	5	6	7	8	9	10	12	14	16	18	20	24
2	5.7	1														
3	15.6	2.8	1													
4	32.0	5.7	2.1	1												
5	55.9	9.9	3.6	1.7	1											
6	88.2	15.6	5.7	2.8	1.6	1										
7	130	22.9	8.3	4.1	2.3	1.5	1									
8	181	32.0	11.7	5.7	3.2	2.1	1.4	1								
9	243	43.0	15.6	7.6	4.3	2.8	1.9	1.3	1							
10	316	55.9	20.3	9.9	5.7	3.6	2.4	1.7	1.3	1						
11	401	70.9	25.7	12.5	7.2	4.6	3.1	2.2	1.7	1.3	1					
12	499	88.2	32.0	15.6	8.9	5.7	3.8	2.8	2.1	1.6	1					
13	609	108	39.1	19.0	10.9	7.1	4.7	3.4	2.5	1.9	1.2					
14	733	130	47.0	22.9	13.1	8.3	5.7	4.1	3.0	2.3	1.5	1				
15	871	154	55.9	27.2	15.6	9.9	6.7	4.8	3.6	2.8	1.7	1.2				
16	1024	181	65.7	32.0	18.3	11.7	7.9	5.7	4.2	3.2	2.1	1.4	1			
17	1197	211	76.4	37.2	21.3	13.5	9.2	6.6	4.9	3.8	2.4	1.6	1.2			
18	1390	243	88.2	43.0	24.6	15.6	10.6	7.6	5.7	4.3	2.8	1.9	1.3	1		
19	1603	278	101	49.1	28.1	17.8	12.1	8.7	6.5	5.0	3.2	2.1	1.5	1.1		
20	1836	316	115	55.9	32.0	20.3	13.8	9.9	7.4	5.7	3.6	2.4	1.7	1.3	1	
22	2208	401	145	70.9	40.6	25.7	17.5	12.5	9.3	7.2	4.6	3.1	2.2	1.7	1.3	
24	2704	499	181	88.2	50.5	32.0	21.8	15.6	11.6	8.9	5.7	3.8	2.8	2.1	1.6	1
26	3225	609	221	108	61.7	39.1	26.6	19.0	14.2	10.9	7.1	4.7	3.4	2.5	1.9	1.2
28	3871	733	266	130	74.2	47.0	32.0	22.9	17.1	13.1	8.3	5.7	4.1	3.0	2.3	1.5
30	4641	871	316	154	88.2	55.9	38.0	27.2	20.3	15.6	9.9	6.7	4.8	3.6	2.8	1.7
36	6093	1197	499	243	130	88.2	60.0	43.0	32.0	24.6	15.6	10.6	7.6	5.7	4.3	2.8
42	7971	1603	733	357	205	130	88.2	63.2	47.0	36.2	19.0	15.6	11.2	8.3	6.4	4.1
48	10245	2111	999	499	286	181	123	88.2	62.7	50.5	32.0	21.8	15.6	11.6	8.9	5.7
54	13029	2781	1333	670	383	243	165	118	88.2	67.8	43.0	29.2	20.9	15.6	12.0	7.6
60	16416	3609	1833	871	499	316	215	154	115	88.2	55.9	38.0	27.2	20.3	15.6	9.9

WIND.

Force of the Wind.— Smeaton in 1759 published a table of the velocity and pressure of wind, as follows:

VELOCITY AND FORCE OF WIND, IN POUNDS PER SQUARE INCH.

Miles per Hour.	Feet per Second.	Force per Sq. Ft., Pounds.	Common Appellation of the Force of Wind.	Miles per Hour.	Feet per Second.	Force per Sq. Ft., Pounds.	Common Appellation of the Force of Wind.
1	1.47	0.005	Hardly perceptible.	18	26.4	1.55	Very brisk.
2	2.93	0.020		20	29.34	1.968	
3	4.4	0.044		25	36.67	3.075	
4	5.87	0.079	Just perceptible.	30	44.00	4.429	High wind.
5	7.33	0.123		35	51.34	6.027	
6	8.8	0.177		40	58.68	7.873	
7	10.25	0.241	Gentle, pleasant wind.	45	66.01	9.963	Very high storm.
8	11.75	0.315		50	73.35	12.30	
9	13.2	0.400		55	80.7	14.9	
10	14.67	0.492	Pleasant, brisk gale	60	88.00	17.71	Great storm.
12	17.6	0.708		65	95.3	20.85	
14	20.5	0.964		70	102.5	24.1	
15	22.00	1.107	Hurricane.	75	110.00	27.7	Immense hurricane.
16	23.45	1.25		80	117.36	31.49	
				100	146.67	49.2	

WARNING: This is a 1910 edition. Some of the material may no longer be accurate

The pressures per square foot in the above table correspond to the formula $P = 0.005 V^2$, in which V is the velocity in miles per hour. *Eng'g News*, Feb. 9, 1893, says that the formula was never well established, and has floated chiefly on Smeaton's name and for lack of a better. It was put forward only for surfaces for use in windmill practice. The trend of modern evidence is that it is approximately correct only for such surfaces, and that for large, solid bodies it often gives greatly too large results. Observations by others are thus compared with Smeaton's formula:

Old Smeaton formula	$P = 0.005 V^2$
As determined by Prof. Martin	$P = 0.004 V^2$
" " " Whipple and Dines	$P = 0.0029 V^2$

At 60 miles per hour these formulas give for the pressure per square foot, 18, 14.4, and 10.44 lbs., respectively, the pressure varying by all of them as the square of the velocity. Lieut. Crosby's experiments (*Eng'g*, June 13, 1890), claiming to prove that $P = fV$ instead of $P = fV^2$, are discredited.

Experiments by M. Eiffel on plates let fall from the Eiffel tower in Paris gave coefficients of V^2 ranging from 0.0027 for small plates to 0.0032 for plates 10 sq. ft. area. For plates larger than 10 sq. ft. the coefficient remained constant at 0.0032. — *Eng'g*, May 8, 1908.

A. R. Wolff ("The Windmill as a Prime Mover," p. 9) gives as the theoretical pressure per sq. ft. of surface, $P = dQv/g$, in which d = density of air in pounds per cu. ft. = $\frac{0.018743(p + P)}{t}$; p being the barometric pres-

sure per square foot at any level, and temperature of 32° F., t any absolute temperature, Q = volume of air carried along per square foot in one second, v = velocity of the wind in feet per second, $g = 32.16$. Since $Q = v$ cu. ft. per sec., $P = dv^2/g$. Multiplying this by a coefficient 0.93 found by experiment, and substituting the above value of d , he obtains

$$P = \frac{0.017431 \times p}{t \times 32.16 - 0.018743}, \text{ and when } p = 2116.5 \text{ lb. per sq. ft., or average}$$

$$\text{atmospheric pressure at the sea-level, } P = \frac{36.8929}{t \times 32.16 - 0.018743}, \text{ an ex-}$$

pression in which the pressure is shown to vary with the temperature; and he gives a table showing the relation between velocity and pressure for temperatures from 0° to 100° F., and velocities from 1 to 80 miles per hour. For a temperature of 45° F. the pressures agree with those in Smeaton's table, for 0° F. they are about 10 per cent greater, and for 100°, 10 per cent less.

Prof. H. Allen Hazen, *Eng'g News*, July 5, 1890, says that experiments with whirling arms, by exposing plates to direct wind, and on locomotives with velocities running up to 40 miles per hour, have invariably shown the resistance to vary with V^2 . The coefficient of V^2 has been found in some experiments with very short whirling arms and low velocities to vary with the perimeter of the plate, but this entirely disappears with longer arms or straight line motion, and the only question now to be determined is the value of the coefficient. Perhaps some of the best experiments for determining this value were tried in France in 1886 by carrying flat boards on trains. The resulting formula in this case was, for 44.5 miles per hour, $p = 0.00535 SV^2$.

Prof. Kernot, of Melbourne (*Eng. Rec.*, Feb. 20, 1894), states that experiments at the Forth Bridge showed that the average pressure on surfaces as large as railway carriages, houses, or bridges never exceeded two-thirds of that upon small surfaces of one or two square feet, and also that an inertia effect, which is frequently overlooked, may cause some forms of anemometer to give false results enormously exceeding the correct indication. Experiments made by Prof. Kernot at speeds varying from 2 to 15 miles per hour agreed with the earlier authorities. The pressure upon one side of a cube, or of a block proportioned like an ordinary carriage, was found to be 0.9 of that upon a thin plate of the same area. The same result was obtained for a square tower. A square pyramid, whose height was three times its base, experienced 0.8 of the pressure upon a thin plate equal to one of its sides, but if an angle was turned to

the wind the pressure was increased by fully 20%. A bridge consisting of two plate-girders connected by a deck at the top was found to experience 0.9 of the pressure on a thin plate equal in size to one girder, when the distance between the girders was equal to their depth, and this was increased by one-fifth when the distance between the girders was double the depth. A lattice-work in which the area of the openings was 55% of the whole area experienced a pressure of 80% of that upon a plate of the same area. The pressure upon cylinders and cones was proved to be equal to half that upon the diametral planes, and that upon an octagonal prism to be 20% greater than upon the circumscribing cylinder. A sphere was subject to a pressure of 0.36 of that upon a thin circular plate of equal diameter. A hemispherical cup gave the same result as the sphere; when its concavity was turned to the wind the pressure was 1.15 of that on a flat plate of equal diameter. When a plane surface parallel to the direction of the wind was brought nearly into contact with a cylinder or sphere, the pressure on the latter bodies was augmented by about 20%, owing to the lateral escape of the air being checked. Thus it is possible for the security of a tower or chimney to be impaired by the erection of a building nearly touching it on one side.

Pressures of Wind Registered in Storms. — Mr. Frizell has examined the published records of Greenwich Observatory from 1849 to 1869, and reports that the highest pressure of wind he finds recorded is 41 lb. per sq. ft., and there are numerous instances in which it was between 30 and 40 lb. per sq. ft. Prof. Henry says that on Mount Washington, N. H., a velocity of 150 miles per hour has been observed, and at New York City 60 miles an hour, and that the highest winds observed in 1870 were of 72 and 63 miles per hour, respectively. Lieut. Dunwoody, U. S. A., says, in substance, that the New England coast is exposed to storms which produce a pressure of 50 lb. per sq. ft. — *Eng. News*, Aug. 20, 1880.

WINDMILLS.

Power and Efficiency of Windmills. — Rankine, S. E., p. 215, gives the following: Let Q = volume of air which acts on the sail, or part of a sail, in cubic feet per second, v = velocity of the wind in feet per second, s = sectional area of the cylinder, or annular cylinder of wind, through which the sail, or part of the sail, sweeps in one revolution, c = a coefficient to be found by experience; then $Q = cvs$. Rankine, from experimental data given by Smeaton, and taking c to include an allowance for friction, gives for a wheel with four sails, proportioned in the best manner, $c = 0.75$. Let A = weather angle of the sail at any distance from the axis, i.e., the angle the portion of the sail considered makes with its plane of revolution. This angle gradually diminishes from the inner end of the sail to the tip; u = the velocity of the same portion of the sail, and E = the efficiency. The efficiency is the ratio of the useful work performed to the whole energy of the stream of wind acting on the surfaces of the wheel, which energy is $Dsv^3 + 2g$, D being the weight of a cubic foot of air. Rankine's formula for efficiency is

$$E = \frac{Ru}{Dsv^3/2g} = c \left\{ \frac{u}{v} \sin 2A - \frac{u^2}{v^2} (1 - \cos 2A + f) - f \right\},$$

in which $c = 0.75$ and f is a coefficient of friction found from Smeaton's data = 0.016. Rankine gives the following from Smeaton's data:

A = weather-angle	$= 7^\circ$	13°	19°
$V + v$ = ratio of speed of greatest efficiency, for a given weather-angle, to that of the wind	$= 2.63$	1.86	1.41
E = efficiency	$= 0.24$	0.29	0.31

Rankine gives the following as the best values for the angle of weather at different distances from the axis:

Distance in sixths of total radius	1	2	3	4	5	6
Weather angle	18°	19°	18°	16°	$12\frac{1}{2}^\circ$	7°

But Wolff (p. 125) shows that Smeaton did not term these the best angles, but simply says they "answer as well as any," possibly any that

were in existence in his time. Wolf says that they "cannot in the nature of things be the most desirable angles." Mathematical considerations, he says, conclusively show that the angle of impulse depends on the relative velocity of each point of the sail and the wind, the angle growing larger as the ratio becomes greater. Smeaton's angles do not fulfil this condition. Wolf develops a theoretical formula for the best angle of weather, and from it calculates a table of the best angles for different relative velocities of the blades and the wind, which differ widely from those given by Rankine.

A. R. Wolff, in an article in the *American Engineer*, gives the following (see also his treatise on Windmills):

- Let c = velocity of wind in feet per second;
- n = number of revolutions of the windmill per minute;
- b_0, b_1, b_2, b_x be the breadth of the sail or blade at distances l_0, l_1, l_2, l_3 , and l , respectively, from the axis of the shaft;
- l_0 = distance from axis of shaft to beginning of sail or blade proper.
- l = distance from axis of shaft to extremity of sail proper;
- v_0, v_1, v_2, v_3, v_x = the velocity of the sail in feet per second at distances l_0, l_1, l_2, l_3, l , respectively, from the axis of the shaft;
- a_0, a_1, a_2, a_3, a_x = the angles of impulse for maximum effect at distances l_0, l_1, l_2, l_3, l , respectively, from the axis of the shaft;
- a = the angle of impulse when the sails or blocks are plane surfaces so that there is but one angle to be considered;
- N = number of sails or blades of windmill;
- $K = 0.93$;
- d = density of wind (weight of a cubic foot of air at average temperature and barometric pressure where mill is erected);
- W = weight of wind-wheel in pounds;
- f = coefficient of friction of shaft and bearings;
- D = diameter of bearing of windmill in feet.

The effective horse-power of a windmill with plane sails will equal

$$\frac{(l - l_0) K c^2 d N}{550 g} \times \text{mean of } \left\{ v_0 \left(\sin a - \frac{v_0}{c} \cos a \right) b_0 \cos a \right. \\ \left. v_x \left(\sin a - \frac{v_x}{c} \cos a \right) b_x \cos a \right\} - \frac{f W \times 0.05236 n D}{550}$$

The effective horse-power of a windmill of shape of sail for maximum effect equals

$$\frac{N (l - l_0) K d c^2}{2200 g} \times \text{mean of } \left(\frac{2 \sin^2 a_0 - 1}{\sin^2 a_0} b_0, \frac{2 \sin^2 a_1 - 1}{\sin^2 a_1} b_1, \dots \right. \\ \left. \dots \frac{2 \sin^2 a_x - 1}{\sin^2 a_x} b_x \right) - \frac{f W \times 0.05236 n D}{550}$$

The mean value of quantities in brackets is to be found according to Simpson's rule. Dividing l into 7 parts, finding the angles and breadths corresponding to these divisions by substituting them in quantities within brackets will be found satisfactory. Comparison of these formulæ with the only fairly reliable experiments in windmills (Coulomb's) showed a close agreement of results.

Approximate formulæ of simpler form for windmills of present construction can be based upon the above, substituting actual average values for a, c, d , and e , but since improvement in the present angles is possible, it is better to give the formulæ in their general and accurate form.

Wolf gives the following table, based on the practice of an American manufacturer. Since its preparation, he says, over 1500 windmills have been sold on its guaranty (1885), and in all cases the results obtained did not vary sufficiently from those presented to cause any complaint. The actual results obtained are in close agreement with those obtained by theoretical analysis of the impulse of wind upon windmill blades.

Capacity of the Windmill.

Designation of Mill.	Velocity of Wind, in Miles per Hour.	Revolutions of Wheel per Minute.	Gallons of Water raised per Minute to an Elevation of						Equivalent Actual Useful Horse-power developed.	Average No. of Hours per Day during which this Result will be obtained.
			25 feet.	50 feet.	75 feet.	100 feet.	150 feet.	200 feet.		
wheel 8 1/2 ft.	16	70 to 75	6.162	3.016	0.04	8
10 "	16	60 to 65	19.179	9.563	6.638	4.750	0.12	8
12 "	16	55 to 60	33.941	17.952	11.851	8.485	5.680	0.21	8
14 "	16	50 to 55	45.139	22.569	15.304	11.246	7.807	4.998	0.28	8
16 "	16	45 to 50	64.600	31.654	19.542	16.150	9.771	8.075	0.41	8
18 "	16	40 to 45	97.682	52.165	32.513	24.421	17.485	12.211	0.61	8
20 "	16	35 to 40	124.550	63.750	40.800	31.248	19.284	15.938	0.78	8
25 "	16	30 to 35	212.381	106.964	71.604	49.725	37.349	26.741	1.34	8

These windmills are made in regular sizes, as high as sixty feet diameter of wheel; but the experience with the larger class of mills is too limited to enable the presentation of precise data as to their performance.

If the wind can be relied upon in exceptional localities to average a higher velocity for eight hours a day than that stated in the above table, the performance or horse-power of the mill will be increased, and can be obtained by multiplying the figures in the table by the ratio of the cube of the higher average velocity of wind to the cube of the velocity above recorded.

He also gives the following table showing the economy of the windmill. All the items of expense, including both interest and repairs, are reduced to the hour by dividing the costs per annum by $365 \times 8 = 2920$; the interest, etc., for the twenty-four hours being charged to the eight hours of actual work. By multiplying the figures in the 5th column by 584, the first cost of the windmill, in dollars, is obtained.

Economy of the Windmill.

Designation of Mill.	Gallons of Water raised 25 ft. per Hour.	Equivalent Actual Useful Horse-power developed.	Average Number of Hours per Day during which this Quantity will be raised.	Expense of Actual Useful Power Developed. in Cents, per Hour.				Expense per Horse-power, in Cents, per Hour.	
				For Interest on First Cost (First Cost, including Coat of Windmill, Pump, and Tower, 5% per Annum).	For Repairs and Depreciation (5% of First Cost per Annum).	For Attendance.	For Oil.		Total.
wheel 8 1/2 ft.	370	0.04	8	0.25	0.25	0.06	0.04	0.60	15.0
10 "	1151	0.12	8	0.30	0.30	0.06	0.04	0.70	5.8
12 "	2036	0.21	8	0.36	0.36	0.06	0.04	0.82	5.9
14 "	2708	0.28	8	0.75	0.75	0.06	0.07	1.63	5.8
16 "	3876	0.41	8	1.15	1.15	0.06	0.07	2.43	5.9
18 "	5861	0.61	8	1.35	1.35	0.06	0.07	2.83	4.6
20 "	7497	0.79	8	1.70	1.70	0.06	0.10	3.56	4.5
25 "	12743	1.34	8	2.05	2.05	0.06	0.10	4.26	3.2

Prof. De Volson Wood (*Am. Mach.*, Oct. 29, 1896) quotes some results by Thos. O. Perry on three wheels, each 5 ft. diam.: A, a good "stock" wheel, B and C, improved wheels. Each wheel was tested with a dynamometer placed 1 ft. from the axis of the wheel, and it registered a constant load at that point of 1.9 lbs. The velocity of the wind in each test was 8.45 miles per hour = 12.4 ft. per second. The number of turns per minute was: A, 30.67; B, 38.13; C, 56.50. The efficiency was: A, 0.142; B, 0.176; C, 0.261. The work of wheel C was 674.5 ft. lb. per min. = 0.020 H.P. Assuming that the power increases as the square of the diameter and as the cube of the velocity, a wheel of the quality of C, 12 1/2 ft. diam., with a wind velocity of 17 miles per hour, would be required for 1 H.P.; but wheel C had an exceptionally high efficiency, and such a high delivery would not likely be obtained in practice.

Prof. O. P. Hood (*Am. Mach.*, April 22, 1897) quotes the following results of experiments by E. C. Murphy; the mills were tested by pumping water:

Wind, miles per hour	8	12.	16.	20.	25.	30
Strokes per min., Mill No. 1, 8-ft. wheel	..	10.2	19.3	25.3	28.1	25
Strokes per min., Mill No. 2, 8-ft. wheel	8	20.2	26.1	28.	27.5	..
Strokes per min., Mill No. 3, 12-ft. wheel	..	4.8	12.7	18.8	23.3	25
Strokes per min., Mill No. 4, 12-ft. wheel	..	6.2	11.9	14.7	16.	..

Mill No. 3 was loaded nearly 90% heavier than mill No. 4.

In a 25-mile wind, seven 12-ft. mills developed, respectively, 0.379, 0.291, 0.309, 0.6, 0.247, 0.219, and 0.184 H.P.; and five 8-ft. mills, 0.043, 0.099, 0.059, 0.099, and 0.005 H.P. These effects include the effects of pumps of unknown and variable efficiency. The variations are largely due to the variable relation of the fixed load on the mill to the most favorable load which that mill might carry at each wind velocity. With each mill the efficiency is a maximum only for a certain load and a certain velocity, and for different loads and velocities the efficiency varies greatly. The useful work of mill No. 3 was equal to 0.6 H.P. in a 25-mile wind, and its efficiency was 5.8%. In a 16-mile wind the efficiency rose to 12.1%, and in a 12-mile wind it fell to 10.9%. The rule of the power developed, varying as the cube of the velocity, is far from true for a single wheel fitted with a single non-adjustable pump, and can only be true when the work of the pump per stroke is adjusted by varying the stroke of the pump, or by other means, for each change of velocity.

R. M. Dyer (*The Iowa Engineer*, July, 1906; also *Mach'y*, Aug., 1907) gives a brief review of the history of windmills and quotes experiments by T. O. Perry, E. C. Murphy, Prof. F. H. King, and the Aermotor Co. Mr. Perry's experiments are reported in pamphlet No. 20 of the Water Supply and Irrigation Papers of the U. S. Geological Survey, Mr. Murphy's in pamphlets Nos. 41 and 42 of the same Papers, and Prof. King's, in Bulletin No. 82 of the Agricultural Experiment Station of the University of Wisconsin. The Aermotor Co.'s experiments are described in catalogues of that company. Some of Mr. Dyer's conclusions are as follows:

Experiments showed that 7/8 of the zone of interruption could be covered with sails; that the gain in power in from 3/4 to 7/8 of the surface was so small that the use of the additional material was not justifiable; that the sail surface should extend only two-thirds the distance from the outer diameter to the center; that a wheel running behind the carrying mast is not nearly as efficient as one running in front of the mast; that there should be the least possible obstruction behind the wheel; that to be efficient the velocity of the travel of the vertical circumference of the wheel should be from 1 to 1 1/4 times the velocity of the wind, hence the necessity of back gearing to reduce the pump speed to 40 strokes per minute as a maximum, which is the limit of safety at which ordinary pumps can be operated.

I hold that no manufacturer will be able to produce a marketable motor which will absorb and deliver, when acted upon by an elastic fluid, like air, in which it is entirely surrounded and submerged, more than 35% of the kinetic energy of the impinging current.

Theoretical demonstrations show that the kinetic energy of the air, impinging on the intercepted area of a wheel, varies as the cube of the wind velocity; consequently, the power of windmills of the same type

varies theoretically as the square of the diameter, and as the cube of the wind velocity; but as a wheel is designed to give its best efficiency in low winds, say 10 to 15 miles per hour, we cannot expect that the same angle of sail would obtain the same percentage of efficiency in winds of considerably higher velocity.

The ordinary wheel works most efficiently under wind velocities of from 10 to 12 miles per hour; such wheels will give reasonable efficiency in from 5- to 6-mile winds, while, if the wind blows more than 12 miles per hour, there will be power to spare. Our wheel must work in light winds, such being nearly always present, while the higher velocities only occur at intervals. Mills built for grinding purposes, or geared mills, will develop power almost approaching to the cube of the wind velocity, within reasonable limits, as their speed need not be kept down to a certain number of revolutions per minute, as in the case of the pumping mill.

Should this theoretic condition hold, the following table, showing the amount of power for different sizes of mills at different wind velocities, would apply: Figures show Horse Power.

	5	10	15	20	25	30	35	40
Size.	mile.	mile.	mile.	mile.	mile.	mile.	mile.	mile.
8 ft.....	0.011	0.088	0.297	0.704	1.375	2.176
12 ft.....	0.025	0.20	0.675	1.6	3.125	5.4	8.57	12.8
16 ft.....	0.045	0.36	1.215	2.88	5.52	9.75	15.3	21.04

These figures have been proven by laboratory tests at velocities ranging from 10 to 25 miles per hour and more practically by the Murphy tests on mills actually in use, which show very close relation at the wind velocities at which the mills are best adapted.

The Murphy figures are as follows:

Size of mill.	10 mile.	15 mile.	20 mile.
12 ft.	0.21 H.P.	0.58 H.P.	1.05 H.P.
16 ft.	0.29	0.82	1.55

For higher wind velocities the Murphy values fall much under the theoretical values, but the range of velocities over which his experiments extend does not justify any change in the general law except inasmuch as common sense teaches us that theoretic conditions can rarely be attained in actual practice.

In view of the fact that a windmill does not work as efficiently in high winds as in winds under 20 miles per hour my experience would lead me to believe that the following figures (H.P.) would be the probable extension of the Murphy tests:

Size of mill.	25-mile wind.	30-mile wind.	35-mile wind.	40-mile wind.
12 ft.	2.5	4	5	6
16 ft.	4.	6	8	10

A 20-ft. mill would deliver approximately 50% greater than a 16-ft.

The foregoing table must be translated with reasonable allowances for conditions under which wind wheels must work and which cannot well be avoided, e.g.: Pumping mills must be made to regulate off at a certain maximum speed to prevent damage to the attached pumping devices. The regulating point is usually between 20- and 25-mile wind velocities, so that no matter how much higher the wind velocity may be the power absorbed and delivered by the wheel will be no greater than that indicated at the regulating point.

Electric storage and lighting from the power of a windmill has been tested on a large scale for several years by Charles F. Brush, at Cleveland, Ohio. In 1887 he erected on the grounds of his dwelling a windmill 56 ft. in diameter, that operates with ordinary wind a dynamo at 500 revolutions per minute, with an output of 12,000 watts — 16 electric horse-power — charging a storage system that gives a constant lighting capacity of 100 16 to 20 candle-power lamps. The current from the dynamo is auto-

matically regulated to commence charging at 330 revolutions and 70 volts, and cutting the circuit at 75 volts. Thus, by its 24 hours' work, the storage system of 408 cells in 12 parallel series, each cell having a capacity of 100 ampere-hours, is kept in constant readiness for all the requirements of the establishment, it being fitted up with 350 incandescent lamps, about 100 being in use each evening. The plant runs at a mere nominal expense for oil, repairs, and attention. (For a fuller description of this plant, and of a more recent one at Marblehead Neck, Mass., see Lieut. Lewis's paper in *Engineering Magazine*, Dec., 1894, p. 475.)

COMPRESSED AIR.

Heating of Air by Compression. — Kimball, in his treatise on Physical Properties of Gases, says: When air is compressed, all the work which is done in the compression is converted into heat, and shows itself in the rise in temperature of the compressed gas. In practice many devices are employed to carry off the heat as fast as it is developed, and keep the temperature down. But it is not possible in any way to totally remove this difficulty. But, it may be objected, if all the work done in compression is converted into heat, and if this heat is got rid of as soon as possible, then the work may be virtually thrown away, and the compressed air can have no more energy than it had before compression. It is true that the compressed gas has no more energy than the gas had before compression, if its temperature is no higher, but the advantage of the compression lies in bringing its energy into more available form.

The total energy of the compressed and uncompressed gas is the same at the same temperature, but the available energy is much greater in the former.

When the compressed air is used in driving a rock-drill, or any other piece of machinery, it gives up energy equal in amount to the work it does, and its temperature is accordingly greatly reduced.

Causes of Loss of Energy in Use of Compressed Air. (Zahner, on Transmission of Power by Compressed Air.) — 1. The compression of air always develops heat, and as the compressed air always cools down to the temperature of the surrounding atmosphere before it is used, the mechanical equivalent of this dissipated heat is work lost.

2. The heat of compression increases the volume of the air, and hence it is necessary to carry the air to a higher pressure in the compressor in order that we may finally have a given volume of air at a given pressure, and at the temperature of the surrounding atmosphere. The work spent in effecting this excess of pressure is work lost.

3. Friction of the air in the pipes, leakage, dead spaces, the resistance offered by the valves, insufficiency of valve-area, inferior workmanship, and slovenly attendance, are all more or less serious causes of loss of power.

The first cause of loss of work, namely, the heat developed by compression, is entirely unavoidable. The whole of the mechanical energy which the compressor-piston spends upon the air is converted into heat. This heat is dissipated by conduction and radiation, and its mechanical equivalent is work lost. The compressed air, having again reached thermal equilibrium with the surrounding atmosphere, expands and does work in virtue of its intrinsic energy.

The intrinsic energy of a fluid is the energy which it is capable of exerting against a piston in changing from a given state as to temperature and volume to a total privation of heat and indefinite expansion.

Adiabatic and Isothermal Compression. — Air may be compressed either *adiabatically*, in which all the heat resulting from compression is retained in the air compressed, or *isothermally*, in which the heat is removed as rapidly as produced, by means of some form of refrigerator.

Volumes, Mean Pressures per Stroke, Temperatures, etc., in the Operation of Air-compression from 1 Atmosphere and 60° Fahr. (F. Richards, *Am. Mach.*, March 30, 1893.)

Gauge-pressure.	Atmospheres.	Volume with Air at Constant Temp.	Volume with Air not Cooled.	Mean Pressure per Stroke; Air Constant Temp.	Mean Pressure per Stroke; Air not Cooled.	Temp. of Air; not Cooled.	Gauge-pressure.	Atmospheres.	Volume with Air at Constant Temp.	Volume with Air not Cooled.	Mean Pressure per Stroke; Air Constant Temp.	Mean Pressure per Stroke; Air not Cooled.	Temp. of Air; not Cooled.
1	2	3	4	5	6	7	1	2	3	4	5	6	7
0	1	1	1	0	0	60°	80	6.442	.1552	.266	27.38	36.64	432
1	1.068	.9363	.95	.96	.975	71	85	6.782	.1474	.2566	28.16	37.94	447
2	1.136	.8803	.91	1.87	1.91	80.4	90	7.122	.1404	.248	28.89	39.18	459
3	1.204	.8305	.876	2.72	2.8	88.9	95	7.462	.134	.24	29.57	40.4	472
4	1.272	.7861	.84	3.53	3.67	98	100	7.802	.1281	.2324	30.21	41.6	485
5	1.34	.7462	.81	4.3	4.5	106	105	8.142	.1228	.2254	30.81	42.78	496
10	1.68	.5952	.69	7.62	8.27	145	110	8.483	.1178	.2189	31.39	43.91	507
15	2.02	.495	.606	10.33	11.51	178	115	8.823	.1133	.2129	31.98	44.98	518
20	2.36	.4237	.543	12.62	14.4	207	120	9.163	.1091	.2073	32.54	46.04	529
25	2.7	.3703	.494	14.59	17.01	234	125	9.503	.1052	.2020	33.07	47.06	540
30	3.04	.3289	.4538	16.34	19.4	252	130	9.843	.1015	.1969	33.57	48.1	550
35	3.381	.2957	.42	17.92	21.6	281	135	10.183	.0981	.1922	34.05	49.1	560
40	3.721	.2687	.393	19.32	23.66	302	140	10.523	.095	.1878	34.57	50.02	570
45	4.061	.2462	.37	20.57	25.59	321	145	10.864	.0921	.1837	35.09	51.	580
50	4.401	.2272	.35	21.69	27.39	339	150	11.204	.0892	.1796	35.48	51.89	589
55	4.741	.2109	.331	22.76	29.11	357	160	11.88	.0841	.1722	36.29	53.65	607
60	5.081	.1968	.3144	23.78	30.75	375	170	12.56	.0796	.1657	37.2	55.39	624
65	5.422	.1844	.301	24.75	32.32	389	180	13.24	.0755	.1595	37.96	57.01	640
70	5.762	.1735	.288	25.67	33.83	405	190	13.93	.0718	.154	38.68	58.57	657
75	6.102	.1639	.276	26.55	35.27	420	200	14.61	.0685	.149	39.42	60.14	672

Column 3 gives the volume of air after compression to the given pressure and after it is cooled to its initial temperature. After compression air loses its heat very rapidly, and this column may be taken to represent the volume of air after compression available for the purpose for which the air has been compressed.

Column 4 gives the volume of air more nearly as the compressor has to deal with it. In any compressor the air will lose some of its heat during compression. The slower the compressor runs the cooler the air and the smaller the volume.

Column 5 gives the mean effective resistance to be overcome by the air-cylinder piston in the stroke of compression, supposing the air to remain constantly at its initial temperature. Of course it will not so remain, but this column is the ideal to be kept in view in economical air-compression.

Column 6 gives the mean effective resistance to be overcome by the piston, supposing that there is no cooling of the air. The actual mean effective pressure will be somewhat less than as given in this column; but for computing the actual power required for operating air-compressor cylinders, the figures in this column may be taken and a certain percentage added — say 10 per cent — and the result will represent very closely the power required by the compressor.

The mean pressures given being for compression from one atmosphere upward, they will not be correct for computations in compound compression or for any other initial pressure.

Loss due to Excess of Pressure caused by Heating in the Compression-cylinder. — If the air during compression were kept at a constant temperature, the compression-curve of an indicator-diagram taken from the cylinder would be an isothermal curve, and would follow the law of Boyle and Mariotte, $p_v = a \text{ constant}$, or $p_1 v_1 = p_0 v_0$, or $p_1 = p_0 \frac{v_0}{v_1}$, $p_1 v_1$ being the pressure and volume at the beginning of compression, and $p_1 v_1$ the pressure and volume at the end, or at any intermediate point. But as the air is heated during compression the pressure increases faster than the volume decreases, causing the work required for any given pressure to be increased. If none of the heat were abstracted by radiation or by injection of water, the curve of the diagram would be an adiabatic curve, with the equation $p_1 = p_0 \left(\frac{v_0}{v_1}\right)^{1.405}$. Cooling the air during compression, or compressing it in two cylinders, called compounding, and cooling the air as it passes from one cylinder to the other, reduces the exponent of this equation, and reduces the quantity of work necessary to effect a given compression. F. T. Gause (*Am. Mach.*, Oct. 20, 1892), describing the operations of the Popp air-compressors in Paris, says: The greatest saving realized in compressing in a single cylinder was 33 per cent of that theoretically possible. In cards taken from the 2000 H.P. compound compressor at Quai De La Gare, Paris, the saving realized is 85 per cent of the theoretical amount. Of this amount only 8 per cent is due to cooling during compression, so that the increase of economy in the compound compressor is mainly due to cooling the air between the two stages of compression. A compression-curve with exponent 1.25 is the best result that was obtained for compression in a single cylinder and cooling with a very fine spray. The curve with exponent 1.15 is that which must be realized in a single cylinder to equal the present economy of the compound compressor at Quai De La Gare.

Horse-power required to compress and deliver One Cubic Foot of Free Air per minute to a given pressure with no cooling of the air during the compression; also the horse power required, supposing the air to be maintained at constant temperature during the compression.

Gauge-pressure.	Air not cooled.	Air constant temperature.
5	0.0196	0.0188
10	0.0361	0.0333
20	0.0628	0.0551
30	0.0846	0.0713
40	0.1032	0.0843
50	0.1195	0.0946
60	0.1342	0.1036
70	0.1476	0.1120
80	0.1599	0.1195
90	0.1710	0.1261
100	0.1815	0.1318

The horse-power given above is the theoretical power, no allowance being made for friction of the compressor or other losses, which may amount to 10 per cent or more.

Formulae for Adiabatic Compression or Expansion of Air (or Other Sensibly Perfect Gas).

Let air at an absolute temperature T_1 , absolute pressure p_1 , and volume v_1 be compressed to an absolute pressure p_2 and corresponding volume v_2 and absolute temperature T_2 ; or let compressed air of an initial pressure, volume, and temperature p_2 , v_2 , and T_2 be expanded to p_1 , v_1 , and T_1 , there being no transmission of heat from or into the air during the operation.

Then the following equations express the relations between pressure, volume, and temperature (see works on Thermodynamics):

$$\frac{v_1}{v_2} = \left(\frac{p_2}{p_1}\right)^{0.71}; \quad \frac{p_2}{p_1} = \left(\frac{v_1}{v_2}\right)^{1.41}; \quad \frac{v_1}{v_2} = \left(\frac{T_2}{T_1}\right)^{2.46};$$

$$\frac{T_2}{T_1} = \left(\frac{v_1}{v_2}\right)^{0.41}; \quad \frac{T_2}{T_1} = \left(\frac{p_2}{p_1}\right)^{0.29}; \quad \frac{p_2}{p_1} = \left(\frac{T_2}{T_1}\right)^{1.16}.$$

The exponents are derived from the ratio $c_p \div c_v = k$ of the specific heats of air at constant pressure and constant volume. Taking $k = 1.406$, $1 \div k = 0.711$; $k - 1 = 0.406$; $1 \div (k - 1) = 2.463$; $k + (k - 1) = 3.463$; $(k - 1) \div k = 0.289$.

Work of Adiabatic Compression of Air. — If air is compressed in a cylinder without clearance from a volume v_1 and pressure p_1 to a smaller volume v_2 and higher pressure p_2 , work equal to $p_1 v_1$ is done by the external air on the piston while the air is drawn into the cylinder. Work is then done by the piston on the air, first, in compressing it to the pressure p_2 and volume v_2 , and then in expelling the volume v_2 from the cylinder against the pressure p_2 . If the compression is adiabatic, $p_1 v_1^k = p_2 v_2^k = \text{constant}$. $k = 1.406$.

The work of compression of a given quantity of air is

$$\frac{p_1 v_1}{k - 1} \left\{ \left(\frac{v_1}{v_2}\right)^{k-1} - 1 \right\} = \frac{p_1 v_1}{k - 1} \left\{ \left(\frac{p_2}{p_1}\right)^{\frac{k-1}{k}} - 1 \right\},$$

or $2.463 p_1 v_1 \left\{ \left(\frac{v_1}{v_2}\right)^{0.41} - 1 \right\} = 2.463 p_1 v_1 \left\{ \left(\frac{p_2}{p_1}\right)^{0.29} - 1 \right\}.$

The work of expulsion is $p_2 v_2 = p_1 v_1 \left(\frac{p_2}{p_1}\right)^{0.29}.$

The total work is the sum of the work of compression and expulsion less the work done on the piston during admission, and it equals

$$p_1 v_1 \left\{ \frac{k}{k - 1} \left(\frac{p_2}{p_1}\right)^{\frac{k-1}{k}} - 1 \right\} = 3.463 p_1 v_1 \left\{ \left(\frac{p_2}{p_1}\right)^{0.29} - 1 \right\}.$$

The mean effective pressure during the stroke is

$$p_1 \frac{k}{k - 1} \left\{ \left(\frac{p_2}{p_1}\right)^{\frac{k-1}{k}} - 1 \right\} = 3.463 p_1 \left\{ \left(\frac{p_2}{p_1}\right)^{0.29} - 1 \right\}.$$

p_1 and p_2 are absolute pressures above a vacuum in atmospheres or in pounds per square inch or per square foot.

EXAMPLE. — Required the work done in compressing 1 cubic foot of air per second from 1 to 6 atmospheres, including the work of expulsion from the cylinder.

$p_2 \div p_1 = 6$; $6^{0.29} - 1 = 0.681$; $3.463 \times 0.681 = 2.358$ atmospheres $\times 14.7 = 34.66$ lb. per sq. in. mean effective pressure, $\times 144 = 4991$ lb. per sq. ft., $\times 1$ ft. stroke = 4991 ft.-lb., $\div 550$ ft.-lb. per second = 9.08 H.P.

If $R =$ ratio of pressures = $p_2 \div p_1$, and if $v_1 = 1$ cubic foot, the work done in compressing 1 cubic foot from p_1 to p_2 is, in foot-pounds,

$$3.463 p_1 (R^{0.29} - 1),$$

p_1 being taken in lb. per sq. ft. For compression at the sea level p_1 may be taken at 14 lbs. per sq. in. = 2016 lb. per sq. ft., as there is some loss of pressure due to friction of valves and passages.

Horse-power required to compress and deliver 100 cubic feet of free air per minute = $1.511 P_1 (R^{0.29} - 1)$; P_1 being the pressure of the free air in pounds per sq. in., absolute.

EXAMPLE. To compress 100 cu. ft. from 1 to 6 atmospheres. $P_1 = 1.47$; $R = 6$; $1.511 \times 14.7 \times 0.681 = 15.13$ H.P.

Indicator-cards from compressors in good condition and under working-speeds usually follow the adiabatic line closely. A low curve indicates piston leakage. Such cooling as there may be from the cylinder-jacket and the re-expansion of the air in clearance-spaces tends to reduce the mean effective pressure, while the "camel-backs" in the expulsion-line, due to resistance to opening of the discharge-valve, tend to increase it.

Work of one stroke of a compressor, with adiabatic compression, in foot-pounds.

$$W = 3.463 P_1 V_1 (R^{0.29} - 1),$$

in which P_1 = initial absolute pressure in lb. per sq. ft. and V_1 = volume traversed by piston in cubic feet.

The work done during adiabatic compression (or expansion) of 1 pound of air from a volume v_1 and pressure p_1 to another volume v_2 and pressure p_2 is equal to the mechanical equivalent of the heating (or cooling). If t_1 is the higher and t_2 the lower temperature, Fahr., the work done is $c_v J (t_1 - t_2)$ foot-pounds, c_v being the specific heat of air at constant volume = 0.1689, and $J = 778$, $c_v J = 131.4$.

The work during compression also equals

$$\frac{c_v J}{R_a} p_1 v_1 \left[\left(\frac{p_2}{p_1} \right)^{0.29} - 1 \right] = 2.463 p_1 v_1 \left[\left(\frac{p_2}{p_1} \right)^{0.29} - 1 \right],$$

R_a being the value of $p v \div$ absolute temperature for 1 pound of air = 53.37.

The work during expansion is

$$2.463 p_1 v_1 \left[1 - \left(\frac{p_2}{p_1} \right)^{0.29} \right] = 2.463 p_2 v_2 \left[\left(\frac{p_1}{p_2} \right)^{0.29} - 1 \right].$$

in which $p_1 v_1$ are the initial and $p_2 v_2$ the final pressures and volumes.

Compressed-air Engines, Adiabatic Expansion. — Let the initial pressure and volume taken into the cylinder be p_1 lb. per sq. ft. and v_1 cubic feet; let expansion take place to p_2 and v_2 according to the adiabatic law $p_1 v_1^{1.41} = p_2 v_2^{1.41}$; then at the end of the stroke let the pressure drop to the back-pressure p_3 , at which the air is exhausted. Assuming no clearance, the work done by one pound of air during admission, measured

above vacuum, is $p_1 v_1$, the work during expansion is $2.463 p_1 v_1 \left[1 - \left(\frac{p_2}{p_1} \right)^{0.29} \right]$, and the negative or back pressure work is $-p_3 v_2$. The total work is $p_1 v_1 + 2.463 p_1 v_1 \left[1 - \left(\frac{p_2}{p_1} \right)^{0.29} \right] - p_3 v_2$, and the mean effective pressure is the total work divided by v_2 .

If the air is expanded down to the back-pressure p_3 the total work is

$$3.463 p_1 v_1 \left\{ 1 - \left(\frac{p_3}{p_1} \right)^{0.29} \right\},$$

or, in terms of the final pressure and volume,

$$3.463 p_3 v_2 \left\{ \left(\frac{p_1}{p_3} \right)^{0.29} - 1 \right\},$$

and the mean effective pressure is

$$3.463 p_3 \left\{ \left(\frac{p_1}{p_3} \right)^{0.29} - 1 \right\}.$$

The actual work is reduced by clearance. When this is considered, the product of the initial pressure p_1 by the clearance volume is to be subtracted from the total work calculated from the initial volume v_1 , including clearance. (See p. 931, under "Steam-engine.")

Mean Effective Pressures of Air Compressed Adiabatically. (F. A. Halsey, *Am. Mach.*, Mar. 10, 1898.)

R.	$R^{0.29}$	M.E.P. from 14 lbs. Initial.	R.	$R^{0.29}$	M.E.P. from 14 lbs. Initial.
1.25	1.067	3.24	4.75	1.570	27.5
1.50	1.125	6.04	5	1.594	28.7
1.75	1.176	8.51	5.25	1.617	29.8
2	1.223	10.8	5.5	1.639	30.8
2.25	1.265	12.8	5.75	1.660	31.8
2.5	1.304	14.7	6	1.681	32.8
2.75	1.341	16.4	6.25	1.701	33.8
3	1.375	18.1	6.5	1.720	34.7
3.25	1.407	19.6	6.75	1.739	35.6
3.5	1.438	21.1	7	1.757	36.5
3.75	1.467	22.5	7.25	1.775	37.4
4	1.495	23.9	7.5	1.793	38.3
4.25	1.521	25.2	8	1.827	39.9
4.5	1.546	26.4			

R = final \div initial absolute pressure.

M.E.P. = mean effective pressure, lb. per sq. in., based on 14 lb. initial. **Compound Compression, with Air Cooled between the Two Cylinders.** (*Am. Mach.*, March 10 and 31, 1898.) — Work in low-pressure cylinder = W_1 , in high-pressure cylinder W_2 . Total work

$$W_1 + W_2 = 3.46 P_1 V_1 [r_1^{0.29} + R^{0.29} \times r_1^{-0.29} - 2].$$

r_1 = ratio of pressures in l. p. cyl., r_2 = ratio in h.p. cyl., $R = r_1 r_2$. When $r_1 = r_2 = \sqrt{R}$, the sum $W_1 + W_2$ is a minimum. Hence for a given total ratio of pressures, R , the work of compression, will be least when the ratios of the pressures in each of the two cylinders are equal.

The equation may be simplified, when $r_1 = \sqrt{R}$, to the following:

$$W_1 + W_2 = 6.92 P_1 V_1 [R^{0.145} - 1].$$

Dividing by V_1 gives the mean effective pressure reduced to the low-pressure cylinder M.E.P. = $6.92 P_1 [R^{0.145} - 1]$.

In the above equation the compression in each cylinder is supposed to be adiabatic, but the intercooler is supposed to reduce the temperature of the air to that at which compression began.

Horse-power required to compress adiabatically 100 cu. ft. of free air per minute in two stages with intercooling, and with equal ratio of compression in each cylinder, = $3.022 P_1 (R^{0.145} - 1)$; P_1 being the pressure in lbs. per sq. in., absolute, of the free air, and R the total ratio of compression.

EXAMPLE. To compress 100 cu. ft. per min. from 1 to 6 atmospheres, $P = 14.7$; $R = 6$; $3.022 \times 14.7 \times 0.2964 = 13.17$ H.P.

Mean Effective Pressures of Air Compressed in Two Stages, assuming the Intercooler to Reduce the Temperature to that at which Compression Began. (F. A. Halsey, *Am. Mach.*, Mar. 31, 1898.)

R.	$R^{0.145}$	M.E.P. from 14 lbs. Initial.	Ultimate Saving by Compounding, %.	R.	$R^{0.145}$	M.E.P. from 14 lbs. Initial.	Ultimate Saving by Compounding, %.
5.0	1.263	25.4	11.5	9.0	1.375	36.3	15.8
5.5	1.280	27.0	12.3	9.5	1.386	37.3	16.2
6.0	1.296	28.6	12.8	10	1.396	38.3	16.6
6.5	1.312	30.1	13.2	11	1.416	40.2	17.2
7.0	1.326	31.5	13.7	12	1.434	41.9	17.8
7.5	1.336	32.8	14.3	13	1.451	43.5	18.4
8.0	1.352	34.0	14.8	14	1.466	45.0	19.0
8.5	1.364	35.2	15.3	15	1.481	46.4	19.4

R = final + initial absolute pressure.
 M.E.P. = mean effective pressure, lb. per sq. in., based on 14 lb. absolute initial pressure reduced to the low-pressure cylinder.

Table for Adiabatic Compression or Expansion of Air.
 (Proc. Inst. M.E., Jan., 1881, p. 123.)

Absolute Pressure.		Absolute Temperature.		Volume.	
Ratio of Greater to Less. (Expansion.)	Ratio of Less to Greater. (Compression.)	Ratio of Greater to Less. (Expansion.)	Ratio of Less to Greater. (Compression.)	Ratio of Greater to Less. (Compression.)	Ratio of Less to Greater. (Expansion.)
1.2	0.833	1.054	0.948	1.138	0.879
1.4	0.714	1.102	0.907	1.270	0.788
1.6	0.625	1.146	0.873	1.396	0.716
1.8	0.556	1.186	0.843	1.518	0.659
2.0	0.500	1.222	0.818	1.636	0.611
2.2	0.454	1.257	0.796	1.750	0.571
2.4	0.417	1.289	0.776	1.862	0.537
2.6	0.385	1.319	0.758	1.971	0.507
2.8	0.357	1.348	0.742	2.077	0.481
3.0	0.333	1.375	0.727	2.182	0.458
3.2	0.312	1.401	0.714	2.284	0.438
3.4	0.294	1.426	0.701	2.384	0.419
3.6	0.278	1.450	0.690	2.483	0.403
3.8	0.263	1.473	0.679	2.580	0.388
4.0	0.250	1.495	0.669	2.676	0.374
4.2	0.238	1.516	0.660	2.770	0.361
4.4	0.227	1.537	0.651	2.863	0.349
4.6	0.217	1.557	0.642	2.955	0.338
4.8	0.208	1.576	0.635	3.046	0.328
5.0	0.200	1.595	0.627	3.135	0.319
6.0	0.167	1.681	0.595	3.569	0.280
7.0	0.143	1.758	0.569	3.981	0.251
8.0	0.125	1.828	0.547	4.377	0.228
9.0	0.111	1.891	0.529	4.759	0.210
10.0	0.100	1.950	0.513	5.129	0.195

Mean Effective Pressures for the Compression Part only of the Stroke when Compressing and Delivering Air from One Atmosphere to given Gauge-pressure in a Single Cylinder. (F. Richards, *Am. Mach.*, Dec. 14, 1893.)

Gauge-Pressure.	Adiabatic Compression.	Isothermal Compression.	Gauge-Pressure.	Adiabatic Compression.	Isothermal Compression.
1	0.44	0.43	45	13.95	12.62
2	0.96	0.95	50	15.05	13.48
3	1.41	1.4	55	15.98	14.3
4	1.86	1.84	60	16.89	15.05
5	2.26	2.22	65	17.88	15.76
10	4.26	4.14	70	18.74	16.43
15	5.99	5.77	75	19.54	17.09
20	7.58	7.2	80	20.5	17.7
25	9.05	8.49	85	21.22	18.3
30	10.39	9.66	90	22.0	18.87
35	11.59	10.72	95	22.77	19.4
40	12.8	11.7	100	23.43	19.92

The mean effective pressure for compression only is always lower than the mean effective pressure for the whole work.

To find the Index of the Curve of an Air-diagram. If P_1V_1 be pressure and volume at one point on the curve, and P_2V_2 the pressure and volume at another point, then $\frac{P_2}{P_1} = \left(\frac{V_1}{V_2}\right)^x$, in which x is the index to be

found. Let $P + P_1 = R$, and $V_1 + V = r$; then $R = r^x$; $\log R = x \log r$, whence $x = \log R \div \log r$. (See also graphic method on page 576.)

Mean and Terminal Pressures of Compressed Air used Expansively for Gauge Pressures from 60 to 100 lb.
 (Frank Richards, *Am. Mach.*, April 13, 1893.)

Point of Cut-off.	Initial Pressure.									
	60		70		80		90		100	
	Mean Air-pressure.	Terminal Air-pressure.	Mean Air-pressure.	Terminal Air-pressure.	Mean Air-pressure.	Terminal Air-pressure.	Mean Air-pressure.	Terminal Air-pressure.	Mean Air-pressure.	Terminal Air-pressure.
.25	23.6	<i>10.65</i>	28.74	<i>12.07</i>	33.89	<i>13.49</i>	39.04	<i>14.91</i>	44.19	1.33
.30	28.9	<i>13.77</i>	34.75	0.6	40.61	2.44	46.46	4.27	53.32	6.11
.35	32.13	0.96	38.41	3.09	44.69	5.22	50.98	7.35	57.26	9.48
.40	33.66	2.33	40.15	4.38	46.64	6.66	53.13	8.95	59.62	11.23
.45	35.85	3.85	42.63	6.36	49.41	7.88	56.2	11.39	62.98	13.89
.50	37.93	5.64	44.99	8.39	52.05	11.14	59.11	13.88	66.16	16.64
.55	41.75	10.71	49.31	12.61	56.9	15.86	64.45	19.11	72.02	22.36
.60	45.14	13.26	53.16	17.	61.18	20.81	69.19	24.56	77.21	28.33
.65	50.75	21.53	59.51	26.4	68.28	31.27	77.05	36.14	85.82	41.01
.70	51.92	23.69	60.84	28.85	69.76	34.01	78.69	39.16	87.61	44.32
.75	53.67	27.94	62.83	33.03	71.99	38.68	81.14	44.33	90.32	49.97
.80	54.93	30.39	64.25	36.44	73.57	42.49	82.9	48.54	92.22	54.59
.85	56.52	35.01	66.05	41.68	75.59	48.35	85.12	55.02	94.66	61.69
.90	57.79	39.78	67.5	47.08	77.2	54.38	86.91	61.69	96.61	68.99
.95	59.15	47.14	69.03	55.43	78.92	63.81	88.81	72.	98.7	80.28
.99	59.46	49.65	69.38	58.27	79.31	66.89	89.24	75.52	99.17	87.82

Pressures in italics are absolute; all others are gauge pressures.

AIR COMPRESSION AT ALTITUDES.

(Ingersoll-Rand Co. Copyright, 1906, by F. M. Hitchcock.)

Multipliers to Determine the Volume of Free Air which, when Compressed, is Equivalent in Effect to a Given Volume of Free Air at Sea Level.

Altitude, Feet.	Barometric Pressure.		Gauge Pressure (Pounds).				
	In. of Mercury.	Lb. per Sq. In.	60	80	100	125	150
1,000	28.88	14.20	1.032	1.033	1.034	1.035	1.036
2,000	27.80	13.67	1.064	1.066	1.068	1.071	1.072
3,000	26.76	13.16	1.097	1.102	1.105	1.107	1.109
4,000	25.76	12.67	1.132	1.139	1.142	1.147	1.149
5,000	24.79	12.20	1.168	1.178	1.182	1.187	1.190
6,000	23.86	11.73	1.206	1.218	1.224	1.231	1.234
7,000	22.97	11.30	1.245	1.258	1.267	1.274	1.278
8,000	22.11	10.87	1.287	1.300	1.310	1.319	1.326
9,000	21.29	10.46	1.329	1.346	1.356	1.366	1.374
10,000	20.49	10.07	1.373	1.394	1.404	1.416	1.424

Horse-power Developed in Compressing One Cubic Foot of Free Air at Various Altitudes from Atmospheric to Various Pressures.

Initial Temperature of the Air in Each Cylinder Taken as 60° F.; Jacket Cooling not Considered; Allowance made for usual losses.

Altitude, Feet.	Simple Compression.			Two Stage Compression.				
	Gauge Pressure (Pounds).			Gauge Pressure (Pounds).				
	60	80	100	60	80	100	125	150
0	0.1533	0.1824	0.2075	0.1354	0.1580	0.1765	0.1964	0.2138
1,000	0.1511	0.1795	0.2040	0.1332	0.1553	0.1734	0.1926	0.2093
2,000	0.1489	0.1766	0.2006	0.1310	0.1524	0.1700	0.1887	0.2048
3,000	0.1469	0.1739	0.1971	0.1286	0.1493	0.1666	0.1848	0.2003
4,000	0.1448	0.1712	0.1939	0.1263	0.1464	0.1635	0.1810	0.1963
5,000	0.1425	0.1685	0.1906	0.1241	0.1438	0.1600	0.1772	0.1921
6,000	0.1402	0.1656	0.1872	0.1218	0.1409	0.1566	0.1737	0.1879
7,000	0.1379	0.1628	0.1839	0.1197	0.1383	0.1536	0.1700	0.1838
8,000	0.1358	0.1600	0.1807	0.1173	0.1358	0.1504	0.1662	0.1797
9,000	0.1337	0.1572	0.1774	0.1151	0.1329	0.1473	0.1627	0.1758
10,000	0.1316	0.1547	0.1743	0.1132	0.1303	0.1442	0.1592	0.1717

EXAMPLE.— Required the volume of free air which when compressed to 100 lb. gauge at 9,000 ft. altitude will be equivalent to 1,000 cu. ft. of free air at sea level; also the power developed in compressing this volume to 100 lb. gauge in two stage compression at this altitude.

From first table the multiplier is 1.356. Equivalent free air = 1,000 × 1.356 = 1,356 cu. ft.

From second table, power developed in compressing 1 cu. ft. of free air is 0.1473 H.P.; 1,356 × 0.1473 = 199.73 H.P.

The Popp Compressed-air System in Paris.— A most extensive system of distribution of power by means of compressed air is that of M. Popp, in Paris. One of the central stations is laid out for 24,000 horse-power. For a very complete description of the system, see *Engineering*, Feb. 15, June 7, 21, and 28, 1889, and March 13 and 20, April 10, and May 1, 1891. Also *Proc. Inst. M. E.*, July, 1889. A condensed description will be found in *Modern Mechanism*, p. 12.

Utilization of Compressed Air in Small Motors.— In the earliest stages of the Popp system in Paris it was recognized that no good results could be obtained if the air were allowed to expand direct into the motor; not only did the formation of ice due to the expansion of the air rapidly accumulate and choke the exhaust, but the percentage of useful work obtained, compared with that put into the air at the central station, was so small as to render commercial results hopeless.

After a number of experiments M. Popp adopted a simple form of cast-iron stove lined with fire-clay, heated either by a gas jet or by a small coke fire. This apparatus answered the desired purpose until a better arrangement was perfected, and the type was accordingly adopted throughout the whole system. The economy resulting from the use of the improved form was very marked.

It was found that more than 70% of the total heating value of the fuel employed was absorbed by the air and transformed into useful work. The efficiency of fuel consumed in this way is at least six times greater than when utilized in a boiler and steam-engine. According to Prof. Riedler, from 15% to 20% above the power at the central station can be obtained by means at the disposal of the power users. By heating the air to 480° F. an increased efficiency of 30% can be obtained.

A large number of motors in use among the subscribers to the Compressed Air Company of Paris are rotary engines developing 1 H.P. and less, and these in the early times of the industry were very extravagant in their consumption. Small rotary engines, working cold air without expansion, used as high as 2330 cu. ft. of air per brake H.P. per hour, and with heated air 1624 cu. ft. Working expansively, a 1-H.P. rotary engine used 1469 cu. ft. of cold air, or 960 cu. ft. of heated air, and a

2-H.P. rotary engine 1059 cu. ft. of cold air, or 847 cu. ft. of air, heated to about 122° F.

The efficiency of this type of rotary motors, with air heated to 122° F., may now be assumed at 43%.

Tests of a small Riedinger rotary engine, used for driving sewing-machines and indicating about 0.1 H.P., showed an air-consumption of 1377 cu. ft. per H.P. per hour when the initial pressure of the air was 83 lb. per sq. in. and its temperature 54° F., and 988 cu. ft. when the air was heated to 338° F., its pressure being 72 lb. With a 1/2-H.P. variable-expansion rotary engine the air-consumption was from 800 to 900 cu. ft. per H.P. per hour for initial pressures of 54 to 85 lb. per sq. in. with the air heated from 336° to 388° F., and 1148 cu. ft. with cold air, 46° F., and an initial pressure of 72 lb. The volumes of air were all taken at atmospheric pressure.

Trials made with an old single-cylinder 80-horse-power Farcot steam-engine, indicating 72 H.P., gave a consumption of air per brake H.P. as low as 465 cu. ft. per hour. The temperature of admission was 320° F., and of exhaust 95° F.

Prof. Elliott gives the following as typical results of efficiency for various systems of compressors and air-motors:

- Simple compressor and simple motor, efficiency..... 39.1%
- Compound compressor and simple motor, "..... 44.9
- " " compound motor, efficiency. 50.7
- Triple compressor and triple motor, "..... 55.3

The efficiency is the ratio of the I.H.P. in the motor cylinders to the I.H.P. in the steam-cylinders of the compressor. The pressure assumed is 6 atmospheres absolute, and the losses are equal to those found in Paris over a distance of 4 miles.

Summary of Efficiencies of Compressed-air Transmission at Paris, between the Central Station at St. Fargeau and a 10-horse-power Motor Working with Pressure Reduced to 4 1/2 Atmospheres.

(The figures below correspond to mean results of two experiments cold and two heated.)

One indicated horse-power at central station gives 0.845 I.H.P. in compressors, and corresponds to the compression of 348 cu. ft. of air per hour from atmospheric pressure to 6 atmospheres absolute.

0.845 I.H.P. in compressors delivers as much air as will do 0.52 I.H.P. in adiabatic expansion after it has fallen to the normal temperature of the mains.

The fall of pressure in mains between central station and Paris (say 5 kilometres) reduces the possibility of work from 0.52 to 0.51 I.H.P.

The further fall of pressure through the reducing valve to 4 1/2 atmospheres (absolute) reduces the possibility of work from 0.51 to 0.50.

Incomplete expansion, wire-drawing, and other such causes reduce the actual I.H.P. of the motor from 0.50 to 0.39.

By heating the air before it enters the motor to about 320° F., the actual I.H.P. at the motor is, however, increased to 0.54. The ratio of gain by heating the air is, therefore, 0.54 ÷ 0.39 = 1.38.

In this process additional heat is supplied by the combustion of about 0.39 lb. of coke per I.H.P. per hour, and if this be taken into account, the real indicated efficiency of the whole process becomes 0.47 instead of 0.54.

Working with cold air the work spent in driving the motor itself reduces the available horse-power from 0.39 to 0.26.

Working with heated air the work spent in driving the motor itself reduces the available horse-power from 0.54 to 0.44.

A summary of the efficiencies is as follows:

- Efficiency of main engines 0.845.
- Efficiency of compressors 0.52 ÷ 0.845 = 0.61.
- Efficiency of transmission through mains 0.51 ÷ 0.52 = 0.98.
- Efficiency of reducing valve 0.50 ÷ 0.51 = 0.98.
- The combined efficiency of the mains and reducing valve between 5 and 4 1/2 atmospheres is thus 0.98 × 0.98 = 0.96. If the reduction had been

to 4, 3 1/2, or 3 atmospheres, the corresponding efficiencies would have been 0.93, 0.89, and 0.85 respectively.

Indicated efficiency of motor 0.39 + 0.50 = 0.78.
 Indicated efficiency of whole process with cold air 0.39. Apparent indicated efficiency of whole process with heated air 0.54.
 Real indicated efficiency of whole process with heated air 0.47.
 Mechanical efficiency of motor, cold, 0.67.
 Mechanical efficiency of motor, hot, 0.81.

Ingersoll-Sergeant Standard Air Compressors.
 (Ingersoll-Rand Co., 1908.)

Class and Type.	Diam. of Cyl., In.				Stroke, In.	Rev. per Min.	Capacity, Cu. Ft. Free Air per Min.	Working Air Pressure.	Horse-power.	Cu. Ft. in Foundation.
	Steam.		Air.							
	High.	Low.	High.	Low.						
A-1* Straight Line Steam Driven.	10	10 1/4	12	160	177	50-100	23-35	113
	12	12 1/4	14	155	285	50-100	37-57	200
	14	14 1/4	18	120	381	50-100	50-76	340
	16	16 1/4	18	120	498	50-100	65-100	340
	18	18 1/4	24	94	656	50-100	86-131	520
	20	20 1/4	24	94	807	50-100	106-161	520
	22	22 1/4	24	94	973	50-100	127-194	520
24	24 1/4	30	80	1223	50-100	161-242	710	
A-2* Straight Line Steam Driven Compound Air.	12	7 1/2	12 1/4	12	160	252	90-110	40-45	145
	14	9 1/4	14 1/4	14	155	375	90-110	60-66	230
	16	10 1/4	16 1/4	18	135	550	90-110	89-97	435
	18	12 1/4	18 1/4	18	135	702	90-110	113-124	435
	20	13 1/4	20 1/4	24	110	940	90-110	151-166	640
	22	14 1/4	22 1/4	24	110	1131	90-110	182-193	640
	24	15 1/4	24 1/4	24	110	1333	90-110	214-236	640
26	16 1/4	26 1/4	30	90	1606	90-110	258-284	950	

B.* Straight line, belt driven. Same as A-1 in sizes up to 16 1/4 x 18 in.
 C. Duplex Corliss Steam, Duplex air. } Designed to suit conditions, not made to standard sizes.
 C-2, Compound Corliss Steam, Compound air. †

D-1* Duplex and Half Duplex Belt Driven.	10 1/4	12	160	352	60-100	50-67	240
	12 1/4	14	155	568	60-100	81-108	400
	14 1/4	18	120	763	65-100	113-146	625
	16 1/4	18	120	994	70-100	154-189	625
	18 1/4	24	100	1338	70-100	207-256	1050
D-2† Duplex Compound Belt Driven.	10 1/4	16 1/4	12	160	444	80-100	65-83	240
	11 1/4	18 1/4	14	155	638	80-100	93-104	400
	14 1/4	22 1/4	18	120	925	80-100	134-150	625
	15 1/4	25 1/4	18	120	1205	80-100	174-194	625
	17 1/4	28 1/4	24	100	1622	80-100	235-263	1050
	18 1/4	30 1/4	24	100	1857	80-100	269-300	1050
	20 1/4	32 1/4	24	100	2130	80	309	1050

E.* Straight line, belt driven; same sizes as F-1.

F-1* Straight Line Steam Driven.	6	6	6	150	29	45-100	4-6	21
	8	8	8	150	69	50-100	9 1/2-14	32
	10	10	10	150	134	55-100	19-27	46
	12	12 1/4	12	150	253	60-100	35-47	63

* Built in intermediate sizes for lower pressures.
 † Most economical form of compressor. ‡ For sea level; also built with larger low pressure cylinders for altitudes of 5,000 and 10,000 ft.

Ingersoll-Sergeant Standard Air Compressors.—Continued.

Class and Type.	Diam. of Cyl., In.				Stroke, In.	Rev. per Min.	Capacity, Cu. Ft. Free Air per Min.	Working Air Pressure.	Horse-power.	Cu. Ft. in Foundation.
	Steam.		Air.							
	High.	Low.	High.	Low.						
G-1* Duplex and Half Duplex Steam Driven.	10	10 1/4	12	160	352	60-100	55-70	330
	12	12 1/4	14	155	568	60-100	85-114	480
	14	14 1/4	18	120	763	65-100	119-152	800
	16	16 1/4	18	120	994	70-100	160-200	800
	18	18 1/4	24	100	1338	70-100	218-267	1450
	20	20 1/4	24	100	1674	70-100	273-335	1450
G-2† Duplex Steam, Compound Air.	10	10 1/4	16 1/4	12	160	444	80-100	67-75	330
	12	11 1/4	18 1/4	14	155	638	80-100	97-108	480
	14	14 1/4	22 1/4	18	120	925	80-100	140-157	800
	16	15 1/4	25 1/4	18	120	1205	80-100	182-204	800
	18	17 1/4	28 1/4	24	100	1622	80-100	245-274	1475
	20	18 1/4	30 1/4	24	100	1857	100	314	1475
	22	20 1/4	32 1/4	24	100	2130	100	360	1475
H-1* Duplex Steam, Duplex Air.	6	6	6	150	58	50-100	7 1/2-11 1/2	115
	8	8 1/4	8	150	140	55-100	20-28	150
	10	10 1/4	10	150	272	60-100	40-54	180
	12	12 1/4	12	150	472	60-100	70-94	220
	14	14 1/4	14	140	680	65-100	106-136	383
	16	16 1/4	16	135	986	70-100	160-197	585
H-2‡ Duplex Steam, Compound Air.	6	7	10	6	150	81	80-100	12 1/2-14 1/2	115
	8	9 1/4	14 1/4	8	150	215	80-100	33-37	150
	10	10 1/4	16 1/4	10	150	348	80-100	53-59	180
	12	12 1/4	18 1/4	12	150	526	80-100	80-90	220
	14	14 1/4	22 1/4	14	140	841	80-100	129-144	383
J-1* Duplex Belt Driven.	6	6	150	58	50-100	7-11	83
	8 1/4	8	150	140	55-100	19-27	125
	10 1/4	10	150	272	60-100	39-53	135
	12 1/4	12	150	472	60-100	67-90	172
	14 1/4	14	140	680	65-100	101-130	315
J-2‡ Duplex Compound Belt Driven.	7	10	6	150	81	80-100	12-14	83
	9 1/4	14 1/4	8	150	215	80-100	31-35	125
	10 1/4	16 1/4	10	150	348	80-100	51-57	135
	12 1/4	18 1/4	12	150	526	80-100	77-86	117
	14 1/4	22 1/4	14	140	841	80-100	123-138	315
	16 1/4	25 1/4	16	135	1205	80-100	176-198	429

* Built in intermediate sizes for lower pressures.
 † For sea level; also built with larger low pressure cylinders for altitudes of 5,000 and 10,000 ft.
 ‡ For sea level; also built in the 4 largest sizes with larger low pressure cylinders for altitudes of 5,000 and 10,000 ft.

Many other styles of compressors are also built. Among them are the following:
 Rand-Corliss, compound condensing steam, compound air; capacities, 750 to 7670 cu. ft. of free air per min.; steam cylinders, 10 and 18 to 28 and 52 in.; air cylinders, 11 1/2 and 18 to 33 and 52 in.; stroke 30 to 48 in.; I.H.P., from 114 to 1166.

WARNING: This is a 1910 edition. Some of the material may no longer be accurate

Vertical duplex single acting, belt driven; capacities, 16.6 to 321 cu. ft. of free air per min.; air cylinders, 4 1/2 to 12 in.; stroke 4 1/2 to 14 in.; I.H.P., 2.5 to 66.

Duplex steam, non condensing, compound air; capacities, 343 to 2209 cu. ft. of free air per min.; steam cylinders, 10 to 20 in.; air cylinders, 9 and 14 to 19 and 30 in.; stroke, 16 to 30 in.; I.H.P., 53 to 380.

Compound steam, non condensing, duplex air; capacities, 349 to 1962 cu. ft. of free air per min.; steam cylinders, 10 and 16 to 20 and 32 in.; air cylinders, 10 to 20 in.; stroke, 16 to 30 in.; I.H.P., 62 to 392.

Straight line, steam driven; capacities, 42 to 630 cu. ft. of free air per min.; steam cylinders, 6 to 12 in.; air cylinders, 6 to 19 in.; stroke, 8 to 16 in.; I.H.P., 8.2 to 54.

Cubic Feet of Air Required to Run Rock Drills at Various Pressures and Altitudes.

(Ingersoll-Rand Co., 1908.)

TABLE I. — CUBIC FEET OF FREE AIR REQUIRED TO RUN ONE DRILL.

Gauge Pressure, Lb. per Sq. In.	Size and Cylinder Diameter of Drill.												
	A 35	A 32 A 86	B	C	D	D	D	E	F	F	G	H	H 9
	2"	2 1/4"	2 1/2"	2 3/4"	3"	3 1/8"	3 3/16"	3 1/4"	3 1/2"	3 5/8"	4 1/4"	5"	5 1/2"
60	50	60	68	82	90	95	97	100	108	113	130	150	164
70	56	68	77	93	102	108	110	113	124	129	147	170	181
80	63	76	86	104	114	120	123	127	131	143	164	190	207
90	70	84	95	115	126	133	136	141	152	159	182	210	230
100	77	92	104	126	138	146	149	154	166	174	199	240	252

TABLE II. — MULTIPLIERS TO GIVE CAPACITY OF COMPRESSOR TO OPERATE FROM 1 TO 70 ROCK DRILLS AT VARIOUS ALTITUDES.

Altitude Above Sea Level.	Number of Drills.																
	1	2	3	4	5	6	7	8	9	10	15	20	25	30	40	50	
0 1.	1.8	2.7	3.4	4.1	4.8	5.4	6.0	6.5	7.1	9.5	11.7	13.7	15.8	21.4	25.3		
1000	1.03	1.85	2.78	3.5	4.22	4.94	5.56	6.18	6.69	7.3	9.78	12.05	14.1	16.3	22.0	26.26	
2000	1.07	1.92	2.89	3.64	4.39	5.14	5.78	6.42	6.95	7.60	10.17	12.52	14.66	16.9	22.9	27.28	
3000	1.10	1.98	2.97	3.74	4.51	5.28	5.94	6.6	7.15	7.81	10.45	12.87	15.07	17.38	23.54	28.05	
5000	1.17	2.10	3.16	3.98	4.8	5.62	6.32	7.02	7.61	8.31	11.12	13.69	16.03	18.49	25.04	29.84	
8000	1.26	2.27	3.40	4.28	5.17	6.05	6.8	7.56	8.19	8.95	11.97	14.74	17.26	19.9	26.96	32.13	
10000	1.32	2.38	3.56	4.49	5.41	6.34	7.13	7.92	8.58	9.37	12.54	15.44	18.08	20.86	28.25	33.66	
15000	1.43	2.57	3.86	4.86	5.86	6.86	7.72	8.58	9.3	10.15	13.58	16.73	19.59	22.59	30.6	36.49	

EXAMPLE. — Required the amount of free air to operate thirty 5-inch "H" drills at 8,000 ft. altitude, using air at a gauge pressure of 80 lb. per sq. in. From Table I, we find that one 5-inch "H" drill operating at 80 lb. gauge pressure requires 190 cu. ft. of free air per minute. From Table II, the factor for 30 drills at 8,000 feet altitude is 19.9; 190 x 19.9 = 3781 = the displacement of a compressor under average conditions, to which must be added pipe line losses.

The tables above are for fair conditions in ordinary hard rock. In soft material, where the drilling time is short more drills can be run with a given compressor than when working in hard material. In tunnel work, more rapid progress can be made if the drills are run at high air pressure, and it is advisable to have an excess of compressor capacity of about 25%. No allowance has been made in the tables for friction or pipe line losses.

Steam Required to Compress 100 Cu. Ft. of Free Air. (O. S. Shantz, Power, Feb. 4, 1908.) — The following tables show the number of pounds of steam required to compress 100 cu. ft. of free air to different gauge pressures, by means of steam engines using from 12 to 40 lbs. of steam per I.H.P. per hour. The figures assume adiabatic compression in the air cylinders, with intercooling to atmospheric temperature in the case of two-stage compression, and 90% mechanical efficiency of the compressor.

STEAM CONSUMPTION OF AIR COMPRESSORS—SINGLE-STAGE COMPRESSION.

Air Gauge Pressure.	Steam per I.H.P. Hour. Lbs.												
	12	14	16	18	20	22	24	26	28	30	32	36	40
20	1.36	1.58	1.82	2.04	2.26	2.49	2.72	2.94	3.17	3.40	3.61	4.08	4.54
30	1.84	2.14	2.45	2.76	3.06	3.37	3.68	3.98	4.29	4.60	4.90	5.51	6.12
40	2.26	2.64	3.02	3.39	3.77	4.15	4.52	4.90	5.26	5.65	6.03	6.78	7.50
50	2.62	3.06	3.50	3.93	4.36	4.80	5.25	5.68	6.10	6.55	7.00	8.86	8.71
60	2.92	3.41	3.90	4.38	4.80	5.36	5.85	6.32	6.80	7.30	7.80	8.76	9.71
70	3.22	3.76	4.30	4.83	5.36	5.90	6.45	6.97	7.50	8.05	8.60	9.66	10.70
80	3.50	4.08	4.67	5.25	5.84	6.42	7.00	7.59	8.15	8.75	9.34	10.50	11.61
90	3.72	4.34	4.96	5.58	6.20	6.82	7.45	8.05	8.66	9.30	9.94	11.15	12.35
100	3.96	4.61	5.29	5.95	6.60	7.25	7.92	8.58	9.22	9.90	10.56	11.88	13.15
110	4.18	4.87	5.58	6.26	6.96	7.66	8.36	9.05	9.75	10.45	11.15	12.52	13.90
120	4.38	5.11	5.85	6.57	7.30	8.04	8.76	9.50	10.20	10.95	11.66	13.13	14.55

TWO-STAGE COMPRESSION.

70	2.82	3.25	3.76	4.23	4.69	5.16	5.63	6.10	6.56	7.04	7.50	8.45	9.35
80	3.01	3.51	4.03	4.52	5.02	5.53	6.03	6.53	7.03	7.53	8.03	9.05	10.01
90	3.19	3.72	4.26	4.79	5.32	5.85	6.38	6.91	7.44	7.98	8.50	9.57	10.60
100	3.37	3.93	4.50	5.05	5.61	6.19	6.74	7.30	7.85	8.42	8.99	10.10	11.20
110	3.54	4.14	4.74	5.32	5.91	6.51	7.10	7.70	8.27	8.86	9.46	10.64	11.80
120	3.69	4.30	4.93	5.54	6.15	6.78	7.38	8.00	8.61	9.24	9.85	11.05	12.27
130	3.83	4.46	5.11	5.75	6.38	7.03	7.66	8.30	8.92	9.57	10.20	11.48	12.72
140	3.96	4.62	5.29	5.94	6.60	7.26	7.92	8.60	9.23	9.90	10.56	11.88	13.15
150	4.10	4.76	5.46	6.14	6.81	7.50	8.18	8.86	9.55	10.20	10.90	12.26	13.60

Compressed-air Table for Pumping Plants.

(Ingersoll-Rand Co., 1908.)

The following table shows the pressure and volume of air required for any size pump for pumping by compressed air. Reasonable allowances have been made for loss due to clearances in pump and friction in pipe. To find the amount of air and pressure required to pump a given quantity of water a given height, find the ratio of diameters between water and air cylinders, and multiply the number of gallons of water by the figure found in the column for the required lift. The result is the number of cubic feet of free air. The pressure required on the pump will be found directly above in the same column. For example: The ratio between cylinders being 2 to 1, required to pump 100 gallons, height of lift 250

feet. We find under 250 feet at ratio 2 to 1 the figures 2.11; $2.11 \times 100 = 211$ cubic feet of free air. The pressure required is 34.38 pounds delivered at the pump piston.

Ratio of Diameters.		Perpendicular Height, in Feet, to which the Water is to be Pumped.										
		25	50	75	100	125	150	175	200	250	300	400
1 to 1	A	13.75	27.5	41.25	55.0	68.25	82.5	96.25	110.0			
	B	0.21	0.45	0.60	0.75	0.89	1.04	1.20	1.34			
1 1/2 to 1	A	12.22	18.33	24.44	30.55	36.66	42.77	48.88	55.00	61.11	67.22	73.33
	B	0.65	0.80	0.95	1.09	1.24	1.39	1.53	1.68	1.83	2.12	2.70
1 3/4 to 1	A	13.75	19.8	25.8	31.8	37.8	43.8	49.8	55.8	61.8	67.8	73.8
	B	0.94	1.14	1.24	1.30	1.54	1.69	1.99	2.39	2.88		
2 to 1	A	13.75	17.19	20.63	24.06	27.5	30.94	34.38	37.81	41.25	44.68	48.11
	B	1.23	1.37	1.52	1.66	1.81	2.11	2.40	2.98			
2 1/4 to 1	A	13.75	16.5	19.25	22.0	24.75	27.5	30.25	33.0	35.75	38.5	41.25
	B	1.53	1.68	1.83	1.97	2.26	2.56	3.15				
2 1/2 to 1	A	13.2	15.4	17.6	19.8	22.0	24.2	26.4	28.6	30.8	33.0	35.2
	B	1.79	1.98	2.06	2.34	2.62	3.18					

A = air-pressure at pump. B = cubic feet of free air per gallon of water.

Compressed-air Table for Hoisting-engines.
(Ingersoll-Rand Co., 1908.)

The following table gives an approximate idea of the volume of free air required for operating hoisting-engines, the air being delivered to the engine at 60 lbs. gauge. There are so many variable conditions to the operation of hoisting-engines in common use that accurate computations can only be offered when fixed data are given. In the table the engine is assumed to actually run but one-half of the time for hoisting, while the compressor runs continuously. If the engine runs less than one-half the time, the volume of air required will be proportionately less, and vice versa. The table is computed for maximum loads, which also in practice may vary widely. From the intermittent character of the work of a hoisting-engine the parts are able to resume their normal temperature between the hoists, and there is little probability of freezing up the exhaust-passages.

Volume of Free Air Required for Operating Hoisting-engines, the Air Compressed to 60 Pounds Gauge Pressure.

SINGLE-CYLINDER HOISTING-ENGINE.

Diam. of Cylinder, Inches.	Stroke, Inches.	Revolutions per Minute.	Normal Horse-power.	Actual Horse-power.	Weight Lifted, Single Rope.	Cubic Ft. of Free Air Required.
5	6	200	3	5.9	600	75
5	8	160	4	6.3	1,000	80
6 1/4	8	160	6	9.9	1,500	125
7	10	125	10	12.1	2,000	151
8 1/4	10	125	15	16.8	3,000	170
8 1/2	12	110	20	18.9	5,000	238
10	12	110	25	26.2	6,000	330

WARNING: This is a 1910 edition. Some of the material may no longer be accurate

DOUBLE-CYLINDER HOISTING-ENGINE.

Diam. of Cylinder, Inches.	Stroke, Inches.	Revolutions per Minute.	Normal Horse-power.	Actual Horse-power.	Weight Lifted, Single Rope.	Cubic Ft. of Free Air Required.
5	6	200	6	11.8	1,000	150
5	8	160	8	12.6	1,650	160
6 1/4	8	160	12	19.8	2,500	250
7	10	125	20	24.2	3,500	302
8 1/4	10	125	30	33.6	6,000	343
8 1/2	12	110	40	37.8	8,000	476
10	12	110	50	52.4	10,000	660
12 1/4	15	100	75	89.2		1,125
14	18	90	100	125.		1,587

Practical Results with Compressed Air. — *Compressed-air System at the Chapin Mines, Iron Mountain, Mich.* — These mines are three miles from the falls which supply the power. There are four turbines at the falls, one of 1000 horse-power and three of 900 horse-power each. The pressure is 60 pounds at 60° Fahr. Each turbine runs a pair of compressors. The pipe to the mines is 24 ins. diameter. The power is applied at the mines to Corliss engines, running pumps, hoists, etc., and direct to rock-drills.

A test made in 1888 gave 1430.27 H.P. at the compressors, and 390.17 H.P. as the sum of the horse-power of the engines at the mines. Therefore, only 27% of the power generated was recovered at the mines. This includes the loss due to leakage and the loss of energy in heat, but not the friction in the engines or compressors. (F. A. Pocock, *Trans. A. I. M. E.*, 1890.)

W. L. Saunders (*Jour. F. I.*, 1892) says: "There is not a properly designed compressed-air installation in operation to-day that loses over 5% by transmission alone. The question is altogether one of the size of pipe; and if the pipe is large enough, the friction loss is a small item."

"The loss of power in common practice, where compressed air is used to drive machinery in mines and tunnels, is about 70%. In the best practice, with the best air-compressors, and without reheating, the loss is about 60%. These losses may be reduced to a point as low as 20% by combining the best systems of reheating with the best air-compressors."

Gain due to Reheating. — Prof. Kennedy says compressed-air transmission system is now being carried on, on a large commercial scale, in such a fashion that a small motor four miles away from the central station can indicate in round numbers 10 horse-power, for 20 horse-power at the station itself, allowing for the value of the coke used in heating the air.

The limit to successful reheating lies in the fact that air-engines cannot work to advantage at temperatures over 350°.

The efficiency of the common system of reheating is shown by the results obtained with the Popp system in Paris. Air is admitted to the reheater at about 83°, and passes to the engine at about 315°, thus being increased in volume about 42%. The air used in Paris is about 11 cubic feet of free air per minute per horse-power. The ordinary practice in America with cold air is from 15 to 25 cubic feet per minute per horse-power. When the Paris engines were worked without reheating the air consumption was increased to about 15 cubic feet per horse-power per minute. The amount of fuel consumed during reheating is trifling.

Effect of Temperature of Intake upon the Discharge of a Compressor. — Air should be drawn from outside the engine-room, and from as cool a place as possible. The gain in efficiency amounts to one per cent for every five degrees that the air is taken in lower than the temperature of the engine-room. The inlet conduit should have an area at least 50% of the area of the air-piston, and should be made of wood, brick, or other non-conductor of heat.

Discharge of a compressor having an intake capacity of 1000 cubic feet per minute, and volumes of the discharge reduced to cubic feet at atmospheric pressure and at temperature of 62 degrees Fahrenheit:

Temperature of Intake, F.	0°	32°	62°	75°	80°	90°	100°	110°
Volume discharged, cubic ft.	1135	1060	1000	975	966	949	932	916

Compressed-Air Motors with a Return-Air Circuit. — In the ordinary use of motors, such as rock-drills, the air, after doing its work in the motor, is allowed to escape into the atmosphere. In some systems, however, notably in the electric air-drill, the air exhausted from the cylinder of the motor is returned to the air compressor. A marked increase in economy is claimed to have been effected in this way (*Cass. Mag.*, 1907).

Intercoolers for Air Compressors. — H. V. Haight (*Am. Mach.*, Aug. 30, 1906). In multi-stage air compressors, the efficiency is greater the more nearly the temperature of the air leaving the intercooler approaches that of the air entering it. The difference of these temperatures for given temperatures of the entering water and air is diminished by increasing the surface of the intercooler and thereby decreasing the ratio of the quantity of air cooled to the area of cooling surface. Numerous tests of intercoolers with different ratios of quantity of air to area of surface, on being plotted, approximate to a straight-line diagram, from which the following figures are taken:

Cu. ft. of free air per min. per sq. ft. of air cooling surface 5 10 15
Diff. of temp. F° between water entering and air leaving 12.5° 25° 37.5°.

Centrifugal Air Compressors. — (*Eng. News*, Nov. 19, 1908.) The General Electric Co. has placed on the market a line of centrifugal air compressors with pressure ratings from 0.75 to 4.0 lbs. per sq. in. and capacities from 750 to 28,000 cu. ft. of free air per minute. The compressor consists essentially of a rotating impeller surrounded by a suitable casing with an intake opening at the center and a discharge opening at the circumference. It is similar to the centrifugal pump, the efficiency depending largely upon the design of the impeller and casing.

The compressors are driven by Curtis steam turbines or by electric motors especially designed for them. With "squirrel-cage" induction motors, since the speed cannot be varied, care must be taken to specify a pressure sufficiently high to cover the operating requirements, because at constant speed the pressure cannot be varied without altering the design of the impeller. For foundry cupola service direct-current motors can be compound wound so as to automatically increase the speed should the volume of air delivered decrease, thus increasing the pressure of the air and preventing undue reduction of flow of air through the cupola when it chokes up. Further adjustments of pressure can be made by changing the speed of the motor by means of the field rheostat.

Standard Single-Stage Centrifugal Air Compressors (1909).

R.P.M.	Standard Conditions.		Minimum Speed Conditions.		Maximum Speed Conditions.		Pipe Diameter Inches.
	Lbs. per Sq. In.	Cu. Ft. per Min.	Lbs. per Sq. In.	Cu. Ft. per Min.	Lbs. per Sq. In.	Cu. Ft. per Min.	
3450	1.0	800	0.75	1,100	1.25	600	10
3450	1.0	1,600	0.75	2,100	1.25	1,300	12
3450	1.0	3,200	0.75	4,100	1.25	2,600	12
3450	1.0	4,500	0.75	5,900	1.25	3,800	16
3450	1.0	7,200	0.75	8,800	1.25	6,000	20
3450	1.0	10,200	0.75	12,000	1.25	8,700	26
1725	1.0	25,000	0.75	31,000	1.25	21,000	36
3450	2.0	750	1.5	1,000	2.50	500	8
3450	2.0	1,600	1.5	2,100	2.50	1,200	10
3450	2.0	2,500	1.5	3,300	2.50	1,900	12
3450	2.0	4,200	1.5	5,400	2.50	3,300	16
3450	2.0	6,200	1.5	8,000	2.50	5,000	20
1725	2.0	15,000	1.5	19,000	2.50	11,000	26
1725	2.0	28,000	1.5	36,000	2.50	24,000	36
3450	3.25	1,250	2.5	1,800	4.00	900	8
3450	3.25	2,400	2.5	3,200	4.00	1,900	12
3450	3.25	3,800	2.5	5,000	4.00	3,000	14
3450 A.C.& tur.	3.25	9,000	2.5	11,500	4.00	7,500	24
1725 D.C.	3.25	9,000	2.5	11,000	4.00	6,400	24
3450 A.C.& tur.	3.25	18,000	2.5	23,000	4.00	15,000	26
1725 D.C.	3.25	18,000	2.5	23,500	4.00	14,000	26

WARNING: This is a 1910 edition. Some of the material may no longer be accurate

Multi-stage compressors have been built of the following sizes.

Cu. ft. free air per min.	Pressures.	Rated speed.
22,500	10 to 25 lbs.	1,800 r.p.m.
8,000	8 to 15 lbs.	3,750 r.p.m.
3,450	25 to 35 lbs.	3,450 r.p.m.

From a curve of the load characteristics of a compressor rated at 1.7 lbs. pressure and 750 cu. ft. per min. the following figures are derived. The actual efficiency is not given:

Delivery, cu. ft. per min.*	0	200	400	600	700	800	900	1000
Discharge pressure, lbs. per sq. in.	1.64	1.75	1.82	1.81	1.80	1.72	1.60	1.46
Effy. per cent of maximum	0	49	77	95	99	100	99	96

* Reduced to atmospheric pressure and 60° F.

As in the case of centrifugal pumps, the pressure depends on the peripheral velocity of the impeller. The volume of free air delivered is limited, however, by the capacity of the driver, and hence must be reduced proportionately to the increase in pressure, otherwise the driver might become overloaded.

The power required to drive centrifugal compressors varies approximately with the volume of air delivered when operating at a constant speed. This gives flexibility and economy to the centrifugal type where variable loads are required, satisfactory efficiency being obtained between the limits of 25% and 125% of the rated load.

When the compressor is operated as an exhaustor against atmospheric pressure, the rated pressure *P* in lbs. per square inch must be multiplied by 14.7 and then divided by 14.7 + *P*. The result represents the vacuum obtained in lbs. per square inch below atmosphere.

High-Pressure Centrifugal Fans. — (A. Rateau, *Engg.*, Aug. 16, 1907.) In 1900, a single wheel fan driven by a steam turbine at 20,200 revs. per min. gave an air pressure of 8¼ lbs. per sq. in.; an output of 26.7 cu. ft. free air per second; useful work in H.P. adiabatic compression, 45.5; theoretical work in H.P. of steam-flow, 162; efficiency of the set, fan and turbine, 28%. An efficiency of 30.7% was obtained with an output of 23 cu. ft. per sec. and 132 theoretical H.P. of steam. The pressure obtained with a fan is — all things being equal — proportional to the specific weight of the gas which flows through it; therefore, if, instead of air at atmospheric pressure, air, the pressure of which has already been raised, or a gas of higher density, such as carbonic acid, be used, comparatively higher pressures still will be obtained, or the engine can run at lower speeds for the same increase of pressure.

Multiple Wheel Fans. — The apparatus having a single impeller gives satisfaction only when the duty and speed are sufficiently high. The speed is limited by the resistance of the metal of which the impeller is made, and also by the speed of the motor driving the fan. But by connecting several fans in series, as is done with high-lift centrifugal pumps, it is possible to obtain as high a pressure as may be desired.

Turbo-Compressor, Bethune Mines, 1906. — This machine compresses air to 6 and 7 atmospheres by utilizing the exhaust steam from the winding-engines. It consists of four sets of multi-cellular fans through which the air flows in succession. They are fitted on two parallel shafts, and each shaft is driven by a low-pressure turbine. A high-pressure turbine is also mounted on one of the shafts, but supplies no work in ordinary times. An automatic device divides the load equally between the two shafts. Between the two compressors are fitted refrigerators, in which cold water is made to circulate by the action of a small centrifugal pump keyed at the end of the shaft. In tests at a speed of 5000 r.p.m., the volume of air drawn per second was 31.7 cu. ft. and the discharge pressure 119.5 lb. per sq. in. absolute. These conditions of working correspond to an effective work in isothermal compression of 252 H.P. The efficiency of the compressor has been as high as 70%. The results of two tests of the compressor are given below. In the first test the air discharged, reduced to atmospheric pressure, was 26 cu. ft. per sec.; in the second test it was 46 cu. ft.

FIRST TEST.

Stages.	1st.	2d.	3d.	4th.
Abs. pressure at inlet, lbs. per sq. in.	15.18	23.37	38.69	66.44
Abs. pressure at discharge	24.10	39.98	66.44	102.60
Speed, revs. per min.	4660	4660	4660	4660
Temperature of air at inlet, deg. F.	57.2	67.8	63.	66.
Temperature of air at discharge, deg. F.	171.	205.	216.	215.6
Adiabatic rise in temp., deg. F.	106.	122.	114.8	105.8
Actual rise in temperature, deg. F.	113.8	137.2	153.	149.6
Efficiency, per cent	60.5	60.5	54.	46.2

SECOND TEST.

Stages.	1st.	2d.	3d.	4th.
Abs. pressure at inlet, lbs. per sq. in.	15.18	21.31	37.33	65.12
Abs. pressure at discharge	23.52	38.22	65.12	99.66
Speed, revs. per min.	5000	5000	4840	4840
Temp. of air at inlet, deg. F.	55.	69.8	64.4	68.5
Temp. of air at discharge, deg. F.	160.7	208.4	208.4	199.6
Adiabatic rise in temp., deg. F.	102.2	131.	123.8	100.4
Efficiency, per cent	62.3	66.6	58.7	48.6

The Gutehoffnungshütte Co. in Germany have in course of construction several centrifugal blowing-machines to be driven by an electric motor, and up to 2000 H.P. Several machines are now being designed for Bessemer converters, some of which will develop up to 4000 H.P. The multicellular centrifugal compressors are identical in every point with centrifugal pumps. In the new machines cooling water is introduced inside the diaphragms, which are built hollow for this purpose, and also inside the diffuser vanes. By this means it is hoped to reduce proportionally the heating of the air; thus approaching isothermal compression much more nearly than is done in the case of reciprocating compressors.

Test of a Hydraulic Air Compressor. — (W. O. Webber, *Trans. A. S. M. E.*, xxii, 599.) The compressor embodies the principles of the old trompe used in connection with the Catalan forges some centuries ago, modified according to principles first described by J. P. Frizell, in *Jour. F. I.*, Sept., 1880, and improved by Charles H. Taylor, of Montreal, (Patent July 23, 1895.) It consists principally of a down-flow passage having an enlarged chamber at the bottom and an enlarged tank at the top. A series of small air pipes project into the mouth of the water inlet and the large chamber at the upper end of the vertically descending passage, so as to cause a number of small jets of air to be entrained by the water. At the lower end of the apparatus, deflector plates in connection with a gradually enlarging section of the lower end of the down-flow pipe are used to decrease the velocity of the air and water, and cause a partial separation to take place. The deflector plates change the direction of the flow of the water and are intended to facilitate the escape of the air, the water then passing out at the bottom of the enlarged chamber into an ascending shaft, maintaining upon the air a pressure due to the height of the water in the uptake, the compressed air being led on from the top of the enlarged chamber by means of a pipe. The general dimensions of the compressor plant are:

Supply penstock, 60 ins. diam.; supply tank at top, 8 ft. diam. × 10 ft. high; air inlets (feeding numerous small tubes), 34 2-in. pipes; down tube, 44 ins. diam.; down tube, at lower end, 60 ins. diam.; length of taper in down tube, 20 ft.; air chamber in lower end of shaft, 16 ft. diam.; total depth of shaft below normal level of head water, about 150 ft.; normal head and fall, about 22 ft.; air discharge pipe, 7 ins. diam.

It is used to supply power to engines for operating the printing department of the Dominion Cotton Mills, Magog, P. Q., Canada.

There were three series of tests, viz.: (1) Three tests at different rates of flow of water, the compressor being as originally constructed. (2) Four tests at different rates of flow of water, the compressor inlet tubes for air being increased by 30 3/4-in. pipes. (3) Four tests at different rates of flow of water, the compressor inlet tubes for air being increased by 15 3/4-in. pipes.

The water used was measured by a weir, and the compressed air by air meters. The table on p. 623 shows the principal results:

Test 1, when the flow was about 3800 cu. ft. per min., showed a decided advantage by the use of 30 3/4-in. extra air inlet pipes. Test 5 shows, when the flow of water is about 4200 cu. ft. per min., that the economy is highest when only 15 extra air tubes are employed. Tests 8 and 9 show, when the flow is about 4600 cu. ft. per min., that there is no advantage in increasing the air-inlet area. Tests 10 and 11 show that a flow of 5000 or more cu. ft. of water is in excess of the capacity of the plant. These four tests may be summarized as follows:

The tests show: (1) That the most economic rate of flow of water with this particular installation is about 4300 cu. ft. per min. (2) That this plant has shown an efficiency of 70.7 % under such a flow, which is excellent for a first installation. (3) That the compressed air contains only from 30 to 20% as much moisture as does the atmosphere. (4) That the air is compressed at the temperature of the water.

Using an old Corliss engine without any changes in the valve gear as a motor there was recovered 81 H.P. This would represent a total efficiency of work recovered from the falling water, of 51.2%. When the compressed air was preheated to 267° F. before being used in the engine, 111 H.P. was recovered, using 115 lbs. coke per hour, which would equal about 23 H.P. The efficiency of work recovered from the falling water and the fuel burned would be, therefore, about 61 1/2%. On the basis of Prof. Riedler's experiments, which require only about 425 cu. ft. of air per B.H.P. per hour, when preheated to 300° F. and used in a hot-air jacketed cylinder, the total efficiency secured would have been about 87 1/2%.

Test No.	1	3	4	5	7	8	10
Flow of water, cu. ft. per min.	3772	3628	4066	4,292	4408	4700	5058
Available head in ft.	20.54	20.00	20.35	19.51	19.93	19.31	18.75
Gross water, H.P.	146.3	136.9	156.2	158.1	165.8	171.4	179.1
Cu. ft. air, at atmos. press., per minute	864	901	967	1148	1091	1103	1165
Pressure of air at comp., lbs.	51.9	53.7	53.2	53.3	53.7	52.9	53.3
Effective work in compressing, H.P.	83.3	88.2	94.3	111.74	107	106.8	113.4
Efficiency of compressor, %	56.8	64.4	60.3	70.7	64.5	62.2	63.3
Temp. of external air, deg. F.	68.3	57.7	66.4	65.2	59.7	65	64.2
Temp. of water and comp. air, deg. F.	66	65.5	66.4	66.5	67	66.5	66
Ratio of water to air, volumes	4.37	4.03	4.20	3.74	4.04	4.26	4.34
Moisture in external air, p. c. of saturation	61	77.5	71	68	90	60.5	63
Moisture in comp. air, p. c. of saturation	51.5	44	38.5	35	29	31.2	30

Tests 1, 4, and 7 were made with the original air inlets; 2, 5, 8 and 10 with the inlets increased by 15 3/4-in. pipes, and 3, 6, 9 and 11 with the inlets increased by 30 3/4-in. pipes. Tests 2, 6, 9 and 11 are omitted here. They gave, respectively, 55.5, 61.3, 62, and 55.4% efficiency.

Three other hydraulic air-compressor plants are mentioned in Mr. Webber's paper, some of the principal data of which are given below:

	Peterboro, Ont.	Norwich, Conn.	Cascade Range, Wash.
Head of water	14 ft.	18 1/2 ft.	45 ft.
Gauge pressure	25 lbs.	85 lbs.	85 lbs.
Diam. of shaft	42 in.	24 ft.	3 ft.
Diam. of compressor pipe	18 ft.	13 ft.	3 ft.
Depth below tailrace	64 ft.	215 ft.	200
Horse-power	1365	1365	200

In the Cascade Range plant there is no shaft, as the apparatus is constructed against the vertical walls of a canyon. The diameter of the up-flow pipe is 4 ft. 9 in.

A description of the Norwich plant is given by J. Herbert Shedd in a paper read before the New England Water Works Assn., 1905 (*Compressed Air*, April, 1906). The shaft, 24 ft. diam., is enlarged at the bottom into a chamber 52 ft. diam., from which leads an air reservoir 100 ft. long, 18 ft. wide and 15 to 20 ft. high. Suspended in the shaft is a downflow pipe 14 ft. diam. connected at the top with a head tank, and at the bottom with the air-chamber, from which a 16-in. main conveys the air four miles to Norwich, where it is used in engines in several establishments.

Pneumatic Postal Transmission.—A paper by A. Falkenau (Eng'rs Club of Philadelphia, April, 1894), entitled the "First United States Pneumatic Postal System," gives a description of the system used in London and Paris, and that recently introduced in Philadelphia between the main post-office and a substation. In London the tubes are 2 1/4 and 3-inch lead pipes laid in cast-iron pipes for protection. The carriers used in 2 1/4-inch tubes are but 1 1/4 inches diameter, the remaining space being taken up by packing. Carriers are despatched singly. First, vacuum alone was used; later, vacuum and compressed air. The tubes used in the Continental cities in Europe are wrought iron, the Paris tubes being 2 1/2 inches diameter. There the carriers are despatched in trains of six to ten, propelled by a piston. In Philadelphia the size of tube adopted is 6 1/8 inches, the tubes being of cast iron bored to size. The lengths of the outgoing and return tubes are 2928 feet each. The pressure at the main station is 7 lb., at the substation 4 lb., and at the end of the return pipe atmospheric pressure. The compressor has two air-cylinders 18 x 24 in. Each carrier holds about 200 letters, but 100 to 150 are taken as an average. Eight carriers may be despatched in a minute, giving a delivery of 48,000 to 72,000 letters per hour. The time required in transmission is about 57 seconds.

Pneumatic postal transmission tubes were laid in 1898 by the Batcheller Pneumatic Tube Co. between the general post-offices in New York and Brooklyn, crossing the East River on the Brooklyn bridge. The tubes are cast iron, 12-ft. lengths, bored to 8 1/8 in. diameter. The joints are bells, caulked with lead and yarn. There are two tubes, one operating in each direction. Both lines are operated by air-pressure above the atmospheric pressure. One tube is operated by an air-compressor in the New York office and the other by one located in the Brooklyn office.

The carriers are 24 in. long, in the form of a cylinder 7 in. diameter, and are made of steel, with fibrous bearing-rings which fit the tube. Each carrier will contain about 600 ordinary letters, and they are despatched at intervals of 10 seconds in each direction, the time of transit between the two offices being 3 1/2 minutes, the carriers travelling at a speed of from 30 to 35 miles per hour.

One of the air-compressors is of the duplex type and has two steam-cylinders 10 x 20 in. and two air-cylinders 24 x 20 in., delivering 1570 cu. ft. of free air per minute, at 75 r.p.m. The power is about 50 H.P.

Two other duplex air-compressors have steam-cylinders 14 x 18 in. and air-cylinders 26 1/4 x 18 in. They are designed for 80 to 90 r.p.m. and to compress to 20 lb. per sq. in.

Another double line of pneumatic tubes has been laid between the main office and Postal Station H, Lexington Ave. and 44th St., in New York City. This line is about 3 1/2 miles in length. There are three intermediate stations. The carriers can be so adjusted when they are put into the tube that they will traverse the line and be discharged automatically from the tube at the station for which they are intended. The tubes are of the same size as those of the Brooklyn line and are operated in a similar manner. The initial air-pressure is about 12 to 15 lb. On the Brooklyn line it is about 7 lb.

There is also a tube system between the New York Post-office and the Produce Exchange. For a very complete description of the system and its machinery see "The Pneumatic Despatch Tube System," by B. C. Batcheller, J. B. Lippincott Co., Philadelphia, 1897.

The Mekarski Compressed-air Tramway at Berne, Switzerland. (*Eng'g News*, April 20, 1893.)—The Mekarski system has been introduced in Berne, Switzerland, on a line about two miles long, with grades of 0.25% to 3.7% and 5.2%. The air is heated by passing it through superheated water at 330° F. It thus becomes saturated with steam, which subsequently partly condenses, its latent heat being absorbed by the expanding air. The pressure in the car reservoirs is 440 lb. per sq. in.

The engine is constructed like an ordinary steam tramway locomotive, and drives two coupled axles, the wheel-base being 5.2 ft. It has a pair of outside horizontal cylinders, 5.1 x 8.6 in.; four coupled wheels, 27.5 in. diameter. The total weight of the car including compressed air is 7.25 tons, and with 30 passengers, including the driver and conductor, about 9.5 tons.

The authorized speed is about 7 miles per hour. Taking the resistance due to the grooved rails and to curves under unfavorable conditions at 30 lb. per ton of car weight, the engine has to overcome on the steepest grade, 5%, a total resistance of about 0.63 ton, and has to develop 25 H.P. At the maximum authorized working pressure in cylinders of 176 lb. per sq. in. the motors can develop a tractive force of 0.64 ton. This maximum is, therefore, just sufficient to take the car up the 5.2% grade, while on the flatter sections of the line the working pressure does not exceed 73 to 147 lb. per sq. in. Sand has to be frequently used to increase the adhesion on the 2% to 5% grades.

Between the two car frames are suspended ten horizontal compressed-air storage-cylinders, varying in length according to the available space, but of uniform inside diameter of 17.7 in., composed of riveted 0.27-in. sheet iron, and tested up to 588 lb. per sq. in., and having a collective capacity of 64.25 cu. ft., and two further small storage-cylinders of 5.3 cu. ft. capacity each, a total capacity for the 12 storage-cylinders per car of 75 cu. ft., divided into two groups, the working and the reserve battery, of 49 cu. ft. and 26 cu. ft. capacity respectively.

From the results of six official trips, the pressure and the mean consumption of air during a double trip per motor car are as follows:

Pressure of air in storage-cylinders at starting, 440 lb. per sq. in.; at end of up-trip, 176 lb., reserve, 260 lb.; at end of down-trip, 103 lb., reserve, 176 lb. Consumption of air during up-trip, 92 lb., during down-trip, 31 lb. The working experience of 1891 showed that the air consumption per motor car for a double trip was from 103 to 154 lb., mean 123 lb., and per car mile from 28 to 42 lb., mean 35 lb.

The disadvantages of this system consist in the extremely delicate adjustment of the different parts of the system, in the comparatively small supply of air carried by one motor car, which necessitates the car returning to the depot for refilling after a run of only four miles or 40 minutes, although on the Nogent and Paris lines the cars, which are, moreover, larger, and carry outside passengers on the top, run seven miles, and the loading pressure is 547 lb. per sq. in. as against only 440 lb. at Berne.

For description of the Mekarski system as used at Nantes, France, see paper by Prof. D. S. Jacobus, *Trans. A. S. M. E.*, xix, 553.

American Experiments on Compressed Air for Street Railways.

—Experiments have been made in Washington, D. C., and in New York City on the use of compressed air for street-railway traction. The air was compressed to 2000 lb. per sq. in. and passed through a reducing-valve and a heater before being admitted to the engine. The system has since been abandoned. For an extended discussion of the relative merits of compressed air and electric traction, with an account of a test of a four-stage compressor giving a pressure of 2500 lb. per sq. in., see *Eng'g News*, Oct. 7 and Nov. 4, 1897. A summarized statement of the probable efficiency of compressed-air traction is given as follows: Efficiency of compression to 2000 lb. per sq. in. 65%. By wire-drawing to 100 lbs. 57.5% of the available energy of the air will be lost, leaving $65 \times 0.425 = 27.625\%$ as the net efficiency of the air. This may be doubled by heating, making 55.25%, and if the motor has an efficiency of 80% the net efficiency of traction by compressed air will be $55.25 \times 0.80 = 44.2\%$. For a description of the Hardie compressed-air locomotive, designed for street-railway work, see *Eng'g News*, June 24, 1897. For use of compressed air in mine haulage, see *Eng'g News*, Feb. 10, 1898.

Operation of Mine Pumps by Compressed Air.—The advantages of compressed air over steam for the operation of mine pumps are: Absence of condensation and radiation losses in pipe lines; high efficiency of compressed-air transmission; ease of disposal of exhaust; absence of danger from broken pipes. The disadvantage is that, at a given initial pressure without reheating, a cylinder full of air develops less power than steam. The power end of the pump should be designed for the use of air, with low clearances and with proper proportions of air and water ends, with regard to the head under which the pump is to operate. Wm. Cox (*Comp.*

Air Mag., Feb., 1899) states the relations of simple or single-cylinder pumps to be $A/W = 1/2 h/p$, where A = area of air cylinder, sq. in., W = area of water cylinder, sq. in., h = head, ft., and p = air pressure, lb. per sq. in. Mr. Cox gives the volume V of free air in cu. ft. per minute to operate a direct-acting, single-cylinder pump, working without cut off, to be

$$V = 0.093 W_2 hG/P.$$

Where W_2 = volume of 1 cu. ft. of free air corresponding to 1 cu. ft. of free air at pressure P , G = gallons of water to be raised per minute, P = receiver-gauge pressure of air to be used, and h = head in feet under which pump works. This formula is based on a piston speed of 100 ft. per minute and 15% has been added to the volume of air to cover losses. The useful work done in a pump using air at full pressure is greater at low pressures than at high, and the efficiency is increased. High pressures are not so economical for simple pumps as low pressures. As high-pressure air is required for drills, etc., and as the air for pumps is drawn from the same main, the air must either be wire-drawn into the pumps, or a reducing valve be inserted between the pump and main. Wire-drawing causes a low efficiency in the pump. If a reducing valve is used, the increase of volume will be accompanied with a drop in temperature, so that the full value of the increase is not realized. Part of the lost heat may be regained by friction, and from external sources. The efficiency of the system may be increased by the use of underground receivers for the expanded air before it passes to the pump. If the receiver be of ample size, the air will regain nearly its normal temperature, the entrained moisture will be deposited and freezing troubles avoided. By compounding the pumps, the efficiency may be increased to about 25 per cent. In simple pumps it ranges from 7 to 16 per cent. For much further information on this subject, see Peele's "Compressed-Air Plant for Mines," 1908.

FANS AND BLOWERS.

Centrifugal Fans. — The ordinary centrifugal fan consists of a number of blades fixed to arms revolving at high speed. The width of the blade is parallel to the shaft. The experiments of W. Buckle (*Proc. Inst. M. E.*, 1847) are often quoted as still standard. Mr. Buckle's conclusions, however, do not agree with those of modern experimenters, nor do the proportions of fans as determined by him have any similarity to those of modern fans. His results are presented here merely for purposes of reference and comparison. The experiments were made on fans of the "paddle-wheel" type, and have no bearing on the more modern multivane fans of the "sirocco" type.

From his experiments Mr. Buckle deduced the following proportions for a fan: 1. The width of the vanes should be one-fourth the diameter; 2. The diameter of the inlet opening in the sides of the fan chest should be one-half the diameter of the fan; 3. The length of the vanes should be one-fourth the diameter of the fan. These rules do not agree with those adopted by modern manufacturers, nor do the rules adopted by different manufacturers agree among themselves. An examination of 18 commercial sizes of fans, of the ordinary steel-plate type, built by two prominent manufacturers, *A* and *B*, shows the following proportions based on the diameter of the fan wheel, *D*, in inches:

PROPORTIONS OF FANS, RECTANGULAR BLADES.

	A Max.	A Min.	A Av.	B Max.	B Min.	B Av.	Buckle.
Diam. inlet	0.666D	0.618D	0.636D	0.495D	0.430D	0.476D	0.5D
Width of blade	0.435D	0.380D	0.398D	0.366D	0.333D	0.356D	0.25D

The rules laid down by Buckle do not give a fan the highest commercial efficiency without loss of mechanical efficiency. By commercial efficiency is meant the ratio of the volume of air delivered per revolution to the cubical contents of the wheel, if the wheel be considered a solid whose dimensions are those of the wheel. This ratio is also known as the *volume efficiency*. Inasmuch as the loss due to friction of the air entering the fan will be less with a large inlet than with a small one, in a wheel of

given diameter, more power will be consumed in delivering a given volume of air with a small inlet than with a larger one.

In the ordinary fan the number of vanes varies from 4 to 8, while with multivane fans it is 60 or more. The number of vanes has a direct relation to the size of the inlet. This is made as large as possible for the reason given above. Any increase in the diameter of the inlet necessarily decreases the depth of the blade, thus diminishing the capacity and pressure. To overcome this decrease, the number of blades is increased to the limit placed by constructional considerations. A properly proportioned fan is one in which a balance is obtained between these two features of maximum inlet and maximum number of blades. Generally speaking, in a purely centrifugal fan, increased pressure is obtained with the increase in depth of the blade. This appears to be due to the greater area of blade working on the air. A smaller wheel, with a greater number of blades, aggregating a larger blade area, gives a higher pressure than a larger wheel with less total blade area.

In some cases two fans mounted on one shaft may be more useful than a single wide one, as in such an arrangement twice the area of inlet opening is obtained, as compared with a single wide fan. Such an arrangement may be adopted where occasionally half the full quantity of air is required, as one of the fans may be put out of gear and thus save power.

Rules for Fan Design. — It is impossible to give any general rules or formulæ covering the proportions of parts of fans and blowers. There are no less than 14 variables involved in the construction and operation of fans, a slight change in any one producing wide variations in the performance. The design of a new fan by manufacturers is largely a matter of trial and error, based on experiments, until a compromise with all the variables is obtained which most nearly conforms to the given conditions.

Pressure Due to Velocity of the Fan Blades. — The pressure of the air due to the velocity of the fan blades may be determined by the formula

$$H = \frac{v^2}{2g},$$

deduced from the law of falling bodies, in which H is the "head"

or height of a homogeneous column of air one-inch square whose weight is equal to the pressure per square inch of the air leaving the fan, v is the velocity of the air leaving the fan in feet per second, and g the acceleration due to gravity. The pressure of the air is increased by increasing the number of revolutions per minute of the fan. Wolff, in his "The Windmill as a Prime Mover," p. 17, argues that it is an error to take $H = v^2 + 2g$, the formula according to him being $H = v^2 \div g$. See also Trowbridge (*Trans. A. S. M. E.*, vii., 536). This law is analogous to that of the pressure of a fluid jet striking a plane surface perpendicularly and escaping at right angles to its original path, this pressure being twice that due the height calculated from the formula $h = v^2 \div 2g$. (See Hawksley, *Proc. Inst. M. E.*, 1882.) Later authorities and manufacturers, however, base all their calculations on the former formula.

Buckle says: "From the experiments it appears that the velocity of the tips of the fan is equal to nine-tenths of the velocity a body would acquire in falling the height of a homogeneous column of air equivalent to the density." D. K. Clark (*R. T. & D.*, p. 924), paraphrasing Buckle, apparently, says: "It further appears that the pressure generated at the circumference is one-ninth greater than that which is due to the actual circumferential velocity of the fan." The two statements, however, are not in harmony, for if $v = 0.9\sqrt{2gH}$, $H = \frac{v^2}{0.81 \times 2g} = 1.234 \frac{v^2}{2g}$ and not $\frac{10 v^2}{9 \cdot 2g}$.

If we take the pressure as that equal to a head or column of air of twice the height due the velocity, as stated by Trowbridge, the paradoxical statements of Buckle and Clark — which would indicate that the actual pressure is greater than the theoretical — are explained, and the formula

$$\text{becomes } H = 0.617 \frac{v^2}{g} \text{ and } v = 1.273 \sqrt{gH} = 0.9 \sqrt{2gH},$$

in which H is

the head of a column producing the pressure, which is equal to twice the theoretical head due the velocity of a falling body ($h = v^2/2g$), multiplied by the coefficient 0.617. The difference between 1 and this coefficient expresses the loss of pressure due to friction, to the fact that the inner portions of the blade have a smaller velocity than the outer edge, and probably to other causes. The coefficient 1.273 means that the tip of the blade must be given a velocity 1.273 times that theoretically required to produce the head H .

Commenting on the above paragraphs and the formulæ below, the B. F. Sturtevant Co., in a letter to the author, says: "Let us assume that the fan considered is of the centrifugal type, which is a wheel in a spiral casing. In any case of centrifugal fan the pressure at the fan outlet is wholly dependent upon the load on the fan, and, therefore, the pressure cannot well be expressed by a formula, unless it includes some term which is an expression in some way of the load upon the fan. The actual pressure depends upon the design of both wheel and housing, upon the blade area and also upon the form of the blades. With a curved blade running with the concave side forward it is possible to obtain a much higher pressure than if the blade is running with the convex side forward. This can only be shown by tests, and can be figured out by blade-velocity diagrams."

It should be noted, however, that while the fan with a blade concaved in the direction of rotation has the highest efficiency, all other things being equal, the noise of operation is increased. A blade convex in the direction of rotation runs more quietly, and in most situations it is necessary to sacrifice efficiency in order to obtain quiet operation.

To convert the head H expressed in feet to pressure in lb. per sq. in. multiply it by the weight of a cubic foot of air at the pressure and temperature of the air expelled from the fan (about 0.08 lb. usually) and divide by 144. Multiply this by 16 to obtain pressure in ounces per sq. in. or by 2.035 to obtain inches of mercury, or by 27.71 to obtain pressure in inches of water column. Taking 0.08 as the weight of 1 cu. ft. of air, and

$$v = 0.9 \sqrt{2gH}$$

p lb. per sq. in. = 0.0001066 v^2 ; $v = 310 \sqrt{p}$ nearly;
 p_1 ounces per sq. in. = 0.0001706 v^2 ; $v = 80 \sqrt{p_1}$ "
 p_2 inches of mercury = 0.0002169 v^2 ; $v = 220 \sqrt{p_2}$ "
 p_3 inches of water = 0.0002954 v^2 ; $v = 60 \sqrt{p_3}$ "

in which v = velocity of tips of blades in feet per second.
 Testing the above formula by one of Buckle's experiments with a vane 14 inches long, we have $p = 0.0001066 v^2 = 9.56$ oz. The experiment gave 9.4 oz.

Testing it by the experiment of H. I. Snell, given below, in which the circumferential speed was about 150 ft. per second, we obtain 3.85 ounces, while the experiment gave from 2.38 to 3.50 ounces, according to the amount of opening for discharge.

Taking the formula $v = 80 \sqrt{p_1}$, we have for different pressures in ounces per square inch the following velocities of the tips of the blades in feet per second:

p_1 = ounces per square inch.	2	3	4	5	6	7	8	10	12	14
v = feet per second.....	113	139	160	179	196	212	226	253	277	299

A rule in *App. Cyc. Mech.*, article "Blowers," gives the following velocities of circumference for different densities of blast in ounces: 3, 170; 4, 180; 5, 195; 6, 205; 7, 215.

The same article gives the following tables, the first of which shows that the density of blast is not constant for a given velocity, but depends on the ratio of area of nozzle to area of blades:

Velocity of circumference, feet per second...	150	150	150	170	200	200	220
Area of nozzle ÷ area of blades.....	2	1	1/2	1/4	1/2	1/6	1/8
Density of blast, oz. per square inch.....	1	2	3	4	4	6	6

QUANTITY OF AIR OF A GIVEN DENSITY DELIVERED BY A FAN.

Total area of nozzles in square feet × velocity in feet per minute corresponding to density (see table) = air delivered in cubic feet per minute, (discharging freely into the atmosphere (approximate). See p. 642.

Density, ounces per sq. in.	Velocity, feet per minute.	Density, ounces per sq. in.	Velocity, feet per minute.	Density, ounces per sq. in.	Velocity, feet per minute.
1	5,000	5	11,000	9	15,000
2	7,000	6	12,250	10	15,800
3	8,600	7	13,200	11	16,500
4	10,000	8	14,150	12	17,300

"Blast Area," or "Capacity Area." When the fan outlet is small the velocity of the outflow is equal to the peripheral velocity of the fan.

Start with the outlet closed; then if the opening be slowly increased while the speed of the fan remains constant the air will continue to flow with the same velocity as the fan tips until a certain size of outlet is reached. If the outlet is still further increased the pressure within the casing will drop, and the velocity of outflow will become less than the tip velocity. The size of the outlet at which this change takes place is called the *blast area*, or *capacity area*, of the fan. This varies somewhat with different types and makes of fans, but for the common form of blower it is approximately, $DW \div 3$, in which D is the diameter of the fan wheel and W its width at the circumference. — (C. L. Hubbard.)

This established capacity area has no relation to the area of the outlet in the casing, which may be of any size, but is usually about twice the capacity area. The velocity of the air discharged through this latter area is practically that of the circumference of the wheel, and the pressure created is that corresponding thereto. — W. B. Snow.

Experiments with Blowers. (Henry I. Snell, *Trans. A. S. M. E.*, ix, 51.) — The following tables give velocities of air discharging through an aperture of any size under the given pressures into the atmosphere. The volume discharged can be obtained by multiplying the area of discharge opening by the velocity, and this product by the coefficient of contraction: 0.65 for a thin plate and 0.93 when the orifice is a conical tube with a convergence of about 3.5 degrees, as determined by the experiments of Weisbach.

The tables are calculated for a barometric pressure of 14.69 lb. (= 235 oz.), and for a temperature of 50° Fahr., from the formula $V = \sqrt{2gh}$.

Allowances have been made for the effect of the compression of the air, but none for the heating effect due to the compression.

At a temperature of 50 degrees, a cubic foot of air weighs 0.078 lb., and calling $g = 32.1602$, the above formula may be reduced to

$$V_1 = 60 \sqrt{31.5812 \times (235 + P) \times P}$$

where V_1 = velocity in feet per minute, P = pressure above atmosphere, or the pressure shown by gauge, in oz. per square inch.

Pressure per sq. in., in. of water.	Corresponding Pressure, oz. per sq. in.	Velocity due to Pressure, ft. per min.	Pressure per sq. in., in. of water.	Corresponding Pressure, oz. per sq. in.	Velocity due to Pressure, ft. per min.
1/32	0.01817	696.78	5/8	0.36340	3118.38
1/16	0.03634	987.66	3/4	0.43608	3416.64
1/8	0.07268	1393.75	7/8	0.50870	3690.62
3/16	0.10902	1707.00	1	0.58140	3946.17
1/4	0.14536	1971.30	1 1/4	0.7267	4362.62
5/16	0.18170	2204.16	1 1/2	0.8721	4836.06
3/8	0.21804	2414.70	1 3/4	1.0174	5224.98
1/2	0.29072	2788.74	2	1.1628	5587.58

Pressure, oz. per sq. in.	Velocity due to Pressure, ft. per min.	Pressure, oz. per sq. in.	Velocity due to Pressure, ft. per min.	Pressure, oz. per sq. in.	Velocity due to Pressure, ft. per min.	Pressure, oz. per sq. in.	Velocity due to Pressure, ft. per min.
0.25	2,582	2.25	7,787	5.50	12,259	11.00	17,534
0.50	3,658	2.50	8,213	6.00	12,817	12.00	18,350
0.75	4,482	2.75	8,618	6.50	13,354	13.00	19,138
1.00	5,178	3.00	9,006	7.00	13,873	14.00	19,901
1.25	5,792	3.50	9,739	7.50	14,374	15.00	20,641
1.50	6,349	4.00	10,421	8.00	14,861	16.00	21,360
1.75	6,861	4.50	11,065	9.00	15,795		
2.00	7,338	5.00	11,676	10.00	16,684		

Pressure in ounces per square inch.	Velocity in feet per minute.	Pressure in ounces per square inch.	Velocity in feet per minute.
0.01	516.90	0.06	1266.24
0.02	722.64	0.07	1367.76
0.03	895.26	0.08	1462.20
0.04	1033.86	0.09	1550.70
0.05	1155.90	0.10	1635.00

Experiments on a Fan with Varying Discharge-opening. Revolutions nearly constant.

Revolutions per minute.	Area of Discharge in square inches.	Observed Pressure in ounces.	Volume of Air discharged per min., cubic feet.	Horse-power.	Actual Number of cu. ft. of Air delivered per H.P.	Theoret. Vol. per min. that may be discharged with 1 H.P. at corresp. Pressure.	Efficiency of Blowers as per experiment.
1519	0	3.50	0	0.80	1048	1048	
1479	6	3.50	406	1.15	353	1048	0.337
1480	10	3.50	676	1.30	520	1048	0.496
1471	20	3.50	1353	1.95	694	1048	0.66
1485	28	3.50	1894	2.55	742	1048	0.709
1485	36	3.40	2400	3.10	774	1078	0.718
1465	40	3.25	2605	3.30	790	1126	0.70
1468	44	3.00	2752	3.55	775	1222	0.635
1500	48	3.00	3002	3.80	790	1222	0.646
1426	89.5	2.38	3972	4.80	827	1544	0.536

The fan wheel was 23 in. diam., 65/8 in. wide at its periphery, and had an inlet 12 1/2 in. diam. on either side, which was partially obstructed by the pulleys, which were 5 9/16 in. diam. It had eight blades, each of an area of 45.49 sq. in. The discharge of air was through a conical tin tube with sides tapered at an angle of 3 1/2 degrees. The actual area of opening was 7% greater than given in the tables, to compensate for the *vena contracta*.

In the last experiment, 89.5 sq. in. represents the actual area of the mouth of the blower less a deduction for a narrow strip of wood placed across it for the purpose of holding the pressure-gauge. In calculating the volume of air discharged in the last experiment the value of *vena contracta* is taken at 0.80.

Experiments were undertaken for the purpose of showing the results obtained by running the same fan at different speeds with the discharge-opening the same throughout the series. The discharge-pipe was a conical tube 8 1/2 in. inside diam. at the end, having an area of 56.74 sq. in., which is 7% larger than 53 sq. in.; therefore 53 sq. in., equal to 0.368 square feet, is called the area of discharge, as that is the practical area by which the volume of air is computed.

Experiments on a Fan with Constant Discharge-opening and Varying Speed. — The first four columns are given by Mr. Snell, the others are calculated by the author.

Revs. per min.	Pressure in ounces, <i>p</i>	Vol. of Air in cu. ft. per minute, <i>V</i> .	Horse-power.	Velocity of Tips of Blades, ft. per sec.	Velocity due Pressure From Formula $v = 80 \sqrt{p}$.	Coefficient of formula $v = r \sqrt{p}$ from Experiment.	Velocity of Air per minute in Efflux Pipe, $V \div 0.368$.	Theoretical Horse-power.	Efficiency per cent.
600	0.50	1336	0.25	60.2	56.6	85.1	3,630	0.182	73
800	0.88	1787	0.70	80.3	75.0	85.6	4,856	0.429	61
1000	1.38	2245	1.35	100.4	94	85.4	6,100	0.845	63
1200	2.00	2712	2.20	120.4	113	85.1	7,370	1.479	67
1400	2.75	3177	3.45	140.5	133	84.8	8,633	2.283	66
1600	3.80	3670	5.10	160.6	156	82.4	9,973	3.803	74
1800	4.80	4172	8.00	180.6	175	82.4	11,337	5.462	68
2000	5.95	4674	11.40	200.7	195	85.6	12,701	7.586	67

Mr. Snell has not found any practical difference between the mechanical efficiencies of blowers with curved blades and those with straight radial ones. From these experiments, says Mr. Snell, it appears that we may expect to receive back 65% to 75% of the power expended, and no more. The great amount of power often used to run a fan is not due to the fan itself, but to the method of selecting, erecting, and piping it. (For opinions on the relative merits of fans and positive rotary blowers, see discussion of Mr. Snell's paper, *Trans. A. S. M. E.*, ix. 66, etc.)

Comparative Efficiency of Fans and Positive Blowers. (H. M. Howe, *Trans. A. I. M. E.*, x. 482.) — Experiments with fans and positive (Baker) blowers working at moderately low pressures, under 20 ounces, show that they work more efficiently at a given pressure when delivering large volumes (*i.e.*, when working nearly up to their maximum capacity) than when delivering comparatively small volumes. Therefore, when great variations in the quantity and pressure of blast required are liable to arise, the highest efficiency would be obtained by having a number of blowers, always driving them up to their full capacity, and regulating the amount of blast by altering the number of blowers at work, instead of having one or two very large blowers and regulating the amount of blast by the speed of the blowers.

There appears to be little difference between the efficiency of fans and of Baker blowers when each works under favorable conditions as regards quantity of work, and when each is in good order.

For a given speed of fan, any diminution in the size of the blast-orifice decreases the consumption of power and at the same time raises the pressure of the blast; but it increases the consumption of power per unit of orifice for a given pressure of blast. When the orifice has been reduced to the normal size for any given fan, further diminishing it causes but slight elevation of the blast pressure; and, when the orifice becomes comparatively small, further diminishing it causes no sensible elevation of the blast pressure, which remains practically constant, even when the orifice is entirely closed.

Many of the failures of fans have been due to too low speed, to too small pulleys, to improper fastening of belts, or to the belts being too nearly vertical; in brief, to bad mechanical arrangement, rather than to inherent defects in the principles of the machine.

If several fans are used, it is probably essential to high efficiency to provide a separate blast pipe for each (at least if the fans are of different size or speed), while any number of positive blowers may deliver into the same pipe without lowering their efficiency.

Capacity of Fans and Blowers.—The following tables supplied (1909) by the American Blower Co., Detroit, show the capacities of exhaust fans and volume and pressure blowers. The tables are all based on curves established by experiment. The pressures, volumes and horse-powers were all actually measured with the apparatus working against maintained resistances formed by restrictions equivalent to those found in actual practice, and which experience shows will produce the best results.

Speed, Capacity and Horse-power of Steel Plate Exhaust Fans.
(American Blower Co., Type E, 1908.)

No. of fan.	Diameter of wheel, in.	Width periphery, in.	Diameter inlet (inside), in.	1/2 oz. pressure.			3/4 oz. pressure.			1 oz. pressure.			2 oz. pressure.		
				R.P.M.	Cubic ft. per minute.	Brake horse-power.	R.P.M.	Cubic ft. per minute.	Brake horse-power.	R.P.M.	Cubic ft. per minute.	Brake horse-power.	R.P.M.	Cubic ft. per minute.	Brake horse-power.
25	16	6 1/8	10	985	1,09	0.30	1200	1,345	0.56	1390	1,555	0.85	1966	2,200	2.40
30	19	7 1/8	12	830	1,580	0.43	1012	1,940	0.80	1170	2,240	1.22	1655	3,175	3.46
35	22	8 1/8	14	715	2,155	0.59	876	2,635	1.08	1010	3,040	1.66	1430	4,310	4.70
40	25	9 3/8	16	630	2,820	0.77	772	3,450	1.41	1890	3,980	2.17	1260	5,640	6.15
45	28	10 7/8	18	563	3,560	0.97	689	4,360	1.78	1795	5,030	2.74	1125	7,140	7.79
50	31	12 3/8	20	508	4,400	1.20	622	5,390	2.20	1719	6,220	3.39	1015	8,820	9.63
55	34	13 1/2	22	464	5,330	1.45	567	6,525	2.66	1655	7,530	4.10	927	10,650	11.60
60	38	14 1/2	24	415	6,350	1.73	509	7,775	3.18	1587	8,960	4.89	830	12,700	13.85
70	44	15 1/8	27	375	7,440	2.02	459	9,120	3.72	1530	10,500	5.72	750	14,875	16.20
80	50	16 1/2	29	328	10,050	2.75	402	12,100	4.94	1464	13,980	7.62	656	19,800	21.60

Speed, Capacity and Horse-power of Volume Blowers.
(American Blower Co., Type V, 1909.)

No. of fan.	Diameter of wheel, in.	Width periphery, in.	Diameter inlet (inside), in.	1/2 oz. pressure.			3/4 oz. pressure.			1 oz. pressure.			1 1/2 oz. pressure.		
				R.P.M.	Cubic ft. per minute.	Brake horse-power.	R.P.M.	Cubic ft. per minute.	Brake horse-power.	R.P.M.	Cubic ft. per minute.	Brake horse-power.	R.P.M.	Cubic ft. per minute.	Brake horse-power.
1	8 1/2	2	4 1/2	1850	223	0.06	2270	273	0.11	2620	315	0.17	3210	386	0.32
2	10 1/4	2 3/8	5 1/2	1535	332	0.09	1880	407	0.17	2170	469	0.26	2660	576	0.48
3	12	3 1/4	6 1/2	1310	464	0.13	1600	569	0.23	1850	656	0.36	2275	805	0.66
4	15 1/2	4 1/2	8 1/2	1015	705	0.22	1240	975	0.40	1435	1122	0.61	1760	1377	1.13
5	19	5 1/8	10 3/8	830	1185	0.32	1013	1450	0.59	1170	1675	0.92	1435	2055	1.68
6	22 1/2	6 1/2	12 3/8	700	1686	0.46	858	2065	0.84	990	2385	1.30	1215	2930	2.40
7	26	7 1/2	14 1/4	606	2235	0.61	742	2740	1.12	858	3160	1.72	1050	3880	3.18
8	29 1/2	8 1/2	16 1/4	534	2910	0.79	654	3560	1.45	755	4110	2.24	928	5040	4.13
9	33	9 1/2	18 1/4	477	3660	1.00	585	4490	1.83	675	5175	2.82	825	6350	5.20

NOTE: This table also applies to Type V, cast-iron exhaust fans.

Steel Pressure Blowers for Cupolas (Average Application).
(American Blower Co., 1909.)

No. of blower.	Dia. of wheel, in.	Width periph y. in.	Circum. of wheel, ft.	Dia. outlet pipes, in.	Area of outlet, sq. ft.	Oz.								
						In.	2	3	4	5	6	7	8	9
1	14 1/2	13/8	3.80	5 3/4	0.18	R.P.M.	1960	2400	2770	3095	3390	3666	3915	4150
						C.F.	361	434	500	560	610	665	708	752
						H.P.	0.45	0.81	1.24	1.74	2.28	2.89	3.51	4.20
2	17	15/8	4.45	6 3/4	0.2485	R.P.M.	1675	2050	2362	2645	2895	3130	3340	3540
						C.F.	498	600	691	774	843	916	978	1038
						H.P.	0.62	1.12	1.72	2.40	3.15	3.99	4.84	5.79
3	19 1/2	17/8	5.11	7 3/4	0.327	R.P.M.	1460	1785	2060	2300	2520	2730	2910	3085
						C.F.	655	789	910	1018	1110	1207	1286	1365
						H.P.	0.82	1.47	2.26	3.16	4.15	5.25	6.36	7.62
4	22	21/8	5.76	8 3/4	0.4176	R.P.M.	1292	1582	1825	2040	2235	2420	2585	2740
						C.F.	838	1006	1162	1300	1415	1540	1643	1746
						H.P.	1.04	1.87	2.88	4.03	5.28	6.70	8.14	9.74
5	24 1/2	23/8	6.41	9 3/4	0.519	R.P.M.	1162	1422	1640	1835	2010	2175	2320	2460
						C.F.	1040	1250	1442	1612	1760	1915	2040	2166
						H.P.	1.30	2.33	3.58	5.00	6.57	8.34	10.10	12.10
6	27	27/8	7.06	10 3/4	0.63	R.P.M.	1055	1290	1490	1665	1825	1975	2105	2233
						C.F.	1262	1520	1750	1960	2135	2375	2475	2630
						H.P.	1.57	2.83	4.34	6.08	7.96	10.10	12.25	14.12
7	32	33/8	8.39	12 1/2	0.852	R.P.M.	889	1087	1255	1405	1535	1660	1775	1880
						C.F.	1705	2055	2366	2650	2890	3140	3350	3555
						H.P.	2.12	3.83	5.86	8.23	10.78	13.66	16.60	19.83
8	37	37/8	9.70	14	1.069	R.P.M.	769	940	1085	1212	1328	1446	1533	1625
						C.F.	2140	2575	2970	3325	3620	3940	4200	4460
						H.P.	2.66	4.79	7.36	10.3	13.5	17.15	20.30	24.90
9	42	43/8	10.98	16	1.396	R.P.M.	679	830	958	1072	1172	1270	1355	1435
						C.F.	2800	3370	3880	4340	4730	5150	5500	5825
						H.P.	3.48	6.27	9.63	13.46	17.65	22.40	27.25	32.50
10	47	47/8	12.30	17 1/2	1.67	R.P.M.	606	742	855	956	1048	1133	1210	1280
						C.F.	3350	4025	4640	5200	5660	6160	6570	6970
						H.P.	4.17	7.5	11.5	16.12	21.12	26.80	32.55	38.90
11	52	53/8	13.6	19 1/4	2.02	R.P.M.	548	670	774	865	947	1025	1093	1160
						C.F.	4050	4870	5610	6290	6850	7450	7950	8440
						H.P.	5.03	9.06	13.9	19.5	25.55	32.40	39.33	47.10
12	57	57/8	14.92	21	2.405	R.P.M.	500	611	705	789	863	934	996	1056
						C.F.	4820	5800	6700	7490	8160	8870	9460	10040
						H.P.	6.00	10.78	16.62	23.25	30.45	38.60	46.85	56.10

WARNING: This is a 1910 edition. Some of the material may no longer be accurate

Steel Pressure Blowers for Cupolas (Average Application).—
Continued.

No. of blower.	Dia. of wheel, in.	Width per y. in.	Circum. of wheel, ft.	Dia. outlet pipes, in.	Area of outlet, sq. ft.	Oz.	10	11	12	13	14	15	16
						In.	17.28	19.02	20.75	22.5	24.22	25.95	27.66
						H.P. const. at 1000 cu. ft.	6.20	6.82	7.44	8.07	8.69	9.30	9.92
2 17	15/8	4.45	63/4	0.2435	R.P.M.	3740	3920	4090
					C.F.	1093	1148	1196	
					H.P.	6.78	7.83	8.9	
3 19 1/2	17/8	5.11	73/4	0.327	R.P.M.	3255	3415	3570	3710	3955	3985	4120	
					C.F.	1440	1510	1575	1642	1700	1762	1820	
					H.P.	8.93	10.3	11.72	13.26	14.75	16.4	18.05	
4 22	21/8	5.76	83/4	0.4175	R.P.M.	2890	3030	3163	3290	3420	3535	3650	
					C.F.	1840	1930	2012	2095	2175	2250	2325	
					H.P.	11.40	13.16	14.96	16.9	18.9	20.9	23.1	
5 24 1/2	23/8	6.41	93/4	0.519	R.P.M.	2595	2720	2845	2960	3075	3180	3280	
					C.F.	2280	2395	2500	2605	2700	2800	2885	
					H.P.	14.13	16.33	18.6	21.05	23.45	26.05	28.66	
6 27	27/8	7.06	103/4	0.63	R.P.M.	2355	2470	2580	2685	2790	2885	2980	
					C.F.	2770	2910	3033	3165	3280	3395	3500	
					H.P.	17.18	19.85	22.6	25.55	28.50	31.55	34.7	
7 32	33/8	8.39	121/2	0.852	R.P.M.	1983	2080	2170	2260	2345	2430	2510	
					C.F.	3750	3930	4110	4276	4430	4590	4730	
					H.P.	23.25	26.80	30.6	34.5	38.5	42.7	47.	
8 37	37/8	9.70	14	1.069	R.P.M.	1715	1800	1880	1955	2030	2100	2170	
					C.F.	4700	4930	5150	5360	5560	5760	5940	
					H.P.	29.15	33.66	38.33	43.25	48.30	53.55	59.	
9 42	43/8	10.98	16	1.396	R.P.M.	1515	1590	1660	1728	1792	1855	1916	
					C.F.	6150	6450	6730	7010	7270	7525	7760	
					H.P.	38.15	44.00	50.15	56.60	63.2	70.	77.	
10 47	47/8	12.30	171/2	1.67	R.P.M.	1352	1418	1480	1540	1600	1655	1710	
					C.F.	7350	7715	8055	8390	8700	9010	9300	
					H.P.	45.60	52.66	60.	67.66	75.6	83.9	92.25	
11 52	53/8	13.6	191/4	2.02	R.P.M.	1222	1282	1340	1393	1447	1498	1546	
					C.F.	8900	9330	9750	10140	10520	10890	11220	
					H.P.	55.20	63.6	72.5	82.	91.5	101.2	111.33	
12 57	57/8	14.92	21	2.405	R.P.M.	1113	1168	1220	1270	1318	1363	1410	
					C.F.	10580	11100	11600	12080	12520	12960	13380	
					H.P.	65.5	75.70	86.33	97.5	109	120.5	132.75	

Caution in Regard to Use of Fan and Blower Tables.—Many engineers report that some manufacturers' tables overrate the capacity of their fans and underestimate the horse-power required to drive them. In some cases the complaints may be due to restricted air outlets, long and crooked pipes, slipping of belts, too small engines, etc. It may also be due to the fact that the volumes are stated without being accompanied by information as to the maintained resistance, and the volumes given

may be those delivered with an unrestricted inlet and outlet. As this condition is not a practical one, the volume delivered in an installation is much smaller than that given in the tables. The underestimating of horse-power required may be due to the fact that the volumes given in tables are for operation against a practical resistance, and in an installation it might be that the resistance was low, consequently the volume and also the horse-power required would be greater.

Capacity of Sturtevant High-Pressure Blowers (1908).

Number of blower.	Capacity in cubic feet per minute, 1/2 lb. pressure.	Revolutions per minute.	Inside dia. of inlet and outlet, inches.	Approx. weight, pounds.*
000	1 to 5	200 to 1000	13/8	40
00	5 to 25	375 to 800	11/2	80
0	25 to 45	370 to 800	21/2	140
1	45 to 130	240 to 600	3	330
2	130 to 225	300 to 500	4	550
3	225 to 325	380 to 525	4	760
4	325 to 560	350 to 565	6	1,080
5	560 to 1,030	300 to 475	8	1,670
6	1,030 to 1,540	290 to 415	10	2,500
7	1,540 to 2,300	280 to 410	10	3,200
8	2,300 to 3,300	265 to 375	12	4,700
9	3,300 to 4,700	250 to 350	16	6,100
10	4,700 to 6,000	260 to 330	16	8,000
11	6,000 to 8,500	220 to 310	20	12,100
12	8,500 to 11,300	190 to 250	24	18,700
13	11,300 to 15,500	190 to 260	30	22,700

* Of blower for 1/2 lb. pressure.

Performance of a No. 7 Steel Pressure Blower under Varying Conditions of Outlet.

Per cent of Rated Capacity.....	0	20	40	60	80	100	120	140	160	180	200	220	240
Per cent of Rated H.P.	28	42	57	72	86	100	116	130	144	159	173	187	202
Total pressure, oz.	10.2	11.4	11.9	12.0	11.9	11.4	10.9	10.3	9.7	9.1	8.5	7.9	7.2
Static pressure, oz.	10.2	11.2	11.6	11.4	11.0	10.2	9.2	8.0	6.6	5.0	3.5	1.9	0.3
Efficiency, per cent.....	0	26	40	50	56	60	62	61	59	56	52	48	45

The above figures are taken from a plotted curve of the results of a test by the Buffalo Forge Co. in 1905. A letter describing the test says:

The object was to determine the variation of pressure, power and efficiency obtained at a constant speed with capacities varying from zero discharge to free delivery. A series of capacity conditions were secured by restricting the outlet of the blower by a series of converging cones, so arranged as to make the convergence in each case very slight, and of sufficient length to avoid any noticeable inequality in velocities at the discharge orifice. The fan was operated as nearly at constant speed as possible. The velocity of the air at the point of discharge was measured by a Pitot tube and draft gauge of usual construction. Readings were taken over several points of the outlet and the average taken, although

WARNING: This is a 1910 edition. Some of the material may no longer be accurate

the variation under nearly all conditions was scarcely perceptible. A coefficient of 93% was assumed for the discharge orifice. The pressure was taken as the reading given by the Pitot tube and draft gauge at outlet. The agreement of this reading with the static pressure in a chamber from which a nozzle was conducted had been checked by a previous test in which the two readings, i.e., velocity and static pressure, were found to agree exactly within the limit of accuracy of the draft gauge, which was about 0.01 in., or, in this case, within 1%. The horsepower was determined by means of a motor which had been previously calibrated by a series of brake tests. Variations in speed were assumed to produce variation in capacity in proportion to the speed, variation in pressure to the square of the speed, and variation in H.P. in proportion to the cube of the speed. These relations had been previously shown to hold true for fans in other tests. They were also checked up by operating the fan at various speeds and plotting the capacities directly with the speed as abscissa, the pressure with the square of the speed as abscissa, and the horse power with the cube of the speed as abscissa. These were found, as in previous cases, to have a practically straight-line relation, in which the line passed through the origin.

Effect of Resistance upon the Capacity of a Fan. — A study of the figures in the above table shows the importance of having ample capacity in the air mains and delivery pipes, and of the absence of sharp bends or other obstructions to the flow which may increase the resistance or pressure against which the fan operates. The fan delivering its rated capacity against a static pressure of 10.2 ounces delivers only 40% of that capacity, with the same number of revolutions, if the pressure is increased to 11.6 ounces; the power is reduced only to 57%, instead of 40%, and the efficiency drops from 60% to 40%.

Dimensions of Sirocco Fans.

(American Blower Co., 1909.)

Diameter of Wheel, in.	Width at Periphery, in.	No. of Blades.	Total Blade Area, sq. in.	Height of Housing, (Approx.)	Width bet. Sides, in.	Length of Housing.	Max. Area of Inlet, sq. ft.	Min. Area of Inlet, sq. ft.	Area of Square Outlet, sq. ft.	Area of Circular Evasé Outlet sq. ft.	Length of Evasé Cone.
6	3	48	56	11"	4	10"	.23	.123	.11	.12	3"
9	4 1/2	48	127	1' 4"	6	1' 3"	.49	.349	.25	.35	4 1/4"
12	6	64	226	1' 9"	8	1' 7"	.85	.616	.44	.60	5 3/4"
15	7 1/2	64	353	2' 4"	10	2' 0"	1.46	.957	.69	.92	7 1/4"
18	9	64	509	2' 10"	12	2' 5"	1.87	1.37	1.00	1.40	8 1/2"
21	10 1/2	64	693	3' 4"	14	2' 10"	2.40	1.87	1.34	1.87	10"
24	12	64	904	3' 8"	16	3' 3"	3.14	2.46	1.78	2.40	11 1/2"
27	13 1/2	64	1144	4' 3"	18	3' 7"	4.59	3.11	2.25	3.14	13"
30	15	64	1413	4' 7"	20	4' 0"	5.58	3.83	2.78	3.83	14 1/2"
36	18	64	2036	5' 6"	24	4' 10"	7.87	5.50	4.00	5.58	17"
42	21	64	2770	6' 5"	28	5' 7"	10.56	7.47	5.44	7.47	20"
48	24	64	3617	7' 3"	32	6' 5"	13.6	9.79	7.11	9.85	23"
54	27	64	4578	8' 2"	36	7' 3"	17.0	12.3	9.00	12.3	26"
60	30	64	5652	9' 1"	40	8' 0"	20.9	15.2	11.11	15.3	28 1/2"
66	33	64	6839	9' 11"	44	8' 10"	25.2	18.4	13.41	18.3	31 1/2"
72	36	64	8144	10' 10"	48	9' 7"	29.8	22.2	16.00	22.3	34 1/2"

Sirocco or Multivane Fans. — There has recently (1909) come into use a fan of radically different proportions and characteristics from the ordinary centrifugal fan. This fan is composed of a great number of shallow vanes, ranging from 48 to 64, set close together around the periphery of the fan wheel. Over a large range of sizes, 64 vanes appear to give the

Speed, Capacities and Horse-power of Sirocco Fans. (American Blower Co., 1909.)

The figures given represent dynamic pressures in oz. per sq. in. For static pressure, deduct 28.8%; for velocity pressure, deduct 71.2%.

Diam. Wheel		1/4 oz.	1/2 oz.	3/4 oz.	1 oz.	1 1/4 oz.	1 1/2 oz.	1 3/4 oz.	2 oz.	2 1/2 oz.	3 oz.
6	Cu. ft.	155	220	270	310	350	380	410	440	490	540
	R.P.M.	1,145	1,615	1,980	2,290	2,560	2,800	3,025	3,230	3,616	3,960
	B.H.P.	.0185	.052	.095	.147	.205	.270	.34	.42	.58	.76
9	Cu. ft.	350	500	610	700	790	860	930	1,000	1,110	1,220
	R.P.M.	762	1,076	1,320	1,524	1,700	1,866	2,020	2,152	2,408	2,640
	B.H.P.	.042	.118	.216	.333	.463	.610	.77	.95	1.32	1.73
12	Cu. ft.	625	880	1,080	1,250	1,400	1,530	1,650	1,770	1,970	2,170
	R.P.M.	572	808	990	1,145	1,280	1,400	1,512	1,615	1,808	1,980
	B.H.P.	.074	.208	.381	.588	.82	1.08	1.36	1.66	2.32	3.05
15	Cu. ft.	975	1,380	1,690	1,950	2,180	2,400	2,590	2,760	3,090	3,390
	R.P.M.	456	645	790	912	1,020	1,120	1,210	1,290	1,444	1,580
	B.H.P.	.115	.326	.600	.923	1.29	1.69	2.14	2.61	3.65	4.8
18	Cu. ft.	1,410	1,990	2,440	2,820	3,160	3,450	3,720	3,980	4,450	4,880
	R.P.M.	381	538	660	762	850	933	1,010	1,076	1,204	1,320
	B.H.P.	.167	.470	.862	1.33	1.85	2.43	3.07	3.75	5.25	6.9
21	Cu. ft.	1,925	2,710	3,310	3,850	4,290	4,700	5,070	5,420	6,060	6,620
	R.P.M.	326	462	565	652	730	800	864	924	1,032	1,130
	B.H.P.	.227	.640	1.17	1.81	2.53	3.33	4.18	5.11	7.15	9.4
24	Cu. ft.	2,500	3,540	4,340	5,000	5,600	6,120	6,620	7,080	7,900	8,680
	R.P.M.	286	404	495	572	640	700	756	807	904	990
	B.H.P.	.296	.832	1.53	2.35	3.28	4.32	5.44	6.64	9.3	12.2
27	Cu. ft.	3,175	4,490	5,500	6,350	7,100	7,780	8,400	8,980	10,050	11,000
	R.P.M.	254	359	440	508	568	622	672	718	804	860
	B.H.P.	.373	1.05	1.94	2.98	4.16	5.48	6.90	8.44	11.8	15.5
30	Cu. ft.	3,910	5,520	6,770	7,820	8,750	9,600	10,350	11,050	12,350	13,550
	R.P.M.	228	322	395	456	510	560	604	645	722	790
	B.H.P.	.460	1.30	2.40	3.68	5.15	6.75	8.53	10.4	14.5	19.1
36	Cu. ft.	5,650	7,950	9,750	11,300	12,640	13,800	14,900	15,900	17,800	19,500
	R.P.M.	190	269	330	381	425	466	504	538	602	660
	B.H.P.	.665	1.87	3.44	5.30	7.40	9.72	12.25	15.0	20.9	27.5
42	Cu. ft.	7,700	10,850	13,300	15,400	17,170	18,800	20,300	21,700	24,250	26,600
	R.P.M.	163	231	283	326	365	400	432	462	516	566
	B.H.P.	.903	2.55	4.69	7.24	10.1	13.3	16.7	20.4	28.5	37.5
48	Cu. ft.	10,000	14,150	17,350	20,000	22,400	24,500	26,500	28,300	31,600	34,700
	R.P.M.	143	202	248	286	320	350	378	403	452	495
	B.H.P.	1.18	3.32	6.10	9.40	13.1	17.2	21.75	26.6	37.1	48.8
54	Cu. ft.	12,700	17,950	22,000	25,400	28,400	31,100	33,600	35,900	40,200	44,000
	R.P.M.	127	179	220	254	284	311	336	359	402	440
	B.H.P.	1.49	4.20	7.75	11.9	16.6	21.9	27.6	33.7	47.1	62.
60	Cu. ft.	15,650	22,100	27,100	31,300	35,000	38,400	41,400	44,200	49,400	54,200
	R.P.M.	114	161	198	228	255	280	302	322	361	396
	B.H.P.	1.84	5.20	9.58	14.7	20.6	27.0	34.1	41.6	58.2	76.5
66	Cu. ft.	18,950	26,800	32,850	37,900	42,300	46,400	50,100	53,600	60,000	65,700
	R.P.M.	104	147	180	208	232	254	275	294	328	360
	B.H.P.	2.23	6.30	11.6	17.8	24.9	32.7	41.2	50.4	70.4	92.6
72	Cu. ft.	22,600	31,800	39,000	45,200	50,600	55,200	59,600	63,600	71,200	78,000
	R.P.M.	95	134	165	190	212	233	252	269	301	330
	B.H.P.	2.66	7.48	13.7	21.2	29.6	38.9	49.0	59.8	83.6	110.
78	Cu. ft.	26,400	37,550	45,800	52,800	59,100	64,700	70,000	74,700	83,500	91,000
	R.P.M.	88	124	153	176	197	215	233	248	278	305
	B.H.P.	3.10	8.77	16.1	24.8	34.7	45.6	57.5	70.2	98.	129.
84	Cu. ft.	30,800	43,400	53,200	61,600	68,700	75,200	81,200	86,800	97,100	106,400
	R.P.M.	81	115	142	163	182	200	216	231	258	283
	B.H.P.	3.61	10.2	18.7	28.9	40.4	53.0	66.8	81.7	114.	150.
90	Cu. ft.	35,250	49,800	61,000	70,500	78,800	86,400	93,300	99,600	111,200	122,000
	R.P.M.	76	107	132	152	170	186	201	214	241	264
	B.H.P.	4.14	11.7	21.5	33.1	46.2	60.7	76.7	93.6	131.	172.

best results. The vanes, measured radially, have a depth 1/16 the fan diameter. Axially, they are much longer than those of the ordinary fan, being 3/5 the fan diameter. The fan occupies about 1/2 the space, and is about 2/3 the weight of the ordinary fan. The vanes are concaved in the direction of rotation and the outer edge is set forward of the inner edge. The inlet area is of the same diameter as the inner edge of the blades. Usually the inlet is on one side of the fan only, and is unobstructed, the wheel being overhung from a bearing at the opposite end. A peculiarity of this type of fan is that the air leaves it at a velocity about 80 per cent in excess of the peripheral speed of the blades. The velocity of the air through the inlet is practically uniform over the entire inlet area. The power consumption is relatively low. This type of fan was invented by S. C. Davidson of Belfast, Ireland, and is known as the "Sirocco" fan. It is made under that name in this country by the American Blower Co., to which the author is indebted for the preceding tables.

A Test of a "Sirocco" Mine Fan at Llwynypia, Wales, is reported in *Eng'g.*, April 16, 1909. The fan is 11 ft. 8 in. diam., double inlet, direct-coupled to a 3-phase motor. Average of three tests: Revs. per min., 184; peripheral speed, 6,705 ft. per min.; water-gauge in fan drift and in main drift, each 6 in.; area of drift, 184.6 sq. ft.; av. velocity of air, 1842 ft. per min.; volume of air, 340,033 cu. ft. per min.; H.P. input at motor, 420; Brake H.P. on fan shaft, 390; Indicated H.P. in air, 321.5; efficiency of motor, 93%; mechanical efficiency of fan, 82.43%; combined mechanical efficiency of fan and motor, 76.6%.

The Sturtevant Multivane Fan. A modification of the Sirocco fan has been developed by the B. F. Sturtevant Co. in which the blades are made with spoon-shaped serrations along their length. The advantage claimed for this construction is that the air is discharged more evenly along the length of the blade. The following table shows the sizes, capacities and horse-power required by the fan.

Sizes, Capacities and Horse-power of Multivane Fans.

(B. F. Sturtevant Co., 1909.)

Height of Fan Casing inches*	Resistance, 1/2 In.			Resistance, 1 In.			Resistance, 1 1/2 In.		
	Vol.	R.P.M.	H.P.	Vol.	R.P.M.	H.P.	Vol.	R.P.M.	H.P.
30	1,800	695	0.45	2,560	985	1.2	3,100	1,200	2.3
35	2,600	580	0.65	3,700	820	1.8	4,500	1,000	3.4
40	3,550	500	0.90	5,000	700	2.5	6,200	860	4.5
50	4,620	435	1.15	6,500	615	3.3	8,000	750	6.0
60	7,220	350	1.8	10,200	490	5.0	12,500	600	9.3
70	10,400	290	2.6	14,700	410	7.3	18,000	500	13.4
80	14,000	250	3.5	20,000	350	10.0	24,500	430	18.0
100	23,500	190	5.8	33,300	275	16.5	40,800	335	30.0
120	35,000	160	8.8	49,700	225	25	61,000	275	45.0
150	48,800	135	12.0	69,000	190	34	85,000	233	63.0
170	65,000	115	16.0	92,000	165	46	112,500	200	85.0

* Full housing. Bottom horizontal discharge.

The above table gives the volumes and horse-powers of Sturtevant multivane fans operating against a continuously maintained resistance, handling air at 65° F. The table is compiled for single-inlet fans, but when used with double inlet the volumes will be considerably increased (about 15-20%), and the power will also be greater (about 25-35%). It is possible to handle any of the volumes given against any stated pressure with quite an appreciable saving in power as compared with the table horse-power by using a larger fan, and by so doing obtaining lower veloci-

ties through the fan. It is also possible to handle any stated volume against any pressure given in the table with a considerably smaller fan, but when this is done it requires an increase in horse-power due to the greater velocity, which is increased in proportion to the decrease in size and to the lower mechanical efficiency of an overloaded fan. By maintained resistance is meant a static pressure existing in the air after it leaves the fan outlet, if the fan is applied to a blowing system. With the suction system, maintained resistance is the static suction existing in the duct just outside the fan inlet. If the fan is so placed in the system that there is resistance to the flow of air on both inlet and outlet, the maintained resistance against which the fan operates is the sum of the static suction existing in the air just before entering the inlet and the static pressure in the air just outside the fan outlet. In ordinary draw-through heating systems a maintained suction is encountered in the fan inlet due to the resistance of the heater, and the maintained pressure is created in the fan outlet due to the piping system. The volumes given are computed from tests in which the average velocity over rectangular or circular pipes is taken as 91% of the velocity (not velocity head) which is read at the center of the pipe by means of the Pitot tube. This method of computing velocity is conservative, especially for pipes having large sectional area.

High-Pressure Centrifugal Fans. (See page 620.)

Methods of Testing Fans.

(Compiled by B. F. Sturtevant Co., 1909.)

Various methods are used in testing centrifugal fans, some of which, being crude, credit fans with performances somewhat different from the true performance. Some of the formulæ used in determining the performances of a fan are given below:

h_v = Velocity head, in. of water; h_t = Total or Impact head, in. of water; h_s = Static head, in. of water; Q = Cu. ft. per min.; v = Velocity, ft. per min.; w = Density of air, lb. per cu. ft.; A = Area of outlet pipe, sq. ft.; A.H.P._s = Air horse-power crediting the fan with the energy due to static pressure only; A.H.P._t = Air horse-power, crediting the fan with both the energy due to static pressure and the kinetic energy in the discharge; B.H.P. = Brake horse-power.

$$V = 1097 \sqrt{\frac{h_v}{w}} \quad Q = 1097 \sqrt{\frac{h_v}{w}} \times A.$$

$$A.H.P._s = Q \times h_s \times 0.0001575; \quad A.H.P._t = Q \times h_t \times 0.0001575.$$

$$\text{Mechanical Efficiency} = A.H.P. \div B.H.P.$$

$$\text{Volumetric Eff'y} = \text{Volume per Revolution} \div \text{Cubical Contents of wheel.}$$

Anemometer Method. Anemometers are subject to considerable error as they are very delicate and must be handled with care. Should they be placed in a draft where the velocity is much over 1000 ft. per min. they are apt to be damaged by bending the blades. The methods of calibrating these instruments are faulty, and give some chance of error, even though the instrument be in the same condition as when calibrated. Unless it is frequently calibrated, the instrument may not be true to its calibration curve, which is often a source of considerable error. An anemometer is seldom adapted to taking readings at the fan outlet, or within pipes, as the velocity in most cases exceeds the limitations of the instrument. Therefore, readings are usually taken at a point where the velocity is lower, and consequently over areas of various shapes with unknown coefficients, thus introducing another source of error. Unless the flow of air is constant, faulty readings are obtained, due to the inertia of the instrument, which results in the fan being credited with a volume greater than the true volume.

Water-Gauge Readings at End of Tapered Cone. In this method, cones are placed on the fan outlet, or on the end of a short outlet pipe. The readings at the end of the cone vary widely, due to the large number of variable eddies. The pressure reading at the end of the cone is a total of two components, static pressure and velocity pressure. Unless the static pressure is deducted from the total pressure the true velocity pressure is not obtained.

Air-tight Room with Sliding Door. This method consists of the fan discharging its air into a closed room whose outlet is a sliding door. In this method, the readings generally take into account not only the volumetric performance but also the static pressure in the room, against which the fan delivers air. All tests by this method must be corrected for leakage of air from the room, the leakage factor being much larger than would be supposed. A variable coefficient of orifice is encountered, since at no two positions of the sliding door is either the area or shape of orifice the same. Readings taken at the door, by anemometers, are subject to the errors of these instruments. If water-gauge readings are taken at the door, the results are in error if it is assumed that all pressure at the door is velocity pressure. Static readings should be made at each station and deducted from the total observed pressure in order to get the velocity head. Even then it is difficult to get a true static reading at the door, as the stream lines are not all perpendicular to the plane of the orifice.

Pitot Tube in Center of Discharge Pipe. This method requires a discharge pipe of the same size as the outlet of the fan. In the center of this pipe and at such a distance from the fan outlet that eddies are practically eliminated, is placed a Pitot tube. The discharge pipe is of such length beyond the tube that when restricted at its end, the stream lines in the vicinity of the tube are not materially affected. By this method the static and total pressures are observed with considerable accuracy. The velocity pressure is determined by subtracting the static pressure from the total pressure. By applying a proper coefficient to the readings at the center the average velocity over the full discharge area is obtained. It is possible to make a more complete test by placing several Pitot tubes in the discharge pipe at different points in a cross-section, thereby obtaining an average. But it is found that by taking readings at a distance of eight or ten diameters from the fan outlet very good results are obtained with one tube placed in the center of the section of the pipe, whose readings are corrected by a proper coefficient. For medium-size pipes it is found that a coefficient of 0.91 applied to the velocity read at the center of the discharge pipe gives good and conservative results. [Other authorities give 0.87 as the value of this coefficient. See Pitot Tube, under Illuminating Gas.]

Experiments with the tapered cone method and the Pitot tube in the center of pipe method show that the former credits a fan with greater volume than the latter, and also show that there is a variable relation between these two methods as regards the volume of air credited to the fan when it is handling a certain volume of air. The difference in volumes credited the fan becomes greater as the size of the discharge pipe increases. In tests on two fans of different sizes, but of symmetrical design, the Pitot tube in the center of the pipe will record symmetrical results under given conditions, while with the tapered cone the results obtained with the larger fan and larger discharge pipe are beyond those which would have been expected from the symmetry of the fan.

From the above formulæ the air horse-power is a function of two variables, volume and pressure. Opinions vary as to the pressure which should be credited to the fan. It is claimed that the fan should be credited with the difference between the static pressure in the medium from which the fan is drawing air and the static pressure in the discharge pipe. It is also claimed that the fan should also be credited with the kinetic energy in the air in the discharge pipe or with the difference between the static pressure in the medium from which the fan is drawing air and the total or impact pressure in the discharge pipe. Efficiencies determined by crediting the fan with the former pressure may be called static efficiencies, and those determined by crediting the fan with the latter pressure may be called impact efficiencies.

The work of compression is negligible, as these methods have to do with air under low pressure. When readings are taken on the suction side of

the fan, for the purpose of determining static efficiency, the fan is often erroneously credited with a pressure equal to the difference between the medium into which the fan is discharging and the negative static pressure in the pipe leading to the fan inlet, whereas it should be credited only with the difference between the static pressure in the discharging medium and the impact pressure in the inlet pipe. The static suction has a greater negative value than the impact pressure at the same point, which is the result of the reduction of pressure caused by the air entering the system changing from rest, or zero velocity, to a finite velocity which it has at the point of measurement. If the object is to determine the impact efficiency where readings are taken at the suction side of the fan, the pressure with which the fan should be credited is the difference between the impact reading at the fan discharge and the impact reading obtained in the inlet pipe. This total pressure with which the fan is credited may also be expressed as the difference between the static pressure in the discharge pipe and the static suction in the inlet pipe, plus the increase of the velocity pressure in the outlet pipe over the velocity pressure in the inlet pipe.

From the above methods it is seen that volumetric and mechanical efficiencies of wide variety are obtained, and that where a test is of any importance it is essential that it be made on the most correct lines. Using a Pitot tube in the center of the pipe through which air flows, affords the best means of getting the true pressures as a whole and their separate components, and, consequently, is most accurate in determining the

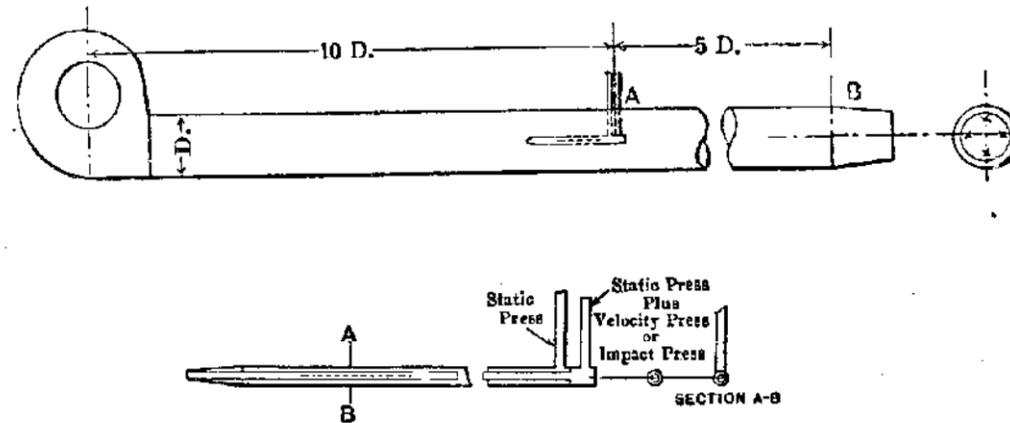

FIG. 140

volume flowing. Fig. 140 shows diagrammatically the method of test where the Pitot tube is used in the center of the discharge pipe. It also shows how readings could be taken by the cone method at the end of a discharge pipe. The details of the Pitot tube in what is considered its best form are also shown. The impact or total pressure is obtained at the end of the horizontal tube nearest the fan, and read by a water gauge connected to the vertical tube communicating with this point. The static pressure is obtained at the slots in the side of the outer horizontal tube which communicates with the second vertical tube, to which a water gauge may be connected.

Efficiency of Fans.— Much useful information on the theory and practice of fans and blowers, with results of tests of various forms, will be found in *Heating and Ventilation*, June to Dec. 1897, in papers by Prof. R. C. Carpenter and Mr. W. G. Walker. It is shown by theory that the volume of air delivered is directly proportional to the speed of rotation, that the pressure varies as the square of the speed, and that the horse-power varies as the cube of the speed. For a given volume of air moved the horse-power varies as the square of the speed, showing the great advantage of large fans at slow speeds over small fans at high speeds delivering the same volume. The theoretical values are greatly modified by variations in practical conditions. Professor Carpenter found that with three fans running at a speed of 6200 ft. per minute at the tips of the vanes, and

an air-pressure of 2 1/2 in. of water column, the mechanical efficiency, or the horse-power of the air delivered divided by the power required to drive the fan, ranged from 32% to 47%, under different conditions, but with slow speeds it was much less, in some cases being under 20%. Mr. Walker in experiments on disk fans found efficiencies ranging all the way from 7.4% to 43%, the size of the fans and the speed being constant, but the shape and angle of the blades varying. It is evident that there is a wide margin for improvements in the forms of fans and blowers, and a wide field for experiment to determine the conditions that will give maximum efficiency.

Flow of Air through an Orifice.

VELOCITY, VOLUME, AND H.P. REQUIRED WHEN AIR UNDER GIVEN PRESSURE IN OUNCES PER SQ. IN. IS ALLOWED TO ESCAPE INTO THE ATMOSPHERE.

(B. F. Sturtevant Co.)

Pressure in ounces per sq. in.	Pressure, inches of water.	Velocity, ft. per min.	Volume through 1 sq. in. effective area, cu. ft. per min.	Horse-power to move the given volume of air.	Horse-power per 1000 cu. ft. per min.	Pressure in ounces per sq. in.	Velocity, ft. per min.	Volume through 1 sq. in. effective area, cu. ft. per min.	Horse-power to move the given volume of air.	Horse-power per 1000 cu. ft. per min.
1/8	0.216	1.828	12.69	0.00043	0.0340	2	7.284	50.59	0.02759	0.5454
1/4	0.432	2.585	17.95	0.00122	0.0680	2 1/8	7.507	52.13	0.03021	0.5795
3/8	0.648	3.165	21.98	0.00225	0.1022	2 1/4	7.722	53.63	0.03291	0.6136
1/2	0.864	3.654	25.37	0.00346	0.1363	2 3/8	7.932	55.08	0.03568	0.6476
5/8	1.080	4.084	28.36	0.00483	0.1703	2 1/2	8.136	56.50	0.03852	0.6818
3/4	1.296	4.473	31.06	0.00635	0.2044	2 5/8	8.334	57.88	0.04144	0.7160
7/8	1.512	4.830	33.54	0.00800	0.2385	2 3/4	8.528	59.22	0.04442	0.7500
1	1.728	5.162	35.85	0.00978	0.2728	2 7/8	8.718	60.54	0.04747	0.7841
1 1/8	1.944	5.473	38.01	0.01166	0.3068	3	8.903	61.83	0.05058	0.8180
1 1/4	2.160	5.768	40.06	0.01366	0.3410	3 1/8	9.084	63.08	0.05376	0.8522
1 3/8	2.376	6.048	42.00	0.01575	0.3750	3 1/4	9.262	64.32	0.05701	0.8863
1 1/2	2.592	6.315	43.86	0.01794	0.4090	3 3/8	9.435	65.52	0.06031	0.9205
1 5/8	2.808	6.571	45.63	0.02022	0.4431	3 1/2	9.606	66.71	0.06368	0.9546
1 3/4	3.024	6.818	47.34	0.02260	0.4772	3 5/8	9.773	67.87	0.06710	0.9887
1 7/8	3.240	7.055	49.00	0.02505	0.5112	3 3/4	9.938	69.01	0.07058	1.0227
(1)	(2)	(3)	(4)	(5)	(6)	3 7/8	10.100	70.14	0.07412	1.0567

The headings of the 3d and 4th columns in the above table have been abridged from the original, which read as follows: Velocity of dry air, 50° F., escaping into the atmosphere through any shaped orifice in any pipe or reservoir in which the given pressure is maintained. Volume of air in cubic feet which may be discharged in one minute through an orifice having an effective area of discharge of one square inch. The 6th column, not in the original, has been calculated by the author. The figures represent the horse-power theoretically required to move 1000 cu. ft. of air of the given pressures through an orifice, without allowance for the work of compression or for friction or other losses of the fan. These losses may amount to 60% or more of the given horse-power.

The change in density which results from a change in pressure has been taken into account in the calculations of the table. The volume of air at a given velocity discharged through an orifice depends upon its shape, and is always less than that measured by its full area. For a given effective area the volume is proportional to the velocity. The power required to move air through an orifice is measured by the product of the velocity and the total resisting pressure. This power for a given orifice varies as the cube of the velocity. For a given volume it varies as the square of the velocity. In the movement of air by means of a fan there are unavoidable resistances which, in proportion to their amount, increase the actual power considerably above the amount here given.

Pipe Lines for Fans and Blowers. -- In installing fans and blowers careful consideration should be given to the pipe line conducting the air from the fan or blower. Bends and turns in the pipe, even of long radii, will cause considerable drop in pressure, and in straight pipe the friction of the moving air is a source of considerable loss. The friction increases with the length of the pipe and is inversely as the diameter. It also varies as the square of the velocity. In long runs of pipe, the increased cost of a larger pipe can often be compensated by the decreased cost of the motor and power for operating the blower.

The advisability of using a large pipe for conveying the air is shown by the following table which gives the size of pipe which should be used for pressure losses not exceeding one-fourth and one-half ounce per square inch, for various lengths of pipe.

Diameters of Blast Pipes.

(B. F. Sturtevant Co., 1908.)

Tons of iron per hour.	Inside dia. of copper, inches.	Cubic ft. of air per minute.	Length of Pipe in Feet.													
			20		40		60		80		100		120		140	
			Diameter of Pipe with Drop of													
			1/4 Oz.	1/2 Oz.	1/4 Oz.	1/2 Oz.	1/4 Oz.	1/2 Oz.	1/4 Oz.	1/2 Oz.	1/4 Oz.	1/2 Oz.	1/4 Oz.	1/2 Oz.	1/4 Oz.	1/2 Oz.
1	23	500	6	5	7	6	7	6	8	7	9	8	9	8	9	8
2	27	1,000	8	7	9	8	10	9	11	9	11	10	12	11	12	11
3	30	1,500	10	8	11	10	11	10	12	11	13	11	13	12	14	12
4	32	2,000	11	9	12	11	13	12	14	12	15	13	15	14	16	14
5	36	2,500	12	10	14	12	15	13	15	14	16	14	17	15	17	15
6	39	3,000	13	11	15	13	16	14	17	15	18	15	18	16	18	16
7	42	3,500	13	12	15	13	17	15	17	15	18	16	19	17	20	18
8	45	4,000	15	12	16	15	18	15	18	16	19	17	20	18	21	18
9	48	4,500	15	13	17	15	18	16	19	17	20	18	21	19	22	19
10	54	5,000	15	13	18	15	19	17	20	18	21	18	22	19	23	20
11	54	5,500	16	14	18	16	20	17	21	18	22	19	23	20	23	20
12	60	6,000	17	14	19	17	20	17	21	19	22	20	23	21	24	21
13	60	6,500	17	14	19	17	21	18	23	19	23	20	24	21	25	22
14	60	7,000	18	15	20	18	22	19	23	20	24	21	25	22	26	23
15	66	7,500	18	16	21	18	22	19	24	21	25	22	26	22	27	23
16	66	8,000	18	16	22	18	23	20	24	22	26	22	26	23	27	24
17	66	8,500	18	16	22	18	23	20	24	22	26	22	27	24	28	24
18	72	9,000	18	17	22	18	24	21	25	22	27	23	27	24	28	25
19	72	9,500	20	17	23	20	24	22	26	23	28	23	28	25	29	26
20	72	10,000	20	18	23	20	25	22	27	23	28	24	29	25	30	26
21	78	10,500	21	18	24	21	26	23	27	23	29	25	30	26	30	26
22	78	11,000	21	18	24	21	27	23	28	24	29	26	30	27	31	27
23	78	11,500	21	19	25	21	27	24	28	25	30	26	30	27	31	27
24	84	12,000	22	19	25	22	28	24	28	25	31	26	31	27	32	28
25	84	12,500	22	19	26	22	28	24	29	26	31	27	32	28	33	28
26	84	13,000	22	19	26	22	28	24	29	26	31	27	32	28	33	28
27	90	13,500	23	20	26	23	28	24	30	26	31	27	32	28	34	28
28	90	14,000	23	20	27	23	29	25	30	27	32	28	33	29	34	29
29	90	14,500	23	20	27	23	29	26	31	27	32	28	33	29	34	30
30	90	15,000	24	21	27	24	29	26	31	27	32	28	34	30	35	30

WARNING: This is a 1910 edition. Some of the material may no longer be accurate

The minimum radius of each turn should be equal to the diameter of the pipe. For each turn thus made add three feet in length, when using this table. If the turns are of less radius, the length added should be increased proportionately.

The above table has been constructed on the following basis: A loss of, say, 1/2 oz. pressure was allowed as a standard for the transmission of a given quantity of air through a given length of pipe of any diameter. The increased loss due to increasing the length of pipe was compensated for by increasing the diameter sufficiently to keep the loss still at 1/2 oz. Thus, if 2500 cu. ft. of air is to be delivered per minute through 100 ft. of pipe with a loss of not more than 1/2 oz., a 14-in. pipe will be required. If it is necessary to increase the length of pipe to 140 ft., a pipe 15 in. diameter will be required if the loss in pressure is not to exceed 1/2 oz. In deciding the size of pipe the loss in pressure in the pipe must be added to the pressure to be maintained at the fan or blower, if the tabulated efficiency of the latter is to be secured at the delivery end of the pipe.

Centrifugal Ventilators for Mines. — Of different appliances for ventilating mines various forms of centrifugal machines having proved their efficiency have now almost completely replaced all others. Most if not all of the machines in use in this country are of this class, being either open-periphery fans, or closed, with chimney and spiral casing, of a more or less modified Guibal type. The theory of such machines has been demonstrated by Mr. Daniel Murgue in "Theories and Practices of Centrifugal Ventilating Machines," translated by A. L. Stevenson, and is discussed in a paper by R. Van A. Norris, *Trans. A. I. M. E.*, xx. 637. From this paper the following formulæ are taken:

Let a = area in sq. ft. of an orifice in a thin plate, of such area that its resistance to the passage of a given quantity of air equals the resistance of the mine;

o = orifice in a thin plate of such area that its resistance to the passage of a given quantity of air equals that of the machine;

Q = quantity of air passing in cubic feet per minute;

V = velocity of air passing through a in feet per second;

V_0 = velocity of air passing through o in feet per second;

h = head in feet air-column to produce velocity V ;

h_0 = head in feet air-column to produce velocity V_0 .

$$Q = 0.65 a V; V = \sqrt{2gh}; Q = 0.65 a \sqrt{2gh};$$

$$a = \frac{Q}{0.65 \sqrt{2gh}} = \text{equivalent orifice of mine};$$

or, reducing to water-gauge in inches and quantity in thousands of cubic feet per minute,

$$a = \frac{0.403 Q}{\sqrt{W.G.}}; Q = 0.65 o V_0; V_0 = \sqrt{2gh_0}; Q = 0.65 o \sqrt{2gh_0};$$

$$o = \sqrt{\frac{Q^2}{0.65^2 h_0 2g}} = \text{equivalent orifice of machine}.$$

The theoretical depression which can be produced by any centrifugal ventilator is double that due to its tangential speed. The formula

$$H = \frac{T^2}{2g} - \frac{V^2}{2g},$$

in which T is the tangential speed, V the velocity of exit of the air from the space between the blades, and H the depression measured in feet of air-column, is an expression for the theoretical depression which can be produced by an uncovered ventilator; this reaches a maximum when the air leaves the blades without speed, that is, $V = 0$, and $H = T^2 \div 2g$.

Hence the theoretical depression which can be produced by any uncovered ventilator is equal to the height due to its tangential speed, and one-

half that which can be produced by a covered ventilator with expanding chimney. Practical considerations in the design of the fan wheel and casing will probably cause the actual results obtained with fans to vary considerably from these formulæ.

So long as the condition of the mine remains constant:

(1) The volume produced by any ventilator varies directly as the speed of rotation.

(2) The depression produced by any ventilator varies as the square of the speed of rotation.

(3) For the same tangential speed with decreased resistance the quantity of air increases and the depression diminishes.

The following table shows a few results, selected from Mr. Norris's paper, giving the range of efficiency which may be expected under different circumstances. Details of these and other fans, with diagrams of the results, are given in the paper.

Experiments on Mine-Ventilating Fans.

Fan.	Revolutions per minute, fan.	Peripheral speed, feet per min.	Cubic feet of air per minute.	Cubic feet of air per revolution.	Cubical contents of fan-blades.	Cubic feet of air per 100 ft. periphery motion.	Water-gauge, inches.	Horse-power in air.	Indicated horse-power of engine.	Efficiency of engine and fan.	Equivalent orifice of mine, square feet.	
A	84	5517	236,684	2818	3040	4290	1.80	67.13	88.40	75.9	Average 80	
	100	6282	336,862	3369	3040	5393	2.50	132.70	155.43	85.4		
	111	6973	347,396	3130	3040	5002	3.20	175.17	209.64	83.6		
	123	7727	394,100	3204	3040	5100	3.60	223.56	295.21	75.7		
B	100	6282	128,888	1889	1520	3007	1.40	41.67	97.99	42.5		22
	130	8167	274,876	2114	1520	3366	2.00	86.63	194.95	44.6		
C	59	3702	59,587	1010	1520	1610	1.20	11.27	16.76	67.83		32
	83	5208	82,969	1000	1520	1593	2.15	27.86	48.54	57.38		
D	40	3140	49,611	1240	3096	1580	0.87	6.80	13.82	49.2		83
	70	5495	137,760	1825	3096	2507	2.55	55.35	67.44	82.07		
E	50	2749	147,232	2944	1522	5356	0.50	11.60	28.55	40.63		26.9
	69	3793	205,761	2982	1522	5451	1.00	32.42	45.98	70.50		
	96	5278	299,600	3121	1522	5676	2.15	101.50	120.64	84.10		
F	200	7540	133,198	666	746	1767	3.35	70.30	102.79	68.40	38.3	
	200	7540	180,809	904	746	2398	3.05	86.89	129.07	67.30		
	200	7540	209,150	1046	746	2774	2.80	92.50	150.08	61.70		
G	10	785	28,896	2890	3022	3680	0.10	0.45	1.30	35.	52	
	20	1570	57,120	2856	3022	3637	0.20	1.80	3.70	49.		
	25	1962	66,640	2665	3022	3399	0.29	2.90	6.10	48.		
	30	2355	73,080	2436	3022	3103	0.40	4.60	9.70	47.		
	35	2747	94,080	2688	3022	3425	0.50	7.40	15.00	48.		
	40	3140	112,000	2800	3022	3567	0.70	12.30	24.90	49.		
	50	3925	132,700	2654	3022	3381	0.90	18.80	38.80	48.		
	60	4710	173,600	2893	3022	3686	1.35	36.90	66.40	55.		
	70	5495	203,280	2904	3022	3718	1.80	57.70	107.10	54.		
	80	6280	222,320	2779	3022	3540	2.25	78.80	152.60	52.		

Type of fan.	Diam.	Width.	No. inlets.	Diam. inlets.
A. Guibal, double	20 ft.	6 ft.	4	8 ft. 10 in.
B. Same, only left hand running	20	6	4	8 10
C. Guibal	20	6	2	8 10
D. Guibal	25	8	1	11 6
E. Guibal, double	17 1/2	4	4	8
F. Capell	12	10	2	7
G. Guibal	25	8	1	12

An examination of the detailed results of each test in Mr. Norris's table shows a mass of contradictions from which it is exceedingly difficult to draw any satisfactory conclusions. The following, he states, appear to be more or less warranted by some of the figures:

1. *Influence of the Condition of the Airways on the Fan.* — Mines with varying equivalent orifices give air per 100 ft. speed of tip of fan, within limits as follows, the quantity depending on the resistance of the mine:

Equivalent orifice. sq. ft.	Cu. ft. air per 100 ft. speed of fan.	Average.	Equivalent orifice. sq. ft.	Cu. ft. air per 100 ft. speed of fan.	Average.
Under 20	1100 to 1700	1300	60 to 70	3300 to 5100	4000
20 to 30	1300 to 1800	1600	70 to 80	4000 to 4700	4400
30 to 40	1500 to 2500	2100	80 to 90	3000 to 5600	4800
40 to 50	2300 to 3500	2700	90 to 100
50 to 60	2700 to 4800	3500	100 to 114	5200 to 6200	5700

The influence of the mine on the efficiency of the fan does not seem to be very clear. Eight fans, with equivalent orifices over 50 square feet, give efficiencies over 70%; four, with smaller equivalent mine-orifices, give about the same figures; while, on the contrary, six fans, with equivalent orifices of over 50 square feet, give lower efficiencies, as do ten fans, all drawing from mines with small equivalent orifices. It would seem that, on the whole, large airways tend to assist somewhat in attaining high efficiency.

2. *Influence of the Diameter of the Fan.* — This seems to be practically *nil*, the only advantage of large fans being in their greater width and the lower speed required of the engines.

3. *Influence of the Width of a Fan.* — This appears to be small as regards the efficiency of the machine; but the wider fans are, as a rule, exhausting more air. However, increasing the width of the fan of a given diameter causes an increase in the velocity of the air through the wheel inlet, and this increased velocity will become at a certain point a serious loss and will decrease the mechanical efficiency.

4. *Influence of Shape of Blades.* — This appears, within reasonable limits, to be practically *nil*. Thus, six fans with tips of blades curved forward, three fans with flat blades, and one with blades curved back to a tangent with the circumference, all give very high efficiencies — over 70 per cent. A prominent manufacturer claims, however, that his tests show a higher efficiency with vanes curved forward as compared with straight or backwardly curved vanes.

5. *Influence of the Shape of the Spiral Casing.* — This appears to be considerable. The shapes of spiral casing in use fall into two classes, the first presenting a large spiral, beginning at or near the point of cut-off, and the second a circular casing reaching around three-quarters of the circumference of the fan, with a short spiral reaching to the *evasée* chimney.

Fans having the first form of casing appear to give in almost every case high efficiencies.

Fans that have a spiral belonging to the first class, but very much contracted, give only medium efficiencies. It seems probable that the proper shape of spiral casing would be one of such form that the air between each pair of blades could constantly and freely discharge into the space between the fan and casing, the whole being swept along to the *evasée* chimney. This would require a spiral beginning near the point of cut-off, enlarging by gradually increasing increments, to allow for the slowing of the air caused by its friction against the casing, and reaching the chimney with an area such that the air could make its exit with its then existing speed — somewhat less than the periphery-speed of the fan.

6. *Influence of the Shutter.* — The shutter certainly appears to be an advantage, as by it the exit area can be regulated to suit the varying quantity of air given by the fan, and in this way re-entries can be prevented. It is not uncommon to find shutterless fans, into the chimneys of which bits of paper may be dropped, which are drawn into the fan, make the circuit, and are again thrown out. This peculiarity has not been noticed with fans provided with shutters.

7. *Influence of the Speed at which a Fan is Run.* — It is noticeable that most of the fans giving high efficiency were running at a rather high periphery velocity. The best speed seems to be between 5000 and 6000 feet per minute. The fans appear to reach a maximum efficiency at somewhere about the speed given, and to decrease rapidly in efficiency when this maximum point is passed. The same manufacturer mentioned in note 4 states that the efficiency is not affected by the tip speed, providing that the comparison is always made at the same point in the efficiency curve.

In discussion of Mr. Norris's paper, Mr. A. H. Storrs says: From the "cubic feet per revolution" and "cubical contents of fan-blades," as given in the table, we find that the enclosed fans empty themselves from one-half to twice per revolution, while the open fans are emptied from one and three-quarters to nearly three times; this for fans of both types, on mines covering the same range of equivalent orifices. One open fan, on a very large orifice, was emptied nearly four times, while a closed fan, on a still larger orifice, only shows one and one-half times. For the open fans the "cubic feet per 100 ft. motion" is greater, in proportion to the fan width and equivalent orifice, than for the enclosed type. Notwithstanding this apparently free discharge of the open fans, they show very low efficiencies.

As illustrating the very large capacity of centrifugal fans to pass air, if the conditions of the mine are made favorable, a 16-ft. diam. fan, 4 ft. 6 in. wide, at 130 revolutions, passed 360,000 cu. ft. per min., and another, of same diameter, but slightly wider and with larger intake circles, passed 500,000 cu. ft., the water-gauge in both instances being about 1/2 in.

T. D. Jones says: The efficiency reported in some cases by Mr. Norris is larger than I have ever been able to determine by experiment. My own experiments, recorded in the Pennsylvania Mine Inspectors' Reports from 1875 to 1881, did not show more than 60% to 65%.

DISK FANS.

Efficiency of Disk Fans. — Prof. A. B. W. Kennedy (*Industries*, Jan. 17, 1890) made a series of tests on two disk fans, 2 and 3 ft. diameter, known as the Verity Silent Air-propeller. The principal results and conclusions are condensed below.

In each case the efficiency of the fan, that is, the quantity of air delivered per effective horse-power, increases very rapidly as the speed diminishes, so that lower speeds are much more economical than higher ones. On the other hand, as the quantity of air delivered per revolution is very nearly constant, the actual useful work done by the fan increases almost directly with its speed. Comparing the large and small fans with about the same air delivery, the former (running at a much lower speed, of course) is much the more economical. Comparing the two fans running at the same speed, however, the smaller fan is very much the more economical. The delivery of air per revolution of fan is very nearly directly proportional to the area of the fan's diameter.

The air delivered per minute by the 3-ft. fan is nearly $12.5R$ cubic feet (R being the number of revolutions made by the fan per minute). For the 2-ft. fan the quantity is $5.7R$ cubic feet. For either of these or any other similar fans of which the area is A square feet, the delivery will be about $1.8AR$ cubic feet. Of course any change in the pitch of the blades might entirely change these figures.

The net H.P. taken up is not far from proportional to the square of the number of revolutions above 100 per minute. Thus for the 3-ft. fan the net H.P. is $\frac{(R-100)^2}{200,000}$, while for the 2-ft. fan the net H.P. is $\frac{(R-100)^2}{1,000,000}$.

The denominators of these two fractions are very nearly proportional inversely to the square of the fan areas or the fourth power of the fan diameters. The net H.P. required to drive a fan of diameter, D feet or area A square feet, at a speed of R revolutions per minute, will therefore be approximately $\frac{D^4(R-100)^2}{17,000,000}$ or $\frac{A^2(R-100)^2}{10,400,000}$.

The 2-ft. fan was noiseless at all speeds. The 3-ft. fan was also noiseless up to over 450 revolutions per minute.

	Propeller, 2 ft. diam.			Propeller, 3 ft. diam.		
	750	676	577	576	459	373
Speed of fan, revolutions per minute	750	676	577	576	459	373
Net H.P. to drive fan and belt	0.42	0.32	0.227	1.02	0.575	0.324
Cubic feet of air per minute	4,183	3,830	3,410	7,400	5,800	4,470
Mean velocity of air in 3-ft. flue, feet per minute	593	543	482	1,046	820	632
Mean velocity of air in flue, same diameter as fan	1,330	1,220	1,085			
Cu. ft. of air per min. per effective H.P.	9,980	11,970	15,000	7,250	10,070	13,800
Motion given to air per rev. of fan, ft.	1.77	1.81	1.88	1.82	1.79	1.70
Cubic feet of air per rev. of fan	5.58	5.66	5.90	12.8	12.6	12.0

Experiments made with a Blackman Disk Fan, 4 ft. diam. by Geo. A. Suter, to determine the volumes of air delivered under various conditions, and the power required; with calculations of efficiency and ratio of increase of power to increase of velocity, by G. H. Babcock. (*Trans. A. S. M. E.*, vii. 547):

Rev. per min.	Cu. ft. of Air delivered per min.	Horse-power, H.P.	Water-gauge, in., <i>h.</i>	Ratio of Increase of Speed.	Ratio of Increase of Delivery	Ratio of Increase of Power.	Exponent <i>x</i> , $H.P. \propto V^x$.	Exponent <i>y</i> , $h \propto V^y$.	Efficiency of Fan.
350	25,797	0.65							1.682
440	32,575	2.29		1.257	1.262	3.523	5.4		.9553
534	41,929	4.42		1.186	1.287	1.843	2.4		1.062
612	47,756	7.41		1.146	1.139	1.677	3.97		.9358
	For series			1.749	1.851	11.140	4.		
340	20,372	0.76							.7110
453	26,660	1.99		1.332	1.308	2.618	3.55		.6063
536	31,649	3.86		1.183	1.187	1.940	3.86		.5205
627	36,543	6.47		1.167	1.155	1.676	3.59		.4802
	For series			1.761	1.794	8.513	3.63		
340	9,983	1.12	0.28						.3939
430	13,017	3.17	0.47	1.265	1.304	2.837	3.93	1.95	.3046
534	17,018	6.07	0.75	1.242	1.307	1.915	2.25	1.74	.3319
570	18,649	8.46	0.87	1.068	1.096	1.394	3.63	1.60	.3027
	For series			1.676	1.704	7.554	3.24	1.81	
330	8,399	1.31	0.26						.2631
437	10,071	3.27	0.45	1.324	1.199	3.142	6.31	3.06	.2188
516	11,157	6.00	0.75	1.181	1.103	1.457	3.66	4.96	.2202
	For series			1.563	1.329	4.580	5.35	3.72	

Nature of the Experiments. — First Series: Drawing air through 30 ft. of 48-in. diam. pipe on inlet side of the fan.

Second Series: Forcing air through 30 ft. of 48-in. diam. pipe on outlet side of the fan.

Third Series: Drawing air through 30 ft. of 48-in. pipe on inlet side of the fan — the pipe being obstructed by a diaphragm of cheese-cloth.

Fourth Series: Forcing air through 30 ft. of 48-in. pipe on outlet side of fan — the pipe being obstructed by a diaphragm of cheese-cloth.

Mr. Babcock says concerning these experiments: The first four experiments are evidently the subject of some error, because the efficiency is such as to prove on an average that the fan was a source of power sufficient to overcome all losses and help drive the engine besides. The second series is less questionable, but still the efficiency in the first two experiments is larger than might be expected. In the third and fourth series the resistance of the cheese-cloth in the pipe reduces the efficiency largely, as would be expected. In this case the value has been calculated from

WARNING: This is a 1910 edition. Some of the material may no longer be accurate

the height equivalent to the water-pressure, rather than the actual velocity of the air.

This record of experiments made with the disk fan shows that this kind of fan is not adapted for use where there is any material resistance to the flow of the air. In the centrifugal fan the power used is nearly proportioned to the amount of air moved under a given head, while in this fan the power required for the same number of revolutions of the fan increases very materially with the resistance, notwithstanding the quantity of air moved is at the same time considerably reduced. In fact from the inspection of the third and fourth series of tests, it would appear that the power required is very nearly the same for a given pressure, whether more or less air be in motion. It would seem that the main advantage, if any, of the disk fan over the centrifugal fan for slight resistances consists in the fact that the delivery is the full area of the disk, while with centrifugal fans intended to move the same quantity of air the opening is much smaller.

It will be seen by columns 8 and 9 of the table that the power used increased much more rapidly than the cube of the velocity, as in centrifugal fans. The different experiments do not agree with each other, but a general average may be assumed as about the cube root of the eleventh power.

Capacity of Disk Fans. (C. L. Hubbard, *The Metal Worker*, Sept. 5, 1908.) — The rated capacities given in catalogues are for fans revolving in free air — that is, mounted in an opening without being connected with ducts or subject to other frictional resistance.

The following data, based upon tests, apply to fans working against a resistance equivalent to that of a shallow heater of open pattern, and connecting with ducts of medium length through which the air flows at a velocity not greater than 600 or 800 ft. per minute. Under these conditions a good type of fan will propel the air in a direction parallel to the shaft, a distance equal to about 0.7 of its diameter at each revolution. From this we have the equation $Q = 0.7 D \times R \times A$, in which Q = cu. ft. of air discharged per minute; D = diam. of fan, in ft.; R = revs. per min.; A = area of fan, in sq. ft. The following table is calculated on this basis.

Diam. of fan, in.	18	24	30	36	42	48	54	60	72	84	96
Cu. ft per rev.	1.85	4.40	8.59	14.8	23.6	35.2	50.1	68.7	118.7	188.6	281.5
Revolutions per min. for velocity of air through fan = 1000 ft. per min.	952	714	571	476	408	357	317	286	238	204	179

The velocity of the air through the fan is proportional to the number of revolutions. For the conditions stated the H.P. required per 1000 cu. ft. of air moved will be about 0.16 when the velocity through the fan is 1000 ft. per min., 0.14 for a velocity of 800 ft., and 0.18 for 1200 ft. For a fan moving in free air the required speed for moving a given volume of air will be about 0.6 of the number of revolutions given above and the H.P. about 0.3 of that required when moving against the resistance stated.

POSITIVE ROTARY BLOWERS.

Rotary Blowers, Centrifugal Fans, and Piston Blowers. (Catalogue of the Connersville Blower Co.) — In ordinary work the advantage of a positive blower over a fan begins at about 8 oz. pressure, and the efficiency of the positive blower increases from 8 oz. as the pressure goes up to a point where the ordinary centrifugal fan fails entirely. The highest efficiency of rotary blowers is when they are working against pressures ranging between 1 and 8 lbs.

Fans, when run at constant speed, cannot be made to handle a constant volume of fluid when the pressure is variable; and they cannot give a high efficiency except for low and uniform pressures.

When a fan blower is used to furnish blast for a cupola it is driven at a constant speed, and the amount of air discharged by it varies according to the resistance met with in the cupola. With a positive blower running at a constant speed, however, there is a constant volume of air forced into the cupola, regardless of changing resistance.

A rotary blower of the two-impeller type is not an economical compressor, because the impellers are working against the full pressure at all times, while in an ideal blowing engine the theoretical mean effective pressure on the piston, when discharging air at 15 lbs. pressure, is 11 1/2 lbs. For high pressures, on account of the increase of leakage and the increase of power required because it does not compress gradually, the rotary blower must give way to the piston type of machine. Commercially, the line is crossed at about 8 lbs. pressure.

1. A fan is the cheapest in first cost, and if properly applied may be used economically for pressures up to 8 oz.

2. A rotary blower costs more than a fan, but much less than a blowing engine; is more economical than either between 8 oz. and 8 lbs. pressure, and can be arranged to give a constant pressure or a constant volume.

3. Piston machines cost much more than rotary blowers, but should be used for continuous duty for pressures above 8 lbs., and may be economical if they are properly constructed and not run at too high a piston speed.

The horse-power required to operate rotary blowers is proportional to the volume and pressure of air discharged. In making estimates for power it is safe to assume that for each 1000 cu. ft. of free air discharged, at one pound pressure, 5 H.P. should be provided.

Test of a Rotary Blower. (Connorsville Blower Co.) — The test was made in 1904 on two 39 × 84 in. blowers coupled direct to two 12 and 24 × 36 in. compound Corliss engines. The results given below are for the combined units.

Air pressure, lbs.	0	0.05	0.5	1.0	1.5	2.	2.5	3.	3.5
Engine, I.H.P.	19.30	23.76	52.83	100.91	132.67	176.11	223.20	256.87	287.56
Displacement, cu. ft.	19,212	18,727	18,508	18,344	18,200	18,028	17,966	17,863	
Efficiency			68.5	79	84	85.6	86	86	85.9

In calculating the efficiency the theoretical horse-power was taken as the power required to compress adiabatically and to discharge the net amount of air at the different pressures and at the same altitude. The test was made up to 3.5 lbs. only. Estimated efficiencies for higher pressures from an extension of the plotted curve are: 6 lbs. 84%, 8 lbs. 82%, 10 lbs. 79.5%. The theoretical discharge of the blower was 19,250 cu. ft.

CAPACITY OF ROTARY BLOWERS FOR CUPOLAS.

Cu. ft. per rev.	Revs. per min.	Tons per hour.	Suitable for cupola in. diam.*	Cu. ft. per rev.	Revs. per min.	Tons per hour.	Suitable for cupola in. diam.
1.5	200	1	18 to 20	45	135	12	54 to 66
	400	2			165	15	
3.3	175	1	24 to 27	57	130	15	60 to 72
	335	2			155	18	
6	185	2	28 to 32	65	185	21	66 to 84
	275	3			140	18	
10	200	4	32 to 38	84	160	21	72 to 90
	250	5			185	24	
13	150	4	32 to 40	100	125	21	84 to 96
	190	5			145	24	
	175	6 1/2	36 to 45	118	160	27	Two cupolas 60 to 66
	150	5			120	24	
17	205	6 1/2	42 to 54	118	135	27	Two cupolas 60 to 66
	250	8 1/2			160	30	
24	166	8	48 to 60	118	115	27	Two cupolas 60 to 66
	200	10			130	30	
33	150	10	48 to 60	118	140	33	Two cupolas 60 to 66
	180	12					
	210	14					

* Inside diam. The capacity in tons per hour is based on 30,000 cu. ft. of air per ton of iron melted.

WARNING: This is a 1910 edition. Some of the material may no longer be accurate

For smith fires: an ordinary fire requires about 60 cu. ft. per min.
For oil furnaces: an ordinary furnace burns about 2 gallons of oil per hour and 1800 cu. ft. of air should be provided for each gallon of oil. For each 100 cu. ft. of air discharged per minute at 16 oz. pressure, 1/2 H.P. should be provided.

Sizes of small blowers.	173	288	576 cu. in. per rev.
Revs. per min.	800 to 1500	500 to 900	300 to 600
Diam. of outlet, in.	2 1/2	2 1/2	3

ROTARY GAS EXHAUSTERS.

Cu. ft. per rev.	2/3	1 1/2	3 3	6	10	13	17	24	33
Rev. per min.	200	180	170	160	150	150	140	130	120
Diam. of pipe opening.	4	6	8	10	12	12	16	16	20
Cu. ft. per rev.	45	57	65	84	100	118	155	200	300
Rev. per min.	110	100	95	90	85	82	80	80	75
Diam. pipe opening	20	24	24	30	30	30	36	36	42

There is no gradual compressing of air in a rotary machine, and the unbalanced areas of the impellers are working against the full difference of pressure at all times. The possible efficiency of such a machine under ordinary temperature and conditions of atmosphere, assuming no mechanical friction, leakage, nor radiation of heat of compression, would be as follows:

Gauge pres. lb.	1	2	3	4	5	10	15
Efficiency %	97.5	95.5	93.3	91.7	90	82.7	76.7

The proper application of rotary positive machines when operating in air or gas under differences of pressures from 8 oz. to 5 lbs. is where constant quantities of fluid are required to be delivered against a variable resistance, or where a constant pressure is required and the volume is variable. These are the requirements of gas works, pneumatic-tube transmission (both the vacuum and pressure systems), foundry cupolas, smelting furnaces, knobbling fires, sand blast, burning of fuel oil, conveying granular substances, the operation of many kinds of metallurgical furnaces, etc. — J. T. Wilkin, *Trans. A. S. M. E.*, Vol. xxiv.

STEAM-JET BLOWER AND EXHAUSTER.

A blower and exhauster is made by L. Schutte & Co., Philadelphia, on the principle of the steam-jet ejector. The following is a table of capacities:

Size No.	Quantity of Air per hr. in cubic feet.	Diameter of Pipes in inches.		Size No.	Quantity of Air per hr. in cubic feet.	Diameter of Pipes in inches.	
		Steam.	Air.			Steam.	Air.
000	1,000	1/2	1	5	30,000	2 1/2	5
00	2,000	3/4	1 1/2	6	36,000	2 1/2	6
0	4,000	1	2	7	42,000	3	6
1	6,000	1 1/4	2 1/2	8	48,000	3	7
2	12,000	1 1/2	3	9	54,000	3 1/2	7
3	18,000	2	3 1/2	10	60,000	3 1/2	8
4	24,000	2	4				

The admissible vacuum and counter-pressure, for which the apparatus is constructed, is up to a rarefaction of 20 inches of mercury, and a counter-pressure up to one-sixth of the steam-pressure.

The table of capacities is based on a steam-pressure of about 60 lbs., and a counter-pressure of about 8 lbs. With an increase of steam-pressure or decrease of counter-pressure the capacity will largely increase.

Another steam-jet blower is used for boiler-firing, ventilation, and similar purposes where a low counter-pressure or rarefaction meets the requirements.

The volumes as given in the following table of capacities are under the supposition of a steam-pressure of 45 lbs. and a counter-pressure of, say, 2 inches of water:

Size No.	Cubic feet of Air delivered per hour.	Diam. of Steam-pipe in inches.	Diam. in inches of—		Size No.	Cubic feet of Air delivered per hour.	Diam. of Steam-pipe in inches.	Diam. in inches of—	
			Inlet.	Disch.				Inlet.	Disch.
00	6,000	3/8	4	3	4	250,000	1	17	14
0	12,000	1/2	5	4	6	500,000	1 1/4	24	20
1	30,000	1/2	8	6	8	1,000,000	1 1/2	32	27
2	60,000	3/4	11	8	10	2,000,000	2	42	36
3	125,000	1	14	10					

The Steam-jet as a Means for Ventilation. — Between 1810 and 1850 the steam-jet was employed to a considerable extent for ventilating English collieries, and in 1852 a committee of the House of Commons reported that it was the most powerful and at the same time the cheapest method for the ventilation of mines: but experiments made shortly afterwards proved that this opinion was erroneous, and that furnace ventilation was less than half as expensive, and in consequence the jet was soon abandoned as a permanent method of ventilation.

For an account of these experiments see *Colliery Engineer*, Feb., 1890. The jet, however, is sometimes advantageously used as a substitute, for instance, in the case of a fan standing for repairs, or after an explosion, when the furnace may not be kept going, or in the case of the fan having been rendered useless.

BLOWING-ENGINES.

Corliss Horizontal Cross-compound Condensing Blowing-engines.
(Philadelphia Engineering Works.)

Indicated Horse-power.		Revs. per min.	Cu. ft. Free Air per min.	Blast-pr. sure per sq. in., lbs.	H. P. Cyl-inder, in.	L. P. Cyl-inder, in.	Blast Cyl-inder, in.	Stroke of All, in.	Approx. Shipping Weight.	Approx. Shipping Weight of Vert. Eng.	
15 Exp. 125 lbs. Steam.	13 Exp. 100 lbs. Steam.										
1,050 1,596	1,572	40	30,400	15	44	78	(2) 84	60	505,000	605,000	
	2,280	60	45,600								
	1,290	40	30,400	12	42	72	(2) 84	60	475,000	550,000	
	2,060	60	45,600								
		40	30,400	10	32	60	(2) 84	60	355,000	436,000	
		60	45,600								
		1,340	40	26,800	15	40	72	(2) 78	60	445,000	545,000
		1,980	60	39,600							
		1,152	40	26,800	12	38	70	(2) 78	60	425,000	491,000
		1,702	60	39,600							
		938	40	26,800	10	36	66	(2) 78	60	415,000	450,000
		1,386	60	39,600							
	789	40	15,680	15	34	60	(2) 72	60	340,000	430,000	
	1,175	60	23,500								
	548	40	15,680	10	28	50	(2) 72	60	270,000	300,000	
	82	60	23,500								

Vertical engines are built of the same dimensions as above, except that the stroke is 48 in. instead of 60, and they are run at a higher number of revolutions to give the same piston-speed and the same I.H.P.

WARNING: This is a 1910 edition. Some of the material may no longer be accurate

The calculations of power, capacity, etc., of blowing-engines are the same as those for air-compressors. They are built without any provision for cooling the air during compression. About 400 feet per minute is the usual piston-speed for recent forms of engines, but with positive air-valves, which have been introduced to some extent, this speed may be increased. The efficiency of the engine, that is, the ratio of the I.H.P. of the air-cylinder to that of the steam-cylinder, is usually taken at 90 per cent, the losses by friction, leakage, etc., being taken at 10 per cent.

HEATING AND VENTILATION.

Ventilation. (A. R. Wolff, *Stevens Indicator*, April, 1890.) — The popular impression that the impure air falls to the bottom of a crowded room is erroneous. There is a constant mingling of the fresh air admitted with the impure air due to the law of diffusion of gases, to difference of temperature, etc. The process of ventilation is one of dilution of the impure air by the fresh, and a room is properly ventilated in the opinion of the hygienists when the dilution is such that the carbonic acid in the air does not exceed from 6 to 8 parts by volume in 10,000. Pure country air contains about 4 parts CO₂ in 10,000, and badly-ventilated quarters as high as 80 parts.

An ordinary man exhales 0.6 of a cubic foot of CO₂ per hour. New York gas gives out 0.75 of a cubic feet of CO₂ for each cubic foot of gas burnt. An ordinary lamp gives out 1 cu. ft. of CO₂ per hour. An ordinary candle gives out 0.3 cu. ft. per hour. One ordinary gaslight equals in vitiating effect about 5 1/2 men, an ordinary lamp 12/3 men, and an ordinary candle 1/2 man.

To determine the quantity of air to be supplied to the inmates of an un-lighted room, to dilute the air to a desired standard of purity, we can establish equations as follows:

- Let v = cubic feet of fresh air to be supplied per hour;
- r = cubic feet of CO₂ in each 10,000 cu. ft. of the entering air;
- R = cubic feet of CO₂ which each 10,000 cu. ft. of the air in the room may contain for proper health conditions;
- n = number of persons in the room;
- 0.6 = cubic feet of CO₂ exhaled by one man per hour.

Then $\frac{v \times r}{10,000} + 0.6 n$ equals cubic feet of CO₂ communicated to the room during one hour.

This value divided by v and multiplied by 10,000 gives the proportion of CO₂ in 10,000 parts of the air in the room, and this should equal R , the standard of purity desired. Therefore

$$R = \frac{10,000 \left[\frac{v \times r}{10,000} + 0.6 n \right]}{v}, \text{ or } v = \frac{6000 n}{R - r}$$

If we place r at 4 and R at 6, $v = 6000 n \div (6 - 4) = 3000 n$, or the quantity of air to be supplied per person is 3000 cubic feet per hour.

If the original air in the room is of the purity of external air, and the cubic contents of the room is equal to 100 cu. ft. per inmate, only 3000 - 100 = 2900 cu. ft. of fresh air from without will have to be supplied the first hour to keep the air within the standard purity of 6 parts of CO₂ in 10,000. If the cubic contents of the room equals 200 cu. ft. per inmate, only 3000 - 200 = 2800 cu. ft. will have to be supplied the first hour to keep the air within the standard purity, and so on.

Again, if we only desire to maintain a standard of purity of 8 parts of carbonic acid in 10,000, the equation gives as the required air-supply per hour

$$v = \frac{6000}{8 - 4} n = 1500 n, \text{ or } 1500 \text{ cu. ft. of fresh air per inmate per hour.}$$

Cubic feet of air containing 4 parts of carbonic acid in 10,000 necessary per person per hour to keep the air in room at the composition of

6	7	8	9	10	15	20	parts of CO ₂ in 10,000.
3000	2000	1500	1200	1000	545	375	cubic feet.

If the original air in the room is of purity of external atmosphere (4 parts of carbonic acid in 10,000), the amount of air to be supplied the first hour, for given cubic spaces per inmate, to have given standards of purity not exceeded at the end of the hour, is obtained from the following table:

Cubic Feet of Space in Room per Individual.	Proportion of Carbonic Acid in 10,000 Parts of the Air, not to be Exceeded at End of Hour.						
	6	7	8	9	10	15	20
	Cubic Feet of Air, of Composition 4 Parts of Carbonic Acid in 10,000, to be Supplied the First Hour.						
100	2900	1900	1400	1100	900	445	275
200	2800	1800	1300	1000	800	345	175
300	2700	1700	1200	900	700	245	75
400	2600	1600	1100	800	600	145	None
500	2500	1500	1000	700	500	45	None
600	2400	1400	900	600	400	None	None
700	2300	1300	800	500	300	None	None
800	2200	1200	700	400	200	None	None
900	2100	1100	600	300	100	None	None
1000	2000	1000	500	200	None	None	None
1500	1500	500	None	None	None	None	None
2000	1000	None	None	None	None	None	None
2500	500	None	None	None	None	None	None

It is exceptional that systematic ventilation supplies the 3000 cubic feet per inmate per hour, which adequate health considerations demand. For large auditoriums in which the cubic space per individual is great, and in which the atmosphere is thoroughly fresh before the rooms are occupied, and the occupancy is of two or three hours' duration, the systematic air-supply may be reduced, and 2000 to 2500 cubic feet per inmate per hour is a satisfactory allowance.

In hospitals where, on account of unhealthy excretions of various kinds, the air-dilution must be largest, an air-supply of from 4000 to 6000 cubic feet per inmate per hour should be provided, and this is actually secured in some hospitals. A report dated March 15, 1882, by a commission appointed to examine the public schools of the District of Columbia, says:

"In each class-room not less than 15 square feet of floor-space should be allotted to each pupil. In each class-room the window-space should not be less than one-fourth the floor-space, and the distance of desk most remote from the window should not be more than one and a half times the height of the top of the window from the floor. The height of the class-room should never exceed 14 feet. The provisions for ventilation should be such as to provide for each person in a class-room not less than 30 cubic feet of fresh air per minute (1800 per hour), which amount must be introduced and thoroughly distributed without creating unpleasant draughts, or causing any two parts of the room to differ in temperature more than 2° Fahr., or the maximum temperature to exceed 70° Fahr." [The provision of 30 cu. ft. per minute for each person in a class-room is now (1909) required by law in several states.]

When the air enters at or near the floor, it is desirable that the velocity of inlet should not exceed 2 feet per second, which means larger sizes of register openings and flues than are usually obtainable, and much higher velocities of inlet than two feet per second are the rule in practice. The velocity of current into vent-flues can safely be as high as 6 or even 10 feet per second, without being disagreeably perceptible.

The entrance of fresh air into a room is coincident with, or dependent on, the removal of an equal amount of air from the room. The ordinary means of removal is the vertical vent-duct, rising to the top of the build-

ing. Sometimes reliance for the production of the current in this vent-duct is placed solely on the difference of temperature of the air in the room and that of the external atmosphere; sometimes a steam coil is placed within the flue near its bottom to heat the air within the duct; sometimes steam pipes (risers and returns) run up the duct performing the same functions; or steam jets within the flue, or exhaust fans, driven by steam or electric power, act directly as exhausters; sometimes the heating of the air in the flue is accomplished by gas-jets.

The draft of such a duct is caused by the difference of weight of the heated air in the duct, and of a column of equal height and cross-sectional area of the external air.

Let d = density, or weight in pounds, of a cubic foot of the external air.
Let d_1 = density, or weight in pounds, of a cubic foot of the heated air within the duct.

Let h = vertical height, in feet, of the vent-duct.
 $h(d - d_1)$ = the pressure, in pounds per square foot, with which the air is forced into and out of the vent-duct.

This pressure expressed in height of a column of air of density within the vent-duct is $h(d - d_1) \div d$.

Or, if t = absolute temperature of external air, and t_1 = absolute temperature of the air in the vent-duct, then the pressure = $h(t_1 - t) \div t$.

The theoretical velocity, in feet per second, with which the air would travel through the vent-duct under this pressure is

$$v = \sqrt{\frac{2gh(t_1 - t)}{t}} = 8.02 \sqrt{\frac{h(t_1 - t)}{t}}$$

The actual velocity will be considerably less than this, on account of loss due to friction. This friction will vary with the form and cross-sectional area of the vent-duct and its connections, and with the degree of smoothness of its interior surface. On this account, as well as to prevent leakage of air through crevices in the wall, tin lining of vent-flues is desirable.

The loss by friction may be estimated at approximately 50%, and the actual velocity of the air as it flows through the vent-duct is

$$v = \frac{1}{2} \sqrt{2gh \frac{(t_1 - t)}{t}}, \text{ or, approximately, } v = 4 \sqrt{h \frac{(t_1 - t)}{t}}$$

If V = velocity of air in vent-duct, in feet per minute, and the external air be at 32° Fahr., since the absolute temperature on Fahrenheit scale equals thermometric temperature plus 459.4,

$$V = 240 \sqrt{h \frac{(t_1 - t)}{491.4}}$$

from which has been computed the following table:

Quantity of Air, in Cubic Feet, Discharged per Minute through a Ventilating Duct, of which the Cross-sectional Area is One Square Foot (the External Temperature of Air being 32° Fahr.).

Height of Vent-duct in feet.	Excess of Temperature of Air in Vent-duct above that of External Air.								
	5°	10°	15°	20°	25°	30°	50°	100°	150°
10	77	108	133	153	171	188	242	342	419
15	94	133	162	188	210	230	297	419	514
20	108	153	188	217	242	265	342	484	593
25	121	171	210	242	271	297	383	541	663
30	133	188	230	265	297	325	419	593	726
35	143	203	248	286	320	351	453	640	784
40	153	217	265	306	342	375	484	683	838
45	162	230	282	325	363	398	514	723	889
50	171	242	297	342	383	419	541	760	937

Multiplying the figures in preceding table by 60 gives the cubic feet of air discharged per hour per square foot of cross-section of vent-duct. Knowing the cross-sectional area of vent-ducts we can find the total discharge; or for a desired air-removal, we can proportion the cross-sectional area of vent-ducts required.

Heating and Ventilating of Large Buildings. (A. R. Wolff, *Jour. Frank. Inst.*, 1893.) — The transmission of heat from the interior to the exterior of a room or building, through the walls, ceilings, windows, etc., is calculated as follows:

- S = amount of transmitting surface in square feet;
- t = temperature F. inside. t_0 = temperature outside;
- K = a coefficient representing, for various materials composing buildings, the loss by transmission per square foot of surface in British thermal units per hour, for each degree of difference of temperature on the two sides of the material;
- Q = total heat transmission = SK (t - t_0).

This quantity of heat is also the amount that must be conveyed to the room in order to make good the loss by transmission, but it does not cover the additional heat to be conveyed on account of the change of air for purposes of ventilation. (See Wolff's coefficients below, page 659.)

These coefficients are to be increased respectively as follows: 10% when the exposure is a northerly one, and winds are to be counted on as important factors; 10% when the building is heated during the daytime only, and the location of the building is not an exposed one; 30% when the building is heated during the daytime only, and the location of the building is exposed; 50% when the building is heated during the winter months intermittently, with long intervals (say days or weeks) of non-heating.

The value of the radiating-surface is about as follows: Ordinary bronzed cast-iron radiating-surfaces, in American radiators (of Bundy or similar type), located in rooms, give out about 250 heat-units per hour for each square foot of surface, with ordinary steam-pressure, say 3 to 5 lbs, per sq. in., and about 0.6 this amount with ordinary hot-water heating.

Non-painted radiating-surfaces, of the ordinary "indirect" type (Climax or pin surfaces), give out about 400 heat-units per hour for each square foot of heating-surface, with ordinary steam-pressure, say 3 to 5 lbs. per sq. in.; and about 0.6 this amount with ordinary hot-water heating.

A person gives out about 400 heat-units per hour; an ordinary gas-burner, about 4800 heat-units per hour; an incandescent electric (16 candle-power) light, about 1600 heat-units per hour.

The following example is given by Mr. Wolff to show the application of the formula and coefficients:

Lecture-room 40 x 60 ft., 20 ft. high, 48,000 cubic feet, to be heated to 69° F.; exposures as follows: North wall, 60 x 20 ft., with four windows, each 14 x 8 feet, outside temperature 0° F. Room beyond west wall and room overhead heated to 69°, except a double skylight in ceiling, 14 x 24 ft., exposed to the outside temperature of 0°. Store-room beyond east wall at 36°. Door 6 x 12 ft. in wall. Corridor beyond south wall heated to 59°. Two doors, 6 x 12, in wall. Cellar below, temperature 36°.

If we assume that the lecture-room must be heated to 69° F. in the daytime when unoccupied, so as to be at this temperature when first persons arrive, there will be required, ventilation not being considered, and bronzed direct low-pressure steam-radiators being the heating media, about 113,550 ÷ 250 = 455 sq. ft. of radiating-surface.

If we assume that there are 160 persons in the lecture-room, and we provide 2500 cubic feet of fresh air per person per hour, we will supply 160 x 2500 = 400,000 cubic feet of air per hour (i.e., over eight changes of contents of room per hour).

To heat this air from 0° F. to 69° F. will require 400,000 x 0.01785 x 69 = 492,660 thermal units per hour (0.01785 being the product of the weight of a cubic foot, 0.075, by the specific heat of air, 0.238). Accordingly there must be provided 492,660 ÷ 400 = 1232 sq. ft. of indirect

surface, to heat the air required for ventilation, in zero weather. If the room were to be warmed entirely indirectly, that is, by the air supplied to room (including the heat to be conveyed to cover loss by transmission through walls, etc.), there would have to be conveyed to the fresh-air supply 492,660 + 118,443 = 611,103 heat-units. This would imply the provision of an amount of indirect heating-surface of the "Climax" type of 611,103 ÷ 400 = 1527 sq. ft., and the fresh air entering the room would have to be at a temperature of about 86° F., viz.,

$$69^\circ + \frac{118,413}{400,000 \times 0.01785}, \text{ or } 69 + 17 = 86^\circ \text{ F.}$$

The above calculations do not, however, take into account that 160 persons in the lecture-room give out 160 x 400 = 64,000 thermal units per hour; and that, say, 50 electric lights give out 50 x 1600 = 80,000 thermal units per hour; or, say, 50 gaslights, 50 x 4800 = 240,000 thermal units per hour. The presence of 160 people and the gaslighting would diminish considerably the amount of heat required. Practically, it appears that the heat generated by the presence of 160 people, 64,000 heat-units, and by 50 electric lights, 80,000 heat-units, a total of 144,000 heat-units, more than covers the amount of heat transmitted through walls, etc. Moreover, that if the 50 gaslights give out 240,000 thermal units per hour, the air supplied for ventilation must enter considerably below 69° Fahr., or the room will be heated to an unbearably high temperature. If 400,000 cubic feet of fresh air per hour are supplied, and 240,000 thermal units per hour generated by the gas must be abstracted, it means

that the air must, under these conditions, enter $\frac{240,000}{400,000 \times 0.01785} =$ about 34° less than 86°, or at about 52° Fahr. Furthermore, the additional vitiation due to gaslighting would necessitate a much larger supply of fresh air than when the vitiation of the atmosphere by the people alone is considered, one gaslight vitiating the air as much as five men.

The following table shows the calculation of heat transmission (some figures changed from the original):

t - t ₀ (Fahr. degrees)	Kind of Transmitting Surface.	Thickness of Wall in inches.	Calculation of Area of Transmitting Surface.	Square feet of Surface.	K (t - t ₀).	Thermal Units.
69°	Outside wall.....	36"	63 x 22 - 448	938	10	9,380
69°	Four windows (single).....		4 x 8 x 14	448	83	37,186
33°	Inside wall (store-room).....	36"	42 x 22 - 72	852	4	3,408
33°	Door.....		6 x 12	72	19	1,368
10°	Inside wall (corridor).....	24"	45 x 22 - 72	918	2	1,836
10°	Door.....		6 x 12	72	5	360
10°	Inside wall (corridor).....	36"	17 x 22 - 72	302	1	302
10°	Door.....		6 x 12	72	5	360
69°	Roof.....		32 x 42 - 336	1,008	10	10,080
69°	Double skylight.....		14 x 24	336	35	11,760
33°	Floor.....		62 x 42	2,604	4	10,416
						86,454
	Supplementary allowance, north outside wall, 10%.....					938
	Supplementary allowance, north outside windows, 10%.....					3,718
						91,110
	Exposed location and intermittent day or night use, 30%.....					27,333
						118,443
	Total thermal units.....					118,443

STANDARD VALUES FOR USE IN CALCULATION OF HEATING AND VENTILATING PROBLEMS.

Heating Value of Coal.

	Volatil Matter in the Combustible, per cent.	Heating Value per lb. Combustible, B.T.U.	Average.	Moisture, in Air-dried Coal, per cent.	Ash in Air-dried Coal, per cent.
Anthracite.....	3 to 7.5	14,700 to 14,900	14,800	0.5 to 1.0	10. to 18.
Semi-anthracite.	7.5 to 12.5	14,900 to 15,500	15,200	0.5 to 1.0	10. to 18.
Semi-bituminous	12.5 to 25	15,500 to 16,000	15,750	0.5 to 1.0	5. to 10.
Bit. eastern.....	25 to 40	14,800 to 15,000	15,150	1. to 4.	5. to 15.
Bit. western.....	35 to 50	13,500 to 14,800	14,150	4. to 14.	10. to 25.
Lignite.....	Over 50	11,000 to 13,500	12,250	10. to 18.	5. to 25.

Average Heating Value of Air-Dried Coal.—Anthracite, 12,600; semi-anthracite, 12,950; semi-bituminous, 14,450; bituminous eastern, 13,250; bituminous western, 10,400; lignite, 9,700.

Eastern bituminous coal is that of the Appalachian coal field extending from Pennsylvania and Ohio to Alabama. Western bituminous coal is that of the great coal fields west of Ohio.

Steam Boiler Efficiency.—The maximum efficiency obtainable with anthracite in low-pressure steam boilers, water heaters or hot-air furnaces is about 80 per cent, when the thickness of the coal bed and the draft are such as to cause enough air to be supplied to effect complete combustion of the carbon to CO₂. With coals high in volatile matter the maximum efficiency is probably not over 70 per cent. Very much lower efficiencies than these figures are obtained when the air supply is either deficient or greatly in excess, or when the furnace is not adapted to burn the volatile matter in the coal. D. T. Randall, in tests made in 1908 for the U. S. Geological Survey, with house-heating boilers, obtained efficiencies ranging from 0.62 with coke, 0.61 with anthracite, and 0.58 with semi-bituminous, down to 0.39 with Illinois coal.

Available Heating Value of the Coal. — Using the figures given above as the average heating value of coal stored in a dry cellar, we have the following as the probable maximum values in British Thermal Units, of the heat available for furnishing steam or heating water or air, for the several efficiencies stated:

	Anthracite.	Semi-An.	Semi-Bit.	Bit. East.	Bit. West.	Lignite.
Eff'y.....	0.80	0.77	0.75	0.70	0.65	0.60
B.T.U. 10,080		9,933	10,837	9,275	6,760	5,820

For average values in practice, about 10 per cent may be deducted from these figures. (It is possible that an efficiency higher than 80% may be obtained with anthracite in some forms of air-heating furnaces in which the escaping chimney gases are cooled, by contact with the cold air inlet pipes, to comparatively low temperatures.)

The value 10,000 B.T.U. is usually taken as the figure to be used in calculation for design of heating and ventilating apparatus. For coals with lower available heating values proper reductions must be made.

Heat Transmission through Walls, Windows, etc., in B.T.U. per sq. ft. per Hour per Degree of Difference of Temperature.

BRICK WALLS.

Thick-ness, In.	Wolff.	Hauss.	Average, B.T.U.*	Thickness, In.	Wolff.	Hauss.	Average, B.T.U.*
4	0.66		0.537	25		0.18	0.188
4 3/4		0.48	0.508	28	0.18		0.172
8	0.45		0.397	30		0.16	0.163
10		0.34	0.351	32	0.16		0.154
12	0.33		0.313	35		0.13	0.143
15		0.26	0.272	36	0.145		0.140
16	0.27		0.260	40	0.13		0.128
20	0.23	0.22	0.222	45		0.11	0.116
24	0.20		0.194				

* The average figure for brick walls was obtained by plotting the reciprocals of Wolff's and Hauss's figures and drawing a straight line between them, representing the average heat resistances, and then taking the reciprocals of the resistances for different thicknesses. The resistance corresponds to the straight line formula $R = 0.12 + 0.165 t$, where t = thickness in inches. (Hauss's figures are from a paper by Chas. F. Hauss, of Antwerp, Belgium, in *Trans. A. S. H. V. E.*, 1904.)

SOLID SANDSTONE WALLS. (HAUSS.)

Thickness, in.	12	16	20	24	28	32	36	40	44	48
B.T.U.	0.45	0.39	0.35	0.32	0.29	0.26	0.24	0.22	0.20	0.19

For limestone walls, add 10 per cent.

	Wolff, B.T.U.	Hauss, B.T.U.		Wolff, B.T.U.	Hauss, B.T.U.
GLASS SURFACES.			FLOORS.		
Vault light.....	1.42		Joists with double floor.....	0.10	0.07
Single window.....	1.20	1.00	Concrete floor.....	0.31	
Double window.....	0.56	0.46	Fireproof construction, planked over.....	0.124	
Single skylight.....	1.03	1.06	Wooden beam construction, planked over.....	0.083	
Double skylight.....	0.50	0.48	Concrete floor on brick arch.....		0.22
DOORS.			Stone floor on arches.....		0.20
Door.....		0.40	Planks laid on earth.....		0.16
1-in. pine.....	0.40		Planks laid on asphalt.....		0.20
2-in. pine.....	0.28		Arch with air space.....		0.09
PARTITIONS.			Stones laid on earth.....		0.08
Solid plaster, 1 3/4 to 2 1/4 in.....		0.60	CEILING.		
2 1/2 to 3 1/4 in.....		0.48	Joists with single floor.....		0.10
Fireproof.....	0.30		Arches with air space.....		0.14
2-in. pine board.....	0.28				

Allowances for Exposures. — Wolf adds 25% for north and west exposures, 15% for east, and 5% for south exposures, also 10% additional for reheating, and 10% to the transmission through floor and ceilings. The allowance for reheating Mr. Wolff explains as follows in a letter to the author, Mar. 10, 1905. The allowance is made on the basis that the apparatus will not be run continuously; in other words, that it will not be run at all, or only lightly, overnight. The rooms will cool off below the required temperature of 70°, and to be able to heat up quickly in the morning an allowance of 10% is made to the transmission figures to meet this condition. Hauss makes allowances as follows: 5% for rooms with unusual exposure; 10% where exposures are north, east, northeast, northwest and west; $2\frac{1}{3}\%$ where the height of ceiling is more than 13 ft.; $6\frac{2}{3}\%$ where it is more than 15 ft.; 10% where it is more than 18 ft. For rooms heated daily, but where heating is interrupted at night, add

$$A = 0.0025 [(N - 1) W_1] \div Z.$$

For rooms not heated daily, add $B = [0.1 W (8 - Z)] \div Z$. In these formulas $W_1 =$ B.T.U. transmitted per hour by exposed surfaces; $W =$ total B.T.U. necessary, including that for ventilation or changes of air; $N =$ time from cessation of heating to time of starting fire again, hours; $Z =$ time necessary after fire is started until required room temperature is reached, hours.

Allowance for Exposure and for Leakage. — In calculations of the quantity of heat required by ordinary residences, the formula total heat

$$= (T_1 - T_0) \left(\frac{W}{4} + G + \frac{nC}{56} \right) \text{ is commonly used. } T_1 = \text{temp. of room,}$$

$T_0 =$ outside temp., $W =$ exposed wall surface less window surface, $G =$ glass surface, $C =$ cubic contents of room, $n =$ number of changes of air per hour. The factor n is usually assumed arbitrarily or guessed at: some writers take its value at 1, others 1 for the rooms, 2 for the halls, etc.; others object to the use of C as a factor, saying that the allowance for exposure and leakage should be made proportional to the exposed wall and glass surface since it is on these surfaces that the leakage occurs, and omitting the term $nC/56$ they multiply the remainder of the expression by a factor for exposure, $c = 1.1$ to 1.3 , depending on the direction of the exposure. To show what different results may be obtained by the use of the two methods, the following table is calculated, applying both to six rooms of widely differing sizes. Two sides of each room, north and east, are exposed. $T_1 = 70^\circ$; $T_0 = 0^\circ$; $G = \frac{1}{5} (W + G)$.

Room.	Size, ft.	C = cu. ft.	Total Wall, (W + G) sq. ft.	Glass, G.	Ratio, (C + W + G).	H = 70(W/4 + G).	70 C/56.	0.2 H.	0.3 H.
A	10 × 10 × 10	1,000	20 × 10 = 200	40	5	5,600	1,250	1,120	1,680
B	10 × 20 × 10	2,000	30 × 10 = 300	60	6 $\frac{2}{3}$	8,400	2,500	1,680	2,520
C	20 × 20 × 12	4,800	40 × 12 = 480	96	10	13,440	6,000	2,688	4,032
D	20 × 40 × 14	11,200	60 × 14 = 840	168	17 $\frac{1}{3}$	23,520	14,000	4,704	7,056
E	40 × 40 × 15	24,000	80 × 15 = 1200	240	20	33,600	30,000	6,720	10,080
F	40 × 80 × 16	51,200	120 × 16 = 1920	384	26 $\frac{2}{3}$	54,460	64,000	10,892	16,338

The figures in the column headed $H = 70 (W/4 + G)$ represent the heat transmitted through the walls, those in the column $70 C/56$ are the heat required for one change of air per hour; $0.2 H$ is the heat corresponding to an allowance of 20% for exposure and leakage, and $0.3 H$ corresponds to an allowance of 30%. For the small rooms A and B the difference between $70 C/56$ and $0.2 H$ or $0.3 H$ is not of great importance, but it becomes very important in the largest rooms; in room F the difference between $70 C/56$ and $0.2 H$ is nearly equal to the total heat transmitted through the walls, indicating that the use of the cubic contents as a factor in calculations of large rooms is likely to lead to great errors. This is due to the fact that the ratio $C \div (W + G)$ varies greatly with different sizes of rooms.

With forced ventilation, the quantity of heat needed depends chiefly upon the number of persons to be provided for. Assuming 2000 cu. ft. per hour per person, heated from 0° to 70°, and 1, 2 and 4 persons per 100 sq. ft. of floor surface, the heat required for the air is as follows:

Room.	A	B	C	D	E	F
1 person per 100 sq. ft.	2,500	5,000	10,000	20,000	40,000	80,000
2 persons per 100 sq. ft.	5,000	10,000	20,000	40,000	80,000	160,000
4 persons per 100 sq. ft.	10,000	20,000	40,000	80,000	160,000	320,000
Ratio of last line to H.	1.8	2.4	3.0	3.4	4.8	5.9

Heating by Hot-air Furnaces. — A simple formula for calculating the total heat in British Thermal Units required for heating and ventilating by any system is $H = \left[c \left(G + \frac{W}{4} \right) + \frac{nC}{56} \right] (T_1 - T_0)$. (See notation above.)

The formula is derived as follows: The heat transmitted through 1 sq. ft. of single glass window is approximately 1 B.T.U. per hour per degree of difference of temperature, and that through 1 sq. ft. of 16-in. brick wall about 0.25 B.T.U. (For more accurate calculations figures taken from the tables (p. 659) should be used.) The specific heat of air is taken at 0.238, and the weight of 1 cu. ft. air at 70° F. at 0.075 lb. per cu. ft. The product of these figures is 0.01785, and its reciprocal is 56.

For a difference $T_1 - T_0 = 70^\circ$, $0.01785 \times 70 = 1.2495$, we may, therefore, write the formula

$$\text{Total heat} = 70 \left[c \left(G + \frac{W}{4} \right) \right] + 1.25 A$$

= heat conducted through walls + heat exhausted in ventilation.

A is the cubic feet of air (measured at 70°) supplied to and exhausted from the building. This formula neglects the heat conducted through the roof, for which a proper addition should be made.

There are two methods of heating by hot-air furnaces: one in which all the air for both heating and ventilation is taken from outdoors and exhausted from the building, and the other in which only the air for ventilation is taken from outdoors, and additional air is recirculated through the furnace from the building itself. The first method is an exceedingly wasteful one in cold weather. By the second it is possible to heat a building with no greater expenditure of fuel than is required for steam or hot-water heating.

EXAMPLE. — Required the amount of heat and the quantity of air to be circulated by the two methods named for a building which has $G = 400$, $W = 2400$, $C = 16,000$, $n = 2$, $T_1 = 70^\circ$, $T_0 = 0^\circ$, T_2 , the temperature at which the air leaves the furnace, being taken for three cases as 100°, 120°, and 140°. Assume c , the coefficient for exposure, including heat lost through roof, = 1.2. When only enough air for ventilation is taken into and exhausted from the building, the formula gives

$$70 \times 1.2 (500 + 400) + 1.25 \times 32,000 = 115,600 \text{ B.T.U.} = 75,600 \text{ for heat} + 40,000 \text{ for ventilation.}$$

Suppose all the air required for heating is taken from outdoors at 0° F., and all exhausted at 70°, the quantity, A , then, instead of being 32,000 cu. ft., has to be calculated as follows:

$$\text{Total heat} = c \left(G + \frac{W}{4} \right) (T_1 - T_0) + A \times 0.01785 \times (T_1 - T_0)$$

$$= 0.01785 A (T_2 - T_0).$$

Heat supplied by furnace = heat for conduction + heat for ventilation

$$\text{From which we find } A = c \left(G + \frac{W}{4} \right) (T_1 - T_0) \div 0.01785 (T_2 - T_1)$$

$$= 75,600 \div 0.01785 (T_2 - 70^\circ).$$

For the value of T_2	$T_2 = 100$	$T_2 = 120$	$T_2 = 140$
$A =$ cu. ft.	141,117	84,706	60,504
Heat lost by exhausting this air at 70° ...	176,396	105,882	75,630
Adding 75,600 loss by walls gives total ...	251,996	181,482	152,230
Excess above 115,600 actually required for heating and ventilating, %	118.0	57.0	31.7

British Thermal Units Absorbed in Heating 1 Cu. Ft. of Air, or given up in cooling it. — (The air is measured at 70° F.)

$T_1 - T_2 =$

10°	20	30	40	50	56	60	70	80	90	100	101	120	126	130	140
0.18	0.36	0.54	0.71	0.89	1.	1.07	1.25	1.43	1.61	1.78	1.96	2.14	2.25	2.32	2.5

Area in Square Inches of Pipe required to Deliver 100 Cu. Ft. of Air per Minute, at Different Velocities. — The air is measured at the temperature of the air in the pipe.

Velocity per second	2	3	4	5	6	7	8	9	10
Area, sq. in.	120	80	60	48	40	34.3	30	26.7	24

The quantity of air required for ventilation or heating should be figured at a standard temperature, say 70° F., but when warmer air is to be delivered into the room through pipes, the area of the pipes should be calculated on the basis of the temperature of the warm air, and not on that of the room.

EXAMPLE. — A room requires to be supplied with 1000 cu. ft. per min. at 70° F. for ventilation, but the air is also used for heating and is delivered into the room at 120° F. Required, the area of the delivery pipe, if the velocity of the heated air in the pipe is 6 ft. per second.

From the table of volumes, given on the next page, 1000 cu. ft. at 70° = 1094 cu. ft. at 120°. From the above table of areas, at 6 ft. velocity 40 sq. in. area is required for 100 cu. ft., therefore 1094 cu. ft. will require $10.94 \times 40 = 437.6$ sq. in. or about 3 sq. ft.

Carrying Capacity of Air Pipes.

Diam.	Area in sq. in.	Area, sq. ft.	Velocity, Feet per Second.					
			3	4	5	6	7	8
			Cu. Ft. per Min.					
5	19.63	.1364	24.6	32.7	40.9	49.1	57.3	65.5
6	28.27	.1963	35.3	47.1	58.9	70.7	82.4	94.2
7	38.48	.2673	48.1	64.2	80.2	96.2	112.	128.
8	50.27	.3491	62.8	83.8	105.	126.	147.	168.
9	63.62	.4418	80.0	106.	133.	159.	186.	212.
10	78.54	.5454	98.2	131.	164.	196.	229.	262.
11	95.03	.6600	119.	158.	198.	238.	277.	317.
12	113.1	.7854	141.	188.	236.	283.	330.	377.
13	132.7	.9218	166.	221.	277.	332.	387.	442.
14	153.9	1.069	192.	257.	321.	385.	449.	513.
15	176.7	1.227	221.	294.	368.	442.	515.	589.
11.3	100.	0.694	125.	167.	208.	250.	292.	333.
15.6	144.	1.	180.	240.	300.	360.	420.	480.

The figures in the table give the carrying capacity of pipes in cu. ft. of air at the temperature of the air flowing in the pipes. To reduce the figures to cu. ft. at a standard temperature (such as 70° F.) divide by the ratio of the volume per cu. ft. of the air in the pipe to that of the air of the standard temperature, as in the following table:

Volume of Air at Different Temperatures. (Atmospheric Pressure.)

Fahr. Deg.	Cu. Ft. in 1 lb.	Comparative Volume.	Fahr. Deg.	Cu. Ft. in 1 lb.	Comparative Volume.	Fahr. Deg.	Cu. Ft. in 1 lb.	Comparative Volume.
0	11.583	0.367	90	13.845	1.038	160	15.603	1.169
32	12.387	0.928	100	14.096	1.056	170	15.854	1.188
40	12.586	0.943	110	14.346	1.075	180	16.106	1.207
50	12.840	0.962	120	14.596	1.094	190	16.357	1.226
62	13.141	0.985	130	14.848	1.113	200	16.608	1.245
70	13.342	1.000	140	15.100	1.132	210	16.860	1.264
80	13.593	1.019	150	15.351	1.151	212	16.910	1.267

Sizes of Air Pipes Used in Furnace Heating. (W. G. Snow, Eng. News, April 12, 1900.)

Wth. of Room Ft.	Length of Room, Ft.										
	10	12	14	16	18	20	21	24	26	28	30
	Diameter of Pipe, Ins.										
8	8, 7	8, 7	9, 8	9, 8							
10	8, 7	9, 8	9, 8	10, 8	10, 8	10, 9	11, 9	11, 9	12, 10		
12		9, 8	10, 8	10, 8	10, 9	11, 9	11, 9	12, 10	12, 10	13, 10	13, 10
14			10, 8	10, 9	11, 9	11, 9	12, 10	12, 10	13, 10	13, 10	13, 11
16				11, 9	11, 9	12, 10	12, 10	13, 10	13, 10	13, 11	13, 11
18					12, 10	12, 10	13, 11	13, 11	13, 11	14, 12	14, 12
20						13, 11	13, 11	13, 11	14, 12	14, 12	14, 12

The first figure in each column shows the size of pipe for the first floor and the second figure the size for the second floor. Temperature at register, 140°; room, 70°; outside, 0°. Rooms 8 to 16 ft. in width assumed to be 9 ft. high; 18 to 20 ft. width, 10 ft. high. When first-floor pipes are longer than 15 ft. use one size larger than that stated. For third floor, use one size smaller than for second floor. For rooms with three exposures, increase the area of pipe in proportion to the exposure.

The table was calculated on the following basis: The loss of heat is calculated by first reducing the total exposure to equivalent glass surface. This is done by adding to the actual glass surface one-quarter the area of exposed wood and plaster or brick walls and 1/20 the area of floor or ceiling. Ten per cent is added where the exposure is severe. The window area assumed is 20% of the entire exposure of the room.

Multiply the equivalent of glass surface by 85. The product will be the total loss of heat by transmission per hour.

Assuming the temperature of the entering air to be 140° and that of the room to be 70°, the air escaping at approximately the latter temperature will carry away one-half the heat brought in. The other half, corresponding to the drop in temperature from 140° to 70°, is lost by transmission. With outside temperature zero, each cubic foot of air at 140° brings into the room 2.2 heat units. Since one-half of this, or 1.1 heat units, can be utilized to offset the loss by transmission, to ascertain the volume of air per hour at 140° required to heat a given room, divide the loss of heat by transmission by 1.1. This result divided by 60 gives the number of cubic feet per minute. In calculating the table, maximum velocities of 280 and 400 ft. were used for pipes leading to the first and second floors respectively. The size of the smaller pipes was based on lower velocities, according to their size, to allow for their greater resistance and loss of temperature.

Furnace-Heating with Forced Air Supply. (*The Metal Worker*, April 8, 1905.) — Tests were made of a Kelsey furnace with the air supply furnished by a 48-in. Sturtevant disk fan driven by a 5 H.P. electric motor. A connection was made from the air intake, between the fan and the furnace, to the ash pit so that the rate of combustion could be regulated independently of the chimney-draft condition. The furnace had 4.91 sq. ft. of grate surface and 238 sq. ft. of heating surface. The volume of air was determined by anemometer readings at 24 points in a cross-section of a rectangular intake of 11.88 sq. ft. area. The principal results obtained in two tests of 8 hours each are as follows:

Av. temp. of the cold air.....	39°	58°
Per cent humidity of the cold air.....	71	56
Av. temp. of the warm air.....	135°	152°
Air delivered to heater, cu. ft. per hour....	250,896	249,195
B.T.U. absorbed by the dry air per hour....	451,872	421,496
B.T.U. absorbed by the vapor per hour....	2,016	3,102
Avg. no. of pounds of coal burned per hour	36	33.5
B.T.U. given by the coal per hour.....	529,200	492,450
Per cent efficiency of the furnace.....	85.7	86.2

Grate Surface and Rate of Burning Coal.

In steam boilers for power plants, which are constantly attended by firemen, coal is generally burned at between 10 and 30 lbs. per sq. ft. of grate per hour. In small boilers, house heaters and furnaces, which even in the coldest weather are supplied with fresh coal only once in several hours, it is necessary to burn the coal at very much slower rates. Taking a cubic foot of coal as weighing 60 lbs., in a bed 12 inches deep, and 1 sq. ft. of grate area, it would be one-half burned away in 7 1/2 hours at a rate of burning of 4 lbs. per sq. ft. of grate per hour. This figure, 4 lbs., is commonly taken in designing grate surface for house-heating boilers and furnaces. Using this figure we have the following as the rated capacity of different areas of grate surface.

Rated Capacity of Furnaces and Boilers for House Heating.

Diam. of Round Grate.	Area in —		Coal-burning Capacity per Hour.	Capacity, B.T.U. per Hour.	Equiv. lbs. Steam Evap. 212° per Hour.	Equiv. lbs. Air per Hour Heated 100°.	Equiv. cu. ft. Air at 70° Heated 100°.
	q. in.	sq. ft.					
12	113.1	1.785	3.142	31,420	32.5	1,320	17,610
14	153.9	1.069	4.276	42,760	44.3	1,797	23,970
16	201.1	1.396	5.585	55,850	57.8	2,347	31,300
18	254.5	1.767	7.069	70,690	73.2	2,970	39,620
20	314.2	2.182	8.728	87,280	90.4	3,667	48,920
22	380.1	2.640	10.560	105,600	109.4	4,437	59,190
24	452.4	3.142	12.566	125,660	130.1	5,280	70,430
26	530.9	3.687	14.748	147,480	152.7	6,197	82,670
28	615.8	4.276	17.104	171,040	177.1	7,187	95,870
30	706.9	4.909	19.636	196,360	203.3	8,260	110,190
32	804.2	5.585	22.340	223,400	231.3	9,387	125,220
34	907.9	6.305	25.220	252,200	261.2	10,597	141,360
36	1017.9	7.069	28.276	282,760	292.8	11,881	158,490

Figures in column (b) = (a) ÷ 965.7.
 Figures in column (c) = (a) ÷ (100 × 0.238).
 Figures in column (d) = (c) × 13.34.
 Latent heat of steam at 212° = 965.7 B.T.U. [new steam tables give 970.4].
 Specific heat of air = 0.238.

Note that the figures in the last three columns are all based on the rate of combustion of 4 lbs. of coal per sq. ft. of grate per hour, which is taken as the standard for house heating. For heating schoolhouses and other large buildings where the furnace is fed with coal more frequently

much higher actual capacity may be obtained from the grate surface named. A committee of the Am. Soc. H. and V. Engrs. in 1909 says:

The grate surface to be provided depends on the rate of combustion, and this in turn depends on the attendance and draft, and on the size of the boiler. Small boilers are usually adapted for intermittent attention and a slow rate of combustion. The larger the boiler, the more attention is given to it, and the more heating surface is provided per square foot of grate. The following rates of combustion are common for internally fired heating boilers:

Sq. ft. of grate	4 to 8	10 to 18	20 to 30
Lbs. coal per sq. ft. grate per hr. not over	4	6	10

Capacity of 1 sq. ft. and of 100 sq. in. of Grate Surface, for Steam, Hot-water, or Furnace Heating.

(Based on burning 4 lbs. of coal per sq. ft. of grate per hour and 10,000 B.T.U. available heating value of 1 lb. of coal.)

1 sq. ft. grate equals	100 sq. ins. grate equals	lbs. of coal per hour.
4	2.775	B.T.U. per hour.
40,000	27,750	lbs. of steam evap. from and at 212° per hr.
41.25	28.61	sq. ft. of steam radiating surface = B.T.U. ÷ 255.6*
156.5	108.7	sq. ft. of hot-water radiating surface = B.T.U. ÷ 153 †
261.4	181.5	cu. ft. of air (measured at 70° F.) per hour heated 100°.
22,420.	15,570.	

* Steam temperature 212°, room temperature 70°, radiator coefficient, that is the B.T.U. transmitted per sq. ft. of surface per hour per degree of difference of temperature, 1.8.

† Water temperature 160°, room temperature 70°, radiator coefficient 1.7.

For any other rate of combustion than 4 lbs., multiply the figures in the table by that rate and divide by 4.

STEAM-HEATING.

The Rating of House-heating Boilers.

(W. Kent, *Trans. A. S. H. V. E.*, 1909.)

The rating of a steam-boiler for house-heating may be based upon one or more of several data: 1, square feet of grate-surface; 2, square feet of heating-surface; 3, coal-burning capacity; 4, steam-making capacity; 5, square feet of steam-radiating-surface, including mains, that it will supply. In establishing such a rating the following considerations should be taken into account:

1. One sq. ft. of cast-iron radiator surface will give off about 250 B.T.U. per hour under ordinary conditions of temperature of steam 212°, and temperature of room 70°.
2. One pound of good anthracite or semi-bituminous coal under the best conditions of air-supply, in a boiler properly proportioned, will transmit about 10,000 B.T.U. to the boiler.
3. In order to obtain this economical result from the coal the boilers should be driven at a rate not greatly exceeding 2 lbs. of water evaporated from and at 212° per sq. ft. of heating-surface per hour, corresponding to a heat transmission of 2 × 970 = 1940, or, say, approximately 2000 B.T.U. per hour per sq. ft. of heating-surface.
4. A satisfactory boiler or furnace for house-heating should not require coal to be fed oftener than once in 8 hours; this requires a rate of burning of only 3 to 5 pounds of coal per sq. ft. of grate per hour.
5. For commercial and constructive reasons, it is not convenient to establish a fixed ratio of heating- to grate-surface for all sizes of boilers. The grate-surface is limited by the available area in which it may be placed, but on a given grate more heating-surface may be piled in one form of boiler than in another, and in boilers of one general form one boiler may be built higher than another, thus obtaining a greater amount of heating-surface.

6. The rate of burning coal and the ratio of heating- to grate-surface both being variable, the coal-burning rate and the ratio may be so related to each other as to establish condition 3, viz., a rate of evaporation of 2 lbs. of water from and at 212° per sq. ft. of heating-surface per hour.

These general considerations lead to the following calculations:

1 lb. of coal, 10,000 B.T.U. utilized in the boiler, will supply $10,000 \div 250 = 40$ sq. ft. radiating-surface, and will require $10,000 \div 2000 = 5$ sq. ft. boiler heating-surface. 1 sq. ft. of boiler-surface will supply $2000 \div 250$ or $40 \div 5 = 8$ sq. ft. radiating-surface.

	Low Boiler.	Medium.	High Boiler.
1 sq. ft. of grate should burn	3	4	5 lb. coal per hour.
1 sq. ft. of grate should develop	30,000	40,000	50,000 B.T.U. per hour.
1 sq. ft. of grate will require	15	20	25 sq. ft. heating-surf.
1 sq. ft. of grate will supply	120	160	200 sq. ft. radiating-sur.
Type of boiler, depending on ratio heating- + grate-surface	A.	B.	C.

TABLE OF RATINGS.

Type and No.	Sq. Ft. Grate.	Sq. Ft. Heat.- surf.	Coal Burned per Hour, lbs.	Water Evap. per Hour, lbs.	Rad.- surf., Sq. Ft.	Type and No.	Sq. Ft. Grate.	Sq. Ft. Heat.- surf.	Coal Burned per Hour, lbs.	Water Evap. per Hour, lbs.	Rad.- surf., Sq. Ft.
A 1	1	15	3	30	120	B 8	8	160	32	320	1,280
A 2	2	30	6	60	240	C 6	6	150	30	300	1,200
A 3	3	45	9	90	360	C 7	7	175	35	350	1,400
A 4	4	60	12	120	480	C 8	8	200	40	400	1,600
A 5	5	75	15	150	600	C 10	10	250	50	500	2,000
B 4	4	80	16	160	640	C 12	12	300	60	600	2,400
B 5	5	100	20	200	800	C 14	14	350	70	700	2,800
B 6	6	120	24	240	960	C 16	16	400	80	800	3,200
B 7	7	140	28	280	1,120						

The table is based on the utilization in the boiler of 10,000 B.T.U. per pound of good coal. For poorer coal the same figures will hold good except the pounds coal burned per hour, which should be increased in the ratio of the B.T.U. of the good to that of the poor coal. Thus for coal from which 8000 B.T.U. can be utilized the coal burned per hour will be 25 per cent greater.

For comparison with the above table the following figures are taken and calculated from the catalogue of a prominent maker of cast-iron boilers:

Height.	G Grate.	H Heat-ing-surf.	R Radiat-ing-surf.	H/G	R/G	R/H	B.T.U. per Hour = R x 250	B.T.U. / H	Coal per Hour per sq. ft. Grate *
Low.....	2.1	45	210	21.5	100	4.7	52,500	1,167	2.5
	4.7	90	600	19.1	128	6.7	150,000	1,667	3.2
Medium..	4.2	103	600	24.5	143	5.8	150,000	1,456	3.6
	8.2	195	1,500	23.8	183	7.7	375,000	1,923	4.6
High.....	6.7	210	1,200	31.3	179	5.7	300,000	1,476	4.5
	14.7	420	3,300	28.6	225	7.9	825,000	1,964	5.6

* Equals B.T.U. per hour ÷ 10,000 G.

TESTING CAST-IRON HOUSE-HEATING BOILERS.

The testing of the evaporating power and the economy of small-sized boilers is more difficult than the testing of large steam-boilers for the reason that the small quantity of coal burned in a day makes it impossible to procure a uniform condition of the coal on the grate throughout the test, and large errors are apt to be made in the calculation on account of the difference of condition at the beginning and end of a test. The following is suggested as a method of test which will avoid these errors.

(a) Measure the grate-surface and weigh out an amount of coal equal to 30, 40, or 50 lbs. per sq. ft. of grate, according to the type A, B, or C, or the ratio of heating- to grate-surface.

(b) Disconnect the steam-pipe, so that the steam may be wasted at atmospheric pressure. Fill the boiler with cold water to a marked level, and take the weight of this water and its temperature.

(c) Start a brisk fire with plenty of wood, so as to cause the coal to ignite rapidly; feed the coal as needed, and gradually increase the thickness of the bed of coal as it burns brightly on top, getting the fire-pot full as the last of the coal is fired. Then burn away all the coal until it ceases to make steam, when the test may be considered as at an end.

(d) Record the temperature of the gases of combustion in the flue every half-hour.

(e) Periodically, as needed, feed cold water, which has been weighed, to bring the water level to the original mark. Record the time and the weight.

CALCULATIONS.

Total water fed to the boiler, including original cold water, pounds × (212° - original cold-water temperature) = B.T.U.

Water apparently evaporated, pounds × 970 = B.T.U.

Add correction for increased bulk of hot water:

Original water, pounds × $\frac{(62.3 - 59.8)}{62.3} \times 970 =$ B.T.U.

Total..... B.T.U.

Divide by 970 to obtain equivalent water evaporation from and at 212° F.

Divide by the number of pounds of coal to obtain equivalent water per pound of coal.

The last result may be considerably less than 10 pounds on account of imperfect combustion at the beginning of the test, excessive air-supply when the coal bed is thin in the latter half of the test, and loss by radiation, but the results will be fairly comparable with results from other boilers of the same size and run under the same conditions. The records of water fed and of temperature of gases should be plotted, with time as the base, for comparison with other tests.

Proportions of House-heating Boilers. — A committee of the Am. Soc. Heating and Ventilating Engineers, reporting in 1909 on the method of rating small house-heating boilers, shows the following ratings, in square feet of radiating surface supplied by certain boilers of nearly the same nominal capacity, as given in makers' catalogues.

Boiler.....	A.	B.	C.	D.	E.	F.
Rated capacity.....	800	800	775	750	750	750
Square inches of grate.....	616	740	648	528	630	648
Ratio of grate to 100 sq. ft. of capacity	77	92.5	83.6	70.4	84	86.2
Estimated rate of combustion.....	5.1	4.2	4.65	5.63	4.4	4.5

The figures in the last line are lbs. of coal per sq. ft. of grate surface per hour, and are based on the assumptions of 10,000 B.T.U. utilized per lb. of coal and 270 B.T.U. transmitted by each sq. ft. of radiating surface per hour.

"The question of heating surface in a boiler seems to be an unknown quantity, and inquiry among the manufacturers does not produce much information on the subject."

Following is the list of sizes and ratings of the "Manhattan" sectional steam boiler. The figures for sq. ft. of grate surface and for the ratio of heating to grate surface (approx.) have been computed from the sizes given in the catalogue (1909).

Number of Sections.	Square feet of Direct Radiation Boiler will Supply	Size of Grate.		Square Feet of Surface in Boiler.	Ratio of Htg. to Grate Surface.	Number of Sections.	Square feet of Direct Radiation Boiler will Supply.	Size of Grate.		Square Feet of Surface in Boiler.	Ratio of Htg. to Grate Surface.
		ins.	sq. ft.					ins.	sq. ft.		
4	450	18x19	2.37	68	29	10	2250	24x63	10.5	212	20
5	600	18x25	3.75	84	23	6	2200	36x36	9	256	28
6	750	18x31	5.87	100	26	7	2700	36x43	11.74	298	26
7	900	18x37	8.65	116	25	8	3200	36x50	13.33	340	26
8	1050	18x43	12.37	132	25	9	3700	36x57	14.25	382	26
5	1000	24x30	5	111	22	10	4200	36x64	16	424	26
6	1250	24x36	6	128	21	11	4700	36x71	17.5	466	27
7	1500	24x43	7.16	149	21	12	5200	36x78	19.5	508	26
8	1750	24x50	8.33	170	20	13	5700	36x84	21	550	26
9	2000	24x57	9.5	191	20	14	6200	36x90	22.5	592	26

It appears from this list that there are three sets of proportions, corresponding to the three widths of grate surface. The average ratio of heating to grate surface in the three sets is respectively 25.0, 20.7, and 25.8; the rated sq. ft. of radiating surface per sq. ft. of grate is 185, 208, and 259, and the sq. ft. of radiating surface per sq. ft. of boiler heating surface is 7.4, 10.1, and 9.8. Taking 10,000 B.T.U. utilized per lb. of coal, and 250 B.T.U. emitted per sq. ft. of radiating surface per hour, the rate of combustion required to supply the radiating surface is respectively 4.62, 5.22, and 6.40 lbs. per sq. ft. of grate per hour

Coefficient of Heat Transmission in Direct Radiation. — The value of *K*, or the B.T.U. transmitted per sq. ft. of radiating surface per hour per degree of difference of temperature between the steam (or hot water) and the air in the room, is commonly taken at 1.8 in steam heating, with a temperature difference of about 142°, and 1.6 in hot-water heating, with a temperature difference averaging 80°. Its value as found by test varies with the conditions; thus the total heat transmitted is not directly proportional to the temperature difference, but increases at a faster rate; single pipes exposed on all sides transmit more heat than pipes in a group; low radiators more than high ones; radiators exposed to currents of cool air more than those in relatively quiet air; radiators with a free circulation of steam throughout more than those that are partly filled with water or air, etc. The total range of the value of *K*, for ordinary conditions of practice, is probably between 1.5 and 2.0 for steam-heating with a temperature difference of 140°, averaging 1.8, and between 1.2 and 1.7, averaging 1.6, for hot-water heating, with a temperature difference of 80°.

C. F. Hauss, *Trans. A. S. H. V. E.*, 1904, gives as a basis for calculation, for a room heated to 70° with steam at 1½ lbs. gauge pressure (temperature difference 146° F.) 1 sq. ft. of single column radiator gives off 309 B.T.U. per hour; 2-column, 275; 3-column, 250; 4-column, 225.

Value of *K* in Cast-iron Direct Radiators. (J. K. Allen, *Trans. A. S. H. V. E.*, 1908.) *T_s* = temp. of steam; *T₁* = temp. of room.

<i>T_s</i> - <i>T₁</i> =	110	120	130	140	150	160
2-col. rad....	1.71	1.745	1.76	1.82	1.855	1.895
3-col. rad....	1.65	1.695	1.745	1.79	1.835	1.885
<i>T_s</i> - <i>T₁</i> =	170	180	200	220	240	260
2-col. rad....	1.93	1.965	2.04	2.11	2.185	2.265
3-col. rad....	1.93	1.98	2.075	2.165	2.260	2.36

B.T.U. Transmitted per Hour per Sq. Ft. of Heating Surface in Indirect Radiators. (W. S. Munroe, *Eng. Rec.*, Nov. 18, 1899.)

	Cu. ft. of air per hour per sq. ft. of surface.								
	100	200	300	400	500	600	700	800	900
	B.T.U. per hour per sq. ft. of heating surface.								
"Gold Pin" } (a) ...	200	325	450	560	670	780	870	950	1030
radiator } (b) ...	300	550	760	950	1130	1300			
"Whittier" (b) ...	250	400	520	620	710				
	B.T.U. per hr. per sq. ft. per deg. diff. of temp.*								
Gold Pin (a).....	1.3	2.2	3.0	3.7	4.5	5.2	5.8	6.3	6.9
Gold Pin (b).....	2.0	3.7	5.1	6.3	7.7	8.7			
Whittier (b).....	1.7	2.7	3.5	4.1	4.7				

Temperature difference between steam and entering air, (a) 150; (b) 215. * Between steam and entering air.

Short Rules for Computing Radiating-Surfaces. — In the early days of steam-heating, when little was known about "British Thermal Units," it was customary to estimate the amount of radiating-surface by dividing the cubic contents of the room to be heated by a certain factor supposed to be derived from "experience." Two of these rules are as follows:

One square foot of surface will heat from 40 to 100 cu. ft. of space to 75° in - 10° latitudes. This range is intended to meet conditions of exposed or corner rooms of buildings, and those less so, as intermediate ones of a block. As a general rule, 1 sq. ft. of surface will heat 70 cu. ft. of air in outer or front rooms and 100 cu. ft. in inner rooms. In large stores in cities, with buildings on each side, 1 to 100 is ample. The following are approximate proportions:

One square foot radiating-surface will heat:

	In Dwellings, Schoolrooms, Offices, etc.	In Hall, Stores, Lofts, Factories, etc.	In Churches, Large Auditoriums, etc.
By direct radiation....	60 to 80 ft.	75 to 100 ft.	150 to 200 ft.
By indirect radiation..	40 to 50 ft.	50 to 70 ft.	100 to 140 ft.

Isolated buildings exposed to prevailing north or west winds should have a generous addition made to the heating-surface on their exposed sides.

1 sq. ft. of boiler-surface will supply from 7 to 10 sq. ft. of radiating-surface, depending upon the size of boiler and the efficiency of its surface, as well as that of the radiating-surface. Small boilers for house use should be much larger proportionately than large plants. Each horse-power of boiler will supply from 240 to 360 ft. of 1-in. steam-pipe, or 80 to 120 sq. ft. of radiating-surface. Under ordinary conditions 1 horse-power will heat, approximately, in —

Brick dwellings, in blocks, as in cities.....	15,000 to 20,000 cu. ft.
Brick stores, in blocks.....	10,000 " 15,000 "
Brick dwellings, exposed all round.....	10,000 " 15,000 "
Brick mills, shops, factories, etc.....	7,000 " 10,000 "
Wooden dwellings, exposed.....	7,000 " 10,000 "
Foundries and wooden shops.....	6,000 " 10,000 "
Exhibition buildings, largely glass, etc.....	4,000 " 15,000 "

Such "rules of thumb," as they are called, are generally supplanted by the modern "heat-unit" methods.

Carrying Capacity of Pipes in Low-Pressure Steam Heating. (W. Kent, *Trans. A. S. H. V. E.*, 1907.) — The following table is based on an assumed drop of 1 pound pressure per 1000 feet, not because that is the drop which should always be used—in fact the writer believes that in large installations a far greater drop is permissible—but because it gives a basis upon which the flow for any other drop may be calculated,

merely by multiplying the figures in the tables by the square root of the assigned drop. The formula from which the tables are calculated is the

well known one, $W = c \sqrt{\frac{w(p_1 - p_2)d^5}{L}}$, in which W = weight of steam in lbs. per minute; w = weight of steam in pounds per cubic foot at the entering pressure, p_1 ; p_2 the pressure at the end of the pipe; d the actual diameter of standard wrought-iron pipe in inches, and L the length in feet. The coefficients c are derived from Darcy's experiments on flow of water in pipes, and are believed to be as accurate as any that have been derived from the very few recorded experiments on steam.

Nominal diam. of pipe..	1/2	3/4	1	1 1/4	1 1/2	2	2 1/2	3	3 1/2
Value of c —	36.8	42	45.3	48	50	52.7	54.8	56.2	57.1
Nominal diam. of pipe..	4	4 1/2	5	6	7	8	9	10	12
Value of c —	57.8	58.3	58.7	59.5	60.2	60.8	61.3	61.7	62.1

FLOW OF STEAM AT LOW PRESSURES IN POUNDS PER HOUR FOR A UNIFORM DROP AT THE RATE OF ONE POUND PER 1000 FEET LENGTH OF STRAIGHT PIPE.

Nominal Diam. of Pipe.	Steam Pressures, by Gauge, at Entrance of Pipe.								
	0.3	1.3	2.3	3.3	4.3	5.3	6.3	8.3	10.3
Flow of Steam, Pounds per Hour.									
1/2	4.2	4.3	4.4	4.6	4.7	4.8	4.9	5.1	5.3
3/4	9.7	10.0	10.3	10.5	10.8	11.0	11.3	11.8	12.3
1	19.0	19.6	20.2	20.7	21.2	21.7	22.3	23.2	24.2
1 1/4	40.1	41.3	42.5	43.7	44.8	45.9	46.9	49.0	50.9
1 1/2	61.4	63.2	65.1	66.8	68.6	70.3	71.9	75.0	78.0
2	120.8	124.5	128.2	131.6	135.0	138.3	141.5	147.7	153.6
2 1/2	195.7	201.8	207.5	213.2	218.7	224.0	229.2	239.2	248.8
3	345.5	356.1	366.5	376.4	386.1	395.5	404.7	422.4	439.3
3 1/2	505.3	520.8	535.9	550.5	564.7	578.5	591.8	618.0	642.6
4	701.4	723.0	744.0	764.4	784.2	803.4	822.0	857.4	891.6
4 1/2	938.7	967.6	995.8	1023.	1049.	1075.	1100.	1148.	1193.
5	1252.	1291.	1328.	1364.	1399.	1433.	1467.	1531.	1592.
6	2011.	2074.	2134.	2192.	2248.	2303.	2356.	2459.	2557.
7	2936.	3027.	3115.	3199.	3281.	3362.	3440.	3590.	3733.
8	4082.	4208.	4331.	4448.	4564.	4674.	4783.	4991.	5191.
9	5462.	5630.	5794.	5951.	6102.	6252.	6396.	6678.	6942.
10	7314.	7536.	7758.	7968.	8172.	8370.	8562.	8940.	9294.
12	11550.	11916.	12264.	12594.	12918.	13236.	13542.	14136.	14700.

For any other drop of pressure per 1000 feet length, multiply the figures in the table by the square root of that drop.

In all cases the judgment of the engineer must be used in the assumption of the drop to be allowed. For small distributing pipes it will generally be desirable to assume a drop of not more than one pound per 1000 feet to insure that each single radiator shall always have an ample supply for the worst conditions, and in that case the size of piping given in the table up to two inches may be used; but for main pipes supplying totals of more than 500 square feet, greater drops may be allowed.

WARNING: This is a 1910 edition. Some of the material may no longer be accurate

Proportioning Pipes to Radiating Surface.

FIGURES USED IN CALCULATION OF RADIATING SURFACE.

P = Pressure by gauge, lbs. per sq. in.

0. 0.3 1.3 2.3 3.3 4.3 5.3 6.3 8.3 10.3

L = latent heat of evaporation, B.T.U. per lb.*

965.7 965.0 962.6 960.4 958.3 956.3 954.4 952.6 949.1 945.8

Temperature Fahrenheit, T_1 .

212. 213. 216.3 219.4 222.4 225.2 227.9 230.5 235.4 240.0

$T_1 = T_2 - 70^\circ$, difference of temperature.

142. 143. 146.3 149.4 152.4 155.2 157.9 160.5 165.4 170.0

$H_1 = T_1 \times 1.8$ = heat transmission per sq. ft. radiating surface, B.T.U. per hour.

255.6 257.4 263.3 268.9 274.3 279.2 284.2 288.9 297.7 306.0

$H_1 \div L$ = steam condensed per sq. ft. radiating surface, lbs. per hour.

0.2647 0.267 0.274 0.280 0.286 0.292 0.298 0.303 0.314 0.324

Reciprocal of above = radiating surface per lb. of steam condensed per hour.

3.78 3.75 3.65 3.57 3.50 3.42 3.36 3.30 3.18 3.09

The last three lines of figures are based on the empirical constant 1.8 for the average British thermal units transmitted per square foot of radiating surface per hour per degree of difference of temperature. This figure is approximately correct for several forms of both cast-iron radiators and pipe coils, not over 30 inches high and not over two pipes in width.

RADIATING SURFACE SUPPLIED BY DIFFERENT SIZES OF PIPE.

On basis of steam in pipe at 3.3 and 10.3 lbs. gauge pressure, temperature of room 70° , heat transmitted per square foot radiating surface 257.4 and 306 British thermal units per hour, and drop of pressure in pipe at the rate of 1 lb. per 1000 feet length; = pounds of steam per hour in the table on the preceding page, 1st column, $\times 3.75$, and last column, $\times 3.09$.

Size of Pipe.	Radiating Surface, Sq. Ft.		Size of Pipe.	Radiating Surface, Sq. Ft.		Size of Pipe.	Radiating Surface, Sq. Ft.	
	0.3 lb.	10.3 lb.		0.3 lb.	10.3 lb.		0.3 lb.	10.3 lb.
1/2	16	16	2 1/2	734	769	6	7,541	7,901
3/4	36	38	3	1,296	1,357	7	11,010	11,535
1	71	75	3 1/2	1,895	1,984	8	15,307	16,040
1 1/4	150	157	4	2,630	2,755	9	20,482	21,451
1 1/2	230	241	4 1/2	3,520	3,686	10	27,427	28,718
2	453	475	5	4,695	4,919	12	43,312	45,423

For greater drops than 1 lb. per 1000 ft. length of pipe, multiply the figures by the square root of the drop.

* The latest steam tables (1909) give somewhat higher figures, but the difference is unimportant here.

Sizes of Steam Pipes in Heating Plants. — C. W. Stanton, in *Heating and Ventilating Mag.*, April, 1908, gives tables for proportioning pipes to radiating surface, from which the following table is condensed:

Supply Pipe Ins.	Radiating Surface Sq. Ft.				Returns.		Drips.		Connections.		
	A	B	C	D	B	C ₁ D	A	B ₁ C ₁ D	A ₁	A ₂ B ₁ C ₁	B ₂ C ₂
1	74	60	36	60	1	1	3/4	3/4	1 1/4	1	1
1 1/4	60	100	72	120	1	1	3/4	3/4	1 1/2	1 1/4	1
1 1/2	125	200	120	240	1 1/4	1 1/4	1	1	2	1 1/2	1 1/4
2	250	400	280	480	1 1/2	1 1/2	1 1/4	1	2 1/2	2	1 1/2
2 1/2	600	700	528	880	2	2	1 1/4	1 1/4	3
3	800	1,000	900	1,500	2	2 1/2	1 1/2	1 1/4	3 1/2
3 1/2	1,000	1,600	1,320	2,200	2 1/2	2 1/2	1 1/2	1 1/4	4
4	1,600	2,300	1,920	3,200	2 1/2	3	1 1/2	1 1/4	4 1/2
4 1/2	1,900	3,200	2,760	4,600	2 1/2	3
5	2,300	4,100	3,720	6,200	3	3 1/2
6	4,100	6,500	6,000	10,000	3	3 1/2
7	6,500	9,600	9,000	15,000	3 1/2	4
8	9,600	13,600	12,800	21,600	4	4
9	13,600	17,800	30,000	4 1/2
10	23,200	39,000	5
12	37,000	62,000	6
14	54,000	92,000	7
16	76,000	130,000	8

A. For single-pipe steam-heating system 0 to 5 lb. pressure. A₁, riser connections. A₂, radiator connections.

B. Two-pipe system 0 to 5 lb. pressure; B₁, C₁, radiator connections, supply; B₂, C₂, radiator connections, return.

C, D. Two-pipe system 2 and 5 lbs. respectively, mains and risers not over 100 ft. length. For other lengths, multiply the given radiating surface by factors, as below:

Length, ft....	200	300	400	500	600	700	800	900	1000
Factor.....	0.71	0.58	0.5	0.45	0.41	0.38	0.35	0.33	0.32

Mr. Stanton says: Theoretically both supply and return mains could be much smaller, but in practice it has been found that while smaller pipes can be used if a job is properly and carefully figured and proportioned and installed, for work as ordinarily installed it is far safer to use the sizes that have been tried and proven. By using the sizes given a job will circulate throughout with 1 lb. steam pressure at the boiler.

Resistance of Fittings. — Where the pipe supplying the radiation contains a large number of fittings, or other conditions make such a refinement necessary, it is advisable to add to the actual distance of the radiation from the source of supply a distance equivalent to the resistance offered by the fittings, and by the entrance to the radiator, the value of which, expressed in feet of pipe of the same diameter as the fitting, will be found in the accompanying table. *Power*, Dec., 1907.

FEET OF PIPE TO BE ADDED FOR EACH FITTING.

Size Pipe.	1	1 1/4	1 1/2	2	2 1/2	3	3 1/2	4	4 1/2	5	6	7	8	9	10
Elbows...	3	4	5	7	8	10	12	13	15	17	20	23	27	30	33
Globe V..	7	8	10	13	17	20	23	27	30	33	40	47	53	60	67
Entrance	5	6	8	10	12	15	18	20	23	25	30	35	40	45	50

Overhead Steam-pipes. (A. R. Wolff, *Stevens Indicator*, 1887.) — When the overhead system of steam-heating is employed, in which system direct radiating-pipes, usually 1 1/4 in. in diam., are placed in rows overhead, suspended upon horizontal racks, the pipes running horizontally, and side by side, around the whole interior of the building, from 2 to 3 ft. from the walls, and from 2 to 4 ft. from the ceiling, the amount of 1 1/4-in. pipe required, according to Mr. C. J. H. Woodbury, for heating mills (for which use this system is deservedly much in vogue), is about 1 ft. in length for every 90 cu. ft. of space. Of course a great range of difference exists, due to the special character of the operating machinery in the mill, both in respect to the amount of air circulated by the machinery, and also the aid to warming the room by the friction of the journals.

Removal of Air from Radiators. Vacuum Systems. — In order that a steam radiator may work at its highest capacity it is necessary that it be neither water-bound nor air-bound. Proper drainage must therefore be provided, and also means for continuously, or frequently, removing air from the system, such as automatic air-valves on each radiator, an air-pump or an air-ejector on a chamber or receiver into which the returns are carried, or separate air-pipes connecting each radiator with a vacuum chamber. When a vacuum system is used, especially with a high vacuum, much lower temperatures than usual may be used in the radiators, which is an advantage in moderate weather.

Steam-consumption in Car-heating.

C., M. & ST. PAUL RAILWAY TESTS. (*Engineering*, June 27, 1890, p. 764.)

Outside Temperature.	Inside Temperature.	Water of Condensation per Car per Hour.
40	70	70 lbs.
30	70	85
10	70	100

Heating a Greenhouse by Steam. — Wm. J. Baldwin answers a question in the *American Machinist* as below: With five pounds steam-pressure, how many square feet or inches of heating-surface is necessary to heat 100 square feet of glass on the roof, ends, and sides of a greenhouse in order to maintain a night heat of 55° to 65°, while the thermometer outside ranges at from 15° to 20° below zero; also, what boiler-surface is necessary? Which is the best for the purpose to use — 2" pipe or 1 1/4" pipe?

Ans. — Reliable authorities agree that 1.25 to 1.50 cubic feet of air in an enclosed space will be cooled per minute per sq. ft. of glass as many degrees as the internal temperature of the house exceeds that of the air outside. Between + 65° and - 20° there will be a difference of 85°, or, say, one cubic foot of air cooled 127.5° F. for each sq. ft. of glass for the most extreme condition mentioned. Multiply this by the number of square feet of glass and by 60, and we have the number of cubic feet of air cooled 1° per hour within the building or house. Divide the number thus found by 48, and it gives the units of heat required, approximately. Divide again by 953, and it will give the number of pounds of steam that must be condensed from a pressure and temperature of five pounds above atmosphere to water at the same temperature in an hour to maintain the heat. Each square foot of surface of pipe will condense from 1/4 to nearly 1/2 lb. of steam per hour, according as the coils are exposed or well or poorly arranged, for which an average of 1/3 lb. may be taken. According to this, it will require 3 sq. ft. of pipe surface per lb. of steam to be condensed. Proportion the heating-surface of the boiler to have about one fifth the actual radiating-surface, if you wish to keep steam over night, and proportion the grate to burn not more than six pounds of coal per sq. ft. of grate per hour. With very slow combustion, such as takes place in base-burning boilers, the grate might be proportioned for four to five pounds of coal per hour. It is cheaper to make coils of 1 1/4" pipe than of 2", and there is nothing to be gained by using 2" pipe unless the coils are very long. The pipes in a greenhouse should be under or in front of the benches, with every chance for a good circulation

of air. "Header" coils are better than "return-head" coils for this purpose.

Mr. Baldwin's rule may be given the following form: Let H = heat-units transferred per hour, T = temperature inside the greenhouse, t = temperature outside, S = sq. ft. of glass surface; then $H = 1.5 S (T - t) \times 60 \div 48 = 1.875 S (T - t)$. Mr. Wolff's coefficient K for single skylights gives $H = 1.03 S (T - t)$, and for single windows, $1.20 S (T - t)$.

Heating a Greenhouse by Hot Water. — W. M. Mackay, of the Richardson & Boynton Co., in a lecture before the Master Plumbers' Association, N. Y., 1889, says: I find that while greenhouses were formerly heated by 4-inch and 3-inch cast-iron pipe, on account of the large body of water which they contained, and the supposition that they gave better satisfaction and a more even temperature, florists of long experience who have tried 4-inch and 3-inch cast-iron pipe, and also 2-inch wrought-iron pipe for a number of years in heating their greenhouses by hot water, and who have also tried steam-heat, tell me that they get better satisfaction, greater economy, and are able to maintain a more even temperature with 2-inch wrought-iron pipe and hot water than by any other system they have used. They attribute this result principally to the fact that this size pipe contains less water and on this account the heat can be raised and lowered quicker than by any other arrangement of pipes, and a more uniform temperature maintained than by steam or any other system.

HOT-WATER HEATING.

The following notes are from the catalogue of the Nason Mfg. Co.:

There are two distinct forms or modifications of hot-water apparatus, depending upon the temperature of the water.

In the first or open-tank system the water is never above 212° temperature, and rarely above 200°. This method always gives satisfaction where the surface is sufficiently liberal, but in making it so its cost is considerably greater than that for a steam-heating apparatus.

In the second method, sometimes called (erroneously) high-pressure hot-water heating, or the closed-system apparatus, the tank is closed. If it is provided with a safety-valve set at 10 lbs. it is practically as safe as the open-tank system.

Law of Velocity of Flow. — The motive power of the circulation in a hot-water apparatus is the difference between the specific gravities of the water in the ascending and the descending pipes. This effective pressure is very small, and is equal to about one grain for each foot in height for each degree difference between the pipes; thus, with a height of 12 in "up" pipe, and a difference between the temperatures of the up and down pipes of 8°, the difference in their specific gravities is equal to 8.16 grains (0.001166 lb.) on each square inch of the section of return-pipe, and the velocity of the circulation is proportioned to these differences in temperature and height.

Main flow-pipes from the heater, from which branches may be taken, are to be preferred to the practice of taking off nearly as many pipes from the heater as there are radiators to supply.

It is not necessary that the main flow and return pipes should equal in capacity that of all their branches. The hottest water will seek the highest level, while gravity will cause an even distribution of the heated water if the surface is properly proportioned.

It is good practice to reduce the size of the vertical mains as they ascend, say at the rate of one size for each floor.

As with steam, so with hot water, the pipes must be unconfined to allow for expansion of the pipes consequent on having their temperatures increased.

An expansion tank is required to keep the apparatus filled with water, which latter expands $1/24$ of its bulk on being heated from 40° to 212°, and the cistern must have capacity to hold certainly this increased bulk. It is recommended that the supply cistern be placed on level with or above the highest pipes of the apparatus, in order to receive the air which collects in the mains and radiators, and capable of holding at least $1/20$ of the water in the entire apparatus.

Arrangement of Mains for Hot-water Heating. (W. M. Mackay, Lecture before Master Plumbers' Assoc., N. Y., 1889). — There are two different systems of mains in general use, either of which, if properly

placed, will give good satisfaction. One is the taking of a single large-flow main from the heater to supply all the radiators on the several floors, with a corresponding return main of the same size. The other is the taking of a number of 2-inch wrought-iron mains from the heater, with the same number of return mains of the same size, branching off to the several radiators or coils with $1\frac{1}{4}$ -inch or 1-inch pipe, according to the size of the radiator or coil. A 2-inch main will supply three $1\frac{1}{4}$ -inch or four 1-inch branches, and these branches should be taken from the top of the horizontal main with a nipple and elbow, except in special cases where it is found necessary to retard the flow of water to the near radiator, for the purpose of assisting the circulation in the far radiator; in this case the branch is taken from the side of the horizontal main. The flow and return mains are usually run side by side, suspended from the basement ceiling, and should have a gradual ascent from the heater to the radiators of at least 1 inch in 10 feet. It is customary, and an advantage where 2-inch mains are used, to reduce the size of the main at every point where a branch is taken off.

The single or large main system is best adapted for large buildings; but there is a limit as to size of main which it is not wise to go beyond — generally 6-inch, except in special cases.

The proper area of cold-air pipe necessary for 100 square feet of indirect radiation in hot-water heating is 75 square inches, while the hot-air pipe should have at least 100 square inches of area. There should be a damper in the cold-air pipe for the purpose of controlling the amount of air admitted to the radiator, depending on the severity of the weather.

Sizes of Pipe for Hot-water Heating. — A theoretical calculation of the required size of pipe in hot-water heating may be made in the following manner. Having given the amount of heat, in B.T.U. to be emitted by a radiator per minute, assume the temperatures of the water entering and leaving, say 160° and 140°. Dividing the B.T.U. by the difference in temperatures gives the number of pounds of water to be circulated, and this divided by the weight of water per cubic foot gives the number of cubic feet per minute. The motive force to move this water, per square inch of the area of the riser, is the difference in weight per cu. ft. of water at the two temperatures, divided by 144, and multiplied by H , the height of the riser, or for $T_1 = 160$ and $T_2 = 140$, $(61.37 - 60.98) \div 144 = 0.00271$ lb. per sq. in. for each foot of the riser. Dividing 144 by 61.37 gives 2.34, the ft. head of water corresponding to 1 lb. per sq. in., and $0.00271 \times 2.34 = 0.0066$ ft. head, or if the riser is 20 ft. high, $20 \times 0.0066 = 0.132$ ft. head, which is the motive force to move the water over the whole length of the circuit, overcoming the friction of the riser, the return pipe, the radiator and its connections. If the circuit has a resistance equal to that of a 50-ft. pipe, then $50 \div 0.132 = 380$ is the ratio of length of pipe to the head, which ratio is to be taken with the number of cubic feet to be circulated, and by means of formulae for flow of water, such as Darcy's, or hydraulic tables, the diameter of pipe required to convey the given quantity of water with this ratio of length of pipe to head is found. This tedious calculation is made more complicated by the fact that estimates have to be made of the frictional resistance of the radiator and its connections, elbows, valves, etc., so that in practice it is almost never used, and "rules of thumb" and tables derived from experience are used instead.

On this subject a committee of the Am. Soc. Heating and Ventilating Engineers reported in 1909 as follows:

The amount of water of a certain temperature required per hour by radiation may be determined by the following formula:

$$\frac{R \times X}{20 \times 60.8 \times 60} = \text{cu. ft. of water per minute.}$$

R = square feet of radiation; X = B.T.U. given off per hour by 1 sq. ft. of radiation (150 for direct and 230 for indirect) with water at 170°. Twenty is the drop in temperature in degrees between the water entering the radiation and that leaving it; 60.8 is the weight of a cubic foot of water at 170 degrees; 60 is to reduce the result from hours to minutes. The average sizes of mains, as used by seven prominent engineers in regular practice for 1800 square feet of radiation, are given below:

2-pipe open-tank system, 100 ft. mains, 5-in. pipe = 26.6 ft. per min.
 1-pipe open-tank system, 100 ft. mains, 6-in. pipe = 18.4 ft. per min.
 Overhead open-tank system, 100 ft. mains, 4-in. pipe = 41.8 ft. per min.
 Overhead open-tank system, 100 ft. mains, 3-in. pipe = 72.1 ft. per min.

For 1200 sq. ft. indirect radiation with separate main, 100 ft. long, direct from boiler, open system, the bottom of the radiator being 1 ft. above the top of the boiler — 5-in. pipe = 22.4 ft. per min.

CAPACITY OF MAINS 100 FT. LONG.

Expressed in the number of square feet of hot-water radiating surface they will supply, the radiators being placed in rooms at 70° F., and 20° drop assumed.

Diameter of Pipes, Ins.	Two-Pipe up Feed Open Tank.	One-Pipe up Feed Open Tank.	Overhead Open Tank.	Overhead Closed Tank.	Two-Pipe Open Tank.
1 1/4	75	45	127	250	48
1 1/2	107	65	181	350	69
2	200	121	339	667	129
2 1/2	314	190	533	1,060	202
3	540	328	916	1,800	348
3 1/2	780	474	1,334	2,600	502
4	1,060	645	1,800	3,350	684
5	1,860	1,130	3,150	6,200	1,200
6	2,960	1,800	5,000	9,800	1,910
7	4,280	2,700	7,200	13,900	2,760
8	5,850	3,500	9,900	19,500	3,778

The figures are for direct radiation except the last column which is for indirect, 12 in. above boiler.

CAPACITY OF RISERS.

Expressed in the number of sq. ft. of direct hot-water radiating surface they will supply, the radiators being placed in rooms at 70° F., and 20° drop assumed. The figures in the last column are for the closed-tank overhead system the others are for the open-tank system.

Diameter of Riser, Inches.	1st Floor.	2d Floor.	3d Floor.	4th Floor.	Drop Risers, not exceeding 4 floors.
1	33	46	57	64	48
1 1/4	71	104	124	142	112
1 1/2	100	140	175	200	160
2	187	262	325	375	300
2 1/2	292	410	492	580	471
3	500	755	875	1,000	810

All horizontal branches from mains to risers or from risers to radiators, more than 10 ft. long (unless within 15 ft. of the boiler), should be increased one size over that indicated for risers in the above table.

For indirect radiation, the amount of surface may be computed as follows:

- Temperature of the air entering the room, 110° = T.
- Average temperature of the air passing through the radiator, 55°.
- Temperature of the air leaving the room, 70° = t.
- Velocity of the air passing through the radiator, 240 ft. per min.
- Cubic feet of air to be conveyed per hour, = C = (H × 55) ÷ (T - t).
- H = exposure loss in B.T.U. per hour.
- Heat necessary to raise this air to the entering temperature from 0° F., T × C + 55 = H.

WARNING: This is a 1910 edition. Some of the material may no longer be accurate

The amount of radiation is found by dividing the total heat by the emission of heat by indirect radiators per square foot per hour per degree difference in temperature. This varies with the velocity, as shown below:

Velocity, ft. per min.	174	246	300	342	378	400	428	450	474	492
B.T.U.	1.70	2.00	2.22	2.38	2.52	2.60	2.67	2.72	2.76	2.80

The difference between 170 degrees (average temperature of the water in the radiator) and 55 degrees (average temperature of the air in the radiator) being 115, the emission at 240 ft. per min. is 2. per degree difference or 230 B.T.U.

Ordinarily the amount of indirect radiation required is computed by adding a percentage to the amount of direct radiation [computed by the usual rules], and an addition of 50% has been found sufficient in many cases; but in buildings where a standard of ventilation is to be maintained, the formula mentioned seems more likely to give satisfactory results. Free area between the sections of radiation to allow passage of the required volume of air at the assumed velocity must be maintained. The cold-air supply duct, on account of less frictional resistance, may ordinarily have 80% of the area between the radiator sections. The hot-air flues may safely be proportioned for the following air velocities per minute: First floor, 200 feet; second floor, 300 feet; third floor, 400 feet.

PIPE SIZES FOR HOT-WATER HEATING.

Based on 20° difference in temperature between flow and return water. (C. L. Hubbard, *The Engineer* July 1, 1902.)

Diam. of Pipe.	1	1 1/4	1 1/2	2	2 1/2	3	3 1/2	4	5	6	7
Length of Run, Feet.	Square Feet of Direct Radiating Surface.										
100	30	60	100	200	350	550	850	1,200	1,400	1,600	1,800
200	50	75	125	200	300	450	600	700	800	900	1,000
300	75	125	200	300	450	600	700	800	900	1,000	1,100
400	100	175	275	400	525	650	750	850	950	1,050	1,150
500	125	225	325	475	625	775	900	1,000	1,100	1,200	1,300
600	150	275	400	575	750	900	1,050	1,200	1,350	1,500	1,650
700	175	325	475	675	875	1,050	1,200	1,350	1,500	1,650	1,800
800	200	375	550	775	1,000	1,200	1,350	1,500	1,650	1,800	1,950
1000	250	475	700	1,000	1,300	1,500	1,700	1,900	2,100	2,300	2,500
	Square Feet of Indirect Radiation.										
100	15	30	50	100	200	300	400	600	1,000	1,400	1,800
200	20	30	70	120	200	300	400	400	700	1,000	1,300
	Square Feet of Direct Radiating Surface.										
1st story	30	60	100	200	350	550	850	1,200	1,400	1,600	1,800
2d "	55	90	140	275	275	550	850	1,200	1,400	1,600	1,800
3d "	65	110	165	375	375	750	1,100	1,400	1,600	1,800	2,000
4th "	75	125	185	425	425	850	1,200	1,500	1,700	1,900	2,100
5th "	85	140	210	500	500	1,000	1,400	1,700	1,900	2,100	2,300
6th "	95	160	240	500	500	1,000	1,400	1,700	1,900	2,100	2,300

The size of pipe required to supply any given amount of hot-water radiating surface depends upon (1) The square feet of radiation; (2) its elevation above the boiler; (3) the difference in temperature of the water in the supply and return pipes; (4) the length of the pipe connecting the radiator with the boiler.

In estimating the length of a pipe the number of bends and valves must be taken into account. It is customary to consider an elbow as equivalent to a pipe 60 diameters in length, and a return bend to 120 diameters. A globe valve may be taken about the same as an elbow.

A series of articles on The Determination of the Sizes of Pipe for Hot Water Heating, by F. E. Geisecke, is printed in *Domestic Engineering*, beginning in May, 1909.

Sizes of Flow and Return Pipes Approximately Proportioned to Surface of Direct Radiators for Gravity Hot-Water Heating. (G. W. Stanton, *Heat. & Ventg. Mag.*, April, 1908.)

Size of Mains.	Mains.		Branches of Mains.			
	In Cellar or Basement.	On One or More Floors. Average.	First Floor 10'-15'.	Second Floor 15'-25'.	Third Floor 25'-35'.	Fourth or Fifth Floor 35'-45'.
	Square Feet of Radiating Surface.					
3/4				40	45	50
1			50	75	80	85
1 1/4	100	155	110	120	135	150
1 1/2	135	220	180	195	210	230
2	225	350	290	320	350	370
2 1/2	320	460	400	490	525	550
3	500	675	620	650	690	730
3 1/2	650	850	820	870	920	970
4	850	1,190	1,050	1,120	1,185	1,250
4 1/2	1,050	1,350	1,325	1,400	1,485	1,560
5	1,350	1,700				
6	2,900	3,600				
7	3,900	4,800				
8	5,000	6,200				
9	6,300	7,700				
10	7,900	9,800				
11	9,500	11,800				
12	11,400	14,000				

Note.—The heights of the several floors are taken as:
1st. 10 to 15 ft.; 2d. 15 to 25 ft.
3d. 25 to 35 ft.; 4th. 35 to 45 ft.

Heating by Hot Water, with Forced Circulation.—The principal defect of gravity hot-water systems, that the motive force is only the difference in weight of two columns of water of different temperatures, is overcome by giving the water a forced circulation, either by means of a pump or by a steam ejector. For large installations a pump gives facilities for forcing the hot water to any distance required. The design of such a system is chiefly a problem in hydraulics. After determining the quantity of heat to be given out by each radiator, a certain drop in temperature is assumed, and from that the volume of water required by each radiator is calculated. The piping system then has to be designed so that it will carry the proper supply of water to each radiator without short-circuiting, and with a minimum total cost for power to force the water, for loss by radiation, and for interest, etc., on cost of plant. No short rules or formulæ have been established for designing a forced hot-water system, and each case has to be studied as an original problem to be solved by application of the laws of heat transmission and hydraulics. Forced systems using steam ejectors have come into use to some extent in Europe in small installations, and some of them are described in the *Transactions of the Amer. Soc'y of Heating and Ventilating Engineers*.

A system of distributing heat and power to customers by means of hot water pumped from a central station was adopted by the Boston Heating Co. in 1888. It was not commercially successful. A description of the plant is given by A. V. Abbott in *Trans. A. I. M. E.*, 1888.

THE BLOWER SYSTEM OF HEATING.

The system provides for the use of a fan or blower which takes its supply of fresh air from the outside of the building to be heated, forces it over steam coils, located either centrally or divided up into a number of independent groups, and then into the several ducts or flues leading to the various rooms. The movement of the warmed air is positive, and the delivery of the air to the various points of supply is certain and entirely independent of atmospheric conditions.

Advantages and Disadvantages of the Plenum System. (Prof. W. F. Barrett, *Brit. Inst. H. & V. Engrs.*, 1905.)—Advantages: (1) The

evenness of temperature produced; (2) the ventilation of the building is concurrent with its warming; (3) the air can be drawn from sources free from contamination and can be filtered from suspended impurities, warmed and brought to the proper hygrometric state before its introduction to the different rooms or wards; (4) the degree of temperature and of ventilation can be easily controlled in any part of the building, and (5) the removal of ugly pipes running through the rooms has a great architectural and esthetic advantage.

Disadvantages: (1) The most obvious is that no windows can be opened nor doors left open; double doors with an air lock between must also be provided if the doors are frequently opened and closed; (2) the mechanical arrangements are elaborate and the system requires to be used with intelligent care; (3) the whole elaborate system needs to be set going even if only one or two rooms in a large building require to be warmed, as often happens in the winter vacation of a college; (4) the temporary failure of the system, through the breakdown of the engines or other cause, throws the whole system into confusion, and if, as in the Royal Victoria Hospital, the windows are not made to open, imminent danger results; (5) then, also, in the case of hospital wards and asylums it is possible that the outlet ducts may become coated with disease germs, and unless periodically cleaned, a back current through a high wind or temporary failure of the system may bring a cloud of these disease germs back into the wards.

Heat Radiated from Coils in the Blower System.—The committee on Fan-blast Heating, of the A. S. H. V. E., in 1909, gives the following formula for amount of heat radiated from hot-blast coils with different velocities of air passing through the heater: $E = B.T.U.$ per sq. ft. of surface per hour per degree of difference between the average temperature of the air and the steam temperature, $= \sqrt{4V}$, in which $V =$ velocity of the air through the free area of the coil in feet per second. A plotted curve of 20 tests of different heaters shows that the formula represents the average results, but individual tests show a wide variation from the average, thus: For velocity 1000 ft. per min., average 9 B.T.U., range 7.5 to 11; 1600 ft. per min., average 10.4, range 9.5 to 12.

The committee also gives the following formula for the rise in temperature of each two-row section of a coil:

$$R = \frac{(T_s - T_a) \times H \times E}{A \times V_m \times W \times 60 \times 0.2377}$$

In which $R =$ degrees F. rise for each two-row section; $T_s =$ temperature of steam; $T_a =$ temperature of air; $H =$ square feet of surface in two-row section; $E = B.T.U.$ per degree difference between air and steam; $E = \sqrt{4V_s}$, in which $V_s =$ air velocity in ft. per sec.; $A =$ area through heater in sq. ft.; $V_m =$ velocity of air in ft. per min.; $W =$ weight of 1 cu. ft. of air, lbs.

The value of R is computed for each two-row section in a coil, and the results added. From a set of curves plotted from the formula the following figures are taken.

	Number of Rows.						
	4	8	12	16	20	24	28
	Temperature Rise, Degrees.						
Steam, 80 lbs. $V_m = 1,200$	43	83	115	144	167	189	209
Steam, 80 lbs. $V_m = 1,800$	36	68	96	122	145	165	182
Steam, 5 lbs. $V_m = 1,200$	31	53	80	100	118	133	146
Steam, 5 lbs. $V_m = 1,800$	25	48	68	86	101	115	128

A formula for the rise in temperature of air in passing through the coils of a hot-blast heater is given by E. F. Child in *The Metal Worker*, Oct. 5, 1907, as follows: $R = KDZ^m N \div \sqrt{V}$, in which $R =$ rise in

temperature of the air; K = a constant depending on the kind of heating surface; D = an average of the summation of temperature differences between the air and the steam = $(T_1 - T_0) \div \log_e [(T_s - T_0) \div (T_s - T_1)]$; Z = number of sq. ft. of heating surface per sq. ft. of clear area per unit depth of heater. m = a power applicable to Z and depending on the type of heating surface; N = number of units in depth of heater; V = velocity of the air at 70° F. in ft. per min. through the clear area; n = a root applicable to V and depending on experiment.

For practical purposes and within the range of present knowledge on the subject the formula may be written $R = 0.85 DZV \div \sqrt[3]{V}$, and from this formula with $T_s = 227^\circ$ and $T_0 = 0^\circ$, with different values of T_1 , the temperature of the air leaving the coils, a set of curves is plotted, from which the figures in the following table are taken.

Velocity, Ft. per Min.	Sq. ft. of heating surface ÷ sq. ft. free area through heater.									
	20	30	40	50	60	70	80	90	100	120
	Rise in Temperature, Degrees F.									
500	43	63	79	95	108	120	131	141	151	170
800	38	55	70	84	97	108	118	128	138	157
1000	36	52	66	79	92	102	112	121	130	147
1200	34	49	63	75	87	98	108	117	125	140
2000	29	42	55	66	76	86	95	104	112	127

Burt S. Harrison (*Htg. and Ventg. Mag.*, Oct. and Nov., 1907) gives the following formula, $R = \frac{1}{\sqrt[3]{V}} (T - t) \frac{1}{8/N + 0.24}$, in which T = temp. of steam

in coils, t = temp. of air entering coils, V = velocity of air through coils in ft. per sec., N = no. of rows of 1-in. pipe in depth of heater. Charts are given by means of which heaters may be designed for any set of conditions.

Tests of Cast-iron Heaters for Hot-blast Work. — An extensive series of tests of the Amer. Radiator Co's, "Vento" cast-iron heater is described by Theo. Weinshank in *Trans. A. S. H. V. E.*, 1908. The tests were made under the supervision of Prof. J. H. Kinealy. The principal results are given below.

TESTS OF A "VENTO" CAST-IRON HEATER.

Velocity, ft. per Min.	Number of sections heater is deep.						Number of sections heater is deep.					
	1	2	3	4	5	6	1	2	3	4	5	6
	Rise of temperature, K, per degree difference between temperature of steam and mean temperature of air for different velocities of air.						Heat units transmitted per square foot of heating surface per hour per degree difference between the temperature of the steam and the mean temperature of the air.					
1600	0.124	0.253	0.395	0.527	0.649	0.761	11.94	12.17	12.67	12.67	12.50	12.20
1500	0.132	0.261	0.403	0.535	0.657	0.769	11.91	11.76	12.11	12.06	11.86	11.56
1400	0.139	0.268	0.410	0.542	0.664	0.776	11.70	11.28	11.50	11.41	11.18	10.89
1300	0.147	0.276	0.418	0.550	0.672	0.784	11.50	10.79	10.89	10.75	10.51	10.22
1200	0.154	0.283	0.425	0.557	0.679	0.791	11.11	10.21	10.22	10.05	9.81	9.52
1100	0.162	0.291	0.433	0.565	0.687	0.799	10.72	9.63	9.55	9.34	9.09	8.82
1000	0.170	0.299	0.441	0.573	0.695	0.807	10.23	8.99	8.84	8.61	8.36	8.10
900	0.177	0.306	0.448	0.580	0.702	0.814	9.59	8.28	8.08	7.85	7.60	7.35
800	0.185	0.314	0.456	0.588	0.710	0.822	8.90	7.56	7.31	7.08	6.48	6.60

WARNING: This is a 1910 edition. Some of the material may no longer be accurate.

TESTS OF A "VENTO" CAST-IRON HEATER. — Continued

Velocity, ft. per min.	Final temperature, T , of air when entering heater at 0° F. Temperature of steam in heater, 227°.						Friction loss in inches of water due to the sections.					
	26.5	51.0	74.9	94.7	111.3	125.2	0.236	0.288	0.416	0.543	0.672	0.800
1500	28.1	52.4	76.3	95.8	112.4	126.0	0.207	0.253	0.366	0.477	0.590	0.703
1400	29.5	53.8	77.2	96.7	113.3	126.8	0.180	0.220	0.318	0.415	0.514	0.613
1300	31.1	55.0	77.6	97.9	114.3	127.7	0.156	0.190	0.274	0.358	0.443	0.528
1200	32.4	56.4	79.6	99.0	115.3	128.7	0.133	0.162	0.234	0.306	0.378	0.450
1100	34.0	57.7	80.5	100.0	116.2	129.6	0.111	0.136	0.197	0.257	0.318	0.378
1000	35.6	59.1	82.0	100.1	117.2	130.5	0.092	0.112	0.162	0.212	0.262	0.312
900	36.9	60.1	83.0	102.1	118.0	131.3	0.074	0.091	0.132	0.172	0.212	0.253
800	38.5	61.6	84.3	103.1	119.0	132.3	0.059	0.072	0.104	0.136	0.167	0.200

Formulae. — s = no. of sections; V = velocity, ft. per min., air measured at 70°; k = rise of temp. per degree difference; t = final temperature. f = friction loss in in. of water. $t = 454k + (2 + k)$. $k = s(0.167 - 0.005s) - 0.061 \left(\frac{v-800}{800}\right)$. $f = (0.8s + 0.2)(V/4000)^2$. Values of k and f when $s=2$ or more.

Factory Heating by the Fan System.

In factories where the space provided per operative is large, warm air is recirculated, sufficient air for ventilation being provided by leakage through the walls and windows. The air is commonly heated by steam coils furnished with exhaust steam from the factory engine. When the engine is not running, or when it does not supply enough exhaust steam for the purpose, steam from the boilers is admitted to the coils through a reducing valve. The following proportions are commonly used in designing. Coils, pipes 1-in., set 2 1/8 in. centers; free area through coils, 40% of cross area. Velocity of air through free area, 1200 to 1800 ft. per min.; number of coils in series 8 to 20; circumferential speed of fan, 4000 to 6000 ft. per min.; temperature of air leaving coils, 120° to 160° F.; velocity of air at outlet of coil stack, 3000 to 4000 ft. per min.; velocity in branch pipes, 2000 to 2800 ft., the lower velocities in the longest pipes.

In factories in which mechanical ventilation as well as heating is required, outlet flues at proper points must be provided, to avoid the necessity of opening windows, and the outflow of air in them may be assisted either by exhaust fans or by steam coils in the flues.

Cooling Air for Ventilation.

The chief difficulty in the artificial cooling of air is due to the moisture it contains, and the great quantity of heat that has to be absorbed or abstracted from the air in order to condense this moisture. The cooled and moisture-laden air also needs to be partially reheated in order to bring it to a degree of relative humidity that will make it suitable for ventilation. To cool 1 lb. of dry air from 82° to 72° requires the abstracting of 10 × 0.2375 B.T.U. (0.2375 being the specific heat at constant pressure). If the air at 82° is saturated, or 100% relative humidity, it contains 0.0235 lb. of water vapor, while 1 lb. at 72° contains 0.0167 lb., so that 0.0068 lb. will be condensed in cooling from vapor at 82° to water at 72°. The total heat (above 32°) in 1 lb. vapor at 82° is 1095.6 B.T.U. and that in 1 lb. of water at 72° is 40 B.T.U. The difference, 1055.6 × 0.0068 = 7.178 B.T.U., is the amount of heat abstracted in condensing the moisture. The B.T.U. in 1 lb. vapor at 72° is 1091.2,

and the B.T.U. abstracted in cooling the remaining vapor from 82° to 72° is $0.0167 \times (1095.6 - 1091.2) = 0.073$ B.T.U. The sum, 7.251 B.T.U., is more than three times that required to cool the dry air from 82° to 72°. Expressing these principles in formulae we have:

Let T_1 = original and T_2 the final temperature of the air,
 a = vapor in 1 lb. saturated air at T_1 ; b = do. at T_2 ,
 H = relative humidity of the air at T_1 ; h = desired do. at T_2 ,
 U = total heat, in B.T.U., in 1 lb. vapor at T_1 ; u = do. at T_2 ,
 w = total heat in water at T_2 .

Then total heat abstracted in cooling air from T_1 to $T_2 = (aH - bh) \times (U - w) + bh(U - u) + 0.2375(T_1 - T_2)$, or $aHU - bhU - (aH - bh)w + 0.2375(T_1 - T_2)$, or $aH(U - w) - bh(u - w) + 0.2375(T_1 - T_2)$.

EXAMPLE. — Required the amount of heat to be abstracted per hour in cooling the air for an audience chamber containing 1000 persons, 1500 cu. ft. (measured at 70° F.), being supplied per person per hour, the temperature of the air before cooling being 82°, with relative humidity 80%, and after cooling 72°, with humidity 70%.

$$1000 \times 1500 = 1,500,000 \text{ cu. ft., at } 0.075 \text{ lb. per cu. ft.} \\ = 112,500 \text{ lbs.}$$

For 1 lb. $aH(U - w) - bh(u - w) + 0.2375(T_1 - T_2)$.

$$0.0235 \times 0.8 \times (1095.6 - 40) - 0.0167 \times 0.7 \times (1091.2 - 40) \\ + 2.375 = 9.932 \text{ B.T.U.} \\ 112,500 \times 9.932 = 1,061,100 \text{ B.T.U.}$$

Taking 142 B.T.U. as the latent heat of melting ice, this amount is equivalent to the heat that would melt 7472 lbs. of ice per hour.

See also paper by W. W. Macon, *Trans. A. S. H. V. E.*, 1909, and Air-cooling of the New York Stock Exchange, *Eng. Rec.*, April, 1905, and *The Metal Worker*, Aug. 5, 1905.

Capacities of Fans or Blowers for Hot-Blast or Plenum Heating.

(Computed by F. R. Still, American Blower Co., Detroit, Mich.)

Size of Blower-Housing.	Diam. of Fan-Wheel.	Revolutions per Minute.	H. P. Required to Drive Fan.	Cu. Ft. of Air Delivered per Minute by Fan through Heater.	Cu. Ft. of Air per Hour.	Heat Units Required per Hour to Raise Air from 0° to 120°.	Velocity of Air through Coils in Ft. per Minute.	Free Area between Pipes in Sq. Ft.	Heat Units Given off per Sq. Ft. Surface per Hour.	Sq. Ft. Heating Surface Required.
70	42	360	2 1/2	6,900	415,200	1,021,000	900	7.7	1760	580
80	48	320	3	8,500	510,000	1,255,000	..	9.45	..	714
90	54	280	4	10,500	630,000	1,550,000	..	11.66	..	880
100	60	250	5	12,500	750,000	1,845,000	..	13.9	..	1050
110	66	230	6	15,800	948,000	2,335,000	..	17.55	..	1325
120	72	210	8	19,800	1,118,000	2,900,000	..	22.	..	1650
140	84	180	10	26,200	1,572,000	3,870,000	..	29.1	..	2200
160	96	160	12	33,000	1,980,000	4,870,000	..	36.7	..	2770
180	108	140	15	41,600	2,496,000	6,130,000	..	46.3	..	3490
200	120	125	18	50,000	3,000,000	7,375,000	..	55.5	..	4140

WARNING: This is a 1910 edition. Some of the material may no longer be accurate

Capacities of Fans or Blowers for Hot-blast or Plenum Heating --
Continued.

Size of Blower-Housing.	Lineal Feet of One-Inch Pipe Required.	Pounds of Steam Condensed per Hour to 212°.	Size Steam-Main Required.	Size Return-Main Required.	Boiler Capacity Required, H.P.; 30 Lbs. Steam per Hour = 1 H.P.	Sq. Ft. Heating Surface in Boiler at 15 Sq. Ft. per H.P.	Sq. Ft. Grate-Surface at 35 Sq. Ft. Heating Surface to Sq. Ft. Grate.	Volume Air Will Expand to by Heating from 6° to 120° Capacity per Minute.	Area of Conduit in Sq. Ft. for 200 Ft. Velocity per Minute.	Net Volume Delivered, Allowance Being Made for Friction Equal to 100 Ft. of Conduit.
70	1,740	1055	3 1/2	2	35	525	15	8,700	9.67	8,200
80	2,142	1295	4	2	43	645	18	10,700	13.05	10,000
90	2,640	1600	4 1/2	2 1/2	53	795	23	13,200	14.72	12,500
100	3,150	1900	5	2 1/2	63	945	27	15,800	17.55	15,000
110	3,975	2410	5 1/2	3	80	1200	34	19,900	22.20	18,900
120	4,950	2990	6	3	100	1500	43	25,000	27.80	23,800
140	6,600	3990	7	3 1/2	133	1995	57	33,100	36.80	31,400
160	8,310	5025	8	4	167	2505	72	41,700	46.30	39,600
180	10,470	6325	9	4 1/2	211	3165	90	52,500	58.40	50,000
200	12,420	7560	10	5	252	3780	108	63,200	70.25	60,000

Temperature of fresh air, 0°; of air from coils, 120°; of steam, 227°; Pressure of steam, 5 lbs.

Peripheral velocity of fan-tips, 4000 ft.; number of pipes deep in coil, 24; depth of coil, 60 inches; area of coils approximately twice free area.

Relative Efficiency of Fans and Heated Chimneys for Ventilation. — W. P. Trowbridge, *Trans. A. S. M. E.* vii. 531, gives a theoretical solution of the relative amounts of heat expended to remove a given volume of impure air by a fan and by a chimney. Assuming the total efficiency of a fan to be only 1/25, which is made up of an efficiency of 1/10 for the engine, 5/10 for the fan itself, and 9/10 for efficiency as regards friction, the fan requires an expenditure of heat to drive it of only 1/38 of the amount that would be required to produce the same ventilation by a chimney 100 ft. high. For a chimney 500 ft. high the fan will be 7.6 times more efficient.

The following figures are given by Atkinson (*Coll. Engr.*, 1889), showing the minimum depth at which a furnace would be equal to a ventilating-machine, assuming that the sources of loss are the same in each case, i.e., that the loss of fuel in a furnace from the cooling in the upcast is equivalent to the power expended in overcoming the friction in the machine, and also assuming that the ventilating-machine utilizes 60 per cent of the engine-power. The coal consumption of the engine per I.H.P. is taken at 8 lbs. per hour.

Average temperature in upcast 100° F. 150° F. 200° F.
 Minimum depth for equal economy.. 960 yards. 1040 yards. 1130 yards.

PERFORMANCE OF HEATING GUARANTEE.

Heating a Building to 70° F. Inside when the Outside Temperature is Zero. — It is customary in some contracts for heating to guarantee that the apparatus will heat the interior of the building to 70° in zero weather. As it may not be practicable to obtain zero weather for the purpose of a test, it may be difficult to prove the performance of the guarantee unless an equivalent test may be made when the outside temperature is above zero, heating the building to a higher temperature than 70°. The following method was proposed by the author (*Eng. Rec.*,

Aug. 11, 1894) for determining to what temperature the rooms should be heated for various temperatures of the outside atmosphere and of the steam or hot water in the radiators.

- Let S = sq. ft. of surface of the steam or hot-water radiator;
- W = sq. ft. of surface of exposed walls, windows, etc.;
- T_s = temp. of the steam or hot water, T_1 = temp. of inside of building or room, T_0 = temp. of outside of building or room;
- a = heat-units transmitted per sq. ft. of surface of radiator per hour per degree of difference of temperature;
- b = average heat-units transmitted per sq. ft. of walls per hour per degree of difference of temperature, including allowance for ventilation.

It is assumed that within the range of temperatures considered Newton's law of cooling holds good, viz., that it is proportional to the difference of temperature between the two sides of the radiating-surface.

Then $aS(T_s - T_1) = bW(T_1 - T_0)$. Let $\frac{bW}{aS} = C$; then

$$T_s - T_1 = C(T_1 - T_0); \quad T_1 = \frac{T_s + CT_0}{1 + C}; \quad C = \frac{T_s - T_1}{T_1 - T_0}$$

If $T_1 = 70$, and $T_0 = 0$, $C = \frac{T_s - 70}{70}$.

Let $T_s = 140^\circ$ 160° 180° 200° 212° 220° 250° 300°
 Then $C = 1$ 1.286 1.571 1.857 2.029 2.143 2.571 3.286
 and from the formula $T_1 = (T_s + CT_0) \div (1 + C)$ we find the inside temperatures corresponding to the given values of T_s and T_0 which should be produced by an apparatus capable of heating the building to 70° in zero weather.

For $T_0 =$	-20	-10	0	10	20	30	40° F.
Inside Temperatures T_1 .							
For $T_s = 140^\circ$ F.	60	65	70	75	80	85	90
160	58.7	64.3	70	75.6	81.3	86.9	92.5
180	57.8	63.9	70	76.1	82.2	88.4	94.5
200	57.0	63.5	70	76.5	83.0	89.5	96.0
212	56.3	63.3	70	76.7	83.4	90.1	96.8
220	56.4	63.2	70	76.8	83.6	90.5	97.3
250	55.6	62.8	70	77.2	84.4	91.6	98.8
300	54.7	62.4	70	77.7	85.3	93.0	100.7

J. K. Allen (*Trans. A. S. H. V. E.*, 1908) develops a complex formula for the inside temperature which takes into consideration the fact that the coefficient of transmission of the radiator is not constant but increases with the temperature. With $T_s = 227$ and a two-column cast-iron radiator he finds for $T_0 = -20$ -10 0 10 20 30 40
 $T_1 = 58$ 64 70 77.5 83 90 97

For all values of T_0 between -10 and 40 these figures are within one degree of those computed by the author's method.

ELECTRICAL HEATING.

Heating by Electricity. — If the electric currents are generated by a dynamo driven by a steam-engine, electric heating will prove very expensive, since the steam-engine wastes in the exhaust-steam and by radiation about 90% of the heat-units supplied to it. In direct steam-heating, with a good boiler and properly covered supply-pipes, we can utilize about 60% of the total heat value of the fuel. One pound of coal, with a heating value of 13,000 heat-units, would supply to the radiators about $13,000 \times 0.60 = 7800$ heat-units. In electric heating, suppose we have a first-class condensing-engine developing 1 H.P. for every 2 lbs. of coal burned per hour. This would be equivalent to 1,980,000 ft.-lbs.

778 = 2545 heat-units, or 1272 heat-units for 1 lb. of coal. The friction of the engine and of the dynamo and the loss by electric leakage and by heat radiation from the conducting wires might reduce the heat-units delivered as electric current to the electric radiator, and there converted into heat, to 50% of this, or only 636 heat-units, or less than one twelfth of that delivered to the steam-radiators in direct steam-heating. Electric heating, therefore, will prove uneconomical unless the electric current is derived from water or wind power which would otherwise be wasted. (See Electrical Engineering.)

MINE-VENTILATION.

Friction of Air in Underground Passages. — In ventilating a mine or other underground passage the resistance to be overcome is, according to most writers on the subject, proportional to the extent of the frictional surface exposed; that is, to the product lo of the length of the gangway by its perimeter, to the density of the air in circulation, to the square of its average speed, v , and lastly to a coefficient k , whose numerical value varies according to the nature of the sides of the gangway and the irregularities of its course.

The formula for the loss of head, neglecting the variation in density as unimportant, is $p = \frac{ksv^2}{a}$, in which p = loss of pressure in pounds per square foot, s = square feet of rubbing-surface exposed to the air, v the velocity of the air in feet per minute, a the area of the passage in square feet, and k the coefficient of friction. W. Fairley, in *Colliery Engineer*, Oct. and Nov., 1893, gives the following formulæ for all the quantities involved, using the same notation as the above, with these additions: h = horse-power of ventilation; l = length of air-channel; o = perimeter of air-channel; q = quantity of air circulating in cubic feet per minute; u = units of work, in foot-pounds, applied to circulate the air; w = water-gauge in inches. Then,

1. $a = \frac{ksv^2}{p} = \frac{ksv^2q}{u} = \frac{ksv^2}{pv} = \frac{u}{pv} = \frac{q}{v}$.
2. $h = \frac{u}{33,000} = \frac{qp}{33,000} = \frac{5.2qw}{33,000}$.
3. $k = \frac{pa}{sv^2} = \frac{u}{sv^3} = \frac{p}{sv^2 + a} = \frac{5.2w}{sv^2 + a}$.
4. $l = \frac{s}{o} = \frac{la}{kv^2o}$.
5. $o = \frac{s}{l} = \frac{pa}{kv^2l}$.
6. $p = \frac{ksv^2}{a} = \frac{u}{q} = 5.2w = \left(\sqrt{\frac{u}{ks}}\right)^2 \frac{ks}{a} = \frac{ksv^2}{q} = \frac{u}{av}$.
7. $pa = ksv^2 = \left(\sqrt{\frac{u}{ks}}\right)^2 ks = \frac{u}{v}; pa^3 = ksq^2$.
8. $q = va = \frac{u}{p} = \frac{ksv^3}{p} = \sqrt{\frac{pa}{ks}} a = \sqrt{\frac{u}{ks}} a$.
9. $s = \frac{pa}{kv^2} = \frac{u}{kv^3} = \frac{qp}{kv^3} = \frac{vpa}{kv^3} = lo$.
10. $u = qp = vpa = \frac{ksv^2q}{a} = ksv^3 = 5.2qw = 33,000h$.
11. $v = \frac{u}{pa} = \frac{q}{a} = \sqrt{\frac{u}{ks}} = \sqrt{\frac{qp}{ks}} = \sqrt{\frac{pa}{ks}}$.
12. $v^2 = \frac{pa}{ks} = \left(\sqrt{\frac{u}{ks}}\right)^2$.

$$13. v^2 = \frac{u}{ks} = \frac{qp}{ks} = \frac{vpa}{ks}$$

$$14. w = \frac{p}{5.2} = \frac{ksv^2}{5.2a}$$

To find the quantity of air with a given horse-power and efficiency (e) of engine:

$$q = \frac{h \times 33,000 \times e}{p}$$

The value of *k*, the coefficient of friction, as stated, varies according to the nature of the sides of the gangway. Widely divergent values have been given by different authorities (see *Colliery Engineer*, Nov., 1893), the most generally accepted one until recently being probably that of J. J. Atkinson, .000000217, which is the pressure per square foot in decimals of a pound for each square foot of rubbing-surface and a velocity of one foot per minute. Mr. Fairley, in his "Theory and Practice of Ventilating Coal-mines," gives a value less than half of Atkinson's or .0000001; and recent experiments by D. Murgue show that even this value is high under most conditions. Murgue's results are given in his paper on Experimental Investigations in the Loss of Head of Air-currents in Underground Workings, *Trans. A. I. M. E.*, 1893, vol. xxiii. 63. His coefficients are given in the following table, as determined in twelve experiments:

		Coefficient of Loss of Head by Friction.	
		French.	British.
Rock gangways.	Straight, normal section.....	.00092	.000,000,00486
	Straight, normal section.....	.00094	.000,000,00497
	Straight, large section.....	.00104	.000,000,00549
	Straight, normal section.....	.00122	.000,000,00645
Brick-lined arched gangways.	Straight, normal section.....	.00030	.000,000,00158
	Straight, normal section.....	.00036	.000,000,00190
	Continuous curve, normal section.....	.00062	.000,000,00328
	Sinuuous, intermediate section....	.00051	.000,000,00269
Timbered gangways.	Sinuuous, small section.....	.00055	.000,000,00291
	Straight, normal section.....	.00168	.000,000,00888
	Straight, normal section.....	.00144	.000,000,00761
	Slightly sinuuous, small section....	.00238	.000,000,01257

The French coefficients which are given by Murgue represent the height of water-gauge in millimeters for each square meter of rubbing-surface and a velocity of one meter per second. To convert them to the British measure of pounds per square foot for each square foot of rubbing-surface and a velocity of one foot per minute they have been multiplied by the factor of conversion, .00005283. For a velocity of 1000 feet per minute, since the loss of head varies as *v*², move the decimal point in the coefficients six places to the right.

Equivalent Orifice. — The head absorbed by the working-chambers of a mine cannot be computed *a priori*, because the openings, cross-passages, irregular-shaped gob-piles, and daily changes in the size and shape of the chambers present much too complicated a network for accurate analysis. In order to overcome this difficulty Murgue proposed in 1872 the method of *equivalent orifice*. This method consists in substituting for the mine to be considered the equivalent thin-lipped orifice, requiring the same height of head for the discharge of an equal volume of air. The area of this orifice is obtained when the head and the discharge are known, by means of the following formulæ, as given by Fairley:

Let *Q* = quantity of air in thousands of cubic feet per minute;
w = inches of water-gauge;
A = area in square feet of equivalent orifice.

Then

$$A = \frac{0.37 Q}{\sqrt{w}} = \frac{Q}{2.7 \sqrt{w}}; * Q = \frac{A \times \sqrt{w}}{0.37}; w = 0.1369 \times \left(\frac{Q}{A}\right)^2$$

* Murgue gives $A = \frac{0.38 Q}{\sqrt{w}}$, and Norris $A = \frac{0.403 Q}{\sqrt{w}}$. See page 644, *ante*.

Motive Column or the Head of Air Due to Differences of Temperature, etc. (Fairley.)

Let *M* = motive column in feet;
T = temperature of upcast;
f = weight of one cubic foot of the flowing air;
t = temperature of downcast;
D = depth of downcast.

Then

$$M = D \frac{T-t}{T \times 459} \text{ or } \frac{5.2 \times w}{f}; p = f \times M; w = \frac{f \times M}{5.2} = \frac{p}{5.2}$$

To find diameter of a round airway to pass the same amount of air as a square airway, the length and power remaining the same:
 Let *D* = diameter of round airway, *A* = area of square airway; *O* =

perimeter of square airway. Then $D^3 = \sqrt[5]{\frac{A^3 \times 3.1416}{0.7854^3 \times O}}$

If two fans are employed to ventilate a mine, each of which when worked separately produces a certain quantity, which may be indicated by *A* and *B*, then the quantity of air that will pass when the two fans are worked together will be $\sqrt[3]{A^3 + B^3}$. (For mine-ventilating fans, see page 644.)

WATER.

Expansion of Water. — The following table gives the relative volumes of water at different temperatures, compared with its volume at 4° C. according to Kopp, as corrected by Porter.

Cent.	Fahr.	Volume.	Cent.	Fahr.	Volume.	Cent.	Fahr.	Volume.
4°	39.1°	1.00000	35°	95°	1.00586	70°	158°	1.02241
5	41	1.00001	40	104	1.00767	75	167	1.02548
10	50	1.00025	45	113	1.00967	80	176	1.02872
15	59	1.00083	50	122	1.01186	85	185	1.03213
20	68	1.00171	55	131	1.01423	90	194	1.03570
25	77	1.00286	60	140	1.01678	95	203	1.03943
30	86	1.00425	65	149	1.01951	100	212	1.04332

Weight of 1 cu. ft. at 39.1° F. = 62.4245 lb. ÷ 1.04332 = 59.833,
 weight of 1 cu. ft. at 212° F.

Weight of Water at Different Temperatures. — The weight of water at maximum density, 39.1°, is generally taken at the figure given by Rankine, 62.425 lbs. per cubic foot. Some authorities give as low as 62.379. The figure 62.5 commonly given is approximate. The highest authoritative figure is 62.428. At 62° F. the figures range from 62.291 to 62.360. The figure 62.355 is generally accepted as the most accurate.

At 32° F. figures given by different writers range from 62.379 to 62.418. Hamilton Smith, Jr. (from Rosetti) gives 62.416.

Weight of Water at Temperatures above 200° F. (Landolt and Börnstein's Tables, 1905.)

Deg. F.	Lbs. Per Cu. Ft.	Deg. F.	Lbs. Per Cu. Ft.	Deg. F.	Lbs. Per Cu. Ft.	Deg. F.	Lbs. Per Cu. Ft.	Deg. F.	Lbs. Per Cu. Ft.	Deg. F.	Lbs. Per Cu. Ft.
200	60.12	270	58.26	340	55.94	410	53.0	480	49.7	550	45.6
210	59.88	280	57.96	350	55.57	420	52.6	490	49.2	560	44.9
220	59.63	290	57.65	360	55.18	430	52.2	500	48.7	570	44.1
230	59.37	300	57.33	370	54.78	440	51.7	510	48.1	580	43.3
240	59.11	310	57.00	380	54.36	450	51.2	520	47.6	590	42.6
250	58.83	320	56.66	390	53.94	460	50.7	530	47.0	600	41.8
260	58.55	330	56.30	400	53.5	470	50.2	540	46.3		

Weight of Water per Cubic Foot, from 32° to 212° F., and heat-units per pound, reckoned above 32° F.: The figures for weight of water in following table, made by interpolating the table given by Clark as calculated from Rankine's formula, with corrections for apparent errors, was published by the author in 1884, *Trans. A. S. M. E.*, vi. 90. The figures for heat units are from Marks and Davis's Steam Tables, 1909.

Temp., deg. F.	Weight, lbs. per cubic foot.	Heat-units.	Temp., deg. F.	Weight, lbs. per cubic foot.	Heat-units.	Temp., deg. F.	Weight, lbs. per cubic foot.	Heat-units.	Temp., deg. F.	Weight, lbs. per cubic foot.	Heat-units.
32	62.42	0.	78	62.25	46.04	123	61.68	90.90	168	60.81	135.86
33	62.42	1.01	79	62.24	47.04	124	61.67	91.90	169	60.79	136.86
34	62.42	2.02	80	62.23	48.03	125	61.65	92.90	170	60.77	137.87
35	62.42	3.02	81	62.22	49.03	126	61.63	93.90	171	60.75	138.87
36	62.42	4.03	82	62.21	50.03	127	61.61	94.89	172	60.73	139.87
37	62.42	5.04	83	62.20	51.02	128	61.60	95.89	173	60.70	140.87
38	62.42	6.04	84	62.19	52.02	129	61.58	96.89	174	60.68	141.87
39	62.42	7.05	85	62.18	53.02	130	61.56	97.89	175	60.66	142.87
40	62.42	8.05	86	62.17	54.01	131	61.54	98.89	176	60.64	143.87
41	62.42	9.05	87	62.16	55.01	132	61.52	99.88	177	60.62	144.88
42	62.42	10.06	88	62.15	56.01	133	61.51	100.88	178	60.59	145.88
43	62.42	11.06	89	62.14	57.00	134	61.49	101.88	179	60.57	146.88
44	62.42	12.06	90	62.13	58.00	135	61.47	102.88	180	60.55	147.88
45	62.42	13.07	91	62.12	59.00	136	61.45	103.88	181	60.53	148.88
46	62.42	14.07	92	62.11	60.00	137	61.43	104.87	182	60.50	149.89
47	62.42	15.07	93	62.10	60.99	138	61.41	105.87	183	60.48	150.89
48	62.41	16.07	94	62.09	61.99	139	61.39	106.87	184	60.46	151.89
49	62.41	17.08	95	62.08	62.99	140	61.37	107.87	185	60.44	152.89
50	62.41	18.08	96	62.07	63.98	141	61.36	108.87	186	60.41	153.89
51	62.41	19.08	97	62.06	64.98	142	61.34	109.87	187	60.39	154.90
52	62.40	20.08	98	62.05	65.98	143	61.32	110.87	188	60.37	155.90
53	62.40	21.08	99	62.03	66.97	144	61.30	111.87	189	60.34	156.90
54	62.40	22.08	100	62.02	67.97	145	61.28	112.86	190	60.32	157.91
55	62.39	23.08	101	62.01	68.97	146	61.26	113.86	191	60.29	158.91
56	62.39	24.08	102	62.00	69.96	147	61.24	114.86	192	60.27	159.91
57	62.39	25.08	103	61.99	70.96	148	61.22	115.86	193	60.25	160.91
58	62.38	26.08	104	61.97	71.96	149	61.20	116.86	194	60.22	161.92
59	62.38	27.08	105	61.96	72.95	150	61.18	117.86	195	60.20	162.92
60	62.37	28.08	106	61.95	73.95	151	61.16	118.86	196	60.17	163.92
61	62.37	29.08	107	61.93	74.95	152	61.14	119.86	197	60.15	164.93
62	62.36	30.08	108	61.92	75.95	153	61.12	120.86	198	60.12	165.93
63	62.36	31.07	109	61.91	76.94	154	61.10	121.86	199	60.10	166.94
64	62.35	32.07	110	61.89	77.94	155	61.08	122.86	200	60.07	167.94
65	62.34	33.07	111	61.88	78.94	156	61.06	123.86	201	60.05	168.94
66	62.34	34.07	112	61.86	79.93	157	61.04	124.86	202	60.02	169.95
67	62.33	35.07	113	61.85	80.93	158	61.02	125.86	203	60.00	170.95
68	62.33	36.07	114	61.83	81.93	159	61.00	126.86	204	59.97	171.96
69	62.32	37.06	115	61.82	82.92	160	60.98	127.86	205	59.95	172.96
70	62.31	38.06	116	61.80	83.92	161	60.96	128.86	206	59.92	173.97
71	62.31	39.06	117	61.78	84.92	162	60.94	129.86	207	59.89	174.97
72	62.30	40.05	118	61.77	85.92	163	60.92	130.86	208	59.87	175.98
73	62.29	41.05	119	61.75	86.91	164	60.90	131.86	209	59.84	176.98
74	62.28	42.05	120	61.74	87.91	165	60.87	132.86	210	59.82	177.99
75	62.28	43.05	121	61.72	88.91	166	60.85	133.86	211	59.79	178.99
76	62.27	43.04	122	61.70	89.91	167	60.83	134.86	212	59.76	180.00

Later authorities give figures for the weight of water which differ in the second decimal place only from those given above, as follows:

Temp. F. 40	50	60	70	80	90
Lbs. per cu. ft. ... 62.43	62.42	62.37	62.30	62.22	62.11
Temp. F. 100	110	120	130	140	150
Lbs. per cu. ft. ... 62.00	61.86	61.71	61.55	61.38	61.18
Temp. F. 160	170	180	190	200	210
Lbs. per cu. ft. ... 61.00	60.80	60.50	60.36	60.12	59.88

WARNING: This is a 1910 edition. Some of the material may no longer be accurate.

Comparison of Heads of Water in Feet with Pressures in Various Units.

One foot of water at 39.1° Fahr. = 62.425 lbs. on the square foot;
 " " " = 0.4335 lbs. on the square inch;
 " " " = 0.0295 atmosphere;
 " " " = 0.8826 inch of mercury at 30°;
 " " " = 773.3 feet of air at 32° and atmospheric pressure;

One lb. on the square foot, at 39.1° Fahr. = 0.01602 foot of water;
 One lb. on the square inch, at 39.1° Fahr. = 2.307 feet of water;
 One atmosphere of 29.922 in. of mercury = 33.9 feet of water;
 One inch of mercury at 32.1° = 1.133 feet of water;
 One foot of air at 32° and 1 atmosphere = 0.001293 feet of water;
 One foot of average sea-water = 1.026 foot of pure water;
 One foot of water at 62° F. = 62.355 lbs. per sq. foot;
 One foot of water at 62° F. = 0.43302 lb. per sq. inch;
 One inch of water at 62° F. = 0.5774 ounce = 0.036085 lb. per sq. inch;
 One lb. of water on the square inch at 62° F. = 2.3094 feet of water.
 One ounce of water on the square inch at 62° F. = 1.732 inches of water.

Pressure in Pounds per Square Inch for Different Heads of Water.
 At 62° F. 1 foot head = 0.433 lb. per square inch, 0.433 × 144 = 62.352 lbs. per cubic foot.

Head, feet.	0	1	2	3	4	5	6	7	8	9
0		0.433	0.866	1.299	1.732	2.165	2.598	3.031	3.464	3.897
10	4.330	4.763	5.196	5.629	6.062	6.495	6.928	7.361	7.794	8.227
20	8.660	9.093	9.526	9.959	10.392	10.825	11.258	11.691	12.124	12.557
30	12.990	13.423	13.856	14.289	14.722	15.155	15.588	16.021	16.454	16.887
40	17.320	17.753	18.186	18.619	19.052	19.485	19.918	20.351	20.784	21.217
50	21.650	22.083	22.516	22.949	23.382	23.815	24.248	24.681	25.114	25.547
60	25.980	26.413	26.846	27.279	27.712	28.145	28.578	29.011	29.444	29.877
70	30.310	30.743	31.176	31.609	32.042	32.475	32.908	33.341	33.774	34.207
80	34.640	35.073	35.506	35.939	36.372	36.805	37.238	37.671	38.104	38.537
90	38.970	39.403	39.836	40.269	40.702	41.135	41.568	42.001	42.436	42.867

Head in Feet of Water, Corresponding to Pressures in Pounds per Square Inch.

1 lb. per square inch = 2.30947 feet head, 1 atmosphere = 14.7 lbs. per sq. inch = 33.94 ft. head.

Pressure.	0	1	2	3	4	5	6	7	8	9
0		2.309	4.619	6.928	9.238	11.547	13.857	16.166	18.476	20.785
10	23.0947	25.404	27.714	30.023	32.333	34.642	36.952	39.261	41.570	43.880
20	46.1894	48.499	50.808	53.118	55.427	57.737	60.046	62.356	64.665	66.975
30	69.2841	71.594	73.903	76.213	78.522	80.831	83.141	85.450	87.760	90.069
40	92.3788	94.688	96.998	99.307	101.617	103.926	106.235	108.545	110.854	113.164
50	115.4735	117.783	120.093	122.402	124.711	127.021	129.330	131.640	133.949	136.259
60	138.5682	140.878	143.188	145.497	147.807	150.116	152.425	154.735	157.044	159.354
70	161.6629	163.972	166.282	168.591	170.901	173.210	175.520	177.829	180.139	182.448
80	184.7576	187.067	189.377	191.686	194.000	196.310	198.620	200.929	203.239	205.548
90	207.8523	210.162	212.472	214.781	217.091	219.400	221.710	224.020	226.330	228.640

Pressure of Water due to its Weight. — The pressure of still water in pounds per square inch against the sides of any pipe, channel, or vessel of any shape whatever is due solely to the "head," or height of the level surface of the water above the point at which the pressure is considered, and is equal to 0.43302 lb. per square inch for every foot of head, or 62.355 lbs. per square foot for every foot of head (at 62° F.).

The pressure per square inch is equal in all directions, downwards, upwards, or sideways, and is independent of the shape or size of the containing vessel.

The pressure against a vertical surface, as a retaining-wall, at any point is in direct ratio to the head above that point, increasing from 0 at the level surface to a maximum at the bottom. The total pressure against a vertical strip of a unit's breadth increases as the area of a right-angled triangle whose perpendicular represents the height of the strip and whose base represents the pressure on a unit of surface at the bottom; that is, it increases as the square of the depth. The sum of all the horizontal pressures is represented by the area of the triangle, and the resultant of this sum is equal to this sum exerted at a point one third of the height from the bottom. (The center of gravity of the area of a triangle is one third of its height.)

The horizontal pressure is the same if the surface is inclined instead of vertical.

(For an elaboration of these principles see Trautwine's Pocket-Book, or the chapter on Hydrostatics in any work on Physics. For dams, retaining-walls, etc., see Trautwine.)

The amount of pressure on the interior walls of a pipe has no appreciable effect upon the amount of flow.

Buoyancy. — When a body is immersed in a liquid, whether it float or sink, it is buoyed up by a force equal to the weight of the bulk of the liquid displaced by the body. The weight of a floating body is equal to the weight of the bulk of the liquid that it displaces. The upward pressure or buoyancy of the liquid may be regarded as exerted at the center of gravity of the displaced water, which is called the center of pressure or of buoyancy. A vertical line drawn through it is called the axis of buoyancy or of flotation. In a floating body at rest a line joining the center of gravity and the center of buoyancy is vertical, and is called the axis of equilibrium. When an external force causes the axis of equilibrium to lean, if a vertical line be drawn upward from the center of buoyancy to this axis, the point where it cuts the axis is called the *metacenter*. If the metacenter is above the center of gravity the distance between them is called the metacentric height, and the body is then said to be in stable equilibrium, tending to return to its original position when the external force is removed.

Boiling-point. — Water boils at 212° F. (100° C.) at mean atmospheric pressure at the sea-level, 14.696 lbs. per square inch. The temperature at which water boils at any given pressure is the same as the temperature of saturated steam at the same pressure. For boiling-point of water at other pressure than 14.696 lbs. per square inch, see table of the Properties of Saturated Steam.

The **Boiling-point of Water may be Raised.** — When water is entirely freed of air, which may be accomplished by freezing or boiling, the cohesion of its atoms is greatly increased, so that its temperature may be raised over 50° above the ordinary boiling-point before ebullition takes place. It was found by Faraday that when such air-free water did boil the rupture of the liquid was like an explosion. When water is surrounded by a film of oil, its boiling temperature may be raised considerably above its normal standard. This has been applied as a theoretical explanation in the instance of boiler explosions.

The freezing-point also may be lowered, if the water is perfectly quiet, to -10° C., or 18° Fahrenheit below the normal freezing-point. (Hamilton Smith, Jr., on Hydraulics, p. 13.)

Freezing-point. — Water freezes at 32° F. at the ordinary atmospheric pressure, and ice melts at the same temperature. In the melting of 1 pound of ice into water at 32° F. about 142 heat-units are absorbed, or become latent; and in freezing 1 lb. of water into ice a like quantity of heat is given out to the surrounding medium.

Sea-water freezes at 27° F. The ice is fresh. (Trautwine.)

Ice and Snow. (From Clark.) — 1 cubic foot of ice at 32° F. weighs 57.50 lbs.; 1 pound of ice at 32° F. has a volume of 0.0174 cu. ft. = 30.067 cu. in.

Relative volume of ice to water at 32° F., 1.0855, the expansion in passing into the solid state being 8.55%. Specific gravity of ice = 0.922, water at 62° F. being 1.

At high pressures the melting-point of ice is lower than 32° F., being at the rate of 0.0133° F. for each additional atmosphere of pressure.

The specific heat of ice is 0.504, that of water being 1.

1 cubic foot of fresh snow, according to humidity of atmosphere: 5 lbs. to 12 lbs. 1 cubic foot of snow moistened and compacted by rain: 15 lbs. to 50 lbs. (Trautwine.)

Specific Heat of Water. (From Davis and Marks's Steam Tables.)

Deg. F.	Sp. Ht.	Deg. F.	Sp. Ht.	Deg. F.	Sp. Ht.	Deg. F.	Sp. Ht.	Deg. F.	Sp. Ht.
20	1.0168	120	0.9974	220	1.007	320	1.035	420	1.072
30	1.0098	130	0.9974	230	1.009	330	1.038	430	1.077
40	1.0045	140	0.9986	240	1.012	340	1.041	440	1.082
50	1.0012	150	0.9994	250	1.015	350	1.045	450	1.086
60	0.9990	160	1.0002	260	1.018	360	1.048	460	1.091
70	0.9977	170	1.0010	270	1.021	370	1.052	470	1.096
80	0.9970	180	1.0019	280	1.023	380	1.056	480	1.101
90	0.9967	190	1.0029	290	1.026	390	1.060	490	1.106
100	0.9967	200	1.0039	300	1.029	400	1.064	500	1.112
110	0.9970	210	1.0050	310	1.032	410	1.068	510	1.117

These figures are based on the mean value of the heat unit, that is, 1/180 of the heat needed to raise 1 lb. of water from 32° to 212°.

Compressibility of Water. — Water is very slightly compressible. Its compressibility is from 0.000040 to 0.000051 for one atmosphere, decreasing with increase of temperature. For each foot of pressure distilled water will be diminished in volume 0.0000015 to 0.0000013. Water is so incompressible that even at a depth of a mile a cubic foot of water will weigh only about half a pound more than at the surface.

THE IMPURITIES OF WATER.

(A. E. Hunt and G. H. Clapp, *Trans. A. I. M. E.*, xvii. 338.)

Commercial analyses are made to determine concerning a given water: (1) its applicability for making steam; (2) its hardness, or the facility with which it will "form a lather" necessary for washing; or (3) its adaptation to other manufacturing purposes.

At the Buffalo meeting of the Chemical Section of the A. A. A. S. it was decided to report all water analyses in parts per thousand, hundred-thousand, and million.

To convert grains per imperial (British) gallon into parts per 100,000, divide by 0.7. To convert parts per 100,000 into grains per U. S. gallon, multiply by 0.5835. To convert grains per U. S. gallon into parts per million multiply by 17.14.

The most common commercial analysis of water is made to determine its fitness for making steam. Water containing more than 5 parts per 100,000 of free sulphuric or nitric acid is liable to cause serious corrosion, not only of the metal of the boiler itself, but of the pipes, cylinders, pistons, and valves with which the steam comes in contact.

The total residue in water used for making steam causes the interior linings of boilers to become coated, and often produces a dangerous hard

scale, which prevents the cooling action of the water from protecting the metal against burning.

Lime and magnesia bicarbonates in water lose their excess of carbonic acid on boiling, and often, especially when the water contains sulphuric acid, produce, with the other solid residues constantly being formed by the evaporation, a very hard and insoluble scale. A larger amount than 100 parts per 100,000 of total solid residue will ordinarily cause troublesome scale, and should condemn the water for use in steam-boilers, unless a better supply cannot be obtained.

The following is a tabulated form of the causes of trouble with water for steam purposes, and the proposed remedies, given by Prof. L. M. Norton.

CAUSES OF INCRUSTATION.

1. Deposition of suspended matter.
2. Deposition of deposited salts from concentration.
3. Deposition of carbonates of lime and magnesia by boiling off carbonic acid, which holds them in solution.
4. Deposition of sulphates of lime, because sulphate of lime is but slightly soluble in cold water, less soluble in hot water, insoluble above 270° F.
5. Deposition of magnesia, because magnesium salts decompose at high temperature.
6. Deposition of lime soap, iron soap, etc., formed by saponification of grease.

MEANS FOR PREVENTING INCRUSTATION.

1. Filtration.
2. Blowing off.
3. Use of internal collecting apparatus or devices for directing the circulation.
4. Heating feed-water.
5. Chemical or other treatment of water in boiler.
6. Introduction of zinc into boiler.
7. Chemical treatment of water outside of boiler.

TABULAR VIEW.

Troublesome Substance.	Trouble.	Remedy or Palliation.
Sediment, mud, clay, etc.	Incrustation.	Filtration; blowing off.
Readily soluble salts.	"	Blowing off.
Bicarbonates of lime, magnesia, iron.	"	Heating feed. Addition of caustic soda, lime, or magnesia, etc.
Sulphate of lime.	"	Addition of carb. soda, barium hydrate, etc.
Chlorid and sulphate of magnesium.	Corrosion.	Addition of carbonate of soda, etc.
Carbonate of soda in large amounts.	Priming.	Addition of barium chloride, etc.
Acid (in mine waters).	Corrosion.	Alkali.
Dissolved carbonic acid and oxygen.	Corrosion.	Feed milk of lime to the boiler, to form a thin internal coating.
Grease (from condensed water).	Corrosion or incrustation.	Different cases require different remedies. Consult a specialist on the subject.
Organic matter (sewage).	Priming, corrosion, or incrustation.	

The mineral matters causing the most troublesome boiler-scales are bicarbonates and sulphates of lime and magnesia, oxides of iron and alumina, and silica. The analyses of some of the most common and troublesome boiler-scales are given in the following table:

Analyses of Boiler-scale. (Chandler.)

	Sulphate of Lime.	Magnesia.	Silica.	Peroxide of Iron.	Water.	Carbonate of Lime.
N. Y. C. & H. R. Ry., No. 1	74.07	9.19	0.65	0.08	1.14	14.78
" " " No. 2	71.37		1.76			
" " " No. 3	62.86	18.95	2.60	0.92	1.28	12.62
" " " No. 4	53.05		4.79			
" " " No. 5	46.83		5.32			
" " " No. 6	30.80	31.17	7.75	1.08	2.44	26.93
" " " No. 7	4.95	2.61	2.07	1.03	0.63	86.25
" " " No. 8	0.88	2.84	0.65	0.36	0.15	93.19
" " " No. 9	4.81		2.92			
" " " No. 10	30.07		8.24			

Analyses in parts per 100,000 of Water giving Bad Results in Steam-boilers. (A. E. Hunt.)

	Bicarbonate of Lime deposited on Boiling.	Bicarbonate of Magnesia deposited on Boiling.	Total Lime.	Total Magnesia.	Sulphuric Acid.	Chlorine.	Iron.	Organic Matter.	Alumina.	Chloride of Sodium.
Coal-mine water.....	110	25	119	39	890	590	780	30	640	
Salt-well.....	151	38	190	48	360	990	38	21	30	1310
Spring.....	75	89	95	120	310	21	75	10	80	36
Monongahela River.....	130	21	161	33	210	38	70			
" ".....	80	70	94	81	219	210	90			
" ".....	32	82	61	104	28	190	38			
Allegheny R., near Oil-works..	30	50	41	68	890	42	23			

Many substances have been added with the idea of causing chemical action which will prevent boiler-scale. As a general rule, these do more harm than good, for a boiler is one of the worst possible places in which to carry on chemical reaction, where it nearly always causes more or less corrosion of the metal, and is liable to cause dangerous explosions.

In cases where water containing large amounts of total solid residue is necessarily used, a heavy petroleum oil, free from tar or wax, which is not acted upon by acids or alkalis, not having sufficient wax in it to cause saponification, and which has a vaporizing-point at nearly 500° F., will give the best results in preventing boiler-scale. Its action is to form a thin greasy film over the boiler linings, protecting them largely from the action of acids in the water and greasing the sediment which is formed, thus preventing the formation of scale and keeping the solid residue from the evaporation of the water in such a plastic suspended condition that it can be easily ejected from the boiler by the process of "blowing off." If the water is not blown off sufficiently often, this sediment forms into a "putty" that will necessitate cleaning the boilers. Any boiler using bad water should be blown off every twelve hours.

Hardness of Water. — The hardness of water, or its opposite quality, indicated by the ease with which it will form a lather with soap, depends almost altogether upon the presence of compounds of lime and magnesia. Almost all soaps consist, chemically, of oleate, stearate, and palmitate of an alkaline base, usually soda and potash. The more lime and magnesia in a sample of water, the more soap a given volume of the water will decompose, so as to give insoluble oleate, palmitate, and stearate of lime and magnesia, and consequently the more soap must be added in order that the necessary quantity of soap may remain in solution to form the lather. The relative hardness of samples of water is generally expressed in terms of the number of standard soap-measures consumed by a gallon of water in yielding a permanent lather.

In Great Britain the standard soap-measure is the quantity required to precipitate one grain of carbonate of lime: in the U. S. it is the quantity required to precipitate one milligramme.

If a water charged with a bicarbonate of lime, magnesia, or iron is boiled, it will, on the excess of the carbonic acid being expelled, deposit a considerable quantity of the lime, magnesia, or iron, and consequently the water will be softer. The hardness of the water after this deposit of lime, after long boiling, is called the *permanent hardness* and the difference between it and the total hardness is called *temporary hardness*.

Lime salts in water react immediately on soap-solutions, precipitating the oleate, palmitate, or stearate of lime at once. Magnesia salts, on the contrary, require some considerable time for reaction. They are, however, more powerful hardeners; one equivalent of magnesia salts consuming as much soap as one and one-half equivalents of lime.

The presence of soda and potash salts softens rather than hardens water. Each grain of carbonate of lime per gallon of water causes an increased expenditure for soap of about 2 ounces per 100 gallons of water. (*Eng'g News*, Jan. 31, 1885.)

Low degrees of hardness (down to 200 parts of calcium carbonate (CaCO₃) per million) are usually determined by means of a standard solution of soap. To 50 c.c. of the water is added alcoholic soap solution from a burette, shaking well after each addition, until a lather is obtained which covers the entire surface of the liquid when the bottle is laid on its side and which lasts five minutes. From the number of c.c. of soap solution used, the hardness of the water may be calculated by the use of Clark's table, given below, in parts of CaCO₃ per million.

c.c. Soap Sol.	Pts. CaCO ₃ .	c.c. Soap Sol.	Pts. CaCO ₃ .	c.c. Soap Sol.	Pts. CaCO ₃ .	c.c. Soap Sol.	Pts. CaCO ₃ .
0.7	0	4.0	46	8.0	103	12.0	164
1.0	5	5.0	60	9.0	118	13.0	180
2.0	19	6.0	74	10.0	133	14.0	196
3.0	32	7.0	89	11.0	148	15.0	212

For waters which are harder than 200 parts per million, a solution of soap ten times as strong may be used, the end or determining point being reached when sufficient soap has been added to deaden the harsh sound produced on shaking the bottle containing the water. — A. H. Gill, Engine-Room Chemistry.

Purifying Feed-water for Steam-boilers. (See also Incrustation and Corrosion, p. 897.) — When the water used for steam-boilers contains a large amount of scale-forming material it is usually advisable to purify it before allowing it to enter the boiler rather than to attempt the prevention of scale by the introduction of chemicals into the boiler. Carbonates of lime and magnesia may be removed to a considerable extent by simple heating of the water in an exhaust-steam feed-water heater or, still better, by a live-steam heater. (See circular of the Hoppes Mfg. Co., Springfield, O.) When the water is very bad it is best treated

with chemicals — lime, soda-ash, caustic soda, etc. — in tanks, the precipitates being separated by settling or filtering. For a description of several systems of water purification see a series of articles on the subject by Albert A. Cary in *Eng'g Mag.*, 1897.

Mr. H. E. Smith, chemist of the Chicago, Milwaukee & St. Paul Ry. Co., in a letter to the author, June, 1902, writes as follows concerning the chemical action of soda-ash on the scale-forming substances in boiler waters:

Soda-ash acts on carbonates of lime and magnesia in boiler water in the following manner: — The carbonates are held in solution by means of the carbonic acid gas also present which probably forms bicarbonates of lime and magnesia. Any means which will expel or absorb this carbonic acid will cause the precipitation of the carbonates. One of these means is soda ash (carbonate of soda), which absorbs the gas with the formation of bicarbonate of soda. This method would not be practicable for softening cold water, but it serves in a boiler. The carbonates precipitated in this manner are in flocculent condition instead of semi-crystalline as when thrown down by heat. In practice it is desirable and sufficient to precipitate only a portion of the lime and magnesia in flocculent condition. As to equations, the following represent what occurs: —

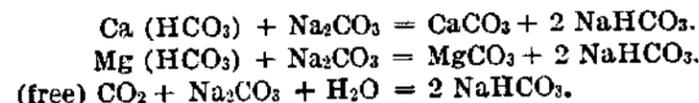

Chemical equivalents: — 106 pounds of pure carbonate of soda — equal to about 109 pounds of commercial 53 degree soda-ash — are chemically equivalent to — i.e., react exactly with — the following weights of the substances named: Calcium sulphate, 136 lbs.; magnesium sulphate, 120 lbs.; calcium carbonate, 100 lbs.; magnesium carbonate, 84 lbs.; calcium chloride, 111 lbs.; magnesium chloride, 95 lbs.

Such numbers are simply the molecular weights of the substances reduced to a common basis with regard to the valence of the component atoms.

Important work in this line should not be undertaken by an amateur. "Recipes" have a certain field of usefulness, but will not cover the whole subject. In water purification, as in a problem of mechanical engineering, methods and apparatus must be adapted to the conditions presented. Not only must the character of the raw water be considered but also the conditions of purification and use.

Water-softening Apparatus. (From the Report of the Committee on Water Service, of the Am. Railway Eng'g and Maintenance of Way Assn., *Eng. Rec.*, April 20, 1907). — Between three and four hours is necessary for reaction and precipitation. Water taken from running streams in winter should have at least four hours' time. At least three feet of the bottom of each settling tank should be reserved for the accumulation of the precipitates.

The proper capacities for settling tanks, measured above the space reserved for sludge, can be determined as follows: *a* = capacity of softener in gallons per hour; *b* = hours required for reaction and precipitation; *c* = number of settling tanks (never less than two); *x* = number of hours required to fill the portion of settling tank above the sludge portion; *y* = number of hours required to transfer treated water from one settling tank to the storage tank (*y* should never be greater than *x*).

Where one pump alternates between filling and emptying settling tanks, *x* = *y*. Settling capacity in each tank = $2ax = ab \div (c - 1)$.

For plants where the quantity of water supplied to the softener and the capacity of the plant are equal, the settling capacity of each tank is equal to *ax*. The number of hours required to fill all the settling tanks should equal the number of hours required to fill, precipitate and empty one tank, as expressed by the following equation: $cx = x + b + y$.

If $y = x$, $ax = ab \div (c - 2)$.

If $y = \frac{1}{2}x$, $ax = ab \div (c - 1.5)$.

An article on "The Present Status of Water Softening," by G. C. Whipple, in *Cass. Mag.*, Mar., 1907, illustrates several different forms of water-purifying apparatus. A classification of degrees of hardness corresponding to parts of carbonates and sulphates of lime and magnesia per million parts of water is given as follows: Very soft, 0 to 10 parts; soft, 10 to 20; slightly hard, 25 to 50; hard, 50 to 100; very hard, 100 to 200; excessively hard, 200 to 500; mineral water, 500 or more. The same article gives the following figures showing the quantity of chemicals required for the various constituents of hard water. For each part per million of the substances mentioned it is necessary to add the stated number of pounds per million gallons of lime and soda.

For Each Part per Million of	Pounds per Million Gallons.	
	Lime.	Soda.
Free CO ₂	10.62	0
Free acid (calculated as H ₂ SO ₄).....	4.77	9.03
Alkalinity.....	4.67	0
Incrustants.....	0.00	8.85
Magnesium.....	19.48	0

The above figures do not take into account any impurities in the chemicals. These have to be considered in actual operation.

An illustrated description of a water-purifying plant on the Chicago & Northwestern Ry. by G. M. Davidson is found in *Eng. News*, April 2, 1903. Two precipitation tanks are used, each 30 ft. diam., 16 ft. high, or 70,000 gallons each. As some water is left with the sludge in the bottom after each emptying, their net capacity is about 60,000 gallons each. The time required for filling, precipitating, settling and transferring the clear water to supply tanks is 12 hours. Once a month the sludge is removed, and it is found to make a good whitewash. Lime and soda-ash, in predetermined quantity, as found by analysis of the water, are used as precipitants. The following table shows the effect of treatment of well water at Council Bluffs, Iowa.

	Before Treatment.	After Treatment.
Total solid matter, grains per gallon.....	53.67	31.35
Carbonates of lime and magnesia.....	25.57	3.14
Sulphates of lime and magnesia.....	19.55	
Silica and oxides of iron and aluminum.....	1.76	0.40
Total incrusting solids.....	46.88	3.54
Alkali chlorides.....	1.21	1.27
Alkali sulphates.....	5.58	26.32
Total non-incrusting solids.....	6.79	27.81
Pounds scale-forming matter in 1000 gals.....	6.69	0.51

The minimum amount of scaling matter which will justify treatment cannot be stated in terms of analysis alone, but should be stated in terms of pounds incrusting matter held in solution in a day's supply. Besides the scale-forming solids, nearly all water contains more or less free carbonic acid. Sulphuric acid is also found, particularly in streams adjacent to coal mines. Serious trouble from corrosion will result from a small amount of this acid. In treating waters, the acids can be neutralized, and the incrusting matter can be reduced to at least 5 grains per gallon in most cases.

WARNING: This is a 1910 edition. Some of the material may no longer be accurate

QUANTITY OF PURE REAGENTS REQUIRED TO REMOVE ONE POUND OF INCRUSTING OR CORROSIVE MATTER FROM THE WATER.

Incrusting or Corrosive Substance Held in Solution.	Amount of Reagent. (Pure.)	Foaming Matter Increased.
Sulphuric acid.....	0.57 lb. lime plus 1.08 lbs. soda ash	1.45 lbs.
Free carbonic acid.....	1.27 lbs. lime.....	None
Calcium carbonate.....	0.56 lb. lime.....	None
Calcium sulphate.....	0.78 lb. soda ash.....	1.04 lbs.
Calcium chloride.....	0.96 lb. soda ash.....	1.05 lbs.
Calcium nitrate.....	0.65 lb. soda ash.....	1.04 lbs.
Magnesium carbonate.....	1.33 lbs. lime.....	None
Magnesium sulphate.....	0.47 lb. lime plus 0.88 lb. soda ash.	1.18 lbs.
Magnesium chloride.....	0.59 lb. lime plus 1.11 lbs. soda ash	1.22 lbs.
Magnesium nitrate.....	0.38 lb. lime plus 0.72 lb. soda ash.	1.15 lbs.
Calcium carbonate.....	1.71 lbs. barium hydrate.....	None
Magnesium carbonate.....	4.05 lbs. barium hydrate.....	None
Magnesium sulphate.....	1.42 lbs. barium hydrate.....	None
*Calcium sulphate.....	1.26 lbs. barium hydrate.....	None

* In precipitating the calcium sulphate, there would also be precipitated 0.74 lb. of calcium carbonate or 0.31 lb. of magnesium carbonate, the 1.26 lbs. of barium hydrate performing the work of 0.41 lb. of lime and 0.78 lb. of soda-ash, or for reacting on either magnesium or calcium sulphate, 1 lb. of barium hydrate performs the work of 0.33 lb. of lime plus 0.62 lb. of soda-ash, and the lime treatment can be correspondingly reduced.

Barium hydrate has no advantage over lime as a reagent to precipitate the carbonates of lime and magnesia and should not be considered except in connection with the treating of water containing calcium sulphate.

HYDRAULICS — FLOW OF WATER.

Formulae for Discharge of Water through Orifices and Weirs. — For rectangular or circular orifices, with the head measured from center of the orifice to the surface of the still water in the feeding reservoir:

$$Q = C \sqrt{2gH} \times a. \dots \dots \dots (1)$$

For weirs with no allowance for increased head due to velocity of approach:

$$Q = C^{2/3} \sqrt{2gH} \times LH. \dots \dots \dots (2)$$

For rectangular and circular or other shaped vertical or inclined orifices; formula based on the proposition that each successive horizontal layer of water passing through the orifice has a velocity due to its respective head:

$$Q = cL^{2/3} \sqrt{2g} \times (\sqrt{H_b^3} - \sqrt{H_t^3}). \dots \dots \dots (3)$$

For rectangular vertical weirs:

$$Q = c^{2/3} \sqrt{2gH} \times Lh. \dots \dots \dots (4)$$

Q = quantity of water discharged in cubic feet per second; C = approximate coefficient for formulas (1) and (2); c = correct coefficient for (3) and (4).

Values of the coefficients c and C are given below.
 g = 32.16; $\sqrt{2g} = 8.02$; H = head in feet measured from center of orifice to level of still water; H_b = head measured from bottom of orifice; H_t = head measured from top of orifice; h = H, corrected for velocity of approach, $V_a = H + 1.33 V_a^2/2g$ for weirs with no end contraction, and $H + 1.4 V_a^2/2g$ for weirs with end contraction; a = area in square feet; L = length in feet.

Flow of Water from Orifices. — The theoretical velocity of water flowing from an orifice is the same as the velocity of a falling body which has fallen from a height equal to the head of water, $= \sqrt{2gH}$. The actual velocity at the smaller section of the *vena contracta* is substantially the same as the theoretical, but the velocity at the plane of the orifice is $C\sqrt{2gH}$, in which the coefficient C has the nearly constant value of 0.62. The smallest diameter of the *vena contracta* is therefore about 0.79 of that of the orifice. If C be the approximate coefficient = 0.62, and c the correct coefficient, the ratio C/c varies with different ratios of the head to the diameter of the vertical orifice, or to H/D . Hamilton Smith, Jr., gives the following:

$H/D=0.5$	0.875	1.	1.5	2.	2.5	5.	10.
$C/c = 0.9604$	0.9849	0.9918	0.9965	0.9980	0.9987	0.9997	1.

For vertical rectangular orifices of ratio of head to width W ;
 For $H/W = 0.5$ 0.6 0.8 1 1.5 2 3 4 5 8
 $C/c = .9428 .9657 .9823 .9890 .9953 .9974 .9988 .9993 .9996 .9998$

For $H \div D$ or $H \div W$ over 8, $C = c$, practically.
 For great heads, 312 ft. to 336 ft., with converging mouthpieces, c has a value of about one, and for small circular orifices in thin plates, with full contraction, $c =$ about 0.60.

Mr. Smith as the result of the collation of many experimental data of others as well as his own, gives tables of the value of c for vertical orifices, with full contraction, with a free discharge into the air, with the inner face of the plate, in which the orifice is pierced, plane, and with sharp inner corners, so that the escaping vein only touches these inner edges. These tables are abridged below. The coefficient c is to be used in the formulæ (3) and (4) above. For formulæ (1) and (2) use the coefficient C found from the values of the ratios C/c above.

Values of Coefficient c for Vertical Orifices with Sharp Edges, Full Contraction, and Free Discharge into Air. (Hamilton Smith, Jr.)

Head from Center of Orifice H .	Square Orifices. Length of the Side of the Square, in feet.												
	.02	.03	.04	.05	.07	.10	.12	.15	.20	.40	.60	.80	1.0
0.4			.643	.637	.628	.621	.616	.611					
0.6	.660	.645	.636	.630	.623	.617	.613	.610	.605	.601	.598	.596	
1.0	.648	.636	.628	.622	.618	.613	.610	.608	.605	.603	.601	.600	.599
3.0	.632	.622	.616	.612	.609	.607	.606	.606	.605	.605	.604	.603	.603
6.0	.623	.616	.612	.609	.607	.605	.605	.605	.604	.604	.603	.602	.602
10.	.616	.611	.608	.606	.605	.604	.604	.603	.603	.603	.602	.602	.601
20.	.606	.605	.604	.603	.602	.602	.602	.602	.602	.601	.601	.601	.600
100. (?)	.599	.598	.598	.598	.598	.598	.598	.598	.598	.598	.598	.598	.598

H .	Circular Orifices. Diameters, in feet.												
	.02	.03	.04	.05	.07	.10	.12	.15	.20	.40	.60	.80	1.0
0.4				.637	.628	.618	.612	.606					
0.6	.655	.640	.630	.624	.618	.613	.609	.605	.601	.596	.593	.590	
1.0	.644	.631	.623	.617	.612	.608	.605	.603	.600	.598	.595	.593	.591
2	.632	.621	.614	.610	.607	.604	.601	.600	.599	.599	.597	.596	.595
4	.623	.614	.609	.605	.603	.602	.600	.599	.599	.598	.597	.597	.596
6	.618	.611	.607	.604	.602	.600	.599	.599	.598	.598	.597	.596	.596
10	.611	.606	.603	.601	.599	.598	.598	.597	.597	.597	.596	.596	.595
20	.601	.600	.599	.598	.597	.596	.596	.596	.596	.596	.596	.595	.594
50 (?)	.596	.596	.595	.595	.594	.594	.594	.594	.594	.594	.594	.593	.593
100. (?)	.593	.593	.592	.592	.592	.592	.592	.592	.592	.592	.592	.592	.592

HYDRAULIC FORMULÆ. — FLOW OF WATER IN OPEN AND CLOSED CHANNELS.

Flow of Water in Pipes. — The quantity of water discharged through a pipe depends on the "head"; that is, the vertical distance between the level surface of still water in the chamber at the entrance end of the pipe and the level of the center of the discharge end of the pipe; also upon the length of the pipe, upon the character of its interior surface as to smoothness, and upon the number and sharpness of the bends; but it is independent of the position of the pipe, as horizontal, or inclined upwards or downwards.

The head, instead of being an actual distance between levels, may be caused by pressure, as by a pump, in which case the head is calculated as a vertical distance corresponding to the pressure, 1 lb. per sq. in. = 2.309 ft. head, or 1 ft. head = 0.433 lb. per sq. in.

The total head operating to cause flow is divided into three parts: 1. The *velocity-head*, which is the height through which a body must fall in *vacuo* to acquire the velocity with which the water flows into the pipe $= v^2 \div 2g$, in which v is the velocity in ft. per sec. and $2g = 64.32$; 2. the *entry-head*, that required to overcome the resistance to entrance to the pipe. With sharp-edged entrance the entry-head = about $1/2$ the velocity-head; with smooth rounded entrance the entry-head is inappreciable; 3. the *friction-head*, due to the frictional resistance to flow within the pipe.

In ordinary cases of pipes of considerable length, the sum of the entry and velocity heads required scarcely exceeds 1 foot. In the case of long pipes with low heads the sum of the velocity and entry heads is generally so small that it may be neglected.

General Formula for Flow of Water in Pipes or Conduits.

Mean velocity in ft. per sec. $= c \sqrt{\text{mean hydraulic radius} \times \text{slope}}$

Do. for pipes running full $= c \sqrt{\frac{\text{diameter}}{4} \times \text{slope}}$

In which c is a coefficient determined by experiment. (See pages following.)

The mean hydraulic radius $= \frac{\text{area of wet cross-section}}{\text{wet perimeter}}$

In pipes running full, or exactly half full, and in semicircular open channels running full it is equal to $1/4$ diameter.

The slope = the head (or pressure expressed as a head, in feet) \div length of pipe measured in a straight line from end to end.

In open channels the slope is the actual slope of the surface, or its fall per unit of length, or the sine of the angle of the slope with the horizon.

Chezy's Formula: $v = c \sqrt{r} \sqrt{s} = c \sqrt{rs}$; r = mean hydraulic radius, s = slope = head \div length, v = velocity in feet per second, all dimensions in feet.

Quantity of Water Discharged. — If Q = discharge in cubic feet per second and a = area of channel, $Q = av = ac \sqrt{rs}$.

$a \sqrt{r}$ is approximately proportional to the discharge. It is a maximum at 308° of the circumference, corresponding to $19/20$ of the diameter, and the flow of a conduit $19/20$ full is about 5 per cent greater than that of one completely filled.

Values of the Coefficient c . (Chiefly condensed from P. J. Flynn on Flow of Water.) — Almost all the old hydraulic formulæ for finding the

mean velocity in open and closed channels have constant coefficients, and are therefore correct for only a small range of channels. They have often been found to give incorrect results with disastrous effects. Gan-guillet and Kutter thoroughly investigated the American, French, and other experiments, and they gave as the result of their labors the formula now generally known as Kutter's formula. There are so many varying conditions affecting the flow of water, that all hydraulic formulæ are only approximations to the correct result.

When the surface-slope measurement is good, Kutter's formula will give results seldom exceeding 7 1/2% error, provided the rugosity coefficient of the formula is known for the site. For small open channels Darcy's and Bazin's formulæ, and for cast-iron pipes Darcy's formulæ, are generally accepted as being approximately correct.

Table giving Fall in Feet per Mile, the Distance on Slope corresponding to a Fall of 1 Ft., and also the Values of *S* and \sqrt{s} for Use in the Formula $v = c \sqrt{rs}$.

$s = H + L =$ sine of angle of slope = fall of water-surface (*H*), in any distance (*L*), divided by that distance.

Fall in Feet per Mi.	Slope, 1 Foot in	Sine of Slope, <i>s</i> .	\sqrt{s} .	Fall in Feet per Mi.	Slope, 1 Foot in	Sine of Slope, <i>s</i> .	\sqrt{s} .
0.25	21120	0.000473	0.006881	17	310.6	0.0032197	0.056742
.30	17600	.0000568	.007538	18	293.3	.0034091	.058388
.40	13200	.0000758	.008704	19	277.9	.0035985	.059988
.50	10560	.0000947	.009731	20	264	.0037879	.061546
.60	8800	.0001136	.010660	22	240	.0041667	.064549
.702	7520	.0001330	.011532	24	220	.0045455	.067419
.805	6560	.0001524	.012347	26	203.1	.0049242	.070173
.904	5840	.0001712	.013085	28	188.6	.0053030	.072822
1	5280	.0001894	.013762	30	176	.0056818	.075378
1.25	4224	.0002367	.015386	35.20	150	.0066667	.081650
1.5	3520	.0002841	.016854	40	132	.0075758	.087039
1.75	3017	.0003314	.018205	44	120	.0083333	.091287
2	2640	.0003788	.019463	48	110	.0090909	.095346
2.25	2347	.0004261	.020641	52.8	100	.010	.1
2.5	2112	.0004735	.021760	60	88	.0113636	.1066
2.75	1920	.0005208	.022822	66	80	.0125	.111803
3	1760	.0005682	.023837	70.4	75	.0133333	.115470
3.25	1625	.0006154	.024807	80	66	.0151515	.123091
3.5	1508	.0006531	.025751	88	60	.0166667	.1291
3.75	1408	.0007102	.026650	96	55	.0181818	.134839
4	1320	.0007576	.027524	105.6	50	.02	.141421
5	1056	.0009470	.030773	120	44	.0227273	.150756
6	880	.0011364	.03371	132	40	.025	.158114
7	754.3	.0013257	.036416	160	33	.0303030	.174077
8	660	.0015152	.038925	220	24	.0416667	.204124
9	586.6	.0017044	.041286	264	20	.05	.223607
10	528	.0018934	.043519	330	16	.0625	.25
11	443.6	.0020833	.045643	340	12	.0833333	.288675
12	440	.0022727	.047673	528	10	.1	.316228
13	406.1	.0024621	.04962	660	8	.125	.353553
14	377.1	.0026515	.051493	880	6	.1666667	.408248
15	352	.0028409	.0533	1056	5	.2	.447214
16	330	.0030303	.055048	1320	4	.25	.5

Values of \sqrt{r} for Circular Pipes, Sewers, and Conduits of Different Diameters.

$r =$ mean hydraulic depth = $\frac{\text{area}}{\text{perimeter}} = 1/4$ diam. for circular pipes running full or exactly half full.

Diam., ft. in.	\sqrt{r} in Feet.	Diam., ft. in.	\sqrt{r} in Feet.	Diam., ft. in.	\sqrt{r} in Feet.	Diam., ft. in.	\sqrt{r} in Feet.
3/8	0.088	2	0.707	4 6	1.061	9	1.500
1/2	.102	2 1	.722	4 7	1.070	9 3	1.521
3/4	.125	2 2	.736	4 8	1.080	9 6	1.541
1	.144	2 3	.750	4 9	1.089	9 9	1.561
1 1/4	.161	2 4	.764	4 10	1.099	10	1.581
1 1/2	.177	2 5	.777	4 11	1.109	10 3	1.601
1 3/4	.191	2 6	.790	5	1.118	10 6	1.620
2	.204	2 7	.804	5 1	1.127	10 9	1.639
2 1/2	.228	2 8	.817	5 2	1.137	11	1.658
3	.251	2 9	.829	5 3	1.146	11 3	1.677
4	.290	2 10	.842	5 4	1.155	11 6	1.696
5	.323	2 11	.854	5 5	1.164	11 9	1.714
6	.354	3	.866	5 6	1.173	12	1.732
7	.382	3 1	.878	5 7	1.181	12 3	1.750
8	.408	3 2	.890	5 8	1.190	12 6	1.768
9	.433	3 3	.901	5 9	1.199	12 9	1.785
10	.456	3 4	.913	5 10	1.208	13	1.803
11	.479	3 5	.924	5 11	1.216	13 3	1.820
1 1	.500	3 6	.935	6	1.225	13 6	1.837
1 2	.520	3 7	.946	6 3	1.250	14	1.871
1 3	.540	3 8	.957	6 6	1.275	14 6	1.904
1 4	.559	3 9	.968	6 9	1.299	15	1.936
1 5	.577	3 10	.979	7	1.323	15 6	1.968
1 6	.595	3 11	.990	7 3	1.346	16	2.001
1 7	.612	4	1.	7 6	1.369	16 6	2.031
1 8	.629	4 1	1.010	7 9	1.392	17	2.061
1 9	.646	4 2	1.021	8	1.414	17 6	2.091
1 10	.661	4 3	1.031	8 3	1.436	18	2.121
1 11	.677	4 4	1.041	8 6	1.458	19	2.180
	.692	4 5	1.051	8 9	1.479	20	2.236

Kutter's Formula for measures in feet is

$$v = \left\{ \frac{1.487}{n} + 41.6 + \frac{0.00281}{s} \right\} \times \sqrt{rs}$$

In which *v* = mean velocity in feet per second; $r = \frac{a}{p}$ = hydraulic mean depth in feet = area of cross-section in square feet divided by wetted perimeter in lineal feet; *s* = fall of water-surface (*h*) in any distance (*l*) divided by that distance, $= \frac{h}{l}$, = sine of slope; *n* = the coefficient of rugosity, depending on the nature of the lining or surface of the channel. If we let the first term of the right-hand side of the equation equal *c*, we have Chezy's formula, $v = c \sqrt{rs} = c \times \sqrt{r} \times \sqrt{s}$.

Values of *n* in Kutter's Formula. — The accuracy of Kutter's formula depends, in a great measure, on the proper selection of the coefficient

of roughness n . Experience is required in order to give the right value to this coefficient, and to this end great assistance can be obtained, in making this selection, by consulting and comparing the results obtained from experiments on the flow of water already made in different channels.

In some cases it would be well to provide for the contingency of future deterioration of channel, by selecting a high value of n , as, for instance, where a dense growth of weeds is likely to occur in small channels, and also where channels are likely not to be kept in a state of good repair.

The following table, giving the value of n for different materials, is compiled from Kutter, Jackson, and Hering, and this value of n applies also in each instance to the surfaces of other materials equally rough.

VALUE OF n IN KUTTER'S FORMULA FOR DIFFERENT CHANNELS.

$n = .009$, well-planed timber, in perfect order and alignment; otherwise, perhaps .01 would be suitable.

$n = .010$, plaster in pure cement; planed timber; glazed, coated, or enameled stoneware and iron pipes; glazed surfaces of every sort in perfect order.

$n = .011$, plaster in cement with one-third sand, in good condition; also for iron, cement, and terra-cotta pipes, well joined, and in best order.

$n = .012$, unplanned timber, when perfectly continuous on the inside; flumes.

$n = .013$, ashlar and well-laid brickwork; ordinary metal; earthen and stoneware pipe in good condition, but not new; cement and terra-cotta pipe not well jointed nor in perfect order, plaster and planed wood in imperfect or inferior condition; and, generally, the materials mentioned with $n = .010$, when in imperfect or inferior condition.

$n = .015$, second class or rough-faced brickwork; well-dressed stonework; foul and slightly tuberculated iron; cement and terra-cotta pipes, with imperfect joints and in bad order; and canvas lining on wooden frames.

$n = .017$, brickwork, ashlar, and stoneware in an inferior condition; tuberculated iron pipes; rubble in cement or plaster in good order; fine gravel, well rammed, $\frac{1}{3}$ to $\frac{2}{3}$ inch diameter; and, generally, the materials mentioned with $n = .013$ when in bad order and condition.

$n = .020$, rubble in cement in an inferior condition; coarse rubble, rough set in a normal condition; coarse rubble set dry; ruined brickwork and masonry; coarse gravel well rammed, from 1 to $1\frac{1}{3}$ inch diameter; canals with beds and banks of very firm, regular gravel, carefully trimmed and rammed in defective places; rough rubble with bed partially covered with silt and mud; rectangular wooden troughs with battens on the inside two inches apart; trimmed earth in perfect order.

$n = .0225$, canals in earth above the average in order and regimen.

$n = .025$, canals and rivers in earth of tolerably uniform cross-section; slope and direction, in moderately good order and regimen, and free from stones and weeds.

$n = .0275$, canals and rivers in earth below the average in order and regimen.

$n = .030$, canals and rivers in earth in rather bad order and regimen, having stones and weeds occasionally, and obstructed by detritus.

$n = .035$, suitable for rivers and canals with earthen beds in bad order and regimen, and having stones and weeds in great quantities.

$n = .05$, torrents encumbered with detritus.

Kutter's formula has the advantage of being easily adapted to a change in the surface of the pipe exposed to the flow of water, by a change in the value of n . For cast-iron pipes it is usual to use $n = .013$ to provide for the future deterioration of the surface.

Reducing Kutter's formula to the form $v = c \times \sqrt{r} \times \sqrt{s}$, and taking n , the coefficient of roughness in the formula, $= .011, .012, \text{ and } .013$, and $s = .001$, we have the following values of the coefficient c of different diameters of conduit.

Values of c in Formula $v = c \times \sqrt{r} \times \sqrt{s}$ for Metal Pipes and Moderately Smooth Conduits Generally.
By KUTTER'S FORMULA. ($s = .001$ or greater.)

Diameter.		$n = .011$	$n = .012$	$n = .013$	Diameter.		$n = .011$	$n = .012$	$n = .013$
ft.	in.	$c =$	$c =$	$c =$	ft.	$c =$	$c =$	$c =$	$c =$
0	1	47.1	7	152.7	139.2	127.9	
	2	61.5	8	155.4	141.9	130.4	
	4	77.4	9	157.7	144.1	132.7	
	6	87.4	77.5	69.5	10	159.7	146	134.5	
1		105.7	94.6	85.3	11	161.5	147.8	136.2	
	6	116.1	104.3	94.4	12	163	149.3	137.7	
2		123.6	111.3	101.1	14	165.8	152	140.4	
3		133.6	120.8	110.1	16	168	154.2	142.1	
4		140.4	127.4	116.5	18	169.9	156.1	144.4	
5		145.4	132.3	121.1	20	171.6	157.7	146	
6		149.4	136.1	124.8

For circular pipes the hydraulic mean depth r equals $\frac{1}{4}$ of the diameter. According to Kutter's formula the value of c , the coefficient of discharge, is the same for all slopes greater than 1 in 1000; that is, within these limits c is constant. We further find that up to a slope of 1 in 2640 the value of c is, for all practical purposes, constant, and even up to a slope of 1 in 5000 the difference in the value of c is very little. This is exemplified in the following:

Value of c for Different Values of \sqrt{r} and s in Kutter's Formula, with $n = .013$.

\sqrt{r}	Slope. 1 in 1000	Slope. 1 in 2500	Slope. 1 in 3333.3	Slope. 1 in 5000	Slope. 1 in 10,000
0.6	93.6	91.5	90.4	88.4	83.3
1	116.5	115.2	114.4	113.2	109.7
2	142.6	142.8	143.0	143.1	143.8

The reliability of the values of the coefficient of Kutter's formula for pipes of less than 6 in. diameter is considered doubtful. (See note under table on page 704.)

Values of c for Earthen Channels, by Kutter's Formula, for Use in Formula $v = c \sqrt{rs}$.

Slope, 1 in	Coefficient of Roughness, $n = .0225$.					Coefficient of Roughness, $n = .035$.				
	\sqrt{r} in feet.					\sqrt{r} in feet.				
	0.4	1.0	1.8	2.5	4.0	0.4	1.0	1.8	2.5	4.0
.1,000	c 35.7	c 62.5	c 80.3	c 89.2	c 99.9	c 19.7	c 37.6	c 51.6	c 59.3	c 69.2
1,250	35.5	62.3	80.3	89.3	100.2	19.6	37.6	51.6	59.4	69.4
1,667	35.2	62.1	80.3	89.5	100.6	19.4	37.4	51.6	59.5	69.8
2,500	34.6	61.7	80.3	89.8	101.4	19.1	37.1	51.6	59.7	70.4
3,333	34	61.2	80.3	90.1	102.2	18.8	36.9	51.6	59.9	71.0
5,000	33	60.5	80.3	90.7	103.7	18.3	36.4	51.6	60.4	72.2
7,500	31.6	59.4	80.3	91.5	106.0	17.6	35.8	51.6	60.9	73.9
10,000	30.5	58.5	80.3	92.3	107.9	17.1	35.3	51.6	60.5	75.4
15,840	28.5	56.7	80.2	93.9	112.2	16.2	34.3	51.6	62.5	78.6
20,000	27.4	55.7	80.2	94.8	115.0	15.6	33.8	51.5	63.1	80.6

WARNING: This is a 1910 edition. Some of the material may no longer be accurate

Darcy's Formula for clean iron pipes under pressure is

$$v = \left\{ \frac{rs}{0.00007726 + \frac{0.00000162}{r}} \right\}^{1/2}$$

Darcy's formula, as given by J. B. Francis, C. E., for old cast-iron pipe, lined with deposit and under pressure, is

$$v = \left(\frac{144 d^2 s}{0.00082 (12d + 1)} \right)^{1/2}$$

in which d = diameter in feet.

For Pipes Less than 5 inches in Diameter, coefficients (c) in the formula $v = c \sqrt{rs}$, from the formula of Darcy, Kutter, and Fanning.

Diam. in inches.	Darcy, for Clean Pipes.	Kutter, for $n = .011$ $s = .001$	Fanning, for Clean Iron Pipes.	Diam. in inches.	Darcy, for Clean Pipes.	Kutter, for $n = .011$ $s = .001$	Fanning, for Clean Iron Pipes.
3/8	59.4	32.	1 3/4	90.7	58.8	92.5
1/2	65.7	36.1	2	92.9	61.5	94.8
3/4	74.5	42.6	2 1/2	96.1	66.
1	80.4	47.4	80.4	3	98.5	70.1	96.6
1 1/4	84.8	51.9	4	101.7	77.4	103.4
1 1/2	88.1	55.4	88.	5	103.8	82.9

Mr. Flynn, in giving the above table, says that the facts show that the coefficients diminish from a diameter of 5 inches to smaller diameters, and it is a safer plan to adopt coefficients varying with the diameter than a constant coefficient. No opinion is advanced as to what coefficients should be used with Kutter's formula for small diameters.

VELOCITY OF WATER IN OPEN CHANNELS.

Irrigation Canals. — The minimum mean velocity required to prevent the deposit of silt or the growth of aquatic plants is in Northern India taken at 1 1/2 feet per second. It is stated that in America a higher velocity is required for this purpose, and it varies from 2 to 3 1/2 feet per second. The maximum allowable velocity will vary with the nature of the soil of the bed. A sandy bed will be disturbed if the velocity exceeds 3 feet per second. Good loam with not too much sand will bear a velocity of 4 feet per second. The Cavour Canal in Italy, over a gravel bed, has a velocity of about 5 per second. (Flynn's "Irrigation Canals.")

Mean Surface and Bottom Velocities. — According to the formula of Bazin,

$$v = v_{max} - 25.4 \sqrt{rs}; v = v_b + 10.37 \sqrt{rs}$$

$\therefore v_b = v - 10.37 \sqrt{rs}$, in which v = mean velocity in feet per second, v_{max} = maximum surface velocity in feet per second, v_b = bottom velocity in feet per second, r = hydraulic mean depth in feet = area of cross-section in square feet divided by wetted perimeter in feet, s = sine of slope.

The least velocity, or that of the particles in contact with the bed, is almost as much less than the mean velocity as the greatest velocity is greater than the mean.

Rankine states that in ordinary cases the velocities may be taken as bearing to each other nearly the proportions of 3, 4, and 5. In very slow currents they are nearly as 2, 3, and 4.

Safe Bottom and Mean Velocities. — Ganguillet & Kutter give the following table of safe bottom and mean velocity in channels, calculated from the formula $v = v_b + 10.87 \sqrt{rs}$:

Material of Channel.	Safe Bottom Velocity v_b , in feet per second.	Mean Velocity v , in feet per second.
Soft brown earth.....	0.249	0.328
Soft loam.....	0.499	0.656
Sand.....	1.000	1.312
Gravel.....	1.998	2.625
Pebbles.....	2.999	3.938
Broken stone, flint.....	4.003	5.579
Conglomerate, soft slate....	4.988	6.564
Stratified rock.....	6.006	8.204
Hard rock.....	10.009	13.127

Ganguillet & Kutter state that they are unable for want of observations to judge how far these figures are trustworthy. They consider them to be rather disproportionately small than too large, and therefore recommend them more confidently.

Water flowing at a high velocity and carrying large quantities of silt is very destructive to channels, even when constructed of the best masonry.

Resistance of Soils to Erosion by Water. — W. A. Burr, *Eng'g News*, Feb. 8, 1894, gives a diagram showing the resistance of various soils to erosion by flowing water.

Experiments show that a velocity greater than 1.1 feet per second will erode sand, while pure clay will stand a velocity of 7.35 feet per second. The greater the proportion of clay carried by any soil, the higher the permissible velocity. Mr. Burr states that experiments have shown that the line describing the power of soils to resist erosion is parabolic. From his diagram the following figures are selected as representing different classes of soils:

Pure sand resists erosion by flow of.....	1.1	feet per second.
Sandy soil, 15% clay.....	1.2	" "
Sandy loam, 40% clay.....	1.8	" "
Loamy soil, 65% clay.....	3.0	" "
Clay loam, 85% clay.....	4.8	" "
Agricultural clay, 95% clay.....	6.2	" "
Clay.....	7.35	" "

Abrading and Transporting Power of Water. — Prof. J. LeConte, in his "Elements of Geology," states:

The erosive power of water, or its power of overcoming cohesion, varies as the square of the velocity of the current.

The transporting power of a current varies as the sixth power of the velocity. * * * If the velocity therefore be increased ten times, the transporting power is increased 1,000,000 times. A current running three feet per second, or about two miles per hour, will bear fragments of stone of the size of a hen's egg, or about three ounces weight. A current of ten miles an hour will bear fragments of one and a half tons, and a torrent of twenty miles an hour will carry fragments of 100 tons.

The transporting power of water must not be confounded with its erosive power. The resistance to be overcome in the one case is weight, in the other, cohesion; the latter varies as the square: the former as the sixth power of the velocity.

In many cases of removal of slightly cohering material, the resistance is a mixture of these two resistances, and the power of removing material will vary at some rate between v^2 and v^6 .

Baldwin Latham has found that in order to prevent deposits of sewage silt in small sewers or drains, such as those from 6 inches to 9 inches diameter, a mean velocity of not less than 3 feet per second should be produced. Sewers from 12 to 24 inches diameter should have a velocity

of not less than 2 1/2 feet per second, and in sewers of larger dimensions in no case should the velocity be less than 2 feet per second.

The specific gravity of the materials has a marked effect upon the mean velocities necessary to move them. T. E. Blackwell found that coal of a sp. gr. of 1.26 was moved by a current of from 1.25 to 1.50 ft. per second, while stones of a sp. gr. of 2.32 to 3.00 required a velocity of 2.5 to 2.75 ft. per second.

Chailly gives the following formula for finding the velocity required to move rounded stones or shingle:

$$v = 5.67 \sqrt{ag}$$

in which v = velocity of water in feet per second, a = average diameter in feet of the body to be moved, g = its specific gravity.

Geo. Y. Wisner, *Eng'g News*, Jan. 10, 1895, doubts the general accuracy of statements made by many authorities concerning the rate of flow of a current and the size of particles which different velocities will move. He says:

The scouring action of any river, for any given rate of current, must be an inverse function of the depth. The fact that some engineer has found that a given velocity of current on some stream of unknown depth will move sand or gravel has no bearing whatever on what may be expected of currents of the same velocity in streams of greater depths. In channels 3 to 5 ft. deep a mean velocity of 3 to 5 ft. per second may produce rapid scouring, while in depths of 18 ft. and upwards current velocities of 6 to 8 ft. per second often have no effect whatever on the channel bed.

Grade of Sewers. — The following empirical formula is given in Baumeister's "Cleaning and Sewerage of Cities," for the minimum grade for a sewer of clear diameter equal to d inches, and either circular or oval in section:

$$\text{Minimum grade, in per cent.} = \frac{100}{5d + 50}$$

As the lowest limit of grades which can be flushed, 0.1 to 0.2 per cent may be assumed for sewers which are sometimes dry, while 0.3 per cent is allowable for the trunk sewers in large cities. The sewers should run dry as rarely as possible.

FLOW OF WATER — EXPERIMENTS AND TABLES.

The Flow of Water through New Cast-iron Pipe was measured by S. Bent Russell, of the St. Louis, Mo., Water-works. The pipe was 12 inches in diameter, 1631 feet long, and laid on a uniform grade from end to end. Under an average total head of 3.36 feet the flow was 43,209 cubic feet in seven hours; under an average head of 3.37 feet the flow was the same; under an average total head of 3.41 feet the flow was 46,700 cubic feet in 8 hours and 35 minutes. Making allowance for loss of head due to entrance and to curves, it was found that the value of c in the formula $v = c \sqrt{rs}$ was from 88 to 93. (*Eng'g Record*, April 14, 1894.)

Flow of Water in a 20-inch Pipe 75,000 Feet Long. — A comparison of experimental data with calculations by different formulæ is given by Chas. B. Brush, *Trans. A. S. C. E.*, 1888. The pipe experimented with was that supplying the city of Hoboken, N. J.

RESULTS OBTAINED BY THE HACKENSACK WATER CO., FROM 1882-1887, IN PUMPING THROUGH A 20-IN. CAST-IRON MAIN 75,000 FEET LONG.

Pressure in lbs. per sq. in. at pumping-station:							
95	100	105	110	115	120	125	130
Total effective head in feet:							
55	66	77	89	100	112	123	135
Discharge in U. S. gallons in 24 hours, $l = 1000$:							
2,848	3,165	3,354	3,566	3,804	3,904	4,116	4,255
Theoretical discharge by Darcy's formula:							
2,743	3,004	3,244	3,488	3,699	3,915	4,102	4,297
Actual velocity in main in feet per second:							
2.00	2.24	2.36	2.52	2.68	2.76	2.92	3.00

Flow of Water in Circular Pipes, Sewers, etc., Flowing Full.
Based on Kutter's Formula, with $n = .013$.

Discharge in cubic feet per second.

Diam-eter.	Slope, or Head Divided by Length of Pipe.							
	1 in 40	1 in 70	1 in 100	1 in 200	1 in 300	1 in 400	1 in 500	1 in 600
5 in.	0.456	0.344	0.288	0.204	0.166	0.144	0.137	0.118
6 "	0.762	0.576	0.482	0.341	0.278	0.241	0.230	0.197
7 "	1.17	0.889	0.744	0.526	0.430	0.372	0.355	0.304
8 "	1.70	1.29	1.08	0.765	0.624	0.54	0.516	0.441
9 "	2.37	1.79	1.50	1.06	0.868	0.75	0.717	0.613
10 in.	$s =$ 1 in 60	1 in 80	1 in 100	1 in 200	1 in 300	1 in 400	1 in 500	1 in 600
11 "	2.59	2.24	2.01	1.42	1.16	1.00	0.90	0.82
12 "	3.39	2.94	2.63	1.86	1.52	1.31	1.17	1.07
13 "	4.32	3.74	3.35	2.37	1.93	1.67	1.5	1.37
14 "	5.38	4.66	4.16	2.95	2.40	2.08	1.86	1.70
15 in.	$s =$ 1 in 100	1 in 200	1 in 300	1 in 400	1 in 500	1 in 600	1 in 700	1 in 800
16 "	6.18	4.37	3.57	3.09	2.77	2.52	2.34	2.19
18 "	7.38	5.22	4.26	3.69	3.30	3.01	2.79	2.61
20 "	10.21	7.22	5.89	5.10	4.56	4.17	3.86	3.61
22 "	13.65	9.65	7.88	6.82	6.10	5.57	5.16	4.83
24 "	17.71	12.52	10.22	8.85	7.92	7.23	6.69	6.26
2 ft.	$s =$ 1 in 200	1 in 400	1 in 600	1 in 800	1 in 1000	1 in 1250	1 in 1500	1 in 1800
2 ft. 2 in.	15.88	11.23	9.17	7.94	7.10	6.35	5.80	5.29
2 " 4 "	19.73	13.96	11.39	9.87	8.82	7.89	7.20	6.58
2 " 6 "	24.15	17.07	13.94	12.07	10.80	9.66	8.82	8.05
2 " 8 "	29.08	20.56	16.79	14.54	13.00	11.63	10.62	9.69
2 " 10 "	34.71	24.54	20.04	17.35	15.52	13.88	12.67	11.57
2 ft. 10 in.	$s =$ 1 in 500	1 in 750	1 in 1000	1 in 1250	1 in 1500	1 in 1750	1 in 2000	1 in 2500
3 "	25.84	21.10	18.27	16.34	14.92	13.81	12.92	11.55
3 " 2 in.	30.14	24.61	21.31	19.06	17.40	16.11	15.07	13.48
3 " 4 "	34.90	28.50	24.68	22.07	20.15	18.66	17.45	15.61
3 " 6 "	40.08	32.72	28.34	25.35	23.14	21.42	20.04	17.93
3 " 8 "	45.66	37.28	32.28	28.87	26.36	24.40	22.83	20.41
3 ft. 8 in.	$s =$ 1 in 500	1 in 750	1 in 1000	1 in 1250	1 in 1500	1 in 1750	1 in 2000	1 in 2500
4 "	51.74	42.52	36.59	32.72	29.87	27.66	25.87	23.14
4 " 2 in.	58.36	47.65	41.27	36.91	33.69	31.20	29.18	26.10
4 " 4 "	65.47	53.46	46.30	41.41	37.80	34.50	32.74	29.28
4 " 6 in.	89.75	73.28	63.47	56.76	51.82	47.97	44.88	40.14
5 "	118.9	97.09	84.08	75.21	68.65	63.56	59.46	53.18
5 ft. 6 in.	$s =$ 1 in 750	1 in 1000	1 in 1500	1 in 2000	1 in 2500	1 in 3000	1 in 3500	1 in 4000
6 "	125.2	108.4	88.54	76.67	68.58	62.60	57.96	54.21
6 " 6 "	157.8	136.7	111.6	96.66	86.45	78.92	73.07	68.35
7 "	195.0	168.8	137.9	119.4	106.8	97.49	90.26	84.43
7 " 6 "	237.7	205.9	168.1	145.6	130.2	118.8	110.00	102.9
8 "	285.3	247.1	201.7	174.7	156.3	142.6	132.1	123.5
8 ft.	$s =$ 1 in 1500	1 in 2000	1 in 2500	1 in 3000	1 in 3500	1 in 4000	1 in 4500	1 in 5000
9 "	239.4	207.3	195.4	169.3	156.7	146.6	138.2	131.1
9 " 6 in.	281.1	243.5	217.8	198.8	184.0	172.2	162.3	154.0
10 "	327.0	283.1	253.3	231.2	214.0	200.2	186.7	179.1
10 " 6 "	376.9	326.4	291.9	266.5	246.7	230.8	217.6	206.4
11 "	431.4	373.6	334.1	305.0	282.4	264.2	249.1	236.3

For U. S. gallons multiply the figures in the table by 7.4805.
 For a given diameter the quantity of flow varies as the square root of the sine of the slope. From this principle the flow for other slopes than those given in the table may be found. Thus, what is the flow for a pipe 8 feet diameter, slope 1 in 125? From the table take $Q = 207.3$ for slope 1 in 2000. The given slope 1 in 125 is to 1 in 2000 as 16 to 1, and the square root of this ratio is 4 to 1. Therefore the flow required is $207.3 \times 4 = 829.2$ cu. ft.

Circular Pipes, Conduits, etc., Flowing Full.

Values of the factor $ac\sqrt{r}$ in the formula $Q = ac\sqrt{r} \times \sqrt{s}$ corresponding to different values of the coefficient of roughness, n . (Based on Kutter's formula.)

Diam. ft. in.	Value of $ac\sqrt{r}$					
	$n = .010$	$n = .011$	$n = .012$	$n = .013$	$n = .015$	$n = .017$
6	6.906	6.0627	5.3800	4.8216	3.9604	3.329
9	21.25	18.742	16.708	15.029	12.421	10.50
1 3	46.93	41.487	37.149	33.497	27.803	23.60
1 6	86.05	76.347	68.44	61.867	51.600	43.93
1 9	141.2	125.60	112.79	102.14	85.496	72.99
2	214.1	190.79	171.66	155.68	130.58	111.8
2 3	307.6	274.50	247.33	224.63	188.77	164
2 6	421.9	377.07	340.10	309.23	260.47	223.9
2 9	559.6	500.78	452.07	411.27	347.28	299.3
3	722.4	647.18	584.90	532.76	451.23	388.8
3 3	911.8	817.50	739.59	674.09	570.90	493.3
3 6	1128.9	1013.1	917.41	836.69	709.56	613.9
3 9	1374.7	1234.4	1118.6	1021.1	856.91	750.8
4	1652.1	1484.2	1345.9	1229.7	1045	906
4 6	1962.8	1764.3	1600.9	1463.9	1245.3	1080.7
5	2682.1	2413.3	2193	2007	1711.4	1487.3
5 6	3543	3191.8	2903.6	2659	2272.7	1977
6	4557.8	4111.9	3742.7	3429	2934.8	2557.2
6 6	5731.5	5176.3	4713.9	4322	3702.3	3232.5
7	7075.2	6394.9	5825.9	5339	4588.3	4010
7 6	8595.1	7774.3	7087	6510	5591.6	4893.2
8	10296	9318.3	8501.8	7814	6717	5884.3
8 6	12196	11044	10083	9272	7978.3	6995.3
9	14298	12954	11832	10889	9377.9	8226.7
9 6	16604	15049	13751	12663	10917	9580
10	19118	17338	15847	14597	12594	11061
10 6	21858	19834	18134	16709	14426	12678
11	24823	22534	20612	18996	16412	14434
11 6	28020	25444	23285	21464	18555	16333
12	31482	28593	26179	24139	20879	18395
12 6	35156	31937	29254	26981	23352	20584
13	39104	35529	32558	30041	26012	22938
13 6	43307	39358	36077	33301	28850	25451
14	47751	43412	39802	36752	31860	28117
14 6	52491	47739	43773	40432	35073	30965
15	57496	52308	47969	44322	38454	33975
16	62748	57103	52382	48413	42040	37147
17	74191	67557	62008	57343	49823	44073
18	86769	79050	72594	67140	58387	51669
19	100617	91711	84247	77932	67839	60067
20	115769	105570	96991	89759	78201	69301
	132133	120570	110905	102559	89423	79259

Flow of Water in Circular Pipes, Conduits, etc., Flowing under Pressure.

Based on Darcy's formulæ for the flow of water through cast-iron pipes. With comparison of results obtained by Kutter's formula, with $n = 0.013$. (Condensed from Flynn on Water Power.)

Values of a , and also the values of the factors $c\sqrt{r}$ and $ac\sqrt{r}$ for use in the formulæ $Q = av$; $v = c\sqrt{r} \times \sqrt{s}$, and $Q = ac\sqrt{r} \times \sqrt{s}$.
 Q = discharge in cubic feet per second, a = area in square feet, v = velocity in feet per second, r = mean hydraulic depth, $1/4$ diam. for pipes running full, s = sine of slope.
 (For values of \sqrt{s} see page 700.)

Size of Pipe. d =diam. in ft. in.	a =area in square feet.	Clean Cast-iron Pipes.		Value of $ac\sqrt{r}$ by Kutter's Formula, when $n = .013$.	Old Cast-iron Pipes Lined with Deposit.	
		For Velocity, $c\sqrt{r}$.	For Discharge, $ac\sqrt{r}$.		For Velocity, $c\sqrt{r}$.	For Discharge, $ac\sqrt{r}$.
3/8	.00077	5.251	.00403		3.532	.00272
1/2	.00136	6.702	.00914		4.507	.00613
3/4	.00367	9.309	.02855		6.261	.01922
1	.00545	11.61	.06334		7.811	.04257
1 1/4	.00852	13.68	.11659		9.255	.07885
1 1/2	.01227	15.58	.19115		10.48	.12855
1 3/4	.01670	17.32	.28936		11.65	.19462
2	.02182	18.96	.41357		12.75	.27824
2 1/2	.0341	21.94	.74786		14.76	.50321
3	.0491	24.63	1.2089		16.56	.81333
4	.0873	29.37	2.5630		19.75	1.7246
5	.136	33.54	4.5610		22.56	3.0681
6	.196	37.28	7.3068	4.822	25.07	4.9147
7	.267	40.65	10.852		27.34	7.2995
8	.349	43.75	15.270		29.43	10.271
9	.442	46.73	20.652	15.03	31.42	13.891
10	.545	49.45	26.952		33.26	18.129
11	.660	52.16	34.428		35.09	23.158
1 1/8	.785	54.65	42.918	33.50	36.75	28.867
1 1/4	1.000	59.34	63.435		39.91	42.668
1 1/2	1.396	63.67	88.886		42.83	59.788
1 3/8	1.767	67.75	119.72	102.14	45.57	80.531
1 1/2	2.182	71.71	156.46		48.34	105.25
1 7/8	2.640	75.32	198.83		50.658	133.74
2	3.142	78.80	247.57	224.63	52.961	166.41
2 1/8	3.687	82.15	302.90		55.258	203.74
2 1/4	4.276	85.39	365.14		57.436	245.60
2 3/8	4.909	88.39	433.92	411.37	59.455	291.87
2 1/2	5.585	91.51	511.10		61.55	343.8
2 7/8	6.305	94.40	595.17		63.49	400.3
3	7.068	97.17	686.76	674.09	65.35	461.9
3 1/8	7.875	99.93	786.94		67.21	529.3
3 1/4	8.726	102.6	895.7		69	602
3 3/8	9.621	105.1	1011.2	1021.1	70.70	680.2
3 1/2	10.559	107.6	1136.5		72.40	764.5
3 7/8	11.541	110.2	1271.4		74.10	855.2
4	12.566	112.6	1414.7	1463.9	75.73	951.6
4 1/8	14.186	116.1	1647.6		78.12	1108.2
4 1/4	15.904	119.6	1901.9	2007	80.43	1279.2
4 3/8	17.721	122.8	2176.1		82.20	1456.8
4 1/2	19.635	126.1	2476.4	2659	84.83	1665.7
4 7/8	21.648	129.3	2799.7		86.99	1883.2
5	23.758	132.4	3146.3	3429	89.07	2116.2
5 1/8	25.967	135.4	3516		91.08	2365
5 1/4	28.274	138.4	3912.8	4322	93.08	2631.7
5 3/8	33.183	144.1	4782.1	5339	96.93	3216.4
5 1/2	38.485	149.6	5757.5	6510	100.61	3872.5

WARNING: This is a 1910 edition. Some of the material may no longer be accurate

Size of Pipe.		Clean Cast-iron Pipes.		Value of $ac\sqrt{r}$ by Kutter's Formula, when $n=.013$	Old Cast-iron Pipes Lined with Deposit.	
d=diam. in ft. in.	a=area in square feet.	For Velocity, $c\sqrt{r}$.	For Discharge, $ac\sqrt{r}$.		For Velocity, $c\sqrt{r}$.	For Discharge, $ac\sqrt{r}$.
7	6	44.179	154.9	7814	104.11	4601.9
8		50.266	160	9272	107.61	5409.9
8	6	56.745	165	10889	111	6299.1
9		63.617	169.8	12663	114.2	7267.3
9	6	70.882	174.5	14597	117.4	8320.6
10		78.540	179.1	16709	120.4	9460.9
10	6	86.590	183.6	18996	123.4	10690
11		95.033	187.9	21464	126.3	12010
11	6	103.869	192.2	24139	129.3	13429
12		113.098	196.3	26981	132	14935
12	6	122.719	200.4	30041	134.8	16545
13		132.733	204.4	33301	137.5	18252
13	6	143.139	208.3	36752	140.1	20056
14		153.938	212.2	40432	142.7	21971
14	6	165.130	216.0	44322	145.2	23986
15		176.715	219.6	48413	147.7	26103
15	6	188.692	223.3	52753	150.1	28335
16		201.062	226.9	57343	152.6	30686
16	6	213.825	230.4	62132	155	33144
17		226.981	233.9	67140	157.3	35704
17	6	240.529	237.3	72409	159.6	38389
18		254.470	240.7	77932	161.9	41199
19		283.529	247.4	89759	166.4	47186
20		314.159	253.8	102559	170.7	53633

Flow of Water in Pipes from 3/8 Inch to 12 Inches Diameter for a Uniform Velocity of 100 Ft. per Min.

Diam. in In.	Area Sq. Ft.	Cu. Ft. per Min.	U. S. Gallons per Min.	Diam. in In.	Area Sq. Ft.	Cu. Ft. per Min.	U. S. Gallons per Min.
3/8	.00077	0.077	.57	4	.0873	8.73	65.28
1/2	.00136	0.136	1.02	5	.136	13.6	102.00
3/4	.00307	0.307	2.30	6	.196	19.6	146.88
1	.00545	0.545	4.08	7	.267	26.7	199.92
1 1/4	.00852	0.852	6.38	8	.349	34.9	261.12
1 1/2	.01227	1.227	9.18	9	.442	44.2	330.48
1 3/4	.01670	1.670	12.50	10	.545	54.5	408.00
2	.02182	2.182	16.32	11	.660	66.0	493.68
2 1/2	.0341	3.41	25.50	12	.785	78.5	587.52
3	.0491	4.91	36.72				

Short Formulae. E. Sherman Gould, Eng. News, Sept. 6, 1900, shows that Darcy's formulae for cast-iron pipes may be reduced to the following approximate forms, in which h is loss of head or drop of hydraulic grade line in feet per 1000, d in ft., v in ft. per sec., Q in cu. ft. per sec.

8 in. to 48 in. diam. { Rough, $Q^2 = hd^5$; $v = 1.27 \sqrt{dh}$.
 { Smooth, $Q^2 = 2hd^5$; $v = 1.80 \sqrt{dh}$.

3 to 8 in. diam. { Rough, $Q^2 = 0.785hd^5$; $v = 1.13 \sqrt{dh}$.
 { Smooth, $Q^2 = 1.57hd^5$; $v = 1.60 \sqrt{dh}$.

Flow of Water in Circular Pipes from 3/8 Inch to 12 Inches Diameter.

Based on Darcy's formula for clean cast-iron pipes. $Q = ac\sqrt{r}\sqrt{s}$.

Value of $ac\sqrt{r}$.	Dia. in.	Slope, or Head Divided by Length of Pipe.							
		1 in 10	1 in 20	1 in 40	1 in 60	1 in 80	1 in 100	1 in 150	1 in 200
		Quantity in cubic feet per second.							
.00403	3/8	.00127	.00090	.00064	.00052	.00045	.00040	.00033	.00028
.00914	1/2	.00289	.00204	.00145	.00118	.00102	.00091	.00075	.00065
.02855	3/4	.00903	.00638	.00451	.00369	.00319	.00286	.00233	.00202
.06334	1	.02003	.01416	.01001	.00818	.00708	.00633	.00517	.00448
.11659	1 1/4	.03687	.02607	.01843	.01505	.01303	.01166	.00952	.00824
.19115	1 1/2	.06044	.04274	.03022	.02468	.02137	.01912	.01561	.01352
.28936	1 3/4	.09140	.06470	.04575	.03736	.03235	.02894	.02363	.02046
.41357	2	.13077	.09247	.06539	.05339	.04624	.04136	.03377	.02927
.74786	2 1/2	.23647	.16722	.11824	.09655	.08361	.07479	.06106	.05288
1.2089	3	.38225	.27031	.19113	.15607	.13515	.12089	.09871	.08548
2.5630	4	.81042	.57309	.40521	.33088	.28654	.25630	.20927	.18123
4.5610	5	1.4422	1.0198	.72109	.58882	.50992	.45610	.37241	.32251
7.3068	6	2.3104	1.6338	1.1552	.94331	.81690	.73068	.59660	.51666
10.852	7	3.4314	2.4265	1.7157	1.4110	1.2132	1.0852	.88607	.76734
15.270	8	4.8284	3.4143	2.4141	1.9713	1.7072	1.5270	1.2468	1.0797
20.652	9	6.5302	4.6178	3.2651	2.6662	2.3089	2.0652	1.6862	1.4603
26.952	10	8.5222	6.0265	4.2611	3.4795	3.0132	2.6952	2.2006	1.9058
34.428	11	10.886	7.6981	5.4431	4.4447	3.8491	3.4428	2.8110	2.4344
42.918	12	13.571	9.5965	6.7853	5.5407	4.7982	4.2918	3.5043	3.0347
Value of \sqrt{s} =		0.3162	0.2236	0.1581	0.1291	0.1118	0.1	0.08165	0.07071
Value of $ac\sqrt{r}$.	Dia. in.	Slope, or Head Divided by Length of Pipe.							
		1 in 250	1 in 300	1 in 350	1 in 400	1 in 450	1 in 500	1 in 550	1 in 600
.00403	3/8	.00025	.00023	.00022	.00020	.00019	.00018	.00017	.00016
.00914	1/2	.00058	.00053	.00049	.00046	.00043	.00041	.00039	.00037
.02855	3/4	.00181	.00165	.00153	.00143	.00134	.00128	.00122	.00117
.06334	1	.00400	.00366	.00339	.00317	.00298	.00283	.00270	.00259
.11659	1 1/4	.00737	.00673	.00623	.00583	.00549	.00521	.00497	.00476
.19115	1 1/2	.01209	.01104	.01022	.00956	.00901	.00855	.00815	.00780
.28936	1 3/4	.01830	.01671	.01547	.01447	.01363	.01294	.01234	.01181
.41357	2	.02615	.02388	.02211	.02068	.01948	.01849	.01763	.01688
.74786	2 1/2	.04730	.04318	.03997	.03739	.03523	.03344	.03189	.03053
1.2089	3	.07645	.06980	.06462	.06045	.05695	.05406	.05155	.04935
2.5630	4	.16208	.14799	.13699	.12815	.12074	.11461	.10929	.10463
4.5610	5	.28843	.26335	.24379	.22805	.21487	.20397	.19448	.18620
7.3068	6	.46208	.42189	.39055	.36534	.34422	.32676	.31156	.29830
10.852	7	.68628	.62660	.58005	.54260	.51124	.48530	.46273	.44303
15.270	8	.96567	.88158	.81617	.76350	.71936	.68286	.65111	.62340
20.652	9	1.3060	1.1924	1.1038	1.0326	.97292	.92356	.88060	.84310
26.952	10	1.7044	1.5562	1.4405	1.3476	1.2697	1.2053	1.1492	1.1003
34.428	11	2.1772	1.9878	1.8402	1.7214	1.6219	1.5396	1.4680	1.4055
42.918	12	2.7141	2.4781	2.2940	2.1459	2.0219	1.9193	1.8300	1.7521
Value of \sqrt{s} =		.06324	.05774	.05345	.05	.04711	.04472	.04264	.04082

For U. S. gals. per sec., multiply the figures in the table by ... 7.4805
 " " " " min., " " " " ... 48.83
 " " " " hour, " " " " ... 28929.8
 " " " " 24 hrs., " " " " ... 648315.

For any other slope the flow is proportional to the square root of the slope; thus, flow in slope of 1 in 100 is double that in slope of 1 in 400.

Mr. E. Kuiching, C. E., furnished the following table to the Thomson Meter Co.:

Flow of Water in House-service Pipes.

Condition of Discharge.	Pressure in Main, pounds per square inch.		Discharge, or Quantity capable of being delivered, in Cubic Feet per Minute, from the Pipe, under the conditions specified in the first column.							
	1/2	5/8	Nominal Diameters of Iron or Lead Service-pipe in Inches.							
Through 35 feet of ser-vice-pipe, no back pressure.	30	1.10	1.92	3.01	6.13	16.58	33.34	88.16	173.85	444.63
	40	1.27	2.22	3.48	7.08	19.14	38.50	101.80	200.75	513.42
	50	1.42	2.48	3.89	7.92	21.40	43.04	113.82	224.44	574.02
Through 100 feet of ser-vice-pipe, no back pressure.	30	0.66	1.16	1.84	3.78	10.40	21.30	58.19	118.13	317.23
	40	0.77	1.34	2.12	4.36	12.01	24.59	67.19	136.41	366.30
	50	0.86	1.50	2.37	4.88	13.43	27.50	75.13	152.51	409.54
Through 100 feet of ser-vice-pipe, and 15 feet vertical rise.	30	0.55	0.96	1.52	3.11	8.57	17.55	47.90	97.17	260.56
	40	0.66	1.15	1.81	3.72	10.24	20.95	57.20	116.01	311.09
	50	0.75	1.31	2.06	4.24	11.97	23.87	65.18	132.20	354.49
Through 100 feet of ser-vice-pipe, and 30 feet vertical rise.	30	0.44	0.77	1.22	2.50	6.80	14.11	38.63	78.54	211.54
	40	0.55	0.97	1.53	3.15	8.68	17.79	48.68	98.98	266.59
	50	0.65	1.14	1.79	3.69	10.16	20.82	56.98	115.87	312.08

In this table it is assumed that the pipe is straight and smooth inside; that the friction of the main and meter are disregarded; that the inlet from the main is of ordinary character, sharp, not flaring or rounded, and that the outlet is the full diameter of pipe. The deliveries given will be increased if, first, the pipe between the meter and the main is of larger diameter than the outlet; second, if the main is tapped, say for 1-inch pipe, but is enlarged from the tap to 1 1/4 or 1 1/2 inch; or, third, if pipe on the outlet is larger than that on the inlet side of the meter. The exact details of the conditions given are rarely met in practice; consequently the quantities of the table may be expected to be decreased, because the pipe is liable to be throttled at the joints, additional bends may interpose, or stop-cocks may be used, or the back-pressure may be increased.

WARNING: This is a 1910 edition. Some of the material may no longer be accurate

Flow of Water Through Nozzles in Cubic Feet per Second. (Joshua Hendy Iron Works.)

H = head in feet at the nozzle. P = pressure due to head lbs. per sq. in. V = theoretical velocity, ft. per sec.

Diam. Nozzle, In.	Flow of Water Through Nozzles in Cubic Feet per Second.															
	1	1 1/2	2	2 1/2	3	3 1/2	4	4 1/2	5	6	7	8	9	10	11	12
5	0.098	0.221	0.392	0.611	0.880	1.197	1.565	2.040	2.445	3.519	4.810	6.26	7.92	9.78	12.83	14.08
10	0.138	0.312	0.553	0.864	1.245	1.694	2.213	2.875	3.459	4.978	6.778	8.85	11.20	13.83	16.74	19.92
20	0.195	0.441	0.784	1.222	1.760	2.395	3.130	4.066	4.885	7.039	9.585	12.52	15.84	19.56	23.67	28.16
30	0.241	0.540	0.957	1.497	2.156	2.933	3.834	4.980	5.990	8.621	11.739	15.33	19.40	23.95	28.99	34.49
40	0.276	0.624	1.105	1.729	2.490	3.388	4.427	5.751	6.918	9.956	13.557	17.71	22.41	27.66	33.48	39.84
50	0.311	0.697	1.236	1.933	2.784	3.788	4.950	6.429	7.735	11.132	15.158	19.80	25.05	30.93	37.43	44.54
60	0.341	0.764	1.354	2.118	3.050	4.149	5.423	7.044	8.437	12.194	16.604	21.69	27.44	33.88	41.00	48.79
70	0.369	0.825	1.464	2.288	3.294	4.482	5.857	7.609	9.152	13.171	17.935	23.42	29.64	36.60	44.29	52.70
80	0.394	0.882	1.564	2.445	3.521	4.791	6.262	8.134	9.783	14.080	19.173	25.04	31.69	39.12	47.34	56.37
90	0.418	0.936	1.659	2.594	3.735	5.082	6.641	8.627	10.377	14.934	20.346	26.56	33.61	41.49	50.21	59.75
100	0.441	0.986	1.748	2.734	3.937	5.377	7.001	9.094	10.940	15.743	21.437	28.00	35.43	43.74	52.93	62.99
120	0.489	1.080	1.866	2.996	4.314	5.870	7.671	9.965	11.986	17.250	23.490	30.68	38.83	47.93	58.00	69.02
140	0.520	1.167	2.069	3.235	4.659	6.349	8.283	10.760	12.942	18.626	25.364	33.13	41.92	51.75	62.63	74.53
160	0.557	1.248	2.212	3.459	4.981	6.776	8.856	11.504	13.837	19.914	27.117	35.42	44.82	55.33	66.96	79.68
180	0.588	1.323	2.345	3.668	5.282	7.187	9.392	12.200	14.675	21.119	28.753	37.56	47.53	58.68	71.01	84.50
200	0.621	1.394	2.472	3.867	5.568	7.575	9.900	12.860	15.469	22.262	30.314	39.59	50.10	61.85	74.85	89.07
250	0.698	1.560	2.764	4.323	6.225	8.470	11.069	14.379	17.295	24.857	33.893	44.27	56.02	69.16	83.69	99.59
300	0.761	1.709	3.028	4.736	6.820	9.270	12.126	15.752	18.899	27.268	37.130	48.49	61.37	75.76	91.68	109.10
350	0.825	1.845	3.271	5.116	7.366	10.022	13.098	17.014	20.465	29.452	40.105	52.38	66.29	81.83	99.03	117.84
400	0.883	1.973	3.497	5.469	7.875	10.714	14.002	18.189	21.878	31.486	42.874	56.00	70.86	87.48	105.86	125.98
450	0.935	2.092	3.709	5.801	8.352	11.364	14.851	19.391	23.204	33.394	45.263	59.39	75.16	92.78	112.23	133.61
500	0.986	2.206	3.909	6.115	8.805	11.979	15.655	20.336	24.460	35.202	47.934	62.60	79.23	97.81	118.36	140.85
600	1.080	2.416	4.282	6.698	9.645	13.122	17.149	22.276	26.794	38.561	52.508	68.58	86.79	107.14	129.65	154.18
700	1.167	2.610	4.626	7.235	10.418	14.173	18.523	24.061	28.941	41.650	56.715	74.07	93.74	115.72	140.04	166.63
800	1.247	2.790	4.945	7.735	11.137	15.152	19.803	25.723	30.940	44.528	60.634	79.19	100.22	123.72	149.71	178.16
900	1.323	2.959	5.245	8.204	11.813	16.072	20.804	27.284	32.817	47.229	64.312	83.99	106.30	131.22	158.80	189.77
1000	1.394	3.119	5.529	8.648	12.452	16.941	22.141	28.759	34.592	49.783	67.789	88.54	112.04	138.32	167.38	199.19
1200	1.527	3.417	6.056	9.473	13.640	18.557	24.260	31.503	37.893	54.534	74.258	96.98	122.74	151.52	183.35	218.19
1400	1.650	3.691	6.542	10.223	14.734	20.046	26.198	34.031	40.933	58.909	80.216	104.76	132.58	163.67	198.07	235.70
1600	1.764	3.946	6.993	10.939	15.751	21.429	27.907	36.378	43.757	62.973	85.749	111.99	141.73	174.96	211.73	251.96
1800	1.872	4.185	7.418	11.503	16.707	22.730	29.706	38.587	46.414	66.796	90.956	118.79	150.34	185.59	224.58	267.26
2000	1.973	4.411	7.818	12.229	17.609	23.957	31.310	40.670	48.919	70.402	95.867	125.21	158.45	195.61	236.71	281.68

the material may no longer be accurate

Flow of Water Through Nozzles in Cubic Feet per Second. (Joshua Hendy Iron Works.)
H = head in feet at the nozzle. *P* = pressure due to head lbs. per sq. in. *V* = theoretical velocity, ft. per sec.

Diam. Nozzle, In.	1	1 1/2	2	2 1/2	3	3 1/2	4	4 1/2	5	6	7	8	9	10	11	12		
<i>H.</i>	<i>P.</i>	<i>V.</i>																
5	2.17	17.93	0.098	0.221	0.392	0.611	0.880	1.197	1.565	2.040	2.445	3.519	4.810	6.26	7.92	9.78	12.83	14.08
10	4.33	35.86	0.138	0.312	0.553	0.864	1.245	1.694	2.213	2.875	3.459	4.978	6.778	8.85	11.20	13.83	16.74	19.92
20	8.66	71.72	0.195	0.441	0.784	1.222	1.760	2.395	3.130	4.066	4.885	7.039	9.585	12.52	15.84	19.56	23.67	28.16
30	12.99	107.58	0.241	0.540	0.957	1.497	2.156	2.933	3.834	4.980	5.990	8.621	11.739	15.33	19.40	23.95	28.99	34.49
40	17.32	143.44	0.276	0.624	1.105	1.729	2.490	3.388	4.427	5.751	6.918	9.956	13.557	17.71	22.41	27.66	33.48	39.84
50	21.65	179.30	0.311	0.697	1.236	1.933	2.784	3.788	4.950	6.429	7.735	11.132	15.158	19.80	25.05	30.93	37.43	44.54
60	25.99	215.16	0.341	0.764	1.354	2.118	3.050	4.149	5.423	7.044	8.437	12.194	16.604	21.69	27.44	33.88	41.00	48.79
70	30.32	251.02	0.369	0.825	1.464	2.288	3.294	4.482	5.857	7.609	9.152	13.171	17.935	23.42	29.64	36.60	44.29	52.70
80	34.65	286.88	0.394	0.882	1.564	2.445	3.521	4.791	6.262	8.134	9.783	14.080	19.173	25.04	31.69	39.12	47.34	56.37
90	38.98	322.74	0.418	0.936	1.659	2.594	3.735	5.082	6.641	8.627	10.377	14.934	20.346	26.56	33.61	41.49	50.21	59.75
100	43.31	358.60	0.441	0.986	1.748	2.734	3.937	5.377	7.001	9.094	10.940	15.743	21.437	28.00	35.43	43.74	52.93	62.99
120	51.97	428.16	0.489	1.080	1.866	2.996	4.314	5.870	7.671	9.965	11.986	17.250	23.490	30.68	38.83	47.93	58.00	69.02
140	60.63	497.72	0.520	1.167	2.069	3.235	4.659	6.349	8.283	10.760	12.942	18.626	25.364	33.13	41.92	51.75	62.63	74.53
160	69.29	567.28	0.557	1.248	2.212	3.459	4.981	6.776	8.856	11.504	13.837	19.914	27.117	35.42	44.82	55.33	66.96	79.68
180	77.96	636.84	0.588	1.323	2.345	3.668	5.282	7.187	9.392	12.200	14.675	21.119	28.753	37.56	47.53	58.68	71.01	84.50
200	86.62	706.40	0.621	1.394	2.472	3.867	5.568	7.575	9.900	12.860	15.469	22.262	30.314	39.59	50.10	61.85	74.85	89.07
250	108.50	882.50	0.698	1.560	2.764	4.323	6.225	8.470	11.069	14.379	17.295	24.857	33.893	44.27	56.02	69.16	83.69	99.59
300	130.20	1058.60	0.761	1.709	3.028	4.736	6.820	9.270	12.126	15.752	18.899	27.268	37.130	48.49	61.37	75.76	91.68	109.10
350	151.90	1234.70	0.825	1.845	3.271	5.116	7.366	10.022	13.098	17.014	20.465	29.452	40.105	52.38	66.29	81.83	99.03	117.84
400	173.60	1410.80	0.883	1.973	3.497	5.469	7.875	10.714	14.002	18.189	21.878	31.486	42.874	56.00	70.86	87.48	105.86	125.98
450	195.30	1586.90	0.935	2.092	3.709	5.801	8.352	11.364	14.851	19.391	23.204	33.394	45.263	59.39	75.16	92.78	112.23	133.61
500	216.00	1763.00	0.986	2.206	3.909	6.115	8.805	11.979	15.655	20.336	24.460	35.202	47.934	62.60	79.23	97.81	118.36	140.85
600	260.11	2116.11	1.080	2.416	4.282	6.698	9.645	13.122	17.149	22.276	26.794	38.561	52.508	68.58	86.79	107.14	129.65	154.18
700	303.80	2469.20	1.167	2.610	4.626	7.235	10.418	14.173	18.523	24.061	28.941	41.650	56.715	74.07	93.74	115.72	140.04	166.63
800	347.20	2822.30	1.247	2.790	4.945	7.735	11.137	15.152	19.803	25.723	30.940	44.528	60.634	79.19	100.22	123.72	149.71	178.16
900	390.60	3175.40	1.323	2.959	5.245	8.204	11.813	16.072	20.804	27.284	32.817	47.229	64.312	83.99	106.30	131.22	158.80	189.77
1000	434.00	3528.50	1.394	3.119	5.529	8.648	12.452	16.941	22.141	28.759	34.592	49.783	67.789	88.54	112.04	138.32	167.38	199.19
1200	520.80	4213.60	1.527	3.417	6.056	9.473	13.640	18.557	24.260	31.503	37.893	54.534	74.258	96.98	122.74	151.52	183.35	218.19
1400	607.60	4898.70	1.650	3.691	6.542	10.223	14.734	20.046	26.198	34.031	40.933	58.909	80.216	104.76	132.58	163.67	198.07	235.70
1600	694.40	5583.80	1.764	3.946	6.993	10.939	15.751	21.429	27.907	36.378	43.757	62.973	85.749	111.99	141.73	174.96	211.73	251.96
1800	781.20	6268.90	1.872	4.185	7.418	11.503	16.707	22.730	29.706	38.587	46.414	66.796	90.956	118.79	150.34	185.59	224.58	267.26
2000	868.00	6954.00	1.973	4.411	7.818	12.229	17.609	23.957	31.310	40.670	48.919	70.402	95.867	125.21	158.45	195.61	236.71	281.68

Multiplying these figures by d gives the length of straight pipe to be added to the actual length to allow for the inlet resistance. In long lengths of pipe the relative value of this length is so small that it may be neglected in practical calculations. — (Unwin.)

Loss of Head in Pipe by Friction. — Loss of head by friction in each 100 feet in length of riveted pipe when discharging the following quantities of water per minute (Pelton Water-wheel Co.).

V = velocity in feet per second; h = loss of head in feet; Q = discharge in cubic feet per minute.

V	Inside Diameter of Pipe in Inches.											
	7		8		9		10		11		12	
	h	Q	h	Q	h	Q	h	Q	h	Q	h	Q
2.0	0.338	32.0	0.296	41.9	0.264	53	0.237	65.4	0.216	79.2	0.198	94.2
3.0	0.698	48.1	0.611	62.8	0.544	79.5	0.488	98.2	0.444	119	0.407	141
4.0	1.175	64.1	1.027	83.7	0.913	106	0.822	131	0.747	158	0.685	188
5.0	1.76	80.2	1.54	105	1.37	132	1.23	163	1.122	198	1.028	235
6.0	2.46	96.2	2.15	125	1.92	159	1.71	196	1.56	237	1.43	283
7.0	3.26	112.0	2.85	146	2.52	185	2.28	229	2.07	277	1.91	330

V	13 in.		14 in.		15 in.		16 in.		18 in.		20 in.	
	h	Q	h	Q	h	Q	h	Q	h	Q	h	Q
	2.0	0.183	110	0.169	128	0.158	147	0.147	167	0.132	212	0.119
3.0	.375	166	.349	192	.325	221	.306	251	.271	318	.245	393
4.0	.632	221	.587	256	.548	294	.513	335	.456	424	.410	523
5.0	.949	276	.881	321	.822	368	.770	419	.685	530	.617	654
6.0	1.325	332	1.229	385	1.148	442	1.076	502	.957	636	.861	785
7.0	1.75	387	1.63	449	1.52	515	1.43	586	1.27	742	1.143	916

V	22 in.		24 in.		26 in.		28 in.		30 in.		36 in.	
	h	Q	h	Q	h	Q	h	Q	h	Q	h	Q
	2.0	0.108	316	0.098	377	0.091	442	0.084	513	0.079	589	0.066
3.0	.222	475	.204	565	.188	663	.174	770	.163	883	.135	1273
4.0	.373	633	.342	754	.315	885	.293	1026	.273	1178	.228	1697
5.0	.561	792	.513	942	.474	1106	.440	1283	.411	1472	.342	2121
6.0	.782	950	.717	1131	.662	1327	.615	1539	.574	1767	.479	2545
7.0	1.040	1109	.953	1319	.879	1548	.817	1796	.762	2061	.636	2868

This table is based on Cox's reconstruction of Weisbach's formula, using the denominator 1000 instead of 1200, to be on the safe side, allowing 20% for the loss of head due to the laps and rivet-heads in the pipe.

EXAMPLE. — Given 200 ft. head and 600 ft. of 11-inch pipe, carrying 119 cubic feet of water per minute. To find effective head: In right-hand column, under 11-inch pipe, find 119 cubic ft.; opposite this will be found the loss by friction in 100 ft. of length for this amount of water, which is 0.444. Multiply this by the number of hundred feet of pipe, which is 6, and we have 2.66 ft., which is the loss of head. Therefore the effective head is 200 - 2.66 = 197.34.

EXPLANATION. — The loss of head by friction in a pipe depends not only upon diameter and length, but upon the quantity of water passed through it. The head or pressure is what would be indicated by a

WARNING: This is a 1910 edition. Some of the material may no longer be accurate

pressure-gauge attached to the pipe near the wheel. Readings of gauge should be taken while the water is flowing from the nozzle.

To reduce heads in feet to pressure in pounds multiply by 0.433. To reduce pounds pressure to feet multiply by 2.309.

Cox's Formula. — Weisbach's formula for loss of head caused by the friction of water in pipes is as follows:

$$\text{Friction-head} = \left(0.0144 + \frac{0.01716}{\sqrt{V}}\right) \frac{L \cdot V^2}{5.367 d^5}$$

where L = length of pipe in feet;
 V = velocity of the water in feet per second;
 d = diameter of pipe in inches.

William Cox (*Amer. Mach.*, Dec. 28, 1893) gives a simpler formula which gives almost identical results:

$$H = \text{friction-head in feet} = \frac{L}{d} \frac{4V^2 + 5V - 2}{1200} \dots (1)$$

$$\frac{Hd}{L} = \frac{4V^2 + 5V - 2}{1200} \dots (2)$$

He gives a table by means of which the value of $\frac{4V^2 + 5V - 2}{1200}$ is at once obtained when V is known, and vice versa.

VALUES OF $\frac{4V^2 + 5V - 2}{1200}$

V	0.0	0.1	0.2	0.3	0.4	0.5	0.6	0.7	0.8	0.9
1	.00583	.00695	.00813	.00938	.01070	.01208	.01353	.01505	.01663	.01828
2	.02000	.02178	.02363	.02555	.02753	.02958	.03170	.03388	.03613	.03845
3	.04083	.04328	.04580	.04838	.05103	.05375	.05653	.05938	.06230	.06528
4	.06833	.07145	.07463	.07788	.08120	.08458	.08803	.09155	.09513	.09878
5	.10250	.10628	.11013	.11405	.11803	.12208	.12620	.13038	.13463	.13895
6	.14333	.14778	.15230	.15688	.16153	.16625	.17103	.17588	.18080	.18578
7	.19083	.19595	.20113	.20638	.21170	.21708	.22253	.22805	.23363	.23928
8	.24500	.25078	.25663	.26255	.26853	.27458	.28070	.28688	.29313	.29945
9	.30583	.31228	.31880	.32538	.33203	.33875	.34553	.35238	.35930	.36628
10	.37333	.38045	.38763	.39488	.40220	.40958	.41703	.42455	.43213	.43978
11	.44750	.45528	.46313	.47105	.47903	.48708	.49520	.50338	.51163	.51995
12	.52833	.53678	.54530	.55388	.56253	.57125	.58003	.58888	.59780	.60678
13	.61583	.62495	.63413	.64338	.65270	.66208	.67153	.68105	.69063	.70028
14	.71000	.71978	.72963	.73955	.74953	.75958	.76970	.77988	.79013	.80045
15	.81083	.82128	.83180	.84238	.85303	.86375	.87453	.88538	.89630	.90728
16	.91833	.92945	.94063	.95188	.96320	.97458	.98603	.99755	1.00913	1.02078
17	1.03250	1.04428	1.05613	1.06805	1.08003	1.09208	1.10420	1.11638	1.12863	1.14095
18	1.15333	1.16578	1.17830	1.19088	1.20353	1.21625	1.22903	1.24188	1.25480	1.26778
19	1.28083	1.29395	1.30713	1.32038	1.33370	1.34708	1.36053	1.37405	1.38763	1.40128
20	1.41500	1.42878	1.44263	1.45655	1.47053	1.48458	1.49870	1.51288	1.52713	1.54145
21	1.55583	1.57028	1.58480	1.59938	1.61403	1.62875	1.64353	1.65838	1.67330	1.68828

The use of the formula and table is illustrated as follows:
 Given a pipe 5 inches diameter and 1000 feet long, with 49 feet head, what will the discharge be?
 If the velocity V is known in feet per second, the discharge is $0.32725 d^2 V$ cubic foot per minute.

Approximate Hydraulic Formulæ. (The Lombard Governor Co., Boston, Mass.)

Head (H) in feet. Pressure (P) in lbs. per sq. in. Diameter (D) in feet. Area (A) in sq. ft. Quantity (Q) in cubic ft. per second. Time (T) in seconds.

$$\text{Spouting velocity} = 8.02 \sqrt{H}.$$

Time (T_1) to acquire spouting velocity in a vertical pipe, or (T_2) in a pipe on an angle (θ) from horizontal:

$$T_1 = 8.02 \sqrt{H} \div 32.17, \quad T_2 = 8.02 \sqrt{H} \div 32.17 \sin \theta.$$

Head (H) or pressure (P) which will vent any quantity (Q) through a round orifice of any diameter (D) or area (A):

$$H = Q^2 \div 14.1 D^4 = Q^2 \div 23.75 A^2; \quad P = Q^2 \div 34.1 D^4 = Q^2 \div 55.3 A^2.$$

Quantity (Q) discharged through a round orifice of any diameter (D) or area (A) under any pressure (P) or under any head (H):

$$Q = \sqrt{P \times 55.3 \times A^2} = \sqrt{P \times 34.1 \times D^4}; \\ = \sqrt{H \times 23.75 \times A^2} = \sqrt{H \times 14.1 \times D^4}.$$

Diameter (D) or area (A) of a round orifice to vent any quantity (Q) under any head (H) or under any pressure (P):

$$D = \sqrt{Q \div 3.84 \sqrt{H}} = \sqrt{Q \div 5.8 \sqrt{P}}; \quad A = Q \div 4.89 \sqrt{H} = Q \div 7.35 \sqrt{P}.$$

Time (T) of emptying a vessel of any area (A) through an orifice of any area (a) anywhere in its side: $T = 0.416 A \sqrt{H} \div a$.

Time (T) of lowering a water level from (H) to (h) in a tank of area A through an orifice of any area (a) in its side. $T = 0.416 A (\sqrt{H} - \sqrt{h}) \div a$.

Kinetic energy (K) or foot-pounds in water in a round pipe of any diameter (D) when moving at velocity (V): $K = 0.76 \times D^2 \times L \times V$.

Area (a) of an orifice to empty a tank of any area (A) in any time (T) from any head (H): $a = T \div 0.409 A \sqrt{H}$.

Area (a) of an orifice to lower water in a tank of area (A) from head (H) to (h) in time (T): $a = T \div 0.409 \times A \times (\sqrt{H} - \sqrt{h})$.

Compound Pipes and Pipes with Branches. (Unwin.) — Loss of head in a main consisting of different diameters. (1) Constant discharge. Total loss of head $H = h_1 + h_2 + h_3 = 0.1008 f Q^2 (l_1/d_1^5 + l_2/d_2^5 + l_3/d_3^5)$.

(2) Constant velocity in the main, the discharge diminishing from section to section. $H = 0.0551 f v^{5/2} (l_1/\sqrt{Q_1} + l_2/\sqrt{Q_2} + l_3/\sqrt{Q_3})$. Equivalent main of uniform diameter. Length of equivalent main

$$l = d^5 (l_1/d_1^5 + l_2/d_2^5 + l_3/d_3^5).$$

Loss of head in a main of uniform diameter in which the discharge decreases uniformly along its length, such as a main with numerous branch pipes uniformly spaced and delivering equal quantities: $h = 0.0336 f Q^2/d^5$, Q being the quantity entering the pipe. The loss of head is just one-third of the loss in a pipe carrying the uniform quantity Q throughout its length.

Loss of head in a pipe that receives Q cu. ft. per sec. at the inlet, and delivers Q_x cu. ft. at x ft. from the inlet, having distributed qx cu. ft. uniformly in that distance, $h_x = 0.1008 f x (Q_x + 0.55 qx) \div d^5$.

Delivery by two or more mains, in parallel. Total discharge $= Q_1 + Q_2 + Q_3 = 3.149 \sqrt{h/f} (\sqrt{d_1^5/l_1} + \sqrt{d_2^5/l_2} + \sqrt{d_3^5/l_3})$. Diameter of an equivalent main to discharge the same total quantity, $d = (\sqrt{d_1^5} + \sqrt{d_2^5} + \sqrt{d_3^5})^{2/5}$.

Long Pipe Lines. — (1) Vyrnwy to Liverpool, 68 miles; 40 million gals. (British) per day. Three lines of cast-iron pipe, 42 to 39 in. diam. One of the 42-in. lines after being laid 12 years, with a hydraulic gradient of

4.5 ft. per mile, discharged 15 million gallons per day; velocity, 2.892 ft. per sec., $f = 0.00574$.

(2) East Jersey riveted steel pipe line, Newark, N. J., 21 miles long, 48 in. diam., 50 million U. S. gals. per day; velocity about 6 ft. per sec.

(3) Perth to Coolgarlie, Western Australia, 351 miles, 30 in. steel pipe with lock-bar joints. Eight pumping stations in the line. Two tests showed delivery of 5 and 5.6 million gals. per day; hydraulic gradient, 2.25 and 2.8 ft. per mile; velocity, 1.889 and 2.115 ft. per sec.; $f = 0.00480$ and 0.00486.

Rifled Pipes for Conveying Heavy Oils. (*Eng. Rec.*, May 23, 1908.) — The oil from the California fields is a heavy, viscous fluid. Attempts to handle it in long pipe lines of the ordinary type have not been practically successful. High pumping pressures are required, resulting in large expense for pipe and for pumping equipment.

The method of pumping in the rifled-pipe line is to inject about 10 per cent of water with the oil and to give the oil and water a centrifugal motion, by means of the rifled pipe, sufficient to throw the water to the outside, where it forms a thin film of lubrication between the oil and the sides of the pipe that greatly reduces the friction. The rifled pipe delivers at ordinary temperatures eight to ten times as much oil, through a long line, as does a line of ordinary pipe under similar conditions. An 8-in. rifled pipe line 282 miles in length has been built from the Kern oil fields to Porta Costa, on tidewater near San Francisco. The pipe is rifled with six helical grooves to the circumference, these grooves making a complete turn through 360 deg. in 10 ft. of length.

Loss of Pressure Caused by Valves and Fittings — The data given below are condensed from the results of experiments by John R. Freeman for the Inspection Department of the Assoc. Fcty. Mut. Ins. Cos. The friction losses in ells and tees are approximate. Fittings of the same nominal size with the different curvatures and different smoothness as made by different manufacturers will cause materially different friction losses. The figures are the number of feet of clean, straight pipe of same size which would cause the same loss as the fitting. Grinnell dry-pipe valve, 6-in., 80 ft.; 4-in., 47 ft. Grinnell alarm check, 6-in., 100 ft.; 4-in., 47 ft. Pratt & Cady check valve, 6-in., 50 ft.; 4-in., 25 ft. 4-in. Watworth globe check valve, 6-in., 200 ft.; 4-in., 130 ft. 2 1/2 in. to 8-in. ells, long-turn, 4 ft.; short-turn 9 ft. 3-in. to 8-in. tees, long-turn, 9 ft.; short-turn, 17 ft. One-eighth bend, 5 ft.

Effect of Bends and Curves in Pipes. — Weisbach's rule for bends:

Loss of head in feet $= \left[0.131 + 1.847 \left(\frac{r}{R} \right)^{7/2} \right] \times \frac{v^2}{64.4} \times \frac{a}{180}$, in which r = internal radius of pipe in feet, R = radius of curvature of axis of pipe, v = velocity in feet per second, and a = the central angle, or angle subtended by the bend.

Hamilton Smith, Jr., in his work on Hydraulics, says: The experimental data at hand are entirely insufficient to permit a satisfactory analysis of this quite complicated subject; in fact, about the only experiments of value are those made by Bossut and Dubuat with small pipes.

Curves. — If the pipe has easy curves, say with radius not less than 5 diameters of the pipe, the flow will not be materially diminished, provided the tops of all curves are kept below the hydraulic grade-line and provision be made for escape of air from the tops of all curves. (Trautwine.)

Williams, Hubbell and Fenkel (*Trans. A. S. C. E.*, 1901) conclude from an extensive series of experiments that curves of short radius, down to about 2 1/2 diameters, offer less resistance to the flow of water than do those of longer radius, and that earlier theories and practices regarding curve resistance are incorrect. For a 90° curve in 30 in. cast-iron pipe, 6 ft. radius, they found the loss of head 15.7% greater than that of a straight pipe of equal length; with 10 ft. radius, 17.3% greater; with 25 ft. radius, 52.7% greater; and with 60 ft. radius, 90.2% greater.

Hydraulic Grade-line. — In a straight tube of uniform diameter throughout, running full and discharging freely into the air, the hydraulic grade-line is a straight line drawn from the discharge end to a point immediately over the entry end of the pipe and at a depth below the surface equal to the entry and velocity heads. (Trautwine.)

In a pipe leading from a reservoir, no part of its length should be above the hydraulic grade-line.

Air-bound Pipes. — A pipe is said to be air-bound when, in consequence of air being entrapped at the high points of vertical curves in the line, water will not flow out of the pipe, although the supply is higher than the outlet. The remedy is to provide cocks or valves at the high points, through which the air may be discharged. The valve may be made automatic by means of a float.

Water-hammer. — Prof. I. P. Church gives the following formula for the pressure developed by the instantaneous closing of a valve in a water pipe:

$$p = vC\gamma/g,$$

in which p is pressure in lbs. per sq. in., v velocity in inches per second, C velocity of pressure wave in inches per second, and $g = 386.4$ ins. The value of C is $\sqrt{gEE_1t/\gamma(E_1 + 2rE)}$, in which E_1 = modulus of elasticity, 30,000,000 for steel, E = bulk modulus of water = 300,000 lbs. per sq. in. at 50° F., $\gamma = 0.03604$ = lbs. of water in 1 cu. in., t = thickness of pipe, ins., and r = internal radius of pipe, ins. Example, a 16-in. steel pipe with 1/4-in. walls, and $v = 60$ ins. per second, gives a velocity of the pressure wave $C = 44,285$ ins. per second and a pressure per sq. in. of 2478 lbs. If the elasticity of the pipe is not considered, the formula reduces to $p = 5.29 v$, which in the example given gives a pressure of 317.4 lbs. per sq. in.

Vertical Jets. (Molesworth.) — H = head of water, h = height of jet, d = diameter of jet, K = coefficient, varying with ratio of diameter of jet to head; then $h = KH$.

If $H = d \times$	300	600	1000	1500	1800	2800	3500	4500
$K =$	0.96	0.9	0.85	0.8	0.7	0.6	0.5	0.25

Water Delivered through Meters. (Thomson Meter Co.) — The best modern practice limits the velocity in water-pipes to 10 lineal feet per second. Assume this as a basis of delivery, and we find, for the several sizes of pipes usually metered, the following approximate results: Nominal diameter of pipe in inches:

Quantity delivered, in cubic feet per minute, due to said velocity:	3/8	1/2	3/4	1	1 1/2	2	3	4	6
	0.46	1.28	1.85	3.28	7.36	13.1	29.5	52.4	117.9

Prices Charged for Water in Different Cities. (National Meter Co.) Average minimum price for 1000 gallons in 163 places. 9.4 cents. Average maximum price for 1000 gallons in 163 places. 28 " Extremes, 2 1/2 cents to. 100 "

FIRE-STREAMS.

Fire-Stream Tables. — The table on the following page is condensed from one contained in the pamphlet of "Fire-Stream Tables" of the Associated Factory Mutual Fire Ins. Cos., based on the experiments of John R. Freeman, *Trans. A. S. C. E.*, vol. xxi, 1889.

The pressure in the first column is that indicated by a gauge attached at the base of the play pipe and set level with the end of the nozzle. The vertical and horizontal distances, in 2d and 3d cols., are those of effective fire-streams with moderate wind. The maximum limit of a "fair stream" is about 10% greater for a vertical stream; 12% for a horizontal stream. In still air much greater distances are reached by the extreme drops. The pressures given are for the best quality of rubber-lined hose, smooth inside. The hose friction varies greatly in different kinds of hose, according to smoothness of inside surface, and pressures as much as 50% greater are required for the same delivery in long lengths of inferior rubber-lined or linen hose. The pressures at the hydrant are those while the stream is flowing, and are those required with smooth nozzles. Ring nozzles require greater pressures. With the same pressures at the base of the play pipe, the discharge of a 3/4-in. smooth nozzle is the same as that of a 7/8-in. ring nozzle; of a 7/8-in. smooth nozzle, the same as that of a 1-in. ring nozzle.

The figures for hydrant pressure in the body of the table are derived by adding to the nozzle or play-pipe pressure the friction loss in the hose, and also the friction loss of a Chapman 4-way independent gate

hydrant ranging from 0.86 lb. for 200 gals. per min. flowing to 2.31 lbs. for 600 gals.

The following notes are taken from the pamphlet referred to. The discharge as stated in Ellis's tables and in their numerous copies in trade catalogues is from 15 to 20% in error.

In the best rubber-lined hose, 2 1/2-in. diam., the loss of head due to friction, for a discharge of 240 gallons per minute, is 14.1 lbs. per 100 ft. length; in inferior rubber-lined mill hose, 25.5 lbs., and in unlined linen hose, 33.2 lbs.

Less than a 1 1/8-in. smooth-nozzle stream with 40 lbs. pressure at the base of the play pipe, discharging about 240 gals. per min., cannot be called a first-class stream for a factory fire. 80 lbs. per sq. in. is considered the best hydrant pressure for general use; 100 lbs. should not be exceeded, except for very high buildings, or lengths of hose over 300 ft.

Hydrant Pressures Required with Different Sizes and Lengths of Hose. (J. R. Freeman, *Trans. A. S. C. E.*, 1889.)

3/4-inch smooth nozzle.

Press. Lbs.	Fire-stream Distance.		Gal. per Min.	Hydrant Pressure with Different Lengths of Hose to Maintain Pressure at Base of Play Pipe.									
	Vert.	Hor.		50 ft.	100 ft.	200 ft.	300 ft.	400 ft.	500 ft.	600 ft.	800 ft.	1000 ft.	
10	17	19	52	10	11	11	12	13	13	14	15	16	
20	33	29	73	21	22	23	24	25	26	28	30	32	
30	48	37	90	31	32	34	36	38	40	41	45	49	
40	60	44	104	42	43	46	48	50	53	55	60	65	
50	67	50	116	52	54	57	60	63	66	69	75	81	
60	72	54	127	63	65	68	72	76	79	83	90	97	
70	76	58	137	73	75	80	84	88	92	97	105	114	
80	79	62	147	84	86	91	96	101	106	111	120	130	
90	81	65	156	94	97	102	108	113	119	124	135	146	
100	83	68	164	105	108	114	120	126	132	138	150	163	

7/8-inch smooth nozzle.

10	18	21	71	11	11	13	14	15	16	17	19	22
20	34	33	100	22	23	25	27	30	32	34	39	43
30	49	42	123	33	34	38	41	45	48	51	58	65
40	62	49	142	43	46	50	55	59	64	68	78	87
50	71	55	159	54	57	63	69	74	80	86	97	108
60	77	61	174	65	69	75	82	89	96	103	116	130
70	81	66	188	76	80	88	96	104	112	120	136	152
80	85	70	201	87	91	101	110	119	128	137	155	173
90	88	74	213	98	103	113	123	134	144	154	174	195
100	90	76	224	109	114	126	137	148	160	171	194	216

1-inch smooth nozzle.

10	18	21	93	12	12	14	16	18	20	22	26	30
20	35	37	132	23	25	29	33	37	41	45	52	60
30	51	47	161	34	37	43	49	55	61	67	79	90
40	64	55	186	46	50	58	66	73	81	89	105	120
50	73	61	208	57	62	72	82	92	102	111	131	151
60	79	67	228	69	75	87	98	110	122	134	157	181
70	85	72	246	80	87	101	115	128	142	156	183	211
80	89	76	263	92	100	115	131	147	162	178	209	241
90	92	80	279	103	112	130	147	165	183	200	236
100	96	83	295	115	125	144	164	183	203	223

Hydrant Pressures Required with Different Sizes and Lengths of Hose. — Continued.

1 1/8-inch smooth nozzle.

Press. lbs.	Fire-Stream Distance.		Gal. per min.	Hydrant Pressure with Different Lengths of Hose to Maintain Pressure at Base of Play Pipe.								
	Vert.	Hor.		50 ft.	100 ft.	200 ft.	300 ft.	400 ft.	500 ft.	600 ft.	800 ft.	1000 ft.
				10	18	22	119	12	14	17	20	24
20	36	38	168	25	28	34	41	47	54	60	73	85
30	52	50	206	37	42	52	61	71	80	90	109	128
40	65	59	238	50	56	69	81	94	107	120	145	171
50	75	66	266	62	70	86	102	118	134	150	181	213
60	83	72	291	74	84	103	122	141	160	180	218	256
70	88	77	314	87	98	120	143	165	187	209	254
80	92	81	336	99	112	138	163	188	214	239
90	96	85	356	112	126	155	183	212	241
100	99	89	376	124	140	172	204	236

1 1/4-inch smooth nozzle.

10	19	22	148	14	16	21	26	31	36	41	51	61
20	37	40	209	27	32	42	52	62	72	82	101	121
30	53	54	256	41	49	63	78	93	108	123	152	182
40	67	63	296	55	65	84	104	124	144	164	203	243
50	77	70	331	68	81	106	130	155	180	204	254
60	85	76	363	82	97	127	156	186	216	245
70	91	81	392	96	113	148	182	217	252
80	95	85	419	110	129	169	208	248
90	99	90	444	123	145	190	234
100	101	93	468	137	162	211	261

1 3/8-inch smooth nozzle.

10	20	23	182	16	19	27	34	42	49	56	71	86
20	38	42	257	31	39	53	68	83	98	113	143	173
30	55	56	315	47	58	80	103	125	147	169	214	259
40	69	66	363	62	77	107	137	166	196	226
50	79	73	405	78	96	134	171	208	245
60	87	79	445	93	116	160	205	250
70	92	84	480	109	135	187	239
80	97	88	514	124	154	214
90	100	92	545	140	173	240
100	103	96	574	156	193

Pump Inspection Table.

Discharge of nozzles attached to 50 ft. of 2 1/2-in. best quality rubber-lined hose, inside smooth. (J. R. Freeman.)

Hydrant Pressure.	Size of Smooth Nozzle.								Ring Nozzle.		
	1 3/4	1 1/2	1 3/8	1 1/4	1 1/8	1	7/8	3/4	1 3/8	1 1/4	1 1/8
10	193	163	146	127	107	87	68	51	118	101	84
20	274	232	206	179	151	123	96	72	167	143	119
30	335	283	251	219	184	150	118	88	205	175	145
40	387	327	291	253	213	173	136	101	237	202	168
50	432	366	325	283	238	194	152	113	264	226	188
60	473	400	357	309	261	213	167	124	289	247	205
70	510	432	385	334	281	230	180	134	313	267	222
80	546	461	412	357	301	246	192	144	334	285	237
90	579	490	437	379	319	261	204	152	355	303	252
100	610	515	461	400	337	275	215	161	374	319	266

Friction Loss in Rubber-Lined Cotton Hose with Smoothest Lining.

Diam. of Hose.	Gallons per Minute Flowing.									Velocity, Ft. per Sec.	Velocity Head $V^2 + 2g$.	
	100	200	300	400	500	600	700	800	1000		Ft.	Lbs.
	Friction Loss, Pounds per 100 ft. Length.											
2	6.836	27.3	61.5	109	171	5	0.39	0.17
2 1/8	5.170	20.7	46.5	82.7	129	189	10	1.6	0.69
2 1/4	3.790	15.2	34.1	60.6	94.7	136	186	15	3.5	1.5
2 3/8	2.895	11.6	26.1	46.3	72.4	104	138	185	20	6.2	2.7
2 1/2	2.240	9.0	20.2	35.8	56.0	80.6	110	143	224	25	9.7	4.2
2 5/8	1.748	7.0	15.7	28.0	43.7	62.9	85.7	112	175	30	14.0	6.1
2 3/4	1.391	5.6	12.5	22.3	34.8	50.1	68.2	89.0	139	35	19.0	8.2
2 7/8	1.097	4.4	9.9	17.6	27.4	39.5	53.8	70.2	110	40	24.8	10.7
3	0.900	3.6	8.1	14.4	22.5	32.4	44.1	57.6	90	45	31.4	13.6
3 1/2	0.416	1.7	3.7	6.7	10.4	15.0	20.4	26.6	41.6	50	38.8	16.7
4	0.214	0.9	1.9	3.4	5.4	7.7	10.5	13.7	21.4

The above table is computed on the basis of 14 lbs. per 100 ft. length of 2 1/2-in. hose with 250 gals. per min. flowing, as found in Freeman's tests, assuming that the loss varies as the square of the quantity, and for different diameters and the same quantity inversely as the 5th power of the diameter.

Rated Capacities of Steam Fire-engines, which is perhaps one third greater than their ordinary rate of work at fires, are substantially as follows:

3d size,	550 gals. per min.,	or	792,000 gals. per 24 hours.
2d "	700 "	"	1,008,000 "
1st "	900 "	"	1,296,000 "
1 ext.,	1,100 "	"	1,584,000 "

THE SIPHON.

The Siphon is a bent tube of unequal branches, open at both ends, and is used to convey a liquid from a higher to a lower level, over an intermediate point higher than either. Its parallel branches being in a vertical plane and plunged into two bodies of liquid whose upper surfaces are at different levels, the fluid will stand at the same level both within and without each branch of the tube when a vent or small opening is made at the bend. If the air be withdrawn from the siphon through this vent, the water will rise in the branches by the atmospheric pressure without, and when the two columns unite and the vent is closed, the liquid will flow from the upper reservoir as long as the end of the shorter branch of the siphon is below the surface of the liquid in the reservoir.

If the water was free from air the height of the bend above the supply level might be as great as 33 feet.

If A = area of cross-section of the tube in square feet, H = the difference in level between the two reservoirs in feet, D the density of the liquid in pounds per cubic foot, then ADH measures the intensity of the force which causes the movement of the fluid, and $V = \sqrt{2gH} = 8.02\sqrt{H}$ is the theoretical velocity, in feet per second, which is reduced by the loss of head for entry and friction, as in other cases of flow of liquids through pipes. In the case of the difference of level being greater than 33 feet, however, the velocity of the water in the shorter leg is limited to that due to a height of 33 feet, or that due to the difference between the atmospheric pressure at the entrance and the vacuum at the bend.

Long Siphons. — Prof. Joseph Torrey, in the *Amer. Machinist*, describes a long siphon which was a partial failure.

The length of the pipe was 1792 feet. The pipe was 3 inches diameter, and rose at one point 9 feet above the initial level. The final level was 20 feet below the initial level. No automatic air valve was provided. The highest point in the siphon was about one third the total distance from the pond and nearest the pond. At this point a pump was placed, whose mission was to fill the pipe when necessary. This siphon would flow for about two hours and then cease, owing to accumulation of air in the pipe. When in full operation it discharged $43\frac{1}{2}$ gallons per minute. The theoretical discharge from such a sized pipe with the specified head is $55\frac{1}{2}$ gallons per minute.

Siphon on the Water-supply of Mount Vernon, N. Y. (*Eng'g News*, May 4, 1893.) — A 12-inch siphon, 925 feet long, with a maximum lift of 22.12 feet and a 45° change in alignment, was put in use in 1892 by the New York City Suburban Water Co. At its summit the siphon crosses a supply main, which is tapped to charge the siphon. The air-chamber at the siphon is 12 inches by 16 feet long. A $\frac{1}{2}$ -inch tap and cock at the top of the chamber provide an outlet for the collected air.

It was found that the siphon with air-chamber as described would run until 125 cubic feet of air had gathered, and that this took place only half as soon with a 14-foot lift as with the full lift of 22.12 feet. The siphon will operate about 12 hours without being recharged, but more water can be gotten over by charging every six hours. It can be kept running 23 hours out of 24 with only one man in attendance. With the siphon as described above it is necessary to close the valves at each end of the siphon to recharge it. It has been found by weir measurements that the discharge of the siphon before air accumulates at the summit is practically the same as through a straight pipe.

A successful siphon is described by R. S. Hale in *Jour. Assoc. Eng. Soc.*, 1900. A 2-in. galvanized pipe had been used, and it had been necessary to open a waste-pipe and thus secure a continuous flow in order to keep the siphon in operation. The trouble seemed to be due to very small air leaks in the joints. When the 2-in. iron pipe was replaced by a 1-in. lead pipe, the siphon was entirely successful. The maximum rise of the pipe above the level of the pond was 12 ft., the discharge about 350 ft. below the level, and the length 500 ft.

MEASUREMENT OF FLOWING WATER.

Piezometer. — If a vertical or oblique tube be inserted into a pipe containing water under pressure, the water will rise in the former, and the vertical height to which it rises will be the head producing the pressure at the point where the tube is attached. Such a tube is called a piezometer or pressure measure. If the water in the piezometer falls below its proper level it shows that the pressure in the main pipe has been reduced by an obstruction between the piezometer and the reservoir. If the water rises above its proper level, it indicates that the pressure there has been increased by an obstruction beyond the piezometer.

If we imagine a pipe full of water to be provided with a number of piezometers, then a line joining the tops of the columns of water in them is the hydraulic grade-line.

Pitot Tube Gauge. — The Pitot tube is used for measuring the velocity of fluids in motion. It has been used with great success in measuring the flow of natural gas. (S. W. Robinson, Report Ohio Geol. Survey, 1890.) (See also *Van Nostrand's Mag.*, vol. xxxv.) It is simply a tube so bent that a short leg extends into the current of fluid flowing from a tube, with the plane of the entering orifice opposed at right angles to the direction of the current. The pressure caused by the impact of the current is transmitted through the tube to a pressure-gauge of any kind, such as a column of water or of mercury, or a Bourdon spring-gauge. From the pressure thus indicated and the known density and temperature of the flowing gas is obtained the head corresponding to the pressure, and from this the velocity. In a modification of the Pitot tube described by Prof. Robinson, there are two tubes inserted into the pipe conveying the gas, one of which has the plane of the orifice at right angles to the current, to receive the static pressure plus the pressure due to impact; the other has the plane of its orifice parallel to the current, so as to receive the static pressure only. These tubes are connected to the legs of a U tube partly filled with mercury, which then registers the difference in pressure in the two tubes, from which the velocity may be calculated. Comparative tests of Pitot tubes with gas-meters, for measurement of the flow of natural gas, have shown an agreement within 3%.

It appears from experiments made by W. M. White, described in a paper before the Louisiana Eng'g Socy., 1901, by Williams, Hubbell and Fenkel (*Trans. A. S. C. E.*, 1901), and by W. B. Gregory (*Trans. A. S. M. E.*, 1903), that in the formula for the Pitot tube, $V = c\sqrt{2gH}$, in which V is the velocity of the current in feet per second, H the head in feet of the fluid corresponding to the pressure measured by the tube, and c an experimental coefficient, $c = 1$ when the plane at the point of the tube is exactly at right angles with the direction of the current, and when the static pressure is correctly measured. The total pressure produced by a jet striking an extended plane surface at right angles to it, and escaping parallel to the plate, equals twice the product of the area of the jet into the pressure calculated from the "head due the velocity," and for this case $H = 2 \times V^2/2g$ instead of $V^2/2g$; but as found in White's experiments the maximum pressure at a point on the plate exactly opposite the jet corresponds to $h = V^2/2g$. Experiments made with four different shapes of nozzles placed under the center of a falling stream of water showed that the pressure produced was capable of sustaining a column of water almost exactly equal to the height of the source of the falling water.

Tests by J. A. Knesche (*Indust. Eng'g*, Nov., 1909), in which a Pitot tube was inserted in a 4-in. water pipe, gave C = about 0.77 for velocities of 2.5 to 8 ft. per sec., and smaller values for lower velocities. He holds that the coefficient of a tube should be determined by experiment before its readings can be considered accurate.

Maximum and Mean Velocities in Pipes. — Williams, Hubbell and Fenkel (*Trans. A. S. C. E.*, 1901) found a ratio of 0.84 between the mean and the maximum velocities of water flowing in closed circular conduits, under normal conditions, at ordinary velocities; whereby observations of velocity taken at the center under such conditions, with a properly rated Pitot tube, may be relied on to give results within 3% of correctness.

The Venturi Meter, invented by Clemens Herschel, and described in a pamphlet issued by the Builders' Iron Foundry of Providence, R.I., is named from Venturi, who first called attention, in 1796, to the relation between the velocities and pressures of fluids when flowing through converging and diverging tubes. It consists of two parts — the tube, through which the water flows, and the recorder, which registers the quantity of water that passes through the tube. The tube takes the shape of two truncated cones joined in their smallest diameters by a short throat-piece. At the up-stream end and at the throat there are pressure-chambers, at which points the pressures are taken.

The action of the tube is based on that property which causes the small section of a gently expanding frustum of a cone to receive, without material resultant loss of head, as much water at the smallest diameter as is discharged at the large end, and on that further property which causes the pressure of the water flowing through the throat to be less, by virtue of its greater velocity, than the pressure at the up-stream end of the tube, each pressure being at the same time a function of the velocity at that point and of the hydrostatic pressure which would obtain were the water motionless within the pipe.

The recorder is connected with the tube by pressure-pipes which lead to it from the chambers surrounding the up-stream end and the throat of the tube. It may be placed in any convenient position within 1000 feet of the meter. It is operated by a weight and clockwork. The difference of pressure or head at the entrance and at the throat of the meter is balanced in the recorder by the difference of level in two columns of mercury in cylindrical receivers, one within the other. The inner carries a float, the position of which is indicative of the quantity of water flowing through the tube. By its rise and fall the float varies the time of contact between an integrating drum and the counters by which the successive readings are registered.

There is no limit to the sizes of the meters nor the quantity of water that may be measured. Meters with 24-inch, 36-inch, 48-inch, and even 20-foot tubes can be readily made.

Measurement by Venturi Tubes. (*Trans. A. S. C. E.*, Nov., 1887, and Jan., 1888.) — Mr. Herschel recommends the use of a Venturi tube, inserted in the force-main of the pumping engine, for determining the quantity of water discharged. Such a tube applied to a 24-inch main has a total length of about 20 feet. At a distance of 4 feet from the end nearest the engine the inside diameter of the tube is contracted to a throat having a diameter of about 8 inches. A pressure-gauge is attached to each of two chambers, the one surrounding and communicating with the entrance or main pipe, the other with the throat. According to experiments made upon two tubes of this kind, one 4 in. in diameter at the throat and 12 in. at the entrance, and the other about 36 in. in diameter at the throat and 9 feet at its entrance, the quantity of water which passes through the tube is very nearly the theoretical discharge through an opening having an area equal to that of the throat, and a velocity which is that due to the difference in head shown by the two gauges. Mr. Herschel states that the coefficient for these two widely-varying sizes of tubes and for a wide range of velocity through the pipe, was found to be within two per cent, either way, of 98%. In other words, the quantity of water flowing through the tube per second is expressed within two per cent by the formula $W = 0.98 \times A \times \sqrt{2gh}$, in which A is the area of the throat of the tube, h the head, in feet, corresponding to the difference in the pressure of the water entering the tube and that found at the throat, and $g = 32.16$.

Measurement of Discharge of Pumping-engines by means of Nozzles. (*Trans. A. S. M. E.*, xii, 575.) — The measurement of water by computation from its discharge through orifices, or through the nozzles of fire-hose, furnishes a means of determining the quantity of water delivered by a pumping-engine which can be applied without much difficulty. John R. Freeman, *Trans. A. S. C. E.*, Nov., 1889, describes a series of experiments covering a wide range of pressures and sizes, and the results showed that the coefficient of discharge for a smooth nozzle of ordinary good form was within one-half of one per cent, either way, of 0.977; the diameter of the nozzle being accurately calipered, and the pressures being determined by means of an accurate gauge attached to a suitable piezometer at the base of the play-pipe.

In order to use this method for determining the quantity of water discharged by a pumping-engine, it would be necessary to provide a pressure-box, to which the water would be conducted, and attach to the box as many nozzles as would be required to carry off the water. According to Mr. Freeman's estimate, four 1 1/4-inch nozzles, thus connected, with a pressure of 80 lbs. per square inch, would discharge the full capacity of a two-and-a-half-million engine. He also suggests the use of a portable apparatus with a single opening for discharge, consisting essentially of a Siamese nozzle, so-called, the water being carried to it by three or more lines of fire-hose.

To insure reliability for these measurements, it is necessary that the shut-off valve in the force-main, or the several shut-off valves, should be tight, so that all the water discharged by the engine may pass through the nozzles.

Flow through Rectangular Orifices. (Approximate. See p. 698.)

CUBIC FEET OF WATER DISCHARGED PER MINUTE THROUGH AN ORIFICE ONE INCH SQUARE, UNDER ANY HEAD OF WATER FROM 3 TO 72 INCHES.

For any other orifice multiply by its area in square inches.

Formula, $Q' = 0.624 \sqrt{h''} \times a$. Q' = cu. ft. per min.; a = area in sq. in.

Heads in inches.	Cubic Feet Discharged per min.	Heads in inches.	Cubic Feet Discharged per min.	Heads in inches.	Cubic Feet Discharged per min.	Heads in inches.	Cubic Feet Discharged per min.	Heads in inches.	Cubic Feet Discharged per min.	Heads in inches.	Cubic Feet Discharged per min.		
3	1.12	13	2.20	23	2.90	33	3.47	43	3.95	53	4.39	63	4.78
4	1.27	14	2.28	24	2.97	34	3.52	44	4.00	54	4.42	64	4.81
5	1.40	15	2.36	25	3.03	35	3.57	45	4.05	55	4.46	65	4.85
6	1.52	16	2.43	26	3.08	36	3.62	46	4.09	56	4.52	66	4.89
7	1.64	17	2.51	27	3.14	37	3.67	47	4.12	57	4.55	67	4.92
8	1.75	18	2.58	28	3.20	38	3.72	48	4.18	58	4.58	68	4.97
9	1.84	19	2.64	29	3.25	39	3.77	49	4.21	59	4.63	69	5.00
10	1.94	20	2.71	30	3.31	40	3.81	50	4.27	60	4.65	70	5.03
11	2.03	21	2.78	31	3.36	41	3.86	51	4.30	61	4.72	71	5.07
12	2.12	22	2.84	32	3.41	42	3.91	52	4.34	62	4.74	72	5.09

Measurement of an Open Stream by Velocity and Cross-section. — Measure the depth of the water at from 6 to 12 points across the stream at equal distances between. Add all the depths in feet together and divide by the number of measurements made; this will be the average depth of the stream, which multiplied by its width will give its area or cross-section. Multiply this by the velocity of the stream in feet per minute, and the result will be the discharge in cubic feet per minute of the stream.

The velocity of the stream can be found by laying off 100 feet of the bank and throwing a float into the middle, noting the time taken in passing over the 100 ft. Do this a number of times and take the average; then, dividing this distance by the time gives the velocity at the surface. As the top of the stream flows faster than the bottom or sides — the average velocity being about 83% of the surface velocity at the middle — it is convenient to measure a distance of 120 feet for the float and reckon it as 100.

Miner's Inch Measurements. (Pelton Water Wheel Co.)

The cut, Fig. 141, shows the form of measuring-box ordinarily used, and the following table gives the discharge in cubic feet per minute of a miner's inch of water, as measured under the various heads and different lengths and heights of apertures used in California.

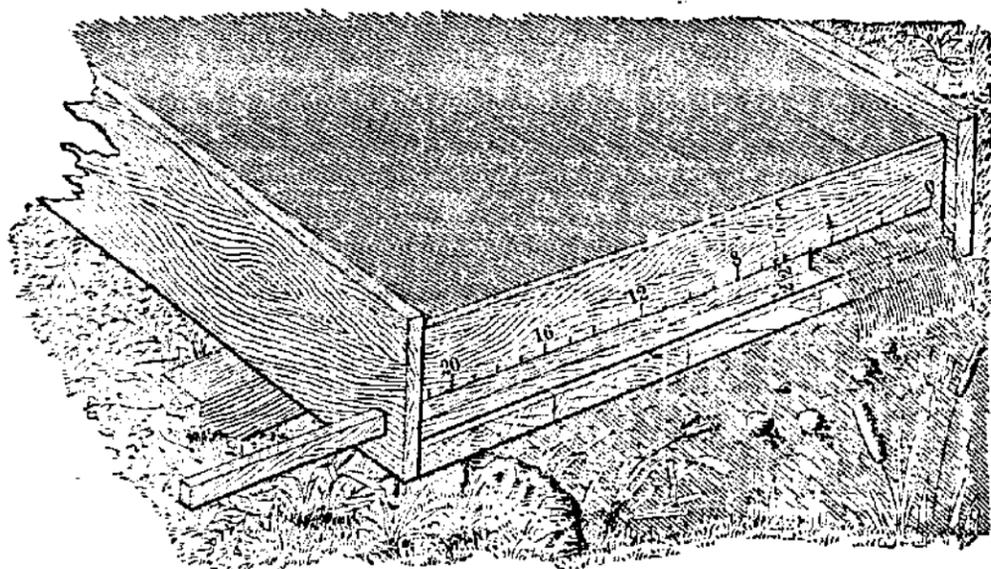

FIG. 141.

Length of Opening in Inches.	Openings 2 Inches High.			Openings 4 Inches High.		
	Head to Center, 5 inches.	Head to Center, 6 inches.	Head to Center, 7 inches.	Head to Center, 5 inches.	Head to Center, 6 inches.	Head to Center, 7 inches.
4	Cu. ft. 1.348	Cu. ft. 1.473	Cu. ft. 1.589	Cu. ft. 1.320	Cu. ft. 1.450	Cu. ft. 1.570
6	1.355	1.480	1.596	1.336	1.470	1.595
8	1.359	1.484	1.600	1.344	1.481	1.608
10	1.361	1.485	1.602	1.349	1.487	1.615
12	1.363	1.487	1.604	1.352	1.491	1.620
14	1.364	1.488	1.604	1.354	1.494	1.623
16	1.365	1.489	1.605	1.356	1.496	1.626
18	1.365	1.489	1.606	1.357	1.498	1.628
20	1.365	1.490	1.606	1.359	1.499	1.630
22	1.366	1.490	1.607	1.359	1.500	1.631
24	1.366	1.490	1.607	1.360	1.501	1.632
26	1.366	1.490	1.607	1.361	1.502	1.633
28	1.367	1.491	1.607	1.361	1.503	1.634
30	1.367	1.491	1.608	1.362	1.503	1.635
40	1.367	1.492	1.608	1.363	1.505	1.637
50	1.368	1.493	1.609	1.364	1.507	1.639
60	1.368	1.493	1.609	1.365	1.508	1.640
70	1.368	1.493	1.609	1.365	1.508	1.641
80	1.368	1.493	1.609	1.366	1.509	1.641
90	1.369	1.493	1.610	1.366	1.509	1.641
100	1.369	1.494	1.610	1.366	1.509	1.642

NOTE. — The apertures from which the above measurements were obtained were through material 1 1/4 inches thick, and the lower edge 2 inches above the bottom of the measuring-box, thus giving full contraction.

Flow of Water Over Weirs. Weir Dam Measurement. (Pelton Water Wheel Co.) — Place a board or plank in the stream, as shown in the sketch, at some point where a pond will form above. The length of the notch in the dam should be from two to four times its depth for small quantities and longer for large quantities. The edges of the notch should be beveled toward the intake side, as shown. The overfall below the notch should not be less than twice its depth. Francis says a fall below the crest equal to one-half the head is sufficient, but there must be a free access of air under the sheet.

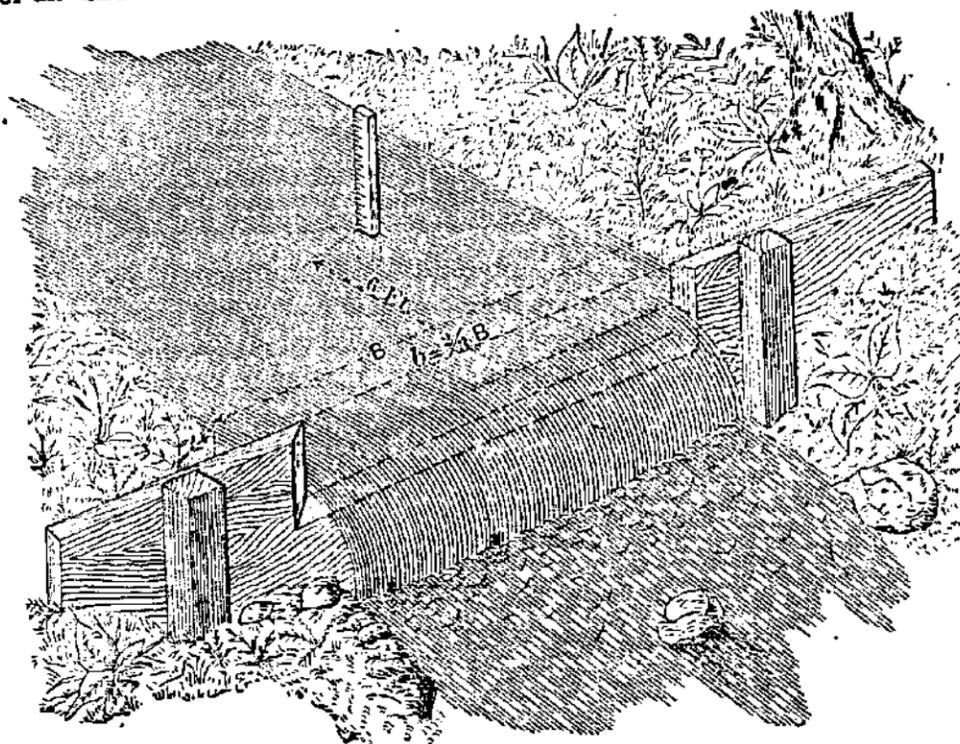

FIG. 142.

In the pond, about 6 ft. above the dam, drive a stake, and then obstruct the water until it rises precisely to the bottom of the notch and mark the stake at this level. Then complete the dam so as to cause all the water to flow through the notch, and, after time for the water to settle, mark the stake again for this new level. If preferred the stake can be driven with its top precisely level with the bottom of the notch and the depth of the water be measured with a rule after the water is flowing free, but the marks are preferable in most cases. The stake can then be withdrawn; and the distance between the marks is the theoretical depth of flow corresponding to the quantities in the weir table on the following page.

Francis's Formulæ for Weirs.

	As given by Francis.	As modified by Smith.
Weirs with both end contractions suppressed.....	$Q = 3.33 l h^{3/2}$	$3.29 \left(l + \frac{h}{7} \right) h^{3/2}$
Weirs with one end contraction suppressed.....	$Q = 3.33 (l - 0.1 h) h^{3/2}$	$3.29 l h^{3/2}$
Weirs with full contraction.	$Q = 3.33 (l - 0.2 h) h^{3/2}$	$3.29 \left(l - \frac{h}{10} \right) h^{3/2}$

The greatest variation of the Francis formulæ from the values of c given by Smith amounts to 3 1/2%. The modified Francis formulæ, says Smith,

will give results sufficiently exact, when great accuracy is not required, within the limits of h , from 0.5 ft. to 2 ft., l being not less than $3h$.

Q = discharge in cubic feet per second, l = length of weir in feet, h = effective head in feet, measured from the level of the crest to the level of still water above the weir.

If Q' = discharge in cubic feet per minute, and l' and h' are taken in inches, the first of the above formula reduces to $Q' = 0.4 l' h'^{3/2}$. From this formula the following table is calculated. The values are sufficiently accurate for ordinary computations of water-power for weirs without end contraction, that is, for a weir the full width of the channel of approach. For weirs with full end contraction multiply the values taken from the table by the length of the weir crest in inches less 0.2 times the head in inches, to obtain the discharge.

Weir Table.

GIVING CUBIC FEET OF WATER PER MINUTE THAT WILL FLOW OVER A WEIR ONE INCH WIDE AND FROM 1/8 TO 20 7/8 INCHES DEEP.

For other widths multiply by the width in inches.

Depth.		1/8 in.	1/4 in.	3/8 in.	1/2 in.	5/8 in.	3/4 in.	7/8 in.
in.	cu. ft.	cu. ft.	cu. ft.	cu. ft.	cu. ft.	cu. ft.	cu. ft.	cu. ft.
0	.00	.01	.05	.09	.14	.19	.26	.32
1	.40	.47	.55	.64	.73	.82	.92	1.02
2	1.13	1.23	1.35	1.46	1.58	1.70	1.82	1.95
3	2.07	2.21	2.34	2.48	2.61	2.76	2.90	3.05
4	3.20	3.35	3.50	3.66	3.81	3.97	4.14	4.30
5	4.47	4.64	4.81	4.98	5.15	5.33	5.51	5.69
6	5.87	6.06	6.25	6.44	6.62	6.82	7.01	7.21
7	7.40	7.60	7.80	8.01	8.21	8.42	8.63	8.83
8	9.05	9.26	9.47	9.69	9.91	10.13	10.35	10.57
9	10.80	11.02	11.25	11.48	11.71	11.94	12.17	12.41
10	12.64	12.88	13.12	13.36	13.60	13.85	14.09	14.34
11	14.59	14.84	15.09	15.34	15.59	15.85	16.11	16.36
12	16.62	16.88	17.15	17.41	17.67	17.94	18.21	18.47
13	18.74	19.01	19.29	19.56	19.84	20.11	20.39	20.67
14	20.95	21.23	21.51	21.80	22.08	22.37	22.65	22.94
15	23.23	23.52	23.82	24.11	24.40	24.70	25.00	25.30
16	25.60	25.90	26.20	26.50	26.80	27.11	27.42	27.72
17	28.03	28.34	28.65	28.97	29.28	29.59	29.91	30.22
18	30.54	30.86	31.18	31.50	31.82	32.15	32.47	32.80
19	33.12	33.45	33.78	34.11	34.44	34.77	35.10	35.44
20	35.77	36.11	36.45	36.78	37.12	37.46	37.80	38.15

When the velocity of the approaching water is less than 1/2 foot per second, the result obtained by the table is fairly accurate. When the velocity of approach is greater than 1/2 foot per second, a correction should be applied, see page 698.

For more accurate computations, the coefficients of flow of Hamilton Smith, Jr., or of Bazin should be used. In Smith's Hydraulics will be found a collection of results of experiments on orifices and weirs of various shapes made by many different authorities, together with a discussion of their several formulæ. (See also Trautwine's Pocket Book, Unwin's Hydraulics, and Church's Mechanics of Engineering.)

Bazin's Experiments. — M. Bazin (*Annales des Ponts et Chaussées*, Oct., 1888, translated by Marichal and Trautwine, Proc. Engrs. Club of Phila., Jan., 1890) made an extensive series of experiments with a sharp-crested weir without lateral contraction, the air being admitted freely behind the falling sheet, and found values of m varying from 0.42 to 0.50, with variations of the length of the weir from 19 3/4 to 78 3/4 in., of the height of the crest above the bottom of the channel from 0.79 to 2.46 ft.,

and of the head from 1.97 to 23.62 in. From these experiments he deduces the following formula:

$$Q = \left[0.425 + 0.21 \left(\frac{H}{P+H} \right)^2 \right] LH \sqrt{2gH},$$

in which P is the height in feet of the crest of the weir above the bottom of the channel of approach, L the length of the weir, H the head, both in feet, and Q the discharge in cu. ft. per sec. This formula, says M. Bazin, is entirely practical where errors of 2% to 3% are admissible. The following table is condensed from M. Bazin's paper:

VALUES OF THE COEFFICIENT m IN THE FORMULA $Q = mLH \sqrt{2gH}$, FOR A SHARP-CRESTED WEIR WITHOUT LATERAL CONTRACTION; THE AIR BEING ADMITTED FREELY BEHIND THE FALLING SHEET.

Head, H .	Height of Crest of Weir Above Bed of Channel.										
	Feet... Inches	0.66	0.98	1.31	1.64	1.97	2.62	3.28	4.92	6.56	∞
		7.87	11.81	15.75	19.69	23.62	31.50	39.38	59.07	78.76	∞
Ft.	In.	m	m	m	m	m	m	m	m	m	m
0.164	1.97	0.458	0.453	0.451	0.450	0.449	0.449	0.449	0.448	0.448	0.4481
0.230	2.76	0.455	0.448	0.445	0.443	0.442	0.441	0.440	0.440	0.439	0.4391
0.295	3.54	0.457	0.447	0.442	0.440	0.438	0.436	0.436	0.435	0.434	0.4340
0.394	4.72	0.462	0.448	0.442	0.438	0.436	0.433	0.432	0.430	0.430	0.4291
0.525	6.30	0.471	0.453	0.444	0.438	0.435	0.431	0.429	0.427	0.426	0.4246
0.656	7.87	0.480	0.459	0.447	0.440	0.436	0.431	0.428	0.425	0.423	0.4215
0.787	9.45	0.488	0.465	0.452	0.444	0.438	0.432	0.428	0.424	0.422	0.4194
0.919	11.02	0.496	0.472	0.457	0.448	0.441	0.433	0.429	0.424	0.422	0.4181
1.050	12.60	0.478	0.462	0.452	0.444	0.436	0.430	0.424	0.421	0.4168
1.181	14.17	0.483	0.467	0.456	0.448	0.438	0.432	0.424	0.421	0.4156
1.312	15.75	0.489	0.472	0.459	0.451	0.440	0.433	0.424	0.421	0.4144
1.444	17.32	0.494	0.476	0.463	0.454	0.442	0.435	0.425	0.421	0.4134
1.575	18.90	0.480	0.467	0.457	0.444	0.436	0.425	0.421	0.4122
1.706	20.47	0.483	0.470	0.460	0.446	0.438	0.426	0.421	0.4112
1.837	22.05	0.487	0.473	0.463	0.448	0.439	0.427	0.421	0.4101
1.969	23.62	0.490	0.476	0.466	0.451	0.441	0.427	0.421	0.4092

A comparison of the results of this formula with those of experiments, says M. Bazin, justifies us in believing that, except in the unusual case of a very low weir (which should always be avoided), the preceding table will give the coefficient m in all cases within 1%; provided, however, that the arrangements of the standard weir are exactly reproduced. It is especially important that the admission of the air behind the falling sheet be perfectly assured. If this condition is not complied with, m may vary within much wider limits. The type adopted gives the least possible variation in the coefficient.

The Cippoletti, or Trapezoidal Weir. — Cippoletti found that by using a trapezoidal weir with the sides inclined 1 horizontal to 4 vertical, with end contraction, the discharge is equal to that of a rectangular weir without end contraction (that is with the width of the weir equal to the width of the channel) and is represented by the simple formula $Q = 3.367 LH^{3/2}$. A. D. Flinn and G. W. D. Dyer (*Trans. A. S. C. E.*, 1894), in experiments with a trapezoidal weir, with values of L from 3 to 9 ft. and of H from 0.24 to 1.40 ft., found the value of the coefficient to average 3.334, the water being measured by a rectangular weir and the results being computed by Francis's formula, and 3.354 when Smith's formula was used. They conclude that Cippoletti's formula when applied to a properly constructed trapezoidal weir will give the discharge with an error due to combined inaccuracies, not greater than 1%.

WATER-POWER.

Power of a Fall of Water — Efficiency. — The gross power of a fall of water is the product of the weight of water discharged in a unit of time into the total head, i.e., the difference of vertical elevation of the upper surface of the water at the points where the fall in question begins and ends. The term "head" used in connection with water-wheels is the difference in height from the surface of the water in the wheel-pit to the surface in the pen-stock when the wheel is running.

If Q = cubic feet of water discharged per second, D = weight of a cubic foot of water = 62.36 lbs. at 60° F., H = total head in feet; then

DQH = gross power in foot-pounds per second,
and $DQH \div 550 = 0.1134 QH$ = gross horse-power.

If Q' is taken in cubic feet per minute, H.P. = $\frac{Q'H \times 62.36}{33,000} = .00189Q'H$.

A water-wheel or motor of any kind cannot utilize the whole of the head H , since there are losses of head at both the entrance to and the exit from the wheel. There are also losses of energy due to friction of the water in its passage through the wheel. The ratio of the power developed by the wheel to the gross power of the fall is the efficiency of the wheel. For 75% efficiency, net horse-power = $0.00142 Q'H = \frac{Q'H}{706}$.

A head of water can be made use of in one or other of the following ways, viz.:

- 1st. By its weight, as in the water-balance and in the overshot-wheel.
- 2d. By its pressure, as in turbines and in the hydraulic engine, hydraulic press, crane, etc.
- 3d. By its impulse, as in the undershot-wheel, and in the Pelton wheel.
- 4th. By a combination of the above.

Horse-power of a Running Stream. — The gross horse-power is $H.P. = QH \times 62.36 \div 550 = 0.1134 QH$, in which Q is the discharge in cubic feet per second actually impinging on the float or bucket, and H = theoretical head due to the velocity of the stream = $\frac{v^2}{2g} = \frac{v^2}{64.4}$, in which v is the velocity in feet per second. If Q' be taken in cubic feet per minute, $H.P. = 0.00189 Q'H$.

Thus, if the floats of an undershot-wheel driven by a current alone be 5 feet \times 1 foot, and the velocity of stream = 210 ft. per minute, or $3\frac{1}{2}$ ft. per sec., of which the theoretical head is 0.19 ft., $Q = 5$ sq. ft. \times 210 = 1050 cu. ft. per minute; $H.P. = 1050 \times 0.19 \times 0.00189 = 0.377$ H.P.

The wheels would realize only about 0.4 of this power, on account of friction and slip, or 0.151 H.P., or about 0.03 H.P. per square foot of float, which is equivalent to 33 sq. ft. of float per H.P.

Current Motors. — A current motor could only utilize the whole power of a running stream if it could take all the velocity out of the water, so that it would leave the floats or buckets with no velocity at all; or in other words, it would require the backing up of the whole volume of the stream until the actual head was equivalent to the theoretical head due to the velocity of the stream. As but a small fraction of the velocity of the stream can be taken up by a current motor, its efficiency is very small. Current motors may be used to obtain small amounts of power from large streams, but for large powers they are not practicable.

Bernoulli's Theorem. — **Energy of Water Flowing in a Tube.** — The head due to the velocity is $\frac{v^2}{2g}$; the head due to the pressure is $\frac{f}{w}$; the head due to actual height above the datum plane is h feet. The total head is the sum of these = $\frac{v^2}{2g} + h + \frac{f}{w}$, in feet, in which v = velocity in feet per second, f = pressure in lbs. per sq. ft., w = weight of 1 cu. ft. of water =

62.36 lbs. If p = pressure in lbs. per sq. in., $\frac{f}{w} = 2,309 p$. If a constant quantity of water is flowing through a tube in a given time, the velocity varying at different points on account of changes in the diameter, the energy remains constant (loss by friction excepted) and the sum of the three heads is constant, the pressure head increasing as the velocity decreases, and *vice-versa*. This principle is known as "Bernoulli's Theorem."

In hydraulic transmission the velocity and the height above datum are usually small compared with the pressure-head. The work or energy of a given quantity of water under pressure = its volume in cubic feet \times its pressure in lbs. per sq. ft.; or if Q = quantity in cubic feet per second, and p = pressure in lbs. per square inch, $W = 144 pQ$, and the H.P. = $\frac{144 pQ}{550} = 0.2618 pQ$.

Maximum Efficiency of a Long Conduit. — A. L. Adams and R. C. Gemmill (*Eng'g News*, May 4, 1893) show by mathematical analysis that the conditions for securing the maximum amount of power through a long conduit of fixed diameter, without regard to the economy of water, is that the draught from the pipe should be such that the frictional loss in the pipe will be equal to one-third of the entire static head.

Mill-Power. — A "mill-power" is a unit used to rate a water-power for the purpose of renting it. The value of the unit is different in different localities. The following are examples (from Emerson):

Holyoke, Mass. — Each mill-power at the respective falls is declared to be the right during 16 hours in a day to draw 38 cu. ft. of water per second at the upper fall when the head there is 20 feet, or a quantity proportionate to the height at the falls. This is equal to 86.2 horse-power as a maximum.

Lowell, Mass. — The right to draw during 15 hours in the day so much water as shall give a power equal to 25 cu. ft. a second at the great fall, when the fall there is 30 feet. Equal to 85 H.P. maximum.

Lawrence, Mass. — The right to draw during 16 hours in a day so much water as shall give a power equal to 30 cu. ft. per second when the head is 25 feet. Equal to 85 H.P. maximum.

Minneapolis, Minn. — 30 cu. ft. of water per second with head of 22 feet. Equal to 74.8 H.P.

Manchester, N.H. — Divide 725 by the number of feet of fall minus 1, and the quotient will be the number of cubic feet per second in that fall. For 20 feet fall this equals 38.1 cu. ft., equal to 86.4 H.P. maximum.

Cohoes, N.Y. — "Mill-power" equivalent to the power given by 6 cu. ft. per second, when the fall is 20 feet. Equal to 13.6 H.P., maximum.

Passaic, N.J. — Mill-power: The right to draw $8\frac{1}{2}$ cu. ft. of water per sec., fall of 22 feet, equal to 21.2 horse-power. Maximum rental \$700 per year for each mill-power = \$33.00 per H.P.

The horse-power maximum above given is that due theoretically to the weight of water and the height of the fall, assuming the water-wheel to have perfect efficiency. It should be multiplied by the efficiency of the wheel, say 75% for good turbines, to obtain the H.P. delivered by the wheel.

Value of a Water-power. — In estimating the value of a water-power, especially where such value is used as testimony for a plaintiff whose water-power has been diminished or confiscated, it is a common custom for the person making such estimate to say that the value is represented by a sum of money which, when put at interest, would maintain a steam-plant of the same power in the same place.

Mr. Charles T. Main (*Trans. A. S. M. E.*, xiii, 140) points out that this system of estimating is erroneous; that the value of a power depends upon a great number of conditions, such as location, quantity of water, fall or head, uniformity of flow, conditions which fix the expense of dams, canals, foundations of buildings, freight charges for fuel, raw materials and finished product, etc. He gives an estimate of relative cost of steam and water-power for a 500 H.P. plant from which the following is condensed:

The amount of heat required per H.P. varies with different kinds of business, but in an average plain cotton-mill, the steam required for heating and slashing is equivalent to about 25% of steam exhausted from the high-pressure cylinder of a compound engine of the power required to run that mill, the steam to be taken from the receiver.

The coal consumption per H.P. per hour for a compound engine is taken at 1 3/4 lbs. per hour, when no steam is taken from the receiver for heating purposes. The gross consumption when 25% is taken from the receiver is about 2.06 lbs.

75% of the steam is used as in a compound engine at 1.75 lbs. = 1.31 lbs.
25% of the steam is used as in a high-pressure engine at 3.00 lbs. = .75 lb.

The running expenses per H. P. per year are as follows:
2.06 lbs. coal per hour = 21.115 lbs. for 10 1/4 hours or one day = 6503.42 lbs. for 308 days, which, at \$3.00 per long ton = \$8.71
Attendance of boilers, one man @ \$2.00, and one man @ \$1.25 = 2.00
Attendance of engine, one man @ \$3.50. 2.16
Oil, waste, and supplies. .80

The cost of such a steam-plant in New England and vicinity of 500 H. P. is about \$65 per H. P. Taking the fixed expenses as 4% on engine, 5% on boilers, and 2% on other portions, repairs at 2%, interest at 5%, taxes at 1 1/2% on 3/4 cost, and insurance at 1/2% on exposed portion, the total average per cent is about 12 1/2%, or $\$65 \times 0.12 1/2 =$ 8.13

Gross cost of power and low-pressure steam per H. P. \$21.80

Comparing this with water-power, Mr. Main says: "At Lawrence the cost of dam and canals was about \$350,000, or \$65 per H. P. The cost per H. P. of wheel-plant from canal to river is about \$45 per H. P. of plant, or about \$65 per H. P. used, the additional \$20 being caused by making the plant large enough to compensate for fluctuation of power due to rise and fall of river. The total cost per H. P. of developed plant is then about \$130 per H. P. Placing the depreciation on the whole plant at 2%, repairs at 1%, interest at 5%, taxes and insurance at 1%, or a total of 9%, gives:

Fixed expenses per H. P. $\$1.30 \times .09 = \11.70
Running expenses per H. P. (Estimated) 2.00
\$13.70

"To this has to be added the amount of steam required for heating purposes, said to be about 25% of the total amount used, but in winter months the consumption is at least 37 1/2%. It is therefore necessary to have a boiler plant of about 37 1/2% of the size of the one considered with the steam-plant, costing about $\$20 \times 0.375 = \7.50 per H. P. of total power used. The expense of running this boiler-plant is, per H. P. of the total plant per year:

Fixed expenses 12 1/2% on \$7.50..... \$0.94
Coal..... 3.26
Labor..... 1.23
Total..... \$5.43

Making a total cost per year for water-power with the auxiliary boiler plant $\$13.70 + \$5.43 = \$19.13$ which deducted from \$21.80 makes a difference in favor of water-power of \$2.67, or for 10,000 H. P. a saving of \$26,700 per year.

"It is fair to say," says Mr. Main, "that the value of this constant power is a sum of money which when put at interest will produce the saving; or if 6% is a fair interest to receive on money thus invested the value would be $\$26,700 \div 0.06 = \$445,000$."

Mr. Main makes the following general statements as to the value of a water-power: "The value of an undeveloped variable power is usually nothing if its variation is great, unless it is to be supplemented by a steam-plant. It is of value then only when the cost per horse-power for the double-plant is less than the cost of steam-power under the same conditions as mentioned for a permanent power, and its value can be represented in the same manner as the value of a permanent power has been represented.

"The value of a developed power is as follows: If the power can be run cheaper than steam, the value is that of the power, plus the cost of plant, less depreciation. If it cannot be run as cheaply as steam, considering its cost, etc., the value of the power itself is nothing, but the value of the plant is such as could be paid for it new, which would bring the total cost of running down to the cost of steam-power, less depreciation."

Mr. Samuel Webber, *Iron Age*, Feb. and March, 1893, writes a series of articles showing the development of American turbine wheels, and incidentally criticises the statements of Mr. Main and others who have made comparisons of costs of steam and of water-power unfavorable to the latter. He says: "They have based their calculations on the cost of steam, on large compound engines of 1000 or more H. P. and 120 pounds pressure of steam in their boilers, and by careful 10-hour trials succeeded in figuring down steam to a cost of about \$20 per H. P., ignoring the well-known fact that its average cost in practical use, except near the coal mines, is from \$40 to \$50. In many instances dams, canals, and modern turbines can be all completed for a cost of \$100 per H. P.; and the interest on that, and the cost of attendance and oil, will bring water-power up to about \$10 or \$12 per annum; and with a man competent to attend the dynamo in attendance, it can probably be safely estimated at not over \$15 per H. P."

WATER-WHEELS.

Water-wheels are classified as vertical wheels (including current motors, undershot, breast, and overshot wheels), turbine wheels, and impulse wheels. Undershot and breast wheels give very low efficiency, and are now no longer built. The overshot wheel when made of large diameter (wheels as high as 72 ft. diameter have been made) and properly designed have given efficiencies of over 80%, but they have been almost entirely supplanted by turbines, on account of their cumbersomeness, high cost, leakage, and inability to work in back water.

Turbines are generally classified according to the direction in which the water flows through them, as follows:

Tangential flow: Barker's mill. Parallel flow: Jonval. Radial outward flow: Fourneyron. Radial inward flow: Thompson vortex; Francis. Inward and downward flow: Central discharge scroll wheels and earlier American type of wheels; Swain turbine. Inward, downward, and outward flow: The American type of turbine.

TURBINE WHEELS.

Proportions of Turbines. — Prof. De Volson Wood discusses at length the theory of turbines in his paper on Hydraulic Reaction Motors, *Trans. A. S. M. E.* xiv. 266. His principal deductions which have an immediate bearing upon practice are condensed in the following:

Notation.

- Q = volume of water passing through the wheel per second,
- h_1 = head in the supply chamber above the entrance to the buckets,
- h_2 = head in the tail-race above the exit from the buckets,
- z_1 = fall in passing through the buckets,
- $H = h_1 + z_1 - h_2$, the effective head,
- m_1 = coefficient of resistance along the guides,
- m_2 = coefficient of resistance along the buckets,
- r_1 = radius of the initial rim,
- r_2 = radius of the terminal rim,
- V = velocity of the water issuing from supply chamber,
- v_1 = initial velocity of the water in the bucket in reference to the bucket,
- v_2 = terminal velocity in the bucket,
- ω = angular velocity of the wheel,
- α = terminal angle between the guide and initial rim = CAB, Fig. 143,
- γ_1 = angle between the initial element of bucket and initial rim = EAD,
- $\gamma_2 = GFI$, the angle between the terminal rim and terminal element of the bucket,
- $\alpha = eb$, Fig. 144 = the arc subtending one gate opening,

a_1 = the arc subtending one bucket at entrance. (In practice a_1 is larger than a .)
 $a_2 = gh$, the arc subtending one bucket at exit.
 $K = bf$, normal section of passage, it being assumed that the passages and buckets are very narrow.
 $k_1 = bd$, initial normal section of bucket,
 $k_2 = gi$, terminal normal section,
 ωr_1 = velocity of initial rim,
 ωr_2 = velocity of terminal rim,
 $\theta = HFI$, angle between the terminal rim and actual direction of the water at exit.
 Y = depth of K , y_1 of a_1 , and y_2 of K_2 , then
 $K = Ya \sin \alpha$; $K_1 = y_1 a_1 \sin \gamma_1$; $K_2 = y_2 a_2 \sin \gamma_2$.

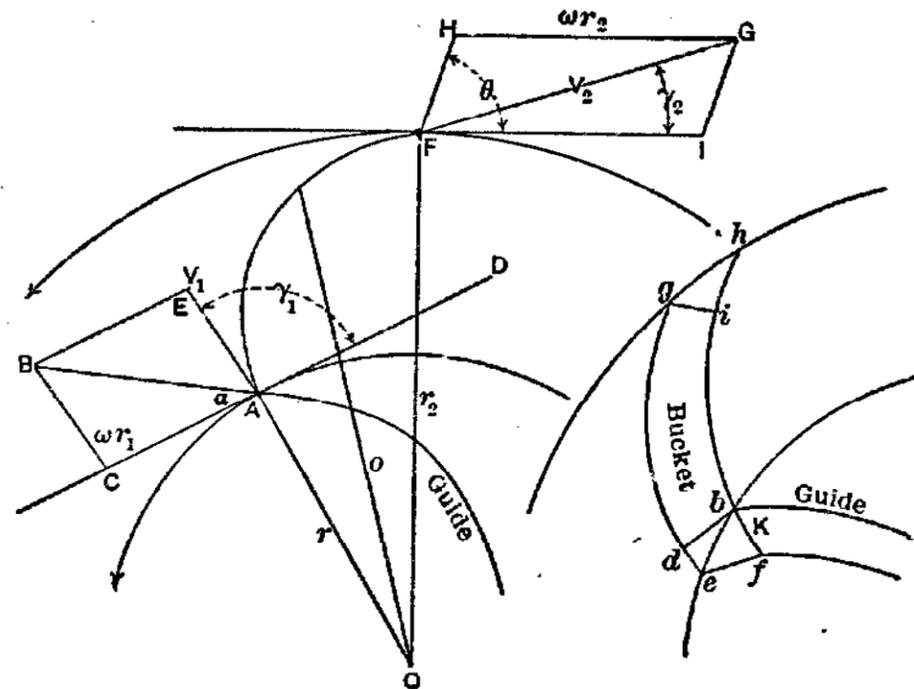

FIG. 143.

Three simple systems are recognized, $r_1 < r_2$, called outward flow; $r_1 > r_2$, called inward flow; $r_1 = r_2$, called parallel flow. The first and second may be combined with the third, making a mixed system.

Value of γ_2 (the quitting angle). — The efficiency is increased as γ_2 decreases, and is greatest for $\gamma_2 = 0$. Hence, theoretically, the terminal element of the bucket should be tangent to the quitting rim for best efficiency. This, however, for the discharge of a finite quantity of water, would require an infinite depth of bucket. In practice, therefore, this angle must have a finite value. The larger the diameter of the terminal rim the smaller may be this angle for a given depth of wheel and given quantity of water discharged. In practice γ_2 is from 10° to 20° .

In a wheel in which all the elements except γ_2 are fixed, the velocity of the wheel for best effect must increase as the quitting angle of the bucket decreases.

Values of $\alpha + \gamma_1$ must be less than 180° , but the best relation cannot be determined by analysis. However, since the water should be deflected from its course as much as possible from its entering to its leaving the wheel, the angle α for this reason should be as small as practicable.

In practice, α cannot be zero, and is made from 20° to 30° . The value $r_1 = 1.4 r_2$ makes the width of the crown for internal flow about the same as for $r_1 = r_2 \sqrt{1/2}$ for outward flow, being approximately 0.3 of the external radius.

Values of μ_1 and μ_2 . — The frictional resistances depend upon the construction of the wheel as to smoothness of the surfaces, sharpness of the angles, regularity of the curved parts, and also upon the speed it is run. These values cannot be definitely assigned beforehand, but Weisbach gives for good conditions $\mu_1 = \mu_2 = 0.05$ to 0.10 .

They are not necessarily equal, and μ_1 may be from 0.05 to 0.075 , and μ_2 from 0.06 to 0.10 or even larger.

Values of γ_1 must be less than $180^\circ - \alpha$.

To be on the safe side, γ_1 may be 20 or 30 degrees less than $180^\circ - 2\alpha$, giving

$$\gamma_1 = 180^\circ - 2\alpha - 25 \text{ (say)} = 155^\circ - 2\alpha.$$

Then if $\alpha = 30^\circ$, $\gamma_1 = 95^\circ$. Some designers make γ_1 90° ; others more, and still others less, than that amount. Weisbach suggests that it be less, so that the bucket will be shorter and friction less. This reasoning appears to be correct for the inflow wheel, but not for the outflow wheel. In the Tremont turbines, described in the Lowell Hydraulic Experiments, this angle is 90° , the angle α 20° , and γ_2 10° , which proportions insured a positive pressure in the wheel. Fourneyron made $\gamma_1 = 90^\circ$, and α from 30° to 33° which values made the initial pressure in the wheel near zero.

Form of Bucket. — The form of the bucket cannot be determined analytically. From the initial and terminal directions and the volume of the water flowing through the wheel, the area of the normal sections may be found.

The normal section of the buckets will be: $K = \frac{Q}{V}$; $k_1 = \frac{Q}{v_1}$; $k_2 = \frac{Q}{v_2}$.

The depths of those sections will be:

$$Y = \frac{K}{a \sin \alpha}; \quad y_1 = \frac{k_1}{a_1 \sin \gamma_1}; \quad y_2 = \frac{k_2}{a_2 \sin \gamma_2}.$$

The changes of curvature and section must be gradual, and the general form regular, so that eddies and whirls shall not be formed. For the same reason the wheel must be run with the correct velocity to secure the best effect. In practice the buckets are made of two or three arcs of circles, mutually tangential.

The Value of ω . — So far as analysis indicates, the wheel may run at any speed; but in order that the stream shall flow smoothly from the supply chamber into the bucket, the velocity V should be properly regulated.

If $\mu_1 = \mu_2 = 0.10$, $r_2 + r_1 = 1.40$, $\alpha = 25^\circ$, $\gamma_1 = 90^\circ$, $\gamma_2 = 12^\circ$, the velocity of the initial rim for outward flow will be for maximum efficiency 0.614 of the velocity due to the head, or $\omega r_1 = 0.614 \sqrt{2gH}$.

The velocity due to the head would be $\sqrt{2gH} = 1.414 \sqrt{gH}$.

For an inflow wheel for the case in which $r_1^2 = 2r_2^2$, and the other dimensions as given above, $\omega r_1 = 0.682 \sqrt{2gH}$.

The highest efficiency of the Tremont turbine, found experimentally, was 0.79375, and the corresponding velocity, 0.62645 of that due to the head, and for all velocities above and below this value the efficiency was less.

In the Tremont wheel $\alpha = 20^\circ$ instead of 25° , and $\gamma_2 = 10^\circ$ instead of 12° . These would make the theoretical efficiency and velocity of the wheel somewhat greater. Experiment showed that the velocity might be considerably larger or smaller than this amount without much diminution of the efficiency.

It was found that if the velocity of the initial (or interior) rim was not less than 44% nor more than 75% of that due to the fall, the efficiency was 75% or more. This wheel was allowed to run freely without any brake except its own friction, and the velocity of the initial rim was observed to be $1.335 \sqrt{2gH}$, half of which is $0.6675 \sqrt{2gH}$, which is not far from the velocity giving maximum effect; that is to say, when the gate is fully raised the coefficient of effect is a maximum when the wheel is moving with about half its maximum velocity.

Number of Buckets. — Successful wheels have been made in which the distance between the buckets was as small as 0.75 of an inch, and others as much as 2.75 inches. Turbines at the Centennial Exposition had buckets from $4\frac{1}{2}$ inches to 9 inches from center to center. If too large they will not work properly. Neither should they be too deep. Horizontal parti-

tions are sometimes introduced. These secure more efficient working in case the gates are only partly opened. The form and number of buckets for commercial purposes are chiefly the result of experience.

Ratio of Radii. — Theory does not limit the dimensions of the wheel. In practice,

for outward flow, $r_2 \div r_1$ is from 1.25 to 1.50;
for inward flow, $r_2 \div r_1$ is from 0.66 to 0.80.

It appears that the inflow-wheel has a higher efficiency than the outward-flow wheel. The inflow-wheel also runs somewhat slower for best effect. The centrifugal force in the outward-flow wheel tends to force the water outward faster than it would otherwise flow; while in the inward-flow wheel it has the contrary effect, acting as it does in opposition to the velocity in the buckets.

It also appears that the efficiency of the outward-flow wheel increases slightly as the width of the crown is less and the velocity for maximum efficiency is slower; while for the inflow-wheel the efficiency slightly increases for increased width of crown, and the velocity of the outer rim at the same time also increases.

Efficiency. — The exact value or the efficiency for a particular wheel must be found by experiment.

It seems hardly possible for the effective efficiency to equal, much less exceed, 86%, and all claims of 90 or more per cent for these motors should be discarded as improbable. A turbine yielding from 75% to 80% is extremely good. Experiments with higher efficiencies have been reported.

The celebrated Tremont turbine gave 79 1/4% without the "diffuser," which might have added some 2%. A Jonval turbine (parallel flow) was reported as yielding 0.75 to 0.90, but Morin suggested corrections reducing it to 0.63 to 0.71. Weisbach gives the results of many experiments, in which the efficiency ranged from 50% to 84%. Numerous experiments give $E = 0.60$ to 0.65 . The efficiency, considering only the energy imparted to the wheel, will exceed by several per cent the efficiency of the wheel, for the latter will include the friction of the support and leakage at the joint between the sluice and wheel, which are not included in the former; also as a plant the resistances and losses in the supply-chamber are to be still further deducted.

The Crowns. — The crowns may be plane annular disks, or conical, or curved. If the partitions forming the buckets be so thin that they may be discarded, the law of radial flow will be determined by the form of the crowns. If the crowns be plane, the radial flow (or radial component) will diminish, for the outward-flow wheel, as the distance from the axis increases — the buckets being full — for the angular space will be greater.

Prof. Wood deduces from the formulæ in his paper the tables on the next page.

It appears from these tables: 1. That the terminal angle, α , has frequently been made too large in practice for the best efficiency.

2. That the terminal angle, α , of the guide should be for the inflow less than 10° for the wheels here considered, but when the initial angle of the bucket is 90° , and the terminal angle of the guide is 5° $28'$, the gain of efficiency is not 2% greater than when the latter is 25° .

3. That the initial angle of the bucket should exceed 90° for best effect for out flow-wheels.

4. That with the initial angle between 60° and 120° for best effect on inflow wheels the efficiency varies scarcely 1%.

5. In the outflow-wheel, column (9) shows that for the outflow for best effect the direction of the quitting water in reference to the earth should be nearly radial (from 76° to 97°), but for the inflow wheel the water is thrown forward in quitting. This shows that the velocity of the rim should somewhat exceed the relative final velocity backward in the bucket, as shown in columns (4) and (5).

6. In these tables the velocities given are in terms of $\sqrt{2gh}$, and the coefficients of this expression will be the part of the head which would produce that velocity if the water issued freely. There is only one case, column (5), where the coefficient exceeds unity, and the excess is so small it may be discarded; and it may be said that in a properly proportioned turbine with the conditions here given none of the velocities will equal that due to the head in the supply-chamber when running at best effect.

Outward-flow Turbine.

$k_1 v_1 = k_2 v_2 = K V = Q = 1.$

$\gamma_1 = \gamma_2 = \sqrt{1/3}, \mu_1 = \mu_2 = 0.10, \gamma_1 = 12^\circ.$

Initial Angle γ_1	Efficiency E	Velocity Outer Rim v_{1w}	Velocity Inner Rim $v_{2w} = \sqrt{1/3} v_{1w}$	Relative Velocity of Exit v_2	Relative Velocity of Entrance v_1	Velocity of Exit from Supply-Chamber v	Terminal Angle of Guide α	Direction of quitting Water θ	Head Equivalent in Water $\frac{v^2}{2g}$	$k_2 \sqrt{gh}$
1	2	3	4	5	6	7	8	9	10	11
60°	0.804	0.972 $\sqrt{2gh}$	0.687 $\sqrt{2gh}$	1.048 $\sqrt{2gh}$	0.356 $\sqrt{2gh}$	0.595 $\sqrt{2gh}$	31°	76°	0.051 H	0.67
90°	0.828	0.874 $\sqrt{2gh}$	0.619 $\sqrt{2gh}$	0.931 $\sqrt{2gh}$	0.274 $\sqrt{2gh}$	0.676 $\sqrt{2gh}$	23°	79°	0.039 H	0.76
120°	0.839	0.798 $\sqrt{2gh}$	0.565 $\sqrt{2gh}$	0.843 $\sqrt{2gh}$	0.286 $\sqrt{2gh}$	0.749 $\sqrt{2gh}$	19°	82°	0.031 H	0.84
150°	0.921	0.709 $\sqrt{2gh}$	0.501 $\sqrt{2gh}$	0.707 $\sqrt{2gh}$	0.416 $\sqrt{2gh}$	0.886 $\sqrt{2gh}$	13°	97°	0.022 H	1.00

Inward-flow Turbine.

$k_1 v_1 = k_2 v_2 = K V = Q = 1.$

$\mu_1 = \mu_2 = 0.10, \gamma_2 = 12^\circ.$

γ_1	E	Velocity Outer Rim v_{1w}	Velocity Inner Rim v_{2w}	v_1	v_2	v	α	θ	$\frac{v^2}{2g}$	$k_2 \sqrt{gh}$
60°	0.920	0.709 $\sqrt{2gh}$	0.501 $\sqrt{2gh}$	0.089 $\sqrt{2gh}$	0.476 $\sqrt{2gh}$	0.672 $\sqrt{2gh}$	7°	110°	0.010 H	1.48
90°	0.920	0.688 $\sqrt{2gh}$	0.487 $\sqrt{2gh}$	0.069 $\sqrt{2gh}$	0.470 $\sqrt{2gh}$	0.691 $\sqrt{2gh}$	5°	106°	0.010 H	1.50
120°	0.919	0.668 $\sqrt{2gh}$	0.473 $\sqrt{2gh}$	0.077 $\sqrt{2gh}$	0.456 $\sqrt{2gh}$	0.709 $\sqrt{2gh}$	4°	105°	0.010 H	1.55
150°	0.918	0.634 $\sqrt{2gh}$	0.448 $\sqrt{2gh}$	0.126 $\sqrt{2gh}$	0.429 $\sqrt{2gh}$	0.743 $\sqrt{2gh}$	3°	107°	0.009 H	1.65

material may no longer be accurate

Outward-flow Turbine.

$r_1 = r_2 \sqrt{1/2}$ $\mu_1 = \mu_2 = 0.10$ $\gamma_2 = 12^\circ$ Parallel Crowns. $k_{1v_1} = k_{2v_2} = KV = Q = 1$.

Initial Angle. γ_1	Efficiency. E	Velocity Outer Rim. $r_1\omega'$	Velocity Inner Rim. $r_2\omega' = \sqrt{1/2}r_1\omega'$	Relative Velocity of Exit. v_2	Relative Velocity of Entrance. v_1	Velocity of Exit from Supply-Chamber. V	Terminal Angle of Guide. α	Direction of quitting Water. θ	Head Equivalent of Energy in quitting Water. $\frac{w^2}{2g}$	$k_2 \sqrt{gH}$.
1	2	3	4	5	6	7	8	9	10	11
60°	0.804	$0.972 \sqrt{2gH}$	$0.687 \sqrt{2gH}$	$1.048 \sqrt{2gH}$	$0.356 \sqrt{2gH}$	$0.595 \sqrt{2gH}$	31° 17'	76°	0.051 H	0.67
90°	0.828	$0.874 \sqrt{2gH}$	$0.619 \sqrt{2gH}$	$0.931 \sqrt{2gH}$	$0.274 \sqrt{2gH}$	$0.676 \sqrt{2gH}$	23° 56'	79°	0.039 H	0.76
120°	0.839	$0.798 \sqrt{2gH}$	$0.565 \sqrt{2gH}$	$0.843 \sqrt{2gH}$	$0.286 \sqrt{2gH}$	$0.749 \sqrt{2gH}$	19° 5'	82°	0.031 H	0.84
150°	0.921	$0.709 \sqrt{2gH}$	$0.501 \sqrt{2gH}$	$0.707 \sqrt{2gH}$	$0.416 \sqrt{2gH}$	$0.886 \sqrt{2gH}$	13° 31'	97°	0.022 H	1.00

Inward-flow Turbine.

$r_1 = \sqrt{2} r_2$ $\mu_1 = \mu_2 = 0.10$ $\gamma_2 = 12^\circ$ Parallel Crowns. $k_{1v_1} = k_{2v_2} = KV = Q = 1$.

γ_1	E	Velocity Outer Rim. $r_1\omega'$	Velocity Inner Rim. $r_2\omega'$	v_2	v_1	V	α	θ	$\frac{w^2}{2g}$	$k_2 \sqrt{gH}$.
60°	0.920	$0.709 \sqrt{2gH}$	$0.501 \sqrt{2gH}$	$0.476 \sqrt{2gH}$	$0.089 \sqrt{2gH}$	$0.672 \sqrt{2gH}$	7° 0'	110°	0.010 H	1.48
90°	0.920	$0.688 \sqrt{2gH}$	$0.487 \sqrt{2gH}$	$0.470 \sqrt{2gH}$	$0.069 \sqrt{2gH}$	$0.691 \sqrt{2gH}$	5° 28'	106°	0.010 H	1.50
120°	0.919	$0.668 \sqrt{2gH}$	$0.473 \sqrt{2gH}$	$0.456 \sqrt{2gH}$	$0.077 \sqrt{2gH}$	$0.709 \sqrt{2gH}$	4° 46'	105°	0.010 H	1.55
150°	0.918	$0.634 \sqrt{2gH}$	$0.448 \sqrt{2gH}$	$0.429 \sqrt{2gH}$	$0.126 \sqrt{2gH}$	$0.743 \sqrt{2gH}$	3° 08'	107°	0.009 H	1.65

TURBINE WHEELS.

7. The inflow turbine presents the best conditions for construction for producing a given effect, the only apparent disadvantage being an increased first cost due to an increased depth, or an increased diameter for producing a given amount of work. The larger efficiency should, however, more than neutralize the increased first cost.

Tests of Turbines. — Emerson says that in testing turbines it is a rare thing to find two of the same size which can be made to do their best at the same speed. The best speed of one of the leading wheels is invariably wide from the tabled rate. It was found that a 54-in. Leffel wheel under 12 ft. head gave much better results at 78 revolutions per minute than at 90.

Overshot wheels have been known to give 75% efficiency, but the average performance is not over 60%.

A fair average for a good turbine wheel may be taken at 75%. In tests of 18 wheels made at the Philadelphia Water-works in 1859 and 1860, one wheel gave less than 50% efficiency, two between 50% and 60%, six between 60% and 70%, seven between 71% and 77%, two 82%, and one 87.77%. (Emerson.)

Tests of Turbine Wheels at the Centennial Exhibition, 1876. (From a paper by R. H. Thurston on The Systematic Testing of Turbine Wheels in the United States, *Trans. A. S. M. E.*, viii. 359.) — In 1876 the judges at the International Exhibition conducted a series of trials of turbines. Many of the wheels offered for tests were found to be more or less defective in fitting and workmanship. The following is a statement of the results of all turbines entered which gave an efficiency of over 75%. Seven other wheels were tested, giving results between 65% and 75%.

Maker's Name, or Name the Wheel is Known by.	Per Cent at Full Gate or Discharge.	Per Cent at about 9/10 of Full Discharge.	Per Cent at about 7/8 of Full Discharge.	Per Cent at about 3/4 of Full Discharge.	Per Cent at about 5/8 of Full Discharge.	Per Cent at about 1/2 of Full Discharge.	Per Cent at about 4/10 of Full Discharge.
Rission.....	87.68		86.20	82.41		75.35	
National.....	83.79			70.79			
Geyelin (single).....	81.30						
Thos. Tait.....	82.13			70.40	66.35		55.00
Goldie & McCullough.....	81.21		71.01	55.90			
Rodney Hunt Mach. Co.....	78.70	71.66		68.60	51.03		
Tyler Wheel.....	79.59		81.24	79.92	67.23	69.59	
Geyelin (duplex).....	77.57						
Knowlton & Dolan.....	77.43	74.25			62.75		
E. T. Cope & Sons.....	76.94		69.92				
Barber & Harris.....	76.16	73.33			70.87	71.74	
York Manufacturing Co.....	75.70		67.08	67.57	62.06		
W. F. Mosser & Co.....	75.15	74.89	71.90	70.52		66.04	

The limits of error of the tests, says Prof. Thurston, were very uncertain; they are undoubtedly considerable as compared with the later work done in the permanent flume at Holyoke — possibly as much as 4% or 5%.

Experiments with "draught-tubes," or "suction-tubes," which were actually "diffusers" in their effect, so far as Prof. Thurston has analyzed them, indicate the loss by friction which should be anticipated in such cases, this loss decreasing as the tube increased in size, and increasing as its diameter approached that of the wheel — the minimum diameter tried. It was sometimes found very difficult to free the tube from air completely, and next to impossible, during the interval, to control the speed with the brake. Several trials were often necessary before the power due to the full head could be obtained. The loss of power by gearing and by belting was variable with the proportions and arrangement of the gears and pulleys, length of belt, etc., but averaged not far from 30% for a single pair of bevel-

gears, uncut and dry, but smooth for such gearing, and but 10% for the same gears, well lubricated, after they had been a short time in operation. The amount of power transmitted was, however, small, and these figures are probably much higher than those representing ordinary practice. Introducing a second pair — spur-gears — the best figures were but little changed, although the difference between the case in which the larger gear was the driver, and the case in which the small wheel was the driver, was perceivable, and was in favor of the former arrangement. A single straight belt gave a loss of but 2% or 3%, a crossed belt 6% to 8%, when transmitting 14 horse-power with maximum tightness and transmitting power. A "quarter turn" wasted about 10% as a maximum, and a "quarter twist" about 5%.

Dimensions of Turbines. — For dimensions, power, etc., of standard makes of turbines consult the catalogues of different manufacturers. The wheels of different makers vary greatly in their proportions for any given capacity.

Rating and Efficiency of Turbines. — The following notes and tables are condensed from a pamphlet entitled "Turbine Water-wheel Tests and Power Tables," by R. E. Horton. Water-supply and Irrigation Paper No. 180, U. S. Geol. Survey, 1906.

Theory does not indicate the numbers of guides or buckets most desirable. If, however, they are too few, the stream will not properly follow the flow lines indicated by theory. If the buckets are too small and too numerous, the surface-friction factor will be large.

It is customary to make the number of guide chutes greater than the number of buckets, so that any object passing through the chutes will be likely to pass through the buckets also.

With most forms of gates the size of the jet is decreased as the gate is closed, the bucket area remaining unchanged, so that the wheel operates mostly by reaction at full gate and by impulse to an increasing extent as the gate is closed. Hence, the speed of maximum efficiency varies as the gate is closed. The ratio peripheral velocity ÷ velocity due head for maximum efficiency for a 36-inch Hercules turbine is given below:

Proportional gate opening ... Full	0.806	0.647	0.489	0.379
Maximum efficiency.....	85.6	87.1	86.3	80
Periph. vel. ÷ vel. due head..	0.677	0.648	0.641	0.603
			0.585	

American turbine practice differs from European practice in that water wheels are placed on the market in standard or stock sizes, whereas in Europe, notably on the Continent, each turbine is designed for the special conditions under which it is to operate, the designs being based on mathematical theory and following chiefly the Jonval and Fourneyron types.

Having been developed by experiment after successive Holyoke tests, American stock pattern turbines probably give their best efficiencies at about the head under which those tests are made — i.e., 14 to 17 ft. The shafts, runners, and cases are so constructed as to enable stock sizes of wheels to be used under heads ranging from 6 to 60 ft. For very low heads they are perhaps unnecessarily cumbersome. For heads exceeding 60 ft. American builders commonly resort to the use of bronze buckets and "special wheels," not designed along theoretical lines, as in Europe, but representing modifications of the standard patterns.

The double Fourneyron turbine used in the first installation of the Niagara Falls Power Co. is operated under a head of about 135 ft. Two wheels are used, one being placed at the top and the other at the bottom of the globe penstock. The runner and buckets are attached to the vertical shaft. Holes are provided in the upper penstock drum to allow water under full pressure of the head to pass through and act vertically against the upper runner. In this way the vertical pressure of the great column of water is neutralized and a means is provided to counterbalance the weight of the long vertical shaft and the armature of the dynamo at its upper end. These turbines discharge 430 cu. ft. per second, make 250 rev. per min., and are rated at 5000 H.P.

A Fourneyron turbine at Trenton Falls, N. Y., operates under 265 ft. gross head and has 37 buckets, each 5½ in. deep and 1½ inch wide at the least section. The total area of outflow at the minimum section is 165 sq. in. The wheel develops 950 H.P.

The theoretical horse-power of a given quantity of water Q, in cu. ft. per min., falling through a height H, in ft., is H.P. = 0.00189 QH.

In practice the theoretical power is multiplied by an efficiency factor *E* to obtain the net power available on the turbine shaft as determinable by dynamometrical test.

Manufacturers' rating tables are usually based on efficiencies of about 80%. In selecting turbines from a maker's list the rated efficiency may be obtained by the following formula:

$$E = \text{tabled efficiency. H.P.} = \text{tabled horse-power, and } Q = \text{tabled discharge (C.F.M.) for any head } H. E = \frac{33,000 \times \text{H.P.}}{62.4 \times Q \times H} = 528.8 \frac{\text{H.P.}}{Q \times H}$$

Relations of Power, Speed and Discharge.—Nearly all American turbine builders publish rating tables showing the discharge in cu. ft. per min., rev. per min., and H.P. for each size pattern under heads varying from 3 or 4 ft. to 40 ft. or more.

Examples of each size of a number of the leading types of turbines have been tested in the Holyoke flume. For such turbines the rating tables have usually been prepared directly from the tests.

Let *M*, *R*, and *Q* denote, respectively, the H.P., r.p.m., and discharge in cu. ft. per min. of a turbine, as expressed in the tables, for any head *H* in feet. The subscripts 1 and 16 added signify the power, speed, and discharge for the particular heads 1 and 16 ft., respectively.

Let *P*, *N*, and *F* denote coefficients of power, speed, and discharge, which represent, respectively, the H.P., r.p.m., and discharge in cu. ft. per sec. under a head of 1 ft.

The speed of a turbine or the number of rev. per min. and the discharge are proportional to the square root of the head. The H.P. varies with the product of the head and discharge, and is consequently proportional to the three-halves power of the head.

Given the values of *M*, *R*, and *Q* from the tables for any head *H*, these quantities for any other head *h* are:

$$M_H : M_h :: H^{3/2} : h^{3/2} ; R_H : R_h :: H^{1/2} : h^{1/2} ; Q_H : Q_h :: H^{1/2} : h^{1/2}$$

If *H* and *h* are taken at 16 ft. and 1 ft., respectively, the values of the coefficients *P*, *N*, and *F* are:

$$P = M_{16}/H^{3/2} = M_{16}/64 = 0.01562 M_{16}$$

$$N = R_{16}/H^{1/2} = R_{16}/4 = 0.25 R_{16}$$

$$F = Q_{16}/60 H^{1/2} = Q_{16}/240 = 0.00417 Q_{16}$$

P, *N*, and *F*, when derived for a given wheel, enable the power, speed, and discharge to be calculated without the aid of the tables, and for any head *H*, by means of the following formulas:

$$M = M_1 H^{3/2} / H_1 = P H^{3/2}$$

$$R = R_1 \sqrt{H/H_1} = N \sqrt{H}$$

$$Q = Q_1 \sqrt{H/H_1} = 60 F \sqrt{H}$$

Since at a head of 1 ft., and *M*₁, *R*₁, and *Q*₁ equal *P*, *N*, and 60 *F*, respectively, *H*₁^{3/2} and $\sqrt{H_1}$ each equals 1. Calculations involving *H*^{3/2} may be facilitated by the use of the appended table of three-halves powers. Rating tables for sizes other than those tested are computed usually on the following basis:

1. The efficiency and coefficients of gate and bucket discharge for the sizes tested are assumed to apply to the other sizes also.

2. The discharge for additional sizes is computed in proportion to the measured area of the vent or discharge orifices.

Having these data, together with the efficiency, the tables of discharge and horse-power can be prepared. The peripheral speed corresponding to maximum efficiency determined from tests of one size of turbine may be assumed to apply to the other sizes also. From this datum the revolutions per minute can be computed, the number of revolutions required to give a constant peripheral speed being inversely proportional to the diameter of the turbine.

In point of discharge, the writer's observation has been that the rating tables are usually fairly accurate. In the matter of efficiency there are undoubtedly much larger discrepancies.

TABLE OF H^{3/2} FOR CALCULATING HORSE-POWER OF TURBINES.

Head ft.	0.0	0.2	0.4	0.6	0.8	Head ft.	0.0	0.2	0.4	0.6	0.8
0	0.00	0.09	0.25	0.46	0.72	51	364.21	366.36	368.50	370.66	372.82
1	1.00	1.32	1.65	2.02	2.42	52	374.93	377.14	379.31	381.48	383.66
2	2.83	3.26	3.72	4.19	4.69	53	385.85	388.03	390.22	392.42	394.61
3	5.20	5.72	6.27	6.83	7.41	54	396.81	399.02	401.23	403.45	405.67
4	8.00	8.61	9.23	9.87	10.52	55	407.89	410.11	412.35	414.58	416.82
5	11.18	11.86	12.55	13.25	13.97	56	419.07	421.31	423.56	425.81	428.07
6	14.70	15.44	16.19	16.96	17.73	57	430.34	432.60	434.87	437.15	439.43
7	18.52	19.32	20.13	20.95	21.78	58	441.71	444.00	446.29	448.58	450.88
8	22.63	23.48	24.35	25.22	26.11	59	453.09	455.49	457.80	460.12	462.43
9	27.00	27.91	28.82	29.75	30.68	60	464.75	467.08	469.41	471.75	474.08
10	31.62	32.53	33.54	34.51	35.49	61	476.42	478.77	481.12	483.47	485.82
11	36.48	37.48	38.49	39.51	40.53	62	488.19	490.55	492.92	495.29	497.67
12	41.57	42.61	43.66	44.73	45.79	63	500.04	502.43	504.82	507.20	509.60
13	46.87	47.95	49.05	50.15	51.26	64	512.00	514.40	516.80	519.22	521.63
14	52.38	53.51	54.64	55.79	56.94	65	524.04	526.46	528.89	531.31	533.75
15	58.09	59.26	60.43	61.61	62.80	66	536.18	538.62	541.07	543.51	545.96
16	64.00	65.20	66.41	67.63	68.85	67	548.42	550.87	553.33	555.80	558.27
17	70.09	71.33	72.58	73.84	75.10	68	560.74	563.22	565.70	568.18	570.66
18	76.37	77.64	78.93	80.22	81.52	69	573.16	575.65	578.14	580.65	583.15
19	82.82	84.13	85.45	86.77	88.10	70	585.66	588.17	590.68	593.20	595.73
20	89.44	90.79	92.14	93.50	94.86	71	598.25	600.77	603.32	605.85	608.39
21	96.23	97.61	99.00	100.39	101.79	72	610.93	613.43	616.04	618.59	621.15
22	103.19	104.60	106.02	107.41	108.87	73	623.71	626.27	628.84	631.41	633.99
23	110.30	111.74	113.19	114.65	116.11	74	636.57	639.15	641.74	644.33	646.92
24	117.58	119.05	120.53	122.01	123.50	75	649.52	652.11	654.72	657.33	659.94
25	125.00	126.50	128.01	129.53	131.05	76	662.55	665.17	667.79	670.41	673.04
26	132.57	134.11	135.65	137.19	138.74	77	675.67	678.20	680.84	683.48	686.13
27	140.30	141.86	143.43	145.00	146.58	78	688.87	691.52	694.18	696.84	699.50
28	148.16	149.75	151.35	152.95	154.56	79	702.16	704.83	707.50	710.18	712.85
29	156.17	157.79	159.41	161.04	162.68	80	715.54	718.22	720.92	723.60	726.30
30	164.32	165.96	167.61	169.27	170.93	81	729.00	731.70	734.40	737.11	739.82
31	172.60	174.27	175.95	177.64	179.33	82	742.54	745.26	747.98	750.70	753.43
32	181.02	182.72	184.42	186.13	187.85	83	756.16	758.90	761.63	764.38	767.12
33	189.57	191.30	193.03	194.76	196.51	84	769.87	772.62	775.37	778.13	780.89
34	198.25	200.00	201.76	203.52	205.29	85	783.66	786.42	789.20	791.97	794.75
35	207.06	208.84	210.62	212.41	214.20	86	797.53	800.31	803.10	805.89	808.68
36	216.00	217.80	219.61	221.42	223.24	87	811.43	814.27	817.08	819.88	822.70
37	225.06	226.89	228.72	230.56	232.40	88	825.51	828.32	831.15	833.97	836.79
38	234.25	236.10	237.96	239.82	241.68	89	839.62	842.45	845.29	848.13	850.96
39	243.56	245.43	247.31	249.20	251.09	90	853.81	856.66	859.51	862.37	865.22
40	252.98	254.88	256.79	258.70	260.61	91	868.08	870.94	873.81	876.68	879.55
41	262.53	264.45	266.38	268.31	270.25	92	882.43	885.30	888.19	891.07	893.96
42	272.19	274.14	276.09	278.05	280.01	93	896.86	899.75	902.65	905.55	908.45
43	281.97	283.94	285.91	287.89	289.88	94	911.36	914.27	917.18	920.10	923.02
44	291.86	293.85	295.85	297.85	299.86	95	925.94	928.87	931.79	934.73	937.66
45	301.87	303.88	305.90	307.93	309.95	96	940.60	943.54	946.48	949.43	952.38
46	311.99	314.02	316.07	318.11	320.16	97	955.33	958.29	961.25	964.21	967.17
47	322.22	324.27	326.34	328.41	330.48	98	970.14	973.11	976.09	979.07	982.05
48	332.55	334.63	336.72	338.81	340.90	99	985.03	988.02	991.01	994.00	996.99
49	343.00	345.10	347.21	349.32	351.43	100	1000.00
50	353.55	355.67	357.80	359.93	362.07						

Rating Table for Turbines.
LEFFEL STANDARD (NEW TYPE). PIVOT GATE. [1900 list.]

Diameter of Runner in Inches.	Manufacturer's Rating for a Head of 16 Ft.			Coefficients.		
	H.P. (=M).	Cu. Ft. per min. (=Q).	Revs. per min. (=R).	Power (=P).	Dis-charge. (=F).	Speed (=N).
10	3.70	53	535	0.058	0.220	133.8
11 1/2	4.9	201	463	.076	.838	115.8
13 1/4	6.5	267	404	.101	1.113	101.0
15 1/4	8.4	348	351	.131	1.451	87.8
17 1/2	11.00	455	306	.172	1.897	76.5
20	14.9	602	268	.232	2.510	67
23	19.4	802	233	.303	3.344	58.2
26 1/2	25.25	1,043	202	.393	4.339	50.5
30 1/2	33.61	1,390	176	.524	5.796	44
35	44.3	1,831	153	.691	7.635	38.2
40	58.2	2,406	134	.908	10.033	33.5
44	67.75	2,800	122	1.058	11.676	30.5
48	84.1	3,475	110	1.312	14.490	27.5
56	142	5,858	96	2.215	24.428	24
61	168	6,950	87	2.621	28.982	21.8
66	202	8,340	80	3.151	34.778	20
74	247	10,222	72	3.853	42.623	18

LEFFEL IMPROVED SAMSON. PIVOT GATE. [1897 and 1900 lists.]

20	51.7	2,111	325	0.806	8.803	81.3
23	68.3	2,792	283	1.065	11.643	70.8
26	87.3	3,569	250	1.362	14.883	62.5
30	116	4,751	217	1.810	19.812	54.3
35	158	6,440	186	2.465	26.855	46.5
40	207	8,446	163	3.229	35.220	40.8
45	262	10,689	145	4.087	44.573	36.3
50	324	13,196	130	5.054	55.027	32.5
56	405	16,554	116	6.318	69.030	29.0
62	497	20,292	105	7.753	84.618	26.3
68	597	24,409	96	9.313	101.786	24.0
74	708	28,906	88	11.045	120.538	22.0

VICTOR HIGH PRESSURE TURBINE. CYLINDER GATE. [1903 list.]
Ratings for 100 Ft. Head.

14	37	247	656	0.037	0.412	65.6
16	50	332	574	.050	.553	57.4
18	66	442	510	.066	.733	51.0
20	82	542	459	.082	.903	45.9
22	106	707	417	.106	1.178	41.7
24	128	850	383	.128	1.417	38.3
26	151	1,001	353	.151	1.668	35.3
28	173	1,147	328	.173	1.912	32.8
30	191	1,265	306	.191	2.108	30.6
33	228	1,512	278	.228	2.520	27.8
36	272	1,805	255	.272	3.008	25.5
39	303	2,005	235	.303	3.342	23.5
42	343	2,277	219	.343	3.795	21.9
45	387	2,563	204	.387	4.272	20.4
48	426	2,820	191	.426	4.700	19.1
51	462	3,063	180	.462	5.105	18.0
54	504	3,340	170	.504	5.567	17.0
57	544	3,605	161	.544	6.008	16.0
60	590	3,907	153	.590	6.512	15.3
63	619	4,100	146	.619	6.833	14.6
66	680	4,505	139	.680	7.508	13.9
69	742	4,910	133	.742	8.183	13.3
72	799	5,290	127	.799	8.817	12.7

(746)

The discharge of turbines is nearly always expressed in cubic feet per minute. The "vent" in square inches is also used by millwrights and manufacturers, although to a decreasing extent. The vent of a turbine is the area of an orifice which would, under any given head, theoretically discharge the same quantity of water that is vented or passed through a turbine under that same head when the wheel is so loaded as to be running at maximum efficiency.

If V = vent in sq. in., Q = discharge in cu. ft. per min. under a head H , F = discharge in cu. ft. per sec. under a head of 1 foot, then $Q = 60 V / 144 \sqrt{2gH} = 3.344 V \sqrt{H}$, and $V = 0.3 Q / \sqrt{H}$; also $V = 17.94 F$ and $F = 0.0557 V$.

The vent of a turbine should not be confused with the area of the outlet orifice of the buckets. The actual discharge through a turbine is commonly from 40 to 60% of the theoretical discharge of an orifice whose area equals the combined cross-sectional areas of the outlet ports measured in the narrowest section.

The high-pressure turbine is a recent design (1903), and is tabled for heads of 70 to 675 feet.

A 10,000 H.P. Turbine at Snoqualmie, Wash. (Arthur Giesler, *Eng. News*, Mar. 20, 1906.)—The fall is about 270 ft. high. The machinery is placed in an underground chamber excavated in the rock about 250 ft. below the surface, and 300 ft. up-stream from the crest of the falls. A tail-race tunnel runs to the lower reach of the river. The wheel was designed by the Platt Iron Works Co., Dayton, O., for an effective head of 260 ft. and 300 r.p.m., the latter being fixed by the limitations of dynamo design. There was no precedent for a generator approximating 10,000 H.P. running at such a speed. The turbine is a horizontal shaft machine, of the Francis type, radial inward flow with central axial discharge. The turbine proper has only one bearing, $8\frac{3}{8} \times 26$ in., the generator having three bearings. The draft tube is on the generator (front) side. The shaft-bearing, thrust-bearing and thrust-balancing devices are at the back side. The wheel is 66 in. outside diam. by 9 in. wide through the vanes. It has 34 vanes which extend a short distance beyond the end plate of the wheel on the discharge side. There are 32 guide vanes, of the swivel type, connected to a rotatable ring which is actuated by a Lombard governor. The turbine wheel or runner is an annular steel casting. It is bolted to a disk 46 in. diam., which is an enlargement of the $13\frac{1}{2}$ in. hollow nickel-steel shaft. A test for efficiency was made, in which the output was measured on the electrical side, and the input by the drop of head across the head gate. At 10,000 H.P. the efficiency shown was 84%, the figure being subject to the inaccuracy of the water measurement. The maximum capacity registered was 8250 K.W. or 11,000 H.P. With the generator and the governor disconnected, with full gates and no load, the wheel ran at 505 r.p.m.

Turbines of 13,500 H.P.—Four Francis turbines, with vertical shafts, rated at 13,500 H.P. each, have been built by Aills-Chalmers Co., for the Great Northern Power Co., Duluth, Minn. The available head is 365 ft., and the wheels run at 375 r.p.m.; discharging, at full load, about 400 cu. ft. per second, each. The runners are 62 in. diam. The penstock for each wheel is 84 in. diam., reduced gradually to 66 in. at the wheel. (Bulletin No. 1613, A.-C. Co.)

The "Fall-increaser" for Turbines.—A circular issued Nov., 1908, by Clemens Herschel, the inventor of the Venturi Meter, illustrates a device, based on the principle of the meter, for diminishing the back-water head which acts against the turbine. The surplus water, which would otherwise run to waste, is caused to flow into a tube of the Venturi shape, and the pressure in the narrow section, or throat of this tube, is less than that due to the head of the back-water into which the tube discharges. The throat is perforated with a great number of 6-in. holes, through which the discharge-water of the turbine is caused to flow, the velocity through the holes being never over 4 ft. per second. The circular says:

The fall-increaser is a form of power-house foundation construction so made that by running through it water, which would otherwise waste over the dam, the fall acting on the turbines is increased, and the output of power is kept at its maximum quantity, in spite of the back-water

which always accompanies an abundance of river flow passing down the river.

The results show that fall-increasers add about 10% to the annual output of power with no appreciable increase in operating expenses.

For half the days of the year the fall-increasers are shut down because there is not enough, or only enough, water to supply the plain turbines; but for the other half of the year the fall-increasers keep the output of power practically constant, and at the full output, where this power output would fall to half the full output or less if the fall-increasers had not been built.

An illustrated description of the fall-increaser, with results of tests, is given in the *Harvard Eng'g Journal*, June, 1908. See also U. S. Pat. No. 873,435 and *Eng. News*, June 11, 1908.

TANGENTIAL OR IMPULSE WATER-WHEELS.

The Pelton Water-wheel. — Mr. Ross E. Browne (*Eng'g News*, Feb. 20, 1892) thus outlines the principles upon which this water-wheel is constructed:

The function of a water-wheel, operated by a jet of water escaping from a nozzle, is to convert the energy of the jet, due to its velocity, into useful work. In order to utilize this energy fully the wheel-bucket, after catching the jet, must bring it to rest before discharging it, without inducing turbulence or agitation of the particles.

This cannot be fully effected, and unavoidable difficulties necessitate the loss of a portion of the energy. The principal losses occur as follows: First, in sharp or angular diversion of the jet in entering, or in its course through the bucket, causing impact, or the conversion of a portion of the energy into heat instead of useful work. Second, in the so-called frictional resistance offered to the motion of the water by the wetted surfaces of the buckets, causing also the conversion of a portion of the energy into heat instead of useful work. Third, in the velocity of the water, as it leaves the bucket, representing energy which has not been converted into work.

Hence, in seeking a high efficiency: 1. The bucket-surface at the entrance will be approximately parallel to the relative course of the jet, and the bucket should be curved in such a manner as to avoid sharp angular deflection of the stream. If, for example, a jet strikes a surface at an angle and is sharply deflected, a portion of the water is backed, the smoothness of the stream is disturbed, and there results considerable loss by impact and otherwise.

2. The path of the jet in the bucket should be short; in other words, the total wetted surface of the bucket should be small, as the loss by friction will be proportional to this.

3. The discharge end of the bucket should be as nearly tangential to the wheel periphery as compatible with the clearance of the bucket which follows; and great differences of velocity in the parts of the escaping water should be avoided. In order to bring the water to rest at the discharge end of the bucket, it is shown, mathematically, that the velocity of the bucket should be one half the velocity of the jet.

A bucket, such as shown in Fig. 145, will cause the heaping of more or less dead or turbulent water at the point indicated by dark shading. This dead water is subsequently thrown from the wheel with considerable velocity, and represents a large loss of energy. The introduction of the wedge in the Pelton bucket (see Fig. 146) is an efficient means of avoiding this loss.



FIG. 145.



FIG. 146.



FIG. 147.

A wheel of the form of the Pelton (Fig. 147) conforms closely in construction to each of these requirements. [In wheels as now made (1909)

the sharp corners shown in this bucket are eliminated. See catalogues of the Pelton Water Wheel Co., Joshua Hendy Iron Works, and Abner Doble Co., all of San Francisco.]

Considerations in the Choice of a Tangential Wheel (Joshua Hendy Iron Works.) — The horse-power that can be developed by a tangential wheel does not depend upon the size of the wheel but *solely upon the head and volume of water available*. The number of revolutions per minute that a wheel makes (running under normal conditions) depends solely upon two factors, viz., its diameter and the head of water.

The choice of the diameter of a wheel is not therefore controlled by the power required but by the speed required when working under a given head. If a wheel has no load, and is not governed, it will speed up until the periphery is revolving at approximately the same velocity as the spouting velocity of the jet, but as soon as the wheel commences to develop power by driving machinery, etc., its velocity will drop. In a properly designed wheel the velocity of the rim in lineal feet per minute, at full load, will be from 48 to 50% of the spouting velocity of the jet.

The diameter of pulley wheels on wheel shaft and countershafts of machinery should be so proportioned that the water wheel shall run at the speed given in the table.

The width, area and curvature of buckets are designed to meet conditions of volume of flow under given heads. The higher the peripheral velocity of the wheel, the greater the volume of water that the buckets can handle, and consequently the same standard wheel can handle more water, the higher the head.

Standard wheels can generally be adapted one size larger or one size smaller to meet conditions of a variation of speed or volume of flow under a given head. Wheels designed for a given horse-power can be used for smaller powers (within reasonable limits) with very little loss of efficiency, but an increase in the volume to be used requires a larger bucket. If, for the purpose of maintaining the same speed conditions, the same diameter of wheel is to be adhered to, then a special wheel must be built with either very large buckets or with two or more nozzles, or else a double or multiple unit must be adopted.

It is advised to subdivide large streams between two, three or more runners, as this insures a greater freedom from breakdown and is often cheapest in the end. Single-nozzle, multiple runner units are easier to govern than multiple-nozzle, single runner units. When two or more nozzles are used in combination on one runner, the increased volume to be dealt with is divided between the different nozzles, which are so arranged that their respective jets impinge on different buckets at different parts of the periphery. Three-nozzle and five-nozzle wheels have many disadvantages, when governing is required, and should only be adopted for handling a very large volume of water when other designs cannot be used.

Combined Heads. — When two or more water powers are available at the same site, but under different heads, it is possible to utilize them by mounting wheels of different diameters in parallel, or, when the difference of head and volume is very great, it would even be possible to arrange for a turbine for the low head and a tangential wheel for the high head, although, in the latter case, it would probably be best to mount them independently and connect to the machinery through the medium of belts and countershafts. In either case, separate pipe lines must be employed.

Reversible Wheels. — In the case of reversible wheels desired for use with hoists, cableways, etc., two wheels of proper dimensions and the same type may be mounted parallel on the same shaft, one of the wheels having the buckets and nozzles arranged to run in the opposite direction to the other. Suitable valves, levers and pipe connections can be arranged to cut the water off one wheel and turn it on to the other.

Horizontal Wheels. — For electric generating stations, when it is desired to place the wheels below the floor of the generators, where vertical direct-connected equipments are used, tangential wheels may be mounted horizontally with vertical shafts and step bearings.

Notes on Hydraulic Power Installations. (Joshua Hendy Iron Works.) — Apertures of screens must be slightly smaller than the diameter of the smallest nozzle used.

When not in use, keep the pipe full by closing the valve at the lower end. There is less liability for trouble from expansion and contraction with a full pipe line.

Equip the pipe line with air valves, approximately one for every 20 ft. of head.

When operating under high heads, when no other precaution has been taken to avoid water ram during the process of governing, it is advisable to install relief valves between the lower end of the pipe line and the gates or controllers.

When operating under even moderately high heads, if no safety device or by-pass has been installed, and a plain valve is to be used, sliding gates and butterfly valves should not be employed, but only screw gates, as the former would be too rapid in their action and might set up a dangerous water ram.

The size of the nozzle that must be used on a wheel for maximum efficiency must be such as will just keep the pipe line full. If water overflows, put on a larger nozzle. If the pipe remains partly empty, put on a smaller nozzle, as otherwise the effective head is reduced, with considerable loss of efficiency.

The nozzles may be placed either above or below the wheel, depending on the direction of rotation required.

Control of Tangential Water-Wheels. — The methods of regulating tangential water-wheels may be classified under five heads:

1. Permanently or semi-permanently altering the area of efflux of the nozzles, with water economy and without loss of efficiency.
2. Reducing the volume of flow without altering the area of efflux, with water economy but with loss of efficiency.
3. Variable alteration of the area of efflux without loss of efficiency and with water economy.
4. Deflection of the jet, so that only a portion of its energy is transmitted to the wheel, without water economy.
5. Combined regulation of 3 and 4, producing an effect whereby the energy of the jet is reduced rapidly without water ram and the area of efflux reduced slowly to effect water economy, or by a combination of 3 with some form of by-pass.

Governors. — Of the five methods of control enumerated above, the first cannot be done automatically; the other four, however, are susceptible to either hand regulation or automatic regulation by means of governors, the function of the governor being merely to automatically bring into action the particular controlling device with which the wheel has been equipped. There are two leading types of governors, the hydraulic and the mechanical. In the first, the mechanism of the water-wheel regulator is actuated by a hydraulically operated piston, the motive power being taken from a small branch pipe from the main water supply, or from an independent high-pressure oil-pumping system, the position of the piston in the cylinder and consequent relative position of the controlling mechanism being dependent upon the amount of fluid under pressure admitted to the cylinder at either end. This is controlled by a main valve, operated by a very sensitive relay valve which, in turn, is directly controlled by the centrifugal balls of the governor.

The second type, or mechanically operated governor, consists of a device for automatically controlling and directing the transmission of the requisite amount of energy taken from the wheel shaft, to operate the water-regulating mechanism. The Lombard governor is a representative of the first type, and the Lombard-Replogle governor of the second.

The close regulation that can be obtained with the latter is remarkable. Any size will go into operation and make connection at so slight a deviation as one-tenth of one per cent from normal, and in installations which have been made they will not permit of a departure of more than five to eight per cent temporarily where there is an instantaneous drop from full load to practically no load. When there is sufficient fly-wheel effect, the deviation will not be over two per cent. The adoption of fly wheels greatly facilitates many problems of governing.

Tangential Water-Wheel Table. (Joshua Hendy Iron Works.)

P = horse-power, Q = cubic feet per minute, R = revs. per min. The smaller figures in the first column give the spouting velocity of the jet in feet per minute. (The table is greatly condensed from the original; 6-in., 15-in., and 30-in. wheels are also listed. P and Q are the same, with any given head, for a 30 as for a 36-in. wheel, but R is 20% greater.)

Head in Ft.		12 Inch.	18 Inch.	24 Inch.	36 Inch.	48 Inch.	60 Inch.	72 Inch.	8 Feet.	10 Feet.	12 Feet.
20 2152	P	.12	.37	.66	1.50	2.64	4.18	6.00	10.64	16.48	23.80
	Q	3.91	11.72	20.83	46.93	83.32	130.36	187.72	332.70	515.04	748.95
	R	342	228	171	114	85	70	57	43	34	29
30 2636	P	.23	.69	1.22	2.76	4.88	7.69	11.04	19.53	30.00	43.80
	Q	4.79	14.36	25.51	57.44	102.04	159.66	229.76	407.03	630.00	916.47
	R	418	279	209	139	104	83	69	52	41	35
40 3043	P	.35	1.06	1.89	4.24	7.58	11.85	16.96	30.08	46.60	67.60
	Q	5.53	16.59	29.46	66.36	107.84	184.36	265.44	470.27	728.16	1058.86
	R	484	323	242	161	121	96	80	62	49	40
50 3403	P	.49	1.49	2.65	5.98	10.60	16.63	23.93	42.05	65.00	94.50
	Q	6.18	18.54	32.93	74.17	131.72	206.13	296.70	525.90	814.32	1184.15
	R	541	361	270	180	135	108	90	69	55	46
60 3727	P	.65	1.96	3.48	7.84	13.94	21.77	31.36	55.20	85.62	124.50
	Q	6.77	20.31	36.08	81.25	144.32	225.80	325.00	576.00	892.00	1297.00
	R	592	395	296	197	148	118	98	75	60	50
70 4026	P	.82	2.47	4.39	9.88	17.58	27.51	39.52	70.00	107.80	157.50
	Q	7.31	21.94	38.97	87.76	155.88	243.89	351.04	624.00	966.24	1405.17
	R	640	427	320	2.13	160	130	106	81	64	54
80 4304	P	1.00	3.01	5.36	12.04	21.44	33.54	48.16	85.76	134.16	192.64
	Q	7.82	23.46	41.66	93.84	166.64	260.73	375.36	666.56	1042.92	1501.44
	R	684	456	342	228	171	137	114	87	69	58
90 4565	P	1.20	3.60	6.39	14.40	25.59	40.04	57.60	102.36	160.16	230.40
	Q	8.29	24.88	44.19	99.52	176.75	276.55	398.08	707.00	1106.20	1592.32
	R	726	484	363	242	181	145	121	93	73	62
100 4812	P	1.40	4.21	7.49	16.84	29.93	46.85	67.36	119.72	187.40	269.44
	Q	8.74	26.22	46.58	104.88	186.32	291.51	419.52	745.28	1166.04	1678.08
	R	765	510	382	255	191	152	127	96	77	64
120 5271	P	1.84	5.54	9.85	22.18	39.41	61.66	88.75	157.64	246.64	355.00
	Q	9.57	28.72	51.02	114.91	204.10	319.33	459.64	816.40	1277.32	1838.56
	R	838	559	419	279	209	167	139	105	83	70
140 5694	P	2.33	6.99	12.41	27.96	49.64	77.71	111.85	198.56	310.84	447.40
	Q	10.34	31.03	55.11	124.12	220.44	344.92	496.48	881.76	1379.68	1985.92
	R	906	604	453	302	226	181	151	114	90	75
160 6087	P	2.84	8.54	15.17	34.16	60.68	94.94	136.65	242.72	377.76	546.60
	Q	11.05	33.17	58.92	132.68	235.68	368.73	530.75	942.72	1474.92	2123.00
	R	969	646	484	323	242	193	161	121	97	81
180 6456	P	3.39	10.19	18.10	40.77	72.41	113.30	163.08	289.64	453.20	652.32
	Q	11.72	35.18	62.49	140.74	249.97	391.10	562.96	999.83	1564.40	2251.84
	R	1024	683	513	342	256	206	171	128	103	86
200 6805	P	3.97	11.93	21.20	47.75	84.81	132.70	191.00	339.24	530.80	764.00
	Q	12.36	37.08	65.87	148.35	263.49	412.25	593.40	1053.96	1649.00	2373.60
	R	1080	720	540	360	270	216	180	135	108	90
225 7215	P	56.99	101.20	158.38	227.96	404.80	633.52	911.84
	Q	157.33	279.44	437.23	629.32	1117.76	1748.92	2517.28
	R	382	287	229	191	144	115	96
250 7608	P	5.56	16.68	29.63	66.74	118.54	185.47	266.96	474.16	741.88	1067.84
	Q	13.82	41.46	73.64	165.86	294.59	460.91	663.45	1178.36	1843.64	2653.80
	R	1209	806	605	403	302	241	202	151	121	101

Tangential Water-Wheel Table.—Continued.

Head in Ft.		12 Inch.	18 Inch.	24 Inch.	36 Inch.	48 Inch.	60 Inch.	72 Inch.	8 Feet.	10 Feet.	12 Feet.
275 7975	P				77.00	136.76	214.00	308.00	547.04	856.00	1232.00
	R				173.94	308.92	483.39	695.76	1235.68	1933.56	2783.04
300 8335	P	7.31	21.93	38.95	87.73	155.83	243.82	350.94	623.32	975.28	1403.76
	R	15.13	45.42	80.67	181.59	322.71	504.91	726.76	1290.84	2019.64	2907.04
325 8672	P				98.93	175.68	274.94	395.72	702.72	1099.76	1582.88
	R				189.10	335.84	525.50	756.40	1343.36	2102.00	3025.60
350 9002	P	9.21	27.64	49.09	110.56	196.38	307.25	442.27	785.52	1229.00	1769.08
	R	16.35	49.06	87.14	196.25	348.57	545.36	785.00	1394.28	2181.44	3140.00
400 9624	P	11.25	33.77	59.98	135.08	239.94	375.40	540.35	959.76	1501.60	2161.40
	R	17.48	52.45	93.16	209.80	372.64	583.02	839.20	1490.56	2332.08	3356.80
450 10208	P	13.43	40.79	71.57	161.19	286.31	447.95	644.78	1145.24	1791.80	2579.12
	R	18.54	55.63	98.81	222.52	395.24	618.38	890.11	1580.96	2473.52	3560.44
500 10760	P	15.73	47.20	83.83	188.80	335.34	524.66	755.20	1341.36	2098.64	3020.80
	R	19.54	58.64	104.15	234.56	416.62	651.83	938.25	1666.48	2607.02	3753.00
550 11279	P				217.82	386.84	605.31	871.28	1547.36	2421.24	3485.12
	R				246.00	436.92	683.62	984.00	1747.68	2734.48	3936.00
600 11787	P	24.26	62.04	110.19	248.16	440.77	689.63	992.65	1763.08	2758.52	3970.60
	R	25.12	64.24	114.09	256.95	456.38	714.05	1027.80	1825.52	2856.20	4111.20
640 12169	P				270.97	484.16	748.80	1083.88	1936.64	2995.20	4335.52
	R				264.63	466.12	731.59	1058.52	1864.48	2926.36	4234.08
700 12731	P	30.57	78.18	138.86	312.73	555.46	869.06	1250.92	2221.84	3476.24	5003.68
	R	27.13	69.38	123.23	277.54	492.95	771.26	1110.16	1971.80	3085.04	4440.64
750 13178	P	33.91	86.70	154.00	346.83	616.03	963.82	1387.34	2464.12	3855.28	5549.36
	R	28.08	71.82	127.56	287.28	510.25	798.33	1149.13	2041.00	3193.32	4596.52
800 13610	P	37.35	95.52	169.66	382.09	678.66	1061.81	1528.36	2714.64	4247.24	6113.44
	R	29.00	74.17	131.74	296.70	526.99	824.51	1186.81	2107.96	3298.04	4747.24
900 14436	P	44.57	113.98	202.45	455.94	809.82	1267.02	1823.76	3239.28	5068.08	7295.04
	R	30.76	78.67	139.74	314.70	558.96	874.53	1258.81	2235.84	3498.12	5035.24
1000 15217	P	52.20	133.50	237.12	534.01	948.48	1483.97	2136.04	3793.92	5935.88	8544.16
	R	32.42	82.93	147.30	331.72	589.19	921.83	1326.91	2356.76	3687.32	5287.64

The above tables are compiled on the following basis:
 The head (*h*) is the net effective head at the nozzle. Proper allowance must be made for all losses in the pipe line.
 The velocity of efflux (*V*) is the approximate spouting velocity of the jet in feet per minute as it issues from the nozzle = $\sqrt{2gh} \times 60 = 481.2\sqrt{h}$.
 The discharge in cubic feet per minute = $Q = V \times a$, where *a* equals the cross-section area of nozzle opening in sq. ft., no allowance being made for friction in the nozzle.

The weight of a cubic foot of water is taken at 39.2° Fahr. = 62.425 lbs.
 The theoretical horse-power = $Q \times 62.425 \times h \div 33,000 = 0.00189 Qh$.
 The horse-power in the tables is based on 85% mechanical efficiency for the wheels.
 The diameter is the effective diameter at the line of the nozzle center, where the jet impinges on the center of the bucket.
 The number of revolutions is based on a peripheral speed for the effective diameter, of half the velocity of efflux of the jet, and equals $V \div 2C$, where *C* = the circumference (in feet) of the effective diameter.
 Small wheels, up to 24-in. diam., are commonly called motors.

Amount of Water Required to Develop a Given Horse-Power, with a Given Available Effective Head.

Effective Head in Feet.	Horse-Power Based on 85% Efficiency of the Water Wheel.									
	10	20	30	40	50	60	70	80	90	100
	Flow in Cubic Feet of Water per Minute Required to Develop Power.									
50	125	250	375	500	625	750	875	1000	1125	1250
60	104	208	312	416	520	624	726	830	934	1038
70	88	177	266	355	444	532	621	709	798	886
80	77	155	232	311	388	466	544	622	699	776
90	70	140	210	280	350	420	490	560	630	700
100	63	125	186	248	312	372	435	498	558	622
110	59	118	176	234	293	350	410	467	525	585
120	52	104	156	208	260	312	364	415	467	520
130	48	96	143	192	240	287	335	385	430	478
140	45	89	133	178	222	266	310	355	400	443
150	42	83	125	166	208	250	292	332	375	416
160	39	78	117	155	195	233	272	312	350	388
170	37	73	110	146	183	220	256	293	330	365
180	35	69	104	138	172	207	242	276	310	345
190	33	65	98	132	164	198	230	262	295	326
200	31	62	93	124	155	186	218	248	280	310
210	30	59	89	118	148	177	206	236	266	295
220	28	57	85	113	141	169	198	225	255	283
230	27	54	81	108	135	162	190	216	243	270
240	26	52	78	104	130	155	181	207	233	258
250	25	50	75	100	125	149	174	199	224	248
260	24	48	72	96	120	144	167	191	215	238
270	23	46	69	92	115	138	161	184	207	230
280	22	45	67	89	111	133	156	178	200	222
290	21	43	65	86	107	129	150	172	193	215
300	20	42	62	83	104	124	145	166	187	208
310	19	41	60	80	100	120	140	160	180	200
320	19	40	59	78	97	117	136	156	175	194
330	19	38	57	76	94	113	132	151	170	188
340	18	37	55	74	92	110	128	146	165	183
350	18	36	53	71	89	106	124	142	160	178
360	18	35	52	69	86	102	121	138	155	172
370	17	34	50	67	84	100	117	134	151	168
380	17	33	49	66	82	98	114	130	147	164
390	16	32	48	64	80	96	111	127	144	160
400	16	31	47	63	77	94	105	124	140	156

Efficiency of the Doble Nozzle. — The nozzle tip is of brass, highly polished in the interior, with concave curves near the end. It contains a conical regulating needle, which is set at any desired distance from the opening to regulate the size of the opening and the diameter of the jet. A jet flowing from the nozzle has a clear, glassy appearance. Tests

by H. C. Crowell and G. C. D. Lenth, at Mass. Inst. of Tech., 1903, gave efficiencies under constant head from 96.4 to 99.3% for different settings of the needle, the coefficient of velocity being from 0.982 to 0.997. The efficiency of a jet is equal to the ratio of the velocity head in the jet to the total head at the entrance to the nozzle, and equal to the square of the coefficient of velocity. — *Bulletin of the Abner Doble Co.*, No. 6, 1904.

Tests of a 12-in. Doble Laboratory Motor (*Bulletin No. 12, 1908, Abner Doble Co.*)—The tests were made by students at the University of Missouri. The available head was 46 ft. The needle valve was opened two, four, six and eight turns in the four series of tests, and with each opening different loads were applied by a Prony brake. The results were recorded and plotted in curves showing the relation of speed, load and efficiency, and from these curves the following approximate figures are taken:

		Speed, Revolutions per Minute.						
Valve open		200	300	400	500	600	700	800
Two turns	B.H.P.	0.20	0.26	0.27	0.26	0.22	0.14	0.03
	Effy. %	62	75	80	77	64	41	13
Four turns	B.H.P.	0.36	0.45	0.51	0.50	0.42	0.30	0.12
	Effy. %	57	75	85	85	71	50	19
Six turns	B.H.P.	0.41	0.55	0.63	0.66	0.60	0.41	0.20
	Effy. %	48	64	73	76	74	66	51
Eight turns	B.H.P.	0.48	0.62	0.70	0.71	0.64	0.43	0.19
	Effy. %	53	70	79	81	72	50	23

Water-power Plants Operating under High Pressures. — The following notes are contributed by the Pelton Water Wheel Co.:

The Consolidated Virginia & Col. Mining Co., Virginia, Nev., has a 3-ft. steel-disk Pelton wheel operating under 2100 ft. fall, equal to 911 lbs. per sq. in. It runs at a peripheral velocity of 10,804 ft. per minute and has a capacity of over 100 H.P. The rigidity with which water under such a high pressure as this leaves the nozzle is shown in the fact that it is impossible to cut the stream with an axe, however heavy the blow, as it will rebound just as it would from a steel rod travelling at a high rate of speed.

The London Hydraulic Power Co. has a large number of Pelton wheels from 12 to 18 in. diameter running under pressure of about 1000 lbs. per sq. in. from a system of pressure-mains. The 18-in. wheels weighing 30 lbs. have a capacity of over 20 H.P. (See Blaine's "Hydraulic Machinery.")

Hydraulic Power-hoist of Milwaukee Mining Co., Idaho. — One cage travels up as the other descends; the maximum load of 5500 lbs. at a speed of 400 ft. per min. is carried by one of a pair of Pelton wheels (one for each cage). Wheels are started and stopped by opening and closing a small hydraulic valve at the engineer's stand which operates the larger valves by hydraulic pressure. An air-chamber takes up the shock that would otherwise occur on the pipe line under the pressure due to 850 ft. fall.

The Mannesmann Cycle Tube Works, North Adams, Mass., are using four Pelton wheels, having a fly-wheel rim, under a pump pressure of 600 lbs. per sq. in. These wheels are direct-connected to the rolls through which the ingots are passed for drawing out seamless tubing.

The Alaska Gold Mining Co., Douglass Island, Alaska, has a 22-ft. Pelton wheel on the shaft of a Riedler duplex compressor. It is used as a fly-wheel as well, weighing 25,000 lbs., and develops 500 H.P. at 75 revolutions. A valve connected to the pressure-chamber starts and stops the wheel automatically, thus maintaining the pressure in the air-receiver.

At Pachuca in Mexico five Pelton wheels having a capacity of 600 H.P. each under 800 ft. head are driving an electric transmission plant. These wheels weigh less than 500 lbs. each, showing over a horse-power per pound of metal.

Formulae for Calculating the Power of Jet Water-wheels, such as the Pelton (F. K. Blue). — HP = horse-power delivered; δ = 62.36 lbs. per cu. ft.; E = efficiency of turbine; q = quantity of water, cubic feet per minute; h = feet effective head; d = inches diameter of jet; p = pounds per square inch effective head; c = coefficient of discharge from nozzle, which may be ordinarily taken at 0.9.

$$HP = \frac{\delta E q h}{33000} = .00189 E q h = .00436 E q p = .00496 E c d^2 \sqrt{h^3} = .0174 E c d^2 \sqrt{p^3}$$

$$q = 529.2 \frac{HP}{E h} = 229 \frac{HP}{E p} = 2.62 c d^2 \sqrt{h} = 3.99 c d^2 \sqrt{p}$$

$$d^2 = 201.6 \frac{HP}{E c \sqrt{h^3}} = 57.4 \frac{HP}{E c \sqrt{p^3}} = 0.381 \frac{q}{c \sqrt{h}} = 0.25 \frac{q}{c \sqrt{p}}$$

THE POWER OF OCEAN WAVES.

Albert W. Stahl, U. S. N. (*Trans. A. S. M. E.*, xiii. 438), gives the following formulæ and table, based upon a theoretical discussion of wave motion:

The total energy of one whole wave-length of a wave H feet high, L feet long, and one foot in breadth, the length being the distance between successive crests, and the height the vertical distance between the crest and the trough, is $E = 8 L H^2 (1 - 4.935 \frac{H^2}{L^2})$ foot-pounds.

The time required for each wave to travel through a distance equal to its own length is $P = \sqrt{\frac{L}{5.123}}$ seconds, and the number of waves passing any given point in one minute is $N = \frac{60}{P} = 60 \sqrt{\frac{5.123}{L}}$. Hence the total energy of an indefinite series of such waves, expressed in horse-power per foot of breadth, is

$$\frac{E \times N}{33,000} = 0.0329 \frac{H^2 L}{\sqrt{L}} (1 - 4.935 \frac{H^2}{L^2})$$

By substituting various values for $H + L$, within the limits of such values actually occurring in nature, we obtain the following table of

TOTAL ENERGY OF DEEP-SEA WAVES IN TERMS OF HORSE-POWER PER FOOT OF BREADTH.

Ratio of Length to Height of Waves.	Length of Waves in Feet.							
	25	50	75	100	150	200	300	400
50	0.04	0.23	0.64	1.31	3.62	7.43	20.46	42.01
40	0.06	0.36	1.00	2.05	5.65	11.59	31.95	65.58
30	0.12	0.64	1.77	3.64	10.02	20.57	56.70	116.38
20	0.25	1.44	3.96	8.13	21.79	45.98	120.70	260.08
15	0.42	2.83	6.97	14.31	39.43	80.94	223.06	457.89
10	0.98	5.53	15.24	31.29	86.22	177.00	487.75	1001.25
5	3.30	18.68	51.48	105.68	291.20	597.78	1647.31	3381.60

The figures are correct for trochoidal deep-sea waves only, but they give a close approximation for any nearly regular series of waves in deep water and a fair approximation for waves in shallow water.

The question of the practical utilization of the energy which exists in ocean waves divides itself into several parts:

1. The various motions of the water which may be utilized for power purposes.

2. The wave-motor proper. That is, the portion of the apparatus in direct contact with the water, and receiving and transmitting the energy thereof; together with the mechanism for transmitting this energy to the machinery for utilizing the same.

3. Regulating devices, for obtaining a uniform motion from the irregular and more or less spasmodic action of the waves, as well as for adjusting the apparatus to the state of the tide and condition of the sea.

4. Storage arrangements for insuring a continuous and uniform output of power during a calm, or when the waves are comparatively small.

The motions that may be utilized for power purposes are the following:
 1. Vertical rise and fall of particles at and near the surface. 2. Horizontal to-and-fro motion of particles at and near the surface. 3. Varying slope of surface of wave. 4. Impetus of waves rolling up the beach in the form of breakers. 5. Motion of distorted verticals. All of these motions, except the last one mentioned, have at various times been proposed to be utilized for power purposes; and the last is proposed to be used in apparatus described by Mr. Stahl.

The motion of distorted verticals is thus defined: A set of particles, originally in the same vertical straight line when the water is at rest, does not remain in a vertical line during the passage of the wave; so that the line connecting a set of such particles, while vertical and straight in still water, becomes distorted, as well as displaced, during the passage of the wave, its upper portion moving farther and more rapidly than its lower portion.

Mr. Stahl's paper contains illustrations of several wave-motors designed upon various principles. His conclusion as to their practicability is as follows: "Possibly none of the methods described in this paper may ever prove commercially successful; indeed the problem may not be susceptible of a financially successful solution. My own investigations, however, so far as I have yet been able to carry them, incline me to the belief that wave-power can and will be utilized on a paying basis."

Continuous Utilization of Tidal Power. (P. Decœur, *Proc. Inst. C. E.* 1890.) — In connection with the training-walls to be constructed in the estuary of the Seine, it is proposed to construct large basins, by means of which the power available from the rise and fall of the tide could be utilized. The method proposed is to have two basins separated by a bank rising above high water, within which turbines would be placed. The upper basin would be in communication with the sea during the higher one-third of the tidal range, rising, and the lower basin during the lower one-third of the tidal range, falling. If H be the range in feet, the level in the upper basin would never fall below $\frac{2}{3}H$ measured from low water, and the level in the lower basin would never rise above $\frac{1}{3}H$. The available head varies between $0.53H$ and $0.80H$, the mean value being $\frac{2}{3}H$. If S square feet be the area of the lower basin, and the above conditions are fulfilled, a quantity $\frac{1}{3}SH$ cu. ft. of water is delivered through the turbines in the space of $9\frac{1}{4}$ hours. The mean flow is, therefore, $\frac{SH}{99,900}$ cu. ft. per sec., and, the mean fall being $\frac{2}{3}H$, the available gross horse-power is about $\frac{1}{30}S'H^2$, where S' is measure in acres. This might be increased by about one-third if a variation of level in the basins amounting to $\frac{1}{2}H$ were permitted. But to reach this end the number of turbines would have to be doubled, the mean head being reduced to $\frac{1}{2}H$, and it would be more difficult to transmit a constant power from the turbines. The turbine proposed is of an improved model designed to utilize a large flow with a moderate diameter. One has been designed to produce 300 horse-power, with a minimum head of 5 ft. 3 in. at a speed of 15 revolutions per minute, the vanes having 13 ft. internal diameter. The speed would be maintained constant by regulating sluices.

PUMPS AND PUMPING ENGINES.

Theoretical Capacity of a Pump. — Let Q' = cu. ft. per min.; G' = U. S. gals. per min. = $7.4805 Q'$; d = diam. of pump in inches; l = stroke in inches; N = number of single strokes per min.

Capacity in cu. ft. per min. $= Q' = \frac{\pi}{4} \cdot \frac{d^2}{144} \cdot \frac{1N}{12} = 0.0004545 N d^2 l$;

Capacity in U. S. gals. per min. $G' = \frac{\pi}{4} \cdot \frac{N d^2 l}{231} = 0.0034 N d^2 l$;

Capacity in gals. per hour $= 0.204 N d^2 l$.

Diameter required for a given capacity per min. } $d = 46.9 \sqrt{\frac{Q'}{Nl}} = 17.15 \sqrt{\frac{G'}{Nl}}$

If v = piston speed in feet per min., $d = 13.54 \sqrt{\frac{Q'}{v}} = 4.95 \sqrt{\frac{G'}{v}}$.

If the piston speed is 100 feet per min.:

$Nl = 1200$, and $d = 1.354 \sqrt{Q'} = 0.495 \sqrt{G'}$; $G' = 4.08 d^2$ per min.

The actual capacity will be from 60% to 95% of the theoretical, according to the tightness of the piston, valves, suction-pipe, etc.

Theoretical Horse-power Required to Raise Water to a Given Height. — Horse-power =

$\frac{\text{Volume in cu. ft. per min.} \times \text{pressure per sq. ft.}}{33,000} = \frac{\text{Weight} \times \text{height of lift}}{33,000}$

Q' = cu. ft. per min.; G' = gals. per min.; W = wt. in lbs.; P = pressure in lbs. per sq. ft.; p = pressure in lbs. per sq. in.; H = height of lift in ft.; $W = 62.355 Q'$, $P = 144 p$, $p = 0.433 H$, $H = 2.3094 p$, $G' = 7.4805 Q'$.

HP. = $\frac{Q'P}{33,000} = \frac{Q'H \times 144 \times 0.433}{33,000} = \frac{Q'H}{529.23} = \frac{G'H}{3958.9} = \frac{1.0104 G'H}{4000}$

HP. = $\frac{WH}{33,000} = \frac{Q' \times 62.355 \times 2.3094 p}{33,000} = \frac{Q'p}{229.17} = \frac{G'p}{1714.3}$

For the actual horse-power required an allowance must be made for the friction, slips, etc., of engine, pump, valves, and passages.

Depth of Suction. — Theoretically a perfect pump will draw water from a height of nearly 34 feet, or the height corresponding to a perfect vacuum (14.7 lbs. \times 2.309 = 33.95 feet); but since a perfect vacuum cannot be obtained on account of valve-leakage, air contained in the water, and the vapor of the water itself, the actual height is generally less than 30 feet. When the water is warm the height to which it can be lifted by suction decreases, on account of the increased pressure of the vapor. In pumping hot water, therefore, the water must flow into the pump by gravity. The following table shows the theoretical maximum depth of suction for different temperatures, leakage not considered:

Temp. Fahr.	Absolute Pressure of Vapor, lbs. per sq. in.	Vacuum in Inches of Mercury.	Max. Depth of Suction, feet.	Temp. Fahr.	Absolute Pressure of Vapor, lbs. per sq. in.	Vacuum in Inches of Mercury.	Max. Depth of Suction, feet.
102.1	1	27.88	31.6	182.9	8	13.63	15.4
126.3	2	25.85	29.3	188.3	9	11.60	13.1
141.6	3	23.83	27.0	193.2	10	9.56	10.8
153.1	4	21.78	24.7	197.8	11	7.52	8.5
162.3	5	19.74	22.3	202.0	12	5.49	6.2
170.1	6	17.70	20.0	205.9	13	3.45	3.9
176.9	7	15.67	17.7	209.6	14	1.41	1.6

The Deane Single Boiler-fed or Pressure Pump. — Suitable for pumping clear liquids at a pressure not exceeding 150 lbs.

Number.	Sizes.			Gallons per Stroke.	Capacity per min. at Given Speed.		Length in inches.	Width in inches.	Sizes of Pipes.			
	Steam-cyl. inder.	Water-cyl. inder.	Length of Stroke.		Strokes.	Gallons.			Steam.	Exhaust.	Suction.	Discharge.
0	3	2	5	.07	150	10	29 1/2	7	1/2	3/4	1 1/4	1
1	3 1/2	2 1/4	5	.09	150	13	33 1/2	7 1/2	1/2	3/4	1 1/4	1
1 1/2	4	2 3/8	5	.10	150	15	33 1/2	7 1/2	1/2	3/4	1 1/4	1
2	4	2 1/2	5	.11	150	16	33 1/2	7 1/2	1/2	3/4	1 1/4	1
2 1/2	4 3/4	3	5	.15	150	22	34	8 1/2	1/2	3/4	1 1/4	1 1/4
3	5	3 1/4	7	.25	125	31	43 1/2	9 1/4	3/4	1	2	1 1/2
4	5 1/2	3 3/4	7	.33	125	42	43 1/2	9 1/4	3/4	1	2	1 1/2
4 1/2	7	4 1/4	8	.49	120	58	51 1/2	12	1	1 1/2	3	2
5	7	4 1/2	10	.69	100	69	55	12	1	1 1/2	3	2
6	7 1/2	5	10	.85	100	85	55	12	1	1 1/2	3	2
6 1/2	8	5	12	1.02	100	102	63	14	1 1/2	2	4	4
7	10	6	12	1.47	100	147	69	19	1 1/2	2	4	4
8	12	7	12	2.00	100	200	69	19	2	2 1/2	5	4
9	14	8	12	2.61	100	261	69	21	2	2 1/2	5	5

The Deane Single Tank or Light-service Pump. — These pumps will all stand a constant working pressure of 75 lbs. on the water-cylinders.

	Sizes.			Gallons per Stroke.	Capacity per min. at Given Speed.		Length in inches.	Width in inches.	Sizes of Pipes.			
	Steam-cyl. inder.	Water-cyl. inder.	Length of Stroke.		Strokes.	Gallons.			Steam.	Exhaust.	Suction.	Discharge.
4	4	5	.27	130	35	33	9 1/2	1/2	3/4	2	1 1/2	
5	4	7	.38	125	48	45 1/2	15	3/4	1	3	2 1/2	
5 1/2	5 1/2	7	.72	125	90	45 1/2	15	3/4	1	3	2 1/2	
7 1/2	7 1/2	10	1.91	110	210	58	17	1	1 1/2	3	4	
8	6	12	1.46	100	146	67	20 1/2	1	1 1/2	4	4	
8	7	12	2.00	100	200	66	17	3/4	1	4	4	
8	7	12	2.00	100	200	67	20 1/2	1	1 1/2	4	4	
9	8	12	2.61	100	261	68	30	1	1 1/2	5	5	
10	8	12	2.61	100	261	68 1/2	30	1 1/2	2	5	5	
10	10	12	4.08	100	408	68	20 1/2	1	1 1/2	8	8	
10	10	12	4.08	100	408	68 1/2	30	1 1/2	2	8	8	
12	12	12	5.87	100	587	64	24	2	2 1/2	8	8	
12	12	12	5.87	100	587	64	24	2	2 1/2	8	8	
12	12	18	8.79	70	616	95	28 1/2	2	2 1/2	8	8	
12	12	18	8.79	70	616	95	25	1 1/2	2	8	8	
12	14	18	12.00	70	840	95	28 1/2	2	2 1/2	8	8	
14	16	18	15.66	70	1096	95	34	2	2 1/2	12	10	
16	16	18	15.66	70	1096	95	34	2	2 1/2	12	10	
16	16	18	15.66	70	1096	97	34	3	3 1/2	12	10	
16	18	24	26.42	50	1321	115	40	2	2 1/2	14	12	
18	18	24	26.42	50	1321	135	40	3	3 1/2	14	12	

WARNING: This is a 1910 edition. Some of the material may no longer be accurate

Amount of Water raised by a Single-acting Lift-pump. — It is common to estimate that the quantity of water raised by a single-acting bucket-valve pump per minute is equal to the number of strokes in one direction per minute, multiplied by the volume traversed by the piston in a single stroke, on the theory that the water rises in the pump only when the piston or bucket ascends; but the fact is that the column of water does not cease flowing when the bucket descends, but flows on continuously through the valve in the bucket, so that the discharge of the pump, if it is operated at a high speed, may amount to considerably more than that calculated from the displacement multiplied by the number of single strokes in one direction.

Proportioning the Steam-cylinder of a Direct-acting Pump. — Let

- A = area of steam-cylinder; a = area of pump-cylinder;
- D = diameter of steam-cylinder; d = diameter of pump-cylinder;
- P = steam-pressure, lbs. per sq. in.; p = resistance per sq. in. on pumps;
- H = head = 2.309 p; p = 0.433 H;

$$E = \text{efficiency of the pump} = \frac{\text{work done in pump-cylinder}}{\text{work done by the steam-cylinder}}$$

$$A = \frac{ap}{EP}; a = \frac{EAP}{p}; D = d \sqrt{\frac{p}{EP}}; d = D \sqrt{\frac{EP}{p}}; P = \frac{ap}{EA}; p = \frac{EAP}{a}$$

$$\frac{A}{a} = \frac{p}{EP} = \frac{0.433 H}{EP}; H = 2.309 EP \frac{A}{a}. \text{ If } E = 75\%, H = 1.732 P \frac{A}{a}$$

E is commonly taken at 0.7 to 0.8 for ordinary direct-acting pumps. For the highest class of pumping-engines it may amount to 0.9. The steam-pressure P is the mean effective pressure, according to the indicator-diagram; the water-pressure p is the mean total pressure acting on the pump plunger or piston, including the suction, as could be shown by an indicator-diagram of the water-cylinder. The pressure on the pump-piston is frequently much greater than that due to the height of the lift, on account of the friction of the valves and passages, which increases rapidly with velocity of flow.

Speed of Water through Pipes and Pump-passages. — The speed of the water is commonly from 100 to 200 feet per minute. If 200 feet per minute is exceeded, the loss from friction may be considerable.

$$\text{The diameter of pipe required is } 4.95 \sqrt{\frac{\text{gallons per minute}}{\text{velocity in feet per minute}}}$$

For a velocity of 200 feet per minute, diam. = 0.35 x √ gallons per min.

Sizes of Direct-acting Pumps. — The tables on pages 758 and 760 are selected from catalogues of manufacturers, as representing the two common types of direct-acting pump, viz., the single-cylinder and the duplex. Both types are made by most of the leading manufacturers.

Efficiency of Small Direct-acting Pumps. — Chas. E. Emery, in Reports of Judges of Philadelphia Exhibition, 1876, Group xx., says: "Experiments made with steam-pumps at the American Institute Exhibition of 1867 showed that average-sized steam-pumps do not, on the average, utilize more than 50 per cent of the indicated power in the steam-cylinders, the remainder being absorbed in the friction of the engine, but more particularly in the passage of the water through the pump. It may be safely stated that ordinary steam-pumps rarely require less than 120 pounds of steam per hour for each horse-power utilized in raising water, equivalent to a duty of only 15,000,000 foot-pounds per 100 pounds of coal. With larger steam-pumps, particularly when they are proportioned for the work to be done, the duty will be materially increased."

The Worthington Duplex Pump.

STANDARD SIZES FOR ORDINARY SERVICE.

Diameter of Steam-cylinders.	Diameter of Water-plungers.	Length of Stroke.	Displacement in Gallons per Stroke of One Plunger.	Proper Strokes per Minute of One Plunger, varying with kind of work and pressure.	Gallons delivered per Minute by both Plungers at stated Number of Strokes.	Diameter of Plunger required in any single-cylinder pump to do the same work at same speed.	Sizes of Pipes for Short Lengths. To be increased as length increases.			
							Steam-pipe.	Exhaust-pipe.	Suction-pipe.	Discharge-pipe.
3	2	3	.04	100 to 250	3 to 20	2 7/8	3/8	1/2	1 1/4	1
4 1/2	2 3/4	4	.10	100 to 200	20 to 40	4	1/2	3/4	2	1 1/2
5 1/4	3 1/2	5	.20	100 to 200	40 to 80	5	3/4	1 1/4	2 1/2	1 1/2
6	4	6	.33	100 to 150	70 to 100	5 5/8	1	1 1/2	3	2
7 1/2	4 1/2	6	.42	100 to 150	85 to 125	6 3/8	1 1/2	2	4	2 1/2
7 1/2	5	6	.51	100 to 150	100 to 150	7	1 1/2	2	4	3
7 1/2	4 1/2	10	.69	75 to 125	100 to 170	6 3/8	1 1/2	2	4	3
9	5 1/4	10	.93	75 to 125	135 to 230	7 1/2	2	2 1/2	4	3
10	6	10	1.22	75 to 125	180 to 300	8 1/2	2	2 1/2	5	4
10	7	10	1.66	75 to 125	245 to 410	9 7/8	2	2 1/2	6	5
12	7	10	1.66	75 to 125	245 to 410	9 7/8	2 1/2	3	6	5
14	7	10	1.66	75 to 125	245 to 410	9 7/8	2 1/2	3	6	5
12	8 1/2	10	2.45	75 to 125	365 to 610	12	2 1/2	3	6	5
14	8 1/2	10	2.45	75 to 125	365 to 610	12	2 1/2	3	6	5
16	8 1/2	10	2.45	75 to 125	365 to 610	12	2 1/2	3	6	5
18 1/2	8 1/2	10	2.45	75 to 125	365 to 610	12	3	3 1/2	6	5
20	8 1/2	10	2.45	75 to 125	365 to 610	12	4	5	6	5
12	10 1/4	10	3.57	75 to 125	530 to 890	14 1/4	2 1/2	3	8	7
14	10 1/4	10	3.57	75 to 125	530 to 890	14 1/4	2 1/2	3	8	7
16	10 1/4	10	3.57	75 to 125	530 to 890	14 1/4	2 1/2	3	8	7
18 1/2	10 1/4	10	3.57	75 to 125	530 to 890	14 1/4	3	3 1/2	8	7
20	10 1/4	10	3.57	75 to 125	530 to 890	14 1/4	4	5	8	7
14	12	10	4.89	75 to 125	730 to 1220	17	2 1/2	3	10	8
16	12	10	4.89	75 to 125	730 to 1220	17	2 1/2	3	10	8
18 1/2	12	10	4.89	75 to 125	730 to 1220	17	3	3 1/2	10	8
20	12	10	4.89	75 to 125	730 to 1220	17	4	5	10	8
18 1/2	14	10	6.66	75 to 125	990 to 1660	19 3/4	3	3 1/2	12	10
20	14	10	6.66	75 to 125	990 to 1660	19 3/4	4	5	12	10
17	10	15	5.10	50 to 100	510 to 1020	14	3	3 1/2	8	7
20	12	15	7.34	50 to 100	730 to 1460	17	4	5	12	10
20	15	15	11.47	50 to 100	1145 to 2290	21
25	15	15	11.47	50 to 100	1145 to 2290	21

Speed of Piston. — A piston speed of 100 feet per minute is commonly assumed as correct in practice, but for short-stroke pumps this gives too high a speed of rotation, requiring too frequent a reversal of the valves. For long-stroke pumps, 2 feet and upward, this speed may be considerably exceeded, if valves and passages are of ample area.

Number of Strokes Required to Attain a Piston Speed from 50 to 125 Feet per Minute for Pumps Having Strokes from 3 to 18 Inches in Length.

Speed of Piston, in feet per min.	Length of Stroke in Inches.									
	3	4	5	6	7	8	10	12	15	18
	Number of Strokes per Minute.									
50	200	150	120	100	86	75	60	50	40	33
55	220	165	132	110	94	82.5	66	55	44	37
60	240	180	144	120	103	90	72	60	48	40
65	260	195	156	130	111	97.5	78	65	52	43
70	280	210	168	140	120	105	84	70	56	47
75	300	225	180	150	128	112.5	90	75	60	50
80	320	240	192	160	137	120	96	80	64	53
85	340	255	204	170	146	127.5	102	85	68	57
90	360	270	216	180	154	135	108	90	72	60
95	380	285	228	190	163	142.5	114	95	76	63
100	400	300	240	200	171	150	120	100	80	67
105	420	315	252	210	180	157.5	126	105	84	70
110	440	330	264	220	188	165	132	110	88	73
115	460	345	276	230	197	172.5	138	115	92	77
120	480	360	288	240	206	180	144	120	96	80
125	500	375	300	250	214	187.5	150	125	100	83

Piston Speed of Pumping-engines. — (John Birkinbine, *Trans. A. I. M. E.*, v. 459.) — In dealing with such a ponderous and unyielding substance as water there are many difficulties to overcome in making a pump work with a high piston speed. The attainment of moderately high speed is, however, easily accomplished. Well-proportioned pumping-engines of large capacity, provided with ample water-ways and properly constructed valves, are operated successfully against heavy pressures at a speed of 250 ft. per minute, without "thug," concussion, or injury to the apparatus, and there is no doubt that the speed can be still further increased.

Speed of Water through Valves. — If areas through valves and water passages are sufficient to give a velocity of 250 ft. per min. or less, they are ample. The water should be carefully guided and not too abruptly deflected. (F. W. Dean, *Eng. News*, Aug. 10, 1893.)

Boiler-feed Pumps. — Practice has shown that 100 ft. of piston speed per minute is the limit, if excessive wear and tear is to be avoided.

The velocity of water through the suction-pipe must not exceed 200 ft. per minute, else the resistance of the suction is too great.

The approximate size of suction-pipe, where the length does not exceed 25 ft. and there are not more than two elbows, may be found as follows:

7/10 of the diameter of the cylinder multiplied by 1/100 of the piston speed in feet. For duplex pumps of small size, a pipe one size larger is usually employed. The velocity of flow in the discharge-pipe should not exceed 500 ft. per minute. The volume of discharge and length of pipe vary so greatly in different installations that where the water is to be forced more than 50 ft. the size of discharge-pipe should be calculated for the particular conditions, allowing no greater velocity than 500 ft. per minute. The size of discharge-pipe is calculated in single-cylinder pumps from 250 to 400 ft. per minute. Greater velocity is permitted in the larger pipes.

In determining the proper size of pump for a steam-boiler, allowance must be made for a supply of water sufficient for the maximum capacity of the boiler when over driven, with an additional allowance for feeding water beyond this maximum capacity when the water level in the boiler becomes low. The average run of horizontal tubular boilers will evaporate from 2 to 3 lbs. of water per sq. ft. of heating-surface per hour, but

may be driven up to 6 lbs. if the grate-surface is too large or the draught too great for economical working.

Pump-Valves. — A. F. Nagle (*Trans. A. S. M. E.*, x. 521) gives a number of designs with dimensions of double-beat or Cornish valves used in large pumping-engines, with a discussion of the theory of their proportions. Mr. Nagle says: There is one feature in which the Cornish valves are necessarily defective, namely, the lift must always be quite large, unless great power is sacrificed to reduce it. A small valve presents proportionately a larger surface of discharge with the same lift than a larger valve, so that whatever the total area of valve-seat opening, its full contents can be discharged with less lift through numerous small valves than with one large one. See also Mr. Nagle's paper on Pump Valves and Valve Areas, *Trans. A. S. M. E.*, 1909.

Henry R. Worthington was the first to use numerous small rubber valves in preference to the larger metal valves. These valves work well under all the conditions of a city pumping-engine. A volute spring is generally used to limit the rise of the valve.

In the Leavitt high-duty sewerage-engine at Boston (*Am. Machinist*, May 31, 1884), the valves are of rubber, 3/4 inch thick, the opening in valve-seat being 13 1/2 X 4 1/2 inches. The valves have iron face and back-plates, and form their own hinges.

The large pumping engines at the St. Louis water works have rubber valves 3 1/2 in. outside diam. There are seven valve cages in each of the suction and discharge diaphragms, each cage having 28 valves. The aggregate free area of 196 valves is 7.76 sq. ft., the area of one plunger being 6.26 sq. ft. The suction and discharge pipes are each 36 in. diam., = 7.07 sq. ft. area. (Bull. No. 1609, Allis-Chalmers Co. Such liberal proportions of valves are found usually only in the highest grade of large high-duty engines. In small and medium sized pumps a valve area equal to one-third the plunger area is commonly used.)

The Worthington "High-Duty" Pumping Engine dispenses with a fly-wheel, and substitutes for it a pair of oscillating hydraulic cylinders, which receive part of the energy exerted by the steam during the first half of the stroke, and give it out in the latter half. For description see catalogue of H. R. Worthington, New York. A test of a triple expansion condensing engine of this type is reported in *Eng. News*, Nov. 29, 1904. Steam cylinders 13, 21, 34 ins.; plungers 30 in., stroke 25 in. Steam pressure, 124 lbs. Total head, 79 ft.; capacity, 14,267,000 gal. in 24 hrs. Duty per million B.T.U., 102,224,000 ft.-lbs.

The d'Auria Pumping Engine substitutes for a fly-wheel a compensating cylinder in line with the plunger, with a piston which pushes water to and fro through a pipe connecting the ends of the cylinder. It is built by the Builders' Iron Foundry, Providence, R. I.

A 72,000,000-gallon Pumping Engine at the Calf Pasture Station of the Boston Main Drainage Works is described in *Eng. News*, July 6, 1905. It has three cylinders, 18 1/2, 33 and 52 3/4 ins., and two plungers, 60-in. diam.; stroke of all, 10 ft. The piston-rods of the two smaller cylinders connect to one end of a walking beam and the rod of the third cylinder to the other. Steam pressure 185 lbs. gauge; revolutions per min., 17; static head 37 to 43 ft. Suction valves 128; ports, 4 X 16 1/4 in.; total port area 8576 sq. in. Delivery valves, 96; ports, 4 X 16 3/4 to 20 3/4 in.; total port area 7215 sq. in. The valves are rectangular, rubber flaps, backed and faced with bronze and weighted with lead. They are set with their longest dimension horizontal, on ports which incline about 45° to the horizontal. At 17 r.p.m. the displacement is 72,000,000 gallons in 24 hours.

The Screw Pumping Engine of the Kinnickinick Flushing Tunnel, Milwaukee, has a capacity of 30,000 cubic feet per minute (= 323,000,000 gal. in 24 hrs.) at 55 r.p.m. The head is 3 1/2 ft. The wheel 12.5 ft. diam., made of six blades, revolves in a casing set in the tunnel lining. A cone, 6 ft. diam. at the base, placed concentric with the wheel on the approach side diverts the water to the blades. A casing beyond the wheel contains stationary deflector blades which reduce the swirling motion of the water (Allis-Chalmers Co., Bulletin No. 1610). The two screw pumping engines of the Chicago sewerage system have wheels 14 3/4 ft. diam., consisting of a hexagonal hub surmounted by six blades, and revolving in cylindrical casings 16 ft. long, allowing 1/4 in. clearance at the sides. The pumps are driven by vertical triple-expansion engines with cylinders 22, 38 and 62 in. diam., and 42 in. stroke.

Finance of Pumping Engine Economy.—A critical discussion of the results obtained by the Nordberg and other high-duty engines is printed in *Eng. News*, Sept. 27, 1900. It is shown that the practical question in most cases is not how great fuel economy can be reached, but how economical an engine it will pay to install, taking into consideration interest, depreciation, repairs, cost of labor and of fuel, etc. The following table is given, showing that with low cost of fuel and labor it does not pay to put in a very high duty engine. Accuracy is not claimed for the figures; they are given only to show the method of computation that should be used, and to show the influence of different factors on the final result.

TABULAR STATEMENT OF TOTAL ANNUAL COST OF PUMPING WITH AN 800-H.P. ENGINE, AS INFLUENCED BY VARYING DUTY OF ENGINE, VARYING PRICE OF FUEL, AND VARYING TIME OF OPERATION.

	Duty per million B.T.U.				
	50.	100.	120.	150.	180.
First cost:					
Engine.....	\$24,000	\$48,000	\$68,000	\$118,000	\$148,000
Engine, per H.P.....	30.00	60.00	85.00	147.50	185.00
Boilers, economizers.....	27,000	13,500	11,250	9,000	7,500
Engine and boilers.....	51,000	61,500	79,250	127,000	155,500
Int. and depreciation:					
On engine, at 6%.....	1,440	2,880	4,080	7,080	8,880
Boilers, 8%.....	2,160	1,080	900	720	600
Total.....	3,600	3,960	4,980	7,800	9,480
Labor per annum.....	6,022	6,022	7,655	9,307	10,220
Fuel cost:					
4,000 hrs. per yr.:					
\$3.00 per ton.....	17,280	8,640	7,200	5,760	4,800
4.00 per ton.....	23,040	11,520	9,600	7,680	6,400
5.00 per ton.....	28,800	14,400	12,400	9,600	8,000
6,000 hrs. per yr.:					
\$3.00 per ton.....	25,920	12,960	10,800	8,640	7,200
4.00 per ton.....	34,560	17,280	14,400	11,520	9,600
5.00 per ton.....	43,200	21,600	18,600	14,400	12,000
Total annual cost:					
4,000 hrs. per yr.:					
Coal, \$3 per ton.....	26,902	18,622	19,835	22,867	24,500
4 per ton.....	32,662	21,502	22,235	24,787	25,100
5 per ton.....	38,422	24,382	25,035	26,707	27,700
6,000 hrs. per yr.:					
Coal, \$3 per ton.....	35,522	22,942	23,435	25,747	26,900
4 per ton.....	44,182	27,262	27,035	28,627	29,300
5 per ton.....	52,822	31,582	31,235	31,507	31,700

Cost of Electric Current for Pumping 1000 Gallons per Minute 100 ft. High. (Theoretical H.P. with 100% efficiency = 100,000 ÷ 3958.9 = 25.259 H.P.)

Assume cost of current = 1 cent per K.W. hour delivered to the motor; efficiency of motor = 90%; mechanical efficiency of triplex pumps = 80%; of centrifugal pumps = 72%; combined efficiency, triplex pumps, 72%; centrifugal, 64.3%. 1 K.W. = 1.34 electrical H.P. on wire.

Triplex, 1.34 X 0.72 = 0.9648 pump H.P.; X 33,000 = 31,838 ft.-lbs. per min.

Centrifugal, 1.34 X 0.648 = 0.86382 pump H.P.; X 33,000 = 28,654 ft.-lbs. per min.

1000 gallons 100 ft. high = 333,400 ft.-lbs. per min.

Triplex, 333,400 ÷ 31,838 = 26.1763 K.W. X 8760 hours per year X \$0.01 = \$2293.04.

Centrifugal, 333,400 ÷ 28,655 = 29.0840 K.W. X 8760 hours per year X \$0.01 = \$2547.76.

For 100% efficiency, \$2293.04 X 0.72 = \$1650.00. For any other efficiency, divide \$1650.00 by the efficiency. For any other cost per K.W. hour, in cents, multiply by that cost.

Cost of Fuel per Year for Pumping 1,000 Gallons per Minute 100 Ft. High by Steam Pumps.

(1)	(2)		(3)	(4)	(5)	(6)	(7)
	100% Effy.	90%					
10.	198.	178.2	142.56	0.5846	0.42090	153.63	460.89
11.88	166.667	150.	120.	0.6945	0.50004	182.51	547.53
14.	141.433	127.87	101.83	0.8184	0.58926	215.08	645.24
14.256	138.889	125.	100.	0.8334	0.60005	219.02	657.06
15.	132.	118.8	95.04	0.8769	0.63125	230.44	691.32
16.	123.75	111.375	89.10	0.9354	0.67344	245.80	737.40
17.82	111.111	100.	80.	1.0417	0.75006	273.77	821.31
20.	99.	89.1	71.28	1.1692	0.84180	307.26	921.78
23.76	83.333	75.	60.	1.3890	1.00008	365.03	1095.09
30.	66.	59.4	47.52	1.7538	1.26270	460.89	1382.67
35.64	55.556	50.	40.	2.0835	1.50012	547.54	1642.62
40.	49.5	44.5	35.64	2.3384	1.68360	614.52	1843.56
47.52	41.667	37.5	30.	2.7780	2.00016	730.06	2190.18
50.	39.6	35.64	28.51	2.9230	2.10450	768.15	2304.45
a	b	c	d	e	f	g	h

- (1) Lbs. steam per I.H.P. per hour.
 - (2) Duty million ft.-lbs. per 1000 lbs. steam, b, 100% effy., c, 90%.
 - (3) Duty per 100 lbs. coal, 90% effy., 8 lbs. steam per lb. coal.
 - (4) Lbs. coal per min. for 1000 gals., 100 ft. high.
 - (5) Tons, 2000 lbs. in 24 hours.
 - (6) Tons per year, 365 days.
 - (7) Cost of fuel per year at \$3.00 per ton.
- Factors for calculation: $b = 1980 \div a$; $c = b \times 0.9$; $d = c \times 0.8$; $e = 8334 \div 100 d$; $f = e \times 0.72$; $g = f \times 365$; $h = g \times 3$.
- For any other cost of coal per ton, multiply the figures in the last column by the ratio of that cost to \$3.00.

Cost of Pumping 1000 Gallons per Minute 100 ft. High by Gas Engines.

Assume a gas engine supplied by an anthracite gas producer using 1.5 lbs. of coal per brake H.P. hour, coal costing \$3.00 per ton of 2000 lbs. Efficiency of triplex pump 80%, of centrifugal pump, 72%. 1000 gals. per min. 100 ft. high = 833,400 ft.-lbs. per min. \div 33,000 = 25.2545 H.P. Fuel cost per brake H.P. hour 1.5 lbs. \times 300 cents \div 2000 = 0.225 cent \times 8760 hours per year = \$19.71 per H.P. \times 25.2545 = \$497.766 for 100% efficiency. For 80% effy., \$622.21; for 72% effy., \$691.34; or the same as the cost with a steam pumping engine of 95,000,000 foot-pounds duty per 100 lbs. of coal.

Cost of Fuel for Electric Current.

Based on 10 lbs. steam per I.H.P. hour, 8 lbs. steam per lb. coal, or 1.25 lbs. coal per I.H.P. per hour. (Electric line loss not included.) Efficiency of engine 0.90, of generator 0.90, combined effy. 0.81. I.H.P. = 0.746 K.W., $0.746 \times 0.81 = 0.6426$ K.W. on wire for 10 lbs. steam. Reciprocal = 16.5492 lbs. steam per K.W. hour. 8 lbs. steam per lb. coal = 2.06865 lbs. coal, at \$3.00 per ton of 2,000 lbs. = 0.3103 cents per K.W. hour.

Lbs. steam per I.H.P. hr. —	12	14	16	18	20	30	40
Fuel cost, cents per K.W. hr. —	0.3724	0.4344	0.4965	0.5585	0.6206	0.9309	1.2412

CENTRIFUGAL PUMPS.

Theory of Centrifugal Pumps. — Bulletin No. 173 of the Univ. of Wisconsin, 1907, contains an investigation by C. B. Stewart of a 6-in. centrifugal pump which gave a maximum efficiency, under the best conditions of load, of only 32%, together with a discussion of the general theory of M. Combe, 1840, which has been followed by Weishach, Rankine, and Unwin. Mr. Stewart says that the theory of the centrifugal

pump, at the times of these writers, seemed practically settled, but it was found later that the pump did not follow the theoretical laws derived, and the subject is still open for investigation. The theoretical head developed by the impeller can be stated for the condition of impending delivery, but as soon as flow begins the ordinary theory does not seem to apply. Experiment shows that the main difficulty to be overcome in order to secure high efficiency with the centrifugal pump is in providing some means of transforming the portion of the energy which exists in the kinetic form, at the outlet of the impeller, to the pressure form, or of reducing the loss of head in the pump casing to a minimum. The theoretical head for impending delivery is $V^2 \div 2g$, while experiment shows that the maximum actual head approaches $V^2 \div 2g$ as a limit. As the flow commences each pound of water discharged will possess the kinetic energy $V^2 \div 2g$ in addition to its pressure energy. To secure high efficiency some means must be found of utilizing this kinetic energy. The use of a free vortex or whirlpool, surrounding the impeller, and this surrounded by a suitable spiral discharge chamber, is practically accepted as one means of utilizing the energy of the velocity head. Guide vanes surrounding the impeller also provide a means of changing velocity head to pressure head, but the comparative advantage of these two means cannot be stated until more experimental data are obtained.

The catalogue of the Alberger Pump Co., 1908, contains the following: It was not until the year 1901 that the centrifugal pump was shown to be nothing more or less than a water turbine reversed, and when designed on similar lines was capable of dealing with heads as great, and with efficiencies as good, as could be obtained with the turbines themselves. Since this date great progress has been made in both the theory and design, until now it is quite possible to build a pump for any reasonable conditions and to accurately estimate the efficiency and other characteristics to be expected during actual operation.

The mechanical power delivered to the shaft of a centrifugal pump by the prime mover is transmitted to the water by means of a series of radial vanes mounted together to form a single member called the impeller, and revolved by the shaft. The water is led to the inner ends of the impeller vanes, which gently pick it up and with a rapidly accelerating motion cause it to flow radially between them so that upon reaching the outer circumference of the impeller the water, owing to the velocity and pressure acquired, has absorbed all the power transmitted to the pump shaft. The problem to be solved in impeller design is to obtain the required velocity and pressure with the minimum loss in shock and friction. Since the energy of the water on leaving the pump is required to be mostly in the form of pressure, the next problem is to transform into pressure the kinetic energy of the water due to its velocity on leaving the impeller and furthermore to accomplish this with the least possible loss.

The next consideration in impeller design is the proportions of the vanes and the water passages, and to properly solve this problem an extensive use of intricate mathematical formulae is necessary in addition to a wide knowledge of the practical side of the question. It is possible to obtain the same results as to capacity and head with practically an infinite number of different shapes, each of which gives a different efficiency as well as other varied characteristics. The change from velocity to pressure is accomplished by slowing down the speed of the water in an annular diffusion space extending from the impeller to the volute casing itself and so designed that there is the least loss from eddies or shock. It is necessary that this change shall take place gradually and uniformly, as otherwise most of the velocity would be consumed in producing eddies. With a proper design of the diffusion space and volute it is possible to transform practically the whole of the velocity into pressure so that the loss from this source may be very small.

It is necessary also to furnish a uniform supply of water to all parts of the inlet or suction opening of the impeller, for unless all the impeller vanes receive the same quantity of water at their inner edges, they cannot deliver an equal quantity at their outer edges, and this would seriously interfere with the continuity of the flow of water and the successful operation of the pump.

Design of a Four-stage Turbine Pump. — C. W. Clifford, in *Am. Mach.*, Oct. 17, 1907, describes the design of a four-stage pump of a capacity of 2300 gallons per minute = 5.124 cu. ft. per sec. Following

is an abstract of the method adopted. The total head was 1000 ft. Three sets of four-stage pumps were used at elevations of 16, 332 and 668 ft., the discharge of the first being the suction of the second, and so on. The speed of the motor shaft is 850 r.p.m. This gives, for the diameter of the impeller, $d = 12 \times 60 \times 75.05 \div 850 \pi = 20.24$ in. Circumference $C = 63.6$ in; $h =$ head for each impeller, in ft.

$V =$ peripheral speed $= 1.015 \sqrt{2gh} = 75.05$ ft. per sec., 1.015 being an assumed coefficient. The velocity V is divided into two parts by the formula $V_1 = V - V_2$; $V_2 = 2gh \div 2V$; whence $V_1 = 38.65$ ft. per sec. This is the tangential component of the actual velocity of the water as it leaves the vane of the impeller. The radial component, or the radial velocity, was taken approximately at 8 ft. per sec.; $8 \div 38.65 =$ tang. of $11^\circ 42'$, the calculated angle between the vane and a tangent at the periphery. Taking this at 12° gives tang. $12^\circ \times 38.65 = 8.215$ ft. per sec. $=$ radial velocity V_r . The outflow area at the impeller then is $5.124 \times 144 \div (8.215 \times 0.85) = 105$ sq. in.; the 0.85 is an allowance for contraction of area in the impeller. The thickness of the vane measured on the periphery is approximately $1\frac{3}{4}$ in.; taking this into account the width of the impeller was made $1\frac{7}{8}$ in. ($105 \div (63.6 - 6 \times 1\frac{3}{4}) = 1.98$ in.). The vanes were then plotted as shown in Fig. 148, keeping the distance between them nearly constant and of uniform section. Care was taken to increase the velocity as gradually as possible.

The suction velocity was 9.37 ft. per sec., the diam. of the opening being 10 in. This was increased to 11 ft. per sec. at the opening of the impeller, from which, after deducting the area of the shaft, the diameter, d , of the impeller inlet was found. Three long and three short vanes were used to reduce the shock.

The diffusive vanes, Fig. 149, were then designed, the object being to change the direction of the water to a radial one, and to reduce the velocity gradually to 2 ft. per sec. at the discharge through the ports.

Fig. 150 shows a cross-section of the pump. The pumps were thoroughly tested, and the following figures are derived from a mean curve of the results:

Gals. per min.	500	1000	1500	2000	2200	2400	2500	3000	3500
Efficiency, %	30	51	68	78	79	78	76	61	31

Relation of the Peripheral Speed to the Head. — For constant speed the discharge of a centrifugal pump for any lift varies with the square root of the difference between the actual lift and the hydrostatic head created by the pump without discharge. If any centrifugal pump connected to a source of supply and to a discharge pipe of considerable height is put in revolution, it will be found that it is necessary to maintain a certain peripheral runner speed to hold the water 1 ft. high without discharge, and that for any other height the requisite speed will be very nearly as the square of the velocity for 1 ft.

Experiments prove that the peripheral speed in ft. per min. necessary to lift water to a given height with vanes of different forms is approximately as follows: $a, 481 \sqrt{h}$; $b, 554 \sqrt{h}$; $c, 610 \sqrt{h}$; $d, 780 \sqrt{h}$; $e, 394 \sqrt{h}$. a is a straight radial vane, b is a straight vane bent backward, c is a curved vane, its extremity making an angle of 27° with a tangent to the impeller, d is a curved vane with an angle of 18° , e is a vane curved in the reverse direction so that outer end is radial.

Applying the above formula, speed ft. per min. $=$ coeff. $\times \sqrt{h}$, to the design of Mr. Clifford, gives $60 \times 75.05 = C \times \sqrt{85}$, whence $C = 488$. The vane angle was 12° . It is evident that the value of C depends on other things than the shape or angle of the vanes, such as smoothness of the vanes and other surfaces, shape and area of the diffusion vanes, and resistance due to eddies in the pump passages.

The coefficient varies with the shape of the vanes; this means that different speeds are necessary to hold water to the same heights with these different forms of vanes, and for any constant speed or lift there must be a form of vane more suitable than any other. It would seem at first glance that the runner which creates a given hydrostatic head with the least peripheral velocity must be the most efficient, but practically it is apparent from tests that the curvature of the vanes can be designed to suit the speed and lift without materially lowering the efficiency. (L. A. Hicks, *Eng. News*, Aug. 9, 1900.)

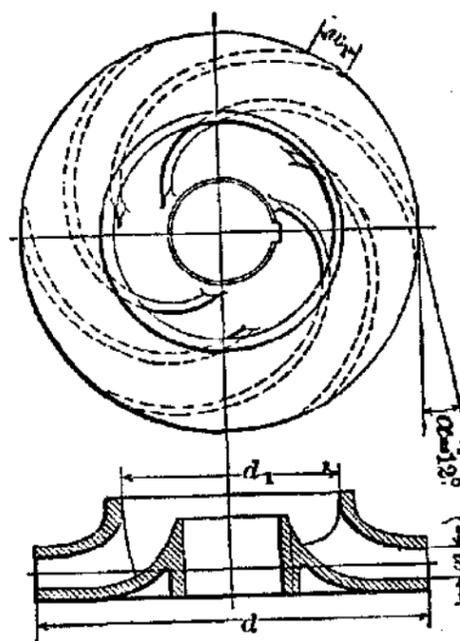

FIG. 148.

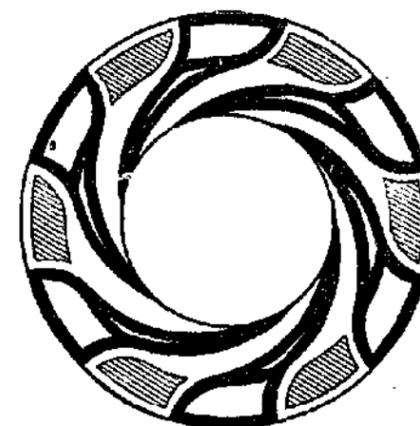

FIG. 149.

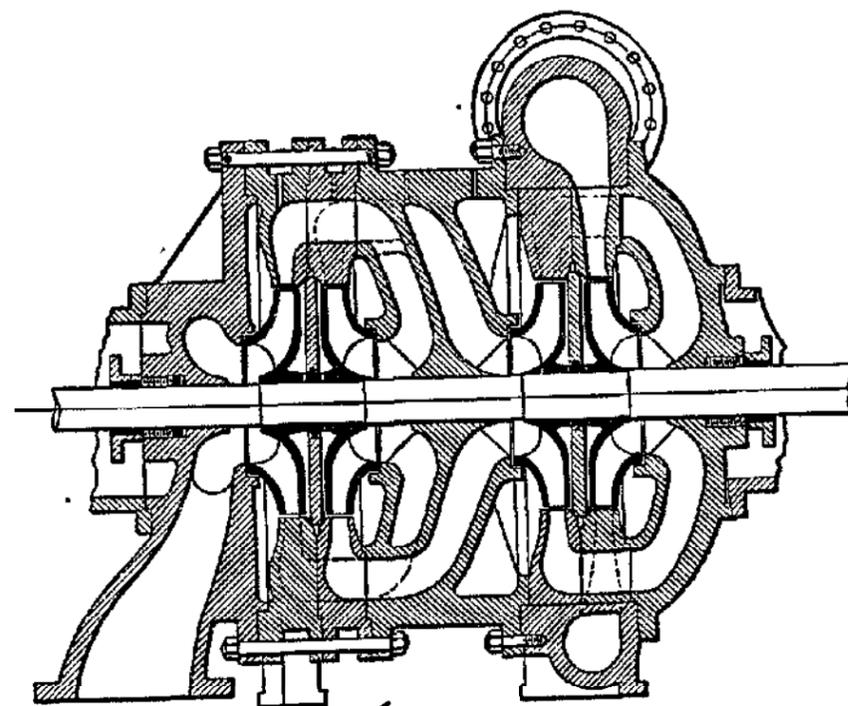

FIG. 150.

A Combination Single-stage and Two-stage Pump, for low and high heads, designed by Rateau, is described by J. B. Sperry in *Power*, July 13, 1909. It has two runners, one carried on the main driving-shaft, and the other on a hollow shaft, driven from the main shaft by a clutch. It has two discharge pipes, either one of which may be closed. When the hollow shaft is uncoupled, one runner only is used, and the pump is then a single-stage pump for low heads. When the shafts are coupled, the water passes through both runners, and may then be delivered against a high head.

Tests of De Laval Centrifugal Pumps. — The tables given below contain a condensed record of tests of three De Laval pumps made by Prof. J. E. Denton and the author in April, 1904. Two of the pumps were driven by De Laval steam turbines, and the other one by an electric motor. In the two-stage pump the small wheel was coupled direct to the high-speed shaft of the turbine, running at about 20,500 r.p.m., and the large wheel was coupled to the low-speed shaft, which is driven by the first through gears of a ratio of 1 to 10. The water delivery and the duty were computed from weir measurements, Francis's formula being used, and this was checked by calibration of the weir at different heads by a tank, the error of the formula for the weir used being less than 1%. Pitot tube measurements of the water delivered through a nozzle were also made.

One inch below the center of the nozzle was located one end of a thin half-inch brass tube, tapered so as to make an orifice of 3/32 inch diameter. The other end of this tube was connected to a vertical glass tube, fastened to the wall of the testing room, graduated in inches over a height of about 30 ft. The stream of water issuing from the nozzle impinged upon the orifice of the brass tube, and thereby maintained a height of water in the glass tube. This height afforded a "Pitot Tube Basis" of measurement of the quantity of water flowing, the reliability of which was tested by the flow as determined from the weir. The Pitot tube gave the same result as the weir from the formula $Q_1 = C \times \text{Area of Nozzle} \times \sqrt{2gh}$ with a value of C varying only between 0.953 and 0.977 for the large nozzle, and between 0.942 and 0.960 for the small nozzle.

TEST OF STEAM TURBINE CENTRIFUGAL PUMP, RATED AT 1700 GAL. PER MIN., 100 FT. HEAD.

No. of Test.	Steam Press. at the Governor Valve. Lbs. per Sq. In.		Inches Vacuum.	Revolutions per Minute.	* Brake Horse-Power Calculated.	* Steam per Brake Horse-power.	Duty: — Millions of Foot-Lbs. per 1000 Lbs. of Steam.	Water Horse-Power.	Total Head, including Suction, Feet.	Water Pumped, Gals. per Min.	Efficiency of Pump.
	Above.	Below.									
6	190	126	25 1/4	1,547	47.7	25.45	37.43	22.95	45.97	1,978	0.481
10	190	148	25 1/2	1,536	56.65	24.42	50.44	34.95	70.75	1,958	0.617
1	188	155.2	25	1,553	59.6	24.06	61.50	44.54	94.9	1,860	0.747
2	188	153.5	25 1/4	1,547	58.9	24.21	61.86	44.55	100.37	1,759	0.756
3	188	150.7	25 1/4	1,540	57.7	24.33	61.47	43.59	106.94	1,615	0.755
4	188	143.5	25 1/2	1,549	54.8	24.53	60.00	40.72	115.46	1,398	0.743
5	188	161	25 3/8	1,540	47.5	24.5	54.47	31.80	125.85	1,001	0.676
6A	189.5	170	25 1/2	1,565	24.9	Shut-off T.	142.15
†7	189	169.5	1,537	45.15	43.85	95.14	1,826
†8	189	169	1,535	45.12	43.82	99.05	1,753
†9	189	169.7	1,538	44.62	42.93	104.42	1,629

* The brake H.P. and the steam per B.H.P. hour were calculated by a formula derived from Prony brake tests of the turbine.
† Non-condensing.

TEST OF ELECTRIC MOTOR CENTRIFUGAL PUMP. DIAM. OF PUMP WHEEL 8 9/32 IN. RATED AT 1200 GAL. PER MIN. — 45 FT. HEAD. 2000 REVS. PER MIN.

No. of Test.	Volts.	Amperes.	E.H.P.	* Brake Horse-Power.	Revolutions per Minute.	Cubic Feet of Water per Sec. by Weir.	Water Horse-Power.	Total Head, Feet.*	Water Pumped, Gals. per Min.	Efficiency of Pump.
1.....	242.5	55.2	17.94	15.07	2,006	3.158	10.25	28.52	1,417	0.680
2.....	242.3	54.8	17.80	14.94	1,996	3.126	10.67	30.12	1,403	0.714
3.....	242	59	19.14	16.22	1,996	2.885	11.80	36.1	1,295	0.728
4.....	242	62.4	20.24	17.27	2,005	2.826	12.18	38.05	1,268	0.706†
5.....	241.8	62.9	20.39	17.41	2,000	2.525	13.06	45.66	1,133	0.750
6.....	240.8	66	21.30	18.28	2,005	2.504	13.40	47.25	1,124	0.733†
7.....	241.4	64	20.71	17.71	2,003	2.197	13.12	52.7	986	0.742
8.....	239.7	66.3	21.30	18.28	1,997	2.179	13.15	53.28	978	0.720†
9.....	240.9	63.2	20.41	17.43	2,007	1.735	11.42	58.10	779	0.665†
10.....	242	62	20.11	17.14	2,003	1.760	11.71	58.76	790	0.683
11.....	248	34	11.30	8.74	2,040	Shut-off	68.39

* Brake H.P. calculated from a formula derived from a brake test of the motor.

† Tests marked † were made with the pump suction throttled so as to make the suction equal to about 22 ft. of water column. In the other tests the suction was from 5.6 to 10.9 ft.

TEST OF STEAM TURBINE TWO-STAGE CENTRIFUGAL PUMP. RATED AT 250 GAL. PER MIN. 700 FT. HEAD. LARGE PUMP WHEEL, 2050 R.P.M.; SMALL WHEEL, 20,500 R.P.M.

No. of Test.	Steam Press. at the Governor Valve. Lbs. per Sq. In.		Pressure between Pumps. Lbs. Sq. In.	Vacuum, In.	Steam Consumption, Lbs.	Revolutions per Minute.	Cu. Ft. of Water per Sec. by Weir.	Total Head, Feet.	Water Horse-Power.	Water Quantity, Gals. per Min. by Weir.	Duty. — Millions of Ft.-Lbs. per 1000 Lbs. of Steam.	Lbs. of Steam per W.H.P. per Hour.
	Above.	Below.										
186	120.7	28.1	25.25	341	2,104	0.830	135.76	12.83	373	18.63	106.2	
175	138.3	27.5	24.4	2,092	0.799	193.85	17.54	359	
181	162.3	27.05	25.5	385	2,074	0.790	288	25.78	354	28.73	68.9	
178	173.7	26.2	25.5	316	2,056	0.775	358.78	31.50	347	32.9	60.2	
180	180.3	26	25.3	326	2,027	0.750	420.5	35.60	336	36.00	54.9	
181	182	25.3	25.25	325	2,001	0.731	494.35	40.92	328	41.55	47.7	
180	182	24.9	25.35	1,962	0.697	585.06	46.19	312	
186	188.3	25.5	26.3	331	2,014	0.664	632.6	47.58	299	47.43	41.77	
185	185	30	25.3	331	2,012	0.558	756.38	47.81	251	47.67	41.5	
185	184	29	26.5	325	2,029	0.544	781.4	48.15	244	48.88	40.50	

A Test of a Lea-Deagan Two-Stage Pump, by Prof. J. E. Denton, is reported in *Eng. Rec.*, Sept. 29, 1906. The pump had a 10-in. suction and discharge line, and impellers 24 in. diam., each with 8 blades. The following table shows the principal results, as taken from plotted curves of the tests. The pump was designed to give equal efficiency at different speeds.

Gal. per min.	400	800	1200	1600	2000	2400	2800	3000	3200	3400	3600	3800
Efficiency.												
400 r.p.m.	42	61	69	75	77	77	70					
500 "	39	56	65	71	75	77	77.6	77	74	70		
600 "	35	50	62	68	71	74	76	77	78	78	76	54
Head.												
400 r.p.m.	55	55	53	51	47	42	34					
500 "	63	86	84	82	78	73	67	63	58	51		
600 "	126	127	125	122	118	115	107	104	101	97	87	55

The following results were obtained under conditions of maximum efficiency:

400 r.p.m.	77.7% effy.	2296 gals. per min.	43.5 ft. lift
500 "	77.6 "	2794 "	67.4 "
600 "	77.97 "	3235 "	100.7 "

A High-Duty Centrifugal Pump.—A 45,000,000 gal. centrifugal pump at the Deer Island sewage pumping station, Boston, Mass., was tested in 1896 and showed a duty of 95,867,476 ft.-lbs., based on coal fired to the boilers. — (Allis-Chalmers Co., Bulletin No. 1062.)

Rotary Pumps.—Pumps with two parallel geared shafts carrying vanes or impellers which mesh with each other, and other forms of positive driven apparatus, in which the water is pushed at a moderate velocity, instead of being rotated at a high velocity as in centrifugal pumps, are known as rotary pumps. They have an advantage over reciprocating pumps in being valveless, and over centrifugal pumps in working under variable heads. They are usually not economical, but when carefully designed with the impellers of the correct cycloidal shape, like those used in positive rotary blowers, they give a moderately high efficiency.

Tests of Centrifugal and Rotary Pumps. (W. B. Gregory, *Bull.* 183, U. S. Dept. of Agriculture, 1907.)—These pumps are used for irrigation and drainage in Louisiana. A few records of small pumps, giving very low efficiencies, are omitted. Oil was used as fuel in the boilers, except in the pump of the New Orleans drainage station No. 7 figures in the last column), which was driven by a gas-engine.

Actual lift.....	15.5	16.2	11.2	30.2	9.5	28.7	31.7	6.5	31.6	13.4
Disch. cu. ft. per sec...	72.6	157.0	116.0	93.2	71.4	68.7	85.6	130.5	152.9	30.5
Water horse-power....	127.5	287.4	147.1	318.0	76.5	222.8	306.8	98.5	547.9	46.2
I.H.P.....	155.6	671.2	229.8	648.0	137.7	503.9	452.3	193.6	657.7	90.6
Effy., engine, gearing and pumps.....	81.7	42.9	64.2	49.9	55.6	44.3	67.9	51.0	83.3	51.0
Duty, per 1000 lbs. stea.	72.1	34.3	40.7	33.8		33.9	78.2	31.4	75.4	
Duty, per million B.T.U. in fuel.....	37.8	18.3	20.7	24.2	22.1	17.3	51.1	16.7	50.1	82.4
Therm. effy. from stea.	8.15	4.23	4.68	4.16		4.09	9.70	3.95	9.61	
Kind of engine, and pump.....	a, f	b, g	b, g	b, g	c, g	b, g	a, g	d, g	a, g	e, g

a, Tandem compound condensing Corliss; b, Simple condensing Corliss; c, Simple non-condensing Corliss; d, Triple-expansion condensing, vertical; e, Three-cylinder vertical gas-engine, with gas-producer, 0.85 lb. coal per I.H.P. per hour; f, Rotary pump; g, Cycloidal rotary.

The relatively low duty per million B.T.U. is due to the low efficiency of the boilers. The test whose figures are given in the next to the last column is reported by Prof. Gregory in *Trans. A. S. M. E.*, to vol. xxviii.

DUTY TRIALS OF PUMPING-ENGINES.

A committee of the A. S. M. E. (*Trans.*, xii, 530) reported in 1891 on a standard method of conducting duty trials. Instead of the old unit of duty of foot-pounds of work per 100 lbs. of coal used, the committee recommend a new unit, foot-pounds of work per million heat-units furnished by the boiler. The variations in quantity of coal make the old standard unfit as a basis of duty ratings. The new unit is the precise equivalent of 100 lbs. of coal in cases where each pound of coal imparts 10,000 heat-units to the water in the boiler, or where the evaporation is $10,000 \div 965.7 = 10.355$ lbs. of water from and at 212° per pound of fuel. This evaporative result is readily obtained from all grades of Cumberland or other semi-bituminous coal used in horizontal return tubular boilers, and, in many cases, from the best grades of anthracite coal.

The committee also recommends that the work done be determined by plunger displacement, after making a test for leakage, instead of by measurement of flow by weirs or other apparatus, but advises the use of such apparatus when practicable for obtaining additional data. The following extracts are taken from the report. When important tests are to be made the complete report should be consulted.

The necessary data having been obtained, the duty of an engine, and other quantities relating to its performance, may be computed by the use of the following formulæ:

$$1. \text{ Duty} = \frac{\text{Foot-pounds of work done}}{\text{Total number of heat-units consumed}} \times 1,000,000$$

$$= \frac{A (P \pm p + s) \times L \times N}{H} \times 1,000,000 \text{ (foot-pounds).}$$

$$2. \text{ Percentage of leakage} = \frac{C \times 144}{A \times L \times N} \times 100 \text{ (per cent).}$$

$$3. \text{ Capacity} = \text{number of gallons of water discharged in 24 hours}$$

$$= \frac{A \times L \times N \times 7.4805 \times 24}{D \times 144} = \frac{A \times L \times N \times 1.24675}{D} \text{ (gallons).}$$

$$4. \text{ Percentage of total frictions,}$$

$$= \left[\frac{\text{I.H.P.} - \frac{A (P \pm p + s) \times L \times N}{D \times 60 \times 33,000}}{\text{I.H.P.}} \right] \times 100$$

$$= \left[1 - \frac{A (P \pm p + s) \times L \times N}{A_s \times \text{M.E.P.} \times L_s \times N_s} \right] \times 100 \text{ (per cent);}$$

or, in the usual case, where the length of the stroke and number of strokes of the plunger are the same as that of the steam-piston, this last formula becomes:

$$\text{Percentage of total frictions} = \left[1 - \frac{A (P \pm p + s)}{A_s \times \text{M.E.P.}} \right] \times 100 \text{ (per cent).}$$

In these formulæ the letters refer to the following quantities:

A = Area, in square inches, of pump plunger or piston, corrected for area of piston rod or rods;

P = Pressure, in pounds per square inch, indicated by the gauge on the force main; *

* E. T. Sederholm, chief engineer of Fraser & Chalmers, in a letter to the author, Feb. 20, 1900, shows that the sum $P \pm p + s$ may lead to erroneous results unless the two gauges are placed below the levels of the water in the discharge and suction air chambers respectively, and the connecting pipes to the gauges run so they will always be full of water. He prefers to connect these gauges to the air spaces of the two air chambers, running the connecting pipes so they will be full of air only, and to add to the sum of the indications of the two gauges the difference in water level of the two chambers.

p = Pressure, in the vacuum-
the vacuum-ounds per square inch, corresponding to indication of
suction-pump-gauge on suction-main (or pressure-gauge, if the
gauge, in e is under a head). The indication of the vacuum-
dividing inches of mercury, may be converted into pounds by
 s = Pressure, in by 2.035;
between the ounds per square inch, corresponding to distance be-
pressure-centers of the two gauges. The computation for this
by the way made by multiplying the distance, expressed in feet,
pump-weight of one cubic foot of water at the temperature of the
 L = Average length of stroke of steam-piston, in feet;
 N = Total number of stroke of pump-plunger, in feet;
trial; of single strokes of pump-plunger made during the
 A_s = Area of steam-cylinder, in square inches, corrected for area of piston-
rod. The cylinder, in square inches, corrected for area of piston-
one cylinder quantity $A_s \times M.E.P.$, in an engine having more than
respective, is the sum of the various quantities relating to the
 L_s = Average length of stroke of steam-piston, in feet;
 N_s = Total number of stroke of steam-piston, in feet;
M.E.P. = Average of single strokes of steam-piston during trial;
measured mean effective pressure, in pounds per square inch,
cylinder; from the indicator-diagrams taken from the steam-
I.H.P. = Indicated horse-power developed by the steam-cylinder;
 C = Total number of cubic feet of water which leaked by the pump-
plunger during the trial, estimated from the results of the leak-
 D = Duration of trial, in hours;
 H = Total amount of heat-units (B.T.U.) consumed by engine =
weight of steam supplied to boiler by main feed-pump \times total
heat of steam supplied to boiler by main feed-pump \times total
main feed-main of boiler pressure reckoned from temperature of
total heat water + weight of water supplied by jacket-pump \times
of jacket-of steam of boiler-pressure reckoned from temperature
heat of steam + weight of any other water supplied \times total
total heat water reckoned from its temperature of supply. The
which the of the steam is corrected for the moisture or superheat
added to steam may contain. No allowance is made for water
cept the main feed-water, which is derived from any source ex-
the water main or some accessory of the engine. Heat added to
deducted, by the use of a flue-heater at the boiler is not to be
a steam re-should heat be abstracted from the flue by means of
engine, this water connected with the intermediate receiver of the
by the boiler heat must be included in the total quantity supplied

Leakage Test of Pump. — The leakage of an inside plunger (the only
type which requires Pump. — The leakage of an inside plunger (the only
the test with the cylinder) is most satisfactorily determined by making
temporarily bolted flange-head removed. A wide board or plank may be
hold back the water on the lower part of the end of the cylinder, so as to
temporary head in the manner of a dam, and an opening made in the
The plunger is blocked provided for the reception of an overflow-pipe,
this position is not fixed at some intermediate point in the stroke (or, if
from the force main practicable, at the end of the stroke), and the water
escapes through this admitted at full pressure behind it. The leakage
measured. The test overflow-pipe, and it is collected in barrels and
various positions. It should be made, if possible, with the plunger in

In the case of a pump so planned that it is difficult to remove the
cylinder-head, it may be desirable to take the leakage from one of the
openings which are provided for the inspection of the suction-valves,
the head being allowed to remain in place.
It is assumed that there is a practical absence of valve leakage. Exami-
nation for such leakage should be made, and if it occurs, and it is found to
be due to disorder should be made, and if it occurs, and it is found to
plunger test. Leaky valves, it should be remedied before making the
passing down into stage of the discharge valves will be shown by water
pressure. Leakage in empty cylinder at either end when they are under
ance of water which of the suction-valves will be shown by the disappear-
ance of water which of the suction-valves will be shown by the disappear-
If valve leakage covers them.
If valve leakage covers them.

If valve leakage covers them. If valve leakage covers them.

water thus lost should also be tested. One method is to measure the
amount of water required to maintain a certain pressure in the pump
cylinder when this is introduced through a pipe temporarily erected, no
water being allowed to enter through the discharge valves of the pump.

Table of Data and Results. — In order that uniformity may be se-
cured, it is suggested that the data and results, worked out in accordance
with the standard method, be tabulated in the manner indicated in the
following scheme:

DUTY TRIAL OF ENGINE.

DIMENSIONS.

1. Number of steam-cylinders.....
 2. Diameter of steam-cylinders..... ins.
 3. Diameter of piston-rods of steam-cylinders..... ins.
 4. Nominal stroke of steam-pistons..... ft.
 5. Number of water-plungers.....
 6. Diameter of plungers..... ins.
 7. Diameter of piston-rods of water-cylinders..... ins.
 8. Nominal stroke of plungers..... ft.
 9. Net area of steam-pistons..... sq. ins.
 10. Net area of plungers..... sq. ins.
 11. Average length of stroke of steam-pistons during trial..... ft.
 12. Average length of stroke of plungers during trial..... ft.
- (Give also complete description of plant.)

TEMPERATURES.

13. Temperature of water in pump-well..... degs.
14. Temp. of water supplied to boiler by main feed-pump..... degs.
15. Temp. of water supplied to boiler from other sources..... degs.

FEED-WATER.

16. Weight of water supplied to boiler by main feed-pump... lbs.
17. Weight of water supplied to boiler from other sources lbs.
18. Total weight of feed-water supplied from all sources..... lbs

PRESSURES.

19. Boiler pressure indicated by gauge..... lbs.
20. Pressure indicated by gauge on force main..... lbs.
21. Vacuum indicated by gauge on suction main..... ins.
22. Pressure corresponding to vacuum given in preceding line lbs.
23. Vertical distance between the centers of the two gauges.. ins.
24. Pressure equivalent to distance between the two gauges.. lbs.

MISCELLANEOUS DATA.

25. Duration of trial..... hrs.
26. Total number of single strokes during trial.....
27. Percentage of moisture in steam supplied to engine, or
number of degrees of superheating..... % or deg.
28. Total leakage of pump during trial, determined from results
of leakage test..... lbs.
29. Mean effective pressure, measured from diagrams taken
from steam-cylinders..... M.E.P.

PRINCIPAL RESULTS.

30. Duty..... ft.-lbs.
31. Percentage of leakage..... %
32. Capacity..... gals.
33. Percentage of total friction..... %

ADDITIONAL RESULTS

34. Number of double strokes of steam-piston per minute....
35. Indicated horse-power developed by the various steam-
cylinders..... I.H.P.
36. Feed-water consumed by the plant per hour..... lbs.
37. Feed-water consumed by the plant per indicated horse-
power per hour, corrected for moisture in steam..... lbs.

- 38. Heat units consumed per I.H.P. per hour..... B.T.U.
- 39. Heat units consumed per I.H.P. per minute..... B.T.U.
- 40. Steam accounted for by indicator at cut-off and release in the various steam-cylinders..... lbs.
- 41. Proportion which steam accounted for by indicator bears to the feed-water consumption.....
- 42. Number of double strokes of pump per minute.....
- 43. Mean effective pressure, measured from pump diagrams . M.E.P.
- 44. Indicated horse-power exerted in pump-cylinders..... I.H.P.
- 45. Work done (or duty) per 100 lbs. of coal..... ft.-lbs.

SAMPLE DIAGRAM TAKEN FROM STEAM-CYLINDERS.

(Also, if possible, full measurement of the diagrams, embracing pressures at the initial point, cut-off, release, and compression; also back pressure, and the proportions of the stroke completed at the various points noted.)

SAMPLE DIAGRAM TAKEN FROM PUMP-CYLINDERS.

These are not necessary to the main object, but it is desirable to give them.

DATA AND RESULTS OF BOILER TEST.

(In accordance with the scheme recommended by the Boiler-test Committee of the Society.)

Notable High-duty Pumping Engine Records.

Date of test.....	(1) 1899	(2) 1900	(3) 1900	(4) 1901	(5) 1906
Locality.....	Wildwood, Pa.	St. Louis (10).	Boston, Chestnut Hill	Boston, Spot Pond.	St. Louis (3) Bissell's Point.
Capacity, mil. gal., 24 hrs.	6	15	30	30	20
Diam. of steam cylinders, in.	19.5, 29, 49.5	34, 62, 92	30, 56, 87	22, 41.5, 62	34, 62, 94
Stroke, in.	57.5 x 42	x 42	x 66	x 60	72
No. and diam. of plungers	(2) 143/4	(3) 29 1/2	(3) 42	(3) 30.5	(3) 337/8
Piston speed, ft. per min.	256	197	195	244	198
Total head, ft.	504	292	140	125	238
Steam pressure.	200	126	185	151	146
Indicated Horse-power	712	801	801	464	859
Friction, %	6.95	3.16	6.71	3.47	2.27
Mechanical efficiency, %	93.05	96.84	93.29	96.53	97.73
Dry steam per I.H.P. hr.	12.26, 11.4	10.68	10.34	11.09
B.T.U. per I.H.P. per min.	186*	202	196	203	202.8
Duty, B.T.U. basis	162.9* 147.5†	158.07	156.8	156.59	158.85
Duty per 1000 lbs. steam	150.2*	179.45	178.49	172.40	181.3†
Thermal efficiency, %	22.81	21.00	21.63	20.84	20.9‡

* With reheaters.

† Without reheaters.

(1), (2). From *Eng. News*, Sept. 27, 1900. (3) Do. Aug. 23, 1900. (4) Do. Nov. 4, 1901. (5) Allis-Chalmers Co., Bulletin No. 1609. The Wildwood engine has double-acting plungers.

The coal consumption of the Chestnut Hill engine was 1.062 lbs. per I.H.P. per hour, the lowest figure on record at that date, 1901.

The Nordberg Pumping Engine at Wildwood, Pa. — *Eng. News*, May 4, 1899, Aug. 23, 1900, *Trans. A. S. M. E.*, 1899. The peculiar feature of this engine is the method used in heating the feed-water. The engine is quadruple expansion, with four cylinders and three receivers. There are five feed-water heaters in series, a, b, c, d, e. The water is taken from the hot-well and passed in succession through a which is heated by the exhaust steam on its passage to the condenser; b receives its heat from the fourth cylinder, and c, d and e respectively from the

third, second and first receivers. An approach is made to the requirement of the Carnot thermodynamic cycle, i.e., that heat entering the system should be entered at the highest temperature; in this case the water receives the heat from the receivers at gradually increasing temperatures. The temperatures of the water leaving the several heaters were, on the test, 105°, 136°, 193°, 260°, and 311° F. The economy obtained with this engine was the highest on record at the date (1900) viz., 162,948,824 ft. lbs. per million B.T.U., and it has not yet been exceeded (1909).

VACUUM PUMPS.

The Pulsometer. — In the pulsometer the water is raised by suction into the pump-chamber by the condensation of steam within it, and is then forced into the delivery-pipe by the pressure of a new quantity of steam on the surface of the water. Two chambers are used which work alternately, one raising while the other is discharging.

Test of a Pulsometer. — A test of a pulsometer is described by De Volson Wood in *Trans. A. S. M. E.*, xiii. It had a 3 1/2-inch suction-pipe, stood 40 in. high, and weighed 695 lbs.

The steam-pipe was 1 inch in diameter. A throttle was placed about 2 feet from the pump, and pressure gauges placed on both sides of the throttle, and a mercury well and thermometer placed beyond the throttle. The wire drawing due to throttling caused superheating.

The pounds of steam used were computed from the increase of the temperature of the water in passing through the pump.

Pounds of steam X loss of heat = lbs. of water sucked in X increase of temp.

The loss of heat in a pound of steam is the total heat in a pound of saturated steam as found from "steam tables" for the given pressure, plus the heat of superheating, minus the temperature of the discharged water; or

$$\text{Pounds of steam} = \frac{\text{lbs. water} \times \text{increase of temp.}}{H - 0.48 t - T}$$

The results for the four tests are given in the following table:

Data and Results.	1	2	3	4
Strokes per minute.....	71	60	57	64
Steam pressure in pipe before throttling.....	114	110	127	104.3
Steam pressure after throttling..	19	30	43.8	26.1
Steam temp. after throttling, °F..	270.4	277	309.0	270.1
Steam superheating, °F.....	3.1	3.4	17.4	1.4
Steam used, lbs.....	1617	931	1518	1019.9
Water pumped, lbs.....	404,786	186,362	228,425	248,053
Water temp. before entering pump	75.15	80.6	76.3	70.25
Water temperature, rise of.....	4.47	5.5	7.49	4.55
Water head by gauge on lift, ft....	29.90	54.05	54.05	29.90
Water head by gauge on suction..	12.26	12.26	19.67	19.67
Water head by gauge, total (H) ..	42.16	66.31	73.72	49.57
Water head by measure, total (h)	32.8	57.80	66.6	41.60
Coeff. of friction of plant, h/H....	0.777	0.877	0.911	0.839
Efficiency of pulsometer.....	0.012	0.0155	0.0126	0.0138
Eff'y of plant exclusive of boiler	0.0093	0.0136	0.0115	0.0116
Eff'y of plant if that of boiler be 0.7	0.0065	0.0095	0.0080	0.0081
Duty, if 1 lb. evaporates 10 lbs. water.....	10,511,400	13,391,000	11,059,000	12,036,300

Of the two tests having the highest lift (54.05 ft.), that was more efficient which had the smaller suction (12.26 ft.), and this was also the most efficient of the four tests. But, on the other hand, the other two tests having the same lift (29.9 ft.), that was the more efficient which had the greater suction (19.67), so that no law in this regard was established. The pressures used, 19, 30, 43.8, 26.1, follow the order of magnitude of

the total heads, but are not proportional thereto. No attempt was made to determine what pressure would give the best efficiency for any particular head. The pressure used was intrusted to a practical runner, and he judged that when the pump was running regularly and well, the pressure then existing was the proper one. It is peculiar that, in the first test, a pressure of 19 lbs. of steam should produce a greater number of strokes and pump over 50% more water than 26.1 lbs., the lift being the same as in the fourth experiment.

Chas. E. Emery in discussion of Prof. Wood's paper says, referring to tests made by himself and others at the Centennial Exhibition in 1876 (see Report of the Judges, Group xx.), that a vacuum-pump tested by him in 1871 gave a duty of 4.7 millions; one tested by J. F. Flagg, at the Cincinnati Exposition in 1875, gave a maximum duty of 3.25 millions. Several vacuum and small steam-pumps, compared later on the same basis, were reported to have given duties of 10 to 11 millions, the steam-pumps doing no better than the vacuum-pumps. Injectors, when used for lifting water not required to be heated, have an efficiency of 2 to 5 millions; vacuum-pumps vary generally between 3 and 10; small steam-pumps between 8 and 15; larger steam-pumps, between 15 and 30, and pumping-engines between 30 and 140 millions.

A very high record of test of a pulsometer is given in *Eng'g*, Nov. 24, 1893, p. 639, viz.: Height of suction 11.27 ft.; total height of lift, 102.6 ft.; horizontal length of delivery-pipe, 118 ft.; quantity delivered per hour, 26,188 British gallons. Weight of steam used per H. P. per hour, 92.76 lbs.; work done per pound of steam 21,345 foot-pounds, equal to a duty of 21,345,000 foot-pounds per 100 lbs. of coal, if 10 lbs. of steam were generated per pound of coal.

The Jet-pump.—This machine works by means of the tendency of a stream or jet of fluid to drive or carry contiguous particles of fluid along with it. The water-jet pump, in its present form, was invented by Prof. James Thomson, and first described in 1852. In some experiments on a small scale as to the efficiency of the jet-pump, the greatest efficiency was found to take place when the depth from which the water was drawn by the suction-pipe was about nine tenths of the height from which the water fell to form the jet; the flow up the suction-pipe being in that case about one fifth of that of the jet, and the efficiency, consequently, $\frac{9}{10} \times \frac{1}{5} = 0.18$. This is but a low efficiency; but it is probable that it may be increased by improvements in proportions of the machine. (Rankine, S. E.)

The Injector when used as a pump has a very low efficiency. (See Injectors, under Steam-boilers.)

PUMPING BY COMPRESSED AIR — THE AIR-LIFT PUMP.

Air-lift Pump.—The air-lift pump consists of a vertical water-pipe with its lower end submerged in a well, and a smaller pipe delivering air into it at the bottom. The rising column in the pipe consists of air mingled with water, the air being in bubbles of various sizes, and is therefore lighter than a column of water of the same height; consequently the water in the pipe is raised above the level of the surrounding water. This method of raising water was proposed as early as 1797, by Loescher, of Freiberg, and was mentioned by Collon in lectures in Paris in 1876, but its first practical application probably was by Werner Siemens in Berlin in 1885. Dr. J. G. Pohle experimented on the principle in California in 1886, and U. S. patents on apparatus involving it were granted to Pohle and Hill in the same year. A paper describing tests of the air-lift pump made by Randall, Browne and Behr was read before the Technical Society of the Pacific Coast in Feb., 1890.

The diameter of the pump-column was 3 in., of the air-pipe 0.9 in., and of the air-discharge nozzle $\frac{5}{8}$ in. The air-pipe had four sharp bends and a length of 35 ft. plus the depth of submerston.

The water was pumped from a closed pipe-well (55 ft. deep and 10 in. in diameter). The efficiency of the pump was based on the least work theoretically required to compress the air and deliver it to the receiver. If the efficiency of the compressor be taken at 70%, the efficiency of the pump and compressor together would be 70% of the efficiency found for the pump alone.

For a given submerston (h) and lift (H), the ratio of the two being kept within reasonable limits, (H) being not much greater than (h), the efficiency was greatest when the pressure in the receiver did not greatly exceed the head due to the submerston. The smaller the ratio $H + h$, the higher was the efficiency.

The pump, as erected, showed the following efficiencies:

For $H + h =$	0.5	1.0	1.5	2.0
Efficiency =	50%	40%	30%	25%

The fact that there are absolutely no moving parts makes the pump especially fitted for handling dirty or gritty water, sewage, mine water, and acid or alkali solutions in chemical or metallurgical works.

In Newark, N. J., pumps of this type are at work having a total capacity of 1,000,000 gallons daily, lifting water from three 8-in. artesian wells. The Newark Chemical Works use an air-lift pump to raise sulphuric acid of 1.72° gravity. The Colorado Central Consolidated Mining Co., in one of its mines at Georgetown, Colo., lifts water in one case 250 ft., using a series of lifts.

For a full account of the theory of the pump, and details of the tests above referred to, see *Eng'g News*, June 8, 1893.

Air-Lifts for Deep Oil-Wells are described by E. M. Ivens, in *Trans. A. S. M. E.* 1909, p. 341. The following are some results obtained in wells in Evangeline, La.:

Cu. ft. free air per minute, displacement of compressor.....	650	442	702	538
Cu. ft. oil pumped per minute.....	4.35	4.87	13.7	5.64
Air pressure at well, lbs. per sq. in.....	155	200	202	252
Pumping head, from oil level while pumping, ft.	1155	1081	1076	917
Submergence, from oil level to air entrance, ft.	358	412	419	583
Submergence ÷ total ft. of vertical pipe, %...	23.6	27.6	28	39
Pumping efficiency, %.....	9.3	13.4	19.5	10.3

Artesian Well Pumping by Compressed Air.—H. Tipper, *Eng. News*, Jan. 18, 1908, mentions cases where 1-in. air lines supplied air for 6-in. wells, with the inside air-pipe system; the length of the pipe was 300 ft. from the well top, and another 350 ft. to the compressor. The wells pumped 75 gals. per min., using 200 cu. ft. of air, the efficiency being 6½%. Changing the pipes to 2½ in. above the well, and 2 in. in the well, and putting an air receiver near the compressor, raised the delivery to 180 gals. per min., with a little less air, and the efficiency to 23%. A large receiver capacity, a large pipe above ground, a submergence of 55%, well piping proportioned for a friction loss of not over 5%, with lifts not over 200 ft., gave the best results, 1 gal. of water being raised per cu. ft. of air. The utmost net efficiency of the air-lift is not over 25 to 30%.

Eng. News, June 18, 1908, contains an account of tests of eleven wells at Atlantic City. The Atlantic City wells were 10 in. diam., water pipes, 4 to 5¼ in., air pipes, ¾ to 1¼ in. The maximum lift of the several wells ranged from 26 to 40 ft., the submergence, 37 to 49 ft., ratio of submergence to lift, 0.9 to 1.8, submergence % of length of pipe, 53 to 64. Capacity test, 3,544,900 gals. in 24 hrs., mean lift, 26.88 ft., air pressure, 31 lbs., duty of whole plant, 19,900,000 ft. lbs. per 1000 lbs. of steam used by the compressors. Two-thirds capacity test, delivery, 2,642,900 gals., mean lift, 25.43 ft., air pressure, 26 lbs., duty, 24,207,000.

An article in *The Engineer* (Chicago), Aug. 15, 1904, gives the following formulæ and rules for the design of air-lifts of maximum efficiency. The authority is not given.

- Ratio of area of air pipe to area of water pipe, 0.16.
- Submerged portion = 65% of total length of pipe.
- Economical range of submerston ratio, 55 to 80%.
- Velocity of air in air pipe, not over 4000 ft. per min.
- Volume of air to raise 1 cu. ft. of water, 3.9 to 4.5 cu. ft.
- $C =$ cu. ft. of water raised per min., $A =$ cu. ft. of air used, $L =$ lift above water level, $D =$ submergence, in feet.
- $A = LC + 16.824; C = 8.24 AD + L^2.$
- Where L exceeds 180 ft. it will be more economical to use two or more air-lifts in series.

THE HYDRAULIC RAM.

Efficiency. — The hydraulic ram is used where a considerable flow of water with a moderate fall is available, to raise a small portion of that flow to a height exceeding that of the fall. The following are rules given by Eytelwein as the results of his experiments (from Rankine):

Let Q be the whole supply of water in cubic feet per second, of which q is lifted to the height h above the pond, and $Q - q$ runs to waste at the depth H below the pond; L , the length of the supply-pipe, from the pond to the waste-clack; D , its diameter in feet; then

$$D = \sqrt{(1.63 Q)}; L = H + h + \frac{h}{H} \times 2 \text{ feet};$$

Efficiency, $\frac{qh}{(Q-q)H} = 1.12 - 0.2 \sqrt{\frac{h}{H}}$, when $\frac{h}{H}$ does not exceed 20;

or

$1 \div (1 + h/10 H)$ nearly, when h/H does not exceed 12.

D'Aubuisson gives $\frac{q(H+h)}{QH} = 1.42 - 0.28 \sqrt{\frac{h}{H}}$.

Clark, using five sixths of the values given by D'Aubuisson's formula, gives:

Ratio of lift to fall.	4	6	8	10	12	14	16	18	20	22	24	26
Efficiency per cent.	72	61	52	44	37	31	25	19	14	9	4	0

The efficiency as calculated by the two formulæ given above is nearly the same for high ratios of lift, but for low ratios there is considerable difference. For example:

Let $Q = 100, H = 10, H + h =$	20	40	100	200
Efficiency, D'Aubuisson's formula, %	80	72	44	14
$q = \text{effy.} \times QH \div (H + h) =$	40	18	4.4	0.7
Efficiency by Rankine's formula, %	66 2/3	65.9	41.4	13.4

D'Aubuisson's formula is that of the machine itself, on the basis that the energy put into the machine is that of the whole column of water, Q , falling through the height h and that the energy delivered is that of q raised through the whole height above the ram, $H + h$; while Rankine's efficiency is that of the whole plant, assuming that the energy put in is only that of the water that runs to waste, and that the work done is lifting the quantity q not from the level of the ram but only from that of the supply pond. D'Aubuisson's formula is the one in harmony with the usual definition of efficiency. It also is applicable (as Rankine's is not) to the case of a ram which uses the quantity Q from one source of supply to pump water of different quality from a source at the level of the ram.

An extensive mathematical investigation of the hydraulic ram, by L. F. Harza, is contained in Bulletin No. 205 of the University of Wisconsin, 1908, together with results of tests of a Rife "hydraulic engine," which appear to verify the theory. It was found both by theory and by experiment that the efficiency bears a relation to the velocity in the drive pipe. From plotted diagrams of the results the following figures (roughly approximate) are taken: Length of 2-in. drive pipe, 85.4 ft.; supply head, 8.2 ft.

Max. vel. in drive pipe, ft. per sec....	1.5	2	3	4	5	6
Pumping head, ft.	2.6	30	20	15	7	0
	12.3	60	45	33	18	0
	23.2	60	65	53	40	0
	43.5	55	60	53	42	0
	63.1	60	55	50	28	0

The author of the paper concludes that the comparison of experiment and theory has demonstrated the practicability of the logical design of a hydraulic ram for any given working conditions.

An interesting historical account, with illustrations, of the development of the hydraulic ram, with a description of Pearsall's hydraulic engine, is given by J. Richards in *Jour. Assn. Eng'g Societies*, Jan., 1898. For a description of the Rife hydraulic engine see *Eng. News*, Dec. 31, 1896.

The Columbia Steel Co., Portland, Ore., furnished the author in July, 1908, records of tests of four hydraulic rams, from which the following is condensed, the efficiency, by D'Aubuisson's formula, being calculated from the data given. L = length in ft. and D = diam. in ins. of the drive pipe, l and d , length and diameter of the discharge pipe.

Size of Ram.	H	$h + H$	Q^*	q^*	L	D	l	d	Effy. %
Ins.	Ft.	Ft.			Ft.	Ins.	Ft.	Ins.	
3.....	4	28	35	3.5	28	3	1008	1 1/2	58.9
4 1/2.....	5	45	100	8	40	4 1/2	325	72.0
6.....	12	36.4	200	50.5	60	4 1/2	945	2 1/2	76.6
6.....	37.6	144.1	6.26	1.15	192.5	6	1785	10†	70.4

* Q and q are in gallons per min., except the last line, which is in cu. ft. per sec.

† Eleven rams discharge into one 10-in. jointed wood pipe. The loss of head in the drive pipe was 0.7 ft., and in the discharge pipe, 2.7 ft. On another test 1 cu. ft. per sec. was delivered with less than 5 cu. ft. entering the drive pipe. Taking 5 cu. ft. gives 76.6% efficiency.

A description and record of test of the Foster "impact engine" is given in *Eng'g News*, Aug. 3, 1905. Two engines are connected into one 8-in. delivery pipe. Using the same notation as before, the data of the tests of the two engines are as follows: Q , gal. per min., 582, 578; q , 232, 228; H , 36.75, 37.25; $H + h$, 84, 84; strokes per min., 130, 130; Effy. (D'Aubuisson), 91.23, 89.06%.

Prof. R. C. Carpenter (*Eng'g Mechanics*, 1894) reports the results of four tests of a ram constructed by Rumsey & Co., Seneca Falls. The supply-pipe used was 1 1/2 inches in diameter, about 50 feet long, with 3 elbows. Each run was made with a different stroke for the waste-valve, the supply and delivery head being constant; the object of the experiment was to find that stroke of clack-valve which would give the highest efficiency.

Length of stroke, per cent	100	80	60	46
Number of strokes per minute	52	56	61	66
Supply head, feet of water	5.67	5.77	5.58	5.65
Delivery head, feet of water	19.75	19.75	19.75	19.75
Total water pumped, pounds	297	296	301	297.5
Total water supplied, pounds	1615	1567	1518	1455.5
Efficiency, per cent	64.1	64.7	70.2	71.4

The highest efficiency realized was obtained when the clack-valve travelled 60% of its full stroke, the full travel being 15/16 in.

HYDRAULIC-PRESSURE TRANSMISSION.

Water under high pressure (700 to 2000 lbs. per sq. in. and upwards) affords a satisfactory method of transmitting power to a distance, especially for the movement of heavy loads at small velocities, as by cranes and elevators. The system consists usually of one or more pumps capable of developing the required pressure; accumulators, which are vertical cylinders with heavily-weighted plungers passing through stuffing-boxes in the upper end, by which a quantity of water may be accumulated at the pressure to which the plunger is weighted; the distributing-pipes; and the presses, cranes, or other machinery to be operated.

The earliest important use of hydraulic pressure probably was in the Bramah hydraulic press, patented in 1796. Sir W. G. Armstrong in 1846 was one of the pioneers in the adaptation of the hydraulic system to cranes. The use of the accumulator by Armstrong led to the extended use of hydraulic machinery. Recent developments and applications of the system are largely due to Ralph Tweddell, of London, and Sir Joseph Whitworth. Sir Henry Bessemer, in his patent of May 13, 1856, No.

1292, first suggested the use of hydraulic pressure for compressing steel ingots while in the fluid state.

The Gross Amount of Energy of the water under pressure stored in the accumulator, measured in foot-pounds, is its volume in cubic feet X its pressure in pounds per square foot. The horse-power of a given quantity steadily flowing is H.P. = $144 pQ/550 = 0.2618 pQ$, in which Q is the quantity flowing in cubic feet per second and p the pressure in pounds per square inch.

The loss of energy due to velocity of flow in the pipe is calculated as follows (R. G. Blaine, *Eng'g*, May 22 and June 5, 1891):

According to Darcy, every pound of water loses $\lambda 4L/D$ times its kinetic energy, or energy due to its velocity, in passing along a straight pipe L feet in length and D feet diameter, where λ is a variable coefficient. For clean cast-iron pipes it may be taken as $\lambda = 0.005 (1 + \frac{1}{12D})$, or for di-

diameter in inches = d .

$d = 1/2$	1	2	3	4	5	6	7	8	9	10	12
$\lambda = .015$.01	.0075	.00667	.00625	.006	.00583	.00571	.00563	.00556	.0055	.00542

The loss of energy per minute is $60 \times 62.36 Q \times \frac{\lambda 4L}{D} \frac{v^2}{2g}$, and the horse-power wasted in the pipe is $W = \frac{0.6363 \lambda L (H.P.)^2}{p^2 D^5}$, in which λ

varies with the diameter as above. p = pressure at entrance in pounds per square inch. Values of 0.6363λ for different diameters of pipe in inches are:

$d = 1/2$	1	2	3	4	5	6	7	8
.00954	.00636	.00477	.00424	.00398	.00382	.00371	.00363	.00358
.00353	.00350	.00345						

Efficiency of Hydraulic Apparatus. — The useful effect of a direct hydraulic plunger or ram is usually taken at 93%. The following is given as the efficiency of a ram with chain-and-pulley multiplying gear properly proportioned and well lubricated:

Gear	2 to 1	4 to 1	6 to 1	8 to 1	10 to 1	12 to 1	14 to 1	16 to 1
Eff'y	0.80	0.76	0.72	0.67	0.63	0.59	0.54	0.50

With large sheaves, small steel pins, and wire rope for multiplying gear the efficiency has been found as high as 66% for a multiplication of 20 to 1.

Henry Adams gives the following formula for effective pressure in cranes and hoists: P = accumulator pressure in pounds per square inch; m = ratio of multiplying power; E = effective pressure in pounds per square inch, including all allowances for friction;

$$E = P (0.84 - 0.02 m).$$

J. E. Tuit (*Eng'g*, June 15, 1888) describes some experiments on the friction of hydraulic jacks from $3 1/4$ to $13 3/8$ -inch diameter, fitted with cupped leather packings. The friction loss varied from 5.6% to 18.8% according to the condition of the leather, the distribution of the load on the ram, etc. The friction increased considerably with eccentric loads. With hemp packing a plunger, 14-inch diameter, showed a friction loss of from 11.4% to 3.4%, the load being central, and from 15.0% to 7.6% with eccentric load, the percentage of loss decreasing in both cases with increase of load.

Thickness of Hydraulic Cylinders. — Sir W. G. Armstrong gives the following, for cast-iron cylinders, for a pressure of 1000 lbs. per sq. in.:

Diam. of cylinder, inches —	2	4	6	8	10	12	16	20	24
Thickness, inches —	0.832	1.146	1.552	1.875	2.222	2.578	3.19	3.69	4.11

For any other pressure multiply by the ratio of that pressure to 1000. These figures correspond nearly to the formula $t = 0.175 d + 0.48$, in which t = thickness and d = diameter in inches, up to 16-inch diameter, but for 20 inches diameter the addition 0.48 is reduced to 0.19 and at 24 inches it disappears. For formulae for thick cylinders see page 316.

Cast iron should not be used for pressures exceeding 2000 lbs. per square inch. For higher pressures steel castings or forged steel should be used. For working pressures of 750 lbs. per square inch the test pressure should be 2500 lbs. per square inch, and for 1500 lbs. the test pressure should not be less than 3500 lbs.

Speed of Hoisting by Hydraulic Pressure. — The maximum allowable speed for warehouse cranes is 6 feet per second; for platform cranes 4 feet per second; for passenger and wagon hoists, heavy loads, 2 feet per second. The maximum speed under any circumstances should never exceed 10 feet per second.

The Speed of Water Through Valves should never be greater than 100 feet per second.

Speed of Water Through Pipes. — Experiments on water at 1600 lbs. pressure per square inch flowing into a flanging-machine ram, 20-inch diameter, through a $1/2$ -inch pipe contracted at one point to $1/4$ -inch, gave a velocity of 114 feet per second in the pipe, and 456 feet at the reduced section. Through a $1/2$ -inch pipe reduced to $3/8$ -inch at one point the velocity was 213 feet per second in the pipe and 381 feet at the reduced section. In a $1/2$ -inch pipe without contraction the velocity was 355 feet per second.

For many of the above notes the author is indebted to Mr. John Platt, consulting engineer, of New York.

High-pressure Hydraulic Presses in Iron-works are described by R. M. Daelen, of Germany, in *Trans. A. I. M. E.*, 1892. The following distinct arrangements used in different systems of high-pressure hydraulic work are discussed and illustrated:

1. Steam-pump, with fly-wheel and accumulator.
 2. Steam-pump, without fly-wheel and with accumulator.
 3. Steam-pump, without fly-wheel and without accumulator.
- In these three systems the valve-motion of the working press is operated in the high-pressure column. This is avoided in the following:
4. Single-acting steam-intensifier without accumulator.
 5. Steam-pump with fly-wheel, without accumulator and with pipe-circuit.
 6. Steam-pump with fly-wheel, without accumulator and without pipe-circuit.

The disadvantages of accumulators are thus stated: The weighted plungers which formerly served in most cases as accumulators, cause violent shocks in the pipe-line when changes take place in the movement of the water, so that in many places, in order to avoid bursting from this cause, the pipes are made exclusively of forged and bored steel. The seats and cones of the metallic valves are cut by the water (at high speed), and in such cases only the most careful maintenance can prevent great losses of power.

Hydraulic Power in London. — The general principle involved is pumping water into mains laid in the streets, from which service-pipes are carried into the houses to work lifts or three-cylinder motors when rotary power is required. In some cases a small Pelton wheel has been tried, working under a pressure of over 700 lbs. on the square inch. Over 55 miles of hydraulic mains are at present laid (1892).

The reservoir of power consists of capacious accumulators, loaded to 800 lbs. per sq. in.

The engine-house contains six sets of triple-expansion pumping engines. Each pump will deliver 300 gallons of water per minute.

The water delivered from the main pumps passes into the accumulators. The rams are 20 inches in diameter, and have a stroke of 23 feet. They are each loaded with 110 tons of slag, contained in a wrought-iron cylindrical box suspended from a cross-head on the top of the ram. One of the accumulators is loaded a little more heavily than the other, so that they rise and fall successively; the more heavily loaded actuates a stop-valve on the main steam-pipe.

The mains in the public streets are so constructed and laid as to be perfectly trustworthy and free from leakage. Every pipe and valve used throughout the system is tested to 2500 lbs. per sq. in. before being placed on the ground and again tested to a reduced pressure in the trenches to insure the perfect tightness of the joints. The jointing material used is gutta-percha.

The average rate obtained by the company is about 3 shillings per thousand gallons. The principal use of the power is for intermittent work in cases where direct pressure can be employed, as, for instance, passenger elevators, cranes, presses, warehouse hoists, etc.

An important use of the hydraulic power is its application to the extinguishing of fire by means of Greathead's injector hydrant. By the use of these hydrants a continuous fire-engine is available.

Hydraulic Riveting-machines. — Hydraulic riveting was introduced in England by Mr. R. H. Tweddell. Fixed riveters were first used about 1868. Portable riveting-machines were introduced in 1872.

The riveting of the large steel plates in the Forth Bridge was done by small portable machines working with a pressure of 1000 lbs. per square inch. In exceptional cases 3 tons per inch were used. (*Proc. Inst. M. E.*, May, 1889.)

An application of hydraulic pressure invented by Andrew Higginson, of Liverpool, dispenses with the necessity of accumulators. It consists of a three-throw pump driven by shafting or worked by steam and depends partially upon the work accumulated in a heavy fly-wheel. The water in its passage from the pumps and back to them is in constant circulation at a very feeble pressure, requiring a minimum of power to preserve the tube of water ready for action at the desired moment, when by the use of a tap the current is stopped from going back to the pumps, and is thrown upon the piston of the tool to be set in motion. The water is now confined, and the driving-belt or steam-engine, supplemented by the momentum of the heavy fly-wheel, is employed in closing up the rivet, or bending or forging the object subjected to its operation.

Hydraulic Forging-press.

For a very complete illustrated account of the development of the hydraulic forging-press, see a paper by R. H. Tweddell in *Proc. Inst. C. E.*, vol. cxvii. 1893-4.

In the Allen forging-press the force-pump and the large or main cylinder of the press are in direct and constant communication. There are no intermediate valves of any kind, nor has the pump any check-valves, but it simply forces its cylinder full of water direct into the cylinder of the press, and receives the same water, as it were, back again on the return stroke. Thus, when both cylinders and the pipe connecting them are full, the large ram of the press rises and falls simultaneously with each stroke of the pump, keeping up a continuous oscillating motion, the ram, of course, traveling the shorter distance, owing to the larger capacity of the press cylinder. (*Journal Iron and Steel Institute*, 1891. See also illustrated article in "Modern Mechanism," page 668.)

A 2000-ton forging-press erected at the Couillet forges in Belgium is described in *Eng. and M. Jour.*, Nov. 25, 1893. The press is composed essentially of two parts — the press itself and the compressor. The compressor is formed of a vertical steam-cylinder and a hydraulic cylinder. The piston-rod of the former forms the piston of the latter. The hydraulic piston discharges the water into the press proper. The distribution is made by a cylindrical balanced valve; as soon as the pressure is released the steam-piston falls automatically under the action of gravity. During its descent the steam passes to the other face of the piston to reheat the cylinder, and finally escapes from the upper end.

When steam enters under the piston of the compressor-cylinder the piston rises, and its rod forces the water into the press proper. The pressure thus exerted on the piston of the latter is transmitted through a cross-head to the forging which is upon the anvil. To raise the cross-head two small single-acting steam-cylinders are used, their piston-rods being connected to the cross-head: steam acts only on the pistons of these cylinders from below. The admission of steam to the cylinders, which stand on top of the press frame, is regulated by the same lever which directs the motions of the compressor. The movement given to the dies is sufficient for all the ordinary purposes of forging.

A speed of 30 blows per minute has been attained. A double press on the same system, having two compressors and giving a maximum pressure of 6000 tons, has been erected in the Krupp works, at Essen.

Hydraulic Engine driving an Air-compressor and a Forging-hammer. (*Iron Age*, May 12, 1892.) — The great hammer in Terni, near Rome, is one of the largest in existence. Its falling weight amounts to 100 tons, and the foundation belonging to it consists of a block of cast iron of 1000 tons. The stroke is 16 feet 4 3/4 inches; the diameter of the cylinder 6 feet 3 1/2 inches; diameter of piston-rod 13 3/4 inches; total height of the hammer, 62 feet 4 inches. The power to work the hammer, as well as the two cranes of 100 and 150 tons respectively, and other auxiliary appliances belonging to it, is furnished by four air-compressors coupled together and driven directly by water-pressure engines, by means of which the air is compressed to 73.5 pounds per square inch. The cylinders of the water-pressure engines, which are provided with a bronze lining, have a 13 3/4-inch bore. The stroke is 47 3/4 inches, with a pressure of water on the piston amounting to 264.6 pounds per square inch. The compressors are bored out to 31 1/2 inches diameter, and have 47 3/4-inch stroke. Each of the four cylinders requires a power equal to 280 horse-power. The compressed air is delivered into huge reservoirs, where a uniform pressure is kept up by means of a suitable water-column.

The Hydraulic Forging Plant at Bethlehem, Pa., is described in a paper by R. W. Davenport, read before the Society of Naval Engineers and Marine Architects, 1893. It includes two hydraulic forging-presses complete, with engines and pumps, one of 1500 and one of 1500 tons capacity, together with two Whitworth hydraulic traveling forging-crane and other necessary appliances for each press; and a complete fluid-compression plant, including a press of 7000 tons capacity and a 125-ton hydraulic traveling crane for serving it (the upper and lower heads of this press weighing respectively about 135 and 120 tons). A new forging-press designed by Mr. John Fritz, for the Bethlehem Works, of 14,000 tons capacity, is run by engines and pumps of 15,000 horse-power. The plant is served by four open-hearth steel furnaces of a united capacity of 120 tons of steel per heat.

The Davy High-speed Steam-hydraulic Forging Press is described in the *Iron Age*, April 15, 1909. It is built in sizes ranging from 150 to 12,000 tons capacity. In the four-column type, in which all but the smaller sizes are built, there is a central press operated by hydraulic pressure from a steam intensifier, and two steam balance cylinders carried on top of the entablature. A single lever controls the press. The operator admits steam to the balance cylinders, lifting the cross head and the main plunger, and forcing the water from the press cylinder into the water cylinder of the intensifier. Exhausting the steam from the balance cylinders, allows the plunger to descend and rest on the forging. To and fro motions of the lever, slow or fast as the operator desires, up to 120 a minute, then are made to reduce the forging. The smaller, or single frame, type has only one balance cylinder, immediately above the press cylinder. The Davy press is made in the United States by the United Engineering & Foundry Co., Pittsburgh.

Some References on Hydraulic Transmission. — Reuleaux's "Constructor;" "Hydraulic Motors, Turbines, and Pressure-engines," G. Bodmer, London, 1889; Robinson's "Hydraulic Power and Hydraulic Machinery," London, 1888; Colyer's "Hydraulic Steam, and Hand-power Lifting and Pressing Machinery," London, 1881. See also *Engineering* (London), Aug. 1, 1884, p. 99; March 13, 1885, p. 262; May 22 and June 5, 1891, pp. 612, 665; Feb. 19, 1892, p. 25; Feb. 10, 1893, p. 170.

FUEL.

Theory of Combustion of Solid Fuel. (From Rankine, somewhat altered.) — The ingredients of every kind of fuel commonly used may be thus classed: (1) Fixed or free carbon, which is left in the form of charcoal or coke after the volatile ingredients of the fuel have been distilled away. These ingredients burn either wholly in the solid state (C to CO₂), or part in the solid state and part in the gaseous state (CO + O = CO₂), the latter part being first dissolved by previously formed carbon dioxide by the reaction CO₂ + C = 2 CO. Carbon monoxide, CO, is produced when the supply of air to the fire is insufficient.

(2) Hydrocarbons, such as olefiant gas, pitch, tar, naphtha, etc., all of which must pass into the gaseous state before being burned.

If mixed on their first issuing from amongst the burning carbon with a large quantity of hot air, these inflammable gases are completely burned with a transparent blue flame, producing carbon dioxide and steam. When mixed with cold air they are apt to be chilled and pass off unburned. When raised to a red heat, or thereabouts, before being mixed with a sufficient quantity of air for perfect combustion, they disengage carbon in fine powder, and pass to the condition partly of marsh gas, CH₄, and partly of free hydrogen; and the higher the temperature, the greater is the proportion of carbon thus disengaged.

If the disengaged carbon is cooled below the temperature of ignition before coming in contact with oxygen, it constitutes, while floating in the gas, smoke, and when deposited on solid bodies, soot.

But if the disengaged carbon is maintained at the temperature of ignition and supplied with oxygen sufficient for its combustion, it burns while floating in the inflammable gas, and forms red, yellow, or white flame. The flame from fuel is the larger the more slowly its combustion is effected. The flame itself is apt to be chilled by radiation, as into the heating surface of a steam-boiler, so that the combustion is not completed, and part of the gas and smoke pass off unburned.

(3) Oxygen or hydrogen either actually forming water, or existing in combination with the other constituents in the proportions which form water. Such quantities of oxygen and hydrogen are to be left out of account in determining the heat generated by the combustion. If the quantity of water actually or virtually present in each pound of fuel is so great as to make its latent heat of evaporation worth considering, that heat is to be deducted from the total available heat of combustion of the fuel.

(4) Nitrogen, either free or in combination with other constituents. This substance is simply inert.

(5) Sulphide of iron, which exists in coal and is detrimental, as tending to cause spontaneous combustion.

(6) Other mineral compounds of various kinds, which are also inert, and form the ash left after complete combustion of the fuel, and also the clinker or glassy material produced by fusion of the ash, which tends to choke the grate.

Oxygen and Air Required for the Combustion of Carbon, Hydrogen, etc.

Chemical Reaction.	Lbs. O per lb. Fuel.	Lbs. N = 3.32 O	Air per lb. = 4.32 O.	Gaseous Products per lb.	Heat of Combustion, B.T.U. per lb.
C to CO ₂ C + 2O = CO ₂	2 1/3	8.85	11.52	12.52	14,600
C to CO C + O = CO	1 1/3	4.43	5.76	6.76	4,450
CO to CO ₂ CO + O = CO ₂	4/7	1.90	2.47	3.47	10,150
H to H ₂ O 2H + O = H ₂ O	8	26.56	34.56	35.56	62,000
CH ₄ to CO ₂ and H ₂ O CH ₄ + 4O = CO ₂ + 2H ₂ O	4	13.28	17.28	18.28	23,600
S to SO ₂ S + 2O = SO ₂	1	3.32	4.32	5.32	4,050

For heat of combustion of various fuels see Heat, page 533.

The imperfect combustion of carbon, making carbon monoxide, produces less than one-third of the heat which is yielded by the complete combustion, making carbon dioxide.

The total heat of combustion of any compound of hydrogen and carbon is nearly the sum of the quantities of heat which the constituents would produce separately by their combustion. (Marsh-gas is an exception.)

In computing the total heat of combustion of compounds containing oxygen as well as hydrogen and carbon, the following principle is to be observed: When hydrogen and oxygen exist in a compound in the proper proportion to form water (that is, by weight one part of hydrogen to eight of oxygen), these constituents have no effect on the total heat of combustion. If hydrogen exists in a greater proportion, only the surplus of hydrogen above that which is required by the oxygen is to be taken into account.

The following is a general formula (Dulong's) for the total heat of combustion of any compound of carbon, hydrogen, and oxygen:

Let C, H, and O be the fractions of one pound of the compound, which consists respectively of carbon, hydrogen, and oxygen, the remainder being nitrogen, ash, and other impurities. Let h be the total heat of combustion of one pound of the compound in British thermal units.

Then
$$h = 14,600 C + 62,000 (H - 1/8 O).$$

Analyses of Gases of Combustion. — The following are selected from a large number of analyses of gases from locomotive boilers, to show the range of composition under different circumstances (P. H. Dudley, Trans. A. I. M. E., iv. 250):

Test.	CO ₂	CO	O	N	
1	13.8	2.5	2.5	81.6	No smoke visible.
2	11.5	6	82.5	Old fire, escaping gas white, engine working hard.
3	8.5	8	83	Fresh fire, much black gas, engine working hard.
4	2.3	17.2	80.5	Old fire, damper closed, engine standing still.
5	5.7	14.7	79.6	" " smoke white, engine working hard.
6	8.4	1.2	8.4	82	New fire, engine not working hard.
7	12	1	4.4	82.6	Smoke black, engine not working hard.
8	3.4	16.8	76.8	" dark, blower on, engine standing still.
9	6	13.5	81.5	" white, engine working hard.

In analyses on the Cleveland and Pittsburgh road, in every instance when the smoke was the blackest, there was found the greatest percentage of unconsumed oxygen in the product, showing that something besides the mere presence of oxygen is required to effect the combustion of the volatile carbon of fuels. (What is needed is thorough mixture of the oxygen with the volatile gases in a hot combustion chamber.)

Temperature of the Fire. (Rankine, S. E., p. 283.) — By temperature of the fire is meant the temperature of the products of combustion at the instant that the combustion is complete. The elevation of that temperature above the temperature at which the air and the fuel are supplied to the furnace may be computed by dividing the total heat of combustion of one lb. of fuel by the weight and by the mean specific heat of the whole products of combustion, and of the air employed for their dilution under constant pressure.

Temperature of the Fire, the Fuel Containing Hydrogen and Water. — The following formula is developed in the author's "Steam-Boiler Economy" on the assumptions that all the hydrogen and the water exist in the combustion chamber as superheated steam at the temperature of the fire, and that the specific heat of the gases is a constant, = 0.237. The last assumption is probably largely in error, since it is now known that the specific heat of gases increases with the temperature. (See page 537.) The formula will give approximate results, however, and is sufficiently accurate when relative figures only are desired.

Let C, H, O, and W represent respectively the percentages of carbon, hydrogen, oxygen, and water in a fuel, and f the pounds of dry gas per

pound of fuel, = $CO_2 + N$ + excess air, then the theoretical elevation of the temperature of the fire above the temperature of the atmosphere,

$$T = \frac{616 C + 2200 H - 327 O - 44 W}{f + 0.02 W + 0.18 H}$$

EXAMPLE. — Required the maximum temperature obtainable by burning moist wood of the composition $C, 38; H, 5; O, 32$; ash, 1; moisture 24; the dry gas being 15 lbs. per pound of wood, and the temperature of the atmosphere 62° .

$$T = \frac{616 \times 38 + 2200 \times 5 - 327 \times 32 - 44 \times 24}{15 + 0.02 \times 24 + 0.18 \times 5} = 1403, \text{ add } 62^\circ = 1465^\circ.$$

Rise of Temperature in Combustion of Gases. (*Eng'g*, March 12 and April 2, 1886.) — It is found that the temperatures obtained by experiment fall short of those obtained by calculation. Three theories have been given to account for this: 1. The cooling effect of the sides of the containing vessel; 2. The retardation of the evolution of heat caused by dissociation; 3. The increase of the specific heat of the gases at very high temperatures. The calculated temperatures are obtainable only on the condition that the gases shall combine instantaneously and simultaneously throughout their whole mass. This condition is practically impossible in experiments. The gases formed at the beginning of an explosion dilute the remaining combustible gases and tend to retard or check the combustion of the remainder.

CLASSIFICATION OF SOLID FUELS.

Gruner classifies solid fuels as follows (*Eng'g and M'g Jour.*, July, 1874).

Name of Fuel.	Ratio $\frac{O}{H}$ or $\frac{O+N^*}{H}$.	Proportion of Coke or Charcoal yielded by the Dry Pure Fuel.
Pure cellulose.....	8	0.28 @ 0.30
Wood (cellulose and encasing matter).....	7	.30 @ .35
Peat and fossil fuel.....	6 @ 5	.35 @ .40
Lignite, or brown coal.....	5	.40 @ .50
Bituminous coals.....	4 @ 1	.50 @ .90
Anthracite.....	1 @ 0.75	.90 @ .92

* The nitrogen rarely exceeds 1 per cent of the weight of the fuel.

Progressive Change from Wood to Graphite.

(J. S. Newberry in Johnson's Cyclopaedia.)

	Wood.	Loss.	Lignite.	Loss.	Bituminous coal.	Loss.	Anthracite.	Loss.	Graphite.
Carbon.....	49.1	18.65	30.45	12.35	18.10	3.57	14.53	1.42	13.11
Hydrogen.....	6.3	3.25	3.05	1.85	1.20	0.93	0.27	0.14	0.13
Oxygen.....	44.6	24.40	20.20	18.13	2.07	1.32	0.65	0.65	0.00
	100.0	46.30	53.70	32.33	21.37	5.82	15.45	2.21	13.24

Classification of Coals.

It is convenient to classify the several varieties of coal according to the relative percentages of carbon and volatile matter contained in their combustible portion as determined by proximate analysis. The following is the classification given in the author's "Steam-boiler Economy":

CLASSIFICATION OF COALS.

	Fixed Carbon.	Volatile Matter.	Heating Value per lb. of Combustible	Relative Value of Combustible Semi-bit. = 100
Anthracite.....	97 to 92.5	3 to 7.5	14600 to 14800	93
Semi-anthracite.....	92.5 to 87.5	7.5 to 12.5	14700 to 15500	96
Semi-bituminous.....	87.5 to 75	12.5 to 25	15500 to 16000	100
Bituminous, Eastern.....	75 to 60	25 to 40	14800 to 15500	96
Bituminous, Western.....	65 to 50	35 to 50	13500 to 14800	90
Lignite.....	under 50	over 50	11000 to 13500	77

The anthracites, with some unimportant exceptions, are confined to three small fields in eastern Pennsylvania. The semi-anthracites are found in a few small areas in the western part of the anthracite field. The semi-bituminous coals are found on the eastern border of the great Appalachian coal field, extending from north central Pennsylvania across the southern boundary of Virginia into Tennessee, a distance of over 300 miles. They include the coals of Clearfield, Cambria, and Somerset counties, Pennsylvania, and the Cumberland, Md., the Pocahontas, Va., and the New River, W. Va., coals.

It is a peculiarity of the semi-bituminous coals that their combustible portion is of remarkably uniform composition, the volatile matter usually ranging between 18 and 22% of the combustible, and approaching in its analysis marsh gas, CH_4 , with very little oxygen. They are usually low also in moisture, ash, and sulphur, and rank among the best steaming coals in the world.

The eastern bituminous coals occupy the remainder of the Appalachian coal field, from Pennsylvania and eastern Ohio to Alabama. They are higher in volatile matter, ranging from 25 to over 40%, the higher figures in the western portion of the field. The volatile matter is of lower heating value, being higher in oxygen. The western bituminous coals are found in most of the states west of Ohio. They are higher in volatile matter and in oxygen and moisture than the bituminous coals of the Appalachian field, and usually give off a denser smoke when burned in ordinary furnaces.

The U. S. Geological Survey classifies coals into six groups, as follows: (1) anthracite; (2) semi-anthracite; (3) semi-bituminous; (4) bituminous; (5) sub-bituminous, or black lignite; and (6) lignite.

Classes 5 and 6 are described as follows: Sub-bituminous coal is commonly known as "lignite," "lignitic coal," "black lignite," "brown coal," etc. It is generally black and shining, closely resembling bituminous coal, but it weathers more rapidly on exposure and lacks the prismatic structure of bituminous coal. Its calorific value is generally less than that of bituminous coal. The localities in which this sub-bituminous coal is found include Montana, Idaho, Washington, Oregon, California, Wyoming, Utah, Colorado, New Mexico, and Texas.

Lignite is commonly known as "lignite," "brown lignite," or "brown coal." It usually has a woody structure and is distinctly brown in color, even on a fresh fracture. It carries a higher percentage of moisture than any other class of coals, its mine samples showing from 30 to 40% of moisture. The localities in which lignite is found are chiefly North Dakota, South Dakota, Texas, Arkansas, Louisiana, Mississippi, and Alabama.

The following analyses of representative coals of the six classes are given by Prof. N. W. Lord:

- Class 1 — Anthracite. Penna.
- Class 2 — Semi-anthracite. Arkansas.
- Class 3 — Semi-bituminous. W. Va.
- Class 4(a) — Bituminous coking. Connellsville, Pa.
- Class 4(b) — Bituminous non-coking. Hocking Valley, Ohio.
- Class 5 — Sub-bituminous. Wyoming; black lignite.
- Class 6 — Lignite. Texas.

COMPOSITION OF ILLUSTRATIVE COALS — CAR-LOAD SAMPLES.
Proximate Analysis of "Air-dried" Sample.

Class.....	1	2	3	4a	4b	5	6
Moisture.....	2.08	1.28	0.65	0.97	7.55	8.68	9.88
Vol. comb.....	7.27	12.82	18.80	29.09	34.03	41.31	36.17
Fixed carbon.....	74.32	73.69	75.92	60.85	52.57	46.49	43.65
Ash.....	16.33	12.21	4.63	9.09	5.85	3.52	10.30
Loss on air-drying	3.40	1.10	1.10	4.20	Undet.	11.30	23.50

Ultimate Analysis of Coal Dried at 105° C.

Hydrogen.....	2.63	3.63	4.54	4.57	5.06	5.31	4.47
Carbon.....	76.86	78.32	86.47	77.10	75.82	73.31	64.84
Oxygen.....	2.27	2.25	2.68	6.67	10.47	15.72	16.52
Nitrogen.....	0.82	1.41	1.08	1.53	1.50	1.21	1.30
Sulphur.....	0.78	2.03	0.57	0.90	0.82	0.60	1.44
Ash.....	16.64	12.36	4.66	9.18	6.33	3.85	11.43

Results Calculated to an Ash and Moisture Free Basis.

Volatile comb.....	8.91	14.82	19.85	32.34	39.30	47.05	45.31
Fixed carbon.....	91.09	85.18	80.15	67.66	60.70	52.95	54.69

Ultimate Analysis.

Hydrogen.....	3.16	4.14	4.76	5.03	5.41	5.50	5.05
Carbon.....	92.20	89.36	90.70	84.89	80.93	76.35	73.21
Oxygen.....	2.72	2.57	2.81	7.34	11.18	16.28	18.65
Nitrogen.....	0.98	1.61	1.13	1.74	1.61	1.25	1.47
Sulphur.....	0.94	2.32	0.60	1.00	0.87	0.62	1.62

Calorific Value in B.T.U. per lb., by Dulong's formula.

Air-dried coal	12,472	13,406	15,190	13,951	12,510	11,620	10,288
Combustible	15,286	15,496	16,037	15,511	14,446	13,235	12,889

Caking and Non-caking Coals. — Bituminous coals are sometimes classified as caking and non-caking coals, according to their behavior when subjected to the process of coking. The former undergo an incipient fusion or softening when heated, so that the fragments coalesce and yield a compact coke, while the latter (also called free-burning) preserve their form, producing a coke which is only serviceable when made from large pieces of coal, the smaller pieces being incoherent. The reason of this difference is not clearly understood, as non-caking coals are often of similar ultimate chemical composition to caking coals. Some coals which cannot be made into coke in a bee-hive oven are easily coked in gas-heated ovens.

Cannel Coals are coals that are higher in hydrogen than ordinary coals. They are valuable as enrichers in gas-making. The following are some ultimate analyses:

	C.	H.	O+N.	S.	Ash.	Combustible.		
						C.	H.	O+N.
Boghead, Scotland.....	63.10	8.91	7.25	0.96	19.78	79.61	11.24	9.15
Albertite, Nova Scotia...	82.67	9.14	8.19	82.67	9.14	8.19
Tasmanite, Tasmania....	79.34	10.41	4.93	5.32	83.80	10.99	5.21

Rhode Island Graphitic Anthracite. — A peculiar variety of coal is found in the central part of Rhode Island and in Eastern Massachusetts. It resembles both graphite and anthracite coal, and has about the following composition (A. E. Hunt, *Trans. A. I. M. E.*, xvii, 678: Graphitic carbon, 78%; volatile matter, 2.60%; silica, 15.06%; phosphorus, .045%. It burns with extreme difficulty.

ANALYSIS AND HEATING VALUE OF COALS.

Coal is composed of four different things, which may be separated by proximate analysis, viz.: fixed carbon, volatile hydrocarbon, ash and moisture. In making a proximate analysis of a weighed quantity, such as a gram of coal, the moisture is first driven off by heating it to about 250° F. then the volatile matter is driven off by heating it in a closed crucible to a red heat, then the carbon is burned out of the remaining coke at a white heat, with sufficient air supplied, until nothing is left but the ash.

The fixed carbon has a constant heating value of about 14,600 B.T.U. per lb. The value of the volatile hydrocarbon depends on its composition, and that depends chiefly on the district in which the coal is mined. It may be as high as 21,000 B.T.U. per lb., or about the heating value of marsh gas, in the best semi-bituminous coals, which contain very small percentages of oxygen, or as low as 12,000 B.T.U. per lb., as in those from some of the western states, which are high in oxygen. The ash has no heating value, and the moisture has in effect less than none, for its evaporation and the superheating of the steam made from it to the temperature of the chimney gases, absorb some of the heat generated by the combustion of the fixed carbon and volatile matter.

The analysis of a coal may be reported in three different forms, as percentages of the moist coal, of the dry coal or of the combustible, as in the following table. By "combustible" is always meant the sum of the fixed carbon and volatile matter, the moisture and ash being excluded. By some writers it is called "coal dry and free from ash" and by others "pure coal."

	Moist Coal.	Dry Coal.	Combustible.
Moisture.....	10
Volatile matter.....	30	33.33	37.50
Fixed carbon.....	50	55.56	62.50
Ash.....	10	11.11
	100	100.00	100.00

The sulphur, commonly reported with a proximate analysis, is determined separately. In the proximate analysis part of it escapes with the volatile matter and the rest of it is found in the ash as sulphide of iron. The sulphur should be given separately in the report of the analysis.

The relation of the volatile matter and of the fixed carbon in the combustible portion of the coal enables us to judge the class to which the coal belongs, as anthracite, semi-anthracite, semi-bituminous, bituminous, or lignite. Coals containing less than 7.5 per cent volatile matter in the combustible, would be classed as anthracite, between 7.5 and 12.5 per cent as semi-anthracite, between 12.5 and 25 per cent as semi-bituminous, between 25 and 50 per cent as bituminous, and over 50 per cent as lignitic coals or lignites. In the classification of the U. S. Geological Survey the sub-bituminous coals and lignites are distinguished by their structure and color rather than by analysis.

The figures in the second column, representing the percentages in the dry coal, are useful in comparing different lots of coal of one class, and they are better for this purpose than the figures in the first column, for the moisture is a variable constituent, depending to a large extent on the weather to which the coal has been subjected since it was mined, on the amount of moisture in the atmosphere at the time when it is analyzed, and on the extent to which it may have accidentally been dried during the process of sampling.

The heating value of a coal depends on its percentage of total combustible matter, and on the heating value per pound of that combustible. The latter differs in different districts and bears a relation to the percentage of volatile matter. It is highest in the semi-bituminous coals, being nearly constant at about 15,750 B.T.U. per pound. It is between 14,500 and 15,000 B.T.U. in anthracite, and ranges from 15,500 down to

13,000 in the bituminous coals, decreasing usually as we go westward, and as the volatile matter contains an increasing percentage of oxygen. In some lignites it is as low as 10,000.

In reporting the heating value of a coal, the B.T.U. per pound of combustible should always be stated, for convenient comparison with other reports.

Proximate Analyses and Heating Values of American Coals.

The accompanying table of proximate analyses and heating values of American coals is condensed from one compiled by the author for the 1898 edition of the Babcock & Wilcox Co.'s book, "Steam." The analyses are selected from various sources, and in general are averages of many samples. The heating values per pound of combustible are either obtained from direct calorimetric determinations or calculated from ultimate analyses, except those marked (?) which are estimated from the heating values of coals of similar composition.

TABLE OF HEATING VALUE OF COALS.

	Moisture.	Volatile Matter.	Fixed Carbon.	Ash.	Sulphur.	Heating Value per lb. Coal, B.T.U.	Volatile Matter per Cent of Combustible.	Heating Value Per lb. Combustible.	Theoretical Evaporation from and at 212° per lb. Combustible.
Anthracite.									
Northern Coal Field..	3.42	4.38	83.27	8.20	0.73	13160	5.00	14900	15.42
East Middle Field....	3.71	3.08	86.40	6.22	0.58	13420	3.44	14900	15.42
West Middle Field....	3.16	3.72	81.59	10.65	0.50	12840	4.36	14900	15.42
Southern Coal Field..	3.09	4.28	83.81	8.18	0.64	13220	4.85	14900	15.42
Semi-anthracite.									
Loyalsock Field.....	1.30	6.10	83.34	6.23	1.63	13920	8.86	15500	16.05
Bernice Basin.....	0.65	9.40	83.69	5.34	0.91	13700	10.98	15500	16.05
Semi-bituminous.									
Clearfield Co., Pa.....	0.76	22.52	71.82	3.99	0.91	14950	24.60	15700	16.25
Cambria Co., Pa.....	0.94	19.20	71.12	7.04	1.70	14450	22.71	15700	16.25
Somerset Co., Pa.....	1.58	16.42	71.51	8.62	1.87	14200	20.37	15800	16.36
Cumberland, Md.....	1.09	17.30	73.12	7.75	0.74	14400	19.79	15800	16.36
Pocahontas, Va.....	1.00	21.00	74.39	3.03	0.58	15070	22.50	15700	16.25
New River, W. Va.....	0.85	17.88	77.64	3.36	0.27	15220	18.95	15800	16.36
Bituminous.									
Connellsville, Pa.....	1.26	30.12	59.61	8.23	0.78	14050	34.03	15300	15.84
Youghiogheny, Pa.....	1.03	36.50	59.05	2.61	0.81	14450	38.73	15000	15.53
Jefferson Co., Pa.....	1.21	32.53	60.99	4.27	1.00	14370	35.47	15200	15.74
Brier Hill, Ohio.....	4.80	34.60	56.30	4.30	13010	38.20	14300	14.80
Vanderpool, Ky.....	4.00	34.10	54.60	7.30	12770	38.50	14400	14.91
Muhlenberg Co., Ky..	4.33	33.65	55.50	4.95	1.57	13060	38.86	14400(?)	14.91
Scott Co., Tenn.....	1.26	35.76	53.14	8.02	1.80	13700	34.17	15100(?)	15.63
Jefferson Co., Ala.....	1.55	34.44	59.77	2.62	1.42	13770	37.63	14400(?)	14.91
Big Muddy, Ill.....	7.50	30.70	53.80	8.00	12420	36.30	14700	15.22
Mt. Olive, Ill.....	11.00	35.65	37.10	13.00	10490	47.00	13800	14.29
Streator, Ill.....	12.00	33.30	40.70	14.00	10580	45.00	14300	14.80
Missouri.....	6.44	37.57	47.94	8.05	12230	43.94	14300(?)	14.80

The heating values per pound of combustible given in the table, except those marked (?) are probably within 3% of the average actual heating values of the combustible portion of the coals of the several districts. When the percentage of moisture and ash in any given lot of coal is known

the heating value per pound of coal may be found approximately by multiplying the heating value per pound of combustible of the average coal of the district by the difference between 100% and the sum of the percentages of moisture and ash.

In 1890 the author deduced from Mahler's tests on European coals the following table of the approximate heating value of coals of different composition.

APPROXIMATE HEATING VALUES OF COALS.

Per Cent Fixed Carbon in Coal Dry and Free from Ash.	Heating Value, B.T.U. per lb. Combustible.	Equivalent Water Evaporation from and at 212° per lb. Combustible.	Per Cent Fixed Carbon in Coal Dry and Free from Ash.	Heating Value, B.T.U. per lb. Combustible.	Equivalent Water Evaporation from and at 212° per lb. Combustible.
100	14,580	15.09	68	15,480	16.03
97	14,940	15.47	63	15,120	15.65
94	15,210	15.75	60	14,760	15.28
90	15,480	16.03	57	14,220	14.72
87	15,660	16.21	55	13,860	14.35
80	15,840	16.40	53	13,320	13.79
72	15,660	16.21	51	12,420	12.86

The experiments of Lord and Haas on American coals (*Trans. A. I. M. E.*, 1897) practically confirm these figures for all coals in which the percentage of fixed carbon is 60% and over of the combustible, but for coals containing less than 60% fixed carbon or more than 40% volatile matter in the combustible, they are liable to an error in either direction of about 4%. It appears from these experiments that the coal of one seam in a given district has the same heating value per pound of combustible within one or two per cent, [true only of some districts] but coals of the same proximate analysis, and containing over 40% volatile matter, but mined in different districts, may vary 6 or 8% in heating value.

The coals containing from 72 to 87 per cent of fixed carbon in the combustible have practically the same heating value. This is confirmed by Lord and Haas's tests of Pocahontas coal. A study of these tests and of Mahler's indicates that the heating value of all the semi-bituminous coals, 75 to 87.5% fixed carbon, is within 1 1/2 % of 15,750 B.T.U. per pound.

The heating value of any coal may also be calculated from its ultimate analysis, with a probable error not exceeding 2%, by Dulong's formula:

$$\text{Heating value per lb.} = 146C + 620 \left(H - \frac{O}{8} \right) + 40S,$$

in which *C*, *H*, and *O* are respectively the percentages of carbon, hydrogen and oxygen. Its approximate accuracy is proved by both Mahler's and Lord and Haas's experiments, and any deviation of the calorimetric determination of any coals (cannel coals and lignites excepted) more than 2% from that calculated by the formula, is more likely to proceed from an error in either the calorimetric test or the analysis, than from an error in the formula.

Tests of the U. S. Geological Survey, 1904-1906. — Coals were selected at the mines in different parts of the country for the purpose of testing their relative value in developing power through a steam boiler and engine and through a gas producer and gas engine. The full account of these tests will be found in Bulletins 261, 290 and 323, and Professional Paper 48, of the U. S. Geological Survey. The following table shows approximately the range of heating values per pound of combustible, as determined by the Mahler calorimeter, and the range of percentages of fixed carbon in the combustible (total of fixed carbon and volatile

matter) in the coals from the several states. The extreme figures, 10,200 and 15,950, fairly represent the whole range of heating values of the combustible of the coals of the United States, but the figures for each state do not nearly cover the range of values in that state, and in some cases, as in Indiana and Illinois, the figures are much lower than the average heating values of the coals of the states.

	Fixed C. %.	B.T.U. per lb.
Penna. anthracite.....	89	14,900
West Va. semi-bituminous.....	80 to 76.5	15,950 to 15,650
Arkansas semi-bituminous.....	84 to 77	15,250 to 15,500
Penna. bituminous.....	67	15,500
West Va. bituminous.....	67.5 to 55	15,500 to 15,000
Eastern Kentucky.....	60	15,000
Western Kentucky.....	55 to 50.5	14,400 to 13,700
Alabama.....	61.5 to 59	14,800 to 14,200
Kansas.....	62 to 53.5	14,800 to 14,100
Oklahoma.....	56 to 51	14,600 to 13,100
Missouri.....	50.5 to 47	14,300 to 12,600
Illinois.....	59 to 47.5	13,700 to 12,400
Iowa.....	57 to 53.5	13,600 to 12,700
Indiana.....	49	13,300
New Mexico.....	50.5 to 47	12,500 to 12,300
Wyoming.....	48 to 41.5	13,300 to 10,900
Montana.....	48.5	12,100
Colorado.....	46	11,500
North Dakota.....	48.5 to 42.5	10,200 to 11,400
Texas.....	44.5 to 34	10,900 to 11,000

Average Results of Lord and Haas's Tests. — ("Steam Boiler Economy," p. 104.)

Name of Coal.	C.	H.	O.	N.	S.	Ash.	Moist.	Vol. Mat.	Fixed C. I	Vol. Mat. % of Comb.	B.T.U.*
Pocahontas, Va.....	84.87	4.20	2.84	0.85	0.59	5.89	0.76	18.51	74.84	19.82	15766
Thacker, W. Va.....	78.65	5.00	6.01	1.41	1.28	6.27	1.38	35.68	56.67	38.62	15237
Pittsburg, Pa.....	75.24	5.01	7.04	1.51	1.79	8.02	1.37	36.80	53.81	40.61	14963
Middle Kittanning, Pa.....	75.19	4.91	7.47	1.46	1.98	7.18	1.81	36.32	54.69	39.91	1480
Upper Freeport, Pa. and O.....	72.65	4.82	7.26	1.34	2.89	9.10	1.93	37.35	51.63	41.98	14755
Mahoning, O.....	71.13	4.56	7.17	1.23	1.86	10.90	3.15	35.00	50.95	40.72	14728
Jackson Co., O.....	70.72	4.45	10.82	1.47	1.13	3.25	8.17	35.79	52.78	40.41	14141
Hocking Valley, O.....	68.03	4.97	9.87	1.44	1.59	8.00	6.59	35.77	49.64	41.84	14040

* Per lb. of combustible, by the Mahler calorimeter. The average figures calculated from the ultimate analyses agreed within 0.5%, except in the case of the Jackson Co. coal in which the calorimetric result was 1.6% higher than that computed from the analysis.

Sizes of Anthracite Coal. — When anthracite is mined it is crushed in a "breaker," and passed over screens separating it into different sizes, which are named as follows:

Lump, passes over bars set 3 1/2 to 5 in. apart; steamboat, over 3 1/2 in. and out of screen; broken, through 3 1/2 in., over 2 3/4 in.; egg, 2 3/4 to 2 in.; stove, 2 to 1 3/8 in.; chestnut, 1 3/8 to 3/4 in.; pea, 3/4 to 1/2 in.; buckwheat, 1/2 to 3/8 in.; rice, 3/8 to 3/16 in.; culm, through 3/16 in.

WARNING: This is a 1910 edition. Some of the material may no longer be accurate

When coal is screened into sizes for shipment the purity of the different sizes as regards ash varies greatly. Samples from one mine gave results as follows:

Name of Coal.	Screened.		Analyses.	
	Through Inches.	Over Inches.	Fixed Carbon.	Ash.
Egg.....	2.5	1.75	88.49	5.66
Stove.....	1.75	1.25	83.67	10.17
Chestnut.....	1.25	0.75	80.72	12.67
Pea.....	0.75	0.50	79.05	14.66
Buckwheat.....	0.50	0.25	76.92	16.62

Space Occupied by Anthracite Coal. (J. C. I. W., vol. iii.)—The cubic contents of 2240 lbs. of hard Lehigh coal is a little over 36 feet; an average Schuylkill white-ash, 37 to 38 feet; Shamokin, 38 to 39 feet; Lorberry, nearly 41.

According to measurements made with Wilkesbarre anthracite coal from the Wyoming Valley, it requires 32.2 cu. ft. of lump, 33.9 cu. ft. broken, 34.5 cu. ft. egg, 34.8 cu. ft. of stove, 35.7 cu. ft. of chestnut, and 36.7 cu. ft. of pea, to make one ton of coal of 2240 lbs.; while it requires 28.8 cu. ft. of lump, 30.3 cu. ft. of broken, 30.8 cu. ft. of egg, 31.1 cu. ft. of stove, 31.9 cu. ft. of chestnut, and 32.8 cu. ft. of pea, to make one ton of 2000 lbs.

Bernice Basin, Pa., Coals.

	Water.	Vol. H.C.	Fixed C.	Ash.	Sulphur.
Bernice Basin, Sullivan } and Lycoming Cos.;	0.96	3.56	82.52	3.27	0.24
range of 8.....	to	to	to	to	to
	1.97	8.56	89.39	9.34	1.04

This coal is on the dividing-line between the anthracites and semi-anthracites, and is similar to the coal of the Lykens Valley district. More recent analyses (Trans. A. I. M. E., xiv. 721) give:

	Water.	Vol. H.C.	Fixed Carb.	Ash.	Sulphur.
Working seam.....	0.65	9.40	83.69	5.34	0.91
60 ft. below seam.....	3.67	15.42	71.34	8.97	0.59

The first is a semi-anthracite, the second a semi-bituminous.

Connellsville Coal and Coke. (Trans. A. I. M. E., xiii. 332.) — The Connellsville coal-field, in the southwestern part of Pennsylvania, is a strip about 3 miles wide and 60 miles in length. The mine workings are confined to the Pittsburgh seam, which here has its best development as to size, and its quality best adapted to coke-making. It generally affords from 7 to 8 feet of coal.

The following analyses by T. T. Morrell show about its range of composition:

	Moisture.	Vol. Mat.	Fixed C.	Ash.	Sulphur.	Phosph's.
Herold Mine.....	1.26	28.83	60.79	8.44	0.67	0.013
Kintz Mine.....	0.79	31.91	56.46	9.52	1.32	0.02

In comparing the composition of coals across the Appalachian field, in the western section of Pennsylvania, it will be noted that the Connellsville variety occupies a peculiar position between the rather dry semi-bituminous coals eastward of it and the fat bituminous coals flanking it on the west.

Beneath the Connellsville or Pittsburgh coal-bed occurs an interval of from 400 to 600 feet of "barren measures," separating it from the lower productive coal-measures of Western Pennsylvania. The following tables show the great similarity in composition in the coals of these upper and lower coal-measures in the same geographical belt or basin.

Analyses from the Upper Coal-measures in a Westward Order.

Localities.	Moisture.	Vol. Mat.	Fixed Carb.	Ash.	Sulphur.
Anthracite.....	1.35	3.45	89.06	5.81	0.30
Cumberland, Md.....	0.89	15.52	74.28	9.29	0.71
Salisbury, Pa.....	1.66	22.35	68.77	5.96	1.24
Connellsville, Pa.....		31.38	60.30	7.24	1.09
Greensburg, Pa.....	1.02	33.50	61.34	3.28	0.86
Irwin's, Pa.....	1.41	37.66	54.44	5.86	0.64

Analyses from the Lower Coal-measures in a Westward Order.

Localities.	Moisture.	Vol. Mat.	Fixed Carb.	Ash.	Sulphur.
Anthracite.....	1.35	3.45	89.06	5.81	0.30
Broad Top.....	0.77	18.18	73.34	6.69	1.02
Bennington.....	1.40	27.23	61.84	6.93	2.60
Johnstown.....	1.18	16.54	74.46	5.96	1.86
Blairsville.....	0.92	24.36	62.22	7.69	4.92
Armstrong Co.....	0.96	38.20	52.03	5.14	3.66

Analyses of Southern Coals.

	Moisture.	Vol. Mat.	Fixed C.	Ash.	Sulphur.
VIRGINIA AND KENTUCKY.					
Big Stone Gap Field,* 9 analyses, range	{ from 0.80 to 2.01	31.44 36.27	54.80 63.50	1.73 8.25	0.56 1.72
KENTUCKY.					
Pulaski Co., 3 analyses, range	{ from 1.26 to 1.32	35.15 39.44	60.85 52.48	1.23 5.52	0.40 1.00
Muhlenberg Co., 4 analyses, range	{ from 3.60 to 7.06	30.60 38.70	58.80 53.70	3.40 6.50	0.79 3.16
Pike Co., Eastern Ky., 37 analyses, range	{ from 1.80 to 1.60	26.80 41.00	67.60 50.37	3.80 7.80	0.97 0.03
Kentucky Cannel Coals, 5 analyses, range	{ from to	40.20 66.30	59.80 coke 33.70 coke	8.31 4.80	0.96 1.32
TENNESSEE.					
Scott Co., range of several †	{ from 0.70 to 1.83	32.33 41.29	46.61 61.66	16.94 1.11	3.37 0.77
Roane Co., Rockwood	1.75	26.62	60.11	11.52	1.49
Hamilton Co., Melville	2.74	26.50	67.08	3.68	0.91
Marion Co., Etna	0.94	23.72	63.94	11.40	1.19
Sewanee Co., Tracy City	1.60	29.30	61.00	7.80	
Kelly Co., Whiteside	1.30	21.80	74.20	2.70	
GEORGIA.					
Dade Co.....	1.20	23.05	60.50	15.16	0.84
ALABAMA.					
Warren Field:					
Jefferson Co., Birmingham	3.01	42.76	48.30	3.21	2.72
Jefferson Co., Black Creek	0.12	26.11	71.64	2.03	0.10
Tuscaloosa Co.	1.59	38.33	54.64	5.45	1.33
Cahaba Field, Helena Vein	2.00	32.90	53.08	11.34	0.68
Bibb Co., Coke Vein	1.78	30.60	66.58	1.09	0.04

* This field covers about 120 square miles in Virginia, and about 30 square miles in Kentucky.

† Volatile matter including moisture.

‡ Single analyses from Morgan, Rhea, Anderson, and Roane counties fall within this range.

Analyses of Southern Coals — Continued.

	Moisture.	Vol. Mat.	Fixed C.	Ash.	Sulphur.
TEXAS.					
Eagle Mine.....	3.54	30.64	50.69	14.93	
Sabinas Field, Vein I.....	1.91	20.04	62.71	15.35	
" " " II.....	1.37	16.42	68.18	13.02	
" " " III.....	0.84	29.35	50.18	19.63	
" " " IV.....	0.45	21.6	45.75	29.1	3.15

Indiana Coals. (J. S. Alexander, *Trans. A. I. M. E.*, iv, 100.) — The typical block coal of the Brazil (Indiana) district differs in chemical composition but little from the coking coals of Western Pennsylvania. The physical difference, however, is quite marked; the latter has a cuboid structure made up of bituminous particles lying against each other, so that under the action of heat fusion throughout the mass readily takes place, while block coal is formed of alternate layers of rich bituminous matter and a charcoal-like substance, which is not only very slow of combustion, but so retards the transmission of heat that agglutination is prevented, and the coal burns away layer by layer, retaining its form until consumed.

An ultimate analysis of block coal from Sand Creek by E. T. Cox gave: C, 72.94; H, 4.50; O, 11.77; N, 1.79; ash, 4.50; moisture, 4.50. Analyses of other Indiana coals are given below.

	Moisture.	Vol. Mat.	Fixed C.	Ash.
Caking Coals.				
Parke Co.....	4.50	45.50	45.50	4.50
Sullivan Co.....	2.35	45.25	51.60	0.80
Clay Co.....	7.00	39.70	47.30	6.00
Spencer Co.....	3.50	45.00	46.00	2.50
Block Coals.				
Clay Co.....	8.50	31.00	57.50	3.00
Martin Co.....	2.50	44.75	51.25	1.50
Daviess Co.....	5.50	36.00	53.50	5.00

Illinois Coals. The Illinois coals are generally high in moisture, volatile matter, ash and sulphur, and the volatile matter is high in oxygen; consequently the coals are low in heating value. The range of quality is a wide one. The Big Muddy coal of Jackson Co., which has a high reputation as a steam coal in the St. Louis market, has about 36% of volatile matter in the combustible, while a coal from Staunton, Macoupin Co., tested by the author in 1883 (*Trans. A. S. M. E.*, v, 266) had 68%. A boiler test with this coal gave only 6.19 lbs. of water evaporated from and at 212° per lb. of combustible, in the same boiler that had given 9.88 lbs. with Jackson, O., nut.

Prof. S. W. Parr, in Bulletin No. 3 of the Ill. State Geol. Survey, 1906, reports the analyses and calorimetric tests of 150 Illinois coals. The two having the lowest and the highest value per pound of combustible have the following analysis:

	Air-dried Coal.					Pure Coal.		
	Moist.	Ash.	Vol.	Fixed C.	S.	Vol.	Fixed C.	B.T.U. per lb.
Lowest..	9.90	5.02	40.75	44.33	2.00	47.90	52.10	12,162
Highest..	5.68	8.90	33.32	52.10	1.18	39.02	60.98	14,830

The poorest coal of the series had a heating value of only 8645 B.T.U. per lb., air dry; it contained 9.70 moisture and 31.18 ash, and the B.T.U. per lb. combustible was 14,623. The best coal had a heating value of 13,303 per lb.; moisture 4.20, ash 5.50, B.T.U. per lb. combustible, 14,734.

Of the 150 coals, 28 gave between 14,500 and 14,830 B.T.U. per lb. combustible; 82 between 14,000 and 14,500; 32 between 13,500 and 14,000; 6 between 13,000 and 13,500; one 12,535 and one 12,162. The average is about 14,200. The volatile matter ranged from 36.24% to 53.80% of the combustible; the sulphur from 0.62 to 4.96%; the ash from 2.22 to 31.18%, and the moisture from 3.28 to 12.74%, all calculated from the air-dried samples. The moisture in the coal as mined is not stated, but was no doubt considerably higher. The author has found over 14% moisture in a lump of Illinois coal that was apparently dry, having been exposed to air, under cover, for more than a month.

Colorado Coals. — The Colorado coals are of extremely variable composition, ranging all the way from lignite to anthracite. G. C. Hewitt (*Trans. A. I. M. E.*, xvii. 377) says: The coal seams, where unchanged by heat and flexure, carry a lignite containing from 5% to 20% of water. In the southeastern corner of the field the same have been metamorphosed so that in four miles the same seams are an anthracite, coking, and dry coal. The dry seams also present wide chemical and physical changes in short distances. A soft and loosely bedded coal has in a hundred feet become compact and hard without the intervention of a fault. A couple of hundred feet has reduced the water of combination from 12% to 5%.

Western Arkansas and Oklahoma, (formerly Indian Territory). (H. M. Chance, *Trans. A. I. M. E.*, 1890.) — The western Arkansas coals are dry semi-bituminous or semi-anthracitic coals, mostly non-coking, or with quite feeble coking properties, ranging from 14% to 16% in volatile matter, the highest percentage yet found, according to Mr. Winslow's Arkansas report, being 17.655.

In the Mitchell basin, about 10 miles west from the Arkansas line, the coal shows 19% volatile matter; the Mayberry coal, about 8 miles farther west, contains 23%; and the Bryan Mine coal, about the same distance west, shows 26%. About 30 miles farther west, the coal shows from 38% to 41 1/2% volatile matter, which is also about the percentage in coals of the McAlester and Lehigh districts.

Western Lignites. — The ultimate analyses of some lignites from Utah, Wyoming, Oregon and Alaska are reported by R. W. Raymond in *Trans. A. I. M. E.*, vol. ii. 1873. The range of the analyses is as follows: C, 55.79 to 69.84; H, 3.26 to 5.08; O, 9.54 to 21.82; N, 0.42 to 1.93; S, 0.63 to 3.92; moisture, 3.08 to 16.52; ash, 1.68 to 9.28. The heating value in B.T.U. per lb. combustible, calculated by Dulong's formula, ranges from 10,090 to 13,970.

Analyses of Foreign Coals. (Selected from D. L. Barnes's paper on American Locomotive Practice, *Trans. A. S. C. E.*, 1893.)

	Volat. Matter.	Fixed Carbon.	Ash.		Volat. Matter.	Fixed Carbon.	Ash.
Great Britain:				South America:			
South-Wales.....	8.5	88.3	3.2	Chili, Chiroqui....	24.11	38.98	36.91
South-Wales.....	6.2	92.3	1.5	Patagonia.....	24.35	62.25	13.4
Lancashire, Eng.	17.2	80.1	2.7	Brazil.....	40.5	57.9	1.6
Derbyshire.....	17.7	79.9	2.4	Canada:			
Durham, " * 15.05	86.8	1.1		Nova Scotia.....	26.8	60.7	12.5
Staffordshire, " 20.4	78.6	1.0		Cape Breton.....	26.9	67.6	5.5
Scotland†.....	17.1	63.1	19.8	Australia:			
Scotland†.....	17.5	80.1	2.4	Lignite.....	15.8	64.3	10.0
South America:				Sydney, N. S. W.	14.98	82.39	2.04
Chili.....	21.93	70.55	7.52	Borneo.....	26.5	70.3	14.2
				Tasmania.....	6.16	63.4	30.45

* Semi-bit. coking coal. † Boghead cannel gas coal.
‡ Semi-bit. steam-coal.

An analysis of Pictou, N. S., coal, in *Trans. A. I. M. E.*, xiv. 560, is: vol., 29.63; carbon, 56.98; ash, 13.39; and one of Sydney, Cape Breton, coal is: vol., 34.07; carbon, 61.43; ash, 4.50.

Sampling Coal for Analysis. — J. P. Kimball, *Trans. A. I. M. E.*, xii. 317, says: The unsuitable sampling of a coal-seam, or the improper preparation of the sample in the laboratory, often gives rise to errors in determinations of the ash so wide in range as to vitiate the analysis for all practical purposes; every other single determination, excepting moisture, showing its relative part of the error. The determinations of sulphur and ash are especially liable to error, as they are intimately associated in the slates.

Wm. Forsyth, in his paper on The Heating Value of Western Coals (*Eng'g News*, Jan. 17, 1895), says: This trouble in getting a fairly average sample of anthracite coal has compelled the Reading R. R. Co., in getting its samples, to take as much as 300 lbs. for one sample, drawn direct from the chutes, as it stands ready for shipment.

The directions for collecting samples of coal for analysis at the C., B. & Q. laboratory are as follows:

Two samples should be taken, one marked "average," the other "select." Each sample should contain about 10 lbs., made up of lumps about the size of an orange taken from different parts of the dump or car, and so selected that they shall represent as nearly as possible, first, the average lot; second, the best coal.

An example of the difference between an "average" and a "select" sample, taken from Mr. Forsyth's paper, is the following of an Illinois coal:

	Moisture.	Vol. Mat.	Fixed Carbon.	Ash.
Average.....	1.36	27.69	35.41	35.54
Select.....	1.90	34.70	48.23	15.17

The theoretical evaporative power of the former was 9.13 lbs. of water from and at 212° per lb. of coal, and that of the latter 11.44 lbs.

RELATIVE VALUE OF STEAM COALS.

The heating value of a coal may be determined, with more or less approximation to accuracy, by three different methods.

1st, by chemical analysis; 2d, by combustion in a coal calorimeter; 3d, by actual trial in a steam-boiler.

The accuracy of the first two methods depends on the precision of the method of analysis or calorimetry adopted, and upon the care and skill of the operator. The results of the third method are subject to numerous sources of variation and error, and may be taken as approximately true only for the particular conditions under which the test is made. Analysis and calorimetry give with considerable accuracy the heating value which may be obtained under the conditions of perfect combustion and complete absorption of the heat produced. A boiler test gives the actual result under conditions of more or less imperfect combustion, and of numerous and variable wastes. It may give the highest practical heating value, if the conditions of grate-bars, draft, extent of heating surface, method of firing, etc., are the best possible for the particular coal tested, and it may give results far beneath the highest if these conditions are adverse or unsuitable to the coal.

In a paper entitled Proposed Apparatus for Determining the Heating Power of Different Coals (*Trans. A. I. M. E.*, xiv. 727) the author described and illustrated an apparatus designed to test fuel on a large scale, avoiding the errors of a steam-boiler test. It consists of a fire-brick furnace enclosed in a water casing, and two cylindrical shells containing a great number of tubes, which are surrounded by cooling water and through which the gases of combustion pass while being cooled. No steam is generated in the apparatus, but water is passed through it and allowed to escape at a temperature below 200° F. The product of the weight of the water passed through the apparatus by its increase in temperature is the measure of the heating value of the fuel.

A study of M. Mahler's calorimetric tests shows that the maximum difference between the results of these tests and the calculated heating power by Dulong's law in any single case is only a little over 3%, and the results of 31 tests show that Dulong's formula gives an average of

only 47 thermal units less than the calorimetric tests, the average total heating value being over 14,000 B.T.U., a difference of less than 0.4%.*

The close agreement of the results of calorimetric tests when properly conducted, and of the heating power calculated from the ultimate chemical analysis, indicates that either the chemical or the calorimetric method may be accepted as correct enough for all practical purposes for determining the total heating power of coal. The results obtained by either method may be taken as a standard by which the results of a boiler test are to be compared, and the difference between the total heating power and the result of the boiler test is a measure of the inefficiency of the boiler under the conditions of any particular test.

The heating value that can be obtained in boiler practice from any given coal depends upon the efficiency of the boiler, and this largely upon the difficulty of thoroughly burning the volatile combustible matter in the boiler furnace.

With the best anthracite coal, in which the combustible portion is, say, 97% fixed carbon and 3% volatile matter, the highest result that can be expected in a boiler-test with all conditions favorable is 12.2 lbs. of water evaporated from and at 212° per lb. of combustible, which is 79% of 15.47 lbs., the theoretical heating-power. With the best semi-bituminous coals, such as Cumberland and Pocahontas, in which the fixed carbon is 80% of the total combustible, 12.5 lbs., or 76% of the theoretical 16.4 lbs., may be obtained. For Pittsburgh coal, with a fixed carbon ratio of 68%, 11 lbs., or 69% of the theoretical 16.03 lbs., is about the best practically obtainable with the best boilers when hand-fired, with ordinary furnaces. (The author has obtained 78% with an automatic stoker set in a "Dutch oven" furnace.) With some good Ohio coals, with a fixed carbon ratio of 60%, 10 lbs., or 66% of the theoretical 15.28 lbs., has been obtained, under favorable conditions, with a fire-brick arch over the furnace. With coals mined west of Ohio, with lower carbon ratios, the boiler efficiency is not apt to be as high as 60% unless a special furnace, adapted to the coal, is used.

From these figures a table of probable maximum boiler-test results with ordinary furnaces from coals of different fixed carbon ratios may be constructed as follows:

Fixed carbon ratio.....	97	80	68	60	54	50
Evap. from and at 212° per lb. combustible, maximum in boiler-tests:	12.2	12.5	11	10	8.3	7.0
Boiler efficiency, per cent.....	80	76	69	66	60	55
Loss, chimney, radiation, imperfect combustion, etc:	20	24	31	34	40	45

The difference between the loss of 20% with anthracite and the greater losses with the other coals is chiefly due to imperfect combustion of the bituminous coals, the more highly volatile coals sending up the chimney the greater quantity of smoke and unburned hydrocarbon gases. It is a measure of the inefficiency of the boiler furnace and of the inefficiency of heating-surface caused by the deposition of soot, the latter being primarily caused by the imperfection of the ordinary furnace and its unsuitability to the proper burning of bituminous coal. If in a boiler-test with an ordinary furnace lower results are obtained than those in the above table, it is an indication of unfavorable conditions, such as bad firing, wrong proportions of boiler, defective draft, a rate of driving beyond the capacity of the furnace, or beyond the capacity of the boiler to absorb the heat produced in the furnace. It is quite possible, however, with automatic stokers and fire-brick combustion chambers to obtain an efficiency of 70% with the highly volatile western coals.

* Mahler gives Dulong's formula with Berthelot's figure for the heating value of carbon, in British thermal units,

$$\text{Heating Power} = 14,550 C + 62,025 \left(H - \frac{(O + N) - 1}{8} \right)$$

The formula commonly used in the United States is 14,600 C + 62,000 (H - 1/8 O) + 4050 S. For a description of the Mahler calorimeter and its method of operation see the author's "Steam Boiler Economy." Prof. S. W. Parr, of the University of Illinois, has put a calorimeter on the market which gives results practically equal to those obtained with Mahler's instrument.

Purchase of Coal under Specifications. — It is customary for large users of coal to purchase it under specifications of its analysis or heating value with a penalty attached for failure to meet the specifications. The following standards for a specification were given by the author in his "Steam Boiler Economy," 1901:

Anthracite and Semi-anthracite. — The standard is a coal containing 5% volatile matter, not over 2% moisture, and not over 10% ash. A premium of 1% on the price will be given for each per cent of volatile matter above 5% up to and including 15%, and a reduction of 2% on the price will be made for each 1% of moisture and ash above the standard.

Semi-bituminous and Bituminous. — The standard is a semi-bituminous coal containing not over 20% volatile matter, 2% moisture, 6% ash. A reduction of 1% in the price will be made for each 1% of volatile matter in excess of 25%, and of 2% for each 1% of ash and moisture in excess of the standard.

For western coals in which the volatile matter differs greatly in its percentage of oxygen, the above specification based on proximate analysis may not be sufficiently accurate, and it is well to introduce either the heating value as determined by a calorimeter or the percentage of oxygen. The author has proposed the following for Illinois coal:

The standard is one containing 14,500 B.T.U. per lb. of pure coal (coal free from moisture and ash), not over 6% moisture and 10% ash in an air-dried sample. For lower heating value per lb. of pure coal, the price shall be reduced proportionately, and for every 1% increase in ash or moisture above the specified figures, 2% on the price shall be deducted.

Several departments of the U. S. government now purchase coal under specifications. See paper on the subject by D. T. Randall, Bulletin No. 339, U. S. Geological Survey, 1908.

Evaporative Power of Bituminous Coals.

(Tests with Babcock & Wilcox Boilers, *Trans. A. S. M. E.*, iv, 267.)

Name of Coal.	Duration of Test.	Grate Surface, sq. ft.	Heating Surface, sq. ft.	Percentage of Refuse.	Coal burned per sq. ft. of Grate, pounds.	Water evaporated per sq. ft. of Heating Surface per hour, pounds.	Water per pound Coal from and at 212° lbs.	Water per pound Combustible from and at 212°.	Rated Horse-power.	Horse-power developed.
1. Welsh.....	13 1/2 hrs	40	1679	7.5	6.3	2.07	11.53	12.46	146	96
2. Anthracite scr's 1/5. Semi-bit. 4/5.	10 1/4 h	60	3126	8.8	17.6	4.32	11.32	12.42	272	448
3. Pittsb'gh fine slack	4 hrs	33.7	1679	12.3	21.9	4.47	8.12	9.29	146	250
" 3d Pool lump	10 "	43.5	2760	4.8	27.5	4.76	10.47	11.00	240	419
4. Castle Shannon, nr. Pittsb'gh, 3/8 nut, 5/8 lump.	4 21/4 h	69.1	4784	10.5	27.9	4.13	10.00	11.17	416	570
5. Ill. "run of mine".	6 days	1196	1.41	9.49	104	54
" Ind. block.....	3 days	1196	2.95	9.47	104	111
6. Jackson, O., nut....	8 hrs.	48	3358	9.6	32.1	4.11	8.93	9.88	292	460
" Staunton, Ill., nut..	8 "	60	3358	17.7	25.1	2.27	5.09	6.19	292	246
7. Renton screenings..	5 h 50 m	21.2	1564	13.8	31.5	2.95	6.88	7.98	136	151
" Wellington scr'gs...	6 h 30 m	21.2	1564	18.3	27	2.93	7.89	9.66	136	150
" Black Diam. scr'gs..	5 h 58 m	21.2	1564	19.3	36.4	3.11	6.29	7.80	136	160
" Seattle screenings..	6 h 24 m	21.2	1564	13.4	31.3	2.91	6.86	7.92	136	150
" Wellington lump....	6 h 19 m	21.2	1564	13.8	28.2	3.52	9.02	10.46	136	171
" Cardiff lump.....	6 h 47 m	21.2	1564	11.7	26.7	3.69	10.07	11.40	136	189
" ".....	7 h 23 m	21.2	1564	19.1	25.6	3.35	9.62	11.89	136	174
" South Paine lump..	6 h 35 m	21.2	1564	13.9	28.9	3.53	8.96	10.41	136	182
" Seattle lump.....	6 h 5 m	21.2	1564	9.5	34.1	3.57	7.68	8.49	136	184

WARNING: This is a 1910 edition. Some of the material may no longer be accurate

Place of Test: 1. London, England; 2. Peacedale, R. I.; 3. Cincinnati; 4. Pittsburgh; 5. Chicago; 6. Springfield, O.; 7. San Francisco.

In all the above tests the furnace was supplied with a fire-brick arch for preventing the radiation of heat from the coal directly to the boiler.

Weathering of Coal. (I. P. Kimball, *Trans. A. I. M. E.*, viii, 204.) — The effect of the weathering of coal, while sometimes increasing its weight, is to diminish the carbon and disposable hydrogen and to increase the oxygen and indisposable hydrogen. Hence a reduction in the calorific value. An excess of pyrites in coal tends to produce rapid oxidation and mechanical disintegration of the mass, with development of heat, loss of coking power, and spontaneous ignition.

The only appreciable results of the weathering of anthracite are confined to the oxidation of its accessory pyrites. In coking coals, however, weathering reduces and finally destroys the coking power.

Richters found that at a temperature of 158° to 180° Fahr., three coals lost in fourteen days an average of 3.6% of calorific power. It appears from the experiments of Richters and Reder that when there is no rise of temperature of coal piled in heaps and exposed to the air for nine to twelve months, it undergoes no sensible change, but when the coal becomes heated it suffers loss of C and H by oxidation and increases in weight by the fixation of oxygen. (See also paper by R. P. Rothwell, *Trans. A. I. M. E.*, iv, 55.)

Experiments by S. W. Parr and N. D. Hamilton (Bull. No. 17 of Univ'y of Ill. Eng'g Experiment Station, 1907) on samples of about 100 lbs. each, show that no appreciable change takes place in coal submerged in water. Their conclusions are:

- (a) Submerged coal does not lose appreciably in heat value.
- (b) Outdoor exposure results in a loss of heating value varying from 2 to 10 per cent.
- (c) Dry storage has no advantage over storage in the open except with high sulphur coals, where the disintegrating effect of sulphur in the process of oxidation facilitates the escape or oxidation of the hydrocarbons.
- (d) In most cases the losses in storage appear to be practically complete at the end of five months. From the seventh to the ninth month the loss is inappreciable.

This paper contains also a historical review of the literature on weathering and on spontaneous combustion, with a summary of the opinions of various authorities.

Later experiments on storing carload lots of Illinois coals (W. F. Wheeler, *Trans. A. I. M. E.*, 1908) confirm the above conclusions, except that 4 per cent seems to be amply sufficient to cover the losses sustained by Illinois coals under regular storage-conditions, the larger losses indicated in the former series being probably due to the small size of the samples exposed. In these latter tests, the losses sustained by the submerged coal, though small in amount, are only slightly less than those indicated for the exposed coal. Screenings and 3-in. nut coal from three mines were stored outdoors, under cover and under water. The average loss in heating value at the end of one week was 0.8%, at the end of two months 1.3%, and at the end of six months 2.0%. Pillar coal exposed underground from 22 to 27 years showed less than 3% loss in heating value as compared with fresh face coal from the same mines.

An extreme case of weathering was found in coal taken from near an outcrop that had been covered with soil and forest. The coal in this case had become so changed as to appear nearly like lignite, and the analysis shows a corresponding resemblance. The dry coal analysis of the outcrop coal, as compared with fresh face coal 300 ft. from the outcrop, is as follows:

	Ash.	Vol. Mat.	Fixed C.	Sulphur.
Outcrop.....	16.86	39.27	43.87	0.85
Fresh coal.....	16.25	40.72	43.03	3.91

The moisture in the outcrop coal was 29.81% and in the fresh coal 13.86%. The heating value of the ash-, water- and sulphur-free coal from the outcrop was 11,164 B.T.U. and that of the fresh coal 14,618 B.T.U.

Pressed Fuel. (E. F. Loiseau, *Trans. A. I. M. E.*, viii, 314.) — Pressed fuel has been made from anthracite dust by mixing the dust with ten per cent of its bulk of dry pitch, which is prepared by separating from tar at a temperature of 572° F. the volatile matter it contains. The mixture is kept heated by steam to 212°, at which temperature the pitch acquires its cementing properties, and is passed between two rollers, on the periphery of which are milled out a series of semi-oval cavities. The lumps of the mixture, about the size of an egg, drop out under the rollers on an endless belt which carries them to a screen in eight minutes, which time is sufficient to cool the lumps, and they are then ready for delivery.

The enterprise of making the pressed fuel above described was not commercially successful, on account of the low price of other coal. In France, however, "briquettes" are regularly made of coal-dust (bituminous and semi-bituminous).

Experiments with briquets for use in locomotives have been made by the Penna. R. R. Co., with favorable results, which were reported at the convention of the Am. Ry. Mast. Mechs. Assn. (*Eng. News*, July 2, 1908). A rate of evaporation as high as 19 lbs. per sq. ft. of heating surface per hour was reached. The comparative economy of raw coal and of briquets was as follows:

Evap. per sq. ft. heat. surf. per hr., lbs	8	10	12	14	16
Evap. from and at } Lloydell coal....	9.5	8.8	8.0	7.3	6.6
212° per lb. of fuel } Briquetted coal.	10.7	10.2	9.7	9.2	8.7

The fuel consumed per draw-bar horse-power with the locomotive running at 37.8 miles per hour and a cut-off of 25% was: with raw coal, 4.48 lbs.; with round briquets, 3.65 lbs.

Experiments on different binders for briquets are discussed by J. E. Mills in Bulletin No. 343 of the U. S. Geological Survey, 1908.

The experiments show that, in general, where it can be obtained, the cheapest binder will be the heavy residuum from petroleum, often known to the trade as asphalt. Four per cent of this binder being sufficient, its cost ranges from 45 to 60 cts. per ton of briquets produced. This binder is available in California, Texas, and adjacent territory.

Second in order of importance comes water-gas tar pitch. Five to six per cent usually proving sufficient, the cost of this binder ranges from 50 to 60 cts. per ton of briquets. As water-gas pitch is also derived from petroleum, it will be available in oil-producing regions.

Third in order is coal-tar pitch. This binder is very widely available. From 6.5 to 8% will usually be required, and the cost ranges from 65 to 90 cts. per ton of briquets.

Other substances are also mentioned which may possibly be used for binders, such as asphalts and tars derived from wood distillation; pitch made from producer-gas tar; and magnesia. Starch and the waste sulphite liquor from paper mills may also be used, but the briquets made with them are not waterproof.

Briquetting tests made at the St. Louis exhibition, 1904, with descriptions of the machines used are reported in Bulletin No. 261 of the U. S. Geological Survey, 1905. See also paper on Coal Briquetting in the U. S., by E. W. Parker, *Trans. A. I. M. E.*, 1907.

COKE.

Coke is the solid material left after evaporating the volatile ingredients of coal, either by means of partial combustion in furnaces called coke ovens, or by distillation in the retorts of gas-works.

Coke made in ovens is preferred to gas coke as fuel. It is of a dark gray color, with slightly metallic luster, porous, brittle, and hard.

The proportion of coke yielded by a given weight of coal is very different for different kinds of coal, ranging from 0.9 to 0.35.

Being of a porous texture, it readily attracts and retains water from the atmosphere, and sometimes, if it is kept without proper shelter, from 0.15 to 0.20 of its gross weight consists of moisture.

Analyses of Coke.

(From report of John R. Procter, Kentucky Geological Survey.)

Where Made.	Fixed Carbon.	Ash.	Sulphur.
Connellsville, Pa. (Average of 3 samples)	88.96	9.74	0.810
Chattanooga, Tenn. " " 4 "	80.51	16.34	1.595
Birmingham, Ala. " " 4 "	87.29	10.54	1.195
Pocahontas, Va. " " 3 "	92.53	5.74	0.597
New River, W. Va. " " 8 "	92.38	7.21	0.562
Big Stone Gap, Ky. " " 7 "	93.23	5.69	0.749

Experiments in Coking. CONNELLSVILLE REGION.
(John Fulton, Amer. Mfr., Feb. 10, 1893.)

No. of Test.	Time in Oven.		Coal Charged.	Ash made.	Fine Coke made.	Market Coke made.	Total Coke made.	Per cent of Yield.				Per Cent Lost.
								Ash.	Fine Coke.	Market Coke.	Total Coke.	
1	h. m.	lb.	lb.	lb.	lb.	lb.	lb.	00.80	3.10	60.53	63.63	35.57
2	67 00	12,420	99	385	7,518	7,903	00.81	3.24	59.33	62.57	36.62	
3	68 00	11,090	90	359	6,580	6,939	00.84	2.98	59.41	62.39	36.77	
4	45 00	9,120	77	272	5,418	5,690	00.82	3.87	59.13	63.00	36.18	

These results show, in a general average, that Connellsville coal carefully coked in a modern beehive oven will yield 66.17% of marketable coke, 2.30% of small coke or breeze, and 0.82% of ash.

The total average loss in volatile matter expelled from the coal in coking amounts to 30.71%.

The beehive coke oven is 12 feet in diameter and 7 feet high at crown of dome. It is used in making 48 and 72 hour coke. [The Belgian type of beehive oven is rectangular in shape.]

In making these tests the coal was weighed as it was charged into the oven; the resultant marketable coke, small coke or breeze and ashes weighed dry as they were drawn from the oven.

Coal Washing. — In making coke from coals that are high in ash and sulphur, it is advisable to crush and wash the coal before coking it. A coal-washing plant at Brookwood, Ala., has a capacity of 50 tons per hour. The average percentage of ash in the coal during ten days' run varied from 14% to 21%, in the washed coal from 4.8% to 8.1%, and in the coke from 6.1% to 10.5%. During three months the average reduction of ash was 60.9%. (*Eng. and Mining Jour.*, March 25, 1893.)

An experiment on washing Missouri No. 3 slack coal is described in Bulletin No. 3 of the Engineering Experiment Station of Iowa State College, 1905. The raw coal analyzed: moisture, 14.37; ash, 28.39; sulphur, 4.30; and the washed coal, moisture, 23.90; ash, 7.59; sulphur, 2.89. Nearly 25% of the coal was lost in the operation.

Recovery of By-products in Coke Manufacture. — In Germany considerable progress has been made in the recovery of by-products. The Hoffman-Otto oven has been most largely used, its principal feature being that it is connected with regenerators. In 1884 40 ovens on this system were running, and in 1892 the number had increased to 1209.

A Hoffman-Otto oven in Westphalia takes a charge of 6¼ tons of dry coal and converts it into coke in 48 hours. The product of an oven annually is 1025 tons in the Ruhr district, 1170 tons in Silesia, and 960 tons in the Saar district. The yield from dry coal is 75% to 77% of coke, 2.5% to 3% of tar, and 1.1% to 1.2% of sulphate of ammonia in

the Ruhr district; 65% to 70% of coke, 4% to 4.5% of tar, and 1% to 1.25% of sulphate of ammonia in the Upper Silesia region, and 68% to 72% of coke, 4% to 4.3% of tar and 1.8% to 1.9% of sulphate of ammonia in the Saar district. A group of 60 Hoffman ovens, therefore, yields annually the following:

District.	Coke, tons.	Tar, tons.	Sulphate Ammonia, tons.
Ruhr.....	51,300	1860	780
Upper Silesia.....	48,000	3000	840
Saar.....	40,500	2400	492

An oven which has been introduced lately into Germany in connection with the recovery of by-products is the Semet-Solvay, which works hotter than the Hoffman-Otto, and for this reason 73% to 75% of gas coal can be mixed with 23% to 27% of coal low in volatile matter, and yet yield a good coke. Mixtures of this kind yield a larger percentage of coke, but, on the other hand, the amount of gas is lessened, and therefore the yield of tar and ammonia is not so great.

The yield of coke by the beehive and the retort ovens respectively is given as follows in a pamphlet of the Solvay Process Co.: Connellsville coal: beehive, 66%, retort, 73%; Pocahontas: beehive, 62%, retort, 83%; Alabama: beehive, 60%, retort, 74%. (See article in *Mineral Industry*, vol. viii, 1900.)

References: F. W. Luerman, Verein Deutscher Eisenhuettenleute 1891, *Iron Age*, March 31, 1892; *Amer. Mfr.*, April 28, 1893. An excellent series of articles on the manufacture of coke, by John Fulton, of Johnstown, Pa., is published in the *Colliery Engineer*, beginning in January, 1893.

Since the above was written, great progress in the introduction of coke ovens with by-product attachments has been made in the United States, especially by the Semet-Solvay Co., Syracuse, N. Y. See paper on The Development of the Modern By-product Coke-oven, by C. G. Atwater, *Trans. A. I. M. E.*, 1902.

Generation of Steam from Waste Heat and Gases of Coke-ovens. (Erskine Ramsey, *Amer. Mfr.*, Feb. 16, 1894.) — The gases from a number of adjoining ovens of the beehive type are led into a long horizontal flue, and thence to a combustion-chamber under a battery of boilers. Two plants are in satisfactory operation at Tracy City, Tenn., and two at Pratt Mines, Ala.

A Bushel of Coal. — The weight of a bushel of coal in Indiana is 70 lbs.; in Penna., 76 lbs.; in Ala., Colo., Ga., Ill., Ohio, Tenn., and W. Va., it is 80 lbs.

A Bushel of Coke is almost uniformly 40 lbs., but in exceptional cases, when the coal is very light, 38, 36, and 33 lbs. are regarded as a bushel, in others from 42 to 50 lbs. are given as the weight of a bushel; in this case the coke would be quite heavy.

Products of the Distillation of Coal. — S. P. Sadler's Handbook of Industrial Organic Chemistry gives a diagram showing over 50 chemical products that are derived from distillation of coal. The first derivatives are coal-gas, gas-liquor, coal-tar, and coke. From the gas-liquor are derived ammonia and sulphate, chloride and carbonate of ammonia. The coal-tar is split up into oils lighter than water or crude naphtha, oils heavier than water — otherwise dead oil or tar, commonly called creosote, — and pitch. From the two former are derived a variety of chemical products.

From the coal-tar there comes an almost endless chain of known combinations. The greatest industry based upon their use is the manufacture of dyes, and the enormous extent to which this has grown can be judged from the fact that there are over 600 different coal-tar colors in use, and many more which as yet are too expensive for this purpose. Many medicinal preparations come from the series, pitch for paving

purposes, and chemicals for the photographer, the rubber manufacturers and tanners, as well as for preserving timber and cloths.

The composition of the hydrocarbons in a soft coal is uncertain and quite complex; but the ultimate analysis of the average coal shows that it approaches quite nearly to the composition of CH₄ (marsh-gas). (W. H. Brauvelt, *Trans. A. I. M. E.*, xx. 625.)

WOOD AS FUEL.

Wood, when newly felled, contains a proportion of moisture which varies very much in different kinds and in different specimens, ranging between 30% and 50%, and being on an average about 40%. After 8 or 12 months' ordinary drying in the air the proportion of moisture is from 20 to 25%. This degree of dryness, or almost perfect dryness if required, can be produced by a few days' drying in an oven supplied with air at about 240° F. When coal or coke is used as the fuel for that oven, 1 lb. of fuel suffices to expel about 3 lbs. of moisture from the wood. This is the result of experiments on a large scale by Mr. J. R. Napier. If air-dried wood were used as fuel for the oven, from 2 to 2½ lbs. of wood would probably be required to produce the same effect.

The specific gravity of different kinds of wood ranges from 0.3 to 1.2. Perfectly dry wood contains about 50% of carbon, the remainder consisting almost entirely of oxygen and hydrogen in the proportions which form water. The coniferous family contain a small quantity of turpentine, which is a hydrocarbon. The proportion of ash in wood is from 1% to 5%. The total heat of combustion of all kinds of wood, when dry, is almost exactly the same, and is that due to the 50% of carbon.

The above is from Rankine; but according to the table by S. P. Sharpless in *Jour. C. I. W.*, iv. 36, the ash varies from 0.03% to 1.20% in American woods, and the fuel value, instead of being the same for all woods, ranges from 3667 (for white oak) to 5546 calories (for long-leaf pine) = 6600 to 9883 British thermal units for dry wood, the fuel value of 0.50 lb. carbon being 7272 B. T. U.

Heating Value of Wood. — The following table is given in several books of reference, authority and quality of coal referred to not stated.

The weight of one cord of different woods (thoroughly air-dried) is about as follows:

	lbs.	equal to	lbs.	
Hickory or hard maple	4500		1800 coal.	(Others give 2000.)
White oak	3850	"	1540 "	" 1715.)
Beech, red and black oak	3250	"	1300 "	" 1450.)
Poplar, chestnut, and elm	2350	"	940 "	" 1050.)
The average pine	2000	"	800	" 925.)

Referring to the figures in the last column, it is said:

From the above it is safe to assume that 2¼ lbs. of dry wood are equal to 1 lb. average quality of soft coal and that the full value of the same weight of different woods is very nearly the same — that is, a pound of hickory is worth no more for fuel than a pound of pine, assuming both to be dry. It is important that the wood be dry, as each 10% of water or moisture in wood will detract about 12% from its value as fuel.

Taking an average wood of the analysis C 51%, H 6.5%, O 42.0%, ash 0.5%, perfectly dry, its fuel value per pound, according to Dulong's formula, $V = [14,600 C + 62,000(H - \frac{O}{8})]$, is 8221 British thermal units. If the wood, as ordinarily dried in air, contains 25% of moisture, then the heating value of a pound of such wood is three quarters of 8221 = 6165 heat-units, less the heat required to heat and evaporate the ¼ lb. of water from the atmospheric temperature, and to heat the steam made from this water to the temperature of the chimney gases, say 150 heat-units per pound to heat the water to 212°, 670 units to evaporate it at that temperature, and 100 heat-units to raise the temperature of the steam to 427° F., or 1220 in all = 305 for ¼ lb., which subtracted from the 6165, leaves 5860-heat-units as the net fuel value of the wood per pound, or about 0.4 that of a pound of carbon.

Composition of Wood.

(Analysis of Woods, by M. Eugene Chevandier.)

Woods.	Carbon.	Hydrogen.	Oxygen.	Nitrogen.	Ash.
Beech.....	49.36%	6.01%	42.69%	0.91%	1.06%
Oak.....	49.64	5.92	41.16	1.29	1.97
Birch.....	50.20	6.20	41.62	1.15	0.81
Poplar.....	49.37	6.21	41.60	0.96	1.86
Willow.....	49.96	5.96	39.56	0.96	3.37
Average.....	49.70%	6.06%	41.30%	1.05%	1.80%

The following table, prepared by M. Violette, shows the proportion of water expelled from wood at gradually increasing temperatures:

Temperature.	Water Expelled from 100 Parts of Wood.			
	Oak.	Ash.	Elm.	Walnut.
257° Fahr.....	15.26	14.78	15.32	15.55
302° Fahr.....	17.93	16.19	17.02	17.43
347° Fahr.....	32.13	21.22	36.94?	21.00
392° Fahr.....	35.80	27.51	33.38	41.77?
437° Fahr.....	44.31	33.38	40.56	36.56

The wood operated upon had been kept in store during two years. When wood which has been strongly dried by means of artificial heat is left exposed to the atmosphere, it reabsorbs about as much water as it contains in its air-dried state.

A cord of wood = 4 × 4 × 8 = 128 cu. ft. About 56% solid wood and 44% interstitial spaces. (Marcus Bull, Phila., 1829. *J. C. I. W.*, vol. i., p. 293.)

B. E. Fernow gives the per cent. of solid wood in a cord as determined officially in Prussia (*J. C. I. W.*, vol. iii. p. 20):

- Timber cords, 74.07% = 80 cu. ft. per cord;
- Firewood cords (over 6" diam.), 69.44% = 75 cu. ft. per cord;
- " Billet " cords (over 3" diam.), 55.55% = 60 cu. ft. per cord;
- " Brush " woods less than 3" diam., 18.52%; Roots, 37.00%.

CHARCOAL.

Charcoal is made by evaporating the volatile constituents of wood and peat, either by a partial combustion of a conical heap of the material to be charred, covered with a layer of earth, or by the combustion of a separate portion of fuel in a furnace, in which are placed retorts containing the material to be charred.

According to Pecllet, 100 parts by weight of wood when charred in a heap yield from 17 to 22 parts by weight of charcoal, and when charred in a retort from 28 to 30 parts.

This has reference to the ordinary condition of the wood used in charcoal-making, in which 25 parts in 100 consist of moisture. Of the remaining 75 parts the carbon amounts to one half, or 37½% of the gross weight of the wood. Hence it appears that on an average nearly half of the carbon in the wood is lost during the partial combustion in a heap, and about one quarter during the distillation in a retort.

To char 100 parts by weight of wood in a retort, 12½ parts of wood must be burned in the furnace. Hence in this process the whole expenditure of wood to produce from 28 to 30 parts of charcoal is 112½ parts;

so that if the weight of charcoal obtained is compared with the whole weight of wood expended, its amount is from 25% to 27%; and the proportion lost is on an average $11\frac{1}{2} \div 37\frac{1}{2} = 0.3$, nearly.

According to Pecler, good wood charcoal contains about 0.07 of its weight of ash. The proportion of ash in peat charcoal is very variable and is estimated on an average at about 0.18. (Rankine.)

Much information concerning charcoal may be found in the Journal of the Charcoal-iron Workers' Assn., vols. i. to vi. From this source the following notes have been taken:

Yield of Charcoal from a Cord of Wood. — From 45 to 50 bushels to the cord in the kiln, and from 30 to 35 in the meiler. Prof. Eggleston in *Trans. A. I. M. E.*, viii. 395, says the yield from kilns in the Lake Champlain region is often from 50 to 60 bushels for hard wood and 50 for soft wood; the average is about 50 bushels.

The apparent yield per cord depends largely upon whether the cord is a full cord of 128 cu. ft. or not.

In a four months' test of a kiln at Goodrich, Tenn., Dr. H. M. Pierce found results as follows: Dimensions of kiln — inside diameter of base, 23 ft. 8 in.; diam. at spring of arch, 26 ft. 8 in.; height of walls, 8 ft.; rise of arch, 5 ft.; capacity, 30 cords. Highest yield of charcoal per cord of wood (measured) 59.27 bushels, lowest 50.14 bushels, average 53.85 bushels.

No. of charges 12, length of each turn or period from one charging to another 11 days. (*J. C. I. W.*, vol. vi., p. 26.)

Results from Different Methods of Charcoal-making.

Coaling Methods.	Character of Wood Used.	Yield.		Bushels of Charcoal per Cord of Wood.	Weight in Lbs. per Bushel of Charcoal.
		In Volume per cent.	In Weight per cent.		
Odelstjerna's experiments	Birch dried at 230 F.	35.9
Mathieu's retorts, fuel excluded	{ Air dry, av. good yellow pine weighing abt. 28 lbs. per cu. ft. }	77.0	28.3	63.4	15.7
Mathieu's retorts, fuel included		65.8	24.2	54.2	15.7
Swedish ovens, av. results	{ Good dry fir and pine, mixed. }	81.0	27.7	66.7	13.3
Swedish ovens, av. results	{ Poor wood, mixed fir and pine. }	70.0	25.8	62.0	13.3
Swedish meilers exceptional.	{ Fir and white-pine wood, mixed. Av. 25 lbs. per cu. ft. }	72.2	24.7	59.5	13.3
Swedish meilers, av. results	{ Av. good yellow pine weighing abt. 25 lbs. per cu. ft. }	52.5	18.3	43.9	13.3
American kilns, av. results		54.7	22.0	45.0	17.5
American meilers, av. results		42.9	17.1	35.0	17.5

Consumption of Charcoal in Blast-furnaces per Ton of Pig Iron; average consumption according to census of 1880, 1.14 tons charcoal per ton of pig. The consumption at the best furnaces is much below this average. As low as 0.853 ton, is recorded of the Morgan furnace; Bay furnace, 0.858; Elk Rapids, 0.884. (1892.)

Absorption of Water and of Gases by Charcoal. — Svedlin, in his hand-book for charcoal-burners, prepared for the Swedish Government, says: Fresh charcoal, also reheated charcoal, contains scarcely any water, but when cool it absorbs it very rapidly, so that, after twenty-four hours, it may contain 4% to 8% of water. After the lapse of a few weeks the moisture of charcoal may not increase perceptibly, and may be estimated at 10% to 15%, or an average of 12%. A thoroughly charred piece of charcoal ought, then, to contain about 84 parts carbon, 12 parts water, 3 parts ash, and 1 part hydrogen.

M. Saussure, operating with blocks of fine boxwood charcoal, freshly burnt, found that by simply placing such blocks in contact with certain gases they absorbed them in the following proportion:

Volumes.		Volumes.	
Ammonia.....	90.00	Carbonic oxide.....	9.42
Hydrochloric acid gas.....	85.00	Oxygen.....	9.25
Sulphurous acid.....	65.00	Nitrogen.....	6.50
Sulphuretted hydrogen.....	55.00	Carburetted hydrogen....	5.00
Nitrous oxide (laughing-gas).....	40.00	Hydrogen.....	1.75
Carbonic acid.....	35.00		

It is this enormous absorptive power that renders of so much value a comparatively slight sprinkling of charcoal over dead animal matter, as a preventive of the escape of odors arising from decomposition.

In a box or case containing one cubic foot of charcoal may be stored without mechanical compression a little over nine cubic feet of oxygen, representing a mechanical pressure of one hundred and twenty-six pounds to the square inch. From the store thus preserved the oxygen can be drawn by a small hand-pump.

Composition of Charcoal Produced at Various Temperatures.
(By M. Violette.)

	Temperature of Carbonization.	Carbon.	Hydrogen.	Oxygen.	Nitrogen and Loss.	Ash.
1	150° Cent. 302° Fahr.	47.51	6.12	46.29	0.08	47.51
2	200	51.82	3.99	43.98	0.23	39.88
3	250	65.59	4.81	28.97	0.63	32.98
4	300	73.24	4.25	21.96	0.57	24.61
5	350	76.64	4.14	18.44	0.61	22.42
6	432	81.64	4.96	15.24	1.61	15.40
7	1023	81.97	2.30	14.15	1.60	15.30

The wood experimented on was that of black alder, or alder buckthorn, which furnishes a charcoal suitable for gunpowder. It was previously dried at 150 deg. C. = 302 deg. F.

MISCELLANEOUS SOLID FUELS.

Dust Fuel — Dust Explosions. — Dust when mixed in air burns with such extreme rapidity as in some cases to cause explosions. Explosions of flour-mills have been attributed to ignition of the dust in confined passages. Experiments in England in 1876 on the effect of coal-dust in carrying flame in mines showed that in a dusty passage the flame from a blown-out shot may travel 50 yards. Prof. F. A. Abel (*Trans. A. I. M. E.*, xiii. 260) says that coal-dust in mines much promotes and extends explosions, and that it may readily be brought into operation as a fiercely burning agent which will carry flame rapidly as far as its mixture with air extends, and will operate as an explosive agent though the medium of a very small proportion of fire-damp in the air of the mine. The explosive violence of the combustion of dust is largely due to the instantaneous heating and consequent expansion of the air. (See also paper on "Coal Dust as an Explosive Agent," by Dr. R. W. Raymond, *Trans. A. I. M. E.*, 1894.) Experiments made in Germany in 1893 show that pulverized fuel may be burned without smoke, and with high economy. The fuel, instead of being introduced into the fire-box in the ordinary manner, is first reduced to a powder by pulverizers of any construction. In the place of the ordinary boiler fire-box there is a combustion chamber in the form of a closed furnace lined with fire-brick and provided with an air-injector. The nozzle throws a constant stream of fuel into the chamber, scattering it throughout the whole space of the fire-box. When this powder is once ignited, and it is very readily done by first raising the lining to a high temperature by an open fire, the combustion continues in an intense and regular manner under the action of the current of air which carries it in. (*Mfrs. Record*, April, 1893.)

Records of tests with the Wegener powdered-coal apparatus, which is now (1900) in use in Germany, are given in *Eng. News*, Sept. 16 1897. An illustrated description is given in the author's *Steam Boiler Economy*, p. 183. Coal-dust fuel is now extensively used in the United States in rotary kilns for burning Portland cement.

Powdered fuel was used in the Crompton rotary puddling-furnace at Woolwich Arsenal, England, in 1873. (*Jour. I. & S. I.*, 1. 1873, p. 91.) Numerous experiments on the use of powdered fuel for steam boilers were made in the U. S. between 1895 and 1905, but they were not commercially successful.

Peat or Turf, as usually dried in the air, contains from 25% to 30% of water, which must be allowed for in estimating its heat of combustion. This water having been evaporated, the analysis of M. Regnault gives, in 100 parts of perfectly dry peat of the best quality: C 58%, H 6%, O 31%, Ash 5%. In some examples of peat the quantity of ash is greater, amounting to 7% and sometimes to 11%.

The specific gravity of peat in its ordinary state is about 0.4 or 0.5. It can be compressed by machinery to a much greater density. (Rankine.)

Clark (*Steam-engine*, i. 51) gives as the average composition of dried Irish peat: C 59%, H 6%, O 30%, N 1.25%, Ash 4%.

Applying Dulong's formula to this analysis, we obtain for the heating value of perfectly dry peat 10,260 heat-units per pound, and for air-dried peat containing 25% of moisture, after making allowance for evaporating the water, 7391 heat-units per pound.

A paper on Peat in the U. S., by M. R. Campbell, will be found in *Mineral Resources of the U. S.* (U. S. Geol. Survey) for 1905, p. 1319.

Sawdust as Fuel. — The heating power of sawdust is naturally the same per pound as that of the wood from which it is derived, but if allowed to get wet it is more like spent tan (which see below). The conditions necessary for burning sawdust are that plenty of room should be given it in the furnace, and sufficient air supplied on the surface of the mass. The same applies to shavings, refuse lumber, etc. Sawdust is frequently burned in saw-mills, etc., by being blown into the furnace by a fan-blast.

Wet Tan Bark as Fuel. — Tan, or oak bark, after having been used in the processes of tanning, is burned as fuel. The spent tan consists of the fibrous portion of the bark. Experiments by Prof. R. H. Thurston (*Jour. Frank. Inst.*, 1874) gave with the Crockett furnace, the wet tan containing 59% of water, an evaporation from and at 212° F. of 4.24 lbs. of water per pound of the wet tan, and with the Thompson furnace an evaporation of 3.19 lbs. per pound of wet tan containing 55% of water. The Thompson furnace consisted of six fire-brick ovens, each 9 ft. X 4 ft. 4 ins., containing 234 sq. ft. of grate in all, for three boilers with a total heating surface of 2000 sq. ft., a ratio of heating to grate surface of 9 to 1. The tan was fed through holes in the top. The Crockett furnace was an ordinary fire-brick furnace, 6 X 4 ft., built in front of the boiler, instead of under it, the ratio of heating surface to grate being 14.6 to 1. The conditions of success in burning wet fuel are the surrounding of the mass so completely with heated surfaces and with burning fuel that it may be rapidly dried, and then so arranging the apparatus that thorough combustion may be secured, and that the rapidity of combustion be precisely equal to and never exceed the rapidity of desiccation. Where this rapidity of combustion is exceeded the dry portion is consumed completely, leaving an uncovered mass of fuel which refuses to take fire.

D. M. Myers (*Trans. A. S. M. E.*, 1909) describes some experiments on tan as a boiler fuel. One hundred lbs. of air dried bark fed to the mill will produce 213 lbs. of spent tan containing 65% moisture. Taking 9500 B.T.U. as the heating value per lb. of dry tan and 500° F. as the temperature of the chimney gases, the available heat in 1 lb. of wet tan is 2665 B.T.U. Based on this value as much as 71% efficiency has been obtained in a boiler test with a special furnace, or 1.93 lbs. of water evaporated from and at 212° per lb. of wet tan.

Straw as Fuel. (*Eng'g Mechanics*, Feb., 1893, p. 55.) — Experiments in Russia showed that winter-wheat straw, dried at 230° F., had the following composition: C, 46.1; H, 5.6; N, 0.42; O, 43.7; Ash, 4.1. Heating value in British thermal units: dry straw, 6290; with 5% water, 5770; with 10% water, 5448. With straws of other grains the heating value of dry straw ranged from 5590 for buckwheat to 6750 for flax.

Clark (S. E., vol. 1, p. 62) gives the mean composition of wheat and barley straw as C, 36; H, 5; O, 38; N, 0.50; Ash, 4.75; water, 15.75, the two straws varying less than 1%. The heating value of straw of this composition, according to Dulong's formula, and deducting the heat lost in evaporating the water, is 5155 heat units. Clark erroneously gives it as 8144 heat units.

Bagasse as Fuel in Sugar Manufacture. — Bagasse is the name given to refuse sugar-cane, after the juice has been extracted. Prof. L. A. Beuel, in a paper read before the Louisiana Sugar Chemists' Association, in 1892, says: "With tropical cane containing 12.5% woody fibre, a juice containing 16.13% solids, and 83.87% water, bagasse of, say, 66% and 72% mill extraction would have the following percentage composition:

66% bagasse:	Woody Fibre, 37;	Combustible Salts, 10;	Water, 53.
72% bagasse:	" " 45;	" " 9;	" " 46.

"Assuming that the woody fibre contains 51% carbon, the sugar and other combustible matters an average of 42.1%, and that 12,906 units of heat are generated for every pound of carbon consumed, the 66% bagasse is capable of generating 297,834 heat-units per 100 lbs. as against 345,200, or a difference of 47,366 units in favor of the 72% bagasse.

"Assuming the temperature of the waste gases to be 450° F., that of the surrounding atmosphere and water in the bagasse at 86° F., and the quantity of air necessary for the combustion of one pound of carbon at 24 lbs., the lost heat will be as follows: In the waste gases, heating air from 86° to 450° F., and in vaporizing the moisture, etc., the 66% bagasse will require 112,546 heat units, and 116,150 for the 72% bagasse.

"Subtracting these quantities from the above, we find that the 66% bagasse will produce 185,288 available heat-units per 100 lbs., or nearly 24% less than the 72% bagasse, which gives 229,050 units. Accordingly, one ton of cane of 2000 lbs. at 66% mill extraction will produce 680 lbs. bagasse, equal to 1,259,958 available heat-units, while the same cane at 72% extraction will produce 560 lbs. bagasse, equal to 1,282,680 units.

"A similar calculation for the case of Louisiana cane containing 10% woody fibre, and 16% total solids in the juice, assuming 75% mill extraction, shows that bagasse from one ton of cane contains 1,573,956 heat-units, from which 561,465 have to be deducted.

"This would make such bagasse worth on an average nearly 92 lbs. coal per ton of cane ground. Under fairly good conditions, 1 lb. coal will evaporate 7½ lbs. water, while the best boiler plants evaporate 10 lbs. Therefore the bagasse from 1 ton of cane at 75% mill extraction, should evaporate from 689 lbs. to 919 lbs. of water. The juice extracted from such cane would under these conditions contain 1260 lbs. of water. If we assume that the water added during the process of manufacture is 10% (by weight) of the juice made, the total water handled is 1410 lbs. From the juice represented in this case, the commercial massecuite would be about 15% of the weight of the original mill juice, or, say, 225 lbs. Said mill juice 1500 lbs., plus 10%, equals 1650 lbs. liquor handled; and 1650 lbs., minus 225 lbs., equals 1425 lbs., the quantity of water to be evaporated during the process of manufacture. To effect a 7½-lb. evaporation requires 190 lbs. of coal, and 142½ lbs. for a 10-lb. evaporation.

"To reduce 1650 lbs. of juice to syrup of, say, 27° Baumé, requires the evaporation of 1170 lbs. of water, leaving 480 lbs. of syrup. If this work be accomplished in the open air, it will require about 156 lbs. of coal at 7½ lbs. boiler evaporation, and 117 at 10 lbs. evaporation.

"With a double effect the fuel required would be from 59 to 78 lbs., and with a triple effect, from 36 to 52 lbs.

"To reduce the above 480 lbs. of syrup to the consistency of commercial massecuite means the further evaporation of 255 lbs. of water, requiring the expenditure of 34 lbs. coal at 7½ lbs. boiler evaporation, and 25½ lbs. with a 10-lb. evaporation. Hence, to manufacture one ton of cane into sugar and molasses, it will take from 145 to 190 lbs. additional coal to do the work by the open evaporator process; from 85 to 112 lbs. with a double effect, and only 7½ lbs. evaporation in the boilers, while with 10 lbs. boiler evaporation the bagasse alone is capable of furnishing 8% more heat than is actually required to do the work. With triple-effect evaporation depending on the excellence of the boiler plant, the 1425 lbs. of water to be evaporated from the juice will require between

62 and 86 lbs. of coal. These values show that from 6 to 30 lbs. of coal can be spared from the value of the bagasse to run engines, grind cane, etc. "It accordingly appears," says Prof. Becuel, "that with the best boiler plants, those taking up all the available heat generated, by using this heat economically the bagasse can be made to supply all the fuel required by our sugar-houses."

E. W. Kerr, in Bulletin No. 117 of the Louisiana Agricultural Experiment Station, Baton Rouge, La., gives the results of a study of many different forms of bagasse furnaces. An equivalent evaporation of 2 1/4 lbs. of steam from and at 212° was obtained from 1 lb. of wet bagasse of a net calorific value of 3256 B.T.U. This net value is that calculated from the analysis by Dulong's formula, minus the heat required to evaporate the moisture and to heat the vapor to the temperature of the escaping chimney gases, 594° F. The approximate composition of bagasse of 75% extraction is given as 51% free moisture, and 28% of water combined with 21% of carbon in the fibre and sugar. For the best results the bagasse should be burned at a high rate of combustion, at least 100 lbs. per sq. ft. of grate per hour. Not more than 1.5 lbs. of bagasse per sq. ft. of heating surface per hour should be burned under ordinary conditions, and not less than 1.5 boiler horse-power should be provided per ton of coal per 24 hours.

LIQUID FUEL.

Products of the Distillation of Crude Petroleum.

Crude American petroleum of sp. gr. 0.800 may be split up by fractional distillation as follows ("Robinson's Gas and Petroleum Engines"):

Temp. of Distillation Fahr.	Distillate.	Per-cent-ages.	Specific Gravity.	Flashing Point. Deg. F.
113°	Rhigolene. }	traces.	.590 to .625	
113 to 140°	Chymogene. }			
140 to 158°	Gasoline (petroleum spirit) . . .	1.5	.636 to .657	
158 to 248°	Benzine, naphtha C, benzolene	10.	.680 to .700	14
248°	{ Benzine, naphtha B.	2.5	.714 to .718	32
to 347°	{ Benzine, naphtha A.			
338° and upwards. }	{ Polishing oils.	50.		100 to 122
482°	Kerosene (lamp-oil).			
	Lubricating oil.	15.	.850 to .915	230
	Paraffine wax.	2.		
	Residue and Loss.	16.		

Lima Petroleum, produced at Lima, Ohio, is of a dark green color, very fluid, and marks 48° Baumé at 15° C. (sp. gr., 0.792).

The distillation in fifty parts, each part representing 2% by volume, gave the following results:

Per cent.	Sp. Gr.	Per cent.	Sp. Gr.	Per cent.	Sp. Gr.	Per cent.	Sp. Gr.	Per cent.	Sp. Gr.	Per cent.	Sp. Gr.
2	0.680	18	0.720	34	0.764	50	0.802	68	0.820	88	0.815
4	.683	20	.728	36	.768	52	.806	70	.825	90	.815
6	.685	22	.730	38	.772	54		72	.830	92	Residuum
8	.690	24	.735	40	.778	56	73	.830	92	Residuum	
10	.694	26	.740	42	.782	60	.800	76	.810		100
12	.698	28	.742	44	.788	62	.804	78	.820	100	Residuum
14	.700	30	.746	46	.792	64	.808	82	.818	Residuum	
16	.706	32	.760	48	.800	66	.812	86	.816		Residuum

RETURNS.

16 per cent naphtha, 70° Baumé. 6 per cent paraffine oil.
68 per cent burning oil. 10 per cent residuum.

The distillation started at 23° C., this being due to the large amount of naphtha present, and when 60% was reached, at a temperature of 310° C., the hydrocarbons remaining in the retort were dissociated, then gases

escaped, lighter distillates were obtained, and, as usual in such cases, the temperature decreased from 310° C. down gradually to 200° C., until 75% of oil was obtained, and from this point the temperature remained constant until the end of the distillation. Therefore these hydrocarbons in *statu morienti* absorbed much heat. (*Jour. Am. Chem. Soc.*)

There is not a good agreement between the character of the materials designated gasoline, kerosene, etc., and the temperature of distillation and densities employed in different places. The following table shows one set of values that is probably as good as any.

Name.	Boiling Point.	Specific Gravity.	Density at 59° F.
	° F.		° Baumé.
Petroleum ether.	104-158	0.650-0.660	85-80
Gasoline.	158-176	.660-.670	80-78
Naphtha C.	176-212	.670-.707	78-68
Naphtha B.	212-248	.707-.722	68-64
Naphtha A.	248-302	.722-.737	64-60
Kerosene.	302-572	.753-.864	56-32

Gasoline is different from a simple substance with a fixed boiling point, and therefore theoretical calculations on the heat of combustion, air necessary, and conditions for vaporizing or carbureting air are of little value. (C. E. Lucke.)

Value of Petroleum as Fuel. — Thos. Urquhart, of Russia (*Proc. Inst. M. E.*, Jan., 1889), gives the following table of the theoretical evaporative power of petroleum in comparison with that of coal, as determined by Messrs. Favre and Silbermann:

Fuel.	Specific Gravity at 32° F., Water = 1.000	Chem. Comp.			Heating power, British Thermal Units.	Theoret. Evap., lbs. Water per lb. Fuel, from and at 212° F.
		C.	H.	O.		
Penna. heavy crude oil.	0.886	84.9	13.7	1.4	20,736	21.48
Caucasian light crude oil.	0.884	86.3	13.6	0.1	22,027	22.79
Caucasian heavy crude oil.	0.938	86.6	12.3	1.1	20,138	20.85
Petroleum refuse.	0.928	87.1	11.7	1.2	19,832	20.53
Good English Coal, Mean of 98 Samples.	1.380	80.0	5.0	8.0	14,112	14.61

In experiments on Russian railways with petroleum as fuel Mr. Urquhart obtained an actual efficiency equal to 82% of the theoretical heating-value. The petroleum is fed to the furnace by means of a spray-injector driven by steam. An induced current of air is carried in around the injector-nozzle, and additional air is supplied at the bottom of the furnace.

Beaumont, Texas, oil analyzed as follows (*Eng. News*, Jan. 30, 1902): C, 84.60; H, 10.90; S, 1.63; O, 2.87. Sp. gr., 0.92; flash point, 142° F.; burning point, 181° F.; heating value per lb., by oxygen calorimeter, 19,060 B.T.U. A test of a horizontal tubular boiler with this oil, by J. E. Denton gave an efficiency of 78.5%. As high as 82% has been reported for California oil.

Bakersfield, Cal., oil; Sp. gr. 16° Baumé; Moisture, 1%; Sulphur, 0.5%. B.T.U. per lb., 18,500.

Redondo, Cal., oil, six lots: Moisture, 1.82 to 2.70%; Sulphur, 2.17 to 2.60%; B.T.U. per lb., 17,717 to 17,966. Kilowatt-hours generated per barrel (334 lbs.) of oil in a 5000 K.W. plant, using water-tube boilers, and reciprocating engines and generators having a combined efficiency of 90.2 to 94.75% (boiler economy and steam-rate of engine not stated). 2000 K.W. load, 237.3; 3000 K.W., 256.7; 5000 K.W., 253.4; variable load, 24 hours, 243.8. (C. R. Weymouth, *Trans. A. S. M. E.*, 1908.)

The following table showing the relative values of petroleum and coal was given by the author in *Power*, Sept., 1902. It is based on the following assumed data: B.T.U. per lb. of oil 20,000; sp. gr., 0.885; = 7.37 lbs. per gal.; 1 barrel = 41 gals. = 310 lbs.

Coal, B.T.U. per lb.	1 lb. coal = lbs. oil.	1 barrel oil = lbs. coal.	1 ton coal = barrels oil.
10,000	2.	620	3.23
11,000	1.818	564	3.55
12,000	1.667	517	3.87
13,000	1.538	477	4.19
14,000	1.429	443	4.52
15,000	1.333	413	4.84

From this table we see that if coal of a heating value of only 10,000 B.T.U. per lb. costs \$3.23 per ton, and coal of 14,000 B.T.U. per lb. at \$4.52 per ton, then the price of oil will have to be as low as \$1 a barrel to compete with coal; or, if the poorer coal is \$6.26 and the better coal \$9.04 per ton, then oil will be the cheaper fuel if it is below \$2 per barrel.

Fuel Oil Burners.—A great variety of burners are on the market, most of them based on the principle of using a small jet of steam at the boiler pressure to inject the oil into the furnace, in the shape of finely divided spray, and at the same time to draw in the air supply and mix it intimately with the oil. So far as economy of oil is concerned these burners are all of about equal value, but their successful operation depends on the construction of the furnace. This should have a large combustion chamber, entirely surrounded with fire brick, and the jet should be so directed that it will strike a fire-brick surface and rebound before touching the heating surface of the boiler. Burners using air at high pressure, 40 lbs. per sq. in., without steam, have been used with advantage. Lower pressures have been found not sufficient to atomize the oil.

When boilers are forced, with a combustion chamber too small to allow the oil spray to be completely burned in it before passing to the boiler surface, dense clouds of smoke result, with deposit of lampblack or soot.

Oil vs. Coal as Fuel. (*Iron Age*, Nov. 2, 1893.)—Test by the Twin City Rapid Transit Company of Minneapolis and St. Paul. This test showed that with the ordinary Lima oil weighing 6.6 pounds per gallon, and costing 2 1/4 cents per gallon, and coal that gave an evaporation of 7 1/2 lbs. of water per pound of coal, the two fuels were equally economical when the price of coal was \$3.85 per ton of 2000 lbs. With the same coal at \$2.00 per ton, the coal was 37% more economical, and with the coal at \$4.85 per ton, the coal was 20% more expensive than the oil. These results include the difference in the cost of handling the coal, ashes, and oil.

In 1892 there were reported to the Engineers' Club of Philadelphia some comparative figures, from tests undertaken to ascertain the relative value of coal, petroleum, and gas.

	Lbs. Water, from and at 212° F.
1 lb. anthracite coal evaporated.....	9.70
1 lb. bituminous coal.....	10.14
1 lb. fuel oil, 36° gravity.....	16.48
1 cubic foot gas, 20 C. P.....	1.28

The gas used was that obtained in the distillation of petroleum, having about the same fuel-value as natural or coal-gas of equal candle-power.

Taking the efficiency of bituminous coal as a basis, the calorific energy of petroleum is more than 60% greater than that of coal; whereas, theoretically, petroleum exceeds coal only about 45%—the one containing 14,500 heat-units, and the other 21,000.

Crude Petroleum vs. Indiana Black Coal for Steam-raising at the South Chicago Steel Works. (E. C. Potter, *Trans. A. I. M. E.*, xvii, 807.)—With coal, 14 tubular boilers 16 ft. X 5 ft. required 25 men to operate them; with fuel oil, 6 men were required, a saving of 19 men at \$2 per day, or \$38 per day.

For one week's work 2731 barrels of oil were used, against 848 tons of coal required for the same work, showing 3.23 barrels of oil to be equivalent to 1 ton of coal. With oil at 60 cents per barrel and coal at \$2.15 per ton, the relative cost of oil to coal is as \$1.93 to \$2.15. No evaporation tests were made.

Petroleum as a Metallurgical Fuel.—C. E. Felton (*Trans. A. I. M. E.*, xvii, 809) reports a series of trials with oil as fuel in steel-heating and open-hearth steel-furnaces, and in raising steam, with results as follows: 1. In a run of six weeks the consumption of oil, partly refined (the paraffine and some of the naphtha being removed), in heating 14-inch ingots in Siemens furnaces was about 6 1/2 gallons per ton of blooms. 2. In melting in a 30-ton open-hearth furnace 48 gallons of oil were used per ton of ingots. 3. In a six weeks' trial with Lima oil from 47 to 54 gallons of oil were required per ton of ingots. 4. In a six months' trial with Siemens heating-furnaces the consumption of Lima oil was 6 gallons per ton of ingots. Under the most favorable circumstances, charging hot ingots and running full capacity, 4 1/2 to 5 gallons per ton were required. 5. In raising steam in two 100-H.P. tubular boilers, the feed-water being supplied at 160° F., the average evaporation was about 12 pounds of water per pound of oil, the best 12 hours' work being 16 pounds.

In all of the trials the oil was vaporized in the Archer producer, an apparatus for mixing the oil and superheated steam, and heating the mixture to a high temperature. From 0.5 lb. to 0.75 lb. of pea-coal was used per gallon of oil in the producer itself.

ALCOHOL AS FUEL.

Denatured alcohol is a grain or ethyl alcohol mixed with a denaturant in order to make it unfit for beverage or medicinal purposes. Under acts of Congress of June 7, 1906 and March 2, 1907, denatured alcohol became exempt from internal revenue taxation, when used in the industries.

The Government formulas for completely denatured alcohol are: 1. To every 100 gal. of ethyl or grain alcohol (of not less than 180% proof) there shall be added 10 gal. of approved methyl or wood alcohol and 1/2 gal. of approved benzine. (180% proof = 90% alcohol, 10% water, by volume.)

2. To every 100 gal. of ethyl alcohol (of not less than 180% proof) there shall be added 2 gal. of approved methyl alcohol and 1/2 gal. of approved pyridin (a petroleum product) bases.

Methyl alcohol, benzine and pyridin used as denaturants must conform to specifications of the Internal Revenue Department.

The alcohol which it is proposed to manufacture under the present law is ethyl alcohol, C₂H₅OH. This material is seldom, if ever, obtained pure, it being generally diluted with water and containing other alcohols when used for engines.

SPECIFIC GRAVITY OF ETHYL ALCOHOL AT 60° F. COMPARED WITH WATER AT 60°. (Smithsonian Tables.)

Sp. Gr.	Per cent Alcohol.		Sp. Gr.	Per cent Alcohol.		Sp. Gr.	Per cent Alcohol.	
	Weight.	Vol.		Weight.	Vol.		Weight.	Vol.
0.834	85.8	90.0	0.826	88.9	92.3	0.818	91.9	94.5
.832	86.6	90.6	.824	89.6	92.9	.816	92.6	95.0
.830	87.4	91.2	.822	90.4	93.4	.814	93.3	95.5
.828	88.1	91.8	.820	91.1	94.0	.812	94.0	96.0

The heat of combustion of ethyl alcohol, 94% by volume, as determined by the calorimeter, is 11,900 B.T.U. per lb.—a little more than half that of gasoline (Lucke). Favre and Silbermann obtained 12,913 B.T.U. for absolute alcohol.

The products of complete combustion of alcohol are H₂O and CO₂. Under certain conditions, with an insufficient supply of air, acetic acid is

formed, which causes rusting of the parts of an alcohol engine. This may be prevented by addition to the alcohol of benzol or acetylene.

With any good small stationary engine as small a consumption as 0.70 lb. of gasoline, or 1.16 lb. of alcohol per brake H.P. hour may reasonably be expected under favorable conditions (Lucke).

References. — H. Diederichs, *Intl. Marine Eng'g.*, July, 1906; *Machy.*, Aug., 1906. C. E. Lucke and S. M. Woodward, *Farmer's Bulletin*, No. 277, U. S. Dept. of Agriculture, 1907. *Eng. Rec.*, Nov. 2, 1907. T. L. White, *Eng. Mag.*, Sept., 1908.

VAPOR PRESSURE OF SATURATION FOR VARIOUS LIQUIDS, IN MILLIMETERS OF MERCURY.

(To convert into pounds per sq. in., multiply by 0.01934; to convert into inches of mercury, multiply by 0.03937.)

Temperature.	Pure Ethyl Alcohol.	Pure Methyl Alcohol.	Water.	Gasoline.	Temperature.		Pure Ethyl Alcohol.	Pure Methyl Alcohol.	Water.	Gasoline.
					°C.	°F.				
0	32	12	30	5	99	35	103	204	42	301
5	41	17	40	7	115	40	104	259	55	360
10	50	24	54	9	133	45	113	327	71	422
15	59	32	71	13	154	50	122	409	92	493
20	68	44	94	17	179	55	131	508	117	561
25	77	59	123	24	210	60	140	624	149	648
30	86	78	159	32	251	65	149	761	187	739

VAPOR TENSION OF ALCOHOL AND WATER, AND DEGREE OF SATURATION OF AIR WITH THESE VAPORS.

Temp. degs. F.	Vapor Tension, Inches Mercury.		1 Pound of Air Contains in Saturated Condition, in Pounds.			
			At 28.95 Inches.		At 26.05 Inches.	
	Alcohol Vapor.	Water Vapor.	Alcohol Vapor.	Water Vapor.	Alcohol Vapor.	Water Vapor.
50	0.950	0.359	0.055	0.008	0.061	0.009
59	1.283	0.500	0.075	0.011	0.084	0.013
68	1.733	0.687	0.104	0.016	0.117	0.018
77	2.325	0.925	0.144	0.022	0.162	0.025
86	3.090	1.240	0.200	0.031	0.227	0.036
104	5.270	2.162	0.390	0.063	0.450	0.072
122	8.660	3.620	0.827	0.135	1.002	0.164

FUEL GAS.

The following notes are extracted from a paper by W. J. Taylor on "The Energy of Fuel" (*Trans. A. I. M. E.*, xviii, 205):

Carbon Gas. — In the old Siemens producer, practically all the heat of primary combustion — that is, the burning of solid carbon to carbon monoxide, or about 30% of the total carbon energy — was lost, as little or no steam was used in the producer, and nearly all the sensible heat of the gas was dissipated in its passage from the producer to the furnace, which was usually placed at a considerable distance.

Modern practice has improved on this plan, by introducing steam with the air blown into the producer, and by utilizing the sensible heat of the gas in the combustion-furnace. It ought to be possible to oxidize

one out of every four lbs. of carbon with oxygen derived from water-vapor. The thermic reactions in this operation are as follows:

	Heat-units.
4 lbs. C burned to CO (3 lbs. gasified with air and 1 lb. with water) develop	17,600
1.5 lbs. of water (which furnish 1.33 lbs. of oxygen to combine with 1 lb. of carbon) absorb by dissociation	10,333
The gas, consisting of 9.333 lbs. CO, 0.167 lb. H, and 13.39 lbs. N, heated 600°, absorbs	3,748
Leaving for radiation and loss	3,519
	<hr/> 17,600

The steam which is blown into a producer with the air is almost all condensed into finely-divided water before entering the fuel, and consequently is considered as water in these calculations.

The 1.5 lbs. of water liberates 0.167 lb. of hydrogen, which is delivered to the gas, and yields in combustion the same heat that it absorbs in the producer by dissociation. According to this calculation, therefore, 60% of the heat of primary combustion is theoretically recovered by the dissociation of steam, and, even if all the sensible heat of the gas be counted, with radiation and other minor items, as loss, yet the gas must carry $4 \times 14,500 - (3748 + 3519) = 50,733$ heat-units, or 87% of the caloric energy of the carbon. This estimate shows a loss in conversion of 13%, without crediting the gas with its sensible heat, or charging it with the heat required for generating the necessary steam, or taking into account the loss due to oxidizing some of the carbon to CO₂. In good producer-practice the proportion of CO₂ in the gas represents from 4% to 7% of the C burned to CO₂, but the extra heat of this combustion should be largely recovered in the dissociation of more water-vapor, and therefore does not represent as much loss as it would indicate. As a conveyor of energy, this gas has the advantage of carrying 4.46 lbs. less nitrogen than would be present if the fourth pound of coal had been gasified with air; and in practical working the use of steam reduces the amount of clinkering in the producer.

Anthracite Gas. — In anthracite coal, there is a volatile combustible varying in quantity from 1.5% to over 7%. The amount of energy derived from the coal is shown in the following theoretical gasification made with coal of assumed composition: Carbon, 85%; vol. HC, 5%; ash, 10%; 80 lbs. carbon assumed to be burned to CO; 5 lbs. carbon burned to CO₂; three fourths of the necessary oxygen derived from air, and one fourth from water.

Process.	Pounds.	Cubic Feet.	Anal. by Vol.
80 lbs. C burned to CO	186.66	2529.24	33.4
5 lbs. C burned to CO ₂	18.33	157.64	2.0
5 lbs. vol. HC (distilled)	5.00	116.60	1.6
120 lbs. oxygen are required, of which 30 lbs. from H ₂ O liberate H	3.75	712.50	9.4
90 lbs. from air are associated with N	301.05	4064.17	53.6
	<hr/> 514.79	<hr/> 7580.15	<hr/> 100.0

Energy in the above gas obtained from 100 lbs. anthracite:

186.66 lbs. CO	807,304 heat-units.
5.00 " CH ₄	117,500 "
3.75 " H	232,500 "

Total energy in gas per lb.	1,157,304
Total energy in 100 lbs. of coal	2,248
Efficiency of the conversion	1,349,500
	86%

The sum of CO and H exceeds the results obtained in practice. The sensible heat of the gas will probably account for this discrepancy and, therefore, it is safe to assume the possibility of delivering at least 82% of the energy of the anthracite.

WARNING: This is a 1910 edition. Some of the material may no longer be accurate

Bituminous Gas. — A theoretical gasification of 100 lbs of coal, containing 55% of carbon and 32% of volatile combustible (which is above the average of Pittsburgh coal), is made in the following table. It is assumed that 50 lbs. of C are burned to CO and 5 lbs. to CO₂; one fourth of the O is derived from steam and three fourths from air; the heat value of the volatile combustible is taken at 20,000 heat-units to the pound. In computing volumetric proportions all the volatile hydrocarbons, fixed as well as condensing, are classed as marsh-gas, since it is only by some such tentative assumption that even an approximate idea of the volumetric composition can be formed. The energy, however, is calculated from weight:

Process.	Products.		
	Pounds.	Cubic Feet.	Anal. by Vol.
50 lbs. C burned to CO.....	116.66	1580.7	27.8
5 lbs. C burned to CO ₂	18.33	157.6	2.7
32 lbs. vol. HC (distilled).....	32.00	746.2	13.2
80 lbs. O are required, of which 20 lbs., derived from H ₂ O, liberate H.....	2.5	475.0	8.3
60 lbs. O, derived from air, are associated with N.....	200.70	2709.4	47.8
	<u>370.19</u>	<u>5668.9</u>	<u>99.8</u>
Energy in 116.66 lbs. CO.....		504,554	heat-units.
" " 32.00 lbs. vol. HC.....		640,000	"
" " 2.50 lbs. H.....		155,000	"
		<u>1,299,554</u>	"
Energy in coal.....		1,437,500	"
Per cent of energy delivered in gas.....			90.0
Heat-units in 1 lb. of gas.....			3,484

Water-gas. — Water-gas is made in an intermittent process, by blowing up the fuel-bed of the producer to a high state of incandescence (and in some cases utilizing the resulting gas, which is a lean producer-gas), then shutting off the air and forcing steam through the fuel, which dissociates the water into its elements of oxygen and hydrogen, the former combining with the carbon of the coal, and the latter being liberated.

This gas can never play a very important part in the industrial field, owing to the large loss of energy entailed in its production, yet there are places and special purposes where it is desirable, even at a great excess in cost per unit of heat over producer-gas; for instance, in small high-temperature furnaces, where much regeneration is impracticable, or where the "blow-up" gas can be used for other purposes instead of being wasted.

The reactions and energy required in the production of 1000 feet of water-gas, composed, theoretically, of equal volumes of CO and H, are as follows:

500 cubic feet of H weigh.....	2.635 lbs.
500 cubic feet of CO weigh.....	36.89 "

Total weight of 1000 cubic feet..... 39.525 lbs.

Now, as CO is composed of 12 parts C to 16 of O, the weight of C in 36.89 lbs. is 15.81 lbs. and of O 21.08 lbs. When this oxygen is derived from water it liberates, as above, 2.635 lbs. of hydrogen. The heat developed and absorbed in these reactions (roughly, as we will not take into account the energy required to elevate the coal from the temperature of the atmosphere to, say, 1800°) is as follows:

	Heat-units.
2.635 lbs. H. absorb in dissociation from water 2.635 × 62,000 =	163,370
15.81 lbs. C burned to CO develops 15.81 × 4400.....	= 69,564
Excess of heat-absorption over heat-development.....	= 93,806

If this excess could be made up from C burnt to CO₂ without loss by radiation, we would only have to burn an additional 4.83 lbs. C to supply this heat, and we could then make 1000 feet of water-gas from 20.64 lbs.

of carbon (equal 24 lbs. of 85% coal). This would be the perfection of gas-making, as the gas would contain really the same energy as the coal; but instead, we require in practice more than double this amount of coal and do not deliver more than 50% of the energy of the fuel in the gas, because the supporting heat is obtained in an indirect way and with imperfect combustion. Besides this, it is not often that the sum of CO and H exceed 90%, the balance being CO₂ and N. But water-gas should be made with much less loss of energy by burning the "blow-up" (producer) gas in brick regenerators, the stored-up heat of which can be returned to the producer by the air used in blowing-up.

The following table shows what may be considered average volumetric analyses, and the weight and energy of 1000 cubic feet, of the four types of gases used for heating and illuminating purposes:

	Natural Gas.	Coal-gas.	Water-gas.	Producer-gas.	
				Anthra.	Bitu.
CO.....	0.50	6.0	45.0	27.0	27.0
H.....	2.18	46.0	45.0	12.0	12.0
CH ₄	92.6	40.0	2.0	1.2	2.5
C ₂ H ₆	0.31	4.0	0.4
CO ₂	0.26	0.5	4.0	2.5	2.5
N.....	3.61	1.5	2.0	57.0	56.2
O.....	0.34	0.5	0.5	0.3	0.3
Vapor.....	1.5	1.5
Pounds in 1000 cubic feet.....	45.6	32.0	45.6	65.6	65.9
Heat-units in 1000 cubic feet.....	1,100,000	735,000	322,000	137,455	156,917

Natural Gas in Ohio and Indiana.
(Eng. and M. J., April 21, 1894.)

	Fos-toria, O.	Find-lay, O.	St. Mary's, O.	Muncie, Ind.	Ander-son, Ind.	Koko-mo, Ind.	Mar-ion, Ind.
Hydrogen.....	1.89	1.64	1.94	2.35	1.86	1.42	1.20
Marsh-gas.....	92.84	93.35	93.65	92.67	93.07	94.16	93.57
Olefiant gas.....	.20	.35	.20	.25	.47	.30	.15
Carbon monoxide.....	.55	.41	.44	.45	.73	.55	.60
Carbon dioxide.....	.20	.25	.23	.25	.26	.29	.30
Oxygen.....	.35	.39	.35	.35	.42	.30	.55
Nitrogen.....	3.82	3.41	2.98	3.53	3.02	2.80	3.42
Hydrogen sulphide.....	.15	.20	.21	.15	.15	.18	.20

Natural Gas as a Fuel for Boilers. — J. M. Whitham (*Trans. A. S. M. E.*, 1905) reports the results of several tests of water-tube boilers with natural gas. The following is a condensed statement of the results:

Kind of Boiler.....	Cook Vertical.		Heine.			Cahall Vert.	
	1500	1500	200	200	200	300	300
Rated H.P. of boilers.....	1642	1507	155	218	258	340	260
H.P. developed.....	521	494	386	450	465	406	374
Temperature at chimney.....	6.9	6.4	4.8	7 to 30
Gas pressure at burners, oz.....	44.9*	41.0*	46.0†	40.7†	38.3†	42.3	34
Cu. ft. of gas per boiler.....	72.7	65.8	74.9
Boiler efficiency, %.....

* Reduced to 4 oz. pressure and 62° F.

† Reduced to atmos. press. and 32° F.

Six tests by Daniel Ashworth on 2-flue horizontal boilers gave cu. ft. of gas per boiler H.P. hour, 58.0; 59.7; 67.0; 63.0; 74.0; 47.0.

On the first Cook boiler test, the chimney gas, analyzed by the Orsat apparatus, showed 7.8 CO₂; 8.05 O; 0.0 CO; 84.15 N. This shows an excessive air supply.

White versus Blue Flame. — Tests were made with the air supply throttled at the burners, so as to produce a white flame, and also unthrottled, producing a blue flame with the following results:

Pressure of gas at burners, oz.....	4		6		8	
	White	Blue	White	Blue	White	Blue
Kind of flame.....	247	213	297	271	255	227
Boiler H.P. made per 250-H.P. boiler						
Cu. ft. of gas (at 4 oz. and 60° F.) per H.P. hour.....	41	41	41.6	37.9	40	43.1
Chimney temperature.....	436	503	478	511	502	508

Average of 6 tests — White, 266 H.P., 43.6 cu. ft.; Blue, 237 H.P., 43.8 cu. ft., showing that the economy is the same with each flame, but the capacity is greatest with the white flame. Mr. Whitham's principal conclusions from these tests are as follows:

- (1) There is but little advantage possessed by one burner over another.
- (2) As good economy is made with a blue as with a white or straw flame, and no better.
- (3) Greater capacity may be made with a straw-white than with a blue flame.
- (4) An efficiency as high as from 72 to 75 per cent in the use of gas is seldom obtained under the most expert conditions.
- (5) Fuel costs are the same under the best conditions with natural gas at 10 cents per 1000 cu. ft. and semi-bituminous coal at \$2.87 per ton of 2240 lbs.
- (6) Considering the saving of labor with natural gas, as compared with hand-firing of coal, in a plant of 1500 H.P., and coal at \$2 per ton of 2240 lbs., gas should sell for about 10 cents per 1000 cu. ft.

ANALYSES OF NATURAL GAS.

Illuminants.....	0.45	0.15	0.50	1.6
Carbonic oxide.....	0.00	0.00	0.15	1.8
Hydrogen.....	0.20	0.30	0.25	0.3
Marsh gas.....	81.05	82.20	83.40	81.9
Ethane.....	17.60	15.55	15.40	13.2
Carbonic acid.....	0.00	0.20	0.00	0.0
Oxygen.....	0.15	0.10	0.00	0.4
Nitrogen.....	0.55	0.50	0.30	0.8
B.T.U. per cu. ft. at 60° F. and 14.7 lbs. barometer.....	1030	1020	1026	1098

The first three analyses are of the gas from nine wells in Lewis Co., W. Va.; the last is from a mixture from fields in three states supplying Pittsburg, Pa., used in the tests of the Cook boiler.

Producer-gas from One Ton of Coal.

(W. H. Blauvelt, *Trans. A. I. M. E.*, xviii, 614.)

Analysis by Vol.	Per Cent.	Cubic Feet.	Lbs.	Equal to —
CO.....	25.3	33,213.84	2451.20	1050.51 lbs. C + 1400.7 lbs. O.
H.....	9.2	12,077.76	63.56	63.56 " H.
CH ₄	3.1	4,069.68	174.66	174.66 " CH ₄ .
C ₂ H ₄	0.8	1,050.24	77.78	77.78 " C ₂ H ₄ .
CO ₂	3.4	4,463.52	519.02	141.54 " C + 377.44 lbs. O.
N (by difference)	58.2	76,404.96	5659.63	7350.17 " Air.
	100.0	131,280.00	8945.85	

Calculated upon this basis, the 131,280 ft. of gas from the ton of coal contained 20,311,162 B.T.U., or 155 B.T.U. per cubic ft., or 2270 B. T.U. per lb.

The composition of the coal from which this gas was made was as follows: Water, 1.26%; volatile matter, 36.22%; fixed carbon, 57.98%; sulphur, 0.70%; ash, 3.78%. One ton contains 1159.6 lbs. carbon and 724.4 lbs. volatile combustible, the energy of which is 31,362,200 B.T.U. Hence, in the processes of gasification and purification there was a loss of 35.2% of the energy of the coal.

The composition of the hydrocarbons in a soft coal is uncertain and quite complex; but the ultimate analysis of the average coal shows that it approaches quite nearly to the composition of CH₄ (marsh-gas).

Mr. Blauvelt emphasizes the following points as highly important in soft-coal producer-practice:

First. That a large percentage of the energy of the coal is lost when the gas is made in the ordinary low producer and cooled to the temperature of the air before being used. To prevent these sources of loss, the producer should be placed so as to lose as little as possible of the sensible heat of the gas, and prevent condensation of the hydrocarbon vapors. A high fuel-bed should be carried, keeping the producer cool on top, thereby preventing the breaking-down of the hydrocarbons and the deposit of soot, as well as keeping the carbonic acid low.

Second. That a producer should be blown with as much steam mixed with the air as will maintain incandescence. This reduces the percentage of nitrogen and increases the hydrogen, thereby greatly enriching the gas. The temperature of the producer is kept down, diminishing the loss of heat by radiation through the walls, and in a large measure preventing clinkers.

The Combustion of Producer-gas. (H. H. Campbell, *Trans. A. I. M. E.*, xix, 128.) — The combustion of the components of ordinary producer-gas may be represented by the following formulæ:

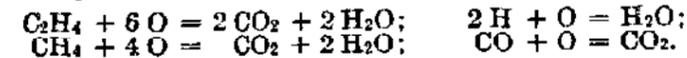

AVERAGE COMPOSITION BY VOLUME OF PRODUCER-GAS: A, MADE WITH OPEN GRATES, NO STEAM IN BLAST; B, OPEN GRATES, STEAM-JET IN BLAST. 10 SAMPLES OF EACH.

	CO ₂	C	C ₂ H ₄	CO	H	CH ₄	N
A min.....	3.6	0.4	0.2	20.0	5.3	3.0	58.7
A max.....	5.6	0.4	0.4	24.8	8.5	5.2	64.4
A average.....	4.84	0.4	0.34	22.1	6.8	3.74	61.78
B min.....	4.6	0.4	0.2	20.8	6.9	2.2	57.2
B max.....	6.0	0.8	0.4	24.0	9.8	3.4	62.0
B average.....	5.3	0.54	0.36	22.74	8.37	2.56	60.13

The coal used contained carbon 82%, hydrogen 4.7%. The following are analyses of products of combustion:

	CO ₂	O	CO	CH ₄	H	N
Minimum.....	15.2	0.2	trace.	trace.	trace.	80.1
Maximum.....	17.2	1.6	2.0	0.6	2.0	83.6
Average.....	16.3	0.8	0.4	0.1	0.2	82.2

Proportions of Gas Producers and Scrubbers. (F. C. Tryon, *Power*, Dec. 1, 1908.) — Small inside diameter means excessive draft through the fire. If a fire is forced, as will be necessary with too small an inside diameter, the results will be clinkers and blow-holes or chimneys through the fire bed, with excess CO₂ and weak gas; clinkers fused to the lining, and burning out of grates. If sufficient steam is used to keep down the excessive heat, the result is likely to be too much hydrogen in the gas, with the attendant engine troubles.

The lining should never be less than 9 in. thick even in the smaller sizes, and a 100-H.P., or larger, producer should have at least 12 in. of generator lining. The lining next to the fire bed should be of the best quality of refractory material. A good lining consists of a course of soft common bricks put in edgewise next to the steel shell of the generator, laid in Portland cement; then a good firebrick 6 in. thick laid inside to fit the circle, the bricks being dipped as laid in a fine grouting of ground firebrick.

If we take 11/4 lbs. of coal per H.P.-hour as a fair average and 10 lbs. of

coal per hour per square foot of internal fuel-bed cross-section, with 9 in. of refractory lining up to 100 H.P. and at least 12 in. of lining on larger sizes, the generator will give good gas without forcing and without excessive heat in the zone of complete combustion. A 200-H.P. producer on this basis consumes 250 lbs. of coal at full load, and at 10 lbs. per sq. ft. internal area 25 sq. ft. will be necessary. With a 12-in. lining the outside diameter will be 92 in.

Practice has shown that the depth of the fuel bed should never be less than the inside diameter up to 6 ft.; above this size the depth can be adjusted as experience indicates the best working results. Assuming for a 200-H.P. producer 18 in. for the ashpit below the grate, 12 in. for the thickness of the grate and the ashes to protect it, 68 in. depth of fuel bed, 24 in. above the fuel to the gas outlet, the height will be 10 ft. 4 in. to the top of the generator; above this the coal-feeding hopper, say 32 in. high, is mounted; this makes the height over all 13 ft.

The wet scrubber of a gas producer should be of ample size to cool the gas to atmospheric temperature and wash out most of the impurities. A good rule is to make its diameter three-fourths that of the inside diameter of the generator and the height one and one-half times the height of the generator shell. For a 100-H.P. producer, 4 ft. inside diam., the wet scrubber should be 3 ft. inside diam., and if the generator shell is 8 ft. 6 in. high, the scrubber should be 12 ft. 9 in. high. When fitted with the proper amount of baffling and scrubbing material (coke commonly used), the scrubber will have space for about 30 cu. ft. of gas. A 100-H.P. gas engine using 12,000 B.T.U. per H.P.-hour will use 160 cu. ft. of 125-B.T.U. gas per minute. The wet scrubber will therefore be emptied 5 1/3 times every minute, and would require about 8 1/3 gallons of water per minute; if the diameter of the scrubber were reduced one-third the volume of water necessary to cool and scrub the gas would have to be doubled. Gas must be cooled below 90° F. to enable it to give up the impurities it carries in suspension, and even lower than this to condense its moisture.

A separate dry scrubber with two compartments should always be provided and the piping between the two scrubbers so arranged that the gas can be turned into either part of the dry scrubber at will. The dry scrubber should be equal in area to the inside of the generator, and the depth of each part should be sufficient to accommodate at least 2 cu. ft. of scrubbing material and give 1 cu. ft. of space next to the outlet. Oil-soaked excelsior is a good scrubbing material and should be packed as closely as possible.

Taking as the standard the dimensions above stated for the different parts of a producer-gas plant, a list of dimensions for different horse-power capacities would be about as in the following table.

DIMENSIONS OF GAS PRODUCERS AND SCRUBBERS.

H.P.	Producers.			Wet Scrubbers.		Dry Scrubbers.		
	Inside Diam.	Out-side Diam.	Height.	Diam.	Height.		Diam.	Height.
	in.	in.	ft. in.	in.	ft. in.		in.	ft. in.
25	24	42	6 6	18	9 9	Single...	24	3 0
35	28	46	6 10	21	10 3	...do...	28	3 0
50	34	52	7 4	26	11 0	Double.	34	6 0
60	37	55	7 7	28	11 5	...do....	37	6 0
75	42	60	8 0	32	12 0	...do....	42	6 0
100	48	72	8 6	36	12 9	...do....	48	7 0
125	54	78	9 6	41	14 3	...do....	52	7 0
150	58	82	9 10	44	14 9	...do....	58	7 6
175	63	87	10 3	48	15 5	...do....	63	7 6
200	68	92	10 8	51	16 0	...do....	68	7 6

The inside diameter of the producers corresponds to the formula H.P. = 6.25d².

Gas Producer Practice. — The following notes on gas producers are condensed from the catalogue of the Morgan Construction Co.

The Morgan Continuous Gas Producer is made in the following sizes:

Diam. inside of lining, ft.....	6	8	10	12
Area of gas-making surface, sq. ft.....	28	50	78.5	113
24-hour capacity with good coal, tons.....	4	7	10	15
Diam. of outlet, in.	20	27	33	40

The best coal to buy for a producer in any locality is that which by analysis or calorimeter test shows the most heat units for a dollar. It rarely pays to buy gas coal unless it can be had at a moderate cost over the ordinary steam bituminous grade. For very high temperature melting operations a fairly high percentage of volatile matter is necessary to give a luminous flame and intensify the radiation from the roof of the furnace. Freely burning gas coals are the most easily gasified, and the capacity of the producer to handle these coals is twice as great as when a slaty, dirty coal, high in ash and sulphur, is used. It is usually best to use "run-of-mine" coal, crushed at the mine to pass a 4-in. ring. It never pays to use slack coal, for it cuts down the capacity by choking the blast, which has to be run at high pressure to get through the fire, overheating the gas and lowering the efficiency of the producer.

There is always a certain amount of CO₂ formed, even in the best practice; in fact, it is inevitable, and if kept within proper limits does not constitute a net loss of efficiency, especially with very short gas flues, because the energy of the fuel so burned is represented in the sensible heat or temperature of the gas, and results in delivering a hot gas to the furnace. The best result is at about 4% CO₂, a gas temperature between 1100° and 1200° F., and flues less than 100 ft. long.

The amount of steam required to blow a gas producer is from 33% to 40% of the weight of the fuel gasified. If 30 lbs. of steam is called a standard horse-power, we have therefore to provide about 1 H.P. of steam for every 80 lbs. of coal gasified per hour or for every ton of coal gasified in 24 hours.

In the original Siemens air-blown producer about 70% of the whole gas was inert and 30% combustible. Then with the advent of steam-blown producers the dilution was reduced to about 60%, with 40% combustible. Now, under the system of automatic feed, uniform conditions, perfect distribution and adjustment of the steam blast here presented, we are able to reduce the nitrogen to 50% and sometimes less.

In the best practice the volume of gas from the producer is now reduced to about 60 cu. ft. per pound of coal, of which 30 cu. ft. are nitrogen. These volumes are measured at 60° F.

The temperature of the gas leaving the producer under best modern conditions is about 1200° F. It can be run cooler than this, but not much, except at a sacrifice of both quantity and quality. At this temperature, the sensible heat carried by the gas is 1200 × 0.35 (average specific heat) = 420 B.T.U. per pound. As one pound of good gas is about 16 cu. ft. and carries about 16 × 180 = 2880 heat units at normal temperature, we see that the sensible heat carried away represents about one-seventh, or over 14% of the combustible energy, which is much too large a percentage to lose whenever it can be utilized by using the gas at the temperature at which it is made.

Capacity of Producers. — The capacity of a gas producer is a varying quantity, dependent upon the construction of the producer and upon the quality of the coal supplied to it. The point is, not to push the producer so hard as to burn up the gas within it; also to avoid blowing dust through into the flues. These two limitations in a well-constructed automatically fed gas producer occur at about the same rate of gasification, namely, at about 10 lbs. per sq. ft. of surface per hour with bituminous coal carrying 10% of ash and 1 1/2 % of sulphur. With gas coal, having high volatile percentage and low ash, this rate can be safely increased to 12 lbs. and in some cases to 15 lbs. per sq. ft. At 10 lbs. per sq. ft., the capacity of a gas producer 8 ft. internal diameter is 500 lbs. per hour, which with gas coals may be increased to a maximum of about 700 lbs. It frequently happens that the cheapest coal available is of such quality that neither of these figures can be reached, and the gasification per sq. ft. has to be cut down to 6 or 7 lbs. per hour to get the best results.

Flues. — It is necessary to provide large flue capacity and to carry the full area right up to the furnace ports, which latter may be slightly reduced to give the gas a forward impetus. Generally speaking, the net area of a flue should not be less than 1/16 of the area of the gas-making surface in the producers supplying it. Or it may be stated thus: — The carrying capacity of a hot gas flue is equivalent to 200 lbs. of coal per hour per sq. ft. of section.

Loss of Energy in a Gas Producer. — The total loss from all sources in the gasification of fuel in a gas producer under fairly good conditions, when the gas is used cold or when its sensible heat is not utilized, ranges between 20% and 25%, which under very bad conditions may be increased to 50%. The loss under favorable conditions, using the gas hot, is reduced to as low as 10%, which also includes the heat of the steam used in blowing.

Test of a Morgan Producer. — The following is the record of a test made in Chicago by Robert W. Hunt & Co. The coal used was Illinois "New Kentucky" run-of-mine of the following analysis: —

Fixed carbon, 50.87; volatile matter, 37.32; moisture, 5.08; ash (1.12 sulphur), 6.73. The average of all the gas analyses by volume is as follows: CO, 24.5; H, 17.8; CH₄ and C₂H₄, 6.8; total combustibles, 49.1%; CO₂, 3.7; O, 0.4; N, 46.8; total non-combustibles, 50.9%.

Average depth of fuel bed, 3 ft. 4 in. Average pressure of steam on blower, 4.7 lbs. per sq. in. Analysis of ash: combustible, 4.66%; non-combustible, 95.34%. Percentage of fuel lost in the ash, 4.66 × 6.73 ÷ 100 = 0.3%.

High Temperature Required for Production of CO. — In an ordinary coal fire, with an excess of air CO₂ is produced, with a high temperature. When the thickness of the coal bed is increased so as to choke the air supply CO is produced, with a decreased temperature. It appears, however, that if the temperature is greatly lowered, CO₂ instead of CO will be produced notwithstanding the diminished air supply. Herr Ernst (*Eng'g*, April 4, 1893) holds that the oxidation of C begins at 752° F., and that CO₂ is then formed as the main product, with only a small amount of CO, whether the air be admitted in large or in small quantities. When the rate of combustion is increased and the temperature rises to 1292° F. the chief product is CO₂ even when the exhaust gases contain 20% by volume of CO₂, which is practically the maximum limit, proving that all the oxygen has been consumed. Above 1292° F. the proportion of CO rapidly increases until 1823° F. is reached, when CO is exclusively produced.

Experiments reported by J. K. Clement and H. A. Grine in Bulletin No. 393 of the U. S. Geological Survey, 1909, show that with the rate of flow of gas and the depth of fuel bed which obtain in a gas producer a temperature of 1100° C. (2012° F.) or more is required for the formation of 90% CO gas from CO₂ and charcoal, and 1300° (2372° F.) for the same percentage from CO₂ and coke, and from CO₂ and anthracite coal. With a temperature 100° C. (180° F.) lower than these the resultant gas will contain about 50% CO. It follows that the temperature of the fuel bed of the gas producer must be at least 1300° C. in order to yield the highest possible percentage of CO.

The Mond Gas Producer is described by H. A. Humphrey in *Proc. Inst. C. E.*, vol. cxxix, 1897. The producer, which is combined with a by-product recovery plant, uses cheap bituminous fuel and recovers from it 90 lbs. of sulphate of ammonia per ton, and yields a gas suitable for gas engines and all classes of furnace work. The producer is worked at a much lower temperature than usual, due to the large quantity of superheated steam introduced with the air, amounting to more than twice the weight of the fuel. The gas containing the ammonia is passed through an absorbing apparatus, and treated so that 70% of the original nitrogen of the fuel is recovered. The result of a test showed that for every ton of fuel about 2.5 tons of steam and 3 tons of air are blown through the grate, the mixture being at a temperature of about 480° F. The greater part of this steam passes through the producer undecomposed, its heat being used in a regenerator to furnish fresh steam for the producer. More than 0.5 ton of steam is decomposed in passing through the hot fuel, and nearly 4.5 tons of gas are produced from a ton of coal, equal to about 160,000 cu. ft. at ordinary atmospheric temperature. The gas has a calorific power of 81% of that of the original fuel. Mr. Humphrey gives the following table showing the relative value of different gases.

Volume per cent.	Mond Producer Gas from Bituminous Fuel.	Siemens Producer Gas.	Dowson Producer Gas from Anthracite.	Lencanhez Producer Gas from Anthracite.	Solvay Coke-Oven Gas.	Coal-Gas (Illuminating).	Pittsburgh Natural Gas.
Hydrogen (H).....	24.8	8.6	18.73	20.0	56.9	48.0	22.0
Marsh gas (CH ₄).....	2.3	2.4	0.31	22.6	39.5	67.0
C _n H _{2n} gases.....	nil	nil	0.31	4.0(?)	3.0	3.8	6.0
Carbonic oxide (CO).....	13.2	24.4	25.07	21.0	8.7	7.5	0.6
Nitrogen (N).....	46.8	59.4	48.98	49.5	5.8	0.5	3.0
Carbonic acid (CO ₂).....	12.9	5.2	6.57	5.0	3.0	nil	0.6
Total volume.....	100.0	100.0	100.0	100.0	100.0	100.0	100.0
Total combustible gases.....	40.3	35.4	44.42	45.0	91.2	98.8	95.6
Theoretical.							
Air required for combustion.....	112.4	101.4	113.2	154.0	410.0	581.0	806.0
Calorific value per cu. ft., in lb. °C. units.....	85.9	74.7	88.9	115.3	284.0	381.0	495.8
Do., B.T.U. per cu. ft.....	154.6	134.5	160.0	207.5	511.2	658.8	892.4
Do., per litre, gram °C. units.....	1,374	1,195	1,432	1,845	4,544	6,096	7,932

NOTE. — Where the volume per cent does not add up to 100 the slight difference is due to the presence of oxygen.

The following is the analysis of gas made in a Mond producer at the works of the Solvay Process Co. in Detroit, Mich. (*Mineral Industry*, vol. viii, 1900): CO₂, 14.1; O, 0.3; N, 42.9; H, 25.9; CH₄, 4.1; CO, 12.7. Combustible, 42.7%. Calories per litre, 1540, = 173 B.T.U. per cu. ft.

Relative Efficiencies of Different Coals in Gas Producer and Engine Tests. — The following is a condensed statement of the principal results obtained in the gas-producer tests of the U. S. Geological Survey at St. Louis in 1904. (R. H. Fernald, *Trans. A. S. M. E.*, 1905.)

Sample.	B.t.u. per lb. combustible.	Pounds per electrical H.P. hour at switchboard.			Sample.	B.t.u. per lb. combustible.	Pounds per electrical H.P. hour at switchboard.		
		Coal as fired.	Dry coal.	Combustible.			Coal as fired.	Dry coal.	Combustible.
Ala. No. 2....	14820	1.71	1.64	1.53	Ky. No. 3..	14650	2.05	1.91	1.72
Colo. No. 3....	13210	2.14	1.71	1.58	Mo. No. 2..	14280	1.94	1.71	1.43
Ill. No. 3.....	14560	1.93	1.79	1.60	Mont. No. 1	13580	2.54	2.25	1.98
Ill. No. 4.....	14344	2.01	1.76	1.57	N. Dak. No. 2	12600	3.80	2.29	2.05
Ind. No. 1....	14720	2.17	1.93	1.71	Texas No. 1	12945	3.34	2.22	1.88
Ind. No. 2....	14500	1.68	1.55	1.39	Texas No. 2	12450	2.58	1.71	1.52
Okla. No. 1....	14800	1.92	1.83	1.66	W. Va. No. 1	15350	1.60	1.57	1.48
Okla. No. 4....	13890	1.57	1.43	1.17	W. Va. No. 4	15600	1.32	1.29	1.17
Iowa No. 2....	13950	2.07	1.73	1.30	W. Va. No. 7	15800	1.53	1.50	1.40
Kan. No. 5....	15200	1.69	1.62	1.43	Wyo. No. 2	13820	2.28	2.07	1.60

The gas was made in a Taylor pressure producer rated at 250 H.P. Its inside diam. was 7 ft., area of fuel bed 38.5 sq. ft., height of casing 15 ft.; rotative ash table; centrifugal tar extractor. The engine was a 3-cylinder

vertical Westinghouse, 19 in. diam., 22 in. stroke, 200 r.p.m., rated at 235 B. H. P. Comparing the results of the W. Va. No. 7 coal, the best on the list, with the North Dakota coal, the one which gave the poorest results, the heat values per lb. combustible of the coals are as 1 to 0.808; reciprocal, 1 to 1.24; the lbs. combustible per E. H. P. hour as 1 to 1.75, and lbs. coal as fired per E. H. P. hour as 1 to 2.88. The relative thermal efficiencies of the engine with the two coals are as 2.05 to 1.17, or as 1 to 0.578. The analyses by volume of the dry gas obtained from the two coals was:

	CO ₂	O	CO	H	CH ₄	N	Total combustible.
N. Dak.....	10.16	0.24	15.82	11.16	3.74	58.88	40.06
W. Va.....	8.69	0.23	20.90	14.33	4.85	51.02	30.72

The dry-gas analysis shows the North Dakota gas to be by far the best; its much lower result in the engine test is due to the smaller quantity of gas produced per lb. of coal, which was 22.7 cu. ft. per lb. of coal as fired, as compared with 70.6 cu. ft. for the W. Va. coal, measured at 62° F. and 14.7 lb. absolute pressure.

Use of Steam in Producers and in Boiler-furnaces. (R. W. Raymond, *Trans. A. I. M. E.*, xx, 635.) — No possible use of steam can cause a gain of heat. If steam be introduced into a bed of incandescent carbon it is decomposed into hydrogen and oxygen.

The heat absorbed by the reduction of one pound of steam to hydrogen is much greater in amount than the heat generated by the union of the oxygen thus set free with carbon, forming either carbonic oxide or carbonic acid. Consequently, the effect of steam alone upon a bed of incandescent fuel is to chill it. In every water-gas apparatus, designed to produce by means of the decomposition of steam a fuel-gas relatively free from nitrogen, the loss of heat in the producer must be compensated by some reheating device.

This loss may be recovered if the hydrogen of the steam is subsequently burned, to form steam again. Such a combustion of the hydrogen is contemplated, in the case of fuel-gas, as secured in the subsequent use of that gas. Assuming the oxidation of H to be complete, the use of steam will cause neither gain nor loss of heat, but a simple transference, the heat absorbed by steam decomposition being restored by hydrogen combustion. In practice, it may be doubted whether this restoration is ever complete. But it is certain that an excess of steam would defeat the reaction altogether, and that there must be a certain proportion of steam, which permits the realization of important advantages, without too great a net loss in heat.

The advantage to be secured (in boiler furnaces using small sizes of anthracite) consists principally in the transfer of heat from the lower side of the fire, where it is not wanted, to the upper side, where it is wanted. The decomposition of the steam below cools the fuel and the grate-bars, whereas a blast of air alone would produce, at that point, intense combustion (forming at first CO₂), to the injury of the grate, the fusion of part of the fuel, etc.

Gas Analyses by Volume and by Weight. — To convert an analysis of a mixed gas by volume into analysis by weight: Multiply the percentage of each constituent gas by its relative density, viz: CO₂ by 11, O by 8, CO and N each by 7, and divide each product by the sum of the products. Conversely, to convert analysis by weight into analysis by volume, divide the percentage by weight of each gas by its relative density, and divide each quotient by the sum of the quotients.

Gas-fuel for Small Furnaces. — E. P. Reichhelm (*Am. Mach.*, Jan. 10, 1895) discusses the use of gaseous fuel for forge fires, for drop-forging, in annealing-ovens and furnaces for melting brass and copper, for case-hardening, muffle-furnaces, and kilns. Under ordinary conditions, in such furnaces he estimates that the loss by draught, radiation, and the heating of space not occupied by work is, with coal, 80%, with petroleum 70%, and with gas above the grade of producer-gas 25%. He gives the following table of comparative cost of fuels, as used in these furnaces:

Kind of Gas.	No. of Heat-units in 1000 cu. ft. used.	No. of Heat-units in Furnaces after Deducting 25% Loss.	Average Cost per 1000 Ft.	Cost of 1,000 Heat-units Obtained in Furnaces.
Natural gas.....	1,000,000	750,000		
Coal-gas, 20 candle-power.....	675,000	506,250	\$1.25	\$2.46
Carburetted water-gas.....	646,000	484,500	1.00	2.06
Gasolene gas, 20 candle-power.....	690,000	517,500	.90	1.73
Water-gas from coke.....	313,000	234,750	.40	1.70
Water-gas from bituminous coal.....	377,000	282,750	.45	1.59
Water-gas and producer-gas mixed....	185,000	138,750	.20	1.44
Producer-gas.....	150,000	112,500	.15	1.33
Naphtha-gas, fuel 2½ gals. per 1000 ft. .	306,365	229,774	.15	.65
Coal, \$4 per ton, per 1,000,000 heat-units utilized.....				.73
Crude petroleum, 3 cts. per gal., per 1,000,000 heat-units.....				.73

Mr. Reichhelm gives the following figures from practice in melting brass with coal and with naphtha converted into gas: 1800 lbs. of metal require 1080 lbs. of coal, at \$4.65 per ton, equal to \$2.51, or, say, 15 cents per 100 lbs. Mr. T.'s report: 2500 lbs. of metal require 47 gals. of naphtha, at 6 cents per gal., equal to \$2.82, or, say, 11¼ cents per 100 lbs.

Blast-Furnace Gas. — The waste-gases from iron blast furnaces were formerly utilized only for heating the blast in the hot-blast ovens and for raising steam for the blowing-engine pumps, hoists and other auxiliary apparatus. Since the introduction of gas engines for blowing and other purposes it has been found that there is a great amount of surplus gas available for other uses, so that a large power plant for furnishing electric current to outside consumers may easily be run by it. H. Freyn, in a paper presented before the Western Society of Engineers (*Eng. Rec.*, Jan. 13, 1906), makes an elaborate calculation for the design of such a plant in connection with two blast furnaces of a capacity of 400 tons of pig iron each per day. Some of his figures are as follows: The two furnaces would supply 4,350,000 cu. ft. of gas per hour, of 90 B.T.U. average heat value per cu. ft. The hot-blast stoves would require 30% of this, or 1,305,000 cu. ft.; the gas-blowing engines 720,000 cu. ft.; pumps, hoists and lighting machinery, 120,000 cu. ft.; gas-cleaning machinery, 120,000 cu. ft.; losses in piping, 48,000 cu. ft.; leaving available for outside uses, in round numbers, 2,000,000 cu. ft. per hour. At the rate of 100 cu. ft. of gas per brake H.P. hour this would supply engines of 20,000 H.P., but assuming that on account of irregular working of the furnaces only half this amount would be available for part of the time, a 10,000-H.P. plant could be run with the surplus gas of the two furnaces. Taking into account the cost of the plant, figured at \$61.60 per B.H.P., interest, depreciation, labor, etc., the annual cost of producing one B.H.P., 24 hours a day, is \$17.88, no value being placed on the blast-furnace gas, and 1 K.W. hour would cost 0.295 cent, which is far below the lowest figure ever reached with a steam-engine power plant.

Blast-furnace gas is composed of nitrogen, carbon dioxide and carbon monoxide, the latter being the combustible constituent. An analysis reported in *Trans. A. I. M. E.*, xvii, 50, is, by volume, CO₂, 7.08; CO, 27.80; O, 0.10; N, 65.02. The relative proportions of CO₂ and CO vary considerably with the conditions of the furnace.

ACETYLENE AND CALCIUM CARBIDE.

Acetylene, C₂H₂, contains 12 parts C and 1 part H, or 92.3% C, 7.7% H. It is described as follows in a paper on Calcium Carbide and Acetylene by J. B. Morehead (*Am. Gas Light Jour.*, July 10, 1905):

Acetylene is a colorless and tasteless gas. When pure it has a sweet, ethereal odor, but in the commercial form it carries small percentages of phosphoreted and sulphureted hydrogen which give it a pungent odor. One cu. ft. requires 11.91 cu. ft. of air for its complete combustion. Its

specific gravity is 0.92, air being 1. It is the nearest approach to gaseous carbon, and it possesses a higher candle power than any other known substance, or 240 candles for 5 cu. ft. It is soluble in its own volume of water, and in varying proportions in ether, alcohol, turpentine and acetone. It liquefies under a pressure of 700 lbs. per sq. in. at 70° F. The pressure necessary for liquefaction varies directly with the temperature up to 98°, which is its critical temperature, beyond which it is impossible to liquefy the gas at any pressure.

When calcium carbide is brought into contact with water, the calcium robs the water of its oxygen and forms lime and thus frees the hydrogen, which combines with the carbon of the carbide to form acetylene. Sixty-four lbs. of calcium carbide combine with 36 lbs. of water and produce 26 lbs. of acetylene and 17 lbs. of pure, slacked lime. [The chemical reaction is $\text{CaC}_2 + 2\text{H}_2\text{O} = \text{C}_2\text{H}_2 + \text{Ca}(\text{OH})_2$.]

Chemically pure calcium carbide will yield at 70° F. and 30 in. mercury, 5.83 cu. ft. acetylene per pound of carbide. Commercially pure carbide is guaranteed to yield 5 cu. ft. of acetylene per pound, and usually exceeds the guarantee by a few per cent. The reaction between calcium carbide and water, and the subsequent slacking of the calcium oxide produced, give rise to considerable heat. This heat from one pound of chemically pure calcium carbide amounts to sufficient to raise the temperature of 4.1 lbs. of water from the freezing to the boiling point.

There are two types of generators; one in which a varying quantity of water is dropped on to the carbide, the other in which the carbide is dropped into a large excess of water. Owing to the large amount of heat generated by the reaction, and the susceptibility of the acetylene to heat, the first, or dry type, is confined to lamps and to small machines.

Acetylene contains 1685 B.T.U. per cubic foot as compared with 1000 for natural gas and 600 for coal or water gas. At the present state of development of the acetylene industry and the calcium carbide manufacture, this gas will not compete with coal gas or water gas, or with electricity as supplied in our cities. Acetylene may be stored under pressure for railway and other portable lighting, and it may be absorbed in acetone and used for the same purpose.

Calcium carbide was discovered on May 4, 1892, at the plant of the Willson Aluminum Co., in North Carolina. It is a crystalline body, hard, brittle and varying in color from almost black to brick red. Its specific gravity is 2.26. A cubic foot of crushed carbide weighs 138 lbs., and in weight, color and most of its physical characteristics is about like granite. If broken hot, the fracture shows a handsome, bluish purple iridescence and the crystals are apt to be quite large.

Calcium carbide, CaC_2 , contains 62.5% Ca and 37.5% C. It is insoluble in most acids and in all alkalis, it is non-inflammable, infusible, non-explosive, unaffected by jars, concussions or time, and, except for the property of giving off acetylene when brought in contact with water, it is an inert and stable body. It is made by the reduction in an electric arc furnace of a mixture of finely pulverized and intimately mixed calcium oxide or quicklime and carbon in the shape of coke. [$3\text{C} + \text{CaO} = \text{CaC}_2 + \text{CO}$.] The temperature is calculated to be from 5000 to 8000° F. The furnaces employ from 250 to 350 electric H.P. each and produce about one ton a day. The output is crushed to different sizes and it is sold for \$70 per ton at the works.

The entire use for calcium carbide is for the production of acetylene. [Wohler, in 1862, obtained calcium carbide by heating an alloy of calcium and zinc together with carbon to a very high temperature.]

Acetylene Generators and Burners.—Lewes classifies acetylene generators under four types: (1) Those in which water drips or flows slowly on a mass of carbide; (2) those in which water rises, coming in contact with a mass of carbide; (3) those in which water rises, coming in contact with successive layers of carbide; (4) those in which the carbide is dropped or plunged into an excess of water. He shows that the first two classes are dangerous; that some generators of the third class are good, but that those of the fourth are the best.

Of the various burners used for acetylene, those of the Naphey type are among the most satisfactory. Two tubes leading from the base of the burner are so adjusted as to cause two jets of flame to impinge upon each other at some little distance from the nozzles, and mutually to splay each other out into a flat flame. The tips of the nozzles, usually of steatite, are

formed on the principle of the Bunsen burner, insuring a thorough mixture of the acetylene with enough air to give the best illumination. (H. C. Biddle, *Cal. Jour. of Tech.*, 1907.)

Acetylene gas is an endothermic compound. In its formation heat is absorbed, and there resides in the acetylene molecule the power of spontaneously decomposing and liberating this heat if it is subjected to a temperature or pressure beyond the capacity of its unstable nature to withstand. (Thos. L. White, *Eng. Mag.*, Sept., 1908.) Mr. White recommends the use of acetylene for carbureting the alcohol used in alcohol motors for automobiles.

The Acetylene Blowpipe.—(Machy., July, 1907.)—The acetylene is produced in a generator and stored in a tank at a pressure of 2.2 to 3 lbs. per sq. in. The oxygen is compressed in a tank at about 150 lbs. pressure. The acetylene is conveyed to the burner through a 1-in. pipe with one 3/8-in. branch leading to each blowpipe connection. The oxygen is conveyed through 3/8-in. pipe with 1/4-in. branches. The blowpipe is of brass, made on the injector principle. As acetylene is so rich in carbon—containing 92.3%—it is possible, when mixed with air in a Bunsen burner, to obtain 3100° F., and when combined with oxygen, 6300° F., which is the hottest flame known as a product of combustion, and nearly equals the electric arc. This is about 1200° higher than the oxy-hydrogen blowpipe flame.

In lighting the blowpipe, the acetylene is first turned on full; then the oxygen is added until the flame is only a single cone. At the apex of this cone is a temperature of 6300° F. In welding, this point is held from 1/8 to 1/4 in. distant from the metal to be welded. Too much acetylene produces two cones and a white color; an excess of oxygen is indicated by a violet tint.

Theoretically, 2 1/2 volumes of oxygen are required for complete combustion of 1 volume of acetylene. Practically, however, with the blowpipe the best welding results are obtained with 1.7 volumes of oxygen to 1 volume of acetylene. The acetylene is, therefore, not completely burned with the blowpipe, according to the reaction:

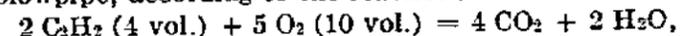

but it is incompletely burned according to the reaction:

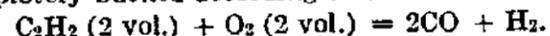

Making Oxygen for the Blowpipe.—The distinctive feature which has done the most to make the acetylene welding process of wide commercial value is the introduction of a means for producing oxygen. By combining a chemical product, known as "epurite," with water, pure oxygen is easily obtained. Epurite is composed of chloride of lime, sulphate of copper and sulphate of iron. The sulphate of copper is pulverized and mixed dry with the chloride of lime. In making oxygen, 50 lbs. of this dry mixture are dissolved in warm water. To this solution is added a solution of about 7 lbs. of sulphate of iron dissolved in one gallon of water.

The oxygen-generating apparatus consists of two lead-lined chambers with a scrubber and settling chamber between. One generator is filled with lukewarm water to which one chemical charge is added. While this solution is being stirred with an agitator a solution of iron sulphate is added which acts as a catalyzer. The reaction is:

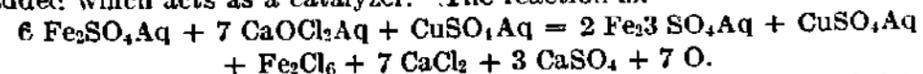

The oxygen, liberated, passes through a scrubber and a water-sealed trap into a gasometer; from which it is compressed to 10 atmospheres, with an air compressor, into a pressure storage tank.

The Theory and Practice of Oxy-Acetylene Welding is described in an illustrated article by J. F. Springer in *Indust. Eng'g.*, Oct., 1909.

IGNITION TEMPERATURE OF GASES.

Mayer and Münch (*Berichte der deutscher Gesellschaft*, xxvi, 2241) give the following:

Marsh gas, C_2H_4 ,	667° C.	1233° F.
Ethane, C_2H_6 ,	616	1141
Propane, C_3H_8 ,	547	1017
Acetylene, C_2H_2 ,	580	1076
Propylene, C_3H_6 ,	504	939

ILLUMINATING-GAS.

Coal-gas is made by distilling bituminous coal in retorts. The retort is usually a long horizontal semi-cylindrical or \square shaped chamber, holding from 160 to 300 lbs. of coal. The retorts are set in "benches" of from 3 to 9, heated by one fire, which is generally of coke. The vapors distilled from the coal are converted into a fixed gas by passing through the retort, which is heated almost to whiteness.

The gas passes out of the retort through an "ascension-pipe" into a long horizontal pipe called the hydraulic main, where it deposits a portion of the tar it contains; thence it goes into a condenser, a series of iron tubes surrounded by cold water, where it is freed from condensable vapors, as ammonia-water, then into a washer, where it is exposed to jets of water, and into a scrubber, a large chamber partially filled with trays made of wood or iron, containing coke, fragments of brick or paving-stones, which are wet with a spray of water. By the washer and scrubber the gas is freed from the last portion of tar and ammonia and from some of the sulphur compounds. The gas is then finally purified from sulphur compounds by passing it through lime or oxide of iron. The gas is drawn from the hydraulic main and forced through the washer, scrubber, etc., by an exhauster or gas pump.

The kind of coal used is generally caking bituminous, but as usually this coal is deficient in gases of high illuminating power, there is added to it a portion of cannel coal or other enricher.

The following table, abridged from one in Johnson's Cyclopedia, shows the analysis, candle-power, etc., of some gas-coals and enrichers:

Gas-coals, etc.	Vol. Matter.	Fixed Carb.	Ash.	Gas per ton of 2240 lbs. in cu. ft.	Cand.-power of Gas.	Coke per ton of 2240 lbs.		Gas purified by 1 bush. of lime, in cu. ft.
						lbs.	bush.	
Pittsburgh, Pa.	36.76	51.93	7.07					
Westmoreland, Pa.	36.00	58.00	6.00	10.642	16.62	1544	40	6420
Sterling, O.	37.50	56.90	5.60	10.528	18.81	1480	36	3993
Despard, W. Va.	40.00	53.30	6.70	10.765	20.41	1540	36	2494
Darlington, O.	43.00	40.00	17.00	9.800	34.98	1320	32	2806
Petonia, W. Va.	46.00	41.00	13.00	13.200	42.79	1380	32	4510
Grahamite, W. Va.	53.50	44.50	2.00	15.000	28.70	1056	44	

The products of the distillation of 100 lbs. of average gas-coal are about as follows. They vary according to the quality of coal and the temperature of distillation.

Coke, 64 to 65 lbs.; tar, 6.5 to 7.5 lbs.; ammonia liquor, 10 to 12 lbs.; purified gas, 15 to 12 lbs.; impurities and loss, 4.5% to 3.5%.

The composition of the gas by volume ranges about as follows: Hydrogen, 38% to 48%; carbonic oxide, 2% to 14%; marsh-gas (Methane, CH_4), 43% to 31%; heavy hydrocarbons (C_2H_2 , ethylene, propylene, benzole vapor, etc.), 7.5% to 4.5%; nitrogen, 1% to 3%.

In the burning of the gas the nitrogen is inert; the hydrogen and carbonic oxide give heat but no light. The luminosity of the flame is due to the decomposition by heat of the heavy hydrocarbons into lighter hydrocarbons and carbon, the latter being separated in a state of extreme subdivision. By the heat of the flame this separated carbon is heated to intense whiteness, and the illuminating effect of the flame is due to the light of incandescence of the particles of carbon.

The attainment of the highest degree of luminosity of the flame depends upon the proper adjustment of the proportion of the heavy hydro-

carbons (with due regard to their individual character) to the nature of the diluent mixed therewith.

Investigations of Percy F. Frankland show that mixtures of ethylene and hydrogen cease to have any luminous effect when the proportion of ethylene does not exceed 10% of the whole. Mixtures of ethylene and carbonic oxide cease to have any luminous effect when the proportion of the former does not exceed 20%, while all mixtures of ethylene and marsh-gas have more or less luminous effect. The luminosity of a mixture of 10% ethylene and 90% marsh-gas being equal to about 18 candles, and that of one of 20% ethylene and 80% marsh-gas about 25 candles. The illuminating effect of marsh-gas alone, when burned in an argand burner, is by no means inconsiderable.

For further description, see the treatises on gas by King, Richards, and Hughes; also Appleton's Cyc. Mech., vol. i. p. 900.

Water-gas.—Water-gas is obtained by passing steam through a bed of coal, coke, or charcoal heated to redness or beyond. The steam is decomposed, its hydrogen being liberated and its oxygen burning the carbon of the fuel, producing carbonic-oxide gas. The chemical reaction is, $\text{C} + \text{H}_2\text{O} = \text{CO} + 2\text{H}$, or $2\text{C} + 2\text{H}_2\text{O} = \text{C} + \text{CO}_2 + 4\text{H}$, followed by a splitting up of the CO_2 , making $2\text{CO} + 4\text{H}$. By weight the normal gas $\text{CO} + 2\text{H}$ is composed of $\text{C} + \text{O} + \text{H} = 28$ parts CO and 2 parts H , $\frac{12}{12} + \frac{16}{16} + \frac{2}{2}$

or 93.33% CO and 6.67% H ; by volume it is composed of equal parts of carbonic oxide and hydrogen. Water-gas produced as above described has great heating-power, but no illuminating-power. It may, however, be used for lighting by causing it to heat to whiteness some solid substance, as is done in the Welsbach incandescent light.

An illuminating-gas is made from water-gas by adding to it hydrocarbon gases or vapors, which are usually obtained from petroleum or some of its products. A history of the development of modern illuminating water-gas processes, together with a description of the most recent forms of apparatus, is given by Alex. C. Humphreys, in a paper on "Water-gas in the United States," read before the Mechanical Section of the British Association for Advancement of Science, in 1889. After describing many earlier patents, he states that success in the manufacture of water-gas may be said to date from 1874, when the process of T. S. C. Lowe was introduced. All the later most successful processes are the modifications of Lowe's, the essential features of which were "an apparatus consisting of a generator and superheater internally fired; the superheater being heated by the secondary combustion from the generator, the heat so stored up in the loose brick of the superheater being used, in the second part of the process, in the fixing or rendering permanent of the hydrocarbon gases; the second part of the process consisting in the passing of steam through the generator fire, and the admission of oil or hydrocarbon at some point between the fire of the generator and the loose filling of the superheater."

The water-gas process has two periods: first the "blow," during which air is blown through the bed coal in the generator, and the partially burned gaseous products are completely burned in the superheater, giving up a great portion of their heat to the fire-brick work contained in it, and then pass out to a chimney; second, the "run" during which the air blast is stopped, the opening to the chimney closed, and steam is blown through the incandescent bed of fuel. The resulting water-gas passing into the carburetting chamber in the base of the superheater is there charged with hydrocarbon vapors, or spray (such as naphtha and other distillates or crude oil), and passes through the superheater, where the hydrocarbon vapors become converted into fixed illuminating gases. From the superheater the combined gases are passed, as in the coal-gas process, through washers, scrubbers, etc., to the gas-holder. In this case, however, there is no ammonia to be removed.

The specific gravity of water-gas increases with the increase of the heavy hydrocarbons which give illuminating power. The following figures, taken from different authorities, are given by F. H. Shelton in a paper on "Water-gas," read before the Ohio Gas Light Association, in 1894:

Candle-power....	19.5	20.	22.5	24.	25.4	26.3	28.3	29.6	.30 to 31.9
Sp. gr. (Air=1)...	.571	.630	.589	.60 to .67	.64	.602	.70	.65	.65 to .71

Analyses of Water-gas and Coal-gas Compared.

The following analyses are taken from a report of Dr. Gideon E. Moore on the Granger Water-gas, 1885:

	Composition by Vol.			Composition by Weight.		
	Water-gas.		Coal-gas. Heidelberg.	Water-gas.		Coal-gas.
	Worcester.	Lake.		Worcester.	Lake.	
Nitrogen.....	2.64	3.85	2.15	0.04402	0.06175	0.04559
Carbonic acid.....	0.14	0.30	3.01	0.00365	0.00753	0.09992
Oxygen.....	0.06	0.01	0.65	0.00114	0.00018	0.01569
Ethylene.....	11.29	12.80	2.55	0.18759	0.20454	0.05389
Propylene.....	0.00	0.00	1.21			0.03834
Benzole vapor.....	1.53	2.63	1.33	0.07077	0.11700	0.07825
Carbonic oxide.....	28.26	23.58	8.88	0.46934	0.37664	0.18758
Marsh-gas.....	18.88	20.95	34.02	0.17928	0.19133	0.41087
Hydrogen.....	37.20	35.88	46.20	0.04421	0.04103	0.06987
	100.00	100.00	100.00	1.00000	1.00000	1.00000
Density: Theory.....	0.5825	0.6057	0.4580			
Practice.....	0.5915	0.6018				
B.T.U. from 1 cu. ft.:						
Water liquid.....	650.1	688.7	642.0			
" vapor.....	597.0	646.6	577.0			
Flame-temperature, °F ...	5311.2	5281.1	5202.9			
Average candle-power.....	22.06	26.31				

The heating-values (B.T.U.) of the gases are calculated from the analysis by weight, by using the multipliers given below (computed from results of J. Thomsen), and multiplying the result by the weight of 1 cu. ft. of the gas at 62° F., and atmospheric pressure.

The flame-temperatures (theoretical) are calculated on the assumption of complete combustion of the gases in air, without excess of air.

The candle-power was determined by photometric tests, using a pressure of 1/2-in. water-column, a candle consumption of 120 grains of spermaceti per hour, and a meter rate of 5 cu. ft. per hour, the result being corrected for a temperature at 62° F. and a barometric pressure of 30 in. It appears that the candle-power may be regulated at the pleasure of the person in charge of the apparatus, the range of candle-power being from 20 to 29 candles, according to the manipulation employed.

Calorific Equivalents of Constituents of Illuminating-gas.

	Heat-units from 1 lb.		Heat-units from 1 lb.	
	Water Liquid.	Water Vapor.	Water Liquid.	Water Vapor.
Ethylene.....	21,524.4	20,134.8		
Propylene.....	21,222.0	19,834.2		
Benzole vapor.....	18,954.0	17,847.0		
Carbonic oxide.....			4,395.6	4,395.6
Marsh-gas.....			24,021.0	21,592.8
Hydrogen.....			61,524.0	51,804.0

Efficiency of a Water-gas Plant. — The practical efficiency of an illuminating water-gas setting is discussed in a paper by A. G. Glasgow (Proc. Am. Gaslight Assn., 1890) from which the following is abridged:

The results refer to 1000 cu. ft. of unpurified carburetted gas, reduced to 60° F. The total anthracite charged per 1000 cu. ft. of gas was 33.4 lbs.,

ash and unconsumed coal removed 9.9 lbs., leaving total combustible consumed 23.5 lbs., which is taken to have a fuel-value of 14,500 B.T.U. per pound, or a total of 340,750 heat-units.

	Com- posi- tion by Vol.	Weight per 100 cu. ft.	Com- posi- tion by W'ht.	Specific Heat.	
I. Carburetted Water-gas..	CO ₂ + H ₂ S.....	3.8	.465842	.09647	.02088
	C _n H _{2n}	14.6	1.139968	.23607	.08720
	CO.....	28.0	2.1868	.45285	.11226
	CH ₄	17.0	.75854	.15710	.09314
	H.....	35.6	.1991464	.04124	.14041
	N.....	1.0	.078596	.01627	.00397
	100.0	4.8288924	1.00000	.45786	
II. Uncarburetted gas.....	CO ₂	3.5	.429065	.1019	.02205
	CO.....	43.4	3.389540	.8051	.19958
	H.....	51.8	.289821	.0688	.23424
	N.....	1.3	.102175	.0242	.00591
	100.0	4.210601	1.0000	.46178	
III. Blast products escap- ing from superheater.	CO ₂	17.4	2.133066	.2464	.05342
	O.....	3.2	.2856096	.0329	.00718
	N.....	79.4	6.2405224	.7207	.17585
	100.0	8.6591980	1.0000	.23645	
IV. Generator blast-gases..	CO ₂	9.7	1.189123	.1436	.031075
	CO.....	17.8	1.390180	.1680	.041647
	N.....	72.5	5.698210	.6884	.167970
	100.0	8.277513	1.0000	.240692	

The heat-energy absorbed by the apparatus is 23.5 × 14,500 = 340,750 heat-units = A. Its disposition is as follows:

- B, the energy of the CO produced;
- C, the energy absorbed in the decomposition of the steam;
- D, the difference between the sensible heat of the escaping illuminating-gases and that of the entering oil;
- E, the heat carried off by the escaping blast products;
- F, the heat lost by radiation from the shells;
- G, the heat carried away from the shells by convection (air-currents);
- H, the heat rendered latent in the gasification of the oil;
- I, the sensible heat in the ash and unconsumed coal recovered from the generator.

The heat equation is A = B + C + D + E + F + G + H + I; A being known. A comparison of the CO in Tables I and II show that $\frac{280}{434}$,

or 64.5% of the volume of carburetted gas, is pure water-gas, distributed thus: CO₂, 2.3%; CO, 28.6%; H, 33.4%; N, 0.8%; = 64.5%. 1 lb. of CO at 60° F. = 13,531 cu. ft. CO per 1000 cu. ft. of gas = 280 ÷ 13,531 = 20.694 lbs. Energy of the CO = 20.694 × 4395.6 = 91,043 heat-units = B. 1 lb. of H at 60° F. = 189.2 cu. ft. H per M of gas = 334 ÷ 189.2 = 1.7653 lbs. Energy of the H per lb. (according to Thomsen, considering the steam generated by its combustion to be condensed to water at 75° F.) = 61,524 B.T.U. In Mr. Glasgow's experiments the steam entered the generator at 331° F.; the heat required to raise the product of combustion of 1 lb. of H, viz., 8.98 lbs. H₂O, from water at 75° to steam at 331° must therefore be deducted from Thomsen's figure, or 61,524 - (8.98 × 1140.2) = 51,285 B.T.U. per lb. of H. Energy of the H, then, is 1.7653 × 51,285 = 90,533 heat-units = C. The heat

lost due to the sensible heat in the illuminating-gases, their temperature being 1450° F., and that of the entering oil 235° F., is 48.29 (weight) X .45786 (sp. heat) X 1215 (rise of temperature) = 26,864 heat-units = D. (The specific heat of the entering oil is approximately that of the issuing gas.)

The heat carried off in 1000 cu. ft. of the escaping blast products is 86.592 (weight) X .23645 (sp. heat) X 1474° (rise of temp.) = 30,180 heat-units: the temperature of the escaping blast gases being 1550° F., and that of the entering air 76° F. But the amount of the blast gases, by registration of an anemometer, checked by a calculation from the analyses of the blast gases, was 2457 cubic feet for every 1000 cubic feet of carburetted gas made. Hence the heat carried off per M. of carburetted gas is 30,180 X 2.457 = 74,152 heat-units = E.

Experiments made by a radiometer covering four square feet of the shell of the apparatus gave figures for the amount of heat lost by radiation = 12,454 heat-units = F, and by convection = 15,696 heat-units = G.

The heat rendered latent by the gasification of the oil was found by taking the difference between all the heat fed into the carburetter and superheater and the total heat dissipated therefrom to be 12,841 heat-units = H. The sensible heat in the ash and unconsumed coal is 9.9 lbs. X 1500° X .25 (sp. ht.) = 3712 heat-units = I.

The sum of all the items B + C + D + E + F + G + H + I = 327,295 heat-units, which subtracted from the heat-energy of the combustible consumed, 340,750 heat-units, leaves 13,455 heat-units, or 4 per cent unaccounted for.

Of the total heat-energy of the coal consumed, or 340,750 heat-units, the energy wasted is the sum of items D, E, F, G, and I, amounting to 132,878 heat-units, or 39 per cent; the remainder, or 207,872 heat-units, or 61 per cent, being utilized. The efficiency of the apparatus as a heat machine is therefore 61 per cent.

Five gallons, or 35 lbs. of crude petroleum, were fed into the carburetter per 1000 cu. ft. of gas made; deducting 5 lbs. of tar recovered, leaves 30 lbs. X 20,000 = 600,000 heat-units as the net heating-value of the petroleum used. Adding this to the heating-value of the coal, 340,750 B.T.U., gives 940,750 heat-units, of which there is found as heat-energy in the carburetted gas, as in the table below, 764,050 heat-units, or 81 per cent, which is the commercial efficiency of the apparatus, i.e., the ratio of the energy contained in the finished product to the total energy of the coal and oil consumed.

The heating-power per M. cu. ft. of the carburetted gas is		The heating-power per M. of the uncarburetted gas is	
CO ₂	38.0	CO ₂	35.0
C ₂ H ₆ *	146.0 X .117220 X 21222.0 = 363200	CO	434.0 X .078100 X 4395.6 = 148991
CO	280.0 X .078100 X 4395.6 = 96120	H	518.0 X .005594 X 61524.0 = 178277
CH ₄	170.0 X .044620 X 24021.0 = 182210	N	13.0
H	356.0 X .005594 X 61524.0 = 122520		1000.0
N	10.0		327268
	1000.0		764050

The candle-power of the gas is 31, or 6.2 candle-power per gallon of oil used. The calculated specific gravity is .6355, air being 1.

For description of the operation of a modern carburetted water-gas plant, see paper by J. Stelfox, *Eng'g*, July 20, 1894, p. 89.

Space Required for a Water-gas Plant. — Mr. Shelton, taking 15 modern plants of the form requiring the most floor-space, figures the average floor-space required per 1000 cubic feet of daily capacity as follows:

Water-gas Plants of Capacity in 24 hours of	Require an Area of Floor-space for each 1000 cu. ft. of about
100,000 cubic feet	4 square feet.
200,000 " "	3.5 " "
400,000 " "	2.75 " "
600,000 " "	2 to 2.5 sq. ft.
7 to 10 million cubic feet	1.25 to 1.5 sq. ft.

* The heating-value of the illuminants C_nH_{2n} is assumed to equal that of C₂H₆.

These figures include scrubbing and condensing rooms, but not boiler and engine rooms. In coal-gas plants of the most modern and compact forms one with 16 benches of 9 retorts each, with a capacity of 1,500,000 cubic feet per 24 hours, will require 4.8 sq. ft. of space per 1000 cu. ft. of gas, and one of 6 benches of 6 retorts each, with 300,000 cu. ft. capacity per 24 hours, will require 6 sq. ft. of space per 1000 cu. ft. The storage-room required for the gas-making materials is: for coal-gas, 1 cubic foot of room for every 232 cubic feet of gas made; for water-gas made from coke, 1 cubic foot of room for every 373 cu. ft. of gas made; and for water-gas made from anthracite, 1 cu. ft. of room for every 645 cu. ft. of gas made.

The comparison is still more in favor of water-gas if the case is considered of a water-gas plant added as an auxiliary to an existing coal-gas plant: for, instead of requiring further space for storage of coke, part of that already required for storage of coke produced and not at once sold can be cut off, by reason of the water-gas plant creating a constant demand for more or less of the coke so produced.

Mr. Shelton gives a calculation showing that a water-gas of 0.625 sp. gr. would require gas-mains eight per cent greater in diameter than the same quantity coal-gas of 0.425 sp. gr. if the same pressure is maintained at the holder. The same quantity may be carried in pipes of the same diameter if the pressure is increased in proportion to the specific gravity. With the same pressure the increase of candle-power about balances the decrease of flow. With five feet of coal-gas, giving, say, eighteen candle-power, 1 cubic foot equals 3.6 candle-power; with water-gas of 23 candle-power, 1 cubic foot equals 4.6 candle-power, and 4 cubic feet gives 18.4 candle-power, or more than is given by 5 cubic feet of coal-gas. Water-gas may be made from oven-coke or gas-house coke as well as from anthracite coal. A water-gas plant may be conveniently run in connection with a coal-gas plant, the surplus retort coke of the latter being used as the fuel of the former.

In coal-gas making it is impracticable to enrich the gas to over twenty candle-power without causing too great a tendency to smoke, but water-gas of as high as thirty candle-power is quite common. A mixture of coal-gas and water-gas of a higher C.P. than 20 can be advantageously distributed.

Fuel-value of Illuminating-gas. — E. G. Love (*School of Mines Qily*, January, 1892) describes F. W. Hartley's calorimeter for determining the calorific power of gases, and gives results obtained in tests of the carburetted water-gas made by the municipal branch of the Consolidated Co. of New York. The tests were made from time to time during the past two years, and the figures give the heat-units per cubic foot at 60° F. and 30 inches pressure: 715, 692, 725, 732, 691, 738, 735, 703, 734, 730, 731, 727. Average, 721 heat-units. Similar tests of mixtures of coal- and water-gases made by other branches of the same company give 694, 715, 684, 692, 727, 665, 695, and 686 heat-units per foot, or an average of 694.7. The average of all these tests was 710.5 heat-units, and this we may fairly take as representing the calorific power of the illuminating gas of New York. One thousand feet of this gas, costing \$1.25, would therefore yield 710,500 heat-units, which would be equivalent to 568,400 heat-units for \$1.00.

The common coal-gas of London, with an illuminating power of 16 to 17 candles, has a calorific power of about 668 units per foot, and costs from 60 to 70 cents per thousand.

The product obtained by decomposing steam by incandescent carbon, as effected in the Motay process, consists of about 40% of CO, and a little over 50% of H.

This mixture would have a heating-power of about 300 units per cubic foot, and if sold at 50 cents per 1000 cubic feet would furnish 600,000 units for \$1.00, as compared with 568,400 units for \$1.00 from illuminating gas at \$1.25 per 1000 cubic feet. This illuminating-gas if sold at \$1.15 per thousand would therefore be a more economical heating agent than the fuel-gas mentioned, at 50 cents per thousand, and be much more advantageous than the latter, in that one main, service, and meter could be used to furnish gas for both lighting and heating.

A large number of fuel-gases tested by Mr. Love gave from 184 to 470 heat-units per foot, with an average of 309 units.

Taking the cost of heat from illuminating-gas at the lowest figure given

by Mr. Love, viz., \$1.00 for 600,000 heat-units, it is a very expensive fuel, equal to coal at \$40 per ton of 2000 lbs., the coal having a calorific power of only 12,000 heat-units per pound, or about 83% of that of pure carbon:
 600,000 : (12,000 × 2000) :: \$1 : \$40.

FLOW OF GAS IN PIPES.

The rate of flow of gases of different densities, the diameter of pipes required, etc., are given in King's Treatise on Coal Gas, vol. ii, 374, as follows:

$$\left. \begin{aligned} \text{If } d &= \text{diameter of pipe in inches,} \\ Q &= \text{quantity of gas in cu. ft. per hour,} \\ l &= \text{length of pipe in yards,} \\ h &= \text{pressure in inches of water,} \\ s &= \text{specific gravity of gas, air being 1,} \end{aligned} \right\} \begin{aligned} d &= \sqrt[5]{\frac{Q^2sl}{(1350)^2h}} \\ h &= \frac{Q^2sl}{(1350)^2d^5} \\ Q &= 1350d^2 \sqrt{\frac{dh}{sl}} = 1350 \sqrt{\frac{d^5h}{sl}} \end{aligned}$$

Molesworth gives $Q = 1000 \sqrt{\frac{d^5h}{sl}}$.

J. P. Gill, *Am. Gas-light Jour.*, 1894, gives $Q = 1291 \sqrt{\frac{d^5h}{s(l+d)}}$.

This formula is said to be based on experimental data, and to make allowance for obstructions by tar, water, and other bodies tending to check the flow of gas through the pipe.

King's formula translated into the form of the common formula for the flow of compressed air or steam in pipes, $Q = c \sqrt{(p_1 - p_2) d^5 / wL}$, in which $Q =$ cu. ft. per min., $p_1 - p_2 =$ difference in pressure in lbs. per sq. in.; $w =$ density in lbs. per cu. ft., $L =$ length in ft., $d =$ diam. in ins., gives 56.6 for the value of the coefficient c , which is nearly the same as that commonly used (60) in calculations of the flow of air in pipes. For values of c based on Darcy's experiments on flow of water in pipes see Flow of Steam.

An experiment made by Mr. Clegg, in London, with a 4-in. pipe, 6 miles long, pressure 3 in. of water, specific gravity of gas 0.398, gave a discharge into the atmosphere of 852 cu. ft. per hour, after a correction of 33 cu. ft. was made for leakage.

Substituting this value, 852 cu. ft., for Q in the formula $Q = C \sqrt{d^5h + sl}$, we find C , the coefficient, = 997, which corresponds nearly with the formula given by Molesworth.

Wm. Cox (*Am. Mach.*, Mar. 20, 1902) gives the following formula for flow of gas in long pipes.

$$Q = 3000 \sqrt{\frac{d^5 \times (p_1^2 - p_2^2)}{L}} = 41.3 \sqrt{\frac{d^5 \times (p_1^2 - p_2^2)}{L}}$$

$Q =$ discharge in cu. ft. per hour at atmospheric pressure; $d =$ diam. of pipe in ins.; $p_1 =$ initial and $p_2 =$ terminal absolute pressure, lbs. per sq. in.; $L =$ length of pipe in feet, $L =$ length in miles. For $p_1^2 - p_2^2$ may be substituted $(p_1 + p_2)(p_1 - p_2)$. The specific gravity of the gas is assumed to be 0.65, air being 1. For fluids of any other sp. gr., s , multiply the coefficients 3000 or 41.3 by $\sqrt{0.65/s}$. For air, $s = 1$, the coefficients become 2419 and 33.3. J. E. Johnson Jr.'s formula for air, page 596, translated into the same notation as Mr. Cox's, makes the coefficients 2449 and 33.5.

Services for Lamps. (Molesworth.)

Lamps.	Ft. from Main.	Require Pipe-bore.	Lamps.	Ft. from Main.	Require Pipe-bore.
2	40	3/8 in.	15	130	1 in.
4	40	1/2 in.	20	150	1 1/4 in.
6	50	5/8 in.	25	180	1 1/2 in.
10	100	3/4 in.	30	200	1 3/4 in.

(In cold climates no service less than 3/4 in. should be used.)

Maximum Supply of Gas through Pipes in cu. ft. per Hour, Specific Gravity being taken at 0.45, calculated from the Formula $Q = 1000 \sqrt{d^5h + sl}$. (Molesworth.)

LENGTH OF PIPE = 10 YARDS.

Diameter of Pipe in Inches.	Pressure by the Water-gauge in Inches.									
	0.1	0.2	0.3	0.4	0.5	0.6	0.7	0.8	0.9	1.0
3/8	13	18	22	26	29	31	34	36	38	41
1/2	26	37	46	53	59	64	70	74	79	83
3/4	73	103	126	145	162	187	192	205	218	230
1	149	211	258	298	333	365	394	422	447	471
1 1/4	260	368	451	521	582	638	689	737	781	823
1 1/2	411	581	711	821	918	1006	1082	1162	1232	1299
2	843	1192	1460	1686	1886	2066	2231	2385	2530	2667

LENGTH OF PIPE = 100 YARDS.

Diameter of Pipe in Inches.	Pressure by the Water-gauge in Inches.										
	0.1	0.2	0.3	0.4	0.5	0.75	1.0	1.25	1.5	2	2.5
1/2	8	12	14	17	19	23	26	29	32	36	42
3/4	23	32	42	46	51	63	73	81	89	103	115
1	47	67	82	94	105	129	149	167	183	211	236
1 1/4	82	116	143	165	184	225	260	291	319	368	412
1 1/2	130	184	225	260	290	356	411	459	503	581	649
2	267	377	462	533	596	730	843	943	1033	1193	1333
2 1/2	466	659	807	932	1042	1276	1473	1647	1804	2083	2329
3	735	1039	1270	1470	1643	2012	2323	2598	2846	3286	3674
3 1/2	1080	1528	1871	2161	2416	2958	3416	3820	4184	4831	5402
4	1508	2133	2613	3017	3373	4131	4770	5333	5842	6746	7542

LENGTH OF PIPE = 1000 YARDS.

Diameter of Pipe in Inches.	Pressure by the Water-gauge in Inches.						
	0.5	0.75	1.0	1.5	2.0	2.5	3.0
1	33	41	47	58	67	75	82
1 1/2	92	113	130	159	184	205	226
2	189	231	267	327	377	422	462
2 1/2	329	403	466	571	659	737	807
3	520	636	735	900	1039	1162	1273
4	1067	1306	1508	1847	2133	2385	2613
5	1863	2282	2635	3227	3727	4167	4564
6	2939	3600	4157	5091	5879	6573	7200

LENGTH OF PIPE = 5000 YARDS.

Diameter of Pipe in Inches.	Pressure by the Water-gauge in Inches.				
	1.0	1.5	2.0	2.5	3.0
2	119	146	169	189	207
3	329	402	465	520	569
4	675	826	955	1067	1168
5	1179	1443	1667	1863	2041
6	1859	2277	2629	2939	3220
7	2733	3347	3865	4321	4734
8	3816	4674	5397	6034	6610
9	5123	6274	7245	8100	8873
10	6667	8165	9428	10541	11547
12	10516	12880	14872	16628	18215

Mr. A. C. Humphreys says his experience goes to show that these tables give too small a flow, but it is difficult to accurately check the tables, on account of the extra friction introduced by rough pipes, bends, etc. For bends, one rule is to allow 1/42 of an inch pressure for each right-angle bend.

Where there is apt to be trouble from frost it is well to use no service of less diameter than 3/4 in., no matter how short it may be. In extremely cold climates this is now often increased to 1 in., even for a single lamp. The best practice in the U. S. now condemns any service less than 3/4 in.

STEAM.

The Temperature of Steam in contact with water depends upon the pressure under which it is generated. At the ordinary atmospheric pressure (14.7 lbs. per sq. in.) its temperature is 212° F. As the pressure is increased, as by the steam being generated in a closed vessel, its temperature, and that of the water in its presence, increases.

Saturated Steam is steam of the temperature due to its pressure — not superheated.

Superheated Steam is steam heated to a temperature above that due to its pressure.

Dry Steam is steam which contains no moisture. It may be either saturated or superheated.

Wet Steam is steam containing intermingled moisture, mist, or spray. It has the same temperature as dry saturated steam of the same pressure.

Water introduced into the presence of superheated steam will flash into vapor until the temperature of the steam is reduced to that due its pressure. Water in the presence of saturated steam has the same temperature as the steam. Should cold water be introduced, lowering the temperature of the whole mass, some of the steam will be condensed, reducing the pressure and temperature of the remainder, until equilibrium is established.

Total Heat of Saturated Steam (above 32° F.). — According to Marks and Davis, the formula for total heat of steam, based on researches by Henning, Knoblauch, Linde and Klebe, is $H = 1150.3 + 0.3745(t + 212) - 0.000550(t - 212)^2$, in which H is the total heat in B.T.U. above water at 32° F. and t is the temperature Fahrenheit.

Latent Heat of Steam. — The latent heat, or heat of vaporization, is obtained by subtracting from the total heat at any given temperature the heat of the liquid, or total heat above 32° in water of the same temperature.

The total heat in steam (above 32°) includes three elements:

- 1st. The heat required to raise the temperature of the water to the temperature of the steam.
- 2d. The heat required to evaporate the water at that temperature, called internal latent heat.
- 3d. The latent heat of volume, or the external work done by the steam in making room for itself against the pressure of the superincumbent atmosphere (or surrounding steam if inclosed in a vessel).

The sum of the last two elements is called the latent heat of steam. Heat required to Generate 1 lb. of Steam from water at 32° F.

Sensible heat, to raise the water from 32° to 212° =	180.0
Latent heat, 1, of the formation of steam at 212° =	897.6
2, of expansion against the atmospheric pressure, 2116.4 lbs. per sq. ft. X 26.79 cu. ft. =	55,786 foot-pounds ÷ 778 =
	72.8
	970.4

Total heat above 32° F. 1150.4

The Heat-Unit, or British Thermal Unit. — The old definition of the heat-unit (Rankine), viz., the quantity of heat required to raise the temperature of 1 lb. of water 1° F., at or near its temperature of maximum density (39.1° F.), is now (1909) no longer used. Peabody defines it as the heat required to raise a pound of water from 62° to 63° F., and Marks and Davis as 1/180 of the heat required to raise 1 lb. of water from 32° to 212° F. By Peabody's definition the heat required to raise 1 lb. of water from 32° to 212° is 180.3 instead of 180 units, and the heat of vaporization at 212° 969.7 instead of 970.4 units.

Specific Heat of Saturated Steam. — When a unit weight of saturated steam is increased in temperature and in pressure, the volume decreasing so as to just keep it saturated, the specific heat is negative, and decreases as temperature increases. (See Wood, Therm., p. 147; Peabody, Therm., p. 93.)

Absolute Zero. — The value of the absolute zero has been variously given as from 459.2 to 460.66 degrees below the Fahrenheit zero. Marks and Davis, comparing the results of Berthelot (1903), Buckingham, 1907, and Ross-Innes, 1908, give as the most probable value — 459°.64 F. The value — 460° is close enough for all engineering calculations.

The Mechanical Equivalent of Heat. — The value generally accepted, based on Rowland's experiments, is 778 ft.-lbs. Marks and Davis give the value 777.52 standard ft. lbs., based on later experiments, and on the value of $g = 980.665$ cm. per sec.², = 32.174 ft. per sec.², fixed by international agreement (1901). These values of the absolute zero and of the mechanical equivalent of heat have been used by Marks and Davis in the computation of their steam tables. In refined investigations involving the value of the mechanical equivalent of heat the value of g for the latitude in which the experiments are made must be considered.

Pressure of Saturated Steam. — Holborn and Henning, *Zeit. des Ver. deutscher Ingenieure*, Feb. 20, 1909, report results of measurements of the pressures of saturated steam at temperatures ranging from 50° to 200° C. (112° to 392° F.). Their values agree closely with those obtained in 1905 by Knoblauch, Linde and Klebe. From a table in the article giving pressures for each degree from 0° to 200° C., the following values have been transformed into English measurements (*Eng. Digest* April, 1909).

Deg. F.	Lbs. per sq. in.	Deg. F.	Lbs. per sq. in.	Deg. F.	Lbs. per sq. in.
32	0.0885	150	3.715	300	66.972
68	0.3386	200	11.527	350	134.508
100	0.9462	250	29.819	400	248.856

Volume of Saturated Steam. — The values of specific volume of saturated steam are computed by Clapyron's equation (Marks and Davis's Tables) which gives results remarkably close to those found in the experiments of Knoblauch, Linde and Klebe.

Volume of Superheated Steam. — Linde's equation (1905),

$$pv = 0.5962 T - p(1 + 0.0014 p) \left(\frac{150,300,000}{T^3} - 0.0833 \right)$$

in which p is in lbs. per sq. ft., v is in cu. ft. and $T = t + 459.6$ is the absolute temperature on the Fahrenheit scale, has been used in the computation of Marks and Davis's tables.

The Specific Density of Gaseous Steam, that is, steam considerably superheated, is 0.622, that of air being 1. That is to say, the weight of a cubic foot of gaseous steam is about five-eighths of that of a cubic foot of air, of the same pressure and temperature.

The density or weight of a cubic foot of gaseous steam is expressible by the same formula as that of air, except that the multiplier or coefficient is less in proportion to the less specific density. Thus,

$$D = \frac{2.7074 p \times .622}{t + 461} = \frac{1.684 p}{t + 461}$$

in which *D* is the weight of a cubic foot, *p* the total pressure per square inch and *t* the temperature Fahrenheit. (Clark's Steam-engine.)

H. M. Prevost Murphy (*Eng. News*, June 18, 1908) shows that the specific density is not a constant, but varies with the temperature, and that the correct value is $0.6113 + \frac{0.092 t}{850 - t}$.

Properties of Superheated Steam. — See the table on page 843, condensed from Marks and Davis's tables.

Specific Heat of Superheated Steam. — Mean specific heats from the temperature of saturation to various temperatures at several pressures English and metric units. — Knoblauch and Jakob (from Peabody's Tables).

Kg. per sq. cm.											
	1	2	4	6	8	10	12	14	16	18	20
Lbs. per sq. in.	14.2	28.4	56.9	85.3	113.3	142.2	170.6	199.1	227.5	256.0	284.4
Temp. sat., °C.	99	120	143	158	169	179	187	194	200	206	211
Temp. sat., °F.	210	248	289	316	336	350	368	381	392	403	412
° F.	° C.										
212	100	0.463									
302	150	.462	.478	.515							
392	200	.462	.475	.502	.530	.560	.597	.635	.677		
482	250	.463	.474	.495	.514	.512	.552	.570	.588	.609	.635
572	300	.464	.475	.492	.505	.517	.530	.541	.550	.561	.572
662	350	.468	.477	.492	.503	.512	.522	.529	.536	.543	.550
752	400	.473	.481	.494	.504	.512	.520	.526	.531	.537	.542

The Rationalization of Regnault's Experiments on Steam. — (J. McFarlane Gray, *Proc. Inst. M. E.*, July, 1889.) — The formulæ constructed by Regnault are strictly empirical, and were based entirely on his experiments. They are therefore not valid beyond the range of temperatures and pressures observed.

Mr. Gray has made a most elaborate calculation, based not on experiments but on fundamental principles of thermodynamics, from which he deduces formulæ for the pressure and total heat of steam, and presents tables calculated therefrom which show substantial agreement with Regnault's figures. He gives the following examples of steam-pressures calculated for temperatures beyond the range of Regnault's experiments.

Temperature.		Pounds per sq. in.	Temperature.		Pounds in sq. in.
C.	Fahr.		C.	Fahr.	
230	446	406.9	340	644	2156.2
240	464	488.9	360	680	2742.5
250	482	579.9	380	716	3448.1
260	500	691.6	400	752	4300.2
280	536	940.0	415	779	5017.1
300	572	1261.8	427	800.6	5659.9
320	608	1661.9			

These pressures are higher than those obtained by Regnault's formula, which gives for 415° C. only 4067.1 lbs. per square inch.

Properties of Saturated Steam.

(Condensed from Marks and Davis's Steam Tables and Diagrams, 1909, by permission of the publishers, Longmans, Green & Co.)

Vacuum, Inches of Mercury.	Absolute Pressure, Lbs. per Sq. In.	Temperature, Fahrenheit.	Total Heat above 32° F.		Latent Heat, $L = H - h$ Heat-Units.	Volume, Cu. Ft. of Steam.	Weight of 1 Cu. Ft. Steam, Lb.	Entropy of the Water.	Entropy of Evaporation.
			In the Water Heat-Units.	In the Steam Heat-Units.					
29.74	0.0886	32	0.00	1073.4	1073.4	3294	0.000304	0.0000	2.1832
29.67	0.1217	40	8.05	1076.9	1068.9	2438	0.000410	0.0162	2.1394
29.56	0.1780	50	18.08	1081.4	1063.3	1702	0.000587	0.0361	2.0865
29.40	0.2562	60	28.08	1085.9	1057.8	1208	0.000828	0.0555	2.0358
29.18	0.3626	70	38.06	1090.3	1052.3	871	0.001148	0.0745	1.9868
29.89	0.505	80	48.03	1094.8	1046.7	636.8	0.001570	0.0932	1.9398
28.50	0.696	90	58.00	1099.2	1041.2	469.3	0.002131	0.1114	1.8944
28.00	0.946	100	67.97	1103.6	1035.6	350.8	0.002851	0.1295	1.8505
27.88	1	101.83	69.8	1104.4	1034.6	333.0	0.00300	0.1327	1.8427
25.85	2	126.15	94.0	1115.0	1021.0	173.5	0.00576	0.1749	1.7431
23.81	3	141.52	109.4	1121.6	1012.3	118.5	0.00845	0.2008	1.6840
21.78	4	153.01	120.9	1126.5	1005.7	90.5	0.01107	0.2198	1.6416
19.74	5	162.28	130.1	1130.5	1000.3	73.33	0.01364	0.2348	1.6084
17.70	6	170.06	137.9	1133.7	995.8	61.89	0.01616	0.2471	1.5814
15.67	7	176.85	144.7	1136.5	991.8	53.56	0.01867	0.2579	1.5582
13.63	8	182.86	150.8	1139.0	988.2	47.27	0.02115	0.2673	1.5380
11.60	9	188.27	156.2	1141.1	985.0	42.36	0.02361	0.2756	1.5202
9.56	10	193.22	161.1	1143.1	982.0	38.38	0.02606	0.2832	1.5042
7.52	11	197.75	165.7	1144.9	979.2	35.10	0.02849	0.2902	1.4895
5.49	12	201.96	169.9	1146.5	976.6	32.36	0.03090	0.2967	1.4760
3.45	13	205.87	173.8	1148.0	974.2	30.03	0.03330	0.3025	1.4639
1.42	14	209.55	177.5	1149.4	971.9	28.02	0.03569	0.3081	1.4523
lbs. gage.	14.70	212	180.0	1150.4	970.4	26.79	0.03732	0.3118	1.4447
0.3	15	213.0	181.0	1150.7	969.7	26.27	0.03806	0.3133	1.4416
1.3	16	216.3	184.4	1152.0	967.6	24.79	0.04042	0.3183	1.4311
2.3	17	219.4	187.5	1153.1	965.6	23.38	0.04277	0.3229	1.4215
3.3	18	222.4	190.5	1154.2	963.7	22.16	0.04512	0.3273	1.4127
4.3	19	225.2	193.4	1155.2	961.8	21.07	0.04746	0.3315	1.4045
5.3	20	228.0	196.1	1156.2	960.0	20.08	0.04980	0.3355	1.3965
6.3	21	230.6	198.8	1157.1	958.3	19.18	0.05213	0.3393	1.3887
7.3	22	233.1	201.3	1158.0	956.7	18.37	0.05445	0.3430	1.3811
8.3	23	235.5	203.8	1158.8	955.1	17.62	0.05676	0.3465	1.3739
9.3	24	237.8	206.1	1159.6	953.5	16.93	0.05907	0.3499	1.3670
10.3	25	240.1	208.4	1160.4	952.0	16.30	0.0614	0.3532	1.3604
11.3	26	242.2	210.6	1161.2	950.6	15.72	0.0636	0.3564	1.3542
12.3	27	244.4	212.7	1161.9	949.2	15.18	0.0659	0.3594	1.3483
13.3	28	246.4	214.8	1162.6	947.8	14.67	0.0682	0.3623	1.3425
14.3	29	248.4	216.8	1163.2	946.4	14.19	0.0705	0.3652	1.3367
15.3	30	250.3	218.8	1163.9	945.1	13.74	0.0728	0.3680	1.3311
16.3	31	252.2	220.7	1164.5	943.8	13.32	0.0751	0.3707	1.3257
17.3	32	254.1	222.6	1165.1	942.5	12.93	0.0773	0.3733	1.3205
18.3	33	255.8	224.4	1165.7	941.3	12.57	0.0795	0.3759	1.3155
19.3	34	257.6	226.2	1166.3	940.1	12.22	0.0818	0.3784	1.3107
20.3	35	259.3	227.9	1166.8	938.9	11.89	0.0841	0.3808	1.3060
21.3	36	261.0	229.6	1167.3	937.7	11.58	0.0863	0.3832	1.3014
22.3	37	262.6	231.3	1167.8	936.6	11.29	0.0886	0.3855	1.2969
23.3	38	264.2	232.9	1168.4	935.5	11.01	0.0908	0.3877	1.2925
24.3	39	265.8	234.5	1168.9	934.4	10.74	0.0931	0.3899	1.2882
25.3	40	267.3	236.1	1169.4	933.3	10.49	0.0953	0.3920	1.2841
26.3	41	268.7	237.6	1169.8	932.2	10.25	0.0976	0.3941	1.2800

Properties of Saturated Steam. (Continued.)

Gauge Pressure, Lbs. per Sq. In.	Absolute Pressure, Lbs. per Sq. In.	Temperature, Fahrenheit.	Total Heat above 32° F.		Latent Heat, L = H - h Heat- Units.	Volume, Cu. Ft. in 1 Lb. of Steam.	Weight of 1 Cu. Ft. Steam, Lb.	Entropy of the Water.	Entropy of Evap- oration.
			In the Water h Heat-Units.	In the Steam H Heat-Units.					
27.3	42	270.2	239.1	1170.3	931.2	10.02	0.0998	0.3962	1.2759
28.3	43	271.7	240.5	1170.7	930.2	9.80	0.1020	0.3982	1.2720
29.3	44	273.1	242.0	1171.2	929.2	9.59	0.1043	0.4002	1.2681
30.3	45	274.5	243.4	1171.6	928.2	9.39	0.1065	0.4021	1.2644
31.3	46	275.8	244.8	1172.0	927.2	9.20	0.1087	0.4040	1.2607
32.3	47	277.2	246.1	1172.4	926.2	9.02	0.1109	0.4059	1.2571
33.3	48	278.5	247.5	1172.8	925.3	8.84	0.1131	0.4077	1.2536
34.3	49	279.8	248.8	1173.2	924.4	8.67	0.1153	0.4095	1.2502
35.3	50	281.0	250.1	1173.6	923.5	8.51	0.1175	0.4113	1.2458
36.3	51	282.3	251.4	1174.0	922.6	8.35	0.1197	0.4130	1.2432
37.3	52	283.5	252.6	1174.3	921.7	8.20	0.1219	0.4147	1.2405
38.3	53	284.7	253.9	1174.7	920.8	8.05	0.1241	0.4164	1.2370
39.3	54	285.9	255.1	1175.0	919.9	7.91	0.1263	0.4180	1.2339
40.3	55	287.1	256.3	1175.4	919.0	7.78	0.1285	0.4196	1.2309
41.3	56	288.2	257.5	1175.7	918.2	7.65	0.1307	0.4212	1.2278
42.3	57	289.4	258.7	1176.0	917.4	7.52	0.1329	0.4227	1.2248
43.3	58	290.5	259.8	1176.4	916.5	7.40	0.1350	0.4242	1.2218
44.3	59	291.6	261.0	1176.7	915.7	7.28	0.1372	0.4257	1.2189
45.3	60	292.7	262.1	1177.0	914.9	7.17	0.1394	0.4272	1.2160
46.3	61	293.8	263.2	1177.3	914.1	7.06	0.1416	0.4287	1.2132
47.3	62	294.9	264.3	1177.6	913.3	6.95	0.1438	0.4302	1.2104
48.3	63	295.9	265.4	1177.9	912.5	6.85	0.1460	0.4316	1.2077
49.3	64	297.0	266.4	1178.2	911.8	6.75	0.1482	0.4330	1.2050
50.3	65	298.0	267.5	1178.5	911.0	6.65	0.1503	0.4344	1.2024
51.3	66	299.0	268.5	1178.8	910.2	6.56	0.1525	0.4358	1.1998
52.3	67	300.0	269.6	1179.0	909.5	6.47	0.1547	0.4371	1.1972
53.3	68	301.0	270.6	1179.3	908.7	6.38	0.1569	0.4385	1.1946
54.3	69	302.0	271.6	1179.6	908.0	6.29	0.1590	0.4398	1.1921
55.3	70	302.9	272.6	1179.8	907.2	6.20	0.1612	0.4411	1.1896
56.3	71	303.9	273.6	1180.1	906.5	6.12	0.1634	0.4424	1.1872
57.3	72	304.8	274.5	1180.4	905.8	6.04	0.1656	0.4437	1.1848
58.3	73	305.8	275.5	1180.6	905.1	5.96	0.1678	0.4449	1.1825
59.3	74	306.7	276.5	1180.9	904.4	5.89	0.1699	0.4462	1.1801
60.3	75	307.6	277.4	1181.1	903.7	5.81	0.1721	0.4474	1.1778
61.3	76	308.5	278.3	1181.4	903.0	5.74	0.1743	0.4487	1.1755
62.3	77	309.4	279.3	1181.6	902.3	5.67	0.1764	0.4499	1.1730
63.3	78	310.3	280.2	1181.8	901.7	5.60	0.1786	0.4511	1.1712
64.3	79	311.2	281.1	1182.1	901.0	5.54	0.1808	0.4523	1.1687
65.3	80	312.0	282.0	1182.3	900.3	5.47	0.1829	0.4535	1.1665
66.3	81	312.9	282.9	1182.5	899.7	5.41	0.1851	0.4546	1.1644
67.3	82	313.8	283.8	1182.8	899.0	5.34	0.1873	0.4557	1.1623
68.3	83	314.6	284.6	1183.0	898.4	5.28	0.1894	0.4568	1.1602
69.3	84	315.4	285.5	1183.2	897.7	5.22	0.1915	0.4579	1.1581
70.3	85	316.3	286.3	1183.4	897.1	5.16	0.1937	0.4590	1.1561
71.3	86	317.1	287.2	1183.6	896.4	5.10	0.1959	0.4601	1.1540
72.3	87	317.9	288.0	1183.8	895.8	5.05	0.1980	0.4612	1.1520
73.3	88	318.7	288.9	1184.0	895.2	5.00	0.2001	0.4623	1.1500
74.3	89	319.5	289.7	1184.2	894.6	4.94	0.2023	0.4633	1.1481
75.3	90	320.3	290.5	1184.4	893.9	4.89	0.2044	0.4644	1.1461
76.3	91	321.1	291.3	1184.6	893.3	4.84	0.2065	0.4654	1.1442
77.3	92	321.8	292.1	1184.8	892.7	4.79	0.2087	0.4664	1.1423
78.3	93	322.6	292.9	1185.0	892.1	4.74	0.2109	0.4674	1.1404
79.3	94	323.4	293.7	1185.2	891.5	4.69	0.2130	0.4684	1.1385
80.3	95	324.1	294.5	1185.4	890.9	4.65	0.2151	0.4694	1.1367

Properties of Saturated Steam. (Continued.)

Gauge Pressure, Lbs. per Sq. In.	Absolute Pressure, Lbs. per Sq. In.	Temperature, Fahrenheit.	Total Heat above 32° F.		Latent Heat, L = H - h Heat- Units.	Volume, Cu. Ft. in 1 Lb. of Steam.	Weight of 1 Cu. Ft. Steam, Lb.	Entropy of the Water.	Entropy of Evap- oration.
			In the Water h Heat-Units.	In the Steam H Heat-Units.					
81.3	96	324.9	295.3	1185.6	890.3	4.60	0.2172	0.4704	1.1348
82.3	97	325.6	296.1	1185.8	889.7	4.56	0.2193	0.4714	1.1330
83.3	98	326.4	296.8	1186.0	889.2	4.51	0.2215	0.4724	1.1312
84.3	99	327.1	297.6	1186.2	888.6	4.47	0.2237	0.4733	1.1295
85.3	100	327.8	298.3	1186.3	888.0	4.429	0.2258	0.4743	1.1277
87.3	102	329.3	299.8	1186.7	886.9	4.347	0.2300	0.4762	1.1242
89.3	104	330.7	301.3	1187.0	885.8	4.268	0.2343	0.4780	1.1208
91.3	106	332.0	302.7	1187.4	884.7	4.192	0.2336	0.4798	1.1174
93.3	108	333.4	304.1	1187.7	883.6	4.118	0.2429	0.4816	1.1141
95.3	110	334.8	305.5	1188.0	882.5	4.047	0.2472	0.4834	1.1109
97.3	112	336.1	306.9	1188.4	881.4	3.978	0.2514	0.4852	1.1071
99.3	114	337.4	308.3	1188.7	880.4	3.912	0.2556	0.4869	1.1045
101.3	116	338.7	309.6	1189.0	879.3	3.848	0.2599	0.4886	1.1014
103.3	118	340.0	311.0	1189.3	878.3	3.786	0.2641	0.4903	1.0984
105.3	120	341.3	312.3	1189.6	877.2	3.726	0.2683	0.4919	1.0954
107.3	122	342.5	313.6	1189.8	876.2	3.668	0.2726	0.4935	1.0924
109.3	124	343.8	314.9	1190.1	875.2	3.611	0.2769	0.4951	1.0895
111.3	126	345.0	316.2	1190.4	874.2	3.556	0.2812	0.4967	1.0865
113.3	128	346.2	317.4	1190.7	873.3	3.504	0.2854	0.4982	1.0837
115.3	130	347.4	318.6	1191.0	872.3	3.452	0.2897	0.4998	1.0809
117.3	132	348.5	319.9	1191.2	871.3	3.402	0.2939	0.5013	1.0782
119.3	134	349.7	321.1	1191.5	870.4	3.354	0.2981	0.5028	1.0755
121.3	136	350.8	322.3	1191.7	869.4	3.308	0.3023	0.5043	1.0728
123.3	138	352.0	323.4	1192.0	868.5	3.263	0.3065	0.5057	1.0702
125.3	140	353.1	324.6	1192.2	867.6	3.219	0.3107	0.5072	1.0675
127.3	142	354.2	325.8	1192.5	866.7	3.175	0.3150	0.5086	1.0649
129.3	144	355.3	326.9	1192.7	865.8	3.133	0.3192	0.5100	1.0624
131.3	146	356.3	328.0	1192.9	864.9	3.092	0.3234	0.5114	1.0599
133.3	148	357.4	329.1	1193.2	864.0	3.052	0.3276	0.5128	1.0574
135.3	150	358.5	330.2	1193.4	863.2	3.012	0.3320	0.5142	1.0550
137.3	152	359.5	331.4	1193.6	862.3	2.974	0.3362	0.5155	1.0525
139.3	154	360.5	332.4	1193.8	861.4	2.938	0.3404	0.5169	1.0501
141.3	156	361.6	333.5	1194.1	860.6	2.902	0.3446	0.5182	1.0477
143.3	158	362.6	334.6	1194.3	859.7	2.868	0.3488	0.5195	1.0454
145.3	160	363.6	335.6	1194.5	858.8	2.834	0.3529	0.5208	1.0431
147.3	162	364.6	336.7	1194.7	858.0	2.801	0.3570	0.5220	1.0409
149.3	164	365.6	337.7	1194.9	857.2	2.769	0.3612	0.5233	1.0387
151.3	166	366.5	338.7	1195.0	856.4	2.737	0.3654	0.5245	1.0365
153.3	168	367.5	339.7	1195.3	855.5	2.706	0.3696	0.5257	1.0343
155.3	170	368.5	340.7	1195.4	854.7	2.675	0.3738	0.5269	1.0321
157.3	172	369.4	341.7	1195.6	853.9	2.645	0.3780	0.5281	1.0300
159.3	174	370.4	342.7	1195.8	853.1	2.616	0.3822	0.5293	1.0278
161.3	176	371.3	343.7	1196.0	852.3	2.588	0.3864	0.5305	1.0257
163.3	178	372.2	344.7	1196.2	851.5	2.560	0.3906	0.5317	1.0235
165.3	180	373.1	345.6	1196.4	850.8	2.533	0.3948	0.5328	1.0215
167.3	182	374.0	346.6	1196.6	850.0	2.507	0.3989	0.5339	1.0195
169.3	184	374.9	347.6	1196.8	849.2	2.481	0.4031	0.5351	1.0174
171.3	186	375.8	348.5	1196.9	848.4	2.455	0.4073	0.5362	1.0154
173.3	188	376.7	349.4	1197.1	847.7	2.430	0.4115	0.5373	1.0134
175.3	190	377.6	350.4	1197.3	846.9	2.406	0.4157	0.5384	1.0114
177.3	192	378.5	351.3	1197.4	846.1	2.381	0.4199	0.5395	1.0095
179.3	194	379.3	352.2	1197.6	845.4	2.358	0.4241	0.5405	1.0076
181.3	196	380.2	353.1	1197.8	844.7	2.335	0.4283	0.5416	1.0056
183.3	198	381.0	354.0	1197.9	843.9	2.312	0.4325	0.5426	1.0038

WARNING: This is a 1910 edition. Some of the material may no longer be accurate

Properties of Saturated Steam. (Continued.)

Gauge Pressure, lbs. per Sq. In.	Absolute Pressure, lbs. per Sq. In.	Temperature, Fahrenheit.	Total Heat above 32° F.		Latent Heat, $L = H - h$ Heat-Units.	Volume, Cu. Ft. of Steam.	Weight of 1 Cu. Ft. Steam, Lb.	Entropy of the Water.	Entropy of Evaporation.
			In the Water h Heat-Units.	In the Steam H Heat-Units.					
185.3	200	381.9	354.9	1198.1	843.2	2.290	0.437	0.5437	1.0019
190.3	205	384.0	357.1	1198.5	841.4	2.237	0.447	0.5463	0.9973
195.3	210	386.0	359.2	1198.8	839.6	2.187	0.457	0.5488	0.9928
200.3	215	388.0	361.4	1199.2	837.9	2.138	0.468	0.5513	0.9885
205.3	220	389.9	363.4	1199.6	836.2	2.091	0.478	0.5538	0.9841
210.3	225	391.9	365.5	1199.9	834.4	2.046	0.489	0.5562	0.9799
215.3	230	393.8	367.5	1200.2	832.8	2.004	0.499	0.5586	0.9758
220.3	235	395.6	369.4	1200.6	831.1	1.964	0.509	0.5610	0.9717
225.3	240	397.4	371.4	1200.9	829.5	1.924	0.520	0.5633	0.9676
230.3	245	399.3	373.3	1201.2	827.9	1.887	0.530	0.5655	0.9638
235.3	250	401.1	375.2	1201.5	826.3	1.850	0.541	0.5676	0.9600
245.3	260	404.5	378.9	1202.1	823.1	1.782	0.561	0.5719	0.9525
255.3	270	407.9	382.5	1202.6	820.1	1.718	0.582	0.5760	0.9454
265.3	280	411.2	386.0	1203.1	817.1	1.658	0.603	0.5800	0.9385
275.3	290	414.4	389.4	1203.6	814.2	1.602	0.624	0.5840	0.9316
285.3	300	417.5	392.7	1204.1	811.3	1.551	0.645	0.5878	0.9251
295.3	310	420.5	395.9	1204.5	808.5	1.502	0.666	0.5915	0.9187
305.3	320	423.4	399.1	1204.9	805.8	1.456	0.687	0.5951	0.9125
315.3	330	426.3	402.2	1205.3	803.1	1.413	0.708	0.5986	0.9065
325.3	340	429.1	405.3	1205.7	800.4	1.372	0.729	0.6020	0.9006
335.3	350	431.9	408.2	1206.1	797.8	1.334	0.750	0.6053	0.8949
345.3	360	434.6	411.2	1206.4	795.3	1.298	0.770	0.6085	0.8894
355.3	370	437.2	414.0	1206.8	792.8	1.264	0.791	0.6116	0.8840
365.3	380	439.8	416.8	1207.1	790.3	1.231	0.812	0.6147	0.8788
375.3	390	442.3	419.5	1207.4	787.9	1.200	0.833	0.6178	0.8737
385.3	400	444.8	422	1208	786	1.17	0.86	0.621	0.868
435.3	450	456.5	435	1209	774	1.04	0.96	0.635	0.844
485.3	500	467.3	448	1210	762	0.93	1.08	0.648	0.822
535.3	550	477.3	459	1210	751	0.83	1.20	0.659	0.801
585.3	600	486.6	469	1210	741	0.76	1.32	0.670	0.783

Available Energy in Expanding Steam. — Rankine Cycle. (J. B. Stanwood, *Power*, June 9, 1908.) — A simple formula for finding, with the aid of the steam and entropy tables, the available energy per pound of steam in B.T.U. when it is expanded adiabatically from a higher to a lower pressure is:

$$U = H - H_1 + T(N_1 - N).$$

U = available B.T.U. in 1 lb. of expanding steam; H and H_1 total heat in 1 lb. steam at the two pressures; T = absolute temperature at the lower pressure; $N - N_1$, difference of entropy of 1 lb. of steam at the two pressures.

EXAMPLE. — Required the available B.T.U. in 1 lb. steam expanded from 100 lbs. to 14.7 lbs. absolute. $H = 1186.3$; $H_1 = 1150.4$; $T = 672$; $N = 1.602$; $N_1 = 1.756$. $35.9 + 103.5 = 138.4$.

Efficiency of the Cycle. — Let the steam be made from feed-water at 212°. Heat required = $1186.3 - 180 = 1006.3$; efficiency = $138.4 \div 1006.3 = 0.1375$.

Rankine Cycle. — This efficiency is that of the Rankine cycle, which assumes that the steam is expanded adiabatically to the lowest pressure and temperature, and that the feed-water from which the steam is made is introduced into the system at the same low temperature.

Carnot Cycle. — The Carnot ideal cycle, which assumes that all the heat entering the system enters at the highest temperature, and in which the efficiency is $(T_1 - T_2) \div T_1$, gives $(327.8 - 212) \div (327.8 + 460) = 0.1470$ and the available energy in B.T.U. = $0.1470 \times 1006.3 = 147.9$ B.T.U.

Properties of Superheated Steam.

(Condensed from Marks and Davis's Steam Tables and Diagrams.)
 v = specific volume in cu. ft. per lb., h = total heat, from water at 32° F. in B.T.U. per lb., n = entropy, from water at 32°.

Press. Abs. lbs. per Sq. In.	Temp. Sat. Steam.	Degrees of Superheat.																		
		0	20	50	100	150	200	250	300	400	500									
20	228.0	v 20.08	20.73	21.69	23.25	24.80	26.33	27.85	29.37	32.39	35.40									
		h 11562	1165.7	1179.9	1203.5	1227.1	1250.6	1274.1	1297.6	1344.8	1392.2									
		n 1.7320	1.7456	1.7652	1.7961	1.8251	1.8524	1.8781	1.9026	1.9479	1.9893									
40	267.3	v 10.49	10.83	11.33	12.13	12.93	13.70	14.48	15.25	16.78	18.30									
		h 1169.4	1179.3	1194.0	1218.4	1242.4	1266.4	1290.3	1314.1	1361.6	1409.3									
		n 1.6761	1.6895	1.7089	1.7392	1.7674	1.7940	1.8189	1.8427	1.8867	1.9271									
60	292.7	v 7.17	7.40	7.75	8.30	8.84	9.36	9.89	10.41	11.43	12.45									
		h 1177.0	1187.3	1202.6	1227.6	1252.1	1276.4	1300.4	1324.3	1372.2	1420.0									
		n 1.6432	1.6568	1.6761	1.7062	1.7342	1.7603	1.7849	1.8081	1.8511	1.8908									
80	312.0	v 5.47	5.65	5.92	6.34	6.75	7.17	7.56	7.95	8.72	9.49									
		h 1182.3	1193.0	1208.8	1234.3	1259.0	1283.6	1307.8	1331.9	1379.8	1427.9									
		n 1.6200	1.6338	1.6532	1.6833	1.7110	1.7368	1.7612	1.7840	1.8265	1.8658									
100	327.8	v 4.43	4.58	4.79	5.14	5.47	5.80	6.12	6.44	7.07	7.69									
		h 1186.3	1197.5	1213.8	1239.7	1264.7	1289.4	1313.6	1337.8	1385.9	1434.1									
		n 1.6020	1.6160	1.6358	1.6658	1.6933	1.7188	1.7428	1.7656	1.8079	1.8468									
120	341.3	v 3.73	3.85	4.04	4.33	4.62	4.89	5.17	5.44	5.96	6.48									
		h 1189.6	1201.1	1217.9	1244.1	1269.3	1294.1	1318.4	1342.7	1391.0	1439.4									
		n 1.5873	1.6016	1.6216	1.6517	1.6789	1.7041	1.7280	1.7505	1.7924	1.8311									
140	353.1	v 3.22	3.32	3.49	3.75	4.00	4.24	4.48	4.71	5.16	5.61									
		h 1192.2	1204.3	1221.4	1248.0	1273.3	1298.2	1322.6	1346.9	1395.4	1443.8									
		n 1.5747	1.5894	1.6096	1.6395	1.6666	1.6916	1.7152	1.7376	1.7792	1.8177									
160	363.6	v 2.83	2.93	3.07	3.30	3.53	3.74	3.95	4.15	4.56	4.95									
		h 1194.5	1207.0	1224.5	1251.3	1276.8	1301.7	1326.2	1350.6	1399.3	1447.9									
		n 1.5639	1.5789	1.5993	1.6292	1.6561	1.6810	1.7043	1.7266	1.7680	1.8063									
180	373.1	v 2.53	2.62	2.75	2.96	3.16	3.35	3.54	3.72	4.09	4.44									
		h 1196.4	1209.4	1227.2	1254.3	1279.9	1304.8	1329.5	1353.9	1402.7	1451.4									
		n 1.5543	1.5697	1.5904	1.6201	1.6468	1.6716	1.6948	1.7169	1.7581	1.7962									
200	381.9	v 2.29	2.37	2.49	2.68	2.86	3.04	3.21	3.38	3.71	4.03									
		h 1198.1	1211.6	1229.8	1257.1	1282.6	1307.7	1332.4	1357.0	1405.9	1454.7									
		n 1.5456	1.5614	1.5823	1.6120	1.6385	1.6632	1.6862	1.7082	1.7493	1.7872									
220	389.9	v 2.09	2.16	2.28	2.45	2.62	2.78	2.94	3.10	3.40	3.69									
		h 1199.6	1213.6	1232.2	1259.6	1285.2	1310.3	1335.1	1359.8	1408.8	1457.7									
		n 1.5379	1.5541	1.5753	1.6049	1.6312	1.6558	1.6787	1.7005	1.7415	1.7792									
240	397.4	v 1.92	1.99	2.09	2.26	2.42	2.57	2.71	2.85	3.13	3.40									
		h 1200.9	1215.4	1234.3	1261.9	1287.6	1312.8	1337.6	1362.3	1411.5	1460.5									
		n 1.5309	1.5476	1.5690	1.5985	1.6246	1.6492	1.6720	1.6937	1.7344	1.7721									
260	404.5	v 1.78	1.84	1.94	2.10	2.24	2.39	2.52	2.65	2.91	3.16									
		h 1202.1	1217.1	1236.4	1264.1	1289.9	1315.1	1340.0	1364.7	1414.0	1463.2									
		n 1.5244	1.5416	1.5631	1.5926	1.6186	1.6430	1.6658	1.6874	1.7280	1.7655									
280	411.2	v 1.66	1.72	1.81	1.95	2.09	2.22	2.35	2.48	2.72	2.95									
		h 1203.1	1218.7	1238.4	1266.2	1291.9	1317.2	1342.2	1367.0	1416.4	1465.7									
		n 1.5185	1.5362	1.5580	1.5873	1.6133	1.6375	1.6603	1.6818	1.7223	1.7597									
300	417.5	v 1.55	1.60	1.69	1.83	1.96	2.09	2.21	2.33	2.55	2.77									
		h 1204.1	1220.2	1240.3	1268.2	1294.0	1319.3	1344.3	1369.2	1418.6	1468.0									
		n 1.5129	1.5310	1.5530	1.5824	1.6082	1.6323	1.6550	1.6765	1.7168	1.7541									
350	431.9	v 1.33	1.38	1.46	1.58	1.70	1.81	1.92	2.02	2.22	2.41									
		h 1206.1	1223.9	1244.6	1272.7	1298.7	1324.1	1349.3	1374.3	1424.0	1473.7									
		n 1.5002	1.5199	1.5423	1.5715	1.5971	1.6210	1.6436	1.6650	1.7052	1.7422									
400	444.8	v 1.17	1.21	1.28	1.40	1.50	1.60	1.70	1.79	1.97	2.14									

FLOW OF STEAM.

Flow of Steam through a Nozzle. (From Clark on the Steam-engine.) — The flow of steam of a greater pressure into an atmosphere of a less pressure increases as the difference of pressure is increased, until the external pressure becomes only 58% of the absolute pressure in the boiler. The flow of steam is neither increased nor diminished by the fall of the external pressure below 58%, or about 4/7 of the inside pressure, even to the extent of a perfect vacuum. In flowing through a nozzle of the best form, the steam expands to the external pressure, and to the volume due to this pressure, so long as it is not less than 58% of the internal pressure. For an external pressure of 58%, and for lower percentages, the ratio of expansion is 1 to 1.624.

When steam of varying initial pressures is discharged into the atmosphere — the atmospheric pressure being not more than 58% of the initial pressure — the velocity of outflow at constant density, that is, supposing the initial density to be maintained, is given by the formula $V = 3.5953 \sqrt{h}$. V = velocity in feet per second, as for steam of the initial density; h = the height in feet of a column of steam of the given initial pressure, the weight of which is equal to the pressure on the unit of base.

The lowest initial pressure to which the formula applies, when the steam is discharged into the atmosphere at 14.7 lbs. per sq. in., is $(14.7 \times 100/58) = 25.37$ lbs. per sq. in.

From the contents of the table below it appears that the velocity of outflow into the atmosphere, of steam above 25 lbs. per sq. in. absolute pressure, increases very slowly with the pressure, because the density, and the weight to be moved, increase with the pressure. An average of 900 ft. per sec. may, for approximate calculations, be taken for the velocity of outflow as for constant density, that is, taking the volume of the steam at the initial volume. For a fuller discussion of this subject see "Steam Turbines," page 1065.

Outflow of Steam into the Atmosphere. — External pressure per square inch, 14.7 lbs. absolute. Ratio of expansion in nozzle, 1.624.

Absolute Initial Pressure per square inch.	Velocity of Outflow as at Constant Density.	Actual Velocity of Outflow Expanded.	Discharge per square inch of Orifice per min.	Horse-power per sq. in. of Orifice if H.P. = 30 lbs. per hour.	Absolute Initial Pressure per square inch.	Velocity of Outflow as at Constant Density.	Actual Velocity of Outflow Expanded.	Discharge per square inch of Orifice per minute.	Horse-power per sq. in. of Orifice if H.P. = 30 lbs. per hour.
lbs.	feet p. sec.	feet per sec.	lbs.	H.P.	lbs.	feet p. sec.	feet per sec.	lbs.	H.P.
25.37	863	1401	22.81	45.6	90	895	1454	77.94	155.9
30	867	1408	26.84	53.7	100	898	1459	86.34	172.7
40	874	1419	35.18	70.4	115	902	1466	98.76	197.5
50	880	1429	44.06	88.1	135	906	1472	115.61	231.2
60	885	1437	52.59	105.2	155	910	1478	132.21	264.4
70	889	1444	61.07	122.1	165	912	1481	140.46	280.9
75	891	1447	65.30	130.6	215	919	1493	181.58	363.2

Rateau's Formula. — A. Rateau, in 1895-6, made experiments with converging nozzles 0.41, 0.59 and 0.95 in. diam., on steam of pressures from 1.4 to 170 lbs. per sq. in. In his paper read at the Intl. Eng'g. Congress at Glasgow (*Eng. Rec.*, Oct. 16, 1901) he gives the following formula, applicable when the final pressure, absolute, is less than 58% of the initial. Pounds per hour per sq. in. area of orifice = $3.6 P (16.3 - 0.96 \log P)$. P = absolute pressure, lbs. per sq. in.

Napier's Approximate Rule. — Flow in pounds per second = absolute pressure X area in square inches + 70. This rule gives results

which closely correspond with those in the above table, and with results computed by Rateau's formula, as shown below.

Abs. press., lbs. per sq. in.	25.37	40	60	75	100	135	165	215
Discharge per min., by table, lbs.	22.81	35.18	52.59	65.30	86.34	115.61	140.46	181.58
By Rateau's formula,	22.76	35.43	52.49	65.25	86.28	115.47	140.28	181.39
By Napier's rule	21.74	34.29	51.43	64.29	85.71	115.71	141.43	184.29

Flow of Steam in Pipes. — A formula formerly used for velocity of flow of steam in pipes is the same as Downing's for the flow of water in smooth cast-iron pipes, viz., $V = 50 \sqrt{HD/L}$, in which V = velocity in feet per second, L = length and D = diameter of pipe in feet, H = height in feet of a column of steam, of the pressure of the steam at the entrance, which would produce a pressure equal to the difference of pressures at the two ends of the pipe. (For derivation of the coefficient 50, see Briggs on "Warming Buildings by Steam," *Proc. Inst. C. E.*, 1882.)

If Q = quantity in cubic feet per minute, d = diameter in inches, L and H being in feet, the formula reduces to

$$Q = 4.7233 \sqrt{\frac{H}{L}} d^5. \quad H = 0.0448 \frac{Q^2 L}{d^5}, \quad d = 0.5374 \sqrt{\frac{Q^2 L}{H}}$$

These formulæ are applicable to air and other gases as well as steam. They are not as accurate as later formulæ (see below) in which the coefficients vary with the diameter of the pipe. G. H. Babcock, in "Steam," gives the formula

$$W = 87 \sqrt{\frac{w(p_1 - p_2) d^5}{L (1 + \frac{3.6}{d})}}$$

W = weight of steam flowing, in lbs. per minute, w = density in lbs. per cu. ft. of the steam at the entrance to the pipe, p_1 = pressure in lbs. per sq. in. at the entrance, p_2 = pressure at the exit, d = diam. in inches, L = length in feet. This formula is apparently derived from Unwin's formula for flow of fluids in *Ency. Brit.*, vol. xii, pp. 508, 516. Putting the formula in the form $W = c \sqrt{w(p_1 - p_2) d^5/L}$, in which c will vary with the diameter of the pipe, we have,

For diameter, inches...	1	2	3	4	6	9	12
Value of c	40.7	52.1	58.8	63	68.8	73.7	79.3

One of the most widely accepted formulæ for flow of water is Darcy's,

$V = c \sqrt{\frac{HD}{L^4}}$, in which c has values ranging from 65 for a 1/2-inch pipe up to 111.5 for 24-inch. Using Darcy's coefficients, and modifying his formula to make it apply to steam, to the form

$$Q = c \sqrt{\frac{(p_1 - p_2) d^5}{wL}}, \quad \text{or} \quad W = c \sqrt{\frac{w(p_1 - p_2) d^5}{L}}$$

we obtain,

For diameter, inches ..	1/2	1	2	3	4	5	6	7	8
Value of c	36.8	45.3	52.7	56.1	57.3	58.4	59.5	60.1	60.7
For diameter, inches ..	9	10	12	14	16	18	20	22	24
Value of c	61.2	61.8	62.1	62.3	62.6	62.7	62.9	63.2	63.2

In the absence of direct experiments these coefficients are probably as accurate as any that may be derived from formulæ for flow of water.

$$\text{Loss of pressure in lbs. per sq. in.} = p_1 - p_2 = \frac{Q^2 w L}{c^2 d^5} = \frac{W^2 L}{c^2 w d^5}$$

For a comparison of different formulæ for flow of steam see a paper by G. F. Gebhardt, in *Power*, June, 1907.

WARNING: This is a 1910 edition. Some of the material may no longer be accurate

Table of Flow of Steam in Pipes of Different Diameters and Different Drops in Pressure. (E. C. Sickles, *Trans. A. S. M. E.*, xx 354.) — The drop is calculated from the formula $p_1 - p_2 = 0.000131$

$(1 + \frac{3.6}{d}) \frac{W^2 L}{w d^5}$, or $W = 87.54 \sqrt{\frac{w(p_1 - p_2) d^5}{L(1 + 3.6/d)}}$. p_1 and p_2 , initial and final pressures, lbs. per sq. in., d = diam. in ins., W = flow in pounds per minute, w = density of steam in lbs. per cu. ft., L = length of pipe in feet. The table is calculated on the basis of $L = 1000$ ft. For any other length the drop is proportional to the length $\div 1000$.

EXAMPLE IN USE OF THE TABLE. — Required the size of pipe to carry 2500 lbs. per min. of steam of 150 lbs. absolute pressure. In the first table we find figures above 2500 lbs. per min. as follows: 2667, 13-in. pipe, line 2; 2736, 14-in. pipe, line 4; 2527, 15-in. pipe, line 8; 2638, 16-in. pipe, line 10; 2623, 18-in. pipe, line 14. In the table on the next page, under 150 lbs., we find the corresponding drops per 1000 ft. as follows: line 2, 9.60 lbs.; line 4, 6.83 lbs.; line 8, 4.10 lbs.; line 10, 3.19 lbs.; line 14, 1.72 lbs.

STEAM DISCHARGE IN POUNDS PER MINUTE.

Corresponding to Drop in Pressure in table on the next page, for Pipe Diameters in Inches in Top Line.

Line No.	24	22	20	18	16	15	14	13	12	11	10
1	14000	11188	8772	6678	4923	4163	3481	2871	2328	1853	1443
2	13000	10392	8144	6203	4573	3867	3233	2667	2165	1721	1341
3	12000	9593	7517	5724	4220	3569	2983	2461	1996	1589	1237
4	11000	8804	6891	5247	3868	3271	2736	2256	1830	1456	1134
5	10000	7992	6265	4770	3517	2974	2486	2051	1665	1324	1031
6	9500	7705	5947	4532	3341	2825	2362	1940	1580	1258	979
7	9000	7205	5638	4293	3165	2676	2237	1846	1497	1192	928
8	8500	6905	5321	4054	2989	2527	2113	1743	1414	1125	876
9	8000	6506	5012	3816	2814	2379	1989	1640	1331	1059	825
10	7500	6106	4695	3577	2638	2230	1865	1538	1248	993	873
11	7000	5707	4385	3339	2462	2082	1740	1435	1164	927	722
12	6500	5307	4069	3100	2286	1933	1616	1333	1081	860	670
13	6000	4908	3758	2862	2110	1784	1492	1230	998	794	619
14	5500	4508	3443	2623	1934	1635	1368	1128	915	728	567
15	5000	4108	3132	2385	1758	1487	1243	1025	832	662	516

STEAM DISCHARGE FOR PIPE DIAMETERS IN INCHES, Continued.

Line No.	9	8	7	6	5	4	3 1/2	3	2 1/2	2	1 1/2	1
1	1093	799	560	371	227	123	71.6	55.9	28.8	18.1	6.81	2.52
2	1015	742	521	344	210	114.6	68.6	51.9	27.6	16.8	6.52	2.34
3	937	685	481	318	194	106.0	65.6	47.9	26.4	15.5	6.24	2.16
4	859	628	441	292	178	97.0	62.7	43.9	25.2	14.2	5.95	1.98
5	781	571	401	265	162	88.2	59.7	39.9	24.0	12.9	5.67	1.80
6	742	542	381	252	154	83.8	56.5	37.9	22.8	12.3	5.29	1.71
7	703	514	361	239	146	79.4	53.5	35.9	21.6	11.6	5.00	1.62
8	664	485	341	226	138	75.0	50.5	33.9	20.4	10.9	4.72	1.53
9	625	457	321	212	130	70.6	47.6	31.9	19.2	10.3	4.43	1.44
10	586	428	301	199	122	66.2	44.5	29.9	18.0	9.68	4.15	1.35
11	547	400	281	186	113	61.7	41.6	27.9	16.8	9.03	3.86	1.26
12	508	371	261	172	105	57.3	38.6	25.9	15.6	8.38	3.68	1.17
13	469	343	241	159	97.2	52.9	35.6	23.9	14.4	7.74	3.40	1.08
14	430	314	221	146	89.1	48.5	32.6	21.9	13.2	7.10	3.11	0.99
15	390	286	200	132	81.0	44.1	29.6	20.0	12.0	6.45	2.83	0.90

DROP IN PRESSURE IN POUNDS PER SQ. IN., PER 1000 FT. LENGTH. Corresponding to Discharge in above Table.

Density * Pressure†	0.208 90	0.230 100	0.273 120	0.295 130	0.316 140	0.338 150	0.401 180	0.443 200	0.485 220	0.548 250
Line. 1	18.10	16.4	13.8	12.8	11.9	11.1	9.39	8.50	7.76	6.87
2	15.60	14.1	11.9	11.0	10.3	9.60	8.09	7.33	6.69	5.92
3	13.3	12.0	10.1	9.38	8.75	8.18	6.90	6.24	5.70	5.05
4	11.1	10.0	8.46	7.83	7.31	6.83	5.76	5.21	4.76	4.21
5	9.25	8.36	7.5	6.52	6.09	5.69	4.80	4.34	3.97	3.51
6	8.33	7.53	6.35	5.87	5.48	5.13	4.32	3.91	3.57	3.16
7	7.48	6.76	5.70	5.27	4.92	4.60	3.88	3.51	3.21	2.84
8	6.67	6.03	5.08	4.70	4.39	4.10	3.46	3.13	2.86	2.53
9	5.91	5.35	4.50	4.17	3.89	3.64	3.07	2.78	2.53	2.24
10	5.19	4.69	3.95	3.66	3.42	3.19	2.69	2.44	2.23	1.97
11	4.52	4.09	3.44	3.19	2.98	2.78	2.34	2.12	1.94	1.72
12	3.90	3.53	2.97	2.75	2.57	2.40	2.02	1.83	1.67	1.48
13	3.32	3.00	2.53	2.34	2.19	2.04	1.72	1.56	1.42	1.26
14	2.79	2.52	2.13	1.97	1.84	1.72	1.45	1.31	1.20	1.06
15	2.31	2.09	1.76	1.63	1.52	1.42	1.20	1.08	0.991	0.877

* Density in lbs. per cu. ft. † Pressure, absolute, lbs. per sq. in.

For Flow of Steam at low pressures, see Heating and Ventilation, page 670.

Carrying Capacity of Extra Heavy Steam Pipes. (Power Speciality Co.)

Nominal size of pipe, in.	Actual inside area in sq. in.	Pounds of steam per hour.				Nominal size of pipe, in.	Actual inside area in sq. in.	Pounds of steam per hour.			
		200 lbs.	150 lbs.	100 lbs.	50 lbs.			200 lbs.	150 lbs.	100 lbs.	50 lbs.
1	0.71	1210	872	618	362	6	25.93	40800	31600	22600	13210
1 1/4	1.27	2000	1555	1105	646	7	34.47	54600	42250	30000	17600
1 1/2	1.75	2750	2140	1525	894	8	44.18	69500	54000	38400	22450
2	2.93	4610	3590	2550	1525	9	58.42	92000	71500	50800	29800
2 1/2	4.20	6610	5150	3660	2140	10	74.66	117300	91500	65000	38100
3	6.56	10300	8050	5720	3450	11	90.76	142800	111500	79200	46300
3 1/2	8.85	13900	10820	7720	4520	12	108.43	170500	133000	94750	55400
4	11.44	18000	14000	10000	5850	14	153.94	242000	188200	133900	78600
4 1/2	14.18	22300	17350	12320	7230	16	176.71	277500	216200	153800	90500
5	18.19	28610	22250	15800	9300	18	226.98	357000	278000	197500	115700

The pounds per hour in the above table are figured for the velocities given below:

Steam superheated degrees F...	0	50	100	150	200	250
Velocity, ft. per min.....	8000	8500	8950	9450	9900	10450

Flow of Steam in Long Pipes. Ledoux's Formula. — In the flow of steam or other gases in long pipes, the volume and the velocity are increased as the drop in pressure increases. Taking this into account a correct formula for flow would be an exponential one. Ledoux gives

$d = 0.699 \sqrt{\frac{W^2 L}{p_1^{1.94} - p_2^{1.94}}}$, his notation being reduced to English measures. (*Annales des Mines*, 1892; *Trans. A. S. M. E.*, xx., 365; *Power*, June, 1907.) See Johnson's formula for flow of air, page 596.

Resistance to Flow by Bends, Valves, etc. (From Briggs on Warming Buildings by Steam.) — The resistance at the entrance to a tube when no special bell-mouth is given consists of two parts. The head $v^2 \div 2g$ is expended in giving the velocity of flow; and the head $0.505 v^2 \div 2g$ in overcoming the resistance of the mouth of the tube. Hence the whole loss of head at the entrance is $1.505 v^2 \div 2g$. This resistance is equal to the resistance of a straight tube of a length equal to about 60 times its diameter.

The loss at each sharp right-angled elbow is the same as in flowing through a length of straight tube equal to about 40 times its diameter. For a globe steam stop-valve the resistance is taken to be 1 1/2 times that of the right-angled elbow.

Sizes of Steam-pipes for Stationary Engines. — An old common rule is that steam-pipes supplying engines should be of such size that the mean velocity of steam in them does not exceed 6000 feet per minute, in order that the loss of pressure due to friction may not be excessive. The velocity is calculated on the assumption that the cylinder is filled at each stroke. In modern practice with large engines and high pressures, this rule gives unnecessarily large and costly pipes. For such engines the allowable drop in steam pressure should be assumed and the diameter calculated by means of the formulæ given above.

An article in *Power*, May, 1893, on proper area of supply-pipes for engines gives a table showing the practice of leading builders. To facilitate comparison, all the engines have been rated in horse-power at 40 pounds mean effective pressure. The table contains all the varieties of simple engines, from the slide-valve to the Corliss, and it appears that there is no general difference in the sizes of pipe used in the different types. The averages selected from this table are as follows:

DIAMETERS OF CYLINDERS CORRESPONDING TO VARIOUS SIZES OF STEAM-PIPES BASED ON PISTON-SPEED OF ENGINE OF 600 FT. PER MINUTE, AND ALLOWABLE MEAN VELOCITY OF STEAM IN PIPE OF 4000, 6000, AND 8000 FT. PER MIN. (STEAM ASSUMED TO BE ADMITTED DURING FULL STROKE.)

Diam. of pipe, inches	2	2 1/2	3	3 1/2	4	4 1/2	5	6
Vel. 4000	5.2	6.5	7.7	9.0	10.3	11.6	12.9	15.5
Vel. 6000	6.3	7.9	9.5	11.1	12.6	14.2	15.8	19.0
Vel. 8000	7.3	9.1	10.9	12.8	14.6	16.4	18.3	21.9
Horse-power, approx.	20	31	45	62	80	100	125	180

Diam. of pipes, inches	7	8	9	10	11	12	13	14
Vel. 4000	18.1	20.7	23.2	25.8	28.4	31.0	33.6	36.1
Vel. 6000	22.1	25.3	28.5	31.6	34.8	37.9	41.1	44.3
Vel. 8000	25.6	29.2	32.9	36.5	40.2	43.8	47.5	51.1
Horse-power, approx.	245	320	406	500	606	718	845	981

Formula. Area of pipe = $\frac{\text{Area of cylinder} \times \text{piston-speed}}{\text{mean velocity of steam in pipe}}$

For piston-speed of 600 ft. per min. and velocity in pipe of 4000, 6000, and 8000 ft. per min., area of pipe = respectively 0.15, 0.10, and 0.075 X area of cylinder. Diam. of pipe = respectively 0.3873, 0.3162, and 0.2739 X diam. of cylinder. Reciprocals of these figures are 2.582, 3.162, and 3.651.

The first line in the above table may be used for proportioning exhaust pipes, in which a velocity not exceeding 4000 ft. per minute is advisable. The last line, approx. H.P. of engine, is based on the velocity of 6000 ft. per min. in the pipe, using the corresponding diameter of piston, and taking H.P. = 1/2 (diam. of piston in inches)².

Sizes of Steam-pipes for Marine Engines. — In marine-engine practice the steam-pipes are generally not as large as in stationary practice for the same sizes of cylinder. Seaton gives the following rules:

Main Steam-pipes should be of such size that the mean velocity of flow does not exceed 8000 ft. per min.

In large engines, 1000 to 2000 H.P., cutting off at less than half stroke, the steam-pipe may be designed for a mean velocity of 9000 ft., and 10,000 ft. for still larger engines.

In small engines and engines cutting off later than half stroke, a velocity of less than 8000 ft. per minute is desirable. Taking 8100 ft. per min. as the mean velocity, S speed of piston in feet per min., and D the diameter of the cylinder,

Diam. of main steam-pipe = $\sqrt{D^2 S + 8100} = D \sqrt{S + 90}$.

Stop and Throttle Valves should have a greater area of passages than the area of the main steam-pipe, on account of the friction through the circuitous passages. The shape of the passages should be designed so as to avoid abrupt changes of direction and of velocity of flow as far as possible.

Area of Steam Ports and Passages = $\frac{\text{Area of piston} \times \text{speed of piston in ft. per min.}}{6000} = \frac{(\text{Diam.})^2 \times \text{speed}}{7639}$

Opening of Port to Steam. — To avoid wire-drawing during admission the area of opening to steam should be such that the mean velocity of flow does not exceed 10,000 ft. per min. To avoid excessive clearance the width of port should be as short as possible, the necessary area being obtained by length (measured at right angles to the line of travel of the valve). In practice this length is usually 0.6 to 0.8 of the diameter of the cylinder, but in long-stroke engines it may equal or even exceed the diameter.

Exhaust Passages and Pipes. — The area should be such that the mean velocity of the steam should not exceed 6000 ft. per min., and the area should be greater if the length of the exhaust-pipe is comparatively long. The area of passages from cylinders to receivers should be such that the velocity will not exceed 5000 ft. per min.

The following table is computed on the basis of a mean velocity of flow of 8000 ft. per min. for the main steam-pipe, 10,000 for opening to steam, and 6000 for exhaust. A = area of piston, D its diameter.

STEAM AND EXHAUST OPENINGS.

Piston-speed, ft. per min.	Diam. of Steam-pipe $\div D$.	Area of Steam-pipe $\div A$.	Diam. of Exhaust $\div D$.	Area of Exhaust $\div A$.	Opening to Steam $\div A$.
300	0.194	0.0375	0.223	0.0500	0.03
400	0.224	0.0500	0.258	0.0667	0.04
500	0.250	0.0625	0.288	0.0833	0.05
600	0.274	0.0750	0.316	0.1000	0.06
700	0.296	0.0875	0.341	0.1167	0.07
800	0.316	0.1000	0.365	0.1333	0.08
900	0.335	0.1125	0.387	0.1500	0.09
1000	0.353	0.1250	0.400	0.1667	0.10

Proportioning Steam-Pipes for Minimum Total Loss by Radiation and Friction. — For a given size of pipe and quantity of steam to be carried the loss of pressure due to friction is calculated by formulæ given above, or taken from the tables. The work of friction, being converted into heat, tends to dry or superheat the steam, but its influence is usually so small that it may be neglected. The loss of heat by radiation tends to destroy the superheat and condense some of the steam into water. For well-covered steam-pipes this loss may be estimated at about 0.3 lb. per sq. ft. of external surface of the pipe per hour per degree of difference of temperature between that of the steam and that of the surrounding atmosphere (see Steam-pipe Coverings, p. 558).

A practical problem in power-plant design is to find the diameter of pipe to carry a given quantity of steam with a minimum total loss of available energy due to both radiation and friction, considering also the money loss due to interest and depreciation on the value of the pipe and covering as erected. Each case requires a separate arithmetical computation, no formula yet being constructed to fit the general case. An approximate method of solution, neglecting the slight gain of heat by

the steam from the work of friction, and assuming that the water condensed by radiation of heat is removed by a separator and lost, is as follows: Calculate the amount of steam required by the engine, in pounds per minute. From a steam pipe formula or table find the several drops of pressure, in lbs. per sq. in., in pipes of different assumed diameters, for the given quantity of steam and the given length of pipe. Compute from a theoretical indicator diagram of steam expanding in the engine the loss of available work done by 1 lb. of steam, due to the several drops already found, and the corresponding fraction of 1 lb. of steam that will have to be supplied to make up for this loss of work. State this loss as equivalent to so many pounds of steam per 1000 lbs. of steam carried. Calculate the loss in lbs. of steam condensed by radiation in the pipes of the different diameters, per 1000 lbs. carried. Add the two losses together for each assumed size of pipe, and by inspection find which pipe gives the lowest total loss. The money loss due to cost and depreciation may also be figured approximately in the same unit of lbs. of steam lost per 1000 lbs. carried, by taking the cost of the covered pipe, assuming a rate of interest and depreciation, finding the annual loss in cents, then from the calculated value of steam, which depends on the cost of fuel, find the equivalent quantity of steam which represents this money loss, and the equivalent lbs. of steam per 1000 lbs. carried. This is to be added to the sum of the losses due to friction and radiation, and it will be found to modify somewhat the conclusion as to the diameter of pipe and the drop which corresponds to a minimum total loss.

Instead of determining the loss of available work per pound of steam from theoretical indicator diagrams, it may be computed approximately on the assumption, based on the known characteristics of the engine, that its efficiency is a certain fraction of that of an engine working between the same limits of temperature on the ideal Carnot cycle, as shown in the table below, and from the efficiency thus found, compared with the efficiency at the given initial pressure less the drop, the loss of work may be calculated.

AVAILABLE MAXIMUM THERMAL EFFICIENCY OF STEAM EXPANDED BETWEEN THE GIVEN PRESSURES AND 1 LB. ABSOLUTE, BASED ON THE CARNOT CYCLE. $E = (T_1 - T_2) \div T_1$.

Initial Pressure less than Maximum.	Maximum Initial Absolute Pressures.								
	100	125	150	175	200	225	250	275	300
	Maximum Thermal Efficiency.								
0 lbs.	0.287	0.302	0.314	0.324	0.333	0.341	0.348	0.354	0.360
2	.286	.301	.313	.323	.332	.340	.347	.354	.359
5	.284	.299	.312	.322	.331	.339	.346	.353	.359
10	.280	.296	.309	.320	.329	.337	.345	.352	.358
20	.272	.290	.304	.316	.326	.335	.342	.349	.356

This table shows that if the initial steam pressure is lowered from 100 lbs. to 80 lbs., the efficiency of the Carnot cycle is reduced from 0.287 to 0.272, or over 5%, but if steam of 300 lbs. is lowered to 280 lbs. the efficiency is reduced only from 0.360 to 0.356 or 1.1%. With high-pressure steam, therefore, much greater loss of pressure by friction of steam pipes, valves and ports is allowable than with steam of low pressure.

Theoretically the loss of efficiency due to drop in pressure on account of friction of pipes should be less than that indicated in the above table, since the work of friction tends to superheat the steam, but practically most, if not all, of the superheating is lost by radiation.

By a method of calculation somewhat similar to that above outlined, the following figures were found, in a certain case, of the cost per day of the transmission of 50,000 lbs. of steam per hour a distance of 1000 feet, with 100 lbs. initial pressure.

Diameter of Pipe.	6 in.	7 in.	8 in.	10 in.	12 in.
1. Interest, etc., 12% per annum..	\$0.39	\$0.46	\$0.53	\$0.66	\$0.84
2. Condensation.....	1.51	1.76	2.01	2.51	3.02
3. Friction.....	0.86	0.38	0.19	0.06	0.02
Total per day.....	\$2.76	\$2.60	\$2.73	\$3.23	\$3.88

STEAM PIPES.

Bursting-tests of Copper Steam-pipes. (From Report of Chief Engineer Melville, U. S. N., for 1892.) — Some tests were made at the New York Navy Yard which show the unreliability of brazed seams in copper pipes. Each pipe was 8 in. diameter inside and 3 ft. 1 5/8 in. long. Both ends were closed by ribbed heads and the pipe was subjected to a hot-water pressure, the temperature being maintained constant at 371° F. Three of the pipes were made of No. 4 sheet copper (Stubs gauge) and the fourth was made of No. 3 sheet.

The following were the results, in lbs. per sq. in., of bursting-pressure:

Pipe number.....	1	2	3	4	4'
Actual bursting-strength..	835	785	950	1225	1275
Calculated "	1336	1336	1569	1568	1568
Difference.....	501	551	619	343	293

The tests of specimens cut from the ruptured pipes show the injurious action of heat upon copper sheets; and that, while a white heat does not change the character of the metal, a heat of only slightly greater degree causes it to lose the fibrous nature that it has acquired in rolling, and a serious reduction in its tensile strength and ductility results.

A Failure of a Brazed Copper Steam-pipe on the British steamer *Prodano* was investigated by Prof. J. O. Arnold. He found that the brazing was originally sound, but that it had deteriorated by oxidation of the zinc in the brazing alloy by electrolysis, which was due to the presence of fatty acids produced by decomposition of the oil used in the engines. A full account of the investigation is given in *The Engineer*, April 15, 1898.

Reinforcing Steam-pipes. (*Eng.*, Aug. 11, 1893.) — In the Italian Navy copper pipes above 8 in. diam. are reinforced by wrapping them with a close spiral of copper or Delta-metal wire. Two or three independent spirals are used for safety in case one wire breaks. They are wound at a tension of about 1 1/2 tons per sq. in.

Materials for Pipes and Valves for Superheated Steam. (M. W. Kellogg, *Trans. A. S. M. E.*, 1907.) — The latest practice is to do away with fittings entirely on high-pressure steam lines and put what are known as "nozzles" on the piping itself. This is accomplished by welding wrought-steel pipe on the side of another section, so as to accomplish the same result as a fitting. In this way rolled or cast steel flanges and a Rockwood or welded joint can be used. This method has three distinct advantages: 1. The quality of the metal used. 2. The lightening of the entire work. 3. The doing away with a great many joints.

As a general average, at least 50% of the joints can be left out; sometimes the proportion runs up as high as 70%.

Above 575° F. the limit of elasticity in cast iron is reached with a pressure varying from 140 to 175 pounds. Under such conditions the material is strained and does not resume its former shape, eventually showing surface cracks which increase until the pipe breaks.

It would seem that iron castings are unsuitable for both fittings and valves to be used in any superheated steam work. The only adaptable metal seems to be cast steel. Tests by Bach on this metal show that at 572° F. the reduction in breaking strength amounts only to 1.1% and at 752° F. to about 8%.

The effect of temperature on nickel is similar to that on cast steel and in consequence this material is very suitable for use in connection with

highly superheated steam. Bach recommends that bronze alloys be done away with for use on steam lines above a temperature of about 390° F.

The old-fashioned screwed joint, no matter how well made, is not suitable for superheated steam work.

In making up a joint, the face of all flanges or pipe where a joint is made should be given a fine tool finish and a plane surface, and a gasket should be used. The best results have been obtained with a corrugated soft Swedish steel gasket with "Smooth-on" applied, and with the McKim gasket, which is of copper or bronze surrounding asbestos. On superheated steam lines a corrugated copper gasket will in time pit out in some part of the flange nearly through the entire gasket.

Specifications for pipes and fittings for superheated steam service were published by Crane Co., Chicago, in the *Valve World*, 1907.

Riveted Steel Steam-pipes have been used for high pressures. See paper on *A Method of Manufacture of Large Steam-pipes*, by Chas. H. Manning, *Trans. A. S. M. E.*, vol. xv.

Valves in Steam-pipes. — Should a globe-valve on a steam-pipe have the steam-pressure on top or underneath the valve is a disputed question. With the steam-pressure on top, the stuffing-box around the valve-stem cannot be repacked without shutting off steam from the whole line of pipe; on the other hand, if the steam-pressure is on the bottom of the valve it all has to be sustained by the screw-thread on the valve-stem, and there is danger of stripping the thread.

A correspondent of the *American Machinist*, 1892, says that it is a very uncommon thing in the ordinary globe-valve to have the thread give out, but by water-hammer and merciless screwing the seat will be crushed down quite frequently. Therefore with plants where only one boiler is used he advises placing the valve with the boiler-pressure underneath it. On plants where several boilers are connected to one main steam-pipe he would reverse the position of the valve, then when one of the valves needs repacking the valve can be closed and the pressure in the boiler whose pipe it controls can be reduced to atmospheric by lifting the safety-valve. The repacking can then be done without interfering with the operation of the other boilers of the plant.

He proposes also the following other rules for locating valves: Place valves with the stems horizontal to avoid the formation of a water-pocket. Never put the junction-valve close to the boiler if the main pipe is above the boiler, but put it on the highest point of the junction-pipe. If the other plan is followed, the pipe fills with water whenever this boiler is stopped and the others are running, and breakage of the pipe may cause serious results. Never let a junction-pipe run into the bottom of the main pipe, but into the side or top. Always use an angle-valve where convenient, as there is more room in them. Never use a gate valve under high pressure unless a by-pass is used with it. Never open a blow-off valve on a boiler a little and then shut it; it is sure to catch the sediment and ruin the valve; throw it well open before closing. Never use a globe-valve on an indicator-pipe. For water, always use gate or angle valves or stop-cocks to obtain a clear passage. Buy if possible valves with renewable disks. Lastly, never let a man go inside a boiler to work, especially if he is to hammer on it, unless you break the joint between the boiler and the valve and put a plate of steel between the flanges.

The "Steam-Loop" is a system of piping by which water of condensation in steam-pipes is automatically returned to the boiler. In its simplest form it consists of three pipes, which are called the riser, the horizontal, and the drop-leg. When the steam-loop is used for returning to the boiler the water of condensation and entrainment from the steam-pipe through which the steam flows to the cylinder of an engine, the riser is generally attached to a separator; this riser empties at a suitable height into the horizontal, and from thence the water of condensation is led into the drop-leg, which is connected to the boiler, into which the water of condensation is fed as soon as the hydrostatic pressure in the drop-leg in connection with the steam-pressure in the pipes is sufficient to overcome the boiler-pressure. The action of the device depends on the following principles: Difference of pressure may be balanced by a water-column; vapors or liquids tend to flow to the point of lowest pressure; rate of flow depends on difference of pressure and mass; decrease of static pressure in a steam-pipe or chamber is proportional to rate of conden-

sation; in a steam-current water will be carried or swept along rapidly by friction. (Illustrated in *Modern Mechanism*, p. 807. Patented by J. H. Blessing, Feb. 13, 1872, Dec. 28, 1883.) Mr. Blessing thus describes the operation of the loop in *Eng. Review*, Sept., 1907.

The heating system is so arranged that the water of condensation from the radiators gravitates towards some low point and thence is led into the top of a receiver. After this is done it is found that owing to friction caused by the velocity of the steam passing through the different pipes and condensation due to radiation, the steam pressure in the small drip receiver is much less than that in the boiler. This difference will determine the height, or the length of the loop, that must be employed so that the water will gravitate through it into the boiler; that is to say, if there is 10 lbs. difference in pressure, the descending leg of the loop should extend about 30 feet above the water-level in the boiler, since a column of water 2.3 ft. is equal to 1 lb. pressure, and a difference in pressure of 10 lbs. would require a column 23 ft. high. If we make the loop 30 feet high we shall have an additional length of 7 ft. with which to overcome friction. The water, after it reaches the top of the loop, composed of a larger section of pipe, will flow into the boiler through the descending leg with a velocity due to the extra 7 ft. added to the discharging leg.

Loss from an Uncovered Steam-pipe. (Bjorling on Pumping-engines.) — The amount of loss by condensation in a steam-pipe carried down a deep mine-shaft has been ascertained by actual practice at the Clay Cross Colliery, near Chesterfield, where there is a pipe 7 1/2 in. internal diam., 1100 ft. long. The loss of steam by condensation was ascertained by direct measurement of the water deposited in a receiver, and was found to be equivalent to about 1 lb. of coal per I.H.P. per hour for every 100 ft. of steam-pipe; but there is no doubt that if the pipes had been in the up-cast shaft, and well covered with a good non-conducting material, the loss would have been less. (For Steam-pipe Coverings, see p. 558, *ante*.)

Condensation in an Underground Pipe Line. (W. W. Christie, *Eng. Rec.*, 1904.) — A length of 300 ft. of 4-in. pipe, enclosed in a box of 1 1/4-in. planks, 10 ins. square inside, and packed with mineral wool, was laid in a trench, the upper end being 1 ft. and the lower end 5 ft. below the surface. With 80 lbs. gauge pressure in the pipe the condensation was equivalent to 0.275 B.T.U. per minute per sq. ft. of pipe surface when the outside temperature was 31° F., and 0.222 per min. when the temperature was 62° F.

Steam Receivers on Pipe Lines. (W. Andrews, *Steam Eng'g*, Dec. 10, 1902.) — In the four large power houses in New York City, with an ultimate capacity of 60,000 to 100,000 H.P. each, the largest steam mains are not over 20 ins. in diameter. Some of the best plants have pipes which run from the header to the engine two sizes smaller than that called for by the engine builders. These pipes before reaching the engine are carried into a steel receiver, which acts also as a separator. This receiver has a cubical capacity of three times that of the high-pressure cylinder and is placed as close as possible to the cylinder. The pipe from the receiver to the cylinder is of the full size called for by the engine builder. The objects of this arrangement are: First, to have a full supply of steam to the throttle; second, to provide a cushion near the engine on which the cut-off in the steam chest may be spent, thereby preventing vibrations from being transmitted through the piping system; and third, to produce a steady and rapid flow of steam in one direction only, by having a small pipe leading into the receiver. The steam flows rapidly enough to make good the loss caused during the first quarter of the stroke. Plants fitted up in this way are successfully running where the drop in steam pressure is not greater than 4 lbs., although the engines are 500 ft. away from the boilers.

Equation of Pipes. — For determining the number of small sized pipes that are equal in carrying capacity to one of greater size the table given under *Flow of Air*, page 597, is commonly used. It is based on the equation $N = \sqrt{d^5 \div d_1^5}$, in which N is the number of smaller pipes of diameter d_1 equal in capacity to one pipe of diameter d . A more accurate equation, based on Unwin's formula for flow of fluids, is $N = \frac{d^3 \sqrt{d_1 + 3.6}}{d_1^2 \sqrt{d + 3.6}}$; (d and d_1 in inches). For $d = 2d_1$, the first formula gives

$N = 5.7$, and the second $N = 6.15$, an unimportant difference, but for $d = 8 d_1$, the first gives $N = 181$ and the second $N = 274$, a considerable difference. (G. F. Gebhardt, *Power*, June, 1907).

Identification of Power House Piping by Different Colors. (W. H. Bryan, *Trans. A. S. M. E.*, 1908.) — In large power plants the multiplicity of pipe lines carrying different fluids causes confusion and may lead to danger by an operator opening a wrong valve. It has therefore become customary to paint the different lines of different colors. The paper gives several tables showing color schemes that have been adopted in different plants. The following scheme, adopted at the New York Edison Co.'s Waterside Station, is selected as an example.

Pipe Lines.	Colors of Pipe.	Bands, Couplings, Valves, etc.
Steam, high pressure to engines, boiler cross-overs, leaders and headers.....	Black	Brass
All other steam lines.....	Buff	Black
Steam, exhaust.....	Orange	Red
Steam, drips including traps.....	Orange	Black
Steam trap discharge.....	Green	Black
Blow-offs, drips from water columns and low-pressure drips.....	Slate	Red
Drains from crank pits.....	Dark Brown	Blue
Cold water to primary heaters and jacket pumps.....	Blue	Red
Feed-water, pumps to boilers.....	Maroon	Same
Hot-water mains, primary heaters to pumps, and cooling-water returns....	Green	Red
Air pump discharge to hot well.....	Slate	Black
Cooling water, pumps to engines.....	Blue	Black
Fire lines.....	Vermillion	Same
Cylinder oil, high pressure.....	Brown	Black
Cylinder oil, low pressure.....	Brown	Green
Engine oil.....	Brown	Red
Pneumatic system.....	Black	Same

THE STEAM-BOILER.

The Horse-power of a Steam-boiler. — The term horse-power has two meanings in engineering; *First*, an absolute unit or measure of the rate of work, that is, of the work done in a certain definite period of time, by a source of energy, as a steam-boiler, a waterfall, a current of air or water, or by a prime mover, as a steam-engine, a water-wheel, or a wind-mill. The value of this unit, whenever it can be expressed in foot-pounds of energy, as in the case of steam-engines, water-wheels, and waterfalls, is 33,000 foot-pounds per minute. In the case of boilers, where the work done, the conversion of water into steam, cannot be expressed in foot-pounds of available energy, the usual value given to the term horse-power is the evaporation of 30 lbs. of water of a temperature of 100° F. into steam at 70 lbs. pressure above the atmosphere. Both of these units are arbitrary; the first, 33,000 foot-pounds per minute, first adopted by James Watt, being considered equivalent to the power exerted by a good London draught-horse, and the 30 lbs. of water evaporated per hour being considered to be the steam requirement per indicated horse-power of an average engine.

The second definition of the term horse-power is an approximate measure of the size, capacity, value, or "rating" of a boiler, engine, water-wheel, or other source or conveyer of energy, by which measure it may be described, bought and sold, advertised, etc. No definite value can be given to this measure, which varies largely with local custom or individual opinion of makers and users of machinery. The nearest approach to uniformity which can be arrived at in the term "horse-power," used in this sense, is to say that a boiler, engine, water-wheel, or other machine, "rated" at a

certain horse-power, should be capable of steadily developing that horse-power for a long period of time under ordinary conditions of use and practice, leaving to local custom, to the judgment of the buyer and seller, to written contracts of purchase and sale, or to legal decisions upon such contracts, the interpretation of what is meant by the term "ordinary conditions of use and practice." (*Trans. A. S. M. E.*, vol. vii, p. 226.)

The Committee of Judges of the Centennial Exhibition, 1876, in reporting the trials of competing boilers at that exhibition adopted the unit, 30 lbs. of water evaporated into dry steam per hour from feed-water at 100° F., and under a pressure of 70 lbs. per square inch above the atmosphere, these conditions being considered by them to represent fairly average practice.

The A. S. M. E. Committee on Boiler Tests, 1884, accepted the same unit, and defined it as equivalent to 34.5 lbs. evaporated per hour from a feed-water temperature of 212° into steam at the same temperature. The committee of 1899 adopted this definition, 34.5 lbs. per hour, from and at 212°, as the unit of commercial horse-power. Using the figures for total heat of steam given in Marks and Davis's steam tables (1909), 34½ lbs. from and at 212°, is equivalent to 33,479 B.T.U. per hour, or to an evaporation of 30.018 lbs. from 100° feed-water temperature into steam at 70 lbs. pressure.

The Committee of 1899 says: A boiler rated at any stated capacity should develop that capacity when using the best coal ordinarily sold in the market where the boiler is located, when fired by an ordinary fireman, without forcing the fires, while exhibiting good economy; and further, the boiler should develop at least one-third more than the stated capacity when using the same fuel and operated by the same fireman, the full draught being employed and the fires being crowded; the available draught at the damper, unless otherwise understood, being not less than ½ inch water column.

Unit of Evaporation. (Abbreviation, U. E.) — It is the custom to reduce results of boiler-tests to the common standard of the equivalent evaporation from and at the boiling-point at atmospheric pressure, or "from and at 212° F." This unit of evaporation, or one pound of water evaporated from and at 212°, is equivalent to 970.4 British thermal units. 1 B.T.U. = the mean quantity of heat required to raise 1 lb. of water 1° F. between 32° and 212°.

Measures for Comparing the Duty of Boilers. — The measure of the efficiency of a boiler is the number of pounds of water evaporated per pound of combustible (coal less moisture and ash), the evaporation being reduced to the standard of "from and at 212°."

The measure of the capacity of a boiler is the amount of "boiler horse-power" developed, a horse-power being defined as the evaporation of 34½ lbs. per hour from and at 212°.

The measure of relative rapidity of steaming of boilers is the number of pounds of water evaporated from and at 212° per hour per square foot of water-heating surface.

The measure of relative rapidity of combustion of fuel in boiler-furnaces is the number of pounds of coal burned per hour per square foot of grate-surface.

STEAM-BOILER PROPORTIONS.

Proportions of Grate and Heating Surface required for a given Horse-power. — The term horse-power here means capacity to evaporate 34.5 lbs. of water from and at 212° F.

Average proportions for maximum economy for land boilers fired with good anthracite coal:

Heating surface per horse-power.....	11.5 sq. ft.
Grate surface per horse-power.....	1/3 "
Ratio of heating to grate surface.....	34.5 "
Water evap'd from and at 212° per sq. ft. H.S. per hr.	3 lbs.
Combustible burned per H.P. per hour.....	3 "
Coal with 1/8 refuse, lbs. per H.P. per hour.....	3.6 "
Combustible burned per sq. ft. grate per hour.....	9 "
Coal with 1/8 refuse, lbs. per sq. ft. grate per hour.....	10.8 "
Water evap'd from and at 212° per lb. combustible....	11.5 "
Water evap'd from and at 212° per lb. coal (1/8 refuse)	9.6 "

Heating-surface. — For maximum economy with any kind of fuel a boiler should be proportioned so that at least one square foot of heating-surface should be given for every 3 lbs. of water to be evaporated from and at 212° F. per hour. Still more liberal proportions are required if a portion of the heating-surface has its efficiency reduced by: 1. Tendency of the heated gases to short-circuit, that is, to select passages of least resistance and flow through them with high velocity, to the neglect of other passages. 2. Deposition of soot from smoky fuel. 3. Incrustation. If the heating-surfaces are clean, and the heated gases pass over it uniformly, little if any increase in economy can be obtained by increasing the heating-surface beyond the proportion of 1 sq. ft. to every 3 lbs. of water to be evaporated, and with all conditions favorable but little decrease of economy will take place if the proportion is 1 sq. ft. to every 4 lbs. evaporated; but in order to provide for driving of the boiler beyond its rated capacity, and for possible decrease of efficiency due to the causes above named, it is better to adopt 1 sq. ft. to 3 lbs. evaporation per hour as the minimum standard proportion.

Where economy may be sacrificed to capacity, as where fuel is very cheap, it is customary to proportion the heating-surface much less liberally. The following table shows approximately the relative results that may be expected with different rates of evaporation, with anthracite coal.

Lbs. water evapor'd from and at 212° persq. ft. heating-surface per hour:	2	2.5	3	3.5	4	5	6	7	8	9	10
Sq. ft. heating-surface required per horse-power:	17.3	13.8	11.5	9.8	8.6	6.8	5.8	4.9	4.3	3.8	3.5
Ratio of heating to grate surface if 1/3 sq. ft. of G.S. is required per H.P.:	52	41.4	34.5	29.4	25.8	20.4	17.4	13.7	12.9	11.4	10.5
Probable relative economy:	100	100	100	95	90	85	80	75	70	65	60
Probable temperature of chimney gases, degrees F.:	450	450	450	518	585	652	720	787	855	922	990

The relative economy will vary not only with the amount of heating-surface per horse-power, but with the efficiency of that heating-surface as regards its capacity for transfer of heat from the heated gases to the water, which will depend on its freedom from soot and incrustation, and upon the circulation of the water and the heated gases.

With bituminous coal the efficiency will largely depend upon the thoroughness with which the combustion is effected in the furnace.

The efficiency with any kind of fuel will greatly depend upon the amount of air supplied to the furnace in excess of that required to support combustion. With strong draught and thin fires this excess may be very great, causing a serious loss of economy. This subject is further discussed below.

Measurement of Heating-surface. — The usual rule is to consider as heating-surface all the surfaces that are surrounded by water on one side and by flame or heated gases on the other, using the external instead of the internal diameter of tubes, for greater convenience in calculation, the external diameter of boiler-tubes usually being made in even inches or half inches. This method, however, is inaccurate, for the true heating-surface of a tube is the side exposed to the hot gases, the inner surface in a fire-tube boiler and the outer surface in a water-tube boiler. The resistance to the passage of heat from the hot gases on one side of a tube or plate to the water on the other consists almost entirely of the resistance to the passage of the heat from the gases into the metal, the resistance of the metal itself and that of the wetted surface being practically nothing. See paper by C. W. Baker, *Trans. A. S. M. E.*, vol. xix.

RULE for finding the heating-surface of vertical tubular boilers: Multiply the circumference of the fire-box (in inches) by its height above the grate; multiply the combined circumference of all the tubes by their length, and to these two products add the area of the lower tube-sheet; from this sum subtract the area of all the tubes, and divide by 144: the quotient is the number of square feet of heating-surface.

RULE for finding the heating-surface of horizontal tubular boilers: Take the dimensions in inches. Multiply two-thirds of the circumference of the shell by its length; multiply the sum of the circumferences of all the tubes

by their common length; to the sum of these products add two thirds of the area of both tube-sheets; from this sum subtract twice the combined area of all the tubes; divide the remainder by 144 to obtain the result in square feet.

RULE for finding the square feet of heating-surface in tubes: Multiply the number of tubes by the diameter of a tube in inches, by its length in feet, and by 0.5.

Horse-power, Builder's Rating. Heating-surface per Horse-power. — It is a general practice among builders to furnish about 10 square feet of heating-surface per horse-power, but as the practice is not uniform, bids and contracts should always specify the amount of heating-surface to be furnished. Not less than one-third square foot of grate-surface should be furnished per horse-power with ordinary chimney draught, not exceeding 0.3 in. of water column at the damper, for anthracite coal, and for poor varieties of soft coal high in ash, with ordinary furnaces. A smaller ratio of grate surface may be allowed for high grade soft coal and for forced draught.

Horse-power of Marine and Locomotive Boilers. — The term horse-power is not generally used in connection with boilers in marine practice, or with locomotives. The boilers are designed to suit the engines, and are rated by extent of grate and heating-surface only.

Grate-surface. — The amount of grate-surface required per horse-power, and the proper ratio of heating-surface to grate-surface are extremely variable, depending chiefly upon the character of the coal and upon the rate of draught. With good coal, low in ash, approximately equal results may be obtained with large grate-surface and light draught and with small grate-surface and strong draught, the total amount of coal burned per hour being the same in both cases. With good bituminous coal, like Pittsburgh, low in ash, the best results apparently are obtained with strong draught and high rates of combustion, provided the grate-surfaces are cut down so that the total coal burned per hour is not too great for the capacity of the heating-surface to absorb the heat produced.

With coals high in ash, especially if the ash is easily fusible, tending to choke the grates, large grate-surface and a slow rate of combustion are required, unless means, such as shaking grates, are provided to get rid of the ash as fast as it is made.

The amount of grate-surface required per horse-power under various conditions may be estimated from the following table:

	Lbs. Water from and at 212° per lb. Coal.	Lbs. Coal per H.P. per hour.	Pounds of Coal burned per square foot of Grate per hour.									
			8	10	12	15	20	25	30	35	40	
			Sq. Ft. Grate per H.P.									
Good coal and boiler,	10	3.45	.43	.35	.28	.23	.17	.14	.11	.10	.09	
	9	3.83	.48	.38	.32	.25	.19	.15	.13	.11	.10	
Fair coal or boiler,	8.61	4.	.50	.40	.33	.26	.20	.16	.13	.12	.10	
	8	4.31	.54	.43	.36	.29	.22	.17	.14	.13	.11	
Poor coal or boiler,	7	4.93	.62	.49	.41	.33	.24	.20	.17	.14	.12	
	6.9	5.	.63	.50	.42	.34	.25	.20	.17	.15	.13	
Lignite and poor boiler,	6	5.75	.72	.58	.48	.38	.29	.23	.19	.17	.14	
	5	6.9	.86	.69	.58	.46	.35	.28	.23	.22	.17	
	3.45	10.	1.25	1.00	.83	.67	.50	.40	.33	.29	.25	

In designing a boiler for a given set of conditions, the grate-surface should be made as liberal as possible, say sufficient for a rate of combustion of 10 lbs. per square foot of grate for anthracite, and 15 lbs. per square foot for bituminous coal, and in practice a portion of the grate-surface may be bricked over if it is found that the draught, fuel, or other conditions render it advisable.

Proportions of Areas of Flues and other Gas-passages. — Rules are usually given making the area of gas-passages bear a certain ratio to the area of the grate-surface; thus a common rule for horizontal tubular boilers is to make the area over the bridge wall $\frac{1}{7}$ of the grate-surface, the flue area $\frac{1}{8}$, and the chimney area $\frac{1}{9}$.

For average conditions with anthracite coal and moderate draught, say a rate of combustion of 12 lbs. coal per square foot of grate per hour, and a ratio of heating to grate surface of 30 to 1, this rule is as good as any, but it is evident that if the draught were increased so as to cause a rate of combustion of 24 lbs., requiring the grate-surface to be cut down to a ratio of 60 to 1, the areas of gas-passages should not be reduced in proportion. The amount of coal burned per hour being the same under the changed conditions, and there being no reason why the gases should travel at a higher velocity, the actual areas of the passages should remain as before, but the ratio of the area to the grate-surface would in that case be doubled.

Mr. Barrus states that the highest efficiency with anthracite coal is obtained when the tube area is $\frac{1}{9}$ to $\frac{1}{10}$ of the grate-surface, and with bituminous coal when it is $\frac{1}{6}$ to $\frac{1}{7}$, for the conditions of medium rates of combustion, such as 10 to 12 lbs. per square foot of grate per hour, and 12 square feet of heating-surface allowed to the horse-power.

The tube area should be made large enough not to choke the draught and so lessen the capacity of the boiler; if made too large the gases are apt to select the passages of least resistance and escape from them at a high velocity and high temperature.

This condition is very commonly found in horizontal tubular boilers where the gases go chiefly through the upper rows of tubes; sometimes also in vertical tubular boilers, where the gases are apt to pass most rapidly through the tubes nearest to the center. It may to some extent be remedied by placing retarders in those tubes in which the gases travel the quickest.

Air-passages through Grate-bars. — The usual practice is, air-opening = 30% to 50% of area of the grate; the larger the better, to avoid stoppage of the air-supply by clinker; but with coal free from clinker much smaller air-space may be used without detriment. See paper by F. A. Scheffler, *Trans. A. S. M. E.*, vol. xv, p. 503.

PERFORMANCE OF BOILERS.

The performance of a steam-boiler comprises both its capacity for generating steam and its economy of fuel. Capacity depends upon size, both of grate-surface and of heating-surface, upon the kind of coal burned, upon the draught, and also upon the economy. Economy of fuel depends upon the completeness with which the coal is burned in the furnace, on the proper regulation of the air-supply to the amount of coal burned, and upon the thoroughness with which the boiler absorbs the heat generated in the furnace. The absorption of heat depends on the extent of heating-surface in relation to the amount of coal burned or of water evaporated, upon the arrangement of the gas-passages, and upon the cleanness of the surfaces. The capacity of a boiler may increase with increase of economy when this is due to more thorough combustion of the coal or to better regulation of the air-supply, or it may increase at the expense of economy when the increased capacity is due to overdriving, causing an increased loss of heat in the chimney gases. The relation of capacity to economy is therefore a complex one, depending on many variable conditions.

A formula expressing the relation between capacity, rate of driving, or evaporation per square foot of heating-surface, to the economy, or evaporation per pound of combustible is given on page 865.

Selecting the highest results obtained at different rates of driving with anthracite coal in the Centennial tests (see p. 867), and the highest results with anthracite reported by Mr. Barrus in his book on Boiler Tests, the author has plotted two curves showing the maximum results which may be expected with anthracite coal, the first under exceptional conditions such as obtained in the Centennial tests, and the second under the best conditions of ordinary practice. (*Trans. A. S. M. E.*, xviii, 354.) From these curves the following figures are obtained.

Lbs. water evaporated from and at 212° per sq. ft. heating-surface per hour:

1.6	1.7	2	2.6	3	3.5	4	4.5	5	6	7	8
-----	-----	---	-----	---	-----	---	-----	---	---	---	---

Lbs. water evaporated from and at 212° per lb. combustible:

Centennial.	11.8	11.9	12.0	12.1	12.05	12	11.85	11.7	11.5	10.85	9.8	8.5
Barrus. . . .	11.4	11.5	11.55	11.6	11.6	11.5	11.2	10.9	10.6	9.9	9.2	8.5
Avg. Cent'l	12.0	11.6	11.2	10.8	10.4	10.0	9.6	8.8	8.0	7.2

The figures in the last line are taken from a straight line drawn as nearly as possible through the average of the plotting of all the Centennial tests. The poorest results are far below these figures. It is evident that no formula can be constructed that will express the relation of economy to rate of driving as well as do the three lines of figures given above.

For semi-bituminous and bituminous coals the relation of economy to the rate of driving no doubt follows the same general law that it does with anthracite, i.e., that beyond a rate of evaporation of 3 or 4 lbs. per sq. ft. of heating-surface per hour there is a decrease of economy, but the figures obtained in different tests will show a wider range between maximum and average results on account of the fact that it is more difficult with bituminous than with anthracite coal to secure complete combustion in the furnace.

The amount of the decrease in economy due to driving at rates exceeding 4 lbs. of water evaporated per square foot of heating-surface per hour differs greatly with different boilers, and with the same boiler it may differ with different settings and with different coal. The arrangement and size of the gas-passages seem to have an important effect upon the relation of economy to rate of driving.

A comparison of results obtained from different types of boilers leads to the general conclusion that the economy with which different types of boilers operate depends much more upon their proportions and the conditions under which they work, than upon their type; and, moreover, that when the proportions are correct, and when the conditions are favorable, the various types of boilers give substantially the same economic result.

Conditions of Fuel Economy in Steam-boilers. — 1. That the boiler has sufficient heating surface to absorb from 75 to 80% of all the heat generated by the fuel. 2. That this surface is so placed, and the gas passages so controlled by baffles, that the hot gases are forced to pass uniformly over the surface, not being short-circuited. 3. That the furnace is of such a kind, and operated in such a manner, that the fuel is completely burned in it, and that no unburned gases reach the heating surface of the boiler. 4. That the fuel is burned with the minimum supply of air required to insure complete combustion, thereby avoiding the carrying of an excessive quantity of heated air out of the chimney.

There are two indices of high economy. 1. High temperature, approaching 3000° F. in the furnace, combined with low temperature, below 600° F., in the flue. 2. Analysis of the flue gases showing between 5 and 8% of free oxygen. Unfortunately neither of these indices is available to the ordinary fireman; he cannot distinguish by the eye any temperature above 2000°, and he cannot know whether or not an excessive amount of oxygen is passing through the fuel. The ordinary haphazard way of firing therefore gives an average of about 10% lower economy than can be obtained when the firing is controlled, as it is in many large plants, by recording furnace pyrometers, or by continuous gas analysis, or by both. Low CO₂ in the flue gases may indicate either excessive air supply in the furnace, or leaks of air into the setting, or deficient air supply with the presence of CO, and therefore imperfect combustion. The latter, if excessive, is indicated by low furnace temperature. The analysis for CO₂ should be made both of the gas sampled just beyond the furnace and of the gas sampled at the flue. Diminished CO₂ in the latter indicates air-leakage.

Less than 5% of free oxygen in the gases is usually accompanied with CO, and it therefore indicates imperfect combustion from deficient air supply. More than 8% means excessive air supply and corresponding waste of heat.

Air Leakage or infiltration of air through the firebrick setting is a common cause of poor economy. It may be detected by analysis as above

stated, and should be prevented by stopping all visible cracks in the brick-work, and by covering it with a coating impervious to air.

Autographic CO₂ Recorders are used in many large boiler plants for the continuous recording of the percentage of carbon dioxide in the gases. When the percentage of CO₂ is between 12 and 16, it indicates good furnace conditions, when below 12 the reverse.

Efficiency of a Steam-boiler. — The efficiency of a boiler is the percentage of the total heat generated by the combustion of the fuel which is utilized in heating the water and in raising steam. With anthracite coal the heating-value of the combustible portion is very nearly 14,800 B.T.U. per lb., equal to an evaporation from and at 212° of 14,800 ÷ 970 = 15.26 lbs. of water. A boiler which when tested with anthracite coal shows an evaporation of 12 lbs. of water per lb. of combustible, has an efficiency of 12 ÷ 15.26 = 78.6%, a figure which is approximated, but scarcely ever quite reached, in the best practice. With bituminous coal it is necessary to have a determination of its heating-power made by a coal calorimeter before the efficiency of the boiler using it can be determined, but a close estimate may be made from the chemical analysis of the coal. (See Coal.)

The difference between the efficiency obtained by test and 100% is the sum of the numerous wastes of heat, the chief of which is the necessary loss due to the temperature of the chimney-gases. If we have an analysis and a calorimetric determination of the heating-power of the coal (properly sampled), and an average analysis of the chimney-gases, the amounts of the several losses may be determined with approximate accuracy by the method described below.

Data given:

1. ANALYSIS OF THE COAL. Cumberland Semi-bituminous.		2. ANALYSIS OF THE DRY CHIMNEY-GASES, BY WEIGHT.				
Carbon	80.55		C.	O.	N.	
Hydrogen	4.50	CO ₂ = 13.6 =	3.71	9.89	
Oxygen	2.70	CO = 0.2 =	0.09	0.11	
Nitrogen	1.08	O = 11.2 =	11.20	
Moisture	2.92	N = 75.0 =	75.00	
Ash	8.25					
	100.00		100.0	3.80	21.20	75.00

Heating-value of the coal by Dulong's formula, 14,243 heat-units.

The gases being collected over water, the moisture in them is not determined.

3. Ash and refuse as determined by boiler-test, 10.25, or 2% more than that found by analysis, the difference representing carbon in the ashes obtained in the boiler-test.

4. Temperature of external atmosphere, 60° F.

5. Relative humidity of air, 60%, corresponding (see air tables) to 0.007 lb. of vapor in each lb. of air.

6. Temperature of chimney-gases, 560° F.

Calculated results:

The carbon in the chimney-gases being 3.8% of their weight, the total weight of dry gases per lb. of carbon burned is 100 ÷ 3.8 = 26.32 lbs. Since the carbon burned is 80.55 ÷ 100 = 78.55% of the weight of the coal, the weight of the dry gases per lb. of coal is 26.32 × 78.55 ÷ 100 = 20.67 lbs.

Each pound of coal furnishes to the dry chimney-gases 0.7855 lb. C, 0.0108 N, and $(2.70 - \frac{4.50}{8}) \div 100 = 0.0214$ lb. O; a total of 0.8177, say 0.82 lb. This subtracted from 20.67 lbs. leaves 19.85 lbs. as the quantity of dry air (not including moisture) which enters the furnace per pound of coal, not counting the air required to burn the available hydrogen, that is, the hydrogen minus one-eighth of the oxygen chemically combined in the coal. Each lb. of coal burned contained 0.045 lb. H, which requires 0.045 × 8 = 0.36 lb. O for its combustion. Of this, 0.027 lb. is furnished by the coal itself, leaving 0.333 lb. to come from the air. The quantity of air needed to supply this oxygen (air containing 23% by weight of oxygen) is 0.333 ÷ 0.23 = 1.45 lb., which added to the 19.85 lbs. already

found gives 21.30 lbs. as the quantity of dry air supplied to the furnace per lb. of coal burned.

The air carried in as vapor is 0.0071 lb. for each lb. of dry air, or 21.3 × 0.0071 = 0.15 lb. for each lb. of coal. Each lb. of coal contained 6.020 lb. of moisture, which was evaporated and carried into the chimney-gases. The 0.045 lb. of H per lb. of coal when burned formed 0.045 × 9 = 0.405 lb. of H₂O.

From the analysis of the chimney-gas it appears that 0.09 ÷ 3.80 = 2.37% of the carbon in the coal was burned to CO instead of to CO₂.

We now have the data for calculating the various losses of heat, as follows, for each pound of coal burned:

	Heat-units.	Per cent of Heat-value of the Coal.
20.67 lbs. dry gas × (560° - 60°) × sp. heat 0.24 =	2480.4	17.41
0.15 lb. vapor in air × (560° - 60°) × sp. ht. 0.48 =	36.0	0.25
0.029 lb. moist. in coal heated from 60° to 212° =	4.4	0.03
0.029 lb. evap. from and at 212°: 0.029 × 966 =	28.0	0.20
0.029 lb. steam (heated 212° to 560°) × 348 × 0.48 =	4.8	0.03
0.405 lb. H ₂ O from H in coal × (152 + 966 + 348 × 0.48) =	520.4	3.65
0.0237 lb. C burned to CO; loss by incomplete combustion, 0.0237 × (14544 - 4451) =	239.2	1.68
0.02 lb. coal lost in ashes; 0.02 × 14544 =	290.9	2.04
Radiation and unaccounted for, by difference =	624.0	4.38
	4228.1	29.69
Utilized in making steam, equivalent evaporation 10.37 lbs. from and at 212° per lb. of coal =	10,014.9	70.31
	14,243.0	100.00

The heat lost by radiation from the boiler and furnace is not easily determined directly, especially if the boiler is enclosed in brickwork, or is protected by non-conducting covering. It is customary to estimate the heat lost by radiation by difference, that is, to charge radiation with all the heat lost which is not otherwise accounted for.

One method of determining the loss by radiation is to block off a portion of the grate-surface and build a small fire on the remainder, and drive this fire with just enough draught to keep up the steam-pressure and supply the heat lost by radiation without allowing any steam to be discharged, weighing the coal consumed for this purpose during a test of several hours' duration.

Estimates of radiation by difference are apt to be greatly in error, as in this difference are accumulated all the errors of the analyses of the coal and of the gases. An average value of the heat lost by radiation from a boiler set in brickwork is about 4 per cent. When several boilers are in a battery and enclosed in a boiler-house the loss by radiation may be very much less, since much of the heat radiated from the boiler is returned to it in the air supplied to the furnace, which is taken from the boiler-room.

An important source of error in making a "heat balance" such as the one above given, especially when highly bituminous coal is used, may be due to the non-combustion of part of the hydrocarbon gases distilled from the coal immediately after firing, when the temperature of the furnace may be reduced below the point of ignition of the gases. Each pound of hydrogen which escapes burning is equivalent to a loss of heat in the furnace of 62,000 heat-units. Another source of error, especially with bituminous slack coal high in moisture, is due to the formation of water-gas, CO + H, by the decomposition of the water, and the consequent absorption of heat, this water-gas escaping unburned on account of the choking of the air supply when fine fresh coal is supplied to the fire.

In analyzing the chimney-gases by the usual method the percentages of the constituent gases are obtained by volume instead of by weight. To reduce percentages by volume to percentages by weight, multiply the percentage by volume of each gas by its specific gravity as compared with air, and divide each product by the sum of the products.

Instead of using the percentages by weight of the gases, the percentage

by volume may be used directly to find the weight of gas per pound of carbon by the formula given below.

If O, CO, CO₂, and N represent the percentages by volume of oxygen, carbonic oxide, carbonic acid, and nitrogen, respectively, in the gases of combustion:

$$\left. \begin{array}{l} \text{Lbs. of air required to burn} \\ \text{one pound of carbon} \end{array} \right\} = \frac{3.032 N}{\text{CO}_2 + \text{CO}}$$

$$\text{Ratio of total air to the theoretical requirement} = \frac{N}{N - 3.782 O}$$

$$\left. \begin{array}{l} \text{Lbs. of air per pound} \\ \text{of coal} \end{array} \right\} = \left\{ \begin{array}{l} \text{Lbs. of air per pound} \\ \text{of carbon} \end{array} \right\} \times \left\{ \begin{array}{l} \text{Per cent of carbon} \\ \text{in coal} \end{array} \right\}$$

$$\text{Lbs. dry gas produced per pound of carbon} = \frac{11 \text{CO}_2 + 8 \text{O} + 7(\text{CO} + \text{N})}{3(\text{CO}_2 + \text{CO})}$$

Relation of Boiler Efficiency to the Rate of Driving, Air Supply, etc. — In the author's Steam Boiler Economy (p. 205) a formula is developed showing the efficiency that may be expected, when the combustion of the coal is complete, under different conditions. The formula is

$$\frac{E_a}{E_p} = \frac{K - tcf}{K(1 + RS/W)} - \frac{970}{K} \frac{ac^2f^2}{(K - tcf)} \frac{W}{S}$$

K = heating value per lb. of combustible; E_a = actual evaporation from and at 212° per lb. of combustible; E_p = possible evaporation = K + 970; t = elevation of the temperature of the water in the boiler above the atmospheric temperature; c = specific heat of the chimney gases, taken at 0.24; f = weight of flue gases per lb. of combustible; S = square feet of heating surface; W = pounds of water evaporated per hour; W/S = rate of driving; R = radiation loss, in units of evaporation per sq. ft. of heating-surface per hour; a is a coefficient found by experiment; it may be called a coefficient of inefficiency of the boiler, and it depends on and increases with the resistance to the passage of heat through the metal, soot or scale on the metal, imperfect combustion, short-circuiting, air leakage, or any other defective condition, not expressed in terms in the formula, which may tend to lower the efficiency. Its value is between 200 and 400 when records of tests show high efficiency, and above 400 for lower efficiencies.

The coefficient a is a criterion of performance of a boiler when all the other terms of the formula are known as the results of a test. By transposition its value is

$$a = \left[\frac{K - tcf}{970(1 + RS/W)} - E_p \right] + \frac{c^2f^2}{(K - tcf)} \frac{W}{S}$$

On the diagram below (Fig. 148), with abscissas representing rates of driving and ordinates representing efficiencies are plotted curves showing the relation of the efficiency to rate of driving for values of a = 100 to 400 and values of f from 20 to 35, together with a broken line showing the maximum efficiencies obtained by six boilers at the Centennial Exhibition, and other lines showing the poorer results obtained from five other boilers. The curves are also based on the following values, K = 14,800; c = 0.24; t = 300 (except one curve, t = 250); R = 0.1.

An inspection of the curves shows the following. 1. The maximum Centennial results all lie below the curve f = 20, a = 200, by 2 to 4%, but they follow the general direction of the curve. This curve may therefore be taken as representing the maximum possible boiler performance with anthracite coal, as the results obtained in 1876 have never been exceeded with anthracite.

2. With f = 20 and a = 200 the efficiency for maximum performance, according to the curve, is a little less than 82% at 2 lbs. evaporation per sq. ft. of heating-surface per hour, but it decreases very slowly at higher rates, so that it is 80% at 3 1/2 lbs., and 76% at 5 3/4 lbs.

With a = 200 and f greater than 30, the efficiency has a lower maximum, reaches the maximum at a lower rate of driving, and falls off rapidly as the rate increases, the more rapidly the higher the value of f. Excessive air supply is thus shown to be a most potent cause of low economy.

3. An increase in the value of a from 200 to 400 with f = 20 is much less detrimental to efficiency than an increase in f from 20 to 30.

In the diagram, Fig. 152, are plotted, together with the curve for f = 20, a = 200, t = 300, and K = 15,750, marked R = 0.1, a straight line, R = 0, showing the theoretical maximum efficiency when there is no loss by

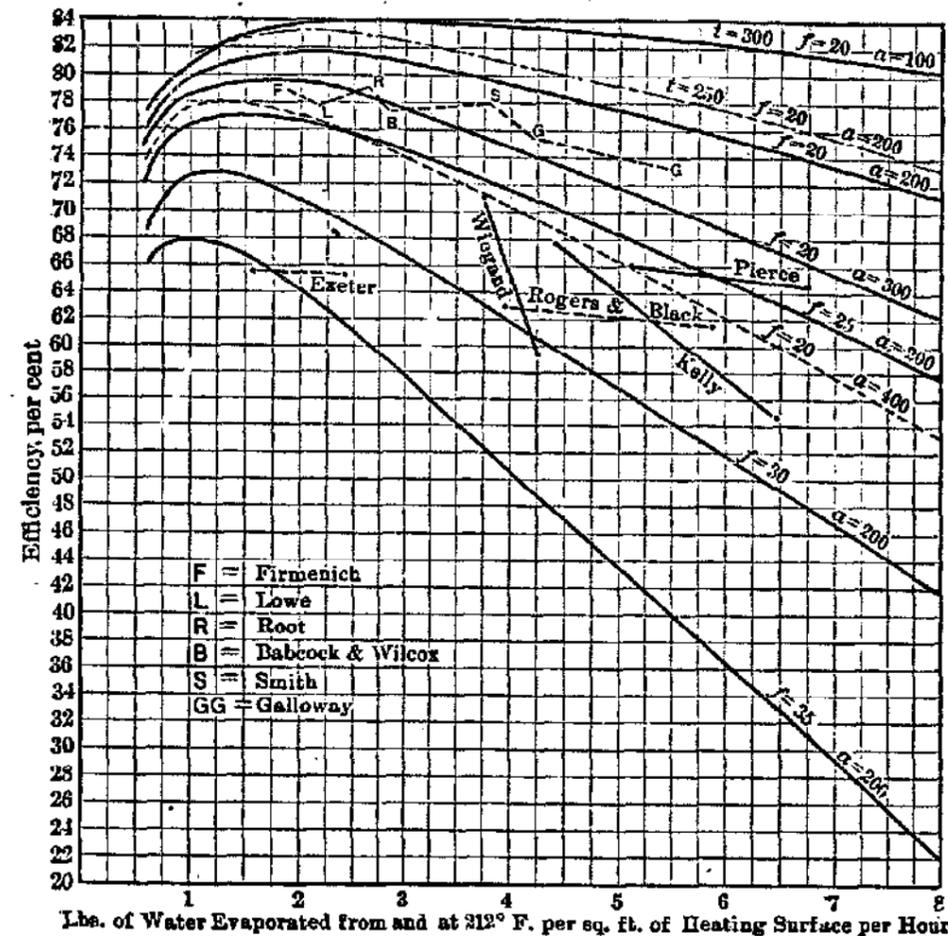

FIG. 151.

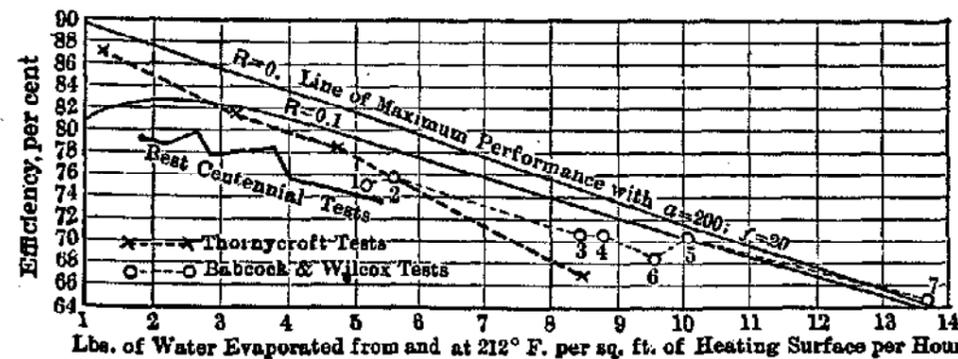

FIG. 152.

radiation, and the plottings of the results of two series of tests, one of a Thornycroft boiler, with W/S from 1.24 to 8.5, and the other of a Babcock & Wilcox marine boiler with W/S from 5.18 to 13.67, together with the

maximum Centennial tests. The calculated value of a in all these tests except one ranged from 191 to 454, the highest values being those showing the largest departure from the curve $R = 0.1$. The one exception is the Thornycroft test showing over 86% efficiency; this gives a value of $a = 57$, which indicates an error in the test, as such a low value is far below the lowest recorded in any other test.

TESTS OF STEAM-BOILERS.

Boiler-tests at the Centennial Exhibition, Philadelphia, 1876. — (See Reports and Awards Group XX, International Exhibition, Phila., 1876; also, Clark on the Steam-engine, vol. i, page 253.)

Competitive tests were made of fourteen boilers, using good anthracite coal, one boiler, the Galloway, being tested with both anthracite and semi-bituminous coal. Two tests were made with each boiler: one called the capacity trial, to determine the economy and capacity at a rapid rate of driving; and the other called the economy trial, to determine the economy when driven at a rate supposed to be near that of maximum economy and rated capacity. The following table gives the principal results obtained in the economy trial, together with the capacity and economy figures of the capacity trial for comparison.

Name of Boiler.	Economy Tests.								Capacity Tests.		
	Ratio Water-heating Surface to Grate-surface.	Coal burned per sq. ft. Grate per hour.	Per cent Ash and Refuse.	Water evap. from 100° to 70 lbs. p. s. ft. H.S. per hr.	Water evap. from and at 212° p. lb. combustible cor. for Quality of Steam.	Temperature in Uptake.	Moisture in Steam.	Superheating of Steam.	Horse-power.	Horse-power.	Water evap. from and at 212° per lb. Combustible.
	lbs.	%	lbs.	lbs.	deg	%	deg	H.P.	H.P.	lbs.	
Root.....	34.6	9.1	10.4	2.25	12.094	393	41.4	119.8	148.6	10.441	
Firmenich.....	64.3	12.0	10.4	1.68	11.988	415	32.6	57.8	68.4	11.064	
Low.....	30.6	6.8	11.3	1.87	11.923	333	9.4	47.0	69.3	11.163	
Smith.....	45.8	12.1	11.1	2.42	11.906	411	1.3	99.8	125.0	11.925	
Babcock & Wilcox.....	37.7	10.0	11.0	2.43	11.822	296	2.7	135.6	186.6	10.330	
Galloway.....	23.7	9.6	11.1	3.63	11.583	303	1.4	103.3	133.8	11.216	
Do. semi-bit. coal.....	23.7	7.9	8.8	3.20	12.125	325	0.3	50.9	125.1	11.609	
Andrews.....	15.6	8.0	10.3	2.32	11.039	420	71.7	42.6	58.7	9.745	
Harrison.....	27.3	12.4	8.5	2.75	10.930	517	0.9	82.4	108.4	9.889	
Wiegand.....	30.7	12.3	9.5	3.30	10.834	524	20.5	147.5	162.8	9.145	
Anderson.....	17.5	9.7	9.3	2.64	10.618	417	15.7	98.0	132.8	9.568	
Kelly.....	20.9	10.8	9.0	3.82	10.312	5.6	81.0	99.9	8.397	
Exeter.....	33.5	9.3	11.4	1.38	10.041	430	4.2	72.1	108.0	9.974	
Pierce.....	14.0	8.0	11.0	4.44	10.021	374	5.2	51.7	67.8	9.865	
Rogers & Black.....	19.0	8.6	9.9	3.43	9.613	572	2.1	45.7	67.2	9.429	
Averages.....	2.77	11.123	85.0	110.8	10.251	

The comparison of the economy and capacity trials shows that an average increase in capacity of 30 per cent was attended by a decrease in economy of 8 per cent, but the relation of economy to rate of driving varied greatly in the different boilers. In the Kelly boiler an increase in capacity of 22 per cent was attended by a decrease in economy of over 18 per cent, while the Smith boiler with an increase of 25 per cent in capacity showed a slight increase in economy.

One of the most important lessons gained from the above tests is that there is no necessary relation between the type of a boiler and economy.

Of the five boilers that gave the best results, the total range of variation between the highest and lowest of the five being only 2.3%, three were water-tube boilers, one was a horizontal tubular boiler, and the fifth was a combination of the two types. The next boiler on the list, the Galloway, was an internally fired boiler, all of the others being externally fired.

Some High Rates of Evaporation. — Eng'g, May 9, 1884, p. 415.

	Locomotive.	Torpedo-boat.
Water evap. per sq. ft. H.S. per hour.....	12.57	13.73
Water evap. per lb. fuel from and at 212°.....	8.22	8.94
Thermal units transf'd per sq. ft. of H.S.....	12,142	13,263
Efficiency.....	0.586	0.637

It is doubtful if these figures were corrected for priming.

Economy Effected by Heating the Air Supplied to Boiler-furnaces.

— An extensive series of experiments was made by J. C. Hoadley (*Trans. A. S. M. E.*, vi, 676) on a "Warm-blast Apparatus," for utilizing the heat of the waste gases in heating the air supplied to the furnace. The apparatus, as applied to an ordinary horizontal tubular boiler 60 in. diameter, 21 ft. long, with 65 3 1/2-in. tubes, consisted of 240 2-in. tubes, 18 ft. long, through which the hot gases passed while the air circulated around them. The net saving of fuel effected by the warm blast was from 10.7% to 15.5% of the fuel used with cold blast. The comparative temperatures averaged as follows, in degrees F.:

	Cold-blast Boiler.	Warm-blast Boiler.	Difference.
In heat of fire.....	2493	2793	300
At bridge wall.....	1340	1600	260
In smoke box.....	373	375	2
Air admitted to furnace.....	32	332	300
Steam and water in boiler.....	300	300	0
Gases escaping to chimney.....	373	162	211
External air.....	32	32	0

With anthracite coal the evaporation from and at 212° per lb. combustible was, for the cold-blast boiler, days 10.85 lbs., days and nights 10.51; and for the warm-blast boiler, days 11.83, days and nights 11.03.

Maximum Boiler Efficiency with Cumberland Coal. — About 12.5 lbs. of water per lb. combustible from and at 212° is about the highest evaporation that can be obtained from the best steam fuels in the United States, such as Cumberland, Pocahontas, and Clearfield. In exceptional cases 13 lbs. has been reached, and one test is on record (F. W. Dean, *Eng'g News*, Feb. 1, 1894) giving 13.23 lbs. The boiler was internally fired, of the Belpaire type, 82 inches diameter, 31 feet long, with 160 3-inch tubes 12 1/2 feet long. Heating-surface, 1998 square feet; grate-surface, 45 square feet, reduced during the test to 30 1/2 square feet. Double furnace, with fire-brick arches and a long combustion-chamber. Feed-water heater in smoke-box. The following are the principal results:

	1st Test.	2d Test.
Dry coal burned per sq. ft. of grate per hour, lbs.....	8.85	16.06
Water evap. per sq. ft. of heating-surface per hour, lbs.....	1.63	3.00
Water evap. from and at 212° per lb. combustible, including feed-water heater.....	13.17	13.23
Water evaporated, excluding feed-water heater.....	12.88	12.90
Temperature of gases after leaving heater, F.....	360°	469°

BOILERS USING WASTE GASES.

Water-tube Boilers using Blast-furnace Gases. — D. S. Jacobus (*Trans. A. I. M. E.*, xvii, 50) reports a test of a water-tube boiler using blast-furnace gas as fuel. The heating-surface was 2535 sq. ft. It developed 328 H.P., or 5.01 lbs. of water from and at 212° per sq. ft. of heating-surface per hour. Some of the principal data obtained were as follows: Calorific value of 1 lb. of the gas, 1413 B.T.U., including the effect

of its initial temperature, which was 650° F. Amount of air used to burn 1 lb. of the gas = 0.9 lb. Chimney draught, 1 1/3 in. of water. Area of gas inlet, 300 sq. in.; of air inlet, 100 sq. in. Temperature of the chimney gases, 775° F. Efficiency of the boiler calculated from the temperatures and analyses of the gases at exit and entrance, 61%. The average analyses were as follows, hydrocarbons being included in the nitrogen:

	By Weight.		By Volume.	
	At Entrance.	At Exit.	At Entrance.	At Exit.
CO ₂	10.69	26.37	7.08	18.64
O.....	.11	3.05	0.10	2.96
CO.....	26.71	1.78	27.80	1.98
Nitrogen.....	62.48	68.80	65.02	76.42
C in CO ₂	2.92	7.19
C in CO.....	11.45	0.76
Total C.....	14.37	7.95

Steam-boilers Fired with Waste Gases from Puddling and Heating-Furnaces. — The *Iron Age*, April 6, 1893, contains a report of a number of tests of steam-boilers utilizing the waste heat from puddling and heating-furnaces in rolling-mills. The following principal data are selected: in Nos. 1, 2, and 4 the boiler is a Babcock & Wilcox water-tube boiler, and in No. 3 it is a plain cylinder boiler, 42 in. diam. and 26 ft. long. No. 4 boiler was connected with a heating-furnace, the others with puddling furnaces.

	No. 1.	No. 2.	No. 3.	No. 4.
Heating-surface, sq. ft.	1026	1196	143	1380
Grate-surface, sq. ft.	19.9	13.6	13.6	16.7
Ratio H.S. to G.S.	52	87.2	10.5	82.8
Water evap. per hour, lbs.	3358	2159	1812	3055
Water evap. per sq. ft. H.S. per hr., lbs.	3.3	1.8	12.7	2.2
Water evap. per lb. coal from and at 212°	5.9	6.24	3.76	6.34
Water evap. per lb. comb. from and at 212°	7.20	4.31	8.34

In No. 2, 1.38 lbs. of iron were puddled per lb. of coal.

In No. 3, 1.14 lbs. of iron were puddled per lb. of coal.

No. 3 shows that an insufficient amount of heating-surface was provided for the amount of waste heat available.

RULES FOR CONDUCTING BOILER-TESTS.

Code of 1899.

(Reported by the Committee on Boiler Trials, Am. Soc. M. E.*)

I. *Determine at the outset* the specific object of the proposed trial, whether it be to ascertain the capacity of the boiler, its efficiency as a steam-generator, its efficiency and its defects under usual working conditions, the economy of some particular kind of fuel, or the effect of changes of design, proportion, or operation; and prepare for the trial accordingly.

II. *Examine the boiler*, both outside and inside; ascertain the dimensions of grates, heating surfaces, and all important parts; and make a full record, describing the same, and illustrating special features by sketches.

III. *Notice the general condition* of the boiler and its equipment, and record such facts in relation thereto as bear upon the objects in view.

* The code is here slightly abridged. The complete report of the Committee may be obtained in pamphlet form from the Secretary of the American Society of Mechanical Engineers, 29 West 39th St., New York.

If the object of the trial is to ascertain the maximum economy or capacity of the boiler as a steam-generator, the boiler and all its appurtenances should be put in first-class condition. Clean the heating surface inside and outside, remove clinkers from the grates and from the sides of the furnace. Remove all dust, soot, and ashes from the chambers, smoke-connections and flues. Close air-leaks in the masonry and poorly fitted cleaning-doors. See that the damper will open wide and close tight. Test for air-leaks by firing a few shovels of smoky fuel and immediately closing the damper, observing the escape of smoke through the crevices; or by passing the flame of a candle over cracks in the brickwork.

IV. *Determine the character of the coal* to be used. For tests of the efficiency or capacity of the boiler for comparison with other boilers the coal should, if possible, be of some kind which is commercially regarded as a standard. For New England and that portion of the country east of the Allegheny Mountains, good anthracite egg coal, containing not over 10 per cent of ash, and semi-bituminous Clearfield (Pa.), Cumberland (Md.), and Pocahontas (Va.) coals are thus regarded. West of the Allegheny Mountains, Pocahontas (Va.) and New River (W. Va.) semi-bituminous, and Youghiogheny or Pittsburg bituminous coals are recognized as standards.*

For tests made to determine the performance of a boiler with a particular kind of coal, such as may be specified in a contract for the sale of a boiler, the coal used should not be higher in ash and in moisture than that specified, since increase in ash and moisture above a stated amount is apt to cause a falling off of both capacity and economy in greater proportion than the proportion of such increase.

V. *Establish the correctness of all apparatus* used in the test for weighing and measuring. These are:

1. Scales for weighing coal, ashes, and water.
2. Tanks or water-meters for measuring water. Water-meters, as a rule, should only be used as a check on other measurements. For accurate work the water should be weighed or measured in a tank.
3. Thermometers and pyrometers for taking temperatures of air, steam, feed-water, waste gases, etc.
4. Pressure-gauges, draught-gauges, etc.

VI. *See that the boiler is thoroughly heated* before the trial to its usual working temperature. If the boiler is new and of a form provided with a brick setting, it should be in regular use at least a week before the trial, so as to dry and heat the walls. If it has been laid off and become cold, it should be worked before the trial until the walls are well heated.

VII. *The boiler and connections* should be proved to be free from leaks before beginning a test, and all water connections, including blow and extra feed-pipes, should be disconnected, stopped with blank flanges, or bled through special openings beyond the valves, except the particular pipe through which water is to be fed to the boiler during the trial. During the test the blow-off and feed pipes should remain exposed to view.

† If an injector is used, it should receive steam directly through a felted pipe from the boiler being tested.†

‡ If the water is metered after it passes the injector, its temperature should be taken at the point where it leaves the injector. If the quantity is determined before it goes to the injector, the temperature should be determined on the suction side of the injector, and if no change of

* These coals are selected because they are about the only coals which possess the essentials of excellence of quality, adaptability to various kinds of furnaces, grates, boilers, and methods of firing, and wide distribution and general accessibility in the markets.

† In feeding a boiler undergoing test with an injector taking steam from another boiler, or from the main steam-pipe from several boilers, the evaporative results may be modified by a difference in the quality of the steam from such source compared with that supplied by the boiler being tested, and in some cases the connection to the injector may act as a drip for the main steam-pipe. If it is known that the steam from the main pipe is of the same pressure and quality as that furnished by the boiler undergoing the test, the steam may be taken from such main pipe.

temperature occurs other than that due to the injector, the temperature thus determined is properly that of the feed-water. When the temperature changes between the injector and the boiler, as by the use of a heater or by radiation, the temperature at which the water enters and leaves the injector and that at which it enters the boiler should all be taken. In that case the weight to be used is that of the water leaving the injector, computed from the heat units if not directly measured; and the temperature, that of the water entering the boiler.

Let w = weight of water entering the injector;
 x = weight of steam entering the injector;
 h_1 = heat-units per pound of water entering injector;
 h_2 = heat-units per pound of steam entering injector;
 h_3 = heat-units per pound of water leaving injector.

Then $w + x$ = weight of water leaving injector;

$$x = w \frac{h_2 - h_1}{h_2 - h_3}.$$

See that the steam-main is so arranged that water of condensation cannot run back into the boiler.

VIII. *Duration of the Test.* — For tests made to ascertain either the maximum economy or the maximum capacity of a boiler, irrespective of the particular class of service for which it is regularly used, the duration should be at least ten hours of continuous running. If the rate of combustion exceeds 25 pounds of coal per square foot of grate-surface per hour, it may be stopped when a total of 250 pounds of coal has been burned per square foot of grate.

IX. *Starting and Stopping a Test.* — The conditions of the boiler and furnace in all respects should be, as nearly as possible, the same at the end as at the beginning of the test. The steam-pressure should be the same; the water-level the same; the fire upon the grates should be the same in quantity and condition; and the walls, flues, etc., should be of the same temperature. Two methods of obtaining the desired equality of conditions of the fire may be used, viz., those which were called in the Code of 1885 "the standard method" and "the alternate method," the latter being employed where it is inconvenient to make use of the standard method.*

X. *Standard Method of Starting and Stopping a Test.* — Steam being raised to the working pressure, remove rapidly all the fire from the grate, close the damper, clean the ash-pit, and as quickly as possible start a new fire with weighed wood and coal, noting the time and the water-level, while the water is in a quiescent state, just before lighting the fire.†

At the end of the test remove the whole fire, which has been burned low, clean the grates and ash-pit, and note the water-level when the water is in a quiescent state, and record the time of hauling the fire. The water-level should be as nearly as possible the same as at the beginning of the test. If it is not the same, a correction should be made by computation, and not by operating the pump after the test is completed.

XI. *Alternate Method of Starting and Stopping a Test.* — The boiler being thoroughly heated by a preliminary run, the fires are to be burned low and well cleaned. Note the amount of coal left on the grate as nearly as it can be estimated; note the pressure of steam and the water-level. Note the time, and record it as the starting-time. Fresh coal which has

* The Committee concludes that it is best to retain the designations "standard" and "alternate," since they have become widely known and established in the minds of engineers and in the reprints in the Code of 1885. Many engineers prefer the "alternate" to the "standard" method on account of its being less liable to error due to cooling of the boiler at the beginning and end of a test.

† The gauge-glass should not be blown out within an hour before the water-level is taken at the beginning and end of a test, otherwise an error in the reading of the water-level may be caused by a change in the temperature and density of the water in the pipe leading from the bottom of the glass into the boiler.

been weighed should now be fired. The ash-pits should be thoroughly cleaned at once after starting. Before the end of the test the fires should be burned low, just as before the start, and the fires cleaned in such a manner as to leave a bed of coal on the grates of the same depth, and in the same condition, as at the start. When this stage is reached, note the time and record it as the stopping-time. The water-level and steam-pressures should previously be brought as nearly as possible to the same point as at the start. If the water-level is not the same as at the start, a correction should be made by computation, and not by operating the pump after the test is completed.

XII. *Uniformity of Conditions.* — In all trials made to ascertain maximum economy or capacity the conditions should be maintained uniformly constant. Arrangements should be made to dispose of the steam so that the rate of evaporation may be kept the same from beginning to end.

XIII. *Keeping the Records.* — Take note of every event connected with the progress of the trial, however unimportant it may appear. Record the time of every occurrence and the time of taking every weight and every observation.

The coal should be weighed and delivered to the fireman in equal proportions, each sufficient for not more than one hour's run, and a fresh portion should not be delivered until the previous one has all been fired. The time required to consume each portion should be noted, the time being recorded at the instant of firing the last of each portion. It is desirable that at the same time the amount of water fed into the boiler should be accurately noted and recorded, including the height of the water in the boiler, and the average pressure of steam and temperature of feed during the time. By thus recording the amount of water evaporated by successive portions of coal, the test may be divided into several periods if desired, and the degree of uniformity of combustion, evaporation, and economy analyzed for each period. In addition to these records of the coal and the feed-water, half-hourly observations should be made of the temperature of the feed-water, of the flue-gases, of the external air in the boiler-room, of the temperature of the furnace when a furnace-pyrometer is used, also of the pressure of steam, and of the readings of the instruments for determining the moisture in the steam. A log should be kept on properly prepared blanks containing columns for record of the various observations.

XIV. *Quality of Steam.* — The percentage of moisture in the steam should be determined by the use of either a throttling or a separating steam-calorimeter. The sampling-nozzle should be placed in the vertical steam-pipe rising from the boiler. It should be made of 1/2-inch pipe, and should extend across the diameter of the steam-pipe to within half an inch of the opposite side, being closed at the end and perforated with not less than twenty 1/8-inch holes equally distributed along and around its cylindrical surface, but none of these holes should be nearer than 1/2 inch to the inner side of the steam-pipe. The calorimeter and the pipe leading to it should be well covered with felting. Whenever the indications of the throttling or separating calorimeter show that the percentage of moisture is irregular, or occasionally in excess of three per cent, the results should be checked by a steam-separator placed in the steam-pipe as close to the boiler as convenient, with a calorimeter in the steam-pipe just beyond the outlet from the separator. The drip from the separator should be caught and weighed, and the percentage of moisture computed therefrom added to that shown by the calorimeter.

Superheating should be determined by means of a thermometer placed in a mercury-well inserted in the steam-pipe. The degree of superheating should be taken as the difference between the reading of the thermometer for superheated steam and the readings of the same thermometer for saturated steam at the same pressure as determined by a special experiment, and not by reference to steam-tables.

XV. *Sampling the Coal and Determining its Moisture.* — As each barrow-load or fresh portion of coal is taken from the coal-pile, a representative shovelful is selected from it and placed in a barrel or box in a cool place and kept until the end of the trial. The samples are then mixed and broken into pieces not exceeding one inch in diameter, and reduced by the process of repeated quartering and crushing until a final sample

weighing about five pounds is obtained, and the size of the larger pieces is such that they will pass through a sieve with 1/4-inch meshes. From this sample two one-quart, air-tight glass preserving-jars, or other air-tight vessels which will prevent the escape of moisture from the sample, are to be promptly filled, and these samples are to be kept for subsequent determinations of moisture and of heating value and for chemical analyses. During the process of quartering, when the sample has been reduced to about 100 pounds, a quarter to a half of it may be taken for an approximate determination of moisture. This may be made by placing it in a shallow iron pan, not over three inches deep, carefully weighing it, and setting the pan in the hottest place that can be found on the brickwork of the boiler-setting or flues, keeping it there for at least 12 hours, and then weighing it. The determination of moisture thus made is believed to be approximately accurate for anthracite and semi-bituminous coals, and also for Pittsburg or Youghiogheny coal; but it cannot be relied upon for coals mined west of Pittsburg, or for other coals containing inherent moisture. For these latter coals it is important that a more accurate method be adopted. The method recommended by the Committee for all accurate tests, whatever the character of the coal, is described as follows:

Take one of the samples contained in the glass jars, and subject it to a thorough air-drying, by spreading it in a thin layer and exposing it for several hours to the atmosphere of a warm room, weighing it before and after, thereby determining the quantity of surface moisture it contains. Then crush the whole of it by running it through an ordinary coffee-mill adjusted so as to produce somewhat coarse grains (less than 1/16 inch), thoroughly mix the crushed sample, select from it a portion of from 10 to 50 grams, weigh it in a balance which will easily show a variation as small as 1 part in 1000, and dry it in an air- or sand-bath at a temperature between 240 and 280 degrees Fahr. for one hour. Weigh it and record the loss, then heat and weigh it again repeatedly, at intervals of an hour or less, until the minimum weight has been reached and the weight begins to increase by oxidation of a portion of the coal. The difference between the original and the minimum weight is taken as the moisture in the air-dried coal. This moisture test should preferably be made on duplicate samples, and the results should agree within 0.3 to 0.4 of one per cent, the mean of the two determinations being taken as the correct result. The sum of the percentage of moisture thus found and the percentage of surface moisture previously determined is the total moisture.

XVI. *Treatment of Ashes and Refuse.* — The ashes and refuse are to be weighed in a dry state. If it is found desirable to show the principal characteristics of the ash, a sample should be subjected to a proximate analysis and the actual amount of incombustible material determined. For elaborate trials a complete analysis of the ash and refuse should be made.

XVII. *Calorific Tests and Analysis of Coal.* — The quality of the fuel should be determined either by heat test or by analysis, or by both.

The rational method of determining the total heat of combustion is to burn the sample of coal in an atmosphere of oxygen gas, the coal to be sampled as directed in Article XV of this code.

The chemical analysis of the coal should be made only by an expert chemist. The total heat of combustion computed from the results of the ultimate analysis may be obtained by the use of Dulong's formula (with constants modified by recent determinations), viz.,

$$14,600 C + 62,000 \left(H - \frac{O}{8} \right) + 4000 S,$$

in which C, H, O, and S refer to the proportions of carbon, hydrogen, oxygen, and sulphur respectively, as determined by the ultimate analysis.*

It is desirable that a proximate analysis should be made, thereby determining the relative proportions of volatile matter and fixed carbon. These proportions furnish an indication of the leading characteristics of the fuel, and serve to fix the class to which it belongs.

* Favre and Silbermann give 14,544 B.T.U. per pound carbon; Berthelot, 14,647 B.T.U. Favre and Silbermann give 62,032 B.T.U. per pound hydrogen; Thomsen, 61,816 B.T.U.

XVIII. *Analysis of Flue-gases.* — The analysis of the flue-gases is an especially valuable method of determining the relative value of different methods of firing or of different kinds of furnaces. In making these analyses great care should be taken to procure average samples, since the composition is apt to vary at different points of the flue. The composition is also apt to vary from minute to minute, and for this reason the drawings of gas should last a considerable period of time. Where complete determinations are desired, the analyses should be intrusted to an expert chemist. For approximate determinations the Orsat or the Hempel apparatus may be used by the engineer.

For the continuous indication of the amount of carbonic acid present in the flue-gases an instrument may be employed which shows the weight of CO₂ in the sample of gas passing through it.

XIX. *Smoke Observations.* — It is desirable to have a uniform system of determining and recording the quantity of smoke produced where bituminous coal is used. The system commonly employed is to express the degree of smokiness by means of percentages dependent upon the judgment of the observer. The actual measurement of a sample of soot and smoke by some form of meter is to be preferred.

XX. *Miscellaneous.* — In tests for purposes of scientific research, in which the determination of all the variables entering into the test is desired, certain observations should be made which are in general unnecessary for ordinary tests. As these determinations are rarely undertaken, it is not deemed advisable to give directions for making them.

XXI. *Calculations of Efficiency.* — Two methods of defining and calculating the efficiency of a boiler are recommended. They are:

1. Efficiency of the boiler = $\frac{\text{Heat absorbed per lb. combustible}}{\text{Calorific value of 1 lb. combustible}}$
2. Efficiency of the boiler and grate = $\frac{\text{Heat absorbed per lb. coal}}{\text{Calorific value of 1 lb. coal}}$

The first of these is sometimes called the efficiency based on combustible, and the second the efficiency based on coal. The first is recommended as a standard of comparison for all tests, and this is the one which is understood to be referred to when the word "efficiency" alone is used without qualification. The second, however, should be included in a report of a test, together with the first, whenever the object of the test is to determine the efficiency of the boiler and furnace together with the grate (or mechanical stoker), or to compare different furnaces, grates, fuels, or methods of firing.

The heat absorbed per pound of combustible (or per pound coal) is to be calculated by multiplying the equivalent evaporation from and at 212 degrees per pound combustible (or coal) by 965.7.

XXII. *The Heat Balance.* — An approximate "heat balance" may be included in the report of a test when analyses of the fuel and of the chimney-gases have been made. It should be reported in the following form: [see next page.]

XXIII. *Report of the Trial.* — The data and results should be reported in the manner given in either one of the two following tables [only the "Short Form" of table is given here], omitting lines where the tests have not been made as elaborately as provided for in such tables. Additional lines may be added for data relating to the specific object of the test. The Short Form of Report, Table No. 2, is recommended for commercial tests and as a convenient form of abridging the longer form for publication when saving of space is desirable. For elaborate trials it is recommended that the full log of the trial be shown graphically, by means of a chart.

HEAT BALANCE, OR DISTRIBUTION OF THE HEATING VALUE OF THE COMBUSTIBLE.

Total Heat Value of 1 lb. of Combustible.....B.T.U.

	B.T.U.	Per Cent.
1. Heat absorbed by the boiler = evaporation from and at 212 degrees per pound of combustible x 965.7 *		
2. Loss due to moisture in coal = per cent of moisture referred to combustible ÷ 100 x [(212 - t) + 966 + 0.48 (T - 212)] (t = temperature of air in the boiler-room, T = that of the flue-gases)		
3. Loss due to moisture formed by the burning of hydrogen = per cent of hydrogen to combustible ÷ 100 x 9 x [(212 - t) + 966 + 0.48 (T - 212)]		
4. † Loss due to heat carried away in the dry chimney-gases = weight of gas per pound of combustible x 0.24 x (T - t)		
5. ‡ Loss due to incomplete combustion of carbon = $\frac{CO}{CO_2 + CO} \times \frac{\text{per cent C in combustible}}{100} \times 10,150$		
6. Loss due to unconsumed hydrogen and hydrocarbons, to heating the moisture in the air, to radiation, and unaccounted for. (Some of these losses may be separately itemized if data are obtained from which they may be calculated)		
Totals.....		100.00

* [The figure 965.7 (or 966) is taken from the old steam tables. If Peabody's new table (1909) is used it should be changed to 969.7, or if Marks & Davis's table is used, to 970.4.]

† The weight of gas per pound of carbon burned may be calculated from the gas analyses as follows:

$$\text{Dry gas per pound carbon} = \frac{11 CO_2 + 8 O + 7 (CO + N)}{3 (CO_2 + CO)}, \text{ in which } CO_2,$$

CO, O, and N are the percentages by volume of the several gases. As the sampling and analyses of the gases in the present state of the art are liable to considerable errors, the result of this calculation is usually only an approximate one. The heat balance itself is also only approximate for this reason, as well as for the fact that it is not possible to determine accurately the percentage of unburned hydrogen or hydrocarbons in the flue-gases.

The weight of dry gas per pound of combustible is found by multiplying the dry gas per pound of carbon by the percentage of carbon in the combustible, and dividing by 100.

‡ CO₂ and CO are respectively the percentage by volume of carbonic acid and carbonic oxide in the flue-gases. The quantity 10,150 = number of heat-units generated by burning to carbonic acid one pound of carbon contained in carbonic oxide.

TABLE NO. 2.

DATA AND RESULTS OF EVAPORATIVE TEST.

Arranged in accordance with the Short Form advised by the Boiler Test Committee of the American Society of Mechanical Engineers. Code of 1899.

Made byon.....boiler, at.....
to determine.....
Kind of fuel.....
Kind of furnace.....

Method of starting and stopping the test ("standard" or "alternate," Arts. X and XI, Code).....	
Grate surface.....	sq. ft.
Water-heating surface.....	"
Superheating surface.....	"

TOTAL QUANTITIES.

1. Date of trial.....	
2. Duration of trial.....	hours
3. Weight of coal as fired *.....	lbs.
4. Percentage of moisture in coal †.....	per cent
5. Total weight of dry coal consumed.....	lbs.
6. Total ash and refuse.....	"
7. Percentage of ash and refuse in dry coal.....	per cent
8. Total weight of water fed to the boiler ‡.....	lbs.
9. Water actually evaporated, corrected for moisture or superheat in steam.....	"
9a. Factor of evaporation §.....	"
10. Equivalent water evaporated into dry steam from and at 212 degrees.¶ (Item 9 x Item 9a.).....	"

HOURLY QUANTITIES.

11. Dry coal consumed per hour.....	"
12. Dry coal per square foot of grate surface per hour....	"
13. Water evaporated per hour corrected for quality of steam.....	"
14. Equivalent evaporation per hour from and at 212 degrees ¶.....	"
15. Equivalent evaporation per hour from and at 212 degrees per square foot of water-heating surface ¶.....	"

* Including equivalent of wood used in lighting the fire, not including unburned coal withdrawn from furnace at times of cleaning and at end of test. One pound of wood is taken to be equal to 0.4 pound of coal, or, in case greater accuracy is desired, as having a heat value equivalent to the evaporation of 6 pounds of water from and at 212 degrees per pound. (6 x 965.7 = 5794 B.T.U.) The term "as fired" means in its actual condition, including moisture.

† This is the total moisture in the coal as found by drying it artificially, as described in Art. XV of Code.

‡ Corrected for inequality of water-level and of steam-pressure at beginning and end of test.

§ Factor of evaporation = $\frac{H - h}{965.7}$, in which H and h are respectively the total heat in steam of the average observed pressure, and in water of the average observed temperature of the feed.

¶ The symbol "U.E.," meaning "units of evaporation," may be conveniently substituted for the expression "Equivalent water evaporated into dry steam from and at 212 degrees," its definition being given in a foot-note.

TABLE NO. 2 — Continued.
DATA AND RESULTS OF EVAPORATIVE TEST.

AVERAGE PRESSURES, TEMPERATURES, ETC.		
16. Steam pressure by gauge.....	lbs. p.sq.in.	
17. Temperature of feed-water entering boiler.....	deg.	
18. Temperature of escaping gases from boiler.....	ins.of water	
19. Force of draught between damper and boiler.....	% or deg.	
20. Percentage of moisture in steam, or number of degrees of superheating.....		
HORSE-POWER.		
21. Horse-power developed. (Item 14 ÷ 34 1/2)*.....	H.P.	
22. Builders' rated horse-power.....		
23. Percentage of builders' rated horse-power developed.....	per cent	
ECONOMIC RESULTS.		
24. Water apparently evaporated under actual conditions per pound of coal as fired. (Item 8 ÷ Item 3.).....	lbs.	
25. Equivalent evaporation from and at 212 degrees per pound of coal as fired. (Item 10 + Item 3.).....	"	
26. Equivalent evaporation from and at 212 degrees per pound of dry coal. (Item 10 + Item 5.).....	"	
27. Equivalent evaporation from and at 212 degrees per pound of combustible. [Item 10 ÷ (Item 5 - Item 6)]......	"	
(If Items 25, 26, and 27 are not corrected for quality of steam, the fact should be stated.)		
EFFICIENCY.		
28. Calorific value of the dry coal per pound.....	B.T.U.	
29. Calorific value of the combustible per pound.....	"	
30. Efficiency of boiler (based on combustible) †.....	per cent	
31. Efficiency of boiler, including grate (based on dry coal).....	"	
COST OF EVAPORATION.		
32. Cost of coal per ton of — lbs. delivered in boiler-room.....	\$	
33. Cost of coal required for evaporating 1000 pounds of water from and at 212 degrees.....	\$	

* Held to be the equivalent of 30 lbs. of water evaporated from 100 degrees Fahr. into dry steam at 70 lbs. gauge-pressure.

† In all cases where the word "combustible" is used, it means the coal without moisture and ash, but including all other constituents. It is the same as what is called in Europe "coal dry and free from ash."

‡ See foot-note on the preceding page.

FACTORS OF EVAPORATION.

The figures in the table on the next four pages are calculated from the formula $F = (H - h) \div 970.4$, in which H is the total heat above 32° of 1 lb. of steam of the observed pressure, h the total heat above 32° of the feed water, and 970.4 the heat of vaporization, or latent heat, of steam at 212° F. The values of these total heats and of the latent heat are those given in Marks and Davis's steam tables.

The factors are given for every 3° of feed water temperature between 32° and 212°, and for every 5 or 10 lbs. steam pressure within the ordinary working limits of pressure. Intermediate values correct to the third decimal place may easily be found by interpolation.

Gauge press. . . 0.3 Abs. press. . . 15.	Lbs.									
	10.3	20.3	30.3	40.3	50.3	60.3	70.3	80.3	85.3	100.
25.	35.	45.	55.	65.	75.	85.	95.	100.	100.	100.
Feed water.	Factors of Evaporation.									
212° F.	1.0003	1.0103	1.0169	1.0218	1.0258	1.0290	1.0316	1.0340	1.0361	1.0370
209	34	34	1.0200	50	89	1.0321	47	71	92	1.0401
206	65	65	31	81	1.0320	52	79	1.0402	1.0423	32
203	96	96	62	1.0312	51	83	1.0410	33	54	63
200	1.0127	1.0227	93	43	82	1.0414	41	64	85	94
197	58	58	1.0324	74	1.0413	45	72	95	1.0516	1.0525
194	89	89	55	1.0405	44	76	1.0503	1.0526	47	56
191	1.0220	1.0320	86	36	75	1.0507	34	57	78	87
188	51	51	1.0417	67	1.0506	38	65	88	1.0609	1.0618
185	82	82	48	98	37	69	1.0619	96	40	49
182	1.0313	1.0413	79	1.0529	68	1.0600	1.0627	50	71	80
179	44	44	1.0510	60	99	31	58	81	1.0702	1.0711
176	75	75	41	91	1.0630	62	89	1.0712	33	42
173	1.0406	1.0506	72	1.0622	61	93	1.0720	43	64	73
170	37	37	1.0603	53	92	1.0724	51	74	95	1.0804
167	68	68	34	84	1.0723	55	82	1.0805	1.0826	35
164	99	99	65	1.0715	54	86	1.0812	36	57	66
161	1.0510	1.0610	96	45	85	1.0817	43	67	88	97
158	61	61	1.0727	76	1.0816	47	74	98	1.0919	1.0928
155	92	92	58	1.0807	46	78	1.0905	1.0929	50	59
152	1.0623	1.0723	89	38	77	1.0909	36	60	80	90
149	54	54	1.0820	69	1.0908	40	67	91	1.1011	1.1021
146	85	85	51	1.0900	39	71	98	1.1022	42	52
143	1.0715	1.0815	81	31	70	1.1002	1.1029	52	73	82
140	46	46	1.0912	62	1.1001	33	60	83	1.1104	1.1113
137	77	77	43	93	32	64	91	1.1114	35	44
134	1.0808	1.0908	74	1.1023	63	95	1.1121	45	66	75
131	39	39	1.1005	54	93	1.1125	52	76	97	1.1206
128	70	70	36	85	1.1124	56	83	1.1207	1.1227	37
125	1.0901	1.1001	67	1.1116	55	87	1.1214	38	58	68
122	31	31	97	47	86	1.1218	45	69	89	98
119	62	62	1.1128	78	1.1217	49	76	99	1.1320	1.1329
116	93	93	59	1.1209	48	80	1.1306	1.1330	51	60
113	1.1024	1.1124	90	39	79	1.1310	37	61	82	91
110	55	55	1.1221	70	1.1309	41	68	92	1.1412	1.1422
107	86	86	52	1.1301	40	72	99	1.1423	43	53
104	1.1116	1.1216	82	32	71	1.1403	1.1430	53	74	83
101	47	47	1.1313	63	1.1402	34	61	84	1.1505	1.1514
98	78	78	44	93	33	65	91	1.1515	36	45
95	1.1209	1.1309	75	1.1424	63	95	1.1522	46	66	76
92	40	40	1.1406	55	94	1.1526	53	77	97	1.1607
89	71	71	37	86	1.1525	57	84	1.1608	1.1628	37
86	1.1301	1.1401	67	1.1518	56	88	1.1615	38	59	68
83	32	32	98	48	87	1.1619	46	69	90	99
80	63	63	1.1529	78	1.1618	50	76	1.1700	1.1721	1.1730
77	94	94	60	1.1609	48	80	1.1707	31	51	61
74	1.1425	1.1525	91	40	79	1.1711	38	62	82	92
71	55	55	1.1621	71	1.1710	42	69	92	1.1813	1.1822
68	86	86	52	1.1702	41	73	1.1800	1.1823	44	53
65	1.1517	1.1617	83	33	72	1.1804	30	54	75	84
62	48	48	1.1714	63	1.1803	35	61	85	1.1906	1.1915
59	79	79	45	94	33	65	92	1.1916	37	46
56	1.1610	1.1710	76	1.1825	64	96	1.1923	47	67	77
53	41	41	1.1807	56	95	1.1927	54	78	98	1.2008
50	72	72	38	87	1.1926	58	85	1.2009	1.2029	39
47	1.1703	1.1803	69	1.1918	57	89	1.2016	40	60	70
44	34	34	1.1900	49	88	1.2020	47	71	91	1.2101
41	65	65	31	80	1.2019	51	78	1.2102	1.2122	32
38	96	96	62	1.2011	50	82	1.2109	33	53	63
35	1.1827	1.1927	93	42	81	1.2113	40	64	84	94
32	58	58	1.2024	73	1.2113	44	71	95	1.2216	1.2225

Feed water.	Factors of Evaporation.										
	Lbs. 90.3	95.3	100.3	105.3	110.3	115.3	120.3	125.3	130.3	135.3	140.3
Gauge press. 105.	110.	115.	120.	125.	130.	135.	140.	145.	150.	155.	
212° F.	1.0379	1.0387	1.0396	1.0404	1.0411	1.0418	1.0425	1.0431	1.0437	1.0443	1.0449
209	1.0410	1.0419	1.0427	1.0435	1.0442	1.0449	1.0456	1.0462	1.0468	1.0474	1.0480
206	41	50	58	66	73	81	87	93	99	1.0505	1.0511
203	72	81	89	97	1.0504	1.0512	1.0518	1.0524	1.0530	36	43
200	1.0504	1.0512	1.0520	1.0528	35	43	49	55	61	67	74
197	35	43	51	59	66	74	80	86	92	98	1.0605
194	66	74	82	90	97	1.0605	1.0611	1.0617	1.0623	1.0629	36
191	97	1.0605	1.0613	1.0621	1.0629	36	42	48	54	60	67
188	1.0628	36	44	52	60	67	73	79	85	91	98
185	59	67	75	83	91	98	1.0704	1.0710	1.0716	1.0722	1.0729
182	90	98	1.0706	1.0714	1.0721	1.0729	35	41	47	53	60
179	1.0721	1.0729	37	45	52	60	66	72	78	84	91
176	52	60	68	76	83	91	97	1.0803	1.0809	1.0815	1.0822
173	82	91	99	1.0807	1.0814	1.0822	34	40	46	53	60
170	1.0813	1.0822	1.0830	38	45	53	59	65	71	77	83
167	44	53	61	69	76	84	90	96	1.0902	1.0908	1.0914
164	75	84	92	1.0900	1.0907	1.0914	1.0921	1.0927	33	39	45
161	1.0906	1.0914	1.0923	31	38	45	52	58	64	70	76
158	37	45	54	62	69	76	82	89	95	1.1001	1.1007
155	68	76	85	93	1.1000	1.1007	1.1013	1.1020	1.1026	32	38
152	99	1.1007	1.1015	1.1024	31	38	44	51	57	63	69
149	1.1030	38	46	55	62	69	75	81	88	94	1.1100
146	61	69	77	86	93	1.1100	1.1106	1.1112	1.1119	1.1125	31
143	92	1.1100	1.1108	1.1116	1.1124	31	37	43	49	56	62
140	1.1123	31	39	47	54	62	68	74	80	86	93
137	53	62	70	78	85	93	99	1.1205	1.1211	1.1217	1.1224
134	84	93	1.1201	1.1209	1.1216	1.1223	1.1230	36	42	48	54
131	1.1215	1.1223	32	40	47	54	60	67	73	79	85
128	46	54	62	71	78	85	91	98	1.1304	1.1310	1.1316
125	77	85	93	1.1302	1.1309	1.1316	1.1322	1.1328	35	41	47
122	1.1308	1.1316	1.1324	32	40	47	53	59	65	71	78
119	39	47	55	63	70	78	84	90	96	1.1402	1.1409
116	69	78	86	94	1.1401	1.1408	1.1415	1.1421	1.1427	33	39
113	1.1400	1.1408	1.1417	1.1425	32	39	45	52	58	64	70
110	31	39	47	56	63	70	76	82	89	95	1.1501
107	62	70	78	87	94	1.1501	1.1507	1.1513	1.1519	1.1526	32
104	92	1.1501	1.1509	1.1517	1.1525	32	38	44	50	56	63
101	1.1523	32	40	48	55	63	69	75	81	87	93
98	54	62	71	79	86	93	1.1600	1.1606	1.1612	1.1618	1.1624
95	85	93	1.1602	1.1610	1.1617	1.1624	30	37	43	49	55
92	1.1616	1.1624	32	41	48	55	61	67	74	80	85
89	47	55	63	71	79	86	92	98	1.1704	1.1711	1.1717
86	78	86	94	1.1702	1.1710	1.1717	1.1723	1.1729	35	41	48
83	1.1708	1.1717	1.1725	33	40	48	54	60	66	72	78
80	39	47	56	64	71	78	85	91	97	1.1803	1.1807
77	70	78	86	95	1.1802	1.1809	1.1815	1.1822	1.1828	34	40
74	1.1801	1.1809	1.1817	1.1826	33	40	46	52	59	65	71
71	32	40	48	56	64	71	77	83	89	96	1.1902
68	62	71	79	87	94	1.1902	1.1908	1.1914	1.1920	1.1926	33
65	93	1.1902	1.1910	1.1918	1.1925	33	39	45	51	57	63
62	1.1924	32	41	49	56	63	70	76	82	88	94
59	55	63	72	80	87	94	1.2000	1.2007	1.2013	1.2019	1.2025
56	86	94	1.2002	1.2011	1.2018	1.2025	31	38	44	50	56
53	1.2017	1.2025	33	42	49	56	62	68	75	81	87
50	48	56	64	73	80	87	93	99	1.2106	1.2112	1.2118
47	79	87	95	1.2104	1.2111	1.2118	1.2124	1.2130	37	43	49
44	1.2110	1.2118	1.2126	35	42	49	55	61	68	74	80
41	41	49	57	66	73	80	86	92	99	1.2205	1.2211
38	72	80	88	97	1.2204	1.2211	1.2217	1.2223	1.2230	36	42
35	1.2203	1.2211	1.2219	1.2228	35	42	48	55	61	67	73
32	34	42	51	59	66	73	79	86	92	98	1.2304

Feed water.	Factors of Evaporation.										
	Lbs. 145.3	150.3	155.3	160.3	165.3	170.3	175.3	180.3	185.3	190.3	195.3
Gauge press. 160.	165.	170.	175.	180.	185.	190.	195.	200.	205.	210.	
212° F.	1.0454	1.0460	1.0464	1.0469	1.0474	1.0478	1.0483	1.0487	1.0492	1.0496	1.0499
209	86	91	95	1.0500	1.0505	1.0509	1.0514	1.0519	1.0523	1.0527	1.0530
206	1.0517	1.0522	1.0526	31	36	40	45	50	54	58	61
203	48	53	57	62	67	71	77	81	85	89	92
200	79	84	88	93	98	1.0602	1.0608	1.0612	1.0616	1.0620	1.0623
197	1.0610	1.0615	1.0619	1.0624	1.0629	33	39	43	47	51	54
194	41	46	50	55	60	64	70	74	78	82	85
191	72	77	81	86	91	95	1.0701	1.0705	1.0709	1.0713	1.0716
188	1.0703	1.0708	1.0712	1.0717	1.0722	1.0727	32	36	40	44	47
185	34	39	43	48	53	58	63	67	71	75	78
182	65	70	74	79	84	88	94	98	1.0802	1.0806	1.0809
179	96	1.0801	1.0805	1.0810	1.0815	1.0819	1.0825	1.0829	33	37	40
176	1.0827	32	36	41	46	50	56	60	64	68	71
173	58	63	67	72	77	81	87	91	95	99	1.0902
170	89	94	98	1.0903	1.0908	1.0912	1.0917	1.0922	1.0926	1.0930	33
167	1.0920	1.0925	1.0929	34	39	43	48	53	57	61	64
164	51	56	60	65	70	74	79	84	88	92	95
161	81	87	91	96	1.1001	1.1005	1.1010	1.1014	1.1019	1.1023	1.1026
158	1.1012	1.1018	1.1022	1.1027	32	36	41	45	49	54	57
155	43	48	53	58	63	67	72	76	80	85	88
152	74	79	83	89	94	98	1.1103	1.1107	1.1111	1.1115	1.1119
149	1.1105	1.1110	1.1114	1.1120	1.1125	1.1129	34	38	42	46	49
146	36	41	45	50	56	60	65	69	73	77	80
143	67	72	76	81	86	91	96	1.1200	1.1204	1.1208	1.1211
140	98	1.1203	1.1207	1.1212	1.1217	1.1221	1.1227	31	35	39	42
137	1.1229	34	38	43	48	52	58	62	66	70	73
134	59	65	69	74	79	83	88	92	97	1.1301	1.1304
131	90	95	1.1300	1.1305	1.1310	1.1314	1.1319	1.1323	1.1327	32	35
128	1.1321	1.1326	30	36	41	45	50	54	58	62	66
125	52	57	61	66	72	76	81	85	89	93	96
122	83	88	92	97	1.1402	1.1407	1.1412	1.1416	1.1420	1.1424	1.1427
119	1.1414	1.1419	1.1423	1.1428	33	37	43	47	51	55	58
116	45	50	54	59	64	68	73	78	82	86	89
113	75	81	85	90	95	99	1.1504	1.1508	1.1512	1.1515	1.1520
110	1.1506	1.1511	1.1515	1.1521	1.1526	1.1530	35	39	43	47	50
107	37	42	46	51	57	61	66	70	74	78	81
104	68	73	77	82	87	92	97	1.1601	1.1605	1.1609	1.1612
101	99	1.1604	1.1608	1.1613	1.1618	1.1622	1.1627	32	36	40	43
98	1.1629	35	39	44	49	53	58	62	67	71	74
95	60	65	70	75	80	84	89	93	97	1.1701	1.1705
92	91	96	1.1700	1.1705	1.1711	1.1715	1.1720	1.1724	1.1728	32	35
89	1.1722	1.1727	31	36	42	46	51	55	59	63	66
86	53	58	62	67	72	76	82	86	90	94	97
83	84	89	93	98	1.1803	1.1807	1.1812	1.1817	1.1821	1.1825	1.1828
80	1.1814	1.1820	1.1824	1.1829	34	38	43	47	52	56	59
77	45	50	54	60	65	69	74	78	82	86	90
74	76	81	85	90	96	1.1900	1.1905	1.1909	1.1913	1.1917	1.1920
71	1.1907	1.1912	1.1916	1.1921	1.1926	31	36	40	44	48	51
68	38	43	47	52	57	61	67	71	75	79	82
65	69	74	78	83	88	92	97	1.2002	1.2006	1.2010	1.2013
62	99</										

Feed water.	Factors of Evaporation.										
	205.3 220.	210.3 225.	215.3 230.	220.3 235.	225.3 240.	230.3 245.	235.3 250.	240.3 255.	245.3 260.	250.3 265.	
212° F.	1.0503	1.0507	1.0510	1.0513	1.0517	1.0520	1.0523	1.0527	1.0529	1.0533	1.0535
209	34	38	41	44	48	52	55	58	60	64	66
206	65	69	72	75	79	83	86	89	91	95	97
203	96	1.0600	1.0603	1.0606	1.0611	1.0614	1.0617	1.0620	1.0622	1.0626	1.0629
200	1.0627	31	34	37	42	45	48	51	53	57	60
197	58	62	65	68	73	76	79	82	84	88	91
194	89	93	96	1.0700	1.0704	1.0707	1.0710	1.0713	1.0715	1.0719	1.0722
191	1.0720	1.0724	1.0727	31	35	38	41	44	46	50	53
188	51	55	58	62	66	69	72	75	78	81	84
185	82	86	89	93	97	1.0800	1.0803	1.0806	1.0809	1.0812	1.0815
182	1.0813	1.0817	1.0820	1.0823	1.0828	31	34	37	39	43	46
179	44	48	51	54	59	62	65	68	70	74	77
176	75	79	82	86	90	93	96	99	1.0901	1.0905	1.0908
173	1.0906	1.0910	1.0913	1.0916	1.0921	1.0924	1.0927	1.0930	32	36	39
170	37	41	44	47	51	55	58	61	63	67	69
167	68	72	75	78	82	86	89	92	94	98	1.1001
164	99	1.1003	1.1006	1.1009	1.1013	1.1016	1.1019	1.1023	1.1025	1.1029	31
161	1.1030	34	37	40	44	47	50	54	56	60	62
158	61	65	68	71	75	78	81	85	87	91	93
155	92	96	99	1.1102	1.1106	1.1109	1.1112	1.1115	1.1118	1.1122	1.1124
152	1.1123	1.1127	1.1130	33	37	40	43	46	49	53	55
149	54	58	61	64	68	71	74	77	80	83	86
146	84	89	92	95	99	1.1202	1.1205	1.1208	1.1211	1.1214	1.1217
143	1.1215	1.1219	1.1223	1.1226	1.1230	33	36	39	42	45	48
140	46	50	53	56	61	64	67	70	72	76	79
137	77	81	84	87	92	95	98	1.1301	1.1303	1.1307	1.1310
134	1.1308	1.1312	1.1315	1.1318	1.1322	1.1326	1.1329	32	34	38	40
131	39	43	46	49	53	56	59	62	65	69	71
128	70	74	77	80	84	87	90	93	96	1.1400	1.1402
125	1.1400	1.1405	1.1408	1.1411	1.1415	1.1418	1.1421	1.1424	1.1427	30	33
122	31	35	39	42	46	49	52	55	58	61	64
119	62	66	69	72	77	80	83	86	88	92	95
116	93	97	1.1500	1.1503	1.1507	1.1511	1.1514	1.1517	1.1519	1.1523	1.1525
113	1.1524	1.1528	31	34	38	41	44	48	50	54	56
110	55	59	62	65	69	72	75	78	81	85	87
107	85	90	93	96	1.1600	1.1603	1.1606	1.1609	1.1612	1.1615	1.1618
104	1.1616	1.1620	1.1624	1.1627	31	34	37	40	43	46	49
101	47	51	54	57	61	65	68	71	73	77	80
98	78	82	85	88	92	95	98	1.1702	1.1704	1.1708	1.1710
95	1.1709	1.1713	1.1716	1.1719	1.1723	1.1726	1.1729	32	35	39	41
92	39	44	47	50	54	57	60	63	66	69	72
89	70	75	78	81	85	88	91	94	97	1.1800	1.1803
86	1.1801	1.1805	1.1808	1.1812	1.1816	1.1819	1.1822	1.1825	1.1827	31	34
83	32	36	39	42	46	50	53	56	58	62	64
80	63	67	70	73	77	80	83	87	89	93	95
77	94	98	1.1901	1.1904	1.1908	1.1911	1.1914	1.1917	1.1920	1.1924	1.1926
74	1.1924	1.1929	32	35	39	42	45	48	51	54	57
71	55	59	63	66	70	73	76	79	82	85	88
68	86	90	93	96	1.2001	1.2004	1.2007	1.2010	1.2012	1.2016	1.2019
65	1.2017	1.2021	1.2024	1.2027	31	35	38	41	43	47	49
62	48	52	55	58	62	65	68	72	74	78	80
59	79	83	86	89	93	96	99	1.2102	1.2105	1.2109	1.2111
56	1.2110	1.2114	1.2117	1.2120	1.2124	1.2127	1.2130	33	36	40	42
53	41	45	48	51	55	58	61	64	67	70	73
50	71	76	79	82	86	89	92	95	98	1.2201	1.2204
47	1.2202	1.2207	1.2210	1.2213	1.2217	1.2220	1.2223	1.2226	1.2229	32	35
44	34	38	41	44	48	51	54	57	60	63	66
41	65	69	72	75	79	82	85	88	91	94	97
38	96	1.2300	1.2303	1.2306	1.2310	1.2313	1.2316	1.2319	1.2322	1.2325	1.2328
35	1.2327	31	34	37	41	44	47	50	53	57	59
32	58	62	65	68	72	75	78	82	84	88	90

STRENGTH OF STEAM-BOILERS. VARIOUS RULES FOR CONSTRUCTION.*

There is a great lack of uniformity in the rules prescribed by different writers and by legislation governing the construction of steam-boilers. In the United States, boilers for merchant vessels must be constructed according to the rules and regulations prescribed by the Board of Supervising Inspectors of Steam Vessels; in the U. S. Navy, according to rules of the Navy Department, and in some cases according to special acts of Congress. On land, in some places, as in Philadelphia, the construction of boilers is governed by local laws; but generally there are no laws upon the subject, and boilers are constructed according to the idea of individual engineers and boiler-makers. In Europe the construction is generally regulated by stringent inspection laws. The rules of the U. S. Supervising Inspectors of Steam-vessels, the British Lloyd's and Board of Trade, the French Bureau Veritas, and the German Lloyd's are ably reviewed in a paper by Nelson Foley, M. Inst. Naval Architects, etc., read at the Chicago Engineering Congress, 1893, Division of Marine and Naval Engineering. From this paper the following notes are taken, chiefly with reference to the U. S. and British rules:

(Abbreviations. — T. S., for tensile strength; el., elongation; contr., contraction of area.)

Hydraulic Tests. — Board of Trade, Lloyd's, and Bureau Veritas. — Twice the working pressure.

United States Statutes. — One and a half times the working pressure.

Mr. Foley proposes that the proof pressure should be 1½ times the working pressure + one atmosphere.

Established Nominal Factors of Safety. — Board of Trade. — 4.5 for a boiler of moderate length and of the best construction and workmanship.

Lloyd's. — Not very apparent, but appears to lie between 4 and 5.

United States Statutes. — Indefinite, because the strength of the joint is not considered, except by the broad distinction between single and double riveting.

Bureau Veritas: 4.4.

German Lloyd's: 5 to 4.65, according to the thickness of the plates.

Material for Riveting. — Board of Trade. — Tensile strength of rivet bars between 26 and 30 tons, el. in 10 in. not less than 25%, and contr. of area not less than 50%. (Tons of 2240 lbs.)

Lloyd's. — T. S., 26 to 30 tons; el. not less than 20% in 8 in. The material must stand bending to a curve, the inner radius of which is not greater than 1½ times the thickness of the plate, after having been uniformly heated to a low cherry-red, and quenched in water at 82° F.

United States Statutes. — No special provision.

Rules Connected with Riveting. — Board of Trade. — The shearing resistance of the rivet steel to be taken at 23 tons per square inch. 5 to be used for the factor of safety independently of any addition to this factor for the plating. Rivets in double shear to have only 1.75 times the single section taken in the calculation instead of 2. The diameter must not be less than the thickness of the plate and the pitch never greater than 8½". The thickness of double butt-straps (each) not to be less than 5/8 the thickness of the plate; single butt-straps not less than 9/8.

Distance from center of rivet to edge of plate = diam. of rivet × 1½.

Distance between rows of rivets

= 2 × diam. of rivet or = [(diam. × 4) + 1] ÷ 2, if chain, and

= $\frac{\sqrt{[(pitch \times 11) + (diam. \times 4)] \times (pitch + diam. \times 4)}}{10}$ if zigzag.

Diagonal pitch = (pitch × 6 + diam. × 4) ÷ 10.

Lloyd's. — Rivets in double shear to have only 1.75 times the single section taken in the calculation instead of 2. The shearing strength of rivet steel to be taken at 85% of the T. S. of the material of shell plates. In any case where the strength of the longitudinal joint is satisfactorily

* For specifications for steel for boilers, see p. 483. For riveted joints, see page 401.

shown by experiment to be greater than given by the formula, the actual strength may be taken in the calculation.

United States Statutes. — No rules. [The rules in 1909 give formulas equivalent to those of the British Board of Trade and tables taken from T. W. Traill's "Boilers, Marine and Land."]

Material for Cylindrical Shells Subject to Internal Pressure. — *Board of Trade.* — T. S. between 27 and 32 tons. In the normal condition, el. not less than 18% in 10 in., but should be about 25%; if annealed, not less than 20%. Strips 2 in. wide should stand bending until the sides are parallel at a distance from each other of not more than three times the plate's thickness.

Lloyd's. — T. S. between the limits of 26 and 30 tons per square inch. El. not less than 20% in 8 in. Test strips heated to a low cherry-red and plunged into water at 82° F. must stand bending to a curve, the inner radius of which is not greater than 1½ times the plate's thickness.

U. S. Statutes. — Plates ½ in. thick and under shall show a contr. of not less than 50%; when over ½ in. and up to ¾ in., not less than 45%; when over ¾ in., not less than 40%.

Mr. Foley's comments: The Board of Trade rules seem to indicate a steel of too high T. S. when a lower and more ductile one can be got; the lower tensile limit should be reduced, and the bending test might with advantage be made after tempering, and made to a smaller radius. Lloyd's rule for quality seems more satisfactory, but the temper test is not severe. The United States Statutes are not sufficiently stringent to insure an entirely satisfactory material.

Mr. Foley suggests a material which would meet the following: 25 tons lower limit in tension; 25% in 8 in. minimum elongation; radius for bending test after tempering = the plate's thickness.

Shell-plate Formulæ. — *Board of Trade:* $P = \frac{T \times B \times t \times 2}{D \times F}$

D = diameter of boiler in inches;

P = working-pressure in lbs. per square inch;

t = thickness in inches;

B = percentage of strength of joint compared to solid plate;

T = tensile strength allowed for the material in lbs. per square inch;

F = a factor of safety, being 4.5, with certain additions depending on method of construction.

Lloyd's: $P = \frac{C \times (t - 2) \times B}{D}$

t = thickness of plate in sixteenths; B and D as before; C = a constant depending on the kind of joint.

When longitudinal seams have double butt-straps, $C = 20$. When longitudinal seams have double butt-straps of unequal width, only covering on one side the reduced section of plate at the outer line of rivets, $C = 19.5$.

When the longitudinal seams are lap-jointed, $C = 18.5$.

U. S. Statutes. — Using same notation as for Board of Trade,

$P = \frac{t \times 2 \times T}{D \times 6}$ for single-riveting; add 20% for double-riveting;

where T is the lowest T.S. stamped on any plate.

Mr. Foley criticises the rule of the United States Statutes as follows: The rule ignores the riveting, except that it distinguishes between single and double, giving the latter 20% advantage; the circumferential riveting or class of seam is altogether ignored. The rule takes no account of workmanship or method adopted of constructing the joints. The factor, one sixth, simply covers the actual nominal factor of safety as well as the loss of strength at the joint, no matter what its percentage; we may therefore dismiss it as unsatisfactory.

Rules for Flat Plates. — *Board of Trade:* $P = \frac{C(t + 1)^2}{S - 6}$

P = working-pressure in lbs. per square inch;

S = surface supported in square inches;

t = thickness in sixteenths of an inch;

C = a constant as per following table;

$C = 125$ for plates not exposed to heat or flame, the stays fitted with nuts and washers, the latter at least three times the diameter of the stay and ⅔ the thickness of the plate;

$C = 187.5$ for the same condition, but the washers ⅔ the pitch of stays in diameter, and thickness not less than plate;

$C = 200$ for the same condition, but doubling plates in place of washers, the width of which is ⅔ the pitch and thickness the same as the plate;

$C = 112.5$ for the same condition, but the stays with nuts only;

$C = 75$ when exposed to impact of heat or flame and steam in contact with the plates, and the stays fitted with nuts and washers three times the diameter of the stay and ⅔ the plate's thickness;

$C = 67.5$ for the same condition, but stays fitted with nuts only;

$C = 100$ when exposed to heat or flame, and water in contact with the plates, and stays screwed into the plates and fitted with nuts;

$C = 66$ for the same condition, but stays with riveted heads.

U. S. Statutes. — Using same notation as for Board of Trade.

$P = \frac{C \times t^2}{p^2}$, where p = greatest pitch in inches, P and t as above;

$C = 112$ to 200 according to various specified conditions. [Rules of 1909.]

Certain experiments were carried out by the Board of Trade which showed that the resistance to bulging does not vary as the square of the plate's thickness. There seems also good reason to believe that it is not inversely as the square of the greatest pitch. Bearing in mind, says Mr. Foley, that mathematicians have signally failed to give us true theoretical foundations for calculating the resistance of bodies subject to the simplest forms of stresses, we therefore cannot expect much from their assistance in the matter of flat plates.

The Board of Trade rules for flat surfaces, being based on actual experiment, are especially worthy of respect; sound judgment appears also to have been used in framing them.

Furnace Formulæ. — *BOARD OF TRADE.* — *Long Furnaces.* —

$P = \frac{C \times t^2}{(L + 1) \times D}$, but not where L is shorter than $(11.5t - 1)$, at which length the rule for short furnaces comes into play.

P = working-pressure in pounds per square inch; t = thickness in inches;

D = outside diameter in inches; L = length of furnace in feet up to 10 ft.;

C = a constant, as per following table, for drilled holes:

$C = 99,000$ for welded or butt-jointed with single straps, double-riveted;

$C = 88,000$ for butts with single straps, single-riveted;

$C = 99,000$ for butts with double straps, single-riveted.

Provided always that the pressure so found does not exceed that given by the following formulæ, which apply also to short furnaces:

$P = \frac{C \times t}{D}$ for all the patent furnaces named;

$P = \frac{C \times t}{3 \times D} \left(5 - \frac{L \times 12}{67.5 \times t} \right)$ when with Adamson rings.

$C = 8,800$ for plain furnaces;

$C = 14,000$ for Fox; minimum thickness ⅝ in., greatest ⅝ in.; plain part not to exceed 6 in. in length;

$C = 13,500$ for Morison; minimum thickness ⅝ in., greatest ⅝ in.; plain part not to exceed 6 in. in length;

$C = 14,000$ for Purves-Brown; limits of thickness ⅞ in. and ⅝ in., plain part 9 in. in length;

$C = 8,800$ for Adamson rings; radius of flange next fire 1½ in.

U. S. STATUTES. — *Long Furnaces.* — Same notation.

$P = \frac{89,800 \times t^2}{L \times D}$, but L not to exceed 8 ft. [New rules are given in 1909; see page 884.]

Mr. Foley comments on the rules for long furnaces as follows: The Board of Trade general formula, where the length is a factor, has a very limited range indeed, viz., 10 ft. as the extreme length, and 135 thicknesses

— 12 in., as the short limit. The original formula, $P = \frac{C \times l^2}{L \times D}$, is that of Sir W. Fairbairn, and was, I believe, never intended by him to apply to short furnaces. On the very face of it, it is apparent, on the other hand, that if it is true for moderately long furnaces, it cannot be so for very long ones. We are therefore driven to the conclusion that any formula which includes simple L as a factor must be founded on a wrong basis.

With Mr. Traill's form of the formula, namely, substituting $(L + 1)$ for L , the results appear sufficiently satisfactory for practical purposes, and indeed, as far as can be judged, tally with the results obtained from experiment as nearly as could be expected. The experiments to which I refer were six in number, and of great variety of length to diameter; the actual factors of safety ranged from 4.4 to 6.2, the mean being 4.78, or practically 5. It seems to me, therefore, that, within the limits prescribed, the Board of Trade formula may be accepted as suitable for our requirements.

Material for Stays. — The qualities of material prescribed are as follows:

Board of Trade. — The tensile strength to lie between the limits of 27 and 32 tons per sq. in., and to have an elongation of not less than 20% in 10 in. Steel stays which have been welded or worked in the fire should not be used. [Tons of 2240 lbs.]

Lloyd's. — 26 to 30 ton steel, with elongation not less than 20% in 8 in.

U. S. Statutes. — The only condition is that the reduction of area must not be less than 40% if the test bar is over 3/4 in. diameter.

Loads allowed on Stays. — **Board of Trade.** — 9000 lbs. per square inch is allowed on the net section, provided the tensile strength ranges from 27 to 32 tons. Steel stays are not to be welded or worked in the fire.

Lloyd's. — For screwed and other stays, not exceeding 1 1/2 in. diameter effective, 8000 lbs. per square inch is allowed; for stays above 1 1/2 in., 9000 lbs. No stays are to be welded.

U. S. Statutes. — Braces and stays shall not be subjected to a greater stress than 6000 lbs. per sq. in. [As high as 9000 lbs. is allowed in some cases in the rules of 1909.]

[Rankine, S. E., p. 459, says: "The iron of the stays ought not to be exposed to a greater working tension than 3000 lbs. on the square inch, in order to provide against their being weakened by corrosion. This amounts to making the factor of safety for the working pressure about 20." It is evident, however, that an allowance in the factor of safety for corrosion may reasonably be decreased with increase of diameter. W.K.]

A discussion of various rules and formulæ for stay bolts, braces and flat surfaces will be found in a paper by R. S. Hale, *Trans. A. S. M. E.*, 1904.

Girders. — **Board of Trade.** $P = \frac{C \times d^2 \times t}{(W - p) D \times L}$. P = working pressure in lbs. per sq. in.; W = width of flame-box; L = length of girder; p = pitch of bolts; D = distance between girders from center to center; d = depth of girder; t = thickness of sum of same; C = a constant = 6600 for 1 bolt, 9900 for 2 or 3 bolts, and 11,220 for 4 bolts. All dimensions in inches.

Lloyd's. — The same formula and constants, except that C = 11,000 for 4 or 5 bolts, 11,550 for 6 or 7, and 11,880 for 8 or more.

U. S. Statutes. — [The rules in 1909 are the same as Lloyd's.]

Tube-Plates. — **Board of Trade.** $P = \frac{t(D - d) \times 20,000}{W \times D}$. D = least

horizontal distance between centers of tubes in inches; d = inside diameter of ordinary tubes; t = thickness of tube-plate in inches; W = extreme width of combustion-box in inches from front tube-plate to back of fire-box, or distance between combustion-box tube-plates when the boiler is double-ended and the box common to both ends.

The crushing stress on tube-plates caused by the pressure on the flame-box top is to be limited to 10,000 lbs. per square inch.

Material for Tubes. — Mr. Foley proposes the following: If iron, the quality to be such as to give at least 22 tons per square inch as the minimum tensile strength, with an elongation of not less than 15% in 8 ins. If steel, the elongation to be not less than 26% in ins. for the material before being rolled into strips; and after tempering, the test bar to stand completely closing together. Provided the steel welds well, there does not seem to be any object in providing tensile limits. The ends should be annealed after manufacture, and stay-tube ends should be annealed before screwing.

Holding-power of Boiler-tubes. (See also page 342.) — In Messrs. Yarrow's experiments on iron and steel tubes of 2 in. to 2 1/4 in. diameter the first 5 tubes gave way on an average of 23,740 lbs., which would appear to be about 2/3 the ultimate strength of the tubes themselves. In all these cases the hole through the tube-plate was parallel with a sharp edge to it, and a ferrule was driven into the tube.

Tests of the next 5 tubes were made under the same conditions as the first 5, with the exception that in this case the ferrule was omitted, the tubes being simply expanded into the plates. The mean pull required was 15,270 lbs., or considerably less than half the ultimate strength of the tubes.

Effect of beading the tubes, the holes through the plate being parallel and ferrules omitted. The mean of the first 3, which are tubes of the same kind, gives 26,876 lbs. as their holding-power, under these conditions, as compared with 23,740 lbs. for the tubes fitted with ferrules only. This high figure is, however, mainly due to an exceptional case where the holding-power is greater than the average strength of the tubes themselves.

It is disadvantageous to cone the hole through the tube-plate unless its sharp edge is removed, as the results are much worse than those obtained with parallel holes, the mean pull being but 16,031 lbs., the experiments being made with tubes expanded and ferruled but not beaded over.

In experiments on tubes expanded into tapered holes, beaded over and fitted with ferrules, the net result is that the holding-power is, for the size experimented on, about 3/4 of the tensile strength of the tube, the mean pull being 28,797 lbs. With tubes expanded into tapered holes and simply beaded over, better results were obtained than with ferrules; in these cases, however, the sharp edge of the hole was rounded off, which appears in general to have a good effect.

In one particular the experiments are incomplete, as it is impossible to reproduce on a machine the racking the tubes get by the expansion of a boiler as it is heated up and cooled down again, and it is quite possible, therefore, that the fastening giving the best results on the testing-machine may not prove so efficient in practice.

N.B. — It should be noted that the experiments were all made under the cold condition, so that reference should be made with caution; the circumstances in practice being very different, especially when there is scale on the tube-plates, or when the tube-plates are thick and subject to intense heat.

Iron versus Steel Boiler-tubes. (Foley.) — Mr. Blechynden prefers iron tubes to those of steel, but how far he would go in attributing the leaky-tube defect to the use of steel tubes we are not aware. It appears, however, that the results of his experiments would warrant him in going a considerable distance in this direction. The test consisted of heating and cooling two tubes, one of wrought iron and the other of steel. Both tubes were 2 3/4 in. in diameter and 0.16 in. thickness of metal. The tubes were put in the same furnace, made red-hot, and then dipped in water. The length was gauged at a temperature of 46° F.

This operation was twice repeated, with results as follows:

	Steel.	Iron.
Original length	55.495 in.	55.495 in.
Heated to 186° F.; increase	0.052 in.	0.048 in.
Coefficient of expansion per degree F.	.0000067	.0000062
Heated red-hot and dipped in water; decrease	.007 in.	.003 in.
Second heating and cooling, decrease	.031 in.	.004 in.
Third heating and cooling, decrease	.017 in.	.006 in.
Total contraction	.055 in.	.013 in.

Mr. A. C. Kirk writes: That overheating of tube ends is the cause of the leakage of the tubes in boilers is proved by the fact that the ferrules at present used by the Admiralty prevent it. These act by shielding the tube ends from the action of the flame, and consequently reducing evaporation, and so allowing free access of the water to keep them cool.

Although many causes contribute, there seems no doubt that thick tube-plates must bear a share of causing the mischief.

Rules for Construction of Boilers in Merchant Vessels in the United States.

(Extracts from General Rules and Regulations of the Board of Supervising Inspectors, Steamboat Inspection (as amended Jan., 1909).)

Tensile Strength of Plate. — From each plate as rolled there shall be taken two test pieces, one for tensile test and one for bending test. The piece for tensile test shall be taken from the side of the plate at about one-third of its length from the top of the plate, and the piece for bending test shall be taken transversely from the top of the plate near the center.

All the pieces shall be prepared so that the skin shall not be removed, the edges only planed or shaped.

In no case shall test pieces be prepared by annealing or reduced in size by hammering.

Tensile-test pieces shall be at least 16 ins. in length, from 1½ to 3¼ ins. in width at the ends, which ends shall join by an easy fillet, a straight part in the center of at least 9 ins. in length and 1½ ins. in width, marked with light prick punch marks at distances 1 inch apart, spaced so as to give 8 inches in length.

Only steel plates manufactured by what is known as the basic or acid open-hearth processes will be allowed to be used in the construction or repairs of boilers for marine purposes.

No plate made by the acid process shall contain more than 0.06% of phosphorus and 0.04% of sulphur, and no plate made by the basic process shall contain more than 0.04% of phosphorus and 0.04% of sulphur.

For steel plates the sample must show, when tested, a tensile strength not lower than 50,000 lbs. and not higher than 75,000 lbs. per sq. in. of section, and no such plate shall be stamped with a higher tensile strength than 70,000 lbs.: Provided, however, that for steel plates exceeding a thickness of 0.3125 in. intended for use in externally fired boilers, the sample must show, when tested, a tensile strength not lower than 54,000 lbs. and not higher than 67,000 lbs. per sq. in. of section, and no plate exceeding a thickness of 0.3125 in. intended for use in externally fired boilers shall be stamped with a higher tensile strength than 62,000 lbs. Such sample must also show an elongation of at least 25% in a length of 2 ins. for thickness up to ¼ in., inclusive; in a length of 4 ins. for over ¼ to 7/16 in., inclusive; in a length of 6 ins. for all plates over 7/16 in. The sample must also show a reduction of sectional area as follows:

At least 50% for thickness up to ½ in., inclusive; 45% for thickness over ½ to ¾ in., inclusive, and 40% for thickness over ¾ in.

Quenching and bending test. — Quenching and bending test pieces shall be at least 12 ins. in length and from 1 to 3¼ ins. in width. The side where sheared or planed must not be rounded, but the edges may have the sharpness taken off with a fine file. The test piece shall be heated to a cherry red (as seen in a dark place) and then plunged into water at a temperature of about 82° F. Thus prepared, the sample shall be bent to a curve, the inner radius of which is not greater than 1½ times the thickness of the sample, without cracks or flaws. The ends must be parallel after bending.

Cylindrical Shells. — The working steam pressure allowable on cylindrical shells of boilers constructed of plates inspected as required by these rules, when single riveted, shall not produce a strain to exceed one-sixth of the tensile strength of the iron or steel plates of which such boilers are constructed; but where the longitudinal laps of the cylindrical parts of such boilers are double riveted, and the rivet holes for such boilers have been fairly drilled, an addition of 20 per cent to the working pressure provided for single riveting will be allowed.

The pressure for any dimension of boilers must be ascertained by the following rule, viz.:

Multiply one-sixth of the lowest tensile strength found stamped on the plates in the cylindrical shell by the thickness — expressed in inches or part of an inch — and divide by the radius or half diameter — also expressed in inches — and the result will be the pressure allowable per square inch of surface for single riveting, to which add 20% for double riveting, when all the rivet holes in the shell of such boiler have been "fairly drilled" and no part of such holes has been punched. The pressure allowed shall be based on the plate whose tensile strength multiplied by its thickness gives the lowest product.

Cylindrical Shells of Water-tube or Coil Boilers. — The working pressure allowable, when such shells have a row or rows of pipes or tubes inserted therein, shall be determined by the formula:

$$P = (D - d) \times T \times S \div (D \times R),$$

where P = working pressure allowable in pounds; D = distance in inches between the tube or pipe centers in a line from head to head; d = diameter of hole in inches; T = thickness of plate in inches; S = one-sixth of the tensile strength of the plate; R = radius of shell in inches.

Convex Heads. — Plates used as heads, when new and made to practically true circles, shall be allowed a steam pressure in accordance with the formula: $P = T \times S \div R$, where P = steam pressure allowable in lbs. per sq. in.; T = thickness of plate in ins.; S = one-sixth of the tensile strength; R = one-half of the radius to which the head is bumped.

Add 20% when the head is double riveted to the shell and the holes are fairly drilled.

Bumped heads may contain a manhole opening flanged inwardly, when such flange is turned to a depth of three times the thickness of material in the head.

Concave Heads. — For concave heads the pressure allowable will be 0.6 times the pressure allowable for convex heads.

Flat Heads. — Where flat heads do not exceed 20 ins. diameter they may be used without being stayed, and the steam pressure allowable shall be determined by the formula: $P = C \times T^2 \div A$, where P = steam pressure allowable in pounds; T = thickness of material in sixteenths of an inch; A = one-half the area of head in inches; $C = 112$ for plates 7/16 in. and under; $C = 120$ for plates over 7/16 in. Provided, the flanges are made to an inside radius of at least 1½ inches.

Flat Surfaces. — The maximum stress allowable on flat plates supported by stays shall be determined by the following formula:

All stayed surfaces formed to a curve the radius of which is over 21 ins. excepting surfaces otherwise provided for, shall be deemed flat surfaces.

$$\text{Working pressure} = C \times T^2 \div P^2,$$

where T = thickness of plates in 16ths of an inch; P = greatest pitch of stays in ins.; $C = 112$ for screw stays with riveted heads, plates 7/16 thick and under; $C = 120$ for screw stays with riveted heads, plates above 7/16 in. thick; $C = 120$ for screw stays with nuts, plates 7/16 in. thick and under; $C = 125$ for screw stays with nuts, plates above 7/16 in. thick and under 9/16 in.; $C = 135$ for screw stays with nuts, plates 9/16 in. thick and above; $C = 175$ for stays with double nuts having one nut on the inside and one nut on the outside of plate, without washers or doubling plates; $C = 160$ for stays fitted with washers or doubling strips which have a thickness of at least 0.5 of the thickness of the plate and a diameter of at least 0.5 of the greatest pitch of the stay, riveted to the outside of the plates, and stays having one nut inside of the plate, and one nut outside of the washer or doubling strip. For T take 72% of the combined thickness of the plate and washer or plate and doubling strip. $C = 200$ for stays fitted with doubling strips which have a thickness equal to at least 0.5 of the thickness of the plate reinforced, and covering the full area braced (up to the curvature of the flange, if any), riveted to either the inside or outside of the plate, and stays having one nut outside and one inside of the plates. Washers or doubling plates to be substantially riveted. For T take 72% of the combined thickness of the two plates. $C = 200$ for stays with plates

stiffened with tees or angle bars having a thickness of at least 2/3 the thickness of plate and depth of webs at least 1/4 of the greatest pitch of the stays, and substantially riveted on the inside of the plates, and stays having one nut inside, bearing on washers fitted to the edges of the webs that are at right angles to the plate. For *T* take 72% of the combined thickness of web and plate.

No such flat plates or surfaces shall be unsupported a greater distance than 18 inches.

Stays. — The maximum stress in pounds allowable per square inch of cross-sectional area for stays used in the construction of marine boilers, when they are accurately fitted and properly secured, shall be ascertained by the following formula:

$P = A \times C \div a$, where *P* = working pressure in lbs. per sq. in.; *A* = least cross-sectional area of stay in inches; *a* = area of surface supported by one stay, in inches; *C* = 9000 for tested steel stays exceeding 2 1/2 ins. diam.; *C* = 8000 for tested steel stays 1 1/4 ins. and not exceeding 2 1/2 ins. diam., when such stays are not forged or welded. The ends, however, may be upset to a sufficient diameter to allow for the depth of the thread. The diameter shall be taken at the bottom of the thread, provided it is the least diameter of the stay. All such stays after being upset shall be thoroughly annealed. *C* = 8000 for a tested Huston or similar type of brace, the cross-sectional area of which exceeds 5 sq. ins.; *C* = 7000 for such tested braces when the cross-sectional area is not less than 1.227 and not more than 5 sq. ins., provided such braces are prepared at one heat from a solid piece of plate without welds; *C* = 6000 for all stays not otherwise provided for.

Flues subjected to External Pressure only. — Plain lap-welded steel flues 7 to 13 ins. diameter. *D* = outside diam., ins.; *T* = thickness, ins.; *P* = working pressure, lbs. per sq. in.; *F* = factor of safety.

$$T = \frac{[(F \times P) + 1388] D}{86670}$$

This formula is applicable to lengths greater than six diameters of flue, to working pressures greater than 100 lbs. per sq. in., and to temperatures less than 650° F.

Riveted flues, made in sections riveted together, 6 to 9 ins. diam., maximum length of sections 60 ins.; over 9 and not over 13 ins. diam., maximum length 42 ins.; $P = 8100 \times T \div D$.

Riveted or lap-welded flues, over 13 and not over 28 ins. diam., lengths not to exceed 3 1/2 times the diam.:

$$P = \frac{51.5}{D} [(18.75 \times T) - (L \times 1.03)]$$

(*L* = length of flue in inches; *T* = thickness in 16ths of an inch.)

Furnaces. — The tensile strength of steel used in the construction of corrugated or ribbed furnaces shall not exceed 67,000, and be not less than 54,000 lbs.; and in all other furnaces the minimum tensile strength shall not be less than 58,000, and the maximum not more than 67,000 lbs. The minimum elongation in 8 inches shall be 20%.

All corrugated furnaces having plain parts at the ends not exceeding 9 inches in length (except flues especially provided for), when new, and made to practically true circles, shall be allowed a steam pressure in accordance with the formula: $P = C \times T \div D$.

P = pressure in lbs. per sq. in., *T* = thickness in inches, *C* = a constant, as below.

- Leeds suspension bulb furnace *C* = 17,000, *T* not less than 5/16 in.
- Morison corrugated type *C* = 15,600, *T* not less than 5/16 in.
- Fox corrugated type *C* = 14,000, *T* not less than 5/16 in.
- Purves type, rib projections *C* = 14,000, *T* not less than 7/16 in.
- Brown corrugated type *C* = 14,000, *T* not less than 5/16 in.
- Type having sections 18 ins. long *C* = 10,000, *T* not less than 7/16 in.

Limiting dimensions from center to center of the corrugations or projecting ribs, and of their depth, are given for each furnace.

Tubes. — Lap-welded tubes are allowed a working pressure of 225 lbs. per sq. in., if of the thicknesses given below, "provided they are deemed safe by the inspectors."

1 and 1 1/4 ins. diam., 0.072 in. thick; 1 1/2 ins., 0.083; 1 3/4, 2 and 2 1/4 ins., 0.095; 2 1/2, 2 3/4 and 3 ins., 0.109; 3 1/4, 3 1/2 and 3 3/4 ins., 0.120; 4 and 4 1/2 ins., 0.134; 5 ins., 0.148; 6 ins., 0.165.

Safe Working Pressure in Cylindrical Shells. — The author desires to express his condemnation of the rule of the U. S. Statutes, as giving too low a factor of safety. (See also criticism by Mr. Foley, page 880, ante.)

If *P_b* = bursting-pressure, *t* = thickness, *T* = tensile strength, *c* = coefficient of strength of riveted joint, that is, ratio of strength of the joint to that of the solid plate, *d* = diameter, $P_b = 2tTc \div d$, or if *c* be taken for double-riveting at 0.7, then $P_b = 1.4tT \div d$.

By the U. S. rule the allowable pressure $P_a = \frac{1/6tT}{1/2d} \times 1.20 = \frac{0.4tT}{d}$;

whence $P_b = 3.5P_a$; that is, the factor of safety is only 3.5, provided the "tensile strength found stamped in the plate" is the real tensile strength of the material.

The author's formula for safe working-pressure of externally fired boilers with longitudinal seams double-riveted, is $P = \frac{14,000t}{d}$; $t = \frac{Pd}{14,000}$;

P = gauge-pressure in lbs. per sq. in.; *t* = thickness and *d* = diam. in inches.

This is derived from the formula $P = \frac{2tTc}{fd}$, taking *c* at 0.7 and *f* = 5

for steel of 50,000 lbs. T.S., or 6 for 60,000 lbs. T.S.; the factor of safety being increased in the ratio of the T.S., since with the higher T.S. there is greater danger of cracking at the rivet-holes from the effect of punching and riveting and of expansion and contraction caused by variations of temperature. For external shells of internally fired boilers, these shells not being exposed to the fire, with rivet-holes drilled or reamed after punching, a lower factor of safety and steel of a higher T.S. may be allowable.

If the T.S. is 60,000, a working pressure $P = 16,000t \div d$ would give a factor of safety of 5.25.

The following table gives safe working pressures for different diameters of shell and thicknesses of plate calculated from the author's formula.

Safe Working Pressures in Cylindrical Shells of Boilers, Tanks, Pipes, etc., in Pounds per Square Inch.

Longitudinal seams double-riveted.

(Calculated from formula $P = 14,000 \times \text{thickness} \div \text{diameter}$.)

Thickness in 16ths of an Inch.	Diameter in Inches.										
	24	30	36	38	40	42	44	46	48	50	52
1	36.5	29.2	24.3	23.0	21.9	20.8	19.9	19.0	18.2	17.5	16.8
2	72.9	58.3	48.6	46.1	43.8	41.7	39.8	38.0	36.5	35.0	33.7
3	109.4	87.5	72.9	69.1	65.6	62.5	59.7	57.1	54.7	52.5	50.5
4	145.8	116.7	97.2	92.1	87.5	83.3	79.5	76.1	72.9	70.0	67.3
5	182.3	145.8	121.5	115.1	109.4	104.2	99.4	95.1	91.1	87.5	84.1
6	218.7	175.0	145.8	138.2	131.3	125.0	119.3	114.1	109.4	105.0	101.0
7	255.2	204.1	170.1	161.2	153.1	145.9	139.2	133.2	127.6	122.5	117.8
8	291.7	233.3	194.4	184.2	175.0	166.7	159.1	152.2	145.8	140.0	134.6
9	328.1	262.5	218.8	207.2	196.9	187.5	179.0	171.2	164.1	157.5	151.4
10	364.6	291.7	243.1	230.3	218.8	208.3	198.9	190.2	182.3	175.0	168.3
11	401.0	320.8	267.4	253.3	240.6	229.2	218.7	209.2	200.5	192.5	185.1
12	437.5	350.0	291.7	276.3	262.5	250.0	238.6	228.3	218.7	210.0	201.9
13	473.9	379.2	316.0	299.3	284.4	270.9	258.5	247.3	237.0	227.5	218.8
14	510.4	408.3	340.3	322.4	306.3	291.7	278.4	266.3	255.2	245.0	235.6
15	546.9	437.5	364.6	345.4	328.1	312.5	298.3	285.3	273.4	266.5	252.4
16	583.3	466.7	388.9	368.4	350.0	333.3	318.2	304.4	291.7	280.0	269.2

Safe Working Pressures in Cylindrical Shells — Continued.

Thickness in 16ths of an Inch.	Diameter in Inches.											
	54	60	66	72	78	84	90	96	102	108	114	120
1	16.2	14.6	13.3	12.2	11.2	10.4	9.7	9.1	8.6	8.1	7.7	7.3
2	32.4	29.2	26.5	24.3	22.4	20.8	19.4	18.2	17.2	16.2	15.4	14.6
3	48.6	43.7	39.8	36.5	33.7	31.3	29.2	27.3	25.7	24.3	23.0	21.9
4	64.8	58.3	53.0	48.6	44.9	41.7	38.9	35.5	34.3	32.4	30.7	29.2
5	81.0	72.9	66.3	60.8	56.1	52.1	48.6	45.6	42.9	40.5	38.4	36.5
6	97.2	87.5	79.5	72.9	67.3	62.5	58.3	54.7	51.5	48.6	46.1	43.8
7	113.4	102.1	92.8	85.1	78.5	72.9	68.1	63.8	60.0	56.7	53.7	51.0
8	129.6	116.7	106.1	97.2	89.7	83.3	77.8	72.9	68.6	64.8	61.4	58.3
9	145.8	131.2	119.3	109.4	101.0	93.8	87.5	82.0	77.2	72.9	69.1	65.6
10	162.0	145.8	132.6	121.5	112.3	104.2	97.2	91.1	85.8	81.0	76.8	72.9
11	178.2	160.4	145.8	133.7	123.4	114.6	106.9	100.3	94.4	89.1	84.4	80.2
12	194.4	175.0	159.1	145.8	134.6	125.0	116.7	109.4	102.9	97.2	92.1	87.5
13	210.7	189.6	172.4	158.0	145.8	135.4	126.4	118.5	111.5	105.3	99.8	94.8
14	226.9	204.2	185.6	170.1	157.1	145.8	136.1	127.6	120.1	113.4	107.5	102.1
15	243.1	218.7	198.9	182.3	168.3	156.3	145.8	136.7	128.7	121.5	115.1	109.4
16	259.3	233.3	212.1	194.4	179.5	166.7	155.6	145.8	137.3	129.6	122.8	116.7

Flat Stayed Surfaces in Steam-boilers. — Clark, in his treatise on the Steam-engine, also in his Pocket-book, gives the following formula: $p = 407ts \div d$, in which p is the internal pressure in pounds per square inch that will strain the plates to their elastic limit, t is the thickness of the plate in inches, d is the distance between two rows of stay-bolts in the clear, and s is the tensile stress in the plate, in tons of 2240 lbs., per square inch, at the elastic limit. Substituting values of s for iron, steel, and copper, 12, 14, and 8 tons respectively, we have the following:

FORMULE FOR ULTIMATE ELASTIC STRENGTH OF FLAT STAYED SURFACES.

	Iron.	Steel.	Copper.
Pressure.....	$p = 5000 \frac{t}{d}$	$p = 5700 \frac{t}{d}$	$p = 3300 \frac{t}{d}$
Thickness of plate.....	$t = \frac{p \times d}{5000}$	$t = \frac{p \times d}{5700}$	$t = \frac{p \times d}{3300}$
Pitch of bolts.....	$d = \frac{5000t}{p}$	$d = \frac{5700t}{p}$	$d = \frac{3300t}{p}$

For Diameter of the Stay-bolts, Clark gives $d' = 0.0024 \sqrt{\frac{PP'p}{s}}$, in which d' = diameter of screwed bolt at bottom of thread, P = longitudinal and P' transverse pitch of stay-bolts between centers, p = internal pressure in lbs. per sq. in. that will strain the plate to its elastic limit, s = elastic strength of the stay-bolts, in lbs. per sq. in. Taking $s = 12, 14,$ and 8 tons, respectively, for iron, steel, and copper, we have

- For iron, $d' = 0.00069 \sqrt{PP'p}$, or if $P = P'$, $d' = 0.00069 P \sqrt{p}$.
- For steel, $d' = 0.00064 \sqrt{PP'p}$, or if $P = P'$, $d' = 0.00064 P \sqrt{p}$.
- For copper, $d' = 0.00084 \sqrt{PP'p}$, or if $P = P'$, $d' = 0.00084 P \sqrt{p}$.

In using formulæ for stays a large factor of safety should be taken to allow for reduction of size by corrosion. Thurston's Manual of Steam-boilers, p. 144, recommends that the factor be as large as 15 or 20. The Hartford Steam Boiler Insp. & Ins. Co. recommends not less than 10.

Strength of Stays. — A. F. Yarrow (*Engr.*, March 20, 1891) gives the following results of experiments to ascertain the strength of water-space stays:

Description.	Length between Plates.	Diameter of Stay over Threads.	Ultimate Stress.
Hollow stays screwed into plates and hole expanded	4.75 in.	1 in. (hole $\frac{7}{8}$ in. and $\frac{5}{16}$ in.)	25,457
	4.64 in.	1 in. (hole $\frac{9}{16}$ in. and $\frac{7}{16}$ in.)	20,992
Solid stays screwed into plates and riveted over.	4.80 in.	$\frac{7}{8}$ in.	22,008
	4.80 in.	$\frac{7}{8}$ in.	22,070

The above are taken as a fair average of numerous tests.

Fusible plugs. — Fusible plugs should be put in that portion of the heating-surface which first becomes exposed from lack of water. The rules of the U. S. Supervising Inspectors specify Banca tin for the purpose. Its melting-point is about 445° F. The rule says: Every boiler, other than boilers of the water-tube type, shall have at least one fusible plug made of a bronze casing filled with good Banca tin from end to end. Fusible plugs, except as otherwise provided for, shall have an external diameter of not less than $\frac{3}{4}$ in. pipe tap, and the Banca tin shall be at least $\frac{1}{2}$ in. in diameter at the smallest end and shall have a larger diameter at the center or at the opposite end of the plug; smaller plugs are allowed for pressures above 150 lbs., also for upright boilers. Cylinder-boilers with flues shall have one plug inserted in one flue of each boiler; and also one plug inserted in the shell of each boiler from the inside, immediately below the fire line and not less than 4 ft. from the front end. Other shell boilers shall have one plug inserted in the crown of the back connection. Upright tubular boilers shall have a fusible plug inserted in one of the tubes at a point at least 2 in. below the lowest gauge-cock, but in boilers having a cone top it shall be inserted in the upper tube sheet. All tubes are to be inserted so that the small end of the tin shall be exposed to the fire.

Steam-domes. — Steam-domes or drums were formerly almost universally used on horizontal boilers, but their use is now generally discontinued, as they are considered a useless appendage to a steam-boiler, and unless properly designed and constructed are an element of weakness.

Height of Furnace. — Recent practice in the United States makes the height of furnace much greater than it was formerly. With large sizes of anthracite there is no serious objection to having the furnace as low as 18 in., measured from the surface of the grate to the nearest portion of the heating surface of the boiler, but with coal containing much volatile matter and moisture a much greater distance is desirable. With very volatile coals the distance may be as great as 5 ft. or even 10 ft. Rankine (*S. E.*, p. 457) says: The clear height of the "crown" or roof of the furnace above the grate-bars is seldom less than about 18 in., and often considerably more. In the fire-boxes of locomotives it is on an average about 4 ft. The height of 18 in. is suitable where the crown of the furnace is a brick arch. Where the crown of the furnace, on the other hand, forms part of the heating-surface of the boiler, a greater height is desirable in every case in which it can be obtained; for the temperature of the boiler-plates, being much lower than that of the flame, tends to check the combustion of the inflammable gases which rise from the fuel. As a general principle a high furnace is favorable to complete combustion.

IMPROVED METHODS OF FEEDING COAL.

Mechanical Stokers. (William R. Roney, *Trans. A. S. M. E.*, vol. xii.) — Mechanical stokers have been used in England to a limited extent since 1785. In that year one was patented by James Watt. (See D. K. Clark's Treatise on the Steam-engine.)

After 1840 many styles of mechanical stokers were patented in England, but nearly all were variations and modifications of the two forms of stokers patented by John Jukes in 1841, and by E. Henderson in 1843.

The Jukes stoker consisted of longitudinal fire-bars, connected by links, so as to form an endless chain. The small coal was delivered from a hopper on the front of the boiler, on to the grate, which slowly moving

from front to rear, gradually advanced the fuel into the furnace and discharged the ash and clinker at the back.

The Henderson stoker consists primarily of two horizontal fans revolving on vertical spindles, which scatter the coal over the fire.

The first American stoker was the Murphy stoker, brought out in 1878. It consists of two coal magazines placed in the side walls of the boiler furnace, and extending back from the boiler front 6 or 7 feet. In the bottom of these magazines are rectangular iron boxes, which are moved from side to side by means of a rack and pinion, and serve to push the coal upon the grates, which incline at an angle of about 35° from the inner edge of the coal magazines, forming a V-shaped receptacle for the burning coal. The grates are composed of narrow parallel bars, so arranged that each alternate bar lifts about an inch at the lower end, while at the bottom of the V, and filling the space between the ends of the grate-bars, is placed a cast-iron toothed bar, arranged to be turned by a crank. The purpose of this bar is to grind the clinker coming in contact with it. Over this V-shaped receptacle is sprung a fire-brick arch.

In the Roney mechanical stoker the fuel to be burned is dumped into a hopper on the boiler front. Set in the lower part of the hopper is a "pusher" which, by a vibratory motion, gradually forces the fuel over the "dead-plate" and on the grate. The grate-bars in their normal condition form a series of steps. Each bar is capable of a rocking motion through an adjustable angle. All the grate-bars are coupled together by a "rocker-bar." A variable back-and-forth motion being given to the "rocker-bar," through a connecting-rod, the grate-bars rock in unison, now forming a series of steps, and now approximating to an inclined plane, with the grates partly overlapping, like shingles on a roof. When the grate-bars rock forward the fire will tend to work down in a body. But before the coal can move too far the bars rock back to the stepped position, checking the downward motion. The rocking motion is slow, being from 7 to 10 strokes per minute, according to the kind of coal. This alternate starting and checking motion is continuous, and finally lands the cinder and ash on the dumping-grate below.

The Hawley Down-draught Furnace. — A foot or more above the ordinary grate there is carried a second grate composed of a series of water-tubes, opening at both ends into steel drums or headers, through which water is circulated. The coal is fed on this upper grate, and as it is partially consumed falls through it upon the lower grate, where the combustion is completed in the ordinary manner. The draught through the coal on the upper grate is downward through the coal and the grate. The volatile gases are therefore carried down through the bed of coal, where they are thoroughly heated, and are burned in the space beneath, where they meet the excess of hot air drawn through the fire on the lower grate. In tests in Chicago, from 30 to 45 lbs. of coal were burned per square foot of grate upon this system, with good economical results. (See catalogue of the Hawley Down-draught Furnace Co., Chicago.)

The Chain Grate Stoker, made by Jukes in 1841, is now (1909) widely used in the United States. It is made by the Babcock & Wilcox Co. and others.

Under-feed Stokers. — Results similar to those that may be obtained with downward draught are obtained by feeding the coal at the bottom of the bed, pushing upward the coal already on the bed which has had its volatile matter distilled from it. The volatile matter of the freshly fired coal then has to pass through a body of ignited coke, where it meets a supply of hot air. (See circular of The Underfeed Stoker Co., Chicago.)

The Taylor Gravity Stoker, made by the Amer. Ship Windlass Co., Providence, R. I., is a combination of an underfeed stoker containing two horizontal rows of pushers with an inclined or step grate through which air is blown by a fan.

SMOKE PREVENTION.

The following article was contributed by the author to a "Report on Smoke Abatement," presented by a Committee to the Syracuse Chamber of Commerce, published by the Chamber in 1907.

Smoke may be made in two ways: (1) By direct distillation of tarry condensable vapors from coal without burning; (2) By the partial burning or splitting up of hydrocarbon gases, the hydrogen burning and the

carbon being left unburned as smoke or soot. These causes usually act conjointly.

The direct cause of smoke is that the gases distilled from the coal are not completely burned in the furnace before coming in contact with the surface of the boiler, which chills them below the temperature of ignition.

The amount and quality of smoke discharged from a chimney may vary all the way from a dense cloud of jet-black smoke, which may be carried by a light wind for a distance of a mile or more before it is finally dispersed into the atmosphere, to a thin cloud, which becomes invisible a few feet from the chimney. Often the same chimney will for a few minutes immediately after firing give off a dense black cloud and then a few minutes later the smoke will have entirely disappeared.

The quantity and density of smoke depend upon many variable causes. Anthracite coal produces no smoke under any conditions of furnace. Semi-bituminous, containing 12.5 to 25% of volatile matter in the combustible part of the coal, will give off more or less smoke, depending on the conditions under which it is burned, and bituminous coal, containing from 25 to 50% of volatile matter, will give off great quantities of smoke with all of the usual old-style furnaces, even with skillful firing, and this smoke can only be prevented by the use of special devices, together with proper methods of firing the fuel and of admission of air.

Practically the whole theory of smoke production and prevention may be illustrated by the flame of an ordinary gas burner or gas stove. When the gas is turned down very low every particle of gas, as it emerges from the burner, is brought in contact with a sufficient supply of hot air to effect its complete and instantaneous combustion, with a pale blue or almost invisible flame. Turn on the gas a little more and a white flame appears. The gas is imperfectly burned in the center of the flame. Particles of carbon have been separated which are heated to a white heat. If a cold plate is brought in contact with the white flame, these carbon particles are deposited as soot. Turn on the gas still higher, and it burns with a dull, smoky flame, although it is surrounded with an unlimited quantity of air. Now, carry this smoky flame into a hot fire-brick or porcelain chamber, where it is brought in contact with very hot air, and it will be made smokeless by the complete burning of the particles.

We thus see: (1) That smoke may be prevented from forming if each particle of gas, as it is made by distillation from coal, is immediately mixed thoroughly with hot air, and (2) That even if smoke is formed by the absence of conditions for preventing it, it may afterwards be burned if it is thoroughly mixed with air at a sufficiently high temperature. It is easy to burn smoke when it is made in small quantities, but when made in great volumes it is difficult to get the hot air mixed with it unless special apparatus is used. In boiler firing the formation of smoke must be prevented, as the conditions do not usually permit of its being burned. The essential conditions for preventing smoke in boiler fires may be enumerated as follows:

1. The gases must be distilled from the coal at a uniform rate.
2. The gases, when distilled, must be brought into intimate mixture with sufficient hot air to burn them completely.
3. The mixing should be done in a fire-brick chamber.
4. The gases should not be allowed to touch the comparatively cold surfaces of the boiler until they are completely burned. This means that the gases shall have sufficient space and time in which to burn before they are allowed to come in contact with the boiler surface.

Every one of these four conditions is violated in the ordinary method of burning coal under a steam boiler. (1) The coal is fired intermittently and often in large quantities at a time, and the distillation proceeds at so rapid a rate that enough air cannot be introduced into the furnace to burn the gas. (2) The piling of fresh coal on the grate in itself chokes the air supply. (3) The roof of the furnace is the cold shell, or tubes, of the boiler, instead of a fire-brick arch, as it should be, and the furnace is not of a sufficient size to allow the gases time and space in which to be thoroughly mixed with the air supply.

In order to obtain the conditions for preventing smoke it is necessary: (1) That the coal be delivered into the furnace in small quantities at a time. (2) That the draught be sufficient to carry enough air into the furnace to burn the gases as fast as they are distilled. (3) That the air

itself be thoroughly heated either by passing through a bed of white-hot coke or by passing through channels in hot brickwork, or by contact with hot fire-brick surfaces. (4) That the gas and the air be brought into the most complete and intimate mixture, so that each particle of carbon in the gas meets, before it escapes from the furnace, its necessary supply of air. (5) That the flame produced by the burning shall be completely extinguished by the burning of every particle of the carbon into invisible carbon dioxide.

If a white flame touches the surface of a boiler, it is apt to deposit soot and to produce smoke. A white flame itself is the visible evidence of incomplete combustion.

The first remedy for smoke is to obtain anthracite coal. If this is not commercially practicable, then obtain, if possible, coal with the smallest amount of volatile matter. Coal of from 15 to 25% of volatile matter makes much less smoke than coals containing higher percentages. Provide a proper furnace for burning coal. Any furnace is a proper furnace which secures the conditions named in the preceding paragraphs. Next, compel the firemen to follow instructions concerning the method of firing.

It is impossible with coal containing over 30% of volatile matter and with a water-tube boiler, with tubes set close to the grate and vertical gas passages, as in an anthracite setting, to prevent smoke even by the most skillful firing. This style of setting for a water-tube boiler should be absolutely condemned. A Dutch oven setting, or a longitudinal setting with fire-brick baffle walls, is highly recommended as a smoke-preventing furnace, but with such a furnace it is necessary to use considerable skill in firing.

Mechanical mixing of the gases and the air by steam jets is sometimes successful in preventing smoke, but it is not a universal preventive, especially when the coal is very high in volatile matter, when the firing is done unskillfully, or when the boiler is being driven beyond its normal capacity. It is essential to have sufficient draught to burn the coal properly and this draught may be obtained either from a chimney or a fan. There is no especial merit in forced draught, except that it enables a larger quantity of coal to be burned and the boiler to be driven harder in case of emergency, and usually the harder the boiler is driven, the more difficult it is to suppress smoke.

Down-draught furnaces and mechanical stokers of many different kinds are successfully used for smoke prevention, and when properly designed and installed and handled skillfully, and usually at a rate not beyond that for which they are designed, prevent all smoke. If these appliances are found giving smoke, it is always due either to overdriving or to unskillful handling. It is necessary, however, that the design of these stokers be suited to the quality of the coal and the quantity to be burned, and great care should be taken to provide a sufficient size of furnace with a fire-brick roof and means of introducing air to make them completely successful.

Burning Illinois Coal without Smoke. (L. P. Breckenridge, Bulletin No. 15 of the Univ. of Ill. Eng'g Experiment Station, 1907.) — Any fuel may be burned economically and without smoke if it is mixed with the proper amount of air at a proper temperature. The boiler plant of the University of Illinois consists of nine units aggregating 2000 H.P. Over 200 separate tests have been made. The following is a condensed statement of the results in regard to smoke prevention.

Boilers Nos. 1 and 2. Babcock & Wilcox. Chain-grate stoker. Usual vertical baffling. Can be run without smoke at from 50 to 120% of rated capacity.

No. 3. Stirling boiler. Chain-grate stoker. Usual baffling and combustion arches. Can be run without smoke at capacities of 50 to 140%.

No. 4. National water-tube. Chain-grate stoker. Vertical baffling. No smoke at capacities of 50 to 120%. With the Murphy furnace it was smokeless except when cleaning fires.

No. 5. Babcock & Wilcox. Roney stoker. Vertical baffling. Nearly smokeless (maximum No. 2 on a chart in which 5 represents black smoke) up to 100% of rating, but cannot be run above 150% without objectionable smoke.

No. 6. Babcock & Wilcox. Roney stoker. Horizontal tile-roof baffling. Can be run without smoke at capacities of 50 to 100% of rating.

Nos. 7 and 8. Stirling, equipped with Stirling bar-grate stoker. Usual baffling and combustion arches. Can be run without smoke at 50 to 140% of rating.

No. 9. Heine boiler. Chain-grate stoker. Combustion arch and tile-roof furnace. Can be run without smoke at capacities of 50 to 140%. It is almost impossible to make smoke with this setting under any condition of operation. As much as 46 lbs. of coal per sq. ft. of grate surface has been burned without smoke.

Conditions of Smoke Prevention. — Bulletin No. 373 of the U. S. Geological Survey, 1909 (188 pages), contains a report of an extensive research by D. T. Randall and J. T. Weeks on The Smokeless Combustion of Coal in Boiler Plants. A brief summary of the conclusions reached is as follows:

Smoke prevention is both possible and economical. There are many types of furnaces and stokers that are operated smokelessly.

Stokers or furnaces must be set so that combustion will be complete before the gases strike the heating surfaces of the boiler. When partly burned gases at a temperature of say 2500° F. strike the tubes of a boiler at say 350° F., combustion may be entirely arrested.

The most economical hand-fired plants are those that approach most nearly to the continuous feed of the mechanical stoker. The fireman is so variable a factor that the ultimate solution of the problem depends on the mechanical stoker — in other words, the personal element must be eliminated.

A well designed and operated furnace will burn many coals without smoke up to a certain number of pounds per hour, the rate varying with different coals. If more than this amount is burned, the efficiency will decrease and smoke will be made, owing to the lack of furnace capacity to supply air and mix gases.

High volatile matter in the coal gives low efficiency, and vice versa. When the furnace was forced the efficiency decreased.

With a hand-fired furnace the best results were obtained when firing was done most frequently, with the smallest charge.

Small sizes of coal burned with less smoke than large sizes, but developed lower capacities.

Peat, lignite, and sub-bituminous coal burned readily in the tile-roofed furnace and developed the rated capacity, with practically no smoke.

Coals which smoked badly gave efficiencies three to five per cent lower than the coals burning with little smoke.

Briquets were found to be an excellent form for using slack coal in a hand-fired plant.

In the average hand-fired furnace washed coal burns with lower efficiency and makes more smoke than raw coal. Moreover, washed coal offers a means of running at high capacity, with good efficiency, in a well-designed furnace.

Forced draught did not burn coal any more efficiently than natural draught. It supplied enough air for high rates of combustion, but as the capacity of the boiler increased, the efficiency decreased and the percentage of black smoke increased.

Fire-brick furnaces of sufficient length and a continuous, or nearly continuous, supply of coal and air to the fire make it possible to burn most coals efficiently and without smoke.

Coals containing a large percentage of tar and heavy hydrocarbons are difficult to burn without smoke and require special furnaces and more than ordinary care in firing.

FORCED COMBUSTION IN STEAM-BOILERS.

For the purpose of increasing the amount of steam that can be generated by a boiler of a given size, forced draught is of great importance. It is universally used in the locomotive, the draught being obtained by a steam-jet in the smoke-stack. It is now largely used in ocean steamers, especially in ships of war, and to a small extent in stationary boilers. Economy of fuel is generally not attained by its use, its advantages being confined to the securing of increased capacity from a boiler of a given bulk, weight, or cost.

There are three different modes of using the fan for promoting combustion: 1, blowing direct into a closed ash-pit; 2, exhausting the gases by the suction of the fan; 3, forcing air into an air-tight boiler-room or stoke-hold. Each of these three methods has its advantages and disadvantages.

In the use of the closed ash-pit the blast-pressure frequently forces the gases of combustion from the joint around the furnace doors in so great a quantity as to affect both the efficiency of the boiler and the health of the firemen.

The chief defect of the second plan is the great size of the fan required to produce the necessary exhaustion, on account of the higher exit temperature enlarging the volume of the waste gases.

The third method, that of forcing cold air by the fan into an air-tight boiler-room — the closed stoke-hold system — though it overcame the difficulties in working belonging to the two forms first tried, has serious defects of its own, as it cannot be worked, even with modern high-class boiler-construction, much, if at all, above the power of a good chimney draught, in most boilers, without damaging them. (J. Howden, Proc. Eng'g Congress at Chicago, in 1893.)

In 1880 Mr. Howden designed an arrangement intended to overcome the defects of both the closed ash-pit and the closed stoke-hold systems.

An air-tight chamber is placed on the front end of the boiler and surrounding the furnaces. This reservoir, which projects from 8 to 10 inches from the end of the boiler, receives the air under pressure, which is passed by valves into the ash-pits and over the fires in proportions suited to the kind of fuel and the rate of combustion. The air used above the fires is admitted to a space between the outer and inner furnace-doors, the inner having perforations and an air-distributing box through which the air passes under pressure. By means of the balance of pressure above and below the fires all tendency of the fire to blow out at the door is removed.

A feature of the system is the combination of the heating of the air of combustion by the waste gases with the controlled and regulated admission of air to the furnaces. This arrangement is effected most conveniently by passing the hot fire-gases after they leave the boiler through stacks of vertical tubes enclosed in the uptake, their lower ends being immediately above the smoke-box doors. Installations on Howden's system have been arranged for a rate of combustion to give an average of from 18 to 22 I.H.P. per square foot of fire-grate with fire-bars from 5 to 5½ ft. in length. It is believed that with suitable arrangement of proportions even 30 I.H.P. per square foot can be obtained.

For an account of uses of exhaust-fans for increasing draught, see paper by W. R. Roney, *Trans. A. S. M. E.*, vol. xv.

FUEL ECONOMIZERS.

Economizers for boiler plants are usually made of vertical cast-iron tubes contained in a long rectangular chamber of brickwork. The feed-water enters the bank of tubes at one end, while the hot gases enter the chamber at the other end and travel in the opposite direction to the water. The tubes are made of cast iron because it is more non-corrosive than wrought iron or steel when exposed to gases of combustion at low temperatures. An automatic scraping device is usually provided for the purpose of removing dust from the outer surface of the tubes.

The amount of saving of fuel that may be made by an economizer varies greatly according to the conditions of operation. With a given quantity of chimney gases to be passed through it, its economy will be greater

(1) the higher the temperature of these gases; (2) the lower the temperature of the water fed into it; and (3) the greater the amount of its heating surface. From (1) it is seen that an economizer will save more fuel if added to a boiler that is overdriven than if added to one driven at a nominal rate. From (2) it appears that less saving can be expected from an economizer in a power plant in which the feed-water is heated by exhaust steam from auxiliary engines than when the feed-water entering it is taken directly from the condenser hot-well. The amount of heating surface that should be used in any given case depends not only on the saving of fuel that may be made, but also on the cost of coal, and on the annual costs of maintenance, including interest, depreciation, etc.

The following table shows the theoretical results possibly attainable from economizers under the conditions specified. It is assumed that the coal has a heating value of 15,000 B.T.U. per lb. of combustible; that it is completely burned in the furnace at a temperature of 2500° F.; that the boiler gives efficiencies ranging from 60 to 75% according to the rate of driving; and that sufficient economizer surface is provided to reduce the temperature of the gases in all cases to 300° F. Assuming the specific heat of the gases to be constant, and neglecting the loss of heat by radiation, the temperature of the gases leaving the boiler and entering the economizer is directly proportional to (100 - % of boiler efficiency), and the combined efficiency of boiler and economizer is $(2500 - 300) \div 2500 = 88\%$, which corresponds to an evaporation of $(15,000 \div 970) \times 0.88 = 13.608$ lbs. from and at 212° per lb. of combustible; or assuming the feed-water enters the economizer at 100° F. and the boiler makes steam of 150 lbs. absolute pressure, to an evaporation of 11.729 lbs. under these conditions. Dividing this figure into the number of heat units utilized by the economizer per lb. of combustible gives the heat units added to the water, from which, by reference to a steam table, the temperature may be found. With these data we obtain the results given in the table below.

Boiler Efficiency, %.	60	65	70	75
B.T.U. absorbed by boiler per lb. combustible.....	9750	10500	11250	12000
B.T.U. in chimney gases leaving boiler.....	6000	5250	4500	3750
Estimated temp. of gases leaving boiler.....	1000°	875°	750°	625°
Estimated temp. of gases leaving economizer.....	300°	300°	300°	300°
B.T.U. saved by economizer.....	4200	3450	2700	1950
Efficiency gained by economizer, %.....	28	23	18	13
Equivalent water evap. per lb. comb. in boiler....	9.278	10.051	10.824	11.598
B.T.U. saved by econ. equivalent to evap. of lbs....	4.330	3.557	2.884	2.010
Temp. of water leaving economizer.....	448°	389°	327°	265°
Efficiency of the economizer, %.....	70	65.7	60	52

Amount of Heating Surface. — The Fuel Economizer Co. says: We have found in practice that by allowing 4 sq. ft. of heating surface per boiler H.P. (34½ lbs. evap. from and at 212° = 1 H.P.) we are able to raise the feed-water 60° F. for every 100° reduction in the temperature, the gases entering the economizer at 450° to 600°. With gases at 600° to 700° we have allowed a heating surface of 4½ to 5 sq. ft. per H.P., and for every 100° reduction in temperature of the gases we have obtained about 65° rise in temperature of the water; the feed-water entering at 60 to 120°. With 5000 sq. ft. of boiler-heating surface (plain cylinder boilers) developing 1000 H.P. we should recommend 5 sq. ft. of economizer surface per boiler H.P. developed, or an economizer of about 500 tubes, and it should heat the feed-water about 300°.

Heat Transmission in Economizers. (Carl S. Dow, *Indust. Eng'g*, April, 1909.) — The rate of heat transmission (C) per sq. ft. per hour per degree of difference between the average temperatures of the gases and the water passing through the economizer varies with the mean temperature of the gas about as follows: Gas, 600°, C = 3.25; gas 500°, C = 3; gas 400°, C = 2.75; gas 300°, C = 2.25.

Calculation of the Saving made by an Economizer. — The usual method of calculating the saving of fuel by an economizer when the boiler and the economizer are tested together as a unit is by the formula $(H_1 - h) + (H_2 - h)$, in which h is the total heat above 32° of 1 lb. of water entering, H_1 the total heat of 1 lb. of water leaving the economizer, and H_2 the total heat above 32° of 1 lb. of steam at the boiler pressure. If $h = 100$, $H_1 = 210$, $H_2 = 1200$, then the saving according to the formula is $(210 - 100) + 1100 = 10\%$. This is correct if the saving is defined as the ratio of the heat absorbed by the economizer to the total heat absorbed by the boiler and economizer together, but it is not correct if the saving is defined as the saving of fuel made by running the combined unit as compared with running the boiler alone making the same quantity of steam from feed-water at the low temperature, so as to cause the boiler to furnish $H_2 - h$ heat units per lb. instead of $H_2 - H_1$. In this case the boiler is called on to do more work, and in doing it it may be overdriven and work with lower efficiency.

In a test made by F. G. Gasche, in Kansas City in 1897, using Missouri coal analyzing moisture 7.58; volatile matter, 36.69; fixed carbon, 35.02; ash, 15.69; sulphur, 5.12, he obtained an evaporation of 5.17 lbs. from and at 212° per lb. of coal with the boiler alone, and when the boiler and economizer were tested together the equivalent evaporation credited to the boiler was 5.55, to the economizer 0.72, and to the combined unit 6.27, the saving by the combined unit as compared with the boiler alone being $(6.27 - 5.17) \div 6.27 = 17.5\%$, while the saving of heat shown by the economizer in the combined test is only $(6.27 - 5.55) \div 6.27 = 11.5\%$, or as calculated by Mr. Gasche from the formula $(H_1 - h) + (H_2 - h)$, $(172.1 - 39.3) \div (1181.8 \div 39.3) = 11.6\%$.

The maximum saving of fuel which may be made by the use of an economizer when attached to boilers that are working with reasonable economy is about 15%. Take the case of a condensing engine using steam of 125 lbs. gauge pressure, and with a hot-well or feed-water temperature of 100° F. The economizer may be expected under the best conditions to raise this temperature about 170° , or to 270° . Then $h = 68$, $H_1 = 239$, $H_2 = 1190$. $(H_1 - h) + (H_2 - h) = 171 + 15.24\%$.

If the boilers are not working with fair economy on account of being overdriven, then the saving made by the addition of an economizer may be much greater.

Test of a Large Economizer. (R. D. Tomlinson, *Power*, Feb., 1904.) — Two tests were made of one of the sixteen Green economizers at the 74th St. Station of the Rapid Transit Railway, New York City. Four 520-H.P. B. & W. boilers were connected to the economizer. It had 512 tubes, 10 ft. long, $4\frac{9}{16}$ in. external diam.; total heating surface 6760 sq. ft., or 3.25 sq. ft. per rated H.P. of the boilers. Draught area through econ., 3 sq. in. per H.P. The stack for each 16 boilers and four economizers was 280 ft. high, 17 ft. internal diam. The first test was made with the boilers driven at 94% of rating, the second at 113%. The results are given below, the figures of the second test being in parentheses.

Water entering econ. 96° (93.5°); leaving 200° (203.8°); rise 104 (110.3).
Gases entering econ. 548° (603°); leaving 295 (325); drop 253 (278).
Steam, gauge pressure, 166 (165). Total B.T.U. per lb. from feed temp. 1132 (1134).

Saving of heat by economizer, %, 9.17 (9.73).

Reduction of draught in passing through econ., in. of water, 0.16 (0.23).

Results from Seven Tests of Sturtevant Economizers (Catalogue of B. F. Sturtevant Co.)

Plants Tested.	Gases Entering. Deg. F.	Gases Leaving. Deg. F.	Water Entering. Deg. F.	Water Leaving. Deg. F.	Increase in Temperature.
1	650	275	180	340	160
2	575	290	160	320	160
3	470	230	130	260	130
4	500	240	110	230	120
5	460	200	90	230	140
6	440	220	120	236	116
7	525	225	180	320	140

THERMAL STORAGE.

In Druitt Halpin's steam storage system (*Industries and Iron*, Mar. 22, 1895) he employs only sufficient boilers to supply the mean demand, and storage tanks sufficient to supply the maximum demand. These latter not being subjected to the fire suffer but little deterioration. The boilers working continuously at their most economical rate have their excess of energy during light load stored up in the water of the tank, from which it may be drawn at will during heavy load. He proposes that the boilers and tanks shall work under a pressure of 265 lbs. per square inch when fully charged, which corresponds to a temperature of 406° F., and that the engines be worked at 130 lbs. per square inch, which corresponds to 347° F. The total available heat stored when the reservoirs are charged is that due to a range of 59° . The falling in temperature of $14\frac{1}{4}$ lbs. of water from 407° to 347° will yield 1 lb. of steam. To allow for radiation of loss and imperfect working, this may be taken at 16 lbs. of water per pound of steam. The steam consumption per effective H.P. may be taken at 18 lbs. per hour in condensing and 25 lbs. per hour in non-condensing engines. The storage-room per effective H.P. by this method would, therefore, be $(16 \times 18) \div 62.5 = 4.06$ cu. ft. for condensing and $(16 \times 25) \div 62.5 = 6.4$ cu. ft. for non-condensing engines.

Gas storage, assuming that illuminating gas is used, would require about 20 cu. ft. of storage room per effective H.P. hour stored, and if ordinary fuel gas were stored it would require about four times this capacity. In water storage 317 cu. ft. would be required at an elevation of 100 ft. to store one H.P. hour, so that of the three methods of storing energy the thermal method is by far the most economical of space.

In the steam storage method the boiler is completely filled with water and the storage tank nearly so. The two are in free communication by means of pipes, and a constant circulation of water is maintained between the two, but the steam for the engines is taken only from the top of the storage tank through a reducing valve.

In the feed storage system, the excess of energy during light load is stored in the tank as before, but the boilers are not completely filled. In this system the steam is taken exclusively from the boilers, the superheated water of the storage tanks being used during heavy load as feed-water to the boilers.

A third method is a combination of these two. In the "combined" feed and steam storage system the pressure in boiler and storage tank is equalized by connecting the steam spaces in both by pipe, and the steam for the engines is, therefore, taken from both. In other words they work in parallel.

INCRUSTATION AND CORROSION.

Incrustation or Scale. — Incrustation (as distinguished from mere sediments due to dirty water, which are easily blown out, or gathered up, by means of sediment-collectors) is due to the presence of salts in the feed-water (carbonates and sulphates of lime and magnesia for the most part), which are precipitated when the water is heated, and form hard deposits upon the boiler-plates. (See Impurities in Water, p. 691, ante.)

Where the quantity of these salts is not very large (12 grains per gallon, say) scale preventives may be found effective. The chemical preventives either form with the salts other salts soluble in hot water; or precipitate them in the form of soft mud, which does not adhere to the plates, and can be washed out from time to time. The selection of the chemical must depend upon the composition of the water, and it should be introduced regularly with the feed.

EXAMPLES. — Sulphate-of-lime scale prevented by carbonate of soda: The sulphate of soda produced is soluble in water; and the carbonate of lime falls down in grains, does not adhere to the plates, and may therefore be blown out or gathered into sediment-collectors. The chemical reaction is:

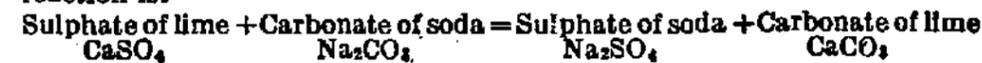

Where the quantity of salts is large, scale preventives are not of much use. Some other source of supply must be sought, or the bad water

purified before it is allowed to enter the boilers. The damage done to boilers by unsuitable water is enormous.

Pure water may be obtained by collecting rain, or condensing steam by means of surface condensers. The water thus obtained should be mixed with a little bad water, or treated with a little alkali, as undiluted, pure water corrodes iron; or, after each periodic cleaning, the bad water may be used for a day or two to put a skin upon the plates.

Carbonate of lime and magnesia may be precipitated either by heating the water or by mixing milk of lime (Porter-Clark process) with it, the water being then filtered.

Corrosion may be produced by the use of pure water, or by the presence of acids in the water, caused perhaps in the engine-cylinder by the action of high-pressure steam upon the grease, resulting in the production of fatty acids. Acid water may be neutralized by the addition of lime.

Amount of Sediment which may collect in a 100-H.P. steam-boiler, evaporating 3000 lbs. of water per hour, the water containing different amounts of impurity in solution, provided that no water is blown off:

Grains of solid impurities per U. S. gallon:											
5	10	20	30	40	50	60	70	80	90	100	
Equivalent parts per 100,000:											
8.57	17.14	34.28	51.42	68.56	85.71	102.85	120	137.1	154.3	171.4	
Sediment deposited in 1 hour, pounds:											
0.257	0.514	1.028	1.542	2.056	2.571	3.085	3.6	4.11	4.63	5.14	
In one day of 10 hours, pounds:											
2.57	5.14	10.28	15.42	20.56	25.71	30.85	36.0	41.1	46.3	51.4	
In one week of 6 days, pounds:											
15.43	30.85	61.7	92.53	123.4	154.3	185.1	216.0	246.8	277.6	308.5	

If a 100-H.P. boiler has 1200 sq. ft. heating-surface, one week's running without blowing off, with water containing 100 grains of solid matter per gallon in solution, would make a scale nearly 0.02 in. thick, if evenly deposited all over the heating-surface, assuming the scale to have a sp. gr. of 2.5 = 156 lbs. per cu. ft.: $0.02 \times 1200 \times 156 \times \frac{1}{12} = 312$ lbs.

Boiler-scale Compounds. — The Bavarian Steam-boiler Inspection Assn. in 1885 reported as follows:

Generally the unusual substances in water can be retained in soluble form or precipitated as mud by adding caustic soda or lime. This is especially desirable when the boilers have small interior spaces.

It is necessary to have a chemical analysis of the water in order to fully determine the kind and quantity of the preparation to be used for the above purpose.

All secret compounds for removing boiler-scale should be avoided. (A list of 27 such compounds manufactured and sold by German firms is then given which have been analyzed by the association.)

Such secret preparations are either nonsensical or fraudulent, or contain either one of the two substances recommended by the association for removing scale, generally soda, which is colored to conceal its presence, and sometimes adulterated with useless or even injurious matter.

These additions as well as giving the compound some strange, fanciful name, are meant simply to deceive the boiler owner and conceal from him the fact that he is buying colored soda or similar substances, for which he is paying an exorbitant price.

Effect of Scale on Boiler Efficiency. — The following statement, or a similar one, has been published and republished for 40 years or more by makers of "boiler compounds," feed-water heaters and water-purifying apparatus, but the author has not been able to trace it to its original source.*

"It has been estimated that scale $\frac{1}{50}$ of an inch thick requires the burning of 5 per cent of additional fuel; scale $\frac{1}{25}$ of an inch thick

* A committee of the Am. Ry. Mast. Mechs. Assn. in 1872 quoted from a paper by Dr. Jos. G. Rodgers before the Am. Assn. for Adv. of Science (date not stated): "It has been demonstrated [how and by whom not stated] that a scale $\frac{1}{16}$ in. thick requires the expenditure of 15% more fuel. As the scale thickens the ratio increases; thus when it is $\frac{1}{4}$ in. thick, 60% more is required."

requires 10 per cent more fuel; $\frac{1}{16}$ of an inch of scale requires 15 per cent additional fuel; $\frac{1}{8}$ of an inch, 30 per cent., and $\frac{1}{4}$ of an inch, 66 per cent."

The absurdity of the last statement may be shown by a simple calculation. Suppose a clean boiler is giving 75% efficiency with a furnace temperature of 2400° F. above the atmospheric temperature. Neglecting the radiation and assuming a constant specific heat for the gases, the temperature of the chimney gases will be 600°. A certain amount of fuel and air supply will furnish 100 lbs. of gas. In the boiler with $\frac{1}{4}$ in. scale 66% more fuel will make 66 lbs. more gas. As the extra fuel does no work in evaporating water, its heat must all go into the chimney gas. We have then in the chimney gases

100 lbs. at 600° F., product	60,000	
66 lbs. at 2400° F., product	<u>158,400</u>	218,400

which divided by 166 gives 1370° above atmosphere as the temperature of the chimney gas, or more than enough to make the flue connection and damper red hot. (Makers of boiler compounds, etc., please copy.)

Another writer says: "Scale of $\frac{1}{16}$ inch thickness will reduce boiler efficiency $\frac{1}{8}$, and the reduction of efficiency increases as the square of the thickness of the scale."

This is still more absurd, for according to it if $\frac{1}{16}$ in. scale reduces the efficiency $\frac{1}{8}$, then $\frac{3}{16}$ in. will reduce it $\frac{9}{8}$, or to below zero.

From a series of tests of locomotive tubes covered with different thicknesses of scale up to $\frac{1}{8}$ in. Prof. E. C. Schmidt (Bull. No. 11 Univ. of Ill. Experiment Station, 1907) draws the following conclusions:

1. Considering scale of ordinary thickness, say varying up to $\frac{1}{8}$ inch, the loss in heat transmission due to scale may vary in individual cases from insignificant amounts to as much as 10 or 12 per cent.

2. The loss increases somewhat with the thickness of the scale.

3. The mechanical structure of the scale is of as much or more importance than the thickness in producing this loss.

4. Chemical composition, except in so far as it affects the structure of the scale, has no direct influence on its heat-transmitting qualities.

In 1896 the author made a test of a water-tube boiler at Aurora, Ill., which had a coating of scale about $\frac{1}{4}$ in. thick throughout its whole heating surface, and obtained practically the same evaporation as in another test, a few days later, after the boiler had been cleaned. This is only one case, but the result is not unreasonable when it is known that the scale was very soft and porous, and was easily removed from the tubes by scraping.

Prof. R. C. Carpenter (*Am. Electrician*, Aug., 1900) says: So far as I am able to determine by tests, a lime scale, even of great thickness, has no appreciable effect on the efficiency of a boiler, as in a test which was conducted by myself the results were practically as good when the boiler was thickly covered with lime scale as when perfectly clean. . . . Observations and experiments have shown that any scale porous to water has little or no detrimental effect on economy of the boiler. There is, I think, good philosophy for this statement: the heating capacity is affected principally by the rapidity with which the heated gases will surrender heat, as the water and the metal have capacities for absorbing heat more than a hundred times faster than the air will surrender heat.

A thin film of grease, being impermeable to water, keeps the latter from contact with the metal and generally produces disastrous results. It is much more harmful than a very thick scale of carbonate of lime.

Kerosene and other Petroleum Oils; Foaming. — Kerosene has been recommended as a scale preventive. See paper by L. F. Lyne (*Trans. A. S. M. E.*, ix, 247). The *Am. Mach.*, May 22, 1890, says: Kerosene used in moderate quantities will not make the boiler foam; it is recommended and used for loosening the scale and for preventing the formation of scale. The presence of oil in combination with other impurities increases the tendency of many boilers to foam, as the oil with the impurities impedes the free escape of steam from the water surface. The use of common oil not only tends to cause foaming, but is dangerous otherwise. The grease appears to combine with the impurities of the water, and when the boiler is at rest this compound sinks to the plates

and clings to them in a loose, spongy mass, preventing the water from coming in contact with the plates, and thereby producing overheating, which may lead to an explosion. Foaming may also be caused by forcing the fire, or by taking the steam from a point over the furnace or where the ebullition is violent; the greasy and dirty state of new boilers is another good cause for foaming. Kerosene should be used at first in small quantities, the effect carefully noted, and the quantity increased if necessary for obtaining the desired results.

R. C. Carpenter (*Trans. A. S. M. E.*, vol. xi) says: The boilers of the State Agricultural College at Lansing, Mich., were badly incrustated with a hard scale. It was fully $\frac{3}{8}$ in. thick in many places. The first application of the oil was made while the boilers were being but little used, by inserting a gallon of oil, filling with water, heating to the boiling-point and allowing the water to stand in the boiler two or three weeks before removal. By this method fully one-half the scale was removed during the warm season and before the boilers were needed for heavy firing. The oil was then added in small quantities when the boiler was in actual use. For boilers 4 ft. in diam. and 12 ft. long the best results were obtained by the use of 2 qts. for each boiler per week, and for each boiler 5 ft. in diam. 3 qts. per week. The water used in the boilers has the following analysis: CaCO_3 , 206 parts in a million; MgCO_3 , 78 parts; Fe_2CO_3 , 22 parts; traces of sulphates and chlorides of potash and soda. Total solids, 325 parts in 1,000,000.

Petroleum Oils heavier than kerosene have been used with good results. Crude oil should never be used. The more volatile oils it contains make explosive gases, and its tarry constituents are apt to form a spongy incrustation.

Removal of Hard Scale. — When boilers are coated with a hard scale difficult to remove the addition of $\frac{1}{4}$ lb. caustic soda per horse-power, and steaming for some hours, according to the thickness of the scale, just before cleaning, will greatly facilitate that operation, rendering the scale soft and loose. This should be done, if possible, when the boilers are not otherwise in use. (*Steam.*)

Corrosion in Marine Boilers. (*Proc. Inst. M. E.*, Aug., 1884.) — The investigations of the Committee on Boilers served to show that the internal corrosion of boilers is greatly due to the combined action of air and sea-water when under steam, and when not under steam to the combined action of air and moisture upon the unprotected surfaces of the metal. There are other deleterious influences at work, such as the corrosive action of fatty acids, the galvanic action of copper and brass, and the inequalities of temperature; these latter, however, are considered to be of minor importance.

Of the several methods recommended for protecting the internal surfaces of boilers, the three found most effectual are: First, the formation of a thin layer of hard scale, deposited by working the boiler with sea-water; second, the coating of the surfaces with a thin wash of Portland cement, particularly wherever there are signs of decay; third, the use of zinc slabs suspended in the water and steam spaces.

As to general treatment for the preservation of boilers when laid up in the reserve, either of the two following methods is adopted. First, the boilers are dried as much as possible by airing-stoves, after which 2 to 3 cwt. of quicklime is placed on trays at the bottom of the boiler and on the tubes. The boiler is then closed and made as air-tight as possible. Inspection is made every six months, when if the lime be found slacked it is renewed. Second, the boilers are filled with sea or fresh water, having added soda to it in the proportion of 1 lb. to every 100 or 120 lbs. of water. The sufficiency of the saturation can be tested by introducing a piece of clean new iron and leaving it in the boiler for ten or twelve hours: if it shows signs of rusting, more soda should be added. It is essential that the boilers be entirely filled, to the complete exclusion of air.

Mineral oil has for many years been exclusively used for internal lubrication of engines, with the view of avoiding the effects of fatty acid, as this oil does not readily decompose and possesses no acid properties.

Of all the preservative methods adopted in the British service, the use of zinc properly distributed and fixed has been found the most effectual

in saving the iron and steel surfaces from corrosion, and also in neutralizing by its own deterioration the hurtful influences met with in water as ordinarily supplied to boilers. The zinc slabs now used in the navy boilers are 12 in. long, 6 ins. wide, and $\frac{1}{2}$ in. thick; this size being found convenient for general application. The amount of zinc used in new boilers at present is one slab of the above size for every 20 I.H.P., or about 1 sq. ft. of zinc surface to 2 sq. ft. of grate surface. Rolled zinc is found the most suitable for the purpose. Especial care must be taken to insure perfect metallic contact between the slabs and the stays or plates to which they are attached. The slabs should be placed in such positions that all the surfaces in the boiler are protected. Each slab should be periodically examined to see that its connection remains perfect, and to renew any that may have decayed; this examination is usually made at intervals not exceeding three months. Under ordinary circumstances of working these zinc slabs may be expected to last in fit condition from 60 to 90 days, immersed in hot sea-water; but in new boilers they at first decay more rapidly. The slabs are generally secured by means of iron straps 2 in. \times $\frac{3}{8}$ in., and long enough to reach the nearest stay, to which the strap is attached by screw-bolts.

To promote the proper care of boilers when not in use the following order has been issued to the French Navy by the Government: On board all ships in the reserve, as well as those which are laid up, the boilers will be completely filled with fresh water. In the case of large boilers with large tubes there will be added to the water a certain amount of milk of lime, or a solution of soda. In the case of tubulous boilers with small tubes milk of lime or soda may be added, but the solution will not be so strong as in the case of the larger tube, so as to avoid any danger of contracting the effective area by deposit from the solution; but the strength of the solution will be just sufficient to neutralize any acidity of the water. (*Iron Age*, Nov. 2, 1893.)

Use of Zinc. — Zinc is often used in boilers to prevent the corrosive action of water on the metal. The action appears to be an electrical one, the iron being one pole of the battery and the zinc being the other. The hydrogen goes to the iron shell and escapes as a gas into the steam. The oxygen goes to the zinc.

On account of this action it is generally believed that zinc will always prevent corrosion, and that it cannot be harmful to the boiler or tank. Some experiences go to disprove this belief, and in numerous cases zinc has not only been of no use, but has even been harmful. In one case a tubular boiler had been troubled with a deposit of scale consisting chiefly of organic matter and lime, and zinc was tried as a preventive. The beneficial action of the zinc was so obvious that its continued use was advised, with frequent opening of the boiler and cleaning out of detached scale until all the old scale should be removed and the boiler become clean. Eight or ten months later the water-supply was changed, it being now obtained from another stream supposed to be free from lime and to contain only organic matter. Two or three months after its introduction the tubes and shell were found to be coated with an obstinate adhesive scale, composed of zinc oxide and the organic matter or sediment of the water used. The deposit had become so heavy in places as to cause overheating and bulging of the plates over the fire. (*The Locomotive.*)

Effect of Deposit on the Fire-surface of Flues. (Rankine.) — An external crust of a carbonaceous kind is often deposited from the flame and smoke of the furnaces in the flues and tubes, and if allowed to accumulate seriously impairs the economy of fuel. It is removed from time to time by means of scrapers and wire brushes. The accumulation of this crust is the probable cause of the fact that in some steamships the consumption of coal per I.H.P. per hour goes on gradually increasing until it reaches one and a half times its original amount, and sometimes more.

Dangerous Steam-boilers discovered by inspection. — The Hartford Steam-boiler Inspection and Insurance Co. reports that its inspectors during 1908 examined 317,537 boilers, inspected 124,990 boilers, both internally and externally, subjected 10,449 to hydrostatic pressure, and found 572 unsafe for further use. The whole number of defects reported was 151,359, of which 15,578 were considered dangerous. A summary is given below. (*The Locomotive*, Jan., 1909.)

SUMMARY, BY DEFECTS, FOR THE YEAR 1893.

Nature of Defects.	Whole No.	Dangerous.	Nature of Defects.	Whole No.	Dangerous.
Deposit of sediment.....	18,879	1,242	Defective tubes.....	8,026	2,136
Incrustation and scale... 37,924	1,193	Tubes too light.....	1,636	432	
Internal grooving.....	2,649	249	Leakage at joints.....	4,845	392
Internal corrosion.....	13,053	555	Water-gauges defective.	2,411	585
External corrosion.....	9,400	698	Blow-offs defective.....	3,818	1,125
Def'tive braces and stays	1,993	503	Deficiency of water.....	391	147
Settings defective.....	5,341	642	Safety-valves overloaded	1,216	379
Furnaces out of shape... 6,981	380	Safety-valves defective.	1,068	359	
Fractured plates.....	3,119	482	Pressure-gauges def'tive	7,120	531
Burned plates.....	4,605	440	Without pressure-gauges..	322	322
Laminated plates.....	666	44	Unclassified defects.....	7	3
Defective riveting.....	3,395	713			
Defective heads.....	1,565	223	Total.....	151,359	15,878
Leakage around tubes... 10,929	2,103				

The above-named company publishes annually a summary like the above, and also a classified list of boiler-explosions, compiled chiefly from newspaper reports, showing that from 200 to 300 explosions take place in the United States every year, killing from 200 to 300 persons, and injuring from 300 to 450. The lists are not pretended to be complete, and may include only a fraction of the actual number of explosions.

Steam-boilers as Magazines of Explosive Energy. — Prof. R. H. Thurston (*Trans. A. S. M. E.*, vol. vi), in a paper with the above title, presents calculations showing the stored energy in the hot water and steam of various boilers. Concerning the plain tubular boiler of the form and dimensions adopted as a standard by the Hartford Steam-boiler Insurance Co., he says: It is 60 ins. in diameter, containing 66 3-in. tubes, and is 15 ft. long. It has 850 sq. ft. of heating and 30 sq. ft. of grate surface is rated at 60 H.P., but is oftener driven up to 75; weighs 9500 lbs., and contains nearly its own weight of water, but only 21 lbs. of steam when under a pressure of 75 lbs. per sq. in., which is below its safe allowance. It stores 52,000,000 foot-pounds of energy, of which but 4% is in the steam, and this is enough to drive the boiler just about one mile into the air, with an initial velocity of nearly 600 ft. per second.

SAFETY-VALVES.

Calculation of Weight, etc., for Lever Safety-valves.

Let W = weight of ball at end of lever; w = weight of lever itself; V = weight of valve and spindle, all in pounds; L = distance between fulcrum and center of ball; l = distance between fulcrum and center of valve; g = distance between fulcrum and center of gravity of lever all in inches; A = area of valve, in sq. ins.; P = pressure of steam, in lbs. per sq. in., at which valve will open.

Then $PA \times l = W \times L + w \times g + V \times L$;
whence $P = (WL + wg + VL) \div Al$; $W = (PAL - wg - VL) \div L$; $L = (PAL - wg - VL) \div W$.

EXAMPLE. — Diameter of valve, 4 ins.; distance from fulcrum to center of ball, 36 ins.; to center of valve, 4 ins.; to center of gravity of lever, 15½ ins.; weight of valve and spindle, 3 lbs.; weight of lever, 7 lbs.; required the weight of ball to make the blowing-off pressure 80 lbs. per sq. in.; area of 4-in. valve = 12.566 sq. ins. Then

$$W = \frac{PAL - wg - VL}{L} = \frac{80 \times 12.566 \times 4 - 7 \times 15\frac{1}{2} - 3 \times 4}{36} = 108.4 \text{ lbs.}$$

By the rules of the U. S. Supervising Inspectors of Steam Vessels the use of lever safety-valves is prohibited on all boilers built for steam vessels after June 30, 1906.

Rules for Area of Safety-valves.

(Rule of U. S. Supervising Inspectors of Steam-vessels (as amended 1909).)

The areas of all safety-valves on boilers contracted for or the construction of which commenced on or after June 1, 1904, shall be determined in accordance with the following formula: $a = 0.2074 \times W/P$, where a = area of safety-valve, in sq. in., per sq. ft. of grate surface; W = pounds of water evaporated per sq. ft. of grate surface per hour; P = absolute pressure per sq. in. = working gauge pressure + 15.

The value of a multiplied by the square feet of grate surface gives the area of safety valve or valves required. When this calculation results in an odd size of safety-valve use the next larger standard size.

EXAMPLE. — Boiler-pressure = 215 lbs. gauge, = 230 absolute, = P . Grate surface = 110 sq. ft. Water evaporated per pound coal = 10 lbs. Coal burned per sq. ft. grate per hour = 30 lbs. Evaporation per sq. ft. grate per hour = 300 lbs. = W . $a = 0.2074 \times 300 \div 230 = 0.270$. Therefore area of safety-valve = $110 \times 0.270 = 29.7$ sq. ins., which is too large for one valve. Use two, 14.85 sq. ins. each. Diameter = 4¾ ins. Each spring-loaded valve shall be supplied with a lever that will raise the valve from its seat a distance of not less than that equal to one-eighth of the diameter of the valve opening.

The valves shall be so arranged that each boiler shall have at least one separate safety-valve, unless the arrangement is such as to preclude the possibility of shutting off the communication of any boiler with the safety valve or valves employed.

Two safety-valves may be allowed on any boiler, provided their combined area is equal to that required by rule for one valve. Whenever the area of a safety-valve, as found by the rule, will be greater than that corresponding to 6 inches in diameter, two or more safety-valves, whose combined area shall be equal at least to the area required, must be used.

The seats of all safety-valves shall have an angle of inclination of 45 degrees to the center lines of their axes.

Comparison of Various Rules for Area of Lever Safety-valves. (Condensed from an article by the author in *American Machinist*, May 24, 1894, with some alterations.) — Assume the case of a boiler rated at 100 horse-power; 40 sq. ft. grate; 1200 sq. ft. heating-surface; using 400 lbs. of coal per hour, or 10 lbs. per sq. ft. of grate per hour, and evaporating 3600 lbs. of water, or 3 lbs. per sq. ft. of heating-surface per hour; steam-pressure by gauge, 100 lbs. What size of safety-valve, of the lever type, should be required?

A compilation of various rules for finding the area of the safety-valve disk, from *The Locomotive* of July, 1892, is given in abridged form below, together with the area calculated by each rule for the above example.

Rule	Disk Area in sq. in.
U. S. Supervisors, heating-surface in sq. ft. ÷ 25 (old rule)	48
English Board of Trade, grate-surface in sq. ft. ÷ 2.....	20
Molesworth, four-fifths of grate-surface in sq. ft.....	32
Thurston, 4 times coal burned per sq. ft. of grate (gauge pressure + 10)...	14.5
Thurston, 2.5 × heating-surface ÷ gauge pressure + 10	27.3
Rankine, 0.006 × water evaporated per hour	21.6
Committee of U. S. Supervisors, 0.005 × water evaporated per hr..	18

Suppose that, other data remaining the same, the draught were increased so as to burn 13⅓ lbs. coal per sq. ft. of grate per hour, and the grate-surface cut down to 30 sq. ft. to correspond, making the coal burned per hour 400 lbs., and the water evaporated 3600 lbs., the same as before; then the English Board of Trade rule and Molesworth's rule would give an area of disk of only 15 and 24 sq. in., respectively, showing the absurdity of making the area of grate the basis of the calculation of disk area.

Other rules give for the area of safety-valve of the same 100-horse-power boiler results ranging all the way from 5.25 to 57.6 sq. ins.

All of the rules quoted give the area of the disk of the valve as the thing to be ascertained, and it is this area which is supposed to bear some direct ratio to the grate-surface, to the heating-surface, to the

water evaporated, etc. It is difficult to see why this area has been considered even approximately proportional to these quantities, for with small lifts the area of actual opening bears a direct ratio, not to the area of disk, but to the circumference.

Thus for various diameters of valve:

Diameter, ins.....	1	2	3	4	5	6	7
Area, sq. ins.....	0.785	3.14	7.07	12.57	19.64	28.27	38.48
Circumference.....	3.14	6.28	9.42	12.57	15.71	18.85	21.99
Circum. X lift of 0.1 in.	0.31	0.63	0.94	1.26	1.57	1.89	2.20
Ratio to area.....	0.4	0.2	0.13	0.1	0.08	0.067	0.057

A correct rule for size of safety-valves should make the product of the diameter and the lift proportional to the weight of steam to be discharged.

A method for calculating the size of safety-valve is given in *The Locomotive*, July, 1892, based on the assumption that the actual opening should be sufficient to discharge all the steam generated by the boiler. Napier's rule for flow of steam is taken, viz., flow through aperture of one sq. in. in lbs. per second = absolute pressure ÷ 70, or in lbs. per hour = 51.43 X absolute pressure.

If the angle of the seat is 45°, the area of opening in sq. in. = circumference of the disk X the lift X 0.71, 0.71 being the cosine of 45°; or diameter of disk X lift X 2.23.

Spring-loaded Safety Valves.

Spring-loaded safety valves to be used on U. S. merchant vessels must conform to the rules prescribed by the Board of Supervising Inspectors, and on vessels for the U. S. Navy to specifications made by the Bureau of Steam Engineering, U. S. N. Valves to be used on stationary boilers must conform in many cases to the special laws made by various states. Few of these rules are on a logical basis, in that they take no account of the lift of the valve, and it is quite clear that the rate of steam discharge through a safety-valve depends upon the area of opening, which varies with the circumference of the valve and the lift. Experiments made by the Consolidated Safety Valve Co. showed that valves made by the different manufacturers and employing various combinations of springs with different designs of valve lips and huddling chambers give widely different lifts. Lifts at popping point of different makes of safety-valves, at 200 lbs. pressure, are as follows:

- 4-in. stationary valves, in., 0.031, 0.056, 0.064, 0.082, 0.094, 0.094, 0.137. Av. 0.079 in.
- 3 1/2-in. locomotive valves, in., 0.040, 0.051, 0.065, 0.072, 0.076, 0.140 ins. Av. 0.074 in.

United States Supervising Inspectors' Rule (adopted in 1904). $A = 0.2074 W/P$. A = area of safety valve in sq. in. per sq. ft. of grate surface; W = lbs. of water evaporated per sq. ft. of grate surface per hour; P = boiler pressure, absolute, lbs. per sq. in. This rule assumes a lift of 1/32 of the nominal diameter, and 75% of the flow calculated by Napier's rule. This 75% corresponds nearly to the cosine of 45°, or 0.707.

Massachusetts Rule of 1909. $A = 770 W/P$, in which W = lbs. evaporated per sq. ft. of grate per second; A and P as above. This is the same as the U. S. rule with a 3.2% larger constant.

Philadelphia Rule. — $A = 22.5 G \div (P + 8.62)$. A = total area of valve or valves, sq. in.; G = grate area, sq. ft.; P = boiler pressure (gauge). This rule came from France in 1868. It was recommended to the city of Philadelphia by a committee of the Franklin Institute, although the committee "had not found the reasoning upon which the rule had been based."

Philip G. Darling (*Trans. A. S. M. E.*, 1909) commenting on the above rules says: The principal defect of these rules is that they assume that valves of the same nominal size have the same capacity, and they rate them the same without distinction, in spite of the fact that in actual practice some have but one-third of the capacity of others. There are other defects, such as varying the assumed lift as the valve diameter, while in

reality with a given design the lifts are more nearly the same in the different sizes, not varying nearly as rapidly as the diameters. And further than this, the actual lifts assumed for the larger valves are nearly double the actual average obtained in practice. The direct conclusion is that existing rules and statutes are not safe to follow. Some of these rules in use were formulated before, and have not been modified since, spring safety-valves were invented, and at a time when 120 lbs. was considered high pressure. None of these rules take account of the different lifts which exist in the different makes of valves of the same nominal size, and they thus rate exactly alike valves which actually vary in lift and relieving capacity over 300%. It would therefore seem the duty of all who are responsible for steam installation and operation to no longer leave the determination of safety-valve size and selection to such statutes as may happen to exist in their territory, but to investigate for themselves.

Formulae for Spring-loaded Safety-Valves. — Let L = lift of valve in.; D = diam. in.; E = discharge, lbs. per hour; P = abs. pressure; A = area of opening; θ = angle of seat with horizontal. By Napier's formula $E = AP \times 3600 + 70 = 51.43 AP$. $A = \pi DL \cos \theta$ (approximately). If $\theta = 45^\circ$, $\cos \theta = 0.707$, whence $E = 114.2 LDP$. Experiments with six different valves, 3, 3 1/2 and 4 in. stationary, and 1 1/2, 3 and 3 1/2 in. locomotive, gave an average flow equal to 92.5% of that calculated by the above formula, which is therefore modified by Mr. Darling to the forms $E = 105 LDP$, and $D = 0.0095 E \div LP$ (1)

To obtain formulae for safety valves in terms of the heating-surface of the boiler Mr. Darling takes for stationary boilers an average evaporation of 3 1/2 lbs. per sq. ft. of heating-surface per hour, with an overload capacity of 100%; for marine boilers, water-tube or Scotch, an overload or maximum evaporation of 10 lbs. per sq. ft. of heating-surface per hour. If H = total boiler heating-surface in sq. ft., these assumptions give for stationary boilers $D = 0.068 H \div LP$ (2) and for marine boilers $D = 0.095 H \div LP$ (3). For locomotive boilers the proper constant in the formula was deduced from numerous experiments to be 0.055. (4).

For flat valves the constants in the last four formulæ are: (1) 0.0067; (2) 0.065; (3) 0.090; (4) 0.052.

The following table is calculated from Napier's formula, on the assumption of a lift of 0.1 in. and a 45° valve-seat. For any other lift than 0.1 in., the discharge is proportional to the lift. The figures should be multiplied by a coefficient expressing the relation of the discharge of actual valves to the discharge through a plain round orifice (Napier's). In the Consolidated Safety Valve Co.'s experiments the average value of this coefficient was found to be 0.925.

STEAM DISCHARGED IN LBS. PER HOUR BY A VALVE LIFTING 0.10 IN.

Gauge Pressure.	Valve diameters, inches.										
	1	1 1/2	2	2 1/2	3	3 1/2	4	4 1/2	5	5 1/2	6
25	460	690	920	1150	1380	1610	1840	2080	2300	2540	2770
50	750	1130	1500	1880	2250	2630	3000	3380	3760	4130	4500
75	1040	1560	2080	2600	3120	3640	4160	4680	5200	5720	6240
100	1330	2000	2660	3330	4000	4660	5320	6000	6650	7320	8000
125	1620	2440	3250	4060	4860	5670	6480	7300	8100	8920	9730
150	1910	2870	3830	4790	5740	6700	7650	8610	9560	10520	11470
175	2200	3300	4400	5500	6600	7700	8800	9900	11000	12100	13200
200	2500	3740	5000	6240	7480	8730	9970	11200	12460	13700	14950
225	2780	4180	5570	6960	8340	9730	11120	12500	13900	15300	16700
250	3070	4610	6140	7680	9200	10740	12300	13800	15360	16900	18450
275	3360	5050	6720	8400	10100	11760	13450	15150	16800	18500	20200
300	3650	5480	7310	9150	10960	12800	14600	16470	18300	20100	22000

Unequal expansion of safety-valve parts under steam temperatures tends to cause leakage, and as this temperature effect becomes more serious in the large sizes the manufacturers do not recommend the use of valves larger than 4 1/2 ins. If greater relieving capacity be required it is the best practice to use duplex valves or additional single valves.

RELIEVING CAPACITIES, CONSOLIDATED POP SAFETY VALVES, STATIONARY TYPE. (Pounds of Steam per hour.)

Size Valve, In.	Gauge Pressures. (lbs. per sq. in.)												
	60	80	100	120	140	160	180	200	220	240	260	280	300
2	1890	2400	2900	3400	3900	4410	4910	5420	5920	6430	6930	7430	7940
2 1/2	2360	3000	3620	4250	4880	5500	6140	6760	7400	8030	8650	9300	9900
3	3070	3890	4700	5530	6350	7170	8000	8800	9620	10400	11200	12100	12900
3 1/2	3860	4880	5910	6950	7960	9020	10000	11100	12100	13100	14200	15200	16300
4	4410	5580	6770	7950	9120	10300	11500	12600	13800	15000	16200	17300	18500
4 1/2	5310	6730	8150	9570	11000	12400	13800	15200	16700	18100	19500	20900	22400
5	6300	7970	9650	11330	13000	14700	16400	18100	19700	21400	23100	24800	26500

For an extended discussion on safety-valves, see *Trans. A. S. M. E.*, 1909.

THE INJECTOR.

Equation of the Injector.

- Let *S* be the number of pounds of steam used;
- W* the number of pounds of water lifted and forced into the boiler;
- h* the height in feet of a column of water, equivalent to the absolute pressure in the boiler;
- h₀* the height in feet the water is lifted to the injector;
- t₁* the temperature of the water before it enters the injector;
- t₂* the temperature of the water after leaving the injector;
- H* the total heat above 32° F. in one pound of steam in the boiler, in heat-units;
- L* the work in friction and the equivalent lost work due to radiation and lost heat;
- 778 the mechanical equivalent of heat.

Then

$$S[H - (t_2 - 32^\circ)] = W(t_2 - t_1) + \frac{(W + S)h + Wh_0 + L}{778}$$

An equivalent formula, neglecting *Wh₀* + *L* as small, is

$$S = \left[W(t_2 - t_1) + \frac{W + S}{d} \cdot p \cdot \frac{144}{778} \right] \frac{1}{H - (t_2 - 32^\circ)}$$

or $S = \frac{W[(t_2 - t_1)d + 0.1851 p]}{[H - (t_2 - 32^\circ)]d - 0.1851 p}$

In which *d* = weight of 1 cu. ft. of water at temperature *t₂*; *p* = absolute pressure of steam, lbs. per sq. in.

The rule for finding the proper sectional area for the narrowest part of the nozzles is given as follows by Rankine, *S. E.*, p. 477:

$$\text{Area in square inches} = \frac{\text{cubic feet per hour gross feed-water}}{500 \sqrt{\text{pressure in atmospheres}}}$$

An important condition which must be fulfilled in order that the injector will work is that the supply of water must be sufficient to condense

the steam. As the temperature of the supply or feed-water is higher, the amount of water required for condensing purposes will be greater.

The table below gives the calculated value of the maximum ratio of water to the steam, and the values obtained on actual trial, also the highest admissible temperature of the feed-water as shown by theory and the highest actually found by trial with several injectors.

Gauge-pressure, pounds per sq. in.	Maximum Ratio Water to Steam.			Gauge-pressure, pounds per sq. in.	Maximum Temperature of Feed-Water.								
	Calculated from Theory.	Actual Experiment.			Theoretical.		Experimental Results.						
		H.	P.		M.	Temp. discharge 180°.	Temp. discharge 212°.	H.	P.	M.	S.		
10	36.5	30.9	10
20	25.6	22.5	19.9	21.5	20	142°	173°	135°	120°	130°	132°
30	20.9	19.0	17.2	19.0	30	132	162	134
40	17.87	15.8	15.0	15.86	40	126	156	140	113	125	132
50	16.2	13.3	14.0	13.3	50	120	150	131
60	14.7	11.2	11.2	12.6	60	114	143	115	123	130
70	13.7	12.3	11.7	12.9	70	109	139	141*	123	130
80	12.9	11.4	11.2	80	105	134	141*	118	122	131
90	12.1	90	99	129	132*
100	11.5	100	95	125	132*
					120	87	117	134*
					150	77	107	121*

* Temperature of delivery above 212°. Waste-valve closed.

H, Hancock inspirator; P, Park injector; M, Metropolitan injector; S, Sellers 1876 injector.

Efficiency of the Injector. — Experiments at Cornell University, described by Prof. R. C. Carpenter, in *Cassier's Magazine*, Feb., 1892, show that the injector, when considered merely as a pump, has an exceedingly low efficiency, the duty ranging from 161,000 to 2,752,000 under different circumstances of steam and delivery pressure. Small direct-acting pumps, such as are used for feeding boilers, show a duty of from 4 to 8 million ft.-lbs., and the best pumping-engines from 100 to 140 million. When used for feeding water into a boiler, however, the injector has a thermal efficiency of 100%, less the trifling loss due to radiation, since all the heat rejected passes into the water which is carried into the boiler.

The loss of work in the injector due to friction reappears as heat which is carried into the boiler, and the heat which is converted into useful work in the injector appears in the boiler as stored-up energy.

Although the injector thus has a perfect efficiency as a boiler-feeder, it is not the most economical means for feeding a boiler, since it can draw only cold or moderately warm water, while a pump can feed water which has been heated by exhaust steam which would otherwise be wasted.

Performance of Injectors. — In *Am. Mach.*, April 13, 1893, are a number of letters from different manufacturers of injectors in reply to the question: "What is the best performance of the injector in raising or lifting water to any height?" Some of the replies are tabulated below.

W. Sellers & Co. — 25.51 lbs. water delivered to boiler per lb. of steam; temperature of water, 64°; steam pressure, 65 lbs.

Schaeffer & Budenberg — 1 gal. water delivered to boiler for 0.4 to 0.8 lb. steam.

Injector will lift by suction water of

140° F. 136° to 133° 122° to 118° 113° to 107°
If boiler pres. is 30 to 60 lbs. 60 to 90 lbs. 90 to 120 lbs. 120 to 150 lbs.

WARNING: This is a 1910 edition. Some of the material may no longer be accurate

If the water is not over 80° F., the injector will force against a pressure 75 lbs. higher than that of the steam.

Hancock Inspirator Co.:				
Lift in feet	22	22	22	11
Boiler pressure, absolute, lbs.	75.8	54.1	95.5	75.4
Temperature of suction	34.9°	35.4°	47.3°	53.2
Temperature of delivery	134°	117.4°	173.7°	131.1°
Water fed per lb. of steam, lbs.	11.02	13.67	8.18	13.3

The theory of the injector is discussed in Wood's, Peabody's, and Rontgen's treatises on Thermodynamics. See also "Theory and Practice of the Injector," by Strickland L. Kneass, New York, 1910.

Boiler-feeding Pumps. — Since the direct-acting pump, commonly used for feeding boilers, has a very low efficiency, or less than one-tenth that of a good engine, it is generally better to use a pump driven by belt from the main engine or driving shaft. The mechanical work needed to feed a boiler may be estimated as follows: If the combination of boiler and engine is such that half a cubic foot, say 32 lbs. of water, is needed per horse-power, and the boiler-pressure is 100 lbs. per sq. in., then the work of feeding the quantity of water is 100 lbs. × 144 sq. in. × 1/2 ft. = 120 ft.-lbs. per min. = 120/33,000 = .0036 H.P., or less than 1/10 of 1% of the power exerted by the engine. If a direct-acting pump, which discharges its exhaust steam into the atmosphere, is used for feeding, and it has only 1/10 the efficiency of the main engine, then the steam used by the pump will be equal to nearly 4% of that generated by the boiler.

The low efficiency of boiler-feeding pumps, and of other small auxiliary steam-driven machinery, is, however, of no importance if all the exhaust steam from these pumps is utilized in heating the feed-water.

The following table by Prof. D. S. Jacobus gives the relative efficiency of steam and power pumps and injector, with and without heater, as used upon a boiler with 80 lbs. gauge-pressure, the pump having a duty of 10,000,000 ft.-lbs. per 100 lbs. of coal when no heater is used; the injector heating the water from 60° to 150° F.

Direct-acting pump feeding water at 60°, without a heater	1.000
Injector feeding water at 150°, without a heater	0.985
Injector feeding water through a heater in which it is heated from 150° to 200°	0.938
Direct-acting pump feeding water through a heater, in which it is heated from 60° to 200°	0.879
Geared pump, run from the engine, feeding water through a heater, in which it is heated from 60° to 200°	0.868

Gravity Boiler-feeders. — If a closed tank be placed above the level of the water in a boiler and the tank be filled or partly filled with water, then on shutting off the supply to the tank, admitting steam from the boiler to the upper part of the tank, so as to equalize the steam-pressure in the boiler and in the tank, and opening a valve in a pipe leading from the tank to the boiler, the water will run into the boiler. An apparatus of this kind may be made to work with practically perfect efficiency as a boiler-feeder, as an injector does, when the feed-supply is at ordinary atmospheric temperature, since after the tank is emptied of water and the valves in the pipes connecting it with the boiler are closed the condensation of the steam remaining in the tank will create a vacuum which will lift a fresh supply of water into the tank. The only loss of energy in the cycle of operations is the radiation from the tank and pipes, which may be made very small by proper covering.

When the feed-water supply is hot, such as the return water from a heating system, the gravity apparatus may be made to work by having two receivers, one at a low level, which receives the returns or other feed-supply, and the other at a point above the boilers. A partial vacuum being created in the upper tank, steam-pressure is applied above the water in the lower tank by which it is elevated into the upper. The operation of such a machine may be made automatic by suitable arrangement of valves.

WARNING: This is a 1910 edition. Some of the material may no longer be accurate

FEED-WATER HEATERS.

Percentage of Saving for Each Degree of Increase in Temperature of Feed-water Heated by Waste Steam.

Initial Temp. of Feed.	Steam Pressure in Boiler, lbs. per sq. in. above Atmosphere.										Initial Temp.	
	0	20	40	60	80	100	120	140	160	180		200
32°	.0872	.0861	.0855	.0851	.0847	.0844	.0841	.0839	.0837	.0835	.0833	32°
40	.0878	.0867	.0861	.0856	.0853	.0850	.0847	.0845	.0843	.0841	.0839	40
50	.0886	.0875	.0868	.0864	.0860	.0857	.0854	.0852	.0850	.0848	.0846	50
60	.0894	.0883	.0876	.0872	.0867	.0864	.0862	.0859	.0856	.0855	.0853	60
70	.0902	.0890	.0884	.0879	.0875	.0872	.0869	.0867	.0864	.0862	.0860	70
80	.0910	.0898	.0891	.0887	.0883	.0879	.0877	.0874	.0872	.0870	.0868	80
90	.0919	.0907	.0900	.0895	.0888	.0887	.0884	.0883	.0879	.0877	.0875	90
100	.0927	.0915	.0908	.0903	.0899	.0895	.0892	.0890	.0887	.0885	.0883	100
110	.0936	.0923	.0916	.0911	.0907	.0903	.0900	.0898	.0895	.0893	.0891	110
120	.0945	.0932	.0925	.0919	.0915	.0911	.0908	.0906	.0903	.0901	.0899	120
130	.0954	.0941	.0934	.0928	.0924	.0920	.0917	.0914	.0912	.0909	.0907	130
140	.0963	.0950	.0943	.0937	.0932	.0929	.0925	.0923	.0920	.0918	.0916	140
150	.0973	.0959	.0951	.0946	.0941	.0937	.0934	.0931	.0929	.0926	.0924	150
160	.0982	.0968	.0961	.0955	.0950	.0946	.0943	.0940	.0937	.0935	.0933	160
170	.0992	.0978	.0970	.0964	.0959	.0955	.0952	.0949	.0946	.0944	.0941	170
180	.1002	.0988	.0981	.0973	.0969	.0965	.0961	.0958	.0955	.0953	.0951	180
190	.1012	.0998	.0989	.0983	.0978	.0974	.0971	.0968	.0964	.0962	.0960	190
200	.1022	.1008	.0999	.0993	.0988	.0984	.0980	.0977	.0974	.0972	.0969	200
210	.1033	.1018	.1009	.1003	.0998	.0994	.0990	.0987	.0984	.0981	.0979	210
2201029	.1019	.1013	.1008	.1004	.1000	.0997	.0994	.0991	.0989	220
2301039	.1031	.1024	.1018	.1012	.1010	.1007	.1003	.1001	.0999	230
2401050	.1041	.1034	.1029	.1024	.1020	.1017	.1014	.1011	.1009	240
2501062	.1052	.1045	.1040	.1035	.1031	.1027	.1025	.1022	.1019	250

An approximate rule for the conditions of ordinary practice is that a saving of 1% is made by each increase of 11° in the temperature of the feed-water. This corresponds to 0.0909% per degree.

The calculation of saving is made as follows: Boiler-pressure, 100 lbs. gauge; total heat in steam above 32° = 1185 B.T.U. Feed-water, original temperature 60°, final temperature 209° F. Increase in heat-units, 150. Heat-units above 32° in feed-water of original temperature = 28. Heat-units in steam above that in cold feed-water, 1185 - 28 = 1157. Saving by the feed-water heater = 150/1157 = 12.96%. The same result is obtained by the use of the table. Increase in temperature 150° × tabular figure 0.0864 = 12.96%. Let total heat of 1 lb. of steam at the boiler-pressure = H; total heat of 1 lb. of feed-water before entering the heater = h₁, and after passing through the heater = h₂; then the saving made by the heater is $\frac{h_2 - h_1}{H - h_1}$.

Strains Caused by Cold Feed-water. — A calculation is made in *The Locomotive* of March, 1893, of the possible strains caused in the section of the shell of a boiler by cooling it by the injection of cold feed-water. Assuming the plate to be cooled 200° F., and the coefficient of expansion of steel to be 0.000067 per degree, a strip 10 in. long would contract 0.013 in., if it were free to contract. To resist this contraction, assuming that the strip is firmly held at the ends and that the modulus of elasticity is 29,000,000, would require a force of 37,700 lbs. per sq. in. Of course this amount of strain cannot actually take place, since the strip is not firmly held at the ends, but is allowed to contract to some extent by the elasticity of the surrounding metal. But, says *The Locomotive*, we may feel pretty confident that in the case considered a longitudinal strain of somewhere in the neighborhood of 8000 or 10,000 lbs. per sq. in. may be produced by the feed-water striking directly upon the plates; and this, in addition to the normal strain produced by the steam-pressure, is quite enough to tax the girth-seams beyond their elastic limit, if the

feed-pipe discharges anywhere near them. Hence it is not surprising that the girth-seams develop leaks and cracks in 99 cases out of every 100 in which the feed discharges directly upon the fire-sheets.

Capacity of Feed-water Heaters. (W. R. Billings, *Eng. Rec.*, Feb., 1898.) — Closed feed-water heaters are seldom provided with sufficient surface to raise the feed temperature to more than 200°. The rate of heat transmission may be measured by the number of British thermal units which pass through a square foot of tubular surface in one hour for each degree of difference in temperature between the water and the steam. One set of experiments gave results as below:

Difference between final temperatures of water and steam	5° F.....	67 B.T.U.	Transmitted in one hour by each sq. ft. of surface for each degree of average difference in temperatures.
	6° ".....	79 "	
	8° ".....	89 "	
	11° ".....	114 "	
	15° ".....	129 "	
	18° ".....	139 "	

Even with the rate of transmission as low as 67 B.T.U. the water was still 5° from the temperature of the steam. At what rate would the heat have been transmitted if the water could have been brought to within 2° of the temperature of the steam, or to 210° when the steam is at 212°?

For commercial purposes feed-water heaters are given a H.P. rating which allows about one-third of a square foot of surface per H.P. — a boiler H.P. being 30 lbs. of water per hour. If the figures given in the table above are accepted as substantially correct, a heater which is to raise 3000 lbs. of water per hour from 60° to 207°, using exhaust steam at 212° as a heating medium, should have nearly 84 sq. ft. of heating surface or nearly a square foot of surface per H.P. That feed-water heaters do not carry this amount of heating surface is well known.

Calculation of Surface of Heaters and Condensers. — (H. L. Hepburn, *Power*, April, 1902.) Let W = lbs. of water per hour; A = area of surface in sq. ft.; T_s = temperature of the steam; I = initial temperature of the water; F = final temperature of the water; S = lbs. of steam per hour; H = B.T.U. above 32° F. in 1 lb. of steam; N = B.T.U. in 1 lb. of condensed steam; U = B.T.U. transmitted per sq. ft. per hour per degree of mean difference of temperature between the steam and the water.

$$\text{Then } AU = W \log_e \frac{T_s - I}{T_s - F}, \text{ for heaters.}$$

$$AU = S \frac{H - N}{F - I} \times \log_e \frac{T_s - I}{T_s - F}, \text{ for condensers.}$$

The value of U varies widely according to the condition of the surface, whether clean or coated with grease or scale, and also with the velocity of the water over the surfaces. Values of 300 to 350 have been obtained in experiments with corrugated copper tubes, but ordinary heaters give much lower values. From the experiments of Loring and Emery on the U. S. S. *Dallas*, Mr. Hepburn finds $U = 192$. Using this value he finds the number of square feet of heating surface required per 1000 lbs. of feed-water per hour to be as follows, the temperature of the entering water being 60° F.

Steam Temperature, 212°.				Steam 25 in. Vacuum.			
F	S	F	S	F	S	F	S
194	11.11	204	15.34	90	2.38	115	6.78
196	11.73	206	16.85	95	3.03	120	8.60
198	12.44	208	18.93	100	3.76	125	11.15
200	13.20	210	22.52	105	4.62	130	16.25
202	14.17	212	Infinite	110	5.65	133	Infinite

F = final temperature of feed-water; S = sq. ft. of surface. From this table it is seen that if 30 lbs. of water per hour is taken to equal 1 H.P.

and a feed-water heater is made with 1/3 sq. ft. per H.P., it may be expected to heat the feed-water from 60° to something less than 194°, or if made with 1/2 sq. ft. per H.P. it may heat the water to 204° F.

For a further discussion of this subject, see Heat, pages 561 to 565.

Proportions of Open Type Feed-water Heaters. — C. L. Hubbard (*Practical Engineer*, Jan. 1, 1909) gives the following:

Exhaust heaters should be proportioned according to the quality of the water to be used, the size being increased with the amount of mud or scale-producing properties which the water contains regardless of the quantity of water to be heated. The general proportions of an open heater will depend somewhat upon the arrangement of the trays or pans, but an approximation of the size of shell for a cylindrical heater is as follows: $A = H \div aL$; $L = H \div aA$; in which A = sectional area of shell in sq. ft.; L = length of shell in linear ft.; H = total weight of water to be heated per hour divided by the weight of steam used per horse-power per hour by the engine; $a = 2.15$ for very muddy water, 6.0 for slightly muddy water, and 8.0 for clear water.

The pan or tray surface varies according to the quality of the water, both as regards the amount of mud and the scale-making ingredients. The surface in square feet for each 1000 lbs. of water heated per hour may be taken as follows, for the vertical and horizontal types respectively:

Very bad water.....	8.5 and 9.1
Medium muddy water.....	6 and 6.5
Clear and little scale.....	2 and 2.2

The space between the pans is made not less than 0.1 the width for rectangular and 0.25 the diameter for round pans. Under ordinary circumstances it is not customary to use more than six pans in a tier, in order to obtain a low velocity over each pan. The size of the storage or settling chamber in the horizontal type varies from 0.25 to 0.4 of the volume of the shell, depending on the quality of the water; 0.33 is about the average. In the case of vertical heaters, this varies from 0.4 to 0.6 of the volume of the shell. Filters occupy from 10 to 15% of the volume of the shell in the horizontal type and from 15 to 20% in the vertical.

Open versus Closed Feed-water Heaters. (W. E. Harrington, *St. Rwy. Jour.*, July 22, 1905.) — There still exists some difference of opinion as to the relative desirability of open or closed type of feed-water heater, but the degree of perfection which the open heater has attained has eliminated formerly objectionable features. The chief objection which attended the early use of the open heater, namely, that the oil from the exhaust steam was carried into the boiler, did much to discourage its more general adoption. This objection does not hold good against the better designs of open heaters now on the market. There are thousands of installations in which the open heater is now being used where no difficulty is experienced from the contamination of the feed-water by oil. The perfection of oil separators for use in the exhaust steam connection to the heater has rendered this possible.

STEAM SEPARATORS.

If moist steam flowing at a high velocity in a pipe has its direction suddenly changed, the particles of water are by their momentum projected in their original direction against the bend in the pipe or wall of the chamber in which the change of direction takes place. By making proper provision for drawing off the water thus separated the steam may be dried to a greater or less extent.

For long steam-pipes a large drum should be provided near the engine for trapping the water condensed in the pipe. A drum 3 feet diameter, 15 feet high, has given good results in separating the water of condensation of a steam-pipe 10 inches diameter and 800 feet long.

Efficiency of Steam Separators. — Prof. R. C. Carpenter, in 1891, made a series of tests of six steam separators, furnishing them with steam containing different percentages of moisture, and testing the quality of steam before entering and after passing the separator. A condensed table of the principal results is given below.

Make of Separator.	Test with Steam of about 10% of Moisture.			Tests with Varying Moisture.		
	Quality of Steam before.	Quality of Steam after.	Efficiency, per cent.	Quality of Steam before.	Quality of Steam after.	Av'ge Efficiency.
B	87.0%	98.8%	90.8	66.1 to 97.5%	97.8 to 99%	87.6
A	90.1	98.0	80.0	51.9 " 98	97.9 " 99.1	76.4
D	89.6	95.8	59.6	72.2 " 96.1	95.5 " 98.2	71.7
C	90.6	93.7	33.0	67.1 " 96.8	93.7 " 98.4	63.4
E	88.4	90.2	15.5	68.6 " 98.1	79.3 " 98.5	36.9
F	88.9	92.1	28.8	70.4 " 97.7	84.1 " 97.9	28.4

Conclusions from the tests were: 1. That no relation existed between the volume of the several separators and their efficiency. 2. No marked decrease in pressure was shown by any of the separators, the most being 1.7 lbs. in E. 3. Although changed direction, reduced velocity, and perhaps centrifugal force are necessary for good separation, still some means must be provided to lead the water out of the current of the steam. The high efficiency obtained from B and A was largely due to this feature. In B the interior surfaces are corrugated and thus catch the water thrown out of the steam and readily lead it to the bottom. In A, as so on as the water falls or is precipitated from the steam, it comes in contact with the perforated diaphragm through which it runs into the space below, where it is not subjected to the action of the steam. Experiments made by Prof. Carpenter on a "Stratton" separator in 1894 showed that the moisture in the steam leaving the separator was less than 1% when that in the steam supplied ranged from 6% to 21%.

Experiments by Prof. G. F. Gebhardt (*Power*, May 11, 1909) on six separators of different makes led to the following conclusions: (1) The efficiency of separation decreases as the velocity of the steam increases. (2) The efficiency increases as the percentage of moisture in the entering steam increases. (3) The drop in pressure increases rapidly with the increase in velocity. The six separators are described as follows:

- U: 2-in. vertical; no baffles; current reversed once.
- V: 4-in. horizontal with single baffle plate of the fluted type; current reversed once.
- W: 4-in. vertical with two baffle plates of the smooth type; current reversed once.
- X: 3-in. horizontal; several fluted baffle plates; no reversal of current.
- Y: 6-in. vertical; centrifugal type; current reversed once.
- Z: 3-in. horizontal; current reversed twice; steam impinges on horizontal fluted baffle during reversal.

The efficiency is defined as the ratio of the water removed from the steam by the separator to the water injected into the dry steam for the purpose of the test. With steam at 100 lbs. pressure containing 10% water, the efficiencies, taken approximately from plotted curves, were as follows:

	U	V	W	X	Y	Z
At 2000 ft. per min.....	64	69	86	88	79	66
At 3000 ft. per min.....	37	45	80	60	61	48

DETERMINATION OF THE MOISTURE IN STEAM—STEAM CALORIMETERS.

In all boiler-tests it is important to ascertain the quality of the steam, i.e., 1st, whether the steam is "saturated" or contains the quantity of heat due to the pressure according to standard experiments; 2d, whether the quantity of heat is deficient, so that the steam is wet; and 3d, whether the heat is in excess and the steam superheated. The best method of ascertaining the quality of the steam is undoubtedly that employed by a committee which tested the boilers at the American Institute Exhibition of 1871-2, of which Prof. Thurston was chairman, i.e., condensing all the water evaporated by the boiler by means of a surface condenser, weighing

the condensing water, and taking its temperature as it enters and as it leaves the condenser; but this plan cannot always be adopted.

A substitute for this method is the barrel calorimeter, which with careful operation and fairly accurate instruments may generally be relied on to give results within two per cent of accuracy (that is, a sample of steam which gives the apparent result of 2% of moisture may contain anywhere between 0 and 4%). This calorimeter is described as follows: A sample of the steam is taken by inserting a perforated 1/2-inch pipe into and through the main pipe near the boiler, and led by a hose, thoroughly felted, to a barrel, holding preferably 400 lbs. of water, which is set upon a platform scale and provided with a cock or valve for allowing the water to flow to waste, and with a small propeller for stirring the water.

To operate the calorimeter the barrel is filled with water, the weight and temperature ascertained, steam blown through the hose outside the barrel until the pipe is thoroughly warmed, when the hose is suddenly thrust into the water, and the propeller operated until the temperature of the water is increased to the desired point, say about 110° usually. The hose is then withdrawn quickly, the temperature noted, and the weight again taken.

An error of 1/10 of a pound in weighing the condensed steam, or an error of 1/2 degree in the temperature, will cause an error of over 1% in the calculated percentage of moisture. See *Trans. A. S. M. E.*, vi, 293. The calculation of the percentage of moisture is made as below:

$$Q = \frac{1}{H - T} \left[\frac{W}{w} (h_1 - h) - (T - h_1) \right]$$

- Q = quality of the steam, dry saturated steam being unity.
- H = total heat of 1 lb. of steam at the observed pressure.
- T = total heat of 1 lb. of water at the temperature of steam of the observed pressure.
- h = total heat of 1 lb. of condensing water, original.
- h₁ = total heat of 1 lb. of condensing water, final.
- W = weight of condensing water, corrected for water-equivalent of the apparatus.
- w = weight of the steam condensed.

Percentage of moisture = 1 - Q.
If Q is greater than unity, the steam is superheated, and the degrees of superheating = 2.0833 (H - T) (Q - 1).

Difficulty of Obtaining a Correct Sample. — Experiments by Prof. D. S. Jacobus (*Trans. A. S. M. E.*, xvi, 1017), show that it is practically impossible to obtain a true average sample of the steam flowing in a pipe. For accurate determinations all the steam made by the boiler should be passed through a separator, the water separated should be weighed and a calorimeter test made of the steam just after it has passed the separator.

Coil Calorimeters. — Instead of the open barrel in which the steam is condensed, a coil acting as a surface-condenser may be used, which is placed in the barrel, the water in coil and barrel being weighed separately. For a description of an apparatus of this kind designed by the author, which he has found to give results with a probable error not exceeding 1/2 per cent of moisture, see *Trans. A. S. M. E.*, vi, 294. This calorimeter may be used continuously, if desired, instead of intermittently. In this case a continuous flow of condensing water into and out of the barrel must be established, and the temperature of inflow and outflow and of the condensed steam read at short intervals of time.

Throttling Calorimeter. — For percentages of moisture not exceeding 3 per cent the throttling calorimeter is most useful and convenient and remarkably accurate. In this instrument the steam which reaches it in a 1/2-inch pipe is throttled by an orifice 1/16 inch diameter, opening into a chamber which has an outlet to the atmosphere. The steam in this chamber has its pressure reduced nearly or quite to the pressure of the atmosphere, but the total heat in the steam before throttling causes the steam in the chamber to be superheated more or less according to whether the steam before throttling was dry or contained moisture. The only observations required are those of the temperature and pressure of the steam on each side of the orifice.

The author's formula for reducing the observations of the throttling calorimeter is as follows (Experiments on Throttling Calorimeters, *Am. Mach.*, Aug. 4, 1892): $w = 100 \times \frac{H - h - K(T - t)}{L}$, in which w = percentage of moisture in the steam; H = total heat, and L = latent heat of steam in the main pipe; h = total heat due the pressure in the discharge side of the calorimeter, = 1146.6 at atmospheric pressure; K = specific heat of superheated steam; T = temperature of the throttled and superheated steam in the calorimeter; t = temperature due to the pressure in the calorimeter, = 212° at atmospheric pressure.

Taking K at 0.48 and the pressure in the discharge side of the calorimeter as atmospheric pressure, the formula becomes

$$w = 100 \times \frac{H - 1146.6 - 0.48(T - 212^\circ)}{L}$$

From this formula the following table is calculated:

MOISTURE IN STEAM — DETERMINATIONS BY THROTTLING CALORIMETER

Degree of Super-heating $T - 212^\circ$	Gauge-pressures.											
	5	10	20	30	40	50	60	70	75	80	85	90
	Per Cent of Moisture in Steam.											
0°	0.51	0.90	1.54	2.06	2.50	2.90	3.24	3.56	3.71	3.86	3.99	4.13
10°	0.01	0.39	1.02	1.54	1.97	2.36	2.71	3.02	3.17	3.32	3.45	3.58
20°	0.51	1.02	1.45	1.83	2.17	2.48	2.63	2.77	2.90	3.03
30°	0.00	0.50	0.92	1.30	1.64	1.94	2.09	2.23	2.35	2.49
40°	0.39	0.77	1.10	1.40	1.55	1.69	1.80	1.94
50°	0.24	0.57	0.87	1.01	1.15	1.26	1.40
60°	0.03	0.33	0.47	0.60	0.72	0.85
70°	0.06	0.17	0.31
Dif. p. deg.	.0503	.0507	.0515	.0521	.0526	.0531	.0535	.0539	.0541	.0542	.0544	.0546

Degree of Super-heating $T - 212^\circ$	Gauge-pressures.											
	100	110	120	130	140	150	160	170	180	190	200	250
	Per Cent of Moisture in Steam.											
0°	4.39	4.63	4.85	5.06	5.29	5.49	5.68	5.87	6.05	6.22	6.39	7.16
10°	3.84	4.08	4.29	4.52	4.73	4.93	5.12	5.30	5.48	5.65	5.82	6.58
20°	3.29	3.52	3.74	3.96	4.17	4.37	4.56	4.74	4.91	5.08	5.25	6.00
30°	2.74	2.97	3.18	3.41	3.61	3.80	3.99	4.17	4.34	4.51	4.67	5.41
40°	2.19	2.42	2.63	2.85	3.05	3.24	3.43	3.61	3.78	3.94	4.10	4.83
50°	1.64	1.87	2.08	2.29	2.49	2.68	2.87	3.04	3.21	3.37	3.53	4.25
60°	1.09	1.32	1.52	1.74	1.93	2.12	2.30	2.48	2.64	2.80	2.96	3.67
70°	0.55	0.77	0.97	1.18	1.38	1.56	1.74	1.91	2.07	2.23	2.38	3.09
80°	0.00	0.22	0.42	0.63	0.82	1.00	1.18	1.34	1.50	1.66	1.81	2.51
90°	0.07	0.26	0.44	0.61	0.78	0.94	1.09	1.24	1.93
100°	0.05	0.21	0.37	0.52	0.67	1.34
110°	0.10	0.76
Dif. p. deg.	.0549	.0551	.0554	.0556	.0559	.0561	.0564	.0566	.0568	.0570	.0572	.0581

Separating Calorimeters. — For percentages of moisture beyond the range of the throttling calorimeter the separating calorimeter is used,

WARNING: This is a 1910 edition. Some of the material may no longer be accurate

which is simply a steam separator on a small scale. An improved form of this calorimeter is described by Prof. Carpenter in *Power*, Feb., 1893.

For fuller information on various kinds of calorimeters, see papers by Prof. Peabody, Prof. Carpenter, and Mr. Barrus in *Trans. A. S. M. E.*, vols. x, xi, xii, 1889 to 1891; Appendix to Report of Com. on Boiler Tests, *A. S. M. E.*, vol. vi, 1884; Circular of Schaeffer & Budenberg, N. Y., "Calorimeters, Throttling and Separating."

Identification of Dry Steam by Appearance of a Jet. — Prof. Denton (*Trans. A. S. M. E.*, vol. x) found that jets of steam show unmistakable change of appearance to the eye when steam varies less than 1% from the condition of saturation in the direction of either wetness or of superheating.

If a jet of steam flow from a boiler into the atmosphere under circumstances such that very little loss of heat occurs through radiation, etc., and the jet be transparent close to the orifice, or be even a grayish-white color, the steam may be assumed to be so nearly dry that no portable condensing calorimeter will be capable of measuring the amount of water in the steam. If the jet be strongly white, the amount of water may be roughly judged up to about 2%, but beyond this only a calorimeter can determine the exact amount of moisture.

A common brass pet-cock may be used as an orifice, but it should, if possible, be set into the steam-drum of the boiler and never be placed further away from the latter than 4 feet, and then only when the intermediate reservoir or pipe is well covered.

Usual Amount of Moisture in Steam Escaping from a Boiler. — In the common forms of horizontal tubular land boilers and water-tube boilers with ample horizontal drums, and supplied with water free from substances likely to cause foaming, the moisture in the steam does not generally exceed 2% unless the boiler is overdriven or the water-level is carried too high.

CHIMNEYS.

Chimney Draught Theory. — The commonly accepted theory of chimney draught, based on Peclet's and Rankine's hypotheses (Rankine, *S. E.*), is discussed by Prof. De Volson Wood, *Trans. A. S. M. E.*, vol. xl. Peclet represented the law of draught by the formula

$$h = \frac{u^2}{2g} \left(1 + G + \frac{fl}{m} \right)$$

In which h is the "head," defined as such a height of hot gases as, if added to the column of gases in the chimney, would produce the same pressure at the furnace as a column of outside air, of the same area of base, and a height equal to that of the chimney;

- u is the required velocity of gases in the chimney;
- G a constant to represent the resistance to the passage of air through the coal;
- l the length of the flues and chimney;
- m the mean hydraulic depth or the area of a cross-section divided by the perimeter;
- f a constant depending upon the nature of the surfaces over which the gases pass, whether smooth, or sooty and rough.

Rankine's formula (*Steam Engine*, p. 238), derived by giving certain values to the constants (so-called) in Peclet's formula, is

$$h = \frac{\tau_0}{\tau_2} (0.0807) H - H = \left(0.98 \frac{\tau_1}{\tau_2} - 1 \right) H;$$

- In which H = the height of the chimney in feet;
- τ_0 = 493° F., absolute (temperature of melting ice);
- τ_1 = absolute temperature of the gases in the chimney;
- τ_2 = absolute temperature of the external air.

Prof. Wood derives from this a still more complex formula which gives the height of chimney required for burning a given quantity of coal per second, and from it he calculates the following table, showing the height of chimney required to burn respectively 24, 20, and 16 lbs. of coal per square foot of grate per hour, for the several temperatures of the chimney gases given.

Outside Air. τ_2 .	Chimney Gas.		Coal per sq. ft. of grate per hour, lbs.		
	τ_1 Absolute.	Temp. Fahr.	24	20	16
			Height H , feet.		
520° absolute or 59° F.	700	239	250.9	157.6	67.8
	800	339	172.4	115.8	55.7
	1000	539	149.1	100.0	48.7
	1100	639	148.8	98.9	48.2
	1200	739	152.0	100.9	49.1
	1400	939	159.9	105.7	51.2
	1600	1139	168.8	111.0	53.5
2000	1539	206.5	132.2	63.0	

Rankine's formula gives a maximum draught when $\tau = 2\frac{1}{2}\tau_2$, or 622° F., when the outside temperature is 60°. Prof. Wood says: "This result is not a fixed value, but departures from theory in practice do not affect the result largely. There is, then, in a properly constricted chimney properly working, a temperature giving a maximum draught,* and that temperature is not far from the value given by Rankine, although in special cases it may be 50° or 75° more or less."

All attempts to base a practical formula for chimneys upon the theoretical formula of Peclet and Rankine have failed on account of the impossibility of assigning correct values to the so-called "constants" G and f . (See *Trans. A. S. M. E.*, xi, 984.)

Force or Intensity of Draught. — The force of the draught is equal to the difference between the weight of the column of hot gases inside of the chimney and the weight of a column of the external air of the same height. It is measured by a draught-gauge, usually a U-tube partly filled with water, one leg connected by a pipe to the interior of the flue, and the other open to the external air.

If D is the density of the air outside, d the density of the hot gas inside, in lbs. per cubic foot, h the height of the chimney in feet, and 0.192 the factor for converting pressure in lbs. per sq. ft. into inches of water column, then the formula for the force of draught expressed in inches of water is,

$$F = 0.192 h (D - d):$$

The density varies with the absolute temperature (see Rankine).

$$d = \frac{\tau_0}{\tau_1} 0.084; D = 0.0807 \frac{\tau_0}{\tau_2},$$

where τ_0 is the absolute temperature at 32° F., = 493, τ_1 the absolute temperature of the chimney gases and τ_2 that of the external air. Substituting these values the formula for force of draught becomes

$$F = 0.192 h \left(\frac{39.79}{\tau_2} - \frac{41.41}{\tau_1} \right) = h \left(\frac{7.64}{\tau_2} - \frac{7.95}{\tau_1} \right).$$

* Much confusion to students of the theory of chimneys has resulted from their understanding the words maximum draught to mean maximum intensity or pressure of draught, as measured by a draught-gauge. It here means maximum quantity or weight of gases passed up the chimney. The maximum intensity is found only with maximum temperature, but after the temperature reaches about 622° F. the density of the gas decreases more rapidly than its velocity increases, so that the weight is a maximum about 622° F., as shown by Rankine. — W. K.

To find the maximum intensity of draught for any given chimney, the heated column being 600° F., and the external air 60°, multiply the height above grate in feet by 0.0073, and the product is the draught in inches of water.

Height of Water Column Due to Unbalanced Pressure in Chimney 100 Feet High. (*The Locomotive*, 1884.)

Temp. in the Chimney.	Temperature of the External Air — Barometer, 14.7 lbs. per sq. in.										
	0°	10°	20°	30°	40°	50°	60°	70°	80°	90°	100°
200	0.453	0.419	0.384	0.353	0.321	0.292	0.263	0.234	0.209	0.182	0.157
220	.488	.453	.419	.388	.355	.326	.298	.269	.244	.217	.192
240	.520	.488	.451	.421	.388	.359	.330	.301	.276	.250	.225
260	.555	.528	.484	.453	.420	.392	.363	.334	.309	.282	.257
280	.584	.549	.515	.482	.451	.422	.394	.365	.340	.313	.288
300	.611	.576	.541	.511	.478	.449	.420	.392	.367	.340	.315
320	.637	.603	.568	.538	.505	.476	.447	.419	.394	.367	.342
340	.662	.638	.593	.563	.530	.501	.472	.443	.419	.392	.367
360	.687	.653	.618	.588	.555	.526	.497	.468	.444	.417	.392
380	.710	.676	.641	.611	.578	.549	.520	.492	.467	.440	.415
400	.732	.697	.662	.632	.598	.570	.541	.513	.488	.461	.436
420	.753	.718	.684	.653	.620	.591	.563	.534	.509	.482	.457
440	.774	.739	.705	.674	.641	.612	.584	.555	.530	.503	.478
460	.793	.758	.724	.694	.660	.632	.603	.574	.549	.522	.497
480	.810	.776	.741	.710	.678	.649	.620	.591	.566	.540	.515
500	.829	.791	.760	.730	.697	.669	.639	.610	.586	.559	.534

For any other height of chimney than 100 ft. the height of water column is found by simple proportion, the height of water column being directly proportioned to the height of chimney.

The calculations have been made for a chimney 100 ft. high, with various temperatures outside and inside of the flue, and on the supposition that the temperature of the chimney is uniform from top to bottom. This is the basis on which all calculations respecting the draught-power of chimneys have been made by Rankine and other writers, but it is very far from the truth in most cases. The difference will be shown by comparing the reading of the draught-gauge with the table given. In one case a chimney 122 ft. high showed a temperature at the base of 320°, and at the top of 230°.

Box, in his "Treatise on Heat," gives the following table:

DRAUGHT POWERS OF CHIMNEYS, ETC., WITH THE INTERNAL AIR AT 552° AND THE EXTERNAL AIR AT 62°, AND WITH THE DAMPER NEARLY CLOSED.

Height of Chimney in feet.	Draught Power in ins. of water.	Theoretical Velocity in feet per second.		Height of Chimney in feet.	Draught Power in ins. of water.	Theoretical Velocity in feet per second.	
		Cold Air Entering.	Hot Air at Exit.			Cold Air Entering.	Hot Air at Exit.
10	0.073	17.8	35.6	80	0.585	50.6	101.2
20	0.146	25.3	50.6	90	0.657	53.7	107.4
30	0.219	31.0	62.0	100	0.730	56.5	113.0
40	0.292	35.7	71.4	120	0.876	62.0	124.0
50	0.365	40.0	80.0	150	1.095	69.3	138.6
60	0.438	43.8	87.6	175	1.277	74.3	149.6
70	0.511	47.3	94.6	200	1.460	80.0	160.0

Rate of Combustion Due to Height of Chimney. — Trowbridge's "Heat and Heat Engines" gives the following figures for the heights of chimney for producing certain rates of combustion per sq. ft. of grate. They may be approximately true for anthracite in moderate and large sizes, but greater heights than are given in the table are needed to secure the given rates of combustion with small sizes of anthracite, and for bituminous coal smaller heights will suffice if the coal is reasonably free from ash — 5% or less.

Height, feet.	Lbs. of Coal per Sq. Ft. of Grate.	Height, feet.	Lbs. of Coal per Sq. Ft. of Grate.	Height, feet.	Lbs. of Coal per Sq. Ft. of Grate.	Height, feet.	Lbs. of Coal per Sq. Ft. of Grate.
20	7.5	45	12.4	70	15.8	95	18.5
25	8.5	50	13.1	75	16.4	100	19.0
30	9.5	55	13.8	80	16.9	105	19.5
35	10.5	60	14.5	85	17.4	110	20.0
40	11.6	65	15.1	90	18.0		

W. D. Ennis (*Eng. Mag.*, Nov., 1907), gives the following as the force of draught required for burning No. 1 buckwheat coal:

Draught, in. of water	0.3	0.45	0.7	1.0
Lbs. coal per sq. ft. grate per hour	10	15	20	25

Thurston's rule for rate of combustion effected by a given height of chimney (*Trans. A. S. M. E.*, xi, 991) is: Subtract 1 from twice the square root of the height, and the result is the rate of combustion in pounds per square foot of grate per hour, for anthracite. Or rate = $2\sqrt{h} - 1$, in which h is the height in feet. This rule gives the following:

$h = 50$	60	70	80	90	100	110	125	150	175	200
$2\sqrt{h} - 1 = 13.14$	14.49	15.73	16.89	17.97	19	19.97	21.36	23.49	25.45	27.28

The results agree closely with Trowbridge's table given above. In practice the high rates of combustion for high chimneys given by the formula are not generally obtained, for the reason that with high chimneys there are usually long horizontal flues, serving many boilers, and the friction and the interference of currents from the several boilers are apt to cause the intensity of draught in the branch flues leading to each boiler to be much less than that at the base of the chimney. The draught of each boiler is also usually restricted by a damper and by bends in the gas-passages. In a battery of several boilers connected to a chimney 150 ft. high, the author found a draught of $\frac{3}{4}$ -inch water-column at the boiler nearest the chimney, and only $\frac{1}{4}$ -inch at the boiler farthest away. The first boiler was wasting fuel from too high temperature of the chimney-gases, 900°, having too large a grate-surface for the draught, and the last boiler was working below its rated capacity and with poor economy, on account of insufficient draught.

The effect of changing the length of the flue leading into a chimney 60 ft. high and 2 ft. 9 in. square is given in the following table, from Box on "Heat":

Length of Flue in feet.	Horse-power.	Length of Flue in feet.	Horse-power.
50	107.6	800	56.1
100	100.0	1,000	51.4
200	85.3	1,500	43.3
400	70.8	2,000	38.2
600	62.5	3,000	31.7

The temperature of the gases in this chimney was assumed to be 552° F., and that of the atmosphere 62°.

High Chimneys not Necessary. — Chimneys above 150 ft. in height are very costly, and their increased cost is rarely justified by increased efficiency. In recent practice it has become somewhat common to build two or more smaller chimneys instead of one large one. A notable example is the Spreckels Sugar Refinery in Philadelphia, where three separate chimneys are used for one boiler-plant of 7500 H.P. The three chimneys are said to have cost several thousand dollars less than a single chimney of their combined capacity would have cost. Very tall chimneys have been characterized by one writer as "monuments to the folly of their builders."

Heights of Chimney required for Different Fuels. — The minimum height necessary varies with the fuel, wood requiring the least, then good bituminous coal, and fine sizes of anthracite the greatest. It also varies with the character of the boiler — the smaller and more circuitous the gas-passages the higher the stack required; also with the number of boilers, a single boiler requiring less height than several that discharge into a horizontal flue. No general rule can be given.

C. L. Hubbard (*Am. Electrician*, Mar., 1904) says: The following heights have been found to give good results in plants of moderate size, and to produce sufficient draught to force the boilers from 20 to 30 per cent above their rating:

With free-burning bituminous coal, 75 feet; with anthracite of medium and large size, 100 feet; with slow-burning bituminous coal, 120 feet; with anthracite pea coal, 130 feet; with anthracite buckwheat coal, 150 feet. For plants of 700 or 800 horse-power and over, the chimney should not be less than 150 feet high regardless of the kind of coal to be used.

SIZE OF CHIMNEYS.

The formula given below, and the table calculated therefrom for chimneys up to 96 in. diameter and 200 ft. high, were first published by the author in 1884 (*Trans. A. S. M. E.*, vi, 81). They have met with much approval since that date by engineers who have used them, and have been frequently published in boiler-makers' catalogues and elsewhere. The table is now extended to cover chimneys up to 12 ft. diameter and 300 ft. high. The sizes corresponding to the given commercial horse-powers are believed to be ample for all cases in which the draught areas through the boiler-flues and connections are sufficient, say not less than 20% greater than the area of the chimney, and in which the draught between the boilers and chimney is not checked by long horizontal passages and right-angled bends.

Note that the figures in the table correspond to a coal consumption of 5 lbs. of coal per horse-power per hour. This liberal allowance is made to cover the contingencies of poor coal being used, and of the boilers being driven beyond their rated capacity. In large plants, with economical boilers and engines, good fuel and other favorable conditions, which will reduce the maximum rate of coal consumption at any one time to less than 5 lbs. per H.P. per hour, the figures in the table may be multiplied by the ratio of 5 to the maximum expected coal consumption per H.P. per hour. Thus, with conditions which make the maximum coal consumption only 2.5 lbs. per hour, the chimney 300 ft. high X 12 ft. diameter should be sufficient for $6155 \times 2 = 12,310$ horse-power. The formula is based on the following data:

1. The draught power of the chimney varies as the square root of the height.

2. The retarding of the ascending gases by friction may be considered as equivalent to a diminution of the area of the chimney, or to a lining of the chimney by a layer of gas which has no velocity. The thickness of this lining is assumed to be 2 inches for all chimneys, or the diminution of area equal to the perimeter X 2 inches (neglecting the overlapping of the corners of the lining). Let D = diameter in feet, A = area, and E = effective area in square feet:

$$\text{For square chimneys, } E = D^2 - \frac{8D}{12} = A - \frac{2}{3}\sqrt{A}.$$

$$\text{For round chimneys, } E = \frac{\pi}{4} \left(D^2 - \frac{8D}{12} \right) = A - 0.591\sqrt{A}.$$

For simplifying calculations, the coefficient of \sqrt{A} may be taken as 0.6 for both square and round chimneys, and the formula becomes

$$E = A - 0.6\sqrt{A}.$$

3. The power varies directly as this effective area E .
4. A chimney should be proportioned so as to be capable of giving sufficient draught to cause the boiler to develop much more than its rated power, in case of emergencies, or to cause the combustion of 5 lbs. of fuel per rated horse-power of boiler per hour.
5. The power of the chimney varying directly as the effective area, E , and as the square root of the height, H , the formula for horse-power of boiler for a given size of chimney will take the form $H.P. = CE\sqrt{H}$, in which C is a constant, the average value of which, obtained by plotting the results obtained from numerous examples in practice, the author finds to be 3.33.

The formula for horse-power then is

$$H.P. = 3.33 E \sqrt{H}, \text{ or } H.P. = 3.33 (A - 0.6\sqrt{A}) \sqrt{H}.$$

If the horse-power of boiler is given, to find the size of chimney, the height being assumed,

$$E = 0.3 H.P. \div \sqrt{H}; = A - 0.6\sqrt{A}.$$

For round chimneys, diameter of chimney = diam. of $E + 4"$.

For square chimneys, side of chimney = $\sqrt{E + 4"}$.

If effective area E is taken in square feet, the diameter in inches is $d = 13.54\sqrt{E + 4"}$, and the side of a square chimney in inches is $s = 12\sqrt{E + 4"}$.

If horse-power is given and area assumed, the height $H = \left(\frac{0.3 H.P.}{E}\right)^2$.

An approximate formula for chimneys above 1000 H.P. is $H.P. = 2.5 D^2 \sqrt{H}$. This gives the H.P. somewhat greater than the figures in the table.

In proportioning chimneys the height should first be assumed, with due consideration of the heights of surrounding buildings or hills near to the proposed chimney, the length of horizontal flues, the character of coal to be used, etc.; then the diameter required for the assumed height and horse-power is calculated by the formula or taken from the table.

For Height of Chimneys see pages 918 and 919. No formula for height can be given which will be satisfactory for different classes of coal, kinds and amounts of ash, styles of grate-bars, etc. A formula in "Ingenieurs Taschenbuch," translated into English measures, is $h = 0.216 R^2 + 6d$. h = height in ft.; R = lbs. coal burned per sq. ft. of grate per hour; d = diam. in ft. This formula gives an insufficient height for small sizes of anthracite, and a height greater than is necessary for free-burning bituminous coal low in ash.

The Protection of Tall Chimney-shafts from Lightning. — C. Molyneux and J. M. Wood (*Industries*, March 28, 1890) recommend for tall chimneys the use of a coronal or heavy band at the top of the chimney, with copper points 1 ft. in height at intervals of 2 ft. throughout the circumference. The points should be gilded to prevent oxidation. The most approved form of conductor is a copper tape about 3/4 in. by 1/8 in. thick, weighing 6 ozs. per ft. If iron is used it should weigh not less than 2 1/4 lbs. per ft. There must be no insulation, and the copper tape should be fastened to the chimney with holdfasts of the same material, to prevent voltaic action. An allowance for expansion and contraction should be made, say 1 in. in 40 ft. Slight bends in the tape, not too abrupt, answer the purpose. For an earth terminal a plate of metal at least 3 ft. sq. and 1/16 in. thick should be buried as deep as possible in a damp spot. The plate should be of the same metal as the conductor, to which it should be soldered. The best earth terminal is water, and when a deep well or other large body of water is at hand, the conductor should be carried down into it. Right-angled bends in the conductor should be avoided. No bend in it should be over 30°.

Size of Chimneys for Steam-boilers. (Assuming 1 H.P. = 5 lbs. of coal burned per hour.)

Diam. inches.	Area A. sq. ft.	Effective Area. $E = A - 0.6\sqrt{A}$ sq. ft.	Height of Chimney.												Equivalent Square Chimney. Side of Square $\sqrt{E + 4}$ ins.																																																																																																																																																																																																																																																																																																																																																																																																																																																																																																																																																																																																																																																																																																																																																																																																																																																																																																																																																																																																																																																																																															
			50 ft.	60 ft.	70 ft.	80 ft.	90 ft.	100 ft.	110 ft.	125 ft.	150 ft.	175 ft.	200 ft.	225 ft.		250 ft.	300 ft.																																																																																																																																																																																																																																																																																																																																																																																																																																																																																																																																																																																																																																																																																																																																																																																																																																																																																																																																																																																																																																																																																													
18	1.77	0.97	23	25	27	29	31	33	35	37	39	41	43	45	47	49	51	53	55	57	59	61	63	65	67	69	71	73	75	77	79	81	83	85	87	89	91	93	95	97	99	101	103	105	107	109	111	113	115	117	119	121	123	125	127	129	131	133	135	137	139	141	143	145	147	149	151	153	155	157	159	161	163	165	167	169	171	173	175	177	179	181	183	185	187	189	191	193	195	197	199	201	203	205	207	209	211	213	215	217	219	221	223	225	227	229	231	233	235	237	239	241	243	245	247	249	251	253	255	257	259	261	263	265	267	269	271	273	275	277	279	281	283	285	287	289	291	293	295	297	299	301	303	305	307	309	311	313	315	317	319	321	323	325	327	329	331	333	335	337	339	341	343	345	347	349	351	353	355	357	359	361	363	365	367	369	371	373	375	377	379	381	383	385	387	389	391	393	395	397	399	401	403	405	407	409	411	413	415	417	419	421	423	425	427	429	431	433	435	437	439	441	443	445	447	449	451	453	455	457	459	461	463	465	467	469	471	473	475	477	479	481	483	485	487	489	491	493	495	497	499	501	503	505	507	509	511	513	515	517	519	521	523	525	527	529	531	533	535	537	539	541	543	545	547	549	551	553	555	557	559	561	563	565	567	569	571	573	575	577	579	581	583	585	587	589	591	593	595	597	599	601	603	605	607	609	611	613	615	617	619	621	623	625	627	629	631	633	635	637	639	641	643	645	647	649	651	653	655	657	659	661	663	665	667	669	671	673	675	677	679	681	683	685	687	689	691	693	695	697	699	701	703	705	707	709	711	713	715	717	719	721	723	725	727	729	731	733	735	737	739	741	743	745	747	749	751	753	755	757	759	761	763	765	767	769	771	773	775	777	779	781	783	785	787	789	791	793	795	797	799	801	803	805	807	809	811	813	815	817	819	821	823	825	827	829	831	833	835	837	839	841	843	845	847	849	851	853	855	857	859	861	863	865	867	869	871	873	875	877	879	881	883	885	887	889	891	893	895	897	899	901	903	905	907	909	911	913	915	917	919	921	923	925	927	929	931	933	935	937	939	941	943	945	947	949	951	953	955	957	959	961	963	965	967	969	971	973	975	977	979	981	983	985	987	989	991	993	995	997	999	1001	1003	1005	1007	1009	1011	1013	1015	1017	1019	1021	1023	1025	1027	1029	1031	1033	1035	1037	1039	1041	1043	1045	1047	1049	1051	1053	1055	1057	1059	1061	1063	1065	1067	1069	1071	1073	1075	1077	1079	1081	1083	1085	1087	1089	1091	1093	1095	1097	1099	1101	1103	1105	1107	1109	1111	1113	1115	1117	1119	1121	1123	1125	1127	1129	1131	1133	1135	1137	1139	1141	1143	1145	1147	1149	1151	1153	1155	1157	1159	1161	1163	1165	1167	1169	1171	1173	1175	1177	1179	1181	1183	1185	1187	1189	1191	1193	1195	1197	1199	1201	1203	1205	1207	1209	1211	1213	1215	1217	1219	1221	1223	1225	1227	1229	1231	1233	1235	1237	1239	1241	1243	1245	1247	1249	1251	1253	1255	1257	1259	1261	1263	1265	1267	1269	1271	1273	1275	1277	1279	1281	1283	1285	1287	1289	1291	1293	1295	1297	1299	1301	1303	1305	1307	1309	1311	1313	1315	1317	1319	1321	1323	1325	1327	1329	1331	1333	1335	1337	1339	1341	1343	1345	1347	1349	1351	1353	1355	1357	1359	1361	1363	1365	1367	1369	1371	1373	1375	1377	1379	1381	1383	1385	1387	1389	1391	1393	1395	1397	1399	1401	1403	1405	1407	1409	1411	1413	1415	1417	1419	1421	1423	1425	1427	1429	1431	1433	1435	1437	1439	1441	1443	1445	1447	1449	1451	1453	1455	1457	1459	1461	1463	1465	1467	1469	1471	1473	1475	1477	1479	1481	1483	1485	1487	1489	1491	1493	1495	1497	1499	1501	1503	1505	1507	1509	1511	1513	1515	1517	1519	1521	1523	1525	1527	1529	1531	1533	1535	1537	1539	1541	1543	1545	1547	1549	1551	1553	1555	1557	1559	1561	1563	1565	1567	1569	1571	1573	1575	1577	1579	1581	1583	1585	1587	1589	1591	1593	1595	1597	1599	1601	1603	1605	1607	1609	1611	1613	1615	1617	1619	1621	1623	1625	1627	1629	1631	1633	1635	1637	1639	1641	1643	1645	1647	1649	1651	1653	1655	1657	1659	1661	1663	1665	1667	1669	1671	1673	1675	1677	1679	1681	1683	1685	1687	1689	1691	1693	1695	1697	1699	1701	1703	1705	1707	1709	1711	1713	1715	1717	1719	1721	1723	1725	1727	1729	1731	1733	1735	1737	1739	1741	1743	1745	1747	1749	1751	1753	1755	1757	1759	1761	1763	1765	1767	1769	1771	1773	1775	1777	1779	1781	1783	1785	1787	1789	1791	1793	1795	1797	1799	1801	1803	1805	1807	1809	1811	1813	1815	1817	1819	1821	1823	1825	1827	1829	1831	1833	1835	1837	1839	1841	1843	1845	1847	1849	1851	1853	1855	1857	1859	1861	1863	1865	1867	1869	1871	1873	1875	1877	1879	1881	1883	1885	1887	1889	1891	1893	1895	1897	1899	1901	1903	1905	1907	1909	1911	1913	1915	1917	1919	1921	1923	1925	1927	1929	1931	1933	1935	1937	1939	1941	1943	1945	1947	1949	1951	1953	1955	1957	1959	1961	1963	1965	1967	1969	1971	1973	1975	1977	1979	1981	1983	1985	1987	1989	1991	1993	1995	1997	1999	2001	2003	2005	2007	2009	2011	2013	2015	2017	2019	2021	2023	2025	2027	2029	2031	2033	2035	2037	2039	2041	2043	2045	2047	2049	2051	2053	2055	2057	2059	2061	2063	2065	2067	2069	2071	2073	2075	2077	2079	2081	2083	2085	2087	2089	2091	2093	2095	2097	2099	2101	2103	2105	2107	2109	2111	2113	2115	2117	2119	2121	2123	2125	2127	2129	2131	2133	2135	2137	2139	2141	2143	2145	2147	2149	2151	2153	2155	2157

Some Tall Brick Chimneys (1895).

	Height.	Internal Diam.	Outside Diameter.		Capacity by the Author's Formula.	
			Base.	Top.	H. P.	Pounds Coal per Hour.
1. Hallsbrückner Hütte, Saxony.....	460	15.7'	33'	16'	13,221	66,105
2. Townsend's, Glasgow.....	454	32
3. Tennant's, Glasgow.....	435	13' 6"	40	9,795	48,975
4. Dobson & Barlow, Bolton, Eng.....	367 1/2	13' 2"	33' 10"	8,245	41,225
5. Fall River Iron Co., Boston.....	350	11	30	21	5,558	27,790
6. Clark Thread Co., Newark, N. J.....	335	11	28' 6"	14	5,435	27,175
7. Merrimac Mills, Lowell, Mass.....	282' 9"	12	5,980	29,900
8. Washington Mills, Lawrence, Mass.....	250	10	3,839	19,195
9. Amoskeag Mills, Manchester, N. H.....	250	10	3,839	19,195
10. Narragansett E. L. Co., Providence, R. I.....	238	14	7,515	37,575
11. Lower Pacific Mills, Lawrence, Mass.....	214	8	2,248	11,240
12. Passaic Print Works, Passaic, N. J.....	200	9	2,771	13,855
13. Edison Station Brooklyn, Two each.....	150	50" x 120"	each	1,541	7,705

NOTES ON THE ABOVE CHIMNEYS. — 1. This chimney is situated near Freiberg, at an elevation of 219 ft. above that of the foundry works, so that its total height above the sea will be 711 3/4 ft. The furnace-gases are conveyed across river to the chimney on a bridge, through a pipe 3227 ft. long. It is built of brick, and cost about \$40,000. — *Mfr. & Bldr.*

2. Owing to the fact that it was struck by lightning, and somewhat damaged, as a precautionary measure a copper extension subsequently was added to it, making its entire height 488 feet.

1, 2, 3, and 4 were built of these great heights to remove deleterious gases from the neighborhood, as well as for draught for boilers.

5. The structure rests on a solid granite foundation, 55 x 30 feet, and 16 feet deep. In its construction there were used 1,700,000 bricks, 2000 tons of stone, 2000 barrels of mortar, 1000 loads of sand, 1000 barrels of Portland cement, and the estimated cost is \$40,000. It is arranged for two flues, 9 feet 6 inches by 6 feet, connecting with 40 boilers, which are to be run in connection with four triple-expansion engines of 1350 horsepower each.

6. It has a uniform batter of 2.85 ins. to every 10 ft. Designed for 21 boilers of 200 H.P. each. It is surmounted by a cast-iron coping which weighs six tons, and is composed of 32 sections bolted together by inside flanges so as to present a smooth exterior. The foundation is 40 ft. square and 5 ft. deep. Two qualities of brick were used; the outer portions were of the first quality North River, and the backing up was of good quality New Jersey brick. Every twenty feet in vertical measurement an iron ring, 4 ins. wide and 3/4 to 1/2 in. thick, placed edge-wise, was built into the walls about 8 ins. from the outer circle. As the chimney starts from the base it is double. The outer wall is 5 ft. 2 ins. in thickness, and inside of this is a second wall 20 ins. thick and spaced

off about 20 ins. from main wall. From the interior surface of the main wall eight buttresses are carried, nearly touching this inner or main flue wall in order to keep it in line should it tend to sag. The interior wall, starting with the thickness described, is gradually reduced until a height of about 90 ft. is reached, when it is diminished to 8 inches. At 165 ft. it ceases, and the rest of the chimney is without lining. The total weight of the chimney and foundation is 5000 tons. It was completed in September, 1888.

- 7. Connected to 12 boilers, with 1200 sq. ft. of grate. Draught 1 9/16 ins.
- 8. Connected to 8 boilers, 6 ft. 8 in. diam. x 18 ft. Grate 448 sq. ft.
- 9. Connected to 64 Manning vertical boilers, total grate surface 1810 sq. ft. Designed to burn 18,000 lbs. anthracite per hour.
- 10. Designed for 12,000 H.P. of engines; (compound condensing).
- 11. Grate-surface 434 square feet; H.P. of boilers about 2500.
- 13. Eight boilers (water-tube) each 450 H.P.; 12 engines, each 300 H.P. For the first 60 feet the exterior wall is 28 ins. thick, then 24 ins. for 20 ft., 20 ins. for 30 ft., 16 ins. for 20 ft., and 12 ins. for 20 ft. The interior wall is 9 ins. thick of fire-brick for 50 ft., and then 8 ins. thick of red brick for the next 30 ft. Illustrated in *Iron Age*, Jan. 2, 1890.

A number of the above chimneys are illustrated in *Power*, Dec., 1890.

More Recent Brick Chimneys (1909). — Heller & Merz Co., Newark, N. J. 350 ft. high, inside diam., 8 ft. Outside diam., top 9 ft. 10 1/4 in., bottom 27 ft. 8 1/2 in. Outside taper 5.2 in 100. Outer shell 7 1/8 in. at the top, 38 in. at the bottom. Custodis radial brick laid in mortar of 1 cement, 2 lime, 5 sand. The changes in thickness are made by 2-in. offsets on the inside every 20 ft. Iron band 3 1/2 x 5/16 in., three courses below the top. Lined with 4 in. of special brick to resist acids. The lining is sectional, being carried on corbels projecting from the shell every 20 ft. An air space of 2 ins. is left between the lining and the shell. The lining bricks are laid in a mortar made of silicate of soda and white asbestos wool, tempered to the consistency of fire-clay mortar. This mortar is acid-proof, and its binding power, which is considerable in comparison to that of fire-clay mortar, is unaffected by temperatures up to 2000° F. (*Eng. News*, Feb. 15, 1906.) Supported on 324 piles driven 60 ft. to solid rock, and covering an area 45 ft. square. Total cost \$32,000. The standard Custodis radial brick is 4 1/2 in. thick and 6 1/2 in. wide; radial lengths are 4, 5 1/2, 7 1/8, 8 5/8 and 10 5/8 ins. The smallest size has six vertical perforations, 1 in. square, and the largest fifteen.

Eastman Kodak Co., Rochester, N. Y. Height 366 ft.; internal diam. at top 9 ft. 10 ins., at bottom 20 ft. 10 ins.; outside diam., top 11 ft., bottom 27 ft. 10 ins. Radial brick, with 4-in. acid-resisting brick lining.

Some notable tall chimneys built by the Alphonse Custodis Chimney Construction Co. are: Dolgeville, N. Y., 6 x 175 ft.; Camden, N. J., 7 x 210 ft.; Newark, N. J., 8 x 350 ft.; Rochester, N. Y., 9 x 366 ft.; Constable Hook, N. J., 10 x 365 ft.; Providence, R. I., 16 x 308 ft.; Garfield, Utah, 30 x 300 ft.; Great Falls, Mont., 50 x 506 ft.

The Largest Chimney in the World. in 1903, is that of the Montana smelter, at Great Falls, Mont. Height 506 ft. Internal diam. at top 50 ft. Built of Custodis radial brick. Designed to remove 4,000,000 cu. ft. of gases per minute at an average temperature of 600° F. Erected on top of a hill 500 ft. above the city, and 246 ft. above the floor of the furnaces, which are about 2000 ft. distant. Designed for a wind pressure of 33 1/3 lbs. per sq. ft. of projected area; bearing pressure limited to 21 lbs. per sq. ft. at any section. Foundation: 111 ft. max. diam., 22 1/2 ft. deep; bearing pressure on bottom (shale rock) 4.83 tons per sq. ft.; octagonal outside, 103 ft. across at bottom, 81 ft. at top, with inner circular opening 47 ft. diam. at bottom, 64 ft. at top; made of 1 cement, 3 sand, 5 crushed slag. Four flue openings in the base, each 15 ft. wide, 36 ft. high. The stack proper consists of an octagonal base, 46 ft. in height, which has a taper of 8%, and above this a circular barrel, the first 180 ft. above the base having a taper of 7%, the next 100 ft. of 4%, and the remaining 180 ft. to the cap 2%.

The chimney wall varies from 66 in. at the base to 18 1/8 in. at the top by uniform decrements of 2 in. per section, excepting at the section immediately above the top of the base, where the thickness decreases from 60 in. to 54 in. The outside diameters of the stack are 78 1/2 ft. at the base, 53 ft. 9 in. at the base of the cap; the inside diameters range from 66 1/2 ft.

at the foundation line to 50 ft. at the top. The chimney is lined with 4-in. acid-proof brick, laid in sections carried on corbels from the main shell.

A description of the methods of design and of erection of the Great Falls chimney is given in *Eng. Rec.*, Nov. 28, 1908.

Stability of Chimneys. — Chimneys must be designed to resist the maximum force of the wind in the locality in which they are built. A general rule for diameter of base of brick chimneys, approved by many years of practice in England and the United States, is to make the diameter of the base one-tenth of the height. If the chimney is square or rectangular, make the diameter of the inscribed circle of the base one-tenth of the height. The "batter" or taper of a chimney should be from $1/16$ to $1/4$ inch to the foot on each side. The brickwork should be one brick (8 or 9 inches) thick for the first 25 feet from the top, increasing $1/2$ brick (4 or $4\frac{1}{2}$ inches) for each 25 feet from the top downwards. If the inside diameter exceeds 5 feet, the top length should be $1\frac{1}{2}$ bricks; and if under 3 feet, it may be $1/2$ brick for ten feet.

(From *The Locomotive*, 1884 and 1886.) For chimneys of four feet in diameter and one hundred feet high, and upwards, the best form is circular with a straight batter on the outside.

Chimneys of any considerable height are not built up of uniform thickness from top to bottom, nor with a uniformly varying thickness of wall, but the wall, heaviest of course at the base, is reduced by a series of steps.

Where practicable the load on a chimney foundation should not exceed two tons per square foot in compact sand, gravel, or loam. Where a solid rock-bottom is available for foundation, the load may be greatly increased. If the rock is sloping, all unsound portions should be removed, and the face dressed to a series of horizontal steps, so that there shall be no tendency to slide after the structure is finished.

All boiler-chimneys of any considerable size should consist of an outer stack of sufficient strength to give stability to the structure, and an inner stack or core independent of the outer one. This core is by many engineers extended up to a height of but 50 or 60 feet from the base of the chimney, but the better practice is to run it up the whole height of the chimney; it may be stopped off, say, a couple of feet below the top, and the outer shell contracted to the area of the core, but the better way is to run it up to about 8 or 12 inches of the top and not contract the outer shell. But under no circumstances should the core at its upper end be built into or connected with the outer stack. This has been done in several instances by bricklayers, and the result has been the expansion of the inner core which lifted the top of the outer stack squarely up and cracked the brickwork.

For a height of 100 feet we would make the outer shell in three steps, the first 20 feet high, 16 inches thick, the second 30 feet high, 12 inches thick, the third 50 feet high and 8 inches thick. These are the minimum thicknesses admissible for chimneys of this height, and the batter should be not less than 1 in 36 to give stability. The core should also be built in three steps, each of which may be about one-third the height of the chimney, the lowest 12 inches, the middle 8 inches, and the upper step 4 inches thick. This will insure a good sound core. The top of a chimney may be protected by a cast-iron cap; or perhaps a cheaper and equally good plan is to lay the ornamental part in some good cement, and plaster the top with the same material.

C. L. Hubbard (*Am. Electrician*, Mar., 1904) says: The following approximate method may be used for determining the thickness of walls. If the inside diameter at the top is less than 3 ft. the walls may be 4 ins. thick for the first 10 ft., and increased 4 ins. for each 25 ft. downward. If the inside diameter is more than 3 ft. and less than 5 ft., begin with a wall 8 ins. thick, increasing 4 ins. for each 25 ft. downward. If the diameter is over 5 ft., begin with a 12-in. wall, increasing below the first 10 ft. as before. The lining or core may be 4 ins. thick for the first 20 ft. from the top, 8 ins. for the next 30 ft., 12 ins. for the next 40 ft., 16 ins. for the next 50 ft., and 20 ins. for the next 50 ft. Using this method for an outer wall 200 ft. high and assuming a cubic foot of brickwork to weigh 130 lbs., it gives a maximum pressure of 8.2 tons per sq. ft. of section at the base; while a lining 190 ft. high would have a maximum pressure of 8.6 tons per sq. ft. The safe load for brickwork may be taken at from

8 to 10 tons per sq. ft., although the strength of best pressed brick will run much higher.

James B. Francis, in a report to the Lawrence Mfg. Co. in 1873 (*Eng. News*, Aug. 28, 1880), concerning the probable effects of wind on that company's chimney as then constructed, says:

The stability of the chimney to resist the force of the wind depends mainly on the weight of its outer shell, and the width of its base. The cohesion of the mortar may add considerably to its strength; but it is too uncertain to be relied upon. The inner shell will add a little to the stability, but it may be cracked by the heat, and its beneficial effect, if any, is too uncertain to be taken into account.

The effect of the joint action of the vertical pressure due to the weight of the chimney, and the horizontal pressure due to the force of the wind is to shift the center of pressure at the base of the chimney, from the axis toward one side, the extent of the shifting depending on the relative magnitude of the two forces. If the center of pressure is brought too near the side of the chimney, it will crush the brickwork on that side, and the chimney will fall. A line drawn through the center of pressure, perpendicular to the direction of the wind, must leave an area of brickwork between it and the side of the chimney, sufficient to support half the weight of the chimney; the other half of the weight being supported by the brickwork on the windward side of the line.

Different experimenters on the strength of brickwork give very different results. Kirkaldy found the weights which caused several kinds of bricks, laid in hydraulic lime mortar and in Roman and Portland cements, to fail slightly, to vary from 19 to 60 tons (of 2000 lbs.) per sq. ft. If we take in this case 25 tons per sq. ft. as the weight that would cause it to begin to fail, we shall not err greatly.

Rankine, in a paper printed in the transactions of the Institution of Engineers, in Scotland, for 1867-68, says: "It had previously been ascertained by observation of the success and failure of actual chimneys, and especially of those which respectively stood and fell during the violent storms of 1856, that, in order that a round chimney may be sufficiently stable, its weight should be such that a pressure of wind, of about 55 lbs. per sq. ft. of a plane surface, directly facing the wind, or $27\frac{1}{2}$ lbs. per sq. ft. of the plane projection of a cylindrical surface, . . . shall not cause the resultant pressure at any bed-joint to deviate from the axis of the chimney by more than one-quarter of the outside diameter at that joint."

Steel Chimneys are largely used, especially for tall chimneys of iron-works, from 150 to 300 feet in height. The advantages claimed are: greater strength and safety; smaller space required; smaller cost, by 30 to 50 per cent, as compared with brick chimneys; avoidance of infiltration of air and consequent checking of the draught, common in brick chimneys. They are usually made cylindrical in shape, with a wide curved flare for 10 to 25 feet at the bottom. A heavy cast-iron base-plate is provided, to which the chimney is riveted, and the plate is secured to a massive foundation by holding-down bolts. No guys are used.

Design of Self-supporting Steel Chimneys. — John D. Adams (*Eng. News*, July 20, 1905) gives a very full discussion of the design of steel chimneys, from which the following is adapted. The bell-shaped bottom of the chimney is assumed to occupy one-seventh of the total height, and the point of maximum strain is taken to be at the top of this bell portion. Let D = diam. in inches, H = height in feet, T = thickness in inches, S = safe tensile stress, lbs. per sq. in. The general formula for moment of resistance of a hollow cylinder is $M = \frac{1}{32} \pi (D^4 - D_1^4) S/D$. When the thickness is a small fraction of the diameter this becomes approximately $M = 0.7854 D^2 T S$.

With steel plate of 60,000 lbs. tensile strength, riveting of 0.6 efficiency, and a factor of safety of 4, we have $S = 9000$ pounds per sq. in., and the safe moment of resistance = $7070 D^2 T$.

The effect of the wind upon a cylinder is equal to the wind pressure multiplied by one-half the diametral plane, and taking the maximum wind pressure at 50 lbs. per sq. ft., we get

$$\text{Total wind pressure} = 50 \times \frac{1}{12} D \times \frac{1}{2} \times \frac{0}{7} H = 25 DH/14.$$

The distance of the center of pressure above the top of the bell portion, $= \frac{3}{7} H$, multiplied by the total wind pressure, gives us the bending moment due to the wind,

$$\text{inch pounds, } 25 DH/14 \times \frac{3}{7} H \times 12 = 9.184 DH^2.$$

Equating the bending and the resisting moment we have $T = 0.0013 H^2/D$.

With this formula the maximum thickness of plates was calculated for different sizes of chimneys, as given in the table below.

In the above formula, no attention has been paid to the weight of the steel in the stack above the bell portion, which weight has a tendency to decrease the tension on the windward side and increase the compression on the leeward side of the stack. A column of steel 150 ft. high would exert a pressure of approximately 500 lbs. per sq. in., which, with steel of 60,000 lbs. tensile strength, is less than 1% of the ultimate strength, and may safely be neglected.

From the table it appears that a chimney 12 x 120 ft. requires, as far as fracture by bending of a tubular section is concerned, a thickness of but little over $\frac{1}{8}$ in. In designing a stack of such extreme proportions as 12 x 120 ft., there are other factors besides bending to take into consideration that ordinarily could be neglected. For instance, such a stack should be provided with stiffening angles, or else made heavier, to guard against lateral flattening. Ordinarily, however, the strength of the chimney determined as a tubular section will be the prime factor in determining the maximum thickness of plates.

THICKNESS OF BASE-RING PLATES OF SELF-SUPPORTING STEEL STACKS. For normal wind pressure of 50 lbs. per sq. ft. on half the diametral plane. Diameter of Stack in feet.

Hgt. ft.	3.5	4	5	6	7	8	8.5	9	9.5	10	11	12
70	0.152	.133	.106									
80	0.198	.182	.139	.116	.099							
90	0.224	.219	.175	.146	.125	.111						
100	0.310	.271	.217	.181	.155	.135	.127	.120				
110	0.375	.328	.262	.218	.187	.164	.154	.146	.138	.131	.119	
120	0.446	.390	.312	.260	.223	.195	.183	.173	.164	.156	.142	.130
130	0.523	.458	.366	.305	.262	.228	.215	.203	.193	.183	.166	.153
140	0.607	.531	.425	.354	.303	.265	.250	.236	.223	.212	.193	.180
150	0.696	.609	.487	.406	.348	.305	.286	.271	.257	.244	.222	.203
160		.693	.555	.462	.396	.346	.326	.308	.292	.277	.252	.231
170			.626	.522	.447	.391	.368	.348	.330	.313	.285	.261
180			.702	.585	.501	.439	.413	.390	.370	.351	.319	.293
190				.652	.559	.489	.460	.434	.411	.391	.356	.326
200					.620	.542	.510	.481	.456	.433	.394	.361
210					.682	.596	.562	.531	.503	.478	.434	.398
220						.655	.617	.582	.552	.524	.476	.437
230							.707	.674	.637	.603	.551	.477
240								.734	.693	.657	.624	.567
250									.752	.713	.677	.615

Foundation. — Neglecting the increase of wind area due to the flare at the base of the chimney, which has but a very small turning effect, if all dimensions be taken in feet, we have

Total wind pressure $= \frac{1}{2} D \times H \times 50 = 25 DH$; lever-arm $= \frac{1}{2} H$; hence, turning moment $= 12.5 DH^2$.

Let d = diameter and h = height of foundation. For average conditions $h = 0.4 d$, then volume of foundation $= 0.7854 d^2 h$, and for concrete at 150 lbs. per cu. ft., weight of foundation $= W = 0.7854 d^2 h \times 150 = 47.124 d^3$.

The stability of the foundation or the tendency to resist overturning is equal to the weight of the foundation multiplied by its radius or $\frac{1}{2} Wd = 23.562 d^4$. Applying a factor of safety of $2\frac{1}{2}$, which is indicated by

current practice, gives safe stability $= 9.425 d^4$. Equating this to the overturning moment we obtain $d = 1.07 \sqrt[4]{DH^2}$, in which all dimensions are in feet.

Anchor-bolts. — The holding power of the bolts depends on three factors: the number of bolts, the diameter of the bolt circle, and the diameter of the bolts. The number of bolts is largely conventional and may be selected so as not to necessitate bolts of too large a diameter. The diameter of the bolt circle is also more or less arbitrary. The bolts will be stretched and therefore strained, in proportion to their distance from the axis of turning, assuming, as we must, that the cast-iron ring at the base of the chimney is rigid. The leverage at which any bolt acts is also directly proportional to its distance from the axis of turning. Therefore, since the effectiveness of any one bolt, as regards overturning, depends upon the strain in that bolt, multiplied by its leverage, it is evident that the effectiveness of any bolt varies as the square of its distance from the axis of turning. If we lay out, say, 12 or 24 bolts equidistant on a circle and add all the squares of these distances, we will find that we may consider the total as though the bolts were all placed at a distance of $\frac{3}{8}$ the diameter of the bolt circle from the axis of turning, which is the tangent to the bolt circle.

Let b = diameter of bolt in inches, n = number of bolts, diameter of bolt circle $= \frac{2}{3} d$. Take safe working stress at 8000 pounds per sq. inch. Then resistance to overturning $= 0.7854 b^2 \times 8000 \times \frac{2}{3} d \times \frac{3}{8} \times N = 6283 b^2 Nd/4$. Equating this to the turning moment, $12.5 DH^2$, gives $b = 0.0257 H \sqrt{D/d}$ for 12 bolts, $0.0222 H \sqrt{D/d}$ for 18 bolts, and $0.0182 H \sqrt{D/d}$ for 24 bolts.

The Babcock & Wilcox Co.'s book "Steam" illustrates a steel chimney at the works of the Maryland Steel Co., Sparrow's Point, Md. It is 225 ft. in height above the base, with internal brick lining 13' 9" uniform inside diameter. The shell is 25 ft. diam. at the base, tapering in a curve to 17 ft. 25 ft. above the base, thence tapering almost imperceptibly to 14' 8" at the top. The upper 40 feet is of $\frac{1}{4}$ -inch plates, the next four sections of 40 ft. each are respectively $\frac{9}{32}$, $\frac{5}{16}$, $\frac{11}{32}$, and $\frac{3}{8}$ inch.

Reinforced Concrete Chimneys began extensively to come into use in the United States in 1901. Some hundreds of them are now (1909) in use. The following description of the method of construction of these chimneys is condensed from a circular of the Weber Chimney Co., Chicago:

The foundation is comparatively light and made of concrete, consisting of 1 cement, 3 sand, and 5 gravel or macadam. The steel reinforcement consists of two networks usually made of T steel of small size. The bars for the lower network are placed diagonally and the bars for the second network (about 4 to 6 ins. above the first one) run parallel to the sides. The vertical bars, forming the reinforcement of the chimney itself, also go down into the foundation and a number of these bars are bent in order to secure an anchorage for the chimney.

The chimney shaft consists of two parts, the lower double shell and the single shell above, which are united at the offset. The inside shell is usually 4 ins. thick, while the thickness of the outer shell depends on the height and varies from 6 to 12 ins. The single shell is from 4 to 10 ins. thick. The height of the double shell depends upon the purpose of the chimney, nature and heat of the gases, etc.

Between the two shells in the lower part there is a circular air space 4 ins. in width. An expansion joint is provided where the two shells unite.

The concrete above the ground level consists of one part Portland cement and three parts of sand. No gravel or macadam is used.

The bending forces caused by wind pressure are taken up by the vertical steel reinforcement. The resistance of the concrete itself against tension is not considered in calculation.

The vertical T bars are from $1 \times 1 \times \frac{1}{8}$ to $1\frac{1}{2} \times 1\frac{1}{2} \times \frac{1}{2}$ in., the weight and number depending upon the dimensions of the chimney. The bars are from 16 to 30 ft. long and overlap not less than 24 ins. They are placed at regular intervals of 18 ins. and encircled by steel rings bent to the desired circle. The work of erection is done from the inside of the chimney; no outside scaffolding is needed.

The following is a list of some of the tallest concrete chimneys that have been built of their respective diameters: Butte, Mont., 350 x 18 ft.; Seattle,

Wash., 278 X 17 ft.; Portland, Ore., 230 X 12 ft.; Lawrence, Mass., 250 X 11 ft.; Cincinnati, Ohio, 200 X 10 ft.; Worcester, Mass., 220 X 9 ft.; Atlanta, Ga., 225 X 8 ft.; Chicago, 175 X 7 ft.; Rockville, Conn., 175 X 6 ft.; Seymour, Ind., 150 X 5 ft.; Iola, Kans., 143 X 4 ft.; St. Louis, Mo., 130 X 3 ft. 4 in.; Dayton, Ohio, 94 X 3 ft.

Sizes of Foundations for Steel Chimneys.

(Selected from circular of Phila. Engineering Works.)

HALF-LINED CHIMNEYS.

Diameter, clear, feet.....	3	4	5	6	7	9	11
Height, feet.....	100	100	150	150	150	150	150
Least diam. foundation..	15'9"	16'4"	20'4"	21'10"	22'7"	23'8"	24'8"
Least depth foundation..	6'	6'	9'	8'	9'	10'	10'
Height, feet.....		125	200	200	250	275	300
Least diam. foundation..		18'5"	23'8"	25'	29'8"	33'6"	36'
Least depth foundation .		7'	10'	10'	12'	12'	14'

Weight of Sheet-iron Smoke-stacks per Foot.

(Porter Mfg. Co.)

Diam. inches.	Thick-ness. W. G.	Weight per ft.	Diam. inches.	Thick-ness. W. G.	Weight per ft.	Diam. inches.	Thick-ness. W. G.	Weight per ft.
10	No. 16	7.20	26	No. 16	17.50	20	No. 14	18.33
12	"	8.66	28	"	18.75	22	"	20.00
14	"	9.58	30	"	20.00	24	"	21.66
16	"	11.68	10	No. 14	9.40	26	"	23.33
20	"	13.75	12	"	11.11	28	"	25.00
22	"	15.00	14	"	13.69	30	"	26.66
24	"	16.25	16	"	15.00			

Sheet-iron Chimneys. (Columbus Machine Co.)

Diameter Chimney, inches.	Length Chimney, feet.	Thick-ness Iron, B. W. G.	Weight lbs.	Diameter Chimney, inches.	Length Chimney, feet.	Thick-ness Iron, B. W. G.	Weight lbs.
10	20	No. 16	160	30	40	No. 15	960
15	20	" 16	240	32	40	" 15	1020
20	20	" 16	320	34	40	" 14	1170
22	20	" 16	350	36	40	" 14	1240
24	40	" 16	760	38	40	" 12	1800
26	40	" 16	826	40	40	" 12	1890
28	40	" 15	900				

THE STEAM-ENGINE.

Expansion of Steam. Isothermal and Adiabatic. — According to Mariotte's law, the volume of a perfect gas, the temperature being kept constant, varies inversely as its pressure, or $p \propto 1/v$; $pv = a$ constant. The curve constructed from this formula is called the *isothermal curve*, or curve of equal temperatures, and is a common or rectangular hyperbola. The expansion of steam in an engine is not isothermal, since the temperature decreases with increase of volume, but its expansion curve approximates the curve of $pv = a$ constant. The relation of the pressure and volume of saturated steam, as deduced from Regnault's experiments, and as given in steam tables, is approximately, according to Rankine (S. E., p. 403), for pressures not exceeding 120 lbs., $p \propto 1/v^{1.16}$, or $p \propto v^{-1.16}$ or $pv^{1.16} = pv^{1.0626} = a$ constant. Zeuner has found that the exponent 1.0646 gives a closer approximation.

When steam expands in a closed cylinder, as in an engine, according to Rankine (S. E., p. 385), the approximate law of the expansion is $p \propto 1/v^{1.3}$, or $p \propto v^{-1.3}$, or $pv^{1.3} = a$ constant. The curve constructed from this formula is called the *adiabatic curve*, or curve of no transmission of heat.

Peabody (Therm., p. 112) says: "It is probable that this equation was obtained by comparing the expansion lines on a large number of indicator-diagrams. . . . There does not appear to be any good reason for using an exponential equation in this connection, . . . and the action of a lagged steam-engine cylinder is far from being adiabatic. . . . For general purposes the hyperbola is the best curve for comparison with the expansion curve of an indicator-card. . . ." Wolff and Denton, *Trans. A. S. M. E.*, ii, 175, say: "From a number of cards examined from a variety of steam-engines in current use, we find that the actual expansion line varies between the 10/9 adiabatic curve and the Mariotte curve."

Prof. Thurston (*Trans. A. S. M. E.*, ii, 203) says he doubts if the exponent ever becomes the same in any two engines, or even in the same engine at different times of the day and under varying conditions of the day.

Expansion of Steam according to Mariotte's Law and to the Adiabatic Law. (*Trans. A. S. M. E.*, ii, 156.) — Mariotte's law $pv =$

p_1v_1 ; values calculated from formula $\frac{P_m}{p_1} = \frac{1}{R} (1 + \text{hyp log } R)$, in which $R = v_2 \div v_1$, $p_1 =$ absolute initial pressure, $P_m =$ absolute mean pressure, $v_1 =$ initial volume of steam in cylinder at pressure p_1 , $v_2 =$ final volume of steam at final pressure. Adiabatic law: $pv^{1.3} = p_1v_1^{1.3}$; values calculated from formula $\frac{P_m}{p_1} = 10 R^{-1} - 9 R^{-1.3}$.

Ratio of Expansion R.	Ratio of Mean to Initial Pressure.		Ratio of Expansion R.	Ratio of Mean to Initial Pressure.		Ratio of Expansion R.	Ratio of Mean to Initial Pressure.	
	Mar.	Adiab.		Mar.	Adiab.		Mar.	Adiab.
1.00	1.000	1.000	3.7	0.624	0.600	6.	0.465	0.438
1.25	.978	.976	3.8	.614	.590	6.25	.453	.425
1.50	.937	.931	3.9	.605	.580	6.5	.442	.413
1.75	.891	.881	4.	.597	.571	6.75	.431	.403
2.	.847	.834	4.1	.588	.562	7.	.421	.393
2.2	.813	.798	4.2	.580	.554	7.25	.411	.383
2.4	.781	.765	4.3	.572	.546	7.5	.402	.374
2.5	.766	.748	4.4	.564	.538	7.75	.393	.365
2.6	.752	.733	4.5	.556	.530	8.	.385	.357
2.8	.725	.704	4.6	.549	.523	8.25	.377	.349
3.	.700	.678	4.7	.542	.516	8.5	.369	.342
3.1	.688	.666	4.8	.535	.509	8.75	.362	.335
3.2	.676	.654	4.9	.528	.502	9.	.355	.328
3.3	.665	.642	5.0	.522	.495	9.25	.349	.321
3.4	.654	.630	5.25	.506	.479	9.5	.342	.315
3.5	.644	.620	5.5	.492	.464	9.75	.336	.309
3.6	.634	.610	5.75	.478	.450	10.	.330	.303

Mean Pressure of Expanded Steam. — For calculations of engines it is generally assumed that steam expands according to Mariotte's law, the curve of the expansion line being a hyperbola. The mean pressure, measured above vacuum, is then obtained from the formula

$$P_m = p_1 \frac{1 + \text{hyp log } R}{R}, \text{ or } P_m = P_t (1 + \text{hyp log } R),$$

in which P_m is the absolute mean pressure, p_1 the absolute initial pressure taken as uniform up to the point of cut-off, P_t the terminal pressure, and R the ratio of expansion. If l = length of stroke to the cut-off, L = total stroke.

$$P_m = \frac{p_1 l + p_t \text{hyp log } \frac{L}{l}}{L}; \text{ and if } R = \frac{L}{l}, P_m = p_1 \frac{1 + \text{hyp log } R}{R}.$$

Mean and Terminal Absolute Pressures. — Mariotte's Law. — The values in the following table are based on Mariotte's law, except those in the last column, which give the mean pressure of superheated steam, which, according to Rankine, expands in a cylinder according to the law $p \propto v^{-1.6}$. These latter values are calculated from the formula

$$\frac{P_m}{p_1} = \frac{17 - 16 R^{-1.6}}{R}. R^{-1.6} \text{ may be found by extracting the square root of } \frac{1}{R} \text{ four times.}$$

From the mean absolute pressures given deduct the mean back pressure (absolute) to obtain the mean effective pressure.

Rate of Expansion.	Cut-off.	Ratio of Mean to Initial Pressure.	Ratio of Mean to Terminal Pressure.	Ratio of Terminal to Mean Pressure.	Ratio of Initial to Mean Pressure.	Ratio of Mean to Initial Dry Steam.
30	0.033	0.1467	4.40	0.227	6.82	0.136
28	0.036	0.1547	4.33	0.231	6.46
26	0.038	0.1638	4.26	0.235	6.11
24	0.042	0.1741	4.18	0.239	5.75
22	0.045	0.1860	4.09	0.244	5.38
20	0.050	0.1998	4.00	0.250	5.00	0.186
18	0.055	0.2161	3.89	0.256	4.63
16	0.062	0.2358	3.77	0.265	4.24
15	0.066	0.2472	3.71	0.269	4.05
14	0.071	0.2599	3.64	0.275	3.85
13.33	0.075	0.2690	3.59	0.279	3.72	0.254
13	0.077	0.2742	3.56	0.280	3.65
12	0.083	0.2904	3.48	0.287	3.44
11	0.091	0.3089	3.40	0.294	3.24
10	0.100	0.3303	3.30	0.303	3.03	0.314
9	0.111	0.3552	3.20	0.312	2.81
8	0.125	0.3849	3.08	0.321	2.60	0.370
7	0.143	0.4210	2.95	0.339	2.37
6.66	0.150	0.4347	2.90	0.345	2.30	0.417
6.00	0.166	0.4653	2.79	0.360	2.15
5.71	0.175	0.4807	2.74	0.364	2.08
5.00	0.200	0.5218	2.61	0.383	1.92	0.506
4.44	0.225	0.5608	2.50	0.400	1.78
4.00	0.250	0.5965	2.39	0.419	1.68	0.582
3.63	0.275	0.6308	2.29	0.437	1.58
3.33	0.300	0.6615	2.20	0.454	1.51	0.648
3.00	0.333	0.6995	2.10	0.476	1.43
2.86	0.350	0.7171	2.05	0.488	1.39	0.707
2.66	0.375	0.7440	1.98	0.505	1.34
2.50	0.400	0.7664	1.91	0.523	1.31	0.756
2.22	0.450	0.8095	1.80	0.556	1.24	0.800
2.00	0.500	0.8465	1.69	0.591	1.18	0.840
1.82	0.550	0.8786	1.60	0.626	1.14	0.874
1.66	0.600	0.9066	1.51	0.662	1.10	0.900
1.60	0.625	0.9187	1.47	0.680	1.09
1.54	0.650	0.9292	1.43	0.699	1.07	0.926
1.48	0.675	0.9405	1.39	0.718	1.06

WARNING: This is a 1910 edition. Some of the material may no longer be accurate

Calculation of Mean Effective Pressure, Clearance and Compression Considered. — In the above tables no account is taken of clearance, which in actual steam-engines modifies the ratio of expansion and the mean pressure; nor of compression and back-pressure, which diminish the mean effective pressure. In the following calculation these elements are considered.

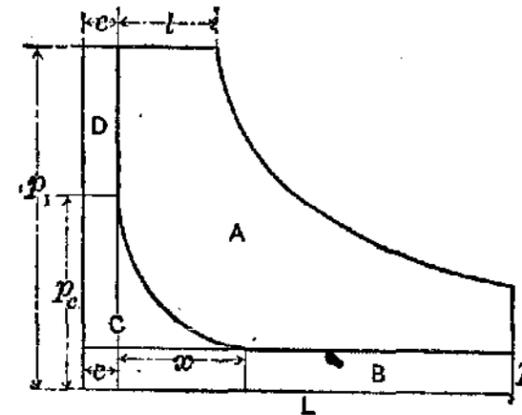

FIG. 153.

L = length of stroke, l = length before cut-off, x = length of compression part of stroke, c = clearance, p_1 = initial pressure, p_b = back pressure, p_c = pressure of clearance steam at end of compression. All pressures are absolute, that is, measured from a perfect vacuum.

$$\text{Area of ABCD} = p_1 (l + c) \left(1 + \text{hyp log } \frac{L + c}{l + c} \right);$$

$$B = p_b (L - x);$$

$$C = p_c c \left(1 + \text{hyp log } \frac{x + c}{c} \right) = p_b (x + c) \left(1 + \text{hyp log } \frac{x + c}{c} \right);$$

$$D = (p_1 - p_c) c = p_1 c - p_b (x + c).$$

$$\text{Area of A} = \text{ABCD} - (B + C + D)$$

$$= p_1 (l + c) \left(1 + \text{hyp log } \frac{L + c}{l + c} \right)$$

$$- \left[p_b (L - x) + p_b (x + c) \left(1 + \text{hyp log } \frac{x + c}{c} \right) + p_1 c - p_b (x + c) \right]$$

$$= p_1 (l + c) \left(1 + \text{hyp log } \frac{L + c}{l + c} \right)$$

$$- p_b \left[(L - x) + (x + c) \text{hyp log } \frac{x + c}{c} \right] - p_1 c.$$

$$\text{Mean effective pressure} = \frac{\text{area of A}}{L}.$$

EXAMPLE. — Let $L=1, l=0.25, x=0.25, c=0.1, p_1=60 \text{ lbs.}, p_b=2 \text{ lbs.}$

$$\text{Area A} = 60 (0.25 + 0.1) \left(1 + \text{hyp log } \frac{1.1}{0.35} \right)$$

$$- 2 \left[(1 - 0.25) + 0.35 \text{hyp log } \frac{0.35}{0.1} \right] - 60 \times 0.1.$$

$$= 21 (1 + 1.145) - 2 [0.75 + 35 \times 1.253] - 6$$

$$= 45.045 - 2.377 - 6 = 36.668 = \text{mean effective pressure.}$$

The actual indicator-diagram generally shows a mean pressure considerably less than that due to the initial pressure and the rate of expansion. The causes of loss of pressure are: 1. Friction in the stop-valves and steam-pipes. 2. Friction or wire-drawing of the steam during admission and cut-off, due chiefly to defective valve-gear and contracted steam-passages. 3. Liquefaction during expansion. 4. Exhausting before the engine has completed its stroke. 5. Compression due to early closure of exhaust. 6. Friction in the exhaust-ports, passages, and pipes.

Re-evaporation during expansion of the steam condensed during admission, and valve-leakage after cut-off, tend to elevate the expansion line of the diagram and increase the mean pressure.

If the theoretical mean pressure be calculated from the initial pressure and the rate of expansion on the supposition that the expansion curve follows Mariotte's law, $pv = a$ constant, and the necessary corrections are made for clearance and compression, the expected mean pressure in practice may be found by multiplying the calculated results by the factor (commonly called the "diagram factor") in the following table, according to Scaton.

Particulars of Engine.	Factor.
Expansive engine, special valve-gear, or with a separate cut-off valve, cylinder jacketed.....	0.94
Expansive engine having large ports, etc., and good ordinary valves, cylinders jacketed.....	0.9 to 0.92
Expansive engines with the ordinary valves and gear as in general practice, and unjacketed.....	0.8 to 0.85
Compound engines, with expansion valve to h.p. cylinder; cylinders jacketed, and with large ports, etc.....	0.9 to 0.92
Compound engines, with ordinary slide-valves, cylinders jacketed, and good ports, etc.....	0.8 to 0.85
Compound engines as in general practice in the merchant service, with early cut-off in both cylinders, without jackets and expansion-valves.....	0.7 to 0.8
Fast-running engines of the type and design usually fitted in war-ships.....	0.6 to 0.8

If no correction be made for clearance and compression, and the engine is in accordance with general modern practice, the theoretical mean pressure may be multiplied by 0.96, and the product by the proper factor in the table, to obtain the expected mean pressure.

Given the Initial Pressure and the Average Pressure, to Find the Ratio of Expansion and the Period of Admission.

- P = initial absolute pressure in lbs. per sq. in.;
- p = average total pressure during stroke in lbs. per sq. in.;
- L = length of stroke in inches;
- l = period of admission measured from beginning of stroke;
- c = clearance in inches;

$$R = \text{actual ratio of expansion} = \frac{L + c}{l + c} \dots \dots \dots (1)$$

$$p = \frac{P(1 + \text{hyp log } R)}{R}$$

To find average pressure p , taking account of clearance,

$$p = \frac{P(l + c) + P(l + c) \text{ hyp log } R - Pc}{L} \dots \dots \dots (2)$$

whence

$$pL + Pc = P(l + c)(1 + \text{hyp log } R);$$

$$\text{hyp log } R = \frac{pL + Pc}{Pl + Pc} - 1 = \frac{\frac{p}{P}L + c}{l + c} - 1 \dots \dots \dots (3)$$

Given p and P , to find R and l (by trial and error). — There being two unknown quantities R and l , assume one of them, viz., the period of admission l , substitute it in equation (3) and solve for R . Substitute this value of R in the formula (1), or $l = \frac{L + c}{R} - c$, obtained from formula (1), and find l . If the result is greater than the assumed value of l , then the assumed value of the period of admission is too long; if less, the assumed value is too short. Assume a new value of l , substitute it in formula (3) as before, and continue by this method of trial and error till the required values of R and l are obtained.

EXAMPLE. — $P=70$, $p=42.78$, $L=60$ in., $c=3$ in., to find l . Assume $l=21$ in.

$$\text{hyp log } R = \frac{\frac{p}{P}L + c}{l + c} - 1 = \frac{\frac{42.78}{70} \times 60 + 3}{21 + 3} - 1 = 1.653 - 1 = 0.653;$$

hyp log $R = 0.653$, whence $R = 1.92$.

$$l = \frac{L + c}{R} - c = \frac{63}{1.92} - 3 = 29.8,$$

which is greater than the assumed value, 21 inches.

Now assume $l = 15$ inches:

$$\text{hyp log } R = \frac{\frac{42.78}{70} \times 60 + 3}{15 + 3} - 1 = 1.204, \text{ whence } R = 3.5;$$

$$l = \frac{L + c}{R} - c = \frac{63}{3.5} - 3 = 18 - 3 = 15 \text{ inches, the value assumed.}$$

Therefore $R = 3.5$, and $l = 15$ inches.

Period of Admission Required for a Given Actual Ratio of Expansion:

$$l = \frac{L + c}{R} - c, \text{ in inches} \dots \dots \dots (4)$$

$$\text{In percentage of stroke, } l = \frac{100 + \text{p. ct. clearance}}{R} - \text{p. ct. clearance} \dots (5)$$

$$\text{Terminal pressure} = \frac{P(l + c)}{L + c} = \frac{P}{R} \dots \dots \dots (6)$$

Pressure at any other Point of the Expansion. — Let L_1 = length of stroke up to the given point.

$$\text{Pressure at the given point} = \frac{P(l + c)}{L_1 + c} \dots \dots \dots (7)$$

Mechanical Energy of Steam Expanded Adiabatically to Various Pressures. — The figures in the following table are taken from a chart constructed by R. M. Neilson in *Power*, Mar. 16, 1909. The pressures are absolute, lbs per sq. in.

Initial Press.	Mechanical Energy, Thousands of Foot-Pounds per Lb. of Steam.											
	15	20	25	40	60	80	100	120	140	170	200	250
15	0	17	29.5	55.5	77.5	94.5	107	116.5	121	136.5	146	160
12	12	29	41	66.5	88	104	116	126	135	145	154.5	168.5
10	22	39	50.5	75.5	97	113	125	135.5	144	154	163.5	176
8	34	50	62	86.5	109	124	136	147	155	165.5	174.5	186
6	49	64	76	101	123	138	150	160	168.5	179.5	188	199
4	68	85	95.5	120	142	157	168	177.5	186	196	204.5	216
2	100	116	128	151	171	186.5	197.5	207	215	224	232.5	244
1	131	147	157.5	181.5	200.5	215	225	234.5	243	250.5	260.5	270.5

Measures for Comparing the Duty of Engines. — Capacity is measured in horse-powers, expressed by the initials, H.P.: 1 H.P. = 33,000 ft.-lbs. per minute, = 550 ft.-lbs. per second, = 1,980,000 ft.-lbs. per hour. 1 ft.-lb. = a pressure of 1 lb. exerted through a space of 1 ft.

Economy is measured, 1, in pounds of coal per horse-power per hour; 2, in pounds of steam per horse-power per hour. The second of these measures is the more accurate and scientific, since the engine uses steam and not coal, and it is independent of the economy of the boiler.

In gas-engine tests the common measure is the number of cubic feet of gas (measured at atmospheric pressure) per horse-power, but as all gas is not of the same quality, it is necessary for comparison of tests to give the analysis of the gas. When the gas for one engine is made in one gas-producer, then the number of pounds of coal used in the producer per hour per horse-power of the engine is a measure of economy. Since different coals vary in heating value, a more accurate measure is the number of heat units required per horse-power per hour.

Economy, or duty of an engine, is also measured in the number of foot-pounds of work done per pound of fuel. As 1 horse-power is equal to 1,980,000 ft.-lbs. of work in an hour, a duty of 1 lb. of coal per H.P. per hour would be equal to 1,980,000 ft.-lbs. per lb. of fuel; 2 lbs. per H.P. per hour equals 990,000 ft.-lbs. per lb. of fuel, etc.

The duty of pumping-engines is expressed by the number of foot-pounds of work done per 100 lbs. of coal, per 1000 lbs. of steam, or per million heat units.

When the duty of a pumping-engine is given, in ft.-lbs. per 100 lbs. of coal, the equivalent number of pounds of fuel consumed per horse-power per hour is found by dividing 198 by the number of millions of foot-pounds of duty. Thus a pumping-engine giving a duty of 99 millions is equivalent to 198/99 = 2 lbs. of fuel per horse-power per hour.

Efficiency Measured in Thermal Units per Minute. — The efficiency of an engine is sometimes expressed in terms of the number of thermal units used by the engine per minute for each indicated horse-power, instead of by the number of pounds of steam used per hour.

The heat chargeable to an engine per pound of steam is the difference between the total heat in a pound of steam at the boiler-pressure and that in a pound of the feed-water entering the boiler. In the case of condensing engines, suppose we have a temperature in the hot-well of 100° F., corresponding to a vacuum of 28 in. of mercury; we may feed the water into the boiler at that temperature. In the case of a non-condensing engine, by using a portion of the exhaust steam in a good feed-water heater, at a pressure a trifle above the atmosphere (due to the resistance of the exhaust passages through the heater), we may obtain feed-water at 212°. One pound of steam used by the engine then would be equivalent to thermal units as follows:

Gauge pressure.....	50	75	100	125	150	175	200
Absolute pressure... 65		90	115	140	165	190	215
Total heat in steam above 32°:	1178.5	1184.4	1188.8	1192.2	1195.0	1197.3	1199.2

Subtracting 68 and 180 heat-units, respectively, the heat above 32° in feed-water of 100° and 212° F., we have —

Heat given by boiler per pound of steam:							
Feed at 100°.....	1110.5	1116.4	1120.8	1124.2	1127.0	1129.3	1131.2
Feed at 212°.....	998.5	1004.4	1008.8	1012.2	1015.0	1017.3	1019.2

Thermal units per minute used by an engine for each pound of steam used per indicated horse-power per hour:

Feed at 100°.....	18.51	18.61	18.68	18.74	18.78	18.82	18.85
Feed at 212°.....	16.64	16.76	16.78	16.87	16.92	16.96	16.99

EXAMPLES. — A triple-expansion engine, condensing, with steam at 175 lbs. gauge, and vacuum 28 in., uses 13 lbs. of water per I.H.P. per hour, and a high-speed non-condensing engine, with steam at 100 lbs. gauge, uses 30 lbs. * How many thermal units per minute does each consume?

Ans. — 13 × 18.82 = 244.7, and 30 × 16.78 = 503.4 thermal units per minute.

A perfect engine converting all the heat-energy of the steam into work would require 33,000 ft.-lbs. ÷ 778 = 42.4164 thermal units per minute per indicated horse-power. This figure, 42.4164, therefore, divided by the number of thermal units per minute per I.H.P. consumed by an engine, gives its efficiency as compared with an ideally perfect engine. In the examples above, 42.4164 divided by 244.3 and by 503.4 gives 17.33% and 8.42% efficiency, respectively.

WARNING: This is a 1910 edition. Some of the material may no longer be accurate

ACTUAL EXPANSIONS
With Different Clearances and Cut-offs.
Computed by A. F. Nagle.

Cut-off.	Per Cent of Clearance.										
	0	1	2	3	4	5	6	7	8	9	10
.01	100.00	50.5	34.0	25.75	20.8	17.5	15.14	13.38	12.00	10.9	10
.02	50.00	33.67	25.50	20.60	17.33	15.00	13.25	11.89	10.80	9.91	9.17
.03	33.33	25.25	20.40	17.16	14.86	13.12	11.78	10.70	9.82	9.08	8.46
.04	25.00	20.20	17.00	14.71	13.00	11.66	10.60	9.73	9.00	8.39	7.86
.05	20.00	16.83	14.57	12.87	11.55	10.50	9.64	8.92	8.31	7.79	7.33
.06	16.67	14.43	12.75	11.44	10.40	9.55	8.83	8.23	7.71	7.27	6.88
.07	14.28	12.62	11.33	10.30	9.46	8.75	8.15	7.64	7.20	6.81	6.47
.08	12.50	11.22	10.2	9.36	8.67	8.08	7.57	7.13	6.75	6.41	6.11
.09	11.11	10.10	9.27	8.58	8.00	7.50	7.07	6.69	6.35	6.06	5.79
.10	10.00	9.18	8.50	7.92	7.43	7.00	6.62	6.30	6.00	5.74	5.50
.11	9.09	8.42	7.84	7.36	6.93	6.56	6.24	5.94	5.68	5.45	5.24
.12	8.33	7.78	7.29	6.86	6.50	6.18	5.89	5.63	5.40	5.19	5.00
.14	7.14	6.73	6.37	6.06	5.78	5.53	5.30	5.10	4.91	4.74	4.58
.16	6.25	5.94	5.67	5.42	5.20	5.00	4.82	4.65	4.50	4.36	4.23
.20	5.00	4.81	4.64	4.48	4.33	4.20	4.08	3.96	3.86	3.76	3.67
.25	4.00	3.88	3.77	3.68	3.58	3.50	3.42	3.34	3.27	3.21	3.14
.30	3.33	3.26	3.19	3.12	3.06	3.00	2.94	2.90	2.84	2.80	2.75
.40	2.50	2.46	2.43	2.40	2.36	2.33	2.30	2.28	2.25	2.22	2.20
.50	2.00	1.98	1.96	1.94	1.92	1.90	1.89	1.88	1.86	1.85	1.83
.60	1.67	1.66	1.65	1.64	1.63	1.615	1.606	1.597	1.588	1.580	1.571
.70	1.43	1.42	1.42	1.41	1.41	1.400	1.395	1.390	1.385	1.380	1.375
.80	1.25	1.25	1.244	1.241	1.238	1.235	1.233	1.230	1.227	1.224	1.222
.90	1.111	1.11	1.109	1.108	1.106	1.105	1.104	1.103	1.102	1.101	1.100
1.00	1.00	1.00	1.000	1.000	1.000	1.000	1.000	1.000	1.000	1.000	1.000

Relative Efficiency of 1 lb. of Steam with and without Clearance; back pressure and compression not considered.

$$\text{Mean total pressure} = p = \frac{P(l+c) + P(l+c) \text{ hyp log } R - Pc}{L}$$

Let $P = 1; L = 100; l = 25; c = 7.$

$$p = \frac{32 + 32 \text{ hyp log } \frac{107}{32} - 7}{100} = \frac{32 + 32 \times 1.209 - 7}{100} = 0.637.$$

If the clearance be added to the stroke, so that clearance becomes zero, the same quantity of steam being used, admission l being then = $l + c = 32$, and stroke $L + c = 107$,

$$p_1 = \frac{32 + 32 \text{ hyp log } \frac{107}{32} - 0}{107} = \frac{32 + 32 \times 1.209}{107} = 0.707.$$

That is, if the clearance be reduced to 0, the amount of the clearance 7 being added to both the admission and the stroke, the same quantity of steam will do more work than when the clearance is 7 in the ratio 707:637, or 11% more.

Back Pressure Considered. — If back pressure = 0.10 of P , this amount has to be subtracted from p and p_1 giving $p = 0.537, p_1 = 0.607$, the work of a given quantity of steam used without clearance being greater than when clearance is 7 per cent in the ratio of 607: 537, or 13% more.

Effect of Compression. — By early closure of the exhaust, so that a portion of the exhaust-steam is compressed into the clearance-space, much of the loss due to clearance may be avoided. If expansion is continued down to the back pressure, if the back pressure is uniform throughout the exhaust-stroke, and if compression begins at such point that the

exhaust-steam remaining in the cylinder is compressed to the initial pressure at the end of the back stroke, then the work of compression of the exhaust-steam equals the work done during expansion by the clearance-steam. The clearance-space being filled by the exhaust-steam thus compressed, no new steam is required to fill the clearance-space for the next forward stroke, and the work and efficiency of the steam used in the cylinder are just the same as if there were no clearance and no compression. When, however, there is a drop in pressure from the final pressure of the expansion, or the terminal pressure, to the exhaust or back pressure (the usual case), the work of compression to the initial pressure is greater than the work done by the expansion of the clearance-steam, so that a loss of efficiency results. In this case a greater efficiency can be attained by inclosing for compression a less quantity of steam than that needed to fill the clearance-space with steam of the initial pressure. (See Clark, S. E., p. 399, *et seq.*; also F. H. Ball, *Trans. A. S. M. E.*, xiv, 1067.) It is shown by Clark that a somewhat greater efficiency is thus attained whether or not the pressure of the steam be carried down by expansion to the back exhaust-pressure.

Cylinder-condensation may have considerable effect upon the best point of compression, but it has not yet (1893) been determined by experiment. (*Trans. A. S. M. E.*, xiv, 1078.)

Clearance in Low- and High-speed Engines. (Harris Tabor, *Am. Mach.*, Sept. 17, 1891.) — The construction of the high-speed engine is such, with its relatively short stroke, that the clearance must be much larger than in the releasing-valve type. The short-stroke engine is, of necessity, an engine with large clearance, which is aggravated when variable compression is a feature. Conversely, the engine with releasing-valve gear is, from necessity, an engine of slow rotative speed, where great power is obtainable from long stroke, and small clearance is a feature in its construction. In one case the clearance will vary from 8% to 12% of the piston-displacement, and in the other from 2% to 3%. In the case of an engine with a clearance equaling 10% of the piston-displacement the waste room becomes enormous when considered in connection with an early cut-off. The system of compounding reduces the waste due to clearance in proportion as the steam is expanded to a lower pressure. The farther expansion is carried through a train of cylinders the greater will be the reduction of waste due to clearance. This is shown from the fact that the high-speed engine, expanding steam much less than the Corliss, will show a greater gain when changed from simple to compound than its rival under similar conditions.

Cylinder-condensation. — Rankine, S. E., p. 421, says: Conduction of heat to and from the metal of the cylinder, or to and from liquid water contained in the cylinder, has the effect of lowering the pressure at the beginning and raising it at the end of the stroke, the lowering effect being on the whole greater than the raising effect. In some experiments the quantity of steam wasted through alternate liquefaction and evaporation in the cylinder has been found to be greater than the quantity which performed the work.

Percentage of Loss by Cylinder-condensation, taken at Cut-off.
(From circular of the Ashcroft Mfg. Co. on the Tabor Indicator, 1889.)

Percentage of Stroke completed at Cut-off.	Per cent of Feed-water accounted for by the Indicator.			Per cent of Feed-water due to Cylinder-condensation.		
	Simple Engines.	Compound Engines, h.p. cyl.	Triple-expansion Engines, h.p. cyl.	Simple Engines.	Compound Engines, h.p. cyl.	Triple-expansion Engines, h.p. cyl.
5	58			42		
10	66	74		34	26	
15	71	76	78	29	24	22
20	74	78	80	26	22	20
30	78	82	84	22	18	16
40	82	85	87	18	15	13
50	86	88	90	14	12	10

Theoretical Compared with Actual Water-consumption, Single-cylinder Automatic Cut-off Engines. (From the catalogue of the Buckeye Engine Co.) — The following table has been prepared on the basis of the pressures that result in practice with a constant boiler-pressure of 80 lbs. and different points of cut-off, with Buckeye engines and others with similar clearance. Fractions are omitted, except in the percentage column, as the degree of accuracy their use would seem to imply is not attained or aimed at.

Cut-off Part of Stroke.	Mean Effective Pressure, lbs. per sq. in.	Total Terminal Pressure, lbs. per sq. in.	Indicated Rate, lbs. Water per I.H.P. per hour.	Assumed.		Product of Cols. 1 and 6.
				Act'l Rate.	% Loss.	
0.10	18	11	20	32	58	5.8
0.15	27	15	19	27	41	6.15
0.20	35	20	19	25	31.5	6.3
0.25	42	25	20	25	25	6.25
0.30	48	30	20	24	21.8	6.54
0.35	53	35	21	25	19	6.65
0.40	57	38	22	26	16.7	6.68
0.45	61	43	23	27	15	6.75
0.50	64	48	24	27	13.6	6.8

It will be seen that while the best indicated economy is when the cut-off is about at 0.15 or 0.20 of the stroke, giving about 30 lbs. M.E.P., and a terminal 3 or 4 lbs. above atmosphere, when we come to add the percentages due to a constant amount of unindicated loss, as per sixth column, the most economical point of cut-off is found to be about 0.30 of the stroke, giving 48 lbs. M.E.P. and 30 lbs. terminal pressure. This showing agrees substantially with modern experience under automatic cut-off regulation.

The last column shows that the actual amount of cylinder condensation is nearly a constant quantity, increasing only from 5.8% of the cylinder volume at 0.10 cut-off to 6.8% at 0.50 cut-off.

Experiments on Cylinder-condensation. — Experiments by Major Thos. English (*Eng'g.*, Oct. 7, 1887, p. 386) with an engine 10 X 14 in., jacketed in the sides but not on the ends, indicate that the net initial condensation (or excess of condensation over re-evaporation) by the clearance surface varies directly as the initial density of the steam, and inversely as the square root of the number of revolutions per unit of time. The mean results gave for the net initial condensation by clearance-space per sq. ft. of surface at one rev. per second 6.06 thermal units in the engine when run non-condensing and 5.75 units when condensing.

G. R. Bodmer (*Eng'g.*, March 4, 1892, p. 299) says: Within the ordinary limits of expansion desirable in one cylinder the expansion ratio has practically no influence on the amount of condensation per stroke, which for simple engines can be expressed by the following formula for the weight of water condensed [per minute, probably; the original does not state]: $W = C \frac{S(T-t)}{L \sqrt{N^2}}$, where T denotes the mean admission temper-

ature, t the mean exhaust temperature, S clearance-surface (square feet), N the number of revolutions per second, L latent heat of steam at the mean admission temperature, and C a constant for any given type of engine.

Mr. Bodmer found from experimental data that for high-pressure non-jacketed engines C = about 0.11, for condensing non-jacketed engines 0.085 to 0.11, for condensing jacketed engines 0.085 to 0.053. The figures for jacketed engines apply to those jacketed in the usual way, and not at the ends.

C varies for different engines of the same class, but is practically constant for any given engine. For simple high-pressure non-jacketed engines it was found to range from 0.1 to 0.112.

Applying Mr. Bodmer's formula to the case of a Corliss non-jacketed

non-condensing engine, 4-ft. stroke, 24 in. diam., 60 revs. per min., initial pressure 90 lbs. gauge, exhaust pressure 2 lbs., we have $T - t = 112^\circ$, $N = 1$, $L = 880$, $S = 7$ sq. ft.; and, taking $C = 0.112$ and $W =$ lbs. water condensed per minute, $W = \frac{0.112 \times 112 \times 7}{1 \times 880} = 0.09$ lb. per minute, or 5.4 lbs. per hour. If the steam used per I.H.P. per hour according to the diagram is 20 lbs., the actual water consumption is 25.4 lbs., corresponding to a cylinder condensation of 27%.

INDICATOR-DIAGRAM OF A SINGLE-CYLINDER ENGINE.

Definitions. — *The Atmospheric Line, AB,* is a line drawn by the pencil of the indicator when the connections with the engine are closed and both sides of the piston are open to the atmosphere.

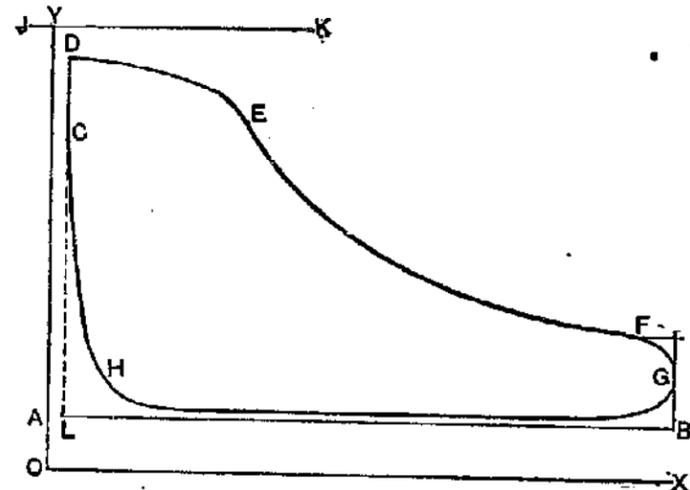

FIG. 154.

atmospheric line, and at a distance from it by scale equal to the boiler-pressure shown by the gauge.

The Admission Line, CD, shows the rise of pressure due to the admission of steam to the cylinder by opening the steam-valve.

The Steam Line, DE, is drawn when the steam-valve is open and steam is being admitted to the cylinder.

The Point of Cut-off, E, is the point where the admission of steam is stopped by the closing of the valve. It is often difficult to determine the exact point at which the cut-off takes place. It is usually located where the outline of the diagram changes its curvature from convex to concave.

The Expansion Curve, EF, shows the fall in pressure as the steam in the cylinder expands doing work.

The Point of Release, F, shows when the exhaust-valve opens.

The Exhaust Line, FG, represents the change in pressure that takes place when the exhaust-valve opens.

The Back-pressure Line, GH, shows the pressure against which the piston acts during its return stroke.

The Point of Exhaust Closure, H, is the point where the exhaust-valve closes. It cannot be located definitely, as the change in pressure is at first due to the gradual closing of the valve.

The Compression Curve, HC, shows the rise in pressure due to the compression of the steam remaining in the cylinder after the exhaust-valve has closed.

The Mean Height of the Diagram equals its area divided by its length.

The Mean Effective Pressure is the mean net pressure urging the piston forward = the mean height \times the scale of the indicator-spring.

To find the Mean Effective Pressure from the Diagram. — Divide the length, LB , into a number, say 10, equal parts, setting off half a part at L , half a part at B , and nine other parts between; erect ordinates perpendicular to the atmospheric line at the points of division of LB , cutting the diagram; add together the lengths of these ordinates intercepted

are open to the atmosphere.

The Vacuum Line, OX, is a reference line usually drawn about 14.7 pounds by scale below the atmospheric line.

The Clearance Line, OY, is a reference line drawn at a distance from the end of the diagram equal to the same per cent of its length as the clearance and waste room is of the piston-displacement.

The Line of Boiler-pressure, JK, is drawn parallel to the

between the upper and lower lines of the diagram and divide by their number. This gives the mean height, which multiplied by the scale of the indicator-spring gives the M.E.P. Or find the area by a planimeter, or other means (see Mensuration, p. 57), and divide by the length LB to obtain the mean height.

The Initial Pressure is the pressure acting on the piston at the beginning of the stroke.

The Terminal Pressure is the pressure above the line of perfect vacuum that would exist at the end of the stroke if the steam had not been released earlier. It is found by continuing the expansion-curve to the end of the diagram.

A single indicator card shows the pressure exerted by the steam at each instant on one side of the piston; a card taken simultaneously from the opposite end of the engine shows the pressure exerted on the other side. By superposing these cards the pressure or tension on the piston rod may be determined. The pressure or pull on the crank pin at any instant is the pressure or tension in the rod modified by the angle of the connecting rod and by the effect of the inertia of the reciprocating parts. For discussion of this subject see Klein's "High-speed Steam Engine," also papers by S. A. Moss, *Trans. A. S. M. E.*, 1904, and by F. W. Hollmann, in *Power*, April 6, 1909.

Errors of Indicators. — The most common error is that of the spring, which may vary from its normal rating; the error may be determined by proper testing apparatus and allowed for. But after making this correction, even with the best work, the results are liable to variable errors which may amount to 2 or 3 per cent. See Barrus, *Trans. A. S. M. E.*, v. 310; Denton, *Trans. A. S. M. E.*, xi, 329; David Smith, U. S. N., *Proc. Eng'g Congress*, 1893, Marine Division.

Other errors of indicator diagrams are those due to inaccuracy of the straight-line motion of the indicator, to the incorrect design or position of the "rig" or reducing motion, to long pipes between the indicator and the engine, to throttling of these pipes, to friction or lost motion in the indicator mechanism, and to drum-motion distortion. For discussion of the last named see *Power*, April, 1909. For methods of testing indicators, see paper by D. S. Jacobus, *Trans. A. S. M. E.*, 1898.

Indicator "Rigs," or Reducing-motions; Interpretation of Diagrams for Errors of Steam-distribution, etc. For these see circulars of manufacturers of Indicators; also works on the Indicator.

Pendulum Indicator Rig. — *Power* (Feb., 1893) gives a graphical representation of the errors in indicator-diagrams, caused by the use of incorrect forms of the pendulum rigging. It is shown that the "brumbo" pulley on the pendulum, to which the cord is attached, does not generally give as good a reduction as a simple pin attachment. When the end of the pendulum is slotted, working in a pin on the crosshead, the error is apt to be considerable at both ends of the card. With a vertical slot in a plate fixed to the crosshead, and a pin on the pendulum working in this slot, the reduction is perfect, when the cord is attached to a pin on the pendulum, a slight error being introduced if the brumbo pulley is used. With the connection between the pendulum and the crosshead made by means of a horizontal link, the reduction is nearly perfect, if the construction is such that the connecting link vibrates equally above and below the horizontal, and the cord is attached by a pin. If the link is horizontal at mid-stroke a serious error is introduced, which is magnified if a brumbo pulley also is used. The adjoining figures show the two forms recommended.

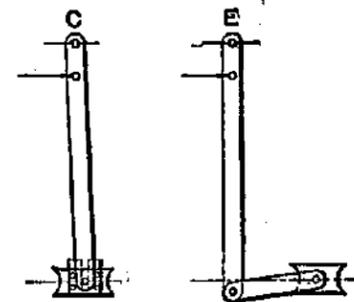

FIG. 155.

The Manograph, for indicating engines of very high speed, invented by Prof. Hospitalier, is described by Howard Greene in *Power*, June, 1907. It is made by Carpentier, of Paris. A small mirror is tilted upward and downward by a diaphragm which responds to the pressure variations in the cylinder, and the same mirror is rocked from side to side by a reducing mechanism which is geared to the engine and reproduces the reciprocations

of the engine piston on a smaller scale. A beam of light is reflected by the mirror to the ground-glass screen, and this beam, by the oscillations of the mirror, is made to traverse a path corresponding to that of the pencil point of an ordinary indicator. The diagram, therefore, is made continuously but varies with varying conditions in the cylinder.

A plate-holder carrying a photographic dry plate can be substituted for the ground-glass screen, and the diagram photographed, the exposure required varying from half a second to three seconds. By the use of special diaphragms and springs the effects of low pressures and vacuums can be magnified, and thus the instrument can be made to show with remarkable clearness the action of the valves of a gas engine on the suction and exhaust strokes.

The **Lea Continuous Recorder**, for recording the steam consumption of an engine, is described by W. H. Booth in *Power*, Aug. 31, 1909. It comprises a tank into which flows the condensed steam from a condenser, a triangular notch through which the water flows from the tank, and a mechanical device through which the variations in the level of the water in the tank are translated into the motion of a pencil, which motion is made proportionate to the quantity flowing, and is recorded on paper moved by clockwork.

INDICATED HORSE-POWER OF ENGINES, SINGLE-CYLINDER.

$$\text{Indicated Horse-power, I.H.P.} = \frac{P \text{ Lan}}{33,000}$$

in which P = mean effective pressure in lbs. per sq. in.; L = length of stroke in feet; a = area of piston in square inches. For accuracy, one half of the sectional area of the piston-rod must be subtracted from the area of the piston if the rod passes through one head, or the whole area of the rod if it passes through both heads; n = No. of single strokes per min. = $2 \times$ No. of revolutions of a double-acting engine.

$$\text{I.H.P.} = \frac{PaS}{33,000} \text{ in which } S = \text{piston speed in feet per minute.}$$

$$\text{I.H.P.} = \frac{PLd^2n}{42,017} = \frac{Pd^2S}{42,017} = 0.000238 PLd^2n = 0.000238 Pd^2S$$

In which d = diam. of cyl. in inches. (The figures 238 are exact, since $7854 \div 33 = 23.8$ exactly.) If product of piston-speed \times mean effective pressure = 42,017, then the horse-power would equal the square of the diameter in inches.

Handy Rule for Estimating the Horse-power of a Single-cylinder Engine. — Square the diameter and divide by 2. This is correct whenever the product of the mean effective pressure and the piston-speed = $1/2$ of 42,017, or, say, 21,000, viz., when M.E.P. = 30 and $S = 700$; when M.E.P. = 35 and $S = 600$; when M.E.P. = 38.2 and $S = 550$; and when M.E.P. = 42 and $S = 500$. These conditions correspond to those of ordinary practice with both Corliss engines and shaft-governor high-speed engines.

Given Horse-power, Mean Effective Pressure, and Piston-speed, to find Size of Cylinder. —

$$\text{Area} = \frac{33,000 \times \text{I.H.P.}}{PLn} \quad \text{Diameter} = 205 \sqrt{\frac{\text{I.H.P.}}{PS}}$$

Brake Horse-power is the actual horse-power of the engine as measured at the fly-wheel by a friction-brake or dynamometer. It is the indicated horse-power minus the friction of the engine.

Electrical Horse-power is the power in an electric current, usually measured in kilowatts, translated into horse-power. 1 H.P. = 33,000 ft. lbs. per min.; 1 K.W. = 1.3405 H.P.; 1 H.P. = 0.746 kilowatts, or 746 watts.

EXAMPLE. — A 100-H.P. engine, with a friction loss of 10% at rated load, drives a generator whose efficiency is 90%, furnishing current to a motor of 90% eff., through a line whose loss is 5%. I.H.P. = 100; B.H.P. = 90; E.H.P. at generator 81, at end of line 76.95. H.P. delivered by motor 69.26.

Table for Roughly Approximating the Horse-power of a Compound Engine from the Diameter of its Low-pressure Cylinder. —

The indicated horse-power of an engine being $\frac{Psd^2}{42,017}$, in which P = mean effective pressure per sq. in., s = piston-speed in ft. per min., and d = diam. of cylinder in inches; if $s = 600$ ft. per min., which is approximately the speed of modern stationary engines, and $P = 35$ lbs., which is an approximately average figure for the M.E.P. of single-cylinder engines, and of compound engines referred to the low-pressure cylinder, then I.H.P. = $1/2 d^2$; hence the rough-and-ready rule for horse-power given above: Square the diameter in inches and divide by 2. This applies to triple and quadruple expansion engines as well as to single cylinder and compound. For most economical loading, the M.E.P. referred to the low-pressure cylinder of compound engines is usually not greater than that of simple engines; for the greater economy is obtained by a greater number of expansions of steam of higher pressures, and the greater the number of expansions for a given initial pressure the lower the mean effective pressure. The following table gives approximately the figures of mean total and effective pressures for the different types of engines, together with the factor by which the square of the diameter is to be multiplied to obtain the horse-power at most economical loading, for a piston-speed of 600 ft. per minute.

Type of Engine.	Initial Absolute Steam-Pressure.	Number of Expansions.	Terminal Absolute Press., lbs.	Ratio Mean Total to Initial Pressure.	Mean Total Pressure, lbs.	Total Back Pressure, Mean, lbs.	Mean Effective Pressure, lbs.	Piston-speed, ft. per min.	Horse-power = diam. ² X
Non-condensing.									
Single Cylinder..	100	5	20	0.522	52.2	15.5	36.7	600	0.524
Compound.....	120	7.5	16	.402	48.2	15.5	32.7	"	.467
Triple.....	160	10.	16	.330	52.8	15.5	37.3	"	.533
Quadruple.....	200	12.5	16	.282	56.4	15.5	40.9	"	.584
Condensing Engines.									
Single Cylinder..	100	10.	10	0.330	33.0	2	31.0	600	0.443
Compound.....	120	15.	8	.247	29.6	2	27.6	"	.390
Triple.....	160	20.	8	.200	32.0	2	30.0	"	.429
Quadruple.....	200	25.	8	.169	33.8	2	31.8	"	.454

For any other piston-speed than 600 ft. per min., multiply the figures in the last column by the ratio of the piston-speed to 600 ft.

Horse-power Constant of a given Engine for a Fixed Speed = product of its area of piston in square inches, length of stroke in feet and number of single strokes per minute divided by 33,000, or $\frac{Lan}{33,000} = C$. The product of the mean effective pressure as found by the diagram and this constant is the indicated horse-power.

Horse-power Constant of any Engine of a given Diameter of Cylinder, whatever the length of stroke, = area of piston \div 33,000 = square of the diameter of piston in inches \times 0.000238. A table of constants derived from this formula is given on page 943.

The constant multiplied by the piston-speed in feet per minute and by the M.E.P. gives the I.H.P.

Table of Engine Constants for Use in Figuring Horse-power. — "Horse-power constant" for cylinders from 1 inch to 30 inches in diameter, advancing by 5ths. for one foot of piston-speed per minute and one pound of M.E.P. Find the diameter of the cylinder in the column at the side. If the diameter contains no fraction the constant will be found in the column headed Even Inches. If the diameter is not in even inches, follow the line horizontally to the column corresponding to the required fraction. The constants multiplied by the piston-speed and by the M.E.P. give the horse-power.

Engine Constants, Constant X Piston Speed X M.E.P. = H.P.

Diam. of Cylinder.	Even Inches.	+ 1/8	+ 1/4	+ 3/8	+ 1/2	+ 5/8	+ 3/4	+ 7/8
1	.000238	.000301	.000372	.000450	.000535	.000628	.000729	.000837
2	.000952	.001074	.001205	.001342	.001487	.001640	.001800	.001967
3	.002142	.002324	.002514	.002711	.002915	.003127	.003347	.003574
4	.003808	.004050	.004299	.004554	.004819	.005091	.005370	.005656
5	.005950	.006251	.006560	.006876	.007199	.007530	.007869	.008215
6	.008568	.008929	.009297	.009672	.010055	.010445	.010844	.011249
7	.011662	.012082	.012510	.012944	.013387	.013837	.014295	.014759
8	.015232	.015711	.016198	.016693	.017195	.017705	.018222	.018746
9	.019278	.019817	.020363	.020916	.021479	.022048	.022625	.023209
10	.023800	.024398	.025004	.025618	.026239	.026867	.027502	.028147
11	.028798	.029456	.030121	.030794	.031475	.032163	.032859	.033561
12	.034272	.034990	.035714	.036447	.037187	.037934	.038690	.039452
13	.040222	.041099	.041983	.042876	.043775	.044682	.045597	.046519
14	.046648	.047484	.048328	.049181	.050039	.050906	.051780	.052661
15	.053550	.054446	.055349	.056261	.057179	.058105	.059039	.059979
16	.060928	.061884	.062847	.063817	.064795	.065780	.066774	.067774
17	.068782	.069797	.070819	.071850	.072887	.073932	.074985	.076044
18	.077112	.078187	.079268	.080360	.081452	.082550	.083652	.084791
19	.085918	.087052	.088193	.089343	.090499	.091663	.092835	.094013
20	.095200	.096393	.097594	.098803	.100019	.101243	.102474	.103712
21	.104958	.106211	.107472	.108739	.110015	.111299	.112589	.113886
22	.115192	.116505	.117825	.119152	.120487	.121830	.123179	.124537
23	.125902	.127274	.128654	.130040	.131435	.132837	.134247	.135664
24	.137088	.138519	.139959	.141405	.142859	.144321	.145789	.147266
25	.148750	.150241	.151739	.153246	.154759	.156280	.157809	.159345
26	.160888	.162439	.163997	.165563	.167135	.168716	.170304	.171899
27	.173502	.175112	.176729	.178355	.179988	.181627	.183275	.184929
28	.186592	.188262	.189939	.191624	.193316	.195015	.196722	.198436
29	.200158	.201887	.203634	.205398	.207179	.208979	.210784	.212594
30	.214200	.215988	.217785	.219588	.221399	.223218	.225044	.226877
31	.228718	.230566	.232422	.234285	.236155	.238033	.239919	.241812
32	.243712	.245619	.247535	.249457	.251387	.253325	.255269	.257222
33	.259182	.261149	.263124	.265106	.267095	.269092	.271097	.273109
34	.275128	.277155	.279189	.281231	.283279	.285336	.287399	.289471
35	.291550	.293636	.295729	.297831	.299939	.302056	.304179	.306309
36	.308448	.310594	.312747	.314908	.317075	.319251	.321434	.323624
37	.325822	.328027	.330239	.332460	.334687	.336922	.339165	.341415
38	.343672	.345937	.348209	.350489	.352775	.355070	.357372	.359681
39	.361998	.364322	.366654	.368993	.371339	.373694	.376055	.378424
40	.380800	.383184	.385575	.387973	.390379	.392793	.395214	.397642
41	.400078	.402521	.404972	.407430	.409895	.412368	.414849	.417337
42	.419832	.422335	.424845	.427362	.429887	.432420	.434959	.437507
43	.440062	.442624	.445194	.447771	.450355	.452947	.455547	.458154
44	.460768	.463389	.466019	.468655	.471299	.473951	.476609	.479276
45	.481950	.484631	.487320	.490013	.492719	.495430	.498149	.500875
46	.503608	.506349	.509097	.511853	.514615	.517386	.520164	.522949
47	.525742	.528542	.531349	.534165	.536988	.539818	.542655	.545499
48	.548352	.551212	.554079	.556953	.559835	.562725	.565622	.568526
49	.571438	.574357	.577284	.580218	.583159	.586109	.589065	.592029
50	.595000	.597979	.600965	.603959	.606959	.609969	.612984	.616007
51	.619038	.622076	.625122	.628175	.631235	.634304	.637379	.640462
52	.643552	.646649	.649753	.652867	.655987	.659115	.662250	.665392
53	.668542	.671699	.674864	.678036	.681215	.684402	.687597	.690799
54	.694008	.697225	.700449	.703681	.706923	.710166	.713419	.716681
55	.719950	.724226	.728510	.732801	.737099	.741397	.745694	.749991
56	.754368	.759704	.765047	.770398	.775755	.781110	.786474	.791847
57	.773262	.778657	.784060	.789473	.794893	.800322	.805759	.811204
58	.800632	.807549	.814487	.821445	.828419	.835409	.842404	.849404
59	.856478	.863514	.870564	.877629	.884709	.891804	.898914	.906029
60	.885680	.893374	.901085	.908811	.916552	.924308	.932079	.939854

Horse-power per Pound Mean Effective Pressure.
Formula, Area in sq. in. X piston-speed ÷ 33,000.

Diam. of Cylinder, inches.	Speed of Piston in feet per minute.								
	100	200	300	400	500	600	700	800	900
4	.0381	.0762	.1142	.1523	.1904	.2285	.2666	.3046	.3427
4 1/2	.0482	.0964	.1446	.1928	.2410	.2892	.3374	.3856	.4338
5	.0595	.1190	.1785	.2380	.2975	.3570	.4165	.4760	.5355
5 1/2	.0720	.1440	.2160	.2880	.3600	.4320	.5040	.5760	.6480
6	.0857	.1714	.2570	.3427	.4284	.5141	.5998	.6854	.7711
6 1/2	.1006	.2011	.3017	.4022	.5028	.6033	.7039	.8044	.9050
7	.1166	.2332	.3499	.4665	.5831	.6997	.8163	.9330	1.0496
7 1/2	.1339	.2678	.4016	.5355	.6694	.8033	.9371	1.0710	1.2049
8	.1523	.3046	.4570	.6093	.7616	.9139	1.0662	1.2186	1.3709
8 1/2	.1720	.3439	.5159	.6878	.8598	1.0317	1.2037	1.3756	1.5476
9	.1920	.3856	.5783	.7711	.9639	1.1567	1.3495	1.5422	1.7350
9 1/2	.2148	.4296	.6444	.8592	1.0740	1.2888	1.5036	1.7184	1.9332
10	.2380	.4760	.7140	.9520	1.1900	1.4280	1.6660	1.9040	2.1420
11	.2880	.5760	.8639	1.1519	1.4399	1.7279	2.0159	2.3038	2.5818
12	.3427	.6854	1.0282	1.3709	1.7136	2.0563	2.3990	2.7418	3.0845
13	.4022	.8044	1.2067	1.6089	2.0111	2.4133	2.8155	3.2178	3.6200
14	.4665	.9330	1.3994	1.8659	2.3324	2.7989	3.2654	3.7318	4.1983
15	.5355	1.0710	1.6065	2.1420	2.6775	3.2130	3.7485	4.2840	4.8195
16	.6093	1.2186	1.8278	2.4371	3.0464	3.6557	4.2650	4.8742	5.4835
17	.6878	1.3756	2.0635	2.7513	3.4391	4.1269	4.8147	5.5026	6.1904
18	.7711	1.5422	2.3134	3.0845	3.8556	4.6267	5.3978	6.1690	6.9401
19	.8592	1.7184	2.5775	3.4567	4.2959	5.1551	6.0143	6.8734	7.7326
20	.9520	1.9040	2.8560	3.8080	4.7600	5.7120	6.6640	7.6160	8.5680
21	1.0496	2.0992	3.1488	4.1983	5.2479	6.2975	7.3471	8.3966	9.4462
22	1.1519	2.3038	3.4558	4.6077	5.7596	6.9115	8.0634	9.2154	10.367
23	1.2590	2.5180	3.7771	5.0361	6.2951	7.5541	8.8131	10.072	11.331
24	1.3709	2.7418	4.1126	5.4835	6.8544	8.2253	9.5962	10.967	12.338
25	1.4875	2.9750	4.4625	5.9500	7.4375	8.9250	10.413	11.900	13.388
26	1.6089	3.2178	4.8266	6.4355	8.0444	9.6534	11.262	12.871	14.480
27	1.7350	3.4700	5.2031	6.9401	8.6751	10.410	12.145	13.850	15.615
28	1.8659	3.7318	5.5978	7.4637	9.3296	11.196	13.061	14.927	16.793
29	2.0016	4.0032	6.0047	8.0063	10.008	12.009	14.011	16.013	18.014
30	2.1420	4.2840	6.4260	8.5680	10.710	12.852	14.994	17.136	19.278
31	2.2872	4.5744	6.8615	9.1487	11.436	13.723	16.010	18.297	20.585
32	2.4371	4.8742	7.3114	9.7485	12.186	14.623	17.060	19.497	21.934
33	2.5918	5.1836	7.7755	10.367	12.959	15.551	18.143	20.735	23.326
34	2.7513	5.5026	8.2538	11.005	13.756	16.508	19.259	22.010	24.762
35	2.9155	5.8310	8.7465	11.662	14.578	17.493	20.409	23.324	26.240
36	3.0845	6.1690	9.2534	12.338	15.422	18.507	21.591	24.676	27.760
37	3.2582	6.5164	9.7747	13.033	16.291	19.549	22.808	26.066	29.324
38	3.4367	6.8734	10.310	13.747	17.184	20.620	24.057	27.494	30.930
39	3.6200	7.2400	10.860	14.480	18.100	21.720	25.340	28.960	32.580
40	3.8080	7.6160	11.424	15.232	19.040	22.848	26.656	30.464	34.272
41	4.0008	8.0016	12.002	16.003	20.004	24.005	28.005	32.006	36.007
42	4.1983	8.3866	12.585	16.783	20.982	25.180	29.378	33.577	37.775
43	4.4006	8.8012	13.202	17.602	22.003	26.404	30.804	35.205	39.606
44	4.6077	9.2154	13.823	18.431	23.038	27.646	32.254	36.861	41.469
45	4.8195	9.6390	14.459	19.278	24.098	28.917	33.737	38.556	43.376
46	5.0361	10.072	15.108	20.144	25.180	30.216	35.253	40.289	45.325
47	5.2574	10.515	15.772	21.030	26.287	31.545	36.802	42.059	47.317
48	5.4835	10.967	16.451	21.934	27.418	32.901	38.385	43.868	49.352
49	5.7144	11.429	17.143	22.858	28.572	34.286	40.001	45.715	51.429
50	5.9500	11.900	17.850	23.800	29.750	35.700	41.650	47.600	53.550
51	6.1904	12.381	18.571	24.762	30.952	37.142	43.333	49.523	55

Nominal Horse-power.—The term "nominal horse-power" originated in the time of Watt, and was used to express approximately the power of an engine as calculated from its diameter, estimating the mean pressure in the cylinder at 7 lbs. above the atmosphere. It has long been obsolete.

Horse-power Constant of a given Engine for Varying Speeds = product of its area of piston and length of stroke divided by 33,000. This multiplied by the mean effective pressure and by the number of single strokes per minute is the indicated horse-power.

To draw the Clearance-line on the Indicator-diagram, the actual clearance not being known.—The clearance-line may be obtained approximately by drawing a straight line, *cbad*, across the compression

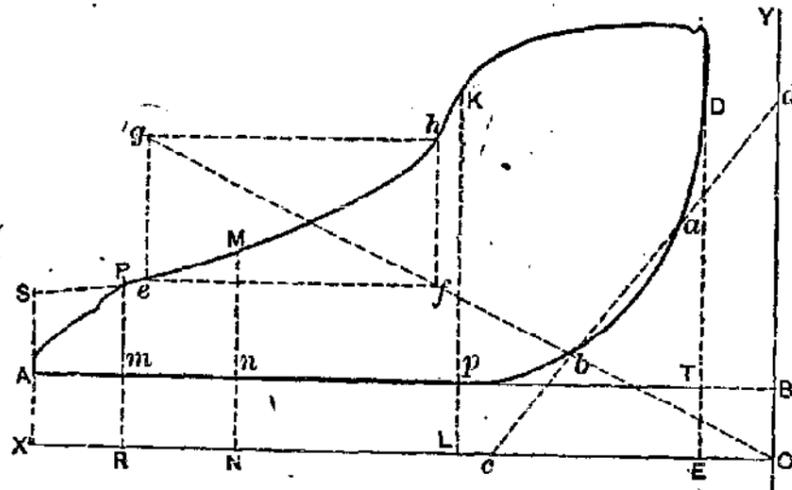

Fig. 156.

curve, first having drawn *OX* parallel to the atmospheric line and 14.7 lbs. below. Measure from *a* the distance *ad*, equal to *cb*, and draw *YO* perpendicular to *OX* through *d*; then will *TB* divided by *AT* be the percentage of clearance. The clearance may also be found from the expansion-line by constructing a rectangle *efhg*, and drawing a diagonal *gf* to intersect the line *XO*. This will give the point *O*, and by erecting a perpendicular to *XO* we obtain a clearance-line *OY*.

Both these methods for finding the clearance require that the expansion and compression curves be hyperbolas. Prof. Carpenter (*Power*, Sept., 1893) says that with good diagrams the methods are usually very accurate, and give results which check substantially.

The Buckeye Engine Co., however, says that, as the results obtained are seldom correct, being sometimes too little, but more frequently too much, and as the indications from the two curves seldom agree, the operation has little practical value, though when a clearly defined and apparently undistorted compression curve exists of sufficient extent to admit of the application of the process, it may be relied on to give much more correct results than the expansion curve.

To draw the Hyperbolic Curve on the Indicator-diagram.—Select any point *I* in the actual curve, and from this point draw a line perpendicular to the line *JB*, meeting the latter in the point *J*. The line *JB* may be the line of boiler-pressure, but this is not material; it may be drawn at any convenient height near the top of the diagram and parallel to the atmospheric line. From *J* draw a diagonal to *K*, the latter point being the intersection of the vacuum and clearance lines; from *I* draw *IL* parallel with the atmospheric line. From *L*, the point of intersection of the diagonal *JK* and the horizontal line *IL*, draw the verti-

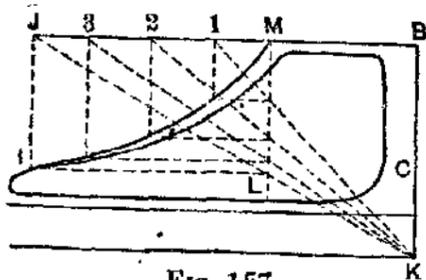

Fig. 157.

intersection of the diagonal *JK* and the horizontal line *IL*, draw the verti-

cal line *LM*. The point *M* is the theoretical point of cut-off, and *LM* the cut-off line. Fix upon any number of points 1, 2, 3, etc., on the line *JB*, and from these points draw diagonals to *K*. From the intersection of these diagonals with *LM* draw horizontal lines, and from 1, 2, 3, etc., vertical lines. Where these lines meet will be points in the hyperbolic curve.

Theoretical Water-consumption calculated from the Indicator-card.—The following method is given by Prof. Carpenter (*Power*, Sept., 1893): *p* = mean effective pressure, *l* = length of stroke in feet, *a* = area of piston in square inches, *a* ÷ 144 = area in square feet, *c* = percentage of clearance to the stroke, *b* = percentage of stroke at point where water rate is to be computed, *n* = number of strokes per minute, *60n* = number per hour, *w* = weight of a cubic foot of steam having a pressure as shown by the diagram corresponding to that at the point where water rate is required, *w'* = that corresponding to pressure at end of compression.

$$\text{Number of cubic feet per stroke} = l \left(\frac{b+c}{100} \right) \frac{a}{144}$$

$$\text{Corresponding weight of steam per stroke in lbs.} = l \left(\frac{b+c}{100} \right) \frac{a}{144} w$$

$$\text{Volume of clearance} = \frac{lca}{14,400}$$

$$\text{Weight of steam in clearance} = \frac{lcaw'}{14,400}$$

$$\text{Total weight of steam per stroke} = l \left(\frac{b+c}{100} \right) \frac{wa}{144} - \frac{lcaw'}{14,400} = \frac{lc}{14,400} [(b+c)w - cw']$$

$$\text{Total weight of steam from diagram per hour} = \frac{60nl}{14,400} [(b+c)w - cw']$$

The indicated horse-power is *pian* + 33,000. Hence the steam-consumption per hour per indicated horse-power is

$$\frac{\frac{60nl}{14,400} [(b+c)w - cw']}{\frac{pian}{33,000}} = \frac{137.50}{p} [(b+c)w - cw']$$

Changing the formula to a rule, we have: To find the water rate from the indicator diagram at any point in the stroke.

RULE.—To the percentage of the entire stroke which has been completed by the piston at the point under consideration add the percentage of clearance. Multiply this result by the weight of a cubic foot of steam, having a pressure of that at the required point. Subtract from this the product of percentage of clearance multiplied by weight of a cubic foot of steam having a pressure equal to that at the end of the compression. Multiply this result by 137.50 divided by the mean effective pressure.*

NOTE.—This method applies only to points in the expansion curve or between cut-off and release.

The beneficial effect of compression in reducing the water-consumption of an engine is clearly shown by the formula. If the compression is carried to such a point that it produces a pressure equal to that at the point under consideration, the weight of steam per cubic foot is equal, and *w* = *w'*. In this case the effect of clearance entirely disappears, and the formula becomes $\frac{137.5}{p} (bw)$.

In case of no compression, *w'* becomes zero, and the water-rate =

$$\frac{137.5}{p} [(b+c)w]$$

* For compound or triple-expansion engines read: divided by the equivalent mean effective pressure, on the supposition that all work is done in one cylinder.

Prof. Denton (*Trans. A. S. M. E.*, xiv, 1363) gives the following table of theoretical water-consumption for a perfect Mariotte expansion with steam at 150 lbs. above atmosphere, and 2 lbs. absolute back pressure:

Ratio of Expansion, r .	M.E.P., lbs. per sq. in.	Lbs. of Water per hour per horse-power, W .
10	52.4	9.68
15	38.7	8.74
20	30.9	8.20
25	25.9	7.84
30	22.2	7.63
35	19.5	7.45

The difference between the theoretical water-consumption found by the formula and the actual consumption as found by test represents "water not accounted for by the indicator," due to cylinder condensation, leakage through ports, radiation, etc.

Leakage of Steam. — Leakage of steam, except in rare instances, has so little effect upon the lines of the diagram that it can scarcely be detected. The only satisfactory way to determine the tightness of an engine is to take it when not in motion, apply a full boiler-pressure to the valve, placed in a closed position, and to the piston as well, which is blocked for the purpose at some point away from the end of the stroke, and see by the eye whether leakage occurs. The indicator-cocks provide means for bringing into view steam which leaks through the steam-valves, and in most cases that which leaks by the piston, and an opening made in the exhaust-pipe or observations at the atmospheric escape-pipe, are generally sufficient to determine the fact with regard to the exhaust-valves.

The steam accounted for by the indicator should be computed for both the cut-off and the release points of the diagram. If the expansion-line departs much from the hyperbolic curve a very different result is shown at one point from that shown at the other. In such cases the extent of the loss occasioned by cylinder condensation and leakage is indicated in a much more truthful manner at the cut-off than at the release. (Tabor Indicator Circular.)

COMPOUND ENGINES.

Compound, Triple- and Quadruple-expansion Engines. — A compound engine is one having two or more cylinders, and in which the steam after doing work in the first or high-pressure cylinder completes its expansion in the other cylinder or cylinders.

The term "compound" is commonly restricted, however, to engines in which the expansion takes place in two stages only — high and low pressure, the terms triple-expansion and quadruple-expansion engines being used when the expansion takes place respectively in three and four stages. The number of cylinders may be greater than the number of stages of expansion, for constructive reasons; thus in the compound or two-stage expansion engine the low-pressure stage may be effected in two cylinders so as to obtain the advantages of nearly equal sizes of cylinders and of three cranks at angles of 120°. In triple-expansion engines there are frequently two low-pressure cylinders, one of them being placed tandem with the high-pressure, and the other with the intermediate cylinder, as in mill engines with two cranks at 90°. In the triple-expansion engines of the steamers *Campania* and *Lucania*, with three cranks at 120°, there are five cylinders, two high, one intermediate, and two low, the high-pressure cylinders being tandem with the low.

Advantages of Compounding. — The advantages secured by dividing the expansion into two or more stages are twofold: 1. Reduction of wastes of steam by cylinder-condensation, clearance, and leakage; 2. Dividing the pressures on the cranks, shafts, etc., in large engines so as to avoid excessive pressures and consequent friction. The diminished

loss by cylinder-condensation is effected by decreasing the range of temperature of the metal surfaces of the cylinders, or the difference of temperature of the steam at admission and exhaust. When high-pressure steam is admitted into a single-cylinder engine a large portion is condensed by the comparatively cold metal surfaces; at the end of the stroke and during the exhaust the water is re-evaporated, but the steam so formed escapes into the atmosphere or into the condenser, doing no work; while if it is taken into a second cylinder, as in a compound engine, it does work. The steam lost in the first cylinder by leakage and clearance also does work in the second cylinder. Also, if there is a second cylinder, the temperature of the steam exhausted from the first cylinder is higher than if there is only one cylinder, and the metal surfaces therefore are not cooled to the same degree. The difference in temperatures and in pressures corresponding to the work of steam of 150 lbs. gauge-pressure expanded 20 times, in one, two, and three cylinders, is shown in the following table, by W. H. Weightman, *Am. Mach.*, July 28, 1892:

	Single Cyl-inder.	Compound Cylinders.		Triple-expansion Cylinders.		
		33	51	28	46	61
Diameter of cylinders, in.	60	33	51	28	46	61
Area ratios	1	1	3.416	1	2.70	4.740
Expansions	20	5	4	2.714	2.714	2.714
Initial steam-pressures — absolute — pounds	165	165	33	165	60.6	22.4
Mean pressures, pounds	32.96	86.11	19.68	121.44	44.75	16.49
Mean effective pressures, pounds	28.96	53.11	15.68	60.64	22.35	12.49
Steam temperatures into cylinders	366°	366°	259.9°	366°	293.5°	234.1°
Steam temperatures out of the cylinders	184.2°	259.9°	184.2°	293.5°	234.1°	184.2°
Difference in temperatures	181.8	106.1	75.7	72.5	59.4	49.9

"Woolf" and Receiver Types of Compound Engines. — The compound steam-engine, consisting of two cylinders, is reducible to two forms, 1, in which the steam from the h.p. cylinder is exhausted direct into the l.p. cylinder, as in the Woolf engine; and 2, in which the steam from the h.p. cylinder is exhausted into an intermediate reservoir, whence the steam is supplied to, and expanded in, the l.p. cylinder, as in the "receiver-engine."

If the steam be cut off in the first cylinder before the end of the stroke, the total ratio of expansion is the product of the two ratios of expansion; that is, the product of the ratio of expansion in the first cylinder, into the ratio of the volume of the second to that of the first cylinder.

Thus, let the areas of the first and second cylinders be as 1 to 3 1/2, the strokes being equal, and let the steam be cut off in the first at 1/2 stroke; then

Expansion in the 1st cylinder 1 to 2
Expansion in the 2d cylinder 1 to 3 1/2

Total or combined expansion, the product of the two ratios 1 to 7

Woolf Engine, without Clearance — Ideal Diagrams. — The diagrams of pressure of an ideal Woolf engine are shown in Fig. 158, as they would be described by the indicator, according to the arrows. In these diagrams *pq* is the atmospheric line, *mn* the vacuum line, *cd* the admission line, *dg* the hyperbolic curve of expansion in the first cylinder, and *gh* the consecutive expansion-line of back pressure for the return-stroke of the first piston, and of positive pressure for the steam-stroke of the second piston. At the point *h*, at the end of the stroke of the second piston, the steam is exhausted into the condenser, and the pressure falls to the level of perfect vacuum, *mn*.

The diagram of the second cylinder, below *gh*, is characterized by the absence of any specific period of admission; the whole of the steam-line *gh* being expansional, generated by the expansion of the initial body of steam contained in the first cylinder into the second.

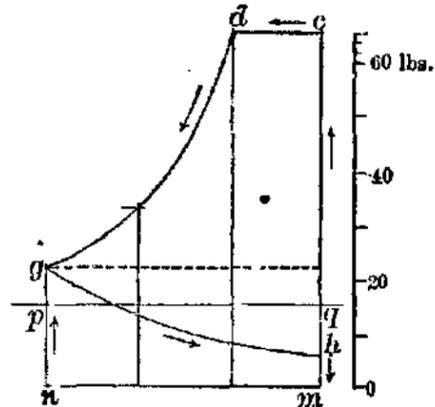

FIG. 158. — WOOLF ENGINE, IDEAL INDICATOR-DIAGRAMS.

When the return-stroke is completed, the whole of the steam transferred from the first is shut into the second cylinder. The final pressure and volume of the steam in the second cylinder are the same as if the whole of the initial steam had been admitted at once into the second cylinder, and then expanded to the end of the stroke in the manner of a single-cylinder engine. The net work of the steam is also the same, according to both distributions.

Receiver-engine, without Clearance — Ideal Diagrams.

In the ideal receiver-engine the pistons of the two cylinders are connected to cranks at right angles to each other on the same shaft. The receiver takes the steam exhausted from the first cylinder and supplies it to the second, in which the steam is cut off and then expanded to the end of the stroke. On the assumption that the initial pressure in the second cylinder is equal to the final pressure in the first, and of course equal to the pressure in the receiver, the volume cut off in the second cylinder must be equal to the volume of the first cylinder, for the second cylinder must admit as much steam at each stroke as is discharged from the first cylinder.

In Fig. 159, *cd* is the line of admission and *hg* the exhaust-line for the first cylinder; and *dg* is the expansion-curve and *pq* the atmospheric line.

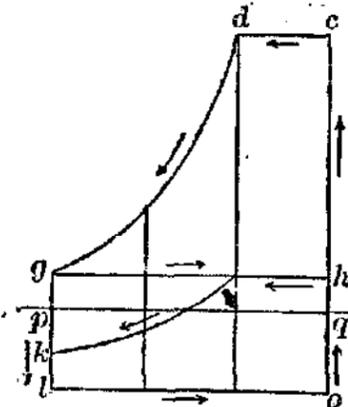
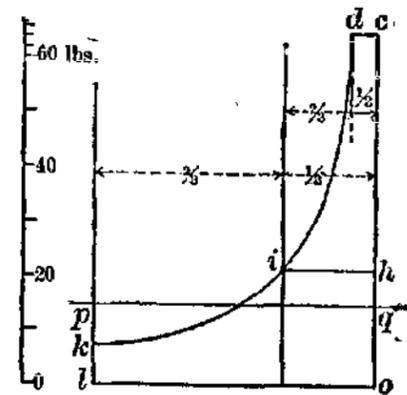

FIG. 159. — RECEIVER-ENGINE, IDEAL INDICATOR-DIAGRAM.

In the region below the exhaust-line of the first cylinder, between it and the line of perfect vacuum, *ol*, the diagram of the second cylinder is formed: *hi*, the second line of admission, coincides with the exhaust-line *hg* of the first cylinder, showing in the ideal diagram no intermediate fall of pressure, and *ik* is the expansion-curve. The arrows indicate the order in which the diagrams are formed.

In the action of the receiver-engine, the expansive working of the steam, though clearly divided into two consecutive stages, is, as in the Woolf engine, essentially continuous from the point of cut-off in the first cylinder to the end of the stroke of the second cylinder, where it is delivered to the condenser; and the first and second diagrams may be placed together and combined to form a continuous diagram. For this purpose take the second diagram as the basis of the combined diagram, namely, *hiko*, Fig. 160. The period of admission, *hi*, is one-third of the stroke, and as the ratios of the cylinders are as 1 to 3, *hi* is also the propor-

FIG. 160. — RECEIVER-ENGINE, IDEAL DIAGRAMS REDUCED AND COMBINED.



tional length of the first diagram as applied to the second. Produce *oh* upwards, and set off *oc* equal to the total height of the first diagram above the vacuum-line; and, upon the shortened base *hi*, and the height *hc*, complete the first diagram with the steam-line *cd* and the expansion line *di*.

It is shown by Clark (S. E., p. 432 *et seq.*) in a series of arithmetical calculations, that the receiver-engine is an elastic system of compound engine, in which considerable latitude is afforded for adapting the pressure in the receiver to the demands of the second cylinder, without considerably diminishing the effective work of the engine. In the Woolf engine, on the contrary, it is of much importance that the intermediate volume of space between the first and second cylinders, which is the cause of an intermediate fall of pressure, should be reduced to the lowest practicable amount.

Supposing that there is no loss of steam in passing through the engine, by cooling and condensation, it is obvious that whatever steam passes through the first cylinder must also find its way through the second cylinder. By varying, therefore, in the receiver-engine, the period of admission in the second cylinder, and thus also the volume of steam admitted for each stroke, the steam will be measured into it at a higher pressure and of a less bulk, or at a lower pressure and of a greater bulk; the pressure and density naturally adjusting themselves to the volume that the steam from the receiver is permitted to occupy in the second cylinder. With a sufficiently restricted admission, the pressure in the receiver may be maintained at the pressure of the steam as exhausted from the first cylinder. On the contrary, with a wider admission, the pressure in the receiver may fall or "drop" to three-fourths or even one-half of the pressure of the exhaust steam from the first cylinder.

(For a more complete discussion of the action of steam in the Woolf and receiver engines, see Clark on the Steam-engine.)

Combined Diagrams of Compound Engines.

The only way of making a correct combined diagram from the indicator-diagrams of the several cylinders in a compound engine is to set off all the diagrams on the same horizontal scale of volumes, adding the clearances to the cylinder capacities proper. When this is attended to, the successive diagrams fall exactly into their right places relatively to one another, and would compare properly with any theoretical expansion-curve, (Prof. A. B. W. Kennedy, *Proc. Inst. M. E.*, Oct., 1886.)

This method of combining diagrams is commonly adopted, but there are objections to its accuracy, since the whole quantity of steam consumed in the first cylinder at the end of the stroke is not carried forward to the second, but a part of it is retained in the first cylinder for compression. For a method of combining diagrams in which compression is taken account of, see discussions by Thomas Mudd and others, in *Proc. Inst. M. E.*, Feb., 1887, p. 48. The usual method of combining diagrams is also criticised by Frank H. Ball as inaccurate and misleading (*Am. Mach.*, April 12, 1894; *Trans. A. S. M. E.*, xiv, 1405, and xv, 403).

Figure 161 shows a combined diagram of a quadruple-expansion engine, drawn according to the usual method, that is, the diagrams are first reduced in length to relative scales that correspond with the relative

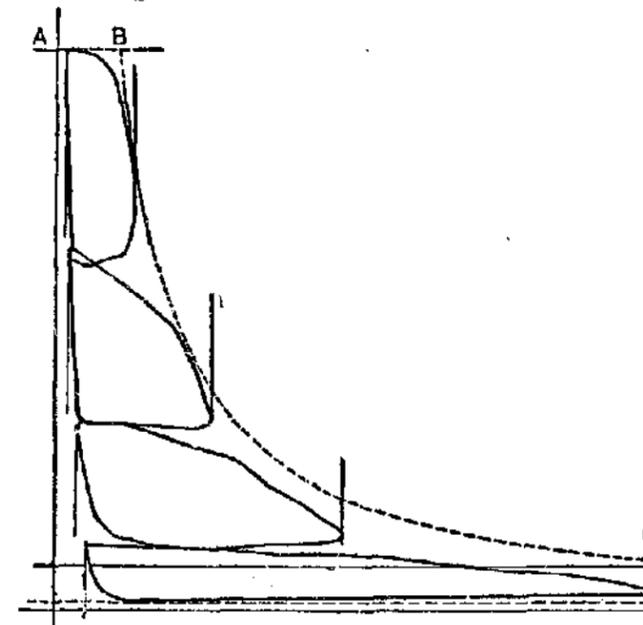

FIG. 161.

piston-displacement of the three cylinders. Then the diagrams are placed at such distances from the clearance-line of the proposed combined diagram as to represent correctly the clearance in each cylinder.

Proportions of Cylinders in Compound Engines. — Authorities differ as to the proportions by volume of the high and low pressure cylinders v and V . Thus Grashof gives $V \div v = 0.85 \sqrt{r}$; Hrabak, $0.90 \sqrt{r}$; Werner, \sqrt{r} ; and Rankine, $\sqrt{r^2}$, r being the ratio of expansion. Busley makes the ratio dependent on the boiler-pressure thus:

Lbs. per sq. in.	60	90	105	120
$V \div v$	=3	4	4.5	5

(See Seaton's Manual, p. 95, etc., for analytical method; Sennett, p. 496, etc.; Clark's Steam-engine, p. 445, etc.; Clark's Rules, Tables, Data, p. 849, etc.)

Mr. J. McFarlane Gray states that he finds the mean effective pressure in the compound engine reduced to the low-pressure cylinder to be approximately the square root of 6 times the boiler-pressure.

Ratio of Cylinder Capacity in Compound Marine Engines. (Seaton.) — The low-pressure cylinder is the measure of the power of a compound engine, for so long as the initial steam-pressure and rate of expansion are the same, it signifies very little, so far as total power only is concerned, whether the ratio between the low and high pressure cylinders is 3 or 4; but as the power developed should be nearly equally divided between the two cylinders, in order to get a good and steady working engine, there is a necessity for exercising a considerable amount of discretion in fixing on the ratio.

In choosing a particular ratio the objects are to divide the power evenly and to avoid as much as possible "drop" and high initial strain. [Some writers advocate drop in the high-pressure cylinder making it smaller than is the usual practice and making the cylinder ratio as high as 6 or 7.]

If increased economy is to be obtained by increased boiler-pressures the rate of expansion should vary with the initial pressure, so that the pressure at which the steam enters the condenser should remain constant. In this case, with the ratio of cylinders constant, the cut-off in the high-pressure cylinder will vary inversely as the initial pressure.

Let R be the ratio of the cylinders; r the rate of expansion; p_1 the initial pressure: then cut-off in high-pressure cylinder = $R \div r$; r varies with p_1 , so that the terminal pressure p_n is constant, and consequently $r = p_1 \div p_n$; therefore, cut-off in high-pressure cylinder = $R \times p_n \div p_1$.

Ratios of Cylinders as Found in Marine Practice. — The rate of expansion may be taken at one-tenth of the boiler-pressure (or about one-twelfth the absolute pressure), to work economically at full speed. Therefore, when the diameter of the low-pressure cylinder does not exceed 100 inches, and the boiler-pressure 70 lbs., the ratio of the low-pressure to the high-pressure cylinder should be 3.5; for a boiler-pressure of 80 lbs., 3.75; for 90 lbs., 4.0; for 100 lbs., 4.5. If these proportions are adhered to, there will be no need of an expansion-valve to either cylinder. If, however, to avoid "drop," the ratio be reduced, an expansion-valve should be fitted to the high-pressure cylinder.

Where economy of steam is not of first importance, but rather a large power, the ratio of cylinder capacities may with advantage be decreased, so that with a boiler-pressure of 100 lbs. it may be 3.75 to 4.

In tandem engines there is no necessity to divide the work equally. The ratio is generally 4, but when the steam-pressure exceeds 90 lbs. absolute 4.5 is better, and for 100 lbs. 5.0.

When the power requires that the l.p. cylinder shall be more than 100 in. diameter, it should be divided in two cylinders. In this case the ratio of the combined capacity of the two l.p. cylinders to that of the h.p. may be 3.0 for 85 lbs. absolute, 3.4 for 95 lbs., 3.7 for 105 lbs., and 4.0 for 115 lbs.

Receiver Space in Compound Engines should be from 1 to 1.5 times the capacity of the high-pressure cylinder, when the cranks are at an angle of from 90° to 120°. When the cranks are at 180° or nearly this, the space may be very much reduced. In the case of triple-compound engines, with cranks at 120°, and the intermediate cylinder leading the high-pressure, a very small receiver will do. The pressure in the receiver should never exceed half the boiler-pressure. (Seaton.)

Formula for Calculating the Expansion and the Work of Steam in Compound Engines.

(Condensed from Clark on the "Steam-engine.")

- a = area of the first cylinder in square inches;
- a' = area of the second cylinder in square inches;
- r = ratio of the capacity of the second cylinder to that of the first;
- L = length of stroke in feet, supposed to be the same for both cylinders;
- l = period of admission to the first cylinder in feet, excluding clearance;
- c = clearance at each end of the cylinders, in parts of the stroke, in ft.;
- L' = length of the stroke plus the clearance, in feet;
- l' = period of admission plus the clearance, in feet;
- s = length of a given part of the stroke of the second cylinder, in feet;
- P = total initial pressure in the first cylinder, in lbs. per square inch, supposed to be uniform during admission;
- P' = total pressure at the end of the given part of the stroke s ;
- p = average total pressure for the whole stroke;
- R = nominal ratio of expansion in the first cylinder, or $L + l$;
- R' = actual ratio of expansion in the first cylinder, or $L' + l'$;
- R'' = actual combined ratio of expansion, in the first and second cylinders together;
- n = ratio of the final pressure in the first cylinder to any intermediate fall of pressure between the first and second cylinders;
- N = ratio of the volume of the intermediate space in the Woolf engine, reckoned up to, and including the clearance of, the second piston, to the capacity of the first cylinder plus its clearance. The value of N is correctly expressed by the actual ratio of the volumes as stated, on the assumption that the intermediate space is a vacuum when it receives the exhaust-steam from the first cylinder. In point of fact, there is a residuum of unexhausted steam in the intermediate space, at low pressure, and the value of N is thereby practically reduced below the ratio here stated.

$$N = \frac{n}{n-1} - 1.$$

w = whole net work in one stroke, in foot-pounds.

Ratio of expansion in the second cylinder:

In the Woolf engine, $\frac{\left(r \frac{L}{L'}\right) + N}{1 + N}$;

In the receiver-engine, $\frac{(n-1)r}{n}$.

Total actual ratio of expansion = product of the ratios of the three consecutive expansions, in the first cylinder, in the intermediate space, and in the second cylinder;

In the Woolf engine, $R' \left(r \frac{L}{L'} + N\right)$;

In the receiver-engine, $r \frac{L'}{l'}$, or rR' .

Combined ratio of expansion behind the pistons = $\frac{n-1}{n} rR' = R''$.

Work done in the two cylinders for one stroke, with a given cut-off and a given combined actual ratio of expansion:

Woolf engine, $w = aP [l'(1 + \text{hyp log } R'') - c]$;

Receiver engine, $w = aP \left[l' (1 + \text{hyp log } R'') - c \left(1 + \frac{r-1}{R'} \right) \right]$,

when there is no intermediate fall of pressure.

When there is an intermediate fall, when the pressure falls to $\frac{3}{4}$, $\frac{2}{3}$, $\frac{1}{2}$ of the final pressure in the 1st cylinder, the reduction of work is 0.2%, 1.0%, 4.6% of that when there is no fall.
Total work in the two cylinders of a receiver-engine, for one stroke for any intermediate fall of pressure,

$$w = aP \left[v \left(\frac{n+1}{n} + \text{hyp log } R^n \right) - c \left(1 + \frac{(n-1)(r-1)}{nR^r} \right) \right].$$

EXAMPLE. — Let $a = 1$ sq. in., $P = 63$ lbs., $v = 2.42$ ft., $n = 4$, $R^r = 5.969$, $c = 0.42$ ft., $r = 3$, $R^r = 2.653$;

$$w = 1 \times 63 \left[2.42 \left(\frac{5}{4} \text{ hyp log } 5.969 \right) - 0.42 \left(1 + \frac{3 \times 2}{4 \times 2.653} \right) \right] = 421.55 \text{ ft.-lbs.}$$

Calculation of Diameters of Cylinders of a compound condensing engine of 2000 H.P. at a speed of 700 feet per minute, with 100 lbs. boiler-pressure.

100 lbs. gauge-pressure = 115 absolute, less drop of 5 lbs. between boiler and cylinder = 110 lbs. initial absolute pressure. Assuming terminal pressure in l.p. cylinder = 6 lbs., the total expansion of steam in both cylinders = $110 \div 6 = 18.33$. $\text{Hyp log } 18.33 = 2.909$. Back pressure in l.p. cylinder, 3 lbs. absolute.

The following formulæ are used in the calculation of each cylinder:

- (1) Area of cylinder = $\frac{\text{H.P.} \times 33,000}{\text{M.E.P.} \times \text{piston-speed}}$
- (2) Mean effective pressure = mean total pressure - back pressure.
- (3) Mean total pressure = terminal pressure $\times (1 + \text{hyp log } R)$.
- (4) Absolute initial pressure = absolute terminal pressure \times ratio of expansion.

First calculate the area of the low-pressure cylinder as if all the work were done in that cylinder.

From (3), mean total pressure = $6 \times (1 + \text{hyp log } 18.33) = 23.454$ lbs.

From (2), mean effective pressure = $23.454 - 3 = 20.454$ lbs.

From (1), area of cylinder = $\frac{2000 \times 33,000}{20.454 \times 700} = 4610$ sq. ins. = 76.6 ins. diam.

If half the work, or 1000 H.P., is done in the l.p. cylinder the M.E.P. will be half that found above, or 10.227 lbs., and the mean total pressure $10.227 + 3 = 13.227$ lbs.

From (3), $1 + \text{hyp log } R = 13.227 \div 6 = 2.2045$.

$\text{Hyp log } R = 1.2045$, whence R in l.p. cyl. = 3.335.

From (4), $3.335 \times 6 = 20.01$ lbs. initial pressure in l.p. cyl. and terminal pressure in h.p. cyl., assuming no drop between cylinders.

$110 \div 20.01 = 5.497$, R in h.p. cyl.

From (3), mean total pres. in h.p. cyl. = $20.01 \times (1 + \text{hyp log } 5.497) = 54.11$.

From (2), $54.11 - 20.01 = 34.10$, M.E.P. in h.p. cyl.

From (1), area of h.p. cyl. = $\frac{1000 \times 33,000}{34.1 \times 700} = 1382$ sq. ins. = 42 ins. diam.

Cylinder ratio = $4610 \div 1382 = 3.336$.

The area of the h.p. cylinder may be found more directly by dividing the area of the l.p. cyl. by the ratio of expansion in that cylinder. $4610 \div 3.335 = 1382$ sq. ins.

In the above calculation no account is taken of clearance, of compression, of drop between cylinders, nor of area of piston-rods. It also assumes that the diagram in each cylinder is the full theoretical diagram, with a horizontal steam-line and a hyperbolic expansion line, with no allowance for rounding of the corners. To make allowance for these, the mean effective pressure in each cylinder must be multiplied by a diagram factor, or the ratio of the area of an actual diagram of the class of engine considered, with the given initial and terminal pressures, to the area of the theoretical diagram. Such diagram factors will range from 0.6 to 0.94, as in the table on p. 932.

Best Ratios of Cylinders. — The question what is the best ratio of areas of the two cylinders of a compound engine is still (1901) a disputed

one, but there appears to be an increasing tendency in favor of large ratios, even as great as 7 or 8 to 1, with considerable terminal drop in the high-pressure cylinder. A discussion of the subject, together with a description of a new method of drawing theoretical diagrams of multiple-expansion engines, taking into consideration drop, clearance, and compression will be found in a paper by Bert C. Ball, in *Trans. A. S. M. E.* xxi, 1002.

TRIPLE-EXPANSION ENGINES.

Proportions of Cylinders. — H. H. Supplee, *Mechanics*, Nov., 1887, gives the following method of proportioning cylinders of triple-expansion engines:

As in the case of compound engines the diameter of the low-pressure cylinder is first determined, being made large enough to furnish the entire power required at the mean pressure due to the initial pressure and expansion ratio given; and then this cylinder is given only pressure enough to perform one-third of the work, and the other cylinders are proportioned so as to divide the other two-thirds between them.

Let us suppose that an initial pressure of 150 lbs. is used and that 900 H.P. is to be developed at a piston-speed of 800 ft. per min., and that an expansion ratio of 16 is to be reached with an absolute back-pressure of 2 lbs.

The theoretical M.E.P. with an absolute initial pressure of $150 + 14.7 = 164.7$ lbs. initial at 16 expansions is

$$\frac{P(1 + \text{hyp log } 16)}{16} = 164.7 \times \frac{3.7726}{16} = 38.83,$$

less 2 lbs. back pressure, = $38.83 - 2 = 36.83$.

In practice only about 0.7 of this pressure is actually attained, so that $36.83 \times 0.7 = 25.781$ lbs. is the M.E.P. upon which the engine is to be proportioned.

To obtain 900 H.P. we must have $33,000 \times 900 = 29,700,000$ foot-pounds, and this divided by the mean pressure (25.78) and by the speed in feet (800) will give 1440 sq. in. as the area of the l.p. cylinder, about equivalent to 43 in. diam.

Now as one-third of the work is to be done in the l.p. cylinder, the M.E.P. in it will be $25.78 \div 3 = 8.59$ lbs.

The cut-off in the high-pressure cylinder is generally arranged to cut off at 0.6 of the stroke, and so the ratio of the h.p. to the l.p. cylinder is equal to $16 \times 0.6 = 9.6$, and the h.p. cylinder will be $1440 \div 9.6 = 150$ sq. in. area, or about 14 in. diameter, and the M.E.P. in the h.p. cylinder is equal to $9.6 \times 8.59 = 82.46$ lbs.

If the intermediate cylinder is made a mean size between the other two, its size would be determined by dividing the area of the l.p. cylinder by the square root of the ratio between the low and the high; but in practice this is found to give a result too large to equalize the stresses, so that instead the area of the int. cylinder is found by dividing the area of the l.p. piston by 1.1 times the square root of the ratio of l.p. to h.p. cylinder, which in this case is $1440 \div (1.1 \sqrt{9.6}) = 422.5$ sq. in., or a little more than 23 in. diam.

The choice of expansion ratio is governed by the initial pressure, and is generally chosen so that the terminal pressure in the l.p. cylinder shall be about 10 lbs. absolute.

Formulæ for Proportioning Cylinder Areas of Triple-Expansion Engines. — The following formulæ are based on the method of first finding the cylinder areas that would be required if an ideal hyperbolic diagram were obtainable from each cylinder, with no clearance, compression, wire-drawing, drop by free expansion in receivers, or loss by cylinder condensation, assuming equal work to be done in each cylinder, and then dividing the areas thus found by a suitable diagram factor, such as those given on page 932, expressing the ratio which the area of an actual diagram, obtained in practice from an engine of the type under consideration, bears to the ideal or theoretical diagram. It will vary in different classes of engine and in different cylinders of the same engine, usual

WARNING: This is a 1910 edition. Some of the material may no longer be accurate

values ranging from 0.6 to 0.9. When any one of the three stages of expansion takes place in two cylinders, the combined area of these cylinders equals the area found by the formulæ.

NOTATION.

- p_1 = initial pressure in the high-pressure cylinder.
- p_t = terminal pressure in the low-pressure cylinder.
- p_b = back pressure in the low-pressure cylinder.
- p_2 = term. press. in h.p. cyl. and initial press. in intermediate cyl.
- p_3 = term. press. in int. cyl. and initial press. in l.p. cyl.
- R_1, R_2, R_3 , ratio of exp. in h.p. int. and l.p. cyls.
- R = total ratio of exp. = $R_1 \times R_2 \times R_3$.
- P = mean effec. press. of the combined ideal diagram, referred to the l.p. cyl.
- P_1, P_2, P_3 = M.E.P. in the h.p., int., and l.p. cyls.
- HP = horse-power of the engine = $PLA_3N \div 33,000$.
- L = length of stroke in feet; N = number of single strokes per min.
- A_1, A_2, A_3 , areas (sq. ins.) of h.p. int. and l.p. cyls. (ideal).
- W = work done in one cylinder per foot of stroke.
- r_2 = ratio of A_2 to A_1 ; r_3 = ratio of A_3 to A_1 .
- F_1, F_2, F_3 , diagram factors of h.p. int. and l.p. cyl.
- a_1, a_2, a_3 , areas (actual) of h.p. int. and l.p. cyl.

Formulæ.

- (1) $R = p_1 \div p_t$.
- (2) $P = p_t (1 + \text{hyp log } R) - p_b$.
- (3) $P_3 = 1/3 P$.
- (4) $\text{Hyp log } R_3 = (P_3 - p_t + p_b) \div p_t$.
- (5) $R_1 R_2 = R \div R_3$; $R_1 = R_2 = \sqrt{R_1 R_2}$.
- (6) $p_3 = p_t \times R_3$.
- (7) $p_2 = p_3 \times R_2$.
- (8) $p_1 = p_2 \times R_1$.
- (9) $P_2 = p_3 (\text{hyp log } R_2) = P_3 R_2$.
- (10) $P_1 = p_2 (\text{hyp log } R_1) = P_2 R_1$.
- (11) $W = 11,000 HP \div LN$.
- (12) $A_1 = W \div P_1$; $A_2 = W \div P_2$; $A_3 = W \div P_3$.
- (13) $r_2 = A_2 \div A_1 = P_1 \div P_2 = R_1$ or R_2 ; $r_3 = A_3 \div A_1 = P_1 \div P_3$.
- (14) $a_1 = A_1 \div F_1$; $a_2 = A_2 \div F_2$; $a_3 = A_3 \div F_3$.

From these formulæ the figures in the following tables have been calculated:

THEORETICAL MEAN EFFECTIVE PRESSURES, CYLINDER RATIOS, ETC., OF TRIPLE EXPANSION ENGINES.

Back pressure 3 lbs. Terminal pressure, 8 lbs. (absolute).

p_1	R	P	P_3	R_3	R_1, R_2 or r_2	p_3	p_2	P_2	P_1	r_2
120	15	26.66	8.89	1.626	3.037	13.01	39.51	14.45	43.89	4.939
140	17.5	27.90	9.30	1.712	3.197	13.70	43.79	15.92	50.89	5.472
160	20	28.97	9.66	1.790	3.343	14.32	47.86	17.29	57.76	5.980
180	22.5	29.91	9.97	1.861	3.477	14.89	51.77	18.55	64.52	6.471
200	25	30.75	10.25	1.928	3.601	15.42	55.54	19.76	71.16	6.942
220	27.5	31.51	10.50	1.990	3.718	15.91	59.16	20.90	77.69	7.397
240	30	32.21	10.74	2.049	3.826	16.39	62.72	22.00	84.15	7.839

THEORETICAL MEAN EFFECTIVE PRESSURES, CYLINDER RATIOS, ETC., OF TRIPLE EXPANSION ENGINES.

Back pressure, 3 lbs. Terminal pressure, 10 lbs. (absolute).

p_1	R	P	P_3	R_3	R_1, R_2 or r_2	p_3	p_2	P_2	P_1	r_2
120	12	31.85	10.62	1.436	2.890	14.36	41.50	15.24	44.04	4.148
140	14	33.39	11.13	1.511	3.044	15.11	45.99	16.32	51.20	4.600
160	16	34.73	11.58	1.580	3.182	15.80	50.28	18.29	58.20	5.027
180	18	35.90	11.97	1.643	3.310	16.43	54.38	19.66	65.09	5.439
200	20	36.96	12.32	1.702	3.428	17.02	58.34	20.97	71.88	5.834
220	22	37.91	12.64	1.757	3.538	17.57	62.15	22.20	78.54	6.215
240	24	38.76	12.93	1.809	3.642	18.09	65.88	23.38	85.15	6.587

Given the required H.P. of an engine, its speed and length of stroke, and the assumed diagram factors F_1, F_2, F_3 for the three cylinders, the areas of the cylinders may be found by using formulæ (11), (12), and (14), and the values of P_1, P_2 , and P_3 in the above table.

A Common Rule for Proportioning the Cylinders of multiple-expansion engines is: for two-cylinder compound engines, the cylinder ratio is the square root of the number of expansions, and for triple-expansion engines the ratios of the high to the intermediate and of the intermediate to the low are each equal to the cube root of the number of expansions, the ratio of the high to the low being the product of the two ratios, that is, the square of the cube root of the number of expansions. Applying this rule to the pressures above given, assuming a terminal pressure (absolute) of 10 lbs. and 8 lbs. respectively, we have, for triple-expansion engines:

Boiler-pressure (Absolute)	Terminal Pressure, 10 lbs.		Terminal Pressure, 8 lbs.	
	No. of Expansions.	Cylinder Ratios, areas.	No. of Expansions.	Cylinder Ratios, areas.
130	13	1 to 2.35 to 5.53	16 1/4	1 to 2.53 to 6.42
140	14	1 to 2.41 to 5.81	17 1/2	1 to 2.60 to 6.74
150	15	1 to 2.47 to 6.08	18 3/4	1 to 2.66 to 7.06
160	16	1 to 2.52 to 6.35	20	1 to 2.71 to 7.37

The ratio of the diameters is the square root of the ratios of the areas, and the ratio of the diameters of the first and third cylinders is the same as the ratio of the areas of first and second.

Seaton, in his Marine Engineering, says: When the pressure of steam employed exceeds 115 lbs. absolute, it is advisable to employ three cylinders, through each of which the steam expands in turn. The ratio of the low-pressure to high-pressure cylinder in this system should be 5, when the steam-pressure is 125 lbs. absolute; when 135 lbs., 5.4; when 145 lbs., 5.8; when 155 lbs., 6.2; when 165 lbs., 6.5. The ratio of low-pressure to intermediate cylinder should be about one-half that between low-pressure and high-pressure, as given above. That is, if the ratio of l.p. to h.p. is 6, that of l.p. to int. should be about 3, and consequently that of int. to h.p. about 2. In practice the ratio of int. to h.p. is nearly 2.25, so that the diameter of the int. cylinder is 1.5 that of the h.p. The introduction of the triple-compound engine has admitted of ships being propelled at higher rates of speed than formerly obtained without exceeding the consumption of fuel of similar ships fitted with ordinary compound engines; in such cases the higher power to obtain the speed has been developed by decreasing the rate of expansion, the low pressure cylinder being only 6 times the capacity of the high-pressure, with a working pressure of 170 lbs. absolute. It is now a very general practice to make the diameter of the low-pressure cylinder equal to the sum of the diameters of the h.p. and int. cylinders; hence:

- Diameter of int. cylinder = 1.5 diameter of h.p. cylinder;
- Diameter of l.p. cylinder = 2.5 diameter of h.p. cylinder.

In this case the ratio of l.p. to h.p. is 6.25; the ratio of int. to h.p. is 2.25; and ratio of l.p. to int. is 2.78.

Ratios of Cylinders for Different Classes of Engines. (*Proc. Inst. M. E.*, Feb., 1887, p. 36.)—As to the best ratios for the cylinders in a triple engine there seems to be great difference of opinion. Considerable latitude, however, is due to the requirements of the case, inasmuch as it would not be expected that the same ratio would be suitable for an economical land engine, where the space occupied and the weight were of minor importance, as in a war-ship, where the conditions were reversed. In the land engine, for example, a theoretical terminal pressure of about 7 lbs. above absolute vacuum would probably be aimed at, which would give a ratio of capacity of high pressure to low pressure of 1 to 8½ or 1 to 9; whilst in a war-ship a terminal pressure would be required of 12 to 13 lbs. which would need a ratio of capacity of 1 to 5; yet in both these instances the cylinders were correctly proportioned and suitable to the requirements of the case. It is obviously unwise, therefore, to introduce any hard-and-fast rule.

Types of Three-stage Expansion Engines.—1. Three cranks at 120 deg. 2. Two cranks with 1st and 2d cylinders tandem. 3. Two cranks with 1st and 3d cylinders tandem. The most common type is the first, with cylinders arranged in the sequence high, intermediate, low.

Sequence of Cranks.—Mr. Wyllie (*Proc. Inst. M. E.*, 1887) favors the sequence high, low, intermediate, while Mr. Mudd favors high, intermediate, low. The former sequence, high, low, intermediate, gave an approximately horizontal exhaust-line, and thus minimizes the range of temperature and the initial load; the latter sequence high, intermediate, low, increased the range and also the load.

Mr. Morrison, in discussing the question of sequence of cranks, presented a diagram showing that with the cranks arranged in the sequence high, low, intermediate, the mean compression into the receiver was 19½ per cent of the stroke; with the sequence high, intermediate, low, it was 57 per cent.

In the former case the compression was just what was required to keep the receiver-pressure practically uniform; in the latter case the compression caused a variation in the receiver-pressure to the extent sometimes of 22½ lbs.

Velocity of Steam through Passages in Compound Engines. (*Proc. Inst. M. E.*, Feb., 1887.)—In the *SS. Para*, taking the area of the cylinder multiplied by the piston-speed in feet per second, and dividing by the area of the port the velocity of the initial steam through the high-pressure cylinder port would be about 100 feet per second; the exhaust would be about 90. In the intermediate cylinder the initial steam had a velocity of about 180, and the exhaust of 120. In the low-pressure cylinder, the initial steam entered through the port with a velocity of 250, and in the exhaust-port the velocity was about 140 feet per second.

A Double-tandem Triple-expansion Engine, built by Watts, Campbell & Co., Newark, N. J., is described in *Am. Mach.*, April 26, 1894. It is two three-cylinder tandem engines coupled to one shaft, cranks at 90°, cylinders 21, 32 and 48 by 60 in. stroke, 65 revolutions per minute, rated H.P. 2000; fly-wheel 28 ft. diameter, 12 ft. face, weight 174,000 lbs.; main shaft 22 in. diameter at the swell; main journals 19 × 38 in.; crank-pins 9½ × 10 in.; distance between center lines of two engines 24 ft. 7½ in.; Corliss valves, with separate eccentrics for the exhaust-valves of the l.p. cylinder.

QUADRUPLE-EXPANSION ENGINES.

H. H. Supplee (*Trans. A. S. M. E.*, x, 583) states that a study of 14 different quadruple-expansion engines, nearly all intended to be operated at a pressure of 180 lbs. per sq. in., gave average cylinder ratios of 1 to 2, to 3.78, to 7.70, or nearly in the proportions 1, 2, 4, 8.

If we take the ratio of areas of any two adjoining cylinders as the fourth root of the number of expansions, the ratio of the 1st to the 4th will be the cube of the fourth root. On this basis the ratios of areas for different pressures and rates of expansion will be as follows:

Gauge-pressures.	Absolute Pressures.	Terminal Pressures.	Ratio of Expansion.	Ratios of Areas of Cylinders.
160	175	12	14.6	1 : 1.95 : 3.81 : 7.43
		10	17.5	1 : 2.05 : 4.18 : 8.55
		8	21.9	1 : 2.16 : 4.68 : 10.12
180	195	12	16.2	1 : 2.01 : 4.02 : 8.07
		10	19.5	1 : 2.10 : 4.42 : 9.28
		8	24.4	1 : 2.22 : 4.94 : 10.98
200	215	12	17.9	1 : 2.06 : 4.23 : 8.70
		10	21.5	1 : 2.15 : 4.64 : 9.98
		8	26.9	1 : 2.28 : 5.19 : 11.81
220	235	12	19.6	1 : 2.10 : 4.43 : 9.31
		10	23.5	1 : 2.20 : 4.85 : 10.67
		8	29.4	1 : 2.33 : 5.42 : 12.62

Seaton says: When the pressure of steam employed exceeds 190 lbs. absolute, four cylinders should be employed, with the steam expanding through each successively; and the ratio of l.p. to h.p. should be at least 7.5, and if economy of fuel is of prime consideration it should be 8; then the ratio of first intermediate to h.p. should be 1.8, that of second intermediate to first int. 2, and that of l.p. to second int. 2.2.

In a paper read before the North East Coast Institution of Engineers and Shipbuilders, 1890, William Russell Cummins advocates the use of a four-cylinder engine with four cranks as being more suitable for high speeds than the three-cylinder three-crank engine. The cylinder ratios, he claims, should be designed so as to obtain equal initial loads in each cylinder. The ratios determined for the triple engine are 1, 2.04, 6.54, and for the quadruple, 1, 2.08, 4.46, 10.47. He advocates long stroke, high piston-speed, 100 revolutions per minute, and 250 lbs. boiler-pressure, unjacketed cylinders, and separate steam and exhaust valves.

ECONOMIC PERFORMANCE OF STEAM-ENGINES.

Economy of Expansive Working under Various Conditions, Single Cylinder.

(Abridged from Clark on the Steam Engine.)

1. SINGLE CYLINDERS WITH SUPERHEATED STEAM, NON-CONDENSING.—Inside cylinder locomotive, cylinders and steam-pipes enveloped by the hot gases in the smoke-box. Net boiler pressure 100 lbs.; net maximum pressure in cylinders 80 lbs. per sq. in.

Cut-off, per cent.	20	25	30	35	40	50	60	70	80
Actual ratio of expansion.	3.91	3.31	2.87	2.53	2.26	1.86	1.59	1.39	1.23
Water per I.H.P. per hour, lbs.	18.5	19.4	20	21.2	22.2	24.5	27	30	33

2. SINGLE CYLINDERS WITH SUPERHEATED STEAM, CONDENSING.—The best results obtained by Hirn, with a cylinder 23¾ × 67 in. and steam superheated 150° F., expansion ratio 3¾ to 4½, total maximum pressure in cylinder 63 to 69 lbs., were 15.63 and 15.69 lbs. of water per I.H.P. per hour.

3. SINGLE CYLINDERS OF SMALL SIZE, 8 or 9 IN. DIAM., JACKETED, NON-CONDENSING.—The best results are obtained at a cut-off of 20 per cent, with 75 lbs. maximum pressure in the cylinder; about 25 lbs. of water per I.H.P. per hour.

4. SINGLE CYLINDERS, NOT STEAM-JACKETED, CONDENSING.—The best result is from a Corliss-Wheelock engine 18 × 48 in.; cut-off, 12.5%; actual expansion ratio, 6.95; maximum absolute pressure in cylinder, 104 lbs.; steam per I.H.P. hour, 19.58 lbs. Other engines, with lower steam pressures, gave a steam consumption as high as 26.7 lbs.

Feed-water Consumption of Different Types of Engines.—The following tables are taken from the circular of the Tabor Indicator (Ashcroft Mfg. Co., 1889). In the first of the two columns under Feed-water required, in the tables for simple engines, the figures are obtained by

computation from nearly perfect indicator diagrams, with allowance for cylinder condensation according to the table on page 936, but without allowance for leakage, with back-pressure in the non-condensing table taken at 16 lbs. above zero, and in the condensing table at 3 lbs. above zero. The compression curve is supposed to be hyperbolic, and commences at 0.91 of the return-stroke, with a clearance of 3% of the piston-displacement.

Table No. 2 gives the feed-water consumption for jacketed compound-condensing engines of the best class. The water condensed in the jackets is included in the quantities given. The ratio of areas of the two cylinders is as 1 to 4 for 120 lbs. pressure; the clearance of each cylinder is 3% and the cut-off in the two cylinders occurs at the same point of stroke. The initial pressure in the l.p. cylinder is 1 lb. per sq. in. below the back-pressure of the h.p. cylinder. The average back-pressure of the whole stroke in the l.p. cylinder is 4.5 lbs. for 10% cut-off; 4.75 lbs. for 20% cut-off; and 5 lbs. for 30% cut-off. The steam accounted for by the indicator at cut-off in the h.p. cylinder (allowing a small amount for leakage) is 0.74 at 10% cut-off, 0.78 at 20%, and 0.82 at 30% cut-off. The loss by condensation between the cylinders is such that the steam accounted for at cut-off in the l.p. cylinder, expressed in proportion of that shown at release in the h.p. cylinder, is 0.85 at 10% cut-off, 0.87 at 20% cut-off, and 0.89 at 30% cut-off.

TABLE No. 1.

FEED-WATER CONSUMPTION, SIMPLE ENGINES.

NON-CONDENSING ENGINES. CONDENSING ENGINES.

Per cent Cut-off.	NON-CONDENSING ENGINES.				CONDENSING ENGINES.				
	Initial Pressure above Atmosphere, lbs.	Mean Effective Pressure, lbs.	Feed-water Required per I.H.P. per Hour.		Per cent Cut-off.	Initial Pressure above Atmosphere, lbs.	Mean effective Pressure, lbs.	Feed-water Required per I.H.P. per Hour.	
			Corresponding to Diagrams with no Leakage, lbs.	Corresponding to Actual Results Attained in Practice, assuming Slight Leakage.				Corresponding to Diagrams with no Leakage, lbs.	Corresponding to Actual Results Attained in Practice, assuming Slight Leakage.
10	80	16.07	27.61	29.88	10	80	29.72	17.30	18.89
	90	19.76	25.43	27.43		90	33.41	17.15	18.70
	100	23.45	23.90	25.73		100	37.10	17.02	18.56
20	80	32.02	21.04	25.68	15	80	38.28	17.60	19.09
	90	37.47	23.00	24.57		90	42.92	17.45	18.91
	100	42.92	22.25	23.77		100	47.56	17.32	18.74
30	80	43.97	24.71	26.29	20	80	45.63	18.27	19.69
	90	50.73	23.91	25.38		90	51.08	18.14	19.51
	100	57.49	23.27	24.68		100	56.53	18.02	19.36
40	80	53.25	25.76	27.17	30	80	57.57	19.91	21.25
	90	61.01	25.03	26.35		90	64.32	19.78	21.06
	100	68.76	24.47	25.73		100	71.08	19.67	20.93
50	80	60.44	26.99	28.38	40	80	66.85	21.36	22.56
	90	68.96	26.32	27.62		90	74.60	21.24	22.41
	100	77.48	25.78	26.99		100	82.36	21.13	22.24

The data upon which table No. 3 is calculated are not given, but the feed-water consumption is somewhat lower than has yet been reached (1894), the lowest steam consumption of a triple-expansion engine yet recorded being 11.7 lbs.

TABLE No. 2.

FEED-WATER CONSUMPTION FOR COMPOUND CONDENSING ENGINES.

Cut-off, per cent.	Initial Pressure above Atmosphere.		Mean Effective Press.		Feed-water Required per I.H.P. per Hour, lbs.
	H.P. Cyl., lbs.	L.P. Cyl., lbs.	H.P. Cyl., lbs.	L.P. Cyl., lbs.	
10	80	4.0	11.67	2.65	16.92
	100	7.3	15.33	3.87	15.00
	120	11.0	18.54	5.23	13.86
20	80	4.3	26.73	5.48	14.60
	100	8.1	33.13	7.56	13.67
	120	12.1	39.29	9.74	13.09
30	80	4.6	37.61	7.48	14.99
	100	8.5	46.41	10.10	14.21
	120	11.7	56.00	12.26	13.87

TABLE No. 3.

FEED-WATER CONSUMPTION FOR TRIPLE-EXPANSION CONDENSING ENGINES.

Cut-off, per cent.	Initial Pressure above Atmosphere.			Mean Effective Pressure.			Feed-water Required per I.H.P. per Hour, lbs.
	H.P. Cyl., lb.	I. Cyl., lbs.	L.P. Cyl., lbs.	H.P. Cyl., lbs.	I. Cyl., lbs.	L.P. Cyl., lbs.	
30	120	37.8	1.3	38.5	17.1	6.5	12.05
	140	43.8	2.8	46.5	18.6	7.1	11.4
	160	49.3	3.8	55.0	20.0	8.0	10.75
	120	38.8	2.8	51.5	22.8	8.6	11.65
40	140	45.8	3.9	59.5	23.7	9.1	11.4
	160	51.3	5.3	70.0	25.5	10.0	10.85
	120	39.8	3.7	60.5	26.7	10.1	12.2
50	140	46.8	4.8	70.5	28.0	10.8	11.6
	160	52.8	6.3	82.5	30.0	11.8	11.15

Sizes and Calculated Performances of Vertical High-speed Engines. — The following tables are taken from an old circular, describing the engines made by the Lake Erie Engineering Works, Buffalo, N. Y. The engines are fair representatives of the type largely used for driving dynamos directly without belts. The tables were calculated by E. F. Williams, designer of the engines. They are here somewhat abridged to save space.

Simple Engines — Non-condensing.

Diam. of Cyl- inder, ins.	Stroke, ins.	Revs. per Minute.	H.P. when cutting off at 1/5 stroke.			H.P. when cutting off at 1/4 stroke.			H.P. when cutting off at 1/3 stroke.			Dimen- sions of Wheels. dia. face		Steam-pipe, ins.	Exhaust- pipe.
			70 lbs.	80 lbs.	90 lbs.	70 lbs.	80 lbs.	90 lbs.	70 lbs.	80 lbs.	90 lbs.	Ft.	In.		
			20	25	30	26	31	36	32	37	43	4	4		
7 1/2	10	370	20	25	30	26	31	36	32	37	43	4	4	2 1/2	3
8 1/2	12	318	27	32	39	34	41	47	41	48	56	4 1/2	5	2 3/4	3 1/2
10 1/2	14	277	41	49	60	52	62	71	63	74	85	5 9/16	6 1/2	3 1/2	4
12	16	246	53	64	77	67	81	93	82	96	111	6 8/16	9	4	4 1/2
13 1/2	18	222	66	80	96	84	100	116	102	120	138	7 1/2	11	4	5
16	20	181	95	115	138	120	144	166	146	172	198	8 4/16	15	4 1/2	6
18	24	158	119	144	173	151	181	208	183	215	248	10	19	5	7
22	28	138	179	216	261	227	272	313	276	324	373	11 8/16	28	6	8
24 1/2	32	120	221	267	322	281	336	386	340	400	460	13 4/16	34	7	9
27	34	112	269	325	392	342	409	470	414	487	560	14 2/16	41	8	10
M.E.P., lbs.			24	29	35	30.5	36.5	42	37	43.5	50	Note. — The nominal-power rating of the engines is at 80 lbs. gauge pressure, steam cut-off at 1/4 stroke.			
Ratio of exp.			5			4			3						
Term'l press. (about), lbs. ...			17.9	20	22.3	22.4	25	27.6	29.8	33.3	36.8				
Cyl. cond'n. % ..			26	26	26	24	24	24	21	21	21				
Steam p. I.H.P. hour, lbs.			32.9	30	27.4	31.2	29.0	27.9	32	31.4	30				

Compound Engines — Non-condensing — High-pressure Cylinder and Receiver Jacketed.

Diam. Cylinder, inches.	H.P.	H.P.	L.P.	Stroke, inches.	Revolutions per Minute.	H.P., cutting off at 1/4 Stroke in h.p. Cylinder.				H.P., cutting off at 1/3 Stroke in h.p. Cylinder.				H.P., cutting off at 1/2 Stroke in h.p. Cylinder.			
						Cyls. 3 1/3 : 1.		Cyls. 4 1/2 : 1.		Cyls. 3 1/3 : 1.		Cyls. 4 1/2 : 1.		Cyls. 3 1/3 : 1.		Cyls. 4 1/2 : 1.	
						80 lbs.	90 lbs.	130 lbs.	150 lbs.	80 lbs.	90 lbs.	130 lbs.	150 lbs.	80 lbs.	90 lbs.	130 lbs.	150 lbs.
5 3/4	6 1/2	12	10	370	7	9	19	32	23	31	35	46	44	55	64	79	
6 3/8	7 1/2	13 1/2	12	318	9	19	24	40	29	39	45	59	56	70	81	101	
7 3/4	9	16 1/2	14	277	14	28	36	60	43	58	67	87	83	104	121	159	
9	10 1/2	19	16	246	18	37	47	78	57	76	87	114	109	136	158	196	
10 1/2	12	22 1/2	18	222	26	53	68	112	81	109	125	164	156	195	226	281	
12	13 1/2	25	20	185	32	65	84	139	100	135	154	202	192	241	279	346	
13 1/2	15 1/2	28 1/2	24	158	43	88	112	186	135	181	206	271	258	323	374	464	
16	18 1/2	33 1/2	28	138	57	118	151	249	180	242	277	363	346	433	502	623	
18	20 1/2	38	32	120	74	152	194	321	232	312	357	468	446	558	647	803	
20	22 1/2	43	34	112	94	194	249	412	297	400	457	601	572	715	829	1030	
24 1/2	28 1/2	52	42	93	138	285	365	603	436	587	670	880	838	1048	1215	1508	
28 1/2	33	60	48	80	180	374	477	789	570	767	877	1151	1096	1370	1589	1973	
Mean eff. pressure, lbs.						3.3	6.8	8.7	14.4	10.4	14.0	16	21	20	25	29	36
Ratio of expansion						13 1/2		18 1/4		10 1/4		13 3/4		6 3/4		9 1/4	
Cyl. condensation, % ..						14	14	16	16	12	12	13	13	10	10	11	11
Ter. pres. (abt.), lbs. ...						7.3	7.7	7.9	9	9.2	10.4	10.5	12	14	15.5	14.6	17.8
Loss from expanding below atmosphere, %						34	15	17	3	5	0	0	0	0	0	0	0
St. per I.H.P. hour, lbs.						55	42	47	29	33.3	27.7	28.7	25.4	30	26.2	21	20

Compound Engines — Condensing — Steam-jacketed.

Diam. Cylinder, inches.	H.P.	H.P.	L.P.	Stroke, inches.	Revolutions per Minute.	H.P. when cutting off at 1/4 Stroke in h.p. Cylinder.				H.P. when cutting off at 1/3 Stroke in h.p. Cylinder.				H.P. when cutting off at 1/2 Stroke in h.p. Cylinder.			
						Ratio, 3 1/3 : 1.		Ratio, 4 : 1.		Ratio, 3 1/3 : 1.		Ratio, 4 : 1.		Ratio, 3 1/3 : 1.		Ratio, 4 : 1.	
						80 lbs.	110 lbs.	115 lbs.	125 lbs.	80 lbs.	110 lbs.	115 lbs.	125 lbs.	80 lbs.	110 lbs.	115 lbs.	125 lbs.
6	6 1/2	12	10	370	44	59	53	62	55	70	68	75	70	97	95	106	
6 1/2	7 1/2	13 1/2	12	318	56	76	67	78	70	90	87	95	90	123	120	134	
8 1/4	9	16 1/2	14	277	83	112	100	116	104	133	129	141	133	183	179	200	
9 1/2	10 1/2	19	16	246	109	147	131	152	136	174	169	185	174	239	234	261	
11	12	22 1/2	18	222	156	210	187	218	195	250	242	265	250	343	335	374	
12 1/2	13 1/2	25	20	185	192	260	231	269	241	308	298	327	308	423	414	462	
14	15 1/2	28 1/2	24	158	258	348	310	361	323	413	400	439	413	568	555	619	
17	18 1/2	33 1/2	28	128	346	467	415	484	433	554	536	588	554	761	744	830	
19	20 1/2	38	32	120	446	602	535	624	558	714	691	758	714	981	959	1070	
21	22 1/2	43	34	112	572	772	686	801	715	915	887	972	915	1258	1230	1373	
26	28 1/2	52	42	93	838	1131	1006	1174	1048	1341	1299	1425	1341	1844	1801	2012	
30	33	60	48	80	1096	1480	1316	1534	1370	1757	1699	1863	1757	2411	2356	2632	
Mean eff. press., lbs.						20	27	24	28	25	32	31	34	32	44	43	48
Ratio of expansion						13 1/2		16 1/4		10		12 1/4		6 3/4		8 1/4	
Cyl. condensation, % ..						18	18	20	20	15	15	18	18	12	12	14	14
St. per I.H.P. hour, lbs.						17.3	16.6	16.6	15.2	17.0	16.4	16.3	15.8	17.5	17.0	16.8	16.0

Triple-expansion Engines, Non-condensing — Receiver only Jacketed.

Diameter Cylinders, inches.	H.P.	I.P.	L.P.	Stroke, inches.	Revolutions per Minute.	Horse-power when cutting off at 42% of Stroke in First Cylinder.		Horse-power when cutting off at 50% of Stroke in First Cylinder.		Horse-power when cutting off at 67% of Stroke in First Cylinder.	
						180 lbs.	200 lbs.	180 lbs.	200 lbs.	180 lbs.	200 lbs.
						180 lbs.	200 lbs.	180 lbs.	200 lbs.	180 lbs.	200 lbs.
4 3/4	7 1/2	12	10	370	55	64	70	84	95	108	
5 1/2	8 1/2	13 1/2	12	318	70	81	90	106	120	137	
6 1/2	10 1/2	16 1/2	14	277	104	121	133	158	179	204	
7 1/2	12	19	16	246	136	158	174	207	234	267	
9	14 1/2	22 1/2	18	222	195	226	250	296	335	382	
10	16	25	20	185	241	279	308	366	414	471	
11 1/2	18	28 1/2	24	158	323	374	413	490	555	632	
13	22	33 1/2	28	138	433	502	554	657	744	848	
15	24 1/2	38	32	120	558	647	714	847	959	1093	
17	27	43	34	112	715	829	915	1089	1230	1401	
20	33	52	42	93	1048	1215	1341	1592	1801	2053	
23 1/2	38	60	48	80	1370	1589	1754	2082	2356	2685	
Mean eff. press., lbs.						25	29	32	38	43	49
No. of expansions.						16		13		10	
Cyl. condensation, % ..						14		12		10	
Steam p. I.H.P.p.hr., lbs.						20.76	19.36	19.25	17.00	17.89	17.20
Lbs. coal at 8lb. evap., lbs.						2.59	2.39	2.40	2.12	2.23	2.15

WARNING: This is a 1910 edition. Some of the material may no longer be accurate

Triple-expansion Engines — Condensing — Steam-jacketed.

Diameter Cylinders, inches.			Stroke, inches.	Revolutions per Minute.	Horse-power when cutting off at 1/4 Stroke in First Cyl.			Horse-power when cutting off at 1/3 Stroke in First Cyl.			Horse-power when cutting off at 1/2 Stroke in First Cyl.			Horse-power when cutting off at 3/4 Stroke in First Cyl.		
H.P.	I.P.	L.P.			120 lbs.	140 lbs.	160 lbs.	120 lbs.	140 lbs.	160 lbs.	120 lbs.	140 lbs.	160 lbs.	120 lbs.	140 lbs.	160 lbs.
43/4	71/2	12	10	370	35	42	48	44	53	59	57	72	84	81	97	110
51/2	81/2	13 1/2	12	318	45	53	62	56	67	76	73	92	107	104	123	140
61/2	10 1/2	16 1/2	14	277	67	79	92	83	100	112	108	137	159	154	183	208
71/2	12	19	16	246	87	103	120	109	131	147	141	180	208	201	239	272
9	14 1/2	22 1/2	18	222	125	148	172	156	187	211	203	257	299	289	343	390
10	16	25	20	185	154	183	212	192	231	260	250	317	368	356	423	481
11 1/2	18	28 1/2	24	158	206	245	284	258	310	348	335	426	494	477	568	645
13	22	33 1/2	28	138	277	329	381	346	415	467	450	571	663	640	761	865
15	24 1/2	38	32	120	357	424	491	446	535	602	580	736	854	825	981	1115
17	27	43	34	112	458	543	629	572	686	772	744	944	1095	1058	1258	1430
20	33	52	42	93	670	796	922	838	1006	1131	1089	1383	1605	1551	1844	2096
23 1/2	38	60	48	80	877	1041	1206	1096	1316	1480	1424	1808	2099	2028	2411	2740
Mean eff. press., lbs....					16	19	22	20	24	27	26	33	38.3	37	44	50
No. of expansions.....					26.8			20.1			13.4			8.9		
Cyl. condensation, %...					19	19	19	16	16	16	12	12	12	8	8	8
St. p. I.H.P. p. hr., lbs..					14.7	13.9	13.3	14.3	13.9	13.2	14.3	13.6	13.0	15.7	14.9	14.7
Coal at 8 lbs. evap., lbs.					1.8	1.73	1.66	1.78	1.7	1.65	1.78	1.70	1.62	1.96	1.86	1.72

The Willans Law. Total Steam Consumption at Different Loads.
 — Mr. Willans found with his engine that when the total steam consumption at different loads was plotted as ordinates, the loads being abscissas, the result would be a straight inclined line cutting the axis of ordinates at some distance above the origin of coördinates, this distance representing the steam consumption due to cylinder condensation at zero load. This statement applies generally to throttling engines, and is known as the Willans law. It applies also approximately to automatic cut-off engines of the Corliss, and probably of other types, up to the most economical load. In Mr. Barrus's book there is a record of six tests of a 16 x 42-in. Corliss twin-cylinder non-condensing engine, which gave results as follows:

I.H.P.....	37	100	146	222	250*	287	342
Feed-water per I.H.P. hour.	73.63	38.28	31.47	25.83	25.0*	25.39	25.91
Total feed-water per hour...	2724	3825	4595	5734	6250	7287	8861

* Interpolated from the plotted curve.

The first five figures in the last line plot in a straight line whose equation is $y = 2122 + 16.55 \text{ H.P.}$, and a straight line through the plotted position of the last two figures has the equation $y = 28.62 \text{ H.P.} - 927$. These two lines cross at 253 H.P., which is the most economical load, the water rate being 24.96 lbs. and the total feed 6314 lbs. The figure 2122 represents the constant loss due to cylinder condensation, which is just over one-third of the total feed-water at the most economical load.

In Geo. H. Barrus's book on "Engine Tests" there is a diagram of condensation and leakage in tight or fairly tight simple engines using saturated steam. The average curve drawn through the several observations shows the condensation and leakage to be about as follows for different percentages of cut-off:

Cut-off, % of stroke = l	5	10	15	20	25	30	35	42
Condens. and leakage, % = p ...	60	43	35	29	24	20	17	15
$c = l \times p \div (100 - p) =$	7.5	7.5	8	8.2	7.9	7.5	7.2	7.4

The figures in the last line represent the condensation and leakage as a percentage of the volume of the stroke of the piston, that is, in the same

terms as the first line, instead of as a percentage of the total steam supplied, in which terms the figures of the second line are expressed. They indicate that the amount of cylinder condensation is nearly a constant quantity for a given engine with a given steam pressure and speed, whatever may be the point of cut-off.

Economy of Engines under Varying Loads. (From Prof. W. C. Unwin's lecture before the Society of Arts, London, 1892.) — The general result of numerous trials with large engines was that with a constant load an indicated horse-power should be obtained with a consumption of 1 1/2 lbs. of coal per I.H.P. for a condensing engine, and 1 3/4 lbs. for a non-condensing engine, corresponding to about 1 3/4 lbs. to 2 1/8 lbs. per effective H.P.

In electric-lighting stations the engines work under a very fluctuating load, and the results are far more unfavorable. An excellent Willans non-condensing engine, which on full-load trials worked with under 2 lbs. per effective H.P. hour, in the ordinary daily working of the station used 7 1/2 lbs. in 1886, which was reduced to 4.3 lbs. in 1890 and 3.8 lbs. in 1891. Probably in very few cases were the engines at electric-light stations working under a consumption of 4 1/2 lbs. per effective H.P. hour. In the case of small isolated motors working with a fluctuating load, still more extravagant results were obtained.

At electric-lighting stations the load factor, viz., the ratio of the average load to the maximum, is extremely small, and the engines worked under very unfavorable conditions, which largely accounted for the excessive fuel consumption at these stations.

In steam-engines the fuel consumption has generally been reckoned on the indicated horse-power. At full-power trials this was satisfactory enough, as the internal friction is then usually a small fraction of the total.

Experiment has, however, shown that the internal friction is nearly constant, and hence, when the engine is lightly loaded, its mechanical efficiency is greatly reduced. At full load small engines have a mechanical efficiency of 0.8 to 0.85, and large engines might reach at least 0.9, but if the internal friction remained constant this efficiency would be much reduced at low powers. Thus, if an engine working at 100 I.H.P. had an efficiency of 0.85, then when the I.H.P. fell to 50 the effective H.P. would be 35 H.P. and the efficiency only 0.7. Similarly, at 25 H.P. the effective H.P. would be 10 and the efficiency 0.4.

Experiments on a Corliss engine at Creusot gave the following results:

Effective power at full load.....	1.0	0.75	0.50	0.25	0.125
Condensing, mechanical efficiency.....	0.82	0.79	0.71	0.63	0.48
Non-condensing, mechanical efficiency.	0.86	0.83	0.78	0.67	0.52

Steam Consumption of Engines of Various Sizes. — W. C. Unwin (*Cassier's Magazine*, 1894) gives a table showing results of 49 tests of engines of different types. In non-condensing simple engines, the steam consumption ranged from 65 lbs. per hour in a 5-horse-power engine to 22 lbs. in a 134-H.P. Harris-Corliss engine. In non-condensing compound engines, the only type tested was the Willans, which ranged from 27 lbs. in a 10-H.P. slow-speed engine, 122 ft. per minute, with steam-pressure of 84 lbs., to 19.2 lbs. in a 40-H.P. engine, 401 ft. per minute, with steam-pressure 185 lbs. A Willans triple-expansion non-condensing engine, 39 H.P., 172 lbs. pressure, and 400 ft. piston speed per minute, gave a consumption of 18.5 lbs. In condensing engines, nine tests of simple engines gave results ranging only from 18.4 to 22 lbs. In compound-condensing engines over 100 H.P., in 13 tests the range is from 13.9 to 20 lbs. In three triple-expansion engines the figures are 11.7, 12.2, and 12.45 lbs., the lowest being a Sulzer engine of 360 H.P. In marine compound engines, the Fusiyama and Colchester, tested by Prof. Kennedy, gave steam consumption of 21.2 and 21.7 lbs.; and the Meteor and Tartar triple-expansion engines gave 15.0 and 19.8 lbs.

Taking the most favorable results which can be regarded as not exceptional it appears that in test trials, with constant and full load, the expenditure of steam and coal is about as follows:

Kind of Engine.	lbs. Per I.H.P. hour.		Per Effective H.P. hr.	
	Coal,	Steam,	Coal,	Steam,
Non-condensing.....	1.80	16.5	2.00	18.0
Condensing.....	1.50	13.5	1.75	15.8

WARNING: This is a 1910 edition. Some of the material may no longer be accurate

These may be regarded as minimum values, rarely surpassed by the most efficient machinery, and only reached with very good machinery in the favorable conditions of a test trial.

Small Engines and Engines with Fluctuating Loads are usually very wasteful of fuel. The following figures, illustrating their low economy, are given by Prof. Unwin, *Cassier's Magazine*, 1894. Small engines in workshops in Birmingham, Eng.

Probable I.H.P. at full load	12	45	60	45	75	60	60
Average I.H.P. during observation	2.96	7.37	8.2	8.8	23.64	19.08	20.08
Coal per I.H.P. per hour during observation, lbs.	36.0	21.25	22.61	18.13	11.68	9.53	8.50

It is largely to replace such engines as the above that power will be distributed from central stations.

Tests at Royal Agricultural Society's show at Plymouth, Eng. *Engineering*, June 27, 1890.

Rated H.P.	Compound or Simple.	Diam. of Cylinders.		Stroke, ins.	Max. Steam-pressure.	Per Brake H.P. per hour.		Water per lb. Coal.
		h.p.	i.p.			Coal.	Water.	
5	simple	7	...	10	75	12.12	78.1 lbs.	6.1 lb.
3	compound	3	6	6	110	4.87	42.03 "	8.72 "
2	simple	4 1/2	...	7 1/2	75	11.77	89.9 "	7.64 "

Steam-consumption of Engines at Various Speeds. (Profs. Denton and Jacobus, *Trans. A. S. M. E.*, x, 722.) — 17 X 30 in. engine, non-condensing, fixed cut-off, Meyer valve. (From plotted diagrams.)

Revs. per min.	8	12	16	20	24	32	40	48	56	72	88
1/8 cut-off, lbs.	39	35	32	30	29.3	29	28.7	28.5	28.3	28	27.7
1/4 cut-off, lbs.	39	34	31	29.5	29	28.4	28	27.5	27.1	26.3	25.6
1/2 cut-off, lbs.	39	36	34	33	32	30.8	29.8	29.2	28.8	28.7	...

Steam-consumption of same engine; fixed speed, 60 revs. per minute. Varying cut-off compared with throttling-engine for same horse-power and boiler-pressures:

Cut-off, fraction of stroke	0.1	0.15	0.2	0.25	0.3	0.4	0.5	0.6	0.7	0.8
Steam, 90 lbs.	29	27.5	27	27	27.2	27.8	28.5
Steam, 60 lbs.	39	34.2	32.2	31.5	31.4	31.6	32.2	34.1	36.5	39

Throttling-engine, 7/8 cut-off, for corresponding horse-powers.

Steam, 90 lbs.	42	37	33.8	31.5	29.8
Steam, 60 lbs.	...	50.1	49	46.8	44.6	41

Some of the principal conclusions from this series of tests are as follows:

1. There is a distinct gain in economy of steam as the speed increases for 1/2, 1/8, and 1/4 cut-off at 90 lbs. pressure. The loss in economy for about 1/4 cut-off is at the rate of 1/12 lb. of water per I.H.P. per hour for each decrease of a revolution per minute from 86 to 26 revolutions, and at the rate of 5/8 lb. of water below 26 revolutions. Also, at all speeds the 1/4 cut-off is more economical than either the 1/2 or 1/8 cut-off.

2. At 90 lbs. boiler-pressure and above 1/3 cut-off, to produce a given H.P. requires about 20% less steam than to cut off at 7/8 stroke and regulate by the throttle.

3. For the same conditions with 60 lbs. boiler-pressure, to obtain, by throttling, the same mean effective pressure at 7/8 cut-off that is obtained by cutting off about 1/3, requires about 30% more steam than for the latter condition.

Capacity and Economy of Steam Fire Engines. (*Eng. News*, Mar. 28, 1895.) — The tests were made by Dexter Brackett for the Board of Fire Commissioners, Boston, Mass.

No. of engine.	Boiler heating Surface.	Coal per sq. ft. of grate, per hour.	Water evap. per lb. coal, from and at 2 1/2°.	Av. steam pressure.	Av. water pressure.	Duty, ft.-lbs. per 100 lbs. of coal.	Av. water pumped per min.
		lbs.	lbs.	lbs.	lbs.		galls.
1	101.0	191.0	2.26	90.2	143.2	7,619,800	549
1		184.0		92.3	124.0	9,632,700	499
2	85.0	191.0	2.66	78.4	123.3	5,900,000	535
3	74.0	141.6	3.57	75.7	113.8	5,882,000	482
4	86.5	138.4	2.88	71.5	136.4	8,112,900	456
5	86.0	163.7		102.7	121.2	8,736,300	449
5		103.3	5.87	72.1	119.6	14,026,000	545
6	86.0	181.6	3.45	92.7	143.0	9,678,400	536
7	112.0	117.3	4.94	68.8	119.2	10,201,600	596
8	140.5	172.1	3.51	101.3	112.6	7,758,300	910
9	174.0	142.5	4.49	76.5	111.5	7,187,400	482
10	225.0	91.1	4.22	59.0	102.1	6,482,100	419
10		151.4	4.10	87.8	126.8	7,993,400	564
11	229.0	148.4	3.76	74.7	128.1	7,265,000	572

Nos. 1, 2, 3 and 4, Amoskeag engines; Nos. 5, 6, 7 and 8, Clapp & Jones; Nos. 9, 10, 11, Silsby. The engines all show an exceedingly high rate of combustion, and correspondingly low boiler efficiency and pump duty.

Economy Tests of High-speed Engines. (F. W. Dean and A. C. Wood, *Jour. A. S. M. E.*, June, 1908.) — Some of these engines had been in service for a long time, and therefore their valves may not have been in the best condition. The results may be taken as fairly representing the economy of average engines of the type, under usual working conditions. The engines were all non-condensing. The 16 X 15-in. engine was vertical, the others horizontal. They were all direct-connected to generators.

No. of Test.	1	2	3	4
Size of engine, ins.	15 X 14	16 X 15	14 X 12	16 X 14
Hours in service	15,216	20,000	28,644	719
Revs. per min.	240	240	300	270
Valves	1 flat	1 flat	1 flat	4 flat
Generator, K.W.	100	2-50	2-40	125
Steam per I.H.P.-hr.	37.2, † 36.2*	36.7, † 35.8	31.7, † 32.0	37.5,* 36.7
Steam per K.W.-hr.	60.2, † 58.4	61.0, † 59.7	57.1, † 57.4	54.9, † 54.7

No. of Test.	5	6	7
Size of engine, ins.	18 X 18	15 X 16	12 X 18
Hours in service	32,000	5,600	10,800
Revs. per min.	220	250	190
Valves	1 piston	1 piston	{ 2 flat inlet 2 Corliss exh.
Generator, K.W.	150	100	75
Steam per I.H.P.-hr.	39.8, † 34.7,* 29.5 †	36.3,* 33.6	44.0, † 36.7, 34.1 †
Steam per K.W.-hr.	61.8, † 51.8, 43.4	55.2, † 49.4	79.3, † 60.5, 53.7

* 3/4 load; † 1/2 load; ‡ 1 1/4 load; § 1 1/2 load; the others full load.

Some of the conclusions of the authors from the results of these tests are as follows:

The performances of the perfectly balanced flat valve engines are so relatively poor as to disqualify them, unless this type of valve can be made with some mechanism by which wear will not increase leakage. The four valve engines, which were built to be more economical than single-valve

engines, have utterly failed in their object. The duplication of valves used in both four-valve engines simply increased the opportunity for leakage. The most economical result was obtained from a piston valve engine, No. 5, heavily loaded. With the lighter loads that are comparable the flat valve engine, No. 3, surpassed No. 5 in economy. The flat valve engines give a flatter load curve than the piston valve engines. Comparing the results of the flat valve engines, the most economical results were obtained from engine No. 3, which had a valve which automatically takes up wear, and if it does not cut, must maintain itself tight for long periods.

From the results we are justified in thinking that most high-speed engines rapidly deteriorate in economy. On the contrary, slower running Corliss or gridiron valve engines improve in economy for some time and then maintain the economy for many years. It is difficult to see that the speed is the cause of this, and it must depend on the nature of the valve.

The steam consumption of small single-valve high-speed engines non-condensing, is not often less than 30 lbs. per I.H.P. per hour. Two Watertown engines, 10 X 12 tested by J. W. Hill for the Philadelphia Dept. of Public Works in 1904, gave respectively 30.67 and 29.70 lbs. at full load, 61.8 and 63.9 I.H.P., and 28.87 and 29.54 lbs. at approximately half-load, 37.63 and 36.36 I.H.P.

High Piston-speed in Engines. (*Proc. Inst. M. E.*, July, 1883, p. 321.) — The torpedo boat is an excellent example of the advance towards high speeds, and shows what can be accomplished by studying lightness and strength in combination. In running at 22 1/2 knots an hour, an engine with cylinders of 16 in. stroke will make 480 revolutions per minute, which gives 1280 ft. per minute for piston-speed; and it is remarked that engines running at that high rate work much more smoothly than at lower speeds, and that the difficulty of lubrication diminishes as the speed increases.

A High-speed Corliss Engine. — A Corliss engine, 20 X 42 in., has been running a wire-rod mill at the Trenton Iron Co.'s works since 1877, at 160 revolutions or 1120 ft. piston-speed per minute (*Trans. A. S. M. E.*, ii, 72). A piston-speed of 1200 ft. per min. has been realized in locomotive practice.

The Limitation of Engine-speed. (Chas. T. Porter, in a paper on the Limitation of Engine-speed, *Trans. A. S. M. E.*, xiv, 806.) — The practical limitation to high rotative speed in stationary reciprocating steam-engines is not found in the danger of heating or of excessive wear, nor, as is generally believed, in the centrifugal force of the fly-wheel, nor in the tendency to knock in the centers, nor in vibration. He gives two objections to very high speeds: First, that "engines ought not to be run as fast as they can be;" second, the large amount of waste room in the port, which is required for proper steam distribution. In the important respect of economy of steam, the high-speed engine has thus far proved a failure. Large gain was looked for from high speed, because the loss by condensation on a given surface would be divided into a greater weight of steam, but this expectation has not been realized. For this unsatisfactory result we have to lay the blame chiefly on the excessive amount of waste room. The ordinary method of expressing the amount of waste room in the percentage added by it to the total piston displacement, is a misleading one. It should be expressed as the percentage which it adds to the length of steam admission. For example, if the steam is cut off at 1/5 of the stroke, 8% added by the waste room to the total piston displacement means 40% added to the volume of steam admitted. Engines of four, five and six feet stroke may properly be run at from 700 to 800 ft. of piston travel per minute, but for ordinary sizes, says Mr. Porter, 600 ft. per minute should be the limit.

British High-speed Engines. (John Davidson, *Power*, Feb. 9, 1909.) — The following figures show the general practice of leading builders:

I.H.P.	50	100	200	500	750	1000	1500	2000
Revs. per min.	600-700	550-600	500	350-375	325	250	200	160-180
Piston speed, ft. per min.	600	650	675	750	775	800	900	1000

Rapid strides have been made during the last few years, despite the

competition of the steam turbine. The single-acting type (Brotherhood, Willans and others) has been superseded by double-acting engines with forced lubrication. There is less wear in a high-speed than in a low-speed engine. A 500-H.P. 3-crank engine after running 7 years, 12 hours per day and 300 days per year, showed the greatest wear to be as follows: crank pins, 0.003 in.; main bearings, 0.003 in.; eccentric sheaves, 0.015 in.; crosshead pins, 0.005 in. All pins, where possible, are of steel, case-hardened. High-speed engines have at least as high economy and efficiency as any other type of engine manufactured. A triple-expansion mill engine, with steam at 175 lbs., vacuum 26 ins., superheat 100° F., gave results as shown below, [figures taken from curves in the original].

Fraction of full load.....	0.1	0.2	0.3	0.4	0.5	0.6	0.7	0.8	0.9	1.0
Lbs. steam per I.H.P. hour..	12.7	11.85	11.4	11.1	10.9	10.8	10.75	10.75	10.8	11.0
Lbs. steam per B.H.P. hour..	16.0	14.8	13.7	12.9	12.4	12.05	11.85	11.8	11.8	11.8

Owing to the forced lubrication and throttle-governing, the economical performance at light loads is relatively much better than in slow-speed engines. The piston valves render the use of superheat practicable. At 200° superheat the saving in steam consumption of a triple-expansion engine is 26%. [A curve of the relation of superheat to saving shows that the percentage of saving is almost uniformly 1.4% for each additional 10° from 0° to 160° of superheat.]

The method of governing small high-speed engines is by means of a plain centrifugal governor fixed to the crank shaft and acting directly on a throttle. Several makers use a governor which at light loads acts by throttling, and at heavy loads by altering the expansion in the high-pressure cylinder. The crank-shaft governor used in America has been found impracticable for high speeds, except perhaps for small engines.

Advantage of High Initial and Low Back Pressure. — The theoretical advantage due to the use of low back pressures or high vacua is shown by the following table, in which the efficiencies are those of the Carnot cycle, $E = (T_1 - T_2) / T_1$. With 100 lbs. absolute initial pressure the efficiency is increased from 0.270 to 0.353, or 30.7%, by raising the vacuum from 27.02 to 29.56 ins. of mercury, and with 200 lbs. it is increased from 0.317 to 0.394, or 24.3%, with the same change in the vacuum.

Abs. Initial Pressure.			100	125	150	175	200	225	250	275	300
Temp. ° F.	Vacuum, In. of Mercury.	Lbs. per Sq. In.	Carnot Efficiencies.								
115	27.02	1.47	0.270	.285	.298	.308	.317	.325	.332	.339	.345
108	27.48	1.20	0.279	.293	.306	.316	.325	.333	.341	.347	.353
100	28.00	0.95	0.289	.303	.316	.325	.335	.343	.350	.356	.362
90	28.50	0.70	0.302	.316	.328	.338	.347	.355	.361	.368	.373
70	29.18	0.74	0.327	.341	.353	.362	.371	.378	.385	.391	.396
50	29.56	0.36	0.353	.366	.377	.386	.394	.402	.408	.414	.419

The same table shows the advantage of high initial pressure. Thus with a vacuum 27.02 ins. the efficiency is increased from 0.270 to 0.317, or 17.4%, by raising the initial absolute-pressure from 100 to 200 lbs., and with a vacuum of 28.5 ins. the efficiency is increased from 0.302 to 0.347, or 14.9%, by the same rise of pressure. In practice the efficiencies given in the table for the given pressures and temperatures cannot be reached on account of imperfections of the steam-engine, and the fact that the engine does not work on the ideal Carnot cycle. The relative advantages, however, are probably proportional to those indicated by the table, provided the expansion is divided into two or more stages at pressures above

100 lbs. The possibility of obtaining very high vacua is limited by the temperature of the condensing water available and by the imperfections of the air pump. The use of high initial pressures is limited by the safe working pressure of the boiler and engine.

Comparison of the Economy of Compound and Single-cylinder Corliss Condensing Engines, each expanding about Sixteen Times. (D. S. Jacobus, *Trans., A. S. M. E.*, xii, 943.)

The engines used in obtaining comparative results are located at Stations I and II of the Pawtucket Water Co.

The tests show that the compound engine is about 30% more economical than the single-cylinder engine. The dimensions of the two engines are as follows: Single 20 X 48 ins.; compound 15 and 30 1/8 X 30 ins. The steam used per I.H.P. hour was: single 20.35 lbs., compound 13.73 lbs.

Both of the engines are steam-jacketed, practically on the barrels only, with steam at full boiler-pressure, viz., single 106.3 lbs., compound 127.5 lbs.

The steam-pressure in the case of the compound engine is 127 lbs., or 21 lbs. higher than for the single engine. If the steam-pressure be raised this amount in the case of the single engine, and the indicator-cards be increased accordingly, the consumption for the single-cylinder engine would be 19.97 lbs. per hour per horse-power.

Two-cylinder vs. Three-cylinder Compound Engine. — A Wheelock triple-expansion engine, built for the Merrick Thread Co., Holyoke, Mass., is constructed so that the intermediate cylinder may be cut out of the circuit and the high-pressure and low-pressure cylinders run as a two-cylinder compound, using the same conditions of initial steam-pressure and load. The diameters of the cylinders are 12, 16, and 24 13/32 ins., the stroke of the first two being 36 ins. and that of the low-pressure cylinder 48 ins. The results of a test reported by S. M. Green and G. I. Rockwood, *Trans. A. S. M. E.*, vol. xiii, 847, are as follows: In lbs. of dry steam used per I.H.P. per hour, 12 and 24 13/32 in. cylinders only used, two tests 13.06 and 12.76 lbs., average 12.91. All three cylinders used, two tests 12.67 and 12.90 lbs., average 12.79. The difference is only 1%, and would indicate that more than two cylinders are unnecessary in a compound engine, but it is pointed out by Prof. Jacobus, that the conditions of the test were especially favorable for the two-cylinder engine, and not relatively so favorable for the three cylinders. The steam-pressure was 142 lbs. and the number of expansions about 25. (See also discussion on the Rockwood type of engine, *Trans. A. S. M. E.*, vol. xvi.)

Economy of a Compound Engine. (D. S. Jacobus, *Trans. A. S. M. E.*, 1903.) — A Rice & Sargent engine, 20 and 40 X 42 ins., was tested with steam about 149 lbs., vacuum 27.3 to 28.8 ins. or 0.82 to 1.16 lbs. absolute, r.p.m. 120 to 122, with results as follows:

I.H.P.	100	853	820	627	491	340
Water per I.H.P. per hr.	12.75	12.37	12.55	12.10	13.92	14.58
B.T.U. per I.H.P. per min.	231.8	226.3	229.9	222.7	256.8	267.7

The Lentz Compound Engine is described in *The Engineer* (London), July 10, 1908. It is the latest development of the reciprocating engine with four double-seated poppet valves to each cylinder, each valve operated by a separate eccentric mounted on a lay-shaft driven by bevel-gearing from the main shaft. The throw of the high-pressure steam eccentrics is varied by slide-blocks which are caused to slide along the lay-shaft by the action of a centrifugal inertia governor, which is also mounted on the lay-shaft. No elastic packing is used in the engine, the piston-rod stuffing box being fitted with ground cast-iron rings, and the valve stems being provided with grooves and ground to fit long bushings to 0.001 in. Two tests of a Lentz engine built in England, 14 1/2 and 24 3/4 by 27 1/2 in., gave results as follows:

Saturated steam, 170 lbs., vacuum 26 in., I.H.P. 366, steam per I.H.P. per hour 12.3 lbs. Steam 170 lbs. superheated 150° F., vac. 26 in., I.H.P. 366, steam per I.H.P. per hour, 10.4 lbs. Revs. per min. in both cases, 167. Piston speed 767 ft. per min. Engines are built for speeds up to 900 ft. per min., and up to 350 r.p.m.

The Lentz engine is built in the United States by the Erie City Iron Works.

Steam Consumption of Sulzer Compound and Triple-expansion Engines with Superheated Steam.

The figures in the table below were furnished to the author (Aug., 1902) by Sulzer Bros., Winterthur, Switzerland. They are the results of official tests by Prof. Schröter of Munich, Prof. Weber of Zurich, and other eminent engineers.

COMPOUND ENGINES.

Normal Power, I.H.P.	Dimensions of Cylinders, Inches.	Revolutions per Minute.	Initial Pressure, Pounds.	Temp. of Steam, Deg. F.	Vacuum, Inches.	I.H.P.	Steam Cons. per I.H.P. Hour, Pounds.
1500 to 1800	30.5 and 49.2 X 59.1	85	130	356	26.4	850	13.30
			132	428	26.4	842	12.05
			122	482	26.6	1719	12.42
800 to 1000	24 and 40.4 X 51.2	83	136	357	28	481	13.00
			134	356	28	750	13.10
			135	356	27.6	1078	14.10
			135	547	28	515	11.32
			135	533	27.8	788	11.52
950 to 1150	26 and 42.3 X 51.2	86	130	358	28.2	1076	14.10
			129	358	28	1316	14.50
			132	496	28.3	1071	11.73
			136	527	1021	15.37
400 to 500	17.7 and 30.5 X 35.4	110	135	577	26.4	519	10.80*
			135	554	26.4	347	10.35*
1000 to 1200	26.9 and 47.2 X 66.9	65	127	655	27.2	788	9.91*
			127	664	27.2	797	9.68*
			128	572	27.1	788	10.70*

TRIPLE-EXPANSION ENGINES.

3000	32 1/4, 47 1/4, 58 X 59	85	188	606	28	2860	8.97
			190	397	27 1/4	2880	11.28
3000	34, 49, 61 X 51	83.5	189	613	27	2908	9.41
			196	381	26 1/4	3040	11.57

* With intermediate superheating. Temperature of steam at entrance to l.p. cylinder, 307 to 349° F.

Steam Consumption of Different Types of Engines.

Tests of a Ridgway 4-valve non-condensing engine, 19 X 18 in., at 200 r.p.m. and 100 lbs. pressure, are reported in *Power*, June, 1909, as follows:

Load.....	1/4	1/2	3/4	Full	11/4
Steam per I.H.P. hour.....	30.7	24.4	23.2	23.8	25.4

The best result obtained at 130 lbs. pressure was 21.6 lbs., at 115 lbs. pressure 22.6 lbs., and at 85 lbs. pressure 24.3 lbs. Maintained economy

in this type of engine is dependent upon reduction of unnecessary over-travel, properly fitted valves, valves which do not span a wide arc, close approach of the movement of the valves to that of a Corliss engine, and good materials.

The probable steam consumption of condensing engines of different types with different pressures of steam is given in a set of curves by R. H. Thurston and L. L. Brinsmade, *Trans. A. S. M. E.*, 1897, from which curves the following approximate figures are derived.

	Steam pressure, absolute, lbs. per sq. in.							
	400	300	250	200	150	100	75	50
Ideal Engine (Rankine cycle)	6.95	7.5	7.9	8.45	9.20	10.50	11.40	12.9
Quadruple Exp. Wastes 20%	8.75	9.15	9.75	10.50	11.60	13.0	14.0	15.6
Triple Exp. Wastes 25%	9.25	9.95	10.50	11.15	12.30	14.0	15.1	16.7
Compound. Wastes 33%	10.50	11.25	11.80	12.70	13.90	15.6	16.9	18.9
Simple Engine. Wastes 50%	14.00	15.00	15.80	16.80	18.40	20.4	22.7	25.2

The same authors give the records of tests of a three-cylinder engine at Cornell University, cylinders 9, 16 and 24 ins., 36-in. stroke, first as a triple-expansion engine; second, with the intermediate cylinder omitted, making a compound engine with a cylinder ratio of 7 to 1; and third, omitting the third cylinder, making a compound engine with a ratio of a little over 3 to 1. The boiler pressure in the first case was 119 lbs., in the second 115, and in the third 117 lbs. Charts are given showing the steam consumption per I.H.P. and per B.H.P. at different loads, from which the following figures are taken.

Indicated Horse-Power	40	60	80	100	110	120	130
Steam consumption per I.H.P. per hour.							
Triple Exp.	19.1	16.7	15.3	14.2	13.7	13.8	14.4
Comp. 7 to 1	19.6	18.2	17.0	16.3	16.	15.8	15.8
Comp. 3 to 1	19.7	18.4	18.1	18.5
Steam consumption per B.H.P. hour.							
Triple Exp.	30.5	23.0	19.6	17.1	16.2	16.2	16.7
Comp. 7 to 1	26.2	21.7	19.3	18.7	18.5	18.4	18.5
Comp. 3 to 1	23.4	20.6	20.	20.

The most economical performance was as follows:

	Triple	Comp. 7 to 1	Comp. 3 to 1
Indicated Horse-Power	112.7	130.0	67.7
Steam per I.H.P. hour	13.68	15.8	18.03

A test of a 7500-H.P. engine, at the 59th St. Station of the Interborough Rapid Transit Co., New York, is reported in *Power*, Feb., 1906. It is a double cross compound engine, with horizontal h.p. and vertical l.p. cylinders. With steam at 175 lbs. gauge and vacuum 25.02 ins., 75 r.p.m. it developed 7365 I.H.P., 5079 K.W. at switchboard. Friction and electrical losses 417.3 K.W. Dry steam per K.W. hour 17.34 lbs.; per I.H.P. hour, 11.96 lbs.

A test of a Fleming 4-valve engine, 15 and 40.5 in. diam., 27-in. stroke, positive-driven Corliss valves, fly-wheel governor, is reported by B. T. Allen in *Trans. A. S. M. E.*, 1903. The following results were obtained. The speed was above 150 r.p.m. and the vacuum 26 in.

	1/10	5/8	7/10	Full load	1.1
Fraction of full load about	87.1	321.5	348.3	501.6	553.5
Horse-power	14.42	13.59	12.33	12.66	12.7
Steam per I.H.P. hour					

Relative Economy of Compound Non-condensing Engines under Variable Loads. — F. M. Rites, in a paper on the Steam Distribution in a Form of Single-acting Engine (*Trans. A. S. M. E.*, xliii, 537), discusses an engine designed to meet the following problem: Given an extreme range of conditions as to load or steam-pressure, either or both, to fluctuate together or apart, violently or with easy gradations, to construct an engine whose economical performance should be as good as though the engine were specially designed for a momentary condition — the adjustment to be complete and automatic. In the ordinary non-condensing compound engine with light loads the high-pressure cylinder is frequently forced to supply all the power and in addition drag along with it the low-pressure piston, whose cylinder indicates negative work. Mr. Rites shows the peculiar value of a receiver of predetermined volume which acts as a clearance chamber for compression in the high-pressure cylinder. The Westinghouse compound single-acting engine is designed upon this principle. The following results of tests of one of these engines rated at 175 H.P. for most economical load are given:

WATER RATES UNDER VARYING LOADS, LBS. PER H.P. PER HOUR.

Horse-power	210	170	140	115	100	80	50
Non-condensing	22.6	21.9	22.2	22.2	22.4	24.6	28.8
Condensing	18.4	18.1	18.2	18.2	18.3	18.3	20.4

Efficiency of Non-condensing Compound Engines. (W. Lee Church, *Am. Mach.*, Nov. 19, 1891.) — The compound engine, non-condensing, at its best performance will exhaust from the low-pressure cylinder at a pressure 2 to 6 pounds above atmosphere. Such an engine will be limited in its economy to a very short range of power, for the reason that its valve-motion will not permit of any great increase beyond its rated power, and any material decrease below its rated power at once brings the expansion curve in the low-pressure cylinder below atmosphere. In other words, decrease of load tells upon the compound engine somewhat sooner, and much more severely, than upon the non-compound engine. The loss commences the moment the expansion line crosses a line parallel to the atmospheric line, and at a distance above it representing the mean effective pressure necessary to carry the frictional load of the engine. When expansion falls to this point the low-pressure cylinder becomes an air-pump over more or less of its stroke, the power to drive which must come from the high-pressure cylinder alone. Under the light loads common in many industries the low-pressure cylinder is thus a positive resistance for the greater portion of its stroke. A careful study of this problem revealed the functions of a fixed intermediate clearance, always in communication with the high-pressure cylinder, and having a volume bearing the same ratio to that of the high-pressure cylinder that the high-pressure cylinder bears to the low-pressure. Engines laid down on these lines have fully confirmed the judgment of the designers. The effect of this constant clearance is to supply sufficient steam to the low-pressure cylinder under light loads to hold its expansion curve up to atmosphere, and at the same time leave a sufficient clearance volume in the high-pressure cylinder to permit of governing the engine on its compression under light loads.

Tests of two non-condensing Corliss engines by G. H. Barrus are reported in *Power*, April 27, 1909. The engines were built by Rice & Sargent. One is a simple engine 22 x 30, and the other a tandem compound 22 and 36 x 36 ins. Both engines are jacketed in both heads, and the compound engine has a reheating receiver with 0.6 sq. ft. of brass pipes per rated H.P. (600). The guarantees were: compound engine, not to exceed 19 lbs. of steam per I.H.P. per hour, with 130 lbs. steam pressure and 1 lb. back pressure in the exhaust pipe, and the simple engine not to exceed 23 lbs. The friction load, engine run with the brushes off the generator and the field not excited, was not to exceed 4 1/2 H.P. in either engine. The results were: compound engine, 99.2 r.p.m.; 608.3 H.P.; 18.33 lbs. steam per I.H.P. per hour; friction load 3.8% of 600 H.P.; simple engine, 98.5 r.p.m.; 306.2 I.H.P.; 20.98 lbs. per I.H.P. per hour; friction 3.6% of 300 H.P.

A single-cylinder engine 12 X 12 ins., made by the Buffalo Forge Co., was tested by Profs. Reeve and Allen. *El. World*, May 23, 1903. Some of the results were:

I.H.P.....	16.39	37.20	56.00	69.00	74.10	81.4	89.3	125.9*	86.42†
Water-rate	52.3	35.3	33.3	31.9	30.6	34.6	33.1	27.6	27.5

* Steam pressure 125 lbs. gauge, all the other tests 80 lbs. † Condensing, other tests all non-condensing.

Effect of Water contained in Steam on the Efficiency of the Steam-engine. (From a lecture by Walter C. Kerr, before the Franklin Institute, 1891.) — Standard writers make little mention of the effect of entrained moisture on the expansive properties of steam, but by common consent rather than any demonstration they seem to agree that moisture produces an ill effect simply proportional to the percentage amount of its presence. That is, 5% moisture will increase the water rate of an engine 5%.

Experiments reported in 1893 by R. C. Carpenter and L. S. Marks, *Trans. A. S. M. E.*, xv, in which water in varying quantity was introduced into the steam-pipe, causing the quality of the steam to range from 99% to 58% dry, showed that throughout the range of qualities used the consumption of dry steam per indicated horse-power per hour remains practically constant, and indicated that the water was an inert quantity, doing neither good nor harm.

Influence of Vacuum and Superheat on Steam Consumption. (*Eng. Digest*, Mar., 1909.) — Herr Roginsky ("Die Turbine") discusses the economies effected by the use of superheat and high vacuums.

In a certain triple-expansion engine, working under good average conditions, there was found a saving of approximately 6% for each 10% increase in vacuum beyond 50%.

The Batulli-Tumlirz formula for superheated steam is: $p(v+a) = RT$, in which p = steam pressure in kgs. per sq. meter, v = cubic meters in 1 kg. of superheated steam at pressure p , a = 0.0084, R = 46.7, and T = absolute temperature in deg. C.

Using this expression, it is found that, neglecting the fuel used for superheating, for each 10° C. of superheat at pressures ranging from 100 to 185 lbs. per sq. in. there is an average increase of volume of 2.8%. The work done by the expansion of superheated steam, as shown by diagrams, is about 1.6% less for 10° of superheating, so that the net saving for each 10° of superheat is 2.8 - 1.6 = 1.2%, approx. (0.66% for each 10° F.).

Rateau's formula for the steam consumption (K) per H.P.-hr. of an ideal steam turbine, in which the steam expands from pressure p_1 to p_2 , is

$$K = 0.85 (6.95 - 0.92 \log p_2) / (\log p_1 - \log p_2),$$

K being in kilograms and p_1 and p_2 in kgs. per sq. meter. From this formula the following table is calculated, the values being transformed into British units.

p_1 Lbs. per sq. in.	Lbs. Steam at 50% Vacuum.	Reduction of Steam Consumption (%) by using a Vacuum of				
		60%	70%	80%	90%	95%
184.9	11.11	5.	11.1	18.1	27.8	34.6
156.5	11.75	5.8	11.8	19.3	28.8	36.4
128	12.57	6.6	12.9	20.5	30.8	38.5
99.6	13.84	7.6	14.4	22.	33.3	40.6

From the entropy diagram it is seen that in expanding from pressures in excess of 100 lbs. per sq. in. down to 1.42 lbs. absolute, approximately 1% more work is performed for every 10° F. of superheat. The effect of increasing the degree of vacuum is summed up in the following table:

Increasing the Vacuum from	Decreases Steam Consumption	
	in Reciprocating Engines.	in Steam Turbines.
50% to 60%	5.8%	6.2%
50% to 70%	11.6%	12.6%
50% to 80%	17.3%	20.0%
50% to 90%	23.1%	30.1%
50% to 95%	26.0%	37.4%

In the last case (from 50% to 95%) the decrease in steam consumption is 44% greater for a steam turbine than for a reciprocating engine.

The following results of tests of a compound engine using superheated steam are reported in *Power*, Aug., 1905. The cylinders were 21 and 36 X 36 ins. The steam pressure was about 117 lbs. gauge. R.p.m. 100, vacuum 26.5 ins.

Test No.....	1	2	3	4	5	6
Indicated H.P.....	481	461	347	145	333	258
Superheat of steam entering h.p. cyl. ...	253° F.	242°	221°	202°	232°	210°
B.T.U. supplied per I.H.P. per min. ...	198.2	201.7	197.6	192.1	194.0	194.0
B.T.U. theoretically required, Rankine cycle.....	142.4	142.5	130.2	128.0	126.0	128.5
Efficiency ratio.....	0.72	0.71	0.66	0.67	0.65	0.66
Thermal efficiency %	21.39	21.02	21.46	22.07	21.86	21.86
Lbs. steam per I.H.P. hour.....	9.098	9.267	8.886	8.585	8.682	8.742

The Practical Application of Superheated Steam is discussed in a paper by G. A. Hutchinson in *Trans. A. S. M. E.*, 1901. Many different forms of superheater are illustrated.

Some results of tests on a 3000-H.P., four-cylinder, vertical, triple-expansion Sulzer engine, using steam from Schmidt independently fired superheaters, are as follows. (*Eng. Rec.*, Oct. 13, 1900.)

Tests Using Steam.	Highly Superheated.			Mod- erately Super- heated	Saturated.	
	187.3	195.5	188.4	190.3	194.6	195.9
Initial pressure in h.p. cyl. (absolute), lbs.....	187.3	195.5	188.4	190.3	194.6	195.9
Temp. of steam in valve chest, deg. F.....	582	585	614	531	381	381
Total I.H.P.....	2,900	2,779	2,868	2,850	2,951	2,999
Lbs. steam per I.H.P. hour	9.64	9.67	9.56	10.29	11.77	11.75
Watt hours per lb. of coal.	477	482	479	447	438	435

The saving due to the use of highly superheated steam is (482-438) + 482 = 9.1%.

Tests of a 4000-H.P. double-compound engine (Van den Kerchove, of Brussels) with superheated steam are reported in *Power*, Dec. 29, 1908. The cylinders are 34 1/4 and 60 ins., stroke 5 ft. Ratio of areas 2.97. The following are the principal results, the first figures given being for the full-load test, and the second (in parentheses) for the half-load test. Steam

pressure at drier, 136.5 lbs. (137.9). R.p.m. 84.3 (84.06). Temp. of steam entering engine 519° F. (498), leaving l.p. cyl. 121.5° (121.5). Vacuum in condenser, ins., 27.5 (27). I.H.P. 3776 (2019). Steam per I.H.P. hour, lbs., 9.62 (9.80).

The saving due to the use of superheated steam is reported in numerous tests as being all the way from less than 10% to more than 40%. The greater saving is usually found with engines that are the most inefficient with saturated steam, such as single-cylinder engines with light loads, in which the cylinder condensation is excessive.

R. P. Bolton (*Eng. Mag.*, May, 1907) states that tests of superheated steam in locomotives, by the Prussian Railway authorities in 1904, with 50°, 104° and 158° F. superheat, showed a saving of water respectively of 2.5, 10 and 16%, and a saving of coal of 2, 7 and 12%. Mr. Bolton's paper concludes with a long list of references on the subject of superheated steam. A paper by J. R. Bibbins in *Elec. Jour.*, March, 1906, gives a series of charts showing the saving made by different degrees of superheating in different types of engines, including steam turbines.

For description of the Foster superheater, see catalogue of the Power Specialty Co., New York.

The Wolf (French) semi-portable compound engine of 40 H.P. with superheater and reheater, the engine being mounted on the boiler, is reported by R. E. Mathot, *Power*, July, 1906, to have given a steam consumption as low as 9.9 lbs. per I.H.P. hour, and 10.98 lbs. per B.H.P. hour. The steam pressure in the boiler was 172.6 lbs., and was superheated initially to 657° F., and reheated to 361° before entering the l.p. cylinder. This is a remarkable record for a small engine.

A test of a Rice & Sargent cross-compound horizontal engine 16 and 28 X 42 ins., with superheated steam, is reported by D. S. Jacobus in *Trans. A. S. M. E.*, 1904. The steam pressure at the throttle was 140 lbs. gauge, the superheating was 350 to 400°, and the vacuum 25 to 26 ins., r.p.m. 102. In three tests with superheated and one with saturated steam the results were:

I.H.P. developed	474.5	420.4	276.8	406.7
Water consumption per I.H.P. hour	9.76	9.56	9.70	13.84
Coal consumption per I.H.P. hour	1.265	1.257	1.288	1.497
B.T.U. per min. per I.H.P.	205.0	203.7	208.8	248.2
Temp. of steam entering h.p. cyl.	634	659	672	
Temp. of steam leaving h.p. cyl.	346	331	288	262
Temp. of steam entering l.p. cyl.	408	396	354	269
Temp. of steam leaving l.p. cyl.	135	141	117	

Performance of a Quadruple Engine.—O. P. Hood (*Trans. A. S. M. E.*, 1906) describes a test of a high-duty air compressor, with four steam cylinders, 14.5, 22, 38 and 54 in. diam., 48-in. stroke. The clearances were respectively 6, 5.7, 4.4 and 3.5%. R.p.m. 57. Steam pressure, gauge, near throttle, 242.8 lbs., in 1st receiver 120.7 lbs., in 2d, 30.8 lbs., in 3d, vac. — 1.24 ins. Moisture in steam near throttle, 5.74%. Steam in No. 1 receiver, dry; in No. 2, 17° superheat; in No. 3, 9° superheat. The engine has poppet valves on the h.p. cylinder and Corliss valves on the other cylinders. The feed-water heaters are four in number, in series, on the Nordberg system; No. 1 receives its steam from the exhaust of No. 4 cylinder; No. 2 from the jacket of No. 4 cyl.; No. 3 from the jackets of No. 3 cylinder and No. 3 reheater; No. 4 from the jacket of No. 2 cylinder. The reheaters are supplied with steam from the boilers. The temperatures of steam and water were as follows: Temperatures of steam: Fed to No. 1 engine, 403°; leaving receivers, No. 1, 351°; No. 2, 291°; No. 3, 216°. Exhaust entering preheater, 114°. Temperature corresponding to condenser pressure, 109.6°. Temperatures of water: Fed to preheater, 93°; fed to heaters, No. 1, 114°; No. 2, 173°; No. 3, 202°; No. 4, 269°; leaving heater No. 4 as boiler feed, 334°. Mr. Hood gives a diagram showing graphically the transfer of heat through the several parts of the apparatus, from which the following is taken. The figures are in B.T.U. transferred per minute.

	Received from Boiler or Receiv'rs.	Received from Jackets.	Converted into Work.	Delivered to Heater.	Delivered to Jackets.
No. 1 Cylinder.....	194,183	862	7,697		
No. 1 Receiver.....	187,348	6,624		17,100	2,000
No. 2 Cylinder.....	174,872	2,000	10,899		
No. 2 Receiver.....	165,973	8,060		12,800	1,150
No. 3 Cylinder.....	160,083	1,150	11,695		
No. 3 Receiver.....	149,538	5,185		5,100	940
No. 4 Cylinder.....	148,683	940	11,688		
Preheater.....	128,835			2,350	
Del'd to Condenser.....	125,885			5,600	
Disch'gd from ".....	120,285				

The principal results of the test are as follows:

	1	2	3	4
Cylinder developed in steam cylinders	181.47	256.96	275.71	275.56
I.H.P. developed in steam cylinders	220.04	222.12	226.20	214.84
I.H.P. used in the cylinders				989.7
Total indicated horse-power, steam cylinders				883.2
Total horse-power used in air cylinders				11.0
Total indicated horse-power of auxiliaries				95.5
Horse-power representing friction of the machine				9.65%
Per cent of friction				90.35%
Mechanical efficiency engine and compressor				

Heat consumed by engine per hour per I.H.P., 10,157 B.T.U.; per B.H.P., 11,382 B.T.U. Equivalent standard coal consumption per hour assuming 10,000 B.T.U. imparted to the boiler per pound coal, per I.H.P., 1.016 lbs.; per B.H.P., 1.138 lbs. Dry steam per hour per I.H.P., 11.23 lbs.; per B.H.P., 12.58 lbs. Heat units consumed per minute, per I.H.P., 169.29 B.T.U.; per B.H.P., 189.70 B.T.U.

Efficiency of Carnot cycle between the temperature of incoming steam and that corresponding to pressure in the condenser	34.0 %
Actual heat efficiency attained by this engine	25.05 %
Relative efficiency compared with Carnot cycle	73.69 %
Relative efficiency compared with Rankine cycle	88.2 %
Duty, ft.-lbs. per million B.T.U. supplied	194,930,000

This engine establishes a new low record for the heat consumed per hour per I.H.P., being 9% lower than that used by the Wildwood pumping engine reported in 1900. (See Pumping Engines.)

The Use of Reheaters in the receivers of multiple-expansion engines is discussed by R. H. Thurston in *Trans. A. S. M. E.*, xxi, 893. He shows that such receivers improve the economy of an engine very little unless they are also superheaters; in which case marked economy may be effected by the reduction of cylinder condensation. The larger the amount of cylinder condensation and the greater the losses, exterior and interior, the greater the effect of any given amount of superheating. The same statement will hold of the use of reheaters: the more wasteful the engine without them and the more effectively they superheat, the larger the gain by their use. A reheater should be given such area of heating surface as will insure at least moderate superheating.

Influence of the Steam-jacket.—Tests of numerous engines with and without steam-jackets show an exceeding diversity of results, ranging all the way from 30% saving down to zero, or even in some cases showing an actual loss. The opinions of engineers at this date (1894) is also as diverse as the results, but there is a tendency towards a general belief that the jacket is not as valuable an appendage to an engine as was formerly supposed. An extensive *résumé* of facts and opinions on the steam-jacket is given by Prof. Thurston in *Trans. A. S. M. E.*, xiv, 462. See

also *Trans. A. S. M. E.*, xiv, 873 and 1340; xiii, 176; xii, 426 and 1340; and *Jour. F. I.*, April, 1891, p. 276. The following are a few statements selected from these papers.

The results of tests reported by the research committee on steam-jackets appointed by the British Institution of Mechanical Engineers in 1886, indicate an increased efficiency due to the use of the steam-jacket of from 1% to over 30%, according to varying circumstances.

Sennett asserts that "it has been abundantly proved that steam-jackets are not only advisable but absolutely necessary, in order that high rates of expansion may be efficiently carried out and the greatest possible economy of heat attained."

Isherwood finds the gain by its use, under the conditions of ordinary practice, as a general average, to be about 20% on small and 8% or 9% on large engines, varying through intermediate values with intermediate sizes, it being understood that the jacket has an effective circulation, and that both heads and sides are jacketed.

Professor Unwin considers that "in all cases and on all cylinders the jacket is useful; provided, of course, ordinary, not superheated, steam is used; but the advantages may diminish to an amount not worth the interest on extra cost."

Professor Cotterill says: Experience shows that a steam-jacket is advantageous, but the amount to be gained will vary according to circumstances. In many cases it may be that the advantage is small. Great caution is necessary in drawing conclusions from any special set of experiments on the influence of jacketing.

Mr. E. D. Leavitt has expressed the opinion that, in his practice, steam-jackets produce an increase of efficiency of from 15% to 20%.

In the Pawtucket pumping-engine, 15 and 30 1/8 x 30 in., 50 revs. per min., steam-pressure 125 lbs. gauge, cut-off 1/4 in h.p. and 1/3 in l.p. cylinder, the barrels only jacketed, the saving by the jackets was from 1% to 4%.

The superintendent of the Holly Mfg. Co. (compound pumping-engines) says: "In regard to the benefits derived from steam-jackets on our steam-cylinders, I am somewhat of a skeptic. From data taken on our own engines and tests made I am yet to be convinced that there is any practical value in the steam-jacket."

Professor Schröter from his work on the triple-expansion engines at Augsburg, and from the results of his tests of the jacket efficiency on a small engine of the Sulzer type in his own laboratory, concludes: (1) The value of the jacket may vary within very wide limits, or even become negative. (2) The shorter the cut-off the greater the gain by the use of a jacket. (3) The use of higher pressure in the jacket than in the cylinder produces an advantage. The greater this difference the better. (4) The high-pressure cylinder may be left unjacketed without great loss, but the other should always be jacketed.

The test of the Laketon triple-expansion pumping-engine showed a gain of 8.3% by the use of the jackets, but Prof. Denton points out (*Trans. A. S. M. E.*, xiv, 1412) that all but 1.9% of the gain was ascribable to the greater range of expansion used with the jackets.

Test of a Compound Condensing Engine with and without Jackets at different Loads. (R. C. Carpenter, *Trans. A. S. M. E.*, xiv, 428.)—Cylinders 9 and 16 in. x 14 in. stroke; 112 lbs. boiler pressure; rated capacity 100 H.P.; 265 revs. per min. Vacuum, 23 in. From the results of several tests curves are plotted, from which the following principal figures are taken.

Indicated H.P.	30	40	50	60	70	80	90	100	110	120	125
Steam per I.H.P. per hr.	22.6	21.4	20.3	19.6	19	18.7	18.6	18.9	19.5	20.4	21.0
With jackets, lbs.	22.6	21.4	20.3	19.6	19	18.7	18.6	18.9	19.5	20.4	21.0
Without jackets, lbs.				22	20.5	19.6	19.2	19.1	19.3	20.1	
Saving by jacket, %				10.9	7.3	4.6	3.1	1.0	-1.0	-1.5	

This table gives a clue to the great variation in the apparent saving due to the steam-jacket as reported by different experimenters. With this

particular engine it appears that when running at its most economical rate of 100 H.P., without jackets, very little saving is made by use of the jackets. When running light the jacket makes a considerable saving, but when overloaded it is a detriment.

At the load which corresponds to the most economical rate, with no steam in jackets, or 100 H.P., the use of the jacket makes a saving of only 1%; but at a load of 60 H.P. the saving by use of the jacket is about 11%, and the shape of the curve indicates that the relative advantage of the jacket would be still greater at lighter loads than 60 H.P.

The Best Economy of the Piston Steam Engine at the Advent of the Steam Turbine is the subject of a paper by J. E. Denton at the International Congress of Arts and Sciences, St. Louis, 1904. (*Power*, Oct. 26, 1905.) Prof. Denton says:

During the last two years the following records have been established:

(1) With an 850-H.P. Rice & Sargent compound Corliss engine, running at 120 r.p.m., having a 4 to 1 cylinder ratio, clearances of 4% and 7%, live jackets on cylinder heads and live steam in reheater, Prof. Jacobus found for 600 H.P. of load, with 150 lbs. saturated steam, 28.6 ins. vacuum, and 33 expansions, 12.1 lbs. of water per I.H.P., with a cylinder-condensation loss of 22%, and a jacket consumption of 10.7% of the total steam consumption.

(2) With a 250-H.P. Belgian poppet-valve compound engine, 126 r.p.m., with 2.97 to 1 cylinder ratio, clearances of 4%, steam-chest jackets on barrels and head, and no reheater, Prof. Schröter, of Munich, found with 117 H.P. of load, 130 lbs. saturated steam, 27.6 ins. of vacuum, and 32 expansions, 11.98 lbs. of water per H.P. per hour, with a cylinder-condensation loss of 23.5%, and a jacket consumption of 7% of the total steam consumption in the high cylinder jacket and 7% in the low jacket.

(3) With the Westinghouse twin compound combined poppet-valve and Corliss-valve engine, at the New York Edison plant, running 76 r.p.m., with 5.8 to 1 cylinder ratio, clearances of 10.5% and 4%, without jackets or reheater, Messrs. Andrew, Whitham and Wells found for the full load of 5400 H.P., 185 lbs. steam pressure, 27.3 ins. vacuum, and 29 expansions, 11.93 lbs. of water per I.H.P. per hour, with an initial condensation of about 32%.

These facts show that the minimum water consumption of the compound engine of the present date, using saturated steam, is not dependent upon any particular cylinder ratio and clearance nor upon any system of jacketing, but that the essential condition is the use of a ratio of expansion of about 30, above which the cylinder-condensation loss is liable to prevail over the influence of the law of expansion. The conclusion appears warranted, therefore, that if this ratio of expansion is secured with any of the current cylinder and clearance ratios, and with any existing system of jackets and reheaters, or without them, a water consumption of 12.4 lbs. per horse-power is possible, and that a variation of 0.4 lb. below or above this figure may occur by the accidental favorable, or unfavorable, jacket and cylinder-wall expenses which are beyond the exact control of the designer.

Compound Piston Engine Economy vs. that of Steam Turbine. — In order to compare the economy of the piston engine with that of the steam turbine, we must use the water consumption per brake horse-power, since no indicator card is possible from the turbine; and furthermore, we must use the average water consumption for the range of loads to which engines are subject in practice.

In all of the public turbine tests to date, with one exception the output was measured through the electric power of a dynamo whose efficiency is not given for the range of loading employed, so that the average brake horse-power is not known. This exception is the Dean and Main test of a 600-H.P. Westinghouse-Parsons turbine using saturated steam at 150 lbs. pressure, and a 28-in. vacuum. We may compare the results of this test with that of the 850-H.P. Rice & Sargent and of the 250-H.P. Belgian engine, by assuming that the power absorbed by friction in these engines is 3% of the indicated load plus the power shown by friction cards taken with the engine unloaded. The latter showed 5% of the rated power in the R. & S. engine and 8% in the Belgian engine. The results are:

WARNING: This is a 1910 edition. Some of the material may no longer be accurate

Per cent of full load	41	75	100	125	Avg. 85%
	Lbs. Water per Brake H.P. Hour.				
600-H.P. Turbine	13.62	13.91	14.48	16.05	14.51
800-H.P. Comp. Engine	13.78	13.44	13.66	17.36	14.56
250 H.P. Belgian Engine	15.10	14.15	13.99	15.31	14.64

These figures show practical equality in economy of the types of engines. The full report of the Van den Kerchove Belgian engine is given in *Power*, June, 1903.

For large-sized units Prof. Denton compares the Elberfeld test of a Parsons turbine at the full load of 1500 electric H.P., allowing 5% for attached air pump, 95% for generator efficiency, with the 5400-H.P. Westinghouse compound engine at the New York Edison station, whose friction at full load was found to be 4%. The turbine with 150 lbs. steam and 28 ins. vacuum required 13.08 lbs. of saturated steam per B.H.P. hour, a gain of 4% over the 600-H.P. turbine. The engine with 18.5 lbs. boiler pressure gave 12.5 lbs. per B.H.P. hour. Crediting the turbine with the possible influence of the difference in size and steam pressure, there is again practical equality in economy between it and the piston engine.

Triple-expansion Pumping Engines. — The triple-expansion engine has failed to supplant the compound for electric light and mill service, because the gain in fuel economy due to its use was not sufficient to overcome its higher first cost, depreciation, etc. It is, however, almost universally used in marine practice, and also in large-sized pumping engines. Prof. Denton says: Pumping engines in the United States have been developed in the triple-expansion fly-wheel type to a degree of economy superior to that afforded by any compound mill or electric engine, and, for saturated steam, superior to that of the pumping engines of any other country. This is because their slow speed permits of greater benefit from jackets and reheaters and of less losses from wire-drawing and back pressure. These causes, together with the greater subdivision of the range of expansion, have resulted in records made between 1894 and 1900 of 11.22, 11.26 and 11.05 lbs. of saturated steam per I.H.P., with 175 lbs. steam pressure and from 25 to 33 expansions, in the cases of the Leavitt, Snow and Allis pumping engines, respectively, the corresponding heat consumption being by different dispositions of the jacket drainage, 204, 208 and 212 thermal units per I.H.P. minute; while later the Allis pump, with 85 lbs. steam pressure, has lowered the record to 10.33 lbs. of saturated steam per I.H.P., with 196 B.T.U. per H.P. minute.

Gain from Superheating. — In the Belgian compound engine above described, with steam at 130 lbs., vacuum 27.6 ins., the average consumption of saturated steam, between 45 and 125% of load, was 12.45 lbs. per I.H.P. hour, or 225 B.T.U. per I.H.P. minute. With steam superheated 224° F. the average consumption for the same loads was 10.09 lbs. per I.H.P. hour, computed to be equivalent to 209 B.T.U. per H.P. minute, a gain due to superheating of 7%. With steam superheated 307° and the load about 80% of rating the water consumption was 8.99 lbs. per I.H.P. hour, equivalent to 192 B.T.U. per H.P. minute. The same load with saturated steam requires 221 B.T.U., showing a gain due to superheating of 13%.

The best performance reported for superheated steam used in the turbine is that of Brown & Boveri Parsons Frankfort 4000-H.P. machine, which, with 183 lbs. gauge pressure and 190° F. superheat, afforded 10.28 lbs. per B.H.P. hour, assuming a generator efficiency of 0.95. Reckoning from the feed temperature of its vacuum of 27.5 ins., the heat consumption is 214 B.T.U. per H.P. minute.

The heat consumption of the 250-H.P. Belgian compound engine per B.H.P. hour at the highest superheating of 307° F. is 220 B.T.U. The turbine, therefore, probably holds the record for brake horse-power economy over the piston engine for superheated steam by a margin of about 3%, although had the compound engine been of the same horse-power as the turbine, so that its friction load would be only 8% of its power instead of the 13% here allowed, it would have excelled the turbine in brake horse-power economy by a margin of about 2.5%.

The Sulphur-dioxide Addendum. — If the expansion in piston engines

could continue until the pressure of 1 pound was attained before exhaust occurred, considerable more work could be obtained from the steam. This cannot be done, for two reasons: first, because the low cylinder would have to be about five times greater in volume, which is commercially impracticable; and, second, because the velocity of exit through the largest exhaust ports possible is so great that the frictional resistance of the steam makes the back pressure from 1 to 3 pounds higher than the condenser pressure in the best engines of ordinary piston speed.

All the work due to this extra expansion can be obtained by exhausting the steam at 6 lbs. pressure against a nest of tubes containing sulphur dioxide which is thereby boiled to a vapor at about 170 lbs. pressure.

Professor Josse, of Berlin, has perfected this sulphur-dioxide system of improvement, and reliable tests have shown that if cooling water of 65° is available, and to the extent of about twice the quantity usually employed for condensing steam under 28 ins. of vacuum, a sulphur-dioxide cylinder of about half the size of the high-pressure cylinder of a compound engine will do sufficient work to improve the best economy of such engines at least 15%. The steam turbine expands its steam to the pressure of its exhaust chamber, and as unlimited escape ports can be provided from this chamber to a condenser, it follows that the turbine can practically expand its steam to the pressure of the condenser. Therefore a steam turbine attached to a piston engine to operate with the latter's exhaust should effect the same saving as the sulphur-dioxide cylinder.

Standard Dimensions of Direct-connected Generator Sets. From a report by a committee of the A. S. M. E., 1901.

Capacity of unit, K.W.	25	35	50	75	100	150	200
Revolutions per minute	310	300	290	275	260	225	200
Armature bore, center-crank engines	4	4	4 1/2	5 1/2	6	7	8
Armature bore, side-crank engines	4 1/2	5 1/2	6 1/2	7 1/2	8 1/2	10	11

The diameter of the engine shaft at the armature fit is 0.001 in. greater than the bore, for bores up to and including 6 ins., and 0.002 in. greater for bores 6 1/2 ins. and larger.

Dimensions of Some Parts of Large Engines in Electric Plants. — The *Electrical World*, Sept. 27, 1902, gives a table of dimensions of the engines in the five large power stations in New York City at that date. The following figures are selected from the table.

Name of station	Metro-politan.	Manhat-tan.	Kings-bridge.	Rapid Transit.	Edison.
Type of engine	Vert. Cross-Comp.	Double, 2 hor. 2 vert. Cyls.	Vert. Cross-Comp.	Double, 2 hor. 2 vert. Cyls.	3 Cyl. Vert.
Rated H.P.	4500	8000	4500	8900	5200
Cylinders, all 60-in. stroke, in.	46, 86	44, 88	46, 86	42, 86	43 1/2, 2-75 1/2
Piston rods, diam. in.	9, 10	8	9, 10	8, 10	9
Crank pins	14 × 14	18 × 18	14 × 14	20 × 18	22 & 16 × 14
Wrist pins	14 × 14	12 × 12	14 × 14	12 × 12	14 × 14
Shaft length	27 ft. 4 in.	25 ft. 3 in.	27 ft.	25 ft. 3 in.	35 ft.
max. diam.	37 in.	37 in.	39 in.	37 in.	29 3/8 in.
bearings	34 × 60	34 × 60	34 × 60	34 × 60	26 × 60

The shafts are hollow, with a 16-in. hole, except the Edison which has 10 in. The speed of all the engines is 75 r.p.m., or 750 ft. per min. The crank pins of the Manhattan and Rapid Transit engines each are attached to two connecting rods, side by side, hor. and vert., each rod having a bearing 9 in. long on the pin. The crank pins of the Edison engine are 16 in. diam. for the side-cranks, and 22 in. for the center-crank.

Some Large Rolling-Mill Engines.

No.	Cylinders.	R.P.M.	Type.	Press., lbs.	Fly-wheel.		Location.	Builders.
					Diam.	Wt.		
1	44 & 82 x 60	65	Cross-C.	140	ft. 24	lbs. 150,000	Republic I. & S. Co., Youngstown, Ohio.	Filer & Stowell.
2	46 & 80 x 60	80	Tandem.	150	24	110,000	Carnegie S. Co., Donora, Pa.	Wisconsin Eng. Co.
3	52 & 90 x 60	Tandem.	25	250,000	Carnegie S. Co., Youngstown, Ohio.	Wm. Tod Co.
4	2 each 42 & 70 x 54	Double Tandem.	150	none		Carnegie S. Co., S. Sharon, Pa.	Allis Chalmers Co.
5	2 each 44 & 70 x 60	60	Double Tandem	150	none		Carnegie S. Co., Duquesne, Pa. Jones & Laughlin Steel Co., Allequippa, Pa.	Mackintosh, Hemp-hill & Co.

Some details: Main bearings, No. 1, 25 x 43 1/2 in.; No. 2, 30 x 52 in.; No. 3, 30 x 60 in. Shaft diam. at wheel pit, No. 1, 26 in.; No. 3, 36 in. Crank pins, No. 1, h.p. 14 x 14; l.p., 14 x 23 in.; No. 2, 18 x 18 in. Crosshead pins, No. 1, 12 x 14; No. 2, 16 x 20 in. No. 4 is a reversing engine with the Marshall gear. No. 5 is a reversing engine with piston valves below the cylinders.

Counterbalancing Engines. — Prof. Unwin gives the formula for counterbalancing vertical engines: $W_1 = W_2 r/p$, (1) in which W_1 denotes the weight of the balance weight and p the radius to its center of gravity, W_2 the weight of the crank-pin and half the weight of the connecting-rod, and r the length of the crank. For horizontal engines:

$$W_1 = 2/3 (W_2 + W_3) r/p \text{ to } 3/4 (W_2 + W_3) r/p. \dots (2)$$

In which W_3 denotes the weight of the piston, piston-rod, cross-head, and the other half of the weight of the connecting-rod.

The *American Machinist*, commenting on these formulæ, says: For horizontal engines formula (2) is often used; formula (1) will give a counterbalance too light for vertical engines. We should use formula (2) for computing the counterbalance for both horizontal and vertical engines, excepting locomotives, in which the counterbalance should be heavier.

For an account of experiments on counterbalancing large engines, with a method of recording vibrations, see paper by D. S. Jacobus, *Trans. A. S. M. E.*, 1905.

Preventing Vibrations of Engines. — Many suggestions have been made for remedying the vibration and noise attendant on the working of the big engines which are employed to run dynamos. A plan which has given great satisfaction is to build hair-felt into the foundations of the engine. An electric company has had a 90-horse-power engine removed from its foundations, which were then taken up to the depth of 4 feet. A layer of felt 5 inches thick was then placed on the foundations and run up 2 feet on all sides, and on the top of this the brickwork was built up. — *Safety Valve*.

Steam-engine Foundations Embedded in Air. — In the sugar-refinery of Claus Spreckels, at Philadelphia, Pa., the engines are distributed practically all over the buildings, a large proportion of them being on upper floors. Some are bolted to iron beams or girders, and are con-

sequently innocent of all foundation. Some of these engines ran noiselessly and satisfactorily, while others produced more or less vibration and rattle. To correct the latter the engineers suspended foundations from the bottoms of the engines, so that, in looking at them from the lower floors, they were literally hanging in the air. — *Iron Age*, Mar. 13, 1890.

COMMERCIAL ECONOMY. — COSTS OF POWER.

The Cost of Steam Power is an exceedingly variable quantity. The principal items to be considered in estimating total annual cost are: load factor; hours run per year; percentage of full load at different hours of the day; cost and quality of fuel; boiler efficiency and steam consumption of engines at different loads; cost of water and other supplies; cost of labor, first cost of plant, depreciation, repairs, interest, insurance and taxes.

In figuring depreciation not only should the probable life of the several parts of the plant, such as buildings, boilers, engines, condensers, etc., be considered, but also the possibility of part of the plant, or the whole of it, depreciating rapidly in value on account of obsolescence of the machinery or of changes in the conditions of the business.

When all of the heat in the exhaust steam from engines and pumps, including water of condensation, is used for heating purposes the fuel cost of steam-engine power may be practically nothing, since the exhaust contains all of the heat in the steam delivered to the engine except from 5 to 10 per cent which is converted into work, and a trifling amount lost by radiation.

Most Economical Point of Cut-off in Steam-engines. (See paper by Wolff and Denton, *Trans. A. S. M. E.*, vol. ii, p. 147-281; also, Ratio of Expansion at Maximum Efficiency, R. H. Thurston, vol. ii, p. 128.)

— The problem of the best ratio of expansion is not one of economy of consumption of fuel and economy of cost of boiler alone. The question of interest on cost of engine, depreciation of value of engine, repairs of engine, etc., enters as well; for as we increase the rate of expansion, and thus, within certain limits fixed by the back-pressure and condensation of steam, decrease the amount of fuel required and cost of boiler per unit of work, we have to increase the dimensions of the cylinder and the size of the engine, to attain the required power. We thus increase the cost of the engine, etc., as we increase the rate of expansion, while at the same time we decrease the fuel consumption, the cost of boiler, etc. So that there is in every engine some point of cut-off, determinable by calculation and graphical construction, which will secure the greatest efficiency for a given expenditure of money, taking into consideration the cost of fuel, wages of engineer and firemen, interest on cost, depreciation of value, repairs to and insurance of boiler and engine, and oil, waste, etc., used for engine. In case of freight-carrying vessels, the value of the room occupied by fuel should be considered in estimating the cost of fuel.

Type of Engine to be used where Exhaust-steam is needed for Heating. — In many factories more or less of the steam exhausted from the engines is utilized for boiling, drying, heating, etc. Where all the exhaust-steam is so used the question of economical use of steam in the engine itself is eliminated, and the high-pressure simple engine is entirely suitable. Where only part of the exhaust-steam is used, and the quantity so used varies at different times, the question of adopting a simple, a condensing, or a compound engine becomes more complex. This problem is treated by C. T. Main in *Trans. A. S. M. E.*, vol. x, p. 48. He shows that the ratios of the volumes of the cylinders in compound engines should vary according to the amount of exhaust-steam that can be used for heating. A case is given in which three different pressures of steam are required or could be used, as in a worsted dye-house: the high or boiler pressure for the engine, an intermediate pressure for crabbing, and low-pressure for boiling, drying, etc. If it did not make too much complication of parts in the engine, the boiler-pressure might be used in the high-pressure cylinder, exhausting into a receiver from which steam could be taken for running small engines and crabbing, the steam remaining in the receiver passing into the intermediate cylinder and expanded there to from 5 to 10 lbs. above the atmosphere and exhausted into a second receiver. From this receiver is drawn the low-pressure steam needed for drying, boiling, warming mills, etc., the steam remaining in the receiver passing into the condensing cylinder.

Cost of Steam-power. (Chas. T. Main, *Trans. A. S. M. E.*, x., 48.)—
Estimated costs in New England in 1888, per horse-power, based on engines
of 1000 H.P.

	Compound Engine.	Condens- ing Engine.	Non-con- densing Engine.
1. Cost engine and piping, complete.....	\$25.00	\$20.00	\$17.50
2. Engine-house.....	8.00	7.50	7.50
3. Engine foundations.....	7.00	5.50	4.50
4. Total engine plant.....	40.00	33.00	29.50
5. Depreciation, 4% on total cost.....	1.60	1.32	1.18
6. Repairs, 2% on total cost.....	0.80	0.66	0.59
7. Interest, 5% on total cost.....	2.00	1.65	1.475
8. Taxation, 1.5% on 3/4 cost.....	0.45	0.371	0.332
9. Insurance on engine and house.....	0.163	0.138	0.125
10. Total of lines 5, 6, 7, 8, 9.....	5.015	4.139	3.702
11. Cost boilers, feed-pumps, etc.....	9.33	13.33	16.00
12. Boiler-house.....	2.92	4.17	5.00
13. Chimney and flues.....	6.11	7.30	8.00
14. Total boiler-plant.....	18.36	24.80	29.00
15. Depreciation, 5% on total cost.....	0.918	1.240	1.450
16. Repairs, 2% on total cost.....	0.367	0.496	0.580
17. Interest, 5% on total cost.....	0.918	1.240	1.450
18. Taxation, 1.5% on 3/4 cost.....	0.207	0.279	0.326
19. Insurance, 0.5% on total cost.....	0.092	0.124	0.145
20. Total of lines 15 to 19.....	2.502	3.379	3.951
21. Coal used per I.H.P. per hour, lbs. ...	1.75	2.50	3.00
22. Cost of coal per I.H.P. per day of 10 1/4 hours at \$5.00 per ton of 2240 lbs. ...	4.00	5.72	6.86
23. Attendance of engine per day.....	0.60	0.40	0.35
24. Attendance of boilers per day.....	0.53	0.75	0.90
25. Oil, waste, and supplies, per day.....	0.25	0.22	0.20
26. Total daily expense.....	5.38	7.09	8.31
27. Yearly running expense, 308 days, per I.H.P.....	\$16.570	\$21.837	\$25.595
28. Total yearly expense, lines 10, 20, and 27.....	24.087	29.355	33.248
29. Total yearly expense per I.H.P. for power if 50% of exhaust-steam is used for heating.....	12.597	14.907	16.663
30. Total if all exhaust-steam is used for heating.....	8.624	7.916	7.700

When exhaust-steam or a part of the receiver-steam is used for heating, or if part of the steam in a condensing engine is diverted from the condenser, and used for other purposes than power, the value of such steam should be deducted from the cost of the total amount of steam generated in order to arrive at the cost properly chargeable to power. The figures in lines 29 and 30 are based on an assumption made by Mr. Main of losses of heat amounting to 25% between the boiler and the exhaust-pipe, an allowance which is probably too large.

See also two papers by Chas. E. Emery on "Cost of Steam Power," *Trans. A. S. M. E.*, vol. xii, Nov., 1883, and *Trans. A. I. E. E.*, vol. x, Mar., 1893.

Decourcey May (*Trans. A. S. M. E.*; 1894) gives the following estimates

of the annual cost of power with different types of engine. He figures interest and depreciation each at 5%, insurance at 1%, and taxes at 1 1/2% of the cost of the plant. No cost of water is charged.

Cost of coal per 2240 lbs.	\$2				3				4				5			
	2	3	4	5	2	3	4	5	2	3	4	5	2	3	4	5
Cost of 1 I.H.P. per year.	365 days of 24 hours.								308 days of 10 1/4 hours.							
Triple-expansion pumping, 20 revs.....	48	55	61	67	31	33	35	37								
Triple-expansion without pumps, 50 revs.....	27	33	39	45	16	18	20	22								
Compound mill, best engine	29	36	44	51	17	19	21	24								
Compound mill, average...	39	46	52	58	22	25	28	30								
Compound elec. light, av...	122	139	157	174	78	84	90	96								
Compound trolley.....	48	58	68	79	29	32	36	39								
Triple-expansion trolley...	45	54	64	74	26	29	33	36								
Condensing mill.....	44	52	61	69	25	29	33	38								
Non-cond., 50 to 200 H.P...	70	76	81	88	49	53	57	62								

Cost of Coal for Steam-power. — The following table shows the amount and the cost of coal per day and per year for various horse-powers, from 1 to 1000, based on the assumption of 4 lbs. of coal being used per hour per horse-power. It is useful, among other things, in estimating the saving that may be made in fuel by substituting more economical boilers and engines for those already in use. Thus with coal at \$3.00 per ton of 2000 lbs., a saving of \$9000 per year in fuel may be made by replacing a steam plant of 1000 H.P., requiring 4 lbs. of coal per hour per horse-power, with one requiring only 2 lbs.

Horse-power.	Coal Consumption, at 4 lbs. per H.P. hour; 10 hours a day; 300 days per Year.					\$2 per Short Ton.		\$3 per Short Ton.		\$4 per Short Ton.	
	Lbs.	Long Tons.		Short Tons.		Cost in Dollars.		Cost in Dollars.		Cost in Dollars.	
		Per Day.	Per Day.	Per Year.	Per Day.	Per Yr.	Day.	Yr.	Day.	Yr.	Day.
	1	40	0.0179	53.57	0.02	6	0.04	12	0.06	18	0.08
10	400	0.1786	53.57	0.20	60	0.40	120	0.60	180	0.80	240
25	1,000	0.4464	133.92	0.50	150	1.00	300	1.50	450	2.00	600
50	2,000	0.8928	267.85	1.00	300	2.00	600	3.00	900	4.00	1,200
75	3,000	1.3393	401.78	1.50	450	3.00	900	4.50	1,350	6.00	1,800
100	4,000	1.7857	535.71	2.00	600	4.00	1,200	6.00	1,800	8.00	2,400
150	6,000	2.6785	803.56	3.00	900	6.00	1,800	9.00	2,700	12.00	3,600
200	8,000	3.5714	1,071.42	4.00	1,200	8.00	2,400	12.00	3,600	16.00	4,800
250	10,000	4.4642	1,339.27	5.00	1,500	10.00	3,000	15.00	4,500	20.00	6,000
300	12,000	5.3571	1,607.13	6.00	1,800	12.00	3,600	18.00	5,400	24.00	7,200
350	14,000	6.2500	1,874.98	7.00	2,100	14.00	4,200	21.00	6,200	28.00	8,400
400	16,000	7.1428	2,142.84	8.00	2,400	16.00	4,800	24.00	7,200	32.00	9,600
450	18,000	8.0356	2,410.69	9.00	2,700	18.00	5,400	27.00	8,100	36.00	10,800
500	20,000	8.9285	2,678.55	10.00	3,000	20.00	6,000	30.00	9,000	40.00	12,000
600	24,000	10.7142	3,214.26	12.00	3,600	24.00	7,200	36.00	10,800	48.00	14,400
700	28,000	12.4999	3,749.97	14.00	4,200	28.00	8,400	42.00	11,600	56.00	16,800
800	32,000	14.2856	4,285.68	16.00	4,800	32.00	9,600	48.00	12,400	64.00	19,200
900	36,000	16.0713	4,821.39	18.00	5,400	36.00	10,800	54.00	14,200	72.00	21,600
1000	40,000	17.8570	5,357.10	20.00	6,000	40.00	12,000	60.00	18,000	80.00	24,000

It is usual to consider that a factory working 10 hours a day requires 10 1/2 hours coal consumption on account of the coal used in banking or in starting the fires, and that there are 306 working days in the year. For these conditions multiply the costs given in the table by 1.071. For 24 hours a day 365 days in the year, multiply them by 2.68. For other rates of coal consumption than 4 lbs. per H.P. hour, the figures are to be modified proportionately.

Relative Cost of Different Sizes of Steam-engines.
(From catalogue of the Buckeye Engine Co., Part III.)

Horse-power....	50	75	100	125	150	200	250	300	350	400	500	600	700	800
Cost per H.P., \$	20	17 1/2	16	15	14 1/2	13 1/2	13	12 3/4	12.5	12.6	12.8	13 1/4	14	15

Relative Commercial Economy of Best Modern Types of Compound and Triple-expansion Engines. (J. E. Denton, *American Machinist*, Dec. 17, 1891.) — The following table and deductions show the relative commercial economy of the compound and triple types for the best stationary practice in steam plants of 500 indicated horse-power. The table is based on the tests of Prof. Schröter, of Munich, of engines built at Augsburg, and those of Geo. H. Barrus on the best plants of America, and of detailed estimates of cost obtained from several first-class builders.

Trip motion, or Corliss engines of the twin-compound-receiver condensing type, expanding 16 times. Boiler pressure 120 lbs.	Lbs. water per hour per H.P., by measurement.	13.8	14.0
	Lbs. coal per hour per H.P., assuming 8.5 lbs. actual evaporation.	1.60	1.65
Trip motion, or Corliss engines of the triple-expansion four-cylinder-receiver condensing type, expanding 22 times. Boiler pressure 150 lbs.	Lbs. water per hour per H.P., by measurement.	12.50	12.80
	Lbs. coal per hour per H.P., assuming 8.5 lbs. actual evaporation.	1.48	1.50

The figures in the first column represent the best recorded performance (1891), and those in the second column the probable reliable performance.

The following table shows the total annual cost of operation, with coal at \$4.00 per ton, the plant running 300 days in the year, for 10 hours and for 24 hours per day.

Hours running per day.....	10	24
Expense for coal. Compound plant.....	Per H.P. \$9.90	Per H.P. \$28.50
Expense for coal. Triple plant.....	9.00	25.92
Annual saving of triple plant in fuel.....	0.90	2.60
Annual interest at 5% on \$4.50.....	\$0.23	\$0.23
Annual depreciation at 5% on \$4.50.....	0.23	0.23
Annual extra cost of oil, 1 gallon per 24-hour day, at \$0.50, or 15% of extra fuel cost.....	0.15	0.36
Annual extra cost of repairs at 3% on \$4.50 per 24 hours.....	0.06	0.14
	\$0.67	\$0.96
Annual saving per H.P.....	\$0.23	\$1.64

Increased cost of triple-expansion plant per horse-power, including boilers, chimney, heaters, foundations, piping and erection \$4.50

Taking the total cost of plants at \$36.50 and \$41 per horse-power respectively, the figures in the table imply that for coal at \$4 per ton a

triple expansion 500 H.P. plant costs \$20,500, and saves about \$114 per year in 10-hour service, or \$826 in 24-hour service, over a compound plant, thereby saving its extra cost in 10-hour service in about 19 3/4 years, or in 24-hour service in about 23 3/4 years.

Power Plant Economics. (H. G. Stott, *Trans. A. I. E. E.*, 1906.) — The following table gives an analysis of the heat losses found in a year's operation of one of the most efficient plants in existence.

AVERAGE LOSSES IN THE CONVERSION OF 1 LB. OF COAL INTO ELECTRICITY.

	B.T.U.	%	B.T.U.	%
1. B.T.U. per lb. of coal supplied	14,150	100.0		
2. Loss in ashes			340	2.4
3. Loss to stack			3,212	22.7
4. Loss in boiler radiation and air leakage			1,131	8.0
5. Returned by feed-water heater	441	3.1		
6. Returned by economizer	960	6.8		
7. Loss in pipe radiation			28	0.2
8. Delivered to circulator			223	1.6
9. Delivered to feed pump			203	1.4
10. Loss in leakage and high-pressure drips			152	1.1
11. Delivered to small auxiliaries			51	0.4
12. Heating			31	0.2
13. Loss in engine friction			111	0.8
14. Electrical losses			36	0.3
15. Engine radiation losses			28	0.2
16. Rejected to condenser			8,524	60.1
17. To house auxiliaries			29	0.2
	15,551	109.9	14,099	99.6
	14,099	99.8		
Delivered to bus bar	1,452	10.3		

The following notes concerning power-plant economy are condensed from Mr. Stott's paper.

Item 1. B.T.U. per lb. of coal. The coal is bought and paid for on the basis of the B.T.U. found by a bomb calorimeter.

Item 3. The chimney loss is very large, due to admitting too much air to the combustion chamber. This loss can be reduced about half by the use of a CO₂ recorder and proper management of the fire.

Item 4. This loss is largely due to infiltration of air into the brick setting. It can be saved by having an air-tight sheet-iron casing enclosing a magnesia lining outside of the brickwork.

Item 5. All auxiliaries should be driven by steam, so that their exhaust may be utilized in the feed-water heater.

Item 6. In all cases where the load factor exceeds 25% the investment in economizers will be justified.

Item 7. The pipes are covered with two layers of covering, each about 1.5 in. thick.

Item 10. The high-pressure drips can be returned to the boiler, so practically all the loss under this heading is recoverable.

Item 13. Recent tests of a 7500-H.P. reciprocating engine show a mechanical efficiency of 93.65%, or an engine friction of 6.35%. The engine is lubricated by the flushing system.

Item 16. The maximum theoretical efficiency of an engine working between 175 lbs. gauge and 28 ins. vacuum is

$$(T_1 - T_2) \div T_1 = (837 - 560) \div 837 = 33\%$$

The actual best efficiency of this engine is 17 lbs. per K.W.-hour = 16.7% thermal efficiency; dividing by 0.98, the generator efficiency, gives the net thermodynamic efficiency of the engine, = 17%. The difference between the theoretical and the actual efficiency is 33 - 17 = 16%, of which 6.35% is due to engine friction, and the balance, 9.65%, is due to cylinder con-

densation, incomplete expansion, and radiation. [Some of this difference is due to the fact that the engine does not work on the Carnot cycle, in which the heat is all received at the highest temperature, and part of this loss might be saved by the Nordberg feed-water heating system. There may also be a slight loss from leakage. W.K.] Superheated steam, to such an extent as to insure dry steam at the point of cut-off in the low-pressure cylinder, might save 5 or 6%.

The present type of power plant using reciprocating engines can be improved in efficiency as follows: Reduction of stack losses, 12%; boiler radiation and leakage, 5%; by superheating, 6%; resulting in a net increase of thermal efficiency of the entire plant of 4.14% and bringing the total from 10.3 to 14.41%.

The Steam Turbine. — The best results from the steam turbine up to date show that its economy on dry saturated steam is practically equal to that of the reciprocating engine, and that 200° superheat reduces its steam consumption 13.5%. The shape of the economy curve is much flatter [from 3300 to 8000 K. W. the range of steam consumption is between 14.8 and 15.0 lbs. per K.W.-hour], so that the all-day efficiency would be considerably better than that of the reciprocating engine, and the cost would be about 33% less for the combined steam motor and electric generator.

High-pressure Reciprocating Engine with Low-pressure Turbine. — The reciprocating engine is more efficient than the turbine in the higher pressures, while the turbine can expand to lower pressures and utilize the gain of full expansion. The combination of the two would therefore be more efficient than a turbine alone.

The Gas Engine. — The best result up to date obtained from gas producers and gas engines is about as follows: Loss in producer and auxiliaries, 20%; in jacket water, 19%; in exhaust gases, 30%; in engine friction, 6.5%; in electric generator, 0.5%. Total losses, 76%. Converted into electric energy, 24%. Only one important objection can be raised to this motor, that its range of economical load is practically limited to between 50% and full load. This lack of overload capacity is probably a fatal defect for the ordinary railway power plant acting under a violently fluctuating load, unless protected by a large storage-battery.

At light loads the economy of gas and liquid fuel engines fell off even more rapidly than in steam-engines. The engine friction was large and nearly constant, and in some cases the combustion was also less perfect at light loads. At the Dresden Central Station the gas-engines were kept working at nearly their full power by the use of storage-batteries. The results of some experiments are given below:

Brake-load, per cent of full Power.	Gas-engine, cu. ft. of Gas per Brake H.P. per hour.	Petroleum Eng., Lbs. of Oil per B.H.P. per hr.	Petroleum Eng., Lbs. of Oil per B.H.P. per hr.
100	22.2	0.96	0.88
75	23.8	1.11	0.99
59	28.0	1.44	1.20
20	40.8	2.38	1.82
12½	66.3	4.25	3.07

Combination of Gas Engines and Turbines. — A steam turbine unit can be designed to take care of 100% overload for a few seconds. If a plant were designed with 50% of its normal capacity in gas engines and 50% in steam turbines, any fluctuations in load likely to arise in practice could be taken care of. By utilizing the waste heat of the gas engine in economizers and superheaters there can be saved approximately 37% of this waste heat, to make steam for the turbines. The average total thermal efficiency of such a combination plant would be 24.5%. This combination offers the possibility of producing the kilowatt-hour for less than one-half its present cost.

The following table shows the distribution of estimated relative maintenance and operation costs of five different types of plant, the total cost of current with the reciprocating engine plant being taken at 100.

	Reciprocating Engines.	Steam Turbines	Reciprocating Engines and Steam Turbines.	Gas-Engine Plant.	Gas Engines and Steam Turbines.
MAINTENANCE.					
1. Engine room mechanical.....	2.57	0.51	1.54	2.57	1.54
2. Boiler room or producer room.....	4.61	4.30	3.52	1.15	1.95
3. Coal- and ash-handling apparatus....	0.58	0.54	0.44	0.29	0.29
4. Electrical apparatus	1.12	1.12	1.12	1.12	1.12
OPERATION.					
5. Coal- and ash-handling labor.....	2.26	2.11	1.74	1.13	1.13
6. Removal of ashes....	1.06	0.94	0.80	0.53	0.53
7. Dock rental.....	0.74	0.74	0.74	0.74	0.74
8. Boiler-room labor....	7.15	6.68	5.46	1.79	3.03
9. Boiler-room oil, waste, etc.	0.17	0.17	0.17	0.17	0.17
10. Coal.....	61.30	57.30	46.87	26.31	25.77
11. Water.....	7.14	0.71	3.46	3.57	2.14
12. Engine-room mechanical labor....	6.71	1.35	4.03	6.71	4.03
13. Lubrication.....	1.77	0.35	1.01	1.77	1.06
14. Waste, etc.....	0.30	0.30	0.30	0.30	0.30
15. Electrical labor.....	2.52	2.52	2.52	2.52	2.52
Relative cost of maintenance and operation ..	100.00	79.64	75.72	50.67	46.32
Relative investment in per cent.....	100.00	82.50	77.00	100.00	91.20

Storing Heat in Hot Water. — (See also p. 897.) There is no satisfactory method for equalizing the load on the engines and boilers in electric-light stations. Storage-batteries have been used, but they are expensive in first cost, repairs, and attention. Mr. Halpin, of London, proposes to store heat during the day in specially constructed reservoirs. As the water in the boilers is raised to 250 lbs. pressure, it is conducted to cylindrical reservoirs resembling English horizontal boilers, and stored there for use when wanted. In this way a comparatively small boiler-plant can be used for heating the water to 250 lbs. pressure all through the twenty-four hours of the day, and the stored water may be drawn on at any time, according to the magnitude of the demand. The steam-engines are to be worked by the steam generated by the release of pressure from this water, and the valves are to be arranged in such a way that the steam shall work at 130 lbs. pressure. A reservoir 8 ft. in diameter and 30 ft. long, containing 84,000 lbs. of heated water at 250 lbs. pressure, would supply 5250 lbs. of steam at 130 lbs. pressure. As the steam consumption of a condensing electric-light engine is about 18 lbs. per horse-power hour, such a reservoir would supply 286 effective horse-power hours. In 1878, in France, this method of storing steam was used on a tramway. M. Francq, the engineer, designed a smokeless locomotive to work by steam-power supplied by a reservoir containing 400 gallons of water at 220 lbs. pressure. The reservoir was charged with steam from a stationary boiler at one end of the tramway.

An installation of the Rateau low-pressure turbine and regenerator system at the rolling mill of the International Harvester Co., in Chicago, is described in *Power*, June, 1907. The regenerator is a cylindrical shell 11½ ft. diam., 30 ft. long, containing six large elliptical tubes perforated with many ¾-in. holes through which exhaust steam from a reversing

Blooming-mill engine enters the water contained in the shell. A large steam pipe leads from the shell to the turbine. A series of tests of the combination was made, giving results as follows: The 42 X 60 in. blooming mill engine developed 820 I.H.P. on the average, with a water rate of 64 lbs. per I.H.P. hour. It delivered its exhaust, averaging a little above atmospheric pressure, to the regenerator, at an irregular rate corresponding to the varying work of the rolling-mill engine. The regenerator furnished steam to the turbine, which in four different tests developed 444, 544, 727 and 869 brake H.P. at the turbine shaft, with a steam consumption of 47.7, 37.1, 30.7 and 33.7 lbs. of steam per B.H.P. hour at the turbine. Had the turbine been of sufficient capacity to use all the exhaust of the mill engine, 1510 H.P. might have been delivered at the switchboard, which added to the 820 of the mill engine would make 2330 H.P. for 52,400 lbs. of steam, or a steam rate of 22.5 lbs. per H.P. hour for the combination.

UTILIZING THE SUN'S HEAT AS A SOURCE OF POWER.

John Ericsson, 1808-1875, experimented on "solar engines," in which reflecting surfaces concentrated the sun's rays at a central point causing them to boil water. A large motor of this type was built at Pasadena, Cal., in 1898. The rays were concentrated upon a water heater through which ether or sulphur dioxide was pumped in pipes, and utilized in a vapor engine. The apparatus was commercially unsuccessful on account of variable weather conditions. *Eng. News*, May 13, 1909, describes the solar heat systems of F. Shuman and of H. E. Willsie and John Boyle, Jr.

In the Shuman invention a tract of land is rolled level, forming a shallow trough. This is lined with asphaltum pitch and covered with about 3 ins. of water. Over the water about 1/16 in. of paraffine is flowed, leaving between this and a glass cover about 6 ins. of dead air space. It is estimated that a power plant of this type to cover a heat-absorption area of 160,000 sq. ft., or nearly four acres, would develop about 1000 H.P. Provision is made for storing hot water in excess of the requirements of a low-pressure turbine during the day, to be utilized for running the turbine during the period when there is no absorption of heat. The heated water is run from the heat absorber to the storage tank, thence to the turbine, through a condenser and back to the heat absorber. The water enters the thermally insulated storage tank, or the turbine, at about 202° F. With a vacuum of 28 ins. in the condenser, the boiling-point of the water is reduced to 192°, and as it enters the turbine nearly 10% explodes into steam. Mr. Shuman estimates that a 1000-H.P. plant built upon his plan would cost about \$40,000.

The Willsie and Boyle plant also utilizes the indirect system of absorbing solar heat and storing the hot water in tanks. This hot water circulates in a boiler containing some volatile liquid, and the vapor generated is used to operate the engine, is condensed, and returned to the boiler to be used again. Mr. Willsie compares the cost per H.P.-hour in a 400-H.P. steam-electric and solar-electric power plant, and finds that the steam plant would have to obtain its coal for \$0.66 a ton to compete with the sun power plant in districts favorable to the latter.

RULES FOR CONDUCTING STEAM-ENGINE TESTS.

A committee of the Am. Soc. M. E. in 1902 made a report on Engine Tests, which is printed in the Transactions for that year, and also in a pamphlet of 78 pages. A greatly condensed abstract only can be given here. Engineers making tests of engines should have the complete report. In the introduction to the report the Committee says:

The heat consumption of a steam-engine plant is ascertained by measuring the quantity of steam consumed by the plant, calculating the total heat of the entire quantity, and crediting this total with that portion of the heat rejected by the plant which is utilized and returned to the boiler. The term "engine plant" as here used should include the entire equipment of the steam plant which is concerned in the production of the power, embracing the main cylinder or cylinders; the jackets and reheaters; the air, circulating, and boiler-feed pumps, if steam driven; and any other

steam-driven mechanism or auxiliaries necessary to the working of the engine. It is obligatory to thus charge the engine with the steam used by necessary auxiliaries in determining the plant economy, for the reason that it is itself finally benefited, or should be so benefited, by the heat which they return; it being generally agreed that exhaust steam from such auxiliaries should be passed through a feed-water heater, and the heat thereby carried back to the boiler and saved.

In that large class of steam engines which are required to run at a certain limited and constant speed, there should be a considerable reserve of capacity beyond the rated power. It is our recommendation that when a steam engine is operating at its rated power at a given pressure there should be a sufficient reserve to allow a drop of at least 15 per cent in the gauge pressure without sensible reduction in the working speed of the engine, and to allow an overload at the stated pressure amounting to at least 25 per cent.

RULES FOR CONDUCTING STEAM-ENGINE TESTS. CODE OF 1902.

I. *Object of Test.* — Ascertain at the outset the specific object of the test, whether it be to determine the fulfilment of a contract guarantee, to ascertain the highest economy obtainable, to find the working economy and defects under conditions as they exist, to ascertain the performance under special conditions, to determine the effect of changes in the conditions, or to find the performance of the entire boiler and engine plant, and prepare for the test accordingly.

II. *General Condition of the Plant.* — Examine the engine and the entire plant concerned in the test; note its general condition and any points of design, construction, or operation which bear on the objects in view. Make a special examination of the valves and pistons for leakage by applying the working pressures with the engine at rest, and observe the quantity of steam, if any, blowing through per hour.

III. *Dimensions, etc.* — Measure or check the dimensions of the cylinders when they are hot. If they are much worn, the average diameter should be determined. Measure also the clearance. If the clearance cannot be measured directly, it can be determined approximately from the working drawings of the cylinder.

IV. *Coal.* — When the trial involves the complete plant, embracing boilers as well as engine, determine the character of coal to be used. The class, name of the mine, size, moisture, and quality of the coal should be stated in the report. It is desirable, for purposes of comparison, that the coal should be of some recognized standard quality for the locality where the plant is situated.

V. *Calibration of Instruments.* — All instruments and apparatus should be calibrated and their reliability and accuracy verified by comparison with recognized standards.

VI. *Leakages of Steam, Water, etc.* — In all tests except those of a complete plant made under conditions as they exist, the boiler and its connections, both steam and feed, as also the steam piping leading to the engine and its connections, should, so far as possible, be made tight. All connections should, so far as possible, be visible and be blanked off, and where this cannot be done, satisfactory assurance should be obtained that there is no leakage either in or out.

VII. *Duration of Test.* — The duration of a test should depend largely upon its character and the objects in view. The standard heat test of an engine, and, likewise, a test for the simple determination of the feed-water consumption, should be continued for at least five hours, unless the class of service precludes a continuous run of so long duration. It is desirable to prolong the test the number of hours stated to obtain a number of consecutive hourly records as a guide in analyzing the reliability of the whole.

The commercial test of a complete plant, embracing boilers as well as engine, should continue at least one full day of twenty-four hours, whether the engine is in motion during the entire time or not. A continuous coal test of a boiler and engine should be of at least ten hours' duration, or the nearest multiple of the interval between times of cleaning fires.

VIII. *Starting and Stopping a Test.* — (a) Standard Heat Test and Feed-Water Test of Engine: The engine having been brought to the normal

condition of running, and operated a sufficient length of time to be thoroughly heated in all its parts, and the measuring apparatus having been adjusted and set to work, the height of water in the gauge glasses of the boilers is observed, the depth of water in the reservoir from which the feed water is supplied is noted, the exact time of day is observed, and the test held to commence. Thereafter the measurements determined upon for the test are begun and carried forward until its close. When the time for the close of the test arrives, the water should, if possible, be brought to the same height in the glasses and to the same depth in the feed-water reservoir as at the beginning, delaying the conclusion of the test if necessary to bring about this similarity of conditions. If differences occur, the proper corrections must be made.

(b) Complete Engine and Boiler Test: For a continuous running test of combined engine or engines, and boiler or boilers, the same directions apply for beginning and ending the feed-water measurements as those just referred to. The time of beginning and ending such a test should be the regular time of cleaning the fires, and the exact time of beginning and ending should be the time when the fires are fully cleaned, just preparatory to putting on fresh coal.

For a commercial test of a combined engine and boiler, whether the engine runs continuously for the full twenty-four hours of the day, or only a portion of the time, the fires in the boilers being banked during the time when the engine is not in motion, the beginning and ending of the test should occur at the regular time of cleaning the fires, the method followed being that already given. In cases where the engine is not in continuous motion, as, for example, in textile mills, where the working time is ten or eleven hours out of the twenty-four, and the fires are cleaned and banked at the close of the day's work, the best time for starting and stopping a test is the time just before banking, when the fires are well burned down and the thickness and condition can be most satisfactorily judged.

IX. Measurement of Heat Units Consumed by the Engine. — The measurement of the heat consumption requires the measurement of each supply of feed water to the boiler — that is, the water supplied by the main feed pump, that supplied by auxiliary pumps, such as jacket water, water from separators, drips, etc., and water supplied by gravity or other means; also the determination of the temperature of the water supplied from each source, together with the pressure and quality of the steam. The temperatures at the various points should be those applying to the working conditions.

The heat to be determined is that used by the entire engine equipment, embracing the main cylinders and all auxiliary cylinders and mechanism concerned in the operation of the engine, including the air pump, circulating pump, and feed pumps, also the jacket and reheater when these are used.

The steam pressure and the quality of the steam are to be taken at some point conveniently near the throttle valve. The quantity of steam used by the calorimeter must be determined and properly allowed for.

X. Measurement of Feed Water or Steam Consumption of Engine, etc. — The method of determining the steam consumption applicable to all plants is to measure all the feed water supplied to the boilers, and deduct therefrom the water discharged by separators and drips, as also the water and steam which escapes on account of leakage of the boiler and its pipe connections and leakage of the steam main and branches connecting the boiler and the engine. In plants where the engine exhausts into a surface condenser the steam consumption can be measured by determining the quantity of water discharged by the air pump, corrected for any leakage of the condenser, and adding thereto the steam used by jackets, reheaters, and auxiliaries as determined independently.

The corrections or deductions to be made for leakage above referred to should be applied only to the standard heat-unit test and tests for determining simply the steam or feed-water consumption, and not to coal tests of combined engine and boiler equipment. In the latter, no corrections should be made except for leakage of valves connecting to other engines and boilers, or for steam used for purposes other than the operation of the plant under test. Losses of heat due to imperfections of the plant should be charged to the plant, and only such losses as are concerned in the working of the engine alone should be charged to the engine.

XI. Measurement of Steam used by Auxiliaries. — It is highly desirable that the quantity of steam used by the auxiliaries, and in many cases that used by each auxiliary, should be determined exactly, so that the net consumption of the main engine cylinders may be ascertained and a complete analysis made of the entire work of the engine plant.

XII. Coal Measurement. — The coal consumption should be determined for the entire time of the test. If the engine runs but a part of the time, and during the remaining portion the fires are banked, the measurement of coal should include that used for banking.

XIII. Indicated Horse-power. — The indicated horse-power should be determined from the average mean effective pressure of diagrams taken at intervals of twenty minutes, and at more frequent intervals if the nature of the test makes this necessary, for each end of each cylinder. With variable loads, such as those of engines driving generators for electric railroad work, and of rubber-grinding and rolling-mill engines, the diagrams cannot be taken too often.

The most satisfactory driving rig for indicating seems to be some form of well-made pantograph, with driving cord of fine annealed wire leading to the indicator. The reducing motion, whatever it may be, and the connections to the indicator, should be so perfect as to produce diagrams of equal lengths when the same indicator is attached to either end of the cylinder, and produce a proportionate reduction of the motion of the piston at every point of the stroke, as proved by test.

The use of a three-way cock and a single indicator connected to the two ends of the cylinder is not advised, except in cases where it is impracticable to use an indicator close to each end. If a three-way cock is used, the error produced should be determined and allowed for.

XIV. Testing Indicator Springs. — To make a perfectly satisfactory comparison of indicator springs with standards, the calibration should be made, if this were practical, under the same conditions as those pertaining to their ordinary use.

XV. Brake Horse-power. — This term applies to the power delivered from the flywheel shaft of the engine. It is the power absorbed by a friction brake applied to the rim of the wheel, or to the shaft. A form of brake is preferred that is self-adjusting to a certain extent, so that it will, of itself, tend to maintain a constant resistance at the rim of the wheel. One of the simplest brakes for comparatively small engines, which may be made to embody this principle, consists of a cotton or hemp rope, or a number of ropes, encircling the wheel, arranged with weighing scales, or other means for showing the strain. An ordinary band brake may also be constructed so as to embody the principle. The wheel should be provided with interior flanges for holding water used for keeping the rim cool.

XVI. Quality of Steam. — When ordinary saturated steam is used, its quality should be obtained by the use of a throttling calorimeter attached to the main steam pipe near the throttle valve. When the steam is superheated, the amount of superheating should be found by the use of a thermometer placed in a thermometer-well filled with mercury, inserted in the pipe. The sampling pipe for the calorimeter should, if possible, be attached to a section of the main pipe having a vertical direction, with the steam preferably passing upward, and the sampling nozzle should be made of a half-inch pipe, having at least 20 1/8-in. holes in its perforated surface.

XVII. Speed. — There are several reliable methods of ascertaining the speed, or the number of revolutions of the engine crank-shaft per minute. The most reliable method is the use of a continuous recording engine register or counter, taking the total reading each time that the general test data are recorded, and computing the revolutions per minute corresponding to the difference in the readings of the instrument. When the speed is above 250 revolutions per minute, it is almost impossible to make a satisfactory counting of the revolutions without the use of some form of mechanical counter.

XVIII. Recording the Data. — Take note of every event connected with the progress of the trial whether it seems at the time to be important or unimportant. Record the time of every event, and time of taking every weight, and every observation. Observe the pressures, temperatures, water heights, speeds, etc., every twenty or thirty minutes when the con-

ditions are practically uniform, and at much more frequent intervals if the conditions vary.

XIX. Uniformity of Conditions. — In a test having for an object the determination of the maximum economy obtainable from an engine, or where it is desired to ascertain with special accuracy the effect of predetermined conditions of operation, it is important that all the conditions under which the engine is operated should be maintained uniformly constant.

XX. Analysis of Indicator Diagrams. — (a) Steam Accounted for by the Indicator: The simplest method of computing the steam accounted for by the indicator is the use of the formula,

$$M = \frac{13750}{\text{M.E.P.}} [(C + E) \times Wc - (H + E) \times Wh],$$

which gives the weight in pounds per indicated horse-power per hour. In this formula the symbol "M.E.P." refers to the mean effective pressure. In multiple-expansion engines, this is the combined mean effective pressure referred to the cylinder in question. *C* is the proportion of the stroke completed at points on the expansion line of the diagram near the actual cut-off or release; *H* the proportion of compression; and *E* the proportion of clearance; all of which are determined from the indicator diagram. *Wc* is the weight of one cubic foot of steam at the cut-off or release pressure; and *Wh* the weight of one cubic foot of steam at the compression pressure; these weights being taken from steam tables.

Should the point in the compression curve be at the same height as the point in the expansion curve, then $Wc = Wh$, and the formula becomes

$$(13,750 \div \text{M.E.P.}) \times (C - H) \times Wc,$$

in which $(C - H)$ represents the distance between the two points divided by the length of the diagram.

When the load and all other conditions are substantially uniform, it is unnecessary to work up the steam accounted for by the indicator from all the diagrams taken. Five or more sample diagrams may be selected and the computations based on the samples instead of on the whole.

(b) **Sample Indicator Diagrams:** In order that the report of a test may afford complete information regarding the conditions of the test, sample indicator diagrams should be selected from those taken and copies appended to the tables of results. In cases where the engine is of the multiple-expansion type these sample diagrams may also be arranged in the form of a "combined" diagram.

(c) **The Point of Cut-off:** The term "cut-off" as applied to steam engines, although somewhat indefinite, is usually considered to be at an earlier point in the stroke than the beginning of the real expansion line. That the cut-off point may be defined in exact terms for commercial purposes as used in steam-engine specifications and contracts, the Committee recommends that, unless otherwise specified, the *commercial cut-off*, which seems to be an appropriate expression for this term, be ascertained as follows: Through a point showing the maximum pressure during admission, draw a line parallel to the atmospheric line. Through the point on the expansion line near the actual cut-off, referred to in Section XX (a), draw a hyperbolic curve. The point where these two lines intersect is to be considered the *commercial cut-off* point. The percentage is then found by dividing the length of the diagram measured to this point, by the total length of the diagram, and multiplying the result by 100.

The *commercial cut-off*, as thus determined, is situated at an earlier point of the stroke than the actual cut-off used in computing the "steam accounted for" by the indicator and referred to in Section XX (a).

(d) **Ratio of Expansion:** The "commercial" ratio of expansion is the quotient obtained by dividing the volume corresponding to the piston displacement, including clearance, by the volume of the steam at the commercial cut-off, including clearance. In a multiple-expansion engine the volumes are those pertaining to the low-pressure cylinder and high-pressure cylinder, respectively.

The "ideal" ratio of expansion is the quotient obtained by dividing the volume of the piston displacement by the volume of the steam at the

cut-off (the latter being referred to the throttle-valve pressure), less the volume equivalent to that retained at compression. In a multiple-expansion engine, the volumes to be used are those pertaining to the low-pressure cylinder and high-pressure cylinder, respectively.

(e) **Diagram Factor:** The diagram factor is the proportion borne by the actual mean effective pressure measured from the indicator diagram to that of a diagram in which the various operations of admission, expansion, release and compression are carried on under assumed conditions. The factor recommended refers to an ideal diagram which represents the maximum power obtainable from the steam accounted for by the indicator diagrams at the point of cut-off, assuming first that the engine has no clearance; second, that there are no losses through wire-drawing the steam during either the admission or the release; third, that the expansion line is a hyperbolic curve; and fourth, that the initial pressure is that of the boiler and the back pressure that of the atmosphere for a non-condensing engine, and of the condenser for a condensing engine.

In cases where there is a considerable loss of pressure between the boiler and the engine, as where steam is transmitted from a central plant to a number of consumers, the pressure of the steam in the supply main should be used in place of the boiler pressure in constructing the diagrams.

XXI. Standards of Economy and Efficiency. — The hourly consumption of heat, determined by employing the actual temperature of the feed water to the boiler, as pointed out in Article IX of the Code, divided by the indicated and brake horse-power, that is, the number of heat units consumed per indicated and per brake horse-power per hour, are the standards of engine efficiency recommended by the Committee. The consumption *per hour* is chosen rather than the consumption per minute, so as to conform with the designation of time applied to the more familiar units of coal and water measurement, which have heretofore been used. The British standard, where the temperature of the feed water is taken as that corresponding to the temperature of the back-pressure steam, allowance being made for any drips from jackets or reheaters, is also included in the tables.

It is useful in this connection to express the efficiency in its more scientific form, or what is called the "thermal efficiency ratio." The thermal efficiency ratio is the proportion which the heat equivalent of the power developed bears to the total amount of heat actually consumed, as determined by test. The heat converted into work represented by one horse-power is 1,980,000 foot-pounds per hour, and this divided by 778 equals 2545 British thermal units. Consequently, the thermal efficiency ratio is expressed by the fraction

$$2545 \div \text{B.T.U. per H.P. per hour.}$$

XXII. Heat Analysis. — For certain scientific investigations, it is useful to make a heat analysis of the diagram, to show the interchange of heat from steam to cylinder walls, etc., which is going on within the cylinder. This is unnecessary for commercial tests.

XXIII. Temperature-Entropy Diagram. — The study of the heat analysis is facilitated by the use of the temperature-entropy diagram in which areas represent quantities of heat, the coördinates being the absolute temperature and entropy.

XXIV. Ratio of Economy of an Engine to that of an Ideal Engine. — The ideal engine recommended for obtaining this ratio is that which was adopted by the Committee appointed by the Civil Engineers, of London, to consider and report a standard thermal efficiency for steam engines. This engine is one which follows the Rankine cycle, where steam at a constant pressure is admitted into the cylinder with no clearance, and after the point of cut-off, is expanded adiabatically to the back pressure. In obtaining the economy of this engine the feed water is assumed to be returned to the boiler at the exhaust temperature.

The ratio of the economy of an engine to that of the ideal engine is obtained by dividing the heat consumption per indicated horse-power per minute for the ideal engine by that of the actual engine.

XXV. Miscellaneous. — In the case of tests of combined engines and boiler plants, where the full data of the boiler performance are to be determined, reference should be made to the directions given by the Boiler Test Committee of the Society, Code of 1899. (See Vol. XXI, p. 34.)

In testing steam pumping engines and locomotives in accordance with the standard methods of conducting such tests, recommended by the committees of the Society, reference should be made to the reports of those committees in the *Transactions*, Volume XII, p. 530, and in Volume XIV, p. 1312.

XXVI. Report of Test. — The data and results of the test should be reported in the manner and in the order outlined in one of the following tables, the first of which gives a summary of all the data and results as applied not only to the standard heat-unit test, but also to tests of combined engine and boiler for determining all questions of performance, whatever the class of service; the second refers to a short form of report giving the necessary data and results for the standard heat test; and the third to a short form of report for a feed-water test.

It is recommended that any report be supplemented by a chart in which the data of the test are graphically presented. [Of the three forms of report mentioned above, the second is given below.]

DATA AND RESULTS OF STANDARD HEAT TEST OF STEAM ENGINE.
Arranged according to the Short Form advised by the Engine Test Committee of the American Society of Mechanical Engineers. Code of 1902.

1. Made by of
on engine located at
to determine
2. Date of trial
3. Type and class of engine; also of condenser
4. Dimensions of main engine. 1st Cyl. 2d Cyl. 3d Cyl.
 - (a) Diameter of cylinder in.
 - (b) Stroke of piston ft.
 - (c) Diameter of piston rod in.
 - (d) Average clearance p.c.
 - (e) Ratio of volume of cylinder to high-pressure cylinder
 - (f) Horse-power constant for one pound mean effective pressure and one revolution per minute
5. Dimensions and type of auxiliaries
6. Duration of test *Total Quantities, Time, etc.*
7. Total water fed to boilers from main source of supply hours
8. Total water fed from auxiliary supplies: lbs.
 - (a)
 - (b)
 - (c)
9. Total water fed to boilers from all sources
10. Moisture in steam or superheating near throttle p. c. or deg.
11. Factor of correction for quality of steam
12. Total dry steam consumed for all purposes lbs.
13. Water fed from main source of supply lbs.
14. Water fed from auxiliary supplies:
 - (a)
 - (b)
 - (c)
15. Total water fed to boilers per hour
16. Total dry steam consumed per hour
17. Loss of steam and water per hour due to drips from main steam pipes and to leakage of plant
18. Net dry steam consumed per hour by engine and auxiliaries

Pressures and Temperatures (Corrected).

19. Pressure in steam pipe near throttle by gauge lbs. per sq. in.
20. Barometric pressure of atmosphere in ins. of mercury ins.
21. Pressure in receivers by gauge lbs. per sq. in.
22. Vacuum in condenser in inches of mercury ins.
23. Pressure in jackets and reheaters by gauge lbs. per sq. in.
24. Temperature of main supply of feed water deg. Fahr.
25. Temperature of auxiliary supplies of feed water:
 - (a)
 - (b)
 - (c)
26. Ideal feed-water temperature corresponding to pressure of steam in the exhaust pipe, allowance being made for heat derived from jacket or reheater drips.

Data Relating to Heat Measurement.

27. Heat units per pound of feed water, main supply B.T.U.
28. Heat units per pound of feed water, auxiliary supplies:
 - (a)
 - (b)
 - (c)
29. Heat units consumed per hour, main supply
30. Heat units consumed per hour, auxiliary supplies:
 - (a)
 - (b)
 - (c)
31. Total heat units consumed per hour for all purposes.
32. Loss of heat per hour due to leakage of plant, drips, etc.
33. Net heat units consumed per hour:
 - (a) By engine alone
 - (b) By auxiliaries
34. Heat units consumed per hour by engine alone, reckoned from temperature given in line 26.

Indicator Diagrams.

35. Commercial cut-off in per cent of stroke
36. Initial pressure, lbs. per sq. in. above atmosphere ... [Separate Columns for each Cylinder.]
37. Back pressure at mid-stroke, above or below atmosphere, in lbs. per sq. in.
38. Mean effective pressure in lbs. per sq. in.
39. Equivalent M.E.P. in lbs. per sq. in.:
 - (a) Referred to first cylinder
 - (b) Referred to second cylinder
 - (c) Referred to third cylinder
40. Pressure above zero in lbs. per sq. in.:
 - (a) Near cut-off
 - (b) Near release
 - (c) Near beginning of compression
- Percentage of stroke at points where pressures are measured:
 - (a) Near cut-off
 - (b) Near release
 - (c) Near beginning of compression
41. Steam accounted for by indicator in (pounds per I.H.P. per hour: (a) Near cut-off; (b) Near release.
42. Ratio of expansion: (a) Commercial; (b) Ideal
43. Revolutions per minute *Speed.* rev.
44. Indicated horse-power developed by main-engine cylinders:
 - First cylinder H.P.
 - Second cylinder
 - Third cylinder
 - Total
45. Brake horse-power developed by engine

Standard Efficiency and other Results.*

- 46. Heat units consumed by engine and auxiliaries per hour:
 - (a) per indicated horse-power..... B.T.U.
 - (b) per brake horse-power.....
- 47. Equivalent standard coal in lbs. per hour:
 - (a) per indicated horse-power..... lbs.
 - (b) per brake horse-power.....
- 48. Heat units consumed by main engine per hour corresponding to ideal maximum temperature of feed water given in line 26:
 - (a) per indicated horse-power..... B.T.U.
 - (b) per brake horse-power.....
- 49. Dry steam consumed per indicated horse-power per hour:
 - (a) Main cylinders including jackets..... lbs.
 - (b) Auxiliary cylinders.....
 - (c) Engine and auxiliaries.....
- 50. Dry steam consumed per brake horse-power per hour:
 - (a) Main cylinders including jackets.....
 - (b) Auxiliary cylinders.....
 - (c) Engine and auxiliaries.....
- 51. Percentage of steam used by main-engine cylinders accounted for by indicator diagrams, near cut-off of high-pressure cylinder..... per cent.

Additional Data.

Add any additional data bearing on the particular objects of the test or relating to the special class of service for which the engine is used. Also give copies of indicator diagrams nearest the mean, and the corresponding scales.

DIMENSIONS OF PARTS OF ENGINES.

The treatment of this subject by the leading authorities on the steam-engine is very unsatisfactory, being a confused mass of rules and formulæ based partly upon theory and partly upon practice. The practice of builders shows an exceeding diversity of opinion as to correct dimensions. The treatment given below is chiefly the result of a study of the works of Rankine, Seaton, Unwin, Thurston, Marks, and Whitham, and is largely a condensation of a series of articles by the author published in the *American Machinist*, in 1894, with many alterations and much additional matter. In order to make a comparison of many of the formulæ they have been applied to the assumed cases of six engines of different sizes, and in some cases this comparison has led to the construction of new formulæ.

[NOTE, 1909. Since the first edition of this book was published, in 1895, no satisfactory treatise on this entire subject has appeared, and therefore the matter on pages 997 to 1020 has been left, in the revision for the 8th edition, in practically its original shape. Two notable papers on the subject, however, have appeared: 1, Current Practice in Engine Proportions, by Prof. John H. Barr, 1897, and 2, Current Practice in Steam-engine Design, by Ole N. Trooien, 1909. Both of these are abstracted on pages 1021 and 1022.]

Cylinder. (Whitham.)—Length of bore = stroke + breadth of piston-ring - 1/8 to 1/2 in.; length between heads = stroke + thickness of piston + sum of clearances at both ends; thickness of piston = breadth of ring + thickness of flange on one side to carry the ring + thickness of follower-plate.

Thickness of flange or follower..... 3/8 to 1/2 in. 3/4 in. 1 in.
For cylinder of diameter..... 8 to 10 in. 36 in. 60 to 100 in.

Clearance of Piston. (Seaton.)—The clearance allowed varies with the size of the engine from 1/32 to 3/8 in. for roughness of castings and 1/16 to 1/8 in. for each working joint. Naval and other very fast-running engines

* The horse-power referred to above items 46-50 is that of the main engine, exclusive of auxiliaries.

have a larger allowance. In a vertical direct-acting engine the parts which wear so as to bring the piston nearer the bottom are three, viz., the shaft journals, the crank-pin brasses, and piston-rod gudgeon-brasses.

Thickness of Cylinder. (Thurston.)—For engines of the older types and under moderate steam-pressures, some builders have for many years restricted the stress to about 2550 lbs. per sq. in.

$$t = ap_1D + b \dots \dots \dots (1)$$

is a common proportion; t , D , and b being thickness, diam., and a constant added quantity varying from 0 to 1/2, all in inches; p_1 is the initial unbalanced steam-pressure, lbs. per sq. in. In this expression b is made larger for horizontal than for vertical cylinders, as, for example, in large engines 0.5 in the one case and 0.2 in the other, the one requiring reboring more than the other. The constant a is from 0.0004 to 0.0005; the first value for vertical cylinders, or short strokes; the second for horizontal engines, or for long strokes.

Thickness of Cylinder and Its Connections for Marine Engines. (Seaton.)— D = the diam. of the cylinder in inches; p = load on the safety-valves in lbs. per sq. in.; f , a constant multiplier, = thickness of barrel + 0.25 in.

Thickness of metal of cylinder barrel or liner, not to be less than $p \times D$ + 3000 when of cast iron * $\dots \dots \dots (2)$

Thickness of cylinder-barrel = $p \times D \div 5000 + 0.6$ in. $\dots \dots \dots (3)$

Thickness of liner = $1.1 \times f \dots \dots \dots (4)$

Thickness of liner when of steel = $p \times D \div 6000 + 0.5$ in.

Thickness of metal of steam-ports = $0.6 \times f$.

Thickness of metal valve-box sides = $0.65 \times f$.

Thickness of metal of valve-box covers = $0.7 \times f$.

" " cylinder bottom = $1.1 \times f$, if single thickness.

" " " " = $0.65 \times f$, if double "

" " " covers = $1.0 \times f$, if single "

" " " " = $0.6 \times f$, if double "

" cylinder flange = $1.4 \times f$.

" " cover-flange = $1.3 \times f$.

" " valve-box flange = $1.0 \times f$.

" " door-flange = $0.9 \times f$.

" " face over ports = $1.2 \times f$.

" " " " = $1.0 \times f$, when there is a false-face.

" " false-face = $0.8 \times f$, when cast iron.

" " " " = $0.6 \times f$, when steel or bronze.

Whitham gives the following from different authorities:

Van Buren: $t = 0.0001 Dp + 0.15 \sqrt{D}$; $\dots \dots \dots (5)$

" " $t = 0.03 \sqrt{Dp}$ $\dots \dots \dots (6)$

Tredgold: $t = (D + 2.5) p + 1900$. $\dots \dots \dots (7)$

Weisbach: $t = 0.8 + 0.00033 pD$ $\dots \dots \dots (8)$

Seaton: $t = 0.5 + 0.0004 pD$ $\dots \dots \dots (9)$

Haswell: $t = 0.0004 pD + 1/8$ (vertical); $\dots \dots \dots (10)$

" " $t = 0.0005 pD + 1/8$ (horizontal) $\dots \dots \dots (11)$

Whitham recommends (6) where provision is made for the reboring, and where ample strength and rigidity are secured, for horizontal or vertical cylinders of large or small diameter; (9) for large cylinders using steam under 100 lbs. gauge-pressure, and

$$t = 0.003 D \sqrt{p} \text{ for small cylinders } \dots \dots \dots (12)$$

The following table gives the calculated thickness of cylinders of engines of 10, 30, and 50 in. diam., assuming p the maximum unbalanced pressure on the piston = 100 lbs. per sq. in. As the same engines will be used for calculations of other dimensions, other particulars concerning them are here given for reference.

* When made of exceedingly good material, at least twice melted, the thickness may be 0.8 of that given by the above rules.

DIMENSIONS, ETC., OF ENGINES.

Engine, No.	1 and 2.	3 and 4.	5 and 6.
Indicated horse-power.....I.H.P.	50	450	1250
Diam. of cyl., in.....D	10	30	50
Stroke, feet.....L	1 ... 2	2 1/2 ... 5	4 ... 8
Revs. per min.....r	250 ... 125	130 ... 65	90 ... 45
Piston speed, ft. per min.....S	500	650	700
Area of piston, sq. in.....a	78.54	706.86	1963.5
Mean effective pressure.....M.E.P.	42	32.3	30
Max. total unbalanced pressure.....P	7854	70,686	196,350
Max. total pressure per sq. in.....p	100	100	100

The thickness of the cylinders of these engines, according to the first eleven formulæ above quoted, ranges for engines 1 and 2 from 0.33 to 1.13 ins., for 3 and 4 from 0.99 to 2.00 ins., and for 5 and 6 from 1.56 to 3.00 ins. The averages of the 11 are, for 1 and 2, 0.76 in.; for 3 and 4, 1.48 ins.; for 5 and 6, 2.26 ins.

The average corresponds nearly to the formula $t = 0.00037 Dp + 0.4$ in. A convenient approximation is $t = 0.0004 Dp + 0.3$ in., which gives for

Diameters	10	20	30	40	50	60 in.
Thicknesses	0.70	1.10	1.50	1.90	2.30	2.70 in.

The last formula corresponds to a tensile strength of cast iron of 12,500 lbs., with a factor of safety of 10 and an allowance of 0.3 in. for reboring.

Cylinder-heads. — Thurston says: Cylinder-heads may be given a thickness, at the edges and in the flanges, exceeding somewhat that of the cylinder. An excess of not less than 25% is usual. It may be thinner in the middle. Where made, as is usual in large engines, of two disks with intermediate radiating, connecting ribs or webs, that section which is safe against shearing is probably ample. An examination of the designs of experienced builders, by Professor Thurston, gave

$$t = Dp \div 3000 + 1/4 \text{ inch,} \quad (1)$$

D being the diameter of that circle in which the thickness is taken.

Thurston also gives $t = 0.005 D \sqrt{p} + 0.25$ (2)

Marks gives $t = 0.003 \sqrt{p}$ (3)

He also says a good practical rule for pressures under 100 lbs. per sq. in. is to make the thickness of the cylinder-heads 1 1/4 times that of the walls; and applying this factor to his formula for thickness of walls, or $0.00028 pD$, we have

$$t = 0.00035 pD (4)$$

Whitham quotes from Seaton,

$$t = (pD + 500) \div 2000, \text{ which is equal to } 0.0005 pD + 0.25 \text{ inch} . . . (5)$$

Seaton's formula for cylinder bottoms, quoted above, is

$$t = 0.1 f, \text{ in which } f = 0.0002 pD + 0.85 \text{ in., or } t = 0.00022 pD + 0.93 . . . (6)$$

Applying the above formulæ to the engines of 10, 30, and 50 inches diameter, with maximum unbalanced steam-pressure of 100 lbs. per sq. in., we have

For cylinder 10-in. diam., 0.35 to 1.15 in.; for 30-in. diam., 0.90 to 1.75 in.; for 50-in. diam., 1.50 to 2.75 in. The averages are respectively 0.65, 1.38 and 2.10 in.

The average is expressed by the formula $t = 0.00036 Dp + 0.31$ inch.

Web-stiffened Cylinder-covers. — Seaton objects to webs for stiffening cast-iron cylinder-covers as a source of danger. The strain on the web is one of tension, and if there should be a nick or defect in the outer edge of the web the sudden application of strain is apt to start a crack. He recommends that high-pressure cylinders over 24 in. and

low-pressure cylinders over 40 in. diam. should have their covers cast hollow, with two thicknesses of metal. The depth of the cover at the middle should be about 1/4 the diam. of the piston for pressures of 80 lbs. and upwards, and that of the low-pressure cylinder-cover of a compound engine equal to that of the high-pressure cylinder. Another rule is to make the depth at the middle not less than 1.3 times the diameter of the piston-rod. In the British Navy the cylinder-covers are made of steel castings, 3/4 to 1 1/4 in. thick, generally cast without webs, stiffness being obtained by their form, which is often a series of corrugations.

Cylinder-head Bolts. — Diameter of bolt-circle for cylinder-head = diameter of cylinder + 2 x thickness of cylinder + 2 x diameter of bolts. The bolts should not be more than 6 inches apart (Whitham).

Marks gives for number of bolts $b = 0.7854 D^2 p + 5000 c$, in which c = area of a single bolt, p = boiler-pressure in lbs. per sq. in.; 5000 lbs. is taken as the safe strain per sq. in. on the nominal area of the bolt.

Seaton says: Cylinder-cover studs and bolts, when made of steel, should be of such a size that the strain in them does not exceed 5000 lbs. per sq. in. When of less than 7/8 inch diameter it should not exceed 4500 lbs. per sq. in. When of iron the strain should be 20% less.

Thurston says: Cylinder flanges are made a little thicker than the cylinder, and usually of equal thickness with the flanges of the heads. Cylinder-bolts should be so closely spaced as not to allow springing of the flanges and leakage, say, 4 to 5 times the thickness of the flanges. Their diameter should be proportioned for a maximum stress of not over 4000 to 5000 lbs. per square inch.

If D = diameter of cylinder, p = maximum steam-pressure, b = number of bolts, s = size or diameter of each bolt, and 5000 lbs. be allowed per sq. in. of actual area at the root of the thread, $0.7854 D^2 p = 3927 bs^2$; whence $bs^2 = 0.0002 D^2 p$;

$$b = 0.0002 \frac{D^2 p}{s^2}; s = 0.01414 D \sqrt{\frac{p}{b}} \text{ For the three engines we have:}$$

Diameter of cylinder, inches.....	10	30	50
Diameter of bolt-circle, approx.....	13	35	57.5
Circumference of circle, approx.....	40.8	110	180
Minimum no. of bolts, circ. + 6.....	7	18	30
Diam. of bolts, $s = 0.01414 D \sqrt{\frac{p}{b}}$	3/4 in.	1.00	1.29

The diameter of bolt for the 10-inch cylinder is 0.54 in. by the formula, but 3/4 inch is as small as should be taken, on account of possible over-strain by the wrench in screwing up the nut.

The Piston. Details of Construction of Ordinary Pistons. (Seaton.) — Let D be the diameter of the piston in inches, p the effective pressure per square inch on it, x a constant multiplier, found as follows:

$$x = (D \div 50) \times \sqrt{p} + 1.$$

The thickness of front of piston near the boss	= 0.2 x x.
" " " " " rim	= 0.17 x x.
" " back " "	= 0.18 x x.
" " boss around the rod	= 0.3 x x.
" " flange inside packing-ring	= 0.23 x x.
" " " " edge	= 0.25 x x.
" " packing-ring	= 0.15 x x.
" " junk-ring at edge	= 0.23 x x.
" " " " inside packing-ring	= 0.21 x x.
" " " " at bolt-holes	= 0.35 x x.
" " metal around piston edge	= 0.25 x x.
The breadth of packing-ring	= 0.63 x x.
" " depth of piston at center	= 1.4 x x.
" " lap of junk-ring on the piston	= 0.45 x x.
" " space between piston body and packing-ring	= 0.3 x x.
" " diameter of junk-ring bolts	= 0.1 x x + 0.25 in.
" " pitch of junk-ring bolts	= 10 diameters.
" " number of webs in the piston	= (D + 20) ÷ 12.
" " thickness of webs in the piston	= 0.18 x x.

Marks gives the approximate rule: Thickness of piston-head = $\sqrt[4]{lD}$, in which l = length of stroke, and D = diameter of cylinder in inches. Whitham says: in a horizontal engine the rings support the piston, or at least a part of it, under ordinary conditions. The pressure due to the weight of the piston upon an area equal to 0.7 the diameter of the cylinder X breadth of ring-face, should never exceed 200 lbs. per sq. in. He also gives a formula much used in this country: Breadth of ring-face = 0.15 X diameter of cylinder.

For our engines we have diameter =

	10	30	50
Marks, $\sqrt[4]{lD}$; long stroke	3.31	5.48	7.00
Marks, $\sqrt[4]{lD}$; short stroke	3.94	6.51	8.32
Seaton, depth at center = 1.4 x	4.20	9.80	15.40
Seaton, breadth of ring = 0.63 x	1.89	4.41	6.93
Whitham, breadth of ring = 0.15 D	1.50	4.50	7.50

Diameter of Piston Packing-rings. — These are generally turned, before they are cut, about 1/4 inch diameter larger than the cylinder, for cylinders up to 20 inches diameter, and then enough is cut out of the rings to spring them to the diameter of the cylinder. For larger cylinders the rings are turned proportionately larger. Seaton recommends an excess of 1% of the diameter of the cylinder.

A theoretical paper on Piston Packing Rings of Modern Steam Engines by O. C. Reymanu will be found in *Jour. Frank. Inst.*, Aug., 1897.

Cross-section of the Rings. — The thickness is commonly made 1/30 of the diam. of cyl. + 1/8 inch, and the width = thickness + 1/8 inch. For an eccentric ring the mean thickness may be the same as for a ring of uniform thickness, and the minimum thickness = 2/3 the maximum.

A circular issued by J. H. Dunbar, manufacturer of packing-rings, Youngstown, Ohio, says: Unless otherwise ordered, the thickness of rings will be made equal to 0.03 X their diameter. This thickness has been found to be satisfactory in practice. It admits of the ring being made about 3/16 in. to the foot larger than the cylinder, and has, when new, a tension of about two pounds per inch of circumference, which is ample to prevent leakage if the surface of the ring and cylinder are smooth.

As regards the width of rings, authorities "scatter" from very narrow to very wide, the latter being fully ten times the former. For instance, Unwin gives $W = 0.014d + 0.08$. Whitham's formula is $W = 0.15d$. In both formulæ W is the width of the ring in inches, and d the diameter of the cylinder in inches. Unwin's formula makes the width of a 20 in. ring $W = 20 \times 0.014 + 0.08 = 0.36$ in., while Whitham's is $20 \times 0.15 = 3$ in. for the same diameter of ring. There is much less difference in the practice of engine-builders in this respect, but there is still room for a standard width of ring. It is believed that for cylinders over 16 in. diameter 3/4 in. is a popular and practical width, and 1/2 in. for cylinders of that size and under.

E. R. McGahey, *Machy.*, Feb., 1906, gives the following tables for sizes of piston rings for cylinders 6 to 20 in., diameter. A = (outside diam. of ring — bore of cylinder); B = thickness (radial) of equal section ring, or least thickness of eccentric ring; C = width of ring (axial); D = amount cut out or lap; E = greatest thickness of eccentric ring.

EQUAL SECTION RINGS.

Diam.	6	7	8	9	10	11	12	13	14	15	16	17	18	19	20
A	5/32	5/32	3/16	3/16	7/32	1/4	1/4	9/32	9/32	5/16	11/32	11/32	3/8	13/32	13/32
B	1/4	9/32	5/16	3/8	13/32	7/16	15/32	1/2	9/16	19/32	5/8	11/16	3/4	3/4	13/16
C	5/16	3/8	3/8	7/16	7/16	1/2	1/2	9/16	9/16	11/16	11/16	3/4	3/4	13/16	13/16
D	35/64	39/64	21/32	23/32	25/32	27/32	7/8	15/16	1	11/16	11/8	13/16	11/4	19/32	11/32

ECCENTRIC RINGS.

Diam.	6	7	8	9	10	11	12	13	14	15	16	17	18	19	20
A	5/32	5/32	3/16	3/16	7/32	1/4	1/4	9/32	9/32	5/16	11/32	11/32	3/8	13/32	13/32
B	3/16	7/32	1/4	9/32	9/32	5/16	11/32	3/8	13/32	7/16	15/32	15/32	1/2	17/32	9/16
C	5/16	3/8	3/8	7/16	7/16	1/2	1/2	9/16	9/16	11/16	11/16	3/4	3/4	13/16	13/16
D	35/64	39/64	21/32	23/32	25/32	27/32	7/8	15/16	1	11/16	11/8	13/16	11/4	19/32	11/32
E	9/32	5/16	11/32	3/8	13/32	7/16	15/32	1/2	9/16	5/8	11/16	11/16	3/4	13/16	7/8

Fit of Piston-rod into Piston. (Seaton.) — The most convenient and reliable practice is to turn the piston-rod end with a shoulder of 1/16 inch for small engines, and 1/8 inch for large ones; make the taper 3 in. to the foot until the section of the rod is three-fourths of that of the body, then turn the remaining part parallel; the rod should then fit into the piston so as to leave 1/8 in. between it and the shoulder for large pistons and 1/16 in. for small. The shoulder prevents the rod from splitting the piston, and allows of the rod being turned true after long wear without encroaching on the taper.

The piston is secured to the rod by a nut, and the size of the rod should be such that the strain on the section at the bottom of the thread does not exceed 5500 lbs. per sq. in. for iron, 7000 lbs. for steel. The depth of this nut need not exceed the diameter which would be found by allowing these strains. The nut should be locked to prevent its working loose.

Diameter of Piston-rods. — Unwin gives

$$d'' = bD \sqrt{p} \dots \dots \dots (1)$$

in which D is the cylinder diameter in inches, p is the maximum unbalanced pressure in lbs. per sq. in., and the constant $b = 0.0167$ for iron, and $b = 0.0144$ for steel. Thurston, from an examination of a considerable number of rods in use, gives

$$d'' = \sqrt{\frac{D^2 p L^2}{a}} + \frac{D}{80}, \text{ nearly } \dots \dots \dots (2)$$

(L in feet, D and d in inches), in which $a = 10,000$ and upward in the various types of engines, the marine screw engines or ordinary fast engines on shore are given the lowest values, while "low-speed engines" being less liable to accident from shock are given $a = 15,000$, often.

Connections of the piston-rod to the piston and to the cross-head should have a factor of safety of at least 8 or 10. Marks gives

$$d'' = 0.0179 D \sqrt{p}, \text{ for iron; for steel } d'' = 0.0105 D \sqrt{p}; \dots (3)$$

$$\text{and } d'' = 0.03901 \sqrt{D^2 l^2 p}, \text{ for iron; for steel } d'' = 0.03525 \sqrt{D^2 l^2 p}, \dots (4)$$

in which l is the length of stroke, all dimensions in inches. Deduce the diameter of piston-rod by (3), and if this diameter is less than 1/12 l , then use (4).

Seaton gives: Diameter of piston-rod = $\frac{\text{Diameter of cylinder}}{F} \sqrt{p}$.

The following are the values of F :

Naval engines, direct-acting	$F = 60$
" " return connecting-rod, 2 rods	$F = 80$
Mercantile ordinary stroke, direct-acting	$F = 50$
" " long " "	$F = 48$
" " very long " "	$F = 45$
" " medium stroke, oscillating	$F = 45$

NOTE. — Long and very long, as compared with the stroke usual for the power of engine or size of cylinder.

In considering an expansive engine, p , the effective pressure, should be taken as the absolute working pressure, or 15 lbs. above that to which the boiler safety-valve is loaded; for a compound engine the value of p for the high-pressure piston should be taken as the absolute pressure, less 15 lbs., or the same as the load on the safety-valve; for the medium-pressure the load may be taken as that due to half the absolute boiler-pressure; and for the low-pressure cylinder the pressure to which the escape-valve is loaded + 15 lbs., or the maximum absolute pressure which can be got in the receiver, or about 25 lbs. It is an advantage to make all the rods of a compound engine alike, and this is now the rule.

Applying the above formulæ to the engines of 10, 30, and 50 in. diameter, both short and long stroke, we have:

Diameter of Piston-rods.

Diameter of Cylinder, inches.....	10		30		50	
Stroke, inches.....	12	24	30	60	48	96
Unwin, iron, $0.0167 D \sqrt{p}$	1.67	1.67	5.01	5.01	8.35	8.35
Unwin, steel, $0.0144 D \sqrt{p}$	1.44	1.44	4.32	4.32	7.20	7.20
Thurston $\sqrt{\frac{D^2 p L^2}{10,000} + \frac{D}{80}}$ (L in feet)....	1.13	3.12	5.10
Thurston, same with $a = 15,000$	1.40	3.88	6.35
Marks, iron, $0.0179 D \sqrt{p}$	1.79	5.37	5.37	8.95	8.95
Marks, iron, $0.03901 \sqrt{D^2 p}$	1.35	1.91	3.70	5.13	6.04	8.54
Marks, steel, $0.0105 D \sqrt{p}$	(1.05)	(3.15)	(5.25)
Marks, steel, $0.03525 \sqrt{D^2 p}$	1.22	1.73	3.34	4.72	5.46	7.72
Seaton, naval engines, $\frac{D}{60} \sqrt{p}$	1.67	5.01	8.35
Seaton, land engine, $\frac{D}{45} \sqrt{p}$	2.22	6.67	11.11
Average of four for iron.....	1.49	1.82	4.30	5.26	7.11	8.74

The figures in parentheses opposite Marks's third formula would be rejected since they are less than $1/8$ of the stroke, and the figures derived by his fourth formula would be taken instead. The figure 1.79 opposite his first formula would be rejected for the engine of 24-inch stroke.

An empirical formula which gives results approximating the above averages is $d'' = 0.0145 \sqrt{Dlp}$ for short stroke and $0.013 \sqrt{Dlp}$ for long stroke engines.

The calculated results for this formula, for the six engines, are, respectively, 1.58, 2.02, 4.35, 5.52, 7.10, 9.01.

Piston-rod Guides. — The thrust on the guide, when the connecting-rod is at its maximum angle with the line of the piston-rod, is found from the formula: Thrust = total load on piston \times tangent of maximum angle of connecting rod = $p \tan \theta$. This angle, θ , is the angle whose sine = half stroke of piston \div length of connecting-rod.

Ratio of length of connecting-rod to stroke....	2	2 1/2	3
Maximum angle of connecting-rod with line of piston-rod.....	14° 29'	11° 33'	9° 36'
Tangent of the angle.....	0.258	0.204	0.169
Secant of the angle.....	1.0327	1.0206	1.014

Seaton says: The area of the guide-block or slipper surface on which the thrust is taken should in no case be less than will admit of a pressure of 400 lbs., on the square inch; and for good working those surfaces which take the thrust when going ahead should be sufficiently large to prevent

the maximum pressure exceeding 100 lbs. per sq. in. When the surfaces are kept well lubricated this allowance may be exceeded.

Thurston says: The rubbing surfaces of guides are so proportioned that if V be their relative velocity in feet per minute, and p be the intensity of pressure on the guide in lbs. per sq. in., $pV < 60,000$ and $pV > 40,000$.

The lower is the safer limit; but for marine and stationary engines it is allowable to take $p = 60,000 \div V$. According to Rankine, for locomotives, $p = \frac{44,800}{V + 20}$, where p is the pressure in lbs. per sq. in. and V the velocity of rubbing in feet per minute. This includes the sum of all pressures forcing the two rubbing surfaces together.

Some British builders of portable engines restrict the pressure between the guides and cross-heads to less than 40, sometimes 35 lbs. per square inch.

For a mean velocity of 600 feet per minute, Prof. Thurston's formulas give, $p < 100$, $p > 66.7$; Rankine's gives $p = 72.2$ lbs. per sq. in.

Whitham gives,

$$A = \text{area of slides in square inches} = \frac{P}{p_0 \sqrt{n^2 - 1}} = \frac{0.7854 d^2 p_1}{p_0 \sqrt{n^2 - 1}}$$

in which P = total unbalanced pressure, p_1 = pressure per square inch on piston, d = diameter of cylinder, p_0 = pressure allowable per square inch on slides, and n = length of connecting-rod \div length of crank. This is equivalent to the formula, $A = P \tan \theta \div p_0$. For $n = 5$, $p_1 = 100$ and $p_0 = 80$, $A = 0.2004 d^2$. For the three engines 10, 30 and 50 in. diam., this would give for area of slides, $A = 20, 180$ and 500 sq. in., respectively. Whitham says: The normal pressure on the slide may be as high as 500 lbs. per sq. in., but this is when there is good lubrication and freedom from dust. Stationary and marine engines are usually designed to carry 100 lbs. per sq. in., and the area in this case is reduced from 50% to 60% by grooves. In locomotive engines the pressure ranges from 40 to 50 lbs. per sq. in. of slide, on account of the inaccessibility of the slide, dirt, cinder, etc.

There is perfect agreement among the authorities as to the formula for area of the slides, $A = P \tan \theta \div p_0$; but the value given to p_0 , the allowable pressure per square inch, ranges all the way from 35 lbs. to 500 lbs.

The Connecting-rod. — Ratio of length of connecting-rod to length of stroke. — Experience has led generally to the ratio of 2 or 2 1/2 to 1, the latter giving a long and easy-working rod, the former a rather short, but yet a manageable one (Thurston). Whitham gives the ratio of from 2 to 4 1/2, and Marks from 2 to 4.

Dimensions of the Connecting-rod. — The calculation of the diameter of a connecting-rod on a theoretical basis, considering it as a strut subject to both compressive and bending stresses, and also to stress due to its inertia, in high-speed engines, is quite complicated. See Whitham, Steam-engine Design, p. 217; Thurston, Manual of S. E., p. 100. Empirical formulas are as follows: For circular rods, largest at the middle, D = diam. of cylinder, l = length of connecting-rod in inches, p = maximum steam-pressure, lbs. per sq. in.

- (1) Whitham, diam. at middle, $d'' = 0.0272 \sqrt{Dl \sqrt{p}}$.
- (2) Whitham, diam. at necks, $d'' = 1.0$ to $1.1 \times$ diam. of piston-rod.
- (3) Sennett, diam. at middle, $d'' = D \sqrt{p + 55}$.
- (4) Sennett, diam. at necks, $d'' = D \sqrt{p + 60}$.
- (5) Marks, diam., $d'' = 0.0179 D \sqrt{p}$, if diam. is greater than $1/24$ length.
- (6) Marks, diam., $d'' = 0.02758 \sqrt{Dl \sqrt{p}}$, if diam. found by (5) is less than $1/24$ length.
- (7) Thurston, diam., at middle, $d'' = a \sqrt{DL \sqrt{p}} + C$, D in inches, L in feet, $a = 0.15$ and $C = 1/2$ inch for fast engines, $a = 0.08$ and $C = 3/4$ inch for moderate speed.
- (8) Seaton says: The rod may be considered as a strut free at both ends, and, calculating its diameter accordingly,

$$\text{diameter at middle} = \sqrt{R(1 + 4ar^2) + 48.5}$$

where R = the total load on piston P multiplied by the secant of the maximum angle of obliquity of the connecting-rod.

For wrought iron and mild steel a is taken at $1/3000$. The following are the values of r in practice:

Naval engines	— Direct-acting	$r = 9$ to 11 ;
"	Return connecting-rod	$r = 10$ to 13 , old;
"	Return connecting-rod	$r = 8$ to 9 , modern;
"	Trunk	$r = 11.5$ to 13 .
Mercantile "	Direct-acting, ordinary	$r = 12$.
Mercantile "	Direct-acting, long stroke	$r = 13$ to 16 .

(9) The following empirical formula is given by Seaton as agreeing closely with good modern practice:

Diameter of connecting-rod at middle = $\sqrt{LK} \div 4$, l = length of rod in inches, and $K = 0.03 \sqrt{\text{effective load on piston in pounds}}$.

The diam. at the ends may be 0.875 of the diam. at the middle.

Seaton's empirical formula when translated into terms of D and p

is the same as the second one by Marks, viz., $d'' = 0.02758 \sqrt{Dl \sqrt{p}}$. Whitam's (1) is also practically the same.

(10) Taking Seaton's more complex formula, with length of connecting-rod = $2.5 \times$ length of stroke, and $r = 12$ and 16 , respectively, it reduces to: Diam. at middle = $0.02294 \sqrt{P}$ and $0.02411 \sqrt{P}$ for short and long stroke engines, respectively.

Applying the above formulas to the engines of our list, we have

Diameter of Connecting-rods.

Diameter of Cylinder, inches.....	10		30		50	
Stroke, inches.....	12	24	30	60	48	96
Length of connecting-rod l	30	60	75	150	120	240
(3) $d'' = \frac{D}{55} \sqrt{p} = 0.0182 D \sqrt{p}$	1.82	1.82	5.46	5.46	9.09	9.09
(5) $d'' = 0.0179 D \sqrt{p}$	1.79		5.37		8.95	
(6) $d'' = 0.02758 \sqrt{Dl \sqrt{p}}$		2.14		5.85		9.51
(7) $d'' = 0.15 \sqrt{DL \sqrt{p} + 1/2}$	2.87		7.00		11.11	
(7) $d'' = 0.08 \sqrt{DL \sqrt{p} + 3/4}$		2.54		5.65		8.75
(9) $d'' = 0.03 \sqrt{P}$	2.67	2.67	7.97	7.97	13.29	13.29
(10) $d'' = 0.02294 \sqrt{P}$; $0.02411 \sqrt{P}$	2.03	2.14	6.09	6.41	10.16	10.68
Average.....	2.24	2.26	6.38	6.27	10.52	10.26

Formulae 5 and 6 (Marks), and also formula 10 (Seaton), give the larger diameters for the long-stroke engine; formulae 7 give the larger diameters for the short-stroke engines. The average figures show but little difference in diameter between long- and short-stroke engines; this is what might be expected, for while the connecting-rod, considered simply as a column, would require an increase of diameter for an increase of length, the load remaining the same, yet in an engine generally the shorter the connecting-rod the greater the number of revolutions, and consequently the greater the strains due to inertia. The influences tending to increase the diameter therefore tend to balance each other, and to render the diameter to some extent independent of the length. The average figures correspond nearly to the simple formula $d'' = 0.021 D \sqrt{p}$. The diameters of rod for the three diameters of engine by this formula are, respectively, 2.10, 6.30, and 10.50 in. Since the total pressure on the piston $P = 0.7854 D^2 p$, the formula is equivalent to $d'' = 0.0237 \sqrt{P}$.

Connecting-rod Ends. — For a connecting-rod end of the marine type, where the end is secured with two bolts, each bolt should be proportioned for a safe tensile strength equal to two-thirds the maximum pull or thrust in the connecting-rod.

The cap is to be proportioned as a beam loaded with the maximum pull of the connecting-rod, and supported at both ends. The calculation should be made for rigidity as well as strength, allowing a maximum deflection of $1/100$ inch. For a strap-and-key connecting-rod end the strap is designed for tensile strength, considering that two-thirds of the pull on the connecting-rod may come on one arm. At the point where the metal is slotted for the key and gib, the straps must be thickened to make the cross-section equal to that of the remainder of the strap. Between the end of the strap and the slot the strap is liable to fail in double shear, and sufficient metal must be provided at the end to prevent such failure.

The breadth of the key is generally one-fourth of the width of the strap, and the length, parallel to the strap, should be such that the cross-section will have a shearing strength equal to the tensile strength of the section of the strap. The taper of the key is generally about $5/8$ inch to the foot.

Tapered Connecting-rods. — In modern high-speed engines it is customary to make the connecting-rods of rectangular instead of circular section, the sides being parallel, and the depth increasing regularly from the crosshead end to the crank-pin end. According to Grashof, the bending action on the rod due to its inertia is greatest at $6/10$ the length from the crosshead end, and, according to this theory, that is the point at which the section should be greatest, although in practice the section is made greatest at the crank-pin end.

Professor Thurston furnishes the author with the following rule for tapered connecting-rod of rectangular section: Take the section as com-

puted by the formula $d'' = 0.1 \sqrt{DL \sqrt{p} + 3/4}$ for a circular section, and for a rod $4/3$ the actual length, placing the computed section at $2/3$ the length from the small end, and carrying the taper straight through this fixed section to the large end. This brings the computed section at the surge point and makes it heavier than the rod for which a tapered form is not required.

Taking the above formula, multiplying L by $4/3$, and changing it to l

in inches, it becomes $d = 1/30 \sqrt{Dl \sqrt{p} + 3/4}$ in. Taking a rectangular section of the same area as the round section whose diameter is d , and making the depth of the section $h =$ twice the thickness t , we have

$0.7854 d^2 = ht = 2 t^2$, whence $t = 0.627 d = 0.0209 \sqrt{Dl \sqrt{p} + 0.47}$ in., which is the formula for the thickness or distance between the parallel sides of the rod. Making the depth at the crosshead end = $1.5 t$, and at $2/3$ the length = $2 t$, the equivalent depth at the crank end is $2.25 t$. Applying the formula to the short-stroke engines of our examples, we have

Diameter of cylinder, inches.....	10	30	50
Stroke, inches.....	12	30	48
Length of connecting-rod.....	30	75	120
Thickness $t = 0.0209 \sqrt{Dl \sqrt{p} + 0.47} =$	1.61	3.60	5.59
Depth at crosshead end, $1.5 t =$	2.42	5.41	8.39
Depth at crank end, $2 1/4 t =$	3.62	8.11	12.58

The thicknesses t , found by the formula $t = 0.0209 \sqrt{Dl \sqrt{p} + 0.47}$, agree closely with the more simple formula $t = 0.01 D \sqrt{p} + 0.60$ in., the thicknesses calculated by this formula being respectively 1.6, 3.6, and 5.6 inches.

The Crank-pin. — A crank-pin should be designed (1) to avoid heating, (2) for strength, (3) for rigidity. The heating of a crank-pin depends on the pressure on its rubbing surface, and on the coefficient of friction, which latter varies greatly according to the effectiveness of

the lubrication. It also depends upon the facility with which the heat produced may be carried away: thus it appears that locomotive crank-pins may be prevented to some degree from overheating by the cooling action of the air through which they pass at a high speed.

Marks gives $l = 0.0000247 fpND^2 = 1.038 f \text{ (I.H.P.)} \div L$. . . (1)

Whitham gives $l = 0.9075 f \text{ (I.H.P.)} \div L$ (2)

in which l = length of crank-pin journal in inches, f = coefficient of friction, which may be taken at 0.03 to 0.05 for perfect lubrication, and 0.08 to 0.10 for imperfect; p = mean pressure in the cylinder in pounds per square inch; D = diameter of cylinder in inches; N = number of single strokes per minute; I.H.P. = indicated horse-power; L = length of stroke in feet. These formulæ are independent of the diameter of the pin, and Marks states as a general law, within reasonable limits as to pressure and speed of rubbing, the longer a bearing is made, for a given pressure and number of revolutions, the cooler it will work; and its diameter has no effect upon its heating. Both of the above formulæ are deduced empirically from dimensions of crank-pins of existing marine engines. Marks says that about one-fourth the length required for crank-pins of propeller engines will serve for the pins of side-wheel engines, and one-tenth for locomotive engines, making the formula for locomotive crank-pins $l = 0.0000247 fpND^2$, or if $p = 150$, $f = 0.06$, and $N = 600$, $l = 0.013D^2$.

Whitham recommends for pressure per square inch of projected area, for naval engines 500 pounds, for merchant engines 400 pounds, for paddle-wheel engines 800 to 900 pounds.

Thurston says the pressure should, in the steam-engine, never exceed 500 or 600 pounds per square inch for wrought-iron pins, or about twice that figure for steel. He gives the formula for length of a steel pin, in inches,

$l = PR \div 600,000$, (3)

in which P and R are the mean total load on the pin in pounds, and the number of revolutions per minute. For locomotives, the divisor may be taken as 500,000. Where iron is used this figure should be reduced to 300,000 and 250,000 for the two cases taken. Pins so proportioned, if well made and well lubricated, may always be depended upon to run cool; if not well formed, perfectly cylindrical, well finished, and kept well oiled, no crank-pin can be relied upon. It is assumed above that good bronze or white-metal bearings are used.

Thurston also says: The size of crank-pins required to prevent heating of the journals may be determined with a fair degree of precision by either of the formulæ given below:

$l = P \div V + 20 \div 44,800 d$ (Rankine, 1865); (4)

$l = PV \div 60,000 d$ (Thurston, 1862); (5)

$l = PN - 350,000$ (Van Buren, 1866). (6)

The first two formulæ give what are considered by their authors fair working proportions, and the last gives minimum length for iron pins. (V = velocity of rubbing surface in feet per minute.)

Formula (1) was obtained by observing locomotive practice in which great liability exists of annoyance by dust, and great risk occurs from inaccessibility while running, and (2) by observation of crank-pins of naval screw-engines. The first formula is therefore not well suited for marine practice.

Steel can usually be worked at nearly double the pressure admissible with iron running at similar speed.

Since the length of the crank-pin will be directly as the power expended upon it and inversely as the pressure, we may take it as

$l = a \text{ (I.H.P.)} \div L$, (7)

in which a is a constant, and L the stroke of piston, in feet. The values of the constant, as obtained by Mr. Skeel, are about as follows: $a = 0.04$ where water can be constantly used; $a = 0.045$ where water is not generally used; $a = 0.05$ where water is seldom used; $a = 0.06$ where water is never needed. Unwin gives

$l = a \text{ (I.H.P.)} + r$, (8)

In which r = crank radius in inches, $a = 0.3$ to $a = 0.4$ for iron and for marine engines, and $a = 0.066$ to $a = 0.1$ for the case of the best steel and for locomotive work, where it is often necessary to shorten up outside pins as much as possible.

J. B. Stanwood (*Eng'g*, June 12, 1891), in a table of dimensions of parts of American Corliss engines from 10 to 30 inches diameter of cylinder, gives sizes of crank-pins which approximate closely to the formula

$l = 0.275 D'' + 0.5 \text{ in.}; d = 0.25 D''$ (9)

By calculating lengths of iron crank-pins for the engines 10, 30, and 50 inches diameter, long and short stroke, by the several formulæ above given, it is found that there is a great difference in the results, so that one formula in certain cases gives a length three times as great as another. Nos. (4), (5), and (6) give lengths much greater than the others. Marks (1), Whitham (2), Thurston (7), $l = 0.06 \text{ I.H.P.} \div L$, and Unwin (8), $l = 0.4 \text{ I.H.P.} + r$, give results which agree more closely.

The calculated lengths of iron crank-pins for the several cases by formulæ (1), (2), (7), and (8) are as follows:

Length of Crank-pins.

Diameter of cylinder D	10	10	30	30	50	50
Stroke L (ft.)	1	2	2 1/2	5	4	8
Revolutions per minute R	250	125	130	65	90	45
Horse-power I.H.P.	50	50	450	450	1,250	1,250
Maximum pressure lbs.	7,854	7,854	70,686	70,686	196,350	196,350
Mean pressure per cent of max.	42	42	32.3	32.3	30	30
Mean pressure P	3,299	3,299	22,832	22,832	58,905	58,905
Length of crank-pin:						
(1) Whitham, $l = 0.9075 \times .05 \text{ I.H.P.} \div L$	2.18	1.09	8.17	4.08	14.18	7.09
(2) Marks, $l = 1.038 \times .05 \text{ I.H.P.} \div L$	2.59	1.30	9.34	4.67	16.22	8.11
(7) Thurston, $l = 0.06 \text{ I.H.P.} \div L$	3.00	1.50	10.80	5.40	18.75	9.38
(8) Unwin, $l = 0.4 \text{ I.H.P.} \div r$	3.33	1.67	12.0	6.0	20.83	10.42
(8) Unwin, $l = 0.3 \text{ I.H.P.} + r$	2.50	1.25	9.0	4.5	15.62	7.81
Average	2.72	1.36	9.86	4.93	17.12	8.56
(8) Unwin, best steel, $l = 0.1 \text{ I.H.P.} \div r$	3.83	0.42	3.0	1.5	5.21	2.61
(3) Thurston, steel, $l = PR \div 600,000$	1.37	0.69	4.95	2.47	8.84	4.42

The calculated lengths for the long-stroke engines are too low to prevent excessive pressures. See "Pressures on the Crank-pins," below.

The Strength of the Crank-pin is determined substantially as is that of the crank. In overhung cranks the load is usually assumed as carried at its extremity, and, equating its moment with that of the resistance of the pin,

$1/2 Pl = 1/32 t \pi d^3$, and $d = \sqrt[3]{5.1 Pl / t}$,

in which d = diameter of pin in inches; P = maximum load on the piston, t = the maximum allowable stress on a square inch of the metal. For iron it may be taken at 9000 lbs. For steel the diameters found by this formula may be reduced 10%. (Thurston.)

Unwin gives the same formula in another form, viz.:

$d = \sqrt[3]{5.1 / t} \sqrt[3]{Pl} = \sqrt[3]{5.1 / t} \sqrt[3]{P l}$,

the last form to be used when the ratio of length to diameter is assumed. For wrought iron, $t = 6000$ to 9000 lbs. per sq. in.,

$\sqrt[3]{5.1/t} = 0.0947$ to 0.0827 ; $\sqrt[3]{5.1/t} = 0.0291$ to 0.0238 .

For steel, $t = 9000$ to 13,000 lbs. per sq. in.,

$\sqrt[3]{5.1/t} = 0.0827$ to 0.0723 ; $\sqrt[3]{5.1/t} = 0.0238$ to 0.0194 .

Whitham gives $d = 0.0827 \sqrt[3]{Pl} = 2.1058 \sqrt[3]{l \times \text{I.H.P.} + LR}$ for strength, and $d = 0.0405 \sqrt[3]{Pl^3}$ for rigidity, and recommends that the diameter be calculated by both formulæ, and the largest result taken. The first is the same as Unwin's formula, with l taken at 9000 lbs. per sq. in. The second is based upon an arbitrary assumption of a deflection of $1/300$ in. at the center of pressure (one-third of the length from the free end).

Marks, calculating the diameter for rigidity, gives

$$d = 0.066 \sqrt[3]{pl^3D^2} = 0.945 \sqrt[3]{(\text{H.P.})^2 + LN};$$

p = maximum steam-pressure in pounds per square inch, D = diameter of cylinder in inches, L = length of stroke in feet, N = number of single strokes per minute. He says there is no need of an investigation of the strength of a crank-pin, as the condition of rigidity gives a great excess of strength.

Marks's formula is based upon the assumption that the whole load may be concentrated at the outer end, and cause a deflection of 0.01 in. at that point. It is serviceable, he says, for steel and for wrought iron alike.

Using the average lengths of the crank-pins already found, we have the following for our six engines:

Diameter of Crank-pins.

Diameter of cylinder.....	10	10	30	30	50	50
Stroke, ft.....	1	2	2 1/2	5	4	8
Length of crank-pin.....	2.72	1.36	9.86	4.93	17.12	8.56
Unwin, $d = \sqrt[3]{\frac{5.1 Pl}{l}}$	2.29	1.82	7.34	5.82	12.40	9.84
Marks, $d = 0.066 \sqrt[3]{pl^3D^2}$	1.39	0.85	6.44	3.78	12.41	7.39

Pressures on the Crank-pins. — If we take the mean pressure upon the crank-pin — mean pressure on piston, neglecting the effect of the varying angle of the connecting-rod, we have the following, using the average lengths already found, and the diameters according to Unwin and Marks:

Engine No.....	1	2	3	4	5	6
Diameter of cylinder, inches.....	10	10	30	30	50	50
Stroke, feet.....	1	2	2 1/2	5	4	8
Mean pressure on pin, pounds.....	3,299	3,299	22,832	22,832	58,905	58,905
Projected area of pin, Unwin.....	6.23	2.36	72.4	28.7	212.3	84.2
Projected area of pin, Marks.....	3.78	1.16	63.5	18.6	212.5	63.3
Pressure per square inch, Unwin.....	530	1,398	315	796	277	700
Pressure per square inch, Marks.....	873	2,845	360	1,228	277	930

The results show that the application of the formulæ for length and diameter of crank-pins give quite low pressures per square inch of projected area for the short-stroke high-speed engines of the larger sizes, but too high pressures for all the other engines. It is therefore evident that after calculating the dimensions of a crank-pin according to the formulæ given the results should be modified, if necessary, to bring the pressure per square inch down to a reasonable figure.

In order to bring the pressures down to 500 pounds per square inch, we divide the mean pressures by 500 to obtain the projected area, or product of length by diameter. Making $l = 1.5 d$ for engines Nos. 1, 2, 4, and 6, the revised table for the six engines is as follows:

Engine No.....	1	2	3	4	5	6
Length of crank-pin, inches..	3.15	3.15	9.86	8.37	17.12	13.30
Diameter of crank-pin.....	2.10	2.10	7.34	5.58	12.40	8.87

Crosshead-pin or Wrist-pin. — Whitham says the bearing surface for the wrist-pin is found by the formula for crank-pin design. Seaton says the diameter at the middle must, of course, be sufficient to withstand the bending action, and generally from this cause ample surface is provided for good working; but in any case the area, calculated by multiplying the diameter of the journal by its length, should be such that the pressure does not exceed 1200 lbs. per sq. in., taking the maximum load on the piston as the total pressure on it.

For small engines with the gudgeon shrunk into the jaws of the connecting-rod, and working in brasses fitted into a recess in the piston-rod end and secured by a wrought-iron cap and two bolts, Seaton gives:

Diameter of gudgeon = 1.25 X diam. of piston-rod,
Length of gudgeon = 1.4 X diam. of piston-rod.

If the pressure on the section, as calculated by multiplying length by diameter, exceeds 1200 lbs. per sq. in., this length should be increased.

J. B. Stanwood, in his "Ready Reference" book, gives for length of crosshead-pin 0.25 to 0.3 diam. of piston, and diam. = 0.18 to 0.2 diam. of piston. Since he gives for diam. of piston-rod 0.14 to 0.17 diam. of piston, his dimensions for diameter and length of crosshead-pin are about 1.25 and 1.8 diam. of piston-rod respectively. Taking the maximum allowable pressure at 1200 lbs. per sq. in. and making the length of the crosshead-pin = $4/3$ of its diameter, we have $d = \sqrt{P} \div 40$, $l = \sqrt{P} + 30$, in which P = maximum total load on piston in lbs., d = diam. and l = length of pin in inches. For the engines of our example we have:

	10	30	50
Diameter of piston, inches.....	10	30	50
Maximum load on piston, lbs.....	7854	70,686	196,350
Diameter of crosshead-pin, inches.....	2.22	6.65	11.08
Length of crosshead-pin, inches.....	2.96	8.80	14.77
Stanwood's rule gives diameter, ins....	1.8 to 2	5.4 to 6	9.0 to 10
Stanwood's rule gives length, inches...	2.5 to 3	7.5 to 9	12.5 to 15
Stanwood's largest dimensions give pressure per sq. in., lbs.....	1309	1329	1309

Which pressures are greater than the maximum allowed by Seaton.

The Crank-arm. — The crank-arm is to be treated as a lever, so that if a is the thickness in a direction parallel to the shaft-axis and b its breadth at a section x inches from the crank-pin center, then, bending moment M at that section = Px , P being the thrust of the connecting-rod, and f the safe strain per square inch,

$$Px = \frac{fab^2}{6} \text{ and } \frac{a \times b^2}{6} = \frac{T}{f}, \text{ or } a = \frac{6T}{b^2 \times f}; b = \sqrt{\frac{6T}{fa}}$$

If a crank-arm were constructed so that b varied as \sqrt{x} (as given by the above rule) it would be of such a curved form as to be inconvenient to manufacture, and consequently it is customary in practice to find the maximum value of b and draw tangent lines to the curve at the points; these lines are generally, for the same reason, tangential to the boss of the crank-arm at the shaft.

The shearing strain is the same throughout the crank-arm; and, consequently, is large compared with the bending strain close to the crank-pin; and so it is not sufficient to provide there only for bending strains. The section at this point should be such that, in addition to what is given by the calculation from the bending moment, there is an extra square inch for every 8000 lbs. of thrust on the connecting-rod (Seaton).

The length of the boss h into which the shaft is fitted is from 0.75 to 1.0 of the diameter of the shaft D , and its thickness e must be calculated from the twisting strain PL . (L = length of crank.)

For different values of length of boss h , the following values of thickness of boss e are given by Seaton:

When $h = D$, then $e = 0.35 D$; if steel, 0.3.
 $h = 0.9 D$, then $e = 0.38 D$; if steel, 0.32.
 $h = 0.8 D$, then $e = 0.40 D$; if steel, 0.33.
 $h = 0.7 D$, then $e = 0.41 D$; if steel, 0.34.

The crank-eye or boss into which the pin is fitted should bear the same relation to the pin that the boss does to the shaft.

The diameter of the shaft-end onto which the crank is fitted should be 1.1 X diameter of shaft.

Thurston says: The empirical proportions adopted by builders will commonly be found to fall well within the calculated safe margin. These proportions are, from the practice of successful designers, about as follows:

For the wrought-iron crank, the hub is 1.75 to 1.8 times the least diameter of that part of the shaft carrying full load; the eye is 2.0 to 2.25 the diameter of the inserted portion of the pin, and their depths are, for the hub, 1.0 to 1.2 the diameter of shaft, and for the eye, 1.25 to 1.5 the diameter of pin. The web is made 0.7 to 0.75 the width of adjacent hub or eye, and is given a depth of 0.5 to 0.6 that of adjacent hub or eye.

For the cast-iron crank the hub and eye are a little larger, ranging in diameter respectively from 1.8 to 2 and from 2 to 2.2 times the diameters of shaft and pin. The flanges are made at either end of nearly the full depth of hub or eye. Cast iron has, however, fallen very generally into disuse.

The crank-shaft is usually enlarged at the seat of the crank to about 1.1 its diameter at the journal. The size should be nicely adjusted to allow for the shrinkage or forcing on of the crank. A difference of diameter of 0.2% will usually suffice; and a common rule of practice gives an allowance of but one-half of this, or 0.1%.

The formulæ given by different writers for crank-arms practically agree, since they all consider the crank as a beam loaded at one end and fixed at the other. The relation of breadth to thickness may vary according to the taste of the designer. Calculated dimensions for our six engines are as follows:

Dimensions of Crank-arms.

	10	10	30	30	50	50
Diam. of cylinder, ins.....	10	10	30	30	50	50
Stroke S, ins.....	12	24	30	60	48	96
Max. pressure on pin P (approx.), lbs.....	7854	7854	70,686	70,686	196,350	196,350
Diam. crank-pin d.....	2.10	2.10	7.34	5.58	12.40	8.87
Dia. shaft, $a \sqrt{\frac{I.H.P.}{R}}$, D (a = 4.69, 5.09 and 5.22).....	2.74	3.46	7.70	9.70	12.55	15.82
Length of boss, 0.8 D.....	2.19	2.77	6.16	7.76	10.04	12.65
Thickness of boss, 0.4 D.....	1.10	1.39	3.08	3.88	5.02	6.32
Diam. of boss, 1.8 D.....	4.93	6.23	13.86	17.46	22.59	28.47
Length crank-pin eye, 0.8 d.....	1.76	1.76	5.87	4.46	9.92	7.10
Thickness of crank-pin eye, 0.4 d.....	0.88	0.88	2.94	2.23	4.46	3.55
Max. mom. T at distance $\frac{1}{2}S - \frac{1}{2}D$ from center of pin, inch-lbs.....	37,149	80,661	788,149	1,848,439	3,479,322	7,871,671
Thickness of crank-arm a = 0.75 D.....	2.05	2.60	5.78	7.28	9.41	11.87
Greatest breadth, $b = \sqrt{6 T + 9000 a}$	3.48	4.55	9.54	13.0	15.7	21.0
Min. mom. T ₀ at distance d from center of pin = Pd.....	16,493	16,493	528,835	394,428	2,434,740	1,741,625
Least breadth, $b_1 = \sqrt{6 T_0 + 9000 a}$	2.32	2.06	7.81	6.01	13.13	9.89

The Shaft. — Twisting Resistance. — From the general formula

for torsion, we have: $T = \frac{\pi}{16} d^3 S = 0.19635 d^3 S$, whence $d = \sqrt[3]{\frac{5.1 T}{S}}$, in which T = torsional moment in inch-pounds, d = diameter in inches, and S = the shearing resistance of the material in pounds per square inch.

If a constant force P were applied to the crank-pin tangentially to its path, the work done per minute would be

$$P \times L \times 2\pi + 12 \times R = 33,000 \times I.H.P.,$$

in which L = length of crank in inches, and R = revs. per min., and the mean twisting moment $T = I.H.P. \div R \times 63,025$. Therefore

$$d = \sqrt[3]{5.1 T \div S} = \sqrt[3]{321,427 I.H.P. \div RS}.$$

This may take the form

$$d = \sqrt[3]{I.H.P. \times F \div R}, \text{ or } d = a \sqrt[3]{I.H.P. \div R},$$

in which F and a are factors that depend on the strength of the material and on the factor of safety. Taking S at 45,000 pounds per square inch for wrought iron, and at 60,000 for steel, we have, for simple twisting by a uniform tangential force,

Factor of safety =	5	6	8	10	5	6	8	10
Iron..... F =	35.7	42.8	57.1	71.4	a = 3.3	3.5	3.85	4.15
Steel.... F =	26.8	32.1	42.8	53.5	a = 3.0	3.18	3.5	3.77

Unwin, taking for safe working strength of wrought iron 9000 lbs., steel 13,500 lbs., and cast iron 4500 lbs., gives a = 3.294 for wrought iron, 2.877 for steel, and 4.15 for cast iron. Thurston, for crank-axes of wrought iron, gives a = 4.15 or more.

Seaton says: For wrought iron, f, the safe strain per square inch, should not exceed 9000 lbs., and when the shafts are more than 10 inches diameter, 8000 lbs. Steel, when made from the ingot and of good materials, will admit of a stress of 12,000 lbs. for small shafts, and 10,000 lbs. for those above 10 inches diameter.

The difference in the allowance between large and small shafts is to compensate for the defective material observable in the heart of large shafting, owing to the hammering failing to affect it.

The formula $d = a \sqrt[3]{I.H.P. \div R}$ assumes the tangential force to be uniform and that it is the only acting force. For engines, in which the tangential force varies with the angle between the crank and the connecting-rod, and with the variation in steam-pressure in the cylinder, and also is influenced by the inertia of the reciprocating parts, and in which also the shaft may be subjected to bending as well as torsion, the factor a must be increased, to provide for the maximum tangential force and for bending.

Seaton gives the following table showing the relation between the maximum and mean twisting moments of engines working under various conditions, the momentum of the moving parts being neglected, which is allowable:

Description of Engine.	Steam Cut-off at	Max. Twist Divided by Mean Twist. Moment.	Cube Root of the Ratio.
Single-crank expansive.....	0.2	2.625	1.38
" " ".....	0.4	2.125	1.29
" " ".....	0.6	1.835	1.22
" " ".....	0.8	1.698	1.20
Two-cylinder expansive, cranks at 90°.....	0.2	1.616	1.17
" " ".....	0.3	1.415	1.12
" " ".....	0.4	1.298	1.09
" " ".....	0.5	1.256	1.08
" " ".....	0.6	1.270	1.08
" " ".....	0.7	1.329	1.10
" " ".....	0.8	1.357	1.11
Three-cylinder compound, cranks 120°.....	h.p. 0.5, l.p. 0.66	1.40	1.12
Three-cylinder compound, l.p. cranks opposite one another, and h.p. midway }.....	" "	1.26	1.08

Seaton also gives the following rules for ordinary practice for ordinary two-cylinder marine engines:

Diameter of the tunnel-shafts = $\sqrt[3]{\text{I.H.P.} \times F/R}$, or $a \sqrt[3]{\text{I.H.P.} + R}$.

Compound engines, cranks at right angles:

- Boiler pressure 70 lbs., rate of expansion 6 to 7, $F = 70, a = 4.12$.
- Boiler pressure 80 lbs., rate of expansion 7 to 8, $F = 72, a = 4.16$.
- Boiler pressure 90 lbs., rate of expansion 8 to 9, $F = 75, a = 4.22$.

Triple compound, three cranks at 120 degrees:

- Boiler pressure 150 lbs., rate of expansion 10 to 12, $F = 62, a = 3.96$.
- Boiler pressure 160 lbs., rate of expansion 11 to 13, $F = 64, a = 4$.
- Boiler pressure 170 lbs., rate of expansion 12 to 15, $F = 67, a = 4.06$.

Expansive engines, cranks at right angles, and the rate of expansion 5, boiler-pressure 60 lbs., $F = 90, a = 4.48$.

Single-crank compound engines, pressure 80 lbs., $F = 96, a = 4.58$.

For the engines we are considering it will be a very liberal allowance for ratio of maximum to mean twisting moment if we take it as equal to the ratio of the maximum to the mean pressure on the piston. The factor a , then, in the formula for diameter of the shaft will be multiplied by the cube

root of this ratio, or $\sqrt[3]{\frac{100}{42}} = 1.34$, $\sqrt[3]{\frac{100}{32.3}} = 1.45$, and $\sqrt[3]{\frac{100}{30}} = 1.49$

for the 10, 30, and 50-in. engines, respectively. Taking $a = 3.5$, which corresponds to a shearing strength of 60,000 and a factor of safety of 8 for steel, or to 45,000 and a factor of 6 for iron, we have for the new coefficient a_1 in the formula $d_1 = a_1 \sqrt[3]{\text{I.H.P.} + R}$, the values 4.69, 5.08, and 5.22 from which we obtain the diameters of shafts of the six engines as follows:

Engine No.	1	2	3	4	5	6
Diam. of cyl.	10	10	30	30	50	50
Horse-power, I.H.P.	50	50	450	450	1250	1250
Revs. per min., R	250	125	130	65	90	45
Diam. of shaft $d =$	2.74	3.46	7.67	9.70	12.55	15.82

These diameters are calculated for twisting only. When the shaft is also subjected to bending strain the calculation must be modified as below:

Resistance to Bending. — The strength of a circular-section shaft to resist bending is one-half of that to resist twisting. If B is the bending moment in inch-lbs., and d the diameter of the shaft in inches,

$$B = \frac{\pi d^3}{32} \times f; \text{ and } d = \sqrt[3]{\frac{B}{f}} \times 10.2;$$

f is the safe strain per square inch of the material of which the shaft is composed, and its value may be taken as given above for twisting (Seaton).

Equivalent Twisting Moment. — When a shaft is subject to both twisting and bending simultaneously, the combined strain on any section of it may be measured by calculating what is called the *equivalent twisting moment*: that is, the two strains are so combined as to be treated as a twisting strain only of the same magnitude and the size of shaft calculated accordingly. Rankine gave the following solution of the combined action of the two strains.

If $T =$ the twisting moment, and $B =$ the bending moment on a section of a shaft, then the equivalent twisting moment $T_1 = B + \sqrt{B^2 + T^2}$.

Seaton says: Crank-shafts are subject always to twisting, bending, and shearing strains; the latter are so small compared with the former that they are usually neglected directly, but allowed for indirectly by means of the factor f .

The two principal strains vary throughout the revolution, and the maximum equivalent twisting moment can only be obtained accurately by a series of calculations of bending and twisting moments taken at fixed intervals, and from them constructing a curve of strains.

Considering the engines of our examples to have overhung cranks, the maximum bending moment resulting from the thrust of the connecting-

rod on the crank-pin will take place when the engine is passing its centers (neglecting the effect of the inertia of the reciprocating parts), and it will be the product of the total pressure on the piston by the distance between two parallel lines passing through the centers of the crank-pin and of the shaft bearing, at right angles to their axes; which distance is equal to $1/2$ length of crank-pin bearing + length of hub + $1/2$ length of shaft-bearing + any clearance that may be allowed between the crank and the two bearings. For our six engines we may take this distance as equal to $1/2$ length of crank-pin + thickness of crank-arm + $1.5 \times$ the diameter of the shaft as already found by the calculation for twisting. The calculation of diameter is then as below:

Engine No.	1	2	3	4	5	6
Diam. of cyl., in....	10	10	30	30	50	50
Horse-power.....	50	50	450	450	1250	1250
Revs. per min.....	250	125	130	65	90	45
Max. press. on pis., P	7,854	7,854	70,686	70,686	196,350	196,350
Leverage, * L in....	6.32	7.94	22.20	26.00	36.80	42.25
Bd. mo. $PL = B$ in.-lb	49,637	62,361	1,569,222	1,837,836	7,225,680	8,295,788
Twist. mom. T	47,124	94,248	1,060,290	2,120,580	4,712,400	9,424,800
Equiv. twist mom.						
$T_1 = B + \sqrt{B^2 + T^2}$ (approx.).....	118,000	175,000	3,463,000	4,647,000	15,840,000	20,850,000

* Leverage = distance between centers of crank-pin and shaft bearing = $1/2 l + 2.25 d$.

Having already found the diameters, on the assumption that the shafts were subjected to a twisting moment T only, we may find the diameter for resisting combined bending and twisting by multiplying the diameters already found by the cube roots of the ratio $T_1 \div T$, or

Giving corrected diameters $d_1 =$ 1.40 1.27 1.46 1.34 1.64 1.36
3.84 4.39 11.35 12.99 20.53 21.52

By plotting these results, using the diameters of the cylinders for abscissas and diameters of the shafts for ordinates, we find that for the long-stroke engines the results lie almost in a straight line expressed by the formula, diameter of shaft = $0.43 \times$ diameter of cylinder; for the short-stroke engines the line is slightly curved, but does not diverge far from a straight line whose equation is, diameter of shaft = 0.4 diameter of cylinder. Using these two formulas, the diameters of the shafts will be 4.0, 4.3, 12.0, 12.9, 20.0, 21.5.

J. B. Stanwood, in *Engineering*, June 12, 1891, gives dimensions of shafts of Corliss engines in American practice for cylinders 10 to 30 in. diameter. The diameters range from $4\frac{15}{16}$ to $14\frac{15}{16}$, following precisely the equation, diameter of shaft = $1/2$ diameter of cylinder - $1/16$ inch.

Fly-wheel Shafts. — Thus far we have considered the shaft as resisting the force of torsion and the bending moment produced by the pressure on the crank-pin. In the case of fly-wheel engines the shaft on the opposite side of the bearing from the crank-pin has to be designed with reference to the bending moment caused by the weight of the fly-wheel, the weight of the shaft itself, and the strain of the belt. For engines in which there is an outboard bearing, the weight of fly-wheel and shaft being supported by two bearings, the point of the shaft at which the bending moment is a maximum may be taken as the point midway between the two bearings or at the middle of the fly-wheel hub, and the amount of the moment is the product of the weight supported by one of the bearings into the distance from the center of that bearing to the middle point of the shaft. The shaft is thus to be treated as a beam supported at the ends and loaded in the middle. In the case of an overhung fly-wheel, the shaft having only one bearing, the point of maximum moment should be taken as the middle of the bearing, and its amount is very nearly the product of half the weight of the fly-wheel and the shaft

into the distance of the middle of its hub from the middle of the bearing. The bending moment should be calculated and combined with the twisting moment as above shown, to obtain the equivalent twisting moment, and the diameter necessary at the point of maximum moment calculated therefrom.

In the case of our six engines we assume that the weights of the fly-wheels, together with the shaft, are double the weight of fly-wheel rim obtained from the formula $W = 785,400 \frac{d^2s}{R^2D^2}$ (given under Fly-wheels); that the shaft is supported by an outboard bearing, the distance between the two bearings being 2 1/2, 5, and 10 feet for the 10-in., 30-in., and 50-in. engines, respectively. The diameters of the fly-wheels are taken such that their rim velocity will be a little less than 6000 feet per minute.

Engine No.....	1	2	3	4	5	6
Diam. of cyl., inches....	10	10	30	30	50	50
Diam. of fly-wheel, ft....	7.5	15	14.5	29	21	42
Revs. per min.....	250	125	130	65	90	45
Half wt. fly-wheel and shaft, lbs.....	268	536	5,968	11,936	26,384	52,769
Lever arm for maximum moment, in.....	15	15	30	30	60	60
Maximum bending moment, in.-lbs.....	4020	8040	179,040	358,080	1,583,070	3,166,140

As these are very much less than the bending moments calculated from the pressures on the crank-pin, the diameters already found are sufficient for the diameter of the shaft at the fly-wheel hub.

In the case of engines with heavy band fly-wheels and with long fly-wheel shafts it is of the utmost importance to calculate the diameter of the shaft with reference to the bending moment due to the weight of the fly-wheel and the shaft.

B. H. Coffey (*Power*, October, 1892) gives the formula for combined bending and twisting resistance, $T_1 = 0.196 d^3 S$, in which $T_1 = B + \sqrt{B^2 + T^2}$; T being the maximum, not the mean twisting moment; and finds empirical working values for $0.196 S$ as below. He says: Four points should be considered in determining this value: First, the nature of the material; second, the manner of applying the loads, with shock or otherwise; third, the ratio of the bending moment to the torsional moment — the bending moment in a revolving shaft produces reversed strains in the material, which tend to rupture it; fourth, the size of the section. Inch for inch, large sections are weaker than small ones. He puts the dividing line between large and small sections at 10 in. diameter, and gives the following safe values of $S \times 0.196$ for steel, wrought iron, and cast iron, for these conditions.

VALUE OF $S \times 0.196$.

Ratio.	Heavy Shafts with Shock.			Light Shafts with Shock. Heavy Shafts No Shock.			Light Shafts No Shock.		
	Steel.	Wro't Iron.	Cast Iron.	Steel.	Wro't Iron.	Cast Iron.	Steel.	Wro't Iron.	Cast Iron.
B to T .									
3 to 10 or less.....	1045	880	440	1566	1320	660	2090	1760	880
3 to 5 or less.....	941	785	393	1410	1179	589	1882	1570	785
1 to 1 or less.....	355	715	358	1281	1074	537	1710	1430	715
B greater than T ..	784	655	328	1176	984	492	1568	1310	655

Mr. Coffey gives as an example of improper dimensions the fly-wheel shaft of a 1500 H.P. engine at Willimantic, Conn., which broke while the engine was running at 425 H.P. The shaft was 17 ft. 5 in. long between

centers of bearings, 18 in. diam. for 8 ft. in the middle, and 15 in. diam. for the remainder, including the bearings. It broke at the base of the fillet connecting the two large diameters, or 56 1/2 in. from the center of the bearing. He calculates the mean torsional moment to be 446,654 inch-pounds, and the maximum at twice the mean; and the total weight on one bearing at 87,530 lbs., which, multiplied by 56 1/2 in., gives 4,945,445 in.-lbs. bending moment at the fillet. Applying the formula $T_1 = B + \sqrt{B^2 + T^2}$, gives for equivalent twisting moment 9,971,045 in.-lbs. Substituting this value in the formula $T_1 = 0.196 S d^3$ gives for S the shearing strain 15,070 lbs. per sq. in., or if the metal had a shearing strength of 45,000 lbs., a factor of safety of only 3. Mr. Coffey considers that 6000 lbs. is all that should be allowed for S under these circumstances. This would give $d = 20.35$ in. If we take from Mr. Coffey's table a value of $0.196 S = 1100$, we obtain $d^3 = 9000$ nearly, or $d = 20.8$ in. instead of 15 in., the actual diameter.

Length of Shaft-bearings. — There is as great a difference of opinion among writers, and as great a variation in practice concerning length of journal-bearings, as there is concerning crank-pins. The length of a journal being determined from considerations of its heating, the observations concerning heating of crank-pins apply also to shaft-bearings, and the formulae for length of crank-pins to avoid heating may also be used, using for the total load upon the bearing the resultant of all the pressures brought upon it, by the pressure on the crank, by the weight of the fly-wheel, and by the pull of the belt. After determining this pressure, however, we must resort to empirical values for the so-called constants of the formulae, really variables, which depend on the power of the bearing to carry away heat, and upon the quantity of heat generated, which latter depends on the pressure, on the number of square feet of rubbing surface passed over in a minute, and upon the coefficient of friction. This coefficient is an exceedingly variable quantity, ranging from 0.01 or less with perfectly polished journals, having end-play, and lubricated by a pad or oil-bath, to 0.10 or more with ordinary oil-cup lubrication.

For shafts resisting torsion only, Marks gives for length of bearing $l = 0.0000247 fpND^2$, in which f is the coefficient of friction, p the mean pressure in pounds per square inch on the piston, N the number of single strokes per minute, and D the diameter of the piston. For shafts under the combined stress due to pressure on the crank-pin, weight of fly-wheel, etc., he gives the following: Let Q = reaction at bearing due to weight, S = stress due steam pressure on piston, and R_1 = the resultant force; for horizontal engines, $R_1 = \sqrt{Q^2 + S^2}$, for vertical engines $R_1 = Q + S$, when the pressure on the crank is in the same direction as the pressure of the shaft on its bearings, and $R_1 = Q - S$ when the steam pressure tends to lift the shaft from its bearings. Using empirical values for the work of friction per square inch of projected area, taken from dimensions of crank-pins in marine vessels, he finds the formula for length of shaft-journals $l = 0.0000325 f R_1 N$, and recommends that to cover the defects of workmanship, neglect of oiling, and the introduction of dust, f be taken at 0.16 or even greater. He says that 500 lbs. per sq. in. of projected area may be allowed for steel or wrought-iron shafts in brass bearings with good results if a less pressure is not attainable without inconvenience. Marks says that the use of empirical rules that do not take account of the number of turns per minute has resulted in bearings much too long for slow-speed engines and too short for high-speed engines.

Whitham gives the same formula, with the coefficient 0.00002575. Thurston says that the maximum allowable mean intensity of pressure may be, for all cases, computed by his formula for journals, $l = PV + 60,000 d$, or by Rankine's, $l = P(V + 20) + 44,800 d$, in which P is the mean total pressure in pounds, V the velocity of rubbing surface in feet per minute, and d the diameter of the shaft in inches. It must be borne in mind, he says, that the friction work on the main bearing next the crank is the sum of that due the action of the piston on the pin and that due that portion of the weight of wheel and shaft and of pull of the belt which is carried there. The outboard bearing carries practically only the latter two parts of the total. The crank-shaft journals will be made longer on one side, and perhaps shorter on the other, than that of the crank-pin, in proportion to the work falling upon each, i.e., to their

respective products of mean total pressure, speed of rubbing surfaces, and coefficients of friction.

Unwin says: Journals running at 150 revolutions per minute are often only one diameter long. Fan shafts running 150 revolutions per minute have journals six or eight diameters long. The ordinary empirical mode of proportioning the length of journals is to make the length proportional to the diameter, and to make the ratio of length to diameter increase with the speed. For wrought-iron journals:

Revs. per min. = 50 100 150 200 250 500 1000 $l/d = 0.004 R + 1$.
 Length ÷ diam. = 1.2 1.4 1.6 1.8 2.0 3.0 5.0.

Cast-iron journals may have $l+d = 9/10$, and steel journals $l+d = 1 1/4$, of the above values.

Unwin gives the following, calculated from the formula $l = 0.4 \text{ H.P.} + r$, in which r is the crank radius in inches, and H.P. the horse-power transmitted to the crank-pin.

THEORETICAL JOURNAL LENGTH IN INCHES.

Load on Journal in pounds.	Revolutions of Journal per Minute.					
	50	100	200	300	500	1000
1,000	0.2	0.4	0.8	1.2	2.	4.
2,000	0.4	0.8	1.6	2.4	4.	8.
4,000	0.8	1.6	3.2	4.8	8.	16.
5,000	1.0	2.	4.	6.	10.	20.
10,000	2.	4.	8.	12.	20.	40.
15,000	3.	6.	12.	18.	30.
20,000	4.	8.	16.	24.	40.
30,000	6.	12.	24.	36.
40,000	8.	16.	32.
50,000	10.	20.	40.

Applying these different formulæ to our six engines, we have:

Engine No.....	1	2	3	4	5	6
Diam. cyl.....	10	10	30	30	50	50
Horse-power.....	50	50	450	450	1,250	1,250
Revs. per min.....	250	125	130	65	90	45
Mean pressure on crank-pin = S	3,299	3,299	23,185	23,185	58,905	58,905
Half wt. of fly-wheel and shaft = Q	268	536	5,968	11,936	26,470	52,940
Resultant pressure on bearing $\sqrt{Q^2 + S^2} = R_1$	3,310	3,335	23,924	26,194	64,580	79,200
Diam. of shaft journal.....	3.84	4.39	11.35	12.99	20.58	21.52
Length of shaft journal:						
Marks, $l = 0.0000325 f R_1 N (f = 0.10)$	5.38	2.71	20.87	11.07	37.78	23.17
Whitham, $l = 0.0000515 f R_1 R (f = 0.10)$	4.27	2.15	16.53	8.77	29.95	18.35
Thurston, $l = P V \div (60,000 d)$	3.61	1.82	14.00	7.43	25.36	15.55
Rankine, $l = P (V + 20) \div (44,800 d)$	5.22	2.78	21.70	10.85	35.16	22.47
Unwin, $l = (0.004 R + 1) d$	7.68	6.59	17.25	16.36	27.99	25.39
Unwin, $l = 0.4 \text{ H.P.} \div r$	3.33	1.60	12.00	6.00	20.83	10.42
Average.....	4.92	2.99	17.05	10.00	29.54	19.22

If we divide the mean resultant pressure on the bearing by the projected area, that is, by the product of the diameter and length of the journal, using the greatest and smallest lengths out of the seven lengths

for each journal given above, we obtain the pressure per square inch upon the bearing, as follows:

Engine No.....	1	2	3	4	5	6
Press. per sq. in., shortest journal.....	259	455	176	336	151	353
Longest journal.....	112	115	97	123	83	145
Average journal.....	175	254	124	202	106	191
Journal of length = diam.....	173	155	175

Many of the formulæ give for the long-stroke engines a length of journal less than the diameter, but such short journals are rarely used in practice. The last line in the above table has been calculated on the supposition that the journals of the long-stroke engines are made of a length equal to the diameter.

In the dimensions of Corliss engines given by J. B. Stanwood (*Eng.*, June 12, 1891), the lengths of the journals for engines of diam. of cyl. 10 to 20 in. are the same as the diam. of the cylinder, and a little more than twice the diam. of the journal. For engines above 20 in. diam. of cyl. the ratio of length to diam. is decreased so that an engine of 30 in. diam. has a journal 26 in. long, its diameter being $1 11/16$ in. These lengths of journal are greater than those given by any of the formulæ above quoted.

There thus appears to be a hopeless confusion in the various formulæ for length of shaft journals, but this is no more than is to be expected from the variation in the coefficient of friction, and in the heat-conducting power of journals in actual use, the coefficient varying from 0.10 (or even 0.16 as given by Marks) down to 0.01, according to the condition of the bearing surfaces and the efficiency of lubrication. Thurston's formula, $l = \frac{PV}{60,000 d}$; reduces to the form $l = 0.000004363 PR$, in which

P = mean total load on journal, and R = revolutions per minute. This is of the same form as Marks's and Whitham's formulæ, in which, if f , the coefficient of friction, be taken at 0.10, the coefficients of PR are, respectively, 0.0000065 and 0.00000515. Taking the mean of these three formulæ, we have $l = 0.0000053 PR$, if $f = 0.10$ or $l = 0.000053 f PR$ for any other value of f . The author believes this to be as safe a formula as any for length of journals, with the limitation that if it brings a result of length of journal less than the diameter, then the length should be made equal to the diameter. Whenever, with $f = 0.10$ it gives a length which is inconvenient or impossible of construction on account of limited space, then provision should be made to reduce the value of the coefficient of friction below 0.10 by means of forced lubrication, end play, etc., and to carry away the heat, as by water-cooled journal-boxes. The value of P should be taken as the resultant of the mean pressure on the crank, and the load brought on the bearing by the weight of the shaft, fly-wheel, etc., as calculated by the formula already given, viz., $R_1 = \sqrt{Q^2 + S^2}$ for horizontal engines, and $R_1 = Q + S$ for vertical engines.

For our six engines the formula $l = 0.0000053 PR$ gives, with the limitation for the long-stroke engines that the length shall not be less than the diameter, the following:

Engine No.....	1	2	3	4	5	6
Length of journal.....	4.39	4.39	16.48	12.99	30.80	21.52
Pressure per square inch on journal.....	196	173	128	155	102	171

Crank-shafts with Center-crank and Double-crank Arms. — In center-crank engines, one of the crank-arms, and its adjoining journal, called the after journal, usually transmit the power of the engine to the work to be done, and the journal resists both twisting and bending moments, while the other journal is subjected to bending moment only. For the after crank-journal the diameter should be calculated the same as for an overhung crank, using the formula for combined bending and

twisting moment, $T_1 = B + \sqrt{B^2 + T^2}$, in which T_1 is the equivalent twisting moment, B the bending moment, and T the twisting moment.

This value of T_1 is to be used in the formula diameter = $\sqrt[3]{5.1 T/S}$. The bending moment is taken as the maximum load on piston multiplied by one-fourth of the length of the crank-shaft between middle points of the two journal bearings, if the center is midway between the bearings, or by one-half the distance measured parallel to the shaft from the middle of the crank-pin to the middle of the after bearing. This supposes the crank-shaft to be a beam loaded at its middle and supported at the ends, but Whitham would make the bending moment only one-half of this, considering the shaft to be a beam secured or fixed at the ends, with a point of contraflexure one-fourth of the length from the end. The first supposition is the safer, but since the bending moment will in any case be much less than the twisting moment, the resulting diameter will be but little greater than if Whitham's supposition is used. For the forward journal, which is subjected to bending moment only, diameter of shaft = $\sqrt[3]{10.2 B/S}$, in which B is the maximum bending moment and S the safe shearing strength of the metal per square inch.

For our six engines, assuming them to be center-crank engines, and considering the crank-shaft to be a beam supported at the ends and loaded in the middle, and assuming lengths between centers of shaft bearings as given below, we have:

Engine No.....	1	2	3	4	5	6
Length of shaft, assumed, in., L ...	20	24	48	60	76	96
Max. press. on crank-pin, P	7,854	7,854	70,686	70,686	196,350	196,350
Max. bending moment, $B = 1/4 PL$...	39,270	49,637	848,232	1,060,290	3,729,750	4,712,400
Twisting mom., T ...	47,124	94,248	1,060,290	2,120,580	4,712,400	9,424,800
Equiv. twist. mom.						
$B + \sqrt{B^2 + T^2}$...	101,000	156,000	2,208,000	3,430,000	9,740,000	15,240,000
Diam. of after jour.						
$d = \sqrt[3]{\frac{5.1 T_1}{8000}}$...	3.98	4.60	11.15	13.00	18.25	21.20
Diam. of forw. jour.,						
$d_1 = \sqrt[3]{\frac{10.2 B}{8000}}$	3.68	3.99	10.28	11.16	16.82	18.18

The lengths of the journals would be calculated in the same manner as in the case of overhung cranks, by the formula $l = 0.000053 fPR$, in which P is the resultant of the mean pressure due to pressure of steam on the piston, and the load of the fly-wheel, shaft, etc., on each of the two bearings. Unless the pressures are equally divided between the two bearings, the calculated lengths of the two will be different; but it is usually customary to make them both of the same length, and in no case to make the length less than the diameter. The diameters also are usually made alike for the two journals, using the largest diameter found by calculation.

The crank-pin for a center crank should be of the same length as for an overhung crank, since the length is determined from considerations of heating, and not of strength. The diameter also will usually be the same, since it is made great enough to make the pressure per square inch on the projected area (product of length by diameter) small enough to allow of free lubrication, and the diameter so calculated will be greater than is required for strength.

Crank-shaft with Two Cranks coupled at 90°. — If the whole power of the engine is transmitted through the after journal of the after

crank-shaft, the greatest twisting moment is equal to 1.414 times the maximum twisting moment due to the pressure on one of the crank-pins. If T = the maximum twisting moment produced by the steam-pressure on one of the pistons, then T_1 , the maximum twisting moment on the after part of the crank-shaft, and on the line-shaft produced, when each crank makes an angle of 45° with the center line of the engine, is 1.414 T . Substituting this value in the formula for diameter to resist simple torsion, viz., $d = \sqrt[3]{5.1 T \div S}$, we have $d = \sqrt[3]{5.1 \times 1.414 T \div S}$, or $d = 1.932 \sqrt[3]{T/S}$, in which T is the maximum twisting moment produced by one of the pistons, d = diameter in inches, and S = safe working shearing strength of the material. For the forward journal of the after crank, and the after journal of the forward crank, the torsional moment is that due to the pressure of steam on the forward piston only, and for the forward journal of the forward crank, if none of the power of the engine is transmitted through it, the torsional moment is zero, and its diameter is to be calculated for bending moment only.

For Combined Torsion and Flexure. — Let B_1 = bending moment on either journal of the forward crank due to maximum pressure on forward piston, B_2 = bending moment on either journal of the after crank due to maximum pressure on after piston, T_1 = maximum twisting moment on after journal of forward crank, and T_2 = maximum twisting moment on after journal of after crank, due to pressure on the after piston.

Then equivalent twisting moment on after journal of forward crank = $B_1 + \sqrt{B_1^2 + T_1^2}$.

On forward journal of after crank = $B_2 + \sqrt{B_2^2 + T_1^2}$.

On after journal of after crank = $B_2 + \sqrt{B_2^2 + (T_1 + T_2)^2}$.

These values of equivalent twisting moment are to be used in the formula for diameter of journals $d = \sqrt[3]{5.1 T/S}$. For the forward journal of the forward crank-shaft $d = \sqrt[3]{10.2 B_1/S}$.

It is customary to make the two journals of the forward crank of one diameter, viz., that calculated for the after journal.

For a Three-cylinder Engine with cranks at 120°, the greatest twisting moment on the after part of the shaft, if the maximum pressures on the three pistons are equal, is equal to twice the maximum pressure on any one piston, and it takes place when two of the cranks make angles of 30° with the center line, the third crank being at right angles to it. (For demonstration, see Whitham's "Steam-engine Design," p. 252.) For combined torsion and flexure the same method as above given for two crank engines is adopted for the first two cranks; and for the third, or after crank, if all the power of the three cylinders is transmitted through it, we have the equivalent twisting moment on the forward

journal = $B_3 + \sqrt{B_3^2 + (T_1 + T_2)^2}$, and on the after journal = $B_3 + \sqrt{B_3^2 + (T_1 + T_2 + T_3)^2}$, B_3 and T_3 being respectively the bending and twisting moments due to the pressure on the third piston.

Crank-shafts for Triple-expansion Marine Engines, according to an article in *The Engineer*, April 25, 1890, should be made larger than the formulæ would call for, in order to provide for the stresses due to the racing of the propeller in a sea-way, which can scarcely be calculated. A kind of unwritten law has sprung up for fixing the size of a crank-shaft, according to which the diameter of the shaft is made about 0.45 D , where D is the diameter of the high-pressure cylinder. This is for solid shafts. When the speeds are high, as in war-ships, and the stroke short, the formula becomes 0.4 D , even for hollow shafts.

The Valve-stem or Valve-rod. — The valve-rod should be designed to move the valve under the most unfavorable conditions, which are when the stem acts by thrusting, as a long column, when the valve is unbalanced (a balanced valve may become unbalanced by the joint leaking) and when it is imperfectly lubricated. The load on the valve is the product of the area into the greatest unbalanced pressure upon it per square inch, and the coefficient of friction may be as high as 20%. The product of this coefficient and the load is the force necessary to move the valve, which

equals the maximum thrust on the valve-rod. From this force the diameter of the valve-rod may be calculated by the usual formula for columns. An empirical formula given by Seaton is: Diam. of rod = $d = \sqrt{lp/F}$, in which l = length, and b = breadth of valve, in inches; p = maximum absolute pressure on the valve in lbs. per sq. in., and F a coefficient whose values are, for iron: long rod 12,000, short 14,500; for steel: long rod 12,000, short 14,500.

Whitham gives the short empirical rule: Diam. of valve-rod = $1/30$ diam. of cyl. = $1/2$ diam. of piston-rod.

Size of Slot-link. (Seaton.) — Let D be the diam. of the valve-rod

$$D = \sqrt{lp \div 12,000};$$

then Diameter of block-pin when overhung = D .
 " " secured at both ends = $0.75 \times D$.
 " eccentric-rod pins = $0.7 \times D$.
 " suspension-rod pins = $0.55 \times D$.
 " pin when overhung = $0.75 \times D$.

Breadth of link = 0.8 to $0.9 \times D$.
 Length of block = 1.8 to $1.6 \times D$.
 Thickness of bars of link at middle = $0.7 \times D$.
 If a single suspension rod of round section, its diameter = $0.7 \times D$.
 If two suspension rods of round section, their diameter = $0.55 \times D$.

Size of Double-bar Links. — When the distance between centers of eccentric pins = 6 to 8 times throw of eccentrics (throw = eccentricity = half-travel of valve at full gear) D as before:

Depth of bars = $1.25 \times D + 3/4$ in.
 Thickness of bars = $0.5 \times D + 1/4$ in.
 Length of sliding-block = 2.5 to $3 \times D$.
 Diameter of eccentric-rod pins = $0.8 \times D + 1/4$ in.
 " center of sliding-block = $1.3 \times D$.

When the distance between eccentric-rod pins = 5 to $5\frac{1}{2}$ times throw of eccentrics:

Depth of bars = $1.25 \times D + 1/2$ in.
 Thickness of bars = $0.5 \times D + 1/4$ in.
 Length of sliding-block = 2.5 to $3 \times D$.
 Diameter of eccentric-rod pins = $0.75 \times D$.

Diameter of eccentric bolts (top end) at bottom of thread = $0.42 \times D$ when of iron, and $0.38 \times D$ when of steel.

The Eccentric. — Diam. of eccentric-sheave = $2.4 \times$ throw of eccentric + $1.2 \times$ diam. of shaft. D as before

Breadth of the sheave at the shaft = $1.15 \times D + 0.65$ in.
 Breadth of the sheave at the strap = $D + 0.6$ in.
 Thickness of metal around the shaft = $0.7 \times D + 0.5$ in.
 Thickness of metal at circumference = $0.6 \times D + 0.4$ in.
 Breadth of key = $0.7 \times D + 0.5$ in.
 Thickness of key = $0.25 \times D + 0.5$ in.
 Diameter of bolts connecting parts of strap = $0.6 \times D + 0.1$ in.

THICKNESS OF ECCENTRIC-STRAP.

When of bronze or malleable cast iron:
 Thickness of eccentric-strap at the middle = $0.4 \times D + 0.6$ in.
 Thickness of eccentric-strap at the sides = $0.3 \times D + 0.5$ in.
 When of wrought iron or cast steel:
 Thickness of eccentric-strap at the middle = $0.4 \times D + 0.5$ in.
 Thickness of eccentric-strap at the sides = $0.27 \times D + 0.4$ in.

The Eccentric-rod. — The diameter of the eccentric-rod in the body and at the eccentric end may be calculated in the same way as that of the connecting-rod, the length being taken from center of strap to center of pin. Diameter at the link end = $0.8 \times D + 0.2$ in.

This is for wrought iron; no reduction in size should be made for steel. Eccentric-rods are often made of rectangular section.

Reversing-gear should be so designed as to have more than sufficient strength to withstand the strain of both the valves and their gear at the

same time under the most unfavorable circumstances; it will then have the stiffness requisite for good working.

Assuming the work done in reversing the link-motion, W , to be only that due to overcoming the friction of the valves themselves through their whole travel, then, if T be the travel of valves in inches, for a compound engine

$$W = \frac{T}{12} \left(\frac{l \times b \times p}{5} \right) + \frac{T}{12} \left(\frac{l_1 \times b_1 \times p_1}{5} \right);$$

l_1 , b_1 , and p_1 being length, breadth, and maximum steam-pressure on valve of the second cylinder; and for an expansive engine

$$W = 2 \times \frac{T}{12} \left(\frac{l \times b \times p}{5} \right); \text{ or } \frac{T}{30} (l \times b \times p).$$

To provide for the friction of link-motion, eccentrics, and other gear, and for abnormal conditions of the same, take the work at one and a half times the above amount.

To find the strain at any part of the gear having motion when reversing, divide the work so found by the space moved through by that part in feet; the quotient is the strain in pounds; and the size may be found from the ordinary rules of construction for any of the parts of the gear. (Seaton.)

Current Practice in Engine Proportions, 1897. (Compare pages 996 to 1020.) — A paper with this title by Prof. John H. Barr, in *Trans. A. S. M. E.*, xviii, 737, gives the results of an examination of the proportions of parts of a great number of single-cylinder engines made by different builders. The engines classed as low speed (L. S.) are Corliss or other long-stroke engines usually making not more than 100 or 125 revs. per min. Those classed as high speed (H. S.) have a stroke generally of 1 to $1\frac{1}{2}$ diameters and a speed of 200 to 300 revs. per min. The results are expressed in formulas of rational form with empirical coefficients, and are here abridged as follows (dimensions in inches):

Thickness of Shell, L. S. only. — $t = CD + B$; D = diam. of piston in in.; $B = 0.3$ in.; C varies from 0.04 to 0.06, mean = 0.05.

Flanges and Cylinder-heads. — 1 to $1.5 \times$ thickness of shell, mean 1.2.

Cylinder-head Studs. — No studs less than $3/4$ in. nor greater than $1\frac{3}{8}$ in. diam. Least number, 8, for 10 in. diam. Average number = $0.7 D$. Average diam. = $D/40 + 1/2$ in.

Ports and Pipes. — a = area of port (or pipe) in sq. in.; A = area of piston, sq. in.; V = mean piston-speed, ft. per min.; $a = AV/C$, in which C = mean velocity of steam through the port or pipe in ft. per min.

Ports, H. S. (same ports for steam as for exhaust). — $C = 4500$ to 6500, mean 5500. For ordinary piston-speed of 600 ft. per min. $a = KA$; $K = 0.09$ to 0.13, mean 0.11.

Steam-ports, L. S. — $C = 5000$ to 9000, mean 6800; $K = 0.08$ to 0.10, mean 0.09.

Exhaust-ports, L. S. — $C = 4000$ to 7000, mean 5500; $K = 0.10$ to 0.125, mean 0.11.

Steam-pipes, H. S. — $C = 5800$ to 7000, mean 6500. If d = diam. of pipe and D = diam. of piston, $d = 0.29 D$ to $0.32 D$, mean $0.30 D$.

Steam-pipes, L. S. — $C = 5000$ to 8000, mean 6000; $d = 0.27$ to $0.35 D$; mean $0.32 D$.

Exhaust-pipes, H. S. — $C = 2500$ to 5500, mean 4400; $d = 0.33$ to $0.50 D$, mean $0.37 D$.

Exhaust-pipes, L. S. — $C = 2800$ to 4700, mean 3800; $d = 0.35$ to $0.45 D$, mean $0.40 D$.

Face of Pistons. — F = face; D = diameter. $F = CD$. H. S.: $C = 0.30$ to 0.60, mean 0.46. L. S.: $C = 0.25$ to 0.45, mean 0.32.

Piston-rods. — d = diam. of rod; D = diam. of piston; L = stroke, in.; $d = C \sqrt{DL}$. H. S.: $C = 0.12$ to 0.175, mean 0.145. L. S.: $C = 0.10$ to 0.13, mean 0.11.

Connecting-rods. — H. S. (generally 6 cranks long, rectangular section): b = breadth; h = height of section; L_1 = length of connecting-rod;

D = diam. of piston; $b = C \sqrt{DL_1}$; $C = 0.045$ to 0.07, mean 0.057;

$h = Kb$; $K = 2.2$ to 4; mean 2.7. L. S. (generally 5 cranks long, circular sections only): $C = 0.082$ to 0.105, mean 0.092.

Cross-head Slides. — Maximum pressure in lbs. per sq. in. of shoe, due to the vertical component of the force on the connecting-rod. H. S.: 10.5 to 38, mean 27. L. S.: 29 to 58, mean 40.

Cross-head Pins. — l = length; d = diam.; projected area = $a = dl = CA$; A = area of piston; $l = Kd$. H. S.: $C = 0.06$ to 0.11 , mean 0.08 ; $K = 1$ to 2 , mean 1.25 . L. S.: $C = 0.054$ to 0.10 , mean 0.07 ; $K = 1$ to 1.5 , mean 1.3 .

Crank-pin. — H.P. = horse-power of engine; L = length of stroke; l = length of pin; $l = C \times \text{H.P.} / L + B$; d = diam. of pin; A = area of piston; $dl = KA$. H. S.: $C = 0.13$ to 0.46 , mean 0.30 ; $B = 2.5$ in.; $K = 0.17$ to 0.44 , mean 0.24 . L. S.: $C = 0.4$ to 0.8 , mean 0.6 ; $B = 2$ in.; $K = 0.065$ to 0.115 , mean 0.09 .

Crank-shaft Main Journal. — $d = C \sqrt[3]{\text{H.P.} \div N}$; d = diam.; l = length; N = revs. per min.; projected area = MA ; A = area of piston. H. S.: $C = 6.5$ to 8.5 , mean 7.3 ; $l = Kd$; $K = 2$ to 3 , mean 2.2 ; $M = 0.37$ to 0.70 , mean 0.46 . L. S.: $C = 6$ to 8 , mean 6.8 ; $K = 1.7$ to 2.1 , mean 1.9 ; $M = 0.46$ to 0.64 , mean 0.56 .

Piston-speed. — H. S.: 530 to 660, mean 600; L. S.: 500 to 850, mean 600.

Weight of Reciprocating Parts (piston, piston-rod, cross-head, and one-half of connecting-rod). — $W = CD^2 \div LN^2$; D = diam. of piston; L = length of stroke, in.; N = revs. per min. H. S. only: $C = 1,200,000$ to $2,300,000$, mean $1,860,000$.

Belt-surface per I.H.P. — $S = C \times \text{H.P.} + B$; S = product of width of belt in feet by velocity of belt in ft. per min. H. S.: $C = 21$ to 40 , mean 28 ; $B = 1800$. L. S.: $S = C \times \text{H.P.}$; $C = 30$ to 42 , mean 35 .

Fly-wheel (H. S. only). — Weight of rim in lbs.: $W = C \times \text{H.P.} \div D_1^2 N^3$; D_1 = diam. of wheel in in.; $C = 65 \times 10^{10}$ to 2×10^{12} mean = 12×10^{11} , or $1,200,000,000,000$.

Weight of Engine per I.H.P. in lbs., including fly-wheel. — $W = C \times \text{H.P.}$. H. S.: $C = 100$ to 135 , mean 115 . L. S.: $C = 135$ to 240 , mean 175 .

Current Practice in Steam-engine Design, 1909. (Ole N. Trooien, *Bull. Univ. of Wis.*, No. 252; *Am. Mach.*, April 22, 1909.) — Practice in proportioning standard steam-engine parts has settled down to certain definite values, which have by long usage been found to give satisfactory results. These values can readily be expressed in formulas showing the relation between the more important factors entering the problem of design.

These formulas may be considered as partly rational and partly empirical; rational in the sense that the variables enter in the same manner as in a strict analysis, and empirical in the sense that the constants, instead of being obtained from assumed working strength, bearing pressures, etc., are derived from actual practice and include elements whose values are not accurately known but which have been found safe and economical.

The following symbols of notation are used in the formulas given:
 D = diameter of piston. A = area of piston. L = length of stroke.
 p = unit steam pressure, taken as 125 lbs. per sq. in. above exhaust as a standard pressure. H.P. = rated horse-power. N = revs. per min.
 C and K , constants, and d = diam. and l = length of unit under consideration. All dimensions in inches.

The commercial point of cut-off is taken at $1/4$ of the stroke. H. S. high-speed engines. L. S., low-speed, or long-stroke engines.

Piston Rod. — $d = C \sqrt{DL}$. H. S.: $C = 0.15$ (min., 0.125 ; max., 0.187); L. S.: $C = 0.114$ (min., 0.1 ; max., 0.156).

Cylinder. — Thickness of wall in ins. = $CD + 0.28$. $C = 0.054$ (min., 0.035 ; max., 0.072). Clearance volume 5 to 11% for H. S. engines, and from 2 to 5% for Corliss engines.

Stud Bolts. — Number = $0.72 D$ for H. S. ($0.65 D$ for Corliss.) Diam. in ins. = $0.04 D + 0.375$.

Ratio (C) of Stroke to Cylinder Diameter (L/D). — For $N > 200$, $C = 1.07$ (min., 0.82 ; max., 1.55); for $N = 110$ to 200 , $C = 1.36$ (min., 1.03 ; max., 1.88); for $N < 110$ (Corliss engines), $C = (L - 8) / D = 1.63$ (min., 1.15 ; max., 2.4).

Piston. — Width of face in ins. = $CD + 1$. Mean value of $C = 0.32$

for H. S. (0.26 for Corliss). Thickness of shell = thickness of cylinder wall $\times 0.6$ (0.7 for Corliss).

Piston Speeds. — H. S., 605 ft. per min. (min. 320; max., 920); Corliss, 592 ft. per min. (min., 400; max., 800).

Cross-head. — Area of shoes in sq. ins. = $0.53 A$ (min., 0.37 ; max., 0.72).

Cross-head Pin. — Diameter = $0.25 D$ (min., 0.17 ; max., 0.28). Length for H. S. = diam. $\times 1.25$ (min., 1 ; max., 1.5); for Corliss = diam. $\times 1.43$ (min., 1 ; max., 1.9).

Connecting-rods. — Breadth for H. S. = $0.073 \sqrt{L_c D}$ (min., 0.55 ; max., 0.094). Height = breadth $\times 2.28$ (min., 1.85 ; max., 3). For L. S., diam. of circular rod = $0.092 \sqrt{L_c D}$ (min., 0.081 ; max., 0.104). L_c = length center to center of bearings.

Crank-pin. — Diam. for H. S. center-crank engines = $0.4 D$ (min., 0.28 ; max., 0.526). Diam. for side-crank Corliss = $0.27 D$ (min., 0.21 ; max., 0.32). Length for H. S. = diam. $\times 0.87$ (min., 0.66 ; max., 1.25). Length for Corliss = diam. $\times 1.14$ (min., 1 ; max., 1.3).

Main Journals of Crank-shaft. — For H. S. center-crank engines, diam. = $6.6 \sqrt[3]{\text{H.P.}/N}$ (min., 5.4 ; max., 8.2). For Corliss, diameter = $7.2 \sqrt[3]{(\text{H.P.}/N) - 0.3}$ (min., 6.4 ; max., 8).

Fly-wheels. — Total weight in pounds for H. S. up to 175 H.P. = $1,300,000,000,000 \text{ H.P.} / D_1^2 N^3$, where D_1 = diam. of wheel in ins. (min., $660,000,000,000$; max., $2,800,000,000,000$). For larger H. S. engines, weight = $(C \times \text{H.P.} / D_1^2 N^3) + 1000$, where $C = 720,000,000,000$ (min., $330,000,000,000$; max., $1,140,000,000,000$). For Corliss engines, weight = $(C \times \text{H.P.} / D_1^2 N^3) - K$, where $C = 890,000,000,000$ (min., $625,000,000,000$; max., $1,330,000,000,000$), and $K = 4000$ (min., $2,800$; max., 6000). Diam. in ins. = $4.4 \times$ length of stroke.

Belt Surface per I.H.P. — Square feet of belt surface per minute (S) for H. S. = $\text{H.P.} \times 26.5$ (min., 10 ; max., 55). For Corliss engines, $S = 1000 + (21 \times \text{H.P.})$ (min., 18.2 ; max., 35).

Velocity of Wheel Rim. — For H. S. 70 ft. per sec. (min., 48 ; max., 70); for Corliss, 68 ft. per sec. (min., 40 ; max., 68).

Weight of Reciprocating Parts (Piston + piston rod + crosshead + $1/2$ connecting-rod). — Weight in lbs. $W = (D^2 / LN^2) \times 2,000,000$ (min., $1,370,000$; max., $3,400,000$). Balance weight opposite crank-pin = $0.75 W$.

Weight of engine per I.H.P. — Lbs. per I.H.P. for belt-connected H. S. engines = $\text{H.P.} \times 82$ (min., 52 ; max., 120). Do., for Corliss = $\text{H.P.} \times 132$ (min., 102 ; max., 164).

Shafts and Bearings of Engines. (James Christie, *Proc. Engrs. Club of Phila.*, 1898.) — The dimensions are determined by two independent considerations: 1. Sufficient size to prevent excessive deflection or torsional yield. 2. To provide sufficient wearing surface; to prevent excessive wear of journals. Usually, when the first condition is preserved, the other is provided for. When the bearings are flexible, — and excessive deflection within the limit of ordinary safety affects nothing external to the bearings, — considerable deflection can be tolerated. When bearings are rigid, or deflection may derange external mechanism, — for example, an overhung crank, — then the deflection must be more restricted. The effect of deflection is to concentrate pressure on the ends of journals, rendering the apparent bearing surface inefficient.

In direct-driven electric generators a deflection of 0.01 in. per foot of length has caused much trouble from hot bearings. I have proportioned such shafts so that the deflection will not exceed one-half this extent.

In some shafts, especially those having an oscillating movement, torsional elasticity is a prime consideration, and the limits can be known only by experience. Reuleaux says: "Limit the torsional yield to 0.1 degree per foot of length." This in some cases can be readily tolerated; in others, it has proved excessive. I have adopted the following as a general guide: Permissible twist per foot of length = 0.10 degree for easy service, without severe fluctuation of load; 0.075 degree for fluctuating loads suddenly applied; 0.050 degree for loads suddenly reversed.

Sufficiency of wearing surface and the limitation of pressure per unit

of surface are determined by several conditions: 1. Speed of movement. 2. Character of material. 3. Permissible wear of journals or bearings. 4. Constancy of pressure in one direction. 5. Alternation of the direction of pressure.

Taking the product of pressure per sq. in. of surface in lbs., and speed of movement in ft. per min., we obtain a quantity, which we can term the permissible foot-pounds per minute for each sq. in. of wearing surface. This product varies in good practice under various conditions from 50,000 to 500,000 ft.-lbs. per min. For instance, good practice, in later years, has largely increased the area of crosshead slide surfaces. For crossheads having maximum speed of 1000 feet per minute, the pressure per inch of wearing surface should not exceed 50 pounds, giving 50,000 ft.-lbs. per min.; whereas crank-pins of the requisite grade of steel, with good lining metal in the boxes and efficient lubrication, will endure 200,000 ft.-lbs. per min. satisfactorily, and more than double this when speeds are very high and the pressure intermittent. On main shafts, with pressures constant in one direction, it is advisable not to exceed 50,000 ft.-lbs. per min. for heavily loaded shafts at low velocity. This may be increased to 100,000 for lighter loads and higher velocities. It can be inferred, therefore, that the product of speed and pressure cannot be used, in any comprehensive way, as a rational basis for proportioning wearing surfaces. The pressure per unit of surface must be reduced as the speed is increased, but not in a constant ratio. A good example of journals severely tested are the recent 110,000-pound freight cars, which bear a pressure of 400 lbs. per sq. in. of journal bearing, and at a speed of ten miles per hour make about 60,000 foot-pounds per minute.

Calculating the Dimensions of Bearings. (F. E. Cardullo, *Mach'y.*, Feb., 1907.) — The durability of the lubricating film is affected in great measure by the character of the load that the bearing carries. When the load is unvarying in amount and direction, as in the case of a shaft carrying a heavy bandwheel, the film is easily ruptured. In those cases where the pressure is variable in amount and direction, as in railway journals and crank-pins, the film is much more durable. When the journal only rotates through a small arc, as with the wrist-pin of a steam-engine, the circumstances are most favorable. It has been found that when all other circumstances are exactly similar, a car journal will stand about twice the unit pressure that a fly-wheel journal will. A crank-pin, since the load completely reverses every revolution, will stand three times, and a wrist-pin will stand four times the unit pressure that the fly-wheel journal will.

The amount of pressure that commercial oils will endure at low speeds without breaking down varies from 500 to 1000 lbs. per sq. in., where the load is steady. It is not safe, however, to load a bearing to this extent, since it is only under favorable circumstances that the film will stand this pressure without rupturing. On this account, journal bearings should not be required to stand more than two-thirds of this pressure at slow speeds, and the pressure should be reduced when the speed increases. The approximate unit pressure which a bearing will endure without seizing is $p = PK \div (DN + K)$ (1). p = allowable pressure in lbs. per sq. in. of projected area, D = diam. of the bearing in ins., N = revs. per min., and P and K depend upon the kind of oil, manner of lubrication, etc.

P is the maximum safe unit pressure for the given circumstances, at a very slow speed. In ordinary cases, its value is 200 for collar thrust bearings, 400 for shaft bearings, 800 for car journals, 1200 for crank-pins, and 1600 for wrist-pins. In exceptional circumstances, these values may be increased by as much as 50%, but only when the workmanship is of the best, the care the most skillful, the bearing readily accessible, and the oil of the best quality, and unusually viscous. In the great units of the Subway power plant in New York, the value of P for the crank-pins is 2000.

The factor K depends upon the method of oiling, the rapidity of cooling, and the care which the journal is likely to get. It will have about the following values: Ordinary work, drop-feed lubrication, 700; first-class care, drop-feed lubrication, 1000; force-feed lubrication or ring-oiling, 1200 to 1500; extreme limit for perfect lubrication and air-cooled bearings, 2000. The value 2000 is seldom used, except in locomotive

work where the rapid circulation of the air cools the journals. Higher values than this may only be used in the case of water-cooled bearings.

In case the bearing is some form of a sliding shoe, the quantity $240 V$ should be substituted for the quantity DN , V being the velocity of rubbing in feet per second. There are a few cases where a unit pressure sufficient to break down the oil film is allowable, such as the pins of punching and shearing machines, pivots of swing bridges, etc.

In general, the diameter of a shaft or pin is fixed from considerations of strength or stiffness. Having obtained the proper diameter, we must next make the bearing long enough so that the unit pressure shall not exceed the required value. This length may be found by means of the equation:

$$L = (W + PK) \times (N + K/D), \dots \dots (2)$$

where L is the length of the bearing in ins., W the load upon it in lbs., and P , K , N , and D are as before.

A bearing may give poor satisfaction because it is too long, as well as because it is too short. Almost every bearing is in the condition of a loaded beam, and therefore it has some deflection.

Shafts and crank-pins must not be made so long that they will allow the load to concentrate at any point. A good rule for the length is to make the ratio of length to diameter about equal to $\frac{1}{8} \sqrt{N}$. This quantity may be diminished by from 10 to 20% in the case of crank-pins and increased in the same proportion in the case of shaft bearings, but it is not wise to depart too far from it. In the case of an engine making 100 r.p.m., the bearings would be by this rule from $1\frac{1}{4}$ to $1\frac{1}{2}$ diams. in length. In the case of a motor running at 1000 r.p.m., the bearings would be about 4 diams. long.

The diameter of a shaft or pin must be such that it will be strong and stiff enough to do its work properly. In order to design it for strength and stiffness, it is first necessary to know its length. This may be assumed tentatively from the equation

$$L = 20 W \sqrt{N} \div PK. \dots \dots (3)$$

The diameter may then be found by any of the standard equations for the strength of shafts or pins given in the different works on machine design. [See The Strength of the Crank-pin, page 1007.] The length is then recomputed from formula No. 2, taking this new value if it does not differ materially from the one first assumed. If it does, and especially if it is greater than the assumed length, take the mean value of the assumed and computed lengths, and try again.

EXAMPLE. — We will take the case of the crank-pin of an engine with a 20-in. cylinder, running at 80 r.p.m., and having a maximum unbalanced steam pressure of 100 lbs. per sq. in. The total steam load on the piston is 31,400 pounds. P is taken at 1200, and K as 1000. We will therefore obtain for our trial length:

$$L = (20 \times 31,400 \times \sqrt{80}) \div (1200 \times 1000) = 4.7, \text{ or say } 4\frac{3}{4} \text{ ins.}$$

In order that the deflection of the pin shall not be sufficient to destroy the lubricating film we have

$$D = 0.09 \sqrt[4]{WL^3},$$

which limits the deflection to 0.003 in. This gives $D = 3.85$ or say $3\frac{7}{8}$ ins. With this diameter, formula No. 2 gives $L = 8.9$, say 9 ins.

The mean of this value and the one obtained before is about 7 ins. Substituting this in the equation for the diameter, we get $5\frac{1}{4}$ ins. Substituting this new diameter in equation No. 2 we have $L = 7.05$, say 7 ins.

Probably most good designers would prefer to take about half an inch off the length of this pin, and add it to the diameter, making it $5\frac{3}{4} \times 6\frac{1}{2}$ inches, and this will bring the ratio of the length to the diameter nearer to $\frac{1}{8} \sqrt{N}$.

Engine-frames or Bed-plates. — No definite rules for the design of engine-frames have been given by authors of works on the steam-engine. The proportions are left to the designer who uses "rule of thumb" or copies from existing engines. F. A. Halsey (*Am. Mach.*,

Feb. 14, 1895) has made a comparison of proportions of the frames of horizontal Corliss engines of several builders. The method of comparison is to compute from the measurements the number of square inches in the smallest cross-section of the frame, that is, immediately behind the pillow block, also to compute the total maximum pressure upon the piston, and to divide the latter quantity by the former. The result gives the number of pounds pressure upon the piston allowed for each square inch of metal in the frame. He finds that the number of lbs. per sq. in. of smallest section of frame ranges from 217 for a 10 x 30 in. engine up to 575 for a 28 x 48 in. A 30 x 60 in. engine shows 350 lbs., and a 32-in. engine which has been running for many years shows 667 lbs. Generally the strains increase with the size of the engine, and more cross-section of metal is allowed with relatively long strokes than with short ones.

From the above Mr. Halsey formulates the general rule that in engines of moderate speed, and having strokes up to 1 1/2 times the diameter of the cylinder, the load per square inch of smallest section should be for a 10-in. engine 300 lbs., which figure should be increased for larger bores up to 500 lbs. for a 30-in. cylinder of the same relative stroke. For high speeds or for longer strokes the load per square inch should be reduced.

FLY-WHEELS.

The function of a fly-wheel is to store up and to restore the periodical fluctuations of energy given to or taken from an engine or machine, and thus to keep approximately constant the velocity of rotation. Rankine calls the quantity $\frac{\Delta E}{2 E_0}$ the coefficient of fluctuation of speed or of unsteadiness, in which E_0 is the mean actual energy, and ΔE the excess of energy received or of work performed, above the mean, during a given interval. The ratio of the periodical excess or deficiency of energy ΔE to the whole energy exerted in one period or revolution General Morin found to be from 1/6 to 1/4 for single-cylinder engines using expansion; the shorter the cut-off the higher the value. For a pair of engines with cranks coupled at 90° the value of the ratio is about 1/4, and for three engines with cranks at 120°, 1/12 of its value for single-cylinder engines. For tools working at intervals, such as punching, slotting and plate-cutting machines, coining-presses, etc., ΔE is nearly equal to the whole work performed at each operation.

A fly-wheel reduces the coefficient $\frac{\Delta E}{2 E_0}$ to a certain fixed amount, being about 1/32 for ordinary machinery, and 1/50 or 1/60 for machinery for fine purposes.

If m be the reciprocal of the intended value of the coefficient of fluctuation of speed, ΔE the fluctuation of energy, I the moment of inertia of the fly-wheel alone, and a_0 its mean angular velocity, $I = \frac{mg\Delta E}{a_0^2}$. As the rim of a fly-wheel is usually heavy in comparison with the arms, I may be taken to equal Wr^2 , in which W = weight of rim in pounds, and r the radius of the wheel; then $W = \frac{mg\Delta E}{a_0^2 r^2} = \frac{mg\Delta E}{v^2}$, if v be the velocity of the rim in feet per second. The usual mean radius of the fly-wheel in steam-engines is from three to five times the length of the crank. The ordinary values of the product mg , the unit of time being the second, lie between 1000 and 2000 feet. (Abridged from Rankine, S. E., p. 62.)

Thurston gives for engines with automatic valve-gear $W = 250,000 \frac{ASp}{R^2 D^2}$, in which A = area of piston in square inches, S = stroke in feet, p = mean steam-pressure in lbs. per sq. in., R = revolutions per minute, D = outside diameter of wheel in feet. Thurston also gives for ordinary forms of non-condensing engine with a ratio of expansion between 3 and

5, $W = \frac{aAS}{R^2 D^2}$, in which a ranges from 10,000,000 to 15,000,000, averaging 12,000,000. For gas-engines, in which the charge is fired with every revolution, the *American Machinist* gives this latter formula, with a

doubled, or 24,000,000. Presumably, if the charge is fired every other revolution, a should be again doubled.

Rankine ("Useful Rules and Tables," p. 247) gives $W = 475,000 \frac{ASp}{VD^2 R^2}$, in which V is the variation of speed per cent of the mean speed.

Thurston's first rule above given corresponds with this if we take $V = 1.9$. Hartnell (*Proc. Inst. M. E.*, 1882, 427) says: The value of V , or the variation permissible in portable engines, should not exceed 3% with an ordinary load, and 4% when heavily loaded. In fixed engines, for ordinary purposes, $V = 2 1/2$ to 3%. For good governing or special purposes, such as cotton-spinning, the variation should not exceed 1 1/2 to 2%.

F. M. Rites (*Trans. A. S. M. E.*, xiv, 100) develops a new formula for weight of rim, viz., $W = \frac{C \times \text{I.H.P.}}{R^2 D^2}$, and weight of rim per horse-power

$= \frac{C}{R^2 D^2}$, in which C varies from 10,000,000,000 to 20,000,000,000; also using the latter value of C , he obtains for the energy of the fly-wheel $\frac{Mv^2}{2} = \frac{W (3.14)^2 D^2 R^2}{2} = \frac{C \times \text{H.P.} (3.14)^2 D^2 R^2}{2} = \frac{850,000 \text{ H.P.}}{R}$. Fly-wheel energy per H.P. = $850,000 \div R$.

The limit of variation of speed with such a weight of wheel from excess of power per fraction of revolution is less than 0.0023.

The value of the constant C given by Mr. Rites was derived from practice of the Westinghouse single-acting engines used for electric-lighting. For double-acting engines in ordinary service a value of $C = 5,000,000,000$ would probably be ample.

From these formulæ it appears that the weight of the fly-wheel for a given horse-power should vary inversely with the cube of the revolutions and the square of the diameter.

J. B. Stanwood (*Eng'g*, June 12, 1891) says: Whenever 480 feet is the lowest piston-speed probable for an engine of a certain size, the fly-wheel weight for that speed approximates closely to the formula

$$W = 700,000 d^2 s \div D^2 R^2.$$

W = weight in pounds, d = diameter of cylinder in inches, s = stroke in inches, D = diameter of wheel in feet, R = revolutions per minute, corresponding to 480 feet piston-speed.

In a Ready Reference Book published by Mr. Stanwood, Cincinnati, 1892, he gives the same formula, with coefficients as follows: For slide-valve engines, ordinary duty, 350,000; same, electric lighting, 700,000; for automatic high-speed engines, 1,000,000; for Corliss engines, ordinary duty 700,000, electric lighting 1,000,000.

Thurston's formula above given, $W = aAS \div R^2 D^2$ with $a = 12,000,000$, when reduced to terms of d and s in inches, becomes $W = 785,400 d^2 s \div R^2 D^2$.

If we reduce it to terms of horse-power, we have I.H.P. = $2 ASPr \div 33,000$, in which P = mean effective pressure. Taking this at 40 lbs., we obtain $W = 5,000,000,000 \text{ I.H.P.} \div R^2 D^2$. If mean effective pressure = 30 lbs., then $W = 6,666,000,000 \text{ I.H.P.} \div R^2 D^2$.

Emil Theiss (*Am. Mach.*, Sept. 7 and 14, 1893) gives the following values of d , the coefficient of steadiness, which is the reciprocal of what Rankine calls the coefficient of fluctuation:

For engines operating —

Hammering and crushing machinery.....	$d = 5$
Pumping and shearing machinery.....	$d = 20$ to 30
Weaving and paper-making machinery.....	$d = 40$
Milling machinery.....	$d = 50$
Spinning machinery.....	$d = 50$ to 100
Ordinary driving-engines (mounted on bed-plate), belt transmission.....	$d = 35$
Gear-wheel transmission.....	$d = 50$

Mr. Theiss's formula for weight of fly-wheel in pounds is $W = i \times \frac{d \times \text{I.H.P.}}{V^2 \times n}$

where d is the coefficient of steadiness, V the mean velocity of the fly-wheel rim in feet per second, n the number of revolutions per minute.

i = a coefficient obtained by graphical solution, the values of which for different conditions are given in the following table. In the lines under "cut-off," *p* means "compression to initial pressure," and *O* "no compression."

VALUES OF *i*. SINGLE-CYLINDER NON-CONDENSING ENGINES.

Piston-speed, ft. per min.	Cut-off, 1/6.		Cut-off, 1/4.		Cut-off, 1/3.		Cut-off, 1/2.	
	Comp. <i>p</i>	<i>O</i>	Comp. <i>p</i>	<i>O</i>	Comp. <i>p</i>	<i>O</i>	Comp. <i>p</i>	<i>O</i>
200	272,690	218,580	242,010	209,170	220,760	201,920	193,340	182,840
400	240,810	187,430	208,200	179,460	188,510	170,040	174,630	167,860
600	194,670	145,400	168,590	136,460	165,210	146,610		
800	158,200	108,690	162,070	135,260				

SINGLE-CYLINDER CONDENSING ENGINES.

Piston-speed, ft. per min.	Cut-off, 1/8.		Cut-off, 1/6.		Cut-off, 1/4.		Cut-off, 1/3.		Cut-off, 1/2.	
	Comp. <i>p</i>	<i>O</i>	Comp. <i>p</i>	<i>O</i>	Comp. <i>p</i>	<i>O</i>	Comp. <i>p</i>	<i>O</i>	Comp. <i>p</i>	<i>O</i>
200	265,560	176,560	234,160	173,660	204,210	167,140	189,600	161,830	172,690	156,990
400	194,550	117,870	174,380	118,350	164,720	133,080	174,630	151,680		
600	148,780	140,090								

TWO-CYLINDER ENGINES, CRANKS AT 90°.

Piston-speed, ft. per min.	Cut-off, 1/6.		Cut-off, 1/4.		Cut-off, 1/3.		Cut-off, 1/2.	
	Comp. <i>p</i>	<i>O</i>	Comp. <i>p</i>	<i>O</i>	Comp. <i>p</i>	<i>O</i>	Comp. <i>p</i>	<i>O</i>
200	71,980	} Mean 60,140	59,420	} Mean 54,340	49,272	} Mean 50,000	37,920	} Mean 36,950
400	70,160		57,000		49,150		35,000	
600	70,040		57,480		49,220			
800	70,040		60,140					

THREE-CYLINDER ENGINES, CRANKS AT 120°.

Piston-speed, ft. per min.	Cut-off, 1/6.		Cut-off, 1/4.		Cut-off, 1/3.		Cut-off, 1/2.	
	Comp. <i>p</i>	<i>O</i>	Comp. <i>p</i>	<i>O</i>	Comp. <i>p</i>	<i>O</i>	Comp. <i>p</i>	<i>O</i>
200	33,810	32,240	33,810	35,500	34,540	33,450	35,260	32,370
800	30,190	31,570	35,140	33,810	36,470	32,850	33,810	32,370

As a mean value of *i* for these engines we may use 33,810.

Weight of Fly-wheels for Alternating-current Units. (J. Begtrup, *Am. Mach.*, July 10, 1902.) —

$$WD^2 + W_1D_1^2 = \frac{14,000,000 HU}{N^3V}$$

in which *W* = weight of rim of fly-wheel in pounds, *D* = mean diameter of rim in feet, *W*₁ = weight of armature in pounds, *D*₁ = mean diameter of armature in feet, *H* = rated horse-power of engine, *U* = a factor of steadiness, *N* = number of revolutions per minute, *V* = maximum instantaneous displacement in degrees, not to exceed 5 degrees divided by the number of poles on the generator, according to the rule of the General Electric Company.

For simple horizontal engines, length of connecting-rod = 5 cranks, *U* = 90; (ditto, no account being taken of angularity of connecting-rod, *U* = 64); cross-compound horizontal engines, connecting-rod = 5 cranks, *U* = 51; ditto, vertical engines, heavy reciprocating parts, unbalanced, *U* = 78; vertical compound engines, cranks 180 degrees apart, reciprocating parts balanced, *U* = 60.

The small periodical variation in velocity (not angular displacement) can be determined from the following formula:

$$F = \frac{387,700,000 HZ}{N^3(WD^2 + W_1D_1^2)}$$

in which *H* = rated horse-power, *Z* = a factor of steadiness, *N* = revs. per min., *D* = mean diameter of fly-wheel rim in feet, *W* = weight of fly-wheel rim in pounds, *D*₁ = mean diameter of armature or field in feet, *W*₁ = weight of armature, *F* = variation in per cent of mean speed.

For simple engines and tandem compounds, *Z* = 16; for horizontal cross-compounds, *Z* = 8.5; for vertical cross-compounds, heavy reciprocating parts, *Z* = 12.5; for vertical compounds, cranks opposite, weights balanced, *Z* = 14. *F* represents here the entire variation, between extremes — not variation from mean speed. It generally varies from 0.25% of mean speed to 0.75% — evidently a negligible quantity.

A mathematical treatment of this subject will be found in a paper by J. L. Astrom, in *Trans. A. S. M. E.*, 1901.

Centrifugal Force in Fly-wheels. — Let *W* = weight of rim in pounds; *R* = mean radius of rim in feet; *r* = revolutions per minute, *g* = 32.16; *v* = velocity of rim in feet per second = $2\pi Rr \div 60$.

$$\text{Centrifugal force of whole rim} = F = \frac{Wr^2}{gR} = \frac{4W\pi^2Rr^2}{3600g} = 0.000341 W R r^2.$$

The resultant, acting at right angles to a diameter, of half of this force, tends to disrupt one half of the wheel from the other half, and is resisted by the section of the rim at each end of the diameter. The resultant of

half the radial forces taken at right angles to the diameter is $1 + \frac{1}{2}\pi = \frac{2}{\pi}$

of the sum of these forces; hence the total force *F* is to be divided by $2 \times 2 \times 1.5708 = 6.2832$ to obtain the tensile strain on the cross-section of the rim, or, total strain on the cross-section = $S = 0.00005427 W R r^2$.

The weight *W*₁ of a rim of cast iron 1 inch square in section is $2\pi R \times 3.125 = 19.635 R$ pounds, whence strain per square inch of sectional area of rim = $S_1 = 0.0010656 R^2 r^2 = 0.0002664 D^2 r^2 = 0.0000270 V^2$,

in which *D* = diameter of wheel in feet, and *V* is velocity of rim in feet per minute. $S_1 = 0.0972 v^2$, if *v* is taken in feet per second.

For wrought iron:

$$S_1 = 0.0011366 R^2 r^2 = 0.0002842 D^2 r^2 = 0.0000288 V^2.$$

For steel:

$$S_1 = 0.0011593 R^2 r^2 = 0.0002901 D^2 r^2 = 0.0000294 V^2.$$

For wood:

$$S_1 = 0.0000888 R^2 r^2 = 0.0000222 D^2 r^2 = 0.00000225 V^2.$$

The specific gravity of the wood being taken at 0.6 = 37.5 lbs. per cu. ft., or 1/12 the weight of cast iron.

EXAMPLE. — Required the strain per square inch in the rim of a cast-iron wheel 30 ft. diameter, 60 revolutions per minute.

Answer. — $15^2 \times 60^2 \times 0.0010656 = 863.1$ lbs.

Required the strain per square inch in a cast-iron wheel-rim running a mile a minute. *Answer.* — $0.000027 \times 5280^2 = 752.7$ lbs.

In cast-iron fly-wheel rims, on account of their thickness, there is difficulty in securing soundness, and a tensile strength of 10,000 lbs. per sq. in. is as much as can be assumed with safety. Using a factor of

safety of 10 gives a maximum allowable strain in the rim of 1000 lbs. per sq. in., which corresponds to a rim velocity of 6085 ft. per minute.

For any given material, as cast iron, the strength to resist centrifugal force depends only on the velocity of the rim, and not upon its bulk or weight.

Chas. E. Emery (*Cass. Mag.*, 1892) says: It does not appear that fly-wheels of customary construction should be unsafe at the comparatively low speeds now in common use if proper materials are used in construction. The cause of rupture of fly-wheels that have failed is usually either the "running away" of the engine, such as may be caused by the breaking or slackness of a governor-belt, or incorrect design or defective materials of the fly-wheel.

Chas. T. Porter (*Trans. A. S. M. E.*, xiv, 808) states that no case of the bursting of a fly-wheel with a solid rim in a high-speed engine is known. He attributes the bursting of wheels built in segments to insufficient strength of the flanges and bolts by which the segments are held together. [The author, however, since the above was written, saw a solid rim fly-wheel of a high-speed engine which had burst, the cause being a large shrinkage hole at the junction between one of the arms and the rim. The wheel was about 6 ft. diam. Fortunately no one was injured by the accident.] (See also Thurston, "Manual of the Steam-engine," Part II, page 413.)

Diameters of Fly-wheels for Various Speeds. — If 6000 feet per minute be the maximum velocity of rim allowable, then $6000 = \pi R D$, in which R = revolutions per minute, and D = diameter of wheel in feet, whence $D = 6000 \div \pi R = 1910 \div R$.

W. H. Boehm, Supt. of the Fly-wheel Dept. of the Fidelity and Casualty Co. (*Eng. News*, Oct. 2, 1902), says: For a given material there is a definite speed at which disruption will occur, regardless of the amount of material used. This mathematical truth is expressed by the formula:

$$V = 1.6 \sqrt{S/W},$$

in which V is the velocity of the rim of the wheel in feet per second at which disruption will occur, W the weight of a cubic inch of the material used, and S the tensile strength of 1 square inch of the material.

For cast-iron wheels made in one piece, assuming 20,000 lbs. per sq. in. as the strength of small test bars, and 10,000 lbs. per sq. in. in large castings, and applying a factor of safety of 10, $V = 1.6 \sqrt{1000/0.26} = 100$ ft. per second for the safe speed. For cast steel of 60,000 lbs. per sq. in., $V = 1.6 \sqrt{6000 \div 0.28} = 233$ ft. per second. This is for wheels made in one piece. If the wheel is made in halves, or sections, the efficiency of the rim joint must be taken into consideration. For belt wheels with flanged and bolted rim joints located between the arms, the joints average only one-fifth the strength of the rim, and no such joint can be designed having a strength greater than one-fourth the strength of the rim. If the rim is thick enough to allow the joint to be reinforced by steel links shrunk on, as in heavy balance wheels, one-third the strength of the rim may be secured in the joint; but this construction can not be applied to belt wheels having thin rims.

For hard maple, having a tensile strength of 10,500 lbs. per sq. in., and weighing 0.0283 lb. per cu. in., we have, using a factor of safety of 20, and remembering that the strength is reduced one-half because the wheel is built up of segments, $V = 1.6 \sqrt{262.5 \div 0.0283} = 154$ ft. per second. The stress in a wheel varies as the square of the speed, and the factor of safety on speed is the square root of the factor of safety on strength.

Mr. Boehm gives the following table of safe revolutions per minute of cast-iron wheels of different diameters. The flange joint is taken at 0.25 of the strength of a wheel with no joint, the pad joint, that is a wheel made in six segments, with bolted flanges or pads on the arms, = 0.50, and the link joint = 0.60 of the strength of a solid rim.

SAFE REVOLUTIONS PER MINUTE OF CAST-IRON FLY-WHEELS.

Diam. in Ft.	No joint.	Flange joint.	Pad joint.	Link joint.	Diam. in Ft.	No joint.	Flange joint.	Pad joint.	Link joint.
	R.P.M.	R.P.M.	R.P.M.	R.P.M.		R.P.M.	R.P.M.	R.P.M.	R.P.M.
1	1910	955	1350	1480	16	120	60	84	92
2	955	478	675	740	17	112	56	79	87
3	637	318	450	493	18	106	53	75	82
4	478	239	338	370	19	100	50	71	78
5	382	191	270	296	20	95	48	68	74
6	318	159	225	247	21	91	46	65	70
7	273	136	193	212	22	87	44	62	67
8	239	119	169	185	23	84	42	59	64
9	212	106	150	164	24	80	40	56	62
10	191	96	135	148	25	76	38	54	59
11	174	87	123	135	26	74	37	52	57
12	159	80	113	124	27	71	35	50	55
13	147	73	104	114	28	68	34	48	53
14	136	68	96	106	29	66	33	47	51
15	128	64	90	99	30	64	32	45	49

The table is figured for a margin of safety on speed of approximately 3, which is equivalent to a margin on stress developed, or factor of safety in the usual sense, of 9. (*Am. Mach.*, Nov. 17, 1904.)

Strains in the Rims of Fly-band Wheels Produced by Centrifugal Force. (James B. Stanwood, *Trans. A. S. M. E.*, xiv, 251.) — Mr. Stanwood mentions one case of a fly-band wheel where the periphery velocity on a 17 ft. 9 in. wheel is over 7500 ft. per minute.

In band-saw mills the blade of the saw is operated successfully over wheels 8 and 9 ft. in diameter, at a periphery velocity of 9000 to 10,000 ft. per minute. These wheels are of cast iron throughout, of heavy thickness, with a large number of arms.

In shingle-machines and chipping-machines where cast-iron disks from 2 to 5 ft. in diameter are employed, with knives inserted radially, the speed is frequently 10,000 to 11,000 ft. per minute at the periphery.

If the rim of a fly-wheel alone be considered, the tensile strain in pounds per square inch of the rim section is $T = V^2/10$ nearly, in which V = velocity in feet per second; but this strain is modified by the resistance of the arms, which prevent the uniform circumferential expansion of the rim, and induce a bending as well as a tensile strain. Mr. Stanwood discusses the strains in band-wheels due to transverse bending of a section of the rim between a pair of arms.

When the arms are few in number, and of large cross-section, the rim will be strained transversely to a greater degree than with a greater number of lighter arms. To illustrate the necessary rim thicknesses for various rim velocities, pulley diameters, number of arms, etc., the following table is given, based upon the formula

$$t = 0.475 d \div N^2 \left(\frac{F}{V^2} - \frac{1}{10} \right),$$

in which t = thickness of rim in inches, d = diameter of pulley in inches, N = number of arms, V = velocity of rim in feet per second, and F = the greatest strain in pounds per square inch to which any fiber is subjected. The value of F is taken at 6000 lbs. per sq. in.

THICKNESS OF RIMS IN SOLID WHEELS.

Diameter of Pulley in inches.	Velocity of Rim in feet per second.	Velocity of Rim in feet per minute.	No. of Arms.	Thickness in inches.
24	50	3,000	6	2/10
24	88	5,280	6	15/32
48	88	5,280	6	15/16
108	184	11,040	16	2 1/2
108	184	11,040	36	1/2

If the limit of rim velocity for all wheels be assumed to be 88 ft. per second, equal to 1 mile per minute, $F = 6000$ lbs., the formula becomes

$$t = 0.475 d \div 0.67 N^2 = 0.7 d \div N^2.$$

When wheels are made in halves or in sections, the bending strain may be such as to make t greater than that given above. Thus, when the joint comes half way between the arms, the bending action is similar to a beam supported simply at the ends, uniformly loaded, and t is 50% greater. Then the formula becomes $t = 0.712 d \div N^2 \left(\frac{F}{V^2} - \frac{1}{10} \right)$, or for a fixed maximum rim velocity of 88 ft. per second and $F = 6000$ lbs., $t = 1.05 d \div N^2$. In segmental wheels it is preferable to have the joints opposite the arms. Wheels in halves, if very thin rims are to be employed, should have double arms along the line of separation.

Attention should be given to the proportions of large receiving and tightening pulleys. The thickness of rim for a 43-in. wheel (shown in table) with a rim velocity of 88 ft. per second, is 15/16 in. Many wrecks have been caused by the failure of receiving or tightening pulleys whose rims have been too thin. Fly-wheels calculated for a given coefficient of steadiness are frequently lighter than the minimum safe weight. This is true especially of large wheels. A rough guide to the minimum weight of wheels can be deduced from our formula. The arms, hub, lugs, etc., usually form from one-quarter to one-third the entire weight of the wheel. If b represents the face of a wheel in inches, the weight of the rim (considered as a simple annular ring) will be $w = 0.82 atb$ lbs. If the limit of speed is 88 ft. per second, then for solid wheels $t = 0.7 d \div N^2$. For sectional wheels (joint between arms) $t = 1.05 d \div N^2$. Weight of rim for solid wheels, $w = 0.57 a^2 b \div N^2$, in pounds. Weight of rim in section, wheels with joints between arms, $w = 0.86 a^2 b \div N^2$, in pounds. Total weight of wheel: for solid wheel, $W = 0.76 a^2 b \div N^2$ to $0.86 a^2 b \div N^2$, in pounds. For segmental wheels with joint between arms, $W = 1.05 a^2 b \div N^2$ to $1.3 a^2 b \div N^2$, in pounds.

(This subject is further discussed by Mr. Stanwood, in vol. xv, and by Prof. Gaetano Lanza, in vol. xvi, *Trans. A. S. M. E.*)

Arms of Fly-wheels and Pulleys. — Professor Torrey (*Am. Mach.*, July 30, 1891) gives the following formula for arms of elliptical cross-section of cast-iron wheels:

W = load in pounds acting on one arm; S = strain on belt in pounds per inch of width, taken at 56 for single and 112 for double belts; v = width of belt in inches; n = number of arms; L = length of arm in feet; b = breadth of arm at hub; d = depth of arm at hub, both in inches; $\Pi = Sv \div n$; $b = WL \div 30 d^2$. The breadth of the arm is its least dimension = minor axis of the ellipse, and the depth the major axis. This formula is based on a factor of safety of 10.

In using the formula, first assume some depth for the arm, and calculate the required breadth to go with it. If it gives too round an arm, assume the depth a little greater, and repeat the calculation. A second trial will almost always give a good section.

The size of the arms at the hub having been calculated, they may be somewhat reduced at the rim end. The actual amount cannot be calculated, as there are too many unknown quantities. However, the depth

and breadth can be reduced about one-third at the rim without danger, and this will give a well-shaped arm.

Pulleys are often cast in halves, and bolted together. When this is done the greatest care should be taken to provide sufficient metal in the bolts. This is apt to be the very weakest point in such pulleys. The combined area of the bolts at each joint should be about 28/100 the cross-section of the pulley at that point. (Torrey.)

Unwin gives $d = 0.6337 \sqrt[3]{BD/n}$ for single belts;

$d = 0.798 \sqrt[3]{BD/n}$ for double belts;

D being the diameter of the pulley, and B the breadth of the rim, both in inches. These formulæ are based on an elliptical section of arm in which $b = 0.4 d$ or $d = 2.5 b$ on a width of belt = 4/5 the width of the pulley rim, a maximum driving force transmitted by the belt of 56 lbs. per inch of width for a single belt and 112 lbs. for a double belt, and a safe working stress of cast iron of 2250 lbs. per square inch.

If in Torrey's formula we make $b = 0.4 d$, it reduces to

$$b = \sqrt{\frac{WL}{187.5}}; d = \sqrt{\frac{WL}{12}}$$

EXAMPLE. — Given a pulley 10 feet diameter; 8 arms, each 4 feet long; face, 36 inches wide; belt, 30 inches; required the breadth and depth of the arm at the hub. According to Unwin,

$d = 0.6337 \sqrt[3]{BD/n} = 0.633 \sqrt[3]{36 \times 120/8} = 5.16$ for single belt, $b = 2.06$;

$d = 0.798 \sqrt[3]{BD/n} = 0.798 \sqrt[3]{36 \times 120/8} = 6.50$ for double belt, $b = 2.60$.

According to Torrey, if we take the formula $b = WL \div 30 d^2$ and assume $d = 5$ and 6.5 inches, respectively, for single and double belts, we obtain $b = 1.08$ and 1.33, respectively, or practically only one-half of the breadth according to Unwin, and, since transverse strength is proportional to breadth, an arm only one-half as strong.

Torrey's formula is said to be based on a factor of safety of 10, but this factor can be only apparent and not real, since the assumption that the strain on each arm is equal to the strain on the belt divided by the number of arms, is, to say the least, inaccurate. It would be more nearly correct to say that the strain of the belt is divided among half the number of arms. Unwin makes the same assumption in developing his formula, but says it is only in a rough sense true, and that a large factor of safety must be allowed. He therefore takes the low figure of 2250 lbs. per square inch for the safe working strength of cast iron. Unwin says that his equations agree well with practice.

A Wooden-rim Fly-wheel, built in 1891 for a pair of Corliss engines at the Amoskeag Mfg. Co.'s mill, Manchester, N.H., is described by C. H. Manning in *Trans. A. S. M. E.*, xiii, 618. It is 30 ft. diam. and 108 in. face. The rim is 12 inches thick, and is built up of 44 courses of ash plank, 2, 3, and 4 inches thick, reduced about 1/2 inch in dressing, set edgewise, so as to break joints, and glued and bolted together. There are two hubs and two sets of arms, 12 in each, all of cast iron. The weights are as follows:

Weight (calculated) of ash rim.....	31,855 lbs.
Weight of 24 arms (foundry 45,020).....	40,349 "
Weight of 2 hubs (foundry 35,030).....	31,394 ± "
Counter-weights in 6 arms.....	664 "
Total, excluding bolts and screws.....	104,262 ± "

The wheel was tested at 76 revs. per min., being a surface speed of nearly 7200 feet per minute.

Wooden Fly-wheel of the Willimantic Linen Co. (Illustrated in *Power*, March, 1893.) — Rim 28 ft. diam., 110 in. face. The rim is carried upon three sets of arms, one under the center of each belt, with 12 arms in each set.

The material of the rim is ordinary whitewood, 7/8 in. in thickness, cut into segments not exceeding 4 feet in length, and either 5 or 8 inches in

width. These were assembled by building a complete circle 13 inches in width, first with the 8-inch inside and the 5-inch outside, and then beside it another circle with the widths reversed, so as to break joints. Each piece as it was added was brushed over with glue and nailed with three-inch wire nails to the pieces already in position. The nails pass through three and into the fourth thickness. At the end of each arm four 14-inch bolts secure the rim, the ends being covered by wooden plugs glued and driven into the face of the wheel.

Wire-wound Fly-wheels for Extreme Speeds. (*Eng'g News*, August 2, 1890.) — The power required to produce the Mannesmann tubes is very large, varying from 2000 to 10,000 H.P., according to the dimensions of the tube. Since this power is needed for only a short time (it takes only 30 to 45 seconds to convert a bar 10 to 12 ft. long and 4 in. in diameter into a tube), and then some time elapses before the next bar is ready, an engine of 1200 H.P. provided with a large fly-wheel for storing the energy will supply power enough for one set of rolls. These fly-wheels are so large and run at such great speeds that the ordinary method of constructing them cannot be followed. A wheel at the Mannesmann Works, made in Komotau, Hungary, in the usual manner, broke at a tangential velocity of 125 ft. per second. The fly-wheels designed to hold at more than double this speed consist of a cast-iron hub to which two steel disks, 20 ft. in diameter, are bolted; around the circumference of the wheel thus formed 70 tons of No. 5 wire are wound under a tension of 50 lbs. In the Mannesmann Works at Landore, Wales, such a wheel makes 240 revolutions a minute, corresponding to a tangential velocity of 15,080 ft. or 2.85 miles per minute.

THE SLIDE-VALVE.

Definitions. — *Travel* = total distance moved by the valve.

Throw of the Eccentric = eccentricity of the eccentric = distance from the center of the shaft to the center of the eccentric disk = $\frac{1}{2}$ the travel of the valve.

Lap of the valve, also called outside lap or steam-lap = distance the outer or steam edge of the valve extends beyond or laps over the steam edge of the port when the valve is in its central position.

Inside lap, or *exhaust-lap* = distance the inner or exhaust edge of the valve extends beyond or laps over the exhaust edge of the port when the valve is in its central position. The inside lap is sometimes made zero, or even negative, in which latter case the distance between the edge of the valve and the edge of the port is sometimes called exhaust clearance, or inside clearance.

Lead of the valve = the distance the steam-port is opened when the engine is on its center and the piston is at the beginning of the stroke.

Lead-angle = the angle between the position of the crank when the valve begins to be opened and its position when the piston is at the beginning of the stroke.

The valve is said to have lead when the steam-port opens before the piston begins its stroke. If the piston begins its stroke before the admission of steam begins, the valve is said to have negative lead, and its amount is the lap of the edge of the valve over the edge of the port at the instant when the piston stroke begins.

Lap-angle = the angle through which the eccentric must be rotated to cause the steam edge to travel from its central position the distance of the lap.

Angular advance of the eccentric = lap-angle + lead-angle.

Linear advance = lap + lead.

Effect of Lap, Lead, etc., upon the Steam Distribution. — Given valve-travel $2\frac{3}{4}$ in., lap $\frac{3}{4}$ in., lead $\frac{1}{16}$ in., exhaust-lap $\frac{1}{8}$ in., required crank position for admission, cut-off, release and compression, and greatest port-opening. (Halsey on Slide-valve Gears.) Draw a circle of diameter fh = travel of valve. From O the center set off Oa = lap and ab = lead, erect perpendiculars Oe , ac , bd ; then ec is the lap-angle and cd the lead-angle, measured as arcs. Set off fg = cd , the lead-angle; then Og is the position of the crank for steam admission. Set off $2ec + cd$ from h to i ; then Oi is the crank-angle for cut-off, and $ik + fh$ is the fraction of stroke completed at cut-off. Set off Ol = exhaust-

lap and draw lm ; em is the exhaust-lap angle. Set off $hn = ec + cd - em$, and On is the position of crank at release. Set off $fp = ec + cd + em$, and Op is the position of crank for compression, $fo \div fh$ is the fraction of stroke completed at release, and $hq + hf$ is the fraction of the return stroke completed when compression begins; Oh , the throw of the eccentric, minus Oa the lap, equals ah the maximum port-opening.

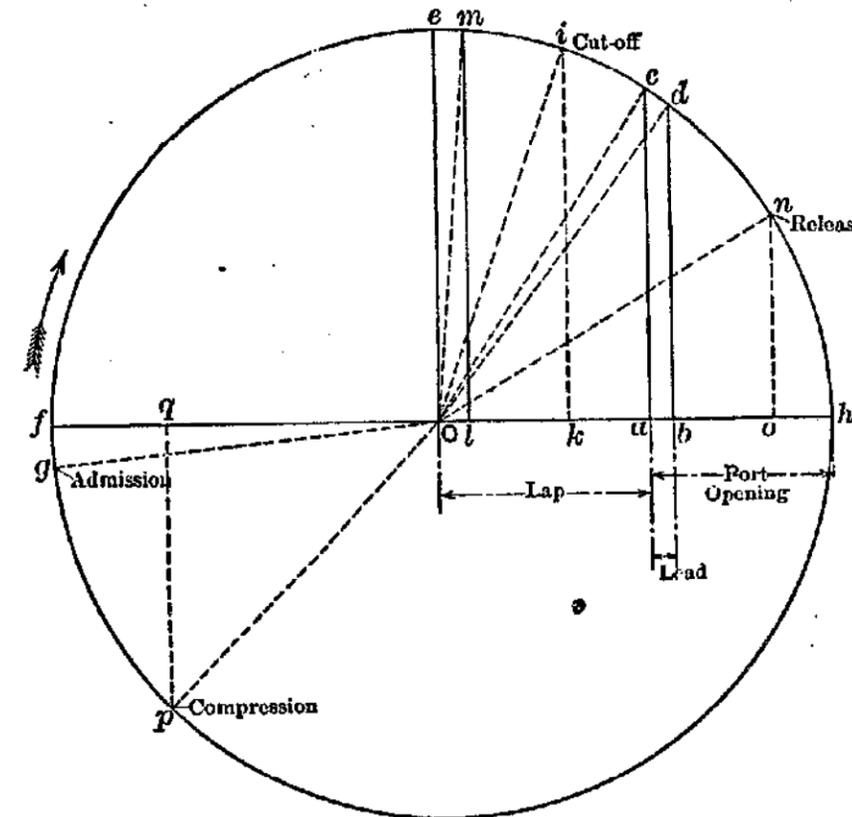

FIG. 162.

If a valve has neither lap nor lead, the line joining the center of the eccentric disk and the center of the shaft being at right angles to the line of the crank, the engine would follow full stroke, admission of steam beginning at the beginning of the stroke and ending at the end of the stroke.

Adding lap to the valve enables us to cut off steam before the end of the stroke. The eccentric being advanced on the shaft an amount equal to the lap-angle enables steam to be admitted at the beginning of the stroke, as before lap was added, and advancing it a further amount equal to the lead-angle causes steam to be admitted before the beginning of the stroke.

Having given lap to the valve, and having advanced the eccentric on the shaft from its central position at right angles to the crank, through the angular advance = lap-angle + lead-angle, the four events, admission, cut-off, release or exhaust-opening, and compression or exhaust-closure, take place as follows: Admission, when the crank lacks the lead-angle of having reached the center; cut-off, when the crank lacks two lap-angles and one lead-angle of having reached the center. During the admission of steam the crank turns through a semicircle less twice the lap-angle. The greatest port-opening is equal to half the travel of the valve less the lap. Therefore for a given port-opening the travel of the valve must be increased if the lap is increased. When exhaust-lap is added to the valve it delays the opening of the exhaust and hastens its closing by an angle of rotation equal to the exhaust-lap angle, which is the angle through which the eccentric rotates from its middle position

while the exhaust edge of the valve uncovers its lap. Release then takes place when the crank lacks one lap-angle and one lead-angle minus one exhaust-lap angle of having reached the center, and compression when the crank lacks lap-angle + lead-angle + exhaust-lap angle of having reached the center.

The above discussion of the relative position of the crank, piston, and valve for the different points of the stroke is accurate only with a connecting-rod of infinite length.

For actual connecting-rods the angular position of the rod causes a distortion of the position of the valve, causing the events to take place too late in the forward stroke and too early in the return. The correction of this distortion may be accomplished to some extent by setting the valve so as to give equal lead on both forward and return stroke, and by altering the exhaust-lap on one end so as to equalize the release and compression. F. A. Halsey, in his Slide-valve Gears, describes a method of equalizing the cut-off without at the same time affecting the equality of the lead. In designing slide-valves the effect of angularity of the connecting-rod should be studied on the drawing-board, and preferably by the use of a model.

Sweet's Valve-diagram. — To find outside and inside lap of valve for different cut-offs and compressions (see Fig. 163): Draw a circle whose diameter equals travel of valve. Draw diameter BA and continue to A^1 , so that the length AA^1 bears the same ratio to XA as the

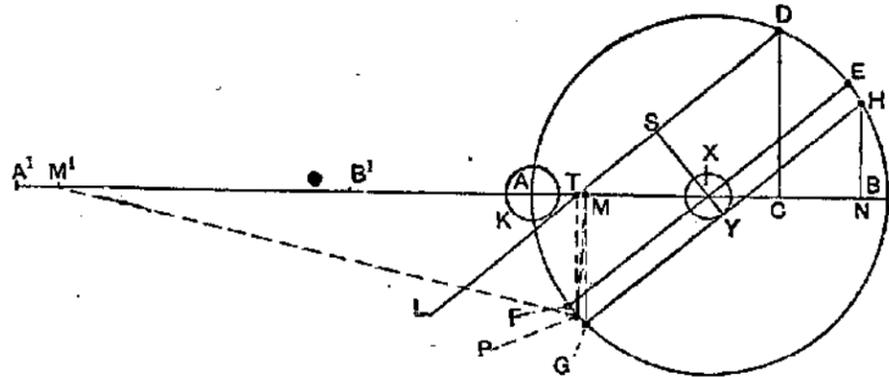

FIG. 163. — Sweet's Valve Diagram.

length of connecting-rod does to length of engine-crank. Draw small circle K with a radius equal to lead. Lay off AC so that ratio of AC to AB = cut-off in parts of the stroke. Erect perpendicular CD . Draw DL tangent to K ; draw XS perpendicular to DL ; XS is then outside lap of valve.

To find release and compression: If there is no inside lap, draw FE through X parallel to DL . F and E will be position of crank for release and compression. If there is an inside lap, draw a circle about X , in which radius XY equals inside lap. Draw HG tangent to this circle and parallel to DL ; then H and G are crank positions for release and for compression. Draw HN and MG , then AN is piston position at release and A^1M piston position at compression, AB being considered stroke of engine.

To make compression alike on each stroke it is necessary to increase the inside lap on crank end of valve, and to decrease by the same amount the inside lap on back end of valve. To determine this amount, through M with a radius $MM^1 = AA^1$, draw arc MP , from P draw PT perpendicular to AB , then TM is the amount to be added to inside lap on crank end, and to be deducted from inside lap on back end of valve, inside lap being XY .

For the *Bilgram Valve-Diagram*, see Halsey on Slide-valve Gears.

The **Zeuner Valve-diagram** is given in most of the works on the steam-engine, and in treatises on valve-gears, as Zeuner's, Peabody's, and Spangler's. The following paragraphs show how the Zeuner valve-diagram may be employed as a convenient means (1) for finding the lap, lead, etc., of a slide-valve when the points of admission, cut-off, and release

are given; and (2) for obtaining the points of admission, cut-off, release, and compression, etc., when the travel, the laps, and the lead of the valve are given. In working out these two problems, the connecting-rod is supposed to be of infinite length.

Determination of the Lap, Lead, etc., of a Slide-valve for Given Steam Distribution. — Given the points of admission, cut-off, and release, to find the point of compression, the lap, the lead, the exhaust lap, the angular advance, and the port-openings at different fractions of the stroke.

Draw a straight line AA' , Fig. 164, to represent on any scale the travel of the valve, and on it draw a circle, with the center O , to represent the path of the center of the eccentric. The line and the circle will also represent on a different scale the length of stroke of the piston and the path of the crank-pin. On the circle, which is called the *crank circle*, mark B ,

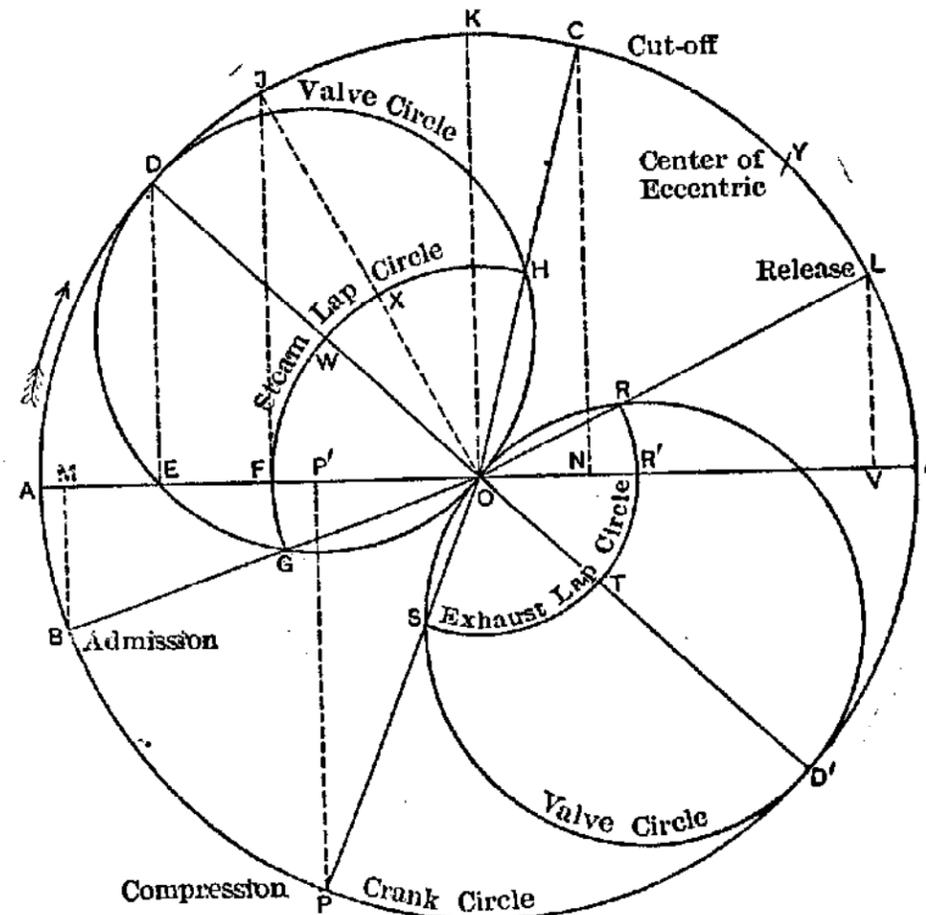

FIG. 164.—Zeuner's Valve Diagram.

the position of the crank-pin when *admission* of steam begins, the direction of motion of the crank being shown by the arrow; C , the position of the crank-pin at *cut-off*; and L , its position at *release*. From these points draw perpendiculars BM , CN , and LV , to the line AA' ; M , N , and V will then represent the positions of the piston at admission, cut-off, and release respectively, the admission taking place, as shown, before the piston reaches the end of the stroke in the direction OA , and release taking place before the end of the stroke in the direction OA' .

Bisect the arc BC at D , and draw the diameter DOD' . On DO draw the circle $DHOGE$, called the *valve circle*. Draw OB , cutting the valve circle at G ; and OC , cutting it at H . Then $OG = OH$ is the *lap* of the valve, measured on the scale in which OA is the half-travel of the valve. With OG as radius draw the arc GFH , called the *steam-lap circle*, or, for short, the *lap circle*.

Mark the point *E*, at which the valve circle cuts the line *OA*. The distance *FE* represents the *lead* of the valve, and *BG = AF* is the *maximum port-opening*. A perpendicular drawn from *OA* at *E* will cut the valve circle and the crank circle at *D*, since the triangle *DEO* is a right-angled triangle drawn in the semicircle *DEGO*.

Erect the perpendicular *FJ*, then angle *DOJ = AOB* is the *lead-angle* and *JOK* is the *lap-angle*, *OK* being a perpendicular to *AA'* drawn from *O*. *DOK* is the sum of the lap and lead angles, that is, the *angular advance*, by which the eccentric must be set beyond 90° ahead of the crank. Set off *KY = KD*; then *Y* is the position of the center of the eccentric when the crank is in the position *OA*.

To find the point of compression, set off *D'P = D'L*; then *P* is the point of compression.

Draw *OP* and *OL*. On *OD'* draw the valve circle *ORD'S*, cutting *OL* at *R* and *OP* at *S*. With *OR* as a radius draw the arc of the exhaust-lap circle, *RTS*; *OR = OS* is the *exhaust lap*.

The *port-opening* at any part of the stroke, or corresponding position of the crank, is represented by the radial distances, as *EF*, *DW*, and *JX*, intercepted between the lap and the valve circles on radii drawn from *O*. Thus, on the radius *OB*, the port-opening is zero when steam admission is about to begin; on the radius *OA*, when the crank is on the dead center the opening is *EF*, or equal to the lead of the valve; on the radius *DO*, midway between the point of admission and the point of cut-off, the opening is a maximum *DW = AF = BG*; on the radius *OC* it is zero again when steam has just been cut off.

In like manner the *exhaust opening* is represented by the radial distances intercepted between the exhaust-lap circle, *RR'TS*, and the valve circle, *ORD'S*. On the radius *OL* it is zero when release begins; on *OD'* it is *TD'*, a maximum; and on *OP* it is zero again when compression begins.

Determination of the Steam Distribution, etc., for a Given Valve. — Given the valve travel, the lap, the lead, and the exhaust lap, to find the maximum port-opening, the angular advance, and the points of admission, cut-off, release, and compression.

This problem is the reverse of the preceding. Draw *AOA'* to represent the valve travel on a certain scale, *O* being the middle point, and on this line on the same scale set off *OF = the lap*, *FE = the lead*, and *OR' = the exhaust lap*. *AF* then will be the *maximum port-opening*. Draw the perpendiculars *OK* and *ED*. *DOK* is the *angular advance*.

Draw the diameter *DOD'*, and on *DO* and *D'O* draw the two valve circles. From *O*, the center, with a radius *OF*, the lap, draw the arc of the steam-lap circle cutting the valve circle in *G* and *H*. Through *G* draw *OB*, and through *H* draw *OC*; *B* then is the *point of admission*, and *C* the *point of cut-off*. With *OR*, the exhaust lap, as a radius, draw the arc of the exhaust-lap circle, *RTS*, cutting the valve circle in *R* and *S*. Through *R* draw *OL*, and through *S* draw *OP*. Then *L* is the *point of release* and *P* the *point of compression*. Draw the perpendiculars *BM*, *CN*, *LV*, and *PP'*, to find *M*, *N*, *V*, and *P'*, the respective positions on the stroke of the piston when *admission*, *cut-off*, *release*, and *compression* take place.

Practical Application of Zeuner's Diagram. — In problems solved by means of the Zeuner diagram, the results obtained on the drawings are *relative dimensions* or the *ratios* of the several dimensions to a given dimension the scale of which is known, such as the valve travel, the maximum port-opening, or the length of stroke. In problems similar to the first problem given above, the known dimensions are usually the length of stroke, the maximum port-opening, *AF*, which is calculated from data of the dimensions of cylinder, the piston speed, and the allowable velocity of steam through the port. The length of the stroke being represented on a certain scale by *AA'*, the points of admission, cut-off, release, and compression, in fractions of the stroke, are measured respectively by *A'M*, *AN*, *AV*, and *A'P* on the same scale. The actual dimension of the maximum port-opening is represented on a different scale by *AF*, therefore the actual dimensions of the lap, lead, and exhaust lap are measured respectively by *OF*, *FE*, and *OR'* on the same scale as *AF*; or, in other words, the lap, lead, and exhaust lap are respectively the ratios $\frac{OF}{AF}$, $\frac{FE}{AF}$, and $\frac{OR'}{AF}$, each multiplied by the maximum port-opening.

In problems similar to the second problem, the actual dimensions of the lap, the lead, the exhaust lap, and the valve travel are all known, and are laid down on the same scale on the line *AA'*, representing the valve travel; and the maximum port-opening is found by the solution of the problem to be *AF*, measured on the same scale; or the maximum port-opening = 1/2 valve travel minus the lap. Also in this problem *AA'* represents the known length of stroke on a certain scale, and the points of admission, cut-off, release, and compression, in fractions of the stroke, are represented by the ratios which *A'M*, *AN*, *AV*, and *A'P*, respectively, bear to *AA'*.

Port-opening. — The area of port-opening is usually made such that the velocity of the steam in passing through it should not exceed 6000 ft. per min. The ratio of port area to piston area will vary with the piston-speed as follows:

For speed of piston, ft. per min.	100	200	300	400	500	600	700	800	900	1000	1200
Port area = piston area X	0.017	.033	.05	.067	.083	.1	.107	.133	.15	.167	.2

For a velocity of 6000 ft. per min.,

$$\text{Port area} = \text{sq. of diam. of cyl.} \times \text{piston speed} \div 7639.$$

The length of the port-opening may be equal to or something less than the diameter of the cylinder, and the width = area of port-opening ÷ its length.

The bridge between steam and exhaust ports should be wide enough to prevent a leak of steam into the exhaust due to overtravel of the valve.

The width of exhaust port = width of steam port + 1/2 travel of valve + inside lap - width of bridge.

Lead. (From Peabody's Valve-gears.) — The lead, or the amount that the valve is open when the engine is on a dead point, varies, with the type and size of the engine, from a very small amount, or even nothing, up to 3/8 of an inch or more. Stationary-engines running at slow speed may have from 1/64 to 1/16 inch lead. The effect of compression is to fill the waste space at the end of the cylinder with steam; consequently, engines having much compression need less lead. Locomotive-engines having the valves controlled by the ordinary form of Stephenson link-motion may have a small lead when running slowly and with a long cut-off, but when at speed with a short cut-off the lead is at least 1/4 inch; and locomotives that have valve-gear which gives constant lead commonly have 1/4 inch lead. The lead-angle is the angle the crank makes with the line of dead points at admission. It may vary from 0° to 8°.

Inside Lead. — Weisbach (vol. ii, p. 296) says: Experiment shows that the earlier opening of the exhaust ports is especially of advantage, and in the best engines the lead of the valve upon the side of the exhaust, or the inside lead, is 1/25 to 1/15; i.e., the slide-valve at the lowest or highest position of the piston has made an opening whose height is 1/25 to 1/15 of the whole throw of the slide-valve. The outside lead of the slide-valve or the lead on the steam side, on the other hand, is much smaller, and is often only 1/100 of the whole throw of the valve.

Effect of Changing Outside Lap, Inside Lap, Travel and Angular Advance. (Thurston.)

	Admission.	Expansion.	Exhaust.	Compression.
Incr. O.L.	is later, ceases sooner	occurs earlier, continues longer	is unchanged	begins at same point
Incr. I.L.	unchanged	begins as before, continues longer	occurs later, ceases earlier	begins sooner, continues longer
Incr. T.	begins sooner, continues longer	begins later, ceases sooner	begins later, ceases later	begins later, ends sooner
Incr. A.A.	begins earlier, period unaltered	begins sooner, per. the same	begins earlier, per. unchanged	begins earlier, per. the same

Zeuner gives the following relations (Weisbach-Dubois, vol. ii, p. 307):
 If S = travel of valve, p = maximum port opening;

L = steam-lap, l = exhaust-lap;

$$R = \text{ratio of steam-lap to half travel} = \frac{L}{0.5 S}, L = \frac{R}{2} \times S;$$

$$r = \text{ratio of exhaust-lap to half travel} = \frac{l}{0.5 S}, l = \frac{r}{2} \times S;$$

$$S = 2p + 2L = 2p + R \times S; S = \frac{2p}{1-R}$$

If α = angle BOC between positions of crank at admission and at cut-off, and β = angle LOP between positions of crank at release and at compression, then $R = \frac{1}{2} \frac{\sin(180^\circ - \alpha)}{\sin \frac{1}{2} \alpha}$; $r = \frac{1}{2} \frac{\sin(180^\circ - \beta)}{\sin \frac{1}{2} \beta}$.

Crank-angles for Connecting-rods of Different Lengths.
 FORWARD AND RETURN STROKES.

Fraction of Stroke from Commencement.	Ratio of Length of Connecting-rod to Length of Stroke.												
	2		2 1/2		3		3 1/2		4		5		Infinite
	For.	Ret.	For.	Ret.	For.	Ret.	For.	Ret.	For.	Ret.	For.	Ret.	
.01	10.3	13.2	10.5	12.8	10.6	12.6	10.7	12.4	10.8	12.3	10.9	12.1	11.5
.02	14.6	18.7	14.9	18.1	15.1	17.8	15.2	17.5	15.3	17.4	15.5	17.1	16.3
.03	17.9	22.9	18.2	22.2	18.5	21.8	18.7	21.5	18.8	21.3	19.0	21.0	19.9
.04	20.7	26.5	21.1	25.7	21.4	25.2	21.6	24.9	21.8	24.6	22.0	24.3	23.1
.05	23.2	29.6	23.6	28.7	24.0	28.2	24.2	27.8	24.4	27.5	24.7	27.2	25.8
.10	33.1	41.9	33.8	40.8	34.3	40.1	34.6	39.6	34.9	39.2	35.2	38.7	36.9
.15	41	51.5	41.9	50.2	42.4	49.3	42.9	48.7	43.2	48.3	43.6	47.7	45.6
.20	48	59.6	48.9	58.2	49.6	57.3	50.1	56.6	50.4	56.2	50.9	55.5	53.1
.25	54.3	66.9	55.4	65.4	56.1	64.4	56.6	63.7	57.0	63.3	57.6	62.6	60.0
.30	60.3	73.5	61.5	72.0	62.2	71.0	62.8	70.3	63.3	69.8	63.9	69.1	66.4
.35	66.1	79.8	67.3	78.3	68.1	77.3	68.8	76.6	69.2	76.1	69.9	75.3	72.5
.40	71.7	85.8	73.0	84.3	73.9	83.3	74.5	82.6	75.0	82.0	75.7	81.3	78.5
.45	77.2	91.5	78.6	90.1	79.6	89.1	80.2	88.4	80.7	87.9	81.4	87.1	84.3
.50	82.8	97.2	84.3	95.7	85.2	94.8	85.9	94.1	86.4	93.6	87.1	92.9	90.0
.55	88.5	102.8	89.9	101.4	90.9	100.4	91.6	99.8	92.1	99.3	92.9	98.6	95.7
.60	94.2	108.3	95.7	107.0	96.7	106.1	97.4	105.5	98.0	105.0	98.7	104.3	101.5
.65	100.2	113.9	101.7	112.7	102.7	111.9	103.4	111.2	103.9	110.8	104.7	110.1	107.5
.70	106.5	119.7	108.0	118.5	109.0	117.8	109.7	117.2	110.2	116.7	110.9	116.1	113.6
.75	113.1	125.7	114.6	124.6	115.6	123.9	116.3	123.4	116.7	123.0	117.4	122.4	120.0
.80	120.4	132	121.8	131.1	122.7	130.4	123.4	129.9	123.8	129.6	124.5	129.1	126.9
.85	128.5	139	129.8	138.1	130.7	137.6	131.5	137.1	131.7	136.8	132.3	136.4	134.4
.90	138.1	146.9	139.2	146.2	139.9	145.7	140.4	145.4	140.8	145.1	141.3	144.8	143.1
.95	150.4	156.8	151.3	156.4	151.8	156.0	152.2	155.8	152.5	155.6	152.8	155.3	154.2
.96	153.5	159.3	154.3	158.9	154.8	158.6	155.1	158.4	155.4	158.2	155.7	158.0	156.9
.97	157.1	162.1	157.8	161.8	158.2	161.5	158.5	161.3	158.7	161.2	159.0	161.0	160.1
.98	161.3	165.4	161.9	165.1	162.2	164.9	162.5	164.8	162.6	164.7	162.9	164.5	163.7
.99	166.8	169.7	167.2	169.5	167.4	169.4	167.6	169.3	167.7	169.2	167.9	169.1	168.5
1.00	180	180	180	180	180	180	180	180	180	180	180	180	180

Ratio of Lap and of Port-opening to Valve-travel. — The table on page 1041, giving the ratio of lap to travel of valve and ratio of travel to port-opening, is abridged from one given by Buel in Weisbach-Dubois,

vol. ii. It is calculated from the above formulæ. Intermediate values may be found by the formulæ, or with sufficient accuracy by interpolation from the figures in the table. By the table on page 1040 the crank-angle may be found, that is, the angle between its position when the engine is on the center and its position at cut-off, release, or compression, when these are known in fractions of the stroke. To illustrate the use of the tables the following example is given by Buel: width of port = 2.2 in.; width of port-opening = width of port + 0.3 in.; overtravel = 2.5 in.; length of connecting-rod = 2 1/2 times stroke; cut-off = 0.75 of stroke; release = 0.95 of stroke; lead-angle, 10°. From the first table we find crank-angle = 114.6; add lead-angle, making 124.6°. From the second table, for angle between admission and cut-off, 125°, we have ratio of travel to port-opening = 3.72, or for 124.6° = 3.74, which, multiplied by port-opening 2.5, gives 9.45 in. travel. The ratio of lap to travel, by the table, is 0.2324, or 9.45 × 0.2324 = 2.2 in. lap. For exhaust-lap, we have for release at 0.95, crank-angle = 151.3; add lead-angle 10° = 161.3°. From the second table, by interpolation, ratio of lap to travel = 0.0811, and 0.0811 × 9.45 = 0.77 in. the exhaust-lap.

Lap-angle = 1/2(180° - lead-angle - crank-angle at cut-off);
 = 1/2(180° - 10 - 114.6) = 27.7°.

Angular advance = lap-angle + lead-angle = 27.7 + 10 = 37.7°.

Exhaust lap-angle = crank-angle at release + lap-angle + lead-angle - 180°
 = 151.3 + 27.7 + 10 - 180° = 9°.

Crank-angle at compression measured on return stroke } = 180° - lap-angle - lead-angle - exhaust lap-angle
 = 180 - 27.7 - 10 - 9 = 133.3°; corresponding, by

table, to a piston position of 0.81 of the return stroke; or
 Crank-angle at compression = 180° - (angle at release - angle at cut-off) + lead-angle
 = 180 - (151.3 - 114.6) + 10 = 133.3°.

The positions determined above for cut-off and release are for the forward stroke of the piston. On the return stroke the cut-off will take place at the same angle, 114.6°, corresponding by table to 66.6% of the return stroke, instead of 75%. By a slight adjustment of the angular advance and the length of the eccentric-rod the cut-off can be equalized. The width of the bridge should be at least 2.5 + 0.25 - 2.2 = 0.55 in.

Lap and Travel of Valve.

Angle between Positions of Crank at Points of Admission and Cut-off, or Release and Compression.	Ratio of Lap to Travel of Valve.	Ratio of Travel of Valve to Width of Port-opening.	Angle between Positions of Crank at Points of Admission and Cut-off, or Release and Compression.	Ratio of Lap to Travel of Valve.	Ratio of Travel of Valve to Width of Port-opening.	Angle between Positions of Crank at Points of Admission and Cut-off, or Release and Compression.	Ratio of Lap to Travel of Valve.	Ratio of Travel of Valve to Width of Port-opening.
30°	0.4830	58.70	85°	0.3686	7.61	135°	0.1913	3.24
35	.4769	43.22	90	.3536	6.83	140	.1710	3.04
40	.4699	33.17	95	.3378	6.17	145	.1504	2.86
45	.4619	26.27	100	.3214	5.60	150	.1294	2.70
50	.4532	21.34	105	.3044	5.11	155	.1082	2.55
55	.4435	17.70	110	.2868	4.69	160	.0868	2.42
60	.4330	14.93	115	.2687	4.32	165	.0653	2.30
65	.4217	12.77	120	.2500	4.00	170	.0436	2.19
70	.4096	11.06	125	.2309	3.72	175	.0218	2.09
75	.3967	9.68	130	.2113	3.46	180	.0000	2.00
80	.3830	8.55						

Relative Motions of Crosshead and Crank. — L = length of connecting-rod, R = length of crank, θ = angle of crank with center line of engine, D = displacement of crosshead from the beginning of its stroke, V = velocity of crank-pin, V_1 = velocity of piston.

For $R=1$, $D = \text{ver sin } \theta \pm (L - \sqrt{L^2 - \sin^2 \theta})$,

$$V_1 = V \sin \theta \left(1 \pm \frac{\cos \theta}{\sqrt{L^2 - \sin^2 \theta}} \right).$$

From these formulæ Mr. A. F. Nagle computes the following:
PISTON DISPLACEMENT AND PISTON VELOCITY FOR EACH 10° OF MOTION OF CRANK. Length of crank = 1. Length of connecting-rod = 5. Piston velocity V_1 for vel. of crank-pin = 1.

Angle of Crank	Displacement.		Velocity.		Angle of Crank	Displacement.		Velocity.	
	Forward.	Back.	Forward.	Back.		Forward.	Back.	Forward.	Back.
10°	0.018	0.012	0.207	60°	0.576	0.424	0.954	0.778
20°	0.072	0.048	0.406	70°	0.747	0.569	1.005	0.875
30°	0.159	0.109	0.587	80°	0.924	0.728	1.019	0.950
40°	0.276	0.192	0.742	84°	1.000	1.011
50°	0.416	0.298	0.865	90°	1.101	0.899	1.000	1.000

PERIODS OF ADMISSION, OR CUT-OFF, FOR VARIOUS LAPS AND TRAVELS OF SLIDE-VALVES.

The two following tables are from Clark on the Steam-engine. In the first table are given the periods of admission corresponding to travels of valve of from 12 in. to 2 in., and laps of from 2 in. to 3/8 in., with 1/4 in. and 1/8 in. of lead. With greater leads than those tabulated, the steam would be cut off earlier than as shown in the table.

The influence of a lead of 5/16 in. for travels of from 15/8 in. to 6 in., and laps of from 1/2 in. to 1 1/2 in., as calculated for in the second table, is exhibited by comparison of the periods of admission in the table, for the same lap and travel. The greater lead shortens the period of admission, and increases the range for expansive working.

Periods of Admission, or Points of Cut-off, for Given Travels and Laps of Slide-valves.

Travel of Valve.	Lead.	Periods of Admission, or Points of Cut-off, for the following Laps of Valves in inches.									
		2	1 3/4	1 1/2	1 1/4	1	7/8	3/4	5/8	1/2	3/8
12 in.	1/4 in.	88	90	93	95	96	97	98	98	99	99
10	1/4	82	87	89	92	95	96	97	98	98	99
8	1/4	72	78	84	88	92	94	95	96	98	98
6	1/4	50	62	71	79	86	89	91	94	96	97
5 1/2	1/8	43	56	68	77	85	88	91	94	96	97
5	1/8	32	47	61	72	82	86	89	92	95	97
4 1/2	1/8	14	35	51	66	78	83	87	90	94	96
4	1/8	17	39	57	72	78	83	88	92	95
3 1/2	1/8	20	44	63	71	79	84	90	94
3	1/8	23	50	61	71	79	86	91
2 1/2	1/8	27	43	57	70	80	88
2	1/8	33	52	70	81

WARNING: This is a 1910 edition. Some of the material may no longer be accurate

Periods of Admission, or Points of Cut-off, for given Travels and Laps of Slide-valves.

Constant lead, 5/16.

Travel. Inches.	Lap.								
	1/2	5/8	3/4	7/8	1	1 1/8	1 1/4	1 3/8	1 1/2
15/8	19
13/4	39
17/8	47	17
2	55	34
21/8	61	42	14
21/4	65	50	30
23/8	68	55	38	13
21/2	71	59	45	27
25/8	74	63	49	36	12
23/4	76	67	56	43	26
27/8	78	70	59	47	32	11
3	80	73	62	50	38	23
3 1/8	81	74	65	55	44	30	10
3 1/4	83	76	68	59	48	34	22
3 3/8	84	78	71	62	51	40	29	9
3 1/2	85	80	73	64	53	45	34	20
3 5/8	86	81	75	66	57	49	38	26	9
3 3/4	87	82	76	68	60	52	42	32	19
3 7/8	87	83	78	70	63	55	46	36	25
4	88	84	79	72	66	58	49	40	29
4 1/4	89	86	81	76	70	63	56	47	37
4 1/2	90	87	83	79	73	67	61	54	45
4 3/4	92	89	85	81	76	70	65	58	51
5	93	90	87	83	78	73	67	62	56
5 1/2	94	92	89	86	82	78	73	68	63
6	95	93	91	88	85	82	78	74	69

Piston-valve. — The piston-valve is a modified form of the slide-valve. The lap, lead, etc., are calculated in the same manner as for the common slide-valve. The diameter of valve and amount of port-opening are calculated on the basis that the most contracted portion of the steam-passage between the valve and the cylinder should have an area such that the velocity of steam through it will not exceed 6000 ft. per minute. The area of the opening around the circumference of the valve should be about double the area of the steam-passage, since that portion of the opening that is opposite from the steam-passage is of little effect.

Setting the Valves of an Engine. — The principles discussed above are applicable not only to the designing of valves, but also to adjustment of valves that have been improperly set; but the final adjustment of the eccentric and of the length of the rod depends upon the amount of lost motion, temperature, etc.; and can be effected only after trial. After the valve has been set as accurately as possible when cold, the lead and lap for the forward and return strokes being equalized, indicator diagrams should be taken and the length of the eccentric-rod adjusted, if necessary, to correct slight irregularities.

To Put an Engine on its Center. — Place the engine in a position where the piston will have nearly completed its outward stroke, and opposite some point on the crosshead, such as a corner, make a mark upon the guide. Against the rim of the pulley or crank-disk place a pointer and mark a line with it on the pulley. Then turn the engine over the center until the crosshead is again in the same position on its inward stroke. This will bring the crank as much below the center as it was above it before. With the pointer in the same position as before make a second mark on the pulley rim. Divide the distance between the marks in two and mark the middle point. Turn the engine until the pointer is opposite this middle point, and it will then be on its center. To avoid

the error that may arise from the looseness of crank-pin and wrist-pin bearings, the engine should be turned a little above the center and then be brought up to it, so that the crank-pin will press against the same brass that it does when the first two marks are made.

Link-motion. — Link-motions, of which the Stephenson link is the most commonly used, are designed for two purposes: first, for reversing the motion of the engine, and second, for varying the point of cut-off by varying the travel of the valve. The Stephenson link-motion is a combination of two eccentrics, called forward and back eccentrics, with a link connecting the extremities of the eccentric-rods; so that by varying the position of the link the valve-rod may be put in direct connection with either eccentric, or may be given a movement controlled in part by one and in part by the other eccentric. When the link is moved by the reversing lever into a position such that the block to which the valve-rod is attached is at either end of the link, the valve receives its maximum travel, and when the link is in mid-gear the travel is the least and cut-off takes place early in the stroke.

In the ordinary shifting-link with open rods, that is, not crossed, the lead of the valve increases as the link is moved from full to mid-gear, that is, as the period of steam admission is shortened. The variation of lead is equalized for the front and back strokes by curving the link to the radius of the eccentric-rods concavely to the axles. With crossed eccentric-rods the lead decreases as the link is moved from full to mid-gear. In a valve-motion with stationary link the lead is constant. (For illustration see Clark's Steam-engine, vol. ii, p. 22.)

The linear advance of each eccentric is equal to that of the valve in full gear, that is, to lap + lead of the valve, when the eccentric-rods are attached to the link in such position as to cause the half-travel of the valve to equal the eccentricity of the eccentric.

The angle between the two eccentric radii, that is, between lines drawn from the center of the eccentric disks to the center of the shaft, equals 180° less twice the angular advance.

Buel, in Appleton's Cyclopaedia of Mechanics, vol. ii, p. 316, discusses the Stephenson link as follows: "The Stephenson link does not give a perfectly correct distribution of steam: the lead varies for different points of cut-off. The period of admission and the beginning of exhaust are not alike for both ends of the cylinder, and the forward motion varies from the backward.

"The correctness of the distribution of steam by Stephenson's link-motion depends upon conditions which, as much as the circumstances will permit, ought to be fulfilled, namely: 1. The link should be curved in the arc of a circle whose radius is equal to the length of the eccentric-rod. 2. The eccentric-rods ought to be long; the longer they are in proportion to the eccentricity the more symmetrical will the travel of the valve be on both sides of the center of motion. 3. The link ought to be short. Each of its points describes a curve in a vertical plane, whose ordinates grow larger the farther the considered point is from the center of the link; and as the horizontal motion only is transmitted to the valve, vertical oscillation will cause irregularities. 4. The link-hanger ought to be long. The longer it is the nearer will be the arc in which the link swings to a straight line, and thus the less its vertical oscillation. If the link is suspended in its center, the curves that are described by points equidistant on both sides from the center are not alike, and hence results the variation between the forward and backward gears. If the link is suspended at its lower end, its lower half will have less vertical oscillation and the upper half more. 5. The center from which the link-hanger swings changes its position as the link is lowered or raised, and also causes irregularities. To reduce them to the smallest amount the arm of the lifting-shaft should be made as long as the eccentric-rod, and the center of the lifting-shaft should be placed at the height corresponding to the central position of the center on which the link-hanger swings."

All these conditions can never be fulfilled in practice, and the variations in the lead and the period of admission can be somewhat regulated in an artificial way, but for one gear only. This is accomplished by giving different lead to the two eccentrics, which difference will be smaller the longer the eccentric-rods are and the shorter the link, and by suspending

the link not exactly on its center line but at a certain distance from it, giving what is called "the offset."

For application of the Zeuner diagram to link-motion, see Holmes on the Steam-engine, p. 290. See also Clark's Railway Machinery (1855), Clark's Steam-engine, Zeuner's and Auchincloss's Treatises on Slide-valve Gears, and Halsey's Locomotive Link Motion. (See page 1095.)

The following rules are given by the *American Machinist* for laying out a link for an upright slide-valve engine. By the term radius of link is meant the radius of the link-arc, *ab*, Fig. 165, drawn through the center of the slot; this radius is generally made equal to the distance from the

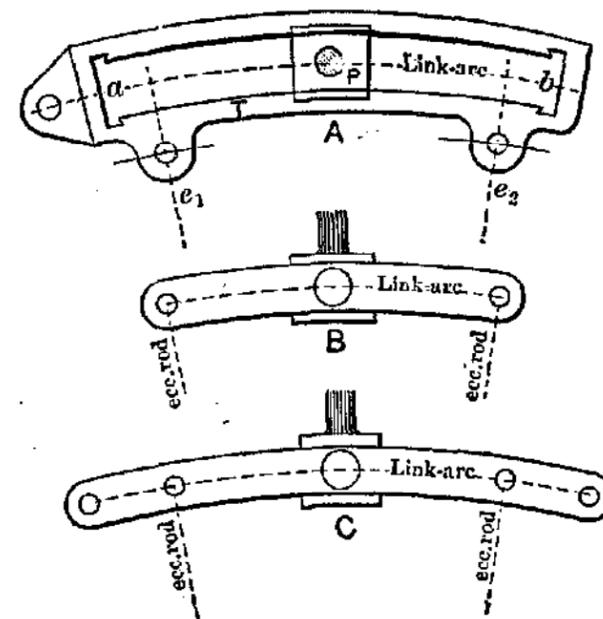

Fig. 165.

center of shaft to center of the link-block pin *P* when the latter stands midway of its travel. The distance between the centers of the eccentric-rod pins *e*₁ *e*₂ should not be less than 2½ times, and, when space will permit, three times the throw of the eccentric. By the throw we mean twice the eccentricity of the eccentric. The slot link is generally suspended from the end next to the forward eccentric at a point in the link-arc prolonged. This will give comparatively a small amount of slip to the link-block when the link is in forward gear; but this slip will be increased when the link is in backward gear. This increase of slip is, however, considered of little importance, because marine engines, as a rule, work but very little in the backward gear. When it is necessary that the motion shall be as efficient in backward gear as in forward gear, then the link should be suspended from a point midway between the two eccentric-rod pins; in marine engine practice this point is generally located on the link-arc; for equal cut-offs it is better to move the point of suspension a small amount towards the eccentrics.

For obtaining the dimensions of the link in inches: Let *L* denote the length of the valve, *B* the breadth, *p* the absolute steam-pressure per sq. in., and *R* a factor of computation used as below; then $R = 0.01 \sqrt{L \times B \times p}$

- Breadth of the link..... = $R \times 1.6$
- Thickness *T* of the bar..... = $R \times 0.8$
- Length of sliding-block..... = $R \times 2.5$
- Diameter of eccentric-rod pins..... = $(R \times 0.7) + 1/4$ in.
- Diameter of suspension-rod pin..... = $(R \times 0.6) + 1/4$ in.
- Diameter of suspension-rod pin when overhung... = $(R \times 0.8) + 1/4$ in.
- Diameter of block-pin when overhung..... = $R \times 1/4$
- Diameter of block-pin when secured at both ends. = $(R \times 0.8) + 1/4$ in.

The length of the link, that is, the distance from *a* to *b*, measured on a straight line joining the ends of the link-arc in the slot, should be such as to allow the center of the link-block pin *P* to be placed in a line with the eccentric-rod pins, leaving sufficient room for the slip of the block. Another type of link frequently used in marine engines is the double-bar link, and this type is again divided into two classes: one class embraces those links which have the eccentric-rod ends as well as the valve-spindle end between the bars, as shown at *B* (with these links the travel of the valve is less than the throw of the eccentric); the other class embraces those links, shown at *C*, for which the eccentric-rods are made with fork-ends, so as to connect to studs on the outside of the bars, allowing the block to slide to the end of the link, so that the centers of the eccentric-rod ends and the block-pin are in line when in full gear, making the travel of the valve equal to the throw of the eccentric. The dimensions of these links when the distance between the eccentric-rod pins is $2\frac{1}{2}$ to $2\frac{3}{4}$ times the throw of eccentrics can be found as follows:

Depth of bars = $(R \times 1.25) + \frac{1}{2}$ in.
 Thickness of bars = $(R \times 0.5) + \frac{1}{4}$ in.
 Diameter of center of sliding-block = $R \times 1.3$

When the distance between the eccentric-rod pins is equal to 3 or 4 times the throw of the eccentrics, then

Depth of bars = $(R \times 1.25) + \frac{3}{4}$ in.
 Thickness of bars = $(R \times 0.5) + \frac{1}{4}$ in.

All the other dimensions may be found by the first table. These are empirical rules, and the results may have to be slightly changed to suit given conditions. In marine engines the eccentric-rod ends for all classes of links have adjustable brasses. In locomotives the slot-link is usually employed, and in these the pin-holes have case-hardened bushes driven into the pin-holes, and have no adjustable brasses in the ends of the eccentric-rods. The link in *B* is generally suspended by one of the eccentric-rod pins; and the link in *C* is suspended by one of the pins in the end of the link, or by one of the eccentric-rod pins. (See note on Locomotive Link Motion, p. 1095.)

The Walschaert Valve-gear. Fig. 166. — This gear, which was invented in Belgium, has for many years been used on locomotives in Europe, and it has now (1909) come largely into use in the United States. The return crank *Q*, which takes the place of an eccentric, through the rod *B* oscillates the link on the fixed pin *F*. The block *D* is raised and

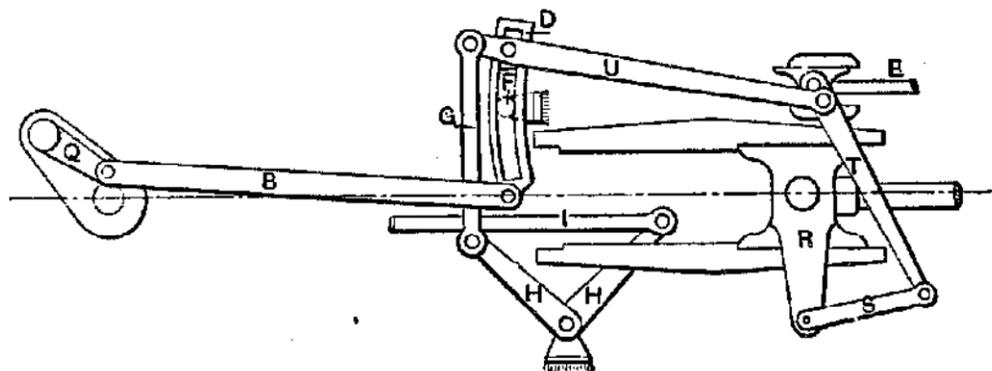

FIG. 166.— The Walschaert Valve-gear.

lowered in the link by the reversing rod *I*, operating through the bell-crank levers *H, H* and the supporting rod *G*. When the block is in its lowest position the radius rod *U* has a motion corresponding in direction to that of the rod *B*; when the block is at its upper position *U* moves in an opposite direction to *B*. The valve-rod *E* is moved by the combined action of *U* and a lever *T* whose lower end is connected through the rod *S* to the crosshead *R*. Constant lead is secured by this gear.

Other Forms of Valve-gear, as the Joy, Marshall, Hackworth, Bremme, Walschaert, Corliss, etc., are described in Clark's Steam-engine, vol. ii. *Power*, May 11, 1909, illustrates the Stephenson, Gooch, Allen, Polonceau, Marshall, Joy, Waidegg, Walschaert, Fink, and Baker-Pilliod gears. The design of the Reynolds-Corliss valve-gear is discussed by A. H. Eldridge in *Power*, Sept., 1893. See also Henthorn on the Corliss Engine. Rules for laying down the center-lines of the Joy valve-gear are given in *American Machinist*, Nov. 13, 1890. For Joy's "Fluid-pressure Reversing-valve," see *Eng'g*, May 25, 1894.

GOVERNORS.

Pendulum or Fly-ball Governor. — The inclination of the arms of a revolving pendulum to a vertical axis is such that the height of the point of suspension *h* above the horizontal plane in which the center of gravity of the balls revolves (assuming the weight of the rods to be small compared with the weight of the balls) bears to the radius *r* of the circle described by the centers of the balls the ratio

$$\frac{h}{r} = \frac{\text{weight}}{\text{centrifugal force}} = \frac{w}{wv^2} = \frac{gr}{v^2},$$

which ratio is independent of the weight of the balls, *v* being the velocity of the centers of the balls in feet per second.

If *T* = number of revolutions of the balls in 1 second, $v = 2\pi rT = ar$, in which *a* = the angular velocity, or $2\pi T$, and

$$h = \frac{gr^2}{v^2} = \frac{g}{4\pi^2 T^2}, \text{ or } h = \frac{0.8146}{T^2} \text{ feet} = \frac{9.775}{T^2} \text{ inches,}$$

$g = 32.16$. If *N* = revs. per minute, $h = 35,190 \div N^2$.

For revolutions per minute . . .	40	45	50	60	75
The height in inches will be . . .	21.99	17.38	14.08	9.775	6.256

Number of turns per minute required to cause the arms to take a given angle with the vertical axis: Let *l* = length of the arm in inches from the center of suspension to the center of gyration, and *a* the required angle; then

$$N = \sqrt{\frac{35190}{l \cos a}} = 187.6 \sqrt{\frac{1}{l \cos a}} = 187.6 \sqrt{\frac{l}{h}}$$

The simple governor is not isochronous; that is, it does not revolve at a uniform speed in all positions, the speed changing as the angle of the arms changes. To remedy this defect loaded governors, such as Porter's, are used. From the balls of a common governor whose collective weight is *A* let there be hung by a pair of links of lengths equal to the pendulum arms a load *B* capable of sliding on the spindle, having its center of gravity in the axis of rotation. Then the centrifugal force is that due to *A* alone, and the effect of gravity is that due to *A* + 2*B*; consequently the altitude for a given speed is increased in the ratio (*A* + 2*B*) : *A*, as compared with that of a simple revolving pendulum, and a given absolute variation in altitude produces a smaller proportionate variation in speed than in the common governor. (Rankine, S. E., p. 551.)

For the weighted governor let *l* = the length of the arm from the point of suspension to the center of gravity of the ball, and let the length of the suspending-link *l*₁ = the length of the portion of the arm from the point of suspension of the arm to the point of attachment of the link; *G* = the weight of one ball, *Q* = half the weight of the sliding weight, *h* = the height of the governor from the point of suspension to the plane of revolution of the balls, *a* = the angular velocity = $2\pi T$, *T* being the number of

revolutions per second; then $a = \sqrt{\frac{32.16}{h} \left(1 + \frac{2l_1 Q}{l G}\right)}$; $h = \frac{32.16}{a^2} \left(1 + \frac{2l_1 Q}{l G}\right)$

in feet, or $h = \frac{35190}{N^2} \left(1 + \frac{2l_1 Q}{l G}\right)$ in inches, *N* being the number of revolutions per minute.

J. H. Barr gives $h = \frac{(187.7)^2 B + 2W}{N}$, in which B is the combined weight of the two balls and W the central weight.

For various forms of governor see App. Cyl. Mech., vol. ii, 61, and Clark's Steam-engine, vol. ii, p. 65.

To Change the Speed of an Engine Having a Fly-ball Governor. — A slight difference in the speed of a governor changes the position of its weights from that required for full load to that required for no load. It is evident therefore that, whatever the speed of the engine, the normal speed of the governor must be that for which the governor was designed; i.e., the speed of the governor must be kept the same. To change the speed of the engine the problem is to so adjust the pulleys which drive the governor that the engine at its new speed shall drive it just as fast as it was driven at its original speed. In order to increase the engine-speed we must decrease the pulley upon the shaft of the engine, i.e., the driver, or increase that on the governor, i.e., the driven, in the proportion that the speed of the engine is to be increased.

Fly-wheel or Shaft-governors. — At the Centennial Exhibition in 1876 there were shown a few steam-engines in which the governors were contained in the fly-wheel or hand-wheel, the fly-balls or weights revolving around the shaft in a vertical plane with the wheel and shifting the eccentric so as automatically to vary the travel of the valve and the point of cut-off. This form of governor has since come into extensive use, especially for high-speed engines. In its usual form two weights are carried on arms the ends of which are pivoted to two points on the pulley near its circumference, 180° apart. Links connect these arms to the eccentric. The eccentric is not rigidly keyed to the shaft but is free to move transversely across it for a certain distance, having an oblong hole which allows of this movement. Centrifugal force causes the weights to fly towards the circumference of the wheel and to pull the eccentric into a position of minimum eccentricity. This force is resisted by a spring attached to each arm which tends to pull the weights towards the shaft and shift the eccentric to the position of maximum eccentricity. The travel of the valve is thus varied, so that it tends to cut off earlier in the stroke as the engine increases its speed. Many modifications of this general form are in use. In the Buckeye and the McIntosh & Seymour engines the governor shifts the eccentric around on the shaft so as to vary the angular advance. In the Sweet "Straight-line" engine and in some others a single weight and a single spring are used. For discussions of this form of governor see Hartnell, *Proc. Inst. M. E.*, 1882, p. 408; *Trans. A. S. M. E.*, ix, 300; xi, 1081; xiv, 92; xv, 929; *Modern Mechanism*, p. 399; Whitham's *Constructive Steam Engineering*; J. Begtrup, *Am. Mach.*, Oct. 19 and Dec. 14, 1893, Jan. 18 and March 1, 1894.

More recent references are: J. Richardson, *Proc. Inst. M. E.*, 1895 (includes electrical regulation of steam-engines); A. K. Mansfield, *Trans. A. S. M. E.*, 1894; F. H. Ball, *Trans. A. S. M. E.*, 1896; R. C. Carpenter, *Power*, May and June, 1898; Thos. Hall, *El. World*, June 4, 1898; F. M. Rites, *Power*, July, 1902; E. R. Briggs, *Am. Mach.*, Dec. 17, 1903.

The Rites Inertia Governor, which is the most common form of the shaft governor at this date (1909), has a long bar, usually made heavy at the ends, like a dumb-bell, instead of the usual weights. This is carried on an arm of the fly-wheel by a pin located at some distance from the center line of the bar, and also at some distance from its middle point. To pins located at two other points are attached the valve-rod and the spring. The bar acts both by inertia and by centrifugal force. When the wheel increases its speed the inertia of the bar tends to make it fall behind, and thus to change the relative position of the fly-wheel arm and the bar, and to change the travel of the valve. A small book on "Shaft Governors" (Hill Pub. Co., 1908) describes and illustrates this and many other forms of shaft governors, and gives practical directions for adjusting them.

Calculation of Springs for Shaft-governors. (Wilson Hartnell, *Proc. Inst. M. E.*, Aug., 1882.) — The springs for shaft-governors may be conveniently calculated as follows, dimensions being in inches:

Let W = weight of the balls or weights, in pounds;
 r_1 and r_2 = the maximum and minimum radial distances of the center of the balls or of the centers of gravity of the weights;

l_1 and l_2 = the leverages, i.e., the perpendicular distances from the center of the weight-pin to a line in the direction of the centrifugal force drawn through the center of gravity of the weights or balls at radii r_1 and r_2 ;

m_1 and m_2 = the corresponding leverages of the springs;
 C_1 and C_2 = the centrifugal forces, for 100 revolutions per minute, at radii r_1 and r_2 ;

P_1 and P_2 = the corresponding pressures on the spring;
 (It is convenient to calculate these and note them down for reference.)

C_3 and C_4 = maximum and minimum centrifugal forces;
 S = mean speed (revolutions per minute);

S_1 and S_2 = the maximum and minimum number of revolutions per minute;

P_3 and P_4 = the pressures on the spring at the limiting number of revolutions (S_1 and S_2);

$P_4 - P_3 = D$ = the difference of the maximum and minimum pressures on the springs;

V = the percentage of variation from the mean speed, or the sensitiveness;

t = the travel of the spring;
 u = the initial extension of the spring;

v = the stiffness in pounds per inch;
 w = the maximum extension = $u + t$.

The mean speed and sensitiveness desired are supposed to be given. Then

$$\begin{aligned} S_1 &= S - \frac{SV}{100}; & S_2 &= S + \frac{SV}{100}; \\ C_1 &= 0.28 \times r_1 \times W; & C_2 &= 0.28 \times r_2 \times W; \\ P_1 &= C_1 \times \frac{l_1}{m_1}; & P_2 &= C_2 \times \frac{l_2}{m_2}; \\ P_3 &= P_1 \times \left(\frac{S_1}{100}\right)^2; & P_4 &= P_2 \times \left(\frac{S_2}{100}\right)^2; \\ v &= \frac{D}{t}, u = \frac{P_3}{v}, w = \frac{P_4}{v}. \end{aligned}$$

It is usual to give the spring-maker the values of P_4 and of t or w . To ensure proper space being provided, the dimensions of the spring should be calculated by the formulæ for strength and extension of springs, and the least length of the spring as compressed be determined.

$$\text{The governor-power} = \frac{P_3 + P_4}{2} \times \frac{t}{12}.$$

With a straight centripetal line, the governor-power

$$= \frac{C_3 + C_4}{2} \times \left(\frac{r_2 - r_1}{12}\right).$$

For a preliminary determination of the governor-power it may be taken as equal to this in all cases, although it is evident that with a curved centripetal line it will be slightly less. The difference D must be constant for the same spring, however great or little its initial compression. Let the spring be screwed up until its minimum pressure is P_5 . Then to find the speed $P_6 = P_5 + D$,

$$S_5 = 100 \sqrt{\frac{P_5}{P_1}}; \quad S_6 = 100 \sqrt{\frac{P_6}{P_1}}.$$

The speed at which the governor would be isochronous would be

$$100 \sqrt{\frac{D}{P_2 - P_1}}.$$

Suppose the pressure on the spring with a speed of 100 revolutions, at the maximum and minimum radii, was 200 lbs. and 100 lbs., respectively,

then the pressure of the spring to suit a variation from 95 to 105 revolutions will be $100 \times \left(\frac{95}{100}\right)^2 = 90.2$ and $200 \times \left(\frac{105}{100}\right)^2 = 220.5$ That is, the increase of resistance from the minimum to the maximum radius must be $220 - 90 = 130$ lbs.

The extreme speeds due to such a spring, screwed up to different pressures, are shown in the following table:

Revolutions per minute, balls shut.....	80	90	95	100	110	120
Pressure on springs, balls shut.....	64	81	90	100	121	144
Increase of pressure when balls open fully.....	130	130	130	130	130	130
Pressure on springs, balls open fully.....	194	211	220	230	251	274
Revolutions per minute, balls open fully.....	98	102	105	107	112	117
Variation, per cent of mean speed.....	10	6	5	3	1	-1

The speed at which the governor would become isochronous is 114. Any spring will give the right variation at some speed; hence in experimenting with a governor the correct spring may be found from any wrong one by a very simple calculation. Thus, if a governor with a spring whose stiffness is 50 lbs. per inch acts best when the engine runs at 95, 90 being its proper speed, then $50 \times \left(\frac{90}{95}\right)^2 = 45$ lbs. is the stiffness of spring required.

To determine the speed at which the governor acts best, the spring may be screwed up until the governor begins to "hunt" and then be slackened until it is as sensitive as is compatible with steadiness.

CONDENSERS, AIR-PUMPS, CIRCULATING-PUMPS, ETC.

The Jet Condenser. — In practice the temperature in the hot-well varies from 110° to 120°, and occasionally as much as 130° is maintained. To find the quantity of injection-water per pound of steam to be condensed: Let T_1 = temperature of steam at the exhaust pressure; T_0 = temperature of the cooling-water; T_2 = temperature of the water after condensation, or of the hot-well; Q = pounds of the cooling-water per lb. of steam condensed; then

$$Q = \frac{1114^\circ + 0.3 T_1 - T_2}{T_2 - T_0}$$

Another formula is: $Q = \frac{WH}{R}$, in which W is the weight of steam condensed, H the units of heat given up by 1 lb. of steam in condensing, and R the rise in temperature of the cooling-water. This is applicable both to jet and to surface condensers.

Quantity of Cooling-water. — The quantity depends chiefly upon its initial temperature, which in Atlantic practice may vary from 40° in the winter of temperate zone to 80° in subtropical seas. To raise the temperature to 100° in the condenser will require three times as many thermal units in the former case as in the latter, and therefore only one-third as much cooling-water will be required in the former case as in the latter. It is usual to provide pumping power sufficient to supply 40 times the weight of steam for general traders, and as much as 50 times for ships stationed in subtropical seas, when the engines are compound. If the circulating pump is double-acting, its capacity may be $\frac{1}{53}$ in the former and $\frac{1}{42}$ in the latter case of the capacity of the low-pressure cylinder. (Seaton.)

The following table, condensed from one given by W. V. Terry in *Power*, Nov. 30, 1909, shows the amount of circulating water required under different conditions of vacuum, temperature of water entering the condenser, and drop. The "drop" is the difference between the temperature of steam due to a given vacuum and the temperature of the water leaving the condenser.

POUNDS OF CIRCULATING WATER PER POUND OF STEAM CONDENSED.

Vacuum, Ins.	Drop, Deg. F.	Injection Water Temperature, Deg. F.									
		45	50	55	60	65	70	75	80	85	90
29.0	6	37.5	45.7	58.3	80.8						
	12	47.8	61.8	87.5							
	18	65.7	95.5								
28.5	6	25.6	29.2	33.9	40.3	50.0	65.7	95.5			
	12	30.0	35.0	42.0	52.5	70.0					
	18	36.2	43.8	55.3	75.0						
28.0	6	21.5	23.9	26.9	30.9	36.3	43.8	55.3	75.0		
	12	24.4	27.7	31.8	37.5	45.7	58.3	80.8			
	18	28.4	32.8	38.9	47.8	61.8	87.5				
27.0	6	16.4	17.8	19.5	21.5	23.9	27.0	30.9	36.2	43.8	55.3
	12	18.1	19.8	21.9	24.4	27.7	31.8	37.5	45.7	58.3	80.8
	18	20.2	22.4	25.0	28.4	32.8	38.9	47.8	61.8	87.5	
26.0	6	14.0	15.0	16.2	17.5	19.1	21.0	23.4	26.3	30.0	35.0
	12	15.2	16.4	17.8	19.5	21.5	23.9	26.9	30.9	36.3	43.8
	18	16.8	18.1	19.8	21.9	24.4	27.7	31.8	37.5	45.7	58.3

Ejector Condensers. — For ejector or injector condensers (Bulkley's, Schutte's, etc.) the calculations for quantity of condensing-water is the same as for jet condensers.

The Barometric Condenser consists of a vertical cylindrical chamber mounted on top of a discharge pipe whose length is 34 ft. above the level of the hot well. The exhaust steam and the condensing water meet in the upper chamber, the water being delivered in such a manner as to expose a large surface to the steam. The external atmosphere maintains a column of water in the tube, as a column of mercury is maintained in a barometer, and no air pump is needed. The Bulkley condenser is the original form of the type. In some modern forms a small air pump draws from the chamber the residue of air which is not drawn out by the descending column of water, discharging it into the column below the chamber.

The Surface Condenser — Cooling Surface. — In practice, with the compound engine, brass condenser-tubes, 18 B.W.G. thick, 13 lbs. of steam per sq. ft. per hour, with the cooling-water at an initial temperature of 60°, is considered very fair work when the temperature of the feed-water is to be maintained at 120°. It has been found that the surface in the condenser may be half the heating surface of the boiler, and under some circumstances considerably less than this. In general practice the following holds good when the temperature of sea-water is about 60°:

Terminal pres., lbs., abs.	30	20	15	12 1/2	10	8	6
Sq. ft. per I.H.P.	3	2.50	2.25	2.00	1.80	1.60	1.50

For ships whose station is in the tropics the allowance should be increased by 20%, and for ships which occasionally visit the tropics 10% increase will give satisfactory results. If a ship is constantly employed in cold climates 10% less suffices. (Seaton, *Marine Engineering*.)

Whitham (*Steam-engine Design*, p. 283, also *Trans. A. S. M. E.*, ix, 431) gives the following: $S = \frac{WL}{ck(T_1 - t)}$, in which S = condensing-surface in

sq. ft.; T_1 = temperature Fahr. of steam of the pressure indicated by the vacuum-gauge; t = mean temperature of the circulating water, or the arithmetical mean of the initial and final temperatures; L = latent heat of saturated steam at temperature T_1 ; k = perfect conductivity of 1 sq. ft. of the metal used for the condensing-surface for a range of 1° F. (or 550 B.T.U. per hour for brass, according to Isherwood's experiments); c = fraction denoting the efficiency of the condensing-surface; W =

pounds of steam condensed per hour. From experiments by Loring and Emery, on U.S.S. Dallas, c is found to be 0.323, and $ck = 180$; making the equation $S = \frac{WL}{180(T_1 - t)}$

Whitham recommends this formula for designing engines having independent circulating-pumps. When the pump is worked by the main engine the value of S should be increased about 10%.

Taking T_1 at 135° F., and $L = 1020$, corresponding to 25 in. vacuum, and t for summer temperatures at 75°, we have: $S = \frac{1020W}{180(135 - 75)} = \frac{17W}{180}$

Much higher results than those quoted by Whitham are obtained from modern forms of condensers. The literature on the subject of condensers from 1900 to 1909 has been quite voluminous, and much difference of opinion as to rules of proportioning condensers is shown.

Coefficient of Heat Transference in Condensers. (Prof. E. Josse of Berlin. Condensed from an abstract in *Power*, Feb. 2, 1909. See also *Transmission of Heat from Steam to Water*, pages 561 to 563.)

The coefficient U , the number of heat units transferred per hour through 1 sq. ft. of metallic condenser wall when the temperature of the steam is 1° F. higher than that of the water, can be deduced from the formula

$$1/U = 1/A_1 + d/L + 1/A_2,$$

in which $1/A_1$ is the resistance to transmission from steam to metal, $1/A_2$ the resistance to transmission from metal to water, and d/L the resistance to transmission of heat through the metal, d being the usual thickness of condenser tubes (1 m.m. or 0.0393 in.). For this thickness the value of L is fairly well known and may be given as 18,430 for brass, 6,500 for copper, 11,270 for iron, 5740 for zinc, 11,050 for tin and 2660 for aluminum. The middle term d/L would have the value of $1/18,430$ and be of comparatively little importance.

The term $1/A_2$ is the most important and has been investigated with the aid of two concentric tubes, water being sent both through the inner tube and the annular jacket. The values of various experimenters differ greatly. Ser gives the approximate formula

$$A - 2 = 510 \sqrt{V},$$

where V is the velocity of water through the tubes in ft. per sec. This velocity is far more important than the material of the condenser tubes and their thickness, and also of greater consequence than the velocity of the steam, about which, or, rather, the term $1/A_1$, there is even less agreement. Prof. Josse adopts the figure 3900. The velocity of the steam has its influence, but the whole term does not count for much. For water flowing at the rate of 1.64 ft. per sec. Josse's formula would be:

$$1/U = 1/3900 + 1/18,430 + 1/653 = 1/445,$$

and $U = 445$.

If A_1 be increased to twice its value U would rise only to 475, and if the tube thickness be doubled U would hardly be affected. An increase, however, in the rate of flow of water from 1.64 to 5 feet per second would raise U to 625. As an increase of the steam flow is undesirable the best plan is to accelerate the flow of the circulating water, and by introducing the baffle strips or retarders into his condenser tubes, in order to break the water currents up into vortices, Josse raised the value of U at a velocity of 3.28 feet per second from 614 to 922.

Opinions differ concerning the increase of U with greater differences of temperature. According to some the heat transferred should increase proportionately to the difference; according to Weiss and others, proportionally to the square of the temperature differences. Josse's investigations were conducted by placing thermo couples in different portions of the condenser tubes. If the heat transferred increases as a linear function of the difference, then the rise of the temperature in the cooling water should follow an exponential law, and it was found to be so.

Curves showing the relation of the extent of surface to the temperatures of steam and water show an agreement with the formula

$$\text{Surface} = S = \frac{Q}{U} \log_e \frac{t_s - t_e}{t_s - t}$$

where t_s is the saturation temperature and t_e the temperature of the cooling-water at entrance, t being the discharge temperature.

Air Leakage. — Air passes into the condenser with the exhaust steam, the temperature of the air being that of the steam; the pressure of the mixture will be the sum of the partial steam pressure and of the partial air pressure. The air must be withdrawn by the air-pump. If the withdrawal takes place at the temperature corresponding to the condenser pressure, the partial steam pressure would be equal to the condenser pressure, and the pump would have to deal with an enormous air volume. The air temperature should, therefore, be lowered, at the spot where the air is withdrawn, below the saturation temperature of the condenser pressure.

In steam turbines it is more easy to keep air out than in reciprocating engines. Experiments with a 300-kw. Parsons turbine show that not more than 1/2 lb. of air was delivered per hour when 6600 lbs. of steam was used per hour.

Condenser Pumps. — The air and condensed water may either be removed separately, by a so-called dry-air pump, or both together, by a wet-air pump. As dry-air pumps have to deal with high compression ratios, with high vacua and single-stage pumps, the clearances must be small. When the clearance amounts to 5% the vacuum cannot be maintained at more than 95%, and the clearance must be reduced, or other expedients adopted. Three are mentioned: (1) the air-pump may be built in two stages; (2) the pump may be fitted with an equalizing pipe so that the two sides of the piston are connected near the end of each stroke; the volumetric efficiency is raised by this expedient, but considerably more power is absorbed to accomplish the result; (3) with the wet-air pump the clearance space is made to receive the condensed water, which will fill at least part of it.

Contraflow and Ordinary Flow. — Prof. Josse questions the distinction between contraflow and ordinary flow. For the greater portion of the condenser there is a rise of temperature only on the water side; the temperature of the steam side remains that of the saturated steam, and the term "contraflow" should, strictly speaking, only be applied if there is a temperature fall in the one direction and a corresponding temperature rise in the opposite direction. As far as the condensation is concerned, it is immaterial in which direction the water flows. The contraflow principle is, however, correct and necessary for the smaller portion of the condenser in which the condensed liquid is cooled together with the air; for the air must be withdrawn from the coldest spot. It seems inadvisable to attempt to direct the flow of the steam on the contraflow principle, as that would obstruct the steam flow and create a pressure difference between different portions of the condenser which would be injurious to the maintenance of high vacua.

The Power Used for Condensing Apparatus varies from about 1 1/2 to 5% of the indicated power of the main engine, depending on the efficiency of the apparatus, on the degree of vacuum obtained, the temperature of the cooling-water, the load on the engine, etc. J. R. Bibbins (*Power*, Feb., 1905) gives the records of test of a 300-kw. plant from which the following figures are taken. Cooling-water per lb. of steam 32 to 37 lbs. Vacuum 27.3 to 27.8 ins. Temp. cooling-water 73. Hot-well 102 to 105.

Indicated H.P.....	151	220	238	260	291	294	457	589
% of total power used...	4.69	3.51	3.22	3.22	3.08	2.97	2.80	2.47
% for air cylinder.....	1.63	1.36	1.27	1.21	1.19	1.09	0.95	0.85
% for water pump.....	3.07	2.14	1.95	2.00	1.90	1.89	1.85	1.52

Vacuum, ins. of Mercury, and Absolute Pressures. — The vacuum as shown by a mercury column is not a direct measure of pressure, but only of the difference between the atmospheric pressure and the absolute pressure in the vacuum chamber. Since the atmospheric pressure varies with the altitude and also with atmospheric conditions, it is necessary when accuracy is desired to give the reading of the barometer as well as

that of the vacuum gauge, or preferably to give the absolute pressure in lbs. per sq. in. above a perfect vacuum.

Temperatures, Pressures and Volumes of Saturated Air. (D. B. Morison, on The Influence of Air on Vacuum in Surface Condensers, *Eng'g*, April 17, 1908.)

VOLUME OF 1 LB. OF AIR WITH ACCOMPANYING VAPOR.

Temp. °F.	Pressure at 7° F.	Vacuum, ins. of Mercury, and lbs. absolute.													
		24 in., 2.947.		26 in., 1.962.		27 in., 1.474.		28 in., 0.9823.		28.5 in., 0.7368.		28.8 in., 0.5894.		29 in., 0.4912.	
		P	V	P	V	P	V	P	V	P	V	P	V	P	V
50°	0.17	2.78	68	1.79	105	1.30	147	0.81	233	0.57	336	0.42	450	0.32	592
60°	0.25	2.70	71	1.71	113	1.22	158	0.73	263	0.49	393	0.34	566	0.24	800
70°	0.35	2.59	75	1.60	124	1.11	178	0.62	315	0.38	520	0.25	852	0.13	1536
80°	0.50	2.45	81	1.46	137	0.97	204	0.48	420	0.24	832	0.09	(d)
90°	0.69	2.26	90	1.27	163	0.78	260	0.29	700	0.05	(c)
100°	0.94	2.01	103	1.02	203	0.53	390	0.042	(b)
110°	1.26	1.69	125	0.70	304	0.21	(a)
120°	1.68	1.27	170	0.28	770

P = partial pressure of air, lbs. per sq. in. V = volume of 1 lb. of air with accompanying vapor, cu. ft. (a) over 1000; (b) nearly 5000; (c) about 4000; (d) over 2000.

TEMPERATURES AND PRESSURES OF SATURATED AIR.

Vacuum, Ins. with Barom. at 30 in.	Proportions of Air and Steam by Weight.				
	Saturated Steam.	Air, 0.25. Steam, 1.	Air, 0.5. Steam, 1.	Air, 0.75. Steam, 1.	Air, 1. Steam, 1.
29	79.5° F.	75	71	67.5	64.5
28	101.5	96.5	92.4	88.8	85.3
27	115	110	105.6	101.7	98.6
26	126	120.2	115.5	111.5	108.3
25	134	128.4	123.5	119.2	116.2
24	141	135.2	130.3	125.8	122.3

From this table it is seen that a temperature of 126° F. corresponds to a 24-in. vacuum if the steam in the condenser has 75% of its weight of air mingled with it, and to a 26-in. vacuum if it is free from air.

One cubic foot of air measured at 60° F. and atmospheric pressure becomes 10 cu. ft. at 27 in. and 30 cu. ft. at 29 in. vacuum at the same temperature; 10.9 cu. ft. at 105° and 27 in.; 30.5 cu. ft. at 70° F. and 29 in. The same cu. ft. of air saturated with water vapor at 70° F. and 29 in. becomes 124.3 cu. ft., or 44.9 cu. ft. at 105° and 27 in. vacuum. The temperatures 105° and 70° are about 10% below the temperatures of saturated steam at 27 in. and 29 in. respectively.

Condenser Tubes are generally made of solid-drawn brass tubes, and tested both by hydraulic pressure and steam. They are usually made of a composition of 68% of best selected copper and 32% of best Silesian spelter. The Admiralty, however, always specify the tubes to be made of 70% of best selected copper and to have 1% of tin in the composition, and test the tubes to a pressure of 300 lbs. per sq. in. (Seaton.)

The diameter of the condenser tubes varies from 1/2 in. in small condensers, when they are very short, to 1 in. in very large condensers and long tubes. In the mercantile marine the tubes are, as a rule, 3/4 in. diam. externally, and 18 B.W.G. thick (0.049 inch); and 16 B.W.G. (0.065), under some exceptional circumstances. In the British Navy the tubes are also, as a rule, 3/4 in. diam., and 18 to 19 B.W.G., tinned on both sides; when the condenser is brass the tubes are not required to be tinned. Some of the smaller engines have tubes 5/8 in. diam., and 19

B.W.G. The smaller the tubes, the larger is the surface which can be got in a certain space. (Seaton.)

In the merchant service the almost universal practice is to circulate the water through the tubes.

Whitham says the velocity of flow through the tubes should not be less than 400 nor more than 700 ft. per min.

Bimetallic Condenser Tubes. (E. K. Davis, *Eng. News*, Sept. 2, 1909.)—Condenser tubes are usually made of a brass containing about 40% zinc. When this alloy is found to be short-lived, due to the presence of corrosive substances in the cooling-water, recourse is had to bronze tubing of "admiralty mixture" (87% copper, 8% tin, 5% zinc) or to pure copper. Sometimes also the tubes for further protection are tinned on the inside or on both sides.

A condenser tube should not split, should be comparatively free from localized corrosion or pit holes, and should not become brittle under the combined action of steam and cooling-water.

A bimetallic tube, composed of a copper envelope over an aluminum lining (or vice versa) is unlikely to split, owing to its being composed of two layers of metal. It is slow to corrode with the aluminum surface exposed to the cooling-water, and there is no tendency shown toward becoming brittle. Aluminum, being electro-positive to copper, protects it from corrosion in somewhat the same way that even porous galvanizing protects iron. No corrosion of the copper will take place until the aluminum has been entirely eaten away for a considerable distance around the perforation, thus leaving a sound tube for a much longer time than is the case when brass or copper is used alone. The usual proportions of metal are, 0.022 in. thickness of copper and 0.043 in. of aluminum, making a total of 0.065 in., or No. 16 Stubs gauge.

Tube-plates are usually made of brass. Rolled-brass tube-plates should be from 1.1 to 1.5 times the diameter of tubes in thickness, depending on the method of packing. When the packings go completely through the plates, the latter thickness, but when only partly through, the former, is sufficient. Hence, for 3/4-in. tubes the plates are usually 7/8 to 1 in. thick with glands and tape-packings, and 1 to 1 1/4 ins. thick with wooden ferrules. The tube-plates should be secured to their seatings by brass studs and nuts, or brass screw-bolts; in fact there must be no wrought iron of any kind inside a condenser. When the tube-plates are of large area it is advisable to stay them by brass rods, to prevent them from collapsing.

Spacing of Tubes, etc.—The holes for ferrules, glands, or india-rubber are usually 1/4 inch larger in diameter than the tubes; but when absolutely necessary the wood ferrules may be only 3/32 inch thick.

The pitch of tubes when packed with wood ferrules is usually 1/4 inch more than the diameter of the ferrule-hole. For example, the tubes are generally arranged zigzag, and the number which may be fitted into a square foot of plate is as follows:

Pitch of Tubes. in.	No. in a sq. ft.	Pitch of Tubes. in.	No. in a sq. ft.	Pitch of Tubes. in.	No. in a sq. ft.
1	172	15/32	128	1 1/4	110
1 1/16	150	13/16	121	1 9/32	106
1 1/8	137	17/32	116	1 5/16	99

Air-pump.—The air-pump in all condensers abstracts the water condensed and the air originally contained in the water when it entered the boiler. In the case of jet-condensers it also pumps out the water of condensation and the air which it contained. The size of the pump is calculated from these conditions, making allowance for efficiency of the pump.

In surface condensation allowance must be made for the water occasionally admitted to the boilers to make up for waste, and the air contained in it, also for slight leaks in the joints and glands, so that the air-pump is made about half as large as for jet-condensation.

Seaton says: The efficiency of a single-acting air-pump is generally taken at 0.5 and that of a double-acting pump at 0.35. When the tem-

perature of the sea is 60°, and that of the (jet) condenser is 120°, Q being the volume of the cooling-water and q the volume of the condensed water in cubic feet, and n the number of strokes per minute.

The volume of the single-acting pump = $2.74 (Q + q) \div n$.
 The volume of the double-acting pump = $4 (Q + q) \div n$.

W. H. Booth, in his "Treatise on Condensing Plant," says the volume to be generated by an air-pump bucket should not be less than 0.75 cu. ft. per pound of steam dealt with by the condensing plant. Mr. R. W. Allen has made tests with as little air-pump capacity as 0.5 cu. ft. and he gives 0.6 cu. ft. as a minimum. An Edwards pump with three 14-in. barrels, 12 in. stroke, single-acting, 150 r.p.m., is rated at 45,000 lbs. of steam per hour from a surface condenser, which is equivalent to 0.66 cu. ft. per pound of feed-water.

In the Edwards pump, the base of the pump and the bottom of the piston are conical in shape. The water from the condenser flows by gravity into the space below the piston, which descending projects it through ports into the space in the barrel above the piston, whence on the ascending stroke of the piston it is discharged through the outlet valves. There are no bucket or foot-valves, and the pump may be run at much higher speeds than older forms of pump. (See Catalogue of the Wheeler Condenser and Engineering Co.)

The Area through Valve-seats and past the valves should not be less than will admit the full quantity of water for condensation at a velocity not exceeding 400 ft. per minute. In practice the area is generally in excess of this. (Seaton.)

Area through foot-valves = $D^2 \times S \div 1000$ square inches.
 Area through head-valves = $D^2 \times S \div 800$ square inches.

Diameter of discharge-pipe = $D \times \sqrt{S} \div 35$ inches.
 D = diam. of air-pump in inches, S = its speed in ft. per min.

James Tribe (*Am. Mach.*, Oct. 8, 1891) gives the following rule for air-pumps used with jet-condensers: Volume of single-acting air-pump driven by main engine = volume of low-pressure cylinder in cubic feet, multiplied by 3.5 and divided by the number of cubic feet contained in one pound of exhaust steam of the given density. For a double-acting air-pump the same rule will apply, but the volume of steam for each stroke of the pump will be but one-half. Should the pump be driven independently of the engine, then the relative speed must be considered. Volume of jet-condenser = volume of air-pump $\times 4$. Area of injection valve = vol. of air-pump in cubic inches $\div 520$.

The Work done by an Air-pump, per stroke, is a maximum theoretically, when the vacuum is between 21 and 22 ins. of mercury. Assuming adiabatic compression, the mean effective pressure per stroke is $P = 3.46 p_1 \left[\left(\frac{p_2}{p_1} \right)^{0.29} - 1 \right]$, where p = absolute pressure of the vacuum and p_2 the terminal, or atmospheric, pressure, = 14.7 lbs. per sq. in. The horse-power required to compress and deliver 1 cu. ft. of air per minute, measured at the lower pressure, is, neglecting friction, $P \times 144 \div 33,000$.

The following table is calculated from these formulæ (R. R. Pratt, *Power*, Sept. 7, 1909).

Vac. in Ins. of Mercury.	Abs. Press., Ins. of Mercury.	$\frac{p_2}{p_1}$	Theoretic. M.E.P.	Theoretic. H.P.	Vac. in Ins. of Mercury.	Abs. Press., Ins. of Mercury.	$\frac{p_2}{p_1}$	Theoretic. M.E.P.	Theoretic. H.P.
29	1	30.00	2.86	0.0124	18	12	2.50	6.21	0.0271
28	2	15.00	4.05	0.0177	16	14	2.14	5.89	0.0256
27	3	10.00	4.83	0.0211	14	16	1.87	5.42	0.0236
26	4	7.50	5.40	0.0235	12	18	1.67	4.88	0.0212
25	5	6.00	5.78	0.0252	10	20	1.50	4.23	0.0184
24	6	5.00	6.05	0.0264	8	22	1.36	3.52	0.0153
23	7	4.28	6.23	0.0271	6	24	1.25	2.73	0.0119
22	8	3.75	6.33	0.0276	4	26	1.15	1.88	0.0082
21	9	3.33	6.37	0.0278	2	28	1.07	0.96	0.0042
20	10	3.00	6.36	0.0277	1	29	1.03	0.49	0.0021

Circulating-pump. — Let Q be the quantity of cooling-water in cubic feet, n the number of strokes per minute, and S the length of stroke in feet.

Capacity of circulating-pump = $Q \div n$ cubic feet.

Diameter of circulating-pump = $13.55 \sqrt{Q \div nS}$ inches.

The clear area through the valve-seats and past the valves should be such that the mean velocity of flow does not exceed 450 feet per minute. The flow through the pipes should not exceed 500 ft. per min. in small pipes and 600 in large pipes. (Seaton.)

For Centrifugal Circulating-pumps, the velocity of flow in the inlet and outlet pipes should not exceed 400 ft. per min. The diameter of the fan-wheel is from $2\frac{1}{2}$ to 3 times the diam. of the pipe, and the speed at its periphery 450 to 500 ft. per min.

The Leblanc Condenser (made by the Westinghouse Machine Co.) accomplishes the separate removal of water and air by means of a pair of relatively small turbine-type rotors on a common shaft in a single casing, which is integral with or attached directly to the lower portion of the condensing chamber. The condensing chamber itself is but little more than an enlargement of the exhaust pipe. The injection water is projected downwards through a spray nozzle, and the combined injection water and condensed steam flow downward to a centrifugal discharge pump under a head of 2 or 3 ft., which insures the filling of the pump. The space above the water level in the condensing chamber is occupied by water vapor plus the air which entered with the injection water and with the exhaust steam, and this space communicates with the air-pump through a relatively small pipe.

The air-pump differs from pumps of the ejector type in that the vanes in traversing the discharge nozzle at high speed constitute a series of pistons, each one of which forces ahead of it a small pocket of air, the high velocity of which effectually prevents its return to the condenser. A small quantity of water is supplied to the suction side of the air-pump to assist in the performance of its functions. The power required for the pumps is said to approximate 2 to 3 per cent of the power generated by the main engine.

Feed-pumps for Marine Engines. — With surface-condensing engines the amount of water to be fed by the pump is the amount condensed from the main engine plus what may be needed to supply auxiliary engines and to supply leakage and waste. Since an accident may happen to the surface-condenser, requiring the use of jet-condensation, the pumps of engines fitted with surface-condensers must be sufficiently large to do duty under such circumstances. With jet-condensers and boilers using salt water the dense salt water in the boiler must be blown off at intervals to keep the density so low that deposits of salt will not be formed. Sea-water contains about $\frac{1}{32}$ of its weight of solid matter in solution. The boiler of a surface-condensing engine may be worked with safety when the quantity of salt is four times that in sea-water. If Q = net quantity of feed-water required in a given time to make up for what is used as steam, n = number of times the saltiness of the water in the boiler is to that of sea-water, then the gross feed-water = $nQ \div (n - 1)$. In order to be capable of filling the boiler rapidly each feed-pump is made of a capacity equal to twice the gross feed-water. Two feed-pumps should be supplied, so that one may be kept in reserve to be used while the other is out of repair. If Q be the quantity of net feed-water in cubic feet, l the length of stroke of feed-pump in feet, and n the number of strokes per minute,

Diameter of each feed-pump plunger in inches = $\sqrt{550 Q \div nl}$.

If W be the net feed-water in pounds,

Diameter of each feed-pump plunger in inches = $\sqrt{8.9 W \div nl}$.

An Evaporative Surface Condenser built at the Virginia Agricultural College is described by James H. Fitts (*Trans. A. S. M. E.*, xiv, 690). It consists of two rectangular end chambers connected by a series of horizontal rows of tubes, each row of tubes immersed in a pan of water. Through the spaces between the surface of the water in each pan and the bottom of the pan above air is drawn by means of an exhaust-fan. At the top of one of the end chambers is an inlet for steam, and a horizontal

diaphragm about midway causes the steam to traverse the upper half of the tubes and back through the lower. An outlet at the bottom leads to the air-pump. The passage of air over the water surfaces removes the vapor as it rises and thus hastens evaporation. The heat necessary to produce evaporation is obtained from the steam in the tubes, causing the steam to condense. It was designed to condense 800 lbs. steam per hour and give a vacuum of 22 in., with a terminal pressure in the cylinder of 20 lbs. absolute. Results of tests show that the cooling-water required is practically equal in amount to the steam used by the engine. And since the consumption of steam is reduced by the application of a condenser, its use will actually reduce the total quantity of water required.

The Continuous Use of Condensing-water is described in a series of articles in *Power*, Aug.-Dec., 1892. It finds its application in situations where water for condensing purposes is expensive or difficult to obtain.

The different methods described include cooling pans on the roof; fountains and other spray pipes in ponds, fine spray discharged at an elevation above a pond; trickling the water discharged from the hot-well over parallel narrow metal tanks contained in a large wooden structure, while a fan blower drives a current of air against the films of water falling from the tanks, etc. These methods are suitable for small powers, but for large powers they are cumbersome and require too much space, and are practically supplanted by cooling towers.

The Increase of Power that may be obtained by adding a condenser giving a vacuum of 26 inches of mercury to a non-condensing engine may

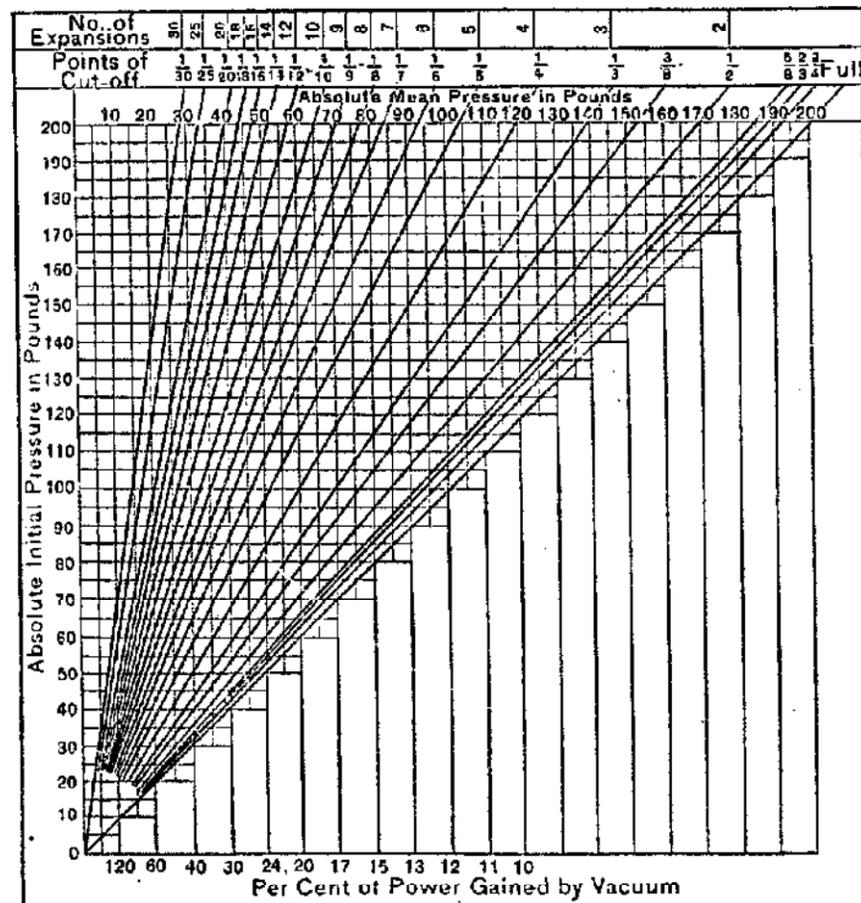

Fig. 166.

be approximated by considering it to be equivalent to a net gain of 12 lbs. mean effective pressure per sq. in. of piston area. If A = area of piston

in sq. ins., S = piston speed in ft. per min., then $12 AS \div 33,000 = AS \div 2750 = \text{H.P. made available by the vacuum}$. If the vacuum = 13.2 lbs. per sq. in. = 27.9 in. of mercury, then $\text{H.P.} = AS \div 2500$.

The saving of steam for a given horse-power will be represented approximately by the shortening of the cut-off when the engine is run with the condenser. Clearance should be included in the calculation. To the mean effective pressure non-condensing, with a given actual cut-off, clearance considered, add 3 lbs. to obtain the approximate mean total pressure, condensing. From tables of expansion of steam find what actual cut-off will give this mean total pressure. The difference between this and the original actual cut-off, divided by the latter and by 100, will give the percentage of saving.

The diagram on page 1058 (from catalogue of H. R. Worthington) shows the percentage of power that may be gained by attaching a condenser to a non-condensing engine, assuming that the vacuum is 12 lbs. per sq. in. The diagram also shows the mean pressure in the cylinder for a given initial pressure and cut-off, clearance and compression not considered.

The pressures given in the diagram are absolute pressures above a vacuum.

To find the mean effective pressure produced in an engine cylinder with 90 lbs. gauge (= 105 lbs. absolute) pressure, cut-off at 1/4 stroke: find 105 in the left-hand or initial-pressure column, follow the horizontal line to the right until it intersects the oblique line that corresponds to the 1/4 cut-off, and read the mean total pressure from the row of figures directly above the point of intersection, which in this case is 63 lbs. From this subtract the mean absolute back pressure (say 3 lbs. for a condensing engine and 15 lbs. for a non-condensing engine exhausting into the atmosphere) to obtain the mean effective pressure, which in this case, for a non-condensing engine, gives 48 lbs. To find the gain of power by the use of a condenser with this engine, read on the lower scale the figures that correspond in position to 48 lbs. in the upper row, in this case 25%. As the diagram does not take into consideration clearance or compression, the results are only approximate.

Advantage of High Vacuum in Reciprocating Engines. (R. D. Tomlinson, *Power*, Feb. 23, 1909.) — Among the transatlantic liners, the best ships with reciprocating engines are carrying from 26 to 28 and more inches of vacuum. Where the results are looked into, the engineers are required to keep the vacuum system tight and carry all the vacuum they can get, and while it is true that greater benefits can be derived from high vacua in a steam turbine than in a reciprocating engine, it is also true that, where primary heaters are not used, the higher the vacuum carried the greater is the justifiable economy which can be obtained from the plant.

The Interborough Rapid Transit Company, New York City, changed the motor-driven air-pump and jet-condenser for a barometric type of condenser and increased the vacuum on each of the 8000-H.P. Allis-Chalmers horizontal vertical engines at the 74th Street station from 26 to 28 ins., thereby increasing the power on each of the eight units approximately 275 H.P., and the economy of the station was increased nearly in the same ratio. This change was made about seven years ago, and the plant is still operating with 28 ins. of vacuum, measured with mercury columns connected to the exhaust pipe at a point just below the exhaust nozzle of the low-pressure cylinders.

A careful test made on the 59th Street station showed a decrease in steam consumption of 8% when the vacuum was raised from 25 to 28 ins. These engines drive 5000-kw. generators.

The Choice of a Condenser. — Condensers may be divided into two general classes:

First. — Jet condensers, including barometric condensers, siphon condensers, ejector condensers, etc., in which the cooling-water mingles with the steam to be condensed.

Second. — Surface condensers, in which the cooling-water is separated from the steam, the cooling-water circulating on one side of this surface and the steam coming into contact with the other.

In the jet-condenser the steam, as soon as condensed, becomes mixed with the cooling-water, and if the latter should be unsuitable for boiler-feed because of scale-forming impurities, acids, salt, etc., the pure distilled

water represented by the condensed steam is wasted, and, if it were necessary to purchase other water for boiler-feeding, this might represent a considerable waste of money. On the other hand, if the cooling-water is suitable for boiler-feeding, or if a fresh supply of good water is easily obtainable, the jet-condenser, because of its simplicity and low cost, is unexcelled.

Surface condensers are recommended where the cooling-water is unfitted for boiler-feed and where no suitable and cheap supply of pure boiler-feed is available.

Where a natural supply of cooling-water, as from a well, spring, lake or river, is not available, a water-cooling tower can be installed and the same cooling-water used over and over again. (Wheeler Condenser and Eng. Co.)

Owing to their great cost as compared with jet-condensers, surface condensers should not be used except where absolutely necessary, i.e., where lack of feed-water for the boiler warrants the extra cost. Of course there are cases, such as at sea, where surface condensers are indispensable. On land, suitable feed-water can always be obtained at some expense, and that cost capitalized makes it a simple arithmetical problem to determine the extra investment permissible in order to be able to return condensed steam as feed-water to the boiler. Unfortunately there is another point which greatly complicates the matter, and one which makes it impossible to give exact figures, viz., the corrosion and deterioration of the condenser tubes themselves, the exact cause of which is not often understood. With clean, fresh water, free from acid, the tubes of a condenser last indefinitely, but where the cooling-water contains sulphur, as in drainage from coal mines, or sea-water contaminated by sewage, such as harbor water, the deterioration is exceedingly rapid.

A better vacuum may possibly be obtained from a surface condenser where there is plenty of cooling-water easily handled. The better vacuum is due to the fact that the air-pump will have much less air to handle inasmuch as the air carried in suspension by the cooling-water does not have to be extracted as in the case of jet-condensers. Water in open rivers, the ocean, etc., is said to carry in suspension 5% by volume of air. It may be said that except for leakages, which should not exist, the air-pump will have no work to do at all inasmuch as the water will have no opportunity to become aerated. On the other hand, if the cooling-water is limited, these advantages are offset by the fact that a surface condenser cannot heat the cooling-water so near to the temperature of the exhaust steam as can a jet-condenser. (F. Hodgkinson, *El. Jour.*, Aug., 1909.)

A barometric condenser used in connection with a 15,000-k.w. steam-engine-turbine unit at the 59th St. station of the Rapid Transit Co., New York, contains approximately 25,000 sq. ft. of cooling surface arranged in the double two-pass system of water circulation, with a 30-in. centrifugal circulating pump having a maximum capacity of 30,000 gal. per hour. The dry vacuum pump is of the single-stage type, 12- and 29-in. X 24-in., with Corliss valves on the air cylinder. The condensing plant is capable of maintaining a vacuum within 1.1 in. of the barometer when condensing 150,000 lb. of steam per hour when supplied with circulating water at 70° F. — (H. G. Stott, *Jour. A.S.M.E.*, Mar., 1910.)

Cooling Towers are usually made in the shape of large cylinders of sheet steel, filled with narrow boards or lath arranged in geometrical forms, or hollow tile, or wire network, so arranged that while the water, which is sprayed over them at the top, trickles down through the spaces it is met by an ascending air column. The air is furnished either by disk fans at the bottom or is drawn in by natural draught. In the latter case the tower is made very high, say 60 to 100 ft., so as to act like a chimney. When used in connection with steam condensers, the water produced by the condensation of the exhaust steam is sufficient to compensate for the evaporation in the tower, and none need be supplied to the system. There is, on the contrary, a slight overflow, which carries with it the oil from the engine cylinders, and tends to clean the system of oil that would otherwise accumulate in the hot-well.

The cooling of water in a pond, spray, or tower goes on in three ways — first, by radiation, which is practically negligible; second, by conduction or absorption of heat by the air, which may vary from one-fifth to one-third of the entire effect; and, lastly, by evaporation. The latter is the

chief effect. Under certain conditions the water in a cooling tower can actually be cooled below the temperature of the atmosphere, as water is cooled by exposing it in porous vessels to the winds of hot and dry climates.

The evaporation of 1 lb. of water absorbs about 1000 heat units. The rapidity of evaporation is determined, first, by the temperature of the water, and, second, by the vapor tension in the air in immediate contact with the water. In ordinary air the vapor present is generally in a condition corresponding to superheated steam, that is, the air is not saturated. If saturated air be brought into contact with colder water, the cooling of the vapor will cause some of it to be precipitated out of the air; on the other hand, if saturated air be brought into contact with warmer water, some of the latter will pass into the form of vapor. This is what occurs in the cooling tower, so that the latter is in a large measure independent of climatic conditions; for even if the air be saturated, the rise in temperature of the atmospheric air from contact with the hot water in the cooling tower will greatly increase the water-carrying capacity of the air, enabling a large amount of heat to be absorbed through the evaporation of the water. The two things to be sought after in cooling-tower design are, therefore, first, to present a large surface of water to the air, and, second, to provide for bringing constantly into contact with this surface the largest possible volume of new air at the least possible expenditure of energy. (Wheeler Condenser and Engineering Co.)

The great advantage of the cooling tower lies in the fact that large surfaces of water can be presented to the air while the latter is kept in rapid motion.

Tests of a Cooling Tower and Condenser are reported by J. H. Vail in *Trans. A. S. M. E.*, 1898. The tower was of the Barnard type, with two chambers, each 12 ft. 3 in. X 18 ft. X 29 ft. 6 in. high, containing galvanized-wire mats. Four fans supplied a strong draught to the two chambers. The rated capacity of each section was to cool the circulating water needed to condense 12,500 lbs. of steam, from 132° to 80° F., when the atmosphere does not exceed 75° F. nor the humidity 85%. The following is a record of some observations.

Date, 1898.	Jan. 31.	Feb.	June 20.	July	Aug. 26.	Nov. 4.	Aug. 2.	
							Max.	Min.
Temperature atmosphere.....	30°	36°	78°	96°	85°	59°	103	83
Temp. condenser discharge.....	110°	110°	120°	130°	118°	129°	128	106
Temp. water from tower.....	65°	84°	84°	93°	88°	92°	98	91
Heat extracted by tower.....	45°	26°	36°	37°	30°	37°	32	21
Speed of fans, r.p.m.....	36	0	145	162	150	148	160	140
Vacuum, inches.....	25 1/2	26	25	24 1/2	25 1/2	25	26	26

The quantity of steam condensed or of water circulated is not stated, but in the two tests on Aug. 2 the H.P. developed was 900 I.H.P. in the first and 400 in the second, the engine being a tandem compound, Corliss type, 20 and 36 X 42 in., 120 r.p.m.

J. R. Bibbins (*Trans. A.S.M.E.*, 1909) gives a large amount of information on the construction and performance of different styles of cooling towers. He suggests a type of combined fan and natural draft tower suited to most efficient running on peak as well as light loads.

Evaporators and Distillers are used with marine engines for the purpose of providing fresh water for the boilers or for drinking purposes.

Weir's Evaporator consists of a small horizontal boiler, contrived so as to be easily taken to pieces and cleaned. The water in it is evaporated by the steam from the main boilers passing through a set of tubes placed in its bottom. The steam generated in this boiler is admitted to the low-pressure valve-chest, so that there is no loss of energy, and the water condensed in it is returned to the main boilers.

In *Weir's Feed-heater* the feed-water before entering the boiler is heated up very nearly to boiling-point by means of the waste water and steam from the low-pressure valve-chest of a compound engine.

ROTARY STEAM-ENGINES — STEAM TURBINES.

Rotary steam engines, other than steam turbines, have been invented by the thousands, but not one has attained a commercial success, as regards economy of steam. For all ordinary uses the possible advantages, such as saving of space, to be gained by a rotary engine are overbalanced by its waste of steam. Rotary engines are in use, however, for special purposes, such as steam fire-engines and steam feeds for sawmills, in which steam economy is not a matter of importance.

Impulse and Reaction Turbines.— A steam turbine of the simplest form is a wheel similar to a water wheel, which is moved by a jet of steam impinging at high velocity on its blades. Such a wheel was designed by Branca, an Italian, in 1629. The De Laval steam turbine, which is similar in many respects to a Pelton water wheel, is of this class. It is known as an impulse turbine. In a book written by Hero, of Alexandria, about 150 B.C., there is shown a revolving hollow metal ball, into which steam enters through a trunnion from a boiler beneath, and escapes tangentially from the outer rim through two arms which are bent backwards, so that the steam by its reaction causes the ball to rotate in an opposite direction to that of the escaping jets. This wheel is the prototype of a reaction turbine. In most modern steam turbines both the impulse and reaction principles are used, jets of steam striking blades or buckets inserted in the rim of a wheel, so as to give it a forward impulse, and escaping from it in a reverse direction so as to react upon it. The name impulse wheel, however, is now generally given to wheels like the De Laval, in which the pressure on the two sides of a wheel containing the blades is the same, and the name reaction wheel to one in which the steam decreases in pressure in passing through the blades. The Parsons turbine is of this class.

The De Laval Turbine.— The distinguishing features of this turbine are the diverging nozzles, in which the steam expands down to the atmospheric pressure in non-condensing, and to the vacuum pressure in condensing wheels; a single forged steel disk carrying the blades on its periphery; a slender, flexible shaft on which the wheel is mounted and which rotates about its center of gravity; and a set of reducing gears, usually 10 to 1 reduction, to change the very high speed of the turbine to a moderate speed for driving machinery. Following are the sizes and speeds of some De Laval turbines:

Horse-power.....	5	30	100	300
Revolutions per minute.....	30,000	20,000	13,000	10,000
Diam. to center of blades, ins.	3.94	8.86	19.68	29.92

The number and size of nozzles vary with the size of the turbine. The nozzles are provided with valves, so that for light loads some of them may be closed, and a relatively high efficiency is obtained at light loads. The taper of the nozzles differs for condensing and non-condensing turbines. Some turbines are provided with two sets of nozzles, one for condensing and the other for non-condensing operation.

The Zolley or Rateau Turbine.— The Zolley or Rateau turbines are developments of the De Laval and consist of a number of De Laval elements in series, each succeeding element utilizing the exhaust steam from the preceding. The steam is partly expanded in the first row of nozzles, strikes the first row of buckets and leaves them with practically zero velocity. It is then further expanded through the second row of nozzles, strikes a second row of moving buckets and again leaves them with zero velocity. This process is repeated until the steam is completely expanded.

The Parsons Turbine.— In the Parsons, or reaction type of turbine, there are a large number of rows of blades, mounted on a rotor or revolving drum. Between each pair of rows there is a row of stationary blades attached to the casing, which take the place of nozzles. A set of stationary blades and the following set of moving blades constitute what is known as a stage. The steam expands and loses pressure in both sets. The speed of rotation, the peripheral speed of the blades and the velocity of the steam through the blades are very much lower than in the De Laval turbine. The rotor, or drum, on which the moving blades are carried, is usually made in three sections of different diameters, the smallest at the high-pressure end, where steam is admitted, and the largest at the

exhaust end. In each section the radial length of the blades and also their width increase from one end to the other, to correspond with the increased volume of steam. The Parsons turbine is built in the United States by the Westinghouse Machine Co. and by the Allis-Chalmers Co.

The Westinghouse Double-flow Turbine.— For sizes above 5000 K.W. a turbine is built in which the impulse and reaction types are combined. It has a set of non-expanding nozzles, an impulse wheel with two velocity stages (that is two wheels with a set of stationary non-expanding blades between), one intermediate section and two low-pressure sections with Parsons blading. After steam has passed through the impulse wheel and the intermediate section it is divided into two parts, one going to the right and the other to the left hand low-pressure section. There is an exhaust pipe at each end. In this turbine, the end thrust, which has to be balanced in reaction turbines of the usual type, is almost entirely avoided. Other advantages are the reduction in size and weight, due to higher permissible speed; blades and casing are not exposed to high temperatures; reduction of size of exhaust pipes and of length of shaft; avoidance of large balance pistons.

The Curtis Turbine, made by the General Electric Company, is an impulse wheel of several stages. Steam is expanded in nozzles and enters a set of three or more blades, at least one of which is stationary. The blades are all non-expanding, and the pressure is practically the same on both sides of any row of blades. In smaller sizes of turbines, only one set of stationary and movable blades is used, but in large sizes there are from two to five sets, each forming a pressure stage, separated by diaphragms containing additional sets of nozzles. The smaller sizes have horizontal shafts, but the larger ones have vertical shafts supported on a step bearing supplied with oil or water under a pressure sufficient to support the whole weight of the shaft and its attached rotating disks. Curtis turbines are made in sizes from 15 K.W. at 3600 to 4000 revs. per minute up to 9000 K.W. at 750 revs. per minute.

Mechanical Theory of the Steam Turbine.— In the impulse turbine of the De Laval type, with a single disk containing blades at its rim, steam at high pressure enters the smaller end or throat of a tapering nozzle, and, as it passes through the nozzle, is expanded adiabatically down to the pressure in the casing of the turbine, that is to the pressure of the atmosphere, in a non-condensing turbine, or to the pressure of the vacuum, if the turbine is connected to a condenser. The steam thus expanded has its volume and its velocity enormously increased, its pressure energy being converted into energy of velocity. It then strikes tangentially the concave surfaces of the curved blades, and thus drives the wheel forward. In passing through the blades it has its direction reversed, and the reaction of the escaping jet also helps to drive the wheel forward. If it were possible for the direction of the jet to be completely reversed, or through an arc of 180°, and the velocity of the blade in the direction of the entering jet was one-half the velocity of the jet, then all the kinetic energy due to the velocity of the jet would be converted into work on the blade, and the velocity of the jet with reference to the earth would be zero. This complete reversal, however, is impossible, since room has to be allowed between the blades for the passage of the steam, and the blades, therefore, are curved through an arc considerably less than 180°, and the jet on leaving the wheel still has some kinetic energy, which is lost. The velocity of the entering steam jet also is so great that it is not practicable to give the wheel rim a velocity equal to one-half that of the jet, since that would be beyond a safe speed. The speed of the wheel being less than half that of the entering jet, also causes the jet to leave the wheel with some of its energy unutilized. The mechanical efficiency of the wheel, neglecting radiation, friction, and other internal losses, is expressed by the fraction $(E_1 - E_2) \div E_1$, in which E_1 is the kinetic energy of the steam jet impinging on the wheel and E_2 that of the steam as it leaves the blades.

In multiple-stage impulse turbines, the high velocity of the wheel is reduced by causing the steam to pass through two or more rows of blades, which rows are separated by a row of stationary curved blades which direct the steam from the outlet of one row to the inlet of the next. The passages through all the blades, both movable and secondary, are parallel, or non-expanding, so that the steam does not change its

pressure in passing through them. The wheel with two rows of movable blades running at half the velocity of a single-stage turbine, or one with three rows at one-third the velocity, causes the same total reduction in velocity as the single-stage wheel; and a greater reduction in the velocity of the wheel can be obtained by increasing the number of rows. It is, therefore, possible by having a sufficient number of rows of blades, or velocity stages, to run a wheel at comparatively slow speed and yet have the steam escape from the last set of blades at a lower absolute velocity than is possible with a single-stage turbine. In the reaction turbine the reduction of the pressure and its conversion into kinetic energy, or energy of velocity, takes place in the blades, which are made of such shape as to allow the steam to expand while passing through them.

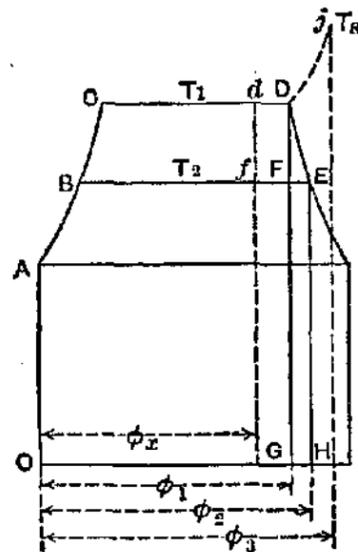

FIG. 167.

discharge the remaining part, H_2 , into the condenser. The thermal efficiency of the operation is $(H_1 - H_2) \div H_1$, and the theoretical limit of this efficiency is $(T_1 - T_2) \div T_2$, in which T_1 is the initial and T_2 the final absolute temperature.

Referring to temperature entropy diagram, Fig. 167, the total heat above 32° F. of 1 lb. of steam at the temperature T_1 is represented by the area $OACDG$ and its entropy is ϕ_1 . Expanding adiabatically to T_2 part of its heat energy is converted into work, represented by the area $BCDF$, while $OABFG$ represents the heat discharged into the condenser. The total heat of 1 lb. of dry saturated steam at T_2 is greater than this by the area $EFGH$, the fraction $FE \div BE$ representing moisture in the 1 lb. of wet steam discharged. If H_1 = heat units in 1 lb. of dry steam at the state-point D , and H_2 = heat units in 1 lb. of dry steam at the state-point E , at the temperature T_2 , then the energy converted into work = $BCDF = H_1 - H_2 + (\phi_2 - \phi_1) T_2$. This quantity is called the available energy E_a , of 1 lb. of steam between the temperatures T_1 and T_2 .

If the steam is initially wet, as represented by the state-point d and entropy ϕ_x , then the work done in adiabatic expansion is $BCdFB$, which is equal to $E_a = H_1 - H_2 + (\phi_2 - \phi_1) T_2 - (\phi_1 - \phi_x)(T_1 - T_2)$. The quantity $\phi_1 - \phi_x = (L/T_1)(1 - x)$, in which L = latent heat of evaporation at the temperature T_1 , and x = the moisture in 1 lb. of steam. The values of H_1 , H_2 , ϕ_1 , ϕ_2 , etc., for different temperatures, may be taken from steam tables or diagrams.

If the steam is initially superheated to the temperature T_s , as represented by the state-point j , the entropy being ϕ_3 , then the total heat at j is $H_1 + C(T_s - T_1)$, in which C is the mean specific heat of superheated steam between T_1 and T_s . The increase of entropy above ϕ_1

The stationary blades also allow of expansion in volume, thus taking the place of nozzles.

In all turbines, whether of the impulse, reaction, or combination type, the object is to take in steam at high pressure and to discharge it into the atmosphere, or into the condenser, at the lowest pressure and largest volume possible, and with the lowest possible absolute velocity, or velocity with reference to the earth, consistent with getting the steam away from the wheel, and to do this with the least loss of energy in the wheel due to friction of the steam through the passages, to shock due to incorrect shape, or position of the blades, to windage or frictional resistance of the steam in contact with the rotating wheel, or other causes. The minimizing of these several losses is a problem of extreme difficulty which is being solved by costly experiments.

Heat Theory of the Steam Turbine.

The steam turbine may also be considered as a heat engine, the object of which is to take a pound of steam containing a certain quantity of heat, H_1 , transform as great a part of this heat as possible into work, and

is $\phi_3 - \phi_1 = C \log_e (T_s/T_1)$. The energy converted into work is $E_a = H_1 - H_2 + (\phi_2 - \phi_1) T_2 + [1/2 (T_s + T_1) - T_2] (\phi_3 - \phi_1)$.

Velocity of Steam in Nozzles. — Having obtained the total available energy in steam expanding adiabatically between two temperatures, as shown above, the maximum possible flow into a vacuum is obtained from the common formula, Energy, in foot-pounds, = $1/2 W/g \times V^2$, in which W is the weight (in this case 1 lb.). V is the velocity in feet per second, and $g = 32.2$. As the energy E_a is in heat units, it is multiplied by 778 to convert it into foot-pounds, and we have

$$V = \sqrt{778 \times 2 g E_a} = 223.8 \sqrt{E_a}$$

This is the theoretically maximum possible velocity. It cannot be obtained in a short nozzle or orifice, but is approximated in the long expanding nozzles used in turbines. In the throat or narrow section of an orifice, the velocity and the weight of steam flowing per second may be found by Napier's or Rateau's formula, see page 847, or from Grashof's formula as given by Moyer, $F = A_0 P_1^{0.9} \div 60$, or $A_0 = 60 F \div P_1^{0.9}$, in which A_0 is the area of the smallest section of the nozzle, sq. in., F is the flow of steam (initially dry saturated) in lbs. per sec., and P is the absolute pressure, lbs. per sq. in. This formula is applicable in all cases where the final pressure P_2 does not exceed 58% of the initial pressure. For wet steam the formula becomes $F = A_0 P_1^{0.97} \div 60 \sqrt{x}$, $A_0 = 60 F \sqrt{x} \div P_1^{0.97}$, in which x is the dryness quality of the inflowing steam, $1 - x$ being the moisture.

For superheated steam $F = A_0 P_1^{0.97} (1 + 0.00065 D) \div 60$; $A_0 = 60 F \div P_1^{0.97} (1 + 0.00065 D)$, D being the superheat in degrees F.

When the final pressure P_2 is greater than $0.58 P_1$, a coefficient is to be applied to F in the above formula, the value of which is most conveniently taken from a curve given by Rateau. The values of this coefficient, c , for different ratios of P_1/P_2 , are approximately as follows:

$P_2 \div P_1 =$	0.58	0.60	0.62	0.64	0.66	0.68	0.70	0.72	0.74	0.76	0.78
$c =$	1.	0.995	0.985	0.975	0.965	0.955	0.945	0.93	0.91	0.88	0.85
$P_2 \div P_1 =$	0.80	0.82	0.84	0.86	0.88	0.90	0.92	0.94	0.96	0.98	1.00
$c =$	0.82	0.79	0.76	0.72	0.675	0.625	0.57	0.51	0.42	0.30	0.00

The quality of steam after adiabatic expansion, x_2 , is found from the formula

$$x_2 = (x_1 L_1 / T_1 + \theta_1 - \theta_2) T_2 / L_2, \quad (8)$$

in which θ_1 and θ_2 are the entropies of the liquid, L_1 and L_2 the latent heats of evaporation, and x_1 and x_2 the dryness quality, at the initial and final conditions respectively. Curves of steam quality are plotted in an entropy-total heat chart given in Moyer's "Steam Turbines" and also in Marks and Davis's "Steam Tables and Diagrams."

The area of the smallest section or throat of the nozzle being found, the area of any section beyond the throat is inversely proportional to the velocity and directly proportional to the specific volume and to the dryness, or $A_1/A_0 = V_0/V_1 \times v_1/v_0 \times x_1/x_0$, in which A is in the area in sq. ins., V the velocity in ft. per sec., v the volume of 1 lb. of steam in cu. ft., and x the dryness fraction, the subscript 0 referring to the smallest section and the subscript 1 to any other section. The ratio A_1/A_0 for the largest cross section of a properly designed nozzle is nearly proportional to the ratio of the initial to the final pressure. Moyer gives it as $A_1/A_0 = 0.172 P_1/P_2 + 0.70$, and for P_1/P_2 greater than 25, $A_1/A_0 = 0.175 (P_1/P_2)^{0.91} + 0.70$.

In practice expanding nozzles are usually made so that an axial section shows the inner walls in straight lines. The transverse section is usually either a circle or a square with rounded corners. The divergence of the walls is about 6 degrees from the axis for the non-condensing and as much as 12 degrees for condensing turbines for low vacuums. Moyer gives an empirical formula for the length between the throat and

the mouth, $L = \sqrt{15 A_0}$ inches. The De Laval turbine uses a much longer nozzle for mechanical reasons. The entrance to the nozzle above the throat should be well rounded. The efficiency of a well-made nozzle with smooth surfaces as measured by the velocity is about 96 to 97%, corresponding to an energy efficiency of 92 to 94%.

Speed of the Blades.—If V_b = peripheral velocity of the blade, V_1 = absolute velocity of the steam entering the blades and α the nozzle angle, or angle of the nozzle to the plane of the wheel, then (in impulse turbines with equal entrance and exit angles of the blade with the plane of the wheel) for maximum theoretical efficiency of the blade, $V_b = \frac{1}{2} V_1 \cos \alpha$. The nozzle angle is usually about 20° , $\cos \alpha = 0.940$, and the efficiency of a single row of blades is $(0.94 - V_b/V_1) \pm V_b/V_1$.

For $V_1 = 3000$ ft. per sec., the efficiency for different blade speeds is about as follows:

$V_b =$	200	400	600	800	1000	1200	1400	1600	1800	2000
Efficiency %	23	44	60	72	81	87	89	87	80	71

The highest efficiency is obtained when $V_b =$ about $\frac{1}{2} V_2$. It is difficult, for mechanical reasons, to use speeds much greater than 500 ft. per sec., therefore the highest efficiencies are often sacrificed in commercial machines. The blade speeds used in practice vary from 500 to 1200 ft. per sec. For an impulse wheel with more than one row of moving

blades in a single pressure stage, efficiency = $\frac{4NV_b}{V_1} \left(\cos \alpha - \frac{NV_b}{V_1} \right)$.

Referring to Fig. 168, if V_1 is the absolute direction and velocity of the entering jet, V_b the direction and velocity of the blade, the resultant,

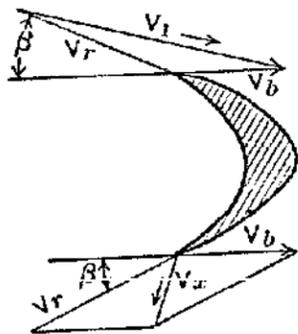

V_r is the velocity and direction of the jet relatively to the blade, and the edge of the blade is made tangent to this direction. Also V_x , the resultant of V_b and V_r at the other edge of the blade, is the absolute velocity and direction of the steam escaping from the wheel. If β is the angle between V_r and V_b , the maximum energy is abstracted from the steam when the angle between V_x and $V_b = 90 - \frac{1}{2} \beta$, and the efficiency is $\cos \beta + \cos^2 \frac{1}{2} \beta$.

For details of design of blades, and of turbines in general, see Moyer, Foster, Thomas, Stodola and other works on Steam Turbines, also Peabody's "Thermodynamics." Calculations of stages, nozzles, etc., are much facilitated by the use of Peabody's "Steam Tables" and Marks and Davis's "Steam Tables and Diagrams."

Comparison of Commercial Impulse and Reaction Turbines. (Moyer.)

- | IMPULSE. | REACTION. |
|--|--|
| 1. Few stages. | 1. Many stages. |
| 2. Expansion in nozzles. | 2. No nozzles. |
| 3. Large drop in pressure in a stage. | 3. Small drop in pressure in a stage. |
| 4. Initial steam velocities 1000 to 4000 ft. per sec. | 4. All steam velocities low, 300 to 600 ft. per sec. |
| 5. Blade velocities 400 to 1200 ft. per sec. | 5. Blade velocities 150 to 400 ft. per sec. |
| 6. Best efficiency when the blade velocity is nearly half the initial velocity of steam. | 6. Best efficiency when the blade velocity is nearly equal to the highest velocity of the steam. |

Loss due to Windage (or friction of a turbine wheel rotating in steam).—Moyer gives for the friction of a plain disk without blades, F_w , and of one row of blades without the disk, F_b , in horse-power:

$$F_w = 0.08 d^2 (u/100)^{2.8} w + (1 + 0.00065 D)^2,$$

$$F_b = 0.3 d^{1.1} (u/100)^{2.8} w + (1 + 0.00065 D)^2,$$

in which d = diam. of disk to inner edge of blade, in feet; u = peripheral velocity of disk, in ft. per sec.; w = density of dry saturated steam at the pressure surrounding the disk, in lbs. per cu. ft., and D = superheat in degrees F. The sum of F_w and F_b is the friction of the disk and blades. For moist steam the term $1 + 0.00065 D$ is to be omitted, and the expression multiplied by a coefficient c , whose value is approximately as follows:

Per cent moisture in steam

	2	4	6	8	10	12	16	20	24
Coefficient c ...	1.01	1.05	1.10	1.16	1.25	1.37	1.65	2.00	2.44

At high rotative speeds the rotation loss of a non-condensing turbine with wheels revolving in steam at atmospheric pressure is quite large, and in small turbines it may be as much as 20% of the total output. The loss decreases rapidly with increasing vacuum. In a turbine with more than one stage part of the friction loss of rotation is converted into heat which in the next stage is converted into kinetic energy, thus partly compensating for the loss.

Efficiency of the Machine.—The maximum possible thermodynamic efficiency of a steam turbine, as of any other steam engine, is expressed by the ratio which the available energy between two temperatures bears to the total heat, measured above absolute zero, of the steam at the higher temperature. In the temperature-entropy diagram Fig. 167 it is represented by the ratio of the area $BCDF$, to $OACDG$. Of this available energy, from 50 to 75 and possibly 80 per cent is obtainable at the shaft of turbines of different sizes and designs. As with steam engines, the highest mechanical and thermal efficiencies are reached only with large sizes and the most expensive designs. The several losses which tend to reduce the efficiency of turbines below the theoretical maximum are: 1, residual velocity, or the kinetic energy due to the velocity of the steam escaping from the turbine; 2, friction and imperfect expansion in the nozzles; 3, windage, or friction due to rotation of the wheel in steam; 4, friction of the steam traveling through the blades; 5, shocks, impacts, eddies, etc., due to imperfect shape or roughness of blades; 6, leakage around the ends of the blades or through clearance spaces; 7, shaft friction; 8, radiation. The sum of all these losses amounts to about 25% of the available energy in the largest and best designs and to 50% or more in small sizes or poor designs.

Steam Consumption of Turbines.—The steam consumption of any steam turbine is so greatly influenced by the conditions of pressure, moisture or superheat, and vacuum, that it is necessary to know the effect of these conditions on any turbines whose performances are to be compared with each other or with a given standard. Manufacturers usually furnish with their guarantees of performance under standard conditions of pressure, superheat and vacuum, a statement or set of curves showing the amount that the steam consumption per K.W.-hour will be increased or diminished by stated variations from these standard conditions. When a test of steam consumption is made under any conditions varying from the standard, the results should be corrected in order to compare them with other tests. Moyer gives the following example of applying corrections to a pair of tests made in 1907, to reduce them both to a steam pressure of 179 lbs. gauge, 28.5 ins. vacuum, and 100° F. superheat.

	7500-K.W. Westinghouse-Parsons.	Corrections, per cent.	9000-K.W. Curtis.	Corrections, per cent.
Average steam pressure.....	177.5	-0.15	179	0
Average vacuum, ins., referred to 30-in. barometer.....	27.3	-3.36	29.55	+12.39
Average superheat, deg. F.....	95.7	-0.29	116	+ 1.28
Average load on generator, K.W.	9830.5	8070
Steam cons., lbs. per K.W.-hr.	15.15	13.0
Net correction, per cent.....	-3.80	+13.67
Corr. st. cons., lbs. per K.W.-hr.	14.57	14.77

For the 7500-K.W. turbine, the following corrections given by the manufacturer were used: pressure, 0.1% for each pound; vacuum, 2.8% for each inch; superheat, 7% for each 100° F. For the 9000-K.W. turbine, the following corrections were used: superheat, 8% for 100° F.; vacuum, 8% for each inch.

The results as corrected show that the two turbines would give practically the same economy if tested under uniform conditions. The results

are equivalent respectively to 9.58 and 9.72 lbs. per I.H.P.-hour, assuming 97% generator efficiency and 91% mechanical efficiency of a steam engine.

The proper correction for moisture in a steam turbine test is stated to be a little more than twice the percentage of moisture. There is a large increase in the disk and blade rotation losses when wet steam is used.

The gain in economy per inch of vacuum at different vacuums is given as follows in *Mech. Engr.*, Feb. 24, 1906.

Inches of Vacuum.	28	27	26	25
Curtis, per cent gain per inch of vacuum..	5.1	4.8	4.6	4.2
Parsons, per cent gain per inch of vacuum	5.0	4.0	3.5	3.0
Westinghouse-Parsons, per cent gain per inch of vacuum.....	3.14	3.05	2.95	2.87
Theoretical per cent gain per inch of vac..	5.2	4.4	3.7	3.0

The following results of tests of turbines of different makes are selected from a series of tables in Moyer's "Steam Turbines".

Rated K.W.	Output K.W.	Gauge Press.	Super-heat, deg. F.	Vacuum, ins.	Lbs. per K.W.-hour.	Rated K.W.	Output B.H.P.	Gauge Press.	Super-heat, deg. F.	Vacuum, ins.	Lbs. per B.H.P.-hour.
2000 C.	555	155	204	28.5	18.09	300 W.-P.	233	145	4.1	28.0	15.99
	1067	170	120	28.4	16.31		461	145	4.8	28.0	13.99
	2024	166	207	28.5	15.02		688	140	7.0	27.2	15.73
9000 C.	5374	182	133	29.4	13.15	500 W.-P.	383	153	2	28.2	14.15
	8070	179	116	29.4	13.00		756	149	1	27.8	13.28
	10186	176	147	29.5	12.90		1122	149	5	26.5	14.32
1500 P.	13900	198	140	29.3	13.60	1000 W.-P.	386	148	3	0.8	24.94
	530	145	110	28.9	21.58		767	147	3	0.8	22.10
	1071	131	124	28.3	18.24		1144	126	11	0.8	24.36
300 P.	1585	128	125	27.5	17.60	3000 W.-P.	752	151	0	27.5	14.77
	303	158	0	26.6	23.15		1503	147	0	27.0	13.61
1000 R.	297	161	0	0	34.20	300 D.	2253	145	0	25.2	15.29
	194	171	47	27.7	31.97		2295	152	102	26.2	12.36
	425	144	21	27.6	24.91		4410	144	87	26.2	11.85
	871	166	11	23.6	24.61		196	198	16	27.4	15.62
	1024	164	10	25.0	21.98		298	197	64	27.4	14.35
							352	199	84	27.2	13.94

C., Curtis; P., Parsons; W.-P., Westinghouse-Parsons; R., Rateau; D., De Laval. Note that the figures of steam consumption in the first half of the table are in lbs. per K.W.-hour; in second half, in lbs. per Brake H.P.-hour.

A test of a Westinghouse double-flow turbine at the Williamsburg power station, Brooklyn N. Y., gave the following results (*Eng. News*, Dec. 30, 1909): Speed, 750 r.p.m.; Steam pressure at throttle, 203.4 lbs.; Superheat, 80.1° F.; Vacuum, 28.6 ins.; Load, 13,384 K.W.; Steam per K.W.-hour, 14.4 lbs.; Efficiency of generator, 98%; Windage, 2.0%; Equivalent B.H.P., 18,620; Steam per B.H.P.-hour, 10.3 lbs.

The Largest Steam Turbine, 1909. (*Eng. News*, Dec. 30.) — A Westinghouse combination double-flow turbine is about to be tested which is capable of developing 22,000 H.P. with 1.75 lbs. steam pressure and 28 ins. vacuum, and it is estimated that the steam consumption will be about 10 lbs. per B.H.P.-hour. The principal dimensions are: length over all, 19 ft. 8 ins.; height, 9 ft.; width, 9 ft.; weight, 110,000 lbs.; weight per H.P. developed, 5 lbs.; speed, 1800 r.p.m.

Steam Consumption of Small Steam Turbines. — Small turbines, from 5 to 200 H.P., are extensively used for purposes where high speed of rotation is not an objection, such as for driving electric generators, centrifugal fans, etc., and where economy of fuel is not as important as saving of space, convenience of operation, etc. The steam consumption of these turbines varies as greatly as does that of small high-speed steam-engines, according to the design, speed, etc. A paper by Geo. A. Orrok in *Trans. A. S. M. E.*, 1909, discusses the details of several makes of machines. From a curve presented by R. H. Rice in discussion of this paper the following figures are taken showing the steam consumption in lbs. per B.H.P.-hour of different makes of impulse turbines.

Type.	Sturtevant.	Terry.	Bliss.	Bliss.	Kerr.	Curtis.	Curtis.
Rated H.P.....	20	50	100	200	150	50	200
Water rate at	1/2 load....	72	59	58	55	52	44
	3/4 load....	65	49	48	47	44	36
	Full load..	61	46	43	42	41	33
	1 1/4 load...	58	44	40	39	39	31

Dry steam, 150 lbs. pressure; atmospheric exhaust.

Mr. Orrok shows that the steam consumption of these turbines largely depends on their peripheral speed. From a set of curves plotted with speed as the base it appears that the steam consumption per B.H.P.-hour ranges about as follows:

Peripheral speed, ft. per min.....	5,000	10,000	15,000	20,000	25,000
Steam per B.H.P.-hour	45 to 70	38 to 60	31 to 52	29 to 45	29 to 40

Low-Pressure Steam Turbines. — Turbines designed to utilize the exhaust steam from reciprocating engines are used to some extent. For steam at or below atmospheric pressure the turbine has a great advantage over reciprocating engines in its ability to expand the steam down to the vacuum pressure, while a reciprocating condensing engine generally does not expand below 8 or 10 lbs. absolute pressure. In order to expand to lower pressures the low-pressure cylinder would have to be inordinately large, and therefore costly, and the increased loss from cylinder condensation and radiation would more than counterbalance the gain due to greater expansion.

Mr. Parsons (*Proc. Inst. Nav. Arch.*, 1908) gives the following figures showing that the theoretical economy of the combination of a reciprocating engine and an exhaust steam turbine is about the same whether the turbine receives its steam at atmospheric pressure or at 7 lbs. absolute, the initial steam pressure in the engine being 200 lbs. absolute and the vacuum 28 ins.

Back pressure of engines, lbs. abs.	16	13 1/2	8
Initial pressure, turbine, lbs. abs.	15	12 1/2	7
Theoretical B.T.U. utilized per lb. of steam	178	189	218
{ in engine	142	131	100
{ total	320	320	318

The following figures, by the General Electric Co., show the percentage over the output of a condensing reciprocating engine that may be made by installing a low-pressure turbine between the engine and the condenser, the vacuum being 28 1/2 ins.

Inches vacuum at admission valve.....	0	4	8	12	16	20	24
Per cent of work gained ...	26.1	26.5	26.8	26.3	25.3	23.6	20

It appears that a well-designed reciprocating compound engine working down to about atmospheric pressure is a more efficient machine than a turbine with the same terminal pressure, and that between the atmosphere and the condenser pressure the turbine is far more economical; therefore a combination of an engine and a turbine can be designed which will give higher economy than either an engine or a turbine working through the whole range of pressure.

When engines are run intermittently, such as rolling-mill and hoisting engines, their exhaust steam may be made to run low-pressure turbines by passing it first into a heat accumulator, or thermal storage system, where it gives up its heat to water, the latter furnishing steam continuously to the turbines. (See Thermal Storage, pages 897 and 987.)

The following results of tests of a Westinghouse low-pressure turbine are reported by Francis Hodgkinson.

Steam Press.,									
lb. abs.	17.4	12.4	11.8	7.7	5.2	11.6	8.7	6.1	4.5
Vacuum, ins. . .	26.0	26.0	27.0	27.0	27.0	27.8	28.0	27.9	28.0
Brake H.P. . . .	920	472	592	321	102	586	458	234	114
Steam per									
B.H.P.-hr.,									
lbs.	27.9	37.1	29.9	37.3	64.4	28.0	30.4	38.6	54.8

Tests of a 1000-K.W. low-pressure double-flow Westinghouse turbine are reported to have given results as follows. (Approximate figures, from a curve.)

Load, Brake H.P.	200	400	600	800	1000	1200	1500	2000
Pressure at inlet, lbs.								
abs.	4.1	5.1	6.1	7.2	8.3	9.4	11.0	13.5
Steam per								
B.H.P.-								
hour, lbs. } 27 1/2 in. vac.	75	47.5	38	33	30	28	26.5	24.5
hour, lbs. } 28 in. vac.	62	42	33	29	27	25.5	24.5	22.5

The total steam consumption per hour followed the Willans law, being directly proportional to the power after adding a constant for 0 load, viz.: for 27 1/2-in. vacuum the total steam consumption per hour was 12,000 lbs. + 18 x H.P., and for 28-in. vacuum, 9000 lbs. + 18 x H.P. (approx.).

The guaranteed steam consumption of a 7000-K.W. Rateau-Smoot low-pressure turbine generator is given in a curve by R. C. Smoot (*Power*, June 22, 1909), from which the following figures are taken. The admission pressure is taken at 16 lbs. absolute and the vacuum 28 1/2 ins.

K.W. output	1500	2000	3000	4000	5000	6000	7000
Steam per K.W.-hr., lb.	40	37	32.5	29.5	27.6	26.2	25.7
Over-all efficiency, %	43	47	54	60	65	68	70

The performance of a combined plant of several reciprocating 2000-K.W. engines and a 7000-K.W. low-pressure turbine is estimated as follows, the engines expanding the steam from 215 to 16 lbs. absolute, and the turbines from 16 lbs. to 0.75 lb., the vacuum being 28.5 ins. with the barometer at 30 ins.

	Engine.	Turbine.
Theoretical steam per K.W.-hour, lbs.	18	17.8
Steam per K.W.-hr. at switchboard, lbs.	27.7	26.6
Combined efficiency of engine and dynamo, per cent.	65	67
Steam per K.W.-hour for combined plant = 1 ÷ (1/27.7 + 1/26.6) =	13.6 lbs.	

The combined efficiency is 66%, representing the ratio of the energy at the switchboard to the available energy of the steam delivered to the engine and expanded down to the condenser pressure, after allowing for all losses in engine, turbine, and dynamo.

Very little difference is made in the plant efficiency if the intermediate pressure is taken anywhere from 3 or 4 lbs. below atmosphere to 15 or 20 lbs. above.

M. B. Carroll (*Gen. Elec. Rev.*, 1909) gives an estimate of the steam consumption of a combined unit of a 1000-K.W. engine and a low-pressure turbine. The engine, non-condensing, will develop 1000 H.P., with 32,000 lbs. of steam per hour. Allowing 8% for moisture in the exhaust, 29,440 lbs. of dry steam will be available for the turbine, which at 33 lbs. per K.W.-hour will develop 893 K.W., making a total output of 1893 K.W. for 32,000 lbs. steam, or 16.9 lbs. per K.W.-hour. The engine alone as a condensing engine will develop 1320 K.W. at 24.2 lbs. per K.W.-hour. The combined unit therefore develops 573 K.W., or 43.5% more than the condensing engine using the same amount of steam. The maximum capacity of the engine, non-condensing, is 1265 K.W., and condensing, 1470 K.W., and of the combined unit 2500 K.W.

Tests of a 15,000 K.W. Steam-Engine-Turbine Unit are reported by H. G. Stott and R. J. S. Pigott in *Jour. A.S.M.E.*, Mar., 1910. The steam-engine is one of the 7500 K.W. Manhattan type engines at the 59th St. station of the Rapid Transit Co., New York, with two 42-in. horizontal h.p. and two 86-in. vertical l.p. cylinders, and the turbine, also 7500 K.W., is of the vertical three-stage impulse type. The principal results are summarized as follows: An increase of 100% in the maximum capacity and 146% in the economical capacity of the plant; a saving of about 85% of the condensed steam for return to the boilers [it was previously wasted]; an average improvement in economy of 13% over the best high-pressure turbine results, and of 2.5% (between 7500 and 15,000 K.W.) over the results obtained by the engine alone; an average thermal efficiency between 6500 and 15,500 K.W. of 20.6%. [This efficiency is not quite equal to that reached by triple-expansion pumping engines. See page 774.]

Reduction Gear for Steam Turbines.—Double spiral reduction gears, usually of a ratio of 1 to 10, are used with the DeLaval turbine to obtain a velocity of rotation suitable for dynamos, centrifugal pumps, etc. G. W. Melville and J. H. McAlpine have designed a similar gear, with the pinion carried in a floating frame supported at a single point between the bearings to equalize the strain on the gear teeth, for reducing the speed of large horizontal turbines to suitable speeds for marine propellers. A 6000 H.P. gear with reduction from 1500 to 300 r.p.m. has been tested, giving an efficiency of 98.5% (*Eng'g*, Sept. 17; *Eng. News*, Oct. 21 and Dec. 30, 1909).

NAPHTHA ENGINES. — HOT-AIR ENGINES.

Naphtha engines are in use to some extent in small yachts and launches. The naphtha is vaporized in a boiler, and the vapor is used expansively in the engine cylinder, as steam is used; it is then condensed and returned to the boiler. A portion of the naphtha vapor is used for fuel under the boiler. According to the circular of the builders, the Gas Engine and Power Co. of New York, a 2-H.P. engine requires from 3 to 4 quarts of naphtha per hour, and a 4-H.P. engine from 4 to 6 quarts. The chief advantages of the naphtha-engine and boiler for launches are the saving of weight and the quickness of operation. A 2-H.P. engine weighs 200 lbs., a 4-H.P. 300 lbs. It takes only about two minutes to get under headway. (*Modern Mechanism*, p. 270.)

Hot-air (or Caloric) Engines.—Hot-air engines are used to some extent, but their bulk is enormous compared with their effective power. For an account of the largest hot-air engine ever built (a total failure) see Church's Life of Ericsson. For theoretical investigation, see Rankin's Steam-engine and Roentgen's Thermodynamics. For description of constructions, see Appleton's Cyc. of Mechanics and Modern Mechanism, and Babcock on Substitutes for Steam, *Trans. A. S. M. E.*, vii, p. 693.

Test of a Hot-air Engine (Robinson).—A vertical double-cylinder (Caloric Engine Co.'s) 12 nominal H.P. engine gave 20.19 I.H.P. in the working cylinder and 11.38 I.H.P. in the pump, leaving 8.81 net I.H.P.; while the effective brake H.P. was 5.9, giving a mechanical efficiency of 67%. Consumption of coke, 3.7 lbs. per brake H.P. per hour. Mean pressure on pistons 15.37 lbs. per square inch, and in pumps 15.9 lbs., the area of working cylinders being twice that of the pumps. The hot air supplied was about 1160° F. and that rejected at end of stroke about 890° F.

INTERNAL-COMBUSTION ENGINES.

References.—For theory of the internal-combustion engine, see paper by Dugald Clerk, *Proc. Inst. C. E.*, 1882, vol. lxix; and Van Nostrand's Science Series, No. 62. See also Wood's Thermodynamics. Standard works on gas-engines are "A Text-book on Gas, Air, and Oil Engines," by Bryan Donkin; "The Gas and Oil Engine," by Dugald Clerk; "Internal Combustion Engines," by Carpenter and Diederichs; "Gas Engine Design," by C. E. Lucke; "Gas and Petroleum Engines," by W. Robinson; "The Modern Gas Engine and the Gas Producer," by A. M. Levinson; "The Modern Gas Engine and the Gas Producer," see "The Gas Engine," for practical operation of gas and oil engines, see "The Gas Engine," by F. R. Jones, and "The Gas Engine Handbook," by E. W. Roberts.

For descriptions of large gas-engines using blast furnace gas see papers in *Proc. Iron and Steel Inst.*, 1906, and *Trans. A. I. M. E.*, 1906. Many papers on gas-engines are in *Trans. A.S.M.E.*, 1905 to 1909.

An **Internal-combustion Engine** is an engine in which combustible gas, vapor, or oil is burned in a cylinder, generating a high temperature and high pressure in the gases of combustion, which expand behind a piston, driving it forward. (Rotary gas-engines or gas turbines, are still, 1910, in the experimental stage.)

Four-cycle and Two-cycle Gas-Engines.—In the ordinary type of single-cylinder gas-engine (for example the Otto) known as a four-cycle engine, one ignition of gas takes place in one end of the cylinder every two revolutions of the fly-wheel, or every two double strokes. The following sequence of operations takes place during four consecutive strokes: (a) inspiration of a mixture of gas and air during an entire stroke; (b) compression during the second (return) stroke; (c) ignition at or near the dead-point, and expansion during the third stroke; (d) expulsion of the burned gas during the fourth (return) stroke. Beau de Rochas in 1862 laid down the law that there are four conditions necessary to realize the best results from the elastic force of gas: (1) The cylinders should have the greatest capacity with the smallest circumferential surface; (2) the speed should be as high as possible; (3) the cut-off should be as early as possible; (4) the initial pressure should be as high as possible.

(Strictly speaking four-cycle should be called four-stroke-cycle, but the term four-cycle is generally used in the trade.)

The two great sources of waste in gas-engines are: 1. The high temperature of the rejected products of combustion; 2. Loss of heat through the cylinder walls to the water-jacket. As the temperature of the water-jacket is increased the efficiency of the engine becomes higher.

Fig. 169 is an indicator diagram of a four-cycle gas-engine. *AB*, the lower line, shows the admission of the mixture, at a pressure slightly

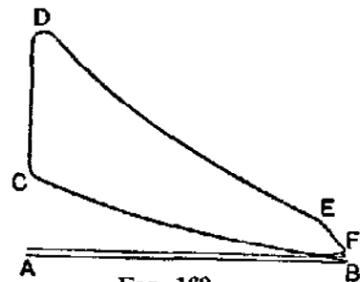

FIG. 169.

below the atmosphere on account of the resistance of the inlet valve, *BC* is the compression into the clearance space, ignition taking place at *C* and combustion with increase of pressure continuing from *C* to *D*. The gradual termination of the combustion is shown by the rounded corner at *D*. *DE* is the expansion line, *EF* the line of pressure drop as the exhaust valve opens, and *FA* the line of expulsion of the burned gases, the pressure being slightly above the atmosphere on account of the resistance of the exhaust valve.

In a two-cycle single-acting engine an explosion takes place with every revolution, or with each forward stroke of the piston. Referring to the diagram Fig. 169 and beginning at *E*, when the exhaust port begins to open to allow the burned gases to escape, the pressure drops rapidly to *F*. Before the end of the stroke is reached an inlet port opens, admitting a mixture of gas and air from a reservoir in which it has been compressed. This mixture being under pressure assists in driving the burned gases out through the exhaust port. The inlet port and the exhaust port close early in the return stroke, and during the remainder of the stroke *BC* the mixture, which may include some of the burned gas, is compressed and the ignition takes place at *C*, as in the four-cycle engine.

In one form of the two-cycle engine only compressed air is admitted while the exhaust port is open, the fuel gas being admitted under pressure after the exhaust port is closed. By this means a greater proportion of the burned gases are swept out of the cylinder. This operation is known as "scavenging."

Theoretical Pressures and Temperatures in Gas-Engines.—Referring to Fig. 169, let P_s be the absolute pressure at *B*, the end of the suction stroke, P_c the pressure at *C*, the end of the compression stroke; P_x the maximum pressure at *D*, when the gases of combustion are at their highest temperature; P_e the pressure at *E*, when the exhaust valve begins to open. For the hypothetical case of a cylinder with walls incapable of absorbing or conducting heat, and of perfect and instantaneous combustion

or explosion of the fuel, an ideal diagram might be constructed which would have the following characteristics. In a four-cycle engine receiving a charge of air and gas at atmospheric pressure and temperature, the pressure at *B*, or P_s , would be 14.7 lbs. per sq. in. absolute, and the temperature say 62° F., or 522° absolute. The pressure at *C*, or P_c , would depend on the ratio $V_1 + V_2$, V_1 being the original volume of the mixture in the cylinder before compression, or the piston displacement plus the volume of the clearance space, and V_2 the volume after compression, or the clearance volume, and its value would be $P_c = P_s (V_1/V_2)^n$. The absolute temperature at the end of compression would be $T_c = 522 \times (V_1/V_2)^{n-1}$, or it may be found from the formula $P_s V_s + T_s = P_c V_c + T_c$, the subscripts *s* and *c* referring respectively to conditions at the beginning and end of compression. The compression would be adiabatic, and the value of the exponent *n* would be about the value for air, or 1.406. The work done in compressing the mixture would be calculated by the formula for compressed air (see page 607). The theoretical rise of temperature at the end of the explosion, T_x , above the temperature at the end of the compression T_c may be found from the formula $(T_x - T_c) C_v = H$, in which *H* is the amount of heat in British thermal units generated by the combustion of the fuel in 1 lb. of the mixture, and C_v the mean specific heat, at constant volume, of the gases of combustion between the temperatures T_x and T_c . Having obtained the temperature, the correspond-

ing pressure P_x may be found from the formula $P_x = P_c \times (T_x/T_c)^{\frac{n}{n-1}}$. In like manner the pressure and temperature at the end of expansion, P_e and T_e , and the work done during expansion, may be calculated by the formula for adiabatic expansion of air.

The ideal diagram of the adiabatic compression of air, instantaneous heating, and adiabatic expansion, differs greatly from the actual diagram of a gas-engine, and the pressures, temperatures, and amount of work done are different from those obtained by the method described above. In the first place the mixture at the beginning of the compression stroke is usually below atmospheric pressure, on account of the resistance of the inlet valve, in a four-cycle engine, but may be above atmospheric pressure in a two-cycle engine, in which the mixture is delivered from a receiver under pressure. Then the temperature is much higher than that of the atmosphere, since it is heated by the walls of the cylinder as it enters. The compression is not adiabatic, since heat is received from the walls during the first part of the stroke. If the clearance space is small and the pressure and temperature at the end of compression therefore high, the gas may give up some heat to the walls during the latter part of the stroke. The explosion is not instantaneous, and during its continuance heat is absorbed by the cylinder walls, and therefore neither the temperature nor the pressure found by calculation will be actually reached. Poole states that the rise in temperature produced by combustion is from 0.4 to 0.7 of what it would be with instantaneous combustion and no heat loss to the cylinder walls. Finally the expansion is not adiabatic, as the gases of combustion, at least during the first part of the expanding stroke, are giving up heat to the cylinder.

Calculation of the Power of Gas-Engines.—If the mean effective pressure in a gas-engine cylinder be obtained from an indicator diagram, its power is found by the usual formula for steam-engines, $H.P. = PLAN \div 33,000$, in which *P* is the mean effective pressure in lbs. per sq. in., *L* the length of stroke in feet, *A* the area of the piston in square inches, and *N* the number of explosion strokes per minute.

For purposes of design, however, the mean effective pressure either has to be assumed from a knowledge of that found in other engines of the same type and working under the same conditions as those of the design, or it may be calculated from the ideal air diagram and modified by the use of a coefficient or diagram factor depending on the kind of fuel used and the compression pressure. Lucke gives the following

factors for four-cycle engines by which the mean effective pressure of a theoretical air diagram is to be multiplied to obtain the actual M.E.P. for the several conditions named.

Kind of Fuel and Method of Use.	Compression Gauge Pressure.	Factor Per Cent.
	Lb.	
Kerosene, when previously vaporized	45-75	30-40
Kerosene, injected on a hot bulb, may be as low as		20
Casoline, used in carburetor requiring a vacuum		25-40
Gasoline, with but little initial vacuum	80-130	50-30
Producer gas	100-160	56-40
Coal gas	Av. 80	Av. 45
Blast-furnace gas	130-180	48-30
Natural gas	90-140	52-40

Factors for two-cycle engines are about 0.8 those for four-cycle engines. Pressures and Temperatures at end of Compression and at Release.—The following tables, greatly condensed from very full tables given by C. P. Poole, show approximately the pressures and temperatures that may be realized in practice under different conditions. Poole says that the value of n , the exponent in the formula for compression, ranges from 1.2 to 1.38, these being extreme cases; the values most commonly obtained are from 1.28 to 1.35. The tables for compression pressures and temperatures are based on $n = 1.3$ and 1.4, on compression ratios or V_1/V_2 from 3 to 8, on absolute pressures in the cylinder before compression from 13 to 16 lbs., and on absolute temperatures before compression from 620° to 780° (160° to 320° F.). The release pressures and temperatures are based on values of n of 1.29 and 1.32, absolute pressures at the end of the explosion from 240 to 360 lbs. per sq. in., and absolute temperatures at the end of the explosion of 1800° to 3000° F.

COMPRESSION PRESSURES.

Compression Ratio r_c	$n = 1.3$					Compression Ratio r_c	$n = 1.34$				
	$P_s = 13$	13.5	14	15	16		$P_s = 13$	13.5	14	15	16
3.00	54.2	56.3	58.4	62.6	66.7	3.00	56.7	58.9	61.0	65.4	69.7
4.00	78.8	81.9	84.9	90.9	97.0	4.00	83.3	86.5	89.7	96.1	102.5
5.00	105.4	109.4	113.5	121.6	129.7	5.00	112.3	116.7	121.0	129.6	138.3
6.00	133.5	138.7	143.8	154.1	164.3	6.00	143.4	148.9	154.5	165.5	176.5
7.00	163.2	169.4	175.7	188.3	200.8	7.00	176.3	183.1	189.9	203.5	217.0
8.00	194.0	201.5	209.0	223.9	238.7	8.00	210.9	219.0	227.1	243.4	259.6

COMPRESSION TEMPERATURES.

Compression Ratio r_c	$n = 1.3$					Compression Ratio r_c	$n = 1.34$				
	$T_s = 620^\circ$	660°	700°	740°	780°		$T_s = 620^\circ$	660°	700°	740°	780°
3.00	862	918	973	1029	1084	3.00	901	959	1017	1075	1132
4.00	940	1000	1061	1122	1182	4.00	993	1057	1122	1186	1250
5.00	1005	1070	1134	1199	1264	5.00	1072	1141	1210	1279	1348
6.00	1061	1130	1198	1267	1335	6.00	1140	1214	1287	1361	1434
7.00	1112	1183	1255	1327	1398	7.00	1201	1279	1357	1434	1512
8.00	1157	1232	1306	1381	1456	8.00	1257	1338	1420	1501	1582

ABSOLUTE PRESSURES PER SQUARE INCH AT RELEASE. Corresponding to Explosion Pressures commonly obtained.

NOTE:—The expansion ratios in the left-hand column are based on the volume behind the piston when the exhaust valve begins to open.

Expansion Ratio r_e	$n_e = 1.29$					Expansion Ratio r_e	$n_e = 1.32$				
	Value of P_x						Value of P_x				
	240	270	300	330	360		240	270	300	330	360
3.00	58.2	65.4	72.7	80.0	87.2	3.00	56.3	63.3	70.4	77.4	84.4
4.00	40.1	45.2	50.2	55.2	60.2	4.00	38.5	43.3	48.1	52.9	57.8
5.00	30.1	33.9	37.6	41.4	45.1	5.00	28.7	32.3	35.8	39.4	43.0
6.00	23.8	26.8	29.7	32.7	35.7	6.00	22.5	25.4	28.2	31.0	33.8
7.00	19.5	21.9	24.4	26.8	29.2	7.00	18.4	20.7	23.0	25.3	27.6
8.00	16.4	18.5	20.5	22.6	24.6	8.00	15.4	17.3	19.3	21.2	23.1

ABSOLUTE TEMPERATURES AT RELEASE. Corresponding to Explosion Temperatures commonly obtained.

Expansion Ratio r_e	$n_e = 1.29$					Expansion Ratio r_e	$n_e = 1.32$				
	Value of T_x						Value of T_x				
	1800	2100	2400	2700	3000		1800	2100	2400	2700	3000
3.00	1309	1527	1745	1963	2182	3.00	1266	1478	1689	1900	2111
4.00	1204	1405	1606	1806	2007	4.00	1155	1348	1540	1733	1925
5.00	1129	1317	1505	1693	1881	5.00	1075	1255	1434	1613	1792
6.00	1070	1249	1427	1606	1784	6.00	1015	1184	1353	1522	1691
7.00	1024	1194	1365	1536	1706	7.00	966	1127	1288	1449	1610
8.00	985	1149	1313	1477	1641	8.00	925	1079	1234	1388	1542

Pressures and Temperatures after Combustion.—According to Poole, the maximum temperature after combustion may be as high as 3000° absolute, F., and the maximum pressure as high as 400 lbs. per sq. in. absolute; these are high figures, however, the more usual figures being about 2300° and 250 lbs. Poole gives the following figures for the average rise in pressure, above the pressure at the end of compression, produced by combustion of different fuels, with different ratios of compression.

AVERAGE PRESSURE RISE IN LBS. PER SQ. IN. PRODUCED BY COMBUSTION.

Comp. Ratio.	Illum. Gas 650 B.T.U.*	Gasoline.	Kerosene.	Comp. Ratio.	Natural Gas 1000 B.T.U.*	Comp. Ratio.	Producer Gas 150 B.T.U.*	Comp. Ratio.	Blast-Furnace Gas 100 B.T.U.*
4.0	146	195	168	5.0	192	6.0	225	7.0	211
4.2	156	208	179	5.2	202	6.2	234	7.2	218
4.4	166	221	190	5.4	211	6.4	243	7.4	225
4.6	175	234	202	5.6	221	6.6	252	7.6	232
4.8	185	247	213	5.8	230	6.8	261	7.8	239
5.0	195	260	224	6.0	240	7.0	270	8.0	246

* Per cubic foot measured at 32° F.

The following figures are given by Poole as a rough approximate guide to the mean effective pressures in lbs. per sq. in. obtained with

different fuels and different compression pressures in a four-cycle engine. In a two-cycle engine the mean effective pressure of the pump diagram should be subtracted. The delivery pressure is usually from 4 to 8 lbs. per sq. in. above the atmosphere, and the corresponding mean effective pressure of the pump about 3.8 to 7.

PROBABLE MEAN EFFECTIVE PRESSURE.

SUCTION ANTHRACITE PRODUCER GAS.						MOND PRODUCER GAS.					
Engine H.P.	Compression Pressure, abs. lbs. per sq. in.					Engine H.P.	Compression Pressure.				
	100	115	130	145	160		100	115	130	145	160
10	55	60	65	10	...	65	65	65	...
25	60	65	70	75	...	25	60	65	65	70	75
50	65	70	75	80	85	50	65	70	70	75	80
100	70	75	80	85	90	100	65	70	75	80	85
250	75	80	85	90	90	250	70	75	80	85	90
500	80	85	90	90	90	500	75	80	85	90	90

NATURAL AND ILLUMINATING GASES.

Engine H.P.	Compression Pressure.					Engine H.P.	Compression Pressures.				
	65	75	85	100	115		75	85	100	115	130
10	60	65	70	75	...	100	80	85	90	95	100
25	65	70	75	80	85	250	85	90	95	100	105
50	70	75	80	90	90	500	...	95	100	105	110

KEROSENE SPRAY.

Engine H.P.	Compression Pressures.					Engine H.P.	Compression Pressures.				
	65	75	85	100	115		65	75	85	100	...
5	50	55	60	65	70	5	70	75	80	85	...
10	55	60	65	70	75	10	75	80	85	90	...
25	60	65	70	75	80	25	80	85	90	90	...
50	65	70	75	80	85	50	85	90	95	95	...

GASOLINE VAPOR.

Sizes of Large Gas Engines. — From a table of sizes of the Nurnberg gas engine, as built by the Allis-Chalmers Co., the following figures are taken. These figures relate to two-cylinder tandem double-acting engines.

Diam. cyl., ins.....	18	20	21	22	24	24	24	28	28	30	32
Stroke cyl., ins.....	24	24	30	30	30	36	36	36	36	42	42
Revs. per min.....	150	150	125	125	125	115	115	115	100	100	100
Piston speed, ft. per min.....	600	600	625	625	625	690	690	690	700	700	700
Rated B.H.P.....	260	320	370	405	490	545	630	740	855	985	985
Factor of C.....	0.8	0.8	0.84	0.84	0.85	0.95	0.93	0.94	0.95	0.96	0.96
Diam., ins.....	34	36	38	40	42	44	46	48	50	52	52
Stroke, ins.....	42	48	48	48	54	54	54	60	60	62	62
Revs. per min.....	100	92	92	92	86	86	86	78	78	78	78
Piston speed.....	700	736	736	736	774	774	774	780	780	780	780
Rated B.H.P.....	1105	1300	1460	1630	1875	2080	2280	2475	2720	2950	2950
Factor of C.....	0.96	1	1.01	1.02	1.06	1.07	1.08	1.07	1.09	1.09	1.09

The figures "factor C" are the values of C in the equation B.H.P. = C × D², in which D = diam. of cylinder in ins. For twin-cylinder double-acting engines, multiply the B.H.P. and the value of C by 0.95; for twin-tandem double-acting engines, multiply by 2; for two-cylinder single-acting, or for single-cylinder double-acting engines, divide by 2; for single-acting single-cylinders, divide by 4. The figures for B.H.P. correspond to mean effective pressures of about 66, 68, and 70 lbs. per sq. in. for 20, 40, and 50 in. cylinders respectively if we assume 0.85 as the mechanical efficiency, or the ratio B.H.P. ÷ I.H.P.

Engine Constants for Gas Engines. — The following constants for figuring the brake H.P. of gas engines are given in *Power*, Dec. 7, 1909. They refer to four-stroke cycle single-cylinder engines, single acting; for double-acting engines multiply by 2. Producer gas, 0.000056. Illuminating gas, 0.000065. Natural gas, 0.00007. Constant × diam.² × stroke in ins. × revs. per min. = probable B.H.P. A deduction should be made for the space occupied by the piston rods, about 5% for small engines up to 10% for very large engines.

Rated Capacity of Automobile Engines. — The standard formula for the American Licensed Automobile Manufacturers Association (called the A. L. A. M. formula) for approximate rating of gasoline engines used in automobiles is Brake H.P. = Diam.² × No. of cylinders ÷ 2.5. It is based on an assumed piston speed of 1000 ft. per min. The following ratings are derived from the formula:

Bore, ins.....	2 1/2	3	3 1/2	4	4 1/2	5	5 1/2	6
Bore, mm.....	64	76	80	102	114	127	140	154
H.P., 1 cylinder....	2 1/2	3.6	4.9	6.4	8.1	10	12.1	14.4
H.P., 2 cylinders....	5	7.2	9.8	12.8	16.2	20	24.2	28.8
H.P., 4 ".....	10	14.4	19.6	25.6	32.4	40	48.4	57.6
H.P., 6 ".....	15	21.6	29.4	38.4	48.6	60	72.6	86.4

Approximate Estimate of the Horse-power of a Gas Engine. — From the formula I.H.P. = PLAN ÷ 33,000, in which P = mean effective pressure in lbs. per sq. in., L = length of stroke in ft., A = area of piston in sq. ins., N = No. of explosion strokes per min., we have I.H.P. = Pd²S ÷ 42,017, in which d = diam. of piston, and S = piston speed in ft. per min., for an engine in which there are two explosion strokes in each revolution, as in a 4-cycle double-acting, 2-cylinder engine, or a 2-cycle, 2-cylinder, single-acting engine. If the mechanical efficiency is taken at 0.84, then the brake horse power B.H.P. = Pd²S ÷ 50,000. Under average conditions the product of P and S is in the neighborhood of 50,000, and in that case B.H.P. = d².

Generally, B.H.P. = C × d², in which C is a coefficient having values as below:

M.E.P. lbs. per sq. in.	Piston speed, ft. per minute.					
	500	600	700	800	900	1000
	Value of C for two explosions per revolution.					
50	0.50	0.60	0.70	0.80	0.90	1.00
60	0.60	0.72	0.84	0.96	1.08	1.20
70	0.70	0.84	0.98	1.12	1.26	1.40
80	0.80	0.96	1.12	1.28	1.44	1.60
90	0.90	1.08	1.26	1.44	1.62	1.80
100	1.00	1.20	1.40	1.60	1.80	2.00
110	1.10	1.32	1.54	1.76	1.98	2.20

These values of C apply to 4-cylinders, 4-cycle, single-acting, to 2-cyl., 2-cycle, single-acting, and to 1-cyl., 2-cycle double-acting. For single cylinders, 4-cycle, single-acting, divide by 4; for single cylinders, 4-cycle, double-acting, or 2-cycle, single acting, divide by 2.

Oil and Gasoline Engines. — The lighter distillates of petroleum, such as gasoline, are easily vaporized at moderate temperatures, and a gasoline engine differs from a gas-engine only in having an atomizer attached, for spraying a fine jet of the liquid into the air-admission pipe. With kerosene and other heavier distillates, or crude oils, it is necessary to

provide some method of atomizing and vaporizing the oil at a high temperature, such as injecting it into a hot vaporizing chamber at the end of the cylinder, or into a chamber heated by the exhaust gases. In the Diesel oil engine the oil is ignited by the heat of the highly compressed air in the cylinder.

The Diesel Oil Engine.—The distinguishing features of the Diesel engine are: It compresses air only, to a predetermined temperature above the firing point of the fuel. This fuel is blown as a cloud of vapor (by air from a separate small compressor) into the cylinder when compression has been completed, ignites spontaneously without explosion, solely by reason of the heat of the air generated by the compression, and burns steadily with no essential rise in pressure. The temperature of gases, developed and rejected, is much lower than with engines of the explosive type. The engine uses crude oil and residual petroleum products. Guarantees of fuel consumption are made as low as 8 gallons of oil (not heavier than 19° Baumé) for each 100 brake H.P. hour at any load between half and full rated load.

American Diesel engines are built for stationary purposes, in sizes of 120, 170, and 225 H.P. in three cylinders, and in "double units" (six cylinders) of 240, 340 and 450 H.P. See catalogue of the American Diesel Engine Co., St. Louis, 1909.

Much larger sizes have been built in Europe, where they are also built for marine purposes, including submarines in the French and other navies. For the theory of the Diesel engine see a lecture by Rudolph Diesel, in *Zeit. des Ver. Deutscher Ing.*, 1897, trans. in *Progressive Age*, Dec. 1 and 15, 1897, and paper by E. D. Meier in *Jour. Frank. Inst.*, Oct. 1893.

The De La Vergne Oil Engine is described in *Eng. News*, Jan. 13, 1910. It is a four-cycle engine. After the charge of air is compressed to about 200 lbs. per sq. in., the charge of oil is injected, by a jet of air at about 600 lbs. per sq. in., into a vaporizing bulb at the end of the cylinder. Ignition of the oil is caused by the high temperature in this bulb. Average results of tests of an engine developing 128 H.P. showed an oil consumption per B.H.P. hour of 0.408 lb. with Solar fuel oil, and 0.484 lb. with California crude oil.

Alcohol Engines.—Bulletin No. 392 of the U.S. Geol. Survey (1909,) on Comparisons of Gasolene and Alcohol Tests in Internal Combustion Engines, by R. M. Strong, contains the following conclusions:

The "low" heat value of completely denatured alcohol will average 10,500 B.T.U. per lb., or 71,900 B.T.U. per gallon. The low heat value of 0.71 to 0.73 sp. gr. gasolene will average 19,200 B.T.U. per lb., or 115,800 B.T.U. per gallon.

A gasolene engine having a compression pressure of 70 lbs. but otherwise as well suited to the economical use of denatured alcohol as gasolene, will, when using alcohol, deliver about 10% greater maximum power than when using gasolene.

When the fuels for which they are designed are used to an equal advantage, the maximum B.H.P. of an alcohol engine having a compression pressure of 180 lbs. is about 30% greater than that of a gasolene engine of the same size and speed having a compression pressure of 70 lbs.

Alcohol diluted with water in any proportion, from denatured alcohol, which contains about 10% water, to mixtures containing about as much water as denatured alcohol, can be used in gasolene and alcohol engines if the engines are properly equipped and adjusted.

When used in an engine having constant compression, the amount of pure alcohol required for any given load increases and the maximum available horse-power of the engine decreases with diminution in the percentage of pure alcohol in the diluted alcohol supplied. The rate of increase and decrease, respectively, however, is such that the use of 80% alcohol instead of 90% has but little effect upon the performance; so that if 80% alcohol can be had for 15% less cost than 90% alcohol and could be sold without tax when denatured, it would be more economical to use the 80% alcohol.

Ignition.—The "hot-tube" method of igniting the compressed mixture of gas and air in the cylinder is practically obsolete, and electric systems are used instead. Of these the "make-and-break" and the "jump-spark" systems are in common use. In the former two insulated contact

pieces are located in the end of the cylinder, and through them an electric current passes while they are in contact. A spark-coil is included in the circuit, and when the circuit is suddenly broken at the proper time for ignition, by mechanism operated from the valve-gear shaft, a spark is made at the contacts, which ignites the gas. In the "jump-spark" system two insulated terminals separated about 0.03 in. apart are located in the cylinder, and the secondary or high-tension current of an induction coil causes a spark to jump across the space between them when the circuit of the primary current is closed by mechanism operated by the engine. In some oil engines the mixture of air and oil vapor is ignited automatically by the temperature generated by compression of the vapor, in a chamber at the end of the cylinder, called the vaporizer, which is not water-jacketed and therefore is kept hot by the repeated ignitions. Before starting the engine the vaporizer is heated by a Bunsen burner or other means.

Timing.—By adjusting the cam or other mechanism operated by the valve-gear shaft for causing ignition, the time at which the ignition takes place, with reference to the end of the compression stroke, can be regulated. The mixture is usually ignited before the end of the stroke, the advance depending upon the inflammability of the mixture and on the speed of the engine. A slow-burning mixture requires to be ignited earlier than a rapid-burning one and a high-speed engine earlier than a low-speed engine.

Governing.—Two methods of governing the speed of an engine are in common use, the "hit-and-miss" and the throttling methods. In the former the engine receives its usual charge of air and gas only when the engine is running at or below its normal speed; at higher speeds the admission of the charge is suspended until the engine regains its normal speed. One method of accomplishing this is to interpose between the valve-rod and its cam or other operating mechanism, a push-rod, or other piece, the position of which with reference to the end of the valve-rod is controlled by a centrifugal governor so that it hits the valve-rod if the speed is at or below normal and misses it if the speed is above normal. The hit-and-miss method is economical of fuel, but it involves irregularity of speed, making a large and heavy fly-wheel necessary if reasonable uniformity of speed is desired. The throttling method of regulating is similar to that used in throttling steam engines; the quantity of mixture admitted at each charge being varied by varying the position of a butterfly valve in the inlet pipe. Cut-off methods of governing are also used, such as varying the time of closing the admission valve during the suction stroke, or varying the time of admission of the gas alone, or "quality regulation."

Gas and Oil Engine Troubles.—The gas engine is subject to a greater number of troubles than the steam engine on account of its greater mechanical complexity and of the variable quality of its operating fluid. Among the causes of troubles are: the variable composition of the fuel; too much or too little air supply; compression ratio not right for the kind of fuel; ignition timer set too late or too early; pre-ignition; back-firing; electrical and mechanical troubles with the igniting system; carbon deposits in the cylinder and on the igniting contacts. For a very full discussion of these and many other troubles and the remedies for them, see Jones on the Gas-Engine.

Conditions of Maximum Efficiency.—The conditions which appear to give the highest thermal efficiency in gas and oil engines are: 1, high temperature of cooling water in the jackets; 2, high pressure at the end of compression; 3, lean mixture; 4, proper timing of the ignition; 5, maximum load. The higher economy of a lean mixture may be due to the fact that high compressions may be used with such a mixture, while with rich mixtures high compression pressures cannot be used without danger of pre-ignition. The effect of different timing on economy is shown in a test by J. R. Bibbins, reported by Carpenter and Diederichs, of an engine using natural gas of a lower heating value* of 934 B.T.U. per cu. ft., delivering 71 H.P. at 297 revs. per min. The maximum thermal efficiency, 23.3%, was obtained when the timing device was set for igni-

* By "lower heating value" is meant the value computed after subtracting the latent heat of evaporation of 9 lbs. of water per pound of hydrogen contained in the gas. See page 533.

tion 30° in advance of the dead center, while the efficiency with ignition at the center was 19%, and with ignition 55° in advance 17.3%.

Other things being equal, the hotter the walls of the cylinder the less heat is transferred into them from the hot gases, and therefore the higher the efficiency. Cool walls, however, allow of higher compression without pre-ignition, and high compression is a cause of high efficiency. Cool walls also tend to give the engine greater capacity, since with hot walls the fuel mixture expands more on entering the cylinder, reducing the weight of charge admitted in the suction stroke.

Heat Losses in the Gas Engine.—The difference between the thermal efficiency, which is the proportion of heat converted into work in the engine, and 100%, is the loss of heat, which includes the heat carried away in the jacket water, that carried away in the waste gases, and that lost by radiation. The relative amounts of these three losses vary greatly, depending on the size of the engine and on the amount of water used for cooling. Thurston, in *Heat as a Form of Energy*, reports a test in which the heat distribution was as follows: Useful work, 17.3%; jacket water, 52%; exhaust gas, 16%; radiation, 15%. Carpenter and Diederichs quote the following, showing that the distribution of the heat losses varies with the rate of compression and with the speed.

Ratio of Compression.	R.p.m.	M.E.P. lbs. per sq. in.	Ratio Air to Gas.	Heat-ing Value of Charge, B.T.U.	Work done by 1 Ft.-lbs.	Ex-haust Temp. Deg. F.	Heat Distribution, Per Cent.		
							Work.	Jacket Water.	Ex-haust.
2.67	187	54.3	7.11	18.5	140	1022	18.0	51.2	30.8
2.67	247	51.5	7.35	17.4	141	1137	18.1	45.6	36.3
4.32	187	69.3	7.43	17.0	190	867	24.4	53.8	21.8
4.32	247	65.2	7.40	16.8	184	992	23.7	49.5	26.8

In the long table of results of tests reported by Carpenter and Diederichs, figures of the distribution of heat show that of the total heat received by the engines the heat lost in the jacket water ranged from 25.0 to 50.4%, and that lost in the exhaust gases from 55 to 23.4%.

In small air-cooled gasoline engines, such as those used in some automobile engines, in which the cylinders are surrounded by thin metal ribs to increase the radiating surface, and air is propelled against them by a fan, the air takes the place of the jacket water, and the total loss of heat is that carried away by the air and by the exhaust gases.

Economical Performance of Gas Engines.—The best performance of a gas engine using producer gas (1909) is about 30% better than the best recorded performance of a triple-expansion steam engine, or about 0.71 lb. coal per I.H.P. hour, as compared with 1.06 lbs. for the steam engine. It is probable that the performance of the combination of a high-pressure reciprocating engine, using superheated steam generated in a well-proportioned boiler supplied with mechanical stokers and an economizer, and a low-pressure steam turbine will ere long reduce the steam engine record to 0.9 lb. per I.H.P. hour. As compared with an ordinary steam engine, however, the gas engine with a good producer is far more economical than the steam engine. Where gas can be obtained cheaply, such as the waste-gas from blast furnaces, or natural gas, the gas-engine can furnish power much more cheaply than it can be obtained from the same gas burned under a boiler to furnish steam to a steam engine.

In tests made for the U. S. Geological Survey at the St. Louis Exhibition, 1904, of a 235-H.P. gas engine with different coals, made into gas in the same producer, the best result obtained was 1.12 lbs. of West Virginia coal per B.H.P. hour, and the poorest result 3.23 lbs. per B.H.P. hour, with North Dakota lignite.

A 170-H.P. Crossley (Otto) engine tested in England in 1892, using producer gas, gave a consumption of 0.85 lb. coal per I.H.P. hour, or a thermal efficiency of engine and producer combined of 21.3%.

Experiments on a Taylor gas producer using anthracite coal and a

100-H.P. Otto gas engine showed a consumption of 0.97 lb. carbon per I.H.P. hour. (*Iron Age*, 1893.)

In a table in Carpenter and Diederichs on Internal Combustion Engines the lowest recorded coal consumption per B.H.P. hour is 0.71 lb., with a Tangye engine and a suction gas producer, using Welsh anthracite coal. Other tests show figures ranging from 0.74 lb. to 1.95, the last with a Westinghouse 500-H.P. engine and a Taylor producer using Colorado bituminous coal.

In the same book are given the following figures of the thermal efficiency on brake H.P. with different gas and liquid fuels. Illuminating gas, 6 tests, 16.1 to 31.0%; natural gas, 4 tests, 16.1 to 29.0%; coke-oven gas, 1 test, 27.5%; Mond gas, 1 test, 23.7%; blast-furnace gas, 3 tests, 20.4 to 28.2%; gasoline, 8 tests, 10.2 to 28%; kerosene, Diesel engine, 3 tests, 25.8 to 31.9%; kerosene, other engines, 8 tests, 9.2 to 19.7%; crude oil, Diesel engine, 1 test, 28.1%; alcohol, 4 tests, 21.8 to 32.7%.

Tests of Diesel engines operating centrifugal pumps in India are reported in *Eng. News*, Nov. 25, 1909. Using Borneo petroleum residue of 0.934 sp. gr., and a fuel value of 18,600 B.T.U. per lb., an average of 151 B.H.P. during a season, for a total of 6003 engine hours, was obtained with a consumption of 0.462 lb. of fuel per B.H.P. hour, or one B.H.P. for about 8600 B.T.U. per hour, equal to a thermal efficiency of 29.5%. The pump efficiency at maximum lift of 14 to 16 ft. was 70%, and the fuel consumption per water H.P. hour at the same lift was 0.7 lb.

Utilization of Waste Heat from Gas Engines.—The exhaust gases from a gas engine may be used to heat air by passing them across a nest of tubes through which air is flowing. A design of this kind, for heating the Ives library building, New Haven, Conn., by Harrison Engineering Co., New York, is illustrated in *Heat and Vent. Mag.*, Jan., 1910.

The waste heat might also be used in a boiler to generate steam at or below atmospheric pressure, for use in a low pressure steam turbine. On account of the comparatively low temperature of the exhaust gases, however, the boiler would require a much greater extent of heating surface for a given capacity than a boiler with an ordinary coal-fired furnace.

RULES FOR CONDUCTING TESTS OF GAS AND OIL ENGINES*, CODE OF 1902.

(From the report of the committee of the A. S. M. E. on Engine Tests.)
[Only a brief abstract is here given. The items, 1, Objects of the Tests; 2, General Conditions of the Engine; 3, Dimensions; 5, Calibration of Instruments, are practically the same as in the report on Steam Engine Tests.]

IV. **Fuel.**—Decide upon the gas or oil to be used, and if the trial is to be made for maximum efficiency, the fuel should be the best of its class that can readily be obtained, or one that shows the highest calorific power.

VI. **Duration of Test.**—The duration of a test should depend largely upon the objects in view, and in any case the test should be continued until the successive readings of the rates at which oil or gas is consumed, taken at say half-hourly intervals, become uniform and thus verify each other. If the object is to determine the working economy, and the period of time during which the engine is usually in motion is some part of twenty-four hours, the duration of the test should be fixed for this number of hours. If the engine is one using coal for generating gas, the test should be of at least twenty-four hours' duration.

VII. **Starting a Test.**—In a test for determining the maximum economy of an engine, it should first be run a sufficient time to bring all the conditions to a normal and constant state.

If a test is made to determine the performance under working conditions, the test should begin as soon as the regular preparations have been made for starting the engine in practical work, and the measurements should then commence and be continued until the close of the period covered by the day's work.

VIII. **Measurement of Fuel.**—If the fuel used is coal furnished to a gas

* Hot-air engines are not included in this code, those in the market being of comparatively small size, and seldom tested.

producer, the same methods apply for determining the consumption as are used in steam-boiler tests.

If the fuel used be gas, the only practical method of measurement is the use of a meter through which the gas is passed. The temperature and pressure of the gas should be measured, and the quantity of gas should be determined by reference to the calibration of the meter, taking into account the temperature and pressure of the gas.

If the fuel is oil, this can be drawn from a tank which is filled to the original level at the end of the test, the amount of oil required for so doing being weighed; or, for a small engine, the oil may be drawn from a calibrated vertical pipe.

IX. Measurement of Heat-Units Consumed by the Engine. — The number of heat-units used is found by multiplying the number of pounds of coal or oil or the cubic feet of gas consumed, by the total heat of combustion of the fuel as determined by a calorimeter test. In determining the total heat of combustion no deduction is made for the latent heat of the water vapor in the products of combustion.

It is sometimes desirable, also, to have a complete chemical analysis of the oil or gas. The total heat of combustion may be computed, if desired, from the results of the analysis, and should agree well with the calorimeter values.

X. Measurement of Jacket Water. — The jacket water may be measured by passing it through a water meter or allowing it to flow from a measuring tank before entering the jacket, or by collecting it in tanks on its discharge.

XI. Indicated Horse-power. — The directions given for determining the indicated horse-power for steam engines apply in all respects to internal combustion engines.

XII. Brake Horse-power. — The determination of the brake horse-power is the same for internal combustion as for steam engines.

XIII. Speed. — The same directions apply to internal combustion engines as to steam engines for the determination of speed.

In an engine which is governed by varying the number of explosions or working cycles, a record should be kept of the number of explosions per minute; or if the engine is running at nearly maximum load, by counting the number of times the governor causes a miss in the explosions.

XIV. Recording the Data. — The pressures, temperatures, meter readings, speeds, and other measurements should be observed every 20 or 30 minutes when the conditions are practically uniform, and at more frequent intervals if they are variable. Observations of the gas or oil measurements should be taken with special care at the expiration of each hour, so as to divide the test into hourly periods, and reveal the uniformity, or otherwise, of the conditions and results as the test goes forward.

XV. Uniformity of Conditions. — When the object of the test is to determine the maximum economy, all the conditions relating to the operation of the engine should be maintained as constant as possible during the trial.

XVI. Indicator Diagrams. — Sample diagrams nearest to the mean should be selected from those taken during the trial and appended to the tables of the results. If there are separate compression or feed cylinders, the indicator diagrams from these should be taken and the power deducted from that of the main cylinder.

XVII. Standards of Economy and Efficiency. — The hourly consumption of heat, divided by the indicated or the brake horse-power, is the standard expression of engine economy recommended.

In making comparisons between the standard for internal combustion engines and that for steam engines, it must be borne in mind that the steam engine standard does not cover the losses due to combustion, while the internal combustion engine standard, in cases where a crude fuel such as oil is burned in the cylinder, does cover these losses.

The thermal efficiency ratio per indicated horse-power or per brake horse-power for internal combustion engines is expressed by the fraction

$$2545 \div \text{B.T.U. per H.P. per hour.}$$

XVIII. Heat Balance. — For purposes of scientific research, a heat balance should be drawn which shows the manner in which the total

heat of combustion is expended in the various processes concerned in the working of the engine. It may be divided into three parts: first, the heat which is converted into the indicated or brake work; second, the heat rejected in the cooling water of the jackets; and third, the heat rejected in the exhaust gases, together with that lost through incomplete combustion and radiation.

To determine the first item, the number of foot-pounds of work performed by, say, one pound or one cubic foot of the fuel, divided by 778, gives the number of heat-units desired. The second item is determined by measuring the amount of cooling water passed through the jackets, equivalent to one pound or one cubic foot of fuel consumed, and multiplying this quantity by the difference in the sensible heat of the water leaving the jacket and that entering. The third item is obtained by subtracting the sum of the first two items from the total heat supplied. The third item can be subdivided by computing the heat rejected in the exhaust gases as a separate quantity. The data for this computation are found by analyzing the fuel and the exhaust gases, or by measuring the quantity of air admitted to the cylinder in addition to that of the gas or oil.

XIX. Report of Test. — The data and results of a test should be reported in the manner outlined in one of the following tables, the first of which gives a complete summary when all the data are determined, and the second is a shorter form of report in which some of the minor items are omitted. [The short form is given below.]

DATA AND RESULTS OF STANDARD HEAT TEST OF GAS OR OIL ENGINE.
Arranged according to the Short Form advised by the Engine Test Committee, American Society of Mechanical Engineers. Code of 1902.

1. Made by..... of.....
on engine located at.....
to determine.....
2. Date of trial.....
3. Type and class of engine.....
4. Kind of fuel used..... deg. Fahr.
(a) Specific gravity.....
(b) Burning point.....
(c) Flashing point.....
5. Dimensions of engine: 1st Cyl. 2d Cyl.
(a) Class of cylinder (working or for compressing the charge).....
(b) Single or double acting.....
(c) Cylinder dimensions:
Bore..... in.
Stroke..... ft.
Diameter piston rod..... in.
(d) Average compression space, or clearance, in per cent.....
(e) Horse-power constant for one lb. M.E.P. and one revolution per minute.....
- Total Quantities.**
6. Duration of test..... hours
7. Gas or oil consumed..... cu. ft. or lbs.
8. Cooling water supplied to jackets.....
9. Calorific value of fuel by calorimeter test, determined by..... calorimeter..... B.T.U.
- Pressures and Temperatures.**
10. Pressure at meter (for gas engine) in inches of water... ins.
11. Barometric pressure of atmosphere:
(a) Reading of barometer.....
(b) Reading corrected to 32 degs. Fahr.....

- 12. Temperature of cooling water:
 - (a) Inlet..... deg. Fahr.
 - (b) Outlet..... "
- 13. Temperature of gas at meter (for gas engine)..... "
- 14. Temperature of atmosphere:
 - (a) Dry bulb thermometer..... "
 - (b) Wet bulb thermometer..... "
 - (c) Degree of humidity..... "
- 15. Temperature of exhaust gases..... "

Data Relating to Heat Measurement.

- 16. Heat units consumed per hour (pounds of oil or cubic feet of gas per hour multiplied by the total heat of combustion)..... B.T.U.
- 17. Heat rejected in cooling water per hour..... "

Speed, etc.

- 18. Revolutions per minute..... rev.
- 19. Average number of explosions per minute..... "

Indicator Diagrams.

- 20. Pressure in lbs. per sq. in. above atmosphere:

	1st Cyl.	2d Cyl.
(a) Maximum pressure.....		
(b) Pressure just before ignition.....		
(c) Pressure at end of expansion.....		
(d) Exhaust pressure.....		
(e) Mean effective pressure.....		

Power.

- 21. Indicated horse-power:

First cylinder.....	H.P.
Second cylinder.....	"
Total.....	"
- 22. Brake horse-power..... "
- 23. Friction horse-power by friction diagrams..... "
- 24. Percentage of indicated horse-power lost in friction.. per cent.

Standard Efficiency, and Other Results.

- 25. Heat units consumed by the engine per hour:
 - (a) Per indicated horse-power..... B.T.U.
 - (b) Per brake horse-power..... "
- 26. Pounds of oil or cubic feet of gas consumed per hour:
 - (a) Per indicated horse-power..... lbs. or cu. ft.
 - (b) Per brake horse-power..... "

Additional Data.

Add any additional data bearing on the particular objects of the test or relating to the special class of service for which the engine is to be used. Also give copies of indicator diagrams nearest the mean, and the corresponding scales.

LOCOMOTIVES.

Resistance of Trains. — Resistance due to Speed. — Various formulæ and tables for the resistance of trains at different speeds on a straight level track have been given by different writers. Among these are the following:

By D. L. Barnes (Eng. Mag.), June, 1894:

Speed, miles per hour.....	50	60	70	80	90	100
Resistance, pounds per gross ton.....	12	12.4	13.5	15	17	20

By Engineering News, March 8, 1894:

Resistance in lbs. per ton of 2000 lbs. = 1/4 v + 4.

Speed.....	5	10	15	20	25	30	35	40	45	50	60	70	80	90	100
Resistance.....	3 1/4	4.5	5 3/4	7	8 1/4	9.5	10 3/4	12	13 1/4	14.5	17	19.5	22	24.5	27

This formula seems to be more generally accepted than the others. It gives results too small, however, below 10 miles an hour. At starting the resistance is about 17 lbs. per ton, dropping to 4 or 5 lbs. at 5 miles an hour.

By Baldwin Locomotive Works:

Resistance in lbs. per ton of 2000 lbs. = 3 + v ÷ 6.

Speed.....	5	10	15	20	25	30	35	40	45	50	55	60	70	80	90	100
Resistance.....	3.8	4.7	5.5	6.3	7.2	8	8.8	9.7	10.5	11.3	12.2	13	14.7	16.3	18	19.7

The resistance due to speed varies with the condition of the track, the number of cars in a train, and other conditions.

For tables showing that the resistance varies with the area exposed to the resistance and friction of the air per top of loads, see Dashiell, Trans. A. S. M. E., vol. xiii, p. 371.

P. H. Dudley (Bulletin International Ry. Congress, 1900, p. 1734) shows that the condition of the track is an important factor of train resistance which has not hitherto been taken account of. The resistance of heavy trains on the N. Y. Central R. R. at 20 miles an hour is only about 3 1/2 lbs. per ton on smooth 80-lb. 5 1/8-in. rails. The resistance of an 80-car freight train, 60,000 lbs. per car, as given by indicator cards, at speeds between 15 and 25 miles per hour, is represented by the formula R = 1 + 1/8 V, in which R = resistance in lbs. per ton and V = miles per hour. These values are much below the average and should not be used in estimating the hauling power needed.

New Formulae for Resistance. — The Amer. Locomotive Co. (Bulletin No. 1001, Feb., 1910) states that the figures obtained from the old formulæ for train resistance are much too high for modern loaded freight cars of 40 to 50 tons capacity, and in some instances too low for very light or empty cars. The best data available show that the resistance varies from about 2.5 to 3 lbs. per ton (of 2000 lbs.) for 72-ton cars (including weight of empty car) to 6 to 8 lbs. for 20-ton cars. From speeds between 5 to 10 and 30 to 35 miles an hour, the resistance of freight cars is practically constant. The resistance of the engine and tender is figured separately, and is composed of the following factors: (a) Engine friction = 22.2 lbs. per ton, or 1.11% of the weight on drivers. (b) Head air resistance = cross-sectional area (taken at 120 sq. ft.) × 0.002 V², V being the speed in miles per hour. (c) Resistance due to weight on engine trucks and trailing wheels, and to the tender, the same per ton as that due to the cars. (d) Grade resistance = 20 lbs. per ton for each per cent of grade. (e) Curve resistance, which varies with the wheel-base of the locomotive, and is taken as 0.4 + cD lbs. per ton, in which D is the degree of the curve and c a constant whose value is:

For wheel-base, ft.	5	6	7	8	9	12	13	15	16	20
Value of c.....	0.380	.415	.460	.485	.520	.625	.660	.730	.795	.905

The sum of these resistances is to be deducted from the tractive force of the locomotive to obtain the available tractive force for overcoming the resistance of the cars. (See Tractive Force, below.) The maximum tractive force is taken for low speeds at 85% of that due to the boiler pressure; for piston speeds over 250 ft. per min. this is to be multiplied by a speed factor to obtain the actual force. Speed factors and percentages of maximum horse-power corresponding to different piston speeds are given below. S = piston speed, ft. per min., F = speed factor, P = % of maximum H.P.

S.....	250	300	350	400	450	500	550	600	650	700	750
F.....	1.00	.954	.908	.863	.817	.772	.727	.680	.636	.592	.550
P.....	60.4	69.1	77.2	83.7	89.0	93.5	96.8	98.7	99.7	100	100
S.....	800	850	900	950	1000	1100	1200	1300	1400	1500	1600
F.....	0.517	.487	.460	.435	.412	.372	.337	.307	.283	.261	.241
P.....	100	100	100	100	100	99	97.8	96.8	95.7	94.7	93.5

The resistance of freight cars, according to experiments on the Penna. R.R., varies with the weight in tons per car as follows:

Tons per car.....	10	20	25	30	40	50	60	70	72
Resistance, lbs. per ton.....	13.10	7.84	6.62	5.78	4.66	3.94	3.44	3.06	3.00

From plotted curves of resistances of trains of empty and loaded cars the following figures are derived. R = resistance in lbs. per ton.

Wt. loaded, tons.....	75	70	65	60	55	50
Wt. empty, tons.....	21	20.3	19.5	18.6	17.6	16.5
Per cent of loaded wt.....	28	29	30	31	32	33
R loaded	2.90	3.07	3.24	3.43	3.65	3.90
R empty	5.63	5.82	6.00	6.26	6.52	6.85

Wt. loaded, tons.....	45	40	35	30	25	20	15
Wt. empty, tons.....	15.3	14.0	12.6	11.1	9.5	7.8	6.0
Per cent of loaded wt....	34	35	36	37	38	39	40
R loaded	4.18	4.40	4.74	5.07	5.44	5.91	6.40
R empty	7.26	7.65	8.05	8.45	9.05	9.60	10.3

The resistance of passenger cars is derived from the formula $R = 5.4 + 0.002(V - 15)^2 + 100 \div (V + 2)^3$. V in miles per hour, R = resistance in lbs. per ton (2000 lbs.) H.P. = horse-power per ton.

V =	5	10	15	20	25	30	35
R =	5.89	5.51	5.42	5.46	5.60	5.85	6.20
H.P. =	0.079	.147	.217	.291	.374	.469	.578

V =	40	45	50	60	70	80	90
R =	6.65	7.20	7.85	9.45	11.45	13.85	16.65
H.P. =709	.864	1.047	1.515	2.135	2.95	4.00

Resistance of Electric Railway Cars and Trains. — W. J. Davis, Jr. (*Street Ry. Jour.*, Dec. 3, 1904), gives as a result of numerous experiments the following formulæ:

(A) For light open platform street cars, 8 tons to 20 tons; maximum speed, 30 miles per hour; cross-section, 85 sq. ft.

$$R = 6 + 0.11V + \frac{0.3V^2}{T} [1 + 0.1(n - 1)].$$

(B) For standard interurban electric cars, 25 tons to 40 tons; maximum speed, 60 m.p.h.; cross section, 100 sq. ft.

$$R = 5 + 0.13V + 0.3V^2/T [1 + 0.1(n - 1)].$$

(C) For heavy interurban electric cars, or steam passenger coaches, 40 tons to 50 tons; maximum speed, 75 m.p.h.; cross-section, 110 sq. ft.

$$R = 4 + 0.13V + 0.33V^2/T [1 + 0.1(n - 1)].$$

(D) For heavy freight trains, cars weighing 45 tons loaded; maximum speed, 35 m.p.h.; average cross-section, 110 sq. ft.

$$R = 3.5 + 0.13V + 0.385V^2/T [1 + 0.1(n - 1)].$$

R = resistance in lbs. per ton of 2000 lbs., V = speed in miles per hour T = weight of train in tons, n = number of cars in train, including leading motor car. The cross-section includes the space bounded by the wheels between the top of rails and the body.

Resistance due to Grade. — The resistance due to a grade of 1 ft. per mile is, per ton of 2000 lbs., $2000 \times 1/5280 = 0.3788$ lb. per ton, or if R_g = resistance in lbs. per ton due to grade and G = ft. per mile $R_g = 0.3788G$.

If the grade is expressed as a percentage of the length, the resistance is 20 lbs. per ton for each per cent of grade.

Resistance due to Curves. — Mr. G. R. Henderson in his book entitled "Locomotive Operation" gives the resistance due to curvature at 0.7 lb. per ton of 2000 lbs. per degree of the curve. (For definition of degrees of a railroad curve see p. 55.) For locomotives, this factor is sometimes doubled, making the resistance in lbs. per ton = $0.7c$ for cars and $1.4c$ for locomotives, c being the number of degrees.

The Baldwin Locomotive Works take the approximate resistance due to each degree of curvature as that due to a straight grade of $1\frac{1}{2}$ ft. per mile. This corresponds to $R_c = 0.5682c$.

The Amer. Locomotive Co. takes 0.8 lb. per ton per degree of curvature for the resistance of cars on curves.

For mine cars, with short wheel-bases and wheels loose on the axles, experiments quoted by the Baldwin Locomotive Works, 1904, lead to the formula, Resistance due to curvature, in pounds, = $0.20 \times$ wheel-base \times weight of loaded cars in pounds, \div radius of curve in feet.

Resistance due to Acceleration. — This may be calculated by the ordinary formula (see page 504), or reduced to common railroad units, and including the rotative energy of wheels and axles, which increases the effect of the weight of the cars by an equivalent of about 5%, we have

$$P = 70 \frac{V^2}{S} = 95.6 \frac{V}{t} = 70 \frac{V_2^2 - V_1^2}{S}, \text{ where } P = \text{the accelerating force in}$$

pounds per ton, V = the velocity in miles per hour, S = the distance in feet, and t = the time in seconds in which the acceleration takes place. V_1 and V_2 = the smaller and greater velocities, respectively, in miles per hour, for a change of speed.

Total Resistance. — The total resistance in lbs. per ton of 2000 lbs. due to speed, to grade, to curves, and to acceleration is the sum of the resistances calculated above.

The Baldwin Locomotive Works in their "Locomotive Data" take the total resistance on a straight level track at slow speeds at from 6 to 10 lbs. per ton, and in a communication printed in the fourth edition (1898) of this Pocket-book, p. 1076, say "We know that in some cases, for instance in mine construction, the frictional resistance has been shown to be as much as 60 lbs. per ton at slow speed. The resistance should be approximated to suit the conditions of each individual case, and the increased resistance due to speed added thereto."

Resistance due to Friction. — In the above formulæ no account has been taken of the resistance due to the friction of the working parts. This is rather an obscure subject. Mr. Henderson estimates the percentage of the indicated power consumed by friction to be $0.15V + c$, where V = speed in miles per hour and c = a constant, whose value may vary from 2 to 8, the latter figure being the safest to use for heavy work at slow speeds. Ordinarily 8% of the indicated power is consumed by internal resistance under these conditions. Professor Goss gives the following formula, obtained from tests at the Purdue locomotive testing laboratory:

Let d = diameter of cylinder; S = stroke of piston; D = diameter of drivers, all in inches. Then the internal friction = $3.8d^2S/D$, in pounds at the circumference of the drivers.

Concerning the effect of increasing speed on tractive force, Mr. Henderson says (1906):

From a number of tests and information from various roads and authorities it seems as if, for ordinary simple engines, the coefficient 0.8

in the equation Actual tractive force = $\frac{0.8Pd^2s}{D}$ could be modified in accordance with the speed in order to obtain the actual tractive force at various speeds about as follows:

Revs. per min. =	20	40	60	80	100	120	140	160	
Coefficient =	0.80	0.80	0.80	0.70	0.61	0.53	0.46	0.40	
Revs. per min. =	180	200	220	240	260	280	300	320	340
Coefficient =	0.35	0.31	0.28	0.26	0.24	0.23	0.21	0.20	0.19

Efficiency of the Mechanism of a Locomotive. — Frank C. Wagner (*Proc. A. A. S.*, 1900, p. 140) gives an account of some dynamometer tests which indicate that in ordinary freight service the power used to drive the locomotive and tender and to overcome the friction of the mechanism is from 10% to 35% of the total power developed in the steam-cylinder. In one test the weight of the locomotive and tender was 16% of the total weight of the train, while the power consumed in the locomotive and tender was from 30% to 33% of the indicated horse-power.

Adhesion. — The limit of the hauling capacity of a locomotive is the adhesion due to the weight on the driving wheels. Holmes gives the adhesion, in English practice, as equal to 0.15 of the load on the driving wheels in ordinary dry weather, but only 0.07 in damp weather or when the rails are greasy. In American practice it is generally taken as from $\frac{1}{4}$ to $\frac{1}{5}$ of the load on the drivers.

Traction Force of a Locomotive. — Single Expansion.

Let F = indicated tractive force in lbs.
 p = average effective pressure in cylinder in lbs. per sq. in.
 S = stroke of piston in inches.
 d = diameter of cylinders in inches.
 D = diameter of driving-wheels in inches. Then

$$F = \frac{4 \pi d^2 p S}{4 \pi D} = \frac{d^2 p S}{D}$$

The average effective pressure can be obtained from an indicator-diagram, or by calculation, when the initial pressure and ratio of expansion are known, together with the other properties of the valve-motion. The subjoined table from Auchincloss gives the proportion of mean effective pressure to boiler-pressure above atmosphere for various proportions of cut-off.

Stroke, Cut-off at —	M.E.P. (Boiler-pres. = 1).	Stroke, Cut-off at —	M.E.P. (Boiler-pres. = 1).	Stroke, Cut-off at —	M.E.P. (Boiler-pres. = 1).
0.1	0.15	0.333 = 1/3	0.5 = 1/2	0.625 = 5/8	0.79
.125 = 1/8	.2	.375 = 3/8	.55	.666 = 2/3	.82
.15	.24	.4	.57	.7	.85
.175	.28	.45	.62	.75 = 3/4	.89
.2	.32	.5 = 1/2	.67	.8	.93
.25 = 1/4	.4	.55	.72	.875 = 7/8	.98
.3	.46				

These values were deduced from experiments with an English locomotive by Mr. Gooch. As diagrams vary so much from different causes, this table will only fairly represent practical cases. It is evident that the cut-off must be such that the boiler will be capable of supplying sufficient steam at the given speed.

We can, however, allow for wire drawing to the steam chest and drop in pressure due to expansion, and internal friction by writing the formula:

$$\text{Actual Tractive Force} = \frac{0.8 P d^2 S}{D}, \text{ } d, S, \text{ and } D \text{ being as before and } P \text{ representing boiler pressure in lbs. per sq. in.}$$

Compound Locomotives. — The Baldwin Locomotive Works give the following formulæ for compound engines of the Vaucrain four-cylinder type:

$$T = \frac{C^2 S \times 2/3 P}{D} + \frac{c^2 S \times 1/4 P}{D}$$

T = tractive force in lbs. C = diam. of high-pressure cylinder in ins. c = diam. of low-pressure cylinder in ins. P = boiler-pressure in lbs. S = stroke of piston in ins. D = diam. of driving-wheels in ins.

For a two-cylinder or cross-compound engine it is only necessary to consider the high-pressure cylinder, allowing a sufficient decrease in boiler pressure to compensate for the necessary back-pressure. The formula is

$$T = \frac{C^2 S \times 2/3 P}{D}$$

The above formulæ are for speeds of from 5 to 10 miles an hour, or less: above that the capacity of the boiler limits the cut-off which can be used, and the available tractive force is rapidly reduced as the speed increases. For a full discussion of this, see page 375 of Henderson's "Locomotive Operation."

The Size of Locomotive Cylinders is usually taken to be such that the engine will just overcome the adhesion of its wheels to the rails under favorable circumstances.

The adhesion is taken by a committee of the Am. Ry. Master Mechanics' Assn. as 0.25 of the weight on the drivers for passenger engines, 0.24 for freight, and 0.22 for switching engines: and the mean effective pressure in the cylinder, when exerting the maximum tractive force, is taken at 0.85 of the boiler-pressure.

Let W = weight on drivers in lbs.; P = tractive force in lbs., = say $0.25 W$; p_1 = boiler-pressure in lbs. per sq. in.; p = mean effective pressure, = $0.85 p_1$; d = diam. of cylinder, S = length of stroke, and D = diam. of driving-wheels, all in inches. Then

$$W = 4 P = \frac{4 d^2 p S}{D} = \frac{4 d^2 \times 0.85 p_1 S}{D}$$

Whence
$$d = 0.5 \sqrt{\frac{DW}{pS}} = 0.542 \sqrt{\frac{DW}{p_1 S}}$$

Von Borries's rule for the diameter of the low-pressure cylinder of a compound locomotive is $d^2 = 2 Z D + p h$, in which d = diameter of l.p. cylinder in inches; D = diameter of driving-wheel in inches; p = mean effective pressure per sq. in., after deducting internal machine friction; h = stroke of piston in inches; Z = tractive force required, usually 0.14 to 0.16 of the adhesion.

The value of p depends on the relative volume of the two cylinders, and from indicator experiments may be taken as follows:

Class of Engine.	Ratio of Cylinder Volumes.	p in percent of Boiler-pressure.	p for Boiler-pressure of 176 lbs.
Large-tender eng's.	1 : 2 or 1 : 2.05	42	74
Tank-engines.....	1 : 2 or 1 : 2.2	40	71

Horse-power of a Locomotive. — For each cylinder the horse-power is $H.P. = p L a N \div 33,000$, in which p = mean effective pressure, L = stroke in feet, a = area of cylinder = $1/4 \pi d^2$, N = number of single strokes per minute, $L N$ = piston speed, ft. per min. Let M = speed of train in miles per hour, S = length of stroke in inches, and D = diameter of driving-wheel in inches. Then $L N = M \times 88 \times 2 S \div \pi D$. Whence for the two cylinders the horse-power is

$$\frac{2 \times p \times 1/4 \pi d^2 \times 176 S \times M}{\pi D \times 33,000} = \frac{p d^2 S M}{375 D}$$

REVOLUTIONS PER MINUTE FOR VARIOUS DIAMETERS OF WHEELS AND SPEEDS.

Diameter of Wheel.	Miles per Hour.							
	10	20	30	40	50	60	70	80
50 in.	67	134	201	268	336	403	470	538
56 in.	60	120	180	240	300	360	420	480
60 in.	56	112	168	224	280	336	392	448
62 in.	54	108	162	217	271	325	379	433
66 in.	51	102	153	204	255	306	357	408
68 in.	49	99	148	198	247	296	346	395
72 in.	47	93	140	187	233	279	326	373
78 in.	43	86	129	172	215	258	301	344
80 in.	42	84	126	168	210	252	294	336
84 in.	40	80	120	160	200	240	280	320
90 in.	37	75	112	150	186	224	261	299

The Size of Locomotive Boilers. (Forney's Catechism of the Locomotive.) — They should be proportioned to the amount of adhesive weight and to the speed at which the locomotive is intended to work. Thus a locomotive with a great deal of weight on the driving-wheels could pull a heavier load, would have a greater cylinder capacity than one with little adhesive weight, would consume more steam, and therefore should have a larger boiler.

The weight and dimensions of locomotive boilers are in nearly all cases determined by the limits of weight and space to which they are necessarily confined. It may be stated generally that *within these limits a locomotive boiler cannot be made too large.* In other words, boilers for

Locomotives should always be made as large as is possible under the conditions that determine the weight and dimensions of the locomotives. (See also Holmes on the Steam-engine, pp. 371 to 377 and 383 to 389, and the Report of the Am. Ry. M. M. Ass'n. for 1897, pp. 218 to 232.)

Holmes gives the following from English practice:

- Evaporation, 9 to 12 lbs. of water from and at 212°.
- Ordinary rate of combustion, 65 lbs. per sq. ft. of grate per hour.
- Ratio of grate to heating surface, 1 : 60 to 90.
- Heating surface per lb. of coal burnt per hour, 0.9 to 1.5 sq. ft.

Mr. Henderson states the approximate heating surface needed per indicated horse-power as follows:

Compound Locomotives.....	2 square feet.
Simple Locomotives (cut-off 1/2 stroke or less).....	2 1/3 square feet.
Simple Locomotives (cut-off 1/2 to 3/4 stroke).....	2 2/3 square feet.
Simple Locomotives (full stroke).....	3 square feet.

For the ratio of heating surface to grate area the Master Mechanics Ass'n Committee of 1902 advised as below:

Fuel.	Passenger.		Freight.	
	Simple.	Compound.	Simple.	Compound.
Free burning bituminous.....	65 to 90	75 to 95	70 to 85	65 to 85
Average bituminous.....	50 to 65	60 to 75	45 to 70	50 to 65
Slow burning bituminous.....	40 to 50	35 to 60	35 to 45	45 to 50
Bituminous slack and free burning anthracite.....	35 to 40	30 to 35	30 to 35	40 to 45
Low grade bituminous, lignite and slow burning anthracite.....	28 to 35	24 to 30	25 to 30	30 to 40

A. E. Mitchell, (*Eng'g News*, Jan. 24, 1891) says: Square feet of boiler-heating surface for bituminous coal should not be less than 4 times the square of the diameter in inches of a cylinder 1 inch larger than the cylinder to be used. One tenth of this should be in the fire-box. On anthracite locomotives more heating-surface is required in the fire-box, on account of the larger grate-area required, but the heating-surface of the flues should not be materially decreased.

Wootten's Locomotive. (Clark's Steam-engine; see also *Jour. Frank. Inst.* 1891, and *Modern Mechanism*, p. 485.) — J. E. Wootten designed and constructed a locomotive boiler for the combustion of anthracite and lignite, though specially for the utilization as fuel of the waste produced in the mining and preparation of anthracite. The special feature of the engine is the fire-box, which is made of great length and breadth, extending clear over the wheels, giving a grate-area of from 64 to 85 sq. ft. The draught diffused over these large areas is so gentle as not to lift the fine particles of the fuel. A number of express-engines having this type of boiler are engaged on the fast trains between Philadelphia and Jersey City. The fire-box shell is 3 ft. 8 in. wide and 10 ft. 5 in. long; the fire-box is 8 X 9 1/2 ft., making 76 sq. ft. of grate-area. The grate is composed of bars and water-tubes alternately. The regular types of cast-iron shaking grates are also used. The height of the fire-box is only 2 ft. 5 in. above the grate. The grate is terminated by a bridge of fire-brick, beyond which a combustion-chamber, 27 in. long, leads to the flue-tubes, about 184 in number, 1 3/4 in. diam. The cylinders are 21 in. diam., with a stroke of 22 inches. The driving-wheels, four-coupled, are 5 ft. 8 in. diam. The engine weighs 44 tons, of which 29 tons are on driving wheels. The heating-surface of the fire-box is 135 sq. ft., that of the flue-tubes is 982 sq. ft.; together, 1117 sq. ft., or 14.7 times the grate-area. Hauling 15 passenger-cars, weighing with passengers 360 tons, at an average speed of 42 miles per hour, over ruling gradients of 1 in 89, the engine consumes 62 lbs. of fuel per mile, or 3 1/4 lbs. per sq. ft. of grate per hour.

Grate-surface, Smoke-stacks, and Exhaust-nozzles for Locomotives. — A. E. Mitchell, Supt. of Motive Power of the Erie R. R., says (1895) that some roads use the same size of stack, 13 1/2 in. diam. at throat, for all engines up to 20 in. diam. of cylinder.

The area of the orifices in the exhaust-nozzles depends on the quantity and quality of the coal burnt, size of cylinder, construction of stack, and the condition of the outer atmosphere. It is therefore impossible to give rules for computing the exact diameter of the orifices. All that can be done is to give a rule by which an approximate diameter can be found. The exact diameter can only be found by trial. Our experience leads us to believe that the area of each orifice in a double exhaust-nozzle should be equal to 1/400 part of the grate-surface, and for single nozzles 1/200 of the grate-surface. These ratios have been used in finding the diameters of the nozzles given in the following table. The same sizes are often used for either hard or soft coal-burners. [These sizes are small at the present day (1909) as locomotives have enormously increased in size.]

Size of Cylinders, in inches.	Grate-area for Anthracite Coal, in sq. in.	Grate-area for Bituminous Coal, in sq. in.	Diameter of Stacks, in inches.	Double Nozzles.	Single Nozzles.
				Diam. of Orifices, in inches.	Diam. of Orifices, in inches.
12x20	1591	1217	9 1/2	2	2 13/16
13x20	1873	1432	10 1/2	2 1/8	3
14x20	2179	1666	11 1/4	2 5/16	3 1/4
15x22	2742	2097	12 1/2	2 9/16	3 11/16
16x24	3415	2611	14	2 7/8	4 1/16
17x24	3856	2948	15	3 1/16	4 5/16
18x24	4321	3304	15 3/4	3 1/4	4 5/8
19x24	4810	3678	16 1/2	3 7/16	4 13/16
20x24	5337	4081	17 1/2	3 5/8	5 1/16

Exhaust-nozzles in Locomotive Boilers. — A committee of the Am. Ry. Master Mechanics' Ass'n. in 1890 reported that they had, after two years of experiment and research, come to the conclusion that, owing to the great diversity in the relative proportions of cylinders and boilers, together with the difference in the quality of fuel, any rule which does not recognize each and all of these factors would be worthless.

The committee was unable to devise any plan to determine the size of the exhaust-nozzle in proportion to any other part of the engine or boiler. The conditions desirable are: That it must create draught enough on the fire to make steam, and at the same time impose the least possible amount of work on the pistons in the shape of back pressure. It should be large enough to produce a nearly uniform blast without lifting or tearing the fire, and be economical in its use of fuel. The Annual Report of the Association for 1896 contains interesting data on this subject.

Much important information regarding stacks and exhaust nozzles is embodied in the tests at Purdue University, reported to the Master Mechanics' Ass'n. in 1896 and in the tests reported in the *American Engineer* in 1902 and 1903.

Fire-brick Arches in Locomotive Fire-boxes. — A committee of the Am. Ry. Master Mechanics' Ass'n. in 1890 reported strongly in favor of the use of brick arches in locomotive fire-boxes. They say: It is the unanimous opinion of all who use bituminous coal and brick arch, that it is most efficient in consuming the various gases composing black smoke, and by impeding and delaying their passage through the tubes, and mingling and subjecting them to the heat of the furnace, greatly lessens the volume ejected, and intensifies combustion, and does not in the least check but rather augments draught, with the consequent saving of fuel and increased steaming capacity that might be expected from such results. This in particular when used in connection with extension front,

Arches now (1909) are not quite so much in favor, largely on account of the difficulty and delay caused to workmen when flues must be calked, as occurs frequently in bad water districts, and some of their former advocates are now omitting them altogether.

Economy of High Pressures. — Tests of a Schenectady locomotive with cylinders 16 X 24 ins., at the Purdue University locomotive testing plant, gave results as follows: (*Eng. Digest*, Mar., 1909; Bull. No. 26, Univ. of Ill. Expt. Station).

Boiler pressure, lbs. per sq. in.	120	140	160	180	200	220	240
Steam per 1 H.P. hour, lbs.	29.1	27.7	26.8	26.	25.5	25.1	24.7
Coal per 1 H.P. hour, lbs.	4	3.77	3.59	3.50	3.43	3.37	3.31

In the same series of tests the economy of the boiler at different rates of driving and different pressures was determined, the results leading to the formula $E = 11.305 - 0.221 H$, in which $E =$ lbs. evaporated from and at 212° per lb. of Youghioghny coal, and H the equivalent evaporation per sq. ft. of heating surface per hour, with an average error for any pressure which does not exceed 2.1%.

Leading American Types of Locomotive for Freight and Passenger Service.

1. The eight-wheel or "American" passenger type, having four coupled driving-wheels and a four-wheeled truck in front.
2. The "ten-wheel" type, for mixed traffic, having six coupled drivers and a leading four-wheel truck.
3. The "Mogul" freight type, having six coupled driving-wheels and a pony or two-wheel truck in front.
4. The "Consolidation" type, for heavy freight service, having eight coupled driving-wheels and a pony truck in front.

Besides these there is a great variety of types for special conditions of service, as four-wheel and six-wheel switching-engines, without trucks: the Forney type used on elevated railroads, with four coupled wheels under the engine and a four-wheeled rear truck carrying the water-tank and fuel; locomotives for local and suburban service with four coupled driving-wheels, with a two-wheel truck front and rear, or a two-wheel truck front and a four-wheel truck rear, etc. "Decapod" engines for heavy freight service have ten coupled driving-wheels and a two-wheel truck in front.

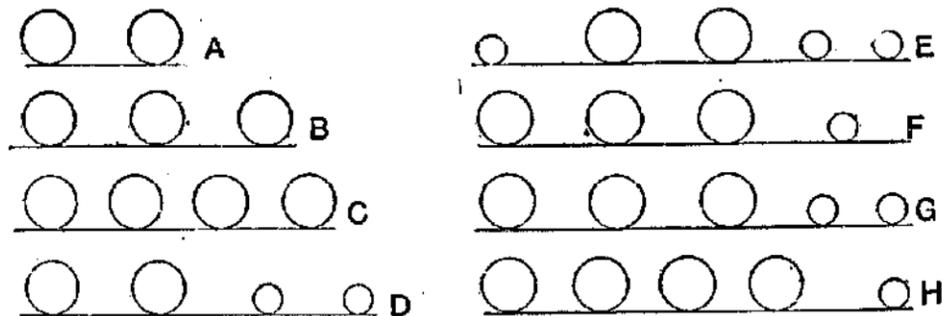

Classification of Locomotives (Penna. R. R. Co., 1900). — Class A, two pairs of drivers and no truck. Class B, three pairs of drivers and no truck. Class C, four pairs of drivers and no truck. Class D, two pairs of drivers and four-wheel truck. Class E, two pairs of drivers, four-wheel truck, and trailing wheels. Class F, three pairs of driving-wheels and two-wheel truck. Class G, three pairs of drivers and four-wheel truck. Class H, four pairs of drivers and two-wheel truck. Class A is commonly called a "four-wheeler"; B, a "six-wheeler"; D, an "eight-wheeler," or "American" type; E, "Atlantic" type; F, "Mogul"; G, "ten-wheeler"; H, "Consolidation."

Modern Classification. — The classes shown above, lettered A, B, C, etc., are commonly represented respectively by the symbols 0-4-0; 0-6-0; 0-8-0, 4-4-0; 4-4-2, 2-6-0; 4-6-0; 2-8-0; the first figure being the number of wheels in the truck, the second the driving-wheels, and the third the trailers. Other types are the "Pacific," 4-6-2; the "Prairie," 2-6-2;

WARNING: This is a 1910 edition. Some of the material may no longer be accurate

and the "Santa Fe." 2-10-2. Engines on the Mallet system, with two locomotive engines under one boiler, are classified 0-8-8-0, 2-6-6-2, etc.

Formulae for Curves. (Baldwin Locomotive Works.)
 Approximate Formula for Radius. $R = 0.7646 W \div 2 P.$
 Approximate Formula for Swing. $WT \div 2R = S.$

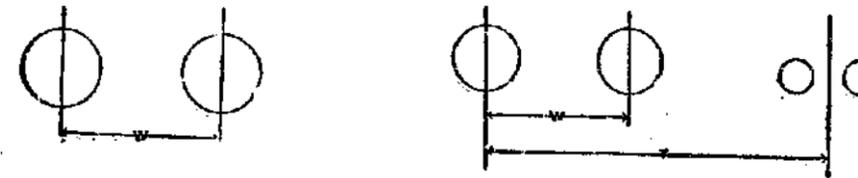

$R =$ radius of min. curve in feet.
 $P =$ play of driving-wheels in decimals of 1 ft.
 $W =$ rigid wheel-base in feet.
 $W =$ rigid wheel-base.
 $T =$ total wheel-base.
 $R =$ radius of curve.
 $S =$ swing on each side of centre.

Steam-distribution for High-speed Locomotives.

(C. H. Quecrean, *Eng'g News*, March 8, 1894.)

Balanced Valves. — Mr. Philip Wallis, in 1886, when Engineer of Tests for the C., B. & Q. R. R., reported that while 6 H.P. was required to work unbalanced valves at 40 miles per hour, for the balanced valves 2.2 H.P. only was necessary.

[Later tests were reported by the Master Mechanics' Committee in 1896. Unbalanced valves required from 3/4 to 2 1/2 per cent of the I.H.P. for their motion, balanced valves from 1/3 to 1/2 as much, and piston valves about 1/5 or 1/6. Generally in balanced valves, the area of balance = area of exhaust port + area of two bridges + area of one steam port.]

Effect of Speed on Average Cylinder-pressure. — Assume that a locomotive has a train in motion, the reverse lever is placed in the running notch, and the track is level; by what is the maximum speed limited? The resistance of the train and the load increase, and the power of the locomotive decreases with increasing speed till the resistance and power are equal, when the speed becomes uniform. The power of the engine depends on the average pressure in the cylinders. Even though the cut-off and boiler-pressure remain the same, this pressure decreases as the speed increases; because of the higher piston-speed and more rapid valve-travel the steam has a shorter time in which to enter the cylinders at the higher speed. The following table, from indicator-cards taken from a locomotive at varying speeds, shows the decrease of average pressure with increasing speed:

Miles per hour.....	46	51	51	53	54	57	60	66
Speed, revolutions.....	224	248	248	258	263	277	292	321
Average pressure per sq. in.:								
Actual.....	51.5	44.0	47.3	43.0	41.3	42.5	37.3	36.3
Calculated.....	46.5	46.5	44.7	43.8	41.6	39.5	35.9	

The "average pressure calculated" was figured on the assumption that the mean effective pressure would decrease in the same ratio that the speed increased. The main difference lies in the higher steam-line at the lower speeds, and consequent higher expansion-line, showing that more steam entered the cylinder. The back pressure and compression-lines agree quite closely for all the cards, though they are slightly better for the slower speeds. That the difference is not greater may safely be attributed to the large exhaust-ports, passages, and exhaust tip, which is 5 in. diameter. These are matters of great importance for high speeds.

Boiler-pressure. — Assuming that the train resistance increases as the speed after about 20 miles an hour is reached, that an average of 50 lbs. per sq. in. is the greatest that can be realized in the cylinders of a given engine at 40 miles an hour, and that this pressure furnishes just sufficient power to keep the train at this speed, it follows that, to increase the speed to 50 miles, the mean effective pressure must be increased in the same proportion. To increase the capacity for speed of any locomotive its power must be increased, and at least by as much as the speed is to be increased. One way to accomplish this is to increase the boiler-

pressure. That this is generally realized, is shown by the increase in boiler-pressure in the last ten years. For twenty-three single-expansion locomotives described in the railway journals this year the steam-pressures are as follows: 3, 160 lbs.; 4, 165 lbs.; 2, 170 lbs.; 13 180 lbs.; 1, 190 lbs.

Valve-travel. — An increased average cylinder-pressure may also be obtained by increasing the valve-travel without raising the boiler-pressure, and better results will be obtained by increasing both. The longer travel gives a higher steam-pressure in the cylinders, a later exhaust-opening, later exhaust-closure, and a larger exhaust-opening — all necessary for high speeds and economy. I believe that a 20-in. port and 6½-in. (or even 7-in.) travel could be successfully used for high-speed engines, and that frequently by so doing the cylinders could be economically reduced and the counter-balance lightened. Or, better still, the diameter of the drivers increased, securing lighter counterbalance and better steam-distribution.

Size of Drivers. — Economy will increase with increasing diameter of drivers, provided the work at average speed does not necessitate a cut-off longer than one fourth the stroke. The piston-speed of a locomotive with 62-in. drivers at 55 miles per hour is the same as that of one with 68-in. drivers at 61 miles per hour.

Steam-ports. — The length of steam-ports ranges from 15 in. to 23 in., and has considerable influence on the power, speed, and economy of the locomotive. In cards from similar engines the steam-line of the card from the engine with 23-in. ports is considerably nearer boiler-pressure than that of the card from the engine with 17¼-in. ports. That the higher steam-line is due to the greater length of steam-port there is little room for doubt. The 23-in. port produced 531 H.P. in an 18½-in. cylinder at a cost of 23.5 lbs. of water per I.H.P. per hour. The 17¼ in. port, 424 H.P., at the rate of 22.9 lbs. of water in a 19-in. cylinder.

Allen Valves. — There is considerable difference of opinion as to the advantage of the Allen ported-valve. (See *Eng. News*, July 6, 1893.)

A Report on the advantage of Allen valves was made by the Master Mechanics' Committee of 1896.

Speed of Railway Trains. — In 1834 the average speed of trains on the Liverpool and Manchester Railway was 20 miles an hour; in 1838 it was 25 miles an hour. But by 1840 there were engines on the Great Western Railway capable of running 50 miles an hour with a train and 80 miles an hour without. (*Trans. A. S. M. E.*, vol. xiii, 363.)

The limitation to the increase of speed of heavy locomotives seems at present to be the difficulty of counterbalancing the reciprocating parts. The unbalanced vertical component of the reciprocating parts causes the pressure of the driver on the rail to vary with every revolution. Whenever the speed is high, it is of considerable magnitude, and its change in direction is so rapid that the resulting effect upon the rail is not inappropriately called a "hammer blow." Heavy rails have been kinked, and bridges have been shaken to their fall under the action of heavily balanced drivers revolving at high speeds. The means by which the evil is to be overcome has not yet been made clear. See paper by W. F. M. Goss, *Trans. A. S. M. E.*, vol. xvi.

Much can be accomplished, however, by carefully designing and proportioning the counter-balance in the wheels and by using light, but strong, reciprocating parts. Pages 41-74 of "Locomotive Operation," gives complete rules and results.

Balanced compound locomotives, with 4 cylinders, the adjacent pistons and crossheads being connected 180° apart have also done much to reduce the disturbance of the moving parts.

Engine No. 999 of the New York Central Railroad ran a mile in 32 seconds equal to 112 miles per hour, May 11, 1893.

$$\left. \begin{array}{l} \text{Speed in} \\ \text{miles per} \\ \text{hour} \end{array} \right\} = \frac{\text{circum. of driving-wheels in in.} \times \text{no. of rev. per min.} \times 60}{63,360}$$

$$= \frac{\text{diam., of driving-wheels in in.} \times \text{no. of rev. per min.} \times .003}{\text{(approximate, giving result } \frac{8}{10} \text{ of 1 per cent too great).}}$$

Performance of a High-speed Locomotive. — The Baldwin compound locomotive No. 1027, on the Phila. & Atlantic City Ry., in 1897 made a record as follows:

For the 52 days the train ran, from July 2d to August 31st, the average time consumed on the run of 55½ miles from Camden to Atlantic City was 48 minutes, equivalent to a uniform rate of speed from start to stop of 69 miles per hour. On July 14th the run from Camden to Atlantic City was made in 46½ min., an average of 71.6 miles per hour for the total distance. On 22 days the train consisted of 5 cars and on 30 days it was made up of 6, the weight of cars being as follows: combination car, 57,200 lbs.; coaches, each, 59,200 lbs.; Pullman car, 85,500 lbs.

The general dimensions of the locomotive are as follows: cylinders, 13 and 22 X 26 in.; height of drivers, 81¼ in.; total wheel-base, 26 ft. 7 in.; driving-wheel base, 7 ft. 3 in.; length of tubes, 13 ft.; diameter of boiler, 58¾ in.; diameter of tubes, 1¾ in.; number of tubes, 278; length of fire-box, 113⅞ in.; width of fire-box, 96 in.; heating-surface of fire-box, 136.4 sq. ft.; heating-surface of tubes, 161.9 sq. ft.; total heating-surface, 1835.1 sq. ft.; tank capacity, 4000 gallons; boiler-pressure, 200 lbs. per sq. in.; total weight of engine and tender, 227,000 lbs.; weight on drivers (about), 78,600 lbs.

Fuel Efficiency of American Locomotives. — Prof. W. M. Goss, as a result of a series of tests run on the Purdue locomotive, finds the disposition of the heat developed by burning coal in a locomotive fire-box to be on the average about as shown in the following table:

Absorbed by steam in the boiler, 52 %; by the superheater, 5 %; total, 57 %. Losses: In vaporizing moisture in the coal, 5 %; discharge of CO., 1 %; high temperature of the products of combustion, 14 %; unconsumed fuel in the form of front-end cinders, 3 %; cinders or sparks passed out of the stack, 9 %; unconsumed fuel in the ash, 4 %; radiation, leakage of steam and water, etc., 7 %. Total losses, 43 %.

It is probable that these losses are considerably less than the losses which are experienced in the average locomotive in regular railway service. — (Bulletin No. 402, U.S. Geol. Survey, 1909.)

Locomotive Link Motion. — Mr. F. A. Halsey, in his work on "Locomotive Link Motion," 1898, shows that the location of the eccentric-rod pins back of the link-arc and the angular vibrations of the eccentric-rods introduce two errors in the motion which are corrected by the angular vibration of the connecting-rod and by locating the saddle-stud back of the link-arc. He holds that it is probable that the opinions of the critics of the locomotive link motion are mistaken ones, and that it comes little short of all that can be desired for a locomotive valve motion. The increase of lead from full to mid gear and the heavy compression at mid gear are both advantages and not defects. The cylinder problem of a locomotive is entirely different from that of a stationary engine. With the latter the problem is to determine the size of the cylinder and the distribution of steam to drive economically a given load at a given speed. With locomotives the cylinder is made of a size which will start the heaviest train which the adhesion of the locomotive will permit, and the problem then is to utilize that cylinder to the best advantage at a greatly increased speed, but under a greatly reduced mean effective pressure.

Negative lead at full gear has been used in the recent practice of some railroads. The advantages claimed are an increase in the power of the engine at full gear, since positive lead offers resistance to the motion of the piston; easier riding; reduced frequency of hot bearings; and a slight gain in fuel economy. Mr. Halsey gives the practice as to lead on several roads as follows, showing great diversity:

	Full Gear Forward, in.	Full Gear Back, in.	Reversing Gear, in.
New York, New Haven & Hartford	1/16 pos.	1/4 neg.	1/4 pos.
Maine Central	0	1/4 neg.
Illinois Central	1/32 pos.	abt 3/16
Lake Shore	1/16 neg.	9/64 neg.	5/16 pos.
Chicago Great Western	0	0	3/16 to 9/16
Chicago & Northwestern ..	3/16 neg.	1/4 pos.

DIMENSIONS OF SOME LARGE AMERICAN LOCOMOTIVES, 1893 AND 1904.

Of the four locomotives described in the table on the next page the first two were exhibited at the Chicago Exposition in 1893. The dimensions are from *Engineering News*, June, 1893. The first, or Decapod engine, has ten-coupled driving-wheels. It is one of the heaviest and most powerful engines built up to that date for freight service. The second is a simple engine, of the standard American 8-wheel type, 4 driving-wheels, and a 4-wheel truck in front. This engine held the world's record for speed in 1893 for short distances, having run a mile in 32 seconds.

The other two engines formed part of the exhibit of the Baldwin Locomotive Works at the St. Louis Exposition in 1904. The Santa Fe type engine has five pairs of driving-wheels, and a two-wheeled truck at the front and at the rear. It is equipped with Vaucrain tandem compound cylinders.

Dimensions of Some American Locomotives.
(Baldwin Loco. Wks., 1904-8.)

Reference Number.	Steam Pressure.	Boilers.		Tubes.			Heating Surface.		Driving Wheels	Weight, lbs.	
		Diam., ins.	Grate, sq. ft.	No.	Diam., ins.	Length, ft. in.	Fire box, sq. ft.	Tubes, sq. ft.		Diam., ins.	on Drivers
1	150	42	9	97	2	11 7	41	586	37	44,420	52,720
2	160	50	14.6	160	2	10 6	75	873	48	72,150	84,650
3	200	60	25.9	287	2	11 7	133	1733	69	83,680	124,420
4	200	62	30	272	2	16 1	136	2279	68	112,000	159,000
5	200	76	37.2	298	2 1/4	13 10	200	2414	51	164,000	179,500
6	200	68	33	306	2 1/4	14 6	195	2593	56	166,000	186,000
7	200	66	49.5	273	2 1/4	18 10	190	3015	79	101,420	191,760
8	200	70	53.5	318	2 1/4	19	195	3543	79	144,600	209,210
9	210	70	55	303	2 1/4	21	190	3772	74	151,290	230,940
10	225	78	58.5	463	2 1/4	19	210	5155	57	237,800	267,800
11	200	84	68.4	401	2 1/4	21	232	4941	57	394,150	425,900

Type and cylinder size: 1 Mogul, 13×18; 2, Mogul, 16×20; 3, American, 18×24; 4, 10-wheel balanced compound, 16×26 and 26×28; 5, Consolidation, 22×29; 6, Consolidation, 23 and 35×32; 7, Atlantic, 15 and 25×26; 8, Prairie, 17 and 28×28; 9, Pacific, 22×28; 10, Decapod, 19 and 32×32; 11, Mallet, two each 26 and 40×30.

The Mallet Compound Locomotive.—The Mallet articulated locomotive consists principally of two sets of engines flexibly connected under one boiler; the rear, which is a high-pressure engine of two cylinders, fixed rigid with the boiler and receiving the steam direct from the dome. The front or low-pressure engine, also provided with two cylinders, is capable of lateral movement to adjust itself to the curvature of the road on the same general principle as a radial truck. The high-pressure engine exhausts into a receiver flexibly connecting the cylinders of the two sets of engines, from which the low-pressure engine receives its steam supply and is exhausted from the latter through a flexible pipe to the stack. Each cylinder has its independent valve and gear connected to and operated with a common reversing rigging. By this means the tractive power can be doubled over that of the ordinary engine for a given weight of rail with a substantial saving in fuel. (See paper by C. J. Mellin, *Trans. A. S. M. E.*, 1909.)

This type of locomotive is adapted to a wider range of service than perhaps any other design. It was originally intended for narrow-gauge roads of light construction, necessitating sharp curves and steep grades, in combination with light rails. The characteristics of this design are flexibility and uniform distribution of weight combined with the use of two separate engines which would not slip at the same time, and the total weight carried on the drivers, giving great tractive power. The first engine of this class

	Baldwin. N. Y., L. E. & W. R. R. Decapod Freight.	N. Y. C. & H. R. R. Empire State Express. No. 999.	Baldwin. Santa Fe Type 2-10-2 Freight.	Baldwin. Pacific Type 4-6-2 Passenger.
Running-gear:				
Driving-wheels, diam.	50 in.	86 in.	57 in.	77 in.
Truck	30 "	40 "	29 1/4 & 40 "	33 1/2 & 45 "
Journals, driving-axes	9 × 10 in.	9 × 12 1/2 in.	11 × 12 "	10 × 12 1/2 "
" truck-	5 × 10 "	6 1/4 × 10 "	6 1/2 × 10 "	6 × 10 "
" tender-	4 1/2 × 9 "	4 1/8 × 8 "	7 1/2 × 12 " *	8 × 12 " *
Wheel-base:				
Driving	18 ft. 10 in.	8 ft. 6 in.	19 ft. 9 in.	13 ft. 4 in.
Total engine	27 " 3 "	23 " 11 "	35 " 11 "	33 " 4 "
" tender	16 " 8 "	15 " 2 1/2 "		
" eng. and tender	53 " 4 "	47 " 8 1/8 "	66 ft. 0 in.	62' 8 3/4 "
Wt. in working-order:				
On drivers	170,000 lbs.	84,000 lbs.	234,580 lbs.	141,290
On truck-wheels	29,500 "	40,000 "	52,660 "	81,230
Engine, total	192,500 "	124,000 "	287,240 "	222,520
Tender	117,500 "	80,000 "		
Eng. and tend., loaded	310,000 "	204,000 "	450,000 "	357,000
Cylinders:				
h.p. (2)	16×28 in.	19×24 in.	19×32 in.	22×28 in.
l.p. (2)	27×28 "		32×32 "	22×28 "
Piston-rod, diam.	4 in.	3 3/8 in.		
Connecting-rod, l'gth.	9' 87/16 "	8 ft. 1 1/2 in.		
Steam-ports	28 1/2 × 2 in.	1 1/2 × 18 in.	29 3/4 × 15 8/8 "	30 7/8 × 1 1/2 "
Exhaust-ports	28 1/2 × 8 "	23 1/4 × 18 "	29 3/4 × 6 3/4 "	30 7/8 × 3 "
Valves, out. lap, h.p.	7/8 in.	1 in.	7/8 in.	1 in.
" out. lap, l.p.	5/8 "		3/4 "	
" in. lap, h.p.		1/10 in.	neg. 1/4 in.	neg. 1/16 "
" in. lap, l.p.			neg. 3/8 "	
" max. travel	6 in.	5 1/2 in.	6 in.	6 in.
" lead, h.p.	1/16 in.		0	3/32 in.
" lead, l.p.	5/16 "		1/8 "	
Boiler.—Type	Straight	Wagon top	Wagon top	Straight
Diam. barrel inside	6 ft. 2 1/2 in.	4 ft. 9 in.	78 3/4 in.	70 in.
Thickness of plates	3/4 in.	9/16 in.	7/8 & 15/16 "	11/16 in.
Height from rail to center line	8 ft. 0 in.	7 ft. 11 1/2 in.		
Length of smoke-box	5 " 77/8 "	4 " 8 "		
Working pressure	180 lbs.	190 lbs.	225 lbs.	
Firebox.—type	Wootten	Buchanan		
Length inside	10' 11 9/16 "	9 ft. 6 3/8 in.	108 in.	108 in.
Width	8 ft. 2 1/8 in.	3 " 47/8 "	78 "	66 "
Depth at front	4 " 6 "	6 " 1 1/4 "	80 1/4 in.	68 "
Thickness side plates	5/16 in.	5/16 in.	78 1/4 "	64 "
" back plate	5/16 "	5/16 "	3/8 "	3/8 "
" crown-sheet	3/8 "	3/8 "	3/8 "	3/8 "
" tube sheet	1/2 "	1/2 "	3/8 "	3/8 "
Grate-area	89.6 sq. ft.	30.7 sq. ft.	9/16 "	1/2 "
Stay-bolts, 1 1/8 in. pitch	41 1/4 in.	4 in.	58.5 sq. ft.	49.5 sq. ft.
Tubes—iron	354	268	391	245
Pitch	23/4 in.			
Diam., outside	2 "	2 in.	2 1/4 in.	2 1/4 in.
Length	11 ft. 11 in.	12 ft. 0 in.	20 ft.	20 ft.
Heating-surface:				
Tubes, exterior	2,208.8 ft.	1,697 sq. ft.	4,586 sq. ft.	2,874 sq. ft.
Fire-box	234.3 "	233 "	210 "	179 "
Miscellaneous:				
Exhaust-nozzle, diam.	5 in.	3 1/2 in.		
Stack, smal'st diam.	1 ft. 6 in.	1 ft. 3 1/4 in.		
" height from rail to top	15 ft. 6 1/2 in.	14 ft. 10 in.		

WARNING: This is a 1910 edition. Some of the material may no longer be accurate

was built about 1887, and in 1909 there were approximately 500 running in Europe. They are now extensively in use in the United States for the heaviest service. The largest locomotive yet built is described in *Eng. News*, April 29, 1909. It was built by the Baldwin Locomotive Works for use on the heavy grades of the Southern Pacific R.R. The principal dimensions are as follows: Cylinders, 26 and 40 X 30 ins.; valves, balanced piston; boiler (steel): diameter, 34 ins.; thickness, 13/16 and 27/32 ins.; working pressure, 200 lbs. per sq. in.; fuel, oil; fire-tubes, 401, 2 1/4 ins. dia. X 21 ft.; firebox: length, 126 ins., width, 78 1/2 ins., depth, front, 75 1/2 ins., depth, back, 70 1/2 ins.; water spaces, 5 ins.; grate area, 68.4 sq. ft.; feed-water heater: length, 63 ins., tubes, 401, 2 1/4 ins. dia.; heating surface: firebox, 232 sq. ft., fire-tubes, 4941 sq. ft., feed-water heater tubes, 1220 sq. ft.; smokebox superheater, 655 sq. ft.; wheels: driving (16), 57 ins. O. dia., main journals, 11 X 12 ins., other journals, 10 X 12 ins.; truck (4), 30 1/2 ins. dia., journals, 6 X 10 ins.; tender (8), 33 1/2 ins. dia., journals, 6 X 11 ins.; wheelbase: driving, 39 ft. 4 ins., rigid, 15 ft., total engine, 56 ft. 7 ins., total engine and tender, 83 ft. 6 ins.; length over all, 93 ft. 6 1/2 ins.; weight: on drivers, 394,150 lbs., on front truck, 14,500 lbs., on back truck, 17,250 lbs., total engine 425,900 lbs., total engine and tender 596,000 lbs.; tender: water tank capy., 9000 gals., oil tank capy., 2850 gals.

Indicated Water Consumption of Single and Compound Locomotive Engines at Varying Speeds.

C. H. Quereau, *Eng'g News*, March 8, 1894.

Two-cylinder Compound.			Single-expansion.		
Revolutions.	Speed, miles per hour.	Water per I.H.P. per hour.	Revolutions.	Miles per Hour.	Water.
100 to 150	21 to 31	18.33 lbs.	151	31	21.70
150 to 200	31 to 41	18.9 lbs.	219	45	20.91
200 to 250	41 to 51	19.7 lbs.	253	52	20.52
250 to 275	51 to 56	21.4 lbs.	307	63	20.23
			321	66	20.01

It appears that the compound engine is the more economical at low speeds, the economy decreasing as the speed increases, and that the single engine increases in economy with increase of speed within ordinary limits, becoming more economical than the compound at speeds of more than 50 miles per hour.

The C., B. & Q. two-cylinder compound, which was about 30% less economical than simple engines of the same class when tested in passenger service, has since been shown to be 15% more economical in freight service than the best single-expansion engine, and 29% more economical than the average record of 40 simple engines of the same class on the same division.

The water rate is also affected by the cut-off: the following table gives what we should consider *very good* results in practice, though better (i.e. lower results) have occasionally been obtained. (G. R. Henderson, 1906.)

Cut-off per cent of stroke	10	20	30	40	50
Lbs. water per I.H.P. hour — simple	26	23	22	22	23
Lbs. water per I.H.P. hour — compound	18	18	18
Cut-off per cent of stroke	60	70	80	90	100
Lbs. water per I.H.P. hour — simple	24	26	29	33	38
Lbs. water per I.H.P. hour — compound	18 1/2	19 1/2	20 1/2	22 1/2	25

Indicator-tests of a Locomotive at High Speed. (*Locomotive Eng'g*, June, 1893.) — Cards were taken by Mr. Angus Sinclair on the locomotive drawing the Empire State Express.

RESULTS OF INDICATOR-DIAGRAMS.

Card No.	Revs.	Miles per hour.	I.H.P.	Card No.	Revs.	Miles per hour.	I.H.P.
1	160	37.1	648	7	304	70.5	977
2	260	60.8	728	8	296	68.8	972
3	190	44	551	9	300	69.6	1,045
4	250	58	891	10	304	70.5	1,059
5	260	60	960	11	340	78.9	1,120
6	298	69	983	12	310	71.9	1,026

The locomotive was of the eight-wheel type, built by the Schenectady Locomotive Works, with 19 X 24 in. cylinders, 78-in. drivers, and a large boiler and fire-box. Details of important dimensions are as follows: Heating-surface of fire-box, 150.8 sq. ft.; of tubes, 1670.7 sq. ft.; of boiler, 1821.5 sq. ft. Grate area, 27.3 sq. ft. Fire-box: length, 8 ft.; width, 3 ft. 4 7/8 in. Tubes, 268; outside diameter, 2 in. Ports: steam, 18 X 1 1/4 in.; exhaust, 18 X 2 3/4 in. Valve-travel, 5 1/2 in. Outside lap, 1 in.; inside lap, 1/8 in. Journals: driving-axle, 8 1/2 X 10 1/2 in.; truck-axle, 6 X 10 in.

The train consisted of four coaches, weighing, with estimated load, 340,000 lbs. The locomotive and tender weighed in working order 200,000 lbs., making the total weight of the train about 270 tons. During the time that the engine was first lifting the train into speed diagram No. 1 was taken. It shows a mean cylinder-pressure of 59 lbs. According to this, the power exerted on the rails to move the train is 6553 lbs., or 24 lbs. per ton. The speed is 37 miles an hour. When a speed of nearly 60 miles an hour was reached the average cylinder-pressure is 40.7 lbs., representing a total traction force of 4520 lbs., without making deductions for internal friction. If we deduct 10% for friction, it leaves 15 lbs. per ton to keep the train going at the speed named. Cards 6, 7, and 8 represent the work of keeping the train running 70 miles an hour. They were taken three miles apart, when the speed was almost uniform. The average cylinder-pressure for the three cards is 47.6 lbs. Deducting 10% again for friction, this leaves 17.6 lbs. per ton as the power exerted in keeping the train up to a velocity of 70 miles. Throughout the trip 7 lbs. of water were evaporated per lb. of coal. The work of pulling the train from New York to Albany was done on a coal consumption of about 3 1/8 lbs. per H.P. per hour. The highest power recorded was at the rate of 1120 H.P.

Locomotive-testing Apparatus at the Laboratory of Purdue University. (W. F. M. Goss, *Trans. A. S. M. E.*, vol. xiv, 826.) — The locomotive is mounted with its drivers upon supporting wheels which are carried by shafts turning in fixed bearings, thus allowing the engine to be run without changing its position as a whole. Load is supplied by four friction-brakes fitted to the supporting shafts and offering resistance to the turning of the supporting wheels. Traction is measured by a dynamometer attached to the draw-bar. The boiler is fired in the usual way, and an exhaust-blower above the engine, but not in pipe connection with it, carries off all that may be given out at the stack.

A Standard Method of Conducting Locomotive-tests is given in a report by a Committee of the A. S. M. E. in vol. xiv of the Transactions, page 1312.

Locomotive Tests of the Penna. R. R. Co. — Eight locomotives were tested in the dynamometer testing plant built by the P. R. R. Co. at the St. Louis Exhibition in 1903. Among the principal results obtained and conclusions derived are the following:

BOILER PERFORMANCE.

Coal per sq. ft. grate per hour, lbs.	20	40	60	80	100	120
Equiv. evap. per sq. ft. H. S. per hour	3-5	5-7.5	7-10	8.2-12	10.4-14	11.4-15.3
Coal per sq. ft. H. S. per hour	0.6	0.8	1.0	1.2	1.4	1.6
Equiv. evap. per lb. dry coal	10-11.5	9-10.5	8.2-9.7	7.7-9.1	7.1-8.5	6.6-8.1
Equiv. evap. per sq. ft. H. S. per hour	4	6	8	10	12	14
Equiv. evap. per lb. dry coal	9.7-12.1	8.8-11.3	7.8-10.5	6.8-9.6	5.8-8.8	5.5-8

The coal used in these tests was a semi-bituminous, containing 16.25% volatile combustible, 7.00% ash and 0.90% moisture.

The maximum boiler capacity ranged from 8 1/2 to more than 16 lbs. of water evaporated per hour per sq. ft. of heating surface. Little or no advantage was found in the use of Serve or ribbed tubes.

The boiler efficiency decreases as the rate of power developed increases.

Furnace losses due to excess air are no greater with large grates properly fired than with smaller ones. The boilers with small grates were inferior in capacity to those with large grates.

No special advantage is derived from large fire-box heating surface; the tube heating surface is effective in absorbing heat not taken up by the fire-box.

ENGINE PERFORMANCE.

Maximum I.H.P., four freight locomotives, 1041, 1050, 1098, 1258
 Maximum I.H.P., four passenger locomotives, 816, 945, 1622, 1641

	Kind of Locomotive.		
	Simple Freight.	Compound Freight.	Compound Passenger.
Minimum water per I.H.P. hour.....	23.67	20.26	18.86
Water per I.H.P. hr. at maximum load.....	23.83	22.03	21.39
Water per I.H.P. hr. at max. consumption...	28.95	25.31	24.41

The steam consumption of simple locomotives operating at all speeds and cut-offs commonly employed on the road falls between the limits of 23.4 and 28.3 lbs. per I.H.P. hour; compound locomotives between 18.6 and 27 lbs.; and with superheating the minimum steam consumption was reduced to 16.6 lbs. of superheated steam.

Comparing a simple and a compound locomotive, the simple engine used 40% more steam than the compound at 40 revs. per min., 27% more at 80 revs., and only 7% more at 160 revs. per min.

The frictional resistance of the engines showed an extreme variation ranging from 6 to 33% of the indicated horse-power. The frictional losses increased rapidly at speeds in excess of 160 revs. per min. It appears that the matter of machine friction is closely related to that of lubrication. With oil lubrication a stress at the draw-bar of approximately 500 lbs. is required to overcome the friction of each coupled axle, while with grease the required force is from 800 to 1100 lbs.

The lowest figures for dry coal consumed per dynamometer H.P. hour were approximately as follows:

Revs. per min.	40	80	160	240
Compound freight engine, lbs. coal	2.10	2.25	3.25
Compound freight engine, D.H.P.	500	800	800
Compound passenger engine, lbs. coal	2.8	2.3	3.0
Compound passenger engine, D.H.P.	600	900	1000

A complete report of the St. Louis locomotive tests is contained in a book of 734 pages and over 800 illustrations, published by the Penna. R.R. Co., Philadelphia, 1906. See also pamphlet on Locomotive Tests, published by Amer. Locomotive Co., New York, 1906, and *Trans. A. S. M. E.*, xxvii, 610.

Weights and Prices of Locomotives, 1885 and 1905.
 (Baldwin Loco. Wks.)

	1885					1905			
	Type.	W'gt	Price	Price per lb.		Type.	W'gt	Price	Price per lb.
American....	80,857	\$6,695	\$.0828	American.....	102,000	\$9,410	\$.092		
Mogul.....	72,800	6,662	.0912	Atlantic.....	187,200	15,750	.083		
Ten wheel...	85,000	7,583	.0892	Pacific.....	227,000	15,830	.070		
Consolidation	92,400	7,888	.0854	Ten wheel.....	156,000	13,690	.088		
				Consolidation.	192,460	14,500	.075		

The price per pound is figured from the weight of the engine in working order, without the tender.

Depreciation of Locomotives.—(Baldwin Loco. Wks.)—It is suggested that for the first five years the full second-hand value of the locomotive (75% of first cost) be taken; for the second five years 85% of this value; for the third five years, 70%; after 15 years, 50% of the second-hand value; and after 20 years, and as long as the engine remains in use, 25% of the first cost.

The Average Train Loads of 14 railroads increased from 229 tons of 2000 lbs. in 1895 to 385 tons in 1904. On the Chicago, Milwaukee & St. Paul Ry. the average load increased from 152 tons in 1895 to 281 tons in 1903, and on the Lake Shore & Michigan Southern Ry. from 318 tons in 1895 to 615 tons in 1903. In the same time the average cost of transportation per ton mile on the C., M. & St. P. Ry. decreased from 0.67 to 0.58 cent; and on the L. S. & M. S. Ry. increased from 0.39 to 0.41 cent, the decrease in cost due to heavier train loads being offset by higher cost for labor and material.

Tractive Force of Locomotives, 1893 and 1905.
 (Baldwin Loco. Wks.)

Passenger, 1893.	Weight on Driver.	Tractive Force.	Passenger, 1905.	Weight on Driver.	Tractive Force.
American, single-ex.	75,210	17,270	Atlantic, comp.....	101,420	22,180
American, comp.....	83,860	12,900	Atlantic, single-ex...	103,600	23,800
American, single-ex..	64,560	15,550	Pacific, single-ex....	141,290	29,910
American, comp.....	78,480	14,050	Pacific, single-ex....	114,390	25,610
Ten-wheel type, com.	93,850	16,480	Atlantic, single-ex...	80,930	21,740
Average.....		15,250			24,648
Freight, 1893.			Freight, 1905.		
Consolidation, comp.	120,600	21,190	Sante Fe type, comp.	234,580	62,740
Ten-wheel, single-ex..	101,000	23,310	Consol., 2-cyl. comp..	166,000	40,200
Mogul, single-ex.....	91,340	21,030	Consol., single-ex....	151,490	40,150
Decapod, compound	172,000	35,580	Consol., single-ex....	171,560	44,080
			Consol., single-ex....	165,770	45,170
Average.....		25,277			46,468

Waste of Fuel in Locomotives.—In American practice economy of fuel is necessarily sacrificed to obtain greater economy due to heavy train-loads. D. L. Barnes, in *Eng. Mag.*, June, 1894, gives a diagram showing the reduction of efficiency of boilers due to high rates of combustion, from which the following figures are taken:

Lbs. of coal per sq. ft. of grate per hour...	12	40	80	120	160	200
Per cent efficiency of boiler.....	80	75	67	59	51	43

A rate of 12 lbs. is given as representing stationary-boiler practice, 40 lbs. English locomotive practice, 120 lbs. average American, and 200 lbs. maximum American, locomotive practice.

Pages 473 and 475 of Henderson's "Locomotive Operation" give diagrams of evaporation per lb. of various kinds of coal for different rates of combustion per sq. ft. grate area and heating surface.

Advantages of Compounding.—Report of a Committee of the American Railway Master Mechanics' Association on Compound Locomotives (*Am. Mach.*, July 3, 1890) gives the following summary of the advantages gained by compounding: (a) It has achieved a saving in the fuel burnt averaging 18% at reasonable boiler-pressures, with encouraging possibilities of further improvement in pressure and in fuel and water economy. (b) It has lessened the amount of water (dead weight) to be

hauled, so that (c) the tender and its load are materially reduced in weight. (d) It has increased the possibilities of speed far beyond 60 miles per hour, without unduly straining the motion, frames, axles, or axle-boxes of the engine. (e) It has increased the haulage-power at full speed, or, in other words, has increased the continuous H.P. developed, per given weight of engine and boiler. (f) In some classes has increased the starting-power. (g) It has materially lessened the slide-valve friction per H.P. developed. (h) It has equalized or distributed the turning force on the crank-pin, over a longer portion of its path, which, of course, tends to lengthen the repair life of the engine. (i) In the two-cylinder type it has decreased the oil consumption, and has even done so in the Woolf four-cylinder engine. (j) Its smoother and steadier draught on the fire is favorable to the combustion of all kinds of soft coal; and the sparks thrown being smaller and less in number, it lessens the risk to property from destruction by fire. (k) These advantages and economies are gained without having to improve the man handling the engine, less being left to his discretion (or careless indifference) than in the simple engine. (l) Valve-motion, of every locomotive type, can be used in its best working and most effective position. (m) A wider elasticity in locomotive design is permitted: as, if desired, side-rods can be dispensed with, or articulated engines of 100 tons weight, with independent trucks, used for sharp curves on mountain service, as suggested by Mallet and Brunner.

Of 27 compound locomotives in use on the Phila. and Reading Railroad (in 1892), 12 are in use on heavy mountain grades, and are designed to be the equivalent of 22 X 24 in. simple consolidations; 10 are in somewhat lighter service and correspond to 20 X 24 in. consolidations; 5 are in fast passenger service. The monthly coal record shows:

Class of Engine.	No.	Gain in Fuel Economy.
Mountain locomotives.....	12	25% to 30%
Heavy freight service.....	10	12% to 17%
Fast passenger.....	5	9% to 11%

(Report of Com. A. R. M. M. Assn. 1892.) For a description of the various types of compound locomotive, with discussion of their relative merits, see paper by A. Von Borries, of Germany, the Development of the Compound Locomotive, *Trans. A. S. M. E.*, 1893, vol. xiv, p. 1172.

As a rule compounds cost considerably more for repairs, and require a better class of engineers and machinists to obtain satisfactory results. (Henderson.)

Balanced Compound Locomotives.—There are two high-pressure cylinders placed between the frames and two low-pressure cylinders outside. The inside crank shaft has cranks 90° apart, and each outside crank pin is 180° from the inside crank pin on the same side, so that the engine on each side is perfectly balanced. The balanced piston valve is so made that high-pressure steam may be admitted to the low-pressure cylinder for starting. See circular of the Baldwin Loco. Wks., No. 62, 1907.

Superheating in Locomotives. (*R. R. Age Gazette*, Nov. 20, 1903.)—Superheating steam in locomotives has been found to effect a saving of 10 to 15% in the fuel consumption of a locomotive, and 8 to 12% of the water used, or with the same fuel to increase the horse-power and the tractive force. The Baldwin Locomotive Works builds a superheater in the smoke-box, where it utilizes part of the heat of the waste gases in drying the steam and superheating it 50 to 100° F. The heating surface of the superheater is from 12 to 22% of the heating surface in the tubes and fire-box of the boiler. It is recommended to use a boiler pressure of about 160 lbs. when a superheater is used, and to have cylinders of larger dimensions than when ordinary steam is used, and to have cylinders of larger dimensions than when ordinary steam of 200 lbs. pressure is used. For an illustrated and historical description of the use of superheating in locomotives, see paper by H. H. Vaughan, read before the Am. Ry. Mast. Mechs. Assn., *Eng. News*, June 22, 1905.

Counterbalancing Locomotives.—Rules for counterbalancing, adopted by different locomotive-builders, are quoted in a paper by Prof. Lanza (*Trans. A. S. M. E.*, x, 302.) See also articles on Counterbalancing Locomotives, in *R. R. & Eng. Jour.*, March and April, 1890; *Trans. A. S. M. E.*, vol. xvi, 305; and *Trans. Am. Ry. Master Mechanics' Assn.*,

1897. W. E. Dalby's book on the "Balancing of Engines" (Longmans, Green & Co., 1902) contains a very full discussion of this subject. See also Henderson's "Locomotive Operation" (*The Railway Age*, 1904).

Narrow-gauge Railways in Manufacturing Works.—A tramway of 18 inches gauge, several miles in length, is in the works of the Lancashire and Yorkshire Railway. Curves of 13 feet radius are used. The locomotives used have the following dimensions (*Proc. Inst. M. E.*, July, 1888): The cylinders are 5 in. in diameter with 6 in. stroke, and 2 ft. 3 1/4 in. centre to centre. Wheels 16 1/4 in. diameter, the wheel-base 2 ft. 9 in.; the frame 7 ft. 4 1/4 in. long, and the extreme width of the engine 3 feet. Boiler, of steel, 2 ft. 3 in. outside diam. and 2 ft. long between tube-plates, containing 55 tubes of 1 3/8 in. outside diam.; fire-box, of iron and cylindrical, 2 ft. 3 in. long and 17 in. inside diam. Heating-surface 10.42 sq. ft. in the fire-box and 36.12 in the tubes, total 46.54 sq. ft.; grate-area, 1.78 sq. ft.; capacity of tank, 26 1/2 gallons; working-pressure, 170 lbs. per sq. in. tractive power, say, 1412 lbs., or 9.22 lbs. per lb. of effective pressure per sq. in., on the piston. Weight, empty, 2.80 tons; full and in working order, 3.19 tons.

For description of a system of narrow-gauge railways for manufacturing, see circular of the C. W. Hunt Co., New York.

Light Locomotives.—For dimensions of light locomotives used for mining, etc., and for much valuable information concerning them, see catalogue of H. K. Porter Co., Pittsburgh.

Petroleum-burning Locomotives. (From Clark's Steam-engine.)—The combustion of petroleum refuse in locomotives has been successfully practised by Mr. Thos. Urquhart, on the Grazi and Tsaritsin Railway, Southeast Russia. Since November, 1894, the whole stock of 143 locomotives under his superintendence has been fired with petroleum refuse. The oil is injected from a nozzle through a tubular opening in the back of the fire-box, by means of a jet of steam, with an induced current of air.

A brickwork cavity or "regenerative or accumulative combustion-chamber" is formed in the fire-box, into which the combined current breaks as spray against the rugged brickwork slope. In this arrangement the brickwork is maintained at a white heat, and combustion is complete and smokeless. The form, mass, and dimensions of the brickwork are the most important elements in such a combination.

Compressed air was tried instead of steam for injection, but no appreciable reduction in consumption of fuel was noticed.

The heating-power of petroleum refuse is given as 19,832 heat-units, equivalent to the evaporation of 20.53 lbs. of water from and at 212° F., or to 17.1 lbs. at 8 1/2 atmospheres, or 125 lbs. per sq. in., effective pressure. The highest evaporative duty was 14 lbs. of water under 8 1/2 atmospheres per lb. of the fuel, or nearly 82% efficiency.

There is no probability of any extensive use of petroleum as fuel for locomotives in the United States, on account of the unlimited supply of coal and the comparatively limited supply of petroleum. Texas and California oils are now (1902) used in locomotives of the Southern Pacific Railway and the Santa Fé System.

Self-propelled Railway Cars.—The use of single railway cars containing a steam or gasoline motor has become quite common in Europe. For a description of different systems see a paper on European Railway Motor Cars by B. D. Gray in *Trans. A. S. M. E.*, 1907.

Fireless Locomotive.—The principle of the Franco locomotive is that it depends for the supply of steam on its spontaneous generation from a body of heated water in a reservoir. As steam is generated and drawn off the pressure falls; but by providing a sufficiently large volume of water heated to a high temperature, at a pressure correspondingly high, a margin of surplus pressure may be secured, and means may thus be provided for supplying the required quantity of steam for the trip.

The fireless locomotive designed for the service of the Metropolitan Railway of Paris has a cylindrical reservoir having segmental ends, about 5 ft. 7 in. in diameter, 26 1/4 ft. in length, with a capacity of about 620 cubic feet. Four-fifths of the capacity is occupied by water, which is heated by the aid of a powerful jet of steam supplied from stationary boilers. The water is heated until equilibrium is established between the boilers and the reservoir. The temperature is raised to about 390° F., corresponding to 225 lbs. per sq. in. The steam from the reservoir is

passed through a reducing-valve, by which the steam is reduced to the required pressure. It is then passed through a tubular superheater situated within the receiver at the upper part, and thence through the ordinary regulator to the cylinders. The exhaust-steam is expanded to a low pressure, in order to obviate noise of escape. In certain cases the exhaust-steam is condensed in closed vessels, which are only in part filled with water.

In working off the steam from a pressure of 225 lbs. to 57 lbs., 530 cubic feet of water at 390° F. is sufficient for the traction of the trains, for working the circulating-pump for the condensers, for the brakes, and for electric-lighting of the train. At the stations the locomotive takes from 2200 to 3300 lbs. of steam — nearly the same as the weight of steam consumed during the run between two consecutive charging stations. There is 210 cubic feet of condensing water. Taking the initial temperature at 60° F., the temperature rises to about 180° F. after the longest runs underground.

The locomotive has ten wheels, on a base 24 ft long, of which six are coupled, 4½ ft. in diameter. The extreme wheels are on radial axles. The cylinders are 23½ in. in diameter, with a stroke of 23½ in.

The engine weighs, in working order, 53 tons, of which 35 tons are on the coupled wheels. The speed varies from 15 miles to 25 miles per hour. The trains weigh about 140 tons.

Compressed-air Locomotives. — A compressed-air locomotive consists essentially of a storage tank mounted upon driving wheels, with two engines similar to those of a steam locomotive. One or more reservoirs or storage tanks are located on the line, from which the locomotive tank is charged. These reservoirs are usually riveted steel cylinders, designed for about 1000 lbs. working pressure; but sometimes seamless steel cylinders of small diameter, designed for a working pressure of 2000 lbs. or upwards, are used. The customary maximum pressure in the locomotive tank is 500 lbs. gauge, and the working pressure in the cylinders is from 130 to 140 lbs. The following table is condensed from one in a circular of the Baldwin Locomotive Works, No. 43, 1934.

See account of the Mekarski compressed-air locomotives, page 624 ante.

DIMENSIONS AND TRACTIVE POWER OF FOUR COUPLED COMPRESSED-AIR LOCOMOTIVES HAVING TWO STORAGE TANKS.

Class.....	4-4-C	4-6-C	4-8-C	4-10-C	4-12-C	4-16-C	4-18-C
Cylinders, inches....	5×10	6×10	7×12	8×14	9×14	11×14	12×16
Diam. of drivers.....	22"	24"	24"	26"	28"	28"	30"
Wheel base.....	4' 0"	4' 3"	4' 6"	5' 3"	5' 5"	5' 6"	6' 0"
Approx. weight, lbs..	10,000	14,000	18,000	23,000	27,000	37,000	44,000
Inside dia. of tanks..	26"	28"	30"	32"	34"	38"	40"
Aggregate tank vol., cu. ft.....	75	100	130	170	200	280	320
App. height.....	4' 5"	4' 10"	5' 0"	5' 4"	5' 8"	6' 0"	6' 4"
App. width over tanks.....	4' 10"	5' 2"	5' 6"	5' 10"	6' 3"	7' 0"	7' 4"
App. width over cylinders.....	Gauge +24"	Gauge +26"	Gauge +27"	Gauge +28"	Gauge +30"	Gauge +32"	Gauge +33"
App. length over bumpers.....	12' 0"	14' 0"	15' 0"	17' 0"	18' 0"	20' 0"	20' 6"
Tractive Power Full stroke.....	1350	1785	2915	4100	4820	7200	9140
¾ Stroke cut-off	1290	1700	2780	3900	4580	6860	8705
½ Stroke cut-off	940	1240	2025	2840	3345	4995	6340
¼ Stroke cut-off	510	670	1100	1540	1815	2710	3440

Draw-bar pull on any grade = tractive power - (.0075 + % of grade) × weight of engine.

Working pressure in cylinders 140 lbs.; tank storage pressure, 800 lbs. Other sizes of engines are 5½ × 10 in., 6 × 12 in., and 8 × 12 in., 24-in. diam. of drivers; 9 × 14 in., 26-in. drivers, and 10 × 14 in., 28-in. drivers.

WARNING: This is a 1910 edition. Some of the material may no longer be accurate

CUBIC FEET OF AIR, AT DIFFERENT STORAGE PRESSURES, REQUIRED TO HAUL ONE TON ONE MILE AT HALF STROKE CUT-OFF, WITH 20, 30 AND 40 LBS. FRICTIONAL RESISTANCE PER TON. (Baldwin Loco. Wks.)

Storage pressure Cylinder working pressure.....	600			700			800			600			700			800			
	130	135	140	130	135	140	130	135	140	130	135	140	130	135	140	130	135	140	
Grade.	R	V	V	V	R	V	V	V	R	V	V	V	R	V	V	V	R	V	V
Level.....	20.0	1.16	0.99	0.87	30.0	1.74	1.50	1.31	40.0	2.33	1.99	1.74	2.33	1.99	1.74	2.33	1.99	1.74	1.74
1½ %.....	31.2	1.81	1.56	1.36	41.2	2.40	2.05	1.79	51.2	2.98	2.56	2.23	2.98	2.56	2.23	2.98	2.56	2.23	2.23
1 %.....	42.4	2.47	2.12	1.85	52.4	3.05	2.61	2.28	62.4	3.64	3.11	2.73	3.64	3.11	2.73	3.64	3.11	2.73	2.73
2 %.....	64.8	3.78	3.24	2.83	74.8	4.35	3.73	3.26	84.8	4.94	4.24	3.70	4.94	4.24	3.70	4.94	4.24	3.70	3.70
3 %.....	87.2	5.08	4.35	3.81	97.2	5.67	4.86	4.25	107.2	6.25	5.35	4.69	6.25	5.35	4.69	6.25	5.35	4.69	4.69
4 %.....	109.6	6.39	5.48	4.79	119.6	6.97	5.97	5.22	129.6	7.56	6.47	5.67	7.56	6.47	5.67	7.56	6.47	5.67	5.67
5 %.....	132.0	7.69	6.60	5.77	142.0	8.27	7.09	6.20	152.0	8.86	7.60	6.64	8.86	7.60	6.64	8.86	7.60	6.64	6.64

R = resistance per ton of 2240 lbs. in pounds. V = cubic feet of air.

Air Locomotives with Compound Cylinders and Atmospheric Interheaters are built by H. K. Porter Co. The air enters the high-pressure cylinder at 250 lbs. gauge pressure and is expanded down to 50 lbs., overcoming resistance, while the temperature drops about 140° F. This loss of heat is practically all restored in the atmospheric interheater, which is a cylindrical reservoir filled with brass tubes located in the passage-way from the high- to the low-pressure cylinder. The air enters the low-pressure cylinder at 50 lbs. gauge and a temperature within 10 or 20° of that of the surrounding atmosphere. The exhaust is used to induce a draught of atmospheric air through the tubes of the interheater. This combination permits of expanding the air from 250 lbs. down to atmosphere without unmanageable refrigeration.

The following calculation shows the relative economy of a single-cylinder locomotive using air at 150 lbs. and of a compound using air at 250 lbs. in the high-pressure and 50 lbs. in the low-pressure cylinder, non-expansive working being assumed in both cases.

11.2 cu. ft. of free air at 150 lbs. gauge and atmospheric temperature would fill a cylinder of 1 cu. ft. capacity, and in moving a piston of 1 sq. ft. area one foot would develop 144 × 150 = 21,600 ft. lbs. of energy.

11.2 cu. ft. of free air at 250 lbs. gauge if used in a cylinder 0.623 sq. ft. area and 1 ft. stroke would develop 0.623 × 144 × 250 = 22,425 ft. lbs.

If expanded in two cylinders with a ratio of 4 to 1 the energy developed would be 0.623 × 144 × 200 plus 4 × 0.623 × 144 × 50 = 35,880 ft. lbs., if the heat is restored between the two cylinders. Gain by compounding with interheating, over simple cylinders with 150 lbs. initial pressure, 35,880 ÷ 21,600 = 1.66.

These results are about the best that can be obtained with either simple or compound locomotives, as any improvement due to expansive working just about balances the losses due to clearance and initial refrigeration. The work done per cubic foot of free air in the two systems is: with simple cylinders, 21,600 ÷ 11.2 = 1840 ft. lbs.; with compound cylinders and atmospheric interheater, 35,880 ÷ 11.2 = 3205 ft. lbs.

The above calculations have been practically confirmed by actual tests, which show 1900 ft. lbs. of work per cubic foot of free air with the simple locomotive and 3000 ft. lbs. with the compound, the gain due to expansive working and the losses due to internal friction being somewhat greater in the compound than in the simple machine.

In the operation of compressed-air locomotives the air compressor is generally delivering compressed air at a pressure fluctuating between 800 and 1000 lbs. per sq. in. into the storage reservoir, and it requires an average of about 12,000 ft. lbs. per cubic foot of free air to compress and deliver it at these pressures. The efficiency of the two systems then is: 1900 ÷ 12000 = 16% for the simple locomotive, and 3000 ÷ 12000 = 25% for the compound with atmospheric interheater.

SHAFTING.

(See also TORSIONAL STRENGTH; also SHAFTS OF STEAM ENGINES.)
 For shafts subjected to torsion only, let d = diam. of the shaft in ins.,
 P = a force in lbs. applied on a lever arm at a distance = a ins. from
 the axis, S = shearing resistance at the outer fiber, in lbs. per sq. in., then

$$Pa = \frac{\pi d^3 S}{16} = \frac{d^3 S}{5.1} = 0.1936 d^3 S; \quad d = \sqrt[3]{\frac{5.1 Pa}{S}} = \sqrt[3]{\frac{Pa}{K}}$$

If R = revolutions per minute, then the horse-power transmitted =

$$\text{H.P.} = \frac{Pa \cdot 2 \pi R}{33,000 \times 12} = \frac{\pi d^3 S \times 2 \pi R}{16 \times 33,000 \times 12} = \frac{RSd^3}{321,000};$$

$$d = \sqrt[3]{\frac{321,000 \text{ H.P.}}{RS}} = \sqrt[3]{\frac{C \times \text{H.P.}}{R}}$$

In practice, empirical values are given to S and to the coefficients
 $K = 5.1/S$ and $C = 321,000/S$, according to the factor of safety assumed,
 depending on the material, on whether the shaft is subjected to steady,
 fluctuating, bending, or reversed strains, on the distance between bear-
 ings, etc. Kimball and Barr (Machine Design) state that the following
 factors of safety are indicated by successful practice: For head shafts,
 15; for line shafts carrying pulleys, 10; for small short shafts, counter-
 shafts, etc., 7. For steel shafting the allowable stress, S , for the above
 factors would be about 4000, 6000 and 8500 lbs. respectively, whence

for head shafts $d = \sqrt[3]{\frac{80 \text{ H.P.}}{R}}$; for line shafts $d = \sqrt[3]{\frac{53 \text{ H.P.}}{R}}$; for short
 shafts $d = \sqrt[3]{\frac{38 \text{ H.P.}}{R}}$

Jones & Laughlin Steel Co. gives the following for steel shafts:

	Turned.	Cold-rolled.
For simply transmitting power and short countershafts, bear- ings not more than 8 ft. apart	H.P. = $d^3 R \div 50$	H.P. = $d^3 R \div 40$
As second movers, or line shafts, bearings 8 ft. apart	H.P. = $d^3 R \div 90$	H.P. = $d^3 R \div 70$
As prime movers or head shafts carrying main driving pulley or gear, well supported by bearings	H.P. = $d^3 R \div 125$	H.P. = $d^3 R \div 100$

Jones & Laughlins give the following notes: Receiving and transmit-
 ting pulleys should always be placed as close to bearings as possible;
 and it is good practice to frame short "headers" between the main tie-
 beams of a mill so as to support the *main receivers*, carried by the head
 shafts, with a bearing close to each side as is contemplated in the for-
 mula. But if it is preferred, or necessary, for the shaft to span the full
 width of the "bay" without intermediate bearings, or for the pulley to
 be placed away from the bearings towards or at the middle of the bay,
 the size of the shaft must be largely increased to secure the *stiffness*
 necessary to support the load without undue deflection.

Diameter of shaft D to carry load at center of bays from 2 to 12 ft.
 span, $D = \sqrt[3]{\frac{c}{c_1}} d$, in which d is the diameter derived from the formula
 for head shafts, c_1 = length of bay in inches, and c = distance in inches
 between centers of bearings in accordance with the formula for horse-

power of head shafts. (Jones & Laughlin Steel Co.) Values of c_1 for
 different diameters d are as follows:

d	c_1	d	c_1	d	c_1	d	c_1	d	c_1	d	c_1
1 to 1 3/8	15	2 1/8 to 3	25	3 1/8 to 4	37	5 1/4 & 5 3/8	55	6 3/8	71	7 3/8	88
1 1/8 & 1 3/4	16	2 7/8 to 3	26	4 3/8 to 4	40	5 1/2	57	6 1/2	73	7 1/2	91
1 3/8 & 1 7/8	17	3 1/8 to 3 1/4	28	4 1/4	41	5 5/8	59	6 5/8	75	7 5/8	93
1 5/8 to 2 1/8	18	3 3/8	30	4 7/8 to 4 1/2	44	5 3/4	61	6 3/4	77	7 3/4	96
2 3/8 & 2 1/4	19	3 7/8 & 3 1/2	31	4 3/4	47	5 7/8	63	6 7/8	79	7 7/8	99
2 5/8 to 2 7/8	20	3 9/8 & 3 5/8	33	4 13/16	49	6	65	7	81	8	101
2 1/2 to 2 5/8	24	3 11/16 & 3 3/4	34	5	51	6 1/8	67	7 1/8	84	8 1/2	112
2 11/16 & 2 3/4	22	3 7/8	36	5 1/8	52	6 1/4	69	7 1/4	86	9	123

Should the load be applied near one end of the span or bay instead of
 at the center, multiply the fourth power of the diameter of the shaft
 required to carry the load at the center of the span or bay by the prod-
 uct of the two parts of the shaft when the load is near one end, and
 divide this product by the product of the two parts of the shaft when
 the load is carried at the center. The fourth root of this quotient will
 be the diameter required.

The shaft in a line which carries a receiving-pulley, or which carries a
 transmitting-pulley to drive another line, should always be considered a
 head-shaft, and should be of the size given by the rules for shafts carrying
 main pulleys or gears.

The greatest admissible distance between bearings of shafts subject to
 no transverse strain except from their own weight is for cold-rolled shafts,
 $L = \sqrt[3]{330,608 \times D^2}$, and for turned shafts, $L = \sqrt[3]{319,586 \times D^2}$. D =
 diam. and L = length of shaft, in inches. These formulæ are based on
 an allowable deflection at the center of 1/80 in. per foot of length, weight
 of steel 490 lbs. per cu. ft., and modulus of elasticity = 29,000,000 for
 turned and 30,000,000 for cold-rolled shafting. [In deriving these formulæ
 the weight of the shaft has been taken as a concentrated instead of a dis-
 tributed load, giving additional safety.]

Kimball and Barr say that the lateral deflection of a shaft should not
 exceed 0.01 in. per 100 ft. of length, to insure proper contact at the bear-
 ings. For ordinary small shafting they give the following as the allow-
 able distance between the hangers: $L = 7 \sqrt[3]{d^2}$, for shaft without pulleys;

$$L = 5 \sqrt[3]{d^2}, \text{ for shaft carrying pulleys. } (L \text{ in ft., } d \text{ in ins.})$$

Deflection of Shafting. (Pencoyd Iron Works.) — For continuous
 line-shafting it is considered good practice to limit the deflection to a
 maximum of 1/100 of an inch per foot of length. The weight of bare shaft-
 ing in pounds = $2.6 d^2 L = W$, or when as fully loaded with pulleys as is
 customary in practice, and allowing 40 lbs. per inch of width for the
 vertical pull of the belts, experience shows the load in pounds to be about
 $13 d^2 L = W$. Taking the modulus of transverse elasticity at 26,000,000
 lbs., we derive from authoritative formulæ the following:

$$L = \sqrt[3]{873 d^2}, \quad d = \sqrt{L^3/873}, \text{ for bare shafting;}$$

$$L = \sqrt[3]{175 d^2}, \quad d = \sqrt{L^3/175}, \text{ for shafting carrying pulleys, etc.}$$

L being the maximum distance in feet between bearings for continuous
 shafting subjected to bending stress alone. d = diam. in inches.

The torsional stress is inversely proportional to the velocity of rota-
 tion, while the bending stress will not be reduced in the same ratio. It
 is therefore impossible to write a formula covering the whole problem
 and sufficiently simple for practical application, but the following rules
 are correct within the range of velocities usual in practice.

For continuous shafting so proportioned as to deflect not more than

1/100 of an inch per foot of length, allowance being made for the weakening effect of key-seats,

$$d = \sqrt[3]{50 \text{ H.P.} \div R}, L = \sqrt{720 d^2}, \text{ for bare shafts;}$$

$$d = \sqrt[3]{70 \text{ H.P.} \div R}, L = \sqrt{140 d^2}, \text{ for shafts carrying pulleys, etc.}$$

d = diam. in inches, L = length in feet, R = revs. per min.

The following are given by J. B. Francis as the greatest admissible distances between the bearings of continuous steel shafts subject to no transverse strain except from their own weight, as would be the case were the power given off from the shaft equal on all sides, and at an equal distance from the hanger-bearings.

Diam. of shaft, in.	2	3	4	5	6	7	8	9
Dist. bet. bearings, ft.	15.9	18.2	20.0	21.6	22.9	24.1	25.2	26.2

These conditions, however, do not usually obtain in the transmission of power by belts and pulleys, and the varying circumstances of each case render it impracticable to give any rule which would be of value for universal application.

For example, the theoretical requirements would demand that the bearings be nearer together on those sections of shafting where most power is delivered from the shaft, while considerations as to the location and desired contiguity of the driven machines may render it impracticable to separate the driving-pulleys by the intervention of a hanger at the theoretically required location. (Joshua Rose.)

Horse-Power Transmitted by Cold-rolled Steel Shafting at Different Speeds as Prime Movers or Head Shafts Carrying Main Driving Pulley or Gear, well Supported by Bearings.

$$\text{Formula H.P.} = d^3 R \div 100.$$

Diam.	Revolutions per minute.					Diam.	Revolutions per minute.				
	100	200	300	400	500		100	200	300	400	500
1 1/2	3.4	6.7	10.1	13.5	16.9	2 7/8	24	48	72	95	119
1 5/8	3.8	7.6	11.4	15.2	19.0	2 15/16	25	51	76	101	127
1 3/4	4.3	8.6	12.8	17.1	21	3	27	54	81	108	135
1 11/16	4.8	9.6	14.4	19.2	24	3 1/8	31	61	91	122	152
1 3/4	5.4	10.7	16.1	21	27	3 3/16	32	65	97	129	162
1 13/16	5.9	11.9	17.8	24	30	3 1/4	34	69	103	137	172
1 7/8	6.6	13.1	19.7	26	33	3 3/8	38	77	115	154	192
1 15/16	7.3	14.5	22	29	36	3 7/16	41	81	122	162	203
2	8.0	16.0	24	32	40	3 1/2	43	86	128	171	214
2 1/16	8.8	17.6	26	35	44	3 9/16	45	90	136	180	226
2 1/8	9.6	19.2	29	38	48	3 5/8	48	95	143	190	238
2 3/16	10.5	21	31	42	52	3 11/16	50	100	150	200	251
2 1/4	11.4	23	34	45	57	3 3/4	55	105	158	211	264
2 7/16	12.4	25	37	49	62	3 7/8	58	116	174	233	291
2 3/8	13.4	27	40	54	67	3 15/16	61	122	183	244	305
2 7/16	14.5	29	43	58	72	4	64	128	192	256	320
2 1/2	15.6	31	47	62	78	4 3/16	74	147	221	294	367
2 9/16	16.8	34	50	67	84	4 1/4	77	154	230	307	383
2 5/8	18.1	36	54	72	90	4 7/16	88	175	263	350	438
2 11/16	19.4	39	58	77	97	4 1/2	91	182	273	365	456
2 3/4	21	41	62	83	104	4 3/4	107	214	322	429	537
2 13/16	22	44	67	89	111	5	125	250	375	500	625

For H.P. transmitted by turned steel shafts, as prime movers, etc., multiply the figures by 0.8.

For shafts, as second movers or line shafts, bearings 8 ft. apart, multiply by	Cold-rolled	Turned
For simply transmitting power, short counter-shafts, etc., bearings not over 8 ft. apart, multiply by	1.43	1.11
	2	2.50

The horse-power is directly proportional to the number of revolutions per minute.

SPEED OF SHAFTING. —

Machine shops	120 to 240
Wood-working	250 to 300
Cotton and woollen mills . .	300 to 400

Flange Couplings. — The bolts should be designed so that their combined resistance to a torsional moment around the axis of the shaft is at least as great as the torsional strength of the shaft itself; and the bolts should be accurately fitted so as to distribute the load evenly among them. Let D = diam. of the shaft, d = diam. of the bolts, r = radius of bolt circle, in inches, n = number of bolts, S = allowable shearing stress per sq. in., then $\pi d^3 S \div 16 = 1/4 \pi d^2 r S$, whence $d = 0.5 \sqrt{D^3 / (nr)}$. Kimball and Barr give $n = 3 + D/2$, but this number may be modified for convenience in spacing, etc.

Effect of Cold Rolling. — Experiments by Prof. R. H. Thurston in 1902 on hot-rolled and cold-rolled steel bars (Catalogue of Jones & Laughlin Steel Co.) showed that the cold-rolled steel in tension had its elastic limit increased 15 to 97%; tensile strength increased 20 to 45%; ductility decreased 40 to 69%. In transverse tests the resistance increased 11 to 30% at the elastic limit and 13 to 69% at the yield point. In torsion the resistance at the yield point increased 31 to 64%, and at the point of fracture it decreased 4 to 10%. The angle of torsion at the elastic limit increased 59 to 103%, while the ultimate angle decreased 19 to 28%. Bars turned from 1 3/4 in. diam. to various sizes down to 0.35 in. showed that the change in quality produced by cold rolling extended to the center of the bar. The maximum strength of the cold-rolled bar of full size was 82,200 lbs. per sq. in., and that of the smallest bar 73,600 lbs. In the hot-rolled steel bars the maximum strength of full-sized bar was 62,900 lbs. and that of the smallest bar 58,600 lbs. per sq. in.

Hollow Shafts. — Let d be the diameter of a solid shaft, and d_1, d_2 the external and internal diameters of a hollow shaft of the same material. Then the shafts will be of equal torsional strength when $d^3 = \frac{d_1^4 - d_2^4}{d_1}$.

A 10-inch hollow shaft with internal diameter of 4 inches will weigh 16% less than a solid 10-inch shaft, but its strength will be only 2.56% less. If the hole were increased to 5 inches diameter the weight would be 25% less than that of the solid shaft, and the strength 6.25% less.

Table for Laying Out Shafting. — The table on the opposite page (from the *Stevens Indicator*, April, 1892) is used by Wm. Sellers & Co. to facilitate the laying out of shafting.

The wood-cuts at the head of this table show the position of the hangers and position of couplings, either for the case of extension in both directions from a central head-shaft or extension in one direction from that head-shaft.

Sizes of Collars for Shafting, Wm. Sellers & Co., *Am. Mach.* Jan. 28, 1897. — D , diam. of collar; T , thickness; d , diam. of set screw; l , length. All in inches.

LOOSE COLLARS.

Shaft	D	T	d	l	Shaft	D	T	d	l	Shaft	D	t	d	l
1	1 3/4	3/4	7/16	5/16	2 1/4	3 3/8	1 3/16	5/8	5/8	4	5 13/16	1 7/8	3/4	1
1 1/4	1 7/8	13/16	7/16	3/8	2 1/2	3 3/4	1 1/4	5/8	1 1/8	4 1/2	6 7/16	1 7/8	3/4	1
1 1/2	2 1/4	1 5/16	7/16	7/16	2 3/4	4	1 5/16	5/8	1 1/16	5	6 15/16	1 7/8	3/4	1
1 5/8	2 5/8	1	7/16	7/16	3	4 1/2	1 7/16	5/8	1 3/16	5 1/2	7 1/2	2	3/4	1
1 3/4	2 3/4	1 1/16	1/2	9/16	3 1/4	4 7/8	1 5/8	3/4	1 3/16	6	8	2	3/4	1
2	3	1 1/8	5/8	9/16	3 1/2	5 3/16	1 3/4	3/4	1 5/16					

FAST COLLARS.

Shaft	D	T	Shaft	D	T	Shaft	D	T	Shaft	D	T
1 1/2	2	1/2	2 1/2	3 1/4	9/16	3 1/2	4 5/8	7/8	5 1/2	7 5/8	1 3/16
1 3/4	2 1/4	1/2	2 3/4	3 5/8	5/8	4	5 3/8	1 5/16	6	8 1/4	1 1/4
2	2 5/8	1/2	3	4	1 1/16	4 1/2	6	1	6 1/2	9	1 3/8
2 1/4	3	9/16	3 1/4	4 1/4	1 1/16	5	7	1 1/8	7	9 3/4	1 1/2

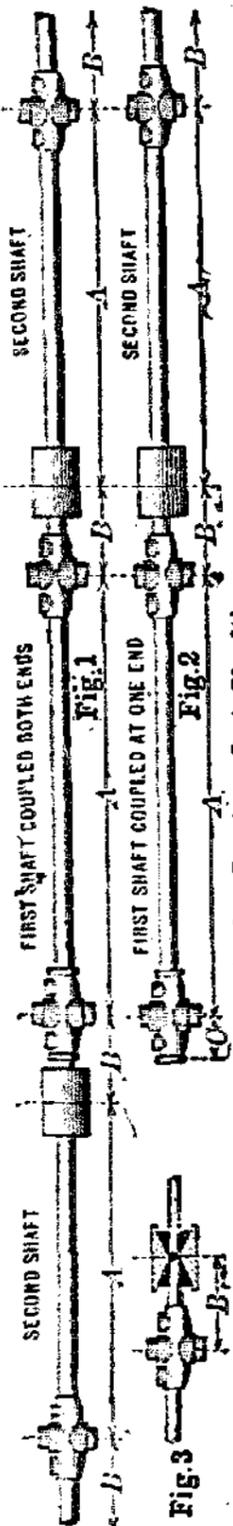

Table for Laying Out Shafting

Length of Collared End for First Coll., ins.	Nominal Size of 2d Shaft.	Nominal Size of 1st Shaft, ins.	Distance from Center of Bearing to End of Shaft for Coupling. See B, Figs. 1, 2, and 3.	Length of Bearings, or Box, ins.	Length, Inches.	Diameter, Inches.
3 1/2	1 1/2	1 1/2	11 1/2	6	5 1/2	3 3/4
4	2	2	12 1/2	7	6 1/2	4 5/8
4 1/2	2 1/4	2 1/4	13 1/2	8	7 1/2	5 3/8
5	2 3/4	2 3/4	14 1/2	9	8 1/2	5 7/8
5 5/8	3	3	15 1/2	10	9 1/2	6 1/4
6 1/4	3 1/4	3 1/4	16 1/2	11	10 1/2	6 7/8
6 3/4	3 1/2	3 1/2	17 1/2	12	11 1/2	7 1/4
7 1/4	4	4	18 1/2	13	12 1/2	7 3/4
7 7/8	4 1/2	4 1/2	19 1/2	14	13 1/2	8 1/4
8 1/2	5	5	20 1/2	15	14 1/2	8 3/4
10	5 1/2	5 1/2	21 1/2	16	15 1/2	9 1/4
11 1/8	6	6	22 1/2	17	16 1/2	9 3/4
12 3/16	6 1/2	6 1/2	23 1/2	18	17 1/2	10
13 1/4	7	7	24 1/2	19	18 1/2	10 3/8
14 3/8	7 1/2	7 1/2	25 1/2	20	19 1/2	10 3/4
15 1/2	8	8	26 1/2	21	20 1/2	11 1/2
16 1/2			27 1/2	22	21 1/2	11 3/8
17 3/4			28 1/2	23	22 1/2	11 3/4
19 5/16			29 1/2	24	23 1/2	12 1/8
19 5/16			30 1/2	25	24 1/2	12 1/2
19 5/16			31 1/2	26	25 1/2	12 3/8
19 5/16			32 1/2	27	26 1/2	12 3/4
19 5/16			33 1/2	28	27 1/2	13 1/8
19 5/16			34 1/2	29	28 1/2	13 1/2
19 5/16			35 1/2	30	29 1/2	14 1/4
19 5/16			36 1/2	31	30 1/2	14 3/8
19 5/16			37 1/2	32	31 1/2	14 3/4
19 5/16			38 1/2	33	32 1/2	15 1/8
19 5/16			39 1/2	34	33 1/2	15 1/2
19 5/16			40 1/2	35	34 1/2	15 3/8
19 5/16			41 1/2	36	35 1/2	15 3/4
19 5/16			42 1/2	37	36 1/2	16 1/4
19 5/16			43 1/2	38	37 1/2	16 3/8
19 5/16			44 1/2	39	38 1/2	16 3/4
19 5/16			45 1/2	40	39 1/2	17 1/8
19 5/16			46 1/2	41	40 1/2	17 1/2
19 5/16			47 1/2	42	41 1/2	17 3/8
19 5/16			48 1/2	43	42 1/2	17 3/4
19 5/16			49 1/2	44	43 1/2	18 1/4
19 5/16			50 1/2	45	44 1/2	18 3/8
19 5/16			51 1/2	46	45 1/2	18 3/4
19 5/16			52 1/2	47	46 1/2	19 1/8
19 5/16			53 1/2	48	47 1/2	19 1/2
19 5/16			54 1/2	49	48 1/2	19 3/8
19 5/16			55 1/2	50	49 1/2	19 3/4
19 5/16			56 1/2	51	50 1/2	20 1/4
19 5/16			57 1/2	52	51 1/2	20 3/8
19 5/16			58 1/2	53	52 1/2	20 3/4
19 5/16			59 1/2	54	53 1/2	21 1/8
19 5/16			60 1/2	55	54 1/2	21 1/2

USE OF TABLE. — Look for size of first shaft in left-hand column under the head of size of first shaft, and in the top line of table, marked size of second shaft, find the size of the shaft to be coupled to it. The intersection gives the length *B*; this added to the length *A*, or distance from center to center of bearing, and in cases similar to Fig. 2, to the length *C*, gives the length of the first shaft, thus: as in Fig. 1, $B + A + B =$ length; Fig. 2, $C + A + B =$ length.

In coupling shafts of different sizes, either reduce the end of the large shaft in diameter, and use a small coupling, or use a coupling to suit the larger shaft, with one cone bored for the smaller nominal shaft.

Make bearings at equal distances from each other, when practicable, and always put two bearings on the first, which is the collared shaft. See Figs. 1 and 2.

PULLEYS.

Proportions of Pulleys. (See also Fly-wheels, page 1031.) — Let n = number of arms, D = diameter of pulley, S = thickness of belt, t = thickness of rim at edge, T = thickness in middle, B = width of rim, β = width of belt, h = breadth of arm at hub, h_1 = breadth of arm at rim, e = thickness of arm at hub, e_1 = thickness of arm at rim, c = amount of crowning; dimensions in inches.

Unwin. Reuleaux.

B = width of rim..... $9/8 (\beta + 0.4)$ $9/8 \beta$ to $5/4 \beta$

t = thickness at edge of rim..... $0.7 S + 0.005 D$ { (thick. of rim.) $1/5 h$ to $1/4 h$

T = thickness at middle of rim... $2t + c$

h = breadth of arm at hub..... { For single belts = $0.6337 \sqrt[3]{\frac{BD}{n}}$ $1/4 \text{ in.} + \frac{B}{4} + \frac{D}{20n}$

h_1 = breadth of arm at rim..... $2/3 h$ $0.8 h$

e = thickness of arm at hub..... $0.4 h$ $0.5 h$

e_1 = thickness of arm at rim..... $0.4 h_1$ $0.5 h_1$

n = number of arms, for a single set $3 + \frac{BD}{150}$ $1/2 (5 + \frac{D}{2B})$

L = length of hub..... { not less than $2.5 S$, B for sin.-arm pulleys. is often $2/3 B$. $2 B$ for double-arm pulleys. h to $3/4 h$

M = thickness of metal in hub.... $1/24 B$

c = crowning of pulley..... $1/24 B$

The number of arms is really arbitrary, and may be altered if necessary, (Unwin.) Pulleys with two or three sets of arms may be considered as two or three separate pulleys combined in one, except that the proportions of the arms should be 0.8 or 0.7 that of single-arm pulleys. (Reuleaux.)

EXAMPLE. — Dimensions of a pulley 60 in. diam., 16 in. face, for double belt 1/2 in. thick.

Solution by	n	h	h_1	e	e_1	t	T	L	M	c
Unwin.....	9	3.79	2.53	1.52	1.01	0.65	1.97	10.7	3.8	0.67
Reuleaux.....	4	5.0	4.0	2.5	2.0	1.25	16	5		

The following proportions are given in an article in the *Amer. Machinist* authority not stated: $h = 0.0625 D + 0.5 \text{ in.}$, $h_1 = 0.04 D + 0.3125 \text{ in.}$, $e = 0.025 D + 0.2 \text{ in.}$, $e_1 = 0.016 D + 0.125 \text{ in.}$

These give for the above example: $h = 4.25 \text{ in.}$, $h_1 = 2.71 \text{ in.}$, $e = 1.7 \text{ in.}$, $e_1 = 1.09 \text{ in.}$ The section of the arms in all cases its taken as elliptical.

The following solution for breadth of arm is proposed by the author: Assume a belt pull of 45 lbs. per inch of width of a single belt, that the whole strain is taken in equal proportions on one-half of the arms, and that the arm is a beam loaded at one end and fixed at the other. We have the formula for a beam of elliptical section $fP = 0.9982 Rbd^2 + l$, in which P = the load, R = the modulus of rupture of the cast iron, b = breadth, d = depth, and l = length of the beam, and f = factor of safety. Assume a modulus of rupture of 36,000 lbs., a factor of safety of 10, and an additional allowance for safety in taking $l = 1/2$ the diameter of the pulley instead of $1/2 D$ less the radius of the hub.

Take $d = h$, the breadth of the arm at the hub, and $b = e = 0.4 h$ the thickness. We then have $fP = 10 \times \frac{45 B}{n + 2} = 900 \frac{B}{n} = \frac{3535 \times 0.4 h^3}{1/2 D}$

whence $h = \sqrt[3]{\frac{900 BD}{3535 n}} = 0.633 \sqrt[3]{\frac{BD}{n}}$, which is practically the same as the value reached by Unwin from a different set of assumptions.

Convexity of Pulleys. — Authorities differ. Morin gives a rise equal to 1/10 of the face; Molesworth, 1/24; others from 1/8 to 1/96. Scott A. Smith says the crown should not be over 1/8 inch for a 24-inch face. Pulleys for shifting belts should be "straight," that is, without crowning.

CONE OR STEP PULLEYS.

To find the diameters for the several steps of a pair of cone-pulleys:

1. **Crossed Belts.** — Let D and d be the diameters of two pulleys connected by a crossed belt, L = the distance between their centers, and β = the angle either half of the belt makes with a line joining the centers of the pulleys: then total length of belt = $(D+d) \frac{\pi}{2} + (D+d) \frac{\pi\beta}{180} + 2L \cos \beta$. β = angle whose sine is $\frac{D+d}{2L}$. $L \cos \beta = \sqrt{L^2 - \left(\frac{D+d}{2}\right)^2}$.

The length of the belt is constant when $D + d$ is constant; that is, in a pair of step-pulleys the belt tension will be uniform when the sum of the diameters of each opposite pair of steps is constant. Crossed belts are seldom used for cone-pulleys, on account of the friction between the rubbing parts of the belt.

To design a pair of tapering speed-cones, so that the belt may fit equally tight in all positions: When the belt is crossed, use a pair of equal and similar cones tapering opposite ways.

2. **Open Belts.** — When the belt is uncrossed, use a pair of equal and similar conoids tapering opposite ways, and bulging in the middle, according to the following formula: Let L denote the distance between the axes of the conoids; R the radius of the larger end of each; r the radius of the smaller end; then the radius in the middle, r_0 , is found as follows:

$$r_0 = \frac{R+r}{2} + \frac{(R-r)^2}{6.28L}. \text{ (Rankine.)}$$

If D_0 = the diameter of equal steps of a pair of cone-pulleys, D and d = the diameters of unequal opposite steps, and L = distance between the axes, $D_0 = \frac{D+d}{2} + \frac{(D-d)^2}{12.566L}$.

If a series of differences of radii of the steps, $R - r$, be assumed, then for each pair of steps $\frac{R+r}{2} = r_0 - \frac{(R-r)^2}{6.28L}$, and the radii of each may be computed from their half sum and half difference, as follows:

$$R = \frac{R+r}{2} + \frac{R-r}{2}; \quad r = \frac{R+r}{2} - \frac{R-r}{2}.$$

A. J. Frith (*Trans. A. S. M. E.*, x, 298) shows the following application of Rankine's method: If we had a set of cones to design, the extreme diameters of which, including thickness of belt, were 40 ins. and 10 ins., and the ratio desired 4, 3, 2, and 1, we would make a table as follows, L being 100 ins.:

Trial Sum of $D+d$	Ratio.	Trial Diams.		Values of $\frac{(D-d)^2}{12.56L}$	Amount to be Added.	Corrected Values.	
		D	d			D	d
50	4	40	10	0.7165	0.0000	40	10
50	3	37.5	12.5	.4975	.2190	37.7190	12.7190
50	2	33.333	16.666	.2212	.4953	33.8286	17.1619
50	1	25	25	.0000	.7165	25.7165	25.7165

The above formulæ are approximate, and they do not give satisfactory results when the difference of diameters of opposite steps is large and when the axes of the pulleys are near together, giving a large belt-angle. Two more accurate solutions of the problem, one by a graphical method, and another by a trigonometrical method derived from it, are given by C. A. Smith (*Trans. A. S. M. E.*, x, 269). These were copied in earlier editions of this Pocket-book, but are now replaced by the more recent graphical solution by Burmester, given below, and by algebraic formulæ deduced

from it by the author, which give results far more accurate than are required in practice.

In all cases 0.8 of the thickness of the belt should be subtracted from the calculated diameter to obtain the actual diameter of the pulley. This should be done because the belt drawn tight around the pulleys is not the same length as a tape-line measure around them. — (C. A. Smith.)

Burmester's Method. Dr. R. Burmester, in his "Lehrbuch der Kinematik" (*Machinery's Reference Series*, No. 14, 1908), gives a graphical solution of the cone-pulley problem, which while not theoretically exact is much more accurate than practice requires.

From A on a horizontal line AB , Fig. 170, draw a 45° line, AC . Lay off AS on AC equal, on any convenient scale, the larger the better, to the distance between centers of the shafts, and from S draw ST perpendicular to AC . Make $SK = \frac{1}{2} AS$, and with radius AK draw an arc of a circle, XY . From a convenient point D on AC draw a vertical line FDE , and make DE equal the given radius of a step on one cone, and EF equal the given radius of the corresponding step on the other cone. Draw FG and EH parallel to AC . From the point G on the arc drop a vertical line cutting EH in H . Through H draw a horizontal line MO , touching AC at M . Then if horizontal distances are measured from M , as Ma , MH , MP , to equal the radii of the pulleys or steps on one cone, the corresponding vertical distances ab , HG and PN will be the radii of the corresponding steps on the other cone.

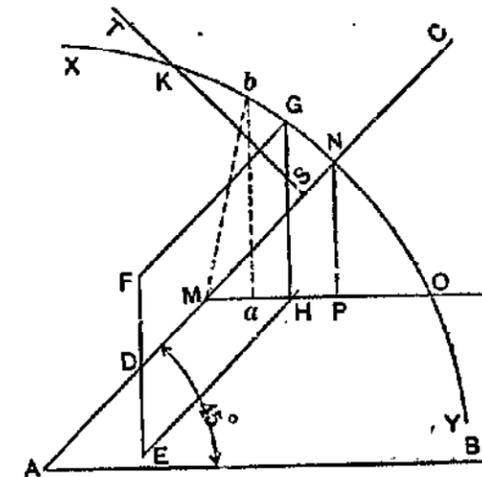

FIG. 170.

If the radii of the two steps of any pair are to bear a certain ratio, as $ab + Ma$, from M draw a line at an angle with MO whose tangent equals that ratio, and from the point where it cuts the arc, as b , drop a vertical, ba . Ma and ba will be the radii required.

Using Burmester's diagram the author has devised an algebraic solution of the problem (*Indust. Eng.*, June, 1910) which leads to the following equations:

Let L = distance between the centers, = AS on the diagram.
 r_0 = radius of the steps of equal diameter on the two cones, = MP = PN .
 $r_1, r_2 = Ma, ab$, radii of any pair of steps.
 a = co-ordinates of M , referred to A , = $0.79057L - r_0$.

If r_1 is given, $r_2 = \sqrt{1.25L^2 - (0.79057L - r_0 + r_1)^2} - 0.79057L + r_0$.
 If the ratio $r_2 + r_1$ is given, let $r_2/r_1 = c$: $r_2 = cr_1$.

We then have $a + cr_1 = \sqrt{R^2 - (a + r_1)^2}$, which reduces to $(1 + c^2)r_1^2 + 2a(1 + c)r_1 = 1.25L^2 - 2a^2$, a quadratic equation, in which $a = 0.79057L - r_0$. Substituting the value of a we have

$$(1 + c^2)r_1^2 + (1.53114L - 2r_0)(1 + c)r_1 = 3.16228Lr_0 - 2r_0^2,$$

in which L, r_0 and c are given and r_1 is to be found.

Let $L = 100, c = 4, r_0 = 12.858$ as in Mr. Frith's example, page 1112. Then $17r_1^2 + 10ar_1 = 12,500 - 8764.62$, from which $r_1 = 5.001, r_2 = 20.004$. If $c = 3, r_1 = 6.304, r_2 = 18.912$. If $c = 2, r_1 = 8.496, r_2 = 16.992$. Checking the results by the approximate formula for length of belt, page 1125, viz, Length = $2L + \pi(r_1 + r_2) + (r_2 - r_1)^2 \div d$, we have

for $c = 1, 200 + 80.79 + 0 = 280.79$
 $2, 200 + 80.07 + 0.72 = 280.79$
 $3, 200 + 79.22 + 1.59 = 280.81$
 $4, 200 + 78.56 + 2.25 = 280.81$

The maximum difference being only 1 part in 14,000.

J. J. Clark (*Indust. Eng.*, Aug., 1910) gives the following solution:
Using the same notation as above,

$$\frac{(c-1)^2}{L} r_1^2 + \pi(c+1) r_1 = 2\pi r_0 \dots\dots\dots (1)$$

$$\pi(c+1) r_1 + Lx \left(\frac{60-13x}{60-18x} \right) = 2\pi r_0 \dots\dots\dots (2)$$

$$x = (r_2 - r_1)^2 \div L^2 \dots\dots\dots (3)$$

The quadratic equation (1) gives the value of r_1 with an approximation to accuracy sufficient for all practical purposes. If greater accuracy is for any reason desired it may be obtained by (2) and (3), using in (3) the values of r_1 and $r_2 = cr_1$, already found from (1). Taking $\pi = 3.1415927$, the result will be correct to the seventh figure.

Speeds of Shaft with Cone Pulleys. — If S = speed (revs. per min.) of the driving shaft,

- s_1, s_2, s_3, s_n = speeds of the driven shaft,
- D_1, D_2, D_3, D_n = diameters of the pulleys on the driving cone,
- d_1, d_2, d_3, d_n = diams. of corresponding pulleys on the driven cone,
- $SD_1 = s_1 d_1; SD_2 = s_2 d_2$, etc.
- $s_1/S = D_1/d_1 = r_1; s_n/S = D_n/d_n = r_n$.

The speed of the driving shaft being constant, the several speeds of the driven shaft are proportional to the ratio of the diameter of the driving pulley to that of the driven, or to D/d .

Speeds in Geometrical Progression. — If it is desired that the speed ratios shall increase by a constant percentage, or in geometrical progression, then $r_2/r_1 = r_3/r_2 = r_n/r_{n-1} = c$, a constant.

$$r_n \div r_1 = c^{n-1}; \quad c = \sqrt[n-1]{r_n - r_1}$$

EXAMPLE. If the speed ratio of the driven shaft at its lowest speed, to the driving shaft be 0.76923, and at its highest speed 2.197, the speeds being in geometrical progression, what is the constant multiplier if $n=5$?

$$\begin{aligned} \text{Log } 2.197 &= 0.341830 \\ \text{Log } 0.76923 &= 1.886056 \\ \hline &0.455774 \end{aligned}$$

Divide by $n-1 = 4$, $0.113943 = \log$ of 1.30.
If $D_2/d_2 = 1$, then $D_1/d_1 = 1 \div 1.3 = 0.769$; $D_3/d_3 = 1.30$; $D_4/d_4 = 1.69$; $D_5/d_5 = 2.197$.

BELTING.

Theory of Belts and Bands. — A pulley is driven by a belt by means of the friction between the surfaces in contact. Let T_1 be the tension on the driving side of the belt, T_2 the tension on the loose side; then $S = T_1 - T_2$, is the total friction between the band and the pulley, which is equal to the tractive or driving force. Let f = the coefficient of friction, θ the ratio of the length of the arc of contact to the length of the radius, a = the angle of the arc of contact in degrees, e = the base of the Napierian logarithms = 2.71828, m = the modulus of the common logarithms = 0.434295. The following formulæ are derived by calculus (Rankine's *Mach'y and Millwork*, p. 351; *Carpenter's Exper. Eng'g*, p. 173):

$$\frac{T_1}{T_2} = e^{f\theta}; \quad T_2 = \frac{T_1}{e^{f\theta}}; \quad T_1 - T_2 = T_1 - \frac{T_1}{e^{f\theta}} = T_1(1 - e^{-f\theta}).$$

$$T_1 - T_2 = T_1(1 - e^{-f\theta}) = T_1(1 - 10^{-f\theta m}) = T_1(1 - 10^{-0.00758 fa});$$

$$\frac{T_1}{T_2} = 10^{0.00758 fa}; \quad T_1 = T_2 \times 10^{0.00758 fa}; \quad T_2 = \frac{T_1}{10^{0.00758 fa}}$$

If the arc of contact between the band and the pulley expressed in turns and fractions of a turn = n , $\theta = 2\pi n$; $e^{f\theta} = 10^{2.7288fn}$; that is, $e^{f\theta}$ is the natural number corresponding to the common logarithm $2.7288fn$.

The value of the coefficient of friction f depends on the state and material of the rubbing surfaces. For leather belts on iron pulleys, Morin found $f = 0.56$ when dry, 0.36 when wet, 0.23 when greasy, and 0.15 when oily. In calculating the proper mean tension for a belt, the smallest value, $f = 0.15$, is to be taken if there is a probability of the belt becoming wet with oil. The experiments of Henry R. Towne and Robert Briggs, however (*Jour. Frank. Inst.*, 1868), show that such a state of lubrication is not of ordinary occurrence; and that in designing machinery we may in most cases safely take $f = 0.42$. Reuleaux takes $f = 0.25$. Later writers have shown that the coefficient is not a constant quantity, but is extremely variable, depending on the velocity of slip, the condition of the surfaces, and even on the weather.

The following table shows the values of the coefficient $2.7288 f$, by which n is multiplied in the last equation, corresponding to different values of f ; also the corresponding values of various ratios among the forces, when the arc of contact is half a circumference:

	$f = 0.15$	0.25	0.42	0.56
	$2.7288f = 0.41$	0.68	1.15	1.53
Let $\theta = \pi$ and $n = 1/2$, then				
	$T_1 \div T_2 = 1.603$	2.188	3.758	5.821
	$T_1 + S = 2.66$	1.84	1.36	1.21
	$T_1 + T_2 \div 2S = 2.16$	1.34	0.86	0.71

In ordinary practice it is usual to assume $T_2 = S$; $T_1 = 2S$; $T_1 + T_2 \div 2S = 1.5$. This corresponds to $f = 0.22$ nearly.

For a wire rope on cast iron f may be taken as 0.15 nearly; and if the groove of the pulley is bottomed with gutta-percha, 0.25. (Rankine.)

Centrifugal Tension of Belts. — When a belt or band runs at a high velocity, centrifugal force produces a tension in addition to that existing when the belt is at rest or moving at a low velocity. This centrifugal tension diminishes the effective driving force.

Rankine says: If an endless band, of any figure whatsoever, runs at a given speed, the centrifugal force produces a uniform tension at each cross-section of the band, equal to the weight of a piece of the band whose length is twice the height from which a heavy body must fall in order to acquire the velocity of the band. (See Cooper on Belting, p. 101.)

- If T_c = centrifugal tension;
- V = velocity in feet per second;
- g = acceleration due to gravity = 32.2;
- W = weight of a piece of the belt 1 ft. long and 1 sq. in. sectional area, —

$$\begin{aligned} \text{Leather weighing 56 lbs. per cubic foot gives } W &= 56 \div 144 = 0.388, \\ T_c &= WV^2 \div g = 0.388 V^2 \div 32.2 = 0.012V^2. \end{aligned}$$

Belting Practice. Handy Formulæ for Belting. — Since in the practical application of the above formulæ the value of the coefficient of friction must be assumed, its actual value varying within wide limits (15% to 135%), and since the values of T_1 and T_2 also are fixed arbitrarily, it is customary in practice to substitute for these theoretical formulæ more simple empirical formulæ and rules, some of which are given below.

Let d = diam. of pulley in inches; πd = circumference;
 V = velocity of belt in ft. per second; v = vel. in ft. per minute;
 a = angle of the arc of contact;
 L = length of arc of contact in feet = $\pi da + (12 \times 360)$;
 F = tractive force per square inch of sectional area of belt;
 w = width in inches; t = thickness;
 S = tractive force per inch of width = $F \div t$;
 r.p.m. = revs. per minute; r.p.s. = revs. per second = r.p.m. \div 60.
 $V = \frac{\pi d}{12} \times \text{r.p.s.} = \frac{\pi d}{12} \times \frac{\text{r.p.m.}}{60} = 0.004363 d \times \text{r.p.m.} = \frac{d \times \text{r.p.m.}}{229.2}$;
 $v = \frac{\pi d}{12} \times \text{r.p.m.}; = 0.2618 d \times \text{r.p.m.}$
 Horse-power, H.P. = $\frac{Svw}{33000} = \frac{SVw}{550} = \frac{Swd \times \text{r.p.m.}}{126050}$.

If F = working tension per square inch = 275 lbs., and $t = 7/32$ inch, $S = 60$ lbs. nearly, then

$$\text{H.P.} = \frac{vw}{550} = 0.109 Vw = 0.000476 wd \times \text{r.p.m.} = \frac{wd \times \text{r.p.m.}}{2101} \quad (1)$$

If $F = 180$ lbs. per square inch, and $t = 1/8$ inch, $S = 30$ lbs., then

$$\text{H.P.} = \frac{vw}{1100} = 0.055 Vw = 0.000238 wd \times \text{r.p.m.} = \frac{wd \times \text{r.p.m.}}{4202} \quad (2)$$

If the working strain is 60 lbs. per inch of width, a belt 1 inch wide traveling 550 ft. per minute will transmit 1 horse-power. If the working strain is 30 lbs. per inch of width, a belt 1 inch wide traveling 1100 ft. per minute will transmit 1 horse-power. Numerous rules are given by different writers on belting which vary between these extremes. A rule commonly used is: 1 inch wide traveling 1000 ft. per min. = I.H.P.

$$\text{H.P.} = \frac{vw}{1000} = 0.06 Vw = 0.000262 wd \times \text{r.p.m.} = \frac{wd \times \text{r.p.m.}}{3820} \quad (3)$$

This corresponds to a working strain of 33 lbs. per inch of width.

Many writers give as safe practice for single belts in good condition a working tension of 45 lbs. per inch of width. This gives

$$\text{H.P.} = \frac{vw}{733} = 0.0818 Vw = 0.000357 wd \times \text{r.p.m.} = \frac{wd \times \text{r.p.m.}}{2800} \quad (4)$$

For double belts of average thickness, some writers say that the transmitting efficiency is to that of single belts as 10 to 7, which would give

$$\text{H.P. of double belts} = \frac{vw}{513} = 0.1169 Vw = 0.00051 wd \times \text{r.p.m.} = \frac{wd \times \text{r.p.m.}}{1960} \quad (5)$$

Other authorities, however, make the transmitting power of double belts twice that of single belts, on the assumption that the thickness of a double belt is twice that of a single belt.

Rules for horse-power of belts are sometimes based on the number of square feet of surface of the belt which pass over the pulley in a minute. Sq. ft. per min. = $wv \div 12$. The above formulæ translated into this form give:

- (1) For $S = 60$ lbs. per inch wide; H.P. = 46 sq. ft. per minute.
- (2) " $S = 30$ " " " H.P. = 92 " " "
- (3) " $S = 33$ " " " H.P. = 83 " " "
- (4) " $S = 45$ " " " H.P. = 61 " " "
- (5) " $S = 64.3$ " " " H.P. = 43 " " " (double belt).

WARNING: This is a 1910 edition. Some of the material may no longer be accurate

The above formulæ are all based on the supposition that the arc of contact is 180°. For other arcs, the transmitting power is approximately proportional to the ratio of the degrees of arc to 180°.

Some rules base the horse-power on the length of the arc of contact in feet. Since $L = \frac{\pi da}{12 \times 360}$ and H.P. = $\frac{Svw}{33000} = \frac{Sw}{33000} \times \frac{v d}{12} \times \text{r.p.m.} \times \frac{a}{180}$.

we obtain by substitution H.P. = $\frac{Sw}{16500} \times L \times \text{r.p.m.}$, and the five formulæ then take the following form for the several values of S :

$$\text{H.P.} = \frac{wL \times \text{r.p.m.}}{275} \quad (1); \quad \frac{wL \times \text{r.p.m.}}{550} \quad (2); \quad \frac{wL \times \text{r.p.m.}}{500} \quad (3); \quad \frac{wL \times \text{r.p.m.}}{387} \quad (4);$$

$$\text{H.P. (double belt)} = \frac{wL \times \text{r.p.m.}}{257} \quad (5).$$

None of the handy formulæ take into consideration the centrifugal tension of belts at high velocities. When the velocity is over 3000 ft. per minute the effect of this tension becomes appreciable, and it should be taken account of, as in Mr. Nagle's formula, which is given below.

Horse-power of a Leather Belt One Inch wide. (Nagle.)

Formula: H.P. = $C V t w (S - 0.012 V^2) \div 550$.

For $f = 0.40$, $a = 180^\circ$, $C = 0.715$, $w = 1$.

Laced Belts, $S = 275$.								Riveted Belts, $S = 400$.							
Velocity, ft. per sec.	Thickness in inches = t .							Velocity, ft. per sec.	Thickness in inches = t .						
	1/7	1/8	3/16	7/32	1/4	5/16	3/8		7/32	1/4	5/16	3/8	7/16	1/2	
10	0.51	0.59	0.63	0.73	0.84	1.05	1.18	15	1.69	1.94	2.42	2.58	2.91	3.39	3.87
15	0.75	0.88	1.00	1.16	1.32	1.66	1.77	20	2.24	2.57	3.21	3.42	3.85	4.49	5.13
20	1.00	1.17	1.32	1.54	1.75	2.19	2.34	25	2.79	3.19	3.98	4.25	4.78	5.57	6.37
25	1.23	1.43	1.61	1.88	2.16	2.69	2.86	30	3.31	3.79	4.74	5.05	5.67	6.62	7.58
30	1.47	1.72	1.93	2.25	2.58	3.22	3.44	35	3.82	4.37	5.46	5.83	6.56	7.65	8.75
35	1.69	1.97	2.22	2.59	2.96	3.70	3.94	40	4.33	4.95	6.19	6.60	7.42	8.66	9.90
40	1.90	2.22	2.49	2.90	3.32	4.15	4.44	45	4.85	5.49	6.86	7.32	8.43	9.70	10.98
45	2.09	2.45	2.75	3.21	3.67	4.58	4.89	50	5.26	6.01	7.51	8.02	9.02	10.52	12.03
50	2.27	2.65	2.98	3.48	3.98	4.97	5.30	55	5.68	6.50	8.12	8.66	9.74	11.36	13.00
55	2.44	2.84	3.19	3.72	4.26	5.32	5.69	60	6.09	7.06	8.70	9.28	10.43	12.17	13.91
60	2.58	3.01	3.38	3.95	4.51	5.64	6.02	65	6.45	7.57	9.22	9.83	11.06	12.90	14.75
65	2.71	3.16	3.55	4.14	4.74	5.92	6.32	70	6.78	7.95	9.69	10.33	11.62	13.56	15.50
70	2.81	3.27	3.68	4.29	4.91	6.14	6.54	75	7.09	8.31	10.13	10.84	12.16	14.18	16.21
75	2.89	3.37	3.79	4.42	5.05	6.31	6.73	80	7.36	8.61	10.51	11.21	12.61	14.71	16.81
80	2.94	3.43	3.86	4.50	5.15	6.44	6.86	85	7.58	8.86	10.82	11.55	13.00	15.16	17.32
85	2.97	3.47	3.90	4.55	5.20	6.50	6.93	90	7.74	9.05	11.06	11.80	13.27	15.48	17.69
90	2.97	3.47	3.90	4.55	5.20	6.50	6.93	100	7.96	9.30	11.37	12.13	13.65	15.92	18.20

The H.P. becomes a maximum at 87.41 ft. per sec. = 5245 ft. p. min.

The H.P. becomes a maximum at 105.4 ft. per sec. = 6324 ft. per min.

In the above table the angle of subtension, a , is taken at 180°.

Should it be.....	90°	100°	110°	120°	130°	140°	150°	160°	170°	180°	200°
Multiply above values by.....	.65	.70	.75	.79	.83	.87	.91	.94	.97	1	1.05

A. F. Nagle's Formula (*Trans. A. S. M. E.*, vol. ii, 1881, p. 91. Tables published in 1882).

$$\text{H.P.} = C V t w \left(\frac{S - 0.012 V^2}{550} \right);$$

- $C = 1 - 10^{-0.00753 fa}$;
- a = degrees of belt contact;
- f = coefficient of friction;
- w = width in inches;
- t = thickness in inches;
- v = velocity in feet per second;
- S = stress upon belt per square inch.

Taking S at 275 lbs. per sq. in. for laced belts and 400 lbs. per sq. in. for lapped and riveted belts, the formula becomes

H.P. = $C V t w (0.50 - 0.0000218 V^2)$ for laced belts;
 H.P. = $C V t w (0.727 - 0.0000218 V^2)$ for riveted belts.

VALUES OF $C = 1 - 10^{-0.00758 fa}$. (NAGLE.)

f = coefficient of friction.	Degrees of contact = a .										
	90°	100°	110°	120°	130°	140°	150°	160°	170°	180°	200°
0.15	0.210	0.230	0.250	0.270	0.288	0.307	0.325	0.342	0.359	0.376	0.408
.20	.270	.295	.319	.342	.364	.386	.408	.428	.448	.467	.503
.25	.325	.354	.381	.407	.432	.457	.480	.503	.524	.544	.582
.30	.376	.408	.438	.467	.494	.520	.544	.567	.590	.610	.649
.35	.423	.457	.489	.520	.548	.575	.600	.624	.646	.667	.705
.40	.467	.502	.536	.567	.597	.624	.649	.673	.695	.715	.753
.45	.507	.544	.579	.610	.640	.667	.692	.715	.737	.757	.792
.55	.578	.617	.652	.684	.713	.739	.763	.785	.805	.822	.853
.60	.610	.649	.684	.715	.744	.769	.792	.813	.832	.848	.877
1.00	.792	.825	.853	.877	.897	.913	.927	.937	.947	.956	.969

The following table gives a comparison of the formulae already given for the case of a belt one inch wide, with arc of contact 180°.

Horse-power of a Belt One Inch wide, Arc of Contact 180°. COMPARISON OF DIFFERENT FORMULÆ.

Velocity in ft. per sec.	Velocity in ft. p. min.	Sq. ft. of Belt p. min.	Form. 1	Form. 2	Form. 3	Form. 4	Form. 5	Nagle's Form.	
			H.P. = $\frac{wv}{550}$	H.P. = $\frac{wv}{1100}$	H.P. = $\frac{wv}{1000}$	H.P. = $\frac{wv}{733}$	double belt H.P. = $\frac{wv}{513}$	7/32-in. single belt.	Laced.
10	600	50	1.09	0.55	0.60	0.82	1.17	0.73	1.14
20	1200	100	2.18	1.09	1.20	1.64	2.34	1.54	2.24
30	1800	150	3.27	1.64	1.80	2.46	3.51	2.25	3.31
40	2400	200	4.36	2.18	2.40	3.27	4.68	2.90	4.33
50	3000	250	5.45	2.73	3.00	4.09	5.85	3.48	5.26
60	3600	300	6.55	3.27	3.60	4.91	7.02	3.95	6.09
70	4200	350	7.63	3.82	4.20	5.73	8.19	4.29	6.78
80	4800	400	8.73	4.36	4.80	6.55	9.36	4.50	7.36
90	5400	450	9.82	4.91	5.40	7.37	10.53	4.55	7.74
100	6000	500	10.91	5.45	6.00	8.18	11.70	4.41	7.96
110	6600	550	4.05	7.97
120	7200	600	3.49	7.75

Width of Belt for a Given Horse-power. — The width of belt required for any given horse-power may be obtained by transposing the formulae for horse-power so as to give the value of w . Thus:

From formula (1), $w = \frac{550 \text{ H.P.}}{v} = \frac{9.17 \text{ H.P.}}{V} = \frac{2101 \text{ H.P.}}{d \times \text{r.p.m.}} = \frac{275 \text{ H.P.}}{L \times \text{r.p.m.}}$
 From formula (2), $w = \frac{1100 \text{ H.P.}}{v} = \frac{18.33 \text{ H.P.}}{V} = \frac{4202 \text{ H.P.}}{d \times \text{r.p.m.}} = \frac{530 \text{ H.P.}}{L \times \text{r.p.m.}}$
 From formula (3), $w = \frac{1000 \text{ H.P.}}{v} = \frac{16.67 \text{ H.P.}}{V} = \frac{3820 \text{ H.P.}}{d \times \text{r.p.m.}} = \frac{500 \text{ H.P.}}{L \times \text{r.p.m.}}$
 From formula (4), $w = \frac{733 \text{ H.P.}}{v} = \frac{12.22 \text{ H.P.}}{V} = \frac{2800 \text{ H.P.}}{d \times \text{r.p.m.}} = \frac{360 \text{ H.P.}}{L \times \text{r.p.m.}}$
 From formula (5), * $w = \frac{513 \text{ H.P.}}{v} = \frac{8.56 \text{ H.P.}}{V} = \frac{1960 \text{ H.P.}}{d \times \text{r.p.m.}} = \frac{257 \text{ H.P.}}{L \times \text{r.p.m.}}$

* For double belts.

Many authorities use formula (1) for double belts and formula (2) or (3) for single belts.

To obtain the width by Nagle's formula, $w = \frac{550 \text{ H.P.}}{C V t (S - 0.012 V^2)}$, or

divide the given horse-power by the figure in the table corresponding to the given thickness of belt and velocity in feet per second.

The formula to be used in any particular case is largely a matter of judgment. A single belt proportioned according to formula (1), if tightly stretched, and if the surface is in good condition, will transmit the horse-power calculated by the formula, but one so proportioned is objectionable, first, because it requires so great an initial tension that it is apt to stretch, slip, and require frequent restretching and relacing; and second, because this tension will cause an undue pressure on the pulley-shaft, and therefore an undue loss of power by friction. To avoid these difficulties, formula (2), (3), or (4), or Mr. Nagle's table, should be used; the latter especially in cases in which the velocity exceeds 4000 ft. per min.

The following are from the notes of the late Samuel Webber. (*Am. Mach.*, May 11, 1909.)

Good oak-tanned leather from the back of the hide weighs almost exactly one avoirdupois ounce for each one-hundredth of an inch in thickness, in a piece of leather one foot square, so that

	Lbs. per Sq. Ft.	Approx. Thick-ness.	Actual Thick-ness.	Vel. per Inch for 1 H.P.	Safe Strain per Inch Width.
Single belt.....	16 oz.	1/8 in.	0.16 in.	625 ft.	52.8 lbs.
Light double.....	24 "	1/4 "	0.24 "	417 "	78.1 "
Medium.....	28 "	5/16 "	0.28 "	357 "	92.5 "
Standard.....	33 "	1/3 "	0.33 "	303 "	109 "
3-ply.....	45 "	9/16 "	0.45 "	222 "	148 "

The rule for velocity per inch width for 1 H.P. is:

Multiply the denominator of the fraction expressing the thickness of the belt in inches by 100, and divide it by the numerator;

Good, well-calendered rubber belting made with 30-ounce duck and new (i. e., not reclaimed vulcanized) rubber will be as follows:

Nomenclature.	Approximate Thickness.	Safe Working Strain for 1 Inch Width.	Velocity per Inch for 1 H.P.
3-ply	0.18 in.	45 pounds	735 ft. per min.
4 "	0.24 "	65 "	508 " " "
5 "	0.30 "	85 "	388 " " "
6 "	0.35 "	105 "	314 " " "
7 "	0.40 "	125 "	264 " " "
8 "	0.45 "	145 "	218 " " "

The thickness of rubber belt does not necessarily govern the strength, but the weight of duck does, and with 30-ounce duck, the safe working strains are as above.

Belt Factors. W. W. Bird (*Jour. Worcester Polyt. Inst.*, Jan. 1910.) — The factors given in the table below, for use in the formula $H.P. = wv \div F$, in which F is an empirical factor, are based on the following assumptions: A belt of single thickness will stand a stress on the tight side, T_1 , of 60 lbs. per inch of width, a double belt 105 lbs., and a triple belt 150 lbs., and have a fairly long life, requiring only occasional taking up; the ratio of tensions T_1/T_2 should not exceed 2 on small, 2.5 on medium and 3 on large pulleys; the creep (travel of the belt relative to the surface of the pulley due to the elasticity of the belt and not to slip) should not exceed 1% — this requires that the differ-

ence in tensions $T_1 - T_2$ should not be greater than 40 lbs. per inch of width for single, 70 for double and 100 for triple belts.

Pulley diam.	Under 8 in.	8 to 36 in.	Over 3 ft.	Under 14 in.	14 to 60 in.	Over 5 ft.	Under 21 in.	21 to 84 in.	Over 7 ft.
	Single.	S'gle.	S'gle.	Dbl.	Dbl.	Dbl.	Triple.	Triple.	Triple.
Factor.....	1100	920	830	630	520	470	440	370	330
$T_1 - T_2$	30	36	40	52.5	63	70	75	90	100
Creep, %.....	0.74	0.89	0.99	0.74	0.89	0.99	0.74	0.89	0.99
$T_1 \div T_2$	2	2.5	3	2	2.5	3	2	2.5	3
T_1	60	60	60	105	105	105	150	150	150

These factors are for an arc of contact of 180°. For other arcs they are to be multiplied by the figures given below.

Arc.....	220°	210°	200°	190°	170°	160°	150°	140°	130°	120°
Multiply by...	0.89	0.92	0.95	0.97	1.04	1.07	1.11	1.16	1.21	1.27

Taylor's Rules for Belting. — F. W. Taylor (*Trans. A. S. M. E.*, xv, 204) describes a nine years' experiment on belting in a machine shop, giving results of tests of 42 belts running night and day. Some of these belts were run on cone pulleys and others on shifting, or fast-and-loose, pulleys. The average net working load on the shifting belts was only 0.4 of that of the cone belts.

The shifting belts varied in dimensions from 39 ft. 7 in. long, 3.5 in. wide, 0.25 in. thick, to 51 ft. 5 in. long, 6.5 in. wide, 0.37 in. thick. The cone belts varied in dimensions from 24 ft. 7 in. long, 2 in. wide, 0.25 in. thick, to 31 ft. 10 in. long, 4 in. wide, 0.37 in. thick.

Belt-clamps were used having spring-balances between the two pairs of clamps, so that the exact tension to which the belt was subjected was accurately weighed when the belt was first put on, and each time it was tightened.

The tension under which each belt was spliced was carefully figured so as to place it under an initial strain — while the belt was at rest immediately after tightening — of 71 lbs. per inch of width of double belts. This is equivalent, in the case of

Oak tanned and fulled belts,	to 192 lbs. per sq. in. section;
Oak tanned, not fulled belts,	to 229 " " " "
Semi-raw-hide belts,	to 253 " " " "
Raw-hide belts	to 284 " " " "

From the nine years' experiment Mr. Taylor draws a number of conclusions, some of which are given in an abridged form below.

In using belting so as to obtain the greatest economy and the most satisfactory results, the following rules should be observed:

	Oak Tanned and Fulled Leather Belts.	Other Types of Leather Belts and 6- to 7-ply Rubber Belts.
A double belt, having an arc of contact of 180°, will give an effective pull on the face of a pulley per inch of width of belt of.....	35 lbs.	30 lbs.
Or, a different form of same rule: The number of sq. ft. of double belt passing around a pulley per minute required to transmit one horse-power is.....	80 sq. ft.	90 sq. ft.
Or: The number of lineal feet of double belting 1 in. wide passing around a pulley per minute required to transmit one horse-power is.....	950 ft.	1100 ft.
Or: A double belt 6 in. wide, running 4000 to 5000 ft. per min., will transmit.....	30 H.P.	25 H.P.

The terms "initial tension," "effective pull," etc., are thus explained by Mr. Taylor: When pulleys upon which belts are tightened are at rest,

both strands of the belt (the upper and lower) are under the same stress per in. of width. By "tension," "initial tension," or "tension while at rest," we mean the stress per in. of width, or sq. in. of section, to which one of the strands of the belt is tightened, when at rest. After the belts are in motion and transmitting power, the stress on the slack side, or strand, of the belt becomes less, while that on the tight side — or the side which does the pulling — becomes greater than when the belt was at rest. By the term "total load" we mean the total stress per in. of width, or sq. in. of section, on the tight side of belt while in motion.

The difference between the stress on the tight side of the belt and its slack side, while in motion, represents the effective force or pull which is transmitted from one pulley to another. By the terms "working load," "net working load," or "effective pull," we mean the difference in the tension of the tight and slack sides of the belt per in. of width, or sq. in. section, while in motion, or the net effective force that is transmitted from one pulley to another per in. of width or sq. in. of section.

The discovery of Messrs. Lewis and Bancroft (*Trans. A. S. M. E.*, vii, 749) that the "sum of the tension on both sides of the belt does not remain constant," upsets all previous theoretical belting formulæ.

The belt speed for maximum economy should be from 4000 to 4500 ft. per minute.

The best distance from center to center of shafts is from 20 to 25 ft. Idler pulleys work most satisfactorily when located on the slack side of the belt about one-quarter way from the driving-pulley.

Belts are more durable and work more satisfactorily made narrow and thick, rather than wide and thin.

It is safe and advisable to use: a double belt on a pulley 12 in. diameter or larger; a triple belt on a pulley 20 in. diameter or larger; a quadruple belt on a pulley 30 in. diameter or larger.

As belts increase in width they should also be made thicker. The ends of the belt should be fastened together by splicing and cementing, instead of lacing, wiring, or using hooks or clamps of any kind.

A V-splice should be used on triple and quadruple belts and when idlers are used. Stepped splice, coated with rubber and vulcanized in place, is best for rubber belts.

For double belting the rule works well of making the splice for all belts up to 10 in. wide, 10 in. long; from 10 in. to 18 in. wide the splice should be the same width as the belt, 18 in. being the greatest length of splice required for double belting.

Belts should be cleaned and greased every five to six months.

Double leather belts will last well when repeatedly tightened under a strain (when at rest) of 71 lbs. per in. of width, or 240 lbs. per sq. in. section. They will not maintain this tension for any length of time, however.

Belt-clamps having spring-balances between the two pairs of clamps should be used for weighing the tension of the belt accurately each time it is tightened.

The stretch, durability, cost of maintenance, etc., of belts proportioned (A) according to the ordinary rules of a total load of 111 lbs. per inch of width, corresponding to an effective pull of 65 lbs. per inch of width, and (B) according to a more economical rule of a total load of 54 lbs., corresponding to an effective pull of 26 lbs. per inch of width, are found to be as follows:

When it is impracticable to accurately weigh the tension of a belt in tightening it, it is safe to shorten a double belt one-half inch for every 10 ft. of length for (A) and one inch for every 10 ft. for (B), if it requires tightening.

Double leather belts, when treated with great care and run night and day at moderate speed, should last for 7 years (A); 18 years (B).

The cost of all labor and materials used in the maintenance and repairs of double belts, added to the cost of renewals as they give out, through a term of years, will amount on an average per year to 37% of the original cost of the belts (A); 14% or less (B).

In figuring the total expense of belting, and the manufacturing cost chargeable to this account; by far the largest item is the time lost on the machines while belts are being relaced and repaired.

The total stretch of leather belting exceeds 6% of the original length.

The stretch during the first six months of the life of belts is 36% of their entire stretch (A); 15% (B).

A double belt will stretch 0.47% of its length before requiring to be tightened (A); 0.81% (B).

The most important consideration in making up tables and rules for the use and care of belting is how to secure the minimum of interruptions to manufacture from this source.

The average double belt (A), when running night and day in a machine-shop, will cause at least 26 interruptions to manufacture during its life, or 5 interruptions per year, but with (B) interruptions to manufacture will not average oftener for each belt than one in sixteen months.

The oak-tanned and fulled belts showed themselves to be superior in all respects except the coefficient of friction to either the oak-tanned not fulled, the semi-raw-hide, or raw-hide with tanned face.

Belts of any width can be successfully shifted backward and forward on tight and loose pulleys. Belts running between 5000 and 6000 ft. per min. and driving 300 H.P. are now being daily shifted on tight and loose pulleys, to throw lines of shafting in and out of use.

The best form of belt-shifter for wide belts is a pair of rollers twice the width of belt, either of which can be pressed onto the flat surface of the belt on its slack side close to the driven pulley, the axis of the roller making an angle of 75° with the center line of the belt.

Remarks on Mr. Taylor's Rules. (W. Kent, *Trans. A. S. M. E.*, xv, 242.)—The most notable feature in Mr. Taylor's paper is the great difference between his rules for proper proportioning of belts and those given by earlier writers. A very commonly used rule is, one horse-power may be transmitted by a single belt 1 in. wide running x ft. per min., substituting for x various values, according to the ideas of different engineers, ranging usually from 550 to 1100.

The practical mechanic of the old school is apt to swear by the figure 600 as being thoroughly reliable, while the modern engineer is more apt to use the figure 1000. Mr. Taylor, however, instead of using a figure from 550 to 1100 for a single belt, uses 950 to 1100 for double belts. If we assume that a double belt is twice as strong, or will carry twice as much power, as a single belt, then he uses a figure at least twice as large as that used in modern practice, and would make the cost of belting for a given shop twice as large as if the belting were proportioned according to the most liberal of the customary rules.

This great difference is to some extent explained by the fact that the problem which Mr. Taylor undertakes to solve is quite a different one from that which is solved by the ordinary rules with their variations. The problem of the latter generally is, "How wide a belt must be used, or how narrow a belt may be used, to transmit a given horse-power?" Mr. Taylor's problem is: "How wide a belt must be used so that a given horse-power may be transmitted with the minimum cost for belt repairs, the longest life to the belt, and the smallest loss and inconvenience from stopping the machine while the belt is being tightened or repaired?"

The difference between the old practical mechanic's rule of a 1-in.-wide single belt, 600 ft. per min., transmits one horse-power, and the rule commonly used by engineers, in which 1000 is substituted for 600, is due to the belief of the engineers, not that a horse-power could not be transmitted by the belt proportioned by the older rule, but that such a proportion involved undue strain from overtightening to prevent slipping, which strain entailed too much journal friction, necessitated frequent tightening, and decreased the length of the life of the belt.

Mr. Taylor's rule substituting 1100 ft. per min. and doubling the belt, is a further step, and a long one, in the same direction. Whether it will be taken in any case by engineers will depend upon whether they appreciate the extent of the losses due to slippage of belts slackened by use under overstrain, and the loss of time in tightening and repairing belts, to such a degree as to induce them to allow the first cost of the belts to be doubled in order to avoid these losses.

It should be noted that Mr. Taylor's experiments were made on rather narrow belts, used for transmitting power from shafting to machinery, and his conclusions may not be applicable to heavy and wide belts, such as engine fly-wheel belts.

Barth's Studies on Belting. (*Trans. A. S. M. E.*, 1909.)—Mr. Carl G. Barth has made an extensive study of the work of earlier writers on the subject of belting, and has derived several new formulæ and diagrams showing the relation of the several variables that enter into the belt problem. He has also devised a slide rule by which calculations of belts may easily be made. He finds that the coefficient of friction depends on the velocity of the belt, and may be expressed by the formula $f = 0.54 A - 140 \div (500 + V)$, in which A is the sum of the tension on the tight side and one-half the tension on the slack side of the belt, and V is the velocity in feet per minute.

Taking Mr. Taylor's data as a starting point, Mr. Barth has adopted the rule, as a basis for use of belts on belt-driven machines, that for the driving belt of a machine the *minimum initial tension* must be such that when the belt is doing the maximum amount of work intended, the *sum of the tension in the tight side of the belt and one-half the tension in the slack side will equal 240 lbs. per square inch of cross-section for all belt speeds*; and that for a belt driving a countershaft, or any other belt inconvenient to get at for retightening or more readily made of liberal dimensions, this sum will equal 160 lbs. Further, the maximum initial tension, that is, the initial tension under which a belt is to be put up in the first place, and to which it is to be retightened as often as it drops to the minimum, must be such that the sum defined above is 320 lbs. for a machine belt, and 240 lbs. for a counter-shaft belt or a belt similarly circumstanced.

From a set of curves plotted by Mr. Barth from his formula the following tables are derived. The figures are based upon the conditions named in the above rule, and on an arc of contact = 180°.

Belts on Machines. Tension in tight side + 1/2 tension in slack side = 240 lbs.

Velocity, ft. per min.	500	1000	2000	3000	4000	5000	6000
Initial tension, t_0	124	120	121	128	136	144	152
Centrifugal tension t_c	0 +	3	13	31	56	86	124
Difference, $t_0 - t_c$	123	117	108	97	80	58	28
Tension on tight side, t_1	210	212	211	207	198	187	173
Tension on slack side, t_2	60	54	57	68	84	107	134
Effective pull, $t_1 - t_2$	150	158	154	139	114	80	39
Sum of tensions $t_1 + t_2$	270	268	269	274	282	294	307
H.P. per sq. in. of section	2.27	4.79	9.33	12.64	13.82	12.12	7.09
H.P. per in. width, 5/16 in. thick	0.71	1.50	2.82	3.95	4.32	3.71	2.22

Belts driving countershafts, $t_1 + 1/2 t_2 = 160$ lbs.

Velocity of belt, ft. per min.	500	1000	2000	3000	4000	5000
Initial tension, t_0	82	81	83	89	96	102
Tension on tight side, t_1	140	141	140	134	125	114
Tension on slack side, t_2	40	38	41	53	69	92
Effective pull, $t_1 - t_2$	100	103	99	81	56	22
Sum of tensions	180	179	181	187	194	206
H.P. per sq. in. of section	1.51	3.12	6.04	7.36	6.79	3.33
H.P. per in. width, 5/16 in. thick	3.47	0.97	1.87	2.30	2.12	1.04

MISCELLANEOUS NOTES ON BELTING.

Formulæ are useful for proportioning belts and pulleys, but they furnish no means of estimating how much power a particular belt may be transmitting at any given time, any more than the size of the engine is a measure of the load it is actually drawing, or the known strength of a horse is a measure of the load on the wagon. The only reliable means of determining the power actually transmitted is some form of dynamometer. (See *Trans. A. S. M. E.*, vol. xii, p. 707.)

If we increase the thickness, the power transmitted ought to increase in proportion; and for double belts we should have half the width required for a single belt under the same conditions. With large pulleys and moderate velocities of belt it is probable that this holds good. With small pulleys, however, when a double belt is used, there is not such per-

fect contact between the pulley-face and the belt, due to the rigidity of the latter, and more work is necessary to bend the belt-fibers than when a thinner and more pliable belt is used. The centrifugal force tending to throw the belt from the pulley also increases with the thickness, and for these reasons the width of a double belt required to transmit a given horse-power when used with small pulleys is generally assumed not less than seven-tenths the width of a single belt to transmit the same power. (Flather on "Dynamometers and Measurement of Power.")

F. W. Taylor, however, finds that great pliability is objectionable, and favors thick belts even for small pulleys. The power consumed in bending the belt around the pulley he considers inappreciable. According to Rankine's formula for centrifugal tension, this tension is proportional to the sectional area of the belt, and hence it does not increase with increase of thickness when the width is decreased in the same proportion, the sectional area remaining constant.

Scott A. Smith (*Trans. A. S. M. E.*, x, 765) says: The best belts are made from all oak-tanned leather, and curried with the use of cod oil and tallow, all to be of superior quality. Such belts have continued in use thirty to forty years when used as simple driving-belts, driving a proper amount of power, and having had suitable care. The flesh side should not be run to the pulley-face, for the reason that the wear from contact with the pulley should come on the grain side, as that surface of the belt is much weaker in its tensile strength than the flesh side; also as the grain is hard it is more enduring for the wear of attrition; further, if the grain is actually worn off, then the belt may not suffer in its integrity from a ready tendency of the hard grain side to crack.

The most intimate contact of a belt with a pulley comes, first, in the smoothness of a pulley-face, including freedom from ridges and hollows left by turning-tools; second, in the smoothness of the surface and evenness in the texture or body of a belt; third, in having the crown of the driving and receiving pulleys exactly alike, — as nearly so as is practicable in a commercial sense; fourth, in having the crown of pulleys not over $\frac{1}{8}$ in. for a 24-in. face, that is to say, that the pulley is not to be over $\frac{1}{4}$ in. larger in diameter in its center; fifth, in having the crown other than two planes meeting at the center; sixth, the use of any material on or in a belt, in addition to those necessarily used in the currying process, to keep them pliable or increase their tractive quality, should wholly depend upon the exigencies arising in the use of belts; non-use is safer than over-use; seventh, with reference to the lacing of belts, it seems to be a good practice to cut the ends to a convex shape by using a former, so that there may be a nearly uniform stress on the lacing through the center as compared with the edges. For a belt 10 ins. wide, the center of each end should recede $\frac{1}{10}$ in.

Lacing of Belts. — In punching a belt for lacing, use an oval punch, the longer diameter of the punch being parallel with the sides of the belt. Punch two rows of holes in each end, placed zigzag. In a 3-in. belt there should be four holes in each end — two in each row. In a 6-in. belt, seven holes — four in the row nearest the end. A 10-in. belt should have nine holes. The edge of the holes should not come nearer than $\frac{3}{4}$ in. from the sides, nor $\frac{7}{8}$ in. from the ends of the belt. The second row should be at least $1\frac{3}{4}$ ins. from the end. On wide belts these distances should be even a little greater.

Begin to lace in the center of the belt and take care to keep the ends exactly in line, and to lace both sides with equal tightness. The lacing should not be crossed on the side of the belt that runs next the pulley. In taking up belts, observe the same rules as in putting on new ones.

Setting a Belt on Quarter-twist. — A belt must run squarely on to the pulley. To connect with a belt two horizontal shafts at right angles with each other, say an engine-shaft near the floor with a line attached to the ceiling, will require a quarter-turn. First, ascertain the central point on the face of each pulley at the extremity of the horizontal diameter where the belt will leave the pulley, and then set that point on the driven pulley plumb over the corresponding point on the driver. This will cause the belt to run squarely on to each pulley, and it will leave at an angle greater or less, according to the size of the pulleys and their distance from each other.

In quarter-twist belts, in order that the belt may remain on the pulleys,

the central plane on each pulley must pass through the point of delivery of the other pulley. This arrangement does not admit of reversed motion.

To find the Length of Belt required for two given Pulleys. — When the length cannot be measured directly by a tape-line, the following approximate rule may be used: Add the diameter of the two pulleys together, divide the sum by 2, and multiply the quotient by $3\frac{1}{4}$, and add the product to twice the distance between the centers of the shafts. (See accurate formula below.)

To find the Angle of the Arc of Contact of a Belt. — Divide the difference between the radii of the two pulleys in inches by the distance between their centers, also in inches, and in a table of natural sines find the angle most nearly corresponding with the quotient. Multiply this angle by 2, and add the product to 180° for the angle of contact with the larger pulley, or subtract it from 180° for the smaller pulley.

Or, let R = radius of larger pulley, r = radius of smaller;
 L = distance between centers of the pulleys;
 a = angle whose sine is $(R - r) \div L$.
 Arc of contact with smaller pulley = $180^\circ - 2a$;
 Arc of contact with larger pulley = $180^\circ + 2a$.

To find the Length of Belt in Contact with the Pulley. — For the larger pulley, multiply the angle a , found as above, by 0.0349, to the product add 3.1416, and multiply the sum by the radius of the pulley. Or length of belt in contact with the pulley

$$= \text{radius} \times (\pi + 0.0349 a) = \text{radius} \times \pi(1 + a/90).$$

For the smaller pulley, length = radius $\times (\pi - 0.0349 a)$
 $= \text{radius} \times \pi(1 - a) \div 90.$

The above rules refer to **Open Belts**. The accurate formula for length of an open belt is,

$$\text{Length} = \pi R(1 + a/90) + \pi r(1 - a/90) + 2L \cos a,$$

$$= R(\pi + 0.0349 a) + r(\pi - 0.0349 a) + 2L \cos a,$$

In which R = radius of larger pulley, r = radius of smaller pulley,
 L = distance between centers of pulleys, and a = angle whose sine is

$$(R - r) \div L; \cos a = \sqrt{L^2 - (R - r)^2} \div L.$$

An approximate formula is

$$\text{Length} = 2L + \pi(R + r) + (R - r)^2/L$$

For $L = 4$, $R = 2$, $r = 1$, this formula gives length = 17.6748, the accurate formula giving 17.6761

For Crossed Belts the formula is

$$\text{Length of belt} = \pi R(1 + \beta/90) + \pi r(1 + \beta/90) + 2L \cos \beta$$

$$= (R + r) \times (\pi + 0.0349 \beta) + 2L \cos \beta,$$

In which β = angle whose sine is $(R + r) \div L$; $\cos \beta = \sqrt{L^2 - (R + r)^2} \div L.$

To find the Length of Belt when Closely Rolled. — The sum of the diameter of the roll, and of the eye in inches, \times the number of turns made by the belt and by 1309, = length of the belt in feet.

To find the Approximate Weight of Belts. — Multiply the length of belt, in feet, by the width in inches, and divide the product by 13 for single and 8 for double belt.

Relations of the Size and Speeds of Driving and Driven Pulleys. — The driving pulley is called the driver, D , and the driven pulley the driven, d . If the number of teeth in gears is used instead of diameter, in these calculations, number of teeth must be substituted wherever diameter occurs. R = revs. per min. of driver, r = revs. per min. of driven,

$$D = dr \div R;$$

Diam. of driver = diam. of driven \times revs. of driven \div revs. of driver.

$$d = DR \div r;$$

Diam. of driven = diam. of driver \times revs. of driver \div revs. of driven.

$$R = dr + D;$$

Revs. of driver = revs. of driven \times diam. of driven \div diam. of driver.

$$r = DR + d;$$

Revs. of driven = revs. of driver \times diam. of driver \div diam. of driven.

Evils of Tight Belts. (Jones and Laughlins.) — Clamps with powerful screws are often used to put on belts with extreme tightness, and with most injurious strain upon the leather. They should be very judiciously used for horizontal belts, which should be allowed sufficient slackness to move with a loose undulating vibration on the returning side, as a test that they have no more strain imposed than is necessary simply to transmit the power.

On this subject a New England cotton-mill engineer of large experience says: I believe that three-quarters of the trouble experienced in broken pulleys, hot boxes, etc., can be traced to the fault of tight belts. The enormous and useless pressure thus put upon pulleys must in time break them, if they are made in any reasonable proportions, besides wearing out the whole outfit, and causing heating and consequent destruction of the bearings. Below are some figures showing the power it takes, in average modern mills with first-class shafting, to drive the shafting alone:

Mill No.	Whole Load, H.P.	Shafting Alone.		Mill No.	Whole Load, H.P.	Shafting Alone.	
		Horse-power.	Per cent of whole.			Horse-power.	Per cent of whole.
1	199	51	25.6	5	759	172.6	22.7
2	472	111.5	23.6	6	235	84.8	36.1
3	486	134	27.5	7	670	262.9	39.2
4	677	190	28.1	8	677	182	26.8

These may be taken as a fair showing of the power that is required in many of our best mills to drive shafting. It is unreasonable to think that all that power is consumed by a legitimate amount of friction of bearings and belts. I know of no cause for such a loss of power but tight belts. These, when there are hundreds or thousands in a mill, easily multiply the friction on the bearings, and would account for the figures.

Sag of Belts. Distance between Pulleys. — In the location of shafts that are to be connected with each other by belts, care should be taken to secure a proper distance one from the other. This distance should be such as to allow of a gentle sag to the belt when in motion.

A general rule may be stated thus: Where narrow belts are to be run over small pulleys 15 feet is a good average, the belt having a sag of 1 1/2 to 2 inches.

For larger belts, working on larger pulleys, a distance of 20 to 25 feet does well, with a sag of 2 1/2 to 4 inches.

For main belts working on very large pulleys, the distance should be 25 to 30 feet, the belts working well with a sag of 4 to 5 inches.

If too great a distance is attempted, the belt will have an unsteady flapping motion, which will destroy both the belt and machinery.

Arrangement of Belts and Pulleys. — If possible to avoid it, connected shafts should never be placed one directly over the other, as in such case the belt must be kept very tight to do the work. For this purpose belts should be carefully selected of well-stretched leather.

It is desirable that the angle of the belt with the floor should not exceed 45°. It is also desirable to locate the shafting and machinery so that belts should run off from each shaft in opposite directions, as this arrangement will relieve the bearings from the friction that would result when the belts all pull one way on the shaft.

In arranging the belts leading from the main line of shafting to the counters, those pulling in an opposite direction should be placed as near

each other as practicable, while those pulling in the same direction should be separated. This can often be accomplished by changing the relative positions of the pulleys on the counters. By this procedure much of the friction on the journals may be avoided.

If possible, machinery should be so placed that the direction of the belt motion shall be from the top of the driving to the top of the driven pulley, when the sag will increase the arc of contact.

The pulley should be a little wider than the belt required for the work. The motion of driving should run with and not against the laps of the belts.

Tightening or guide pulleys should be applied to the slack side of belts and near the smaller pulley.

Jones and Laughlins, in their Useful Information, say: The diameter of the pulleys should be as large as can be admitted, provided they will not produce a speed of more than 4750 feet of belt motion per minute.

They also say: It is better to gear a mill with small pulleys and run them at a high velocity, than with large pulleys and to run them slower. A mill thus geared costs less and has a much neater appearance than with large heavy pulleys.

M. Arthur Achard (*Proc. Inst. M. E.*, Jan., 1881, p. 62) says: When the belt is wide a partial vacuum is formed between the belt and the pulley at a high velocity. The pressure is then greater than that computed from the tensions in the belt, and the resistance to slipping is greater. This has the advantage of permitting a greater power to be transmitted by a given belt, and of diminishing the strain on the shafting.

On the other hand, some writers claim that the belt entraps air between itself and the pulley, which tends to diminish the friction, and reduce the tractive force. On this theory some manufacturers perforate the belt with numerous holes to let the air escape.

Care of Belts. — Leather belts should be well protected against water, loose steam, and all other moisture, with which they should not come in contact. But where such conditions prevail fairly good results are obtained by using a special dressing prepared for the purpose of water-proofing leather, though a positive water-proofing material has not yet been discovered.

Belts made of coarse, loose-fibered leather will do better service in dry and warm places, but if damp or moist conditions exist then the very finest and firmest leather should be used. (Fayerweather & Ladew.)

Do not allow oil to drip upon the belts. It destroys the life of the leather. Leather belting cannot safely stand above 110° of heat.

Strength of Belting. — The ultimate tensile strength of belting does not generally enter as a factor in calculations of power transmission.

The strength of the solid leather in belts is from 2000 to 5000 lbs. per square inch; at the lacings, even if well put together, only about 1000 to 1500. If riveted, the joint should have half the strength of the solid belt. The working strain on the driving side is generally taken at not over one-third of the strength of the lacing, or from one-eighth to one-sixteenth of the strength of the solid belt. Dr. Hartig found that the tension in practice varied from 30 to 532 lbs. per sq. in., averaging 273 lbs.

Adhesion Independent of Diameter. (Schultz Belting Co.) — 1. The adhesion of the belt to the pulley is the same — the arc or number of degrees of contact, aggregate tension or weight being the same — without reference to width of belt or diameter of pulley.

2. A belt will slip just as readily on a pulley four feet in diameter as it will on a pulley two feet in diameter, provided the conditions of the faces of the pulleys, the arc of contact, the tension, and the number of feet the belt travels per minute are the same in both cases.

3. To obtain a greater amount of power from belts the pulleys may be covered with leather; this will allow the belts to run very slack and give 25% more durability.

Endless Belts. — If the belts are to be endless, they should be put on and drawn together by "belt clamps" made for the purpose. If the belt is made endless at the belt factory, it should never be run on to the pulleys, lest the irregular strain spring the belt. Lift out one shaft, place the belt on the pulleys, and force the shaft back into place.

Belt Data. — A fly-wheel at the Amoskeag Mfg. Co., Manchester, N.H., 30 feet diameter, 110 inches face, running 61 revs. per min., carried two

heavy double-leather belts 40 inches wide each, and one 24 inches wide. The engine indicated 1950 H.P., of which probably 1850 H.P. was transmitted by the belts. The belts were considered to be heavily loaded, but not overtaxed. $(30 \times 3.14 \times 104 \times 61) \div 1850 = 323$ ft. per min. for 1 H.P. per inch of width.

Samuel Webber (*Am. Mach.*, Feb. 22, 1894) reports a case of a belt 30 ins. wide, $\frac{3}{8}$ in. thick, running for six years at a velocity of 3900 ft. per min., on to a pulley 5 ft. diameter, and transmitting 556 H.P. This gives a velocity of 210 ft. per min. for 1 H.P. per in. of width. By Mr. Nagle's table of riveted belts this belt would be designed for 332 H.P. By Mr. Taylor's rule it would be used to transmit only 123 H.P.

The above may be taken as examples of what a belt may be made to do, but they should not be used as precedents in designing. It is not stated how much power was lost by the journal friction due to over-tightening of these belts.

Belt Dressings. — We advise that no belt dressing should be used except when the belt becomes dry and husky, and in such instances we recommend the use of a dressing. Where this is not used beef tallow at blood-warm temperature should be applied and then dried in either by artificial heat or the sun. The addition of beeswax to the tallow will be of some service if the belts are used in wet or damp places. Our experience convinces us that resin should never be used on leather belting. (Fayerweather & Ladew.)

Belts should not be soaked in water before oiling, and penetrating oils should but seldom be used, except occasionally when a belt gets very dry and husky from neglect. It may then be moistened a little, and have neat's-foot oil applied. Frequent applications of such oils to a new belt render the leather soft and flabby, thus causing it to stretch, and making it liable to run out of line. A composition of tallow and oil, with a little resin or beeswax, is better to use. Prepared castor-oil dressing is good, and may be applied with a brush or rag while the belt is running. (Alexander Bros.)

Some forms of belt dressing, the compositions of which have not been published, appear to have the property of increasing the coefficient of friction between the belt and the pulley, enabling a given power to be transmitted with a lower belt tension than with undressed belts. C. W. Evans (*Power*, Dec., 1905), gives a diagram, plotted from tests, which shows that three of these compositions gave increased transmission for a given tension, ranging from about 10% for 90 lbs. tension per inch of width to 100% increase with 20 lbs. tension.

Cement for Cloth or Leather. (Molesworth.) — 16 parts gutta-percha, 4 india-rubber, 2 pitch, 1 shellac, 2 linseed-oil, cut small, melted together and well mixed.

Rubber Belting. — The advantages claimed for rubber belting are perfect uniformity in width and thickness; it will endure a great degree of heat and cold without injury; it is also specially adapted for use in damp or wet places, or where exposed to the action of steam; it is very durable, and has great tensile strength, and when adjusted for service it has the most perfect hold on the pulleys, hence is less liable to slip than leather.

Never use animal oil or grease on rubber belts, as it will greatly injure and soon destroy them.

Rubber belts will be improved, and their durability increased, by putting on with a painter's brush, and letting it dry, a composition made of equal parts of red lead, black lead, French yellow, and litharge, mixed with boiled linseed-oil and japan enough to make it dry quickly. The effect of this will be to produce a finely polished surface. If, from dust or other cause, the belt should slip, it should be lightly moistened on the side next the pulley with boiled linseed-oil. (From circulars of manufacturers.)

The best conditions are large pulleys and high speeds, low tension and reduced width of belt. 4000 ft. per min. is not an excessive speed on proper sized pulleys.

H. P. of a 4-ply rubber belt = (length of arc of contact on smaller pulley in ft. \times width of belt in ins. \times revs. per min.) \div 325. For a 5-ply belt multiply by $1\frac{1}{3}$, for a 6-ply by $1\frac{2}{3}$, for a 7-ply by 2, for an 8-ply by $2\frac{1}{3}$. When the proper weight of duck is used a 3- or 4-ply rubber belt is equal to a single leather belt and a 5- or 6-ply rubber to a double leather belt.

When the arc of contact is 180° , H.P. of a 4-ply belt = width in ins. \times velocity in ft. per min. \div 650. (Boston Belting Co.)

Steel Belts. — The Eloesser-Kraftband-Gesellschaft, of Berlin, has introduced a steel belt for heavy power transmission at high speeds (*Am. Mach.*, Dec. 24, 1908). It is a thin flat band of tempered steel. The ends are soldered and then clamped by a special device consisting of two steel plates, tapered to thin edges, which are curved to the radius of the smallest pulley to be used, and joined together by small screws which pass through holes in the ends of the belt. It is stated that the slip of these belts is less than 0.1%; they are about one-fifth the width of a leather belt for the same power, and they are run at a speed of 10,000 ft. per minute or upwards. The following figures give a comparison of a rope drive with six ropes 1.9 ins. diam., a leather belt 9.6 ins. wide and a steel belt 4 ins wide, for transmitting 100 H.P. on pulley 3 ft. diam., 30 ft. apart at 200 r.p.m.

	Rope Drive.	Leather Belt.	Steel Belt.
Weight of pulley, lbs.....	2200	1120	460
Weight of rope or belt, lbs.....	530	240	30
Total cost of drive.....	\$335	\$425	\$250
Power lost, per cent of 100 H.P.....	13	6	0.5

ROLLER CHAIN AND SPROCKET DRIVES.

The following is abstracted from an article by A. E. Michel, in *Machy*, Feb., 1905.

Steel chain of accurate pitch, high tensile strength, and good wearing qualities, possesses, when used within proper limitations, advantages enjoyed by no other form of transmission. It is compact, affords a positive speed ratio, and at slow speeds is capable of transmitting heavy strains. On short transmissions it is more efficient than belting and will operate more satisfactorily in damp or oily places. There is no loss of power from stretch, and as it allows of a low tension, journal friction is minimized.

Roller chain has been known to stand up at a speed of 2,000 ft. per min., and transmit 25 H.P. at 1,250 ft. per min.; but speeds of 1,000 ft. per min. and under give better satisfaction. Block chain is adapted to slower speeds, say 700 ft. per min. and under, and is extensively used on bicycles, small motor cars and machine tools. Where speed and pull are not fixed quantities, it is advisable to keep the speed high, and chain pull low, yet it should be borne in mind that high speeds are more destructive to chains of large than to those of small pitch.

The following table of tensile strengths, based on tests of "Diamond" chains taken from stock, may be considered a fair standard:

ROLLER CHAIN.								
Pitch, in.....	$\frac{1}{2}$	$\frac{5}{8}$	$\frac{3}{4}$	1	$1\frac{1}{4}$	$1\frac{1}{2}$	$1\frac{3}{4}$	2
Tens. strength, lbs.	1,200	1,200	4,000	6,000	9,000	12,000	19,000	25,000
Block chain.....	1 inch,		1,200 to 2,500;		$1\frac{1}{2}$ inch,		5,000.	

The safe working load of a chain is dependent on the amount of rivet bearing surface, and varies from $\frac{1}{5}$ to $\frac{1}{40}$ of the tensile strength, according to the speed, size of sprockets, and other conditions peculiar to each case. The tendency now is to use the widest possible chain in order to secure maximum rivet bearing surface, thus insuring minimum wear from friction. Manufacturers are making heavier chains than heretofore for the same duty. As short pitch is always desirable, special double and even triple width chains are now made to conform to the requirements when a heavy single width chain of greater pitch is not practical. A double chain has twice the rivet bearing surface and half again as much tensile strength as the similar single one.

The length of chain for a given drive may be found by the following formula:

All dimensions in inches. D = Distance between centers of shafts. A = Distance between limiting points of contact. R = Pitch radius of large sprocket. r = Pitch radius of small sprocket. N = Number of teeth of large sprocket. n = Number of teeth of small sprocket. P = Pitch of chain and sprockets. $(180^\circ + 2\alpha)$ = angle of contact on large sprocket. $(180^\circ - 2\alpha)$ = angle of contact on small sprocket. α = angle whose sine is $(R - r)/D$. $A = D \cos \alpha$.

Length of chain required:

$$L = \frac{180 + 2\alpha}{360} NP + \frac{180 - 2\alpha}{360} nP + 2D \cos \alpha.$$

For block chain, the total length specified in ordering should be in multiples of the pitch. For roller chain, the length should be in multiples of twice the pitch, as a union of the ends can be effected only with an outside and an inside link.

Wherever possible, the distance between centers of shafts should permit of adjustment in order to regulate the sag of the chain. A chain should be adjusted, in proportion to its length, to show slack when running, care being taken to have it neither too tight nor too loose, as either condition is destructive. If a fixed center distance must be used, and results in too much sag, the looseness should be taken up by an idler, and when there is any considerable tension on the slack side, this idler must be a sprocket. Where an idler is not practical, another combination of sprockets giving approximately the same speed ratio may be tried, and in this manner a combination giving the proper sag may always be obtained.

In automobile drives, too much sag or too great a distance between shafts causes the chain to whip up and down — a condition detrimental to smooth running and very destructive to the chain. In this class of work a center distance of over 4 ft. has been used, but greater efficiency and longer life are secured from the chain on shorter lengths, say 3 ft. and under.

Sprocket Wheels. Properly proportioned and machined sprockets are essential to successful chain gearing. The important dimensions of a sprocket are the pitch diameter and the bottom and outside diameters. For block chain these are obtained as follows:

N = No. of teeth. b = Diameter of round part of chain block. B = Center to center of holes in chain block. A = Center to center of holes in side links. $\alpha = 180^\circ/N$. $\tan \beta = \sin \alpha \div (B/A + \cos \alpha)$.

$$\text{Pitch diameter} = A/\sin \beta.$$

Bottom diam. = pitch diam. - b . Outside diam. = pitch diam. + b .

For roller chain: N = Number of teeth. P = Pitch of chain. D = Diameter of roller. $\alpha = 180^\circ/N$. Pitch diameter = $P/\sin \alpha$.

Bottom diam. = pitch diam. - D .

For sprockets of 17 teeth and over, outside diam = pitch diam. + D .

The outside diameters of small sprockets are cut down so that the teeth will clear the roller perfectly at high speeds.

$$\text{Outside diam.} = \text{pitch diam.} + D - E.$$

Pitch.	Values of E .	
	8 to 12 Teeth.	13 to 16 Teeth.
1/2 in. to 3/4 in.....	0.062 in.	0.031 in.
1 in. to 2 ins.....	0.125 in.	0.062 in.

Sprocket diameters should be very accurate, particularly the base diameter, which should not vary more than 0.002 in. from the calculated values. Sprockets should be gauged to discover thick teeth and inaccurate diameters. A poor chain may operate on a good sprocket, but a bad sprocket will ruin a good chain. Sprockets of 12 to 60 teeth give best

results. Fewer may be used, but cause undue elongation in the chain, wear the sprockets and consume too much power. Eight-tooth sprockets ruin almost every roller chain applied to them, and ten and eleven teeth are fitted only for medium and slow speeds with other conditions unusually favorable.

Sprocket teeth seldom break from insufficient strength, but the tooth must be properly shaped. A chain will not run well unless the sprockets have sidewise clearance and teeth narrowed at the ends by curves beginning at the pitch line.

Calling W the width of the chain between the links,

$A = 1/2 W$ = width of tooth at top. B = uniform width below pitch line.

$B = W - 1/64$ in. when $W = 1/4$ in. or less.

= $W - 1/32$ in. when $W = 5/16$ to $5/8$ in. inclusive.

= $W - 1/16$ in. when $W = 3/4$ in. or over.

If the sprocket is flanged the chain must seat itself properly without the side bars coming into contact with the flange.

The principal cause of trouble within the chain is elongation. It is the result of stretch of material or natural wear of rivets and their bearings. To guard against the former, chain makers use special materials of high tensile strength, but a chain subjected to jars and jolts beyond the limit of elasticity of the material may be put in worse condition in an instant than in months of natural wear. If for any reason a link elongates unduly it should be replaced at once, as one elongated link will eventually ruin the entire chain. Such elongation frequently results from all the load being thrown on at once.

To minimize natural wear, chains should be well greased inside and out, protected from mud and heavy grit, cleaned often and replaced to run in the same direction and same side up. A new chain should never be applied to a much-worn sprocket.

Importance of pitch line clearances: In a sprocket with no clearances a new chain fits perfectly, but after natural wear the pitch of chain and sprocket become unlike. The chain is then elongated and climbs the teeth, which act as wedges, producing enormous strain, and it quickly wrecks itself. With the same chain on a driven sprocket, cut with clearances, all rollers seat against their teeth. After long and useful life, the working roller shifts to the top, and the other rollers still seat with the same ease as when new. Theoretically, all the rollers share the load. This never occurs in practice, for infinitesimal wear within the chain causes one, and only one, roller to bear perfectly seated against the working face of the sprocket tooth at any one time. Clearance alone on the driver will not provide for elongation. To operate properly the pitch of the driver must be lengthened, which is done by increasing the pitch diameter by an amount dependent upon the clearance allowed. For theoretical reasoning on this subject see "Roller Chain Gear," a treatise on English practice, by Hans Renold.

When the load reverses, each sprocket becomes alternately driver and driven. This happens in a motor car during positive and negative acceleration, or in ascending or descending a hill. In this event, the above construction is not applicable, for a driven sprocket of longer pitch than the chain will stretch it. No perfect method of equalizing the pitch of a roller chain and its sprockets under reversible load and at all periods of chain elongation has been found. This fault is eliminated in the "silent" type of chain; hence it runs smooth at a very much greater speed than roller chain will stand.

In practice there are comparatively few roller chain drives with chain pull always in the same direction, so manufacturers generally cut the driver sprockets for these with normal pitch diameter, same as the driven. Recent experiments have proven that the difficulties are greatly lessened by cutting both driver and driven with liberal pitch line clearance. Accordingly, chain makers now advise the following pitch line clearance for standard rollers:

Pitch, in.,	1/2	3/4	1	1 1/4	1 1/2	1 3/4	2
Clearance, in.,	1/32	1/16	3/32	3/16	7/32	1/8	5/32

Cutters may be obtained from Brown & Sharpe Mfg. Co. with this clearance.

Belting versus Chain Drives. — Chains are suitable for positive transmissions of very heavy powers at slow speed. They are properly used for conveying ashes, sand, chemicals and liquids which would corrode or destroy belting. Chains of this kind are generally made of malleable iron. For conveyers for clean substances, flour, wheat and other grains, belts are preferable, and in the best installations leather is preferred to cotton or rubber, being more durable. Transmission chains have to be carefully made. If the chain is to run smoothly, noiselessly, and without considerable friction, both the links and the sprockets must be mathematically correct. This perfection of design is found only in the highest and best makes of steel chain.

Deterioration of chains starts in with the beginning of service. Even in such light and flexible duty as bicycle transmission, a chain is subjected to sudden severe strains, which either stretch the chain or distort the bearing surfaces. Either mishap is fatal to smooth frictionless running. If the transmission is positive, as from motor or shaft to a machine tool, sudden variations in strain become sledge-hammer blows, and the chain must either break or the parts yield. To avoid the evils arising from the stretching of the chain, self-adjusting forms of teeth have been invented, of which the Renold silent-chain gear is one of the best.

The makers of the Morse rocker chain, also an excellent chain, recommend it for use under the following conditions: (1) Where room is lacking for the proper sized pulleys for belts. (2) Where the centers between shafts are too short for belts. (3) Where a positive speed ratio is desired. (4) Where there is moisture, heat or dust that would prevent a belt working properly. (5) Where a maximum power per inch of width is desired.

The Renold silent chain and the Morse rocker chain find springs necessary in the sprocket wheel. This springiness the belt naturally possesses, and where maximum power is not necessary at a low speed under service conditions of moisture and dirt, as in automobile transmission, the belt will be cheaper to install, cheaper to maintain, cheaper to repair in case of breakdown, and more efficient than any chain. A leather belt will run on very short centers and transmit very high powers, but it should be run at higher speed than a long belt.

For slow service, for positive transmission, for rough service, gears are rivals of chain transmission. For fast service, for springy transmission, for clean, dry work, leather belts are still the best. — Harrington Emerson, *Am. Mach.*, April 6, 1909.

It is to be regretted that there is no standard among chain manufacturers for the correct outline of sprocket cutters and amount of clearance for various sizes of chain. If it is clearly understood that the high quality roller and block chains now on the market require correctly cut sprockets properly proportioned for the particular conditions of service they are to work under, there will be a large increase in their use for power transmission, and the troubles now incident to incorrect installations could be wholly obviated. — C. C. Myers, *Am. Mach.*, Aug. 5, 1909.

A 350-H.P. Silent Chain Drive has been built by the Link Belt Co. The gears are 12 ft. apart, centers. The drive consists of two strands, each 12 ins. wide, of Renold silent chain of 2-in. pitch. The pinion is of forged steel, about 16 1/2 in. diameter, 27-in. face, 26 teeth, bore 29 in. long 10 in. diameter. The main gear is made of two cast-iron wheels, side by side, each 76 1/2 in. diameter, 13 1/2 in. face, 120 teeth. Each wheel is provided with steel flanges and a special hub containing a series of stiff coiled springs in compression through which the driving force is transmitted from the hub to the wheel. The object of this device is to provide an equalizing factor between the power shaft and the teeth of the wheel, so that any unevenness in the rotation and consequent shock will be absorbed by the device. The pinion is mounted on the armature of a motor running 300 r.p.m., and the speed of the driven gear is 65 r.p.m. The speed of the chain belt is 780 ft. per minute. Three of these drives have been constructed to transmit power for wire drawing. — (*Power*, Dec. 28, 1909.)

GEARING.

TOOTHED-WHEEL GEARING.

Pitch, Pitch-circle, etc. — If two cylinders with parallel axes are pressed together and one of them is rotated on its axis, it will drive the other by means of the friction between the surfaces. The cylinders may be considered as a pair of spur-wheels with an infinite number of very small teeth. If actual teeth are formed upon the cylinders, making alternate elevations and depressions in the cylindrical surfaces, the distance between the axes remaining the same, we have a pair of gear-wheels which will drive one another by pressure upon the faces of the teeth, if the teeth are properly shaped. In making the teeth the cylindrical surface may entirely disappear, but the position it occupied may still be considered as a cylindrical surface, which is called the "pitch-surface," and its trace on the end of the wheel, or on a plane cutting the wheel at right angles to its axis, is called the "pitch-circle" or "pitch-line." The diameter of this circle is called the pitch-diameter, and the distance from the face of one tooth to the corresponding face of the next tooth on the same wheel, measured on an arc of the pitch-circle, is called the "pitch of the tooth," or the circular pitch.

If two wheels having teeth of the same pitch are geared together so that their pitch-circles touch, it is a property of the pitch-circles that their diameters are proportional to the number of teeth in the wheels, and vice versa; thus, if one wheel is twice the diameter (measured on the pitch-circle) of the other, it has twice as many teeth. If the teeth are properly shaped the linear velocities of the two wheels are equal, and the angular velocities, or speeds of rotation, are inversely proportional to the number of teeth and to the diameter. Thus the wheel that has twice as many teeth as the other will revolve just half as many times in a minute.

The "pitch," or distance measured on an arc of the pitch-circle from the face of one tooth to the face of the next, consists of two parts — the "thickness" of the tooth and the "space" between it and the next tooth. The space is larger than the thickness by a small amount called the "backlash," which is allowed for imperfections of workmanship. In finely cut gears the backlash may be almost nothing.

The length of a tooth in the direction of the radius of the wheel is called the "depth," and this is divided into two parts: First, the "addendum," the height of the tooth above the pitch line; second, the "dedendum," the depth below the pitch-line, which is an amount equal to the addendum of the mating gear. The depth of the space is usually given a little "clearance" to allow for inaccuracies of workmanship, especially in cast gears.

Referring to Fig. 171, *pl, pl* are the pitch-lines, *al* the addendum-line, *rl* the root-line or dedendum-line, *cl* the clearance-line, and *b* the backlash. The addendum and dedendum are usually made equal to each other.

$$\text{Diametral pitch} = \frac{\text{No. of teeth}}{\text{diam. of pitch-circle in inches}} = \frac{3.1416}{\text{circular pitch}}$$

$$\text{Circular pitch} = \frac{\text{diam.} \times 3.1416}{\text{No. of teeth}} = \frac{3.1416}{\text{diametral pitch}}$$

Some writers use the term diametral pitch to mean $\frac{\text{diam.}}{\text{No. of teeth}} = \frac{\text{circular pitch}}{3.1416}$, but the first definition is the more common and the more

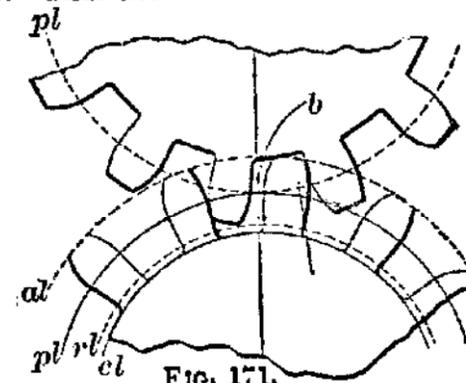

FIG. 171.

convenient. A wheel of 12 in. diam. at the pitch-circle, with 48 teeth, is $\frac{48}{12} = 4$ diametral pitch, or simply 4 pitch. The circular pitch of the same wheel is $12 \times 3.1416 \div 48 = 0.7854$, or $3.1416 \div 4 = 0.7854$ in.

Relation of Diametral to Circular Pitch.

Diametral Pitch.	Circular Pitch.	Diametral Pitch.	Circular Pitch.	Circular Pitch.	Diametral Pitch.	Circular Pitch.	Diametral Pitch.
1	3.142 in.	11	0.286 in.	3	1.047	15/16	3.351
1 1/2	2.094	12	.262	2 1/2	1.257	7/8	3.590
2	1.571	14	.224	2	1.571	13/16	3.867
2 1/4	1.396	16	.196	1 7/8	1.676	3/4	4.189
2 1/2	1.257	18	.175	1 3/4	1.795	11/16	4.570
2 3/4	1.142	20	.157	1 5/8	1.933	5/8	5.027
3	1.047	22	.143	1 1/2	2.094	9/16	5.585
3 1/2	.898	24	.131	1 7/16	2.185	1/2	6.283
4	.785	26	.121	1 3/8	2.285	7/16	7.181
5	.628	28	.112	1 5/16	2.394	3/8	8.378
6	.524	30	.105	1 1/4	2.513	5/16	10.053
7	.449	32	.098	1 3/16	2.646	1/4	12.566
8	.393	36	.087	1 1/8	2.793	3/16	16.755
9	.349	40	.079	1 1/16	2.957	1/8	25.133
10	.314	48	.065	1	3.142	1/16	50.266

Since circ. pitch = $\frac{\text{diam.} \times 3.1416}{\text{No. of teeth}}$, diam. = $\frac{\text{circ. pitch} \times \text{No. of teeth}}{3.1416}$

which always brings out the diameter as a number with an inconvenient fraction if the pitch is in even inches or simple fractions of an inch. By the diametral-pitch system this inconvenience is avoided. The diameter may be in even inches or convenient fractions, and the number of teeth is usually an even multiple of the number of inches in the diameter.

Diameter of Pitch-line of Wheels from 10 to 100 Teeth of 1 in. Circular Pitch.

No. Teeth.	Diam., in.	No. Teeth.	Diam., in.	No. Teeth.	Diam., in.	No. Teeth.	Diam., in.	No. Teeth.	Diam., in.	No. Teeth.	Diam., in.
10	3.183	26	8.276	41	13.051	56	17.825	71	22.600	86	27.375
11	3.501	27	8.594	42	13.369	57	18.144	72	22.918	87	27.693
12	3.820	28	8.913	43	13.687	58	18.462	73	23.236	88	28.011
13	4.138	29	9.231	44	14.006	59	18.781	74	23.555	89	28.329
14	4.456	30	9.549	45	14.324	60	19.099	75	23.873	90	28.648
15	4.775	31	9.868	46	14.642	61	19.417	76	24.192	91	28.966
16	5.093	32	10.186	47	14.961	62	19.735	77	24.510	92	29.285
17	5.411	33	10.504	48	15.279	63	20.054	78	24.828	93	29.603
18	5.730	34	10.823	49	15.597	64	20.372	79	25.146	94	29.921
19	6.048	35	11.141	50	15.915	65	20.690	80	25.465	95	30.239
20	6.366	36	11.459	51	16.234	66	21.008	81	25.783	96	30.558
21	6.685	37	11.777	52	16.552	67	21.327	82	26.101	97	30.876
22	7.003	38	12.096	53	16.870	68	21.645	83	26.419	98	31.194
23	7.321	39	12.414	54	17.189	69	21.963	84	26.738	99	31.512
24	7.639	40	12.732	55	17.507	70	22.282	85	27.056	100	31.831

For diameter of wheels of any other pitch than 1 in., multiply the figures in the table by the pitch. Given the diameter and the pitch, to find the number of teeth. Divide the diameter by the pitch, look in the table under diameter for the figure nearest to the quotient, and the number of teeth will be found opposite.

WARNING: This is a 1910 edition. Some of the material may no longer be accurate

Proportions of Teeth. Circular Pitch = 1.

	1.	2.	3.	4.	5.	6.
Depth of tooth above pitch-line.....	0.35	0.30	0.37	0.33	0.30	0.30
Depth of tooth below pitch-line.....	.40	.40	.43	.40	.40	.35
Working depth of tooth.....	.70	.60	.73	.66	.70	.65
Total depth of tooth.....	.75	.70	.80	.75	.70	.65
Clearance at root.....	.05	.10	.07	.05	.05	.05
Thickness of tooth.....	.45	.45	.47	.45	.475	.485
Width of space.....	.54	.55	.53	.55	.525	.515
Backlash.....	.09	.10	.06	.10	.05	.03
Thickness of rim.....			.47	.45	.70	.65

	7.	8.	9.	10.*
Depth of tooth above pitch-line.....	0.25 to 0.33	0.30	0.318	1 ÷ P
Depth of tooth below pitch-line.....	.35 to .42	.35 + .08"	.369	1.157 ÷ P
Working depth of tooth.....	.6 to .75	.65 + .08"	.687	2 ÷ P
Total depth of tooth.....			.687	2.157 ÷ P
Clearance at root.....			.04 to .05	0.157 ÷ P
Thickness of tooth.....	.48 to .485	.48 - .03"	.48 to .5	1.51 ÷ P to 1.57 ÷ P
Width of space.....	.52 to .515	.52 + .03"	.52 to .5	1.57 ÷ P to 1.63 ÷ P
Backlash.....	.04 to .03	.04 + .06"	.0 to .04	.0 to .06 ÷ P

* In terms of diametral pitch.

AUTHORITIES. — 1. Sir Wm. Fairbairn. 2, 3. Clark, R. T. D.; "used by engineers in good practice." 4. Molesworth. 5, 6. Coleman Sellers; 5 for cast, 6 for cut wheels. 7, 8. Unwin. 9, 10. Leading American manufacturers of cut gears.

The Chordal Pitch (erroneously called "true pitch" by some authors) is the length of a straight line or chord drawn from center to center of two adjacent teeth. The term is now but little used, except in connection with chain and sprocket gearing.

Chordal pitch = diam. of pitch-circle × sine of $\frac{180^\circ}{\text{No. of teeth}}$. Chordal pitch of a wheel of 10 in. pitch diameter and 10 teeth, $10 \times \sin 18^\circ = 3.0902$ in. Circular pitch of same wheel = 3.1416. Chordal pitch is used with chain or sprocket wheels, to conform to the pitch of the chain.

Gears with Short Teeth. — There is a tendency in recent years to depart widely from the proportions of teeth given in the above and to use much shorter teeth, especially for heavy machinery. C. W. Hunt gives addendum and dedendum each = 0.25, and the clearance 0.05 of the circular pitch, making the total depth of tooth 0.55 of the circular pitch. The face of the tooth is involute in form, and the angle of action is $14\frac{1}{2}^\circ$. C. H. Logue uses a 20° involute with the following proportions: Addendum $0.25P' = 0.7854 \div P$; dedendum $0.30P' = 0.9424 \div P$; clearance, $0.05P' = 0.157P$; whole depth $0.55P' = 1.7278 \div P$. P' = circular pitch, P = diametral pitch. See papers by R. E. Flanders and Norman Litchfield in *Trans. A. S. M. E.*, 1908.

John Walker (*Am. Mach.*, Mar. 11, 1897) says: For special purposes of slow-running gearing with great tooth stress I should prefer a length of tooth of 0.4 of the pitch, but for general work a length of 0.6 of the pitch. In 1895 Mr. Walker made two pairs of cut steel gears for the Chicago cable railway with 6-in. circular pitch, length = 0.4 pitch. The pinions had 42 teeth and the gears 62, each 20-in. face. The two pairs were set side by side on their shafts, so as to stagger the teeth, making the total face 40 ins. The gears transmitted 1500 H.P. at 60 r.p.m. replacing cast-iron gears of $7\frac{1}{2}$ in. pitch which had broken in service.

Formulae for Determining the Dimensions of Small Gears.
(Brown & Sharpe Mfg. Co.)

P = diametral pitch, or the number of teeth to one inch of diameter of pitch-circle;

D' = diameter of pitch-circle.....	Larger Wheel.	These wheels run together.
D = whole diameter.....		
V = number of teeth.....		
V = velocity.....		
d' = diameter of pitch-circle.....	Smaller Wheel.	
d = whole diameter.....		
n = number of teeth.....		
u = velocity.....		

a = distance between the centers of the two wheels;
 b = number of teeth in both wheels;
 t = thickness of tooth or cutter on pitch-circle;
 s = addendum;
 D'' = working depth of tooth;
 f = amount added to depth of tooth for rounding the corners and for clearance;
 $D'' + f$ = whole depth of tooth;
 π = 3.1416.
 P' = circular pitch, or the distance from the center of one tooth to the center of the next measured on the pitch-circle.

Formulae for a single wheel:

$$P = \frac{N+2}{D}; D' = \frac{D \times N}{N+2}; D'' = \frac{2}{P} = 2s; s = \frac{1}{P} = \frac{P'}{\pi} = 0.3183 P';$$

$$P = \frac{N}{D'}; D' = \frac{N}{P}; N = PD - 2; s = \frac{D'}{N} = \frac{D}{N+2};$$

$$P' = \frac{\pi}{P}; D = \frac{N+2}{P}; f = \frac{t}{10}; s + f = \frac{1}{P} \left(1 + \frac{\pi}{20}\right) = 0.3685 P.$$

$$P = \frac{\pi}{P'}; D = D' + \frac{2}{P}; t = \frac{1.57}{P} = \frac{1}{2} P'.$$

Formulae for a pair of wheels:

$$b = 2aP; n = \frac{PD'V}{v}; D = \frac{2a(N+2)}{b};$$

$$N = \frac{nv}{V}; v = \frac{PD'V}{n}; d = \frac{2a(n+2)}{b};$$

$$n = \frac{NV}{v}; v = \frac{NV}{n}; a = \frac{b}{2P};$$

$$N = \frac{bv}{v+V}; V = \frac{nv}{N}; a = \frac{D'+d'}{2};$$

$$n = \frac{bV}{v+V}; D' = \frac{2av}{v+V}; d' = \frac{2aV}{v+V}.$$

Width of Teeth. — The width of the faces of teeth is generally made from 2 to 3 times the circular pitch, that is from 6.28 to 9.42 divided by the diametral pitch. There is no standard rule for width.

The following sizes are given in a stock list of cut gears in "Grant's Gears:"

Diametral pitch..	2	4	6	8	12	16
Face, inches.....	3 and 4	2 1/2 13/4 and 2	1 1/4 and 1 1/2	3/4 and 1	1 1/2 and 5/8	

The Walker Company gives:

Circular pitch, in..	1/2	5/8	3/4	7/8	1	1 1/2	2	2 1/2	3	4	5	6
Face, in.....	1 1/4	1 1/2	1 3/4	2	2 1/2	4 1/2	6	7 1/2	9	12	16	20

The following proportions of gear-wheels are recommended by Prof. Coleman Sellers. (Stevens Indicator, April, 1892.)

Proportions of Gear-wheels.

Diametral Pitch.	Circular Pitch. P	Outside of Pitch-line. P x 0.3.	Inside of Pitch-line.		Width of Space.	
			For Cast or Cut Bevels or for Cast Spurs. P x 0.4.	For Cut Spurs. P x 0.35	For Cast Spurs or Bevels. P x 0.525.	For Cut Bevels or Spurs. P x 0.51.
12	1/4	0.075	0.100	0.088	0.131	0.128
10	0.2618	.079	.105	.092	.137	.134
8	0.31416	.094	.126	.11	.165	.16
7	3/8	.113	.150	.131	.197	.191
6	0.3927	.118	.157	.137	.206	.2
5	0.4477	.134	.179	.157	.235	.228
4	1/2	.15	.20	.175	.263	.255
3	0.5236	.157	.209	.183	.275	.267
2 3/4	9/16	.169	.225	.197	.295	.287
2 1/2	5/8	.188	.25	.219	.328	.319
2	0.62832	.188	.251	.22	.33	.32
1 3/4	3/4	.225	.3	.263	.394	.383
1 1/2	0.7854	.236	.314	.275	.412	.401
1 1/4	7/8	.263	.35	.307	.459	.446
1	1	.3	.4	.35	.525	.51
3/4	1.0472	.314	.419	.364	.55	.534
2/3	1 1/8	.338	.45	.394	.591	.574
1/2	1.1424	.343	.457	.40	.6	.583
1/3	1 1/4	.375	.5	.438	.656	.638
1/4	1.25664	.377	.503	.44	.66	.641
1/5	1 3/8	.413	.55	.481	.722	.701
1/6	1 1/2	.45	.6	.525	.788	.765
1/8	1.5708	.471	.628	.55	.825	.801
1/10	1 3/4	.525	.7	.613	.919	.893
1/12	2	.6	.8	.7	1.05	1.02
1/16	2.0944	.628	.838	.733	1.1	1.068
1/20	2 1/4	.675	.9	.788	1.181	1.148
1/25	2 1/2	.75	1.0	.875	1.313	1.275
1/30	2 3/4	.825	1.1	.963	1.444	1.403
1/40	3	.9	1.2	1.05	1.575	1.53
1/50	3 1/4	.942	1.257	1.1	1.649	1.602
1/60	3 1/2	.975	1.3	1.138	1.706	1.657
1/80		1.05	1.4	1.225	1.838	1.785

Thickness of rim below root = depth of tooth.

Rules for Calculating the Speed of Gears and Pulleys. — The relations of the size and speed of driving and driven gear-wheels are the same as those of belt pulleys. In calculating for gears, multiply or divide by the diameter of the pitch-circle or by the number of teeth, as may be required. In calculating for pulleys, multiply or divide by their diameter in inches.

If D = diam. of driving wheel, d = diam. of driven, R = revolutions per minute of driver, r = revs. per min. of driven, $RD = rd$;

$$R = rd \div D; r = RD \div d; D = dr \div R; d = DR \div r.$$

If N = No. of teeth of driver and n = No. of teeth of driven, $NR = nr$;

$$N = nr \div R; n = NR \div r; R = rn \div N; r = RN \div n.$$

To find the number of revolutions of the last wheel at the end of a train of spur-wheels, all of which are in a line and mesh into one another, when the revolutions of the first wheel and the number of teeth or the

diameter of the first and last are given: Multiply the revolutions of the first wheel by its number of teeth or its diameter, and divide the product by the number of teeth or the diameter of the last wheel.

To find the number of teeth in each wheel for a train of spur-wheels, each to have a given velocity: Multiply the number of revolutions of the driving-wheel by its number of teeth, and divide the product by the number of revolutions each wheel is to make.

To find the number of revolutions of the last wheel in a train of wheels and pinions, when the revolutions of the first or driver, and the diameter, the teeth, or the circumference of all the drivers and pinions are given: Multiply the diameter, the circumference, or the number of teeth of all the driving-wheels together, and this continued product by the number of revolutions of the first wheel, and divide this product by the continued product of the diameter, the circumference, or the number of teeth of all the driven wheels, and the quotient will be the number of revolutions of the last wheel.

EXAMPLE. — 1. A train of wheels consists of four wheels each 12 in. diameter of pitch-circle, and three pinions 4, 4, and 3 in. diameter. The large wheels are the drivers, and the first makes 36 revs. per min. Required the speed of the last wheel.

$$\frac{36 \times 12 \times 12 \times 12}{4 \times 4 \times 3} = 1296 \text{ r.p.m.}$$

2. What is the speed of the first large wheel if the pinions are the drivers, the 3-in. pinion being the first driver and making 36 revs. per min.?

$$\frac{36 \times 3 \times 4 \times 4}{12 \times 12 \times 12} = 1 \text{ r.p.m. Ans.}$$

Milling Cutters for Interchangeable Gears. — The Pratt & Whitney Co. makes a series of cutters for cutting epicycloidal teeth. The number of cutters to cut from a pinion of 12 teeth to a rack is 24 for each pitch coarser than 10. The Brown & Sharpe Mfg. Co. makes a similar series, and also a series for involute teeth, in which eight cutters are made for each pitch, as follows:

No.	1.	2.	3.	4.	5.	6.	7.	8.
Will cut from	135	55	35	26	21	17	14	12
to	Rack	134	54	34	25	20	16	13

FORMS OF THE TEETH.

In order that the teeth of wheels and pinions may run together smoothly and with a constant relative velocity, it is necessary that their working faces shall be formed of certain curves called odontoids. The essential property of these curves is that when two teeth are in contact the common normal to the tooth curves at their point of contact must pass through the pitch-point, or point of contact of the two pitch-circles. Two such curves are in common use — the cycloid and the involute.

The Cycloidal Tooth. — In Fig. 172 let *PL* and *pl* be the pitch-circles of two gear-wheels; *GC* and *gc* are two equal generating-circles, whose radii should be taken as not greater than one-half of the radius of the smaller pitch-circle. If the circle *gc* be rolled to the left on the larger pitch-circle *PL*, the point *O* will describe an epicycloid, *Oefgh*. If the other generating-circle *GC* be rolled to the right on *PL*, the point *O* will describe a hypocycloid *Oabcd*. These two curves, which are tangent at *O*, form the two parts of a tooth curve for a gear whose pitch-circle is *PL*. The upper part *Oh* is called the face and the lower part *Od* is called the flank. If the same circles be rolled on the other pitch-circle *pl*, they will describe the curve for a tooth of the gear *pl*, which will work properly with the tooth on *PL*.

The cycloidal curves may be drawn without actually rolling the generating-circle, as follows: On the line *PL*, from *O*, step off and mark equal distances, as 1, 2, 3, 4, etc. From 1, 2, 3, etc., draw radial lines toward the center of *PL*, and from 6, 7, 8, etc., draw radial lines from the same

center, but beyond *PL*. With the radius of the generating-circle, and with centers successively placed on these radial lines, draw arcs of circles tangent to *PL* at 1, 2, 3, 6, 7, 8, etc. With the dividers set to one of the equal divisions, as *O1*, step off on the generating circle *gc* the points *a'*, *b'*, *c'*, *d'*, then take successively the chordal distances *Oa*, *Oa'*, *Oa''*, *Oa'''*, and lay them off on the several arcs *6e*, *7f*, *8g*, *9h*, and *1a*, *2b*, *3c*, *4d*; through the points *efgh* and *abcd* draw the tooth curves.

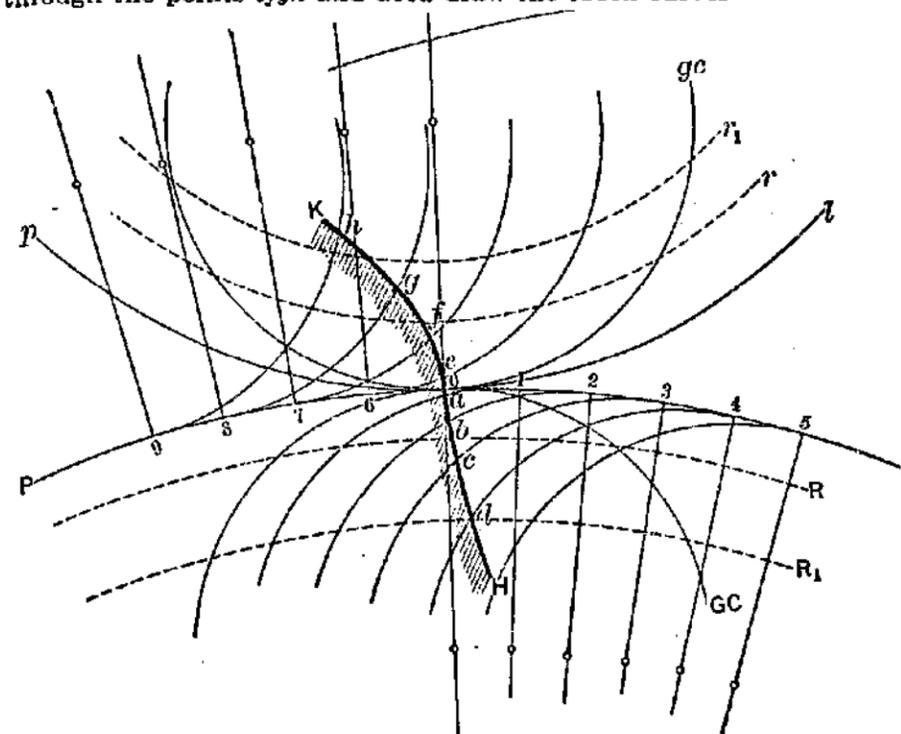

FIG. 172.

The curves for the mating tooth on the other wheel may be found in like manner by drawing arcs of the generating-circle tangent at equidistant points on the pitch-circle *pl*.

The tooth curve of the face *Oh* is limited by the addendum-line *r* or *r₁*, and that of the flank *Oh* by the root curve *R* or *R₁*. *R* and *r* represent the root and addendum curves for a large number of small teeth, and *R₁* the like curves for a small number of large teeth. The form or appearance of the tooth therefore varies according to the number of teeth, while the pitch-circle and the generating-circle may remain the same.

In the cycloidal system, in order that a set of wheels of different diameters but equal pitches shall all correctly work together, it is necessary that the generating-circle used for the teeth of all the wheels shall be the same, and it should have a diameter not greater than half the diameter of the pitch-line of the smallest wheel of the set. The customary standard size of the generating-circle of the cycloidal system is one having a diameter equal to the radius of the pitch-circle of a wheel having 12 teeth. (Some gear-makers adopt 15 teeth.) This circle gives a radial flank to the teeth of a wheel having 12 teeth. A pinion of 10 or even a smaller number of teeth can be made, but in that case the flanks will be undercut, and the tooth will not be as strong as a tooth with radial flanks. If in any case the describing circle be half the size of the pitch-circle, the flanks will be radial; if it be less, they will spread out toward the root of the tooth, giving a stronger form; but if greater, the flanks will curve in toward each other, whereby the teeth become weaker and difficult to make.

In some cases cycloidal teeth for a pair of gears are made with the generating-circle of each gear having a radius equal to half the radius of its pitch-circle. In this case each of the gears will have radial flanks.

This method makes a smooth working gear, but a disadvantage is that the wheels are not interchangeable with other wheels of the same pitch but different numbers of teeth.

The rack in the cycloidal system is equivalent to a wheel with an infinite number of teeth. The pitch is equal to the circular pitch of the mating gear. Both faces and flanks are cycloids formed by rolling the generating-circle of the mating gear-wheel on each side of the straight pitch-line of the rack.

Another method of drawing the cycloidal curves is shown in Fig. 173. It is known as the method of tangent arcs. The generating-circles, as before, are drawn with equal radii, the length of the radius being less than half the radius of pl , the smaller pitch-circle. Equal divisions 1, 2,

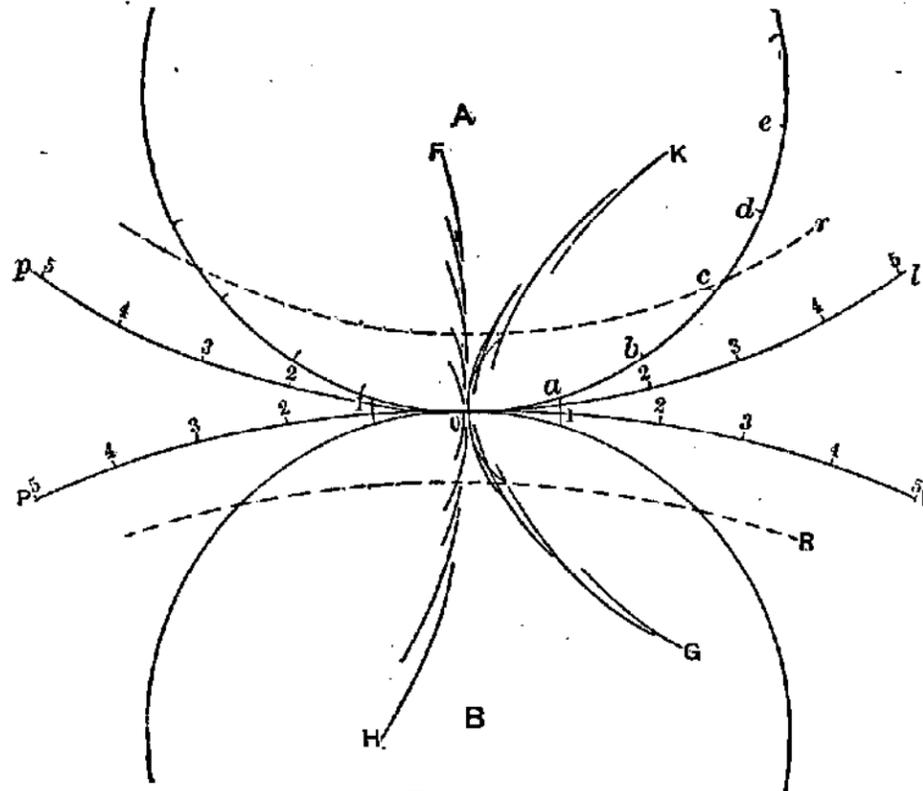

FIG. 173.

3, 4, etc., are marked off on the pitch-circles and divisions of the same length stepped off on one of the generating-circles, as O, a, b, c . From the points 1, 2, 3, 4, 5 on the line pO , with radii successively equal to the chord distances Oa, Ob, Oc, Od, Oe , draw the five small arcs F . A line drawn through the outer edges of these small arcs, tangent to them all, will be the hypocycloidal curve for the flank of a tooth below the pitch-line pl . From the points 1, 2, 3, etc., on the line Ol , with radii as before, draw the small arcs G . A line tangent to these arcs will be the epicycloid for the face of the same tooth for which the flank curve has already been drawn. In the same way, from centers on the line PO , and OL , with the same radii, the tangent arcs H and K may be drawn, which will give the tooth for the gear whose pitch-circle is PL .

If the generating-circle had a radius just one-half of the radius of pl , the hypocycloid F would be a straight line, and the flank of the tooth would have been radial.

The Involute Tooth. — In drawing the involute-tooth curve, Fig. 174, the angle of obliquity, or the angle which a common tangent to the teeth, when they are in contact at the pitch-point, makes with a line joining the centers of the wheels, is first arbitrarily determined. It is customary to take it at 15° . The pitch-lines pl and PL being drawn in contact at O , the line of obliquity AB is drawn through O normal to a common tangent

to the tooth curves, or at the given angle of obliquity to a common tangent to the pitch-circles. In the cut the angle is 20° . From the centers of the pitch-circles draw circles c and d tangent to the line AB . These circles are called base-lines or base-circles, from which the involutes F and K are drawn. By laying off convenient distances, 0, 1, 2, 3, which should each be less than $1/10$ of the diameter of the base-circle, small arcs can be drawn with successively increasing radii, which will form the involute. The involute extends from the points F and K down to their

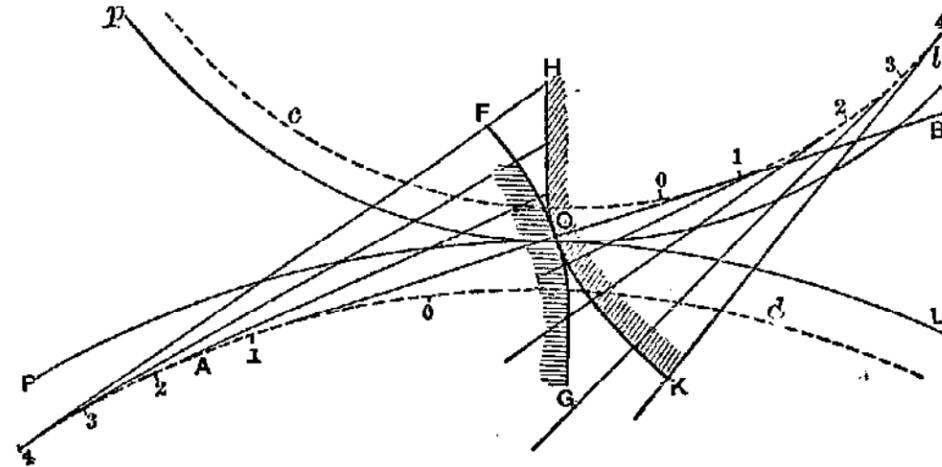

FIG. 174.

respective base-circles, where a tangent to the involute becomes a radius of the circle, and the remainders of the tooth curves, as G and H , are radial straight lines.

In the involute system the customary standard form of tooth is one having an angle of obliquity of 15° (Brown and Sharpe use $14\frac{1}{2}^\circ$), an addendum of about one-third the circular pitch, and a clearance of about one-eighth of the addendum. In this system the smallest gear of a set has 12 teeth, this being the smallest number of teeth that will gear together when made with this angle of obliquity. In gears with less than 30 teeth the points of the teeth must be slightly rounded over to avoid interference (see Grant's Teeth of Gears). All involute teeth of the same pitch and with the same angle of obliquity work smoothly together. The rack to gear with an involute-toothed wheel has straight faces on its teeth, which make an angle with the middle line of the tooth equal to the angle of obliquity, or in the standard form the faces are inclined at an angle of 30° with each other.

To draw the teeth of a rack which is to gear with an involute wheel (Fig. 175). — Let AB be the pitch-line of the rack and $AI = I'A' =$ the pitch. Through the pitch-point I draw EF at the given angle of obliquity.

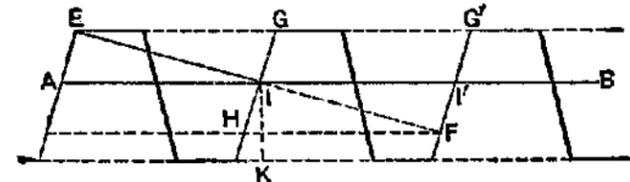

FIG. 175.

Draw AE and $I'F$ perpendicular to EF . Through E and F draw lines EGG' and FH parallel to the pitch-line. EGG' will be the addendum-line and FH the flank-line. From I draw IK perpendicular to AB equal to the greatest addendum in the set of wheels of the given pitch and obliquity plus an allowance for clearance equal to $1/8$ of the addendum. Through K , parallel to AB , draw the clearance-line. The fronts of the teeth are planes perpendicular to EF , and the backs are planes inclined at the same angle to AB in the contrary direction. The outer half of the working face AE may be slightly curved. Mr. Grant makes it a circular

arc drawn from a center on the pitch-line with a radius = 2.1 inches divided by the diametral pitch, or 0.67 in. \times circular pitch.

To Draw an Angle of 15° without using a Protractor. — From C , on the line AC , with radius AC , draw an arc AB , and from A , with the same

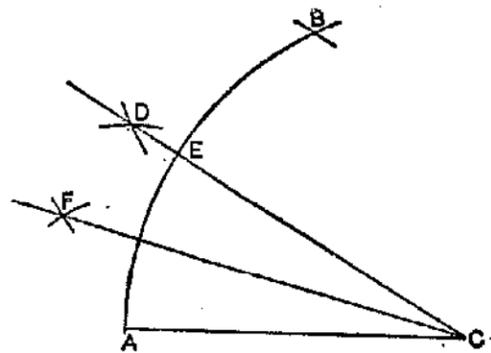

FIG. 176.

radius, cut the arc at B . Bisect the arc BA by drawing small arcs at D from A and B as centers, with the same radius, which must be greater than one-half of AB . Join DC , cutting BA at E . The angle ECA is 30° . Bisect the arc AE in like manner. Bisect the angle FCA will be 15° .

A property of involute-toothed wheels is that the distance between the axes of a pair of gears may be altered to a considerable extent without interfering with their action. The backlash is therefore variable at will, and may be adjusted by moving the wheels farther from or nearer to each other, and

may thus be adjusted so as to be no greater than is necessary to prevent jamming of the teeth.

The relative merits of cycloidal and involute-shaped teeth are a subject of dispute, but there is an increasing tendency to adopt the involute tooth for all purposes.

Clark (R. T. D., p. 734) says: Involute teeth have the disadvantage of being too much inclined to the radial line, by which an undue pressure is exerted on the bearings.

Unwin (Elements of Machine Design, 8th ed., p. 265) says: The obliquity of action is ordinarily alleged as a serious objection to involute wheels. Its importance has perhaps been overrated.

George B. Grant (*Am. Mach.*, Dec. 26, 1885) says:

1. The work done by the friction of an involute tooth is always less than the same work for any possible epicycloidal tooth.
2. With respect to work done by friction, a change of the base from a gear of 12 teeth to one of 15 teeth makes an improvement for the epicycloid of less than one-half of one per cent.
3. For the 12-tooth system the involute has an advantage of $1\frac{1}{5}$ per cent, and for the 15-tooth system an advantage of $\frac{3}{4}$ per cent.
4. That a maximum improvement of about one per cent can be accomplished by the adoption of any possible non-interchangeable radial flank tooth in preference to the 12-tooth interchangeable system.
5. That for gears of very few teeth the involute has a decided advantage.

6. That the common opinion among millwrights and the mechanical public in general in favor of the epicycloid is a prejudice that is founded on long-continued custom, and not on an intimate knowledge of the properties of that curve.

Wilfred Lewis (*Proc. Engrs. Club of Phila.*, vol. x, 1893) says a strong reaction in favor of the involute system is in progress, and he believes that an involute tooth of $22\frac{1}{2}^\circ$ obliquity will finally supplant all other forms.

Approximation by Circular Arcs. — Having found the form of the actual tooth-curve on the drawing-board, circular arcs may be found by trial which will give approximations to the true curves, and these may be used in completing the drawing and the pattern of the gear-wheels. The root of the curve is connected to the clearance by a fillet, which should be as large as possible to give increased strength to the tooth, provided it is not large enough to cause interference.

Molesworth gives the following method of construction by circular arcs:

From the radial line at the edge of the tooth on the pitch-line, lay off the line HK at an angle of 75° with the radial line; on this line will be the centers of the root AB and the point EF . The lines struck from these centers are shown in thick lines. Circles drawn through centers thus

found will give the lines in which the remaining centers will be. The radius DA for striking the root AB is the pitch + the thickness of the tooth. The radius CE for striking the point of the tooth EF = the pitch.

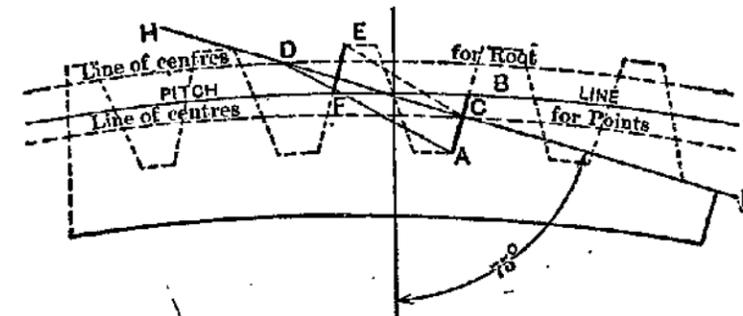

FIG. 177.

George B. Grant says: It is sometimes attempted to construct the curve by some handy method or empirical rule, but such methods are generally worthless.

Stepped Gears. — Two gears of the same pitch and diameter mounted side by side on the same shaft will act as a single gear. If one gear is keyed on the shaft so that the teeth of the two wheels are not in line, but the teeth of one wheel slightly in advance of the other, the two gears form a stepped gear. If mated with a similar stepped gear on a parallel shaft the number of teeth in contact will be twice as great as in an ordinary gear, which will increase the strength of the gear and its smoothness of action.

Twisted Teeth. — If a great number of very thin gears were placed together, one slightly in advance of the other, they would still act as a stepped gear. Continuing the subdivision until the thickness of each separate gear is infinitesimal, the faces of the teeth instead of being in steps take the form of a spiral or twisted surface, and we have a twisted gear. The twist may take any shape, and if it is in one direction for half the width of the gear and in the opposite direction for the other half, we have what is known as the herring-bone or double helical tooth. The obliquity of the twisted tooth if twisted in one direction causes an end thrust on the shaft, but if the herring-bone twist is used, the opposite obliquities neutralize each other. This form of tooth is much used in heavy rolling-mill practice, where great strength and resistance to shocks are necessary. They are frequently made of steel castings (Fig. 178). The angle of the tooth with a line parallel to the axis of the gear is usually 30° .



FIG. 178.

Spiral or Helical Gears. — If a twisted gear has a uniform twist it becomes what is commonly called a spiral gear (properly a helical gear). The line in which the pitch-surface intersects the face of the tooth is part of a helix drawn on the pitch-surface. A spiral wheel may be made with only one helical tooth wrapped around the cylinder several times, in which it becomes a screw or worm. If it has two or three teeth so wrapped, it is a double- or triple-threaded screw or worm. A spiral-gear meshing into a rack is used to drive the table of some forms of planing-machine. For methods of laying out and producing spiral gears see Brown and Sharpe's treatise on Gearing and Halsey's Worm and Spiral Gearing, also *Machy.*, May 1906 and *Machy's Reference Series No. 20*.

Worm-gearing. — When the axes of two spiral gears are at right angles, and a wheel of one, two, or three threads works with a larger wheel of many threads, it becomes a worm-gear, or endless screw, the smaller wheel or driver being called the worm, and the larger, or driven wheel, the worm-wheel. With this arrangement a high velocity ratio may be obtained with a single pair of wheels. For a one-threaded wheel the velocity ratio is the number of teeth in the worm-wheel. The worm and wheel are commonly so constructed that the worm will drive the wheel, but the wheel will not drive the worm.

To find the diameter of a worm-wheel at the throat, number of teeth and pitch of the worm being given: Add 2 to the number of teeth, multiply the sum by 0.3183, and by the pitch of the worm in inches.

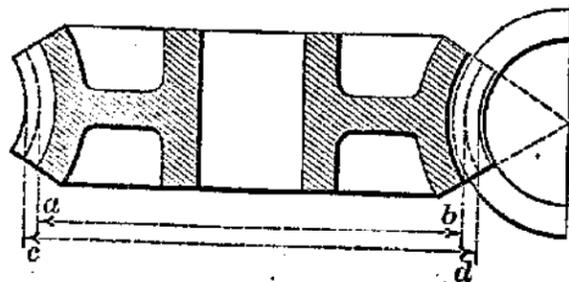

FIG. 179.

To find the number of teeth, diameter at throat and pitch of worm being given: Divide 3.1416 times the diameter by the pitch, and subtract 2 from the quotient.

In Fig. 179 *ab* is the diam. of the pitch-circle, *cd* is the diam. at the throat.

EXAMPLE. — Pitch of worm $\frac{1}{4}$ in., number of teeth 70; required the diam. at the throat. $(70 + 2) \times 0.3183 \times 0.25 = 5.73$ in. For design of worm gearing see Kimball and Barr's Machine Design. For efficiency of worm gears see page .

The Hindley Worm. — In the Hindley worm-gear the worm, instead of being cylindrical in outline, is of an hour-glass shape, the pitch line of the worm being a curved line corresponding to the pitch line of the gear. It is claimed that there is surface contact between the faces of the teeth of the worm and gear, instead of only line contact as in the case of the ordinary worm gear, but this is denied by some writers. For discussion of the Hindley worm see *Am. Mach.*, April 1, 1897 and *Machy.*, Dec. 1908. The Hindley gear is made by the Albro-Clem Elevator Co., Philadelphia.

Teeth of Bevel-wheels. (Rankine's Machinery and Millwork.) — The teeth of a bevel-wheel have acting surfaces of the conical kind, generated by the motion of a line traversing the apex of the conical pitch-surface, while a point in it is carried round the traces of the teeth upon a spherical surface described about that apex.

The operations of drawing the traces of the teeth of bevel-wheels exactly, whether by involutes or by rolling curves, are in every respect analogous to those for drawing the traces of the teeth of spur-wheels; except that in the case of bevel-wheels all those operations are to be performed on the surface of a sphere described about the apex, instead of on a plane, substituting poles for centers and great circles for straight lines.

In consideration of the practical difficulty, especially in the case of large wheels, of obtaining an accurate spherical surface, and of drawing upon it when obtained, the following approximate method, proposed originally by Tredgold, is generally used:

Let *O*, Fig. 180, be the common apex of the pitch-cones, *OBI*, *OB'I*, of a pair of bevel-wheels; *OC*, *OC'*, the axes of those cones; *OI* their line of contact. Perpendicular to *OI* draw *AI*, *A'I*, cutting the axes in *A*, *A'*; make the outer rims of the patterns and of the wheels portions of the cones *ABI*, *A'B'I*, of which the narrow zones occupied by the teeth will be sufficiently near for practical purposes to a spherical surface described about *O*. As the cones *ABI*, *A'B'I* cut the pitch-cones at right angles in the outer pitch-circles *IB*, *IB'*, they may be called the normal cones. To find the traces of the teeth upon the normal cones, draw on a flat surface circular arcs, *ID*, *ID'*, with the radii *AI*, *A'I*; those arcs will be the developments of arcs of the pitch-circles *IB*, *IB'* when the conical surfaces *ABI*, *A'B'I* are spread out flat. Describe the traces of teeth for the developed arcs as for a pair of spur-wheels, then wrap the

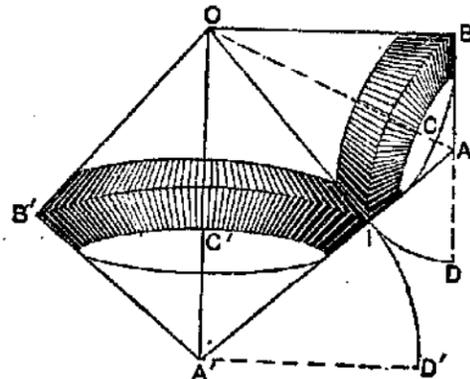

FIG. 180.

developed arcs on the normal cones, so as to make them coincide with the pitch-circles, and trace the teeth on the conical surfaces.

For formulæ and instructions for designing bevel-gears, and for much other valuable information on the subject of gearing, see "Practical Treatise on Gearing," and "Formulas in Gearing," published by Brown & Sharpe Mfg. Co.; and "Teeth of Gears," by George B. Grant, Lexington, Mass. The student may also consult Rankine's Machinery and Millwork, Reuleaux's Constructor, and Unwin's Elements of Machine Design. See also article on Gearing, by C. W. MacCord in *App. Cyc. Mech.*, vol. ii.

Annular and Differential Gearing. (S. W. Balch, *Am. Mach.*, Aug. 24, 1893.) — In internal gears the sum of the diameters of the describing circles for faces and flanks should not exceed the difference in the pitch diameters of the pinion and its internal gear. The sum may be equal to this difference or it may be less; if it is equal, the faces of the teeth of each wheel will drive the faces as well as the flanks of the teeth of the other wheel. The teeth will therefore make contact with each other at two points at the same time.

Cycloidal tooth-curves for interchangeable gears are formed with describing circles of about $\frac{5}{8}$ the pitch diameter of the smallest gear of the series. To admit two such circles between the pitch-circles of the pinion and internal gear the number of teeth in the internal gear should exceed the number in the pinion by 12 or more, if the teeth are of the customary proportions and curvature used in interchangeable gearing.

Very often a less difference is desirable, and the teeth may be modified in several ways to make this possible.

First. The tooth curves resulting from smaller describing circles may be employed. These will give teeth which are more rounding and narrower at their tops, and therefore not as desirable as the regular forms.

Second. The tips of the teeth may be rounded until they clear. This is a cut-and-try method which aims at modifying the teeth to such outlines as smaller describing circles would give.

Third. One of the describing circles may be omitted and one only used, which may be equal to the difference between the pitch-circles. This will permit the meshing of gears differing by six teeth. It will usually prove inexpedient to put wheels in inside gears that differ by much less than 12 teeth.

If a regular diametral pitch and standard tooth forms are determined on, the diameter to which the internal gear-blank is to be bored is calculated by subtracting 2 from the number of teeth, and dividing the remainder by the diametral pitch.

The tooth outlines are the match of a spur-gear of the same number of teeth and diametral pitch, so that the spur-gear will fit the internal gear as a punch fits its die, except that the teeth of each should fail to bottom in the tooth spaces of the other by the customary clearance of one-tenth the thickness of the tooth.

Internal gearing is particularly valuable when employed in differential action. This is a mechanical movement in which one of the wheels is mounted on a crank so that its center can move in a circle about the center of the other wheel. Means are added to the device which restrain the wheel on the crank from turning over and confine it to the revolution of the crank.

The ratio of the number of teeth in the revolving wheel compared with the difference between the two will represent the ratio between the revolving wheel and the crank-shaft by which the other is carried. The advantage in accomplishing the change of speed with such an arrangement, as compared with ordinary spur-gearing, lies in the almost entire absence of friction and consequent wear of the teeth.

But for the limitation that the difference between the wheels must not be too small, the possible ratio of speed might be increased almost indefinitely, and one pair of differential gears made to do the service of a whole train of wheels. If the problem is properly worked out with bevel-gears this limitation may be completely set aside, and external and internal bevel-gears, differing by but a single tooth if need be, made to mesh perfectly with each other.

Differential bevel-gears have been used with advantage in mowing-machines. A description of their construction and operation is given by Mr. Balch in the article from which the above extracts are taken.

EFFICIENCY OF GEARING.

An extensive series of experiments on the efficiency of gearing, chiefly worm and spiral gearing, is described by Wilfred Lewis in *Trans. A. S. M. E.*, vii, 273. The average results are shown in a diagram, from which the following approximate average figures are taken:

EFFICIENCY OF SPUR, SPIRAL, AND WORM GEARING.

Gearing.	Pitch.	Velocity at pitch-line in feet per min.				
		3	10	40	100	200
Spur pinion.....		0.90	0.935	0.97	0.98	0.985
Spiral pinion.....	45°	.81	.87	.93	.955	.965
" ".....	30	.75	.815	.89	.93	.945
" ".....	20	.67	.75	.845	.90	.92
" ".....	15	.61	.70	.805	.87	.90
Spiral pinion or worm.....	10	.51	.615	.74	.82	.86
" ".....	7	.43	.53	.72	.765	.815
" ".....	5	.34	.43	.60	.70	.765

The experiments showed the advantage of spur-gearing over all other kinds in both durability and efficiency. The variation from the mean results rarely exceeded 5% in either direction, so long as no cutting occurred, but the variation became much greater and very irregular as soon as cutting began. The loss of power varies with the speed, the pressure, the temperature, and the condition of the surfaces. The excessive friction of worm and spiral gearing is largely due to the end thrust on the collars of the shaft. This may be considerably reduced by roller-bearings for the collars.

When two worms with opposite spirals run in two spiral worm-gears that also work with each other, and the pressure on one gear is opposite that on the other, there is no thrust on the shaft. Even with light loads a worm will begin to heat and cut if run at too high a speed, the limit for safe working being a velocity of the rubbing surfaces of 200 to 300 ft. per minute, the former being preferable where the gearing has to work continuously. The wheel teeth will keep cool, as they form part of a casting having a large radiating surface; but the worm itself is so small that its heat is dissipated slowly. Whenever the heat generated increases faster than it can be conducted and radiated away, the cutting of the worm may be expected to begin. A low efficiency for a worm-gear means more than the loss of power, since the power which is lost reappears as heat and may cause the rapid destruction of the worm.

Unwin (*Elements of Machine Design*, p. 294) says: The efficiency is greater the less the radius of the worm. Generally the radius of the worm = 1.5 to 3 times the pitch of the thread of the worm or the circular pitch of the worm-wheel. For a one-threaded worm the efficiency is only 2/5 to 1/4; for a two-threaded worm, 4/7 to 2/5; for a three-threaded worm, 2/3 to 1/2. Since so much work is wasted in friction it is not surprising that the wear is excessive. The following table gives the calculated efficiencies of worm-wheels of 1, 2, 3, and 4 threads and ratios of radius of worm to pitch of teeth of from 1 to 6, assuming a coefficient of friction of 0.15:

No. of Threads.	Radius of Worm ÷ Pitch.								
	1	1 1/4	1 1/2	1 3/4	2	2 1/2	3	4	6
1	0.50	0.44	0.40	0.36	0.33	0.28	0.25	0.20	0.14
2	.67	.62	.57	.53	.50	.44	.40	.33	.25
3	.75	.70	.67	.63	.60	.55	.50	.43	.33
4	.80	.76	.73	.70	.67	.62	.57	.50	.40

Efficiency of Worm Gearing. — Worm gearing as a means of transmitting power has generally been looked upon with suspicion, its efficiency being considered necessarily low and its life short. When properly proportioned, however, it is both durable and reasonably efficient. Mr. F. A. Halsey discusses the subject in *Am. Machinist*, Jan. 13 and 20, 1898. He quotes two formulas for the efficiency of worm gearing:

$$E = \frac{\tan \alpha (1 - f \tan \alpha)}{\tan \alpha + f} \dots (1) \quad E = \frac{\tan \alpha (1 - f \tan \alpha)}{\tan \alpha + 2f} \text{ approx.} \dots (2)$$

in which E = efficiency; α = angle of thread, being angle between thread and a line perpendicular to the axis of the worm; f = coefficient of friction.

Eq. (1) applies to the worm thread only, while (2) applies to the worm and step combined, on the assumption that the mean friction radius of the two is equal. Eq. (1) gives a maximum for E when $\tan \alpha = \sqrt{1 + f^2} - f$

(3) and eq. (2) a maximum when $\tan \alpha = \sqrt{2 + 4f^2} - 2f \dots (4)$

Using 0.05 for f gives α in (3) = 43° 34' and in (4) = 52° 49'. On plotting equations (1) and (2) the curves show the striking influence of the pitch-angle upon the efficiency, and since the lost work is expended in friction and wear, it is plain why worms of low angle should be short-lived and those of high angle long-lived. The following table is taken from Mr. Halsey's plotted curves:

RELATION BETWEEN THREAD-ANGLE SPEED AND EFFICIENCY OF WORM GEARS.

Velocity of Pitch-line, feet per minute.	Angle of Thread.					
	5	10	20	30	40	45
	Efficiency.					
3	35	52	66	73	76	77
5	40	56	69	76	79	80
10	47	62	74	79	82	82
20	52	67	78	83	85	86
40	60	74	83	87	88	88
100	70	82	88	91	91	91
200	76	85	91	92	92	92

The experiments of Mr. Wilfred Lewis on worms show a very satisfactory correspondence with the theory. Mr. Halsey gives a collection of data comprising 16 worms doing heavy duty and having pitch-angles ranging between 4° 30' and 45°, which show that every worm having an angle above 12° 30' was successful in regard to durability, and every worm below 9° was unsuccessful, the overlapping region being occupied by worms some of which were successful and some unsuccessful. In several cases worms of one pitch-angle had been replaced by worms of a different angle, an increase in the angle leading in every case to better results and a decrease to poorer results. He concludes with the following table from experiments by Mr. James Christie, of the Pencoyd Iron Works, and gives data connecting the load upon the teeth with the pitch-line velocity of the worm.

LIMITING SPEEDS AND PRESSURES OF WORM GEARING.

	Single-thread Worm 1" Pitch, 2 1/2" Pitch Diam.			Double-thread Worm 2" Pitch, 2 1/2" Pitch Diam.			Double-thread Worm 2 1/2" Pitch, 4 1/2" Pitch Diam.		
	128	201	272	128	201	272	201	272	425
Revolutions per minute.....	128	201	272	128	201	272	201	272	425
Velocity at pitch-line, feet per minute.....	96	150	205	96	150	205	235	319	498
Limiting pressure, pounds.....	1700	1300	1100	700	1100	1100	1100	700	400

Efficiency of Automobile Gears. (G. E. Quick, *Horseless Age*, Feb. 12, 1908.)—A set of slide gears was tested by an electric-driven absorption dynamometer. The following approximate results are taken from a series of plotted curves:

Horse-power input	r.p.m.	2	4	6	8	10	14	18
		Efficiency, per cent.						
Direct driven, third speed.....	800	89	95	97	97.5	97.5	97.5	96
Direct driven, third speed.....	1,500	80	89	93	95	96.5	97	97
Second speed, ratio 1.76 to 1....	800	87	92.5	94	95	94	93
Second speed, ratio 1.76 to 1....	1,500	79	88	92.5	94	95	95	94
First speed, ratio 3.36 to 1.....	800	75	87.5	93	94	94	93.5	92.5
First speed, ratio 3.36 to 1.....	1,500	70	84	89	92	93	92
Reverse speed, ratio 4.32 to 1....	800	75	84	87	87	86	82.5
Reverse speed, ratio 4.32 to 1....	1,500	70	79	83	86	87	85
Worm-gear axle, ratio 6.83 to 1..	400	85	87	86.5	85.5	84	80	75
Worm-gear axle, ratio 6.83 to 1..	800	83	87	88.5	89	89	88	87
Worm-gear axle, ratio 6.83 to 1..	1,500	80	85	87.5	88.5	89	89	89

Two bevel-wheel axles were tested, one a floating type, ratio 15 to 32, 14 1/2° involute; the other a solid wheel and axle type, ratio 13 to 54, 20° involute. Both gave efficiencies of 95 to 96% at 800 to 1500 r.p.m., and 10 to 26 H.P., with lower efficiencies at lower power and at lower speed. The friction losses include those of the journals and thrust ball bearings.

The worm was 6-threaded, lead, 4.69 in.; pitch diam., 2.08 in.; the gear had 41 teeth; pitch diam., 10.2 in. The worm was of hardened steel and the gear of phosphor-bronze. A test of a steel gear and steel worm gave somewhat lower efficiencies. In both tests the heating was excessive both in the gears and in the thrust bearings, the balls in which were 7/16 in. diam.

STRENGTH OF GEAR-TEETH.

The strength of gear-teeth and the horse-power that may be transmitted by them depend upon so many variable and uncertain factors that it is not surprising that the formulas and rules given by different writers show a wide variation. In 1879 John H. Cooper (*Jour. Frank. Inst.*, July, 1879) found that there were then in existence about 48 well-established rules for horse-power and working strength, differing from each other in extreme cases about 500%. In 1886 Prof. Wm. Harkness (*Proc. A. A. A. S.*, 1886), from an examination of the bibliography of the subject, beginning in 1796, found that according to the constants and formulæ used by various authors there were differences of 15 to 1 in the power which could be transmitted by a given pair of geared wheels. The various elements which enter into the constitution of a formula to represent the working strength of a toothed wheel are the following:

1. The strength of the metal, usually cast iron, which is an extremely variable quantity.
2. The shape of the tooth, and especially the relation of its thickness at the root or point of least strength to the pitch and to the length.
3. The point at which the load is taken to be applied, assumed by some authors to be at the pitch-line, by others at the extreme end, along the whole face, and by still others at a single outer corner.
4. The consideration of whether the total load is at any time received by a single tooth or whether it is divided between two teeth.
5. The influence of velocity in causing a tendency to break the teeth by shock.
6. The factor of safety assumed to cover all the uncertainties of the other elements of the problem.

Prof. Harkness, as a result of his investigation, found that all the formulæ on the subject might be expressed in one of three forms, viz.:

Horse-power = $CVpf$, or CVp^2 , or CVp^2f ;

in which C is a coefficient, V = velocity of pitch-line in feet per second, p = pitch in inches, and f = face of tooth in inches.

From an examination of precedents he proposed the following formula for cast-iron wheels:

$$H.P. = \frac{0.910 Vpf}{\sqrt{1 + 0.65 V}}$$

He found that the teeth of chronometer and watch movements were subject to stresses four times as great as those which any engineer would dare to use in like proportion upon cast-iron wheels of large size.

It appears that all of the earlier rules for the strength of teeth neglected the consideration of the variations in their form; the breaking strength, as said by Mr. Cooper, being based upon the thickness of the teeth at the pitch-line or circle, as if the thickness at the root of the tooth were the same in all cases as it is at the pitch-line.

Wilfred Lewis (*Proc. Engr's Club, Phila.*, Jan., 1893; *Am. Mach.*, June 22, 1893) seems to have been the first to use the form of the tooth in the construction of a working formula and table. He assumes that in well-constructed machinery the load can be more properly taken as well distributed across the tooth than as concentrated in one corner, but that it cannot be safely taken as concentrated at a maximum distance from the root less than the extreme end of the tooth. He assumes that the whole load is taken upon one tooth, and considers the tooth as a beam loaded at one end, and from a series of drawings of teeth of the involute, cycloidal, and radial flank systems, determines the point of weakest cross-section of each, and the ratio of the thickness at that section to the pitch. He thereby obtains the general formula,

$$W = spfy;$$

in which W is the load transmitted by the teeth, in pounds; s is the safe working stress of the material, taken at 8000 lbs. for cast iron, when the working speed is 100 ft. or less per minute; p = pitch; f = face, in inches; y = a factor depending on the form of the tooth, whose value for different cases is given in the following table:

No. of Teeth.	Factor for Strength, y .			No. of Teeth.	Factor for Strength, y .		
	Involute 20° Obliquity.	Involute 15° and Cycloidal	Radial Flanks.		Involute 20° Obliquity.	Involute 15° and Cycloidal	Radial Flanks.
12	0.078	0.067	0.052	27	0.111	0.100	0.064
13	.083	.070	.053	30	.114	.102	.065
14	.088	.072	.054	34	.118	.104	.066
15	.092	.075	.055	38	.122	.107	.067
16	.094	.077	.056	43	.126	.110	.068
17	.096	.080	.057	50	.130	.112	.069
18	.098	.083	.058	60	.134	.114	.070
19	.100	.087	.059	75	.138	.116	.071
20	.102	.090	.060	100	.142	.118	.072
21	.104	.092	.061	150	.146	.120	.073
23	.106	.094	.062	300	.150	.122	.074
25	.108	.097	.063	Rack.	.154	.124	.075

SAFE WORKING STRESS, s , FOR DIFFERENT SPEEDS.

Speed of Teeth in ft. per minute.	100 or less.	200	300	600	900	1200	1800	2400
	Cast iron.....	8000	6000	4800	4000	3000	2400	2000
Steel.....	20000	15000	12000	10000	7500	6000	5000	4300

The values of s in the above table are given by Mr. Lewis tentatively, in the absence of sufficient data upon which to base more definite values, but they have been found to give satisfactory results in practice.

Mr. Lewis gives the following example to illustrate the use of the tables: Let it be required to find the working strength of a 12-toothed pinion of 1-inch pitch, 2 1/2-inch face, driving a wheel of 60 teeth at 100 feet or less per minute, and let the teeth be of the 20-degree involute form. In the formula $W = spfy$ we have for a cast-iron pinion $s = 8000$, $pf = 2.5$, and $y = 0.078$; and multiplying these values together, we have $W = 1560$ pounds. For the wheel we have $y = 0.134$ and $W = 2680$ pounds.



FIG. 181. The cast-iron pinion is, therefore, the measure of strength; but if a steel pinion be substituted we have $s = 20,000$ and $W = 3900$ pounds, in which combination the wheel is the weaker, and it therefore becomes the measure of strength.

For bevel-wheels Mr. Lewis gives the following, referring to Fig. 181: $D =$ large diameter of bevel; $d =$ small diameter of bevel; $p =$ pitch at large diameter; $n =$ actual number of teeth; $f =$ face of bevel; $N =$ formative number of teeth $= n \times \sec \alpha$, or the number corresponding to radius R ; $y =$ factor depending upon shape of teeth and formative number N ; $W =$ working load on teeth.

$$W = spfy \frac{D^3 - d^3}{3 D^2 (D - d)}; \text{ or, more simply, } W = spfy \frac{d}{D},$$

which gives almost identical results when d is not less than $2/3 D$, as is the case in good practice.

In *Am. Mach.*, June 22, 1893, Mr. Lewis gives the following formulæ for the working strength of the three systems of gearing, which agree very closely with those obtained by use of the table:

For involute, 20° obliquity, $W = spf \left(0.154 - \frac{0.912}{n} \right);$

For involute 15°, and cycloidal, $W = spf \left(0.124 - \frac{0.684}{n} \right);$

For radial flank system, $W = spf \left(0.075 - \frac{0.276}{n} \right);$

in which the factor within the parenthesis corresponds to y in the general formula. For the horse-power transmitted, Mr. Lewis's general formula

$$W = spfy = \frac{33,000 \text{ H.P.}}{v}, \text{ may take the form } \text{H.P.} = \frac{spf y v}{33,000}, \text{ in which } v = \text{velocity in feet per minute; or since } v = d\pi \times \text{r.p.m.} \div 12 = 0.2618 d \times \text{r.p.m.}, \text{ in which } d = \text{diameter in inches,}$$

$$\text{H.P.} = \frac{Wv}{33,000} = \frac{spf y \times d \times \text{r.p.m.}}{126,050} = 0.00007933 dsfy \times \text{r.p.m.}$$

It must be borne in mind, however, that in the case of machines which consume power intermittently, such as punching and shearing machines, the gearing should be designed with reference to the maximum load W , which can be brought upon the teeth at any time, and not upon the average horse-power transmitted.

Comparison of the Harkness and Lewis Formulas. — Take an average case in which the safe working strength of the material, $s = 6000$, $v = 200$ ft. per min., and $y = 0.100$, the value in Mr. Lewis's table for an involute tooth of 15° obliquity, or a cycloidal tooth, the number of teeth in the wheel being 27.

$$\text{H.P.} = \frac{spf y v}{33,000} = \frac{6000 p f v \times 0.100}{33,000} = \frac{p f v}{55} = 1.091 p f V,$$

if V is taken in feet per second.

Prof. Harkness gives $\text{H.P.} = \frac{0.910 V p f}{\sqrt{1 + 0.65 V}}$. If the V in the denominator

be taken at $200 \div 60 = 3 1/3$ ft. per sec., $\text{H.P.} = 0.571 p f V$, or about 52% of the result given by Mr. Lewis's formula. This is probably as close an agreement as can be expected, since Prof. Harkness derived his formula from an investigation of ancient precedents and rule-of-thumb practice, largely with common cast gears, while Mr. Lewis's formula was

derived from considerations of modern practice with machine-molded and cut gears.

Mr. Lewis takes into consideration the reduction in working strength of a tooth due to increase in velocity by the figures in his table of the values of the safe working stress s for different speeds. Prof. Harkness gives expression to the same reduction by means of the denominator of his formula, $\sqrt{1 + 0.65 V}$. The decrease in strength as computed by this formula is somewhat less than that given in Mr. Lewis's table, and as the figures given in the table are not based on accurate data, a mean between the values given by the formula and the table is probably as near to the true value as may be obtained from our present knowledge. The following table gives the values for different speeds according to Mr. Lewis's table and Prof. Harkness's formula, taking for a basis a working stress s , for cast-iron 8000, and for steel 20,000 lbs. at speeds of 100 ft. per minute and less:

$v =$ speed of teeth, ft. per min.	100	200	300	600	900	1200	1800	2400
$V =$ speed of teeth, ft. per sec.	12/3	31/3	5	10	15	20	30	40
Safe stress s , cast iron, Lewis ..	8000	6000	4800	4000	3000	2400	2000	1700
Relative do., $s \div 8000$	1	0.75	0.6	0.5	0.375	0.3	0.25	0.2125
$1 \div \sqrt{1 + 0.65 V}$	0.6930	0.5621	0.4850	0.3650	0.3050	0.2672	0.2208	0.1924
Relative val. $c \div 0.693$	1	0.811	0.700	0.526	0.439	0.385	0.318	0.277
$s_1 = 8000 \times (c \div 0.693)$	8000	6488	5600	4208	3512	3080	2544	2216
Mean of s and s_1 , cast-iron = s_2 ..	8000	6200	5200	4100	3300	2700	2300	2000
Mean of s and s_1 , for steel = s_3 ..	20000	15500	13000	10300	8100	6800	5700	4900
Safe stress for steel, Lewis	20000	15000	12000	10000	7500	6000	5000	4300

In *Am. Mach.*, Jan. 30, 1902, Mr. Lewis says that 8,000 lbs. was given as safe for cast-iron teeth, either cut or cast, and that 20,000 lbs. was intended for any steel suitable for gearing whether cast or forged. These were the unit stresses for static loads.

The iron should be of good quality capable of sustaining about a ton on a test bar 1 in. square between supports 12 in. apart, and the steel should be solid and of good quality. The value given for steel was intended to include the lower grades, but when the quality is known to be high, correspondingly higher values may be assigned.

Comparing the two formulæ for the case of $s = 8000$, corresponding to a speed of 100 ft. per min., we have

Harkness: $\text{H.P.} = 1 \div \sqrt{1 + 0.65 V} \times 0.910 V p f = 1.053 p f,$

Lewis: $\text{H.P.} = \frac{spf y v}{33,000} = \frac{spf y V}{550} = \frac{8000 \times 1 2/3 p f y}{550} = 24.24 p f y,$

in which y varies according to the shape and number of the teeth.

For radial-flank gear with 12 teeth $y = 0.052$; $24.24 p f y = 1.260 p f$;
 For 20° inv., 19 teeth, or 15° inv., 27 teeth $y = 0.100$; $24.24 p f y = 2.424 p f$;
 For 20° involute, 300 teeth $y = 0.150$; $24.24 p f y = 3.636 p f$.

Thus the weakest-shaped tooth, according to Mr. Lewis, will transmit 20 per cent more horse-power than is given by Prof. Harkness's formula, in which the shape of the tooth is not considered, and the average-shaped tooth, according to Mr. Lewis, will transmit more than double the horse-power given by Prof. Harkness's formula.

Comparison of Other Formulas. — Mr. Cooper, in summing up his examination, selected an old English rule, which Mr. Lewis considers as a passably correct expression of good general averages, viz.: $X = 2000 p f$, $X =$ breaking load of tooth in pounds, $p =$ pitch, $f =$ face. If a factor of safety of 10 be taken, this would give for safe working load $W = 200 p f$.

George B. Grant, in his *Teeth of Gears*, page 33, takes the breaking load at 3500 $p f$, and, with a factor of safety of 10, gives $W = 350 p f$. Nystrom's *Pocket-Book*, 20th ed., 1891, says: "The strength and durability of cast-iron teeth require that they shall transmit a force of 80 lbs.

per inch of pitch and per inch breadth of face." This is equivalent to $W = 80 pf$, or only 40% of that given by the English rule.

F. A. Halsey (Clark's Pocket-Book) gives a table calculated from the formula $H.P. = pfd \times r.p.m. \div 850$.

Jones & Laughlins give $H.P. = pfd \times r.p.m. \div 550$.

These formulæ transformed give $W = 128 pf$ and $W = 218 pf$, respectively.

Unwin, on the assumption that the load acts on the corners of the teeth, derives a formula $p = K \sqrt{W}$, in which K is a coefficient derived from existing wheels, its values being: for slowly moving gearing not subject to much vibration or shock $K = 0.04$; in ordinary mill-gearing, running at greater speed and subject to considerable vibration, $K = 0.05$; and in wheels subjected to excessive vibration and shock, and in mortise gearing, $K = 0.06$. Reduced to the form $W = Cpf$, assuming that $f = 2p$, these values of K give $W = 262 pf$, $200 pf$, and $139 pf$, respectively.

Unwin also give the following, based on the assumption that the pressure is distributed along the edge of the tooth: $p = K_1 \sqrt{p/f} \sqrt{W}$, where $K_1 =$ about 0.0707 for iron wheels and 0.0848 for mortise wheels when the breadth of face is not less than twice the pitch. For the case of $f = 2p$ and the given values of K_1 this reduces to $W = 200 pf$ and $W = 139 pf$, respectively.

Box, in his Treatise on Mill Gearing, gives $H.P. = 12 p^2 f \sqrt{dn} \div 1000$, in which $n =$ number of revolutions per minute. This formula differs from the more modern formulæ in making the H.P. vary as $p^2 f$, instead of as pf , and in this respect it is no doubt incorrect.

Making the H.P. vary as \sqrt{dn} or as \sqrt{v} , instead of directly as v , makes the velocity a factor of the working strength as in the Harkness and Lewis formulæ, the relative strength varying as $1/\sqrt{v}$, which for different velocities is as follows:

Speed of teeth in ft. per min., $v =$	100	200	300	600	900	1200	1800	2400
Relative strength =	1	0.707	0.574	0.408	0.333	0.289	0.236	0.20

showing a somewhat more rapid reduction than is given by Mr. Lewis.

For the purpose of comparing different formulæ they may in general be reduced to either of the following forms:

$$P. = Cpfv, \quad H.P. = C_1 pfd \times r.p.m., \quad W = cpf,$$

in which $p =$ pitch, $f =$ face, $d =$ diameter, all in inches; $v =$ velocity in feet per minute, r.p.m. revolutions per minute, and C, C_1 and c coefficients. The formulæ for transformation are as follows:

$$H.P. = Wv \div 33,000 = W \times d \times r.p.m. \div 126,050;$$

$$W = \frac{33,000 H.P.}{v} = \frac{126,050 H.P.}{d \times r.p.m.} = 33,000 Cpf; \quad pf = \frac{H.P.}{Cv} = \frac{H.P.}{C_1 d \times r.p.m.} = \frac{W}{c}$$

$$C_1 = 0.2618 C; \quad c = 33,000 C; \quad C = 3.82 C_1, \quad c = \frac{c}{33,000}; \quad c = 126,050 C_1.$$

In the Lewis formula C varies with the form of the tooth and with the speed, and is equal to $sy + 33,000$, in which y and s are the values taken from the table, and $c = sy$.

In the Harkness formula C varies with the speed and is equal to $\frac{910}{\sqrt{1 + 0.65 V}}$ (V being in feet per second), $= 0.01517 \div \sqrt{1 + 0.011 v}$.

In the Box formula C varies with the pitch and also with the velocity; and equals $\frac{12 p \sqrt{d} \times r.p.m.}{1000 v} = 0.02345 \frac{p}{\sqrt{v}}$, $c = 33,000 C = 774 \frac{p}{\sqrt{v}}$.

For $v = 100$ ft. per min. $C = 77.4 p$; for $v = 600$ ft. per min., $c = 31.6 p$. In the other formulæ considered C, C_1 , and c are constants. Reducing the several formulæ to the form $W = cpf$, we have the following:

COMPARISON OF DIFFERENT FORMULÆ FOR STRENGTH OF GEAR-TEETH.

Safe working pressure per inch pitch and per inch of face, or value of c in formula $W = cpf$:

	$v =$ ft. per min.	100	600
Lewis: Weak form of tooth, radial flank, 12 teeth	$c =$	416	208
Medium tooth, inv. 15°, or cycloid, 27 teeth	$c =$	800	400
Strong form of tooth, inv. 20°, 300 teeth	$c =$	1200	600
Harkness: Average tooth	$c =$	347	184
Box: Tooth of 1 inch pitch	$c =$	77.4	31.6
Box: Tooth of 3 inches pitch	$c =$	232	95

The Gleason Works gives for ft. per min. 500 1000 1500 2000 2500 working stress in pounds = p.f. \times 480 400 340 290 240

These are for cut gears, 18 teeth or more, rigidly supported, for average steady loads. Hammering loads, as in rolling mills and saw mills, require heavier gears.

C. W. Hunt, *Trans. A.S.M.E.*, 1908, gives a table of working loads of cut cast gears with a strong shoot form of tooth, which is practically equivalent to $W = 700 pf$.

Various, in which c is independent of form and speed: Old English rule, $c = 200$; Grant, $c = 350$; Nystrom, $c = 80$; Halsey, $c = 128$; Jones & Laughlins, $c = 218$; Unwin, $c = 262, 200$, or 139 , according to speed, shock, and vibration.

The value given by Nystrom and those given by Box for teeth of small pitch are so much smaller than those given by the other authorities that they may be rejected as having an entirely unnecessary surplus of strength. The values given by Mr. Lewis seem to rest on the most logical basis, the form of the teeth as well as the velocity being considered; and since they are said to have proven satisfactory in an extended machine practice, they may be considered reliable for gears that are so well made that the pressure bears along the face of the teeth instead of upon the corners. For rough ordinary work the old English rule $W = 200 pf$ is probably as good as any, except that the figure 200 may be too high for weak forms of tooth and for high speeds.

The formula $W = 200 pf$ is equivalent to $H.P. = pfd \times r.p.m. \div 630 = pfv \div 165$ or, $H.P. = 0.0015873 pfd \times r.p.m. = 0.006063 pfv$.

Raw-hide Pinions. — Pinions of raw-hide are in common use for gearing shafts driven by electric motors to other shafts which carry machine-cut cast-iron or steel gears, in order to reduce vibration, noise and wear. A formula for the maximum horse-power to be transmitted by such gears, given by the New Process Raw-Hide Co., Syracuse, N. Y., is $H.P. =$ pitch diam. \times circ. pitch \times face \times r.p.m. $\div 850$, or $pfd \times r.p.m. \div 850$. This is about $3/4$ of the H.P. for cast-iron teeth by the old English rule. The formula is to be used only when the circular pitch does not exceed 1.65 ins.

Composite gears also are made, consisting of alternate sheets of raw-hide or fibre and steel or bronze, so that a high degree of strength is combined with the smooth-running quality of the fibre.

Maximum Speed of Gearing. — A. Towler, *Eng'g*, April 19, 1889, p. 388, gives the maximum speeds at which it was possible under favorable conditions to run toothed gearing safely as follows, in ft. per min.: Ordinary cast-iron wheels, 1800; Helical, 2400; Mortise, 2400; Ordinary cast-steel wheels, 2600; Helical, 3000; special cast-iron machine-cut wheels, 3000.

Prof. Coleman Sellers (*Stevens Indicator*, April, 1892) recommends that gearing be not run over 1200 ft. per minute, to avoid great noise. The Walker Company, Cleveland, Ohio, say that 2200 ft. per min. for iron gears and 3000 ft. for wood and iron (mortise gears) are excessive, and should be avoided if possible. The Corliss engine at the Philadelphia Exhibition (1876) had a fly-wheel 30 ft. in diameter running 35 r.p.m. geared into a pinion 12 ft. diam. The speed of the pitch-line was 3300 ft. per min.

A Heavy Machine-cut Spur-gear was made in 1891 by the Walker Company, Cleveland, Ohio, for a diamond mine in South Africa, with dimensions as follows: Number of teeth, 192; pitch diameter, 30 ft. 6.66 ins.; face, 30 ins.; pitch, 6 ins.; bore, 27 ins.; diameter of hub, 9 ft. 2 ins.; weight of hub, 15 tons; and total weight of gear, 66 3/4 tons. The

rim was made in 12 segments, the joints of the segments being fastened with two bolts each. The spokes were bolted to the middle of the segments and to the hub with four bolts in each end.

Frictional Gearing. — In frictional gearing the wheels are toothless, and one wheel drives the other by means of the friction between the two surfaces which are pressed together. They may be used where the power to be transmitted is not very great; when the speed is so high that toothed wheels would be noisy; when the shafts require to be frequently put into and out of gear or to have their relative direction of motion reversed; or when it is desired to change the velocity-ratio while the machinery is in motion, as in the case of disk friction-wheels for changing the feed in machine tools.

Let P = the normal pressure in pounds at the line of contact by which two wheels are pressed together, T = tangential resistance of the driven wheel at the line of contact, f = the coefficient of friction, V the velocity of the pitch-surface in feet per second, and H.P. = horse-power; then T may be equal to or less than fP ; H.P. = $TV \div 550$. The value of f for metal on metal may be taken at 0.15 to 0.20; for wood on metal, 0.25 to 0.30; and for wood on compressed paper, 0.20. The tangential driving force T may be as high as 80 lbs. per inch width of face of the driving surface, but this is accompanied by great pressure and friction on the journal-bearings.

In frictional grooved gearing circumferential wedge-shaped grooves are cut in the faces of two wheels in contact. If P = the force pressing the wheels together, and N = the normal pressure on all the grooves, $P = N(\sin a + f \cos a)$, in which $2a$ = the inclination of the sides of the grooves, and the maximum tangential available force $T = fN$. The inclination of the sides of the grooves to a plane at right angles to the axis is usually 30° .

Frictional Grooved Gearing. — A set of friction-gears for transmitting 150 H.P. is on a steam-dredge described in *Proc. Inst. M. E.*, July, 1888. Two grooved pinions of 54 in. diam., with 9 grooves of $1\frac{3}{4}$ in. pitch and angle of 40° cut on their face, are geared into two wheels of $127\frac{1}{2}$ in. diam. similarly grooved. The wheels can be thrown in and out of gear by levers operating eccentric bushes on the large wheel-shaft. The circumferential speed of the wheels is about 500 ft. per min. Allowing for engine friction, if half the power is transmitted through each set of gears the tangential force at the rims is about 3960 lbs., requiring, if the angle is 40° and the coefficient of friction 0.18, a pressure of 7524 lbs. between the wheels and pinion to prevent slipping.

The wear of the wheels proving excessive, the gears were replaced by spur-gear wheels and brake-wheels with steel brake-bands, which arrangement has proven more durable than the grooved wheels. Mr. Daniel Adamson states that if the frictional wheels had been run at a higher speed the results would have been better, and says they should run at least 30 ft. per second.

Power Transmitted by Friction Drives. (W. F. M. Goss, *Trans. A. S. M. E.*, 1907.)—A friction drive consists of a fibrous or somewhat yielding driving wheel working in rolling contact with a metallic driven wheel. Such a drive may consist of a pair of plain cylinder wheels mounted upon parallel shafts, or a pair of beveled wheels, or of any other arrangement which will serve in the transmission of motion by rolling contact.

Driving wheels of each of the materials named in the table below were tested in peripheral contact with driving wheels of iron, aluminum and type metal. All the wheels were 16 in. diam.; the face of the driving wheels was $1\frac{3}{4}$ in., and that of the driven wheels $\frac{1}{2}$ in. Records were made of the pressure of contact, of the coefficient of friction developed, and of the percentage of slip resulting from the development of the said coefficient of friction. Curves were plotted showing the relation of the coefficient and the slip for pressures of 150 and 400 lbs. per inch width of face in contact. Another series of tests was made in which the slip was maintained constant at 2% and the pressures were varied. In most of the combinations it was found that with constant slip the coefficient of friction diminished very slightly as the pressure of contact was increased, so that it may be considered practically constant for all pressures between 150 and 400 lbs. per sq. in.

The crushing strength of each material under the conditions of the test was determined by running each combination with increasing loads until a load was found under which the wheel failed before 15,000 revolutions had been made. The results showed the failure of the several fiber wheels under loads per inch of width as follows: Straw fiber 750 lbs.; leather fiber, 1,200 lbs.; tarred fiber, 1,200 lbs.; leather, 750 lbs.; sulphite fiber, 700 lbs. One-fifth of these pressures is taken as a safe working load. The coefficient of friction approaches its maximum value when the slip between driver and driven wheel is 2%. The safe working horse-power of the drive is calculated on the basis of 60% the coefficient developed at a pressure of 150 lbs. per inch of width, a reduction of 40% being made to cover possible decrease of the coefficient in actual service and to cover also loss due to friction of the journals. From these data the following table is constructed showing the H.P. that may be transmitted by driving wheels of the several materials named when in frictional contact with iron, aluminum and type metal.

The formula for horse-power is $H.P. = \frac{\pi d}{12} \times \frac{WPN \times 0.6f}{33000} = KdWN$, in which d = diam. in inches, W = width of face in inches, P = safe working pressure in lbs. per in. of width, N = revs. per min., f = coefficient of friction, 0.6 a factor for the decrease of the coefficient in service and for the loss in journal friction, K a coefficient including P , f and the numerical constants.

COEFFICIENTS OF FRICTION AND HORSE-POWER OF FRICTION DRIVES.

	On iron.		On aluminum.		On type metal.	
	f	k	f	k	f	k
Straw fiber.....	0.255	0.00030	0.273	0.00033	0.186	0.00022
Leather fiber.....	0.309	0.00059	0.297	0.00057	0.183	0.00035
Tarred fiber.....	0.150	0.00029	0.183	0.00035	0.165	0.00031
Sulphite fiber.....	0.330	0.00037	0.318	0.00035	0.309	0.00034
Leather.....	0.135	0.00016	0.216	0.00026	0.246	0.00029

Horse-power = $K \times dWN$.

Friction Clutches. — Much valuable information on different forms of friction clutches is given in a paper by Henry Souther in *Trans. A. S. M. E.*, 1908, and in the discussion on the paper. All friction clutches contain two surfaces that rub on each other when the clutch is thrown into gear, and until the friction between them is increased, by the pressure with which they are forced together, to such an extent that the surfaces bind and enable one surface to drive the other. The surfaces may be metal on metal, metal on wood, cork, leather or other substance, leather on leather or other substance, etc. The surfaces may be disks, at right angles to the shaft, blocks sliding on the outer or inner surface, or both, of a pulley rim, or two cones, internal and external, one fitting in the other, or a band or ribbon around a pulley. The driving force which is just sufficient to cause one part of the clutch to drive the other is the product of the total pressure, exerted at right angles to the direction of sliding, and the coefficient of friction. The latter is an exceedingly variable quantity, depending on the nature and condition of the sliding surfaces and on their lubrication. The surfaces must have sufficient area so that the pressure per square inch on that area will not be sufficient to cause undue heating and wear. The total pressure on the parts of the mechanism that forces the surfaces together also must not cause undue wear of these parts.

For cone clutches, Reuleaux states that the angle of the cone should not be less than 10° , in order that the parts may not become wedged together. He gives the coefficient of cast iron on cast iron, for such clutches, at 0.15.

For clutches with maple blocks on cast iron Mr. Souther gives a coefficient of 0.37, and for a speed of 100 r.p.m. he gives the following table of capacity of such clutches, made by the Dodge Mfg. Co.

Horse-power.	Block Area.	Diam. at Block, Ins.	Circumferential Pull at Block Center.	Total Pressure.	Total Pressure per sq. in.
25	120	16	1,960	5,300	44
32	141	18	2,240	6,000	44.5
50	208	21.5	2,900	7,800	37.5
98	280	27.5	4,500	12,000	43.5

Prof. I. N. Hollis has found the coefficient of cork on cast iron to be from 0.33 to 0.37, or about double that of cast iron on cast iron or on bronze. A set of cork blocks outlasted a set of maple blocks in the ratio of five to one. Prof. C. M. Allen has found the torque for cork inserts to be nearly double that of a leather-faced clutch for a given dimension.

Disk clutches for automobiles are made with frictional surfaces of leather, bronze, or copper against iron or steel. The Cadillac Motor Car Co. give the following: Mean radius of leather frictional surface $4\frac{5}{16}$ ins.; area of do., $36\frac{1}{2}$ sq. ins.; axial pressure, 1000 to 1200 lbs.; H.P. capacity at 400 r.p.m., $5\frac{1}{2}$ H.P.; at 1400 r.p.m., 10 H.P.

C. H. Schlesinger (*Horseless Age*, Oct. 2, 1907) gives the following formula for the ordinary cone clutch:

$$\text{H.P.} = PfrR \div 63,000 \sin. \theta,$$

in which P = assumed pressure of engaging spring in lbs., f = coeff. of friction, which in ordinary practice is about 0.25; r = mean radius of the cone, ins.; R = r.p.m. of the motor; θ = angle of the cone with the axis. Mr. Souther says the value of $f = 0.25$ is probably near enough for a properly lubricated leather-iron clutch.

The Hele-Shaw clutch, with V-shaped rings struck up in the surfaces of disks, is described in *Proc. Inst. M. E.*, 1903. A clutch of this form 18 ins. diam. between the V's transmitted 1000 H.P. at 700 or 800 r.p.m.

Coil Friction Clutches. (H. L. Nachman, *Am. Mach.*, April 1, 1909.) — Friction clutches are now in use which will transmit 1000, and even more, horse-power. A type of clutch which is satisfactory for the transmission of large powers is the coil friction clutch. It consists of a steel coil wound on a chilled cast-iron drum. At each end of the coil a head is formed. The head at one end is attached to the pulley or shaft that is to be set in motion, while that at the other end of the coil serves as a point of application of a force which pulls on the coil to wind it on the drum, thus gripping it firmly.

The friction of the coil on the drum is the same as that of a rope or belt on a pulley. That is, the relation of the tensions at the two ends of the coil may be found from the equation $P/Q = e^{\mu\alpha}$ where P = pull at fixed end of coil; Q = pull at free end of coil; e = base of natural logarithms = 2.718; μ = coefficient of friction between coils and drum; and α = Angle subtended by coil in radian measure, = 6.283 for each turn of coil.

Values of P/Q for different numbers of turns are as follows, assuming $N = 0.05$ for steel on cast iron, lubricated:

No. of turns	1	2	3	4	5	6	7	8
$P/Q =$	1.37	1.87	2.57	3.51	4.81	6.58	8.60	12.33

If D = diam. of drum in ins., N = revs., per min., then $\text{H.P.} = \pi DNP + (12 \times 33,000) = 0.00000793 DNP$.

HOISTING AND CONVEYING.

Strength of Ropes and Chains. — For the weight and strength of rope for hoisting see notes and tables on pages 386 to 391. For strength of chains see page 251.

Working Strength of Blocks.
(Boston and Lockport Block Co., 1908.)

REGULAR BLOCKS WITH LOOSE HOOKS—LOADS IN POUNDS.

Size, Inches.	5	6	8	10	12	14
Rope diameter, inches.....	$9/16$	$3/4$	$7/8$	1	$1\frac{1}{8}$	$1\frac{1}{4}$
2 single blocks.....	150	250	700	2000	4000	7000
2 double blocks.....	250	400	1200	4000	8000	12000
2 triple blocks.....	400	650	1900	6000	12000	19000

LOADS IN TONS.

Size, inches.....	WIDE MORTISE WITH LOOSE HOOKS.					EXTRA HEAVY WITH SHACKLES.			
	8	10	12	14	16	18	20	22	24
Rope, diam., in.....	1	$1\frac{1}{4}$	$1\frac{5}{16}$	$1\frac{3}{8}$	$1\frac{3}{4}$	2	$2\frac{1}{4}$	$2\frac{1}{2}$	3
2 single blocks.....	$1\frac{1}{2}$	2	4	6	10	25	30	35	40
2 double blocks.....	1	3	6	8	12	30	35	40	50
2 triple blocks.....	2	4	8	16	14	40	45	55	70
2 fourfold blocks.....									

WORKING LOADS FOR A PAIR OF WIRE-ROPE BLOCKS—TONS.

Sheave Diam., In.	LOOSE HOOKS.			SHACKLES.		
	Two Singles.	Two Doubles.	Two Triples.	Two Singles.	Two Doubles.	Two Triples.
8	3	4	5	4	5	6
10	4	5	6	6	8	10
12	5	6	7	8	10	12
14	6	7	8	10	12	15
16	7	8	10	12	15	20
18	8	10	12	15	20	25

Chain Blocks. — Referring to the table on the next page, the speed of a chain block is governed by the pull required on the hand chain and the distance the hand chain must travel to lift the load the required distance. The speeds are given for short lifts with men accustomed to the work; for continuous easy lifting two-thirds of these speeds are attainable. The triplex block lifts rapidly, and the speed increases for light loads because the length of hand chain to be overhauled is small. This fact also enables the operator to lower the load very quickly with the triplex block. The 12- to 20-ton triplex blocks are provided with two separate hand wheels, thus permitting two men to hoist simultaneously, thereby securing double speed. In the triplex block the power is transmitted to the hoisting-chain wheel by means of a train of spur gearing operated by the hand chain. In the duplex block

Chain Block Hoisting Speeds.
(Yale & Towne Mfg. Co., 1908.)

Capacity in Tons.	Pull in Pounds required on Hand-Chain to Lift Full Loads.			Feet of Hand-Chain to be Pulled by Operator to Lift Load One Foot High.			Hoisting Speeds. Feet per Minute Attainable and No. of Men required for Hoisting Full Loads without Pulling over 80 Lb.							
							Triplex.			Duplex.		Differential.		
	Triplex.	Duplex.	Differential.	Triplex.	Duplex.	Differential.	Full Load.	Half Load.	Quarter Load.	† No. of Men.	Full Load.	† No. of Men.	Full Load.	† No. of Men.
1/4	62	68	72	21	40	18	8	16	24	1	4	1	6	1
1/2	82	87	216	31	59	30	4	8	12	1	2	1	3.70	3
1	110	94	246	35	80	36	4.8	9.6	14.4	2	2.40	2	2.50	3
1 1/2	120	115	308	42	93	42	3.6	7.2	10.8	2	1.80	2	2.30	4
2	114	132	557	69	126	38	2.3	4.6	6.9	2	1.10	2	2.30	7
3	124	142	...	84	155	...	1.7	3.5	5.2	2	0.80	2
4	110	145	...	126	195	...	1.3	2.6	3.9	2	0.65	2
5	130	145	...	126	252	...	1.1	2.2	3.3	2	0.50	2
6	135	160	...	168	310	...	0.8	1.6	2.4	2	0.35	2
8	140	160	...	210	390	...	0.6	1.2	1.8	2	0.30	2
10	130*	125*	1.1	2.2	3.3	4
12	135*	168*	0.8	1.6	2.4	4
16	140*	210*	0.6	1.2	1.8	4

* On each of the two hand-chains.
† The number of men is based on each man pulling not over 80 lb. One man pulling 160 lb. or less, as given in the first two columns, can lift the full capacity of any Triplex or Duplex Block.

the power is transmitted through a worm wheel and screw. In the differential block the power is applied by pulling on the slack part of the load chain and the force is multiplied by means of a differential sheave. (See page 513.) The relative efficiency and durability of the three types are as follows:

	Differential.	Duplex.	Triplex.
Relative efficiency.....	35	50	100
Relative durability.....	20	80	100
Relative cost.....	40	80	100

Efficiency of Hoisting Tackle. — (S. L. Wonsen, *Eng. News*, June 11, 1903.)

1 1/4 to 2-in. Manila rope.										
Parts of line.	2	3	4	5	6	7	8	9
Ratio of load to pull.....	1.91	2.64	3.30	3.84	4.33	4.72	5.08	5.37
Efficiency, per cent.....	96	88	83	77	72	67	64	60

3/4-in. Wire rope.												
Parts of line.	3	4	5	6	7	8	9	10	11	12	13	
Ratio load to pull.....	2.73	3.47	4.11	4.70	5.20	5.68	6.08	6.46	6.78	7.08	7.34	
Efficiency, per cent.....	91	87	82	78	74	71	68	65	62	59	56	

Proportions of Hooks. — The following formulae are given by Henry R. Towne, in his *Treatise on Cranes*, as a result of an extensive experimental and mathematical investigation. They apply to hooks of capacities from 250 lb. to 20,000 lb. Each size of hook is made from some commercial size of round iron. The basis in each case is, therefore, the size of iron of which the hook is to be made, indicated by *A* in the diagram. The dimension *D* is arbitrarily assumed. The other dimensions, as given by the formulae, are those which, while preserving a proper bearing-face on the interior of the hook for the ropes or chains which may be passed through it, give the greatest resistance to spreading and to ultimate rupture, which the amount of material in the original bar admits of. The symbol Δ is used to indicate the nominal capacity of the hook in tons of 2000 lb. The formulae which determine the lines of the other parts of the hooks of the several sizes are as follows, the measurements being all expressed in inches:

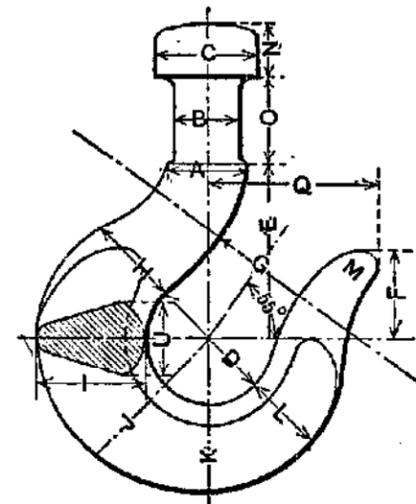

FIG. 182.

$$\begin{aligned}
 D &= 0.5 \Delta + 1.25; & G &= 0.75 D; & H &= 1.08 A; & L &= 1.05 A; \\
 E &= 0.64 \Delta + 1.60; & O &= 0.363 \Delta + 0.66; & I &= 1.33 A; & M &= 0.50 A; \\
 F &= 0.33 \Delta + 0.85; & Q &= 0.64 \Delta + 1.60; & J &= 1.20 A; & N &= 0.85 B - 0.16; \\
 & & K &= 1.13 A; & U &= 0.866 A.
 \end{aligned}$$

The dimensions *A* are necessarily based upon the ordinary merchant sizes of round iron. The sizes which it has been found best to select are the following:

Capacity of hook:	1/8	1/4	1/2	1	1 1/2	2	3	4	5	6	8	10 tons.
Dimension <i>A</i> :	5/8	11/16	3/4	1 1/16	1 1/4	1 3/8	1 3/4	2	2 1/4	2 1/2	2 7/8	3 1/4 in.

Experiment has shown that hooks made according to the above formulae will give way first by opening of the jaw, which, however, will not occur except with a load much in excess of the nominal capacity of the hook. This yielding of the hook when overloaded becomes a source of safety, as it constitutes a signal of danger which cannot easily be overlooked, and which must proceed to a considerable length before rupture will occur and the load be dropped.

Iron versus Steel Hooks. — F. A. Waldron, for over fifteen years connected with the manufacturing of hooks, in the works of the Yale & Towne Mfg. Co., after careful observation of hooks made of different materials and in different forms, says that the only proper material from which hooks can be made and be perfectly reliable is a high-grade puddled iron. While a steel hook, properly made, may stand from 25 to 50% greater load than a wrought-iron hook, it does not follow that the steel hook is better and more reliable than the iron hook.

Iron hooks, made in accordance with the Towne formula, having serious surface defects, have been tested to destruction, and none of them, in spite of these defects, have broken at less than 2 1/2 times the working load, while several steel hooks broke at the working load, without a moment's warning. (*Trans. A. S. M. E.*, 1903.)

Heavy Crane Hooks. — A. E. Holcomb, vice-pres. of the Earth Moving Machinery Co., contributes the following (1908). Seven years ago, while engaged in the design of a 100-ton crane, I made a study of the variations in strength with the different sectional forms for hooks in most common use. As a result certain values which gave the best results were substituted in "Gordon's" formula and a formula was thereby obtained which was good for hooks of any size desired, provided the proper allowable fiber stress per square inch was made use of when designing. From this

formula the enclosed table was made up and was published in the *American Machinist* of Oct. 31, 1901. Since that time hundreds of hooks of cast or hammered steel have been designed and made according to my formula, and not one of them, so far as I know, has ever failed.

The Industrial Works, Bay City, Michigan, manufacturers of heavy cranes, in December, 1904, made the following test under actual working conditions:

A hook was made of hammered steel having an elastic limit or yield point at approximately 36,000 lbs. per sq. in. fiber stress and having the following important dimensions: $d = 7\frac{5}{8}$ in.; $r = 4\frac{1}{2}$ in.; $D = 20\frac{7}{16}$ in.

When the applied load reached 150,000 lbs. the hook straightened out until the opening at the mouth of the hook was $2\frac{1}{2}$ in. larger than formerly, and the distance from center of action line of load to center of gravity of section was found to have decreased $\frac{1}{2}$ in., at which point the hook held the load. Upon increasing the load still further, the hook opened still more. From the dimensions of the hook as originally formed, we find from the formula or table that the fiber stress with a load of 150,000 lbs. was 37,900 lbs. per sq. in., or in excess of the yield point, whereas making use of the dimensions obtained from the hook when it held we find that the fiber stress per square inch was reduced to 35,940 lbs., or under the yield point.

The designer must use his own judgment as to the selection of a proper allowable fiber stress, being governed therein by the nature of the material to be used and the probability of the hook being overloaded at some time. Under average conditions I have made use of the following values for (f):

	Values of (f) in pounds for a load of —					
	1,000 to 5,000 lbs.	5,000 to 15,000 lbs.	15,000 to 30,000 lbs.	30,000 to 60,000 lbs.	60,000 to 100,000 lbs.	100,000 lbs. and up.
Cast iron	2,000	2,500				
Steel casting	6,000	8,000	10,000	11,250	12,500	
Hammered steel	12,000	16,000	20,000	22,500	25,000	27,500

Mr. Holcomb's formula and his table in condensed form are given below:

DIRECTIONS. — P and f being known, assume r to suit the requirements for which the hook is to be designed. Divide P by f and find the quotient in the column headed by the required r . At the side of the Table, in the same row, will be found the necessary depth of section, d .

Notation. — P = load. S = area of section. R^2 = square of the radius of gyration. f = allowable fiber stress in lbs. per sq. in., 20,000 lbs. for hammered steel. For other letters see Fig. 183.

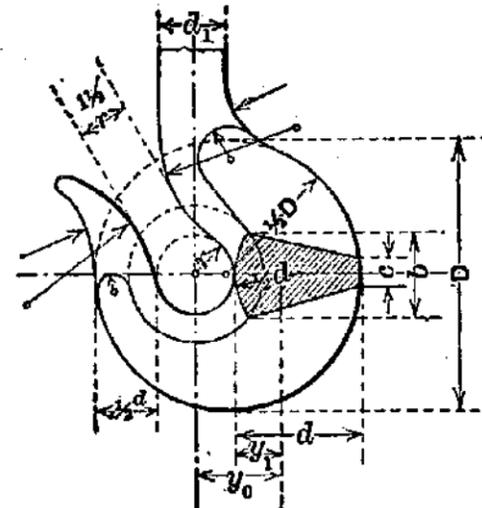

FIG. 183.

$$\frac{P}{f} = \frac{S}{1 + \frac{y_0^2}{R^2}} \text{ General formula.}$$

$$S = \frac{b + c}{2} \times d \dots (1)$$

$$R^2 = \frac{d^2(b^2 + 4bc + c^2)}{18(b^2 + 2bc + c^2)} \dots (2)$$

$$y_1 = \frac{b + 2c}{b + c} \times \frac{d}{3} \dots (3)$$

$$y_0 = \left(\frac{b + 2c}{b + c} \times \frac{d}{3} \right) + r \dots (4)$$

Assuming $b = 0.66d$; $c = 0.22d$, we have:

$$\frac{P}{f} = \frac{d^3}{7.44d + 12.393r} = K \dots (5)$$

$$d_1 = 0.5d.$$

$$D = 2r + 1.5d.$$

Values of K.

d.	r.										
	0.50	0.75	1.00	1.50	2.00	2.50	3.00	3.50	4.00	5.00	6.00
2.00	0.379	0.331	0.292	0.240	0.203	0.176	0.155				
2.25	.496	.437	.391	.329	.275	.239	.212				
2.50	.629	.559	.504	.420	.360	.316	.281				
2.75	.778	.697	.632	.532	.460	.404	.360				
3.00	.944	.852	.776	.659	.572	.506	.454	0.411			
3.25	1.143	1.039	.953	.801	.700	.621	.559	.508			
3.50	1.342	1.226	1.129	.957	.841	.750	.677	.617			
3.75	1.558	1.429	1.321	1.148	.998	.893	.808	.738			
4.00	1.790	1.649	1.530	1.336	1.187	1.067	.953	.873	0.805		
4.25	2.038	1.886	1.754	1.544	1.373	1.239	1.129	1.038	0.943		
4.50	2.304	2.138	1.995	1.760	1.575	1.426	1.321	1.214	1.124		
4.75	2.586	2.408	2.253	1.996	1.793	1.627	1.490	1.374	1.275		
5.00	2.884	2.694	2.527	2.248	2.072	1.843	1.691	1.563	1.453		
5.25	3.214	3.008	2.828	2.525	2.281	2.081	1.913	1.770	1.647		
5.50	3.532	3.315	3.124	2.801	2.538	2.321	2.140	1.983	1.849	1.628	
5.75		3.651	3.447	3.101	2.818	2.583	2.385	2.215	2.067	1.825	
6.00		4.003	3.787	3.418	3.115	2.861	2.646	2.461	2.300	2.035	
6.50		4.757	4.516	4.100	3.754	3.463	3.213	2.998	2.809	2.496	2.246
7.00		5.578	5.311	4.848	4.459	4.128	3.842	3.594	3.377	3.012	2.719
7.50			6.173	5.661	5.227	4.855	4.533	4.252	4.003	3.584	3.244
8.00			7.102	6.540	6.061	5.648	5.287	4.970	4.689	4.213	3.825
8.50			8.096	7.485	6.960	6.504	6.104	5.750	5.436	4.900	4.460
9.00			9.158	8.496	7.924	7.424	6.984	6.593	6.243	5.645	5.152
9.50				9.574	8.954	8.409	7.928	7.498	7.113	6.450	5.901
10.00				10.788	10.220	9.660	9.232	8.867	8.444	7.816	7.208
10.50				12.098	11.381	10.746	10.308	9.939	9.509	8.821	8.241
11.00				13.374	12.608	11.922	11.316	10.766	10.267	9.528	8.948
11.50				14.717	13.901	13.173	12.518	11.926	11.388	10.448	9.825
12.00				16.126	15.261	14.485	13.785	13.150	12.572	11.558	10.927
12.50				17.601	16.686	15.862	15.117	14.442	13.820	12.730	12.082
13.00					18.178	17.305	16.514	15.792	15.132	13.965	13.297
13.50					19.735	18.814	17.976	17.210	16.508	15.263	14.495
14.00					21.359	20.389	19.504	18.694	17.948	16.624	15.684
14.50					23.050	22.031	21.098	20.242	19.453	18.049	16.835
15.00					24.807	23.738	22.758	21.846	21.023	19.536	18.248
15.50					26.630	25.511	24.483	23.535	22.658	21.088	19.724
16.00					28.520	27.351	26.274	25.388	24.358	22.704	21.262

For values of K and r intermediate to those given in the table approximate values of d may be found by interpolation. Thus, for $K = 3.700$, $r = 2.75$.

Tabular values,	$r = 2.5$	3.0	Int. for 2.75
$d = 6.50$	$K = 3.462$	3.213	3.338
$d = 7.00$	$K = 4.128$	3.842	3.985

Whence: $d = 6.5 + \left\{ \frac{(3.700 - 3.338)}{(3.985 - 3.338)} \right\} \times (7.0 - 6.5) = 6.78.$

In like manner, if d and r are given the value of K and the corresponding safe load may be found.

Strength of Hooks and Shackles. (Boston and Lockport Block Co., 1908.) — Tests made at the Watertown arsenal on the strength of hooks and shackles showed that they failed at the loads given in the table below. In service they should be subjected to only 50% of the figures in the table. Ordinarily the hook of a block gives way first, and where heavy weights are to be handled shackles are superior to hooks and should be used wherever possible.

Strength of Hooks and Shackles.

HOOKS.*		SHACKLES.		HOOKS.*		SHACKLES.	
Size, Inches.	Tensile Strength, Pounds.	Tensile Strength, Pounds.	Description of Fracture.	Size, Inches.	Tensile Strength, Pounds.	Tensile Strength, Pounds.	Description of Fracture.
1/2	1,890	13/8	17,310	103,750	Eye of shackle.
9/16	2,560	1 1/2	20,940	119,800	Eye of shackle.
5/8	3,020	1 5/8	23,670	125,900	Eye of shackle.
3/4	4,370	20,700	Eye of shackle.	1 3/4	27,420	146,804	Sheared shackle pin.
7/8	6,280	38,100	Eye of shackle.	1 7/8	36,120	162,700	Eye of shackle.
1	12,600	51,900	Eye of shackle.	2	38,100	196,600	Shackle at neck of eye.
1 1/8	13,520	62,900	Sheared shackle pin.	2 1/2	55,380	210,400	Eye of shackle.
1 1/4	16,800	75,200	Eye of shackle.				

* All the hooks failed by straightening the hook.

Horse-power Required to Raise a Load at a Given Speed. — H.P. = $\frac{\text{Gross weight in lb.} \times \text{speed in ft. per min.}}{33,000}$ To this add 25% to 50% for

friction, contingencies, etc. The gross weight includes the weight of cage, rope, etc. In a shaft with two cages balancing each other use the net load + weight of one rope, instead of the gross weight.

To find the load which a given pair of engines will start. — Let A = area of cylinder in square inches, or total area of both cylinders, if there are two; P = mean effective pressure in cylinder in lb. per sq. in.; S = stroke of cylinder, inches; C = circumference of hoisting-drum, inches; L = load lifted by hoisting-rope, lb.; F = friction, expressed as a diminution of the load. Then $L = \frac{A \times P \times 2S}{C} - F$.

An example in *Coll'n Engr.*, July, 1891, is a pair of hoisting-engines 24" x 40", drum 12 ft. diam., average steam-pressure in cylinder = 59.5 lb.; $A = 904.8$; $P = 59.5$; $S = 40$; $C = 452.4$. Theoretical load, not allowing for friction, $A \times P \times 2S + C = 9589$ lb. The actual load that could just be lifted on trial was 7988 lb., making friction loss $F = 1601$ lb., or 20 + per cent of the actual load lifted, or 16 2/3% of the theoretical load.

The above rule takes no account of the resistance due to inertia of the load, but for all ordinary cases in which the acceleration of speed of the cage is moderate, it is covered by the allowance for friction, etc. The resistance due to inertia is equal to the force required to give the load the velocity acquired in a given time, or, as shown in Mechanics, equal to the

product of the mass by the acceleration, or $R = \frac{WV}{gT}$, in which R = resistance in lb. due to inertia; W = weight of load in lb.; V = maximum velocity in ft. per second; T = time in seconds taken to acquire the velocity V ; $g = 32.16$.

Effect of Slack Rope upon Strain in Hoisting. — A series of tests with a dynamometer are published by the Trenton Iron Co., which show that a dangerous extra strain may be caused by a few inches of slack rope. In one case the cage and full tubs weighed 11,300 lb.; the strain when the load was lifted gently was 11,525 lb.; with 3 in. of slack chain it was 19,025 lb.; with 6 in. slack 25,750 lb., and with 9 in. slack 27,950 lb.

Limit of Depth for Hoisting. — Taking the weight of a cast-steel hoisting-rope of 1 1/8 in. diameter at 2 lb. per running foot, and its break-

ing strength at 84,000 lb., it should, theoretically, sustain itself until 42,000 feet long before breaking from its own weight. But taking the usual factor of safety of 7, then the safe working length of such a rope would be only 6000 ft. If a weight of 3 tons is now hung to the rope, which is equivalent to that of a cage of moderate capacity with its loaded cars, the maximum length at which such a rope could be used, with the factor of safety of 7, is 3000 ft., or

$$2x + 6000 = 84,000 \div 7; \therefore x = 3000 \text{ feet.}$$

This limit may be greatly increased by using special steel rope of higher strength, by using a smaller factor of safety, and by using taper ropes. (See paper by H. A. Wheeler, *Trans. A. I. M. E.*, xix, 107.)

Large Hoisting Records. — At a colliery in North Derbyshire during the first week in June, 1890, 6309 tons were raised from a depth of 50 yards, the time of winding being from 7 a.m. to 3.30 p.m.

At two other Derbyshire pits, 170 and 140 yards in depth, the speed of winding and changing has been brought to such perfection that tubs are drawn and changed three times in one minute. (*Proc. Inst. M. E.*, 1890.)

At the Nottingham Colliery near Wilkesbarre, Pa., in Oct., 1891, 70,152 tons were shipped in 24.15 days, the average hoist per day being 1318 mine cars. The depth of hoist was 470 feet, and all coal came from one opening. The engines were fast motion, 22 x 48 inches, conical drums 4 feet 1 inch long, 7 feet diameter at small end and 9 feet at large end. (*Eng'g News*, Nov., 1891.)

The Most Powerful Hoisting Engines ever built are said to be two 32 x 72 duplex double-drum units built in 1906 for the Boston and Montana Co., at Butte, Mont. Each is designed to lift a dead load, unbalanced, of 17 tons out of a 3,500-ft. vertical shaft, at the rate of 2,500 ft. per minute. Each hoist has two drums, 12 ft. diameter and 5 ft. 6 ins. face, mounted on the same shaft and driven by 12-ft. diameter flat-disk reversible friction clutches.

Pneumatic Hoisting. (H. A. Wheeler, *Trans. A. I. M. E.*, xix, 107.) — A pneumatic hoist was installed in 1876 at Epinac, France, consisting of two continuous air-tight iron cylinders extending from the bottom to the top of the shaft. Within the cylinder moved a piston from which was hung the cage. It was operated by exhausting the air from above the piston, the lower side being open to the atmosphere. Its use was discontinued on account of the failure of the mine. Mr. Wheeler gives a description of the system, but criticises it as not being equal on the whole to hoisting by steel ropes.

Pneumatic hoisting-cylinders using compressed air have been used at blast-furnaces, the weighted piston counterbalancing the weight of the cage, and the two being connected by a wire rope passing over a pulley-sheave above the top of the cylinder. In the more modern furnaces steam-engine or electric hoists are generally used.

Electric Mine-Hoists. — An important paper on this subject, by D. B. Rushmore and K. A. Paulv, will be found in *Trans. A. I. M. E.*, 1910.

Counterbalancing of Winding-engines. (H. W. Hughes, *Columbia Coll. Qly.*) — Engines running unbalanced are subject to enormous variations in the load; for let W = weight of cage and empty tubs, say 6270 lb.; c = weight of coal, say 4480 lb.; r = weight of hoisting rope, say 6000 lb.; r' = weight of counterbalance rope hanging down pit, say 6000 lb. The weight to be lifted will be:

If weight of rope is unbalanced. If weight of rope is balanced.

At beginning of lift: $W + c + r - W$ or 10,480 lb. $W + c + r - (W + r')$

At middle of lift: $W + c + \frac{r}{2} - (W + \frac{r}{2})$ or 4480 lb. $W + c + \frac{r}{2} - (W + \frac{r}{2} + \frac{r'}{2})$ } or 4480 lb.

At end of lift: $W + c - (W + r)$ or minus 1520 lb. $W + c + r' - (W + r)$

That counterbalancing materially affects the size of winding-engines is shown by a formula given by Mr. Robert Wilson, which is based on the fact that the greatest work a winding-engine has to do is to get a given mass into a certain velocity uniformly accelerated from rest, and to raise a load the distance passed over during the time this velocity is being obtained.

Let W = the weight to be set in motion: one cage, coal, number of empty tubs on cage, one winding rope from pit head-gear to bottom, and one rope from banking level to bottom.

v = greatest velocity attained, uniformly accelerated from rest;

g = gravity = 32.2;

t = time in seconds during which v is obtained;

L = unbalanced load on engine;

R = ratio of diameter of drum and crank circles;

P = average pressure of steam in cylinders;

N = number of cylinders;

S = space passed over by crank-pin during time t ;

$C = 2/3$, constant to reduce angular space passed through by crank to the distance passed through by the piston during the time t ;

A = area of one cylinder, without margin for friction. To this an addition for friction, etc., of engine is to be made, varying from 10 to 30% of A .

1st. Where load is balanced,

$$A = \frac{\left\{ \left(\frac{Wv^2}{2g} \right) + \left(L \frac{vt}{2} \right) \right\} R}{PNSC}$$

2d. Where load is unbalanced:

The formula is the same, with the addition of another term to allow for the variation in the lengths of the ascending and descending ropes. In this case

h_1 = reduced length of rope in t attached to ascending cage;

h_2 = increased length of rope in t attached to descending cage;

w = weight of rope per foot in pounds. Then

$$A = \frac{\left[\left(\frac{Wv^2}{2g} \right) + \left\{ \left(L \frac{vt}{2} \right) - \frac{h_1w + h_2w}{2} \right\} \right] R}{PNSC}$$

Applying the above formula when designing new engines, Mr. Wilson found that 30 in. diameter of cylinders would produce equal results, when balanced, to those of the 36-in. cylinder in use, the latter being unbalanced.

Counterbalancing may be employed in the following methods:

(a) *Tapering Rope.* — At the initial stage the tapering rope enables us to wind from greater depths than is possible with ropes of uniform section. The thickness of such a rope at any point should only be such as to safely bear the load on it at that point.

With tapering ropes we obtain a smaller difference between the initial and final load, but the difference is still considerable, and for perfect equalization of the load we must rely on some other resource. The theory of taper ropes is to obtain a rope of uniform strength, thinner at the cage end where the weight is least, and thicker at the drum end where it is greatest.

(b) *The Counterpoise System* consists of a heavy chain working up and down a staple pit, the motion being obtained by means of a special small drum placed on the same axis as the winding drum. It is so arranged that the chain hangs in full length down the staple pit at the commencement of the winding; in the center of the run the whole of the chain rests on the bottom of the pit, and, finally, at the end of the winding the counterpoise has been rewound upon the small drum, and is in the same condition as it was at the commencement.

(c) *Loaded-wagon System.* — A plan, formerly much employed, was to have a loaded wagon running on a short incline in place of this heavy chain; the rope actuating this wagon being connected in the same manner as the above to a subsidiary drum. The incline was constructed steep at the commencement, the inclination gradually decreasing to nothing. At the beginning of a wind the wagon was at the top of the incline, and during a portion of the run gradually passed down it till, at the meet of cages, no pull was exerted on the engine — the wagon by this time being at the bottom. In the latter part of the wind the resistance was all against the engine, owing to its having to pull the wagon up the incline,

and this resistance increased from nothing at the meet of cages to its greatest quantity at the conclusion of the lift.

(d) *The Endless-rope System* is preferable to all others, if there is sufficient sump room and the shaft is free from tubes, cross timbers, and other impediments. It consists in placing beneath the cages a tail rope, similar in diameter to the winding rope, and, after conveying this down the pit, it is attached beneath the other cage.

(e) *Flat Ropes Coiling on Reels.* — This means of winding allows of a certain equalization, for the radius of the coil of ascending rope continues to increase, while that of the descending one continues to diminish. Consequently, as the resistance decreases in the ascending load the leverage increases, and as the power increases in the other, the leverage diminishes. The variation in the leverage is a constant quantity, and is equal to the thickness of the rope where it is wound on the drum.

By the above means a remarkable uniformity in the load may be obtained, the only objection being the use of flat ropes, which weigh heavier and only last about two-thirds the time of round ones.

(f) *Conical Drums.* — Results analogous to the preceding may be obtained by using round ropes coiling on conical drums, which may either be smooth, with the successive coils lying side by side, or they may be provided with a spiral groove. The objection to these forms is, that perfect equalization is not obtained with the conical drums unless the sides are very steep, and consequently there is great risk of the rope slipping; to obviate this, scroll drums were proposed. They are, however, very expensive, and the lateral displacement of the winding rope from the center line of pulley becomes very great, owing to their necessary large width.

(g) *The Koepe System of Winding.* — An iron pulley with a single circular groove takes the place of the ordinary drum. The winding rope passes from one cage, over its head-gear pulley, round the drum, and, after passing over the other head-gear pulley, is connected with the second cage. The winding rope thus encircles about half the periphery of the drum in the same manner as a driving-belt on an ordinary pulley. There is a balance rope beneath the cages, passing round a pulley in the sump; the arrangement may be likened to an endless rope, the two cages being simply points of attachment.

CRANES.

Classification of Cranes. (Henry R. Towne, *Trans. A. S. M. E.*, iv. 288. Revised in *Hoisting*, published by The Yale & Towne Mfg. Co.)

A Hoist is a machine for raising and lowering weights. A Crane is a hoist with the added capacity of moving the load in a horizontal or lateral direction.

Cranes are divided into two classes, as to their motions, viz., *Rotary* and *Rectilinear*, and into four groups, as to their source of motive power, viz.:

Hand. — When operated by manual power.

Power. — When driven by power derived from line shafting.

Steam, Electric, Hydraulic, or Pneumatic. — When driven by an engine or motor attached to the crane, and operated by steam, electricity, water, or air transmitted to the crane from a fixed source of supply.

Locomotive. — When the crane is provided with its own boiler or other generator of power, and is self-propelling; usually being capable of both rotary and rectilinear motions.

Rotary and Rectilinear Cranes are thus subdivided:

ROTARY CRANES.

(1) *Swing-cranes.* — Having rotation, but no trolley motion.

(2) *Jib-cranes.* — Having rotation, and a trolley traveling on the jib.

(3) *Column-cranes.* — Identical with the jib-cranes, but rotating around a fixed column (which usually supports a floor above).

(4) *Pillar-cranes.* — Having rotation only; the pillar or column being supported entirely from the foundation.

(5) *Pillar Jib-cranes.* — Identical with the last, except in having a jib and trolley motion.

(6) *Derrick-cranes.* — Identical with jib-cranes, except that the head of the mast is held in position by guy-rods, instead of by attachment to a roof or ceiling.

(7) *Walking-cranes.* — Consisting of a pillar or jib-crane mounted on wheels and arranged to travel longitudinally upon one or more rails.

(8) *Locomotive-cranes.* — Consisting of a pillar-crane mounted on a truck, and provided with a steam-engine capable of propelling and rotating the crane, and of hoisting and lowering the load.

RECTILINEAR CRANES.

(9) *Bridge-cranes.* — Having a fixed bridge spanning an opening, and a trolley moving across the bridge.

(10) *Tram-cranes.* — Consisting of a truck, or short bridge, traveling longitudinally on overhead rails, and without trolley motion.

(11) *Traveling-cranes.* — Consisting of a bridge moving longitudinally on overhead tracks, and a trolley moving transversely on the bridge.

(12) *Gantries.* — Consisting of an overhead bridge, carried at each end by a trestle traveling on longitudinal tracks on the ground, and having a trolley moving transversely on the bridge.

(13) *Rotary Bridge-cranes.* — Combining rotary and rectilinear movements and consisting of a bridge pivoted at one end to a central pier or post, and supported at the other end on a circular track; provided with a trolley moving transversely on the bridge.

For descriptions of these several forms of cranes see Towne's "Treatise on Cranes."

Stresses in Cranes. — See Stresses in Framed Structures, p. 515, ante.

Position of the Inclined Brace in a Jib-crane. — The most economical arrangement is that in which the inclined brace intersects the jib at a distance from the mast equal to four-fifths the effective radius of the crane. (*Hoisting.*)

Electric Overhead Traveling Cranes. (From data supplied by Alliance Machine Co., Alliance, O., and Pawling & Harnischfeger, Milwaukee.) — Electric overhead traveling cranes usually have 3 motors, for hoisting, traversing the hoist trolley on the bridge and for moving the bridge, respectively. The usual range of motor sizes is as follows: Hoist, 15-50 H.P.; trolley, 3-15 H.P.; bridge, 15-50 H.P. The speeds at which the various motions are made range as follows, the figures being feet per minute: Hoist, 8-60; trolley traverse, 75-200; bridge travel, 200-600. These speeds are varied in the same capacity of crane to suit each particular installation. In general, the speed of the bridge in feet per minute should not exceed (length of runway + 100). If the runway is long and covered by more than one crane, the speed may be made equal to the average distance between cranes + 100. Usually 300 ft. per min. is a good speed. For small cranes in special cases, the speeds may be increased, but for cranes of over 50 tons capacity the speed should be below 300 ft. per min. unless the building is made especially strong to stand the strains incident to starting and stopping heavy cranes geared for high speeds. Cranes of over 15 tons capacity usually have an auxiliary hoist of 1/5 the capacity of the main hoist, and usually operated by the same motor. Wire rope is now almost exclusively used for hoisting with cranes. The diameter of the drums and sheaves should be not less than 30 times the diameter of the hoisting rope, and should have a factor of safety of 5. Cranes are equipped with automatic load brakes to sustain the load when lifted and to regulate the speed when lowering, it being necessary for the hoist to drive the load down.

The voltage now standard for crane service is 220 volts at the crane motor, although 110 volts for small cranes is not objectionable. Voltages of 500-600 are inadvisable, especially in foundries and steel works, where dust and metallic oxides cover many parts of the crane and necessitate frequent cleaning to avoid grounds. On account of the danger from the higher voltages, the operators are apt to neglect this part of their work.

Power Required to Drive Cranes. (Morgan Engineering Co., Alliance, O., 1909.) — The power required to drive the different parts of cranes is determined by allowing a certain friction percentage over the power required to move the dead load. On hoist motions 33 1/3% is allowed for friction of the moving parts, thus giving a motor of 1/3 greater capacity than if friction were neglected. For bridge and trolley motions, a journal friction of the track wheel axles of 10% of the total weight of the crane and load is allowed. There is then added an allowance of 33 1/3% of the horse-power required to drive the crane and load plus the track wheel

axle friction, to cover friction of the gearing. In selecting motors, the most important consideration is the maximum starting torque which the motor can exert. With alternating-current motors, this is less than with direct-current motors, requiring a larger motor, particularly on the bridge and trolley motions which require the greatest starting torque.

Walter G. Stephan says (*Iron Trade Rev.*, Jan. 7, 1909) that the bridge girders should be made of two plates latticed, or box girders, their depth varying from 1/10 to 1/20 of the span. The important feature of crane girder design is ample strength and stiffness, both vertically and laterally. Especial attention should be given to the transverse strain on the bridge due to sudden stopping or starting of heavy loads. The wheel base on the end trucks should have a ratio to the crane span of 1 to 6, although for long spans this ratio must necessarily be reduced to 1 to 8. Quick-traveling cranes should have as long a wheel base as possible, since the tendency to twist increases with the speed. Where several wheels are necessary at each end to support the crane, equalizing means should be used.

A recent development in cranes is the four- or six-girder crane for handling ladles of molten metal in steel works. The main trolley runs on the outer girders, with the hoist ropes depending between the outer and inner girders. The auxiliary trolley runs on the inner girders, thus being able to pass between the main ropes, and tilt the ladle in either direction.

Dimensions and Wheel Loads of Electric Traveling Cranes.

Based on 60-ft. span and 25-ft. lift; wire rope hoist.
(Alliance Machine Co., 1908.)

Capacity, Tons (2000 Lb.).	Distance Runway Rail to Highest Point.		Distance Center of Rail to Ends of Crane.	Wheel Base of End Truck.		Maximum Load per Wheel; Trolley at End of Bridge.
	Ft.	In.		Ft.	In.	
5	6	0	9	0	20,000	
10	6	6	10	0	27,000	
25	7	4	12	6	51,000	
40	8	0	12	3	82,000	
50	8	9	12	6	48,000*	

* Has 8 track wheels on bridge.

Standard cranes are built in intermediate sizes, varying by 5 tons, up to 40 tons.

Standard Hoisting and Traveling Speeds of Electric Cranes.

(Pawling & Harnischfeger, 1908.)

Capacity, Tons (2000 Lb.).	Hoisting Speed, Ft. per Min.	Bridge Travel Speed, Ft. per Min.	Capacity Aux. Hoist, Tons.	Speed Aux. Hoist, Ft. per Min.
5	25-100	300-450	3	30-75
10	20-75	300-450	3	50-125
25	10-40	250-350	10	25-60
40	9-30	250-350	5	40-100
50	8-30	200-300	10	25-60
75	6-25	200-250	15	20-50
125	5-15	200-250	25	20-50
150	5-15	200-250	25	20-50

Trolley travel speed from 100-150 ft. per min. in all cases.

Notable Crane Installations. (1909.)

Capacity, Tons.	Span.		No. of Trolleys.	Capacity of Auxiliary Hoist, Tons.	H.P. of Hoist Motor.		H.P. of Trolley Motor.	H.P. of Bridge Motor.	Hoisting Speed, Ft. per Min.	Bridge Speed, Ft. per Min.	Trolley Travel Speed, Ft. per Min.	Depth of Main Girders.	Where Installed.	Maker.
	Ft.	In.			Main.	Auxiliary.								
150	65	0	1	25	75†	{35 110}	30	75	8-24	150-200	100-150	7 0	4	1
150	55	0	1	30	120	50	35	50	8	150-200	75-100	5	3
150	65	0	2	15	75†	30†	18†	75	10-25	150-200	100-150	7 6	4	1
125*	2	110	{50 30}	{30 15}	100†	10	200	{80 125}	5 10	6	2
120	56	7	2	10	50†	18	10†	52†	10-25	150-300	100-150	5 5	7	1
100	65	0	2	10	50†	18	10†	50	10-25	200-250	100-150	5 5	8	1
80	74	0	2	10	40†	18†	10†	40	10-25	200-250	100-150	5 10 1/2	9	1
50	129	11 1/4	1	15	50	25	7 1/2	50	10	100-150	80-100	8 6	10	3
50	125	10	1	15	50	25	7 1/2	50	10	100-150	80-100	8 6	11	3
50	121	2	1	5	75	15	15	75	11 1/2	225	125	8 4	12	2

* Four-girder ladle crane. † On each trolley.
‡ Divided equally between 2 motors for series-parallel control.

1. Pawling & Harnischfeger; 2. Alliance Mach. Co.; 3. Morgan Engineering Co.; 4. Midvale Steel Co., Phila.; 5. Homestead Steel Works, Munhall, Pa.; 6. Indiana Steel Co., Gary, Ind.; 7. Oregon Ry. & Nav. Co., Portland, Ore.; 8. El Paso & S. W. Ry., El Paso, Tex.; 9. C. & E. I. Ry., Danville, Ill.; 10. 3d Ave. Ry., N. Y. City; 11. United Rys. Co., Baltimore; 12. Carnegie Steel Co., Youngstown, Ohio.

A 150-ton Pillar-crane was erected in 1893 on Finnieston Quay, Glasgow. The jib is formed of two steel tubes, each 39 in. diam. and 90 ft. long. The radius of sweep for heavy lifts is 65 ft. The jib and its load are counterbalanced by a balance-box weighted with 100 tons of iron and steel punchings. In a test a 130-ton load was lifted at the rate of 4 ft. per minute, and a complete revolution made with this load in 5 minutes. *Eng'g News*, July 20, 1893.

Compressed-air Traveling-cranes.—Compressed-air overhead traveling-cranes have been built by the Lane & Bodley Co., of Cincinnati. They are of 20 tons nominal capacity, each about 50 ft. span and 400 ft. length of travel, and are of the triple-motor type, a pair of simple reversing-engines being used for each of the necessary operations, the pair of engines for the bridge and the pair for the trolley travel being each 5-inch bore by 7-inch stroke, while the pair for hoisting is 7-inch bore by 9-inch stroke. The air-pressure when required is somewhat over 100 pounds. The air-compressor is allowed to run continuously without a governor, the speed being regulated by the resistance of the air in a receiver. An auxiliary receiver is placed on each traveler, whose object is to provide a supply of air near the engines for immediate demands and independent of the hose connection. Some of the advantages said to be possessed by this type of crane are: simplicity; absence of all moving parts, excepting those required for a particular motion when that motion is in use; no danger from fire, leakage, electric shocks, or freezing; ease of repair; variable speeds and reversal without gearing; almost entire absence of noise; and moderate cost.

Quay-cranes.—An illustrated description of several varieties of stationary and traveling cranes, with results of experiments, is given in a paper on Quay-cranes in the Port of Hamburg by Chas. Nehls, *Trans. A. S. C. E.*, 1893.

Hydraulic Cranes, Accumulators, etc.—See Hydraulic Pressure Transmission, page 779, ante.

Electric versus Hydraulic Cranes for Docks.—A paper by V. L. Raven, in *Trans. A. S. M. E.*, 1904, describes some tests of capacity and

efficiency of electric and hydraulic power plants for dock purposes at Middlesbrough, Eng. In loading two cargoes of rails, weighing respectively 1210 and 1225 tons, the first was done with a hydraulic crane, in 7 hours, with 3584 lbs. of coal burned in the power station, and the second with an electric crane in 5 1/4 hours, with 2912 lbs. of coal. The total cost including labor, per 100 tons, was 327 pence with the hydraulic and 245 pence for the electric crane, a saving by the latter of 25 %.

Loading and Unloading and Storage Machinery for coal, ore, etc., is described by G. E. Titcomb in *Trans. A. S. M. E.*, 1908. The paper illustrates automatic ore unloaders for unloading ore from the hold of a vessel and loading it onto cars, and car-dumping machinery, by which a 50-ton car of coal is lifted, turned over and its contents discharged through a chute into a vessel. Methods of storage of coal and of re-loading it on cars are also described.

Power Required for Traveling-Cranes and Hoists.—Ulrich Peters, in *Machy*, Nov. 1907, develops a series of formulæ for the power required to hoist and to move trolleys on cranes. The following is a brief abstract. Resistance to be overcome in moving a trolley or crane-bridge. P_1 = rolling friction of trolley wheels, P_2 = journal friction of wheels or axles, P_3 = inertia of trolley and load. P = sum of these

resistances = $P_1 + P_2 + P_3 = (T + L) \left(\frac{f_1 + f_2 d}{D} + \frac{v}{1932t} \right)$ in which T = weight of trolley, L = load, f_1 = coeff. of rolling friction, about 0.002, (0.001 to 0.003 for cast iron on steel); f_2 = coeff. of journal friction, = 0.1 for starting and 0.01 for running, assuming a load on brasses of 1000 to 3000 lb. per sq. in.; f_2 is more apt to be 0.05 unless the lubrication is perfect. See Friction and Lubrication, W. K.] d = diam. of journal; D = diam. of wheels; v = trolley speed in ft. per min.; t = time in seconds in which the trolley under full load is required to come to the maximum speed. Horse-power = sum of the resistances X speed, ft. per min. ÷ 33,000.

Force required for hoisting and lowering: F_h = actual hoisting force, F_0 = theoretical force or pull, L = load, v = speed in ft. per min. of the rope or chain, c = hoisting speed of the load L , c/v = transmission ratio of the hoist, e = efficiency = F_0/F_h . The actual work to raise the load per minute = $F_h v = Lc = F_0 v ÷ e$. The efficiency e is the product of the efficiencies of all the several parts of the hoisting mechanism, such as sheaves, windlass, gearing, etc. Methods of calculating these efficiencies, with examples, are given at length in the original paper by Mr. Peters.

Lifting Magnets.—(From data furnished by the Electric Controller and Mfg. Co., Cleveland, and the Cutler-Hammer Clutch Co., Milwaukee). Lifting magnets first came into use about 1898. They have had wide application for handling pig iron, scrap, castings, etc. A lifting magnet comprises essentially a magnet winding, a pole-piece, a shoe and a protecting case, which is ribbed to afford ample radiating surface to dissipate the heat generated in operation. The winding usually consists of coils, each wound with copper ribbon and insulated with asbestos. The insulation must be designed to withstand a higher voltage than the line voltage, due to the inductive kick when the circuit is opened. The wearing plate, which takes the shocks incident to picking up the load, is usually made of manganese steel. The shape of the pole piece or lifting surface of the magnet must be varied, as the same shape is not usually applicable to all classes of materials. For handling pig iron, scrap, etc., a concave pole surface is usually superior to a flat one, which is adapted to handling plates or flat material of similar character, and which bear equally on the piece to be lifted at both the edge and center. A test of a lifting magnet made at the works of the Youngstown Sheet and Tube Co., in 1907, showed the following results:

Total pig iron unloaded, 109,350 pounds; weight of average lift, 785 pounds; time required, 2 hours, 15 minutes; current on magnet, 1 hour 15 minutes; current required, 30 amperes.

The No. 3 and No. 4 magnets are particularly fitted for use on steam-driven locomotive cranes, and when so used are usually supplied with current from a small steam-driven generator set mounted on the crane, steam being drawn from the boiler of the crane. Nos. 5 and 6 are adapted for use with overhead electric traveling cranes in cases where large lifts and high speed of handling are essential.

SIZES AND CAPACITIES OF THE ELECTRIC CONTROLLER & MFG. Co.'s TYPE S-A LIFTING MAGNETS. (1909).

Size.	Diam.	Weight.	Average current at 220 volts.	Lifts in machine cast pig iron.	
				Maximum lift.	Average lift.
3	In. 36	Lb. 2,100	Amp. 11	Lb. 1,405	Lb. 750
4	43	3,200	27	2,180	1,250
5	52	4,800	35	3,087	1,800
6	61	6,600	45	4,589	2,600

SIZES AND CAPACITIES OF LIFTING MAGNETS (CUTLER-HAMMER), 1908.

Sizes, in.	Weight lb.	Maximum* Lifting Capacity, lb.	Average Lifting Capacity, lb.	Current Required at 220 volts, amperes.	Head room required, ft.
10	75	800	100-300	1
35	1,650	5,000	500-1,000	15-18	4
50	5,000	20,000	1,000-2,000	30-35	6

*This capacity can be obtained only under the most favorable conditions, with complete magnetic contact between the magnet and the piece to be lifted.

The capacity of a lifting magnet in service depends on many other factors than the design of the magnet. Most important is the character of the material handled. Much more can be handled at a single lift with material like billets, ingots, etc., than with scrap, wire, pig iron, etc. The speed of the crane, from which the magnet is suspended, and the distance it must transport the material are also important factors to be considered in calculating the capacity of a given magnet under given conditions. The following results have been selected from a great number of tests of the Electric Controller and Mfg. Co.'s No. 2 Type S magnets in commercial service, and represent what is probably average practice. It should be borne in mind that the average lift is determined from a large number of lifts, including lifts made from a full car of, say, pig iron, where the magnetic conditions are very favorable, and also the "lean" lifts where the car is nearly empty, and magnetic conditions unfavorable; the magnet can reach only a few pigs at one time on the lean lifts, with a consequent heavy decrease in the size of the load. The average lift is therefore less than the maximum lift in handling a given lot of material.

When operated from an ordinary electric overhead traveling crane a magnet of the type used in these trials will handle from 20 to 30 tons per hour of the scrap used by open-hearth furnaces. If operated from a special fast crane, the amount may be somewhat increased. Average lifts in pounds for various materials are as follows:

Skull cracker balls up to 20,000; ingot (or if ground man places magnet, two), each, 6,000; billet slabs, 900-6,000.

The above weights depend on dimensions and whether in pile or stacked evenly.

Machine cast pig iron, 1,250; sand cast pig iron, 1,150.

These are values obtained in unloading railway cars, including lean lifts in cleaning up.

Machine cast pig iron, 1,350; sand cast pig iron, 1,200.

The above are average lifts from stockpile.

Heavy melting stock (billets, crop ends of billets, rails or structural shapes, 1,250; boiler plate scrap, 1,100; farmers' scrap (harvesting machinery parts, plow points, etc.), 900; small risers from steel castings, 1,800; fine wire scrap, scrap tubing not over 3 ft. long, loose even or lamination scrap, 500; bundled scrap, 1,200; miscellaneous junk dealers' scrap, 400-800.

WARNING: This is a 1910 edition. Some of the material may no longer be accurate

COMMERCIAL RESULTS WITH A 52-INCH, 5,000 POUND MAGNET. (Electric Controller & Mfg. Co., 1908.)

Hoist speed, ft. per min.	Crane.		Distance moved.			Total Weight Moved, Tons.	No. of Lifts.	Aver. weight per lift, lbs.	Total time, Minutes.	Conditions of Working.
	Trolley speed, ft. per min.	Bridge speed, ft. per min.	Hoist, Ft.	Trolley, Ft.	Bridge, Ft.					
60	80	315	3	6	6	35	55	1,275	60	2
60	80	315	10	36	15	39.3	60	1,328	60	3
60	80	315	10	20	40	33.9	55	1,234	55	4
50	200	550	3	6	3	78.	132	1,182	135	5
50	200	550	4	7	8	78	168	929	190	6
50	200	550	5	8	0	26	30	173	45	7
50	200	550	4	6	3	80	300	534	300	8
240	171	160	12	30	12	25	25	2,000	80	9
240	171	160	15	10	150	112	56	4,000	120	10
240	171	160	7	12	5	7	8	1,740	15	11
240	171	160	5	13	0	5	4	2,660	10	12

* 1. Machine cast pig handled from stock pile to charging boxes. 2. Bull heads, ditto. 3. Sand cast pig unloaded from car to stock pile. 4. Baled tin and wire unloaded from car to stock pile. 5. Boiler plate scrap handled from stock pile to charging boxes. 6. Farmers' scrap, comprising knotters and butters from threshing and binding machines, sections of cutter bars from mowers, broken steel teeth from hay rakes, plow points, etc., from stock pile to charging boxes. 7. Small risers from steel castings, handled from stock pile to charging boxes. 8. Laminated plates from armatures and transformers, mixed sizes, from stock pile to charging boxes. 9. Cast iron sewer pipe, 3 feet diameter, weighing 2,000 pounds each, lifted from cars to flat boat. Each pipe had to be blocked and lashed to prevent washing overboard. 10. Pennsylvania Railroad East River tunnel section castings, convex on one side, concave on other, weighing 4,000 pounds each. Handled from local float to barge for shipment. 11. Steel plate 1/2-inch X 10 inches X 6 feet 0 inches handled from car to float. 12. Steel rails, 40 pounds per yard, 25 feet long. Handled from car to lighter, about 8 rails per lift.

The above results of tests relate to the Electric Controller & Mfg. Co.'s No. 2 Type "S" magnet, 52 in. diameter and weighing 5200 lbs. and are the average of a large number of tests made at various plants between the years 1905 and 1908. This type of magnet is being superseded by the No. 4 Type S-A magnet which is 43 in. diameter, weighs 3200 lbs. and gives substantially the same average lift.

TELPHERAGE.

Telpherage is a name given to a system of transporting materials in which the load is suspended from a trolley or small truck running on a cable or overhead rail, and in which the propelling force is obtained from an electric motor carried on the trolley. The trolley, with its motor, is called a "telpher." A historical and illustrated description of the system is given in a paper by C. M. Clark, in *Trans. A. I. E. E.*, 1902. A series of circulars of the United Telpherage Co., New York, show numerous illustrations of the system in operation for handling different classes of materials. Telpherage is especially applicable for moving packages in warehouses, on wharfs, etc. The moving machinery consists of the telpher or the conveying power, with accompanying trailers; the portable electric hoist or the vertical elevating power, and the carriers containing the load. Among the accessories are brakes, switches and controlling devices of many kinds.

An automatic line is controlled by terminal and intermediate switches which are operated by the men who do the loading and unloading, no additional labor being required. A non-automatic line necessitates a boy to accompany the telfer. The advisability of using the non-automatic rather than the automatic line is usually determined by the distance between stations.

COAL-HANDLING MACHINERY.

The following notes and tables are supplied by the Link-Belt Co.

In large boiler-houses coal is usually delivered from hopper-cars into a track-hopper, about 10 feet wide and 12 to 16 feet long. A feeder set under the track-hopper feeds the coal at a regular rate to a crusher, which reduces it to a size suitable for stokers.

After crushing, the coal is elevated or conveyed to overhead storage-bins. Overhead storage is preferred for several reasons:

1. To avoid expensive wheeling of coal in case of a breakdown of the coal-handling machinery.
2. To avoid running the coal-handling machinery continuously.
3. Coal kept under cover indoors will not freeze in winter and clog the supply-spouts to the boilers.
4. It is often cheaper to store overhead than to use valuable ground-space adjacent to the boiler-house.
5. As distinguished from vault or outside hopper storage, it is cheaper to build steel bins and supports than masonry pits.

Weight of Overhead Bins. — Steel bins of approximately rectangular cross-section, say 10 X 10 feet, will weigh, exclusive of supports, about one-sixth as much as the contained coal. Larger bins, with sloping bottoms, may weigh one-eighth as much as the contained coal. Bag bottom bins of the Berquist type will weigh about one-twelfth as much as the contained coal, not including posts, and about one-ninth as much, including posts.

Supply-pipes from Bins. — The supply-pipes from overhead bins to the boiler-room floor, or to the stoker-hoppers, should not be less than 12 inches in diameter. They should be fitted at the top with a flanged casting and a cut-off gate, to permit removal of the pipe when the boilers are to be cleaned or repaired.

Types of Coal Elevators. — Coal elevators consist of buckets of various shapes attached to one or more strands of link-belt or chain, or to rubber belting. The buckets may either be attached continuously or at intervals. The various types are as follows:

Continuous bucket elevators consist usually of one strand of chain and two sprocket-wheels with buckets attached continuously to the chain. Each bucket after passing the head wheel acts as a chute to direct the flow from the next bucket. This type of elevator will handle the larger sizes of coal. It runs at slow speeds, usually from 90 to 175 feet per minute, and has a maximum capacity of about 120 tons per hour.

Centrifugal discharge elevators consist usually of a single strand of chain, with the buckets attached thereto at intervals. They are used to handle the smaller sizes of coal in small quantities. They run at high speeds, usually 34 to 40 revolutions of the head wheel per minute, and have a capacity up to 40 tons per hour.

Perfect discharge elevators consist of two strands of chain, with buckets at intervals between them. A pair of idlers set under the head wheels cause the buckets to be completely inverted, and to make a clean delivery into the chutes at the elevator head. This type of elevator is useful in handling material which tends to cling to the buckets. It runs at slow speeds, usually less than 150 feet per minute. The capacity depends on the size of the buckets.

Combined Elevators and Conveyors are of the following types:

Gravity discharge elevators, consisting of two strands of chain, with spaced V-shaped buckets fastened between them. After passing the head wheels the buckets act as conveyor-flights and convey the coal in a trough to any desired point. This is the cheapest type of combined elevator and conveyor, and is economical of power. A machine carrying 100 tons of coal per hour, in buckets 20 inches wide, 10 inches deep, and 24 inches long,

spaced 3 feet apart, requires 5 H.P. when loaded and 1 1/2 H.P. when empty for each 100 feet of horizontal run, and 1/10 H.P. for each foot of vertical lift.

Rigid bucket-carriers consist of two strands of chain with a special bucket rigidly fastened between them. The buckets overlap and are so shaped that they will carry coal around three sides of a rectangle. The coal is carried to any desired point and is discharged by completely inverting the bucket over a turn-wheel.

Pivoted bucket-carriers consist of two strands of long pitch steel chain to which are attached, in a pivotal manner, large malleable iron or steel buckets so arranged that their adjacent lips are close together or overlap. Overlapping buckets require special devices for changing the lap at the corner turns. Carriers in which the buckets do not overlap should be fitted with auxiliary pans or buckets, arranged in such a manner as to catch the spill which falls between the lips at the loading point, and so shaped as to return the spill to the buckets at the corner turns. Pivoted bucket-carriers will carry coal around four sides of a rectangle, the buckets being dumped on the horizontal run by striking a cam suitably placed. Buckets for these carriers are usually of 2 ft. pitch, and range in width from 18 in. to 48 in. They run at low speeds, usually not over 50 ft. per minute, 40 ft. per minute being most usual. At the latter speed, the capacities when handling coal vary from 40 tons per hour for the 18 in. width to 120 tons for the 48 in. width. On account of the superior construction of these carriers and the slow speed at which they run, they are economical of power and durable. The rollers mounted on the chain joints are usually 6 in. diameter, but for severe duty 8-in. rollers are often used. It is usual to make these hollow to carry a quantity of oil for internal lubrication.

Coal Conveyors. — Coal conveyors are of four general types, viz., scraper or flight, bucket, screw, and belt conveyors.

The flight conveyor consists of a trough of any desired cross-section and a single or double strand of chain carrying scrapers or flights of approximately the same shape as the trough. The flights push the coal ahead of them in the trough to any desired point, where it is discharged through openings in the bottom of the trough.

For short, low-capacity conveyors, malleable link hook-joint chains are used. For heavier service, malleable pin-joint chains, steel link chains, or monobar, are required. For the heaviest service, two strands of steel link chain, usually with rollers, are used.

Flight conveyors are of three types: plain scraper, suspended flight, and roller flight.

In the plain scraper conveyor, the flight is suspended from the chain and drags along the bottom of the trough. It is of low first cost and is useful where noise of operation is not objectionable. It has a maximum capacity of about 30 tons per hour, and requires more power than either of the other two types of flight conveyors.

Suspended flight conveyors use one or two strands of chain. The flights are attached to cross-bars having wearing-shoes at each end. These wearing-shoes slide on angle-iron tracks on each side of the conveyor trough. The flights do not touch the trough at any point. This type of conveyor is used where quietness of operation is a consideration. It is of higher first cost than the plain scraper conveyor, but requires one-fourth less power for operation. It is economical up to a capacity of about 80 tons per hour.

The roller flight conveyor is similar to the suspended flight, except that the wearing-shoes are replaced by rollers. It is highest in first cost of all the flight conveyors, but has the advantages of low power consumption (one-half that of the scraper), low stress in chain, long life of chain, trough, and flights, and noiseless operation. It has an economical maximum capacity of about 120 tons per hour.

The following formula gives approximately the horse-power at the head wheel required to operate flight conveyors:

$$\text{H.P.} = (\text{ATL} + \text{BWS}) \div 1000.$$

T = tons of coal per hour; L = length of conveyor in feet, center to center; W = weight of chain, flights, and shoes (both runs) in pounds; S = speed in feet per minute; A and B constants depending on angle of incline from horizontal. See example below.

Values of A and B.

Angle, Deg.	A	B	Angle, Deg.	A	B	Angle, Deg.	A	B
0	0.343	0.01	10	0.50	0.01	30	0.79	0.009
2	0.378	0.01	14	0.57	0.01	34	0.84	0.008
4	0.40	0.01	18	0.63	0.009	38	0.88	0.008
6	0.44	0.01	22	0.69	0.009	42	0.92	0.007
8	0.47	0.01	26	0.74	0.009	46	0.95	0.007

For suspended flight conveyors take B as 0.8, and for roller flights as 0.6, of the values given in the table.

Weight of Chain in Pounds per Foot.

LINK-BELTING.					MONOBAR.							
Chain No.	Pitch of Flights, Inches.				Chain No.*	Pitch of Flights, Inches.						
	12	18	24	36		12	18	24	36	48	54	72
78	2.4	2.3	2.26	2.2	612	3.9	3.6	3.5				
88	2.8	2.7	2.6	2.5	618	3.0	2.8			2.7		
85	3.1	2.8	2.7	2.6	818	5.7	5.5			5.3		
103	4.6	4.4	4.3	4.2	824		4.9			4.7		4.6
108	4.9	4.7	4.4	4.1	1018	11.5		10.7		10.4		
110	5.6	5.2	4.9	4.7	1024		9.6			9.07		8.8
114	6.3	6.0	5.9	5.7	1224		14.7			14.04		13.8
122	8.1	7.7	7.4	7.2	1236			11.8				11.34
124	8.9	8.4	8.2	7.9	1424		20.5			19.7		19.4

* In monobar the first one or two figures in the number of the chain denote the diameter of the chain in eighths of an inch. The last two figures denote the pitch in inches.

PIN CHAINS.					ROLLER CHAINS.				
No.	Pitch of Flights, Inches.				No.	Pitch of Flights, Inches.			
	12	18	24	36		12	18	24	36
720	5.9	5.6	5.4	5.3	1112	7.7	6.9	6.2	5.7
730	6.9	6.6	6.4	6.3	1113	9.5	8.8	8.0	7.5
825	9.6	9.3	9.1	8.9	1130	10.5	9.5	9.0	7.8

Weight of Flights with Wearing-shoes and Bolts.

Size, Inches.	Steel.	Malleable Iron.	Suspended Flights.	
			Size.	Weight, Lb.
4x10	3.5	4.3	6x14	12.37
4x12	3.9	4.7	8x19	15.55
5x10	4.1	5.2	10x24	25.57
5x12	4.6	5.7	10x30	29.37
5x15	5.8	5.9	10x36	33.17
6x18	8.1	9.2	10x42	34.97
8x18	10.1	12.7		
8x20	11.0	13.4		
8x24	12.6	14.4		
10x24	15.2	17.4		

EXAMPLE. — Required the H.P. for a monobar conveyor 200 ft. center to center carrying 100 tons of coal per hour, up a 10° incline at a speed of 100 feet per minute. Conveyor has No. 818 chain and 8 x 19 suspended flights, spaced 18 inches apart.

$$H.P. = \frac{0.5 \times 100 \times 200 + 0.008 (400 \times 5.7 + 267 \times 15.55) \times 100}{1000} = 15.15.$$

The following table shows the conveying capacities of various sizes of flights at 100 feet per minute in tons, of 2000 lb., per hour. The values are true for continuous feed only.

Size of Flight.	Horizontal Conveyors.				Inclined Conveyors.		
	Flight Every 16".	Flight Every 18".	Flight Every 24".	Pounds Coal per Flight.	10° Flights Every 24".	20° Flights Every 24".	30° Flights Every 24".
	Tons.	Tons.	Tons.		Tons.	Tons.	Tons.
6x14	69.75	62	46.5	31	40.5	31.5	22.5
8x19		130	97.5	65	78	62	52
10x24			172.5	115	150	120	90
10x30			220	147	184	146	116
10x36			268	179	225	177	142
10x42			315	210	264	210	167

Bucket Conveyors. — Rigid bucket-carriers are used to convey large quantities of coal over a considerable distance when there is no intermediate point of discharge. These conveyors are made with two strands of steel roller chain. They are built to carry as much as 10 tons of coal per minute.

Screw Conveyors. — Screw conveyors consist of a helical steel flight, either in one piece or in sections, mounted on a pipe or shaft, and running in a steel or wooden trough. These conveyors are made from 4 to 18 inches in diameter, and in sections 3 to 12 feet long. The speed ranges from 20 to 60 revolutions per minute and the capacity from 10 to 30 tons of coal per hour. It is not advisable to use this type of conveyor for coal, as it will only handle the smaller sizes and the flights are very easily damaged by any foreign substance of unusual size or shape.

Belt Conveyors. — Rubber and cotton belt conveyors are used for handling coal, ore, sand, gravel etc., in all sizes. They combine a high carrying capacity with low power consumption.

In some cases the belt is flat, the material being fed to the belt at its center in a narrow stream. In the majority of cases, however, the belt is troughed by means of idler pulleys set at an angle from the horizontal and placed at intervals along the length of the belt. Rubber belts are often made more flexible for deep troughing by removing some of the layers of cotton from the belt and substituting therefor an extra thickness of rubber.

Belt conveyors may be used for elevating materials up to about 23° incline. On greater inclines the material slides back on the belt and spills. With many substances it is important to feed the belt steadily if the conveyor stands at or near the limiting angle. If the flow is interrupted the material may slide back on the belt.

Belt conveyors are run at any speed from 200 to 800 feet per minute, and are made in widths varying from 12 inches to 60 inches.

Capacity of Belt Conveyors in Tons of Coal per Hour.

Width of Belt, Ins.	Velocity, Feet per Minute.			Width of Belt, ins.	Velocity, Feet per Minute.				
	300	350	400		300	350	400	450	500
12	34			20	96	112	128		
14	47			24	139	162	186	210	
16	62	72	82	30	218	254	290	326	
18	78	91	104	36	315	368	420	472	520

For materials other than coal, the figures in the above table should be multiplied by the coefficients given in the table below:

Material.	Coefficient.	Material.	Coefficient.
Ashes (damp).....	0.86	Earth.....	1.4
Cement.....	1.76	Sand.....	1.8
Clay.....	1.26	Stone (crushed).....	2.0
Coke.....	0.60		

Belt Conveyor Construction. (C. K. Baldwin, *Trans. A. S. M. E.*, 1908.) — The troughing idlers should be spaced as follows, depending on the weight of the material carried:

Belt width	12-16 in.	18-22 in.	24-30 in.	32-36 in.
Spacing, ft.	4 1/2-5	4-4 1/2	3 1/2-4	3-3 1/2

The stress in the belt should not exceed 18 to 20 lb. per inch of width per ply with rubber belts. This may be increased about 20% with belts in which 28 oz. duck is used. Where the power required is small the stiffness of the belt fixes the number of plies. The minimum number of plies is as follows:

Belt width, in.	12-14	16-20	22-28	30-36
Minimum plies	3	4	5	6

Pulleys of small diameter should be avoided on heavy belts, or the constant bending of the belt under heavy stress will cause the friction to lose its hold and destroy the belt. In many cases it is advisable to cover the driving pulley with a rubber lagging to increase the tractive power, particularly in dusty places. The minimum size of driving pulleys to be used is shown in the table below.

Smallest Diameter of Driving Pulleys for Belt Conveyors.

Width of Belt.	Diameter of Pulley.	Width of Belt.	Diameter of Pulley.	Width of Belt.	Diameter of Pulley.
In.	In.	In.	In.	In.	In.
12	16-18	22	20-30	32	30-36
14	16-18	24	24-30	34	30-42
16	20-24	26	24-30	36	30-48
18	20-24	28	24-30		
20	20-24	30	30-36		

Horse-power to Drive Belt Conveyors. (C. K. Baldwin, *Trans. A. S. M. E.*, 1908.) — The power required to drive a belt conveyor depends on a great variety of conditions, as the spacing of idlers, type of drive, thickness of belt, etc. In figuring the power required, the belt should run no faster than is necessary to carry the desired load. If it should be necessary to increase the speed, the load should be increased in proportion and the power figured accordingly.

For level conveyors

$$H.P. = C \times T \times L \div 1000.$$

For inclined conveyors

$$H.P. = (C \times T \times L \div 1000) + (T \times H \div 1000).$$

C = power constant from table below; T = load, tons per hour; L = length of conveyor, center to center, ft.; H = vertical height material is lifted, ft.; S = belt speed, ft. per minute; B = width of belt, in.

For each movable or fixed tripper add horse-power in column 3 of table. Add 20% to horse-power for each conveyor under 50 ft. long. Add 10% to horse-power for each conveyor between 50 ft. and 100 ft. long. The formulae above do not include gear friction, should the conveyor be gear-driven.

Constants for Formulæ Above.

Width of Belt.	1	2	3	4	5
	C for Material Weighing from 25 Lb. to 75 Lb. per Cu. Ft.	C for Material Weighing from 75 Lb. to 125 Lb. per Cu. Ft.	H.P. Required for Each Movable or Fixed Tripper.	Minimum Plies of Belt.	Maximum Plies of Belt.
In.					
12	0.234	0.147	1/2	3	4
14	0.226	0.143	1/2	3	4
16	0.220	0.140	3/4	4	5
18	0.209	0.138	1	4	5
20	0.205	0.136	1 1/4	4	6
22	0.199	0.133	1 1/2	5	6
24	0.195	0.131	1 3/4	5	7
26	0.187	0.127	2	5	7
28	0.175	0.121	2 1/4	5	8
30	0.167	0.117	2 1/2	6	8
32	0.163	0.115	2 3/4	6	9
34	0.161	0.114	3	6	10
36	0.157	0.112	3 1/4	6	10

When horse-power and speed are known the stress in the belt in pounds per inch of width is

$$\text{Stress} = \frac{H.P. \times 33,000}{S \times B}$$

From this the number of plies can be found, using 20 lb. per ply per inch of width as a maximum for rubber belts.

Relative Wearing Power of Conveyor Belts. (T. A. Bennett, *Trans. A. S. M. E.*, 1908.) — Different materials used in the construction of conveyors were subjected to the uniform action of a sand blast for 45 minutes, and the relative abrasive resisting qualities were found to be as follows, taking the volume of rubber belt worn away as 1.0:

Rubber belt.....	1.0	Woven cotton belt, high grade	6.5
Rolled steel bar.....	1.5	Stitched duck, high grade	8.0
Cast iron.....	3.5	Woven cotton belt, low grade	9.0 to 15.0
Balata belt, including gum cover	5.0		

A *Symposium on Hoisting and Conveying* was presented at the Detroit meeting of the A. S. M. E., 1908 (*Trans.*, vol. xxx.), in papers by G. E. Titcomb, S. B. Peck, C. K. Baldwin, C. J. Tomlinson and E. J. Haddock. Among the subjects discussed are the loading and unloading of cargo steamers; car unloaders; storing of ore and coal; continuous conveying of merchandise; conveying in a Portland cement plant, and suspension cableways.

WIRE-ROPE HAULAGE.

Methods for transporting coal and other products by means of wire rope, though varying from each other in detail, may be grouped in five classes:

- I. The Self-acting or Gravity Inclined Plane.
- II. The Simple Engine-plane.
- III. The Tail-rope System.
- IV. The Endless-rope System.
- V. The Cable Tramway.

The following brief description of these systems is abridged from a pamphlet on *Wire-rope Haulage*, by Wm. Hildenbrand, C.E., published by John A. Roebling's Sons Co., Trenton, N. J.

I. The Self-acting Inclined Plane. — The motive power for the self-acting inclined plane is gravity; consequently this mode of transporting coal finds application only in places where the coal is conveyed from a higher to a lower point and where the plane has sufficient grade for the loaded descending cars to raise the empty cars to an upper level.

At the head of the plane there is a drum, which is generally constructed of wood, having a diameter of seven to ten feet. It is placed high enough to allow men and cars to pass under it. Loaded cars coming from the pit are either singly or in sets of two or three switched on the track of the plane, and their speed in descending is regulated by a brake on the drum.

Supporting rollers, to prevent the rope dragging on the ground, are generally of wood, 5 to 6 in. in diameter and 18 to 24 in. long, with 3/4 to 7/8 in. iron axles. The distance between the rollers varies from 15 to 30 ft., steeper planes requiring less rollers than those with easy grades. Considering only the reduction of friction and what is best for the preservation of rope, a general rule may be given to use rollers of the greatest possible diameter, and to place them as close as economy will permit.

The smallest angle of inclination at which a plane can be made self-acting will be when the motive and resisting forces balance each other. The motive forces are the weights of the loaded car and of the descending rope. The resisting forces consist of the weight of the empty car and ascending rope, of the rolling and axle friction of the cars, and of the axle friction of the supporting rollers. The friction of the drum, stiffness of rope, and resistance of air may be neglected. A general rule cannot be given, because a change in the length of the plane or in the weight of the cars changes the proportion of the forces; also, because the coefficient of friction, depending on the condition of the road, construction of the cars, etc., is a very uncertain factor.

For working a plane with a 5/8-in. steel rope and lowering from one to four pit cars weighing empty 1400 lb. and loaded 4000 lb., the rise in 100 ft. necessary to make the plane self-acting will be from about 5 to 10 ft., decreasing as the number of cars increase, and increasing as the length of plane increases.

A gravity inclined plane should be slightly concave, steeper at the top than at the bottom. The maximum deflection of the curve should be at an inclination of 45 degrees, and diminish for smaller as well as for steeper inclinations.

II. The Simple Engine-plane. — The name "Engine-plane" is given to a plane on which a load is raised or lowered by means of a single wire rope and stationary steam-engine. It is a cheap and simple method of conveying coal underground, and therefore is applied wherever circumstances permit it. Under ordinary conditions such as prevail in the Pennsylvania mine region, a train of twenty-five to thirty loaded cars will descend, with reasonable velocity, a straight plane 5000 ft. long on a grade of 1 3/4 ft. in 100, while it would appear that 2 1/4 ft. in 100 is necessary for the same number of empty cars. For roads longer than 5000 ft. or containing sharp curves, the grade should be correspondingly larger.

III. The Tail-rope System. — Of all methods for conveying coal underground by wire rope, the tail-rope system has found the most application. It can be applied under almost any condition. The road may be straight or curved, level or undulating, in one continuous line or with side branches. In general principle a tail-rope plane is the same as an engine-plane worked in both directions with two ropes. One rope, called the "main rope," serves for drawing the set of full cars outward; the other, called the "tail-rope," is necessary to take back the empty set, which on a level or undulating road cannot return by gravity. The two drums may be located at the opposite ends of the road, and driven by separate engines, but more frequently they are on the same shaft at one end of the plane. In the first case each rope would require the length of the plane, but in the second case the tail rope must be twice as long, being led from the drum around a sheave at the other end of the plane and back again to its starting-point. When the main rope draws a set of full cars out, the tail-rope drum runs loose on the shaft, and the rope, being attached to the rear car, unwinds itself steadily. Going in, the reverse takes place. Each drum is provided with a brake to check the speed of the train on a down grade and prevent its overrunning the forward rope. As a rule, the tail rope is strained less than the main rope, but in cases of heavy grades dipping outward it is possible that the strain in the former may become as large, or even larger, than in the latter, and in the selection of the sizes reference should be had to this circumstance.

IV. The Endless-rope System. — The principal features of this system are as follows:

1. The rope, as the name indicates, is endless.
2. Motion is given to

the rope by a single wheel or drum, and friction is obtained either by a grip-wheel or by passing the rope several times around the wheel. 3. The rope must be kept constantly tight, the tension to be produced by artificial means. It is done in placing either the return-wheel or an extra tension wheel on a carriage and connecting it with a weight hanging over a pulley, or attaching it to a fixed post by a screw which occasionally can be shortened. 4. The cars are attached to the rope by a grip or clutch, which can take hold at any place and let go again, starting and stopping the train at will, without stopping the engine or the motion of the rope. 5. On a single-track road the rope works forward and backward, but on a double track it is possible to run it always in the same direction, the full cars going on one track and the empty cars on the other.

This method of conveying coal, as a rule, has not found as general an introduction as the tail-rope system, probably because its efficacy is not so apparent and the opposing difficulties require greater mechanical skill and more complicated appliances. Its advantages are, first, that it requires one-third less rope than the tail-rope system. This advantage, however, is partially counterbalanced by the circumstance that the extra tension in the rope requires a heavier size to move the same load than when a main and tail rope are used. The second and principal advantage is that it is possible to start and stop trains at will without signaling to the engineer. On the other hand, it is more difficult to work curves with the endless system, and still more so to work different branches, and the constant stretch of the rope under tension or its elongation under changes of temperature frequently causes the rope to slip on the wheel, in spite of every attention, causing delay in the transportation and injury to the rope.

Stress in Hoisting-ropes on Inclined Planes.

(Trenton Iron Co., 1906.)

Rise per 100 Ft. Horizontal.	Angle of Inclination.	Stress in Lb. per Ton of 2000 Lb.	Rise per 100 Ft. Horizontal.	Angle of Inclination.	Stress in Lb. per Ton of 2000 Lb.	Rise per 100 Ft. Horizontal.	Angle of Inclination.	Stress in Lb. per Ton of 2000 Lb.
5	2° 52'	140	55	28° 49'	1003	110	47° 44'	1516
10	5° 43'	240	60	30° 58'	1067	120	50° 12'	1573
15	8° 32'	336	65	33° 02'	1128	130	52° 26'	1620
20	11° 10'	432	70	35° 00'	1185	140	54° 28'	1663
25	14° 03'	527	75	36° 53'	1238	150	56° 19'	1699
30	16° 42'	613	80	38° 40'	1287	160	58° 00'	1730
35	19° 18'	700	85	40° 22'	1332	170	59° 33'	1758
40	21° 49'	782	90	42° 00'	1375	180	60° 57'	1782
45	24° 14'	860	95	43° 32'	1415	190	62° 15'	1804
50	26° 34'	933	100	45° 00'	1450	200	63° 27'	1822

The above table is based on an allowance of 40 lb. per ton for rolling friction, but an additional allowance must be made for stress due to the weight of the rope proportional to the length of the plane. A factor of safety of 5 to 7 should be taken.

In hoisting the slack-rope should be taken up gently before beginning the lift, otherwise a severe extra strain will be brought on the rope.

V. Wire-rope Tramways. — The methods of conveying products on a suspended rope tramway find especial application in places where a mine is located on one side of a river or deep ravine and the loading station on the other. A wire rope suspended between the two stations forms the track on which material in properly constructed "carriages" or "buggies" is transported. It saves the construction of a bridge or trestlework and is practical for a distance of 2000 feet without an intermediate support.

There are two distinct classes of rope tramways:

1. The rope is stationary, forming the track on which a bucket holding the material moves forward and backward, pulled by a smaller endless wire rope. 2. The rope is movable, forming itself an endless line, which serves at the same time as supporting track and as pulling rope.

Of these two the first method has found more general application, and is especially adapted for long spans, steep inclinations, and heavy loads. The second method is used for long distances, divided into short spans, and is only applicable for light loads which are to be delivered at regular intervals.

For detailed descriptions of the several systems of wire-rope transportation, see circulars of John A. Roebling's Sons Co., The Trenton Iron Co., A. Leschen & Sons Rope Co. See also paper on Two-rope Haulage Systems, by R. Van A. Norris, *Trans. A. S. M. E.*, xii, 626.

In the Bleichert System of wire-rope tramways, in which the track rope is stationary, loads up to 2000 lb. are carried at a speed of 3 to 4 miles per hour. While the average spans on a level are from 150 to 200 ft., in crossing rivers, ravines, etc., spans up to 1500 ft. are frequently adopted. In a tramway on this system at Bingham, Utah, the total length of the line is 12,700 ft. with a fall of 1120 ft. The line operates by gravity and carries 35 tons per hour. The cost of conveying on this carrier is 7³/₄ cents per ton of 2000 lb. for labor and repairs, without any apparent deterioration in the condition of track cables and traction rope.

The Aerial Wire-rope Tramway of A. Leschen & Sons Co. is of the double-rope type, in which the buckets travel upon stationary track cables and are propelled by an endless traction rope. The buckets are attached to the traction rope by means of clips — spaced according to the desired tonnage. The hold on the rope is positive, but the clip is easily removable. The bucket is held in its normal position in the frame by two malleable iron latches — one on each side. A tripping bar engages these latches at the unloading terminal when the bucket discharges its material. This operation is automatic and takes place while the carriers are moving. At the loading terminal, the bucket is automatically returned to its normal position and latched. Special carriers are provided for the accommodation of any class of material. At each of the terminal stations is a 10-ft. sheave wheel around which the traction rope passes, these wheels being provided with steel grids for the control of the traction rope. When the loaded carriers travel down grade and the difference in elevation is sufficient, this tramway will operate by the force due to gravity, otherwise the power is applied to the sheaves through bevel gearing. Numerous modifications of the system are in use to suit different conditions.

An Aerial Tramway 21.5 miles long, with an elevation of the loading end above the discharging end of 11,500 ft., built by A. Bleichert & Co. for the government of the Argentine Republic, connecting the mines of La Mejicana with the town of Chilecito, is described by Wm. Hewitt in *Indust. Eng.*, Aug. 15, 1909. Some of the inclinations are as much as 45 deg., there are some spans nearly 3000 ft. long, and there is a tunnel nearly 500 ft. long. The line is divided into eight sections, each with an independent traction rope. The gravity of the descending loaded carriers is sufficient to make the line self-operating when it is once set in motion, but in order to ensure full control, and to provide for carrying four tons upward while the descending carriers are empty, four steam engines are installed, one for each two sections. The carriers hold 10 cu. ft., or about 1100 lbs. of ore. The speed is 500 ft. per minute, and the interval between carriers 45 seconds. The stress in the traction rope is as high as 11,000 lbs. in some sections.

General Formulæ for Estimating the Deflection of a Wire Cable Corresponding to a Given Tension.

(Trenton Iron Co., 1906.)

Let s = distance between supports or span AB ; m and n = arms into which the span is divided by a vertical through the required point of deflection x , m representing the arm corresponding to the loaded side; y = horizontal distance from load to point of support corresponding with m ; w = wt. of rope per ft.; g = load; t = tension; h = required deflection at any point x ; all measures being in feet and pounds.

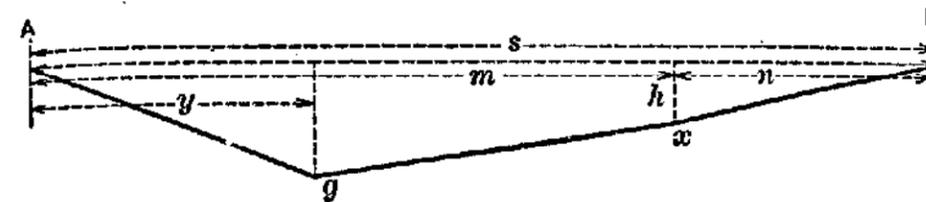

FIG. 184.

For deflection due to rope alone,

$$h = \frac{mnw}{2t} \text{ at } x, \text{ or } \frac{ws^2}{8t} \text{ at center of span.}$$

For deflection due to load alone,

$$h = \frac{gny}{ts} \text{ at } x, \text{ or } \frac{gy}{2t} \text{ at center of span.}$$

$$\text{If } y = 1/2 s, h = \frac{gn}{2t} \text{ at } x, \text{ or } \frac{gs}{4t} \text{ at center of span.}$$

$$\text{If } y = m, h = \frac{gmn}{ts} \text{ at } x, \text{ or } \frac{gs}{4t} \text{ at center of span.}$$

For total deflection,

$$h = \frac{wmns + 2gny}{2ts} \text{ at } x, \text{ or } \frac{ws^2 + 4gy}{8t} \text{ at center of span.}$$

$$\text{If } y = 1/2 s, h = \frac{wmn + gn}{2t} \text{ at } x, \text{ or } \frac{ws^2 + 2gs}{8t} \text{ at center of span.}$$

$$\text{If } y = m, h = \frac{wmns + 2gmn}{2ts} \text{ at } x, \text{ or } \frac{ws^2 + 2gs}{8t} \text{ at center of span.}$$

If the tension is required for a given deflection, transpose t and h in above formulæ.

Suspension Cableways or Cable Hoist-conveyors.

(Trenton Iron Co.)

In quarrying, rock-cutting, stripping, piling, dam-building, and many other operations where it is necessary to hoist and convey large individual loads economically, it frequently happens that the application of a system of derricks is impracticable, by reason of the limited area of their efficiency and the room which they occupy. To meet such conditions cable hoist-conveyors are adopted, as they can be operated in clear spans up to 1500 ft., and in lifting individual loads up to 15 tons. Two types are made — one in which the hoisting and conveying are done by separate running ropes, and the other applicable only to inclines in which the carriage descends by gravity, and but one running rope is required. The moving of the carriage in the former is effected by means of an endless rope, and these are commonly known as "endless-rope" hoist-conveyors to distinguish them from the latter, which are termed "inclined" hoist-conveyors.

The general arrangement of the endless-rope hoist-conveyors consists of a main cable passing over towers, A-frames or masts, as may be most convenient, and anchored firmly to the ground at each end, the requisite tension in the cable being maintained by a turnbuckle at one anchorage.

Upon this cable travels the carriage, which is moved back and forth over the line by means of the endless rope. The hoisting is done by a separate rope, both ropes being operated by an engine specially designed for the purpose, which may be located at either end of the line, and is constructed in such a way that the hoisting-rope is coiled up or paid out automatically as the carriage is moved in and out. Loads may be picked up or discharged at any point along the line. Where sufficient inclination can be obtained in the main cable for the carriage to descend by gravity, and the loading and unloading are done at fixed points, the endless rope can be dispensed with. The carriage, which is similar in construction to the carriage used in the endless-rope cableways, is arrested in its descent by a

stop-block, which may be clamped to the main cable at any desired point, the speed of the descending carriage being under control of a brake on the engine-drum.

A *Double-suspension Cableway*, carrying loads of 15 tons, erected near Williamsport, Pa., by the Trenton Iron Co., is described by E. G. Spillsbury in *Trans. A. I. M. E.*, xx. 766. The span is 733 ft., crossing the Susquehanna River. Two steel cables, each 2 in. diam., are used. On these cables runs a carriage supported on four wheels and moved by an endless cable 1 inch in diam. The load consists of a cage carrying a railroad-car loaded with lumber, the latter weighing about 12 tons. The power is furnished by a 50-H.P. engine, and the trip across the river is made in about three minutes.

A hoisting cableway on the endless-rope system, erected by the Lidgerwood Mfg. Co., at the Austin Dam, Texas, had a single span 1350 ft. in length, with main cable 2 1/2 in. diam., and hoisting-rope 1 3/4 in. diam. Loads of 7 to 8 tons were handled at a speed of 600 to 800 ft. per minute.

Another, of still longer span, 1650 ft., was erected by the same company at Holyoke, Mass., for use in the construction of a dam. The main cable is the Elliott or locked-wire cable, having a smooth exterior. In the construction of the Chicago Drainage Canal twenty cableways, of 700 ft. span and 8 tons capacity, were used, the towers traveling on rails.

Tension required to Prevent Slipping of Rope on Drum. (Trenton Iron Co., 1906.) — The amount of artificial tension to be applied in an endless rope to prevent slipping on the driving-drum depends on the character of the drum, the condition of the rope and number of laps which it makes. If *T* and *S* represent respectively the tensions in the taut and slack lines of the rope; *W*, the necessary weight to be applied to the tail-sheave; *R*, the resistance of the cars and rope, allowing for friction; *n*, the number of half-laps of the rope on the driving-drum; and *f*, the coefficient of friction, the following relations must exist to prevent slipping:

$$T = Se^{fn\pi}, W = T + S, \text{ and } R = T - S;$$

$$\text{from which we obtain } W = \frac{e^{fn\pi} + 1}{e^{fn\pi} - 1} R,$$

in which *e* = 2.71828, the base of the Napierian system of logarithms.

The following are some of the values of *f*:

	Dry.	Wet.	Greasy.
Wire-rope on a grooved iron drum . . .	0.120	0.085	0.070
Wire-rope on wood-filled sheaves	0.235	0.170	0.140
Wire-rope on rubber and leather filling	0.495	0.400	0.205

The importance of keeping the rope dry is evident from these figures.

The values of the coefficient $\frac{e^{fn\pi} + 1}{e^{fn\pi} - 1}$, corresponding to the above values of *f*, for one up to six half-laps of the rope on the driving-drum or sheaves, are as follows:

<i>f</i>	<i>n</i> = Number of Half-laps on Driving-wheel.					
	1	2	3	4	5	6
0.070	9.130	4.623	3.141	2.418	1.999	1.729
0.085	7.536	3.833	2.629	2.047	1.714	1.505
0.120	5.345	2.777	1.953	1.570	1.358	1.232
0.140	4.623	2.418	1.729	1.416	1.249	1.154
0.170	3.833	2.047	1.505	1.268	1.149	1.085
0.205	3.212	1.762	1.338	1.165	1.083	1.043
0.235	2.831	1.592	1.245	1.110	1.051	1.024
0.400	1.795	1.176	1.047	1.013	1.004	1.001
0.495	1.538	1.093	1.019	1.004	1.001

WARNING: This is a 1910 edition. Some of the material may no longer be accurate

When the rope is at rest the tension is distributed equally on the two lines of the rope, but when running there will be a difference in the tensions of the taut and slack lines equal to the resistance, and the values of *T* and *S* may be readily computed from the foregoing formulae.

The increase in tension in the endless rope, compared with the main rope of the tail-rope system, where the stress in the rope is equal to the resistance, is about as follows:

<i>n</i> =	1	2	3	4	5	6
Increase in tension in endless rope, compared with direct stress %	40	9	2 1/3	2/3	1/5	1/10

These figures are useful in determining the size of rope. For instance, if the rope makes two half-laps on the driving drum, the strength of the rope should be 9% greater than a main rope in the tail-rope system.

Taper Ropes of Uniform Tensile Strength. — The true form of rope is not a regular taper but follows a logarithmic curve, the girth rapidly increasing toward the upper end. Mr. Chas. D. West gives the following formula, based on a breaking strain of 80,000 lb. per sq. in. of the rope, core included, and a factor of safety of 10: $\log G = F \div 3680 + \log g$, in which *F* = length in fathoms, and *G* and *g* the girth in inches at any two sections *F* fathoms apart. The girth *g* is first calculated for a safe strain of 8000 lb. per sq. in., and then *G* is obtained by the formula. For a mathematical investigation see *The Engineer*, April, 1880, p. 267.

TRANSMISSION OF POWER BY WIRE ROPE.

The following notes have been furnished to the author by Mr. Wm. Hewitt, Vice-President of the Trenton Iron Co. (See also circulars of the Trenton Iron Co. and of the John A. Roebling's Sons Co., Trenton, N. J.; "Transmission of Power by Wire Ropes," by A. W. Stahl, Van Nostrand's Science Series, No. 28; and Reuleaux's Constructor.)

The load stress or working tension should not exceed the difference between the safe stress and the bending stress as determined by the table on page 1185.

The approximate strength of iron-wire rope composed of wires having a tensile strength of 75,000 to 90,000 lbs. per sq. in. is half that of cast-steel rope composed of wires of a tensile strength of 150,000 to 190,000 lbs. per sq. in. Extra strong steel wires have a tensile strength of 190,000 to 225,000 and plow-steel wires 225,000 to 275,000 lbs. per sq. in.

The 19-wire rope is more flexible than the 7-wire, and for the same load stress may be run around smaller sheaves, but it is not as well adapted to withstand abrasion or surface wear.

The working tension may be greater, therefore, as the bending stress is less; but since the tension in the slack portion of the rope cannot be less than a certain proportion of the tension in the taut portion, to avoid slipping, a ratio exists between the diameter of sheave and the wires composing the rope corresponding to a maximum safe working tension. This ratio depends upon the number of laps that the rope makes about the sheaves, and the kind of filling in the rims or the character of the material upon which the rope tracks.

For ordinary purposes the maximum safe stress should be about one-third the ultimate, and for shafts and elevators about one-fourth the ultimate. In estimating the stress due to the load for shafts and elevators allowance should be made for the additional stress due to acceleration in starting. For short inclined planes not used for passengers a factor of safety as low as 2 1/2 is sometimes used, and for derricks, in which large sheaves cannot be used, and long life of the rope is not expected, the factor of safety may be as low as 2.

The Seale wire rope is made of six strands of 19 wires, laid 9 around 9 around 1, the intermediate layer being smaller than the others. It is intermediate in flexibility between the 7-wire and the ordinary 19-wire rope.

Approximate Breaking Strength of Steel-Wire Ropes.

6 strands of 19 wires each.				6 strands of 7 wires each.					
Diam. Rope, In.	Wt. per ft., lbs.	Approximate breaking stress, lbs.			Diam. Rope, In.	Wt. per ft., lbs.	Approximate breaking stress, lbs.		
		Cast steel.	Extra strong steel.	Plow steel.			Cast steel.	Extra strong steel.	Plow steel.
2 1/4	8.00	312,000	364,000	416,000	1 1/2	3.55	136,000	158,000	182,000
2	6.30	248,000	288,000	330,000	1 3/8	3.00	116,000	136,000	156,000
1 3/4	4.85	192,000	224,000	256,000	1 1/4	2.45	96,000	112,000	128,000
1 5/8	4.15	168,000	194,000	222,000	1 1/8	2.00	80,000	92,000	106,000
1 1/2	3.55	144,000	168,000	192,000	1	1.58	64,000	74,000	84,000
1 3/8	3.00	124,000	144,000	164,000	7/8	1.20	48,000	56,000	64,000
1 1/4	2.45	100,000	116,000	134,000	3/4	0.89	37,200	42,000	48,000
1 1/8	2.00	84,000	98,000	112,000	11/16	0.75	31,600	36,800	42,000
1	1.58	68,000	78,000	88,000	5/8	0.62	26,400	30,200	34,000
7/8	1.20	52,000	60,000	68,000	9/16	0.50	21,200	24,600	28,000
1/4	0.89	38,800	44,000	50,000	1/2	0.39	16,800	19,400	22,000
5/8	0.62	27,200	31,600	36,000	7/16	0.30	13,200	15,000	17,100
9/16	0.50	22,000	25,400	29,000	3/8	0.22	9,600	11,160	12,700
1/2	0.39	17,600	20,200	22,800	5/16	0.15	6,800	7,760	8,800
7/16	0.30	13,600	15,600	17,700	9/32	0.125	5,600	6,440	7,300
3/8	0.22	10,000	11,500	13,100					
5/16	0.15	6,800	8,100	9,300					
1/4	0.10	4,800	5,400	6,000					

The sheaves (Fig. 185) are usually of cast iron, and are made as light as possible consistent with the requisite strength. Various materials have been used for filling the bottom of the groove, such as tarred oakum, jute yarn, hard wood, India-rubber, and leather. The filling which gives the best satisfaction, however, in ordinary transmissions consists of segments of leather and blocks of India-rubber soaked in tar and packed alternately in the groove. Where the working tension is very great, however, the wood filling is to be preferred, as in the case of long-distance transmissions where the rope makes several laps about the sheaves, and is run at a comparatively slow speed.

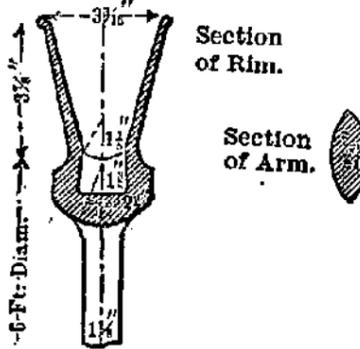

Fig. 185.

$$k = \frac{Ea}{2.06(R + d) + C}$$

k = bending stress in lbs.; E = modulus of elasticity = 28,500,000; a = aggregate area of wires, sq. ins.; R = radius of bend; d = diam. of wires, ins.

- For 7-wire rope $d = 1/9$ diam. of rope; $C = 9.27$.
- " 19-wire " $d = 1/15$ " " " ; $C = 15.45$.
- " the Seale cable $d = 1/12$ " " " ; $C = 12.36$.

From this formula the tables below have been calculated.

Bending Stresses, 7-wire Rope.

Diam. bend.	24	36	48	60	72	84	96	108	120	132
1/4	826	553	412	333	277	238	208	185	166	151
5/32	1,120	750	563	451	376	323	282	251	226	206
3/16	1,609	1,078	810	649	541	464	406	361	325	296
1/8	2,774	1,859	1,398	1,120	934	801	702	624	562	511
3/16	4,385	2,982	2,217	1,777	1,482	1,272	1,113	990	892	811
1/4	6,200	4,161	3,131	2,510	2,095	1,797	1,574	1,400	1,260	1,146
5/16	9,072	6,095	4,589	3,679	3,071	2,635	2,308	2,053	1,848	1,681
3/8	12,547	8,547	6,438	5,164	4,310	3,699	3,240	2,882	2,595	2,360
1/2	17,422	10,922	8,230	6,603	5,513	4,731	4,144	3,687	3,320	3,020
3/4	24,202	14,202	10,706	8,591	7,174	6,158	5,394	4,799	4,322	3,931
1	32,592	17,045	13,685	11,431	9,815	8,599	7,651	6,892	6,269	5,731
1 1/8			25,476	20,464	17,100	14,686	12,869	11,452	10,317	9,386
1 1/4			36,289	29,165	24,416	20,942	18,355	16,336	14,718	13,391
1 1/2				40,020	33,464	28,754	25,206	22,437	20,216	18,396
1 3/4						44,551	38,290	33,571	29,888	26,933
2							57,835	49,718	43,599	38,821
2 1/4									34,987	31,842

Bending Stresses, 19-wire Rope.

Diam. Bend.	12	24	36	48	60	72	84	96	108	120
1/4	993	502	336	252	202	168	144	126	112	101
5/16	1,863	944	632	475	380	317	272	238	212	191
3/8	2,771	1,406	942	708	567	473	406	355	316	285
1/2	4,859	2,473	1,658	1,247	1,000	834	716	627	557	502
5/8	7,125	3,635	2,440	1,836	1,472	1,228	1,054	923	821	739
3/4		5,319	3,573	2,690	2,157	1,800	1,545	1,353	1,203	1,084
7/8		7,452	5,011	3,774	3,027	2,526	2,169	1,900	1,690	1,522
1		9,767	6,572	4,953	3,973	3,317	2,847	2,494	2,219	1,998
1 1/8		12,512	8,427	6,352	5,098	4,257	3,654	3,201	2,848	2,565
1 1/4		19,436	13,111	9,891	7,941	6,633	5,696	4,990	4,440	3,999
1 1/2		29,799	20,136	15,205	12,214	10,206	8,766	7,681	6,836	6,158
1 3/4			28,153	21,276	17,099	14,293	12,278	10,761	9,578	8,689
2			38,034	28,766	23,130	19,340	16,618	14,567	12,967	11,683
2 1/4			51,609	39,057	31,430	26,290	22,594	19,811	17,637	15,893
2 1/2			66,065	50,049	40,284	33,707	28,976	25,410	22,625	20,390
3				62,895	50,647	42,391	36,450	31,969	28,470	25,661
3 1/4				79,749	64,252	53,798	46,270	40,590	36,152	32,589
3 1/2				97,018	78,202	65,500	56,347	49,438	44,039	39,701
4					94,016	78,769	67,778	59,478	52,989	47,777
4 1/4						134,319	112,611	96,943	85,103	75,840
4 1/2							154,870	133,386	117,137	104,417

Horse-Power Transmitted. — The general formula for the amount of power capable of being transmitted is as follows:

$$H.P. = [cd^2 - 0.000006(w + g_1 + g_2)]v$$

in which d = diameter of the rope in inches, v = velocity of the rope in feet per second, w = weight of the rope, g_1 = weight of the terminal sheaves and shafts, g_2 = weight of the intermediate sheaves and shafts (all in lbs.), and c = a constant depending on the material of the rope, the filling in the grooves of the sheaves, and the number of laps about the sheaves or drums, a single lap meaning a half-lap at each end. The values of c for one up to six laps for steel rope are given in the following table:

c = for steel rope on	Number of laps about sheaves or drums.					
	1	2	3	4	5	6
Iron.....	5.61	8.81	10.62	11.65	12.16	12.56
Wood.....	6.70	9.93	11.51	12.26	12.66	12.83
Rubber and leather..	9.29	11.95	12.70	12.91	12.97	13.00

The values of *c* for iron rope are one half the above. When more than three laps are made, the character of the surface in contact is immaterial as far as slippage is concerned. From the above formula we have the general rule, that the actual horse-power capable of being transmitted by any wire rope approximately equals *c* times the square of the diameter of the rope in inches, less six millionths the entire weight of all the moving parts, multiplied by the speed of the rope, in feet per second.

Instead of grooved drums or a number of sheaves, about which the rope makes two or more laps, it is sometimes found more desirable, especially where space is limited, to use grip-pulleys. The rim is fitted with a continuous series of steel jaws, which bite the rope in contact by reason of the pressure of the same against them, but as soon as relieved of this pressure they open readily, offering no resistance to the egress of the rope.

In the ordinary or "flying" transmission of power, where the rope makes a single lap about sheaves lined with rubber and leather or wood, the ratio between the diameter of the sheaves and the wires of the rope, corresponding to a maximum safe working tension, is: For 7-wire rope, steel, 79.6; iron, 160.5. For 12-wire rope, steel, 59.3; iron, 120. For 19-wire rope, steel, 47.2; iron, 95.8.

Diameters of Minimum Sheaves in Inches, Corresponding to a Maximum Safe Working Tension.

Diameter of Rope, In.	Steel.			Iron.		
	7-Wire.	12-Wire.	19-Wire.	7-Wire.	12-Wire.	19-Wire.
1/4	20	15	12	40	30	24
5/16	25	19	15	50	38	30
3/8	30	22	18	60	45	36
7/16	35	26	21	70	53	42
1/2	40	30	24	80	60	48
9/16	45	33	27	90	68	54
5/8	50	37	30	100	75	60
11/16	55	41	32	110	83	66
3/4	60	44	35	120	90	72
7/8	70	52	41	140	105	84
1	80	59	47	160	120	96

Assuming the sheaves to be of equal diameter, and of the sizes in the above table, the horse-power that may be transmitted by a steel rope making a single lap on wood-filled sheaves is given in the table on the next page. The transmission of greater horse-powers than 250 is impracticable with filled sheaves, as the tension would be so great that the filling would quickly cut out, and the adhesion on a metallic surface would be insufficient where the rope makes but a single lap. In this case it becomes necessary to use the Reuleaux method, in which the rope is given more than one lap, as referred to below, under the caption "Long-distance Transmissions."

Horse-power Transmitted by a Steel Rope on Wood-filled Sheaves.

Diameter of Rope, In.	Velocity of Rope in Feet per Second.									
	10	20	30	40	50	60	70	80	90	100
1/4	4	8	13	17	21	25	28	32	37	40
5/16	7	13	20	26	33	40	44	51	57	62
3/8	10	19	28	38	47	56	64	73	80	89
7/16	13	26	38	51	63	75	88	99	109	121
1/2	17	34	51	67	83	99	115	130	144	159
9/16	22	43	65	86	106	128	147	167	184	203
5/8	27	53	79	104	130	155	179	203	225	247
11/16	32	63	95	126	157	186	217	245
3/4	38	76	103	150	186	223
7/8	52	104	156	206
1	68	135	202

The horse-power that may be transmitted by iron ropes is one-half of the above.

This table gives the amount of horse-power transmitted by wire ropes under maximum safe working tensions. In using wood-lined sheaves, therefore, it is well to make some allowance for the stretching of the rope, and to advocate somewhat heavier equipments than the above table would give; that is, if it is desired to transmit 20 horse-power, for instance, to put in a plant that would transmit 25 to 30 horse-power, avoiding the necessity of having to take up a comparatively small amount of stretch. On rubber and leather filling, however, the amount of power capable of being transmitted is 40 per cent greater than for wood, so that this filling is generally used, and in this case no allowance need be made for stretch, as such sheaves will likely transmit the power given by the table, under all possible deflections of the rope.

Under ordinary conditions, ropes of seven wires to the strand, laid about a hemp core, are best adapted to the transmission of power, but conditions often occur where 12- or 19-wire rope is to be preferred, as stated below, under "Limits of Span."

Deflections of the Rope. — The tension of the rope is measured by the amount of sag or deflection at the center of the span, and the deflection corresponding to the maximum safe working tension is determined by the following formulæ, in which *S* represents the span in feet:

		Steel Rope.	Iron Rope.
Def. of still rope at center, in feet..	<i>h</i>	= .00004 <i>S</i> ²	<i>h</i> = .00008 <i>S</i> ²
" driving " " "	<i>h</i> ₁	= .000025 <i>S</i> ²	<i>h</i> ₁ = .00005 <i>S</i> ²
" slack " " "	<i>h</i> ₂	= .0000875 <i>S</i> ²	<i>h</i> ₂ = .000175 <i>S</i> ²

Limits of Span. — On spans of less than sixty feet, it is impossible to splice the rope to such a degree of nicety as to give exactly the required deflection, and as the rope is further subject to a certain amount of stretch, it becomes necessary in such cases to apply mechanical means for producing the proper tension in order to avoid frequent splicing, which is very objectionable; but care should always be exercised in using such tightening devices that they do not become the means, in unskilled hands, of overstraining the rope. The rope also is more sensitive to every irregularity in the sheaves and the fluctuations in the amount of power transmitted, and is apt to sway to such an extent beyond the narrow limits of the required deflections as to cause a jerking motion, which is very injurious. For this reason on very short spans it is found desirable to use a considerably heavier rope than that actually required to transmit the power; or in other words, instead of a 7-wire rope corresponding to the conditions of maximum tension, it is better to use a 19-wire rope of the same size wires, and to run this under a tension considerably below the maximum. In this way are obtained the advantages of increased weight and less stretch, without having to use larger sheaves, while the wear will be greater in proportion to the increased surface.

In determining the maximum limit of span, the contour of the ground and the available height of the terminal sheaves must be taken into consideration. It is customary to transmit the power through the lower portion of the rope, as in this case the greatest deflection in this portion occurs when the rope is at rest. When running, the lower portion rises and the upper portion sinks, thus enabling obstructions to be avoided which otherwise would have to be removed, or make it necessary to erect very high towers. The maximum limit of span in this case is determined by the maximum deflection that may be given to the upper portion of the rope when running, which for sheaves of 10 ft. diameter is about 600 feet.

Much greater spans than this, however, are practicable where the contour of the ground is such that the upper portion of the rope may be the driver, and there is nothing to interfere with the proper deflection of the under portion. Some very long transmissions of power have been effected in this way without an intervening support, one at Lockport, N.Y., having a clear span of 1700 feet.

Long-distance Transmissions.—When the distance exceeds the limit for a clear span, intermediate supporting sheaves are used, with plain grooves (not filled), the spacing and size of which will be governed by the contour of the ground and the special conditions involved. The size of these sheaves will depend on the angle of the bend, gauged by the tangents to the curves of the rope at the points of inflection. If the curvature due to this angle and the working tension, regardless of the size of the sheaves, as determined by the table on the next page, is less than that of the minimum sheave (see table p. 1186), the intermediate sheaves should not be smaller than such minimum sheave, but if the curvature is greater, smaller intermediate sheaves may be used.

In very long transmissions of power, requiring numerous intermediate supports, it is found impracticable to run the rope at the high speeds maintained in "flying transmissions." The rope therefore is run under a higher working tension, made practicable by wrapping it several times about grooved terminal drums, with a lap about a sheave on a take-up or counter-weighted carriage, which preserves a constant tension in the slack portion.

Inclined Transmissions.—When the terminal sheaves are not on the same elevation, the tension at the upper sheave will be greater than that at the lower, but this difference is so slight, in most cases, that it may be ignored. The span to be considered is the horizontal distance between the sheaves, and the principles governing the limits of span will hold good in this case, so that for very steep inclinations it becomes necessary to resort to tightening devices for maintaining the requisite tension in the rope. The limiting case of inclined transmissions occurs when one wheel is directly above the other. The rope in this case produces no tension whatever on the lower wheel, while the upper is subject only to the weight of the rope, which is usually so insignificant that it may be neglected altogether, and on vertical transmissions, therefore, mechanical tension is an absolute necessity.

Bending Curvature of Wire Ropes.—The curvature due to any bend in a wire rope is dependent on the tension, and is not always the same as the sheave in contact, but may be greater, which explains how it is that large ropes are frequently run around comparatively small sheaves without detriment, since it is possible to place these so close that the bending angle on each will be such that the resulting curvature will not overstrain the wires. This curvature may be ascertained from the formula and table on the next page, which give the theoretical radii of curvature in inches for various sizes of ropes and different angles for one pound tension in the rope. Dividing these figures by the actual tension in pounds, gives the radius of curvature assumed by the rope in cases where this exceeds the curvature of the sheave. The rigidity of the rope or internal friction of the wires and core has not been taken into account in these figures, but the effect of this is insignificant, and it is on the safe side to ignore it. By the "angle of bend" is meant the angle between the tangents to the curves of the rope at the points of inflection. When the rope is straight the angle is 180°. For angles less than 160° the radius of curvature in most cases will be less than that corresponding to the safe working tension, and the proper size of sheave to use in such

cases will be governed by the table headed "Diameters of Minimum Sheaves Corresponding to a Maximum Safe Working Tension" on page 1186.

Radius of Curvature of Wire Ropes in Inches for 1-lb. Tension.

Formula: $R = E\delta^3n + 5.25t \cos \frac{1}{2}\theta$; in which R = radius of curvature; E = modulus of elasticity = 28,500,000; δ = diameter of wires; n = no. of wires; θ = angle of bend; t = working stress (lbs. and ins.).

Divide by stress in pounds to obtain radius in inches.

Diam. of Wire.	160°	165°	170°	172°	174°	176°	178°
19-Wire Rope.	1/2	4,226	5,623	8,421	10,949	14,593	21,884
	5/8	11,090	14,753	22,095	26,731	35,628	53,429
	3/4	22,274	29,633	45,412	54,417	72,530	108,767
	7/8	43,184	57,451	86,040	102,688	136,869	205,251
	1	71,816	95,541	143,085	175,182	233,492	350,150
	1 1/8	112,763	150,016	224,667	280,607	374,010	560,872
7-Wire Rope.	1 1/4	169,135	225,012	336,982	427,689	570,050	854,858
	1/2	12,914	17,179	25,727	31,125	41,485	62,212
	5/8	29,762	39,594	59,297	75,988	101,282	151,884
	3/4	62,313	82,899	124,151	157,570	210,018	314,948
	7/8	116,239	154,641	231,593	291,917	389,085	583,479
	1	199,323	265,173	397,129	497,998	663,767	995,390
1 1/8	320,556	426,459	638,674	797,697	1,063,217	1,594,422	2,388,359
	504,402	671,041	1,004,965	1,215,817	1,629,513	2,430,151	3,659,561

ROPE-DRIVING.

The transmission of power by cotton or manila ropes is a competitor with gearing and leather belting when the amount of power is large, or the distance between the power and the work is comparatively great. The following is condensed from a paper by C. W. Hunt, *Trans. A. S. M. E.*, xii, 230:

But few accurate data are available, on account of the long period required in each experiment, a rope lasting from three to six years. Installations which have been successful, as well as those in which the wear of the rope was destructive, indicate that 200 lbs. on a rope one inch in diameter is a safe and economical working strain. When the strain is materially increased, the wear is rapid.

In the following equations

- C = circumference of rope, inches; g = gravity;
- D = sag of the rope in inches; H = horse-power;
- F = centrifugal force in pounds; L = distance between pulleys, ft.;
- P = pounds per foot of rope; w = working strain in pounds;
- R = force in pounds doing useful work;
- S = strain in pounds on the rope at the pulley;
- T = tension in pounds of driving side of the rope;
- t = tension in pounds on slack side of the rope;
- v = velocity of the rope in feet per second;
- W = ultimate breaking strain in pounds.

$W = 720 C^2; P = 0.032 C^2; w = 20 C^2.$

This makes the normal working strain equal to 1/30 of the breaking strength, and about 1/25 of the strength at the splice. The actual strains are ordinarily much greater, owing to the vibrations in running, as well as from imperfectly adjusted tension mechanism.

For this investigation we assume that the strain on the driving side of a rope is equal to 200 lbs. on a rope one inch in diameter, and an equivalent strain for other sizes, and that the rope is in motion at various velocities of from 10 to 140 ft. per second.

The centrifugal force of the rope in running over the pulley will reduce

the amount of force available for the transmission of power. The centrifugal force $F = Pv^2 \div g$.

At a speed of about 80 ft. per second, the centrifugal force increases faster than the power from increased velocity of the rope, and at about 140 ft. per second equals the assumed allowable tension of the rope. Computing this force at various speeds and then subtracting it from the assumed maximum tension, we have the force available for the transmission of power. The whole of this force cannot be used, because a certain amount of tension on the slack side of the rope is needed to give adhesion to the pulley. What tension should be given to the rope for this purpose is uncertain, as there are no experiments which give accurate data. It is known from considerable experience that when the rope runs in a groove whose sides are inclined toward each other at an angle of 45° there is sufficient adhesion when the ratio of the tensions $T \div t = 2$.

For the present purpose T can be divided into three parts: 1. Tension doing useful work; 2. Tension from centrifugal force; 3. Tension to balance the strain for adhesion.

The tension t can be divided into two parts: 1. Tension for adhesion; 2. Tension from centrifugal force.

It is evident, however, that the tension required to do a given work should not be materially exceeded during the life of the rope.

There are two methods of putting ropes on the pulleys; one in which the ropes are single and spliced on, being made very taut at first, and less so as the rope lengthens, stretching until it slips, when it is re-spliced. The other method is to wind a single rope over the pulleys as many turns as needed to obtain the necessary horse-power and put a tension pulley to give the necessary adhesion and also take up the wear. The tension t on one of the ropes required to transmit the normal horse-power for the ordinary speeds and sizes of rope is computed by formula (1), below. The total tension T on the driving side of the rope is assumed to be the same at all speeds. The centrifugal force, as well as an amount equal to the tension for adhesion on the slack side of the rope, must be taken from the total tension T to ascertain the amount of force available for the transmission of power.

It is assumed that the tension on the slack side necessary for giving adhesion is equal to one half the force doing useful work on the driving

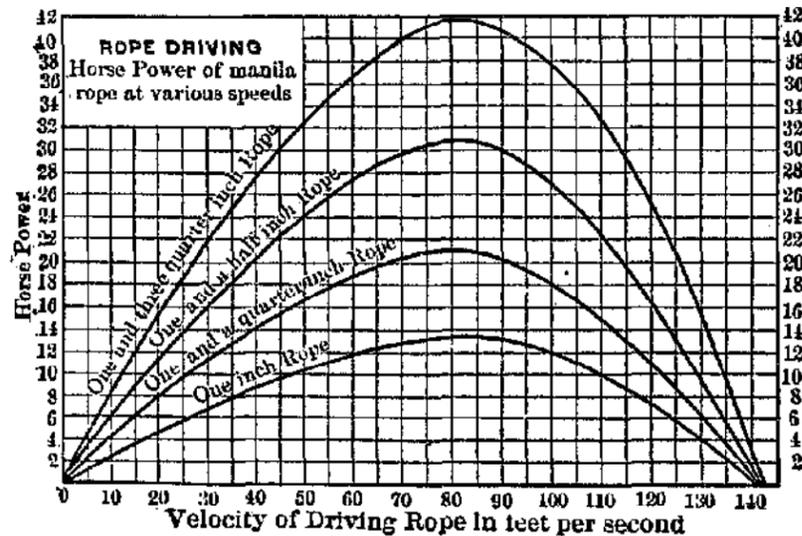

FIG. 186.

side of the rope; hence the force for useful work is $R = 2/3 (T - F)$; and the tension on the slack side to give the required adhesion is $1/3 (T - F)$. Hence

$$t = (T - F)/3 + F \dots \dots \dots (1)$$

The sum of the tensions T and t is not the same at different speeds, as the equation (1) indicates. As F varies as the square of the velocity, there is, with an increasing speed of the rope, a decreasing useful force, and an increasing total tension, t , on the slack side.

With these assumptions of allowable strains the horse-power will be

$$H = 2v (T - F) \div (3 \times 550) \dots \dots \dots (2)$$

Transmission ropes are usually from 1 to 2 inches in diameter. A computation of the horse-power for four sizes at various speeds and under ordinary conditions, based on a maximum strain equivalent to 200 lbs. for a rope one inch in diameter, is given in Fig. 186. The horse-power of other sizes is readily obtained from these. The maximum power is transmitted, under the assumed conditions, at a speed of about 80 feet per second.

The wear of the rope is both internal and external: the internal is caused by the movement of the fibers on each other, under pressure in bending over the sheaves, and the external is caused by the slipping and the wedging in the grooves of the pulley. Both of these causes of wear are, within the limits of ordinary practice, assumed to be directly proportional to the speed.

The rope is supposed to have the strain T constant at all speeds on the driving side, and in direct proportion to the area of the cross-section; hence the catenary of the driving side is not affected by the speed or by the diameter of the rope.

The deflection of the rope between the pulleys on the slack side varies with each change of the load or change of the speed, as the tension equation (1) indicates.

The deflection of the rope is computed for the assumed value of T and t by the parabolic formula $S = \frac{PL^2}{8D} + PD$, S being the assumed strain T on the driving side, and t , calculated by equation (1), on the slack side. The tension t varies with the speed.

Horse-power of Transmission Rope at Various Speeds.
Computed from formula (2) given above.

Diam. of Ropes.	Speed of the Rope in feet per minute.										Smallest Diam. of Pulleys in inches.	
	1500	2000	2500	3000	3500	4000	4500	5000	6000	7000		8000
1/2	1.45	1.9	2.3	2.7	3	3.2	3.4	3.4	3.1	2.2	0	20
5/8	2.3	3.2	3.6	4.2	4.6	5.0	5.3	5.3	4.9	3.4	0	24
3/4	3.3	4.3	5.2	5.8	6.7	7.2	7.7	7.7	7.1	4.9	0	30
7/8	4.5	5.9	7.0	8.2	9.1	9.8	10.8	10.8	9.3	6.9	0	36
1	5.8	7.7	9.2	10.7	11.9	12.8	13.6	13.7	12.5	8.8	0	42
1 1/4	9.2	12.1	14.3	16.8	18.6	20.0	21.2	21.4	19.5	13.8	0	54
1 1/2	13.1	17.4	23.1	26.8	28.8	30.6	30.8	28.2	19.8	0	60	
1 3/4	18	23.7	28.2	32.8	36.4	39.2	41.5	41.8	37.4	27.6	0	72
2	23.2	30.8	36.8	42.8	47.6	51.2	54.4	54.8	50	35.2	0	84

The following notes are from the circular of the C. W. Hunt Co.:
For a temporary installation, it might be advisable to increase the work to double that given in the table.

For convenience in estimating the necessary clearance on the driving and on the slack sides, we insert a table showing the sag of the rope at different speeds when transmitting the horse-power given in the preceding table. When at rest the sag is not the same as when running, being greater on the driving and less on the slack sides of the rope. The sag of the driving side when transmitting the normal horse-power is the same no matter what size of rope is used or what the speed driven at, because the assumption is that the strain on the rope shall be the same at all speeds when transmitting the assumed horse-power, but on the slack side the strains, and consequently the sag, vary with the speed of the rope and also with the horse-power. The table gives the sag for three speeds. If the actual sag is less than given in the table, the rope is strained more than the work requires.

This table is only approximate, and is exact only when the rope is running at its normal speed, transmitting its full load and strained to the assumed amount. All of these conditions are varying in actual work.

SAG OF THE ROPE BETWEEN PULLEYS.

Distance between Pulleys in feet.	Driving Side.		Slack Side of Rope.		
	All Speeds.		80 ft. per sec.	60 ft. per sec.	40 ft. per sec.
	0 feet	4 inches	0 feet 7 inches	0 feet 9 inches	0 feet 11 inches
40	0	10	1	5	1
60	1	5	2	4	2
80	2	0	3	8	4
100	2	11	5	3	6
120	3	10	7	2	8
140	5	1	9	3	11
160					

The size of the pulleys has an important effect on the wear of the rope — the larger the sheaves, the less the fibers of the rope slide on each other, and consequently there is less internal wear of the rope. The pulleys should not be less than forty times the diameter of the rope for economical wear, and as much larger as it is possible to make them. This rule applies also to the idle and tension pulleys as well as to the main driving-pulley.

The angle of the sides of the grooves in which the rope runs varies, with different engineers, from 45° to 60°. It is very important that the sides of these grooves should be carefully polished, as the fibers of the rope rubbing on the metal as it comes from the lathe tools will gradually break fiber by fiber, and so give the rope a short life. It is also necessary to carefully avoid all sand or blow holes, as they will cut the rope out with surprising rapidity.

TENSION ON THE SLACK PART OF THE ROPE.

Speed of Rope, in feet per second.	Diameter of the Rope and Pounds Tension on the Slack Rope.								
	1/2	5/8	3/4	7/8	1	1 1/4	1 1/2	1 3/4	2
20	10	27	40	54	71	110	162	216	283
30	14	29	42	56	74	115	170	226	296
40	15	31	45	60	79	123	181	240	315
50	16	33	49	65	85	132	195	259	339
60	18	36	53	71	93	145	214	285	373
70	19	39	59	78	107	158	236	310	406
80	21	43	64	85	111	173	255	340	445
90	24	48	70	93	122	190	279	372	487

Much depends also upon the arrangement of the rope on the pulleys, especially where a tension weight is used. Experience shows that the increased wear on the rope from bending the rope first in one direction and then in the other is similar to that of wire rope. At mines where two cages are used, one being hoisted and one lowered by the same engine doing the same work, the wire ropes, cut from the same coil, are usually arranged so that one rope is bent continuously in one direction and the other rope is bent first in one direction and then in the other, in winding on the drum of the engine. The rope having the opposite bends wears much more rapidly than the other, lasting about three quarters as long as its mate. This difference in wear shows in manila rope, both in transmission of power and in coal-hoisting. The pulleys should be arranged, as far as possible, to bend the rope in one direction.

DIAMETER OF PULLEYS AND WEIGHT OF ROPE.

Diameter of Rope, in inches.	Smallest Diameter of Pulleys, in inches.	Length of Rope to allow for Splicing, in feet.	Approximate Weight, in lbs. per foot of rope.
1/2	20	6	0.12
5/8	24	6	0.18
3/4	30	7	0.24
7/8	36	8	0.32
1	42	9	0.49
1 1/4	54	10	0.60
1 1/2	60	12	0.83
1 3/4	72	13	1.10
2	84	14	1.40

WARNING: This is a 1910 edition. Some of the material may no longer be accurate

For large amounts of power it is common to use a number of ropes lying side by side in grooves, each spliced separately. For lighter drives some engineers use one rope wrapped as many times around the pulleys as is necessary to get the horse-power required, with a tension pulley to take up the slack as the rope wears when first put in use. The weight put upon this tension pulley should be carefully adjusted, as the overstraining of the rope from this cause is one of the most common errors in rope-driving. We therefore give a table showing the proper strain on the rope for the various sizes, from which the tension weight to transmit the horse-power in the tables is easily deduced. This strain can be still further reduced if the horse-power transmitted is usually less than the nominal work which the rope was proportioned to do, or if the angle of groove in the pulleys is acute.

With a given velocity of the driving-rope, the weight of rope required for transmitting a given horse-power is the same, no matter what size rope is adopted. The smaller rope will require more parts, but the weight will be the same.

Data of Manila Transmission Rope.

From the "Blue Book" of The American Mfg. Co., New York.

Diam. of Rope.	Square of Diam.	Approximate Weight per ft.	Breaking Strength, lbs.	Maximum Allowable Tension.	Length of Splice, ft.			Smallest Diam. of Sheaves, ins.	Maximum No. of Revolutions per Minute.
					3 Strands.	4 Strands.	6 Strands.		
3/4	0.5625	0.20	3,950	112	6	8	28	760	
7/8	0.7656	0.26	5,400	153	6	8	32	650	
1	1	0.34	7,000	200	7	10	36	570	
1 1/8	1.2656	0.43	8,900	253	7	10	40	510	
1 1/4	1.5625	0.53	10,900	312	7	10	46	460	
1 3/8	1.8906	0.65	13,200	378	8	12	50	415	
1 1/2	2.25	0.77	15,700	450	8	12	54	380	
1 5/8	2.6406	0.90	18,500	528	8	12	60	344	
1 3/4	3.0625	1.04	21,400	612	8	12	64	330	
2	4	1.36	28,000	800	9	14	72	290	
2 1/4	5.0625	1.73	35,400	1,012	9	14	82	255	
2 1/2	6.25	2.13	43,700	1,250	10	16	90	230	

- Weight of transmission rope = 0.34 × diam.²
- Breaking strength = 7,000 × diam.²
- Maximum allowable tension = 200 × diam.²
- Diam. smallest practicable sheave = 36 × diam.
- Velocity of rope (assumed) = 5,400 ft. per min.

Miscellaneous Notes on Rope-Driving. — Reuleaux gives formulae for calculating sources of loss in hemp-rope transmission due to (1) journal friction, (2) stiffness of ropes, and (3) creep of ropes. The constants in these formulae are, however, uncertain from lack of experimental data. He calculates an average case giving loss of power due to journal friction = 4%, to stiffness 7.8%, and to creep 5%, or 16.8% in all, and says this is not to be considered higher than the actual loss.

Spencer Miller, in a paper entitled "A Problem in Continuous Rope-driving" (Trans. A. S. C. E., 1897), reviews the difficulties which occur in rope-driving, with a continuous rope from a large to a small pulley. He adopts the angle of 45° as a minimum angle to use on the smaller pulley, and recommends that the larger pulley be grooved with a wider angle to a degree such that the resistance to slipping is equal in both wheels.

Mr. Miller refers to a 250-H.P. drive which has been running ten years, the large pulley being grooved 60° and the smaller 45°. This drive was designed to use a 1 1/4-in. manila rope, but the grooves were made deep enough so that a 7/8-in. rope would not bottom. In order to determine the value of the drive a common 7/8-in. rope was put in at first, and lasted six years, working under a factor of safety of only 14. He recommends, however, for continuous rope-driving a factor of safety of not less than 20.

A heavy rope-drive on the separate, or English, rope system is described and illustrated in *Power*, April, 1892. It is in use at the India Mill at Darwen, England, and is driven by a 2000-H.P. engine at 54 revs. per min. The fly-wheel is 30 ft. diameter, weighs 65 tons, and is arranged with 30 grooves for 1 3/4-in. ropes. These ropes lead off to receiving-pulleys upon the several floors, so that each floor receives its power direct from the fly-wheel. The speed of the ropes is 5089 ft. per min., and five 7-ft. receivers are used. Lambeth cotton ropes are used. (For much other information on this subject see "Rope-Driving," by J. J. Flather, John Wiley & Sons.)

Cotton Ropes are advantageously used as bands or cords on the smaller machine appliances; the fiber, being softer and more flexible than manila hemp, gives good results for small sheaves; but for large drives, where power transmitted is in considerable amounts, cotton rope, as compared with manila, is hardly to be considered, on account of the following disadvantages: It is less durable; it is injuriously affected by the weather, so that for exposed drives, paper-mill work, or use in water-wheel pits, it is absolutely unsatisfactory; it is difficult, if not impossible, to splice uniformly; ever the best quality cotton rope is much inferior to manila in strength, the breaking strain of the highest grade being but 4000 × diam.² as against 7000 × diam.² for manila; while, for the transmission of equal powers, the cost of a cotton rope varies from one-third to one-half more than manila. — ("Blue Book" of the Amer. Mfg. Co.)

A different opinion is found in a paper by E. Kenyon in *Proc. Inst. Engrs. and Shipbuilders of Scotland*, 1904. He says: Evidences of the progress of cotton in the manufacture of driving-ropes are so far-reaching that its superiority may be considered as much an accepted principle in enhanced power-transmitting value, its immunity from frequent atteno-rope transmission as the law of gravitation is in science. As to the longevity of cotton ropes, 24 cotton ropes 1 3/4-in. diam. are transmitting 820 H.P. at a peripheral speed of 4396 ft. per min., from a driving pulley 28 ft. diam. All the card-room ropes in this drive have been running since 1878, a period of 26 years, without any attention whatever.

FRICITION AND LUBRICATION.

Friction is defined by Rankine as that force which acts between two bodies at their surface of contact so as to resist their sliding on each other, and which depends on the force with which the bodies are pressed together.

Coefficient of Friction. — The ratio of the force required to slide a body along a horizontal plane surface to the weight of the body is called the coefficient of friction. It is equivalent to the tangent of the *angle of repose*, which is the angle of inclination to the horizontal of an inclined plane on which the body will just overcome its tendency to slide. The angle is usually denoted by θ , and the coefficient by f . $f = \tan \theta$.

Friction of Rest and of Motion. — The force required to start a body sliding is called the friction of rest, and the force required to continue its sliding after having started is called the friction of motion.

Rolling Friction is the force required to roll a cylindrical or spherical body on a plane or on a curved surface. It depends on the nature of the surfaces and on the force with which they are pressed together, but is essentially different from ordinary, or sliding, friction.

Friction of Solids. — Rennie's experiments (1829) on friction of solids, usually unlubricated and dry, led to the following conclusions:

1. The laws of sliding friction differ with the character of the bodies rubbing together.
2. The friction of fibrous material is increased by increased extent of surface and by time of contact, and is diminished by pressure and speed.
3. With wood, metal, and stones, within the limit of abrasion, friction varies only with the pressure, and is independent of the extent of surface, time of contact, and velocity.
4. The limit of abrasion is determined by the hardness of the softer of the two rubbing parts.
5. Friction is greatest with soft and least with hard materials.
6. The friction of lubricated surfaces is determined by the nature of the lubricant rather than by that of the solids themselves.

Friction of Rest. (Rennie.)

Pressure, lbs. per square inch.	Values of f .			
	Wrought iron on Wrought Iron.	Wrought on Cast Iron.	Steel on Cast Iron.	Brass on Cast Iron.
187	0.25	0.28	0.30	0.23
224	.27	.29	.33	.22
336	.31	.33	.35	.21
448	.38	.37	.35	.21
560	.41	.37	.36	.23
672	Abraded	.38	.40	.23
784	"	Abraded	Abraded	.23

Law of Unlubricated Friction. — A. M. Wellington, *Eng'g News*, April 7, 1888, states that the most important and the best determined of all the laws of unlubricated friction may be thus expressed:

The coefficient of unlubricated friction decreases materially with velocity, is very much greater at minute velocities of 0+, falls very rapidly with minute increases of such velocities, and continues to fall much less rapidly with higher velocities up to a certain varying point, following closely the laws which obtain with lubricated friction.

Friction of Steel Tires Sliding on Steel Rails. (Westinghouse & Galton.)

Speed, miles per hour	10	15	25	38	45	50
Coefficient of friction	0.110	.087	.080	.051	.047	.040
Adhesion, lbs. per gross ton	246	195	179	128	114	90

Rolling Friction is a consequence of the irregularities of form and the roughness of surface of bodies rolling one over the other. Its laws are not yet definitely established in consequence of the uncertainty which exists in experiment as to how much of the resistance is due to roughness of surface, how much to original and permanent irregularity of form, and how much to distortion under the load. (Thurston.)

Coefficients of Rolling Friction. — If R = resistance applied at the circumference of the wheel, W = total weight, r = radius of the wheel, and f = a coefficient, $R = fW \div r$. f is very variable. Coulomb gives 0.06 for wood, 0.005 for metal, where W is in pounds and r in feet. Tred-gold made the value of f for iron on iron 0.002.

For wagons on soft soil Morin found $f = 0.065$, and on hard smooth roads 0.02.

A Committee of the Society of Arts (Clark, R. T. D.) reported a loaded omnibus to exhibit a resistance on various loads as below:

Pavement.	Speed per hour.	Coefficient.	Resistance.
Granite	2.87 miles.	0.007	17.41 per ton.
Asphalt	3.56 "	0.0121	27.14 "
Wood	3.34 "	0.0185	41.60 "
Macadam, graveled	3.45 "	0.0199	44.48 "
Macadam, granite, new	3.51 "	0.0451	101.09 "

Thurston gives the value of f for ordinary railroads, 0.003; well-laid railroad track, 0.002; best possible railroad track, 0.001.

The few experiments that have been made upon the coefficients of rolling friction, apart from axle friction, are too incomplete to serve as a basis for practical rules. (Trautwine.)

Laws of Fluid Friction. — For all fluids, whether liquid or gaseous, the resistance is (1) independent of the pressure between the masses in contact; (2) directly proportional to the area of rubbing-surface; (3) proportional to the square of the relative velocity at moderate and high speeds, and to the velocity nearly at low speeds; (4) independent of the nature of the surfaces of the solid against which the stream may flow, but dependent to some extent upon their degree of roughness; (5) proportional to the density of the fluid, and related in some way to its viscosity. (Thurston.)

The Friction of Lubricated Surfaces approximates to that of solid friction as the journal is run dry, and to that of fluid friction as it is flooded with oil.

Angles of Repose and Coefficients of Friction of Building Materials.
(From Rankine's Applied Mechanics.)

	θ .	$f = \tan \theta$.	$\frac{1}{\tan \theta}$.
Dry masonry and brickwork...	31° to 35°	0.6 to 0.7	1.67 to 1.4
Masonry and brickwork with damp mortar.....	36 1/2°	0.74	1.35
Timber on stone.....	22°	about 0.4	2.5
Iron on stone.....	35° to 162/3°	0.7 to 0.3	1.43 to 3.3
Timber on timber.....	26 1/2° to 11 1/3°	0.5 to 0.2	2 to 5
Timber on metals.....	31° to 11 1/3°	0.6 to 0.2	1.67 to 5
Metals on metals.....	14° to 8 1/2°	0.25 to 0.15	4 to 6.67
Masonry on dry clay.....	27°	0.51	1.96
Masonry on moist clay.....	18 1/4°	0.33	3.
Earth on earth.....	14° to 45°	0.25 to 1.0	4 to 1
Earth on earth, dry sand, clay, and mixed earth.....	21° to 37°	0.38 to 0.75	2.63 to 1.33
Earth on earth, damp clay.....	45°	1.0	1
Earth on earth, wet clay.....	17°	0.31	3.23
Earth on earth, shingle and gravel.....	39° to 48°	0.81	1.23 to 0.9

Coefficients of Friction of Journals. (Morin.)

Material.	Unguent.	Lubrication.	
		Intermittent	Continuous.
Cast iron on cast iron.....	Oil, lard, tallow.	0.07 to 0.08	0.03 to 0.054
	Unctuous and wet	0.14	
Cast iron on bronze.....	Oil, lard, tallow.	0.07 to 0.08	0.03 to 0.054
	Unctuous and wet	0.16	
Cast iron on lignum vitæ.....	Oil, lard.		0.09
Wrought iron on cast iron.....	Oil, lard, tallow.	0.07 to 0.08	0.03 to 0.054
Wrought iron on bronze.....	Oil, lard.	0.11	
Iron on lignum vitæ.....	Unctuous.	0.19	
	Olive oil.	0.10	
Bronze on bronze.....	Lard.	0.09	

Prof. Thurston says concerning the above figures that much better results are probably obtained in good practice with ordinary machinery. Those here given are so greatly modified by variations of speed, pressure, and temperature, that they cannot be taken as correct for general purposes.

Friction of Motion. — The following is a table of the angle of repose θ , the coefficient of friction $f = \tan \theta$, and its reciprocal, $1 \div f$, for the materials of mechanism — condensed from the tables of General Morin (1831) and other sources, as given by Rankine:

No.	Surfaces.	θ .	f .	$1 \div f$.
1	Wood on wood, dry.....	14° to 26 1/2°	0.25 to 0.5	4 to 2
2	" " " soaped.....	11 1/2° to 2°	0.2 to 0.04	5 to 25
3	Metals on oak, dry.....	26 1/2° to 31°	0.5 to 0.6	2 to 1.67
4	" " " wet.....	13 1/2° to 14°	0.24 to 0.26	4.17 to 3.85
5	" " " soapy.....	11 1/2°	0.2	5
6	" " elm, dry.....	11 1/2° to 14°	0.2 to 0.25	5 to 4
7	Hemp on oak, dry.....	28°	0.53	1.89
8	" " " wet.....	18 1/2°	0.33	3
9	Leather on oak.....	15° to 19 1/2°	0.27 to 0.38	3.7 to 2.86
10	" " metals, dry.....	29 1/2°	0.56	1.79
11	" " metals, wet.....	20°	0.36	2.78
12	" " " greasy.....	13°	0.23	4.35
13	" " " oily.....	8 1/2°	0.15	6.67
14	Metals on metals, dry.....	8 1/2° to 11°	0.15 to 0.2	6.67 to 5
15	" " " wet.....	16 1/2°	0.3	3.33
16	Smooth surfaces, occasionally greased.....	4° to 4 1/2°	0.07 to 0.08	14.3 to 12.5
17	Smooth surfaces, continuously greased.....	3°	0.05	20
18	Smooth surfaces, best results.....	13 1/4° to 2°	0.03 to 0.036	
19	Bronze on lignum vitæ, constantly wet.....	3°?	0.05?	

Average Coefficients of Friction. — Journal of cast iron in bronze bearing; velocity 720 feet per minute; temperature 70° F.; intermittent feed through an oil-hole. (Thurston on Friction and Lost Work.)

Oils.	Pressures, pounds per square inch.			
	8	16	32	48
Sperm, lard, neat's-ft., etc..	.159 to .250	.138 to .192	.086 to .141	.077 to .144
Olive, cotton-seed, rape, etc..	.160 to .283	.107 to .245	.101 to .168	.079 to .131
Cod and menhaden.....	.248 to .278	.124 to .167	.097 to .102	.081 to .122
Mineral lubricating-oils.....	.154 to .261	.145 to .233	.086 to .178	.094 to .222

With fine steel journals running in bronze bearings and continuous lubrication, coefficients far below those above given are obtained. Thus with sperm-oil the coefficient with 50 lbs. per square inch pressure was 0.0034; with 200 lbs., 0.0051; with 300 lbs., 0.0057.

For very low pressures, as in spindles, the coefficients are much higher. Thus Mr. Woodbury found, at a temperature of 100° and a velocity of 600 feet per minute,

Pressures, lbs. per sq. in.	1	2	3	4	5
Coefficient.....	0.38	0.27	0.22	0.18	0.17

These high coefficients, however, and the great decrease in the coefficient at increased pressures are limited as a practical matter only to the smaller pressures which exist especially in spinning machinery, where the pressure is so light and the film of oil so thick that the viscosity of the oil is an important part of the total frictional resistance.

Experiments on Friction of a Journal Lubricated by an Oil-bath. (reported by the Committee on Friction, Proc. Inst. M. E. Nov., 1883) show that the absolute friction, that is, the absolute tan-

cast-iron slide-valve will wear longer of itself and cause less wear to its seat, if the latter is of cast iron, than if of steel, wrought iron, or brass.

Friction of Metals under Steam-pressure. — The friction of brass upon iron under steam-pressure is double that of iron upon iron. (G. H. Babcock, *Trans. A. S. M. E.*, i, 151.)

Morin's "Laws of Friction." — 1. The friction between two bodies is directly proportioned to the pressure; i.e., the coefficient is constant for all pressures.

2. The coefficient and amount of friction, pressure being the same, are independent of the areas in contact.

3. The coefficient of friction is independent of velocity, although static friction (friction of rest) is greater than the friction of motion.

Eng'g News, April 7, 1888, comments on these "laws" as follows: From 1831 till about 1876 there was no attempt worth speaking of to enlarge our knowledge of the laws of friction, which during all that period was assumed to be complete, although it was really worse than nothing, since it was for the most part wholly false. In the year first mentioned Morin began a series of experiments which extended over two or three years, and which resulted in the enunciation of these three "fundamental laws of friction," no one of which is even approximately true.

For fifty years these laws were accepted as axiomatic, and were quoted as such without question in every scientific work published during that whole period. Now that they are so thoroughly discredited it has been attempted to explain away their defects on the ground that they cover only a very limited range of pressures, areas, velocities, etc., and that Morin himself only announced them as true within the range of his conditions. It is now clearly established that there are no limits or conditions within which any one of them even approximates to exactitude, and that there are many conditions under which they lead to the wildest kind of error, while many of the constants were as inaccurate as the laws. For example, in Morin's "Table of Coefficients of Moving Friction of Smooth Plane Surfaces, perfectly lubricated," which may be found in hundreds of text-books now in use, the coefficient of wrought iron on brass is given as 0.075 to 0.103, which would make the rolling friction of railway trains 15 to 20 lbs. per ton instead of the 3 to 6 lbs. which it actually is.

General Morin, in a letter to the Secretary of the Institution of Mechanical Engineers, dated March 15, 1879, writes as follows concerning his experiments on friction made more than forty years before: "The results furnished by my experiments as to the relations between pressure, surface, and speed on the one hand, and sliding friction on the other, have always been regarded by myself, not as mathematical laws, but as close approximations to the truth, within the limits of the data of the experiments themselves. The same holds, in my opinion, for many other laws of practical mechanics, such as those of rolling resistance, fluid resistance, etc."

Prof. J. E. Denton (*Stevens Indicator*, July, 1890) says: It has been generally assumed that friction between lubricated surfaces follows the simple law that the amount of the friction is some fixed fraction of the pressure between the surfaces, such fraction being independent of the intensity of the pressure per square inch and the velocity of rubbing, between certain limits of practice, and that the fixed fraction referred to is represented by the coefficients of friction given by the experiments of Morin or obtained from experimental data which represent conditions of practical lubrication, such as those given in Webber's *Manual of Power*.

By the experiments of Thurston, Woodbury, Tower, etc., however, it appears that the friction between lubricated metallic surfaces, such as machine bearings, is not directly proportional to the pressure, is not independent of the speed, and that the coefficients of Morin and Webber are about tenfold too great for modern journals.

Prof. Denton offers an explanation of this apparent contradiction of authorities by showing, with laboratory testing-machine data, that Morin's laws hold for bearings lubricated by a restricted feed of lubricant, such as is afforded by the oil-cups common to machinery; whereas the modern experiments have been made with a surplus feed or superabun-

dance of lubricant, such as is provided only in railroad-car journals, and a few special cases of practice.

That the low coefficients of friction obtained under the latter conditions are realized in the case of car-journals, is proved by the fact that the temperature of car-boxes remains at 100° at high velocities; and experiment shows that this temperature is consistent only with a coefficient of friction of a fraction of one per cent. Deductions from experiments on train resistance also indicate the same low degree of friction. But these low coefficients do not account for the internal friction of steam-engines as well as do the coefficients of Morin and Webber.

In *American Machinist*, Oct. 23, 1890, Prof. Denton says: Morin's measurements of friction of lubricated journals did not extend to light pressures. They apply only to the conditions of general shafting and engine work.

He clearly understood that there was a frictional resistance, due solely to the viscosity of the oil, and that therefore, for very light pressures, the laws which he enunciated did not prevail.

He applied his dynamometers to ordinary shaft-journals without special preparation of the rubbing-surfaces, and without resorting to artificial methods of supplying the oil.

Later experimenters have with few exceptions devoted themselves exclusively to the measurement of resistance practically due to viscosity alone. They have eliminated the resistance to which Morin confined his measurements, namely, the friction due to such contacts of the rubbing-surfaces as prevail with a very thin film of lubricant between comparatively rough surfaces.

Prof. Denton also says (*Trans. A. S. M. E.*, x, 518): "I do not believe there is a particle of proof in any investigation of friction ever made, that Morin's laws do not hold for ordinary practical oil-cups or restricted rates of feed."

Laws of Friction of Well-lubricated Journals. — John Goodman (*Trans. Inst. C. E.*, 1886, *Eng'g News*, April 7 and 14, 1888), reviewing the results obtained from the testing-machines of Thurston, Tower, and Stroudley, arrives at the following laws:

LAWS OF FRICTION: WELL-LUBRICATED SURFACES.
(Oil-bath.)

1. The coefficient of friction with the surfaces efficiently lubricated is from 1/6 to 1/10 that for dry or scantily lubricated surfaces.
2. The coefficient of friction for moderate pressures and speeds varies approximately inversely as the normal pressure; the frictional resistance varies as the area in contact, the normal pressure remaining constant.
3. At very low journal speeds the coefficient of friction is abnormally high; but as the speed of sliding increases from about 10 to 100 ft. per min., the friction diminishes, and again rises when that speed is exceeded, varying approximately as the square root of the speed.
4. The coefficient of friction varies approximately inversely as the temperature, within certain limits, namely, just before abrasion takes place.

The evidence upon which these laws are based is taken from various modern experiments. That relating to Law 1 is derived from the "First Report on Friction Experiments," by Mr. Beauchamp Tower.

Method of Lubrication.	Coefficient of Friction.	Comparative Friction.
Oil-bath.....	0.00139	1.00
Siphon lubricator.....	0.0098	7.06
Pad under journal.....	0.0090	6.48

With a load of 293 lbs. per sq. in. and a journal speed of 314 ft. per min. Mr. Tower found the coefficient of friction to be 0.0016 with an oil-bath, and 0.0097, or six times as much, with a pad. The very low coefficients obtained by Mr. Tower will be accounted for by Law 2, as he found that the frictional resistance per square inch under varying loads is nearly constant, as below:

Load in lbs. per sq. in.	529	468	415	363	310	258	205	153	100
Frictional resist. per sq. in.	0.416	0.514	0.498	0.472	0.464	0.438	0.43	0.458	0.45

The frictional resistance per square inch is the product of the coefficient of friction into the load per square inch on horizontal sections of the brass. Hence, if this product be a constant, the one factor must vary inversely as the other, or a high load will give a low coefficient, and *vice versa*.

For ordinary lubrication, the coefficient is more constant under varying loads; the frictional resistance then varies directly as the load, as shown by Mr. Tower in Table VIII of his report (*Proc. Inst. M. E.*, 1883).

With respect to Law 3, A. M. Wellington (*Trans. A. S. C. E.*, 1884), in experiments on journals revolving at very low velocities, found that the friction was then very great, and nearly constant under varying conditions of the lubrication, load, and temperature. But as the speed increased the friction fell slowly and regularly, and again returned to the original amount when the velocity was reduced to the same rate. This is shown in the following table:

Speed, feet per minute:	0+	2.16	3.33	4.86	8.82	21.42	35.37	53.01	89.28	106.02
Coefficient of friction:	0.118	0.094	0.070	0.069	0.055	0.047	0.040	0.035	0.030	0.026

It was also found by Prof. Kimball that when the journal velocity was increased from 6 to 110 ft. per minute, the friction was reduced 70%; in another case the friction was reduced 67% when the velocity was increased from 1 to 100 ft. per minute; but after that point was reached the coefficient varied approximately with the square root of the velocity. The following results were obtained by Mr. Tower:

Feet per minute.	209	262	314	366	419	471	Nominal Load per sq. in.
Coeff. of friction.	0.0010	0.0012	0.0013	0.0014	0.0015	0.0017	520 lbs.
" "	.0013	.0014	.0015	.0017	.0018	.002	468 lbs.
" "	.0014	.0015	.0017	.0019	.0021	.0024	415 lbs.

The variation of friction with temperature is approximately in the inverse ratio, Law 4. Take, for example, Mr. Tower's results, at 262 ft. per minute:

Temp. F.	110°	100°	90°	80°	70°	60°
Observed.	0.0044	0.0051	0.006	0.0073	0.0092	0.0119
Calculated.	0.00451	0.00518	0.00608	0.00733	0.00964	0.01252

This law does not hold good for pad or siphon lubrication, as then the coefficient of friction diminishes more rapidly for given increments of temperature, but on a gradually decreasing scale, until the normal temperature has been reached; this normal temperature increases directly as the load per sq. in. This is shown in the following table taken from Mr. Stroudley's experiments with a pad of rape-oil:

Temp. F.	105°	110°	115°	120°	125°	130°	135°	140°	145°
Coefficient.	0.022	0.0180	0.0160	0.0140	0.0125	0.0115	0.0110	0.0106	0.0102
Decrease of coeff.		0.0040	0.0020	0.0020	0.0015	0.0010	0.0005	0.0004	0.0002

In the Galton-Westinghouse experiments it was found that with velocities below 100 ft. per min., and with low pressures, the frictional resistance varied directly as the normal pressure; but when a velocity of 100 ft. per min. was exceeded, the coefficient of friction greatly diminished:

from the same experiments Prof. Kennedy found that the coefficient of friction for high pressures was sensibly less than for low.

Allowable Pressures on Bearing-surfaces. (*Proc. Inst. M. E.*, May, 1888.)—The Committee on Friction experimented with a steel ring of rectangular section, pressed between two cast-iron disks, the annular bearing-surfaces of which were covered with gun-metal, and were 12 in. inside diameter and 14 in. outside. The two disks were rotated together, and the steel ring was prevented from rotating by means of a lever, the holding force of which was measured. When oiled through grooves cut in each face of the ring and tested at from 50 to 130 revs. per min., it was found that a pressure of 75 lbs. per sq. in. of bearing-surface was as much as it would bear safely at the highest speed without seizing, although it carried 90 lbs. per sq. in. at the lowest speed. The coefficient of friction is also much higher than for a cylindrical bearing, and the friction follows the law of the friction of solids much more nearly than that of liquids. This is doubtless due to the much less perfect lubrication applicable to this form of bearing compared with a cylindrical one. The coefficient of friction appears to be about the same with the same load at all speeds, or, in other words, to be independent of the speed; but it seems to diminish somewhat as the load is increased, and may be stated approximately as 1/20 at 15 lbs. per sq. in., diminishing to 1/30 at 75 lbs. per sq. in.

The high coefficients of friction are explained by the difficulty of lubricating a collar-bearing. It is similar to the slide-block of an engine, which can carry only about one-tenth the load per sq. in. that can be carried by the crank-pins.

In experiments on cylindrical journals it has been shown that when a cylindrical journal was lubricated from the side on which the pressure bore, 100 lbs. per sq. in. was the limit of pressure that it would carry; but when it came to be lubricated on the lower side and was allowed to drag the oil in with it, 600 lbs. per sq. in. was reached with impunity; and if the 600 lbs. per sq. in., which was reckoned upon the full diameter of the bearing, came to be reckoned on the sixth part of the circle that was taking the greater proportion of the load, it followed that the pressure upon that part of the circle amounted to about 1200 lbs. per sq. in.

In connection with these experiments Mr. Wicksteed states that in drilling-machines the pressure on the collars is frequently as high as 336 lbs. per sq. in., but the speed of rubbing in this case is lower than it was in any of the experiments of the Research Committee. In machines working very slowly and intermittently, as in testing-machines, very much higher pressures are admissible.

Mr. Adamson mentions the case of a heavy upright shaft carried upon a small footstep-bearing, where a weight of at least 20 tons was carried on a shaft of 5 in. diameter, or, say, 20 sq. in. area, giving a pressure of 1 ton per sq. in. The speed was 190 to 200 revs. per min. It was necessary to force the oil under the bearing by means of a pump. For heavy horizontal shafts, such as a fly-wheel shaft, carrying 100 tons on two journals, his practice for getting oil into the bearings was to flatten the journal along one side throughout its whole length to the extent of about an eighth of an inch in width for each inch in diameter up to 8 in. diameter; above that size rather less flat in proportion to the diameter. At first sight it appeared alarming to get a continuous flat place coming round in every revolution of a heavily loaded shaft; yet it carried the oil effectually into the bearing, which ran much better in consequence than a truly cylindrical journal without a flat side.

In thrust-bearings on torpedo-boats Mr. Thornycroft allows a pressure of never more than 50 lbs. per sq. in.

Prof. Thurston (*Friction and Lost Work*, p. 240) says 7000 to 9000 lbs. pressure per square inch is reached on the slow-working and rarely moved pivots of swing bridges.

Mr. Tower says (*Proc. Inst. M. E.*, Jan., 1884): In eccentric-pins of punching and shearing machines very high pressures are sometimes used without seizing. In addition to the alternation in the direction, the pressure is applied for only a very short space of time in these machines, so that the oil has no time to be squeezed out.

In the discussion on Mr. Tower's paper (*Proc. Inst. M. E.*, 1885) it was stated that it is well known from practical experience that with a con-

stant load on an ordinary journal it is difficult and almost impossible to have more than 200 lbs. per square inch, otherwise the bearing would get hot and the oil go out of it; but when the motion was reciprocating, so that the load was alternately relieved from the journal, as with crank-pins and similar journals, much higher loads might be applied than even 700 or 800 lbs. per square inch.

Mr. Goodman (*Proc. Inst. C. E.*, 1886) found that the total frictional resistance is materially reduced by diminishing the width of the brass.

The lubrication is most efficient in reducing the friction when the brass subtends an angle of from 120° to 60°. The film is probably at its best between the angles 80° and 110°.

In the case of a brass of a railway axle-bearing where an oil-groove is cut along its crown and an oil-hole is drilled through the top of the brass into it, the wear is invariably on the off side, which is probably due to the oil escaping as soon as it reaches the crown of the brass, and so leaving the off side almost dry, where the wear consequently ensues.

In railway axles the brass wears always on the forward side. The same observation has been made in marine-engine journals, which always wear in exactly the reverse way to what might be expected. Mr. Stroudley thinks this peculiarity is due to a film of lubricant being drawn in from the under side of the journal to the aft part of the brass, which effectually lubricates and prevents wear on that side; and that when the lubricant reaches the forward side of the brass it is so attenuated down to a wedge shape that there is insufficient lubrication, and greater wear consequently follows.

C. J. Field (*Power*, Feb., 1893) says: One of the most vital points of an engine for electrical service is that of main bearings. They should have a surface velocity of not exceeding 350 feet per minute, with a mean bearing-pressure per square inch of projected area of journal of not more than 80 lbs. This is considerably within the safe limit of cool performance and easy operation. If the bearings are designed in this way, it would admit the use of grease on all the main wearing-surfaces, which in a large type of engines for this class of work we think advisable.

Oil-pressure in a Bearing. — Mr. Beauchamp Tower (*Proc. Inst. M. E.*, Jan., 1885) made experiments with a brass bearing 4 ins. diameter by 6 ins. long, to determine the pressure of the oil between the brass and the journal. The bearing was half immersed in oil, and had a total load of 8008 lbs. upon it. The journal rotated 150 r.p.m. The pressure of the oil was determined by drilling small holes in the bearing at different points and connecting them by tubes to a Bourdon gauge. It was found that the pressure varied from 310 to 625 lbs. per sq. in., the greatest pressure being a little to the "off" side of the center line of the top of the bearing, in the direction of motion of the journal. The sum of the upward force exerted by these pressures for the whole lubricated area was nearly equal to the total pressure on the bearing. The speed was reduced from 150 to 20 r.p.m., but the oil-pressure remained the same, showing that the brass was as completely oil-borne at the lower speed as at the higher. The following was the observed friction at the lower speed:

Nominal load, lbs. per sq. in....	443	333	211	89
Coefficient of friction.....	0.00132	0.00168	0.00247	0.0044

The nominal load per square inch is the total load divided by the product of the diameter and length of the journal. At the low speed of 20 r.p.m. it was increased to 676 lbs. per sq. in. without any signs of heating or seizing.

Friction of Car-journal Brasses. (J. E. Denton, *Trans. A. S. M. E.*, xii, 403.) — A new brass dressed with an emery-wheel, loaded with 5000 lbs., may have an actual bearing-surface on the journal, as shown by the polish of a portion of the surface, of only 1 square inch. With this pressure of 5000 lbs. per sq. in., the coefficient of friction may be 6%, and the brass may be overheated, scarred and cut, but, on the contrary, it may wear down evenly to a smooth bearing, giving a highly polished area of contact of 3 sq. ins., or more, inside of two hours of running, gradually decreasing the pressure per square inch of contact, and a coefficient of friction of less than 0.5%. A reciprocating motion in the direction of the axis is of importance in reducing the friction. With such polished surfaces any oil will lubricate, and the coefficient of friction then depends

on the viscosity of the oil. With a pressure of 1000 lbs. per sq. in., revolutions from 170 to 320 per min., and temperatures of 75° to 113° F., with both sperm and paraffine oils, a coefficient of as low as 0.11% has been obtained, the oil being fed continuously by a pad.

Experiments on Overheating of Bearings. — Hot Boxes. (Denton.) — Tests with car brasses loaded from 1100 to 4500 lbs. per sq. in. gave 7 cases of overheating out of 32 trials. The tests show how purely a matter of chance is the overheating, as a brass which ran hot at 5000 lbs. load on one day would run cool on a later date at the same or higher pressure. The explanation of this apparently arbitrary difference of behavior is that the accidental variations of the smoothness of the surfaces, almost infinitesimal in their magnitude, cause variations of friction which are always tending to produce overheating, and it is solely a matter of chance when these tendencies preponderate over the lubricating influence of the oil. There is no appreciable advantage shown by sperm-oil, when there is no tendency to overheat — that is, paraffine can lubricate under the highest pressures which occur, as well as sperm, when the surfaces are within the conditions affording the minimum coefficients of friction.

Sperm and other oils of high heat-resisting qualities, like vegetable oil and petroleum cylinder stocks, differ from the more volatile lubricants, like paraffine, only in their ability to reduce the chances of the continual accidental infinitesimal abrasion producing overheating.

The effect of emery or other gritty substance in reducing overheating of a bearing is thus explained:

The effect of the emery upon the surfaces of the bearings is to cover the latter with a series of parallel grooves, and apparently after such grooves are made the presence of the emery does not practically increase the friction over its amount when pure oil only is between the surfaces. The infinite number of grooves constitute a very perfect means of insuring a uniform oil supply at every point of the bearings. As long as grooves in the journal match with those in the brasses the friction appears to amount to only about 10% to 15% of the pressure. But if a smooth journal is placed between a set of brasses which are grooved, and pressure be applied, the journal crushes the grooves and becomes brazed or coated with brass, and then the coefficient of friction becomes upward of 40%. If then emery is applied, the friction is made very much less by its presence, because the grooves are made to match each other, and a uniform oil supply prevails at every point of the bearings, whereas before the application of the emery many spots of the bearing receive no oil between them.

Moment of Friction and Work of Friction of Sliding-surfaces, etc.

	Moment of Friction, inch-lbs.	Energy lost by Friction in ft.-lbs. per min.
Flat surfaces.....	fWS	fWS
Shafts and journals.....	$\frac{1}{2}fWd$	$0.2618fWdn$
Flat pivots.....	$\frac{2}{3}fWr$	$0.349fWrn$
Collar-bearing.....	$\frac{2}{3}fW \frac{r_2^3 - r_1^3}{r_2^2 - r_1^2}$	$0.349fWn \frac{r_2^3 - r_1^3}{r_2^2 - r_1^2}$
Conical pivot.....	$\frac{2}{3}fWr \operatorname{cosec} a$	$0.349fWrn \operatorname{cosec} a$
Conical journal.....	$\frac{2}{3}fWr \sec a$	$0.349fWrn \sec a$
Truncated-cone pivot.....	$\frac{2}{3}fW \frac{r_2^3 - r_1^3}{r_2 \sin a}$	$0.349fW \frac{r_2^3 - r_1^3}{r_2 \sin a}$
Hemispherical pivot.....	fWr	$0.5236fWrn$
Tractrix, or Schiele's "anti-friction" pivot.....	fWr	$0.5236fWrn$

In the above f = coefficient of friction;

W = weight on journal or pivot in pounds;

r = radius, d = diameter, in inches;

S = space in feet through which sliding takes place;

r_2 = outer radius, r_1 = inner radius;

n = number of revolutions per minute;

a = the half-angle of the cone, i.e., the angle of the slope with the axis.

To obtain the horse-power, divide the quantities in the last column by 33,000. Horse-power absorbed by friction of a shaft = $\frac{fWdn}{126,050}$.

The formula for energy lost by shafts and journals is approximately true for loosely fitted bearings. Prof. Thurston shows that the correct formula varies according to the character of fit of the bearing; thus for loosely fitted journals, if U = the energy lost,

$$U = \frac{2f\pi r}{\sqrt{1+f^2}} Wn \text{ inch-pounds} = \frac{0.2618 fWdn}{\sqrt{1+f^2}} \text{ foot-lbs.}$$

For perfectly fitted journals $U = 2.54 f\pi rWn$ inch-lbs. = $0.3325 fWdn$ ft.-lbs.

For a bearing in which the journal is so grasped as to give a uniform pressure throughout, $U = f\pi^2 rWn$ inch-lbs. = $0.4112 fWdn$ ft.-lbs.

Resistance of railway trains and wagons due to friction of trains:

Pull on draw-bar = $f \times 2240 \div R$ pounds per gross ton,

in which R is the ratio of the radius of the wheel to the radius of journal.

A cylindrical journal, perfectly fitted into a bearing, and carrying a total load, distributes the pressure due to this load unequally on the bearing, the maximum pressure being at the extremity of the vertical radius, while at the extremities of the horizontal diameter the pressure is zero. At any point of the bearing-surface at the extremity of a radius which makes an angle θ with the vertical radius the normal pressure is proportional to $\cos \theta$. If p = normal pressure on a unit of surface, w = total load on a unit of length of the journal, and r = radius of journal,

$$w \cos \theta = 1.57 rp, \quad p = w \cos \theta \div 1.57 r.$$

Tests of Large Shaft Bearings are reported by Albert Kingsbury in *Trans. A. S. M. E.*, 1905. A horizontal shaft was supported in two bearings 9 X 30 ins., and a third bearing 15 X 40 ins., midway between the other two, was pressed upwards against the shaft by a weighed lever, so that it was subjected to a pressure of 25 to 50 tons. The journals were flooded with oil from a supply tank. The shaft was driven by an electric motor, and the friction H.P. was determined by measuring the current supplied. Following are the principal results:

Load, tons*	25	25	25	25	25	33.6	42.3	47	47	50.5
Load per sq. in.*	83	83	83	83	83	112	141	157	157	168
Speed, r.p.m.	309	506	180	179	301	454	480	946	1243	1286
Speed, ft. per min.*	1215	1990	708	704	1180	1785	1890	3720	4900	5050
Friction H.P.†	12.6	21.7	6.43	5.12	10.1	16	17.9	41.9	47.8	52.3
Coeff. of friction†	.0045	.0048	.0040	.0037	.0037	.0029	.0024	.0025	.0022	.0022

* On the large bearing. † Three bearings.

The last three tests were with paraffin oil; the others with heavy machine oil.

Clearance between Journal and Bearing. — John W. Upp, in *Trans. A. S. M. E.*, 1905 gives a table showing the diameter of bore of horizontal and vertical bearings according to the practice of one of the leading builders of electrical machinery. The maximum diameter of the journal is the same as its nominal diameter, with an allowable variation below maximum of 0.0005 in. up to 3 in. diam., 0.001 in. from 3½ to 9 in., and 0.0015 in. from 10 to 24 in. The maximum bore of a horizontal bearing is larger than the diam. of the journal by from 0.002 in. for a ½-in. journal to 0.009 for 6 in., for journals 7 to 15 in. it is 0.004 + 0.001 X diam., and for 16 to 24 in. it is uniformly 0.02 in. For vertical journals the clearance is less by from 0.001 to 0.004 in. according to the diameter. The allowable variation above the minimum bore is from 0.001 to 0.005.

Allowable Pressures on Bearings. — J. T. Nicholson, in a paper read before the Manchester Assoc. of Engrs. (*Am. Mach.*, Jan. 16, 1908,

Eng. Digest, Feb., 1908), as a result of a theoretical study of the lubrication of bearings and of their emission of heat, obtains the formula $p = P/l d = 40 (dN)^{1/4}$, in which p = allowable pressure per sq. in. of projected area, P = total pressure, l = length and d = diam. of journal, N = revs. per min. It appears from this formula that the greater the speed the greater the allowable pressure per sq. in., so that for a 1-in. journal the allowable pressure per sq. in. is 126 lbs. at 100 r.p.m. and 189 lbs. at 500 r.p.m., and for a 5-in. journal 189 lbs. at 100 and 283 lbs. at 500 r.p.m. W. H. Scott (*Eng. Digest*, Feb., 1908) says this is contrary to the teaching of practical experience, and therefore the formula is inaccurate. Mr. Scott, from a study of the experiments of Tower, Lasche, and Stribeck, derives the following formulæ for the several conditions named:

- For main bearings of double-acting vertical engines. $p = 750 D^{1/4}/N^{1/4}$
 - " " " " " horizontal " $p = 660 D^{1/2}/N^{1/4}$
 - " " " " " single-acting four-cycle gas engines $p = 1350 D^{1/2}/N^{1/4}$
 - For crank pins of vert. and hor. double-acting engines. $p = 1560 D^{1/4}/N^{1/4}$
 - " " " " " single-acting four-cycle gas engines. $p = 3000 D^{1/4}/N^{1/4}$
 - For dead loads with ordinary lubrication. $p = 400 N^{-1/5}$
 - " " " " " forced " $p = 1600 N^{-1/4}$
- p = allowable pressure in lbs. per sq. in. of projected area; D = diam. in ins.; N = revs. per. min.

F. W. Taylor (*Trans. A. S. M. E.*, 1905), as the result of an investigation of line shaft and mill bearings that were running near the limit of durability and heating yet not dangerously heating, gives the formula $PV = 400$. P = pressure in lbs. per sq. in. of projected area, V = velocity of circumference of bearing in ft. per sec.

The formula is applicable to bearings in ordinary shop or mill use on shafting which is intended to run with the care and attention which such bearings usually receive, and gives the maximum or most severe duty to which it is safe to subject ordinary chain or oiled ball and socket bearings which are *babbitted*. It is not safe for ordinary shafting to use *cast-iron boxes*, with either sight feed, wick feed, or grease-cup oiling, under as severe conditions as $P \times V = 200$.

Archbutt and Deeley's "Lubrication and Lubricants" gives the following table of allowable pressures in lbs. per sq. in. of projected area of different bearings:

Crank-pin of shearing and punching machine, hard steel, intermittent load bearing.	3000
Bronze crosshead neck journals.	1200
Crank pins, large slow engine.	800-900
Crank pins, marine engines.	400-500
Main crankshaft bearing, fast marine.	400
Same, slow marine.	600
Railway coach journals.	300-400
Flywheel shaft journals.	150-200
Small engine crank pin.	150-200
Small slide block, marine engine.	100
Stationary engine slide blocks.	25-125
Same, usual case.	30- 60
Propeller thrust bearings.	50- 70
Shafts in cast-iron steps, high speed.	15

Bearing Pressures for Heavy Intermittent Loads. (Oberlin Smith, *Trans. A. S. M. E.*, 1905.) — In a punching press of about 84 tons capacity, the pressure upon the front journal of the main shaft is about 2400 lbs. per sq. in. of projected area. Upon the eccentric the pressure against the pitman driving the ram is some 7000 lbs. per sq. in. — both surfaces being of cast iron, and sometimes running at a surface speed of 140 feet per minute. Such machines run year in and year out with but little trouble in the way of heating or "cutting." An instance of excessive pressure may be cited in the case of a Ferracute toggle press, where the whole ram pressure of 400 tons is brought to bear upon hardened steel

toggle-pins, running in cast iron or bronze bearings, 3 in. in diam. by nearly 14 in. long. These run habitually, for maximum work, under a load of 20,000 lbs. per sq. in.

Bearings for Very High Rotative Speeds. (*Proc. Inst. M. E.*, Oct., 1888, p. 482.) — In the Parsons steam-turbine, which has a speed as high as 18,000 rev. per min., as it is impossible to secure absolute accuracy of balance, the bearings are of special construction so as to allow of a certain very small amount of lateral freedom. For this purpose the bearing is surrounded by two sets of steel washers 1/16 in. thick and of different diameters, the larger fitting close in the casing and about 1/32 in. clear of the bearing, and the smaller fitting close on the bearing and about 1/32 in. clear of the casing. These are arranged alternately, and are pressed together by a spiral spring. Consequently any lateral movement of the bearing causes them to slide mutually against one another, and by their friction to check or damp any vibrations that may be set up in the spindle. The tendency of the spindle is then to rotate about its axis of mass, and the bearings are thereby relieved from excessive pressure, and the machine from undue vibration. The allowing of the turbine itself to find its own center of gyration is a well-known device in other branches of mechanics: as in the instance of the centrifugal hydro-extractor, where a mass very much out of balance is allowed to find its own center of gyration; the faster it runs the more steadily does it revolve and the less is the vibration. Another illustration is to be found in the spindles of spinning machinery which run at about 10,000 or 11,000 revs. per min.; although of very small dimensions, the outside diameter of the largest portion or driving whorl being perhaps not more than 1 1/4 in., it is found impracticable to run them at that speed in what might be called a hard-and-fast bearing. They are therefore run with some elastic substance surrounding the bearing, such as steel springs, hemp, or cork. Any elastic substance is sufficient to absorb the vibration, and permit of absolutely steady running.

Thrust Bearings in Marine Practice. (G. W. Dickie, *Trans. A. S. M. E.*, 1905.) — The approximate pressure on a thrust bearing of a propeller shaft assuming two thirds of the indicated horse-power to be effective on the propeller is $P = \text{I.H.P.} \times \frac{2 \times 60 \times 33000}{S \times 3 \times 6080} = \frac{\text{I.H.P.}}{S} \times 217.1$, in which S = speed of ship in knots per hour, P = total thrust in lbs. The following are data of water-cooled bearings which have given satisfactory service:

Speed in knots.....	22	22 1/2	28	21
Thrust-ring surface, horse-shoe type, sq. ins.....	1188	891	581	2268
Horse-power, one engine, I.H.P.	11,500	6,800	4,200	15,000
Indicated pressure on bearing, lbs....	112,700	89,000	33,600	154,000
Pressure per sq. in. of surface, lbs.	95	100	58	68.1
Mean speed of bearing surfaces, ft. per min.....	642	610	827	504

Bearings for Locomotives. (G. M. Basford, *Trans. A. S. M. E.*, 1905.) — Bearing areas for locomotive journals are determined chiefly by the possibilities of lubrication. On driving journals the following figures of pressure in lbs. per sq. in. of projected area give good service: passenger, 190; freight, 200; switching, 220 lbs. Crank pins may be loaded from 1500 to 1700 lbs.; wrist pins to 4000 lbs. per sq. in. Car and tender bearings are usually loaded from 300 to 325 lbs. per sq. in.

Bearings of Corliss Engines. (P. H. Been, *Trans. A. S. M. E.*, 1905.) — In the practice of one of the largest builders the greatest pressure allowed per sq. in. of projected area for all shafts is 140 lbs. On most engines the pressure per sq. in. multiplied by the velocity of the bearing surface in ft. per sec. lies between 1000 and 1300.

Edwin Reynolds says that a main engine bearing to be safe against undue heating should be of such a size that the product of the square root of the speed of rubbing-surface in feet per second multiplied by the pounds per square inch of projected area, should not exceed 375 for a horizontal engine, or 500 for a vertical engine when the shaft is lifted at every revolution. Locomotive driving boxes in some cases give the product as high

as 585, but this is accounted for by the cooling action of the air. (*Am. Mach.*, Sept. 17, 1903.)

Temperature of Engine Bearings. (A. M. Mattice, *Trans. A. S. M. E.*, 1905.) — An examination of the temperature of bearings of a large number of engines of various makes showed more above 135° F. than below that figure. Many bearings were running with a temperature over 150°, and in one case at 180°, and in all of these cases the bearings were giving no trouble.

PIVOT-BEARINGS.

The Schiele Curve. — W. H. Harrison (*Am. Mach.*, 1891) says the Schiele curve is not as good a form for a bearing as the segment of a sphere. He says: A mill-stone weighing a ton frequently bears its whole weight upon the flat end of a hard-steel pivot 1 1/8 in. diam., or 1 sq. in. area of bearing; but to carry a weight of 3000 lbs. he advises an end bearing about 4 ins. diam., made in the form of a segment of a sphere about 1/2 in. in height. The die or fixed bearing should be dished to fit the pivot. This form gives a chance for the bearing to adjust itself, which it does not have when made flat, or when made with the Schiele curve. If a side bearing is necessary it can be arranged farther up the shaft. The pivot and die should be of steel, hardened; cross-gutters should be in the die to allow oil to flow, and a central oil-hole should be made in the shaft.

The advantage claimed for the Schiele bearing is that the pressure is uniformly distributed over its surface, and that it therefore wears uniformly. Wilfred Lewis (*Am. Mach.*, April 19, 1891) says that its merits as a thrust-bearing have been vastly overestimated; that the term "anti-friction" applied to it is a misnomer, since its friction is greater than that of a flat step or collar of the same diameter. He advises that flat thrust-bearings should always be annular in form, having an inside diameter one-half of the external diameter.

Friction of a Flat Pivot-bearing. — The Research Committee on Friction (*Proc. Inst. M. E.*, 1891) experimented on a step-bearing, flattened, 3 in. diam., the oil being forced into the bearing through a hole in its center and distributed through two radial grooves, insuring thorough lubrication. The step was of steel and the bearing of manganese-bronze.

At revolutions per min.	50	128	194	290	353
The coefficient of friction	0.0181	0.0053	0.0051	0.0044	0.0053
varied between	and 0.0221 0.0113 0.0102 0.0178 0.0167				

With a white-metal bearing at 128 revs. the coefficient of friction was a little larger than with the manganese-bronze. At the higher speeds the coefficient of friction was less, owing to the more perfect lubrication, as shown by the more rapid circulation of the oil. At 128 revs. the bronze-bearing heated and seized on one occasion with a load of 260 lbs., and on another occasion with 300 lbs. per sq. in. The white-metal bearing under similar conditions heated and seized with a load of 240 lbs. per sq. in. The steel footstep on manganese-bronze was afterwards tried, lubricating with three and with four radial grooves; but the friction was from one and a half times to twice as great as with only the two grooves.

Mercury-bath Pivot. — A nearly frictionless step-bearing may be obtained by floating the bearing with its superincumbent weight upon mercury. Such an apparatus is used in the lighthouses of La Heve, Havre. It is thus described in *Eng'g*, July 14, 1893, p. 41:

The optical apparatus, weighing about 1 ton, rests on a circular cast-iron table, which is supported by a vertical shaft of wrought iron 2.36 in. diameter. This is kept in position at the top by a bronze ring and outer iron support, and at the bottom in the same way, while it rotates on a removable steel pivot resting in a steel socket, which is fitted to the base of the support. To the vertical shaft there is rigidly fixed a floating cast-iron ring 17.1 in. diameter and 11.8 in. in depth, which is plunged into and rotates in a mercury bath contained in a fixed outer drum or tank, the clearance between the vertical surfaces of the drum and ring being only 0.2 in., so as to reduce as much as possible the volume of mercury (about 220 lbs.), while the horizontal clearance at the bottom is 0.4 in.

BALL-BEARINGS, ROLLER-BEARINGS, ETC.

Friction-rollers. — If a journal instead of revolving on ordinary bearings be supported on friction-rollers the force required to make the journal revolve will be reduced in nearly the same proportion that the diameter of the axles of the rollers is less than the diameter of the rollers themselves. In experiments by A. M. Wellington with a journal 3 1/2 in. diam. supported on rollers 8 in. diam., whose axles were 1 3/4 in. diam., the friction in starting from rest was 1/4 the friction of an ordinary 3 1/2-in. bearing, but at a car speed of 10 miles per hour it was 1/2 that of the ordinary bearing. The ratio of the diam. of the axle to diam. of roller was 1 3/4 : 8, or as 1 to 4.6.

Coefficients of Friction of Roller Bearings. C. H. Benjamin, *Machy*, Oct., 1905. — Comparative tests of plain babbitted, McKeel plain roller, and Hyatt roller bearings gave the following values of the coefficient of friction at a speed of 560 r.p.m.:

Diameter of Journal.	Hyatt Bearing.			McKeel Bearing.			Babbitt Bearing.		
	Max.	Min.	Ave.	Max.	Min.	Ave.	Max.	Min.	Ave.
1 15/16	.032	.012	.018	.033	.017	.022	.074	.029	.043
2 3/16	.019	.011	.014				.088	.078	.082
2 7/16	.042	.025	.032	.028	.015	.021	.114	.083	.096
2 15/16	.029	.022	.025	.039	.019	.027	.125	.089	.107

The friction of the roller bearing is from one-fifth to one-third that of a plain bearing at moderate loads and speeds. It is noticeable that as the load on a roller bearing increases the coefficient of friction decreases.

A slight change in the pressure due to the adjusting nuts was sufficient to increase the friction considerably. In the McKeel bearing the rolls bore on a cast-iron sleeve and in the Hyatt on a soft-steel one. If roller bearings are properly adjusted and not overloaded a saving of from 2-3 to 3-4 of the friction may be reasonably expected.

McKeel bearings contained rolls turned from solid steel and guided by spherical ends fitting recesses in cage rings at each end. The cage rings were joined to each other by steel rods parallel to the rolls.

Lubrication is absolutely necessary with ball and roller bearings, although the contrary claim is often advanced. Under favorable conditions an almost imperceptible film is sufficient; a sufficient quantity to immerse half the lowest ball should always be provided as a rust preventive. Rust and grit must be kept out of ball and roller bearings. Acid or rancid lubricants are as destructive as rust. (Henry Hess.)

Both ball and roller bearings, to give the best satisfaction, should be made of steel, hardened and ground; accurately fitted, and in proper alignment with the shaft and load; cleaned and oiled regularly, and fitted with as large-size balls or rollers as possible, depending upon the revolutions per minute and load to be carried. Oil is absolutely necessary on both ball and roller bearings, to prevent rust. (S. S. Eveland.)

Roller Bearings. — The Mossberg roller bearings for journals are made in the sizes given in the table below. *D* = diam. of journal; *d* = diam. of roll; *N* = number of rolls; *P* = safe load on journals, in lbs. The rolls are enclosed in a bronze supporting cage. (*Trans. A. S. M. E.*, 1905.)

<i>D</i>	<i>d</i>	<i>N</i>	<i>P</i>	<i>D</i>	<i>d</i>	<i>N</i>	<i>P</i>	<i>D</i>	<i>d</i>	<i>N</i>	<i>P</i>
2	1/4	20	3,500	6	11/16	24	50,000	15	1 3/8	28	255,000
2 1/2	5/16	22	7,000	7	13/16	22	70,000	18	1 3/8	32	325,000
3	3/8	22	13,000	8	7/8	22	90,000	20	1 1/2	34	400,000
4	7/16	24	24,000	9	1	24	115,000	24	1 1/2	38	576,000
5	9/16	24	37,000	12	1 1/4	26	175,000

Surface speed of journal 0 to 50 ft. per min. Length of journal 1 1/2 diameters. The rolls are made of tool steel not too high in carbon, and of spring temper. The journal or shaft should be made not above a medium spring temper. The box should be made of high carbon steel and tempered as hard as possible.

Conical Roller Thrust Bearings. — The Mossberg thrust bearing is made of conical rollers contained in a cage, and two collars, one being stationary and the other fixed to the shaft and revolving with it. One side of each collar is made conical to correspond with the rollers which bear on it. The apex of the cones is at the center of the shaft. The angle of the cones is 6 to 7 degrees. Larger angles are objectionable, giving excessive end thrust. The following sizes are made:

Diameter of Shaft. Ins.	Outside Diameter of Ring. Ins.	No. of Rolls.	Safe Pressure on Bearing.		
			Area of Pressure Plate. Sq. ins.	Speed 75 Rev. Lbs.	Speed 150 Rev. Lbs.
2 1/16-2 1/4	59/16	30	10	19,000	9,500
3 1/16-3 1/4	8	30	20	40,000	20,000
4 1/16-4 1/4	105/16	30	35	70,000	35,000
5 1/16-5 1/4	123/8	30	54	108,000	56,000
6 1/16-6 1/2	147/8	30	78	125,000	62,000
8 1/16-8 1/2	183/4	32	132	200,000	100,000
9 1/16-9 1/2	20 1/2	32	162	300,000	150,000

Plain Roller Thrust Bearings. — S. S. Eveland, of the Standard Roller Bearing Co., contributes the following data of plain roller thrust bearings in use in 1903. The bearing consists of a large number of short cylindrical rollers enclosed in openings in a disk placed between two hardened steel plates. He says "our plain roller bearing is theoretically wrong, but in practice it works perfectly, and has replaced many thousand ball-bearings which have proven unsatisfactory."

Size of Bearing. ins.	Number and Size of Rollers. ins.	R.p.m.	Weight on Bearings, lbs.	Lineal inches.	Weight per lin. in., lbs.	Weight on each roll, lbs.
4 3/4 x 6 11/16	36 5/8 x 5/16	500	6,000	11 1/4	546	167
4 3/4 x 7 1/4	32 3/4 x 5/8	470	10,000	12	833	312
5 1/2 x 8 1/2	54 3/4 x 5/8	420	15,000	20 1/4	750	279
7 x 10 3/8	48 1 x 1/2	370	20,000	24	833	417
7 1/2 x 11 5/16	54 1 x 1/2	325	25,000	27	988	463
8 x 15 1/2	70 1 1/4 x 5/8	300	60,000	45	1334	833

The Hyatt Roller Bearing. (A. L. Williston, *Trans. A. S. M. E.*, 1905.) — The distinctive feature of the Hyatt roller bearing is a flexible roller, made of a strip of steel wound into a coil or spring of uniform diameter. A roller of this construction insures a uniform distribution of the load along the line of contact of the roller and the surfaces on which it operates. It also permits any slight irregularities in either journal or box without causing excessive pressure. The roller is hollow and serves as an oil reservoir. For a heavy load, a roller of heavy stock can be made, while for a high-speed bearing under light pressure a roller of light weight, made from thin stock, can be used. Following are the results of some tests of the Hyatt bearing in comparison with other bearings:

A shaft 152 ft. long, 2 15/16 in. diam. supported by 20 bearings, belt-driven from one end, gave a friction load of 2.28 H.P. with babbitted bearings, and 0.80 H.P. with Hyatt bearings. With 88 countershafts running in babbitted bearings, the H.P. required was 8.85 when the main shaft was in babbitted bearings and 6.36 H.P. when it was in Hyatt bearings.

Comparative tests of solid rollers and of Hyatt rollers were made in 1898 at the Franklin Institute by placing two sets of rollers between three flat plates, putting the plates under load in a testing machine and measuring the force required to move the middle plate. All the rollers were $3/4$ in. diam., 10 ins. long. The Hyatt rollers were made of $1/2 \times 1/8$ in. steel strip. With 2000 lbs. load and plain rollers it took 26 lbs. to move the plate, and with the Hyatt rollers 9 lbs. With 3000 lbs. load and plain rollers the resistance was 34 lbs., with Hyatt rollers 17 lbs.

In tests with a pendulum friction testing machine at the Case Scientific School, with a bearing $1 15/16$ in. diam. the coefficient of friction with the Hyatt bearing was from 0.0362 down to 0.0196, the loads increasing from 64 to 264 lbs.; with cast-iron bearings and the same loads the coefficient was from 0.165 to 0.098.

In tests at Purdue University with bearings $4 \times 1 1/2$ ins. and loads from 1900 to 8300 lbs., the average coefficients with different bearings and different speeds were as follows:

Hyatt bearing	130 r.p.m.	0.0114	302 r.p.m.	0.0099	585 r.p.m.	0.0147
Cast-iron bearing	128 "	0.0548	302 "	0.0592	410 "	0.0683
Bronze bearing	130 "	0.0576	320 "	0.0661	582 "	0.140

The cast-iron bearing at 128 r.p.m. seized with 8300 lbs., and at 410 r.p.m. with 5900 lbs. The bronze bearing seized at 130 r.p.m. with 3500 lbs., at 320 r.p.m. with 5100 lbs., and at 582 r.p.m. with 2700 lbs.

The makers have found that the advantages of roller bearings of the type described are especially great with either high speeds or heavy loads. Generally, the best results are obtained for line-shaft work up to speeds of 600 rev. per min., when a load of 30 lbs. per square inch of projected area is allowed. For heavy load at slow speed, such as in crane and truck wheels, a load of 500 lbs. gives the best results.

The Friction Coefficient of a well-made annular ball-bearing is 0.001 and 0.002 of the load referred to the shaft diameter and is independent of the speed and load. The friction coefficient of a good roller bearing is from 0.0035 to 0.014; it rises very much if the load is light. It increases also when the speeds are very low, though not so much as with plain bearings. (Henry Hess.)

Notes on Ball Bearings. — The following notes are contributed by Mr. Henry Hess, 1910. Ball bearings in modern use date from the bicycle. That brought in the adjustable cup and cone and three-point contact type. Under the demands for greater load resistance and reliability the two-point contact type, without adjustability, was evolved; that is now used under loads from a few pounds to many tons. Such a bearing consists of an inner race, an outer race and the series of balls that roll in tracks of curved cross section. Various designs are used, differing chiefly in the devices for separating the balls and in the arrangement for introducing the balls between the races. The most widely used type has races that are of the same cross section throughout, unbroken by any openings for the introduction of balls. To introduce the balls the two races are first eccentrically placed; the balls will fill slightly more than a half circumference; elastic separators or solid cages are used to space the balls.

Another type has a filling opening of sufficient depth cut into one race; the race continuity is restored by a small piece that is let in. This type is usually filled with balls, without cages or separators. The filling opening is always placed at the unloaded side of the bearing, where the weakening of the race is not important. This type has been almost entirely discarded in favor of the one above described.

A third type has a filling opening cut into each race not quite deep enough to tangent the bottom of the ball track. As this weakened section necessarily comes under the load during each revolution, the carrying capacity is reduced. After slight wear there develops an interference of the balls with the edges of these openings, which seriously reduces the speeds and load capacity. This interference precludes the use of this type to take end thrust.

The carrying capacity of a ball-bearing is directly proportional to the number of balls and to the square of the ball diameter.

It may be written as:
 $L = Knd^2$, in which L = load capacity in pounds; n = number of balls; d = ball diameter in eighths of an inch. K varies with the condition and type of bearing, as also with the material and speed.
 For a certain special steel that hardens throughout and is also unusually tough, employed by "DWF" or "HB" (the originators of the modern two-point type), the following values apply. For other steels lesser values must be used.

I. For Radial Bearings:

$K = 9$ for uninterrupted race track, cross-section curvature = 0.52 and $9/16$ in. ball diameter respectively for inner and outer races, separated balls, uniform load, and steady speed up to 3000 revs. per min.

$K = 5$ for full ball type, filling opening in one race at the unloaded side, otherwise as above.

$K = 2.5$ for both ball tracks interrupted by filling openings, inelastic cage separators for balls, or full ball, speeds not above 2000 revs. per min., uniform load.

$K = 0.9$ for thrust on a radial bearing of the first type, as above. The larger the balls the smaller K . The type with filling openings in each race is not suitable for end thrust.

The radial load bearing is, up to high speeds, practically unaffected by speed, as to carrying capacity.

II. Thrust Bearings:

With the thrust type, consisting of one flat plate and one seat plate with grooved ball races, the load capacity decreases with speed or

$$L = \frac{K_1 nd^2}{\sqrt{R}}$$

K_1 = constant for material and race cross-section, etc., R = revolutions per minute. R ranges from about 3000 revs. per min. down to 1 rev. per min. as for crane hooks and similar elements.

$K_1 = 25$ to 40 for material used by the DWF or HB, and race cross-section radius = approx. 1.66 ball radius.

$K_1 = 0.5$ for unhardened steel, occasionally used for very large races; a steel that is fairly hard without tempering must be used, and then only when there is no hammering or sharp load variation.

Balls must be carefully selected to make sure that all that are used in the same bearing do not vary among one another by more than 0.0001 inch. A ball that is more than that larger than its fellows will sustain more than its proportion of the load, and may therefore be overloaded and will in turn overload the races.

The usual test of ball quality, which consists in compressing a ball between flat plates and noting the load at rupture, gives the quality of the plates, but not of the balls. It is the ability of the ball to resist permanent deformation that is of importance. As the deformations involved are very small the test is a difficult one to carry out. Of even greater importance than a small deformation under load is uniformity of such deformation between the balls employed; a hard ball will deform less than its softer mate and so will carry more than its share of the load, and will therefore be overloaded and in turn overload the races.

Coned bearings for balls are objectionable. The defect in all these forms of bearings is their adjustable feature. A bearing properly proportioned with reference to a certain load may be enormously overloaded by a little extra effort applied to the wrench, or on the other hand the bearing may be adjusted with too little pressure, so that the balls will rattle, and the results consequently be unsatisfactory. The prevalent idea that coned ball-bearings can be adjusted to compensate for wear is erroneous.

Mr. Hess's paper, in *Trans. A. S. M. E.*, 1907, contains a great deal of useful information on the practical design of ball-bearings, including different forms of raceways. He prefers a two-point bearing, in which the ball races have a curved section, with sustaining surfaces at right angles with the direction of the load.

Formulae for Number of Balls in a Bearing. (H. Rolfe, *Am. Mach.*, Dec. 3, 1896.) — Let D = diam. of ball circle (the circle passing through

the centers of the balls); d = diam. of balls; n = number of balls; s = average clearance space between the balls. Then $D = (d + s) \div \sin(180^\circ/n)$; $d = D \sin(180^\circ/n) - s$; $s = D \sin(180^\circ/n) - d$; $n = 180^\circ \div$ angle whose sine is $(d + s) \div D$. The clearance s should be about 0.003 in.

VALUES OF $180^\circ/n$ AND OF $\sin 180^\circ/n$.

n	$180^\circ/n$	$\sin 180^\circ/n$	n	$180^\circ/n$	$\sin 180^\circ/n$	n	$180^\circ/n$	$\sin 180^\circ/n$	n	$180^\circ/n$	$\sin 180^\circ/n$
3	60	0.86603	15	12	0.20791	27	6.667	0.11609	39	4.615	0.08047
4	45	.70711	16	11.250	.19509	28	6.429	.11197	40	4.500	.07846
5	36	.58799	17	10.588	.18375	29	6.207	.10812	41	4.390	.07655
6	30	.50000	18	10	.17365	30	6	.10453	42	4.286	.07473
7	25.714	.43388	19	9.474	.16454	31	5.806	.10117	43	4.186	.07300
8	22.500	.38268	20	9	.15643	32	5.625	.09801	44	4.091	.07134
9	20	.34202	21	8.571	.14904	33	5.455	.09506	45	4	.06976
10	18	.30902	22	8.182	.14233	34	5.294	.09227	46	3.913	.06825
11	16.364	.28173	23	7.826	.13616	35	5.143	.08963	47	3.830	.06679
12	15	.25882	24	7.500	.13053	36	5	.08716	48	3.750	.06540
13	13.846	.23931	25	7.200	.12533	37	4.865	.08510	49	3.673	.06407
14	12.857	.22252	26	6.923	.12055	38	4.737	.08258	50	3.600	.06279

Grades of Balls for Bearings. (S. S. Eveland, *Trans. A. S. M. E.*, 1905.) — "A" grade balls vary about 0.0025 in. in diameter; "B" grade, 0.001 to 0.002 in.; while "high-duty" or special balls are furnished varying not over 0.0001 in. The crushing strength of balls is of little importance as to the load a bearing will carry, the revolutions per minute being quite as important as the load.

Saving of Power by Use of Ball-Bearings. — Henry Hess (*Trans. A. S. M. E.*, 1909) describes a series of tests made by Dodge and Day on a $2\frac{15}{16}$ in. line shaft 72 ft. long, alternately equipped with plain ring-oiling babbitted boxes and with Hess-Bright ball-bearings. Eight countershafts were driven from pulleys on the line shaft. The countershaft pulleys had plain bearings. The conclusions from the tests made under normal belt conditions of 44 and 57 lbs. per inch width of angle of single belt are as follows:

a. Savings due to the substitution of ball-bearings for plain bearings on line shafts may be safely calculated by using 0.0015 as the coefficient of ball-bearing friction, 0.03 as the coefficient of line shaft friction, and 0.08 as the coefficient of countershaft friction.

b. When the belts from line shaft to countershaft pull all in one direction and nearly horizontally the saving due to the substitution of ball-bearings for plain bearings on the line shaft may be safely taken as 35% of the bearing friction.

c. When ball-bearings are used also on the countershafts the savings will be correspondingly greater and may amount to 70% or more of the bearing friction.

d. These percentages of savings are percentages of the friction work lost in the plain bearings; they are not percentages of the total power transmitted. The latter will depend upon the ratio of the total power transmitted to that absorbed in the line and countershafts.

e. The power consumed in the plain line and countershafts varies, as is well known, from 10 to 60% in different industries and shops. The substitution of ball-bearings for plain bearings on the line shaft only, under conditions of paragraph "a," will thus result in saving of total power of $35 \times 0.10 = 3.5\%$ to $35 \times 0.60 = 21\%$. By using ball-bearings on the countershafts also, the saving of total power will be from $70 \times 0.10 = 7\%$ to $70 \times 0.60 = 42\%$.

KNIFE-EDGE BEARINGS.

Allowable loads on knife-edges vary with the manner in which the pivots or knife-edges are held in the lever and the pivot supports or seats secured to the base of weighing machines. The extension of the

pivot beyond the solid support is practically worthless. A high-grade uniform tool steel with carbon 0.90% to 1.00% should be used. The temper of the seats should be drawn to a very light straw color; that of the pivots should be slightly darker. The angle of 90° for the knife-edge has given good results for heavy loads. For ordinary weighing machinery and most testing machinery 5000 lbs. per inch of length is ample. Loads of 10,000 lbs. per inch of length are permissible, but the pivot must be flat at its upper portion, normal to the load and supported its whole length, with a minimum deflection of parts to secure reasonable accuracy. The edge may be made perfectly sharp, for loads up to 1000 lbs. per inch of length. For greater loads the sharp edge is rubbed with an oilstone, so that a smoothness is just visible. A pronounced radius of knife-edge will decrease the sensibility of the apparatus. (Jos. W. Bramwell, *Eng. News*, June 14, 1906.)

FRICION OF STEAM-ENGINES.

Distribution of the Friction of Engines. — Prof. Thurston, in his "Friction and Lost Work," gives the following:

	1.	2.	3.
Main bearings.....	47.0	35.4	35.0
Piston and rod.....	32.9	25.0	21.0
Crank-pin.....	6.8	5.1	13.0
Cross-head and wrist-pin.....	5.4	4.1	
Valve and rod.....	2.5	26.4	22.0
Eccentric strap.....	5.3	4.0	
Link and eccentric.....	9.0
Total.....	100.0	100.0	100.0

No. 1, Straight-line, 6 x 12 in., balanced valve; No. 2, Straight-line, 6 x 12 in., unbalanced valve; No. 3, 7 x 10 in., Lansing traction, locomotive valve-gear.

Prof. Thurston's tests on a number of different styles of engines indicate that the friction of any engine is practically constant under all loads. (*Trans. A. S. M. E.*, viii, 86; ix, 74.)

In a straight-line engine, 8 x 14 in., I.H.P. from 7.41 to 57.54, the friction H.P. varied irregularly between 1.97 and 4.02, the variation being independent of the load. With 50 H.P. on the brake the I.H.P. was only 52.6, the friction being only 2.6 H.P., or about 5%.

A compound condensing-engine, tested from 0 to 102.6 brake H.P., gave I.H.P. from 14.92 to 117.8 H.P., the friction H.P. varying only from 14.92 to 17.42. At the maximum load the friction was 15.2 H.P., or 12.9%.

The friction increases with increase of the boiler-pressure from 30 to 70 lbs., and then becomes constant. The friction generally increases with increase of speed, but there are exceptions to this rule.

Prof. Denton (*Stevens Indicator*, July, 1890), comparing the calculated friction of a number of engines with the friction as determined by measurement, finds that in one case, a 75-ton ammonia ice-machine, the friction of the compressor, 17 1/2 H.P., is accounted for by a coefficient of friction of 7 1/2% on all the external bearings, allowing 6% of the entire friction of the machine for the friction of pistons, stuffing-boxes, and valves. In the case of the Pawtucket pumping-engine, estimating the friction of the external bearings with a coefficient of friction of 6% and that of the pistons, valves, and stuffing-boxes as in the case of the ice-machine, we have the total friction distributed as follows:

	Horse-power.	Per cent of whole.
Crank-pins and effect of piston-thrust on main shaft	0.71	11.4
Weight of fly-wheel and main shaft.....	1.95	32.4
Steam-valves.....	0.23	3.7
Eccentric.....	0.07	1.2
Pistons.....	0.43	7.2
Stuffing-boxes, six altogether.....	0.72	11.3
Air-pump.....	2.10	32.8
Total friction of engine with load.....	6.21	100.0
Total friction per cent of indicated power.	4.27	

The friction of this engine, though very low in proportion to the indicated power, is satisfactorily accounted for by Morin's law used with a coefficient of friction of 5%. In both cases the main items of friction are those due to the weight of the fly-wheel and main shaft and to the piston-thrust on crank-pins and main-shaft bearings. In the ice-machine the latter items are the larger owing to the extra crank-pin to work the pumps, while in the Pawtucket engine the former preponderates, as the crank-thrusts are partly absorbed by the pump-pistons, and only the surplus effect acts on the crank-shaft.

Prof. Denton describes in *Trans. A. S. M. E.*, x, 392, an apparatus by which he measured the friction of the piston packing-ring. When the parts of the piston were thoroughly devoid of lubricant, the coefficient of friction was found to be about 7½%; with an oil-feed of one drop in two minutes the coefficient was about 5%; with one drop per minute it was about 3%. These rates of feed gave unsatisfactory lubrication, the piston groaning at the ends of the stroke when run slowly, and the flow of oil left upon the surfaces was found by analysis to contain about 50% of iron. A feed of two drops per minute reduced the coefficient of friction to about 1%, and gave practically perfect lubrication, the oil retaining its natural color and purity.

FRICION BRAKES AND FRICION CLUTCHES.

Friction Brakes are used for slowing down or stopping a moving machine by converting its energy of motion into heat, or for controlling the speed of a descending load. The simplest form is the block brake, commonly used for railway car wheels, which resists the motion of the wheel not only with the force due to ordinary sliding friction, but with that due to cutting or grinding away the surface of the metals in contact. If P = total pressure acting normal to the sliding surface, f = coefficient of friction, and v = velocity in feet per minute, then the energy absorbed, in foot-pounds per minute, is Pfv . If the surface is lubricated and the pressure per square inch not great enough to squeeze out the lubricant, then the value of f for different materials may be taken from Morin's tables for friction of motion, page 1196, but if the pressure is great enough to force out the lubricant, then the coefficient becomes much greater and the surface or surfaces will cut and wear, with a rapid rise of temperature.

Other forms of brakes are disk brakes and cone brakes, in which a disk or cone is carried by the rotating shaft and a mating disk or cone is pressed against it by a lever or other means; and band brakes, also called strap or ribbon brakes, in which a flexible band encircles the cylindrical surface of a rotating drum or wheel, and tension applied to one end of the band brings it in contact with that surface. For band brakes the theory of friction of belts applies. See page 1115. For much information on the theory and practice of friction brakes see articles by C. F. Blake in *Mach'y*, Jan., 1901, Mar., 1905, and Aug., 1906, and by E. R. Douglas, *Am. Mach.*, Dec. 26, 1901, and R. B. Brown, *Mach'y*, April, 1909. For friction brake dynamometers see Dynamometers.

Friction Clutches are used for putting shafts in motion gradually, without shock. If two shafts, in line with each other, one in motion and the other at rest, each having a disk keyed to the end, and the disks almost touching, are moved toward each other so that the disks are brought in contact with some pressure, the shaft at rest will be put in motion gradually, while the disks rub on each other, until it acquires the velocity of the driving shaft, when the friction ceases and the disks may then be locked together. This is an elementary form of friction clutch. A great variety of styles are made in which the sliding surfaces may be disks, cones, and gripping blocks of various forms. The work done by a clutch while the surfaces are in sliding contact, and before they are locked together, is the overcoming of the inertia of the driven shaft and of all the mechanism driven by it, and giving it the velocity of the driving shaft. The principles of friction brakes apply to friction clutches. The sliding surfaces must be of sufficient area to keep the normal pressure below that at which they will overheat, cut and wear, and to dissipate the heat generated by friction. The following values of the coefficient of friction to be used in designing clutches are given by C. W. Hunt: cork on iron, 0.35; leather on iron, 0.3; wood on iron, 0.2; iron on iron,

0.25 to 0.3. Lower values than these should be assumed for velocities exceeding 400 ft. per minute. The pressure per square inch in disk clutches should not exceed 25 or 30 lbs., and wooden surfaces should not be loaded beyond 20 to 25 lbs. per sq. in. See Kimball and Barr on Machine Design, also *Trans. A. S. M. E.*, 1903 and 1908.

Electrically Operated Brakes are discussed by H. A. Steen in a paper read before the Engrs. Socy. of W. Penna., reprinted in *Iron Trade Rev.*, Dec. 24, 1908. Formulæ are given for the time required for stopping, for the heat generated and the temperature rise, for different types of brakes.

Magnetic and Electric Brakes.—For braking the load on electric cranes a band brake is used which is held off the drum by the action of a magnet or solenoid, and is put on by the action of a spring or weight. The solenoid usually consists of a coil of wire connected in series with the motor, and a plunger working inside of the coil. It should be so proportioned that its action is not delayed by residual magnetism when the current is cut off. Too rapid action is prevented by making the end of the solenoid an air dash-pot.

For electric-driven machinery an electric motor makes a most efficient brake by reversing the direction of the electric current, causing the motor to become a generator supplying current to a rheostat in which it is converted into heat and dissipated. In some cases the electric current generated, instead of being absorbed in a rheostat, is fed into the main electric circuit. In this case the energy of the rotating mass, instead of being wasted in friction or in electrical heating, is converted into electric energy and thus conserved for further use.

Design of Band Brakes. (R. A. Greene, *Am. Mach.*, Oct. 8, 1908.)—In the practice of the Browning Engineering Co., Cleveland, O., in regard to the design of band brakes the equations are:

$$T = PX, t = T - P, S = \frac{2T}{D \times F}, \theta = S \times D \times 0.262 \times \text{revolutions per minute, in which } T = \text{the greater tension on the band, } t = \text{the lesser tension on the band, } P = \text{equivalent load on the brake drum, } X = \text{factor from the accompanying table, } X = \frac{N}{N-1} \text{ in which } \log. N = 10^{2.7288} fc,$$

where f = the coefficient of friction and c the length of arc of contact in degrees divided by 360. D = diam. of brake drum, F = width of face of brake drum, S = a checking factor which has a maximum limit of 65, θ = a checking factor which has a limit of 54,000 (Yale & Towne practice) or 60,000 (Brown hoist practice).

EXAMPLE.—A band brake is to be designed having an arc of contact of 260°, coefficient of friction = 0.2, drum diameter 30 ins., face 4 ins., speed 100 r.p.m., and a load of 3000 lbs. acting on a diameter of 20 ins.

Then
 $P = 3000 \times 20 \div 30 = 2000$ pounds, $X = 1.68$ (from table), $T = 2000 \times 1.68 = 3360$ pounds, $t = 3360 - 2000 = 1360$ pounds, $S = 2 \times 3360 \div (30 \times 4) = 56$ (within the limit), $\theta = 56 \times 30 \times 0.62 \times 100 = 44,000$ (within the limit).

Degrees.	Values of X.			Degrees.	Values of X.		
	f=0.2.	f=0.3.	f=0.4.		f=0.2.	f=0.3.	f=0.4.
180	2.14	1.64	1.40	260	1.68	1.35	1.19
195	2.03	1.56	1.35	270	1.64	1.32	1.18
210	1.93	1.50	1.30	280	1.60	1.30	1.17
240	1.76	1.40	1.23	290	1.57	1.28	1.15
250	1.72	1.37	1.21	300	1.54	1.26	1.14

FRICION OF HYDRAULIC PLUNGER PACKING.

The "Taschenbuch der Hutte" (15th edition, vol. 1, p. 202) says: "For stuffing boxes with hemp, cotton or leather packing, with water pressures between 1 and 50 atmospheres, the frictional loss is dependent upon the water pressure, the circumference of the packed surface, and a coefficient

μ , which is constant for this range of pressure. The loss is independent of the depth of stuffing-box or leather ring, and is given by the formula $F = Kpd$, in which F = total frictional loss in pounds, p = pressure in pounds per sq. in., d = diameter of plunger in inches.

K is a coefficient, which depends on the kind and condition of the packing, and is given as follows for various cases.

For cotton or hemp, loose or braided, dipped in hot tallow; plungers smooth, glands not pulled down too tight, packing therefore retaining its elasticity; dimensions such as usually occur, $K = 0.072$.

Same conditions, after packing is some months old, $K = 0.132$.

Materials the same, but with hard packing, unfavorable conditions, etc., K = as much as 0.299.

Leather packing; soft leather, well made, etc., $K = 0.036$ to 0.084.

Hard, stiffly tanned leather, $K = 0.12$ to 0.156.

Unfavorable conditions; rough plungers, gritty water, etc., K = as much as 0.239.

Weisbach-Hermann, "Mechanics of Hoisting Machinery," gives a formula which when translated into the same notation as the one in "Hutte" is

$$F = 0.0312 pd \text{ to } 0.0767 pd.$$

Since the total pressure on a plunger is $\frac{1}{4}\pi d^2 p$, the ratio of the loss of pressure to the total pressure is $Kpd + \frac{1}{4}\pi d^2 p$, or, using the extreme values of K , 0.0312 and 0.299, the ratio ranges from $0.04 \div d$ to $0.38 \div d$, or from 4 to 38 per cent divided by the diameter in inches.

Walter Ferris (*Am. Mach.*, Feb. 3, 1898) derives from the formula given above the following formula for the pressure produced by a hemp-packed hydraulic intensifier made with two plungers of different diameters:

$$p_2 = p_1 \frac{A - KD}{a + ka}$$

in which p_2 = pressure per sq. in. produced by the intensifier, p_1 = initial pressure, A = area and D = diam. of the larger plunger, a = area and d = diam. of the smaller plunger, and K an experimental coefficient. He gives the following results of tests of an intensifier with a small plunger 8 ins. diam. and two large plungers, 14 1/4 and 17 3/4 ins., either one of which could be used as desired.

Diam. of large plunger, in.	14 1/4	14 1/4	17 3/4	17 3/4
Initial pressure, lbs. per sq. in.	285	475	335	350
Intensified pressure, lbs. per sq. in.	750	1450	1450	1510
Intensified if there were no friction	905	1505	1650	1725
Intensified calculated by formula*	806	1433	1572	1643
Efficiency of machine	0.83	0.965	0.88	0.875

LUBRICATION.

Measurement of the Durability of Lubricants. — (J. E. Denton, *Trans. A. S. M. E.*, xi, 1013.) — Practical differences of durability of lubricants depend not on any differences of inherent ability to resist being "worn out" by rubbing, but upon the rate at which they flow through and away from the bearing-surfaces. The conditions which control this flow are so delicate in their influence that all attempts thus far made to measure durability of lubricants may be said to have failed to make distinctions of lubricating value having any practical significance. In some kinds of service the limit to the consumption of oil depends upon the extent to which dust or other refuse becomes mixed with it, as in railroad-car lubrication and in the case of agricultural machinery. The economy of one oil over another, so far as the quality used is concerned — that is, so far as durability is concerned — is simply proportional to the rate at which it can insinuate itself into and flow out of minute orifices or cracks. Oils will differ in their ability to do this, first, in proportion to their viscosity, and, second, in proportion to the capillary properties which they may possess by virtue of the particular ingredients used in their composition. Where the thickness of film between rubbing-surfaces must be so great that large amounts of oil pass through bearings in a given time, and the surroundings are such as to permit oil to be fed at high

*Assuming $K = 0.2$. The efficiency calculated by the formula in each case was 0.953.

temperatures or applied by a method not requiring a perfect fluidity, it is probable that the least amount of oil will be used when the viscosity is as great as in the petroleum cylinder stocks. When, however, the oil must flow freely at ordinary temperatures and the feed of oil is restricted, as in the case of crank-pin bearings, it is not practicable to feed such heavy oils in a satisfactory manner. Oils of less viscosity or of a fluidity approximating to lard-oil must then be used.

Relative Value of Lubricants. (J. E. Denton, *Am. Mach.*, Oct. 30, 1890.) — The three elements which determine the value of a lubricant are the cost due to consumption of lubricants, the cost spent for coal to overcome the frictional resistance caused by use of the lubricant, and the cost due to the metallic wear on the journal and the brasses.

The Qualifications of a Good Lubricant, as laid down by W. H. Bailey, in *Proc. Inst. C. E.*, vol. xiv, p. 372, are: 1. Sufficient body to keep the surfaces free from contact under maximum pressure. 2. The greatest possible fluidity consistent with the foregoing condition. 3. The lowest possible coefficient of friction, which in bath lubrication would be for fluid friction approximately. 4. The greatest capacity for storing and carrying away heat. 5. A high temperature of decomposition. 6. Power to resist oxidation or the action of the atmosphere. 7. Freedom from corrosive action on the metals upon which the lubricant is used.

The Examination of Lubricating Oils. (Prof. Thos. B. Stillman, *Stevens Indicator*, July, 1890.) — The generally accepted conditions of a good lubricant are as follows:

1. "Body" enough to prevent the surfaces to which it is applied from coming in contact with each other. (Viscosity.)
2. Freedom from corrosive acid, of either mineral or animal origin.
3. As fluid as possible consistent with "body."
4. A minimum coefficient of friction.
5. High "flash" and burning points.
6. Freedom from all materials liable to produce oxidation or "gumming."

The examinations to be made to verify the above are both chemical and mechanical, and are usually arranged in the following order:

1. Identification of the oil, whether a simple mineral oil, or animal oil, or a mixture.
2. Density.
3. Viscosity.
4. Flash-point.
5. Burning-point.
6. Acidity.
7. Coefficient of friction.
8. Cold test.

Detailed directions for making all of the above tests are given in Prof. Stillman's article. See also Stillman's *Engineering Chemistry*, p. 366.

Notes on Specifications for Petroleum Lubricants. (C. M. Everest, Vice-Pres. Vacuum Oil Co., *Proc. Engineering Congress*, Chicago World's Fair, 1893.) — The specific gravity was the first standard established for determining quality of lubricating oils, but it has long since been discarded as a conclusive test of lubricating quality. However, as the specific gravity of a particular petroleum oil increases the viscosity also increases.

The object of the fire test of a lubricant, as well as its flash test, is the prevention of danger from fire through the use of an oil that will evolve inflammable vapors. The lowest fire test permissible is 300°, which gives a liberal factor of safety under ordinary conditions.

The cold test of an oil, i.e., the temperature at which the oil will congeal, should be well below the temperature at which it is used; otherwise the coefficient of friction would be correspondingly increased.

Viscosity, or fluidity, of an oil is usually expressed in seconds of time in which a given quantity of oil will flow through a certain orifice at the temperature stated, comparison sometimes being made with water, sometimes with sperm-oil, and again with rape-seed oil. It seems evident that within limits the lower the viscosity of an oil (without a too near approach to metallic contact of the rubbing surfaces) the lower will be the coefficient of friction. But we consider that each bearing in a mill or factory would probably require an oil of different viscosity from any other bearing in the mill, in order to give its lowest coefficient of friction, and that slight variations in the condition of a particular bearing would change the requirements of that bearing; and further, that when nearing the "danger point" the question of viscosity alone probably does not govern.

The requirement of the New England Manufacturers' Association, that an oil shall not lose over 5% of its volume when heated to 140° Fahr. for 12 hours, is to prevent losses by evaporation, with the resultant effects.

The precipitation test gives no indication of the quality of the oil itself, as the free carbon in improperly manufactured oils can be easily removed. It is doubtful whether oil buyers who require certain given standards of laboratory tests are better served than those who do not. Some of the standards are so faulty that to pass them an oil manufacturer must supply oil he knows to be faulty; and the requirements of the best standards can generally be met by products that will give inferior results in actual service.

Penna. R. R. Specifications for Petroleum Products, 1900. — Five different grades of petroleum products will be used.

The materials desired under this specification are the products of the distillation and refining of petroleum unmixed with any other substances.

150° Fire-test Oil. — This grade of oil will not be accepted if sample (1) is not "water-white" in color; (2) flashes below 130° Fahrenheit; (3) burns below 151° Fahrenheit; (4) is cloudy or shipment has cloudy barrels when received, from the presence of glue or suspended matter; (5) becomes opaque or shows cloud when the sample has been 10 minutes at a temperature of 0° Fahrenheit.

300° Fire-test Oil. — This grade of oil will not be accepted if sample (1) is not "water-white" in color; (2) flashes below 249° Fahrenheit; (3) burns below 298° Fahrenheit; (4) is cloudy or shipment has cloudy barrels when received, from the presence of glue or suspended matter; (5) becomes opaque or shows cloud when the sample has been 10 minutes at a temperature of 32° Fahrenheit; (6) shows precipitation when some of the sample is heated to 450° F. The precipitation test is made by having about two fluid ounces of the oil in a six-ounce beaker, with a thermometer suspended in the oil, and then heating slowly until the thermometer shows the required temperature. The oil changes color, but must show no precipitation.

Paraffine and Neutral Oils. — These grades of oil will not be accepted if the sample from shipment (1) is so dark in color that printing with long-primer type cannot be read with ordinary daylight through a layer of the oil 1/2 inch thick; (2) flashes below 298° F.; (3) has a gravity at 60° F., below 24° or above 35° Baumé; (4) from October 1st to May 1st has a cold test above 10° F., and from May 1st to October 1st has a cold test above 32° F.

The color test is made by having a layer of the oil of the prescribed thickness in a proper glass vessel, and then putting the printing on one side of the vessel and reading it through the layer of oil with the back of the observer toward the source of light.

Well Oil. — This grade of oil will not be accepted if the sample from shipment (1) flashes, from May 1st to October 1st, below 298° F., or from October 1st to May 1st, below 249° F.; (2) has a gravity at 60° F., below 28° or above 31° Baumé; (3) from October 1st to May 1st has a cold test above 10° F., and from May 1st to October 1st has a cold test above 32° F.; (4) shows any precipitation when 5 cubic centimeters are mixed with .5 c.c. of gasoline. The precipitation test is to exclude tarry and suspended matter. It is made by putting 95 c.c. of 88° B. gasoline, which must not be above 80° F. in temperature, into a 100 c.c. graduate, then adding the prescribed amount of oil and shaking thoroughly. Allow to stand ten minutes. With satisfactory oil no separated or precipitated material can be seen.

500° Fire-test Oil. — This grade of oil will not be accepted if sample from shipment (1) flashes below 494° F.; (2) shows precipitation with gasoline when tested as described for well oil.

Printed directions for determining flashing and burning tests and for making cold tests and taking gravity are furnished by the railroad company.

Penna. R. R. Specifications for Lubricating Oils (1894). (In force in 1902.)

Constituent Oils.	Parts by volume.								
	A	B	C ₁	C ₂	C ₃	D ₁	D ₂	D ₃	E
Extra lard-oil.....									1
Extra No. 1 lard-oil.....			1	1	1	1	1	1	1
500° fire-test oil.....	1	1	1	2	1	1	2	4	
Paraffine oil.....			4	2	1				
Well oil.....	1					4	2	1	
Used for.....	A	B	C ₁	C ₂	C ₃	D ₁	D ₂	D ₃	E

WARNING: This is a 1910 edition. Some of the material may no longer be accurate

A, freight cars; engine oil on shifting-engines; miscellaneous greasing in foundries, etc. B, cylinder lubricant on marine equipment and on stationary engines. C, engine oil; all engine machinery; engine and tender truck boxes; shafting and machine tools; bolt cutting; general lubrication except cars. D, passenger-car lubrication. E, cylinder lubricant for locomotives. C₁, D₁, for use in Dec., Jan., and Feb.; C₂, D₂, in March, April, May, Sept., Oct., and Nov.; C₃, D₃, in June, July, and August. Weights per gallon, A, 7.4 lbs.; B, C, D, E, 7.5 lbs.

Grease Lubricants. — Tests made on an Olsen lubricant testing machine at Cornell University are reported in *Power*, Nov. 9, 1909. It was found that some of the commercial greases stood much higher pressures than the oils tested, and that the coefficients of friction at moderate loads were often as low as those of the oils. The journal of the testing machine was 3 3/4 in. diam., 3 1/2 in. long, and the babbit bearing shoe had a projected area of 5.8 sq. in. The speed was 240 r.p.m. and each test lasted one hour, except when the bearing showed overheating. The following are the coefficients of friction obtained in the tests:

Lbs. per sq. in.	Min-eral Grease.	Ani-mal Grease.	Graph-ite Grease.	Min-eral Grease.	Engine Oil.	Engine Oil.	Grease.	Grease.
86.2	0.024	0.023	0.04	0.023	0.019	0.015	0.020	0.025
172.4	0.021	0.023	0.05	0.018	0.04	0.022	0.015	0.022
258.6	0.021	0.023	0.018	0.06	0.037	0.014	0.020
344.8	0.025	0.025	0.019	0.017	0.020
431.0	0.050	0.035	0.028	0.026	0.019

Testing Oil for Steam Turbines. (Robert Job, *Trans. Am. Soc. for Testing Mats.*, 1909.) —

In some types of steam-turbines, the bearings are very closely adjusted and, if the oil is not clear and free from waxy substances, clogging and heating quickly results. A number of red engine and turbine oils some of which had given good service and others bad service were tested and it was found that clearness and freedom from turbidity were of importance, but mere color, or lack of color, seemed to have little influence, and good service results were obtained with oils which were of a red color, as well as with those which were filtered to an amber color.

Heating Test. — It was found that on heating the oils to 450° F. all which had given bad service showed a marked darkening of color, while those which had proved satisfactory showed little change. With oils that had been filtered or else had been chemically treated in such manner that the so-called "amorphous waxes" had been completely removed, on applying the heating test only a slight darkening of color resulted. It is of advantage in addition to other requirements to specify that an oil for steam turbines on being heated to 450° F. for five minutes shall show not more than a slight darkening of color. The test is that commonly used in test of 300° oil for burning purposes.

Separating Test. — It is known that elimination of the waxes causes an increase in the ease with which the oil separates from hot water when thoroughly shaken with it. This condition can be taken advantage of by prescribing that when one ounce of the oil is placed in a 4-oz. bottle with two ounces of boiling water, the bottle corked and shaken hard for one minute and let stand, the oil must separate from the water within a specified time, depending upon the nature of the oil, and that there must be no appearance of waxy substances at the line of demarcation between the oil and the water.

Quantity of Oil needed to Run an Engine. — The Vacuum Oil Co. in 1892, in response to an inquiry as to cost of oil to run a 1000-H.P. Corliss engine, wrote: The cost of running two engines of equal size of the same make is not always the same. Therefore, while we could furnish figures showing what it is costing some of our customers having Corliss engines of 1000 H.P., we could only give a general idea, which in itself might be considerably out of the way as to the probable cost of cylinder- and engine-oils per year for a particular engine. Such an engine ought to

run readily on less than 8 drops of 600 W oil per minute. If 3000 drops are figured to the quart, and 8 drops used per minute, it would take about two and one half barrels (52.5 gallons) of 600 W cylinder-oil, at 65 cents per gallon, or about \$85 for cylinder-oil per year, running 3 days a week and 10 hours a day. Engine-oil would be even more difficult to guess at what the cost would be, because it would depend upon the number of cups required on the engine, which varies somewhat according to the style of the engine. It would doubtless be safe, however, to calculate at the outside that not more than twice as much engine-oil would be required as of cylinder-oil.

The Vacuum Oil Co. in 1892 published the following results of practice with "600 W" cylinder-oil:

Corliss compound engine,	{ 20 and 33 x 48; 83 revs. per min.; 1 drop of oil per min. to 1 drop in two minutes.
" triple exp. "	{ 20, 33, and 46 x 48; 1 drop every 2 minutes.
Porter-Allen "	{ 20 and 36 x 36; 143 revs. per min.; 2 drops of oil per min., reduced afterwards to 1 drop per min.
Ball "	{ 15 and 25 x 16; 240 revs. per min.; 1 drop every 4 minutes.

Results of tests on ocean-steamers communicated to the author by Prof. Denton in 1892 gave: for 1200-H.P. marine engine, 5 to 6 English gallons (6 to 7.2 U. S. gals.) of engine-oil per 24 hours for external lubrication; and for a 1500-H.P. marine engine, triple expansion, running 75 revs. per min., 6 to 7 English gals. per 24 hours. The cylinder-oil consumption is exceedingly variable, — from 1 to 4 gals. per day on different engines, including cylinder-oil used to swab the piston-rods.

Cylinder Lubrication. — J. H. Spoor, in *Power*, Jan. 4, 1910, has made a study of a great number of records of the amount of oil used for lubricating cylinders of different engines, and has reduced them to a systematic basis of the equivalent number of pints of oil used in a 10-hour day for different areas of surface lubricated. The surface is determined in square inches by multiplying the circumference of the cylinder by the length of stroke. The results are plotted in a series of curves for different types of engines, and approximate average figures taken from these curves are given below:

	Compound Engines.						
Sq. ins. lubricated	2,000	4,000	6,000	8,000	10,000	12,000	18,000
Pints of oil used in 10 hrs.	2	3.5	4.3	5	5.5	6	8.5
	Corliss Engines.						
Sq. ins. lubricated.....	1,000	2,000	3,000	4,000			
Pints of oil in 10 hrs. Avge.....	0.9	1.65	2.25	3.75			
Max.....	1.2	2.25					
Min.....	—	1.00	—	—			

Automatic high-speed engines, about 2 pints per 1,000 sq. in.
Simple slide-valve engines, about 0.5 pints per 1,000 sq. ins.

As shown in the figures under 2,000. Corliss, a certain engine may take 2 1/4 times as much oil as another engine of the same size. The difference may be due to smoothness of cylinder surface, kind and pressure of piston rings, quality of oil, method of introducing the lubricant, etc. Variations in speed of a given type of engine and in steam pressure do not appear to make much difference, but the small automatic high-speed engine takes more oil than any other type. Vertical marine engines are commonly run without any cylinder oil, except that used occasionally to swab the piston rods.

Quantity of Oil used on a Locomotive Crank-pin. — Prof. Denton, *Trans. A. S. M. E.*, xi, 1920, says: A very economical case of practical oil-consumption is when a locomotive main crank-pin consumes about six cubic inches of oil in a thousand miles of service. This is equivalent to a consumption of one milligram to seventy square inches of surface rubbed over.

Soda Mixture for Machine Tools. (Penna. R. R. 1894.) — Dissolve 5 lbs. of common sal-soda in 40 gallons of water and stir thoroughly. When needed for use mix a gallon of this solution with about a pint of engine oil. Used for the cutting parts of machine tools instead of oil.

Water as a Lubricant. (C. W. Naylor, *Trans. A. S. M. E.*, 1905.) — Two steel jack-shafts 18 ft. long with bearings 5 x 14 ins. each receiving 175 H.P. from engines and driving 5 electric generators, with six belts all pulling horizontally on the same side of the shaft, gave trouble by heating when lubricated with oil or grease. Water was substituted, and the shafts ran for 11 years, 10 hours a day, without serious interruption. Oil was fed to the shaft before closing down for the night, to prevent rusting. The wear of the babbitted bearings in 11 years was about 1/4 in., and of the shaft nil.

Acheson's "Deflocculated" Graphite. (*Trans. A. I. E. E.*, 1907; *Eng. News*, Aug. 1, 1907.) — In 1906, Mr. E. G. Acheson discovered a process of producing a fine, pure, unctuous graphite in the electric furnace. He calls it deflocculated graphite. By treating this graphite in the disintegrated form with a water solution of tannin, the amount of tannin being from 3% to 6% of the weight of the graphite treated, he found that it would be retained in suspension in water, and that it was in such a fine state of subdivision that a large part of it would run through the finest filter paper, the filtrate being an intensely black liquid in which the graphite would remain suspended for months. The addition of a minute quantity of hydrochloric acid causes the graphite to flocculate and group together so that it will no longer flow through filter paper. The same effect has been obtained with alumina, clay, lampblack and siloxicon, by treatment with tannin. The graphite thus suspended in water, known as "aquedag," has been successfully used as a lubricant for journals with sight-feed and with chain-feed oilers. It also prevents rust in iron and steel. The deflocculated graphite has also been suspended in oil, in a dehydrated condition, making an excellent lubricant known as "oildag." Tests by Prof. C. H. Benjamin of oil with 0.5% of graphite showed that it had a lower coefficient of friction than the oil alone.

SOLID LUBRICANTS.

Graphite in a condition of powder and used as a solid lubricant, so called, to distinguish it from a liquid lubricant, has been found to do well where the latter has failed.

Rennie, in 1829, says: "Graphite lessened friction in all cases where it was used." General Morin, at a later date, concluded from experiments that it could be used with advantage under heavy pressures; and Prof. Thurston found it well adapted for use under both light and heavy pressures when mixed with certain oils. It is especially valuable to prevent abrasion and cutting under heavy loads and at low velocities.

For comparative tests of various oils with and without graphite, see paper on lubrication and lubricants, by C. F. Mabery, *Jour. A. S. M. E.*, Feb., 1910.

*Soapstone, also called talc and steatite, in the form of powder and mixed with oil or fat, is sometimes used as a lubricant. Graphite or soapstone, mixed with soap, is used on surfaces of wood working against either iron or wood.

Metalline is a solid compound, usually containing graphite, made in the form of small cylinders which are fitted permanently into holes drilled in the surface of the bearing. The bearing thus fitted runs without any other lubrication.

To every pound of fuel on the bed, three, and sometimes four pounds of metal can be added with safety, if the cupola has proper blast; in after-charges, to every pound of fuel add 8 to 10 pounds of metal; any well-constructed cupola will stand ten.

F. P. Wolcott (*Am. Mach.*, Mar. 5, 1891) gives the following as the practice of the Corwell Iron-works, Carteret, N. J.: "We melt daily from twenty to forty tons of iron, with an average of 11.2 pounds of iron to one of fuel. In a 36-in. cupola seven to nine pounds is good melting, but in a cupola that lines up 48 to 60 inches, anything less than nine pounds shows a defect in arrangement of tuyeres or strength of blast, or in charging up."

"The Molder's Text-book," by Thos. D. West, gives forty-six reports in tabular form of cupola practice in thirty States, reaching from Maine to Oregon.

Improvement of Cupola Practice. — The following records are given by J. R. Fortune and H. S. Wells (*Proc. A. S. M. E.*, Mar., 1908) showing how ordinary cupola practice may be improved by making a few changes. The cupola is 13 ft. 4 in. in height from the top of the sand bottom to the charging door, and of three diameters, 50 in. for the first 3 ft. 6 in., then 54 in. for the next 2 ft. 4 in., then 60 in. to the top. When driven with a No. 8 Sturtevant blower, the maximum melting rate, from iron down to blast off, was 8.5 tons per hour. A No. 11 high-pressure blower was then installed. Test No. 1 in the table below gives the result with cupola charges as follows in pounds: Bed, 590 coke, followed by 826 coke, 2000 iron; 400 coke, 2000 iron; 300 coke, 2000 iron; and thereafter all charges were 200 coke, 2000 iron. The time between starting fire and starting blast was 2 hr. 30 min., and the time from blast on to iron down, 11 min. The melting rate, tons per hour, is figured for the time from iron down to blast off. The tuyeres were eight rectangular openings 1 1/4 in. high and of a total area of 1/9.02 of the area of the 54-in. circle.

No. of Test.	1	2	3	4	5	6	7	8	9	10
Total tons...	22.7	24.	22.15	24.25	24.25	22.65	24.	20.30	23.85	22.35
Tons per hr..	9.45	8.88	8.86	9.15	9.66	10.24	10.43	10.91	11.35	11.17
Lbs. per min*†	19.81	18.61	18.55	19.17	20.25	21.44	21.82	22.95	23.77	23.39
Iron ÷ coke†	7.54	7.40	7.28	8.58	8.94	8.71	9.02	9.07	10.02	9.49
Blast, oz.....	11.60	10.63	10.00	9.47	9.80	9.86	10.00	10.13	10.55	10.55

* Per sq. ft. cupola area at 54 in. diam. from iron down to blast off.
† Including bed.

The tuyeres were then enlarged, making their area 1/5.98 of the cupola (54 in.) area, and the results are shown in tests No. 2 and 3 of the table. The iron was too hot, and the coke charge was decreased to a ratio of 1/13.33 instead of 1/10, the bed of coke being increased. The result, test No. 4, was an increased rate of melting, a decrease in the amount of coke, and a decrease in the blast pressure. Tests 5, 6, 7, 8 and 9 were then made, the coke being decreased, while the blast pressure was increased, resulting in a decided increase in the melting speed. In tests 5, 6 and 7 the iron layer was 13.33 times the weight of the coke layer; in test 8, 14.28 times; and in test 9, 15.38 times. In test 9 it was noticed that the iron was not at the proper temperature, and in test 10 the coke layer was increased to a ratio of 1 to 14.28 without altering the blast pressure; this resulted in a decreased melt per hour. It has been found that a coke charge of 150 lbs. to 2000 lbs. of iron, with a blast pressure of 10.5 ounces, results in a melt of 11.5 tons per hour, the iron coming down at the proper temperature.

An excess of coke decreases the melting rate. Iron in the cupola is melted in a fixed zone, the first charge of iron above the bed being melted by burning coke in the bed. As this iron is melted, the charge of coke above it descends and restores to the bed the amount which has been burned away. If there is too much coke in the charge, the iron is held above the melting zone, and the excess coke must be burned away before it can be melted, and this of course decreases the economy and the melting speed.

Cupola Charges in Stove-foundries. (*Iron Age*, April 10, 1892.) — No two cupolas are charged exactly the same. The amount of fuel on the bed or between the charges differs, while varying amounts of iron are used in the charges. Below will be found charging-lists from some of the prominent stove-foundries in the country:

A—Bed of fuel, coke.....	1,500 lbs.	Four next charges of coke, each.....	150 lbs.
First charge of iron.....	5,000	Six next charges of coke, each.....	120
All other charges of iron....	1,000	Nineteen next charges of coke, each.....	100
First and second charges of coke, each.....	200		

Thus for a melt of 18 tons there would be 5120 lbs. of coke used, giving a ratio of 7 to 1. Increase the amount of iron melted to 24 tons, and a ratio of 8 pounds of iron to 1 of coal is obtained.

B—Bed of fuel, coke.....	1,600 lbs.	Second and third charges of fuel.....	130 lbs.
First charge of iron.....	1,800	All other charges of fuel, each.....	100
First charge of fuel.....	150		
All other charges of iron, each.....	1,000		

For an 18-ton melt 5060 lbs. of coke would be necessary, giving a ratio of 7.1 lbs. of iron to 1 pound of coke.

C—Bed of fuel, coke.....	1,600 lbs.	All other charges of iron.....	2,000 lbs.
First charge of iron.....	4,000	All other charges of coke.....	150
First and second charges of coke.....	200		

In a melt of 18 tons 4100 lbs. of coke would be used, or a ratio of 8.5 to 1.

D—Bed of fuel, coke.....	1,800 lbs.	All charges of coke, each.....	200 lbs.
First charge of iron.....	5,600	All other charges of iron.....	2,900

In a melt of 18 tons, 3900 lbs. of fuel would be used, giving a ratio of 9.4 pounds of iron to 1 of coke. Very high, indeed, for stove-plate.

E—Bed of fuel, coal.....	1,900 lbs.	All other charges of iron, each.....	2,000 lbs.
First charge of iron.....	5,000	All other charges of coal, each.....	175
First charge of coal.....	200		

In a melt of 18 tons 4700 lbs. of coal would be used, giving a ratio of 7.7 lbs. of iron to 1 lb. of coal.

These are sufficient to demonstrate the varying practices existing among different stove-foundries. In all these places the iron was proper for stove-plate purposes, and apparently there was little or no difference in the kind of work in the sand at the different foundries.

Foundry Blower Practice. (W. B. Snow, *Trans. A. S. M. E.*, 1907.) — The velocity of air produced by a blower is expressed by the formula $V = \sqrt{2gp/d}$. If p , the pressure, is taken in ounces per sq. in., and d , the density, in pounds per cu. ft. of dry air at 50° and atmospheric pressure of 14.69 lbs. or 235 ounces, = 0.77884 lb., the formula reduces to $V = \sqrt{1,746,700 p / (235 + p)}$, no allowance being made for change of temperature during discharge. From this formula the following figures are obtained. Q = volume discharged per min. through an orifice of 1 sq. ft. effective area, H.P. = horse-power required to move the given volume under the given conditions, p = pressure in ounces per sq. in.

p	Q	H.P.	p	Q	H.P.	p	Q	H.P.	p	Q	H.P.
1	35.85	0.00978	6	86.89	0.1422	11	116.45	0.3493	16	139.03	0.6067
2	50.59	0.02759	7	93.66	0.1788	12	121.38	0.3972	17	143.03	0.6631
3	61.83	0.05058	8	99.92	0.2180	13	126.06	0.4470	18	146.88	0.7211
4	71.24	0.07771	9	105.76	0.2596	14	130.57	0.4986	19	150.61	0.7804
5	79.48	0.1084	10	111.25	0.3034	15	134.89	0.5518	20	154.22	0.8412

The greatest effective area over which a fan will maintain the maximum velocity of discharge is known as the "capacity area" or "square inches of blast." As originally established by Sturtevant it is represented by $DW/3$, D = diam. of wheel in ins., W = width of wheel at circumference,

in inches. For the ordinary type of fan at constant speed maximum efficiency and power are secured at or near the capacity area; the power per unit of volume and the pressure decrease as the discharge area and volume increase; with closed outlet the power is approximately one-third of that at capacity area.

The following table is calculated on these bases: Capacity area per inch of width at periphery of wheel = 1/3 of diam. Air, 50° F. Velocity of discharge = circumferential speed of the wheel. Power = double the theoretical. In rotary positive blowers, as well as in fans, the velocity and the volume vary as the number of revolutions, the pressure varies as the square, and the power as the cube of the number of revolutions. In the fan, however, increase of pressure can be had only by increasing the revolutions, while in the rotary blower a great range of pressure is obtainable with constant speed by merely varying the resistance. With a rotary blower at constant speed, theoretically, and disregarding the effect of changes in temperature and density, the volume is constant; the velocity varies inversely as the effective outlet area; the pressure varies inversely as the square of the outlet area, hence as the square of the velocity; and the power varies directly as the pressure. The maximum power is required when a fan discharges against the least, and when a rotary blower discharges against the greatest resistance.

PERFORMANCE OF CUPOLA FAN BLOWERS AT CAPACITY AREA PER INCH OF PERIPHERAL WIDTH.

Diam. of Wheel, ins.	Item.	Total Pressure in Ounces per Square Inch.										
		6	7	8	9	10	11	12	13	14	15	16
18	r.p.m.	2660.0	2860.0	3050.0	3230.0	3400.0	3560.0	3710.0	3850.0	3990.0	4120.0	4250.0
	cu. ft.	520.0	560.0	600.0	640.0	670.0	700.0	730.0	760.0	780.0	810.0	830.0
	h.p.	1.7	2.1	2.6	3.1	3.6	4.2	4.8	5.4	6.0	6.6	7.3
24	r.p.m.	2000.0	2150.0	2290.0	2420.0	2550.0	2670.0	2780.0	2890.0	2990.0	3090.0	3190.0
	cu. ft.	700.0	750.0	800.0	850.0	890.0	930.0	970.0	1010.0	1040.0	1080.0	1110.0
	h.p.	2.3	2.9	3.5	4.2	4.9	5.6	6.4	7.1	8.0	8.8	9.7
30	r.p.m.	1590.0	1720.0	1830.0	1940.0	2040.0	2140.0	2230.0	2310.0	2390.0	2470.0	2550.0
	cu. ft.	870.0	940.0	1000.0	1060.0	1110.0	1160.0	1210.0	1260.0	1310.0	1350.0	1390.0
	h.p.	2.8	3.6	4.4	5.2	6.1	7.0	7.9	8.9	10.0	11.0	12.1
36	r.p.m.	1330.0	1430.0	1530.0	1620.0	1700.0	1780.0	1850.0	1930.0	2000.0	2060.0	2120.0
	cu. ft.	1040.0	1120.0	1200.0	1270.0	1340.0	1400.0	1460.0	1510.0	1570.0	1620.0	1670.0
	h.p.	3.4	4.3	5.2	6.2	7.3	8.4	9.5	10.7	11.9	13.2	14.5
42	r.p.m.	1140.0	1230.0	1310.0	1380.0	1460.0	1530.0	1590.0	1650.0	1710.0	1770.0	1820.0
	cu. ft.	1220.0	1310.0	1400.0	1480.0	1560.0	1630.0	1700.0	1770.0	1830.0	1890.0	1950.0
	h.p.	3.9	5.0	6.1	7.3	8.5	9.8	11.1	12.5	13.9	15.4	17.0
48	r.p.m.	1000.0	1070.0	1150.0	1210.0	1270.0	1330.0	1390.0	1450.0	1500.0	1550.0	1590.0
	cu. ft.	1390.0	1500.0	1600.0	1690.0	1780.0	1860.0	1940.0	2020.0	2090.0	2160.0	2230.0
	h.p.	4.5	5.7	7.0	8.3	9.7	11.2	12.7	14.3	15.9	17.7	21.0

The air supply required by a cupola varies with the melting ratio, the density of the charges, and the incidental leakage. Average practice is represented by the following:

Lbs. iron per lb. coke	6	7	8	9	10
Cu. ft. air per ton of iron	33,000	31,000	29,000	27,000	25,000

It is customary to provide blower capacity on a basis of 30,000 cu. ft., which corresponds to 75 to 80% of the chemical requirements for complete combustion with average coke, and a melting ratio of 7.5 to 1.

In comparative tests with a 54-inch lining cupola under identical conditions as to contents, alternately run with a No. 10 Sturtevant fan and a 33 cu. ft. Connersville rotary, with the fan the pressure varied between 12 1/2 and 14 1/8 ounces in the wind box, the net power from 25 to 38.5 H.P., while with the rotary blower the pressure varied between 10 1/2 and 25 ounces, and the power between 19 and 45 H.P. With the fan 28.84 tons

were melted in 3.77 hours, or 7.65 tons per hour, while with the rotary blower 2.82 hours were required to melt 31.5 tons, an hourly rate of 19.6 tons, an increase of nearly 40 per cent in output. This reduces to a net input of 4.09 H.P. per ton melted per hour with the fan, and 2.98 H.P. with the rotary blower; an apparent advantage of 27% in favor of the rotary. Had the rotary been of smaller capacity such excessive pressures would not have been necessary, the power would have been decreased, and the duration of the heat prolonged, with probable decrease in the H.P. hours per ton. Had the fan been run at higher speed the H.P. would have increased, the time decreased and the power per ton per hour would have more closely approached that required by the rotary blower.

Theoretically, for otherwise constant conditions, the following relations hold for cupolas and melting rates within the range of practical operation:

For a given cupola: For a given melting rate: For a given volume: For a given cupola

$$M \propto V, \sqrt{P}, \text{ or } \sqrt[3]{\text{H.P.}}$$

$$V \propto M$$

$$P \propto V^2$$

$$\text{H.P.} \propto M^3 \text{ or } \sqrt{P^3}$$

$$V \propto 1 \div D^2$$

$$P \propto d$$

$$\text{H.P.} \propto P \text{ or } 1 \div D^4$$

$$E \propto M, P, \text{ or } 1 \div D^4$$

$$M \propto D$$

$$E \propto M^2, \text{ or } P$$

$$\text{Duration of heat} \propto 1 \div \sqrt{P}$$

M = melting rate; V = volume; P = pressure; H.P. = horse-power; D = diam. of lining; E = operating efficiency = power per ton per hour; d = depth of the charge; α, varies as.

These relations might be the source of formulae for practical use were it possible to establish accurate coefficients. But the variety in cupolas, tuyere proportions, character of fuel and iron, and difference in charging practice are bewildering and discouraging. Maximum efficiency in a given case can only be assured after direct experiment. Something short of the maximum is usually accepted in ignorance of the ultimate possibilities.

The actual melting range of a cupola is ordinarily between 0.6 and 0.75 ton per hour per sq. ft. of cross section. The limits of air supply per minute per sq. ft. are roughly 2500 and 4000 cu. ft. The possible power required varies even more widely, ranging from 1.5 to 3.75 H.P. per sq. ft., corresponding to 2.5 and 5 H.P. per ton per hour for the melting rates specified. The power may be roughly calculated, from the theoretical requirement of 0.27 H.P. to deliver 1000 cu. ft. per minute against 1 oz. pressure. The power increases directly with the pressure, and depends also on the efficiency of the blower. Current practice can only be expressed between limits as in the following table.

RANGE OF PERFORMANCE OF CUPOLA BLOWERS.

Diameter inside Lining, in.	Capacity per Hour, tons.	Pressure per sq. in., oz.	Volume of Air per min., cu. ft.	Horse-power.
18	0.25-0.5	5-7	150-300	0.5-1.5
24	1.00-1.5	7-9	600-900	2.0-6.0
30	2.00-3.5	8-11	1,200-2,000	5.0-15.0
36	4.00-5.0	8-12	2,200-2,800	10.0-23.0
42	5.00-7.0	8-13	2,700-3,700	12.0-32.0
48	8.00-10.0	8-13	4,000-5,000	18.0-45.0
54	9.00-12.0	9-14	4,500-6,000	22.0-60.0
60	12.00-15.0	9-14	6,000-7,500	30.0-75.0
66	14.00-18.0	9-15	7,000-9,000	35.0-90.0
72	17.00-21.0	10-15	8,500-10,500	45.0-110.0
78	19.00-24.0	10-16	9,500-12,000	52.0-130.0
84	21.00-27.0	10-16	10,500-13,500	60.0-150.0

Results of Increased Driving. (Erie City Iron-works, 1891.)— May-Dec., 1890: 60-in. cupola, 100 tons clean castings a week, melting 8 tons per hour; iron per pound of fuel, 7 1/2 lbs.; per cent weight of good castings to iron charged, 75 3/4. Jan.-May, 1891: Increased rate of melting to 11 1/2 tons per hour; iron per lb. fuel, 9 1/2; per cent weight of good castings, 75; one week, 13 1/4 tons per hour, 10.5 lbs. iron per lb. fuel; per cent weight of good castings, 75.3. The increase was made by putting in an additional row of tuyeres and using stronger blast, 14 ounces. Coke was used as fuel. (W. O. Webber, Trans. A. S. M. E., xii, 1045.)

Power Required for a Cupola Fan. (Thos. D. West, *The Foundry*, April, 1904.) — The power required when a fan is connected with a cupola depends on the length and diameter of the piping, the number of bends, valves, etc., and on the resistance to the passage of blast through the cupola. The approximate power required in everyday practice is the difference between the power required to run the fan with the outlet open and with it closed. A better rule is to take 75% of the maximum power or that with the outlet open. A fan driving a cupola 66 ins. diam., 1800 r.p.m., driven by an electric motor required horse-power and gave pressures as follows: Outlet open, 146.6; outlet closed, 37.2, pressure 15 oz.; attached to cupola, with no fuel in it, 120.5, 5 oz.; after kindling and coke had been fired, 101.0, 10 oz.; during the run 70.8 to 76.7, 11 to 13 oz., the variations being due to changes in the resistances to the passage of the blast.

Utilization of Cupola Gases. — Jules De Clercy, in a paper read before the Amer. Foundrymen's Assn., advises the return of a portion of the gases from the upper part of the charge to the tuyeres, and thus utilizing the carbon monoxide they contain. He says that A. Baillet has thereby succeeded in melting 15 lbs. of iron per lb. of coke, and at the same time obtained a greater melting speed and a superior quality of castings.

Loss in Melting Iron in Cupolas. — G. O. Vair, *Am. Mach.*, March 5, 1891, gives a record of a 45-in. Colliau cupola as follows:

Ratio of fuel to iron, 1 to 7.42.	
Good castings.....	21,314 lbs.
New scrap.....	3,005 "
Millings.....	200 "
Loss of metal.....	1,481 "

Amount melted..... 26,000 lbs.
Loss of metal, 5.69%. Ratio of loss, 1 to 17.55.

Use of Softeners in Foundry Practice. (W. Graham, *Iron Age*, June 27, 1889.) — In the foundry the problem is to have the right proportions of combined and graphitic carbon in the resulting casting; this is done by getting the proper proportion of silicon. The variations in the proportions of silicon afford a reliable and inexpensive means of producing a cast iron of any required mechanical character which is possible with the material employed. In this way, by mixing suitable irons in the right proportions, a required grade of casting can be made more cheaply than by using irons in which the necessary proportions are already found.

Hard irons, mottled and white irons, and even steel scrap, all containing low percentages of silicon and high percentages of combined carbon, could be employed if an iron having a large amount of silicon were mixed with them in sufficient amount. This would bring the silicon to the proper proportion and would cause the combined carbon to be forced into the graphitic state, and the resulting casting would be soft. High-silicon irons used in this way are called "softeners."

Mr. Keep found that more silicon is lost during the remelting of pig of over 10% silicon than in remelting pig iron of lower percentages of silicon. He also points out the possible disadvantage of using ferro-silicons containing as high a percentage of combined carbon as 0.70% to overcome the bad effects of combined carbon in other irons.

The Scotch irons generally contain much more phosphorus than is desired in irons to be employed in making the strongest castings. It is a mistake to mix with strong low-phosphorus irons an iron that would increase the amount of phosphorus for the sake of adding softening qualities, when softness can be produced by mixing irons of the same low phosphorus.

(For further discussion of the influence of silicon see pages 415 and 422.)

Weakness of Large Castings. (W. A. Bole, *Trans. A. S. M. E.*, 1907.) — Thin castings, by virtue of their more rapid cooling, are almost certain to be stronger per unit section than would be the case if the same metal were poured into larger and heavier shapes. Many large iron castings are of questionable strength, because of internal strains and lack of harmony between their elements, even though the casting is poured out of iron of the best quality. This may be due to lack of experience on the part of

the designer, especially in the cooling and shrinking of the various parts of a large casting after being poured.

Castings are often designed with a useless multiplicity of ribs, walls, gussets, brackets, etc., which, by their asynchronous cooling and their inharmonious shrinkage and contraction, may entirely defeat the intention of the designer.

There are some castings which, by virtue of their shapes, can be specially treated by the foundryman, and artificial cooling of certain critical parts may be effected in order to compel such parts to cool more rapidly than they would naturally do, and the strength of the casting may by such means be beneficially affected. As for instance in the case of a fly-wheel with heavy rim but comparatively light arms and hub; it may be beneficial to remove the flask and expose the rim to the air so as to hasten its natural rate of cooling, while the arms and hub are still kept muffled up in the sand of the mold and their cooling retarded as much as possible.

Large fillets are often highly detrimental to good results. Where two walls meet and intersect, as in the shape of a T if a large fillet is swept at the juncture, there will be a pool of liquid metal at this point which will remain liquid for a longer time than either wall, the result being a void, or "draw," at the juncture point.

Risers and sink heads should often be employed on iron castings. In large iron-foundry work interior cavities may exist without detection, and some of these may be avoided by the use of suitable feeding devices, risers and sink heads.

Specimens from a casting having at one point a tensile strength as high as 30,250 lbs. per sq. in. have shown as low as 20,500 in another and heavier section. Large sections cannot be cast to yield the high strength of specimen test pieces cast in smaller sections.

The paper describes a successful method of artificial cooling, by means of a coil of pipe with flowing water, of portions of molds containing cylinder heads with ports cast in them. Before adopting this method the internal ribs in these castings always cracked by contraction.

Shrinkage of Castings. — The allowance necessary for shrinkage varies for different kinds of metal, and the different conditions under which they are cast. For castings where the thickness runs about one inch, cast under ordinary conditions, the following allowance can be made:

For cast iron, 1/8 inch per foot.	For zinc, 5/16 inch per foot.
" brass, 3/16 " " " "	" tin, 1/12 " " "
" steel, 1/4 " " " "	" aluminum, 3/16 " " "
" mal. iron, 1/8 " " " "	" britannia, 1/32 " " "

Thicker castings, under the same conditions, will shrink less, and thinner ones more, than this standard. The quality of the material and the manner of molding and cooling will also make a difference. (See also Shrinkage of Cast Iron, page 423.)

Mr. Keep (*Trans. A. S. M. E.*, vol. xvi) gives the following "approximate key for regulating foundry mixtures" so as to produce a shrinkage of 1/8 in. per ft. in castings of different sections:

Size of casting.....	1/2	1	2	3	4 in. sq.
Silicon required, per cent.....	3.25	2.75	2.25	1.75	1.25 per cent.
Shrinkage of a 1/2-in. test-bar..	0.125	.135	.145	.155	.165 in per. ft.

Growth of Cast Iron by Heating. (*Proc. I. and S. Inst.*, 1909.) — Investigations by Profs. Rugan and Carpenter confirm Mr. Outerbridge's experiments. (See page 425.) They found: 1. Heating white iron causes it to become gray, and it expands more than sufficient to overcome the original shrinkage. 2. Iron when heated increases in weight, probably due to absorption of oxygen. 3. The change in size due to heating is not only a molecular change, but also a chemical one. 4. The growth of one bar was shown to be due to penetration of gases. When heated in vacuo it contracted.

Hard Iron due to Excessive Silicon. — W. J. Keep in *Jour. Am. Foundrymen's Assn.*, Feb., 1898, reports a case of hard iron containing graphite, 3.04; combined C, 0.10; Si, 3.97; P, 0.61; S, 0.05; Mn, 0.56. He says: For stove plate and light hardware castings it is an advantage to have Si as high as 3.50. When it is much above that the surface of the castings often become very hard, though the center will be very soft.

The surface of heavier parts of a casting having 3.97 Si will be harder than the surface of thinner parts. Ordinarily if a casting is hard an increase of silicon softens it, but after reaching 3.00 or 3.50 per cent, silicon hardens a casting.

Ferro-Alloys for Foundry Use. E. Houghton (*Iron Tr. Rev.*, Oct. 24, 1907.) — The objects of the use of ferro-alloys in the foundry are: 1, to act as deoxidizers and desulphurizers, the added element remaining only in small quantities in the finished casting; 2, to alter the composition of the casting and so to control its mechanical properties. Some of these alloys are made in the blast furnace, but the purest grades are made in the electric furnace. The following table shows the range of composition of blast furnace alloys made by the Darwen & Mostyn Iron Co. All of these alloys may be made of purer quality in the electric furnace.

	Ferro-Mn.	Spiegel-eisen.	Silicon Spiegel.	Ferr-sil.	Ferro-phos.	Ferro-Chrome.
Mn.....	41.5- 87.9	9.25-29.75	17.50-20.87	1.17- 2.20	3.00- 5.90	1.55- 2.30
Si.....	0.10- 0.63	0.42- 0.95	9.45-14.23	8.10-17.00	0.50- 0.84	0.13- 0.36
P.....	0.09- 0.20	0.06- 0.09	0.07- 0.10	0.06- 0.08	15.71-20.50	0.04- 0.07
C.....	5.62- 7.00	3.94- 5.20	1.05- 1.89	0.90- 1.75	0.27- 0.30	5.34- 7.12
S.....	nil	nil-trace	nil	0.02- 0.05	0.16- 0.33	Cr, 13.50-41.39

The following are typical analyses of other alloys made in the electric furnace:

	Si	Fe	Mn	Al	Ca	Mg	C	S	P	Ti
Ferro-titanium.....	1.21	0.30	3.28	0.03	0.02	53.0
Ferro-aluminum-silicide.....	45.65	44.15	tr.	9.45	nil	nil	0.55	0.01	0.03
Ferro-calcium-silicide.....	69.80	11.15	0.22	2.55	15.05	0.26	1.14	0.01	0.04

Ferro-aluminum, Al, 5, 10 and 20%. Metallic manganese, Mn, 95 to 98; Fe, 2 to 4; C, under 5. Do. refined, Mn, 99; Fe, 1; C, 0.

Dangerous Ferro-silicon. — Phosphoretted and arseniuretted hydrogen, highly poisonous gases, are said to be disengaged in a humid atmosphere from ferro-silicon containing between 30 and 40% and between 47 and 65% of Si, and there is therefore danger in transporting it in passenger steamships. A French commission has recommended the abandonment of the manufacture of FeSi of these critical percentages. (*La Lumiere Electrique*, Dec. 11, 1909. *Elec. Rev.*, Feb. 26, 1910.)

Quality of Foundry Coke. (R. Moldenke, *Trans. A. S. M. E.*, 1907.) — Usually the sulphur, ash and fixed carbon are sufficient to give a fair idea of the value of coke, apart from its physical structure, specific gravity, etc. The advent of by-product coke will necessitate closer attention to moisture. Beehive coke, when shipped in open cars, may, through inattention, cause the purchase of from 6 to 10 per cent of water at coke prices.

Concerning sulphur, very hot running of the cupola results in less sulphur in the iron. In good coke, the amount of S should not exceed 1.2 per cent; but, unfortunately, the percentage often runs high as 2.00. If the coke has a good structure, an average specific gravity, not over 11 per cent of ash and over 86 per cent of fixed carbon, it does not matter much whether it be of the "72 hour" or "24 hour" variety. Departure from the normal composition of a coke of any particular region should place the foundryman on his guard at once, and sometimes the plentiful use of limestone at the right moment may save many castings.

Castings made in Permanent Cast-Iron Molds. — E. A. Custer, in a paper before the Am. Foundrymen's Assn. (*Eng. News*, May 27, 1909), describes the method of making castings in iron molds, and the quality of these castings. Very heavy molds are used, no provision is made against shrinkage, and the casting is removed from the mold as soon as it has set, giving it no time to chill or to shrink by cooling. Over 6000 pieces have been cast in a single mold without its showing any signs of

failure. The mold should be so heavy that it will not become highly heated in use. Casting a 4-in. pipe weighing 65 lbs. every seven minutes in a mold weighing 6500 lbs. did not raise the temperature above 300° F. In using permanent molds the iron as it comes from the cupola should be very hot. The best results in casting pipe are had with iron containing over 3% carbon and about 2% silicon. Iron when cast in an iron mold and removed as soon as it sets, possesses some unusual properties. It will take a temper, and when tempered will retain magnetism. If the casting be taken from the mold at a bright heat and suddenly quenched in cold water, it has the cutting power of a good high-carbon steel, whether the iron be high or low in silicon, phosphorus, sulphur or manganese. There is no evidence of "chill"; no white crystals are shown.

Chilling molten iron swiftly to the point of setting, and then allowing it to cool gradually, produces a metal that is entirely new to the art. It has the chemical characteristics of cast iron, with the exception of combined carbon, and it also possesses some of the properties of high-carbon steel. A piece of cast iron that has 0.44% combined, and over 2% free carbon, has been tempered repeatedly and will do better service in a lathe than a good non-alloy steel. Once this peculiar property is imparted to the casting, it is impossible to eliminate it except by remelting. A bar of iron so treated can be held in a flame until the metal drips from the end, and yet quenching will restore it to its original hardness.

The character of the iron before being quenched is very fine, close-grained, and yet it is easily machined. If permanent molds can be used with success in the foundry, and a system of continuous pouring be inaugurated which in duplicate work would obviate the necessity of having molders, why is it necessary to melt pig iron in the cupola? What could be more ideal than a series of permanent molds supplied with molten iron practically direct from the blast furnace? The interposition of a reheating ladle such as is used by the steel makers makes possible the treatment of the molten iron.

The molten iron from the blast furnace is much hotter than that obtained from the cupola, so that there is every reason to believe that the castings obtained from a blast furnace would be of a better quality than when the pig is remelted in the cupola.

It is immaterial whether an iron contains 1.75 or 3% silicon, so long as the molten mass is at the proper temperature, so that the high temperatures obtained from the blast furnace would go far toward offsetting the variations in the impurities.

R. H. Probert (*Castings*, July, 1909) gives the following analysis of molds which gave the best results: Si, 2.02; S, 0.07; P, 0.89; Mn, 0.29; C.C., 0.84; G.C., 2.76. Molds made from iron with the following analysis were worthless: Si, 3.30; S, 0.06; P, 0.67; Mn, 0.12; C.C., 0.19; G.C., 2.98.

Weight of Castings determined from Weight of Pattern.
(Rose's Pattern-makers' Assistant.)

A Pattern weighing One Pound, made of —	Will weigh when cast in				
	Cast Iron.	Zinc.	Copper.	Yellow Brass.	Gun metal.
	lbs.	lbs.	lbs.	lbs.	lbs.
Mahogany—Nassau.....	10.7	10.4	12.8	12.2	12.5
" Honduras.....	12.9	12.7	15.3	14.6	15.
" Spanish.....	8.5	8.2	10.1	9.7	9.9
Pine, red.....	12.5	12.1	14.9	14.2	14.6
" white.....	16.7	16.1	19.8	19.0	19.5
" yellow.....	14.1	13.6	16.7	16.0	16.5

Molding Sand. (Walter Bagshaw, *Proc. Inst. M. E.*, 1891.) — The chemical composition of sand will affect the nature of the casting, no matter what treatment it undergoes. Stated generally, good sand is composed of 94 parts silica, 5 parts alumina, and traces of magnesia and oxide of iron. Sand containing much of the metallic oxides, and especially

lime, is to be avoided. Geographical position is the chief factor governing the selection of sand; and whether weak or strong, its deficiencies are made up for by the skill of the molder. For this reason the same sand is often used for both heavy and light castings, the proportion of coal varying according to the nature of the casting. A common mixture of facing-sand consists of six parts by weight of old sand, four of new sand, and one of coal-dust. Floor-sand requires only half the above proportions of new sand and coal-dust to renew it. German founders adopt one part by measure of new sand to two of old sand; to which is added coal-dust in the proportion of one-tenth of the bulk for large castings, and one-twentieth for small castings. A few founders mix street-sweepings with the coal in order to get porosity when the metal in the mold is likely to be a long time in setting. Plumbago is effective in preventing destruction of the sand; but owing to its refractory nature, it must not be dusted on in such quantities as to close the pores and prevent free exit of the gases. Powdered French chalk, soapstone, and other substances are sometimes used for facing the mold; but next to plumbago, oak charcoal takes the best place, notwithstanding its liability to float occasionally and give a rough casting.

For the treatment of sand in the molding-shop the most primitive method is that of hand-riddling and treading. Here the materials are roughly proportioned by volume, and riddled over an iron plate in a flat heap, where the mixture is trodden into a cake by stamping with the feet; it is turned over with the shovel, and the process repeated. Tough sand can be obtained in this manner, its toughness being usually tested by squeezing a handful into a ball and then breaking it; but the process is slow and tedious. Other things being equal, the chief characteristics of a good molding-sand are toughness and porosity, qualities that depend on the manner of mixing as well as on uniform ramming.

Toughness of Sand. — In order to test the relative toughness, sand mixed in various ways was pressed under a uniform load into bars 1 in. sq. and about 12 in. long, and each bar was made to project further and further over the edge of a table until its end broke off by its own weight. Old sand from the shop floor had very irregular cohesion, breaking at all lengths of projections from 1/2 in. to 1 1/2 in. New sand in its natural state held together until an overhang of 2 3/4 in. was reached. A mixture of old sand, new sand, and coal-dust

Mixed under rollers..... broke at 2 to 2 1/4 in. of overhang-
 in the centrifugal machine... " " 2 " 2 1/4 " " "
 " through a riddle..... " " 1 3/4 " 2 1/8 " " "

showing as a mean of the tests only slight differences between the last three methods, but in favor of machine-work. In many instances the fractures were so uneven that minute measurements were not taken.

Heinrich Ries (*Castings*, July, 1908) says that chemical analysis gives little or no information regarding the bonding power, texture, permeability or use of sand, the only case in which it is of value being in the selection of a highly silicious sand for certain work such as steel casting.

Dimensions of Foundry Ladles. — The following table gives the dimensions, inside the lining, of ladles from 25 lbs. to 16 tons capacity. All the ladles are supposed to have straight sides. (*Am. Mach.*, Aug. 4, 1892.)

Cap'y.	Diam.	Depth.	Cap'y.	Diam.	Depth.	Cap'y.	Diam.	Depth.
	in.	in.		in.	in.		in.	in.
16 tons	54	56	3 tons	31	32	300 lbs.	11 1/2	11 1/2
14 "	52	53	2 "	27	28	250 "	10 3/4	11
12 "	49	50	1 1/2 "	24 1/2	25	200 "	10	10 1/2
10 "	46	48	1 ton	22	22	150 "	9	9 1/2
8 "	43	44	3/4 "	20	20	100 "	8	8 1/2
6 "	39	40	1/2 "	17	17	75 "	7	7 1/2
4 "	34	35	1/4 "	13 1/2	13 1/2	50 "	6 1/2	6 1/2

THE MACHINE-SHOP.

SPEED OF CUTTING-TOOLS IN LATHES, MILLING MACHINES, ETC.

Relation of diameter of rotating tool or piece, number of revolutions and cutting-speed:

Let d = diam. of rotating piece in inches, n = No. of revs. per min.;
 S = speed of circumference in feet per minute;

$$S = \frac{\pi dn}{12} = 0.2618 dn; n = \frac{S}{0.2618 d} = \frac{3.82 S}{d}; d = \frac{3.82 S}{n}$$

Approximate rule: Number of revolutions per minute = 4 X speed in feet per minute ÷ diameter in inches.

Table of Cutting-speeds.

Diameter, inches.	Feet per minute.									
	5	10	15	20	25	30	35	40	45	50
	Revolutions per minute.									
1/4	76.4	152.8	229.2	305.6	382.0	458.4	534.8	611.2	687.6	764.0
3/8	50.9	101.9	152.8	203.7	254.6	305.6	356.5	407.4	458.3	509.3
1/2	38.2	76.4	114.6	152.8	191.0	229.2	267.4	305.6	343.8	382.0
5/8	30.6	61.1	91.7	122.2	152.8	183.4	213.9	244.5	275.0	305.6
3/4	25.5	50.9	76.4	101.8	127.3	152.8	178.2	203.7	229.1	254.6
7/8	21.8	43.7	65.5	87.3	109.1	130.9	152.8	174.6	196.4	218.3
1	19.1	38.2	57.3	76.4	95.5	114.6	133.7	152.8	171.9	191.0
1 1/8	17.0	34.0	50.9	67.9	84.9	101.8	118.8	135.8	152.8	169.7
1 1/4	15.3	30.6	45.8	61.1	76.4	91.7	106.9	122.2	137.5	152.8
1 3/8	13.9	27.8	41.7	55.6	69.5	83.3	97.2	111.1	125.0	138.9
1 1/2	12.7	25.5	38.2	50.9	63.6	76.4	89.1	101.8	114.5	127.2
1 3/4	10.9	21.8	32.7	43.7	54.6	65.5	76.4	87.3	98.2	109.2
2	9.6	19.1	28.7	38.2	47.8	57.3	66.9	76.4	86.0	95.5
2 1/4	8.5	17.0	25.5	34.0	42.5	50.9	59.4	67.9	76.4	84.9
2 1/2	7.6	15.3	22.9	30.6	38.2	45.8	53.5	61.1	68.8	76.4
2 3/4	6.9	13.9	20.8	27.8	34.7	41.7	48.6	55.6	62.5	69.5
3	6.4	12.7	19.1	25.5	31.8	38.2	44.6	50.9	57.3	63.7
3 1/2	5.5	10.9	16.4	21.8	27.3	32.7	38.2	43.7	49.1	54.6
4	4.8	9.6	14.3	19.1	23.9	28.7	33.4	38.2	43.0	47.8
4 1/2	4.2	8.5	12.7	17.0	21.2	25.5	29.7	34.0	38.2	42.5
5	3.8	7.6	11.5	15.3	19.1	22.9	26.7	30.6	34.4	38.1
5 1/2	3.5	6.9	10.4	13.9	17.4	20.8	24.3	27.8	31.2	34.7
6	3.2	6.4	9.5	12.7	15.9	19.1	22.3	25.5	28.6	31.8
7	2.7	5.5	8.2	10.9	13.6	16.4	19.1	21.8	24.6	27.3
8	2.4	4.8	7.2	9.6	11.9	14.3	16.7	19.1	21.5	23.9
9	2.1	4.2	6.4	8.5	10.6	12.7	14.8	17.0	19.1	21.2
10	1.9	3.8	5.7	7.6	9.6	11.5	13.3	15.3	17.2	19.1
11	1.7	3.5	5.2	6.9	8.7	10.4	12.2	13.9	15.6	17.4
12	1.6	3.2	4.8	6.4	8.0	9.5	11.1	12.7	14.3	15.9
13	1.5	2.9	4.4	5.9	7.3	8.8	10.3	11.8	13.2	14.7
14	1.4	2.7	4.1	5.5	6.8	8.2	9.5	10.9	12.3	13.6
15	1.3	2.5	3.8	5.1	6.4	7.6	8.9	10.2	11.5	12.7
16	1.2	2.4	3.6	4.8	6.0	7.2	8.4	9.5	10.7	11.9
18	1.1	2.1	3.2	4.2	5.3	6.4	7.4	8.5	9.5	10.6
20	1.0	1.9	2.9	3.8	4.8	5.7	6.7	7.6	8.6	9.6
22	.9	1.7	2.6	3.5	4.3	5.2	6.1	6.9	7.8	8.7
24	.8	1.6	2.4	3.2	4.0	4.8	5.6	6.4	7.2	8.0
26	.7	1.5	2.2	2.9	3.7	4.4	5.1	5.9	6.6	7.3
28	.7	1.4	2.0	2.7	3.4	4.1	4.8	5.5	6.1	6.8
30	.6	1.3	1.9	2.5	3.1	3.8	4.5	5.1	5.7	6.4
36	.5	1.1	1.6	2.1	2.6	3.2	3.7	4.2	4.8	5.3
42	.5	.9	1.4	1.8	2.3	2.7	3.2	3.6	4.1	4.5
48	.4	.8	1.2	1.6	2.0	2.4	2.8	3.2	3.6	4.0
54	.4	.7	1.1	1.4	1.8	2.1	2.5	2.8	3.2	3.5
60	.3	.6	1.0	1.3	1.6	1.9	2.2	2.5	2.9	3.2

The Speed of Counter-shaft of the lathe is determined by an assumption of a slow speed with the back gear, say 6 feet per minute, on the largest diameter that the lathe will swing.

EXAMPLE. — A 30-inch lathe will swing 30 inches =, say, 90 inches circumference = 7 feet 6 inches; the lowest triple gear should give a speed of 5 or 6 feet per minute.

Spindle Speeds of Lathes.— The spindle speeds of lathes are usually in geometric progression, being obtained either by a combination of cone-pulley and back gears, or by a single pulley in connection with a gear train. Either of these systems may be used with a variable speed motor, giving a wide range of available speeds.

It is desirable to keep work rotating at a rate that will give the most economical cutting speed, necessitating, sometimes, frequent changes in spindle speed. A variable speed motor arranged for 20 speeds in geometric progression, any one of which can be used with any speed due to the mechanical combination of belts and back gears, gives a fine gradation of cutting speeds. The spindle speeds obtained with the higher speeds of the motor in connection with a certain mechanical arrangement of belt and back gears may overlap those obtained with the lower speeds available in the motor in connection with the next higher speed arrangement of belt and gears, but about 200 useful speeds are possible. E. R. Douglas (*Elec. Rev.*, Feb. 10, 1906) presents an arrangement of variable speed motor and geared head lathe, with 22 speed variations in the motor and 3 in the head. The speed range of the spindle is from 4.1 to 500 r.p.m. By the use of this arrangement, and taking advantage of the speed changes possible for different diameters of the work, a saving of 35.4 per cent was obtained in the time of turning a piece ordinarily requiring 289 minutes.

Rule for Gearing Lathes for Screw-cutting. (Garvin Machine Co.) — Read from the lathe index the number of threads per inch cut by equal gears, and multiply it by any number that will give for a product a gear on the index; put this gear upon the stud, then multiply the number of threads per inch to be cut by the same number, and put the resulting gear upon the screw.

EXAMPLE. — To cut 11½ threads per inch. We find on the index that 48 into 48 cuts 6 threads per inch, then 6 × 4 = 24, gear on stud, and 11½ × 4 = 46, gear on screw. Any multiplier may be used so long as the products include gears that belong with the lathe. For instance, instead of 4 as a multiplier we may use 6. Thus, 6 × 6 = 36, gear upon stud, and 11½ × 6 = 69, gear upon screw.

Rules for Calculating Simple and Compound Gearing where there is no Index. (*Am. Mach.*) — If the lathe is simple-g geared, and the stud runs at the same speed as the spindle, select some gear for the screw, and multiply its number of teeth by the number of threads per inch in the lead-screw, and divide this result by the number of threads per inch to be cut. This will give the number of teeth in the gear for the stud. If this result is a fractional number, or a number which is not among the gears on hand, then try some other gear for the screw. Or, select the gear for the stud first, then multiply its number of teeth by the number of threads per inch to be cut, and divide by the number of threads per inch on the lead-screw. This will give the number of teeth for the gear on the screw. If the lathe is compound, select at random all the driving-gears, multiply the numbers of their teeth together, and this product by the number of threads to be cut. Then select at random all the driven gears except one; multiply the numbers of their teeth together, and this product by the number of threads per inch in the lead-screw. Now divide the first result by the second, to obtain the number of teeth in the remaining driven gear. Or, select at random all the driven gears. Multiply the numbers of their teeth together, and this product by the number of threads per inch in the lead-screw. Then select at random all the driving-gears except one. Multiply the numbers of their teeth together, and this result by the number of threads per inch of the screw to be cut. Divide the first result by the last, to obtain the number of teeth in the remaining driver. When the gears on the compounding stud are fast together, and cannot be changed, then the driven one has usually twice as many teeth as the other, or driver, in which case in the calculations consider the lead-screw to have twice as many threads per inch as it actually has, and then ignore

the compounding entirely. Some lathes are so constructed that the stud on which the first driver is placed revolves only half as fast as the spindle. This can be ignored in the calculations by doubling the number of threads of the lead-screw. If both the last conditions are present ignore them in the calculations by multiplying the number of threads per inch in the lead-screw by four. If the thread to be cut is a fractional one, or if the pitch of the lead-screw is fractional, or if both are fractional, then reduce the fractions to a common denominator, and use the numerators of these fractions as if they equaled the pitch of the screw to be cut, and of the lead-screw, respectively. Then use that part of the rule given above which applies to the lathe in question. For instance, suppose it is desired to cut a thread of 25/32-inch pitch, and the lead-screw has 4 threads per inch. Then the pitch of the lead-screw will be 1/4 inch, which is equal to 8/32 inch. We now have two fractions, 25/32 and 8/32, and the two screws will be in the proportion of 25 to 8, and the gears can be figured by the above rule, assuming the number of threads to be cut to be 8 per inch, and those on the lead-screw to be 25 per inch. But this latter number may be further modified by conditions named above, such as a reduced speed of the stud, or fixed compound gears. In the instance given, if the lead-screw had been 2½ threads per inch, then its pitch being 4/10 inch, we have the fractions 4/10 and 25/32, which, reduced to a common denominator, are 64/160 and 125/160, and the gears will be the same as if the lead-screw had 125 threads per inch, and the screw to be cut 64 threads per inch.

On this subject consult also "Formulas in Gearing," published by Brown & Sharpe Mfg. Co., and Jamieson's Applied Mechanics.

Change-gears for Screw-cutting Lathes.—There is a lack of uniformity among lathe-builders as to the change-gears provided for screw-cutting. W. R. Macdonald, in *Am. Mach.*, April 7, 1892, proposed the following series, by which 33 whole threads (not fractional) may be cut by changes of only nine gears:

SCREW.	Spindle.									Whole Threads.			
	20	30	40	50	60	70	110	120	130				
20	18	8	6	4 4/5	4	3 3/7	2 2/11	2	1 11/13	2	11	22	44
30	18	9	7 1/5	6	5 1/7	3 3/11	3	2 10/13	3	12	24	48	
40	24	16	12	9 3/5	8	6 6/7	4 4/11	4	3 9/13	4	13	26	52
50	30	20	15	10	8 4/7	5 5/11	5	4 8/13	5	14	28	66	
60	36	24	18	14 2/5	10 2/7	6 6/11	6	5 7/13	6	15	30	72	
70	42	28	21	16 4/5	14	7 7/11	7	6 6/13	7	16	33	78	
110	66	44	33	26 2/5	22	18 6/7	11	10 2/13	8	18	36		
120	72	48	36	28 4/5	24	20 4/7	13 1/11	11 1/13	9	20	39		
130	78	52	39	31 1/5	26	22 3/7	14 2/11	13	...	10	21	42	

Ten gears are sufficient to cut all the usual threads, with the exception of perhaps 11½, the standard pipe-thread; in ordinary practice any fractional thread between 11 and 12 will be near enough for the customary short pipe-thread; if not, the addition of a single gear will give it.

In this table the pitch of the lead-screw is 12, and it may be objected to as too fine for the purpose. This may be rectified by making the real pitch 6 or any other desirable pitch, and establishing the proper ratio between the lathe spindle and the gear-stud.

"Quick Change Gears."— About 1905, lathe manufacturers began building "quick change" lathes in which gear changing for screw cutting is eliminated. The lead-screw carries a cone of gears, one of which is in mesh with a movable gear in a nest of gears driven from the spindle. By changing the position of this movable gear, in relation to the cone of gears, the proper ratio of speeds between the spindle and lead-screws is obtained for cutting any desired thread usual in the range of the machine. About 16 different numbers of threads per inch can usually be cut by means of the "quick change" gear train. Different threads from those usually available can be cut by means of change gears between the spindle

and "quick change" gear train. The threads per inch usually available range from 2 to 46 in a 12-inch lathe to 1 to 24 in a 30-inch lathe. Catalogs of lathe manufacturers should be consulted for constructional details.

Shapes of Tools. — For illustrations and descriptions of various forms of cutting-tools, see Taylor's Experiments, below; also see articles on Lathe Tools in Appleton's Cyc. Mech., vol. ii. and in Modern Mechanism.

Cold Chisels. — Angle of cutting-faces (Joshua Pose): For cast steel, about 65 degrees; for gun-metal or brass, about 50 degrees; for copper and soft metals, about 30 to 35 degrees.

Metric Screw-threads may be cut on lathes with inch-divided leading-screws, by the use of change-wheels with 50 and 127 teeth; since 127 centimeters = 50 inches ($127 \times 0.3937 = 49.9999$ in.).

Rule for Setting the Taper in a Lathe. (*Am. Mach.*) — No rule can be given which will produce exact results, owing to the fact that the centers enter the work an indefinite distance. If it were not for this circumstance the following would be an exact rule, and it is an approximation as it is. To find the distance to set the center over: Divide the difference in the diameters of the large and small ends of the taper by 2, and multiply this quotient by the ratio which the total length of the shaft bears to the length of the tapered portion. **EXAMPLE:** Suppose a shaft three feet long is to have a taper turned on the end one foot long, the large end of the taper being two inches and the small end one inch diameter,

$$\frac{2 - 1}{2} \times \frac{3}{1} = 1\frac{1}{2} \text{ inches.}$$

TAYLOR'S EXPERIMENTS.

Fred W. Taylor directed a series of experiments, extending over 26 years, on feeds, speeds, shape of tool, composition of tool steel, and heat treatment. His results are given in Trans. A. S. M. E., xxviii, "The Art of Cutting Metals." The notes below apply mainly to tools of high speed steel and to heavy work requiring tools not less than 1/2 by 3/4 inch in cross-section.

Proper Shape of Lathe Tool. — Mr. Taylor discovered the best shape for lathe tools to be as shown in Fig. 187 with the angles given in the following table, when used on materials of the class shown. The exact outline of the nose of the tool is shown in Fig. 188. The actual dimensions of a 1-inch roughing tool are shown in Fig. 189. Let *R* = radius of point of tool, *A* = width of tool, *L* = length of shank, and *H* = height of shank, all in inches. Then $L = 14A + 4$; $H = 1.5A$; $R = 0.5A - 0.3125$ for cutting hard steel and cast iron; $R = 0.5A - 0.1875$ for soft steel. The meaning of the terms back slope, etc., is shown in Fig. 187.

Angles for Tools.

* Material cut.	<i>a</i> = clearance.	<i>b</i> = back slope.	<i>c</i> = side slope.
Cast iron; Hard steel.	6 degrees.	8 degrees.	14 degrees.
Medium steel; Soft steel.	6 degrees.	8 degrees.	22 degrees.
Tire steel.	6 degrees.	5 degrees.	9 degrees.

* As far as the shape of the tool is concerned, Taylor divides metals to be cut into general classes: (a) cast iron and hard steel, steel of 0.45-0.50 per cent carbon, 100,000 pounds tensile strength, and 18 per cent stretch, being a low limit of hardness; (b) soft steel, softer than above; (c) chilled iron; (d) tire steel; (e) extremely soft steel of carbon, say, 0.10-0.15 per cent.

The table presupposes the use of an automatic tool grinder. If tools are ground by hand the clearance angle should be 9 degrees. The lip angles for tools cutting hard steel and cast iron should be 68 degrees;

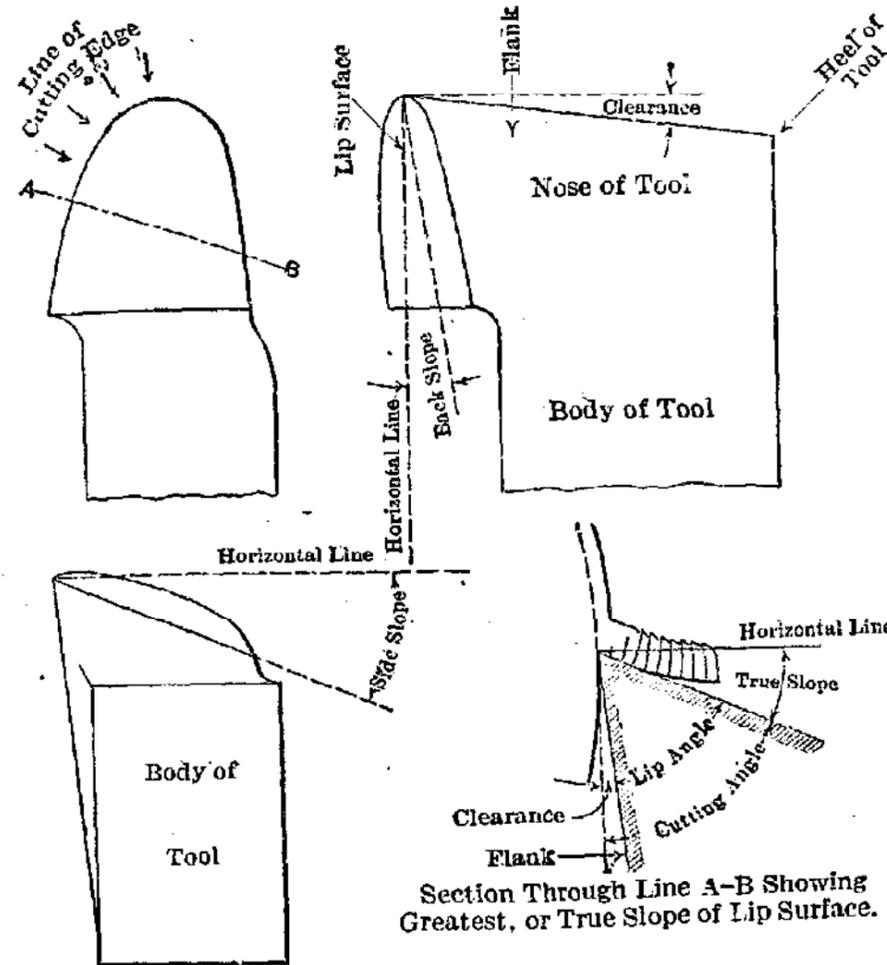

Section Through Line A-B Showing Greatest, or True Slope of Lip Surface.

FIG. 187.

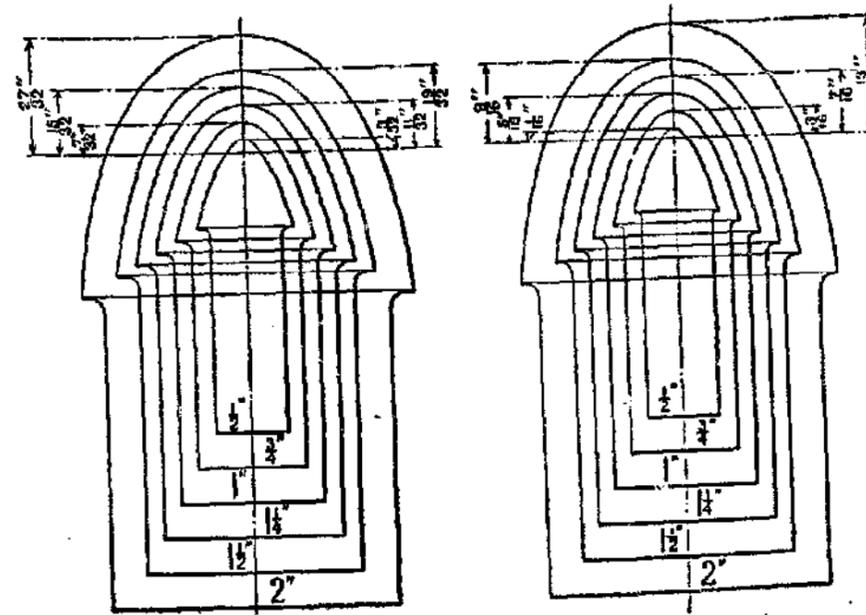

FIG. 188.

for soft steel, 61 degrees; for chilled iron, 86 to 90 degrees; for tire steel, 74 degrees; for extremely soft steel, keener than 61 degrees. A tool should be given more side than back slope; it can then be ground more times without weakening, the chip does not strike the tool post or clamps,

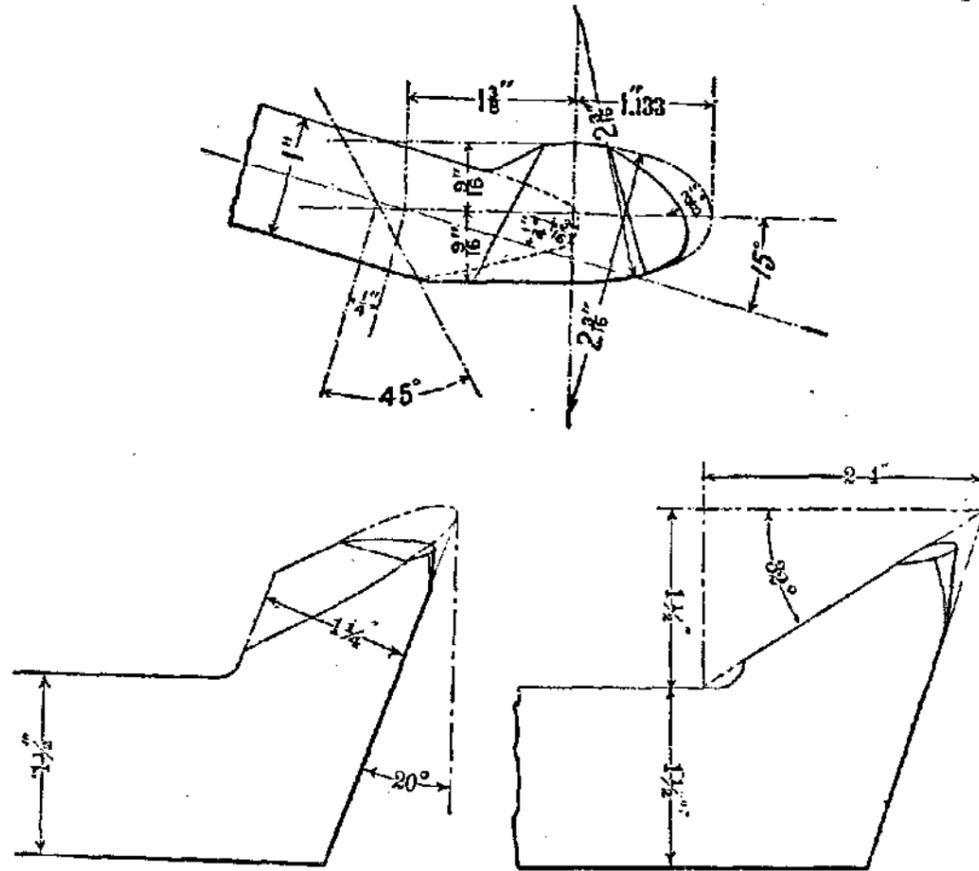

FIG. 189.

and it is also easier to feed. The nose of the tool should be set to one side, as in Fig. 189 above, to avoid any tendency to upset. To use a tool of this shape, lathe tool posts should be set lower below the center of the work than is now (1907) customary.

Forging and Grinding Tools.—The best method of dressing a tool is to turn one end up nearly at right angles to the shank, so that the nose will be high above the top of the body of the tool. Dressing can be thus done in two heats. Tools should leave the smith shop with a clearance angle of 20 degrees. Detailed directions for dressing a tool are given in Mr. Taylor's paper. To avoid overheating the tool in grinding, a stream of water, of at least five gallons a minute, should be thrown at low velocity on the nose of the tool where it is in contact with the emery wheel. In hand grinding, tools should not be held firmly against the wheel, but should be moved over its surface. It is of the utmost importance that high speed steel tools should not be heated above 1200° F. in grinding. Automatic tool grinders are economical, even in a small shop. Grinding machines should have some means for automatically adjusting the pressure of the tool against the grinding wheel. Each size of tool should have adapted to it a pressure, automatically adjusted, and which is just sufficient to grind rapidly without overheating the tool. Standard shapes should be adopted, to which all tools should be ground, there being no economy in automatic grinding without standard shapes.

Best Grinding Wheel.—The best grinding wheel was found to be a corundum wheel, of a mixture of 24 and 30 grit.

Pressure of Tool, etc.—Mr. Taylor found that there is no definite relation between the cutting speed of tools and the pressure with which the chip bears on the lip surface of the tool. He found, however, that the pressure per square inch of sectional area of the chip increases slightly as the thickness of the chip decreases. The feeding pressure of the tool is sometimes equal to the entire driving pressure of the chip against the lip surface of the tool, and the feed gears should be designed to deliver a pressure of this magnitude at the nose of the tool.

Chatter.—Chatter is caused by: too small lathe dogs; imperfect bearing at the points where the face plate drives the dogs; badly made or badly fitted gears; shafts in the machine of too small diameter, or of too great length; loose fits in bearings. A tool which chatters must be run at a cutting speed about 15 per cent slower than can be used if the tool does not chatter, irrespective of the use or non-use of water on the tool. A higher cutting speed can be used with an intermittent cut, as occurs on a planer, or shaper, or in turning, say, the periphery of a gear, than with a steady cut. To avoid chatter, tools should have curved cutting edges, or two or more tools should be used at the same time in the same machine. The body of the tool should be greater in height than width, and should have a true, solid bearing on the tool support, which latter should extend to almost beneath the cutting edge of the tool. Machines should be made massive beyond the metal needed for strength alone, and steady rests should be used on long work. It is advisable to use a steady rest, when turning any cylindrical piece of diameter D , when the length exceeds $12 D$.

Use of Water on Tool.—With the best high speed steel tools, a gain of 16 per cent in cutting speed can be made in cutting cast iron, steel or wrought iron by throwing a heavy stream of water directly on the chip at the point where it is being removed from the forging by the tool. Not less than three gallons a minute should be used for a $2 \times 2\frac{1}{2}$ -inch tool. The gain is practically the same for all qualities of steel, regardless of hardness and whether thick or thin chips are being cut.

Interval between Grindings.—Mr. Taylor derived a table showing how long various sizes of tools should run without regrinding to give the maximum work for the lowest all-around cost. Time a tool should run continuously without regrinding equals $7 \times$ (time to change tool + proper portion of time for redressing + time for grinding + time equivalent to cost of the tool steel ground off).

INTERVAL BETWEEN GRINDINGS, AT MAXIMUM ECONOMICAL CUTTING SPEEDS.

Size of tool.					
Inches.	$\frac{1}{2} \times \frac{3}{4}$	$\frac{5}{8} \times 1$	$\frac{3}{4} \times 1\frac{1}{8}$	$\frac{7}{8} \times 1\frac{3}{8}$	$1 \times 1\frac{1}{2}$
Hours.	1.25	1.25	1.25	1.5	1.5

Size of tool.				
Inches.	$1\frac{1}{4} \times 1\frac{7}{8}$	$1\frac{1}{2} \times 2\frac{1}{4}$	$1\frac{3}{4} \times 2\frac{3}{4}$	2×3
Hours.	1.75	2.0	2.5	2.75

If the proper cutting speed (A) is known for a cut of given duration, the speed for a cut (B) of different duration can be obtained by multiplying (A) by the factor given in the following table:

	Duration of cut in minutes:					
At known speed (A).....	20	40	20	40	80	80
At derived speed (B).....	40	80	80	20	40	20
Factor.....	0.92	0.92	0.84	1.09	1.09	1.19

For cutting speeds of high-speed lathe tools to last $1\frac{1}{2}$ hours, see tables on pages 1244 and 1245.

Effect of Feed and Depth of Cut on Cutting Speed.—With a given depth of cut, metal can be removed faster with a coarse feed and slow speed, than with fine feed and high speed. With a given depth of cut, a cutting speed of S , and a feed of F , S varies as $1/\sqrt{F}$. With tools of the best high speed steel, varying the feed and depth of cut varies the cutting speed in the same ratio when cutting hard steel as when cutting soft steel.

Best High Speed Tool Steel — Composition — Heat Treatment. — Mr. Taylor and Maunsel White developed a number of high speed steels, the one showing the best all-around qualities having the following chemical composition: Vanadium, 0.29; tungsten, 18.19; chromium, 5.47; carbon, 0.674; manganese, 0.11; silicon, 0.043. The use of vanadium materially improves high speed steel. The following method of treatment is described as the best for this or any other composition of high speed steel. The tool should be forged at a light yellow heat, and, after forging slowly and uniformly, heated to a bright cherry red, allowing plenty of time for the heat to penetrate to the center of the tool, in order to avoid danger of cracking due to too rapid heating. The tool should then be heated from a bright cherry red to practically its melting-point as rapidly as possible in an intensely hot fire; if the extreme nose of the tool is slightly fused no harm is done. Time should be allowed for the tool to become uniformly hot from the heel to the lip surface.

After the high heat has been given the tools, as above described, they should be cooled rapidly until they are below the "breaking-down point," or, say, down to or below 1550° F. The quality of the tool will be but little affected whether it is cooled rapidly or slowly from this point down to the temperature of the air. Therefore, after all parts of a tool from the outside to the center have reached a uniform temperature below the breaking-down point, it is the practice sometimes to lay it down in any part of the room or shop which is free from moisture, and let it cool in the air, and sometimes to cool it in an air blast to the temperature of the air.

The best method of cooling from the high heat to below the breaking-down point is to plunge the tools into a bath of red-hot molten lead below the temperature of 1550° F. They should then be plunged into a lead bath maintained at a uniform temperature of 1150° F., because the same bath is afterward used for reheating the tools to give them their second treatment. This bath should contain a sufficiently large body of the lead so that its temperature can be maintained uniform; and for this purpose should be used preferably a lead bath containing about 3600 lb. of lead.

Too much stress cannot be laid upon the importance of never allowing the tool to have its temperature even slightly raised for a very short time during the process of cooling down. The temperature must either remain absolutely stationary or continue to fall after the operation of cooling has once started, or the tool will be injured. Any temporary rise of temperature during cooling, however small, will injure the tool. This, however, applies only to cooling the tool to the temperature of about 1240° F. Between the limits of 1240 degrees and the temperature of the air, the tool can be raised or lowered in temperature time after time and for any length of time without injury. And it should also be noted that during the first operation of heating the tool from its cold state to the melting-point, no injury results from allowing it to cool slightly and then reheating. It is from reheating during the operation of cooling from the high heat to 1240° F. that the tool is injured.

The above-described operation is commonly known as the first or high-heat treatment.

To briefly recapitulate, the first or high-heat treatment consists of heating the tool —

- (a) slowly to 1500° F.;
- (b) rapidly from that temperature to just below the melting-point.
- (c) cooling fast to below the breaking-down point, i.e., 1550° F.
- (d) cooling either fast or slowly from 1550° F. to temperature of the air.

Second Treatment, Reheating the Cooled Tool. — After air-temperature has been reached the tool should be reheated to a temperature of from 700 to 1240° F., preferably by plunging it in the before-mentioned lead bath at 1150° F. and kept at that temperature at least five minutes. To avoid danger of fire cracks, the tool should be heated slowly before immersing in the bath. The above tool heated in this fashion possesses a high degree of "red hardness" (ability to cut steel with the nose of the tool at red heat), while it is not extraordinarily hard at ordinary temperatures. It is difficult to injure it by overheating on the grindstone or in the lathe. It will operate at 90 per cent of its maximum cutting speed, even without the second or low-heat treatment. A coke fire is preferable for giving the first heat, and it should be made as deep as possible.

Cooling the tool by plunging it in oil or water, renders it liable to fire cracks and to brittleness in the body. Next to the lead bath an air blast is preferable for cooling.

Best Method of Treating Tools in Small Shops. — For small shops, in treating high-speed tools, Mr. Taylor considers the best method to be as follows for the blacksmith who is equipped only with the apparatus ordinarily found in a smith-shop.

After the tools have been forged and before starting to give them their heat, fuel should be added to the smith's fire so as to give a good deep bed either of coke about the size of a walnut or of first-class blacksmiths' soft coal. A number of tools should then be laid with their noses at a slight distance from the hotter portion of the fire, so that they may all be pre-heating while the fire is being blown up to its proper intensity. After reaching its proper intensity, the tools should be heated one at a time over the hottest part of the fire as rapidly as practicable up to just below their melting-point. During this operation they should be repeatedly turned over and over so as to insure a uniform high heat throughout the whole end of the tool. As soon as each tool reaches its high heat, it should be placed with its nose under a heavy air blast and allowed to cool to the temperature of the air before being removed from the blast.

Unfortunately, however, the blacksmith's fire is so shallow that it is incapable of maintaining its most intense heat for more than a comparatively few minutes, and, therefore, it is only through these few minutes that first-class high-speed tools can be properly heated in the smith's fire. Great numbers of high-speed tools are daily turned out from smiths' fires which are not sufficiently intense in their heat, and they are therefore inferior in red hardness and produce irregular cutting tools.

On the whole, a blacksmith's fire made from coke may be regarded as better for giving the high heat to tools than a soft-coal fire, merely because a coke fire can be more easily made by the smith which will remain capable for a longer period of heating the tools quickly to their melting-points.

Quality of Different Tool Steels. — Mr. Taylor in a letter to the author, Dec. 30, 1907, says:

First. Any of a half dozen makes of high speed tools now on the market are amply good, and but little attention need be paid to the special directions for heating and cooling high speed tools given by the makers of the tool steel. The most important matter is that an intensely hot fire should be used for giving the tools their high heat, and that they should not be allowed to soak a long time in this fire. They should be heated as fast as possible and then cooled in an air blast.

Second. The greatest number of tools are ruined on the emery wheel through overheating, either because a wheel whose surface is glazed is used, or because too small a stream of water is run upon the nose of the tool. The emery wheel should be kept sharp through frequent dressings with a diamond tool.

Third. Uniformity is the most important quality in high speed tools. For this reason, only one make of high speed tool steel should be used in each shop.

Economical Cutting Speeds. — Tools shaped as in Fig. 189, and of the chemical composition and heat treatment given in the preceding paragraphs, should be run at the cutting speeds given in the tables on pages 1244 and 1245 in order to last one hour and 30 minutes without re-grinding.

Cutting Speed of Parting and Thread Tools. — To find the economical cutting speed of a parting tool of the best high speed steel, find the proper value for the size of tool in the tables below and divide by 2.7. The economical speed for a thread tool is similarly found by dividing by 4. The thickness of chip in the latter case is the advance in inches per revolution of the tool toward the center of the work.

Durability of Cutting Tools. — E. G. Herbert (*Am. Mach.*, June 24, 1909) shows that the durability of a tool depends mainly on the temperature to which its extreme edge is raised, and that the rate of evolution of heat and consequently the durability is proportional to the thickness and to the area of the chip and to the cube of the cutting speed. Or if t_1 = thickness or feed, c_1 = depth of cut, a_1 = area of the cut and s_1 = cutting speed, for any given set of working conditions, and t_2, c_2, a_2 and s_2 values for another set of conditions, then the durability of the tool

Cutting Speeds in Feet per Minute of Standard Taylor-White Tools, Tool to Last 1 1/2 Hours between Grindings.

Tool.		1 1/8-Inch.						1-Inch.						7/8-Inch.					
Material Cut.		Steel.			Cast Iron.			Steel.			Cast Iron.			Steel.			Cast Iron.		
Cut, in.	Feed, in.	Soft.	Medium.	Hard.	Soft.	Medium.	Hard.	Soft.	Medium.	Hard.	Soft.	Medium.	Hard.	Soft.	Medium.	Hard.	Soft.	Medium.	Hard.
3/32	1/64	518.0	259.0	118.0	239.0	119.6	69.8	490.0	245.0	111.0	226.0	113.0	66.0	476.0	238.0	108.0	220.0	110.0	64.2
	1/32	366.0	183.0	83.2	191.0	95.3	55.6	339.0	169.0	77.0	177.0	88.4	51.6	325.0	162.0	73.8	169.0	84.6	49.4
	3/16	257.0	129.0	58.4	142.0	70.8	41.3	235.0	117.0	53.4	130.0	64.8	37.8	222.0	111.0	50.4	122.0	61.2	35.7
	1/8	209.0	105.0	47.5	118.0	59.1	34.4	189.0	94.5	43.0	107.0	53.5	31.2	177.0	88.4	40.2	99.8	49.9	29.1
	3/16	85.0	42.5	24.8	75.7	37.8	70.1	35.1	20.5
1/8	1/64	450.0	225.0	102.0	216.0	108.0	63.1	427.0	214.0	97.0	205.0	102.0	59.8	420.0	210.0	95.5	202.0	101.0	58.9
	1/32	317.0	158.0	72.0	172.0	86.2	50.3	296.0	148.0	67.2	160.0	85.1	46.8	286.0	143.0	65.0	156.0	77.8	45.4
	3/16	223.0	112.0	50.7	128.0	64.0	37.3	205.0	102.0	46.6	118.0	58.8	34.3	195.0	97.6	44.4	112.0	56.2	32.8
	1/4	182.0	90.8	41.4	107.0	53.4	31.2	165.0	83.0	37.5	97.0	48.5	23.3	156.0	77.9	35.4	91.8	45.9	26.8
	3/16	157.0	78.5	35.7	93.4	46.7	27.3	142.0	71.0	32.3	84.2	42.1	24.6	133.0	66.4	30.2	79.3	39.7	23.2
3/16	1/64	370.0	185.0	84.1	187.0	93.5	54.6	358.0	179.0	81.3	181.0	90.6	52.9	352.0	176.0	80.0	178.0	89.0	52.0
	1/32	260.0	130.0	59.1	149.0	74.6	43.6	247.0	124.0	56.1	142.0	70.8	41.3	240.0	120.0	54.5	137.0	68.6	40.1
	3/16	183.0	91.7	41.6	111.0	55.5	32.7	171.0	85.5	38.8	104.0	51.9	30.3	164.0	82.0	37.3	99.4	49.7	29.0
	1/8	149.0	74.6	35.8	92.5	46.3	27.0	138.0	69.0	31.3	85.8	42.9	25.0	131.0	65.5	29.8	81.0	40.5	23.7
	3/16	129.0	64.5	29.3	73.1	35.5	21.3	119.0	59.0	26.8	74.3	37.2	21.7	112.0	56.0	25.5	70.1	35.0	20.5
1/4	1/64	322.0	161.0	73.2	168.0	84.1	49.1	315.0	157.0	71.6	165.0	82.3	48.1	312.0	156.0	70.9	163.0	81.5	47.7
	1/32	227.0	113.0	51.6	134.0	67.2	39.2	218.0	109.0	49.5	129.0	64.4	37.5	213.0	107.0	48.4	126.0	62.9	36.7
	3/16	159.0	79.7	36.1	99.8	49.9	29.1	150.0	75.0	34.1	94.3	47.1	27.5	145.0	72.6	33.0	90.8	45.4	26.5
	1/8	130.0	65.0	29.5	83.2	41.6	24.3	121.0	60.5	27.5	77.8	38.9	22.7	116.0	58.1	26.4	74.1	37.0	21.6
	3/16	91.4	45.7	20.8	59.7	29.8	17.4	104.0	52.0	23.6	67.5	33.7	19.7	64.1	32.0	18.7
5/16	1/64	264.0	132.0	60.0	144.0	71.8	41.9	263.0	132.0	59.8	147.0	71.5	41.8	264.0	132.0	60.0	144.0	71.8	41.9
	1/32	186.0	93.1	42.3	115.0	57.3	33.4	132.0	66.0	41.4	112.0	56.0	32.6	180.0	90.2	41.0	111.0	55.4	32.3
	3/16	131.0	65.5	29.8	85.1	42.6	24.8	126.0	62.8	28.5	81.9	41.0	23.9	122.0	61.1	27.8	80.0	40.0	23.4
	1/8	107.0	53.4	24.1	70.9	35.5	20.7	101.0	50.6	23.0	67.6	33.8	19.7	65.3	32.6	19.1
	3/16	92.2	46.1	20.8	62.0	31.0	18.1	58.6	29.3	17.1	56.4	28.2	16.5
1/2	1/64	230.0	115.0	52.3	131.0	65.6	38.3	232.0	116.0	52.7	132.0	66.2	38.6	237.0	118.0	53.8	135.0	67.5	39.4
	1/32	162.0	80.9	36.8	105.0	52.3	30.5	161.0	80.5	36.6	104.0	51.6	30.2	162.0	80.8	36.7	104.0	52.1	30.4
	3/16	114.0	56.9	25.9	77.6	38.8	22.7	111.0	55.7	23.3	75.8	37.9	22.1	75.2	37.6	22.0
	1/8	92.6	46.3	21.0	64.7	32.4	18.9	42.6	31.3	18.3	61.4	30.7	17.9
	3/16	46.5	23.3	13.6	44.2	22.1	12.9	43.1	21.6	12.6

Cutting Speeds, Feet per Minute, of Taylor-White Steel Lathe Tools, to Last 1 1/2 Hours Between Grindings.

Tool.		3/8-Inch.						5/8-Inch.						1/2-Inch.					
Material Cut.		Steel.			Cast Iron.			Steel.			Cast Iron.			Steel.			Cast Iron.		
Cut, in.	Feed, in.	Soft.	Medium.	Hard.	Soft.	Medium.	Hard.	Soft.	Medium.	Hard.	Soft.	Medium.	Hard.	Soft.	Medium.	Hard.	Soft.	Medium.	Hard.
3/32	1/64	482.0	241.0	110.0	222.0	111.0	65.0	467.0	234.0	106.0	216.0	108.0	63.0	445.0	223.0	101.0	206.0	103.0	60.0
	1/32	323.0	161.0	73.4	169.0	84.3	49.2	306.0	153.0	69.5	160.0	80.0	46.6	281.0	141.0	63.9	147.0	73.3	42.8
	3/16	217.0	108.0	49.3	126.0	59.8	34.9	200.0	100.0	45.5	110.0	55.0	32.2	177.0	88.7	40.2	97.5	48.8	28.5
	1/8	172.0	85.8	39.0	97.0	48.5	28.3	156.0	78.0	35.5	88.4	44.2	25.8	135.0	67.4	30.7	76.0	38.0	22.2
	3/16	83.4	41.7	24.4	75.4	37.7	22.0	64.1	32.1	18.7
1/8	1/64	423.0	212.0	96.1	203.0	102.0	59.3	417.0	209.0	94.8	200.0	100.0	58.6	404.0	202.0	91.8	194.0	97.0	56.7
	1/32	284.0	142.0	64.5	156.0	78.2	45.6	273.0	136.0	62.0	148.0	74.0	43.3	255.0	128.0	57.9	138.0	69.3	40.4
	3/16	190.0	95.2	43.2	110.0	55.0	32.0	179.0	89.3	40.6	104.0	51.8	30.2	161.0	81.0	36.6	93.1	46.5	27.2
	1/8	151.0	75.3	34.2	88.8	44.4	25.9	140.0	69.8	31.7	82.6	41.3	24.1	72.1	36.1	21.3
	3/16	128.0	63.8	29.3	76.2	38.1	22.3	69.6	34.8	20.3	41.8	20.9	12.2
3/16	1/64	358.0	179.0	81.4	181.0	90.6	52.9	362.0	181.0	82.2	183.0	91.6	68.0	359.0	179.0	81.6	182.0	91.0	53.0
	1/32	240.0	120.0	54.5	137.0	68.5	40.0	236.0	118.0	53.8	135.0	67.5	39.4	226.0	113.0	51.4	128.0	64.0	37.7
	3/16	161.0	80.5	36.6	97.7	48.9	28.5	155.0	77.4	35.2	94.0	47.0	27.4	86.1	43.1	25.1
	1/8	127.0	63.7	28.7	78.0	39.0	22.8	75.4	37.7	22.0	67.4	33.7	19.6
	3/16	67.5	33.7	19.7	64.3	32.2	18.8
1/4	1/64	320.0	160.0	72.7	167.0	83.6	48.8	328.0	164.0	74.5	171.0	85.7	50.1	330.0	165.0	75.0	173.0	86.3	50.4
	1/32	215.0	107.0	48.8	126.0	63.2	36.9	215.0	107.0	48.8	126.0	63.2	36.9	122.0	61.0	35.7
	3/16	144.0	72.0	32.7	90.8	45.4	26.3	87.8	43.9	25.6	81.9	41.0	23.9
	1/8	72.7	36.3	21.2	70.4	35.2	20.6
	3/16	62.7	31.3	18.3
5/8	1/64	276.0	138.0	62.7	150.0	75.0	43.8	286.0	143.0	65.0	156.0	77.8	45.4
	1/32	185.0	92.4	42.0	113.0	56.7	33.1	116.0	57.8	33.8
	3/16	81.0	40.5	23.6	79.7	39.9	23.3
	1/8	65.5	32.7	19.1
	3/8

WARNING: This is a 1910 edition. Some of the material may no longer be accurate

will be the same when $t_1 a_1 s_1^2 = t_2 a_2 s_2^2$, or for constant durability $s_2 = s_1 \sqrt{(t_1^2 c_1 \div t_2^2 c_2)}$.

New High-Speed Steels. — *Am. Mach.*, April 8, May 20 and 27, 1909, describes the operations of some new varieties of high-speed steel made by Sheffield manufacturers, which show results superior to those of the earlier high-speed steels in endurance of tool, ability to cut very hard metals, and higher speeds. The following are the results of some of the tests in lathe-work.

Tool size, in.	Material Cut.	Diam. in.	Depth, cut in.	Feed in.	Speed ft. per min.	Length of Cut.
1 1/4	Steel, 2.00 C.....	3/8	1/16	36	4 3/4 in.*
1 1/4	Steel, 0.70 C.....	1/4	1/10	48	13 in.†
1 1/4	Steel, 0.70 C.....	3/16	1/16	65	87/8 in.
7/8	Steel, 0.40 C.....	4	1/8	1/8	65	28 ins., ‡
7/8	Steel, 0.40 C.....	4	1/8	1/32	120	28 ins., §
7/8	Cast iron.....	5 ft.	1/8 to 3/16	1/10	56	4 1/2 ins.
1 1/4	Cast iron.....	5 ft.	5/16	1/32	107	6 ins.
1 1/2	Cast iron.....	5 ft.	1/8	1/8	55	8 ins.
1 1/4	Steel, 0.40 C.....	5 3/8 in.	1/8	1/10	90	54 ins.
1 x 2	Steel.....	9 3/4 in.	3/8	1/8	64	72 ins.
1 x 2	Nickel steel.....	3 1/2 in.	1/2	0.072	52	124 ins.
1 1/4	Steel casting, 0.45 C..	20 in.	3/8	1/8	50	15 to 20 min.¶
1 1/4	Steel, 0.60 C.....	7 1/2 in.	9/64	1/20	115	18 in.

* Then 1 3/4 in. at 50 ft. per min. † Then 1 1/8 in. at 65 ft. per min.
 ‡ Then 28 ins. at 98 ft. § Then 22 ins. at 160 ft. ¶ Required 28 H.P.
 Chilled rolls, too hard for ordinary high-speed steel, were cut at a speed of 80 ft. per min., with 5/16 in. depth of cut and 1/8 in. feed.

The following results were obtained in drilling:

Drill size.	Material.	Rev. per min.	Feed per rev.	Speed per min.	Drilled without Re-grinding.
3/4 in.	Close cast iron.....	466	0.018	8 1/2 in.	70 holes, 3 ins. deep.
3/4	Steel, 0.25 C.....	247	0.011	60 holes, 2 3/4 ins. deep.
3/4	Hard steel.....	526	6 in.	12 holes, 2 1/2 ins. deep.
13/16	Steel.....	400	3 1/2	14 in. at one operation.

A milling cutter 5 in. diam., with 54 teeth, milling teeth in saw-blanks, at a cutting speed of 56 ft. per min. and a feed of 1 in. per min., cuts 80 blanks (three or more together), each 32 in. diam., 3/8 in. thick, 240 teeth, before re-grinding.

Use of a Magnet to Determine the Hardening Temperature. (Catalogue of Firth-Sterling Steel Co.) — At the proper hardening heat a piece of regular tool steel loses its power to attract a magnet. By touching a magnet against the tool as it heats up in the furnace, the magnet will take hold until the proper heat for quenching is reached, and then it will not take hold at any point. This determines the lowest heat at which it can be hardened.

By heating slowly, trying with a magnet frequently, and dipping the tool when the magnet will not take hold, an extremely hard tool will be secured and one which will do excellent work. The magnet should not be allowed to become heated. In order to guard against the loss of magnetism in a horseshoe magnet an electro-magnet may be made by passing an electric current through a coil of wire wound on an iron rod.

CASE-HARDENING, ETC.

Case-hardening of Iron and Steel, Cementation, Harveyizing. — When iron or soft steel is heated to redness or above in contact with charcoal or other carbonaceous material, the carbon gradually penetrates

the metal, converting it into high carbon steel. The depth of penetration and the percentage of carbon absorbed increase with the temperature and with the length of time allowed for the process. In the old cementation process for converting wrought iron into "blister steel" for re-melting in crucibles flat bars were packed with charcoal in an oven which was kept at a red heat for several days. In the Harvey process of hardening the surface of armor plate, the plate is covered with charcoal and heated in a furnace for a considerable time, and then rapidly cooled by a spray of water.

In case-hardening, a very hard surface is given to articles of iron or soft steel by covering them or packing them in a box or oven with a material containing carbon, heating them to redness while so covered, and then chilling them. Many different substances have been used for the purpose, such as wood or bone charcoal, charred leather, sugar, cyanide of potassium, bichromate of potash, etc. Hydrocarbons, such as illuminating gas, gasolene or naphtha, are also used. *Amer. Machinist*, Feb. 20, 1908, describes a furnace made by the American Gas Furnace Company of Elizabeth, N. J., for case-hardening by gas. The best results are obtained with soft steel, 0.12 to 0.15 carbon, and not over 0.35 manganese, but steel of 0.20 to 0.22 carbon may be used. The carbon begins to penetrate the steel at about 1300° F., and 1700° F. should never be exceeded with ordinary steels. A depth of carbonizing of 1/64 in. is obtained with gas in one hour, and 1/4 in. in 12 hours. After carbonizing the steel should be annealed at about 1625° F. and cooled slowly, then re-heated to about 1400° F. and quenched in water. Nickel-chrome steels may be carbonized at 2000° F. and tungsten steels at 2200° F.

Change of Shape due to Hardening and Tempering. — J. E. Storey, *Am. Mach.*, Feb. 20, 1908, describes some experiments on the change of dimensions of steel bars 4 in. long, 7/8 in. diam. in hardening and tempering. On hardening the length increased in different pieces .0001 to .0014 in., but in two pieces a slight shrinkage, maximum .00017, was found. The diameters increased .0003 to .0036 in. On tempering the length decreased .0017 to .0108 in. as compared with the original 4 ins. length, while the diameter was increased .0003 to .0029; a few samples showing a decrease, max. 0.0009 in. The general effect of hardening is a slight increase in bulk, which increase is reduced by tempering. The distortion is more important than the increase in bulk.

MILLING CUTTERS.

George Addy (*Proc. Inst. M. E.*, Oct., 1890, p. 537) gives the following:

Analyses of Steel. — The following are analyses of milling cutter blanks, made from best quality crucible cast steel and from self-hardening "Ivanhoe" steel:

	C	Si	P	Mn	S	Tungsten	Iron, by difference
Crucible Steel,	1.2	0.112	0.018	0.36	0.02	...	98.29
Ivanhoe Steel,	1.67	0.252	0.051	2.56	0.01	4.65	90.81

The first analysis is of a cutter 14 in. diam., 1 in. wide, which gave very good service at a cutting-speed of 60 ft. per min. Large milling cutters are sometimes built up, the cutting-edges only being of tool steel. A cutter 22 in. diam. by 5 1/2 in. wide has been made in this way, the teeth being clamped between two cast-iron flanges. Mr. Addy recommends for this form of tooth one with a cutting-angle of 70°, the face of the tooth being set 10° back of a radial line on the cutter, the clearance-angle being thus 10°. At the Clarence Iron Works, Leeds, the face of the tooth is set 10° back of the radial line for cutting wrought iron and 20° for steel.

Pitch of Teeth. — For obtaining a suitable pitch of teeth for milling-cutters of various diameters there exists no standard rule, the pitch being usually decided in an arbitrary manner according to individual taste. For estimating the pitch of teeth in a cutter of any diameter from 4 in. to 15 in., Mr. Addy has worked out the following rule, which he has found capable of giving good results in practice:

Pitch in inches = $\sqrt{(\text{diam. in inches} \times 8) \times 0.0625} = 0.177 \sqrt{\text{diam.}}$

J. M. Gray gives a rule for pitch as follows: The number of teeth in a milling cutter ought to be 100 times the pitch in inches; that is, if there were 27 teeth, the pitch ought to be 0.27 in. The rules are practically

the same, for if $d = \text{diam.}$, $n = \text{no. of teeth}$, $p = \text{pitch}$, $c = \text{circumference}$, $c = pn$; $d = \frac{pn}{\pi} = \frac{100p^2}{\pi} = 31.83p^2$; $p = \sqrt{0.0314d} = 0.177 \sqrt{d}$;

No. of teeth, $n = 3.14d \div p$.

Teeth of Plain or Spiral Milling Cutters. (*Mach'y*, April, 1907.) — Plain milling cutters are usually manufactured in sizes from 2 to 5 in. diameter, and up to 6-in. face. The use of solid plain milling cutters of over 5-in. face is not advised, and cutters over 5-in. face should be made in two or more interlocking sections.

NUMBER OF TEETH AND AMOUNT OF SPIRAL OF PLAIN MILLING CUTTERS.

No. of teeth = $\frac{5 \times \text{diam.} + 24}{2}$; Length of Spiral = $9 \times \text{diam.} + 4$.

Diameter of cutter,	2	2 1/4	2 1/2	2 3/4	3	3 1/2	4	4 1/2	5	5 1/2	6	6 1/2	7	7 1/2	8
Number of teeth,	16	18	18	20	20	22	24	24	26	26	28	30	30	32	32
Length of one turn of spiral, inches,	22	24 1/4	26 1/2	28 3/4	31	35 1/2	40	44 1/2	49	53 1/2	58	62 1/2	67	71 1/2	76

A cutter with an included angle of 60° (12° on one side and 48° on the other) is recommended for fluting plain milling cutters, although cutters of 52° (12° and 40°) are commonly furnished by manufacturers. The angle of relief of milling cutters should be between 5° and 7°.

Nicked Cutters. — Cutters for milling broad surfaces, whether of the spiral or straight type, usually have nicks cut in the teeth, the nicks being staggered in consecutive teeth. These afford relief from jamming the teeth with chips.

Side Milling Cutters. (*Mach'y*, April, 1907.) — The teeth of side milling cutters should have the same general form as those of plain milling cutters, excepting that the cutter used to form them should have an included angle of about 75°.

NUMBER OF TEETH IN SIDE MILLING CUTTERS.

Number of teeth = $3.1 \text{ diam.} + 11$.

Diam. of cutter,	2	2 1/4	2 1/2	2 3/4	3	3 1/2	4	4 1/2	5	5 1/2	6	6 1/2	7	7 1/2	8	9
Number of teeth,	18	18	18	20	20	22	24	24	26	28	30	32	32	34	36	38

Milling Cutters with Inserted Teeth. — When it is required to use milling cutters of a greater diameter than about 8 in., it is preferable to insert the teeth in a disk or head, so as to avoid the expense of making solid cutters and the difficulty of hardening them, not merely because of the risk of breakage in hardening them, but also on account of the difficulty in obtaining a uniform degree of hardness or temper.

Keyways in Milling Cutters. — A number of manufacturers have adopted the keyways shown below, as standards. The dimensions in inches are given in the tables.

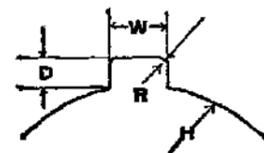

FIG. 190.—Square Keyway.

Diam. Hole,	3/8-9/16	5/8-7/8	15/16-1 1/8	1 3/16-1 3/8	1 7/16-1 3/4	1 13/16-2	2 1/16-2 1/2	2 9/16-3
Width W	3/32	1/8	5/32	3/16	1/4	5/16	3/8	7/16
Depth, D	3/64	1/16	5/64	3/32	1/8	5/32	3/16	3/16
Radius, R	0.020	0.030	0.035	0.040	0.050	0.060	0.060	0.060

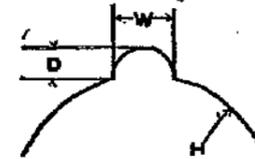

FIG. 191.—Half-round Keyway

Diam. Hole, H	3/8-5/8	1 1/16-1 3/16	1 7/8-1 3/16	1 1/4-1 7/16	1 1/2-2	2 1/16-2 7/16	2 1/2-3
Width W	1/8	3/16	1/4	5/16	3/8	7/16	1/2
Depth, D	1/16	3/32	1/8	5/32	3/16	7/32	1/4

Power Required for Milling. (*Mech. Engr.*, Oct. 26, 1907.) — Mr. S. Strieff made a series of experiments to determine the power required to drive milling cutters of high-speed steel. The results are shown in the table below. A proportionately higher amount of power is required for light than heavy milling, as the power to drive the machine is the same at all loads. The table also shows that the depth of cut does not increase the power required in the same proportion as the width, and that work with a quick feed and a deep but comparatively narrow cut requires less power than a wide cut of moderate depth with slow feed, the amount of metal removed being the same in both cases.

Power Required for Milling.

Number of Revolutions of Cutter per Minute.	Feed.		Cutting Speed of Cutter, Feet per Minute.	Depth of Cut, Inches.	Width of Cut, Inches.	Horse-Power Required.	Metal Removed per Hour, Pounds.	Horse-Power Required per Pound-Hour.
	Per Minute, Inches.	Per Revolution, Inches.						
24	2.46	0.10	37	0.26	23.6	25	245	0.102
24	3.50	0.15	37	0.26	10.2	17	150	0.113
24	4.35	0.18	37	0.14	9.8	17	97	0.175
24	3.50	0.15	37	0.49	9.8	27	490	0.055
19	4.33	0.23	29.5	0.28	9.3	17	331	0.051
23	4.17	0.18	36	0.28	20.5	27	386	0.070
23	4.17	0.18	36	0.28	9.8	20	183	0.109
40	1.89	0.05	64	0.24	10.2	17	74	0.230
40	3.94	0.10	64	0.37	13.8	21	331	0.063
40	5.79	0.14	64	0.16	16.5	17	123	0.138

Extreme Results with Milling Machines. — Horace L. Arnold (*Am. Mach.*, Dec. 28, 1893) gives the following results in flat-surface milling, obtained in a Pratt & Whitney milling machine: The mills for the flat cut were 5 in. diam., 12 teeth, 40 to 50 r.p.m. and 47/8 in. feed per min. One single cut was run over this piece at a feed of 9 in. per min., but the mills showed plainly at the end that this rate was greater than they could endure. At 50 r.p.m. for these mills the figures are as follows, with 47/8 in. feed: Surface speed, 64 ft., nearly; feed per tooth, 0.00812 in.; cuts per in., 123. And with 9-in. feed per min.: Surface speed, 64 ft. per min.; feed per tooth, 0.015 in.; cuts per in., 66 2/3.

At a feed of $4\frac{7}{8}$ in. per min., the mills stood up well in this job of cast-iron surfacing, while with a 9-in. feed they required grinding after surfacing one piece; in other words, it did not damage the mill-teeth to do this job with 123 cuts per in. of surface finished, but they would not endure $66\frac{2}{3}$ cuts per in. In this cast-iron milling the surface speed of the mills does not seem to be the factor of mill destruction; it is the increase of feed per tooth that prohibits increased production of finished surface. This is precisely the reverse of the action of single-pointed lathe and planer tools in general; with such tools there is a surface-speed limit which cannot be economically exceeded for dry cuts, and so long as this surface-speed limit is not reached, the cut per tooth or feed can be made anything up to the limit of the driving power of the lathe or planer, or to the safe strain on the work itself, which can in many cases be easily broken by a too great feed.

In wrought metal extreme figures were obtained in one experiment made in cutting keyways $\frac{5}{16}$ in. wide by $\frac{1}{8}$ in. deep in a bank of 8 shafts $1\frac{1}{4}$ in. diam. at once, on a Pratt & Whitney, No. 3 column milling machine. The 8 mills were successfully operated with 45-ft. surface speed and $19\frac{1}{2}$ in. per min. feed; the cutters were 5-in. diam., with 28 teeth, giving the following figures, in steel: Surface speed, 45 ft. per minute; feed per tooth, 0.02024 in.; cuts per inch, 50, nearly. Fed with the revolution of mill. Flooded with oil, that is, a large stream of oil running constantly over each mill. Face of tooth radial. The resulting keyway was described as having a heavy wave or cutter-mark in the bottom, and it was said to have shown no signs of being heavy work on the cutters or on the machine. As a result of the experiment it was decided for economical steady work to run at 17 r.p.m., with a feed of 4 in. per min., flooded cut, work fed with mill revolution, giving the following figures: Surface speed, $22\frac{1}{4}$ ft. per min.; feed per tooth, 0.0084 in.; cuts per in., 119.

The Cincinnati Milling Machine Co. (1906) gives the following examples of rapid milling machine work: Gray iron castings $10\frac{1}{4}$ in. wide, 14 in. long \times $1\frac{3}{4}$ in. thick, finished all over, and a slot $\frac{5}{8} \times 1$ in. cut from the solid. A gang of five cutters was used, two of 8 in., two of $3\frac{1}{2}$ in. and one of $5\frac{3}{4}$ in. diameter, respectively. These took a cut $\frac{3}{16}$ in. deep across the top and two edges, and milled the slot in one operation. The table travel was 4.2 in. per minute. The average time, including chucking, was 15.6 minutes.

Gray iron castings 3 in. and $6\frac{1}{2}$ in. wide \times $25\frac{1}{4}$ in. long, $1\frac{1}{4}$ in. thick, were surfaced by a face mill 8 in. diameter at a surface speed of 80 feet per minute. The cut was $\frac{3}{16}$ in., and the table travel 11.4 in. per minute in the 3-in. part and 8 in. per minute in the $6\frac{1}{2}$ -in. part. The total time for finishing, including chucking, was seven minutes. The planer required 23 minutes for the same operation. In finishing the opposite side of these castings, two castings are milled at one setting, $\frac{3}{16}$ in. of stock being removed all over and two slots $\frac{5}{8} \times \frac{5}{8}$ in. milled from the solid. A gang of seven cutters, 3 of 3 in., 2 of $4\frac{1}{4}$ in., and 1 of $8\frac{1}{4}$ in. diameter, was used at 38 revolutions per minute and a feed of 0.1 in., giving a table travel of 3.8 in. per minute. These two castings were finished in 18 minutes, including chucking, the actual milling time being eight minutes on each piece. A planer working at 55 ft. cutting speed finished the same job in 36 minutes.

An inserted-tooth face mill 12 in. diameter took a 9-in. cut, $\frac{1}{8}$ in. deep across the entire face of a gray iron casting at a table travel of 5 in. per minute. The length of cut was 18 inches and the time required $6\frac{1}{2}$ minutes.

The following table summarizes a number of typical jobs of milling:

Typical Milling Jobs.

(Cincinnati Milling Mach. Co.; Brown & Sharpe Mfg. Co., 1907.)

Nature of Work.	Material Cut.	Cut, Inches.		Cutter.		Feed per Rev., in.	Table Travel per min., in.	Metal Removed per Minute, cu. in.	
		Deep.	Wide.	Diam. in.	Rev. per min.				Surface Speed ft. per min.
Spline (R) . . .	Steel	$\frac{5}{32}$	$\frac{3}{16}$	$2\frac{1}{2}$	166	108	0.05	8.3	0.243
Keyseat (R) . . .	Gray iron	$\frac{3}{16}$	$\frac{3}{8}$	$2\frac{1}{2}$	166	108	0.108	17.9	1.04
Keyseat (R) . . .	Lumen metal . . .	$\frac{1}{8}$	$\frac{3}{16}$	2	211	110	0.15	31.6	0.74
Surfacing (F) . .	Brass	0.01	$2\frac{1}{2}$	$3\frac{1}{2}$	100	78	0.25	25.0	0.675
Surfacing (F) . .	Tool steel	$\frac{1}{16}$	$2\frac{1}{2}$	$3\frac{1}{2}$	37	29	0.05	1.85	0.289
Face Milling (F)	Gray iron	0.015	8	10	47	123	0.30	14.1	1.692
Face Milling (R)	Gray iron	$\frac{1}{8}$	6	8	26	54	0.168	4.36	3.27
Surfacing (R) . .	Gray iron	$\frac{1}{8}$	$2\frac{1}{2}$	$3\frac{1}{2}$	100	78	0.30	30.0	9.375
Surfacing (F) . .	Bronze casting . .	$\frac{1}{64}$	3	$3\frac{1}{2}$	166	130	0.05	8.3	0.389
T-slotting . . .	Gray iron	See Note 3	$1\frac{1}{16}$	$2\frac{1}{2}$	252	75	0.05	12.6	6.693
Surfacing	Gray iron	0.10	12	$4\frac{5}{8}$	45	52	0.266	12.	14.4
Surfacing	Gray iron	$\frac{1}{8}$	12	$3\frac{5}{8}$	53	55	0.226	12.	18.0
Surfacing	Gray iron	0.20	12	$4\frac{1}{2}$	61	65	0.148	9.02	21.6

(F) Finishing cut; (R) Roughing cut.

¹ End mill; ² spiral mill with nicked teeth; work done by peripheral teeth. ³ Both sides of cutter engaged, making slot width equal to cutter diameter; slot $\frac{1}{16} \times \frac{1}{2}$ inch. ⁴ Carbon steel nicked spiral cutter.

Tests with a Helical Milling Cutter, 3 in. diam., 6 in. long; 8 teeth; pitch of helix, $18\frac{3}{4}$ in.; notched teeth; on cast iron and on mild steel, are reported by P. V. Vernon in *Am. Mach.*, June 3, 1909. The cutter was run at a constant speed, 84 turns per minute, cutting speed 66 ft. per min. In the tests on cast iron the depth of cut was varied from 0.14 to 1.10 in., and the feed per min. from $10\frac{9}{16}$ in. to $12\frac{7}{32}$ in. The material removed per minute ranged from 7.39 to 15.23 cu. in., and the cu. in. per min. per net machine horse-power from 1.06 to 1.52, averaging about 1.30.

In the tests on steel the depth of cut was 0.10 to 1.10 in. and the feed $10\frac{3}{8}$ to $0\frac{5}{8}$ in. per min.; the material removed per min. from 2.88 to 6.27 cu. in. per min.; and the cu. in. per min. per net H.P. from 0.47 to 0.71, averaging about 0.57. No regular relation appears between the rate of feed and the metal removed per min., but the maximum output on cast iron was obtained with a cut $\frac{5}{8}$ in. deep and a feed of $4\frac{7}{8}$ in. per min.; and on mild steel with a cut 0.12 in. deep and a feed of $9\frac{1}{2}$ in. per min.

Milling "with" or "against" the Feed.—Tests made with the Brown & Sharpe No. 5 milling-machine (described by H. L. Arnold, in *Am. Mach.*, Oct. 18, 1884) to determine the relative advantage of running the milling cutter with or against the feed—"with the feed" meaning that the teeth of the cutter strike on the top surface or "scale" of cast-iron work in process of being milled, and "against the feed" meaning that the teeth begin to cut in the clean, newly cut surface of the work and cut upwards toward the scale—showed a decided advantage in favor of running the cutter against the feed. The result is directly opposite to that obtained in tests of a Pratt & Whitney machine by experts of the Pratt & Whitney Co.

In the tests with the Brown & Sharpe machine the cutters used were 6 inches face by $4\frac{1}{2}$ and 3 inches diameter, respectively, 15 teeth in each mill, 42 revolutions per minute in each case, or nearly 50 feet per minute surface speed for the $4\frac{1}{2}$ -inch and 33 feet per minute for the 3-inch mill. The revolution marks were 6 to the inch, giving a feed of 7 inches per

minute, and a cut per tooth of 0.011 inch. When the machine was forced to the limit of its driving the depth of cut was 11/32 inch when the cutter ran in the "old" way, or against the feed, and only 1/4 inch when it ran in the "new" way, or with the feed. The endurance of the milling cutters was much greater when they were run in the "old" way. The Brown & Sharpe Co. says that it is sometimes advisable to mill with the feed, as in surfacing two sides of a piece with straddle mills, the cutters will then tend to hold the work down. In milling deep slots or cutting off stock with thin cutters or saws milling with the feed is less likely to crowd the cutter sidewise and make a crooked slot.

Modern Milling Practice. (Cincinnati Milling Machine Co., 1907.)—The limit of milling operations is determined by the strength and durability of the cutter. A rigid frame on the machine and powerful feed mechanism increase these. The chief causes of low output are: Improperly constructed cutters; insufficient rigidity in the machine; and timidity, due to lack of experience, of both builders and operators. The principal cause of cutter failures is insufficient space for chips between the cutter teeth. Fixed rules cannot be laid down for proper feeds and speeds of milling cutters, these depending on the character and hardness of the metal being cut. On roughing cuts it is desirable to run the cutter at a speed well within its limit, and use as heavy a feed as the machine can pull. The size of chip taken by each tooth of the cutter with the heaviest feeds is comparatively light, and with properly sharpened cutters there is little danger of breaking the cutter by giving too great a feed. It is considered better practice, however, to break an occasional cutter than to run machines at a low rate. It is not considered desirable to run even high speed steel cutters at excessive speeds. The great value of these cutters is their long life and ability to hold a cutting edge as compared with carbon steel cutters. It is important to keep the cutters sharp, as accurate or fast work is impossible with dulled teeth. The clearance angle should be kept low; about 3 degrees for steel, and not more than 5 degrees for gray iron.

The following speeds in feet per minute are a good basis for roughing the materials indicated:

Carbon steel cutters.			
Cast Iron.	Machinery Steel.	Tool Steel.	Brass and Bronze.
40	40	20	60
High speed steel cutters.			
80	80	40	120

On cast-iron work a jet of air delivered to the cutter with sufficient force to blow the chips away as fast as made permits faster feeds and prolongs the cutter's life. A stream of oil fed under heavy pressure to wash the chips away has the same effect when cutting steel. On finishing cuts the rate of feed used determines the grade of the finish. If a spiral mill is used the feed should range from 0.036 in. to 0.05 in. per revolution of a 3-in. diameter cutter. As such cuts are light the speed of cutting can be much higher than used for roughing cuts. The nature of the cut is a factor in determining speeds; a saw can run twice as fast as a surface mill. Keyseating and similar work can be best done with a plain cutter rather than a side mill.

In general small cutters are preferable to large ones, and the hole should be as small as the strength of the arbor will permit. It is advisable in surface milling to have the cutter wider than the work.

Lubricant for Milling Cutters. (Brown & Sharpe Mfg. Co., 1907.)—An excellent lubricant, to use with a pump, for milling cutters is made by mixing together and boiling for one half hour, 1/4 lb. sal soda, 1/2 pint lard oil, 1/2 pint soft soap and water enough to make 10 quarts.

Milling Machine versus Planer.—For comparative data of work done by each see paper by J. J. Grant, Trans. A. S. M. E., ix, 259. He says: The advantages of the milling machine over the planer are many, among which are the following: Exact duplication of work; rapidity of production—the cutting being continuous; lower cost of production, as several machines can be operated by one workman, and he not a skilled mechanic; and lower cost of tools for producing a given amount of work.

DRILLS.

Constant for Finding Speeds of Drills.—For finding the speed in feet when the number of revolutions is given; or the number of revolutions, when the speed in feet is given.

Constant = $12 \div (\text{size of drill} \times 3.1416)$.
 Number of revolutions = Constant \times speed in feet.
 Speed in feet = Number of revolutions \div constant.

Size Drill. In.	Con-stant. In.	Size Drill. In.	Con-stant. In.	Size Drill. In.	Con-stant. In.	Size Drill. In.	Con-stant. In.	Size Drill. In.	Con-stant. In.
1/8	30.55	3/4	5.09	1 3/8	2.78	2	1.91	2 5/8	1.45
3/16	20.38	13/16	4.70	1 7/8	2.66	2 1/16	1.85	2 11/16	1.42
1/4	15.28	7/8	4.36	1 1/2	2.55	2 1/8	1.80	2 3/4	1.39
5/16	12.22	15/16	4.07	1 9/16	2.44	2 3/16	1.75	2 13/16	1.36
3/8	10.19	1	3.82	1 5/8	2.35	2 1/4	1.70	2 7/8	1.33
7/16	8.73	1 1/16	3.59	1 11/16	2.26	2 5/16	1.65	2 15/16	1.30
1/2	7.64	1 1/8	3.39	1 3/4	2.18	2 3/8	1.61	3	1.27
9/16	6.79	1 3/16	3.22	1 13/16	2.11	2 7/16	1.57	3 1/16	1.25
5/8	6.11	1 1/4	3.06	1 7/8	2.04	2 1/2	1.53	3 1/8	1.22
11/16	5.56	1 5/16	2.91	1 15/16	1.97	2 9/16	1.49	3 1/4	1.18

Speed of Drills.—The Cleveland Twist Drill Co. (1907) gives the following speeds in r.p.m. for drilling wrought iron, machinery steel or soft tool steel, with high speed and carbon steel drills.

Diam. In.	Carbon Steel.	High Speed.	Diam. In.	Carbon Steel.	High Speed.	Diam. In.	Carbon Steel.	High Speed.	Diam. In.	Carbon Steel.	High Speed.
1/10	1834	3057	13/16	141	235	1 9/16	73.4	122	2 5/16	49.5	62.7
1/8	917	1528	7/8	131	218	1 5/8	70.5	117	2 3/8	48.2	60.5
3/16	611	1020	15/16	122	204	1 11/16	67.9	113	2 7/16	47.0	58.5
1/4	458	765	1	115	191	1 3/4	65.5	109	2 1/2	45.8	56.5
5/16	367	612	1 1/16	108	180	1 13/16	63.2	105.3	2 9/16	44.7	54.6
3/8	306	510	1 1/8	102	170	1 7/8	61.1	102	2 5/8	43.7	52.8
7/16	262	437	1 3/16	96.5	160	1 15/16	59.2	98.7	2 11/16	42.6	51.1
1/2	229	382	1 1/4	91.8	153	2	57.3	95.6	2 3/4	41.7	49.5
9/16	204	340	1 5/16	87.3	145	2 1/16	55.6	92.7	2 13/16	40.7	48.0
5/8	184	306	1 3/8	83.3	139	2 1/8	54.0	90.0	2 7/8	39.8	46.5
11/16	167	277	1 7/16	79.8	133	2 3/16	52.4	87.4	2 15/16	39.0	45.1
3/4	153	255	1 1/2	76.3	127	2 1/4	51.0	85.0	3	38.2	43.6

The feed per revolution recommended for drills smaller than 1/2-in. is from 0.004 to 0.007 in.; and from 0.005 to 0.01 in. for drills larger than 1/2-in.

High Speed Steel Drills.—The Cleveland Twist Drill Co. says that a high speed steel drill should be started with a peripheral speed between 50 and 60 ft. per minute, and a feed of 0.005 to 0.010 in. per revolution for drills over 1/2-in. A drill with a tendency to wear away on the outside is running too fast; if it breaks or chips on the cutting edges it has too much feed. When used in steel or wrought iron, the drill should be flooded with a good lubricant. For brass, paraffine oil is recommended, and for cast iron, an air blast.

Power Required to Drive High Speed Steel Drills.—The American Tool Works Co. (1907) obtained some remarkable results with drills of high-speed steel as shown in the tables below. The machine used was a triple-gear radial, and the drill was of the "Celfors" type, a flat bar of steel, twisted, affording ease of lubrication, and a free escape for the chips.

Power Required to Drill Steel with High Speed Steel Drills.

Size of Drill, Inches.	R.P.M.	Cutting Speed, Ft. per Min.	Feeds.		H.P. Required.
			In. per Rev.	In. per Min.	
9/16	356	52.3	.012	4.27	4.2
3/4	313	61.5	.012	3.75	10.8
11/32	188	50.9	.024	4.51	9.0
15/32	188	56.9	.024	4.51	9.3
123/32	128	57.6	.024	3.07	8.4
131/32	167	86.2	.012	2.00	7.8

Power Required to Drill Cast Iron 2 in. thick with High Speed Steel Drill.

Size of Drill, Inches.	R.P.M.	Cutting Speed, Ft. per Min.	Feeds.		H.P.
			In. per Rev.	In. per Min.	
11/32	313	84.5	.046	14.4	13.2
17/32	313	99.8	.046	14.4	15.3
115/32	216	83.1	.033	7.1	12.6
123/32	216	97.0	.033	7.1	16.8
131/32	128	66.0	.033	4.22	15.6
31/2	60	55.0	.024	1.44	10.2

Extreme Results with Radial Drills. (F. E. Bocorselski, *Am. Mach.*, Mar. 17, 1910.) — Three different radial drilling machines, designed to drive high-speed steel drills of the twisted type to the limit of their endurance, were tested by drilling steel billets of about 0.70 carbon at speeds and feeds which caused the drills to break after drilling holes from 2 to 11 ins. deep. The following are a few of the results obtained with different sizes of drill.

Drill size, ins.	Revs. per min.	Cutting speed, ft. per min.	Feed.		Metal removed.		Max. H.P.	H.P. per lb. per min.
			Per rev. in.	Ins. per min.	Cu. ins. per min.	Lbs. per min.		
11/2	290	113	0.0207	6	10.56	2.95	25	8.48
11/2	312	123	0.0323	10.08	17.23	4.97	56.6	11.4
11/4	330	107	0.0207	6.83	8.33	2.33	24.8	10.6
11/8	208	61.3	0.022	4.58	4.54	1.27	22.6	17.8
11/16	330	91	0.0207	6.83	6.	1.68	24.8	14.8

The H.P. of one of the machines running light at full speed was 4.4; running light at slow speed 2 H.P.

It was concluded from these tests, which were destructive to the drills, that for maximum production and considering the life of the drills, it is best to run a 1-in. drill at about 300 r.p.m. with a feed of 0.015 in. per rev., and a 1 1/2-in. drill 225 r.p.m. with a feed of 0.02 in. per revolution.

Some Data on High-Speed Drilling are given by G. E. Hallenbeck in *Iron Tr. Rev.*, April 29, 1909. A Baker high-speed drilling machine was used. Holes 11/8 in. diam. were drilled through 4 1/4-in. blocks of cast iron in 82/3 seconds per hole, or at the rate of 29 in. per min. Holes 15/16 in. diam. were drilled through 3/4 in. steel plate in 3 1/2 seconds.

Experiments on Twist Drills. — An extensive series of experiments on the forces acting on twist drills of high-speed steel when operating

on cast-iron and steel is reported by Dempster Smith and A. Pollakoff, in *Proc. Inst. M. E.*, 1909. Abstracted in *Am. Mach.*, May, 1909, and *Indust. Eng.*, May, 1909. Approximate equations derived from the first set of experiments are as follows:

Torque in pounds-feet, $T = (1800t + 9)d^2$, for medium cast-iron; $T = (3200t + 20)d^2$, for medium steel. End thrust, lbs., $P = 115,000t - 200$, for medium cast-iron; $P = 160,000(d - 0.5)t + 1000$, for medium steel; $d =$ diam., $t =$ feed per revolution of drill, both in inches. The steel was of medium hardness, 0.29 C, 0.625 Mn.

The end thrust in enlarging holes in medium steel from one size to a larger was as follows: 3/4 in. to 1 in., $P = 15,200t - 60$; 1 in. to 1 1/2 in., $P = 25,500t + 3$; 3/4 in. to 1 1/2 in., $P = 30,000t + 200$.

A second series of experiments, with soft cast-iron of C.C., 0.2; G.C., 2.9; Si, 1.41; Mn, 0.68; S, 0.035; P, 1.48, and medium steel of C, 0.31; Si, 0.07; Mn, 0.50; S, 0.018; P, 0.033; tensile strength, 72,600 lbs. per sq. in., gave results from which were derived the following approximate equations:

Torque, lbs.-ft., $T = 740 d^{1.8} t^{0.7}$, or $10 d^2 + 100 t(14 d^2 + 3)$ for cast-iron, $T = 1640 d^{1.8} t^{0.7}$, or $23 d^2(1 + 100 t)$ for medium steel, End thrust, lbs., $P = 35,500 d^{0.7} t^{0.75}$, or $200 d + 10,000 t$ for cast iron, $P = 35,500 d^{0.7} t^{0.6}$, or $750 d + 1000 t(75 d + 50)$ for medium steel,

and for different sizes of drill the following equations:

Drill.	3/4	1	1 1/2
Cast iron $T =$	5 + 1,100 t	10 + 1,759 t	25 + 3,700 t
Cast iron $P =$	125 + 82,000 t	200 + 89,000 t	350 + 103,000 t
Steel $T =$	7.5 + 3,350 t	17.5 + 4,400 t	40 + 9,000 t
Steel $P =$	550 + 109,000 t	750 + 131,000 t	1,250 + 162,000 t

Drill.	2	2 1/2	3
Cast iron $T =$	40 + 580 t	60 + 8,800 t	90 + 12,900 t
Cast iron $P =$	500 + 110,000 t	600 + 126,000 t	850 + 140,000 t
Steel $T =$	75 + 12,500 t	112.5 + 19,050 t	175 + 26,250 t
Steel $P =$	1,500 + 181,250 t	1,725 + 224,375 t	2,350 + 280,000 t

The tests above referred to were made without lubricants. When lubricants were used in drilling steel the average torque varied from 72% with 1/400 in. feed to 92% with 1/35 in. feed of that obtained when operating dry. The thrust for soft, medium and hard steel is 26%, 37% and 12% respectively less than when operating dry, no marked difference being found, as in the torque, with different feed. The horse-power varies as $t^{0.7}$ and as $d^{0.8}$ for a given drill and speed. The torque and horse-power when drilling medium steel is about 2.1 times that required for cast iron with the same drill speed and feed. The horse-power per cu. in. of metal removed is inversely proportional to $d^{0.2} t^{0.3}$, and is independent of the revolutions.

While the chisel point of the drill scarcely affects the torque it is accountable for about 20% of the thrust. Tests made with a preliminary hole drilled before the main drill was used to enlarge the hole showed that the work required to drill a hole where only one drill is used is greater than that required to drill the hole in two operations, with drills of different diameter.

For economy of power a drill with a larger point angle than 120° is to be preferred, but the increased end thrust strains the machine in proportion, and there is more danger of breaking the drill.

Taking the average recommended speed of 48 ft. per minute for cast iron and 60 ft. for mild steel, and the results obtained in these tests, the figures given in the following table are derived.

REVOLUTIONS PER MINUTE, FEED PER REVOLUTION, CUBIC INCHES REMOVED PER MINUTE, AND HORSE-POWER WHEN DRILLING SOFT CAST-IRON AND MEDIUM HARD STEEL.

Soft Cast Iron.					Medium Hard Steel.						
Diam. of drill, inches.	R.P.M. at cutting speed of 48 ft. per min. = $12 \times 48 / \pi d$.	Feed in ins. per revolution of drill, $f = d^2 / 64$.	Cubic inches removed per min. $1.715 d^3 f$.	Total horse-power.	H.P. per cu. in. of metal removed per min.	Diam. of drill, inches.	R.P.M. at cutting speed of 60 ft. per min. = $12 \times 60 / \pi d$.	Feed in ins. per revolution, $f = d^2 / 100$.	Cubic inches removed per min. $1.8 d^3 f$.	Total horse-power.	H.P. per cu. in. of metal removed per min.
1/4	735	0.0075	0.27	0.295	1.092	1/4	920	0.0063	0.284	0.721	2.54
3/8	490	0.0086	0.462	0.4405	0.953	3/8	614	0.0072	0.485	1.078	2.22
1/2	368	0.0094	0.682	0.586	0.852	1/2	460	0.00795	0.716	1.426	1.99
5/8	245	0.0109	1.17	0.8766	0.748	3/4	306	0.0091	1.23	2.152	1.75
1	184	0.0119	1.715	1.167	0.681	1	230	0.01	1.8	2.863	1.59
1 1/4	147	0.0129	2.32	1.457	0.628	1 1/4	184	0.0108	2.44	3.574	1.47
1 1/2	122	0.0136	2.92	1.748	0.595	1 1/2	153	0.0114	3.08	4.285	1.39
1 3/4	105	0.0144	3.63	2.038	0.563	1 3/4	131	0.0121	3.81	5.005	1.31
2	92	0.015	4.32	2.328	0.539	2	115	0.0126	4.54	5.715	1.26
2 1/4	81.7	0.0156	5.05	2.619	0.519	2 1/4	102	0.0131	5.3	6.436	1.21
2 1/2	73.5	0.0162	5.82	2.939	0.500	2 1/2	92	0.0136	6.12	7.136	1.165
2 3/4	66.75	0.0167	6.6	3.199	0.485	2 3/4	83.5	0.014	6.92	7.857	1.135
3	61.3	0.0172	7.4	3.489	0.472	3	76.5	0.0144	7.76	8.567	1.105
3 1/4	56.5	0.0176	8.22	3.78	0.46	3 1/4	70.5	0.0148	8.66	9.267	1.07
3 1/2	52.5	0.0181	9.05	4.07	0.45	3 1/2	65.6	0.0151	9.5	9.998	1.05
3 3/4	49	0.0185	10.0	4.36	0.436	3 3/4	61.25	0.0155	10.48	10.718	1.024
4	46	0.019	10.8	4.65	0.431	4	57.5	0.0158	11.4	11.42	1.0

POWER REQUIRED FOR MACHINE TOOLS.

Resistance Overcome in Cutting Metal. (Trans. A. S. M. E., viii, 308.) — Some experiments made at the works of William Sellers & Co. showed that the resistance in cutting steel in a lathe would vary from 180,000 to 700,000 pounds per square inch of section removed, while for cast iron the resistance is about one third as much. The power required to remove a given amount of metal depends on the shape of the cut and on the shape and the sharpness of the tool used. If the cut is nearly square in section, the power required is a minimum; if wide and thin, a maximum. The dullness of a tool affects but little the power required for a heavy cut.

Heavy Work on a Planer. — Wm. Sellers & Co. write as follows in the *American Machinist*: The 120-inch planer table is geared to run 15 feet per minute under cut, and 72 feet per minute on the return, which is equivalent, without allowance for time lost in reversing, to continuous cut of 14.4 feet per minute. Assuming the work to be 28 feet long, we may take 14 feet as the continuous cutting speed per minute, the 0.8 of a foot being much more than sufficient to cover time loss in reversing and feeding. The machine carries four tools. At 1/8 inch feed per tool, the surface planed per hour would be 35 square feet. The section of metal cut at 3/4 inch depth would be 0.75 inch X 0.125 inches X 4 = 0.375 square inch, which would require approximately 30,000 pounds pressure to remove it. The weight of metal removed per hour would be 14 X 12 X 0.375 X 0.26 X 60 = 1082.8 lb. Our earlier form of 36 in. planer has removed with one tool on 3/4 in. cut on work 200 lb. of metal per hour, and the 120 in. machine has more than five times its capacity. The total pulling power of the planer is 45,000 lb.

Horse-power Required to Run Lathes. — The power required to do useful work varies with the depth and breadth of chip, with the

shape of tool, and with the nature and density of metal operated upon; and the power required to run a machine empty is often a variable quantity. For instance, when the machine is new, and the working parts have not become worn or fitted to each other as they will be after running a few months, the power required will be greater than will be the case after the running parts have become better fitted.

Another cause of variation of the power absorbed is the driving-belt; a tight belt will increase the friction.

A third cause is the variation of journal-friction, due to slacking up or tightening the cap-screws, and also the end-thrust bearing screw.

Hartig's investigations show that it requires less total power to turn off a given weight of metal in a given time than it does to plane off the same amount; and also that the power is less for large than for small diameters. (J. J. Flather, *Am. Mach.*, April 23, 1891.)

Horse-power Required to Remove Metal in Lathes.

(Lodge & Shipley Mach. Tool Co., 1906.)

20-INCH CONE-HEAD LATHE.

Material Cut.	Cutting Speed, ft. per min.	Cut, In.		Diam. of work, in.	Cu. in. removed per min.	Lb. removed per hour.	H.P. used by Lathe.		Cu. in. removed per H.P.
		Depth.	Feed.				Idle.	With Cut.	
Crucible Steel	35	0.109	1/8	2 27/32	5.74	96	0.48	3.90	1.471
	65	0.055	1/8	3 5/8	5.33	90	0.74	4.60	1.158
	62.5	0.109	1/16	3 5/16	5.125	86	0.49	4.65	1.102
Carbon	32.5	0.094	1/10	3 5/16	3.656	62	0.49	2.64	1.384
	62.5	0.273	1/12	3 5/32	17.09	266	0.66	5.44	3.141
Cast Iron	60	0.430	1/19	2 21/64	16.27	253	0.59	4.77	3.410
	37.5	0.334	1/16	2 21/32	10.76	167	0.45	3.91	2.751
	115	0.086	1/12	1 55/64	9.88	153	0.21	2.54	3.869
Open-hearth Steel	50	0.109	1/8	2 23/32	8.2	138	0.69	5.34	1.535
	45	0.117	1/8	2 1/2	7.91	134	0.53	5.11	1.547
	43	0.217	1/10	2 17/64	6.439	109	0.69	4.10	1.570
Carbon	32.5	0.109	1/8	2 23/64	5.33	90	0.36	4.04	1.319

Average H.P. running idle 0.53; average H.P. with cut 4.25.

20-INCH GEARED-HEAD LATHE.

Material Cut.	Cutting Speed, ft. per min.	Cut, in.		Diam. of work, in.	Cu. in. removed per min.	Lb. removed per hour.	H.P. used by Lathe.		Cu. in. removed per H.P.
		Depth.	Feed.				Idle.	With Cut.	
0.50 Carbon	40	0.266	1/10	2 27/32	12.75	215	2.11	11.1	1.142
	50	0.281	1/15	2 27/32	11.25	190	1.58	8.35	1.347
	75	0.281	1/15	2 27/32	16.87	285	1.58	12.69	1.329
	85	0.109	1/15	2 1/4	7.43	126	1.28	8.98	0.827
Crucible Steel.	45	0.609	1/16	7 21/32	20.57	320	1.34	6.94	2.963
	62.5	0.609	1/16	7 21/32	28.56	445	1.35	9.50	3.006
	85	0.641	1/16	7 21/32	40.82	636	1.64	12.69	3.216
Cast Iron	80	0.281	1/8	3 3/32	33.75	526	1.18	10.49	3.217
	125	0.250	1/28	4 21/32	13.4	226	1.62	10.60	1.265
Open-hearth Steel	105	0.188	1/12	4 5/32	19.68	332	0.94	11.56	1.702
	40	0.172	1/6	3 27/32	13.75	232	1.75	12.49	1.100
	180	0.094	1/16	3 1/16	12.65	213	2.15	11.20	1.129

Average H.P. running idle 1.543; average H.P. with cut 10.55.

Owing to the demand imposed by high speed tool steels stouter machines are more necessary than formerly; these possess more rigid frames and powerful driving gears. The most modern (1907) forms of lathes obtain all speed changes by means of geared head-stocks, power being delivered at a single speed by a belt, or by a motor. If a motor drive is used, a speed variation may be obtained in addition to those available in the head, by using a variable speed motor, whose range usually is about 3:1. The Lodge & Shipley Co. (1906) made an exhaustive series of tests to determine the power required to remove metal, using both the cone-head lathe and the more modern geared-head lathe. The table on page 1257 shows the results obtained with 20-in. lathes of each type.

Power Required to Drive Machine Tools. — The power required to drive a machine tool varies with the material to be cut. There is considerable lack of agreement among authorities on the power required. Prof. C. H. Benjamin (*Mach'y*, Sept., 1902) gives a formula $H.P. = cW$, c being a constant and W the pounds of metal removed per hour. c varies both with the quality of metal and the type of machine.

Values of c .

	Lathe.	Planer.	Shaper.	Milling Machine.
Cast iron	0.035	0.032	0.030	0.14
Machinery steel	0.067
Tool steel	0.30
Bronze	0.10

In each case the power to drive the machine without load should be added. G. M. Campbell (*Proc. Engr. Soc. W., Pa.*, 1906) gives, exclusive of friction losses, $H.P. = Kw$, K being a constant and w the pounds of metal removed per minute. For hard steel $K=2.5$; for soft steel $K=1.8$; for wrought iron, $K=2.0$; for cast iron, $K=1.4$. This formula gives results about 50% lower than Prof. Benjamin's.

The Westinghouse Elec. and Mfg. Co. (1906) gives a set of formulae based on the dimensions of the machine.

For Engine Lathes using one cutting tool of water-hardened steel, cutting 20 ft. per minute, $H.P. = 0.15 S - 1$; for heavy engine lathes, as forge lathes, $H.P. = 0.234 S - 2$, S being the swing of the lathe, inches.

For Boring Mills using one cutting tool of water-hardened steel, cutting 20 ft. per min., $H.P. = 0.25 S - 4$. S = swing of mill, inches.

For Milling Machines using water-hardened steel cutters at 20 ft. per minute, $H.P. = 0.3 W$. W = distance between housings, inches.

For Drill Presses using water-hardened steel drills, running at a peripheral cutting speed of 20 feet per minute, $H.P. = 0.06 S$.

For Heavy Radial Drill Presses, $H.P. = 0.1 S$.

S = swing of drill, inches, in both cases.

In general, in all the above Westinghouse formulae, if high-speed steel tools are used, running at higher cutting speeds than above, the increase in horse-power is proportional to the increase in speed.

Planers. For planers, in which the length of bed in feet is approximately two-tenths of the width between housings in inches, using water-hardened steel tools, cutting at 15 to 20 ft. per minute, $H.P. = 3 W$.

For Heavy Forge Planers, $H.P. = 4.92 W$.

W = width between housings, feet.

These formulae are for planers having a ratio of return to cutting speeds of about 3:1, and are for planers with two tools in operation. If more than two tools are operated, or if the ratio of cutting and return speeds is increased, or if the length of bed is greater than given above, the horse-power given by the above formulae should be increased. The horse-power required by motor-driven planers is principally determined by the current inrush at the instant of quick reverse, rather than by that actually required to cut the metal. Motors for operating planers should have greater overload capacity than for any other tool.

Horse-power to Drive Machine Tools.

Tool.	Material.	Cut, Inches.		Speed, Ft. per Min.	Wt. Removed, l.b. per Min.	H.P. Required.		Motor Used.
		Feed.	Depth.			Actual.	Formula.	
72-in. wheel lathe	Hard steel	1/12	3/16 & 1/4	13.7	1.69	4.5	4.2	25 H.P. shunt wound variable speed.
		1/8	3/16 & 1/4	11.6	2.15	6.4	5.4	
		3/16	5/16 & 3/8	13.2	5.55	8.4	13.9	
		3/16	3/8 & 3/8	13.2	6.3	12.0	15.7	
90-in. wheel lathe	Hard steel	3/16	3/16 & 3/16	13.0	3.1	12.0	7.7	25 H.P. shunt wound variable speed.
		3/16	5/16 & 5/16	8.8	3.5	8.1	8.7	
		1/5	1/4 & 1/4	15.5	5.3	9.0	13.2	
42-in. lathe	Soft steel	1/16	1/4	44	2.33	3.8	4.2	15 H.P. shunt wound variable speed.
		1/16	1/8	44	1.17	1.7	1.9	
	Cast iron	1/16	1/8	44	1.17	2.6	1.9	
		1/16	3/16	108	2.63	5.8	3.7	
30-in. lathe	Wro't iron	1/8	3/16	54	4.2	6.6	8.4	10 H.P. shunt wound variable speed.
		1/8	3/16	42	3.2	4.0	6.4	
	Cast iron	3/32	5/32	42	1.92	3.0	2.7	
		3/32	1/16	61	1.12	1.5	1.6	
Axle lathe	Soft steel	3/16	1/4	27	4.3	5.9	7.7	35 H.P. sh. w'd var. speed.
		1/16	1/4	51	2.7	5.0	4.9	
72-in. boring mill	Soft steel	1/8	1/16 & 1/32	44	1.76	2.9	3.2	25 H.P. shunt wound variable speed.
		3/16	1/32 & 1/16	40	2.38	2.6	4.3	
	Cast iron	1/8	1/8 & 1/8	51	5.41	9.6	9.7	
		1/8	3/16	47	3.75	7.2	6.8	
24-in. drill press	Wro't iron	1/64	11/4 to 3*	25.1	0.81	2.3	1.6	
		1/64	11/4 to 3*	29.7	0.96	2.7	1.9	
	" "	1/64	11/4 to 3*	25.9	0.83	1.3	1.7	
		1/64	11/4 drill	74.5	0.52	3.5	1.0	
60-in. planer	Soft steel	1/6	1/4	25.5	3.62	5.9	6.5	20 H.P. compound wound variable speed.
		1/8	1/4	25.7	3.65	6.5	6.6	
	Wro't iron	3/16	5/16 & 5/16	23	8.95	21.0	17.9	
		1/2	1/32 & 1/32	17.5	1.82	2.7	3.6	
42-in. planer	Cast iron	1/8	1/8 & 1/16	22.2	1.72	6.5	3.4	15 H.P. compound wound variable speed.
		1/8 & 1/16	1/4 & 5/16	30	4.74	9.3	6.6	
	" "	1/7	1/4 & 1/4	22.6	5.03	7.6	7.1	
		1/4	7/16 & 3/8	28.9	18.3	23.2	25.6	
19-in. slotter	Hard steel	1/32	1/4	30.0	0.8	2.0	2.0	13 H.P. comp. w'd var. speed.
		1/32	3/8	23.3	0.93	1.3	1.7	
		1/32	3/8	37	4.06	4.7	5.7	

* Enlarging hole from smaller dimensions to larger.

Actual tests (1906) of a number of machine tools in the shops of the Pittsburg and Lake Erie R. R. showed the horse-power absorbed in driving under the conditions given in the table on page 1259. The results obtained are compared with those computed by Campbell's formula above.

L. L. Pomeroy (*Gen. Elec. Rev.*, 1908) gives: H.P. required to drive = $12 FDSNC$, in which F = feed and D = depth of cut, in inches, S = speed in ft. per min., N = number of tools cutting, C = a constant, whose values with ordinary carbon steel tools are: for cast iron, 0.35 to 0.5; soft steel or wrought iron, 0.45 to 0.7; locomotive driving-wheel tires, 0.7 to 1.0; very hard steel, 1.0 to 1.1. This formula is based on Prof. Flather's dynamometer tests. An analysis of experiments by Dr. Nicholson of Manchester, which confirm the formula, showed the average H.P. required at the motor per pound of metal removed per minute to be as follows: Medium or soft steel, or wrought iron, 2.4 H.P.; hard steel, 2.65 H.P.; cast-iron, soft or medium, 1.00 H.P.; cast iron, hard, 1.36 H.P.

Size of Motors for Machine Tools. (*Elec. World*, May 27, 1905.)—The average size of motor usually fitted to machine tools is shown by the table below, being compiled by the Electro-Dynamic Co. from published data. In special cases the power required may be several times the value here given.

Boring Mills.			
H.P.	H.P.	H.P.	H.P.
34 and 36 in. 5	60 in. 10	8 ft. 20	
42, 48 and 50 in. 7 1/2	6 ft. and 7 ft. 15	10 ft. 25	
Engine Lathes.			
H.P.	H.P.	H.P.	H.P.
12 and 14 in. 1	20 and 30 in. 3	54 in. 6	
16 in. 1 1/2	36 in. 4	60 in. 7 1/2	
20 to 25 in. 2	42 and 48 in. 5	72 in. 10	
Drill Presses.			
H.P.	H.P.	H.P.	H.P.
21 to 32 in. 2	36 to 48 in. 3	50 to 60 in. 5	
Planers.			
H.P.	H.P.	H.P.	H.P.
17 x 17 in. x 3 to 6 ft. 4	42 x 42 in. x 10 to 12 ft. 10		
22 x 24 in. x 4 to 10 ft. 5	48 x 48 in. x 12 to 14 ft. 15		
26 x 26 in. x 6 to 12 ft. 6	50 x 60 in. x 14 to 18 ft. 20		
30 x 30 in. x 6 to 14 ft. 7 1/2	60 x 60 in. x 20 to 22 ft. 25		
36 x 36 in. x 8 to 16 ft. 7 1/2	72 x 72 in. x 20 to 24 ft. 30		
Slotters.			
H.P.	H.P.	H.P.	H.P.
12 to 14 in. 5	16 and 18 in. 7 1/2	26 to 36 in. 10	
Shapers.			
H.P.	H.P.	H.P.	H.P.
12 to 16 in. 2	24 to 26 in. 5	36 in. 8	
18 to 20 in. 3	28 to 30 in. 6		

The values given above for engine lathes are less than those used by the R. K. LeBlond Mach. Tool Co., which recommends (1907) the following size motors for use with its lathes.

Swing of lathe. in.	Horse-power of Motor.		Speed ratio.	Maximum speed range R.P.M.
	Medium duty.	Heavy duty.		
12 and 14	2	3	3 to 1	1500
16	3	5	3 to 1	1500
18, 20, 22	5	7 1/2	3 to 1	1500
24, 27, 30	7 1/2	10	3 to 1	1500
32, 36	15	25	3 to 1	1500
24*			2 to 1	750-1500

* High Speed Roughing Lathe.

Horse-power Required to Drive Shafting.—Samuel Webber in his "Manual of Power" gives, among numerous tables of power required to drive textile machinery, a table of results of tests of shafting. A line of 2 1/8-in. shafting, 342 ft. long, weighing 4098 lb., with pulleys weighing 5331 lb., or a total of 9429 lb., supported on 47 bearings, 216 revolutions per minute, required 1.858 H.P. to drive it. This gives a coefficient of friction of 5.52%. In seventeen tests the coefficient ranged from 3.34% to 11.4%, averaging 5.73%.

Horse-power consumed in Machine-shops.—How much power is required to drive ordinary machine tools? and how many men can be employed per horse-power? are questions which it is impossible to answer by any fixed rule. The power varies greatly according to the conditions in each shop. The following table given by J. J. Flather in his work on Dynamometers gives an idea of the variation in several large works. The percentage of the total power required to drive the shafting varies from 15 to 80, and the number of men employed per total H.P. varies from 0.62 to 6.04.

Horse-power; Friction; Men Employed.

Name of Firm.	Kind of Work.	Horse-power.			Number of Men.	No. of Men per Total H.P.	No. of Men per Effective H.P.	
		Total.	Required to Drive Shafting.	Required to Drive Machinery.				Per cent to Drive Shafting.
Lane & Bodley	E. & W. W.	58			132	2.27		
J. A. Fay & Co.	W. W.	100	15	85	300	3.00	3.53	
Union Iron Works	E., M. M.	400	95	305	1600	4.00	5.24	
Frontier Iron & Brass Works	M. E., etc.	25	8	17	150	6.00	8.82	
Taylor Mfg. Co.	E.	95			230	2.42		
Baldwin Loco. Works	L.	2500	2000	500	4100	1.64	8.20	
W. Sellers & Co. (one department)	H. M.	102	41	61	300	2.93	4.87	
Pond Mach. Tool Co.	M. T.	180	75	105	432	2.40	4.11	
Pratt & Whitney Co.	"	120			725	6.04		
Brown & Sharpe Co.	"	230			900	3.91		
Yale & Towne Co.	C. & L.	135	67	68	700	5.11	10.25	
Ferracute Mach. Co.	P. & D.	35	11	24	90	2.57	3.75	
T. B. Wood's Sons	P. & S.	12			30	2.50		
Bridgeport Forge Co.	H. F.	150	75	75	130	0.86	1.73	
Singer Mfg. Co.	S. M.	1300			3500	2.69		
Howe Mfg. Co.	"	350			1500	4.28		
Worcester Machine Screw Co.	M. S.	40			80	2.00		
Hartford Mach. Screw Company	M. S.	400	100	300	250	0.62	0.83	
Nicholson File Co.	F.	350			400	1.14		
Averages		346.4			38.6	818.3	2.96	5.13

Abbreviations: E., engine; W. W., wood-working machinery; M. M., mining machinery; M. E., marine engines; L., locomotives; H. M., heavy machinery; M. T., machine tools; C. & L., cranes and locks; P. & D., presses and dies; P. & S., pulleys and shafting; H. F., heavy forgings; S. M., sewing-machines; M. S., machine-screws; F., files.

J. T. Henthorn states (*Trans. A. S. M. E.*, vi. 462) that in print-mills which he examined the friction of the shafting and engine was in 7 cases

below 20% and in 35 cases between 20% and 30%, in 11 cases from 30% to 35% and in 2 cases above 35%, the average being 25.9%. Mr. Barrus in eight cotton-mills found the range to be between 18% and 25.7%, the average being 22%. Mr. Flather believes that for shops using heavy machinery the percentage of power required to drive the shafting will average from 40% to 50% of the total power expended. This presupposes that under the head of shafting are included elevators, fans and blowers.

Power Required to Drive Machines in Groups.—L. P. Alford (*Am. Mach.*, Oct. 31, 1907) gives the results of an investigation to determine the power required to drive machinery in groups. The method employed comprised disconnecting parts of the shafting in a belt-driven plant, and driving the disconnected portion with its machines by an electric motor, readings of the power required being taken every 5 minutes. The average power required for the entire factory was considerably less than the sum of the power required for the individual machines, due to tools being stopped at some portion of the day for adjustment, replacement of work, etc. The conditions of group driving are such that fixed rules cannot be laid down, but a study must be made of each individual case.

ABRASIVE PROCESSES.

Abrasive cutting is performed by means of stones, sand, emery, glass, corundum, carborundum, crocus, rouge, chilled globules of iron, and in some cases by soft, friable iron alone. (See paper by John Richards, read before the Technical Society of the Pacific Coast, *Am. Mach.*, Aug. 20, 1891, and *Eng. & M. Jour.*, July 25 and Aug. 15, 1891.)

The "Cold Saw."—For sawing any section of iron while cold the cold saw is sometimes used. This consists simply of a plain soft steel or iron disk without teeth, about 42 inches diameter and $\frac{3}{16}$ inch thick. The velocity of the circumference is about 15,000 feet per minute. One of these saws will saw through an ordinary steel rail cold in about one minute. In this saw the steel or iron is ground off by the friction of the disk, and is not cut as with the teeth of an ordinary saw. It has generally been found more profitable, however, to saw iron with disks or band-saws fitted with cutting-teeth, which run at moderate speeds and cut the metal as do the teeth of a milling-cutter.

Reese's Fusing-disk.—Reese's fusing-disk is an application of the cold saw to cutting iron or steel in the form of bars, tubes, cylinders, etc., in which the piece to be cut is made to revolve at a slower rate of speed than the saw. By this means only a small surface of the bar to be cut is presented at a time to the circumference of the saw. The saw is about the same size as the cold saw above described, and is rotated at a velocity of about 25,000 feet per minute. The heat generated by the friction of this saw against the small surface of the bar rotated against it is so great that the particles of iron or steel in the bar are actually fused, and the "sawdust" welds as it falls into a solid mass. This disk will cut either cast iron, wrought iron, or steel. It will cut a bar of steel $\frac{13}{8}$ inch diameter in one minute, including the time of setting it in the machine, the bar being rotated about 200 turns per minute.

Cutting Stone with Wire.—A plan of cutting stone by means of a wire cord has been tried in Europe. While retaining sand as the cutting agent, M. Paulin Gay, of Marseilles, has succeeded in applying it by mechanical means, and as continuously as formerly the sand-blast and band-saw, with both of which appliances his system—that of the "helicoidal wire cord"—has considerable analogy. An engine puts in motion a continuous wire cord (varying from five to seven thirty-seconds of an inch in diameter, according to the work), composed of three mild-steel wires twisted at a certain pitch, that is found to give the best results in practice, at a speed of from 15 to 17 feet per second.

The Sand-blast.—In the sand-blast, invented by B. F. Tilghman, of Philadelphia, and first exhibited at the American Institute Fair, New York, in 1871, common sand, powdered quartz, emery, or any sharp cutting material is blown by a jet of air or steam on glass, metal, or other comparatively brittle substance, by which means the latter is cut, drilled, or engraved. To protect those portions of the surface which it is desired shall not be abraded it is only necessary to cover them with a soft or tough material, such as lead, rubber, leather, paper, wax, or rubber-

paint. (See description in *App. Cyc. Mech.*; also U. S. report of Vienna Exhibition, 1873, vol. iii. 316.)

A "jet of sand" impelled by steam of moderate pressure, or even by the blast of an ordinary fan, depolishes glass in a few seconds; wood is cut quite rapidly; and metals are given the so-called "frosted" surface with great rapidity. With a jet issuing from under 300 pounds pressure, a hole was cut through a piece of corundum $1\frac{1}{2}$ inches thick in 25 minutes. The sand-blast has been applied to the cleaning of metal castings and sheet metal, the graining of zinc plates for lithographic purposes, the frosting of silverware, the cutting of figures on stone and glass, and the cutting of devices on monuments or tombstones, the recutting of files, etc. The time required to sharpen a worn-out 14-inch bastard file is about four minutes. About one pint of sand, passed through a No. 120 sieve, and 4 H.P. of 60-lb. steam are required for the operation. For cleaning castings, compressed air at from 8 to 10 pounds pressure per square inch is employed. Chilled-iron globules instead of quartz or flint-sand are used with good results, both as to speed of working and cost of material, when the operation can be carried on under proper conditions. With the expenditure of 2 H.P. in compressing air, 2 square feet of ordinary scale on the surface of steel and iron plates can be removed per minute. The surface thus prepared is ready for tinning, galvanizing, plating, bronzing, painting, etc. By continuing the operation the hard skin on the surface of castings, which is so destructive to the cutting edges of milling and other tools, can be removed. Small castings are placed in a sort of slowly rotating barrel, open at one or both ends, through which the blast is directed downward against them as they tumble over and over. No portion of the surface escapes the action of the sand. Plain cored work, such as valve-bodies, can be cleaned perfectly both inside and out. One hundred lbs. of castings can be cleaned in from 10 to 15 minutes with a blast created by 2 H.P. The same weight of small forgings can be scaled in from 20 to 30 minutes. —*Iron Age*, March 8, 1894.

EMERY WHEELS AND GRINDSTONES.

References: "Precision Grinding," by Darbyshire; "Emery Wheels, their Selection and Use," published by Brown & Sharpe Mfg. Co.; "Points on Grinding," C. H. Norton; "Versuche ueber die Leistung von Schmirgel und Karborundum Scheiben bei Wasserzufuehrung," G. Schlesinger; "Die Festigkeit der kuenstlichen Schmirgel und Karborundum Scheiben, ihre Arbeitsleistung und ihre Wirthschaftlichkeit im Werkstattbetriebe," G. Schlesinger.

Selection of Grinding Wheels. (Contributed by Norton Co., 1908.)—The essential features of a modern grinding wheel which should be thoroughly understood by the user are: the definition of grain and grade, and the particular conditions of grinding which cause them to vary.

Grain.—Abrasive grains are numbered according to the meshes per lineal inch of the screen through which they have been graded. The numbers used in wheels are 8, 10, 12, 14, 16, 20, 24, 30, 36, 46, 54, 60, 70, 80, 90, 120, 150, 180, and 200; when finer than 200, the grits are termed flours, being designated as F, FF, FFF and SF; F being the coarsest and SF the finest. Grits from 12 to 30 are generally used on all heavy work, such as snagging; 36 to 80 cover nearly all tool-grinding, saw-gumming, and nearly all operations where precision in measurement is sought; 90 and finer are used for special work, such as grinding steel balls and fine edge work; over 200 is used mostly for oil and hand rubbing stones.

Grade.—When the retentive properties of the bond are great, the wheel is called hard; when the grains are easily broken out, it is called soft. A wheel is of the proper grade when its cutting grains are automatically replaced when dulled. Wheels that are too hard glaze. Dressing re-sharpens them, the points of the dresser breaking out and breaking off the cutting grains by percussion.

Soft wheels are used on hard materials, like hardened steel. Here the cutting particles are quickly dulled and must be renewed. On softer materials, like mild steel and wrought iron, harder grades can be used, the grains not dulling so quickly.

The area of surface to be ground in contact with the wheel is of the utmost importance in determining the grade. If it is a point contact like grinding a ball or if an extremely narrow fin is to be removed, we

of 80 lb. per sq. in. A section of the same stone dry, broke at 146 lb. per sq. in. A better quality stone broke at stresses of 186 and 116 lb. per sq. in. when dry and wet respectively.

Selection of Emery Wheels. — The Norton Co. (1907) publishes the following table showing the proper grain and grade of wheel for different services. The column headed grain indicates the coarseness of the material composing the wheel, being designated by the number of meshes per inch of a sieve through which the grains pass. A No. 20 grain will pass through a 20-mesh sieve, but not through a 30-mesh, etc.

Table for Selection of Grades.

Class of Work.	No. of Grain or Degree of Coarseness usually Furnished.	Grade Letters or Degrees of Hardness usually Furnished.	Grade Letters or Degrees of Hardness. Furnished in Exceptional Cases.	
			Sometimes Soft as	Sometimes Hard as
Large cast iron and steel castings	12 to 20	Q to R	P	U
Small cast iron and steel castings	20 " 30	Q to R	P	U
Large malleable iron castings	16 " 20	Q to R	P	W
Small malleable iron castings	20 " 30	Q to R	P	U
Chilled iron castings	16 " 20	Q to R	P	U
Wrought iron	16 " 30	Q to R	P	U
Brass castings	16 " 30	Q to R	P	U
Bronze castings	16 " 30	Q to R	P	U
Rough work in general	16 " 30	Q to R	O	R
General machine-shop use	30 " 46	Q to R	O	R
Lathe and planer tools	30 " 46	Q to R	M	P
Small tools	36 " 100	N " P	N	P
Wood-working tools	36 " 60	M " N	L	P
Twist drills (hand grinding)	36 " 60	M " N	L	P
Twist drills (special machines)	46 " 60	K " M	H	O
Reamers, taps, milling cutters, etc. (hand grinding)	46 " 100	N " P	N	P
Reamers, taps, milling cutters, etc. (special machines)	46 " 60	H " K	H	O
Edging and joining agricultural implements	16 " 30	Q " R	M	W
Grinding plow points	16 " 30	Q " R	M	U
Surfacing plow bodies	16 " 30	Q " R	M	Q
Stove mounting	20 " 36	P " Q	M	Q
Finishing edges of stoves	30 " 46	O " P	M	Q
Drop forgings	20 " 30	P " Q	M	Q
Gumming and sharpening saws	36 " 60	M " N	L	O
Planing-mill and paper-cutting knives	30 " 46	J " K	I	M
Car-wheel grinding	20 " 30	O " P	N	R

EXPLANATION OF GRADE LETTERS.

Extremely Soft	Soft.	Medium Soft.	Medium.	Medium Hard.	Hard.	Extremely Hard.
A	E	I	M	Q	U	Y
B	F	J	N	R	V	Z
C	G	K	O	S	W	
D	H	L	P	T	X	

The intermediate letters between those designated as soft, medium soft, etc., indicate so many degrees harder or softer; e.g., L is one grade or degree softer than medium; O, 2 degrees harder than medium but not quite medium hard.

For Grinding High-speed Tool Steel, The American Emery Wheel Co. recommends a wheel one number coarser and one grade softer than a wheel for grinding carbon steel for the same service.

Special Wheels. — Rim wheels and iron-center wheels are specialties that require the maker's guarantee and assignment of speed.

Strains in Grindstones.

LIMIT OF VELOCITY AND APPROXIMATE ACTUAL STRAIN PER SQUARE INCH OF SECTIONAL AREA FOR GRINDSTONES OF MEDIUM TENSILE STRENGTH.

Diameter.	Revolutions per Minute.						
	100	150	200	250	300	350	400
feet.	lbs.	lbs.	lbs.	lbs.	lbs.	lbs.	lbs.
2	1.58	3.57	6.35	9.93	14.30	18.36	25.42
2 1/2	2.47	5.57	9.88	15.49	22.29	28.64	39.75
3	3.57	8.04	14.28	22.34	32.16		
3 1/2	4.86	10.93	19.44	30.38			
4	6.35	14.30	27.37				
4 1/2	8.04	18.08	32.16				
5	9.93	22.34					
6	14.30	32.17					
7	19.44						

Approximate breaking strain ten times the strain for size opposite the bottom figure in each column.

The figures at the bottom of columns designate the limit of velocity (in revolutions per minute at the head of the columns) for stones of the diameter in the first column opposite the designating figure.

A general rule of safety for any size grindstone that has a compact and strong grain is to limit the peripheral velocity to 47 feet per second.

Joshua Rose (Modern Machine-shop Practice) says: The average circumferential speed of grindstones in workshops may be given as follows:

For grinding machinists' tools, about..... 900 feet per minute.
carpenters' 600

The speeds of stones for file-grinding and other similar rapid grinding is thus given in the "Grinders' List."

Diam ft.	8	7 1/2	7	6 1/2	6	5 1/2	5	4 1/2	4	3 1/2	3
Revs. per min.	135	144	154	166	180	196	216	240	270	308	360

The following table, from the Mechanical World, is for the diameter of stones and the number of revolutions they should run per minute (not to be exceeded), with the diameter of change of shift-pulleys required, varying each shift or change 2 1/2 inches, 2 1/4 inches, or 2 inches in diameter for each reduction of 6 inches in the diameter of the stone.

Diameter of Stone.	Revolutions per Minute.	Shift of Pulleys, in inches.		
		2 1/2	2 1/4	2
ft. in.				
8 0	135	40	36	32
7 6	144	37 1/2	33 3/4	30
7 0	154	35	31 1/2	28
6 6	166	32 1/2	29 1/4	26
6 0	180	30	27	24
5 6	196	27 1/2	24 3/4	22
5 0	216	25	22 1/2	20
4 6	240	22 1/2	20 1/4	18
4 0	270	20	18	16
3 6	308	17 1/2	15 3/4	14
3 0	360	15	13 1/2	12

Columns 3, 4, and 5 are given to show that if we start an 8-foot stone with, say, a countershaft pulley driving a 40-inch pulley on the grindstone spindle, and the stone makes the right number (135) of revolutions per minute, the reduction in the diameter of the pulley on the grinding-stone spindle, when the stone has been reduced 6 inches in diameter, will require to be also reduced 2 1/2 inches in diameter, or to shift from 40 inches to 37 1/2 inches, and so on similarly for columns 4 and 5. Any other suitable dimensions of pulley may be used for the stone when eight feet in diameter, but the number of inches in each shift named, in order to be correct, will have to be proportional to the numbers of revolutions the stone should run, as given in column 2 of the table.

Varieties of Grindstones.
(Joshua Rose.)

FOR GRINDING MACHINISTS' TOOLS.

Name of Stone.	Kind of Grit.	Texture of Stone.	Color of Stone.
Nova Scotia.	All kinds, from finest to coarsest	All kinds, from hardest to softest	Blue or yellowish gray.
Bay Chaleur (New Brunswick).			
Liverpool or Melling	Medium to finest	Soft and sharp	Uniformly light blue
	Medium to fine	Soft, with sharp grit	Reddish

FOR WOODWORKING TOOLS.

Name of Stone.	Kind of Grit.	Texture of Stone.	Color of Stone.
Wickersley.	Medium to fine	Very soft	Grayish yellow
Liverpool or Melling	Medium to fine	Soft, with sharp grit	Reddish
Bay Chaleur (New Brunswick).	Medium to finest	Soft and sharp	Uniform light blue
Huron, Michigan	Fine	Soft and sharp	Uniform light blue

FOR GRINDING BROAD SURFACES, AS SAWS OR IRON PLATES.

Newcastle	Coarse to med'm	The hard ones	Yellow
Independence	Coarse	Hard to medium	Grayish white
Massillon	Coarse	Hard to medium	Yellowish white

SCREWS, SCREW-THREADS, ETC.

Efficiency of a Screw. — Let a = angle of the thread, that is, the angle whose tangent is the pitch of the screw divided by the circumference of a circle whose diameter is the mean of the diameters at the top and bottom of the thread. Then for a square thread

$$\text{Efficiency} = \frac{1 - f \tan a}{1 + f \cotan a'}$$

in which f is the coefficient of friction. (For demonstration, see Cotterill and Slade, Applied Mechanics.) Since $\cotan a = 1 \div \tan a$, we may substitute for $\cotan a$ the reciprocal of the tangent, or if p = pitch, and c = mean circumference of the screw,

$$\text{Efficiency} = \frac{1 - fp/c}{1 + fc/p}$$

WARNING: This is a 1910 edition. Some of the material may no longer be accurate

TAP DRILLS.
(The Morse Twist Drill and Machin Co.)

Diam. of Tap.	No. Threads to Inch.	Drill for V Thread.	Drill for U. S. S. Thread.	Diam. of Tap.	No. Threads to Inch.	Drill for V Thread.	Drill for U. S. S. Thread.
1/4	20	5/32	3/16	1 1/8	7	11/64	59/64
9/32	18	3/16	1/8	1 5/32	7	15/64	61/64
5/16	18	7/32	1/8	1 3/16	7	17/64	63/64
11/32	16	1/4	1/8	1 1/4	7	19/64	65/64
3/8	16	17/64	1/8	1 1/2	7	21/64	67/64
13/32	16	N	1/8	1 3/4	7	23/64	69/64
7/16	14	Q	1/8	1 7/8	6	25/64	71/64
15/32	14	23/64	1/8	1 11/16	6	27/64	73/64
1/2	14	3/8	1/8	1 13/16	6	29/64	75/64
9/16	12	13/32	1/8	1 15/16	6	31/64	77/64
19/32	12	7/16	1/8	1 17/16	6	33/64	79/64
5/8	12	27/64	1/8	1 19/16	6	35/64	81/64
21/32	12	20/64	1/8	1 21/16	6	37/64	83/64
11/16	12	1/2	1/8	1 23/16	6	39/64	85/64
23/32	12	17/32	1/8	1 25/16	6	41/64	87/64
3/4	12	35/64	1/8	1 27/16	6	43/64	89/64
25/32	12	9/16	5/8	1 29/16	5	45/64	91/64
13/16	12	13/32	5/8	1 31/16	5	47/64	93/64
27/32	10	39/64	5/8	1 33/16	5	49/64	95/64
7/8	10	41/64	5/8	1 35/16	5	51/64	97/64
29/32	10	43/64	5/8	1 37/16	5	53/64	99/64
15/16	10	45/64	5/8	1 39/16	5	55/64	101/64
31/32	9	47/64	5/8	1 41/16	5	57/64	103/64
1	9	49/64	5/8	1 43/16	5	59/64	105/64
1 1/16	9	51/64	5/8	1 45/16	5	61/64	107/64
1 1/8	8	53/64	5/8	1 47/16	5	63/64	109/64
1 1/4	8	55/64	5/8	1 49/16	5	65/64	111/64
1 3/8	8	57/64	5/8	1 51/16	5	67/64	113/64
1 1/2	8	59/64	5/8	1 53/16	5	69/64	115/64
1 5/8	8	61/64	5/8	1 55/16	5	71/64	117/64
1 3/4	8	63/64	5/8	1 57/16	5	73/64	119/64
1 7/8	8	65/64	5/8	1 59/16	5	75/64	121/64
1 15/16	8	67/64	5/8	1 61/16	5	77/64	123/64
1 1/2	8	69/64	5/8	1 63/16	5	79/64	125/64
1 13/16	8	71/64	5/8	1 65/16	5	81/64	127/64
1 11/8	8	73/64	5/8	1 67/16	5	83/64	129/64
1 5/4	8	75/64	5/8	1 69/16	5	85/64	131/64
1 3/2	8	77/64	5/8	1 71/16	5	87/64	133/64
1 11/4	8	79/64	5/8	1 73/16	5	89/64	135/64
1 3/2	8	81/64	5/8	1 75/16	5	91/64	137/64
1 11/8	8	83/64	5/8	1 77/16	5	93/64	139/64
1 5/4	8	85/64	5/8	1 79/16	5	95/64	141/64
1 3/2	8	87/64	5/8	1 81/16	5	97/64	143/64
1 11/8	8	89/64	5/8	1 83/16	5	99/64	145/64
1 5/4	8	91/64	5/8	1 85/16	5	101/64	147/64
1 3/2	8	93/64	5/8	1 87/16	5	103/64	149/64
1 11/8	8	95/64	5/8	1 89/16	5	105/64	151/64
1 5/4	8	97/64	5/8	1 91/16	5	107/64	153/64
1 3/2	8	99/64	5/8	1 93/16	5	109/64	155/64
1 11/8	8	101/64	5/8	1 95/16	5	111/64	157/64
1 5/4	8	103/64	5/8	1 97/16	5	113/64	159/64
1 3/2	8	105/64	5/8	1 99/16	5	115/64	161/64
1 11/8	8	107/64	5/8	1 101/16	5	117/64	163/64
1 5/4	8	109/64	5/8	1 103/16	5	119/64	165/64
1 3/2	8	111/64	5/8	1 105/16	5	121/64	167/64
1 11/8	8	113/64	5/8	1 107/16	5	123/64	169/64
1 5/4	8	115/64	5/8	1 109/16	5	125/64	171/64
1 3/2	8	117/64	5/8	1 111/16	5	127/64	173/64
1 11/8	8	119/64	5/8	1 113/16	5	129/64	175/64
1 5/4	8	121/64	5/8	1 115/16	5	131/64	177/64
1 3/2	8	123/64	5/8	1 117/16	5	133/64	179/64
1 11/8	8	125/64	5/8	1 119/16	5	135/64	181/64
1 5/4	8	127/64	5/8	1 121/16	5	137/64	183/64
1 3/2	8	129/64	5/8	1 123/16	5	139/64	185/64
1 11/8	8	131/64	5/8	1 125/16	5	141/64	187/64
1 5/4	8	133/64	5/8	1 127/16	5	143/64	189/64
1 3/2	8	135/64	5/8	1 129/16	5	145/64	191/64
1 11/8	8	137/64	5/8	1 131/16	5	147/64	193/64
1 5/4	8	139/64	5/8	1 133/16	5	149/64	195/64
1 3/2	8	141/64	5/8	1 135/16	5	151/64	197/64
1 11/8	8	143/64	5/8	1 137/16	5	153/64	199/64
1 5/4	8	145/64	5/8	1 139/16	5	155/64	201/64
1 3/2	8	147/64	5/8	1 141/16	5	157/64	203/64
1 11/8	8	149/64	5/8	1 143/16	5	159/64	205/64
1 5/4	8	151/64	5/8	1 145/16	5	161/64	207/64
1 3/2	8	153/64	5/8	1 147/16	5	163/64	209/64
1 11/8	8	155/64	5/8	1 149/16	5	165/64	211/64
1 5/4	8	157/64	5/8	1 151/16	5	167/64	213/64
1 3/2	8	159/64	5/8	1 153/16	5	169/64	215/64
1 11/8	8	161/64	5/8	1 155/16	5	171/64	217/64
1 5/4	8	163/64	5/8	1 157/16	5	173/64	219/64
1 3/2	8	165/64	5/8	1 159/16	5	175/64	221/64
1 11/8	8	167/64	5/8	1 161/16	5	177/64	223/64
1 5/4	8	169/64	5/8	1 163/16	5	179/64	225/64
1 3/2	8	171/64	5/8	1 165/16	5	181/64	227/64
1 11/8	8	173/64	5/8	1 167/16	5	183/64	229/64
1 5/4	8	175/64	5/8	1 169/16	5	185/64	231/64
1 3/2	8	177/64	5/8	1 171/16	5	187/64	233/64
1 11/8	8	179/64	5/8	1 173/16	5	189/64	235/64
1 5/4	8	181/64	5/8	1 175/16	5	191/64	237/64
1 3/2	8	183/64	5/8	1 177/16	5	193/64	239/64
1 11/8	8	185/64	5/8	1 179/16	5	195/64	241/64
1 5/4	8	187/64	5/8	1 181/16	5	197/64	243/64
1 3/2	8	189/64	5/8	1 183/16	5	199/64	245/64
1 11/8	8	191/64	5/8	1 185/16	5	201/64	247/64
1 5/4	8	193/64	5/8	1 187/16	5	203/64	249/64
1 3/2	8	195/64	5/8	1 189/16	5	205/64	251/64
1 11/8	8	197/64	5/8	1 191/16	5	207/64	253/64
1 5/4	8	199/64	5/8	1 193/16	5	209/64	255/64
1 3/2	8	201/64	5/8	1 195/16	5	211/64	257/64
1 11/8	8	203/64	5/8	1 197/16	5	213/64	259/64
1 5/4	8	205/64	5/8	1 199/16	5	215/64	261/64
1 3/2	8	207/64	5/8	1 201/16	5	217/64	263/64
1 11/8	8	209/64	5/8	1 203/16	5	219/64	265/64
1 5/4	8	211/64	5/8	1 205/16	5	221/64	267/64
1 3/2	8	213/64	5/8	1 207/16	5	223/64	269/64
1 11/8	8	215/64	5/8	1 209/16	5	225/64	271/64
1 5/4	8	217/64	5/8	1 211/16	5	227/64	273/64
1 3/2	8	219/64	5/8	1 213/16	5	229/64	275/64
1 11/8	8	221/64	5/8	1 215/16	5	231/64	277/64
1 5/4	8	223/64	5/8	1 217/16	5	233/64	279/64
1 3/2	8	225/64	5/8	1 219/16	5	235/64	281/64
1 11/8	8	227/64	5/8	1 221/16	5	237/64	283/64
1 5/4	8	229/64	5/8	1 223/16	5	239/64	285/64
1 3/2	8	231/64	5/8	1 225/16	5	241/64	287/64
1 11/8	8	233/64	5/8	1 227/16	5		

EXAMPLE. — Efficiency of square-threaded screws of 1/2 inch pitch.

Diameter at bottom of thread, in.	1	2	3	4
Diameter at top of thread, in.	1 1/2	2 1/2	3 1/2	4 1/2
Mean circumference of thread, in.	3.927	7.069	10.21	13.35
Cotangent $a = c + p$	= 7.854	14.14	20.42	26.70
Tangent $a = p \div c$	= 0.1273	.0707	.0490	.0375
Efficiency if $f = 0.10$	= 55.3%	41.2%	32.7%	27.2%
Efficiency if $f = 0.15$	= 45%	31.7%	24.4%	19.9%

The efficiency thus increases with the steepness of the pitch. The above formulæ and examples are for square-threaded screws, and consider the friction of the screw-thread only, and not the friction of the collar or step by which end thrust is resisted, and which further reduces the efficiency. The efficiency is also further reduced by giving an inclination to the side of the thread, as in the V-threaded screw. For discussion of this subject, see paper by Wilfred Lewis, Jour. Frank. Inst. 1880; also *Trans. A. S. M. E.*, vol. xii, 784.

Efficiency of Screw-bolts. — Mr. Lewis gives the following approximate formula for ordinary screw-bolts (V-threads, with collars): p = pitch of screw, d = outside diameter of screw, F = force applied at circumference to lift a unit of weight, E = efficiency of screw. For an average case, in which the coefficient of friction may be assumed at .15,

$$F = \frac{p + d}{3d}, \quad E = \frac{p}{p + d}$$

For bolts of the dimensions given above, 1/2-inch pitch, and outside diameters 1 1/2, 2 1/2, 3 1/2, and 4 1/2 inches, the efficiencies according to this formula would be, respectively, 0.25, 0.167, 0.125, and 0.10.

James McBride (*Trans. A. S. M. E.*, xii, 781) describes an experiment with an ordinary 2-inch screw-bolt, with a V-thread, 4 1/2 threads per inch, raising a weight of 7500 pounds, the force being applied by turning the nut. Of the power applied 89.8 per cent was absorbed by friction of the nut on its supporting washer and of the threads of the bolt in the nut. The nut was not faced, and had the flat side to the washer.

Professor Ball in his "Experimental Mechanics" says: "Experiments showed in two cases respectively about 2/3 and 3/4 of the power was lost."

Trautwine says: "In practice the friction of the screw (which under heavy loads becomes very great) make the theoretical calculations of but little value."

Weisbach says: "The efficiency is from 19 per cent to 30 per cent."

Efficiency of a Differential Screw. — A correspondent of the *American Machinist* describes an experiment with a differential screw-punch, consisting of an outer screw 2 inch diameter, 3 threads per inch, and an inner screw 1 3/8 inch diameter, 3 1/2 threads per inch. The pitch of the outer screw being 1/3 inch and that of the inner screw 2/7 inch the punch would advance in one revolution 1/3 - 2/7 = 1/21 inch. Experiments were made to determine the force required to punch an 11/16-inch hole in iron 1/4 inch thick, the force being applied at the end of a lever-arm of 47 3/4 inch. The leverage would be 47 3/4 x 2π x 21 = 6300. The mean force applied at the end of the lever was 95 pounds, and the force at the punch, if there was no friction, would be 6300 x 95 = 598,500 pound. The force required to punch the iron, assuming a shearing resistance of 50,000 pounds per square inch, would be 50,000 x 11/16 x π x 1/4 = 27,000 pounds, and the efficiency of the punch would be 27,000 ÷ 598,500 = only 4.5 per cent. With the larger screw only used as a punch the mean force at the end of the lever was only 82 pounds. The leverage in this case was 47 3/4 x 2π x 3 = 900, the total force referred to the punch, including friction, 900 x 82 = 73,800, and the efficiency 27,000 ÷ 73,800 = 36.7 per cent. The screws were of tool-steel, well fitted, and lubricated with lard-oil and plumbago.

TAPER BOLTS, PINS, REAMERS, ETC.

Taper Bolts for Locomotives. — Bolt-threads, U. S. Standard, except stay-bolts and boiler-studs, V-threads, 12 per inch; valves, cocks, and plugs, V-threads, 14 per inch, and 1/8-inch taper per 1 inch. Standard bolt taper 1/16 inch per foot.

Taper Reamers. — The Pratt & Whitney Co. makes standard taper reamers for locomotive work taper 1/10 inch per foot from 1/4 inch diameter;

4 inch length of flute to 2 inch diameter; 18 inch length of flute, diameters advancing by 16ths and 32ds. P. & W. Co.'s standard taper pin reamers taper 1/4 inch per foot, are made in 15 sizes of diameters, 0.135 to 1.250 inches; length of flute 1 7/16 inches to 14 inches.

Morse Tapers.

Taper	Diam. of Plug at Small End.	Diam. at End of Socket.	Standard Plug Depth.	Whole Length of Shank.	Depth of Hole.	End of Socket to Key-way.	Length of Key-way.	Width of Key-way.	Length of Tongue.	Diameter of Tongue.	Thickness of Tongue.	Rad. of Mill for Tongue.	Radius of Tongue.	Shank Depth.	Taper per Foot.	Number of Key.
	D	A	P	B	H	K	L	W	T	d	t	R	a	S		
0	.252	.356	2	2 11/32	2 1/32	1 15/16	9/16	.160	1/4	.24	5/32	5/32	.04	27/32	.625	0
1	.369	.475	2 1/8	2 9/16	2 3/10	2 1/16	3/4	.213	1/5	.35	13/64	3/16	.05	23/8	.600	1
2	.572	.700	2 9/16	3 1/16	2 5/8	2 1/2	7/8	.26	3/8	.47	1/4	1/4	.06	27/8	.602	2
3	.778	.938	3 3/16	3 3/4	3 1/4	3 1/16	1 1/10	.322	7/16	.64	5/16	9/32	.08	3 9/10	.602	3
4	1.020	1.231	4 1/16	4 3/4	4 1/8	3 7/8	1 1/4	.478	1/2	.94	15/32	5/16	.10	4 1/2	.623	4
5	1.475	1.748	5 3/16	6	5 1/4	4 15/16	1 1/2	.635	5/8	1.27	5/8	3/8	.12	5 3/4	.630	5
6	2.116	2.494	7 1/4	8 5/16	7 3/8	7	1 3/4	.76	7/8	1.52	3/4	1/2	.15	8	.626	6
7	2.75	3.27	10	11 5/8	10 1/8	9 1/2	2 5/8	1.135	1 3/8	2.27	1 1/8	3/4	.18	11 1/4	.625	7

Brown & Sharpe Mfg. Co. publishes (*Machy's Data Sheets*) a list of 18 sizes of tapers ranging from 0.20 in. to 3 in. diam. at the small end; taper 0.5 in. to 1 ft., except No. 10, which is 0.5151 in. per ft.

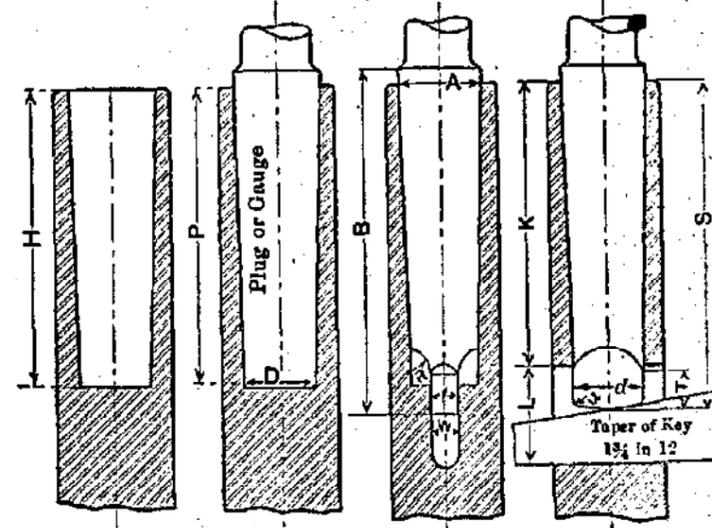

FIG. 192. — Morse Tapers. See table above.

The Jarno Taper is 0.05 inch per inch = 0.6 inch per foot. The number of the taper is its diameter in tenths of an inch at the small end, in eighths of an inch at the large end, and the length in halves of an inch.

Thus, No. 3 Jarno taper is 1 1/2 inches long, 0.3 inch diameter at the small end and 3/8 inch diameter at the large end.

Standard Steel Taper-pins. — The following sizes are made by The Pratt & Whitney Co.: Taper 1/4 inch to the foot.

Number:	0	1	2	3	4	5	6	7	8	9	10
Diameter large end:	0.156	0.172	0.193	0.219	0.250	0.289	0.341	0.409	0.492	0.591	0.706
Approximate fractional sizes:	5/32	11/64	3/16	7/32	1/4	19/64	11/32	13/32	1/2	19/32	23/32
Lengths from	3/4	3/4	3/4	3/4	3/4	3/4	1	1 1/4	1 1/2	1 1/2	
To*	1	1 1/4	1 1/2	1 3/4	2	2 1/4	3 1/4	3 3/4	4 1/2	5 1/4	6
Diameter small end of standard taper-pin reamer:†	0.135	0.146	0.162	0.183	0.208	0.240	0.279	0.331	0.398	0.482	0.581

Standard Steel Mandrels. (The Pratt & Whitney Co.) — These mandrels are made of tool-steel, hardened, and ground true on their centers. Centers are also ground to true 60 degree cones. The ends are of a form best adapted to resist injury likely to be caused by driving. They are slightly taper. Sizes, 1/4 inch diameter by 3 3/4 inches long to 4 inches diameter by 17 inches long, diameters advancing by 16ths.

PUNCHES AND DIES, PRESSES, ETC.

Clearance between Punch and Die. — For computing the amount of clearance that a die should have, or, in other words, the difference in size between die and punch, the general rule is to make the diameter of die-hole equal to the diameter of the punch, plus 2/10 the thickness of the plate. Or, $D = d + 0.2t$, in which D = diameter of die-hole, d = diameter of punch, and t = thickness of plate. For very thick plates some mechanics prefer to make the die-hole a little smaller than called for by the above rule. For ordinary boiler-work the die is made from 1/10 to 3/10 of the thickness of the plate larger than the diameter of the punch; and some boiler-makers advocate making the punch fit the die accurately. For punching nuts, the punch fits in the die. (*Am. Mach.*)

Kennedy's Spiral Punch. (The Pratt & Whitney Co.) — B. Martell, Chief Surveyor of Lloyd's Register, reported tests of Kennedy's spiral punches in which a 7/8-inch spiral punch penetrated a 5/8-inch plate at a pressure of 22 to 25 tons, while a flat punch required 33 to 35 tons. Steel boiler-plates punched with a flat punch gave an average tensile strength of 58,579 pounds per square inch, and an elongation in two inches across the hole of 5.2 per cent, while plates punched with a spiral punch gave 63,929 pounds, and 10.6 per cent elongation.

The spiral shear form is not recommended for punches for use in metal of a thickness greater than the diameter of the punch. This form is of greatest benefit when the thickness of metal worked is less than two thirds the diameter of punch.

Size of Blanks used in the Drawing-press. — Oberlin Smith (*Jour. Frank. Inst.*, Nov. 1886) gives three methods of finding the size of blanks. The first is a tentative method, and consists simply in a series of experiments with various blanks, until the proper one is found. This is for use mainly in complicated cases, and when the cutting portions of the die and punch can be finally sized after the other work is done. The second method is by weighing the sample piece, and then, knowing the weight of the sheet metal per square inch, computing the diameter of a piece having the required area to equal the sample in weight. The third method is by computation, and the formula is $x = \sqrt{d^2 + 4dh}$ for a sharp-cornered cup, where x = diameter of blank, d = diameter of cup, h = height of cup. For a round-cornered cup

* Lengths vary by 1/4 inch each size.
† Taken 1/2 inch from extreme end. Each size overlaps smaller one about 1/2 inch.

where the corner is small, say radius of corner less than 1/4 height of cup, the formula is $x = (\sqrt{d^2 + 4dh}) - r$, about; r being the radius of the corner. This is based upon the assumption that the thickness of the metal is not to be altered by the drawing operation.

Pressure attainable by the Use of the Drop-press. (R. H. Thurston, *Trans. A. S. M. E.*, v, 53.) — A set of copper cylinders was prepared, of pure Lake Superior copper; they were subjected to the action of presses of different weights and of different heights of fall. Companion specimens of copper were compressed to exactly the same amount, and measures were obtained of the loads producing compression, and of the amount of work done in producing the compression by the drop. Comparing one with the other it was found that the work done with the hammer was 90 per cent of the work which should have been done with perfect efficiency. That is to say, the work done in the test-machine was equal to 90 per cent of that due the weight of the drop falling the given distance.

Formula: Mean pressure in pounds = $\frac{\text{Weight of drop} \times \text{fall} \times \text{efficiency}}{\text{compression}}$

For pressures per square inch, divide by the mean area opposed to crushing action during the operation.

Similar experiments on Bessemer steel plugs by A. W. Moseley and J. L. Bacon (*Trans. A. S. M. E.*, xxvii, 605) indicated an efficiency for the drop hammer of about 70 per cent.

Flow of Metals. (David Townsend, *Jour. Frank. Inst.*, March, 1878.) — In punching holes 1/16-inch diameter through iron blocks 1 3/4 inches thick, it was found that the core punched out was only 11/18 inches thick, and its volume was only about 32 per cent of the volume of the hole. Therefore, 68 per cent of the metal displaced by punching the hole flowed into the block itself, increasing its dimensions.

FORCING, SHRINKING AND RUNNING FITS.

Forcing Fits of Pins and Axles by Hydraulic Pressure. — A 4-inch axle is turned 0.015 inch diameter larger than the hole into which it is to be fitted. They are pressed on by a pressure of 30 to 35 tons. (Lecture by Coleman Sellers, 1872.)

For forcing the crank-pin into a locomotive driving-wheel, when the pinhole is perfectly true and smooth, the pin should be pressed in with a pressure of 6 tons for every inch of diameter of the wheel fit. When the hole is not perfectly true, which may be the result of shrinking the tire on the wheel center after the hole for the crank-pin has been bored, or if the hole is not perfectly smooth, the pressure may have to be increased to 9 tons for every inch of diameter of the wheel-fit. (*Am. Machinist.*)

Shrinkage Fits. — In 1886 the American Railway Master Mechanics' Association recommended the following shrinkage allowances for tires of standard locomotives. The tires are uniformly heated by gas-flames, slipped over the cast-iron centers, and allowed to cool. The centers are turned to the standard sizes given below, and the tires are bored smaller by the amount of the shrinkage designated for each:

Diameter of center, in.	38	44	50	56	62	66
Shrinkage allowance, in.040	.047	.053	.060	.066	.070

This shrinkage allowance is approximately 1/50 inch per foot, or 1/1000. A common allowance is 1/1000. Taking the modulus of elasticity of steel at 30,000,000, the strain caused by shrinkage would be 30,000 lb. per sq. in., less an uncertain amount due to compression of the center.

Amer. Machinist published at a later date a table of "M. M. allowances for shrink fits" which correspond to the following: Allowance = 0.001 for $d = 20$ to 40 in.; 0.001 ($d + 2$) for $d = 41$ to 60 in.; 0.001 ($d + 1$) for $d = 61$ to 83 in.; 0.088 for $d = 84$ in. d = diam. of wheel center. For running force fits, *Am. Mach.* gives the following allowances: d = diam. of bearing or hole, a = allowance.

$d =$	1	2	3	4	5	6	7	8	9	10
Running, $a =$	-0.001	.002	.003	.0035	.0037	.004	.0042	.0042	.0043	.0044
Force, $a =$	+0.001	.003	.005	.006	.007	.008	.0085	.009	.01	.0105

$d =$	11	12	13	14	15	16	17	18	19	20
Running, $a = \dots$	-0.0045	.0046	.0047	.0048	.0049	.005	.0051	.0052	.0053	.0055
Force, $a = \dots$	+0.011	.0115	.012	.013	.014	.0145	.015	.0155	.016	.017

Allowances for drive fits are one-half those for force fits.

Limits of Diameters for Fits. C. W. Hunt Co. (*Am. Mach.*, July 16, 1903.) — For parallel shafts and bushings (shafts changing): $d =$ diam. in ins.

Shafts: Press fit, $+0.001 d + (0 \text{ to } 0.001 \text{ in.})$. Drive fit, $+0.0005 d + (0 \text{ to } 0.001 \text{ in.})$.

Shafts: Hand fit, $+0.001$ to 0.002 in. for shafts 1 to 3 in.; 0.002 to 0.003 in. for 4 to 6 in.; 0.003 to 0.004 in. for 7 to 10 in.

Holes: all fits 0 to -0.002 in. for 1 to 3 in.; 0 to -0.003 in. for 4 to 6 in.; 0 to -0.004 in. for 7 to 10 in.

Parallel journals and bearings (journals changing):

Close fit $-0.001 d + (0.002 \text{ to } 0.004 \text{ in.})$; Free fit $-0.001 d + (0.007 \text{ to } 0.01 \text{ in.})$; Loose fit, $-0.003 d + (0.02 \text{ to } 0.025)$. Limits of diameters for taper shaft and bushings (holes changing). Shaft turned to standard taper $3/16$ in. per ft., large end to nominal size ± 0.001 in. Holes are reamed until the large end is small by from $0.001 d + 0.004$ to 0.005 in. for press fit, from $0.0005 d + 0.001$ in. for drive fit, and from 0 to 0.001 in. for hand fit. In press fits the shaft is pressed into the hole until the true sizes match, or $1/16$ in. for each $1/1000$ in. that the hole is small. The above formulae apply to steel shafts and cast-iron wheels or other members.

Shaft Allowances for Electrical Machinery. — In use by General Electric Co. (John Riddell, *Trans. A. S. M. E.*, xxiv, 1174).

Diam. ins.	2	4	8	12	15	20	24	28	32	36	40	44	48
A, B	0.0005	.00075	.001	.001	.0012	.0012	.0015	.0015	.0017	.0017	.002	.002	.0023
C	0.0005	.00075	.0015	.0017	.0020	.0023	.0025	.0028	.003	.0033	.0035	.0038	.004
D	0.0005	.00075	.0017	.0025	.0033	.004	.0045	.005	.0058	.0063	.0068	.0073	.008
E	0.0015	.0027	.0045	.0057	.007	.008	.0093	.0115	.0125	.0128	.0138	.015	.016

A, minus allowance for sliding fit. B, plus allowance for commutators and split hubs. C, press fit for armature spiders, solid steel. D, do., solid cast iron. E, press fit for couplings, and shrink fit.

Running Fits. — Wm. Sangster (*Am. Mach.*, July 8, 1909) gives the practice of different manufacturers as follows:

An electric manufacturing Co. allows a clearance of 0.003 to 0.004 in. for shafts $1 1/2$ to $2 1/4$ in. diam.; 0.003 to 0.006 for $2 1/2$ ins.; 0.004 to 0.006 for $2 3/4$ to $3 1/2$ ins.; 0.005 to 0.007 in. for 4 and $4 1/2$ ins.; 0.006 to 0.008 in. for 5 ins.; 0.009 to 0.011 in. for 6 ins. Dodge Mfg. Co. allows from $1/64$ for 1-in. ordinary bearings to a little over $1/32$ in. for 6-in. Clutch sleeves, 0.008 to 0.015 in.; loose pulleys as close as 0.003 in. in the smaller sizes, and about $1/64$ in. on a $2 1/2$ -in. hole.

Watt Mining Car Wheel Co. allows $1/16$ in. for all sizes of wheels, and $1/16$ in. end play. A large fan-blower concern allows 0.005 to 0.01 in. on fan journals from $9/16$ to $2 7/16$ ins.

Pressure Required for Press Fits. (*Am. Mach.*, March 7, 1907.) — The following approximate formulae give the pressures required for press fits of cranks and crank-pins, as used by an engine-building firm. P = total pressure on ram, tons; D = diameter inches.

Crank fits up to $D = 10$. $P = 9.9 D - 14$.
 Crank fits $D = 12$ to 24 . $P = 5 D + 40$.
 Straight crank-pins. $P = 13 D$.
 Taper crank-pins. $P = 14 D - 7$.

The allowance for cranks and straight pins is 0.0025 inch per inch of diameter. Taper cranks, taper $1/16$ inch per inch, are fitted on the lathe to within $1/8$ inch of shoulder and then forced home.

Stresses due to Force and Shrink Fits. — S. H. Moore, *Trans. A. S. M. E.*, vol. xxiv, gives the following allowances for different fits.

For shrinkage fits, $d = (17/16 D + 0.5) \div 1000$. For forced fits, $d = (2 D + 0.5) \div 1000$. For driven fits, $d = (1/2 D + 0.5) \div 1000$. d = allowance or the amount the diameter of the shaft exceeds the diameter of the hole in the ring and D = nominal diameter of the shaft. A. L. Jenkins, *Eng. News*, Mar. 17, 1910, says the values obtained from the formula for forced fits are about twice as large as those frequently used in practice, and in many cases they lead to excessive stresses in the ring. He calculates from Lamé's formula for hoop stress in a ring subjected to internal pressure the relation between the stress and the allowance for fit, and deduces the following formulae.

$S_{h1} = 15,000,000 d \div (k + 0.6)$; $S_{h2} = 15,000,000 d \div (1 + 0.6/k)$; for a cast-iron ring on a steel shaft.

$S_{h1} = 30,000,000 d \div (1 + k)$; $S_{h2} = 30,000,000 d \div (1 + 1/K)$; for a steel ring on a steel shaft.

S_{h1} = radial unit pressure between the surfaces; S_{h2} = unit tensile or hoop stress in the ring;

d = allowance per inch of diameter, K a constant whose value depends on t , the thickness, and r , the radius of the ring, as follows.

Values of $t \div r$.	0.4	0.5	0.6	0.7	0.8	0.9	1.0	1.25	1.5	1.75	2.0	3.0
------------------------	-----	-----	-----	-----	-----	-----	-----	------	-----	------	-----	-----

Values of K .	3.083	2.600	2.282	2.058	1.892	1.766	1.666	1.492	1.380	1.300	1.250	1.133
-----------------	-------	-------	-------	-------	-------	-------	-------	-------	-------	-------	-------	-------

The allowances for forced and shrinkage fits should be based on the stresses they produce, as determined by the above formula, and not on the diameter of the shaft.

Force Required to Start Force and Shrink Fits. (*Am. Mach.*, Mar. 7, 1907.) — A series of experiments was made at the Alabama Polytechnic Institute on spindles 1 in. diam. pressed or shrunk into cast-iron disks 6 in. diam., $1 1/4$ in. thick. The disks were bored and finished with a reamer to 1 in. diam. with an error believed not to exceed 0.00025 in. The shafts were ground to sizes 0.001 to 0.003 in. over 1 in. Some of the spindles were forced into the disks by a testing machine, the others had the disks shrunk on. Some of each sort were tested by pulling the spindle from the disk in the testing machine, others by twisting the disk on the spindle. The force required to start the spindle in the twisting tests was reduced to equivalent force at the circumference of the spindle, for comparison with the tension tests. The results were as follows: D = diam. of spindle; F = force in lbs.:

Force Fits, Tension.			Force Fits, Torsion.			Shrink Fits, Tension.			Shrink Fits, Torsion.		
D	F , lbs.	Per sq. in.	D	F , lbs.	Per sq. in.	D	F , lbs.	Per sq. in.	D	F , lbs.	Per sq. in.
1.001	1000	318	1.0015	2200	700	1.001	5320	1695	1.001	2200	700
1.0015	2150	685	1.0015	2800	892	1.001	5820	1853	1.0015	7200	2290
1.002	2570	818	1.002	4200	1335	1.002	7500	2385	1.0015	9800	3118
1.0025	4000	1272	1.0025	4600	1465	1.002	8100	2580	1.0025	13800	4395
.....	1.0025	9340	2974	1.003	17000	5410
.....	1.0025	9710	3090

PROPORTIONING PARTS OF MACHINES IN A SERIES OF SIZES.

The following method was used by Coleman Sellers (*Stevens Indicator*, April, 1892) to get the proportions of the parts of machines, based upon the size obtained in building a large machine and a small one to any series of machines. This formula is used in getting up the proportion-book and arranging the set of proportions from which any machine can be constructed of intermediate size between the largest and smallest of the series.

Rule to Establish Construction Formulae.—Take difference between the nominal sizes of the largest and the smallest machines that have been designed of the same construction. Take also the difference between the sizes of similar parts on the largest and smallest machines selected. Divide the latter by the former, and the result obtained will be a "factor," which, multiplied by the nominal capacity of the intermediate machine, and increased or diminished by a constant "increment," will give the size of the part required. To find the "increment:" Multiply the nominal capacity of some known size by the factor obtained, and subtract the result from the size of the part belonging to the machine of nominal capacity selected.

EXAMPLE.—Suppose the size of a part of a 72-inch machine is 3 inches, and the corresponding part of a 42-inch machine is 1 7/8, or 1.875 inches; then 72 - 42 = 30, and 3 inches - 1 7/8 inches = 1 1/8 inches = 1.125. 1.125 ÷ 30 = 0.0375 = the "factor," and .0375 × 42 = 1.575. Then 1.875 - 1.575 = .3 = the "increment" to be added. Let *D* = nominal capacity; then the formula will read: $x = D \times .0375 + .3$.

Proof: 42 × .0375 + .3 = 1.875, or 1 7/8, the size of one of the selected parts.

Some prefer the formula: $aD + c = x$, in which *D* = nominal capacity in inches or in pounds, *c* is a constant increment, *a* is the factor, and *x* = the part to be found.

KEYS.

Sizes of Keys for Mill-gearing. (*Trans. A. S. M. E.*, xiii, 229.)—E. G. Parkhurst's rule: Width of key = 1/8 diameter of shaft, depth = 1/9 diameter of shaft; taper 1/8 inch to the foot.

Custom in Michigan saw-mills: Keys of square section, side = 1/4 diameter of shaft, or as nearly as may be in even sixteenths of an inch.

J. T. Hawkins's rule: Width = 1/3 diameter of hole; depth of side abutment in shaft = 1/8 diameter of hole.

W. S. Huson's rule: 1/4-inch key for 1 to 1 1/4-in. shafts, 5/16-in. key for 1 1/4 to 1 1/2-inch shafts, 3/8-inch key for 1 1/2 to 1 3/4-inch shafts and so on. Taper 1/8 inch to the foot. Total thickness at large end of splice, 4/5 width of key.

Unwin (*Elements of Machine Design*) gives: Width = 1/4 *d* + 1/8 inch. Thickness = 1/8 *d* + 1/8 inch, in which *d* = diameter of shaft in inches. When wheels or pulleys transmitting only a small amount of power are keyed on large shafts, he says, these dimensions are excessive. In that case, if H.P. = horse-power transmitted by the wheel or pulley, *N* = r.p.m., *P* = force acting at the circumference, in pounds, and *R* = radius of pulley in inches, take

$$d = \sqrt[3]{\frac{100 \text{ H.P.}}{N}} \text{ or } \sqrt[3]{\frac{PR}{630}}$$

Prof. Coleman Sellers (*Stevens Indicator*, April, 1892) gives the following: The size of keys, both for shafting and for machine tools, are the proportions adopted by William Sellers & Co., and rigidly adhered to during a period of nearly forty years. Their practice in making keys and fitting them is, that the keys shall always bind tight sidewise, but not top and bottom; that is, not necessarily touch either at the bottom of the key-seat in the shaft or touch the top of the slot cut in the gear-wheel that is

fastened to the shaft; but in practice keys used in this manner depend upon the fit of the wheel upon the shaft being a forcing fit, or a fit that is so tight as to require screw-pressure to put the wheel in place upon the shaft.

Size of Keys for Shafting.

Diameter of Shaft, in.	Size of Key, in.
1 1/4	5/16 × 3/8
1 5/16	7/16 × 1/2
1 7/16	9/16 × 5/8
1 9/16	1 1/16 × 3/4
1 11/16	1 3/16 × 7/8
1 13/16	1 5/16 × 1
1 5/8	1 7/16 × 1 1/8

Length of key-seat for coupling = 1 1/2 × nominal diameter of shaft.

Size of Keys for Machine Tools.

Diam. of Shaft, in.	Size of Key, in. sq.	Diam. of Shaft, in.	Size of Key, in. sq.
15/16 and under	1/8	4 to 5 7/16	13/16
1 to 1 3/16	3/16	5 1/2 to 6 15/16	15/16
1 1/4 to 1 7/16	1/4	7 to 8 15/16	1 1/16
1 1/2 to 1 11/16	5/16	9 to 10 15/16	1 3/16
1 3/4 to 2 3/16	7/16	11 to 12 15/16	1 5/16
2 1/4 to 2 11/16	9/16	13 to 14 15/16	1 7/16
2 3/4 to 3 15/16	1 1/16		

John Richards, in an article in *Cassier's Magazine*, writes as follows: There are two kinds or systems of keys, both proper and necessary, but widely different in nature. 1. The common fastening key, usually made in width one fourth of the shaft's diameter, and the depth five eighths to one third the width. These keys are tapered and fit on all sides, or, as it is commonly described, "bear all over." They perform the double function in most cases of driving or transmitting and fastening the keyed-on member against movement endwise on the shaft. Such keys, when properly made, drive as a strut, diagonally from corner to corner.

2. The other kind or class of keys are not tapered and fit on their sides only, a slight clearance being left on the back to insure against wedge action or radial strain. These keys drive by shearing strain.

For fixed work where there is no sliding movement such keys are commonly made of square section, the sides only being planed, so the depth is more than the width by so much as is cut away in finishing or fitting.

For sliding bearings, as in the case of drilling-machine spindles, the depth should be increased, and in cases where there is heavy strain there should be two keys or feathers instead of one.

The following tables are taken from proportions adopted in practical use.

Flat keys, as in the first table, are employed for fixed work when the parts are to be held not only against torsional strain, but also against movement endwise; and in case of heavy strain the strut principle being the strongest and most secure against movement when there is strain each way, as in the case of engine cranks and first movers generally. The objections to the system for general use are, straining the work out of truth, the care and expense required in fitting, and destroying the evidence of good or bad fitting of the keyed joint. When a wheel or other part is fastened with a tapering key of this kind there is no means of knowing whether the work is well fitted or not. For this reason such keys are not employed by machine-tool-makers, and in the case of accurate work of any kind, indeed, cannot be, because of the wedging strain, and also the difficulty of inspecting completed work.

I. DIMENSIONS OF FLAT KEYS, IN INCHES.

Diam. of shaft ..	1	1 1/4	1 1/2	1 3/4	2	2 1/2	3	3 1/2	4	5	6	7	8
Breadth of keys	1/4	5/16	3/8	7/16	1/2	5/8	3/4	7/8	1	1 1/8	1 3/8	1 1/2	1 3/4
Depth of keys ..	5/32	3/16	1/4	9/32	5/16	3/8	7/16	1/2	5/8	11/16	13/16	7/8	1

II. DIMENSIONS OF SQUARE KEYS, IN INCHES.

Diameter of shaft ..	1	1 1/4	1 1/2	1 3/4	2	2 1/2	3	3 1/2	4
Breadth of keys	5/32	7/32	9/32	11/32	13/32	15/32	17/32	9/16	11/16
Depth of keys	3/16	1/4	5/16	3/8	7/16	1/2	9/16	5/8	3/4

III. DIMENSIONS OF SLIDING FEATHER-KEYS, IN INCHES.

Diameter of shaft ...	1 1/4	1 1/2	1 3/4	2	2 1/4	2 1/2	3	3 1/2	4	4 1/2
Breadth of keys	1/4	1/4	5/16	5/16	3/8	3/8	1/2	9/16	9/16	5/8
Depth of keys	3/8	3/8	7/16	7/16	1/2	1/2	5/8	3/4	3/4	7/8

P. Prybil furnishes the following table of dimensions to the *Am. Machinist*. He says: "On special heavy work and very short hubs we put in two keys in one shaft 90 degrees apart. With special long hubs, where we cannot use keys with noses, the keys should be thicker than the standard.

Diameter of Shafts, Inches.	Width, Inches.	Thick-ness, In.	Diameter of Shafts, Inches.	Width, Inches.	Thick-ness, In.
3/4 to 1 1/16	3/16	3/16	37/16 to 3 11/16	7/8	5/8
1 1/8 to 1 5/16	5/16	1/4	3 15/16 to 4 3/16	1	11/16
1 7/16 to 1 11/16	3/8	5/16	4 7/16 to 4 11/16	1 1/8	3/4
1 15/16 to 2 3/16	1/2	3/8	4 7/8 to 5 3/8	1 1/4	15/16
2 7/16 to 2 11/16	5/8	1/2	5 7/8 to 6 3/8	1 1/2	1
2 15/16 to 3 3/16	3/4	9/16	6 7/8 to 7 3/8	1 3/4	1 1/8

Keys longer than 10 inches, say 14 to 16 inches, 1/16 inch thicker; keys longer than 10 inches, say 18 to 20 inches, 1/8 inch thicker; and so on. Special short hubs to have two keys.

For description of the Woodruff system of keying, see circular of the Pratt & Whitney Co.; also *Modern Mechanism*, page 455. For keyways in milling cutters see page 1248.

HOLDING-POWER OF KEYS AND SET-SCREWS.

Tests of the Holding-power of Set-screws in Pulleys. (G. Lanza, *Trans. A. S. M. E.*, x, 230.) — These tests were made by using a pulley fastened to the shaft by two set-screws with the shaft keyed to the holders: then the load required at the rim of the pulley to cause it to slip was determined, and this being multiplied by the number 6.037 (obtained by adding to the radius of the pulley one-half the diameter of the wire rope, and dividing the sum by twice the radius of the shaft, since there were two set-screws in action at a time) gives the holding-power of the set-screws. The set-screws used were of wrought iron, 3/8 of an inch in diameter, and ten threads to the inch; the shaft used was

of steel and rather hard, the set-screws making but little impression upon it. They were set up with a force of 75 pounds at the end of a ten-inch monkey-wrench. The set-screws used were of four kinds, marked respectively A, B, C, and D. The results were as follows:

- A, ends perfectly flat, 9/16-in. diam. 1412 to 2294 lbs.; average 2064.
- B, radius of rounded ends about 1/2-in. 2747 to 3079 lbs.; average 2912.
- C, radius of rounded ends about 1/4-in. 1962 to 3079 lbs.; average 2573.
- D, ends cup-shaped and case-hardened 1962 to 2958 lbs.; average 2470.

REMARKS. — A. The set-screws were not entirely normal to the shaft; hence they bore less in the earlier trials, before they had become flattened by wear.

B. The ends of these set-screws, after the first two trials, were found to be flattened, the flattened area having a diameter of about 1/4 inch.

C. The ends were found, after the first two trials, to be flattened, as in B.

D. The first test held well because the edges were sharp, then the holding-power fell off till they had become flattened in a manner similar to B, when the holding-power increased again.

Tests of the Holding-power of Keys. (Lanza.) — The load was applied as in the tests of set-screws, the shaft being firmly keyed to the holders. The load required at the rim of the pulley to shear the keys was determined, and this, multiplied by a suitable constant, determined in a similar way to that used in the case of set-screws, gives us the shearing strength per square inch of the keys.

The keys tested were of eight kinds, denoted, respectively, by the letters A, B, C, D, E, F, G and H, and the results were as follows: A, B, D, and F, each 4 tests; E, 3 tests; C, G, and H, each 2 tests.

A, Norway iron, 2" X 1/4" X 15/32"	40,184 to	47,760 lbs.:	average,	42,726
B, refined iron, 2" X 1/4" X 15/32"	36,482 to	39,254 lbs.:	average,	38,059
C, tool steel, 1" X 1/4" X 15/32"	91,344 &	100,056 lbs.:		
D, mach'y steel, 2" X 1/4" X 15/32"	64,630 to	70,186 lbs.:	average,	66,875
E, Norway iron, 1 1/3" X 3/8" X 7/16"	36,850 to	37,222 lbs.:	average,	37,036
F, cast-iron, 2" X 1/4" X 15/32"	30,278 to	36,944 lbs.:	average,	33,034
G, cast-iron, 1 1/3" X 3/8" X 7/16"	37,222 &	38,700.		
H, cast-iron, 1" X 1/2" X 7/16"	29,814 &	38,978.		

In A and B some crushing took place before shearing. In E, the keys, being only 7/16 inch deep, tipped slightly in the key-way. In H, in the first test, there was a defect in the key-way of the pulley.

DYNAMOMETERS.

Dynamometers are instruments used for measuring power. They are of several classes, as: 1. Traction dynamometers, used for determining the power required to pull a car or other vehicle, or a plow or harrow, 2. Brake or absorption dynamometers, in which the power of a rotating shaft or wheel is absorbed or converted into heat by the friction of a brake; and 3. Transmission dynamometers, in which the power in a rotating shaft is measured during its transmission through a belt or other connection to another shaft, without being absorbed.

Traction Dynamometers generally contain two principal parts: (1) A spring or series of springs, through which the pull is exerted, the extension

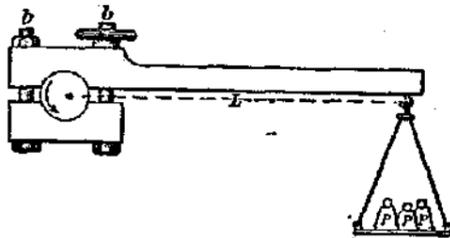

FIG. 193.

of the spring measuring the amount of the pulling force; and (2) a paper-covered drum, rotated either at a uniform speed by clock-work, or at a speed proportional to the speed of the traction, through gearing, on which the extension of the spring is registered by a pencil. From the average height of the diagram drawn by the pencil above the zero-line the average pulling force in pounds is obtained, and this multiplied by the distance traversed, in feet, gives the work done, in foot-pounds. The product divided by the time in minutes and by 33,000 gives the horse-power.

The Prony brake is the typical form of absorption dynamometer. (See Fig. 193, from Flatler on Dynamometers.)

Primarily this consists of a lever connected to a revolving shaft or pulley in such a manner that the friction induced between the surfaces in contact will tend to rotate the arm in the direction in which the shaft revolves. This rotation is counterbalanced by weights *P*, hung in the scale-pan at the end of the lever. In order to measure the power for a given number of revolutions of pulley, we add weights to the scale-pan and screw up on bolts *b, b*, until the friction induced balances the weights and the lever is maintained in its horizontal position while the revolutions of the shaft per minute remain constant.

For small powers the beam is generally omitted — the friction being measured by weighting a band or strap thrown over the pulley. Ropes or cords are often used for the same purpose.

Instead of hanging weights in a scale-pan, as in Fig. 107, the friction may be weighed on a platform-scale; in this case, the direction of rotation being the same, the lever-arm will be on the opposite side of the shaft.

In a modification of this brake, the brake-wheel is keyed to the shaft, and its rim is provided with inner flanges which form an annular trough for the retention of water to keep the pulley from heating. A small stream of water constantly discharges into the trough and revolves with the pulley — the centrifugal force of the particles of water overcoming the action of gravity; a waste-pipe with its end flattened is so placed in the trough that it acts as a scoop, and removes all surplus water. The brake consists of a flexible strap to which are fitted blocks of wood forming the rubbing-surface; the ends of the strap are connected by an adjustable bolt-clamp, by means of which any desired tension may be obtained.

The horse-power or work of the shaft is determined from the following:

- Let *W* = work of shaft, equals power absorbed, per minute;
- P* = unbalanced pressure or weight in pounds, acting on lever-arm at distance *L*;
- L* = length of lever-arm in feet from center of shaft;
- V* = velocity of a point in feet per minute at distance *L*, if arm were allowed to rotate at the speed of the shaft;
- N* = number of revolutions per minute;
- H.P. = horse-power.

Then will $W = PV = 2\pi LNP$.

Since H.P. = $PV \div 33,000$, we have H.P. = $2\pi LNP \div 33,000$.

If $L = 33 \div 2\pi$, we obtain H.P. = $NP \div 1000$. $33 \div 2\pi$ is practically 5 ft. 3 in., a value often used in practice for the length of arm.

If the rubbing-surface be too small, the resulting friction will show great irregularity — probably on account of insufficient lubrication — the jaws being allowed to seize the pulley, thus producing shocks and sudden vibrations of the lever-arm.

Soft woods, such as bass, plane-tree, beech, poplar, or maple, are all to be preferred to the harder woods for brake-blocks. The rubbing-surface should be well lubricated with a heavy grease.

The Alden Absorption-dynamometer. (G. I. Alden, *Trans. A. S. M. E.*, vol. xi, 958; also xii, 700 and xiii, 429.) — This dynamometer is a friction-brake, which is capable in quite moderate sizes of absorbing large powers with unusual steadiness and complete regulation. A smooth cast-iron disk is keyed on the rotating shaft. This is inclosed in a cast-iron shell, formed of two disks and a ring at their circumference, which is free to revolve on the shaft. To the interior of each of the sides of the shell is fitted a copper plate, inclosing between itself and the side a water-tight space. Water under pressure from the city pipes is admitted into each of these spaces, forcing the copper plate against the central disk. The chamber inclosing the disk is filled with oil. To the outer shell is fixed a weighted arm, which resists the tendency of the shell to rotate with the shaft, caused by the friction of the plates against the central disk. Four brakes of this type, 56 in. diam., were used in testing the experimental locomotive at Purdue University (*Trans. A. S. M. E.*, xiii, 429). Each was designed for a maximum moment of 10,500 foot-pounds with a water-pressure of 40 lbs. per sq. in. The area in effective contact with the copper plates on either side is represented by an annular surface having its outer radius equal to 28 ins. and its inner radius equal to 10 ins. The apparent coefficient of friction between the plates and the disk was 3 1/2 %.

Capacity of Friction-brakes. — W. W. Beaumont (*Proc. Inst. C. E.*, 1889) has deduced a formula by means of which the relative capacity of brakes can be compared, judging from the amount of horse-power ascertained by their use.

If *W* = width of rubbing-surface on brake-wheel in inches; *V* = vel. of point on circum. of wheel in feet per minute; *K* = coefficient; then $K = WV \div H.P.$

Prof. Flatler obtains the values of *K* given in the last column of the subjoined table:

Horse-power.	R.P.M. Brake pulley.	Brake-pulley.		Length of Arm, inches.	Design of Brake.	Value of <i>K</i> .
		Face, in inches.	Diameter, in feet.			
21	150	7	5	33	Royal Ag. Soc., compensating	785
19	148.5	7	5	33.38	McLaren, compensating	858
20	146	7	5	32.19	McLaren, water-cooled and comp	802
40	180	10.5	5	32	Garrett, water-cooled and comp	741
33	150	10.5	5	32	Garrett, water-cooled and comp	749
150	150	10	9	Schoenheyder, water-cooled	282
24	142	12	6	38.31	Balk	1385
180	100	24	5	126.1	Gately & Kletsch, water-cooled	209
475	76.2	24	7	191	Webber, water-cooled	84.7
125	290	24	4	63	Westinghouse, water-cooled	465
250	250	24	4	63	Westinghouse, water-cooled	465
40	322	13	4	27 3/4	Westinghouse, water-cooled	847
125	290	13	4	27 3/4	Westinghouse, water-cooled	847

The above calculations for eleven brakes give values of *K* varying from 84.7 to 1385 for actual horse-powers tested, the average being *K* = 655.

Instead of assuming an average coefficient, Prof. Flather proposes the following:

Water-cooled brake, non-compensating, $K = 400$; $W = 400 \text{ H.P.} \div V$.

Water-cooled brake, compensating, $K = 750$; $W = 750 \text{ H.P.} \div V$.

Non-cooling brake, with or without compensating device, $K = 900$; $W = 900 \text{ H.P.} \div V$.

A brake described in *Am. Mach.*, July 27, 1905, had an iron water-cooled drum, 30 in. diam., 20 in. face, with brake blocks of maple attached to an iron strap nearly surrounding the drum. At 250 r.p.m., or a circumferential speed of 1963 ft. per min., the limit of its capacity was about 140 H.P.; above that power the blocks took fire. At 140 H.P. the total surface passing under the brake blocks per minute was 3272 sq. ft., or 23.37 per H.P. This corresponds to a value of $K = 285$.

Several forms of Prony brake, including rope and strap brakes, are described by G. E. Quick in *Am. Mach.*, Nov. 17, 1908. Some other forms are shown in *Am. Electrician*, Feb., 1903.

A 6000 H.P. Hydraulic Absorption Dynamometer, built by the Westinghouse Machine Co., is described by E. H. Longwell in *Eng. News*, Dec. 30, 1909. It was designed for testing the efficiency of the Melville and McAlpine turbine reduction gear (see page 1071). This dynamometer consists of a rotor mounted on a shaft coupled to the reduction gear and rotating within a closed casing which is prevented from turning by a 6½ ft. lever arm, the end of which transmits pressure through an I-beam lever to a platform scale. The rotor carries several rows of steam turbine vanes and the casing carries corresponding rows of stationary vanes, so arranged as to baffle and agitate the water passing through the brake, which is heated to boiling temperature by the friction. The dynamometer was run for 40 hours continuously, and proved to be a highly accurate instrument.

Transmission Dynamometers are of various forms, as the Batchelder dynamometer, in which the power is transmitted through a "train-arm" of bevel gearing, with its modifications, as the one described by the author in *Trans. A. S. M. E.*, viii, 177, and the one described by Samuel Webber in *Trans. A. S. M. E.*, x, 514; belt dynamometers, as the Tatham; the Van Winkle dynamometer, in which the power is transmitted from a revolving shaft to another in line with it, the two almost touching, through the medium of coiled springs fastened to arms or disk keyed to the shafts; the Brackett and the Webb cradle dynamometers, used for measuring the power required to run dynamo-electric machines. Descriptions of the four last named are given in Flather on Dynamometers.

The Kenerson transmission dynamometer is described in *Trans. A. S. M. E.*, 1909. It has the form of a shaft coupling, one part of which contains a cavity filled with oil and covered by a flexible copper diaphragm. The other part, by means of bent levers and a thrust ball-bearing, brings an axial pressure on the diaphragm and on the oil, and the pressure of the oil is measured by a gauge.

Much information on various forms of dynamometers will be found in *Trans. A. S. M. E.*, vols. vii to xv, inclusive, indexed under Dynamometers.

ICE-MAKING OR REFRIGERATING MACHINES.

References. — An elaborate discussion of the thermodynamic theory of the action of the various fluids used in the production of cold was published by M. Ledoux in the *Annales des Mines*, and translated in *Van Nostrand's Magazine* in 1879. This work, revised and additions made in the light of recent experience by Professors Denton, Jacobus, and Riesenberger, was reprinted in 1892. (Van Nostrand's Science Series, No. 46.) The work is largely mathematical, but it also contains much information of immediate practical value, from which some of the matter given below is taken. Other references are Wood's *Thermodynamics*, Chap. V, and numerous papers by Professors Wood, Denton, Jacobus, and Linde in *Trans. A. S. M. E.*, vols. x to xiv; Johnson's *Cyclopædia*, article on Refrigerating-machines; and the following books: Siebel's *Compend of Mechanical Refrigeration*; *Modern Refrigerating Machinery*, by Lorenz, translated by Pope; *Refrigerating Machines*, by Gardner T. Voorhees; Re-

frigeration, by J. Wemyss Anderson, and *Refrigeration, Cold Storage and Ice-making*, by A. J. Wallis-Taylor. For properties of Ammonia and Sulphur Dioxide, see papers by Professors Wood and Jacobus, *Trans. A. S. M. E.*, vols. x and xii.

For illustrated descriptions of refrigerating-machines, see catalogues of builders, as Frick & Co., Waynesboro, Pa.; De La Vergne Refrigerating-machine Co., New York; Vilter Mfg. Co., Milwaukee; York Mfg., York, Co., Pa.; Henry Vogt Machine Co., Louisville, Ky.; Carbondale Machine Co., Carbondale, Pa.; and others. See also articles in *Ice and Refrigeration*.

Operations of a Refrigerating-machine. — Apparatus designed for refrigerating is based upon the following series of operations:

Compress a gas or vapor by means of some external force, then relieve it of its heat so as to diminish its volume; next, cause this compressed gas or vapor to expand so as to produce mechanical work, and thus lower its temperature. The absorption of heat at this stage by the gas, in resuming its original condition, constitutes the refrigerating effect of the apparatus.

A refrigerating-machine is a heat-engine reversed.

From this similarity between heat-motors and freezing-machines it results that all the equations deduced from the mechanical theory of heat to determine the performance of the first, apply equally to the second.

The efficiency depends upon the difference between the extremes of temperature.

The useful effect of a refrigerating-machine depends upon the ratio between the heat-units eliminated and the work expended in compressing and expanding.

This result is independent of the nature of the body employed.

Unlike the heat-motors, the freezing-machine possesses the greatest efficiency when the range of temperature is small, and when the final temperature is elevated.

If the temperatures are the same, there is no theoretical advantage in employing a gas rather than a vapor in order to produce cold.

The choice of the intermediate body would be determined by practical considerations based on the physical characteristics of the body, such as the greater or less facility for manipulating it, the extreme pressures required for the best effects, etc.

Air offers the double advantage that it is everywhere obtainable, and that we can vary at will the higher pressures, independent of the temperature of the refrigerant. But to produce a given useful effect the apparatus must be of larger dimensions than that required by liquefiable vapors.

The maximum pressure is determined by the temperature of the condenser and the nature of the volatile liquid; this pressure is often very high.

When a change of volume of a saturated vapor is made under constant pressure, the temperature remains constant. The addition or subtraction of heat, which produces the change of volume, is represented by an increase or a diminution of the quantity of liquid mixed with the vapor.

On the other hand, when vapors, even if saturated, are no longer in contact with their liquids, and receive an addition of heat either through compression by a mechanical force, or from some external source of heat, they comport themselves nearly in the same way as permanent gases, and become superheated.

It results from this property, that refrigerating-machines using a liquefiable gas will afford results differing according to the method of working, and depending upon the state of the gas, whether it remains constantly saturated, or is superheated during a part of the cycle of working.

The temperature of the condenser is determined by local conditions. The interior will exceed by 9° to 18° the temperature of the water furnished to the exterior. This latter will vary from about 52° F., the temperature of water from considerable depth below the surface, to about 95° F., the temperature of surface-water in hot climates. The volatile liquid employed in the machine ought not at this temperature to have a tension above that which can be readily managed by the apparatus.

On the other hand, if the tension of the gas at the minimum temperature is too low, it becomes necessary to give to the compression-cylinder large dimensions, in order that the weight of vapor compressed by a

WARNING: This is a 1910 edition. Some of the material may no longer be accurate

single stroke of the piston shall be sufficient to produce a notably useful effect.

These two conditions, to which may be added others, such as those depending upon the greater or less facility of obtaining the liquid, upon the dangers incurred in its use, either from its inflammability or unhealthfulness, and finally upon its action upon the metals, limit the choice to a small number of substances.

The gases or vapors generally available are: sulphuric ether, sulphurous oxide, ammonia, methylic ether, and carbonic acid.

The following table, derived from Regnault, shows the tensions of the vapors of these substances at different temperatures between -22° and +104°.

Pressures and Boiling-points of Liquids available for Use in Refrigerating-machines.

Temp. of Ebullition.	Tension of Vapor, in lbs. per sq. in., above Zero.							
	Deg. Fahr.	Sulphuric Ether.	Sulphur Dioxide.	Ammonia.	Methylic Ether.	Carbonic Acid.	Pictet Fluid.	Ethyl Chloride.
-40			10.22					
-31			13.23					
-22		5.56	16.95	11.15				2.13
-13		7.23	21.51	13.85	251.6			2.80
-4	1.30	9.27	27.04	17.06	292.9	13.5		3.63
5	1.70	11.76	33.67	20.84	340.1	16.2		4.63
14	2.19	14.75	41.58	25.27	393.4	19.3		5.84
23	2.79	18.31	50.91	30.41	453.4	22.9		7.28
32	3.55	22.53	61.85	36.34	520.4	26.9		9.00
41	4.45	27.48	74.55	43.13	594.8	31.2		11.01
50	5.54	33.26	89.21	50.84	676.9	36.2		13.36
59	6.84	39.93	105.99	59.56	766.9	41.7		16.10
68	8.38	47.62	125.08	69.35	864.9	48.1		19.26
77	10.19	56.39	146.64	80.28	971.1	55.6		22.90
86	12.31	66.37	170.83	92.41	1085.6	64.1		27.05
95	14.76	77.64	197.83		1207.9	73.2		31.78
104	17.59	90.32	227.76		1338.2	82.9		37.12

The table shows that the use of ether does not readily lead to the production of low temperatures, because its pressure becomes then very feeble.

Ammonia, on the contrary, is well adapted to the production of low temperatures.

Methylic ether yields low temperatures without attaining too great pressures at the temperature of the condenser. Sulphur dioxide readily affords temperatures of -14 to -5, while its pressure is only 3 to 4 atmospheres at the ordinary temperature of the condenser. These latter substances then lend themselves conveniently for the production of cold by means of mechanical force.

The "Pictet fluid" is a mixture of 97% sulphur dioxide and 3% carbonic acid. At atmospheric pressure it affords a temperature 14° lower than sulphur dioxide. (It is not now used - 1910.)

Carbonic acid is in use to a limited extent, but the relatively greater compactness of compressor that it requires, and its inoffensive character, are leading to its recommendation for service on shipboard.

Certain ammonia plants are operated with a surplus of liquid present during compression, so that superheating is prevented. This practice is known as the "cold" or "wet" system of compression.

Ethyl chloride, C₂H₅Cl, is a colorless gas which at atmospheric pressure condenses to a liquid at 54.5° F. The latent heat at 23° F. is given at 174 B.T.U. Density of the gas (air=1) = 2.227. Specific heat at constant pressure, 0.274; at constant volume, 0.243.

Nothing definite is known regarding the application of methylic ether or of the petroleum product chymogene in practical refrigerating service. The inflammability of the latter and the cumbrousness of the compressor required are objections to its use.

PROPERTIES OF SULPHUR DIOXIDE AND AMMONIA GAS.

Ledoux's Table for Saturated Sulphur-dioxide Gas. Heat-units expressed in B.T.U. per pound of sulphur dioxide.

Temperature of Ebullition in deg. F.	Absolute Pressure in lbs. per sq. in. P + 144	Total Heat reckoned from 32° F. λ	Heat of Liquid reckoned from 32° F. q	Latent Heat of Evaporation. r	Heat Equivalent of External Work. A Pu	Internal Latent Heat. p	Increase of Volume during Evaporation. v	Density of Vapor or Weight of 1 cu. ft. l + v
Deg. F.	Lbs.	B.T.U.	B.T.U.	B.T.U.	B.T.U.	B.T.U.	Cu. ft.	Lbs.
-22	5.56	157.43	-19.56	176.99	13.59	163.39	13.17	0.076
-13	7.23	158.64	-16.30	174.95	13.83	161.12	10.27	.097
-4	9.27	159.84	-13.05	172.89	14.05	158.84	8.12	.123
5	11.76	161.03	-9.79	170.82	14.26	156.56	6.50	.153
14	14.74	162.20	-6.53	168.73	14.46	154.27	5.25	.190
23	18.31	163.36	-3.27	166.63	14.66	151.97	4.29	.232
32	22.53	164.51	0.00	164.51	14.84	149.68	3.54	.282
41	27.48	165.65	3.27	162.38	15.01	147.37	2.93	.340
50	33.25	166.78	6.55	160.23	15.17	145.06	2.45	.407
59	39.93	167.90	9.83	158.07	15.32	142.75	2.07	.483
68	47.61	168.99	13.11	155.89	15.46	140.43	1.75	.570
77	56.39	170.09	16.39	153.70	15.59	138.11	1.49	.669
86	66.36	171.17	19.69	151.49	15.71	135.78	1.27	.780
95	77.64	172.24	22.98	149.26	15.82	133.45	1.09	.906
104	90.31	173.30	26.28	147.02	15.91	131.11	0.91	1.046

E. F. Miller (*Trans. A. S. M. E.*, 1903) reports a series of tests on the pressure of SO₂ at various temperatures, the results agreeing closely with those of Regnault up to the highest figure of the latter, 149° F., 178 lbs. absolute. He gives a table of pressures and temperatures for every degree between -40° and 217°. The results obtained at temperatures between 113° and 212° are as below:

Temp. °F.	113	122	131	140	149	158	167	176	194	203	212
Pres. lbs. per sq. in.	104.4	120.1	137.5	156.7	179.5	203.8	230.7	260.5	331.1	371.8	418.

Density of Liquid Ammonia. (D'Andreff, *Trans. A. S. M. E.*, x, 641.)

At temperature C.	-10	-5	0	5	10	15	20
At temperature F.	+14	23	32	41	50	59	68
Density	0.6492	.6429	.6364	.6298	.6230	.6160	.6086

These may be expressed very nearly by
 $\delta = 0.6364 - 0.0014t^{\circ}$ Centigrade;
 $\delta = 0.6502 - 0.000777T^{\circ}$ Fahr.

Latent Heat of Evaporation of Ammonia. (Wood, *Trans. A. S. M. E.*, x, 641.)
 $h_e = 555.5 - 0.613T - 0.000219T^2$ (in B.T.U., ° F);

Ledoux found $h_e = 583.33 - 0.5499T - 0.0001173T^2$.

For experimental values at different temperatures determined by Prof. Denton, see *Trans. A. S. M. E.*, xii, 356. For calculated values, see vol. x, 646.

Properties of the Saturated Vapor of Ammonia.
(Wood's Thermodynamics.)

Temperature.		Pressure, Absolute.		Heat of Vaporization, thermal units.	Volume of Vapor per lb., cu. ft.	Volume of Liquid per lb., cu. ft.	Weight of a cu. ft. of Vapor, lbs.
Degs. F.	Absolute, F.	Lbs. per sq. ft.	Lbs. per sq. in.				
-40	420.66	1540.7	10.69	579.67	24.372	0.0234	0.0410
-35	425.66	1773.6	12.31	576.69	21.319	.0236	.0468
-30	430.66	2035.8	14.13	573.69	18.697	.0237	.0535
-25	435.66	2329.5	16.17	570.68	16.445	.0238	.0608
-20	440.66	2657.5	18.45	567.67	14.507	.0240	.0689
-15	445.66	3022.5	20.99	564.64	12.834	.0242	.0779
-10	450.66	3428.0	23.80	561.61	11.384	.0243	.0878
-5	455.66	3877.2	26.93	558.56	10.125	.0244	.0988
0	460.66	4373.5	30.37	555.50	9.027	.0246	.1108
5	465.66	4920.5	34.17	552.43	8.069	.0247	.1239
10	470.66	5522.2	38.34	549.35	7.229	.0249	.1383
15	475.66	6182.4	42.93	546.26	6.492	.0250	.1544
20	480.66	6905.3	47.95	543.15	5.842	.0252	.1712
25	485.66	7695.2	53.43	540.03	5.269	.0253	.1898
30	490.66	8556.6	59.41	536.92	4.763	.0254	.2100
35	495.66	9493.9	65.93	533.78	4.313	.0256	.2319
40	500.66	10512	73.00	530.63	3.914	.0257	.2555
45	505.66	11616	80.66	527.47	3.559	.0259	.2809
50	510.66	12811	88.96	524.30	3.242	.0261	.3085
55	515.66	14102	97.93	521.12	2.958	.0263	.3381
60	520.66	15494	107.60	517.93	2.704	.0265	.3698
65	525.66	16993	118.03	514.73	2.476	.0266	.4039
70	530.66	18605	129.21	511.52	2.271	.0268	.4403
75	535.66	20336	141.25	508.29	2.087	.0270	.4793
80	540.66	22192	154.11	505.05	1.920	.0272	.5208
85	545.66	24178	167.86	501.81	1.770	.0273	.5650
90	550.66	26300	182.8	498.11	1.632	.0274	.6128
95	555.66	28565	198.37	495.29	1.510	.0277	.6623
100	560.66	30980	215.14	492.01	1.398	.0279	.7153
105	565.66	33550	232.98	488.72	1.296	.0281	.7716
110	570.66	36284	251.97	485.42	1.203	.0283	.8312
115	575.66	39188	272.14	482.41	1.119	.0285	.8937
120	580.66	42267	293.49	478.79	1.045	.0287	.9569
125	585.66	45528	316.16	475.45	0.970	.0289	1.0309
130	590.66	48978	340.42	472.11	0.905	.0291	1.1049
135	595.66	52626	365.16	468.75	0.845	.0293	1.1834
140	600.66	56483	392.22	465.39	0.791	.0295	1.2642
145	605.66	60550	420.49	462.01	0.741	.0297	1.3495
150	610.66	64833	450.20	458.62	0.695	.0299	1.4388
155	615.66	69341	481.54	455.22	0.652	.0302	1.5337
160	620.66	74086	514.40	451.81	0.613	.0304	1.6343
165	625.66	79071	549.04	448.39	0.577	.0306	1.7333

Density of Ammonia Gas. — Theoretical, 0.5894; experimental, 0.596. Regnault (*Trans. A. S. M. E.*, x, 633).

Specific Heat of Liquid Ammonia. (Wood, *Trans. A. S. M. E.*, x, 645.) — The specific heat is nearly constant at different temperatures, and about equal to that of water, or unity. From 0° to 100° F., it is

$$c = 1.096 - 0.0012T, \text{ nearly.}$$

In a later paper by Prof. Wood (*Trans. A. S. M. E.*, xii, 136) he gives a higher value, viz., $c = 1.12136 + 0.000438T$.

L. A. Elleau and Wm. D. Ennis (*Jour. Franklin Inst.*, April, 1898) give the results of nine determinations, made between 0° and 20° C., which range from 0.983 to 1.056, averaging 1.0206. Von Stroubeck

(*Jour. Franklin Inst.*, Dec., 1890) found the specific heat between 62° and 31° C. to be 1.22876. Ludeking and Starr (*Am. Jour. Science*, iii, 45, 200) obtained 0.886. Prof. Wood deduced from thermodynamic equations $c = 1.093$ at -34° F. or -38° C., and Ledoux in like manner finds $c = 1.0058 + 0.003658t^{\circ}C$. Elleau and Ennis give Ledoux's equation with a new constant derived from their experiments, thus $c = 0.9834 + 0.003658t^{\circ}C$.

Strength of Aqua Ammonia at 60° F.

% NH ₃ by wt.	2	4	6	8	10	12	14	16	18
Sp. gr.	0.986	.979	.972	.966	.960	.953	.945	.938	.931
% NH ₃	20	22	24	26	28	30	32	34	36
Sp. gr.	0.925	.919	.913	.907	.902	.897	.892	.888	.884

Specific Heat of Ammonia Vapor at the Saturation Point. (Wood, *Trans. A. S. M. E.*, x, 644.) — For the range of temperatures ordinarily used in engineering practice, the specific heat of saturated ammonia is negative, and the saturated vapor will condense with adiabatic expansion. The liquid will evaporate with the compression of the vapor, and when all is vaporized will superheat.

Regnault (*Rel. des. Exp.*, ii, 162) gives for specific heat of ammonia-gas 0.50836. (Wood, *Trans. A. S. M. E.*, xii, 133.)

Weight of Superheated Ammonia Vapor at 15.67 lbs. Gauge Pressure (= 30.67 lbs. abs.) (C. E. Lucke, *Ice and Refrigeration*, Mar., 1908.) Weight at 0° F. 0.1107 lbs.

Temp. ° F.	Lb. per cu. ft.	Temp. ° F.	Lb. per cu. ft.	Temp. ° F.	Lb. per cu. ft.	Temp. ° F.	Lb. per cu. ft.
5	0.1095	25	0.1050	125	0.08706	225	0.07438
10	0.1085	50	0.09986	150	0.08351	250	0.07176
15	0.1072	75	0.0952	175	0.08033	275	0.06932
20	0.1061	100	0.09096	200	0.07713	300	0.06703

Specific Heat and Available Latent Heat of Hot Liquid Ammonia at 15.67 lbs. gauge pressure. (Lucke.) Latent heat at 15.67 lbs. and 0° F. = 550.5 B.T.U. Specific heat = 1.096 - 0.0012 T°.

Temp. of Liquid Supply.	Specific Heat.	Correc-tion for Cooling.	Available Latent Heat for Saturated Vapor.	Temp. of Liquid Supply.	Specific Heat.	Correc-tion for Cooling.	Available Latent Heat for Saturated Vapor.
5	1.090	5.45	550.05	55	1.030	56.65	498.85
10	1.084	10.84	544.66	60	1.024	61.44	494.06
15	1.078	16.17	539.33	65	1.018	66.17	489.33
20	1.072	21.44	534.06	70	1.012	70.84	484.66
25	1.066	26.65	528.85	75	1.006	75.45	480.05
30	1.060	31.80	523.70	80	1.000	80.00	475.50
35	1.054	36.89	518.61	85	0.994	84.49	471.01
40	1.048	41.92	513.68	90	0.988	88.92	466.58
45	1.042	46.89	508.61	95	0.982	93.29	462.21
50	1.036	51.80	503.70	100	0.976	97.60	457.90

The latent heat for saturated vapor is subject to three corrections in determining the available latent heat. First, for the temperature of the liquid which must be cooled from its supply temperature to the temperature corresponding to the back pressure, as in the table above; second, for wetness of vapor, a deduction of 5.555 B.T.U. for each 1% of moisture; third, for superheat of vapor in case it leaves the expansion coils or cooler hotter than the temperature corresponding to the pressure, an addition of the number of degrees superheat multiplied by the specific heat, taken as 0.508.

Solubility of Ammonia. (Siebel.) — One pound of water will dissolve the following weights of ammonia at the pressures and temperatures F° stated.

Abs. Press. per sq. in.	32°			68°			104°				
	lb.	lb.	lb.	lb.	lb.	lb.	lb.	lb.	lb.		
14.67	0.899	0.518	0.338	21.23	1.236	0.651	0.425	27.99	1.603	0.780	0.486
15.44	0.937	0.635	0.349	22.19	1.283	0.669	0.434	28.95	1.656	0.801	0.493
16.41	0.980	0.556	0.362	23.16	1.330	0.685	0.445	30.88	1.758	0.842	0.511
17.37	1.029	0.574	0.378	24.13	1.388	0.704	0.454	32.81	1.861	0.881	0.530
18.34	1.077	0.594	0.391	25.09	1.442	0.722	0.463	34.74	1.966	0.919	0.547
19.30	1.126	0.613	0.404	26.06	1.496	0.741	0.472	36.67	2.070	0.955	0.565
20.27	1.177	0.632	0.414	27.02	1.549	0.761	0.479	38.60	2.174	0.992	0.579

Properties of Saturated Vapors. — The figures in the following table are given by Lorenz, on the authority of Mollier and of Zeuner.

° F.	Heat of Vaporization, B.T.U. per lb.			Heat of Liquid, B.T.U. per lb.			Absolute Pressure, lbs. per sq. in.			Volume of 1 lb., cubic feet.		
	NH ₃	CO ₂	SO ₂	NH ₃	CO ₂	SO ₂	NH ₃	CO ₂	SO ₂	NH ₃	CO ₂	SO ₂
	- 4°	589.0	117.6	171.0	-31.21	-17.19	-11.16	27.1	288.7	9.27	10.33	0.312
+14°	580.0	110.7	168.2	-15.89	- 9.00	- 5.69	41.5	385.4	14.75	6.92	0.229	5.27
32°	569.0	99.8	164.2	0	0	0	61.9	503.5	22.53	4.77	0.167	3.59
50°	555.5	86.0	158.9	16.51	10.28	5.90	89.1	650.1	33.26	3.38	0.120	2.44
68°	539.9	66.5	152.5	33.58	23.08	12.03	125.0	826.4	47.61	2.47	0.083	1.71
86°	521.4	27.1	144.8	51.28	45.45	18.34	170.8	1040.	66.36	1.63	0.048	1.22
104°	500.4	135.9	69.58	24.88	227.7	90.30	1.39	0.88

The figures for CO₂ in the above table differ widely from those of Regnault, and are no doubt more reliable.

Heat Generated by Absorption of Ammonia. (Berthelot, from Siebel.) — Heat developed when a solution of 1 lb. NH₃ in n lbs. water is diluted with a great amount of water = $Q = 142/n$ B.T.U. Assuming 925 B.T.U. to be developed when 1 lb. NH₃ is absorbed by a great deal (say 200 lbs.) of water, the heat developed in making solutions of different strengths (1 lb. NH₃ to n lbs. water) = $Q_1 = 925 - 142/n$ B.T.U. Heat developed when b lbs. NH₃ is added to a solution of 1 lb. NH₃ + n lbs. water = $Q_2 = 925 - 142(2b + b^2)/n$ B.T.U.

Let the weak liquor enter the absorber with a strength of 10%, = 1 lb. NH₃ + 9 lbs. water, and the strong liquor leave the absorber with a strength of 25%, = 3 lbs. NH₃ + 9 lbs. water, $b = 2, n = 9; Q_2 = 925 \times 2 - 142(4 + 4)/9 = 1724$ B.T.U. Hence by dissolving 2 lbs. of ammonia gas or vapor in a solution of 1 lb. ammonia in 9 lbs. water we obtain 12 lbs. of a 25% solution, and the heat generated is 1724 B.T.U.

Cooling Effect, Compressor Volume, and Power Required. — The following table gives the theoretical results computed on the basis of a temperature in the evaporator of 14° F. and in the condenser of 68° F.; in the first three columns of figures the cooling agent is supposed to flow through the regulating valve with this latter temperature; in the last three it is previously cooled to 50° F.

From the stroke-volume per 100,000 B.T.U. the minimum theoretical horse-power is obtained as follows: Adiabatic compression is assumed for the ratio of the absolute condenser pressure to that of the vaporizer, and the mean pressure through the stroke thus found, in lbs. per sq. ft.; multiplying this by the stroke volume per hour and dividing by 1,980,000 gives the net horse-power. The ratio of the mean effective pressure, M.P., to the vaporizer pressure, V.P., for different ratios of condenser pressure, C.P., to vaporizer pressure is given on the next page.

Cooling Effect, Compressor Volume, and Power Required, with Different Cooling Agents. (Lorenz.)

Cooling Agent:	NH ₃	CO ₂	SO ₂	NH ₃	CO ₂	SO ₂
1. Temp. in front of regulating valve.....	68	68	68	50	50	50
2. Vaporizer pressure, lbs. per sq. in.....	41.5	385.4	14.75	41.5	385.4	14.75
3. Condenser pressure, lbs. per sq. in.....	125.0	826.4	47.61	125.0	826.4	47.61
4. Heat of evaporation, B.T.U. per lb.....	580.2	110.7	168.2	580.2	110.7	168.2
5. Heat imparted to the liquid.....	49.47	32.08	17.72	32.4	19.28	11.59
6. Cold produced per lb. B.T.U.....	530.73	78.62	150.48	547.8	91.42	156.61
7. Cooling agent circulated for yield of 100,000 B.T.U. per hour, lbs.....	188.4	1272.	664.3	182.5	1094.	638.5
8. Stroke volume for 100,000 B.T.U. per hour, cu. ft.....	1,300	292	3,507	1,264	242	3,365
9. Minimum H.P. per 100,000 B.T.U. per hour.....	4.98	4.98	4.98	4.98	4.98	4.98
10. Ratio Heat of evap. + cold produced.....	1.093	1.408	1.118	1.059	1.211	1.074
11. Ratio total work to minimum.....	1.175	1.513	1.202	1.138	1.302	1.155
12. Total I.H.P. per 100,000 B.T.U. per hour.....	5.85	7.53	5.99	5.67	6.48	5.75
13. Cooling effect per I.H.P. hr..	17,100	13,300	16,700	17,600	15,400	17,400

RATIOS OF CONDENSER PRESSURE, C. P., AND MEAN EFFECTIVE PRESSURE, M. P., TO VAPORIZER PRESSURE, V. P.

CP + VP	MP + VP	CP + VP	MP + VP	CP + VP	MP + VP	CP + VP	MP + VP	CP + VP	MP + VP	CP + VP	MP + VP
1.0	0.	2.0	0.752	3.0	1.249	4.0	1.684	5.0	1.947	6.0	2.216
1.2	0.186	2.2	0.865	3.2	1.344	4.2	1.711	5.2	2.006	6.2	2.454
1.4	0.350	2.4	0.970	3.4	1.414	4.4	1.766	5.4	2.062	6.4	2.666
1.6	0.487	2.6	1.070	3.6	1.491	4.6	1.829	5.6	2.116	6.6	2.858
1.8	0.630	2.8	1.163	3.8	1.564	4.8	1.891	5.8	2.168	6.8	3.036

The minimum theoretical horse-power thus obtained is increased by the ratio of the heat of evaporation to the available cooling action (line 4 ÷ line 6, = line 10 of the table) and by an allowance for the resistance of the valves taken at 7.5% to obtain the total H.P. given in the table.

To the theoretical horse-power given in line 12 Lorenz makes numerous additions, viz.: friction of the compression and driving machine 0.90, 1.10, 0.90, 0.85, 0.95, 0.85 respectively for the six columns in the table; also H.P. for stirring 0.3; for cooling-water pumps, 0.45; for brine pumps, 2.2; for transmission of power, 0.6, making the total H.P. for the six cases 10.30, 12.18, 10.44, 10.07, 10.98, 10.15. He also makes deductions from the theoretical generation of cold of 100,000 B.T.U. per hour, for a brewery cooling installation, for irregularities of valves, etc., for NH₃ and SO₂ machines 10% and for CO₂ machines 5%; for cooling loss through stirring 765 B.T.U., through brine pumps 5610 B.T.U., and through radiation 4500 B.T.U., making the net cooling for NH₃ and SO₂ machines 79,125 B.T.U. and for CO₂ machines 84,125 B.T.U., and the cold generated per effective H.P. in the six cases, 7682, 6908, 7578, 7848, 7662, and 7796 B.T.U.

The figures given in the tables are not to be considered as holding generally or extended to other condenser and evaporator temperatures. Each change of condition requires a separate calculation. The final

results indicate that for the various cooling systems no appreciable difference exists in the work required for the same amount of cold delivered at the place where it is to be applied.

Properties of Brine Used to Absorb Refrigerating Effect of Ammonia. (J. E. Denton, *Trans. A. S. M. E.*, x, 799.) — A solution of Liverpool salt in well-water having a specific gravity of 1.17, or a weight per cubic foot of 73 lbs., will not sensibly thicken or congeal at 0° F.

The mean specific heat between 39° and 16° Fahr. was found by Denton to be 0.805. Brine of the same specific gravity has a specific heat of 0.805 at 65° Fahr., according to Naumann.

Naumann's values are as follows (*Lehr- und Handbuch der Thermochemie*, 1882):

Specific heat	0.791	0.805*	0.863	0.895	0.931	0.962	0.978
Specific gravity	1.187	1.170	1.103	1.072	1.044	1.023	1.012

Properties of Salt Brine (Carbondale Calcium Co.)

Deg. Baumé 60° F.	1	5	10	15	19	23
Deg. Salinometer 60° F.	4	20	40	60	80	100
Sp. gravity 60° F.	1.007	1.037	1.073	1.115	1.150	1.191
Per cent of salt, by wt.	1	5	10	15	20	25
Wt. of 1 gallon, lbs.	8.40	8.65	8.95	9.30	9.60	9.94
Wt. of 1 cu. ft., lbs.	62.8	64.7	66.95	69.57	71.76	74.26
Freezing point ° F.	31.8	25.4	18.6	12.2	6.86	1.00
Specific heat	0.992	0.960	0.892	0.855	0.829	0.783

Chloride of Calcium solution is commonly used instead of brine. According to Naumann, a solution of 1.0255 sp. gr. has a specific heat of 0.957. A solution of 1.163 sp. gr. in the test reported in *Eng'g*, July 22, 1887, gave a specific heat of 0.827.

H. C. Dickinson (*Science*, April 23, 1909) gives the following values of the specific heat of solutions of chemically pure calcium chloride.

Density	Specific Heat	Temperature, C.
1.07	0.869 + 0.00057 t	(- 5° to + 15°)
1.14	0.773 + 0.00064 t	(- 10° to + 20°)
1.20	0.710 + 0.00064 t	(- 20° to + 20°)
1.26	0.662 + 0.00064 t	(- 25° to + 20°)

The advantages of chloride of calcium solution are its lower freezing point and that it has little or no corrosive action on iron and brass. Calcium chloride is sold in the fused or granulated state, in steel drums, containing about 75% anhydrous chloride and 25% water, or in solution containing 40 to 50% anhydrous chloride, in tank cars. The following data are taken from the catalogue of the Carbondale Calcium Co.

PROPERTIES OF "SOLVAY" CALCIUM CHLORIDE SOLUTION.

Deg. Baumé, 60° F.	Spec. Grav., 60° F.	Per cent, CaCl.	Freezes at Deg. F.	Deg. Baumé, 60° F.	Spec. Grav., 60° F.	Per cent, CaCl.	Freezes at Deg. F.	Deg. Baumé, 60° F.	Spec. Grav., 60° F.	Per cent, CaCl.	Freezes at Deg. F.
1	1.007	1	+31.10	21	1.169	19	+ 1.76	32	1.283	30	-54.40
5.5	1.041	5	27.68	22	1.179	20	- 1.48	35	1.316	33	-25.24
11	1.085	10	22.38	23	1.189	21	- 4.90	35.5	1.327	34	- 9.76
17	1.131	15	12.20	26	1.219	24	-17.14	36.5	1.338	35	+ 2.84
20	1.159	18	4.64	29	1.250	27	-32.62	37.5	1.349	36	14.36

Quantity of 75% calcium chloride required to make solutions of different specific gravities and freezing points.

Sp. gravity	1.250	1.225	1.200	1.175	1.150	1.125	1.100
Lbs. per cu ft. solution	28.06	25.06	22.05	19.15	16.26	13.47	10.70
Lbs. per gallon	3.76	3.36	2.95	2.56	2.18	1.80	1.43
Freezing point ° F.	-32.6	-19.5	-8.7	Zero	+7.5	+13.3	+18.5

* Interpolated.

Boiling points of calcium chloride solutions:

Sp. Gr. at 59° F.	1.104	1.185	1.268	1.341	1.383	solid at 59°
Boiling point ° F.	215.6	221.0	230.0	240.8	248.0	266.0 282.2 306.5
Sp. gr. at boiling point	1.085	1.119	1.209	1.308	1.365	1.452 1.526 1.619

"Ice-melting Effect." — It is agreed that the term "ice-melting effect" means the cold produced in an insulated bath of brine, on the assumption that each 144 B.T.U. represents one pound of ice, this being the latent heat of fusion of ice, or the heat required to melt a pound of ice at 32° to water at the same temperature.

The performance of a machine, expressed in pounds or tons of "ice-melting capacity," does not mean that the refrigerating-machine would make the same amount of actual ice, but that the cold produced is equivalent to the effect of the melting of ice at 32° to water of the same temperature.

In making artificial ice the water frozen is generally about 70° F. when submitted to the refrigerating effect of a machine; second, the ice is chilled from 12° to 20° below its freezing-point; third, there is a dissipation of cold, from the exposure of the brine tank and the manipulation of the ice-cans: therefore the weight of actual ice made, multiplied by its latent heat of fusion, 144 thermal units, represents only about three-fourths of the cold produced in the brine by the refrigerating fluid per I.H.P. of the engine driving the compressing-pumps. Again, there is considerable fuel consumed to operate the brine-circulating pump, the condensing-water and feed-pumps, and to reboil, or purify, the condensed steam from which the ice is frozen. This fuel, together with that wasted in leakage and drip water, amounts to about one-half that required to drive the main steam-engine. Hence the pounds of actual ice manufactured from distilled water is just about half the equivalent of the refrigerating effect produced in the brine per indicated horse-power of the steam-cylinders.

When ice is made directly from natural water by means of the "plate system," about half of the fuel, used with distilled water, is saved by avoiding the reboiling, and using steam expansively in a compound engine.

Ether-machines, used in India, are said to have produced about 6 lbs. of actual ice per pound of fuel consumed.

The ether machine is obsolete, because the density of the vapor of ether, at the necessary working-pressure, requires that the compressing-cylinder shall be about 6 times larger than for sulphur dioxide, and 17 times larger than for ammonia.

Air-machines require about 1.2 times greater capacity of compressing cylinder, and are, as a whole, more cumbersome than ether machines, but they remain in use on shipboard. In using air the expansion must take place in a cylinder doing work, instead of through a simple expansion-cock which is used with vapor machines. The work done in the expansion-cylinder is utilized in assisting the compressor.

The *Allen Dense Air Machine* takes for compression air of considerable pressure which is contained in the machine and in a system of pipes. The air at 60 or 70 lbs. pressure is compressed to 210 or 240 lbs. It is then passed through a coil immersed in circulating water and cooled to nearly the temperature of the water. It then passes into an expander, which is, in construction, a common form of steam-engine with a cut-off valve. This engine takes out of the air a quantity of heat equivalent to the work done by the air while expanding, to the original pressure of 60 or 70 lbs., and reduces its temperature to about 90° to 120° F. below the temperature of the cooling water supply. The return stroke of the piston pushes the air out through insulated pipes to the places that are to be refrigerated, from which it is returned to the compressor.

The air pushed out by the expander is commonly about 35 to 55 below zero F. In arrangements where not all the cold is taken out of the air by the refrigerating apparatus, the highly compressed air after cooling in the coil is further cooled by being brought in surface contact with the returning and still cold air, before entering the expander. By this means temperatures of 70 to 90 below zero may be obtained.

The refrigerating effect in B.T.U. per minute is: Lbs. of air handled per

min. $\times 0.2375 \times$ difference of temperature of air passing out of expander and of that returning to the machine.

Carbon-dioxide Machines are in extensive use on shipboard. S. H. Bunnell (*Eng. News*, April 9, 1903) says there are over 1500 CO₂ plants on shipboard. He describes a large duplex CO₂ compressor built by the Brown-Cochrane Co., Lorain, O. Tests of CO₂ machines by a committee of the Danish Agricultural Society were reported in 1899, in "Ice and Cold Storage," of London. Carbon-dioxide machines are built also by Kroeschel Bros., Chicago.

Methyl-Chloride machines are made by Railway and Stationary Refrigerating Co., New York City. The compressor is a rotary pump. When driven by an electric motor the complete apparatus is very compact, and is therefore suitable for refrigerator cars or other places where space is restricted.

Sulphur-Dioxide Machines.—Results of theoretical calculations are given in a table by Ledoux showing an ice-melting capacity per hour per horse-power ranging from 134 to 63 lbs., and per pound of coal ranging from 44.7 to 21.1 lbs., as the temperature corresponding to the pressure of the vapor in the condenser rises from 59° to 104° F. The theoretical results do not represent the actual.

Prof. Denton says concerning Ledoux's theoretical results: The figures given are higher than those obtained in practice, because the effect of superheating of the gas during admission to the cylinder is not considered. This superheating may cause an increase of work of about 25%. There are other losses due to superheating the gas at the brine-tank, and in the pipe leading from the brine-tank to the compressor, so that in actual practice a sulphur-dioxide machine, working under the conditions of an absolute pressure in the condenser of 56 lbs. per sq. in. and the corresponding temperature of 77° F., will give about 22 lbs. of ice-melting capacity per pound of coal, which is about 60% of the theoretical amount neglecting friction, or 70% including friction.

Sulphur-dioxide machines are not now used in the United States (1910). **Refrigerating-Machines using Vapor of Water.** (Ledoux.)—In these machines, sometimes called vacuum machines, water, at ordinary temperatures, is injected into, or placed in connection with, a chamber in which a strong vacuum is maintained. A portion of the water vaporizes, the heat to cause the vaporization being supplied from the water not vaporized, so that the latter is chilled or frozen to ice. If brine is used instead of pure water, its temperature may be reduced below the freezing-point of water. The water vapor is compressed from, say, a pressure of 0.1 lb. per sq. in. to 1½ lbs. and discharged into a condenser. It is then condensed and removed by means of an ordinary air-pump. The principle of action of such a machine is the same as that of volatile-vapor machines.

A theoretical calculation for ice-making, assuming a lower temperature of 32° F., a pressure in the condenser of 1½ lbs. per sq. in., and a coal consumption of 3 lbs. per I.H.P. per hour, gives an ice-melting effect of 34.5 lbs. per pound of coal, neglecting friction. Ammonia for ice-making conditions gives 40.9 lbs. The volume of the compressing cylinder is about 150 times the theoretical volume for an ammonia machine for these conditions.

[The Patten Vacuum Ice Co., of Baltimore, has a large plant on this system in operation (1910).]

Ammonia Compression-machines.— "Cold" vs. "Dry" Systems of Compression. — In the "cold" system or "humid" system some of the ammonia entering the compression cylinder is liquid, so that the heat developed in the cylinder is absorbed by the liquid and the temperature of the ammonia thereby confined to the boiling-point due to the condenser-pressure. No jacket is therefore required about the cylinder.

In the "dry" or "hot" system all ammonia entering the compressor is gaseous, and the temperature becomes by compression several hundred degrees greater than the boiling-point due to the condenser-pressure. A water-jacket is therefore necessary to permit the cylinder to be properly lubricated.

Dry, Wet and Flooded Systems. (York Mfg. Co.)—An expansion system, or one where the ammonia leaves the coil slightly superheated, requires about 33¼% more pipe surface than a wet compression system,

in which the ammonia leaves the coils containing sufficient entrained liquid to maintain a wet compression condition in the compressor.

The flooded system is one where the ammonia is allowed to flow through the coils and into a trap, where the gas is separated from the liquid, the gas passing on to the compressor, while the liquid goes around through the coils again, together with the fresh liquid, which is fed into the trap. Such a system requires only about one-half the evaporating surface that an expansion system does to do the same work. The relative proportions of the three systems may be expressed as follows:

A Dry Compression plant will need, with an Expansion Evaporating System, a medium size compressor, a large size evaporating system, a small amount of ammonia.

A Dry Compression plant will need, with a Flooded Evaporating System, a small size compressor, a small size evaporating system, a large amount of ammonia.

A Wet Compression plant will need, with a Wet Compression Evaporating System, a large size compressor, a medium size evaporating system, a medium amount of ammonia.

The Ammonia Absorption-machine comprises a generator which contains a concentrated solution of ammonia in water; this generator is heated either directly by a fire, or indirectly by pipes leading from a steam-boiler. The vapor passes first into an "analyzer," a chamber connected with the upper part of the generator which separates some of the water from the vapor, then into a rectifier, where the vapor is partly cooled, precipitating more water, which returns to the generator, and then to the condenser. The upper part of the cooler or brine-tank is in communication with the lower part of the condenser.

An absorption-chamber is filled with a weak solution of ammonia; a tube puts this chamber in communication with the cooling-tank.

The absorption-chamber communicates with the boiler by two tubes; one leads from the bottom of the generator to the top of the chamber, the other leads from the bottom of the chamber to the top of the generator. Upon the latter is mounted a pump, to force the liquid from the absorption-chamber, where the pressure is maintained at about one atmosphere, into the generator, where the pressure is from 8 to 12 atmospheres.

To work the apparatus the ammonia solution in the generator is first heated. This releases the gas from the solution, and the pressure rises. When it reaches the tension of the saturated gas at the temperature of the condenser there is a liquefaction of the gas, and also of a small amount of steam. By means of a cock the flow of the liquefied gas into the refrigerating coils contained in the cooler is regulated. It is here vaporized by absorbing the heat from the substance placed there to be cooled. As fast as it is vaporized it is absorbed by the weak solution in the absorbing-chamber.

Under the influence of the heat in the boiler the solution is unequally saturated, the stronger solution being uppermost. The weaker portion is conveyed by the pipe entering the top of the absorbing-chamber, the flow being regulated by a cock, while the pump sends an equal quantity of strong solution from the chamber back to the boiler.

The working of the apparatus depends upon the adjustment and regulation of the flow of the gas and liquid; by these means the pressure is varied, and consequently the temperature in the cooler may be controlled.

The working is similar to that of compression-machines. The absorption-chamber fills the office of aspirator, and the generator plays the part of compressor. The mechanical force producing exhaustion is here replaced by the affinity of water for ammonia gas, and the mechanical force required for compression is replaced by the heat which severs this affinity and sets the gas at liberty.

Reece's absorption apparatus (1870) is thus described by Wallis-Taylor. The charge of liquid ammonia (26° Baumé) is vaporized by the application of heat, and the mixed vapor passed to the analyzer and rectifier, wherein the bulk of the water is condensed at a comparatively elevated temperature and returned to the generator. The ammoniacal vapor or gas is then passed to the condenser, where it is liquefied under the combined action of the cooling-water and of the pressure maintained in the generator. The liquid ammonia, practically anhydrous, is then used in the refrigerator, and the vapor therefrom, still under considerable pressure, is admitted to

the cylinder of an engine used to drive a pump for returning the strong solution to the generator, after which it is passed to the absorber, where it meets and is absorbed by the weak liquor from the generator, and the strong liquor so formed is forced back into the generator by means of the pump. The temperature exchanger, introduced in 1875, provides for the hot liquor on its way from the generator to the absorber giving up its heat to the cooler liquid from the absorber on its way to the generator.

Wallis-Taylor describes also marine refrigerating, ice-making, cold storage, the application of refrigeration in breweries, dairies, etc.; and the management and testing of apparatus.

For the best results the following conditions are necessary (Voorhees):
 1. The generator should have ample liquid evaporating surface to make dry gas. 2. The temperature of the gas to the rectifier should be as low as possible. 3. The drip liquor returned to the generator from the rectifier should be as hot as possible. 4. The gas from the rectifier to the condenser should not be over 10° to 50° hotter than the condensing temperature of the gas. 5. The exchanger should exchange upwards of 90% of the heat of the hot weak liquor to the cold strong liquor. The weight of strong liquor pumped should be from 7 to 8 times that of the anhydrous ammonia circulated in the refrigerator.

To produce one ton of refrigeration at 8.5 lbs. suction and 170 lbs. gauge condenser pressure, about 3.5 times as many heat units are actually used by an absorption machine as by a compression machine (compound condensing engine driven), but, owing to the low efficiency of the steam engine, due to the heat wasted in the exhaust and in cylinder condensation, the actual weight of steam used per hour per ton of refrigeration is the same for both the absorption machine and the compressor.

Relative Performance of Ammonia Compression- and Absorption-machines, assuming no Water to be Entrained with the Ammonia-gas in the Condenser. (Denton and Jacobus, *Trans. A. S. M. E.*, xiii.) — It is assumed in the calculation for both machines that 1 lb. of coal imparts 10,000 B.T.U. to the boiler. The condensed steam from the generator of the absorption-machine is assumed to be returned

Temp. in degrees Fahr.	Condenser.		Refrigerating Coils.		Temp. of Absorber, degrees F.	Pounds of Ice-melting Effect per lb. of Coal.				Heat furnished to generator of absorption-machine, B.T.U. per lb. of ammonia circulated.
	Absolute pressure, lbs. per sq. in.	Temp. in degrees Fahr.	Absolute pressure, lbs. per sq. in.	Temp. in degrees Fahr.		Compress. Machine.		Absorption-Machine.*		
						Using 3 lbs. of coal per hour per I.H.P.	Using 1.6 lbs. of coal per hour per I.H.P.	Absorption-machine in which the ammonia circulating-pump exhausts into the generator.	In which the amm. circ. pump exhausts into the atmosphere through a heater, yielding 212° temp. to the feed-water.	
61.2	110.6	5	33.7	61.2	38.1	71.4	38.1	33.5	969	
59.0	106.0	5	33.7	59.0	39.8	74.6	38.3	33.9	967	
59.0	106.0	5	33.7	130.0	39.8	74.6	39.8	35.1	931	
59.0	106.0	-22	16.9	59.0	23.4	43.9	36.3	31.5	1000	
86.0	170.8	5	33.7	86.0	25.0	46.9	35.4	28.6	988	
86.0	170.8	5	33.7	130.0	25.0	46.9	36.2	29.2	966	
86.0	170.8	-22	16.9	86.0	16.5	30.8	33.3	26.5	1025	
86.0	170.8	-22	16.9	130.0	16.5	30.8	34.1	27.0	1002	
104.0	227.7	5	33.7	104.0	19.6	36.8	33.4	25.1	1002	
104.0	227.7	-22	16.9	104.0	13.5	25.3	31.4	23.4	1041	

* 5% of water entrained in the ammonia will lower the economy of the absorption-machine about 15% to 20% below the figures given in the table.

to the boiler at the temperature of the steam entering the generator. The engine of the compression-machine is assumed to exhaust through a feed-water heater that heats the feed-water to 212° F. The engine is assumed to consume 26 1/4 lbs. of water per hour per horse-power. The figures for the compression-machine include the effect of friction, which is taken at 15% of the net work of compression.

(For discussion of the efficiency of the absorption system, see Ledoux's work; paper by Prof. Linde, and discussion on the same by Prof. Jacobus, *Trans. A. S. M. E.*, xiv, 1416, 1436; and papers by Denton and Jacobus, *Trans. A. S. M. E.*, x, 792, xiii, 507.)

Relative Efficiency of a Refrigerating-Machine.—The efficiency of a refrigerating-machine is sometimes expressed as the quotient of the quantity of heat received by the ammonia from the brine, that is, the quantity of useful work done, divided by the heat equivalent of the mechanical work done in the compressor. Thus in column 1 of the table of performance of the 75-ton machine (page 1311) the heat given by the brine to the ammonia per minute is 14,776 B.T.U. The horse-power of the ammonia cylinder is 65.7, and its heat equivalent = 65.7 × 33,000 ÷ 778 = 2786 B.T.U. Then 14,776 ÷ 2786 = 5.304, efficiency. The apparent paradox that the efficiency is greater than unity, which is impossible in any machine, is thus explained. The working fluid, as ammonia, receives heat from the brine and rejects heat into the condenser. (If the compressor is jacketed, a portion is rejected into the jacket-water.) The heat rejected into the condenser is greater than that received from the brine; the difference (plus or minus a small difference radiated to or from the atmosphere) is heat received by the ammonia from the compressor. The work to be done by the compressor is not the mechanical equivalent of the refrigeration of the brine, but only that necessary to supply the difference between the heat rejected by the ammonia into the condenser and that received from the brine. If cooling water colder than the brine were available, the brine might transfer its heat directly into the cooling water, and there would be no need of ammonia or of a compressor; but since such cold water is not available, the brine rejects its heat into the colder ammonia, and then the compressor is required to heat the ammonia to such a temperature that it may reject heat into the cooling water.

The maximum theoretical efficiency of a refrigerating machine is expressed by the quotient $T_0 \div (T_1 - T_0)$, in which T_1 is the highest and T_0 the lowest temperature of the ammonia or other refrigerating agent.

The efficiency of a refrigerating plant referred to the amount of fuel consumed is

$$\text{Ice-melting capacity per pound of fuel} = \frac{\left\{ \begin{array}{l} \text{Pounds circulated per hour} \\ \times \text{specific heat} \times \text{range} \end{array} \right\} \text{ of brine or other circulating fluid of temperature}}{144 \times \text{pounds of fuel used per hour}}$$

The ice-melting capacity is expressed as follows:

$$\text{Tons (of 2000 lbs.) ice-melting capacity per 24 hours} = \frac{\left\{ \begin{array}{l} 24 \times \text{pounds} \\ \times \text{specific heat} \\ \times \text{range of temp.} \end{array} \right\} \text{ of brine circulated per hour}}{144 \times 2000}$$

The analogy between a heat-engine and a refrigerating-machine is as follows: A steam-engine receives heat from the boiler, converts a part of it into mechanical work in the cylinder, and throws away the difference into the condenser. The ammonia in a compression refrigerating-machine receives heat from the brine-tank or cold-room, receives an additional amount of heat from the mechanical work done in the compression-cylinder, and throws away the sum into the condenser. The efficiency of the steam-engine = work done ÷ heat received from boiler. The efficiency of the refrigerating-machine = heat received from the brine-tank or cold-room ÷ heat required to produce the work in the compression-cylinder. In the ammonia absorption-apparatus, the ammonia receives heat from the brine-tank and additional heat from the boiler or generator, and rejects the sum into the condenser and into the cooling water supplied to the absorber. The efficiency = heat received from the brine + heat received from the boiler.

The Efficiency of Refrigerating Systems depends on the temperature of the condenser water, whether there is sufficient condenser surface for the compressor and whether or not the condenser pipes are free from uncondensable foreign gases. With these things right, condenser pressure for different temperatures of cooling water should be approximately as follows:

1 gallon per minute per ton per 24 hours—Cooling water, ° F.....	60	65	70	75	80	85	90
Condenser pressure, gage, lb.....	183	200	220	235	255	280	300
Condensed liquid ammonia, ° F.....	95	100	105	110	115	120	125
2 gallons per minute per ton per 24 hours—Condenser pressure, gage, lb..	130	153	168	183	200	220	235
Condensed liquid ammonia, ° F.....	77	85	90	93	100	105	110
3 gallons per minute per ton per 24 hours—Condenser pressure, gage, lb..	125	140	155	170	185	200	215
Condensed liquid ammonia, ° F.....	75	85	90	93	95	100	105

The evaporating or back pressure within the expansion coils of a refrigerating system depends upon the temperatures on the outside of such coils, i.e., the air or brine to be cooled. For average practice back pressures for the production of required temperatures should be approximately as follows:

Temperature of room, ° F.....	10	15	20	28	32	36	40	50	60
Back pressure, gage, lb.....	10	12	15	22	25	27	30	35	40
Temperature of ammonia, ° F....	-10	-5	0	8	12	14	17	22	26

The condenser pressure should be kept as low as possible and the back pressure as high as possible, narrow limits between such pressures being as important to the efficiency of a refrigerating system as wide ones are to that of a steam engine in which the economy increases with the range between boiler pressure and condenser pressure. (F. E. Matthews, Power, Jan. 26, 1909.)

Cylinder-heating.—In compression-machines employing volatile vapors the principal cause of the difference between the theoretical and the practical result is the heating of the ammonia, by the warm cylinder walls, during its entrance into the compressor, thereby expanding it, so that to compress a pound of ammonia a greater number of revolutions must be made by the compressing-pumps than corresponds to the density of the ammonia-gas as it issues from the brine-tank.

Volumetric Efficiency.—The volumetric efficiency of a compressor is the ratio of the actual weight of ammonia pumped to the amount calculated from the piston displacement. Mr. Voorhees deduces from Denton's experiments the formula: Volumetric efficiency = $E = 1 - (t_1 - t_0)/1330$, in which t_1 = the theoretical temperature of gas after compression and t_0 = temperature of gas delivered to the compressor. The temperature $t_1 = T_1 - 460$, is calculated from the formula for adiabatic compression, $T_1 = T_0 (P_1/P_0)^{0.23}$, in which T_1 and T_0 are absolute temperatures and P_1 and P_0 absolute pressures. In eight tests by Prof. Denton the volumetric efficiency ranged from 73.5% to 84%, and they vary less than 1% from the efficiencies calculated by the formula. The temperature of the gas discharged from the compressor averaged 57° less than the theoretical.

The volumetric efficiency of a dry compressor is greatest when the vapor comes to the compressor with little or no superheat: 30° superheat of the suction gas reduces the capacity of the compressor 4%, and 100° 9%.

The following table (from Voorhees) gives the theoretical discharge temperatures (t_1) and volumetric efficiencies (E) by the formula, and the actual cubic feet of displacement of compressor (F) per ton of refrigeration per minute for the given gage pressures of suction and condenser.

Suction pressures.	0			15			30		
	t_1	E	F	t_1	E	F	t_1	E	F
Cond. press. 140....	323°	0.76	10.35	358°	0.73	11.02	388°	0.71	11.57
Cond. press. 170....	221°	0.83	4.57	254°	0.81	4.78	280°	0.79	5.03
Cond. press. 200....	167°	0.87	2.96	192°	0.86	3.07	216°	0.84	3.21

Pounds of Ammonia per Minute to Produce 1 Ton of Refrigeration, and Percentage of Liquid Evaporated at the Expansion Valve.

Condenser, Pressure and Temperature.	140 lbs., 80°.	170 lbs., 90°.	200 lbs., 100°.
Refrigerator, pressure and temperature 0 lbs., -29°...	0.431 lb., 19%	0.441 lb., 20.8%	0.451 lb., 22.5%
Refrigerator pressure and temperature 15 lbs., -0°...	0.420 lb., 14.4%	0.430 lb., 16.2%	0.440 lb., 18.0%
Refrigerator pressure and temperature, 30 lbs., -17°...	0.415 lb., 11.6%	0.425 lb., 13.4%	0.434 lb., 15.2%

Mean Effective Pressure, and Horse-power.—Voorhees deduces the following (*Ice and Refrig.*, 1902): M.E.P. = $4.333 p_0 [(p_1/p_0)^{0.23} - 1]$, p_0 = suction and p_1 condenser pressure, abs. lbs. per sq. in. The maximum M.E.P. occurs when $p_0 = p_1 + 3.113$. The percentage of stroke during which the gas is discharged from the compressor is $V_1 = (p_0/p_1)^{0.769}$.

The compressor horse-power, C.H.P., is $0.00437 F \times \text{M.E.P.}$. The friction of the compressor and its engine combined is given by Voorhees as 33 1/3% of the compressor H.P. or 25% of the engine H.P. Values of the mean effective pressure per ton of refrigeration (M), the compressor horse-power (C) and the engine horse-power (E) are given below for the conditions named.

Suction pressure.	0			15			30		
	(M)	(C)	(E)	(M)	(C)	(E)	(M)	(C)	(E)
Cond. press., 140...	46.5	2.10	2.89	59.5	1.19	1.59	64.5	0.83	1.11
Cond. press., 170...	50.5	2.42	3.23	67.0	1.40	1.87	75.0	1.00	1.33
Cond. press., 200...	55.0	2.78	3.71	74.5	1.64	2.19	85.0	1.19	1.59

By cooling the liquid between the condenser and the expansion valve the capacity will be increased and the horse-power per ton reduced. With compression from 15 to 170 lbs., if the liquid at the expansion valve is cooled to 76° instead of 90° the H.P. per ton will be reduced 3%.

Prof. Lacke deduces a formula for the I.H.P. per ton of refrigerating capacity, as follows:

p = mean effective pressure, lbs. per sq. in.; L = length of stroke in ft.; a = area of piston in sq. ins.; n = no. of compressions per minute; E_c = apparent volumetric efficiency, the ratio of the volume of ammonia apparently taken in per stroke to the full displacement of the piston; w_c = weight of 1 cu. ft. of ammonia vapor at the back pressure, as it exists in the cylinder when compression begins; L_c = latent heat of vaporization available for refrigeration; 288,000 = B.T.U. equivalent to 1 ton of refrigeration; T = tons refrigeration per 24 hours.

$$\frac{\text{I.H.P.}}{T} = \frac{pLa n + 33,000}{La E_c n w_c \times L_c \times 60 \times 24} = \frac{0.87}{w_c L_c} \times \frac{p}{E_c}$$

144 × 288,000

The Voorhees Multiple Effect Compressor is based upon the fact that both the economy and the capacity of a compression machine vary with the back pressure. In the past it has always been necessary to run a compressor at a gas suction pressure corresponding to the lowest required temperature. The multiple effect compressor takes in gas from two or more refrigerators at two or more different suction pressures and temperatures on the same suction stroke of the compressor. The suction gas of the higher pressure helps to compress the lower suction pressure gas. There are two sets of suction valves in the compressor cylinder; the low temperature and corresponding low back pressure being connected to one suction port, usually in the cylinder head, and the high back pressure connected to the other. At the beginning of the stroke the cylinder is filled with the low pressure gas and as the piston reaches the end of its

suction stroke the second or high back pressure port is uncovered, the low pressure suction valve closing automatically, and the cylinder is completely filled with gas at the high pressure. By this means the compressor operates with an economy and capacity corresponding to the higher back pressure, making a gain in capacity of often 50% or more. (*Trans. Am. Soc. Refrig. Engrs.*, 1906.)

Quantity of Ammonia Required per Ton of Refrigeration.—The following table is condensed from one given by F. E. Matthews in *Trans. A. S. M. E.*, 1905. The weight in lbs. per minute is calculated from the formula $P = (144 \times 2000) \div [1440l - (h_1 - h_0)]$ in which l is the latent heat of evaporation at the back pressure in the cooler, and h_1 and h_0 the heat of the liquid at the temperatures of the condenser and the cooler respectively. The specific heat of the liquid has been taken at unity. The ton of refrigeration is 2000 lbs. in 24 hours = 288,000 B.T.U.

B = Pounds of ammonia evaporated per minute.
C = Cubic feet of gas to be handled per minute by the compressor.

l. w. B.P.	Head or Condenser Gauge Pressure and Corresponding Temperature.											
	100 lb. 63.5°	110 lb. 68°	120 lb. 72.6°	130 lb. 77.4°	140 lb. 80.3°	150 lb. 83.8°	160 lb. 87.4°	170 lb. 90.8°	180 lb. 93.8°	190 lb. 96.9°	200 lb. 100°	
572.78 } .0556 } 0	B	.4159	.4199	.4240	.4284	.4310	.4343	.4376	.4408	.4440	.4470	.4501
	C	7.482	7.551	7.626	7.703	7.761	7.812	7.870	7.929	7.986	8.041	8.095
566.14 } .0133 } 5	B	.4122	.4160	.4202	.4243	.4271	.4308	.4335	.4366	.4397	.4437	.4458
	C	5.636	5.675	5.732	5.790	5.826	5.878	5.914	5.970	5.999	6.039	6.081
560.69 } .0910 } 10	B	.4093	.4130	.4171	.4204	.4237	.4271	.4302	.4332	.4363	.4392	.4423
	C	4.502	4.543	4.587	4.625	4.662	4.698	4.733	4.766	4.799	4.833	4.865
556.11 } .1083 } 15	B	.4068	.4106	.4145	.4186	.4211	.4244	.4276	.4288	.4336	.4365	.4394
	C	3.756	3.791	3.827	3.866	3.889	3.918	3.948	3.975	4.003	4.030	4.058
552.83 } .1258 } 20	B	.4040	.4077	.4116	.4158	.4182	.4214	.4245	.4275	.4304	.4333	.4362
	C	3.211	3.241	3.272	3.305	3.324	3.350	3.375	3.398	3.422	3.444	3.467
548.40 } .1429 } 25	B	.4025	.4062	.4102	.4140	.4167	.4198	.4229	.4258	.4287	.4316	.4345
	C	2.819	2.843	2.870	2.898	2.916	2.938	2.959	2.980	3.000	3.020	3.040
545.13 } .1600 } 30	B	.4013	.4049	.4088	.4128	.4152	.4184	.4213	.4243	.4273	.4300	.4329
	C	2.507	2.530	2.555	2.580	2.600	2.615	2.633	2.653	2.671	2.687	2.706
542.80 } .1766 } 35	B	.3991	.4028	.4066	.4105	.4130	.4161	.4188	.4220	.4249	.4277	.4305
	C	2.260	2.280	2.302	2.325	2.338	2.356	2.373	2.390	2.406	2.422	2.443
539.35 } .1941 } 40	B	.3984	.4020	.4058	.4098	.4122	.4153	.4183	.4211	.4240	.4269	.4296
	C	2.052	2.071	2.090	2.111	2.123	2.139	2.155	2.175	2.185	2.200	2.214

l. Latent heat of volatilization. w, weight of vapor per cubic foot. B.P. back pressure or suction gauge pressure.

Back Pressures	0	5	10	15	20	25	30	35	40
Temperatures	-28.5°	-17.5°	-8.5°	-1°	5.66°	11.5°	16.8°	21.7°	26.1

Mr. Matthews defines a standard ton of refrigeration as the equivalent of 27 lbs. of anhydrous ammonia evaporated per hour from liquid at 90° F. into saturated vapor at 15.67 lbs. gauge pressure (0° F.), which requires 12,000 B.T.U.; or 20,950 units of evaporation, each of which is equal to 572.78 B.T.U., the heat required to evaporate 1 lb. of ammonia from a temperature of -28.5° F. into saturated vapor at atmospheric pressure.

WARNING: This is a 1910 edition. Some of the material may no longer be accurate

Size and Capacities of Ammonia Refrigerating Machines.—York Mfg. Co. Based on 15.67 lbs. back-pressure, 185 lbs. condensing pressure, and condensing water at 60° F.

SINGLE-ACTING COMPRESSORS.					DOUBLE-ACTING COMPRESSORS.				
Compressors.		Engine.		Capacity Tons Refrig- eration.	Compressors.		Engine.		Capacity Tons Refrig- eration.
Bore.	Stroke.	Bore.	Stroke.		Bore.	Stroke.	Bore.	Stroke.	
7 1/2	10	11 1/2	10	10	9	15	13 1/2	12	20
9	12	13 1/2	12	20	11	18	16	15	30
11	15	16	15	30	12 1/2	21	18	18	40
12 1/2	18	18	18	40	14	24	20	21	65
14	21	20	21	65	16	28	24	24	90
16	24	24	24	90	18	32	26	28	125
18	28	26	28	125	21	36	28 1/2	32	175
21	32	28 1/2	32	175	24	40	34	36	250
24	36	34	36	250	26	60	38	54	350
27	42	36	42	350					
30	48	44	48	500					

For larger capacities the machines are built with duplex compressors, driven by simple, tandem or cross compound engines.

DISPLACEMENT AND HORSE-POWER PER TON OF REFRIGERATION.
Dry Compression. S. A., Single-acting; D. A., double-acting.

Condenser Gauge Pressure and Corresp. Temp. of Liquid at Expansion valve.	Suction Gauge Pressure and Corresponding Temp.									
	5 lb. = - 17.5° F.		10 lb. = - 8.5° F.		15.67 lb. - 0° F.		20 lb. = 5.7° F.		25 lb. = 11.5° F.	
	Cu. in. Disp.*	I.H.P. per Ton.	Cu. in. Disp.	I.H.P. per Ton.	Cu. in. Disp.	I.H.P. per Ton.	Cu. in. Disp.	I.H.P. per Ton.	Cu. in. Disp.	I.H.P. per Ton.
145 lb. 82° F., S.A.....	12,608	1.654	9,811	1.4	7829	1.195	6765	1.065	5836	0.943
145 lb. 82° F., D.A.....	14,645	1.921	11,300	1.612	8901	1.358	7625	1.2	6522	1.054
165 lb. 89° F., S.A.....	13,045	1.834	10,148	1.56	8092	1.341	6990	1.201	6027	1.071
165 lb. 89° F., D.A.....	15,203	2.137	11,720	1.802	9224	1.529	7898	1.357	6751	1.2
185 lb. 95.5° F., S.A.....	13,491	2.013	10,487	1.72	8362	1.4865	7219	1.336	6223	1.197
185 lb. 95.5° F., D.A.....	15,774	2.354	12,150	1.993	9555	1.7	8176	1.513	6985	1.344
205 lb. 101.4° F., S.A.....	13,947	2.192	10,834	1.879	8630	1.631	7450	1.47	6420	1.323
205 lb. 101.4° F., D.A.....	16,362	2.571	12,590	2.184	9890	1.87	8459	1.67	7222	1.488

* Cu. in. Displacement per Min. per Ton of Refrigeration.

The volumetric efficiency ranges from 63.5 to 76.5% for double-acting, and from 74.5 to 85.5% for single-acting compressors, increasing with the decrease of condenser pressure and with the increase of suction pressure. Where the liquid is cooled lower than the temperature corresponding to the condensing pressure, there will be a reduction in horse-power and displacement proportional to the increase of work done by each pound of liquid handled. The I.H.P. is that of the compressor. For Engine Horse-Power add 17% up to 20 tons capacity and 15% for larger machines.

SMALL SIZES OF REFRIGERATING MACHINES.

	Single-acting Vertical.			Double-acting Horizontal.		
	1 1/4	3	6	2 1/2	6	10
Capacity, tons						
Compressor, diam., in.	4 1/2	6	2-6	4	5 1/2	7
Compressor, stroke, in.	5	6	6	6	8	10
Engine, diam., in.	5	6	8	6	8	10
Engine, stroke, in.	5	6	6	8	8	10

Rated Capacity of Refrigerating Machines. — It is customary to rate refrigerating machines in tons of refrigerating capacity in 24 hours, on the basis of a suction pressure of 15.67 lbs. gauge, corresponding to 0° F. temperature of saturated ammonia vapor, and a condensing pressure of 185 lbs. gauge, corresponding to 95.5° F. The actual capacity increases with the increase of the suction pressure, and decreases with the increase of the condensing pressure. The following table shows the calculated capacities and horse-power of a machine rated at 40 H.P., when run at different pressures. (York Mfg. Co.) The horse-power required increases with the increase of both the suction and the condensing pressure.

Condenser Press. Temp.	Suction Gauge Pressure and Corresponding Temp.											
	5 lb. = -17.5°		10 lb. = -8.5° F.		15.67 lb. = 0° F.		20 lb. = 5.7° F.		25 lb. = 11.5° F.		30 lb. = 16.8° F.	
	Tons.	H.P.	Tons.	H.P.	Tons.	H.P.	Tons.	H.P.	Tons.	H.P.	Tons.	H.P.
145 lb. = 82° F.	26.6	50.6	34.2	55.1	42.8	58.8	49.6	60.7	57.5	62.3	65.3	63.4
165 lb. = 89° F.	25.7	54.2	33.1	59.4	41.4	63.8	48	66.3	55.7	68.6	63	270.1
185 lb. = 95.5° F.	24.8	57.4	32	63.3	40	68.6	46.5	71.4	53.9	74.2	61.3	76.5
205 lb. = 101.4° F.	24	60.5	31	67	38.9	72.9	45	76.1	52.3	79.6	59.4	86.2

Piston Speeds and Revolutions per Minute. — There is a great diversity in the practice of different builders as to the size of compressor, the piston speed and the number of revolutions per minute for a given rated capacity. F. E. Matthews, *Trans. A. S. M. E.*, 1905, has plotted a diagram of the various speeds and revolutions adopted by four prominent builders, and from average curves the following figures are obtained:

Tons.....	20	30	40	50	60	80	100	120	140	160	180	200	240	300	400	500
R.P.M.....	90	78	73	68	64	60	58 1/2	57	56	55	54	53	52	51	48 1/2	46
Piston speeds...	200	215	228	240	250	270	280	286	290	293	296	300	315	340	378	425

Mr. Matthews recommends a standard rating of machines based on these revolutions and speeds and on an apparent compressor displacement of 4.4 cu. ft. per minute per ton rating.

Condensers for Refrigerating Machines are of two kinds: submerged, and open-air evaporative. The submerged condenser requires a large volume of cooling water for maximum efficiency. According to Siebel the amount of condensing surface, the water entering at 70° and leaving at 80°, is 40 sq ft., for each ton of refrigerating capacity, or 64 lineal feet of 2-in. pipe. Frequently only 20 sq. ft., or 90 ft. of 1 1/4-in. pipe, is used, but this necessitates higher condenser pressures. If F = sq. ft. of cooling surface, h = heat of evaporation of 1 lb. ammonia at the condenser temperature, K = lbs. of ammonia circulated per minute, m = B.T.U. transferred per minute per sq. ft. of condenser surface, t = temperature of the ammonia in the coils and t_1 the temperature of the water outside, $F = hK \div m(t - t_1)$. For $t = 80$ and $t_1 = 70$, m

may be taken at 0.5. Practically the amount of water required will vary from 3 to 7 gallons per minute per ton of refrigeration. When cooling water is scarce, cooling towers are commonly used.

E. T. Shinkle gives the average surface of several submerged condensers as equal to 167 lineal feet of 1-in. pipe per ton of refrigeration.

Open air or evaporation surface condensers are usually made of a stack of parallel tubes with return bends, and means for distributing the water so that it will flow uniformly over the pipe surface. Shinkle gives as the average surface of open-air coolers 142 ft. of 1-in. pipe, or 99 ft. of 1 1/4 in. pipe per ton of refrigerating capacity.

CAPACITY OF CONDENSERS. (York Mfg. Co.) — The following table shows the capacities and horse-power per ton refrigeration of one section counter-current double-pipe condenser, 1 1/4-in. and 2-in. pipe, 12 pipes high, 19 feet in length outside of water bends, for water velocities 100 ft. to 400 ft. per minute: initial temperature of condensing water 70°.

High Pressure Constant.

Velocity thr'gh 1 1/4-in. pipe. Ft. per min.	Condensing Water.			Cap'y Tons Refrig. per 24 hours.	Con-densing Pressure Lbs. per sq. in.	Horse-power per Ton Refrigeration.		
	Total gallons used per min.	Gallons per min per ton Refrig.	Fric-tion thr'gh Coil. Lbs. per sq. in.			Engine driving Com-pressor	Circu-lating Water thr'gh Con-denser.	Total Engine and Water Circu-lation.
100	7.77	1.16	2.28	6.7	185	1.71	0.0016	1.7116
150	11.65	1.165	5.75	10.	185	1.71	0.004	1.714
200	15.54	1.165	9.98	13.4	185	1.71	0.007	1.717
250	19.42	1.18	15.	16.4	185	1.71	0.011	1.721
300	23.31	1.24	21.6	18.8	185	1.71	0.016	1.726
400	31.08	1.30	37.8	24.	185	1.71	0.030	1.74

Capacity Constant.

100	7.77	0.777	2.28	10.	225	2.04	0.001	2.041
150	11.65	1.165	5.75	10.	185	1.71	0.004	1.714
200	15.54	1.554	9.98	10.	165	1.54	0.009	1.549
250	19.42	1.942	15.	10.	155	1.46	0.018	1.478
300	23.31	2.331	21.6	10.	148	1.40	0.030	1.43
400	31.08	3.108	37.8	10.	140	1.33	0.071	1.401

The horse-power per ton is for single-acting compressor with 15.67 lbs. suction pressure.

The friction in water pump and connections should be added to water horse-power and to total horse-power.

Cooling-Tower Practice in Refrigerating Plants. (B. F. Hart, Jr., *Southern Engr.*, Mar., 1909.) — The efficiency of a cooling tower depends on exposing the greatest quantity of water surface to the cooling air-currents. In a tower designed to handle 100 gallons per minute the ranges of temperature found when handling different quantities of water were as follows:

Gallons of water per minute.....	148	109	58
Temperature of the atmosphere.....	78°	78.5°	78°
Relative humidity, %.....	47	49	97
Initial temperature.....	85.5°	85°	86°
Final temperature.....	78°	76°	75°
Range.....	7.5°	9°	11°

The final temperatures which may be obtained when the initial temperature does not exceed 100° are as follows:

Atmosphere temp.	95°	90°	85°	80°	75°	70°
Final temperature of water leaving tower.						
Humidity, %	90	100	95	90	85	80
	80	98	92	88	83	78
	70	95	90	86	80	76
	60	92	88	83	78	74
	50	89	84	79	75	70
40	85	80	76	71	67	63

For ammonia condensers we figure on supplying 3 gallons per minute of circulating water per ton of refrigeration, or 6 gallons per minute per ton of ice made per 24 hours, and guarantee a reduction range from 150° to 160° down to about 100° when the temperature of the atmosphere does not exceed 80° nor the relative humidity 60%. When the temperature of the atmosphere and the humidity are both above 90° the speed of the pumps and the ammonia pressure must be increased.

The Refrigerating-Coils of a Pictet ice-machine described by Ledoux had 79 sq. ft. of surface for each 100,000 theoretic negative heat-units produced per hour. The temperature corresponding to the pressure of the dioxide in the coils is 10.4° F., and that of the bath (calcium chloride solution) in which they were immersed is 19.4°.

Comparison of Actual and Theoretical Ice-melting Capacity. — The following is a comparison of the theoretical ice-melting capacity of an ammonia compression machine with that obtained in some of Prof. Schröter's tests on a Linde machine having a compression-cylinder 9.9-in. bore and 16.5-in. stroke, and also in tests by Prof. Denton on a machine having two single-acting compression-cylinders 12 in. x 30 in.:

No. of Test.	Temp. in Degrees F. Corresponding to Pressure of Vapor.		Ice-melting Capacity per lb. of Coal, assuming 3 lbs. per hour per Horse-power.			
	Condenser.	Suction.	Theoretical Friction* included.	Actual.	Per cent of Loss Due to Cylinder Superheating.	
Schröter {	1	72.3	26.6	50.4	40.6	19.4
	2	70.5	14.3	37.6	30.0	20.2
	3	69.2	0.5	29.4	22.0	25.2
	4	68.5	-11.8	22.8	16.1	29.4
Denton {	24	84.2	15.0	27.4	24.2	11.7
	26	82.7	-3.2	21.6	17.5	19.0
	25	84.6	-10.8	18.8	14.5	22.9

* Friction taken at figures observed in the tests, which range from 14% to 20% of the work of the steam-cylinder.

TEST-TRIALS OF REFRIGERATING MACHINES.

(G. Linde, *Trans. A. S. M. E.*, xiv, 1414.)

The purpose of the test is to determine the ratio of consumption and production, so that there will have to be measured both the refrigerative effect and the heat (or mechanical work) consumed, also the cooling water. The refrigerative effect is the product of the number of heat-units (Q) abstracted from the body to be cooled, and the quotient (T_c - T) ÷ T: in which T_c = absolute temperature at which heat is transmitted to the cooling water, and T = absolute temperature at which heat is taken from the body to be cooled. (Continued on page 1305.)

Ammonia compression-machines. — Ammonia gas possesses the advantage of affording about three times the useful effect of sulphur dioxide for the same volume described by the piston. The perfection of ammonia apparatus now renders it so convenient and reliable that no practical advantage results from the lower pressures afforded by sulphur dioxide. The results of the calculations for ammonia are given in the table below:

PERFORMANCE OF AMMONIA COMPRESSION-MACHINES.

Gas superheated during compression as in ordinary practice. Temperature of condenser, 64.4° Fahr. Pressure in condenser, 117.44 lbs per sq. in. (Ledoux.)

Temperature Corresponding to Pressure of Vapor in Refrigerating-coils.	t ₂	Deg. F.	Lbs. per sq. in.	P ₂ + 144	Temperature of Gas at End of Compression.	t ₁	Deg. F.	Weight of Gas Compressed.	m	Lbs.	Per Cubic Foot of Piston Displacement.		Work of Compression.		Performance in British Thermal Units.		Ice-melting Capacity per Ton of Ice-melting Capacity, assuming 30° F. Range of Temperature.
											Heat Abstracted at Condenser.	Number of Negative Thermal Units Developed.	Without Friction.	With Friction, or Indicated Steam-power.	Per ft.-lb. of Work With Friction.	Per hour per Horse-power With Friction.	
9.66		158.9	37.76				158.9	0.1329		0.1329	7070	8130	0.00854	16.900	0.00244	39.6	1290
5.00		170.1	33.67				170.1	0.1206		0.1206	7120	8190	0.00766	15.170	0.00221	35.6	1310
-22.00		241.3	16.95				241.3	0.0639		0.0639	6080	6990	0.00466	9.230	0.00115	21.6	1410

The theoretical results for ammonia are higher than the actual, for the same reasons that have been stated for sulphur dioxide. In the case of ammonia the action of the cylinder-walls in superheating the entering vapor has been determined experimentally by Prof. Denton, and the amount found to agree with that indicated by theory. In these experiments the ammonia circulated in a 75-ton refrigerating machine was measured directly by means of a special meter, so that, in addition to determining the effect of superheating, the latent heats can be calculated at the suction and condenser pressure.

Economy of Ammonia Compression-machines at Various Condenser Temperatures. (LEBOUX.)
REFRIGERATING EFFECT OF 1 CU. FT. OR 0.1206 LB. OF AMMONIA EXPANDED THROUGH A SIMPLE COCK TO 33.67 LBS.
ABSOLUTE PRESSURE PER SQ. IN., AND TAKEN INTO THE COMPRESSOR AT THIS PRESSURE AND THE
CORRESPONDING TEMPERATURE OF 5° F.

Temp. Due to Press. of Vapor in Condens.	Deg. F.	Lbs. per sq. in.	Temperature at End of Compression.	Heat Carried away from Condenser.	Refrigerating Effect in Heat Units.	Ratio of Refrigerating Effect to Heat Expended.	Work of Compression, without Friction.	Work of Compression, with Friction, or Indicated Steam-power.	Refrigerating Effect in Heat Units.			Ice-melting Capacity.				Condensing-water.			
									Per ft.-lb. of Work Expended, without Friction.	Per ft.-lb. of Work Expended, including Friction.	Per Hour per H.P., including Friction.	Without Friction.	With Friction.	Per Hour per H.P., Without Friction.	With Friction.	Per Lb. of Conl.	Per cu. ft. of Piston Displacement, assuming 30° Range of Temp.	Per Ton of Ice-melting Capacity.	Per Minute per Ton of Ice-melting Capacity in 24 hours.
59	106.0	154.6	179.9	71.81	63.47	7.61	6,450	7,410	(9)	(10)	(11)	(12)	(13)	(14)	(15)	(16)	(17)	(18)	(19)
68	125.1	179.9	72.05	72.05	62.31	6.40	7,530	8,660	0.0984	0.0657	16,960	137.0	119.3	45.8	39.8	0.00223	0.2872	1,290	0.89
77	146.6	205.1	72.26	72.26	61.13	5.49	8,600	9,890	0.0827	0.0719	14,250	115.2	100.2	38.4	33.4	0.00219	0.2882	1,320	0.92
86	170.8	230.3	72.46	72.46	59.93	4.78	9,680	11,130	0.0711	0.0618	12,240	99.0	86.1	33.0	28.7	0.00215	0.2890	1,350	0.94
95	197.8	255.4	72.61	72.61	58.70	4.22	10,750	12,360	0.0619	0.0538	10,660	86.2	75.0	28.7	25.0	0.00211	0.2898	1,380	0.96
104	227.8	280.3	72.74	72.74	57.45	3.76	11,820	13,590	0.0546	0.0475	9,400	76.0	66.1	25.3	22.0	0.00206	0.2904	1,410	0.98
									0.0486	0.0423	8,380	67.7	58.9	22.6	19.6	0.00202	0.2910	1,440	1.00

REFRIGERATING EFFECT OF 1 CU. FT. OR 0.06386 LB. OF AMMONIA EXPANDED THROUGH A SIMPLE COCK TO 16.95 LBS. ABSOLUTE PRESSURE PER SQ. IN., AND TAKEN INTO THE COMPRESSOR AT THIS PRESSURE AND THE CORRESPONDING TEMPERATURE OF -22° F.

(1)	59	106.0	224.1	40.28	32.93	4.48	5,680	6,530	(9)	(10)	(11)	(12)	(13)	(14)	(15)	(16)	(17)	(18)	(19)
68	125.1	179.9	232.2	40.50	32.31	3.95	6,330	7,280	0.0580	0.0504	9,980	80.7	70.2	25.4	23.4	0.00116	0.1611	1,390	0.97
77	146.6	205.1	280.2	40.70	31.69	3.52	6,960	8,000	0.0510	0.0444	8,790	71.0	61.8	20.6	18.4	0.00114	0.1620	1,420	0.99
86	170.8	230.3	308.3	40.90	31.05	3.15	7,610	8,750	0.0455	0.0396	7,840	63.3	55.1	18.4	16.5	0.00111	0.1628	1,470	1.02
95	197.8	255.4	336.2	41.07	30.41	2.85	8,240	9,480	0.0408	0.0355	7,030	56.8	49.4	18.9	16.5	0.00109	0.1636	1,500	1.04
104	227.8	280.3	364.0	41.23	29.75	2.59	8,870	10,200	0.0369	0.0321	6,560	51.4	44.7	17.1	14.9	0.00107	0.1643	1,540	1.07
									0.0335	0.0292	5,780	46.6	40.6	13.5	13.5	0.00105	0.1649	1,570	1.09

The determination of the quantity of cold will be possible with the proper exactness only when the machine is employed during the test to refrigerate a liquid; and if the cold be found from the quantity of liquid circulated per unit of time, from its range of refrigeration, and from its specific heat. Sufficient exactness cannot be obtained by the refrigeration of a current of circulating air, nor from the manufacture of a certain quantity of ice, nor from a calculation of the fluid circulating within the machine (for instance, the quantity of ammonia circulated by the compressor). Thus the refrigeration of brine will generally form the basis for tests making any pretension to accuracy. The degree of refrigeration should not be greater than necessary for allowing the range of temperature to be measured with the necessary exactness; a range of temperature of from 5° to 6° Fahr. will suffice.

The condenser measurements for cooling water and its temperatures will be possible with sufficient accuracy only with submerged condensers.

The measurement of the quantity of brine circulated, and of the cooling water, is usually effected by water-meters inserted into the conduits. If the necessary precautions are observed, this method is admissible. For quite precise tests, however, the use of two accurately gauged tanks which are alternately filled and emptied must be advised.

To measure the temperatures of brine and cooling water at the entrance and exit of refrigerator and condenser respectively, the employment of specially constructed and frequently standardized thermometers is indispensable; no less important is the precaution of using at each spot simultaneously two thermometers, and of changing the position of one such thermometer series from inlet to outlet (and vice versa) after the expiration of one-half of the test, in order that possible errors may be compensated.

It is important to determine the specific heat of the brine used in each instance for its corresponding temperature range, as small differences in the composition and the concentration may cause considerable variations.

As regards the measurement of consumption, the programme will not have any special rules in cases where only the measurement of steam and cooling water is undertaken, as will be mainly the case for trials of absorption-machines. For compression-machines the steam consumption depends both on the quality of the steam-engine and on that of the refrigerating-machine, while it is evidently desirable to know the consumption of the former separately from that of the latter. As a rule steam-engine and compressor are coupled directly together, thus rendering a direct measurement of the power absorbed by the refrigerating-machine impossible, and it will have to suffice to ascertain the indicated work both of steam-engine and compressor. By further measuring the work for the engine running empty, and by comparing the differences in power between steam-engine and compressor resulting for wide variations of condenser-pressures, the effective consumption of work L_e for the refrigerating-machine can be found very closely. In general, it will suffice to use the indicated work found in the steam-cylinder, especially as from this observation the expenditure of heat can be directly determined. Ordinarily the use of the indicated work in the compressor-cylinder, for purposes of comparison, should be avoided; firstly, because there are usually certain accessory apparatus to be driven (agitators, etc.), belonging to the refrigerating-machine proper; and secondly, because the external friction would be excluded.

Heat Balance. — We possess an important aid for checking the correctness of the results found in each trial by forming the balance in each case for the heat received and rejected. Only those tests should be regarded as correct beyond doubt, which show a sufficient conformity in the heat balance. It is true that in certain instances it may not be easy to account fully for the transmission of heat between the several parts of the machine and its environment by radiation and convection, but generally (particularly for compression-machines) it will be possible to obtain for the heat received and rejected a balance exhibiting small discrepancies only.

Report of Test. — Reports intended to be used for comparison with the figures found for other machines will therefore have to embrace at least the following observations:

Refrigerator:

- Quantity of brine circulated per hour.....
- Brine temperature at inlet to refrigerator.....
- Brine temperature at outlet of refrigerator.....
- Specific gravity of brine (at 64° Fahr.).....
- Specific heat of brine.....
- Heat abstracted (cold produced)..... Q_1
- Absolute pressure in the refrigerator.....

Condenser:

- Quantity of cooling water per hour.....
- Temperature at inlet to condenser.....
- Temperature at outlet of condenser..... T_c
- Heat abstracted..... Q_2
- Absolute pressure in the condenser.....
- Temperature of gases entering the condenser.....

ABSORPTION-MACHINE.

Still:

- Steam consumed per hour.....
- Abs. pressure of heating steam.....
- Temperature of condensed steam at outlet.....
- Heat imparted to still..... Q'_e

Absorber:

- Quantity of cooling water per hour.....
- Temperature at inlet.....
- Temperature at outlet.....
- Heat removed..... Q_2

Pump for Ammonia Liquor:

- Indicated work of steam-engine.....
- Steam-consumption for pump.....
- Thermal equivalent for work of pump..... ALp
- Total sum of losses by radiation and convection..... $\pm Q_3$

Heat Balance:

$$Q_e + Q'_e = Q_1 + Q_2 \pm Q_3.$$

For the calculation of efficiency and for comparison of various tests, the actual efficiencies must be compared with the theoretical maximum of efficiency $Q \div (AL) \max. = T \div (T_c - T)$ corresponding to the temperature range.

Temperature Range. — For the temperatures (T and T_c) at which the heat is abstracted in the refrigerator and imparted to the condenser, it is correct to select the temperature of the brine leaving the refrigerator and that of the cooling water leaving the condenser, because it is in principle impossible to keep the refrigerator pressure higher than would correspond to the lowest brine temperature, or to reduce the condenser pressure below that corresponding to the outlet temperature of the cooling water.

Prof. Linde shows that the *maximum theoretical efficiency* of a compression-machine may be expressed by the formula

$$Q \div (AL) = T \div (T_c - T),$$

- in which Q = quantity of heat abstracted (cold produced);
- AL = thermal equivalent of the mechanical work expended;
- L = the mechanical work, and $A = 1 \div 778$;
- T = absolute temperature of heat abstraction (refrigerator);
- T_c = absolute temperature of heat rejection (condenser).

If u = ratio between the heat equivalent of the mechanical work AL and the quantity of heat Q' which must be imparted to the motor to produce the work L , then

$$AL \div Q' = u, \text{ and } Q'/Q = (T_c - T) \div (uT).$$

It follows that the expenditure of heat Q' necessary for the production of the quantity of cold Q in a compression-machine will be the smaller, the smaller the difference of temperature $T_c - T$.

Metering the Ammonia. — For a complete test of an ammonia refrigerating-machine it is advisable to measure the quantity of ammonia circulated, as was done in the test of the 75-ton machine described by Prof. Denton. (*Trans. A. S. M. E.*, xii, 326.)

ACTUAL PERFORMANCES OF ICE-MAKING MACHINES.

The table given on page 1308 is abridged from Denton, Jacobus, and Riesenberger's translation of Ledoux on Ice-making Machines. The following shows the class and size of the machines tested, referred to by letters in the table, with the names of the authorities:

Class of Machines.	Authority.	Dimensions of Compression-cylinder in inches.	
		Bore.	Stroke.
A. Ammonia cold-compression.....	Schröter.	9.9	16.5
B. Pictet fluid dry-compression.....	"	11.3	24.4
C. Bell-Coleman air.....	"	28.0	23.8
D. Closed cycle air.....	{ Renwick & Jacobus.	10.0	18.0
E. Ammonia dry-compression.....	Denton.	12.0	30.0
F. Ammonia absorption.....	"		

In class A, a German double-acting machine with compression cylinder 9.9 in. bore, 16 in. stroke, tested by Prof. Schröter, the ice-melting capacity ranges from 46.29 to 16.14 lbs. of ice per pound of coal, according as the suction pressure varies from about 45 to 8 lbs. above the atmosphere, this pressure being the condition which mainly controls the economy of compression machines. These results are equivalent to realizing from 72% to 57% of theoretically perfect performances. The higher per cents appear to occur with the higher suction-pressures, indicating a greater loss from cylinder-heating (a phenomenon the reverse of cylinder condensation in steam-engines), as the range of the temperature of the gas in the compression-cylinder is greater.

In E, an American single-acting compression-machine, two compression cylinders each 12 x 30 in., operating on the "dry system," tested by Prof. Denton, the percentage of theoretical effect realized ranges from 69.5% to 62.6%. The friction losses are higher for the American machine. The latter's higher efficiency may be attributed, therefore, to more perfect displacement.

The largest "ice-melting capacity" in the American machine is 24.16 lbs. This corresponds to the highest suction-pressures used in American practice for such refrigeration as is required in beer-storage cellars using the direct-expansion system. The conditions most nearly corresponding to American brewery practice in the German tests are those in line 5, which give an "ice-melting capacity" of 19.07 lbs.

For the manufacture of artificial ice, the conditions of practice are those of lines 3 and 4, and lines 25 and 26. In the former the condensing pressure used requires more expense for cooling water than is common in American practice. The ice-melting capacity is therefore greater in the German machine, being 22.03 and 16.14 lbs. against 17.55 and 14.52 for the American apparatus.

CLASS B. Sulphur Dioxide or Pictet Machines. — No records are available for determination of the "ice-melting capacity" of machines using pure sulphur dioxide. In the "Pictet fluid," a mixture of about 97% of sulphur dioxide and 3% of carbonic acid, the presence of the carbonic acid affords a temperature about 14 Fahr. degrees lower than is obtained with pure sulphur dioxide at atmospheric pressure. The latent heat of this mixture has never been determined, but is assumed to be equal to that of pure sulphur dioxide.

1308 ICE-MAKING OR REFRIGERATING MACHINES.

For brewery refrigerating conditions, line 17, we have 26.24 lbs. "ice-melting capacity," and for ice-making conditions, line 13, the "ice-melting capacity" is 17.47 lbs. These figures are practically as economical as those for ammonia, the per cent of theoretical effect realized ranging from 65.4 to 57.8. At extremely low temperatures, -15° Fahr., lines 14 and 18, the per cent realized is as low as 42.5.

Actual Performance of Ice-making Machines.

Machine.	Number of Test.	Absolute Pressure, in lbs. per square inch.		Temperature corresponding to Pressure, in degrees Fahr.		Temperature of Brine, in degrees Fahr.		Revolutions per minute.	Horse-power of Steam-cylinder.	Per cent of Indicated Power of Steam-cylinder lost in Friction.	Ice-melting Capacity, in tons per 24 hours.	Ice-melting Capacity, in pounds per pound of Coal. Actual.†	Diff. between theoretical Ice-melting Capacity, no Cylinder Heating or Friction, and actual, % †	Heat losses. Per cent of Theoretical Amount with Friction.‡	Mean Effective Pressure, in lbs. per square inch †
		Condenser.	Suction.	Condenser.	Suction.	Inlet.	Outlet.								
A	1	135	55	72	27	43	37	44.9	17.9	14.4	26.2	40.63	30.8	19.1	54.8
	2	131	42	70	14	28	23	45.1	18.0	16.7	19.5	30.01	33.5	20.2	53.4
	3	128	30	69	1	14	9	45.1	16.8	16.0	13.3	22.03	37.1	25.2	50.3
	4	126	22	68	-12	30	-5	44.8	15.5	19.5	9.0	16.14	42.9	29.1	44.7
	5	200	42	95	14	28	23	45.0	24.1	10.5	16.5	19.07	36.0	28.5	77.0
	6	136	60	72	30	44	37	45.2	17.9	10.7	29.8	46.29	28.5	19.9	56.8
	7	131	45	71	18	28	23	45.1	18.0	12.1	21.6	33.23	31.3	21.9	56.4
	8	126	24	68	-9	0	-6	44.7	15.6	18.0	9.9	17.55	41.1	28.3	46.1
	9	117	41	64	13	28	23	45.0	16.4	13.5	20.0	33.77	33.1	22.9	50.6
	10	130	60	70	31	43	37	31.7	12.0	14.8	19.5	45.01	35.2	23.8	52.0
B	11	57	21	77	28	43	37	57.0	21.5	22.9	25.6	33.07	39.9	22.2	24.1
	12	56	15	76	14	28	23	56.8	20.6	22.9	17.9	24.11	41.3	24.0	23.1
	13	55	10	75	-2	14	9	57.1	18.5	24.0	11.6	17.47	42.2	25.2	20.4
	14	60	7	81	-16	0	-6	57.6	15.7	25.7	5.7	10.14	54.5	38.5	16.8
	15	91	15	104	14	28	23	59.3	27.2	16.9	15.7	16.05	36.2	23.1	31.5
	16	61	22	81	31	44	37	57.3	21.6	14.0	28.1	36.19	33.4	22.5	26.8
	17	59	16	80	16	28	23	57.5	20.5	12.8	19.3	26.24	34.6	25.0	25.6
	18	59	7	79	-16	0	-6	57.8	15.9	21.1	6.8	11.93	47.5	33.4	18.0
	19	54	22	75	31	43	37	35.3	12.4	22.3	17.0	38.04	39.5	22.6	22.6
	20	89	16	103	16	28	23	42.9	19.9	14.7	11.9	16.68	37.7	27.0	32.7
	21	62	6	82	-17	0	-5	34.8	9.9	24.3	3.5	9.86	54.2	39.5	17.7
C	22	59	15	65*	-53*	63.2	83.2	21.9	10.3	3.42	71.7	56.9	26.6
D	23	175	54	81*	-40*	93.4	38.1	32.1	4.9	3.0	80.0	63.0	89.2
E	24	166	43	84	15	37	28	58.1	85.0	22.7	73.9	24.16	32.8	11.7	65.9
	25	167	23	85	-11	6	2	57.7	72.6	18.6	37.9	14.52	37.4	22.7	57.6
	26	162	28	83	-3	14	2	57.9	73.6	19.3	46.5	17.55	34.9	18.6	59.9
	27	176	42	88	14	36	28	58.9	88.6	19.7	74.4	23.31	30.5	13.5	70.5
F	28	152	40	79	13	21	16	42.2	20.1	47.8

* Temperature of air at entrance and exit of expansion-cylinder.
 † On a basis of 3 lbs. of coal per hour per H.P. of steam-cylinder of compression-machine and an evaporation of 11.1 lbs. of water per pound of combustible from and at 212° F. in the absorption-machine.
 ‡ Per cent of theoretical with no friction.
 § Loss due to heating during aspiration of gas in the compression-cylinder and to radiation and superheating at brine-tank.
 || Actual, including resistance due to inlet and exit valves.

WARNING: This is a 1910 edition. Some of the material may no longer be accurate

PERFORMANCES OF ICE-MAKING MACHINES. 1309

Performance of a 75-ton Ammonia Compression-machine. (J. E. Denton, *Trans. A. S. M. E.*, xii, 326.) — The machine had two single-acting compression cylinders 12 × 30 in., and one Corliss steam-cylinder, double-acting, 18 × 36 in. It was rated by the manufacturers as a 50-ton machine, but it showed 75 tons of ice-refrigerating effect per 24 hours during the test.

The most probable figures of performance in eight trials are as follows:

No. of Trials.	Ammonia Pressures, lbs. above Atmosphere.		Brine Temperatures, Degrees F.		Capacity Tons Refrigerating Effect per 24 hours.	Efficiency lbs. of Ice per lb. of Coal at 3 lbs. Coal per hour per H.P.	Water-consumption, gals. of Water per min. per ton of Capacity.	Ratio of Actual Weights of Ammonia circulated.	Ratio of Capacities.
	Con-densing	Suc-tion.	Inlet.	Outlet.					
1	151	28	36.76	28.86	70.3	22.60	0.80	1.0	1.0
2	161	27.5	36.36	28.45	70.1	22.27	1.09	1.0	1.0
3	147	13.0	14.29	2.29	42.0	16.27	0.83	1.70	1.60
4	152	8.2	6.27	2.03	36.43	14.10	1.1	1.93	1.92
5	105	7.6	6.40	-2.22	37.20	17.00	2.00	1.91	1.88
6	135	15.7	4.62	3.22	27.2	13.20	1.25	2.59	2.57

The principal results in four tests are given in the table on page 1311. The fuel economy under different conditions of operation is shown in the following table:

Condensing Pressure, lbs.	Suction-pressure, lbs.	Pounds of Ice-melting Effect with Engines —						B.T.U. per lb. of Steam with Engines —		
		Non-condensing.		Non-compound Condensing.		Compound Condensing.		Non-condensing.	Condensing.	Compound Condensing.
		Per lb. Coal.	Per lb. Steam.	Per lb. Coal.	Per lb. Steam.	Per lb. Coal.	Per lb. Steam.			
150	28	24	2.90	30	3.61	37.5	4.51	393	513	640
150	7	14	1.69	17.5	2.11	21.5	2.58	240	300	366
105	28	34.5	4.16	43	5.18	54	6.50	591	725	923
105	7	22	2.65	27.5	3.31	34.5	4.16	376	470	591

The non-condensing engine is assumed to require 25 lbs. of steam per I.H.P. per hour, the non-compound condensing 20 lbs., and the compound condensing 16 lbs., and the boiler efficiency is assumed at 8.3 lbs. of water per lb. coal under working conditions. The following conclusions were derived from the investigation:

1. The capacity of the machine is proportional, almost entirely, to the weight of ammonia circulated. This weight depends on the suction-pressure and the displacement of the compressor-pumps. The practical suction-pressures range from 7 lbs. above the atmosphere, with which a temperature of 0° F. can be produced, to 28 lbs. above the atmosphere, with which the temperatures of refrigeration are confined to about 28° F. At the lower pressure only about one-half as much weight of ammonia can be circulated as at the upper pressure, the proportion being about in accordance with the ratios of the absolute pressures, 22 and 42 lbs.

respectively. For each cubic foot of piston-displacement per minute a capacity of about one-sixth of a ton of refrigerating effect per 24 hours can be produced at the lower pressure, and of about one-third of a ton at the upper pressure. No other elements practically affect the capacity of a machine, provided the cooling-surface in the brine-tank or other space to be cooled is equal to about 36 sq. ft. per ton of capacity at 28 lbs. back pressure. For example, a difference of 100% in the rate of circulation of brine, while producing a proportional difference in the range of temperature of the latter, made no practical difference in capacity.

The brine-tank was 10 1/2 x 13 x 10 2/3 ft., and contained 8000 lineal feet of 1-in. pipe as cooling-surface. The condensing-tank was 12 x 10 x 10 ft., and contained 5000 lineal feet of 1-in pipe as cooling-surface.

2. The economy in coal-consumption depends mainly upon both the suction-pressures and condensing-pressures. Maximum economy with a given type of engine, where water must be bought at average city prices, is obtained at 28 lbs. suction-pressure and about 150 lbs. condensing-pressure. Under these conditions, for a non-condensing steam-engine consuming coal at the rate of 3 lbs. per hour per I.H.P. of steam-cylinders, 24 lbs. of ice-refrigerating effect are obtained per lb. of coal consumed. For the same condensing-pressure, and with 7 lbs. suction-pressure, which affords temperatures of 0° F., the possible economy falls to about 14 lbs. of refrigerating effect per lb. of coal consumed. The condensing-pressure is determined by the amount of condensing-water supplied to liquefy the ammonia in the condenser. If the latter is about 1 gallon per minute per ton of refrigerating effect per 24 hours, a condensing-pressure of 150 lbs. results, if the initial temperature of the water is about 56° F. Twenty-five per cent less water causes the condensing-pressure to increase to 190 lbs. The work of compression is thereby increased about 20%, and the resulting "economy" is reduced to about 18 lbs. of "ice effect" per lb. of coal at 28 lbs. suction-pressure and 11.5 at 7 lbs. If, on the other hand, the supply of water is made 3 gallons per minute, the condensing-pressure may be confined to about 105 lbs. The work of compression is thereby reduced about 25%, and a proportional increase of economy results. Minor alterations of economy depend on the initial temperature of the condensing-water and variations of latent heat, but these are confined within about 5% of the gross result, the main element of control being the work of compression, as affected by the back pressure and condensing-pressure, or both. If the steam-engine supplying the motive power may use a condenser to secure a vacuum, an increase of economy of 25% is available over the above figures, making the lbs. of "ice effect" per lb. of coal for 150 lbs. condensing-pressure and 28 lbs. suction-pressure 30.0, and for 7 lbs. suction-pressure, 17.5. It is, however, impracticable to use a condenser in cities where water is bought. The latter must be practically free of cost to be available for this purpose. In this case it may be assumed that water will also be available for condensing the ammonia to obtain as low a condensing-pressure as about 100 lbs., and the economy of the refrigerating-machine becomes, for 28 lbs. back pressure, 43.0 lbs. of "ice-effect" per lb. of coal, or for 7 lbs. back pressure 27.5 lbs. of ice effect per lb. of coal. If a compound condensing-engine can be used with a steam-consumption per hour per horse-power of 16 lbs. of water, the economy of the refrigerating-machine may be 25% higher than the figures last named, making for 28 lbs. back pressure a refrigerating-effect of 54.0 lbs. per lb. of coal, and for 7 lbs. back pressure a refrigerating effect of 34.0 lbs. per lb. of coal.

Performance of a 75-ton Refrigerating-machine. (Denton.)

	Maximum Capacity and Economy at 28 lbs. Back Pressure.	Maximum Capacity and Economy at Zero, Brine, and 8 lbs. Back Pressure.	Maximum Capacity and Economy for Zero, Brine, 13 lbs. Pressure.	Maximum Capacity and Economy at 27.5 lbs. Back Pressure.
Av. high ammonia press. above atmos.	151 lbs.	152 lbs.	147 lbs.	161 lbs.
Av. back ammonia press. above atmos.	28 "	8.2 "	13 "	27.5 "
Av. temperature brine inlet	36.76°	6.27°	14.29°	
Av. temperature brine outlet	28.86°	2.03°	2.29°	28.45°
Av. range of temperature	7.9°	4.24°	12.00°	7.91°
Lbs. of brine circulated per minute	2281	2173	943	2374
Av. temp. condensing-water at inlet	44.65°	56.65°	46.9°	54.00°
Av. temp. condensing-water at outlet	83.66°	85.4°	85.46°	82.86°
Av. range of temperature	39.01°	28.75°	38.56°	28.80°
Lbs. water circulated p. min. thro' cond'ser	442	315	257	601.5
Lbs. water per min. through jackets	25	44	40	14
Range of temperature in jackets	24.0°	16.2°	16.4°	29.1°
Lbs. ammonia circulated per min.	*28.17	14.68	16.67	28.32
Probable temperature of liquid ammonia, entrance to brine-tank	*71.3°	*68°	*63.7°	76.7°
Temp. of amm. corresp. to av. back press.	+14°	-8°	-5°	14°
Av. temperature of gas leaving brine-tanks	34.2°	14.7°	3.0°	29.2°
Temperature of gas entering compressor	*39°	25°	10.13°	34°
Av. temperature of gas leaving compressor	213°	263°	239°	221°
Av. temp. of gas entering condenser	200°	218°	209°	168°
Temperature due to condensing pressure. .	84.5°	84.0°	82.5°	88.0°
Heat given ammonia:				
By brine, B.T.U. per minute	14776	7186	8824	14647
By compressor, B.T.U. per minute	2786	2320	2518	3020
By atmosphere, B.T.U. per minute	140	147	167	141
Total heat rec. by amm., B.T.U. per min....	17702	9653	11409	17708
Heat taken from ammonia:				
By condenser, B.T.U. per min.	17242	9056	9910	17359
By jackets, B.T.U. per min.	608	712	656	406
By atmosphere, B.T.U. per min.	182	338	250	252
Total heat rej. by amm., B.T.U. per min....	18032	10106	10816	18017
Dif. of heat rec'd and rej., B.T.U. per min....	330	453	407	309
% work of compression removed by jackets	22%	31%	26%	13%
Av. revolutions per min.	58.09	57.7	57.88	58.89
Mean eff. press. steam-cyl., lbs. per sq. in. .	32.5	27.17	27.83	32.97
Mean eff. press. amm.-cyl., lbs. per sq. in. .	65.9	53.3	59.86	70.54
Av. H.P. steam-cylinder	85.0	71.7	73.6	88.63
Av. H.P. ammonia-cylinder	65.7	54.7	59.37	71.20
Friction in per cent of steam H.P.	23.0	24.0	20.0	19.67
Total cooling water, gallons per min. per ton per 24 hours	0.75	1.185	0.797	0.990
Tons ice-melting capacity per 24 hours	74.8	36.43	44.64	74.56
Lbs. ice-refrigerating eff. per lb. coal at 3 lbs. per H.P. per hour	24.1	14.1	17.27	23.37
Cost coal per ton of ice-refrigerating effect at \$4 per ton	\$0.166	\$0.283	\$0.231	\$0.170
Cost water per ton of ice-refrigerating effect at \$1 per 1000 cu. ft.	\$0.128	\$0.200	\$0.136	\$0.169
Total cost of 1 ton of ice-refrigerating eff. .	\$0.294	\$0.483	\$0.467	\$0.339

Figures marked thus (*) are obtained by calculation; all other figures obtained from experimental data; temperatures in Fahrenheit are degrees.

Ammonia Compression-machine.
ACTUAL RESULTS OBTAINED AT THE MUNICH TESTS.
 (Prof. Linde, *Trans. A. S. M. E.*, xiv, 1419.)

No. of Test.....	1	2	3	4	5
Temp. of refrigerated brine } Inlet, deg. F....	43.194	28.344	13.952	-0.279	28.251
} Outlet, deg. F....	37.054	22.885	8.771	-5.879	23.072
Specific heat of brine.....	0.861	0.851	0.843	0.837	0.851
Brine circ. per hour, cu. ft.....	1,039.38	908.84	633.89	414.98	800.93
Cold produced, B.T.U. per hour...	342,909	263,950	172,776	121,474	220,284
Cooling water per hour, cu. ft.....	338.76	260.83	187.506	139.99	97.76
I.H.P. in steam-engine cylinder...	15.80	16.47	15.28	14.24	21.61
Cold produced per } Per I.H.P. in comp-cyl	24,813	18,471	12,770	10,140	11,151
} Per I.H.P. in steam-cyl	21,703	16,026	11,307	8,530	10,194
h..B.T.U.) Per lb. of steam.....	1,100.8	785.6	564.9	435.82	512.12

A test of a 35-ton absorption-machine in New Haven, Conn., by Prof. Denton (*Trans. A. S. M. E.*, x, 792), gave an ice-melting effect of 20.1 lbs. per lb. of coal on a basis of boiler economy equivalent to 3 lbs. of steam per I.H.P. in a good non-condensing steam-engine. The ammonia was worked between 138 and 23 lbs. pressure above the atmosphere.

Performance of a Single-acting Ammonia Compressor. — Tests were made at the works of the Eastman Kodak Co., Rochester, N.Y., of a machine fitted with two York Mfg. Co.'s single-acting compressors, 15 in. diam., 22 in. stroke, to determine the horse-power per ton of refrigeration. Following are the principal average results (Bulletin of York Mfg. Co.):

Date of test, 1908.....	Mar. 6	Mar. 7	Mar. 8	Mar. 9	Mar. 10	Mar. 11	Mar. 14
Temp. dischg. gas, av.	216.2	217.8	250.6	245.8	253.0	242.9	255.5
Temp. suction gas, av.	15.2	14.3	16.8	14.8	13.5	18.2	17.9
Temp. suction at cooler...	9.33	9.36	10.37	9.29	9.90	13.20	9.13
Temp. liquid at exp. valve	74.85	74.16	71.98	77.91	76.61	82.88	76.98
Temp. brine, inlet.....	22.89	23.19	25.26	22.73	27.35	28.41	23.43
Temp. brine, outlet.....	13.58	13.96	14.44	13.02	15.53	16.06	12.87
Revs. per min.....	45.1	45.0	45.1	34.3	56.0	67.8	44.8
Lbs. liquid NH ₃ per min..	20.76	20.43	21.04	15.59	25.99	20.40
Suc. press. at mach. lb. ...	20.11	19.90	19.97	20.04	20.18	18.13	20.38
Condenser pressure.....	183.96	184.41	186.99	187.27	187.90	186.8	183.81
Indicated H.P.....	69.35	69.80	70.05	52.57	89.48	105.11	68.61
Tons Refrig. Capy, 24 hrs.	49.08	48.79	50.38	37.01	61.39	66.65	49.31
I.H.P. per ton capacity ..	1.418	1.427	1.389	1.422	1.425	1.439	1.375

Full details of these tests were reported to the Am. Socy. of Refrig. Engrs. and published in *Ice and Refrigeration*, 1908.

Performance of Absorption Machines. — From an elaborate review by Mr. Voorhees of the action of an absorption machine under certain stated conditions, showing the quantity of ammonia circulated per hour per ton of refrigeration, its temperature, etc., at the several stages of the operation, and its course through the several parts of the apparatus, the following condensed statement is obtained:

Generator. — 30.9 lbs. dry steam, 38 lbs. gauge pressure condensed, evaporates 32.2% strong liquor to 22.3% weak liquor.

Exchanger. — 3.01 lbs. weak liquor at 264° cools to 111°.

Absorber. — Adds 0.43 lbs. vapor from the brine cooler, making 3.44 lbs. strong liquor at 111° to go to the pump.

Exchanger. — 3.41 lbs. heated to 224°, some of it is now gas, and the rest liquor of a little less than 32% NH₃.

Analyzer. — (A series of shelves in a tank above the generator) delivers strong liquor to the generator, while the vapor, 91% NH₃, 0.4082 lb., goes to the rectifier.

Rectifier. — Cools the gas to 110° separating water vapor as 0.0682 lb. drip liquor which returns through a trap to the generator.

Condenser. — 0.43 lb. NH₃ gas at 110° cooled and condensed to liquid at 90° by 2 gals. of water per min. heated from 73° to 86°.

Expansion Valve and Cooler. — Reduces liquid to 0° and boils it at 0°, cooling 3 gals. of brine per min. from 12° to 3°. Gas passes to absorber and the cycle is repeated.

Of the 2 gals. per min. of cooling water flowing from the condenser, 0.2 gal. goes to the rectifier, where it is heated to 142°, and 1.8 gal. through the absorber, where it is heated to 110°.

Heat Balance. — Absorbed in the generator 496; in the brine cooler, 200; Total 696 B.T.U. Rejected; condenser, 220; absorber, 383; rectifier, 93; Total 696 B.T.U.

The following table shows the strength of the liquors and the quantity of steam required per hour per ton of refrigeration under the conditions stated:

	Condenser Pressures.								
	140			170			200		
	Suction Pressures.								
	0	15	30	0	15	30	0	15	30
Sl per cent.....	24	35	42	22	32	38	18	28	36
Wl per cent.....	13.13	25.75	33.70	10.85	22.3	29.15	6.28	17.7	26.9
SG, pounds.....	30.1	27.9	22.9	41.3	30.9	26.2	48.7	34.1	27.9
SL, pounds.....	1.7	1.6	1.4	2.1	1.9	1.8	2.4	2.3	2.2

Sl, strong liquor; Wl, weak liquor; SG, lbs. of steam per hour per ton of refrigeration for the generator, SL, do. for the liquor pump. Pressures are in lbs. per sq. in., gauge.

The following table gives the steam consumption in lbs. per hour per ton of refrigeration, for engine-driven compressors and for absorption machines with liquor pump not exhausting into the generator at the suction and condenser pressures (gauge) given: SC, simple non-condensing engine, CC, compound condensing engine, A, absorption machine.

	Condenser Pressures.								
	140			170			200		
	Suction Pressures.								
	0	15	30	0	15	30	0	15	30
SC.....	78.3	44.5	31.1	90.5	52.5	37.2	104.0	61.4	44.5
CC.....	42.0	23.8	16.6	48.4	28.0	19.0	55.6	32.7	23.9
A.....	31.8	29.5	24.3	43.4	32.8	28.0	51.1	36.4	30.1

The economy of the absorption machine is much better for all conditions than that of a simple non-condensing engine-driven compressor. At suction gauge pressures above 8 to 10 lbs. the economy of the compound condensing engine-driven compressor exceeds that of the absorption machine, the absorption machine giving the superior economy at suction pressures below 8 to 10 lbs.

Means for Applying the Cold. (M. C. Bannister, Liverpool Eng's Soc'y, 1890.) — The most useful means for applying the cold to various uses is a saturated solution of brine or chloride of magnesium, which remains liquid at 5° Fahr. The brine is first cooled by being circulated in contact with the refrigerator-tubes, and then distributed through coils of pipes, arranged either in the substances requiring a reduction of temperature, or in the cold stores or rooms prepared for them; the air coming in contact with the cold tubes is immediately chilled, and the moisture in the air deposited on the pipes. It then falls, making room for warmer air, and so circulates until the whole room is at the temperature of the brine in the pipes.

The **Direct Expansion Method** consists in conveying the compressed cooled ammonia (or other refrigerating agent) directly to the room to be cooled, and then expanding it through an expansion cock into pipes in the room. Advantages of this system are its simplicity and its rapidity of action in cooling a room; disadvantages are the danger of leakage of the gas and the fact that the machine cannot be stopped without a rapid rise in the temperature of the room. With the brine system, with a large amount of cold brine in the tank, the machine may be stopped for a considerable time without serious cooling of the room.

Air has also been used as the circulating medium. The ammonia-pipes refrigerate the air in a cooling-chamber, and large conduits are used to convey it to and return it from the rooms to be cooled. An advantage of this system is that by it a room may be refrigerated more quickly than by brine-coils. The returning air deposits its moisture on the ammonia-pipes, in the form of snow, which is removed by mechanical brushes.

ARTIFICIAL-ICE MANUFACTURE.

Under summer conditions, with condensing water at 70°, artificial-ice machines use ammonia at a condenser pressure, about 190 lbs. above the atmosphere and 15 lbs. suction-pressure.

In a compression type of machine the useful circulation of ammonia, allowing for the effect of cylinder-heating, is about 13 lbs. per hour per indicated horse-power of the steam-cylinder. This weight of ammonia produces about 32 lbs. of ice at 15° from water at 70°. If the ice is made from distilled water, as in the "can system," the amount of the latter supplied by the boilers is about 33% greater than the weight of ice obtained. This excess represents steam escaping to the atmosphere from the re-boiler and steam-condenser, to purify the distilled water, or free it from air; also, the loss through leaks and drips, and loss by melting of the ice in extracting it from the cans. The total steam consumed per horse-power is, therefore, about $32 \times 1.33 = 43.0$ lbs. About 7.0 lbs. of this covers the steam-consumption of the steam-engines driving the brine circulating-pumps, the several cold-water pumps, and leakage, drips, etc. Consequently, the main steam-engine must consume 36 lbs. of steam per hour per I.H.P., or else live steam must be condensed to supply the required amount of distilled water. There is, therefore, nothing to be gained by using steam at high rates of expansion in the steam-engines, in making artificial ice from distilled water. If the cooling water for the ammonia-coils and steam-condenser is not too hard for use in the boilers, it may enter the latter at about 175° F., by restricting the quantity to 1½ gallons per minute per ton of ice. With good coal 8½ lbs. of feed-water may then be evaporated, on the average, per lb. of coal.

The ice made per pound of coal will then be $32 \div (43.0 \div 8.5) = 6.0$ lbs. This corresponds with the results of average practice.

If ice is manufactured by the "plate system," no distilled water is used for freezing. Hence the water evaporated by the boiler may be reduced to the amount which will drive the steam-motors, and the latter may use steam expansively to any extent consistent with the power required to compress the ammonia, operate the feed and filter pumps, and the hoisting machinery. The latter may require about 15% of the power needed for compressing the ammonia.

If a compound condensing steam-engine is used for driving the compressors, the steam per indicated steam horse-power, or per 32 lbs. of net ice, may be 14 lbs. per hour. The other motors at 50 lbs. of steam per horse-power will use 7.5 lbs. per hour, making the total consumption per steam horse-power of the compressor 21.5 lbs. Taking the évapora-

tion at 8 lbs., the feed-water temperature being limited to about 110°, the coal per horse-power is 2.7 lbs. per hour. The net ice per lb. of coal is then about $32 \div 2.7 = 11.8$ lbs. The best results with "plate-system" plants, using a compound steam-engine, have thus far afforded about 10½ lbs. of ice per lb. of coal.

In the "plate system" the ice gradually forms, in from 8 to 10 days, to a thickness of about 14 inches, on the hollow plates, 10 x 14 feet in area, in which the cooling fluid circulates.

In the "can system" the water is frozen in blocks weighing about 300 lbs. each, and the freezing is completed in from 40 to 45 hours. The freezing-tank area occupied by the "plate system" is, therefore, about twelve times, and the cubic contents about four times, as much as required in the "can system."

The investment for the "plate" is about one-third greater than for the "can" system. In the latter system ice is being drawn throughout the 24 hours, and the hoisting is done by hand tackle. Some "can" plants are equipped with pneumatic hoists and on large hoists electric cranes are used to advantage. In the "plate system" the entire daily product is drawn, cut, and stored in a few hours, the hoisting being performed by power. The distribution of cost is as follows for the two systems, taking the cost for the "can" or distilled-water system as 100, which represents an actual cost of about \$1.25 per net ton:

	Can System.	Plate System.
Hoisting and storing ice	14.2	2.8
Engineers, firemen, and coal-passer	15.0	13.9
Coal at \$3.50 per gross ton	42.2	20.0
Water pumped directly from a natural source at 5 cts. per 1000 cubic feet	1.3	2.6
Interest and depreciation at 10%	24.6	32.7
Repairs	2.7	3.4
	100.00	75.4

A compound condensing engine is assumed to be used by the "plate system."

Test of the New York Hygeia Ice-making Plant. — (By Messrs. Hupfel, Griswold, and Mackenzie; *Stevens Indicator*, Jan., 1894.)

The final results of the tests were as follows:

Net ice made per pound of coal, in pounds	7.12
Pounds of net ice per hour per horse-power	37.8
Net ice manufactured per day (12 hours) in tons	97
Av. pressure of ammonia-gas at condenser, lbs. per sq. in. above atmos.	135.2
Average back pressure of amm.-gas, lbs. per sq. in. above atmos.	15.8
Average temperature of brine in freezing-tanks, degrees F.	19.7
Total number of cans filled per week	4389
Ratio of cooling-surface of coils in brine-tank to can-surface	7 to 10

An Absorption Evaporator Ice-making System, built by the Carbon-dale Machine Co. is in operation at the ice plant of the Richmond Ice Co., Clifton, Staten Island, N. Y., which produces the extra distilled water by an evaporator at practically no fuel cost, and thus about 10 tons of distilled water ice per ton of coal is obtained. Steam from the boiler at 100 lbs. pressure enters an evaporator, distilling off steam at 70 lbs., which operates the pumps and auxiliary machinery. These exhaust into the ice machine generator under 10 lbs. pressure, where the exhaust is condensed. In a 100-ton plant the evaporator will condense 43 tons of live steam, distilling off 40 tons of steam to operate the auxiliaries, which exhaust into the generator; 20 tons of live steam has to be added to this exhaust, making 60 tons in all, which is the amount required to operate the generator. The 60 tons of condensation from the generator and 43 tons from the evaporator go to the re-boiler, making 103 tons of distilled water to be frozen into ice. The total steam consumption is the 60 tons condensed in the generator plus 3 tons for radiation, or 63 tons in all. Hence if the boiler evaporates 6.6 lbs. water per pound of coal the economy of the plant will be 10½ lbs. ice per pound of coal, a result which cannot be obtained even with compound condensing engines and compression machines.

Heat-exchanging coils, on the order of a closed feed-water heater, are used to heat the feed-water going to the boiler. The condensation leaving the generator and evaporator at a high temperature is utilized for this purpose; by this means securing a feed-water temperature considerably in excess of 212°.

Ice-Making with Exhaust Steam. — The exhaust steam from electric light plants is being utilized to manufacture ice on the absorption system. A 10-ton plant at the Holdredge Lighting Co., Holdredge, Neb., built by the Carbondale Machine Co., is described in *Elec. World*, April 7, 1910. Here 11 tons of ice were made per day with exhaust steam from the electric engines at 2 1/2 lbs. pressure, using 6 1/3 K.W., or 8 1/2 H.P., for driving the circulating pumps.

Tons of Ice per Ton of Coal. — From a long table by Mr. Voorhees, showing the net tons of plate ice that may be made in well-designed plants under a variety of conditions as to type of engine, the following figures are taken:

Compression, Simple Corliss engine, non-condensing.....	6.1 tons
Absorption liquor pump and auxiliaries not exhausting into generator, simple, non-condensing engine.....	10.0
Compression, compound condensing engine.....	11.2
Compression triple-expansion condensing engine.....	12.8
Absorption, pump and auxiliaries exhausting into generator, Corliss non-condensing engine.....	13.3
Compression and absorption, compound engine, non-condensing.....	16.0
Compression, triple-expansion condensing engine, multiple effect.....	16.5
Compression and absorption, triple-expansion non-condensing engine, multiple effect.....	19.5

Standard Ice Cans or Moulds.
(Buffalo Refrigerating Machine Co.)

Weight of Block.	Size of Can.	Time of Freezing.	Weight of Block.	Size of Can.	Time of Freezing.
pounds		hours	pounds		hours
25	4x10x24	12	100	11x11x32	48
50	6x12x26	20	200	11x22x32	54
100	8x15x32	36	300	11x22x44	54
150	8x15x44	36	400	11x22x56	54
150	10x15x36	48	200	14x14x40	66
200	10x20x36	48			

The above given time of freezing is with a brine temperature of 15° F.

MARINE ENGINEERING.

Rules for Measuring Dimensions and Obtaining Tonnage of Vessels. (Record of American and Foreign Shipping. American Bureau of Shipping, N. Y., 1890.) — The dimensions to be measured as follows:

I. Length, *L*. — From the fore-side of stem to the after-side of stern-post measured at middle line on the upper deck of all vessels, except those having a continuous hurricane-deck extending right fore and aft, in which the length is to be measured on the range of deck immediately below the hurricane-deck.

Vessels having clipper heads, raking forward, or receding stems, or raking stern-posts, the length to be the distance of the fore-side of stem from aft-side of stern-post at the deep-load water-line measured at middle line. (The inner or propeller-post to be taken as stern-post in screw-steamers.)

II. Breadth, *B*. — To be measured over the widest frame at its widest part; in other words, the molded breadth.

III. Depth, *D*. — To be measured at the dead-flat frame and at middle line of vessel. It shall be the distance from the top of floor-plate to the upper side of upper deck-beam in all vessels except those having a continuous hurricane-deck, extending right fore and aft, and not intended for the American coasting trade, in which the depth is to be the distance

from top of floor-plate to midway between top of hurricane deck-beam and the top of deck-beam of the deck immediately below hurricane-deck. In vessels fitted with a continuous hurricane-deck, extending right fore and aft, and intended for the American coasting trade, the depth is to be the distance from top of floor-plate to top of deck-beam of deck immediately below hurricane-deck.

Rule for Obtaining Tonnage. — Multiply together the length, breadth, and depth, and their product by 0.75; divide the last product by 100; the quotient will be the tonnage. $L \times B \times D \times 0.75 \div 100 = \text{tonnage}$.

The U. S. Custom-house Tonnage Law, May 6, 1864, provides that "the register tonnage of a vessel shall be her entire internal cubic capacity in tons of 100 cubic feet each." This measurement includes all the space between upper decks, however many there may be. Explicit directions for making the measurements are given in the law.

The Displacement of a Vessel (measured in tons of 2240 lbs.) is the weight of the volume of water which it displaces. For sea-water it is equal to the volume of the vessel beneath the water-line, in cubic feet, divided by 35, which figure is the number of cubic feet of sea-water at 60° F. in a ton of 2240 lbs. For fresh water the divisor is 35.93. The U. S. register tonnage will equal the displacement when the entire internal cubic capacity bears to the displacement the ratio of 100 to 35.

The displacement or gross tonnage is sometimes approximately estimated as follows: Let *L* denote the length in feet of the boat, *B* its extreme breadth in feet, and *D* the mean draught in feet; the product of these three dimensions will give the volume of a parallelepipedon in cubic feet. Putting *V* for this volume, we have $V = L \times B \times D$.

The volume of displacement may then be expressed as a percentage of the volume *V*, known as the "block coefficient." This percentage varies for different classes of ships. In racing yachts with very deep keels it varies from 22 to 33; in modern merchantmen from 55 to 90; for ordinary small boats probably 50 will give a fair estimate. The volume of displacement in cubic feet divided by 35 gives the displacement in tons.

Coefficient of Fineness. — A term used to express the relation between the displacement of a ship and the volume of a rectangular prism or box whose lineal dimensions are the length, breadth, and draught.

Coefficient of fineness = $D \times 35 \div (L \times B \times W)$; *D* being the displacement in tons of 35 cubic feet of sea-water to the ton, *L* the length between perpendiculars, *B* the extreme breadth and *W* the mean draught, all in feet.

Coefficient of Water-lines. — An expression of the relation of the displacement to the volume of the prism whose section equals the midship section of the ship, and length equal to the length of the ship.

Coefficient of water-lines = $D \times 35 \div (\text{area of immersed water section} \times L)$. Seaton gives the following values:

	Coefficient of Fineness.	Coefficient of Water-lines
Finely-shaped ships.....	0.55	0.63
Fairly-shaped ships.....	0.61	0.67
Ordinary merchant steamers 10 to 11 knots... ..	0.65	0.72
Cargo steamers, 9 to 10 knots.....	0.70	0.76
Modern cargo steamers of large size.....	0.78	0.83

Resistance of Ships. — The resistance of a ship passing through water may vary from a number of causes, as speed, form of body, displacement, midship dimensions, character of wetted surface, fineness of lines, etc. The resistance of the water is twofold: 1st. That due to the displacement of the water at the bow and its replacement at the stern, with the consequent formation of waves. 2d. The friction between the wetted surface of the ship and the water, known as skin resistance. A common approximate formula for resistance of vessels is

$\text{Resistance} = \text{speed}^2 \times \sqrt[3]{\text{displacement}^2} \times \text{a constant, or } R = S^2 D^{\frac{2}{3}} \times C$.

If *D* = displacement in pounds, *S* = speed in feet per minute, *R* resistance in foot-pounds per minute, $R = CS^2 D^{\frac{2}{3}}$. The work done in overcoming the resistance through a distance equal to *S* is $R \times S = CS^3 D^{\frac{2}{3}}$; and if *E* is the efficiency of the propeller and machinery combined, the indicated horse-power I. H.P. = $CS^3 D^{\frac{2}{3}} \div (E \times 33,000)$.

If *S* = speed in knots, *D* = displacement in tons, and *C* a constant

which includes all the constants for form of vessel, efficiency of mechanism, etc., I.H.P. = $S^3 D^3 + C$.

The wetted surface varies as the cube root of the square of the displacement; thus, let L be the length of edge of a cube just immersed, whose displacement is D and wetted surface W . Then $D = L^3$ or $L = \sqrt[3]{D}$, and $W = 5 \times L^2 = 5 \times (\sqrt[3]{D})^2$. That is, W varies as $D^{2/3}$.

Another approximate formula is

$$\text{I.H.P.} = \text{area of immersed midship section} \times S^3 + K.$$

The usefulness of these two formulæ depends upon the accuracy of the so-called "constants" C and K , which vary with the size and form of the ship, and probably also with the speed. Seaton gives the following, which may be taken roughly as the values of C and K under the conditions expressed:

General Description of Ship.	Speed, knots.	Value of C.	Value of K.
Ships over 400 feet long, finely shaped	15 to 17	240	620
" " 300 " "	15 " 17	190	500
" " " " " "	13 " 15	240	650
" " " " " "	11 " 13	260	700
Ships over 300 feet long, fairly shaped	11 " 13	240	650
" " " " " "	9 " 11	260	700
Ships over 250 feet long, finely shaped	13 " 15	200	580
" " " " " "	11 " 13	240	660
" " " " " "	9 " 11	260	700
Ships over 250 feet long, fairly shaped	11 " 13	220	620
" " " " " "	9 " 11	250	680
Ships over 200 feet long, finely shaped	11 " 12	220	600
" " " " " "	9 " 11	240	640
Ships over 200 feet long, fairly shaped	9 " 11	220	620
Ships under 200 feet long, finely shaped	11 " 12	200	550
" " " " " "	10 " 11	210	580
" " " " " "	9 " 10	230	620
Ships under 200 feet long, fairly shaped	9 " 10	200	600

Coefficient of Performance of Vessels. — The quotient

$$\sqrt[3]{(\text{displacement})^2 \times (\text{speed in knots})^3 \div \text{tons of coal in 24 hours}}$$

gives a coefficient of performance which represents the comparative cost of propulsion in coal expended. Sixteen vessels with three-stage expansion-engines in 1890 gave an average coefficient of 14,810, the range being from 12,150 to 16,700.

In 1881 seventeen vessels with two-stage expansion-engines gave an average coefficient of 11,710. In 1881 the length of the vessels tested ranged from 260 to 320, and in 1890 from 295 to 400. The speed in knots divided by the square root of the length in feet in 1881 averaged 0.539; and in 1890, 0.579; ranging from 0.520 to 0.641. (*Proc. Inst. M. E.*, July, 1891, p. 329.)

Defects of the Common Formula for Resistance. — Modern experiments throw doubt upon the truth of the statement that the resistance varies as the square of the speed. (See Robt. Mansel's letters in *Engineering*, 1891; also his paper on The Mechanical Theory of Steamship Propulsion, read before Section G of the Engineering Congress, Chicago, 1893.)

Seaton says: In small steamers the chief resistance is the skin resistance. In very fine steamers at high speeds the amount of power required seems excessive when compared with that of ordinary steamers at ordinary speeds.

In torpedo-launches at certain high speeds the resistance increases at a lower rate than the square of the speed.

In ordinary sea-going and river steamers the reverse seems to be the case.

Rankine's Formula for total resistance of vessels of the "wave-line" type is:

$$R = ALBV^2 (1 + 4 \sin^2 \theta + \sin^4 \theta),$$

in which equation θ is the mean angle of greatest obliquity of the streamlines, A is a constant multiplier, B the mean wetted girth of the surface exposed to friction, L the length in feet, and V the speed in knots. The power demanded to impel a ship is thus the product of a constant to be determined by experiment, the area of the wetted surface, the cube of the speed, and the quantity in the parenthesis, which is known as the "coefficient of augmentation." In calculating the resistance of ships the last term of the coefficient may be neglected as too small to be practically important. In applying the formula, the mean of the squares of the sines of the angles of maximum obliquity of the water-lines is to be taken for $\sin^2 \theta$, and the rule will then read thus:

To obtain the resistance of a ship of good form, in pounds, multiply the length in feet by the mean immersed girth and by the coefficient of augmentation, and then take the product of this "augmented surface," as Rankine termed it, by the square of the speed in knots, and by the proper constant coefficient selected from the following:

- For clean painted vessels, iron hulls..... $A = 0.01$
- For clean coppered vessels..... $A = 0.009$ to 0.008
- For moderately rough iron vessels..... $A = 0.011 +$

The net, or effective, horse-power demanded will be quite closely obtained by multiplying the resistance calculated, as above, by the speed in knots and dividing by 326. The gross, or indicated, power is obtained by multiplying the last quantity by the reciprocal of the efficiency of the machinery and propeller, which usually should be about 0.6. Rankine uses as a divisor in this case 200 to 260.

The form of the vessel, even when designed by skillful and experienced naval architects, will often vary to such an extent as to cause the above constant coefficients to vary somewhat; and the range of variation with good forms is found to be from 0.8 to 1.5 the figures given.

For well-shaped iron vessels, an approximate formula for the horse-power required is $H.P. = SV^3 + 20,000$, in which S is the "augmented surface." The expression $SV^3 + H.P.$ has been called by Rankine the *coefficient of propulsion*. In the Hudson River steamer "Mary Powell," according to Thurston, this coefficient was as high as 23,500.

The expression $D^3 V^3 + H.P.$ has been called the *locomotive performance*. (See Rankine's Treatise on Shipbuilding, 1864; Thurston's Manual of the Steam-engine, part ii, p. 16; also paper by F. T. Bowles, U. S. N., Proc. U. S. Naval Institute, 1883.)

Rankine's method for calculating the resistance is said by Seaton to give more accurate and reliable results than those obtained by the older rules, but it is criticised as being difficult and inconvenient of application.

E. R. Mumford's Method of Calculating Wetted Surfaces is given in a paper by Archibald Denny, *Eng'g*, Sept. 21, 1894. The following is his formula, which gives closely accurate results for medium draughts, beams, and finenesses:

$$S = (L \times D \times 1.7) + (L \times B \times C),$$

In which S = wetted surface in square feet; L = length between perpendiculars in feet; D = middle draught in feet; B = beam in feet; C = block coefficient.

The formula may also be expressed in the form $S = L(1.7D + BC)$. In the case of twin-screw ships having projecting shaft-casings, or in the case of a ship having a deep keel or bilge keels, an addition must be made for such projections. The formula gives results which are in general much more accurate than those obtained by Kirk's method. It underestimates the surface when the beam, draught, or block coefficients are excessive; but the error is small except in the case of abnormal forms, such as stern-wheel steamers having very excessive beams (nearly one-fourth the length), and also very full block coefficients. The formula gives a surface about 6% too small for such forms.

The wetted surface of the block is nearly equal to that of the ship of the same length, beam and draught; usually 2% to 5% greater. In exceedingly fine hollow-line ships it may be 8% greater.

Area of bottom of block = $(F + M) \times B$;
 Area of sides = $2 M \times H$.

Area of sides of ends = $4 \times \sqrt{F^2 + \left(\frac{H}{2}\right)^2} \times H$;

Tangent of half angle of entrance = $\frac{1}{2} B/F = B/(2F)$.

From this, by a table of natural tangents, the angle of entrance may be obtained:

	Angle of Entrance	Fore-body in parts of length
Ocean-going steamers, 14 knots and upw'd	18° to 15°	0.3 to 0.36
" " 12 to 14 knots	21° to 18°	0.26 to 0.3
" " cargo steamers, 10 to 12 knots	30° to 22°	0.22 to 0.26

Dr. Kirk's Method. — This method is generally used on the Clyde. The general idea proposed by Dr. Kirk is to reduce all ships to so definite and simple a form that they may be easily compared; and the magnitude of certain features of this form shall determine the suitability of the ship for speed, etc.

The form consists of a middle body, which is a rectangular parallelepiped, and fore-body and after-body, prisms having isosceles triangles for bases, as shown in Fig. 194.

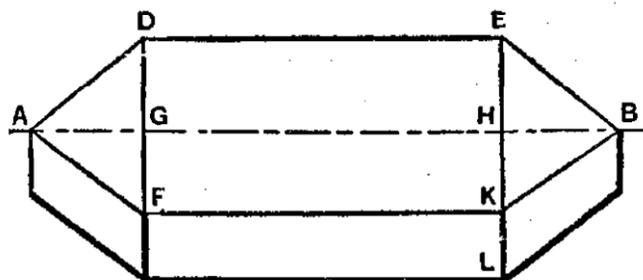

FIG. 194.

This is called a block model, and is such that its length is equal to that of the ship, the depth is equal to the mean draught, the capacity equal to the displacement volume, and its area of section equal to the area of immersed midship section. The dimensions of the block model may be obtained as follows: Let $AG = HB =$ length of fore- or after-body = F ; $GH =$ length of middle body = M ; $KL =$ mean draught = H ; $EK =$ area of immersed midship section $\div KL = B$. Volume of block = $(F + M) \times B \times H$; midship section = $B \times H$; displacement in tons = volume in cubic ft. $\div 35$.

$AH = AG + GH = F + M =$ displacement $\times 35 \div (B \times H)$.

To find the Indicated Horse-power from the Wetted Surface. (Seaton.) — In ordinary cases the horse-power per 100 feet of wetted surface may be found by assuming that the rate for a speed of 10 knots is 5, and that the quantity varies as the cube of the speed. For example: To find the number of I.H.P. necessary to drive a ship at a speed of 15 knots, having a wetted skin of block model of 16,200 square feet:

The rate per 100 feet = $(15/10)^3 \times 5 = 16.875$.
 Then I.H.P. required = $16.875 \times 162 = 2734$.

When the ship is exceptionally well-proportioned, the bottom quite clean, and the efficiency of the machinery high, as low a rate as 4 I.H.P. per 100 feet of wetted skin of block model may be allowed.

The gross indicated horse-power includes the power necessary to overcome the friction and other resistance of the engine itself and the shafting, and also the power lost in the propeller. In other words, I.H.P. is no measure of the resistance of the ship, and can only be relied on as a means of deciding the size of engines for speed, so long as the efficiency of the engine and propeller is known definitely, or so long as similar engines and

propellers are employed in ships to be compared. The former is difficult to obtain, and it is nearly impossible in practice to know how much of the power shown in the cylinders is employed usefully in overcoming the resistance of the ship. The following example is given to show the variation in the efficiency of propellers:

	Knots.	I.H.P.
H.M.S. "Amazon," with a 4-bladed screw, gave	12.064	with 1940
H.M.S. "Amazon," with a 2-bladed screw, increased pitch, and fewer revolutions per minute	12.396	" 1863
H.M.S. "Iris," with a 4-bladed screw	16.577	" 7503
H.M.S. "Iris," with 2-bladed screw, increased pitch, fewer revolutions per knot	18.587	" 7556

Relative Horse-power Required for Different Speeds of Vessels. (Horse-power for 10 knots = 1.) — The horse-power is taken usually to vary as the cube of the speed, but in different vessels and at different speeds it may vary from the 2.8 power to the 3.5 power, depending upon the lines of the vessel and upon the efficiency of the engines, the propeller, etc. (The power may vary at a much higher rate than the 3.5 power of the speed when the speed is much less than normal, and the machinery is therefore working at less than its normal efficiency.)

Speed knots	4	6	8	10	12	14	16	18	20	22	24	26	28	30
$S^{2.8}$.0769	.239	.535	1.	1.666	2.565	3.729	5.185	6.964	9.095	11.60	14.52	17.87	21.67
$S^{2.9}$.0701	.227	.524	1.	1.697	2.653	3.908	5.499	7.464	9.841	12.67	15.97	19.80	24.19
S^3	.0640	.216	.512	1.	1.728	2.744	4.096	5.832	8.	10.65	13.82	17.58	21.95	27.
$S^{3.1}$.0584	.205	.501	1.	1.760	2.838	4.293	6.185	8.574	11.52	15.09	19.34	24.33	30.14
$S^{3.2}$.0533	.195	.490	1.	1.792	2.935	4.500	6.559	9.189	12.47	16.47	21.28	26.97	33.63
$S^{3.3}$.0486	.185	.479	1.	1.825	3.036	4.716	6.957	9.849	13.49	17.98	23.41	29.90	37.54
$S^{3.4}$.0444	.176	.468	1.	1.859	3.139	4.943	7.378	10.56	14.60	19.62	25.76	33.14	41.90
$S^{3.5}$.0405	.167	.458	1.	1.893	3.247	5.181	7.824	11.31	15.79	21.42	28.34	36.73	46.77

EXAMPLE IN USE OF THE TABLE. — A certain vessel makes 14 knots speed with 587 I.H.P. and 16 knots with 900 I.H.P. What I.H.P. will be required at 18 knots, the rate of increase of horse-power with increase of speed remaining constant? The first step is to find the rate of increase, thus: $14^x : 16^x :: 587 : 900$.

$x \log 16 - x \log 14 = \log 900 - \log 587$;
 $x (0.204120 - 0.146128) = 2.954243 - 2.768638$,

whence x (the exponent of S in formula $H.P. \propto S^x$) = 3.2.

From the table, for $S^{3.2}$ and 16 knots, the I.H.P. is 4.5 times the I.H.P. at 10 knots; \therefore H.P. at 10 knots = $900 \div 4.5 = 200$.

From the table for $S^{3.2}$ and 18 knots, the I.H.P. is 6.559 times the I.H.P. at 10 knots; \therefore H.P. at 18 knots = $200 \times 6.559 = 1312$ H.P.

Resistance per Horse-power for Different Speeds. (One horse-power = 33,000 lbs. resistance overcome through 1 ft. in 1 min.) — The resistances per horse-power for various speeds are as follows: For a speed of 1 knot, or 6080 feet per hour = $101\frac{1}{3}$ ft. per min., $33,000 \div 101\frac{1}{3} = 325.658$ lbs. per horse-power; and for any other speed 325.658 lbs. divided by the speed in knots; or for

1 knot	325.66 lbs.	8 knots	40.71 lbs.	15 knots	21.71 lbs.
2 knots	162.83 "	9 "	36.18 "	16 "	20.35 "
3 "	108.55 "	10 "	32.57 "	17 "	19.16 "
4 "	81.41 "	11 "	29.61 "	18 "	18.09 "
5 "	65.13 "	12 "	27.14 "	19 "	17.14 "
6 "	54.28 "	13 "	25.05 "	20 "	16.28 "
7 "	46.52 "	14 "	23.26 "		

More accurate methods than those above given for estimating the horse-power required for any proposed ship are: 1. Estimations calculated from the results of trials of "similar" vessels driven at "corresponding"

speeds; "similar" vessels being those that have the same ratio of length to breadth and to draught, and the same coefficient of fineness, and "corresponding" speeds those which are proportional to the square roots of the lengths of the respective vessels. Froude found that the resistances of such vessels varied almost exactly as wetted surface \times (speed)².

2. The method employed by the British Admiralty and by some Clyde shipbuilders, viz., ascertaining the resistance of a model of the vessel, 12 to 20 ft. long, in a tank, and calculating the power from the results obtained.

Estimated Displacement, Horse-power, etc. — The table on the next page, calculated by the author, will be found convenient for making approximate estimates.

The figures in 7th column are calculated by the formula $H.P. = S^2 D^{\frac{2}{3}} + c$ in which $c = 200$ for vessels under 200 ft. long when $C = 0.65$, and 210 when $C = 0.55$; $c = 200$ for vessels 200 to 400 ft. long when $C = 0.75$, 220 when $C = 0.65$, 240 when $C = 0.55$; $c = 230$ for vessels over 400 ft. long when $C = 0.75$, 250 when $C = 0.65$, 260 when $C = 0.55$.

The figures in the 8th column are based on 5 H.P. per 100 sq. ft. of wetted surface.

The diameters of screw in the 9th column are from formula $D = 3.31 \sqrt[5]{I.H.P.}$, and in the 10th column from formula $D = 2.71 \sqrt[6]{I.H.P.}$.

To find the diameter of screw for any other speed than 10 knots, revolutions being 100 per minute, multiply the diameter given in the table by the 5th root of the cube of the given speed \div 10. For any other revolutions per minute than 100, divide by the revolutions and multiply by 100.

To find the approximate horse-power for any other speed than 10 knots, multiply the horse-power given in the table by the cube of the ratio of the given speed to 10, or by the relative figure from table on p. 1321.

F. E. Cardullo, *Mach'y*, April, 1907, gives the following formula as closely approximating the speed of modern types of hulls: $S = 6.35 \sqrt[3]{\frac{I.H.P.}{D^{2/3}}}$, in which $S =$ speed in knots, $D =$ displacement in tons. If we take $S = 10$ knots, then $I.H.P. \div D^{2/3} = 3.906$. Let $D = 10,000$, and $S = 10$, then $H.P. = 1813$. The table on page 1323 gives for a displacement of 10,400 tons and a coefficient of fineness 0.65, 1966 and 1760 H.P., averaging 1863 H.P.

Internal Combustion Marine Engines. — Linton Hope (*Eng'g*, April 8, 1910), in a paper on the application of internal combustion engines to fishing boats and fine-lined commercial vessels, gives a table showing the brake H.P. required to propel such vessels at various speeds. The following table is an abridgment. $L =$ load water line; $D =$ displacement in tons.

Internal Combustion Marine Engines. — Linton Hope (*Eng'g*, April 8, 1910), in a paper on the application of internal combustion engines to fishing boats and fine-lined commercial vessels, gives a table showing the brake H.P. required to propel such vessels at various speeds. The following table is an abridgment. $L =$ load water line; $D =$ displacement in tons.

Block Coefficient.								Speed in Knots.							
0.25		0.3		0.35		0.4		4	5	6	7	8	9	10	
L	D	L	D	L	D	L	D	Brake Horse-power.							
78	105	75	100	72	95	69	90	20	30	43	60	81	110	150	
71	81	69	77	66	73	63	70	17	25	37	51	69	93	
65	62	63	60	60	58	57	55	15	22	32	44	60	82	
59	47	57	45	54	44	52	42	13	19	27	39	53	76	
54	36	52	35	50	34	48	32	11	16	24	34	48	71	
50	28	48	27	46	26	44	25	9	13	20	29	44	
46	22	44	21	42	20	40	19	8	12	17	25	40	
41	17	40	16	38	15	37	14	7	11	15	22	37	
38	13	37	12	35	11 1/2	34	11	6	9	13	19	34	
35	9	34	8 1/2	32	8	31	7 1/2	5	7	11	16	
32	6 1/2	31	6	30	5 1/2	29	5	4	5 1/2	9	14	
30	4 1/2	29	4 1/4	28	3 3/4	27	3 1/2	3	5	7	12	
28	3 1/4	27	3	26	2 3/4	25	2 1/2	2 1/2	4 1/2	6 1/2	11	

Estimated Displacement, Horse-power, etc., of Steam-vessels of Various Sizes.

Length, feet, L	Breadth, feet, B	Draught, feet, D	Coefficient of Fineness, C	Displacement, $\frac{LBD \times C}{35}$ tons.	Wetted Surface $L(1.7D + BC)$ sq. ft.	Estimated Horse-power at 10 knots.		Diam. of Screw for 10, knots speed and 100 revs. per minute.	
						Calc. from Displacement.	Calc. from Wetted Surface.	If Pitch = Diam.	If Pitch = 1.4 Diam.
12	3	1.5	0.55	0.85	48	4.3	2.4	4.4	3.6
16	3	1.5	.55	1.13	64	5.2	3.2	4.6	3.8
	4	2	.65	2.38	96	8.9	4.8	5.1	4.2
20	3	1.5	.55	1.41	80	6.0	4.0	4.7	3.9
	4	2	.65	2.97	120	10.3	6.0	5.3	4.3
24	3.5	1.5	.55	1.98	104	7.5	5.2	5	4.1
	4.5	2	.65	4.01	152	12.6	7.6	5.5	4.5
30	4	2	.55	3.77	168	11.5	8.4	5.4	4.4
	5	2.5	.65	6.96	224	18.2	11.2	5.9	4.8
40	4.5	2	.55	5.66	235	15.1	11.8	5.7	4.7
	6	2.5	.65	11.1	326	24.9	16.3	6.3	5.2
50	6	3	.55	14.1	420	27.8	21.0	6.4	5.4
	8	3.5	.65	26	558	43.9	27.9	7.1	5.8
60	8	3.5	.55	26.4	621	42.2	31.1	7.0	5.7
	10	4	.65	44.6	798	62.9	39.9	7.6	6.2
70	10	4	.55	44	861	59.4	43.1	7.5	6.1
	12	4.5	.65	70.2	1082	85.1	54.1	8.1	6.6
80	12	4.5	.55	67.9	1140	79.2	57.0	7.9	6.5
	14	5	.65	104.0	1408	111	70.4	8.5	7.0
90	13	5	.55	91.9	1408	97	70.4	8.3	6.8
	16	6	.65	160	1854	147	92.7	9	7.3
100	13	5	.55	102	1565	104	78.3	8.4	6.9
	15	5.5	.65	153	1910	143	95.5	8.9	7.3
120	17	6	.75	219	2295	202	115	9.6	7.8
	14	5.5	.55	145	2046	131	102	8.8	7.2
140	16	6	.65	214	2472	179	124	9.4	7.6
	18	6.5	.75	301	2946	250	147	10	8.2
160	16	6	.55	211	2660	169	133	9.2	7.4
	18	6.5	.65	306	3185	227	159	9.8	8.0
180	20	7	.75	420	3766	312	188	10.5	8.5
	17	6.5	.55	278	3264	203	163	9.6	7.8
200	19	7	.65	395	3880	269	194	10.1	8.3
	21	7.5	.75	540	4560	368	228	10.8	8.8
220	20	7	.55	396	4122	257	206	10.1	8.2
	22	7.5	.65	552	4869	337	243	10.6	8.7
240	24	8	.75	741	5688	455	284	11.3	9.2
	22	7	.55	484	4800	257	240	10.1	8.2
260	25	8	.65	743	5970	373	299	10.8	8.8
	28	9	.75	1080	7260	526	363	11.6	9.5
280	28	8	.55	880	7250	383	363	10.9	8.9
	32	10	.65	1486	9450	592	473	11.9	9.7
300	36	12	.75	2314	11850	875	593	12.8	10.5
	32	10	.55	1509	10380	548	519	11.7	9.6
350	36	12	.65	2407	13140	806	657	12.6	10.4
	40	14	.75	3600	17140	1175	857	13.6	11.1
400	38	12	.55	2508	14455	769	723	12.5	10.2
	42	14	.65	3822	17885	1111	894	13.5	11.0
450	46	16	.75	5520	21595	1562	1080	14.4	11.8
	44	14	.55	3872	19200	1028	960	13.3	10.8
500	48	16	.65	5705	23360	1451	1168	14.2	11.6
	52	18	.75	8023	27840	2006	1392	15.2	12.4
550	50	16	.55	5657	24515	1221	1226	13.7	11.2
	54	18	.65	8123	29565	1616	1478	14.5	11.9
600	58	20	.75	11157	34875	2171	1744	15.4	12.6
	52	18	.55	7354	29600	1454	1480	14.2	11.6
650	56	20	.65	10400	35200	1966	1760	15.1	12.4
	60	22	.75	14143	41200	2543	2060	15.9	13.0
700	56	20	.55	9680	36245	1747	1812	14.7	12.0
	60	22	.65	13483	42735	2266	2137	15.5	12.7
750	64	24	.75	18103	49665	2998	2483	16.4	13.4
	60	22	.55	12446	42900	2065	2145	15.2	12.5
800	64	24	.65	17115	50220	2656	2511	15.4	13.1
	68	26	.75	22731	58020	3489	2901	16.9	13.8

THE SCREW-PROPELLER.

The "pitch" of a propeller is the distance which any point in a blade describing a helix will travel in the direction of the axis during one revolution, the point being assumed to move around the axis. The pitch of a propeller with a uniform pitch is equal to the distance a propeller will advance during one revolution, provided there is no slip. In a case of this kind, the term "pitch" is analogous to the term "pitch of the thread" of an ordinary single-threaded screw.

Let P = pitch of screw in feet, R = number of revolutions per second, V = velocity of stream from the propeller = $P \times R$, v = velocity of the ship in feet per second, $V - v$ = slip, A = area in square feet of section of stream from the screw, approximately the area of a circle of the same diameter, $A \times V$ = volume of water projected astern from the ship in cubic feet per second. Taking the weight of a cubic foot of sea-water at 64 lbs., and the force of gravity at 32, we have from the common formula for force of acceleration, viz.: $F = M \frac{v_1}{t} = \frac{W}{g} \frac{v_1}{t}$, or $F = \frac{W}{g} v_1$, where 1 second.

Thrust of screw in pounds = $\frac{64 AV}{32} (V - v) = 2 AV (V - v)$.

Rankine (Rules, Tables, and Data, p. 275) gives the following: To calculate the thrust of a propelling instrument (jet, paddle, or screw) in pounds, multiply together the transverse sectional area, in square feet, of the stream driven astern by the propeller; the speed of the stream relatively to the ship in knots; the real slip, or part of that speed which is impressed on the stream by the propeller, also in knots; and the constant 5.66 for sea-water, or 5.5 for fresh water. If S = speed of the screw in knots, s = speed of ship in knots, A = area of the stream in square feet (of sea-water).

Thrust in pounds = $A \times S (S - s) \times 5.66$.

The real slip is the velocity (relative to water at rest) of the water projected sternward; the apparent slip is the difference between the speed of the ship and the speed of the screw; i.e., the product of the pitch of the screw by the number of revolutions.

This apparent slip is sometimes negative, due to the working of the screw in disturbed water which has a forward velocity, following the ship. Negative apparent slip is an indication that the propeller is not suited to the ship. The apparent slip should generally be about 8% to 10% at full speed in well-formed vessels with moderately fine lines; in bluff cargo boats it rarely exceeds 5%.

The effective area of a screw is the sectional area of the stream of water laid hold of by the propeller, and is generally, if not always, greater than the actual area, in a ratio which in good ordinary examples is 1.2 or thereabouts, and is sometimes as high as 1.4; a fact probably due to the stiffness of the water, which communicates motion laterally amongst its particles. (Rankine's Shipbuilding, p. 89.)

Prof. D. S. Jacobus, *Trans. A. S. M. E.*, xi, 1028, found the ratio of the effective to the actual disk area of the screws of different vessels to be as follows:

Tug-boat, with ordinary true-pitch screw	1.42
Tug-boat, with screw having blades projecting backward	0.57
Ferryboat "Bergen," with ordinary true-pitch screw	1.53
Steamer "Homer Ramsdell," with ordinary true-pitch screw	1.20

Size of Screw. — Seaton says: The size of a screw depends on so many things that it is very difficult to lay down any rule for guidance, and much must always be left to the experience of the designer, to allow for all the circumstances of each particular case. The following rules are given for ordinary cases (Seaton and Rounthwaite's Pocket-book):

P = pitch of propeller in feet = $\frac{10133 S}{R (100 - x)}$, in which S = speed in

knots, R = revolutions per minute, and x = percentage of apparent slip. For a slip of 10%, pitch = $112.6 S \div R$.

D = diameter of propeller = $K \sqrt{\frac{I.H.P.}{\left(\frac{P \times R}{100}\right)^3}}$, K being a coefficient given

in the table below. If $K = 20$, $D = 20,000 \sqrt{\frac{I.H.P.}{(P \times R)^3}}$.

Total developed area of blades = $C \sqrt{I.H.P. \div R}$, in which C is a coefficient to be taken from the table.

Another formula for pitch, given in Seaton's Marine Engineering, is $P = \frac{C}{R} \sqrt{\frac{I.H.P.}{D^2}}$, in which $C = 737$ for ordinary vessels, and 660 for slow-speed cargo vessels with full lines.

Thickness of blade at root = $\sqrt{\frac{d^3}{nb}} \times k$, in which d = diameter of tail shaft in inches, n = number of blades, b = breadth of blade in inches where it joins the boss, measured parallel to the shaft axis; $k = 4$ for cast iron, 1.5 for cast steel, 2 for gun-metal, 1.5 for high-class bronze.

Thickness of blade at tip: Cast iron $0.04 D + 0.4$ in.; cast steel $0.03 D + 0.4$ in.; gun-metal $0.03 D + 0.2$ in.; high-class bronze $0.02 D + 0.3$ in., where D = diameter of propeller in feet.

Propeller Coefficients.

Description of Vessel.	Approximate Speed in knots.	Number of Screws.	Number of Blades per Screw.	Values of K .	Values of C .	Usual Material of Blades.
Bluff cargo boats	8-10	One	4	17-17.5	19-17.5	Cast iron
Cargo, moderate lines	10-13	"	4	18-19	17-15.5	"
Pass. and mail, fine lines	13-17	"	4	19.5-20.5	15-13	C.I. or S.
" " " very fine	13-17	Twin	4	20.5-21.5	14.5-12.5	"
" " " "	17-22	One	4	21-22	12.5-11	G.M. or B.
" " " "	17-22	Twin	3	22-23	10.5-9	"
Naval vessels	16-22	"	4	21-22.5	11.5-10.5	"
" " " "	16-22	"	3	22-23.5	8.5-7	"
Torpedo-boats	20-26	One	3	25	7-6	B. or F.S.

C. I., cast iron; G. M., gun-metal; B., bronze; S., steel; F.S., forged steel.

From the formulae $D = 20,000 \sqrt{\frac{I.H.P.}{(P \times R)^3}}$ and $P = \frac{737 I.H.P.}{R D^2}$, if

$P = D$ and $R = 100$, we obtain $D = \sqrt[5]{400 \times I.H.P.} = 3.31 \sqrt[5]{I.H.P.}$.

If $P = 1.4 D$ and $R = 100$, then $D = \sqrt[5]{145.8 \times I.H.P.} = 2.71 \sqrt[5]{I.H.P.}$.

From these two formulae the figures for diameter of screw in the table on page 1323 have been calculated. They may be used as rough approximations to the correct diameter of screw for any given horse-power, for a speed of 10 knots and 100 revolutions per minute.

For any other number of revolutions per minute multiply the figures in the table by 100 and divide by the given number of revolutions. For any other speed than 10 knots, since the I.H.P. varies approximately as the cube of the speed, and the diameter of the screw as the 5th root of the I.H.P., multiply the diameter given for 10 knots by the 5th root of the cube of one-tenth of the given speed. Or, multiply by the following factors:

For speed of knots:	4	5	6	7	8	9	11	12	13	14	15	16
$\sqrt[5]{(S + 10)^3}$	0.577	0.660	0.736	0.807	0.875	0.939	1.059	1.116	1.170	1.224	1.275	1.327

Speed:

17	18	19	20	21	22	23	24	25	26	27	28
$\sqrt[5]{(S \div 10)^3}$											
1.375	1.423	1.470	1.515	1.561	1.605	1.648	1.691	1.733	1.774	1.815	1.855

For more accurate determinations of diameter and pitch of screw, the formulæ and coefficients given by Seaton, quoted above, should be used.

Efficiency of the Propeller. — According to Rankine, if the slip of the water be s , its weight W , the resistance R , and the speed of the ship v ,
 $R = Ws \div g$; $Rv = Wsv \div g$.

This impelling action must, to secure maximum efficiency of propeller, be effected by an instrument which takes hold of the fluid without shock or disturbance of the surrounding mass, and, by a steady acceleration, gives it the required final velocity of discharge. The velocity of the propeller overcoming the resistance R would then be
 $[v + (v + s)] \div 2 = v + s/2$;

and the work performed would be
 $R(v + s/2) = Wvs \div g + Ws^2 \div 2g$,

the first of the last two terms being useful, the second the minimum lost work; the latter being the wasted energy of the water thrown backward. The efficiency is $E = v \div (v + s/2)$; and this is the limit attainable with a perfect propelling instrument, which limit is approached the more nearly as the conditions above prescribed are the more nearly fulfilled. The efficiency of the propelling instrument is probably rarely much above 0.60, and never above 0.80.

In designing the screw-propeller, as was shown by Dr. Froude, the best angle for the surface is that of 45° with the plane of the disk; but as all parts of the blade cannot be given the same angle, it should, where practicable, be so proportioned that the "pitch-angle at the center of effort" should be made 45° . The maximum possible efficiency is then, according to Froude, 77%.

In order that the water should be taken on without shock and discharged with maximum backward velocity, the screw must have an axially increasing pitch.

The true screw is by far the more usual form of propeller, in all steamers, both merchant and naval. (Thurston, Manual of the Steam-engine, part ii, p. 176.)

The combined efficiency of screw, shaft, engine, etc., is generally taken at 50%. In some cases it may reach 60% or 65%. Rankine takes the effective H.P. to equal the I.H.P. $\div 1.63$.

Results of Researches on the efficiency of screw-propellers are summarized by S. W. Barnaby, in a paper read before section G of the Engineering Congress, Chicago, 1893. He states that the following general principles have been established:

(a) There is a definite amount of real slip at which, and at which only, maximum efficiency can be obtained with a screw of any given type, and this amount varies with the pitch-ratio. The slip-ratio proper to a given ratio of pitch to diameter has been discovered and tabulated for a screw of a standard type, as below:

Pitch-ratio and Slip for Screws of Standard Form.

Pitch-ratio.	Real Slip of Screw.	Pitch-ratio.	Real Slip of Screw.	Pitch-ratio.	Real Slip of Screw.
0.8	15.55	1.4	19.5	2.0	22.9
0.9	16.22	1.5	20.1	2.1	23.5
1.0	16.88	1.6	20.7	2.2	24.0
1.1	17.55	1.7	21.3	2.3	24.5
1.2	18.2	1.8	21.8	2.4	25.0
1.3	18.8	1.9	22.4	2.5	25.4

(b) Screws of large pitch-ratio, besides being less efficient in themselves, add to the resistance of the hull by an amount bearing some proportion to their distance from it, and to the amount of rotation left in the race.

(c) The best pitch-ratio lies probably between 1.1 and 1.5.

(d) The fuller the lines of the vessel, the less the pitch-ratio should be.

(e) Coarse-pitched screws should be placed further from the stern than fine-pitched ones.

(f) Apparent negative slip is a natural result of abnormal proportions of propellers.

(g) Three blades are to be preferred for high-speed vessels, but when the diameter is unduly restricted, four or even more may be advantageously employed.

(h) An efficient form of blade is an ellipse having a minor axis equal to four-tenths the major axis.

(i) The pitch of wide-bladed screws should increase from forward to aft, but a uniform pitch gives satisfactory results when the blades are narrow, and the amount of the pitch variation should be a function of the width of the blade.

(j) A considerable inclination of screw-shaft produces vibration, and with right-handed twin-screws turning outwards, if the shafts are inclined at all, it should be upwards and outwards from the propellers.

For results of experiments with screw-propellers, see F. C. Marshall, *Proc. Inst. M. E.*, 1881; R. E. Froude, *Trans. Inst. Nav. Archs.*, 1886; G. A. Calvert, *Trans. Inst. Nav. Archs.*, 1887; S. W. Barnaby, *Proc. Inst. C. E.*, 1890, vol. cii, and D. W. Taylor's "Resistance of Ships and Screw Propulsion." Also Mr. Taylor's paper in *Proc. Soc. Nav. Arch. & Marine Engrs.*, 1904. Mr. Taylor found the highest efficiencies, exceeding 70%, in propellers with pitch ratios from 1.0 to 1.5 ratio of width of blade to diameter of $1/8$ to $1/5$, and ratio of developed area of blade to disk area of 0.201 to 0.322.

One of the most important results deduced from experiments on model screws is that they appear to have practically equal efficiencies throughout a wide range both in pitch-ratio and in surface-ratio; so that great latitude is left to the designer in regard to the form of the propeller. Another important feature is that, although these experiments are not a direct guide to the selection of the most efficient propeller for a particular ship, they supply the means of analyzing the performances of screws fitted to vessels, and of thus indirectly determining what are likely to be the best dimensions of screw for a vessel of a class whose results are known. Thus a great advance has been made on the old method of trial upon the ship itself, which was the origin of almost every conceivable erroneous view respecting the screw-propeller. (*Proc. Inst. M. E.*, July, 1891.)

Mr. Barnaby in *Proc. Inst. C. E.*, 1890, gives a table to be used in calculations for determining the best dimensions of screws for any given speed and H.P. from which the following table is abridged. It is deduced from Froude's experiments at Torquay. (*Trans. Inst. Nav. Archs.*, 1886.)

C_A = disk area in sq. ft. $\times V^3/H.P.$ C_R = revs. per min. $\times D/V$.
 V = speed in knots, D = diam. of screw in ft. H.P. = effective H.P. on the screw shaft. Disk area = $0.7854 D^2 = C_A \times I.H.P./V^3$. Revs. per min. = $C_R \times V/D$. The constants C_A and C_R assume a standard value of the speed of the wake, equal to 10% of the speed of the ship. In a very full ship it may amount to 30%, therefore V should be reduced when using the constants by amounts varying from 20% to 0 as the form varies from "very full" to "fairly fine."

Effy. of Screw, %.	63		67		68		69		68		65		63	
	C_A	C_R	C_A	C_R	C_A	C_R	C_A	C_R	C_A	C_R	C_A	C_R	C_A	C_R
0.80	468	122	304	128	215	134	157	142	115	150	86	160	65	171
1.00	546	99	355	104	251	109	184	115	135	123	100	131	76	140
1.20	625	83	405	87	288	92	210	97	154	104	115	111	87	119
1.40	704	72	456	76	325	80	236	85	173	90	129	97	98	104
1.60	780	63	507	67	360	71	263	75	193	80	144	87	109	93
1.80	558	60	396	64	290	68	212	73	159	78	120	84
2.00	609	55	432	58	315	62	231	67	173	72	131	77
2.20	660	50	469	54	342	57	250	62	187	67	142	72
2.40	710	47	505	50	369	53	270	57	202	62	153	67

Dimensions and Performances of Notable Atlantic Steamers (Eng'g, Aug. 2, 1907).

Name.	Date.	Length, ft.*	Breadth, ft.	Depth, ft.	Draft, ft.	Displacement, t.	Gross Tonnage, t.	Steam Pressure.	Indicated H.P.	Speed on Trial, Knots.	Cylinders, diam., ins.	Stroke, ins.	Heating Surface, sq. ft.	Grate Surface, sq. ft.
Great Eastern.....	1858	680	80	83	57.5	27	24.4	30	7,650	14.5	Screw, 4, 84; paddle, 4, 74
Britannic.....	1874	455	45	36	23.5	8.5	5	70	5,500	16	2, 48; 2, 83	60
Arizona.....	1879	450	45	37.5	22	5	90	6,300	17	1, 62; 2, 90	66
Servia.....	1881	515	52	40.5	23.2	9.9	7.4	90	10,300	17	1, 72; 2, 100	78	27,483	1014
Alaska.....	1881	500	50	39.7	22	6.9	100	10,500	18	1, 68; 2, 100	72
City of Rome.....	1881	543	52	38.8	22	11.2	8.1	90	11,900	18.2	3, 46; 3, 86	72	29,286	1398
Oregon.....	1883	500	54	40	23	10.5	7.4	110	13,300	18.3	1, 70; 2, 104	72	38,047	1428
Umbria.....	1884	500	57	40	22.5	10.5	7.7	110	14,320	20.18	1, 71; 2, 105	72	38,817	1666
Paris.....	1888	528	63	41.1	23	13	10.5	150	20,000	21.8	2, 45; 2, 71; 2, 113	60	50,265	1293
Teutonic.....	1890	565	57.5	42.2	22	12	9.7	180	19,500	21	2, 43; 2, 68; 2, 110	60	40,072	1154
Campania.....	1893	600	65	41.5	23	18	12.5	165	30,000	22.01	4, 37; 2, 79; 4, 98	69	82,000	2630
Kais. Wilhelm d. Grosse	1897	625	66	43	28	20.9	14.3	178	30,000	22.5	2, 52; 2, 89; 4, 96	69	84,285	2618
Oceanic.....	1899	685	68.5	49.0	32.5	28.5	17.3	192	27,000	20.72	2, 47 1/2; 2, 79; 4, 93	72	74,686	1962
Deutschland.....	1901	663	67	44	29	23.6	16.5	220	36,000	23.5	4, 36.6; 2, 73.6; 2, 103.9; 4, 106.3	73	85,468	2188
Kaiser Wilhelm II.....	1903	678	72	52.5	29	26	20	225	38,000	23.5	4, 37.4; 4, 49.2; 4, 74.8; 4, 112.2	71	107,643	3121
Lusitania.....	1907	760	88	60.4	33.5	38	32.5	195	68,000	25	Turbines	158,350	4048

* Between perpendiculars. † Thousands of tons.

Relative Economy of Turbines and Reciprocating Engine. (C. A. Parsons, *Trans. Inst. Nav. Archs.*, 1910.)—The "Vespasian," a cargo vessel 275 ft. long, 38 ft. 9 in. breadth, 19 ft. 8 in. mean loaded draught, 4350 tons displacement, was at first fitted with a triple-expansion engine, cylinders 22 1/4, 35 and 59 ins., 42-in. stroke; and afterwards with two Parsons turbines, high and low pressure, each connected by a flexible coupling to a 20-tooth pinion, the two pinions gearing into a wheel 8 ft. 3 in. pitch diam., with 398 double helical teeth, 20° angle, 24 in. face, the gear ratio being 19.9 to 1. The boilers, propeller, shafting and thrust block remained the same as with the reciprocating engine. Tests were made before and after the installation of the turbines with the following results: At a speed of 8.87 knots the reciprocating engine used 11,750 lbs. of water per hour, as against 10,750 lbs. taken by the turbines — a saving of 8.5%; at 9.55 knots the figures were 14,500 and 12,600, respectively — a saving of 13.0%; at 10.2 knots, 17,500 and 14,750 lbs., respectively — a saving of 16.0%.

Marine Practice, 1901.—The following tables and "summary of results" are taken from a paper on "Review of Marine Engineering in the Last Ten Years," by Jas. McKechnie, *Proc. Inst. M. E.*, 1901: *Eng. News*, Aug. 29, 1901.
Particulars of Cargo Steamers for North Atlantic Trade, to illustrate Fuel Economy of Large-Capacity Ships. (All are three-decked vessels, with shelter deck, to Class 100 A1 at Lloyd's. Speed of all at sea, 13 knots.)

Dimensions.	Draft, ft. ins.	Displacement, tons.	Co-eff. of Displacement.	Dead-weight, tons.	I.H.P.	D ² /s constant.	Immersed.		Coal: 100 ton-miles,* lbs.
							Area, sq. ft.	Girth, ft.	
390' x 45' 9" x 29' 6"	24	6 1/2	8,640	0.69	5,000	266	1,092	87.8	8.0
415' x 48' 9" x 31' 0"	25	6	10,240	0.696	6,000	277	1,209	92.46	7.1
438' x 51' 5" x 32' 8"	26	3 1/2	11,870	0.702	7,000	287	1,314	96.46	6.5
458' x 55' 9" x 34' 0"	27	0 1/2	13,500	0.71	8,000	295	1,412	103.0	5.05
475' x 55' 9" x 35' 5"	27 1/2	1 1/2	15,100	0.715	9,000	300	1,513	103.64	5.7
495' x 58' 0" x 36' 7"	28	7	16,750	0.72	10,000	305	1,610	107.0	5.42
521' x 61' 2" x 38' 9"	30	0	19,850	0.728	12,000	311	1,780	112.8	4.97
555' x 62' 9" x 39' 9"	30	7	21,470	0.732	13,000	313	1,862	115.4	4.8
548' x 64' 1" x 40' 9"	31	3	23,070	0.736	14,000	314	1,946	118.0	4.66
570' x 66' 9" x 42' 4"	32	4 1/2	26,150	0.742	16,000	316	2,097	122.5	4.4

* The rate of coal consumption is assumed in all cases at 1.5 lbs. per I.H.P. per hour.

Comparison of Marine Engines for the Years 1872, 1881, 1891, 1901.

Boilers, Engines and Coal.	Average Results.			
	1872.	1881.	1891.	1901.
Boiler press., lbs. per sq. in.....	52.4	77.4	158.5	197
Heating surface, per sq. ft. grate.....	4.41	30.4	31.0	38 & 43*
Heat'g surf., per I.H.P., sq. ft.....	3.917	3.275	3.0
Coal, per sq. ft. of grate, lbs. per hr.....	55.67	13.8	15.0	18 & 28*
Revolutions per minute.....	376	59.76	63.75	87
Piston speed, ft. per min.....	467	467	529	654
Coal per I.H.P. per hr., lbs.....	2.11	1.83	1.52	1.48
Av. consumption, long voyage.....	2.0	1.75	1.55

* Natural and forced draft respectively.

Summary of Results.—Steam pressures have been increased in the merchant marine from 158 lbs. to 197 lbs. per sq. in., the maximum attained being 267 lbs. per sq. in., and 300 lbs. in the naval service. The piston speed of merchant machinery has gone up from 529 to 654 ft. per minute, the maximum in merchant practice being about 900 ft. and in naval practice 960 ft. for large engines, and 1300 ft. in torpedo-boat destroyers. Boilers also yield a greater power for a given surface, and thus the average power per ton of machinery has gone up from an average of 6 to about 7 I.H.P. per ton of machinery. The net result in respect of speed is that while ten years ago the highest sustained ocean speed was 20.7 knots, it is now 23.38 knots; the highest speed for large warships was 22 knots and is now 23 knots on a trial of double the duration of those of ten years ago; the maximum speed attained by any craft was 25 knots, as compared with 36.581 knots now, while the number of ships of over 20 knots was 8 in 1891, and is 58 now (1901).

WARNING: This is a 1910 edition. Some of the material may no longer be accurate

Turbines and Boilers of the "Lusitania." (Thomas Bell, *Proc. Inst. Nav. Archts.*, 1908.)—Some of the principal dimensions of the turbines and boilers of the "Lusitania" are as follows:

Turbines.	Diameter of Rotor, ins.	Length of Blades, ins.	
		In First Expansion.	In Last Expansion.
H.P.	96	23/4	123/8
L.P.	140	81/4	22
Astern	104	21/4	8

Total cooling surface, main condensers, 82,800 sq. ft.; area of exhaust inlet, 158 sq. ft.; bore of circulating discharge pipes, 32 ins.

BOILERS.—Working pressure, 195 lbs. per sq. in.; 23 double-ended boilers, 17 ft. 6 in. mean diameter by 22 ft. long; 2 single-ended boilers, 17 ft. 6 in. mean diameter by 11 ft. 4 in. long; total number of furnaces, 192; total grate surface, 4048 sq. ft.; total heating surface, 158,352 sq. ft.; total length of boiler-rooms, 336 ft.; total length of main and auxiliary engine rooms, 149 ft. 8 in.

The following are the weights of the various revolving parts, together with the size of bearings and the pressure:

Weight of one H.P. turbine rotor complete, 86 tons; one L.P. rotor, 120 tons; one astern rotor, 62 tons.

	Main Bearing Journals.		Pressure Per Sq. In. of Bearing Surface.	At 190 Revs. Surface Speed of Journal.
	Diameter.	Effective Length.		
H.P. rotor	27 1/8 in.	44 3/4 in.	80 lbs.	1350 ft. per min.
L.P. rotor	33 1/8 in.	56 1/2 in.	72 lbs.	1650 ft. per min.
Astern rotor	24 1/8 in.	34 3/4 in.	83 lbs.	1200 ft. per min.

Performance of the "Lusitania." (Thos. Bell, *Proc. Inst. Nav. Archts.*, 1908; *Power*, May 12, 1908.)—The following records were obtained in the official trials:

Speed in knots	15.77	18	21	23	25.4
Shaft horse-power	13,400	20,500	33,000	48,000	68,850
Steam cons. per shaft, H.P. hr.					
of turbines, lbs.	21.23	17.24	14.91	13.92	12.77
of auxiliaries, lbs.	5.3	3.72	2.6	2.01	1.69
total lbs.	26.53	20.96	17.51	15.93	14.46
Temperature of feed water, °F.	200	200	199	179	165
Coal cons. lbs. per shaft H.P. hr.	2.52	2.01	1.68	1.56	1.43
Estimated steam and coal consumption under service conditions, at same speeds:					
Steam cons. of auxiliaries, per shaft H.P. hr., lbs.	6.97	4.92	3.41	2.65	2.17
Steam cons. of total per shaft H.P. hr., lbs.	28.20	22.16	18.32	16.57	14.94
Coal cons., lbs. per shaft H.P. hr., lbs.	2.76	2.17	1.8	1.62	1.46
Est. coal cons., on a voyage of 3100 nautical miles, gross tons	3,270	3,440	3,930	4,700	5,490

The following figures are taken from the records of a voyage from Queenstown to Sandy Hook, 2781 nautical miles, Nov. 3-8, 1908, 4 days, 18 hrs. 40 m.: Averages: Steam pressure at boilers, 168 lbs.; temperature hot-well, 74.5°; feed water, 197°; vacuum, 28.1 in.; speed, 24.25 knots;

speed, best day, 24.8 knots; revolutions, 181.1; slip, 15.9%. Total coal, 4976 tons. Steam consumption: main turbines, 851,500 lbs., = 13.1 lbs. per shaft H.P. hr. (on a basis of 65,000 shaft H.P.); auxiliary machinery, 114,000 lbs., = 1.75 per H.P. hr.; evaporating plant and heating, 32,500 lbs., = 0.5 lb. per H.P. hr. Total, 998,000 lbs., = 15.35 lbs. per shaft H.P. hour. Average coal burned, 43 1/2 tons per hour. Water evaporated per lb., coal 10.2 lbs. from feed at 196°, = 10.9 lbs. from and at 212°. Coal for all purposes per shaft H.P. hour, 1.5 lbs. Coal per sq. ft. of grate per hour, 24.1 lbs. The coal was half Yorkshire and half South Wales.

In September, 1909, the "Lusitania" made the westward passage, 2784 miles from Daunt's Rock near Queenstown to Ambrose Channel Lightship, off Sandy Hook, in 4 days 11 h. 42 m., averaging 25.85 knots for the entire passage. Four successive days' runs, from noon to noon, were 650, 652, 651 and 674 miles.

Relation of Horse-Power to Speed.—If S_1 and S_2 are two successive speeds and P_1, P_2 the corresponding horse-powers, then to find the value of the exponent x in the equation $H.P. \propto S^x$, we have

$$x = (\log P_2 - \log P_1) \div (\log S_2 - \log S_1).$$

Applying this formula to the horse-powers and speeds of the "Lusitania" we find that between 15.77 and 18 knots $x = 3.21$; between 18 and 21 knots $x = 3.09$; between 21 and 23 knots $x = 4.12$; between 23 and 25.4 knots $x = 3.63$.

Reciprocating Engines with a Low-Pressure Turbine.—The "Laurentic," built for the Canadian trade of the White Star Line, 14,000 tons gross register, is a triple-screw steamer, with the two outer screws driven by four-cylinder triple-expansion engines, and the central screw by a Parsons turbine. The steam, of 200 lbs. boiler pressure, first passes to the reciprocating engines, where it expands to from 14 to 17 lbs. absolute, and then passes to the turbine. For manœvering the ship into and out of port the turbine is not used, and the steam passes directly from the engines to the condensers. During the trial trip the combined engine-turbine outfit developed 12,000 H.P., with a speed of 17 1/2 knots, and showed a coal consumption of 1.1 lbs. and a water consumption of 11 lbs. per indicated horse-power hour. (*Power*, May 18, 1909.)

The "Kronprinzessin Cecilie" of the North German Lloyd Co., is probably the last high-speed transatlantic steamer of very great power that will be built with reciprocating engines. Its dimensions are: length, 706 ft.; beam, 72 ft.; depth, 44 ft. 2 in.; displacement, 26,000 tons. Four 12,000 H.P. engines, two on each shaft, in tandem. Cylinders, 37 3/8, 49 1/4, 74 7/8 and 112 1/4 ins., by 6 ft. stroke. Steam, 230 lbs., delivered from 19 cylindrical boilers, through four 17-in. steam pipes. Coal used in 24 hours, 764 tons, in 124 furnaces; 1.4 lbs. per H.P. hour, including auxiliaries. Speed on trial trip on a 60-mile course, 24.02 knots. (*Sci. Am.*, Aug. 24, 1907.)

THE PADDLE-WHEEL.

Paddle-wheels with Radial Floats. (Seaton's Marine Engineering.)—The effective diameter of a radial wheel is usually taken from the centers of opposite floats; but it is difficult to say what is absolutely that diameter, as much depends on the form of float, the amount of dip, and the waves set in motion by the wheel. The slip of a radial wheel is from 15 to 30 per cent, depending on the size of float.

$$\text{Area of one float} = C \times \text{I.H.P.} \div D.$$

D is the effective diameter in feet, and C is a multiplier, varying from 0.25 in tugs to 0.175 in fast-running light steamers.

The breadth of the float is usually about 1/4 its length, and its thickness about 1/8 its breadth. The number of floats varies directly with the diameter, and there should be one float for every foot of diameter.

(For a discussion of the action of the radial wheel, see Thurston, *Manual of the Steam-engine*, part II, p. 182.)

Feathering Paddle-wheels. (Seaton.)—The diameter of a feathering-wheel is found as follows: The amount of slip varies from 12 to 20 per cent, although when the floats are small or the resistance great it is as high as 25 per cent; a well-designed wheel on a well-formed ship should not exceed 15 per cent under ordinary circumstances.

If K is the speed of the ship in knots, S the percentage of slip, and R the revolutions per minute,

$$\text{Diameter of wheel at centers} = K(100 + S) \div (3.14 \times R).$$

The diameter, however, must be such as will suit the structure of the ship, so that a modification may be necessary on this account, and the revolutions altered to suit it.

The diameter will also depend on the amount of "dip" or immersion of float.

When a ship is working always in smooth water the immersion of the top edge should not exceed $1/3$ the breadth of the float; and for general service at sea an immersion of $1/2$ the breadth of the float is sufficient. If the ship is intended to carry cargo, the immersion when light need not be more than 2 or 3 inches, and should not be more than the breadth of float when at the deepest draught; indeed, the efficiency of the wheel falls off rapidly with the immersion of the wheel.

$$\text{Area of one float} = C \times \text{I.H.P.} \div D.$$

C is a multiplier, varying from 0.3 to 0.35; D is the diameter of the wheel to the float centers, in feet.

- The number of floats = $1/2(D + 2)$.
- The breadth of the float = $0.35 \times$ the length.
- The thickness of floats = $1/12$ the breadth.
- Diameter of gudgeons = thickness of float.

Seaton and Rounthwaite's Pocket-book gives:

$$\text{Number of floats} = 60 \div \sqrt{R},$$

where R is number of revolutions per minute.

$$\text{Area of one float (in square feet)} = \frac{\text{I.H.P.} \times 33,000 \times K}{N \times (D \times R)^2},$$

where N = number of floats in one wheel.

For vessels plying always in smooth water $K = 1200$. For sea-going steamers $K = 1400$. For tugs and such craft as require to stop and start frequently in a tide-way $K = 1600$.

It will be quite accurate enough if the last four figures of the cube $(D \times R)^3$ be taken as ciphers.

For illustrated description of the feathering paddle-wheel see Seaton's Marine Engineering, or Seaton and Rounthwaite's Pocket-book. The diameter of a feathering-wheel is about one-half that of a radial wheel for equal efficiency. (Thurston.)

Efficiency of Paddle-wheels. — Computations by Prof. Thurston of the efficiency of propulsion by paddle-wheels give for light river steamers with ratio of velocity of the vessel, v , to velocity of the paddle-float at center of pressure, V , or v/V , = $3/4$, with a dip = $3/20$ radius of the wheel and a slip of 25 per cent, an efficiency of 0.714; and for ocean steamers with the same slip and ratio of v/V , and a dip = $1/3$ radius, an efficiency of 0.685.

JET-PROPULSION.

Numerous experiments have been made in driving a vessel by the reaction of a jet of water pumped through an orifice in the stern, but they have all resulted in commercial failure. Two-jet propulsion steamers, the "Waterwitch," 1100 tons, and the "Squirt," a small torpedo-boat, were built by the British Government. The former was tried in 1867, and gave an efficiency of apparatus of only 18 per cent. The latter gave a speed of 12 knots, as against 17 knots attained by a sister-ship having a screw and equal steam-power. The mathematical theory of the efficiency of the jet was discussed by Rankine in *The Engineer*, Jan. 11, 1867, and he showed that the greater the quantity of water operated on by a jet-propeller, the greater is the efficiency. In defiance both of the theory and of the results of earlier experiments, and also of the opinions of many naval engineers, more than \$200,000 were spent in 1888-90 in New York upon two experimental boats, the "Prima Vista" and the "Evolution," in which the jet was made of very small size, in the latter case only $5/8$ -inch diameter, and with a pressure of 2500 lbs. per square inch. As had been predicted, the vessel was a total failure. (See article by the author in *Mechanics*, March, 1891.)

The theory of the jet-propeller is similar to that of the screw-propeller. If A = the area of the jet in square feet, V its velocity with reference to the orifice, in feet per second, v = the velocity of the ship in reference to

the earth, then the thrust of the jet (see Screw-propeller, ante) is $2AV(V - v)$. The work done on the vessel is $2AV(V - v)v$, and the work wasted on the rearward projection of the jet is $1/2 \times 2AV(V - v)^2$.

The efficiency is $\frac{2AV(V - v)v + AV(V - v)^2}{2AV(V - v)v} = \frac{2v}{V + v}$. This expression

equals unity when $V = v$, that is, when the velocity of the jet with reference to the earth, or $V - v = 0$; but then the thrust of the propeller is also 0. The greater the value of V as compared with v , the less the efficiency. For $V = 20v$, as was proposed in the "Evolution," the efficiency of the jet would be less than 10 per cent, and this would be further reduced by the friction of the pumping mechanism and of the water in pipes.

The whole theory of propulsion may be summed up in Rankine's words: "That propeller is the best, other things being equal, which drives astern the largest body of water at the lowest velocity."

It is practically impossible to devise any system of hydraulic or jet propulsion which can compare favorably, under these conditions, with the screw or the paddle-wheel.

Reaction of a Jet. — If a jet of water issues horizontally from a vessel, the reaction on the side of the vessel opposite the orifice is equal to the weight of a column of water the section of which is the area of the orifice, and the height is twice the head.

The propelling force in jet-propulsion is the reaction of the stream issuing from the orifice, and it is the same whether the jet is discharged under water, in the open air, or against a solid wall. For proof, see account of trials by C. J. Everett, Jr., given by Prof. J. Burkitt Webb, *Trans. A. S. M. E.*, xii, 904.

CONSTRUCTION OF BUILDINGS.*

FOUNDATIONS.

Bearing Power of Soils. — Ira O. Baker, "Treatise on Masonry Construction."

Kind of Material.	Bearing Power in Tons per Square Foot.	
	Minimum.	Maximum.
Rock — the hardest — in thick layers, in native bed.	200
Rock equal to best ashlar masonry.....	25	30
Rock equal to best brick masonry.....	15	20
Rock equal to poor brick masonry.....	5	10
Clay on thick beds, always dry.....	4	6
Clay on thick beds, moderately dry.....	2	4
Clay, soft.....	1	2
Gravel and coarse sand, well cemented.....	8	10
Sand, compact, and well cemented.....	4	6
Sand, clean, dry.....	2	4
Quicksand, alluvial soils, etc.....	0.5	1

* The limitations of space forbid any extended treatment of this subject. Much valuable information upon it will be found in Trautwine's "Civil Engineers' Pocket-book" and in Kidder's "Architects' and Builders' Pocket-book." The latter in its preface mentions the following works of reference: "Notes on Building Construction," 3 vols., Rivingtons, publishers, London; "Building Superintendence," by T. M. Clark (J. R. Osgood & Co., Boston); "The American House Carpenter," and "The Theory of Transverse Strains," both by R. G. Hatfield; "Graphical Analysis of Roof-trusses," by Prof. C. E. Greene; "The Fire Protection of Mills," by C. J. H. Woodbury; "House Drainage and Water Service," by James C. Bayles; "The Builder's Guide and Estimator's Price-book," and "Plastering Mortars and Cements," by Fred. T. Hodgson; "Foundations and Concrete Works," and "Art of Building," by E. Dobson, Weale's Series, London.

The building code of Greater New York specifies the following as the maximum permissible loads for different soils:

- "Soft clay, one ton per square foot;
- "Ordinary clay and sand together, in layers, wet and springy, two tons per square foot;
- "Loam, clay or fine sand, firm and dry, three tons per square foot;
- "Very firm coarse sand, stiff gravel or hard clay, four tons per square foot, or as otherwise determined by the Commissioner of Buildings having jurisdiction."

Bearing Power of Piles. — *Engineering News Formula:* Safe load in tons = $2Wh \div (S + 1)$. W = weight of hammer in tons, h = height of fall of hammer in feet, S = penetration under last blow, or the average under last five blows.

Safe Strength of Brick Piers, exceeding six diameters in height. (Kidder.)

- Piers laid with rich lime mortar, tons per sq. in., $110 - 5H/D$.
- Piers laid with 1 to 2 natural cement mortar, $140 - 5\frac{1}{2}H/D$.
- Piers laid with 1 to 3 Portland cement mortar, $200 - 6H/D$.
- H = height; D = least horizontal dimension, in feet.

Thickness of Foundation Walls. (Kidder.)

Height of Building.	Dwellings, Hotels, etc.		Warehouses.	
	Brick.	Stone.	Brick.	Stone.
Two stories.....	Inches. 12 or 16	Inches. 20	Inches. 16	Inches. 20
Three stories.....	16	20	20	24
Four stories.....	20	24	24	28
Five stories.....	24	28	24	28
Six stories.....	28	32	28	32

MASONRY.

Allowable Pressures on Masonry in Tons per Square Foot. (Kidder.)

Different Cities.*							
	(1)	(2)	(3)	(4)	(5)	(6)	(7)
Granite, cut.....	60		72-172				40
Marble and limestone, cut.....	40		50-165				
Sandstone, hard, cut.....	30		28-115				12
Hard-burned brick in Portland cement.....		18		12 1/2	15		
Hard-burned brick in natural cement.....	15	9	15	9		15	9
Hard-burned brick in cement and lime.....	12		11 1/2		11 1/2	12	
Hard-burned brick in lime mortar.....	8	6	8	6 1/2	11	8	8
Pressed brick in Portland cement.....		12					12
Pressed brick in natural cement.....		9					12
Rubble stone in natural cement.....		5	8				10
In foundations:							
Dimension stone.....		6		5-7			30
Portland cement concrete.....		4	15			15	10
Natural cement concrete.....			8	4			4

* From building laws, (1) Boston, 1897; (2) Buffalo, 1897; (3) New York, 1899; (4) Chicago, 1893; (5) St. Louis, 1897; (6) Philadelphia, 1899; (7) Denver, 1898.

Crushing Strength of 12-in. Cubes of Concrete. (Kidder.) — Pounds per square foot. The concrete was made of 1 part Portland cement, 2 parts sand, with average concrete stone and gravel, as below.

	10 days.	45 days.	3 mos.	6 mos.	1 year.
6 parts stone.....	130,750	172,325	324,875	361,600	440,040
3 parts stone, 3 gravel.....	136,750	266,962		298,037	396,200
4 parts stone, 2 gravel.....					408,300
6 parts (3/4 stone, 1/4 granolithic).....					388,700
6 parts average gravel.....	99,900	234,475	385,612	265,550	406,700
6 parts coarse stone, no fine.....			234,475	220,350	266,300

Reinforced Concrete. — The building laws of New York, St. Louis, Cleveland and Buffalo, and the National Board of Fire Underwriters agree in prescribing the following as the maximum allowable working stresses:

Extreme fiber stress in compression in concrete.....	500 lbs. per sq. in.
Shearing stress in concrete.....	50
Direct compression in concrete.....	350
Adhesion of steel to concrete.....	50
Tensile stress in steel.....	16,000
Shearing stress in steel.....	10,000

BEAMS AND GIRDERS.

Safe Loads on Beams. — Uniformly distributed load:

$$\text{Safe load in lbs.} = \frac{2 \times \text{breadth} \times \text{square of depth} \times A}{\text{span in feet}}$$

$$\text{Breadth in inches} = \frac{\text{span in feet} \times \text{load}}{2 \times \text{square of depth} \times A}$$

The depth is taken in inches. The coefficient A , is $1/18$ the maximum fiber stress for safe loads, and is the safe load for a beam 1 in. square, 1 ft. span. The following values of A are given by Kidder as one-third of the breaking weight of timber of the quality used in first-class buildings. The values for stones are based on a factor of safety of six.

VALUES FOR A. — COEFFICIENT FOR BEAMS.

Cast iron.....	308	Pine, Texas yellow.....	90
Wrought iron.....	666	Spruce.....	70
Steel.....	888	Whitewood (poplar).....	65
American Woods:		Redwood (California).....	60
Chestnut.....	60	Bluestone flagging (Hudson River).....	25
Hemlock.....	55	Granite, average.....	17
Oak, white.....	75	Limestone.....	14
Pine, Georgia yellow.....	100	Marble.....	17
Pine, Oregon.....	90	Sandstone.....	8 to 11
Pine, red or Norway.....	70	Slate.....	50
Pine, white, Eastern.....	60		
Pine, white, Western.....	65		

Maximum Permissible Stresses in Structural Materials used in Buildings. (Building Ordinances of the City of Chicago, 1893.) — Cast iron, crushing stress: For plates, 15,000 lbs. per square inch; for lintels, brackets, or corbels, compression 13,500 lbs. per square inch, and tension 3000 lbs. per square inch. For girders, beams, corbels, brackets, and trusses, 16,000 lbs. per square inch for steel and 12,000 lbs. for iron.

For plate girders:

$$\text{Flange area} = \frac{\text{maximum bending moment in ft.-lbs.} \div (CD)}{D}$$

D = distance between center of gravity of flanges in feet.

C = 13,500 for steel, 10,000 for iron.

Web area = maximum shear $\div C$.

C = 10,000 for steel; 6,000 for iron.

For rivets in single shear per square inch of rivet area:
 If shop-driven, steel, 9000 lbs.; iron, 7500 lbs.; if field-driven, steel,
 7500 lbs.; iron, 6000 lbs.
 For timber girders; $S = cbd^2 + l$,
 b = breadth of beam in inches, d = depth of beam in inches, l = length
 of beam in feet, c = 160 for long-leaf yellow pine, 120 for oak, 100 for
 white or Norway pine.

Safe Loads in Tons, Uniformly Distributed, for White-oak Beams.
 (In accordance with the Building Laws of Boston.)

Formula: $W = \frac{4PBD^2}{3L}$.
 W = safe load in pounds; P , extreme fiber-stress = 1000 lbs. per square inch, for white oak; R , breadth in inches; D , depth in inches; L , distance between supports in inches.

Size of Timber.	Distance between Supports in Feet.														
	6	8	10	11	12	14	15	16	17	18	19	21	23	25	26
	Safe Load in Tons of 2000 Pounds.														
2x6	0.67	0.50	0.40	0.36	0.33	0.29	0.27	0.25	0.24	0.22					
2x8	1.19	0.89	0.71	0.65	0.59	0.51	0.47	0.44	0.42	0.40	0.37	0.34	0.31	0.28	
2x10	1.85	1.39	1.11	1.01	0.93	0.79	0.74	0.69	0.65	0.62	0.58	0.53	0.48	0.43	0.43
2x12	2.67	2.00	1.60	1.45	1.33	1.14	1.07	1.00	0.94	0.89	0.84	0.76	0.70	0.64	0.62
3x6	1.00	0.75	0.60	0.55	0.50	0.43	0.40	0.37	0.35	0.33	0.32	0.29	0.25		
3x8	1.78	1.33	1.07	0.97	0.89	0.76	0.71	0.67	0.63	0.59	0.56	0.51	0.46	0.43	0.41
3x10	2.78	2.08	1.67	1.52	1.39	1.19	1.11	1.04	0.98	0.93	0.88	0.79	0.72	0.67	0.64
3x12	4.00	3.00	2.40	2.18	2.00	1.71	1.60	1.50	1.41	1.33	1.26	1.14	1.04	0.96	0.92
3x14	5.45	4.08	3.27	2.97	2.72	2.37	2.18	2.04	1.92	1.82	1.72	1.56	1.42	1.31	1.25
3x16	7.11	5.33	4.27	3.88	3.56	3.05	2.84	2.67	2.51	2.37	2.25	2.03	1.86	1.71	1.64
4x10	3.70	2.78	2.22	2.02	1.85	1.59	1.48	1.39	1.31	1.23	1.17	1.06	0.97	0.89	0.85
4x12	5.33	4.00	3.20	2.91	2.67	2.29	2.13	2.00	1.88	1.78	1.68	1.52	1.39	1.28	1.23
4x14	7.26	5.44	4.36	3.96	3.63	3.11	2.90	2.72	2.56	2.42	2.29	2.07	1.90	1.74	1.68
4x16	9.48	7.11	5.69	5.17	4.74	4.06	3.79	3.56	3.35	3.16	3.00	2.71	2.47	2.28	2.19
4x18	12.00	9.00	7.20	6.55	6.00	5.14	4.80	4.50	4.24	4.00	3.79	3.43	3.13	2.88	2.77

For other kinds of wood than white oak multiply the figures in the table by a figure selected from those given below (which represent the safe stress per square inch on beams of different kinds of wood according to the building laws of the cities named) and divide by 1000.

	Hemlock.	Spruce.	White Pine.	Oak.	Yellow Pine.
New York	800	900	900	1100	1100*
Boston		750	750	1000†	1250
Chicago			900	1080	1440

* Georgia pine. † White oak.

WALLS.

Thickness of Walls of Buildings. — Kidder gives the following general rule for mercantile buildings over four stories in height: For brick equal to those used in Boston or Chicago, make the thickness of the three upper stories 16 ins., of the next three below 20 ins., the next three 24 ins., and the next three 28 ins. For a poorer quality of material make only the two upper stories 16 ins. thick, the next three 20 ins., and so on down.

In buildings less than five stories in height the top story may be 12 ins. in thickness.

THICKNESS OF WALLS IN INCHES, FOR MERCANTILE BUILDINGS AND FOR ALL BUILDINGS OVER FIVE STORIES IN HEIGHT. (The figures show the range of the thicknesses required by the ordinances of eight different cities. — Condensed from Kidder.)

Stories High.	Stories.											
	1st.	2d.	3d.	4th.	5th.	6th.	7th.	8th.	9th.	10th.	11th.	12th.
2	12-18	12-13										
3	13-20	12-18	12-16									
4	16-22	16-18	12-16									
5	18-22	16-22	16-20	12-20	12-16							
6	20-26	18-22	16-22	16-20	13-20	12-16						
7	20-28	20-26	18-24	16-22	16-20	13-20	12-17					
8	22-32	20-28	20-26	18-24	16-22	16-20	13-20	12-17				
9	24-32	24-32	20-28	20-26	20-24	16-22	16-20	16-20	12-17			
10	24-36	24-32	24-32	20-28	20-26	20-24	16-22	16-20	16-20	12-17		
11	28-36	28-36	24-32	24-30	24-28	20-26	20-24	20-22	16-20	16-20	13-17	
12	28-40	28-36	28-36	24-32	24-32	24-28	20-26	20-24	20-22	16-20	16-20	13-17

(Extract from the Building Laws of the City of New York, 1893.)

Walls of Warehouses, Stores, Factories, and Stables. — 25 feet or less in width between walls, not less than 12 in. to height of 40 ft.; If 40 to 60 ft. in height, not less than 16 in. to 40 ft., and 12 in. thence to top;

60 to 80 ft. in height, not less than 20 in. to 25 ft., and 16 in. thence to top;

75 to 85 ft. in height, not less than 24 in. to 20 ft.; 20 in. to 60 ft., and 16 in. to top;

85 to 100 ft. in height, not less than 28 in. to 25 ft.; 24 in. to 50 ft.; 20 in. to 75 ft., and 16 in. to top;

Over 100 ft. in height, each additional 25 ft. in height, or part thereof, next above the curb, shall be increased 4 inches in thickness, the upper 100 feet remaining the same as specified for a wall of that height.

If walls are over 25 feet apart, the bearing-walls shall be 4 inches thicker than above specified for every 12 1/2 feet or fraction thereof that said walls are more than 25 feet apart.

Strength of Floors, Roofs, and Supports.

Floors calculated to bear safely per sq. ft., in addition to their own wt.

Floors of dwelling, tenement, apartment-house or hotel, not less than	70 lbs.
Floors of office-building, not less than	100 "
Floors of public-assembly building, not less than	120 "
Floors of store, factory, warehouse, etc., not less than	150 "
Roofs of all buildings, not less than	50 "

Every floor shall be of sufficient strength to bear safely the weight to be imposed thereon, in addition to the weight of the materials of which the floor is composed.

Columns and Posts. — The strength of all columns and posts shall be computed according to Gordon's formulæ, and the crushing weights in pounds, to the square inch of section, for the following-named materials, shall be taken as the coefficients in said formulæ, namely: Cast iron, 80,000; wrought or rolled iron, 40,000; rolled steel, 48,000; white pine and spruce, 3500; pitch or Georgia pine, 5000; American oak, 6000. The breaking strength of wooden beams and girders shall be computed according to the formulæ in which the constants for transverse strains for central load shall be as follows, namely: Hemlock, 400; white pine, 450; spruce, 450; pitch or Georgia pine, 550; American oak, 550; and for wooden beams and girders carrying a uniformly distributed load the constants will be doubled.

The factors of safety shall be as one to four for all beams, girders, and other pieces subject to a transverse strain; as one to four for all posts, columns, and other vertical supports when of wrought iron or rolled steel; as one to five for other materials, subject to a compressive strain; as one to six for tie-rods, tie-beams, and other pieces subject to a tensile strain. Good, solid, natural earth shall be deemed to sustain safely a load of four tons to the superficial foot, or as otherwise determined by the superintendent of buildings, and the width of footing-courses shall be at least sufficient to meet this requirement. In computing the width of walls, a cubic foot of brickwork shall be deemed to weigh 115 lbs. Sandstone, white marble, granite, and other kinds of building-stone shall be deemed to weigh 160 lbs. per cubic foot. The safe-bearing load to apply to good brickwork shall be taken at 8 tons per superficial foot when good lime mortar is used, 11½ tons per superficial foot when good lime and cement mortar mixed is used, and 15 tons per superficial foot when good cement mortar is used.

Fire-proof Buildings — Iron and Steel Columns. — All cast-iron, wrought-iron, or rolled-steel columns shall be made true and smooth at both ends, and shall rest on iron or steel bed-plates, and have iron or steel cap-plates, which shall also be made true. All iron or steel trimmer-beams, headers, and tail-beams shall be suitably framed and connected together, and the iron girders, columns, beams, trusses, and all other iron-work of all floors and roofs shall be strapped, bolted, anchored, and connected together, and to the walls, in a strong and substantial manner. Where beams are framed into headers, the angle-irons, which are bolted to the tail-beams, shall have at least two bolts for all beams over 7 inches in depth, and three bolts for all beams 12 inches and over in depth, and these bolts shall not be less than ¾ inch in diameter. Each one of such angles or knees, when bolted to girders, shall have the same number of bolts as stated for the other leg. The angle-iron in no case shall be less in thickness than the header or trimmer to which it is bolted, and the width of angle in no case shall be less than one third the depth of beam, excepting that no angle-knee shall be less than 2½ inches wide, nor required to be more than 6 inches wide. All wrought-iron or rolled-steel beams 8 inches deep and under shall have bearings equal to their depth, if resting on a wall; 9 to 12 inch beams shall have a bearing of 10 inches, and all beams more than 12 inches in depth shall have bearings of not less than 12 inches if resting on a wall. Where beams rest on iron supports, and are properly tied to the same, no greater bearings shall be required than one third of the depth of the beams. Iron or steel floor-beams shall be so arranged as to spacing and length of beams that the load to be supported by them, together with the weights of the materials used in the construction of the said floors, shall not cause a deflection of the said beams of more than 1/30 of an inch per linear foot of span; and they shall be tied together at intervals of not more than eight times the depth of the beam.

Under the ends of all iron or steel beams, where they rest on the walls, a stone or cast-iron template shall be built into the walls. Said template shall be 8 inches wide in 12-inch walls, and in all walls of greater thickness said template shall be 12 inches wide; and such templates, if of stone, shall not be in any case less than 2½ inches in thickness, and no template shall be less than 12 inches long.

No cast-iron post or columns shall be used in any building of a less average thickness of shaft than three quarters of an inch, nor shall it have an unsupported length of more than twenty times its least lateral dimensions or diameter. No wrought-iron or rolled-steel column shall have an unsupported length of more than thirty times its least lateral dimensions or diameter, nor shall its metal be less than one fourth of an inch in thickness.

Lintels, Bearings and Supports. — All iron or steel lintels shall have bearings proportionate to the weight to be imposed thereon, but no lintel used to span any opening more than 10 feet in width shall have a bearing less than 12 inches at each end, if resting on a wall; but if resting on an iron post, such lintel shall have a bearing of at least 6 inches at each end, by the thickness of the wall to be supported.

Strains on Girders and Rivets. — Rolled iron or steel beam girders, or riveted iron or steel plate girders used as lintels or as girders, carrying

a wall or floor or both, shall be so proportioned that the loads which may come upon them shall not produce strains in tension or compression upon the flanges of more than 12,000 lbs. for iron, nor more than 15,000 lbs. for steel per square inch of the gross section of each of such flanges, nor a shearing strain upon the web-plate of more than 6000 lbs. per square inch of section of such web-plate, if of iron, nor more than 7000 pounds if of steel; but no web-plate shall be less than ¼ inch in thickness. Rivets in plate girders shall not be less than 5/8 inch in diameter, and shall not be spaced more than 6 inches apart in any case. They shall be so spaced that their shearing strains shall not exceed 9000 lbs. per square inch, on their diameter, multiplied by the thickness of the plates through which they pass. The riveted plate girders shall be proportioned upon the supposition that the bending or chord strains are resisted entirely by the upper and lower flanges, and that the shearing strains are resisted entirely by the web-plate. No part of the web shall be estimated as flange area, nor more than one half of that portion of the angle-iron which lies against the web. The distance between the centers of gravity of the flange areas will be considered as the effective depth of the girder. The building laws of the city of New York contain a great amount of detail in addition to the extracts above, and penalties are provided for violation. See An Act creating a Department of Buildings, etc., Chapter 275, Laws of 1892. Pamphlet copy published by Baker, Voorhies & Co., New York.

FLOORS.

Maximum Load on Floors. (*Eng'g*, Nov. 18, 1892, p. 644.) — Maximum load per square foot of floor surface due to the weight of a dense crowd. Considerable variation is apparent in the figures given by many authorities, as the following table shows:

Authorities.	Weight of Crowd, lbs. per sq. ft.
French practice, quoted by Trautwine and Stoney	41
Hatfield ("Transverse Strains," p. 80).....	70
Mr. Page, London, quoted by Trautwine.....	84
Maximum load on American highway bridges according to Waddell's general specifications.....	100
Mr. Nash, architect of Buckingham Palace.....	120
Experiments by Prof. W. N. Kernot, at Melbourne	126
Experiments by Mr. B. B. Stoney ("On Stresses," p. 617)	143.1
Experiments by Prof. L. J. Johnson, <i>Eng. News</i> , April 14, 1904.....	147.4
	134.2
	to 156.9

The highest results were obtained by crowding a number of persons previously weighed into a small room, the men being tightly packed so as to resemble such a crowd as frequently occurs on the stairways and platforms of a theatre or other public building.

Safe Allowances for Floor Loads. (Kidder.) Pounds per square foot.

For dwellings, sleeping and lodging rooms.....	40 lbs.
For schoolrooms.....	50 "
For offices, upper stories.....	60 "
For offices, first story.....	80 "
For stables and carriage houses.....	65 "
For banking rooms, churches and theaters.....	80 "
For assembly halls, dancing halls, and the corridors of all public buildings, including hotels.....	120 "
For drill rooms.....	150 "
For ordinary stores, light storage, and light manufacturing.....	120* "

* Also to sustain a concentrated load at any point of 4000 lbs.

STRENGTH OF FLOORS.

(From circular of the Boston Manufacturers' Mutual Insurance Co.)

The following tables were prepared by C. J. H. Woodbury, for determining safe loads on floors. Care should be observed to select the figure giving the greatest possible amount and concentration of load as the one

which may be put upon any beam or set of floor-beams; and in no case should beams be subjected to greater loads than those specified, unless a lower factor of safety is warranted under the advice of a competent engineer.

Beams or heavy timbers used in the construction of a factory or warehouse should not be painted, varnished or oiled, filled or encased in impervious concrete, air-proof plastering, or metal for at least three years, lest fermentation should destroy them by what is called "dry rot."

It is, on the whole, safer to make floor-beams in two parts with a small open space between, so that proper ventilation may be secured.

These tables apply to distributed loads, but the first can be used in respect to floors which may carry concentrated loads by using half the figure given in the table, since a beam will bear twice as much load when evenly distributed over its length as it would if the load was concentrated in the center of the span.

The weight of the floor should be deducted from the figure given in the table, in order to ascertain the net load which may be placed upon any floor. The weight of spruce may be taken at 36 lbs. per cubic foot, and that of Southern pine at 48 lbs. per cubic foot.

Table I was computed upon a working modulus of rupture of Southern pine of 2180 lbs., using a factor of safety of six. It can also be applied to ascertaining the strength of spruce beams if the figures given in the table are multiplied by 0.78; or in designing a floor to be sustained by spruce beams, multiply the required load by 1.28, and use the dimensions as given by the table.

These tables are computed for beams one inch in width, because the strength of beams increase directly as the width when the beams are broad enough not to cripple.

EXAMPLE. — Required the safe load per square foot of floor, which may be safely sustained by a floor on Southern pine 10 X 14 in. beams, 8 ft. on centers, and 20 ft. span. In Table I a 1 X 14 in. beam, 20 ft. span, will sustain 118 lbs. per foot of span; and for a beam 10 ins. wide the load would be 1180 lbs. per foot of span, or 147 1/2 lbs. per sq. ft. of floor for Southern-pine beams. From this should be deducted the weight of the floor, 17 1/2 lbs. per sq. ft., leaving 130 lbs. per sq. ft. as a safe load. If the beams are of spruce, multiply 147 1/2 by 0.78, reducing the load to 115 lbs. Deducting the weight of the floor, 16 lbs., leaves the safe net load as 99 lbs. per sq. ft. for spruce beams.

Table II applies to floors whose strength must be in excess of that necessary to sustain the weight, in order to meet the conditions of delicate or rapidly moving machinery, to the end that the vibration or distortion of the floor may be reduced to the least practicable limit.

In the table the limit is that of a load which would cause a bending of the beams to a curve of which the average radius would be 1250 ft.

This table is based upon a modulus of elasticity obtained from observations upon the deflection of loaded storehouse floors, and is taken at 2,000,000 lbs. for Southern pine; the same table can be applied to spruce, whose modulus of elasticity is taken as 1,200,000 lbs., if six tenths of the load for Southern pine is taken as the proper load for spruce; or, in the matter of designing, the load should be increased one and two thirds times, and the dimension of timbers for this increased load as found in the table should be used for spruce.

It can also be applied to beams and floor-timbers supported at each end and in the middle, remembering that the deflection of a beam supported in that manner is only 0.4 that of a beam of equal span which rests at each end; that is to say, the floor-planks are 2 1/2 times as stiff, cut two bays in length, as they would be if cut only one bay in length. When a floor-plank two bays in length is evenly loaded, 3/18 of the load on the plank is sustained by the beam at each end of the plank, and 10/18 by the beam under the middle of the plank; so that for a completed floor 3/8 of the load would be sustained by the beams under the joints of the plank, and 5/8 of the load by the beams under the middle of the plank; this is the reason of the importance of breaking joints in a floor-plank every 3 ft. in order that each beam shall receive an identical load. If

it were not so, 3/8 of the whole load upon the floor would be sustained by every other beam, and 5/8 of the load by the corresponding alternate beams.

Repeating the former example for the load on a mill floor on Southern pine-beams 10 X 14 ins., and 20 ft. span, 8 ft. centers: In Table II a 1 X 14 in. beam should receive 61 lbs. per foot of span, or 75 lbs. per sq. ft. of floor, for Southern-pine beams. Deducting the weight of the floor, 17 1/2 lbs. per sq. ft., leaves 57 lbs. per sq. ft. as the advisable load.

If the beams are of spruce, the result of 75 lbs. should be multiplied by 0.6, reducing the load to 45 lbs. The weight of the floor, in this instance amounting to 16 lbs., would leave the net load as 29 lbs. for spruce beams.

If the beams were two spans in length, they could, under these conditions, support two and a half times as much load with an equal amount of deflection, unless such load should exceed the limit of safe load as found by Table I, as would be the case under the conditions of this problem.

Mill Columns. — Timber posts offer more resistance to fire than iron pillars, and have generally displaced them in millwork. Experiments at the U. S. Arsenal at Watertown, Mass., show that sound timber posts of the proportions customarily used in millwork yield by direct crushing, the strength being directly as the area at the smallest part. The columns yielded at about 4500 lbs. per sq. in., confirming the general practice of allowing 600 lbs. per sq. in. as a safe load. Square columns are one fourth stronger than round ones of the same diameter.

I. Safe Distributed Loads upon Southern-pine Beams One Inch in Width.

(C. J. H. Woodbury.)

(If the load is concentrated at the center of the span, the beams will sustain half the amount given in the table.)

Span, feet.	Depth of Beam in inches.															
	2	3	4	5	6	7	8	9	10	11	12	13	14	15	16	
	Load in pounds per foot of Span.															
5	38	86	154	240	346	470	614	778	960							
6	27	60	107	167	240	327	427	540	667	807						
7	20	44	78	122	176	240	314	397	490	593	705	828				
8	15	34	60	94	135	184	240	304	375	454	540	634	735			
9		27	47	74	107	145	190	240	296	359	427	501	581	667	759	
10			22	38	60	86	118	154	194	240	290	346	406	470	540	
11				32	50	71	97	127	161	198	240	286	335	389	446	
12					27	42	60	82	107	135	167	202	240	282	327	
13						36	51	70	90	115	142	172	205	240	278	
14							31	44	60	78	99	123	148	176	207	
15								27	38	52	68	86	107	129	154	
16									34	46	60	76	94	113	135	
17										41	53	67	83	101	120	
18											36	47	60	74	90	
19												43	54	66	80	
20													49	60	73	
21														54	66	
22															50	
23															45	
24															50	
25															46	

II. Distributed Loads upon Southern-pine Beams Sufficient to Produce Standard Limit of Deflection.

Span, feet.	Depth of Beam in inches.															Deflection, inches.										
	2	3	4	5	6	7	8	9	10	11	12	13	14	15	16											
	Load in pounds per foot of Span.																									
5	3	10	23	44	77	122	182	259									0.300									
6	2	7	16	31	53	85	126	180	247								0.432									
7		5	12	23	39	62	93	132	181	241							0.588									
8			4	9	17	30	48	71	101	139	185	240	305				0.768									
9				7	14	24	38	56	80	110	146	190	241	301			0.972									
10					6	11	19	30	46	65	89	118	154	195	244	300	1.200									
11						9	16	25	38	54	73	98	127	161	202	248	301	1.452								
12							13	21	32	45	62	82	107	136	169	208	253	1.728								
13								18	27	38	53	70	91	116	144	178	215	2.028								
14									16	23	33	45	60	78	100	124	153	2.352								
15										14	20	29	40	53	68	87	108	2.700								
16											18	25	35	46	60	76	95	3.072								
17												22	31	41	53	68	84	3.468								
18													20	27	37	47	60	75	3.888							
19														18	25	33	43	54	68	4.332						
20															22	30	38	49	61	75	4.800					
21																27	35	44	55	68	83	5.292				
22																	24	32	40	50	62	75	5.808			
23																		22	29	37	46	57	69	6.348		
24																			27	34	42	52	63	75	6.912	
25																				25	31	39	48	58	70	7.500

Maximum Spans for 1, 2 and 3 Inch Plank. (*Am. Mach.*, Feb. 11, 1904.) — Let w = load per sq. ft.; l = length in ins.; W = $wl/12$; S = safe fiber stress, using a factor of safety of 10; b = width of plank; d = thickness; p = deflection, E = coefficient of elasticity, I = moment of inertia = $1/12 bd^3$.

Then $W/8 = Sbd^2/6$; $s = 5W/8 \div 384EI$. Taking S at 1200 lbs., E at 850,000 and $s = l \div 360$ for long-leaf yellow pine, the following figures for maximum span, in inches, are obtained:

Uniform load, lbs. per sq. ft.	40	60	80	100	150	200	250	300
1-in. plank { For strength..	75	61	53	48	39	33
{ For deflection..	37	33	30	28	24	22
2-in. plank { For strength..	151	123	107	96	78	67	60	55
{ For deflection..	75	66	60	55	48	44	41	38
3-in. plank { For strength..	227	185	161	144	117	101	91	83
{ For deflection..	113	99	90	83	73	66	61	58

For white oak S may be taken at 1000 and E at 550,000; for Canadian spruce, $S = 800$, $E = 600,000$; for hemlock, $S = 600$, $E = 450,000$.

COST OF BUILDINGS.

Approximate Cost of Mill Buildings. — Chas. T. Main (*Eng. News*, Jan. 27, 1910) gives a series of diagrams of the cost in New England Jan., 1910, per sq. ft. of floor space of different sizes of brick mill buildings, one to six stories high, of the type known as "slow-burning," calculated for total floor loads of about 75 lbs. per sq. ft. Figures taken from the diagrams are given in the table below. The costs include ordinary foundations and plumbing, but no heating, sprinklers or lighting.

COST OF BRICK MILL BUILDINGS PER SQ. FT. OF FLOOR AREA.

Length, feet.	50	100	150	200	250	300	350	400	500
One Story.									
Width 25 ft.	\$1.90	\$1.66	\$1.58	\$1.54	\$1.51	\$1.49	\$1.48	\$1.47	\$1.46
50	1.52	1.29	1.21	1.18	1.16	1.15	1.14	1.13	1.13
75	1.41	1.21	1.12	1.08	1.06	1.04	1.03	1.02	1.02
125	1.32	1.09	1.02	0.98	0.96	0.94	0.94	0.93	0.92
Two Stories.									
25	2.00	1.62	1.52	1.47	1.44	1.41	1.39	1.38	1.36
50	1.50	1.21	1.13	1.09	1.06	1.05	1.04	1.03	1.02
75	1.34	1.08	1.01	0.97	0.94	0.92	0.92	0.91	0.90
125	1.22	0.97	0.90	0.86	0.84	0.82	0.81	0.80	0.86
Three Stories.									
25	1.98	1.57	1.47	1.42	1.39	1.38	1.36	1.35	1.34
50	1.47	1.17	1.07	1.03	1.01	1.00	0.98	0.98	0.98
75	1.30	1.07	0.98	0.94	0.91	0.89	0.88	0.87	0.86
125	1.18	0.93	0.86	0.82	0.80	0.78	0.77	0.76	0.76
Four Stories.									
25	2.00	1.61	1.50	1.45	1.42	1.40	1.38	1.37	1.36
50	1.38	1.17	1.10	1.05	1.02	1.00	1.00	0.99	0.98
75	1.32	1.08	0.97	0.93	0.90	0.88	0.88	0.87	0.87
125	1.20	0.93	0.85	0.81	0.78	0.77	0.76	0.75	0.74
Six Stories.									
25	2.10	1.72	1.57	1.51	1.48	1.46	1.44	1.43	1.42
50	1.53	1.21	1.12	1.08	1.05	1.04	1.03	1.02	1.02
75	1.35	1.08	0.98	0.94	0.92	0.90	0.89	0.88	0.86
125	1.22	0.96	0.86	0.82	0.79	0.78	0.77	0.76	0.76

The cost per sq. ft. of a building 100 ft. wide will be about midway between that of one 75 ft. wide and one 125 ft. wide, and the cost of a five-story building about midway between the costs of a four- and a six-story. The data for estimating the above costs are as follows:

		Stories High.					
		1	2	3	4	5	6
Foundations, including excavations, cost per lin. ft.	Outside walls..	\$2.00	\$2.90	\$3.80	\$4.70	\$5.60	\$6.50
	Inside walls...	1.75	2.25	2.80	3.40	3.90	4.50
Brick walls, cost per sq. ft. of surface...	Outside walls..	0.40	0.44	0.47	0.50	0.53	0.57
	Inside walls...	0.40	0.40	0.40	0.43	0.45	0.47

Columns, including piers and castings, cost each \$15.

Assumed Height of Stories. — From ground to first floor, 3 ft. Buildings 25 ft. wide, stories 13 ft. high; 50 ft. wide, 14 ft. high; 75 ft. wide, 15 ft. high; 100 ft. and 125 ft. wide, 16 ft. high.

Floors, 32 cts. per sq. ft. of gross floor space not including columns. Columns included, 38 cts.

Roof, 25 cts. per sq. ft., not including columns. Columns included, 30 cts. Roof to project 18 ins. all around buildings.

Stairways, including partitions, \$100 each flight. Two stairways and one elevator tower for buildings up to 150 ft. long; two stairways and two elevator towers for buildings up to 300 ft. long. In buildings over two stories, three stairways and three elevator towers for buildings over 300 ft. long.

In buildings over two stories, plumbing \$75 for each fixture including piping and partitions. Two fixtures on each floor up to 5000 sq. ft. of floor space and one fixture for each additional 5000 sq. ft. of floor or fraction thereof.

Modifications of the above Costs:

1. If the soil is poor or the conditions of the site are such as to require more than ordinary foundations, the cost will be increased.
 2. If the building is to be used for ordinary storage purposes with low stories and no top floors, the cost will be decreased from about 10% for large low buildings to 25% for small high ones, about 20% usually being a fair allowance.
 3. If the building is to be used for manufacturing and is substantially built of wood, the cost will be decreased from about 6% for large one-story buildings to 33% for high small buildings; 15% would usually be a fair allowance.
 4. If the building is to be used for storage with low stories and built substantially of wood, the cost will be decreased from 13% for large one-story buildings to 50% for small high buildings; 30% would usually be a fair allowance.
 5. If the total floor loads are more than 75 lbs. per sq. ft. the cost is increased.
 6. For office buildings, the cost must be increased to cover architectural features on the outside and interior finish.
- Reinforced-concrete buildings designed to carry floor loads of 100 lbs. per sq. ft. or less will cost about 25% more than the slow-burning type of mill construction.

ELECTRICAL ENGINEERING.

STANDARDS OF MEASUREMENT.

C.G.S. (Centimeter, Gramme, Second) or "Absolute" System of Physical Measurements:

Unit of space or distance	= 1 centimeter, cm.;
Unit of mass	= 1 gramme, gm.;
Unit of time	= 1 second, s.;
Unit of velocity = space ÷ time	= 1 centimeter in 1 second;
Unit of acceleration = change of 1 unit of velocity in 1 second;	
Acceleration due to gravity, at Paris,	= 981 centimeters in 1 second;
Unit of force = 1 dyne = $\frac{1}{981}$ gramme = $\frac{0.0022046}{981}$ lb. = 0.000002247 lb.	

A dyne is that force which, acting on a mass of one gramme during one second, will give it a velocity of one centimeter per second. The weight of one gramme in latitude 40° to 45° is about 980 dynes, at the equator 973 dynes, and at the poles nearly 984 dynes. Taking the value of g , the acceleration due to gravity, in British measures at 32.185 feet per second at Paris, and the meter = 39.37 inches, we have

1 gramme = 32.185 × 12 ÷ 0.3937 = 981.00 dynes.
Unit of work = 1 erg = 1 dyne-centimeter = 0.00000007373 ft.-lb.;
Unit of power = 1 watt = 10 million ergs per second,
= 0.7373 foot-pound per second,
= $\frac{0.7373}{550} = \frac{1}{746}$ of 1 horse-power = 0.00134 H.P.

C.G.S. unit magnetic pole is one which reacts on an equal pole at a centimeter's distance with the force of 1 dyne.

C.G.S. unit of magnetic field strength, the *gauss*, is the intensity of field which surrounding unit pole acts on it with a force of 1 dyne.

C.G.S. unit of electro-motive force = the force produced by the cutting of a field of 1 gauss intensity at a velocity of 1 centimeter per second (in a direction normal to the field and to the conductor) by 1 centimeter of conductor. The *volt* is 100,000,000 times this unit.

C.G.S. unit of electrical current = the current in a conductor (located in a plane normal to the field) when each centimeter is urged across a magnetic field of 1 gauss intensity with a force of 1 dyne. One-tenth of this is the *ampere*.

The C.G.S. unit of quantity of electricity is that represented by the flow of 1 C.G.S. unit of current for 1 second. One-tenth of this is the *coulomb*.

The Practical Units used in Electrical Calculations are:

Ampere, the unit of current strength, or rate of flow, represented by I .
Volt, the unit of electro-motive force, electrical pressure, or difference of potential, represented by E .
Ohm, the unit of resistance, represented by R .
Coulomb (or ampere-second), the unit of quantity, Q .
Ampere-hour = 3600 coulombs, Q' .
Watt (ampere-volt, or volt-ampere), the unit of power, P .
Joule (volt-coulomb), the unit of energy or work, W .
Farad, the unit of capacity, represented by C .
Henry, the unit of inductance, represented by L .

Using letters to represent the units, the relations between them may be expressed by the following formulæ, in which t represents one second and T one hour:

$$I = \frac{E}{R}, \quad Q = It, \quad Q' = IT, \quad C = \frac{Q}{E}, \quad W = QE, \quad P = IE.$$

As these relations contain no coefficient other than unity, the letters may represent any quantities given in terms of those units. For example, if E represents the number of volts electro-motive force, and R the number of ohms resistance in a circuit, then their ratio $E \div R$ will give the number of amperes current strength in that circuit.

The above six formulæ can be combined by substitution or elimination, so as to give the relations between any of the quantities. The most important of these are the following:

$$Q = \frac{E}{R} t, \quad C = \frac{I}{E} t, \quad W = IEt = \frac{E^2}{R} t = I^2 R t = Pt,$$

$$E = IR, \quad R = \frac{E}{I}, \quad P = \frac{E^2}{R} = I^2 R = \frac{W}{t} = \frac{QE}{t}.$$

The definitions of these units as adopted at the International Electrical Congress at Chicago in 1893, and as established by Act of Congress of the United States, July 12, 1894, are as follows:

The *ohm* is substantially equal to 10^9 (or 1,000,000,000) units of resistance of the C.G.S. system, and is represented by the resistance offered to an unvarying electric current by a column of mercury at 32° F., 14.4521 grammes in mass, of a constant cross-sectional area, and of the length of 106.3 centimeters.

The *ampere* is $1/10$ of the unit of current of the C.G.S. system, and is the practical equivalent of the unvarying current which when passed through a solution of nitrate of silver in water in accordance with standard specifications deposits silver at the rate of 0.001118 gramme per second.

The *volt* is the electro-motive force that, steadily applied to a conductor whose resistance is one ohm, will produce a current of one ampere, and is practically equivalent to 1000/1431 (or 0.6974) of the electro-motive force between the poles or electrodes of a Clark's cell at a temperature of 15°C., and prepared in the manner described in the standard specifications.

The *coulomb* is the quantity of electricity transferred by a current of one ampere in one second.

The *farad* is the capacity of a condenser charged to a potential of one volt by one coulomb of electricity.

The *joule* is equal to 10,000,000 units of work in the C.G.S. system, and is practically equivalent to the energy expended in one second by an ampere in an ohm.

The *watt* is equal to 10,000,000 units of power in the C.G.S. system, and is practically equivalent to the work done at the rate of one joule per second.

The *henry* is the induction in a circuit when the electro-motive force induced in this circuit is one volt, while the inducing current varies at the rate of one ampere per second.

The ohm, volt, etc., as above defined, are called the "international" ohm, volt, etc., to distinguish them from the "legal" ohm, B.A. unit, etc.

The value of the ohm, determined by a committee of the British Association in 1863, called the B.A. unit, was the resistance of a certain piece

of copper wire. The so-called "legal" ohm, as adopted at the International Congress of Electricians in Paris in 1884, was a correction of the B.A. unit, and was defined as the resistance of a column of mercury 1 square millimeter in section and 106 centimeters long, at a temperature of 32° F.

1 legal ohm = 1.0112 B.A. units, 1 B.A. unit = 0.9889 legal ohm;
 1 international ohm = 1.0136 B.A. units, 1 B.A. unit = 0.9866 int. ohm;
 1 international ohm = 1.0023 legal ohm, 1 legal ohm = 0.9977 int. ohm.

DERIVED UNITS.

1 megohm = 1 million ohms;
 1 microhm = 1 millionth of an ohm;
 1 milliampere = 1/1000 of an ampere;
 1 micro-farad = 1 millionth of a farad.

RELATIONS OF VARIOUS UNITS.

1 ampere = 1 coulomb per second;
 1 volt-ampere = 1 watt = 1 volt-coulomb per sec.;
 = 0.7373 foot-pound per second,
 = 0.0009477 heat-unit per sec. (Fahr.),
 = 1/740 of one horse-power;
 1 watt { = 0.7373 foot-pound,
 = work done by one watt in one sec.,
 = 0.0009477 heat-unit;
 1 joule { = 1055.2 joules;
 1 British thermal unit. = 1000/746 or 1.3405 horse-powers;
 1 kilowatt, or 1000 watts = 1.3405 horse-power hours,
 1 kilowatt-hour, = 2,654,200 foot-pounds,
 1000 volt-ampere hours, = 3412 heat-units;
 1 British Board of Trade unit, = 746 watts = 746 volt-amperes,
 1 horse-power { = 33,000 foot-pounds per minute.

The ohm, ampere, and volt are defined in terms of one another as follows: Ohm, the resistance of a conductor through which a current of one ampere will pass when the electro-motive force is one volt. Ampere, the quantity of current which will flow through a resistance of one ohm when the electro-motive force is one volt. Volt, the electro-motive force required to cause a current of one ampere to flow through a resistance of one ohm.

For Methods of making Electrical Measurements, Testing, etc., see Munroe & Jamieson's Pocket-Book of Electrical Rules, Tables, and Data; S. P. Thompson's Dynamo-Electric Machinery; Carhart & Patterson's Electrical Measurements; and works on Electrical Engineering.

Equivalent Electrical and Mechanical Units. — H. Ward Leonard published in *The Electrical Engineer*, Feb. 25, 1895, a table of useful equivalents of electrical and mechanical units, from which the table on page 1347 is taken, with some modifications.

Units of the Magnetic Circuit.

Unit magnetic pole is a pole of such strength that when placed at a distance of one centimeter from a similar pole of equal strength it repels it with a force of one dyne.

Magnetic Moment is the product of the strength of either pole into the distance between the two poles.

Intensity of Magnetization is the magnetic moment of a magnet divided by its volume.

Intensity of Magnetic Field is the force exerted by the field upon a unit magnetic pole. The unit is the gauss.

Gauss = unit of field strength, or density, symbol H, is that intensity of field which acts on a unit pole with a force of one dyne, = one line of force per square centimeter. One gauss produces 1 dyne of force per centimeter length of conductor upon a current of 10 amperes, or an electro-motive force of 1/100,000,000 volt in a centimeter length of conductor when its velocity across the field is 1 centimeter per second. A field of

Equivalent Values of Electrical and Mechanical Units.

Unit.	Equivalent Value in Other Units.	Unit.	Equivalent Value in Other Units.	Unit.	Equivalent Value in Other Units.
1,000 watt hours.	1,000 watts.	1 Heat-unit	746 watts.	1 watt-second.	1 joule per second.
1.34 horse-power.	0.746 K.W.	per Sq. Ft. per min. =	0.746 K.W.	1 watt-second.	0.00134 H.P.
2,654,200 ft.-lbs.	33,000 ft.-lbs. per minute.	1 Kilo-gram Meter =	33,000 ft.-lbs. per second.	1 watt-second.	3.412 heat-units per hour.
3,600,000 joules.	2,545 heat-units per hour.	1 lb. Carbon Oxidized with perfect efficiency =	2,545 heat-units per hour.	1 watt-second.	0.7373 ft.-lbs. per second.
367,000 kilogram meters.	42.4 heat-unit per minute.	1 lb. Carbon Oxidized with perfect efficiency =	42.4 heat-unit per minute.	1 watt-second.	0.0035 lb. water evap. per hr.
0.235 lb. carbon oxidized with perfect efficiency.	0.707 heat-units per second.	1 lb. Carbon Oxidized with perfect efficiency =	0.707 heat-units per second.	1 watt-second.	44.24 ft.-lbs. per minute.
3.53 lbs. water evap. from and at 212° F.	0.175 lb. carbon oxidized per hour.	1 lb. Carbon Oxidized with perfect efficiency =	0.175 lb. carbon oxidized per hour.	1 watt-second.	8.19 heat-units per sq. ft. per minute.
22.75 lbs. of water raised from 62° to 212° F.	2.64 lbs. water evap. per hour from and at 212° F.	1 lb. Carbon Oxidized with perfect efficiency =	2.64 lbs. water evap. per hour from and at 212° F.	1 watt-second.	6371 ft.-lbs. per sq. ft. per minute.
0.746 K.W. hour.	1 watt-second.	1 Joule =	1 watt-second.	1 watt-second.	0.193 H.P. per sq. ft.
1,980,000 ft.-lbs.	0.00000278 K.W. hour.	1 Joule =	0.00000278 K.W. hour.	1 watt-second.	
2,545 heat-units.	0.102 k.g.m.	1 Joule =	0.102 k.g.m.	1 watt-second.	
273,740 k.g.m.	0.0009477 heat-units.	1 Joule =	0.0009477 heat-units.	1 watt-second.	
0.175 lb. carbon oxidized with perfect efficiency.	0.7373 ft.-lb.	1 Joule =	0.7373 ft.-lb.	1 watt-second.	
2.64 lbs. water evaporated from and at 212° F.	1.356 joules.	1 Joule =	1.356 joules.	1 watt-second.	
17.0 lbs. water raised from 62° F. to 212° F.	0.1383 k.g.m.	1 Joule =	0.1383 k.g.m.	1 watt-second.	
0.746 K.W. hour.	0.00000377 K.W. hour.	1 Joule =	0.00000377 K.W. hour.	1 watt-second.	
1,980,000 ft.-lbs.	0.001285 heat-unit.	1 Joule =	0.001285 heat-unit.	1 watt-second.	
2,545 heat-units.	0.0000005 H.P. hour.	1 Joule =	0.0000005 H.P. hour.	1 watt-second.	
273,740 k.g.m.	1 joule per second.	1 Joule =	1 joule per second.	1 watt-second.	
0.175 lb. carbon oxidized with perfect efficiency.	0.00134 H.P.	1 Joule =	0.00134 H.P.	1 watt-second.	
2.64 lbs. water evaporated from and at 212° F.	3.412 heat-units per hour.	1 Joule =	3.412 heat-units per hour.	1 watt-second.	
17.0 lbs. water raised from 62° F. to 212° F.	0.7373 ft.-lbs. per second.	1 Joule =	0.7373 ft.-lbs. per second.	1 watt-second.	
0.746 K.W. hour.	0.0035 lb. water evap. per hr.	1 Joule =	0.0035 lb. water evap. per hr.	1 watt-second.	
1,980,000 ft.-lbs.	44.24 ft.-lbs. per minute.	1 Joule =	44.24 ft.-lbs. per minute.	1 watt-second.	
2,545 heat-units.	8.19 heat-units per sq. ft. per minute.	1 Joule =	8.19 heat-units per sq. ft. per minute.	1 watt-second.	
273,740 k.g.m.	6371 ft.-lbs. per sq. ft. per minute.	1 Joule =	6371 ft.-lbs. per sq. ft. per minute.	1 watt-second.	
0.175 lb. carbon oxidized with perfect efficiency.	0.193 H.P. per sq. ft.	1 Joule =	0.193 H.P. per sq. ft.	1 watt-second.	
2.64 lbs. water evaporated from and at 212° F.		1 Joule =		1 watt-second.	
17.0 lbs. water raised from 62° F. to 212° F.		1 Joule =		1 watt-second.	
0.746 K.W. hour.		1 Joule =		1 watt-second.	
1,980,000 ft.-lbs.		1 Joule =		1 watt-second.	
2,545 heat-units.		1 Joule =		1 watt-second.	
273,740 k.g.m.		1 Joule =		1 watt-second.	
0.175 lb. carbon oxidized with perfect efficiency.		1 Joule =		1 watt-second.	
2.64 lbs. water evaporated from and at 212° F.		1 Joule =		1 watt-second.	
17.0 lbs. water raised from 62° F. to 212° F.		1 Joule =		1 watt-second.	
0.746 K.W. hour.		1 Joule =		1 watt-second.	
1,980,000 ft.-lbs.		1 Joule =		1 watt-second.	
2,545 heat-units.		1 Joule =		1 watt-second.	
273,740 k.g.m.		1 Joule =		1 watt-second.	
0.175 lb. carbon oxidized with perfect efficiency.		1 Joule =		1 watt-second.	
2.64 lbs. water evaporated from and at 212° F.		1 Joule =		1 watt-second.	
17.0 lbs. water raised from 62° F. to 212° F.		1 Joule =		1 watt-second.	
0.746 K.W. hour.		1 Joule =		1 watt-second.	
1,980,000 ft.-lbs.		1 Joule =		1 watt-second.	
2,545 heat-units.		1 Joule =		1 watt-second.	
273,740 k.g.m.		1 Joule =		1 watt-second.	
0.175 lb. carbon oxidized with perfect efficiency.		1 Joule =		1 watt-second.	
2.64 lbs. water evaporated from and at 212° F.		1 Joule =		1 watt-second.	
17.0 lbs. water raised from 62° F. to 212° F.		1 Joule =		1 watt-second.	
0.746 K.W. hour.		1 Joule =		1 watt-second.	
1,980,000 ft.-lbs.		1 Joule =		1 watt-second.	
2,545 heat-units.		1 Joule =		1 watt-second.	
273,740 k.g.m.		1 Joule =		1 watt-second.	
0.175 lb. carbon oxidized with perfect efficiency.		1 Joule =		1 watt-second.	
2.64 lbs. water evaporated from and at 212° F.		1 Joule =		1 watt-second.	
17.0 lbs. water raised from 62° F. to 212° F.		1 Joule =		1 watt-second.	
0.746 K.W. hour.		1 Joule =		1 watt-second.	
1,980,000 ft.-lbs.		1 Joule =		1 watt-second.	
2,545 heat-units.		1 Joule =		1 watt-second.	
273,740 k.g.m.		1 Joule =		1 watt-second.	
0.175 lb. carbon oxidized with perfect efficiency.		1 Joule =		1 watt-second.	
2.64 lbs. water evaporated from and at 212° F.		1 Joule =		1 watt-second.	
17.0 lbs. water raised from 62° F. to 212° F.		1 Joule =		1 watt-second.	
0.746 K.W. hour.		1 Joule =		1 watt-second.	
1,980,000 ft.-lbs.		1 Joule =		1 watt-second.	
2,545 heat-units.		1 Joule =		1 watt-second.	
273,740 k.g.m.		1 Joule =		1 watt-second.	
0.175 lb. carbon oxidized with perfect efficiency.		1 Joule =		1 watt-second.	
2.64 lbs. water evaporated from and at 212° F.		1 Joule =		1 watt-second.	
17.0 lbs. water raised from 62° F. to 212° F.		1 Joule =		1 watt-second.	
0.746 K.W. hour.		1 Joule =		1 watt-second.	
1,980,000 ft.-lbs.		1 Joule =		1 watt-second.	
2,545 heat-units.		1 Joule =		1 watt-second.	
273,740 k.g.m.		1 Joule =		1 watt-second.	
0.175 lb. carbon oxidized with perfect efficiency.		1 Joule =		1 watt-second.	
2.64 lbs. water evaporated from and at 212° F.		1 Joule =		1 watt-second.	
17.0 lbs. water raised from 62° F. to 212° F.		1 Joule =		1 watt-second.	
0.746 K.W. hour.		1 Joule =		1 watt-second.	
1,980,000 ft.-lbs.		1 Joule =		1 watt-second.	
2,545 heat-units.		1 Joule =		1 watt-second.	
273,740 k.g.m.		1 Joule =		1 watt-second.	
0.175 lb. carbon oxidized with perfect efficiency.		1 Joule =		1 watt-second.	
2.64 lbs. water evaporated from and at 212° F.		1 Joule =		1 watt-second.	
17.0 lbs. water raised from 62° F. to 212° F.		1 Joule =		1 watt-second.	
0.746 K.W. hour.		1 Joule =		1 watt-second.	
1,980,000 ft.-lbs.		1 Joule =		1 watt-second.	
2,545 heat-units.		1 Joule =		1 watt-second.	
273,740 k.g.m.		1 Joule =		1 watt-second.	
0.175 lb. carbon oxidized with perfect efficiency.		1 Joule =		1 watt-second.	
2.64 lbs. water evaporated from and at 212° F.		1 Joule =		1 watt-second.	
17.0 lbs. water raised from 62° F. to 212° F.		1 Joule =		1 watt-second.	
0.746 K.W. hour.		1 Joule =		1 watt-second.	
1,980,000 ft.-lbs.		1 Joule =		1 watt-second.	
2,545 heat-units.		1 Joule =		1 watt-second.	
273,740 k.g.m.		1 Joule =		1 watt-second.	
0.175 lb. carbon oxidized with perfect efficiency.		1 Joule =		1 watt-second.	
2.64 lbs. water evaporated from and at 212° F.		1 Joule =		1 watt-second.	
17.0 lbs. water raised from 62° F. to 212° F.		1 Joule =		1 watt-second.	
0.746 K.W. hour.		1 Joule =		1 watt-second.	
1,980,000 ft.-lbs.		1 Joule =		1 watt-second.	
2,545 heat-units.		1 Joule =		1 watt-second.	
273,740 k.g.m.		1 Joule =		1 watt-second.	
0.175 lb. carbon oxidized with perfect efficiency.		1 Joule =		1 watt-second.	
2.64 lbs. water evaporated from and at 212° F.		1 Joule =		1 watt-second.	
17.0 lbs. water raised from 62° F. to 212° F.		1 Joule =		1 watt-second.	
0.746 K.W. hour.		1 Joule =		1 watt-second.	
1,980,000 ft.-lbs.		1 Joule =		1 watt-second.	
2,545 heat-units.		1 Joule =		1 watt-second.	
273,740 k.g.m.		1 Joule =		1 watt-second.	
0.175 lb. carbon oxidized with perfect efficiency.		1 Joule =		1 watt-second.	
2.64 lbs. water evaporated from and at 212° F.		1 Joule =		1 watt-second.	
17.0 lbs. water raised from 62° F. to 212° F.		1 Joule =		1 watt-second.	
0.746 K.W. hour.		1 Joule =		1 watt-second.	
1,980,000 ft.-lbs.		1 Joule =		1 watt-second.	
2,545 heat-units.		1 Joule =		1 watt-second.	
273,740 k.g.m.		1 Joule =		1 watt-second.	
0.175 lb. carbon oxidized with perfect efficiency.		1 Joule =		1 watt-second.	
2.64 lbs. water evaporated from and at 212° F.		1 Joule =		1 watt-second.	
17.0 lbs. water raised from 62° F. to 212° F.		1 Joule =		1 watt-second.	
0.746 K.W. hour.		1 Joule =		1 watt-second.	
1,980,000 ft.-lbs.		1 Joule =		1 watt-second.	
2,545 heat-units.		1 Joule =		1 watt-second.	
273,740 k.g.m.		1 Joule =		1 watt-second.	
0.175 lb. carbon oxidized with perfect efficiency.		1 Joule =		1 watt-second.	
2.64 lbs. water evaporated from and at 212° F.		1 Joule =		1 watt-second.	
17.0 lbs. water raised from 62° F. to 212° F.		1 Joule =		1 watt-second.	
0.746 K.W. hour.		1 Joule =		1 watt-second.	
1,980,000 ft.-lbs.		1 Joule =		1 watt-second.	
2,545 heat-units.		1 Joule =		1 watt-second.	
273,740 k.g.m.		1 Joule =		1 watt-second.	
0.175 lb. carbon oxidized with perfect efficiency.		1 Joule =		1 watt-second.	
2.64 lbs. water evaporated from and at 212° F.		1 Joule =		1 watt-second.	
17.0 lbs. water raised from 62° F. to 212° F.		1 Joule =		1 watt-second.	
0.746 K.W. hour.		1 Joule =		1 watt-second.	
1,980,000 ft.-lbs.		1 Joule =		1 watt-second.	
2,545 heat-units.		1 Joule =		1 watt-second.	
273,740 k.g.m.		1 Joule =		1 watt-second.	
0.175 lb. carbon oxidized with perfect efficiency.		1 Joule =		1 watt-second.	
2.64 lbs. water evaporated from and at 212° F.		1 Joule =		1 watt-second.	
17.0 lbs. water raised from 62° F. to 212° F.		1 Joule =		1 watt-second.	
0.746 K.W. hour.		1 Joule =		1 watt-second.	
1,980,000 ft.-lbs.		1 Joule =		1 watt-second.	
2,545 heat-units.		1 Joule =		1 watt-second.	
273,740 k.g.m.		1 Joule =		1 watt-second.	
0.175 lb. carbon oxidized with perfect efficiency.		1 Joule =		1 watt-second.	
2.64 lbs. water evaporated from and at 212° F.		1 Joule =		1 watt-second.	
17.0 lbs. water raised from 62° F. to 212° F.		1 Joule =		1 watt-second.	
0.746 K.W. hour.		1 Joule =		1 watt-second.	
1,980,000 ft.-lbs.		1 Joule =		1 watt-second.	
2,545 heat-units.		1 Joule =		1 watt-second.	
273,740 k.g.m.		1 Joule =		1 watt-second.	
0.175 lb. carbon oxidized with perfect efficiency.		1 Joule =		1 watt-second.	
2.64 lbs. water evaporated from and at 212° F.		1 Joule =		1 watt-second.	
17.0 lbs. water raised from 62° F. to 212° F.		1 Joule =		1 watt-second.	
0.746 K.W. hour.		1 Joule =		1 watt-second.	
1,980,000 ft.-lbs.		1 Joule =		1 watt-second.	
2,545 heat-units.		1 Joule =		1 watt-second.	
273,740 k.g.m.		1 Joule =		1 watt-second.	
0.175 lb. carbon oxidized with perfect efficiency.		1 Joule =		1 watt-second.	
2.64 lbs. water evaporated from and at 212° F.		1 Joule =		1 watt-second.	
17.0 lbs. water raised from 62° F. to 212° F.		1 Joule =	</		

H units is one which acts with H dynes on unit pole, or H lines per square centimeter. A unit magnetic pole has 4π lines of force proceeding from it.

Maxwell = unit of magnetic flux, is the amount of magnetism passing through a square centimeter of a field of unit density. Symbol, ϕ .

In non-magnetic materials a unit of intensity of flux is the same as unit intensity of field. The name maxwell is given to a unit quantity of flux, and one maxwell per square centimeter in non-magnetic materials is the same as the gauss. In magnetic materials the flux produced by the molecular magnets is added to the field (Norris).

Magnetic Flux, ϕ , is equal to the average field intensity multiplied by the cross-sectional area. The unit is the maxwell. Maxwells per square inch = gauss $\times 6.45$.

Magnetic Induction, symbol B, is the flux or the number of magnetic lines per unit of area of cross-section of magnetized material, the area being at every point perpendicular to the direction of the flux. It is equal to the product of the field intensity, H, and the permeability, μ .

Gilbert = unit of magnetomotive force, is the amount of M.M.F. that would be produced by a coil of $10 \div 4\pi$ or 0.7958 ampere-turns. Symbol F. The M.M.F. of a coil is equal to 1.2566 times the ampere-turns.

If a solenoid is wound with 100 turns of insulated wire carrying a current of 5 amperes, the M.M.F. exerted will be 500 ampere-turns $\times 1.2566 = 628.3$ gilberts.

Oersted = unit of magnetic reluctance; it is the reluctance of a cubic centimeter of an air-pump vacuum. Symbol, R.

Reluctance is that quantity in a magnetic circuit which limits the flux under a given M.M.F. It corresponds to the resistance in the electric circuit.

Permeance is the reciprocal of reluctance.

The **reluctivity** of any medium is its specific reluctance, and in the C.G.S. system is the reluctance offered by a cubic centimeter of the body between opposed parallel faces. The reluctivity of nearly all substances, other than the magnetic metals, is sensibly that of vacuum, is equal to unity, and is independent of the flux density.

Permeability is the reciprocal of magnetic reluctivity. It is a number and the symbol is μ .

Materials differ in regard to the resistance they offer to the passage of lines of force; thus iron is more permeable than air. The permeability of a substance is expressed by a coefficient, μ , which denotes its relation to the permeability of air, which is taken as 1. If H = number of magnetic lines per square centimeter which will pass through an air-space between the poles of a magnet, and B the number of lines which will pass through a certain piece of iron in that space, then $\mu = B \div H$. The permeability varies with the quality of the iron, and the degree of saturation, reaching a practical limit for soft wrought iron when B = about 18,000 and for cast iron when B = about 10,000 C.G.S. lines per square centimeter.

The permeability of a number of materials may be determined by means of the table on page 1384.

ANALOGIES BETWEEN THE FLOW OF WATER AND ELECTRICITY.

WATER.	ELECTRICITY.
Head, difference of level, in feet.	Volts; electro-motive force; difference of potential: E. or E.M.F.
Difference of pressure, lbs. per sq. in.	
Resistance of pipes, apertures, etc., increases with length of pipe, with contractions, roughness, etc.; decreases with increase of sectional area.	Ohms, resistance, R. Increases directly as the length of the conductor or wire and inversely as its sectional area, $R \propto l \div s$. It varies with the nature of the conductor.
Rate of flow, as cubic ft. per second, gallons per min., etc., or volume divided by the time. In the mining regions sometimes expressed in "miners' inches."	Amperes; current; current strength; intensity of current; rate of flow; 1 ampere = 1 coulomb per second.
	Amperes = $\frac{\text{volts}}{\text{ohms}}$; $I = \frac{E}{R}$; $E = IR$.

ANALOGIES BETWEEN THE FLOW OF WATER AND ELECTRICITY — Continued.

WATER.	ELECTRICITY.
Quantity, usually measured in cubic ft. or gallons, but is also equivalent to rate of flow \times time, as cu. ft. per second for so many hours.	Coulomb, unit of quantity, Q, = rate of flow \times time, as ampere-seconds. 1 ampere-hour = 3600 coulombs.
Work, or energy, measured in foot-pounds; product of weight of falling water into height of fall; in pumping, product of quantity in cubic feet into the pressure in lbs. per square foot against which the water is pumped.	Joule, volt-coulomb, IF, the unit of work, = product of quantity by the electro-motive force = volt-ampere-second. 1 joule = 0.7373 foot-pound. If C (amperes) = rate of flow, and E (volts) = difference of pressure between two points in a circuit, energy expended = IEt , = I^2Rt .
Power, rate of work. Horse-power = ft.-lbs. of work in 1 min. $\div 33,000$. In water flowing in pipes, rate of flow in cu. ft. per second \times resistance to the flow in lbs. per sq. ft. $\div 550$.	Watt, unit of power, P, = volts \times amperes, = current or rate of flow \times difference of potential. 1 watt = 0.7373 foot-pound per sec. = 1746 of a horse-power.

ELECTRICAL RESISTANCE.

Laws of Electrical Resistance. — The resistance, R, of any conductor varies directly as its length, l, and inversely as its sectional area, s, or $R \propto l \div s$.

If r = the resistance of a conductor 1 unit in length and 1 square unit in sectional area, $R = rl \div s$. The common unit of length for electrical calculations in English measure is the foot, and the unit of area of wires is the circular mil = the area of a circle 0.001 in. diameter. 1 mil-foot = 1 foot long 1 circ.-mil area.

Resistance of 1 mil-foot of soft copper wire at 51° F. = 10 international ohms.

EXAMPLE. — What is the resistance of a wire 1000 ft. long, 0.1 in. diam.? 0.1 in. diam. = 10,000 circ. mils.

$R = rl \div s = 10 \times 1000 \div 10,000 = 1$ ohm.

Specific resistance, also called resistivity, is the resistance of a material of unit length and section as compared with the resistance of soft copper. Conductivity is the reciprocal of specific resistance, or the relative conducting power compared with copper taken at 100.

Relative Conductivities of Different Metals at 0° and 100° C.
(Matthiessen.)

Metals.	Conductivities.		Metals.	Conductivities.	
	At 0° C. At 32° F.	At 100° C. At 212° F.		At 0° C. At 32° F.	At 100° C. At 212° F.
Silver, hard.....	100	71.56	Tin.....	12.36	8.67
Copper, hard....	99.95	70.27	Lead.....	8.32	5.86
Gold, hard.....	77.96	55.90	Arsenic.....	4.76	3.33
Zinc, pressed....	29.02	20.67	Antimony.....	4.62	3.26
Cadmium.....	23.72	16.77	Mercury, pure..	1.60
Platinum, soft...	18.00	Bismuth.....	1.245	0.878
Iron, soft.....	16.80			

Resistance of Various Metals and Alloys. — Condensed from a table compiled by H. F. Parshall and H. M. Hobart from different authorities. R = resistance in ohms per mil foot = resistance per centimeter cube $\times 6.015$. C = percent increase of resistance per degree C.

In terms of the units of the three quantities,

$$\text{Amperes} = \frac{\text{volts}}{\text{ohms}}; \text{volts} = \text{amperes} \times \text{ohms}; \text{ohms} = \frac{\text{volts}}{\text{amperes}}$$

EXAMPLES: Simple Circuits. — 1. If the source has an effective electrical pressure of 100 volts, and the resistance is two ohms, what is the current?

$$I = \frac{E}{R} = \frac{100}{2} = 50 \text{ amperes.}$$

2. What pressure will give a current of 50 amperes through a resistance of 2 ohms? $E = IR = 50 \times 2 = 100$ volts.

3. What resistance is required to obtain a current of 50 amperes when the pressure is 100 volts? $R = E \div I = 100 \div 50 = 2$ ohms.

Ohm's law applies equally to a complete electrical circuit and to any part thereof.

Series Circuits. — If conductors are arranged one after the other they are said to be in series, and the total resistance of the circuit is the sum of the resistances of its several parts. Let A, Fig. 195, be a source of current, such as a battery or generator, producing a difference of potential or E.M.F. of 120 volts, measured across *ab*, and let the circuit contain four conductors whose resistances, r_1, r_2, r_3, r_4 , are 1 ohm each, and three other resistances, R_1, R_2, R_3 , each 2 ohms. The total resistance is 10 ohms, and by Ohm's law the current $I = E \div R = 120 \div 10 = 12$ amperes. This current is constant throughout the circuit, and a series circuit is therefore one of constant current. The drop of potential in the whole circuit from *a* around to *b* is 120 volts, or $E = RI$. The drop in any portion depends on the resistance of that portion: thus from *a* to

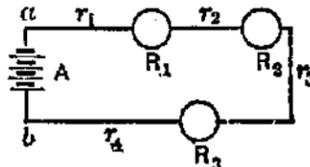

FIG. 195.

R_1 the resistance is 1 ohm, the constant current 12 amperes, and the drop $1 \times 12 = 12$ volts. The drop in passing through each of the resistance R_1, R_2, R_3 is $2 \times 12 = 24$ volts.

Parallel, Divided, or Multiple Circuits. — Let B, Fig. 196, be a generator producing an E.M.F. of 220 volts across the terminals *ab*. The current is divided, so that part flows through the main wires *ac* and part through the "shunt" *s*, having a resistance of 0.5 ohm. Also the current has three paths between *c* and *d*, viz., through the three resistances in parallel R_1, R_2, R_3 , of 2 ohms each. Consider that the resistance of the wires is so small that it may be neglected. Let the conductances of the four paths be represented by C_s, C_1, C_2, C_3 . The total

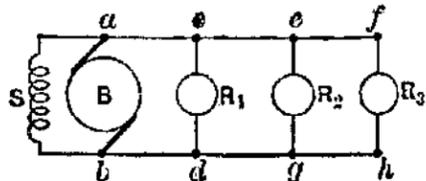

FIG. 196.

conductance is $C_s + C_1 + C_2 + C_3 = C$ and the total resistance $R = 1 \div C$. The conductance of each path is the reciprocal of its resistance, the total conductance is the sum of the separate conductances, and the resistance of the combined or "parallel" paths is the reciprocal of the total conductance.

$$R = 1 \div \left(\frac{1}{0.5} + \frac{1}{2} + \frac{1}{2} + \frac{1}{2} \right) = 1 \div 3.5 = 0.286 \text{ ohm.}$$

The current $I = E \div R = 770$ amperes.

Conductors in Series and Parallel. — Let the resistances in parallel be the same as in Fig. 196, with the additional resistance of 0.1 ohm in each of the six sections of the main wires, *ac, bd*, etc., in series. The voltage across *ab* being 220 volts, determine the drop in voltage at the several points, the total current, and the current through each path. The problem is somewhat complicated. It may be solved as follows: Consider first the points *cg*: here there are two paths for the current, *efgh* and *eg*. Find the resistance and the conductance of each and the total resistance (the reciprocal of the joint conductance) of the parallel

paths. Next consider the points *cd*; here there are two paths — one through *e* and the other through *cd*. Find the total resistance as before. Finally consider the points *ab*; here there are two paths — one through *c*, the other through *s*. Find the conductances of each and their sum. The product of this sum and the voltage at *ab* will be the total amperes of current, and the current through any path will be proportional to the conductance of that path. The resistances, R , and conductances, C , of the several paths are as follows:

	R	C
R_a of <i>efRshg</i>	$0.1 + 2 + 0.1 = 2.2$	0.4545
R_b of <i>eRsg</i>	$= 2$	0.5
Joint R_c	$= 1.048$	0.9545
R_d of <i>ce + dg + R_c</i>	$= 1.248$	0.8013
R_e of <i>cRsd</i>	$= 2$	0.5
Joint R_f	$= 0.7687$	1.3013
R_g of <i>ac + bd + R_f</i>	$= 0.9687$	1.0332
R_h of <i>s</i>	$= 0.5$	2
Joint $R_a + R_h$	$= 0.330$	3.0332

Total current = $220 \times 3.0332 = 667.3$ amperes.
 Current through *s* = $220 \times 2 = 440$ amp.; through *c* = 227.3 amp.
 " " *cd* = $227.3 \times 0.5 \div 1.3013 = 87.34$ amp.
 " " *e* = $227.3 \times 0.8013 \div 1.3013 = 139.96$ "
 " " *eRsg* = $139.96 \times 0.5 \div 0.9545 = 73.31$ "
 " " *fg* = $139.96 \times 0.4545 \div 0.9545 = 66.65$ "

The drop in voltage in any section of the line is found by the formula $E = RI$, R being the resistance of that section and I the current in it. As the R of each section is 0.1 ohm we find E for *ac* and *bd* each = 22.7 volts, for *ce* and *dg* each 14.0 volts, and for *ef* and *gh* each 6.67 volts. The voltage across *cd* is $220 - 2 \times 22.7 = 174.6$ volts; across *eg*, $174.6 - 2 \times 14.0 = 146.6$, and across *fh* $146.6 - 2 \times 66.7 = 133.3$ volts. Taking these voltages and the resistances R_1, R_2, R_3 , each 2 ohms, we find from $I = E \div R$ the current through each of these resistances 87.3, 73.3, and 66.65 amperes as before.

Internal Resistance. — In a simple circuit we have two resistances, that of the circuit R and that of the internal parts of the source of electro-motive force, called internal resistance, r . The formula of Ohm's law when the internal resistance is considered is $I = E \div (R + r)$.

Power of the Circuit. — The power, or rate of work, in watts = current in amperes \times electro-motive force in volts = $I \times E$. Since $I = E \div R$, watts = $E^2 \div R = \text{electro-motive force}^2 \div \text{resistance}$.

EXAMPLE. — What H.P. is required to supply 100 lamps of 40 ohms resistance each, requiring an electro-motive force of 60 volts?

The number of volt-amperes for each lamp is $\frac{E^2}{R} = \frac{60^2}{40}$, 1 volt-ampere = 0.00134 H.P.; therefore $\frac{60^2}{40} \times 100 \times 0.00134 = 12$ H.P. (electrical) very nearly.

Electrical, Brake, and Indicated Horse-power. — The power given by a dynamo = volts \times amperes \div 1000 = kilowatts, kw. Volts \times out amperes \div 746 = electrical horse-power, E.H.P. The power put into a dynamo shaft by a direct-connected engine or other prime mover is called the shaft or brake horse-power, B.H.P. If e_1 is the efficiency of the dynamo, B.H.P. = E.H.P. $\div e_1$. If e_2 is the mechanical efficiency of the engine, the indicated horse-power, I.H.P. = brake H.P. $\div e_2 = \text{E.H.P.} \div (e_1 \times e_2)$.

If e_1 and e_2 each = 91.5%, I.H.P. = E.H.P. \times 1.194 = kw. \times 1.60. In direct-connected units of 250 kw. or less the rated H.P. of the engine is commonly taken as 1.6 \times the rated kw. of the generator.

Electric motors are rated at the H.P. given out at the pulley or belt. H.P. of motor = E.H.P. supplied \times efficiency of motor.

Heat Generated by a Current. — Joule's law shows that the heat developed in a conductor is directly proportional, 1st, to its resistance; 2d, to the square of the current strength; and 3d, to the time during which the current flows, or $H = I^2Rt$. Since $I = E \div R$,

$$I^2Rt = \frac{E}{R} IRt = EIt = E \frac{E}{R} t = \frac{E^2t}{R}$$

Or, heat = current² \times resistance \times time
 = electro-motive force \times current \times time.
 = electro-motive force² \times time \div resistance.
 Q = quantity of electricity flowing = $It = (Et \div R)$.
 $H = EQ$; or heat = electro-motive force \times quantity.

The electro-motive force here is that causing the flow, or the difference in potential between the ends of the conductor.

The electrical unit of heat, or "joule" = 10^7 ergs = heat generated in one second by a current of 1 ampere flowing through a resistance of one ohm = 0.239 gramme of water raised 1° C. $H = I^2Rt \times 0.239$ gramme calories = $I^2Rt \times 0.0009478$ British thermal units.

In electric lighting the energy of the current is converted into heat in the lamps. The resistance of the lamp is made great so that the required quantity of heat may be developed, while in the wire leading to and from the lamp the resistance is made as small as is commercially practicable, so that as little energy as possible may be wasted in heating the wire.

Heating of Conductors. (From Kapp's Electrical Transmission of Energy.) — It becomes a matter of great importance to determine beforehand what rise in temperature is to be expected in each given case; and if that rise should be found to be greater than appears safe, provision must be made to increase the rate at which heat is carried off. This can generally be done by increasing the superficial area of the conductor. Say we have one circular conductor of 1 square inch area, and find that with 1000 amperes flowing it would become too hot. Now by splitting up this conductor into 10 separate wires each one-tenth of a square inch cross-sectional area, we have not altered the total amount of energy transformed into heat, but we have increased the surface exposed to the cooling action of the surrounding air in the ratio of 1: $\sqrt{10}$, and therefore the ten thin wires can dissipate more than three times the heat, as compared with the single thick wire.

Prof. Forbes states that an insulated wire carries a greater current without overheating than a bare wire if the diameter be not too great. Assuming the diameter of the cable to be twice the diam. of the conductor, a greater current can be carried in insulated wires than in bare wires up to 1.9 inch diam. of conductor. If diam. of cable = 4 times diam. of conductor, this is the case up to 1.1 inch diam. of conductor.

Heating of Bare Wires. — The following formulæ are given by Kennelly:

$$T = \frac{I^2}{65} \times 90,000 + t; \quad d = 44.8 \sqrt[3]{\frac{I^2}{T-t}}$$

T = temperature of the wire and t that of the air, in Fahrenheit degrees;
 I = current in amperes, d = diameter of the wire in mils.

If we take $T - t = 90^\circ F.$, $\sqrt[3]{90} = 4.48$, then

$$d = 10 \sqrt[3]{I^2} \quad \text{and} \quad I = \sqrt{d^3 \div 1000}$$

This latter formula gives for the carrying capacity in amperes of bare wires almost exactly the figures given for weather-proof wires in the Fire Underwriters' table, except in the case of Nos. 18 and 16, B. & S. gauge, for which the formula gives 8 and 11 amperes, respectively, instead of 5 and 8 amperes, given in the table.

Heating of Coils. — The rise of temperature in magnet coils due to the passage of current through the wire is approximately proportional to the watts lost in the coil per unit of effective radiating surface, thus:

$$t \propto \frac{I^2R}{S} \quad \text{or} \quad t = \frac{I^2R}{kS}$$

t being the temperature rise in degrees Fahr.; S , the effective radiating surface; and k a coefficient which varies widely, according to condition. In electromagnet coils of small size and power, k may be as large as 0.015. Ordinarily it ranges from 0.012 down to 0.003; a fair average is 0.007. The more exposed the coil is to air circulation, the larger is the value of k ; the larger the proportion of iron to copper, by weight, in the core and winding, the thinner the winding with relation to its dimension parallel with the magnet core, and the larger the "space factor" of the winding, the larger will be the value of k . The space factor is the ratio of the actual copper cross-section of the whole coil to the gross cross-section of copper, insulation, and interstices.

Fusion of Wires. — W. H. Preece gives a formula for the current required to fuse wires of different metals, viz., $I = ad^2$, in which d is the diameter in inches and a a coefficient whose value for different metals is as follows: Copper, 10,244; aluminum, 7585; platinum, 5172; German silver, 5230; platinumoid, 4750; iron, 3148; tin, 1462; lead, 1379; alloy of 2 lead and 1 tin, 1318.

Allowable Carrying Capacity of Copper Wires.
 (For inside wiring, National Board of Fire Underwriters' Rules.)

B. & S. Gauge.	Circular Mils.	Amperes.		Circular Mils.	Amperes.	
		Rubber Covered.	Other Insulation.		Rubber Covered.	Other Insulation.
18	1,624	3	5	200,000	200	300
16	2,583	6	8	300,000	270	400
14	4,107	12	16	400,000	330	500
12	6,530	17	23	500,000	390	590
10	10,380	24	32	600,000	450	680
8	16,510	33	46	700,000	500	760
6	26,250	46	65	800,000	550	840
5	33,100	54	77	900,000	600	920
4	41,740	65	92	1,000,000	650	1,000
3	52,630	76	110	1,100,000	690	1,080
2	66,370	90	131	1,200,000	730	1,150
1	83,690	107	156	1,300,000	770	1,220
0	105,500	127	185	1,400,000	810	1,290
00	133,100	150	220	1,600,000	890	1,430
000	167,800	177	262	1,800,000	970	1,550
0000	211,600	210	312	2,000,000	1,050	1,670

Wires smaller than No. 14 B. & S. gauge must not be used except in fixtures and pendant cords.

The lower limit is specified for rubber-covered wires to prevent deterioration of the insulation by the heat of the wires.

For insulated aluminum wire the safe-carrying capacity is 84 per cent of that of copper wire with the same insulation.

See pamphlets published by the National Board of Fire Underwriters, New York, for complete specifications and rules for wiring.

Underwriters' Insulation. — The thickness of insulation required by the rules of the National Board of Fire Underwriters varies with the size of the wire, the character of the insulation, and the voltage. The thickness of insulation on rubber-covered wires carrying voltages up to 600 varies from 1/32 inch for a No. 18 B. & S. gauge wire to 1/8 inch for a wire of 1,000,000 circular mils. Weather-proof insulation is required to be slightly thicker. For voltages of over 600 the insulation is required to be at least 3/32 inch thick for all sizes from No. 14 B. & S. gauge to 500,000 mils and 1/8 inch thick for larger sizes.

Drop of Voltage of Wires with Currents Allowed by Underwriters' Rules, as in the above Table.

Table with columns: B. & S. Gauge, Volts drop per 1000 ampere feet, Rubber Covered, Weather proof, Circular Mils., Volts drop per 1000 ampere feet, Rubber Covered, Weather proof.

Copper-wire Table. — The table on pages 1357 and 1358 is abridged from one computed by the Committee on Units and Standards of the American Institute of Electrical Engineers (Trans., Oct., 1893).

Wiring Table for Motor Service.

Carrying Capacity in Amperes is Figured at 25% increased Capacity, as Required by the Underwriters.

Table with columns: Wire Gauge No. B. and S., Safe Carrying Capacity in Amperes, Horse-power, Distance in Feet that the Different Horse-powers can be Transmitted with a Loss of One Volt.

Weights, Lengths, and Resistances of Cool, Warm, and Hot Copper Wires.

Large table with columns: Gauge, Area, Diam-eter, Weight, Length, Resistance in International Ohms at various temperatures.

Weights, Lengths, and Resistances of Cool, Warm, and Hot Copper Wires. — Continued.

A. W. G. B. & S.	Gauges B. W. G. Stubs.	Diam- eter, inches.	Area, Circular Mils.	Weight.		Length.		Resistance in International Ohms.		
				Lbs. per Foot.	Lbs. per Ohm, at 20° C., 68° F.	Feet per Lb.	Ft. per Ohm, at 20° C., 68° F.	Ohms per Lb., at 20° C., 68° F.	Ohms per ft., at 20° C., 68° F.	Ohms per ft., at 50° C., 122° F.
17	19	0.04526	2,048	1.226	197.8	0.006200	181.3	0.8153	0.005955	0.006259
18		0.04200	1,764	0.907	170.4	0.005340	187.3	1.099	0.005870	0.007267
19	20	0.04010	1,624	0.773	156.9	0.004917	201.4	1.296	0.006374	0.007892
20	21	0.03769	1,288	0.481	124.4	0.003699	236.5	2.061	0.008038	0.009952
21		0.03500	1,225	0.437	118.3	0.003708	269.7	2.279	0.008452	0.01047
22	22	0.03200	1,024	0.306	98.90	0.003100	322.6	3.262	0.01011	0.01252
23	23	0.03196	810.1	0.301	98.69	0.003092	321.6	3.278	0.01014	0.01255
24	24	0.02846	784.0	0.1919	78.24	0.002452	407.8	5.212	0.01278	0.01583
25	25	0.02535	642.4	0.1797	62.05	0.002371	421.4	5.565	0.01321	0.01635
26	26	0.02500	625.0	0.1707	60.36	0.001945	514.2	8.287	0.01612	0.01956
27	27	0.02257	509.5	0.1142	49.21	0.001892	528.6	8.756	0.01657	0.02051
28	28	0.02152	464.0	0.07869	46.75	0.001542	648.4	14.60	0.02032	0.02516
29	29	0.02010	404.0	0.06849	39.02	0.001465	662.6	20.95	0.02139	0.02649
30	30	0.02000	400.0	0.06773	38.63	0.001223	817.6	32.32	0.02363	0.03173
31	31	0.01800	324.0	0.04578	31.29	0.001211	825.9	33.32	0.02568	0.03205
32	32	0.01600	256.0	0.03099	24.54	0.000908	1,020	52.19	0.03196	0.03957
33	33	0.01594	254.1	0.02749	24.54	0.000902	1,031	52.97	0.03231	0.04001
34	34	0.0142	201.5	0.007692	19.46	0.000769	1,290	84.23	0.04075	0.05008
35	35	0.0140	195.0	0.005933	18.93	0.0006100	1,683	119.8	0.05138	0.06362
36	36	0.0130	169.0	0.005116	16.32	0.0004837	1,955	133.9	0.06127	0.08541
37	37	0.0126	144.0	0.004837	15.43	0.0004359	2,067	165.0	0.06479	0.09586
38	38	0.01126	126.7	0.003636	13.91	0.0003662	2,294	213.0	0.06799	0.12022
39	39	0.01003	100.5	0.003042	12.24	0.0004696	2,607	283.6	0.07190	0.15803
40	40	0.01000	100.0	0.003027	12.24	0.002953	2,607	313.0	0.08170	0.18903
		0.0090	81.0	0.002027	9.707	0.002924	3,287	338.6	0.1030	0.2276
		0.008928	79.70	0.002452	9.658	0.002413	3,304	342.0	0.1035	0.2282
		0.007950	64.0	0.002413	7.823	0.001918	4,078	321.3	0.1299	0.278
		0.007080	63.21	0.001917	7.698	0.001857	4,145	338.4	0.1618	0.3583
		0.0070	50.13	0.001168	6.162	0.001197	5,162	411.2	0.1807	0.4609
		0.006305	49.0	0.001517	6.591	0.0007346	6,591	485.2	0.1850	0.5008
		0.005615	39.75	0.001483	6.242	0.0007019	6,742	538.6	0.2113	0.6034
		0.0050	31.52	0.0004620	8.311	0.0004620	8,311	616.8	0.2308	0.7258
		0.004453	25.0	0.0002995	3.441	0.0002995	10,480	729.0	0.2605	0.8686
		0.0040	19.83	0.0007568	13.210	0.0001827	13,210	870.2	0.3284	1.129
		0.003965	16.72	0.0005001	11.915	0.000149	11,915	950.0	0.4142	1.428
		0.003531	12.47	0.0002759	20.650	0.0000484	20,650	1,360.0	0.5222	1.851
		0.003145	9.816	0.0002210	21.010	0.0000545	21,010	1,470.0	0.6471	2.350
				0.00003774	26.500	0.0000545	26,500	1,600.0	0.8154	3.024
				0.00002993	33.410	0.00002993	33,410	1,980.0	1.047	3.770

ELECTRIC TRANSMISSION, DIRECT CURRENTS.

Cross-section of Wire Required for a Given Current. —

Let R = resistance of a given line of copper wire, in ohms;
 r = " " " 1 mil-foot of copper;
 L = length of wire, in feet;
 e = drop in voltage between the two ends;
 I = current, in amperes;
 A = sectional area of wire, in circular mils;
 then $I = \frac{e}{R}$; $R = \frac{e}{I}$; $R = r \frac{L}{A}$; whence $A = \frac{rIL}{e}$.

The value of r for soft copper wire at 75° F. is 10.505 international ohms. For ordinary drawn copper wire the value of 10.8 is commonly taken, corresponding to a conductivity of 97.2 per cent.

For a circuit, going and return, the total length is $2L$, and the formula becomes $A = 21.6IL \div e$, L here being the distance from the point of supply to the point of delivery.

If E is the voltage at the generator and a the per cent of drop in the line, then $e = Ea \div 100$, and $A = \frac{2160IL}{aE}$.

If P = the power in watts, $= EI$, then $I = \frac{P}{E}$, and $A = \frac{2160PL}{aE^2}$.

If P_k = the power in kilowatts, $A = 2,160,000 F_k L \div aE^2$.

If L_m = the distance in miles and A_c the area in circular inches, then $A_c = 6405 P_k L_m \div aE^2$. If A_s = area in square inches, $A_s = 5030 P_k L_m \div aE^2$. When the area in circular mils has been determined by either of these formulae reference should be made to the table of Allowable Capacity of Wires, to see if the calculated size is sufficient to avoid overheating. For all interior wiring the rules of the National Board of Fire Underwriters should be followed. See Appendix to Vol. II of "Crocker's Electric Lighting."

Weight of Copper for a Given Power. — Taking the weight of a mil-foot of copper at 0.00003027 lb., the weight of copper in a circuit of length $2L$ and cross-section A , in circ. mils, is $0.00006054 LA$ lbs., $= W$. Substituting for A its value $2160PL \div aE^2$ we have

$$W = 0.0130766 PL^2 \div aE^2; \quad P \text{ in watts, } L \text{ in ft.}$$

$$W = 13.0766 P_k L^2 \div aE^2; \quad P_k \text{ in kilowatts, } L \text{ in ft.}$$

$$W = 364,556,000 P_k L_m^2 \div aE^2; \quad P_k \text{ in kilowatts, } L_m \text{ in miles.}$$

The weight of copper required varies directly as the power transmitted; inversely as the percentage of drop or loss; directly as the square of the distance; and inversely as the square of the voltage.

From the last formula the following table has been calculated:

WEIGHT OF COPPER WIRE TO CARRY 1000 KILOWATTS WITH 10% LOSS.

Volts.	Distance in miles.					
	1	5	10	20	50	100
500	145,822	3,645,560	3,645,560	3,645,560	3,645,560	3,645,560
1,000	36,456	911,390	911,390	911,390	911,390	911,390
2,000	9,114	227,848	227,848	227,848	227,848	227,848
5,000	1,458	36,456	36,456	36,456	36,456	36,456
10,000	365	9,114	9,114	9,114	9,114	9,114
20,000	91	2,278	2,278	2,278	2,278	2,278
40,000		570	570	570	570	570
60,000			1,013	1,013	1,013	1,013

In calculating the distance, an addition of about 5 per cent should be made for sag of the wires.

Short-circuiting. - From the law $I = E/R$ it is seen that with any pressure E , the current I will become very great if R is made very small. In short-circuiting the resistance becomes small and the current therefore great. Hence the dangers of short-circuiting a current.

Economy of Electric Transmission. - Lord Kelvin's rule for the most economical section of conductor for a given voltage is that for which the annual interest on capital outlay is equal to the annual cost of energy wasted.

Tables have been compiled by Professor Forbes and others in accordance with modifications of this rule. For a given entering horse-power the question is merely one as to what current density, or how many amperes per square inch of conductor, should be employed. Kelvin's rule gives about 393 amperes per square inch, and Professor Forbes's tables give a current density of about 380 amperes per square inch as most economical.

Bell ("Electric Transmission of Power") shows that while Kelvin's rule correctly indicates the condition of minimum cost in transmission for a given current and line, it omits many practical considerations and is inapplicable to most power transmission work. Each plant has to be considered on its merits and very various conditions are likely to determine the line loss in different cases. Several cases are cited by Bell to show that neither Kelvin's law nor any modification of it is a safe guide in determining the proper allowance for loss of energy in the line.

Wire Tables. - The tables on this and the following page show the relation between load, distance, and "drop" or loss by voltage in a two-wire direct-current circuit of any standard size of wire. The tables are based on the formula

$$(21.6 IL) \div A = \text{Drop in volts.}$$

I = current in amperes, L = distance in feet from point of supply to point of delivery, A = sectional area of wire in circular mils. The factors I and L are combined in the table, in the compound factor "ampere feet."

WIRE TABLE - RELATION BETWEEN LOAD, DISTANCE, LOSS, AND SIZE OF CONDUCTOR.

NOTE. - The numbers in the body of the tables are Ampere-Feet, i.e., Amperes X Distance (length of one wire). See examples on next page.

Table I. - 110-volt and 220-volt Two-wire Circuits.

Wire Sizes; B. & S. Gauge.		Line Loss in Percentage of the Rated Voltage; and Power Loss in Percentage of the Delivered Power.									
110 V.	220 V.	1	1 1/2	2	3	4	5	6	8	10	
	0000	21,550	32,325	43,100	64,650	86,200	107,750	129,300	172,400	215,500	
	000	17,080	25,620	34,160	51,240	68,320	85,400	102,480	136,640	170,800	
	00	13,550	20,325	27,100	40,650	54,200	67,750	81,300	108,400	135,500	
0000	0	10,750	16,125	21,500	32,250	43,000	53,750	64,500	86,000	107,500	
000	1	8,520	12,780	17,040	25,560	34,080	42,600	51,120	68,160	85,200	
	2	6,750	10,140	13,520	20,280	27,040	33,800	40,560	54,080	67,600	
0	3	5,360	8,040	10,720	16,080	21,440	26,800	32,160	42,880	53,600	
1	4	4,250	6,375	8,500	12,750	17,000	21,250	25,500	34,000	42,500	
2	5	3,370	5,055	6,740	10,110	13,480	16,850	20,220	26,960	33,700	
3	6	2,670	4,005	5,340	8,010	10,680	13,350	16,020	21,360	26,700	
4	7	2,120	3,180	4,240	6,360	8,480	10,600	12,720	16,960	21,200	
5	8	1,680	2,520	3,360	5,040	6,720	8,400	10,800	13,440	16,800	
6	9	1,330	1,995	2,660	3,990	5,320	6,650	7,980	10,640	13,300	
7	10	1,055	1,582	2,110	3,165	4,220	5,275	6,330	8,440	10,550	
8	11	838	1,257	1,675	2,514	3,350	4,190	5,028	6,706	8,380	
9	12	665	997	1,330	1,995	2,660	3,320	3,990	5,320	6,650	
10	13	527	790	1,054	1,580	2,108	2,635	3,160	4,215	5,270	
11	14	418	627	836	1,254	1,672	2,090	2,508	3,344	4,180	
12	332	498	665	997	1,330	1,660	1,995	2,660	3,325	
14	209	313	418	627	836	1,045	1,354	1,672	2,090	

Table II. - 500, 1000, and 2000 Volt Circuits.

Wire Sizes; B. & S. Gauge.			Line Loss in Percentage of the Rated Voltage; and Power Loss in Percentage of the Delivered Power.							
500 V.	1000 V.	2000 V.	1	1 1/2	2	2 1/2	3	4	5	
	0000	0	97,960	146,940	195,920	244,900	293,880	391,840	489,800	
	000	1	77,690	116,535	155,380	194,225	233,970	310,760	388,450	
	00	2	61,620	92,430	123,240	154,050	184,860	246,480	308,100	
0000	0	3	48,880	73,320	97,760	122,200	146,640	195,420	244,400	
000	1	4	38,750	58,125	77,500	96,875	116,250	155,000	193,750	
	2	5	30,760	46,140	61,520	76,900	92,280	123,040	153,800	
00	3	6	24,370	36,555	48,740	60,925	73,110	97,480	121,850	
0	4	7	19,320	28,980	38,640	48,300	57,960	77,280	96,600	
1	5	8	15,320	22,980	30,640	38,300	45,960	61,280	76,600	
2	6	9	12,150	18,225	24,300	30,375	36,450	48,300	60,750	
3	7	10	9,640	14,460	19,280	24,100	28,920	38,560	48,200	
4	8	11	7,640	11,460	15,280	19,100	22,920	30,560	38,200	
5	9	12	6,060	9,090	12,120	15,150	18,180	24,240	30,300	
6	10	13	4,805	7,207	9,610	12,010	14,415	19,220	24,025	
7	11	14	3,810	5,715	7,620	9,525	11,430	15,220	19,050	
8	
9	12	3,020	4,530	6,040	7,550	9,060	12,080	15,100	
10	13	2,395	3,592	4,790	5,985	7,185	9,580	11,975	
11	14	1,900	2,850	3,800	4,750	5,700	7,600	9,500	
12	1,510	2,265	3,020	3,775	4,530	6,040	7,550	
14	950	1,425	1,900	2,375	2,850	3,800	4,750	

EXAMPLES IN THE USE OF THE WIRE TABLES. - 1. Required the maximum load in amperes at 220 volts that can be carried 95 feet by No. 6 wire without exceeding 1 1/2% drop.

Find No. 6 in the 220-volt column of Table I: opposite this in the 1 1/2% column is the number 4005, which is the ampere-feet. Dividing this by the required distance (95 feet) gives the load, 42.15 amperes.

Example 2. A 500-volt line is to carry 100 amperes 600 feet with a drop not exceeding 5%; what size of wire will be required?

The ampere-feet will be $100 \times 600 = 60,000$. Referring to the 5% column of Table II, the nearest number of ampere-feet is 60,750, which is opposite No. 3 wire in the 500-volt column.

These tables also show the percentage of the power delivered to a line that is lost in non-inductive alternating-current circuits. Such circuits are obtained when the load consists of incandescent lamps and the circuit wires lie only an inch or two apart, as in conduit wiring.

Efficiency of Electric Systems. - The efficiency of a system is the ratio of the power delivered by the electric motors at the distant end of the line to the power delivered to the dynamo-electric machines at the other end. The efficiency of a dynamo or motor varies with its load and with the size of machine, ranging about as follows for dynamos at full load:

Kilowatts	30	50	100	200	500	1000
Efficiency %	90	91	92	93	94	95

For motors at full load the efficiencies run about as follows:

H.P.	1	2	5	10	20	50	75	100
Effy. %	75	80	85	88.5	90	91	91.5	91.6

The efficiency of both generators and motors decreases, at first very slowly and then more rapidly, as the load decreases. Each machine has its "characteristic" curve of efficiency, showing the ratio of output to input at different loads. The following is a rough approximation for direct-current machines: Decrease of efficiency at half-load, 3%; 1/4 load, 10%; 1/8 load, 20%; 1/16 load, 50%. The loss in transmission, due to fall in

Resistances of Pure Aluminum Wire.*

Conductivity 62 in the Matthiessen Standard Scale. Pure aluminum weighs 167.111 pound's per cubic foot.

Am. Gauge, B. & S. No.	Resistances at 70° F.				Am. Gauge, B. & S. No.	Resistances at 70° F.			
	Ohms per 1000 Feet.	Ohms per Mile.	Feet per Ohm.	Ohms per Pound.		Ohms per 1000 Feet.	Ohms per Mile.	Feet per Ohm.	Ohms per Pound.
0000	0.07904	0.41730	12652.	0.00040985	19	12.985	68.564	77.05	11.070
000	.09966	.52623	10034.	.00065102	20	16.381	86.500	61.06	17.595
00	.12569	.66362	7956.	.0010364	21	20.649	109.02	48.43	27.971
0	.15849	.83684	6310.	.0016479	22	26.025	137.42	38.44	44.450
1	.19982	1.0552	5005.	.0026194	23	32.830	173.35	30.45	70.700
2	.25200	1.3305	3968.	.0041656	24	41.400	218.60	24.16	112.43
3	.31778	1.6779	3147.	.0066250	25	52.200	275.61	19.16	178.78
4	.40067	2.1156	2496.	.010531	26	65.856	347.70	15.19	284.36
5	.50526	2.6679	1975.	.016749	27	83.010	438.32	12.05	452.62
6	.63720	3.3687	1569.	.026628	28	104.67	552.64	9.55	718.95
7	.80350	4.2425	1245.	.042335	29	132.00	697.01	7.58	1142.9
8	1.0131	5.3498	987.0	.067318	30	166.43	876.80	6.01	1817.2
9	1.2773	6.7442	783.0	.10710	31	209.85	1108.0	4.77	2888.0
10	1.6111	8.5065	620.8	.17028	32	264.68	1397.6	3.78	4595.5
11	2.0312	10.723	492.4	.27061	33	333.68	1760.2	3.00	7302.0
12	2.5615	13.525	390.5	.43040	34	420.87	2222.2	2.38	11627.
13	3.2300	17.055	309.6	.68437	35	530.60	2801.8	1.86	18440.
14	4.0724	21.502	245.6	1.0877	36	669.00	3532.5	1.50	29352.
15	5.1354	27.114	194.8	1.7306	37	843.46	4453.0	1.19	46600.
16	6.4755	34.190	154.4	2.7505	38	1064.0	5618.0	0.95	74240.
17	8.1670	43.124	122.5	4.3746	39	1341.2	7082.0	0.75	118070.
18	10.300	54.388	97.10	6.9590	40	1691.1	8930.0	0.59	187700.

* Calculated on the basis of Dr. Matthiessen's standard, viz.: The resistance of a pure soft copper wire 1 meter long, having a weight of 1 gram = 0.141729 International Ohm at 0° C.
(From Aluminum for Electrical Conductors; Pittsburgh Reduction Co.)

electrical pressure or "drop" in the line, is governed by the size of the wires, the other conditions remaining the same. For a long-distance transmission plant this will vary from 5% upwards.
With generator efficiency and motor efficiency each 90%, and transmission loss 5%, the combined efficiency is $0.90 \times 0.90 \times 0.95 = 76.95\%$.
The methods for long-distance transmission may be divided into three general classes: (1) continuous current; (2) alternating current; and (3) rotary-converter or "motor-dynamo" systems. There are many factors which govern the selection of a system. For each problem considered there will be found certain fixed and certain unfixed conditions. In general the fixed factors are: (1) capacity of source of power; (2) cost of power at source; (3) cost of power by other means at point of delivery; (4) danger considerations at motors; (5) operating conditions; (6) construction conditions (length of line, character of country, etc.). The partly fixed conditions are: (7) power which must be delivered, i.e., the efficiency of the system; (8) size and number of delivery units. The variable conditions are: (9) initial voltage; (10) pounds of copper on line; (11) original cost of all apparatus and construction; (12) expenses, operating (fixed charges, interest, depreciation, taxes, insurance, etc.); (13) liability of trouble and stoppages; (14) danger at station and on line; (15) convenience in operating, making changes, extensions, etc.

Systems of Electrical Distribution in Common Use.

I. DIRECT CURRENT.

A. Constant Potential.

110 to 125 and 220 to 250 Volts.—Distances less than, say, 1500 feet.

For incandescent lamps.

For arc-lamps, usually 2 in series.

For motors of moderate sizes.

200 to 250 and 440 Volts, 3-wire.—Distances less than, say, 5000 feet.

For incandescent lamps.

For arc-lamps, usually 2 in series on each branch.

For motors 110 or 220 volts, usually 220 volts.

500 Volts.—Distances less than, say, 20,000 feet.

Incidentally for arc-lamps, usually 10 in series.

For motors, stationary and street-car.

B. Constant Current.

Usually 5, 6 1/2, or 9 1/2 amperes, the volts increasing to several thousand, as demanded, for series arc-lamps.

II. ALTERNATING CURRENT.

A. Constant Potential.

For incandescent lamps, arc-lamps, and motors.

Polyphase Systems.

For arc and incandescent lamps, motors, and rotary converters for giving direct current.

Polyphase—2- and 3-phase—high tension (25,000 volts and over), for long-distance transmission; transformed by step-up and step-down transformers.

B. Constant Current.

Usually 5 to 6.6 amperes. For arc-lamps.

The Relative Advantages of Different Systems vary with each particular transmission problem, but in a general way may be tabulated as below:

	System.	Advantages.	Disadvantages.	
Continuous.	2-wire {	Low voltage.	Safety, simplicity.	Expense for copper.
		High voltage.	Economy, simplicity.	Danger; difficulty of building machines.
	3-wire.	Low voltage on machines and saving in copper.	Not saving enough in copper for long distances. Necessity for "balanced" system.	
Alternating	Multiple-wire.	Low voltage at machines and saving in copper.		
	Single phase.	Economy of copper.	Cannot start under load. Low efficiency.	
	Multiphase.	Economy of copper, synchronous speed unnecessary; applicable to very long distances.	Requires more than two wires.	
	Motor-dynamo.	High-voltage A.C. transmission. Low-voltage D.C. delivery.	Expensive. Low efficiency.	

TABLE OF ELECTRICAL HORSE-POWERS.

Formula: $\frac{\text{Volts} \times \text{Amperes}}{746} = \text{H.P.}$, or 1 volt ampere = .0013405 H.P.

Read amperes at top and volts at side or vice versa.

Amperes or Volts.	Volts or Amperes.												
	1	10	20	30	40	50	60	70	80	90	100	110	120
1	.00134	.0134	.0268	.0402	.0536	.0670	.0804	.0938	.1072	.1206	.1341	.1475	.1609
2	.00268	.0268	.0536	.0804	.1072	.1341	.1609	.1877	.2145	.2413	.2681	.2949	.3217
3	.00402	.0402	.0804	.1206	.1609	.2011	.2413	.2815	.3217	.3619	.4022	.4424	.4826
4	.00536	.0536	.1072	.1609	.2145	.2681	.3217	.3753	.4290	.4826	.5362	.5898	.6434
5	.00670	.0670	.1341	.2011	.2681	.3351	.4022	.4692	.5362	.6032	.6703	.7373	.8043
6	.00804	.0804	.1609	.2413	.3217	.4022	.4826	.5630	.6434	.7239	.8043	.8847	.9652
7	.00938	.0938	.1877	.2815	.3753	.4692	.5630	.6568	.7507	.8445	.9384	1.0322	1.1260
8	.01072	.1072	.2145	.3217	.4290	.5362	.6434	.7507	.8579	.9652	1.0724	1.1796	1.2868
9	.01206	.1206	.2413	.3619	.4826	.6032	.7239	.8445	.9652	1.0858	1.2065	1.3271	1.4478
10	.01341	.1341	.2681	.4022	.5362	.6703	.8043	.9384	1.0724	1.2065	1.3405	1.4745	1.6085
11	.01475	.1475	.2949	.4424	.5898	.7373	.8847	1.0322	1.1796	1.3271	1.4745	1.6219	1.7693
12	.01609	.1609	.3217	.4826	.6434	.8043	.9652	1.1260	1.2868	1.4476	1.6085	1.7693	1.9301
13	.01743	.1743	.3485	.5228	.6970	.8713	1.0456	1.2200	1.3943	1.5686	1.7429	1.9172	2.0915
14	.01877	.1877	.3753	.5630	.7507	.9384	1.1260	1.3136	1.5012	1.6888	1.8764	2.0640	2.2516
15	.02011	.2011	.4022	.6032	.8043	1.0054	1.2065	1.4076	1.6087	1.8098	2.0109	2.2120	2.4131
16	.02145	.2145	.4290	.6434	.8579	1.0724	1.2868	1.5012	1.7157	1.9301	2.1445	2.3589	2.5733
17	.02279	.2279	.4558	.6837	.9115	1.1393	1.3671	1.5949	1.8227	2.0505	2.2783	2.5061	2.7339
18	.02413	.2413	.4826	.7239	.9652	1.2065	1.4478	1.6891	1.9304	2.1717	2.4130	2.6543	2.8956
19	.02547	.2547	.5094	.7641	1.019	1.273	1.528	1.783	2.037	2.292	2.547	2.801	3.055
20	.02681	.2681	.5362	.8043	1.0724	1.3405	1.6085	1.8764	2.1445	2.4126	2.6807	2.9488	3.2169
21	.02815	.2815	.5630	.8445	1.1260	1.4076	1.699	1.971	2.252	2.533	2.815	3.097	3.378
22	.02949	.2949	.5898	.8847	1.180	1.475	1.789	2.064	2.359	2.654	2.949	3.244	3.539
23	.03083	.3083	.6166	.9219	1.233	1.542	1.850	2.158	2.467	2.775	3.083	3.391	3.700
24	.03217	.3217	.6434	.9652	1.287	1.609	1.940	2.252	2.574	2.895	3.217	3.539	3.861
25	.03351	.3351	.6703	1.005	1.341	1.676	2.011	2.346	2.681	3.016	3.351	3.686	4.022
26	.03485	.3485	.6971	1.046	1.394	1.743	2.091	2.440	2.788	3.137	3.485	3.834	4.182
27	.03619	.3619	.7239	1.086	1.448	1.810	2.172	2.534	2.895	3.257	3.619	3.981	4.343
28	.03753	.3753	.7507	1.126	1.501	1.877	2.252	2.627	3.003	3.378	3.753	4.129	4.504
29	.03887	.3887	.7775	1.166	1.555	1.944	2.332	2.721	3.110	3.499	3.887	4.276	4.665
30	.04022	.4022	.8043	1.206	1.609	2.011	2.413	2.815	3.217	3.619	4.022	4.424	4.826
31	.04156	.4156	.8311	1.247	1.662	2.078	2.493	2.909	3.324	3.740	4.156	4.571	5.087
32	.04290	.4290	.8579	1.287	1.716	2.145	2.574	3.003	3.432	3.861	4.290	4.719	5.148
33	.04424	.4424	.8847	1.327	1.769	2.212	2.654	3.097	3.539	3.986	4.424	4.866	5.308
34	.04558	.4558	.9115	1.367	1.823	2.279	2.735	3.190	3.646	4.102	4.558	5.013	5.469
35	.04692	.4692	.9384	1.408	1.877	2.346	2.815	3.284	3.753	4.223	4.692	5.161	5.630
40	.05362	.5362	1.072	1.609	2.145	2.681	3.217	3.753	4.290	4.826	5.362	5.898	6.434
45	.06032	.6032	1.206	1.810	2.413	3.016	3.619	4.223	4.826	5.439	6.032	6.635	7.239
50	.06703	.6703	1.341	2.011	2.681	3.351	4.022	4.692	5.362	6.032	6.703	7.373	8.043
55	.07373	.7373	1.475	2.212	2.949	3.686	4.424	5.161	5.898	6.635	7.373	8.110	8.847
60	.08043	.8043	1.609	2.413	3.217	4.022	4.826	5.630	6.434	7.239	8.043	8.847	9.652
65	.08713	.8713	1.743	2.614	3.485	4.357	5.228	6.099	6.970	7.842	8.713	9.584	10.46
70	.09384	.9384	1.877	2.815	3.753	4.692	5.630	6.568	7.507	8.445	9.384	10.32	11.26
75	.10054	1.005	2.011	3.016	4.021	5.027	6.032	7.037	8.043	9.048	10.05	11.06	12.06
80	.10724	1.072	2.145	3.217	4.290	5.362	6.434	7.507	8.579	9.652	10.72	11.80	12.87
85	.11394	1.139	2.279	3.418	4.558	5.697	6.830	7.970	9.110	10.25	11.39	12.53	13.67
90	.12065	1.206	2.413	3.619	4.826	6.032	7.230	8.445	9.652	10.86	12.06	13.27	14.48
95	.12735	1.273	2.547	3.820	5.094	6.367	7.641	8.914	10.18	11.46	12.73	14.01	15.28
100	.13405	1.341	2.681	4.022	5.362	6.703	8.043	9.384	10.72	12.06	13.41	14.75	16.09
200	.2681	2.681	5.362	8.043	10.72	13.41	16.09	18.77	21.45	24.13	26.81	29.49	32.17
300	.4022	4.022	8.043	12.06	16.09	20.11	24.13	28.15	32.17	36.19	40.22	44.24	48.26
400	.5362	5.362	10.72	16.09	21.45	26.81	32.17	37.53	42.90	48.26	53.62	58.98	64.34
500	.6703	6.703	13.41	20.11	26.81	33.51	40.22	46.92	53.62	60.32	67.03	73.73	80.43
600	.8043	8.043	16.09	24.13	32.17	40.22	48.26	56.30	64.34	72.39	80.43	88.47	96.52
700	.9384	9.384	18.77	28.15	37.53	46.92	55.30	65.68	75.07	84.45	93.84	103.2	112.6
800	1.0724	10.72	21.45	32.17	42.90	53.62	64.34	75.07	85.79	96.52	107.2	118.0	128.7
900	1.2065	12.06	24.13	36.19	48.26	60.32	72.39	84.45	96.52	108.6	120.6	132.7	144.8
1,000	1.3405	13.41	26.81	40.22	53.62	67.03	80.43	93.84	107.2	120.6	134.1	147.5	160.9
2,000	2.681	26.81	53.62	80.43	107.2	134.1	160.9	187.7	214.5	241.3	268.1	294.9	321.7
3,000	4.022	40.22	80.43	120.6	160.9	201.1	241.3	281.5	321.7	361.9	402.2	442.4	482.6
4,000	5.362	53.62	107.2	160.9	214.5	268.1	321.7	375.3	429.0	482.6	536.2	589.8	643.4
5,000	6.703	67.03	134.1	201.1	268.1	335.1	402.2	469.2	536.2	603.2	670.3	737.3	804.3
6,000	8.043	80.43	160.9	241.3	321.7	402.2	482.6	563.0	643.4	723.9	804.3	884.7	965.2
7,000	9.384	93.84	187.7	281.5	375.3	469.2	563.0	656.8	750.7	844.5	938.4	1032	1126
8,000	10.724	107.2	214.5	321.7	429.0	536.2	643.4	750.7	857.9	965.2	1072	1180	1287
9,000	12.065	120.6	241.3	361.9	482.6	603.2	723.9	844.5	965.2	1086	1206	1327	1448
10,000	13.405	134.1	268.1	402.2	536.2	670.3	804.3	938.3	1072	1206	1341	1475	1609

WARNING: This is a 1910 edition. Some of the material may no longer be accurate

Cost of Copper for Long-distance Transmission.

(Westinghouse El. and Mfg. Co.)

COST OF COPPER REQUIRED FOR THE DELIVERY OF ONE MECHANICAL HORSE-POWER AT MOTOR SHAFT WITH VARIOUS VOLTAGES AT MOTOR TERMINALS, OR AT TERMINALS OF LOWERING TRANSFORMERS.

Loss of energy in conductors (drop) equals 20%. Motor efficiency, 90%. Length of conductor per mile of single distance, 11,000 ft., to allow for sag. Cost of copper taken at 16 cents per pound.

Miles.	1000 v.	2000 v.	3000 v.	4000 v.	5000 v.	10,000 v.
1	\$2.08	\$0.52	\$ 0.23	\$0.13	\$0.08	\$0.02
2	8.33	2.08	0.93	0.52	0.33	0.08
3	18.70	4.68	2.08	1.17	0.75	0.19
4	33.30	8.32	3.70	2.08	1.33	0.33
5	52.05	13.00	5.78	3.25	2.08	0.52
6	74.90	18.70	8.32	4.68	3.00	0.75
7	102.00	25.50	11.30	6.37	4.08	1.02
8	133.25	33.30	14.80	8.32	5.33	1.33
9	168.60	42.20	18.75	10.50	6.74	1.69
10	208.19	52.05	23.14	13.01	8.33	2.08
11	251.90	63.00	28.00	15.75	10.08	2.52
12	299.80	75.00	33.30	18.70	12.00	3.00
13	352.00	88.00	39.00	22.00	14.08	3.52
14	408.00	102.00	45.30	25.50	16.32	4.08
15	468.00	117.00	52.00	29.25	18.72	4.68
16	533.00	133.00	59.00	33.30	21.52	5.33
17	600.00	150.00	67.00	37.60	24.00	6.00
18	675.00	169.00	75.00	42.20	27.00	6.75
19	750.00	188.00	83.50	47.00	30.00	7.50
20	833.00	208.00	92.60	52.00	33.32	8.33

COST OF COPPER REQUIRED TO DELIVER ONE MECHANICAL HORSE-POWER AT MOTOR-SHAFT WITH VARYING PERCENTAGES OF LOSS IN CONDUCTORS, UPON THE ASSUMPTION THAT THE POTENTIAL AT MOTOR TERMINALS IS IN EACH CASE 3000 VOLTS.

Motor efficiency, 90%. Cost of copper equals 16 cents per pound. Length of conductor per mile of single distance, 11,000 ft.

Miles.	10%	15%	20%	25%	30%
1	\$0.52	\$0.33	\$0.23	\$0.17	\$0.13
2	2.08	1.31	0.93	0.69	0.54
3	4.68	2.95	2.08	1.55	1.21
4	8.32	5.25	3.70	2.77	2.15
5	13.00	8.20	5.78	4.33	3.37
6	18.70	11.75	8.32	6.23	4.85
7	25.50	16.00	11.30	8.45	6.60
8	33.30	21.00	14.80	11.00	8.

ELECTRIC RAILWAYS.

Space will not admit of a proper treatment of this subject in this work. Consult Crosby and Bell, *The Electric Railway in Theory and Practice*; Fairchild, *Street Railways*; Merrill, *Reference Book of Tables and Formulae for Street Railway Engineers*; Bell, *Electric Transmission of Power*; Dawson, *Engineering and Electric Traction Pocket-book*; The Standard Handbook for Electrical Engineers; and Foster's *Electrical Engineers' Pocket-book*. The last named devotes 240 pages to the subject of electric railways.

Electric Railway Cars and Motors. (Foster.) — Small cars weighing 10 to 12 tons may be fitted with two 35-H.P. motors and be geared for a maximum speed of 25 to 30 miles per hour. Larger cars of the single-truck variety weighing close to 15 tons may be equipped with 40-H.P. motors. Suburban cars weighing 18 to 25 tons and measuring 45 ft. over all may be equipped with four 50-H.P. motors and be geared for a maximum speed of 40 m.p.h. Larger types of suburban cars, 50 ft. over all, seating 52 passengers, weigh 28 to 30 tons and are equipped with four 75-H.P. motors geared for a maximum speed of 45 m.p.h. The largest type of suburban car is equipped with four 125-H.P. motors, and is geared for a maximum speed of 60 m.p.h.

Grades upon city lines may run as high as 13 per cent, and to surmount these it is necessary to have every axle on the car equipped with motors; thus single-truck cars require two, and double-truck cars four motors; and even then the cars will be unable to surmount these grades with very bad conditions of track. The motor capacity per car should be liberal, not so much from the danger of overheating the motors as to prevent undue sparking when surmounting the heavy grades.

A 4000-H.P. Electric Locomotive, built by the Westinghouse El. & Mfg. Co., for the New York terminal and tunnel of the Penna. R.R., is described in *Eng'g News*, Nov. 11, 1909.

In wheel arrangement, weight distribution, and general character of the running gear it is the practical equivalent of two American-type steam locomotives coupled back to back. The motors are mounted upon the frame and are side-connected through jack shafts to driving wheels by a system of cranks and parallel connecting rods. The connecting rods are all rotating links between rotating elements, and thus can be perfectly counterbalanced for all speeds. The center of gravity is approximately 72 ins. above the rails.

In these electric locomotives the variable pressure of the unbalanced piston of the steam locomotive is replaced by the more constant torque and more constant rotating effort of the drive wheels, so that the pull upon the drawbar is thereby constant and uniform. The engine will start a train of 550 tons trailing load upon grades of approximately 2%. A tractive effort of 60,000 lbs., and a normal speed of 60 miles per hour, with full train load on a level track, are guaranteed.

The total weight of the locomotive is 332,100 lbs., of which 208,000 lbs. is on the eight drivers. The locomotive is claimed to develop 4000 H.P. for short times, say 20 minutes, without abnormal temperature rise. Each half of the locomotive carries a single motor, four 68-in. drive wheels and one four-wheel, swing-bolster, swivel truck, with 36-in. wheels. Each section has its own steel cab, the two cabs being connected by a vestibule.

The rigid wheel-bases are 7 ft. 2 in. and the total wheel-base of each half is 23 ft. The motive power consists of two motors of a 600-volt, 2000-H.P., commutating-pole type. Each motor weighs complete without its crank, 42,000 lbs. The main-field winding is in two sections, both of which are used together at low-speed operation. At high speeds only one-half is needed, and at intermediate control points one is shunted with resistance. These field positions are available for all series and parallel groupings of the motors, so that eight running positions (or speeds) are possible. Bridging connections are used in passing from series to parallel groupings of the motors, so that the main circuits are not opened in the process.

ELECTRIC LIGHTING. — ILLUMINATION.

Illumination. — Some writers distinguish "lighting" and "illumination." Lighting refers to the character of the lights themselves, as dazzling, brilliant, or soft and pleasing, and illumination to the quantity of light reflected from objects, by which they are rendered visible. If the objects in a room are clearly seen, then the room is well illuminated.

The quantity of light is estimated in candle-power per square foot of area or per cubic foot of space. The amount of illumination given by one candle at a distance of 1 ft. is known as a candle-foot. Since the illumination varies inversely as the square of the distance, one candle-foot is given by a 16-candle-power lamp at a distance of 4 ft., or by a 25-c.p. lamp at a distance of 5 ft.

Terms, Units, Definitions. — Quantity of light proceeding from a source of light, measured in units of luminous flux, or lumens.

Intensity with which the flux is emitted from a radiant in a single direction, called candle-power.

Illumination, density of the light flux incident upon an area.

Luminosity, brightness of surface; flux emitted per unit area of surface.

Candle-power, the unit of luminous intensity. A spermacefl candle burning at the rate of 120 grains per hour is the old standard used in the gas industry. It is very unsatisfactory as a standard and is being displaced by others.

The hefner lamp, burning amyl acetate, is the legal standard in Germany. The unit of luminous intensity produced by this lamp when constructed and operated as prescribed is called a *hefner*. The standard laboratories of Great Britain, France and America have agreed upon the following relative values of the units used in the several countries: 1 International Candle = 1 Pentane Candle = 1 Bougie Decimale = 1 American Candle = 1.11 Hefners = 0.104 Carcel unit. 1 Hefner = 0.90 International Candle.

Intrinsic Brilliancy of a source of light = candle-power per square inch of surface exposed in a given direction.

Lumen, the unit of luminous flux, is the quantity of light included in a unit solid angle and radiated from a source of unit intensity. A unit solid angle is the angular space subtended at the surface of a sphere by an area equal to the square of the radius, or by $1 \div 4\pi$, or $1/12.5664$ of the surface of the sphere. The light of a source whose average intensity in all directions is 1 candle-power, or one mean spherical candle-power, has a total flux of 12.5664 lumens.

Foot-candle, the unit of illumination, = 1 lumen per square foot; the illumination received by a surface every point of which is distant one foot from a source of one candle-power.

Lux, or meter-candle, 1 lumen per square meter; 1 foot-candle = 10.76 meter-candles.

Law of Inverse Squares. — The illumination of any surface is inversely proportional to the square of its distance from the source of light. This is strictly true when the source of light is a point, and is very nearly true in all cases when the distance is more than ten times the greatest dimension of the light-giving surface.

Law of Cosines. When a surface is illuminated by a beam of light striking it at an angle other than a right angle, the illumination is proportional to the cosine of the angle the beam makes with a normal to the surface.

If E = the illumination at any point in a surface, I the intensity of light coming from a source, θ the angle of deviation of the direction of the beam from a normal to the surface, and l the distance from the source, then $E = I \cos \theta \div l^2$.

Relative Color Values of Various Illuminants. — The light proceeding from any source may be analyzed in terms of the elementary color elements, red, green and blue, by means of the spectroscope or by a colorimeter. The following relative values have been obtained by the Ives colorimeter (*Trans. Ill., Eng. Soc.* iii, 631). In all cases the red rays in the light are taken as 100, and the two figures given are respectively the proportions of green and blue relative to 100 red.

Average daylight, 100, 100. Blue sky, 106, 120. Overcast sky, 92, 85. Afternoon sunlight, 91, 56. Direct-current carbon arc, 64, 39. Mercury

arc (red 100), 130, 190. Moore carbon dioxide tube, 120, 520. Welsbach mantle, 3/4% cerium, 81, 28. Do., 1 1/4% cerium, 69, 14.5. Do., 1 3/4% cerium, 63, 12.3. Tungsten lamp, 1.25 watts per mean horizontal candle-power, 55, 12.1. Nernst glower, bare, 51.5, 11.3. Tantalum lamp, 2 watts per m. h. c.-p., 49, 8.3. Gem lamp, 2.5 watts per m. h. c.-p., 43, 8.3. Carbon incandescent lamp, 3.1 watts per m. h. c.-p., 45, 7.4. Flaming arc, 36.5, 9. Gas flame, open fish-tail burner, 40, 5.8. Moore nitrogen tube, 28, 6.6. Hefner lamp, 35, 3.8.

Relation of Illumination to Vision. — Wickenden gives the following summary of the principles of effective vision:

1. The eye works with approximately normal efficiency upon surfaces possessing an effective luminosity of one lumen per square foot or more.
2. Excessive illumination and inadequate illumination strain and fatigue the eye in an effort to secure sharp perception.
3. Intrinsic brilliancy of more than 5 c.-p. per sq. in. should be reduced by a diffusing medium when the rays enter the eye at an angle below 60° with the horizontal.
4. Flickering, unsteady, and streaky illumination strains the retina in the effort to maintain uniform vision.
5. True color values are obtained only from light possessing all the elements of diffused daylight in approximately equivalent proportions.
6. An excess of ultra-violet rays is to be avoided for hygienic reasons.
7. Aesthetic considerations commend light of a faint reddish tint as warm and cheerful in comparison with the cold effects of the green tints, although the latter are more effective in revealing fine detail.

Arc Lamps are divided into three classes: 1. Those which produce light by the incandescence of intensely hot refractory electrodes. 2. Those which produce light mainly from the luminescence in the arc of mineral salts vaporized from carbon electrodes. 3. Those which produce light by the luminescence of metallic vapor derived solely from the cathode, the anode being unconsumed.

The Carbon Arc. — In direct-current open arcs the anodes are consumed at the rate of 1 to 2 inches per hour, and the cathodes, or negatives, at half this rate. In alternating-current open arcs the consumption is equal in both carbons, 1 to 1.5 inches per hour. Enclosed arcs have longer life owing to the restricted oxidation of the carbons, but they are of reduced brilliancy and lower efficiency. Carbons of the ordinary sizes burn 1/16 to 1/8 in. per hour, giving a life of 100 to 150 hours for direct-current and 80 to 100 hours for alternating-current lamps. The enclosing globes absorb from 8 to 40% of the light.

The Flaming Arc. — The carbons are impregnated with calcium fluoride or other luminescent salts. The current is usually 8 to 12 amperes and the voltage per lamp 35 to 60. The regenerative flame arc is a highly efficient variety of the flame arc.

The Magnetite Arc has for a cathode a thin iron tube packed with a mixture of magnetite, Fe₃O₄, and titanium and chromium oxides. The anode consists of copper or brass. It is well adapted to series operation with low currents. The 4-ampere lamp, using 80 volts per lamp, is highly successful for street illumination.

Illumination by Arc Lamps at Different Distances. — Several diagrams and curves showing the light distribution in a vertical plane and the illumination at different distances of different types of lamps are given by Wickenden. From the latter are taken the approximate figures in the table below. The carbon and the magnetite lamps were 25 ft. high, the flame arcs 21 ft.

Horizontal Distance from Lamp, Feet.	Foot-candles, normal illumination.							
	20	30	40	50	100	150	200	250
A. Open carbon arc, D.C., 6.6 amps.	0.40	0.29	0.20	.032	.014	.006	.002	
B. Enclosed carbon arc, A.C. 6.6 "	0.30	.19	.135	.10	.027	.013	.006	.002
C. Flame arc, 10 "				1.10	.31	.14	.08	.05
D. Regenerative arc, 7 "			.85	.65	.15	.055	.03	.02
E. Magnetite arc, 6.6 "	1.00	.69	.51	.15	.075	.045	.025	
F. Magnetite arc, 4. "	.47	.40	.30	.21	.07	.035	.022	.018

- A. 6.6 amp., D. C., open arc, clear globe.
- B. 6.6 amp., A. C., enclosed arc, opal inner and clear outer globe, small reflector.
- C. 10 amp., flame arc, vertical electrodes: 50 volts, 1520 M.H.C.-P.;* 0.33 watt per M.L.H.C.-P.;* 10 hours per trim.
- D. 7 amp., regenerative flame arc, 70 volts, 2440 M.L.H.C.-P., 0.2 watt per M.L.H.C.-P., 70 hours per trim.
- E. 6.6 amp., D.C. series magnetite arc, 79 volts, 510 watts, 1450 M.L.H.C.-P. 75 to 100 hours per trim.
- F. 4 amp., D.C. series magnetite arc, 80 volts, 320 watts, 575 M.L.H.C.-P., 150 to 200 hours per trim.

Data of Some Arc Lamps.

Type of Lamp.	Hours per Trim.	Amperes.	Terminal Volts.	Terminal Watts.	Watts per m.l.h. c.-p.
D.C. series carbon, open.....	9 to 12	9.6	50	480	0.6
D.C. series carbon, enclosed.	100 to 150	6.6	72	475	0.9
A.C. series carbon, enclosed.	70 to 100	7.5	75	480	1.25
D.C. multiple carbon, enclosed.....	100 to 150	5.0	110	550	2.25
A.C. multiple carbon, enclosed.....	70 to 100	6.0	110	430	2.40
D.C. flame arcs, open.....	10 to 16	10	55	440	0.45
Regenerative, semi-enclosed	70	5	70	350	0.26
A.C. flame arcs, open.....	10 to 16	10	55	467	0.55
Magnetite, open.....	70 to 100	6.6	80	528	0.45

Values of watts per m.l.h. c.-p. approximate for open carbon arcs and magnetite arcs with clear globes, enclosed arcs with opalescent inner and clear outer globes, and for flame and regenerative arcs with opal globes.

Watts per Square Foot Required for Arc Lighting. — W. D'A. Ryan (*Am. Elect'n*, Feb., 1903) gives the following table, deduced from experience, showing the amount of energy required for good illumination by means of enclosed arcs, based on watts at lamp terminals.

Building.	Watts per sq. ft.
Machine-shops; high roofs, electrically driven machinery, no belts.....	0.5 to 1
Machine-shops; low roofs, belts and other obstructions.....	0.75 to 1.25
Hardware and shoe stores.....	0.5 to 1
Department stores; light material, bric-a-brac, etc.....	0.75 to 1.25
Department stores; colored material.....	1 to 1.5
Mill lighting; plain white goods.....	0.9 to 1.3
Mill lighting; colored goods, high looms.....	1.1 to 1.5
General office; no incandescents.....	1.25 to 1.75
Drafting rooms.....	1.5 to 2

The space in sq. yds. properly illuminated by 450-watt enclosed arc lamps is given as follows in the Int. Library of Technology, vol. 13: Outdoor areas, 2000-2500 sq. yds.; trainsheds, 1400-1600; foundries (general illumination), 600-800; machine-shops, 200-250; thread and cloth mills, 200-230.

The Mercury Vapor Lamp, invented by Peter Cooper Hewitt, is an arc of luminous mercury vapor contained in a glass tube from which the air has been exhausted. A small quantity of mercury is contained in the tube, and platinum wires are inserted in each end. When the tube is placed in a horizontal position, so that a thin thread of mercury lies along it, making electric connection with the wires, and a current is passed through it, part of the mercury is vaporized, and on the tube being inclined so that the liquid mercury remains at one end, an electric arc is

* M.H.C.-P. = mean horizontal candle-power; M.L.H.C.-P. = mean lower hemispherical candle-power.

formed in the vapor throughout the tube. The tubes are made about 1 in. in diameter and of different lengths, as below. The mercury vapor lamp is very efficient, but the color of the light is unsatisfactory, being deficient in red rays. The spectrum consists of three bands, of yellow, green and violet, respectively. The intrinsic brilliancy of the lamp is very moderate, about 17 candle-power per square inch. Commercial lamps are made of the sizes given below. The lamp is essentially a direct-current lamp, but it may be adapted to alternating-current by use of the principle of the mercury arc rectifier. The tubes have a life ordinarily of about 1000 hours.

MERCURY ARC LAMPS.

Type.	Kind of Circuit.	Length, inches.	Volts.	Amperes.	Watts.	Hemi-spher. Candle-power.	Watts per Candle
H	d.c.	20 3/4	52-55	3.5	177-193	300	0.64
A	d.c.	45	100-120	3.5	350-420	700	0.55
U	d.c.	78	206-240	2.0	412-480	900	0.48
P	d.c.	50	100-120	3.5	350-420	800	0.48
F	a.c.	50	100-120	400-520	750-900	0.53-0.58

Incandescent Lamps. — Candle-power of nominal 16-c.p. 110-volt carbon lamp:

Mean horizontal 15.7 to 16.6, mean spherical 12.7 to 13.8, mean hemispherical 14.0 to 14.6, mean within 30° from tip 7.9 to 10.9.

Ordinary carbon lamps take from 3 to 4 watts per candle-power. A 16-candle-power lamp using 3.5 watts per candle-power or 56 watts at 110 volts takes a current of $56 \div 110 = 0.51$ ampere. For a given efficiency or watts per candle-power the current and the power increase directly as the candle-power. An ordinary lamp taking 56 watts, 13 lamps take 1 H.P. of electrical energy, or 18 lamps 1.008 kilowatts.

Rating of Incandescent Lamps. — Lamps are commonly rated in terms of their mean horizontal candle-power, and their energy consumption in terms of watts per mean horizontal candle-power. The mean spherical intensity differs from the horizontal intensity by a factor which varies with different kinds and styles of lamp. In carbon lamps it is usually about 82%, and in tantalum and tungsten lamps about 76 to 78% of the mean horizontal candle-power.

The new lamp ratings (May, 1910) of the National Electric Lamp Association designate all lamps by wattage instead of by candle-power as formerly.

Lamps are labeled with a three-voltage label and the regular type of 16 c.p. carbon lamp, in general use, will be made on the basis of 3.1 watts per c.p. at top voltage.

CARBON LAMPS.

Nominal Watts.	Actual Watts.	Actual Watts per Candle.	Actual Candle-power.	Hours Life.	Nominal Watts	Actual Watts.	Actual Watts per Candle.	Actual Candle-power.	Hours Life.
10	10	5.00	2.0	2000	60	T. 60.0	2.97	20.2	700
20	20	4.15	4.8	2000		M. 57.9	3.18	18.3	1000
	T. 25.0	3.10	8.1	500		B. 55.7	3.39	16.4	1500
25	M. 24.1	3.31	7.3	725	100	T. 100.0	2.97	33.6	600
	B. 23.2	3.52	6.6	1050		M. 96.4	3.18	30.5	850
30	T. 30.0	3.23	9.3	1050	120	B. 92.9	3.39	27.4	1350
	M. 28.9	3.46	8.4	1500		T. 120.0	2.97	40.4	600
50	B. 27.8	3.69	7.5	2100	1500	M. 115.8	3.18	36.6	850
	T. 50.0	2.97	16.8	700		B. 111.4	3.39	32.8	1350
	M. 48.2	3.18	15.2	1000					
	B. 46.4	3.39	13.7	1500					

T, top; M, middle; B, bottom voltage.

The 50- and 60-watt sizes correspond respectively to the old 16-c.p., 3.1-watt lamp (at top voltage) and the old 16-c.p., 3.5-watt lamp (at bottom voltage).

The hours life of all of the listed carbon lamps shows the total life and not the useful life or that formerly given as to 80% of initial c.p.

The Gem Lamp is an improved type of the carbon lamp, having a carbon filament heated to such a degree in an electric oven that it takes on the properties of metal and hence the name, Gem "Metalized Filament."

Variation in Candle-Power, Efficiency, and Life. — The following table shows the variation in candle-power, etc., of standard 100 to 125 volt, 3.1 and 3.5 watt carbon lamps, due to variation in voltage supplied to them. It will be seen that if a 3.1-watt lamp is run at 10% below its normal voltage, it may have over 9 times as long a life, but it will give only 53% of its normal lighting power, and the light will cost 50% more in energy per candle-power. If it is run at 6% above its normal voltage, it will give 37% more light, will take nearly 20% less energy for equal light power, but it will have less than one-third of its normal life.

Per cent Normal Voltage.	Per cent of Normal Candle-power.	Watts per Candle, 3.1 watt Lamp.	Relative Life, 3.1 watt	Watts per Candle, 3.5 watts.	Relative Life, 3.5 watts.
90	53	4.65	9.41	5.36
92	61	4.24	5.55	4.85
94	69.5	3.90	3.45	4.44	3.94
96	79	3.60	2.20	4.09	2.47
98	89	3.34	1.46	3.78	1.53
99	94.5	3.22	1.21	3.64	1.26
100	100	3.10	1.00	3.50	1.00
101	106	2.99	.818	3.38	.84
102	112	2.90	.681	3.27	.68
104	124	2.70	.452	3.05	.47
106	137	2.54	.310	2.85	.31

The candle-power of a lamp falls off with its length of life, so that during the latter half of its life it has only 60 per cent or 70 per cent of its rate candle-power, and the watts per candle-power are increased 60 per cent or 70 per cent. After a lamp has burned for 500 or 600 hours it is more economical to break it and supply a new one if the price of electrical energy is that usually charged by central stations.

Incandescent Lamp Characteristics. — From a series of curves given in Wickenden's "Illumination and Photometry" the following approximate figures have been derived:

LIFE, CANDLE-POWER AND WATTS PER CANDLE-POWER.											
Hours	0	50	100	200	300	400	500	600	700	800	900
Lamps	Per cent of candle-power.										
Carbon	100	102	96	95	91	88	86	83	81		
Tantalum	100	144	119	100	97	95	93	90	88	84	80
Tungsten	100	104	110	112	110	104	100	98	95	92	90
	Per cent Watts per candle.										
Carbon	100	99	98	103	107	109	111	112	115	119	
Tantalum	100	80	90	101	104	106	107	109	109	110	112
Tungsten	100	97	96	97	100	102	103	107	108	110	111

RELATION OF CANDLE-POWER TO TERMINAL VOLTS.								
Per cent normal volts	81	88	92	96	100	104	108	112
	Per cent normal candle-power.							
Carbon		46	60	78	100	123	154	
Tantalum		46	56	68	82	100	118	139
Tungsten		54	63	73	86	100	115	134

The above figures show the necessity of close regulation of voltage of lighting circuits. Slight reductions of voltage cause the light to fall far below normal, while excess voltage greatly diminishes the life of the lamps.

RELATION OF ENERGY CONSUMPTION TO TERMINAL VOLTS.

Per cent normal volts	92	94	96	98	100	102	104	106	108
Per cent normal watts per candle-power.									
Carbon		124	118	108	100	94	88	82	
Tantalum	126	118	112	106	100	95	90	87	83
Tungsten	120	115	110	105	100	96	92	88	85

Average Performance of Tantalum and Tungsten Lamps. — (Winchenden.) 100 to 125 volts.

	Tantalum.			Tungsten.				
	12.5	20	40	20	32	48	80	200
Rated horizontal c-p.	12.5	20	40	20	32	48	80	200
Mean spherical c-p.	8.9	15.8	31.6	15.6	24.0	37.6	62.9	152
Rated watts per c-p.	2.5	2.0	2.0	1.25	1.25	1.25	1.25	1.25
Watts per m. spher. c-p.	2.53	2.53	2.53	1.60	1.62	1.59	1.58	1.64
Total watts.	25.	40.	80	25	35-45	50-70	85-115	230-270
Useful hours.	900*	900*	800†	800	800	800	800	800

*For direct current; 500 hrs. for 60 cycle alt. current. †500 to 700 hrs. for alt. current.

Specifications for Lamps. (Crocker.) — The initial candle-power of any lamp at the rated voltage should not be more than 9 per cent above or below the value called for. The average candle-power of a lot should be within 6 per cent of the rated value. The standard efficiencies (of the carbon lamp) are 3.1, 3.5, and 4 watts per candle-power. Each lamp at rated voltage should take within 6 per cent of the watts specified, and the average for the lot should be within 4 per cent. The useful life of a lamp is the time it will burn before falling to a certain candle-power, say 80 per cent of its initial candle-power. For 3.1 watt lamps the useful life is about 400 to 450 hours, for 3.5 watt lamps about 800, and 4 watt lamps about 1600 hours.

Special Lamps. — The ordinary 16 c.-p. 110-volt is the old standard for interior lighting. Improved forms of incandescent lamp, such as the tungsten, are now, 1910, rapidly coming into use, so that no one style of lamp can be considered the standard. Thousands of varieties of lamps for different voltages and candle-power are made for special purposes, from the primary lamp, supplied by primary batteries using three volts and about 1 ampere and giving 1/2 c.-p., and the 3/4 c.-p. bicycle lamp, 4 volts and 0.5 ampere, lamps of 100 c-p. at 220 volts. Series lamps of 1 c.-p. are used in illuminating signs, 2 1/2 ampere and 12.5 to 15 volts, eight lamps being used on a 110-volt circuit. Standard sizes for different voltages, 50, 110, or 220, are 8, 16, 24, 32, 50, and 100 c.-p.

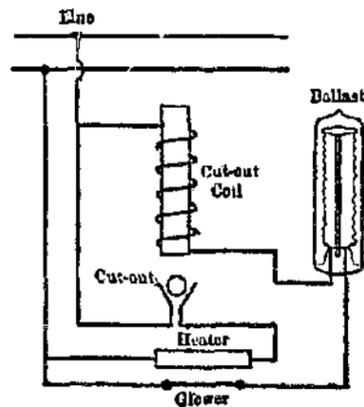

FIG. 197.

The Nernst Lamp depends for its operation upon the peculiar property of certain rare earths, such as yttrium, thorium, zirconium, etc., of becoming electrical conductors when heated to a certain temperature; when cold, these oxides are non-conductors. The lamp comprises a "glower" composed of rare earths mixed with a binding material and pressed into a small rod; a heater for bringing the glower up to the conducting temperature; an automatic cut-out for disconnecting the heater when the glower lights up, and a "ballast" consisting of a small resistance coil of wire having a positive temperature-resistance coefficient. The ballast is connected in series with the glower; its presence is required to compensate the negative temperature-resistance coefficient of

the glower; without the ballast, the resistance of the glower would become lower and lower as its temperature rose, until the flow of current through it would destroy it. Fig. 195 shows the elementary circuits of a simple Nernst lamp. The cut-out is an electromagnet connected in series with the glower. When current begins to flow through the glower, the magnet pulls up the armature lying across the contacts of the cut-out, thereby cutting out the heater. The heater is a coil of fine wire either located very near the glower or encircling it. The glower is from 1/32 to 1/16 inch in diameter and about 1 inch long.

In the original Nernst lamp the glowers were adapted only for alternating-current, but direct-current glowers are now made.

The lamps are made with one glower, or with two, three, or six glowers connected in parallel, and for operation on 100 to 120 and 200 to 240 volt circuits. A 30-glower lamp for 220 volts, rated at 2000 c.-p., is also made.

Lamps with one glower are rated at 66 watts (110 volt), 88 (220 v.), 110 and 132 watts (110 or 220 v.) with a corresponding mean horizontal candle-power of 50, 77, 96 and 114, respectively. The 2- 3- and 4-glower lamps are multiples of the 132 watt (220 v.) single glower lamps, their m.h.c.-p. being respectively 231, 359 and 504. The Nernst lamp is commonly used where units of intermediate size between incandescent and arc lamps are desired.

Cost of Electric Lighting. A. A. Wohlauer (*EL. World*, July, 1908.)

— The following table shows the relative cost of 1000 candle-hours of illumination by lamps of different kinds, based on costs of 2, 4 and 10 cents per K.W. hour for electric energy. The life, *K*, is that of the lamp for incandescent lamps, of the glower for Nernst lamps, of the electrode for arc lamps, and of the vapor tube for vapor lamps.

- L_s = mean spherical candle-power.
- S_s = watts per mean spherical candle.
- P = renewal cost per trim or life, cents.
- K = life in hours.
- C_r = 1000 $P/(KL_s)$.
- $C_t = (S_s \times R) + C_r$ = cost per 1000 candle hours.
- R = rate in cts. per K.W. hour.

Illuminant.	Amp.	Volts.	L_s	S_s	P	K	C_r	Rating.	$C_t = (S_s \times R) + C_r$		
									R=2	4	10
Incandescent Lamps.											
Carbon.....	0.31	110	13.2	3.8	8	450	1.35	16 c.p.	10.3	17.9	40.7
Gem.....	0.45	110	16.5	3.05	10	450	1.35	20 c.p.	8.8	14.8	33.2
Meridian.....	2.3	110	82	3.05	35	450	0.95	100 c.p.	8	14.1	32.4
Nernst.....	1.0	110	42.5	2.6	32.5	500	1.5	110 Watt	8.2	13.4	29
Tantalum.....	0.36	110	17	2.3	25	700	2.25	20 c.p.	9.1	13.7	27.5
Tungsten.....	0.91	110	72	1.4	100	800	1.8	80 c.p.	6.4	9.2	17.6
Direct-Current Arc Lamps.											
Open arc.....	10	55	400	1.3	4	10	1	10 amp.	4.6	7.2	15
Enclosed.....	5.0	110	260	2.1	4.5	150	0.1	5	4.4	8.6	21.2
Carbon.....	10	110	550	2.0	4	160	0.5	10	5	9	21
Miniature.....	2.5	110	150	1.8	3	20	1.	2.5	5.6	9.2	20
Magnetite.....	3.5	110	225	1.7	5	150	0.155	3.5	3.71	7.11	17.2
Flaming.....	10	55	600	0.75	8.5	10	1.2	10	3.9	5.4	9.6
Blondel.....	5	55	550	0.5	17.5	18	1.25	5	3.5	4.5	7.5
Inclined flaming..	10	55	1100	0.5	9	10	0.8	10	2.6	3.6	6.6
Inclined enclosed flaming	5.5	100	1500	0.365	15	70	1.55	5.5	1.03	1.76	4

Illuminant.	Amp.	Volts.	L_s	S_s	P	K	C_r	Rating.	$C_l = (S_s \times R) + C_r$			
Alternating-Current Arc Lamps.												
Open arc.....	15	300	1.75	5	13	1.1	15 amp.	5.7	9.2	19.7	
Enclosed.....	7.5	230	2.6	4.5	100	0.2	7.5	5.6	10.8	26.4	
Flaming.....	10	425	0.8	8.5	7	2.8	10	7.2	8.8	13.6	
Inclined flaming.....	10	1000	0.55	9	10	0.65	10	2.9	4	7.3	
Blondel.....	10	715	0.5	12.5	15	1.15	10	3.3	4.3	37.	
Mercury-Vapor Lamps.												
Cooper Hewitt.....	3.5	110	770	0.5	600	4000	0.2	3.5 amp.	1.4	2.4	5.4	
Quartz.....	4.0	220	2740	0.33	350	1000	0.125	4.2	0.85	1.45	3.25	

ELECTRIC WELDING.

The apparatus most generally used consists of an alternating-current dynamo, feeding a comparatively high-potential current to the primary coil of an induction-coil or transformer, the secondary of which is made so large in section and so short in length as to supply to the work currents not exceeding two or three volts, and of very large volume or rate of flow. The welding clamps are attached to the secondary terminals. Other forms of apparatus, such as dynamos constructed to yield alternating currents direct from the armature to the welding-clamps, are used.

The conductivity for heat of the metal to be welded has a decided influence on the heating, and in welding iron its comparatively low heat conduction assists the work materially. (See papers by Sir F. Bramwell, Proc. Inst. C. E., part iv., vol. cii. p. 1; and Elihu Thomson, Trans. A. I. M. E., xix. 877.)

Fred. P. Royce, *Iron Age*, Nov. 28, 1892, gives the following figures showing the amount of power required to weld axles and tires:

AXLE-WELDING.	Seconds
1-inch round axle requires 25 H.P. for.....	45
1-inch square axle requires 30 H.P. for.....	48
1 1/4-inch round axle requires 35 H.P. for.....	60
1 1/4-inch square axle requires 40 H.P. for.....	70
2-inch round axle requires 75 H.P. for.....	95
2-inch square axle requires 90 H.P. for.....	100

The slightly increased time and power required for welding the square axle is not only due to the extra metal in it, but in part to the care which it is best to use to secure a perfect alignment.

TIRE-WELDING.	Seconds.
1 x 3/16-inch tire requires 11 H.P. for.....	15
1 1/4 x 3/8-inch tire requires 23 H.P. for.....	25
1 1/2 x 3/8-inch tire requires 20 H.P. for.....	30
1 1/2 x 1/2-inch tire requires 23 H.P. for.....	40
2 x 1/2-inch tire requires 29 H.P. for.....	55
2 x 3/4-inch tire requires 42 H.P. for.....	62

The time above given for welding is of course that required for the actual application of the current only, and does not include that consumed by placing the axles or tires in the machine, the removal of the upset and other finishing processes. From the data thus submitted, the cost of welding can be readily figured for any locality where the price of fuel and cost of labor are known.

In almost all cases the cost of the fuel used under the boilers for producing power for electric welding is practically the same as the cost of fuel used in forges for the same amount of work, taking into consideration the difference in price of fuel used in either case.

Prof. A. B. Kennedy found that 2 1/2-inch iron tubes 1/4-inch thick were welded in 61 seconds, the net horse-power required at this speed being 23.4 (say 33 indicated horse-power) per square inch of section. Brass tubing required 21.2 net horse-power. About 60 total indicated horse-power would be required for the welding of angle-irons 3 x 3 x 1/2-inch in from two to three minutes. Copper requires about 80 horse-power per square inch of section, and an inch bar can be welded in 25 seconds. It takes about 90 seconds to weld a steel bar 2 inches in diameter.

ELECTRIC HEATERS.

Wherever a comparatively small amount of heat is desired to be automatically and uniformly maintained, and started or stopped on the instant without waste, there is the province of the electric heater.

The elementary form of heater is some form of resistance, such as coils of thin wire introduced into an electric circuit and surrounded with a substance which will permit the conduction and radiation of heat, and at the same time serve to electrically insulate the resistance.

This resistance should be proportional to the electro-motive force of the current used and to the equation of Joule's law:

$$H = I^2 R t \times 0.24,$$

where I is the current in amperes; R , the resistance in ohms; t , the time in seconds; and H , the heat in gram-centigrade units.

Since the resistance of metals increases as their temperature increases, a thin wire heated by current passing through it will resist more, and grow hotter and hotter until its rate of loss of heat by conduction and radiation equals the rate at which heat is supplied by the current. In a short wire, before heat enough can be dispelled for commercial purposes, fusion will begin; and in electric heaters it is necessary to use either long lengths of thin wire, or carbon, which alone of all conductors resists fusion. In the majority of heaters, coils of thin wire are used, separately embedded in some substance of poor electrical but good thermal conductivity.

The Consolidated Car-heating Co.'s electric heater consists of a galvanized iron wire wound in a spiral groove upon a porcelain insulator. Each heater is 30 5/8 in. long, 8 7/8 in. high, and 6 5/8 in. wide. Upon it is wound 392 ft. of wire. The weight of the whole is 23 1/2 lbs.

Each heater is designed to absorb 1000 watts of a 500-volt current. Six heaters are the complement for an ordinary electric car. For ordinary weather the heaters may be combined by the switch in different ways, so that five different intensities of heating-surface are possible, besides the position in which no heat is generated, the current being turned off.

For heating an ordinary electric car the Consolidated Co. states that from 2 to 12 amperes on a 500-volt circuit is sufficient. With the outside temperature at 20° to 30°, about 6 amperes will suffice. With zero or lower temperature, the full 12 amperes is required to heat a car effectively.

Compare these figures with the experience in steam-heating of railway-cars, as follows:

$$1 \text{ B. T. U.} = 0.29084 \text{ watt-hours.}$$

$$6 \text{ amperes on a 500-volt circuit} = 3000 \text{ watts.}$$

$$\text{A current consumption of 6 amperes will generate } 3000 \div 0.29084 = 10,315 \text{ B.T.U. per hour.}$$

In steam-car heating, a passenger coach usually requires from 60 lbs. of steam in freezing weather to 100 lbs. in zero weather per hour. Supposing the steam to enter the pipes at 20 lbs. pressure, and to be discharged at 200° F., each pound of steam will give up 983 B.T.U. to the car. Then

the equivalent of the thermal units delivered by the electrical-heating system in pounds of steam, is $10,315 \div 983 = 10\frac{1}{2}$, nearly.

Thus the Consolidated Co.'s estimates for electric-heating provide the equivalent of $10\frac{1}{2}$ lbs. of steam per car per hour in freezing weather and 21 lbs. in zero weather.

Suppose that by the use of good coal, careful firing, well-designed boilers and triple-expansion engines we are able in daily practice to generate 1 H.P. delivered at the fly-wheel with an expenditure of $2\frac{1}{2}$ lbs. of coal per hour.

We have then to convert this energy into electricity, transmit it by wire to the heater and convert it into heat by passing it through a resistance-coil. We may set the combined efficiency of the dynamo and line circuit at 85%, and will suppose that all the electricity is converted into heat in the resistance-coils of the radiator. Then 1 brake H.P. at the engine = 0.85 electrical H.P. at the resistance coil = 1,683,000 ft.-lbs. energy per hour = 2180 heat-units. But since it required $2\frac{1}{2}$ lbs. of coal to develop 1 brake H.P., it follows that the heat given out at the radiator per pound of coal burned in the boiler furnace will be $2180 \div 2\frac{1}{2} = 872$ H.U. An ordinary steam-heating system utilizes 9652 H.U. per lb. of coal for heating; hence the efficiency of the electric system is to the efficiency of the steam-heating system as 872 to 9652, or about 1 to 11. (*Eng'g News*, Aug. 9, '90; Mar. 30, '92; May 15, '93.)

Electric Furnaces. (Condensed from an article by J. Wright in *Elec. Age*, May, 1904. The original contains illustrations of many styles of furnace.) — Electric furnaces may be divided into two main classes, (1) those in which the heating effect is produced by the electric arc established between two carbon or other electrodes connected with the source of current, commonly known as arc furnaces; and (2) those in which the heating effect is produced by the passage of the current through a resistance, which either forms part of the furnace proper, or is constituted by a suitable conducting train, of the material to be treated in the furnace. Such furnaces are known as resistance furnaces.

The Moissan arc furnace consists of two chalk blocks, bored out to receive a carbon crucible which encloses the center or hearth of the furnace proper. Into this cavity pass two massive carbon electrodes, through openings provided for them in the walls of the structure, which is held together by clamps. The arc established between the ends of the carbons when the current is turned on plays over the center of the crucible, heating its contents.

In the Siemens arc furnace a refractory crucible of plumbago, magnesia, lime, or other suitable material is supported at the center of a cylinder or jacket, and packed around with broken charcoal, or other poor conductor of heat. The negative electrode consists of a massive carbon rod passing vertically through the lid of the crucible, and free to move vertically therein. The positive electrode, which may be of iron, platinum or carbon, consists of a rod passing up through the base of the crucible. The furnace was originally designed for the fusion of refractory metals and their ores. Electrical contact is established between the lower electrode and the semi-metallic mass in the crucible, and the arc continues to play between the surface of the mass and the movable carbon rod. As the current through the furnace increases, that through the shunt winding of a solenoid which controls the position of the movable rod diminishes, thereby raising the negative electrode and restoring equilibrium.

The Wilson furnace is a modification of the Siemens, the solenoid regulation of the upper movable carbon being replaced by a worm and hand wheel, while the furnace is made continuous in operation by the provision of a tapping hole for drawing off the molten products. This type of furnace was employed by Willson in the manufacture of calcium carbide; many other types of arc furnaces have been developed from these earlier forms. (See *EL. Age*, May, 1904, for illustrations.)

The Borchers furnace is typical of that class in which a core, forming part of the furnace itself, is heated by the passage of the current through it, and imparts its heat to the surrounding mass of material contained in the furnace. It consists of a block of refractory material, in the center of which is an opening forming the crucible, into which is fed the material to

be treated. This space is bridged by a thin carbon rod which is attached, at its extremities, to two carbon electrodes, passing through the walls of the furnace. The current heats the smaller rod to a very high temperature, and the rod diffuses its heat throughout the mass, from its center outwards.

H. I. Irvine has brought out a resistance furnace in which the heated column consists of a fused electrolyte, maintained in a state of fusion by the passage of the current, and communicating its heat by radiation and diffusion, to the encircling charge, which is packed around it.

A novel type of resistance furnace, patented independently, with some slight variation of detail, by Colby, Ferranti, and Kjellin, is worked on the inductive principle, and consists of an annular, or helical, channel in a refractory base, filled with a conducting, or semi-conducting, medium, which constitutes the furnace charge, and has a heavy current induced in it by a surrounding coil of many turns, carrying an alternating current. The device, in fact, acts as the closed-circuit secondary of a step-down transformer.

The Acheson furnace for the manufacture of carborundum is a rough firebrick structure, through the end walls of which project the electrodes consisting of composite bundles of carbon rods set in metal clamps. The space between the two electrodes is bridged by a conducting path of coke, which constitutes the core of the furnace. This core is packed round with the raw material, consisting of coke, sand, sawdust and common salt.

A $2\frac{1}{2}$ ton Heroult electric steel furnace has been installed by the Firth-Sterling Steel Co. at Denimber, Pa. In this furnace an arc is formed between the bath of metal and two graphite electrodes which are suspended over it. Single-phase, sixty-cycle alternating current is used and is stepped down to 110 volts by transformers from the 11,000-volt mains. The furnace consumes about 250 kilowatts. It produces steel equal in quality to crucible steel, at a cost little greater than open-hearth steel. (*El. Review*, May 14, 1910.)

The *Iron Trade Review*, 1906, contains a series of illustrated articles on electric furnaces, by J. B. C. Kershaw. See also paper by C. F. Burgess, in *Trans. Western Socy. of Engrs.*, 1905, and papers in *Trans. Am. Electro Chemical Society*, 1902 and later dates.

Silundum, or silicified carbon, is a product obtained when carbon is heated in the vapor of silicon in an electric furnace. It is a form of carborundum, and has similar properties; it is very hard, resists high temperatures and is acid-proof. It is a conductor of electricity, its resistance being about three times that of carbon. It can be heated in the air up to 1600° C. without showing any sign of oxidation. At about 1,700°, however, the silicon leaves the carbon and combines with the oxygen of the air. Silundum cannot be melted. The first use to which the material was applied was for electric cooking and heating. For heating purposes the silundum rods can be used single, in lengths up to 32 ins., depending on the diameter, as solid, round, flat or square rods or tubes, or in the form of a grid mounted in a frame and provided with contact wires. (*El. Review*, London, *Eng. Digest*, Feb., 1909.)

PRIMARY BATTERIES.

Following is a partial list of some of the best known primary cells or batteries.

Name.	Elements.		Electrolyte.	Depolarizer.	E.M.F. volts.
	-	+			
Daniell.....	Cu	Zn	Dilute H ₂ SO ₄	Concent. CuSO ₄	1.07
Gravity.....	Cu	Zn	ZnSO ₄	Concent. CuSO ₄	1.
Grove.....	Pt	Zn	Dilute H ₂ SO ₄	HNO ₃	1.9
Fuller.....	C	Zn	Dilute H ₂ SO ₄	K ₂ Cr ₂ O ₇	2.1
Edison-Lalande....	Cu	Zn	Conc. NaOH	CuO	0.7-0.9
Leclanche.....	C	Zn	NH ₄ Cl	MnO ₂	1.4
Clark.....	Pt	Zn	ZnSO ₄	Hg ₂ SO ₄	1.44
Weston.....	Pt	Cd	CdSO ₄	Hg ₂ SO ₄	1.02
Dry battery.....	C	Zn	Various electrolyte pastes.		1-1.8

The gravity cell is used for telegraph work. It is suitable for closed circuits, and should not be used where it is to stand for a long time on open circuit.

The Fuller cell is adapted to telephones or any intermittent work. It can stand on open circuit for months without deterioration.

The Edison-Lalande cell is suitable for either closed or open circuits.

The Leclanché cell is adapted for open circuit intermittent work, such as bells, telephones, etc.

The Clark and Weston cells are used for electrical standards. The Weston cell has largely superseded the Clark.

Dry cells are in common use for house service, igniters for gas engines, etc.

Batteries are coupled in series of two or more to obtain an e.m.f. greater than that of one cell, and in multiple to obtain more amperes without change of e.m.f.

Spark coils, or induction coils with interrupters, are used to obtain ignition sparks for gas engines, etc.

ELECTRICAL ACCUMULATORS OR STORAGE-BATTERIES.

The original, or Planté, storage battery consisted of two plates of metallic lead immersed in a vessel containing sulphuric acid. An electric current being sent through the cell the surface of the positive plate was converted into peroxide of lead, PbO₂. This was called charging the cell. After being thus charged the cell could be used as a source of electric current, or discharged. Planté and other authorities consider that in charging, PbO₂ is formed on the positive plate and spongy metallic lead on the negative, both being converted into lead oxide, PbO, by the discharge, but others hold that sulphate of lead is made on both plates by discharging, and that during the charging PbO₂ is formed on the positive plate and metallic Pb on the other, sulphuric acid being set free.

The acid being continually abstracted from the electrolyte as the discharge proceeds, the density of the solution becomes less. In the charging operation this action is reversed, the acid being reinstated in the liquid and therefore causing an increase in its density.

The difference of potential developed by lead and lead peroxide immersed in dilute H₂SO₄ is about two volts. A lead-peroxide plate gradually loses its electrical energy by local action, the rate of such loss varying according to the circumstances of its preparation and the condition of the cell.

In the Faure or pasted cells lead plates are coated with minium or litharge made into a paste with acidulated water. When dry these plates are placed in a bath of dilute H₂SO₄ and subjected to the action of the current, by which the oxide on the positive plate is converted into peroxide and that on the negative plate reduced to finely divided or porous lead.

The "Chloride Accumulator" made by The Electric Storage Battery Co., of Philadelphia, consists of modified Planté positives and modified Faure negatives. The positive plate, called the Manchester type, consists of a hard lead grid into which are pressed "buttons" of corrugated pure lead tape, rolled into spirals. When electrolytically "formed," these buttons become coated with lead peroxide. The negative is the so-called "Box" type, in which the grid is made in two halves which are riveted together after "pasting" with lead oxide, the latter upon charging being reduced to spongy lead. The outside faces are covered with perforated lead sheet, which serves to retain the spongy lead or active material.

The following tables give the elements of several sizes of "chloride" accumulators. Type G is furnished in cells containing 11-75 plates, and type H from 21 plates to any greater number desired. The voltage of cells of all sizes is slightly above two volts on open circuit, and during discharge

varies from that point at the beginning to 1.75 at the end when working at the normal (eight-hour) rate. At higher rates the final voltage is lower.

Accumulators are largely used in central lighting and power stations, in office buildings and other large isolated plants, for the purpose of absorbing the energy of the generating plant during times of light load, and for giving it out during times of heavy load or when the generating plant is idle. The advantages of their use for such purposes are thus enumerated:

1. Reduction in coal consumption and general operating expenses, due to the generating machinery being run at the point of greatest economy while in service, and being shut down entirely during hours of light load, the battery supplying the whole of the current.

TYPE.	Size of Plates.	"B"			"C"			"D"				
		3x3 in.	4 3/8 x 4 in.			6 x 6 in.						
Number of plates.....		3	3	5	7	3	5	7	9	11	13	
Discharge in } amperes: {	For 8 hours.....	5/8	1 1/4	2 1/2	3 3/4	2 1/2	5	7 1/2	10	12 1/2	15	
	For 5 hours.....	7/8	1 3/4	3 1/2	5 1/4	3 1/2	7	10 1/2	14	17 1/2	21	
	For 3 hours.....	1 1/4	2 1/2	5	7 1/2	5	10	15	20	25	30	
Normal charge rate.....		5/8	1 1/4	2 1/2	3 3/4	2 1/2	5	7 1/2	10	12 1/2	15	
Outside dimensions of } rubber jar, inches: {	Length.....	13/4	13/4	2 3/4	3 7/8	13/4	2 3/4	3 7/8	5	6 1/8	7 1/4	
	Width.....	15/8	4 1/2	4 1/2	4 1/2	6 1/2	6 1/2	6 1/2	6 1/2	6 1/2	6 1/2	
	Height.....	5	7	7	7	9	9	9	9	9	9	
Outside dimensions of } glass jar, inches: {	Length.....	2 1/2	3 1/2	4 1/4	5 1/4	3 1/4	4 3/4	6 1/2	8 3/4	8 3/4	8 3/4	
	Width.....	4	5 1/4	5 1/4	5 1/4	7 7/8	7 7/8	7 7/8	8	8	8 1/4	
	Height.....	*	7 1/4	7 1/4	7 1/4	9 1/2	9 1/2	9 1/2	9 1/2	9 1/2	9 1/2	
Weight of electrolyte. } lbs.: {	rubber jars.....	†	†	†	†	†	†	†	†	†	†	
	glass jars.....	1/2	1 1/2	2 1/4	2 3/4	2 1/4	3 3/4	5 1/4	6 3/4	7 3/4	10	
Weight of cell com- } plete, with acid, lbs.: {	rubber jars.....	5 3/4	11	15	19	20	28	38	48	53	63	
	glass jars.....	†	†	†	†	†	†	†	†	†	†	
Height of cell over } all, inches: {	rubber jars.....	3 1/2	6 1/2	10	13	12	18 1/2	24 1/2	32 1/2	39 3/4	47 1/4	
	glass jars.....	†	†	†	†	†	†	†	†	†	†	

* 4 1/2, 5 1/2, and 6 1/2 ins. † 3/4, 1, and 1 1/4 lbs. ‡ 7 1/2, 9 1/2 and 11 1/2 lbs.
"D" Yacht type, rubber jars, 5, 7, and 9 plates, 2 1/2 in. higher than standard.

TYPE "E."	Size of Plates, 7 3/4 x 7 3/4 in.						TYPE "F."					D*
	Size of Plates, 11 x 10 1/2 in.											
Number of plates.....	5	7	9	11	13	15	9	11	13	15	17	
Discharge in am- } peres: {	For 8 hrs.	10	15	20	25	30	40	50	60	70	80	5
	For 5 hrs.	14	21	28	35	42	56	70	84	98	112	7
	For 3 hrs.	20	30	40	50	60	80	100	120	140	160	10
	For 1 hr.	40	60	80	100	120	160	200	240	280	320	20
Normal charge rate.....	10	15	20	25	30	35	40	50	60	70	80	5
Outside } dimens- } ions: {	Length, in. } rubber jar.....	27/8	3 7/8	5	6 1/8	8 1/8	8 1/2	15	15 3/4	18 3/8	20	7/8
	Width, in. } rubber jar.....	8 1/2	8 1/2	8 1/2	8 1/2	8 1/2	12 1/2	12 1/2	12 1/2	12 3/4	12 3/4	
	Height, in. } glass jar.....	11	11	11	11	11	17 1/2	17 1/2	17 1/2	17 1/2	17 1/2	
	Height, in. } glass jar.....	5 1/2	6 3/4	8	8 3/8	11	11 3/8	9	10 5/8	10 5/8	12	
Weight of electrolyte: } lbs.: {	rubber jars.....	18 1/2	20	24 1/2	26	35	34	69	67	79		
	glass jars.....	5 1/2	8	10 1/2	12	17	18 1/2	99	111	123	133	6
Weight of cell com- } plete, with acid: {	rubber jar.....	49	60	74	86 1/2	104	112					
	glass jar.....	29 1/2	40 1/2	52	65	77	87	tank	332	372	411	20
Height of cell over } all, in } ches: {	rubber jar.....	20	20	20	20	20	27 3/4	27 3/4	27 3/4	27 3/4	27 3/4	
	glass jar.....	12 1/2	12 1/2	12 1/2	12 1/2	12 1/2	12 1/2	33 1/4	33 1/4	33 1/4	33 1/4	

*D= addition per plate from 25 to 75 plates; approximate as to dimensions and weights.

TYPE "G."							TYPE "H."						
Size of Plates, 15 ⁵ / ₁₆ × 15 ⁵ / ₁₆ in.							Size of Plates, 15 ⁵ / ₁₆ × 30 ¹¹ / ₁₆ in.						
Number of plates...	11	13	15	17	25	75	D*	21	23	25	75	D*	
Discharge in amperes:	For 8 hrs.	100	120	140	160	240	740	10	400	440	480	480	20
	For 5 hrs.	140	168	196	224	336	1036	14	560	616	672	2072	28
	For 3 hrs.	200	240	280	320	480	1480	20	800	880	960	2960	40
Normal charge rate	400	480	560	640	960	2960	40	1600	1760	1920	5920	20	
Outside dimensions of tank, inches:													
Length	15 ¹ / ₂	16 ¹ / ₄	18 ¹ / ₂	20	27 ⁵ / ₈	69 ⁷ / ₈	7 ⁷ / ₈	25 ¹ / ₂	26 ³ / ₄	28 ³ / ₈	69 ⁷ / ₈	7 ⁷ / ₈	
Width	19 ³ / ₄	19 ³ / ₄	19 ³ / ₄	19 ³ / ₄	20 ³ / ₄	21 ¹ / ₂	...	21 ¹ / ₂	21 ¹ / ₂	21 ¹ / ₂	21 ¹ / ₂	...	
Height	26	26	26	26	26 ¹ / ₂	27 ⁷ / ₈	...	48 ⁷ / ₈	48 ⁷ / ₈	48 ⁷ / ₈	49 ⁷ / ₈	...	
Weight of electrolyte in pounds	188	210	231	253	338	876	10.5	583	625	668	1741	21.5	
Weight of cell, complete, with electrolyte in lead-lined tank, pounds	568	645	719	798	1165	3300	40	1967	2121	2278	6215	78	
Height of cell over all, inches	39	39	39	39	40	41 ¹ / ₂	...	62 ¹ / ₄	62 ¹ / ₄	62 ¹ / ₄	63 ¹ / ₄	...	

*D = addition per plate from 25 to 75 plates; approximate as to dimensions and weights.

2. The possibility of obtaining good regulation in pressure during fluctuations in load, especially when the day load consists largely of elevators and similar disturbing elements.

3. To meet sudden demands which arise unexpectedly, as in the case of darkness caused by storm or thunder-showers; also in case of emergency due to accident or stoppage of generating-plant.

4. Smaller generating-plant required where the battery takes the peak of the load, which usually only lasts for a few hours, and yet where no battery is used necessitates sufficient generators, etc., being installed to provide for the maximum output, which in many cases is about double the normal output.

The Working Current, or Energy Efficiency, of a storage-cell is the ratio between the value of the current or energy expended in the charging operation, and that obtained when the cell is discharged at any specified rate.

In a lead storage-cell, if the surface and quantity of active material be accurately proportioned, and if the discharge be commenced immediately after the termination of the charge, then a current efficiency of as much as 98% may be obtained, provided the rate of discharge is low and well regulated. Since the current efficiency decreases as the discharge rate increases, and since very low discharge rates are seldom used in practice, efficiencies as high as this are never obtained practically, the average being about 90%.

As the normal average discharging electro-motive force of a lead secondary cell never exceeds 2 volts, and as an average electro-motive force during normal charge of about 2.35 volts is required at its poles to overcome both its opposing electro-motive force and its internal resistance, there is an initial loss of at least 15% between the voltage required to charge it and that at which it discharges. Thus with a current efficiency of 90% and a volt efficiency of 85% the energy efficiency under the best conditions cannot be much over 75%, while in practice it is nearer 70%.

Important General Rules.—Storage cells should not be excessively charged, undercharged or allowed to stand when completely discharged.

In setting up new cells the manufacturer should always be consulted as to the proper purity and specific gravity of the electrolyte (solution) to be used in the cells and also as to the duration of the initial charge.

Charging should be done at the normal rate (as given by the manufacturer) or as near to it as possible. At regular periods once each week or two weeks, depending on whether the cells have to be charged daily or not, an overcharge should be given, lasting until the specific gravity of the electrolyte and the cell voltage have risen to a maximum and remained constant for about one hour. The end of charge voltage may vary from 2.40 to 2.70 volts per cell. All other charges termed "regular charges" should cease shortly before the maximum values obtained on the preceding overcharge are reached. If cells are standing idle they should receive an overcharge once every two weeks.

Discharges should be stopped when the cell voltage has fallen to 1.80 volts with current flowing at or about the normal rate. The fall in specific gravity of the electrolyte is also useful as a guide on the discharge and the manufacturer should be consulted as to the proper limits.

The level of the electrolyte should be kept above the top of the plates by adding pure fresh water. Addition of new electrolyte is seldom necessary and should be done only on advice from the manufacturer.

The sediment which collects in the bottom of the cells should always be removed before it touches the plates.

The battery room should be well ventilated, especially when charging, and great care taken not to bring an exposed flame near the cells when charging or shortly after.

Metals or impurities of any kind must not be allowed to get into the cells. If such should happen, the impurity should be removed at once, and if badly contaminated, the electrolyte replaced with new. If in doubt as to the purity of electrolyte or water, the manufacturers should be consulted.

To take cells out of commission, the electrolyte should be drawn off; the cells filled with water and allowed to stand for 12 or 15 hours. The water can then be drawn off and the plates allowed to dry. When putting into service again, the same procedure should be followed as with the initial charge.

ELECTROLYSIS.

The separation of a chemical compound into its constituents by means of an electric current. Faraday gave the nomenclature relating to electrolysis. The compound to be decomposed is the Electrolyte, and the process Electrolysis. The plates or poles of the battery are Electrodes. The plate where the greatest pressure exists is the Anode, and the other pole is the Cathode. The products of decomposition are Ions.

Lord Rayleigh found that a current of one ampere will deposit 0.017253 grain, or 0.001118 gram, of silver per second on one of the plates of a silver voltameter, the liquid employed being a solution of silver nitrate containing from 15% to 20% of the salt. The weight of hydrogen similarly set free by a current of one ampere is 0.00001038 gram per second.

Knowing the amount of hydrogen thus set free, and the chemical equivalents of the constituents of other substances, we can calculate what weight of their elements will be set free or deposited in a given time by a given current. Thus, the current that liberates 1 gram of hydrogen will liberate 8 grams of oxygen, or 107.7 grams of silver, the numbers 8 and 107.7 being the chemical equivalents for oxygen and silver respectively.

To find the weight of metal deposited by a given current in a given time, find the weight of hydrogen liberated by the given current in the given time, and multiply by the chemical equivalent of the metal.

The table on page 1382 (from "Practical Electrical Engineering") is calculated upon Lord Rayleigh's determination of the electro-chemical equivalents and Roscoe's atomic weights.

ELECTRO-CHEMICAL EQUIVALENTS.

Elements.	Valency.*	Atomic Weight.†	Chemical Equivalent.	Electro-chemical Equivalent (milligrams per coulomb).	Coulombs per gram.	Grams per ampere hour.
ELECTRO-POSITIVE.						
Hydrogen.....	H ₁	1.00	1.00	0.010384	96293.00	0.03738
Potassium.....	K ₁	39.04	39.04	0.40539	2467.50	1.45950
Sodium.....	Na ₁	22.99	22.99	0.23873	4188.90	0.85942
Aluminum.....	Al ₃	27.3	9.1	0.09449	1058.30	0.34018
Magnesium.....	Mg ₂	23.94	11.97	0.12430	804.03	0.44747
Gold.....	Au ₃	196.2	65.4	0.67911	1473.50	2.44480
Silver.....	Ag ₁	107.66	107.66	1.11800	894.41	4.02500
Copper (cupric).....	Cu ₂	63.00	31.5	0.32709	3058.60	1.17700
(cuprous).....	Cu ₁	63.00	63.00	0.65419	1525.30	2.35500
Mercury (mercuric).....	Hg ₂	199.8	99.9	1.03740	963.99	3.73450
(mercurous).....	Hg ₁	199.8	199.8	2.07470	481.99	7.46900
Tin (stannic).....	Sn ₄	117.8	29.45	0.30581	3270.00	1.10090
(stannous).....	Sn ₂	117.8	58.9	0.61162	1635.00	2.20180
Iron (ferric).....	Fe ₃	55.9	18.64	0.19356	5166.4	0.69681
(ferrous).....	Fe ₂	55.9	27.95	0.29035	3445.50	1.04480
Nickel.....	Ni ₂	58.6	29.3	0.30425	3286.80	1.09530
Zinc.....	Zn ₂	64.9	32.45	0.33696	2967.10	1.21330
Lead.....	Pb ₂	206.4	103.2	1.07160	933.26	3.85780
ELECTRO-NEGATIVE.						
Oxygen.....	O ₂	15.96	7.98	0.08286
Chlorine.....	Cl ₁	35.37	35.37	0.36728
Iodine.....	I ₁	126.53	126.53	1.31300
Bromine.....	Br ₁	79.75	79.75	0.82812
Nitrogen.....	N ₃	14.01	4.67	0.04849

*Valency is the atom-fixing or atom-replacing power of an element compared with hydrogen, whose valency is unity.

†Atomic weight is the weight of one atom of each element compared with hydrogen, whose atomic weight is unity.

‡Becquerel's extension of Faraday's law showed that the electro-chemical equivalent of an element is proportional to its chemical equivalent. The latter is equal to its combining weight, and not to atomic weight ÷ valency, as defined by Thompson, Hospitalier, and others who have copied their tables. For example, the ferric salt is an exception to Thompson's rule, as are sesqui-salts in general.

Thus: Weight of silver deposited in 10 seconds by a current of 10 amperes = weight of hydrogen liberated per second × number of seconds × current strength × 107.7 = 0.00001038 × 10 × 10 × 107.7 = 0.11178 gram.

Weight of copper deposited in 1 hour by a current of 10 amperes =

$$0.00001038 \times 3600 \times 10 \times 31.5 = 11.77 \text{ grams.}$$

Since 1 ampere per second liberates 0.00001038 gram of hydrogen, strength of current in amperes

$$= \text{weight in grams of H liberated per second} \div 0.00001038$$

$$= \frac{\text{weight of element liberated per second}}{0.00001038 \times \text{chemical equivalent of element}}$$

$$= \frac{\text{weight of element liberated per second}}{0.00001038 \times \text{chemical equivalent of element}}$$

WARNING: This is a 1910 edition. Some of the material may no longer be accurate

THE MAGNETIC CIRCUIT.

For units of the magnetic circuit, see page 1346.

Lines and Loops of Force. — It is conventionally assumed that the attractions and repulsions shown by the action of a magnet or a conductor upon iron filings are due to "lines of force" surrounding the magnet or conductor. The "number of lines" indicates the magnitude of the forces acting. As the iron filings arrange themselves in concentric circles, we may assume that the forces may be represented by closed curves or "loops of force." The following assumptions are made concerning the loops of force in a conductive circuit:

1. That the lines or loops of force in the conductor are parallel to the axis of the conductor.
2. That the loops of force external to the conductor are proportional in number to the current in the conductor, that is, a definite current generates a definite number of loops of force. These may be stated as the strength of field in proportion to the current.
3. That the radii of the loops of force are at right angles to the axis of the conductor.

The magnetic force proceeding from a point is equal at all points on the surface of an imaginary sphere described by a given radius about that point. A sphere of radius 1 cm. has a surface of 4π square centimeters. If ϕ = total flux, expressed as the number of lines of force emanating from a magnetic pole having a strength M ,

$$\phi = 4\pi M; M = \phi \div 4\pi.$$

Magnetic moment of a magnet = product of strength of pole M and its length, or distance between its poles L . Magnetic moment = $\phi L \div 4\pi$.

If B = number of lines flowing through each square centimeter of cross-section of a bar-magnet, or the "specific induction," and A = cross-section

$$\text{Magnetic Moment} = LAB \div 4\pi.$$

If the bar-magnet be suspended in a magnetic field of density H and so placed that the lines of the field are all horizontal and at right angles to the axis of the bar, the north pole will be pulled forward, that is, in the direction in which the lines flow, and the south pole will be pulled in the opposite direction, the two forces producing a torsional moment or torque, Torque = $MLH = LABH \div 4\pi$, in dyne-centimeters.

Magnetic attraction or repulsion emanating from a point varies inversely as the square of the distance from that point. The law of inverse squares, however, is not true when the magnetism proceeds from a surface of appreciable extent, and the distances are small, as in dynamo-electric machines and ordinary electromagnets.

The Magnetic Circuit. — In the electric circuit

$$\text{Current} = \frac{\text{E.M.F.}}{\text{Resistance}}, \text{ or } I = \frac{E}{R}; \text{ Amperes} = \frac{\text{volts}}{\text{ohms}}.$$

Similarly, in the magnetic circuit

$$\text{Flux} = \frac{\text{Magnetomotive Force}}{\text{Reluctance}}, \text{ or } \phi = \frac{F}{R}. \text{ Maxwells} = \frac{\text{Gilberts}}{\text{Oersteds}}.$$

Reluctance is the reciprocal of permeance, and permeance is equal to permeability × path area ÷ path length (metric measure); hence

$$\phi = F\mu a \div l.$$

One ampere-turn produces 1.257 gilberts of magnetomotive force and one inch equals 2.54 centimeters; hence, in inch measure,

$$\phi = (1.257 A_t) \mu 6.45 a \div 2.54 l = 3.192 \mu a A_t \div l.$$

The ampere-turns required to produce a given magnetic flux in a given path will be

$$A_t = \phi l \div 3.192 \mu a = 0.3133 \phi l \div \mu a.$$

Since magnetic flux ÷ area of path = magnetic density, the ampere-turn required to produce a density B , in lines of force per square inch of area of path, will be

$$A_t = 0.3133 B l \div \mu.$$

This formula is used in practical work, as the magnetic density must be predetermined in order to ascertain the permeability of the material under its working conditions. When a magnetic circuit includes several qualities of material, such as wrought iron, cast iron, and air, it is most direct to work in terms of ampere-turns per unit length of path. The

ampere-turns for each material are determined separately, and the winding is designed to produce the sum of all the ampere-turns. The following table gives the average results from a number of tests made by Dr. Samuel Sheldon:

VALUES OF B AND H

H	Ampere-turns per cent length.	Ampere-turns per inch length.	Cast Iron.		Cast Steel.		Wrought Iron.		Sheet Metal.	
			Kilo-gausses.	Kilomax-wells per sq. in.	Kilo-gausses.	Kilomax-wells per sq. in.	Kilo-gausses.	Kilomax-wells per sq. in.	Kilo-gausses.	Kilomax-wells per sq. in.
10	7.95	20.2	4.3	27.7	11.5	74.2	13.0	83.8	14.3	92.2
20	15.90	40.4	5.7	36.8	13.8	89.0	14.7	94.8	15.6	100.7
30	23.85	60.6	6.5	41.9	14.9	96.1	15.3	98.6	16.2	104.5
40	31.80	80.8	7.1	45.8	15.5	100.0	15.7	101.2	16.6	107.1
50	39.75	101.0	7.6	49.0	16.0	103.2	16.0	103.2	16.9	109.6
60	47.70	121.2	8.0	51.6	16.5	106.5	16.3	105.2	17.3	111.6
70	55.65	141.4	8.4	59.2	16.9	109.0	16.5	106.5	17.5	112.9
80	63.65	161.6	8.7	56.1	17.2	111.0	16.7	107.8	17.7	114.1
90	71.60	181.8	9.0	58.0	17.4	112.2	16.9	109.0	18.0	116.1
100	79.50	202.0	9.4	60.6	17.7	114.1	17.2	110.9	18.2	117.3
150	119.25	303.0	10.5	68.3	18.5	119.2	18.0	116.1	19.0	122.7
200	159.0	404.0	11.7	75.5	19.2	123.9	18.7	120.8	1.96	125.5
250	198.8	505.0	12.4	80.0	19.7	127.1	19.2	123.9	20.2	131.2
300	238.5	606.0	13.2	85.1	20.1	129.6	19.7	127.1	20.7	133.5

H = 1.257 ampere-turns per cm. = 0.495 ampere-turns per inch.

EXAMPLE.—A magnetic circuit consists of 12 ins. of cast steel of 8 sq. ins. cross-section; 4 ins. of cast iron of 22 sq. ins. cross-section; 3 ins. of sheet iron of 8 sq. ins. cross-section; and two air-gaps each $\frac{1}{16}$ in. long and of 12 sq. ins. area. Required, the ampere-turns to produce a flux of 768,000 maxwells, which is to be uniform throughout the magnetic circuit.

The flux density in the steel is $768,000 \div 8 = 96,000$ maxwells; the ampere-turns per inch of length, according to Sheldon's table, are 60.6, so that the 12 in. of steel will require 727.2 ampere-turns.

The density in the cast iron is $768,000 \div 22 = 34,900$; the ampere-turns = $4 \times 40 = 160$.

The density in the sheet iron = $768,000 \div 8 = 96,000$; ampere-turns per inch = 30; total ampere-turns for sheet iron = 90.

The air-gap density is $768,000 \div 12 = 64,000$; ampere-turns per in. = $0.3133B$; ampere-turns required for air-gap = $0.3133 \times 64,000 \div 8 = 2506.4$.

The entire circuit will require $727.2 + 160 + 90 + 2506.4 = 3483.6$ ampere-turns, assuming uniform flux throughout.

In practice there is considerable "leakage" of magnetic lines of force; that is, many of the lines stray away from the useful path, there being no material opaque to magnetism and therefore no means of restricting it to a given path. The amount of leakage is proportional to the permeance of the leakage paths available between two points in a magnetic circuit which are at different magnetic potentials, such as opposite ends of a magnet coil. It is seldom practicable to predetermine with any approach to accuracy the magnetic leakage that will occur under given conditions unless one has profuse data obtained experimentally under similar conditions. In dynamo-electric machines the leakage coefficient varies from 1.3 to 2.

Traction or Lifting Force of a Magnet.—The lifting power or "pull" exerted by an electro-magnet upon an armature in actual contact with its pole-faces is given by the formula

$$\text{Lbs.} = B^2 a \div 72,134,000,$$

a being the area of contact in square inches and B the magnetic density over this area. If the armature is very close to the pole-faces this formula also applies with sufficient accuracy for all practical purposes, but a considerable air-gap renders it inapplicable.

The design of solenoids for the coil-and-plunger type of electro-magnets

is discussed in a series of articles by C. R. Underhill, in *Elec. World*, April 29, May 13, and Oct. 7, 1905.

Various forms of magnetic chucks are illustrated and described by O. S. Walker, in *Am. Mach.*, Feb. 11, 1909.

For magnets used in hoisting, see page 1169.

Determining the Polarity of Electro-magnets.—If a wire is wound around a magnet in a right-handed helix, the end at which the current flows into the helix is the south pole. If a wire is wound around an ordinary wood-screw, and the current flows around the helix in the direction from the head of the screw to the point, the head of the screw is the south pole. If a magnet is held so that the south pole is opposite the eye of the observer, the wire being wound at a right-handed helix around it, the current flows in a right-handed direction, with the hands of a clock.

Determining the Direction of a Current.—Place a wire carrying a current above and parallel to a pivoted magnetic needle. If the current be flowing along the wire from N. to S., it will cause the N.-seeking pole to turn to the eastward; if it be flowing from S. to N., the pole will turn to the westward. If the wire be below the needle, these motions will be reversed.

Maxwell's rule. The direction of the current and that of the resisting magnetic force are related to each other as are the rotation and the forward travel of an ordinary (right-handed) corkscrew.

DYNAMO-ELECTRIC MACHINES.

There are three classes of dynamo-electric machines, viz.:

1. Generators, for the conversion of mechanical into electrical energy.
2. Motors, for the conversion of electrical into mechanical energy.

Generators and motors are both subdivided into direct-current and alternating-current machines.

3. Transformers, for the conversion of one character or voltage of current into another, as direct into alternating or alternating into direct, or from one voltage into a higher or lower voltage.

Kinds of Dynamo-electric Machines as regards Manner of Winding.

1. *Separately-excited Dynamo.*—The field magnet coils have no connection with the armature-coils, but receive their current from a separate machine or source.

2. *Series-wound Dynamo.*—The field winding and the external circuit are connected in series with the armature winding, so that the entire armature current must pass through the field-coils.

Since in a series-wound dynamo the armature-coils, the field, and the external circuit are in series, any increase in the resistance of the external circuit will decrease the electromotive force from the decrease in the magnetizing currents. A decrease in the resistance of the external circuit will, in a like manner, increase the electromotive force from the increase in the magnetizing current. The use of a regulator avoids these changes in the electromotive force.

3. *Shunt-wound Dynamo.*—The field magnet coils are placed in a shunt to the armature circuit, so that only a portion of the current generated passes through the field magnet coils, but all the difference of potential of the armature acts at the terminals of the field-circuit.

In a shunt-wound dynamo an increase in the resistance of the external circuit increases the electromotive force, and a decrease in the resistance of the external circuit decreases the electromotive force. This is just the reverse of the series-wound dynamo.

In a shunt-wound dynamo a continuous balancing of the current occurs, the current dividing at the brushes between the field and the external circuit in the inverse proportion to the resistance of these circuits. If the resistance of the external circuit becomes greater, a proportionately greater current passes through the field magnets, and so causes the electromotive force to become greater. If, on the contrary, the resistance of the external circuit decreases, less current passes through the field, and the electromotive force is proportionately decreased.

4. *Compound-wound Dynamo.*—The field magnets are wound with two separate sets of coils, one of which is in series with the armature and the external circuit, and the other in shunt with the armature or the external circuit.

Motors.—The above classification in regard to winding applies also to motors.

Moving Force of a Dynamo-electric Machine.—A wire through which a current passes has, when placed in a magnetic field, a tendency to move perpendicular to itself and at right angles to the lines of the field. The force producing this tendency is $P = lBI$ dynes, in which l = length of the wire, I = the current in C.G.S. units, and B = the induction, or flux density, in the field in gaussses or lines per square centimeter. If the current I is taken in amperes, $P = lBI \div 10 = lBI \times 10^{-1}$.

If P_k is taken in kilograms,

$$P_k = lBI \div 9,810,000 = 10.1937 lBI \times 10^{-8} \text{ kilograms.}$$

EXAMPLE.—The mean strength of field, B , of a dynamo is 5000 C.G.S. lines; a current of 100 amperes flows through a wire; the force acts upon 10 centimeters of the wire = $10.1937 \times 10 \times 100 \times 5000 \times 10^{-8} = 0.5097$ kilograms.

Torque of an Armature.—The torque of an armature is the moment tending to turn it. In a generator it is the moment which must be applied to the armature to turn it in order to produce current. In a motor it is the turning moment which the armature gives to the pulley.

Let I = current in the armature in amperes, E = the electromotive force in volts, T = the torque in pound-feet, ϕ = the flux through the armature in maxwells, N = the number of conductors around the armature, and n = the number of revolutions per second. Then

$$\text{Watts} = IE = 2\pi nT \times 1.356,*$$

In any machine if the flux be constant, E is directly proportional to the speed and = $\phi Nn \div 10^8$; whence

$$\phi NI \div 10^8 = 2\pi T \times 1.356;$$

$$T = \frac{\phi NI}{10^8 \times 2\pi \times 1.356} = \frac{\phi NI}{8.52 \times 10^8} \text{ pound-feet.}$$

Let l = length of armature in inches, d = diameter of armature in inches, B = flux density in maxwells per square inch, and let m = the ratio of the conductors under the influence of the pole-pieces to the whole number of conductors on the armature. Then

$$\phi = \frac{1}{2}\pi d \times l \times B \times m.$$

These formulæ apply to both generators and motors. They show that torque is independent of the speed and varies directly with the current and the flux. The total peripheral force is obtained by dividing the torque by the radius (in feet) of the armature, and the drag on each conductor is obtained by dividing the total peripheral force by the number of conductors under the influence of the pole-pieces at one time.

EXAMPLE.—Given an armature of length $l = 20$ inches, diameter $d = 12$ inches, number of conductors $N = 120$, of which 80 are under the influence of the pole-pieces at one time; let the flux density $B = 30,000$ maxwells per sq. in. and the current $I = 400$ amperes.

$$\phi = \frac{12\pi}{2} \times 20 \times 30,000 \times \frac{80}{120} = 7,540,000.$$

$$T = \frac{7,540,000 \times 120 \times 400}{8.52 \times 100,000,000} = 424.8 \text{ pound-feet.}$$

Total peripheral force = $424.8 \div 0.5 = 849.6$ lbs.

Drag per conductor = $849.6 \div 120 = 7.08$ lbs.

The work done in one revolution = torque \times circumference of a circle of 1 foot radius = $424.8 \times 6.28 = 2670$ foot-pounds.

Let the revolutions per minute equal 500, then the horse-power

$$= \frac{2670 \times 500}{33000} = 40.5 \text{ H.P.}$$

Torque, Horse-power and Revolutions.— T = torque in pound-feet, H.P. = $T \times \text{Rpm.} \times 6.2832 \div 33,000 = IE \div 746$. Whence Torque = $7.0403 EI \div \text{Rpm.}$ or 7 times the watts \div the revs. per min. nearly.

Electromotive Force of the Armature Circuit.—From the horse-power, calculated as above, together with the amperes, we can obtain the E.M.F., for $IE = \text{H.P.} \times 746$, whence E.M.F. or $E = \text{H.P.} \times 746 \div I$.

* 1 ft.-lb. per second = 1.356 watts.

If H.P., as above, = 40.5, and $I = 400$, $E = \frac{40.5 \times 746}{400} = 75.5$ volts.

The E.M.F. may also be calculated by the following formulæ:

I = Total current through armature;

e_a = E.M.F. in armature in volts;

N = Number of active conductors counted all around armature;

p = Number of pairs of poles ($p = 1$ in a two-pole machine);

n = Speed in revolutions per minute;

ϕ = Total flux in maxwells.

$$\text{Electromotive force: } \begin{cases} e_a = \phi N \frac{n}{60} 10^{-8} \text{ for two-pole machines.} \\ e_a = \frac{p\phi N n}{10^8 \cdot 60} \text{ for multipolar machines with series-wound armature} \end{cases}$$

Strength of the Magnetic Field.—Let I = current in amperes, N = number of turns in the coil, A = area of the cross-section of the core in square centimeters, l = length of core in centimeters, μ the permeability of the core, and ϕ = flux in maxwells. Then

$$\phi = \frac{\text{Magnetomotive Force}}{\text{Reluctance}} = \frac{1.257 NI}{(l + A\mu)}$$

In a dynamo-electric machine the reluctance will be made up of three separate quantities, viz.: that of the field magnet cores, that of the air spaces between the field magnet pole-pieces and the armature, and that of the armature. The total reluctance is the sum of the three. Let L_1 , L_2 , L_3 be the length of the path of magnetic lines in the field magnet cores,* in the air-gaps, and in the armature respectively; and let A_1 , A_2 , A_3 be the areas of the cross-sections perpendicular to the path of the magnetic lines in the field magnet cores, the air-gaps, and the armature respectively. Let the permeability of the field magnet cores be μ_1 , and of the armature μ_3 . The permeability of the air-gaps is taken as unity. Then the total reluctance of the machine will be

$$\frac{L_1}{A_1\mu_1} + \frac{L_2}{A_2} + \frac{L_3}{A_3\mu_3}$$

$$\text{The flux, } \phi = \frac{1.257 NI}{(L_1 \div A_1\mu_1) + (L_2 \div A_2) + (L_3 \div A_3\mu_3)}$$

The ampere-turns necessary to create a given flux in a machine may be found by the formula,

$$NI = \phi \frac{[(L_1 \div A_1\mu_1) + (L_2 \div A_2) + (L_3 \div A_3\mu_3)]}{1.257}$$

But the total flux generated by the field coils is not available to produce current in the armature. There is a leakage between the field magnets, and this must be allowed for in calculations. The leakage coefficient varies from 1.3 to 2 in different machines. The meaning of the coefficient is that if a flux of say 100 maxwells per square cm. are desired in the field coils, it will be necessary to provide ampere turns for $1.3 \times 100 = 130$ maxwells, if the leakage coefficient be 1.3.

Another method of calculating the ampere-turns necessary to produce a given flux is to calculate the magnetomotive force required in each portion of the machine, separately, introducing the leakage coefficient in the calculation for the field magnets, and dividing the sum of the magnetomotive forces by 1.257.

In the ordinary type of multipolar machine there are as many magnetic circuits as there are poles. Each winding energizes part of two circuits. The calculation is made in the same manner as for a single magnetic circuit.

*The length of the path in the field magnet cores L_1 includes that portion of the path which lies in the piece joining the cores of the various field magnets.

ALTERNATING CURRENTS.*

The advantages of alternating over direct currents are: 1. Greater simplicity of dynamos and motors, no commutators being required; 2. The feasibility of obtaining high voltages, by means of static transformers, for cheapening the cost of transmission; 3. The facility of transforming from one voltage to another, either higher or lower, for different purposes.

A direct current is uniform in strength and direction, while an alternating current rapidly rises from zero to a maximum, falls to zero, reverses its direction, attains a maximum in the new direction, and again returns to zero. This series of changes can best be represented by a curve the abscissas of which represent time and the ordinates either current or electromotive force (e.m.f.). The curve usually chosen for this purpose is the sine curve, Fig. 172; the best forms of alternators give a curve that is a very close approximation to the sine curve, and all calculations and deductions of formulæ are based on it. The equation of the sine curve is $y = \sin x$, in which y is any ordinate, and x is the angle passed over by a moving radius vector.

After the flow of a direct current has been once established, the only opposition to the flow is the resistance offered by the conductor to the passage of current through it. This resistance of the conductor, in treating of alternating currents, is sometimes spoken of as *ohmic resistance*. The word resistance, used alone, always means the ohmic resistance. In alternating currents, in addition to the resistance, several other quantities, which affect the flow of current, must be taken into consideration. These quantities are inductance, capacity, and skin effect. They are discussed under separate headings.

The current and the e.m.f. may be in phase with each other, that is, they may attain their maximum strength at the same instant, or they may not, depending on the character of the circuit. In a circuit containing only resistance, the current and e.m.f. are in phase; in a circuit containing inductance the e.m.f. attains its maximum value before the current, or leads the current. In a circuit containing capacity the current leads the e.m.f. If both capacity and inductance are present in a circuit, they will tend to neutralize each other.

Maximum, Average, and Effective Values.—The strength and the e.m.f. of an alternating current being constantly varied, the maximum value of either is attained only for an instant in each period. The maximum values are little used in calculations, except in deducing formulæ and for proportioning insulation, which must stand the maximum pressure.

The average value is obtained by averaging the ordinates of the sine curve representing the current, and is $2 \div \pi$ or 0.637 of the maximum value.

The value of greatest importance is the effective, or "square root of the mean square," value. It is obtained by taking the square root of the mean of the squares of the ordinates of the sine curve. The effective value is the value shown on alternating-current measuring instruments. The product of the square of the effective value of the current and the resistance of the circuit is the heat lost in the circuit.

The comparison of the maximum, average, and effective values is as follows:

$$E_{\text{Effec.}} = E_{\text{Max.}} \times 0.707; E_{\text{Aver.}} = E_{\text{Max.}} \times 0.637; E_{\text{Max.}} = 1.41 \times E_{\text{Effec.}}$$

Frequency.—The time required for an alternating current to pass through one complete cycle, as from one maximum point to the next (a and b , Fig. 172), is termed the period. The number of periods in a second is termed the frequency of the current. Since the current changes its direction twice in each period, the number of reversals or alternations is

*Only a very brief treatment of the subject of alternating currents can be given in this book. The following works are recommended as valuable for reference: Alternating Currents and Alternating Current Machinery, by D. C. and J. P. Jackson; Standard Polyphase Apparatus and Systems, by M. A. Oudin; Polyphase Electric Currents, by S. P. Thompson; Electric Lighting, by F. B. Crocker, 2 vols.; Electric Power Transmission, by Louis Bell; Alternating Currents, by Bedell and Crehore; Alternating-current Phenomena, by Chas. P. Steinmetz. The two last named are highly mathematical.

double the frequency. A current of 120 alternations per second has a period of $1/60$ and a frequency of 60. The frequency of a current is equal to one-half the number of poles on the generator, multiplied by the number of revolutions per second. Frequency is denoted by the letter f .

The frequencies most generally used in the United States are 25, 40, 60, 125, and 133 cycles per second. The Standardization Report of the A. I. E. E. recommends the adoption of three frequencies, viz. 25, 60 and 120.

With the higher frequencies both transformers and conductors will be less costly in a circuit of a given resistance but the capacity and inductance effects in each will be increased, and these tend to increase the cost. With high frequencies it also becomes difficult to operate alternators in parallel.

A low frequency current cannot be used on lighting circuits, as the lights will flicker when the frequency drops below a certain figure. For arc lights the frequency should not be less than 40. For incandescent lamps it should not be less than 25. If the circuit is to supply both power and light a frequency of 60 is usually desirable. For power transmission to long distances a low frequency, say 25, is considered desirable, in order to lessen the capacity effects. If the alternating current is to be converted into direct current for lighting purposes a low frequency may be used, as the frequency will then have no effect on the lights.

Inductance.—Inductance is that property of an electrical circuit by which it resists a change in the current. A current flowing through a conductor produces a magnetic flux around the conductor. If the current be changed in strength or direction, the flux is also changed, producing in the conductor an e.m.f. whose direction is opposed to that of the current in the conductor. This counter e.m.f. is the *counter e.m.f. of inductance*. It is proportional to the rate of change of current, provided that the permeability of the medium around the conductor remains constant. The unit of inductance is the *henry*, symbol L . A circuit has an inductance of one henry if a uniform variation of current at the rate of one ampere per second produces a counter e.m.f. of one volt.

The effect of inductance on the circuit is to cause the current to lag behind the e.m.f. as shown in Fig. 198, in which abscissas represents time, and ordinates represent e.m.f. and current strengths respectively.

Capacity.—Any insulated conductor has the power of holding a quantity of static electricity. This power is termed the *capacity* of the body. The capacity of a circuit is measured by the quantity of electricity in it when at unit potential. It may be increased by means of a condenser. A condenser consists of two parallel conductors, insulated from each other by a non-conductor. The conductors are usually in sheet form.

The unit of capacity is a *farad*, symbol C . A condenser has a capacity of one farad when one coulomb of electricity contained in it produces a difference of potential of one volt, or when a rate of change of pressure of one volt per second produces a current of one ampere. The farad is too large a unit to be conveniently used in practice, and the micro-farad or one-millionth of a farad is used instead.

The effect of capacity on a circuit is to cause the e.m.f. to lag behind the current. Both inductance and capacity may be measured with a Wheatstone bridge by substituting for a standard resistance a standard of inductance or a standard of capacity.

Power Factor.—In direct-current work the power, measured in watts, is the product of the volts and amperes in the circuit. In alternating-current work this is only true when the current and e.m.f. are in phase. If the current either lags or leads, the values shown on the volt and ammeters will not be true simultaneous values. Referring to Fig. 172, it will be seen that the product of the ordinates of current and e.m.f. at any particular instant will not be equal to the product of the effective values which are shown on the instruments. The power in the circuit at any instant is the product of the simultaneous values of current and e.m.f., and the volts and amperes shown on the recording instruments must be multiplied together and their product multiplied by a power factor before the true

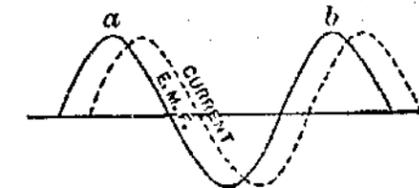

FIG. 198.

watts are obtained. This power factor, which is the ratio of the volt-amperes to the watts, is also the cosine of the angle of lag or lead of the current. Thus

$$P = I \times E \times \text{power factor} = I \times E \times \cos \theta,$$

where θ is the angle of lag or lead of the current.

A watt-meter, however, gives the true power in a circuit directly. The method of obtaining the angle of lag is shown below, in the section on Impedance Polygons.

Reactance, Impedance, Admittance.—In addition to the ohmic resistance of a circuit there are also resistances due to inductive, capacity, and skin effect. The virtual resistance due to inductance and capacity is termed the reactance of the circuit. If inductance only be present in circuit, the reactance will vary directly as the inductance. If capacity only be present, the reactance will vary inversely as the capacity.

$$\text{Inductive reactance} = 2\pi fL.$$

$$\text{Condensive reactance} = \frac{1}{2\pi fC}.$$

The total apparent resistance of the circuit, due to both the ohmic resistance and the total reactance, is termed the impedance, and is equal to the square root of the sum of the squares of the resistance and the reactance.

$$\text{Impedance} = Z = \sqrt{R^2 + (2\pi fL)^2} \text{ when inductance is present in the circuit.}$$

$$\text{Impedance} = Z = \sqrt{R^2 + \left(\frac{1}{2\pi fC}\right)^2} \text{ when capacity is present in the circuit.}$$

Admittance is the reciprocal of impedance, $= 1 \div Z$.

If both inductance and capacity are present in the circuit, the reactance of one tends to balance that of the other; the total reactance is the algebraic sum of the two reactances; thus,

$$\text{Total reactance} = X = 2\pi fL - \frac{1}{2\pi fC}; \quad Z = \sqrt{R^2 + \left(2\pi fL - \frac{1}{2\pi fC}\right)^2}.$$

In all cases the tangent of the angle of lag or lead is the reactance divided by the resistance. In the last case

$$\tan \theta = \frac{2\pi fL - \frac{1}{2\pi fC}}{R}.$$

Skin Effect.—Alternating currents tend to have a greater density at the surface than at the axis of a conductor. The effect of this is to make the virtual resistance of a wire greater than its true ohmic resistance. With low frequencies and small wires the skin effect is small, but it becomes quite important with high frequencies and large wires.

The skin effect factor, by which the ohmic resistance is to be multiplied to obtain the virtual resistance, for different sizes of wire and frequencies is as follows:

Wire No.	0	00	000	0000	1/2 in.	3/4 in.	1 in.
25 cycles, factor				1.001	1.002	1.007	1.020
60 cycles, factor	1.001	1.002	1.005	1.006	1.008	1.040	1.111
130 cycles, factor	1.008	1.010	1.017	1.027	1.039	1.156	1.397

Ohm's Law applied to Alternating-Current Circuits.—To apply Ohm's law to alternating-current circuits a slight change is necessary in the expression of the law. Impedance is substituted for resistance. The law should read

$$I = \frac{E}{\sqrt{R^2 + X^2}} = \frac{E}{Z}.$$

Impedance Polygons.—1. *Series Circuits.*—The impedance of a circuit can be determined graphically as follows. Suppose a circuit to contain a resistance R and an inductance L , and to carry a current I of frequency f . In Fig. 199 draw the line ab proportional to R , and representing the direction of current. At b erect bc perpendicular to ab and proportional to $2\pi fL$. Join a and c . The line ac represents the impedance of the circuit. The angle θ between ab and ac is the angle of lag of the cur-

rent behind the e.m.f., and the power factor of the circuit is cosine θ . The e.m.f. of the circuit is $E = IZ$.

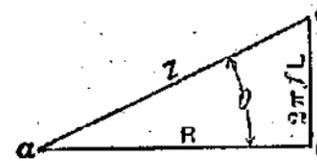

FIG. 199.

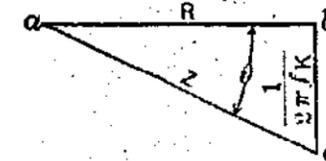

FIG. 200.

If the above circuit contained, instead of the inductance L , a capacity C , then would the polygon be drawn as in Fig. 200. The line bc would be proportional to $\frac{1}{2\pi fC}$ and would be drawn in a direction opposite to that of bc in Fig. 199. The impedance would again be Z , the e.m.f. would be $Z \times I$, but the current would lead the e.m.f. by the angle θ .

Suppose the circuit to contain resistance, inductance, and capacity. The lines of the impedance polygon would then be laid off as in Fig. 201. The impedance of the circuit would be represented by ad , and the angle of lag by θ . If the capacity of the circuit had been such that cd was less than bc , then would the e.m.f. have led the current.

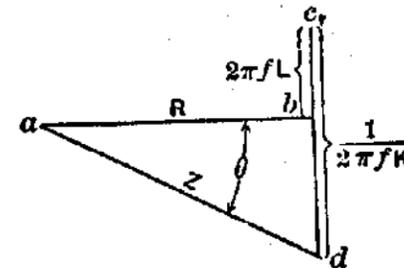

FIG. 201.

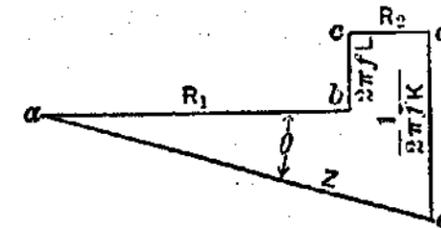

FIG. 202.

If between the inductance and capacity in the circuit in the previous examples there be interposed another resistance, the impedance polygon will take the form of Fig. 202. The lines representing either resistances, inductances, or capacities in the circuit follow each other in all cases as do the resistances, inductances, and capacities in the circuit, each line having its appropriate direction and magnitude.

EXAMPLE.—A circuit (Fig. 203) contains a resistance, R_1 , of 15 ohms, a capacity, C_1 , of 100 microfarads (0.000100 farad), a resistance, R_2 , of 12

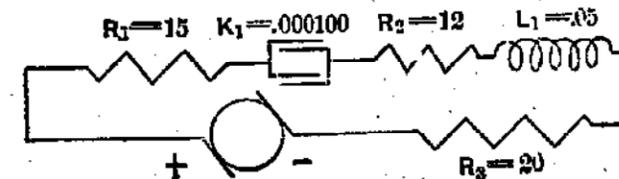

FIG. 203.

ohms, and inductance of L_1 , of 0.05 henry, and a resistance R_3 , of 20 ohms. Find the impedance and electromotive force when a current of 2 amperes is sent through the circuit, and the current when e.m.f. of 120 volts is impressed on the circuit, frequency being taken as 60. Also find the angle of lag, the power factor, and the power in the circuit when 120 volts are impressed.

The resistance is represented in Fig. 204 by the horizontal line ab , 15

units long. The capacity is represented by the line *bc*, drawn downwards from *b* and whose length is

$$\frac{1}{2\pi f C_1} = \frac{1}{2 \times 3.1416 \times 60 \times 0.0001} = 26.55.$$

From the point *c* a horizontal line *cd*, 12 units long, is drawn to represent *R*₂. From the point *d* the line *de* is drawn vertically upwards to represent the inductance *L*₁. Its length is

$$2\pi f L_1 = 2 \times 3.1416 \times 60 \times 0.05 = 18.85.$$

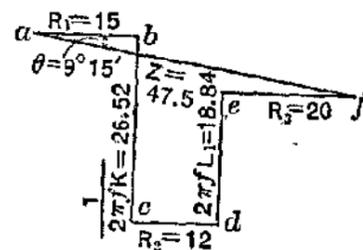

FIG. 204.

From the point *e* a horizontal line *ef*, 20 units long, is drawn to represent *R*₃. The line adjoining *a* and *f* will represent the impedance of the circuit in ohms. The angle θ , between *ab* and *af*, is the angle of lag of the e.m.f. behind the current. The impedance in this case is 47.5 ohms, and the angle of lag is $9^\circ 15'$.

The e.m.f. when a current of 2 amperes is sent through is

$$IZ = E = 2 \times 47.5 = 95 \text{ volts.}$$

If an e.m.f. of 120 volts be impressed on the circuit, the current flowing through will be

$$I = \frac{120}{Z} = \frac{120}{47.5} = 2.53 \text{ amperes.}$$

The power factor = $\cos \theta = \cos 9^\circ 15' = 0.987$.

The power in the circuit at 120 volts is

$$I \times E \times \cos \theta = 2.53 \times 120 \times 0.987 = 299.6 \text{ watts.}$$

2. *Parallel Circuits.*—If two circuits be arranged in parallel, the current flowing in each circuit will be inversely proportional to the impedance of that circuit. The e.m.f. of each circuit is the e.m.f. across the terminals at either end of the main circuit, where the various branches separate. Consider a circuit, Fig. 205, consisting of two branches. The first branch contains a resistance *R*₁ and an inductance *L*₁ in series with it. The second branch contains a resistance *R*₂ in series with an inductance *L*₂. The impedance of the circuit may be determined by treating each of the two branches as a separate series circuit, and drawing the impedance polygon for each branch on that assumption. Having found the impedance the current flowing in either branch will be the reciprocal of the impedance multiplied by the e.m.f. across the terminals. The current in the entire circuit is the geometrical sum in the two branches.

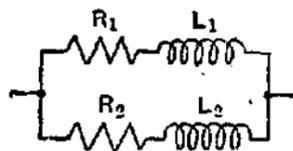

FIG. 205.

The admittance of the equivalent simple circuit may be obtained by drawing a parallelogram, two of whose adjoining sides are made parallel to the impedance lines of each branch and equal to the two admittances respectively.

The diagonal of the parallelogram will represent the admittance of the equivalent simple circuit. The admittance multiplied by the e.m.f. gives the total current in the circuit.

EXAMPLE.—Given the circuit in Fig. 206, consisting of two branches. Branch 1 consists of a resistance *R*₁ = 12 ohms, an inductance *L*₁ = 0.05 henry, a resistance *R*₂ = 4 ohms, and a capacity *C*₁ = 120 microfarads (0.00012 farad). Branch 2 consists of an inductance *L*₂ = 0.015 henry, a resistance *R*₃ = 10 ohms, and an inductance *L*₃ = 0.03 henry. An e.m.f. of 100 volts is impressed on the circuit at a frequency of 60. Find the admittance of the entire circuit, the current, the power factor, and the power in the circuit. Construct the impedance polygons for the two branches separately as shown in Fig. 207, *a* and *b*. The impedance in branch 1 is 16.4 ohms, and the current is $(1/16.4) \times 100 = 6.19$ amperes. The angle of lead of the current is $1^\circ 45'$. The impedance in branch 2 is 19.5 ohms and the current is $(1/19.5) \times 100 = 5.13$ amperes. The angle of lag of the current is 61° .

The current in the entire circuit is found by taking the admittances of

the two branches, and drawing them from the point *o*, in Fig. 207 *c*, parallel to the impedance lines in their respective polygons. The diagonal from *o* is the admittance of the entire circuit, and in this case is equal to 0.092.

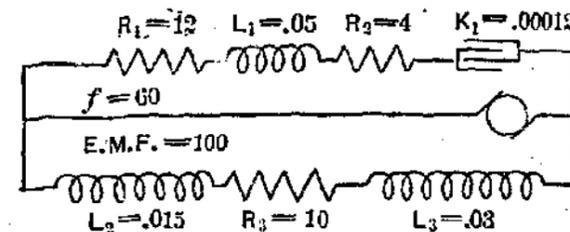

FIG. 206.

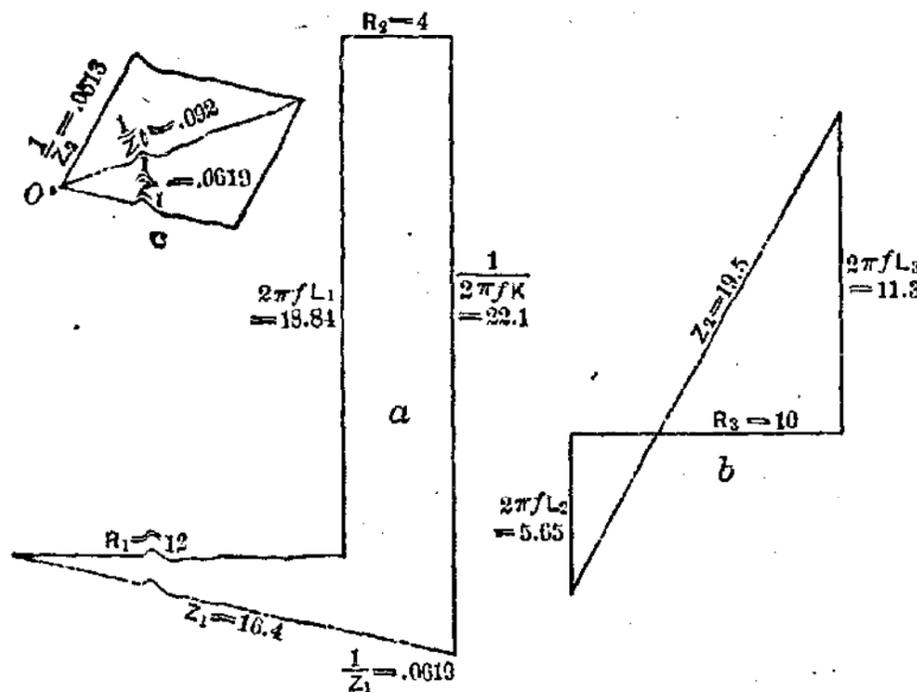

FIG. 207.

The current in the circuit is $0.092 \times 100 = 9.2$ amperes. The power factor is 0.944 and the power in the circuit is $100 \times 0.944 \times 9.2 = 868.48$ watts.

Self-Inductance of Lines and Circuits.—The following formulæ and table, taken from Crocker's "Electric Lighting," give a method of calculating the self-inductance of two parallel aerial wires forming part of the same circuit and composed of copper, or other non-magnetic material:

$$L \text{ per foot} = \left(15.24 + 140.3 \log \frac{2A}{d} \right) 10^{-9}.$$

$$L \text{ per mile} = \left(80.5 + 740 \log \frac{2A}{d} \right) 10^{-6}.$$

in which *L* is the inductance in henrys of each wire, *A* is the interaxial distance between the two wires, and *d* is the diameter of each, both in inches. If the circuit is of iron wire, the formulæ become

$$L \text{ per foot} = \left(2286 + 140.3 \log \frac{2A}{d} \right) 10^{-9}.$$

$$L \text{ per mile} = \left(12070 + 740 \log \frac{2A}{d} \right) 10^{-6}.$$

INDUCTANCE, IN MILLIHENRYS PER MILE, FOR EACH OF TWO PARALLEL COPPER WIRES.

Interaxial Distance, Ins.	American Wire Gauge Number.											
	0000	000	00	0	1	2	3	4	6	8	10	12
6	1.130	1.168	1.205	1.242	1.280	1.317	1.354	1.392	1.466	1.540	1.615	1.690
12	1.353	1.391	1.428	1.465	1.502	1.540	1.577	1.614	1.689	1.764	1.838	1.913
24	1.576	1.614	1.651	1.688	1.725	1.764	1.800	1.838	1.912	1.986	2.061	2.135
36	1.707	1.745	1.784	1.818	1.856	1.893	1.931	1.968	2.043	2.117	2.192	2.266
60	1.871	1.909	1.946	1.982	2.023	2.058	2.095	2.132	2.208	2.282	2.356	2.432
96	2.023	2.059	2.097	2.134	2.172	2.210	2.246	2.283	2.358	2.433	2.507	2.582

Capacity of Conductors.—All conductors are included in three classes, viz.: 1. Insulated conductors with metallic protection; 2. Single aerial conductor with earth return; 3. Metallic circuit consisting of two parallel aerial wires. The capacity of the lines may be calculated by means of the following formulæ taken from Crocker's "Electric Lighting."

Class 1. C per foot = $\frac{7361 k 10^{-15}}{\log(D + d)}$, C per mile = $\frac{38.83 k 10^{-9}}{\log(D + d)}$.

Class 2. C per foot = $\frac{7361 \times 10^{-15}}{\log(4h + d)}$, C per mile = $\frac{38.83 \times 10^{-9}}{\log(4h + d)}$.

Class 3. $\begin{cases} C \text{ per foot of each wire} = \frac{3681 \times 10^{-15}}{\log(2A + d)} \\ C \text{ per mile of each wire} = \frac{19.42 \times 10^{-9}}{\log(2A + d)} \end{cases}$

In which C is the capacity in farads, D the internal diameter of the metallic covering, d the diameter of the conductor, h the height of the conductor above the ground, and A the interaxial distance between two parallel wires all in inches; k is a dielectric constant which for air is equal to 1 and for pure rubber is equal to 2.5. The formulæ in classes 2 and 3 assume the wires to be bare. If they are insulated, k must be introduced in the numerator and given a value slightly greater than 1.

Single-phase and Polyphase Currents.—A single-phase current is a simple alternating current carried on a single pair of wires, and is generated on a machine having a single armature winding. It is represented by a single sine curve.

Polyphase currents are known as two-phase, three-phase, six-phase, or any other number, and are represented by a corresponding number of sine curves. The most commonly used systems are the two-phase and three-phase.

1. **Two-phase Currents.**—In a two-phase system there are two single-phase alternating currents bearing a definite time relation to each other and represented by two sine curves (Fig. 208). The two separate currents may be generated by the same or by separate machines. If by separate machines, the armatures of the two should be positively coupled together. Two-phase currents are usually generated by a machine with two armature windings, each winding terminating in two collector rings. The two windings are so related that the two currents will be 90°

apart. For this reason two phase-currents are also called "quarter-phase" currents.

Two-phase currents may be distributed on either three or four wires. The three-wire system of distribution is shown in Fig. 209. One of the return wires is dispensed with, connection being made across to the other as shown. The common return wire should be made 1.41 times the area of either of the other two wires, these two being equal in size.

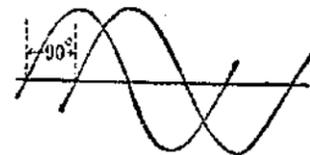

FIG. 208.

The four-wire system of distribution is shown in Fig. 210. The two phases are entirely independent, and for lighting purposes may be operated as two single-phase circuits.

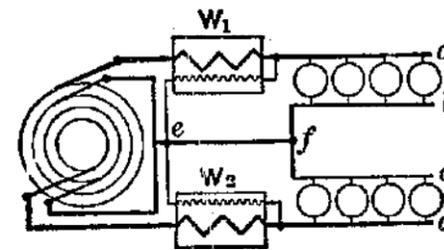

FIG. 209.

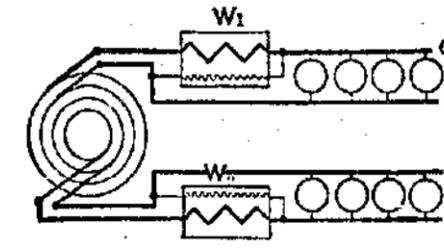

FIG. 210.

2. **Three-phase Currents.**—Three-phase currents consist of three alternating currents, differing in phase by 120°, and represented by three sine curves, as in Fig. 211. They may be distributed by three or six wires. If distributed by the six-wire system, it is analogous to the four-wire, two-phase system, and is equivalent to three single-phase circuits. In the three-wire system of distribution the circuits may be connected in two different ways, known respectively as the Y or star connection, and the Δ (delta) or mesh connection.

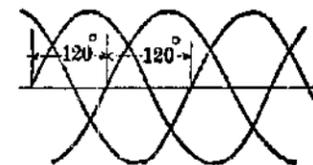

FIG. 211.

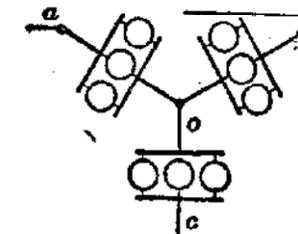

FIG. 212.

The Y connection is shown in Fig. 212. The three circuits are joined at the point o , known as the neutral point, and the three wires carrying the current are connected at the points a , b , and c , respectively. If the three circuits ao , bo , and co are composed of lights, they must be equally loaded or the lights will fluctuate. If the three circuits are perfectly balanced, the lights will remain steady. In this form of connection each wire may be considered as the return wire for the other two. If the three circuits are unbalanced, a return wire may be run from the neutral point o to the neutral point of the armature winding on the generator. The system will then be four-wire, and will work properly with unbalanced circuits.

The Δ connection is shown in Fig. 213. Each of the three circuits ab , ac , bc , receives the current due to a separate coil in the armature winding. This form of connection will work properly even if the circuits are unbalanced; and if the circuit contains lamps, they will not fluctuate when the circuit changes from a balanced to an unbalanced condition, or vice versa.

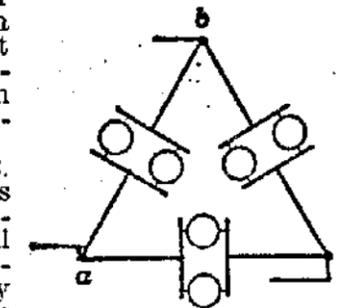

FIG. 213.

Measurement of Power in Polyphase Circuits.—1. **Two-phase Circuits.**—The power of two-phase currents distributed by four wires may be measured by two wattmeters introduced into the circuit as shown in Fig. 210. The sum of the readings of the two instruments is the total power. If but one wattmeter is available, it should be introduced first in one circuit, and then in the other. If the current or e.m.f. does not vary during the operation, the result will be correct. If the circuits are perfectly balanced, twice the reading of one wattmeter will be the total power.

The power of two-phase currents distributed by three wires may be measured by two wattmeters as shown in Fig. 209. The sum of the two readings is the total power. If but one wattmeter is available, the coarse-wire coil should be connected in series with the wire *ef* and one extremity of the pressure-coil should be connected to some point on *ef*. The other end should be connected first to the wire *a* and then to the wire *d*, a reading being taken in each position of the wire. The sum of the readings gives the power in the circuits.

2. *Three-phase Circuits.*—The power in a three-phase circuit may be measured by three wattmeters, connected as in Fig. 214 if the system is Y-connected, and as in Fig. 215 if the system is Δ-connected. The sum of

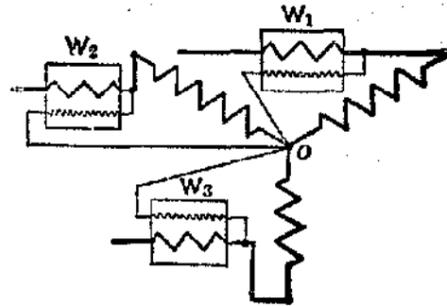

FIG. 214.

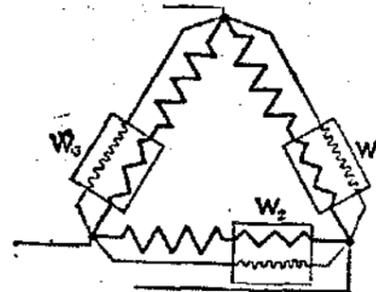

FIG. 215.

the wattmeter readings gives the power in the system. If the circuits are perfectly balanced, three times the reading of one wattmeter is the total power.

The power in a Δ-connected system may be measured by two wattmeters, as shown in Fig. 216. If the power factor of the system is greater than 0.50, the arithmetical sum of the readings is the power in the circuit. If the power factor is less than 0.50, the arithmetical difference of the readings is the power. Whether the power factor is greater or less than 0.50 may be discovered by interchanging the wattmeters without disturbing the relative connection of their coarse- and fine-wire coils. If the deflections of the needles are reversed, the difference of the readings is the power. If the needles are deflected in the same direction as at first, the sum of the readings is the power.

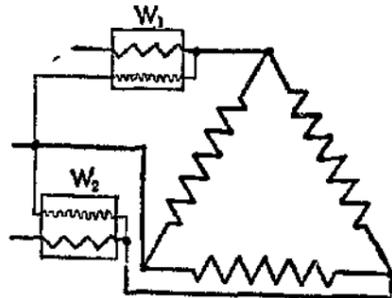

FIG. 216.

sometimes compounded by shunting some of their own current around the fields through a rectifying device which changes the current to pulsating direct current. In all large machines the armature is stationary and the field magnets revolve.

ALTERNATING-CURRENT CIRCUITS.

Calculation of Alternating-current Circuits.—The following formulae and tables are issued by the General Electric Co. They afford a convenient method of calculating the sizes of conductors for, and determining the losses in, alternating-current circuits. They apply only to circuits in which the conductors are spaced 18 inches apart, but a slight increase or decrease in this distance does not alter the figures appreciably. If the conductors are less than 18 inches apart, the loss of voltage is decreased, and vice versa.

WARNING: This is a 1910 edition. Some of the material may no longer be accurate

- Let *W* = total power delivered in watts;
- D* = distance of transmission (one way) in feet;
- P** = per cent loss of delivered power (*W*);
- E* = voltage between main conductors at consumer's end of circuit;
- K* = a constant; for continuous current = 2160;
- T* = a variable depending on the system and nature of the load; for continuous current = 1;
- M* = a variable, depending on the size of wire and frequency; for continuous current = 1;
- A* = a factor; for continuous current = 6.04.

$$\text{Area of conductor, circular mils} = \frac{D \times W \times K}{P \times E^2}$$

$$\text{Current in main conductors} = W \times T + E$$

$$\text{Volts lost in lines} = P \times E \times M + 100$$

$$\text{Pounds copper} = \frac{D^2 \times W \times K \times A}{P \times E^2 \times 1,000,000}$$

The following tables give values for the various constants:

VALUES OF *M* — WIRES 18 IN. APART.*

Power Factors	25 Cycles				40 Cycles				60 Cycles				125 Cycles			
	.95	.90	.85	.80	.95	.90	.85	.80	.95	.90	.85	.80	.95	.90	.85	.80
0.000	.17	.16	.12	.06	.32	.36	.36	.32	.55	.64	.67	.66	2.21	2.34	2.72	2.76
0.001	.13	.09	.05	.09	.24	.26	.24	.19	.41	.49	.50	.47	.97	2.22	2.34	2.37
0.005	.08	.03	.09	.02	.18	.18	.14	.09	.32	.36	.35	.31	.77	.96	2.04	2.04
0.01	.05	.00	.04	.07	.13	.11	.06	.07	.24	.26	.24	.19	.61	.74	1.80	1.79
0.02	.02	.96	.90	.83	.09	.05	.00	.04	.18	.17	.14	.10	.47	.57	1.59	1.56
0.03	1.00	.95	.86	.79	.05	.01	.95	.88	.12	.10	.06	.00	.37	.42	1.42	1.39
0.04	.98	.91	.84	.76	.02	.97	.90	.83	.08	.09	.99	.93	.27	.30	1.29	1.24
0.05	.96	.89	.81	.74	.00	.94	.86	.80	.05	1.00	.94	.87	.20	.21	1.18	1.13
0.06	.95	.88	.80	.72	.98	.92	.84	.77	.02	.97	.90	.85	.15	.13	1.09	1.03
0.07	.94	.86	.78	.70	.97	.90	.82	.74	.00	.94	.87	.79	.10	.07	1.02	.96
0.08	.94	.85	.77	.69	.95	.88	.80	.72	.98	.91	.84	.76	.06	.02	.96	.90
0.09	.93	.85	.76	.68	.94	.87	.79	.71	.97	.89	.82	.74	.03	.98	.92	.85
0.10	.92	.84	.76	.67	.94	.86	.77	.69	.95	.88	.80	.72	.01	.95	.88	.81
	.92	.83	.75	.67	.93	.85	.76	.68	.94	.86	.79	.71	.99	.92	.85	.78

Wires 36 in. Apart. †

0.000	1.22	1.23	1.20	1.15
0.001	1.16	1.15	1.11	1.05
0.005	1.11	1.08	1.04	.97
0.01	1.07	1.03	.98	.91
0.02	1.04	.99	.93	.86
0.03	.02	.95	.89	.82

† For higher voltages, 10,000–200,000.

$M = \left(1 + \frac{X}{R} \tan \alpha\right) \cos^2 \alpha$

X = Reactance.
R = Resistance, ohms per 1000 ft. at 60° F. (Wire 100% Matthiessen's standard.)

$X = 0.000882 \left[\log_{10} \left(\frac{d}{r}\right) + 0.109 \right]$

In which *d* = inches between wires,
r = radius of wire, inches,
f = cycles per sec.

* As corrected by Harold Pender, see *Elec. World*, July 1, 1905. The formula for *M* is approximate, and gives values correct within 2% for any case likely to arise in practice.

System:	Value of <i>K</i> .				Value of <i>T</i> .				Value of <i>A</i> .
	100	95	85	80	100	95	85	80	
Single-phase.....	2160	2400	3000	3380	1.00	1.05	1.17	1.25	6.04
Two-phase, 4-wire.....	1080	1200	1500	1690	0.50	0.53	0.59	0.62	12.08
Three-phase, 3-wire.....	1080	1200	1500	1690	0.58	0.61	0.68	0.72	9.06

**P* should be expressed as a whole number, not as a decimal; thus a 5 per cent loss should be written 5 and not .05.

Relative Weight of Copper Required in Different Systems for Equal Effective Voltages.

Direct current, ordinary two-wire system.....	1.000
" " three-wire system, all wires same size.....	0.375
" " neutral one-half size.....	0.313
Alternating current, single-phase two-wire, and two-phase four-wire.....	1.000
Two-phase three-wire, voltage between outer and middle wire same as in single-phase two-wire.....	0.729
voltage between two outer wires same.....	1.457
Three-phase three-wire.....	0.750
four-wire.....	0.333

The weight of copper is inversely proportional to the squares of the voltages, other things being equal. The maximum value of an alternating e.m.f. is 1.41 times its effective rating. For derivation of the above figures see Crocker's Electric Lighting, vol. ii.

Approximate Rule for Size of Wires for Three-Phase Transmission Lines. (General Electric Co.)

The table given below is for use in making rough estimates for the sizes of wires for three-phase transmission, as in the following example.

Required.—The size of wires to deliver 500 Kw. at 6000 volts, at the end of a three-phase line 12 miles long, allowing an energy loss of 10% and a power factor of 85%. If the example called for the transmission of 100 Kw. (on which the table is based), we should look in the 6000-volt column for the nearest figure to the given distance, and take the size of wire corresponding. But the example calls for the transmission of five times this amount of power, and the size of wire varies directly as the distance, which in this case is 12 miles. Therefore we look for the product $5 \times 12 = 60$ in the 6000-volt column of the table. The nearest value is 60.44 and the size of wire corresponding is No. 00, which is, therefore, the size capable of transmitting 100 Kw. over a line 60.44 miles long, or 500 Kw. over a line 12 miles long, as required by the example.

If it is desired to ascertain the size of wire which will give an energy loss of 5%, or one-half the loss for which the table is computed, it is only necessary to multiply the value obtained by 2, since the area varies inversely as the per cent energy loss.

DISTANCES TO WHICH 100 KW. THREE-PHASE CURRENT CAN BE TRANSMITTED OVER DIFFERENT SIZES OF WIRES AT DIFFERENT POTENTIALS, ASSUMING AN ENERGY LOSS OF 10% AND A POWER FACTOR OF 85%

Number B. & S.	Area in Circular Mils.	Distance of Transmission for Various Potentials at Receiving End, in feet											
		2,000	3,000	4,000	5,000	6,000	8,000	10,000	12,000	15,000	20,000	25,000	30,000
6	26,250	1.32	2.98	5.28	8.27	11.92	21.12	33.1	47.68	74.50	132.4	206.75	298
9	33,100	1.66	3.75	6.64	10.40	15.00	26.56	41.6	60.00	93.75	166.4	260.00	375
4	41,740	2.10	4.74	8.40	13.15	18.96	33.60	52.6	75.84	118.50	210.4	328.75	474
3	52,630	2.54	5.96	10.16	16.55	23.84	40.64	66.2	95.36	149.00	254.8	413.75	596
2	66,370	3.33	7.51	13.32	20.85	30.04	53.28	83.4	120.16	187.75	333.6	521.25	751
1	83,690	4.21	9.48	16.84	26.32	37.92	67.36	105.3	151.68	212.00	421.2	658.00	948
0	105,500	5.29	11.92	21.16	33.10	47.68	84.64	132.4	191.72	298.00	529.6	827.50	1192
00	133,100	6.71	15.11	26.84	41.97	60.44	107.36	167.9	241.76	377.75	671.6	1049.25	1511
000	167,800	8.45	19.04	33.80	52.85	76.16	135.20	211.4	304.64	476.00	845.6	1321.25	1904
0000	211,600	10.62	23.92	42.48	66.42	95.68	169.92	265.7	382.72	598.00	1062.8	1660.50	2392
	250,000	12.58	28.33	50.32	78.67	113.32	201.28	314.7	453.28	708.25	1258.8	1966.75	2833
	500,000	25.17	56.66	100.68	157.35	226.64	402.72	629.4	906.56	1416.50	2517.6	3933.75	5666

Notes on High-tension Transmission. (General Electric Co., 1909.)—The cross-sectional area and, consequently, weight of conductors varies inversely as the square of the voltage for a given power transmission. The cost of conductors is therefore reduced 75% every time the voltage is doubled. The cost of other apparatus and appliances increases with increasing voltage. In the longest lines, from about 190 miles up, the saving in copper with the highest practicable voltages is so great that the

other expenses are rendered practically negligible. In the shorter lines, however, from about one mile to 60 or 75 miles, the most suitable voltage must be determined in each individual case. The voltages in the following table will serve as a guide.

VOLTAGES ADVISABLE FOR VARIOUS LINE LENGTHS.

Miles.	Volts.	Miles.	Volts.	Miles.	Volts.
1	500-1000	3-10	6,600-13,200	20-40	44,000-66,000
1-2	1000-2300	10-15	13,200-22,000	40-60	66,000-88,000
2-3	2300-6600	15-20	22,000-44,000	60-100	88,000-110,000

Standard machinery is made for 2300, 6600, 13,200, 22,000, 33,000, 44,000, 66,000, 88,000 and 110,000 volts, and standard generators are made for the above voltages up to and including 13,200 volts. When the line voltage is higher than 13,200, step-up transformers must be employed. In a given case the saving in cost of conductor by using the higher voltage may be more than offset by the cost of transformers, and the question of voltage must be determined for each case.

Line Spacing.—Line conductors should be so spaced as to lessen the tendency to leakage and to prevent the wires from swinging together or against the towers. With suspended disk insulators the radius of free movement is increased, and special account should be taken of spacing when these insulators are used. The spacing should be only sufficient for safety, since increased spacing increases the self-induction of the line, and while it lessens the capacity, it does so only in a slight degree. The following spacing is in accordance with average practice.

CONDUCTOR SPACING ADVISABLE FOR VARIOUS VOLTAGES.

Volts.	Inches.	Volts.	Inches.	Volts.	Inches.
5,000	28	45,000	60	90,000	96
15,000	40	60,000	72	105,000	108
30,000	48	75,000	84	120,000	120

Skin Effects.—For the frequencies and sizes of cables used in transmission lines, skin effect does not appreciably alter the resistance; for example, the resistance of a solid copper wire 3/4 in. diameter at 60 cycles is increased only 2 1/2%, the resistance of a stranded cable of the same external diameter being increased a still smaller amount. This refers only to non-magnetic materials; with steel cable skin effect cannot be neglected, and a calculation must be made for it.

Frequency.—So far as the transmission line alone is concerned, the lower frequencies are the more desirable, because they reduce the inductance drop and charging current. Oscillations of dangerous magnitude are less likely with the lower frequencies than with the higher. The A.I.E.E. recognizes two frequencies, viz: 25 and 60, as standard, but frequencies of 15 and in some cases 12.5 are being advocated.

Aluminum Conductors.—The conductivity of aluminum is generally taken at 63.3% that of hard-drawn copper of the same cross-sectional area. The weight of Al is 30.2% that of copper, and therefore an Al conductor of the same length and conductivity as a given copper conductor weighs 47.7% as much. The cost of Al must therefore be 2.097 times that of hard-drawn copper to give equal cost for the same length and conductivity. Owing to the mechanical unreliability of solid Al conductors, stranded conductors are used in all sizes, including even the smallest.

TRANSFORMERS, CONVERTERS, ETC.

Transformers.—A transformer consists essentially of two coils of wire, one coarse and one fine, wound upon an iron core. The function of a transformer is to convert electrical energy from one potential to another. If the transformer causes a change from high to low voltage, it is known as a "step-down" transformer; if from low to high voltage, it is known as a "step-up" transformer.

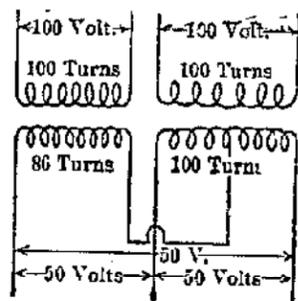

FIG. 217.

The relation of the primary and secondary voltages depends on the number of turns in the two coils. Transformers may also be used to change current of one phase to current of another phase. The windings and the arrangement of the transformers must be adapted to each particular case. In Fig. 217 an arrangement is shown whereby two-phase currents may be converted into three-phase. Two transformers are required, one having its primary and secondary coils in the relation of 100 to 100, and the other having its primary and secondary in the relation of 100 to 86. The secondary of the 100-to-100 transformer is tapped at its middle point and joined to one terminal of the other secondary. Between any pair of the three remaining terminals of the secondaries there will exist a difference of potential of 50.

There are two sources of loss in the transformer, viz., the copper loss and the iron loss. The copper loss is proportional to the square of the current, being the I^2R loss due to heat. If I_1, R_1 , be the current and resistance respectively of the primary, and I_2, R_2 , the current and resistance respectively of the secondary, then the total copper loss is $W_c = I_1^2R_1 + I_2^2R_2$ and the percentage of copper loss is $\frac{I_1^2R_1 + I_2^2R_2}{W_p}$, where W_p is the energy

delivered to the primary. The iron loss is constant at all loads, and is due to hysteresis and eddy currents.

Transformers are sometimes cooled by means of forced air or water currents or by immersing them in oil, which tends to equalize the temperature in all parts of the transformer.

Efficiency of Transformers.—The efficiency of a transformer is the ratio of the output in watts at the secondary terminals to the input at the primary terminals. At full load the output is equal to the input less the iron and copper losses. The full-load efficiency of a transformer is usually very high, being from 92 per cent to 98 per cent. As the copper loss varies as the square of the load, the efficiency of a transformer varies considerably at different loads. Transformers on lighting circuits usually operate at full load but a very small part of the day, though they use some current all the time to supply the iron losses. For transformers operated only a part of the time the "all-day" efficiency is more important than the full-load efficiency. It is computed by comparing the watt-hours output to the watt-hours input.

The all-day efficiency of a 10-K.W. transformer, whose copper and iron losses at full load are each 1.5 per cent, and which operates 3 hours at full load, 2 hours at half load, and 19 hours at no load, is computed as follows:

$$\begin{aligned} \text{Iron loss, all loads} &= 10 \times 0.015 = 0.15 \text{ K.W.} \\ \text{Copper loss, full load} &= 10 \times 0.015 = 0.15 \text{ K.W.} \\ \text{Copper loss, } \frac{1}{2} \text{ load} &= 0.15 \times (\frac{1}{2})^2 = 0.0375 \text{ K.W.} \\ \text{Iron loss K.W. hours} &= 0.15 \times 24 = 3.6 \\ \text{Copper loss, full load, K.W. hours} &= 0.15 \times 3 = 0.45 \\ \text{Copper loss, } \frac{1}{2} \text{ load, K.W. hours} &= 0.0375 \times 2 = 0.075 \\ \text{Output, K.W. hours} &= \{ (10 \times 3) + (5 \times 2) \} = 40 \\ \text{Input, K.W. hours} &= 40 + 3.6 + 0.45 + 0.075 = 44.125 \\ \text{All-day efficiency} &= 40 \div 44.125 = 0.907 \end{aligned}$$

The transformers heretofore discussed are constant-potential transformers and operate at a constant voltage with a variable current. For the operation of lamps in series a constant-current transformer is required. There are a number of types of this transformer. That manufactured by the General Electric Co. operates by causing the primary and secondary coils to approach or to separate on any change in the current.

Converters, etc.—In addition to static transformers, various machines are used for the purpose of changing the voltage of direct currents or the voltage phase or frequency of alternating currents, and also for changing alternating currents to direct or vice versa. These machines are all rotary and are known as rotary converters, motor-dynamos, and dynamotors.

A rotary converter consists of a field excited by the machine itself, and an armature which is provided with both collector rings and a commutator. It receives direct current and changes it to alternating, working as a direct-current motor, or it changes alternating to direct current working as a synchronous motor.

A motor-dynamo consists of a motor and a dynamo mounted on the same base and coupled together by a shaft.

A dynamotor has one field and two armature windings on the same core. One winding performs the functions of a motor armature, and the other those of a dynamo armature.

A booster is a machine inserted in series in a direct-current circuit to change its voltage. It may be driven either by an electric motor or otherwise.

The Mercury Arc Rectifier consists of a mercury vapor arc enclosed in an exhausted glass vessel into which are sealed two terminal anodes connected to the two wires of an alternating-current circuit. A third terminal, at the bottom of the vessel, is a mercury cathode. When an arc is operating, it is a good conductor from either anode to the cathode, but practically an insulator in the other direction. The two anodes connected across the terminals of the alternating-current line become alternately positive and negative. While either anode is positive, there is an arc carrying the current between it and the cathode. When the polarity of the alternating-current reverses, the arc passes from the other anode to the mercury cathode, which is always negative. The current leading out from the mercury cathode is uni-directional. By means of reactances, the pulsations are smoothed out and the current at the cathode becomes a true direct current with pulsations of small amplitude.

ELECTRIC MOTORS.

Classification of Motors.—(From the Standardization Rules of the A. I. E. E.)

a. **Constant-speed Motors**, in which the speed is either constant or does not materially vary; such as synchronous motors, induction motors with small slip, and ordinary direct-current shunt motors.

b. **Multi-speed Motors** (two-speed, three-speed, etc.), which can be operated at any one of several distinct speeds, these speeds being practically independent of the load, such as motors with two armature windings.

c. **Adjustable-speed Motors**, in which the speed can be varied gradually over a considerable range; but when once adjusted remains practically unaffected by the load, such as shunt motors designed for a considerable range of field variation.

d. **Varying-speed Motors**, or motors in which the speed varies with the load, decreasing when the load increases; such as series motors.

The selection of a motor for a specified service involves,

a. Mechanical ability to develop the requisite torque and speeds, as given by its speed-torque curve.

b. Ability to commutate successfully the current demanded.

c. Ability to operate in service without occasioning a temperature rise in any part which will endanger the life of the insulation.

The nominal rating, or the horse-power output which a motor can give with a rise of temperature not exceeding 90 degrees at the commutator and 75 degrees at any other part after an hour's run on a test stand is a method of designating motors which is in common usage, though it is not a proper measure of service capacity.

Motor Classification of the Am. Assn. of Electric Motor Manufacturers. (Elec. Jour., Aug. 1909.)—Alternating-current motors and direct-current motors can easily be classified under the same speed headings, and this has been done as below.

A. — **Constant Speed Motors**—in which the speed is either constant or does not vary materially, such as synchronous motors, induction motors with small slip, ordinary direct-current shunt motors, and direct current

compound-wound motors, the no-load speed of which is not more than 20 per cent higher than the full-load speed.

B. — Multi-Speed Motors — (two-speed, three-speed, etc.) — which can be operated at any one of several distinct speeds, these speeds being practically independent of the load, such as direct-current motors with two armature windings and induction motors with primary windings capable of being grouped so as to form different numbers of poles.

C. — Adjustable Speed Motors. — (1) Shunt-wound motors in which the speed can be varied gradually over a considerable range, but when once adjusted remains practically unaffected by the load, such as motors designed for a considerable range of speed by field variation.

(2) Compound-wound motors in which the speed can be varied gradually over a considerable range, as in (1), and, when once adjusted, varies with the load, similar to compound-wound constant-speed motors or varying-speed motors, depending upon the percentage of compounding.

D. — Varying Speed Motors, or motors in which the speed varies with the load, decreasing when the load increases, such as series motors and heavily compounded motors. Examples of heavily compounded motors are those designed for bending roll service and mill service, in which shunt-winding is provided only to limit the light-load operating speed.

Many motor applications can be made more intelligently if, in addition to using the classification given above, the service is described in terms of continuous or intermittent duty, and load constant or varying. In order to make this point clear, the following table has been prepared, giving one example of each of the different classes of service. Practically every motor application can be listed under one or the other of these headings.

CLASSIFICATION OF MOTORS.

Speed.	Duty.	Load.	Example.
Constant.	Continuous.	Constant.	Fan.
	Intermittent.	Varying.	Line-shaft.
Adjustable.	Continuous.	Constant.	Vacuum pump.
		Varying.	Paper-cutter.
	Intermittent.	Constant.	Paper calender.
		Varying.	Printing press.
Varying.	Continuous.	Constant.	Vacuum pump.
		Varying.	Lathe.
	Intermittent.	Constant.	Small fan.
Multi-speed.	Continuous.	Varying.	Bending press.
		Constant.	House pump.
	Intermittent.	Varying.	Crane.
	Intermittent.	Constant.	Fan.
		Varying.	*
		Constant.	Fire pump.
		Varying.	*

The Auxiliary-pole Type of Motor. (J. M. Hipple, *El. Jour.*, May, 1906.) —

Among the methods of controlling the motor speed, the most satisfactory is the single voltage direct-current system in which the variation of speed is obtained by shunt-field control. The insertion of resistance in the shunt-field circuit varies the strength of the magnetic field, and as the strength of field is decreased the speed of the motor is increased in direct proportion.

An ordinary shunt-wound motor operating under the above conditions over a speed range of four to one will spark excessively at the brushes unless the motor is rated considerably under its normal capacity. This sparking is due principally to the weakened magnetic field and to the distortion or shifting of this field due to reaction on it by the field produced by the ampere turns in the armature.

The use of an auxiliary field by correcting this condition produces

*Multi-speed motors are at present almost exclusively alternating-current motors. The classes of service in which these motors are used are limited, but a considerable field may develop later.

sparkless commutation and a condition of practical stability of field and consequently of speed in the motor. This auxiliary field is produced by a winding in series with the armature and placed on pole-pieces midway between the main pole-pieces. The distortion at the point of commutation which would occur if there was no auxiliary winding is prevented by the field produced by the auxiliary winding. This field being always proportional to the load the commutation is accomplished sparklessly at all loads up to heavy overloads.

Motors of this type are reversible with no change in setting of brushes or other adjustment. The brushes being fixed in the neutral position it is only necessary to reverse the current in both auxiliary field and armature to secure exactly similar operating conditions in the reverse as in the forward direction.

Speed of Electric Motors.—Any direct-current motor, no matter what its type of field winding, if supplied with current of constant potential at its terminals, will run at constant speed if its field strength and the load do not change. The speed of a given motor is directly proportional to the net impressed e.m.f. divided by the effective field strength. The net impressed e.m.f. is that part of the supply e.m.f. which must be exactly opposed by the counter e.m.f. of the armature. Thus, if the supply voltage is 250 volts, the load 50 amperes and the armature circuit resistance 0.2 ohm, the net impressed e.m.f. will be 240 volts, because the armature drop is $0.2 \times 50 = 10$ volts. The "effective" field strength is the actual field flux set up by the field winding after overcoming the armature reaction, which always weakens the field slightly.

In the case of a shunt-wound motor operated on a constant-potential circuit with an adjustable external resistance in series with the armature, no matter at what point the external resistance may be set, so long as it remains at that point, giving unchanging voltage at the motor terminals, the speed will be constant unless the field strength or load be altered. The speed of a series-wound motor increases very rapidly with decreasing load when operated on a constant-potential circuit, becoming so high at no load as to be destructive to the armature. The reason for this is that the armature current passes also through the field winding, so that any decrease in armature current weakens the field and causes the speed to increase far beyond the rate it would attain with a constant field. (C.P. Poole, *Power*, July, 1907.)

The speed of a shunt motor is dependent upon the details of its entire design. The following equation shows the relation of the speed to the main elements of the machine:

$$n = \frac{(E - I_a R_a) c 10^8}{M p N}$$

where E is the impressed electromotive force, R_a the resistance of the armature, I_a the current through it, c the number of parallel circuits for the current through the armature, M the magnetic flux (number of lines of force) per pole, p the number of poles, N the number of armature conductors, and n the speed in revolutions per second. (*El. Review*, July 17, 1909.)

The simplest form of an electric motor is the shunt-wound machine. When connected with an ordinary electric lighting circuit, it runs at a steady speed, drawing hardly any current until it is required to furnish power, and at that moment it consumes power only in proportion to the work done. If connected to a circuit of lower pressure, it will run equally well, but at lower speed. If required to make extra effort, as in starting machinery, it will furnish up to five times its full power without trouble.

When running free, if its speed is increased by the application of external power, as by a belt, it becomes a dynamo and pumps current into the line; this, in turn, throws work upon the machine and tends to slow it down. The machine is, therefore, in itself a factor tending to the preservation of constancy of speed and to the preservation of constancy in the pressure on the circuit, and it is ideal in its simplicity, having absolutely no governing or accessory parts.

The shunt-wound motor runs at practically constant speed under all loads, and if closer uniformity of speed is desired, it can be arranged to run within any desired limits of variation by setting the brushes in a position shifted slightly from their usual place, or by adding to the field

winding a few turns, connected in series with the armature, and reversed in comparison with the main winding. Either of these arrangements causes the motor to speed up under load, and the extent of this action may be adjusted to equal precisely the tendency ordinarily met of slowing down under load. (S. S. Wheeler, *Elec. Age*, Dec., 1904.)

Speed Control of Electric Motors. Rheostats. (The Electric Controller and Mfg. Co.)—A motor of any size, when its armature is at rest, offers a very low resistance to the flow of current and an excessive and perhaps destructive current would flow through it if it were connected across the supply mains while at rest. Take the case of a motor adapted to a normal full-load current of 100 amperes and having a resistance of 0.25 ohm; if this motor were connected across a 250-volt circuit a current of 1,000 amperes would flow through its armature—in other words, it would be overloaded 900% with consequent danger to its windings and also to the driven machine. In the case of the same motor, with a rheostat having a resistance of 2.25 ohms inserted in the motor circuit, at the time of starting the total resistance to the flow of current would be the resistance of the motor (0.25 ohm) plus the resistance of the rheostat (2.25 ohms), or a total of 2.5 ohms. Under these conditions exactly full-load current, or 100 amperes, would flow through the motor, and neither the motor nor the driven machine would be overstrained in starting. This shows the necessity of a rheostat for limiting the flow of current in starting the motor from rest.

An electric motor is simply an inverted generator or dynamo—consequently when its armature begins to revolve a voltage is generated within its windings just as a voltage is generated in the windings of a generator when driven by a prime-mover. This voltage generated within the moving armature of a motor opposes the voltage of the circuit from which the motor is supplied, and hence is known as a "counter-electromotive force." The net voltage tending to force current through the armature of a motor when the motor is running is, therefore, the line voltage minus the counter-electromotive force.

In the case of the motor above cited, when the armature reaches such a speed that a voltage of 125 is generated within its windings, the effective voltage will be 250 minus 125, or 125 volts, and, therefore, the resistance of the rheostat may be reduced to one ohm without exceeding the full-load current of the motor. As the armature further increases its speed the resistance of the rheostat may be further reduced until when the motor has almost reached full speed all of the rheostat may be cut out, and the counter-electromotive force generated by the motor will almost equal the voltage supplied by the line so that an excessive current cannot flow through the armature.

In practice, a rheostat is provided for starting an electric motor, the resistance conductor being divided into sections, such that the entire length or maximum resistance of the rheostat is in circuit with the motor at the instant of starting and the effective length of the conductor, and hence its resistance may be reduced as the motor comes up to speed.

In cutting out the resistance of a starting rheostat care must be used not to cut it out too rapidly. If the resistance is cut out more rapidly than the armature can speed up, a sufficient counter-electromotive force will not be generated to properly oppose the flow of current, and the motor will be overloaded.

If all the resistance of the starting rheostat is not cut out the motor will operate at reduced voltage, and hence at less than normal speed. A rheostat so arranged that all or a portion of its resistance may be left in a motor circuit to secure reduced speeds is called a "rheostatic controller." Such rheostatic controllers are used for controlling series and compound-wound motors driving cranes, and similar machinery requiring variable speed under the control of an operator.

In a series-wound motor the speed varies inversely as the load—the lighter the load the higher the speed. A series-wound motor of any size when supplied with full voltage under no load, or a very light load, will "run away" just as will a steam-engine without a governor when given an open throttle.

For a given load a series-wound motor draws the same current irrespective of the speed and for a given load the speed varies directly as the voltage. The speed at a given load may be varied by varying the resistance

in the motor circuit—in the meantime if the load on the motor be constant the current drawn from the line will be constant regardless of the speed.

The above statements relate to the use of a rheostat in series with a series-wound motor. If a resistance or rheostat be placed in parallel with the field of a series-wound motor the speed will be increased instead of decreased at a given load. This is known as shunting the field of the motor. This shunt would never be applied till the motor has been brought up to normal full speed by cutting out the starting resistance. With a "shunted field" a motor is driving a load at a speed higher than normal and therefore requires a correspondingly increased current.

If a resistance is placed in parallel with the armature of a series motor, the motor will operate at less than normal speed when all of the starting resistance has been cut out. This connection is known as a "shunted armature connection" and is useful where a low speed is desired at light loads and is particularly useful in some cases where the load becomes a negative one, that is, where the load tends to overhaul the motor, as in lowering a heavy weight.

A shunt-wound motor, unlike a series motor, when supplied with full voltage, maintains practically a constant speed regardless of variations in load within the limits of its capacity. It automatically acts like a steam-engine having a very efficient governor.

The speed of a shunt-wound motor may be decreased below normal by a rheostatic controller in series with its armature and may be increased above normal by means of a rheostat in series with its field winding. The latter rheostat is known as a "field rheostat," and, to be effective, must have a high resistance owing to the small current which flows through the shunt-field winding.

A compound-wound motor is a hybrid between a series and shunt-wound motor and its characteristics are likewise of a hybrid nature.

A compound-wound motor will not "run away" under no load as will a series motor, but its speed decreases as the load increases, though not so rapidly as is the case with a series-wound motor.

The characteristics of a compound-wound motor are particularly valuable in cases where the load is subject to wide variation. It will give a strong torque in starting and driving heavy loads and at the same time will not race dangerously when the load is suddenly relieved.

The speed of a compound-wound motor may be reduced below normal by means of a rheostat in the circuit of its armature. The speed may be increased above normal by shunting and even short-circuiting the series field winding, and may be still further increased by means of a field rheostat in series with the shunt-field winding.

Rheostatic controllers are also employed for the control of alternating current induction motors of the so-called "slip-ring type." Such motors have characteristics in many ways similar to those of direct current shunt-wound motors, and speeds lower than normal may be obtained by inserting resistance in series with the windings of the secondary or rotor.

Selection of Motors for Different Kinds of Service. (F. B. Crocker and M. Arendt, *El. World*, Nov., 1907.)—The types of direct-current motor are as follows:

DIRECT-CURRENT MOTORS.

Type.	Operative Characteristics.
Shunt-wound motors.....	Starting torque usually 50 to 100 per cent greater than rated running torque, and fairly constant speed over wide load ranges.
Series-wound motors.....	Powerful starting torque, speed varying greatly (inversely) with load changes.
Compound-wound motors....	Compromise between shunt and series types.
Differently-wound motors...	Starting torque very small, speed can be made almost absolutely constant for load changes within rated capacity.

The conditions under which machinery operates, in regard to varying speed and power required of the driving motor, may be divided into four

classes, and certain types of motors are usually best suited to these divisions, which are as follows:

(a) Work which requires the motor to operate automatically at a practically constant speed, regardless of load changes or other conditions.

(b) Work requiring frequent starting and stopping and wide variations in speed, including sometimes rapid acceleration.

(c) An approximately steady load or work that varies as some function of the speed should it change.

(d) Work in which the power varies regardless of the speed, or where speed variations with constant torque may be desired.

The first case (a) applies to line-shaft equipments with many machines operated by the same motor and where slight speed variations may be allowed; the direct-current shunt or slightly compounded motor or the alternating-current induction motor would answer, depending upon the character of electric current available. A refinement of this problem is encountered in the driving of textile machinery, especially silk looms, with which even a slight speed variation might affect the appearance of the finished product. In such instances the alternating-current motors, polyphase induction or polyphase synchronous, are generally employed because the speed of direct-current motors varies considerably with voltage changes and the variation in temperature which occurs after several hours of operation, whereas the speed of the alternating-current motors, unless the voltage varies greatly, is primarily dependent upon the frequency of the supplied current.

The second class (b) is divided into two parts, the first being electric traction and crane service, in which the motor is frequently started and stopped and rapidly accelerated at starting; or where the speed is to be adjusted automatically to the load, slowing down when heavily loaded or climbing a steep grade. These conditions are well satisfied by the series motor of either the direct or alternating-current types, depending upon the current supplied. Elevator service is of this character as regards frequent starting and stopping, but after rapid acceleration it calls for a speed independent of the load. Hence, to fulfill both requirements, elevator motors when of direct-current type are heavily over-compounded to give the series characteristic at starting; then, when the motor is up to speed, the series field winding is short-circuited and it operates as a shunt machine. Recently, however, two-speed shunt motors have been employed for this service, the field being of maximum strength for starting and sparking prevented by use of inter-poles. If only alternating current is available the polyphase induction motor should be employed, but for powerful starting torque either slip-ring or compensator control would be necessary. For the second subdivision of this class the motor must be started and stopped frequently and not rapidly accelerated, but on the contrary simply "inched" forward at the start, as in the operation of printing presses, gun turrets, etc. These conditions of service are satisfied by a direct-current compound motor provided with double armature and series-parallel control of the machine.

The third class (c) of work is the operation of pumps, fans or blower equipments and its requirements are satisfied by the series motor, whose speed adjusts itself to the work, and also because it exerts the maximum torque required at starting. It must be, however, either geared or directly connected to the apparatus, because the breaking of the belt or the sudden removal of the load would cause a series motor to race and become injured. The operation of pumps by electric motors is usually effected by gearing, since ordinary plunger pumps do not operate efficiently if driven in excess of fifty strokes per minute, and to accomplish this by direct connection would demand a very low speed and costly motor. Centrifugal pumps operating at high speed may be direct driven.

The fourth class (d) is found in individual machine-tool service, for which the maximum allowable cutting or turning speed requires the number of revolutions of the work or tool to vary inversely as the diameter of the cut. This condition is satisfied best by the direct-current shunt or slightly compounded motors, as they are readily controlled in speed by variation of the applied voltage, shunt field weakening, etc.

It is to be noted that (a) and (c) regulate automatically to maintain a constant speed while (b) and (d) are controlled by hand to give variable speeds. Furthermore, (b) is usually under control of the hand all the time,

whereas (d) is set to operate at a desired speed for some time and regulates automatically when so adjusted.

The Electric Drive in the Machine-Shop. (A. L. De Leeuw, *Trans. A.S.M.E.*, 1909.)—Absence of reliable data is apparent all over the field of this subject, and it will therefore be impossible to say beforehand with any fair degree of certainty how much, if anything, can be gained by the conversion of a shop from a shaft to motor drive.

Nothing but an exhaustive study of the entire plant in all its aspects will clearly show what may be accomplished. The saving of power is by no means the only nor the most important economy resulting from a conversion to electric drive, and such a conversion may even be highly economical, though there be an actual loss in power consumed.

The question whether alternating or direct current should be used is especially difficult of solution, and there is a wide difference of opinion among engineers as to which is best. Given a plant covering a large area and using large amounts of current, of which only a small portion is used for variable-speed machinery, and of sufficient size to permit of the use of a separate unit for lighting current, then alternating current would be the logical solution. On the other hand, given a compact plant, using a large portion of the power for variable-speed machinery, direct-driven by motors, and of which the lighting load is small in the daytime, then it would be natural to select direct current. As a rule, however, conditions are not so simple. Of late the problem has been complicated by the fact that many machine tools may be had with single-pulley drive, to which an alternating-current or a direct-current motor is equally applicable.

The points in favor of the alternating-current motor are:

a High break-down point; that is, the motor goes on with no material change of speed under very heavy overload.

b Freedom from commutator trouble. This is especially valuable where fine chips are made, or where compressed air is used in connection with the machine. The better makes of direct-current motors are now equally free from this kind of trouble.

c Most cities are now lighted by alternating current, so that city current can be used in smaller plants, provided the machine tools are arranged for this kind of motor.

The points in favor of the direct-current motor are:

a Wider air-gap, allowing a greater amount of wear in the bearings before the motor has to be repaired.

b The possibility of power and lighting-loads on the same circuits without the poor regulation due to inductive load.

c The possibility of using variable-speed motors. This is, perhaps, the greatest argument in favor of the direct-current motor. Though it is possible to run a great many machine tools by a motor, yet one of the greatest advantages of such a drive is not available, unless the motor is of the variable-speed variety.

The combination of alternating and direct current has its advantages, especially where it is possible to purchase current from some large power company which delivers its product as alternating current. Transformers reduce the voltage at the entrance to the shop, and the low-voltage alternating current can be used for all purposes except for driving variable-speed motors, and perhaps some auxiliary apparatus such as magnetic clutches, lifting magnets, etc.

See also papers on this subject by Chas. Robbins and John Riddell, *Trans. A.S.M.E.*, 1910.

Choice of Motors for Machine Tools. (Chas. Fair, *Proc. A. I. E. E.*, 1910.)—Shunt-wound direct-current, or squirrel-cage rotor, alternating current: For bolt cutter; boring machine; boring mill; boring bar; centering machine; chucking machine; boring, milling and drilling machines; drill, radial; drill press; grinder-tool, etc.; keyseater, milling-broach; lathe; milling machine; pipe-cutter; saw, small circular; screw machine; tapper.

Compound-wound direct-current, or squirrel-cage rotor: For grinder-castings; reciprocating keyseater; saw, cold bar and I-beam; saw, hot; shaper; slotter; tumbling barrel or mill.

Compound-wound direct-current or squirrel-cage rotor, or squirrel-cage rotor with high starting torque: For bolt and rivet header; bulldozer; bending machine; corrugating roll; punch press; shear.

Other machines may be driven as indicated below. (a) shunt, (b)

compound, (c) series, direct-current motor, (d) squirrel-cage rotor, (e) ditto, high starting torque, (f) slip ring induction motor with external rotor resistance. Tapping and lowering cross mills on boring mills and planers, (b), (c), (e). Bending rolls, (b), (c), (f). Gear cutters, (a), (b), (d). Drop hammers, (b), (e). The lathes, (f) may be used, as it allows for slowing down when cutting hard spots. Lathe cutlases, (c), (e). Heavy slab milling, (a), (b), (d). Planers, (b), (d), (e). Planers, rotary, (c), (b), (d). Swaging, (b), (d), (e). Shunt motors are used in the following cases: when the work is of a fairly steady nature; when considerable range of adjustment of speed is required, as on lathes and boring mills; and on group and line-shaft drives, etc.

Compound-wound motors are used where there are sudden calls for excessive power of short duration, as on planers, punch presses, etc. Series motors should be used where speed regulation is not essential and where excessive starting torque and slow starting speeds are required, as for operating cranes.

When in doubt as to the choice of compound or series motor of small horse-power, the choice might be determined by the simplicity of control in favor of the series motor. Series motors, however, should never be used when the motor can run without load, as the speed would accelerate beyond the point of safety.

The alternating-current motor of the squirrel-cage rotor type corresponds to the constant-speed, shunt, direct-current motor, but with a high-resistance rotor it approaches more closely the characteristics of a compound direct-current motor. Variable speed machines, driven by squirrel-cage rotors must have the necessary mechanical speed changes.

The slip-ring induction motor with external rotor resistance would be used for variable speed, but this must not be construed to mean that it corresponds to a direct-current, adjustable-speed motor, as it has the characteristics of a direct-current shunt motor with armature control.

The self-contained, rotor resistance type would be used for line-shaft drives, and for groups when of sufficient size.

Multi-speed, alternating-current motors are those giving a number of definite speeds, usually 600 and 1200 or 800, 900, 1200 and 1800 rev. per min., and are made for both constant horse-power and constant torque. These motors would be used where alternating current only was available, or direct current limited; and the speed range of the motor, together with one or two change gears, would give the required speeds.

ALTERNATING-CURRENT MOTORS.

Synchronous Motors.—Any alternator may be used as a motor, provided it be brought into synchronism with the generator supplying the current to it. The operation of the alternating-current motor and generator is similar to the operation of two generators in parallel. It is necessary to supply direct current to the field. The field circuit is left open until the machine is in phase with the generator. If the motor has the same number of poles as the generator, it will run at the same speed; if a different number, the speed will be that of the generator multiplied by the ratio of the number of poles of the motor to that of the generator. Single-phase, synchronous motors are not self-starting. Polyphase motors may be made self-starting, but it is better to bring the machines to speed by independent means before supplying the current. The machines may be started by a small induction motor, the load on the synchronous motor being thrown off, or the field may be excited by a small direct-current generator belted to the motor, and this generator may be used as a motor to start the machine, current to run it being taken from a storage battery. If the field of a synchronous motor be properly regulated to the load, the motor will exercise no inductive effect on the line, and the power factor will be 1. If the load varies, the current in the motor will either lead or lag behind the e.m.f. and will vary the power factor. If the motor be overloaded so that there is a diminution of speed, the motor will fall out of step with the generator and stop.

Synchronous motors are often put on the same circuit with induction motors. The synchronous motor in this case may, by increasing the field excitation, be made to cause the current to lead, while the induction motor will cause it to lag. The two effects will thus tend to balance each other and cause the power factor of the circuit to approach 1.

Synchronous motors are best used for large units of power at high voltages, where the load is constant and the speed invariable. They are unsuited, where the required speed is variable and the load changes.

Induction Motors.—The distinguishing feature of an induction motor is the rotating magnetic field. It is thus explained: In Fig. 218 let *a*, *c* and *d* be two pairs of poles of a motor, *a* and *b* being wound from one leg or pair of wires of a two-phase alternating circuit, and *c* and *d* from the other leg, the two phases being 90° apart. As the instant when *a* and *b* are receiving maximum current so as to make *a* a north



FIG. 218.

pole and *b* a south pole, *c* and *d* are demagnetized, and a needle placed between the poles would stand as shown in the cut. During the progress of the cycle of the current, the magnetic flux as *a* decreases and that at *c* increases, causing the point of resultant maximum intensity to shift, and the needle to move clockwise toward *c*. A complete rotation of the resultant point is performed during each cycle of the current. An armature placed within the ring is caused to rotate simply by the shifting of the magnetic field without the use of a collector ring. The words "rotating magnetic field" refer to an area of magnetic intensity and must be distinguished from the "revolving field," which refer to the portion of the machine constituting the field magnet.

The field or "primary" of an induction motor is that portion of the machine to which current is supplied from the outside circuit.

The armature or "secondary" is that portion of the machine in which currents are induced by the rotating magnetic field. Either the primary or the secondary may rotate. In the most modern machines the secondary rotates. The revolving part is called the "rotor." The stationary part the "stator." The rotor may be either of the ring or the drum type, the drum type being more common. A common type of armature is the "squirrel-cage." It consists of a number of copper bars placed on the armature-core and insulated from it. A copper ring at each end connects the bars. The field windings are always so arranged that more than one pair of poles are produced. This is necessary in order to bring the speed down to a practical limit. If but one pair of poles were produced, with a frequency of 60, the revolutions per minute would be 3600.

The revolving part of an induction motor does not rotate as fast as the field, except at no load. When loaded, a slip is necessary, in order that the lines of force may cut the conductors in the rotor and induce currents therein. The current required for starting an induction motor of the squirrel-cage type under full load is 7 or 8 times as great as the current for running at full load. A type of induction motor known as "Form L," built by the General Electric Co., will start with the full-load current, provided the starting torque is not greater than the torque when running at full load.

Induction motors should be run as near their normal primary e.m.f. as possible, as the output and torque are directly proportional to the square of the primary pressure. A machine which will carry an overload of 50 per cent at normal e.m.f. will hardly carry its full load at 30 per cent of the normal e.m.f.

Induction Motor Applications. (A. M. Dudley, *Elec. Jour.*, July, 1908.)

Squirrel-Cage Motors for Constant Speed Service.—Small starting torque is required and good motor-generator sets. Small starting torque is required and good speed regulation, which characteristics are prominently met by a squirrel-cage motor with very low resistance in the secondary circuit. A full specification on a large set is that it shall start on 30 to 40% of full voltage, and draw current not in excess of 1 1/2 times full-load current.

Pumps.—With a centrifugal pump decreasing the head opposed against increases the load on the motor. This type of pump will raise considerably more than four-thirds the amount of water 30 feet that it will 40 feet, with the result that the motor is overloaded if it is designed for 40 ft.

WARNING: This is a 1910 edition. Some of the material may no longer be accurate.

head. In this the centrifugal pump is exactly opposite to the plunger or reciprocating pump, which, being positive in its action, increases its load with increase of head and vice versa. [In some modern types of centrifugal pump the load decreases with decrease of head after reaching the maximum load corresponding to the head for which the pump is designed. See catalogue of the De Laval Steam Turbine Co., 1910. W. K.]

INDUCTION MOTOR APPLICATIONS.

Squirrel Cage.		Phase-Wound.	
Constant Speed.	Variable Speed.	Constant Speed.	Variable Speed.
1—Motor-generator sets.	1—Starting motors.	1—Flour mills.	1—Hoists and winches.
2—Pumps.	2—Crane motors	2—Paper machinery, pulp grinders, beaters.	2—Cranes.
3—Blowers.	3—Fly-wheel service.	3—Belt conveyors.	3—Elevators.
4—Line-shaft drive.	4—Punches, Shears, etc.	4—Wood planers.	4—Fly-wheel motor-generator sets.
5—Cement machinery.	5—Sugar centrifugals.	5—Air compressors.	5—Steel mill machinery, charging machines, hoists.
6—Wood-working machinery (except planers).	6—Laundry extractors.	6—Line shafting.	6—Coal and ore unloaders.
7—Cotton-mill machinery.	7—Brake motors	7—Driving-wheel lathes.	7—Dredging machinery.
8—Paper machinery, calenders, Jordan engines.	8—Cross-head motors.		8—Shovels.
9—Concrete mixers.	9—Valve motors.		9—Mine haulage.

Blowers.—Rotary blowers, except positive blowers, have a characteristic similar to centrifugal pumps, in that the load varies with the amount of air delivered and becomes less as the pressure against which the blower is working increases. That is to say, the maximum load which could be put on a motor driving a blower of this nature would be to take away all delivery pipes and let the blower exhaust into the open air.

Line Shafting.—Squirrel-cage motors are used very successfully for driving line-shafting where the idle belts are run on loose pulleys, in this way keeping down the starting torque.

Cement Mills.—The possibility of entirely covering the bearings and the absence of all moving contacts make the squirrel-cage motor successful where the more complicated construction and moving contact surfaces of the wound secondary motor or the direct-current machine are damaged by accumulation of dust. In starting up a tube mill it must be rotated through nearly 90° before the charge of pebbles and cement begins to roll. This makes the starting condition severe and a motor should have a starting torque of not less than twice full-load torque to do the work.

Wood-working Machinery.—On account of high friction and great inertia, the starting torque is sometimes so high and of so long duration (thirty seconds to one minute) that it is better to apply a wound-secondary motor.

Paper Machinery.—If calenders are driven with a constant speed motor it is necessary to make some provision either by mechanical speed-changing devices or a small auxiliary motor for securing a slow threading speed.

Squirrel-Cage Variable Speed Motors.—These motors in general have high resistance end rings, high slip and high starting torque. The torque increases automatically as the speed decreases. In these general respects they resemble a direct-current series motor and are in fact fitted for the same class of work, with the added advantage that they have a limiting speed and cannot run away under light load.

Fly-Wheel Service.—In driving tools which are used with fly-wheels such as punches, shears, straightening rolls and the like, the usefulness

of high slip comes in, as if the fly-wheel is to give up its energy, it is obliged to slow down in speed when the load comes on. A motor with good regulation and low slip would try to run at constant speed, carrying the fly-wheel and load as well, but the motor in question "lies down" and allows the fly-wheel to carry the peak load, speeding up again when the peak has passed.

Centrifugals.—In sugar centrifugals is an application where the sole purpose of the motor is to accelerate the load to full speed, in say thirty seconds, where it is allowed to run one minute and then shut down to repeat the cycle a minute later. The centrifugal consists of a cylindrical basket with perforated walls and mounted around a vertical shaft as an axis. The same principle is used in laundry extractors where the wet linen is placed in a similarly perforated basket and the water whirled out by centrifugal force.

Constant-Speed Motors with Phase-wound Secondaries.—There are classes of service which require a heavy starting torque combined with close speed regulation after the motor is up to speed. These requirements are exactly met by a motor with a phase-wound secondary. The secondary winding itself has a very low resistance, which means a small "slip," high running efficiency and power-factor and good regulation when the secondary is short-circuited. The insertion of external resistance enables the motor to develop maximum torque at the start with a moderate starting current.

Flour-Mills.—The number of line shafts, belts and gears in flour mills makes a very heavy starting condition and the nature of the product and its quality demand absolute speed within a few revolutions per minute. The best solution is the phase-wound rotor.

Other Examples.—There is another class of machinery which is not so exacting about regulation but which has the same feature of heavy starting and runs continuously after once up to speed. Under this head come most of the applications of this type of motor. They are, paper pulp grinders, which, on account of the inertia of the grindstones, are hard to start; pulp beaters; belt conveyors, which may be required to start when full of coal, rock or cement crushers; air compressors, which have a high starting friction because of the construction and the number of parts; line shafting where the belts run for the most part on the working pulleys and are therefore heavy to start. Under the best possible conditions, if line shafting is employed, the loss of power from this source alone, due to friction, is 25 to 30% and may run up to 40 or 50%. This is a strong argument for individual drive of machines wherever practicable.

Motors with Phase-wound Secondaries for Variable Speed Service.—The application, which is typical of this class, is found in hoist and crane service. Motors for this work are designed for intermittent operation and given a nominal rating based upon the horse-power which they will develop for one-half hour with a temperature rise of 40° C. They never operate for as long a period as thirty minutes continuously and they are called upon at times to develop a torque greatly in excess of their nominal rating. For these reasons motors of this class should never be applied on a horse-power basis, but always on a torque basis. Since torque is the main consideration and the service is intermittent these motors are usually wound for the maximum torque which they will develop and given a nominal rating based upon one-third to one-half of this torque. Double drum hoists, hoisting in balance, and large mine haulage propositions in general require a motor rated on a different basis. For this service the motor should have the necessary maximum torque and be able to develop for about two or three hours, with a safe rise in temperature, a horse-power equivalent to the square root of the mean square requirement of the hoisting cycle. These are only general rules and the most careful consideration should be given in each individual case to secure a motor which will perform the work satisfactorily.

Coal and Ore Unloading Machinery.—Dredges—Power-Shovels.—Owing to the complication of the cycle of operation there is more difficulty in providing a motor for this apparatus than in the case of a plain hoist. Usually the number of cycles per hour given is the maximum which the apparatus can develop and in practice it will not be possible to operate at so high a speed. This in itself is somewhat of a factor of

safety, though not one which can be relied upon, as the test for acceptance is ordinarily made at the contract number of operations per hour.

The most impressive application of motors of this class and perhaps in the operation of any electrical apparatus is the fly-wheel motor-generator set for hoisting or heavy reversing roll service in steel mills. Service of this nature is extremely fluctuating in its requirements, having very great peaks one instant and almost nothing the next. This is a severe strain on the generating plant from which power is being drawn.

Alternating-Current Motors for Variable Speed. (W. I. Slichter, *Trans. A.S.M.E.*, 1903.) —

The speed of an alternating-current motor may be controlled in a number of ways:

- (a) By varying the potential applied to the primary of a motor having a suitable resistance in the secondary.
- (b) By varying the resistance in the secondary circuit.
- (c) By changing the connections of the primary in a manner to change the number of poles.
- (d) By varying the frequency of the applied voltage.

The changeable pole and variable frequency methods are the most efficient, but do not permit of a variation through a wide range of speed. The rheostatic control is the simplest and easiest of control, giving a range from standstill to full speed, but is not as efficient as the first two, although more efficient than potential control. The last mentioned has the disadvantages of low efficiency and considerably increased heating in the motor itself, and is also unstable at low speeds, say below one-third speed. That is, a small variation in torque or a smaller variation in voltage will cause a considerable variation in speed.

Mr. Geo. W. Colles, in a discussion of Mr. Schlichter's paper, says that the variable-speed induction-motor problem has not yet been solved.

Of the four possible methods given, the first is the simplest, as here it is merely necessary to insert a compensator in circuit with the motor. This, however, is decidedly unsatisfactory, as, owing to the necessity of having a high-resistance secondary, even the full-speed efficiency of the motor is largely reduced, while at quarter-speed it is about 17%, and even at half-speed only 37%.

All the other solutions given are too complicated, and they cannot be regarded as other than makeshifts. The resistance-in-secondary method is the only one that has been used to any extent. This nullifies the meritorious natural features of the squirrel-cage motor, whose complete freedom from exposed contacts, commutator and slip-rings made it much simpler, and therefore cheaper, than the direct-current motor; and it now becomes more expensive and delicate, and considerably less efficient. The efficiency is now but 65% at 3/4 load, 43% at 1/2 load, and only 22% at 1/4 load.

SIZES OF ELECTRIC GENERATORS AND MOTORS.

(Condensed from Bulletins of the General Electric Co., 1910.)

Direct-connected Engine-driven Railway Generators. Form S.

6-pole, Kw.	100	150	200	200	200
Speed, r.p.m.	275	200	200	150	120
8-pole, 300 Kw., 120 and 100 r.p.m.; 400 Kw., 150, 120 and 100 r.p.m.; 500 Kw., 120 r.p.m.					
10-pole, 500 Kw., 100 and 90 r.p.m. 14-pole, 800 Kw., 100 and 80 r.p.m.:					
14-pole, 1000 Kw., 100 and 80 r.p.m.; 1200-Kw., 80 r.p.m., 16-pole, 1600 Kw., 100 and 75 r.p.m.					
20-pole, 2000 Kw., 75 r.p.m.; 24-pole, 2500 Kw., 75 r.p.m.; 26-pole, 2700 Kw., 90 r.p.m.					

Slow and Moderate Speed Belt-driven Generators. Type CL. Form B.

Slow Speed	6 poles, Kw.	16	22	22	30	40
	Speed, 125 and 250 volts	750	900	725	700	650
Moderate Speed	6 poles, Kw.	55	75	100	150	650
	Speed, 125 and 250 volts	625	550	550	550	550
Moderate Speed	6 poles, Kw.	25	35	45	60	75
	Speed, 125, 250 and 500 v.	1100	1050	975	925	850

Slow and Moderate Speed Belt-driven Motors. Type CL. Form B.

Slow Speed	6 poles, Kw.	20	25	25	35	50
	Speed, 125 and 250 volts, speed.	690	735	675	650	600
	110 and 220 volts, speed.	650	730	635	610	560
	500 volts, speed	750	800	375	650	600
Moderate Speed	6 poles, Kw.	65	90	125	185	250
	Speed, 125 and 250 volts, speed.	575	500	470	440	410
	110 and 220 volts, speed.	540	470	440	410	410
	500 volts, speed	575	500	500	430	430
Moderate Speed	6 poles, Kw.	30	40	55	70	85
	125, 250 and 500 volts, speed	1025	975	900	850	800
	110 and 220 volts, speed	965	915	845	800	750

After a continuous run of 10 hours, at full-rated load, the rise in temperature above that of the surrounding air, as measured by the thermometer, will not exceed the following: Armature, 35° C.; Commutator, 40° C.; Field, 45° C. The motors will operate for two hours at 25% overload, and withstand a momentary overload of 50% without injurious heating.

Belt-driven Alternators. Form P. Revolving Field.

Poles.....	6	6	8	8	12	12
Kw.....	30	50	75	100	150	200
Speed.....	1200	1200	900	900	600	600
Amperes at full load	balanced 3-phase load	7.5	12.5	18.8	25	37.5
	balanced 2-phase load	6.5	11	16.5	22	33
2300 volts	single-phase load	10	16.5	24.5	33	49
	10	16.5	24.5	33	49

Built with or without direct-connected exciters. Adapted to 2- or 3-phase windings without change except in the armature coils. Potentials, 3-phase, 240, 480, 600, 1150, 2300; 2-phase, 240, 480, 1150, 2300. When used as synchronous motors these machines have a condenser effect, and in consequence can be used to improve the power factor when used in combination with induction motors.

The full-load single-phase rating at 100% power factor is 80% of the full-load 3-phase rating at both 100% and 80% power factor. The full-load single-phase rating at any power factor from 100 to 80% is the unity power factor single-phase rating multiplied by the power factor. For instance, for the 8-100-900 machine, which is the full-load 3-phase rating unity and 80% power factor, the single-phase rating for 100% at both power factors is 80 Kw., and for 80% power factor it is 80 x 0.8 = 64 Kw.

Slow and Moderate Speed Machines with Commutating Poles. GENERATORS, TYPE DLC, FORM A.

Frame.	Poles.	Kw.	Slow Speed.			Kw.	Moderate Speed.		
			Speed.				Speed.		
			125 v. 250 v.	500 v.	575 v.		125 v. 250 v.	500 v.	575 v.
1	4	20	950	950	1050	30	1300	1300	1425
2	4	25	900	900	1000	40	1200	1200	1325
3	4	35	850	850	950	50	1150	1150	1250
4	6	45	775	775	850	65	1100	1100	1200
5	6	60	750	750	825	80	1050	1050	1150
6	6	75	700	700	775	100	1000	1000	1000
7	6	100	675	675	750	125	950	950	1050
8	6	125	650	650	700	150	900	875	900
9	6	150	600	600	650	200	*850	775	850
10	6	200	*500	500	550	300	*750	700	750

* Not to be made for 125 volts.

MOTORS, TYPE DLC.

Frame	Poles	H.P.	Slow Speed.			H.P.	Moderate Speed.		
			Speed.				Speed.		
			125 v. 250 v.	115 v. 230 v.	550 v.		125 v. 250 v.	115 v. 230 v.	550 v.
1	4	20	825	800	925	30	1150	1100	1250
2	4	25	775	750	875	40	1100	1050	1200
3	4	35	725	700	825	55	1050	1000	1150
4	6	50	675	650	750	70	1000	950	1100
5	6	65	650	625	700	90	950	900	1025
6	6	80	625	600	675	115	900	850	975
7	6	100	600	575	650	150	825	800	925
8	6	125	575	550	625	175	775	750	850
9	6	175	525	500	575	250	*725	700	750
10	6	250	*450	425	500	350	*675	650	675

* Not to be made for 125 or 115 volts.

The first eight sizes are made with enclosed and partly enclosed as well as open casings. For the several types of casings the horse-powers are as below:

Frame	H.P., Slow Speed.				Frame	H.P., Moderate Speed.			
	Open	Semi-Enclosed.	En-closed Ventilated.	Totally En-closed.		Open	Semi-Enclosed.	En-closed Ventilated.	Totally En-closed.
1	20	20	20	10	1	30	30	30	15
2	25	25	25	12 1/2	2	40	40	40	20
3	35	35	35	17 1/2	3	55	55	55	27
4	50	50	50	25	4	70	70	70	
5	65	65	65	30	5	90	90	90	
6	80	80	80	40	6	125	125	125	
7	100	100	100	50	7	150	150	150	
8	125	125	125	60	8	175	175	175	

Small Moderate Speed Engine-driven Alternators.

Poles.....	24	26	28	32	36
Kw.....	50	75	105	150	240
Speed.....	300	276	257	225	200
Amperes at (balanced 3-phase load.	12.6	17.6	26.5	37.6	60
full load (balanced 2-phase load.	10.8	15.2	23	33	52
2300 volts (single-phase load.	15	21	32	45	73
Potentials, 3-phase, 240, 480, 600, 1150, 2300; 2-phase, 240, 480, 1150, 2300.					

Box-Frame Type of Railway Motors. Four Field Coils.

H.P., 18, 42, 45, 75, 50, 75, 100, 125, 160, 170, 200, 225.
The first two sizes are for 24-in. gauge, the next two for 36-in., and the others for standard gauge.

Commutating Pole Railway Motors.

Made in six sizes 50 to 200 H.P. Wound for 600 volts. The two smallest have split frames; the others box frames.
The commutating poles, located between the main exciting pole pieces, are connected up with their windings in series with one another and with the armature. The magnetic strength of the commutating poles varies

WARNING: This is a 1910 edition. Some of the material may no longer be accurate

therefore with the current through the armature, and a magnetic field is produced of such intensity as to properly reverse the current in the armature coils short-circuited during commutation. The pole pieces are so proportioned and wound as to compensate for armature reaction, and practically non-flashing and sparkless commutation is insured up to the severest overloads. As the magnetizing current around the commutating poles is reversed with the armature, the poles perform their functions equally well in whichever direction the motors are running.

Due to the good commutating characteristics of commutating pole railway motors, their overload capacities are considerably increased, and a more rugged form of motor is obtained which is less subject to injury through careless handling by motormen than the present standard railway motor.

Small Polyphase Motors.

60-cycle, 4-pole, 1800 r.p.m., H.P., 1/6, 1/4, 1/2, 3/4, 1, 1 1/2, 2, 3, 5, 7 1/2, 10, 15.
60-cycle, 4-pole, 1200 r.p.m., H.P., 1/4, 1/2, 3/4, 1, 1 1/2, 2, 3, 5, 7 1/2.
60-cycle, 8-pole, 900 r.p.m., H.P., 1/4, 1/2, 3/4, 1, 2, 3, 5. 12-pole, 600 r.p.m., H.P., 1/4, 1/2, 3/4, 1, 2, 3.
40-cycle, 4-pole, 1200 r.p.m., H.P., 1/4, 1/2, 1, 1 1/2, 2, 3, 5. 6-pole, 800 r.p.m., H.P., 1/4, 1/2, 1, 2, 3.
25-cycle, 2-pole, 1500 r.p.m., H.P., 1/4, 1/2, 1, 2, 3, 5, 7 1/2.
25-cycle, 4-pole, 750 r.p.m., H.P., 1/4, 1/2, 1, 2, 3, 5. 6-pole, 500 r.p.m., H.P., 1/4, 1/2, 1, 2, 3.

The speeds given are synchronous speeds. Full-load speeds are from 93 to 97% of the synchronous.

Motors below 1 H.P. are adapted for 110 and 220 volts; others for 110, 220, 440 and 550 volts.

Single-phase Motors, 110 and 220 volts.

60-cycle, 4-pole, 1800 r.p.m., H.P., 1/4, 1/2, 1, 2, 3, 5, 7 1/2, 10, 15.
60-cycle, 6-pole, 1200 r.p.m., H.P., 1/4, 1/2, 1, 1 1/2, 2, 3, 5, 7 1/2, 10.
25-cycle, 2-pole, 1500 r.p.m., H.P., 1/4, 1/2, 3/4, 2, 3, 5, 7 1/2, 10.
25-cycle, 4-pole, 750 r.p.m., H.P., 1/4, 1/2, 1, 1 1/2, 2, 3, 5.

Type CQ Motors. Continuous Current.

Type and Class.	No. of Poles	H.P.	* Speed (Shunt-Wound Motors).										
			110 v.	115 v.	125 v.	220 v.	230 v.	250 v.	500 v.	550 v.	600 v.		
CQ 1/6	2	1/6	2200	2300	2450	2200	2300	2450					
CQ 1/4	2	1/4	1800	1850	1950	1800	1850	1950	2100	2250	2400		
CQ 1/2	2	1/2	1600	1650	1750	1600	1650	1750	1850	2000	2150		
CQ 3/4	2	3/4	1425	1475	1550	1425	1475	1550	1675	1800	1925		
CQ 1	2	1	1935	2000	2100	1935	2000	2100	2240	2400	2575		
CQ 1	2	1	1240	1275	1350	1240	1275	1350	1450	1575	1700		
CQ 2	2	2	1825	1900	2090	1825	1900	2050	2200	2350	2500		
CQ 2	2	2	1060	1100	1175	1060	1100	1175	1250	1350	1450		
CQ 3	2	3	1600	1650	1750	1600	1650	1750	1850	2000	2150		
CQ 3	2	3	1060	1100	1175	1060	1100	1175	1250	1350	1450		
CQ 5	2	5	1600	1650	1750	1600	1650	1750	1850	2000	2150		
CQ 5	2	5	1060	1100	1175	1060	1100	1175	1250	1350	1450		
CQ 7 1/2	4	7 1/2	1475	1525	1625	1475	1525	1625	1725	1850	1975		
CQ 7 1/2	4	7 1/2	800	825	875	800	825	875	1050	1125	1200		
CQ 10	4	10	1220	1250	1310	1220	1250	1310	1400	1500	1600		
CQ 10	4	10	635	650	685	635	650	685	835	900	965		
CQ 15	4	15	975	1000	1050	975	1000	1050	1250	1350	1450		
CQ 15	4	15	610	625	660	610	625	660	775	835	890		
CQ 15	4	20	900	925	975	900	925	975	1150	1250	1350		

* Speed at full load is subject to a maximum variation of 4% above or below standard.

The standard CQ open motor will deliver its rated horse-power output continuously without a temperature rise in any part exceeding 45° C. by the thermometer above the surrounding air. An overload of 25% may be maintained for *one hour* continuously without injurious heating or sparking, or a 40% overload *momentarily*.

Motors developed from the CQ1 frame and smaller will operate semi or totally enclosed within the same load limits as when open. Owing to the fact that the CQ2 and larger frames have less radiating surface per horse-power than the smaller frames, the ratings attainable with them when enclosed are necessarily reduced to keep the heating within established limits.

The voltages for which standard motors are built are 115, 230 and 550. When motors are rated at 115 volts, they may be used on circuits ranging between 110 and 125 volts, and when rated at 230 volts, they may be used on circuits ranging between 220 and 250 volts, and standard heating guarantees will be maintained.

When motors are rated at 550 volts, they may be used on circuits ranging between 500 and 600 volts, inclusive, and standard heating guarantees will be maintained up to 550 volts, and at 600 volts the heating will not be injurious.

Sewing-Machine Motors.

Ratings, H.P., 1/30, 1/15, 1/10, 1/8, 1/6.
Speed, r.p.m., 1800, 1800, 1500, 1800, 2300, for direct current; alternating current 1800 r.p.m. for all sizes.

Wound for 115 and 230 volts, D.C., and 110 and 220 volts, A.C., 60 cycles.

On special order, machines may be furnished for any commercial voltage between 50 and 250, and for any standard frequency between 25 and 145 cycles.

SYMBOLS USED IN ELECTRICAL DIAGRAMS.

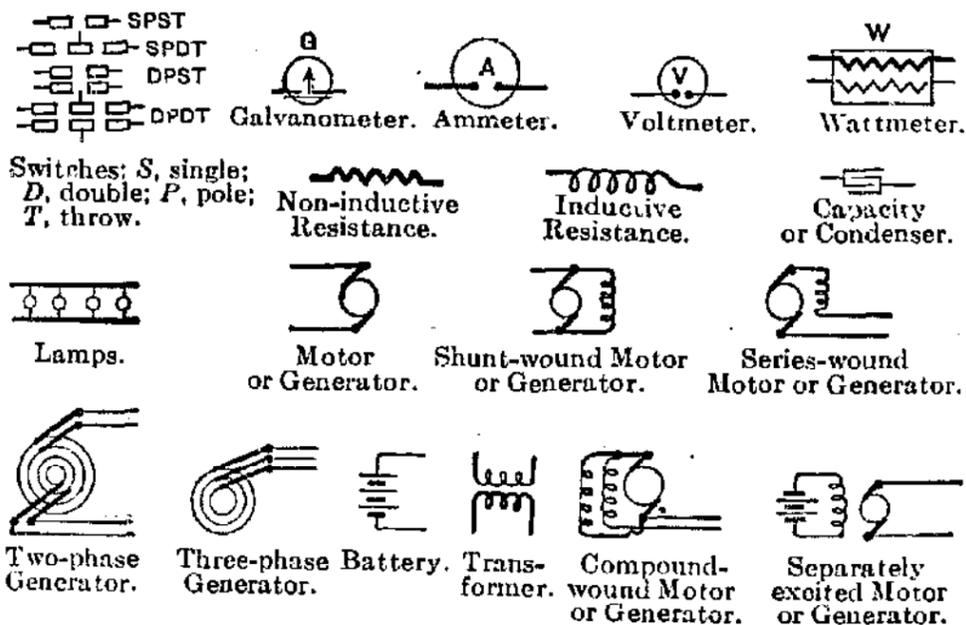

INDEX.

- Abbreviations, 1
- Abrasion, resistance to, of manganese steel, 471
- Abrasive processes, 1262-1268
- Abscissas, 71
- Absolute temperature, 540 zero, 540
- Absorption of gases, 579 of water by brick, 348 refrigerating-machines, 1293-1313
- Accelerated motion, 501
- Acceleration, definition of, 497 force of, 501 work of, 504
- Accumulators, electric, 1378
- Acetylene and calcium carbide, 825
- Acetylene blowpipe, 827 -flame welding, 464 generators and burners, 826
- Acheson's deflocculated graphite, 1223
- Acme screw thread, 226
- Adiabatic compression of air, 604 curve, 929 expansion, 575 expansion of air, 606 expansion in compressed air-engines, 608 expansion of steam, 929
- Adiabatically compressed air, mean effective pressures, table, 609
- Admiralty metal, composition of, 366
- Admittance of alternating currents, 1389
- Air (*see also* Atmosphere), 580-653 and vapor mixture, weight of, 584, 586 -bound pipes, 722 carbonic acid allowable in, 653 cooling of, 568, 681 compressed, 593, 604-626 (*see* Compressed air) compressor, hydraulic, 622 compressors, centrifugal, 620 compressors, effect of intake temperatures, 619 compressors, high altitude, table of, 611 compressors, intercoolers for, 620 compressors, tables, 614, 615 density and pressure, 581, 586 flow of, in pipes, 591 flow of, in long pipes, 595 flow of, in ventilating ducts, 655
- Air, flow of, through orifices, 588 friction of, in underground passages, 685 head of, due to temperature differences, 687 heating of, *see also* Heating heating of, by compression, 604 horse-power required to compress, 606 lift pump, 776 liquid, 579 loss of pressure of, in pipes, tables, 593-595 manometer, 581 properties of, 580 pump, 1055 pump for condenser, 1053, 1055 pump, maximum work of, 1056 pyrometer, 528 specific heat of, 537 thermometer, 530 velocity of, in pipes, by anemometer, 596 volumes, densities, and pressures, 581, 586, 663 volume transmitted in pipes, 591 weight and volume of, 28 weight of (table), 586 weight of, 173
- Alcohol as fuel, 813 denatured, 813 engines, 1078 vapor tension of, 814
- Alden absorption dynamometer, 1281
- Algebra, 34-38
- Algebraic symbols, 1
- Alligation, 9
- Alloys, 360-385 aluminum, 371, 375, 376 aluminum-antimony, 375 aluminum-copper, 371 aluminum-silicon-iron, 374 aluminum, tests of, 374 aluminum-tungsten, 375 aluminum-zinc, 375 antimony, 381, 383 bearing metal, 380 bismuth, 379 caution as to strength of, 373 composition of, in brass foundries, 366 composition by mixture and by analysis, 364 copper-manganese, 376

Alloys, copper-tin, 360
 copper-tin-lead, 369
 copper-tin-zinc, 363-367
 copper-zinc, 362
 copper-zinc-iron, 369
 ferro-, 1232
 for casting under pressure, 371
 fusible, 380
 Japanese, 368
 liquation of metals in, 364
 magnetic, of non-magnetic met-
 als, 378
 nickel, 378
 the strongest bronze, 365
 vanadium and copper, 371
 white metal, 382
 Alloy steels, 470-480 (*see* Steel)
 Alternating-current motors, vari-
 able speed, 1412
 Alternating currents, 1387
 admittance, 1389
 average, maximum, and effective
 values, 1388
 calculation of circuits, 1397
 capacity, 1389
 capacity of conductors, 1394
 converters, 1400
 delta connection, 1395
 frequency, 1388
 generators for, 1396
 impedance, 1389
 impedance polygons, 1390
 inductance, 1389
 induction motor, 1409
 measurement of power in poly-
 phase circuits, 1395
 Ohm's law applied to, 1390
 power factor, 1389
 reactance, 1389
 single and polyphase, 1395
 skin effect, 1390
 synchronous motors, 1409
 transformers, 1400
 Y-connection, 1395
 Alternators, sizes of, tables, 1413
 Altitude by barometer, 582
 Aluminum, 174
 alloys (*see* Alloys)
 alloys used in automobile con-
 struction, 370
 alloys, various, 371, 375, 376
 alloys, tests of, 374
 brass, 373
 bronze, 371
 bronze wire, 243
 coating on iron, 449
 conductors, cost compared with
 copper, 1399
 effect of, on cast iron, 416
 electrical conductivity of, 1350
 properties and uses, 357
 sheets and bars, table, 220
 solder, 359
 steel, 472
 strength of, 358
 thermite process, 372
 wire, 243, 359

Aluminum wire, electrical resistance
 of, table, 1362
 Ammonia, carbon dioxide and sul-
 phur dioxide, cooling effect,
 and compressor volume, 1289
 gas, properties of, 1287
 heat generated by absorption of,
 1288
 liquid, density of, 1285
 liquid, specific heat of, 1286
 liquid, specific heat and available
 latent heat, 1287
 solubility of, 1288
 vapor, superheated, weight of,
 1287
 Ammonia-absorption refrigerating
 machine, 1293, 1313
 test of, 1315
 Ammonia-compression refrigerating
 machines, 1292, 1303.
 tests of, 1307-1311
 Ampere, definition of, 1345
 Analyses, asbestos, 257
 boiler scale, 693
 boiler water, 693
 cast iron, 416-419
 coals, 789-797
 crucible steel, 466, 469
 fire-clay, 255
 gas, 824
 gases of combustion, 785
 magnesite, 257
 Analysis of rubber goods, 356
 Analytical geometry, 71-74
 Anchor forgings, strength of, 331
 Anemometer, 596
 Angle, economical, of framed struc-
 tures, 532
 of repose of building material,
 1196
 Angles, Carnegie steel, properties of,
 table, 295-298
 plotting without protractor, 54
 problems in, 39, 40
 steel, table of properties of, 295,
 296
 steel, table of safe loads, 297, 298
 steel, tests of, 340
 trigonometrical properties of, 67
 Angular velocity, 498
 Animal power, 507-509
 Annealing, effect on conductivity,
 1351
 effect of, on steel, 454, 455
 influence of, on magnetic capa-
 city of steel, 459
 malleable castings, 431
 of steel, 460, 468 (*see* Steel)
 of steel forgings, 458
 of structural steel, 460
 Annuities, 15-17
 Annular gearing, 1145
 Anthracite, classification of, 787
 composition of, 787
 gas, 815
 sizes of, 792
 space occupied by, 793

Anti-friction curve, 51, 1209
 metals, 1199
 Anti-logarithm, 135
 Antimony, in alloys, 383, 336
 properties of, 175
 Apothecaries' measure and weight,
 18, 20
 Arbitration bar, for cast iron, 418
 Arc, circular, length of, 59
 circular, relations of, 59
 lamps, *see* Electric lighting
 lighting of areas, watts per
 square foot required for, 1369
 lights, electric, 1368
 Arcs, circular, table, 123, 124
 Arches, corrugated, 186
 Area of circles, table, 111-119
 of circles, square feet, diameters
 feet and inches, 127, 128
 of geometrical plane figures,
 55-62
 of irregular figures, 57, 58
 of sphere, 63
 Arithmetic, 2-33
 Arithmetical progression, 10
 Armature, torque of, 1385
 Armature-circuit, e.m.f. of, 1386
 Armor-plates, heat treatment of,
 458
 Asbestos, 257
 Asphaltum coating for iron, 447
 Asses, work of, 509
 Asymptotes of hyperbola, 74
 Atmosphere, *see also* Air
 equivalent pressures of, 27
 moisture in, 583
 pressure of, 581
 Atomic weights (table), 170
 Autogenous welding, 464
 Austenite, 456
 Automatic cut-off engines, 937
 Automobile engines, rated capacity
 of, 1077
 gears, efficiency of, 1148
 screws and nuts, table, 222
 Automobiles, steel used in, 486
 Avogadro's law of gases, 578
 Avoirdupois weight, 19
 Axles, forcing fits of, by hydraulic
 pressure, 1273
 railroad, effect of cold on, 441
 steel, specifications for, 483, 485
 steel, strength of, 332
 Babbitt metal, 383, 384
 Babcock & Wilcox boilers, tests
 with various coals, 799
 Bagasse as fuel, 809
 Balances, to weigh on incorrect, 20
 Ball-bearings, 1210
 saving of power by, 1214
 Balls and rollers, carrying capacity
 of, 317
 Balls for bearings, grades of, 1214
 hollow copper, 322
 Band brakes, design of, 1217

Bands and belts for carrying coal,
 etc., 1175
 and belts, theory of, 1115
 Bank discount, 13
 Bar iron, *see also* Wrought iron
 Bars, eye, tests of, 338
 iron and steel, commercial sizes
 of, 179
 Lowmoor iron, strength of, 330
 of various materials, weights of,
 178
 steel, 461, *see* Steel
 twisted, tensile strength of, 264
 wrought-iron, compression tests
 of, 337
 Barometer, leveling with, 582
 to find altitude by, 582
 Barometric readings for various alti-
 tudes, 582
 Barrels, number of, in tanks, 133
 to find volume of, 66
 Basic Bessemer steel, strength of,
 452
 Batteries, primary electric, 1377
 storage, 1378
 Baumé's hydrometer, 172
 Bazin's experiments on weirs, 732
 Beams and girders, safe loads on,
 1335
 formula for flexure of, 282
 formulæ for transverse strength
 of, 282-285
 of uniform strength, 286
 special, coefficients for loads on,
 285
 steel, formulæ for safe loads on,
 284
 wooden, safe loads, by building
 laws, 1336
 yellow pine, safe loads on, 1336,
 1340
 Beardlee's tests on elevation of
 elastic limit, 261
 Bearing pressure on rivets, 403
 Bearing pressures with intermittent
 loads, 1207
 Bearings, allowable pressure on,
 1203, 1206
 and journals clearance in, 1206
 ball, 1210
 calculating dimensions of, 1025
 cast-iron, 1199
 conical roller, 1211
 engine, temperature of, 1209
 for high rotative speeds, 1203
 for steam turbines, 1208
 knife-edge, 1214
 mercury pivot, 1209
 of Corliss engines, 1208
 of locomotives, 1208
 oil pivot, in Curtis steam turbine,
 1063
 oil pressure in, 1204
 overheating of, 1205
 pivot, 1205, 1209
 roller, 1210
 shaft, length of, 1015

Bearings, steam-engine, 1165
 thrust, 1208
 Bearing-metal alloys, 380-384
 practice, 382
 Bearing-metals, anti-friction, 1199
 composition of, 367
 Bed-plates of steam-engine, 1025
 Bell-metal, composition of, 366
 Belt conveyors, 1175
 Belt dressings, 1128
 factors, 1119
 Belts, arrangement of, 1126
 care of, 1127
 cement for leather or cloth, 1128
 centrifugal tension of, 1115
 endless, 1127
 evil of tight, 1126
 lacing of, 1124
 length of, 1125
 open and crossed, 1112
 quarter twist, 1124
 sag of, 1126
 steel, 1120
 Belting, 1115-1132
 Barth's studies on, 1123
 formulae, 1116
 friction of, 1115
 horse-power of, 1116-1119
 notes on, 1123
 practice, 1116
 rubber, 1128
 strength of, 335, 1127
 Taylor's rules, 1120-1122
 theory of, 1115
 vs. chain drives, 1132
 width for given horse-power,
 1118
 Bends, effects of, on flow of water
 in pipes, 721
 in pipes, 593
 in pipes, table, 214, 215
 pipe, flexibility of, 215
 valves, etc., resistance to flow in,
 848
 Bending curvature of wire rope,
 1188
 tests of steel, 454
 Bent lever, 511
 Bernoulli's theorem, 734
 Bessemer converter, temperature
 in, 527
 steel, 451 (*see* Steel, Bessemer)
 Bessemerized cast iron, 429
 Bevel wheels, 1144
 Billets, steel, specifications for, 483
 Binomial, any power of, 34
 theorem, 38
 Bins, coal-storage, 1172
 Birmingham gauge, 29
 Bismuth alloys, 379
 Bismuth, properties of, 175
 Bituminous coal (*see* Coal)
 Black body radiation, 552
 Blast area of fans, 629
 furnaces, consumption of char-
 coal in, 806
 furnaces, steam-boilers for, 865

Blast furnaces, temperatures in, 528
 pipes, *see* Pipes
 Blechynden's tests of heat trans-
 mission, 567
 Blocks or pulleys, 513
 efficiency of, table, 1158
 strength of, 1157
 Blooms, steel, weight of, table, 185
 Blow, force of, 504
 Blowers, *see also* Fans.
 Blowers and fans, 626-652
 and fans, comparative efficiency,
 631
 blast-pipe diameters for, 643
 capacity of, 632
 experiments with, 629
 for cupolas, 633, 634
 in foundries, 1227
 rotary, 649
 rotary, table of, 650
 steam-jet, 651
 velocity due to pressure, 629
 Blowing-engines, dimensions of,
 652
 machines, centrifugal, 622
 Blue heat, effect on steel, 458
 Board measure, 20
 Boats, *see* Ships
 Bodies, falling, laws of, 497
 Boiler compounds, 898
 explosions, 902
 feeders, gravity, 908
 feed-pumps, 761
 furnaces, height of, 889
 furnaces, use of steam in, 824
 heads, 885
 heads, strength of, 314, 316
 heating-surface for steam heat-
 ing, 664, 667
 plate, strength of, at high tem-
 peratures, 439
 scale, analyses of, 693
 tubes used as columns, 341
 tubes, expanded, holding power
 of, 342
 tubes, dimensions of, table, 209
 tube joints, rolled, slipping point
 of, 342
 Boilers for house heating, 665
 horse-power of, 854
 incrustation of, 691, 692
 locomotive, 1089
 natural gas as fuel for, 817
 of the "Lusitania" 1330
 for steam-heating, 667
 steam, 854 (*see* Steam-boilers)
 Boiling, resistance to, 543
 Boiling-point of water, 690
 Boiling-points of substances, 532
 Bolts and nuts, 221-228
 and pins, taper, 1271
 effect of initial strain in, 325
 holding power of in white pine,
 324
 square-head, table of weights of,
 229

Bolts, strength of, tables, 325, 326
 track, weight of, 230
 variation in size of iron for, 223
 Boyle's or Mariotte's law, 574, 577
 Braces, diagonal, stresses in, 516
 Brackets, cast-iron, strength of, 277
 Brake horse-power, definition of,
 991
 Prony, 1280
 Brakes, band, design of, 1217
 electric, 1217
 friction, 1216
 magnetic, 1217
 Brass alloys, 366
 and copper tubes, coils and bends,
 214
 influence of lead on, 369
 plates and bars, weight of,
 tables, 219, 220
 rolled, composition of, 367
 sheet and bars, table, 220
 tube, seamless, table, 215, 216
 wire, weight of, table, 219
 Brazing of aluminum bronze, 373
 metal, composition of, 366
 solder, composition of, 366
 Brick, absorption of water by, 348
 kiln, temperature in, 528
 piers, safe strength of, 1334
 sand-lime, tests of, 349
 specific gravity of, 174
 strength of, 336, 347-350
 weight of, 174, 347
 Bricks, fire, number required for
 various circles, table, 254
 fire, sizes and shapes of, 253
 Bricks, magnesia, 257
 Brickwork, allowable pressures on,
 1334
 measure of, 177
 weight of, 177
 Bridge iron, durability of, 442
 links, steel, strength of, 331
 members, strains allowed in, 272
 trusses, 517-521
 Brine, boiling of, 543
 properties of, 543, 544
 Brinell's tests of hardness, 342
 Briquettes, coal, 801
 Britannia metal, composition of,
 383
 British thermal unit (B.T.U.),
 532, 837
 Brittleness of steel, *see* Steel
 Bronze, aluminum, strength of, 372
 ancient, composition of, 364
 deoxidized, composition of, 371
 Gurley's, composition of, 366
 manganese, 377
 navy-yard, strength of, 374
 phosphor, 370
 strength of, 319, 321, 334
 Tobin, 367, 368
 variation in strength of, 362
 Buildings, construction of, 1333-
 1344
 fire-proof, 1338

Buildings, heating and ventilation
 of, 656
 mill, approximate cost of, 1342
 transmission of heat through
 walls of, 659
 walls of, 1336
 Building-laws, New York City,
 1337-1340
 on columns, New York, Boston,
 and Chicago, 277
 Building-materials, coefficients of
 friction of, 1196
 sizes and weights, 174, 178, 186,
 190
 Bulkheads, plating and framing for,
 table, 316
 stresses in due to water-pressure,
 315
 Buoyancy, 690
 Burmester's method of calculating
 cone pulleys, 1113
 Burning of steel, 457
 Burr truss, stresses in, 518
 Bush-metal, composition of, 366
 Bushel of coal and of coke, weight
 of, 803
 Butt-joints, riveted, 465
 C. G. S. system of measurements,
 1344
 CO₂, carbon dioxide, carbonic acid
 CO₂ recorders, autographic, 860
 CO₂, temperature required for pro-
 duction of, 322
 Cable, formula for deflection of,
 1180
 traction ropes, 247
 Cables, chain, proving tests of, 251
 chain, wrought-iron, 251-252
 flexible steel wire, 249
 galvanized steel, 248
 suspension-bridge, 248
 Cable-ways, suspension, 1181
 Cadmium, properties of, 175
 Calcium carbide and acetylene, 825
 chloride in refrigerating-ma-
 chines, 1290
 Calculus, 74-83
 Caloric engines, 1071
 Calorie, definition of, 532
 Calorimeter for coal, Mahler bomb,
 798
 steam, 912-915
 steam, coil, 913
 steam, separating, 914
 steam, throttling, 913
 Calorimetric tests of coal, 797, 798
 Cam, 512
 Campbell's formula for strength of
 steel, 453
 Canals, irrigation, 704
 Candle-power and life of lamps,
 1370
 definition of, 1367
 of electric lights, 1368-1373
 of gas lights, 830
 Canvas, strength of, 335

Capacity, electrical, 1389
 electrical, of conductors, 1394
 Cap-screws, table of standard, 225
 Cars, steel plate for, 483
 Car-heating by steam, 673
 Car-journals, friction of, 1204
 Car-wheels, cast iron for, 426, 427
 Carbon, burning out of steel, 461
 dioxide, *see* CO₂
 effect of on strength of steel, 452
 gas, 814
 Carbonic acid allowable in air, 653
 Carbonizing *see* Case-hardening
 Carborundum, made in the electric
 furnace, 1377
 Cargo hoisting by rope, 390
 Carnegie steel sections, properties
 of, 287-306
 Carnot cycle, 572, 574
 cycle, efficiencies of, 967
 cycle, efficiency of steam in, 850
 Carriages, resistance of, on roads,
 509
 Carriers, bucket, 1172
 Case-hardening of iron and steel,
 486, 1246
 Casts, volume of, 66
 Cast copper, strength of, 334, 360
 Cast-iron, 414-429
 addition to, of ferro-silicon,
 titanium, vanadium and man-
 ganese, 426
 analyses of, 416-419
 and aluminum alloys, 375
 bad, 429
 bars, tests of, 419
 beams, strength of, 427
 Bessemerized, 429
 chemistry of, 415-419
 columns, eccentric loading of, 278
 columns, strength of, 274-278
 columns, tests of, 275
 columns, weight of, table, 191
 combined carbon changed to
 graphitic by heating, 424
 compressive strength of, 267
 corrosion of, 441
 cylinders, bursting strength of,
 427
 durability of, 442
 effect of cupola melting, 425
 expansion in cooling, 423
 growth of by heating, 1231
 hard, due to excessive silicon,
 1231
 influence of length of bar on
 strength, 422
 influence of phosphorus, sulphur,
 etc., 415
 journal bearings, 1199
 malleable, 429
 manufacture of, 414
 mixture of, with steel, 429
 mobility of molecules of, 424
 permanent expansion of, by heat-
 ing, 429

Cast-iron pipe, 191-195 (*see* Pipe,
 cast-iron)
 pipe-fittings, sizes and weights,
 196, 199
 relation of chemical composition
 to fracture, 421
 shrinkage of, 415, 423, 1231
 specifications for, 418
 specific gravity and strength, 428
 strength of, 421
 strength in relation to silicon and
 cross-section, 422
 strength in relation to size of
 bar and to chemical constitu-
 tion, 421
 tests of, 330, 419, 420
 theory of relation of strength to
 composition, 421
 variation of density and tenacity,
 428
 water pipe, transverse strength
 of, 427
 white, converted into gray by
 heating, 424
 Castings, deformation of, by shrink-
 age, 423
 from blast-furnace metal, 425
 hard, from soft pig, 425
 hard to drill, due to low Mn., 426
 iron, analysis of, 417
 iron, strength of, 330
 made in permanent cast-iron
 molds, 1232
 malleable, rules for use of 433
 shrinkage of, 1231
 specifications for, 418
 steel, 464-466
 steel, specifications for, 464, 486
 steel, strength of, 333
 weakness of large, 1230
 weight of, from pattern, 1233
 Catenary, to plot, 53
 Cement as a preservative coating,
 447
 for leather belts, 1128
 Portland, strength of, 336
 Portland, tests of, 351
 weight and specific gravity of,
 174
 Cements, mortar, strength of, 350
 Cementation or case-hardening,
 483, 1246
 Cementite, 416, 456
 Center of gravity, 492
 of regular figures, 492.
 of gyration, 494
 of oscillation, 494
 of percussion, 494
 Centigrade Fahrenheit conversion
 table, 524, 525
 thermometer scale, 524, 525
 Centrifugal fans (*see* Fans, cen-
 trifugal)
 fans, high-pressure, 621
 force, 497
 force in fly-wheels, 1029

Centrifugal pumps (*see* Pumps,
 centrifugal), 764-770
 tension of belts, 1115
 Chains, formulas for safe load on,
 326
 link belting, 1172
 monobar, 1174
 pin, 1174
 pitch, breaking and working
 strains of, 252
 roller, 1174
 sizes, weights and properties,
 251, 252
 specifications for, 251
 strength of, table, 251, 252
 test of, table, 251, 252
 Chain-blocks, efficiency of, 1158
 Chain-cables, proving tests of, 251
 weight and strength of, 251
 Chain-drives, 1129
 vs. belting, 1132
 silent, 350 H.P., 1132
 Chain-hoists, 1157
 Chalk, strength of, 349
 Change gears for lathes, 1237
 Channels, Carnegie steel, properties
 of, table, 292
 open, velocity of water in, 704
 safe loads, table, 293
 strength of, 330
 Charcoal, 805-807
 absorption of gases and water
 by, 806
 bushel of, 177
 composition of, 806
 pig iron, 417, 428
 results of different methods of
 making, 806
 weights per cubic foot, 177
 Charles's law, 574, 578
 Chatter in tools, 1241
 Chemical elements, table, 170
 symbols, 170
 Chemistry of cast iron, 415
 Chezy's formula for flow of water,
 699
 Chilling cast iron, 418
 Chimneys, 915-928
 draught, power of, 917
 draught, theory, 915
 effect of flues on draught, 918
 for ventilating, 683
 height of, 919
 height of water column due to
 unbalanced pressure in, 917
 largest in the world, 923
 lightning protection of, 920
 radial brick, 923
 rate of combustion due to, 918
 reinforced concrete, 927
 sheet iron, 928
 size of, 919-928
 size of, table, 921
 stability of, 924
 steel, 925
 steel, design of, 925
 steel, foundation for, 926, 928

Chimneys, tall brick, 922
 velocity of air in, 917
 Chisels, cold, cutting angle of, 1238
 Chord of circle, 59
 Chords of trusses, strains in, 519
 Chrome paints, anti-corrosive, 445
 steel, 471
 Chromium vanadium steels, 476-
 478
 Cippoletti weir, 733
 Circle, 58-61
 area of, 58
 diameter of to enclose a number
 of rings, 52
 equation of, 72
 large, to describe an arc of, 52
 length of arc of, 59
 length of arc of, Huyghen's
 approximation, 59
 length of chord of, 59
 problems, 40-42
 properties of, 58, 59
 relations of arc, chord, etc., of, 59
 relations of, to equal, inscribed
 and circumscribed square, 60
 sectors and segments of, 61
 area in square feet, diameter in
 inches (tables of cylinders),
 127, 128
 circumference and area of, table,
 111-119
 circumferences in feet, diameters
 in inches, table, 1265
 circumferences of, 1 inch to 32
 feet, 120
 Circuits, alternating current, *see*
 Alternating current
 electric, *see* Electric circuits
 electric, e.m.f. in, 1352
 electric, polyphase, 1395 (*see*
 Alternating currents)
 electric, power of, 1353
 magnetic, 1383
 Circular arcs, lengths of, 59
 lengths of, tables, 123, 124
 curve, formulas for, 60
 functions, Calculus, 82
 inch, 18
 measure, 20
 mil, 18, 30, 31
 mil wire gauge, 31
 mil wire gauge, table, 30
 pitch, 1134
 ring, 61
 segments, areas of, 121, 122
 Circumference of circles, 1 inch to
 32 feet, table, 120
 of circles, table, 111-119
 Cisterns and tanks, no. of barrels
 in, 133
 capacity of, 128
 Classification of iron and steel, 413
 Clay, cubic feet per ton, 178
 fire, analysis, 255
 melting point of, 529
 Clearance between journal and
 bearing, 1206

- Clearance in steam-engines, 936, 996
 Clutches, friction, 1155, 1210
 friction coil, 1156
 Coal, analysis of, 789-797
 analyses of various, table, 794
 and coke, Connellsville, 793
 approximate heating value of, 791
 anthracite, sizes of, 792
 bituminous, classification of, 787
 caking and non-caking, 788
 calorimeter, 798
 calorimetric tests of, 797, 798
 cannel, 788
 classification of, 786, 787
 conveyors, 1172
 cost of for steam power, 983
 cubic feet per ton, 177
 Dulong's formula for heating value of, 798
 efficiencies of, in gas-engine tests, 823
 evaporative power of, 799
 foreign, analysis of, 796
 furnaces for different, 798
 heating value of, 789-792, 797
 products of distillation of, 803
 proximate analysis and heating value of, table, 790
 purchase of by specification, 799
 Rhode Island graphitic, 788
 sampling of, for analysis, 797
 semi-anthracite, 793
 semi-bituminous, composition of, 787-792
 space occupied by anthracite, 793
 steam, relative value of, 797
 storage bins, 1172
 tests of, 791
 vs. oil as fuel, 812
 washing, 802
 weathering of, 800
 Welsh, analysis of, 796
 Coal-gas, composition of, 830
 manufacture, 828
 Coatings, preservative, 447-450
 Coefficient of elasticity, 260, 351
 of fineness, 1317
 of friction, definition, 1194
 of friction of journals, 1197
 of friction, rolling, 1195
 of friction, tables, 1195-1197
 of performance of ships, 1318
 of propellers, 1325
 of transverse strength, 282
 of water lines, 1317
 of expansion, 539 (see Expansion by heat)
 Coils and bends of brass tubes, 214
 Coils, electric, heating of, 1355
 Coils, heat radiated from, in blower system, 679
 Coiled pipes, 214
 Coke, analyses of, 802
 by-products of manufacture of, 802, 803
 Coke, foundry, quality of, 1232
 weight of, 177
 Coke-ovens, generation of steam from waste heat of, 803
 Coking, experiments in, 802
 Cold, effect of, on railroad axles, 441
 effect of on strength of iron and steel, 440
 Cold-chisels, form of, 1238
 Cold-drawing, effect of, on steel, 339
 Cold-drawn steel, tests of, 339
 Cold-rolled steel, tests of, 339
 Cold-rolling, effect of, on steel, 455
 Cold-saw, 1262
 Collapse of corrugated furnaces, 318
 of tubes, tests of, 320
 resistance of hollow cylinders to, 318-322
 Collars for shafting, 1109
 Cologarithm, 136
 Color determination of temperature, 531
 scale for steel tempering, 469
 values of various illuminants, 1367
 Columns, Bethlehem shapes, 309, 310
 built, 272
 Carnegie channel, dimensions and safe loads, 305, 306
 cast-iron, strength of, 274-278
 cast-iron, tests of, 275
 cast-iron, weight of, table, 191
 eccentric, loading of, 278
 Gordon's formula for, 270
 Hodgkinson's formula for, 269
 made of old boiler tubes, tests of, 341
 mill, 1341
 permissible stresses in, 277
 strength of, 274
 strength of, by New York building laws, 1337
 wrought-iron, tests of, 338
 wrought-iron, ultimate strength of, table, 271
 steel, built, 272
 Z-bar, tables of safe loads on, 300-304
 Combination, 10
 Combined stresses, 312
 Combustion, analyses of gases of, 785
 heat of, 533
 of fuels, 784
 of gases, rise of temperature in, 786
 rate of, due to chimneys, 918
 theory of, 784
 Composition of forces, 489
 Compound engines (see Steam-engines, compound), 946-953
 interest, 14
 locomotives, 1098, 1101

- Compound numbers, 5
 proportion, 7
 units of weights and measures, 27, 28
 Compressed-air, 593, 604-626
 adiabatic and isothermal compression, 604
 adiabatic expansion and compression, tables, 609, 610
 compound compression, 609
 cranes, 1168
 diagrams, curve of, 611
 drills driven by, 616
 engines, adiabatic expansion in, 608
 engines, efficiency, 613
 flow of, in pipes, 594
 for motors, effect of heating, 612
 formula, 606
 for street railways, 625
 heating of, 604
 hoisting engines, 618
 horse-power required to compress air, 606
 locomotive, 1104
 losses due to heating, 606
 loss of energy in, 604
 machines, air required to run, 616, 618
 mean effective pressures, tables, 609, 610
 mine pumps, 625
 moisture in, 584
 motors, 612
 motors with return-air circuit, 620
 Popp system, 612
 practical applications of, 619
 pumping with (see also Air-lift), 617
 reheating of, 619
 tramways, 624, 625
 transmission, 593
 transmission, efficiencies of, 613
 volumes, mean pressures per stroke, etc., table, 605
 work of adiabatic compression, 607
 Compressed steel, 464
 Compressibility of liquids, 172
 of water, 691
 Compression, adiabatic, formula for, 606
 and flexure combined, 312
 and shear combined, 312
 and torsion combined, 312
 in steam-engines, 935
 of air, adiabatic, tables, 609, 610
 Compressive strength, 267-269
 strength of iron bars, 337
 strengths of woods, 344, 346
 tests, specimens for, 268
 Compressors, air, effect of intake temperature, 619
 air, tables of, 614-615
 Concrete, crushing strength of 12-in. cubes, 1334
 Concrete, durability of iron in, 412
 reinforced, allowable working stresses, 1335
 Condenser, barometric, 1051
 the Leblanc, 1057
 Condensers, 1050-1061
 air-pump for, 1053, 1055
 calculation of surface of, 910
 choice of, 1059
 circulating pump for, 1057
 cooling towers for, 1060
 cooling water required, 1050
 continuous use of cooling water in, 1058
 contraflow, 1053
 ejector, 1051
 evaporative surface, 1057
 for refrigerating machines, 1300
 heat transference in, 1052
 increase of power due to, 1058
 jet, 1050
 surface, 1051
 tubes and tube plates of, 1054, 1055
 tubes, heat transmission in, 563
 Condensing apparatus, power used by, 1053
 Conduction of heat, 553
 of heat external, 554
 of heat internal, 553
 Conductivity, electric (see Electric conductivity)
 electrical, of metals, 1349
 Conductors, electrical, heating of, 1354
 electrical, in series or parallel, resistance of, 1352
 Conduit, water, efficiency of, 735
 Cone, measures of, 63
 pulleys, 1112
 Connecting-rods, steam-engine, 1003, 1004
 tapered, 1005
 Conic sections, 74
 Conoid, parabolic, 66
 Conservation of energy, 506
 Constantan, copper-nickel alloy, 379
 Constants, steam-engine, 941
 Construction of buildings, 1333-1344
 Controllers, for electric motors, 1404
 Convection, loss of heat due to, 570
 Convection of heat, 553
 Dulong's law of, table of factors for, 571
 Conversion tables, metric, 23-27
 Converter, Bessemer, temperature in, 527
 Converters, electric, 1400
 Conveying of coal in mines, 1178
 Conveyors, belt, 1175
 cable-hoist, 1181
 coal, 1172
 horse-power required for, 1173

Conveyors, screw, 1175
 Cooling agents in refrigeration, 1289
 Cooling of air, 568
 for ventilation, 681
 Cooling-tower practice in refrigerating plants, 1301
 for condensers, 1060
 Co-ordinate axes, 71
 Copper, 175
 Copper and vanadium alloys, 371
 Copper ball pyrometer, 526
 balls, hollow, 322
 cast, strength of, 334, 360
 drawn, strength of, 334
 effect of on cast iron, 415
 manganese alloys, 376
 nickel alloys, 378
 plates, strength of, 334
 rods, weight of, table, 218
 steels, 475
 strength of at high temperatures, 344
 tubing, bends and coils, 214
 tubing, weight of, table, 216
 weight required in different systems of transmission, 1398
 wire and plates, weight of, table, 219
 wire, carrying capacity of. Underwriter's table, 1355
 wire, cost of for long-distance transmission, 1363
 wire, cross section required for a given current, 1350
 wire, electrical resistance, table, 1357, 1358
 wire, stranded, 242
 wire, weight of for electric circuits, 1359
 tin-aluminum alloys, 375
 tin alloys, 360
 tin alloys, properties and composition of, 360
 tin-zinc alloys, properties and composition, 363
 tin-zinc alloys, law of variation of strength of, 364
 zinc alloys, strength of, 364
 zinc alloys, table of composition and properties, 362
 zinc-iron alloys, 369
 Cord of wood, 805
 Cordage, technical terms relating to, 388
 weight of, table, 386-391, 1157
 Cork, properties of, 355
 Corn, weight of, 178
 Corrosion by stray electric currents, 446
 due to overstrain, 446
 electrolytic theory of, 444
 of iron, 443
 of steam-boilers, 443, 897
 prevention of, 444

Corrosion, resistance of aluminum alloys to, 376
 resistance to of nickel steel, 474
 Corrosive agents in atmosphere, 442
 Corrugated arches, 186
 furnaces, 319, 881
 iron, sizes and weights, 186
 plates, properties of Carnegie steel, table, 289
 Cosecant of an angle, table, 166-169
 Cosine of an angle, 67
 table, 166, 169
 Cost of coal for steam-power, 983
 of steam-power, 981, 982-984
 Cotangent of an angle, 67
 Cotangents of angles, table, 166-169
 Cotton ropes, strength of, 335
 Coulomb, definition of, 1345
 Counterbalancing of hoisting-engines, 1163
 of locomotives, 1102
 of steam-engines, 980
 Counterpoise system of hoisting, 1164
 Couples, 491
 Couplings, flange, 1109
 hose, standard sizes, 207
 Coverings for steam-pipe, tests of, 558-561
 Coversine of angles, table, 166-169
 Cox's formula for loss of head, 717
 Crane chains, 251, 252
 installations, notable, 1168
 pillar, 150-ton, 1168
 Cranes, 1165
 and hoists, power required for, 1169
 classification of, 1165
 compressed-air, 1168
 electric, 1166-1168
 electric, loads and speeds of, 1167
 guyed, stresses in, 516
 jib, 1165
 power required for, 1166
 quay, 1168
 simple, stresses in, 515
 traveling, 1166-1169
 Crank angles, steam-engine, table, 1040
 arm, dimensions of, 1009
 pins, steam-engine, 1005-1009
 pins, steel, specifications for, 483
 shaft, steam-engine, torsion and flexure of, 1019
 shafts, steam-engine, 1017-1019
 Cranks, steam-engine, 1009
 Critical point in heat treatment of steel, 456
 temperature and pressure of gases and liquids, 580
 Cross-head guides, 1002
 pin, 1009
 Crucible steel, 451, 457, 466-470
 (see Steel, crucible)

Crushing strength of masonry materials, 349
 Crystallization of iron by fatigue, 441
 Cubature of volumes, 78
 Cube root, 9
 roots, table of, 94-109
 Cubes of decimals, table, 109
 Cubes of numbers, table, 94-109
 Cubic feet and gallons, table, 129
 measure, 18
 Cupola fan, power required for, 1230
 gases, utilization of, 1230
 practice, 1224-1230
 practice, improvement of, 1226
 results of increased driving, 1229
 Cupolas, blast-pipes for, 643
 blast-pressure in, 1224-1228
 blowers for, 633, 634
 charges for, 1224-1227
 charges in stove foundries, 1227
 dimensions of, 1224
 loss in melting iron in, 1230
 rotary blowers for, 650
 slag in, 1225
 Current motors, 734
 Currents, electric (see Electric currents)
 Curve of PVⁿ construction of, 576
 Curves in pipe-lines, resistance of, 721
 Cutting metal, resistance overcome in, 1256
 metals by oxyacetylene flame, 464
 speeds of machine tools (see also Tools, cutting), 1235
 speeds of tools, economical, 1243
 stone with wire, 1262
 Cut-off for various laps and travel of slide valves, 1042
 Cycloid, construction of, 51
 differential equations of, 82, 83
 integration of, 82
 measures of, 62
 Cycloidal gear-teeth, 1138
 Cylinder-condensation in steam-engines, 936-937
 lubrication, 1222
 measures of, 63
 Cylinders, hollow, resistance of to collapse, 318-322
 hollow, under tension, 316
 hooped, 317
 hydraulic press, thickness of, 317, 780
 locomotive, 1088
 steam-engine (see Steam-engines)
 steam-engine, ratios of, 950, 952, 956
 tables of capacities of, 127
 thick hollow, under tension, 316
 thin hollow, under tension, 317
 Cylindrical ring, 65
 tanks, capacities of, table, 128

Dalton's law of gaseous pressures, 578
 Dam, stability of, 491
 Darcy's formula, flow of water, 704
 formula, table from, of flow of water in pipes, 709-711
 Decimal equivalents of fractions, 3
 equivalents of feet and inches, 5
 gauge, 33
 Decimals, 3
 squares and cubes of, 109
 Delta connection for alternating currents, 1395
 metal wire, 243, 369
 Denominate numbers, 5
 Deoxidized bronze, 371
 Derrick, stresses in, 516
 Diagonals, formulæ for strains in, 519
 Diametral pitch, 1134
 Diesel oil engine, 1078
 Differential calculus, 74-83
 coefficient, 76
 coefficient, sign of, 79
 gearing, 1145
 of exponential function, 80, 81
 partial, 76
 pulley, 513
 second, third, etc., 78
 screw, 514
 screw, efficiency of, 1270
 windlass, 514
 Differentials of algebraic functions, 75
 Differentiation, formulæ for, 75
 Discount, 12
 Disk fans (see Fans, disk)
 Displacement of ships, 1317, 1322
 Distillation of coal, 803
 Distiller for marine work, 1061
 Distilling apparatus, multiple system, 543
 Domed heads of boilers, 316
 Domes on steam boilers, 889
 Draught power of chimneys, 916, 917
 Draught theory of chimneys, 915
 Drawing-press, blanks for, 1272
 Dressings, belt, 1128
 Driers and drying, 547
 performance of, 549
 Drift bolts, resistance of in timber, 323
 Drill gauge, table, 30
 Drill press, horse-power required by, 1253, 1256
 Drills, high-speed steel, 1253
 rock, air required for, 616.
 rock, requirements of air-driven, 616
 tap, sizes of, 225, 1269
 twist, experiments with, 1254
 twist, speed of, 1253
 Drilling, high-speed, data on, 1254
 holes, speed of, 1253
 steel and cast iron, power required for, 1254

- Drop in electric circuits, 1352
in voltage of wires of different sizes, 1356
press, pressures obtainable by, 1273
- Dry measure, 19
- Drying and evaporation, 542-547
apparatus, design of, 550
in a vacuum, 546
of different materials, 547
- Ductility of metals, table, 177
- Dulong's formula for heating value of coal, 798
law of convection, table of factors for, 571
law of radiation, table of factors for, 570
- Durability of cutting tools, 1243
of iron, 441, 442
- Durand's rule for areas, 57
- Dust explosions, 807
fuel, 807
- Duty, measure of, 28
of pumping-engine, 771
trials of pumping-engines, 771-775
- Dynamic and static properties of steels, 476
- Dynamics, fundamental equations of, 502
- Dynamo-electric machines, classification of, 1385
machines, e.m.f. of armature circuit, 1386
machines, moving force of, 1385
machines, strength of field, 1387
machines, tables of, 1412
machines, torque of armature, 1385
- Dynamometers, 1280
Alden absorption, 1281
hydraulic absorption, 6000 H.P., 1282
Prony brake, 1280
traction, 1280
transmission, 1282
- Dyne, definition of, 488
- Earth, cubic feet per ton, 178
- Eccentric loading of columns, 278
steam-engine, 1020
- Economical angle of framed structures, 522
- Economics of power-plants, 984
- Economizers, fuel, 894
- Edison wire gauge, 31
wire-gauge table, 30
- Efficiency, definition of, 12
of a machine, 507
of compressed-air engines, 613
of compressed-air transmission, 613
of electric transmission, 1361
of fans, 631
of fans and chimneys for ventilation, 683
of injector, 907
- Efficiency of pumps, 759
of riveted joints, 405, 407
of screws, 1270
of steam-boilers, 860
of steam-engines, 934
- Effort, definition of, 503
- Ejector condensers, 1051
- Elastic limit, 259-262
apparent, 260
Bauschinger's definition of, 261
elevation of, 261
relation of, to endurance, 261
resilience, 260
resistance to torsion, 311
Wohler's experiments on, 261
- Elasticity, coefficient of, 260
modules of, 260
module of, of various materials, 351
- Electric brakes, 1217
- Electric circuits (see Circuits, electric)
- current, cost of fuel for, 764
current, determining the direction of, 1384
current required to fuse wires, 1355
currents, alternating, 1387 (see Alternating currents)
currents, direct, 1352
currents, heating due to, 1354
currents, short-circuiting of, 1360
drive in the machine-shop, 1407
furnaces, 1376
generators, usual sizes, tables, 1412
heaters, 684
light stations, economy of engines in, 963
lighting, 1367
lighting, cost of, 1373
lighting, terms used in, 1367
locomotive, 4000 H.P., 1366
motors (see also Motors), 1385, 1402
motors, alternating current, variable speed, 1412
motors, auxiliary pole type, 1402
motors, commercial sizes, tables, 1412
motors for machine tools, 1407
motors, selection of, for different service, 1405
motors, speed of, 1403
motors, speed control of, 1404
motors, types used for various purposes, 1410
process of treating iron surfaces, 449
railway cars, resistance of, 1086
railway cars and motors, 1366
railways, 1366
storage-batteries, 1378
transmission, 1359-1364 (see Transmission, electric)

- Electric transmission, high tension, notes on, 1399
transmission lines, spacing for high voltages, 1399
welding, 1374
wires (see Wires and Copper wires)
- Electrical and mechanical units, equivalent values of, 1347
conductivity of steel, 453
distribution, systems in use, 1364
engineering, 1344-1416
heating, 684
horse-power, 940, 1353
horse-power, table, 1364
machinery, alternating current, standard voltages of, 1399
machinery, shaft fit, allowances for, 1274
machines, tables of (see Dynamo-electric machines), 1412
power, cost of, 985
resistance, 1349
resistance of different metals and alloys, 1350
symbols, 1416
systems, relative advantages of, 1363
units, relations of, 1346
- Electricity, analogies to flow of water, 1348
standards of measurements, 1344
systems of distribution, 1364
units used in, 1344
- Electro-chemical equivalents, 1381
- Electro-magnets, 1384
polarity of, 1384
strength of, 1384
- Electro-magnetic measurements, 1348
- Electro-motive force of armature circuit, 1386
- E.M.F. of electric circuits, 1352
- Electrolysis, 1382
- Electrolytic theory of corrosion, 444
- Elements, chemical, table, 170
- Elements of machines, 510-515
- Elevators, coal, 1172
gravity discharge, 1172
perfect discharge, 1172
- Ellipse, construction of, 46, 47
equations of, 72
measures of, 61
- Ellipsoid, 65
- Elongation, measurement of, 265
- Emery, grades of, 1263-1266
wheels, speed and selection of, 1263, 1266
wheels, strains in, 1264
- Endless screw, 514
- Endurance of materials, relation of, to elastic limit, 261
- Energy, available, of expanding steam, 842
conservation of, 506
- Energy, definition of, 503
intrinsic or internal, 574
measure of, 503
mechanical, of steam expanded to various pressures, 933
of recoil of guns, 506
of water in a pipe, 720
of water flowing in a tube, 734
sources of, 506
- Engines, alcohol, 1078
automobile, capacity of, 1077
blowing, 652
compressed-air, efficiency of, 613
fire, capacities of, 725
gas, 1071-1084 (see Gas-engines)
hoisting, 1163
hot-air or caloric, 1071
hydraulic, 783
internal combustion, 1071-1084
oil and gasoline, 1077
marine, steam-pipes for, 848
naphtha, 1071
petroleum, 1077
pumping, 771-775 (see Pumping-engines)
solar, 988
steam, 929 (see Steam-engines)
winding, 1163
- Entropy, definition of, 573
of water and steam, 576
of water and steam, tables, 839-843
temperature diagram, 574
- Epicycloid, 51
- Equalization of pipes, 596, 853
- Equation of payments, 14
of pipes, 853
- Equations, algebraic, 35-37
of circle, 72
of ellipse, 72
of hyperbola, 73
of parabola, 73
quadratic, 36
referred to co-ordinate axes, 7
- Equilibrium of forces, 492
- Equivalent orifice, mine ventilation, 686
- Equivalents, electro-chemical, 1381
- Erosion of soils by water, 705
- Euler's formula for long columns, 269
- Evaporation, 542-547
by exhaust steam, 545
by multiple system, 543
factors of, 874-878
in a vacuum, 546
in salt manufacture, 543
latent heat of, 542
of sugar solutions, 545
of water from reservoirs and channels, 543
total heat of, 542
unit of, 855
- Evaporator, for marine work, 1061
- Evolution, 8
- Exhauster, steam-jet, 651

- Exhaust-steam, evaporation by, 545
for heating, 981
- Expansion, adiabatic, formulæ for, 606
by heat, 538
coefficients of, 539
of air, adiabatic, tables, 609, 610
of cast iron, permanent by heating, 429
of gases, construction of curve of, 576
of gases, curve of, 74
of iron and steel, 441
of liquids, 540
of nickel steel, 474
of solids by heat, 539
of steam, 929
of steam, actual ratios of, 935
of timber, 345
of water, 687
- Explosions, dust, 807
- Explosive energy of steam-boilers, 902
- Exponents, theory of, 37
- Exponential function, differential of, 80, 81
- Eye bars, tests of, 338
- Factor of safety, 352-355
of safety, formulas for, 354
of safety in steam-boilers, 879
of evaporation, 874-878
- Factory heating by fan system, 681
- Fahrenheit-Centigrade conversion table, 524, 525
- Failures of stand-pipes, 328
of steel, 462
- Fairbairn's experiments on riveted joints, 401
- Falling bodies, graphic representation, 498
bodies, height and velocity of tables, 499, 500
bodies, laws of, 497
- Fans (*see also* Blowers)
and blowers, 623-653
and blowers, comparative efficiencies, 631
best proportions of, 627
blast-area of, 629
centrifugal, 621, 626
cupola, power required for, 1230
design of, 627
disk, 647-649
effect of resistance on capacity of, 636
efficiency of, 631, 641, 648
experiments on, 630, 631
for cupolas, 633
high-pressure, capacity of, 635
influence of speed on efficiency, 647
influence of spiral casings, 646
methods of testing, 639
- Fans, pipe lines for, 643
pressure due to velocity of, 627
quantity of air delivered by, 628
theory of efficiency of, 641
- Farad, definition and value of, 1345
- Fatigue, effect of, on iron, 441
resistance of steels, 447
- Feed and depth of cut, effect of, on speed of tools, 1241
- Feed-pump (*see* Pumps)
- Feed water, cold, strains caused by, 909
water heaters, 909-911
water heaters, transmission of heat in, 584
water heating, saving due to, 909
water, purification of, 694, 695
water to boilers by gravity, 908
- Feet and inches, decimal equivalents of, table, 5
- Fence wires, corrosion of, 444
- Ferrite, 416, 456
- Ferro-alloys for foundry use, 1232
silicon, addition of, to cast-iron, 426
silicon, dangerous, 1232
- Field, magnetic, 1346
- Fifth roots and powers of numbers, 110
- Fineness, coefficient of, 1317
- Finishing temperature, effect of, in steel rolling, 454
- Fink roof truss, 521
- Fire, temperature of, 785
- Fire-brick arches in locomotives, 1091
- Fire-brick, number required for various circles, table, 254
refractoriness of, 255
sizes and shapes of, 253
weight of, 253
- Fire-clay, analysis of, 255
pyrometer, 526, 529
- Fire-engines, capacities of, 725
- Fire-proof buildings, 1338
- Fire-streams, 722-725
discharge from nozzles at different pressures, 723
effect of increased hose length, 723
friction loss in hose, 725
pressure required for given length of, table, 723
- Fireless locomotive, 1103
- Fits, force and shrink, 1273
force and shrink, pressure required to start, 1275
limits of diameter for, 1274
press, pressure required for, 1274
running, 1274
stresses due to, 1275
- Fittings (*see* Pipe-fittings)
cast-iron pipe, sizes and weights, table, 196-197

- Flagging, strength of, 550
- Flanges, cast-iron, forms of, 202
forged and rolled steel, 200
forged steel, for riveted pipe, 214
for riveted pipe, 201
pipe, extra heavy, table, 199
pipe, standard, table, 198
- Flat plates in steam-boilers, 880, 885, 888
plates, strength of, 313
steel ropes, 248
surfaces in steam-boilers, 888
- Flanged fittings, cast-iron, 203
fittings, cast-steel, 204
- Flexure of beams, formula for, 282
and compression combined, 312
and tension combined, 312
and torsion combined, 312
- Flight conveyors, 1172
- Flights, sizes and weights of, 1174
- Floors, maximum load on, 1337, 1340
strength of, 1337-1340
- Flow of air in long pipes, 595
of air in pipes, 591
of air through orifices, 588, 642
of compressed air, 594
of gases, 579
of gas in pipes, 834-836
of gas in pipes, tables, 835
of metals, 1273
of steam at low pressure, 669
of steam, capacities of pipes, 847
of steam in long pipes, 847
of steam in pipes, 845
of steam, loss of pressure due to friction, 845
of steam, loss of pressure due to radiation, 849
of steam, Napier's rule, 844
of steam, resistance of bends, valves, etc., 848
of steam through a nozzle, 844, 1065
of steam through safety valves, 905
of steam, tables of, 669, 846, 847
of water, 697
of water, approximate formulæ, 720
of water, Chezy's formula, 699
of water, D'Arcy's formula, 704
of water, experiments and tables, 706-713
of water, exponential formula, 718
of water, fall per mile and slope, table, 700
of water, formulæ for, 697-706
of water in cast-iron pipe, 706
of water in house service pipes, table, 712
of water in pipes, 699
- Flow of water in pipes at uniform velocity, table, 710
of water in pipes, table from D'Arcy's formula, 709-711
of water in pipes, table from Kutter's formula, 707, 708.
of water in 20-in. pipe, 706
of water in riveted steel pipes, 714
of water, Kutter's formula, 701
of water over weirs, 697, 731
of water through nozzles, table, 713
of water through orifices, 697
of water through rectangular orifices, 729
of water, \sqrt{r} for pipes and conduits, table, 701
of water, values of c , 703
of water, values of coefficient of friction, 715
- Flowing water, horse-power of, 734
water, measurement of, 727-733
- Flues, collapsing pressure of, 318
corrugated, British rules, 318, 881
corrugated, U. S. rules, 886
(*see also* Tubes and Boilers)
- Flux, magnetic, 1348
- Fly-wheels, centrifugal force in, 1029
diameters for various speeds, 1030
steam-engine, 1026-1034 (*see* Steam-engines)
wire-wound, for extreme speeds, 1034
weight of, for alternating current units, 1028
- Foaming or priming of steam-boilers, 692, 899
- Foot-pound, unit of work, 503
- Force, centrifugal, 497
definitions of, 488
graphic representation of, 489
moment of, 490
of a blow, 504
of acceleration, 501
of wind, 597
units of, 488
- Forces, composition of, 489
equilibrium of, 492
parallel, 491
parallelogram of, 489
parallelepipedon of, 490
polygon of, 489
resolution of, 489
work, power, etc., 503
- Forced draught in steam-boilers, 894
- Forcing and shrinking fits, 1273
(*see* Fits)
- Forging and grinding of tools, 1240
heating of steel for, 468
hydraulic, 782
of tool steel, 464, 468, 1240

- Forgings, steel, annealing of, 458
strength of, 331
Forging-press, hydraulic, 782
Foundation walls, thickness of, 1334
Foundations of buildings, 1333
masonry, allowable pressures on, 1334
Foundry coke, quality of, 1232
irons (see Pig iron and Cast iron)
ladles, dimensions of, 1234
molding-sand, 1233
practice, 1224-1234
practice, shrinkage of castings, 1231
practice, use of softeners, 1230
use of ferro alloys in, 1232
Fractions, 2
product of, in decimals, 4
Frames, steam-engine, 1025
Framed structures, stresses in, 515-522
Framing, for tanks with flat sides, 316
Francis's formulæ for weirs, 731
Freezing point of water, 690
French measures and weights, 22-27
thermal unit, 532
Frequency of alternating currents, 1387
standard, in electric currents, 1399
Friction and lubrication, 1194-1223
brakes and friction clutches, 1216
brakes, capacity of, 1281
clutches, 1155
coefficient of, definition, 1194
coefficient of, in water-pipes, 715
coefficient of, tables, 1195-1197
drives, power transmitted by, 1154
fluid, laws of, 1196
laws of, of lubricated journals, 1201
loss of head by, in water-pipes, 716
moment of, 1205
Morin's laws of, 1200
of car journals, 1204
of hydraulic packing, 780, 1217
of lubricated journals, 1199-1209
of air in mine passages, 685
of metals, under steam pressure, 1200
of motion, 1194, 1197
of pivot bearings, 1205, 1209
of rest, 1195
of solids, 1195
of steam-engines, 1215
of steel tires on rails, 1195
rollers, 1210
rolling, 1195
unlubricated, law of, 1195
work of, 1205
Frictional gearing, 1154
heads, flow of water, 716
Frustum of cone, 63
of parabolic conoid, 66
of pyramid, 63
of spheroid, 65
of spindle, 66
Fuel, 784-827
bagasse, 809
charcoal, 805-807 (see Charcoal)
coke, 801-804 (see Coke)
combustion of, 784
dust, 807
economizers, 894
for cupolas, 1225, 1232
gas, 814 (see Gas)
gas, for small furnaces, 824
heat of combustion of, 533, 784
liquid, 810-814
peat, 808
pressed, 801
sawdust, 808
solid, classification of, 786
straw, 808
theory of combustion of, 784
turf, 808
weight of, 177
wet tan bark, 808
wood, 804, 805
Functions, of sun and difference of angles, 69
of twice an angle, 70
trigonometric, tables of, 166, 169
trigonometric, of half an angle, 70
Furnace flues, steam-boiler, formulæ for, 881
Furnace for melting iron for malleable castings, 430
heating (see Heating)
Furnaces, blast, gases of, 825
blast, temperature in, 528
corrugated, 319
down draught, 890
electric, 1376
for different coals, 798
for house heating, 664
gas, fuel for, 824
hot-air, heating of, 661
industrial, temperatures, in, 527
open hearth, temperature in, 528
steam-boiler (see Boiler-furnaces)
Fusibility of metals, 175-177
Fusible alloys, 380
plugs in boilers, 379, 889
Fusing temperatures of substances, 527, 532
Fusing-disk, 1262
Fusion, latent heat of, 541
of electrical wires, 1355
g, value of, 498
Gallon, British and American, 28
Gallons and cubic feet, table, 129
per minute, cubic feet per second, 129
Galvanic action, corrosion by, 443
Galvanized wire rope, 247
wire, test for, 450

- Galvanizing by cementation, 450
iron surfaces, 449, 450
Gas (see also Fuel-gas, Water-gas, Producer gas, Illuminating gas)
ammonia, 1285-1289
analyses by volume and weight, 824
and oil engines, rules for testing, 1081
and vapor mixtures, laws of, 578
anthracite, 815
bituminous, 816
carbon, 814
coal, 828
flow of, in pipes, 834-836 (see Flow of gas)
flow of, in long pipes, 596
fuel (see also Water-gas)
fuel, cost of, 833
fuel for small furnaces, 824
illuminating, 828-834 (see Illuminating-gas)
natural, 817, 818
perfect, equations of a, 574
producer, 818
producer, combustion of, 819
producer, from ton of coal, 818
sulphur-dioxide, 1285
water, 817, 829-833 (see Water-gas)
Gases, absorption of, by liquids, 579
Avogadro's law of, 578
combustion of, rise of temperature in, 786
cupola, utilization of, 1230
densities of, 578
expansion of, 575, 577
expansion of by heat, table, 538
flow of, 579
heat of combustion of, 533
law of Charles, 574, 578
liquefaction of, 579
Mariotte's law of, 577
of combustion, analyses of, 785
physical properties of, 577-580
specific heats of, 535, 537
waste, use of, under boilers, 865, 866
weight and specific gravity of, table, 173
Gas-engine, economical performance of, 1080
heat losses in, 1080
tests with different coals, 823
Gas-engines, 1071-1084
calculation of the power of, 1073
conditions of maximum efficiency, 1079
efficiency of, 1079
four-cycle and two-cycle, 1072
governing, 1079
horse-power, estimate of, 1077
ignition, 1078
mean effective pressure in, 1076
pressures developed in, 1072
Gas-engines, sizes of, 1076
temperatures and pressures in, 1072, 1074
tests of, 1081-1084
Gas-exhausters, rotary, 651
Gas-producer practice, 821
Gas-producers and scrubbers, proportions of, 819
use of steam in, 824
Gasoline engines, 1077
vapor pressures of, 814
Gauge, decimal, 33
sheet metal, 29, 31-33
Stub's wire, 29, 30
wire, 29-31
Gauges, limit, for iron for screw threads, 223
Gauss, definition and value of, 1346, 1348
Gear, reduction, for steam turbines, 1071
reversing, 1020
wheels, calculation of speed of, 1137
wheels, formulæ for dimensions, 1135, 1136
wheels, milling cutters for, 1138
wheels, proportions of, 1137
worm, 514
Gears, automobile, efficiency of, 1148
lathe, for screw cutting, 1236
of lathes, quick change, 1237
Gears, spur, machine-cut, 1153
with short teeth, 1135
Gearing, annular, 1145
bevel, 1144
chordal pitch, 1135
comparison of formulæ, 1150-1153
cycloidal teeth, 1138
differential, 1145
efficiency of, 1146-1148
forms of teeth, 1138-1145
formulæ for dimensions of, 1135, 1136
frictional, 1154
involute teeth, 1140
pitch, pitch-circle, etc., 1133
pitch diameters for 1-inch circular pitch, 1135
proportions of teeth, 1135, 1136
racks, 1141
raw-hide, 1153
relation of diametral and circular pitch, 1134
speed of, 1153
spiral, 1143
stepped, 1143
strength of, 1148-1156
toothed-wheel, 514, 1133-1153
twisted, 1143
worm, 1143
worm, efficiency of, 1147
Generator sets, standard dimensions of, 979

- Generators, alternating current, 1396 (see Dynamo electric machines)
electric, 1385, 1412
- Geometrical problems, 38-54
progression, 11
propositions, 54
- Geometry, analytical, 71
- German silver, 334, 378
conductivity of, 1350
- Gesner process, treating iron surfaces, 449
- Gilbert, unit of magneto-motive force, 1348
- Girders, allowed stresses in plate and lattice, 274
and beams, safe load on, 1334
building, New York building laws, 1338
iron-plate, strength of, 331
steam-boiler, rules for, 882
Warren, stresses in, 520
- Glass, skylight, sizes and weights, 190
strength of, 343
weight of, 174
- Gordon's formula for columns, 270
- Gold, melting temperature of, 527
properties of, 175
- Governing of gas-engines, 1079
- Governor, inertia, 1048
- Governors, steam-engine, 1047-1050
- Grade line, hydraulic, 721
- Grain, weight of, 178
- Granite, strength of, 335, 348
- Graphite, Acheson's deflocculated, 1223
lubricant, 1223
paint, 447
- Grate surface, for house heating, boilers and furnaces, 665
surface in locomotives, 1091
surface of a steam-boiler, 857
- Gravel, cubic feet per ton, 178
- Gravity, acceleration due to, 497
boiler-feeders, 908
center of, 492
specific (see Specific gravity), 170-174
- Grease lubricants, 1221
- Greatest common measure or divisor, 2
- Greek letters, 1
- Greenhouses, hot-water, heating of, 674
steam-heating of, 673
- Grinding of tools, 1240, 1241
wheel for high-speed tools, 1240, 1267
wheels (see Grindstones and Emery wheels)
wheels, speeds of, 1264
- Grindstones, speed of, 1267
strains in, 1267
varieties of, 1268
- Guest's formula for combined stresses, 312
- Gun-bronze, variation in strength of, 362
- Gun-iron, variation in strength of, 428
- Gun-metal (bronze), composition of, 366
- Guns, energy of recoil of, 506
- Gurley's bronze, composition of, 366
- Guy ropes, wire, 247
for stand-pipes, 327
- Guy-wires, table of weights, and strength, 249
- Gyration, center of, 494
radius of, 279
table of radii of, 495
- H-columns, Bethlehem steel, 509, 310
- Halpin heat storage system, 897, 987
- Hammering, effect of, on steel, 464
- Hardening of steel, 455
- Hardness of copper-tin alloys, 361
of metals, Brinell's tests, 342
electro-magnetic tests of, 343
scleroscope tests, 343
of water, 694
- Harvey process of hardening steel, 1246
- Haulage, wire-rope, 1177-1181
wire-rope, endless rope system, 1178
wire-rope, engine-plane, 1178
wire-rope, inclined-plane, 1177
wire-rope, tail-rope system, 1178
wire-rope tramway, 1179
- Hauling capacity of locomotives, 1087
- Hawley down-draught furnace, 890
- Hawsers, flexible steel wire, 249
steel, table of sizes and strength, 249
steel, weight of, 249
- Head, frictional, in cast-iron pipe, table, 719
loss of, 714-722 (see Loss of head)
of air, due to temperature differences, 687
of water, 690
of water, comparison of, with various units, 689
- Heads of boilers, 885
of boilers, unbraced, wrought-iron, strength of, 314
- Heat, 523-577
conducting power of metals, 553
conduction by various substances, 554-561
conduction of, 553
convection of, 553
effect of on grain of steel, 456
expansion due to, 538
generated by electric current, 1354

- Heat, latent, 541 (see Latent heat)
loss by convection, 570
losses in steam power plants, 985
mechanical equivalent of, 532, 837
of combustion, 533
of combustion of fuels, 533, 784
quantitative measurement of, 532
radiating power of substances, 552
radiation of, 551 (see also Radiation)
reflecting power of substances, 552
resistance, coefficients of, 556
resistance, reciprocal of conductivity, 555
specific, 534-538 (see Specific heat)
steam, storing of, 897, 987
storage, Halpin system, 897, 987
transmission, Blechynden's tests of, 567
transmission from flame to water, 567
transmission from gases to water, 566
transmission from steam to water, 561, 652
transmission, in condenser tubes, 563
transmission in feed water heater, 564
transmission in radiators, 669
transmission, resistance of metals, 553
transmission through building walls, etc., 557, 659
transmission through plates, 553, 567
transmission through plates from steam or hot water to air, 569
treatment of steel (see Steel)
treatment of high speed tool steel, 1242
unit of, 532, 837
units per pound of water, 688
- Heaters and condensers, calculation of surface of, 910
cast iron, for hot-blast heating, 680
cast iron, tests of, 680
electric, 1375
feed-water, 909-911
feed-water, open type, 911
feed-water, transmission of heat in, 564
- Heating a building to 70°, 683
- Heating and Ventilation, 653-687
allowance for exposure and leakage, 660
blower system, 678-681
boiler heating surface, 667
computation of radiating surface, 669
heating surface, indirect, 669
- Heating and Ventilation, heating value of radiators, 656, 668
hot-water heating, 674-678 (see Hot-water heating)
overhead steam pipes, 673
steam-heating, 665-674 (see Steam-heating)
transmission of heat through building walls, 659
- Heating air, heat absorbed in, 662
- Heating, blower system, capacity of fans for, 682
by electricity, 684
by exhaust steam, 981
by hot-air furnaces, 661
by hot water, 675 (see Hot-water heating)
by steam (see Steam-heating)
furnace, size of air pipes for, 663
furnace, with forced air supply, 664
guarantees, performance of, 683
of electrical conductors, 1354
of factories by blower system, 681
of greenhouses, 673
of large buildings, 656
of steel for forging, 468
of tool steel, 467
value of coals, 797, 798
value of wood, 804
water by steam coils, 565
- Heating-surface of steam boiler, 855, 856
- Heat-insulating materials, tests of, 555
- Height, table of, corresponding to a given velocity, 499
- Helical steel springs, 395
- Helix, 62
- Hemp rope, table of strength and weight of, 386, 387
rope strength of, 335
- Henry, definition and value of, 1345
- High speed tool steel (see Steel, and Tools)
- Hindley worm gear, 1144
- Hobson's hot-blast pyrometer, 528
- Hodgkinson's formula for columns, 269
- Hoisting by hydraulic pressure, 781
counterpoise system, 1164
cranes, 1165 (see Cranes)
effect of slack rope, 1162
endless rope system, 1165
engines, 1163
engines, compressed-air, 618
engines, counterbalancing of, 1163
horse-power required for, 1162
Koepe system, 1165
limit of depth for, 1162
loaded wagon system, 1164
of cargoes, 390
pneumatic, 1163

- Hoisting rope, 386
 rope, iron or steel, dimensions, strength, and properties, table, 244
 ropes, sizes and strength of, 390, 906
 ropes, stresses in, on inclined planes, 1179
 rope, tension required to prevent slipping, 1182
 suspension cable ways, 1181
 tapering ropes, 1164
- Holding power of bolts in white pine, 324
 power of expanded boiler tubes, 342
 power of lag-screws, 324
 power of nails in wood, 324
 power of nails, spikes and screws, 323
 power of tubes expanded into sheets, 342
 power of wood screws, 324
- Hollow cylinders, resistance of to collapse, 318-322
 shafts, torsional strength of, 311
- Homogeneity test for fire-box steel, 484
- Hooks and shackles, strength of, 1161
 heavy crane, 1159
 proportions of, 1159
- Horse-gin, 509
 Horse, work of, 508
 Horse-power, brake, definition of, 991
 computed from torque, 1386
 constants, of steam-engines, 941-944
 cost of, 735
 definition of, 28, 503
 electrical, 940, 1353
 electrical, table of, 1364
 hours, definition of, 503
 nominal, definition of, 944
 of fans, 630
 of flowing water, 734
 of marine and locomotive boilers, 857
 of steam-boilers, 854
 of steam-boilers, builders' rating, 857
 of steam-engines, 940-946
- Hose couplings, national standard, 207
 fire, friction losses in, 725
 hydrant pressures required with different lengths of, 723
 rubber-lined, friction loss in, 725
- Hot-air engines, 1071
 Hot-air heating (*see* Heating)
- Hot-blast pyrometer, Hobson's, 528
 system of heating, 680 (*see* Heating)
- Hot boxes, 1205
- Hot-water heating, 674-678
 heating, arrangement of mains, 674
 heating, computation of radiating surface, 675, 677
 heating, indirect, 676
 heating of greenhouses, 674
 heating, rules for, 674
 heating, size of pipes for, 675
 heating, sizes of flow and return pipes, 678
 heating, velocity of flow, 674
 heating with forced circulation, 678
- House-heating (*see* Heating)
- House-service pipes, flow of water in, table, 712
- Howe truss, stresses in, 520
- Humidity, relative, table of, 551, 583
- Hyatt roller bearings, 1211
- Hydraesfer process, treating iron surfaces, 449
- Hydrant pressures required with different lengths of hose, 723
- Hydraulic air compressor, 622
 apparatus, efficiency of, 780
 cylinders, thickness of, 780
 engine, 783
 forging, 782
 formulae, 697-706
 formulae, approximate, 720
 grade-line, 721
 packing, friction of, 780
 pipe, table, 212
 power in London, 781
 press, thickness of cylinders for, 317
 presses in iron works, 781
 pressure, hoisting by, 781
 pressure, transmission, 779-783
 pressure transmission, energy of, 779, 780
 pressure transmission, speed of water through pipes and valves, 781
 ram, 778, 779
 riveting machines, 782
- Hydraulics (*see* Flow of water)
- Hydrometer, 172
 dry and wet bulb, 583
- Hyperbola, asymptotes of, 74
 construction of, 50
 curve on indicator diagrams, 944
 equations of, 73
- Hyperbolic logarithms, tables of, 163-165
- Hypocycloid, 51
- I-beams (*see also* Beams)
 Carnegie, table of, 288
 safe loads on, 290
 spacing of, for uniform load, 291
- Ice, properties of, 691
 strength of, 344

- Ice-making, absorption evaporator system, 1316
 making machines, 1282-1316 (*see* Refrigerating machines)
 making plant, test of, 1315
 making, tons of ice per ton of coal, 1316
 making with exhaust steam, 1316
 manufacture, 1314 (*see* Refrigerating machines)
 melting effect, 1291
- Ignition in gas engines, 1078
- Illuminating-gas, 828-834
 calorific equivalents of constituents, 830
 coal-gas, 828
 fuel value of, 833
 space required for plants, 832
 water-gas, 829
- Illumination, 1367
 by arc lamps at different distances, 1368
 of buildings, watts per square foot required for, 1369
 relation of, to vision, 1368
- Illuminants, relative color values of, 1367
- Impact, 505
- Impedance, 1389
 polygons, 1390
- Impulse water wheels, 749 (*see* Water wheel, tangential)
- Impurities of water, 691
- Incandescent lamp, 1370
 lamps (*see* Lamps)
- Inches and fractions as decimals of a foot, table, 5
- Inclined-plane, 512
 motion on, 502
 stresses in hoisting ropes on, 1179
 wire-rope haulage, 1177
- Incrustation and scale, 691, 692
- India rubber, action under tension, 356
 vulcanized, tests of, 356
- Indicated horse-power, 940-946
- Indicator diagrams, analysis of, 992
 rig, 939
 tests of locomotives, 1098
- Indicators, steam-engine, 938-946
 (*see* Steam-engines)
 steam-engine, errors of, 939
- Indirect heating radiators, 669
- Inductance, 1389
 of lines and circuits, 1393
- Induction, magnetic, 1348
 motor applications, 1410
 motors, 1409
- Inertia, definition of, 488
 moment of, 279, 493
- Ingots, steel, segregation in, 462
- Injector, 776
 efficiency of, 907
 equation of, 906
- Inoxidizable surfaces, production of, 448
- Inspection of steam-boilers, 901
- Insulation, underwriters', 1355
- Insulators, electrical value of, 1350
 heat, 555
- Intensity of magnetization, 1346
- Integrals, 76
 table of, 81, 82
- Integration, 77
- Intercoolers for air compressors, 620
- Interest, 12
 compound, 13
- Interpolation, formula for, 87
- Invar, iron-nickel alloy, 475, 540
- Involute, 53
 gear-teeth, 1140
 gear-teeth, approximation of, 1142
- Involution, 7
- Iron and steel, 175, 413-484
 and steel, classification of, 413
 and steel, effect of cold on strength of, 440
 and steel, inoxidizable surface for, 448
 and steel, Pennsylvania Railroad specification for, 438
 and steel, preservative coatings for, 447-450
 and steel, relative corrosion of, 444
 and steel, rustless coatings for, 447-450
 and steel sheets, weight of, 181
 and steel, specific heat of, 535, 536
 and steel, tensile strength at high temperatures, 439
- Iron bars (*see* Bars)
 bars, weight of square and round, 180
 bridges, durability of, 442
 cast, 414-429 (*see* Cast-iron)
 coefficients of expansion of, 441
 color of, at various temperatures, 531
 copper-zinc alloys, 369
 corrosion of, 443
 corrugated, sizes and weights, 186
 durability of, 441-442
 flat-rolled, weight of, 182, 183
 for bolts, variation in size of, 223
 for stay-bolts, 438
 latent heat of fusion of, 541
 malleable, 429 (*see* Malleable iron)
 pig (*see* Pig-iron and Cast-iron)
 plates, approximating weight of, 461
 plate, weight of, table, 184
 properties of, 175
 rivets, shearing resistance of, 407
 rope, flat, table of strength of, 387
 rope, table of strength of, 386
 shearing strength of, 310
 sheets, weights of, 33, 181

- Iron tubes, collapsing pressure of, 318
silicon-aluminum alloys, 374
wrought, 435-439 (see Wrought iron)
- Iridium, properties of, 175
- Irregular figure, area of, 57, 58
solid, volume of, 66
- Irrigation canals, 704
- Isothermal compression of air, 604
expansion, 575
expansion of steam, 929
- Japanese alloys, composition of, 368
- Jarno tapers, 1271
- Jet condensers, 1050
propulsion of ships, 1333
reaction of a, 1333
- Jets, vertical water, 722
- Joints, riveted, 401-412 (see Riveted joints)
- Joists, contents of, 21
- Joule, definition and value of, 1345
- Joule's equivalent, 533
- Journals (see also Shafts, and Bearings)
coefficients of friction of, 1197
- Journal-bearings, cast-iron, 1199
friction of, 1199-1209
of engines, 1015
- Kaolin, melting point of, 529
- Kelvin's rule for electric transmission, 1360
- Kerosene for scale in boilers, 899
- Keys, dimensions of, 1276
for machine tools, 1277
for shafting, sizes of, 1277
holding power of, 1278
sizes of, for mill-gearing, 1276
- Keyways for milling cutters, 1248
- Kinetic energy, 503
- King-post truss, stresses in, 517
- Kirkaldy's test on strength of materials, 330-336
- Knife-edge bearings, 1214
- Knot, or nautical mile, 17
- Knots, 391-392
- Koepe's system of hoisting, 1165
- Krupp steel tires and axles, 332
- Kutter's formula, flow of water, 701
formula, table from, of flow of water in pipes, 707, 708
- Lacing of belts, 1124
- Ladles, foundry, sizes of, 1234
- Lag screws, 234
holding power of, 324
- Lamp, mercury vapor, 1369
- Lamps, arc, 1368
arc, data of, 1369
arc, illumination by, at different distances, 1368
incandescent, characteristics of, 1371
- Lamps, incandescent electric, 1370
incandescent, rating of, 1370
incandescent, variation in candle-power, efficiency and life, 1371
life of, 1370-1376
Nernst, 1372
specifications for, 1372
tantalum and tungsten, 1372
- Land measure, 17
- Lang lay rope, 246
- Lap and lead in slide valves, 1034-1036
- Lap-joints, riveted, 406
- Latent heat of ammonia, 1235
heat of evaporation, 542
heat of fusion of various substances, 541
heat of fusion of iron, 541
- Lathe, change-gears for, 1237
cutting speed of, 1235
horse-power to run, 1257-1260
rules for screw-cutting gears, 1236
setting taper in, 1238
tools, forms of, 1238
- Lattice girders, allowed stresses in, 274
- Laws of falling bodies, 497
of motion, 488
- Lead and tin tubing, 217, 218
coatings on iron surfaces, 450
effect of, on copper alloys, 369
pipe, tin-lined, sizes and weights, table, 217
pipe, weights and sizes of, table, 217
properties of, 175
sheet, weight of, 218
waste-pipe, weights and sizes of, 218
- Lead-lined iron pipe, 218
- Leakage of steam in engines, 946
- Least common multiple, 2
- Leather, strength of, 335
- Le Chatelier's pyrometer, 526
- Lentz compound engine, 968
- Leveling by barometer, 582
by boiling water, 582
- Lever, 510
bent, 511
- Lighting, electric, 1367
electric, cost of, 1373
- Lightning protection of chimneys, 920
- Lignites, analysis of, 796
- Lime and cement mortar, strength of, 350
weight of, 178
- Limestone, strength of, 349
- Limit, elastic, 259-262
gages for screw-thread iron, 223
- Lines of force, 1382
- Links, steel bridge, strength of, 331
steam-engine, size of, 1020
- Link-beltting, sizes and weights, 1174

- Link-motion, locomotive, 1095
steam-engine, 1044-1046
- Lintels in buildings, 1338
- Liquation of metals in alloys, 364
- Liquefaction of gases, 579
- Liquid air, 579
measure, 18
- Liquids, absorption of gases by, 579
compressibility of, 172
expansion of, 540
specific gravity of, 172
specific heats of, 535
- Loading and storing machinery, 1169
- Locomotive boilers, size of, 1089
crank-pin, quantity of oil used on, 1223
cylinders, 1088
electric, 4000 H.P., 1366
engine performance, 1099
forgings, strength of, 331
link-motion, 1095
testing, 1099
- Locomotives, 1084-1105
boiler pressure, 1093
classification of, 1092
compounding of, 1101
compressed-air, 1104
compressed-air, with compound cylinders, 1105
counterbalancing of, 1102
dimensions of, 1096-1098
drivers, sizes of, 1094
economy of high pressures in, 1092
effect of speed on cylinder pressure, 1093
efficiency of, 1087
exhaust-nozzles, 1091
fire-brick arches in, 1091
fireless, 1103
fuel efficiency of, 1095
fuel waste of, 1101
grate surface of, 1091
hauling capacity of, 1087
horse-power of, 1089
indicator tests of, 1098
light, 1103
leading types of, 1092
Mallet compound, 1096
narrow gauge, 1103
performance of high speed, 1094
petroleum burning, 1103
smoke-stacks, 1091
speed of, 1094
steam distribution of, 1093
steam-ports, size of, 1094
superheating in, 1102
tractive power of, 1088, 1101
types of, 1092
valve travel, 1094
water consumption of, 1098
weight of, 1100
- Wooten, 1090
- Logarithmic curve, 74
- ruled paper, 85
sines, etc., table, 169
- Logarithms, 80
hyperbolic, tables of, 163-165
tables of, 136-163
use of, 134-136
- Logs, area of water required to store, 254
weight of, 254
- Loop, steam, 852.
- Loops of force, 1382
- Long measure, 17
- Loss and profit, 12
of head, 714-722
of head, Cox's formula, 717
of head in cast-iron pipe, tables, 719
of head in riveted steel pipes, 714
- Lowmoor iron bars, strength of, 230
- Lubricant water as a, 1222
- Lubricants, examination of, 1219
grease, 1221
measurement of durability, 1218
oil, specifications for, 1219
qualifications of good, 1219
relative value of, 1219
soda mixture, 1223
solid, 1223
specifications for petroleum, 1219
- Lubrication, 1218-1223
of engines, quantity of oil needed for, 1221
of steam-engine cylinders, 1222
- Lumber, weight of, 254
- Lumen, definition of, 1367
- "Lusitania," turbines and boilers of, 1330
performance of, 1330
- Lux, definition of, 1367
- Machine screws, A.S.M.E. standard, table, 226
screws, taps for, 1269
shop, 1235-1279
shop, electric drive in, 1407
shops, horse-power required in, 1256-1262
- Machines, dynamo-electric (see Dynamo-electric machines)
- light, 1103
- Machine tools, electric motors for, 1260, 1407
tools, keys for, 1277
tools, power required for, 1256-1260
tools, proportioning a series of sizes of, 1276
tools, soda mixture for, 1222
tools, speed of, 1235
- Machines, efficiency of, 507
elements of, 510-515
- Machinery, coal-handling, 1172-1177
horse-power required to run, 1256-1262
- Maclaurin's theorem, 79
- Magnalium, magnesium-aluminum alloy, 376
- Magnesia bricks, 257
- Magnesium, properties of, 176

- Magnet, use of, to determine hardening temperature of steel, 1246
 magnets, electro-, 1384
 lifting, 1169
 Magnetic alloys of non-magnetic metals, 378
 balance, 459
 brakes, 1217
 capacity of iron, effect of annealing on, 459
 circuit, 1382
 circuit, units of, 1348
 field, 1346
 flux, strength of, 1387
 flux, magnetic induction, 1348
 moment, 1346
 pole, unit of, definition, 1346
 Magnetization, intensity of, 1346
 Magneto-motive force, 1348, 1383
 Magnolia metal, composition of, 381
 Mahler's calorimeter, 798
 Malleability of metals, table, 177
 Malleable castings, annealing, 431
 castings, design of, 433
 castings, pig iron for, 430
 castings, rules for use of, 433
 castings, tests of, 435
 iron, 429
 iron, composition and strength of, 430
 iron, improvement in quality, 434
 iron, physical characteristics, 432
 iron, shrinkage of, 431
 iron, specifications, 433
 iron, strength of, 430, 434
 iron test bars, 432
 Mandrels, standard steel, 1272
 Manganese bronze, 377
 -copper alloys, 376
 effect of, on cast-iron, 415, 426
 effect of, on steel, 452
 properties of, 176
 steel, 470
 Manila rope, 386
 rope, weight and strength of, 391
 Manograph, a high-speed engine-indicator, 939
 Manometer, air, 581
 Man-wheel, 508
 Man, work of, tables, 507, 508
 Marble, strength of, 335
 Marine engine, internal combustion, 1322
 engineering, 1316-1333 (*see* Ships and Steam-engines)
 practice, 1329
 Mariotte's law of gases, 577
 Martensite, 416, 456
 Masonry, allowable pressures on, 1334
 crushing strength of, 349
 materials, weight and specific gravity of, 174
 Mass, definition of, 487, 501
 = weight + *g*, 503
 Materials, 170-257
 strength of, 258-359
 strength of, Kirkaldy's tests, 330-336
 various, weights of, table, 178
 Maxima and minima, 79, 80
 Maxwell, definition and value of, 1348
 Measure and weights, compound units, 27, 28
 and weights, metric system, 22-27
 Measures, apothecaries, 18, 20
 board and timber, 20
 circular, 20
 dry, 19
 liquid, 18
 long, 17
 nautical, 17
 of work, power and duty, 28
 old land, 17
 shipping, 19
 solid or cubic, 18
 square, 18
 surface, 18
 time, 20
 Measurement of vessels, 1316
 of air velocity, 596
 of elongation, 265
 of flowing water, 727-733
 Measurements, miner's inch, 730
 Mechanics, 487-522
 Mechanical and electrical units, equivalent values of, 1347
 equivalent of heat, 532, 837
 powers, 510
 stokers, 889
 Mekarski compressed-air tramway, 624
 Melting points of substances, 532
 temperatures, 527
 Mensuration, 55-67
 Mercury, properties of, 176
 vapor lamp, 1369
 Mercury-bath pivot, 1209
 Mercurial thermometer, 523
 Mesuré and Nouel's pyrometric telescope, 529
 Metacenter, definition of, 690
 Metals, anti-friction, 1179
 coefficients of expansion of, 539
 coefficients of friction of, 1196
 electrical conductivity of, 1349
 flow of, 1273
 heat-conducting power of, 553
 life of under shocks, 262
 properties of, 174-177
 resistance overcome in cutting of, 1256
 specific gravity of, 171
 specific heats of, 535, 536
 table of ductility, infusibility, malleability and tenacity, 177
 tenacity of at various temperatures, 439
 weight of, 171

- Metaline lubricant, 1223
 Metallography, 456
 Meter, Venturi, 728
 Meters, water delivered through, 722
 Metric conversion tables, 23-27
 measures and weights, 22-27
 screw-threads, cutting of, 1238
 Microscopic constituents of cast-iron and steel, 416, 456
 Mil, circular, 18, 30, 31
 Mill buildings, approximate cost of, 1342
 columns, 1341
 power, 735
 Milling cutters, for gear-wheels, 1138
 cutters, helical, tests with, 1251
 cutters, inserted teeth, 1248
 cutters, keyways in, 1248
 cutters, lubricant for, 1252
 cutters, number of teeth in, 1248
 cutters, pitch of teeth, 1247
 cutters, side, 1248
 cutters, spiral, 1248
 cutters, steel for, 1247
 machines, cutting speed of, 1249
 machines, feed of, 1249
 machines, high results with, 1250
 machines, typical jobs on, 1251
 machines vs. planer, 1252
 power required for, 1249
 practice, modern, 1252
 Mine fans, experiments on, 645
 ventilation, 685
 Mines, centrifugal fans for, 644
 Mine-ventilating fans, 645
 Miner's inch, 18
 inch measurements, 730
 Modulus of elasticity, 260
 of elasticity of various materials, 351
 of resistance or section modulus, 280
 of rupture, 282
 Moisture in atmosphere, 583
 in steam, determination of, 912-915
 Molding-sand, 1233
 Molds, cast-iron, for iron castings, analysis of, 1233
 Moment of a couple, 491
 of a force, 490
 of friction, 1205
 of inertia, 279, 493
 statical, 490
 Moments, method of, for determining stresses, 519
 of inertia of regular solids, 493
 of inertia of structural shapes, 279
 Momentum, 502
 Mond gas producer, 822
 Monel metal, copper-nickel alloy, 379
 Monobar, chain conveyor, 1173
 Morin's laws of friction, 1200
 Morse tapers, 1271
 Mortar, strength of, 350
 Motion, accelerated, formulæ for, 501
 friction of, 1194, 1197
 Newton's laws of, 488
 on inclined planes, 502
 perpetual, 507
 retarded, 497
 Motor boats, power of engines for, 1322
 Motors, alternating-current, 1408
 compressed-air, 612
 electric (*see* Electric motors)
 electric, classification of, 1401
 for electric railways, 1366
 water current, 734
 Moving strut, 511
 Mule, work of, 509
 Multiphase electric currents, 1395
 Multiple system of evaporation, 543
 Multivane fans, 636
 Muntz metal, composition of, 366
 Mushet steel, 472
 Nails, cut, table of sizes and weights, 234
 cut vs. wire, 324
 holding power of, 323
 wire, table of sizes and weights, 235, 236
 Nail-holding power of wood, 324
 Naphtha engines, 1071
 Napier's rule for flow of steam, 844
 Natural gas, 817, 818
 Nautical measure, 17
 mile, 17
 Nernst electric lamps, 1372
 Newton's laws of motion, 488
 Nickel-copper alloys, 378
 Nickel, effect of on properties of steel, 473
 properties of, 176, 357
 steel, 472
 steel, tests of, 472
 steel, uses of, 474
 -vanadium steels, 475
 Niter process, treating iron surfaces, 449
 Nordberg feed-water heating system, 974
 Nozzles, flow of steam through, 844, 1065
 flow of water in, 713
 for measuring discharge of pumping engines, 728
 water, efficiency of, 753
 Nut and bolt heads, thickness of, 222
 Oats, weight of, 178
 Ocean waves, power of, 755
 Oersted, unit of magnetic reluctance, 1348

- Ohm, definition and value of, 1345
 Ohm's law, 1352
 law applied to alternating currents, 1390
 law applied to parallel circuits, 1352
 law applied to series circuits, 1352
 Oil as fuel, 812
 fire-test of, 1220
 for steam turbines, 1221
 lubricating 1218-1223 (see Lubricants)
 paraffine, 1220
 pressure in a bearing, 1204
 quantity needed for engines, 1221
 vs. coal as fuel, 812
 well, 1220
 -engines, 1077
 tempering of steel forgings, 458
 Open-hearth furnace, temperatures in, 527
 steel (see Steel, open-hearth), 451
 Ordinates and abscissas, 71
 Ores, cubic feet per ton, 178
 Orifice, equivalent, in mine ventilation, 686
 flow of air through, 588
 flow of water through, 697
 rectangular, flow of water through, table, 729
 Oscillation, center of, 494
 radius of, 494
 Overhead steam-pipe radiators, 673
 Ox, work of, 509
 Oxy-acetylene welding, 464
 Oxygen, effect of on strength of steel, 453

 z. value and relations of, 58
 Packing, hydraulic, friction of, 1217
 Packing-rings of engines, 1000
 Paddle-wheels, 1331
 Paint, 447
 qualities of, 448
 quantity of, for a given surface, 448
 Paper, logarithmic ruled, 85
 Parabola, area of by calculus, 77
 construction of, 49, 50
 equations of, 73
 path of a projectile, 501
 Parabolic conoid, 66
 spindle, 66
 Parallel forces, 491
 Parallelogram area of, 55
 of forces, 489
 of velocities, 499
 Parallelepipedon of forces, 490
 Parentheses in algebra, 35
 Partial payments, 14
 Parting and threading tools, speed of, 1243
 Patterns, weight of, for castings, 1233
 Payments, equation of, 14
 Pearlite, 416, 456
 Peat, 808
 Pelton water-wheel, 748
 Pendulum, 496
 conical, 496
 Percentage, 12
 Percussion, center of, 494
 Perforated plates, strength of, 402
 Permeability, magnetic, 1348, 1383
 Permeance, magnetic, 1348
 Permutation, 10
 Perpetual motion, 507
 Petroleum as a metallurgical fuel, 813
 cost of as fuel, 812
 engines, 1077
 Lima, 810
 products of distillation of, 810
 products, specifications for, 1219
 value of as fuel, 811
 Petroleum-burning locomotives, 1103
 Pewter, composition of, 383
 Phosphor-bronze, composition of, 366
 specifications for, 370
 springs, 401
 strength of, 370
 Phosphorus, influence of, on cast-iron, 415
 influence of, on steel, 452
 Piano-wire, strength of, 239
 Pictet fluid, for refrigerating, 1284
 Piezometer, 727
 Pig-iron (see also Cast iron)
 analysis of, 416
 charcoal, strength of, 423
 distribution of silicon in, 424
 for malleable castings, 430
 grading of, 414
 influence of silicon, etc., on, 415
 sampling, 413
 specifications for, 418
 tests of, 419
 Piles, bearing power of, 1334
 Pillars, strength of, 269
 Pine, strength of, 344
 Pins, forcing fits of by hydraulic pressure, 1273
 taper, 1272
 Pinions, raw-hide, 1153
 Pipe bends, flexibility of, 215
 branches, compound pipes, formula for, 720
 cast-iron, friction loss in, table, 719
 cast-iron, specifications for metal for, 419
 coverings, tests of, 559
 dimensions, Briggs standard, 202, 207
 fittings, flanged, 203-206
 fittings, valves, etc., resistance of, 672
 flanges, extra heavy, table, 199
 flanges, table of standard, 198

- Pipe, iron and steel, strength of, 341
 iron, tin-lined and lead-lined, 218
 threading of, force required for, 341
 wooden stave, 218
 Pipes, air, carrying capacity of, 662
 air, loss of pressure in, tables, 593-595
 air-bound, 722
 and valves for superheated steam, 851
 bent and coiled, 214, 215
 block-tin, weights and sizes of, 218
 cast-iron, 191-195
 cast-iron, formulae for thickness of, 193
 cast-iron, safe pressures for, tables, 194, 195
 cast-iron, thickness of, for various heads, 192, 193
 cast-iron, transverse strength of, 427
 cast-iron, weight of, 191-195
 coiled, table of, 214
 effects of bends in, 593, 727
 equalization of, table, 597
 equation of, 853
 flow of air in, 591
 flow of gas in, 834-836
 flow of steam in, 845
 flow of water in, 699
 for steam heating, 669
 house-service, flow of water in, table, 712
 iron and steel, corrosion of, 443
 lead, safe heads for, 217
 lead, tin-lined, sizes and weights, table, 217
 lead, weights and sizes of, table, 217
 lines for fans and blowers, 643
 lines, long, 721
 loss of head in, 714-722 (see Loss of head)
 maximum and mean velocities in, 727
 proportioning to radiating surface, 671
 resistance of the inlet, 715
 rifed, for conveying heavy oils, 721
 riveted flanges for, table, 213
 riveted hydraulic, weights and safe heads, table, 212
 riveted-iron, dimensions of, table, 211
 riveted, safe pressure in, 887
 riveted steel, loss of head in, 717
 riveted steel, water, 329
 sizes of threads on, 207
 spiral riveted, table of, 213
 steam (see Steam-pipes)
 steam, sizes of in steam heating, 672
 table of capacities of, 127
 Pipes, volume of air transmitted in table, 591
 welded, standard, table of dimensions, 208
 Pipe-joint, Rockwood, 202
 Piping, power-house, identification of by different colors, 854
 Piston rings, steam-engine, 1000
 rods, steam-engine, 1001-1003
 Piston valves, steam-engine, 1043
 Pistons, steam-engine, 999
 Pivot-bearings, 1205, 1209
 Pivot-bearing, mercury bath, 1209
 Pitch, diametral, 1134
 of gearing, 1133
 of rivets, 404
 of screw-propeller, 1325
 Pitot tube gauge, 727
 tube, use in testing fans, 640
 Plane, inclined, 512 (see Inclined Plane)
 surfaces, mensuration of, 55
 Planer, heavy work on, 1256
 horse-power required to run, 1258, 1260
 vs. Milling machine, 1252
 Planers, cutting speed of, 1256
 Planished and Russia iron, 449
 Plank, wooden, maximum spans for, 1332
 Plates (see also Sheets)
 acid-pickled, heat transmission through, 565
 areas of, in square feet, table, 130, 131
 boiler, strength of at high temperatures, 439
 brass, weight of, tables, 219, 220
 Carnegie trough, properties of, table, 289
 circular, strength of, 313
 copper, strength of, 334
 copper, weight of, table, 219
 corrugated steel, properties of, table, 289
 flat, cast-iron, strength of, 313
 flat, for steam-boilers, rules for, 880, 885, 888
 flat, unstayed, strength of, 314
 for stand-pipes, 327
 iron and steel, approximating weight of, 461
 iron, weight of, table, 184
 of different materials, table for calculating weights of, 178
 perforated, strength of, 402
 punched, loss of strength in, 401
 stayed, strength of, 315
 steel boiler, specifications for, 483
 steel, for cars, specifications for, 483
 steel, specifications for, 481
 steel, tests of, 331, 333
 transmission of heat through, 561

- Ohm, definition and value of, 1345
 Ohm's law, 1352
 law applied to alternating currents, 1390
 law applied to parallel circuits, 1352
 law applied to series circuits, 1352
 Oil as fuel, 812
 fire-test of, 1220
 for steam turbines, 1221
 lubricating 1218-1223 (*see* Lubricants)
 paraffine, 1220
 pressure in a bearing, 1204
 quantity needed for engines, 1221
 vs. coal as fuel, 812
 well, 1220
 -engines, 1077
 tempering of steel forgings, 458
 Open-hearth furnace, temperatures in, 527
 steel (*see* Steel, open-hearth), 451
 Ordinates and abscissas, 71
 Ores, cubic feet per ton, 178
 Orifice, equivalent, in mine ventilation, 686
 flow of air through, 588
 flow of water through, 697
 rectangular, flow of water through, table, 729
 Oscillation, center of, 494
 radius of, 494
 Overhead steam-pipe radiators, 673
 Ox, work of, 509
 Oxy-acetylene welding, 464
 Oxygen, effect of on strength of steel, 453

 π , value and relations of, 58
 Packing, hydraulic, friction of, 1217
 Packing-rings of engines, 1000
 Paddle-wheels, 1331
 Paint, 447
 qualities of, 448
 quantity of, for a given surface, 448
 Paper, logarithmic ruled, 85
 Parabola, area of by calculus, 77
 construction of, 49, 50
 equations of, 73
 path of a projectile, 501
 Parabolic conoid, 66
 spindle, 66
 Parallel forces, 491
 Parallelogram area of, 55
 of forces, 489
 of velocities, 499
 Parallelepipedon of forces, 490
 Parentheses in algebra, 35
 Partial payments, 14
 Parting and threading tools, speed of, 1243
 Patterns, weight of, for castings, 1233
 Payments, equation of, 14
 Pearlite, 416, 456
 Peat, 808
 Pelton water-wheel, 748
 Pendulum, 496
 conical, 496
 Percentage, 12
 Percussion, center of, 494
 Perforated plates, strength of, 402
 Permeability, magnetic, 1348, 1383
 Permeance, magnetic, 1348
 Permutation, 10
 Perpetual motion, 507
 Petroleum as a metallurgical fuel, 813
 cost of as fuel, 812
 engines, 1077
 Lima, 810
 products of distillation of, 810
 products, specifications for, 1219
 value of as fuel, 811
 Petroleum-burning locomotives, 1103
 Pewter, composition of, 383
 Phosphor-bronze, composition of, 366
 specifications for, 370
 springs, 401
 strength of, 370
 Phosphorus, influence of, on cast-iron, 415
 influence of, on steel, 452
 Piano-wire, strength of, 239
 Pictet fluid, for refrigerating, 1284
 Piezometer, 727
 Pig-iron (*see also* Cast iron)
 analysis of, 416
 charcoal, strength of, 428
 distribution of silicon in, 424
 for malleable castings, 430
 grading of, 414
 influence of silicon, etc., on, 415
 sampling, 418
 specifications for, 418
 tests of, 419
 Piles, bearing power of, 1334
 Pillars, strength of, 269
 Pine, strength of, 344
 Pins, forcing fits of by hydraulic pressure, 1273
 taper, 1272
 Pinions, raw-hide, 1153
 Pipe bends, flexibility of, 215
 branches, compound pipes, formula for, 720
 cast-iron, friction loss in, table, 719
 cast-iron, specifications for metal for, 419
 coverings, tests of, 559
 dimensions, Briggs standard, 202, 207
 fittings, flanged, 203-206
 fittings, valves, etc., resistance of, 672
 flanges, extra heavy, table, 199
 flanges, table of standard, 198

- Pipe, iron and steel, strength of, 341
 iron, tin-lined and lead-lined, 218
 threading of, force required for, 341
 wooden stave, 218
 Pipes, air, carrying capacity of, 662
 air, loss of pressure in, tables, 593-595
 air-bound, 722
 and valves for superheated steam, 851
 bent and coiled, 214, 215
 block-tin, weights and sizes of, 218
 cast-iron, 191-195
 cast-iron, formulæ for thickness of, 193
 cast-iron, safe pressures for, tables, 194, 195
 cast-iron, thickness of, for various heads, 192, 193
 cast-iron, transverse strength of, 427
 cast-iron, weight of, 191-195
 coiled, table of, 214
 effects of bends in, 593, 727
 equalization of, table, 597
 equation of, 853
 flow of air in, 591
 flow of gas in, 834-836
 flow of steam in, 845
 flow of water in, 699
 for steam heating, 669
 house-service, flow of water in, table, 712
 iron and steel, corrosion of, 443
 lead, safe heads for, 217
 lead, tin-lined, sizes and weights, table, 217
 lead, weights and sizes of, table, 217
 lines for fans and blowers, 643
 lines, long, 721
 loss of head in, 714-722 (*see* Loss of head)
 maximum and mean velocities in, 727
 proportioning to radiating surface, 671
 resistance of the inlet, 715
 rifed, for conveying heavy oils, 721
 riveted flanges for, table, 213
 riveted hydraulic, weights and safe heads, table, 212
 riveted-iron, dimensions of, table, 211
 riveted, safe pressure in, 887
 riveted steel, loss of head in, 717
 riveted steel, water, 329
 sizes of threads on, 207
 spiral riveted, table of, 213
 steam (*see* Steam-pipes)
 steam, sizes of in steam heating, 672
 table of capacities of, 127
 Pipes, volume of air transmitted in table, 591
 welded, standard, table of dimensions, 208
 Pipe-joint, Rockwood, 202
 Piping, power-house, identification of by different colors, 854
 Piston rings, steam-engine, 1000
 rods, steam-engine, 1001-1003
 Piston valves, steam-engine, 1043
 Pistons, steam-engine, 999
 Pivot-bearings, 1205, 1209
 Pivot-bearing, mercury bath, 1209
 Pitch, diametral, 1134
 of gearing, 1133
 of rivets, 404
 of screw-propeller, 1325
 Pitot tube gauge, 727
 tube, use in testing fans, 640
 Plane, inclined, 512 (*see* Inclined Plane)
 surfaces, mensuration of, 55
 Planer, heavy work on, 1256
 horse-power required to run, 1258, 1260
 vs. Milling machine, 1252
 Planers, cutting speed of, 1256
 Planished and Russia iron, 449
 Plank, wooden, maximum spans for, 1332
 Plates (*see also* Sheets)
 acid-pickled, heat transmission through, 565
 areas of, in square feet, table, 130, 131
 boiler, strength of at high temperatures, 439
 brass, weight of, tables, 219, 220
 Carnegie trough, properties of, table, 289
 circular, strength of, 313
 copper, strength of, 334
 copper, weight of, table, 219
 corrugated steel, properties of, table, 289
 flat, cast-iron, strength of, 313
 flat, for steam-boilers, rules for, 880, 885, 888
 flat, unstayed, strength of, 314
 for stand-pipes, 327
 iron and steel, approximating weight of, 461
 iron, weight of, table, 184
 of different materials, table for calculating weights of, 178
 perforated, strength of, 402
 punched, loss of strength in, 401
 stayed, strength of, 315
 steel boiler, specifications for, 483
 steel, for cars, specifications for, 483
 steel, specifications for, 481
 steel, tests of, 331, 333
 transmission of heat through, 561

- Plates, transmission of heat through,
from air to water, 566
transmission of heat through,
from steam to air, 569
- Plate-girder, strength of, 331
- Plate-girders, allowed stresses in,
274
- Plating for bulkheads, table, 316
for tanks, table, 316
steel, stresses in, due to water
pressure, 315
- Platinite, 475, 540
- Platinum, properties of, 176
pyrometer, 526
wire, 243
- Plenum system of heating, 678
- Plough-steel rope, 246
wire, 239
- Plugs, fusible, in steam boilers, 889
- Plunger packing, hydraulic, friction
of, 1217
- Pneumatic hoisting, 1163
postal transmission, 624
- Polarity of electro-magnets, 1384
- Polishing wheels, speed of, 1264
- Polyhedron, 64
- Polygon, area of, 56
construction of, 43-45
- Polygons, impedance, 1390
of forces, 489
table of, 46, 56
- Polyphase circuits, 1395
- Popp system of compressed-air, 612
- Population of the United States, 11
- Portland cement, strength of, 336
- Port opening in steam-engines,
1039
- Postal transmission, pneumatic,
624
- Potential energy, 503
- Pound-calorie, definition of, 532
- Pounds per square inch, equiva-
lents of, 27
- Power and work, measures of, 28,
animal, 507
definition of, 503
electrical cost of, 985
factor of alternating currents,
1389
hydraulic, in London, 781
of a waterfall, 734
of electric circuits, 1353
of ocean waves, 755
unit of, 503
- Powers of numbers, algebraic, 34
of numbers, tables, 7, 94-110
- Power-plant economics, 984
- Pratt truss, stresses in, 518
- Preservative coatings, 447-450
- Press fits, pressure required for,
1274
high-speed steam-hydraulic, 783
hydraulic forging, 782
hydraulic, thickness of cylinders
for, 317
- Presses, hydraulic, in iron works,
781
- Presses, punches, etc., 1272
- Pressed fuel, 801
- Pressure, collapsing of flues, 318
collapsing of hollow cylinders,
318
- Pressures of adiabatically com-
pressed air, 609
- Priming, or foaming, of steam
boilers, 692, 899
- Prism, 63
- Prismoid, 64
rectangular, 63
- Prismoidal formula, 64
- Problems, geometrical, 38-54
in circles, 40-42
in lines and angles, 38-40
in polygons, 43-46
in triangles, 42
- Process, the thermit, 372
- Producers, gas (*see* Gas-producers)
- Producer-gas, 818-825 (*see* Gas)
- Producers, gas, use of steam in, 824
- Profit and loss, 12
- Progression, arithmetical and geo-
metrical, 10, 11
- Projectile, parabola path of, 501
- Prony brake, 1280
- Propeller shafts, strength of, 332
screw, 1324 (*see* Screw-propeller)
- Proportion, 6
compound, 7
- Pulleys, 1111-1114
arms of, 1032
cone, 1112
convexity of, 1112
differential, 513
for rope-driving, 1192
or blocks, 513
proportion of, 1111
speed of, 1125, 1137
- Pulsometer, tests of, 775
- Pumps, air, for condensers, 1053,
1055
air-lift, 776
and pumping engines, 757-779
boiler-feed, 761
boiler-feed, efficiency of, 908
centrifugal, 764-770
centrifugal, design of, 765
centrifugal, multi-stage, 765
centrifugal, relation of height of
lift to velocity, 766
centrifugal, tests of, 768, 770
circulating, for condensers, 1057
depth of suction of, 757
direct-acting, efficiency of, 759
direct-acting, proportion of steam
cylinder, 759
feed, for marine engines, 1057
high-duty, 762
horse-power of, 757
jet, 776
leakage, test of, 772
lift, water raised by, 759
mine, operated by compressed-
air, 625
piston speed of, 760

- Pumps, rotary, 770
speed of water in passages of, 759
steam, sizes of, tables, 758, 760
suction of, with hot water, 757
theoretical capacity of, 757
vacuum, 775
valves, 761, 762
- Pump-inspection table, 725
- Pumping by compressed air, 617,
777 (*see also* Air-lift)
by gas-engines, cost of, 764
by steam pumps, cost of fuel for,
764
cost of electric current for, 763
engine, screw, 762
engine, the d' Auria, 762
- Pumping-engines, duty trials of,
771-775
economy of, 763
high-duty records, 774
table of data for duty trials of,
773
use of nozzles to measure dis-
charge of, 728
- Punches, clearance of, 1272
spiral, 1272
- Punched plates, strength of, 402
- Punching and drilling of steel, 459,
460
- Purification of water, 694
- Pyramid, 63
frustum of, 63
- Pyrometer, air, Wiborgh's, 528
copper-ball, 526
fire-clay, Seger's, 528
Hobson's hot-blast, 528
LeChatelier's, 526
principles of, 523
thermo-electric, 526
Uehling-Steinbart, 530
- Pyrometers, graduation of, 527
- Pyrometric telescope, 529
- Pyrometry, 523
- Quadratic equations, 36
- Quadrature of plane figures, 77
of surfaces of revolution, 78
- Quadrilateral, area of, 44
area of, inscribed in circle, 55
- Quadruple-expansion engines, 956
- Quantitative measurement of heat,
532
- Quarter-twist belt, 1124
- Quartz, cubic feet per ton, 178
- Queen-post truss, inverted, stresses
in, 518
truss, stresses in, 517
- Quenching test for soft steel, 483
- Rack, gearing, 1141
- Radian, definition of, 499
- Radiating power of substances,
552
surface, computation of, for hot-
water heating, 675
surface, computation of, for
steam heating, 669
- Radiating surface, proportioning
pipes for, 671
- Radiation, black body, 552
of heat, 551
of various substances, 552, 569
Stefan and Boltzman's law, 552
table of factors for Dulong's
laws of, 570
- Radiators, experiments with, 668,
679
indirect, 669
overhead steam-pipe, 673
steam and hot-water, 668
steam, removal of air from, 673
transmission of heat in, 668
- Radius of gyration, 279, 494
of gyration, graphical method
for finding, 280
of gyration of structural shapes,
279, 280
of oscillation, 494
- Rails, steel, specifications for, 484
steel, strength of, 331
- Railroad axles, 441
track, material required for one
mile of, 232
trains, resistance of, 1084-1087
trains, speed of, 1094
- Railway, street, compressed-air,
624, 625
track bolts and nuts, 230
- Railways, electric, 1366
narrow-gauge, 1103
- Ram, hydraulic, 778
- Rankine's formula for columns,
270
- Ratio, 6
- Raw-hide pinions, 1153
- Reactance of alternating currents,
1389
- Reamers, taper, 1270
- Reaumur thermometer-scale, 523
- Recalcence of steel, 455
- Receiver-space in engines, 950
- Reciprocals of numbers, tables of,
88-93
use of, 93
- Recorder, continuous, of water or
steam consumption, 940
carbon dioxide, or CO₂, 860
- Rectangle, definition of, 55
value of diagonal of, 55
- Rectangular prismoid, 63
- Rectifier, in absorption refrigera-
ting machine, 1293
mercury arc, 1401
- Red lead as a preservative, 447
- Reduction, ascending and de-
scending, 5
- Reese's fusing disk, 1262
- Reflecting power of substances,
552
(Refrigerating (*see also* Ice-making),
1282
direct-expansion method, 1314

Refrigerating-machines, actual and theoretical capacity, 1302
 air-machines, 1291
 ammonia absorption, 1293, 1313
 ammonia compression, 1292, 1303
 condensers for, 1300
 cylinder-heating, 1296
 dry, wet, and flooded systems, 1292
 ether-machines, 1291
 heat-balance, 1305
 ice-melting effect, 1291
 liquids for, pressure and boiling-points of, 1284
 mean effective pressure and horse-power, 1297
 operations of, 1283
 performance of, 1307
 performance of a single acting compressor, 1312
 pipe-coils for, 1302
 pounds of ammonia per minute, 1297
 properties of brine, 1290
 properties of vapor, 1284-1287
 quantity of ammonia required for, 1298
 rated capacity of, 1300
 relative efficiency of, 1295
 relative performance of ammonia-compression and absorption machines, 1294
 sizes and capacities, 1299
 speed of, 1300
 sulphur-dioxide machine, 1292
 test reports of, 1306
 temperature range, 1306
 tests of, 1302
 using water vapor, 1292
 volumetric efficiency, 1296
 Voorhees multiple-effect, 1297
 Refrigerating plants, cooling tower practice in, 1301
 Refrigerating systems, efficiency of, 1296
 Refrigeration, 1282-1316
 a reversed heat cycle, 574
 means of applying the cold, 1314
 Regenerator, heat, 987
 Regnault's experiments on steam, 838
 Reinforced concrete, working stresses of, 1335
 Reluctance, magnetic, 1348, 1383
 Reluctivity, magnetic, 1348
 Reservoirs, evaporation of water in, 543
 Resilience, elastic, 260
 of materials, 260
 Resistance, elastic, to torsion, 311
 electrical (*see* Electrical resistance), 1349
 electrical, effect of annealing on, 1351
 electrical, effect of temperature on, 1350

Resistance, electrical, in circuits, 1352
 electrical, internal, 1353
 electrical, of copper-wire, 1351, 1357
 electrical, of steel, 453
 electrical, standard of, 1351
 elevation of ultimate, 261
 modulus of, or section modulus, 280
 of copper wire, rule for, 242
 of metals to repeated shocks, 262
 of ships, 1317
 of trains, 1084
 work of, of a material, 260
 Resolution of forces, 489
 Retarded motion, 497
 Reversing-gear for steam-engines, dimensions of, 1020
 Rheostats, 1404
 Rhomboid, definition and area of, 55
 Rhombus, definition and area of, 55
 Rivets, bearing pressure on, 403
 cone-head, for boilers, 231
 diameters of, for riveted joints, table, 406
 in steam-boilers, rules for, 879
 pitch of, 404
 pressure required to drive, 412
 round head, weight of, 228
 steel, chemical and physical tests of, 412
 steel, specifications for, 481
 tinnings, table, 232
 Riveted iron pipe, dimensions of, table, 211
 joints, 333, 401-412
 joints, British rules for, 410
 joints, drilled, *vs.* punched holes, 401
 joints, efficiencies of, 405
 joints, notes on, 402
 joints of maximum efficiency, 408
 joints, proportions of, 405
 joints, single riveted lap, 404
 joints, table of proportions, 411
 joints, tests of double riveted lap and butt, 406
 joints, tests of, table, 337
 joints, triple and quadruple, 408
 pipe, flow of water in, 714
 pipe, weight of iron for, 213
 Rivet-iron and steel, shearing resistance of, 407
 Riveting, cold, pressure required for, 412
 efficiency of different methods, 402
 hand and hydraulic, strength of, 402
 machines, hydraulic, 782
 of structural steel, 459
 pressure required for, 412
 Roads, resistance of carriages on, 509

Rock-drills, air required for, 616
 requirements of air-driven, 616
 Rods of different materials, table for calculating weights of, 178
 Rollers and balls, steel, carrying capacity of, 317
 Roller bearings, 1210
 chain and sprocket drives, 1129
 Rolling of steel, effect of finishing temperature, 454
 Roofs, strength of, 1337
 Roof-truss, stresses in, 521
 Roofing materials, 186-190
 materials, weight of various, 190
 Rope for hoisting or transmission, 386
 hoisting, iron and steel, 244
 manila, data of, 1189-1193
 manila, hoisting and transmission, life of, 391
 wire (*see* Wire-rope)
 Ropes and cables, 386-393
 cable-traction, 247
 cotton and hemp, strength of, 335
 flat iron and steel, table of strength of, 248, 387
 hemp, iron and steel, table of strength and weight of, 386
 hoisting (*see* Hoisting-rope)
 "Lang Lay," 246
 locked-wire, 250
 manila, 386
 manila, weight and strength of, 390, 391
 splicing of, 389
 steel flat, table of sizes, weight and strength, 248, 387
 steel-wire hawsers, 249
 table of strength of iron, steel and hemp, 386
 taper, of uniform strength, 1183
 technical terms relating to, 388
 wire (*see* Wire-rope)
 Rope-driving, 1191-1194
 English practice, 1194
 pulleys for, 1192
 horse-power of, 1191
 sag of rope, 1191
 tension of rope, 1190
 various speeds of, 1191
 weight of rope, 1193
 Rope-transmission, 386
 Rotary blowers, 649
 steam-engines, 1062
 Rotation, accelerated, work of, 504
 Rubber belting, 1128
 goods, analysis of, 356
 vulcanized, tests of, 356
 Rule of three, 6, 7
 Running fits, 1274
 Rupture, modulus of, 282
 Russia and planished iron, 449
 Safety, factor of, 352-355
 Safety valves for steam-boilers, 902-906

Safety valves, spring-loaded, 904
 Salt, weight of, 178
 solubility of, 544
 Salt-brine manufacture, evaporation in, 543
 properties of, 543, 544, 1290
 solution, specific heat of, 537
 Sand, cubic feet per ton, 178
 molding, 1233
 Sand-blast, 1262
 Sand-lime brick, tests of, 349
 Sandstone, strength of, 349
 Saturation point of vapors, 578
 Sawing metal, 1262
 Sawdust as fuel, 808
 Scale, boiler, 692, 897
 boiler, analyses of, 693
 effect of, on boiler efficiency, 898
 removal of, from steam boilers, 900
 Scales, thermometer, comparison of, 524, 525
 Scantling, table of contents of, 21
 Schiele pivot bearing, 1209
 Schiele's anti-friction curve, 51
 Scleroscope, for testing hardness, 343
 Screw, 62
 bolts, efficiency of, 1270
 conveyors, 1175
 differential, 514
 differential, efficiency of, 1270
 efficiency of, 1270
 (element of machine), 512
 heads, A.S.M.E. standard, table, 228
 propeller, 1324
 propeller, coefficients of, 1325
 propeller, efficiency of, 1326
 propeller, slip of, 1326
 Screws and nuts for automobiles, table, 222
 cap, table of standard, 225
 lag, holding power of, 324
 lag, table of, 234
 machine, A.S.M.E. standard, 226
 set, table of standard, 225
 wood, dimensions of, 234
 wood, holding power of, 324
 Screw-thread, Acme, 223
 Screw-threads, 220-227
 British Association standard, 222
 English or Whitworth standard, table, 220
 International (metric) standard, 222
 limit gauges for, 223
 metric, cutting of, 1238
 standard sizes for bolts and taps, 224
 U. S. or Sellers standard table of, 221
 Scrubbers for gas producers, 819
 Sea-water, freezing-point of, 690
 Secant of an angle, 67
 Secants of angles, table of, 166-169

- Section modulus of structural shapes, 280, 281
Sector of circle, 61
Sediment in steam-boilers, 898
Seger pyrometer cones, 528
Segment of circle, 61
Segments, circular, areas of, 121, 122
Segregation in steel ingots, 462
Self-inductance of lines and circuits, 1393
"Semi-steel," 428
Separators, steam, 911
Set-screws, holding power of, 1278
standard table of, 225
Sewers, grade of, 706
Shackles, strength of, 1161
Shaft-bearings, 1015
bearings, large, tests of, 1206
couplings, flange, 1109
Shaft fit, allowances for electrical machinery, 1274
governors, 1048
Shafts and bearings of engines, 1023
hollow, 1109
hollow, torsional strength of, 311
steam-engine, 1010-1019
steel propeller, strength of, 1106-1110
Shafting, 1106-1110
collars for, 1109
deflection of, 1107
formulae for, 1106
horse-power transmitted by, 1108
keys for, 1277
laying out, 1109, 1110
power required to drive, 1261
Shaku-do, Japanese alloy, 368
Shapers, power required to run, 1260
Shapes of test specimens, 266
structural steel, properties of, 287-310
Shear and compression combined, 312
and tension combined, 312
poles, stresses in, 516
Shearing, effect of on structural steel, 459
resistance of rivets, 407
strength of iron and steel, 340
Shearing strength of woods, table, 347
strength, relation to tensile strength, 340
Sheaves, diameter of, for given tension of wire rope, 1186
for wire rope transmission, 1184
size of, for manila rope, 390
Sheets (see also Plates)
Sheet aluminum, weight of, 220
brass, weight of, 220
copper, weight of, 219
metal, strength of, 334
Sheet metal, weight of, by decimal gauge, 33
iron and steel, weight of, 181
Shelby cold-drawn tubing, 210
Shells for steam-boilers, material for, 880
spherical, strength of, 316
Shell-plate formulae for steam-boilers, 880
Sherardizing, 450
Shibu-ichi, Japanese alloy, 368
Shingles, weights and areas of, 189
Ship "Lusitania," performance of, 1330
Ships, Atlantic steam, performance of, 1328
coefficient of fineness of, 1317
coefficient of performance, 1318
coefficient of water lines, 1317
displacement of, 1317, 1322
horse-power of, 1321-1323
horse-power of, from wetted surface, 1323
horse-power of internal combustion engines for, 1322
horse-power for given speeds, 1321
jet propulsion of, 1332
relation of horse-power to speed, 1331
resistance of, 1317
resistance of, per horse-power, 1321
resistance of, Rankine's formula, 1319
rules for measuring, 1316
rules for tonnage, 1317
small sizes, engine power required for, 1322
wetted surface of, 1320
with reciprocating engine, and turbine combined, 1331
Shipbuilding, steel for, 483
Shipping measure, 19, 1316
Shocks, resistance of metals to repeated, 262
stresses produced by, 263
Short circuits, electric, 1360
Shrinkage fits (see Fits, 1273)
of cast-iron, 415, 423
of alloys, 384
of castings, 1231
of malleable iron castings, 431
strains relieved by uniform cooling, 423
Sign of differential coefficients, 79
of trigonometrical functions, 68
Signs, arithmetical, 1
Silicon, distribution of, in pig iron, 424
excessive, making cast-iron hard, 1231
influence of, on cast-iron, 415, 422
influence of, on steel, 452
relation of, to strength of cast-iron, 415, 422

- Silicon-aluminum-iron alloys, 374
Silicon-bronze, 371
Silicon-bronze wire, 243, 371
Silundum, 1377
Silver, melting temperature, 527
properties of, 176
Simpson's rule for areas, 57
Sine of an angle, 67
Sines of angles, table, 166-169
Single-phase circuits, 1395
Siphon, 726
Sirocco Fans, 633
Skin effect in alternating currents, 1390, 1399
Skylight glass, sizes and weights, 190
Slag bricks and slag blocks, 256
Slag in cupolas, 1225
in wrought iron, 436
Slate roofing, sizes, areas, and weights, 189
Slide Rule, 83
Slide-valves, steam-engine, (see Steam-engines, 1034-1047)
Slope, table of, and fall in feet per mile, 700
Slotters, power required to run, 1260
Smoke-prevention, 890-893
Smoke-stacks, sheet-iron, 928
locomotive, 1091
Snow, weight of, 691
Soapstone lubricant, 1223
strength of, 349
Soda mixture for machine tools, 1222
Softeners in foundry practice, 1230
Softening of water, 695
Soils, bearing power of, 1333
resistance of, to erosion, 705
Solar engines, 988
Solder, brazing, composition of, 366
for aluminum, 359
Soldering aluminum bronze, 373
Solders, composition of various, 385
Solid bodies, mensuration of, 62-67
measure, 18
Solid of revolution, 65
Solubility of common salt, 544
of sulphate of lime, 545
Sorbite, 456
Sources of energy, 506
Specific gravity, 170-174
gravity and Baume's hydrometer compared, table, 172
gravity and strength of cast iron, 428
gravity of brine, 544
gravity of cast-iron, 428
gravity of copper-tin alloys, 360
gravity of copper-tin-zinc alloys, 364
gravity of gases, 173
Specific gravity of ice, 691
gravity of liquids, table, 172
gravity of metals, table, 171
gravity of steel, 461
gravity of stones, brick, etc., 174
Specific heat, 534-538
heat, determination of, 534
heat of ammonia, 1286
heat of air, 587
heat of gases, 535, 537
heat of ice, 691
heat of iron and steel, 535, 536
heat of liquids, 535
heat of metals, 536
heat of saturated steam, 837
heat of solids, 535
heat of superheated steam, 838
heat of water, 536, 691
heat of woods, 536
Specifications for boiler-plate, 483
for castings, 418
for cast iron, 418
for chains, 251
for elliptical steel springs, 399
for foundry pig iron, 418
for galvanized wire, 239
for helical steel springs, 395
for incandescent lamps, 1372
for malleable iron, 433
for metal for cast-iron pipe, 419
for oils, 1219
for petroleum lubricants, 1219
for phosphor-bronze, 370
for purchase of coal, 799
for spring steel, 483
for steel axles, 483, 485
for steel billets, 483
for steel castings, 464, 486
for steel crank-pins, 433
for steel for automobiles, 486
for steel forgings, 482
for steel rails, 484
for steel rivets, 481
for steel splice-bars, 485
for steel tires, 485
for structural steel, 480
for structural steel for ships, 483
for tin and terne-plate, 188
for wrought iron, 437-438
Speed of cutting; effect of feed and depth of cut on, 1241
of cutting tools, 1235
of vessels, 1321
Sphere, measures of, 63
Spheres of different materials, table for calculating weight of, 178
table of volumes and surfaces, 125, 126
Spherical polygon, area of, 64
segment, volume of, 65
shells and domed boiler heads, 316
shells, strength of, 316
shell, thickness of, to resist a given pressure, 316
triangle, area of, 64
zone, area and volume of, 65

Spheroid, 65
 Spikes, holding power of, 323
 wire, 233
 railroad and boat, 233
 Spindle, surface and volume of, 65, 66
 Spiral, 52, 62
 conical, 62
 construction of, 52
 gears, 1143
 plane, 62
 Spiral-rieveted pipe-fittings, table, 214
 pipe, table of, 213
 Splices, railroad track, tables, 233
 Splice-bars, steel, specifications for, 485
 Splicing of ropes, 388
 of wire rope, 393
 Springs, 394-401
 elliptical, specifications for, 399
 elliptical, sizes of, 399
 for engine-governors, 1048-1050
 helical, 396
 helical, formulæ for deflection and strength, 395
 helical, specifications for, 395
 helical, steel, tables of capacity and deflection, 395-400
 laminated steel, 394
 phosphor-bronze, 401
 semi-elliptical, 394
 steel, strength of, 333
 steel, chromium-vanadium, 401
 to resist torsion, 399
 Sprocket wheels, 1130
 Spruce, strength of, 345
 Square, definition of, 55
 measure, 18
 root, 8
 roots, tables of, 94-109
 value of diagonal of, 55
 Squares of decimals, table, 109
 of numbers, table, 94-109
 Stability, 490
 of dam, 491
 Stand-pipe at Yonkers, N. Y., 328
 Stand-pipes, 327-329
 failures of, 328
 guy-ropes for, 327
 heights of, for various diameters and plates, table, 329
 thickness of plates of table, 329
 thickness of side plates, 327
 wind-strain on, 328
 Statical moment, 490
 Static and dynamic properties of steel, 476
 Stays, steam-boiler, loads on, 882
 steam-boiler, material for, 882
 Stay-bolt iron, 438
 Stay-bolts in steam-boilers, 888
 Stayed surfaces, strength of, 315
 Steam, 836-854
 determining moisture in, 912-915
 dry, definition, 836

Steam, dry, identification of, 915
 energy of, expanded to various pressures, 933
 entropy of, tables, 839-843
 expanding, available energy of, 842
 expansion of, 929
 flow of, 844-851 (*see* Flow of steam)
 gaseous, 838
 generation of, from waste heat of coke-ovens, 803
 heat required to generate 1 pound of, 837
 latent heat of, 836
 loop, 852
 loss of pressure in pipes, 849
 maximum efficiency of, in Carnot cycle, 850
 mean pressure of expanded, 930
 metal, 368
 power, cost of, 981-984
 receivers on pipe lines, 853
 Regnault's experiments on, 838
 saturated, definition, 836
 saturated, density, volume and latent heat of, 839
 saturated, properties of, table, 839-842
 saturated, specific heat of, 837
 saturated, temperature and pressure of, 837
 saturated, total heat of, 836
 separators, 911
 superheated (*see also* Superheated steam)
 superheated, definition, 836
 superheated, economy of steam-engines with, 969
 superheated, pipes and valves for, 851
 superheated, properties of, 843
 superheated, specific heat of, 838
 temperature of, 836
 vessels (*see* Ships)
 weight of, per cubic foot, table, 839
 wet, definition, 836
 Steam-boiler, 854-901
 compounds, 898
 efficiency, computation of, 860
 efficiency, relation of, to rate of driving, air-supply, etc., 862
 furnaces, height of, 889
 plates, ductility of, 884
 plates, tensile strength of, 884
 tests, heat-balance in, 872
 tests, rules for, 866-874
 tubes, holding power of, 883
 tubes, iron and steel, 883
 tubes, material for, 883
 Steam-boilers, bumped heads, rules for, 885
 conditions to secure economy of, 859, 862
 construction of, 879-889

Steam-boilers, construction of, United States merchant-vessel rules, 884
 corrosion of, 443, 897
 curves of performance of, 863
 dangerous, 901
 domes on, 889
 down-draught furnace for, 890
 effect of heating air for furnaces of, 865
 evaporative tests of, 864-868
 explosive energy of, 902
 factors of evaporation, 874-878
 factors of safety of, 879
 feed-pumps for, efficiency of, 908
 feed-water heaters for, 909-911
 feed-water saving due to heating of, 909
 flat plates in, rules for, 880, 885, 888
 flues and gas passages, proportions of, 858
 foaming or priming of, 692, 899
 for blast-furnaces, 865
 forced combustion in, 894
 fuel economizers, 894
 furnace formulæ, 881
 fusible plugs in, 889
 girders, rules for, 882
 grate-surface, 855, 857
 grate-surface, relation to heating-surface, 857
 gravity feeders, 908
 heating-surface in, 855, 856
 heating-surface, relation of, to grate-surface, 857
 heat losses in, 861
 height of chimney for, 919, 921
 high rates of evaporation, 865
 horse-power of, 854
 hydraulic test of, 879
 incrustation of, 897-902
 injectors on, 906-908 (*see* Injectors)
 marine, corrosion of, 900
 maximum efficiency with Cumberland coal, 865
 measure of duty of, 855
 mechanical stokers for, 889
 performance of, 858
 pressure allowable in, 884-888
 proportions of, 855-858
 proportions of grate and heating-surface for given horse-power, 855, 857
 proportions of grate-spacing, 857
 riveting, rules for, 879
 safety-valves, discharge of steam through, 905
 safety-valves for, 902-906
 safety-valves, formulæ for, 902
 safety-valves, spring-loaded, 904
 safe working-pressure, 887
 scale compounds, 898
 scale in, 897-902
 sediment in, 898
 shells, material for, 880

Steam-boilers, shell-plate, formulæ for, 880
 smoke prevention, 890-893
 stay bolts in, 888
 stays, loads on, 882
 stays, material for, 882
 strain caused by cold feed-water, 909
 strength of, 879-889
 strength of rivets, 879
 tests of, at Centennial Exposition, 864
 tube-plates, rules for, 882
 use of kerosene in, 899
 use of zinc in, 901
 using waste gases, 865, 866
 Steam-calorimeters, 912-915
 Steam-consumption in engines, Willans law, 962
 continuous recorder of, 940
 Steam-domes on boilers, 889
 Steam-engines, 929
 advantages of compounding, 946
 advantages of high initial and low back pressure, 967
 and turbine, in 1904, best economy of, 977
 bed-plates, dimensions of, 1025
 bearings, size of, 1015
 clearance in, 936
 compound, 946-953
 compound, best cylinder ratios, 952
 compound, calculation of cylinders of, 952
 compound, combined indicator diagram, 949
 compound condensing, test of with and without jackets, 976
 compound, economy of, 968
 cylinder condensation, experiments on, 937
 cylinder condensation, loss by, 936
 compound, two vs. three cylinders, 968
 compound, formulæ for expansion and work in, 951
 compound, high-speed, performance of, 960, 961
 compound, high-speed, sizes of, 960, 961
 compound, non-condensing, efficiency of, 971
 compound, receiver, ideal diagram, 947
 compound, receiver space in, 950
 compound, receiver type, 947
 compound, steam-jacketed, performances of, 960
 compound, steam-jacketed, test of, 976
 compound, Sulzer, water consumption of, 969
 compound, velocity of steam in passages of, 956
 compound vs. triple-expansion, 968, 984

Steam-engines, compound, water consumption of, 959
 compound, Wolff, ideal diagram, 947
 compression, effect of, 935
 condensers, 1050-1061 (see Condensers)
 connecting-rod ends, 1005
 connecting-rods, dimensions of, 1003-1005
 cost of, 981-984
 counterbalancing of, 980
 crank-pins, dimensions of, 1005-1009
 crank-pins, pressure on, 1008
 crank-pins, strength of, 1007
 cranks, dimensions of, 1009
 crank-shafts, dimensions of, 1017-1019
 crank-shafts for torsion and flexure, 1019
 crank-shafts for triple-expansion, 1019
 crank-shafts, three-throw, 1019
 cross head and crank, relative motion of, 1042
 cross head-pin, dimensions of, 1009
 cut-off, most economical point of, 981
 cylinders, dimensions of, 996, 997
 cylinder-head bolts, size of, 999
 cylinder-heads, dimensions of, 998
 design, current practice, 1022
 dimensions of parts of, 979, 996-1026
 eccentric-rods, dimensions of, 1020
 eccentrics, dimensions of, 1020
 effect of moisture in steam, 972
 economic performance of, 957-981
 economy at various loads and speeds, 963, 964
 economy, effect on, of wet steam, 972
 economy of compound vs. triple-expansion, 984
 economy of, in central stations, 963
 economy of, simple and compound compared, 968
 economy under variable loads, 963
 economy with superheated steam, 969
 efficiency in thermal units per minute, 934
 estimating I.H.P. of single cylinder and compound, 940
 exhaust steam used for heating, 981
 expansions in, table, 935
 fly-wheels, 1026-1034
 fly-wheels, arms of, 1032

Steam-engines, fly-wheels, centrifugal force in, 1029
 fly-wheels, diameters of, 1030
 fly-wheels, formulæ for, 1026, 1027
 fly-wheels, speed, variation in, 1026, 1027
 fly-wheels, strains in, 1031
 fly-wheels, thickness of rim of, 1032
 fly-wheels, weight of, 1027, 1028
 fly-wheels, wooden rim, 1033
 foundations embedded in air, 980
 frames, dimensions of, 1025
 friction of, 1215
 governors, fly-ball, 1047
 governors, fly-wheel, 1048
 governors, shaft, 1048
 governors, springs for, 1048-1050
 guides, sizes of, 1002
 highest economy of, 975
 high piston speed in, 966
 high-speed, British, 966
 high-speed Corliss, 966
 high-speed, economy of, 965
 high-speed, performance of, 959-962
 high-speed, sizes of, 959-962
 high-speed throttling, 967
 horse-power constants, 941-944
 indicated horse-power of single-cylinder, 940-946
 indicator diagrams, 938
 indicator diagram, analysis of, 992
 indicator diagrams, to draw clearance line on, 944
 indicator diagrams, to draw expansion curve, 944
 indicator rigs, 939
 indicators, effect of leakage, 946
 indicators, errors of, 939
 influence of vacuum and superheat on economy, 972
 Lentz compound, 968
 limitations of speed of, 966
 link motions, 1044-1046
 links, size of, 1020
 mean and terminal pressures, 930
 mean effective pressure, calculations of, 931
 measures of duty of, 933
 non-condensing, 958, 960, 961
 oil required for, 1221
 pipes for, 848
 pistons, clearance of, 996
 pistons, dimensions of, 999
 piston-rings, size of, 1000
 piston-rod guides, size of, 1002
 piston-rods, fit of, 1001
 piston-rods, size of, 1001
 piston-valves, 1043
 prevention of vibration in, 980
 proportions, current practice, 1021
 proportions of, 996-1026
 quadruple expansion, 956

Steam-engines, quadruple, performance of, 971
 ratio of expansion in, 932
 reversing gear, dimensions of, 1020
 rolling-mill, sizes of, 980
 rotary, 1062
 setting the valves of, 1043
 shafts and bearings, 1010-1023
 shafts, bearings for, 1015
 shafts, bending resistance of, 1012
 shafts, dimensions of, 1010-1017
 shafts, equivalent twisting moment of, 1012
 shafts, fly-wheel, 1013
 shafts, twisting resistance of, 1010
 single-cylinder, economy of, 957
 single-cylinder, high-speed, sizes and performance of, 960
 single-cylinder, water consumption of, 957-959
 slide-valve, definitions, 1034
 slide-valve diagrams, 1035-1039
 slide-valve, effect of changing lap, lead, etc., 1039
 slide-valve, effect of lap and lead, 1034-1036
 slide-valve, lead, 1039
 slide-valve, port opening, 1039
 slide-valve, ratio of lap to travel, 1040
 slide-valves, crank-angles, table, 1040
 slide-valves, cut-off for various lap and travel, table, 1042, 1043
 slide-valve, setting of, 1043
 slide-valves, relative motion of crosshead and crank, 1042
 small, coal consumption of, 964
 small, water consumption of, 963
 steam consumption of different types, 969
 steam-jackets, influence of, 975
 steam-turbines and gas-engines compared, 986
 Sulzer compound and triple-expansion, 969
 superheated steam in, 969
 to change speed of, 1048
 to put on center, 1043
 three-cylinder, 1019
 rules for tests of, 988
 triple-expansion, 953-956
 triple-expansion and compound, relative economy, 984
 triple-expansion, crank-shafts for, 1019
 triple-expansion, cylinder proportions 953-955
 triple-expansion, cylinder ratios, 956
 triple-expansion, high-speed, sizes and performances of, 961, 962

Steam - engines, triple - expansion, non-condensing, 961
 triple-expansion, sequence of cranks in, 956
 triple-expansion, steam-jacketed, performance of, 961, 962
 triple-expansion, theoretical mean effective pressures, 954
 triple-expansion, types of, 956
 triple-expansion, water consumption of, 959, 969
 use of reheaters in, 975
 using superheated steam, 972-974
 valve-rods, dimensions of, 1019
 Walschaert valve-gear, 1046
 water consumption from indicator-cards, 945
 water consumption of, 937
 with fluctuating loads, wasteful, 934
 with sulphur-dioxide addendum, 978
 wrist-pin, dimensions of, 1009
 Steam fire-engines, capacity and economy of, 964
 Steam heating, 665-674
 heating, diameter of supply mains, 671, 673
 heating, indirect, 669
 heating, indirect, size of registers and ducts, 669
 heating of greenhouses, 673
 heating, pipes for, 669
 heating, vacuum systems of, 673
 jackets on engines, 975
 jet blower, 651
 jet exhauster, 651
 jet ventilator, 652
 pipe coverings, tests of, 558-561
 pipes, 851-854
 pipes, copper, tests of, 851
 pipes, copper, strength of, 851
 pipes, failures of, 851
 pipes for engines, 848
 pipes for marine engines, 848
 pipes, proportioning for minimum loss by radiation and friction, 849
 pipes, riveted-steel, 852
 pipes, uncovered, loss from, 853
 pipes, underground, condensation in, 853
 pipes, valves in, 852
 pipes, wire-wound, 851
 turbines, 1062-1071
 turbine, low-pressure, combined with high pressure reciprocating engine, 1331
 turbines, testing oil for, 1221
 turbines and gas-engine, combined plant of, 986
 turbine and steam-engine compared, 978
 turbines, efficiency of, 1067
 turbines, impulse and reaction, 1062, 1066

Steam turbines, low-pressure, 1069
 turbines, reduction gear for, 1071
 turbines, speed of the blades, 1066
 turbines, steam consumption of, 1067
 turbines, theory of, 1063
 turbines using exhaust, from reciprocating engines, 1069, 1331
 Steamships, Atlantic, performances of, 1328
 Steel, 451-487
 alloy, heat treatment of, 479
 aluminum, 472
 analyses and properties of, 452
 and iron, classification of, 413
 annealing of, 459, 460, 468
 axles, specifications for, 483, 485
 axles, strength of, 332
 bars, effect of nicking, 461
 beams, safe load on, 284
 bending tests of, 454
 Bessemer basic, ultimate strength of, 452
 Bessemer, range of strength of, 454
 billets, specifications for, 483
 blooms, weight of, table, 185
 bridge-links, strength of, 331
 brittleness due to heating, 458
 burning carbon out of, 461
 burning, overheating, and re-storing, 457
 castings, 464-466
 castings, specifications for, 464, 486
 castings, strength of, 333
 cementation or case-hardening of, 1246
 chrome, 471
 chromium-vanadium, 476-478
 chromium-vanadium spring, 401
 cold-drawn, tests of, 339
 cold-rolled, tests of, 339
 color-scale for tempering, 469
 comparative tests of large and small pieces, 455
 copper, 475
 corrosion of, 443, 444
 crank-pins, specifications for, 483
 critical point in heat treatment of, 456
 crucible, 466-470
 crucible, analyses of, 466, 469
 crucible, effect of heat treatment, 457, 466
 crucible, selection of grades of, 466
 crucible, specific gravities of, 466
 effect of annealing, 455
 effect of annealing on grain of, 454
 effect of annealing on magnetic capacity, 459
 effect of cold on strength of, 440
 effect of finishing temperature in rolling, 454

Steel, effect of heating, 457
 effect of heat on grain, 456, 466
 effect of oxygen on strength of, 453
 electrical conductivity of, 453
 endurance of, under repeated stresses, 463
 expansion of, by heat, 540
 eye-bars, test of, 338
 failures of, 462
 fatigue resistance of, 477
 fire-box, homogeneity test for, 484
 fluid-compressed, 464
 for car-axles, specifications, 483, 485
 for different uses, analyses of, 481-486
 forgings, annealing of, 458
 forgings, oil-tempering of, 458
 forgings, specifications for, 482
 for rails, specifications, 484
 hardening of, 455
 hardening temperature of, use of a magnet to determine, 1246
 harveyizing, 1246
 heating in a lead bath, 467
 heating in melted salts by an electric current, 467
 heating of, for forging, 468
 heat treatment of Cr-Va steel, 478
 high-speed tool, 470
 high-speed tool, emery wheel for grinding, 1240, 1267
 high-speed tool new, tests of, 1246
 high-speed tool, Taylor's experiments, 1238
 high-strength, for shipbuilding, 483
 ingots, segregation in, 462
 life of, under shock, 263
 low strength of, 453
 low strength due to insufficient work, 454
 manganese, 470
 manganese, resistance to abrasion of, 470-471
 manufacture of, 451
 melting, temperature of, 528
 mixture of, with cast iron, 429
 Mushet, 472
 nickel, 472
 nickel, tests of, 472
 nickel-vanadium, 475
 of different carbons, uses of, 469
 open-hearth, range of strength of, 454
 open-hearth, structural, strength of, 454
 plates (see Plates, steel)
 rails, specifications for, 484
 rails, strength of, 331
 range of strength in, 454
 recalescence of, 455

Steel, relation between chemical composition and physical character of, 452
 rivet, shearing resistance of, 407
 rivets, specifications for, 481
 rope, flat, table of strength of, 387
 rope, table of strength of, 386
 shearing strength of, 340
 sheets, weight of, 181
 soft, quenching test for, 483
 specifications for, 480-487
 specific gravity of, 461
 splice-bars, specifications for, 485
 spring, strength of, 333
 springs (see Springs, steel)
 static and dynamic properties of, 476
 strength of, Kirkaldy's tests, 331
 strength of, variation in, 454
 structural, annealing of, 460
 structural, drilling of, 460
 structural, effect of punching and shearing, 459
 structural, for bridges, specifications of, 480
 structural, for buildings, specifications of, 480
 structural, for ships, specifications of, 483
 structural, punching of, 460
 structural, riveting of, 459
 structural shapes, properties of, 287-310
 structural, specifications for, 480
 structural, treatment of, 459-460
 structural, upsetting of, 460
 structural, welding of, 460
 struts, 271
 tempering of, 468
 tensile strength of, at high temperatures, 439
 tensile strength of, pure, 453
 tires, specifications for, 485
 tires, strength of, 332
 tool, composition and heat treatment of, 1243
 tool, heating of, 467
 tungsten, 472
 used in automobile construction, 486
 very pure, low strength of, 453
 water-pipe, 329
 welding of, 460, 463
 wire gauge, tables, 30
 working of, at blue heat, 458
 working stresses in bridge members, 272
 Stefan and Boltzman law of radiation, 552
 Sterro metal, 369
 St. Gothard tunnel, loss of pressure in air-pipe mains in, 595
 Stoker, Taylor gravity underfeed, 890
 Stokers, mechanical, for steam-boilers, 889

Stokers, under-feed, 890
 Stone, strength of, 335, 347
 weight and specific gravity of, table, 174
 Stone-cutting with wire, 1262
 Storage of steam heat, 897, 987
 batteries, 1378
 batteries, efficiency of, 1380
 batteries, rules for care of, 1381
 Storms, pressure of wind in, 599
 Stoves, for heating compressed-air, efficiency of, 612
 foundries, cupola charges in, 1227
 Straight-line formula for columns, 271
 Strain and stress, 258
 Strand, steel wire, for guys, 249
 Straw as fuel, 808
 Stream, open, measurement of flow, 729
 Streams, fire, 722-725 (see Fire-streams)
 running, horse-power of, 734
 Strength and specific gravity of cast iron, 428
 compressive, 267-269
 compressive, of woods, 344, 346
 loss of, in punched plates, 401
 of anchor-forgings, 331
 of aluminum, 358
 of aluminum-copper alloys, 371
 of basic Bessemer steel, 452
 of belting, 335
 of blocks for hoisting, 1157
 of boiler-heads, 314, 315
 of boiler-plate at high temperatures, 439
 of bolts, 325, 326
 of brick, 326
 of brick and stone, 347, 350
 of bridge-links, 331
 of bronze, 334, 360
 of canvas, 335
 of castings, 320
 of cast iron, 421
 of cast-iron beams, 427
 of cast-iron columns, 274
 of cast-iron cylinders, 427
 of cast-iron flanged fittings, 428
 of cast iron, relation to size of bar, 421
 of cast-iron water-pipes, 194, 427
 of chain cables, table, 251, 252
 of chains, table, 251, 252
 of chalk, 349
 of cement mortar, 350
 of columns, 269-278, 1337
 of copper at high temperatures, 344
 of copper plates, 334
 of copper-tin alloys, 361
 of copper-tin-zinc alloys, graphic representation, 364
 of copper-zinc alloys, 364
 of cordage, table, 386-391, 1157
 of crank-pins, 1007

- Strength of electro-magnet, 1386
 of lagging, 350
 of flat plates, 313
 of floors, 1337-1340
 of German silver, 334
 of glass, 343
 of granite, 335
 of gun-bronze, 362
 of hand and hydraulic riveted joints, 402
 of ice, 344
 of iron and steel, effect of cold on, 440
 of iron and steel pipe, 341
 of lime-cement mortar, 350
 of limestone, 349
 of locomotive forgings, 331
 of Lowmoor iron bars, 330
 of malleable iron, 430, 434
 of marble, 335
 of masonry, 349
 of materials, 258-359
 of materials, Kirkaldy's tests 330-336
 of perforated plates, 402
 of phosphor-bronze, 370
 of Portland cement, 336
 of riveted joints, 337, 401-411
 of roof trusses, 521
 of rope, 335, 338, 1193
 of sandstone, 349
 of sheet metal, 334
 of silicon-bronze wire, 371
 of soapstone, 349
 of spring steel, 333
 of spruce timber, 345
 of stayed surfaces, 315
 of steam-boilers, 879-889
 of steel axles, 332
 of steel castings, 333
 of steel, open-hearth structural 454
 of steel propeller-shafts, 332
 of steel rails, 331
 of steel tires, 332
 of structural shapes, 287-310
 of timber, 341-347
 of twisted iron, 264
 of unstayed surfaces, 314
 of welds, 251, 333
 of wire, 335, 336
 of wire and hemp rope, 334, 335
 of wrought-iron columns, 271
 of yellow pine, 344
 range of, in steel, 454
 shearing, of iron and steel, 340
 shearing, of woods, table, 347
 tensile, 265
 tensile, of iron and steel at high temperatures, 439
 tensile, of pure steel, 453
 torsional, 311
 transverse, 282-286
 Stress and strain, 253
 due to temperature, 312
 Stresses allowed in bridge members, 272
- Stresses combined, 312
 effect of, 258
 in framed structures, 515-522
 in plating of bulkheads, etc., due to water-pressure, 315
 in steel plating due to water pressure, 315
 produced by shocks, 263
 Structures, framed, stresses in, 515
 Structural materials, permissible stresses in, 1335
 shapes, elements of, 280
 shapes, moment of inertia of, 279
 steel shapes, properties of, 287-310
 shapes, radius of gyration of, 279
 shapes, steel (see Steel, structural, *also* Beams, angles, etc.),
 steel, rolled sections, properties of, 287-310
 Strut, moving, 511
 Struts, steel, formulae for, 271
 strength of, 269
 wrought-iron, formulae for, 271
 Suction lift of pumps, 757
 Sugar manufacture, 809
 solutions, concentration of, 545
 Sulphate of lime, solubility of, 545
 Sulphur dioxide addendum to steam-engine, 978
 dioxide and ammonia-gas, properties of, 1285
 dioxide refrigerating-machine, 1292
 influence of, on cast iron, 415
 influence of, on steel, 452
 Sum and difference of angles, functions of, 69
 Sun, heat of, as a source of power, 988
 Superheated steam, effect of on steam consumption, 972
 steam, economy of steam-engines with, 969
 steam, practical application of, 973
 Superheating, economy due to, 978
 in locomotives, 1102
 Surface condensers, 1051
 of sphere, table, 125, 126
 Surfaces of geometrical solids, 62-67
 of revolution, quadrature of, 78
 unstayed flat, 314
 Suspension cableways, 1181
 Sweet's slide-valve diagram, 1036
 Symbols, chemical, 170
 electrical, 1416
 Synchronous-motor, 1409
 T-shapes, properties of Carnegie steel, table, 294
 Tackle, hoisting, 1158
 Tackles, rope, efficiency of, 391

- Tail-rope, system of haulage, 1178
 Tanbark as fuel, 808
 Tangent of an angle, 67
 Tangents of angles, table of, 166-169
 Tangential or impulse water-wheels, tables of, 751
 Tanks and cisterns, number of barrels in, 133
 capacities of, tables, 128, 132
 with flat sides, plating and framing for, 316
 Tantalum electric lamps, 1371
 Taps, A.S.M.E. standard, 227
 formulæ and table for screw-threads of, 224
 Tap-drills, tables of, 227, 1269
 Taper, to set in a lathe, 1238
 Tapered wire rope, 1183
 Taper pins, 1272
 Tapers, Jarno, 1271
 Morse, 1271
 Taylor's experiments on cutting tools of high-speed steel, 1238
 Taylor's rules for belting, 1120
 theorem, 79
 Teeth of gears, forms of, 1138-1145
 of gears, proportions of, 1135, 1136
 Telegraph-wire, joints in, 239
 tests of, table, 238
 Telferage, 1171
 Temperature, absolute, 540
 determination of by color, 531
 determinations of melting-points 527, 532
 effect of on strength, 544, 439-441
 of fire, 785
 rise of, in combustion of gases, 786
 stress due to, 312
 Temperature-entropy diagram, 574
 -entropy diagram of water and steam, 576
 Temper carbon, in cast-iron, 416
 Tempering, effect of, on steel, 468
 of steel, 468
 oil, of steel forgings, 458
 Tenacity of different metals, 177
 of metals at various temperatures, 344, 439
 Tensile strength, 265
 strength, increase of, by twisting, 264
 strength of iron and steel at high temperatures, 439
 strength of pure steel, 453
 strength (see Strength)
 tests, precautions in making, 266
 tests, shapes of specimens for, 266
 Tension and flexure combined, 312
 and shear, combined, 312
 Terne-plate, 188
 Terra cotta, weight of, 186
- Tests, compressive (see Compressive strength)
 of steam-boilers, rules for, 866
 of steam-engines, rules for, 988
 of strength of materials (see Strength)
 tensile (see Strength and Tensile strength)
 Test-pieces, comparison of large and small, 455
 Thermal capacity, 534
 storage, 897, 987
 units, 532
 Thermit process, the, 372
 welding process, 463
 Thermodynamics, 571-577
 laws of, 572
 Thermometer, air, 530
 centigrade and Fahrenheit compared, tables, 524
 Threads, pipe, 202, 207
 Threading and parting tools, speed of, 1243
 pipe, force required for, 341
 Three-phase transmission, rule for sizes of wires, 1398
 circuits, 1395
 Thrust bearings, 1208
 Tides, utilization of power of, 756
 Ties, railroad, required per mile of track, 232
 Tiles, weight of, 186
 Timber (see *also* wood)
 beams, safe loads, 1335, 1341
 beams, strength of, 344
 expansion of, 345
 measure, 20
 preservation of, 347
 strength of, 344-347
 table of contents in feet, 21
 Time, measures of, 20
 Tin, alloys of (see Alloys)
 lined iron pipe, 218
 plates, 187
 properties of, 176
 plates, 187
 Tires, locomotive, shrinkage fits, 1273
 steel, friction of on rails, 1195
 steel, specifications for, 485
 steel, strength of, 331
 Titanium, additions to cast-iron, 416, 426
 aluminum alloy, 375
 Tobin bronze, 368
 Toggle-joint, 511
 Tool steel (see *also* Steel)
 steel high-speed, composition and heat-treatment, of, 1242
 steel, best quality, 1242,
 steel, high-speed, new (1909), tests of, 1246
 steel, high-speed, Taylor's experiments, 1238
 steel in small shops, best treatment of, 1243
 steel of different qualities, 1243

- Tools, cutting, durability of, 1243
 economical cutting speed of, 1243
 cutting, effect of feed and depth of cut on speed of, 1241
 cutting, in small shops, best method of treatment, 1243
 cutting, interval between grindings of, 1241
 cutting, pressure on, 1241
 forging and grinding of, 1240
 cutting, use of water on, 1241
 machine (*see* Machine tools)
 parting and thread, cutting speed of, 1243
- Toothed-wheel gearing, 514, 1133
- Tonnage of vessels, 1316
- Tons per mile, equivalent of, in lbs. per yard, 28
- Torque computed from watts and revolutions, 1386
 horse-power and revolutions, 1386
 of an armature, 1386
- Torsion and compression combined, 312
 and flexure combined, 312
 elastic resistance to, 311
 of shafts, 1010, 1106
 tests of refined iron, 339
- Torsional strength, 311
- Track bolts, 232
 spikes, 233
- Tractive force of a locomotive, 1087
- Tractrix, Schiele's anti-friction curve, 51
- Trains, railroad, resistance of, 1084
 railroad, speed of, 1094
 loads, average, 1101
- Trammels, to describe an ellipse with, 46
- Tramways, compressed-air 624
 wire-rope, 1180
- Transformers, efficiency of, 1400
 electrical, 1400
- Transmission, compressed-air (*see* compressed-air)
 electric, 1359, 1396
 electric, area of wires, 1359
 electric, cost of copper, 1365
 electric, economy of, 1360
 electric, efficiency of, 1361
 electric, systems of, 1363
 electric, weight of copper for, 1359
 electric, wire table for, 1360
 hydraulic-pressure (*see* Hydraulic-pressure transmission)
 of heat (*see* Heat)
 of power by wire-rope (*see* Wire-rope), 1183-1189
 pneumatic postal, 624
 rope, iron and steel, 245
 rope (*see* Rope-driving)
 wire-rope (*see* Wire-rope)
- Transporting power of water, 565
- Triple-expansion engine (*see* Steam-engines)
- Transverse strength, 282-286
- Trapezium and Trapezoid, 55
- Triangles, mensuration of, 55
 problems in, 42
 spherical, 64
 solution of, 70
- Trigonometrical computations by slide rule, 84
 formulæ, 69
 functions, table, 166-169
 functions, logarithmic, 169
- Trigonometry, 67-70
- Triple effect evaporators, 543
- Troostite, 456
- Trough plates, properties of, 289
- Troy weight, 19
- Trusses, bridge, stresses in, 517
 roof, stresses in, 521
- Tubes, boiler, table, 209
 boiler, used as columns, 341
 brass, seamless, 216
 collapse of, formulæ for, 320
 collapse of, tests of, 320
 collapsing pressure of, table, 321
 copper, 216
 expanded, holding power of, 342, 883
 lead and tin, 217
 of different materials, weight of, 178
 seamless aluminum bronze, 372
 steel, cold-drawn, Shelby, 210
 surface per foot of length, 211
 welded, extra strong, 209
- Tube-plates, steam-boiler, rules for, 882
- Tungsten and aluminum alloy, 375
 electric lamps, 1371
 steel, 472
- Turbine wheel, tests of, 742
 wheels, 737-748
 wheels, proportions of, 739
 wheel tables, 751
- Turbines, fall-increaser for, 747
 of 13,500 H.P., 747
 rating and efficiency of, 743
 steam (*see* Steam-turbines)
- Turf or peat, as fuel, 808
- Turnbuckles, 231
- Tuyeres for cupolas, 1224
- Twist drills (*see* Drills)
 drills, sizes and speeds, 1254
- Twist-drill gauge, table, 30
- Twisted steel bars, strength of, 264
- Two-phase currents, 1394
- Type-metal, 384
- Uehling and Steinbart pyrometer, 530
- Underwriters' rules for electrical wiring, 1355
- Unequal arms on balances, 20
- Unit of evaporation, 855
 of force, 488
 of power, 503

- Unit of heat, 532
 of work, 502
- Units, electrical and mechanical, equivalent values of, 1347
 electrical, relations of, 1346
 of the magnetic circuit, 1346
- United States, population of, 11
 standard sheet metal, gauge, 31
- Unstayed surfaces, strength of, 314
- Upsetting of structural steel, 459
- Vacuum at different temperatures, 757
 drying in, 546
 high advantage of, 1059
 high, influence of on economy, 972
 inches of mercury and absolute pressures, 1053
 pumps, 775
 systems of steam heating, 673
- Valve-gear, Stephenson, 1044
 Walschaert, 1046
- Valves and elbows, friction of air in, 593
 and fittings, loss of pressure due to, 721
 pump, 762
 in steam pipes, 852
 straight-way gate, 199
- Valve-stem or rod, design of, 1019
 (*see* Steam-engines)
- Vanadium and copper alloys, 371
 effect of on cast iron, 416, 426
 steel spring, 401
 -chrome steel, 476-478
 -nickel steels, 475
- Vapor pressures of various liquids, 814
 water, and air mixture, weight of, 584, 586
 ammonia, carbon dioxide and sulphur dioxide, properties of, 1288
 and gases, mixtures of, 578
 saturation point of, 573
- Vaporizer pressures in refrigerating, 1288
- Varnishes, 448
- Velocity, angular, 498
 due to filling a given height, 500
 parallelogram of, 499
 table of height corresponding to a given, 499
- Ventilating ducts, quantity of air carried by, 655
 fans, 626-648
- Ventilation (*see also* Heating and Ventilation)
 cooling air for, 681
 of mines (*see* Mine-Ventilation)
 by a steam-jet, 652
 of mines; equivalent orifice, 686
- Ventilators, centrifugal for mines, 644
- Venturi meter, 728
- Versed line of an arc, 68
 sines, table, 166-169
- Verticals, formulæ for strains in, 519
- Vessels (*see also* Ships)
- Vessels, framing of, table, 316
- Vibrations in engines, preventing, 980
- Vis-viva, 502
- Volt, definition of, 1345
- Voltages used in long-distance transmission, 1399
- Volumes of revolution, cubature of, 78
- Vulcanized India rubber, 356
- Walls of buildings, thickness of, 1336
 of warehouses, factories, etc., 1337
 windows, etc., heat loss through, 659
- Walschaert valve-gear, 1046
- Warren girder, stresses in, 520
- Washers, wrought and cast, tables of, 230
- Washing of coal
- Water, 687-697
 amount of to develop a given horse-power, 753
 abrading power of, 705
 analysis of, 693
 as a lubricant, 1222
 boiling point of, 690
 boiling point at various barometric pressures, 582
 comparison of head in feet with various units, 689
 compressibility of, 691
 conduits, long, efficiency of, 735
 consumption of locomotives, 1098
 consumption of steam-engines (*see* Steam-engines)
 current motors, 734
 erosion and abrading by, 705
 flow of (*see* Flow of water)
 flowing in a tube, power of, 734
 flowing, measurement of, 727
 freezing-point of, 690
 hammer, 722
 hardness of, 694
 head of, 689
 heating of, by steam coils, 565
 heat-units per pound of, 688
 horse-power required to raise, 757
 impurities of, 691
 in pipes, loss of energy in, 780
 jets, vertical, 722
 meters, capacity of, 722
 pipe, cast-iron, transverse strength of, 427
 pipes, compound with branches, 720
 power, 734
 power plants, high pressure, 754
 power, value of, 735
 pressures and heads, table, 689

- Water pressure on vertical surfaces, 690
 pressure per square inch, equivalents of, 28, 689
 prices charged for in cities, 722
 pumping by compressed air, 776
 purification of, 694-697
 quantity of discharged from pipes, 707-712
 specific heat of, 536, 691
 total heat and entropy of, 839-842
 tower (*see* Stand-pipe)
 tower at Yonkers, N. Y., 328
 transporting power of, 565
 under pressure, energy of, 734
 units of pressure and head, 680
 velocity of, in open channels, 704
 velocity of, in pipes, 707-712
 vapor and air mixture weight of, 584, 586
 weight at different temperatures, 687, 688
 weight of one cubic foot, 28
 wheels, 737
 wheels, jet, power, of, 755
 wheels, Pelton, 748
 wheels, tangential, 750
 wheels, tangential choice of, 749
 wheel, tangential table, 751
 Waterfall, power of a, 734
 Water-gas, 829
 analyses of, 830
 manufacture of, 830
 plant, efficiency of, 831
 plant, space required for, 832
 Water-softening apparatus, 695
 Waves, ocean, power of, 755
 Weathering of coal, 800
 Webster's formula for strength of steel, 452
 Wedge, 512
 volume of, 63
 Weighing on an incorrect balance, 20
 Weight, definition of, 487
 and specific gravity of materials 171-174 (*see also* Material in question)
 measures of, 19
 Weir dam measurement, 731
 flow of water over, 731
 trapezoidal, 733
 Welds, strength of, 333
 Welding by oxy-acetylene flame, 464
 electric, 1374
 of steel, 460, 463
 process, the thermit, 463
 Welding by oxy-acetylene flame, 464
 electric, 1374
 of steel, 460, 463
 process, the thermit, 463
 Wheat, weight of, 178
 Wheel and axle, 514
 Wheels, turbine (*see* Turbine Wheel)
 Whipple truss, 518
 White-metal alloys, 382, 383
 Whitworth process of compressing steel, 464
 Wiborgh air-pyrometer, 528
 Wildwood pumping-engine, high economy of, 774
 Willans law of steam consumption, 962
 Wind, 597-603
 force of, 597
 pressure of, in storms, 598
 strain on stand-pipes, 328
 Winding engines, 1163
 Windlass, 514
 differential, 514
 Windmills, 599-604
 capacity and economy, 601
 Wire, aluminum, properties of, 243, 1362
 aluminum bronze, 243
 brass, properties of, 243
 brass, weight of, table, 219
 copper, hard-drawn, specification for, 243
 copper, stranded, 242
 copper, rule for resistance of, 242
 copper, table of size, weight and resistance of Edison gauge, 240
 copper, telegraph and telephone, 241
 copper, weight of bare and insulated, 241
 galvanized, for telegraph and telephone lines, 238
 galvanized iron, specifications for, 239
 galvanized steel strand, 249
 gauges, tables, 29
 insulated copper, 241
 iron and steel 237-239
 nails, 235, 236
 phosphor-bronze, 243
 piano, strength of, 239
 platinum, properties of, 243
 plow steel, 239
 of different metals, 243
 silicon-bronze, 243, 371
 steel, properties of, 237
 stranded feed, table, 242
 telegraph, joints in, 239
 telegraph, tests of, 238
 weight per mile-ohm 238
 Wires of various metals, strength of 336
 Wire-rope, 244-250
 rope, bending curvature of, 1188
 rope, bending stress of, 1184
 rope, breaking strength of, 1184
 rope, flat, 248
 rope, galvanized, 247
 rope haulage (*see* Haulage)
 rope, horse-power transmitted by 1185
 rope, horse-power transmitted 1185
 rope, locked, 250
 rope, notes on use of, 250
 rope, plow steel, 246

- Wire-rope, radius of curvature of, 1189
 rope, sag or deflection of, 1187
 rope, splicing of, 395
 ropes, strength of, 334
 rope, sheaves for, 1184
 rope, tapered, 1183
 rope tramways, 1179
 rope transmission, deflection of rope, 1180, 1187
 rope transmission, inclined, 1188
 rope transmission, limits of span, 1187
 rope transmission, long distance, 1188
 rope, transmission of power by, 1183
 rope transmission, sheaves for 1186
 Wire-wound fly-wheels, 1034
 Wiring rules, Underwriters' 355,
 table for direct currents, 1360
 table for motor service, 1356
 table for three-phase transmission lines, 1398
 Wohler's experiments on strength of materials, 261
 Wood (*see also* Timber)
 as fuel, 804
 composition of, 805
 drying of, 347
 expansion of, by heat, 345
 expansion of, by water, 345
 heating value of, 804
 holding power of bolts in, 323
 nail-holding power of, 323
 screws, dimensions of, 234
 screws, holding power of, 323
 strength of, 344-347
 strength of, Kirkaldy's tests, 336
 weight of, table, 173
 weight and heating values of, 804
 weight per cord, 255
 Woods, American, shearing strength of, 347
 tests of, 346
 Wooden fly-wheels, 1033
 stove pipe, 218
 Wool compound engines, 947
 Wooten locomotive, 1090
 Work, definition of, 28, 502
 energy, power, 502
 of adiabatic compression, 607
 of acceleration, 504
 of accelerated rotation, 504
 of a man, horse, etc., 507-509
 of friction, 1205
 Worm gearing, 514, 1143
 Wrist-pins, dimensions of, 1009
 Wrought iron, chemical composition of, 436
 iron, effect of rolling on strength of, 437
 iron, manufacture of, 435
 iron, slag in, 436
 iron, specifications, 437, 438
 strength of, 330, 337, 435-439
 iron, strength of, at high temperatures, 439
 iron, strength of, Kirkaldy's tests, 331
 Yacht rigging, galvanized steel, 248
 Yield point, 259
 Z-bar columns, dimensions of, 300-304
 Z-bars, Carnegie, properties of, 299
 Zero, absolute, 540, 837
 Zeuner's slide-valve diagram, 1036
 Zinc alloys (*see* Alloys)
 properties of, 177
 use of, in steam boilers, 901
 Zone, spherical, 65
 of spheroid, 65
 of spindle, 65