

**AT** MICROFICHE  
REFERENCE  
LIBRARY

A project of Volunteers in Asia

Fish Culture in Central East Africa

by: A. Maar, M.A.E. Mortimer, and I. Van der  
Lingen

Published by:

Food and Agriculture Organization of the  
United Nations

Via delle Terme di Caracalla

00100 Rome

Italy

Paper copies are \$ 6.00.

Available from:

META Publications

P.O. Box 128

Marblemount, WA 98267 USA

Reproduced by permission of the Food and  
Agriculture Organization of the United Nations.

Reproduction of this microfiche document in any  
form is subject to the same restrictions as those  
of the original document.

# FISH CULTURE IN CENTRAL EAST AFRICA

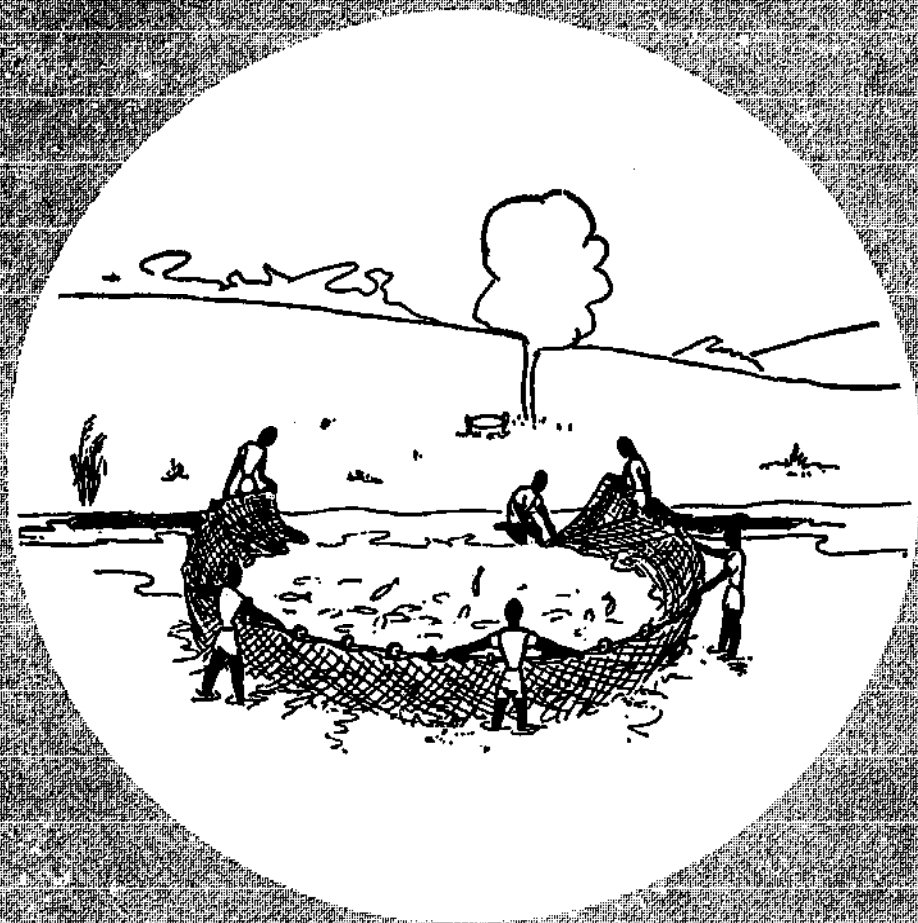

FOOD AND AGRICULTURE ORGANIZATION OF THE UNITED NATIONS

**FISH CULTURE IN CENTRAL EAST AFRICA**



A bas-relief on the Mastaba or Tomb of Akthetep, showing net fishing on the Nile (2500 B.C.); and *Tilapia* being split in half for drying in the sun. (Photo by courtesy of Caisse nationale des monuments historiques, Paris.)

**FISH CULTURE  
IN CENTRAL EAST AFRICA**

*by*

**A. MAAR, M. A. E. MORTIMER and I. VAN DER LINGEN**

**FOOD AND AGRICULTURE ORGANIZATION OF THE UNITED NATIONS**

**Rome 1966**

This publication has been financed by the United Nations Children's Fund under a project jointly sponsored by the Food and Agriculture Organization of the United Nations, the World Health Organization and UNICEF. The views expressed are, however, those of the authors.

© FAO 1966

---

*Printed in Italy*

## PREFACE

In most African countries the importance of fish culture has not been fully recognized and its development has not been pursued, mainly because of a lack of fisheries organizations and a shortage of professional and trained staff. Another hindrance is the small amount of educational material and instructional booklets related to local conditions.

As part of its applied nutrition program in Africa in conjunction with FAO and WHO, UNICEF has sponsored a number of manuals aimed at the improvement of nutritional standards. This manual of fish culture is one of the series and presents the essentials of fish culture to the farmer or landowner wishing either to raise fish for the family alone or to enter a commercial venture and produce fish for sale in the market. It may also serve as a text for training extension workers and others to help in promoting fish culture in their areas.

Since a large part of the protein now lacking in the diets of many African families could be supplied by fish, a fuller and more widespread development of fish culture must be encouraged.

First printing 1966  
Second printing 1974



## CONTENTS

|  |    |
|--|----|
| PREFACE .....  | v  |
| <b>Part One</b>  |    |
| INTRODUCTION .....   | 3  |
| 1. FISH CULTURE IN AFRICA .....                                  | 7  |
| <b>Part Two</b>  |    |
| 2. POND CONSTRUCTION .....                                       | 11 |
| Areas for development .....                                      | 11 |
| Kinds of fish ponds .....  | 12 |
| Sites for fish ponds .....                                       | 17 |
| Parts of a fish pond.....  | 22 |
| Pond shape, size and depth .....                                 | 27 |
| Making fish ponds .....  | 33 |
| Equipment for pond construction and management .....             | 42 |
| 3. FISH CULTURE PRACTICES IN PONDS .....                         | 43 |
| General principles of pond management and care .....             | 43 |
| Types of culture .....   | 57 |
| Types of fish used for fish culture in central east Africa ..... | 62 |
| General biology of the species of value in fish culture ...      | 70 |
| Suitable combinations of fish for stocking .....                 | 78 |

|   |     |
|---|-----|
| 4. FISH CULTURE PRACTICES IN DAMS .....                                     | 79  |
| How dams and weirs can be used to grow fish .....                           | 81  |
| Methods of fishing dams .....   | 89  |
| Fish production in dams .....   | 97  |
| Plants in dams .....  | 99  |
| Exotic fish species in dams .....   | 103 |
| Growing fish in dams that dry up .....                                      | 103 |
| Dam cropping schemes .....  | 104 |
| 5. PREDATORS, DISEASES AND MORTALITIES .....                                | 105 |
| Predators .....   | 105 |
| Diseases .....  | 105 |
| Mortalities .....   | 106 |
| 6. ECONOMICS OF FISH CULTURE: TRANSPORT AND PRESERVA-<br>TION OF FISH ..... | 108 |
| Economic fish culture .....   | 108 |
| Transport of live fish .....  | 109 |
| Preservation of fish .....  | 112 |

### Part Three

|  |     |
|--|-----|
| 7. BACKGROUND TO BIOLOGICAL PRODUCTION .....       | 123 |
| Physical and chemical qualities of waters .....    | 124 |
| Biological production in a water.....              | 126 |
| 8. STRUCTURE AND GENERAL BIOLOGY OF FISH .....     | 131 |
| Fish anatomy .....                                 | 131 |
| Fish biology .....                                 | 135 |
| MODEL RECORD SHEET FOR INDIVIDUAL PONDS .....      | 140 |
| SUGGESTED LITERATURE FOR FURTHER INFORMATION ..... | 141 |

---

|   |     |
|---|-----|
| APPENDIXES .....  | 142 |
| 1. Note on fish spoilage and preservation.....              | 142 |
| 2. Control of bilharzia and malaria in dams and ponds ..    | 143 |
| 3. Recording relevant factors prevailing in ponds and dams  | 145 |
| 4. Useful tables .....                                      | 151 |
| 5. Items for estimating labor costs in pond construction .. | 152 |
| 6. Notes on the economics of fish ponds in Zambia .....     | 153 |
| 7. Double conversion table .....                            | 155 |
| 8. Glossary.....  | 157 |
| INDEX .....   | 159 |

## LIST OF FIGURES

### *Figure*

|  |    |
|--|----|
| 1. Contour ponds .....   | 13 |
| 2. Barrage ponds made in small dambo .....                           | 14 |
| 3. Barrage ponds made below a conservation dam .....                 | 15 |
| 4. Paddy ponds made in a flat dambo .....                            | 16 |
| 5. Arrangements for water supplies to fish ponds .....               | 20 |
| 6. The parts of a fish pond .....                                    | 23 |
| 7. The measurements of pond walls .....                              | 24 |
| 8. Pond inlets .....   | 25 |
| 9. Pond pipe outlets .....   | 26 |
| 10. The sluice .....   | 28 |
| 11. The monk .....   | 29 |
| 12. The siphon .....   | 30 |
| 13. Pipe overflow .....  | 31 |
| 14. Another kind of overflow .....                                   | 31 |
| 15. Spillway overflow .....  | 32 |
| 16. Marking the height of the walls for a contour pond .             | 34 |
| 17. Marking the height of the wall for a barrage pond ..             | 35 |
| 18. Marking out the walls of a paddy pond .....                      | 35 |
| 19. Making the key trench .....                                      | 36 |
| 20. Putting in the outlet pipe .....                                 | 36 |
| 21. Making the walls of a contour pond .....                         | 37 |
| 22. Making the wall of a barrage pond .....                          | 38 |
| 23. Making the walls of a paddy pond .....                           | 38 |
| 24. Finishing the pond .....   | 39 |
| 25. Fencing the pond .....   | 40 |
| 26. The most important equipment for fish pond manage-<br>ment ..... | 41 |

*Figure*

|     |   |         |
|-----|---|---------|
| 27. | How to crop fish ponds .....  | 52-55   |
| 28. | Combined fish, crop and livestock farming .....                     | 59      |
| 29. | Fish and rice .....   | 60      |
| 30. | Gill rakers of <i>Serranochromis robustus</i> .....                 | 64      |
| 31. | Gill rakers of <i>T. macrochir</i> and <i>T. melanopleura</i> ..... | 64      |
| 32. | <i>Tilapia melanopleura</i> .....                                   | 65      |
| 33. | <i>Tilapia mossambica</i> .....                                     | 65      |
| 34. | <i>Tilapia macrochir</i> .....                                      | 66      |
| 35. | <i>Tilapia andersonii</i> .....                                     | 66      |
| 36. | Teeth of <i>Serranochromis</i> .....                                | 67      |
| 37. | <i>Serranochromis</i> species .....                                 | 68      |
| 38. | Nests of <i>Tilapia</i> species .....                               | 74      |
| 39. | Growth of <i>Tilapia melanopleura</i> in ponds .....                | 76      |
| 40. | Growth of <i>Tilapia macrochir</i> in ponds .....                   | 76      |
| 41. | Growth of <i>Tilapia andersonii</i> in ponds .....                  | 76      |
| 42. | A dam .....   | 80      |
| 43. | A weir .....  | 80      |
| 44. | Where to stump a big dam .....                                      | 82      |
| 45. | Stumping a dam .....  | 84      |
| 46. | How to use a winch to pull out tree stumps from a dam .....         | 85-87   |
| 47. | How to use a seine net in a dam .....                               | 91-92   |
| 48. | How to set gill nets in dams .....                                  | 93-94   |
| 49. | Lines set in the shallow water around the side of the dam .....     | 95      |
| 50. | Long lines .....  | 95      |
| 51. | Fish traps used in dams .....                                       | 96      |
| 52. | Water hyacinth .....  | 100     |
| 53. | Kariba weed .....   | 101     |
| 54. | Snails that live in water .....                                     | 101     |
| 55. | Carp, black bass, yellow fish .....                                 | 102     |
| 56. | Cans and drums for fish transport .....                             | 109     |
| 57. | Method of catching and handling live <i>Tilapia</i> species .....   | 110-111 |
| 58. | A fish sump .....   | 113     |
| 59. | A container with prepared saltpeter solution .....                  | 114     |
| 60. | Fish split along the back .....                                     | 115     |
| 61. | Heat/smoke curing of fish on a grid.....                            | 116     |
| 62. | Reed or grass hut for cold smoking .....                            | 117     |
| 63. | Dry salting in a wooden box .....                                   | 117     |

*Figure*

|   |     |
|---|-----|
| 64. Boiling of offal for extracting fish oil .....          | 119 |
| 65. Scheme of limnological zonations .....                  | 126 |
| 66. Plankton .....  | 127 |
| 67. Benthos .....   | 128 |
| 68. External features of fish .....                         | 132 |
| 69. Gill and gill rakers in <i>Tilapia mossambica</i> ..... | 135 |
| 70. Male and female <i>Tilapia mossambica</i> .....         | 136 |
| 71. Growth of <i>Tilapia</i> .....                          | 139 |
| 72. Water sample bottle .....                               | 146 |
| 73. A. Plankton net; B. Secchi disk .....                   | 149 |

*Figures drawn by Muriel G. Russell Watts and H. Maar.*

**PART ONE**

## INTRODUCTION

It is an established fact that protein from foods of animal origin is dangerously lacking in the everyday diet of much of the population of Africa. This deficiency is responsible for a great deal of ill health and many deaths each year in almost all the countries of Africa including Rhodesia and Zambia. Even in the absence of ill health, protein deficiency leads to poor growth, muscular weakness and an increased susceptibility to many diseases. The supply of meat from game, various domestic animals and fish from natural waters has so far failed to provide the population with the balanced diet needed. It is imperative therefore to increase protein production by all possible means, first by the intensification of the existing means of production, and second, by the introduction and development of additional sources of protein.

Fish culture in artificial waters is one of the best ways of increasing the availability of food rich in protein. One of the advantages of fish culture is that the protein it produces is generally more economically obtained than that of agriculture, which calls for nitrogenous fertilizers for fodder production, and protein concentrate supplements for feeding livestock, cattle, pigs, poultry, etc. Another advantage is that animal protein produced in fish ponds may exceed the production from agriculture on an equal area. That animal protein may be produced in ponds cheaply and in large quantities is important to a national economy. Low production costs mean low food prices, which, in turn, influence the general cost of living.

Fish is high quality food. It contains as much as 60 percent first class protein on a dry matter basis. It is rich in vitamins and also contains variable quantities of fat, calcium, phosphorus and other nutrients important to human health and growth. Fish in many ways is even more nutritious than most meats from warm-blooded animals. Nutrition experts agree that fish with the addition



of a variety of vegetable products constitutes a completely balanced diet.

The cultivation of animal and vegetable life in a water is known as *aquiculture*. All kinds of water are used — sea water, brackish water and fresh water. Fresh water for aquiculture is used in artificially built ponds and reservoirs, as well as the fresh water of natural lakes, rivers and streams.

Aquiculture takes many forms, such as, for example, growing fish, frogs, oysters, rice and vegetables. A branch of aquiculture dealing with fish is called *pisciculture* or *fish culture*. Fish culture may be combined with other cultures, either animal or vegetable.

The variety of kinds and conditions of water calls for different methods of fish culture in natural as well as in artificial waters.

The aim of fish culture is always to achieve the highest possible fish production in any given circumstances and in the most economical way. Complete control over the physical, chemical and biological factors, which either directly or indirectly influence fish production, can rarely be achieved by management in natural waters. Despite good management, production may be limited by such factors as water which is too deep, absence of essential fertilizers, excessive invasion by water plants, undesirable composition of the fish population, and so on. In artificial waters, on the other hand, these adverse factors can be kept under control and a high fish production achieved.

Fish culture in natural waters is usually extensive and in artificial waters intensive. In either case extensive or intensive ways of management may be applied. Fish culture in ponds is always associated with intensive management.

Cultivation of fish in a variety of waters under different climatic conditions requires different approaches. Methods of fish culture used in salt, or brackish waters, or in temperate climates, are not described in this manual, as in central east Africa we are only concerned with fish culture in the fresh waters of tropical and subtropical zones.

Since in central east Africa both the warm and cold climatic zones exist, the critical dividing factor for either warm or cold water fish is a temperature of 11°C (52°F). Typical tropical fish do not survive water temperatures below 11°C for any length of time, whereas subtropical fish can resist fluctuations of temperature to below this point without harm.

Special chapters deal chiefly with fish culture in artificially built ponds, reservoirs, dams and lakes. With few exceptions all these waters are warm, so that the prevailing type of fish culture in central east Africa is warm water fish culture.

Fish culture in both ponds and reservoirs is undertaken mainly to produce fish for food. Sometimes, especially in reservoirs, fish is cultivated for recreational purposes. In addition, ponds are used to produce fish for stocking other ponds, fish for sanitary purposes and ornamental fish.

As to varieties, in central east Africa the culture of warm water fish, such as the species of the Cichlid family, predominates. Cold water fish such as trout are cultivated to a lesser degree. The warm water varieties also include such exotic fish as tench, black bass and bluegill. One of the latest introductions is carp, which is adaptable to cooler waters as well.

In principle, all artificial waters could be regarded as ponds if they conform to the following requirements:

1. They must be shallow.
2. It must be possible to drain them.
3. It must be possible to keep ponds dry or under water alternately for certain periods.

Not all artificial waters conform to these requirements. Some are closer in character to natural waters, others to proper fish ponds. Accordingly, two types of fish culture are applied in the artificial waters of central east Africa -- culture in reservoirs and culture in ponds.

## 1. FISH CULTURE IN AFRICA

A bas-relief found on an ancient Egyptian tomb shows *Tilapia* being fished out of an artificial pond, presumably a drainable one (frontispiece). This bas-relief is evidence that *Tilapia* culture was already practiced in Egypt about 2500 B.C. This is the oldest presentation of a fish culture pond in the world. It is also the oldest evidence of fish culture on the African continent. There are no records to suggest that, during the thousands of years which have since elapsed, fish culture has developed on the African continent until recent times.

With regard to other parts of the world, it is known that carp culture was widespread in China in 2000 B.C. and the ancient Romans introduced carp from Asia Minor into Greece and Italy. In central Europe, carp culture was already well established in the seventh century, and became widespread over the European continent at the beginning of the seventeenth century. In recent times first attempts to cultivate the *Tilapia* species were made in Kenya in 1924, which rightfully mark the turning point in *Tilapia* culture in modern Africa. The Congo followed the example in 1937. In central east Africa the first trials of fish pond culture were made in Zambia in 1942, to be followed by Rhodesia in 1950.

The development of pond culture in Africa is reflected in the records of the Anglo-Belgian Fisheries Conference held in Elizabethville in 1949 and in the records of the fisheries symposia which followed, sponsored by the Commission for Technical Co-operation in Africa South of the Sahara through its Scientific Council. These symposia were held in Entebbe, in 1952 in Brazzaville, and in 1960 in Lusaka.

Developments in fish culture in Africa during the last 20 years may be summarized as follows:

1. New research institutions have been established in some countries, while existing institutions have been enlarged.
2. Results so far have shown that crops of 3,000 pounds per acre per annum can be obtained from fish ponds with correct management and crops up to 6,000 pounds per acre per annum have been obtained. However, with unsophisticated rural pond management in central Africa, crops are more likely to be of the order of 1,000-1,500 pounds per acre per annum.
3. As a result of research work and publicity, fisheries are now recognized in many countries as a vital factor in national nutritional policy and more attention is being given to their development.

Results already achieved justify the intensification of fish culture, in order to reduce the deficiency of protein in the diet of the majority of African people today.

**PART TWO**

## 2. POND CONSTRUCTION

### Areas for development

Too often in the past 20 years pond fish culture has been freely advocated as a form of development of food resources. No especial consideration was given to whether this was really the best development in relation to the environmental conditions and economic state of the area.

Before planning any fish culture project, it is necessary first to decide whether it is really the best method of fish production for the area, or whether another form of fisheries development should be considered. In areas where large natural fisheries exist, for example, there is little point in developing any form of fish culture. First, there must be full exploitation of the natural fishery, bringing benefit to as many people as possible in the region.

Generally speaking, the areas in which fish pond culture is likely to be a sound form of development are those which satisfy some of the following conditions:

- a.* There is a shortage of animal protein for consumption.
- b.* There are no large natural fisheries.
- c.* There are adequate surface water supplies.
- d.* There is a ready market for the cash sale of fish.
- e.* There already exists a combination of fish ponds with forms of agriculture such as vegetable growing, poultry, pig farming, etc., or a potential for this combination.

Once the form of fish culture development for an area has been decided upon, the development may be put into effect.

It has been found by experience that no matter what type of fish culture is contemplated, the development is most easily and surely brought about through the following stages: (*a*) demonstration; (*b*) instruction; (*c*) extension.

*Demonstration* involves the setting up of a demonstration unit consisting of a small unit of fish ponds or conservation dams.

A fish pond unit must be of economic size, sited in a place and constructed in a manner typical of what is possible for the area as a whole. It must also be combined with other forms of agriculture applicable to the region.

A conservation dam unit may consist of either one or two dams, characteristic of the area, where both good and bad management practices can be demonstrated.

It cannot be overstressed that the demonstration should be typical of what *can* be done in the area, because individual efforts will exactly reflect the demonstration. It is therefore of little use to demonstrate a unit of barrage-type fish ponds when the terrain of the development area is better suited to contour ponds. Similarly, a demonstration of large perennial dam management is futile in an area where most dams are likely to be small and nonperennial.

*Instruction* involves the use of the demonstration unit for field days and courses of instruction to show the people of the region how the unit is managed and what results can be obtained. Usually a short time after the demonstration and instruction stages, inquiries are received from potential fish farmers and dam owners. This leads to the third and most important stage of development, extension.

*Extension* involves the use of trained staff to advise and assist farmers on the spot. This staff chooses sites, lays out fish ponds, advises and checks on construction, arranges for pond stocking and pays frequent visits to advise and assist in pond management. In conservation dam fishery development, staff are required to work with dam owners, whether private or local authorities, and advise on stumping, stocking and cropping. It is even desirable that they should run dam cropping schemes for the first year.

Extension work is very important and the provision of adequate staff is most essential.

### **Kinds of fish ponds**

Ponds can be described according to where and how they are made and the use to which they are put.

The main kinds of ponds are contour ponds, barrage ponds and paddy ponds.

*Contour ponds* are made on sloping ground. The bottom walls of the pond lie along the contour of the ground. Contour ponds are constructed along the sides of valleys and sometimes dambos (vleis), the water coming in a furrow from a stream or sometimes a conservation dam. A unit of contour ponds is illustrated in Figure 1.

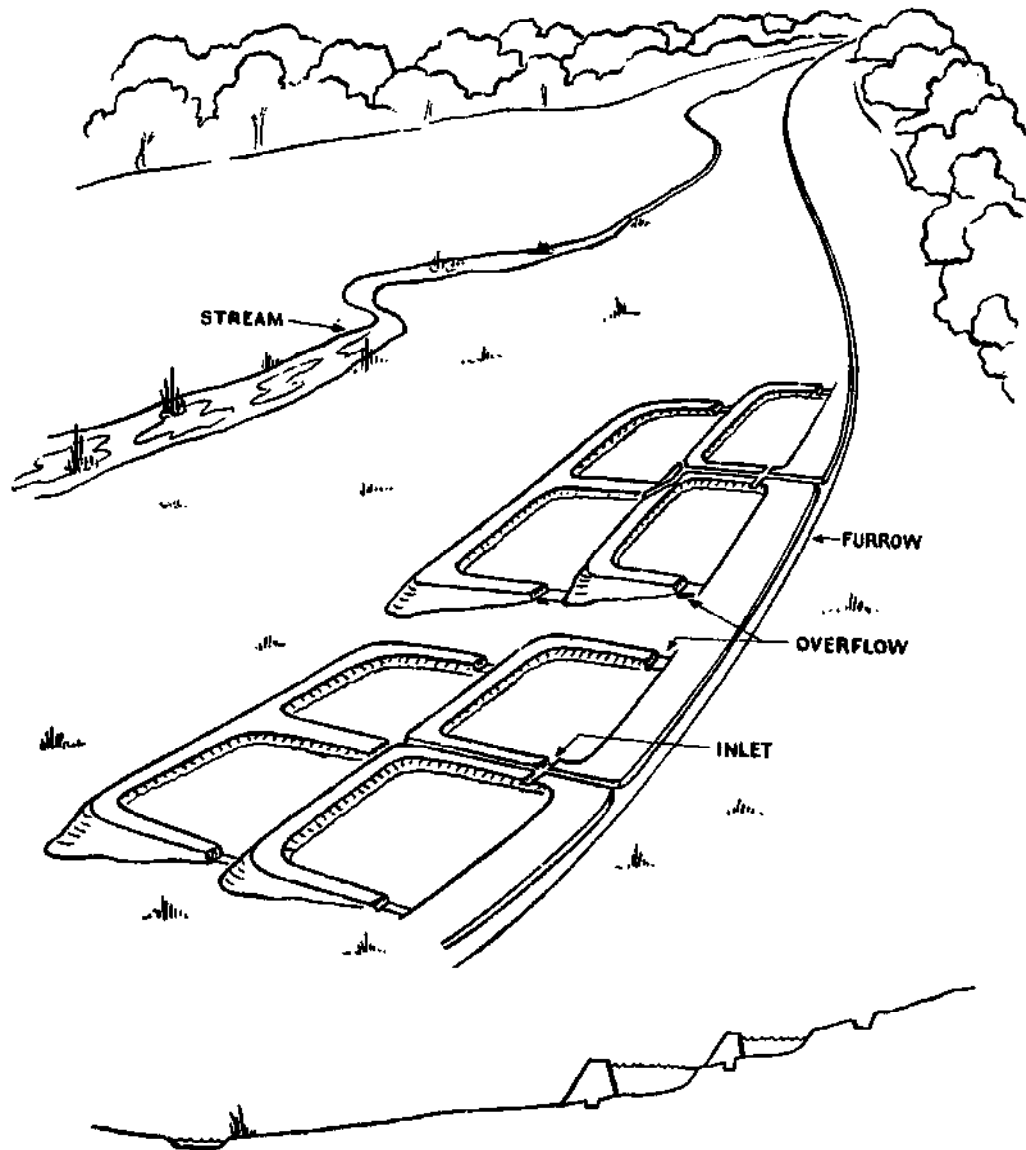

FIGURE 1. Contour ponds.



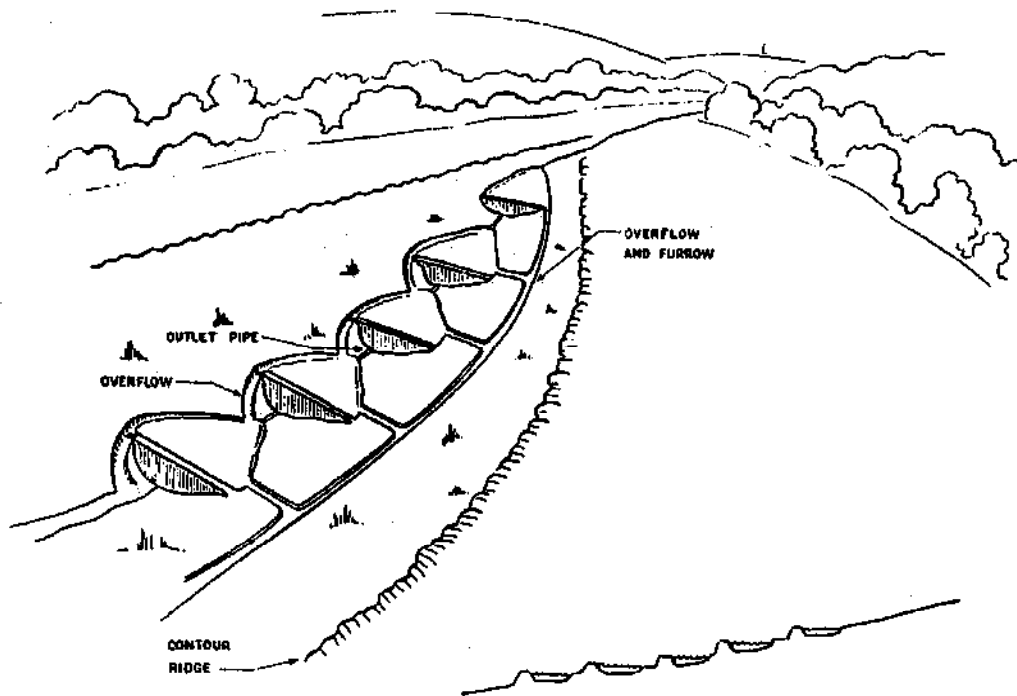

FIGURE 2. Barge ponds made in a small dambo. Walls about 4 ft high are built across the dambo one below the other. Each pond has an outlet pipe and an overflow. At the first pond the overflow is continued as a furrow so that water can be put into the lower ponds when it is needed. Contour ridges are made on either side of the dambo and thus the ponds are not flooded in the rains.

*Barge ponds* are made by building a wall across a small dambo or stream and the ponds are therefore like small conservation dams. Water for these ponds comes from a spring, or a "mushitu" or seepage area. It is very important that ponds of this type should not be constructed in places where there will be a very large flood of water down the stream or dambo in the rainy season.

Sometimes barge ponds are made below large conservation dams making use of seepage water. In such cases the water in the first pond of a series must be at least 50 feet from the bottom of the dam wall. Units of barge ponds are illustrated in Figures 2 and 3.

*Paddy ponds* are made in places where the ground is flat, or almost flat, such as in dambos or swamps and flood plains. The water for the ponds comes in a furrow from a stream, or from seepage in the area, or sometimes from springs. Because paddy ponds are made on fiat ground, four walls must usually be made to each pond, as

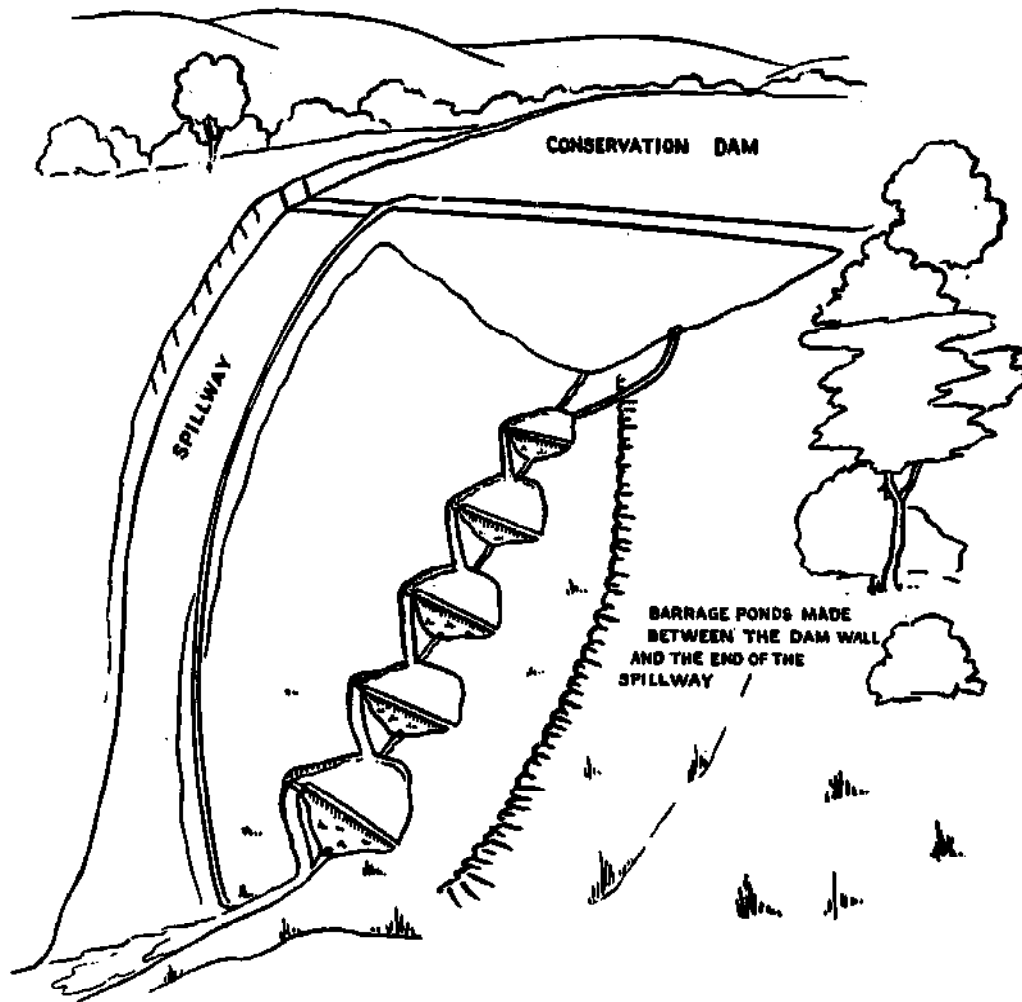

FIGURE 3. Barrage ponds made below a conservation dam.

compared with three for contour ponds and only one for barrage ponds. The water supply often has to be brought to the ponds on top of a specially constructed dike and is distributed by furrows on top of the pond walls. The walls of paddy ponds are of a wider construction than the walls of other kinds of ponds because the soil is usually not so firm. A unit of paddy ponds is illustrated in Figure 4.

In some parts of the world where the culture of fish in ponds tends to be rather specialized, ponds are used for special purposes. In Europe, for example, carp culture requires special ponds for breeding, special ponds for rearing and special ponds for growing table fish.

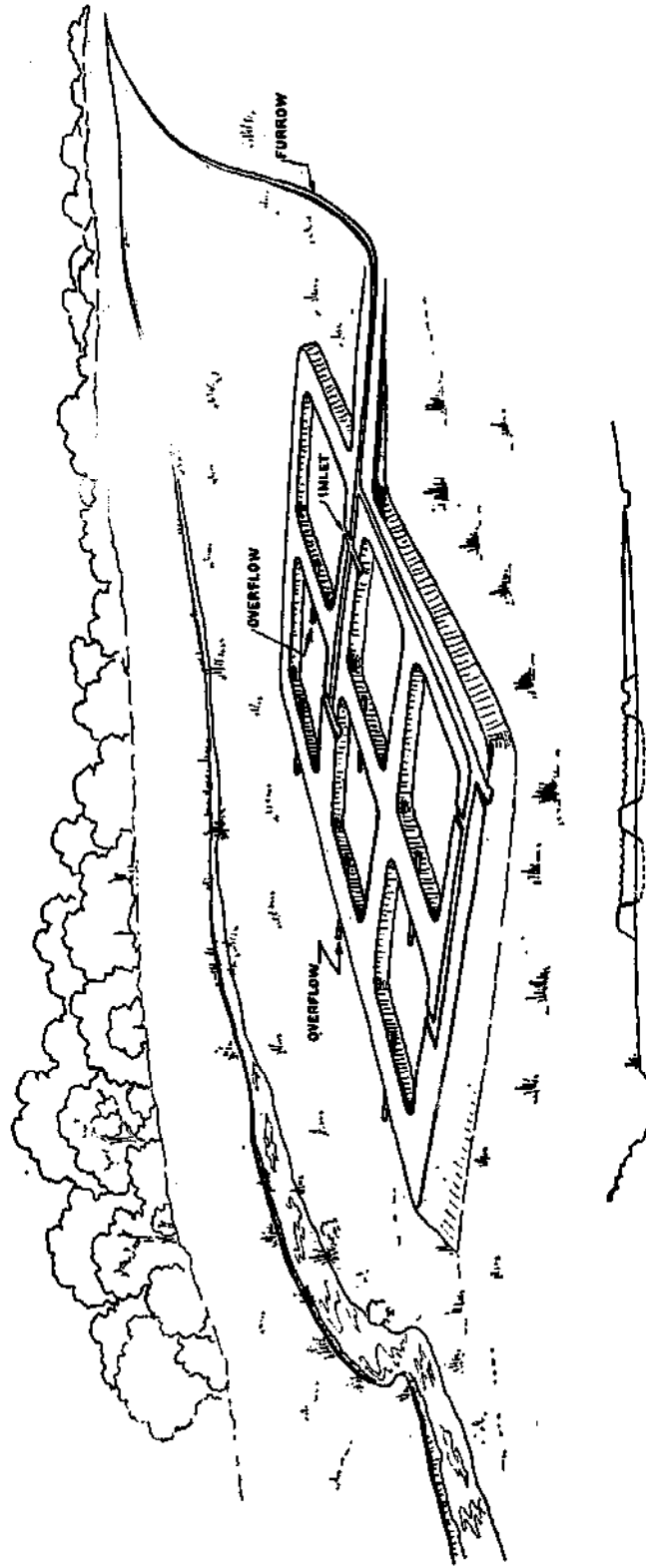

FIGURE 4. Paddy ponds made in a flat dambo. There should be provision for drainage.

In central east Africa where pond fish culture is very largely of the Cichlids, such as *Tilapia* and *Haplochromis*, normally no ponds of special construction are needed for any particular stage of their culture.

Fish breed and grow in the same pond and, in fact, one of the greatest problems of Cichlid culture is their prolific breeding in ponds.

With the development of *Tilapia* "hybrids," it will be necessary to have separate ponds set aside for crossbreeding and separate ponds for growing the progeny to edible size. These ponds will not, however, differ materially in construction, but merely in size and in the degree of control devices.

### Sites for fish ponds

The place where fish ponds are made is called the pond site. When choosing a site for fish ponds these factors must be considered:

- a. Water supply;
- b. Soil, rocks and trees;
- c. Supporting services.

Of course, fish ponds can be made almost anywhere, but some sites are better than others and may be developed more economically. Fish ponds could be constructed on the top of Kilimanjaro, but it would hardly be an economic proposition.

### WATER AND WATER SUPPLY

#### *Amount of water*

One of the most important requirements for the successful development of fish ponds is an adequate water supply. Water is required not only to fill up ponds in the first place, but to replace water lost by evaporation and by seepage. The loss of water by evaporation is greatest in hot dry weather.

The amount of water lost by seepage will depend on the kind of soil in the place where the ponds are sited and on how well the ponds are made. If walls are not properly constructed, seepage may some-

times be so great that ponds will not hold water for more than a few hours after being filled up.

Suitable soils for making fish ponds are referred to on page 21.

New ponds often lose more water from seepage than old ponds. Fish in ponds stir up mud at the bottom and make a fine silt that helps to stop the leaks.

In central east Africa it has been found that the water supply to a unit of contour ponds could vary between 4,000 and 25,000 gallons per acre per day. On average, contour ponds require between 10,000 and 15,000 gallons of water per acre per day in areas where the rainfall is 30 to 35 inches a year and mean monthly temperatures are within the range of 15° to 26°C (59° to 78°F), where there is little pond seepage.

Barrage ponds require less water than contour ponds, because the seepage from one pond is used by the next in the series. Usually with barrage ponds it is necessary only to run water into the first of the series to keep it full.

If ponds are combined with the irrigation of vegetables and other crops, then extra water will be needed. For example, for a small holding of half an acre of ponds and half an acre of vegetables and fruit trees, recorded water requirements have been 30,000 to 50,000 gallons of water a day depending on the time of year. In this instance, however, seepage from the pond unit was excessive and irrigation was not efficient.

The water supply for fish ponds is very important. If there is not enough water all the year round, it is no good making ponds, as they will dry up and the fish will die. It is better to overestimate rather than underestimate water requirements.

Careful planning and situation of ponds can result in a reduction of the amount of water needed, e.g., for contour ponds made in terraces, the lower series seldom require a direct water supply, as they are kept full from seepage from the upper terraces' water table.

#### *Water sources*

It has already been stated that the water supply for a fish pond is very important and that there must be *enough water all the year round*. The most important sources of water for fish ponds are:

1. Perennial streams and rivers.
2. Springs and "mushitu." (A mushitu is a relict of tropical forests found in certain areas of central east Africa and always has water seeping from it.)
3. Very large conservation dams. Small dams are not a reliable source of water.

The important feature of the water source is that it must be reliable and adequate. Many rivers and streams in central east Africa have adequate water in the rainy season but stop flowing in the dry season. Such rivers and streams are not recommended as a direct source of water for fish ponds. Where river and stream water supplies are unreliable, conservation dams should be built and used for fish production.

#### *Quality of water*

It is not within the scope of this section to deal in detail with the quality of water. Just as some soils are better than others for growing crops, so some waters are better than others for growing food on which fish feed.

Water may be improved by adding fertilizers in the same way that soils can be improved.

In many parts of central east Africa where plenty of water occurs in rivers and streams the quality of the water is poor. This is not a serious matter because the water can be improved.

It is far more important that there should be enough water for fish ponds than that the water should be of good quality.

#### *Arranging the water supply*

Various ways of arranging the water supply to fish ponds are shown in Figure 5.

When a furrow is used to supply water, care must be taken to ensure that it is large enough to carry all the water required and that there is not too much seepage. Information on furrow sizes is given on page 151. Since fish pond development is usually part of other agricultural, irrigation development, there is seldom need for fisheries staff to be concerned over furrow siting.

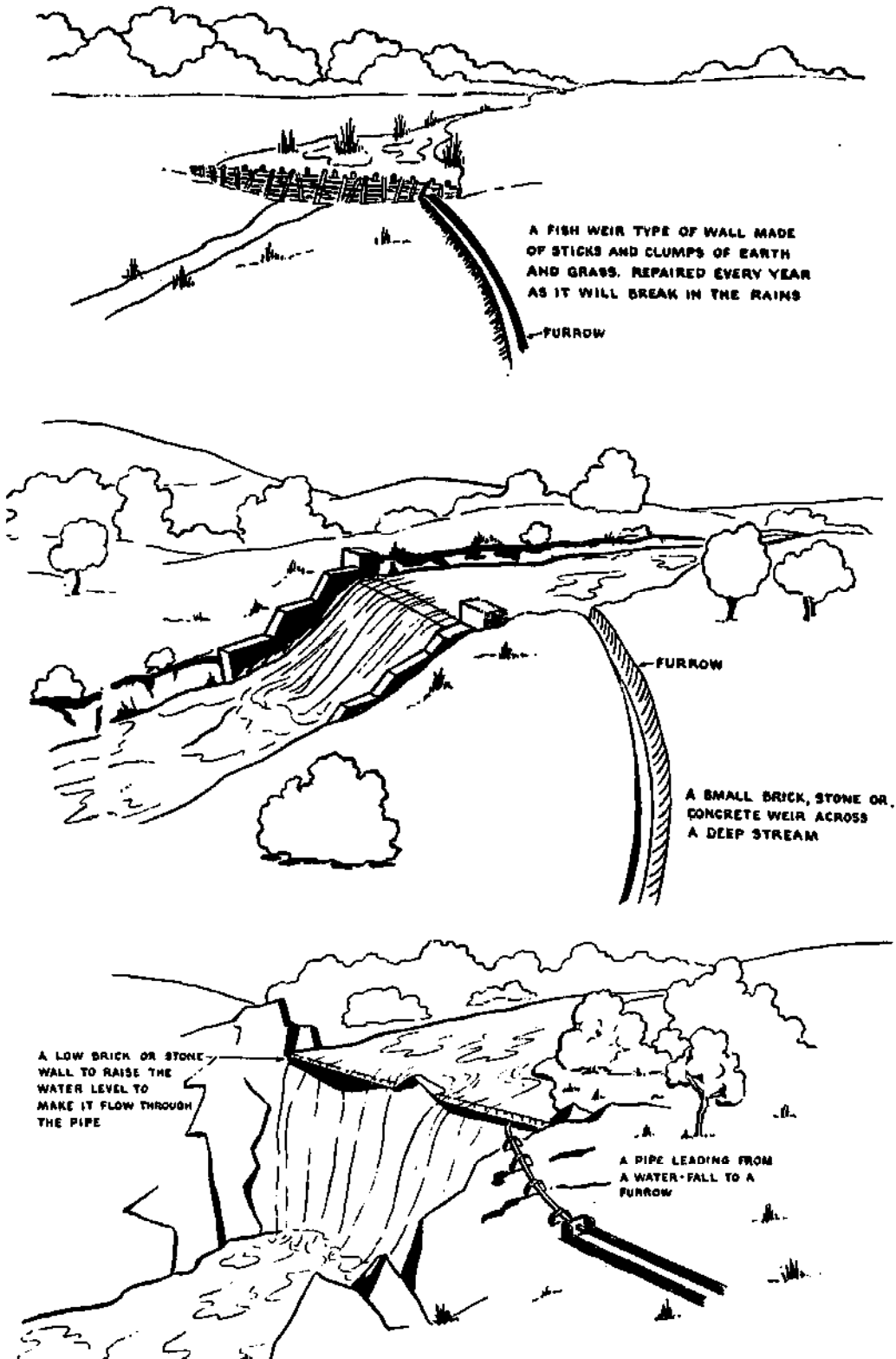

FIGURE 5. Arrangements for water supplies to fish ponds.

## SOILS, ROCKS AND TREES

### *Soils*

Soils are considered here in regard to their water retention properties rather than from the point of view of fertility.

There are a number of different kinds of soil which are suitable for making fish ponds. Wet, swampy ground such as that found in dambos is usually very appropriate for this purpose. In fact, swampy ground is most usually used for fish pond sites. Sandy clay, some schists and laterites are also suitable.

Some heavy clays are very good for pond building, others not so good. The reason for this is that heavy clays when dry are very hard and crack, and some are difficult to seal up. If however the cracks are sealed up, then the ponds are usually very good and hold water well.

Well-drained soils and red soils have not proved to be particularly adapted for making ponds as seepage is often very great indeed.

Places in which there are anthills must be avoided as excessive seepage will occur through them.

### *Rocks and trees*

Fish ponds must *never* be made where there are rock outcroppings because they will leak too much and cannot be sealed up properly. Sites having too many trees should also be avoided for it is costly to remove the trees properly. If there are a few trees they must be taken out and all the stumps and roots removed *completely*. The hole caused by the removal of the tree stump and roots must be filled with soil which must be stamped down hard. If trees and stumps are not taken out completely the pond may leak very badly, and also cannot be netted.

## SIZE AND POSITION OF SITE

The size of the site for fish ponds depends on the purpose of the ponds. If the aim is to be subsistence fishing only, then smaller sites may be used. Generally a subsistence pond should not be smaller than 1/10th of an acre, e.g., 20 × 25 yards.



If, however, the purpose is to be commercial production, a larger site is needed. A minimum of an acre of ponds is the smallest unit which should be considered for a commercial farm. A convenient unit is to have a minimum of 12 ponds so that one pond can be drained and the fish harvested each month of the year, thus assuring a regular supply of fish for sale and home consumption. For larger establishments, ponds in multiples of 12 are suggested for the same reason.

Although there is no objection to starting commercial pond fish culture in a small way with one or two ponds, the eventual aim should be a unit of ponds sufficient to produce economic results and the site selected should therefore have sufficient area of suitable ground for making the ponds.

The pond site should if possible be within sight of the house of the owner. If it is far from the owner's house, there is always danger of fish being stolen or eaten by animals such as otters. Also, when the pond is near the house of the owner, there is less chance that he will forget to look after the pond and the fish in it. The fish-pond site should preferably be near the farmer's other agricultural activities, such as the vegetable garden, poultry, pigs, etc.

### **Parts of a fish pond**

A fish pond is not just a hole in the ground, but a properly constructed place for breeding and growing fish. It has walls above the natural ground level, special places where water can be let in and taken out, and a place where, if necessary, water can overflow without breaking the walls. The different parts of a pond are shown in Figure 6.

### **WALLS**

The walls retain the water and form the pond. Their size depends on the depth of the pond. A deep pond must have larger walls than a shallow pond.

It is very important that the walls be sloped. The slope on the inside of the walls should be about 2 or  $2\frac{1}{2}$  to 1. The slope on the outside of the walls can be about 1:1. The slope depends on the

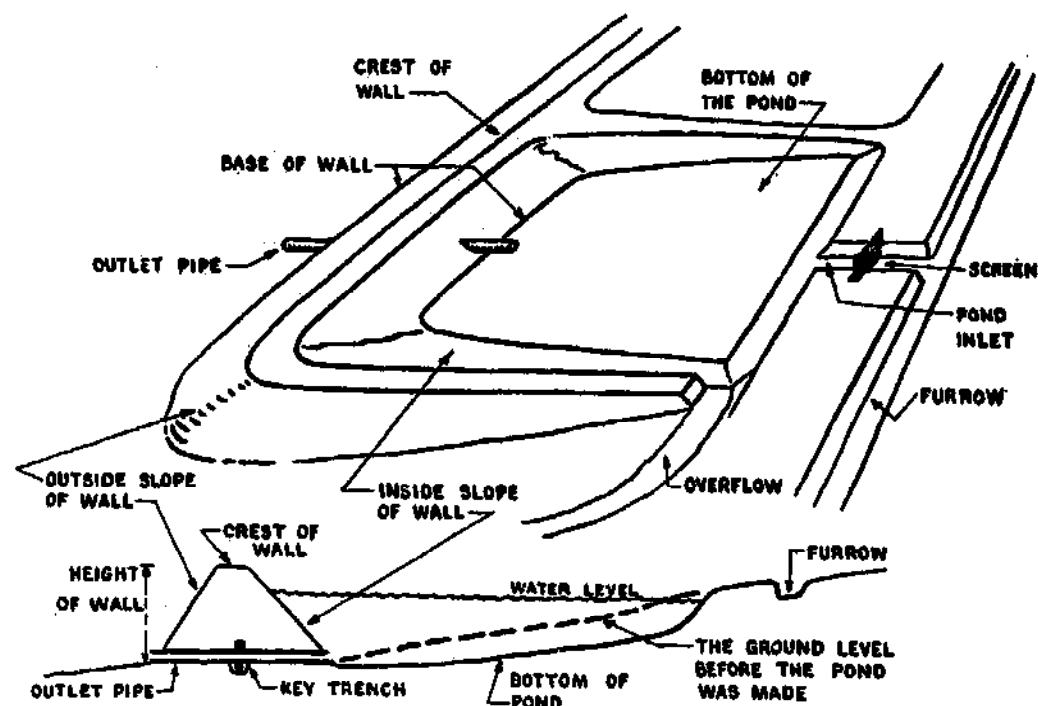

FIGURE 6. The parts of a fish pond.

kind of soil used to make the walls. Firm soils such as laterite or clay can have steeper slopes than the soft soils usually found in dambos.

The crest of the wall should not be less than 3 feet wide, and if ponds are made in swampy areas such as in dambos, the crest should be at least 4 to 5 feet wide.

If pond walls do not have the correct slopes on the inside and the crests are not wide enough, the walls may break and much repair work may have to be done. Measurements of walls of different crest widths are given in Figure 7.

The *base widths* of a pond wall vary with the height and can be roughly worked out as follows:

|                |                                |
|----------------|--------------------------------|
| For firm soils | Base width = $4 \times$ height |
|                | Crest width 2 - 3 feet         |
| For soft soils | Base width = $5 \times$ height |
|                | Crest width 4 - 5 feet         |

### POND INLET

The pond inlet is the place where water can be let into a pond. It can be made in various ways and some of those more common and easily made are shown in Figure 8. To prevent erosion of the side of the pond when filling it with water, there should be an overhang at the inlet, or grass laid as a mat, or stones.

It is important that the inlet should be at least 6 in. above the water level of the pond, when the latter is full, and there should also be some sort of a screen. The screen serves to prevent fish escaping from the pond into the furrow, as well as to prevent "wild" fish coming down the furrow into the pond.

Arrangements must also be made for stopping the flow of water into the pond, since it is undesirable in Cichlid culture to have a continual flow of water into and out of the pond.

### POND OUTLET

The place where the water can be let out of the pond is called the pond outlet. This is usually a pipe underneath the bottom wall. In the case of small ponds a pipe of 2-in. diameter is suitable, but for larger ponds a larger pipe is needed (Figure 9).

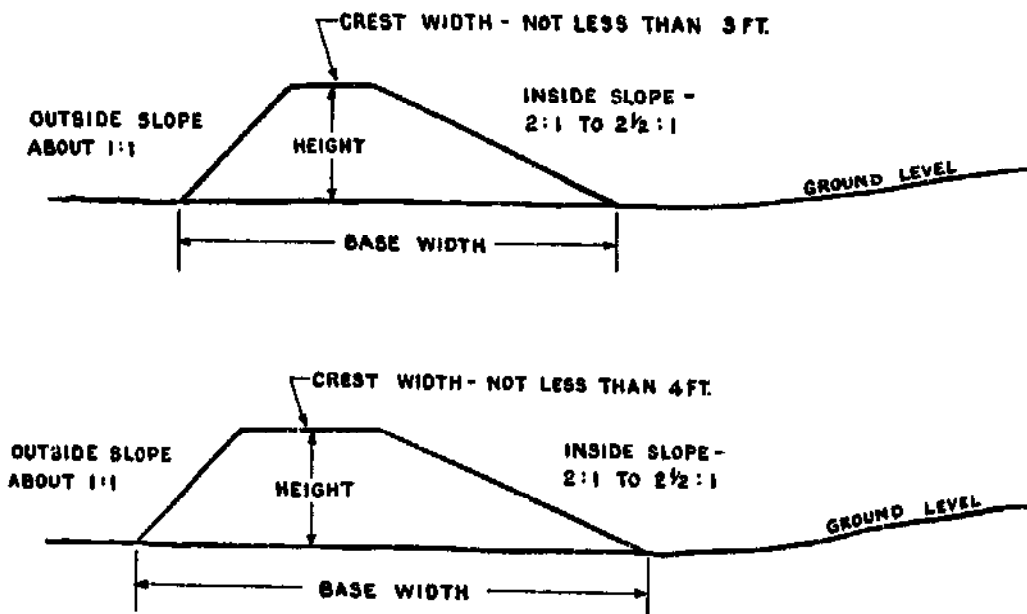

FIGURE 7. The measurements of pond walls. *Above:* Size of the wall for a contour pond made in firm soil such as laterite or clay. *Below:* Size of wall for paddy pond made in dambo types of soil.

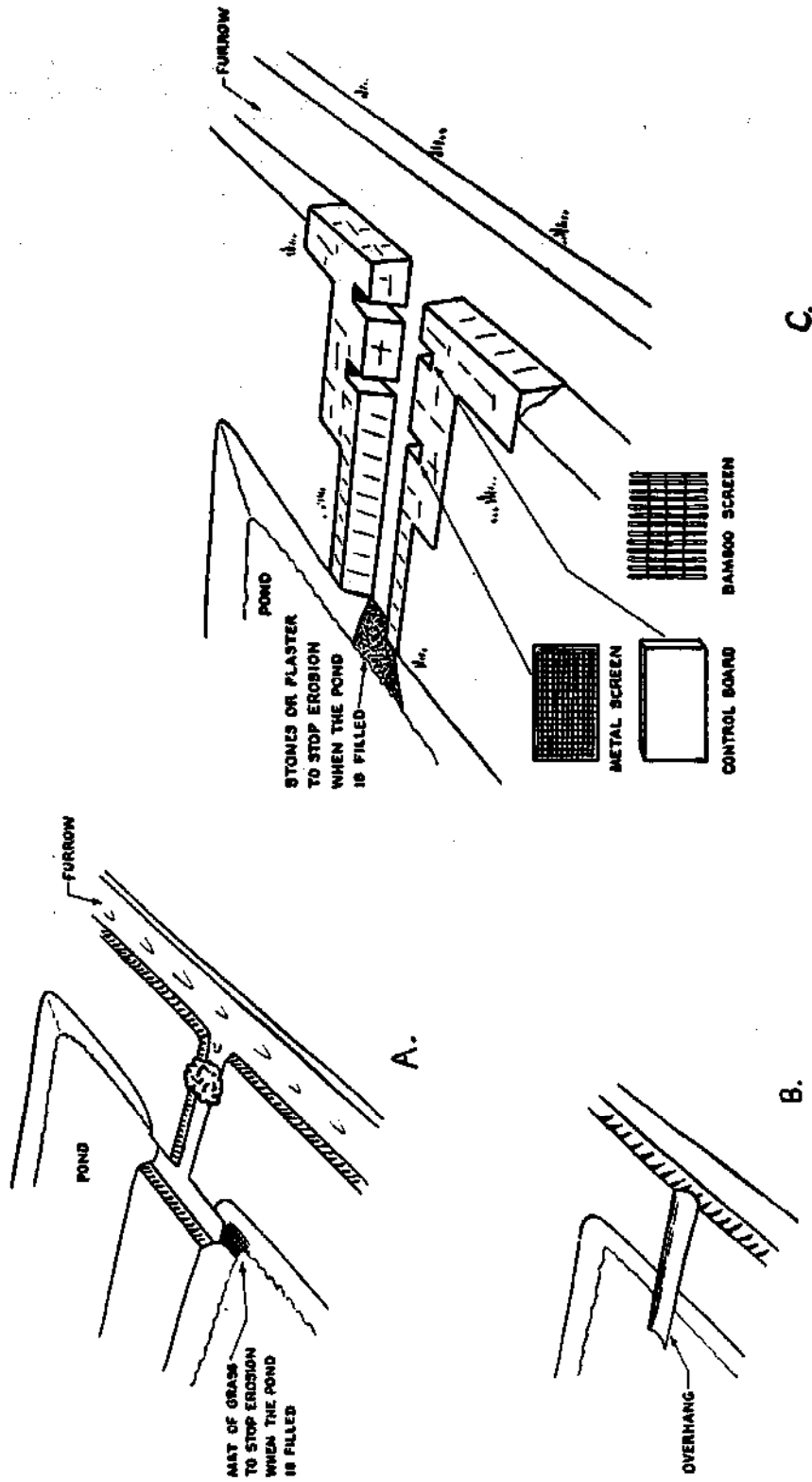

FIGURE 8. Pond inlets. A. A simple furrow type of inlet. It is blocked with earth when not in use. The sides of this type of furrow must be sloped. B. An inlet made of a section of pipe or a piece of bark. C. A furrow type of inlet made of brick or concrete, with slots for a control board and a screen. The control board is about 3/4 in. thick. The screen can be cut from gravel screening of 1/4-in. mesh or of bamboo.

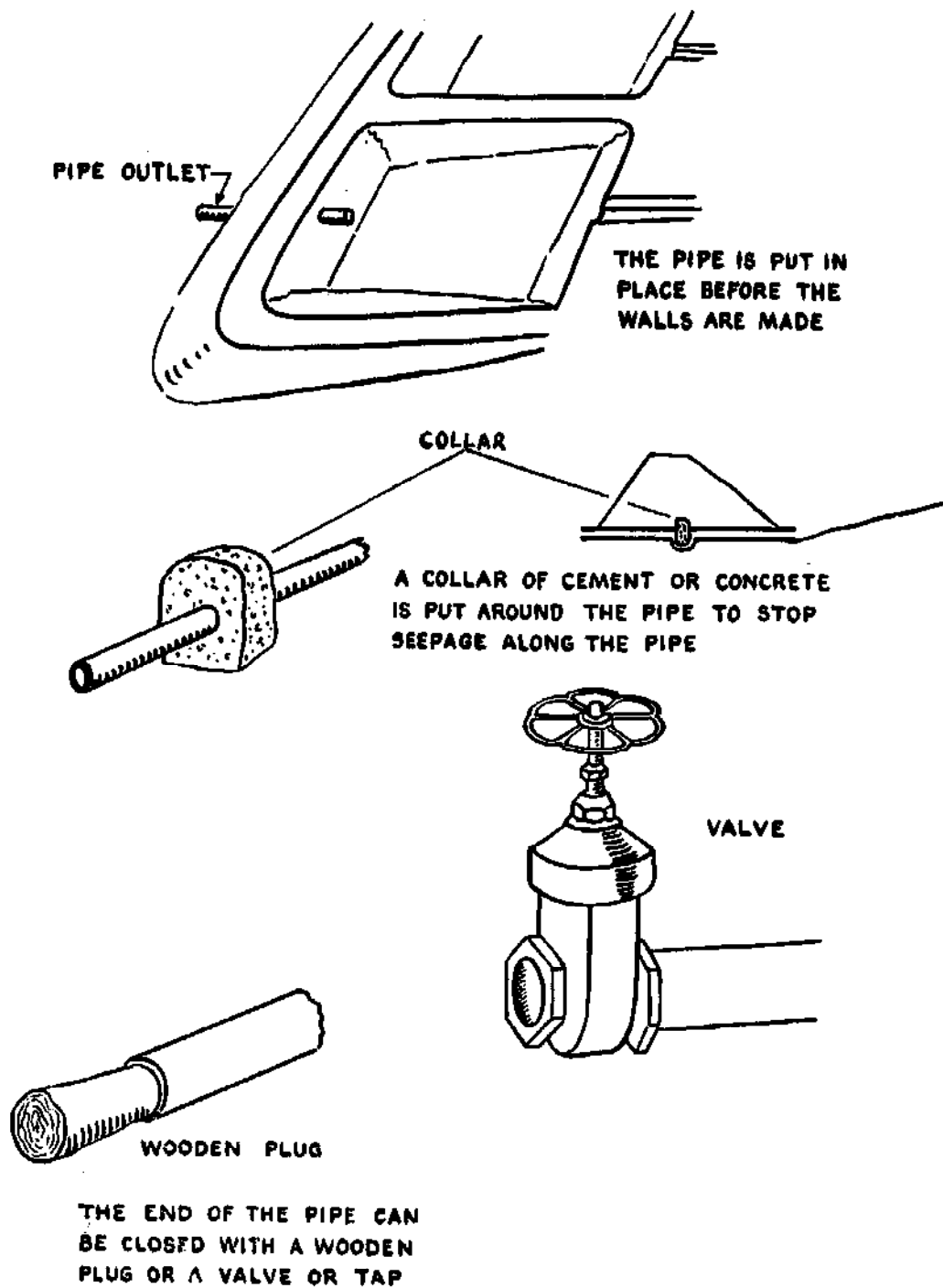

FIGURE 9. Pond pipe outlets.

Special kinds of outlets are the sluice and the monk. They are usually made of brick or concrete and are expensive (Figures 10 and 11).

If a pond does not have a pipe outlet, it can sometimes be emptied by siphoning or even by cutting through the wall (Figure 12).

#### POND OVERFLOW

The pond overflow is the place where water can flow out of the pond in emergencies — such as when there is very heavy rain — without breaking the walls. If a pond is looked after properly, it should not be necessary to use the overflow very often, because it is not a good thing to have water running through the pond all the time.

There are several different kinds of overflow which can sometimes be combined with the outlet, e.g., as in a monk or sluice.

Should the occasion arise, a screen, such as is used for inlets, can be put across the overflow to prevent fish going out of the pond. Various kinds of overflows are illustrated in Figures 13, 14 and 15.

#### Pond shape, size and depth

The shape of contour and paddy-type ponds should be rectangular or square, preferably the former. Barrage ponds should have as regular a shape as possible.

Ponds irregular in shape are difficult to crop.

The size of a fish pond is the area of the water surface and is usually given in acres. The area of rectangular ponds can be worked out from the length and width in yards. (In Appendix 4 the lengths and widths of different sizes of ponds are given.)

A unit of ponds should be planned so that all the ponds are of about the same size.

The larger the pond, the lower is the cost of construction relative to the area. For example, the total cost of making 10 ponds, each 1/10th acre in area, could be twice as much as the total cost of making two ponds of 1/2 acre each, even if made under similar conditions. However, not everyone has sufficient money to build large ponds and in rural areas units of ponds of about 1/10th of an acre each

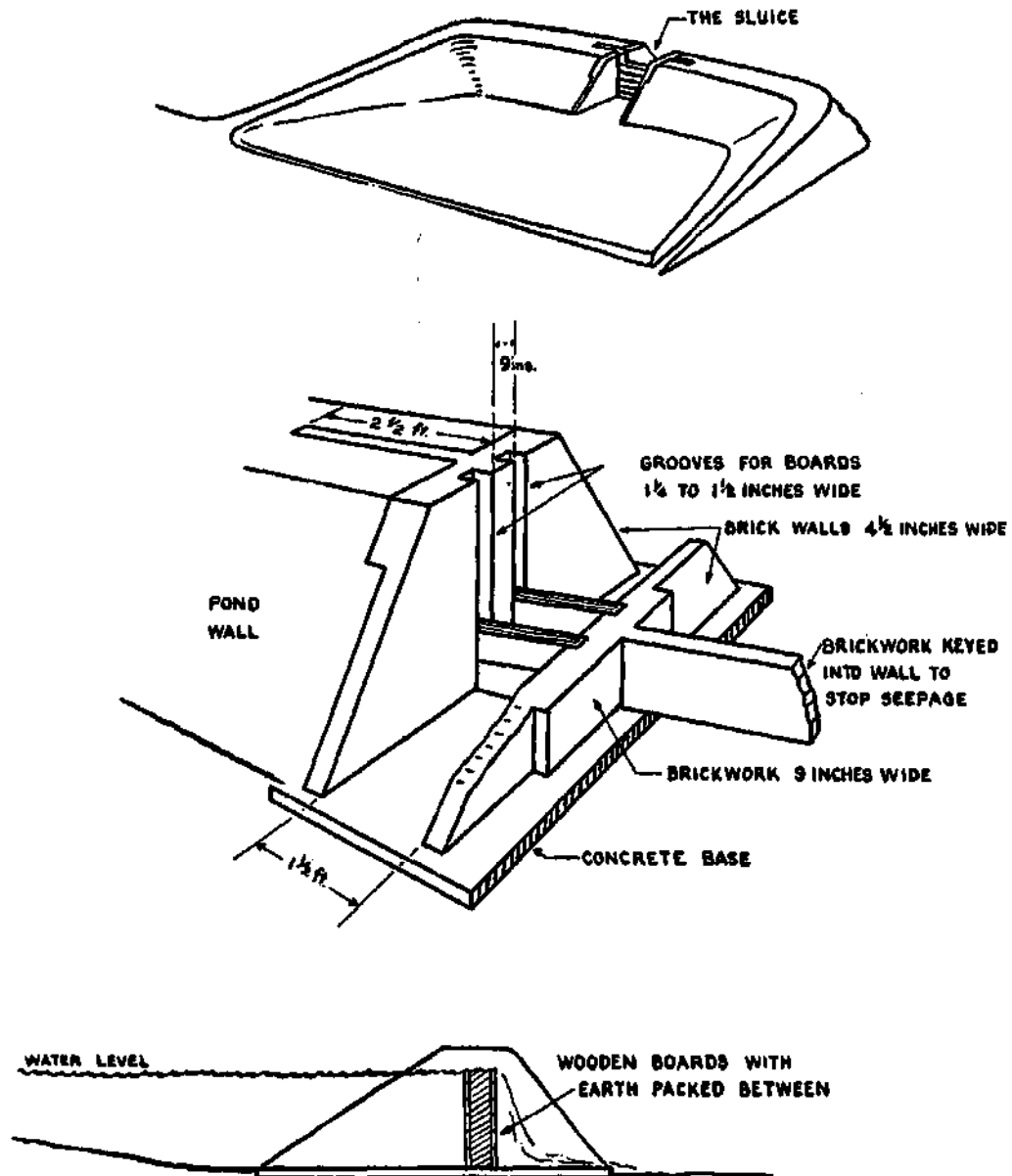

WHEN THE WATER LEVEL REACHES THE TOP OF THE BOARDS IT  
OVERFLOWS TO EMPTY THE POND THE BOARDS ARE TAKEN OUT.

FIGURE 10. The sluice.

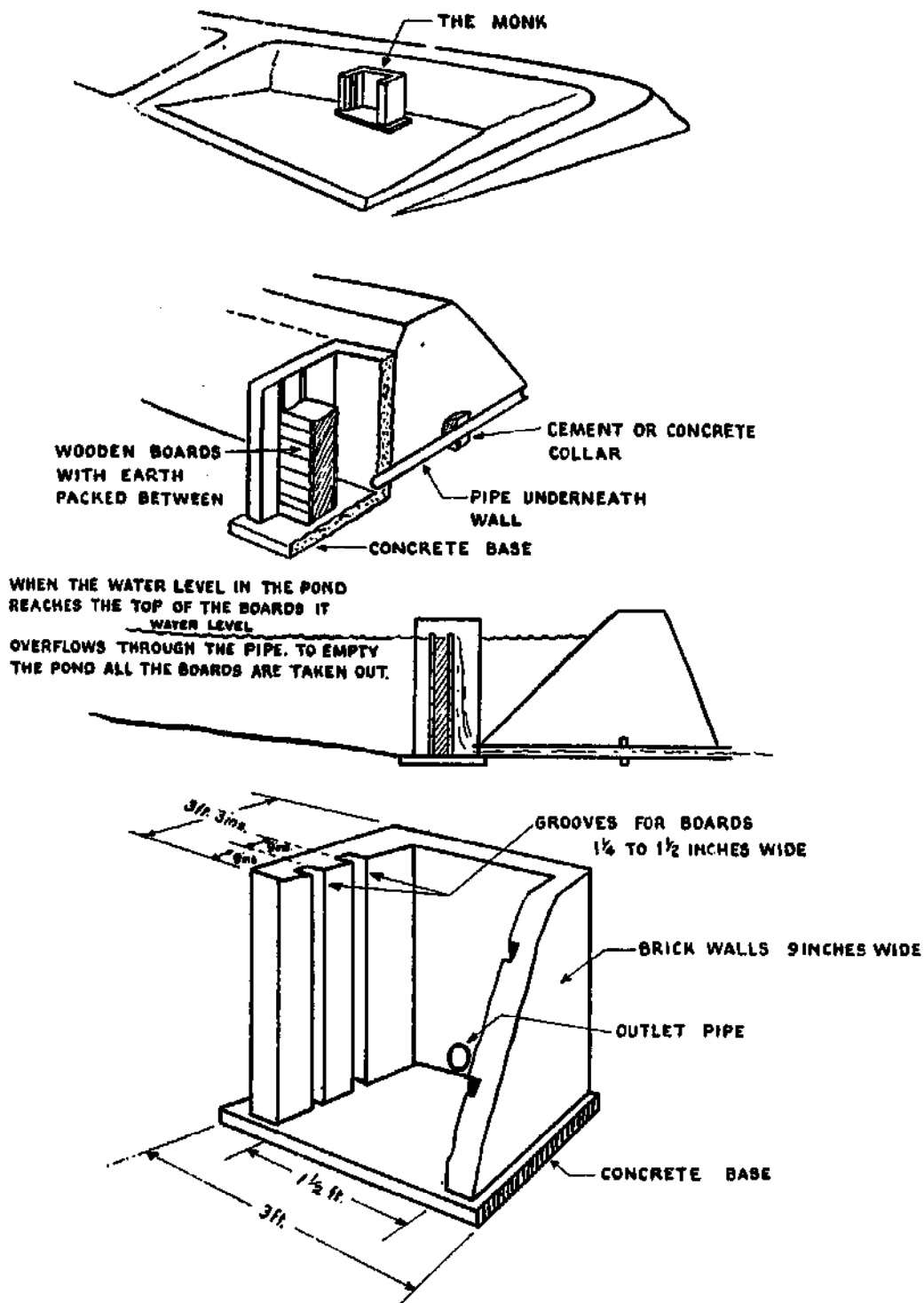

FIGURE 11. The monk.



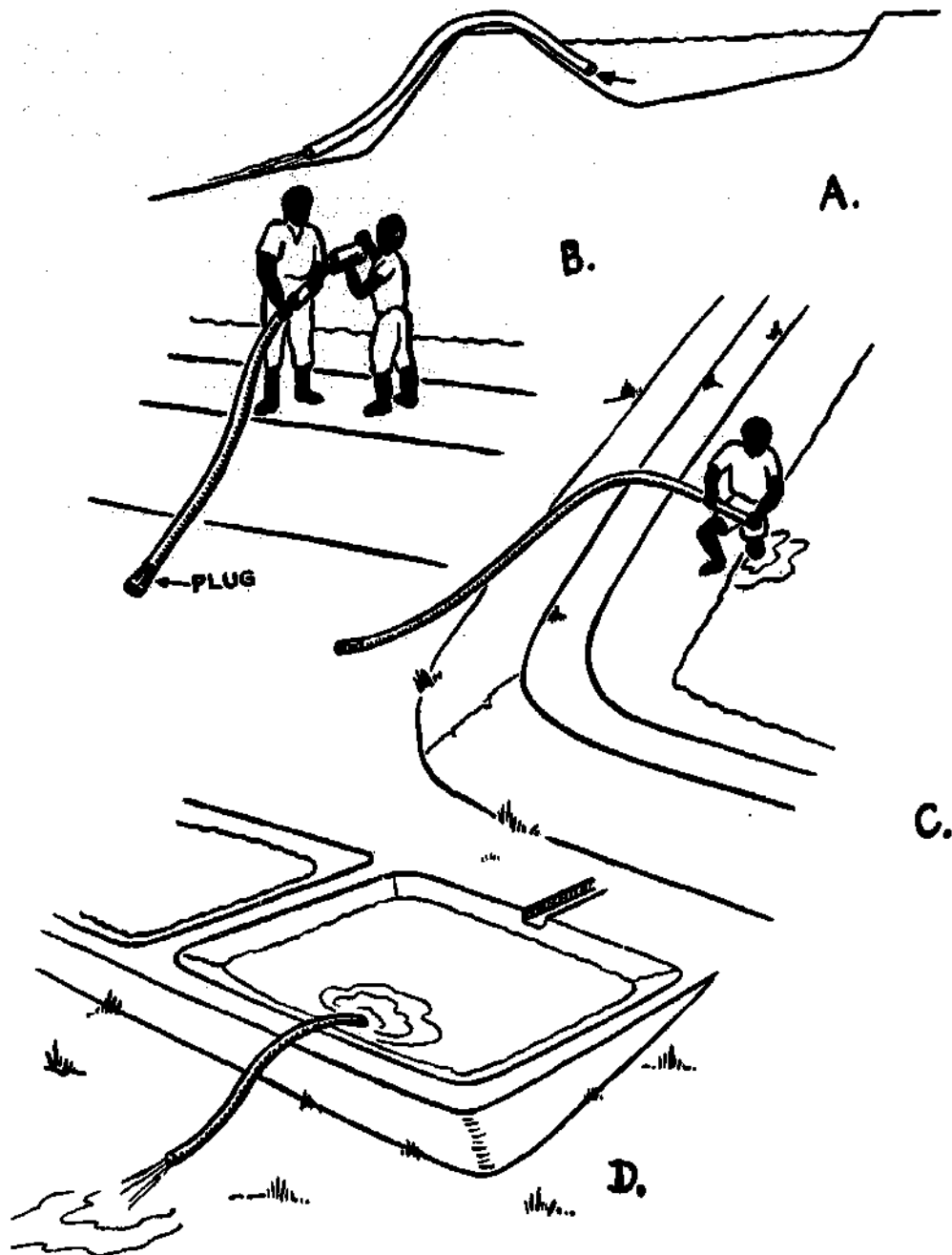

FIGURE 12. The siphon, a plastic or rubber hose pipe about  $1\frac{1}{2}$  in. diam. A. The pipe is put over the wall of the pond. The end of the pipe outside the pond must be lower than the end in the water. B. To start the siphon: Put an airtight plug in the end of the pipe outside the pond, and fill the pipe with water. C. When the pipe is full and overflowing put hand tightly over the end and put it quickly under water in the pond; then remove hand. D. Take the plug out of the pipe and the siphon should start.

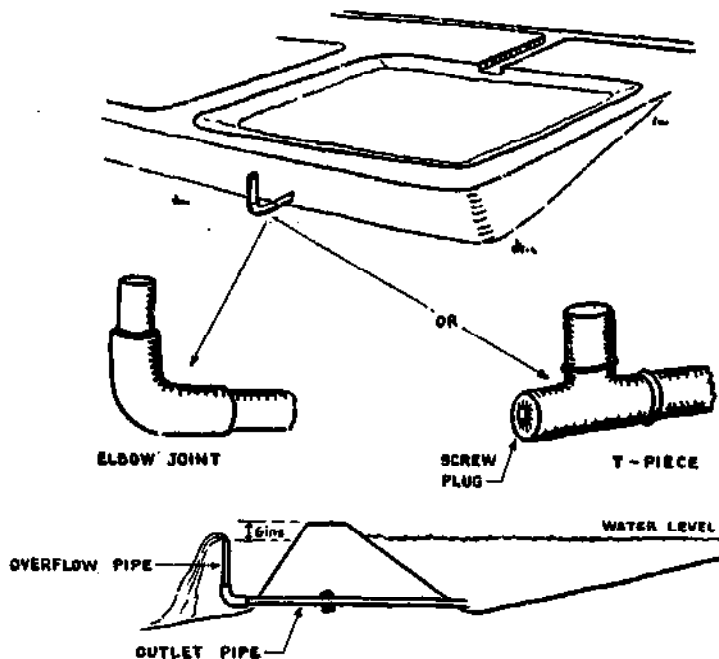

FIGURE 13. Pipe overflow. A pipe outlet can be fitted with an elbow or T-piece into which another piece of pipe is fitted. This pipe is upright outside the pond and is about 6 in. or more below the top of the wall. Water will come out of the top of the pipe if the pond becomes too full. It is only suitable for small ponds.

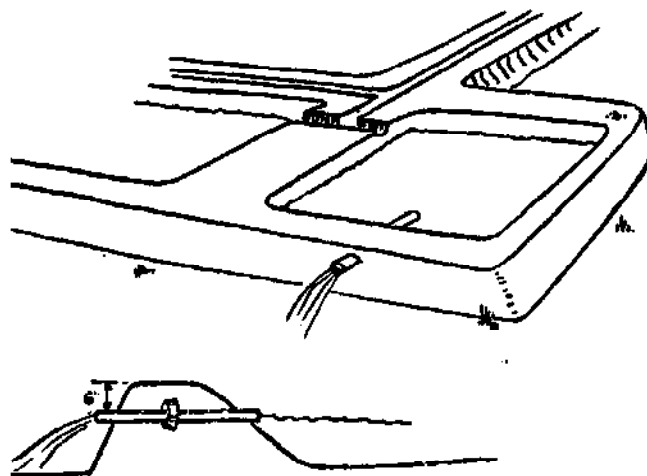

FIGURE 14. Another kind of overflow is a pipe through the top part of the pond wall. The pipe should not be less than 2 in. in diameter. A collar of cement or concrete must be put around the pipe to stop seepage along the pipe. This kind of overflow is suitable for paddy ponds.

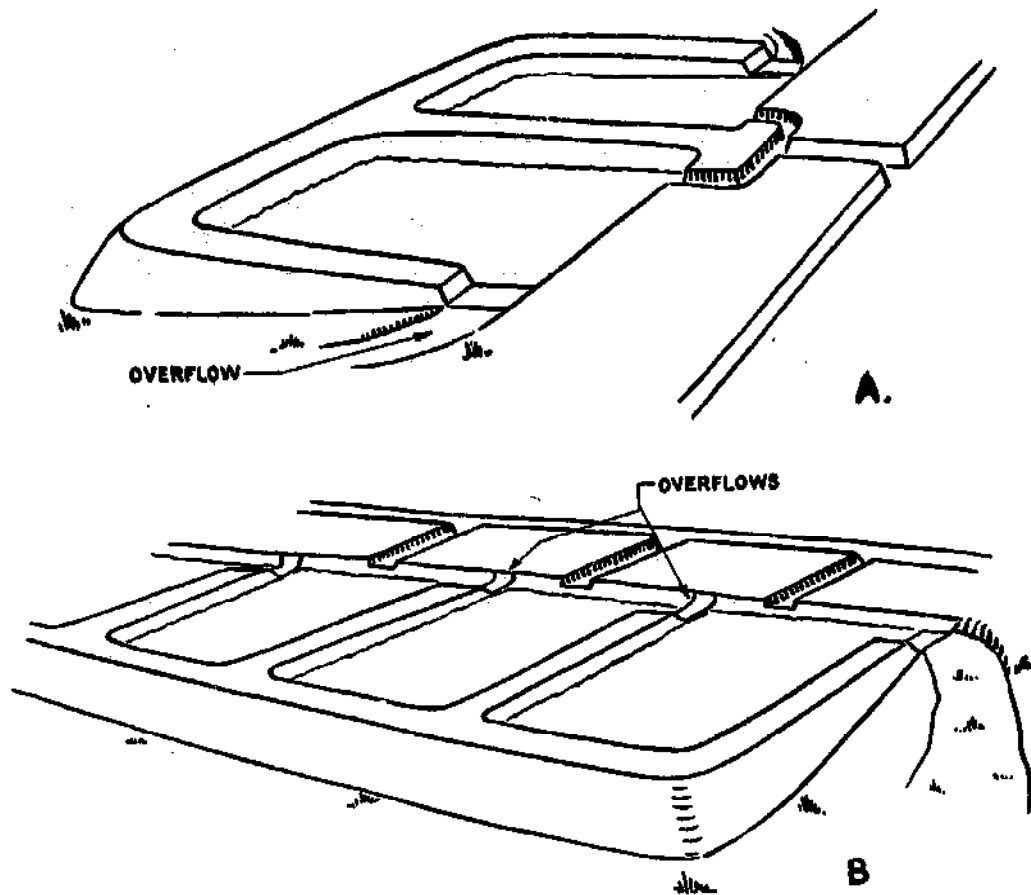

FIGURE 15. Spillway overflow. Overflows made like spillways can be used on large and small contour barrage ponds. The overflow spillway is made near the top of the pond and must be planted with grass. The danger of this kind of overflow is that fish can get into and out of the pond if water is kept running out all the time. Contour ponds can be made in pairs, each with a spillway type of overflow (A), or in series with overflows leading from one to the other (B).

in surface area have been the most successful. Not only can the owner afford to build one or two ponds at a time, but these smaller ponds tend to be better managed and to produce relatively more fish than larger ones.

Fish ponds must never be less than  $1/20$ th of an acre in area. This is the smallest size worth managing.

Small fish ponds can be made with about the same depth of water all over, but it is better if the pond is deeper in one part near the outlet.

If ponds are made with the same depth all over, the depth of water can be about 3 ft.

If ponds are made with one part deeper than another, the water in the shallow part must not be less than 1½ ft, and in the deepest part it can be 3 to 3½ ft.

If ponds are made in places where the water supply is not reliable, the depth of water in the ponds should be increased to about 5 ft at the deep end. The same is suggested in areas where frosts or severe winters occur. If the water supply fails there is enough water in the pond to last another one or two months, the level dropping gradually.

### **Making fish ponds**

#### **WHEN TO MAKE FISH PONDS**

If fish ponds are made at the most suitable time, the work will be easier and the cost less than if they are made at another time.

The best time of the year for making ponds in soils such as clay and laterite is at the end of the rainy season when the soil is soft, rather than at the end of the dry season when it is very hard. The best time of year for making ponds in swampy ground, such as dambos, is in the dry season when the ground is not flooded with water.

#### **HOW TO MAKE FISH PONDS**

It is not possible in this manual to describe in detail all the ways in which fish ponds can be constructed. There are, however, certain steps to be taken and certain points to be watched to ensure that a pond is properly made.

#### *Marking out the walls*

The place for the bottom wall is marked out first, with height being shown with posts and width of the wall at the bottom with short pegs. For contour ponds the position of the bottom walls of the pond will depend on the slope of the ground. If the ground is steep then the bottom wall will be closer to the furrow than if the wall is not so steep.

For example, if the bottom wall of a contour pond is 15 yd from the furrow and the pond is 1/10th of an acre in area, then the side walls will be 30 to 35 yd apart. A "farmer's" type level, or a line

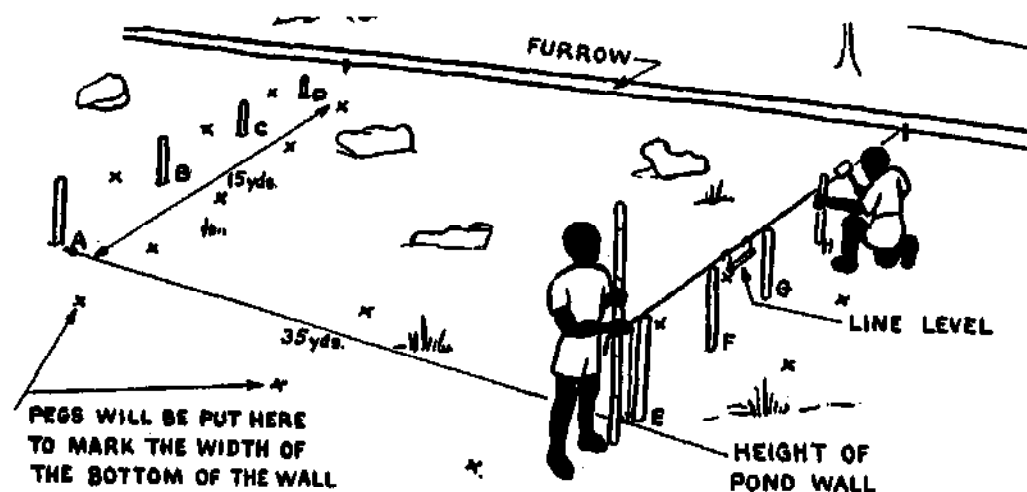

FIGURE 16. Marking the height of the walls for a contour pond. The distance from A to D is measured. If this distance is 15 yd (about 15 paces), another line of posts is put in 35 yd (about 35 paces) away, along the slope. These are posts E to H. The distance of the line of posts E to H away from the posts A to D depends on the distance A to D to make a pond of about 1/10th acre. Posts A-E-H-D mark the corners of the pond and show the height of the wall to be made.

level can be used for marking out pond walls. For barrage ponds the position of the wall will depend on the slope of the stream bed. For paddy ponds made on flat, or nearly flat, ground the bottom wall can be made in any position (Figures 16, 17 and 18).

It is important to mark out the bottom and side walls in the right places, because if they are in the wrong places it is more difficult to make the ponds and they will cost more.

Once the pond walls have been marked out, grass and any small bushes must be cleared away. If this is not done, the pond will leak when it is filled with water.

#### *Key or core trench*

The *key* or *core trench* is a small ditch or furrow dug along the line of the center of the walls, about 1 ft wide and 1 ft deep. As the walls are built, the trench is filled in again with a good clay soil and is well packed. If good clay soil is lacking in the area, the ordinary soil should be well compacted into the trench. The purpose of the trench is to stop the seepage of water underneath the walls. If there are any small anthills along the line of the walls, then the trench must be dug much deeper in order to prevent seepage (Figure 19).

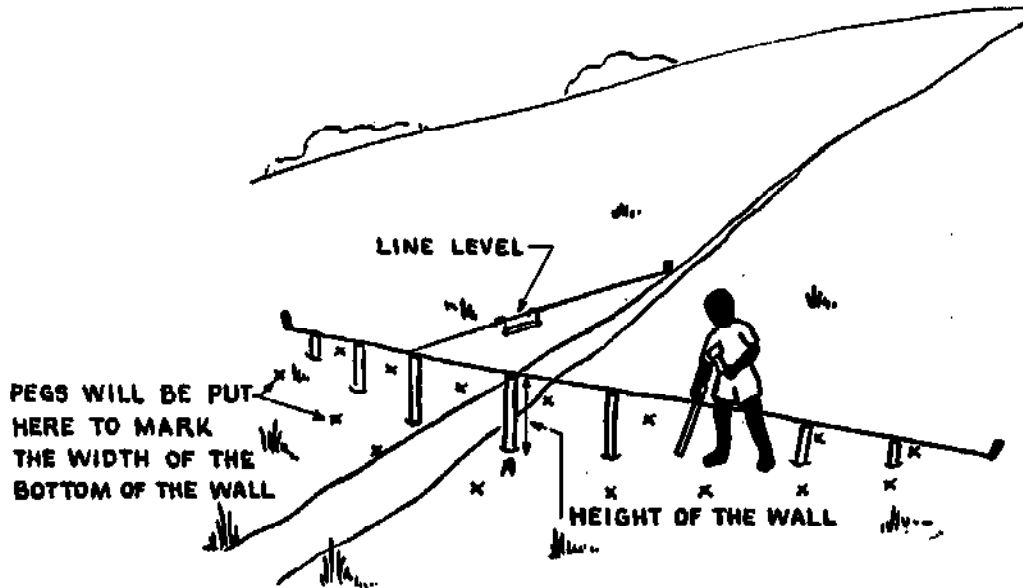

FIGURE 17. Marking the height of the wall for a barrage pond. Posts are put in a straight line across the dambo. The tops of the posts must be level with the top of the center post, A. These posts mark the center line of the bottom wall and the height to be made.

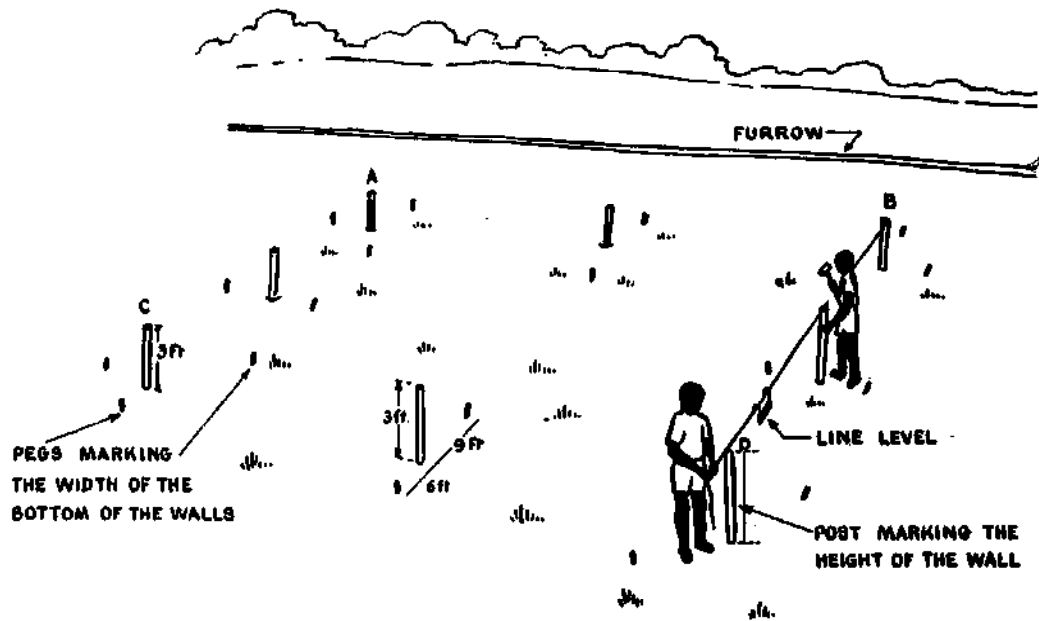

FIGURE 18. Marking out the walls of a paddy pond.

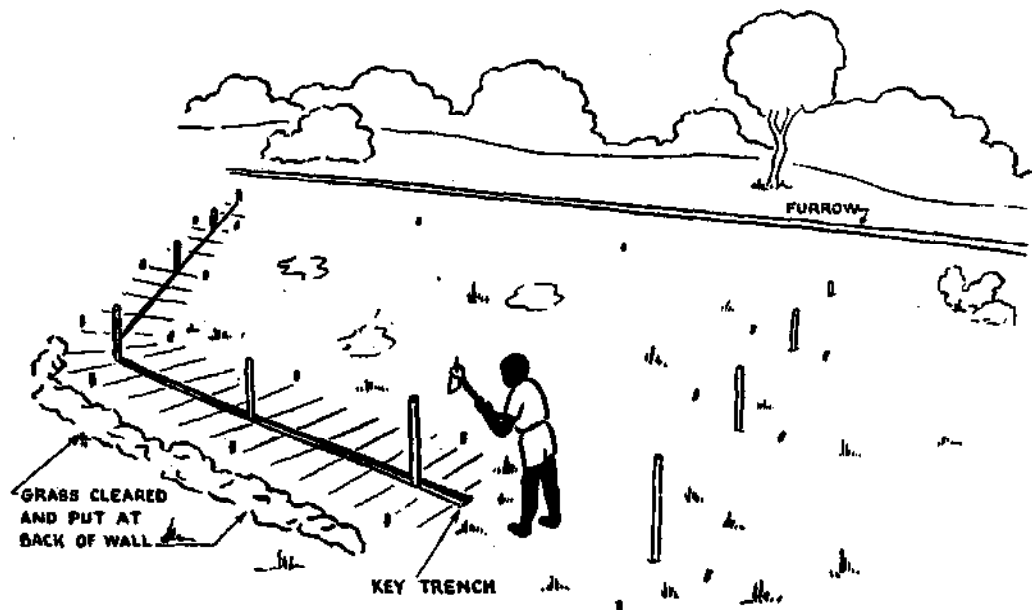

FIGURE 19. Making the key trench.

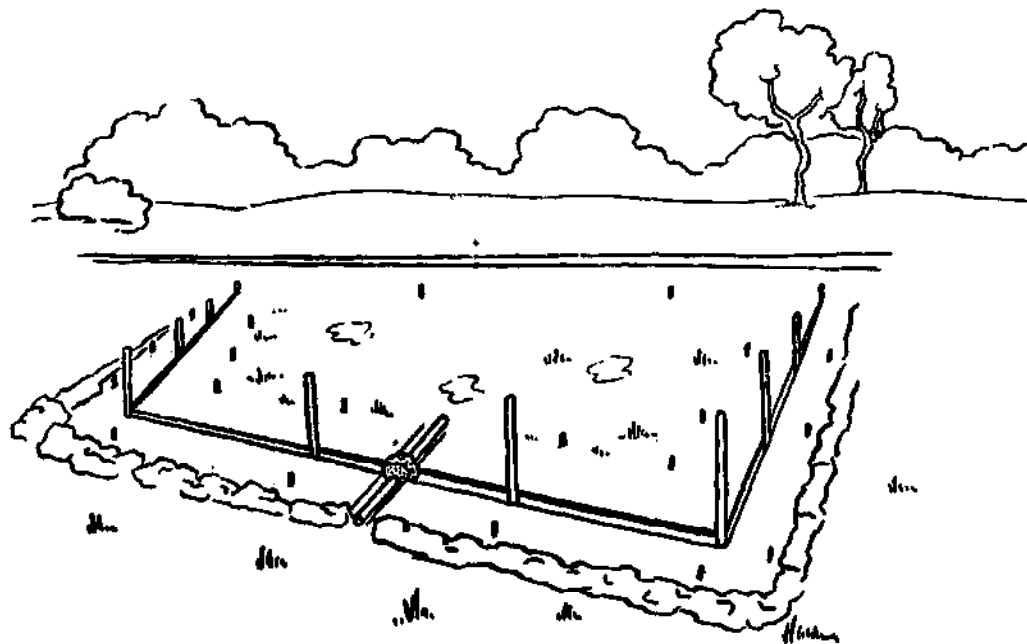

FIGURE 20. Putting in the outlet pipe.

### *Outlet pipe*

Before the walls are made, the outlet pipe is put in. A collar of cement or concrete is put around the pipe at about the middle of the wall to stop water seeping along the pipe (Figure 20).

### *Making the walls*

Soil for making the pond walls is taken from inside the pond. For contour ponds it is best to start digging the part of the pond nearest the intake furrow, i.e., furthest from the bottom wall. More soil is taken from the top of the contour pond than from near the bottom wall. For paddy ponds it is best to start in the middle of the pond and work toward the walls.

Where a good layer of fertile topsoil exists it is a good practice to remove this top layer to a pile near the pond site. Then the less fertile soil is used for the walls and on pond completion a layer of fertile soil is replaced on the bottom of the pond to promote pond fertility.

The bottom wall is the most substantial and needs more soil than the side walls (Figures 21, 22 and 23).

When the walls are the right height, stop digging. It is not necessary to have walls 10 or 12 ft high if the water is to be only 3 or 4 ft deep. When finished, the crests of all the walls should be level.

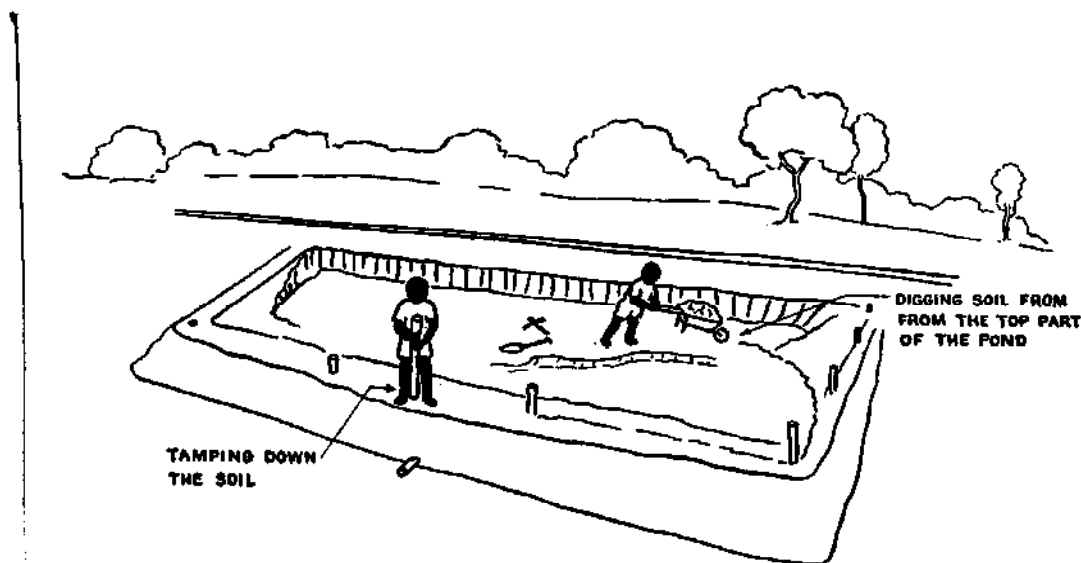

FIGURE 21. Making the walls of a contour pond. Soil to make the walls is dug first from the top of the pond. It is dug to a depth of 1 ft. Nearer the bottom wall, soil is dug less and less deep. As the walls are built up, the width is made less and less so that when the top of the posts is reached, the width is only 2 or 3 ft. Then the walls are high enough and digging stops. The bottom of the pond is made smooth.



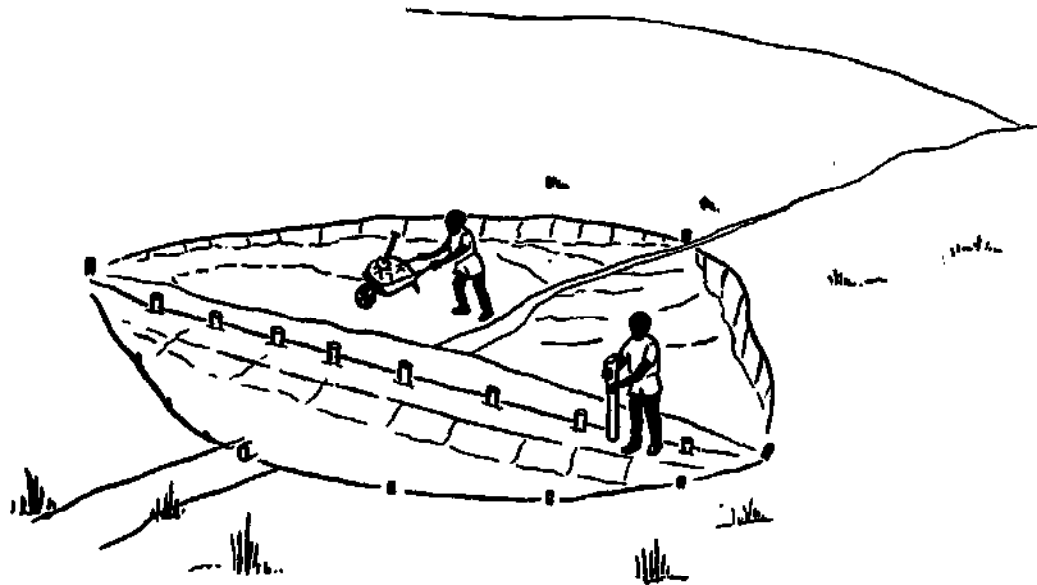

FIGURE 22. Making the wall of a barrage pond. Earth is dug from inside the pond to make the wall. The wall is made narrower as it is built up. Earth is tamped down with a tree trunk or pole. When the top of the posts is reached, the wall is finished.

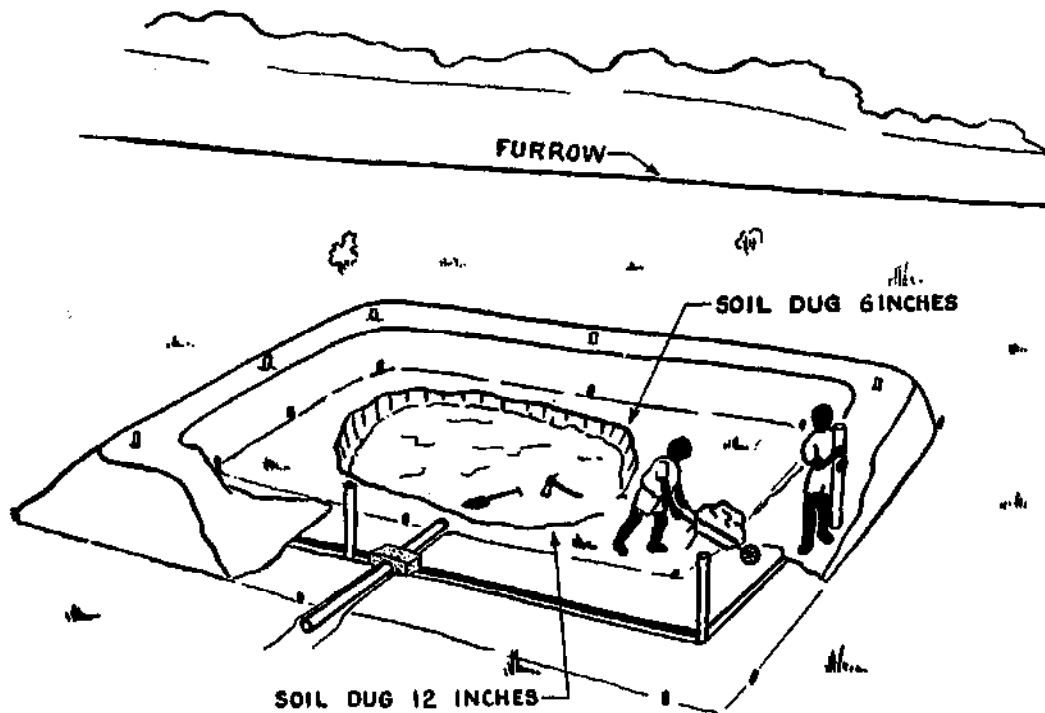

FIGURE 23. Making the walls of a paddy pond. Soil to make the walls is dug first from the center of the pond. It is dug to a depth of about 9 in. in the center but at the top of the pond it is dug to only about 6 in. At the bottom end of the pond the soil is dug to a depth of about 12 in.

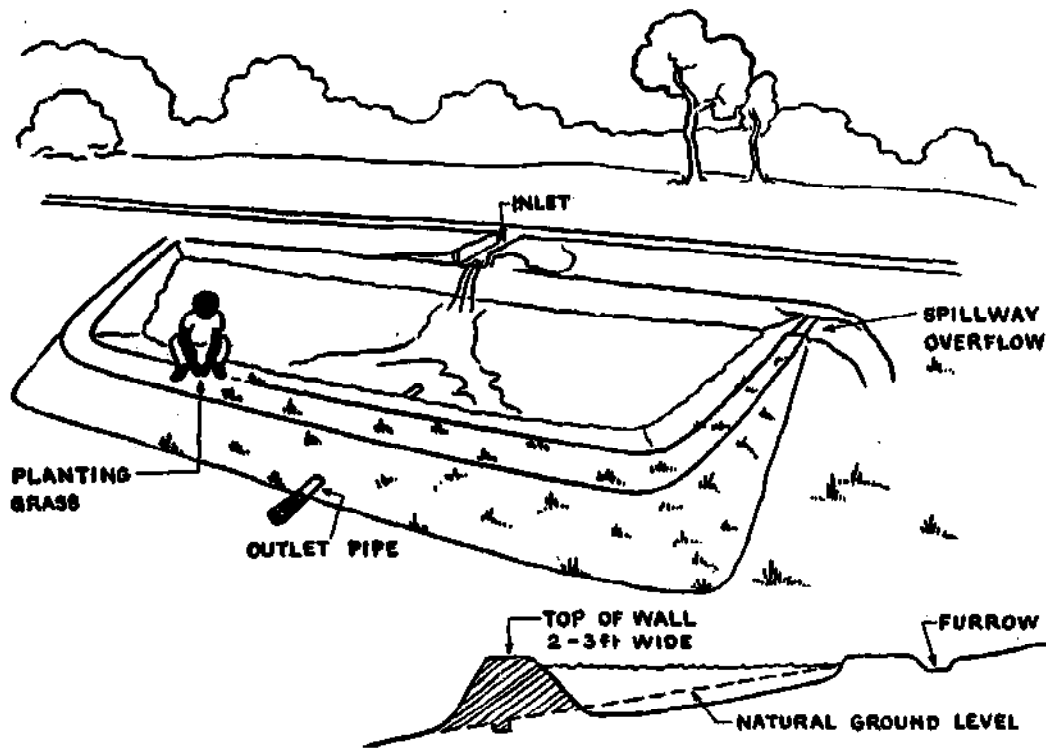

FIGURE 24. Finishing the pond. An overflow is made at the side of the pond. An inlet from the furrow is made. A wooden tap or plug is put in the outlet pipe and the pond filled with water. Grass is planted on the walls.

The walls should be sloped below the natural ground level first, then the slope can be continued to the top of the wall. If the soil is very dry it must be watered. If the pond is made by hand, the soil must be beaten down with a pole or small tree trunk.

#### *Inlet and overflow*

When the pond walls are completed the inlet and overflow are put in and the pond can be filled with water (Figure 24).

#### *Grass planting*

After the pond is finished grass should be planted on the walls as a protection. It can also be cut for fish food. Good grasses are

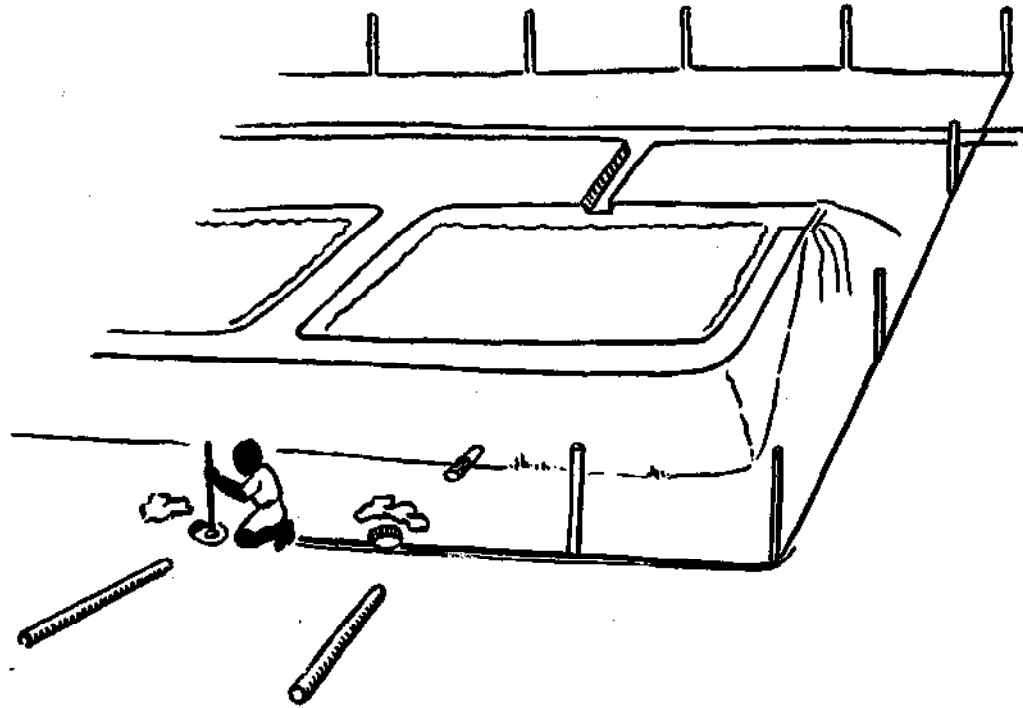
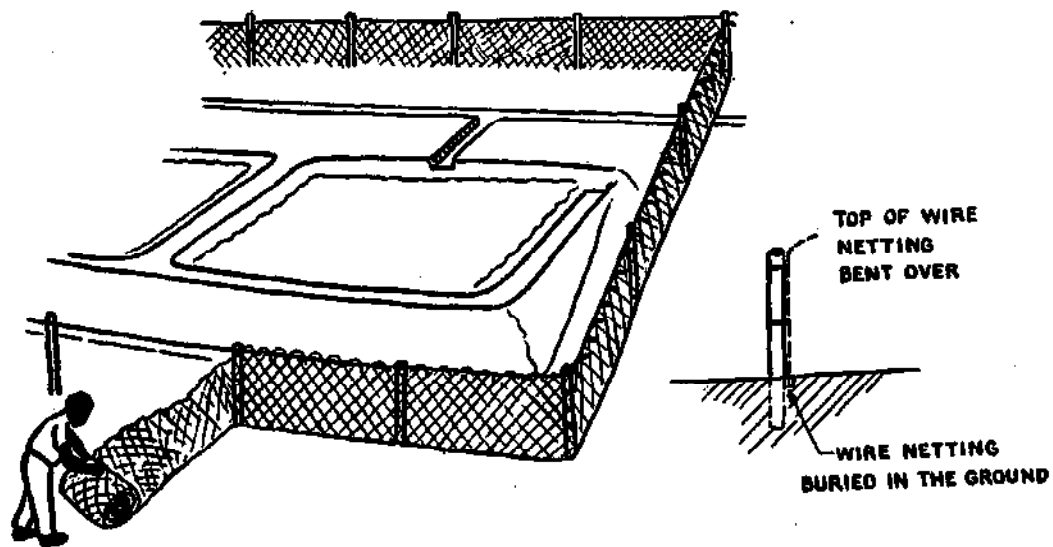
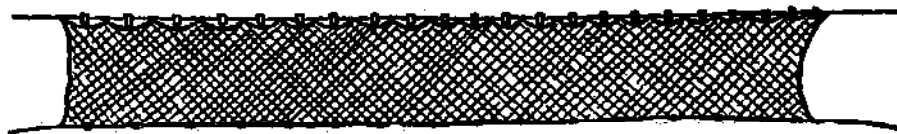

FIGURE 25. Fencing the pond. *Above:* Poles are put in around the ponds. They are buried at least 2 ft in the ground, with 4 to 5 ft above the ground. Just outside the line of the poles a trench is dug. It is about 4 to 6 in. deep. *Below:* Fencing wire is put between the poles at the top. The wire netting is buried in the ground at the bottom and is bent over outside at the top. The wire netting is tied to the top wire and the poles.





A SMALL SEINE NET OF 1 INCH OR 1½ INCH MESH



A HAND NET

BUCKETS AND A BATH

A BALANCE  
OR  
SCALEA CLEAN DRUM OR FISH CANS  
ARE NEEDED IF THERE IS ONLY  
ONE POND IN THE SERIES

FIGURE 26. The most important equipment for fish pond management.

Kikuyu, Swazi, Couch, Star and Rhodes. Tanner grass should not be used because it is very difficult to get rid of the long tough stalks that are in the way when the pond is cropped.

### *The fence*

A fence is put around ponds to keep out predatory animals, such as otters, which eat a lot of fish from ponds. The best fence is one of diamond mesh wire netting or chicken netting of 2½- or 3-in. mesh and 4 to 6 ft wide. The netting is buried 4 to 6 in. in the ground and is bent outward at the top. Poles can also be used for fencing and must be at least 5½ ft long, be buried 1½ ft in the ground and put very close together (Figure 25).

**Equipment for pond construction and management**

Small ponds are quite quickly and easily made with hand labor using picks, hoes, shovels and wheelbarrows. For larger ponds a tractor with a disk plow and a small bucket scoop or wheeled scraper can be used economically.

Once ponds have been made certain tools and equipment are needed in management (Figure 26). For a unit of 12 ponds these are:

|                                    |                     |
|------------------------------------|---------------------|
| 1 small seine net 1 to 1½ in.-mesh | 1 shovel            |
| 2 or 3 buckets                     | 1 mattock or pickax |
| 1 or 2 baths                       | 1 hoe               |
| 1 balance or scales                | 1 wheelbarrow       |
| 1 hand net                         | 1 sickle            |

For a demonstration and stock pond unit the additional tools and equipment needed are:

|                          |                          |
|--------------------------|--------------------------|
| 6 small fish cans        | 2 baths                  |
| 1 hand net               | 1 × 56 lb platform scale |
| 1 × 1 in.-mesh seine net |                          |

### **3. FISH CULTURE PRACTICES IN PONDS**

#### **General principles of pond management and care**

Fish culture, or intensive raising of fish, or fish farming, is a type of farming activity and is very similar in its principles to stock raising. As it is a business activity it must be run profitably. The main object is to raise the largest amount of fish by the most economical means, namely by:

1. Keeping the pond and installations such as outlets in a state of good repair so they will work efficiently.
2. Providing the best conditions in the pond for the growth of fish.
3. Increasing the natural food in the pond.
4. Making the best use of wastes and artificial foods for increasing the amount of fish production.

#### **GOOD MANAGEMENT EQUALS SUCCESSFUL CULTURE AND HIGH YIELDS OF FISH**

The simplest and best way to manage a pond is to:

1. Prepare bottom soil.
2. Fill the pond with water.
3. Stock it with the right fish in the right quantity.
4. Feed the fish and keep the water fertilized.
5. Keep the pond in good order.
6. Crop the pond by removing the fish.

In order to have good results frequent attention is necessary to see that all is well.

*The fence* around the pond or pond area must at all times be kept in good repair to prevent the theft of fish by otters.

*Walls* if properly constructed and planted require little maintenance. After each emptying of the pond for cropping, slopes which have slipped and erosion caused by water or fish should be repaired.

#### POND BOTTOM

The soil and mud in the pond bottom is of great importance in raising good crops of fish. Excessive siltation may reduce the depth; if this occurs excess silt must be removed when the pond is drained for cropping. Ponds which have been in use for a number of years, more especially those on heavy soils, benefit from drying and exposure to the sun and air for short periods between draining and stocking. A pond used over a number of years in which the annual crop has noticeably dropped may be left for a short period of two to three weeks, (or less if it dries quickly), after one of the annual drainings for cropping. Light tillage and the working in of lime and manures restore productivity.

#### WATER LEVEL

Ponds should never be filled level with walls. From 6 to 9 in. freeboard is necessary according to the size of the pond. The freeboard is the distance between the top of the wall and the water level. Once the pond is filled it should remain at about the same level. Water must not flow in at such a rate that there is water running through the pond. Just enough is needed to keep the pond full and water flow may be adjusted so that it flows all the time, or water may be let in once a day for a period which is sufficient to keep the water level more or less constant.

#### FILLING

The first filling should be done very carefully and slowly and each filling after draining must be done slowly, especially if the walls are dry, to avoid slumping and sliding of walls because of uneven wetting.

## DRAINING

Draining is done at the end of the period for which the fish are grown, to remove all fish. This should be slow, to avoid damage to walls and prevent fish being left in the mud and lost. Do not leave overnight a pond in which there are still numbers of fish with too little water, as birds will come and remove many of them.

## ROUTINE MANAGEMENT

It is a good idea to pay at least one visit a day to the ponds in the early morning. If possible another visit should be made in the late afternoon to aid full control. The following points should be checked every day:

### *Daily*

1. Check fence for damage. Repair holes which will let otters in.
2. Check the water level and see that no water is running through the outlet. Fill or adjust furrow if necessary.
3. Check the outlets and inlets and all screens for clogging. Remove rubbish from screens.
4. Carry out necessary daily feeding after checking that food is being eaten.
5. Look for any evidence of theft by birds, or otters, or other animals and take necessary action.
6. Check furrows for correct flow and any rubbish or stones.
7. Make a point of noting any observations on fish — spawning, feeding, nesting, etc.

### *Weekly*

Each week on the same day a fuller check must be made.

1. Carry out fully any necessary repairs that have been temporarily fixed.
2. Carry out manuring.
3. Feed with vegetation, unless this is done each day.



4. See that there is sufficient food available for the next week.
5. Check for any leaks or weak points in the walls and repair them.
6. See that the furrow is working properly and make any repairs.

### *Monthly*

Each month at the beginning or end of the month:

1. Lime, if needed.
2. Remove rough vegetation such as bulrushes, etc.
3. Attend to any replanting of grass cover.

Each month at the end of the first week:

Fertilize.

### *After each draining and cropping*

1. Inspect and repair slopes of walls.
2. Attend to any repairs to outlets and inlets after properly checking them. Fill cracks, replace worn brick or concrete and paint wooden parts with creosote or solignum.
3. Inspect the pond bottom and if there is too much silt remove some and use it on the vegetable garden.

### WEED CONTROL

In ponds when herbivorous fish are used and the ponds fertilized correctly, weeds are rarely found. At low stocking rates, and in the absence of weed-eating fish, weeds may occur. The main types of weeds are:

1. Reeds, bulrushes and sedges rooted in the bottom and growing in shallow water.
2. Water lilies and pond weeds with leaves on or near the surface.
3. Submerged soft weeds.

Proper construction of the pond will reduce the possibility that fringing vegetation, such as bulrushes, will be a nuisance. Shallow parts should be at least 1½ ft deep.

Weeds can be removed from small ponds by cutting or pulling out, and if this is not possible when the pond is full, by digging out after the draining.

Some weeds can be controlled by chemicals, but special advice on this is necessary.

#### LIMING

Lime, in itself, is not a fertilizer, but it is used to keep the pond bottom from getting too acid, to help release valuable fertilizing materials in the mud, and to prevent the water from becoming acid. It is useful in all cases, but it is essential where the soil is acid. The best kind of lime is agricultural lime or ground limestone.

The amount needed depends on the acidity of the soil and whether a water is soft or hard. Soft waters have little lime and salts dissolved in them; hard waters have larger quantities of lime and salts. Hard waters are best for fish culture.

More lime is needed on acid or heavy clay soils than on neutral or sandy soils. More lime is needed in soft waters than in hard waters.

It is difficult to give figures for liming as the soils and waters vary greatly. The following is a rough guide.

##### *New ponds*

Clay soils: 1,500 to 2,000 lb of lime per acre on the bottom when the pond is dry, lightly worked in if possible.

Sandy soils: 1,000 to 1,500 lb of lime per acre on the bottom.

##### *Once a year after draining for cropping*

Clay soils: 1,000 lb of lime per acre on the bottom.

Sandy soils: 500 to 1,000 lb of lime per acre on the bottom.

In small ponds where intensive feeding and manuring is being done, lime should be spread over the surface once a month at rates of 150 to 200 lb per acre, unless the inflowing water is very rich in calcium (lime).

Liming must never be done at the same time as fertilizing with phosphates.

## FERTILIZING THE POND

The fertilizer which is added to the pond helps the growth of small plants which make up fish food.

### *Commercial fertilizers*

The most important fertilizer is one which has a lot of phosphates. Basic slag, powdered single superphosphate, or granular double superphosphate may be used.

It is more economical in transport costs to use granular double superphosphate because only half the quantity, as compared with single superphosphate, is required.

The phosphate should be spread over the surface of the water once a month, seven days after liming, at the following rates per acre:

Basic slag and single superphosphate, 100 lb per month per acre.  
Granular double superphosphate, 50 lb per month per acre.

Very weedy ponds must first have the weeds removed, as fertilizing a weedy pond is of no value to the fish.

Inorganic fertilizers are generally spread over most of the water surface. Lime can be put on the bottom of a dry or empty pond, but superphosphate should be applied when the pond contains water. Organic manures should be placed in little heaps around the pond bottom to avoid oxygen loss all over the pond.

### *Manures*

Manures are very useful in addition to the phosphates. Pig and poultry (duck and chicken) manure may be used. Cattle manure is not as satisfactory since large quantities are needed and the response is more easily obtained with phosphates and other manures.

Either pig or poultry manure can be used (but do not use both at the recommended rates or overfertilization will result).

Pig manure - 500 to 1,500 lb per week per acre.  
Poultry manure - 100 to 200 lb per week per acre.

### STOCKING OF PONDS

Ponds are stocked (i.e., live fish are put into the ponds) with such number or weight of herbivorous, plankton-eating and bottom feeding fish so as to make the best use of the naturally available foods in the pond. Likewise different kinds of artificial foods may then be used.

The usual amount of fish stock in ponds in rural areas is 200 lb per acre. Thus in a 1/10-acre pond 20 lb would be stocked, in a 1/15-acre pond 14 lb, etc. The amount of each kind of fish stocked should be about the same. For example, if two species are stocked in a 1/10-acre pond, 10 lb of each would be stocked. If three kinds, then 7 lb of each would be satisfactory.

Fish for stocking the ponds the first time after being constructed can be obtained from government fish farms. Usually later stockings are made from small fish obtained at the time of drainage, although some may also be obtained from the governmental farms.

Advice on stocking rates or species combinations and general management of ponds can also be obtained from the governmental fisheries officers.

### FEEDING OF FISH

In intensive culture the use of added foodstuffs increases the weight of fish that can be harvested.

To be of use food must be in a form that can be easily eaten by the fish. It is a waste to use fine meals or whole grains which are too large for them to eat.

In small ponds vegetation is thrown into the pond. Often the wind drives all of this into one corner. In bigger ponds it is often an advantage to keep the food from drifting everywhere by making a rectangle of bamboo or sticks which floats on the surface and is held in place by stakes driven to the bottom. In this way it is possible to see whether the fish are eating the food and whether more or less is required. Grain fodders should be soaked for some hours beforehand, so that they sink to the bottom of the pond. This food should not be strewn all over the pond but put in at definite points marked if necessary by a pole. These feeding spots should be changed from time to time. It is possible by inspection or by

scooping from the bottom to see whether the food is all eaten. Floating foods like bran should be put into a feeding circle.

One of the cheapest and most useful foods is fresh green plants. *T. melanopleura* should therefore always be stocked in ponds as they are the fish that eat these.

Suitable types of plants are: green grass, napier fodder, banana leaves, cassava leaves, papaw leaves, sweet potato leaves, cabbage and lettuce leaves, spinach, carrot tops, kale. Large leaves can be coarsely chopped.

Grain foods that are suitable are: maize wastes and crushed cobs or crushed maize, maize bran, rice wastes, beer wastes.

Vegetation should be fed once a week.

Other foods and wastes should be fed when available, but it is better to feed small quantities frequently, rather than to give too much food only now and again. Good results are obtained by regular feeding.

Household scraps, such as pot scrapings, vegetable tops, etc., can be collected and fed daily.

In cold areas fish may stop feeding in winter when the temperature is below 15°C (59°F). Observation will show whether the food is being eaten or not.

Some foods are better than others. This is expressed by the conversion rate of the food which means the amount of food in pounds required to produce one pound of fish flesh. For example, most cereals have a conversion rate of about 5 to 1, that is 5 lb of food will produce 1 lb of fish. The conversion rate for vegetation varies, e.g., banana leaves 25, cassava leaves 13 and napier fodder 48.

#### *Quantities that can be fed*

Fresh green vegetation, 20 to 40 lb per week per pond of 1/10th-acre (200-400 lb/acre). One of the following:

|                      |  |
|----------------------|--|
| Maize or rice wastes | 3 lb per day (30 lb/acre) or           |
| Dried beer waste     | 2 lb per day (20 lb/acre) or           |
| Cassava roots        | 5 to 10 lb per day (50 to 100 lb/acre) |

NOTE: All figures are for ponds stocked at 200 lb/acre.

**CROPPING (Figure 27)**

In order to get the best results the simplest way, it is suggested that the small rural ponds of the size recommended, 1/10th-acre, be completely cropped once a year by draining.

If there is only one pond, enough fish must be kept alive to restock the pond.

If there is a set of 12 ponds, one can be cropped completely by draining every month of the year. This pond is then restocked a month later from the pond cropped in that month. Rotational cropping is a very good scheme since it makes available a regular supply of fish.

In the case of less than 12 but more than one pond, the last pond must be restocked with fish kept alive while the pond is being drained.

It is not necessary to take all the fish out at once if there are too many to dispose of. Cropping may be extended for a period of a month and the pond then drained completely. For example, if there are 12 ponds and one wants to supply fish every week, the following arrangement would be possible. Suppose that:

Pond No. 1 has been totally cropped and is empty.

Pond No. 2 has been under culture for a year in February.

Pond No. 3 will have been a year under culture in March.

Start cropping Pond 2 in the first week in February and restock Pond 1 with 20 lb (if 1/10th-acre). Convenient amounts of fish (in the best cases about 40 lb per week) may then be taken out of Pond 2 during February.

At the end of the month drain Pond 2 completely and restock it from Pond 3 which should then be cropped.

If there are less than 12 ponds it is a good idea to crop the ponds at the end of summer. Care must be taken in colder areas with winter stocking, however, and in the colder parts of Rhodesia it should, if possible, be avoided.

A farmer with one or two ponds can crop the ponds using a rod and line with a small hook baited with worm or porridge. The fish must stay in the pond for one complete rainy season before this kind of fishing starts. The catch in the pond will be less after a few weeks. Fishing should cease for a while and begin again a few

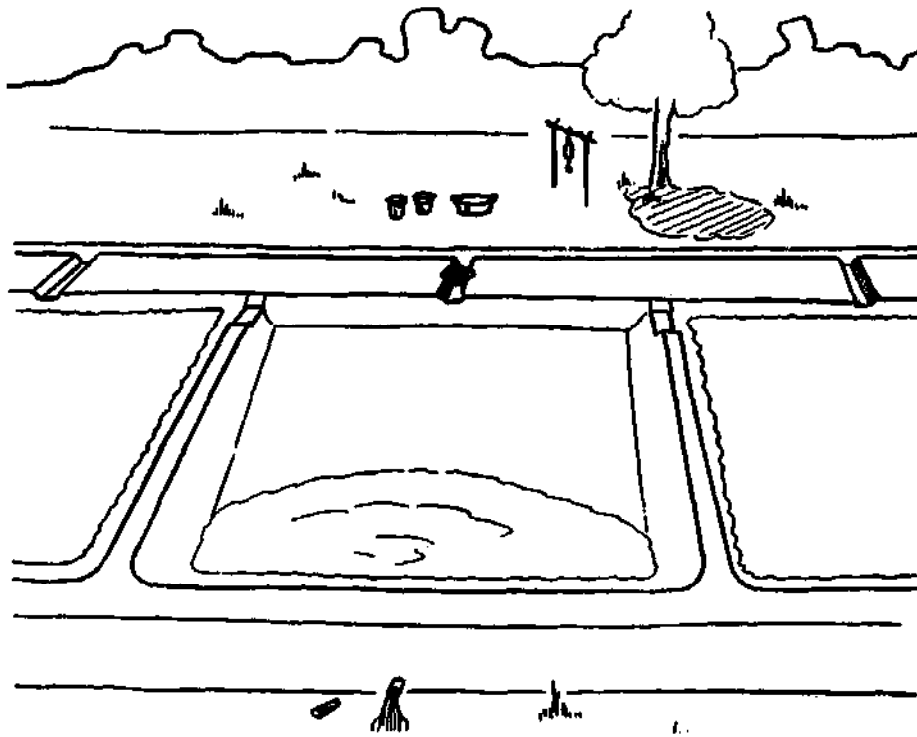
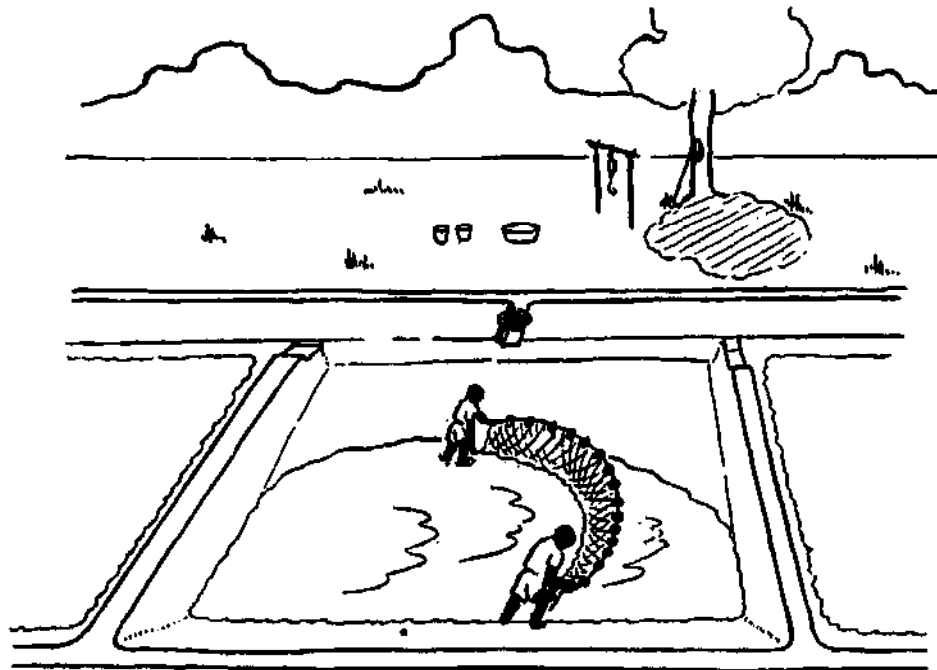

FIGURE 27. How to crop fish ponds. *Above:* Preparing a pond for netting. The pond is made ready for netting by letting the water out until there is only a pool left. Do not let ALL the water out. *Below:* Netting the pond. The net is pulled through the pond.



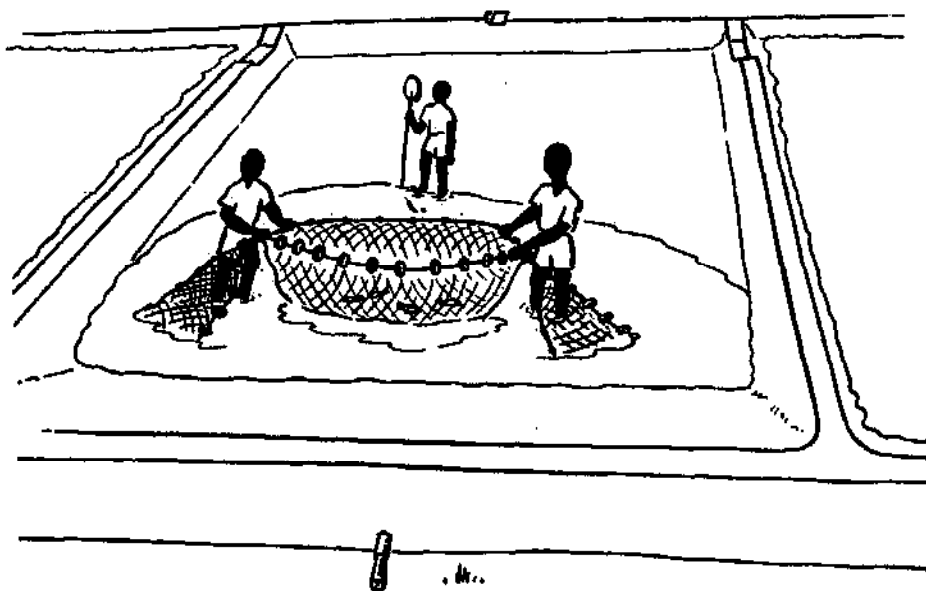
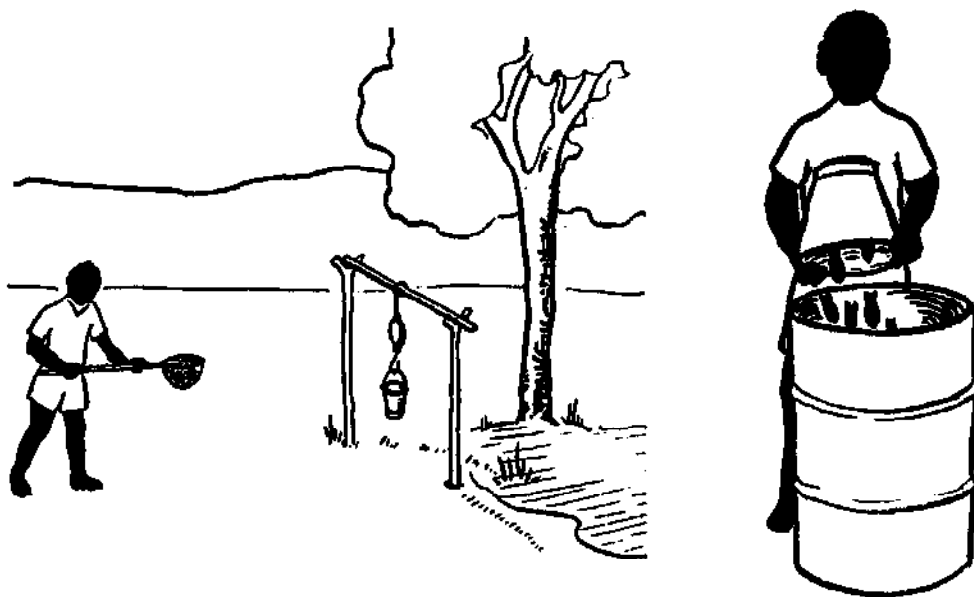

FIGURE 27 (CONTINUED). How to crop fish ponds. *Above:* Washing the fish in the pond. Fish caught in the net are washed in the pond. *Below left:* Weighing the fish. Fish are taken from the pond in a hand net and weighed, a few pounds at a time. *Below:* Fish for restocking if only one pond is used. Some fish must be put alive into drums or cans of water and later put back into the pond. The water in the drums must be agitated to keep it aerated. Not more than 20 lb of fish should be put into one drum.





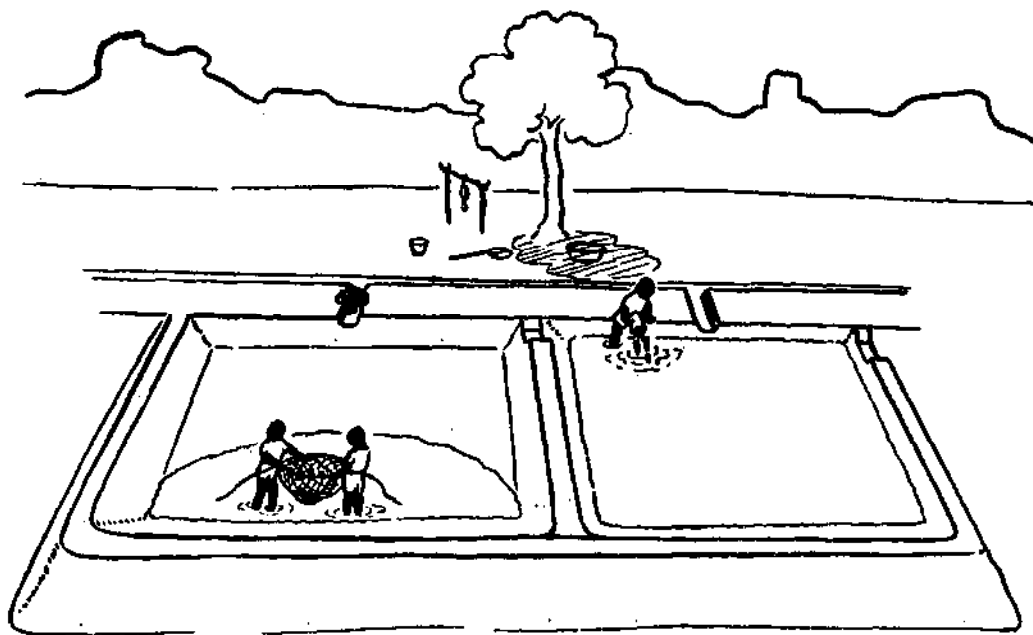
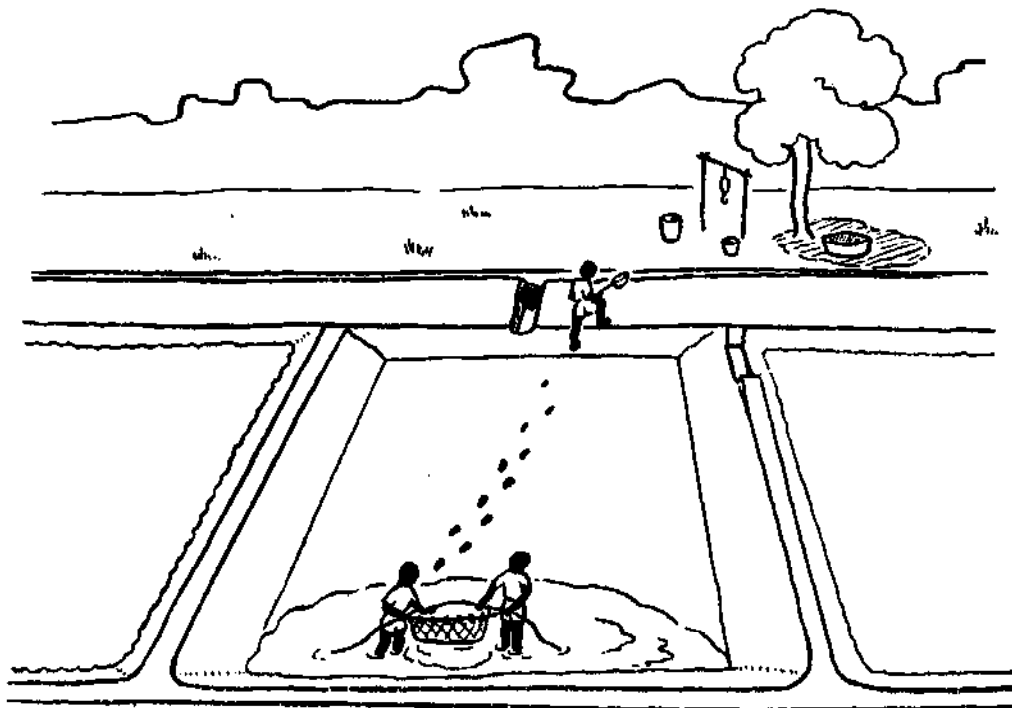

FIGURE 27 (CONTINUED). How to crop fish ponds. *Above:* Fish for restocking if more than one pond is used. If there are a number of ponds and one pond is cropped every month, then the live fish can be put straight into the pond that was cropped the previous month. *Below:* Removing fish. The rest of the fish that are not wanted alive are taken from the net in the pond. The fish are weighed and put in a bath in the shade. These fish are to be eaten or sold. The net is pulled through the pond again and again until only a very few fish are taken. It does not matter if a few fish are left in the pond.



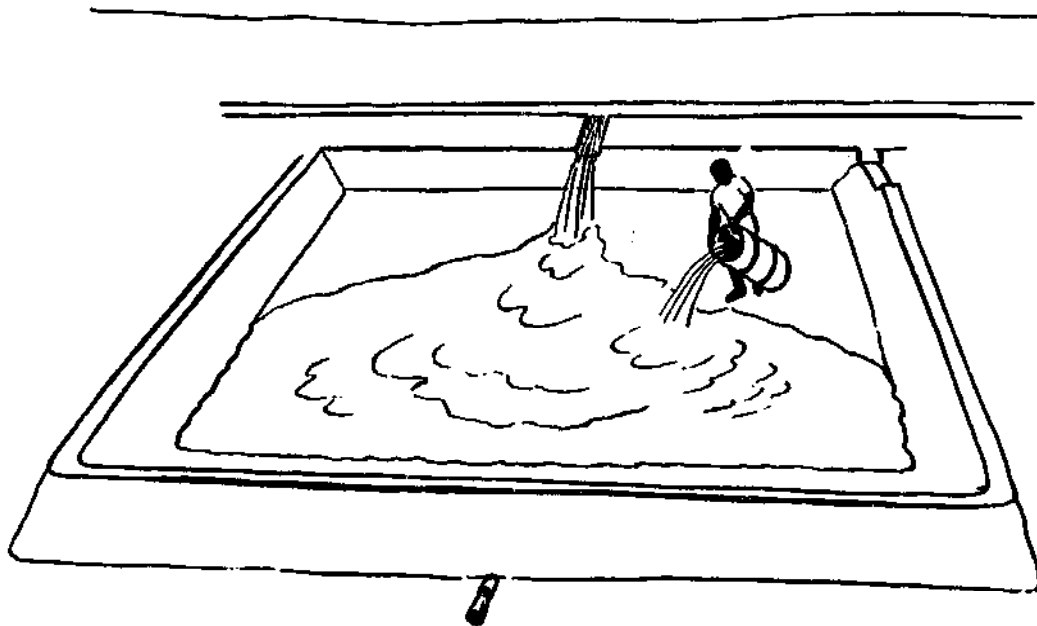
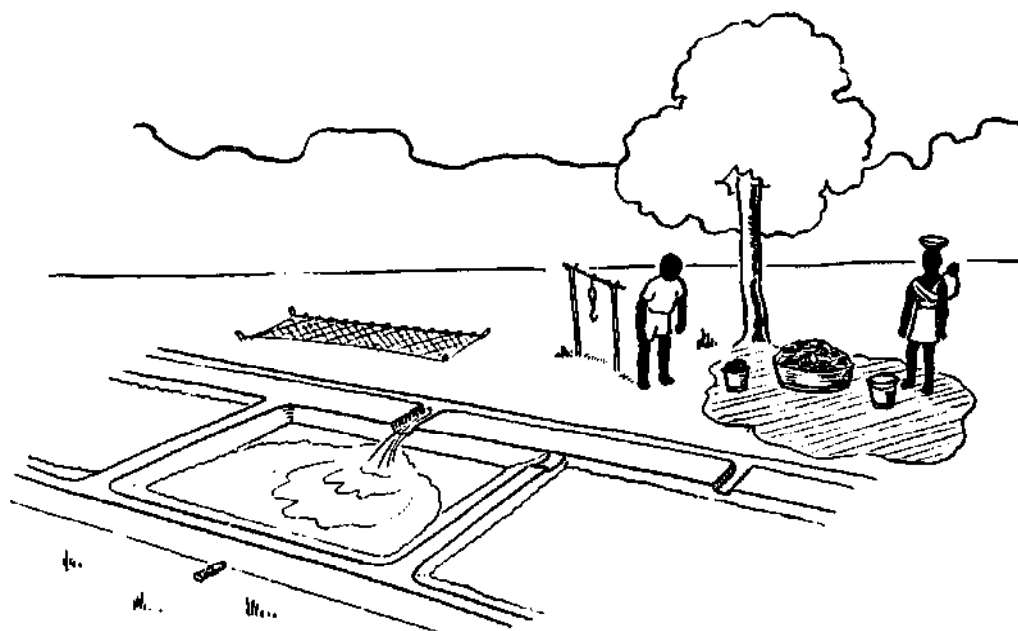

FIGURE 27 (CONCLUDED). How to crop fish ponds. *Above:* Restocking the pond. When netting has finished, the pond is inspected for holes in the walls, etc. The pond is mended if necessary and then refilled with water. If there is only one pond the live fish in the drums are put back. If there are a number of ponds then the pond will not have fish put back until the next pond is cropped. *Below:* Pond restocked and fish crop ready for disposal. The fish from the pond can be eaten fresh or sold or preserved.



months later. A pond in which this kind of fishing is done should still be completely cropped after one year.

Traps may be used in small ponds. Traps are made of 1-in. chick wire mounted on a 1/4-in. rod and, baited with maize porridge, may be used for cropping small daily quantities. This is often dangerous as the traps or the fish may be stolen unless the pond owner's house is near the pond. Where rod and line or trap fishing has been done, the total crop is the same as if the pond were cropped on draining. The amount taken at the draining will, of course, be less.

The total amount (in weight) of fish taken from the pond is the yield or crop. The production is the amount taken out less what was put in. In order to compare the crops from ponds of different sizes it is often the practice to work out the result per acre and if, as in the case we have used as an example, the period is a year, the crop is said to be so many pounds per acre per year.

For example, a well-managed pond of 1/10th of an acre may give on cropping one year after stocking, a weight of 200 lb of fish. The yield would then be 2,000 lb/acre/year.

The fish crop consists of fish of all sizes. If there has been good feeding, growth will have been good and there will be a fair number of fish of 5 to 6 oz and possibly more. There will also be many small fish of 1 oz or less.

If the pond has not been well looked after and the fish have not been fed, the crop will consist mainly of small stunted fish which have grown poorly.

To obtain a good crop of fish:

1. The pond should be properly situated and built and be adequately supplied with water.
2. There should be no throughflow of water.
3. The pond should be stocked with the right quantity and kinds of fish.
4. The pond area should be protected against otters and bird predators.
5. The correct liming and fertilizing should be carried out.
6. The fish must be fed.

## Types of culture

There are a number of ways of raising fish, differing in method, aim and ease of carrying out. These are briefly described below.

### MIXED METHOD

The mixed method consists of using fish of different ages, sizes and species. This is the simplest and the only method described here in detail. Large crops of fish are obtainable, but the individual size of fish is never great.

This method is suitable for areas where water is available for the whole year and is combined with other types of farming with great advantage. Figures are given for a pond of an ideal size of 1/10th-acre.

1. Lime the pond bottom with 150 lb agricultural lime.
2. Fill the pond with water.
3. Stock the pond with 20 lb of fish (200 lb/acre) using about the same amount of each kind, and fish of from 3 in. long up to 6 oz or a little more in weight.
4. Lime the pond every month with 15 lb of agricultural lime spread over the surface (150 lb/acre).
5. One week after liming spread superphosphate over the surface of the pond water at a rate of 5 lb double superphosphate (50 lb/acre) or 10 lb single superphosphate or basic slag (100 lb/acre).
6. Feed the fish regularly (see page 49) or put in pig manure, 100 lb per week or poultry manure, 15 lb per week.
7. After a period of one year, crop the fish entirely by draining.

### SEPARATE AGE METHOD

The aim in separate-age type of culture is to grow the fish as rapidly as possible so that they are big before they start spawning, in order to get a more uniform size and larger fish. Stocking is done with young fish of the same age, and of individual weights of

less than  $\frac{1}{2}$  oz. The number to be stocked depends on the area of the pond, available food and growing time. This is a complex method requiring different ponds and a lot of handling.

#### MONOSEX CULTURE

Monosex culture is not practical on a large scale and is not easy to carry out. The sexes are kept separate and usually only male fish are used. No spawning occurs so the fish do not become crowded and can grow fast.

#### CULTURE WITH PREDATORY FISH

This method is used to cut down the production of fry so that most of the fish produced will be big. The numbers of the predatory fish must be carefully worked out. The predatory fish used are *Serranochromis robustus* and the largemouth black bass (*Micropterus salmoides*). Though total production may be a good deal lower than when no predatory fish are present, the fish are bigger.

It is clear that the first method is the most suitable for rural fish ponds and that the other methods require more specialized techniques. They are of importance only where it is necessary to produce bigger quality fish in semi-industrial fish cultures, where the market requirements merit the extra trouble.

#### FISH FARMING COMBINED WITH OTHER BRANCHES OF AGRICULTURE

The rearing of *Tilapia* is best combined with other types of farming. This makes for greater overall efficiency, as by-products from some of the activities are used "on site" in other branches. An ideal situation is to combine fish with a vegetable garden, perhaps under irrigation, and some form of intensive livestock raising such as pigs or poultry. Waste from the vegetable garden is used for the fish, as well as manure and food wastes from the animals; small, under-sized fish and fish offal can be fed to the animals, and excess mud from the bottom of the pond can be used for fertilizing the garden. It often happens that much of the fertility in a pond becomes locked in the soil and does not affect the growth of fish; it is wasted unless it can be used elsewhere. Figure 28 illustrates these interrelationships.

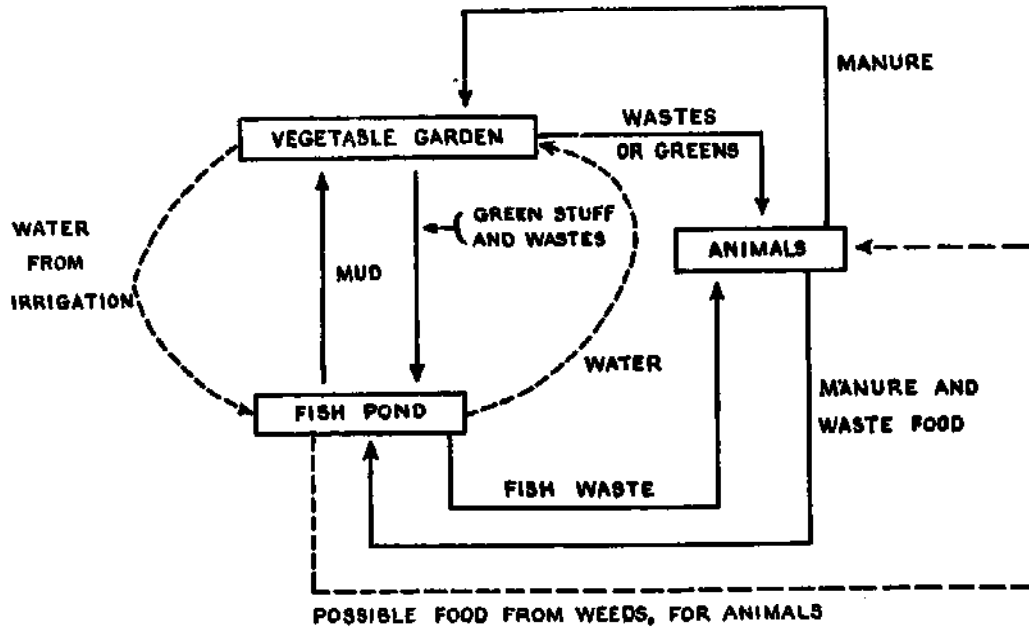

FIGURE 28. Combined fish, crop and livestock farming. The figure shows the relation between ponds, crops, and animals.

Ducks may be kept in conjunction with a pond, being penned nearby for fattening and the pens washed into the pond. They may be allowed on the pond, or the pond areas. In this way they get some food from the pond and help to control weeds and snails which carry bilharzia. Too many ducks should not be kept on the pond area as they destroy the walls. For larger ponds, geese may be allowed to pasture near the water. Excellent results have been obtained by using duck manure on fish ponds — yields of over 2 tons per year per acre. Peking or Muscovy are the varieties of duck most commonly used. Breeding flocks must be allowed access to the water and a suitable combination would be to allow the breeders on the pond, while keeping the fattening stock in pens. Small fish and fish offal mixed with maize is a valuable food for both ducks and poultry. Muscovy ducks are the hardiest and easiest to rear.

For a small unit of say, six 1/10-acre ponds, a breeding stock of about 40 ducks with their young will provide a suitable quantity of manure for the fish.

If hens and ducks are kept on deep litter, the litter makes excellent fertilizer for the pond, used in quantities of 500 lb per acre and either strewn on the surface or worked into the bottom.

The use of pig manure and the washings from pig sties leads to high production. As much as 500 lb per week of pig manure per acre may be used. There is a considerable amount of direct food value from this in addition to its fertilizing action. The manure from six sows and their young may be used regularly over one acre of water. One or two sows and young pigs will supply sufficient manure for a small pond.

Where there is a possibility of growing paddy rice, consideration should be given to mixed rice-fish farming. In this case the paddies are modified by having higher bunds built and a channel round the perimeter which holds 2 to 2½ ft of water when the central rice-growing area is inundated to 4 to 6 in. Fish may be stocked at any time after the rice has rooted provided the channel is full, and when the rice crop is ready for flooding will have the entire surface area at their disposal. It is advisable to use nonherbivorous fish, e.g., *T. mossambica*, *T. macrochir* or *T. andersonii* for rearing in paddies. The fish act as cultivators and manure the soil on which the rice is growing. When the rice crop is reaped the ponds can be filled to a full level and used entirely for fish production (Figure 29).

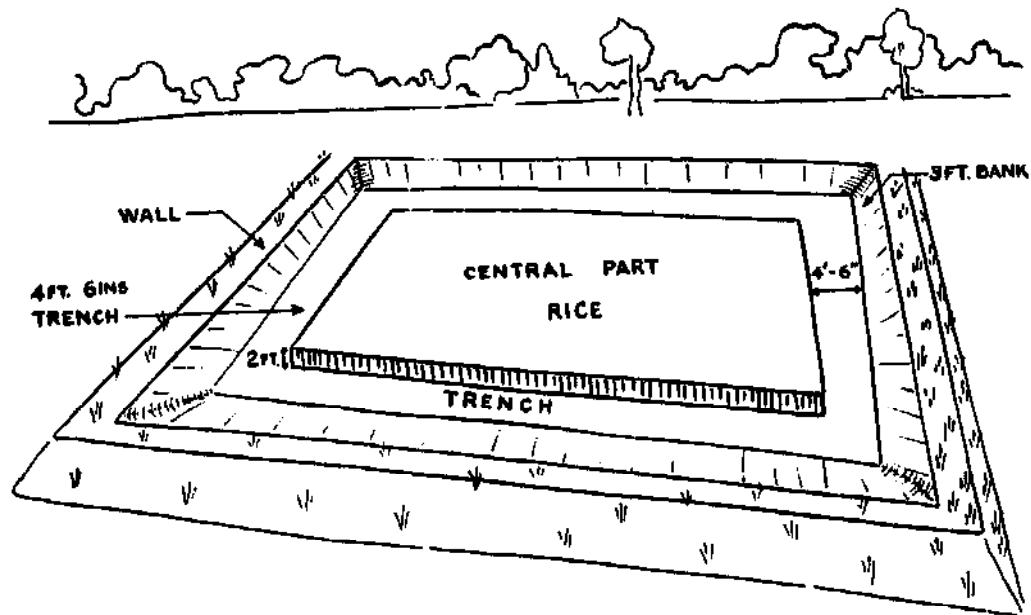

FIGURE 29. Fish and rice. The figure shows a pond in which fish and rice are growing.

### REARING OF FISH FOR PURPOSES OTHER THAN FOOD

At centers established for the purpose of producing fry or young fish for stocking, special measures are often taken and separate species reared in different ponds. There are also ponds for breeding, for rearing fry, and for holding fish prior to transportation.

Forty or fifty pairs of adult *Tilapia* per acre are stocked in ponds of  $\frac{1}{4}$ - or  $\frac{1}{2}$ -acre in larger centers. The adult fish are usually between 6 oz and 1 lb and preferably not more than two years old.

The ponds are kept well fertilized with phosphate and the young fish are removed after the breeding season. Smaller breeding ponds may be used and the young fry removed with fine nets when they are still moving in shoals and put into fry-rearing ponds. Two to five pairs of adults are used in ponds of  $\frac{1}{20}$ th-acre.

*Serranochromis* are reared in the same way as *Tilapia* but precautions must be taken to prevent the adults from eating the fry once they are free from parental care. Fencing off a part of the pond with wire mesh to enable the young fish to escape is one method; or, alternatively, large ponds with vegetation growing and giving protection to the young may be used.

*Haplochromis* may be grown in a similar way to *Tilapia*.

### OTHER FISH CULTURES

There are other important kinds of fish culture dealing with food fish which are big industries in some parts of the world, although they have been of little importance in Africa up to the present. There are two main cultures, those of trout and of carp. Carp culture is a very old art, and began in the Far East. Carp are able to withstand lower water temperatures than *Tilapia*, but are also able to grow very well in warm areas. Because the culture of carp properly done requires more involved methods than *Tilapia* culture, and several different kinds of ponds, and since in most parts of Africa where food is short conditions are suitable for *Tilapia*, no consideration will be given here to carp culture.

Trout are an important culture fish in colder climates. As a basic food supply they are not of importance because they require protein food themselves, usually in the form of meat or special pellets. They are reared in small ponds, where many are crowded together



without coming to harm, because fresh water passes through all the time. Their value as a high priced food is their main importance. Abundant cold, clear water is required for their culture. Breeding of the trout is generally done artificially by extracting the eggs from the female and mixing them with the milt of the male.

Other types of fish culture of some economic importance but not as food production are the breeding and culture of various kinds of ornamental fish for aquariums. This is a flourishing industry in many parts of the world.

### **Types of fish used for fish culture in central east Africa**

#### **CICHLID FAMILY**

The fish of the greatest value in fish culture in central east Africa are all members of the Cichlid family and the most important belong to the genus *Tilapia*. For the following reasons *Tilapia* are highly desirable for use in intensive culture:

- a. They are efficient converters of waste foodstuffs.
- b. They have a short food chain.
- c. They can be readily adapted to crowded conditions in artificial culture.
- d. They can be easily bred.
- e. They are generally free from parasites.

#### *Identification*

It is important to be able to identify the species of fish used for culture because some of the related species are not of value.

Each fish has two names, a generic and a specific. The generic name, for example, *Tilapia*, is written with a capital letter, while the specific name, e.g., *melanopleura*, is written with a small letter. Fish of the same species are almost identical and form a group which interbreeds freely. Fish of the same genus have certain characteristics in common in their anatomy.

The main genera (plural of genus) used in fish culture are *Tilapia*, *Serranochromis*, and *Haplochromis*.

One of the best ways of deciding to which of these genera a fish of the Cichlid family belongs is to examine the gill rakers, i.e., the teethlike projections on the gill arch, which may be seen by lifting up the gill cover or cutting it away.

- a. If the gill rakers are thick and partly T-shaped or knoblike, the mouth large, set at an angle to the horizontal, spots on the anal fin, and bodies long in proportion to depth, the genus is *Serranochromis* (Figure 30).
- b. If the gill rakers are fine, the mouth usually small, and there are no spots on the anal fin, the genus is *Tilapia* (Figure 31).
- c. If the gill rakers are short and stout and there are orange spots on the anal fin, the genus is *Haplochromis*.

### *Tilapia*

This is a widespread group. Five species are of importance (*T. melanopleura*, *T. sparrmanii*, *T. andersonii*, *T. mossambica* and *T. macrochir*). In various countries in central east Africa there has been and is being introduced *Tilapia zillii*. The *Tilapia* are relatively easily separated into species by counting the gill rakers and by identifying other features:

- a. 8 to 12 rakers on lower part of first gill arch:

*T. melanopleura*: Usually with a pink or red chest and five or six dark vertical bars on the body. The tail fin is speckled and darker in the upper half than in the lower. Widespread from Upper Congo to South Africa (Figure 32).

*T. sparrmanii*: The color varies but there is never a pink chest, the number of dark bars is seven to nine and the tail is uniform. Widespread in occurrence.

- b. 14 to 20 gill rakers:

*T. mossambica*: The snout is often longish and the profile is concave. Does not occur in Upper Zambesi, but is widespread from Rhodesia southward and in tributaries of the middle and lower Zambesi (Figure 33).

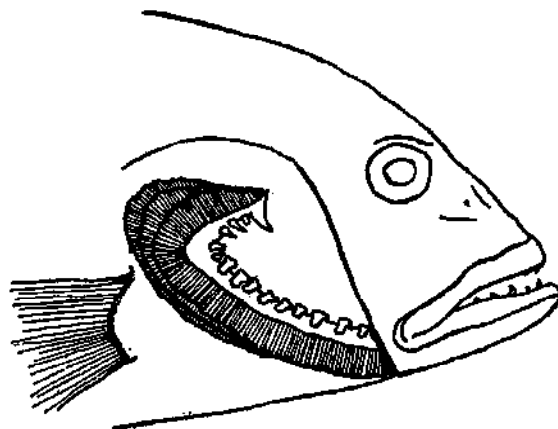

FIGURE 30. Gill rakers of *Serranochromis robustus*, thick, knoblike. Compare with *Tilapia* (Figure 31).

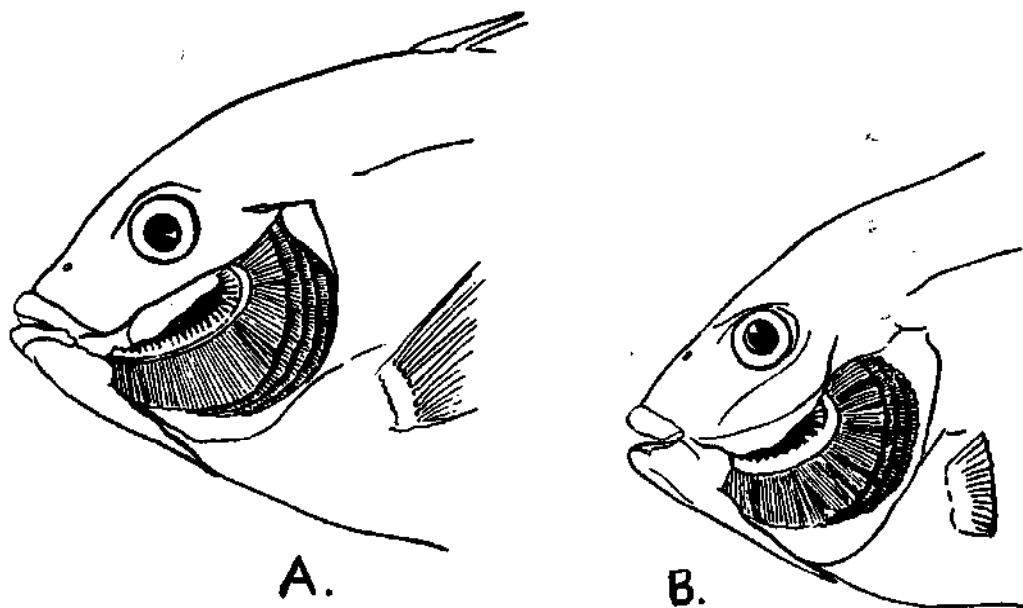

FIGURE 31. Gill rakers of *T. macrochir* and *T. melanopleura*. A. *T. macrochir* head with gill cover removed to show 23 gill rakers on lower part of arch. B. *T. melanopleura* head showing 10 gill rakers on lower part of arch.

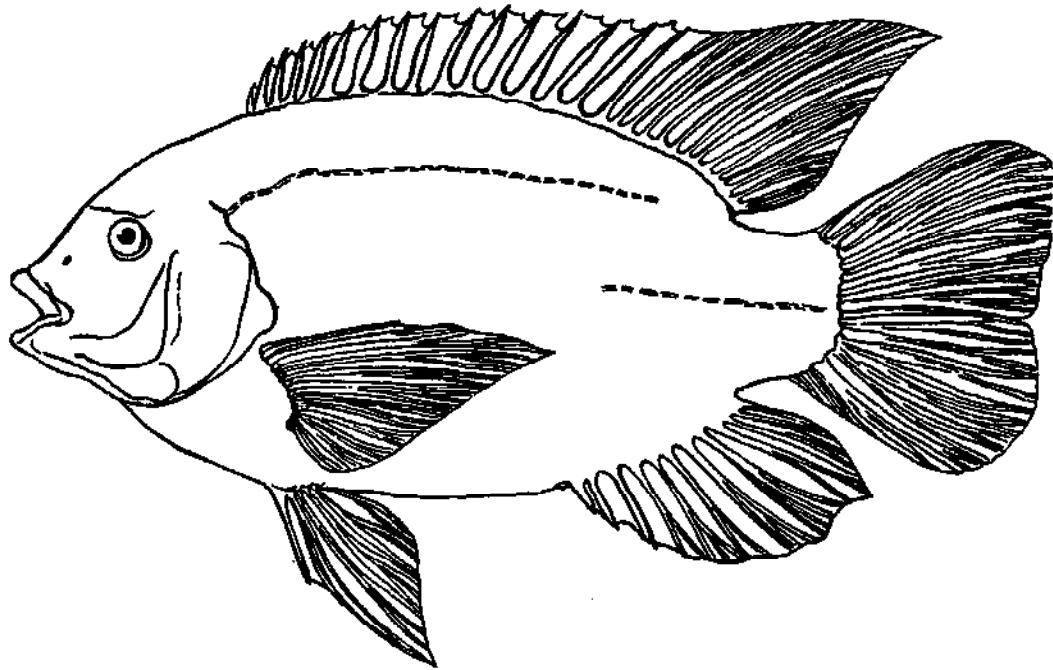

FIGURE 32. *Tilapia melanopleura*.

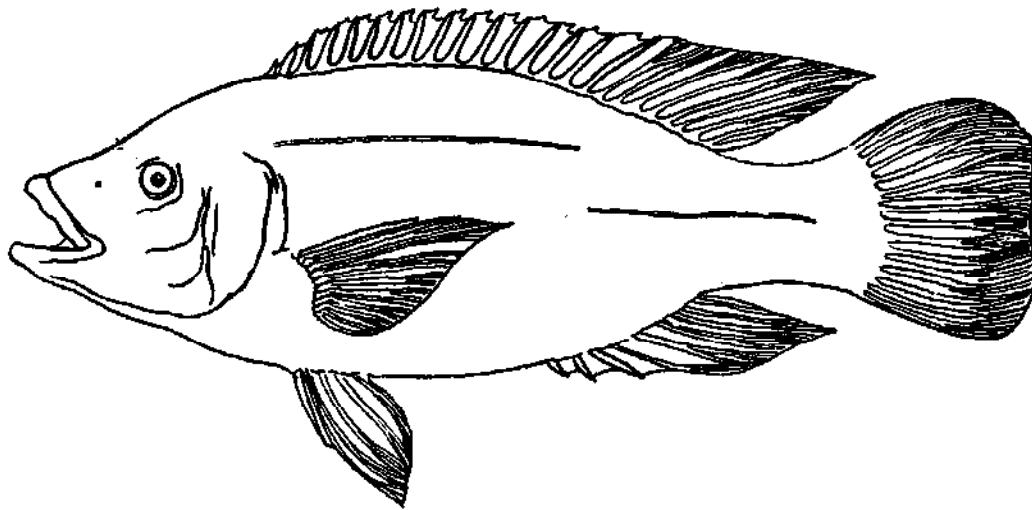

FIGURE 33. *Tilapia mossambica*.

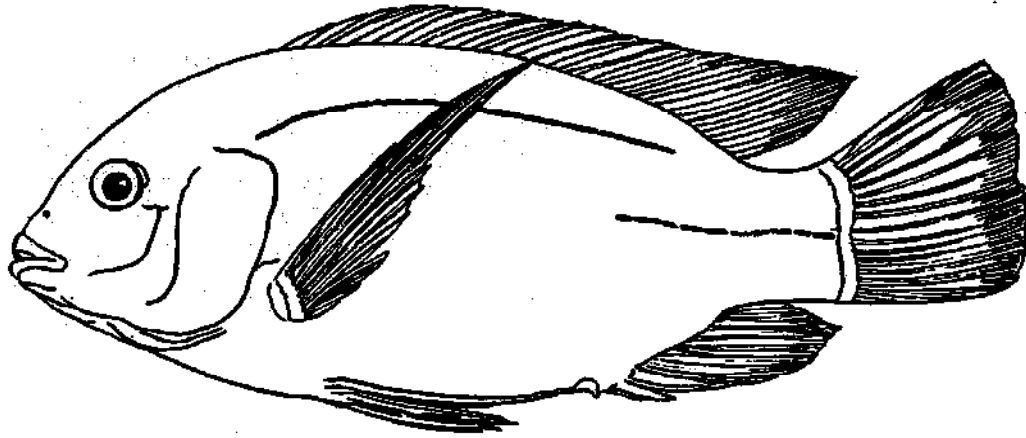

FIGURE 34. *Tilapia macrochir*.

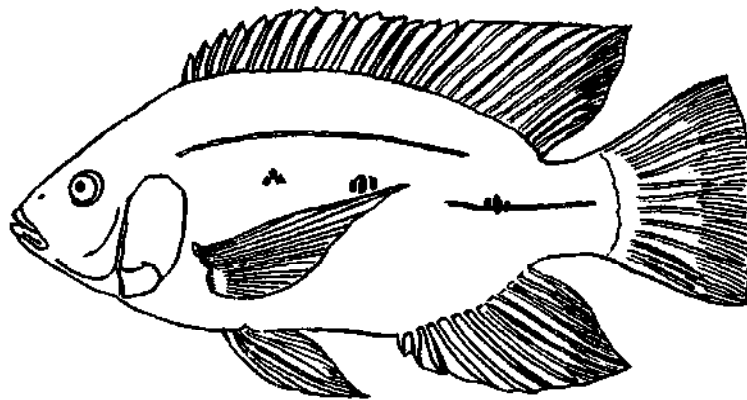

FIGURE 35. *Tilapia andersonii*.

c. 20 to 26 gill rakers:

*T. macrochir*: Sides of head speckled, body greenish and always with a rounded or convex snout. There is often a red rim round the eye. Occurs in Congo, Upper Zambesi, Kafue and Okavango river systems (Figure 34).

*T. andersonii*: Profile of head sloping, silvery in color. Often has three black spots along the side of the body. Occurring in the Kafue, Upper Zambesi and Okavango river systems, generally found only in large rivers or swamps (Figure 35).

*Serranochromis*

There are four species which occur in the Kafue River in Zambia, in the Upper Zambesi and the Okavango, and some of these are also found in the Congo River system.

The teeth in the upper jaw are used as a guide in separating the species (Figure 36).

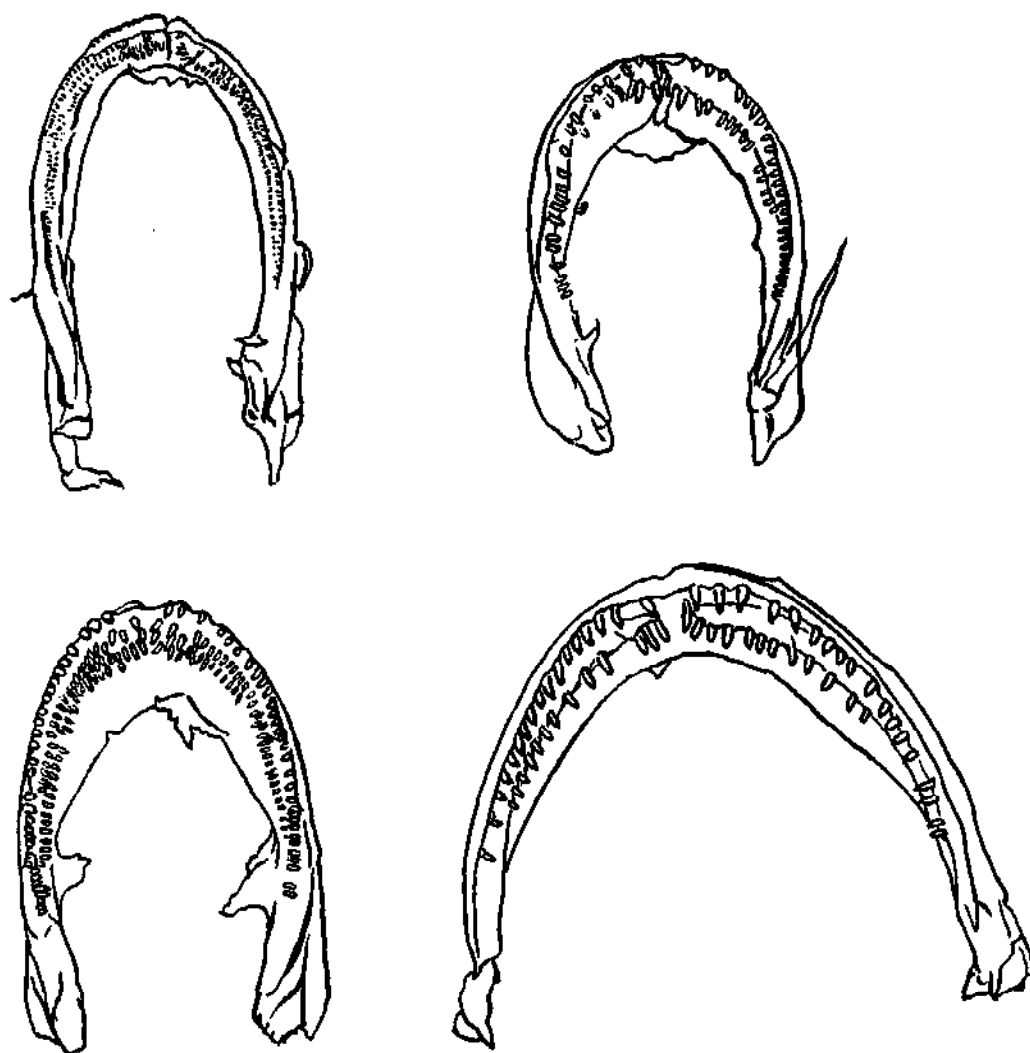

FIGURE 36. Teeth of *Serranochromis*. Left: More than 3 rows of teeth in upper jaw. Top *S. angusticeps*. Bottom: *S. thumbergi*. Right: 2-3 rows of teeth in upper jaw. Top *S. macrocephala*. Bottom: *S. robustus*.



FIGURE 37. *Serranochromis* species. A. *S. robustus*. B. *S. macrocephala*. C. *S. angusticeps*. D. *S. thumbergi*.

- a. 2 to 3 rows of widely spaced teeth in the upper jaw.

*S. robustus*: Body color green above the lateral line and yellow to white below. Profile often concave (Figure 37A).

*S. macrocephala*: Body dark blue to purple above the lateral line. Profile of head usually straight or slightly concave (Figure 37B).

- b. More than three rows of teeth close together in upper jaw.

*S. angusticeps*: Variable body color. Head narrow with eyes placed close together and profile concave. Deeper bodies than most. Mouth is able to be pushed out somewhat (protractile) (Figure 37C).

*S. thumbergi*: Body color light green above lateral line and whitish below. Broad head with eyes wide apart. Profile convex. Body slender. Caudal fin truncate (Figure 37D).

### *Haplochromis*

Fish suitable for fish culture are included in the *Haplochromis* group, as well as fish which rarely grow to a size of more than a few inches. Identification of the larger growing species is difficult and reference should be made to fisheries departments.

The main features are a short snout, gill rakers usually less than 12, a large mouth with small teeth in three or four rows and orange spotted anal fins, noticeably in the two smaller species.

The most common small species are:

*H. philander*: rounded tail fin.

*H. darlingi*: square-cut tail fin and usually slender body as compared with the former.

There are five other larger species of which three are of interest in fish culture and which feed on water snails:

*H. mellandi*

*H. carlottae*

*Pelmatochromis robustus*



### General biology of the species of value in fish culture

In the following descriptions vernacular names have been omitted, as they vary from area to area. The numbers following the name refer to the number of the fish mentioned in the works of Jackson (1961) and Jubb (1961), respectively.

#### TILAPIA MELANOPLEURA (Jackson, 132; Jubb, 80: see Figure 32)

This fish is less tolerant of cold water than *T. mossambica* and *T. sparrmanii* and deaths occasionally occur in cold areas when the water temperature drops below 12°C (53°F) or 13°C (55°F). It has been satisfactorily established in ponds and conservation dams in areas where it does not generally occur in the rivers because of cold water.

#### *Breeding*

The fish start to spawn when the water reaches about 20°C (68°F). The nest is built by the male and consists of a group of five to ten holes close together, usually in a larger depression when they are built on the bottom of ponds. Each hole is 2¼ to 4 in. in diameter and is built from 6 in. to 3 ft below the surface, but usually rather less than 3 ft. The number of eggs laid at a time varies according to the size of the female — from 1,000 for small fish, and up to 5,000 to 6,000 for larger fish over 10 oz.

Females usually become mature after one summer at about seven months, but under pond conditions maturity may be reached earlier. The eggs are laid in one of the depressions and from time to time moved in the mouths of the parents to neighboring holes. Hatching takes place after about five days, depending on the water temperature. The young fish are cared for over a period of two to three weeks by the adult fish, until they are big enough to look after themselves. Egg laying occurs at approximately seven-week intervals if the temperature remains high enough. From each spawning, or egg laying, approximately half of the eggs result in free swimming fry.

### Feeding

Young fish of up to 2 in. eat small crustacea and animal plankton, but this is gradually replaced by plant food as the fish grow.

When plant material is lacking, the fish will eat detritus, muck on the bottom, insects or artificial feeds of various kinds. The food habits of this fish make it a useful agent for weed control in conservation dams. In culture the fish are fed on chopped grasses, papaw and banana leaves and similar vegetable matter.

### Growth

The males grow faster than the females and reach a bigger size. In big open waters where food is abundant sizes of 2½ to 3 lb and lengths of 15 to 16 in. are attained. In ponds growths of 6 oz to ½ lb per year are recorded under moderate stocking rates, or 4 to 6 oz under normal conditions.

### T. SPARRMANII (Jackson, 133; Jubb, 79)

This is a hardy fish which can stand up to water temperatures much lower than those tolerated by the other *Tilapia* and the lowest limit is recorded as 7°C (45°F). Therefore this fish has a place in fish culture in cold areas, but it rarely grows much above ¼ lb. The largest size recorded from Zambia is 10 oz. It is widely distributed and occurs naturally in many conservation dams, where it is readily caught in gill nets of 2½ to 3-in. stretched mesh. Breeding occurs at temperatures of 17°C (62°F) and when the fish are small. Like *T. melanopleura*, this fish is a guarder and not a mouthbreeder. A female of 7½ in. is recorded as having 3,300 eggs in the ovaries. Small fish feed on animal plankton and as they grow bigger get more food from the bottom and also eat a certain amount of vegetation. When alive the fish is clearly distinguished from *T. melanopleura* by its coloring, and when dead by the fact that it has a lower number of spiny and soft rays on the dorsal fin and fewer scales along the lateral line.

*T. melanopleura*, 29 to 32 scales in lateral line. 13 to 16 spiny rays, 10 to 14 soft rays.

*T. sparrmanii*, 27 to 29 scales in lateral line. 12 to 15 spiny rays, 9 to 12 soft rays.

**T. MOSSAMBICA** (Jackson, 130; Jubb, 78: see Figure 33)

This fish is widespread and is tolerant of water temperatures of 10°C (50°F) for short periods, although for extended periods water of 12-14°C (53-57°F) may be lethal.

It is well suited to fish culture and has been introduced into many parts of the world.

***Breeding***

Spawning starts once the water temperature reaches 19° to 20°C (66°-68°F). The nest dug by the male is in the form of a large saucer-shaped hole on the pond bottom in 1 to 3 ft of water — generally at depths greater than those of *T. melanopleura*. Breeding is reported from an age of two to three months under pond conditions, but in the wild state, and more generally in ponds, does not occur until the fish is 6 to 9 months old. Fish of 4 in. lay about 100 eggs, while fish of over 7 in. produce about 1,000. The lower number of eggs is associated with a greater amount of care by the adults. The eggs, after being laid, are taken by the female into her mouth and there hatch after two to three days. The fry remain in the mouth for a further five to eight days and once they are free swimming are guarded by the female, taking refuge in her mouth to escape danger. Guarding continues for approximately three to six weeks from spawning. Spawning is reported to continue at approximately six weekly intervals as long as the water remains above 19°C (66°F). Frequency of spawning varies according to the conditions and is probably much less frequent in the natural state than in ponds.

***Feeding***

Young fish eat small animals in the water, small, single-celled plants and some plants and animals from the bottom. Fish of over 3 in. become feeders mainly on plant plankton, some vegetation and bottom algae. Artificial foods such as mill sweepings, bran, etc., are readily taken by the fish in ponds.

**T. MACROCHIR:** (Jackson, 129; Jubb, 76: see Figure 34)

This fish is widely used in fish culture in Zambia and further north. There appear to be two different varieties distinguished by the type of nest built. The fish from the Congo basin build a starshaped nest, while those found in the Kafue and Upper Zambesi build a cone with a saucer-shaped depression on top (Figure 38). It is possible that the Kafue/Upper Zambesi fish are better adapted to cooler water and appear to start spawning earlier than the Congo variety.

*Breeding*

Spawning starts at temperatures of 20° to 21°C (68° to 70°F). The male builds a nest in water of 1 to 4 ft in depth and the female is a mouthbreeder. The number of eggs is greater the larger the female; fish of 8 in. or ½ lb lay 1,000 to 1,500 eggs at a time. Females mature from eight months to a year, reaching sizes of 4 to 8 in. After the eggs hatch, usually within about five days, the female retains them for a short period in her mouth and cares for them for two to three weeks. Spawning occurs every five weeks or so in warm areas during the rainy season from October to March. One female will produce some 3,000 to 4,000 eggs per year.

*Feeding*

Young fish are similar in feeding habits to the other *Tilapia*, while those over 3 in. are almost entirely plankton feeders and browsers, taking small plants (algae) growing on larger plants. The fish readily take artificial food and grow well in fertilized ponds.

*Growth*

Large specimens of over 5 lb occur, but the usual size in most waters is less. As a result of frequent breeding the growth of the female is very much slower than that of the male. In ponds the larger fish of 8-12 oz are usually males and the smaller fish of 6-8 oz are females. Growth of 8 oz per year for young fish is normal and a satisfactory rate of increase. Intense stocking rates give less satisfactory growth. In large open waters females reach 1 lb and males 2 lb in a year. As with all fish the growth rate in part depends on food and the extent of the warm period.

### Growth

The females grow more slowly than the males. In six months fish reach 2 to 4 oz with good feeding and 6 to 8 oz in a year.

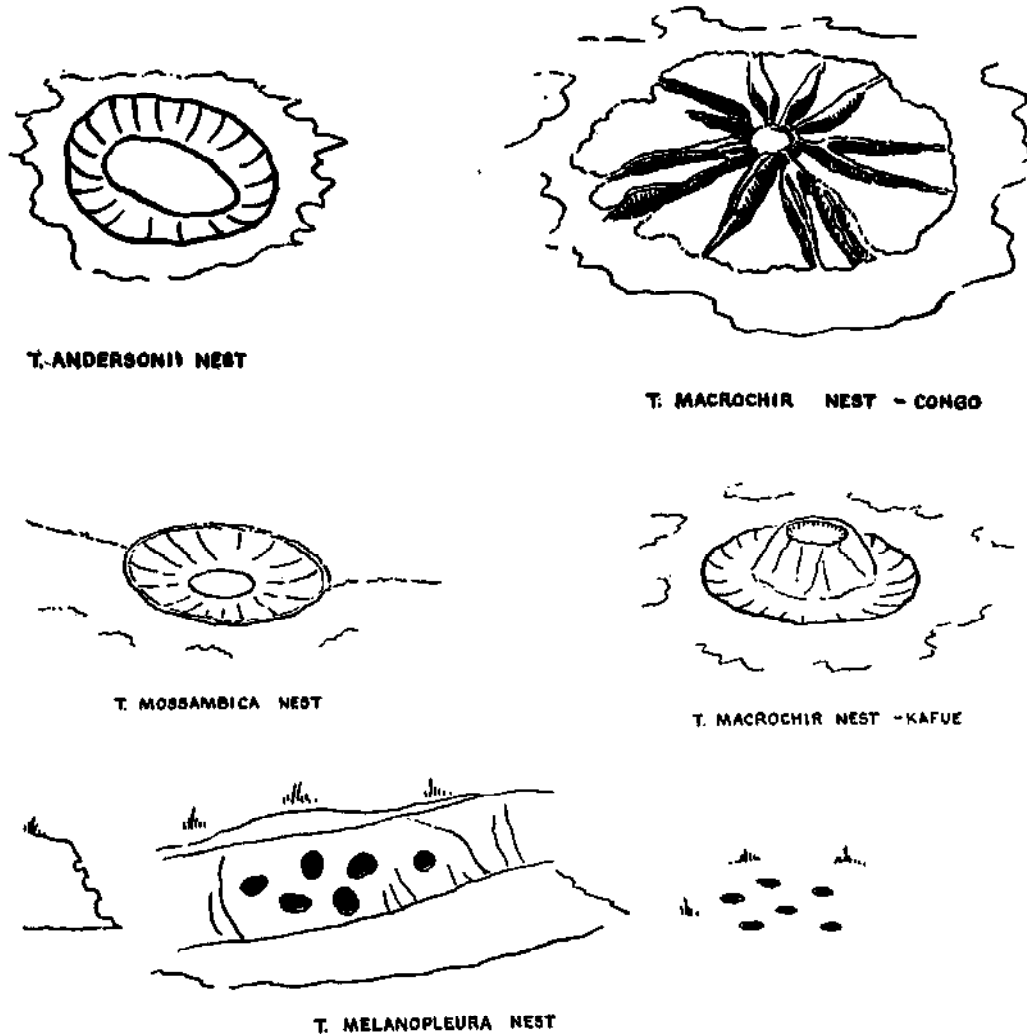

FIGURE 38. Nests of *Tilapia* species.

### *T. ANDERSONII* (Jackson, 131; Jubb, 77: see Figure 35)

This fish may at first sight be confused with *T. mossambica*, but its high gill raker count and longer gill rakers differentiate it, as does a closer inspection of external characteristics, e.g., the tail is less speckled. It does not naturally occur in the same waters as *T. mossambica* and replaces the latter in the Okavango and Kafue systems.

### *Breeding*

The nests are saucer-shaped hollows in water of 12 in. to 1½ ft deep and are 7 in. to 2 ft in diameter, depending on the size of the male. Females mature later than the other *Tilapia*, the youngest recorded being 11 months and the smallest (although not necessarily the youngest) 7 in. and between 3 and 4 oz. The usual age at which females mature in ponds is between 12 and 15 months, at sizes of 6 to 8½ in. The females produce fewer eggs than the other species, usually between 300 and 700 depending on the size of the adult. Spawning starts at temperatures above 21°C (70°F) and usually only one brood per female is produced before being harvested. This is of importance in pond culture, since overpopulation is not, therefore, so likely to occur. The female carries the eggs in her mouth and cares for them for two to three weeks after hatching. The time from egg laying to the end of parental care is five to five and a half weeks.

### *Feeding*

The fish are bottom feeders from their earliest stages and feed on algae. Artificial food of suitable size sinking to the bottom is readily taken. In many respects their feeding habits are similar to *T. mosambica*.

### *Growth*

In larger waters specimens of 4 lb occur. Growth in ponds varies according to the feeding and may be 6 to 8 oz in a year.

The *T. andersonii* shows better growth than *T. macrochir* or *T. melanopleura* when the three species are kept in the same pond at the same rate of fish per acre.

Under normal pond conditions with good feeding the average growth of fish introduced as fry is roughly 4 to 6 oz per year.

Figures 39, 40 and 41 show the growth of three species of *Tilapia* in small fish ponds in Zambia and at different stocking rates.

FIGURE 39. Growth of *Tilapia melanopleura* in ponds.

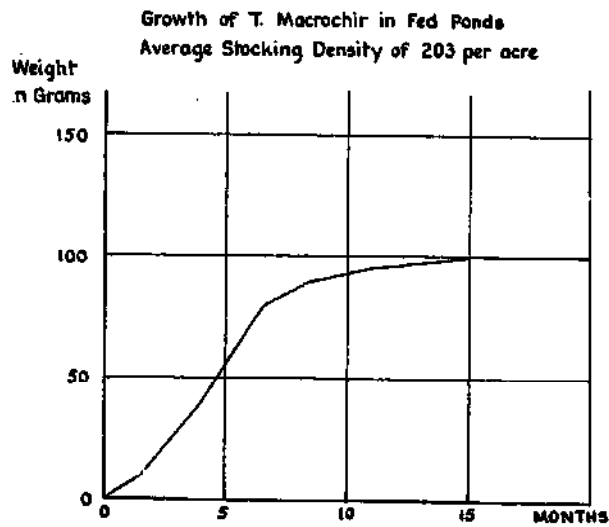
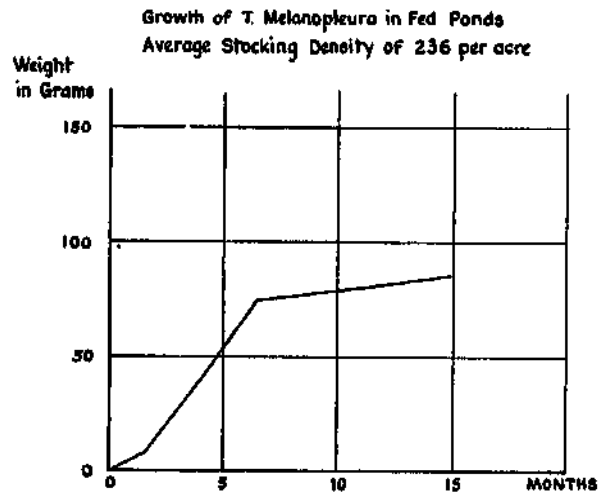
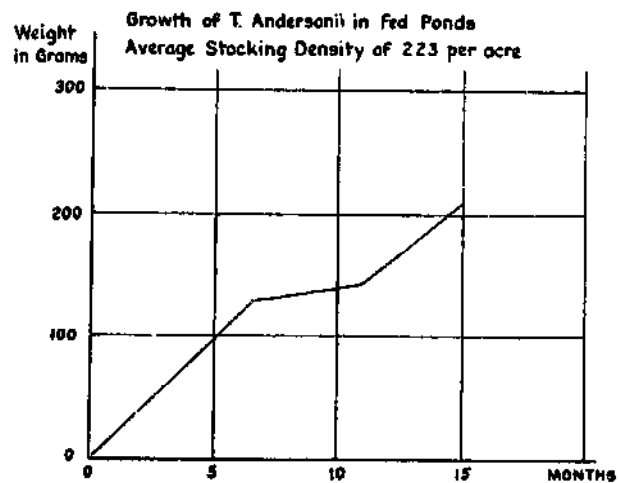

FIGURE 40. Growth of *Tilapia macrochir* in ponds.

FIGURE 41. Growth of *Tilapia andersonii* in ponds.



**SERRANOCHROMIS** (see Figure 37, A-D)

*S. robustus*: (Jackson, 136; Jubb, 83)

*S. macrocephala*: (Jackson, 135; Jubb, 84)

*S. angusticeps*: (Jackson, 134; Jubb, 85)

*S. thumbergi*: (Jackson, 137; Jubb, 86)

**Breeding**

All species are mouthbreeders and the eggs are hatched in the mouth of the female. The male constructs a nest and breeding occurs from August to January in Zambia during the period of high temperatures. Each female may breed more than once during the season. Fish of 8- to 12-in. length lay between 200 and 1,000 eggs at a time. In conservation dams the smallest mature females found are about 8 in., but in ponds fish of smaller sizes may be mature.

**Feeding**

The young of all species feed on insects, but fish play a more important part in the diet of large fish.

As yet little is known of the rates of growth of these fish in ponds and dams. *S. robustus* appear to be faster growing than the other three species, with a recorded average of 10-oz increases in eight months from 8 to 18 oz.

The largest recorded weights for the species are:

*S. robustus*        7 lb 5 oz

*S. macrocephala* 3 lb 2 oz

*S. angusticeps*   5 lb 8 oz

*S. thumbergi*     2 lb 10 oz

**HAPLOCHROMIS** (larger species only)**Breeding**

All the species are mouthbreeders, the eggs and fry being carried by the female. Little information is available on the number of eggs produced but in ponds and small dams overpopulation — too many fish for the available food — may occur. *H. mellandi* mature at 6 in. All are snail-eating fish and *H. mellandi*



is commonly stocked in small dams in Zambia. Ponds and small dams with *H. mellandi* have few or no snails, while larger dams stocked with this fish have reduced numbers. This may have some effect on the incidence of bilharzia.

#### Suitable combinations of fish for stocking

| <i>Type of feeder</i>      | <i>Name of fish</i>    |
|----------------------------|------------------------|
| Herbivorous                | <i>T. melanopleura</i> |
| Plankton eater and browser | <i>T. macrochir</i>    |
| Bottom feeder and algae    | <i>T. andersonii</i>   |
| Plankton and bottom feeder | <i>T. mossambica</i>   |
| Snail eater                | <i>H. mellandi</i>     |

Suitable combinations of fish, therefore, are:

|                          |                          |
|--------------------------|--------------------------|
| <i>T. melanopleura</i> } | <i>T. melanopleura</i> } |
| <i>T. macrochir</i> }    | <i>T. macrochir</i> }    |
| <i>T. andersonii</i> }   |                          |
| <i>T. melanopleura</i> } | <i>T. melanopleura</i> } |
| <i>T. mossambica</i> }   | <i>T. macrochir</i> }    |
|                          | <i>T. mossambica</i> }   |
| <i>T. melanopleura</i> } |                          |
| <i>T. andersonii</i> }   |                          |

In addition *H. mellandi* is used in Zambia where it occurs in ponds in order to cut down the number of snails.

It is highly desirable to use fish only from river systems to which the pond culture is connected.

#### 4. FISH CULTURE PRACTICES IN DAMS

The main differences between ponds and conservation dams are listed below:

| <i>Ponds</i>  | <i>Conservation dams</i>  |
|---|---|
| The main purpose is to grow fish.                     | The main purpose is to store water.                                   |
| The water supply is controlled.                       | The water supply is not always controlled.                            |
| Only special kinds of fish are stocked.               | Often there are many kinds of fish present naturally.                 |
| The fish are fed and the water manured or fertilized. | The fish are not necessarily fed, or the water manured or fertilized. |
| The fish are protected against predators.             | The fish are not protected against predators.                         |
| The production of fish is large per unit area.        | The production of fish is small per unit area.                        |

Dams and weirs for water conservation are common in parts of central east Africa where the rainfall is low and there is little water in rivers and streams during the dry season.

The dam or weir is actually the wall built across a stream or river to hold back the water to form a reservoir or small lake. However, in central east Africa, the whole place, i.e., the wall and the water it holds back, is called a dam or weir. In North America small conservation dams are usually called farm ponds, while larger ones are called lakes or reservoirs.

Dams and weirs fill up in the rainy season with water which may then flow over or around the wall. In the dry season the level of the water may drop and sometimes there is no water left at the end of the season.

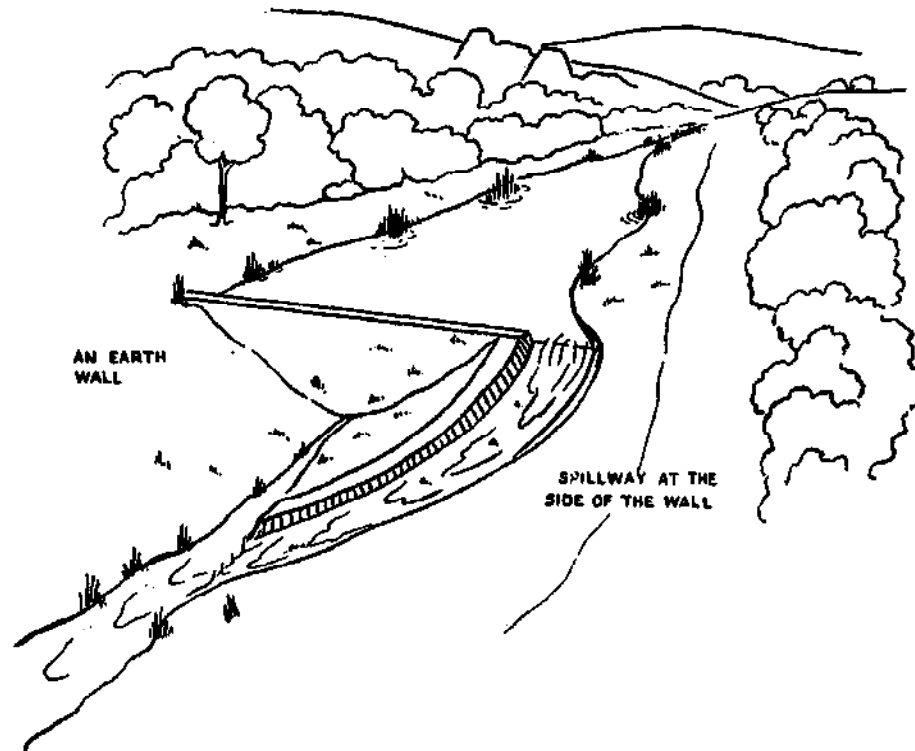

FIGURE 42. A dam.

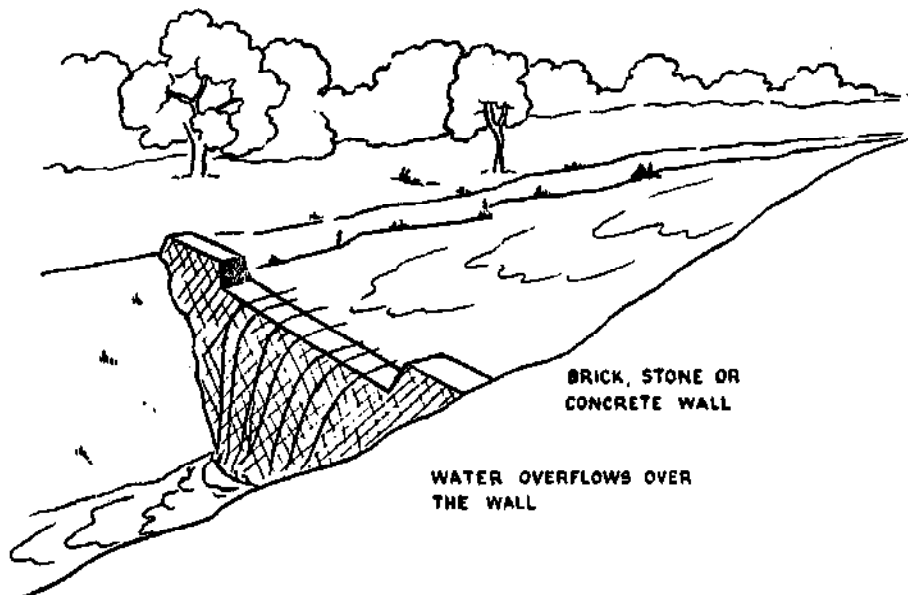

FIGURE 43. A weir.

The water stored in dams and weirs is used for many purposes, such as for cattle to drink, domestic supplies, irrigation of crops, or for driving turbines for electric power. In addition to all these functions dams and weirs can also be used to grow fish.

A dam is slightly different from a weir. In a weir the water overflows the whole wall, but in a dam the water overflows through a special place called a spillway (Figures 42 and 43).

### **How dams and weirs can be used to grow fish**

In order to grow fish properly in dams there are three important procedures to be followed: (1) stumping and clearing the dam; (2) stocking the dam; (3) cropping the dam.

#### **DAM STUMPING AND CLEARING**

Stumping a dam means removing the trees, bushes and roots in the flooded area to below ground level. Stumps must be removed and roots must not be left sticking out of the ground.

Small dams, of less than 10 acres in area, should be stumped completely. In large dams this may cost too much, so only certain parts are stumped.

The best places in which to stump a large dam are where the water is shallow and where there are bays. If it is possible all places where the water is less than 15 feet deep should be stumped. Places where there are large rocks need not be stumped. Loose boulders can be removed and gulleys, holes, excavations, bumps and small anthills should be leveled as much as possible.

Stumping is done so that seine nets can be used to catch fish (Figure 44).

#### *How to stump a dam*

If a dam is stumped when it is built, the tractors used to make the wall can also be used to pull out stumps and level the ground. Laborers with mattocks, pickax and axes can dig out small stumps and roots. Stumping a new dam is done in the same way as stumping land for crops.

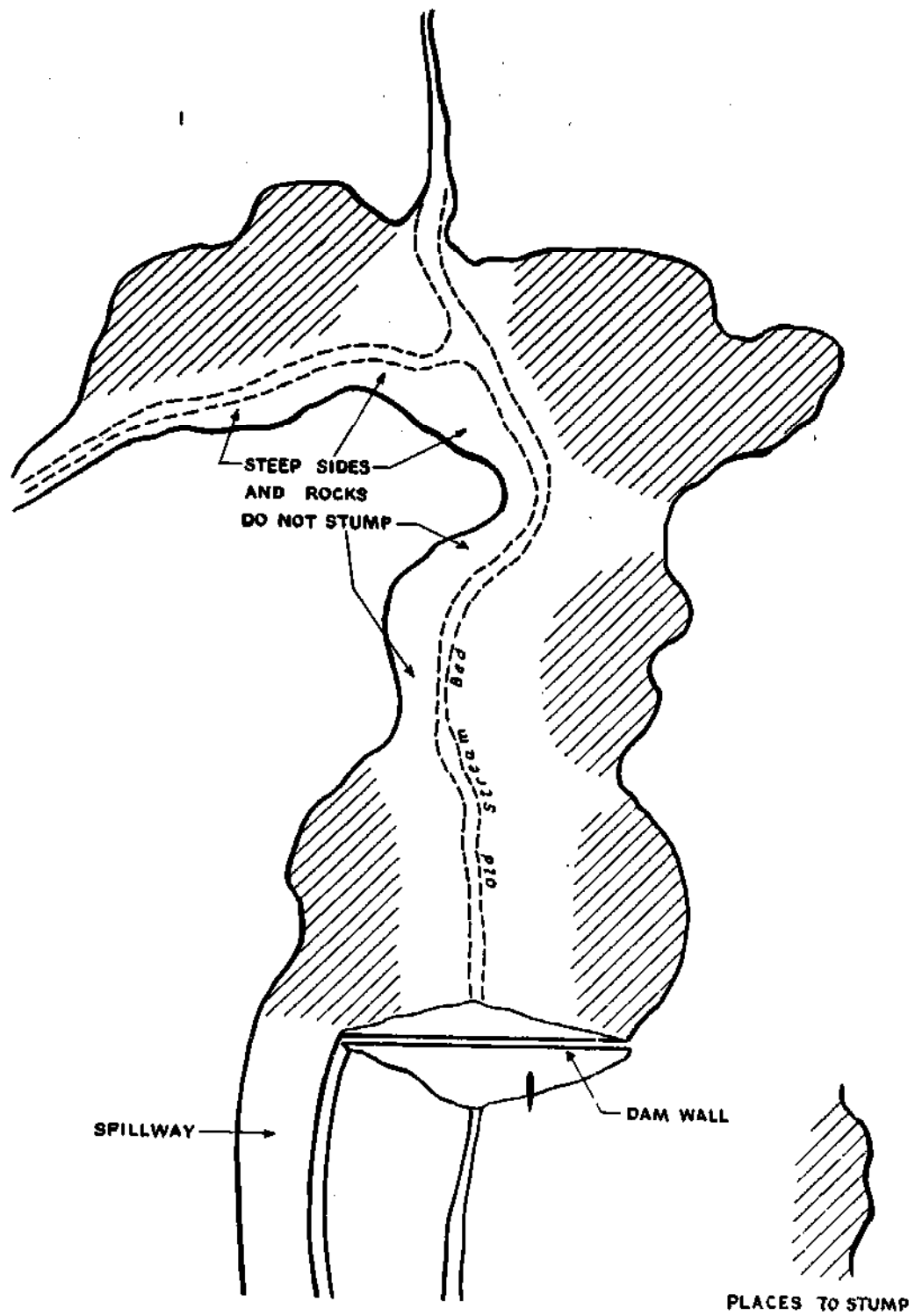

FIGURE 44. Where to stump a big dam.

Although most dams built in recent years were stumped when they were built, there are many in central east Africa which were not. Of these old dams many can easily be stumped when the water level is at its lowest at the end of the dry season.

In dams where there is always water, trees and stumps in shallow parts can often be pulled out with a winch (Figures 45 and 46).

*Stumping a dam is very important because unstumped dams cannot be cropped properly.*

## DAM STOCKING

### *Kinds of fish in dams*

Most dams in central east Africa have some kind of fish in them naturally. These fish were in the rivers and streams before the dam was made. The number and variety of fish occurring naturally in a dam depend on where the dam is located and the size of the river or stream which is flooded.

It is not within the scope of this manual to list the species of fish likely to be found in the various districts of central east Africa. It is, however, important to appreciate that in most small farm dams the only species of fish at all common, and that can grow to a fairly large size, are species of *Clarias*, the so-called barbel. Very few dams have the important species of Cichlids or so-called bream, such as *Tilapia*, *Haplochromis* and *Serranochromis*. These species have to be stocked.

### *Why stock a dam?*

The reasons why a dam should be stocked are:

1. Most dams do not have Cichlid species occurring naturally in them.
2. If Cichlids are put into a dam, the amount of fish which can be produced is greater than if the dam is not stocked.
3. A certain kind of Cichlid, *Tilapia melanopleura*, will eat underwater plants, so that there will be fewer mosquitoes and places for snails to live.
4. There are special fish, such as *Haplochromis* species, which eat snails, so there will be less bilharzia and liver fluke.

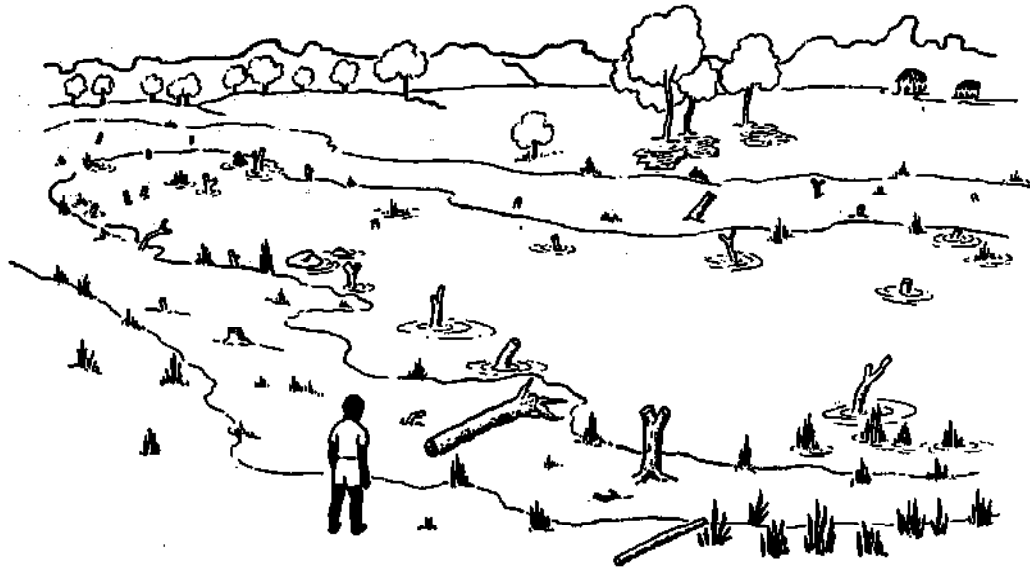
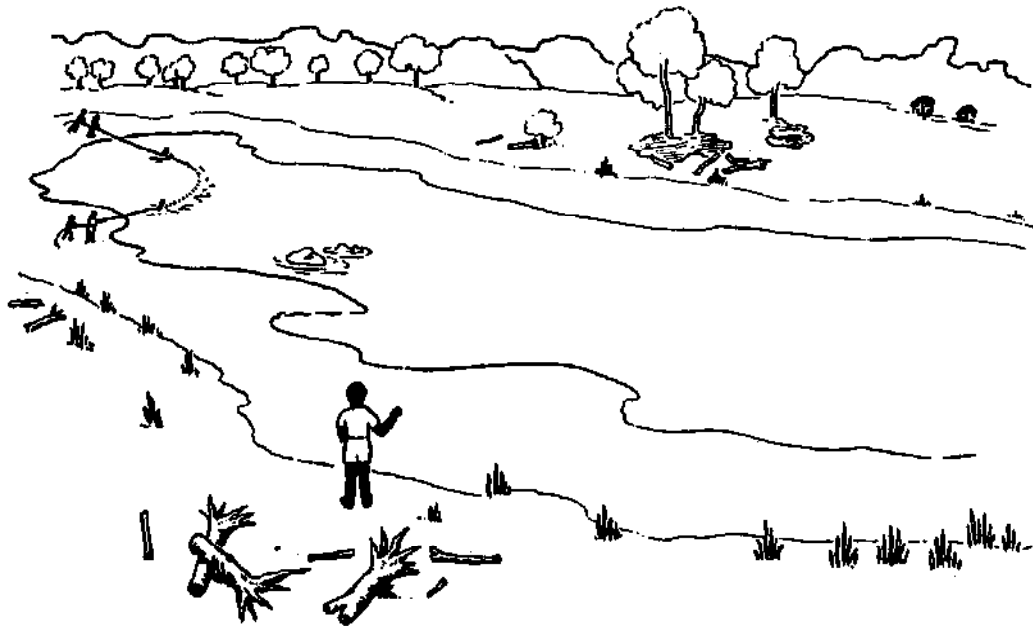

FIGURE 45. Stumping a dam. *Above:* A dam with stumps in it. Nets cannot be used. *Below:* The dam with the stumps taken out. Nets can now be used.



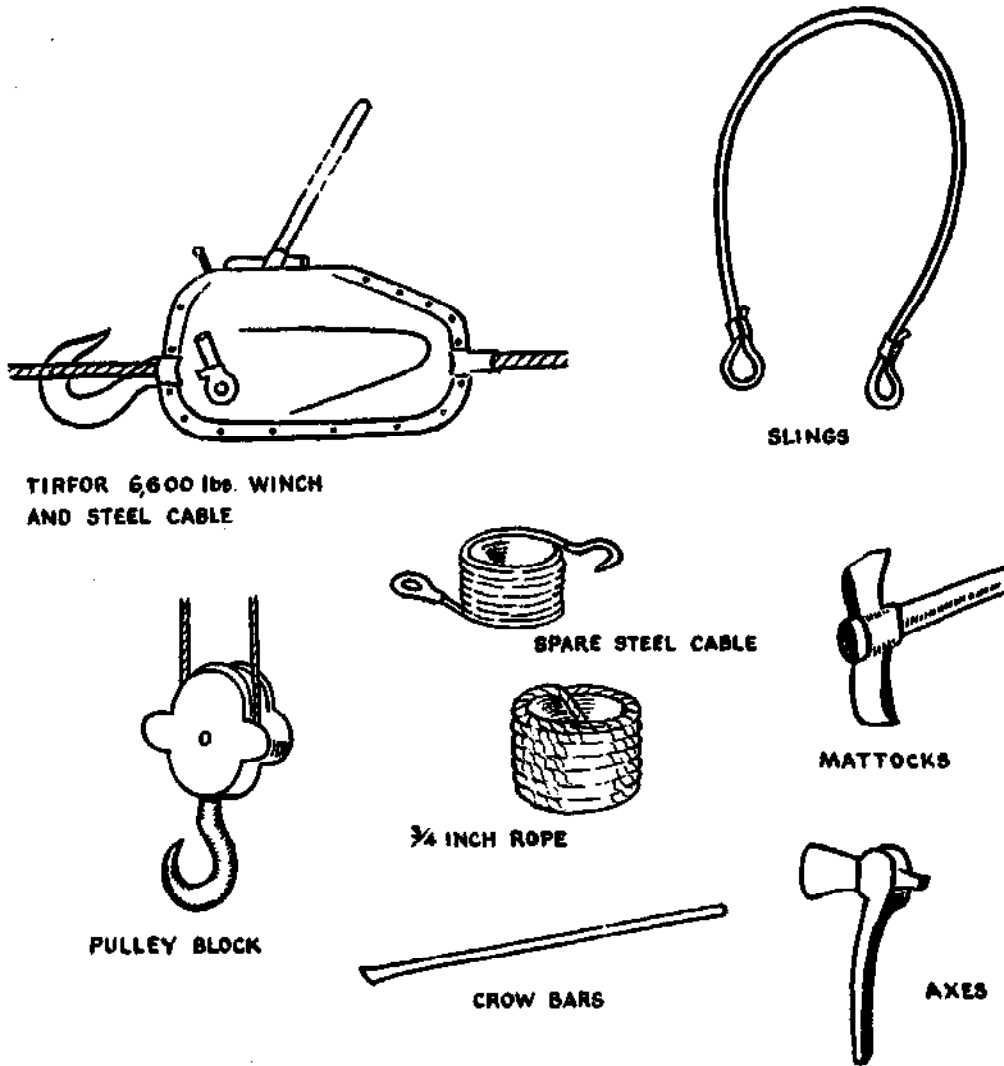
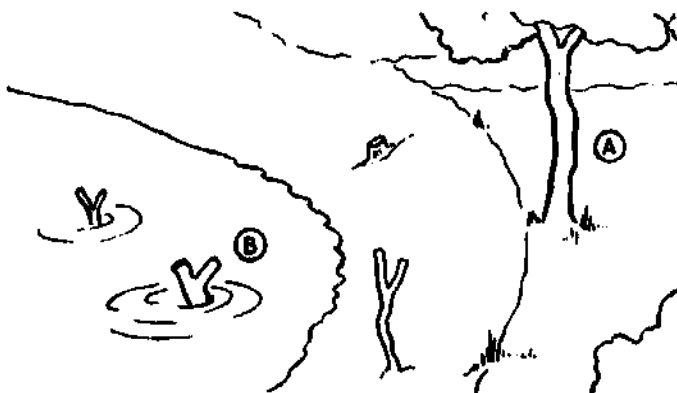

FIGURE 46. How to use a winch to pull out tree stumps from a dam. (a) Equipment.



(b) Operation. The winch is tied to a big tree on the side of the dam, at (A). A sling is put around a tree stump (B). The cable from the winch is hooked on to the sling.



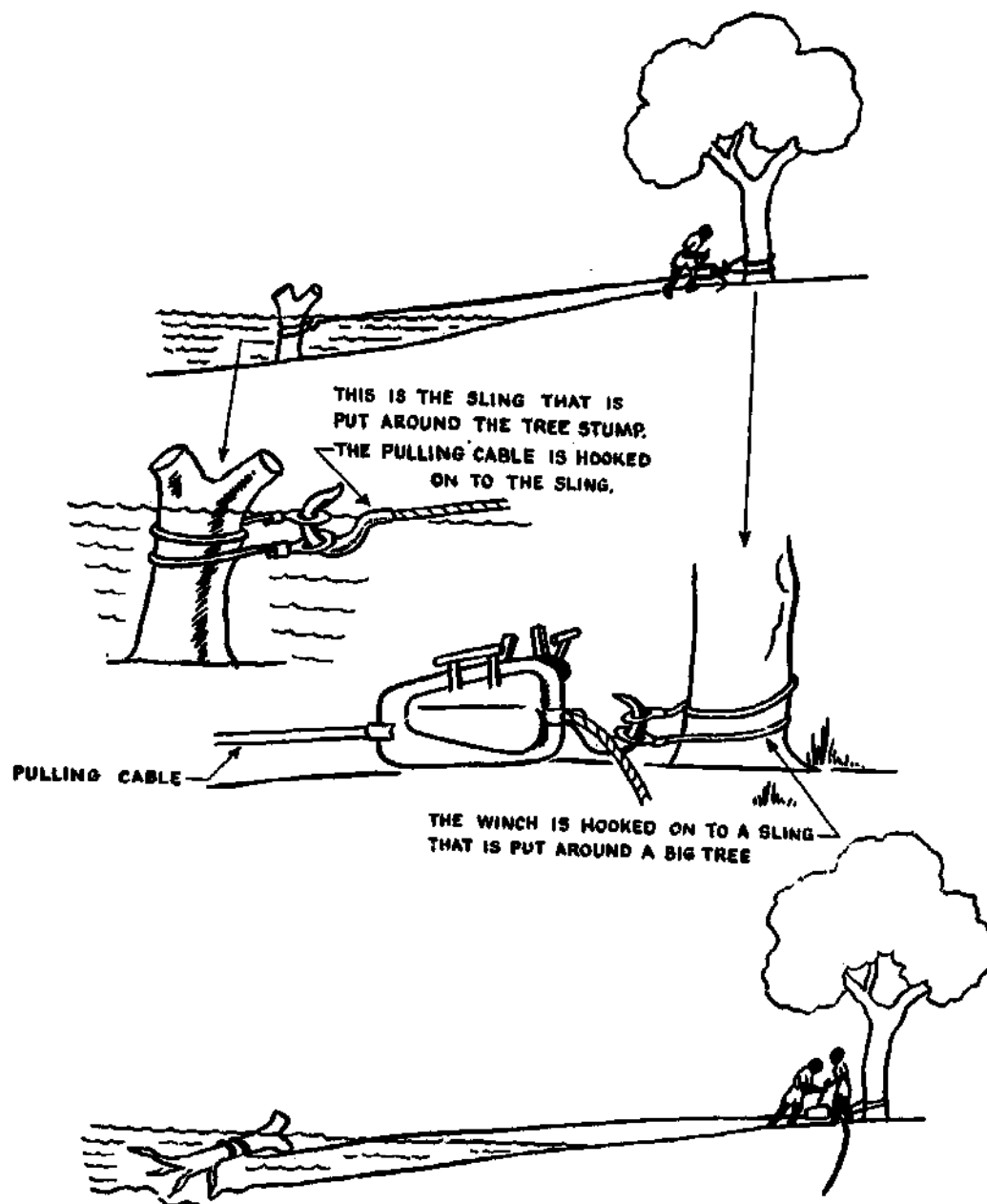

FIGURE 46 (CONTINUED). How to use a winch to pull out tree stumps from a dam.  
(c) When the winch is worked, the tree stump is pulled out.

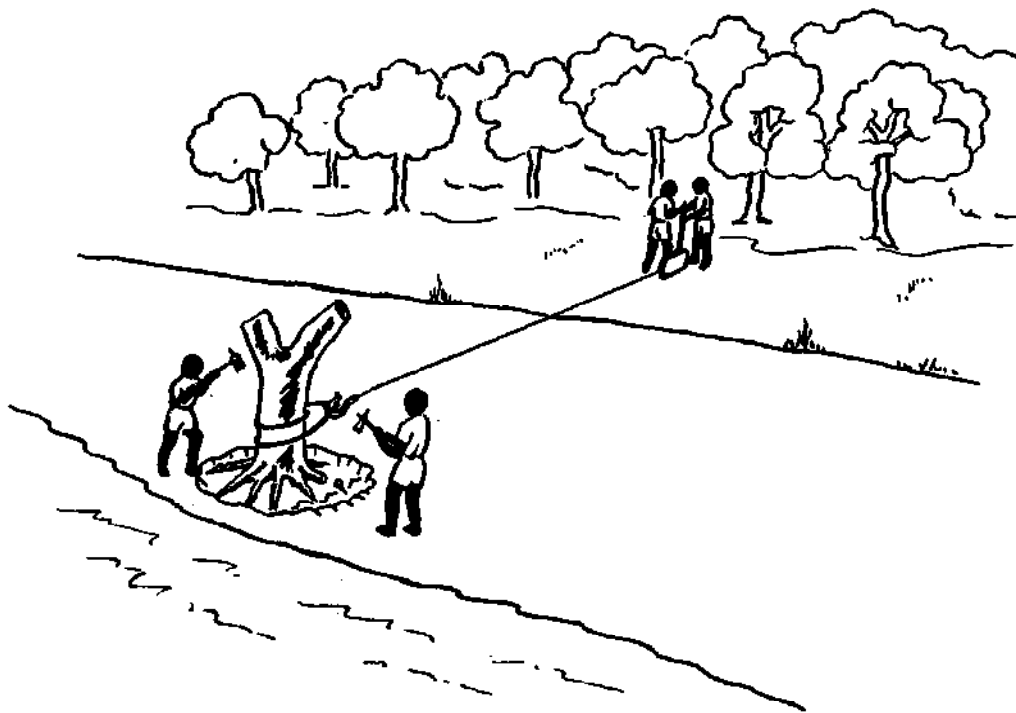
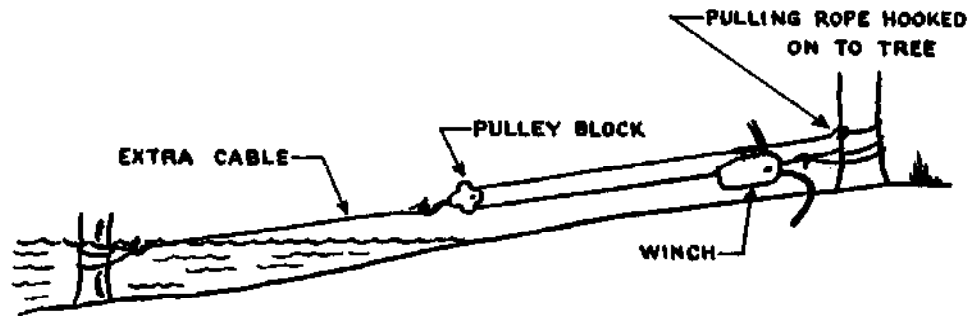

FIGURE 46 (CONCLUDED). How to use a winch to pull out tree stumps from a dam.  
(d) If a tree stump is hard to pull out, then a pulley block can be used. Tree stumps that are not in the water can be pulled out with a winch but at the same time the roots can be cut with axes and so make pulling easier.

### *Kinds of fish for stocking dams*

In Zambia the most important kinds of fish to stock in dams are:

*Tilapia melanopleura*

*Tilapia macrochir*

*Tilapia andersonii*

*Haplochromis* spp.

In the Eastern Province of Zambia, *Tilapia mossambica* is used instead of *T. andersonii* for stocking dams.

In Rhodesia the fish most commonly used for dam stocking are *Tilapia mossambica*, *Tilapia melanopleura* and some exotic species such as *T. macrochir* and bass or even trout. Exotic species used for dam stocking will be mentioned in a later section.

### *Where to get fish for dam stocking*

Fish for stocking dams are best obtained from government fish farms or fish breeding stations. It is possible sometimes to get fish for stocking dams from other dams, streams or rivers in the same area. This should be done under expert supervision, because the wrong kinds of fish are often taken if dam owners do it themselves. Ideally there should be a small fish breeding station for each area of conservation development.

### *Amount of fish for stocking dams*

In Zambia the following amounts of *Tilapia* are recommended for dam stocking:

|                            |                     |
|----------------------------|---------------------|
| Dams of 10 acres and under | not less than 20 lb |
| Dams of 10 to 20 acres     | not less than 40 lb |
| Dams of over 20 acres      | not less than 60 lb |

These amounts are for fingerlings of *T. melanopleura*, *T. macrochir* and *T. andersonii* in roughly equal proportions.

### *When to stock a dam*

A dam can be stocked as soon as there is water in it. If the fish have to be sent a long way to a dam and the roads are bad, it is best

to wait until the cool weather before sending them. In Rhodesia stocking of dams is not as a rule done in periods of severe cold weather, because of the danger of mortality. In Zambia such severe cold weather does not occur.

#### DAM CROPPING

##### *Why crop a dam?*

If a dam is properly stocked the fish will grow and breed and there will soon be too many. If there are too many, there will not be enough food to go round and the fish will not grow properly. So fish must be taken out of the dam; that is, the dam must be cropped.

##### *When to start cropping a dam*

In Zambia, if a dam has been properly stocked, cropping can start after the rainy season following stocking.

In Rhodesia, cropping is also started after the breeding season following stocking, but cropping is selective depending on the fish stocked.

#### Methods of fishing dams

##### SEINE NETTING IN DAMS

As with fish ponds, the best method of fishing dams is with a seine net, though the nets are larger than those used in ponds.

Of the many different kinds of fish caught in seine nets in dams more Cichlids are caught than other species.

The amount of fish caught each time a seine net is pulled will depend on the length of the net, where the net is set, how well it is pulled, the time of the year and even the time of day.

In large dams an average catch would be 20 to 50 lb per haul, but in small dams at low water, the catch might be as much as 100 lb per haul.

The two sizes of seine nets recommended for use in dams are of 1½-in. stretched mesh in the center and 2-in. mesh in the wings, 200 ft long or 100 ft long when mounted; the 200-ft net has a bag in the center and the 100 ft a bunt.

There is not sufficient space in this manual to describe in detail how a seine net is used in dams, but it is easily demonstrated (Figure 47).

It is very important to appreciate that seine nets can only be used in dams that have been stumped and where there is not too much underwater weed.

#### GILL NETTING IN DAMS

Gill nets can be used in dams. Unlike seine nets, they are not pulled, but are either left in the water overnight or are set and the fish are driven into the net. With gill nets fish get tangled up in the net and drown. Gill nets are made of thin twine, usually nylon.

The kinds of fish caught in gill nets will depend on the kind of fish present and the size and mesh of the net.

*Tilapia sparrmanii* are readily caught in 2-in. and 3-in. stretched mesh gill nets, as are usually *Gnathonemus macrolepidotus*, the smaller *Labeo* spp. and *Schilbe mystus*. All species of *Clarias*, *Tilapia* and *Serranochromis* are also caught in gill nets, but not always in such large numbers as other species. The net mesh sizes of most economic value for use in most dams are from 2-in. to 3½-in. stretched mesh.

The amount of fish caught in gill nets varies very considerably. Sometimes as much as 40 or 50 lb of fish are caught in a 50-yd net in a night and sometimes nothing at all. More fish are usually caught if the net is set alongside grass and reeds and the fish are driven out from among the vegetation into the net.

Ground baiting has also been used with some success with gill nets, the nets being set around the area where the bait has been put.

As with seine nets, the method of use of gill nets is easily demonstrated (Figure 48).

#### LINES, TRAPS AND BASKETS

Long lines, traps and baskets are useful methods of fishing dams. Long lines are quite good for catching *Clarias* species. Traps and baskets are very useful for catching the small kinds of fish which are not caught in nets, such as small species of *Barbus* and *Haplochromis*.

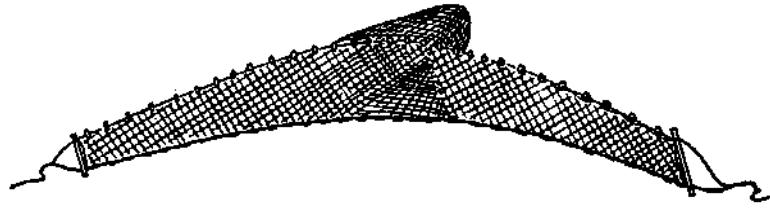
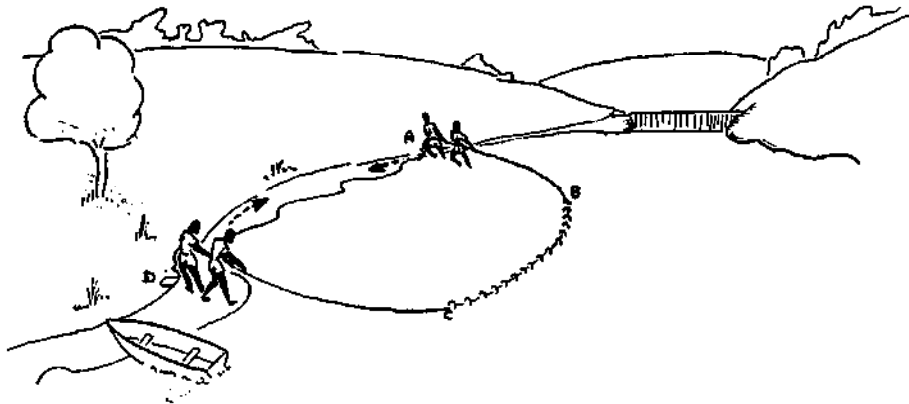

FIGURE 47. How to use a seine net in a dam. *Top:* A seine net. For fishing in dams a seine net of 100 to 200 ft in length is best. Seine nets may or may not have a bag. The net is put into a boat the same way as a gill net (see Figure 48). *Center:* Setting a seine net. The net is rowed out from A for about 20 or 30 yd. One end of the pulling rope is held by a man at A. When the end of the pulling rope is reached the man in the boat starts to put the net in the water (B). When the other end of the rope is reached (C) the boat continues to D, letting out the second pulling rope. As the net is pulled the men at A and D move toward each other. The net must NOT be pulled too quickly.



*Below:* Pulling the bottom rope. When the ends of the rope reach the shore, one man at each end pulls the bottom rope of the net and the others hold the top rope to keep the net out of the way of the man pulling. The man pulling must watch the middle of the net to make sure it is not closer to one side or the other. The net must not be pulled straight but rather U-shaped.



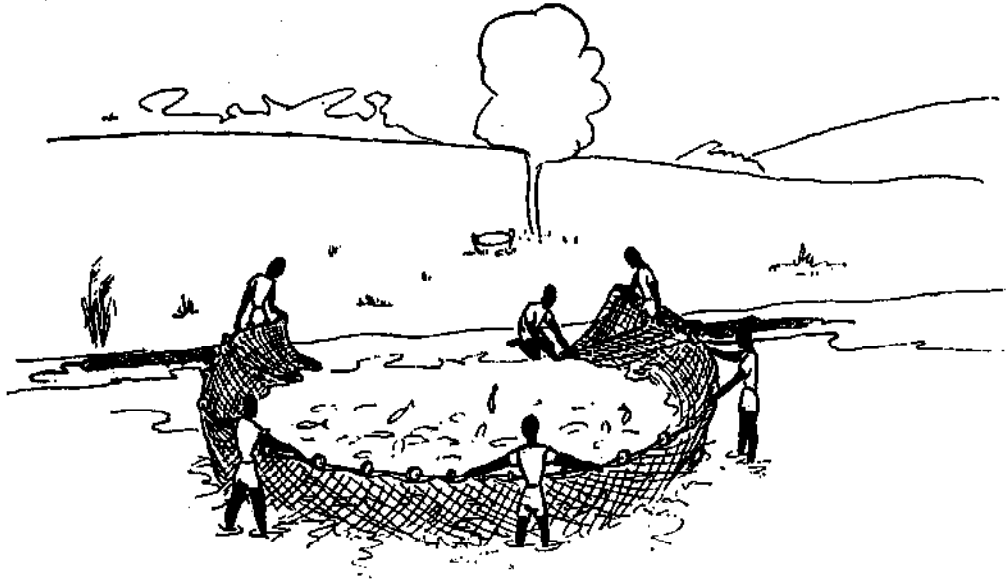
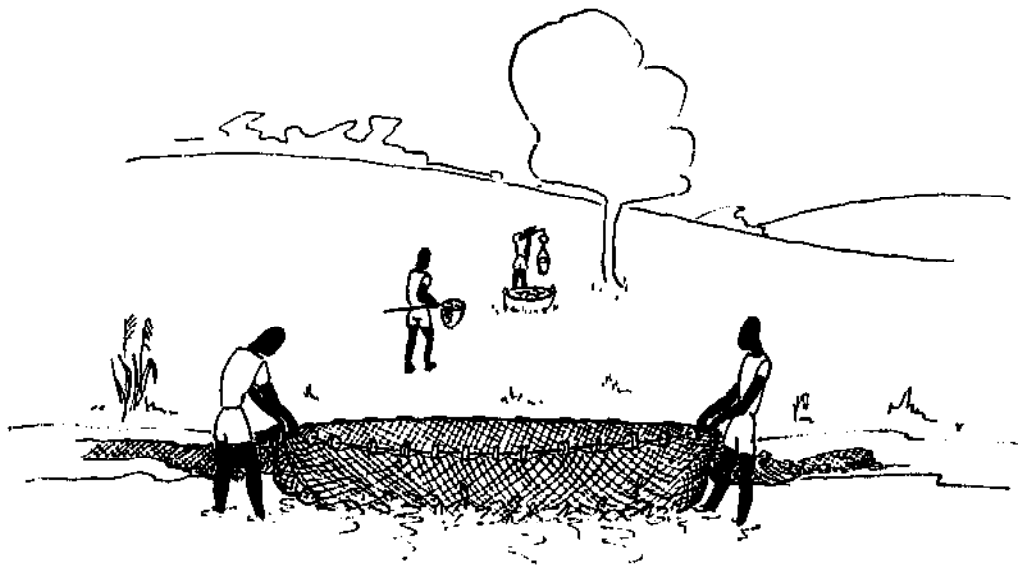

FIGURE 47 (CONCLUDED). How to use a seine net in a dam. *Above:* Holding up the net. As the net gets close to the side fish will start jumping out. Then the net can be held up. *Below:* Washing the fish, emptying the net and weighing the fish. When the net is at the side the bottom rope is lifted up. The fish are washed in the net and taken out and weighed.



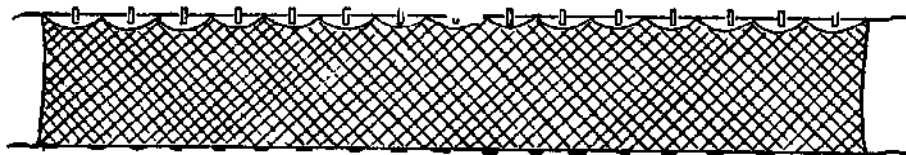
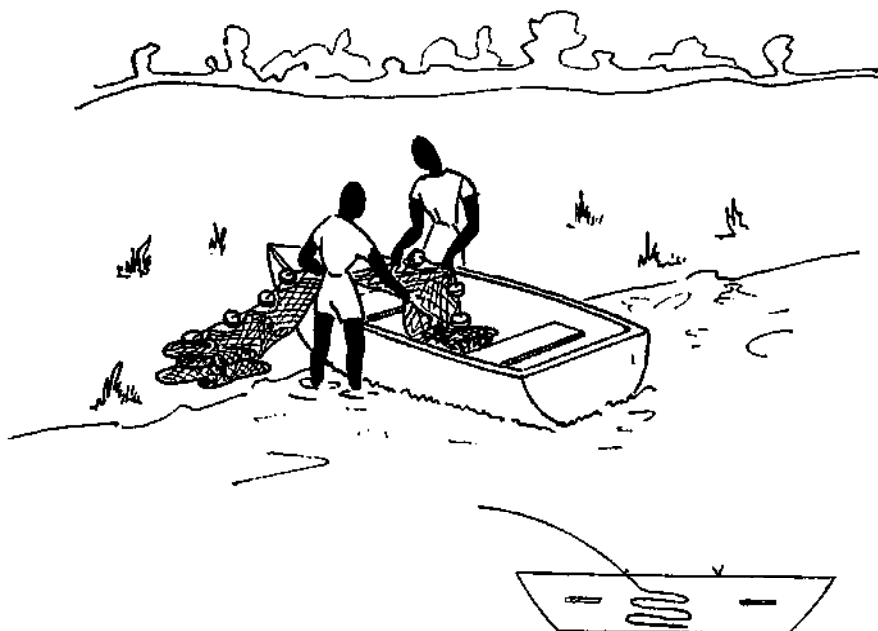

FIGURE 48. How to set gill nets in dams. *Above:* A gill net. The length of the net is on an average 150 ft.



Loading the net into the boat. A net is put into the boat carefully, folding one piece on top of the other. It must not be rolled up or just thrown into the bottom of the boat.

Dams may also be fished with rod and line, because many of the small kinds of fish occurring naturally are caught by this method. Lines and traps are illustrated in Figures 49, 50 and 51.

It is important to remember that traps and baskets must never be put in weirs across the spillways of dams.



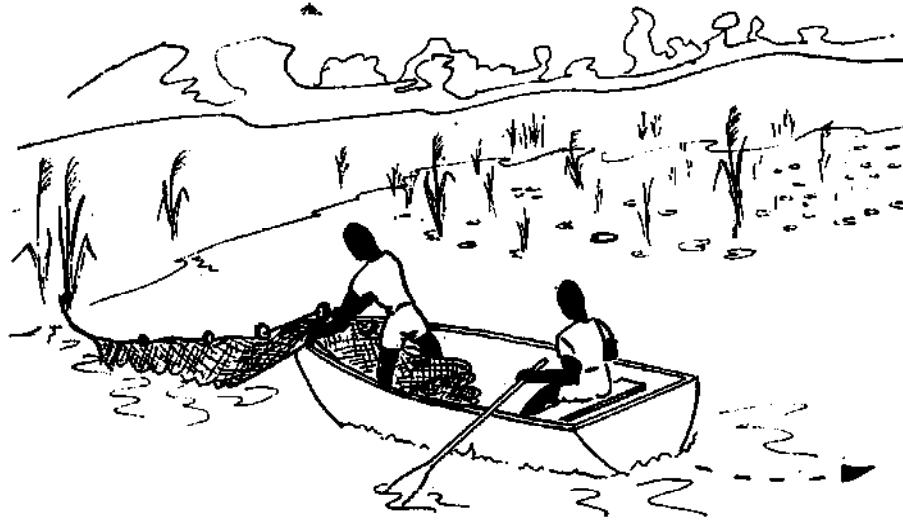
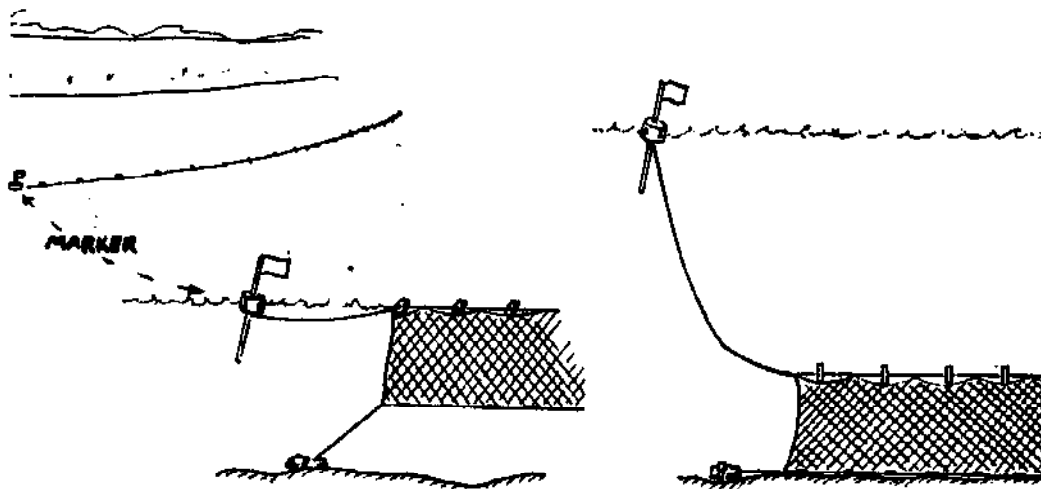

FIGURE 48 (CONCLUDED). How to set gill nets in dams. *Above:* In dams floating nets are usually used. They are put in shallow water up to 10 ft deep, so that the floats on the top of the net are on the surface of the water. In very large dams it is often a good idea to show where the net is by using a marker. The marker can be a thin stick put through a cork. A piece of cloth is tied to the stick as a flag. *Below:* Net on the bottom of the dam. In dams that are very deep, sink nets are sometimes used which are put on the bottom. To make the net sink to the bottom, more weight must be put on the bottom rope.



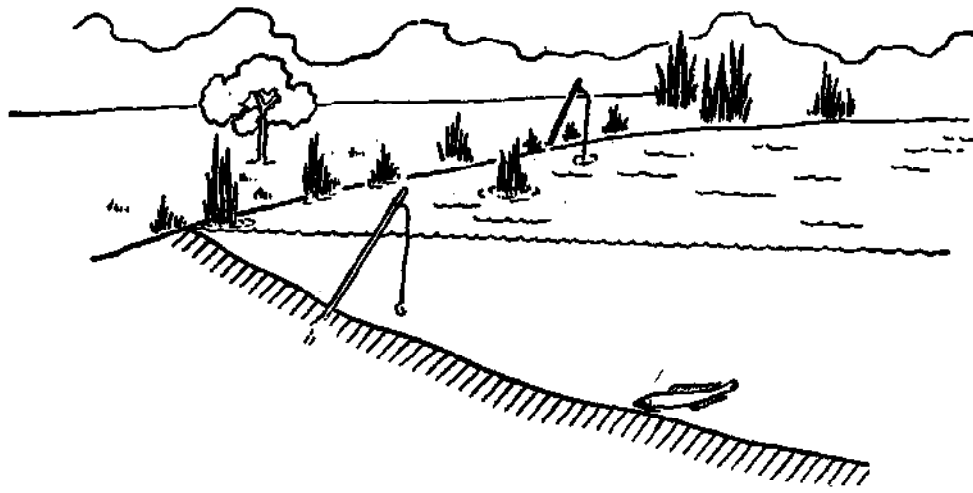

FIGURE 49. Lines set in the shallow water around the side of the dam.

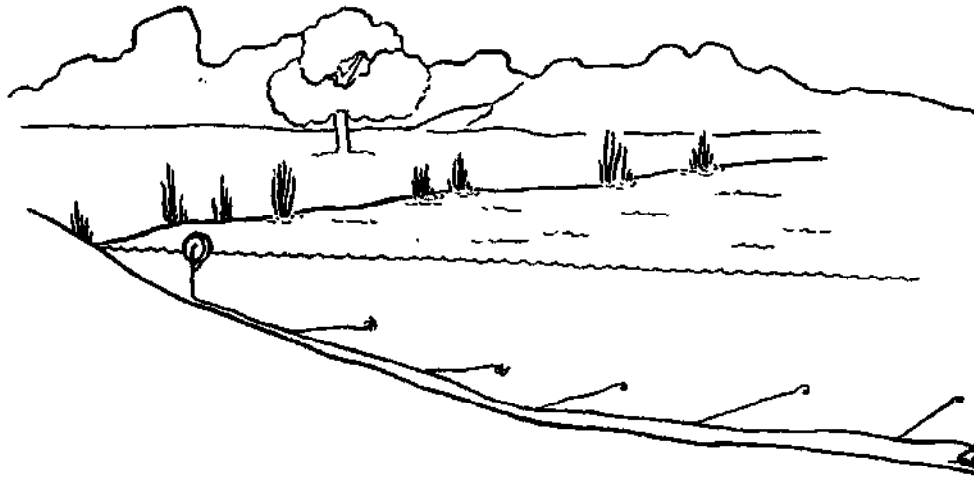
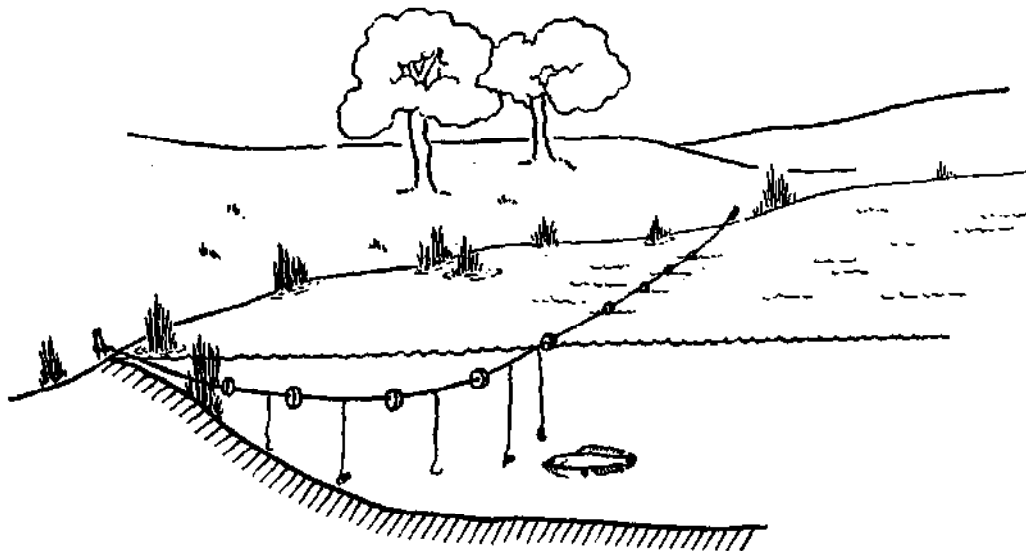

FIGURE 50. Long lines. *Above:* Long lines set near the bottom. *Below:* Long lines set near the surface of the water.



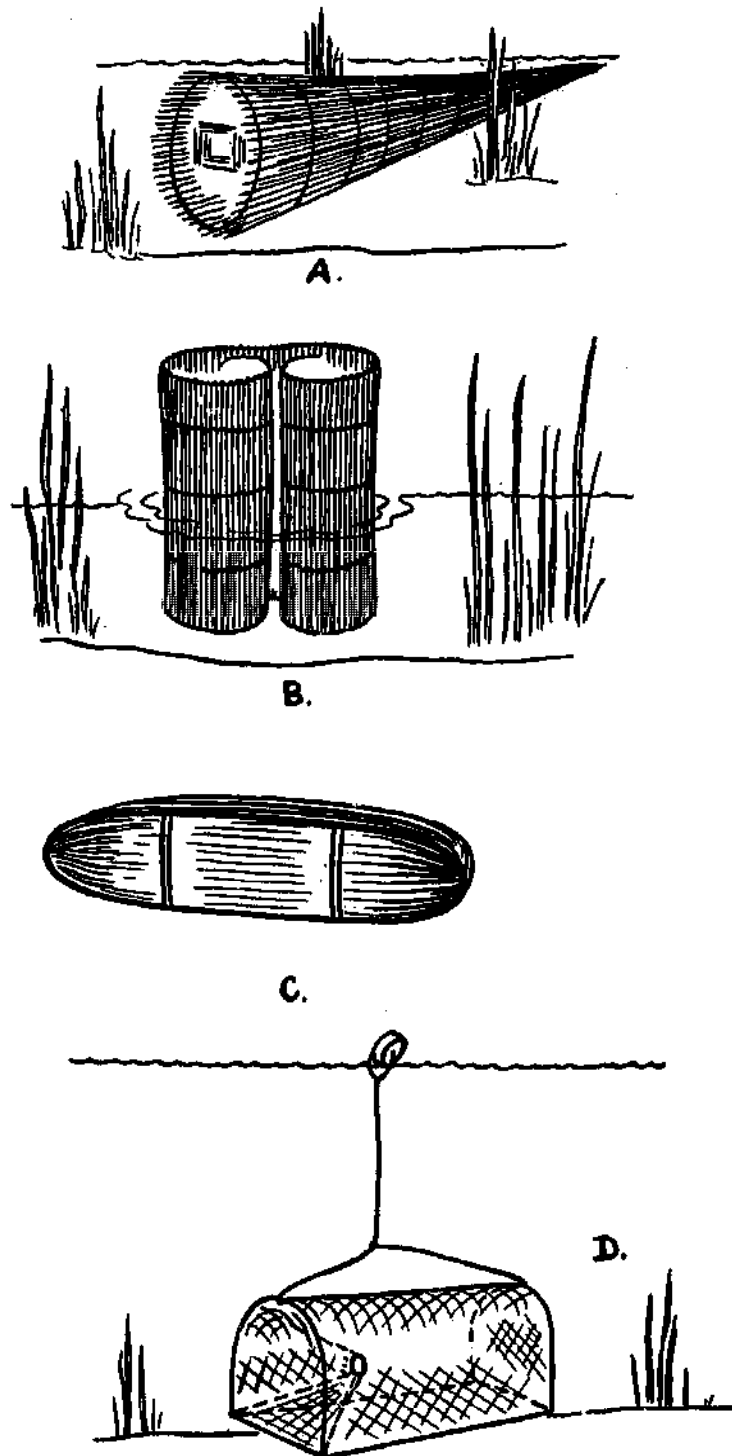

FIGURE 51. Fish traps used in dams. A. Conical basket made of reeds. Set in small weirs or in shallow water among grass. B. Trap made of reeds. Set in shallow water. Often baited with maize meal. C. Drag basket made of reeds. Pulled through shallow waters. Sometimes set in lines and fish driven into the baskets. D. Perch trap. A wire frame covered with 1-in. chicken wire. Bait may be put inside.

*When to fish in dams*

In dams, lines, traps and baskets can be used all the year round, but it will be found that catches are larger at certain times of the year. For example, in the hot weather usually more fish are caught on rod and line than in the cold weather.

Gill nets can be used all the year round, but again more fish are likely to be caught in the hot weather than in the cold weather.

Seine nets are best used in dams at the end of the dry season when water levels are at their lowest and when there are no marginal reeds and grasses to hamper netting. Small dams are most economically netted for a few days only and the crop of fish for the year removed. Large dams, say 20 acres or more in area, can be netted for longer periods, perhaps every week for five or six months.

**Fish production in dams****CROPS OF FISH**

The production or amount of fish that a dam can produce is not always the same as the amount that is cropped in practice. For example, a dam may be able to produce 1,000 lb of fish in a year, but in practice the actual crop taken may be only 300 or 400 lb, possibly because the dam cannot be netted properly.

The production — hence the crop of fish that a dam can produce — depends on a number of factors, such as stocking, quality of water, water temperature and the size of the dam, which have already been described.

In Zambia records have been kept over a number of years of fish crops taken from dams; these are listed in Table 1.

TABLE 1. — FISH CROPS FROM DAMS

| Size of dam<br>(acres) | Average crops actually obtained<br>(lb/acre/annum) | Crops obtainable<br>with good management<br>(lb/acre/annum) |
|------------------------|--|---|
| 1 to 4                 | 175  | 800 to 900  |
| 5 to 9                 | 100  | 400 to 500  |
| 10 to 19               | 100  | 200 to 250  |
| 20 to 49               | 60   | 100 to 150  |
| 50 to 100              | 30   | 50 to 100   |
| over 5 000             | 6  | 5 to 10   |

### SIZE OF FISH

As a general rule the smaller the dam, the smaller the average size which *Tilapia* and other Cichlids reach. For example, in a dam of 5 to 10 acres in area, although there will be some fish that have grown to about half a pound, in a dam of 40 acres the size can be as much as 1½ to 2 lb.

Even if *Tilapia* are left for several years in a small dam, most of them will never grow larger than about ½ lb and the dam will be full of small-sized fish.

Experiments are being made in order to breed a fish that will grow large in small dams. It takes a long time, however, to obtain results from this work which can be applied in the field.

### IMPROVING FISH PRODUCTION

The quality of the water in dams can be improved by manures, fertilizers and so on, thus increasing the food available for fish to eat. Phosphate is a good artificial fertilizer and can be put into a dam after the end of the rains when overflow has ceased. There is still much to be learned about the quantity of fertilizer to add to dams in different areas. A dose of 50 lb per acre of double-superphosphate has given quite good results in areas where the water in general has a good alkalinity. In areas where water has poor alkalinity, lime should be added, at least at the rate of 100 lb per acre and at least a week before adding phosphate.

Many dams which are used as places for watering cattle are manured automatically; dung left around the edges at low water level is immersed when the dam fills up during the rains.

In small dams, fish can be fed directly with wastes such as maize hullings, beer wastes, waste vegetables and so on. Even if wastes are not eaten directly by fish, they will rot in the water and act as manures.

### LOSS OF FISH OVER DAM SPILLWAYS

Small fish and young fish are often found in very shallow water such as that in the entrance of a dam spillway. After a heavy rain these small fish may be washed over the spillway. The number of fish washed over in this way may seem many but in fact they are few

compared with the total number of fish in the dam. Many fish try to swim up the spillway again and manage to do so if it is not too steep.

The erection of screens and traps in dam spillways to stop fish being washed out must not be permitted. It is dangerous as these screens can easily become clogged with rubbish and the water may then go over the dam wall and break it.

### Plants in dams

All dams have plants of some sort growing in them and around their edges. The amount of plants growing in and around a dam depends on the depth of the water and also on whether the dam has been stocked with *T. melanopleura*. If this fish is stocked the dam will have fewer plants. Some dams without *T. melanopleura* become completely choked with underwater weeds, so that even a boat cannot be rowed and nets cannot be used.

A dam with many water plants may also have more mosquito larvae, which are vectors of malaria, and snails that are vectors of bilharzia and liver fluke.

Marginal vegetation of dams is also eaten by *T. melanopleura* when flooding occurs and if the plants are not too old and tough.

Vegetation must never be planted deliberately in a dam, because the wrong kinds can choke up the dam completely. One very bad exotic plant that does occur in Rhodesia, but not yet in Zambia, is the water hyacinth (*Eichhornia crassipes*). Kariba weed (*Salvinia auriculata*), which has been a source of trouble in Lake Kariba and the Chobe River, is another plant that should not be introduced deliberately into dams (Figures 52 and 53).

### CONTROL OF BILHARZIA AND MALARIA IN DAMS (See Appendix 2)

Bilharzia is a disease of humans and is caused by a minute animal which gets into the blood. This animal has a complex life history and at one stage lives within the body of certain kinds of water snails. Bilharzia is much more common in Rhodesia than in Zambia.

One way of controlling bilharzia is to kill the organism in the human with medicine. Another is to reduce the number of snails living in the water. Clearing water plants, mechanically or with



FIGURE 52. Water hyacinth. *Eichhornia crassipes*. Water hyacinth floats in the water, but will also grow in wet mud.

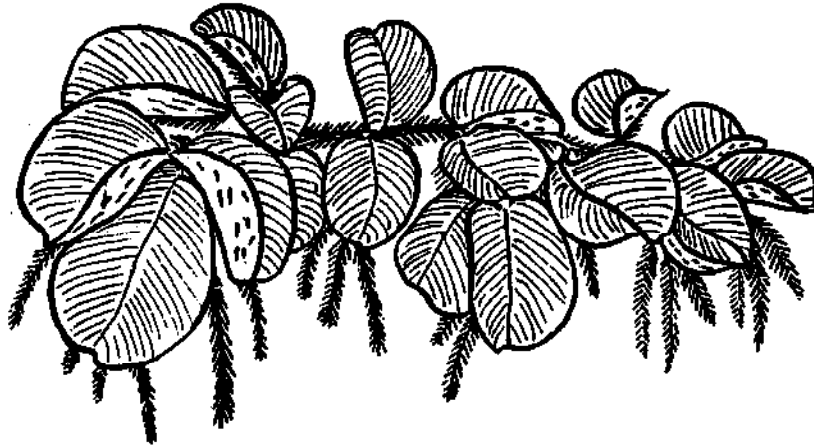

FIGURE 53. Kariba weed. *Salvinia auriculata*. Kariba weed floats on the surface of the water.



LYMNAEA SP.

FIGURE 54. Snails that live in water. *Physopsis* sp. and *Biomphalaria* sp. can transmit bilharzia. *Lymnaea* sp. can transmit liver fluke. *Melanoides* sp., *Pila* sp. and *Cleopatra* sp. do not transmit bilharzia or liver fluke.



PHYSOPSIS SP.



MELANOIDES SP.



PILA SP.



BIOMPHALARIA SP.



CLEOPATRA SP.



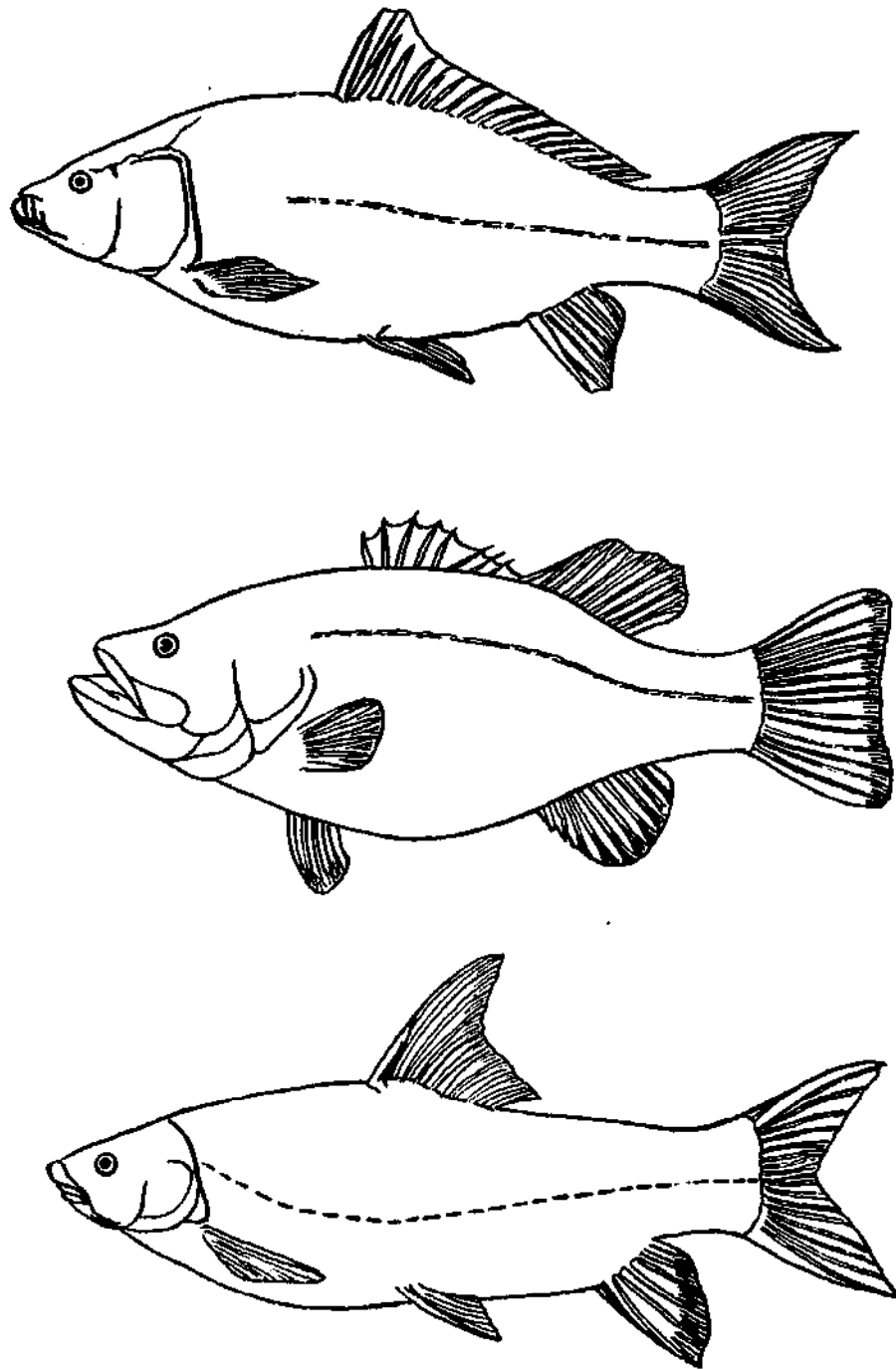

FIGURE 55. Top: Carp, *Cyprinus carpio*. Center: Black bass, *Micropterus salmoides*. Bottom: Yellow fish, *Barbus marequensis*.

fish, helps to reduce the number of snails, but this is not the complete answer. Though chemicals can be used to kill the snails, they may, however, also kill fish and the organisms on which fish feed. There are several kinds of fish which eat snails, such as species of *Haplochromis*. In small dams stocked with *Haplochromis* the number of snails is very greatly reduced (Figure 54).

Dams are often cited as a source of mosquitoes but these mosquitoes usually come from places around the dam and below the wall, where cattle have left footprints that fill up with water. Empty tins, or holes dug in the ground which have water in them, are places where mosquitoes will usually breed rather than in the dam itself, particularly if a dam is stocked with fish and properly managed.

### **Exotic fish species in dams**

Exotic fish species are fish that have been introduced into a country and are not indigenous. Some countries of Africa have very limited varieties of good sized, good eating fish occurring naturally, so fish of different species have been introduced from other parts of the world.

In the Republic of South Africa and in Rhodesia, bass, trout and carp have been introduced for dam and stream stocking. In Zambia there are very many different kinds of fish living naturally in the rivers, streams and lakes, and it has not been necessary to introduce exotic species for stocking dams or other waters. There is no point in introducing a new kind of fish to waters where fish that are just as good already occur naturally (Figure 55).

### **Growing fish in dams that dry up**

Some small dams dry up completely during the dry season, but even these can be used to grow fish. As soon as a dam has water in it, it should be stocked with *Tilapia*. When there is only a little water left, the dam is netted and all the fish taken out.

Dams stocked with 20 lb per acre of *Tilapia* can produce as much as 100 to 150 lb of fish per acre in about six months.

If there are a number of dams in an area, then a small, centrally located fish pond can be used for providing fish for stocking.

The brick tanks and reservoirs used for water storage on farms can also be used for breeding fish for stocking small, nonperennial dams.

#### **Dam cropping schemes**

In areas where dams are owned by local authorities, simple fish cropping schemes have been initiated. A successful scheme is one whereby the local authority employs fishermen who go from one dam to another netting fish with gill nets and a seine net, and who sell the fish locally. The money obtained is paid to the local authority.

Another less successful scheme is one where the local authority issues a netting license on the basis of one license per dam. The licensee nets on his own account and keeps all the profit. The disadvantage of this scheme is that licenses are often issued for dams that are too small and often unstocked; thus the licensee does not recover the cost of his license. In addition, licensees seldom have the capital for adequate fishing gear, such as a seine net.

## 5. PREDATORS, DISEASES AND MORTALITIES

### Predators

By far the most important and damaging predators of fish in ponds are otters, *Lutra maculicollis* and *Aonyx capensis*. These animals have been known to take up to 80 percent of the fish stocked in unprotected ponds.

The only sure way of protecting fish ponds against otters is to put a fence around the ponds.

There are a number of birds that will take fish from ponds, such as cormorants, kingfishers, fish eagles and herons. Cormorants become a nuisance and should be discouraged by every possible means. Ponds that are adjacent to a garden, or near the owner's house where there is some form of activity all day, are less likely to be affected by predatory birds than ponds that are isolated and seldom visited.

Predatory fish sometimes get into fish ponds down the furrow, particularly if the screen at the pond inlet is inefficient or broken. Since, however, these fish are usually small specimens, the damage they do is not very great.

There are some aquatic insects which will kill very small fish, but unless the damage they do is very great, no special precautions are taken against them.

The control of predators in dams is seldom a practical proposition, because of the situation of the dams and their larger size.

### Diseases

In properly managed ponds and dams that are regularly cropped, there should not be any serious or fatal diseases of fish.

Even under natural conditions, in rivers and lakes, most fish species have parasites. However, the fish have "learnt to live" with them and consequently do not suffer greatly, if at all, from the infection. The common parasites of fish in central east Africa do not infect or cause disease in humans.

In badly managed ponds and dams there have been instances of a disease known as black spot. This is caused by the larval stage of a flat worm (*Strigeidae*) that encysts on the body and fins of aged fish. In extreme cases of infection the cysts erupt as open wounds. Even so, no fish mortality has yet been recorded from this parasite.

Occasionally, infection of *T. sparrmanii* with a parasite in the snout of the fish has been noted. This parasite is also the larval stage of a flat worm, but again there is no record that it is fatal.

The *Tilapia* are extremely tough fish and are not known to succumb to endemic diseases. They also have remarkable powers of recovery from wounds. It is not uncommon to find healthy fish with fins missing, mouths distorted, or blind as a result of physical damage caused by bad handling, or even from predator attacks.

One of the most important things that must be watched for is the danger of a disease or parasite being introduced from outside, possibly in exotic fish imported for study or for ornamental ponds and aquariums. All imported fish should be kept in quarantine for several months before they are allowed anywhere near indigenous fish species.

### **Mortalities**

Deaths of fish may and do occur from time to time in fish ponds and dams, not because of diseases of the fish themselves but because of changes in environment.

One known cause of fish mortalities in ponds and dams is poison, usually from vegetation growing near the water. All trees that have seeds in pods should be considered as potential fish poisons, i.e., *Acacia*, *Bauhinia* and so on. The seed pods on falling into the water release a substance that is capable of causing the death of fish, even if it is in very low concentrations. The effect of these poisons wears off in a few days. An indication of this type of poisoning is that the fish lose control of their swimming movements, "skittering"

on or near the water surface and "gassing." The water too tends to become clear.

Contamination of the water supply by insecticides and chemicals is another known cause of fish mortalities. Care should be taken to ensure that cattle dips and sprays are not sited so that they can overflow or drain into ponds or dams. In populated areas, detergents draining into streams can also cause fish mortality.

Another cause of fish mortality in ponds is lack of oxygen in the water, particularly at night. This oxygen lack can be caused by overfeeding, or, more often, by dense phytoplankton blooms. Overfeeding results in uneaten foodstuffs decomposing and using up available oxygen in the water. Dense phytoplankton uses up the available oxygen at night, although during the daytime, of course, there is ample oxygen from photosynthesis.

A lack of oxygen is usually indicated by fish lying near the surface of the water and "gassing." The remedy is to run in fresh water.

Certain minute plant organisms, e.g., *Microcystis toxica*, if in large concentrations can cause deaths of fish. It has not, however, been recorded from ponds in central east Africa.

Although *Tilapia* are very tolerant of temperature changes, there have been recorded cases of death occurring as a result of low water temperatures in too shallow ponds particularly when cold water is run into ponds at night. In places where there is a danger of low night temperatures, water should only be run into ponds in the daytime.

As a general rule the lowest lethal temperature, over a period of time, for *Tilapia* species in central east Africa is about 11°C (52°F) although *T. sparrmanii* can withstand temperatures a few degrees lower.

## **6. ECONOMICS OF FISH CULTURE: TRANSPORT AND PRESERVATION OF FISH**

### **Economic fish culture**

It is most worthwhile to engage in fish culture in close association with irrigation, vegetable growing and intensive rearing of poultry and pigs. The costs of building a furrow to the pond are then shared between the pond and the irrigation. Maximum use is made of the by-products and nothing goes to waste. While the small unit of one or two ponds may have its place, the aim should be a number of ponds which can be run as an economic proposition in association with other activities.

Poor waters can be made more productive by the right use of lime, fertilizer and food and the better the management the higher the yields. The mark of a good fish culturist is not how much he spends on foods and fertilizers but the wise use of available resources to get the best possible yields from the ponds. Good economical management results in yields of 1,000 lb to 2,000 lb per acre and may in some cases be even higher.

Where foodstuffs are costly and have to be transported it may be more profitable to grow fish by using only fertilizers and green-stuffs as a food. Careful thought must be given to the price of feeds, the selling time of the fish and the total yield expected.

It is necessary in order to see where improvements can be made and for the efficient running of the ponds to keep accurate figures of crops taken, stockings (date and amount) and costs of the enterprise. A simple record sheet is shown which can serve as a basis for pond records. Changes can be made to suit the individual farm needs. (See page 140.)

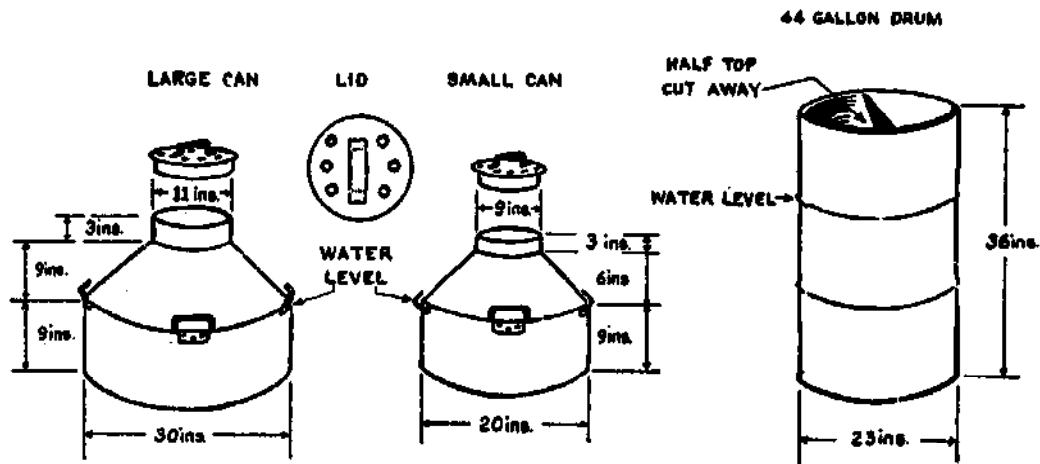

FIGURE 56. *Left:* Cans and drums for fish transport.

|                   | Large can | Small can |
|-------------------|-----------|-----------|
| Water             | 20 gal    | 11 gal    |
| Weight with water | 200 lb    | 110 lb    |
| Fish              | 8-10 lb   | 4-5 lb    |

The two cans of different sizes are made of galvanized iron sheet, 22 or 24 gauge. All joints are riveted and soldered.

*Right:* A 44-gal drum.

### Transport of live fish

The three most effective ways of transporting live fish in central Africa are:

1. In special fish cans or 44-gal drums (Figure 56).
2. In a special fish tanker, used for large quantities of fish, 300-500 lb.
3. In polythene bags, used for small quantities of special fish sent by air.

In all methods of transport of *Tilapia* (Figure 57) there are certain important rules to be observed to ensure success:

- a. The containers must be clean.
- b. The water must be clean.
- c. The fish must be clean.
- d. The water temperature must be as low as possible, but not lower than about 15°C (59°F). Ice can be used to lower the water



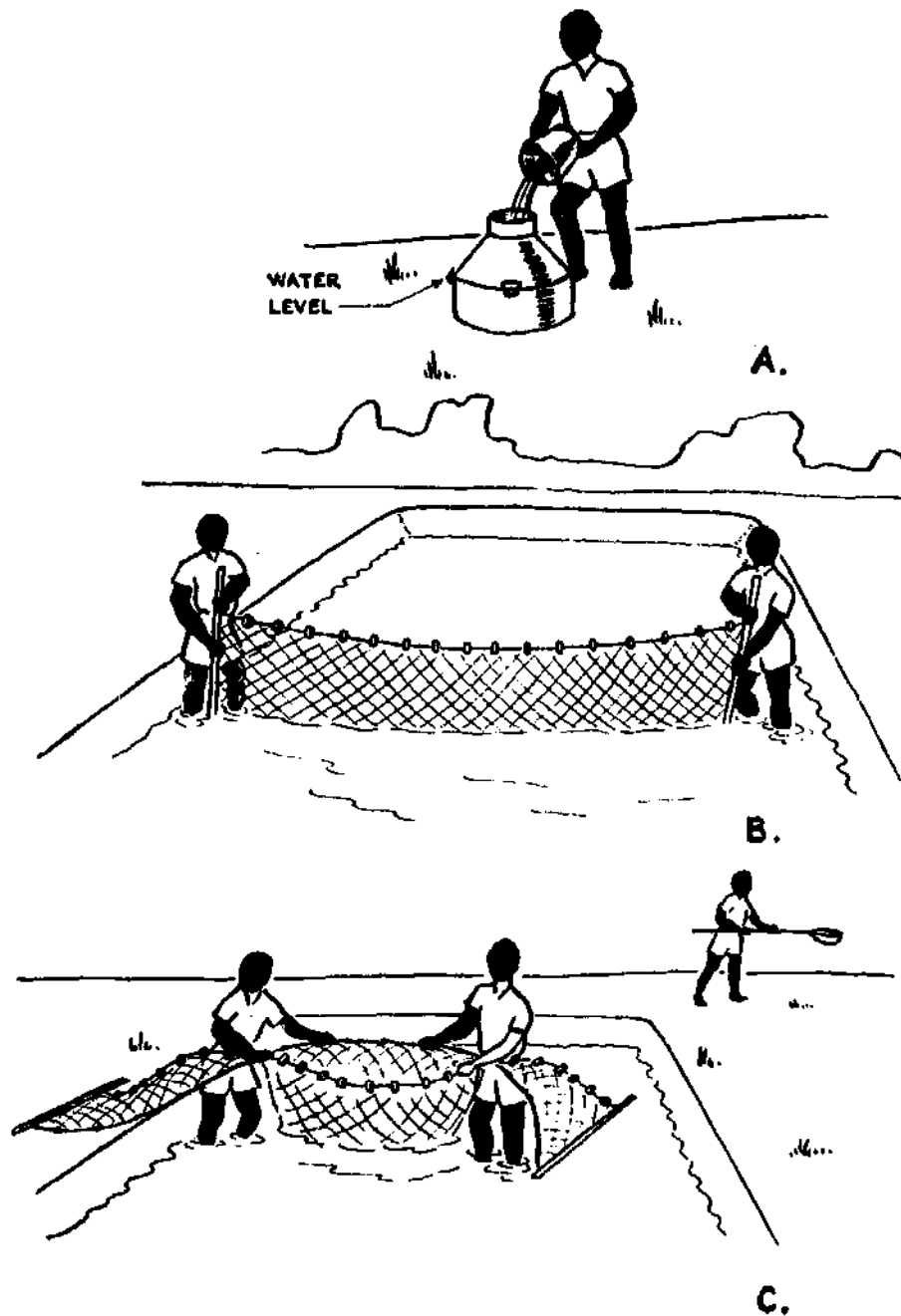

FIGURE 57. Method of catching and handling live *Tilapia* species. A. Make sure the can or drum does not leak. Fill the can or drum to the level with CLEAN water. B. Net the stock pond. Use a net of 1-in. or 1½-in. stretched mesh. C. Wash the fish in the net in the pond. Carry fish from the net in a hand net.

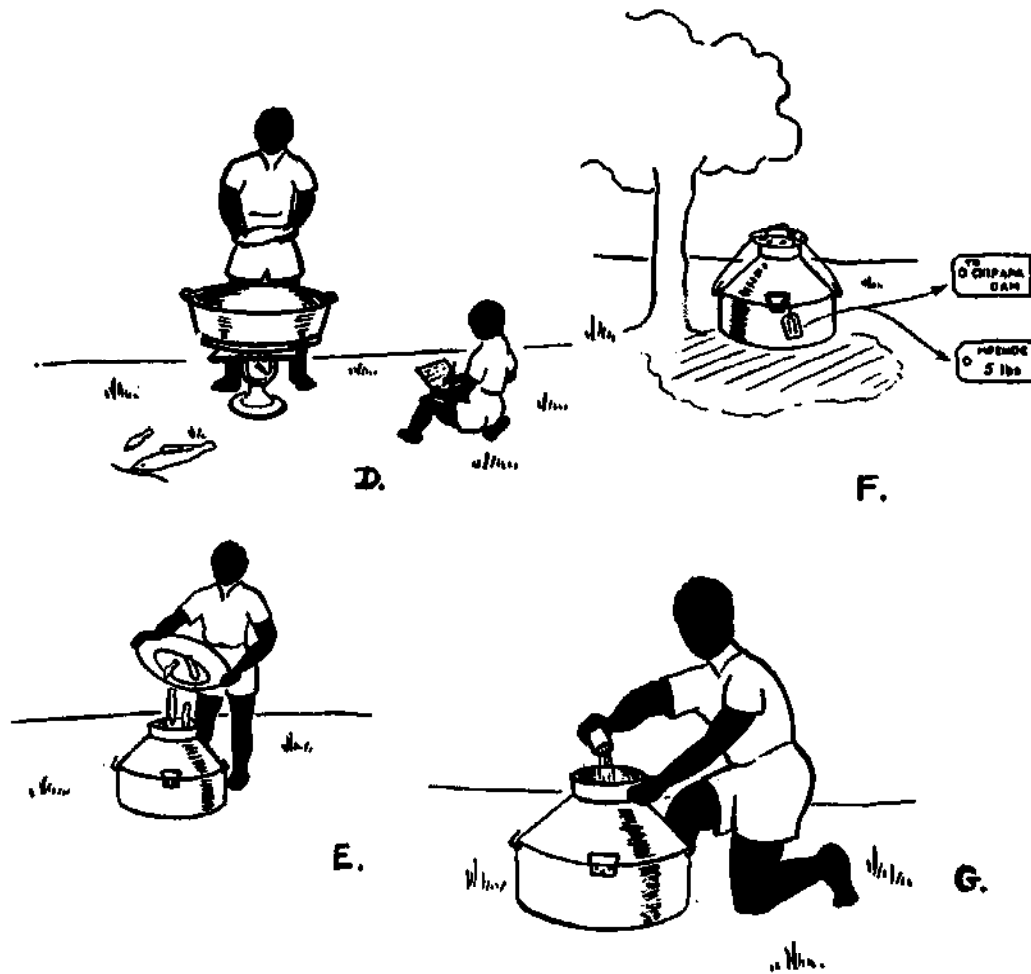

FIGURE 57 (CONCLUDED). Method of catching and handling live *Tilapia* sp. D. Weigh the fish in clean bath, without water. Weigh about 5 lb of fish at a time. Take out any kinds of fish that are not wanted. Write down the weight of the fish. E. Put the right amount of fish in the can or drum; large can, 8-10 lb; small can, 4-5 lb; 44-gal drum, 12-15 lb. F. Tie the lid on the can. Attach a label. Send the fish away. Do not leave the can standing in the sun. G. If cans containing fish have to be kept standing for any time, then the water must be aerated. This is done by dipping water out and pouring it back with a tin or cup. When the can is on a lorry or a car, the water is kept aerated by the bumping of the vehicle. On a long journey by road some water may be lost from the cans, so clean water should be put in now and again to keep the cans full.

temperature. It follows, therefore, that the best time of year to transport fish is when the weather is coldest.

- e. The size of fish should be between 3 to 6 in. in length and the best length is 4 to 5 in.
- f. Avoid handling the fish with the hands as much as possible.
- g. If fish are being sent long distances the survival rate can be improved by putting the fish in concrete or brick tanks overnight, so that their guts empty and the fouling of the water during transportation is reduced.
- h. When unloading *Tilapia* into ponds or dams there is seldom any need to make the temperature of the water in the container the same as the water of the pond or dam. *Tilapia* are able to withstand temperature differences of 5.6° to 8.4°C or of 10° to 15°F. For differences greater than these it is better to equalize the water temperature in the container with that in the pond or dam.

Not all fish are necessarily as easy to transport as the *Tilapia*, although the *Serranochromis* are fairly resistant to handling and can be transported with *Tilapia*. Certain *Haplochromis*, however, are more difficult. These species should not be carried in the same container as *Tilapia* as they tend to die more easily, and by fouling the water cause the deaths of other species present.

In many parts of the world certain chemicals called tranquilizers are used to quiet fish when they are being transported. Tranquilizers have to be used carefully and are not always reliable. They are not necessary for local distribution of Cichlids in central east Africa, where the best form of tranquilizer is cool water.

### Preservation of fish

The preservation of fish means keeping fish acceptable for consumption for some length of time by using the methods needed to prevent deterioration. (See Appendix I.)

### PRESERVATION OF LIVE FISH

The simplest way to keep fish alive is to leave them in a rearing pond, or to place them in a special small storage pond, where care

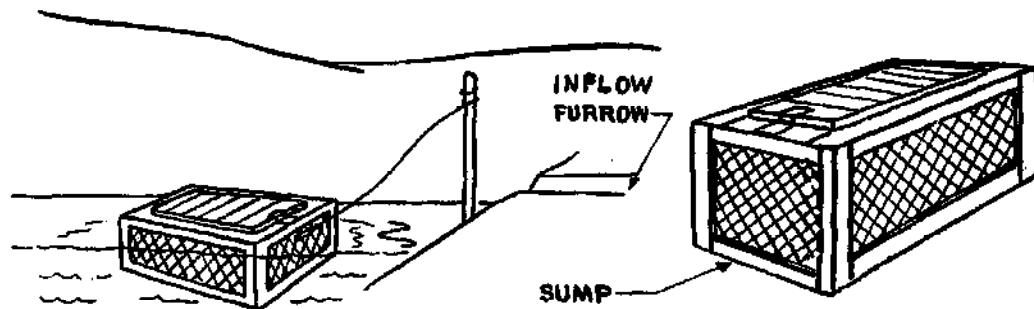

FIGURE 58. *Left:* A fish sump floating on the surface of a pond near the intake furrow. *Right:* A fish sump.

must be taken to ensure a sufficient inflow of fresh water. If only small quantities of fish have to be handled, it is suggested that they be placed in a small floating fish sump, kept in the pond near the inflow of water (Figure 58).

The live fish must be placed in a storage pond or a sump immediately it is caught, though this should be avoided in winter when the water is cold.

#### PRESERVATION OF FRESH FISH

The process of preservation with regard to fresh fish must start from the moment the fish is taken out of the water. Bacteria that cause deterioration are always present. They are mainly concentrated in the gills and guts where deterioration starts first and from where it quickly spreads through the lymphatic and blood systems throughout the whole body. The first thing to do, therefore, is to remove the gills and the whole inside of the fish. For gutting, the full length of the belly is split open with a sharp knife. Care must be taken during the cleaning process to cover the fish with wet weeds, wet bags or at least to avoid exposing them to the sun.

After being cleaned in this manner, the fish should be kept for about one minute in a cold bath of a solution of 0.2 percent saltpeter (sodium nitrate). This solution is prepared by means of dissolving 28 grams (1 oz) saltpeter in  $12\frac{1}{2}$  liters (3 gal) of water (Figure 59).

Naturally, if ice or refrigeration is available fish can be kept fresh for a longer period.

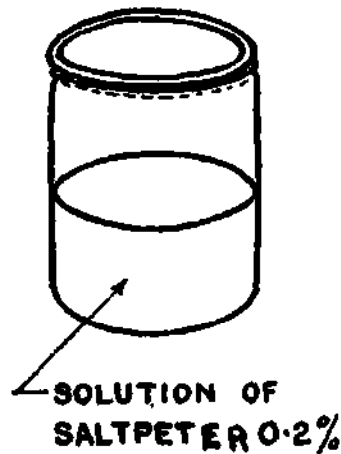

FIGURE 59. A container with prepared saltpeter solution. The container is half filled to avoid spilling when dipping the fish.

If the fish is disposed of quickly, cleaning is not necessary. Dipping into the saltpeter solution and cooling on ice or by refrigeration, if available, is all that is needed.

#### PRESERVATION OF FISH BY DRYING

The preservation of fresh fish is only possible in cases where it reaches the consumer in a short time. The most popular way of preserving fish for a longer time is, in central east Africa, to dry it in the sun.

There are many ways of drying fish:

- a. Drying in the sun when fresh;
- b. Drying in the sun after a preliminary heating/smoking over a fire;
- c. Drying fresh fish by the cold smoke curing method;
- d. Drying in the sun after a preliminary salting.

To get dried fish of good quality it is essential that only fresh fish of an impeccable standard be used. No drying method will improve the quality of a fish which has already partially deteriorated.

The same procedure is employed in preparing fish for drying as that described in the chapter on the preservation of fresh fish with the exception that, when cleaning, the fish is split at the back along the dorsal fin, so that the head is also split into two halves (Figure 60). This is essential because the fish is thickest at the back, and by splitting it in this way drying will take place more evenly over the whole body.

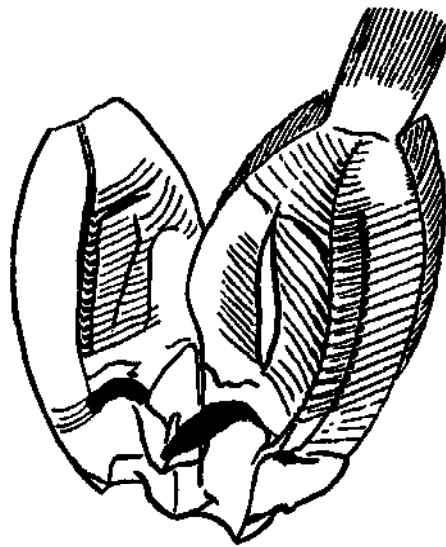

FIGURE 60. Fish split along the back.

### *Drying fresh fish*

Fresh fish prepared in the manner described above is spread out to dry in the sun on rocks, grass mats, or screens. No further preliminary preparations are necessary. To ensure even drying, the fish should be turned periodically. As the drying process may take many days, the fish should be gathered up and put into tight heaps each day before sunset. Next morning, after sunrise, they should be spread out again, and the procedure repeated until the fish is thoroughly dry but not brittle. This method of drying is applicable only to small-sized fish. In the case of larger sized fish deterioration may set in before the fish has had a chance to dry properly and other methods of drying have therefore to be applied.

Attention should be paid to the seasonal appearance of certain kinds of flies and beetles which may cause great damage to the fish when drying. They lay eggs in the flesh and heads of the drying fish and the product may be completely ruined by their larvae. Preliminary salting and smoke curing does prevent attacks by insects to some extent.

In air temperatures of over 38°C (100°F) it is advisable to dry the fish in the shade, or hung up on stretched wire or on sticks, as fish lying flat in the hot sun may be baked before they are dried.

### *Drying by preliminary heat/smoke curing*

The prepared fresh fish is heat/smoke cured before being spread out to dry. For heat/smoke curing the fish is placed for 10 minutes

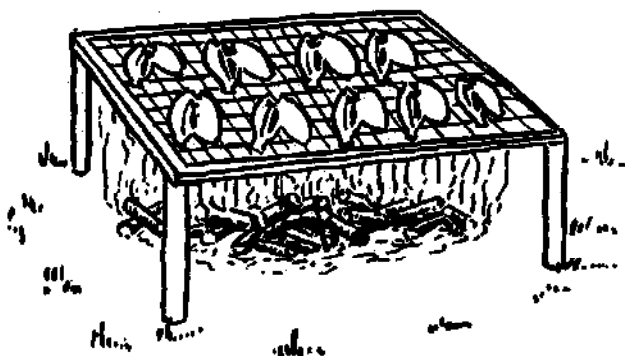

FIGURE 61. Heat/smoke curing of fish on a grid.

on a grid under which a smoking, smoldering fire is kept burning (Figure 61).

#### *Drying by preliminary cold smoke curing*

The prepared fresh fish is hung up, or placed on a screen, 6 feet above smoking and gently smoldering logs in a smoking hut. The fish can be kept there until completely dry, in which case further drying in the sun is not necessary. Or the fish can be kept in the smoking hut until it has attained a certain degree of dryness and then set out in the sun until the drying process is complete. Although cold smoke curing may last for days, it has the advantage that insect damage is kept at a minimum (Figure 62).

#### *Drying by preliminary salt curing*

This method of drying is somewhat more elaborate. A wooden box, or any container, the bottom of which is holed for drainage, is needed for salting. Crude salt is used for salting, at a ratio of 1 lb of salt to every 4 to 5 lb of fish. First, a layer of salt is spread over the bottom of the box or container. Then a layer of prepared fresh fish is tightly packed on top of it and covered by another layer of salt. Thus alternate layers of fish and salt are tightly packed into the container, finishing with a layer of salt. Care must be taken that the salt is spread evenly between the layers of fish. The container should be kept, wherever possible, in a cool place (Figure 63).

The salt will dissolve in the fluid of the fish and penetrate into the flesh, while the excess fluid will begin to run out through the

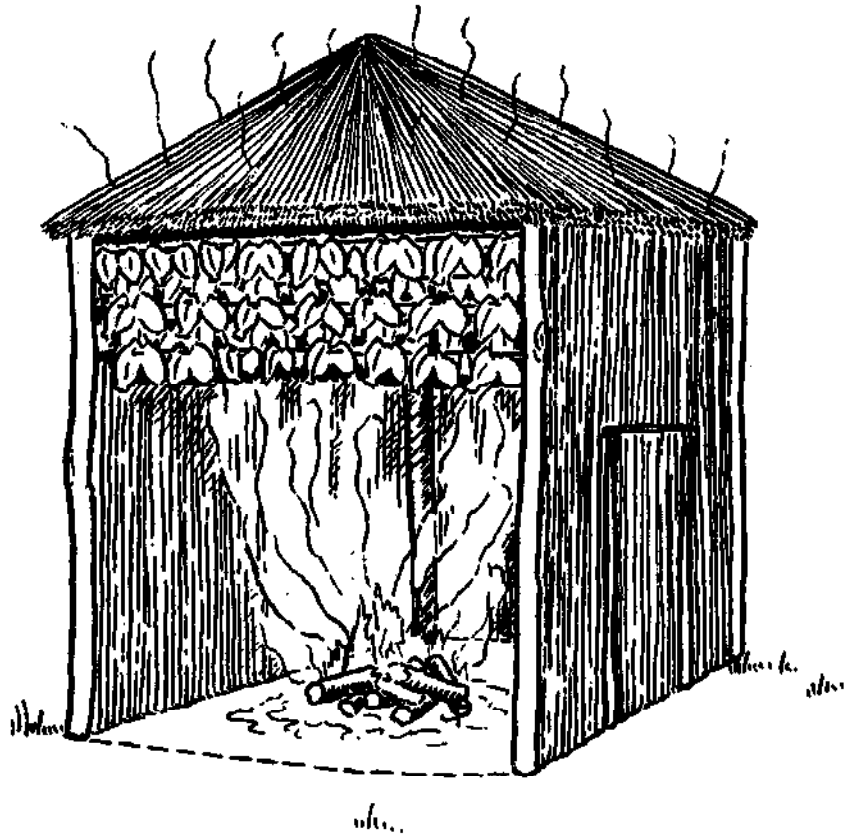

FIGURE 62. Reed or grass hut for cold smoking measuring  $6 \times 6 \times 9$  ft. In order to have a view of the inside one wall is omitted from the figure.

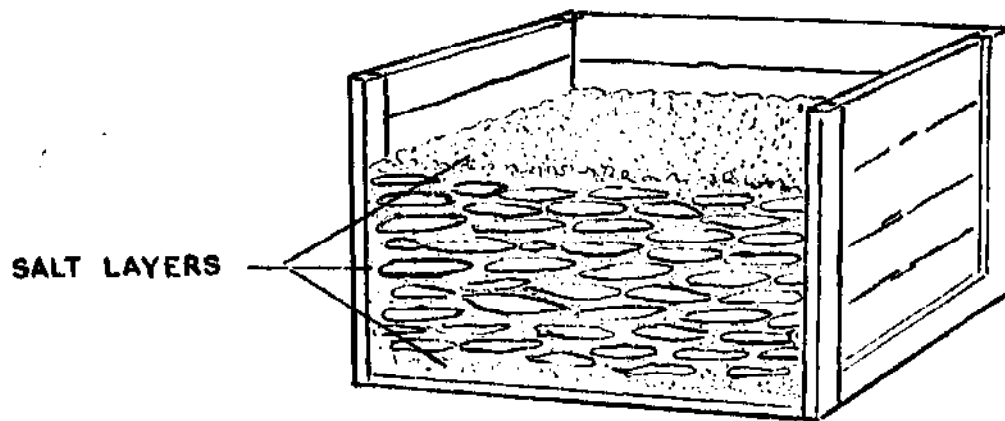

FIGURE 63. Dry salting in a wooden box.



holes in the bottom of the container. Next day the fish should be taken out of the container and repacked in such a way that the fish previously on the top will be placed on the bottom. No new salt is added.

Care should be taken, however, to see that no salt stuck to the fish is brushed away and that all the undissolved salt which remains is put back carefully between the layers. It is useful to have two identical containers. In this case relayering is done by lifting the fish layer by layer from the first container and putting them straight into the second. Thereafter, changing top to bottom layers must take place every third day, until no more liquid seeps through the holes and almost all the salt has dissolved. The fish is then ready for drying in the sun.

In very hot weather when the air temperature rises to over approximately 32°C (90°F) the dry salting method may prove too slow, and the fish may deteriorate before the salting process is accomplished. In such conditions the method of wet salting is suggested.

For wet salting a container, such as a bucket or a drum, is half filled with water. Enough crude salt is added to the water so that when as much as possible is dissolved a thin layer of salt remains on the bottom. The fish is then placed in the salt solution and kept there for about 18 hours. Thereafter the fish is spread out for drying in the sun in the usual way.

If desired, the salted fish can be treated by smoke in a smoking hut, which gives it the taste and appearance of smoked fish.

#### STORING

Fish, if properly dried, can be stored for some length of time. It should be kept tightly packed to prevent it from turning rancid and to protect it from the moisture in the air. The fish must also be protected from insects which eat it and lay their eggs in it, the larvae causing the product to deteriorate.

#### USE OF FISH OFFAL

A considerable amount of offal is usually left after the fish are gutted. Such offal should never be thrown away. It should be used for feeding domestic animals, such as pigs and poultry, and the oil should be extracted for human consumption.

The fresh guts, gills, heads and some undesirable kinds of fish can be chopped into small pieces and fed to animals, especially poultry, in a raw state. Some fish, and especially their offal, are, however, rich in fat and too much fat in animal feed is not desirable. It is preferable, therefore, to extract the oil from such offal.

The procedure for the extraction of oil is very simple. All that is needed is a container four times as big as the amount of offal. This is half filled with water which is brought to the boil (Figure 64).

FIGURE 64. Boiling of offal for extracting fish oil.

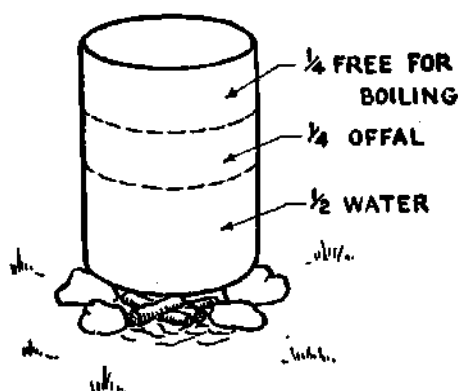

Finely chopped offal to the amount of half the volume of water is then added to the boiling water and kept boiling for 20 minutes. The container is then taken off the fire. When the offal has set and the oil risen to the surface, the oil is skimmed off.

Oil extracted in this manner has a very high nutritional value being rich in Vitamins A and D. It is generally used as cooking oil.

The oil-free residue, when it has cooled, can be fed to animals by mixing it with other animal feeds. Or it can first be poured into a tightly woven cloth bag, the liquid squeezed out and the liquid and the residue then fed separately to animals.

**PART THREE**

## 7. BACKGROUND TO BIOLOGICAL PRODUCTION

In order to live, animals must have access to food, air and water. They cannot survive if one of these essential elements is missing. If an element is not available in the requisite quantity an animal will not be able to fulfill its natural functions of growth and reproduction. Instead, it will become weak and diseased and will die before reaching its natural age limit.

We all know that game, for instance, can live only in places where the climate and soil provide enough vegetation for food, or, in the case of predatory animals, where there are sufficient other animals present for them to prey upon. There must also be enough water for drinking and air to breathe. Exactly the same law of nature applies to fish.

Some types of fish live mainly on water plants just as cattle live on grass; others live mainly on small animals such as snails, worms and insects, like the birds. There are also predatory fish which prey on other fishes, just as the predatory lion feeds on other animals.

Like other animals, the fish needs air to live. Air consists of a mixture of gases, mainly of oxygen (21 percent) and nitrogen (78 percent). Fish take up oxygen from air dissolved in the water by means of gills. Some fishes, such as the lungfish, have proper lungs; other such as the catfish group, of which the most common is *Clarias* (barbel), have both gills and accessory breathing organs.

The physiological processes of the body of fish are adapted to the condition of the water, which depends, in turn, on dissolved and suspended matter in it. In their natural state, rivers and lakes have fresh water, the sea has salt water.

The natural food of fish is mainly derived from the world of living water organisms, which are dependent directly for life and reproduction on the physical and chemical qualities of the water.

### **Physical and chemical qualities of waters**

Water is always contained in some kind of hollow bed or basin which is variable in area and depth. It is either stagnant, as in ponds, lakes and reservoirs; through-running, as in river pools and some lakes; or running water as in rivers. All these waters are, in the main, filled by water running off from the catchment area and, to a lesser extent, by water from rain, wells and seepage.

From the point of view of biological value runoff water is best, as on its way it brings down dissolved nutrient salts and organic matter from the ground surface of the catchment area. If the ground is poor in nutrient salts and organic matter, as is the case in areas consisting of rock and sand, the runoff water is also deficient in these. On the other hand, if the catchment area is composed of rich soil, such as fertile arable land, the runoff water is also rich and we call it fertile water. The quality of the water is also influenced by the substance forming its bed as valuable nutrient salts are leached out from the ground.

Nutrient salts, such as those of calcium, potash, phosphorus and other elements, as well as organic matter, are as important in water as organic and artificial fertilizers are to agriculture. The grade of fertility of the water depends on the amount of nutrient salts present. On this, in turn, depends the intensity of biological production of such living organisms as bacteria, algae, plants and fish.

Other important influences in biological production are the sun's rays, temperature and dissolved air. Water temperature depends firstly on the climate of a particular region, and secondly on being warmed directly by the rays of the sun. The sun's rays can only penetrate the water to a certain depth. In deep, stagnant waters, therefore, the upper layer can be noticeably warmer than the lower layers. It is only in shallow waters that the temperature remains even in all parts. This is not only due to a uniform penetration by the sun's rays, but is also because wind helps to even out the temperature by moving the water. In rivers and also, partly, in reservoirs which have through-running water, the temperature is evened out by the flow of water. Warm waters stimulate higher and more intensive biological production.

Dissolved air is carried into the waters by runoff water and rain, but much of this is used up in various chemical and biological proc-

esses. Direct contact of the water surface with the atmosphere helps to replace these deficiencies, and keeps the upper layers of the water at saturation point. The deeper parts of a water are only supplied with dissolved air from the saturated surface layer, either by means of the vertical movement of the water, or by the air being "pushed" down through the action of wind and flow.

Apart from warming up the water, the sun's rays play an important part in chemical and biological processes, such as the assimilation of green plants, etc., which react more intensively to higher temperatures.

All the factors mentioned are of major importance for supporting life in a water, both in regard to food for the fish and for the fish themselves.

As stated above, distribution of these factors is not even in stagnant waters. This is chiefly because of limited penetration by the sun's rays and limited action by the wind. In deeper lakes and reservoirs these limitations, and their consequences, can be clearly seen in the formation of typical strata and zones.

The upper portion of the water mass in lakes and reservoirs is distinguished by higher temperatures, higher air content and greater penetration by the sun's rays. This is the zone which has the highest biological activity and it is called *epilimnion*.

The lower part of the water mass is called *hypolimnion*. The conditions typical of this zone are the opposite to those in the epilimnion. Water temperature and air content are lower here and the light is dim to dark. Biological activity is always lower here than in the upper parts.

A transitional zone, the *metalimnion*, is found between these two zones. Here the biological conditions of both the epilimnion and hypolimnion meet.

This stratification, or differentiation into layers, is not necessarily present in all waters. Where it appears it need not be permanent, but may disappear and then reappear. Its appearance, however, gives the water its character. For example, stratification may disappear in a stagnant water through forced water movement. In rivers, where the water flows constantly, a stratification has no chance of becoming established. This is also the case in shallow waters, where the movement of the water caused by winds would extend to the bottom.

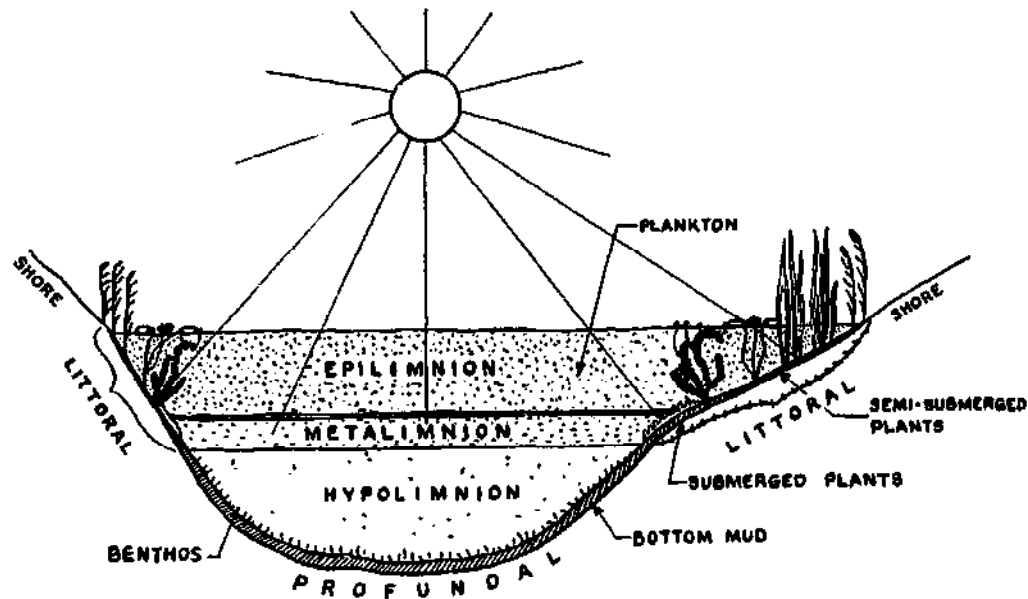

FIGURE 65. Scheme of limnological zonations.

The mass of water lies in a hollow as in a bowl or plate and the horizontal stratification zones of the water mass are in contact with certain areas of that hollow. These areas are directly influenced by the physical, chemical and biological properties of the stratification layers with which they are in contact. So the area of the hollow covered by the epilimnion is the most active in biological production and the most important. This is mainly the inshore area of a water and is called the *littoral* zone. The bottom area covered by the hypolimnion, mainly the offshore, is called the *profundal* zone. The profundal zone is biologically less productive than the littoral. The portion of the hollow covered by the metalimnion has no specific characteristics because of the changes occurring in this region and is usually treated as the littoral (Figure 65).

It can be understood that in waters which are unstable, or where no stratification appears, the bottom of the water has all the characteristics of a littoral formation.

#### **Biological production in a water**

The type of biological life in any water is related largely to the horizontal stratification of the water mass and the bottom zones.

The water mass produces *plankton*, the group name for extremely small freely floating organisms, which when dying or dead sink to the bottom. Plankton consisting of plant organisms is called *phytoplankton*, which lives on nutrient salts. Plankton consisting of animal organisms is called *zooplankton*. This, in turn, feeds on phytoplankton. Most plankton is of microscopical size. There are, however, many varieties, especially among the zooplankton, such as the water flea, which can be seen with the naked eye. If plankton grows vigorously in concentrated masses it gives the water a specific coloring: green, yellowish green, bluish green, brownish green, etc. It is said of such cases that the water is "in bloom." The color depends on the density and variety of plankton. The transparency of a water "in bloom" can be considerably reduced, sometimes to only a few inches. Intensive growth of plankton occurs especially in the epilimnion (Figure 66).

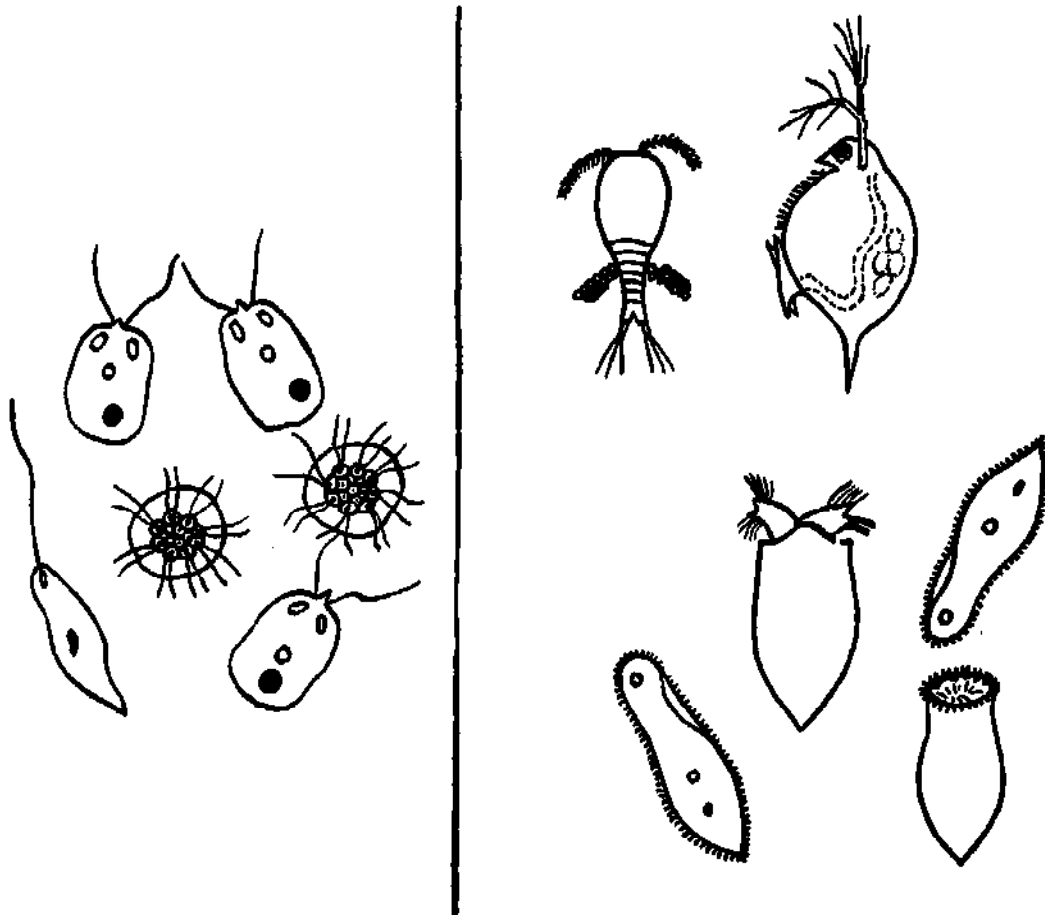

FIGURE 66. Plankton. *Left: phytoplankton. Right: zooplankton.*



The bottom of a water produces generally bigger (macroscopical) organisms. These organisms, known by the group name *benthos*, include such animals as insect larvae, oligochaetes, nematodes, snails, certain kinds of crayfish and so on. All these organisms live as a rule on the surface of the bottom or in the bottom mud. They feed normally on decaying plankton and organic matter (Figure 67).

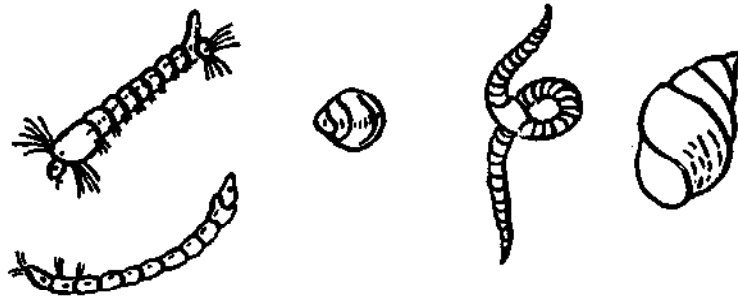

FIGURE 67. Benthos.

A variety of plants grow in the littoral on the inshore part of the bottom. Some plants, such as reeds, bulrushes, etc., while having their roots in the bottom under the water, grow and bloom above the water surface. Semisubmerged plants, like water lilies, the *Potamogeton* species and others, have their leaves and flowers floating on the surface of the water. Submerged plants, such as *Chara* and the *Nitella* varieties, grow and bloom under the water generally deeper than the semisubmerged plants. These, by vigorous growth, can build a solid mat on the bottom of the water.

A variety of littoral plants are used by some grass-eating fish as food; their main importance, however, is that, together with underwater stones and rocks, they form a base on which specific macroscopical organisms called *periphyton* live. These organisms, generally algae, insect larvae, etc., are distinct from benthos in that they never use the bottom or mud of a water to live on.

This mass of different living organisms multiplies and grows in different parts of a water, and forms a close association; one kind depending for its living on the other. One member of this association is the fish which depends for its existence on other members for food.

Nutrient salts and other chemicals are used by plants, such as the littoral plants and phytoplankton. Plant matter, in turn, is used by animal organisms, such as zooplankton, insect larvae, fish and so on. All these organisms in time die a natural death or are eaten by other organisms. Dead organisms, as well as the excreta of living organisms, sink to the bottom and it is on such matter that the benthos organisms live. In the end all sediments are turned into bottom mud through the activity of bacteria, which split the wastes into more elementary materials. These processes go on and on in an uninterrupted life cycle.

The intensity of these biological processes depends on the harmonious relationship of the main factors. These factors have already been described, but are summarized here again.

1. Optimal water temperatures.
2. Sufficient amounts of each of the nutrient salts needed.
3. Sufficient dissolved air, especially oxygen.
4. A high degree of penetration by the sun's rays.

The factors leading to biological production in natural waters are not balanced and its operation is determined by the smallest factor. Let us suppose, for instance, that a water contains sufficient amounts of some fertilizers, but only some of the superphosphate needed. In such a case, the plants will thrive as long as the superphosphate lasts, but once it is used up the plants will suffer despite the presence of other fertilizers. In this instance superphosphate is the limiting factor.

No amount of biological production in two natural waters is identical. Waters are divided into the following three main groups in respect of their productivity:

- a. Waters with high biological productivity are called *eutrophic*.
- b. Waters of medium biological productivity are called *mesotrophic*.
- c. Waters of low biological productivity are called *oligotrophic*.

The biological productivity of a water is judged mainly by the pH, by the alkaline reserve, by the oxygen content and by the amount and quality of plankton and benthos production.

The rate of fish production in each of these groups depends firstly on the kind of fish and, secondly, on the existence of the right number of fish in the water for the best utilization of available food resources.

In artificial waters such as fish ponds, it is possible to correct almost all the deficiencies found in natural waters and thereby to bring biological productivity to the highest possible level.

The advantage of fish pond culture over fish production in natural waters is evident. Ponds are shallow and, therefore, easily aerated. On account of this shallowness, the water is easily warmed and the sun's rays penetrate to the bottom. The fertility of a pond is easily controlled and corrected by adding the missing fertilizers.

By raising biological productivity to a maximum, a pond can be stocked with an increased amount of the kind of fish most suitable for higher production on natural food. The production of natural food has its limits, however. Just as a pasture can only produce grass up to a certain limit, so there is also a limit to the production of fish food in the water. Production limitations in ponds can be overcome by adding artificial food to the natural food.

## **8. STRUCTURE AND GENERAL BIOLOGY OF FISH**

In order to be able to rear fish successfully, it is necessary to know at least a little of how fish live and grow in nature and something of their habits. To recognize and identify correctly the different fish with which he may be dealing, the fish culturist has also to know the terms used in describing fish and the main features of their structure. Anatomy deals with the structure of the fish, the form of its body and internal organs. Biology covers the way of life of the fish, its feeding habits, breeding, growth and how it is able to live under the particular conditions in which it is commonly found. In the following section, some of the fundamentals of fish anatomy are described and points in biology are briefly discussed.

### **Fish anatomy**

#### **FINS**

The basic structure of fish is similar to that of the other backboned animals or vertebrates, but because they spend their lives in water there are differences which, at first glance, appear to be very great. There are paired limbs which aid in movement and these limbs are called fins. In front, at the shoulder, are two paired pectoral fins, while on the ventral, or underside, of the body, either at the back or near the front, is another pair of fins, the pelvic fins. These two pairs of fins correspond to the fore and hind legs of the land vertebrates. The fins are supported by bony spines and soft fin rays. Along the top of the body, or dorsal surface, is the dorsal fin, which again has soft and spiny rays (Figure 68). At the hind end of the body is the tail, or caudal fin, with only soft rays. Just

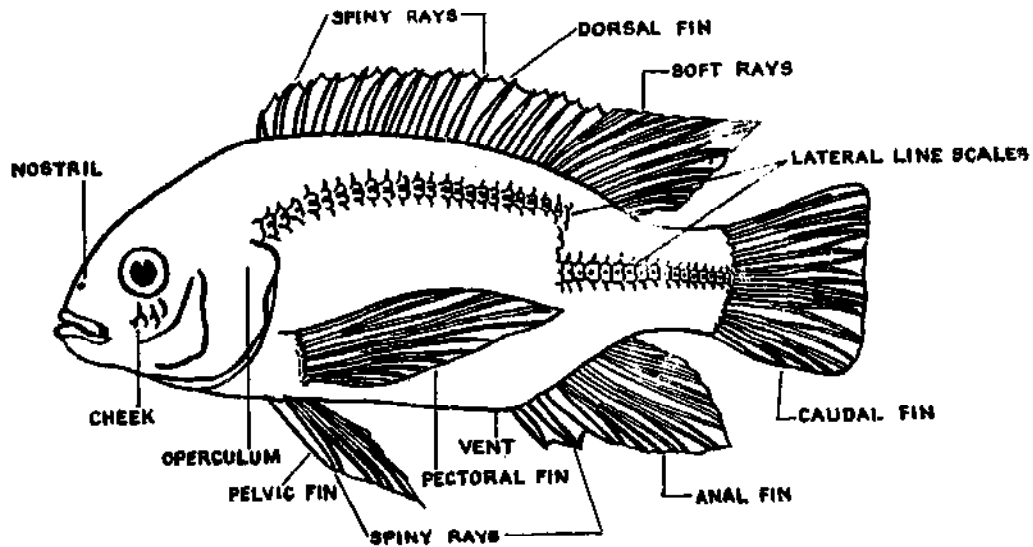
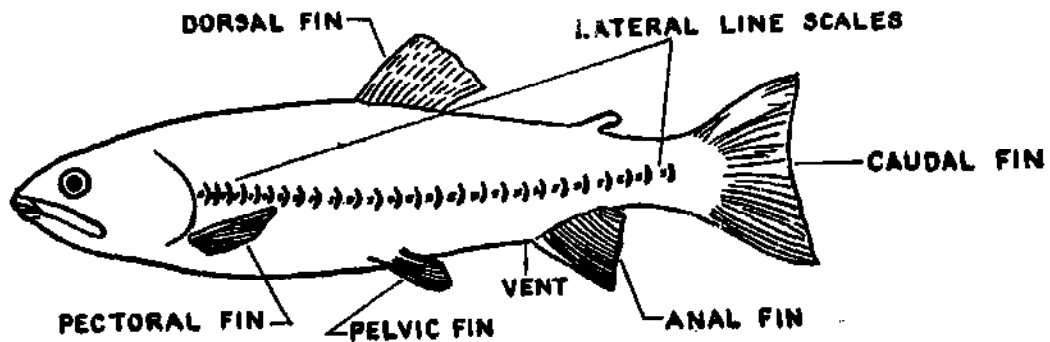

FIGURE 68. External features of fish. *Above:* Outline sketch of a Cichlid fish (after Greenwood); note split lateral line and pelvic fin in forward or thoracic position. *Below:* Outline of fish with single continuous lateral line and pelvic fin in hind or abdominal position.



behind the anus, or vent, is another unpaired fin, the anal fin, with soft and spiny rays.

Movement of the fish through the water is by means of wriggling movements of the body, rather as a snake moves through grass. Although the fins assist in movement, they are used mainly for balance, steering and braking, as can easily be seen by watching fish in an aquarium.

## BODY

The bodies of most fish are covered with scales. An exception is the catfish family, while eels and some other fish appear to have no scales, but, in fact have very small ones. The body is covered by a layer of slime or mucus which forms a protective sheath and assists the fish to move smoothly through the water. If this layer is removed by rough handling, for example, the underlying skin cells may become injured or infected. Care, therefore, should always be taken to handle fish with wet hands and to avoid rough contact with containers, nets, etc. Running along the side of the body, from behind the gill cover to the tail, is a line of scales which have little pits in them. This appears as a line running along the body of the fish and is called the lateral line. In some fish there is a continuous line, in others it is interrupted. Others, again, have two lines, an upper line going backward from the gill cover for about three quarters of the way, and a lower line running forward for a quarter of the way from the center of the tail. The pits are sensory organs and are responsive to changes in pressure in the surrounding water. The number of scales in the lateral line and the way the lateral line lies along the body are important in identification.

## MOUTH

The form of the mouth of a fish differs according to its feeding habits. For example, some fish have large mouths with sharp teeth for seizing prey, while others have small mouths on the under surface of the head suitable for scraping algae up from the bottom. The strange looking *Mormyrus* spp., or elephant-snout fish and bottle-nose fish, have mouths which are well adapted for grubbing on the bottom.

## TEETH

The teeth of fish also tell us something of their probable habits. Predatory, or hunting fish, such as the tigerfish, are well supplied with sharp teeth. Vegetation-eating fish may have coarse teeth, in the case of the *Tilapia melanopleura* arranged in bands along the side of the jaws. In the fish family of greatest importance in central African fish culture there is, in addition to the teeth in the jaws, a bony plate bearing teeth in the back of the throat. These are called pharyngeal teeth.

On the snout are either one or two pairs of nostrils. The Cichlid fish — the family to which some of the fish used in pond culture belong — have only one pair. The nostrils are not used for breathing, and, in fact, have no connection with the mouth, but are purely organs of smell.

## GILLS

At the hind end of the head are two slits, one on each side, called gill openings. These slits are formed by two bony flaps attached to the head and called opercula (singular, operculum) or gill covers. If these flaps are lifted, the gills are seen underneath. There are a number of semibony arches carrying long red filaments or threads on one side and short teethlike, or longer comblike projections on the other. The red part is called the gill filament and the comblike projections are called gill rakers. The number of these gill rakers on the lower part of the first gill arch is important in identifying fish. To count them, one starts at the bottom and counts upward until the gill bends (Figure 69).

The gills are the breathing organs of the fish and, in some fish, the gill rakers are used as a sort of strainer to sieve out food particles from the water.

At the hind end of the body is the anus or vent and slightly in front of this is the genital opening. In most species this is different in the two sexes (Figure 70).

There are also other external differences between the sexes which are noticeable during breeding. Male fish are often more brightly colored and generally more aggressive than females.

FIGURE 69. Gills and gill rakers in *Tilapia mossambica*. Head with gill cover removed to show gill rakers, gill arch, and gill filaments. Note that only the gill rakers on the lower part of the arch are counted. The figure shows a fish with 18 gill rakers.

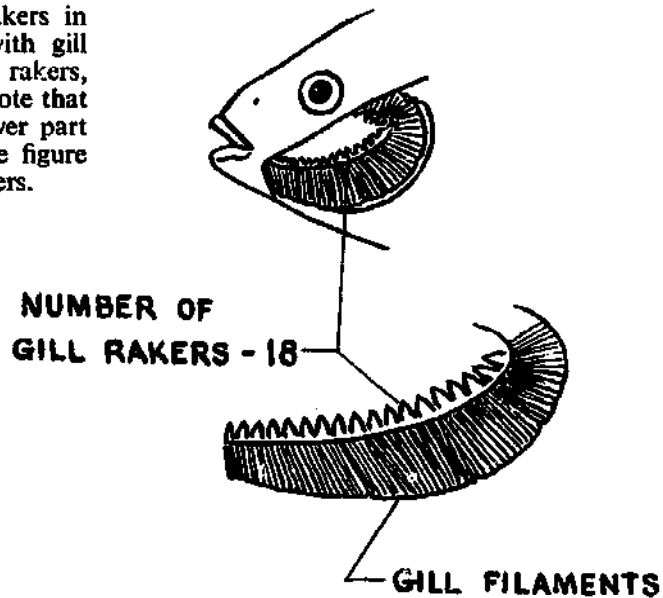

## Fish biology

### OXYGEN

Like all other animals fish need oxygen, but since they live in water they must get their oxygen there. The amount of oxygen dissolved in water depends on the temperature of the water. Colder water can carry more dissolved oxygen than warm water. Large amounts of decaying matter require oxygen, and by using up what is available in the water, leave smaller quantities for the fish. Waters with large amounts of decaying vegetation, or too great a quantity of manure, may have too little oxygen for healthy fish life. How does the fish get the oxygen from the water? Anyone looking at fish in an aquarium will notice that the gill covers open and close in a regular rhythm, and that the mouth opens and closes. The mouth is opened and water taken in while the gill covers are kept closed. The gill covers then open and the mouth closes and water is forced out through the gill openings over the gills where the oxygen is passed into the blood vessels in the gill filaments. When large numbers of fish are crowded together in small amounts of water they may die of suffocation as the oxygen is used up. Catfish or barbel have, in addition to gills, a special breathing organ above the gill and can live for long periods in poorly oxygenated water,



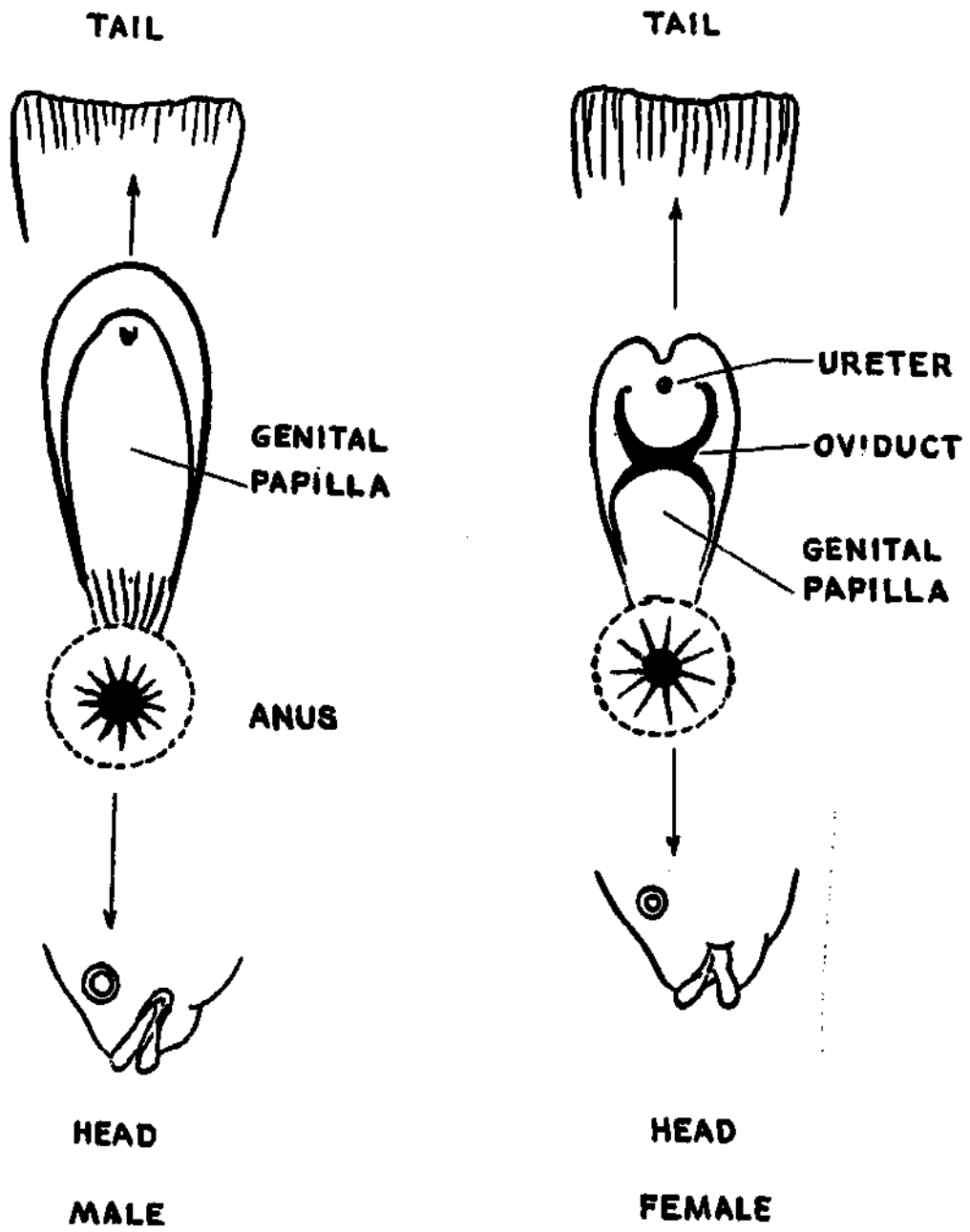

FIGURE 70. Male and female *Tilapia mossambica*. Diagram of genitalia in adult fish.

e.g., swamps, or even out of water, provided they are kept damp. Fish vary in the amount of oxygen they require. Some, which are said to be tolerant of low oxygen values, can live in very crowded conditions, or where there is very little oxygen in the water. Others need relatively greater amounts of oxygen and are found only in fast-flowing, well-oxygenated waters. In ponds where the oxygen is temporarily at a low level, fish may often be seen gulping for breath at the surface, taking in the surface water and air as well.

### TEMPERATURE

Fish differ in their temperature preferences. Some, which are found only in colder waters, are unable to withstand warm waters. Others die if exposed to lower temperatures than those found where they normally live. A sudden drop in water temperature or a severe winter often causes deaths among the less hardy species. Within the range of temperatures which they can tolerate, generally fish feed more and grow faster at higher temperatures. Other things being equal, fish production is therefore higher in warmer areas.

### FEEDING

The feeding habits of different fish often differ widely. The same fish also may show a preference for different types of food as it grows, or at different times of the year. Fish which prey on other fish are called predatory fish. Those living on vegetation are called herbivorous fish, whilst those feeding on the minute plant and animal life floating in the water are called plankton feeders. Fish with a large number of fine gill rakers are usually plankton feeders, sieving out the plankton from the water. Carnivorous fish live on other animal life, while some species are known as omnivorous because they shift readily from plant to animal food or eat both depending on availability. When the preferred food is not available, some species readily turn to other sorts of food, while other species do not.

## BREEDING

The breeding habits of fish vary greatly and are characteristic of each species. Some breed only once a year, usually at the beginning of the rains. Others may breed many times a year, providing that the temperature is high enough. Just as temperature affects the feeding of fish, so it affects breeding and there are temperatures below which certain fish will not breed. There must also be other favorable conditions, such as a suitable area in which the fish can spawn or lay its eggs.

Very often the age and size at which fish breed in the wild state and the number of times they breed in a year changes very greatly under artificial conditions in ponds. There is also a great deal of variation in the number of eggs laid at a time by females of the same size and species.

## GROWTH

Although the rate of growth of different kinds of fish and even of different individual fish of the same species varies greatly, the way in which they grow is the same. At first fish grow very quickly, but the rate of growth slows down gradually until very little growth occurs at all.

The curves (Figure 71) show the increase in weight in *Tilapia mosambica*. Once the female tilapias start breeding this growth slows down very greatly. Many different factors affect the rate of growth of fish. It is impossible to tell the age of a fish from an unknown water by its size, since if there has been little food, large numbers of fish and poor living conditions, a fish of 4 oz may be three, four or five years old. Whereas a fish of the same size from a water rich in food and with good living conditions may be only six months old.

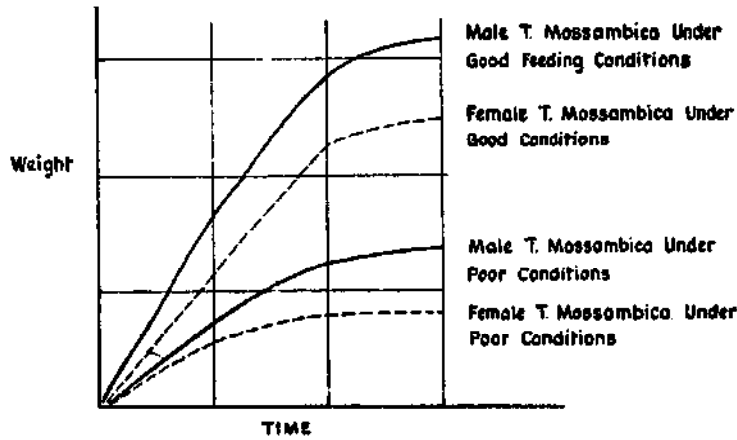
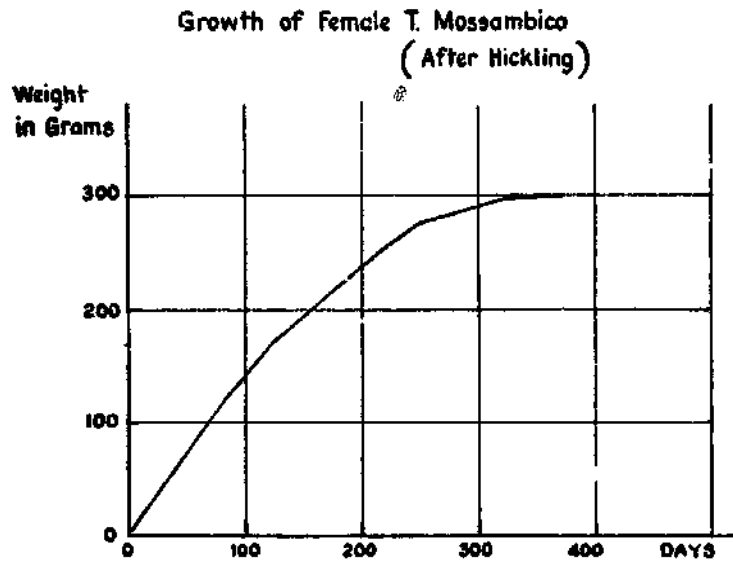

**FIGURE 71.** Growth of *Tilapia*. Above: Growth rate of *T. mossambica*. Below: Diagrammatic representation of growth rate of male and female *T. mossambica* under different conditions.

**Model record sheet for individual ponds**

## POND RECORD SHEET

Pond no. .... Area ..... Av. depth ..... Year .....

1. Date filled .....
2. *Stocking*  
 Date ..... Total wt. .... Av. wt. .... No. .... Wt./acre ...  
 Species ..... Wt. or proportion .....
3. *Cropping*  
 Date ..... Total wt. ... Av. wt. ... No. ... Wt./acre .....  
 Remarks on species .....
4. *Net production* ..... *Net production/acre* .....
5. Food ..... Weight ..... Cost .....
6. lb food per lb of fish .....
7. Fertilizer ..... Weight ..... Cost .....
- Manure ..... Weight ..... Cost .....
8. Lime ..... Weight ..... Cost .....
9. Repairs ..... Costs .....
10. Vegetation or weed control .....
11. Remarks on diseases, etc. ....
12. Total costs .....
13. Total sales .....
14. Net profit .....

## SUGGESTED LITERATURE FOR FURTHER INFORMATION

- CHIMITS, P. Tilapia and its culture. *FAO Fisheries Bulletin*, 8 (i): 1-33.  
1955
- COMMISSION FOR TECHNICAL COOPERATION IN AFRICA SOUTH OF THE SAHARA.  
1961 *Harmful aquatic plants in Africa and Madagascar*, by H. Wild. Salisbury. CCTA/CSA Publication No. 73.
- CONFÉRENCE PISCICOLE ANGLO-BELGE, 1919, ELISABETHVILLE. *Comptes rendus*.  
1950 Bruxelles, Direction de l'agriculture du Ministère des colonies et du Gouvernement général du Congo belge.
- HICKLING, C.F. *Tropical inland fisheries*. London, Longmans, Green.  
1962
- HICKLING, C.F. *Fish culture*. London, Faber.  
1963
- JACKSON, P.B.N. *Fishes of Northern Rhodesia*. Lusaka, Government Printer.  
1961
- JOINT FISHERIES RESEARCH ORGANIZATION, RHODESIA AND NYASALAND.  
1959-62 *Annual reports, 1958-1961*. Lusaka, Government Printer.
- JUBB, R.A. *Illustrated guide to the freshwater fishes of the Zambesi River, Lake Kariba, Pungwe, Sabi, Lundi, and Limpopo Rivers*. Bulawayo, Manning.
- LAGLER, K.F. *Freshwater fishery biology*. Dubuque, Iowa, Brown.  
1959
- MAAR, A. Tilapia culture in farm dams in Southern Rhodesia. *Rhodesia*  
1956 *Agricultural Journal*, 53: 139-151.
- SYMPOSIUM ON AFRICAN HYDROBIOLOGY AND INLAND FISHERIES, 1, ENTEBBE,  
1954 1952. *Record*. Bukavu, Scientific Council for Africa South of the Sahara.
- SYMPOSIUM ON HYDROBIOLOGY AND INLAND FISHERIES, 2, 1956, BRAZZAVILLE.  
1957 [*Papers.*] Louvain, Scientific Council for Africa South of the Sahara.
- SYMPOSIUM ON HYDROBIOLOGY AND INLAND FISHERIES, 3, 1960, LUSAKA.  
1960? [*Papers.*] Problems of major lakes. Louvain, Scientific Council for Africa South of the Sahara.

## **Appendix 1**

### **NOTE ON FISH SPOILAGE AND PRESERVATION**

Deterioration or spoilage is due mainly to the multiplication of minute organisms called bacteria in the flesh of the fish. These bacteria putrify the fish liberating a bad smell and causing the fish to soften, spoil and become unacceptable. All methods of preservation are in essence an attempt to reduce or limit this multiplication of bacteria between the time when the fish is caught and when it is consumed.

Certain basic facts should be understood:

1. A living fish has bacteria in its guts and to a less extent in its gills but not in its flesh. When the fish dies the bacteria quickly invade the flesh. Therefore, the sooner the guts and gills are removed the better. When they are removed the fish must be washed so that the smallest possible number of bacteria from the guts spread to the flesh. Time is therefore important.
2. Bacteria multiply faster in a warm than in a cool environment. Chilling or cooling will limit bacterial reproduction. The temperature at which fish are kept is therefore important.
3. Bacteria cannot multiply where there is no moisture and so drying limits bacterial reproduction.
4. Smoke, salt and other preservatives (e.g., vinegar) reduce or prevent bacterial reproduction.

Because all preservation methods are based on limiting the total number of bacteria, it is necessary that all containers, utensils and other gear used in preparing, transporting or storing fish should be kept thoroughly clean. If they contain traces of fish from the time they were previously in use they will also be heavily contaminated with bacteria which will hasten spoilage of the new catch.

## CONTROL OF BILHARZIA AND MALARIA IN DAMS AND PONDS

The production of fish serves to improve health by providing protein and other nutrients which are frequently deficient in African diets. Fish ponds and dams are therefore important in reducing malnutrition and allied illness, but if not properly managed they may also contribute to ill health. Consequently it is desirable that those concerned with building or managing them should be aware of ways to minimize this danger. The two important diseases which are affected by such bodies of water in central east Africa are bilharzia (schistosomiasis) and malaria.

### **Bilharzia**

Bilharzia is a disease of humans who are infected by contact with water containing the minute organisms responsible for initiating the disease. These free swimming organisms, called cercariae, penetrate the skin and enter the blood stream of the infected person. There they eventually grow into worms which live and feed in the blood vessels of the abdomen causing, after a period of time, various symptoms and signs which characterize the disease. They may include the passing of blood in the urine or feces of the infected person. This human excreta contains the worms' eggs which, if they reach water, hatch out to produce larvae or miracidia which must enter the body of a snail if they are to survive. The snails involved are small rather inconspicuous water snails of several different shapes. The larvae undergo change in the snail and eventually leave the snail as numerous free swimming cercariae which are now capable of penetrating the skin of man and thereby infecting him and continuing the cycle. This cycle involving man, human excreta, water and snails is vital to the bilharzia organism. If persons with the disease are treated then there will be no eggs in their excreta. If human excreta is properly disposed of, the eggs cannot hatch to infect another person. By avoiding contact with water containing cercariae man will not become infected. The water of a fish pond or dam containing no snails will not infect man.

Control of the disease depends on various measures designed to break the chain of infection. These include:

1. Urination and defecation in places where bilharzia eggs cannot reach bodies of fresh water that might harbor snails.



2. Medical treatment of all persons with the disease so that they no longer pass out eggs in their feces or urine.
3. Avoiding or minimizing contact with water which may be infected. Water for drinking, bathing and washing clothes should be drawn from water free of infection or which has been drawn 24-48 hours prior to use. The cercariae will die in water which has been allowed to stand for this length of time.
4. Destruction of snails by clearing away water plants either mechanically or with fish. There are several kinds of fish which eat snails. For example, in dams containing fish of the species *Haplochromis*, the snail population will be greatly reduced.
5. Killing snails with certain chemicals or poisons such as with copper sulfate put into the water. These, however, should only be used after consultation with an expert, because some may kill the fish or the organisms on which fish feed.

These points have been stressed because bilharzia is extremely prevalent and is responsible for a great deal of ill health in Africa. The disease is a major public health problem in Rhodesia and to a less extent also in Zambia.

### **Malaria**

Malaria, which causes much illness in large areas of Africa, is spread from man to man by certain mosquitoes. Mosquitoes all breed by laying their eggs in water. Dams and fish ponds are often cited if there are a lot of mosquitoes in an area. The breeding seldom takes place in the open water of a dam or fish pond but rather in small collections of water in the environs of the pond or dam. Breeding may also take place in areas at the edge of the pond where the water is sheltered by vegetation growing in the pond. Another common breeding site is in water which has collected in the footprints of animals that have drunk from a dam. A properly managed pond or dam, especially if stocked with fish that eat mosquito eggs and larvae, will not cause mosquito breeding. It is important, however, to keep the edges and backwaters clear of vegetation and also to see that water does not stand in puddles in the vicinity of the dam or pond. There are insecticides and oils which can be put into water to stop mosquito breeding but these may sometimes be harmful to the fish in the pond or dam. They can, however, be used on the stagnant pools and seepage not connected with the pond or its inflow.

Other malaria control measures not directly related to fish culture include the prevention of mosquito breeding in empty tin cans and holes which collect water, the spraying of insecticides in houses to kill mosquitoes which enter, the screening of houses to prevent the entry of mosquitoes, the medical treatment of all cases of malaria and the regular taking of certain drugs which prevent malaria even in persons bitten by infected mosquitoes.

**RECORDING RELEVANT FACTORS PREVAILING  
IN PONDS AND DAMS**

Every fish culturist should have an adequate knowledge of the chief physical, chemical and biological factors which, in one way or another, influence the production of fish. To this end, it is suggested that observations be made regarding the temperature, oxygen content, pH and alkalinity of the water, as well as the quality and density of plankton and the benthos.

**Temperature**

Any reliable thermometer, which has a graduation scale from 0.0°C (32°F) to 40°C (104°F) can be used for recording water temperatures. The thermometer is kept at about 6 to 12 in. under the water surface until the mercury comes to a standstill. At that point the temperature is recorded. In pond intake furrows the temperature must be taken near the inlet into the pond. In reservoirs, where the water is more than about 5 ft deep, the temperature of the deep water must also be taken. To that end, a water sampler, as described in the section on "oxygen content," is used. The water sampler is kept at the required depth for a few minutes. It is then quickly lifted to the surface of the water and the temperature is taken by inserting the thermometer into the water sampling bottle. It is essential that temperatures be taken shortly after sunrise, and again some hours before sunset.

**APPLICATION**

Water temperature is a decisive factor when making the choice of the kind of fish to be reared in a particular place. For instance, temperatures below 11°C (52°F) are not suitable for Cichlid culture but trout can be bred, provided the temperature of the water never rises above 21-24°C (70-75°F). Carp, however, can be bred in both cases. The water temperature also has a great influence on the biological production, determination of the spawning season, etc.

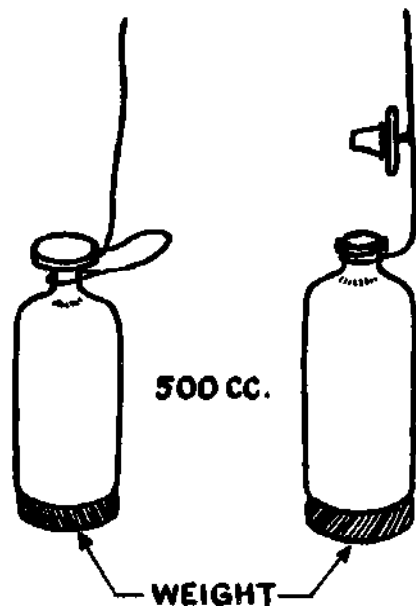

FIGURE 72. Water sample bottle.

### Oxygen content

To ascertain the amount of oxygen ( $O_2$ ) dissolved in a water is a somewhat elaborate proceeding and should be undertaken only by persons who have a basic knowledge of chemistry.

To ascertain the oxygen content in surface water, a water sample bottle is filled by dipping with water from the surface. To determine the oxygen content at depth, however, a water sample is taken by means of a water sampler. In taking samples, the sample bottle should be filled to overflowing and the stopper then pushed in. This is essential to avoid air bubbles under the stopper.

A 500-cc bottle with a glass stopper is used to make a simple water sampler. A weight of about  $1\frac{1}{2}$ lb, such as a stone or a length of metal, is tied firmly to the lower part of the bottle. A sinking string is tied to the neck of the bottle and, a little higher up, a glass stopper is tied to the same string. The length of the string between the edge of the bottle neck and the stopper must be at least twice the length of the stopper (Figure 72).

To take a sample the stopper is firmly pushed into the bottle neck, so that no water can get into the bottle while it is sinking. The bottle is sunk to the desired depth. Then the stopper is pulled out of the bottle neck by means of a sharp jerk at the sinking string. The bottle starts filling with water while air bubbles appear on the water surface. When the air bubbles no longer appear, the bottle is full. The bottle containing the water sample is then quickly pulled out and closed with the stopper.

To determine the amount of dissolved oxygen the following items are needed:

1. One 500-cc glass bottle with a glass stopper for water sampling.
2. The necessary number of 100-cc glass bottles for water samples.
3. One 50-cc bottle of manganous chloride solution: 100 g pure crystalline  $MnCl_2 \cdot 4H_2O$  dissolved in 200 cc of distilled water.
4. One 50-cc bottle of alkaline-iodide reagent: 100 g potassium hydroxide (KOH) dissolved in 200 cc of distilled water plus 60 g potassium iodide (KI).
5. Three 1-cc graduated pipettes.
6. A color chart for the identification of the amount of dissolved oxygen.

The determination of the oxygen content in a water sample is conducted in the following way: by means of separate pipettes, first add 1 cc of manganous chloride solution and then 1 cc of alkaline-iodide reagent to the water sample by placing the tip of the pipette in the water and allowing the solution to flow into the bottle. Then the bottle is closed with a stopper and the contents shaken. At this stage, the water sample will turn into shades from white to dark brown in color. The white color indicates the presence of dissolved oxygen. The more dissolved oxygen the water contains the darker is the shade of brown. For practical purposes the interpretation of the value of the coloring is done by means of a special color chart. The coloring of the test water is compared with the color specimen on the chart, on which the value of each shade is indicated.

#### APPLICATION

The oxygen determination discloses the amount of dissolved oxygen in the water, which is needed, for instance, by the fish for breathing. An oxygen content of less than approximately 3 mg per liter will cause the *Tilapia* to move close to the water surface gasping for air instead of feeding, and prolonged deficiency in oxygen may cause the death of fish. In the deep parts of the water the oxygen content can be very low, or even absent, in which case there will be very few fish or none at all.

Through the intensive growth of submerged plants and phytoplankton, the deficiency in oxygen can be noticeable, especially at night as by then much of the oxygen has been absorbed by the plants.

#### pH

The pH is a quantitative expression for the acidity or alkalinity of a water. To determine the pH the use of a Hellige glass comparator is suggested, with comparator disks ranging from 5.2 to 8.4. Instructions for use are always included with the set, which consists of the comparator, disks and indicators.

For a simple pH determination litmus paper is used. This is obtainable at chemists in ready-cut blue and red strips. If a strip of blue litmus paper changes its color from blue to red when dipped into water it shows that the pH content of the water is below 7.0 (acid reaction). If a strip

of red litmus paper is dipped into water, and the red color turns to blue, the pH content of the water is over 7.0 (alkaline reaction). If the blue and red strips do not change their color in water it means that the pH content of the water is 7.0 (neutral).

#### APPLICATION

The pH scale ranges from 0-14; pH 7 is neutral, below 7 acid and above 7 alkaline. For fish culture the best water is neutral, or a pH slightly on the alkaline side. Generally waters with a pH value of from 6.5 to 8.0 are regarded as "normal waters" for fish culture. Waters with a pH below 5.0 and over 9.0 are usually fatal to the life of fish.

#### Alkalinity

For the detailed determination of alkalinity of a water some skill and laboratory equipment are needed. It is, therefore, advisable to send a water sample to a recognized laboratory for analysis. Any clean bottle filled with a water sample taken from the surface of the water can be used for this purpose.

The total alkalinity of fresh waters can be as high as 350 ppm, although the figure is generally somewhere between 45 and 200 ppm.

The total hardness of water based on calcium-carbonate is classified as:

- very soft water (0-5 ppm)
- soft water (5-10 ppm)
- medium soft water (10-20 ppm)
- medium hard water (20-30 ppm)
- hard water (more than 30 ppm)

#### APPLICATION

Hard waters are biologically more productive than soft waters.

#### Plankton

Plankton are minute organisms floating in the water. The density of plankton is easily seen by measuring the transparency of a water, while the kind of plankton can be recognized, to some extent, by the coloring of the water. For more detailed determination of the quality, a sample is taken by sieving a specific amount of water through a plankton net (Figure 73).

For measuring the transparency of a water, a white painted metal disk of 25 cm (12 in.) in diameter is used (Figure 73). The disk is fixed to a cord and sunk into the water until it disappears from sight. Further sinking is stopped at the moment of disappearance and the depth measured on the sinking cord.

If the water is not very muddy, the limit of transparency generally indicates the density of plankton. The coloring of the water, clearly

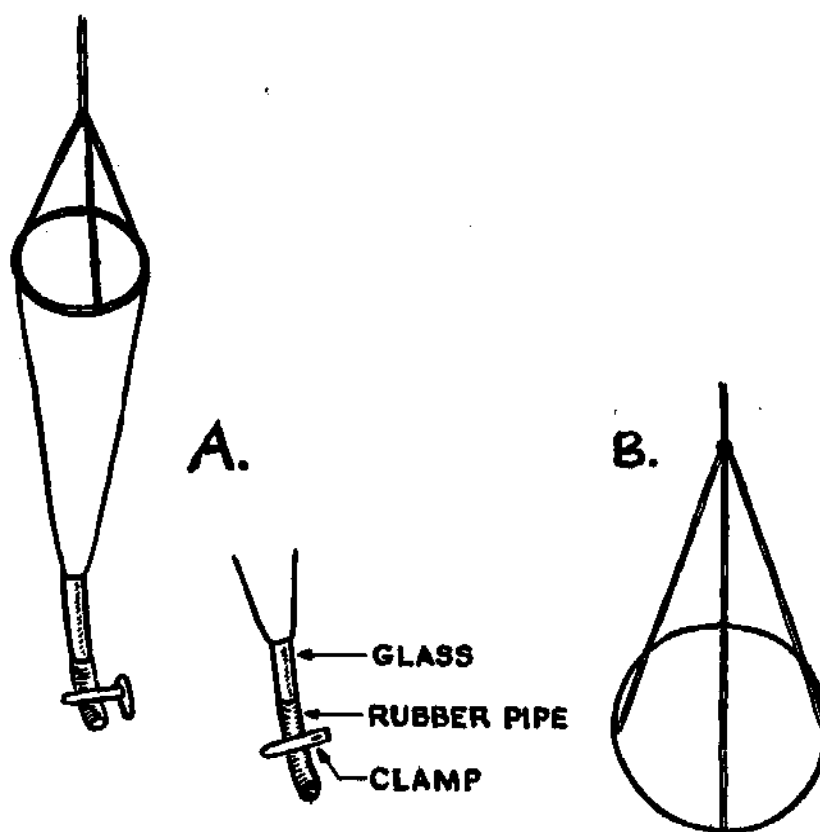

FIGURE 73. A. Plankton net. B. Secchi disk.

seen on the white disk, is caused mainly by the presence of plankton. Different kinds of plankton give the water their specific coloring.

To determine the quality and quantity, or composition, of plankton in a water, a sample is taken in the following way. Ten liters (approximately 18 pt) of water are poured through an extremely fine-meshed (No. 20) silk plankton net. The plankton caught in the net is then transferred to a 100-cc wide-necked jar and conserved in a 5 percent formalin solution. This is achieved by adding 40 percent formalin in a quantity of  $1/8$ th of the sample volume.

The following day, the plankton conserved in the jar is poured into a (preferably narrow) graduated cylinder and left there for 24 hours to set. After 24 hours the volume of the set plankton is read from the graduation scale of the cylinder. If in the example given, the graduation scale of the measuring cylinder showed, say, 5 cc plankton, this would mean that the density of plankton in the tested water was 5 cc to every 10 liters of water.

The sample taken for quantitative analysis can be used for the analysis of the quality, or composition, of plankton, or a new sample taken by dragging the plankton net through the water. Plankton so collected is

then transferred to a bottle and fixed with 5 percent formalin. A plankton quality determination sample should always be sent to a specialist for analysis.

#### APPLICATION

The analysis taken from different waters in different seasons will give an idea of the plankton production. Plankton is of great value to fish as food, especially in the younger stages of their lives. Some fish are mainly plankton eaters. The amount and quality of plankton indicate the fertility of a water on which fish production, either directly or indirectly, generally depends.

The best waters for fish culture are waters with a greenish color. This indicates that they are rich in green and blue-green algae and are, usually, also rich in zooplankton.

Appendix 4

USEFUL TABLES

WIDTH AND LENGTH OF PONDS IN YARDS FOR PONDS FROM 1/16 TO 1/4 ACRE IN SURFACE AREA

| Width (yd)<br>Length (yd) | 10   | 15   | 20   | 25   | 30   | 35   | 40   | 45   | 50   | 55  | 60  |
|---------------------------|------|------|------|------|------|------|------|------|------|-----|-----|
| 10                        |      |      |      |      | 1/16 | 1/14 | 1/12 | 1/11 | 1/10 | 1/9 | 1/8 |
| 15                        |      |      | 1/16 | 1/12 | 1/11 | 1/9  | 1/8  | 1/7  | 1/6  | 1/6 | 1/5 |
| 20                        |      | 1/16 | 1/12 | 1/10 | 1/8  | 1/7  | 1/6  | 1/5  | 1/5  | 1/4 | 1/4 |
| 25                        |      | 1/12 | 1/10 | 1/8  | 1/6  | 1/6  | 1/5  | 1/5  | 1/4  |     |     |
| 30                        | 1/16 | 1/11 | 1/8  | 1/6  | 1/5  | 1/5  | 1/4  |      |      |     |     |
| 35                        | 1/14 | 1/9  | 1/7  | 1/6  | 1/5  | 1/4  |      |      |      |     |     |
| 40                        | 1/12 | 1/8  | 1/6  | 1/5  | 1/4  |      |      |      |      |     |     |
| 45                        | 1/11 | 1/7  | 1/5  | 1/5  | 1/4  |      |      |      |      |     |     |
| 50                        | 1/10 | 1/6  | 1/5  | 1/4  |      |      |      |      |      |     |     |
| 55                        | 1/9  | 1/6  | 1/4  |      |      |      |      |      |      |     |     |
| 60                        | 1/8  | 1/5  | 1/4  |      |      |      |      |      |      |     |     |

CAPACITY OF WATER FLOW IN SQUARE FURROWS

| Grade      | Gallons per second |     |     |      |
|------------|--------------------|-----|-----|------|
| 1 in 1 000 | 1.8                | 3.9 | 4.6 | 10.9 |
| 1 in 500   | 2.6                | 5.5 | 6.5 | 15.5 |
| 1 in 300   | 3.3                | 6.7 | 8.0 | 19.0 |

| Width<br>Depth | Size of furrow<br>Inches |         |         |          |
|----------------|--------------------------|---------|---------|----------|
|                | 9<br>6                   | 9<br>10 | 18<br>6 | 18<br>10 |
|                |                          |         |         |          |

CAPACITY OF WATER FLOW IN V-SHAPED FURROWS <sup>1</sup>

| Grade      | Gallons per second |     |     |     |
|------------|--------------------|-----|-----|-----|
| 1 in 1 000 | 0.9                | 2.2 | 3.6 | 5.4 |
| 1 in 500   | 1.3                | 3.2 | 4.3 | 7.8 |
| 1 in 300   | 1.6                | 3.9 | 6.5 | 9.6 |

| Width of bottom | Size of furrow <sup>1</sup><br>Inches |    |   |    |
|-----------------|---------------------------------------|----|---|----|
|                 | 0.0                                   | 4½ | 9 | 14 |
|                 |                                       |    |   |    |

<sup>1</sup> All furrows with 9-in. sides and a slope of 135°.



## Appendix 5

### ITEMS FOR ESTIMATING LABOR COSTS IN POND CONSTRUCTION

- A. 1/10th-acre pond; 3 ft to 1 ft in depth; made in firm soil.  
Hand labor: 50-80 man days  
Tractor and dam scoop: 15-20 hours  
Minimum task for digging:  $1 \times 3 \times 18$  ft 54 cu/ft  
or  $\frac{1}{2} \times 3 \times 36$  ft  
Minimum task for carrying: as much as one man digs.
- B. 1/10th-acre pond; 3 ft depth all over; made in wet dambo soil.  
Hand labor: 60-100 days  
Tractor and dam scoop usually not possible  
Minimum task for digging:  $1 \times 3 \times 18$  ft 54 cu/ft  
or  $\frac{1}{2} \times 3 \times 36$  ft  
Minimum task for carrying: as much as one man digs.

## NOTES ON THE ECONOMICS OF FISH PONDS IN ZAMBIA

### Mixed irrigation unit

(a) The unit comprises:

- 6 fish ponds (approx. 0.5 acre total area)
- Vegetable garden (approx. 0.4 acre)
- Fruit trees, bananas and sugarcane
- Dwelling house
- 20-30 breeding ducks
- Duck houses
- Total area of plot 2 acres

(b) Capital cost

- Fencing £70
- Buildings £80
- Ponds £60
- Furrows, piping £30
- Tools and equipment £15
- Breeding ducks £15
- Total £270

(c) Balance sheet:

|                            | <i>Debit</i> |                 | <i>Credit</i> |
|----------------------------|--------------|-----------------|---------------|
| First year:                | £ s. d       |                 | £ s. d        |
| Seeds, etc.                | 8.18. 0      | Fish sales      | 29.15. 4      |
| Duck food - young stock    | 25.15. 4     | Vegetable sales | 54. 1.10      |
| Duck food - breeding stock | 32.10. 0     | Duck sales      | 55.10. 8      |
| Capital repayment          | 15. 0. 0     |                 |               |
|                            | 82. 3. 4     |                 | 139. 7.10     |
| Totals                     |              |                 |               |
| Net profit to owner        | 57. 4. 6     |                 |               |

| Second year:               |  | £ s. d    | £ s. d          |           |
|----------------------------|--|-----------|-----------------|-----------|
| Seeds                      |  | 4. 5.11   | Fish sales      | 18. 2. 6  |
| Duck food - young stock    |  | 26. 7. 6  | Vegetable sales | 63. 1. 6  |
| Duck food - breeding stock |  | 30. 9. 0  | Duck sales      | 28.10. 0  |
| Capital repayment          |  | 10. 0. 0  |                 |           |
|                            |  | <hr/>     |                 | <hr/>     |
| Totals                     |  | 71. 2. 5  |                 | 109.14. 0 |
|                            |  | <hr/>     |                 | <hr/>     |
| Net profit to owner        |  | 38.11. 7  |                 |           |
|                            |  |           |                 |           |
| Third year:                |  | £ s. d    | £ s. d          |           |
| Seeds                      |  | 6. 3. 1   | Fish sales      | 19. 5. 8  |
| Duck food - young stock    |  | 52.18. 6  | Vegetable sales | 84.17. 0  |
| Duck food - breeding stock |  | 26.14. 1  | Duck sales      | 124.19. 0 |
| Capital repayment          |  | 10. 0. 0  |                 |           |
|                            |  | <hr/>     |                 | <hr/>     |
| Totals                     |  | 95.15. 8  |                 | 229. 1. 8 |
|                            |  | <hr/>     |                 | <hr/>     |
| Net profit to owner        |  | 133. 6. 0 |                 |           |

## (d) Notes:

- (i) All ducks sold at 10/- each if over 4 lb liveweight and 7/6 d each if under 4 lb liveweight.
- (ii) Average price obtained for vegetables approx. 4d per lb.
- (iii) Fish sold at 6d to 8d per lb.

DOUBLE CONVERSION TABLE 1

| Inches | Centimeters | Feet  | Meters  | Acres | Hectares | Gallons | Liters   | Pounds | Kilograms |
|--------|-------------|-------|---------|-------|----------|---------|----------|--------|-----------|
| 0.39   | 1 2.54      | 3.28  | 1 0.30  | 2.47  | 1 0.40   | 0.21    | 1 4.55   | 2.20   | 1 0.45    |
| 0.79   | 2 5.08      | 6.56  | 2 0.61  | 4.94  | 2 0.81   | 0.44    | 2 9.09   | 4.41   | 2 0.91    |
| 1.18   | 3 7.62      | 8.84  | 3 0.91  | 7.41  | 3 1.21   | 0.65    | 3 13.64  | 6.61   | 3 1.36    |
| 1.57   | 4 10.16     | 13.12 | 4 1.22  | 9.98  | 4 1.62   | 0.88    | 4 17.18  | 8.82   | 4 1.81    |
| 1.97   | 5 12.70     | 16.40 | 5 1.52  | 12.46 | 5 2.02   | 1.10    | 5 22.72  | 11.02  | 5 2.26    |
| 2.36   | 6 15.24     | 17.68 | 6 1.83  | 14.83 | 6 2.41   | 1.30    | 6 27.28  | 13.23  | 6 2.72    |
| 2.76   | 7 17.78     | 20.96 | 7 2.13  | 17.30 | 7 2.82   | 1.52    | 7 31.82  | 15.43  | 7 3.17    |
| 3.15   | 8 20.32     | 26.24 | 8 2.44  | 19.97 | 8 3.24   | 1.76    | 8 36.37  | 17.63  | 8 3.62    |
| 3.54   | 9 22.86     | 29.52 | 9 2.74  | 22.44 | 9 3.64   | 1.95    | 9 40.91  | 19.84  | 9 4.08    |
| 3.94   | 10 25.40    | 32.80 | 10 3.05 | 24.71 | 10 4.04  | 2.20    | 10 45.46 | 22.05  | 10 4.53   |
| 4.33   | 11 27.94    |       |         |       |          |         |          |        |           |
| 4.72   | 12 30.48    |       |         |       |          |         |          |        |           |

1 The numbers from 1 to 10 between the columns stand for either of the columns beside them as the case may be, e.g., one inch = 2.54 cm and one centimeter = 0.39 inch.

CONVERSION OF CENTIGRADE TO FAHRENHEIT <sup>1</sup>

| °C | °F    |
|----|-------|
| 0  | 32.0  |
| 1  | 33.8  |
| 2  | 35.6  |
| 3  | 37.4  |
| 4  | 39.2  |
| 5  | 41.0  |
| 6  | 42.8  |
| 7  | 44.6  |
| 8  | 46.4  |
| 9  | 48.2  |
| 10 | 50.0  |
| 20 | 68.0  |
| 30 | 86.0  |
| 40 | 104.0 |

<sup>1</sup> For converting Fahrenheit to Centigrade, use the following formula:

$$\frac{(F - 32) \times 5}{9} = C$$

or the reverse, Centigrade to Fahrenheit:

$$\frac{C \times 9}{5} + 32 = F$$

## GLOSSARY

|                  |   |
|------------------|---|
| Anus, or vent    | The posterior opening of the alimentary canal through which the excreta are ejected   |
| Brackish water   | Mainly marine water with reduced salinity caused by the mingling of salty water with fresh water  |
| Browsers         | Fishes living on leaves and shoots  |
| Calcium          | A chemical element (Ca)<br>Calcium carbonate ( $\text{CaCO}_3$ ) is known as lime   |
| Concave          | A hollow shape  |
| Conservation dam | see Dam   |
| Contour          | A line joining up points of equal height  |
| Convex           | A curved or rounded shape   |
| Crustacea        | Animals including shrimps, crabs, water fleas, etc., mostly aquatic   |
| Dam              | Artificially built storage for water  |
| Dambo            | see Vlei  |
| Detritus         | Organic debris from decomposing plants and animals  |
| Diet, balanced   | The way of feeding that includes all the essential foodstuff  |
| Encysted         | Surrounded by a cyst or shell   |
| Endemic          | Fishes occurring in a specified region  |
| Environment      | Conditions or influences under which any organism lives   |
| Erosion          | Wearing away of land by rain, floods, etc.  |
| Exotic fish      | Fish species introduced from other areas and not indigenous to a given region   |
| Factor           | A circumstance, fact, or influence which produces a result, e.g., physical, chemical, and biological factors  |
| Flood plain      | Plain regularly overflowed by flood water   |
| Food chain       | A chain of organisms where one of the organisms feeds on another from the chain below, and is eaten in turn by an organism from the chain above<br>A short food chain is present when, e.g., a plant is eaten by a fish. If the same fish is eaten in turn by a carnivorous fish, a longer food chain will be present |
| Herbivorous fish | Fish feeding on plants  |
| Hullings, maize  | Maize waste   |
| Hybrid fish      | The offspring of fishes of two different species  |
| Hypolimnion      | That part of the water mass in a lake which is deep and removed from surface influences and generally very low in oxygen  |

|                          |   |
|--------------------------|---|
| <b>Indigenous</b>        | Native to a region or a country   |
| <b>Larvae</b>            | The preadult form, which in the case of some animals hatches from the egg; e.g., tadpole of frog, larvae of mosquitoes, larvae of flies, etc. |
| <b>Laterite</b>          | Red porous rock containing iron   |
| <b>Lymphatic system</b>  | A system for the secretion and conveyance of lymph  |
| <b>Mercury</b>           | A chemical element commonly known as quicksilver (Hg), used in thermometers and for other purposes  |
| <b>Nematode</b>          | A group of small, unsegmented roundworms (thread-worms)   |
| <b>Nitrogen</b>          | A chemical element (N), contained in all nitrogenous fertilizers  |
| <b>Oligochaete</b>       | A class of Annelida comprising the earthworms and several families of small mud-living or aquatic species                                     |
| <b>Ovaries</b>           | Organs which produce eggs   |
| <b>Oxygen</b>            | A chemical element (O) essential for the respiration of most forms of life  |
| <b>Parasite</b>          | An organism living in or on another organism and drawing its food directly from it  |
| <b>Photosynthesis</b>    | The conversion by a plant of the carbon dioxide and water of the air into carbohydrates brought about by exposure to sunlight                 |
| <b>Plankton feeder</b>   | A fish that feeds on plankton   |
| <b>Progeny</b>           | A stock or line descended from a common ancestor  |
| <b>Prolific breeding</b> | A method of breeding that produces the maximum amount of offspring  |
| <b>Proteins</b>          | A complex organic compound composed of numerous amino acids   |
| <b>Proteins, animal</b>  | Proteins of animal origin   |
| <b>Reservoir</b>         | see Dam   |
| <b>Reservoir culture</b> | Artificial breeding of fish in reservoirs   |
| <b>Schist</b>            | A crystalline rock, the component minerals of which are arranged in a more or less parallel manner  |
| <b>Silt, siltation</b>   | Sediment deposited by water   |
| <b>Spawning</b>          | Breeding, the release of eggs and sperm resulting in fertilized eggs  |
| <b>Swamp</b>             | A piece of wet, spongy ground which never dries up  |
| <b>Vector</b>            | An animal which transmits parasites   |
| <b>Vitamins</b>          | Occur in minute quantities in many foodstuffs and are regarded as essential to normal growth and development                                  |
| <b>Vlei</b>              | A piece of low-lying, wet ground sometimes covered with water during the rainy season   |

## INDEX

- Acacia* 106  
Algae 128  
Alkaline reserve 129  
Alkalinity 148  
Animals, predatory 41  
Aquatic plants 99, 128  
Aquiculture 4  
Artificial food 130
- Barbus* 90, 102  
Basic slag 57  
Baskets 90  
Bass 5, 88  
*Bauhinia* 106  
Benthos 128, 129  
Bilharzia 59, 83, 99, 143  
Biological production 123 et seq.  
Biological productivity of waters 129  
Bluegill 5  
Breeding habits, 138  
    *Haplochromis* 77  
    *T. andersonii* 75  
    *T. macrochtr* 73  
    *T. melanopleura* 70  
    *T. mossambica* 72  
    *T. sparrmanii* 71  
    *Serranochromis* 77
- Calcium 124  
Carp 5, 7, 15, 61  
Catfish 123, 133, 135  
*Chara* 128  
Checks daily, 45  
    weekly 45, 46  
    monthly 46  
Cichlid (family) 5, 17, 24, 62, 63, 83, 89, 134  
*Clarias* 83, 123  
Core (or key) trench 34  
Cropping See under ponds and dams
- Dambo 11, 12, 16, 21, 33  
Dams (conservation) 79  
    clearing 81  
    cropping 89, 104  
    stocking 83, 88  
    stumping 81, 83, 84-85  
Demonstration 12  
Diseases 105,106  
Draining (ponds) 45  
Ducks 59
- Eichhornia crassipes* (water hyacinth) 99  
Epilimnion 125  
Equipment for pond construction 42  
Eutrophic 129  
Extension 12
- Fence 41, 43  
Fertilizers organic, 48  
    inorganic 48  
Filling (of ponds) 44  
Fish, anatomy of 131 et seq.  
    biology of 131 et seq.  
    carnivorous 137  
    culture 3, 7-8, 11, 43, 108  
    drying of 114-118  
    farming 58  
    grass-eating 128  
    growth of 71-76, 138  
    herbivorous 137  
    identification of 62-63, 134  
    loss of 98  
    mortalities 106-107  
    omnivorous 137  
    predatory 58, 105, 137  
    production 3, 97, 98  
    size of 98  
    spawning 138, 145  
    spoilage and preservation 142, 112-114  
    storage of 118



Fish, structure of 131 et seq.  
Fish culture economics of, 108  
Furrow 19

Gill netting 90, 93, 94  
*Gnathonemus macrolepidotus* 90  
Grain foods 50  
Grass planting 39, 41

*Haplochromis* 17, 61, 62, 63, 69, 77-78,  
83, 88, 103, 144  
Hypolimnion 125

Individual pond record 140  
Insect larvae 128  
Instruction 12

Key trench See core trench

*Labeo* spp. 90  
Liming 47, 57  
Lines 90  
Littoral zone 126  
Liver fluke 83, 99  
Lungfish 123

Malaria 99, 143, 144  
Manure (duck, pig) 59-60  
Mesotrophic 129  
Metalimnion 125  
*Micropterus salmoides* 58  
Mixed method culture 57  
Monosex culture 58  
*Mormyrus* spp. 133  
Mosquitoes 83, 103, 144

Nematodes 128  
*Nitella* 128  
Nitrogen 123  
Nutrient salts 124, 129

Offal 118-119  
Oligochaets 128  
Oligotrophic 129  
Operculum(a) 134  
Otters 22, 41, 105  
Oxygen 123, 129, 135, 137, 145-147

Ponds 79  
barrage 14, 15, 18, 27, 34  
construction 11 et seq.  
construction - labor costs 152  
construction - walls 22-23, 44

Ponds contour 13, 15, 18, 33  
paddy 14-15, 16, 27, 34  
sites for 17, 21 22  
stocking of 49, 57, 60  
water level in 44

Paddy rice 60  
*Periphyton* 128  
pH 129, 147  
Pharyngeal teeth 134  
Phosphorus 124  
Phytoplankton 127, 129  
Pisciculture 4  
Plankton 127, 129, 137, 148  
Plants as food 50  
Potash 124  
*Potamogeton* 128  
Production (of ponds) 56  
Profundal zone 126  
Protein for consumption 3, 11, 143

Quantities of food 50

*Schilbe mystus* 90  
*Salvinia auriculata* (Kariba weed) 99  
Seine netting 89, 91, 92  
Separate age method culture 57-58  
*Serranochromis* 58, 61-64, 67, 68-69, 83  
Snails 59, 103, 128, 144  
*Strigeidae* 106  
Superphosphate 48, 57

Temperature 124, 125, 137, 145  
Tench 5  
*Tilapia* 7, 17, 58, 61, 62, 63, 83, 88, 103,  
106  
*Tilapia andersonii* 60, 63, 74-75, 76  
*Tilapia macrochir* 60, 63, 73, 76, 88  
*Tilapia melanopleura* 62, 63, 70, 71, 76,  
83, 99, 134  
*Tilapia mossambica* 60, 63, 72, 88, 138  
*Tilapia sarrmanii* 63, 70, 71  
*Tilapia zillii* 63  
Transport 109, 112  
Traps 90  
Trout 5, 61, 62, 88

Water level 44  
lilies 128  
quality of 19, 98, 124-126  
sources of 18, 19  
supply of 17-19  
Weed control 46, 47  
Weirs 79

Zooplankton 127, 129

## FAO SALES AGENTS AND BOOKSELLERS

|                                 |   |
|---------------------------------|---|
| <b>Mauritius</b>                | Nalanda Company Limited, 30 Bourbon Street, Port Louis.   |
| <b>Mexico</b>                   | Sucesión de Manuel Gómez Pazuala y M., Donceles 12, México, D.F.; Editorial Iztaccihuatl, S.A., Miguel Schultz 21, México 4, D.F.; Av. Morelos Ote 437, Monterrey, N.L.; Colón 178, Guadalajara, Jal.; Librería Casarrubias, S.A., Apartado Postal 1-962, Guadalajara, Jal.; Librería Agropecuaria, Av. La Paz 1622, Guadalajara, Jal.                        |
| <b>Morocco</b>                  | Librairie "Aux Belles Images," 281 avenue Mohammed V, Rabat.  |
| <b>Netherlands</b>              | N.V. Martinus Nijhoff, Lange Voorhout 9, The Hague.   |
| <b>New Zealand</b>              | Government Printing Office: Government Bookshop at Rutland Street, P.O. Box 5344, Auckland; Mulgrave Street, Private Bag, Wellington; 130 Oxford Terrace, P.O. Box 1721, Christchurch; Princes Street, P.O. Box 1104, Dunedin; Alma Street, P.O. Box 857, Hamilton.   |
| <b>Nicaragua</b>                | Librería Universal, 15 de Septiembre 301, Managua.  |
| <b>Nigeria</b>                  | University Bookshop Nigeria Ltd., University College, Ibadan.   |
| <b>Norway</b>                   | Johan Grundt Tanum Forlag, Karl Johanagt. 43, Oslo.   |
| <b>Pakistan</b>                 | Mirza Book Agency, 65 The Mall, Lahore 3.   |
| <b>Panama</b>                   | Agencia Internacional de Publicaciones J. Menéndez, Apartado 2052, Panama.  |
| <b>Peru</b>                     | Librería La Universidad, Av. Nicolás de Piérola 639, Lima; Librería Studium, Amargura 939, Lima; Distribuidora Inca, Emilio Althaus 470, Lince, Lima.   |
| <b>Philippines</b>              | The Modern Book Company, 928 Rizal Avenue, Manila.  |
| <b>Poland</b>                   | Ars Polona-Ruch, Krakowskie Przedmiescie 7, Warsaw.   |
| <b>Portugal</b>                 | Livraria Bertrand, S.A.R.L., Apartado 37, Amadora; Galeria Itau, Rua de Entrecampos 66-A, Lisbon 6.   |
| <b>Romania</b>                  | Rompresifitetia, P.O. Box 2001, Bucharest (periodicals only); Romlibri, Str. Biserica Antzei 3-5, Bucharest (nonperiodical publications).   |
| <b>Saudi Arabia</b>             | Khazindar Establishment, King Faysal Street, Riyadh.  |
| <b>Singapore</b>                | Parrys Book Centre, 25 Lobby Arcade, K.L. Hilton, Rn. Treacher, Kuala Lumpur (Malaysia).  |
| <b>Somalia</b>                  | "Samater's," P.O. Box 936, Mogadiscio.  |
| <b>Spain</b>                    | Librería Mundi-Pransa, Castelló 37, Madrid; Librería Agrícola, Fernando VI 2, Madrid 4; José Bosch, Librero, Ronda Universidad 11, Barcelona; "Adha," Av. General Mitre 100, Barcelona.   |
| <b>Sri Lanka</b>                | M.D. Gunasena and Co. Ltd., 217 Norris Road, Colombo 11.  |
| <b>Sweden</b>                   | C.E. Fritz, Fredsgatan 2, 103 27 Stockholm 16; Universitetsbokhandel, Sveavägen 166, Stockholm Va.; Gumperts A.B., Göteborg.  |
| <b>Switzerland</b>              | Librairie Payot S.A., Lausanne and Geneva; Hans Raunhardt, Kirchgasse 17, Zurich 1.   |
| <b>Syrian Arab Rep.</b>         | Librairie Internationale, B.P. 2456, Damascus.  |
| <b>Tanzania</b>                 | Dar es Salaam Bookshop, P.O. Box 9030, Dar es Salaam.   |
| <b>Thailand</b>                 | FAO Regional Office for Asia and the Far East, Mafiwan Mansion, Bangkok; Suksapan Panit, Mansion 9, Rajadamnern Avenue, Bangkok.  |
| <b>Togo</b>                     | Librairie du Bon Pasteur, B.P. 1164, Lomé.  |
| <b>Turkey</b>                   | Librairie Hachette, 469 Istiklal Caddesi, Beyoglu, Istanbul.  |
| <b>Uganda</b>                   | The E.S.A. Bookshop, P.O. Box 2615, Kampala.  |
| <b>United Kingdom</b>           | Her Majesty's Stationery Office, 49 High Holborn, London, W.C.1; P.O. Box 569, London, S.E.1 (trade and London area mail orders); 13, Castle Street, Edinburgh EH2 3AR; 109 St. Mary Street, Cardiff CF1 1JW; 7 Linenhall Street, Belfast BT2 8AY; Brazennose Street, Manchester M60 8AS; 268 Broad Street, Birmingham 1; 60 Fairfax Street, Bristol BS1 3DE. |
| <b>United States of America</b> | UNIPUB, Inc., 660 First Avenue, P.O. Box 433, Murray Hill Station, New York, N.Y. 10016.  |
| <b>Uruguay</b>                  | Barreiro y Ramos, 25 de Mayo esq. J.C. Gómez, Montevideo; Librería Albe, Soc. Com., Cerrito 566, Montevideo.  |
| <b>Venezuela</b>                | Librería Politécnica, Apartado 50739, Sabana Grande, Caracas; Librería del Este, Pericáe S.A., Av. Fco. de Miranda 52, Edificio Galipán, Caracas.   |
| <b>Yugoslavia</b>               | Jugoslovenska Knjiga, Terazije 27/11, Belgrade; Prosveta Export-Import Agency, Terazije 16, Belgrade; Cankarjeva Založba, P.O. Box 201 - IV, Ljubljana.   |
| <b>Other countries</b>          | Requests from countries where sales agents have not yet been appointed may be sent to: Distribution and Sales Section, Food and Agriculture Organization of the United Nations, Via delle Terme di Caracalla, 00100 Rome, Italy.  |

*FAO publications are priced in U.S. dollars and pounds sterling. Payment to FAO sales agents may be made in local currencies.*