

AT MICROFICHE
REFERENCE
LIBRARY
A project of Volunteers in Asia

Vegetable Production Under Arid and Semi-Arid
Conditions in Tropical Africa

By: FAO Plant Production and Protection: Paper 89

Published by: Food and Agriculture Organization of the United Nations
Publications Division
Via delle Terme di Caracalla
00100 Rome
Italy

Available from: UNIPUB
4611-F Assembly Drive
Lanham MD 20706-4391
U.S.A.

Reproduced with permission.

Reproduction of this microfiche document in any form is subject to the same restrictions as those of the original document.

Vegetable production under arid and semi-arid conditions in tropical Africa

FAO
PLANT
PRODUCTION
AND PROTECTION
PAPER



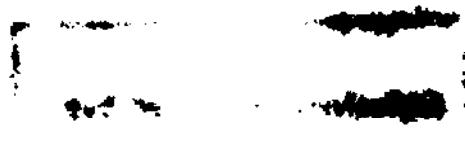

Cover photo: Healthy tomato plantlet of the cultivar "ROMA", at the correct stage for transplanting (Dagana, Senegal - October 1978)

Vegetable production under arid and semi-arid conditions in tropical Africa

A manual prepared by
the Horticultural Crops Group of the
FAO Plant Production and Protection Division

Exclusively Distributed by:

~~BERNARD~~ - UNIPUB

4611 - F Assembly Drive

Lanham, MD 20706-4391

(301) 459-7666

Order No.: F 7/88

Price: \$45.00

Plus postage and handling

The designations employed and the presentation of material in this publication do not imply the expression of any opinion whatsoever on the part of the Food and Agriculture Organization of the United Nations concerning the legal status of any country, territory, city or area or of its authorities, or concerning the delimitation of its frontiers or boundaries.

M-11-

ISBN 92-5-102718-8

All rights reserved. No part of this publication may be reproduced, stored in a retrieval system, or transmitted in any form or by any means, electronic, mechanical, photocopying or otherwise, without the prior permission of the copyright owner. Applications for such permission, with a statement of the purpose and extent of the reproduction, should be addressed to the Director, Publications Division, Food and Agriculture Organization of the United Nations, Via delle Terme di Caracalla, 00100 Rome, Italy.

© FAO 1988

This manual has been prepared by the Horticultural Crops Group of the Plant Production and Protection Division, under the technical supervision of W.O. Baudoin, coordinating editor, based on the contributions made by:

- E.F. Collingwood, L. Bourdouxhe and M. D'Hondt, in the field of Plant Protection;
- H. Van Der Veken, in the field of Crop Production Management;
- G. De Lannoy, in the fields of Plant Breeding, Seed Production and Crop Ecology;
- J. Delvaque, in the fields of Post Harvest Handling and Marketing;

and

- L.B. Thrower, in the fields of Development Policy and Research, and as technical editor of the manual

Special guidance has been provided by U.G. Menini, Senior Officer of the Horticultural Crops Group, on selected technical subjects.

Particular acknowledgement is made of contributions from A. Pecrot who prepared the section in the manual on soils, from M. Frère and G.F. Popov for their assistance in revising the section on climatology and from J. Meyer for his scientific advice.

FOREWORD

Over the past decade vegetable growing has developed in most of the countries of the arid and semi-arid region. In tropical Africa, mainly as a result of expanding urbanization.

Particularly in the Sahelian belt, intensive irrigated vegetable crop production is being promoted to make efficient use of limited water resources and also to further a growing awareness of the high potential yields of vitamins, protein and essential minerals produced by vegetables in terms of both yields per unit area and duration of the cropping season.

These comparatively new trends in the development of vegetable crop production in this region raises questions related to production and protection techniques, crop varieties, storage, and marketing organization. In addition to production for local markets, there has also been some growth for export to European and Near Eastern countries which has led, in certain favoured districts, to specialized and intensified production for these markets. In such cases, the technical problems are complicated by the need for high quality, freedom from blemish and expert grading and packing. The seasons of production must also be carefully controlled to meet market demands.

Vegetable species have been introduced to tropical Africa from the Near East, Europe and the Americas over the course of several centuries and many have become well adapted to local conditions, but the introduction of modern high-yielding varieties from Europe and the USA during the twentieth century has not always been successful. Pests and diseases have been common sources of unwelcome surprises; the introduction of modern equipment and techniques from highly specialized regions has sometimes proved uneconomic and impractical. It has been demonstrated repeatedly that careful trial and investigation must precede successful commercial production and, it must be added, successful storage and marketing.

In the present study, an attempt has been made to illustrate and explain the technical principles underlying the selection of suitable production and protection techniques and plant material. A brief review is made of the methods of analyzing production costs and of the various ways in which production and marketing can be developed. Many difficulties and failures in all these fields have resulted and, of course, solutions have to be worked out in each locality according to ecological and economic conditions. There are, nevertheless, a number of common factors which apply throughout each climatic zone of the region under discussion and tables are presented suggesting suitable varieties, irrigation rates and other technical details, to serve as an orientation and to indicate the range of practices and material within which a satisfactory choice can probably be made. There is nothing final about these tables because conditions change and the search for adaptation and improvement must be continuous. Constant observation must be maintained of changing weather conditions, changing pest and disease conditions and changes in market demand. All these factors call for changes in production and protection techniques, and the search for better adapted, more resistant and higher yielding varieties.

It is emphasized that the information in this manual applies primarily to the dry, lowland climates of tropical Africa. Conditions in the warm, humid climates of the gulf of Guinea and the Congo Basin and in the cool, humid climates of many highland areas of Ethiopia and Kenya,

demand different techniques and varieties, and often concern different species. Vegetable production techniques in these areas and, of course, in the sub-tropical and temperate regions of Africa are, for the most part, subjects for separate research.

It must be admitted that research work in vegetables in the semi-arid tropical zone of Africa has been late in commencement. Although some pioneer trials were made in the 1960s, it was not until the 1970s that much serious work was undertaken.

The most intensive research programme on vegetable production in the region has been carried out in Senegal, where the "Centre pour le Développement de l'Horticulture" (C.D.H.) was established with FAO assistance at Cambérèbe in the Cap Vert in 1972, and since 1975 has been supported through the FAO Trust Fund by the Government of Belgium.

Unfortunately, technical information in this field has not always been easily accessible as it has been scattered in numerous official reports from 'CDH' and other research stations in the region.

This manual has been prepared by the Horticultural Crops Group on the basis of a series of texts on development policy, production and protection techniques, breeding and marketing by specialized authors, all of whom, including the coordinating editor, have served as FAO field officers in the "Centre pour le Développement de l'Horticulture".

Reference has also been made to technical publications on related subjects, including FAO bulletins and reports from FAO experts formerly attached to the Institute of Agricultural Research in Ethiopia, the National Horticultural Research Institute in Nigeria and the Horticultural Research Institute in Kenya.

This document attempts to give an account of available information regarding irrigated vegetable cultivation in arid and semi arid regions of tropical Africa together with a discussion of the results obtained which can be the basis for further research to be continued and developed.

L. Brader
Director
Plant Production and Protection Division

51. Handbook on jute, 1983 (E')
52. The palmyrah palm: potential and perspectives, 1983 (E')
53. Selected medicinal plants, Vol. I, 1984 (E')
54. Manual of fumigation for insect control, 1984 (E')
55. Breeding for durable disease and pest resistance, 1984 (E')
56. Pesticide residues in food 1983 — Report, 1984 (E' F')
57. Coconut, tree of life, 1984 (E')
58. Economic guidelines for crop pest control, 1984 (E' F')
59. Micropropagation of selected rootcrops, palms, citrus and ornamentals, 1984 (E')
60. Minimum requirements for receiving and maintaining tissue culture propagating material, 1984 (E' F' S')
61. Pesticide residues in food 1983 — Evaluations, 1985 (E')
62. Pesticide residues in food 1984 — Report, 1985 (E' F' S')
63. Manual of pest control for food security reserve grain stocks, 1985 (E')
64. Contribution à l'écologie des apilles africains, 1985 (F')
65. Amélioration de la culture irriguée du riz des petits fermiers, 1985 (F')
66. Sesame safflower: status and potentials, 1985 (E')
67. Pesticide residues in food 1984 — Evaluations, 1985 (E')
68. Pesticide residues in food 1985 — Report, 1985 (E' F')
69. Breeding for horizontal resistance to wheat diseases, 1986 (E')
70. Breeding for durable resistance in perennial crops, 1986 (E')
71. Technical guideline on seed potato micropropagation and multiplication, 1986 (E')
- 72/1. Pesticide residues in food 1985 — Evaluations — Part I: Residues, 1986 (E')
- 72/2. Pesticide residues in food 1985 — Evaluations — Part II: Toxicology, 1986 (E')
73. Early agrometeorological crop yield assessment, 1986 (E')
74. Ecology and control of perennial weeds in Latin America, 1986 (E')
75. Guía técnica para ensayos de variedades en campo, 1986 (S')
76. Guidelines for seed exchange and plant introduction in tropical crops, 1986 (E')
77. Pesticide residues in food 1986 - Report, 1986 (E' F')
78. Pesticide residues in food 1986 - Evaluations - Part I: Residues, 1986 (E')
- 78/2. Pesticide residues in food 1986 - Evaluations - Part II: Toxicology, 1987 (E')
79. Tissue culture of selected tropical fruit plants, 1987 (E')
80. Improved weed management in the Near East, 1987 (E')
81. Weed science and weed control in Southeast Asia, 1987 (E')
82. Hybrid seed production of selected cereal, oil and vegetable crops, 1987 (E')
83. El litche y su cultivo, 1987 (S')
84. Pesticide residues in food 1987 — Report, 1987 (E' F' S')
85. Manual on the development and use of FAO specifications for plant protection products, 1987 (E')
- 86/1. Pesticide residues in food 1987 — Evaluations — Part I: Residues, 1988 (E')
- 86/2. Pesticide residues in food 1987 — Evaluations — Part II: Toxicology, 1988 (E')
87. Root and tuber crops, plantains and bananas in developing countries — challenges and opportunities, 1988 (E')
88. *Jessenia* and *Oenocarpus*: neotropical oil palms worthy of domestication, 1988 (E')
89. Vegetable production under arid and semi-arid conditions in tropical Africa, 1988 (E' F')
90. Cultures protégées en climat méditerranéen, 1988 (F')

Availability: September 1988

Ar — Arabic
 C — Chinese
 E — English
 F — French
 S — Spanish

• Available
 .. Out of print
 ... In preparation

The FAO Technical Papers can be purchased locally through the authorized FAO Sales Agents or directly from Distribution and Sales Section, FAO, Via delle Terme di Caracalla, 00100 Rome, Italy.

CONTENTS

	<u>Page</u>
FOREWORD	i
I. <u>DEVELOPMENT POLICY AND RESEARCH</u> by L.B. Throver	1
1. Expanding needs of urban markets	1
2. The organization of surveys	5
3. Production for internal markets versus exports	5
4. Government services to growers	8
5. Conclusions	13
II. <u>THE INFLUENCE OF ECOLOGICAL CONDITIONS</u> by G. de Lannoy	14
1. Atmospheric conditions controlling the meteorological characteristics of the region	14
(a) Atmospheric circulation	14
(b) The movement of the meteorological equator	19
(c) Prevailing winds	19
(d) The discontinuity of trade winds	20
(e) The Inter-Oceanic Confluence	20
2. Climatic classification according to rainfall	20
3. Influence of principle climatic elements other than rainfall on the growth and development of vegetable crops	23
(a) Solar radiation	23
(b) Temperature	30
(c) Atmospheric humidity	33
(d) Wind	35
4. Major soils of the region and their suitability for vegetable production	37
(a) Major soil units	37
(b) Distribution of main soil associations	40
(c) Soils adaptable to vegetable production	41
References	44
III. <u>PRODUCTION MANAGEMENT AND TECHNIQUES</u> by H. Van der Veken	
A. Different types of production units	46
B. Factors affecting the choice of site and the influence on production	48
C. Manual and mechanical soil cultivation	59
D. Propagation and Planting	62
E. Protection of crops from adverse climatic factors	68

	<u>Page</u>
F. Cultural operations	72
G. Fertilization	75
H. Irrigation	87
I. Rotations	101
J. General conclusions	111
Annex A : Water quality	112
Annex B : Irrigation	118
Annex C : Fertilization	130
References	140
IV. <u>THE INCIDENCE OF PESTS AND DISEASES AND METHODS OF CONTROL</u> <u>by E.F. Collingwood, L. Bourdouxhe and M. D'Hondt</u>	144
A. General	145
B. The agents responsible for crop losses	145
1. Insects	145
2. Spider mites	150
3. Fungi	150
4. Viruses	154
5. Mycoplasma-like organisms	155
6. Bacteria	155
7. Plant parasite nematodes	156
8. Weeds	156
9. Non-parasitic disorders	157
C. Crop losses	158
D. The effect of some environmental factors	163
1. On insect pests	163
2. On fungus diseases	164
E. Control of pests and diseases	166
1. Control methods not involving the use of pesticides	167
2. Use of pesticides	176
3. Application of pesticides	182
4. Integrated control	
References	194
V. <u>SOME SPECIFIC PROBLEMS OF IRRIGATED VEGETABLE CROPS</u> <u>by E.F. Collingwood, L. Bourdouxhe and M. D'Hondt</u>	196
A. Problems common to several crops	197
1. Insect pests	197
2. Spider mites	199
3. Nematodes	201

	<u>Page</u>
4. Damping off	202
5. Vertebrates	202
B. Bean (dwarf, French, haricot, snap)	202
C. Cabbage	207
D. Carrot	215
E. Cucurbits	218
F. Eggplant or aubergine	226
G. Lettuce	231
H. Okra	232
I. Onion	238
J. Peppers (sweet and hot)	243
K. Potato	247
L. Roselle	256
M. Scarlet eggplant	256
N. Sweet potato	257
O. Tomato	260
Annex A : Some pesticides used for protection of vegetable crops	274
References	276
VI. <u>THE BREEDING AND IMPROVEMENT OF VEGETABLE CROPS</u> by G. de Lannoy	279
A. Natural evolution and genetic variability	279
B. Domestication and differentiation of local varieties	281
C. Objectives of breeding	282
D. General principles	283
E. Sexual expression and classification of species	285
F. Systems of reproduction in vegetable species	286
G. Breeding self-pollinated species	288
1. Basic principles	288
2. Mass selection	289
3. Pure line selection	291
4. Genealogical selection	291
5. Cross breeding	294
6. Bulk population method	297
7. Other methods of breeding	299
H. BREEDING OF CROSS-POLLINATED SPECIES	300
1. Basic principles	300
2. Mass selection	302
3. Selection by families	302
4. Selection by inbred lines	308

	<u>Page</u>
5. Creation of hybrid varieties	308
6. Other methods of improvement	312
I. Improvement of vegetatively propagated species	317
J. Selection for resistance to parasites	319
1. General principles	319
2. Types of resistance and their genetic control	321
3. Search for sources of resistance	322
4. Methods of genetic improvement	325
K. Evaluation of varieties	327
1. General principles	327
2. Choice of experimental units	327
3. Choice of observations	329
4. Different types of error	330
5. Choice of experimental design	330
L. Multi-local and/or pluriannual trials	335
Annex A : Classification of vegetable species according to system of reproduction and sexual expression	336
Annex B : Calculation of the effects of a series of self-pollinations	337
Annex C : Calculation of selection differential and of the selection response	338
Annex D : Back-crossing techniques	340
Annex E : Male sterility and the creation of hybrid varieties of onion	343
References	345
VII. SEED PRODUCTION by G. de Lannoy	346
1. Introduction	346
2. Registration, certification and classification	346
3. Production techniques	348
4. The influence of climatic conditions	348
5. Control of pollination	349
6. Roguing	350
7. Harvesting	351
8. Extraction and drying	352
9. Cleaning, sorting, grading and disinfection	354
10. Storing	355

	<u>Page</u>
Annex A : Example of a programme of seed production of a variety of onion for the provision of a local market	357
Annex B : Classification of certain vegetable species according to their heat requirement for flowering, mode of pollination and distance necessary for isolation for seed production ..	358
Annex C : Stage of development for roguing and characteristics to observe during selection ..	359
Annex D : Classification of certain vegetable species according to season and duration of harvest condition of fruit and seed yield	360
VIII. <u>THE PREPARATION OF CROPS FOR MARKET</u>	361
by J. Delvaque	
A. General considerations	361
B. Characteristics of vegetable crops	361
C. The relationships between producer, distributor and consumer	363
D. Harvesting	364
E. Storing	367
F. Packing and grading	371
G. Standardisation	381
H. Transport	386
Annex A : The heat of respiration	389
Annex B : Temperatures and humidities for vegetable storage	390
Annex C : Temperatures and humidity for the transport of vegetables under refrigeration . .	391
Annex D : Quality standards for tomatoes	392
IX. <u>COMMERCIAL ORGANIZATION OF PRODUCTION AND MARKETING</u>	393
by J. Delvaque	
A. Types of production unit	393
B. Types of marketing organization	396
C. Commercial conditions in Africa	397
D. The systems of sale	398
E. Settlement of accounts	400
F. Special systems of sale	401

	<u>Page</u>
G. Retail trade	402
H. The evolution of prices	403
I. Export markets	407
Annex A : Production costs	412
References	434

LIST OF TABLES

	<u>Page</u>
<u>CHAPTER I</u>	
1. Eight arid and semi-arid countries of tropical Africa Population statistics	3
<u>CHAPTER II</u>	
1. Classification of tropical climates of Boreal Africa	21
2. Classification of selected vegetable species according to their photosynthetic response to intensity of illumination and temperature levels	25
3. Classification of the principal vegetable species according to their photoperiodic responses	29
<u>CHAPTER III</u>	
1. Classification of vegetable crops according to their optimum growing temperatures	49
2. Classification of vegetable crops according to their tolerance of acidity	55
3. Time necessary for manual planting or sowing of a total area of 1000 m ² on sandy soil	66
4. List of trees suitable for wind-breaks	71
5. Average weight of mineral elements removed by different vegetable crops (kg/ha per ton harvested)	76
6. Foliar applications for various nutritional deficiencies	81
7. Coefficient of evaporation (Kp) for a Class A vat	89
8. Efficiency of irrigation methods	90
9. Speeds of infiltration in different types of soil	91
10. Available water in different types of soil	92
11. Depth of effective rooting of vegetable crops at maturity	93
12. Guide to vegetable crop rotation	104
Annex A, 1 : The calculation of adjusted S.A.R.	112
A, 2 : Tables for calculation of pHc	112
A, 3 : Example of the calculation of pHc	113
A, 4 : Laboratory determination needed to evaluate water quality	114
A, 5 : Tolerance of vegetable crops to salinity and boron	115

	<u>Page</u>
A, 6 : The tolerance of vegetable crops to the presence of boron in the irrigation water	116
A, 7 : Recommended maximum concentrations of trace elements in irrigation waters	117
Annex B, 1 : Water requirements in m ³ /ha of irrigation per crop according to species and method	118
B, 2 : Determination of the Evapotranspiration of the reference crop at CDH, based on the values of evaporation in mm from a Class A vat	119
B, 3 : Crop co-efficient (Kc) of vegetable crops for the last two phases of growth with indications of atmospheric humidity	120
B, 4 : Average duration in days of the total cycle and different stages of growth by species at CDH	121
B, 5 : Estimation of available water in soil by appearance and touch	122
B, 6 : Doses and frequency of irrigation in l/m ² /day by species according to different phases of development in a sandy soil	123
B, 7 : Class A evaporation vat	124
B, 8 : Description of an irrigation system covering one hectare using drag-line sprinklers	125
B, 9 : Maximum length of furrows according to type of soil, slope and depth of water distributed	128
B,10 : Relationship of the maximum water debit and critical slope of furrow for avoidance of erosion	128
B,11 : Water debit of small siphons and tubes according to diameter and pressure	128
B,12 : Calculation of average depth of water applied by furrow irrigation	129
Annex C, 1 : Content of fertilizer equivalents in selected organic manures	130
C, 2 : Principle inorganic fertilizers and their characteristics	131
C, 3 : Manurial applications and dosages	133

CHAPTER IV

1. Classification of insects	147
2. (a) to (f) Crop losses in Senegal caused by insect pests and nematodes	160
3. Susceptibility of vegetable and other crops to <u>Meloidogyne</u> attack	174

CHAPTER V

Annex A : Some pesticides used for the protection of vegetable crops	274
--	-----

CHAPTER VII

Annex A	:	Classification of vegetable species according to heat requirement for flowering, mode of pollination and distance necessary for isolation for seed production	358
Annex C	:	Stage of development for roguing and characteristics to observe during selection	359
Annex D	:	Classification of vegetable species according to season and duration of seed harvest and seed yield	360

CHAPTER VIII

1.		The principle types of packing used for vegetables	377
Annex A	:	Heat of respiration in Kcal/ton/24 hours	389
Annex B	:	Temperature and humidities for vegetable storage	390
Annex C	:	Temperature and humidities for transport of vegetables under refrigeration	391

LIST OF FIGURES

	<u>Page</u>
<u>CHAPTER II</u>	
1. Structure of troposphere in January and July	15
2. The movement of the meteorological equator between January and July	16
3. General meteorological conditions over Africa in January	17
4. General meteorological conditions over Africa in July	18
5. Distribution of tropical arid, semi-arid and sub-humid climatic zones of Africa in northern hemisphere	22
6. Mean minimum and maximum temperatures ($^{\circ}\text{C}$) in January and July in the arid and semi-arid zones of tropical Africa	24
7. A. Variations in photosynthetically effective illumination during fine weather at different latitudes in northern hemisphere during the course of the year	27
B. Monthly variations of day-length in function of the latitude at certain stations in the arid and semi-arid zones of tropical Africa	28
8. Photoperiodic responses of the potato and onion, and the classification of their varieties according to critical photoperiods for tuberisation and bulb formation	31
9. Relationship between temperature, vapour pressure and relative humidity	34
10. Potential evapotranspiration (PET) calculated according to the modified Penman Method for 47 stations in the arid and semi-arid zone	36
11. Main soil associations of tropical Africa north of the Equator	38
<u>CHAPTER III</u>	
1. Diagrammatic classification of irrigation waters	52
2. Influence of pH on availability of nutritive elements in organic soils	56
3. Influence of pH on availability of nutritive elements in mineral soils	57
4. Effect of an impermeable wind-break	69
5. Effect of a permeable wind-break	69

	<u>Page</u>
6. Roads crossing lines of wind-breaks oblique to the direction of prevalent winds	70
7. Staking of vegetable crops	73
8. Different layouts for sprinkler irrigation systems	96
9. Example of a sprinkler irrigation system showing essential items of equipment	97
10. Layout of irrigation by rotating ramp	98
11. Furrow irrigation	99
12. Annex B : Class A vat	125
13. Annex B : Irrigation by drag-line sprinklers	126

CHAPTER IV

1. Identification of insect larvae	148
2. Insects	149
3. Some fungal spores	153
4.1 Injector	185
4.2 Piston pump (section)	185
4.3 Section through sprayer with diaphragm pump	186
5. Herbicide application using impact nozzle	190

CHAPTER V

1. Some pests which attack a variety of vegetable crop	198
2. Examples of the effects of attacks of the nematode <u>Meloidogyne</u>	200
3. Examples of the effects of sunburn and desert wind	201
4. Some pests of beans	204
5. Some diseases of French beans	206
6. Some insect pests of cabbage	209
7. Bacterial and fungal diseases of cabbage	212
8. Exposure of cabbage to attacks by insect pests, fungi and nematodes in the Cap-Vert region of Senegal	216
9. Some pests and diseases of Cucurbitaceous vegetables	220
10. Some pests and diseases of aubergines	228
11. Some insect pests of okra	233

	<u>Page</u>
12. Some fungus diseases of okra	236
13. Some fungus diseases of onion	240
14. Some pests and diseases of peppers	244
15. Some insect and mite pests of potato	248
16. Some fungus diseases of potato	252
17. Caterpillar and bacterial attacks and physiological diseases of tomato	261
18. Fungus diseases of tomato	265

CHAPTER VI

1. Positive mass selection repeated through several generations	290
2. Pure line selection	292
3. Genealogical selection	293
4. Bulk population method	298
5. Selection by families for an annual species	304
6. Selection by families over 4 years in the case of a biennial species whose principle characters can be evaluated before flowering	305
7. Selection by families over a 6-year cycle of a biennial species whose principle characters can be evaluated before flowering	306
8. Phenotypic selection of an annual species based on a progeny test by the "plant to row" method	307
9. Selection by inbred lines of a biennial, self-fertile species whose principle characters can be evaluated before flowering	309
10. Simple recurrent selection of a self-fertile annual species	313
11. Recurrent selection of a self-fertile annual species with a combining aptitude test	314
12. Reciprocal recurrent selection of an annual self-fertile species	316
13. Clonal selection of a vegetatively propagated species	318
14. Principle types of borders for use between contiguous plots of different varieties of the same species	328

	<u>Page</u>
15. Example of a completely randomised layout for the comparison of 4 varieties replicated 5 times, plus the diagram for the corresponding analysis of variance	331
16. Example of a layout in completely randomised blocks for the comparison of 4 varieties replicated 5 times, plus the diagram for the corresponding analysis of variance	333
17. Example of layout in a latin square, of five varieties replicated five times, plus the diagram for the corresponding analysis of variance	334
Annex B : Effect of selfing over 10 successive generations on an autogamous population with different numbers of heterozygotic pairs of alleles	337
Annex D,1 : Evolution of a self-pollinated population after successive back-crosses on the scale of a single locus	340
D,2 : Back-crossing technique in the case of a single dominant gene	341
D,3 : Back-crossing technique on alternate generations in the case of a recessive gene	342
Annex E : Diagram of the production of an F ₁ hybrid variety of onion by the use of genetic and cytoplasmic male sterility	344

CHAPTER VII

1. Relationship of the water content of seeds of certain vegetable species to the atmospheric humidity at 25°C	356
--	-----

CHAPTER VIII

1. Naturally ventilated onion store	369
2. Packing for sale in wooden trays and boxes	378
3. Packing for sale in cardboard containers	379

CHAPTER IX

1. The distribution of vegetables: routes between consumer and producer	404
2. Theoretical price curve of horticultural products	405

CHAPTER I

DEVELOPMENT POLICY AND RESEARCH

by L.B. Thrower

1. EXPANDING NEEDS OF URBAN MARKETS

One of the many important historical changes of the 20th century has been the population explosion in Africa, combined with rapid urbanisation since the 1950's. Statistics for the Sahelian and neighbouring countries are incomplete and not always easy to trace, but the following figures indicate the general trend (see Table 1).

Senegal, the Sudan and Somalia are among the best documented and have exhibited some of the most remarkable examples of urban growth, but other countries in the region show the same general tendencies.

- The total population of Senegal in 1961 was estimated at 3,102,000 increasing to 4,907,000 in 1976 (census), an estimated 5,900,000 in 1982 and 6,400,000 in 1984. The population of Dakar was 230,887 in 1955 (census) and 798,792 in 1976. Figures for 1984 have not been traced but the rural exodus is known to have been marked and the population now is expected to be at least one million.
- The total population of the Sudan is reported to have been 10,263,000 in 1955/56, 14,958,000 in 1973, 16,126,000 in 1976 and 20,564,000 in 1983. The population of the urban agglomeration of the three towns Khartoum/Khartoum North/Omdurman was about 245,800 in 1956, 610,600 in 1970, 784,204 in the 1973 census and about 1,424,000 in 1983. The percentage of urban population increased from 12.5% in 1972 to 20.2% in 1983.
- Estimates of the total population of Somalia in the 1960's have not been traced. U.N. estimates in 1974 were 3,090,000 and in 1980 4,637,000. The total population in 1984 has been estimated at 5,450,000. Mogadishu, although not a large city, has also shown a rapid increase in size. The population was estimated at 173,000 in 1969, 250,000 in 1970, 350,000 in 1980 and 400,000 in 1983.
- Mali had a total population of 6,524,650 according to the 1976 census, becoming about 7,160,000 in 1981 and 7,700,000 in 1984. The population of Bamako was 404,000 at the 1976 census. More recent statistics for the city have not been traced.
- The total population of Niger was estimated at 2,501,000 in 1959, 4,356,000 in 1973, 4,994,000 in 1978 and 5,354,266 in the 1979 census. It has been estimated at 5,844,000 in 1982. The population of Niamey was reported as 225,314 in 1977 and 300,000 in 1980. Estimates for 1984 have not been traced.
- The total population of Burkina Faso was estimated at 4,400,000 in 1960 and found to be 5,638,203 in the 1975 census. Subsequent estimates have been 6,908,000 for 1980 and 6,361,000 for 1982. The population of Ouagadougou was said to be 168,607 in 1975 and 247,877 in 1980.

- The total population of Chad was estimated at 3,254,000 in 1963, 3,859,000 in 1973 and 4,401,000 in 1979. The population of N'Djamena increased from an estimated 150,000 in 1971 to 303,000 in 1979. Later estimates have not been traced.

Despite the lack of complete statistics, it may be deduced from the general experience in the region that the tendency has been for the population in the capital cities to increase at overall rates of 200% to 500% over the last 30 years, and that this has reflected a general large increase in the percentage of urban population.

These sudden increases have brought many terrible problems to national and local governments. Housing, health, education, roads, drainage and electricity demand heavy expenditure, but water and food supplies must come first among the necessities. One of the most tiresome of these problems is the provision of a regular supply of fresh fruit and vegetables at a reasonable price. Storage of such commodities is often impracticable or uneconomic and price controls don't work. The usual practice has been to leave the problem to private enterprise to sort itself out somehow. This has worked, after a fashion, and small-scale farmers in regions neighbouring the towns, or at least near a main road to town, send in a variety of produce daily, which is sold every morning in the rather tumultuous traditional markets. Consumption of fruit and vegetables per head of the urban populations is low, since families with a restricted income have to rely on a mainly farinaceous diet, spending their money primarily on the local staple. In this area this is nearly always a grain - for example, sorghum in the Sudan, pearl millet in Senegal, sorghum and maize in Somalia - although in all the urban areas there is a strong tendency for imported rice to take the place of locally produced grains. However, to the extent that seasonal rainfall is sufficient in some parts of these countries and whenever irrigation is available, consumption of tubers, especially cassava and sweet potatoes is important. Everywhere there is also a good market for grain legumes such as cowpea (Vigna unguiculata) and dry haricot beans (Phaseolus vulgaris). (Whether these tubers and legumes are counted as vegetables or not is really an academic question, but they are usually classified as such in African countries).

Meat, milk and dairy products are becoming very expensive in town markets so that the main dietary requirements must be met from other sources. The grains, tubers and grain legumes can cover the greater part of requirements of both calories and proteins - but since there is now a tragic shortage of all food for many millions, we must say rather that this should be the objective, in normal times.

Conditions of adequate food supplies also imply a need for vitamins and minerals. These are partly supplied by the vegetables used as a sauce and flavouring for the farinaceous main dish; chilli peppers, onions and tomatoes are always in great demand for this purpose. Important sources of vitamins A and C and the minerals calcium and iron are the spinach-type vegetables, especially varieties of Amaranthus and the leaves of Hibiscus sabdariffa ("bissop") which are purchased even by poor families. More prosperous families now seek variety in their diet by the use of many other species. Cabbages and carrots are especially popular in Senegal; "Bamia" or "Gombo" (Abelmoschus esculentus) and "Mulukhiya" (Corchorus indicus) in the Sudan and many other countries of the region.

Table 1 POPULATION STATISTICS OF EIGHT ARID AND SEMI-ARID COUNTRIES OF TROPICAL AFRICA

[Refs: U.N.Demographic Yearbooks/Area Handbook Series. American University, Washington;/Istituto Geografico de Agostini, Novara, Italy.]

Country	1950's and 60's	1970's	1980's
BURKINA FASO			
Total	4,400,000 (1960)	5,638,203 (1975*)	6,908,000 (1980) 6,361,000 (1982)
Ouagadougou		168,607 (1975)	247,877 (1980)
Urban		362,614 (1975*) [6.4%]	[7.7%] (1980)
CHAD			
Total	3,254,000 (1963)	3,859,000 (1973) 4,401,000 (1979)	
N'Djamena		150,000 (1971) 281,000 (1978) 303,000 (1979)	
Urban		501,338 (1972) [13.1%] 792,041 (1978) [18.4%]	
THE GAMBIA			
Total (1983*)	315,486 (1963)	493,197 (1973*)	695,886
Banjul (1983*)		45,604 (1978)	44,536
Urban	27,809 (1963) [8.8%]	54,430 (1972) [14.2%]	109,486 (1980) [18.2%]

../.. (Cont.)

Footnote: Statistics refer to census results where indicated (*), but are otherwise estimations from official or institutional sources.

Country	1950's and 60's	1970's	1980's
MALI			
Total	3,484,500 (1960)	6,525,650 (1976*)	7,160,000 (1981) 7,700,000 (1984)
Bamako		404,000 (1976*)	
Urban		1,047,529 (1976) [17.4%]	1,207,367 (1980) [17.2%]
NIGER			
Total	2,501,800 (1959)	4,356,000 (1973) 5,354,266 (1979*)	5,844,700 (1982)
Niamey		225,314 (1977)	300,000 (1980)
Urban		[11.8%] (1977)	
SENEGAL			
Total	3,102,000 (1961)	4,907,000 (1976*) 5,507,000 (1979)	5,900,000 (1982) 6,460,000 (1984)
Dakar	230,887 (1955*)	798,792 (1976*)	[est. 15%]
Urban		1,148,700 (1970) [31.7%] 1,713,296 (1976*) [34.3%]	
SOMALIA			
Total		3,090,000 (1974) 3,406,000 (1975)	4,637,000 (1980) 5,450,000 (1984)
Mogadishu	173,000 (1969)	250,000 (1970)	350,000 (1980) 400,000 (1983)
SUDAN			
Total	10,263,000 (1955/56)	14,958,000 (1973)	20,564,364 (1983*)
Khartoum ^{1/}	245,800 (1956)	610,600 (1970) 784,294 (1973*)	1,424,000 (1983)
Urban		2,057,000 (1972) [12.5%] 3,288,000 (1976) [20.4%]	4,153,559 (1983) [20.2%]

^{1/} includes Khartoum, Khartoum North and Omdurman.

The quantities of these various types of vegetables bought per head of population in the urban markets is still fairly small and, even in normal times, there must be many families whose requirements of vitamins are not met. The total requirements for a city are nevertheless very considerable and are increasing rapidly.*

2. THE ORGANISATION OF SURVEYS

With all the troubles that the small-scale vegetable grower has to face, his yields are only one-third or one-quarter of what they could be and sometimes much less.

In order to assist the grower and improve supplies of vegetables, it is necessary to find out the precise nature and extent of his difficulties and the only reliable way to do this is by a farm survey. This means that a few horticulturists or agronomists, well versed in local conditions, speaking the local language and preferably young and strong (since much of the work must be done on foot), must go round the farms and personally interview the growers. It is not necessary to see every grower; good statistical information may be obtained by collecting detailed information from a fixed percentage of growers in each of the main vegetable growing villages - or, where applicable, the main vegetable growing irrigation schemes. The information collected must be standardised to allow for the deduction of general conclusions and for this purpose the use of standard forms are essential. The forms should cover type of soil, means and frequency of irrigation, area of each crop grown, estimates of yield, inputs used, source of seed, production, protection and marketing problems, equipment and machinery, labour, etc. The result of the survey should be to give a clear picture of what vegetables are grown and where, the systems of production and marketing and the main problems affecting the market gardeners.

3. THE PLANNING OF INCREASED PRODUCTION FOR INTERNAL AND EXPORT MARKETS

A distinction must be made between production for local markets and production for export, because different types of organisation are involved.

Export markets for vegetables have frequently attracted the interest of governments, merchants and commercial companies in the region, because of the prospects they offer of production in large mechanised units and earning "hard" currency.

A superficially convincing argument is often heard - "Certain vegetables, such as sweet peppers, French beans and cantaloupe melons, fetch high prices in Europe during the winter, because they can only be grown in European countries in expensively heated glasshouses. As heat and sunlight are free in tropical countries all the year round, these vegetables can be grown cheaply in Africa and shipped to Europe from November to May at great profit".

* It should be noted that vegetables have frequently been under-rated as a source of protein and vitamins because their nutrient yields have seldom been calculated on a basis of unit area and the duration of their production seasons. See statistics quoted by H.M. Munger, Cornell University, in "The Potential of Vegetables for Meeting World Food Needs", March 1983.

There are many fallacies in this argument and although a good trade has been established at different times, mostly in French beans, melons and sweet peppers, there have been many disappointments.

The main problem on the production side is climatic. These vegetables certainly need warmth, but they cannot stand scorching desert winds! They are also sensitive to day-length which may be unsuitable in the tropics for some varieties. Worst of all, they are sensitive to the wide range of fungi, bacteria, viruses, nematodes and insects which flourish in the tropics and often make it difficult to produce the very high quality which is demanded for export markets. Not only this, but the attacks of pests and diseases and the occasional depredations from rats, birds, monkeys, wild pigs - and even larger visitors - may affect the regularity of supply in a disastrous manner.

The problems of marketing are, moreover, often more intractable than those of production. First of all, specialised and experienced selling agents must be accredited in the main importing markets. Contact with buyers must be maintained on a daily basis to ensure satisfaction over price, delivery and quality, and the selling agents must be able to depend on a regular supply of high-grade produce throughout the season. This involves not only well organised production, grading, packing and storage, but also regular and dependable refrigerated transport at a reasonable price.

The general experience has been that this latter service is rarely available. Perishables are difficult to accommodate on shipping lines dealing with non-perishables and on airlines devoted primarily to passenger service. It might seem that a satisfactory solution to the problem would be a specialised refrigerated boat service, (like the banana boats from tropical America and humid tropical Africa), but the problem here is that a separate fleet of boats would be required and would have to be kept busy all the year round and not just for the winter season.

As a rule, the only satisfactory means of transport available is a chartered air-freight service, but naturally this is expensive and not always economic.

All this is not to say that off-season exports of vegetables to Europe is impossible; but experience over recent years has clearly shown that it is not to be undertaken lightly.

Internal markets. The need to improve supplies to local markets is unavoidable and poses problems that can be tackled internally. The technical discussions in this book are, in fact, devoted primarily to this end. Villages in the region have traditionally been self-supporting in vegetables, but this is not always the case and they now often need help to improve production. The most urgent problem, however, as already explained, is to supply the rapidly expanding urban markets.

The small cities of the early 20th century and before did generate minor vegetable and fruit markets, of course, but the commercial growing of vegetables was limited to small plots in those villages nearby which had suitable resources of river water or well water. These traditional vegetable gardens can still be seen in the "Niayes" round Dakar and in the coastal region between Dakar and St. Louis, where water is lifted by hand in water-cans from shallow wells. They are also found, for example, along the banks of the Nile near Khartoum and Omdurman where the water in some of the gardens is still lifted by animal-drawn "sagias" ("Persian wheels" or "Norias").

These old systems cannot go on for ever and modern conditions may be expected to lead to the production of vegetables in larger units and the introduction of some measure of mechanisation. Manual water lifting and animal power is being rapidly replaced by the use of small motor pumps but hand cultivation is being more slowly replaced by horticultural tractors, since many market gardens are too small for the use of tractors. Vegetable growers are already becoming conscious of the need for seed of improved varieties and for fertilizers and pesticides.

The location of vegetable growing is also changing, as cities expand to cover the old market garden areas and as the advent of paved roads and lorry transport make it economic to carry produce over longer distances. New production areas are being established to supply the expanding urban markets, but problems are often met. It is sometimes difficult to find adequate resources of soil and water within a few hours' drive of the town centre, and such problems are often linked with those of town water supplies and the extension of the road network.

Wherever they may be established, however, the vegetable growers are likely to need assistance. They often have difficulty in obtaining their inputs of seed, pesticides and fertilizers; they need credit to buy implements and machines; they have transport and marketing problems and, most of all, they have technical problems. Of the technical problems, those most likely to cause distress occur in the field of plant protection and in the use of suitable varieties. Concentrations of vegetable crops are susceptible to a wide range of pests and diseases and the means of control are often unknown or incompletely understood by the growers.

When a new market garden area is to be developed, the question of production organisation arises. Should official encouragement be given to vegetable growing co-operatives or growers' associations? Should vegetables be grown in state farms or should a free rein be given to private enterprise? Apart from any questions of political theory, it seems that the production and marketing of vegetables, although it may be a comparatively small-scale affair, offers more complex problems of organisation than production and marketing of, say, rice or cotton. Instead of marketing from one or two harvests a year, vegetables are harvested and marketed daily and instead of one main crop species, plus a cash crop, there may be a total of anything from ten to twenty or more species delivered to each market during the year. Prices and returns are also much more complex, since there can be no standard grading and no nation-wide or world-wide price for grades "1, 2 and 3" - but a multitude of qualities, varieties and prices, varying greatly according to the season. It is perhaps necessary to add that, under African conditions, horticultural production on state farms has not usually been successful. It seems to the authors that, whatever may be the case for large plantations of industrial crops, fresh vegetable production for African markets is best left in the hands of small-scale farmers. However, in order for them to obtain a fair return for their labour, these farmers need protection from market forces through some form of group organisation.

It is usually expedient for each grower to have his separate account for receipts and expenditure, rather than a fixed share of a joint account. Nevertheless, a small grower needs help in marketing his produce and purchasing his supplies, otherwise he is liable to be treated with little consideration by merchants and suppliers. Growers' association, if properly organised, can be of great assistance in arranging delivery of reliable supplies of produce of good quantity and quality, and in purchasing inputs in wholesale quantities. They are also in a better position than individual growers to negotiate credit arrangements with development banks and government departments.

Assuming that the growers have suitable land and suitable water resources, we think it is safe to say that any programme of production development must include official action in four main spheres:

- (a) Applied research to select varieties and production and protection techniques suited to local conditions.
- (b) Availability of technical information and training to all parties concerned.
- (c) Availability of good quality seed from selected varieties, and of suitable fertilizers, pesticides and equipment.
- (d) Improvement of crop handling and marketing systems.

4. GOVERNMENT SERVICES TO GROWERS

(a) Research

It might sometimes seem that, with all the technical horticultural information that has been collected by research stations in the more advanced industrial countries, it would only be necessary for trained specialists in Africa to set up an advisory service to tell farmers what vegetables to grow and how to grow them. However, it has been found that when the advisory service is not backed up by local research, it is not usually very successful.

The reasons for failure to improve the quality and productivity of vegetable crops are frequently environmental, although there are also economic and social constraints. In tropical African countries, caution must be exercised in adopting methods recommended on the basis of research in temperate and sub-tropical regions. Although these studies deal with some of the vegetable species grown in Africa, the varieties and techniques recommended must be tested under specific tropical conditions, before they are grown on a commercial scale. There are, nevertheless, a few research stations whose findings are relevant to the tropics. The Asian Vegetable Research and Development Center (AVRDC) is situated at Shanhua, Tainan, China, and temperature and day-length conditions there are typically tropical. AVRDC has carried out much important research and its publications are a valuable source of information. However, the mean annual rainfall in Tainan is 1770 mm, and although AVRDC has "outreach" programmes in many tropical countries, it is primarily concerned with vegetables grown for Asian markets in warm, humid, tropical lowland conditions. As far as climatic conditions are concerned, the same remarks apply to the well-known investigations carried out at Mayaguez Campus, Puerto Rico, U.S.A.

There are a number of smaller vegetable research stations and departments in tropical Africa with greater or lesser relevance to arid conditions. One of the oldest research efforts for irrigated vegetable production is in the Sudan, where work has continued for many years at four stations - Shambat (Khartoum North, 380 m), Hodeiba (Northern Province, 345 m), Sennar (420 m) and Wad Medani (405 m). Mean annual rainfall in these stations varies from less than 100 mm at Hodeiba and something over 200 mm at Shambat to about 300 mm at Wad Medani.

Work at Nazareth, Ethiopia (altitude 1600 m and annual rainfall about 700 mm) refers, of course, primarily to highland conditions.

Results at the National Horticultural Research Institute, Ibadan, Nigeria (altitude 227 m, mean annual rainfall 1420 mm) refer primarily to

the humid lowland tropics, but at the Institute of Agricultural Research at Samaru near Zaria in the northern and drier part of Nigeria (altitude 600 m, mean annual rainfall approx. 1100 mm), valuable investigations on vegetable production of interest to semi-arid zones have been carried out for many years.

For the Sahelian zone and neighbouring semi-arid areas, the most relevant research is that carried out at the "Centre pour le Développement de l'Horticulture" (C.D.H.) in Cambérène, Senegal, since 1973, but even here some caution is necessary, because most of the CDH field trials have been carried out at Cambérène in the Cap-Vert or at the sub-station at N'Diol in the River Senegal delta area, since the most important concentrations of vegetable production are found in these districts. In both of these stations, to a different extent, climate is modified for much of the year by the influence of cool sea breezes from the Atlantic, although for the Cap-Vert, the conditions from June to October are close to those prevailing in the humid lowland tropics.

To sum up: Considerable information on vegetable production in the tropics is in existence, and much time can be saved by a study of results in other countries, but environmental conditions in the tropics are so variable that local field trials are necessary before new methods and materials are recommended for commercial use. Due allowance must be made for local economic and social conditions as well as for environmental factors. A proper analysis of production costs for each crop, with labour inputs and material inputs correctly balanced against net receipts, will be of great value. Whether an improved implement or a new insecticide should be recommended must obviously depend on its local cost and the economics resulting from its use. It is in this field, amongst others, that investigations intermediate between "research" and "extension" are so valuable. It is not enough to prove that variety 'A' yields 50% more than variety 'B' or that the use of fertilizer dose 'X' increases yield 30% over fertilizer dose 'Y'. It has to be demonstrated and proved to farmers that a particular variety, with a particular fertilizer dose, on a particular soil, using locally available facilities, yields a crop which, sold on a local market, gives a better and surer profit than they are obtaining with their present methods and materials! This simple demonstration may be difficult to put into effect, but without some such detailed technical and economic application of scientific information, it is not to be expected that poor farmers will risk their livelihood by trying something new.

The following remarks, based on experience in FAO-assisted projects, may be of interest to authorities considering the establishment of a more advanced research department or station.

- Whether or not attached to a central agricultural research station, a specialist vegetable (or fruit and vegetable) research station or department is recommended.

- Because of the specialised nature of vegetable studies, the vegetable station or research department should undertake research on all the main aspects of vegetable production as well as protection. It will also be necessary to collect and analyse information on production economics, marketing and storage and to establish communications through the extension service with producers and merchants.

- Priority subjects of investigation will obviously vary according to the nature of the problems met in the country concerned. The information in other Chapters of this publication should be of assistance in developing suitable research programmes. They should be critically justified according to specific problems identified at the growers' level and will probably be classifiable under the following headings:

- (i) production techniques: varietal selection - fertilization - irrigation;
- (ii) protection techniques: diagnosis - use of fungicides, pesticides and weedicides - resistant varieties - rotations and hygiene;
- (iii) production economics and outreach: costs and returns of different crops according to scale, locality and techniques - surveys and "on-farm" trials - extension liaison;
- (iv) marketing and storage: market enquiries and surveys - packing and transport - natural and refrigerated storage.

- The area of land for field trials and the requirements for staff, buildings and facilities will naturally depend on the programme of work to be attempted, but it is suggested that the most efficient use of funds will be attained by starting with a practical minimum and expanding gradually, according to felt needs. It is usually difficult to plan scientific work far ahead; many of the lines of investigation will develop progressively in a way that cannot be precisely forecast. The essential minimum for field trials is an area of level, easily worked, well drained soil, free from noxious perennial weeds and with good irrigation facilities. Tools and machinery must be adequate and facilities for maintenance and repair must be readily available on station or near to it. In calculating the total area required, it should be borne in mind that an average field trial on vegetables will occupy from 100 m² to 1000 m². At CDH a suitable unit for a single plot has been found to be a strip of 5 x 2 m. A high level of soil uniformity in each plot and within each group of plots is of more importance than having large plots.

- Laboratory and office facilities should be simple but adequate. The plant protection laboratory, for example, should have two or three microscopes of different magnification ranges, an incubation chamber, scales, glassware, benches and sinks.

- The marketing and storage section will need facilities for natural ventilated and cold storage trials and packing demonstrations.

- Each research officer will need a quiet office with facilities for filing and the station will need central facilities for typing and duplication, plus a good library and a meeting room.

- Staffing should certainly be arranged on a phased basis, as it is not possible to begin with a large research programme in the first few years. A start could be made with a (station or department) 'Chief Officer', with one 'Research Officer' plus one 'Assistant Research Officer' for each section, later expanding as the work requires and funds allow. If the horticultural industry to be served is large and scattered, it may be necessary to open one or two sub-stations for field trials in different ecological areas. At a later stage, it may be necessary to strengthen staffing in the original sections.

- The location of research stations is often a subject of discussion. It is suggested that, in addition to the availability of suitable soil and water, attention should be given to the following:

- (i) The station should be located in or near a commercial production area. This not only facilitates contact with concerned farmers, but ensures that the environmental conditions of the field trials are typical of at least one commercial area.

- (ii) The station should be located within easy road distance of a large town or capital city. Not only are rapid communications essential for supplies, administration and information, but it must be remembered that research workers are educated individuals; they need social contact with other professionals and their families need educational and other facilities, which are not available "in the bush". Given such a background, researchers should be ready to spend long periods in the countryside to supervise 'on-farm' trials.

- Shortage of scientifically trained and experienced staff and of funds for research work are limiting factors in most African countries. It is suggested that this is an activity where it is often advisable to call on assistance from international or bilateral agencies. They should be able to supply research workers who have already had experience in the field and will be in a good position to establish the international contacts which are so desirable in this type of work. This approach should naturally be associated with a programme for training local research workers. Graduates in agricultural or natural sciences should be offered fellowships, followed by a period of experimental work under the guidance of an experienced researcher. It might be added that appointments in the research division should carry adequate status and rewards to ensure long term service in research.

(b) Extension and research liaison

Experience with the establishment of extension services in countries where there is no tradition of this type of organisation has often been disappointing, but it is suggested that a proper adaptation of the standard methods to African conditions can lead to success.

In the first place, the natural conservatism of small farmers must be accepted. Poor people cannot be expected to take voluntary risks in an already uncertain profession - and risks in vegetable production are exceptionally high. Ways must therefore be found to reduce the risks of using new materials and methods by adequate investigations before they are recommended. Fears of failure must be reduced by the use of 'onfarm' trials in which seed and inputs are supplied by the extension service and practical help is given with planting and lay-out. Farmers will then be able to profit from the conclusions of one of their own kind, instead of the recommendations of a salaried official.

In the second place, quick results must not be expected - something can be achieved in the space of each five-year plan, for example, but considerably increased production from one year to the next is rare.

Thirdly, effective service can only be obtained if adequate provisions are made. Frequently the staff and financial budgets for extension services are so meagre that it would be unfair to expect results. If a 'District Agricultural Officer' is given a heavy load of administrative work, has few trained assistants and receives scarce funds to buy new tyres or petrol, he can hardly be asked to achieve much in extension and should not be called an extension officer.

Attention is drawn to the Training and Visit (T & V) system which has given excellent results in many developing countries and may prove particularly suitable to districts in African countries devoted to vegetable production or small holdings. The characteristic of this system is the guidance of a selected number of contact farmers in an agricultural district by a group of specially trained village extension workers. The agronomist/extensionist in charge of each T & V project holds training sessions every two weeks for the groups of village extension workers in which clear messages are given as to what farmers should be doing with the

target crops in the current period. Each village extension worker visits his allotted contact farmers once every two weeks to deliver the message (on planting, pest control, etc.) and collect information on farmers' problems; which is then fed back through the training sessions to the research service. Although it may not be possible to reach all vegetable growing villages in a country through training and visit systems, successful campaigns in key districts can be expected to have effects over a wide area. Progress in the production of vegetables, as for other crops, may also be assisted by the establishment of suitably situated agricultural service centres. Farmers will visit these centres if they can obtain from them material needs, such as reliable seeds, plants and fertilizers at competitive prices, and will then be likely to seek technical information.

It is emphasised that the validity of these systems of agricultural extension will depend on a background of local research and an adequate research/extension liaison system. It is also suggested that, unless special provision is made for establishing such liaison, it will not be effective. Research workers are best left to devote their prime attention to their investigations; they should be available for consultation when called upon, but they should be free from frequent interruptions to meet visitors, attend meetings and deal with correspondence.

For this reason, every research station needs an "outreach" section whose work may well be combined, in the early stages of the station's development, with duties in the field of production economics, since both involve close contact with farmers. "Outreach" sections can supply technical information to extension officers and co-operate with them in arranging surveys, demonstrations, seminars and field days. They should also be made responsible for providing a constant source of information on current conditions and problems in the field, to the research staff.

As to the training of senior extension workers, it must be emphasised that the traditional curriculum of instruction at agricultural colleges needs to be supplemented by regular in-service training courses, where extension methods and current problems are discussed. Extensionists should be given every possible opportunity to keep abreast of technical progress in their field.

(c) Improvement in the supplies of inputs

As already stated, small-scale vegetable growers often suffer from constraints in the supplies of equipment, fertilizers, chemicals and seeds. While these requirements are usually supplied commercially, the grower does not always find it easy to obtain what he needs, at prices he can afford. While it is not possible to enter into questions of rural credit in the present work, it is emphasised that government intervention to improve supplies is often necessary and that the formation of growers' associations is often valuable in this respect.

Official intervention in the supply of seeds is often particularly important, because suitable improved varieties for African climatic conditions are often unavailable and, in some instances, do not yet exist. The technical aspects of selection and seed production are discussed in Chapters VI and VII.

(d) Improvements in marketing systems

As all efforts in production development and research are liable to be useless if they are not matched by progress in marketing, great attention is required to this aspect of the vegetable growing industry. The functions and limitations of official intervention in this field are discussed in Chapters VIII and IX.

5. CONCLUSIONS

Conclusions on development policy may be summarised as follows:

Commercial vegetable production in the region of Africa concerned is closely associated with future urban development and population growth, the use of land and water resources and with the economics of imports and exports. A rapid increase in future demand is inevitable and it follows that vegetable production should be carefully considered in development plans. Experience has indicated that, given the proper plant material, equipment and techniques, large quantities of vegetables can be grown on comparatively restricted areas, wherever suitable soil and water is available in the region. The following Chapters give an indication of the varieties and methods to be employed and the requirements for a rational organisation of production and distribution. It seems reasonable to suppose that all important local needs for vegetables could be supplied from within this region and that, in some cases, profitable exports could be developed.

Conclusions on research and extension may be summarised as follows:

Adaptive research is necessary to ascertain the most suitable plant material and production and protection methods under local conditions, to provide the technical basis for production development. Research in production and marketing costs and on demand and returns is also required as a guide to the economic aspects of supplying home and export markets.

Where strengthening of research activities in vegetable crops is to be undertaken, it is recommended that a specialist vegetable research station or department should be established and that it would be suitable to divide the station or department's work among four main sections:

- (i) production techniques,
- (ii) protection techniques,
- (iii) production economics and outreach,
- (iv) marketing and storage.

The importance is emphasised of "outreach" activities designed to establish regular communications with farmers through the agricultural extension service.

Extension work should concentrate on the dissemination of research results, especially through the use of "on-farm" trials, demonstrations and field days.

CHAPTER II

THE INFLUENCE OF ECOLOGICAL CONDITIONS

by G. de Lannoy

1. ATMOSPHERIC CONDITIONS CONTROLLING THE METEOROLOGICAL CHARACTERISTICS OF THE REGION

(a) Atmospheric circulation

The climate of the zone of Africa under study reflects the seasonal movements in the atmosphere, resulting from the rotation of the Earth and the temperature gradients between the Equator and the Poles.

The earth's surface receives energy from the sun in amounts increasing from a minimum at the Poles to a maximum at the Equator. Taking into account the losses to the atmosphere, the energy balance of the system at the earth's surface is positive in the intertropical zone, but negative outside it. The redistribution of accumulated energy in the form of heat, takes place via air movements and sea currents.

Temperature conditions over the Poles and over the tropics have a great influence on atmospheric pressures. The rise of the heated air over the tropics creates a "Tropical Low Pressure Zone" (or "tropical trough") in the lower atmosphere, whereas the descent of cold air over the Poles causes a "Polar High Pressure Zone". The result is a general tendency for air to move from the Poles towards the Equator in the lower atmosphere (Fig. 1).

These air movements at the lower levels, however, are balanced by movements in an opposite direction in the upper atmosphere. Thus, the descent of air over the Poles creates a zone of low pressure in the upper atmosphere and the rising air over the Equator causes a tropical high pressure belt.

The winds originating from this air movement cannot follow straight northerly or southerly courses, however, because of the "Coriolis force". This force is the result of the mechanical effects of the rotation of the earth and causes a deflection of the trade winds originating from the tropical high pressure belts in the lower atmosphere which become N.E. winds in the Northern hemisphere and S.E. winds in the Southern hemisphere.

The movement in the upper atmosphere from the Equator to the Poles is deviated more completely by the Coriolis force into two violent western "jet streams" in the two hemispheres at about the latitudes of 35°N and 35°S, respectively.

Returning to consideration of the trade winds in the lower atmosphere, it should be noted that an important complicating factor in their seasonal variation is that the northern and southern hemispheres do not absorb or liberate the same amounts of energy into the atmosphere surrounding them. Comparison of Figs. 3 and 4 show the different effects of the northern winter in January and of the southern winter in July.

The main cause of the greater influence of the southern (austral) winter is that, during its ecliptical passage round the sun, the globe is located at the "aphelion", i.e. the furthest point from the sun, in June.

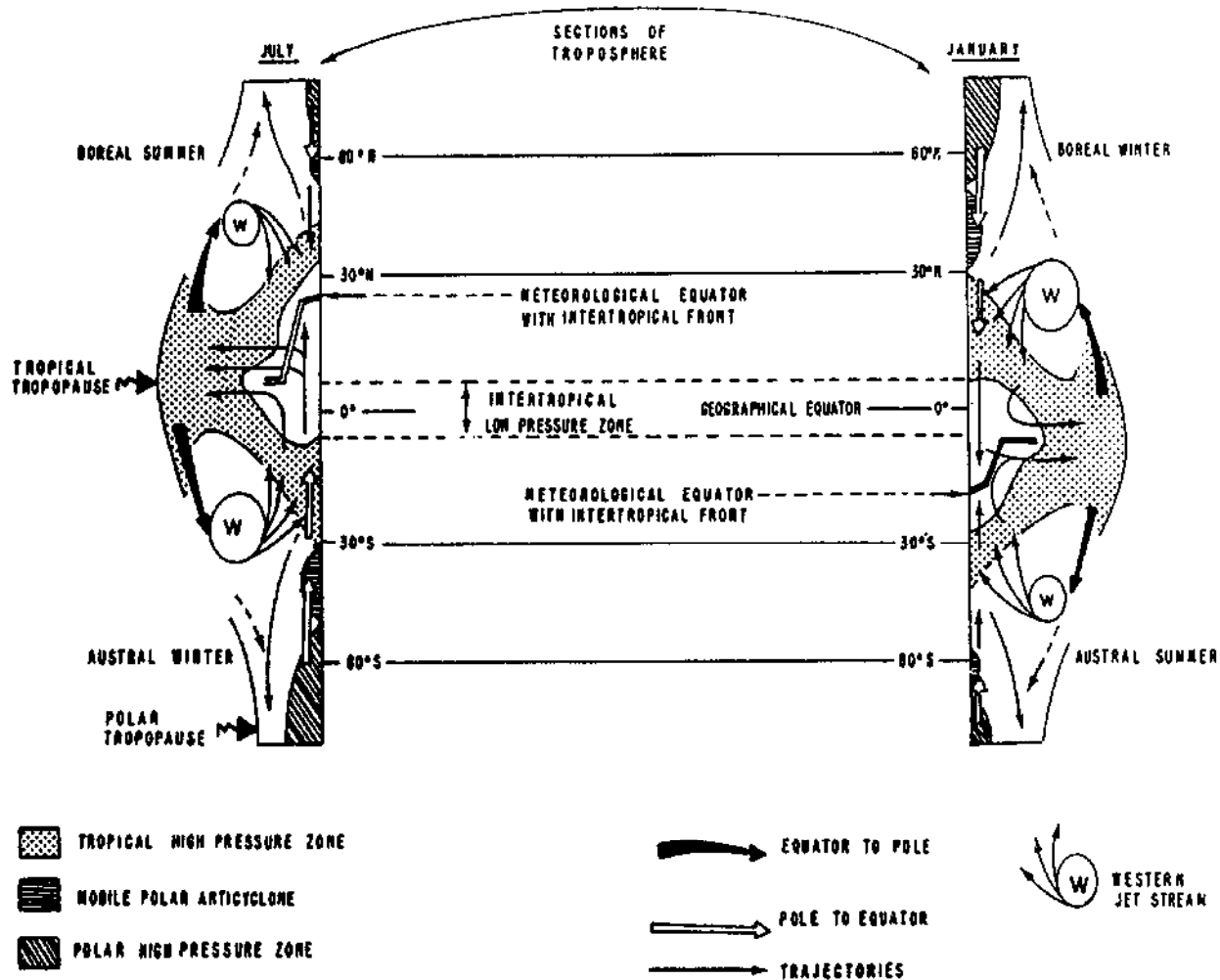

Fig. 1 : Structure of the Troposphere in January and July (after Leroux, 1983 - Modified)

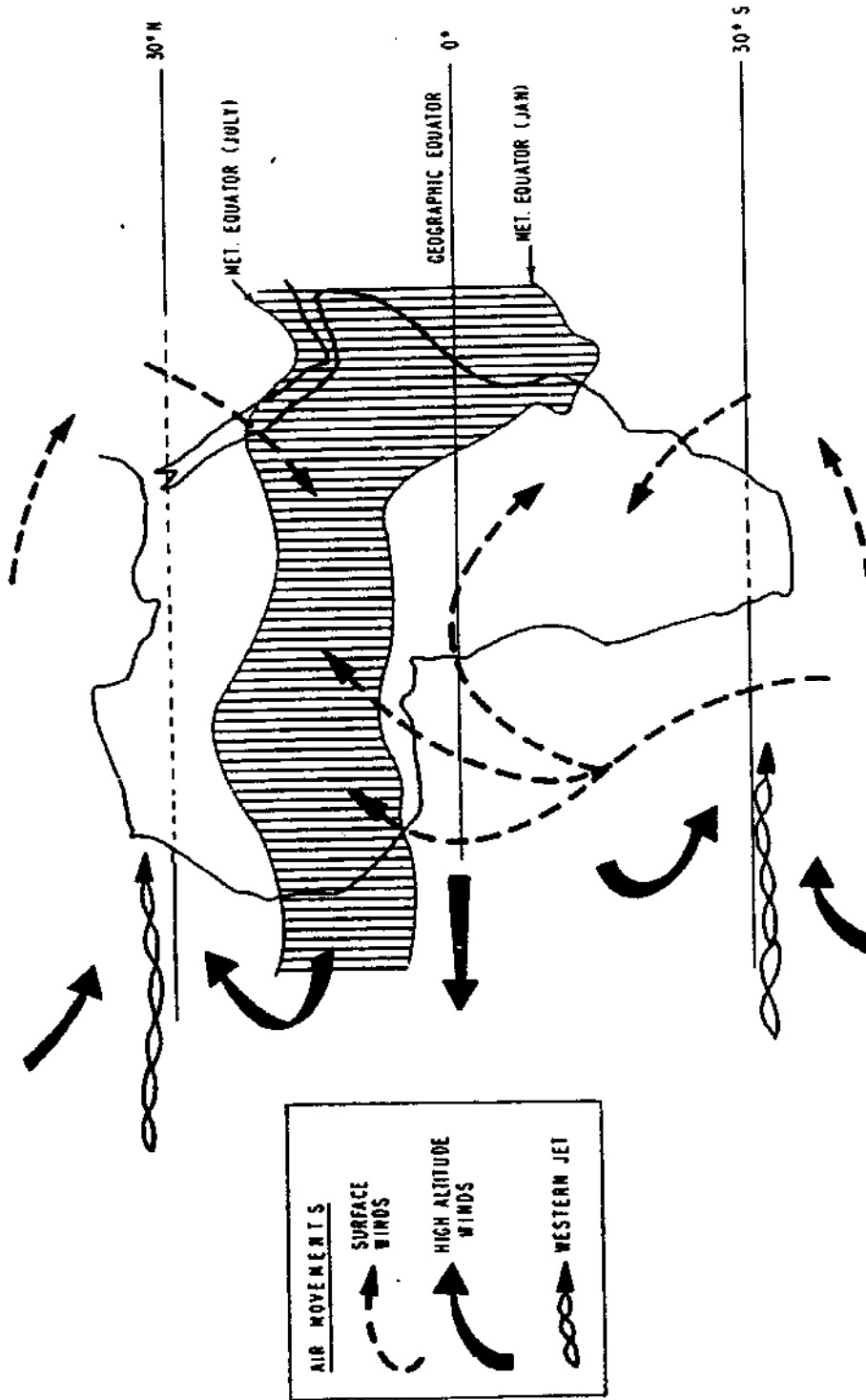

Fig. 2 : Movements of Meteorological Equator between January and July

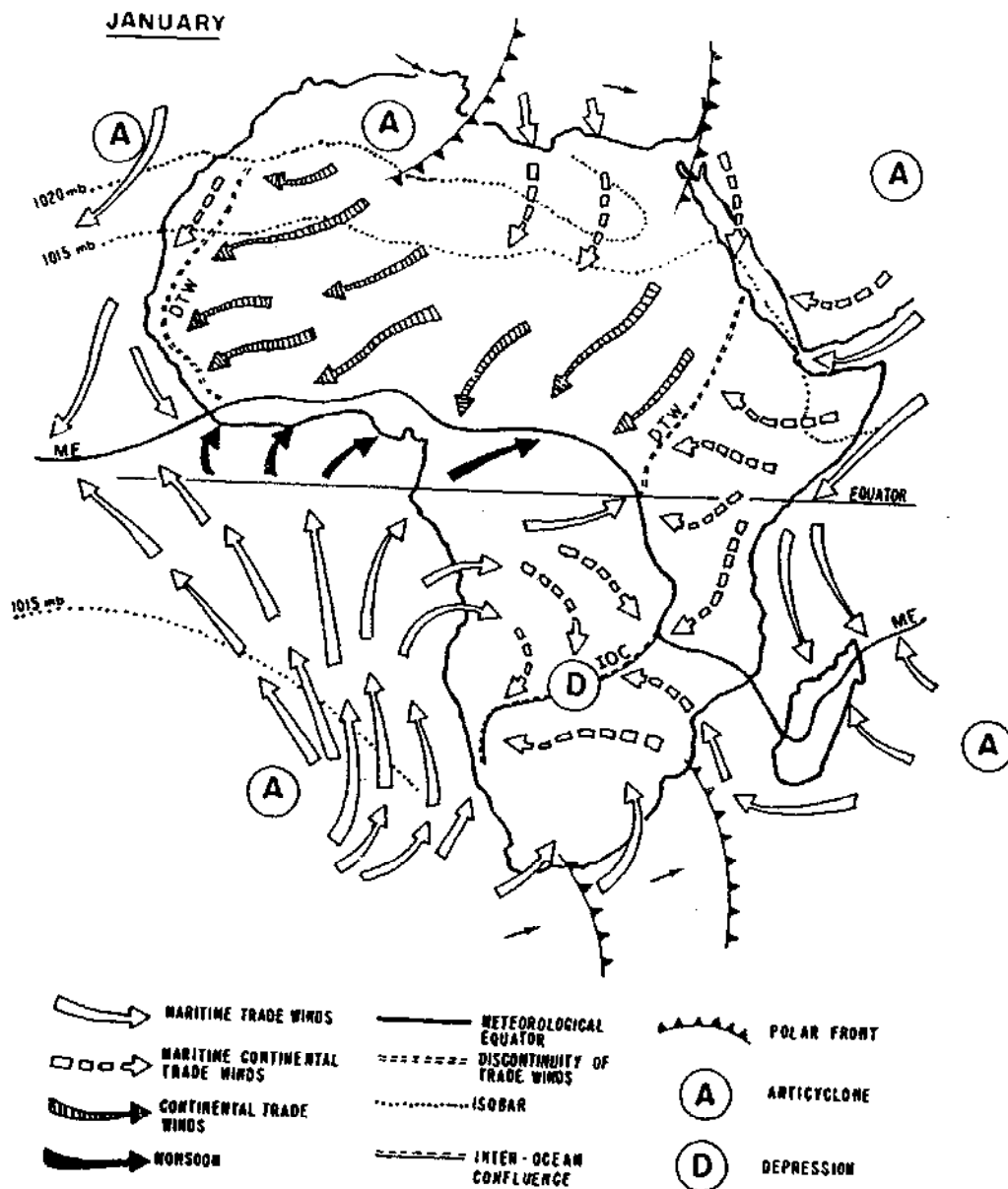

Fig. 3 : General meteorological conditions over Africa in January
(After M. Leroux, 1983, modified)

JULY

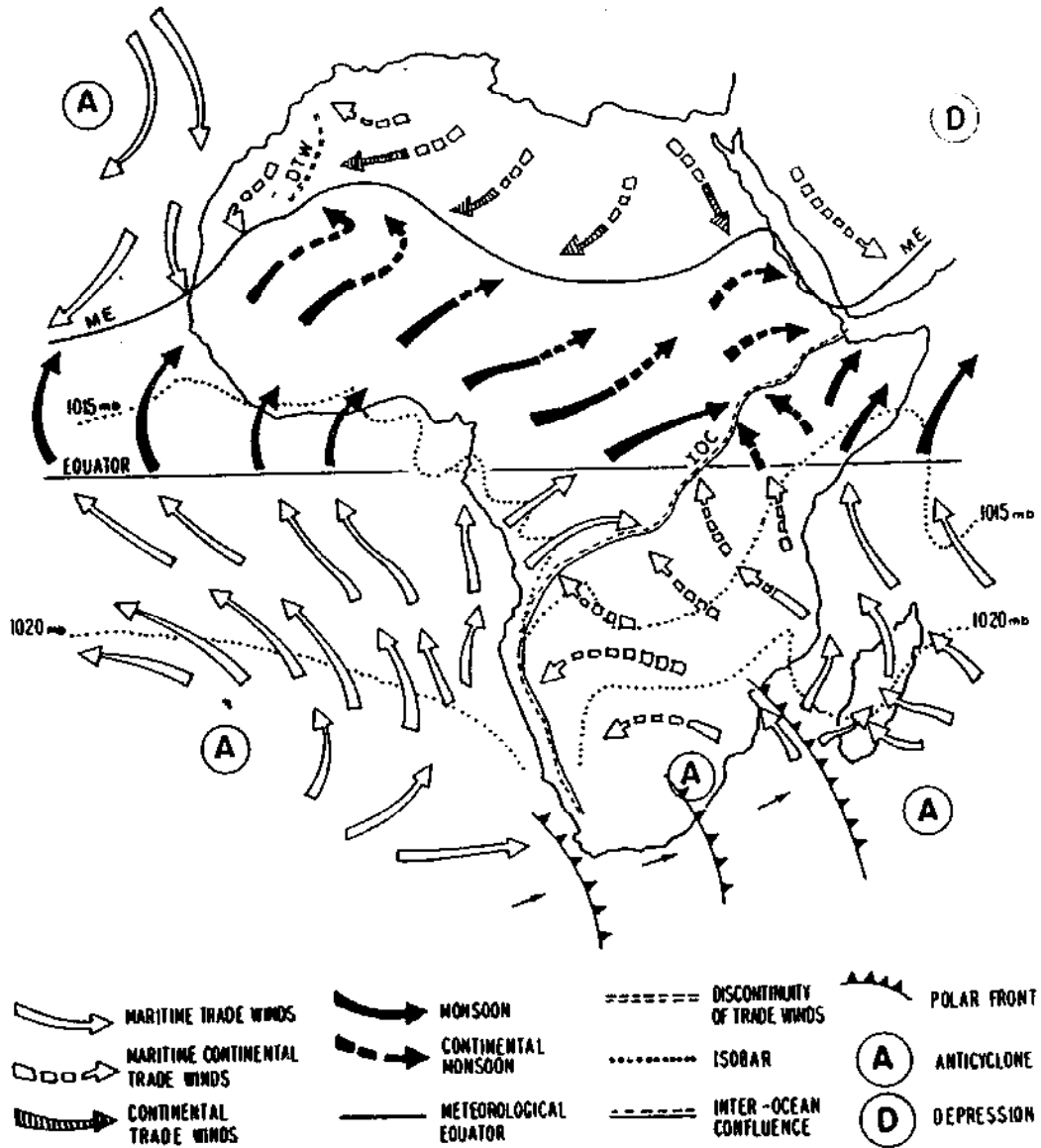

Fig. 4 : General meteorological conditions over Africa in July

(After M. Leroux, 1983, modified)

The "austral" winter is therefore always more rigorous than the "boreal" winter, which occurs around the season in December when the globe is nearest the sun ("perihelion").

(b) The movement of the meteorological equator

As will be seen from the diagrams of vertical sections of the troposphere in Fig. 1, the dominant meteorological structure in the tropics is the large band of low pressure characterizing the equatorial latitudes and the high pressure belts covering the tropical latitudes about 30°N and 30°S (Leroux, 1983). Figure 2 illustrates the movements of this whole structure north during the boreal summer and south during the austral summer.

The winds from the Tropical High Pressure Zone in the north and from the corresponding high pressure zone in the south blow towards the Intertropical Low Pressure Zone. The point at which the northerly and southerly winds meet and cancel each other is known as the Meteorological Equator (M.E.). This is shown as a wavy line running across Africa in Figs. 3 and 4.

The position and configuration of the M.E. is influenced by thermic and dynamic factors in the atmosphere and vary with the season. Its seasonal movements, with the associated "Intertropical Front" (I.T.F.), is the most important factor governing the rainy seasons in the arid and semi-arid zones of tropical Africa.

(c) Prevailing winds

The climate throughout this region of Africa is controlled by two types of air current: the trade winds and the monsoon winds.

Trade winds may be divided geographically into the "Northern Trades" of the northern hemisphere, which come from the N.E., and the "Southern Trades" of the southern hemisphere, which come generally from the S.E. Trade winds, as such, do not generally cross the geographical equator. Their characters are variable, in speed, temperature and humidity, depending on the territory that they traverse:

- "Maritime Trade Winds" are, in general, of high humidity and cool; although originating over the sea, they change their characteristics, to varying degrees, if they pass over large continental areas.
- "Continental Trade Winds" (such as the "Harmattan" which predominates in southern areas of North Africa), are very dry and of marked variability in temperature.

Monsoon winds are, in origin, southern trade winds that have crossed the geographical equator into the northern hemisphere and have been deviated by the Coriolis force, so that they become South-west rain-bearing winds. Reference to Figs. 3 and 4 will explain why the Guinea Coast and Central Africa receive heavy rainfall from the Southwest monsoon coming from the Atlantic, although these same winds carry progressively less rain as they travel to North and East Africa.

There is, of course, another powerful group of monsoon winds travelling over the Indian Ocean, but these are headed in the wrong direction to have much effect in Eastern boreal Africa which, apart from favoured highland and coastal regions, remains comparatively drier. Nevertheless, there are some monsoon winds which come up along the southern coasts and

bring rain to the Horn of Africa in July and some easterly trade winds which impinge on eastern Africa in January.

(d) The discontinuity of trade winds (D.T.W.)

The splitting up of the Tropical High Pressure Zone into segments (over the Azores, the Libyan-Egyptian spine and St. Helena) causes a disorientation of trade winds from different areas and the dividing lines (D.T.W.) between different prevailing winds are, in fact, discontinuities of climate, involving marked changes of temperature and humidity as well as of winds. In the northern hemisphere of Africa in January there are two important D.T.W's; one is a line from the Red Sea to the Equator in eastern Zaire, which divides the winds from North Africa from those originating over the Indian Ocean, and the other is a line a little inland from the west coast which divides the zone influenced by the maritime winds from the zone subject to desert winds (Fig.3).

In July (Fig. 4), with the northwards movement of the Meteorological Equator, this last D.T.W. is reduced to little more than a line across central Morocco and the eastern D.T.W. is replaced by the InterOceanic Confluence.

(e) The Inter-Oceanic Confluence (I.O.C.)

The Inter-Oceanic Confluence (I.O.C.) is a major climatic division between the monsoons and trade winds of the Atlantic and Indian Oceans during the monsoon season (Leroux, 1983). Along the west coast of southern Africa, it coincides throughout the austral winter (Fig. 4) with the great Angolan-Namibian escarpment and reaches north-east right across Africa to the Ethiopian highlands where it separates the eastern and western monsoons.

2. CLIMATIC CLASSIFICATION ACCORDING TO RAINFALL

Various classifications of tropical African climates according to rainfall have been made by different authors. Le Houérou and Popov (FAO, 1982) proposed the following classification, which depends on a combination of the factors for total rainfall and the number of "humid months". The latter conception is based on plant water requirements during the first phase of development, a "humid month" being defined as one in which the total precipitation is 35% or more of the potential evapotranspiration. In this classification, the climatic zones are equated with agro-ecological zones (Table 1).

It should be noted that this manual is concerned with vegetable production in tropical arid and semi-arid conditions under irrigation. It therefore refers, in practice, not only to production in areas where irrigation is possible in desert, arid and semi-arid regions, but also to irrigated production during the long dry seasons in the dry sub-humid and sub-humid regions. Discussions on climates and vegetable production techniques are, moreover, limited mainly to those of the northern hemisphere, but there are also large tropical regions in southern Africa with rather similar ecological and agronomical characteristics.

Table 1 CLASSIFICATION OF TROPICAL CLIMATES OF BOREAL AFRICA

Climatic Zone	Ecological Zone	Mean Annual Rainfall (mm)	Length of Rainy Season in "Humid Months"
Desert	Saharan	Less than 100	0
Very Arid	Saharo-Sahelian	100-200	0-1
Arid	Sahelian	200-400	2-3
Semi-Arid	Sudano-Sahelian	400-600	3-5
Dry Sub-Humid	Northern Sudanian	600-800	4-5
Sub-Humid	Southern Sudanian	800-1200	5-7
Humid	Northern Guinean, secondary derived Savanna	1200-1500	8-10
Very Humid	Southern Guinean rain forest	More than 1500	More than 10

The above classification refers primarily to the areas of Africa north of the Equator with unimodal rainfall, but applies also to some areas of East Africa with bimodal rainfall.

A distinction is made between the "unimodal rainfall pattern" of the so-called tropical climates, with one rainy season per year, and the "bimodal rainfall pattern" of the so-called equatorial climates, with two rainy seasons a year. Equatorial climates are usually very humid with few or no dry months, but this is not always the case. In the Horn of Africa, there are large semi-arid areas which, nevertheless, have an equatorial bimodal rainfall pattern. While most of the existing vegetable growing areas are in the "unimodal rainfall" regions, there is also a potential in some "bimodal rainfall" regions, although these regions are characterized by shorter seasons. Modifications of technique, seasons and varieties are required for the many different subclimates, but the general principles are the same for all tropical arid and semi-arid conditions.

References to Figures 1 to 5 will clarify the relationship of the movements of the Meteorological Equator (M.E.) and the associated Inter-tropical Front (I.T.F.) to the successive climatic belts running across the Sudanian and Sahelian regions and the Horn of Africa. In short, a broad band of rainfall over the Equator, affecting the Guinea coast and central Africa in January, moves north during the boreal summer until it reaches the southern limits of the Sahara in July/August, when it then covers the whole area south of the Sahara down to the Equator, but with a marked reduction of precipitations in the Equatorial areas. From some time in July and throughout August, the belt of rainfall retreats progressively south. The northern parts of the tropical areas thus have a shorter rainy season than the southern, but all have only one such season.

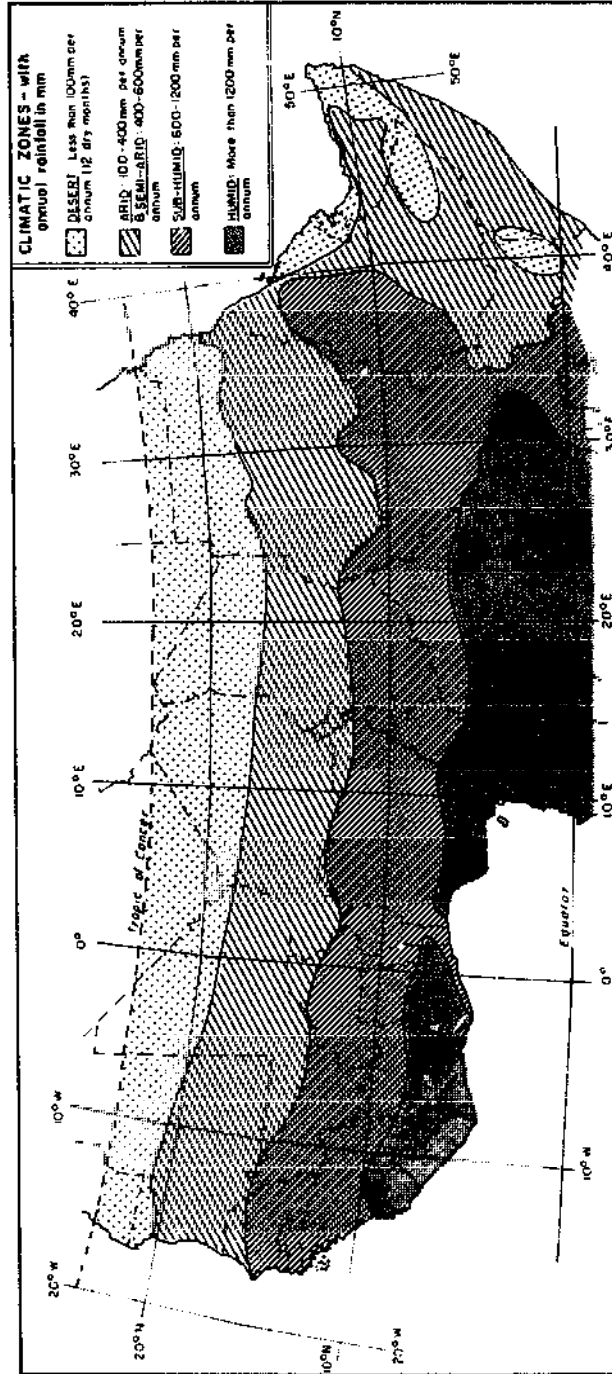

Fig.5: Diagram of tropical arid, semi-arid and sub-humid climatic zones of Africa

The Equatorial regions, where the monsoon precipitation has been relatively light in summer, get a second season of heavy rains as the rainbelt returns south in autumn.

In the Horn of Africa, the isohyets are distorted by the mountains of Ethiopia and the winds from the Indian Ocean. The result is that the highlands and some coastal regions catch a good rainfall in July from the monsoon winds from the Indian Ocean and a second, much lighter, rainfall around January from the North-eastern trade winds.

Throughout these regions, when the monsoon winds are weak, they do not reach so far north and they arrive later, and retreat sooner, thus causing droughts in the Sahelian and Sudanian areas. The drought years arrive in cycles but, at present, the prediction of the duration of these cycles is impossible. Moreover, a series of dry years may be broken by an exceptionally wet year and vice-versa.

The above comments concern the different climates of the region classed according to rainfall, which is the dominant factor throughout the lowlands of tropical Africa. Naturally, there are also considerable differences in temperature between the various climatic regions depending, like rainfall, on their latitudes and altitudes, their distance from the oceans and the effects of prevailing winds. Figure 6 illustrates the contrast between winter temperatures in January and summer temperatures in July.

3. THE INFLUENCE OF THE PRINCIPAL CLIMATIC ELEMENTS OTHER THAN RAINFALL ON THE GROWTH AND DEVELOPMENT OF VEGETABLE CROPS

(a) Solar radiation

Photosynthesis will be directly affected by the quality, intensity and duration of the solar radiation received at the surface of the Earth.

The intensity depends on the relative position of the sun, which determines the distance that the sun-rays have to travel through the Earth's atmosphere to reach the surface. It varies with the time of day, the season and the latitude concerned.

Naturally, the intensity is greatest at midday when the sun is at its zenith which, at the Tropics (Cancer and Capricorn) happens only once a year and in the inter-tropical areas twice a year at dates varying with the latitudes. Intensity also varies with the transparency of the atmosphere, as affected by clouds, water vapour and dust.

Increases in intensity generally involve an increase in photosynthesis, which can be expressed as mg CO₂ absorbed per hour per dm² of foliar surface. Nevertheless, each species has a point of saturation above which the rate of photosynthesis cannot be increased by increases in light intensity. There are some species whose point of saturation is between 0.2 and 0.8 cal/cm²/minute and others where it lies between one and 1.4 cal/cm²/minute (FAO, 1979). At the same time, there are certain species, like the sweet potato, which have a relatively low point of light saturation, coupled with a relatively high rate of carbon dioxide absorption (see Table 2).

It should be remembered that the rate of photosynthesis is also affected by the condition of the individual plants, i.e. their stage of development, health and vigour and thus by spacing and cultural methods.

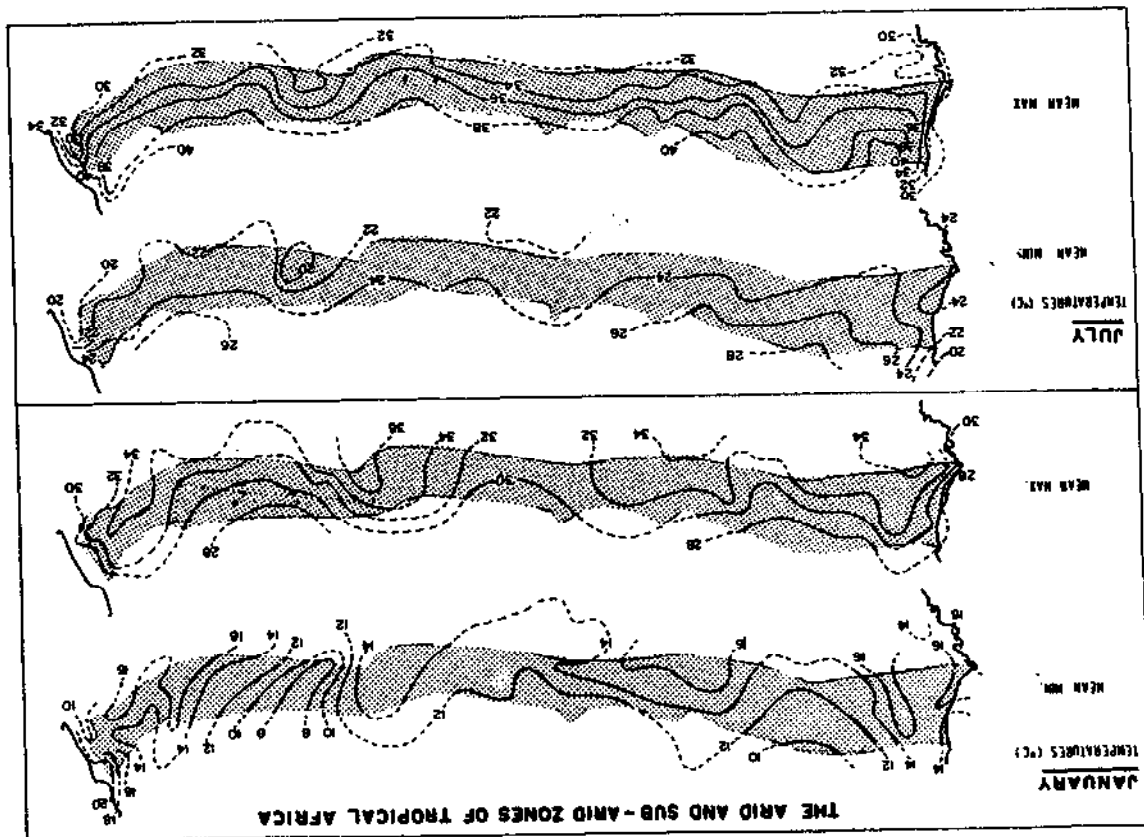

Fig.6 : Mean minimum and maximum temperatures($^{\circ}$ C) in January and July in the Arid and Sub-Arid Zones of Tropical Africa(Boreal). (After Leroux, 1983)

In this connection, it should also be noted that sudden variations of the level of illumination can be harmful. Even with tropical vegetable species adapted to a high level of insolation, the sudden transfer of plants from a shaded nursery to brilliant sunshine can cause burning and wilting. On the other hand, insufficient radiation, through excessive shading or inadequate spacing, causes a reduction in photosynthesis and production, and can result in an etiolation of growth and a decrease in resistance to pests and diseases.

Apart from its effects on photosynthesis and growth, the intensity of radiation influences numerous other aspects of plant development. For example, intense radiation can increase the critical photoperiod for tuber formation of potatoes, thus enabling it to take place under conditions of longer days and at higher temperatures than would normally be possible.

The quality of light also has important effects, and varies with the position of the sun. Light of shorter wavelength is absorbed as it travels through the atmosphere, to a greater extent than light of a longer wavelength.

The absorption of light by foliage and thus the rate of photosynthesis are greatest for the blue-violet and the red light rays than for other wavelengths. As a result of such factors, differences in light quality, due to latitude or season, or to the presence of dust, water vapour, CO₂ gas, etc., in the atmosphere, is liable to affect rates of photosynthesis.

Table 2 CLASSIFICATION OF SELECTED VEGETABLE SPECIES ACCORDING TO THEIR PHOTOSYNTHETIC RESPONSE TO INTENSITY OF ILLUMINATION AND TEMPERATURE LEVELS (after FAO, 1979, modified)

Group of Vegetable Species	Photosynthetic Class	Intensity of Solar Radiation at the max. rate of photosynthesis (cal/cm ² /min)	Rate of Photosynthesis at the point of saturation of optimum radiation and temperature (mg CO ₂ /dm ² /hr)	Optimum temperature at the max. rate of photosynthesis (°C)
Potato French bean (CTP) Cabbage	C ₃	0.2 - 0.6	20 - 30	15 - 20
Tomato (CTR) Sweet potato Cassava Roselle	C ₃	0.3 - 0.8	40 - 50	25 - 30
Sweetcorn (CTR) Amaranthus	C ₄	above 1	70 - 100	30 - 35

CTR = Tropical cultivars
CTP = Temperate cultivars

(It should not be forgotten, of course, that photosynthesis is also affected by foliage characteristics - morphology, anatomy and concentration of pigments of the leaves - and the degree of foliage cover.)

Finally, there is the factor of photoperiodism, i.e. the plant's reactions to variations in day-length during the course of the year or growing season. This is mainly a factor of latitude - variation is nil at the Equator and increases progressively towards the tropics (Figures 7A and 7B).

Day-length does not only affect photosynthesis, but has a marked influence on plant development, notably on flowering, and on bulb and tuber formation. In this respect, vegetable species may be classed as "short day", "long day" or "day-length indifferent" (Table 3).

Short day plants, mostly of tropical origin, are characterised by a critical photoperiod beneath which flowering, or in certain species (such as sweet potato, potato and cassava) tuberisation, takes place, but above which these processes are retarded or inhibited.

On the other hand, in long day plants, mainly originating from the temperate zone, their critical photoperiod is the minimum below which these processes are retarded or inhibited.

In each of these two groups, some varieties have strict photoperiodic responses and others are more flexible. For example, in the potato, varieties of the sub-species 'andigena' are incapable of tuberisation above a certain day-length, while in those of the sub-species 'tuberosum', some tuberisation takes place at any day-length, although it occurs more readily during short days.

It is necessary to classify varieties of flexible species according to their approximate day-length requirements. However, given the interaction which exists between photoperiodism and other factors, including temperature, light and nutrition, the critical day-length should never be regarded as an absolute value.

Details of the behaviour of different varieties of two important species, potato and onion, may be summarised as follows.

Potato: There are two cultivated sub-species (ssp) with very different photoperiodic responses, both between the ssp and between varieties of the ssp.

- (a) Solanum tuberosum ssp andigena with very low minimum critical day-length.
- (b) S. tuberosum ssp tuberosum (late varieties) with low minimum critical day-length.
- (c) S. tuberosum ssp tuberosum (early and half-early varieties), with high minimum critical day-length.

Both ssp and all varieties produce vegetative growth at day-lengths above 16 hours a day. Below this maximum critical photoperiod, they all commence tuberisation, but the minimum critical photoperiod below which there is no tuberisation varies: being 12 hours for ssp andigena, 13 hours for ssp tuberosum (late varieties) and 14 hours for ssp tuberosum (early varieties).

calories/cm²/day

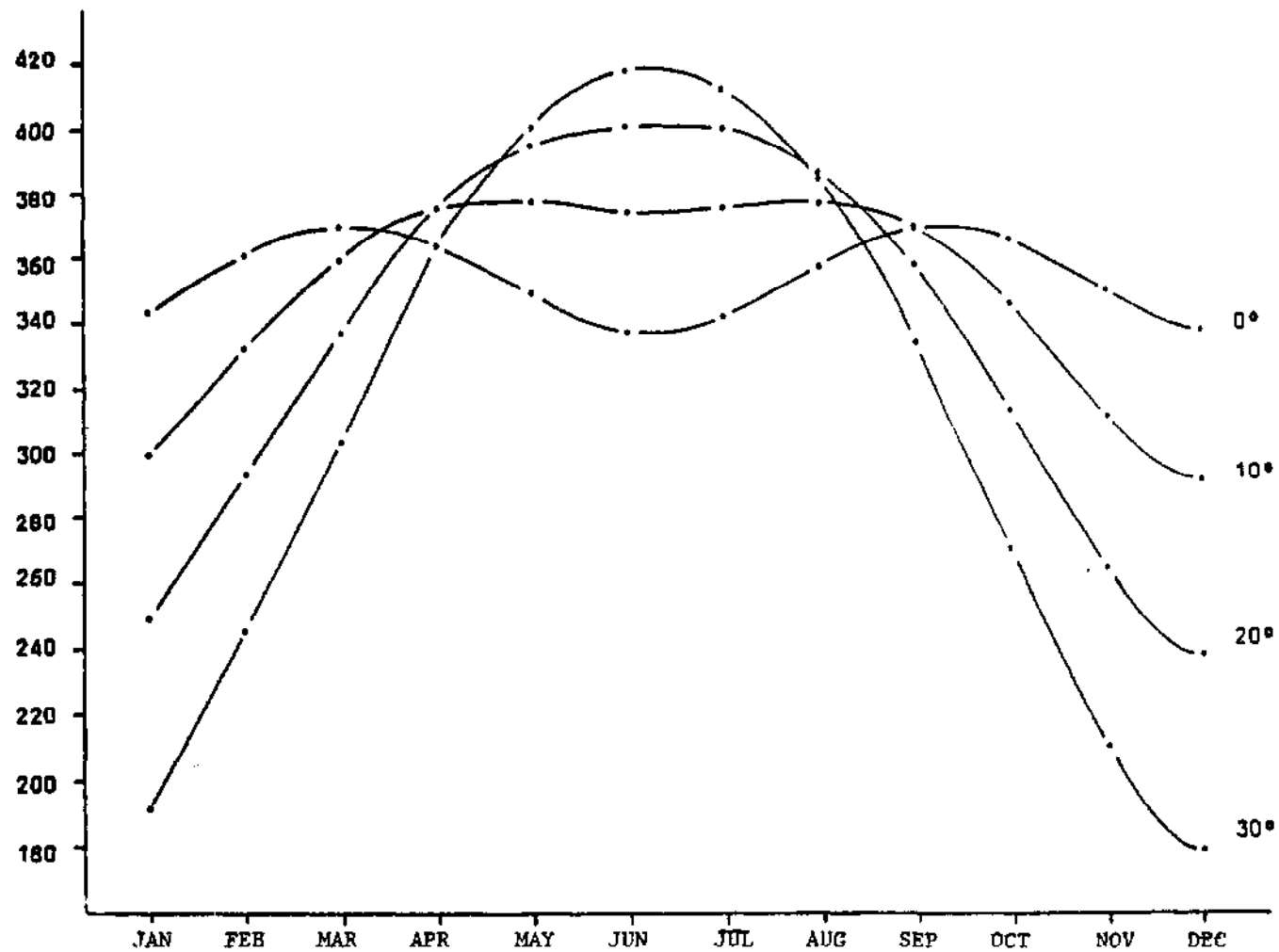

Fig. 7A Variations in photosynthetically effective illumination during fine weather at different latitudes in the northern hemisphere during the course of the year. (The values indicated are those of the 15th day of each month). (After de Wit, 1965)

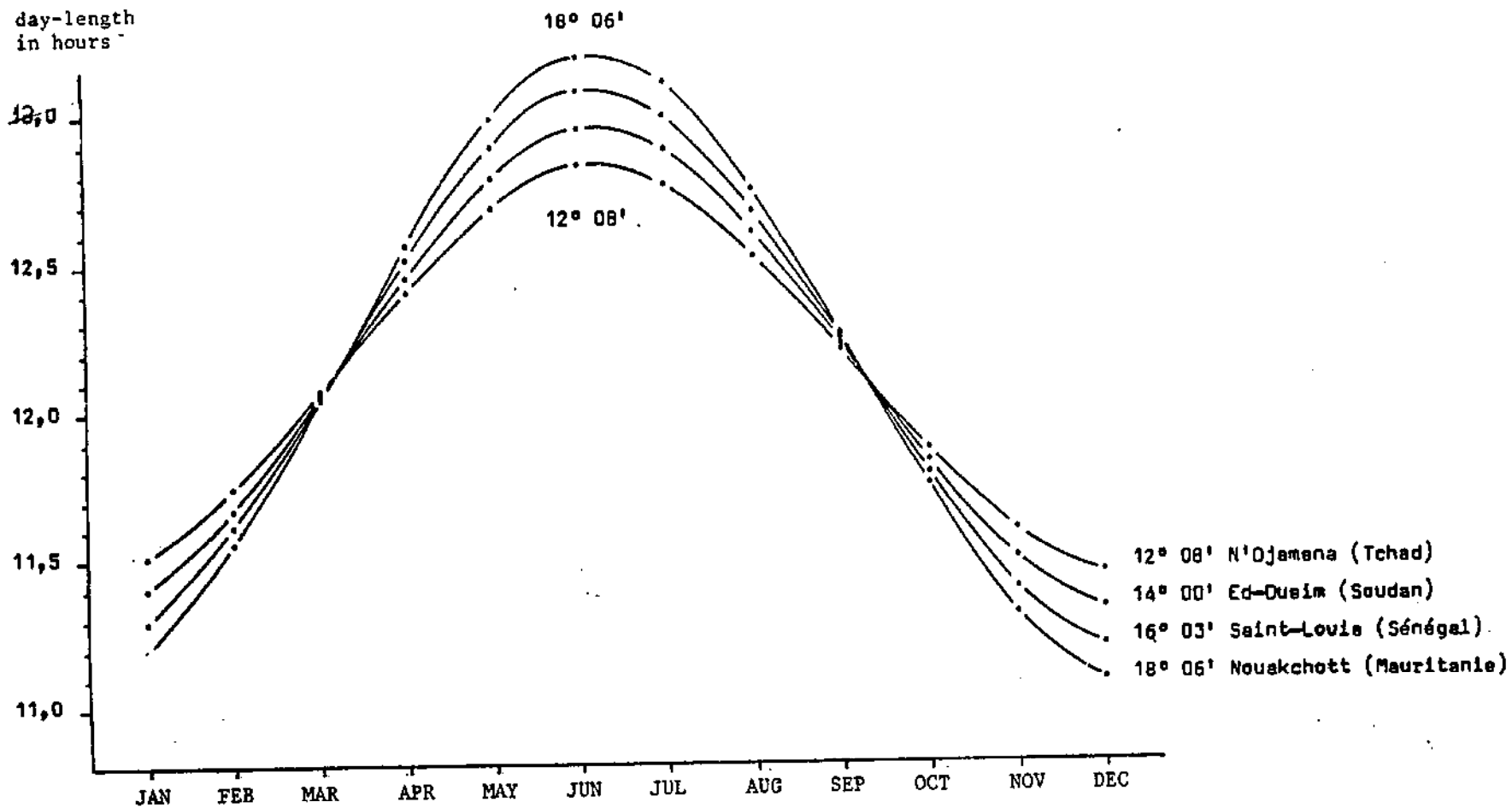

Fig. 7 B Monthly variations of day-length in function of the latitude at certain stations in the arid and semi-arid zones of tropical Africa (northern hemisphere).

Table 3

**CLASSIFICATION OF THE PRINCIPAL VEGETABLE SPECIES
ACCORDING TO THEIR PHOTOPERIODIC RESPONSES**

Crop Species according to Photoperiodic Responses	Phase of Development Sensitive to the Photoperiod	Practical Importance
<u>Short day species</u>		
African eggplant	Flowering	Seed & crop production
Basil	"	Seed production
Colocasia	"	" "
Sweet potato	Flowering and tuber formation	Breeding Crop production
Roselle	Flowering	" "
Potato	Tuber formation	" "
Onion (some cvs)	Seed and bulb formation	Seed & crop production
Cassava	Tuber formation	Crop production
Amaranth (some cvs)	Flowering	Seed production
Okra (some cvs)	"	Seed & crop production
<hr/>		
<u>Long day species</u>		
Beetroot	Flowering	Seed production
Carrot	"	" "
Chinese cabbage	"	" "
Spinach	"	" "
Lettuce	"	" "
Onion (some cvs)	Bulb formation	Crop production
Cassava	Flowering	Breeding
Radish	"	Seed production
Potato	"	Breeding
<hr/>		
<u>Day-length indifferent species</u>		
Asparagus, cucumber, cauliflower, cabbage, French bean, melon, chili pepper, sweet pepper, tomato, maize, pea.		

Onion: Although all are of the species Allium cepa, photoperiodic response varies between varieties.

All varieties produce vegetative growth at day-length below the minimum critical day-length of 11 hours/day and at that point all varieties commence bulb formation, but the critical maximum photoperiod above which there is no bulb formation varies between varieties - being:

- 12 hours for short day varieties ('Violet de Galmi', 'Texas Early Grano'),
- 13 hours for short to medium day varieties (Egyptian),
- 15 hours for medium day varieties (Australian Brown),
- 16 hours for long day varieties ('Rijnsburger')

On the practical level, the objectives of production must also be taken into account. For example, if it is required to produce 'green' or 'salad' onions at latitudes under 30° , a long day variety may very well be used, since bulbs are not required. If, however, the objective is to produce bulbils, a short-day variety must always be used and grown either at a sufficiently high latitude (over 30°) or during a period of the year when the day-length is above the critical photoperiod of the variety concerned.

For vegetables grown for their fruits (tomato, red pepper, African eggplant, okra, melon, cucumber, etc.), it is best to choose varieties whose day-length allows for early flowering under local day-length conditions, whereas for leaf vegetables (lettuce, basil, amaranth, spinach) it is better to use varieties which flower as late as possible.

Finally, it should be noted that some tuber vegetables (potato and cassava), which are 'short-day' as concerns tuberisation require 'long days' for flowering. This factor is a major consideration in programmes of varietal improvement of such species.

(b) Temperature

The quantity of energy received from the sun varies according to latitude and altitude. There are also seasonal differences in the energy received. At the Tropic of Cancer, maximum temperatures occur at the summer solstice (i.e. the longest day) and the minimum at the winter solstice (i.e. the shortest day). At the Equator, however, maximum temperatures occur a little after the equinoxes and the minima after the solstices.

The basic seasonal and daily variations depend in extent primarily on latitude, altitude and distance from the moderating influence of the ocean, but there are, of course, variations of temperature due to clouds and winds.

A frequent characteristic of the arid and semi-arid zones of tropical Africa, associated with daily temperature changes, is the formation of dew. This phenomenon results from the condensation of atmospheric humidity as the soil surface cools at night. The nocturnal drop in temperature is especially marked when nights are long, calm and clear and in sites where there are large areas of open land. Incidentally, it should be noted that temperatures at soil level show a greater daily

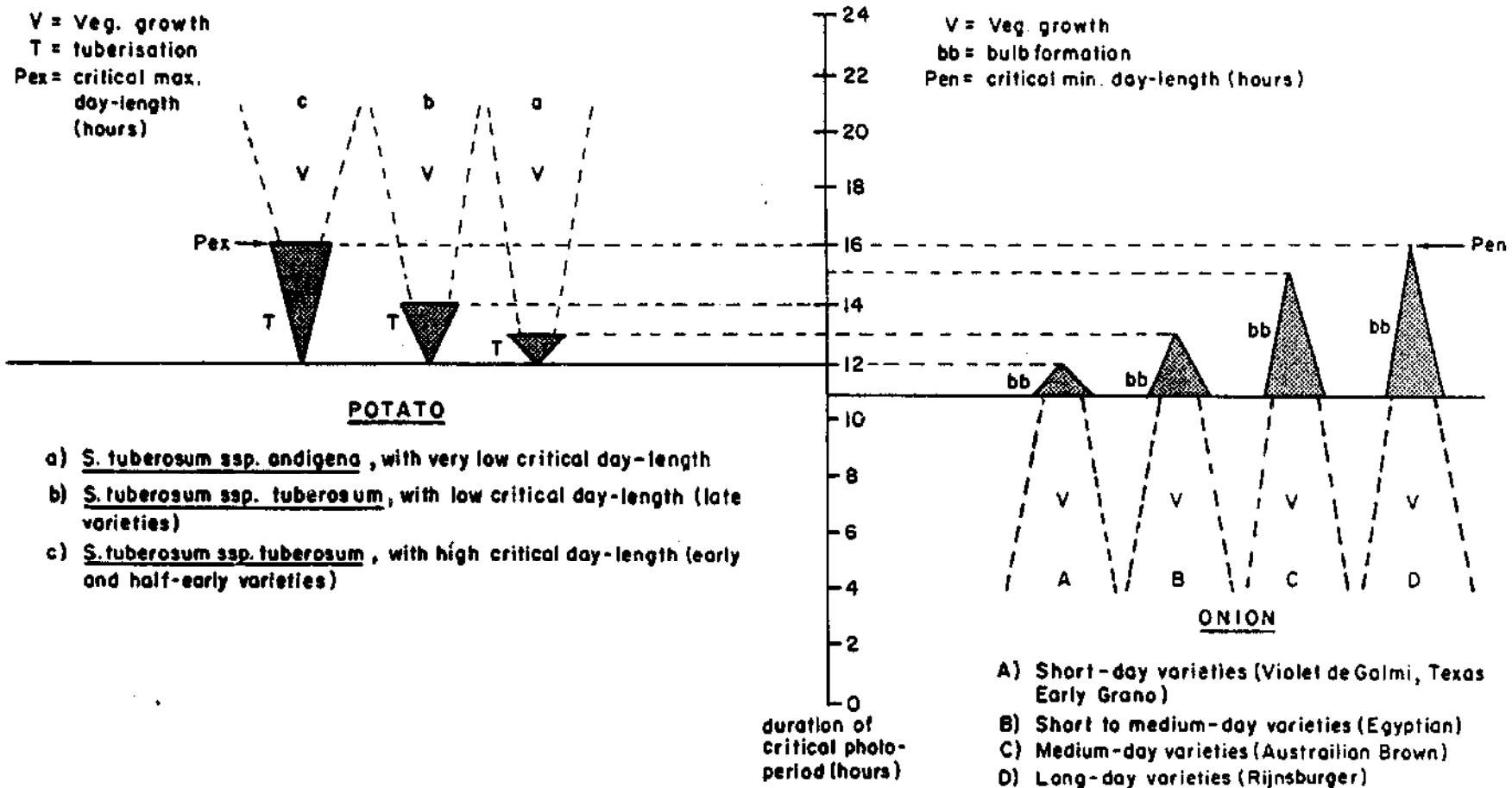

Fig. 8 : Photoperiodic Responses of the Potato and the Onion, and the Classification of their Varieties according to the Critical Photoperiods for Tuberisation and Bulb Formation

range than is reflected by the thermometers in the standard meteorological stations; the microclimates enjoyed by different crop species vary, in fact, with the height of the plants.

Temperature has an important effect on plant growth and crop yields, through its combined effects on photosynthesis and on the growth processes.

In the first place, vegetable species vary in the temperature they require for optimum rates of photosynthesis (Table 2). For species which have a photosynthetic circuit classified as C_3 - including potato, cabbage, tomato and sweet potato - the optimum is between 15 and 30°C, below which the rate of photosynthesis decreases by about 50% at each reduction of temperature of 10°C, down to a minimum level of 5°C.

Those species classified photosynthetically as C_4 - including maize and amaranth - are adapted for development at higher temperatures, with a maximum potential between 30 and 35°C (FAO, 1979).

In the second place, temperature affects the rate at which the products of photosynthesis are used in the plant for growth, respiration and the accumulation of food reserves. Crop yields depend on the balance between the levels of photosynthesis and the use of its products; they are generally poor if temperatures are high and solar radiation is inadequate or if solar radiation is adequate but temperatures are too low. To obtain maximum crop yields, it is necessary that each species (and in some cases, each variety) be grown in temperature conditions which allow optimum photosynthesis while maintaining a normal rate of respiration. Table 1, Chapter III indicates optimum temperatures for important vegetables grown in the tropics.

In this connection, the difference between night and day temperatures can be very important. Moderate day temperatures and relatively low night temperatures are necessary, for example, for the high yielding of potatoes and tomatoes. This is both because of the effects of a good balance between photosynthesis and respiration during the day and, above all, because of the better storage of nutrients at night. In fact, it is during the dark hours that the new cells are formed for the storage of reserves in bulbs, roots, tubers and seeds. Respiration is related to requirements for energy in the growth processes and necessitates the consumption of part of the available carbohydrates. If night temperatures exceed the optimum, the process of respiration accelerates to the detriment of the storage of food reserves and hence of crop yield.

In the potato, for example, the initiation of tuber formation is retarded by night temperatures above 20°C and is often completely inhibited above 29°C.

In the tomato, fruiting is normally greatly reduced if night temperatures remain above 17°C, but in this case, there is a certain genetic variability in some individuals in their ability to fruit at high temperatures. In fact, by selection of genotypes tolerant to both heat and humidity, trials in Senegal indicated that satisfactory fruiting can be obtained even at night temperatures between 23 and 25°C (De Lannoy, 1980).

The importance of night temperatures has also been observed for sweet potato in trials at the experimental station at Cambérène, Senegal. The production of tubers proved to be greater with night minima between 18 and 23°C than with minima between 23 and 25°C. This is partly also the result of higher light intensities during the dry season when night temperatures are lower than in the rainy season.

It has been observed that biennial species sometimes tend to flower in their first year when night temperatures are below their optimum. With

onion, this behaviour spoils the crop, but as there is usually a great genetic variability in response to climatic factors, tendencies to premature flowering can be reduced by selection.

As well as these responses to temperature differences between night and day, there is also, for some species, a response to seasonal changes. This is especially important for biennial vegetables like onion, cabbage, carrot, beetroot and turnip, which flower in their second year of growth. These species require low temperatures (vernalisation) at a certain stage to enable them to pass into the reproductive phase. This obviously raises problems for seed production of such vegetables in the tropics, if cold storage is impracticable. However, the duration and temperature levels required for vernalisation vary considerably from one variety to another and, in some cases, it is possible to select varieties of biennials which require little or no vernalisation. This is the case with the onion 'Violet de Galmi'.

Differences in temperature responses are often the explanation for the occurrence of serious pest or disease outbreaks in one region, while the parasite seems practically inoffensive in another. Temperatures may also act directly on the capacity of resistance of the host plant, as well as on its growth processes. For example, it has been found at Cambérène that certain varieties of tomato resistant to the rootknot eelworm (*Meloidogyne* spp) become sensitive to attack when the average temperature of the soil at a depth of 10 cm exceeds 30°C.

(c) Atmospheric humidity

Atmospheric humidity is subject to considerable variation, following the effects of condensation and evaporation. It is expressed as relative humidity (RH), defined as the relation (in %) between the actual vapour pressure and the potential vapour pressure at saturation, at the same temperature.

The quantity of water vapour that can be contained by the atmosphere at saturation varies directly with the temperature. Thus, at a relative humidity of 80% at 30°C the water content of the atmosphere is 24 gms per m³, but at 18°C it would be only 12 gms per m³.

Air humidity is an important climatic factor affecting the growth and development of plants, through its effect on evaporation of water from the foliage. The precise factor involved is the deficit of saturation of the atmosphere in contact with the leaves, i.e. the difference between the saturation vapour pressure and the actual vapour pressure at the level of the leaves (see Fig. 9). In other words, the 'dryness' of the air depends not only on the actual quantity of water vapour it contains, but also on the temperature, which conditions saturation vapour pressure. The 'drier' the air in contact with the foliage, the greater is the transpiration rate.

The water vapour in the air may be considered as originating from the seas and oceans and continental natural water surfaces. Naturally, the evaporation is greatest during the hottest part of the year and least in the coldest period. The effect of maritime humidity is most marked in coastal regions.

As for daily variations, it will also be clear that, other things being equal, the RH will be lowest during the hottest period of the day and highest when it is most cool - that is to say, the atmosphere is normally most humid just before sunrise. In tropical areas, however, though RH is variable during the day, the vapour pressure remains rather stable and

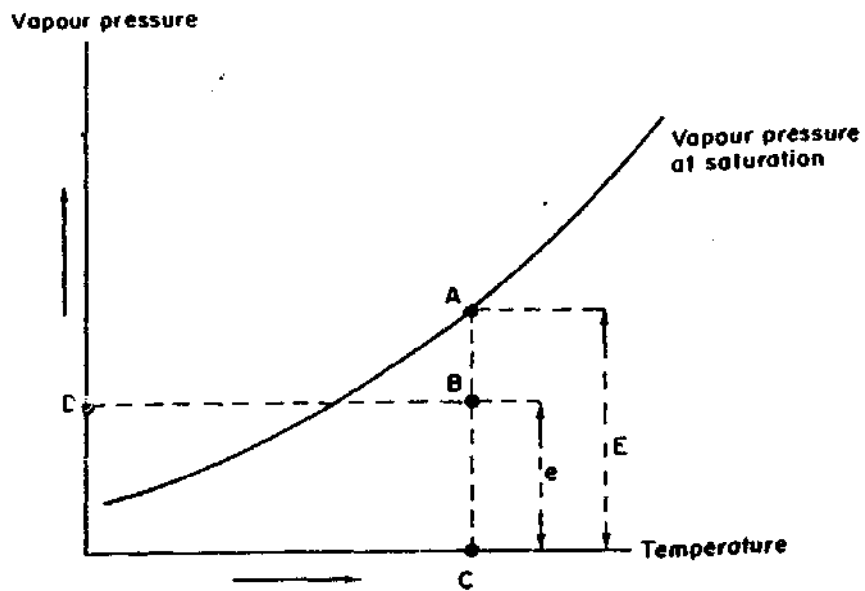

B = Air particle of a given vapour pressure 'D' and a given temperature C

$$\frac{BC}{AC} \times 100 = \frac{\text{actual vapour pressure}}{\text{saturation vapour pressure}} \times 100 = \text{Relative Humidity}$$

AC - BC = Saturation Deficit

E = Saturation vapour pressure

e = actual vapour pressure

**Fig. 9 : The Relationship between Temperature,
Vapour Pressure and Relative Humidity**

corresponds in general to a value which is slightly lower than the saturation vapour pressure corresponding to the average minimum temperature of a given location and period.

The effect of all these factors on crops is best expressed by the 'Potential Evapo-Transpiration' (PET), expressed in mm per day. The PET as defined independently by Penman and Thornthwaite is the quantity of water which is evaporated from a soil covered with a dense and uniform short grass when water supply to that soil is not limited. Fig. 10 shows the minima and maxima mean daily PET per month according to the modified Penman method, together with the months corresponding to these extreme values in 47 stations in tropical arid and semi-arid Africa.

The effect of PET on crops depends on the reaction of the stomata in the leaves. In dry atmospheric conditions, these will close because, in extreme conditions, there is a danger that transpiration will be so great as to cause the plants to wilt. In humid atmospheric conditions, the stomata will open, allowing a better diffusion of carbon-dioxide, oxygen and water vapour, and thus more active photosynthesis and nutrients absorption.

The various plant species vary greatly in their adaptation to different levels of saturation deficit, as to other climatic factors, the mechanism depending on the number, distribution and type of stomata, thickness of cuticle, type of leaf, etc., as well as on their physiological make-up. This variation is illustrated by measurements of the quantities of water which the plant has to transpire to synthesise 1 kg of dry matter, which varies according to species from 300 to 1 000 kg of water (Duvigneaud, 1974). However, this 'transpiration coefficient' varies not only with the species but also with the climate - vegetable species, for example, consume, in general, about twice as much water in arid zones as in humid zones to produce the same crop yield.

Another way in which air humidity has an effect on plant growth is through the formation of mists and dew, when there is a marked drop in night temperatures in circumstances of high RH. Dew most frequently occurs in coastal regions, such as the Cap-Vert of Senegal. It can provide useful quantities of water via absorption by the leaves, although little or no dew is absorbed by the soil, because it is quickly lost by evaporation after sunrise.

The negative effects of a high RH include the improved germination of certain fungal spores and the rapid spread of bacterial activity on crop foliage. This is the case, for example, with the mildew Pseudoperonospora cubensis on Cucurbitaceae, which prefers high humidity and cool temperatures (18-22°C) to develop. It also applies to the gall producing bacteria Xanthomonas campestris var. vesicatoria which attacks Solanaceous crops under high humidities and high temperatures (30°C and over).

(d) Wind

The origin and character of winds in tropical Africa have been discussed in the section on climatology. The following remarks refer to their effects on crop production:

Moderate cool winds are favourable to seed production of the wind-pollinated crops - beetroot, spinach and sweetcorn - as they assist an adequate distribution of pollen grains, provided that pollen production is plentiful. They may also, of course, assist in the dissemination of weed seeds, fungus spores and insects!

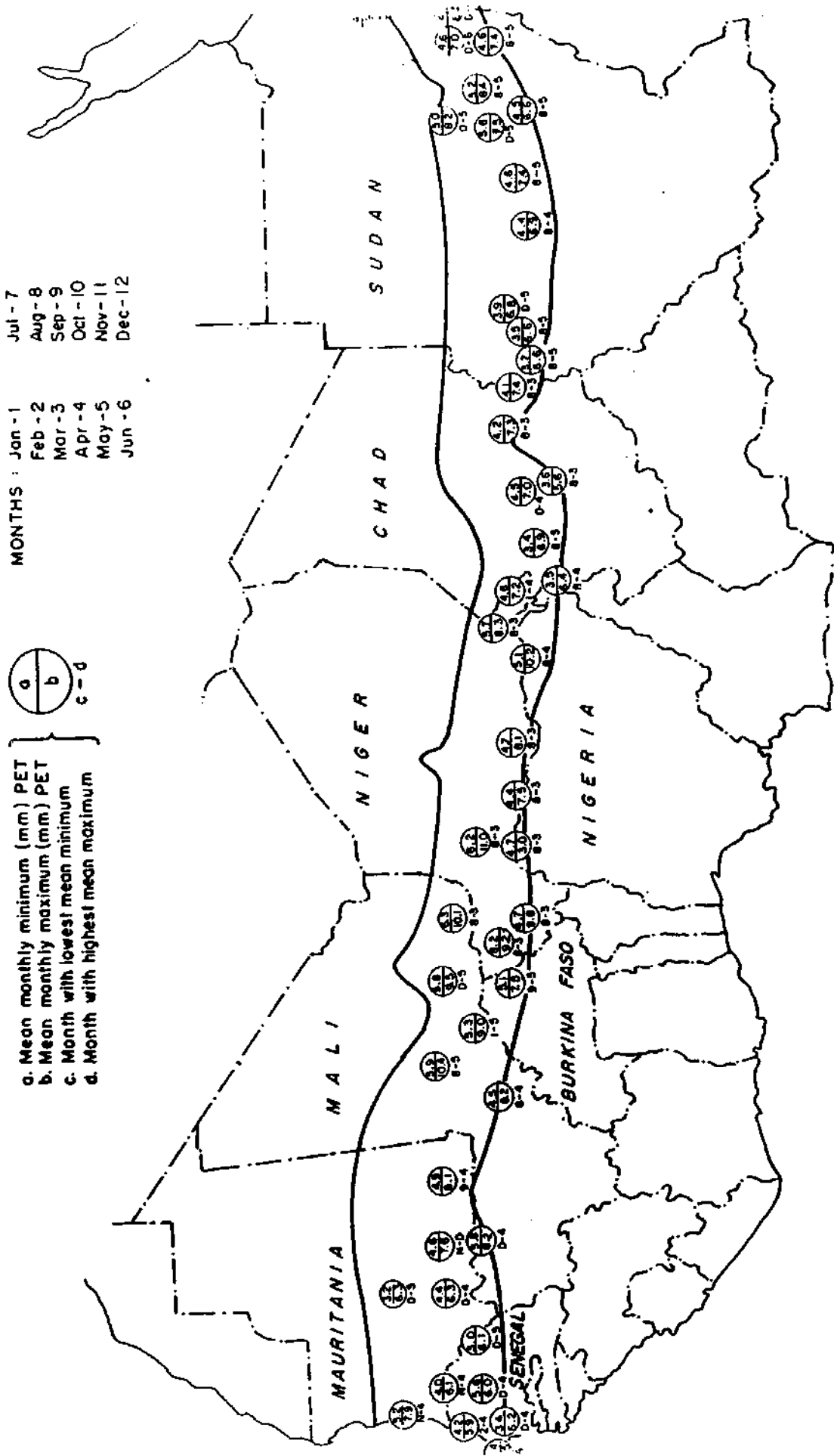

Fig. 10 : Potential evapotranspiration (PET) calculated according to the modified Penman method (FAO, 1984) in 47 stations in the arid and semi-arid zone. (Mean annual minima and maxima shown in mm per day.)

Other incidental inconveniences caused by wind are interference with sprinkler irrigation and the application of insecticides and fungicides by spraying and dusting.

Violent winds may cause serious mechanical damage to plants, and are harmful to efficient pollination. When strong maritime trade winds are cool, they may also cause a sudden and harmful drop in temperature and thus delay crop harvest.

In coastal regions, maritime winds may cause, moreover, physiological damage to plants through the quantity of salt they carry.

The most damaging wind throughout most of arid and semi-arid Africa, however, is the desert wind called "Harmattan" or "Sirocco". This usually comes from the East or North-east during the long dry season (Fig. 3). It is a continental trade wind blowing at feeble or moderate velocity above the soil surface. It is hot (28-30°C) and extremely dry and, in some cases, can kill or severely damage a crop by desiccation. At the least, the Harmattan reduces photosynthesis through its effect on stomata and can thus cause important reductions in yield. In coastal regions, this wind causes occasional damage, although its effects there are usually counteracted by the maritime trade winds - since the trades are cooler and heavier and thus force the desert wind away from the soil surface.

In vast inland regions of arid tropical Africa, the Harmattan blows unobstructed and is one of the main hazards of horticultural production. The market gardeners working in the irrigated parts of these regions are obliged to select their crops and seasons and judge their risks, always with this wind in mind.

4. THE MAJOR SOILS OF THE REGION AND THEIR SUITABILITY FOR VEGETABLE PRODUCTION

(a) Major soil units of the region

The major soil units of the region, according to the classification and nomenclature of the FAO/Unesco Soil Map of the World (1974), are as follows and their geographical distribution, in terms of nine main soil associations or pedological regions, is shown in a sketch map (Fig. 11)*.

1. Desert soils

Yermosols are weakly developed soils in hyperarid zones; they are generally stony and may show hardened accumulations of lime or gypsum. Plant cover is absent or very scarce.

Xerosols are also weakly developed soils in arid or semi-arid conditions, poor in organic matter, having usually a high base saturation. The pH is often alkaline, which results in frequent deficiencies in trace elements. Rocky debris, shifting sands, shallow and saline soils cover sizeable areas in the association.

* This sketch map is part of the "Main Soil Association" map of Africa, prepared by AGLS in October 1985 for the 'In-depth study of agricultural and food problems in Africa'.

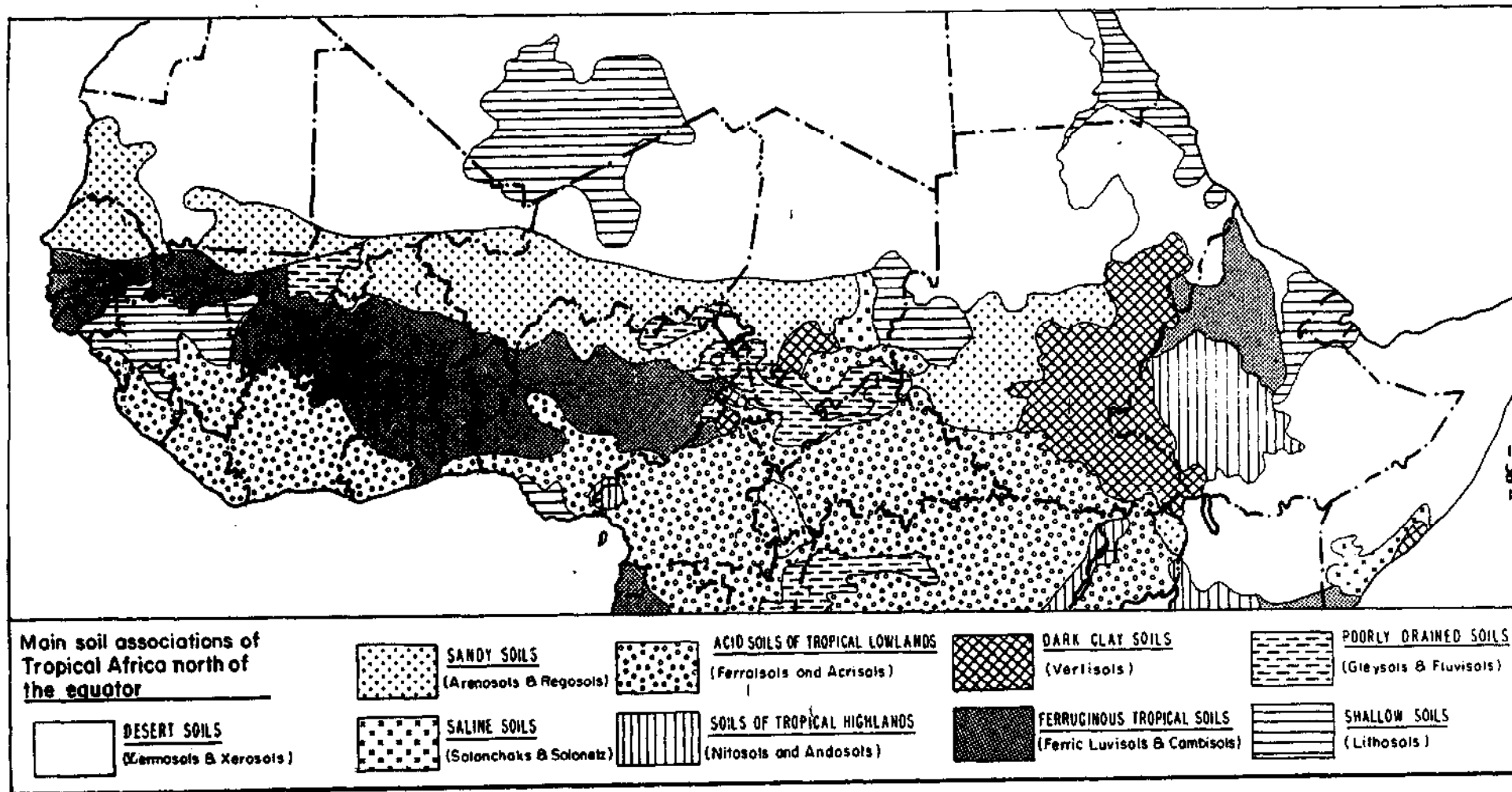

Fig. 11 : The main soil associations of tropical Africa north of the Equator

2. Sandy soils

Arenosols are weakly developed, coarse-textured, sandy soils. In arid and semi-arid zones, Cambric and Luvic Arenosols predominate. Cambric Arenosols show a stronger colour in their B horizon, Luvic Arenosols show layers of clay accumulation in their subsoil. They are poor in organic matter and nutrient reserves.

Regosols are soils on unconsolidated materials (excluding recent alluvial deposits). In the region, they are generally sandy, and have no diagnostic horizons other than a weak A horizon. Eutric Regosols (having a high base saturation) are dominant in the arid and semi-arid areas of the region, whilst Dystric Regosols (having low base saturation) are present in the moist sub-humid areas. They may be limited in depth by ironstone formations.

Shallow, Calcic Regosols occur in south-eastern Ethiopia and north-eastern Kenya.

These soils are all poor in organic matter and plant nutrient reserves. Inclusions of poorly drained soils (Gleysols and Fluvisols), saline soils, sand dunes are locally present in the association.

3. Saline soils

Solonchaks are soils having a high salinity, reflected in an electric conductivity of the saturation extract of more than 15 mmhos per cm at 25°C.

Solonetz have a slowly permeable subsoil with a columnar or prismatic structure and a saturation with exchangeable sodium of more than 15 percent.

4. Acid soils of tropical lowlands

Ferralsols are highly weathered deep soils with high contents of iron and aluminium oxides and low cation exchange capacity. They are poor in organic matter and plant nutrients. Layers of oxidic concretions are often present at shallow depths.

Acrisols are also highly weathered acid soils showing a horizon of clay accumulation in the subsoil and having low base saturation. Like Ferralsols, they usually have a low organic matter content and low plant nutrient reserves. Layers of oxidic concretions and, locally, ironstone formations may restrict development of root systems.

This association is typical of humid tropical areas, but is locally present on the southern fringes of the moist sub-humid zone.

5. Soils of tropical highlands

Nitosols are deep clayey soils showing a well developed and stable structure and diffuse horizon boundaries. They have a low cation exchange capacity and are usually of a strong brown to red colour. Eutric Nitosols have good plant nutrient reserves and favourable physical properties for agricultural production in areas where topography is not a strong limiting factor.

Andosols are weakly developed soils on volcanic ash. In the region, they are deep, usually dark coloured, fertile soils, easy to cultivate and with a high production potential. Topography is, however, a frequent limiting factor.

Areas of shallow stony soils on basic rocks and dark clay soils are locally present in this association.

6. Dark clay soils

Vertisols are heavy clay soils, usually dark coloured in the region. They develop cracks over 50 cm deep during the dry season and are very sticky and slowly permeable when wet. Vertic groups of other soil units (e.g. Vertic Cambisols), having similar but less pronounced characteristics, are often included in the association.

7. Ferruginous tropical soils

Ferric Luvisols occur in hot tropical climates with a pronounced dry season. They show a horizon of clay accumulation in the subsoil with a high base saturation, but low cation exchange capacity of the clay minerals. They often include layers of oxidic concretions or hardened ironstone, which restrict root system development and soil moisture retention.

Cambisols are weakly developed soils on medium-fine textured materials, showing some evidence of limited weathering through structure development or stronger colour of the subsoil. Eutric Cambisols, common in the region, have a high base saturation and are suitable for agricultural production in areas where topography is not a limiting factor.

Plinthic and Gleyic Luvisols also locally occur in this association.

8. Poorly drained soils

Gleysols are soils formed on unconsolidated materials (excluding recent alluvial deposits), which are strongly influenced by ground water and show hydromorphic properties.

Fluvisols are weakly developed soils on recent alluvial deposits. Most of them are hydromorphic, but their texture and drainage conditions vary widely with geographical location in the alluvial plains.

Saline soils and Planosols are locally associated with Gleysols and Fluvisols.

9. Shallow soils

Lithosols are soils which are limited in depth by continuous coherent hard rock at very shallow depths.

(b) Distribution of main soil associations

The general distribution of the nine main soil associations of the region is outlined in Fig. 11.

1. Desert soils cover the northern and eastern parts of the region. Yermosols are dominant and cover vast areas north of the 18° parallel N., as well as in eastern Ethiopia, Somalia and northeastern Kenya. They are stony, often shallow and are associated with Lithosols, areas of base rocks and both fixed and mobile sand dunes.

Haplic Xerosols: a large area stretches across central Sudan nearly to the Red Sea, extending to northern Ethiopia. Parts of this region are very stony and shallow.

2. Sandy soils cover vast areas on the southern fringes of the Sahara, from Senegal and Mauritania, through southern Mali, southern Niger and Chad and some northern parts of Burkina Faso and Nigeria to central Sudan. Luvic and Cambic Arenosols associated with sandy Regosols and local Eutric or Calcic Cambisols are the main components of the association.

3. Saline soils. Solonchaks and Solonetz are present in the lowlands east of lake Chad and in Somalia, and locally in coastal plains of Senegal and Mauritania. Limited areas of Solodic Planosols and saline Gleysols occur in southern Mali in the Niger basin and south of lake Chad. The total extend of this association in the region is not very large.

4. Acid soils of tropical lowlands: limited areas of this association occur in the southern fringes of the moist sub-humid zone, namely in Côte d'Ivoire and Central African Republic.

5. Soils of tropical highlands: Nitosols and Andosols, often associated with Cambisols, Vertisols and Lithosols, is a common soil association of the highlands of central Ethiopia.

6. Dark clay soils: large areas of Vertisols extend in east and south-central Sudan and also parts of southern Chad. Vertisols also occur in smaller areas in southern Mali and the Senegal River basin.

7. Ferruginous tropical soils: Ferric Luvisols usually associated with other Luvisol units, such as Plinthic and Gleyic, with some Cambisols, are the main components of the association, which stretches from The Gambia through southern Mali, Burkina Faso and northern Nigeria to northern Cameroon along the 10th parallel N. A large area of Eutric Cambisols, associated with Luvisols and Vertisols, occur in northern Ethiopia and eastern Sudan.

8. Poorly drained soils: Gleysols are extensive in the inland delta of the Niger River in Mali. Fluvisols occupy the flood plains of the major rivers and are particularly extensive south of lake Chad in the Chari River basin. Saline Fluvisols occur in the river valley south-west of lake Chad.

9. Shallow soils: large areas of Lithosols occur in Guinea, northern Chad and along the coast of the Red Sea.

(c) Soils adaptable to vegetable production

It is assumed that vegetable production over most of the arid and semi-arid regions - and at least for a large part of the year in subhumid regions - will be confined to soils that can be easily reached, from rivers or wells, for supplies of water for irrigation, and many of the best soils are, in fact, situated in the river valleys.

It will be clear from the above description of the soils of the area, however, that many are not suitable for horticultural purposes.

1. Desert soils. Yermosols are practically useless for vegetable production, often being very stony and limited in depth by hardened calcic or gypsic crusts. In addition, irrigation water is usually unavailable in Yermosol areas.

Xerosols, found over large areas in East Africa, are marginal for agricultural and particularly vegetable production. They are usually stony and in many districts, have hardened calcic horizons at shallow depth. In areas where deep Xerosols of medium texture can be found, they may be used for market gardening, on condition that irrigation is possible and that

suitable fertilizers (mainly N and P) are applied and due attention is paid to trace element deficiencies, particularly zinc and iron.

2. Sandy soils. Luvic and Cambic Arenosols are the most extensive soils in many districts, as they occupy such a large part of the region, including the steppe in the drier Sahelian areas with less than 200 mm rainfall per annum, and the wooded Savannah in the Sudanian districts with over 500 mm. They are not rich agricultural soils, since they are poor in nitrogen and phosphorus and very poor in the capacity to retain water. They are, however, easy to cultivate and are usually found on fairly level or moderately undulating country. The pH is slightly acid near the surface, but nearly neutral at deeper levels. Arenosols may, in fact, give good yields of vegetables under frequent (preferably sprinkler) irrigation, if adequate organic matter is incorporated and suitable fertilizers applied at regular intervals.

Sandy Regosols on the desert fringes are usually unproductive. They form large areas of desert and semi-desert in Mauritania, Mali, Niger and Chad, where they consist of pure coarse sand, often over a rock substratum and are generally associated with moving sand dunes. However, where local conditions are particularly favourable, they may be used for small production units after the addition of massive amounts of organic manure and with the use of adequate quantities of irrigation water. However, wind erosion is a major problem of these soils.

3. Saline soils. Solonchaks are marginally suitable for vegetable production, depending on the possibility of leaching by abundant irrigation and draining of surplus water to carry away the salts. They are unsuitable if located in closed basins where there is no possibility of drainage.

Solonetz are even more difficult to manage, owing to their clayey and slowly permeable subsoil which prevents adequate leaching of sodium. In addition, there are difficulties in controlling the rise of saline groundwater under irrigation. The problems of Solonetz management have seldom been resolved satisfactorily, because it is difficult to find good irrigation water and establish an efficient drainage system in the regions concerned.

Local inclusions of Solodic Planosols provide similar management problems to Solonetz, or even worse, due to their impermeable subsoil.

4. Acid soils of tropical lowlands. Ferralsols are strongly weathered soils with a low cation exchange capacity and practically no mineral reserves. Soil suitability varies with the clay content, which determines structure development and water and nutrient retention. They are deep soils, where not limited by ironstone or layers of oxidic concretions, and with adequate organic and mineral fertilization (particularly Phosphates which are strongly fixed), may be moderately suitable for vegetable production.

Acrisols are also strongly weathered acid soils with low base saturation, which show a horizon of clay accumulation in the subsoil. The plant nutrient availability is also low. The increase of clay in the subsoil reduces permeability and increases susceptibility to water erosion.

5. Soils of tropical highlands. Nitosols are deep, well structured clayey soils which have a moderate to high potential for food crops where topography is not a limiting factor. In the Ethiopian high lands they mostly have a high base saturation and are suitable for vegetable production with adequate organic and mineral fertilizers and improved erosion control measures where needed.

Andosols show considerable potential fertility owing to their usually high reserves of weatherable minerals, but topography is often the chief limitation, as it prevents mechanisation and requires substantial erosion control work. In favourable topographic conditions, Andosols are highly suitable for vegetable production with adequate irrigation.

6. Dark clay soils. Vertisols are heavy clay soils which are hard when dry and sticky, slowly permeable when wet. They are problem soils, particularly for traditional agriculture. They are locally alkaline and their exploitation requires a combined irrigation and surface drainage system and the choice of crops adapted to alkaline conditions. In any case, caution must be exercised in the choice of sites and preference given to areas situated in alluvial valleys where water may be found. Soils which are too heavy to allow adequate drainage and strongly saline or alkaline soils should be avoided. It is possible to improve soil physical properties with green manure and application of gypsum in alkaline areas, but this is an expensive and time-consuming process which can hardly be considered in traditional agriculture.

Inclusions of Vertic Cambisols, which are often associated with Vertisols, have similar management properties, albeit less strongly expressed and offer better possibilities for vegetable production.

7. Ferruginous tropical soils. Ferric Luvisols are soils in hot tropical zones with a marked dry season, during which they are often subject to strong surface crusting. They have a high base saturation and therefore some mineral plant nutrient reserves, but are poor in organic matter. Their cropping possibilities depend on texture, presence of oxidic concretions or layers of shallow hardened ironstone. They have a mediocre agronomic value.

Plinthic and Gleyic Luvisols are waterlogged during the rainy season, show surface crusting and are hard when dry. They are very marginal for vegetable production, particularly where the content of oxidic concretions is high.

Cambisols, particularly the Eutric and Calcic units, have a higher suitability for vegetable production. They are good soils, rich in nutrient elements. However, rolling to steep topography is a frequent limiting factor. Some areas with a level to undulating topography (e.g. in Burkina Faso and eastern Sudan) could be managed for irrigation. Availability of trace elements and presence of a cemented calcic horizon at shallow depth may raise problems on Calcic Cambisols.

8. Poorly drained soils. Gleysols have a moderate to high suitability for vegetable production, particularly the medium textured Eutric and Mollic units which have a high base saturation and good supply of plant nutrients. A basic management requirement is the control of the water-table level with a good system of ditches and surface or subsoil drainage and local leaching of excess soluble salts.

Fluvisols are mostly Eutric in the region. They are the best soils for vegetable production, owing to their high content of plant nutrients and their location in level topography with the availability of irrigation water from rivers or shallow wells. However, soil drainage may vary strongly from place to place and artificial drainage, as well as salinity control, may be necessary. Flood control may also be required for intensive production.

Local inclusions of Planosols have a low suitability for vegetable production.

9. Shallow soils. Lithosols are thin, stony soils on steep slopes and are not suitable for vegetable production.

Conclusion

From the above description, it appears that Fluvisols and Gleysols, with adequate inputs for drainage, irrigation and fertilizers, offer major possibilities for vegetable production in the region. Cambisols, Nitosols and Andosols are also suitable where topography is not a limiting factor. Arenosols offer some limited possibilities where irrigation water is available and large amounts of fertilizer applied. There are, therefore, ample resources of soil in the region for horticultural purposes. The limiting factor is usually supplies of irrigation water. For the scale of vegetable growing required in the region, water supplies should, in fact, be adequate, but they are highly localised and therefore dictate the location of the areas suitable for horticultural development.

REFERENCES

- ATKINSON, G.D. Forecaster's Guide to Tropical Meteorology. Air Weather Service (M.A.C.) Tech. Report. 240, USAF
1971
- AUBREVILLE, A. Climats, forêts et désertification de l'Afrique tropicale. Soc. Edit. Géog. Marit. et Col., Paris (351 pp.)
1949
- BAGNOULS, F. and GAUSSEN, H. Les climats biologiques et leurs classifications. Ann. de Géogr., p. 193-220
1957
- CHILDERS, N.F. et al. Vegetable gardening in the Tropics. Federal Experimental Station, Puerto Rico, USDA Circ. no. 32
1950
- CURTIS, O.F. and CLARK, D.G. An introduction to plant physiology, McGraw-Hill.
1965
- DE LANNOY, G. Bref aperçu de la climatologie du Sénégal. Centre pour le Développement de l'Horticulture, Cambérène.
1975
- DE LANNOY, G. Amélioration de la mise à fruits chez la tomate en culture d'hivernage par une sélection de lignées tolérantes à la chaleur. Centre pour le Développement de l'Horticulture, Cambérène
1980
- DE WIT, C.T. Photosynthesis of leaf canopies. Agric. Research Report No. 663. Centre for Agricultural Publications and Documentation, Wageningen
1965
- DUVIGNEAUD, P. La Synthèse écologique. Doin, Paris
1974
- EDMOND, J.B. et al. Fundamentals of Horticulture. McGraw-Hill Book Company
1975
- FAO Les besoins en eau des cultures. Bulletin d'irrigation et de drainage, No. 24. FAO, Rome.
1975
- FAO Rapport sur le projet relatif aux zones agro-écologiques. Vol. 1 : "Méthodologie et résultats pour l'Afrique". FAO, Rome.
1979

- FAO Agroclimatological Data. Plant Production and Protection Series No. 1984 22. FAO, Rome.
- FAO-UNESCO Carte Mondiale des Sols. Volume VI : "Afrique". Paris 1976
- KÖPPEN, W. Grundriss der Klimakunde. Walter de Gruyter and Co., Berlin. 1931
- LE HOUEROU, H.N. and POPOV, G.F. An eco-climatic classification of 1982 inter-tropical Africa. FAO Plant Production and Protection Paper No. 31, FAO, Rome.
- LE ROUX, M. L'Alizé. Bull. Ass. Géog. Franç, No. 410, p. 627-634. Paris 1973
- LE ROUX, M. Les Basses Pressions Intertropicales. Annales Fac. Lettres, 1974 univ. Dakar, Sénégal.
- LE ROUX, M. Le Climat de l'Afrique Tropicale. Ed. Champion, Paris. 1983
- LORENZ, O.A. and MAYNARD, D.N. Knott's Handbook for Vegetable Growers. 1980 John Wiley & Sons
- MASSON, M. Condensations atmosphériques non enregistrables au pluviomètre. 1948 L'eau de condensation et la végétation. Bull. IFAN, No. 10, Dakar, p.1-181
- PEDELABORDE, P. Introduction à l'étude scientifique du climat. SEDES, 1970 Paris.
- RODIER, J. Régimes hydrologiques de l'Afrique Noire à l'Ouest du Congo. 1964 ORSTOM, Paris.
- THORNTON, C.W. An approach toward a rational classification of 1948 climate. Geogr. Rev. No. 38, p. 55-94

CHAPTER III

PRODUCTION MANAGEMENT AND TECHNIQUES

by H. Van der Veken

A. DIFFERENT TYPES OF PRODUCTION UNITS

1. DOMESTIC FAMILY PRODUCTION UNITS

The main objective of this type of vegetable garden is the improvement of food supplies for the producer and his family. The surplus provides some goods for exchange on the local market, which often gives the villager a small supplementary revenue during a season when other agricultural work is limited and leaves some time available for vegetable growing.

The drought which has cursed the region during recent years has stimulated the establishment of numerous new wells and water points. The water was originally intended for human consumption and for watering livestock, but it appears that enough has often been available to establish village gardens, sometimes small and sometimes fairly large.

These initiatives should be encouraged and certain precautions should be taken to assure successful production.

In the first place, the quality of the water should be checked, to see if it is suitable for vegetable production. The company or government department responsible for sinking the well can normally make an analysis of the salt content. The quantity of water available daily for irrigation should be measured, taking account of other requirements, the available facilities for pumping and the possibilities for water storage (see p. 50).

These preliminary data will allow an estimation to be made of the area of land that can be irrigated, basing calculations on ten litres of water per day, per m² of land. Adjustments should be made for climatic conditions, species cultivated, cultural methods and water management, taking into account local experience.

In any case, even if the available water is sufficient for a large garden, it is preferable to start with a small surface of two to four beds, say 20m², per family. Better returns are obtained from a small surface, well cultivated, than from a large surface carelessly cultivated. The area can be increased, if water is available, as experience is gained.

The choice of species to be grown in this type of garden should be based initially on local dietary customs. The species most preferred are onions, tomatoes, cabbage, sweet potato, bitter eggplant, okra ("gombo") roselle (Hibiscus sabdariffa) and chilli peppers.

Villagers should not allow themselves to be influenced by merchants who offer attractive prices for certain species which are difficult to grow, especially for farmers who have had no previous experience of this type of production. It should not be supposed that village gardens can be quickly adapted to the supply of, for example, tourist holiday camps, where high standards of quality and regular deliveries are demanded. Even well organized commercial concerns find it difficult to meet the requirements of this type of market.

In order to ensure the success of village gardens, the vegetables produced should be limited to vigorous varieties of a small number of species, well adapted to the season and climate and resistant or tolerant to the main pests and diseases. Maximum advantage should be taken of previous local experience and the cause of any failures should be carefully examined. The possibilities of preserving vegetables at village level by sun-drying and other simple methods should be fully explored and production arranged accordingly.

An important point to consider, in projects for village garden development, is the supply of tools, which is often planned in excess of real needs and leads to loss and careless use of the material.

Factors affecting the choice of soil are explained in section B.3. of this Chapter, but it should be borne in mind that, for the very small areas concerned in village gardens, one can often make use of mediocre soils, since they can be improved quickly through the use of farmyard manure from livestock enclosures or compost from village waste.

2. COMMERCIAL PRODUCTION UNITS

The establishment of any enterprise for the commercial production of vegetables should be based on careful technical, economic and commercial studies, related to the size of the proposed enterprise and to all local circumstances. Neglect in this direction generally leads to disastrous results. The following notes summarize the main factors to be studied in detail before investments are committed.

(a) Choice of business

The enterprise may be designed either to serve local markets, export markets or processing industries or combinations between these markets. The outlets will determine the range of species and varieties to be grown. Market studies should indicate the quantities and qualities required and the prices available at different seasons. This essential economic information provides the guide to a production programme for the species, varieties and timing required by the outlets. Production must be controlled strictly according to these factors.

(b) Choice of site and related economic considerations

Once the type of production has been decided, a site must be chosen which combines the maximum of favourable conditions available. The physical and social factors are discussed in Section 4; other factors are discussed in the following paragraphs.

The site should, as far as possible, be located in proximity either to the local market or to the factory or, for export trade, to a suitable sea-port or airport. Transport expenses and the lapse of time between harvest and delivery to market must be reduced to a minimum to ensure the arrival of the produce in a good fresh condition. Transport in refrigerated lorries is certainly a possibility, but is very expensive.

The means of communication and the distance between the places of production and sale are critical factors and can, in some cases, limit the choice of species. They also, of course, affect the supply of inputs (fertilizers, pesticides, etc.). Again the presence of a supply of electricity may represent an important advantage for running pumping installations, and cold stores.

The cost per cubic metre of irrigation water delivered to the field should be carefully calculated, especially where the use of deep sources of underground water and high pumping costs are involved. At the same time, the system of irrigation must be studied, so as to establish the cost of water as actually delivered to the plant. This point is often forgotten, although the cost of water is usually the prime factor determining the cost of production of vegetables.

Finally, an analysis must be made of the profitability of each crop, including the cost of production and all other expenses up to the point of sale. This will make clear the differences in returns from the different species and facilitate decisions to eliminate those that do not reach the level required.

(c) Production management

Commercial market gardening requires very good organization. To plan production according to demand requires personnel of real technical ability. No important factor must be forgotten if heavy losses are to be avoided. Capable management for all stocks and equipment is essential. Breakdowns of irrigation or phytosanitary equipment must be dealt with immediately and a close inspection of all crops must be carried out every day. The most common causes of financial failure have proven to be neglect of these simple principles of good management.

(d) Progressive expansion of the enterprise

The creation of a new market garden should proceed in phases, taking account of the human and financial resources obtainable, not forgetting that vegetable crops are delicate and require constant care and a certain level of technical knowledge, especially in the tropics. It is therefore recommended that new enterprises should be started on a modest scale. Infrastructures and equipment can then be better adapted to local conditions than if a start is made on a grand scale.

B. FACTORS AFFECTING THE CHOICE OF SITE AND THEIR INFLUENCE ON PRODUCTION

1. CLIMATE

Climate factors play an important role in the choice of production sites and the species and varieties to be grown. The choice of species and variety must be adapted both to region and season, desired quality and yield per hectare, otherwise the crops will suffer from various constraints.

The factor most liable to effect a major constraint is temperature. Trials carried out at the experimental station at Puerto Rico (Childers and Winters, 1950), were among the first to have made possible the establishment of an approximate classification of vegetables according to their optimum thermal requirements (Table 1). Certain species, of course, can only be produced at an economic level in the cool season, whereas others develop better in the warm season. It should be noted, however, that important progress has been made during recent years in the selection of varieties adapted to cultivation under difficult climatic conditions. There now exist, for example, varieties of cabbage and lettuce relatively well adapted to warm seasons, varieties of tomato very little affected by daily temperature variations and varieties of onion which do not require vernalisation to produce seed and which are well adapted to short days.

Table 1 : CLASSIFICATION OF VEGETABLE CROPS ACCORDING TO THEIR OPTIMUM

		Growing Temperature							
		13°C	16°C	18°C	21°C	24°C	27°C	29°C	32°C
		55°F	60°F	65°F	70°F	75°F	80°F	85°F	90°F
Cold season crops	Peas Spinach Brussels sprouts								
	Head cabbage* Chinese cabbage* Celery Cauliflower Head lettuce Turnip								
	Beetroot Dry onion Chayote Carrot Leaf lettuce* Potato								
Cool season crops	Cucumber Green onion Melon Courgette, etc. Pumpkin Strawberry								
	French bean Beetroot Hyacinth bean* Parsley Sweet pepper* Chilli*pepper* Radish* Tomato								
Warm season crops	Aubergine Okra Sweet potato Watermelon								

* Species for which there are now varieties relatively well adapted to the warm humid season, according to trials in Senegal.

After: "Vegetable Gardening in the Tropics". Federal Experimental Station in Puerto Rico. USDA, 1950.

The climate is subject to great influence from winds. They may be very harmful to vegetable growing, especially when they are hot and dry like the "harmattan", and provoke rapid evapo-transpiration. On the other hand, cool winds, like the "alizes", along the Atlantic coast during certain seasons of the year, render the climate more temperate and allow the production of species sensitive to high temperatures - such as the potato (*Solanum tuberosum*), which cannot produce tubers at temperatures above 29°C. Species and varieties of vegetables vary in their sensitivity to persistent winds. One of the most sensitive species in this respect is the dwarf French bean.

Amongst other climatic difficulties, one must especially note that heavy precipitations during the rainy season can cause serious damage to seedlings and young plants.

2. QUANTITY AND QUALITY OF WATER

It should be remembered, not only that the tissues of vegetable crops generally contain up to 90% of water, but that during their growth they require 300-500 litres of water to produce each kilogramme of dry matter. It follows that a shortage of water during the growing season has immediate repercussions on quality and yield and that water supply is thus one of the most important factors in vegetable production. It is therefore indispensable to adapt the dimensions of the surface cultivated to the quantity of water regularly available, making allowance for all requirements, including pre-irrigation, the water necessary for removing excess salts in the soil and the water used for sprays and the application of fertilizers. One should estimate a daily water supply of 80 to 100 m³/ha throughout the growing season to cover all needs.

Irrigation water must meet certain criteria of quality. The Salinity Laboratory at Riverside, USA, has established a classification in diagrammatic form (Fig. 1) which illustrates the quality of water, according to two parameters.- electric conductivity (E.C.), which shows overall salinity, and the coefficient of sodium absorption (S.A.R.), which shows the alkalinity potential. Electric conductivity is expressed in millimhos or micromhos and can be measured easily with the aid of a conductivity metre.

Water can be classified according to its salt content into four classes.

Class	E.C. at 25°C in micromhos/cm	Utilization for Irrigation
C 1	Less than 250	Good quality, with little risk of causing soil salinity.
C 2	250 to 750	Usable for plants with moderate salinity tolerance, with the employment of light leaching irrigations.
C 3	750 to 2 250	Usable only on well drained soils and for plants with good salinity tolerance.
C 4	Over 2 250	Not normally suitable for irrigation.

The sodium absorption coefficient (S.A.R.) is a value calculated and defined by the following equation, proposed by the Salinity Laboratory, USA (1954):

$$\text{S.A.R.} = \frac{\text{Na}^+}{\frac{\sqrt{\text{Ca}^{++} + \text{Mg}^{++}}}{2}}$$

The concentration is expressed in milli-equivalents per litre.

The use of water with a high sodium content can have very harmful effects on the physical properties of the soil: defloculation and degradation of structure, leading to a condition in which the soil becomes impermeable and suffocating to plant roots. Generally one classifies the risk of alkalisation in relation to salinity as follows:

Class	Sodium content of water	Utilization for Irrigation
S 1	Slight	Usable on nearly all soils with precaution for sensitive species
S 2	Medium	Usable on soils of coarse texture (sandy soils) or on organic soils with a high capacity for water absorption. Risk of alkalisation on fine-textured soils (clays)
S 3	Strong	High risk of alkalisation on most soils
S 4	Very strong	Generally not usable for irrigation. Very high risk of alkalisation.

The content of carbonates (CO₂) and bicarbonates (HCO₃) in irrigation water can also influence the permeability of soils (Rhoades, 1972). This risk can be calculated from an adjustment of the S.A.R. according to the formula shown in Annex A1. There is generally no risk where the S.A.R. is inferior to 6.

It is strongly advised that the electrical conductivity of the water concerned is measured before any work on the installation of an irrigation system is undertaken. If the E.C. is high, a chemical analysis of the water will be necessary (Annex A4). It is also useful to measure the pH, which indicates the acidity or alkalinity of the water; normal satisfactory levels are between pH 6.5 to pH 8.4. pH measurements outside these levels should be taken as a warning that careful investigations of water quality should be undertaken.

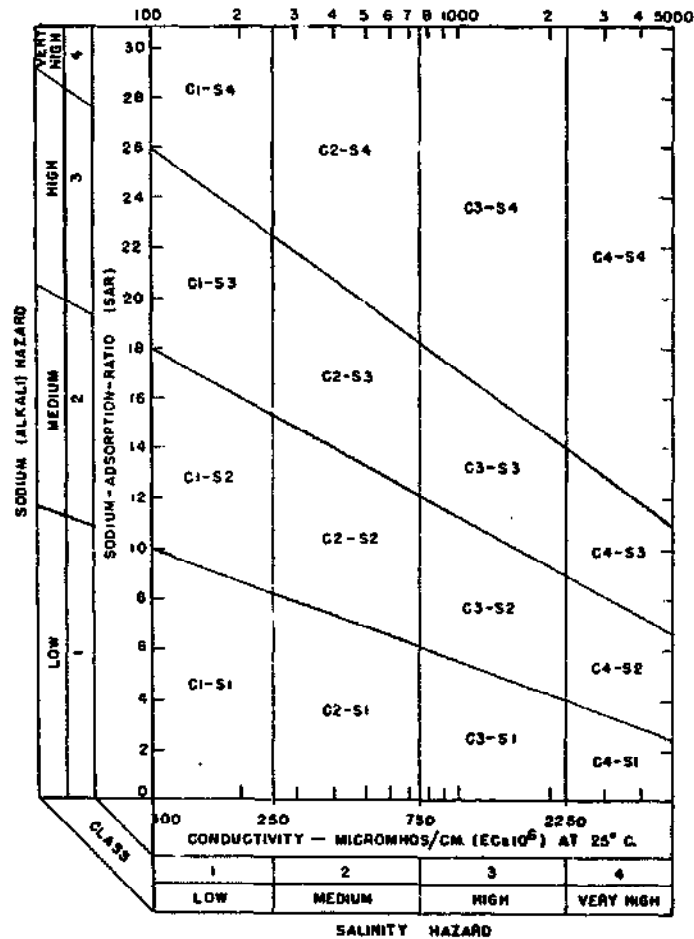

Fig. 1. Diagrammatic classification of irrigation waters. USA Salinity Laboratory (1954)

Certain salts, even at low concentrations, can have a toxic effect according to the relative susceptibility of the species concerned. The contents of Boron, Chlorine and Sodium should be examined. Tolerance levels of the different vegetable species to salinity and the boron content of irrigation water are shown in Annex A5. It should be noted that no difficulty is generally caused to absorption of water by the roots when the concentration of boron is below 0.55 ppm, the concentration of chlorine below 4 meq/ml or when the coefficient of sodium absorption (S.A.R.) is inferior to 3. It should also be remembered that, with overhead irrigation systems, damage can occur to the foliage of sensitive plants, such as French beans, when the chlorine or sodium content exceeds 3 meq/l (Ayers and Westcott, 1976).

Other elements in irrigation water, even at the "trace" level, can have a toxic effect on crops. Such cases are rare, but are summarized in Annex A7 (Ayers and Westcott, 1976), which indicate the maximum acceptable concentrations of these elements.

3. CHOICE OF SOILS

Vegetable species can be grown in soils of rather widely different physical and chemical character. It is nevertheless desirable to look for soils containing the most favourable characteristics for the species to be grown, otherwise one must choose the species most appropriate to the soil available, within the limits of economic imperatives. The choice of soils is the more important, the greater the area to be cultivated, and is especially critical where intensive production methods are to be employed. The availability of organic material for soil improvement is also an important consideration. Furthermore, as vegetable cropping in arid and semi-arid zones usually involves irrigation, the reaction of the soil to repeated irrigations with the available quality of water needs investigation.

(a) Surveys

Observation of the natural vegetative cover will give a preliminary indication of the type of soil and its fertility. For large areas it may be desirable to study the various soil properties, assuming that the requisite services are available for laboratory analysis.

The study of the soil profiles may best be undertaken by digging pits in the higher soil horizons and exploring the lower horizons with a soil auger. In this way, an evaluation may be obtained of the texture, structure and consistency of the soil, of the presence of concretions, organic matter (roots), and fauna, and the level of humidity. An important point is the state of drainage at the different horizons.

(b) The collection of soil samples

A soil sample is a minimal portion of the terrain under study, selected in order to assess fertility and the methods required for improving it. The necessity for precision and care in selecting the sample is obvious. The area to be cultivated should be divided into a number of more or less homogenous zones, which are then sampled separately.

Each sample should be composed of at least 15 portions per hectare, taken at random over the whole surface of the hectare, excluding paths, borders and areas which are clearly unrepresentative. Each portion should consist of a slice of soil cut vertically and at a constant thickness down to the depth of cultivation or else down to about 20 cm after removal of surface vegetation. If the topsoil includes a layer rich in humus, the slice should be cut through the complete thickness of the layer unless it is too deep. Finally, all the selections from the same homogenous zone should be carefully crushed and mixed by hand on a clean bench (never on old fertilizer or pesticide sacks!), without removal of stones or gravel. After slow drying in the shade, a sample of about 1 kg is taken from the mixture and placed in a small bag, with one identification tag in the interior and another tied outside the bag.

The samples should then be sent to the analytical laboratory, accompanied by a table showing the place and date of sampling and a description of the soil, indicating vegetation, relief, erosion and, if possible, the depth of the water table. For soils already under cropping, one should indicate the crop rotation, type of cultivation, manurial treatments and other relevant information.

(c) Analysis and interpretation

The information gathered at the time of survey should be completed and confirmed by the chemical and physical analysis of the soil samples.

The texture is one of the most important of soil characters. It influences the rate of filtration, the capacity of retention of water and nutritive elements, potential for drainage and susceptibility to erosion. All these properties are influenced by soil structure, the nature and relative quantity of clay and the content of calcareous and organic material. Determination of the soil content of nitrogen and organic carbon, gives the C/N ratio. The total content of nitrogen in a soil is a measure of its organic content. In this respect, a poor soil contains less than 1% of organic matter, and medium to rich soils 1 - 2%.

The ratio C/N shows the level of decomposition of the organic matter. At a level of about 10, it indicates that the humus is well decomposed; below 8, it shows that the reserve of organic matter is poor. A high C/N ratio often indicates a content of ligneous material which is resistant to decomposition (C. Tietjen, 1962). The content of organic material, and especially of humic acids, constitutes the essential part of the absorption complex and is the principal element in the stability of soil structure.

It is also important to know the level of assimilable phosphoric acid in the soil. The extraction of assimilable phosphorus from soil samples is generally affected by certain physical factors - such as the humidity of the sample, the way it is crushed, the duration of contact with the extracting solution and the temperature - these factors all being liable to cause variations in the measurements of phosphorus. The interpretation of results is therefore a delicate question, but as a general rule it is accepted that, using the classical methods and according as to whether the soil concerned is of a light or heavy texture, levels respectively of 0.10 to 0.12% of phosphorus are considered poor and 0.30 to 0.40% are considered rich.

The capacity of cation exchange (C.E.C.) or the total exchange capacity (T) of a soil, indicate the maximum quantity of cations that a given weight of soil is capable of fixing. It is often expressed in milliequivalents per 100 gm of soil (me/100). In function of soil texture, one may say that, for a coarse texture, the total exchange capacity is poor when T is inferior to 5 me/100 and high when it is superior to 10 me/100. For a medium texture, the figures would be respectively inferior to 10 me/100 and superior to 15 me/100, and for a very fine texture respectively inferior to 15 me/100 and superior to 25 me/100.

The pH of a soil can be measured either by the colorimetric or the electrometric methods. It is important to know the reaction of the soil, since it indicates the solubility of the different nutritive elements and their assimilability by plants. The following figures 2 and 3 show the influence of pH on the availability of nutritive elements in a predominantly mineral soil (figure 2) and a predominantly organic soil (figure 3).

Vegetables can develop within very variable limits of pH, but they can be divided in three classes according to their tolerance in this respect, as shown in Table 2.

The salinity of a soil is determined by measuring the electrical conductivity (E.C. 25°C) of a saturated extract. Following the scale of salinity of the Riverside Laboratory, a soil is slightly saline when E.C.25 of the saturated extract is above 2,000 micromhos and is saline from 4,000 micromhos upwards. For vegetable production in general, it should not exceed 1,000 micromhos. Table 5, Annex A, indicates the tolerance of certain vegetable crops and associated crop reductions. The exploitation of saline soils poses special problems and calls for detailed study before it is undertaken.

Table 2 CLASSIFICATION OF VEGETABLE CROPS ACCORDING TO THEIR TOLERANCE OF ACIDITY

Little Tolerant pH 6.8 - 6.0	Fairly Tolerant pH 6.8 - 5.5	Very Tolerant pH 6.8 - 5.0
Asparagus	Egg-plant	Shallot
Red beetroot	Carrot	Watermelon
Celery	Cucumber	Sweet potato
Chinese cabbage	Marrow	Potato
Head cabbage	Courgette	Endive
Cauliflower	French beans	
Lettuce	Maize	
Melon	Parsley	
Leek	Peas	
New Zealand spinach	Sweet pepper	
	Radish	
	Tomato	

After: Knott's "Handbook for Vegetable Growers"
by Lorenz and Maynard, 2nd Edition (1980)

(d) Some soil types suitable for vegetable growing

Sandy soils are those containing more than 85% of sand. They are easy to work and are generally well drained and aerated, especially when there is a sufficient content of coarse sand. The speed of infiltration varies from 25 to 250 mm/hour and the retention of humidity in the soil is very weak; Rivers and Shipp (1971) found that the field capacities of soils of coarse sand, fine sand and very fine sand are respectively 5.6%, 7.3% and 7.9%. Sandy soils are poor in organic matter (less than 0.2%) and in nutritive elements. Potassium and, especially, nitrate nitrogen, are easily leached out by irrigation. These soils are generally very sensitive to wind erosion. Most vegetable crops, particularly asparagus and root and tuber vegetables, can be grown under irrigation on sandy soils, provided that the content of organic matter is increased and the appropriate fertilizer elements are supplied.

Sandy clay soils can also be used for vegetable growing, but it is preferable for the clay content to be inferior to 35%. When large areas are to be used, it would be useful to determine the mineralogical nature of the clay, since this mineralogical nature can influence soil permeability, aeration and retention of nutrients.

Sandy-clay soils are difficult to work, especially when they are wet. Their low rate of infiltration (1 to 25 mm/hour) is a disadvantage for some systems of irrigation; on the other hand, they retain water well and are thus suited to the use of furrow irrigation. Crops of tomato, sweet pepper, cabbage and melon grow well on sandy-clay soils that are sufficiently deep and well aerated.

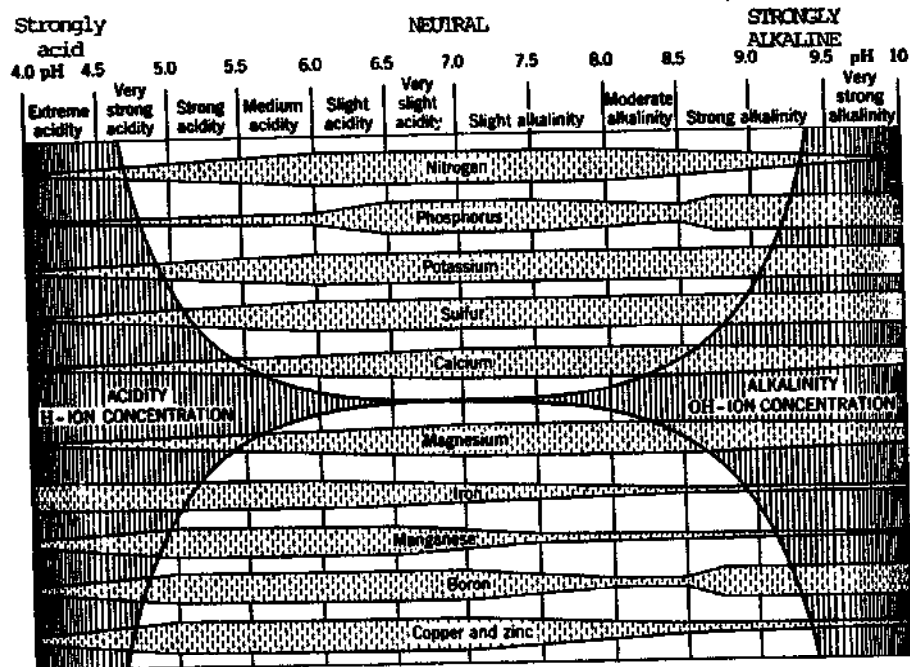

Fig. 2

Influence of the pH on the availability of nutritive elements in mineral soils; the width of the dark bands indicates the maximum availability of each element. (After Knotts "Handbook for Vegetable Growers" and adapted from R.E. Lucas and J.F. Davis "Relationship between pH values of organic soils and availability of twelve plant nutrients", Soil Science, 92: 177-182).

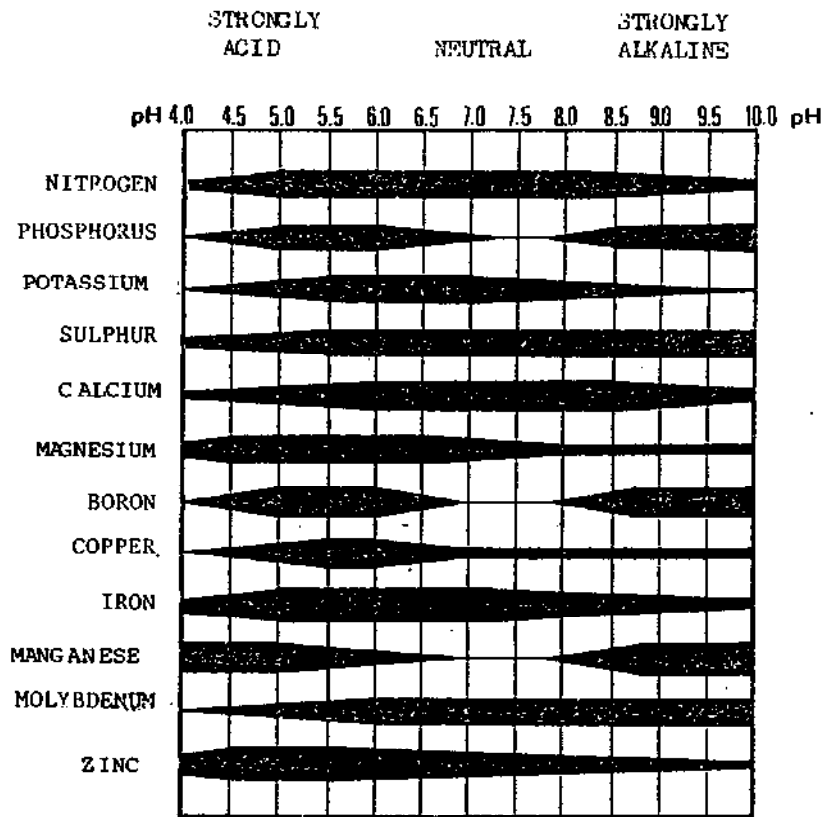

Fig. 3

Influence of the pH on the availability of nutritive elements in organic soils; the width of the dark bands indicates the maximum availability of each element. (After Knotts 'Handbook for Vegetable Growers', adapted).

The soils that are best suited to vegetable growing are the sandy-silts and silty-sands, containing between 50% and 85% of sand and 1% to 3% of organic matter. They are generally well drained and aerated, moderately fertile and have a satisfactory capacity for water retention. Although these soils are more fertile than sandy soils, it is necessary to apply fertilizers to improve and maintain their cropping capacity.

Humiferous soils are most often found in damp or marshy depressions. These soils can produce good crops of some species of vegetable provided they are sufficiently well drained and are not too acid or too salty and do not have an excessive content of chlorides or sulphates. In Senegal, certain hydromorphic soils in the "niayes" (coastal sand-dune regions) contain 2% of sulphates, which is considered toxic for vegetable crops. On the other hand, the regular flooding of most soils in the niayes keeps them free from root-knot nematodes. Their content of organic matter, however, which is very abundant to start with, rapidly disappears when they are put under regular cropping. It is, therefore, strongly recommended not to burn off the vegetation at the time of breaking up these soils for cultivation, as this will further reduce their content of organic matter. In peaty soils, which maintain a very high water content, it is not advisable to grow potatoes or onions, as they will produce crops of poor keeping quality. Such soils are very suitable, however, for leaf vegetables (e.g. cabbage) and for tomatoes, eggplant, roselle (oseille de Guinée), sweet potato and cassava.

4. TOPOGRAPHY

When choosing a soil, account should be taken of the relief. As far as possible, preference should be given to fairly level, flat sites. The land will then be easier to work and to irrigate and will not be subject to erosion. Furthermore, land levelling or the construction of terraces involves much scraping and filling, which is very costly and often decreases the agricultural qualities of the soil.

5. HUMAN RESOURCES AND SOCIAL CONDITIONS

The production of vegetables of good quality and the obtaining of good yields calls for sustained and permanent efforts on the part of the grower. In fact, vegetable crops develop rapidly and need intensive care from seeding to harvest, including daily observations of phyto-sanitary conditions and a constant succession of delicate operations. This does not make for an easy life and demands a different work pattern from the one required for traditional village crops. Besides qualities of an indefatigable worker, the grower needs to possess a range of technical knowledge for growing a variety of crops and must also be capable of planning his production according to market demand, foresee his requirements of inputs and arrange a suitable rotation.

All these qualities are not easy to find in one and the same person and this is one of the reasons that, at a certain concentration of production in a region, growers will benefit by forming a cooperative or producers' group. Such an organization can assist them over many management problems.

The principal functions of an organization of this sort could be in the following fields:

- Search for market outlets
- Planning of production
- Purchase and distribution of inputs

- Coordination of production
- Negotiation of loans with public and private institutions for credit, taking responsibility for the group of producers and their production.
- Liaison work between the group of villagers and the technical and social services, making available modern information and means of production.
- Organization and supervision of quality and the grading and packing of produce for sale.

The role of these cooperative organizations should be strongly educational, in that their objectives are primarily to train the growers in the management of their production and to encourage mutual assistance in business affairs.

The producers' group or cooperative should be neither too small nor too large, but of a sufficient size for volume of production to justify the necessary equipment and administrative services and to generate sufficient funds for indispensable investments. Care should be taken to avoid over-equipment and to keep financial costs to the essential minimum. Success of the group will depend primarily on the quality of management and on the level of general and technical education of the growers.

C. MANUAL AND MECHANICAL SOIL CULTIVATION

The preparation of the soil through various cultural operations demands careful attention from the grower, since the success of his crops will depend on it. The techniques used and the timing of the operations must be perfectly adapted to the physical nature of the soil and current climatic conditions - also to the species to be grown, the area cultivated and the system of irrigation employed. These operations should improve the physical, chemical and biological condition of the soil as well as destroying weeds and preparing conditions for sowing or planting.

The mechanical preparation of the soil with well chosen equipment can, of course, allow growers to cultivate much larger areas than by arduous manual methods, but it is important that the mechanisation is economically justified. It often happens that excessively large areas of land are made available to villagers with the idea of justifying mechanical cultivation, but when these areas are too large to be correctly operated, the result is that they are poorly managed, and give poor yields per hectare. The high costs of the mechanical cultivation are then harmful to the growers' revenue.

1. CLEARING AND PREPARATION OF THE SITE

After the site has been chosen and the cropping plan established, the cropping blocks may be cleared and laid out ready for primary operations. The magnitude of the work will depend on the character of the natural vegetation. Clearing can be carried out either manually or mechanically. Manual clearing of savannah with sparse tree population needs about 60 to 70 man/days/ha for pegging out, cutting back the vegetation, uprooting trees and bushes and piling up the material in heaps. (It is recommended that the vegetative material should be left in heaps to decompose and not burnt.)

The clearing can be carried out mechanically, but care must be taken to preserve the top soil in place; all movement of soil causes a loss in fertility which can only be replaced at the expense of the grower. There

are, however, exceptions to this rule, when levelling the sandy soils in coastal dunes, for example, or when working on very deep soils of alluvial or volcanic origin, which sometimes require terracing before they can be cropped. The content of fertilizing elements in the sandy soils is so low and in a deep layer of alluvial and volcanic soils is often sufficiently high, that the movement of the soil does not have much effect on fertility in these cases.

The machines suitable for site clearance (tractors with chain-tracks equipped with bulldozer blades or rotary bush cleaners) are usually not locally available, because it is rarely justifiable to purchase such costly machines for tasks of limited duration. Normally, one should apply to companies employed in public works or to the relevant official departments to arrange for the work to be performed under contract.

It may sometimes be possible to combine manual work with mechanical clearing. In livestock-raising areas, one can occasionally hire rotary bush cleaners capable of clearing dense vegetation.

2. SUB-SOILING

Sub-soiling is rarely undertaken; sometimes it is unavoidable, but in most cases it is uneconomic. If one wants to put into cultivation a site invaded by plants with deep roots or rhizomes, it is necessary to clear the soil from these weeds or they will always continue to invade the crops. Again, in shallow soils, an impermeable layer such as a plough-pan or a lateritic horizon, should be broken up by a sub-soiler, so as to ensure good drainage and deeper root penetration, if alternative sites are not available. The work must always be carried out in a soil sufficiently dry to permit thorough breaking up.

Sub-soiling can be carried out on small areas by hand, with the aid of spade, hoe or pick-axe, in such a way that the topsoil remains in place, but this is very hard work and is only justified where absolutely necessary and when there is no other means available. Sub-soiling is usually carried out mechanically by the use of a sub-soil plough or chisel plough drawn by a powerful tractor. For certain soils and for cropping on ridges with furrow irrigation, cultivation with the chisel plough, followed by careful ridging, can be sufficient soil preparation.

3. PLOUGHING AND DIGGING

The object of cultivation is to break up the soil, to incorporate organic and chemical base manures and lime if necessary and to bury surface rubbish and weeds. It can be carried out with simple hand tools like the spade, hoe and digging-fork. For larger areas, especially on lighter soils, animal-drawn instruments may be used or, if economically justified, mechanical means can be adopted. The most usual machines are motor-cultivators and tractor mounted ploughs; digging machines may also be useful for incorporating organic manures. Light cultivations may be carried out with stubble ploughs, disc cultivators and toothed harrows. All these implements have their advantages and disadvantages according to the character of the soil and the nature of the operation.

Before deciding on the purchase of an expensive machine, however, it is advisable to consult the specialised services of the Ministry of Agriculture, who can advise on the equipment best suited to local conditions. In any case, a warning should be given about the use of motor-cultivators. In Africa, generally speaking, they are overburdened,

they are not suitable for very heavy work and when equipped with rotary cultivators are not capable of burying organic manures.

When ploughing, care should be taken to bury the organic dressing evenly. The depth of ploughing should depend on the type of soil, the material that has to be incorporated and the species to be grown. Root vegetables usually need deep soil cultivation, but in light soils, it is better to keep to shallow ploughing for all crops.

Successive cultivations of the same plot of soil should be made at variable depths, so as to avoid the formation of a plough-pan. Flat land can be ploughed in any direction, but on sloping sites, subject to erosion, ploughing should be along the contour line. Finally, soil should not be ploughed unless it is sufficiently dry.

In the sandy soils of Senegal, the use of a digging machine has proved satisfactory for the incorporation of green manures. When it is necessary to bury a heavy cover of vegetation with these machines, the tops should first be cut down. Before all other cultural operations, in light soils, rolling after ploughing is indispensable.

For tomato production in the Senegal river valley, it has proved possible to reduce mechanical cultivations to one ploughing followed by a ridging. In the majority of cases offsetting is not essential. Trials of cultivation with a chisel cultivator, however, did not give satisfaction (L. Constantinov, 1980). It was also observed that the use of small machinery in this region cost three times as much as the use of large machines and that the life of small machines was sometimes shorter.

4. HARROWING AND RAKING

These operations are carried out on freshly ploughed ground in order to break up and level the surface of the soil and prepare it for sowing or planting.

Small areas may be worked by going over the soil in different directions with the rake, until all lumps have been broken down and the surface nicely levelled. If the lumps of soil have become hardened in the sun, a light irrigation may be given a little before raking. Raking may also be used for covering seed after broadcasting.

When the soil preparation is carried out mechanically, harrowing follows immediately after ploughing, while the soil is moist enough to be easily pulverised.

There are a number of different types of harrows and cultivators which may be chosen according to the nature of the soil.

5. ROLLING OR PRESSING

The object of this operation is, firstly, to re-establish the capillary movement of water from the lower, uncultivated to the upper, cultivated soil levels and, secondly, for land recently sown, to establish a good contact between soil and seed in order to encourage germination.

The operation may be carried out manually on small areas or in the nursery, either with a simple plank which is pressed down on the soil surface or with an instrument made of a thick plank 25 x 40-50 cm fitted with a long handle. For larger areas, one may use a hand roller of wood or metal.

For large market gardens, there are a number of different types of tractor-drawn rollers suited to work on various soil types. The operation must not, in any case, be carried out on soil that is too damp. The weight of the roller may be adjusted according to soil type and condition.

D. PROPAGATION AND PLANTING

1. SEED SOWING

Most vegetables are propagated by seeds, either sown in a nursery or direct in the production beds. Vegetables which do not respond well, or are otherwise unsuitable for transplanting, are sown direct ("in situ"). This is the case for practically all root vegetables (carrots, radish, turnip, red beetroot), for the legumes (beans and peas), the cucurbits and for certain other vegetables such as okra ("gombo").

For large scale production, sometimes other sorts of vegetables are sown direct "in situ", when this is economically justified, but one must always allow for the extra costs of cultivating and irrigating the seedlings in the field, which is then much higher than for plants grown in the nursery. On the other hand, the planting out of such species as onion, which are grown at close spacing, involves a great deal of hand labour.

Seedling nurseries

The site of the nursery should be chosen with care. It should preferably be on soil which has not previously carried vegetable crops, so as to avoid infection from nematodes. One should also pay attention to the soil texture and the availability of irrigation water.

If the soil is too heavy, it should be improved by the incorporation of sand and well rotted compost. The nursery site should be flat and well drained and the nursery beds must be absolutely level. When the use of a sloping site is unavoidable, the nursery beds must be raised and levelled and lie across the direction of the slope.

One should avoid situating the nursery under tree shade, as this may harm the development of the young plants because of insufficient light and the competition from tree roots.

In some regions, during some seasons of the year or some parts of the day, it may be necessary to shade the nursery. In this case, it is important that the nursery beds should be oriented in the East-West direction. The shading should be movable and should be sloped at about 35° to afford the best protection from the sun's rays.

The nursery should also be sheltered from the dominant winds, which can damage seedlings and young plants. A natural or artificial wind-break in a suitable position, is always necessary in regions exposed to the sea winds ("alizés") or desert winds ("harmattan").

The soil of the nursery must be carefully prepared. First, one should remove all stones and debris, then the beds should be marked out and well dug, incorporating 4-5 kg of compost or well rotted farmyard manure per m². Fertilization may be supplemented by spreading a dressing of complete fertilizer at 40 gm per m², before raking and levelling the beds.

During the dry season, the borders of each bed may be slightly raised to help retain irrigation water; during the rainy season, the beds should be kept at a higher level than the passages between them, to ensure good drainage.

Sowing in lines

This technique consists in first marking out, in the freshly levelled soil little furrows about 1 cm deep at a regular distance of 10 to 20 cm apart, according to the species to be sown and the size to which they will be grown in the nursery. The marking out of the furrows can be carried out with a special marking rake or simply with a wooden lath that is pressed into the soil. Seeds are sown in the furrows, taking care to preserve a regular and suitable density. This method is strongly recommended for several reasons. It avoids waste of seed and over-crowding of the seedlings, which usually results in weak and spindly plantlets. In addition, the time saved later in weeding and cultivating more than compensates for the extra trouble of marking out the furrows. After sowing each furrow, the seed is immediately covered by hand or rake and when the whole bed is sown, the soil is pressed flat with a plank to ensure that the seed is in close contact with the soil and thus to facilitate rapid germination.

Sowing is naturally followed by an irrigation, after which it is better to cover the seed bed with straw. This keeps the soil surface moist and helps rapid and easy seedling emergence. It also makes for economy of water and protects the seed bed against high temperatures and the drying action of winds. The straw should be removed after the seedlings have emerged, to avoid any etiolation of the plantlets.

Sowing broadcast

Broadcasting consists of spreading the seed over the soil surface as evenly as possible. It is difficult to do well without practice and it is preferable anyway to avoid the system. It has several serious drawbacks - one generally uses too much seed and weeding and thinning the seed bed take much longer than when seed has been sown in line. The density of sowing depends, of course, on the species and it is suggested that the seed is mixed with dry, sifted sand before broadcasting, to help avoid sowing too thickly. The seed may be covered by a light raking or by a thin top dressing of soil. In either case, the operation is completed by firming down the soil followed by irrigation.

Seeding in pockets

This method is used for leguminous vegetables, such as French beans and peas, for cucurbits, such as sweet melons, cucumbers and watermelons, and for certain other species like okra ("gombo") and roselle. With this method, no transplanting is necessary. The technique consists of placing a few seeds in each of a series of soil pockets. The size and depth of the pockets and the distance between them depends on the crop species. The seeds in each pocket should be placed a little apart, so that the seedlings may develop correctly; if it is later necessary to thin them out, the seedlings to be left in place will not then be unduly disturbed when excess plants are removed. The seeds are covered by hand immediately after sowing and the soil lightly firmed.

Seeding by machine

There is now a great variety of seed-sowing machines available, ranging from small hand drills to wheeled drills pushed by hand, and large precision seed drills drawn by tractor. The small hand seeder, consisting of a metal cylinder with an adjustable outlet and spout is sometimes useful for sowing seed in line in the nursery. The manually-drawn seed drill, mounted on a wheel, can be very useful, even for comparatively large areas. Onions, for example, can be conveniently sown in this way, either in a seed bed or by direct seeding in the field. It is always advisable to test the

apparatus over a line of newspapers before sowing, so as to check the speed and quantity of output. Particular attention should be paid to the depth of seeding, which should be adjusted carefully according to the species sown.

Tractor-drawn precision seed-drills can also be useful for large scale production, on condition that their cost is economically justified.

It is recommended that growers should consult the competent services before purchasing a seed-drill to make sure that they obtain a machine well suited to their conditions and to the crops they wish to grow.

Germination

A good germination depends, in the first place, on the quality of the seed and secondly, on soil preparation and the physical condition of the soil during the period of germination. The soil should be well aerated and sufficiently humid, without being too wet. Vegetables can be classified according to their requirements in soil humidity at the time of germination (L.D. Doonen and J.H. MacGillivray, 1971).

Vegetable seeds which germinate with a soil humidity only slightly above wilting point are: cabbages, cucurbits, onions, peppers, tomatoes and radish. The second group, which require medium soil humidity are: legumes, lettuces and red beetroots. Lastly, celery seed needs a soil humidity approaching field capacity. It should also be noted that certain vegetable seed needs to be soaked in water for several hours before sowing, to increase the rapidity of germination; this is the case with okra and New Zealand spinach (Tetragonia).

Soil temperature also affects germination and in the climatic area concerned, it is high temperatures that are most likely to be a problem. Lettuce seed does not support temperatures above 30°C and for the majority of other vegetables, the limit is around 35°C. (University of California, Davis, USA).

2. THINNING

This operation consists in removing seedlings surplus to the required planting density, retaining only healthy and vigorous plants.

Nursery seedlings sown in line at the correct density do not usually need thinning. If seeding has been too dense, a first thinning should be carried out as soon as possible after emergence, removing the least well developed seedlings. According to the growth of the remaining plants and the time they are to be left in the nursery, it may be necessary to carry out a second thinning.

Crops sown direct "in situ" may also need thinning, when the plants are sufficiently well developed and after there is no fear of further important losses. Strong and healthy plants which have been removed in the course of thinning can be used for filling any gaps in the crop.

In order to avoid damage to the remaining plants at the time of thinning, it is recommended that the crop should be irrigated on the previous day and that a second irrigation is given immediately after the operation. These irrigations should preferably not be given during the hottest part of the day. Thinning is usually accompanied by a thorough weeding of the crop.

3. PLANTING

Planting should be carried out with every care, as the successful production of the crop depends on the efficiency of the operation. The plants should be given the spacing required for the particular species and variety, so they may attain their optimum development and quality and give a high yield per hectare. Spacing also depends on the quality of soil and cultural factors, such as the methods of planting, type of irrigation, production and harvesting techniques. Table 3 indicates currently-used spacing by species; these should be modified to suit local conditions.

Planting material

The type of planting material varies greatly according to crop species. Nursery plants are used for tomatoes, aubergine, cabbage and the other crops mentioned in Table 3. Tubers are used for potatoes; bulbils or seedlings may be used for onions and cuttings for sweet potatoes. For species or under conditions that are difficult for transplanting, one may even use plants grown from seed sown in presspots or peat blocks. In any case, the planting material should be of top quality. Any plants showing signs of disease, pests, weakness or malformation are eliminated - with special attention to signs of nematode attack. In short, one should only plant material which is healthy, strong and vigorous.

Planting technique

Planting involves several operations which can be carried out according to circumstances by one person or a group of persons, properly coordinated.

The preparation of the soil, should take place as nearly as possible just before planting. One starts with pegging out the lines and the planting sites along each line, followed by digging the holes, laying out the plants, planting and irrigation. From the digging of the holes until the irrigation, these operations should follow one another without interruption, if a good "take" of the plants is to be ensured. One should make sure that the holes are sufficiently large to accommodate the root systems without crushing or doubling and take care that the plants are thus properly fixed in the soil at the depth suitable to each species. After planting, the roots should be in firm contact with the soil. This result is obtained by exerting the correct lateral pressure when planting, without squeezing the neck of the plant.

Planting cuttings or seedlings from the nursery should be done when the sky is covered or in the late afternoon or evening when the heat of the day is passed. The operation is carried out either manually with a dibble or trowel or mechanically, with a planting machine. Various different systems of planting may be adopted, according to the type of soil, method of irrigation and crop species concerned.

Planting on ridges is used where the irrigation is by furrow; industrial tomatoes and sweet potatoes are often grown in this way. The seedlings or cuttings are planted at about 2/3 of the height of the ridge, or at the limit marked by the water after pre-irrigation.

Planting on level ground is desirable when using overhead irrigation.

Planting may also be arranged on raised beds or mounds when dealing with rather impermeable soils which need careful drainage. It is also possible to plant in trenches in order to economize water or when growing species which need earthing up, which can be arranged by progressively

Table 3 : Time Necessary for Manual Planting or Sowing of a Total Surface of 1,000 m² on Sandy Soil

Crop	Spacing (metres)	Number of lines	Width of passage (m)	Surface actually cultivated (m ²)	Number of plants	Time taken to plant or sow (hrs)
Eggplant	0.50 x 0.70	2	1	666	1.666	15
Bitter eggplant	0.50 x 0.60	2	1.2	760	2.666	27
Cabbage	0.40 x 0.40	4	0.60	727	4.544	23
Cucumber	0.50 x 2	1	0.50	750	1.000	9
Courgette	1.00 x 1.00	3	0.60	833	8.333	7.5
Okra	0.50 x 0.90	1	1	527	2.222	17
Okra	0.50 x 0.60	2	1.2	709	2.500	20.5
French bean	0.40 x 0.40	3	1.2	667	4.166	16.5
Sweet potato	0.30 x 0.80	2	1.60	872	3.663	13.5
Chilli pepper	0.50 x 0.50	3	1.50	820	3.000	15.5
Chilli pepper	0.90 x 0.90	2	1.80	700	1.065	9.5
Potato	0.30 x 0.60	3	0.50	783	4.347	18
Onion	0.12 x 0.20	5	0.50	667	2.779	70
Tomato	0.40 x 0.40	2	0.60	700	2.500	17

After: C.D.H. Tecnico-Economic Leaflet, prepared by S. Navez and I. Biaye

filling up the trench at the time of hoeing and weeding. Table 7 indicates the time taken by manual planting operations in sandy soil, for several species.

Factors influencing the establishment of transplants

Seedlings should be transplanted at a stage in development when they re-establish their growth ("take") readily - neither too big nor too small. This stage varies with the different species; for lettuce, it is rarely necessary for the seedlings to be left in the nursery for more than 30 days from seeding; for leeks, the period may vary according to season from 45 to 75 days, for cabbage 30 to 40 days, for aubergine and tomato 30 to 45 days, and for sweet and chili peppers, about 45 days. The grower should always watch the development of the plants in the nursery and seize the proper moment for planting, depending on their size, vigour and number of leaves.

The way in which the plants are prepared, lifted and transported for the nursery plays a big part in the success of the establishment. One must be very careful not to damage the root system or stems of the plants. They should be lifted from the nursery bed with a trowel after a thorough irrigation, placed gently in a shallow box, covered with a damp sack and carried to the cropping bed.

Seedlings of some vegetables, especially leeks and onions, are trimmed before planting by shortening both the roots and shoots, although for other species only the roots are trimmed. This operation takes a good deal of time and it is not clear whether it makes for a better "take". If the nursery is well managed and the planting time well judged, it should be possible to avoid trimming, especially in the tropics where the period spent in the nursery is relatively short. In some cases, however, for example when using a mechanical planter, trimming may facilitate the work.

Carelessness over depth of planting is a common cause of failures in transplanting. As a general rule, plants which have been well grown in the nursery have developed at the proper depth and it is sufficient to preserve this depth in the cropping bed. Certain species, however, like tomatoes, which are capable of sprouting adventitious roots from the stem may be planted deeper. This is especially convenient for plants which have grown too tall by the time of transplanting. Leeks are also planted deep, but this is only to increase the blanched area of the vegetable. Onion bulbils, on the other hand, should be only just covered with 1 to 3 mm of soil. If they are planted too deep they will rot in the ground. Cuttings of sweet potato should be buried for 2/3 of their length, i.e. for about six nodes.

Under certain conditions, when a successful "take" may be difficult to obtain, it may be useful to dip the roots of the transplants in a mud slurry. It may also be useful to employ hormone solutions - at dosages according to the instructions of the manufacturers of the different products. These hormone solutions are expensive, however, and should not be necessary if the rules of good cultural methods are followed. The major factor for success after transplanting has been well executed, is adequate irrigation, with a minimum delay.

E. PROTECTION OF CROPS FROM ADVERSE CLIMATIC FACTORS

1. WIND-BREAKS

Wind-breaks may be permeable or impermeable to wind. When they are impermeable, as is the case with walls, they cause turbulence on the leeward side of the wind-break which reduces its effectiveness. An impermeable wind-break is estimated to give protection for a distance equivalent to 6 or 8 times its height.

Following the studies by Jensen on the permeability of wind-breaks, the best condition is about a 35% permeability. Other authors have found 50% preferable. In general, wind-breaks should be of only moderate density and not too thick; they may then afford protection for a distance equivalent to 20 times their height (Fig. 4 and 5).

Wind-breaks may consist of living plants or of inert material. In the latter case, one may use mats made of the dry stems of sorghum, pearl millet or split bamboo, or curtains of plastic netting (which, however, are expensive).

For wind-breaks of living plants, one should choose plants or trees which produce an adequately dense vegetation for their full height and which are resistant to drought, well adapted to the soil and climate, quick growing and not subject to the same pests as the vegetables. If possible, it is also useful if the wind-break produces a crop of its own.

The line of wind-breaks should be placed at right angles to the direction of prevalent winds. On sloping land (over 5% slope), it should follow the contour. The space between wind-breaks should be about 15 times their height. Roads which cross the lines of wind-breaks should, if possible, not be in line with the direction of the prevalent winds to reduce the effect of the gaps in the wind-break (Fig. 6).

For large-scale enterprises, a line of trees should be planted round the boundary. According to the height of the trees and the area to be protected, further wind-breaks may be planted within the farm. (A list of trees suitable for use as wind-breaks is given in Table 4.)

Between the lines of trees, curtains of inert material may be erected or living hedges may be planted of maize, sorghum, pearl millet, sugarcane, Pennisetum purpureum, Cajanus cajan, Arundo donax, etc. It should be noted that wind-breaks have an effect on air temperature which varies in proportion to the permeability of the screen. It is, therefore, frequently necessary to remove the secondary wind-breaks when the season of strong winds is passed, in order to increase the cooling effect of air movement. The lines of trees will naturally remain in place.

2. SHADING

According to the region and the season, it may be necessary to protect seeds and young plants during the hottest part of the day. However, this technique should not be used unless it is impossible to obtain the desired results without it and, in any case, the shade should be removed as soon as possible. If the seed beds need permanent shade, one can suspend a shade curtain in the nursery at the height of a man, which facilitates work. The density of shade should be reduced to the minimum necessary - often considered to be 25%. When shade is only required for part of the day, movable screens must be constructed. These should be easy to lift and use on other seed beds.

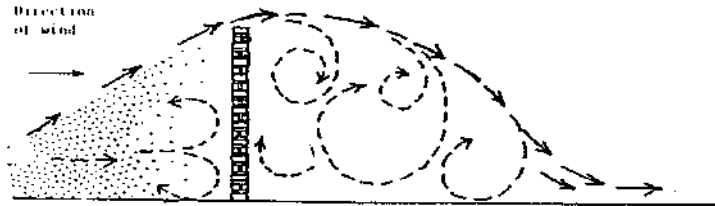

Fig.4 Effect of an impermeable wind-break.

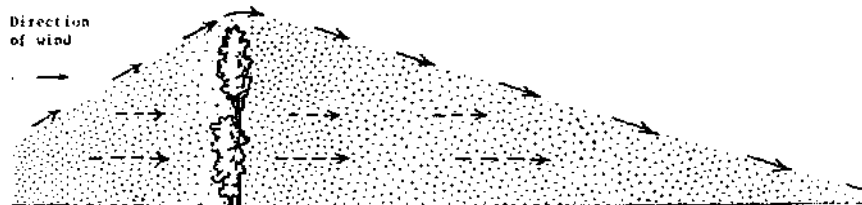

Fig.5 Effect of a permeable wind-break.

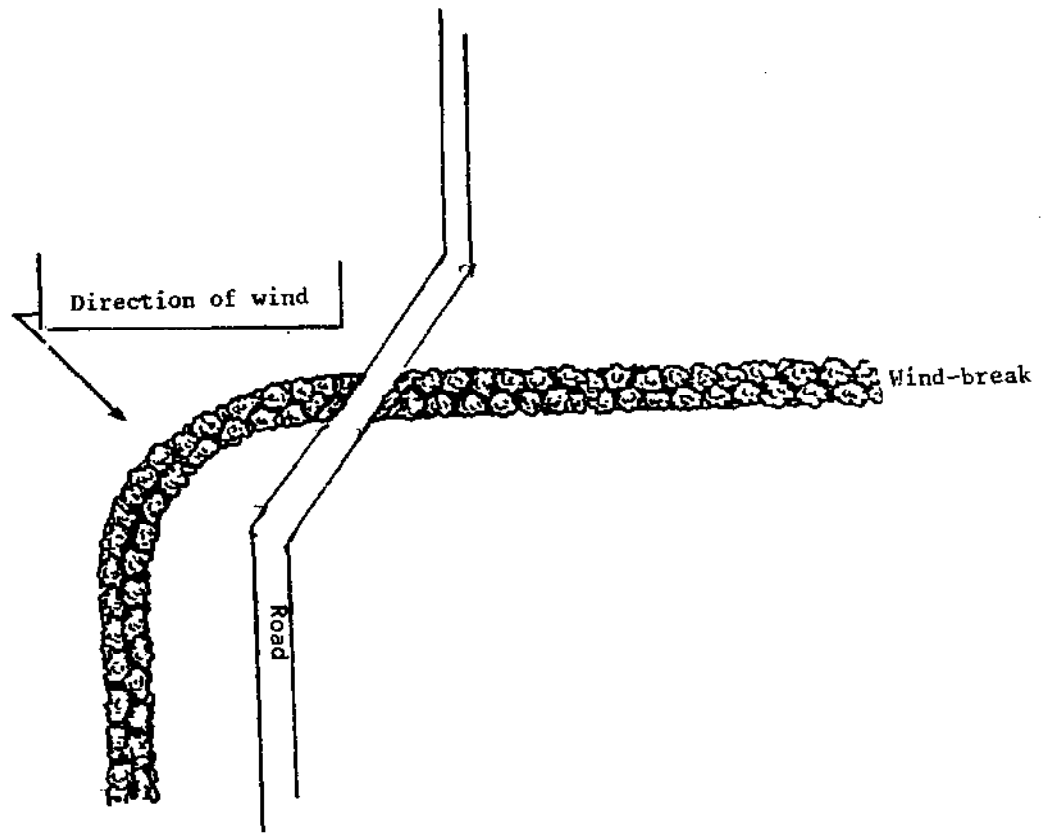

Fig. 6. Road Crossing Line of Wind-breaks obliquely.

Table 4

LIST OF TREES SUITABLE FOR USE AS WIND-BREAKS

Tree Species	Characteristics
<u>Anacardium occidentale</u> (Cashew)	Bushy, vigorous and very resistant
<u>Azadirachta indica</u> (Neem)	Well adapted to arid zones, quick growing, resistant to high temperatures.
<u>Cassia siamea</u>	Vigorous branching. Resistant to termites.
<u>Casuarina equisetifolia</u>	Well adapted to hot arid conditions. Quick growing, salt tolerant, needs irrigation.
<u>Conocarpus laurifolius</u>	Adaptable, quick growing. Very salt tolerant. Needs irrigation.
<u>Eucalyptus camaldulensis</u>	Quick growing, subject to wind damage. Very strongly developed root system competitive to crops. Use only for boundaries.
<u>Tamarix articulata</u>	Very resistant to drought. Salt tolerant. Adapted to shallow calcareous soils.

Usually, local material can be employed for the construction of shade screens, but it should be noted that one can purchase nets of polythene thread, resistant to ultra-violet rays and available at various shade densities from 20 to 70%. These nets can also be used as wind-breaks, but they are generally expensive.

3. STAKING

There are some crop species that, for various reasons, require staking.

Many tomato varieties need staking to produce high quality fruits and to avoid the rotting of fruits in contact with the soil. A comparative trial in Senegal demonstrated that, with a single stake of a height of 75 cm above soil level, the yield of the variety "Hope No. 1-H" was increased by 18% compared with the unstaked control, and that the percentage of undamaged fruit was increased by 19% (Gaudoin, 1981).

Climbing French beans and Hyacinth beans develop better when supported and this also makes harvesting easier.

In short, for certain crops, staking allows better aeration, reduces attacks of fungus diseases and ensures better exposure of the foliage to light, thus making for better photosynthesis.

One method of staking often used for legumes and tomatoes, is by the use of groups of two or three stakes of wood tied together at the top and connected with other groups by a light horizontal cane. An alternative

means of support is an iron wire stretched horizontally at a suitable height, from which strings are suspended. The stems of the beans or tomato plants are twisted round the strings.

Another system is the construction of a sort of shelf of twigs or bamboo about 20 cm above the soil surface. The crop foliage is spread along the shelf as it develops.

In all cases, the erection of stakes and supports is best carried out before sowing or planting the crop to avoid damage to the young plants (Figure 7).

F. CULTURAL OPERATIONS

1. HOEING

The object of hoeing is to improve the aeration and the structure of the soil, to facilitate the penetration of water, to eliminate surface weeds and to reduce loss of water by evaporation.

It consists in moving the surface layer of the soil without turning it. Hoeing is carried out at various depths, depending on the nature of the soil, the species cultivated and its root system; if it cuts too deep, it may harm or destroy this root system. The soil should be well drained and preferably dry on the surface for satisfactory work.

The time to hoe is when a crust forms on the soil surface encouraging the loss of soil water through capillarity and evaporation. In some soils, because of their capacity for rapid re-consolidation, the effects of hoeing are very temporary. This is the case with the tropical unleached ferruginous soils of Senegal, known as "Dior" (G. Herblot, 1979). The operation may be carried out by hand with the help of such tools as the hand hoe or Dutch hoe. For larger areas, a wheel hoe is convenient; when dealing with mechanised farms a motor hoe or tractor mounted hoes are used.

With mechanised operations, one should remember that the hoes must work the same number of rows (or a multiple of the same) as was covered by the seed drill or the mechanical planter. This is necessary so as to follow exactly the spacing and alignment of the plant rows. The work must be precise; the position of each blade must be carefully adjusted with regard to the spacing, and the wheel controlling the depth of work and other components must likewise be correctly placed. These machines must be well maintained; to use them properly requires care and practice.

2. WEEDING

Mechanical hoeing should be completed by removal of all remaining weeds in the rows by the use of a small hand weeder or fork. This simple job is indispensable for good crop growth; delays in weed removal are often the cause of poor yields, especially during the early growth of the crop and sometimes even when the crop is well established.

It is also possible to attack weeds with herbicides, but this method is only to be recommended under certain conditions - notably if hand labour is scarce or too costly in comparison with the cost of herbicides. Moreover, careful trials are necessary on the use of the herbicides concerned on the crop and with the weeds concerned, under local conditions, before large scale operations are undertaken.

Fig. 7 Staking of vegetable crops

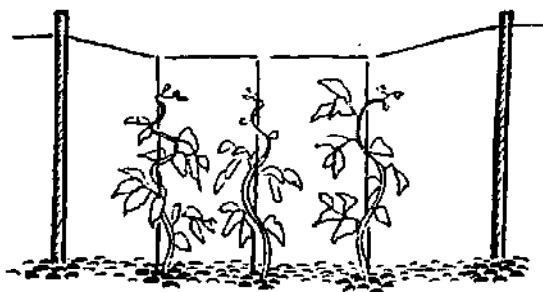
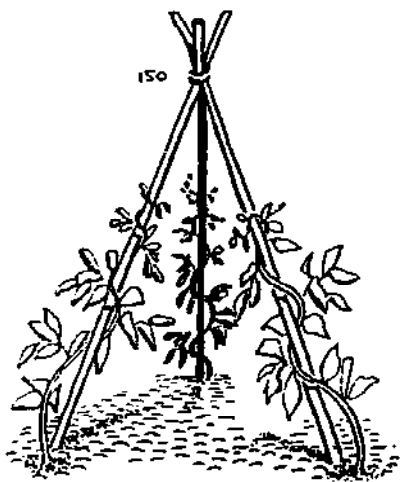
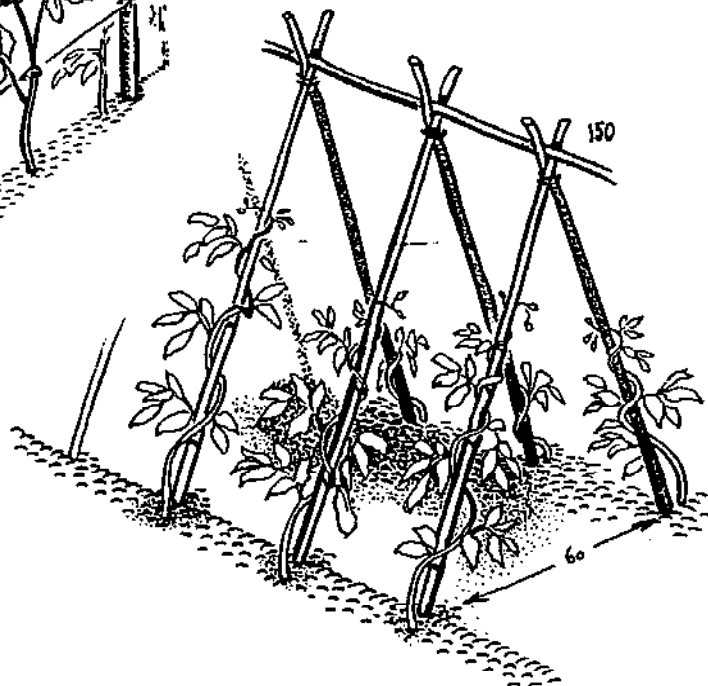
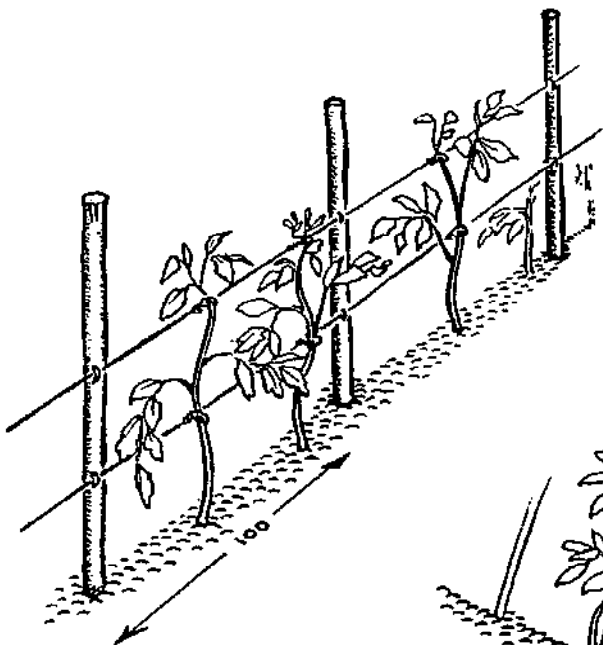
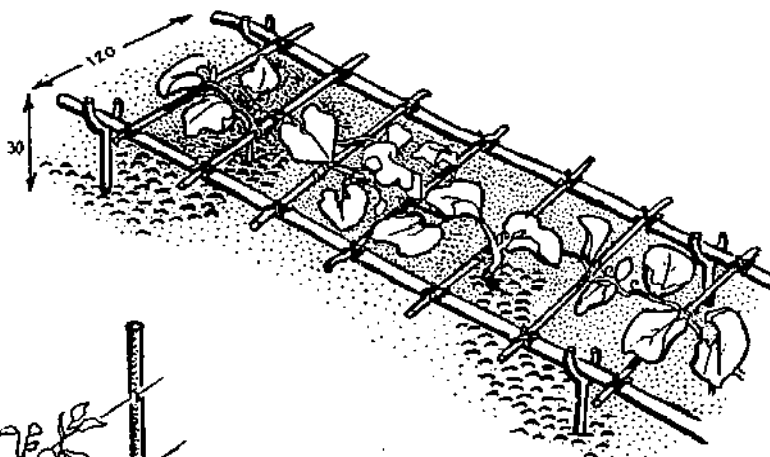
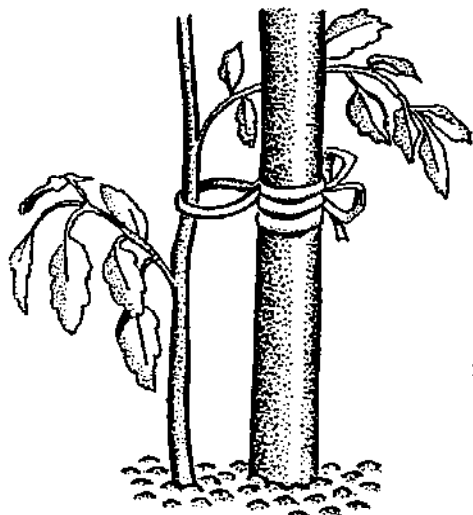

Serious problems may result if a careful study is not made of the dose, season, timing and mode of application of the weedicide and on its after-effects on successive crops and on the condition of the soil.

The National Agricultural Research Centre in Senegal has carried out trials on chemical control of weeds in a direct sown onion crop, using "Chlortal" at 7 kg a.m./ha, dissolved in 180 litres of water, applied as a spray at the pre-emergence stage. This treatment successfully controlled several annual weed species, but not the crucifers.

Several trials on sandy soil at C.D.H. Cambérène have confirmed the efficacy of "Chlortal" at pre-emergence, at the same strength, against Portulaca oleracea and Trianthema sp. "Ioxynil" has also been tested as a pre-emergence spray at 600 gms/a.m. It proved to be slightly phytotoxic. "Nitrofène" at 3 kg/a.m./ha gave excellent results against Portulaca meridiana but a serious wilting of the onions was observed.

Chemical weeding of soil sown with tomatoes has been tested in Senegal by Hernandez, using a mixture of two herbicides, "Trifluraline", an anti-germination herbicide affecting the Gramineae and several of the dicotyledones, and "Metribuzine", which acts against the dicotyledon when absorbed through the roots, by inhibiting phytosynthesis.

The doses used in the mixture were 1.2 kg/a.m./ha of "Trifluraline" and 0.25 kg/a.m./ha of "Metribuzine", both in solution in 180 litres of water. Application is by sprayer just before seeding, followed by incorporation in the soil at 3-5 cm, within the hour. The applications should not be made when the weather is hot, nor when there is a wind.

3. EARTHING UP

This operation consists in piling earth round the base of such crops as leek and asparagus with the object of blanching a certain part of the plant and thus improving its eating quality and commercial value. In the case of potatoes, this operation supplements the planting depth, favours root development, inhibits the greening of the tubers and protects them from the attacks of mildew and tuber moth. "Earthing up" can, in some cases, be used to support the crop or to stimulate development of adventitious roots from the stem, or to help to drain off an excess of water.

Whatever the reason for the operation one must be careful to carry it out progressively according to the growth of the plants and after having tested its effect on a few of them. In fact, considerable crop losses often occur after earthing up, for a variety of reasons - such as damage to the root system, working the soil too deeply, injuries to the plant or development of disease on the stems. The operation, indeed, should be avoided unless it is really necessary, especially during hot weather.

Top dressings should be applied before earthing up. The work may be carried out by hand hoe or, on sandy soils, even by rake. On large areas, the ridging plough is usually employed.

* a.m./ha = active material/hectare

G. FERTILIZATION

1. GENERAL

Fertilization concerns improving the physical, chemical and biological properties of the soil to improve the growing conditions for crops and thus to obtain higher yields and better quality.

The costs of production for irrigated market garden crops, grown under intensive conditions, are in any case high, and the application of a good fertilization only adds a relatively small percentage to the total, from the viewpoint of the probable gains in productivity. For example, it was observed during a fertilization trial on industrial tomatoes in the Senegal River Valley that the application of a mineral fertilizer (151N-92P-27OK) resulted in more than treble the yield, namely to 69.2 tons/ha compared with 23.8 tons/ha on the control plots. It should be pointed out, however, that a dressing of fertilizer loses much of its effect if other factors are neglected, such as soil preparation, correct planting density, cultivations and phyto-sanitary treatments.

Since the growth cycle of vegetable crops is generally of short duration and the yields obtainable are substantial, it is essential that there is an adequate supply of nutritive elements in the soil in a readily assimilable form.

It should be explained, however, that correct fertilization depends on the interaction of numerous factors which are generally insufficiently understood and in these circumstances it is very difficult to prescribe the formula perfectly adapted to a particular soil and crop. The grower must rely on available information and experience and, if need be, should experiment with different dosages, to establish the best possible formula for his crop, soil, climate and other conditions.

2. SOME PRINCIPLES OF FERTILIZATION

Good fertilization is based on the maximum available information on the soil, the needs of the crop, the composition of the fertilizers and their effect on the plant. Studies carried out by numerous research workers have established the general principles for the use of fertilizers which have to be applied as best as possible to available information on local conditions. The general principles are as follows:-

Replacement

The plant removes considerable quantities of nutritive elements from the soil and numerous studies have been made to evaluate the quantities removed by vegetable crops. These demands vary according to the yield, variety, duration and season of the crop and the soil character, climatic conditions, type of irrigation and cultural techniques. They provide, nevertheless, useful indications for the orientation of the fertilization of a crop; Table 5 gives a summary of the demands on certain elements in kg/ha according to different research workers.

G. FERTILIZATION

1. GENERAL

Fertilization concerns improving the physical, chemical and biological properties of the soil to improve the growing conditions for crops and thus to obtain higher yields and better quality.

The costs of production for irrigated market garden crops, grown under intensive conditions, are in any case high, and the application of a good fertilization only adds a relatively small percentage to the total, from the viewpoint of the probable gains in productivity. For example, it was observed during a fertilization trial on industrial tomatoes in the Senegal River Valley that the application of a mineral fertilizer (151N-92P-27OK) resulted in more than treble the yield, namely to 69.2 tons/ha compared with 23.8 tons/ha on the control plots. It should be pointed out, however, that a dressing of fertilizer loses much of its effect if other factors are neglected, such as soil preparation, correct planting density, cultivations and phyto-sanitary treatments.

Since the growth cycle of vegetable crops is generally of short duration and the yields obtainable are substantial, it is essential that there is an adequate supply of nutritive elements in the soil in a readily assimilable form.

It should be explained, however, that correct fertilization depends on the interaction of numerous factors which are generally insufficiently understood and in these circumstances it is very difficult to prescribe the formula perfectly adapted to a particular soil and crop. The grower must rely on available information and experience and, if need be, should experiment with different dosages, to establish the best possible formula for his crop, soil, climate and other conditions.

2. SOME PRINCIPLES OF FERTILIZATION

Good fertilization is based on the maximum available information on the soil, the needs of the crop, the composition of the fertilizers and their effect on the plant. Studies carried out by numerous research workers have established the general principles for the use of fertilizers which have to be applied as best as possible to available information on local conditions. The general principles are as follows:-

Replacement

The plant removes considerable quantities of nutritive elements from the soil and numerous studies have been made to evaluate the quantities removed by vegetable crops. These demands vary according to the yield, variety, duration and season of the crop and the soil character, climatic conditions, type of irrigation and cultural techniques. They provide, nevertheless, useful indications for the orientation of the fertilization of a crop; Table 5 gives a summary of the demands on certain elements in kg/ha according to different research workers.

Table 5 AVERAGE WEIGHT OF MINERAL ELEMENTS REMOVED BY DIFFERENT VEGETABLE CROPS (kg/ha PER TON HARVESTED)

Species	N	P ₂ O ₅	K ₂ O	CaO	MgO
Aubergine	6.9	1.5	7.4	-	0.8
Asparagus	22.2	7.6	30	16	2.5
Red Beetroot	4.7	1.4	8.6	1.3	1
Carrot	3.5	1.4	6.1	5.9	1
Celery	2.2	1.2	4.7	2.3	0.3
Cabbage	3	1.2	4.3	3.4	0.5
Cauliflower	8	3.2	10	6	1
Cucumber	2.3	1.5	3.6	1.5	0.6
Strawberry	8.2	3.7	13.5	-	-
Ladies fingers (gombo)	10.9	4.1	18.1	11.2	2.3
French beans	21.7	6	24.7	17.1	1.2
Lettuce	2.2	1	4.8	1.1	0.2
Melon	3.3	0.9	6.4	4.5	0.8
Turnip	4.7	1.5	5.3	3.2	0.7
Onion	4.2	1.8	5.8	3.7	0.6
Sweet potato	3.5	1.1	5	-	-
Leek	3.1	1.3	3.6	1.9	0.6
Pea	16.1	5.3	12	11.9	1.3
Sweet pepper	4	1	5.8	2.8	0.7
Potato	3.4	1.4	5.8	0.3	0.2
Radish	2.9	1.4	5.2	2.7	0.2
Tomato	3	0.8	4.6	4	0.6

Apart from the demands of the plant, there are also losses caused by leaching, which vary according to the soil content of organic matter and clay, climatic conditions, technique of fertilizer application, and the type of irrigation. The elements which are most readily leached are sulphur, nitrogen, lime and, to a lesser extent, potassium and magnesium.

Reserves of fertilizing elements

Reserves of nutritive elements in the soil are necessary so that plants may call on them when required. The programme of fertilization must therefore take into account the rotation of crops and the remaining availability of organic and mineral material applied to previous crops, which constitute a reserve for present crops.

Limiting factors and balanced fertilization

The growth factor which is least satisfactory during crop growth and development will determine the final yield. One must therefore try to keep all the factors involved in such a balance that all nutritive elements are available in the optimum quantity throughout the cropping period, to permit good growth and give a maximum yield.

The Maximum dose and the economic dose

For each nutritive element, there is a maximum dose above which an increased application of fertilizer will not increase the yield, and may, in some cases, cause a reduction. One must try to ascertain the level of fertilizer application which gives the maximum economic benefit.

The Influence of manuring on the quality of vegetables and on their resistance or susceptibility to parasites

It is well known that fertilization can have a great effect on the quality of vegetables. For example, potassium increases the production of sugar in melons, and phosphoric acid improves their flavour. On the other hand, an excess of nitrogen may result in an excessive nitrate content in some leaf vegetables.

It should also be noted that an excess of nitrogen renders plants more liable to attack by parasites. Potassium, however, stimulates a certain level of resistance, if applied according to crop requirements.

3. ORGANIC MANURES

Organic manures are formed mainly from vegetative waste material and animal excrements. When buried in the soil, they improve structure, increase biological activity and supply a reserve of nutrient elements. Use of organic manures is essential for good vegetable growing but, unfortunately, supplies are often inadequate. The grower should provide for supplies in advance, according to whatever is available locally, including, for example, fish waste and groundnut waste. Along the coast, algae can be used after rain-leaching, which removes the excess salt.

The incorporation of green manure is often recommended. Although green manure crops are not without disadvantages, they will certainly increase biological activity and help protect the soil from erosion during the rainy season. The most suitable species are rapid growing legumes and grasses that are resistant to nematode attack.

The quantity of organic manure to apply depends on the nature of the soil and on what material is available. As a general guide, it is considered that a good organic content is 1.5% in a coarse and 3% in a fine-textured soil.

Table 1, Annex C, indicates the nutrient content of different types of organic manure.

It should be noted that specific 'soil conditioners' are on sale, consisting of synthetic substances to improve soil structure and aeration. Because of their high cost, they are usually only economic for use in nurseries.

4. THE EFFECTS OF FERTILIZERS

Inorganic manures or 'fertilizers' are classed according to their nutrient content (see Table 2, Annex C). Their influence on crop development is summarized in the following paragraphs.

Nitrogenous fertilizers

Nitrogen represents from 1% to 4% of the dry weight of a plant and is an important constituent of vegetable cells. Crop needs for nitrogen vary according to the stage of development - onions, for example, have a high nitrogen requirement from the seedling stage to the onset of bulb formation; tomatoes have an especially high requirement during fruit maturation, and strawberries from the onset of flowering.

The effects of deficiency of nitrogen are the progressive chlorosis of the foliage, from pale green to yellow, weak growth and premature fall of the lower leaves.

The effects of excess of nitrogen may include the dropping of the flowers, increased susceptibility to fungus diseases and a deterioration of keeping quality. In the carrot, it results in the risk of nitrite formation. In the dry Haricot bean, it causes a delay in maturity, and in the potato a delay in tuberisation and maturity.

Phosphatic fertilizers

Phosphoric acid (represented as P_2O_5) is an essential constituent of cell nuclei and reproductive organs and represents from about 0.5% to 1% of the dry weight of most vegetables. Suitable dressings of phosphatic fertilizers encourage the growth of root systems and the development of seedlings. They favour earliness and good quality of crops and their resistance to fungus diseases.

The effects of a deficiency of phosphates are slow growth, poor fruiting, a dark bluish-green colour of the laminae, drying of the leaf margins and premature ageing of the foliage. Fruits are often soft and more acid than normal.

The effects of an excess of phosphate are not usually notable, but interactions may involve the production of symptoms of manganese and zinc deficiency, and may hinder fruit formation.

Potassic fertilizers

The potassium content (expressed as K_2O) of vegetables is variable, it may be from 0.5% to 3% of dry matter. Although it is a major nutrient

element, some aspects of the function of potassium in the plant are still poorly understood. It is known, however, to play an important role in photosynthesis, in the synthesis of proteins and in the regulation of osmosis. It is involved in the control of transpiration, and hence the resistance of the plant to drought. Potassium also affects the formation of glucosides and their transfer to storage organs, and this improves the quality of fruit-vegetables and the keeping quality of root-vegetables. Application of potassic fertilizers are, therefore, particularly important during dry periods and seasons of poor photosynthesis, such as during the season of short days, when supplies of nitrogen in proportion to potassium should be reduced.

The effects of a deficiency of potassium usually involve a shortening of the stem internodes. Some plants take on a 'rosette' appearance and some, through a reduction in apical dominance, become bushy. Other symptoms are the yellowing of the borders of young leaves, with subsequent necrosis, and the discolouration and distortion of leaves, the Laminae becoming convex and developing yellowish, white or bronze-coloured areas. Certain varieties of lettuce, which contain authocyanin, show a red colouration of leaf borders. The foliage of tomatoes and onions develops a blue-grey colouration; French beans develop an erect habit and a dark green colour of the stems and the foliage of potatoes becomes curled and yellowed, then necrotic. In all cases, a shortage of potassium tends to reduce the yield of crops and their resistance to insect and fungal attack.

The effects of an excess of potassium are not always notable. Plants are usually greedy absorbers of potash: the more there is, the more they take, but a great deal of potash may be wastefully absorbed, without any effect. Nevertheless, an excess of potassium may hinder the absorption of magnesium and it seems, may, like deficiencies, reduce resistance to attacks by insects and fungi.

Compounds of Calcium and Magnesium

These elements are naturally present in many soils in adequate quantities for plant nutrition. Consideration of soil analysis and pH may indicate a deficiency in some cases.

A deficiency in Calcium causes deformation of the youngest leaves; growth is stunted and yellow and brown areas appear on the leaf margins and between the veins. In tomatoes, it may cause apical necrosis of the fruits and necrosis of the flowers.

Deficiency in magnesium, in contrast, affects the older leaves, where it causes marginal and intervenal yellowing. Ground dolomitic limestone (40% CaO, 20% MgO) will supply both calcium and magnesium, but excessive applications to the soil may damage the organic structure and cause artificial deficiencies in other elements, notably in phosphorus.

(Dressings of superphosphate (24-31% CaO) or calcium nitrate (28% CaO) also add considerable quantities of calcium to the soil. It should be noted that on a small scale, magnesium deficiency may be corrected by foliar sprays).

5. THE CHOICE OF FERTILIZERS

Inorganic nitrogenous fertilizers include ammoniacal, nitrate and ammonium-nitrate compounds.

Ammoniacal compounds are soluble in water and are retained in the argilo-humic soil complex. Under favourable conditions, they are rapidly

nitrified. They are used as basic dressings or top-dressings when long-lasting effects are needed.

Nitrates are very soluble in water and immediately assimilable by the plant, but easily leached, especially in light soils. They are used in top dressings to stimulate growth.

Ammonium-nitrate compounds have the combined characteristics of ammoniacal and nitrate fertilizers. They are markedly hygroscopic.

Phosphatic fertilizers are classified according to their solubility. Calcium superphosphate and ammonium phosphate are soluble in water and rapidly assimilable. They may be used for all species of vegetable, both as base dressings and top dressings. 'Mineral phosphates', obtained from African deposits of phosphate, are suitable as base dressings. 'Phospal', prepared from phosphate deposits in Senegal, contains about 32% P_2O_5 of which 26% is soluble in ammonium citrate.

Untreated natural phosphates are insoluble in water or ammonium citrate but may be used as base dressings in acid soils or humic soils with a good microbiologic activity.

Potassic fertilizers, include the sulphate, chlorate and nitrate salts of the element.

Sulphate of potash is the best form for vegetable growing, as it can be used on all crops and all soils. It makes a good top dressing and can be used in special 'placements' or dissolved in the irrigation water. In addition, it contains 17% sulphur which is an advantage for some crops, like cabbage, which have a high sulphur requirement. The only drawback of this form of potassium is its relatively high cost.

Chloride of potash is the most economic form of the nutrient and the most widely used. Nevertheless, it should be avoided for chlorine sensitive vegetables such as French beans, cucumber and strawberries. In these crops, it may cause scorching of the leaf borders.

Nitrate of potash is doubly valuable because of its content in potassium (44%) as well as nitrogen (13%). It can be used for all crops in all soils. In view of its high water solubility, it is especially recommended for top dressings, 'placements' or dissolving in irrigation water.

6. APPLICATION OF FERTILIZERS

There are various different methods of applying fertilizers and a variety of manual and mechanical equipment for the job. The main principle should be that the fertilizers should be available in the root zone at the time when they are required, without danger to the germination of seeds or the good development of the plants.

Organic manures and base dressings of the fertilizers are usually spread evenly over the surface and ploughed in at the time of soil preparation. Sometimes the dressing may be placed in bands along the future crop rows to achieve some economy, but this method may have negative effects on the uniformity of subsequent crops.

All vegetable crops, except on the most fertile soils, also require 'top dressings' during the course of their growth. These may either be spread evenly over the surface or along the crop rows, or applied in solution in the irrigation water. However, solid fertilizers should not be placed too close to rows of sensitive species or their seeds, and care

should be taken not to allow powdered or granulated fertilizers to fall on the leaves, especially when they are wet. (Burning from this cause is especially frequent with nitrogeous and potassic fertilizers). In any case, it is advisable to irrigate after each top dressing, normally followed by hoeing or, in the case of potatoes, by earthing-up.

It is often convenient to apply top dressings in solution in the irrigation water, whether applied by surface flow, sprinklers or drip equipment. For the last two methods, an installation is required for correct and automatic dosage. It is necessary, in this case, to exercise caution to avoid burning the foliage of sensitive crops and only to use fertilizers which mix well and do not cause precipitations in the irrigation system. Ready-mixed solutions are very expensive, but it is possible to prepare a suitable solution from highly soluble solid salts like urea, nitrate of potash and ammonium phosphate. It is important that after each application of fertilized irrigation water, the irrigation system should be rinsed out with plain water.

Foliar application

In some cases, including the correction of deficiencies of 'minor elements' such as manganese or zinc or unexpected deficiencies of magnesium or other major nutrients, foliar applications with a knapsack sprayer may be adopted during the development of the crop. Strengths of solutions are indicated in Table 6.

Table 6 FOLIAR APPLICATIONS FOR VARIOUS NUTRITIONAL DEFICIENCIES

Deficiency	Fertilizer	Dose per 100 litres of water (grammes)
Nitrogen	Urea (46% N)	500-600
Potassium	Nitrate of Potash	500-1000
Phosphorus	Phosphate of Ammonia	700-1000
Calcium	Nitrate of Calcium	1000
Magnesium	Sulphate of Magnesia	1000-2000
Boron	Pentaborate of Soda (20.5% B)	20-40
Copper	Oxychloride of Copper	100
Iron	Nitrate of Iron	500
Manganese	Sulphate of Manganese	200
Molybdenum	Molybdenate of Ammonia	2
Zinc	Neutralised sulphate of Zinc	1000

It is desirable to save time by applying nutrients mixed with insecticidal or fungicidal sprays, great care should be taken to ensure that the mixture is compatible and effective and has no harmful effect on the crop.

7. NOTES ON THE NUTRITION OF SOME MAJOR VEGETABLE CROPS

Dosage: For all applications of fertilizer, correct dosage, timing and regularity are essential. The details have to be worked out through observation and trial in each location, but a general guide, based on trials at the CDH, Cambérène, Senegal, and the range of standard formulae (often a wide range) recommended in leading publications, is included in Annex C3. It must be remembered that the experiments at CDH were carried out on a very light soil derived from sand dunes, but comparison of these results with the range of other formulae should serve as an orientation, bearing in mind that light sandy soils usually need heavier applications of fertilizer than heavy loams.

The following notes on the nutrition of major vegetable crops discuss the reactions to nutrients and quote the observations of leading authorities on the subject. Quantitative recommendations for fertilizer applications are summarized in Annex C3.

Asparagus

Nitrates have proved superior to sulphate of ammonia as a source of nitrogen for this crop (Depardon, 1951). Phosphates have a favourable effect on the quality of the shoots ('spears') both on flavour, tenderness and appearance (Gericke, 1954). Potassium increases resistance to the rust fungus and a deficiency of this element affects the quality of the shoots.

Asparagus reacts well to the use of chloride of potash. This crop also needs a good supply of magnesium for the production and storage of carbo-hydrates - the literature indicates that an annual dressing containing 25-30 units of MgO is required. Boron is also an important nutrient; the soil should contain between 55 and 130 ppm of the element. Applications of boron have given considerable increases in yield in the USA (Brasher, 1959).

Aubergine (Eggplant)

Response to nitrogen must be carefully managed. Nitrogenous fertilizers should not be applied to the crop before the setting of seed in the first fruits, so as to avoid too luxuriant a type of vegetation.

Phosphates and sulphates accelerate maturity; phosphates stimulate flowering and potash favours seed setting (Toderi).

Aubergine is sensitive to deficiencies of magnesium (Knott, 1980). If necessary, an application of 40-60 units/ha of magnesium carbonate should be included in the base dressing.

Note: Fertilizer applications according to Formula (1) (Annex C3) used in comparative variety trials at CDH permitted yields to be obtained of 32 to 37 tons/ha according to variety.

Formula (2) used in demonstration plots of 10 acres with five replications, gave an average yield of 37 T/ha at 150 days from planting, using 1 900 plants/ha.

Beetroot

This crop needs a good supply of decomposed organic matter. Fertilizer applications in Florida are recommended on the basis of 180 N - 160 P₂O₅ - 220 K₂O; in California the formula is 110 N - 54 P₂O₅ - 28 K₂O.

In France, it has been shown (Gerst and Stengel, Invuflec, 1973/74) that the nitrogen supply should be between 150 and 200 units and that an excess of nitrogen reduces the quality of the roots. Laumonier (1964) recommends NPK 150-100-200.

To avoid a reaction to boron deficiency, the soil should have a content of at least 0.5 ppm of the element (Knott, 1980).

Note: Experiments on beetroot have not been carried out at CDH.

Cabbage and Chinese Cabbage

These crops both require extra careful manurial treatment. It should be noted that the two formulae used at CDH on sandy soil (see Annex C3), gave good results in both cases, from 25-40 T/ha, according to variety. If applications of nitrogenous fertilizer are too generous, they may cause the formation of loose heads and internal decay. An excess of potash can cause the heads to burst and a deficiency of that element can provoke marginal necrosis of the leaves and damage to the keeping quality of the heads.

Cabbages have a high sulphur requirement and are also sensitive to deficiencies of magnesium and boron.

Cauliflower

This crop also requires extra careful fertilization. A generous application of organic manure is desirable. For inorganic fertilizers, the formulae used at CDH gave yields of 11-17 T/ha, according to variety.

In Italy, best results have been reported from the formula 120-160 N : 120-160 P_2O_5 : 60-80 K_2O (kg/ha). Nitrogen is important for the production of compact heads, but heavy doses of ammoniacal nitrogen can cause a deficiency in molybdenum. No nitrogenous manure should be applied after the appearance of the inflorescence.

Excess of phosphates can cause yellowing of the inflorescence.

Potassium and magnesium are important for the quality of the vegetable. The crop is also sensitive to deficiencies of calcium, sulphur, boron and molybdenum.

Carrot

Dressings of organic manure must be well decomposed to avoid the production of "forked" roots.

Nitrogenous fertilizers should be used with caution, as an excess of nitrogen stimulates foliar development at the expense of root development. Mappes (1951) reported that a dressing of 60-90 units N/ha produced roots with better storage qualities than dressings of 150-200 units. Råber *et al* (1982) demonstrated that an increase from 75 units to 210 units N/ha can more than triple the content of nitrates in the roots. Carrots respond well to chlorides (Mikko Sillanpää, 1979). The use of chloride of potash is said to increase drought resistance in the crop and to produce a better yield than the use of sulphate of potash. Carrots have a moderate requirement of boron.

Celery

Experiments on this crop have not been carried out at the CDH. In Zaire, on alluvial soil, good results have been reported from the use of the formula 80 N : 60 P₂O₅ : 250 K₂O with generous applications of organic manure.

In California on sandy soils under irrigation, doses have been recommended of 435-500 N : 335 P₂O₅ : 550-620 K₂O.

In Europe, applications are usually in the range of 100-300 N : 100-150 P₂O₅ : 300-400 K₂O. The crop responds well to the use of chloride of potash. Boron deficiency in some varieties causes a cracking of the leaf stalks.

Chili

Phosphorus and potassium improve the quality of fruits and hasten maturity.

Courgette

A generous dressing of well decomposed manure is important. Too much nitrogen should not be given, as it can encourage dropping of the flowers. The manurial formula (2) quoted in Annex C3 applied as combined fertilizer, (10:10:20), plus a complement of sulphate of ammonia gave a yield of 30 t/ha in 90 days. Formula (1) used in variety trials at CDH gave 25-40 t/ha according to variety.

Cucumber

Reports from Israel, California and Europe suggest that nitrogenous dressings between 80 and 120 units N are usually satisfactory. Simple superphosphate has been reported to give better results than triple superphosphate or phosphate of ammonia. Various researchers have observed that requirements of P₂O₅ for this crop are not high.

Requirements for potassic fertilizers seem to vary considerably according to the quantity of organic manure applied. Organic dressings should be generous and a level of 100-150 units K₂O is often recommended. Cucumbers are sensitive to magnesium deficiency. It has been reported that the crop responds well to applications of manganese and fairly well to copper.

The two formulae used at CDH (see Annex C3) gave good results on the sandy soil.

French bean

Both the climbing and the bush type varieties are very sensitive to salinity. Poorly decomposed organic matter should also be avoided. The application of mineral N fertilizer is useful in the early stages of growth, but at a later stage, atmospheric N is fixed by bacteria in root nodules - if the right bacteria are present in the soil. This is not always the case, if the crop has not previously been grown in the plot concerned. It may then be necessary to apply nitrogen in several doses. It was recorded by Haag et al that the French bean absorbs most of its needs of N, K and Ca in the first 50 days of growth; S and Mg in the first 60 days and P throughout the growth of the crop.

French beans are sensitive to deficiency of Mg and the use of dolomitic (magnesian) limestone may be required.

Lettuce

The formula (1) in Annex C3 refers to transplanted crops and formula (2) to crops sown "in situ".

It should be noted that insufficient fertilisation slows development, reduces quality and encourages bolting. It has been reported that tip-burn is caused by a lack of Ca in the young leaves and can be remedied by a foliar spray containing calcium nitrate before hearting. Tip-burn may also be caused by a shortage of water or a disequilibrium of the N/K balance.

N/K balance is usually recommended at 1:1 to 1:2.

Note: in 1972, IRAT at Farako-Ba (Burkina Faso) reported the successful use of the formula 140 N : 180 P : 180 K for lettuce production.

Melon

A deeply worked, well aerated and well drained soil and a supply of well rotted organic material is strongly recommended. Melons are very sensitive to shortage of nutrients and a lack of any of the major elements or of molybdenum can greatly reduce growth and flowering. Huguet & Cornillon (1970) report that a lack of nitrogen or magnesium reduces fruit-set and that an excess of N with a deficit of P causes great harm to fruit set and development. Dolomitic limestone (magnesium/calcium) should be applied, if necessary.

Okra

Okra is said to be moderately tolerant of salinity (Morgan, 1966). Sutton (1964, in Siemonsha) observed that high doses of N during the vegetative phase delays fruiting. Several research workers have reported better results from urea than sulphate of ammonia. The long cropping period makes it advisable to apply fertilizers in several doses (Siemonsha, 1982); there is little assimilation in the first month of growth.

Onion

The organic manure must be well rotted. N should be given gradually and moderately, since an excess causes the formation of thick collars to the bulbs and reduces keeping quality. Zink (1962) demonstrated that onions absorb 53% of their NPK in the 21 days prior to full development.

Deficiencies in copper have been noted in peaty soils and other acid organic soils. Deficiencies in manganese are more common in alkaline organic soils.

Potato

N is absorbed during the first 40 to 60 days after planting. An excess stimulates growth of foliage, but delays the formation and maturity of tubers - whereas a shortage of N causes poor growth, with an early loss of foliage and the reduction of the size and number of tubers.

P encourages root development and early tuber formation. Russel and Gurner (1941) observed that P increases the number of tubers but not their size. K improves quality and keeping of tubers - early varieties have the highest requirements for K.

Peas

Organic matter must be well decomposed. A supply of inorganic N is useful in the early stages of growth before the development of fixation of atmospheric N (see remarks for French beans). If the necessary nitrogen-fixing bacteria are not present, it may be necessary to supply several doses of inorganic N. An excess of N delays flowering and decreases production. P encourages the development of root growth and rhizobium activity and K improves quality and yield.

Shallot

Organic matter must be well decomposed. Applications of N should be moderate, to avoid development of foliage at the expense of the bulbils, and their keeping qualities. The formula indicated in Annex C3 gave yield at CDH of 23 t/ha in 70 days, at a spacing of 0.05 x 0.20 m.

Strawberry

The crop persists for only 7-8 months in Senegal. A good supply of well decomposed organic matter is considered essential, although the use of farmyard manure is not recommended. The application of inorganic N should be moderate, so as to avoid the production of foliage at the expense of fruit. Sulphate of ammonia seems to give better results than urea. P is important for the development of the heart of the plant (Trioreau 1961). A deficiency can cause red coloration of the leaves and acidity of the fruit. K should be given, as sulphate of potash, because the strawberry is exceptionally sensitive to the effects of sodium and chlorine. K improves the flavour and keeping quality of the fruit.

Sweet pepper

Sweet pepper needs a deep, well cultivated and aerated soil. Needs of N, P and K are very moderate during the first month of growth; thereafter for N and K they increase progressively until harvest. Requirements of P are considerable during flowering and maturation of the fruit.

The absorption of Mg reaches its maximum at the start of flowering (Cornillon, 1974).

Sweet pepper is sensitive to deficiencies of both Ca and Mg.

Sweet potato

This crop requires a relatively generous supply of K, and has average needs for N and P. Trials in Taiwan indicate that application of N and K give an increase both in number and weight of tubers, whereas N alone (or in predominance) stimulates the growth of shoots and foliage. P increases the individual weight of tubers but does not seem to increase the total crop. According to Knott (1980) sweet potato is tolerant to deficiencies of Mg and fairly tolerant to those of B.

Tomato

The needs of tomato for N are moderate until fruit set. According to Hester and Sheldon (1949), 80-100 kg N are absorbed for 25 tons of fruit. Only 3.5 to 4.5 kg N are absorbed during the first month, but 23-28 kg in the second month of growth. An excess of N causes luxuriant vegetative growth, but retards production and decreases fruit quality. P is very important throughout growth and cropping - violet coloration of the foliage is often caused by P deficiency.

Requirements of potash are very important as from fruit set, but diminish towards the end of the crop. An N:K ratio of 1:1 to 1:2 is needed to achieve high fruit quality.

Tomato is intolerant of deficiency of Mg. A deficiency of Ca, associated with irregular irrigation, can cause 'blossom end rot' (apical necrosis).

Turnip

Organic matter should be well rotted or else incorporated during the preceding crop. Particular attention should be given to the availability of magnesium and boron.

Watermelon

N increases the number of pistillate flowers and of fruits (Brantley and Warren, 1960). Good results under tropical conditions have been reported (Mortensen) from the localized application of phosphate of ammonia at 165-330 kg/ha.

This crop is sensitive to deficiencies in Mg. In Florida, USA, on sandy soils, the formula 180 N : 160 P₂O₅ : 220 K/ha is used.

Other authorities recommend 80-100 N : 25-60 P₂O₅ : 35-80 K/ha.

It should be noted that watermelon grown in heavy soils are subject to fruit cracking.

H. IRRIGATION

1. ESTIMATION OF WATER REQUIREMENTS

Water requirements must be considered from two aspects - first, the global requirements for the whole farm and second, the daily requirements for the crops that are to be grown. These estimations are required to prepare an irrigation programme based on doses and frequencies of application per hectare and total daily and annual use of water, within the resources available.

The main factors controlling global requirements are evapotranspiration, the duration of the various phases of growth of the crops produced, the efficiency of application, rainfall and the level of the water table.

(The calculations in Annex B illustrate the great variation in global requirements, depending on the method of irrigation, crop cycle and local conditions of soil and climate.)

(a) Evapotranspiration and phases of growth

Evapotranspiration is equivalent to the water transpired by the plant, plus evaporation from the soil surface. Potential evapotranspiration (ETp) is the quantity of water transpired by a healthy crop in full development and covering the whole surface of the soil, plus the maximum evaporation from the soil surface.

There are various methods of estimating ETp based on precise climatic data over a period of years. Such data are often unobtainable or unreliable and it is preferable to depend on measures of evaporation from a 'Class A Vat'. This method has proved reliable for agricultural purposes and is recommended as the basis for irrigation planning and control. The vat may be constructed locally following the specifications in Annex B7. Its use makes it possible to measure the combined effects of insolation, wind, temperature and atmospheric humidity on the evaporation from an open water surface. Plants react in a similar way to the same variables and one can establish the relation between the evaporation from the vat and evapotranspiration of a given crop (ETo) by the use of an empirical co-efficient.

The method has been fully explained by Doorenbos and Pruitt in 'Crop water requirements' (FAO, 1972). Their calculations are based on a standard crop evapotranspiration figure (ETo) corresponding to "the rate of evapotranspiration from an area of green turf of a uniform height of 8-15 cm in active growth, completely covering the soil and adequately supplied with water".

Calculations of ETo from figures of evaporation from a "Class A Vat" may be made according to the formula: $E_{to} = K_p \times E_{bac}$

where:- Eto is expressed in mm/day

- EBac is the average daily evaporation from the vat in mm/day for the period under consideration (10 to 30 days)
- Kp is the co-efficient of evaporation determined according to Table 7.

As shown in the example in Annex B, Table 2, the mean daily value of ETo in mm may be calculated and, by using the crop co-efficient (Kc), the crop evapotranspiration (ET crop) may be obtained.

The values of the crop co-efficient (Kc) are a function of the characteristics of the crop, the stage of growth and the prevailing agro-climatic conditions. Doorenbos et al. have established the Kc for certain vegetable crops at different stages of growth under standard climatic conditions (Annex B, Table 3).

The co-efficients for the first two stages of growth, comprising the seedling growth in the nursery or field (or plantation in the field), and the growth of the crop to the point where 80% of the soil surface is covered, vary considerably according to the production techniques used and to agro-climatic conditions. The variation of Kc for these phases indicated by Doorenbos et al. (FAO Bulletin 33, 1979) varies, for different vegetable crops, between 0.4 and 0.5 for the first phase and 0.7 and 0.85 for the second phase. The first of these figures refers to conditions of high humidity (RH more than 70%) and low wind speed ($u < 5$ m/s) and the second figures to conditions of low humidity (RH less than 20%) and strong wind (> 5 m/s).

At CDH Senegal, under a sub-Canarian climate (average wind 6.2 m/s, average Ev Bac 5.5), on sandy soils with wind breaks and sprinkler irrigation, it has been observed that most vegetable species have an irrigation requirement of 4-5 mm/day during the first and second phases of growth, indicating a relation of Irrigation/Vat Evaporation of 0.7 to 0.9 (Baudoin, 1975).

Under the same sub-Canarian climate, commercial production of vegetables (French beans, melon, sweet pepper, tomato) practised on vertisols, with a vat evaporation of 7 mm/day, the relation Irrigation/Vat Evaporation is 0.6 in phase 1 and 0.9 up to flowering.

Table 7 - Coefficient of evaporation (Kp) for a "class a vat" according to the soil cover, average relative humidity and wind speed over 24 hours.

Class A Vat	A. Vat surrounded by a low green crop			B. *Vat surrounded by dry fallow land				
	[Average RH%]	Low <40	Medium 40-70	High >70		Low <40	Medium 40-70	High >70
Wind Km/day	Distance covered by green crop in windward direction (m)				Distance covered by dry fallow in windward direction (m)			
Light 175	0	0,55	0,65	0,75	0	0,7	0,8	0,85
Moderate 175-425	10	0,65	0,75	0,85	10	0,6	0,7	0,8
	100	0,7	0,8	0,85	100	0,55	0,65	0,75
	1.000	0,75	0,85	0,85	1.000	0,5	0,6	0,7
Strong 425-700	0	0,5	0,6	0,65	0	0,65	0,75	0,8
	10	0,6	0,7	0,75	10	0,55	0,65	0,7
	100	0,65	0,75	0,8	100	0,5	0,6	0,65
	1.000	0,7	0,8	0,8	1.000	0,45	0,55	0,6
Very strong >700	0	0,45	0,5	0,60	0	0,6	0,65	0,7
	10	0,55	0,6	0,65	10	0,5	0,55	0,65
	100	0,6	0,65	0,7	100	0,45	0,5	0,6
	1.000	0,65	0,7	0,75	1.000	0,4	0,45	0,55
	0	0,4	0,45	0,5	0	0,5	0,6	0,65
	10	0,45	0,55	0,6	10	0,45	0,5	0,55
	100	0,5	0,6	0,65	100	0,4	0,45	0,5
	1.000	0,55	0,6	0,65	1.000	0,35	0,4	0,45

* In the case of very large areas of bare dry fallow and the complete absence of agricultural crops, reduce the values of Kp by 20% for warm and windy weather and by 5-10% when wind, temperature and relative humidity are moderate.

After J. Doorenbos and W.O. Pruitt "Irrigation and Drainage Bulletin No. 24" (FAO, 1975)

At the National Agricultural Research Centre at Bambej, Senegal, Tran Minh Duc et al. recorded on a tomato crop, during the first month after transplanting, a relation Irrigation/Vat Evaporation of about 0.55, increasing to 0.96 during the second month. Figures for onion grown 'in situ' were recorded as 0.60, 0.68 and 0.70 for the first three months.

It is clear that the local records, based on vegetative stages, facilitate the correct adjustment of irrigation rates. (It should be noted that the stages of growth vary with variety as well as species.) As a basis for comparison, Table 4, Annex B, shows the duration in days of the different stages of growth for various species at CDH, Senegal.

(b) Efficiency of irrigation

The efficiency of irrigation is expressed in the relationship between the volume of water actually used in evapotranspiration and the total volume of water applied. The potential efficiency varies with the method of irrigation as well as other conditions. The following table quotes rates of efficiency under good conditions, according to various authors.

Table 8 EFFICIENCY OF IRRIGATION METHODS

Source	Method of Irrigation		
	Sprinkler	Furrow	Drip
U.S.A.	0.60 (1)	0.55-0.70	-
C.I.I.D (Bos and Nugteren)	0.67	0.57	-
U.S.D.A.	-	(0.45 (2) (0.65 (3) (0.60 (4)	-
C.D.H.	0.60	-	-
Feyen, Liliaert, Badji	-	-	0.95 (5)

(1) Hot dry climate

(2) Light soil

(3) Medium soil

(4) Heavy soil

(5) According to the authors, this degree of efficiency is attained if the variation in pressure is 30% according to nozzle orifice, 20% for long spiral, and 15% with long rectilinear connections.

(c) Additional water requirements

Apart from the requirements for regular irrigations, provision is necessary for the "pre-irrigations" to moisten the soil, to a suitable depth, from 20 to 40 mm, before seed sowing or planting out. Extra irrigations may also be required to initiate germination of weeds in order to clean seed beds before sowing with crops which are slow in germination or difficult to hoe. Additional water may also be required for pesticide sprays, foliar nutrition or the leaching of saline soils.

The balance of requirements, moreover, may be reduced by rainfall, provided this occurs in effective precipitations.

Account must also be taken of the level of ground water which may have a considerable value in cases where sweet water is found within the root zone. Tensiometres may be used to measure the effect of ground moisture and piezometers may be installed to measure the fluctuations of the water table.

(d) Irrigation programmes

Irrigation programmes depend on the calculation of the dose and frequency of applications according to the crop species and its stage of development. They are established on the basis of the ETo and the ET (crop), speed of infiltration and capacity of retention in the soil concerned, and the rooting depth of the crop.

Speed of infiltration

The speed of infiltration of irrigation water depends on the volume of inter-connected air spaces in the soil. Coarse sands and highly structured soils generally have large air spaces and their permeability is thus higher than that of heavy clays and heavily compacted soils. In most soils, the speed of infiltration is most rapid at first and progressively reduces until it reaches a constant low level, at the point known as the 'limited rate of absorption'.

The speed of infiltration naturally limits the rate and duration of the application, according to the depth of soil to be wetted.

The delivery rate by sprinklers in mm/hr must be equal or inferior to the speed of infiltration. If excessive, it causes the formation of rivulets with a loss of efficiency, soil erosion, and formation of a soil cap through the breaking down of the superficial soil structure.

The following table indicates the order of magnitude of the speeds of infiltration for the main types of soil texture.

Table 9 **SPEEDS OF INFILTRATION IN DIFFERENT SOILS**

Rate of Infiltration	mm/hr	Soil types
High	30-80	Sand, silt, silty clay sand.
Fairly high	15-30	Silt, fine silt.
Fairly low	5-15	Silty clay, clay, fine silty clay.
Low	2-5	Heavy clay

After: L.D. Doneen (1971), Irrigation Practice and Water Management.

It should be noted that the speed of infiltration can vary considerably from one place to another and local measurements are always advisable.

Water retention capacity of soils

The 'field capacity' of a soil is the maximum quantity of water that a soil can retain after free drainage. The water which leaves the soil under the influence of gravity is the 'free water', which is normally lost to the crop, whilst of the water retained, 45% is available to plants (30% freely available and 15% with some difficulty). When this 45% of the soil water is exhausted by evapotranspiration, a permanent wilting point is reached, since the remaining 55% of the soil water is unavailable to plants, the power of retention of the soil being at that point superior to the suction power of the roots.

Each soil has certain characteristics which determine its water retaining capacity and the percentage available to plants. The approximate quantity of available water at field capacity in different types of soil is given in the following table.

Table 10 AVAILABLE WATER IN DIFFERENT TYPES OF SOIL

Type of Soil	% Humidity in Relation to Dry Weight *		Depth of Water available per cm. of Soil at field capacity
	At Field Capacity	At Permanent Wilting Point	
Coarse sand	3-5%	1-3%	0.20 - 0.40 mm
Fine sand	5-10%	3-6%	0.40 - 0.70 mm
Silty sand	10-15%	6-8%	0.70 - 1.00 mm
Silt	12-13%	7-10%	0.80 - 1.30 mm
Silty clay	15-20%	8-15%	1.00 - 1.80 mm
Clay	25-40%	12-20%	1.60 - 3.00 mm

* As determined by the difference in weight after drying in a stove.

After: 'Surface Irrigation', by L.J. Booker and 'The Practice of Sprinkler Irrigation', by A.F. Pillsburg

In practice, irrigation is applied when soil water content drops to 50% of field capacity. Some authors, however, (Desaunette, 1958) recommend giving only 2/3 of the dose theoretically required for field capacity, in order to avoid excessive application.

It is possible to assess soil water content by the use of tensiometers after a certain experience in interpretation of the readings in different soil types.

Rooting depth

The quantity of water to be applied at each irrigation is affected as much by the depth of the root system as by the water content of the soil. Seeds or young plants, after transplanting, need only enough water to moisten the superficial layers of the soil. The root system grows

laterally and in depth as the aerial system expands, attaining its full development as maturity approaches.

Table 11 gives a general indication of the depth of rooting of mature plants of various species of vegetables when cultivated in deep homogeneous soils. In practice, it is reckoned that the depth of soil to be reached by irrigation varies between about 35 and 70 cm, according to the vegetable species.

Table 11 THE DEPTH OF EFFECTIVE ROOTING OF VEGETABLE CROPS AT MATURITY (cms)

Asparagus	150-180	Aubergine	75-90
Beetroot	75-90	Carrot	45-60
Celery	45-60	Cabbage	45-60
Cauliflower	45-60	Chilli	40-70
Courgette	45-75	Cucumber	45-75
Gherkin	45-75	Shallott	30-50
Strawberry	30-45	Haricot Bean	50-70
Leek	30-50	Lettuce	30-50
Melon	75-90	Onion	30-50
Peas	50-70	Potato	30-60
Radish	20-30	Sweet pepper	40-70
Sweet Potato	90-150	Turnip	75-90
Tomato	40-80	Watermelon	90-150

Adapted from several authors: F. Pillsburg, J. Doorenbos et al., J. Feyen et al.

Irrigation Practice

The practical control of irrigation calls for care and adequate technical knowledge. In the arid regions of tropical Africa water is a scarce and valuable commodity and its rational use should be the first priority.

It is possible to calculate the dosage and frequency of irrigation on the basis of the principles discussed above. Starting with the depth of soil corresponding to the depth of rooting of the crop, the quantity of available water may be calculated (Table 10). The evapotranspiration is calculated every day or every few days from readings of the Class A Vat and allowing for any effective rainfall the point at which 50% of available water is exhausted can be determined. Irrigation is then commenced.

Example

A crop of dwarf French beans is grown on a sandy soil and has a rooting depth of 60 cm.

- Water available at field capacity: 0.5 mm/cm (Table 10)
0.5 mm x 60 (rooting depth) = 30 mm
- Minimum safe water level 50% of field capacity = $\frac{30}{2}$ mm
i.e. 15 mm which is the basic dose for restoring field capacity.
- In the absence of effective precipitation, if the ET crop is 5 mm/day, the frequency of irrigation should be $\frac{15}{5} = 3$ days
- If the efficiency of the method of application used is 60%, the quantity of water should be increased correspondingly, i.e. the dose actually applied should be:

$$15 \text{ mm} \times \frac{100}{60} = 25 \text{ mm.}$$

These calculations are very useful to establish rates and standards. However, many experienced irrigators develop an ability to judge water requirements by touch and the appearance of the soil (see Annex B.5). For this purpose, it is convenient to examine samples of the soil taken with an auger in the root zone.

The following five rules will provide a good guide for rational irrigation practice.

- i. Remember that the species of vegetable, the stage of growth and the type of soil are the main factors governing the rate and frequency of irrigation.
- ii. During the first phase of crop development (seed, germination, transplanting) use light doses and frequent applications to avoid drying out of the upper layer of soil.
- iii. Increase the doses as the crop develops and the roots penetrate deeper. Decrease the frequency according to the level of evapotranspiration of the crop (ETc).
- iv. When the older leaves wither and the crop is mature (e.g. onions) or the greater part of the harvest has been taken (e.g. French beans), the ETc will decline and the frequency of application may be progressively decreased.
- v. If the resources of water are limited, especial care should be given to the planning of irrigation, especially at the critical periods of development. For fruit vegetables (e.g. tomato and eggplant), this occurs between flowering and fruit development.

2. CHOICE OF IRRIGATION METHOD AND EFFECTS ON THE SOIL AND CROP

The chief irrigation methods for vegetable crops are by sprinkler, surface and drip applications. The choice of method depends primarily on the costs of equipment and of operations, the efficiency of water use, the simplicity of the lay-out, the quality (salinity, etc.) of the water available, the type of soil and dangers of its erosion and the species of vegetables to be grown. The advantages and disadvantages of each system will be discussed.

(a) Sprinkler irrigation

This method may, in fact, be employed either by manual or mechanical means.

Irrigation by water-can is the method usually employed by the small market gardeners of West Africa. The method is extravagant in its use of labour but is actually the most economical in water use, if properly practised, especially for widely spaced crops. It has been recorded that a labourer with two water-cans can apply about 0.8 m^3 of water an hour over a radius of between 16 and 38 m from the well, or 1.2 m^3 per hour if the radius is between 5 and 21 m.

The use of this method depends on the existence of numerous shallow wells or basins and the work involved obviously depends on the depth of the wells and the distance to be covered around each.

When water is available under pressure, on a small scale, a hose-pipe with a 'rose' can be used for sprinkling the crop. This system is much less laborious than the use of water-cans, but special measures are required to control the dosage. It is recommended that the rate of flow from the hose is measured and the watering of each plot timed, so as to provide the necessary quantity of water per m^2 (see Annex B.6 for quantities used at CDH).

Mechanical irrigation is carried out by rotating sprinklers fed by water under pressure. It has a great advantage over surface irrigation in not requiring the perfect levelling of the land for installation and it allows better aeration and better conservation of soil fertility.

Sprinkler irrigation may also permit some economics in labour, considering the work required for the maintenance of canals for surface irrigation and it certainly involves an economy in water use, estimated as between 16 and 60% (Strong: West Africa and Irrigation).

In regions subject to dust and sand storms, there is the additional advantage that sprinklers wash the leaves and thus allow more efficient photo-synthesis.

Finally, the manoevrability of sprinklers provides considerable benefits. Irrigation may easily be applied in small doses, at frequent intervals, for seed and seedlings and may be used to apply fertilizers in solution. Moreover, the apparatus may be readily moved, reduced or extended.

Among the chief disadvantages of the system are the high initial costs and costs of maintenance and operation. Furthermore, sprinkling is adversely affected by high winds and hot, dry desert winds may cause greater evaporation losses with this system. Again, fungus diseases may be favoured by the frequent wetting of the plants and the application of fungicides and insecticides may be rendered less effective.

It is pointed out that a great variety of sprinkler equipment is now available, ranging from simple 'drag-line' mobile sprinklers fed by plastic hose to highly automatic mechanised lay-outs (see Figs. 8, 9 and 10). The choice depends on the area to be covered and the availability of funds and skilled labour (see Annex B.8).

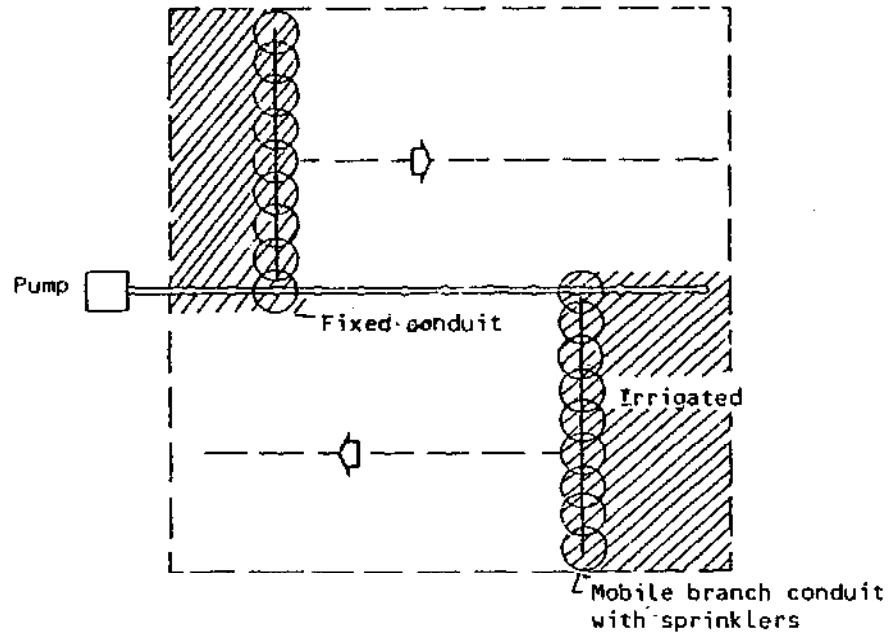

(a) Irrigation system with fixed central conduit

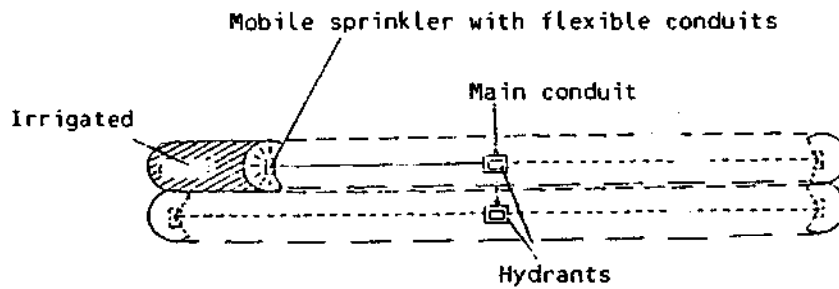

(b) Irrigation system with a series of fixed hydrants (water points)

Fig. 8. Different lay-outs for sprinkler irrigation systems.

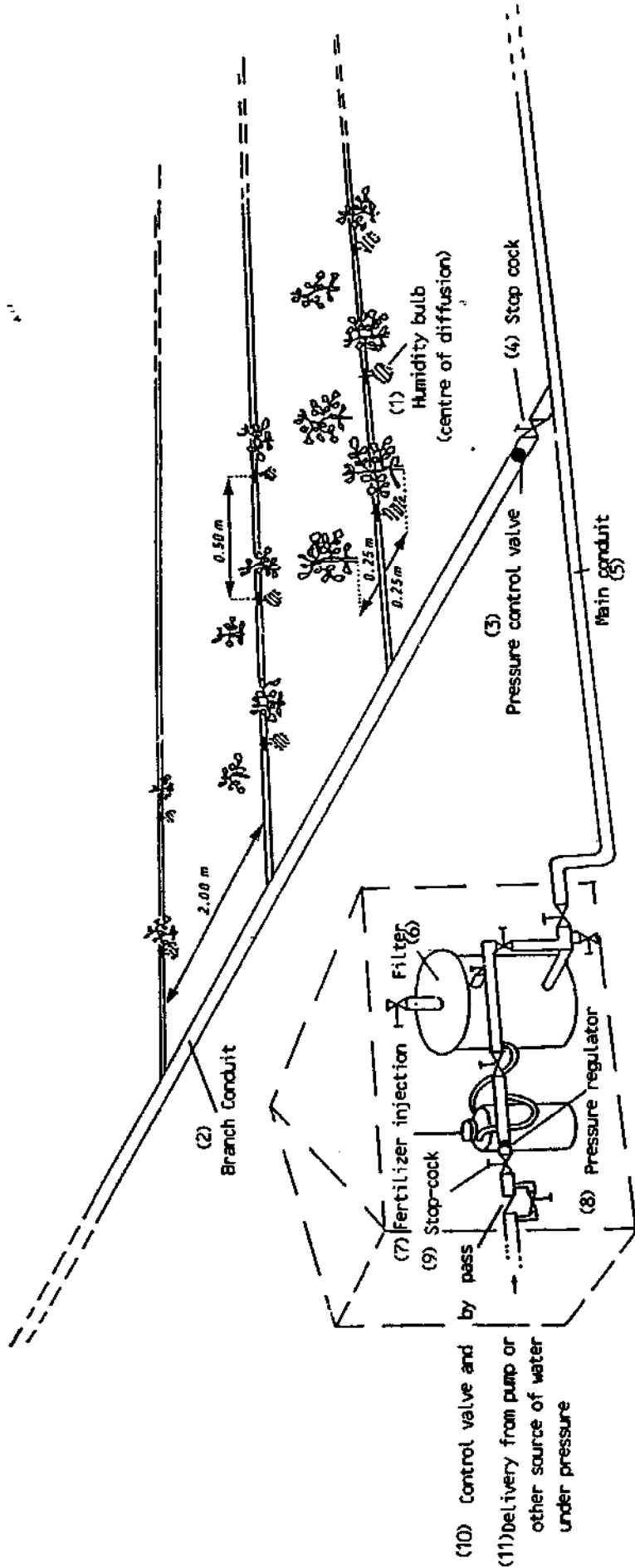

Fig. 9 - Example of a drip irrigation lay-out showing the main components of the system

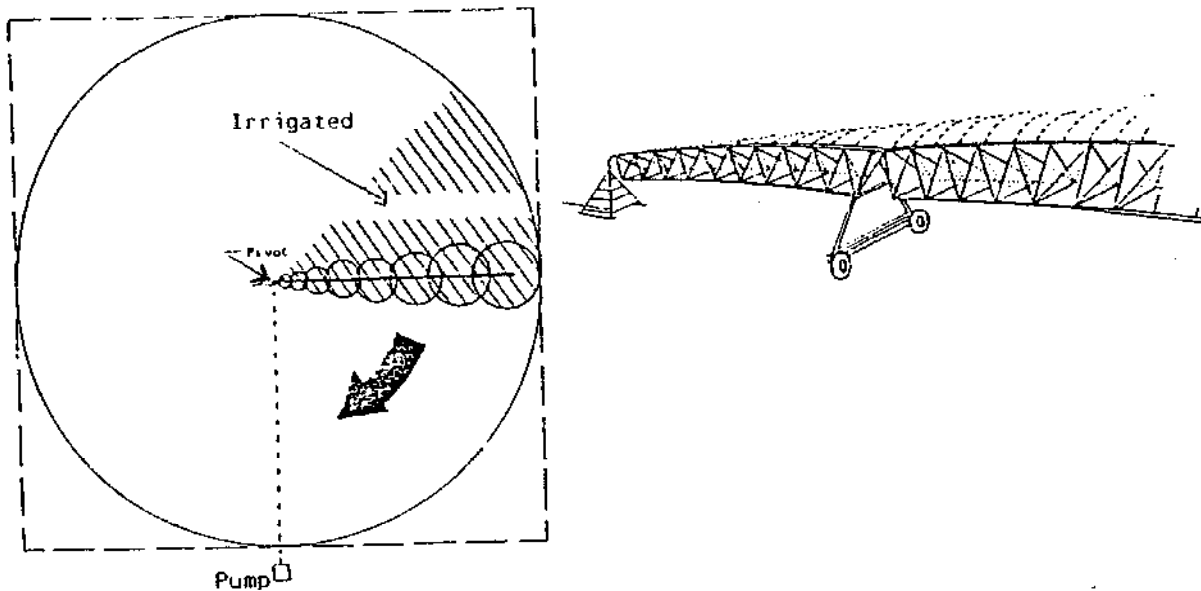

Fig. 10. Lay-out of irrigation by rotating ramp.

The selection of equipment and installation of large irrigation systems should normally be assigned to specialist engineers.

(b) Surface irrigation

Surface irrigation may be applied in basins or borders, or through furrows, but for vegetables, furrows are the most frequently used.

The system is only suitable for well levelled deep soils, preferably of a medium texture. Water consumption is generally high and there is a danger of erosion if the land is not well prepared. Other disadvantages are the compaction of the soil and the loss of nutrients through leaching.

Furrow irrigation is illustrated in Fig. 10. It is well adapted for vegetable species which need generous spacing, such as tomatoes, melons, watermelons, potatoes, sweet potatoes and eggplant. It is important that the levelling, slope and spacing of the furrows is carefully controlled to allow a correct flow of water and adequate lateral infiltration for the wetting of the complete root zone. The best way of checking the latter is to cut a section across several furrows, after irrigations of various duration, to observe the exact area of soil wetted.

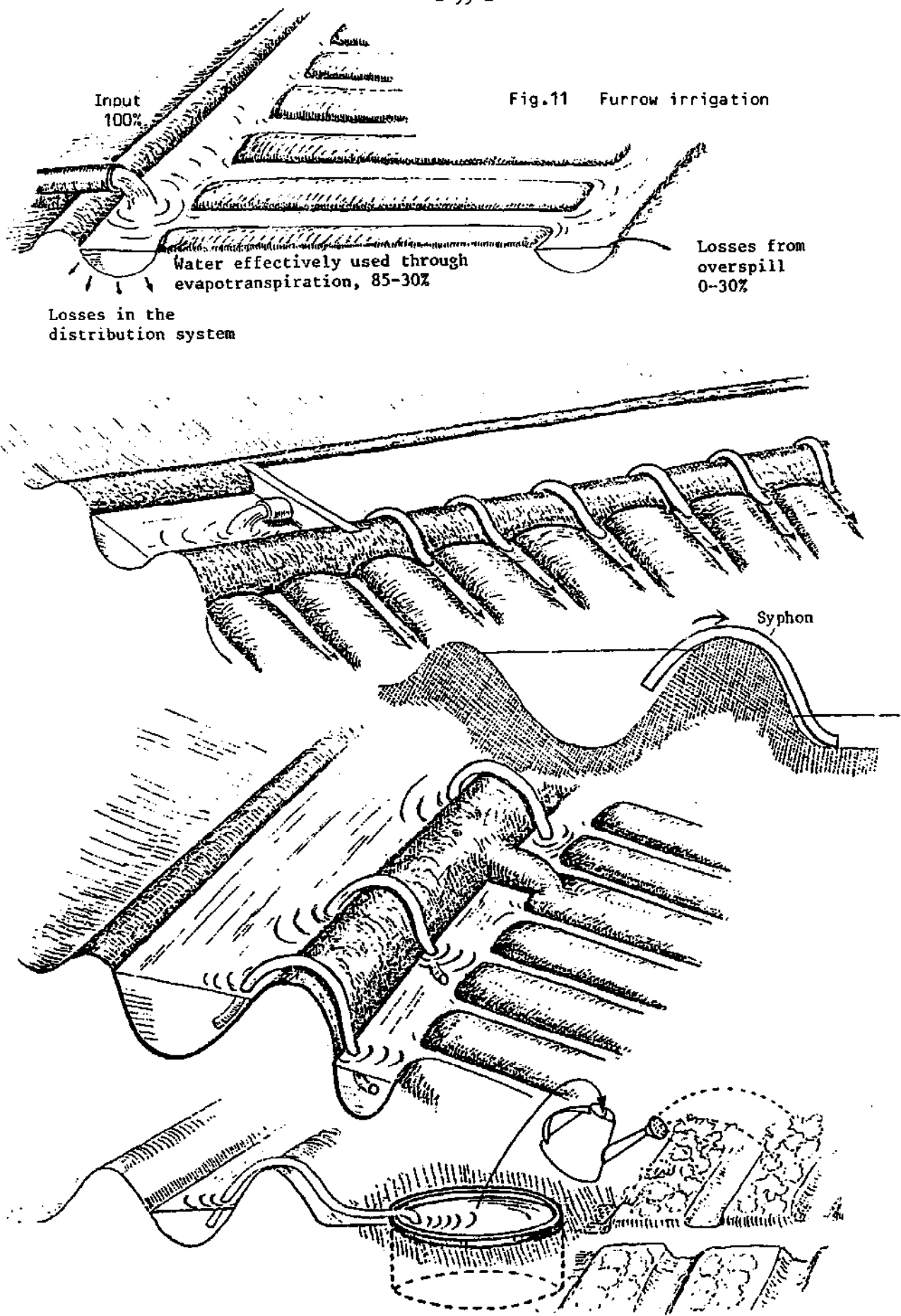

Fig.11 Furrow irrigation

Input
100%

Water effectively used through
evapotranspiration, 85-30%

Losses from
overspill
0-30%

Losses in the
distribution system

Syphon

The length and dimensions of the furrows, their longitudinal slope and the water debit employed should be such as to allow a uniform distribution of irrigation without erosion. Tables in Annex B.9 indicate the approximate maximum length of furrow, according to the nature of the soil, slope and water debit, on well levelled sites. On sloping sites, the furrows must be much shorter and, if necessary, divided by partitions so that each section may receive the necessary quantity of water.

Control of the water debit in the course of each irrigation is important to ensure that the depth of soil moistened is about the same from one end of the furrow to the other. To start the flow, the maximum allowable debit is given to send the water to the end of the furrow. (Tables in Annex B.10 indicate maximum debits for critical slopes). Subsequently, the debit is reduced to a level that will allow the water distributed along the whole length of the furrow to infiltrate the soil without overflowing. For efficient operation, the period for infiltration is usually 4-5 times the period required for the first flush.

The furrows may be fed from a distribution canal by means of short siphons in plastic or PVC, which have the advantage of easy installation and removal, without damage to the canal bank. The debit may be adjusted according to the number, length and diameter of the siphons. Tables in Annex B.11 illustrate the approximate debit of siphons in litres/second. The depth of water applied may be calculated from the debit, the duration of application and the area irrigated.

(c) Irrigation by drip or micro-jet

These systems involve the application of water at a very low debit through drippers, micro-jets or even perforated plastic sleeves. They have the outstanding advantages of effecting an economy of both water and labour and leave the cropping area freely accessible during irrigations.

Moreover, soils which are too heavy to be well adapted to sprinklers or too light for furrows are quite suitable for drip irrigation. When the available water is rather saline, micro-irrigation is the most suitable method, since salts usually accumulate around the periphery of the moistened parts of the soil.

The disadvantages usually experienced in the use of drippers in arid and semi-arid climates are the blocking of nozzles and damage by rodents. The blocking of the drip nozzles may be caused either through insufficient filtering of the water supply or by the influence of sand storms. Because of the number of drip-lines involved, this system is found to be most suitable for vegetables like melon and tomatoes which are grown at wide spacings. It must be admitted that there are often difficulties caused by the drying of the soil surface and the accumulation of dry sand over seed or seedlings. Control of pests and diseases may also be affected, one way or the other, by dry surface conditions.

Given the high capital cost of the installation, careful study is required of the advantages and disadvantages of the drip system, and it is recommended that a specialist is consulted before purchase is decided.

There are various different types of equipment; staff at CNRA, Bambey, Senegal, tested 14 different systems and found that, under local conditions, the 'nétafim' drippers are the best adapted for vegetable crops (T.M. Duc, 1978).

It may be noted that, in order to reduce the costs of investment, some authors (Boaz et al.) have suggested that drip lines may be moved from plot to plot in the same way as sprinkler equipment. In any case, many operational questions are involved - water filtration, the cleaning of filters, the choice of nozzles, the inspection of drip function, regulation of debit, etc., and a well trained supervisor is required if the system is to work efficiently.

I. ROTATION

1. PRINCIPLES OF ROTATION

The object of rotating a succession of different crop species on the same plot of land is to preserve the soil in a good fertile condition and to avoid the various negative effects of repeated planting of the same crop species. Rotation facilitates the production of high yields of healthy crops, but in practice is often neglected in the interest of short-term economic gains.

The choice of a suitable rotation involves consideration of numerous factors and depends, in the first place, on the size and objectives of the production unit. A garden producing vegetables for a village market or for the use of one family presents, in certain respects, fewer problems than a farm run on commercial lines, which must serve market demands. On the other hand, it is easier to design rotations for large farms where it is possible to restrict vegetable crops to one year in two, three or more years, for each plot of land.

'Mixed farming', combining vegetable growing and stock raising is ideal from this point of view, as it allows the alternation of vegetables and forage crops. Small commercial holdings, however, call for the use of intensive cropping of high-value crop species which makes for complications; careful planning of rotation is required to preserve a high standard of fertility and hygiene in such cases.

Rotation, in fact, must be designed for each holding according to production objectives, to the local water quality, soil character and climate and to the production techniques to be employed. The correct choice of rotation, therefore, varies not only with the type and size of farm, but on its geographic situation.

In each individual case, before deciding on a rotation, the following factors should be considered:

(a) Nematode control

All soils of the region used for vegetable production are subject to the rapid increase of nematode infestation. This is a major obstacle, and one of the main pre-occupations of the grower should be the limitation of development of these pests in general, and of the root-knot nematode, Meloidogyne spp., in particular.

As the use of nematocides is too costly in most circumstances, control must be exercised through rotation. Studies undertaken by ORSTOM at CDH (C. Netscher, 1974) demonstrated that, in Senegal, crops of groundnut can be used as a 'plant trap' against nematodes, and it is therefore recommended that all vegetable crops should be followed by a crop of groundnuts during the rainy season. ORSTOM researchers (J.C. Prot, 1982),

also recommended that, in the first season after a trap crop, a resistant crop should be grown, followed by a crop of low sensitivity; in the second year, following a second trap crop, a nematode susceptible crop should be planted, followed by bare fallow during a hot dry season. In this way, it is hoped to avoid the appearance of a race B of nematodes capable of overcoming crop resistance.

Nematode resistant species that can be used in such rotations include: Tagetes erecta, Amaranthus spp., Mentha spp., Crotalaria spp., Fragaria spp., Pennisetum typhoides, Sorghum spp., Digitaria decumbens and Panicum maximum.

Tagetes spp., or 'African marigold' is a flowering plant reported to be a non-host to Meloidogyne (Whithead, 1961; Winoto, 1969; Nivula and Bassi, 1965).

Crotalaria spp., are often used as a green manure in rotation with tobacco for nematode control (De Guiran, 1960).

Digitaria decumbens, a graminaceous forage plant, has been reported (Messiaen, 1981) as producing root secretions which activate, then kill, the larvae of Rotylenchulus and Meloidogyne nematodes and prevent contamination of soils by Pseudomonas solanacearum bacteria.

Panicum maximum, a forage plant, is a non-host to Meloidogyne (Lenné, J.M., 1981).

'Sudax', a Sorghum x Sudangrass hybrid forage plant, is reported (Messiaen, 1981) to reduce potential soil infestation by the bacterium Pseudomonas solanacearum, the nematodes Meloidogyne and Rotylenchus spp. and by the fungus Pythium aphanidermatum. The fodder crop should be ploughed in after three cuttings.

Strawberry and mint are not susceptible to Meloidogyne attack and Amaranth is not very susceptible.

The tomato variety "Rossol" and the variety of African eggplant "Improved Soxna", selected by CDH, and varieties of sweet potato, like "Walo", have proved resistant to Meloidogyne.

The natural occurrence of flooding of low-lying areas during the rainy season has an important effect in decreasing Meloidogyne infestation (Thanes and Storer, 1953; Mallamaure, 1965; Netscher, 1970) and this may be used as a control measure in some circumstances. (Persistently damp soils, however, should be avoided, particularly where onions and potato crops are grown).

For all susceptible crops, and in most rotations, the use of bare fallow for two to four months during the hot, dry season is recommended for the reduction of nematode infestation (Thanes and Storer, 1953; Mallamaure, 1965 and Netscher, 1970).

(b) Alternation of crop species for other hygienic and cultural reasons

In addition to avoiding a succession of nematode-susceptible species, crops susceptible to the same pests and diseases should not follow one another. This usually applies to crops belonging to the same botanical family, like tomatoes and eggplants, but may also apply to crops of

different families. For example, the soil fungus Pythium aphanidermatum attacks potatoes just as readily as beans and cucumbers, and none of these crops should follow one of the other.

Similarly, infections of Rhizoctonia solani may be checked by avoiding legume crops after crucifers and of potatoes after bush beans, and vice-versa.

Apart from hygienic considerations, it is also desirable to vary crops according to their rooting characteristics and nutrient requirements, as far as possible, to exploit the nutrient content of the different soil horizons to the best advantage. The cropping plan must, of course, take into account the season of each species in the rotation, allowing sufficient time between crops for adequate soil preparation, plus a margin for unexpected circumstances.

(c) Commercial requirements

Market gardeners must plan their rotation according to market demand. This involves planning production for the most profitable season, within practical limits, as well as for the most profitable species and varieties. The varieties used should be kept under constant revision, as selections become available with improved quality, climatic adaptability and resistance to parasites.

(d) Production costs and workload

A well-designed rotation should also take into account the distribution of work during the year and thus the needs for labour and machinery, so as to avoid periods when staff and facilities are overloaded.

The following Table 12 is presented as a guide to the succession of crops in rotations, according to the technical requirements and peculiarities of the main commercial vegetable species. The species listed vertically (column A) are mostly susceptible to attack by Meloidogyne. None of these crops should immediately follow another in a rotation, if it can be avoided. The species listed horizontally (column B) are either not susceptible or only moderately susceptible to attack or are trap crops. Each of the species listed vertically can be followed by each of the species listed horizontally, except where marked by a shaded square, but it should be noted that the last five crops listed horizontally (column B), namely Crotalaria, Digitaria, Panicum, Sudax and Tagetes, should be tested in local trials for their resistance to Meloidogyne, before inclusion in a rotation.

Crops A	Crops B	Crops A														Crops B													
		Amaranthus	Groundnut [Trap crop]	African Aubergine	Cabbage	Strawberry	Maize	Mint	Turnip	Onion	Roselle	Sweet potato	Leek	Radish	Tomato	Crotalaria	Digitaria decumbens	Only local crop	Penicium maximum	Sudax	Targetes	Flooding	Bare fallow						
Aubergine	XXX																												
African Aubergine	R																												
Basil	XXX																												
Beet	XXX																												
Carrot	XXX																												
Celery	XXX																												
Cabbage	XX																												
Cucumber	XXX																												
Cherkin	XXX																												
Courgette	XXX																												
Okra	XXX																												
French Bean	XXX																												
Lettuce	XXX																												
Cassava	XXX																												
Melon	XXX																												
Turnip	XX																												
Onion	XX																												
Roselle	XX																												
Watermelon	X																												
Sweet Potato	R																												
Parsley	XXX																												
Chilli	XX																												
Leek	X																												
Peas	XXX																												
Sweet Pepper	XX																												
Potato	XXX																												
Radish	XX																												
Tomato	R																												

Key to susceptibility to Meloidogyne attack

- X = Slightly susceptible
- XX = Fairly susceptible
- XXX = Very susceptible
- O = Not susceptible

R = ONLY resistant varieties to be planted.

Note Avoid succession of crops indicated by shaded squares.

Table 12 Recommended succession of crops for vegetable production rotations

2. DIFFERENT TYPES OF ROTATION

Rotations should be adapted to the type and size of production unit and its objectives. The following examples indicate systems suited to the major classes of vegetable production in the region and are limited to 2 and 3 year rotations, i.e. systems which are repeated every 2 or 3 years on the same plots.

(a) Rotation for small family gardens

Small family gardens require intensive rotations to produce the maximum quantity and variety of vegetables on the space available and therefore require rigid application of the principles, especially those concerning nematode control.

Plot No.	First Year			Second Year		
	Cool season	Hot dry season	Hot rainy season	Cool season	Hot dry season	Hot rainy season
1	Onion (1)	Okra	Groundnut	Cabbage	Bare fallow	Roselle(3)
2	Cabbage	Bare fallow	Roselle(3)	Onion (1)	Okra	Groundnut
3	Carrot	Mint	Mint (2)	Tomato	Cabbage	Groundnut
4	Tomato(N)	Cabbage	Groundnut	Carrot	Mint	Mint (2)
5	Basil	Sweet potato(N)	Groundnut	African aubergine (N)	Bare fallow	Turnip
6	African aubergine(N)	Bare fallow	Sweet potato	Basil	Onion	Groundnut

- (1) Early onions grown from bulbils
- (2) continuation of same crop
- (3) Grown for the young leaves
- (N) Variety resistant to Meloidogyne spp.

This rotation allows the production of six vegetable species in the cool season, four in the hot dry season and three (plus groundnut) in the rainy season. The same species are repeated only after two years.

(b) Rotations for large family gardens

In this case, the grower has enough land to permit a rotation which involves vegetable production on the same plot only every third or fourth year, thus greatly reducing the risk of nematode infestation.

(i) Two-year Rotation for Large Family Garden

Plot No.	First Year			Second Year		
	Cool season	Hot dry season	Hot rainy season	Cool season	Hot dry season	Hot rainy season
1	French bean	Tomato	Turnip	Maize	Bare fallow	Groundnut
2	Carrot	Cabbage	Chilli (1)	"	"	"
3	Tomato (N)	Lettuce	Sweet potato	"	"	"
4	Lettuce	Onion	African aubergine(N)	"	"	"
5	Onion	African auber.(N)	Amaranthus	"	"	"
6	African Aubergine(N)	Turnip	Mint	"	"	"
7	Cabbage	Sweet potato(N)	Okra	"	"	"
8	Potato	Amaranthus	Watermelon	"	"	"
9	Maize	Bare fallow	Groundnut	French bean	Tomato	Turnip
10	"	"	"	Carrot	Cabbage	Chilli (1)
11	"	"	"	Tomato	Lettuce	Sweet potato (N)
12	"	"	"	Lettuce	Onion	African auber.(N)
13	"	"	"	Onion	African auber.(N)	Amaranthus
14	"	"	"	African auber.(N)	Turnip	Mint
15	"	"	"	Cabbage	Sweet potato(N)	Okra
16	"	"	"	Potato	Amaranthus	Watermelon

Key

- (1) The crop of chilli peppers may last for 6-10 months
 (N) Varieties resistant to Meloidogyne spp.

Key

(1) The crop of chilli peppers may last for 6-10 months

(N) Varieties resistant to Meloidogyne spp.

(ii) Three-Year Rotation for Large Family Garden

Plot No.	First Year			Second Year			Third Year		
	Cool season	Hot dry season	Hot rainy season	Cool season	Hot dry season	Hot rainy season	Cool season	Hot dry season	Hot rainy season
1	Fr.bean	Tomato(N)	Turnip	Mint	Mint	Sweet potato	Maize	Bare fallow	Groundnut
2	Carrot	Cabbage	Chilli(1)	"	"	"	"	"	"
3	Tomato(N)	Fr.bean	Lettuce	"	"	"	"	"	"
4	Lettuce	Onion	Afr.auber.	"	"	"	"	"	"
5	Onion	Afr.auber.	Basil	"	"	"	"	"	"
6	Afr.auber.	Turnip	Watermelon	"	"	"	"	"	"
7	Cabbage	Carrot	Roselle	"	"	"	"	"	"
8	Potato	Amaranthus	Okra	"	"	"	"	"	"
9	Maize	Bare fallow	Groundnut	Fr.bean	Tomato	Turnip	Mint	Mint	Sweet potato
10	"	"	"	Carrot	Cabbage	Chilli(1)	"	"	"
11	"	"	"	Tomato(N)	Fr.bean	Lettuce	"	"	"
12	"	"	"	Lettuce	Onion	Afr.auber.	"	"	"
13	"	"	"	Onion	Afr.aub.	Basil	"	"	"
14	"	"	"	Afr.aub.	Turnip	Watermelon	"	"	"
15	"	"	"	Cabbage	Carrot	Roselle	"	"	"
16	"	"	"	Potato	Amaranthus	Okra	"	"	"
17	Mint	Mint	Sweet potato	Maize	Bare fallow	Groundnut	Fr.bean	Tomato	Turnip
18	"	"	"	"	"	"	Carrot	Cabbage	Chilli (1)
19	"	"	"	"	"	"	Tomato(N)	Fr.bean	Lettuce
20	"	"	"	"	"	"	Lettuce	Onion	Afr.auber.
21	"	"	"	"	"	"	Onion	Afr.aub.	Basil
22	"	"	"	"	"	"	Afr.aub.	Turnip	Watermelon
23	"	"	"	"	"	"	Cabbage	Carrot	Roselle
24	"	"	"	"	"	"	Potato	Amaranthus	Okra

(c) A two-year Rotation for a Small Intensive Commercial Market Garden

In this case, shortage of land obliges the grower to cultivate all plots more or less permanently and, at the same time, to maintain their fertility and limit infestations to the minimum. The choice of species is dictated by market demand and the planning of rotations is therefore difficult. The future of the business depends on the establishment of a suitable rotation.

Plot No.	First year			Second year		
	Cool season	Hot dry season	Hot rainy season	Cool season	Hot dry season	Hot rainy season
1	Melon	Onion (1)	Groundnut	Tomato (N)	French bean	Sweet potato (N)
2	Tomato(N)(2)	French bean	Sweet potato(N)	Melon	Onion(1)	Groundnut
3	Strawberry	Strawberry	Sweet potato(N)	French bean	Onion(1)	Cabbage
4	French bean	Onion (1)	Cabbage	Strawberry	Strawberry	Sweet potato(N)

(1) Long keeping onion

(2) Early tomato

(N) Variety resistant to Meloidogyne spp.

(d) A Two-year Rotation for a Large Commercial Market Garden

In this case, the grower has a large area available which allows for a fallow after 2, 3 or 4 vegetable crops. The fallow consists of at least one season of bare fallow followed by groundnuts, with longer periods of bare fallow, if necessary. The rotation also allows for the variation of vegetable crops, using species more or less susceptible to Meloidogyne attack according to circumstances and the hygienic condition of the soil.

Plot No.	First year			Second year		
	Cool season	Hot dry season	Hot rainy season	Cool season	Hot dry season	Hot rainy season
1	French bean	African auber.(N)	Cabbage	Tomato(N)	Bare fallow	Groundnut
2	Melon	Sweet potato(N)	Okra	Onion	Bare fallow	Groundnut
3	Potato	Cabbage	African auber.(N)	Leek	Bare fallow	Groundnut
4	Tomato(N)	Bare fallow	Groundnut	French bean	African auber.(N)	Cabbage
5	Onion (1)	Bare fallow	Groundnut	Melon	Sweet potato(N)	Okra
6	Leek	Bare fallow	Groundnut	Potato	Cabbage	African auber.(N)

(1) Early onions grown from bulbils.

(N) Variety resistant to Meloidogyne spp.

(e) A Three-Year Rotation for Mixed Farming with Stock-Raising and Vegetable Production

This type of rotation resolves the problem of supplies of organic matter to the soil and allows the production of forage during the seasons unfavourable to vegetable production.

The inclusion of graminaceous crops like Digitaria decumbens, Panicum maximum and Sudax, makes possible a considerable reduction of nematode infestation.

Plot No.	First Year			Second Year			Third Year		
	Cool season	Hot dry season	Hot rainy season	Cool season	Hot dry season	Hot rainy season	Cool season	Hot dry season	Hot rainy season
1	Melon	Sweet potato (N)	Maize	Onion(1)	P A N I C U M M A X I M U M F O R A G E				
2	P A N I C U M M A X I M U M F O R A G E			Melon	Sweet potato(N)	Maize	Onion	F O R A G E	
3	Onion(1)	P A N I C U M M A X I M U M F O R A G E					Melon	Sweet potato(N)	Maize
4	French bean	Tomato(2)	Watermelon	Cabbage(2)	P A N I C U M M A X I M U M F O R A G E				
5	P A N I C U M M A X I M U M F O R A G E			French bean	Tomato(2)	Watermelon	Cabbage(2)	F O R A G E	
6	Cabbage(2)	P A N I C U M M A X I M U M F O R A G E					French bean	Tomato(2)	Watermelon
7	Potato	Cabbage(2)	Afr.auberg. (N)	Carrot	P A N I C U M M A X I M U M F O R A G E				
8	P A N I C U M M A X I M U M F O R A G E			Potato	Cabbage(2)	Afr.auberg. (N)	Carrot	F O R A G E	
9	Carrot	P A N I C U M M A X I M U M F O R A G E					Potato	Cabbage(2)	Afr.auberg. (N)

- (1) Early onions grown from bulbils.
(2) Late varieties
(N) Variety resistant to Meloidogyne spp.

J. GENERAL CONCLUSIONS

The foregoing account of production techniques should provide a general guide to the growing of vegetables under irrigation in arid and semi-arid conditions in tropical Africa. It is emphasized that success can only be assured by careful trials of species, varieties and techniques under local conditions.

Climatic difficulties will always limit the selection of crops that can be grown in the hot dry and rainy seasons, but the use of new adapted varieties should enable the production of cool season crops over a longer period. When good soil and adequate supplies of sweet water have been assured, the correct choice of crop variety with regard to climate, pest and disease resistance, market and keeping qualities, is the essential first step to success and the seed used must be of first quality and free from infection.

It is not suggested that the problems of irrigation, fertilization and plant protection are thereafter easily resolved, but, nevertheless, if care is taken, sufficient information is now available for the production in the region of a wide variety of vegetables of excellent quality and the potential yields are many times greater than those usually obtained.

Many crop failures in the past have been due to poor production organization and this question merits very serious consideration. The dangers of scale should not be under-estimated; vegetables require intensive methods and hence the scale of production must be increased progressively if problems of production, as well as those of protection and marketing, are to be kept under control.

**ANNEX A
WATER QUALITY**

1. CALCULATION OF ADJUSTED S.A.R.

The adjusted Sodium Absorption Ratio (adjusted S.A.R.) is calculated by means of the following formula:

$$\text{Adjusted S.A.R.} = \frac{\text{Na}}{\sqrt{\frac{\text{Ca} + \text{Mg}}{2}}} (1 + (8.4 - \text{pHc}))$$

where Na, Ca and Mg, as determined by analysis of the water, are expressed in meq/l, and pHc is calculated using the following tables, which relate to the concentration values from the water analysis. The values from the tables are then substituted in the following formula for pHc:

$$\text{pHc} = (\text{pK}'_2 - \text{pK}'_c) + \text{p}(\text{Ca} + \text{Mg}) + \text{p}(\text{Alk})$$

2. TABLES FOR THE CALCULATION OF pHc *

(pK'₂ - pK'_c) is obtained from the sum of Ca + Mg + Na in meq/l) Data
 p(Ca + Mg) is obtained from the sum of Ca + Mg in meq/l) obtained
 p(Alk) is obtained from the sum of CO₃ + HCO₃ in meq/l) from water
) analysis

Sum of concentration	pK' ₂ - pK' _c	p(Ca + Mg)	p(Alk)
0.05	2.0	4.6	4.3
0.10	2.0	4.3	4.0
0.15	2.0	4.1	3.8
0.20	2.0	4.0	3.7
0.25	2.0	3.9	3.6
0.30	2.0	3.8	3.5
0.40	2.0	3.7	3.4
0.50	2.1	3.6	3.3
0.75	2.1	3.4	3.1
1.00	2.1	3.3	3.0
1.25	2.1	3.2	2.9
1.5	2.1	3.1	2.8
2.0	2.2	3.0	2.7
2.5	2.2	2.9	2.6
3.0	2.2	2.8	2.5
4.0	2.2	2.7	2.4
5.0	2.2	2.6	2.3
6.0	2.2	2.5	2.2
8.0	2.3	2.4	2.1
10.0	2.3	2.3	2.0
12.5	2.3	2.2	1.9
15.0	2.3	2.1	1.8
20.0	2.4	2.0	1.7
30.0	2.4	1.8	1.5
50.0	2.5	1.6	1.3
80.0	2.5	1.4	1.1

* pHc is a theoretical pH of irrigation water in contact with lime and in equilibrium with soil CO₂.

3. EXAMPLE OF THE CALCULATION OF pHc

Given	Ca = 2.32 meq/l	CO ₃ = 0.42 meq/l
	Mg = 1.44 meq/l	HCO ₃ = 3.66 meq/l
	Na = 7.73 meq/l	
	<hr/>	<hr/>
Total	11.49 meq/l	Total 4.08 meq/l

Following the tables and using the equation for pHc:

$$\begin{aligned}
 pK'_2 - pK'_c &= 2.3 \\
 p(\text{Ca} + \text{Mg}) &= 2.7 \\
 p(\text{Alk}) &= 7.4 \\
 \hline
 \text{pHc} &= 7.4
 \end{aligned}$$

These values are inserted in the formula:

$$\begin{aligned}
 \text{Adjusted S.A.R.} &= \frac{7.73}{\sqrt{\frac{3.76}{2}}} (1 + (8.4 - 7.4)) \\
 \text{Adjusted S.A.R.} &= 5.64 (2.0) = 11.3
 \end{aligned}$$

Note: Values of pHc above 8.4 indicate a tendency to dissolve lime from the soil through which the water moves; the values below 8.4 indicate a tendency to precipitate lime from the water applied (Ref.: L.V. Wilcox, U.S. Salinity laboratory, Mimeo. 30 December 1966, and Rhoades, 1972).

(Extract from the FAO Irrigation and Drainage Paper No. 29, "Water Quality for Agriculture", by R.S. Ayers and D.W. Westcot, 1976).

4. LABORATORY DETERMINATIONS NEEDED TO EVALUATE WATER QUALITY

Laboratory Determinations	Symbol	Reporting Units (1)	Equivalent Weight
Electrical conductivity	ECw	mmhos/cm	-
Calcium	Ca	meq/l	20
Magnesium	Mg	meq/l	12.2
Sodium	Na	meq/l	23
Carbonate	CO ₃	meq/l	30
Bicarbonate	HCO ₃	meq/l	61
Chloride	Cl	meq/l	35.4
Sulphate	SO ₄	meq/l	48
Boron	B	mg/l	-
Nitrate nitrogen (2)	NO ₃ -N	mg/l	14
Acidity - alkilinity	pH	pH (3)	-
Adjusted Sodium Absorption Ratio	Adj SAR(4)	-	-

(Extract from the FAO Irrigation and Drainage paper No. 29 "Water Quality for Agriculture", by R.S. Ayers and D.W. Wescot, 1976).

(1) mmhos/cm = millimhos/cm at 25°C (mmhos/cm x 640 = mg/l)
 meq/l = milliequivalents per litre
 mg/l = milligrammes per litre

(2) NO₃ - N indicates nitrogen in the form of NO₃ while NH₄ - N indicates nitrogen in the form of NH₄, reported as N in mg/l.

(3) Acidity (pH 1-7)
 Alkalinity (pH 7-14)
 Neutral (pH 7.0)

(4) For methods of calculation, see Table 3

5. TOLERANCE OF VEGETABLE CROPS TO SALINITY AND BORON

Expected reduction in yield of vegetable crops due to salinity of irrigation water when common surface irrigation methods are used.

CROPS	0%		10%		25%		50%		Maximum ECe (3)
	ECe(1)	ECw(2)	ECe	ECw	ECe	ECw	ECe	ECw	
Beetroot (4) <u>Beta vulgaris</u>	4.0	2.7	5.1	3.4	6.8	4.5	9.6	6.4	15
Broccoli <u>Brassica oleracea</u> <u>botrytis</u>	2.8	1.9	3.9	2.6	5.5	3.7	8.2	5.5	13.5
Tomato (<u>Lycopersicon</u> <u>esculentum</u>)	2.5	1.7	3.5	2.3	5.0	3.4	7.6	5.0	12.5
Cucumber (<u>Cucumis sativum</u>)	2.5	1.7	3.3	2.2	4.4	2.9	6.3	4.2	10
Cantaloupe melon (<u>Cucumis melo</u>)	2.2	1.5	3.6	2.4	5.7	3.8	9.1	6.1	16
Cabbage <u>Brassica oleracea</u> <u>capitata</u>)	1.8	1.2	2.8	1.9	4.4	2.9	7.0	4.6	12
Potato (<u>Solanum tuberosum</u>)	1.7	1.1	2.5	1.7	3.8	2.5	5.9	3.9	10
Sweet corn (<u>Zea mays</u>)	1.7	1.1	2.5	1.7	3.8	2.5	5.9	3.9	10
Sweet potato <u>Ipomoea batatas</u>	1.5	1.0	2.4	1.6	3.8	2.5	6.0	4.0	10.5
Sweet pepper <u>Capsicum annuum</u>	1.5	1.0	2.2	1.5	3.3	2.2	5.1	3.4	8.5
Lettuce <u>Lactuca sativa</u>	1.3	0.9	2.1	1.4	3.2	2.1	5.2	3.4	9
Radish <u>Raphanus sativus</u>	1.2	0.8	2.0	1.3	3.1	2.1	5.0	3.4	9
Onion <u>Allium cepa</u>	1.2	0.8	1.8	1.2	2.8	1.8	4.3	2.9	7.5
Carrot <u>Daucus carota</u>	1.0	0.7	1.7	1.1	2.8	1.9	4.6	3.1	8
French bean <u>Phaseolus vulgaris</u>	1.0	0.7	1.5	1.0	2.3	1.5	3.6	2.4	6.5
Strawberry <u>Fragaria</u> spp.	1.0	0.7	1.3	0.9	1.8	1.2	2.5	1.7	4

- (1) ECe means electrical conductivity of the saturation extract of the soil reported in millimhos per centimetre at 25°C.
- (2) ECw means electrical conductivity of the irrigation water in millimhos per centimetre at 25°C.
- (3) ECe maximum means the maximum electrical conductivity of the soil saturation extract that can develop due to the listed crop with drawing soil water to meet its evapotranspiration demand. At this salinity, crop growth ceases (100% yield decrease) due to the osmotic effect and reduction in crop water availability to zero.
- (4) During germination of red beetroot ECe should not exceed 3 millimhos per centimetre.

Source: Standards given by Maas and Hoffman (1977); Bernstein (1964) and the Committee of Consultants of the University of California (1974)

Extract from the FAO Irrigation and Drainage Paper No. 29 "Water Quality for Agriculture", by R.S. Ayers and D.W. Westcot, 1976.

6. THE TOLERANCE OF VEGETABLE CROPS TO THE PRESENCE OF BORON (1) IN THE IRRIGATION WATER
(D.S. Farnham, R.S. Ayers and R.F. Hasek, 1977)

Tolerant 4.0 mg/l of boron	Fairly tolerant 2.0 mg/l of boron	Sensitive 1.0 mg/l of boron
Asparagus	Celery	French bean
Red beetroot	Potato	
Melon	Radish	
Onion	Pea	
Turnip	Maize	
Cabbage	Pumpkin	
Lettuce	Tomato	
Carrot	Sweet pepper	
	Sweet potato	
2.0 mg/l of boron	1.0 mg/l of boron	0.3 mg/l of boron

(1) Tolerance decreases in descending order in each column (Wilcox, 1960).

7. RECOMMENDED MAXIMUM CONCENTRATIONS OF TRACE ELEMENTS IN IRRIGATION WATERS

Element (Symbol)	For waters used continuously on all soils (mg/l)	For use up to 20 years on fine textured soils of pH 6 to 8.5 (mg/l)
Aluminium (Al)	5.0	20.0
Arsenic (As)	0.1	2.0
Beryllium (Be)	0.1	0.5
Boron (B)	(1)	2.0
Cadmium (Cd)	0.01	0.05
Chromium (Cr)	0.1	1.0
Cobalt (Co)	0.05	5.0
Copper (Cu)	0.2	5.0
Fluoride (F)	1.0	15.0
Iron (Fe)	5.0	20.0
Lead (Pb)	5.0	10.0
Lithium (Li) (2)	2.5	2.5
Manganese (Mn)	0.2	10.0
Molybdenum (Mo)	0.01	0.05 (3)
Nickel (Ni)	0.2	2.0
Selenium (Se)	0.02	0.02
Vanadium (V)	0.2	1.0
Zinc (Zn)	2.0	10.0

These levels will not normally adversely effect plants or soils. No data available for Mercury (Hg), Silver (Ag), Tin (Sn), Titanium (Ti) or Tungsten (W).

(1) See table 4 (b)

(2) The maximum concentration of Lithium recommended for the irrigation of citrus is 0.075 mg/l.

(3) Only for acid soils of fine texture or acid soils with a relatively high content of iron oxide.

Source: Environmental Studies Board, Nat. Acad. of Sci., Nat. Acad. of Eng., Water Quality Criteria, 1972.

(Extract from the FAO Irrigation and Drainage Paper No. 29 "Water Quality for Agriculture", by R.S. Ayers and D.W. Westcot, 1976).

ANNEX B
IRRIGATION

1. WATER REQUIREMENTS IN m³/ha OF IRRIGATION PER CROPS
ACCORDING TO SPECIES AND METHOD

Species	C.D.H. Sprinkler (1)	C.D.H. Drip (2)	C.D.H. Water-can (3)	C.N.R.A. Bambey sprinkler (4)	Furrow Irrigation
Eggplant	10.000-12.000	-	5.910	12.160	
Carrot	7.000-10.000				
Cabbage	6.300-9.400		3.640	7.170	
Chinese cabbage	5.800-6.200				
Cauliflower	6.700-8.700				
Cucumber	2.150-9.500	-	1.700		
Gherkin	5.600-6.300	-	-		
Courgette	5.800-7.300	-	1.130		
Shallot	3.000-3.200				
Strawberry	16.000-17.000	5.313			
Okra	7.800-10.100				
French bean -dwarf	5.150- 6.000		2.980		
-climbing	7.150- 8.200				
African eggplant	9.000- 9.500			12.160	
Lettuce -soft	5.400- 6.100				
-crisp	6.400- 7.100				
Melon	8.250- 9.800	5.313			
Onion -bulbils	4.300- 4.500				
-seed	6.440- 8.100		4.300	8.030 to 12.950	22.000 (5)
Watermelon	7.600-11.900	3.720			
Sweet potato	9.300-11.100		3.500		
Chili	17.000-28.000				
Peas	5.000- 5.900				
Sweet pepper	10.000-12.000				
Potato	6.900- 8.400		4.950		
Tomato	8.000- 9.800		2.160	9.180 to 12.160	13.000 (6)

- (1) According to results at CDH, Camberène, on sandy soil during the dry season (Sept. to June), including 40% water losses. See "Considérations sur l'irrigation des cultures maraîchères", Baudoin, 1975, and other CDH reports.
 (2) Baudoin et al. Système Chapin Watermaties "Compte-rendu de quelques essais d'irrigation au goutte à goutte", 1976.
 (3) Navez et al. "Irrigation localisée au pied des plantes par arrosoir" (système traditionnel).
 (4) Trau Minn Duc et al., novembre 1975 "Irrigation de la zone Centre-Nord du Sénégal".
 (5) Verguin: "Le maraîchage" - Kayes, Mauritanie (1973), cycle 120 jours.
 (6) Baudoin et al., "Culture tomate industrielle à Dagana - Fleuve Sénégal" (1979), cycle 200 jours (repliage-fin récolte).

ANNEX B (cont.)

2 : Determination of the Evapotranspiration (ETO) of the Reference crop at CDH, Senegal, based on the Values of Evaporation in mm from a Class A Vat (monthly data, 1983)

	Jan.	Feb.	Mars.	April	May	June	July	Aug.	Sept.	Oct.	Nov.	Déc.
Wind	1,7 Light	2,3 ←	2,3 Moderate	2,6	2,3	2,2	2,3	1,9 ←	1,7 ←	1,5 ←	1,8 ←	1,7 ←
Average R.H. %	53,9 Medium →	67,4	79,5	78,2	80,1	77,6	76,9	78,8	81,2	77,7	74,4	57,4 ←Med.
Surroundings of VAT	Vat surrounded by a short green crop for a radius of 100 m											
Kp	0,8	0,75	0,8	0,8	0,8	0,8	0,8	0,85	0,85	0,85	0,85	0,8
E from VAT mm/day	4,9	4,7	4,7	4,7	4,5	5,9	6	5,9	5,8	5	6	4,8
ETO mm/ day	3,92	3,52	3,76	3,76	3,6	4,72	4,8	5,0	4,93	4,25	5,1	3,84

3. CROP COEFFICIENT (K_c) OF VEGETABLE CROPS FOR THE LAST TWO PHASES OF GROWTH; WITH INDICATIONS OF ATMOSPHERIC HUMIDITY

CROP	HUMIDITY		R.H min 70%		R.H min 20%	
	WIND	M/S	0 - 5	5 - 8	0 - 5	5 - 8
Eggplant	3		0.95	1.00	1.05	1.10
	4		0.80	0.85	0.85	0.90
Forage beet	3		1.00	1.00	1.05	1.10
	4		0.90	0.90	0.95	1.00
Carrot	3		1.00	1.05	1.10	1.15
	4		0.70	0.75	0.80	0.85
Celery	3		1.00	1.05	1.10	1.15
	4		0.90	0.95	1.00	1.05
Cabbage	3		0.95	1.00	1.05	1.10
	4		0.80	0.85	0.90	0.95
Cucumber	3		0.90	0.90	0.95	1.00
	4		0.70	0.70	0.75	0.80
Courgette	3		0.90	0.90	0.95	1.00
	4		0.70	0.70	0.75	0.80
French bean - green	3		0.95	0.95	1.00	1.05
	4		0.85	0.85	0.90	0.90
	3		1.05	1.10	1.15	1.20
	4		0.30	0.30	0.25	0.25
Lettuce	3		0.95	0.95	1.00	1.05
	4		0.90	0.90	0.90	1.00
Melon	3		0.95	0.95	1.00	1.05
	4		0.65	0.65	0.75	0.75
Onion -dry	3		0.95	0.95	1.05	1.10
	4		0.75	0.75	0.80	0.85
	3		0.95	0.95	1.00	1.05
	4		0.95	0.95	1.00	1.05
Pea	3		1.05	1.10	1.15	1.20
	4		0.95	1.00	1.05	1.10
Sweet pepper	3		0.95	1.00	1.05	1.10
	4		0.80	0.85	0.85	0.90
Potato	3		1.05	1.10	1.15	1.20
	4		0.70	0.70	0.75	0.75
Radish	3		0.80	0.80	0.85	0.90
	4		0.75	0.75	0.80	0.85
Tomato	3		1.05	1.10	1.20	1.25
	4		0.60	0.60	0.65	0.65

After J. Doorenbos and W.O. Pruitt, "Crop Water Requirements", 1975 (FAO)

4. AVERAGE DURATION IN DAYS OF THE TOTAL CYCLE AND THE DIFFERENT STAGES OF GROWTH BY SPECIES AT CDH, SENEGAL

Species	Total Growth Cycle	Phase 1 *	Phase 2	Phase 3	Phase 4
Eggplant	150 - 180	25	45	60 - 80	20 - 30
Carrot	115 - 150	20	30	45 - 80	20
Cabbage	95 - 115	20	40	35 - 55	-
Chinese Cabbage	80 - 85	20	25	35 - 40	-
Cauliflower	85 - 120	20	35	35 - 60	-
Cucumber	90 - 120	10 - 15	20 - 25	40 - 60	20
Gherkin	75 - 80	10	15	40 - 45	10
Courgette	86 - 109	12	12 - 20	50 - 65	12
Shallot	70	15	20	20	15 (1)
Strawberry	240	30	30	180	-
Okra	125 - 160	20	30 - 45	65 - 85	10
French bean (dwarf)	67 - 77	10	12	35 - 45	10
" " (climbing)	77 - 87	10	12	40 - 50	15
African eggplant	155	30	45	60	20
Lettuce ⁺	80 - 90	10	25	45 - 55	-
Lettuce ⁺⁺	90 - 100	15	20	55 - 65	-
Melon	115 - 135	20	35	40 - 60	20
Onion (bulbils)	100	15	20	50	15 (1)
" (seed)	140 - 170	30	25	55 - 85	30 (1)
Watermelon	125 - 150	10 - 15	20 - 25	65 - 90	20
Sweet Potato	110 - 130	20	40	30 - 50	20
Chili	290 - 335	60 - 80	55 - 85	100 - 195	25
Pea	95	15	40	30	10
Sweet Pepper	145 - 175	30	45	60 - 80	10 - 20
Potato	80 - 95	10	15	40 - 55	15 (2)
Tomato	120 - 140	15	35	50 - 70	20

+ Butterhead varieties.

++ 'Great Lakes' type crisp varieties

(1) Stop irrigation 15 days before harvest.

(2) " " 10 " " "

* Phases

1 = germination

2 = young plant

3 = adult plant

4 = after max. veg. devt.

5. THE ESTIMATION OF AVAILABLE WATER IN SOIL BY APPEARANCE AND TOUCH

1. Remove a sample of soil from the root zone of the crop.
2. Squeeze a handful of soil strongly three or four times. Note if the soil crumbles or retains an oblong form.
3. In the latter case throw the lump of soil in the air for about 30 cm. and catch it. If the lump breaks after being thrown and caught five times or less it is classed as fragile, if not it is classed as durable.
4. Try to make a small 'sausage' of soil by rolling it between the thumb and first finger and note if the soil sticks to the thumb.
5. Following these tests, estimate the water content of the soil according to the following table:

Percentage of available water in soil	Silty Sands and Sandy Silts (Coarse-Textured)	Sandy Silts and Fine Medium Silts (Medium Textured)	Fine Clay Silts and Clay Silts (Fine Textured)
0-25	Dry, loose, runs through fingers.	Powdery, sometimes forms light crust but easily broken into powder.	Hard, cracking; difficult to break into powder.
25-50	Seems dry. Does not form ball when squeezed.	Somewhat friable but forms ball when squeezed.	Malleable. Forms a ball when squeezed.
50-75	Tends to form a ball when squeezed but breaks up when thrown in the air.	Forms a ball readily. Tends to stick when squeezed.	Forms a ball readily. Can be rolled into a 'sausage' between thumb and forefinger. Smooth to the touch.
75-100	Forms a ball but not strongly, easily breaks up when thrown in the air. Cannot be smoothed.	Forms a very malleable ball. Can be readily smoothed.	Can easily be rolled between thumb and forefinger. Smooth to the touch.
100 (i.e. at field capacity)	When the soil is squeezed no water escapes but a trace of moisture remains on the hand. The soil sticks to the thumb when rolled between thumb & forefinger.	Same as for sandy soils.	Same as for sandy soils.
Saturation	Water escapes when the soil is squeezed.	Same.	Same.

After: "Irrigation Practice and Water Management" (FAO, 1971), by L.D. Donsen

ANNEX B (contd.)

6. Doses and frequency of irrigation in litres/m² per day by species according to the different phases of development in a sandy soil (CDH, Senegal).

Species	Doses and Frequency in litres/m ² *			
	Stage 1 Germination	Stage 2 Young Plant	Stage 3 Adult Plant	Stage 4 After max. veg. dev.
Eggplant	2 twice per day	4 per day	10 every 2 days- 25 every 4 days	25 every 6 days
Carrot	2 twice per day	4 per day	10 every 2 days	12 every 2-3 days
Cabbage	2 twice per day	4 per day	15 every 2 days	15 every 2 days
Chinese cabbage	2 twice per day	5 per day	12 every 2 days	12 every 2 days
Cauliflower	2 twice per day	4 per day	12 every 2 days	12 every 2 days
Cucumber	5 per day	5 per day	12 every 2 days	12 every 2-3 days
Gherkin	5 per day	5 per day	12 every 2 days	12 every 2-3 days
Courgette	4 per day	8 every 2 days	15 every 3 days	15 every 3-4 days
Shallot	2 twice per day	4 per day	8 every 2 days- 13 every 3 days	stop 15 days before harvest
Strauberry	1.5 thrice per day	5 per day	10 every 2 days	10 every 2 days
Okra	2 twice per day	4 per day	10 every 2 days	12 every 3 days
French bean, dwarf	4 per day	8 every 2 days	12 every 2 days	12 every 2-3 days
" " climbing	4 per day	10 every 2 days	15 every 2 days	15 every 2-3 days
African eggplant	2 twice per day	4 per day	10 every 2 days	12 every 3 days
Lettuce	2 twice per day	5 per day	10 every 2 days	10 every 2 days
Melon	4 per day	10-12 every 2 days	20-25 every 4 days	25 every 6 days
Onion	2 twice per day	4 per day	8 every 2 days- 13 every 3 days	stop 15 days before harvest
Watermelon	4 per day	10-12 every 2 days	20-25 every 4 days	25 every 6 days
Sweet potato	4 per day	4 per day	10 every 2 days	15 every 3-4 days
Chilli	2 twice per day	5 per day	12 every 2 days	12 every 3 days
Pea	4 per day	8 every 2 days	10 every 2 days	10 every 2 days
Sweet pepper	2 twice per day	5 every 2 days	12 every 2 days	12 every 3 days
Potato	5-6 per day	10-12 per day	12-15 every 2 days	15 every 3 days **
Tomato	2 twice per day	5-10 every 2 days	15-20 every 2-3 days	15 every 3 days

After: W. Baudoin, G. Benvenuti, T. Ba "Report of Experimental Section, CDH", 1973-1985.

* On dry sandy soil, after a period of fallow, pre-irrigation is indispensable. The dose can vary between 20 and 40 litres/square metre.

** (for potato). Stop irrigation 10 days before harvest. If the weather is very warm, dampen the soil regularly to prevent it becoming too hot and dry, which favours the development of dry rot of tubers (*Rhizoctonia bataticola*).

7. 'CLASS A' EVAPORATION VAT

Description

The vat is circular, 120.7 cm in diameter and 25 cm deep, and is constructed of galvanised iron (gauge 22) or 'monel' (0.8 mm thick). It should be mounted on a platform of duckboard at a height of 15 cm above the soil surface (Fig.11) and should be perfectly level. (All the wood should be treated against insect and fungal attack).

The vat should always be filled up to 5 cm below the rim and care should be taken that the water level never drops beneath 7.5 cm from the rim. If this is neglected, air turbulence can cause errors in readings which may reach 15% with a water level 10 cm below the normal.

Readings are made from a small tube in the vat to avoid the effects of surface turbulence.

Installation

The installation of the vat should be chosen according to the data to be collected. For studies on crop water requirements, the conditions of the environment should, therefore, be similar to those surrounding the crop in the field. The site should preferably be a turf-covered area of 20 x 20 m, free on all sides to unobstructed air circulation. It should be distant from all buildings, trees and roads and surrounded by low-growing crops. If, for example, the vat is placed in a small area surrounded by a maize crop 2½ m high, the evaporation can be reduced by as much as 30% under arid conditions subject to hot, dry winds or by 5-10% under calm, humid conditions.

It is preferable for the vat to be situated in the middle of a cultivated area - if, however, it is placed to the windward of the fields, the evaporation will give an indication of the effect of the wind as it passes through the crop.

If it is necessary to situate the vat on fallow land, the data can be about 20% above those when surrounded by a crop under conditions of moderate warm, dry winds, and 5% if conditions are calm, cool and humid.

Protection

The evaporation station should be surrounded by a fence and care should be taken that the stakes of the fence do not cast a shadow on the vat. The fixing of a fine wire screen above the vat is better avoided, but may be necessary to prevent animals or birds drinking the contents. One should check on the effects of the screen by comparing the evaporation of vats with and without screening. Standard specifications for screens do not exist although it is known that fine wire screens can reduce evaporation by up to 10%.

Measurement

The level of the water in the vat is recorded early every morning at the same time, as observations on the rainfall. Readings are made in a metal cylinder in the vat of about 10 cm diameter and 20 cm depth.

The water in the cylinder is connected to the water in the vat via an aperture at the base of the cylinder. The best way of reading the amount of evaporation is by recording the volume of water necessary to bring the level in the vat up to the standard indicated by a mark inside the cylinder.

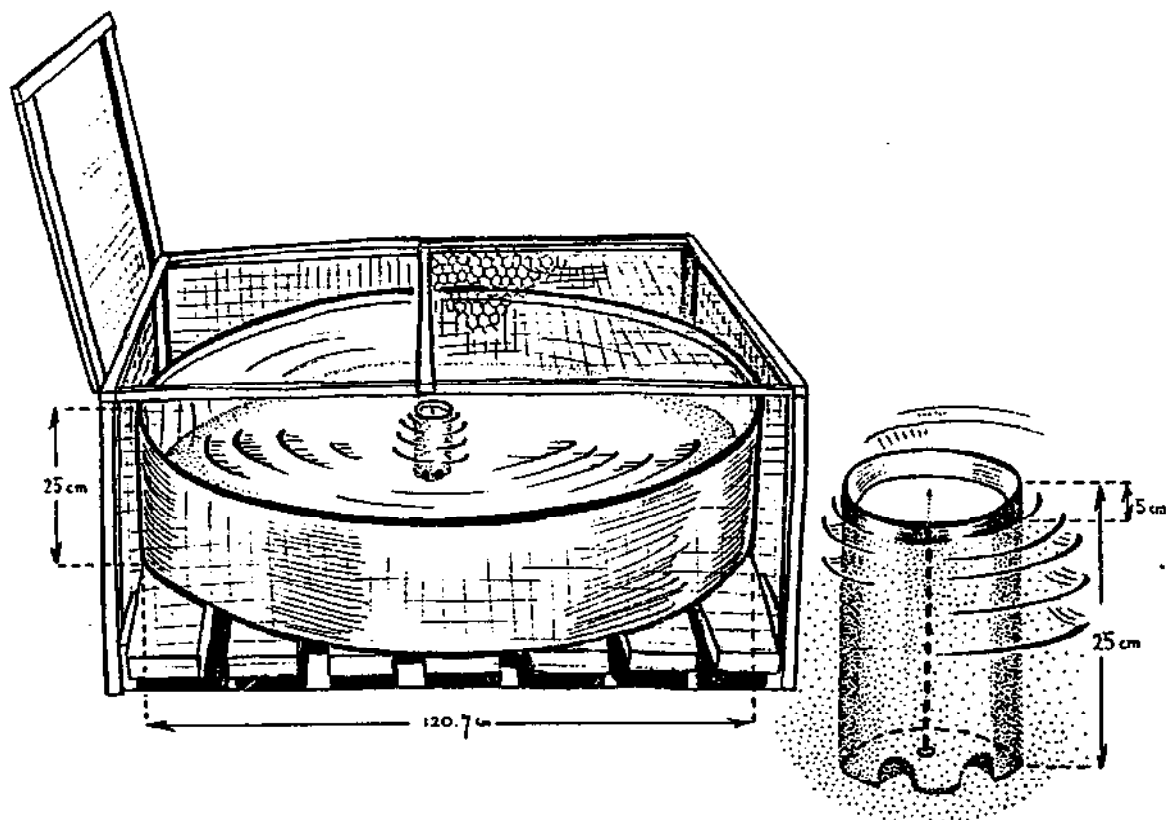

Fig. 12 Class A Evaporation Vat.

8. DESCRIPTION OF AN IRRIGATION SYSTEM COVERING ONE HECTARE USING DRAG-LINE SPRINKLERS

Water Requirements

6 mm/day required by plant	60	m ³
+ losses due to wind (under extreme conditions of wind at 4 m/s and temperature of 30°C)	20	m ³
+ losses by sprinkling outside the crop area	17.5	m ³
	<hr/>	
Total	97.5	m ³ /day
-	9.75	mm/day
	<hr/>	

Organisation of Installation

Nine sprinklers mounted on a drag-line, connected to the water main by 50 m lengths of supple hose-pipe.

The water main pipe divides the hectare in two blocks of 5 000 m² each.

Each of the nine sprinklers is moved four times in each of the two blocks (see Fig. 13), plus one extra move to cover the position of the central main.

The sprinklers are used at a water debit of 1 530 litres/hour (1.53 m³) at 2 kg pressure equivalent to a rainfall of 10 mm/hour to cover an area of 12 x 12 m.

For the nine sprinklers working together, the water use will be 1 530 litres x 9 = 13 770 litres/hour.

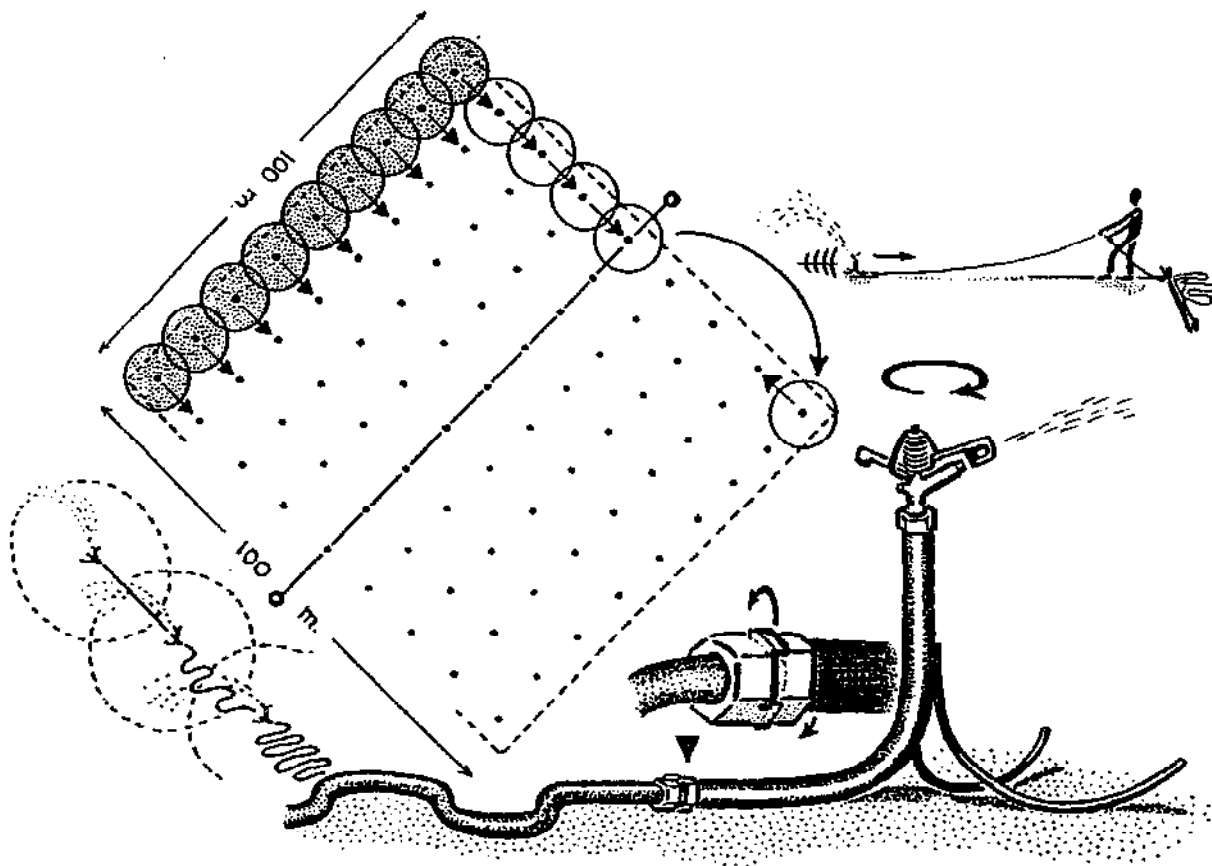

Fig. 13 Irrigation by Drag-Line Sprinkler

Frequency and Dose

In this example, daily irrigations may be limited to 7 hours and cover 5 000 m² (½ ha):

- water use in mm/day losses included are 9.75 mm, i.e. one ha receives in two days: 2 x 9.75 = 19.5 mm
 - 19.5 mm x 5 000 m² = 97.500 litres on ½ ha
 - the nine sprinklers use 13 770 litres/hour
 - 97 500 = approx. seven hours for the required dose.
- 13 770

Each of the nine sprinklers will stay in each of four positions for 1 hour 34 mins for each half-hectare, except for the central position which will be irrigated 45 minutes for each of the 2 days. (4 x 94 + 45 minutes = approx. 7 hours).

Equipment Required

- 9 Sprinklers mounted on drag frame as described above
- 9 Flexible pipes of 50 m and interior diameter 24 mm with 9 rapid universal connections.
- 1 Water main in PVC, internal diameter 55 mm, length 110 m, buried, connection to pump and 9 water gates with reduction to 25 mm diameter.
- 2 Petrol-driven motor-pumps (to work alternately), 5 HP at 2,500 t/m delivery 1.5 m³ at 30 HMT, equipped with galvanised suction pipes with bronze strainer and retainer valves.

Operating Costs

- petrol consumption 1.1 litre/hour
- oil consumption 50 litres/year
- labour: the presence of one man for 8 hours each operating day is essential for moving sprinklers, checking fuel and working motor-pumps. Only 4 hours will be taken for irrigation work and the rest of the time can be devoted to other duties.

ANNEX B (cont.)

9. : Maximum Length of Furrows according to the Type of Soil, the Slope and the Depth of Water Distributed

Slope of Furrow	Type of Soil											
	7,5	15	22,5	30	5	10	15	20	5	7,5	10	12,5
	Clay				Silt				Sand			
Z	metres											
0,05	300	400	400	400	120	270	400	400	60	90	150	190
0,1	340	440	470	500	180	340	440	470	90	120	190	220
0,2	370	470	530	620	220	370	470	530	120	190	250	300
0,3	400	500	620	800	280	400	500	600	150	220	280	400
0,5	400	500	560	750	280	370	470	530	120	190	250	300
1,0	280	400	500	600	250	300	370	470	90	150	220	250
1,5	250	340	430	500	220	280	340	400	80	120	190	220
2,0	220	270	340	400	180	250	300	340	60	90	150	190

After: "Surface Irrigation", Booker (1974), FAO

10. : Relationship of the Maximum Water Debit and the Critical Slope of Furrow for the Avoidance of Erosion.

Critical slope of furrow (I)	Maximum Debit (Qm)	Observations
Z	1/a	
0,1	6,0	The debit indicated is about double the delivery capacity of most furrows with a slope of 0.1%; the erosion is thus negligible when water runs at full capacity in a furrow with this slope.
0,3	2,0	A slope of 0.3% is near to the upper limit to avoid erosion when water is running at full capacity.
0,5	1,2	Furrows with a slope of 0.5% will cause erosion if the water debit is not considerably below the capacity of the furrow.
2,0	0,3	This figure indicates the reduction of water necessary to avoid severe erosion with a slope of 2%, which is considered to be the steepest allowable in normal furrows.

After: Marr (1967)

11. : Water Debit of small Siphons and Tubes according to Diameter and Pressure

Diameter of Tube	Pressure (cm)							
	2,5	5	7,5	10	12,5	15	17,5	20
cm	litres/second							
1	0,03	0,05	0,06	0,07	0,07	0,08	0,09	0,09
2	0,13	0,19	0,23	0,26	0,30	0,32	0,35	0,37
3	0,30	0,42	0,51	0,59	0,66	0,73	0,79	0,84
4	0,53	0,75	0,91	1,06	1,18	1,29	1,40	1,49
5	0,83	1,17	1,43	1,65	1,85	2,02	2,18	2,33
6	1,19	1,68	2,06	2,38	2,66	2,91	3,14	3,36
7	1,62	2,29	2,80	3,24	3,62	3,96	4,28	4,58
8	2,11	2,99	3,66	4,23	4,72	5,18	5,59	5,98
9	2,67	3,79	4,63	5,35	5,99	6,55	7,07	7,56
10	3,30	4,67	5,72	6,60	7,38	8,09	8,73	9,34

After "Surface Irrigation", Booker, 1974 (FAO)

12. CALCULATION OF AVERAGE DEPTH OF WATER APPLIED BY FURROW IRRIGATION

The average depth of water can be calculated from the following formula, if the debit, duration and area irrigated are known. (Area irrigated = space between furrows (l) and their length (L) in metres.

$$\text{mm/hour} = \frac{\text{litres/second} \times 3,600}{l \times L}$$

Thus, if the furrows are spaced at 0.90 m and are 210 m long, and if the initial debit is 2.2 litres/second for 1.5 hours, reduced to 0.5 litres/second for 5.3 hours:

$$\begin{array}{l} \text{The depth of water applied} \\ \text{in the first period is:} \end{array} \quad \frac{2.2 \times 3,600}{0.9 \times 210} = 42 \text{ mm/hour}$$

$$\begin{array}{l} \text{and the second period:} \end{array} \quad \frac{0.5 \times 3,600}{0.9 \times 210} = 9.5 \text{ mm/hour}$$

The total depth of water is therefore as follows:

$$\begin{array}{r} 1.5 \text{ hours} \times 42 \text{ mm/hour} = 63 \text{ mm} \\ + 5.3 \text{ hours} \times 9.5 \text{ mm/hour} = \underline{50 \text{ mm}} \\ \text{Total} \quad \underline{113 \text{ mm}} \end{array}$$

This figure does not, of course, indicate that 113 mm has been applied uniformly over each portion of the furrows. The uniformity can be judged from a suitable series of soil samples.

ANNEX C
FERTILIZATION

1. The Content of Fertilizer Equivalents in Selected Organic Manures (% by weight of fertilizer units)

	N	P ₂ O ₅	K ₂ O	CaO	MgO	Footnotes
Cattle faeces ⁽¹⁾	1.28	0.25	0.56	(i)	(i)	(1) Collected dry from soil surface: analysed ORSTOM, Burkina Faso.
Cattle manure ⁽²⁾	4.09	1.31	1.05	1.35	0.38	
Horse faeces	0.45	0.15	0.35	0.15	0.10	(2) Samples collected in Senegal: analysed Agric. Faculty, Gent, Belgium.
Faeces of small ruminants (1)	2.20	0.27	0.88	(i)	(i)	
Poultry manure ⁽⁵⁾	2.00	1.85	0.85	8.95	0.7	(3) Analysed Centre Oceanographic Research, Thiaroye, Dakar.
Dry farmyard manure (4)	5.00	3.00	1.50	4.00	1.00	
Compost	0.8	0.3	0.3	(i)	(i)	(4) After 'Efficient Use of Fertilizers' (FAO).
Groundnut waste (powder) (2)	2.41	0.57	0.97	0.27	0.31	
Seaweed ⁽³⁾						(5) Analysed ORSTOM, Adiopodoumé, Ivory Coast.
Ulva	1.39	0.41	1.31	(i)	(i)	
Hynea	2.94	0.27	0.86	(i)	(i)	(i) Information not available.
Cladophora	2.51	0.27	4.46	(i)	(i)	
Groundnut shells ⁽²⁾	2.32	4.4	1.87	12.38	0.71	
Groundnut shells ⁽²⁾	2.11	0.17	0.71	0.54	0.22	

2. The principle inorganic fertilizers and their characteristics

Fertilizer	Formula	N	P ₂ O ₅	K ₂ O	CaO	MgO	SO ₃	Kg per Unit		Characteristics
Nitrogenous Ammoniacal	Calcium Cyanamide	Ca CN ₂	18-22		60-70			5.5-4.6N		Nematicidal and insecticidal action in soil as base dressing. Expensive
	Urea	CO(NH ₂) ₂	46					2.2		Especially suitable for acid soils and for application in solution as spray or in irrigation.
	Sulphate of Ammonia	(NH ₄) ₂ SO ₄	21					23	5-4.8	Recommended for crops with high sulphur requirement. Easy to spread. Suitable for mixtures with superphosphate and chloride of potash.
Nitrogenous Phosphatic	Phosphate of Ammonia	NH ₄ H ₂ PO ₄ & (NH ₄) ₂ H ₂ P ₂ O ₇	17.5	40				5.2-5N		Double acting. Highly soluble P ₂ O ₅ . Suitable local placement, solution irrigation. Stimulates root development and early maturity.
			20	52				2.5-2 P ₂ O ₅		
Nitrates	Nitrate of Calcium and Magnesium	Ca(NO ₃) ₂ 4H ₂ O	15-15.5		28			6.6		Very hygroscopic. Easily absorbed by plants in dry conditions. Very hygroscopic. Recommended for soils deficient in magnesium.
			13-15		25.2	8	7.7-6.6			
Nit. Potas.	Nitrate of Potassium	KNO ₃	13	44	0.5	0.5		7.7N	2.3K ₂ O	Double acting. Soluble in water. Suitable top dressing or spray applications.
Phosphatic	Superphosphate Simple Triple	Ca(H ₂ PO ₄) ₂ -H ₂ O	16-22	24-31	0.5	0.5	25-32	7.2-5		90% soluble in water. Rapid in effect. Suitable both as base and top dressings.
			44-48	17-23	0.5	3.5	2.5-2			
Phosphal			34				3			26% soluble in citrate, 8% insoluble. Recommended for base dressings mixed with potassium and nitrogenous fertilizers.

	Fertilizer	Formula	% Nutrient Elements						Kg per Unit	Characteristics
			N	P ₂ O ₅	K ₂ O	Ca	MgO	SO ₃		
Potassic	Chloride of Potash	KCl			60				1.7	Recommended base dressings but not for French beans. Comparitively economic
	Sulphate of Potash	K ₂ SO ₄			48-52	0.2	0.2	17	2.1	Preferred source of Potassium, suited for all crops and all soils especially those with high sulphur requirements.
	Calcium Magnesium Carbonate	CaCO ₃ , MgCO ₃				40	20			(Dolomitic limestone)

3. MANURIAL APPLICATIONS AND DOSAGES

	Organic Manure T/ha	CDH Formula (units)	Standard Formulae (units)	Programme of Applications
ASPARAGUS	(1) 15 (2) 15	N (1) 40 (2) 160 P ₂ O ₅ (1) 180 (2) 90 K ₂ O (1) 90 (2) 140	N (1) 30-50 (2) 100-180 P ₂ O ₅ (1) 60-200 (2) 45-60 K ₂ O (1) 90-100 (2) 100-180	<u>Base dressing (1)</u> 15 T organic manure plus 40 units N; 180 u P ₂ O ₅ ; 90 u K ₂ O <u>Annual dressings (2)</u> Before earthing-up: 15T organic manure spread over whole surface and incorporated, plus 90 units P ₂ O ₅ ; 140 u K ₂ O. After earthing up: localised dressing 80 units N After harvest: localised dressing 80 units N
EGGPLANT	10-20	N (1) 84. (2) 144 P ₂ O ₅ (1) 184 (2) 144 K ₂ O (1) 200 (2) 192	N 45-240 P ₂ O ₅ 100-250 K ₂ O 60-250	<u>Base dressing (1)</u> All organic manure plus 33% N and K ₂ O. 100% P ₂ O ₅ <u>Localised top dressing (2)</u> After seed set of first fruits: 33% N and K ₂ O After harvest of first fruits: 33% N and K ₂ O
BEETROOT	20-30	(Not tested)	N 75-200 P ₂ O ₅ 54-150 K ₂ O 28-220	<u>Base dressing</u> All organic manure plus 50% N, 100% P ₂ O ₅ and 50% K ₂ O <u>Localised top dressing</u> Sixty days from sowing: 50% N, 50% K ₂ O. NB: On heavy soils, 100% K ₂ O is used in base dressing.
CABBAGE	15-20	N 65 P ₂ O ₅ 66 K ₂ O 98	N 90-310 P ₂ O ₅ 69-134 K ₂ O 90-350	<u>Base dressing</u> All organic manure plus 33% N and K ₂ O: 100% P ₂ O ₅ . <u>Localised top dressing</u> 20 days from planting out: 33% N and K ₂ O. Thirty days from planting out: 33% N and K ₂ O.

ANNEX C (cont.)

	Organic Manure T/ha	CDH Formula (units)	Standard Formulae (units)	Programme of Applications
CHINESE CABBAGE	20	N 125 P ₂ O ₅ 45 K ₂ O 157	N 90-310 P ₂ O ₅ 69-134 K ₂ O 90-350	As per Cabbage.
CAULIFLOWER	10-20	N 49 P ₂ O ₅ 120 K ₂ O 100 or N 70 P ₂ O ₅ 95 K ₂ O 60	N 40-400 P ₂ O ₅ 38-300 K ₂ O 90-380	<u>Base dressing</u> All organic manure, plus 50% N and K ₂ O, 100% P ₂ O ₅ <u>Localised top dressing</u> 30 days from planting out: 50% N and K ₂ O
CARROT	20	N 60 P ₂ O ₅ 60 K ₂ O 120	N 60-80 P ₂ O ₅ 60-100 K ₂ O 120-200	<u>Base dressing</u> All organic dressing, plus 20% N and K ₂ O, 100% P ₂ O ₅ <u>Localised top dressing</u> 30 days from sowing 40% N & 40% K ₂ O 60 " " " " " " " " " " " "
CELERY	20	(Not tested)	N 100-450 P ₂ O ₅ 40-150 K ₂ O 300-400	<u>Base dressing</u> All organic dressing, plus 33% N, 33% K ₂ O, 100% P ₂ O ₅ <u>Localised top dressing</u> 30 days from planting out 33% N & K ₂ O 60 " " " " " " " " " " " "
CUCUMBER	10-20	(Alternative) N 132 P ₂ O ₅ 96 K ₂ O 200 or N 101 P ₂ O ₅ 103 K ₂ O 80	N 80-240 P ₂ O ₅ 40-135 K ₂ O 100-270	<u>Base dressing</u> All organic dressing plus 33% N, 33% K ₂ O, 100% P ₂ O ₅ <u>Localised top dressing</u> 30 days from sowing 33% N & K ₂ O 50 " " " " " " " " " " " "

	Organic Manure T/ha	CDM Formula (units)	Standard Formulae (units)	Programme of Application
CHILI	16	N 60 P ₂ O ₅ 60 K ₂ O 120	N 100-135 P ₂ O ₅ 60-100 K ₂ O 100-150	(as for sweet pepper)
	30	N 111 P ₂ O ₅ 30 K ₂ O 149		
COURGETTES	20	N 96 P ₂ O ₅ 64 K ₂ O 99	N 100-240 P ₂ O ₅ 60-200 K ₂ O 200-400	<u>Base dressing</u> Organic material, plus $\frac{1}{2}$ N, 1 P, $\frac{1}{2}$ K
	10	N 123 P ₂ O ₅ 50 K ₂ O 100		<u>Top Dressing (localized)</u> 2/5 P 25 days after dressing 2/5 N, $\frac{1}{2}$ P, $\frac{1}{2}$ K 25 days after dressing 1/5 N 55 " " "
FRENCH BEANS (CLIMBER VARIETIES)	5	N 108 P ₂ O ₅ 157 K ₂ O 80	N 20-120 P ₂ O ₅ 40-180 K ₂ O 25-290	<u>Base manure</u> Organic material (well rotted) plus dolomitic (magnesian) limestone, if necessary <u>Top dressing (localized)</u> (sandy soils) $\frac{1}{2}$ N, $\frac{1}{2}$ P, $\frac{1}{2}$ K 15 days after sowing (other soils) $\frac{1}{2}$ N 15 " " " (sandy soils) $\frac{1}{2}$ N, $\frac{1}{2}$ P, $\frac{1}{2}$ K 30 days after sowing (other soils) $\frac{1}{2}$ N, $\frac{1}{2}$ K 30 " " " (sandy soils) $\frac{1}{2}$ N, $\frac{1}{2}$ P, $\frac{1}{2}$ K, 40 days after sowing (other soils) $\frac{1}{2}$ N 40 " " "
	15	N 79 P ₂ O ₅ 126 K ₂ O 60	N 25-120 P ₂ O ₅ 40-180 K ₂ O 25-290	<u>Base dressing</u> Organic material well rotted and dolomitic limestone, if necessary; plus (sandy soil) $\frac{1}{2}$ N, $\frac{1}{2}$ P, $\frac{1}{2}$ K (other soils) $\frac{1}{2}$ N, all P and K <u>Top dressings</u> (sandy soil) $\frac{1}{2}$ N, $\frac{1}{2}$ P, $\frac{1}{2}$ K 15 days after sowing (other soils) $\frac{1}{2}$ N 15 " " " (sandy soils) $\frac{1}{2}$ N, $\frac{1}{2}$ P, $\frac{1}{2}$ K 25 days after sowing (other soils) $\frac{1}{2}$ N 25 " " "

ANNEX C (cont.)

	Organic manure T/Ha	CDH Formula (units)	Standard formula (units)	Programme of application
LETTUCE	(1) 5	84 N 80 P ₂ O ₅ — 192 K ₂ O		<u>Base manure</u> Organic material, plus (sandy soils) 1/4 N, 2/3 P, 1/4 K (other soils) 1/4 N, 1 P, 1 K <u>Top dressing for transplanted seedlings (localised)</u> (sandy soils) 1/4 N, 2/5 P, 1/4 K, 15 days after planting out (other soils) N 15 days after planting out (sandy soils) 1/2 N, 1/5 P, 1/2 K, 40 days after planting out (other soils) 1/2 N, 40 days after planting out <u>Top dressing for sowing in situ (localised)</u> N: rate of potash as foliar dressing in solution (5 gms in 10 litres per square metre) (sandy soils) 1/4 N, 2/5 P, 1/4 K 30 days after sowing (other soils) 1/4 N, 2/5 P, 1/4 K 30 days after sowing (sandy soils) 1/4 N, 1/5 P, 1/4 K 50 days after sowing (other soils) 1/4 N 50 days after sowing (sandy soils) 1/4 N, 1/4 K 75 days after sowing (other soils) 1/4 N 75 days after sowing
	(2) 5	123 N 176 P ₂ O ₅ 282 K ₂ O		<u>Base manure</u> : organic material + dolomitic limestone, if required, + (sandy soils) 1/4 N, 1/5 P, 1/4 K (other soils) 1/4 N, 1/2 P, 1/2 K <u>Top dressing (localised)</u> (sandy soils) 1/4 N, 1/5 P, 1/4 K at 2-leaf stage (other soils) 1/4 N at 2-leaf stage 1/4 N, 2/5 P, 1/4 K at flowering 1/4 N, 1/5 P, 1/4 K at start harvesting
MELON	15	80 N 170 P ₂ O ₅ 200 K ₂ O	50-300 N 100-250 P ₂ O ₅ 150-400 K ₂ O	<u>Base manure</u> : organic material + dolomitic limestone, if required, + (sandy soils) 1/4 N, 1/5 P, 1/4 K (other soils) 1/4 N, 1/2 P, 1/2 K <u>Top dressing (localised)</u> (sandy soils) 1/4 N, 1/5 P, 1/4 K at 2-leaf stage (other soils) 1/4 N at 2-leaf stage 1/4 N, 2/5 P, 1/4 K at flowering 1/4 N, 1/5 P, 1/4 K at start harvesting
	20	60 N 60 P ₂ O ₅ 120 K ₂ O	50-150 N 20-73 P ₂ O ₅ 40-232 K ₂ O	<u>Base manure</u> Organic matter <u>Top dressing</u> 1/3 N, 1/3 P, 1/3 K after germination 1/3 N, 1/3 P, 1/3 K start harvest 1/3 N, 1/3 P, 1/3 K full harvest (70 days after sowing)
OKRA	20	60 N 60 P ₂ O ₅ 120 K ₂ O	50-150 N 20-73 P ₂ O ₅ 40-232 K ₂ O	<u>Base manure</u> Organic matter <u>Top dressing</u> 1/3 N, 1/3 P, 1/3 K after germination 1/3 N, 1/3 P, 1/3 K start harvest 1/3 N, 1/3 P, 1/3 K full harvest (70 days after sowing)

ANNEX C (cont.)

	Organic Manure T/ha	CDH Formula (units)	Standard Formulae (units)	Programme of Applications
ONION	(1) 2.5	28 N 69 P ₂ O ₅ 75 K ₂ O		<u>Base manure</u> (for production of bulbils) Organic manure, well decomposed, plus 2/3 N, 2/3 P, 2/3 K
	(1) 10	55 N 125 P ₂ O ₅ 140 K ₂ O		1. <u>Top dressing</u> (localised) Balance of NPK, 30-35 d after sow. 2. <u>Base manure</u> (production of crop from bulbils or seedlings)
	(2) 10	100 N 120 P ₂ O ₅ 180 K ₂ O	50-270 N 40-180 P ₂ O ₅ 40-310 K ₂ O	Organic manure, well decomposed, plus 2/5 N, 1/2 P, 1/4 K
	(2) 16	80-85 N 90-110 P ₂ O ₅ 100 K ₂ O		2. <u>Top dressing</u> (localised) Three 75 N, 1/6 P, 1/4 K, 20, 40 and 60 days after planting.
POTATO	- (1)	136 N 111 P ₂ O ₅ 180 K ₂ O	70-200 N 96-300 P ₂ O ₅ 150-330 K ₂ O	<u>Base manure</u> : Organic manure, well decomposed, plus 1/3 N, 1/2 P, 1/3 K
	10 10	126 N 210 P ₂ O ₅ 300 K ₂ O		<u>Top dressing</u> (localised) 1/3 N, 1/4 P, 1/3 K after germination 1/3 N, 1/4 P, 1/3 K before last earthing up
PEAS	5	66 N 113 P ₂ O ₅ 225 K ₂ O	20-130 N 60-150 P ₂ O ₅ 90-210 K ₂ O	<u>Base manure</u> : Organic manure, plus 1/3 N, 1/2 P, 1/3 K
	10	73 N 135 P ₂ O ₅ 90 K ₂ O		<u>Top dressing</u> (localised) 1/3 N, 1/4 P, 1/3 K 2 weeks after sowing 1/3 N, 1/4 P, 1/3 K start flowering
SHALLOT	10	73 N 72 P ₂ O ₅ 100 K ₂ O	60-80 N 75-100 P ₂ O ₅ 120-180 K ₂ O	<u>Base dressing</u> : Organic matter, plus 50% N, 100% P, 50% K <u>Top dressing</u> (localised) 50% N, 50% K, 30 days after planting

	Organic Manure T/ha	CDM Formula (units)	Standard Formulae (units)	Programme of Applications
STRAWBERRY	20	150 N 71 P ₂ O ₅ 200 K ₂ O		<p><u>Base manure:</u> Organic matter, plus 20 (U) N, 14 (U) P, 50 (U) K</p> <p><u>Top dressing</u> 45.5 (U) N, 11.5 (U) P, 30 (U) K first month after planting 21 (U) N, 11.5 (U) P, 30 (U) K 2nd to 5th month after planting</p>
RAIISI	10	68 N 45 P ₂ O ₅ 90 K ₂ O	35-150 N 20-100 P ₂ O ₅ 70-170 K ₂ O	<p><u>Base Manure:</u> Organic matter, plus dolomitic limestone if required, plus 2/3N, 2/3P, 2/3K</p> <p><u>Top dressing (localised)</u> 1/3N, 1/3P, 1/3K 25 days after sowing</p> <p><u>Note:</u> For seed production, repeat top dressing 50 days after sowing.</p>
SWEET PEPPER (and MULLI)	10 30	140 N 100 P ₂ O ₅ 200 K ₂ O 121 N 30 P ₂ O ₅ 149 K ₂ O	25-300 N 90-300 P ₂ O ₅ 100-340 K ₂ O	<p><u>Base manure:</u> Organic matter, plus dolomitic limestone if required, plus 1/7N, 4/7P, 1/7K (sandy soil) 1/4N, 5/8P, 1/4K (other soil)</p> <p><u>Top dressing (localised)</u> (sandy soil): Balance of N and K in 6 dressings at 3-week intervals from 2 weeks after planting. Balance of P before flowering or in 3 dressings at 6-week intervals (other soils): Balance of NPK in 3 dressings - before flowering, after first harvest - mid-harvest.</p>
SWEET POTATO	10 (1)	60 N 60 P ₂ O ₅ 120 K ₂ O 70 N 90 P ₂ O ₅ 120 K ₂ O	60-170 N 55-200 P ₂ O ₅ 120-330 K ₂ O	<p><u>Base manure:</u> Organic matter, plus 1/2N, 1/2P, 1/2K</p> <p><u>Top dressing (localised)</u> 1/2N, 1/2P, 1/2K 25 days after planting</p>

ANNEX C (cont.)

	Organic Manure T/ha	CDH Formula (units) -	Standard Formulae (units)	Programme of Applications
TOMATO	15	68 N 205 P ₂ O ₅ 70 K ₂ O	60-440 N 60-400 P ₂ O ₅ 60-470 K ₂ O	<u>Base manure:</u> Organic matter, plus 1/5N, 1/5P, 1/5K <u>Top dressing (localised)</u>
	20 (1)	70 N 70 P ₂ O ₅ 140 K ₂ O		1/5N, 1/5P, 1/5K, in 4 dressings at 20-day intervals, starting 15 days after planting.
	- (2)	215 N 138 P ₂ O ₅ 240 K ₂ O		
	20 (3)	100 N 100 P ₂ O ₅ 200 K ₂ O		
	- (4)	190 N 225 P ₂ O ₅ 300 K ₂ O		
WATERMELON	10 (1)	60 N 60 P ₂ O ₅ 120 K ₂ O	50-230 N 25-160 P ₂ O ₅ 35-260 K ₂ O	<u>Base manure (localised):</u> organic matter, plus 1/5N, 1/3P, 1/3K <u>Top dressing (localised)</u> 1/5N, 1/3P, 1/3K when runners start growth 1/5N, 1/3P, 1/3K start of fruit swelling
<p>NOTE FOR TOMATO:</p> <p>(1) Formula used in dry season, with complete NPK fertilizer 10:10:20.</p> <p>(2) Formula used for production of industrial tomatoes under furrow irrigation.</p> <p>(3) Formula used in hot humid season with 10:10:20 fertilizer.</p> <p>(4) Formula used for production of industrial tomatoes under sprinkler irrigation in sandy soil. (Application every two weeks gives higher production than monthly doses.)</p>				

REFERENCES

- AYERS, R.S. and WESTCOT, D.W. Water quality for agriculture. FAO, Rome. 1976
- BOOHER, L.J. Surface irrigation, FAO, Rome 1974
- BRANTLEY, B. and WARREN, G. Effect of nitrogen on the flowering, fruiting 1960 and quality in the watermelon. Proc. Amer. Soc. Hort. Sci., 75.
- BRASHER, E.P. Proc. Amer. Soc. Hort. Sci., 73, 334-338, New York. 1959
- CORNILLON, P. Croissance et développement du piment doux sous serre. 1974 P.H.M.
- CHAUX, C. Production Légumière, 189. Baillièrè, Paris. 1972
- CLEMENT, R. and GALLANT, A. Irrigation par aspersion et réseaux collectifs 1979 de distribution sous pression.
- CONSTANTINOV, I. Le développement de la mécanisation rurale dans la vallée 1980 de Fleuve Sénégal. OMVS.
- COOKE, G.W. Fertilizing for maximum yield. London, U.K. Grenada. 1982
- d'ARONDEL DE HAYES and HUYEZ. Les essais maraichers à Farako-Ba. IRAT. 1973
- DEBON, H. Rapport sur les cultures maraichères en Mauritanie. CNRADA. 1980
- DELOYE, M. and REBOUR, H. L'irrigation en grande culture. 1958
- DEPARDON, L. and BURON, P. Nature géologique et composition physiques des 1951 sols à asperges. 2^{ème} Congrès Mondial des Engrais Chimiques, Rome.
- DEUSE, J. and LAVABRE, E.M. Les désherbages des cultures sous les 1979 tropiques. Maisonneuve et Larose, Paris.
- DEWIS, J. and FREITAS. Méthode d'analyse physique et chimique des sols et 1972 des eaux. FAO, Rome.
- DOONEN, L.D. and MacGILLIVARY. Irrigation practice and water management. 1971 Bulletin Rev. 1 Irrigation and Drainage. FAO, Rome.
- DOORENBOS, J. Agrometeorological field stations. Bulletin no. 27, 1976 Irrigation and Drainage, FAO, Rome.
- DOORENBOS, J., KASSAM, A.H. et al. Yield response to water. Bulletin no. 1980 33, Irrigation and Drainage. FAO, Rome.
- DOORENBOS, J., PRUITT, W.O. et al. Crop water requirements. Bulletin no. 1976 24, Irrigation and Drainage. FAO, Rome.
- DUC, T.M., DUTILLY and MBODJ. Irrigation de la zone centre-Nord du 1975 Sénégal. ISRA.

- DURAND, J.H. Les sols irrigables: étude périodique. Presses Universitaires de France, Paris. 1983
- EDMOND, J.B., SENN, T.L., ANDREWS and HALFACRE. Fundamentals of horticulture. McGraw Hill, New York. 1975
- FAO Programme d'irrigation dans les villages: vers une utilisation rationnelle de l'eau. Bulletin no. 4, Irrigation and Drainage. FAO, Rome. 1971
- FAO L'emploi des matières organiques comme engrais. Bulletin Pedologiques de la FAO, No. 17. 1975
- FAO Sandy soils. Bull. Ped. FAO. No. 25. 1975
- FAO Conservation des ressources naturelles en zones arides et semi-arides. Cahier FAO: Conservation des Sols, No. 3. 1980
- GERICKE Phosphordungung im gemüsebau. Essen. 1954
- GERST, J.S. and STENGEL, B. Fertilisation azotée de la betterave rouge. 1973-74 Invuflec, Alsace.
- GERVY, R. Les phosphates et l'agriculture. Dunod, Paris. 1970
- DE GUIRAM and NETSCHER, C. Les nématodes du genre Méloïdogyne, parasites des cultures maraichères. ORSTOM. 1970
- GUYOT, G. Les effets des brise-vents en matière plastique. 4^{eme} Colloque International des Plastiques en Agriculture, Paris (1970) 18^{eme} Colloque sur les Plastiques en Agriculture, Agners (1967). 1976-70
- GROS, A. Engrais. Guide pratique de la fertilisation. 7e édition. La Maison Rustique, Paris. 1979
- HERBLOT, G. Le point sur le désherbage mécanique des cultures. CEEMAT, Paris 1979
- HERNANDEZ Fiche technique provisoire no. 19. Désherbage chimique de l'oignon de semis direct. CNRA, ISRA, Sénégal. 1977
- HESTER, J. and SHELTON, P. Research monograph. Campbell Soup Company. Riverton, New Jersey. 1949
- HUGUET and CORNILLON, P. Connaissances actuelles sur la croissance et la nutrition du melon. Journée du melon, Cavaillon. 1970
- IGNATIEFF, V. and PAGE, H.J. The efficient use of fertilizers.. FAO, Rome. 1959
- JONES, H.A. and HANN, L.K. Onions and their allies. Leonard Hill Ltd., Interscience Publishers, Inc., New York. 1963
- JURION, F. and HENRY, J. De l'agriculture itinérante à l'agriculture intensifiée. INEAC. 1967
- LAUMONNIER, R. Cultures maraichères. Baillière, Paris. 1964

- LENNE, J.M. Controlling Meloidogyne javanica on Desmodium ovalifolium
1981 with grasses. CIAT.
- LORENZ, O.A. and MAYNARD. Knott's Handbook for Vegetable Growers. 2nd Ed.
1980 Wiley. Interscience Publications, Raffins Lane, P.O. Box 191,
Chichester, Sussex, UK.
- MAPPES, F. Nue versuchsergebnisse und erfahrungen aus dem gemusebau
1951 lirnburgerhof.
- MAZZOCCHI, G.B. Trees and shrubs in the Maltese islands. FAO, Rome.
1969
- MESSIAEN, C.M. Les variétés résistantes. INRA, Paris.
1981
- MESSIAEN, C.M. and LAFON, R. Les maladies des plantes maraichères. INRA,
1970 Paris.
- MESSIAEN, C.M. Le potager tropical. Presses Univ. de France, Paris.
1975
- MIKKO SILLANPÄÄ. Les éléments tracés dans les sols et en agriculture.
1979 FAO Bull. Péd. No. 17.
- MORGAN, G.W. A note on the salt tolerance of Okra (Hibiscus esculentus
1966 L.). Trop. Agric. (Trinidad), 43 (3), 263-264
- MORTENSEN, E. and BULLARD, E. Manuel d'horticulture tropicale et sub-
(no date) tropicale. Regional Technical Aids Centre (AID), Paris.
- NAVEZ, S. et al Fiches technico-économiques. CDH, Dakar, Sénégal.
1977-78
- NELSON, L.B. et al. Changing patterns in fertilizer use. Soil Sci. Soc. of
1968 America, Inc. Madison, Wisconsin, USA.
- NETSCHER, C. Les nématodes parasites des cultures maraichères au Sénégal.
1970 ORSTOM.
- NETSCHER, C. Control of Meloidogyne incognita in vegetable production by
1984 crop rotation in Ivory Coast. ORSTOM.
- OLSON, R.A., et al. Fertilizer technology and use. Soil Sci. Soc. of
1971 America, Inc. Madison, Wisconsin, USA.
- PILLSBURY, A.F. and DEGAN, A. La pratique de l'irrigation par aspersion.
1968 FAO, Rome.
- PROT, J.C. Les nématodes parasites des cultures maraichères. ORSTOM.
1982
- QUILFEN, J.P. and MILLEVILLE. Résidus de culture et fumure animale: un
1984 aspect des relations agriculture-élevage dans le Nord du Burkina
Faso.
- RÄBER, F. and KÜNSCH. Ueber den einfluss des erntezeitpntes auf den
1982 nitratgehalt von karotten. Die Industrielle Obstund Gemüsever-
wertung, 67.
- ROLLAND, L. La mécanisation de l'irrigation par aspersion. FAO, Rome.
1980

- ROLLIN, C. Rapport d'expérimentation cultures maraichères. SODEFEL, Côte
1974 d'Ivoire.
- RUSSEL and GURNER
1941
- SALTER, P.J. and GOODE, J.E. Crop responses to water at different stages
1967 of growth. CAB, Reading, UK.
- SIEMONSMA, J.S. La culture du gombo (Abelmoschus spp.), Légume-fruit
1982 tropical. (M. Pub.). Wageningen, Netherlands.
- SINGH, B., BHATTI, D.S. and SINGH, K. Resistance to root-knot nematodes
1974 (Meloidogyne spp.) in vegetable crops. Haryana Agricultural
University, Hissar, India.
- SOITOUT, M. Les recherches légumières entreprises par l'IRAT. IRAT.
1969
- SOLTNER, D. Les bases de la production végétale, Tome I. Collection
1982 Sciences et techniques agricoles, Angers.
- SPRENGER INSTITUUT. Produktiegegevens groente en fruit mededeling No. 30,
Sprenger Instituut, Wageningen, Netherlands.
- SUTTON, P. The response of okra to nitrogen, phosphorus and potassium
1964 fertilization. proc. Fla. St. Hort. Soc. (1963), 76: 149-153.
- TABRESSE, L. Cultures maraichères au sahel Tunisien. AGCD.
1981
- TINDALL, H.D. Vegetables in the Tropics. MacMillan Press, London, UK.
1983
- TRIOREAU Le fraisier. Baillière et Fils, Paris.
1961
- UNIVERSITY OF NEW JERSEY. Vegetable production recommendations.
1976 University of New Jersey, USA.
- VERGUIN, G. Le maraichage, opération de pré vulgarisation dans la région de
1973 Kayes (Mali). SATEC.
- VERMEIREN, L. and JOBLING. L'irrigation localisée. FAO, Rome.
1983
- WALSH, L.M. and BEATON, J.D. Soil testing and plant analysis. Soil Sci.
1973 Soc. of America, Inc., Madison, Wisconsin, USA.
- WIENBERG
- WHYTE, R.O., NILSON, G., LEISSNER and TRUMBLE. Legumes in agriculture.
1955 FAO, Rome.
- YARON, B., DANFORS, E. and VAADIA, Y. Arid zone irrigation.
1973 J. Jacobs, München, Ol Lange Wurzburg.
- ZUANG, H. La fertilisation des cultures légumières. CTIFL.
1982
- ZINK, F.W. In: Onions and Their Allies, by Henry A. Jones and Louis
1962 K. Mann. Interscience Publishers, Inc., New York.

CHAPTER IV

THE INCIDENCE OF PESTS AND DISEASES AND METHODS OF CONTROL

by E.F. Collingwood , L. Bourdouxhe and M. D'Hondt

A. GENERAL

Growers of plants in all parts of the world face numerous production problems, not the least of which are those posed by insect-pests, fungi and other disease-provoking agents which can cause serious losses in production and profits, and which call for the application of effective crop protection measures. During the past twenty years or so, the practice of crop protection has become infinitely more complex. Serious problems of resistance to pesticides have developed, giving rise to the need for continuing research for new products in an economic climate where the cost of researching and launching a new pesticide has risen astronomically to about ten million US dollars. The Conservationists have become a force to be reckoned with and the realization is fast growing of the undesirability of indiscriminate and excessive use of pesticides, particularly those such as the persistent, wide-spectrum organo-chlorine insecticides, and the consequent pollution of the environment. In addition the number of pesticides has risen to a bewildering level, the latest edition of the Pesticide Manual (1983) listing over 500 distinct, active ingredients in current use as pesticidal chemicals.

The days of applying pesticides by the calendar "as an insurance policy" are giving way to a more precise system of pest and disease control which demands for its correct functioning, a detailed knowledge of the identity, life-cycle, aetiology and loss-producing potential of individual pests and pathogens, in order to assist in the formulation of an overall crop protection strategy. Precise information is lacking in many cases as to how much damage can be tolerated before crop protection measures become necessary, and much time and effort is being devoted to this problem in present-day research programmes.

This chapter is designed, not to give detailed information on all crop-protection problems of vegetables in the arid and semi-arid regions, but to act as a general guide to the different agents causing damage and losses, and the techniques available for combatting them; and finally to discuss some specific examples.

Much of the information dealing with specific problems results from experience in Senegal, particularly in the Cap Vert region near Dakar (designated C.D.H. - Le Centre pour le Developpement de l'Horticulture, or Senegal CV. in the text), which might be compared to a semi-arid region, and in the northern part of Senegal which is much hotter, drier and more arid than the south. Comparisons are made between the two zones where appropriate.

B. THE AGENTS RESPONSIBLE FOR CROP LOSSES

Numerous factors are responsible for influencing the growth of plants, both favourably and adversely. Amongst the adverse effects are those due to the action of several types of living organisms, including a variety of insects, spider-mites, fungi, nematodes and bacteria. Another group, the viruses, are difficult to classify as living or non-living, but require living cells in order to multiply and are responsible for a range of plant diseases differing widely in both type and severity. Occupying a place somewhere between the viruses and bacteria are the mycoplasma-like organisms, which are associated principally with 'yellows' diseases.

Unsuitable environmental conditions are sometimes responsible for physiological disorders and poor growth in plants: these include shortage or excess of water, imbalance of nutritional elements, shortage of trace-elements, excessive heat, unsuitable soil-reaction, etc.

The nature of many of these disease-producing agents is discussed below.

1. INSECTS

Belonging to the phylum Arthropoda ('jointed limbs') the insects represent the most numerous class in the animal kingdom, comprising more than a million described species, or nearly 80% of the earth's fauna. An adaptability to a wide range of environmental conditions, and a prodigious power of reproduction are two outstanding characteristics of the group.

Morphology. The body and the limbs of insects are covered by an integument of resistant, jointed plates composed of chitin, forming an exoskeleton which protects them against the adversities of the environment. The body of all insects is divided into three distinct parts:

The head, generally carrying three simple eyes or ocelli, and two compound eyes; the antennae, equipped with tactile and olfactory organs; and the mouthparts, comprising an upper lip, two mandibles, two maxillae and a lower lip. The structure of the mouthparts varies according to the feeding-mode of the insect.

The thorax, divided into three segments (pro, meso and meta-thorax) each of which carries a pair of legs: in addition, in winged insects the meso- and meta-thorax each carry a pair of wings.

The segmented abdomen, without legs, encloses the organs of reproduction and oviposition, and the circulatory, digestive and respiratory organs.

Mouthparts. As stated above, the structure of the mouthparts varies according to the feeding-mode of the insect.

Biting and chewing types of mouthparts are characterised by heavy, toothed mandibles, permitting the insect to chew-off pieces of solid foods: this type is found in Orthoptera (crickets, grasshoppers), Coleoptera (beetles) and in the larval stage (caterpillars) of Lepidoptera.

The piercing type, in which mandibles and maxillae are modified to form elongated stylets lying closely side-by-side forming a tube, the rostrum, enabling the insect to pierce tissue and suck up sap, etc. This form of mouthparts is typical of the Hemiptera.

The licking-sucking type of mouthparts are represented either by a long trunk or proboscis, used by adult Lepidopterae to suck-up nectar from flowers (the proboscis is coiled-up beneath the head when not in use) or a ligula or tongue, such as is found in the Hymenoptera.

From a practical point of view, the distinction between these different types of insect is important, because on it may depend the choice of control measures. Contact insecticides can be used to control biting and licking insects, whilst against piercing-type insects, systemic insecticides are effective.

Development. In the course of their life-cycle, insects pass through important internal and external transformations or metamorphoses. There are two main groups:

Insects with complete metamorphosis (holometabolism) pass through four stages which are completely different, both in form and in mode of life - egg, larva (mobile stage), pupa (immobile stage) and adult (mobile and reproductory stage). Examples of insects belonging to this group are: Coleoptera (beetles); Diptera (flies) and Lepidoptera (butterflies and moths). Generally it is the mobile larvae (caterpillars in Lepidoptera, maggots in Diptera) which cause damage to plants: however, in Coleoptera, both larvae and adults cause damage.

Insects with incomplete metamorphosis (hemimetabolism) have larvae which at birth resemble adults except in their size, their lack of wings and their lack of reproductory apparatus: All the stages are mobile and can cause damage to crops. Insects belonging to this group include jassids and aphids (Homoptera) shield-bugs (Heteroptera) crickets (Orthoptera) and thrips (Thysanoptera).

The presence of a rigid cuticle hinders the regular growth of insects which are obliged to undergo periodic moults to rid themselves of an integument which has become too small to permit development.

Reproduction. The majority of insects reproduce sexually: however, parthenogenesis (reproduction without fertilisation) is not rare. The majority of species are egg-layers, although certain insects such as aphids give birth directly to larvae, the eggs having undergone development within the body of the female: such insects are thus viviparous.

Type of damage. Biting and chewing insects devour various parts of the plant: buds, flowers, fruits, grains etc. resulting in loss of yield or quality, deformations, or disruption in development.

Piercing insects enfeeble plants by sucking-out sap with the aid of their rostrum: they are able to transmit plant diseases, particularly viruses, and cause deformities, decolorations, leaf-rolling, etc. They are often pests of specific crops and their development is usually very rapid.

Subterranean insects attack root-systems of plants, or tubers; they can also uproot seedlings or young plants during their activities whilst forming underground galleries in the soil.

Classification of insects

Table 1 gives a brief description of certain orders which include species causing crop damage.

TABLE 1 Classification of Insects.

Order	Characteristics	Examples of African Species
Orthoptera (crickets, grasshoppers)	Biting, crushing mouthparts, Hemimetabolism. Forewings carried roofwise at rest. Hind-wings folded into pleats.	<u>Zonocerus</u> sp. <u>Gryllotalpa</u> sp.
Coleoptera (beetles, weevils)	Biting mouthparts. Holometabolism. Forewings chitinous, transformed into wing-cases or elytra, protecting the membranous hind-wings which are used in flying and which, at rest are folded under the elytra.	<u>Pachnoda</u> sp. <u>Epilachna</u> sp. <u>Aulacophora</u> sp.
Hymenoptera (ants, wasps)	Biting or licking mouthparts. Holometabolism. Two pairs of membranous wings. Forewings larger than hind-wings.	Various species of ants.
Lepidoptera (butterflies, moths)	Adults- sucking mouthparts, larvae- biting mouthparts. Holometabolism. Fore- and hind- wings covered with minute scales; wings often highly coloured, usually held vertically by resting butterfly. Larval stage causes damage.	<u>Heliothis</u> sp. <u>Plutella</u> sp. <u>Agrotis</u> sp. <u>Spodoptera</u> sp.
Diptera (flies)	Sucking or piercing-sucking. Holometabolism. Forewings membranous. Hindwings transformed into 'balancers' (halteres).	<u>Dacus</u> sp. <u>Ceratitis</u> sp. <u>Liriomyza</u> sp.
Heteroptera (plant-bugs)	Piercers, with a rostrum Hemimetabolism. Forewings stiffened in the basal part, membranous at the point (hemelytra). Hind-wings membranous.	<u>Nezara</u> sp. <u>Dysdercus</u> sp. <u>Oxycarenus</u> sp.
Homoptera (aphid, whitefly, jassid..)	Piercing-type mouthparts (rostrum). Hemimetabolism. Two pairs of wings, transparent and membranous, held roofwise at rest.	<u>Aphis</u> spp. <u>Bemisia</u> spp. <u>Empoasca</u> spp.
Thysanoptera (“thrips”)	Piercing-type mouthparts Hemimetabolism. Wings narrow, bordered by long hairs.	<u>Thrips</u> spp.

Differentiation of larvae of holometabolic insects

Several simple characteristics permit the assignment of larvae of holometabolic insects to their appropriate orders (Fig. 1). This identification is important, as it often aids in deciding on suitable control measures.



<u>ORDER</u>		<u>CHARACTERISTICS</u>
LEPIDOPTERA (caterpillar) "typical"		4 pairs of false abdominal legs 1 pair of false anal legs <u>3 pairs of thoracic legs</u>
"Looper"		1 pair of false abdominal legs 1 pair of false anal legs 3 pairs of thoracic legs
COLEOPTERA (larva)		No abdominal legs 3 pairs of thoracic legs
DIPTERA (maggot)		Without legs

Fig. 1 : Identification of insect larvae

Fig. 2 INSECTS.

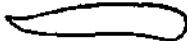
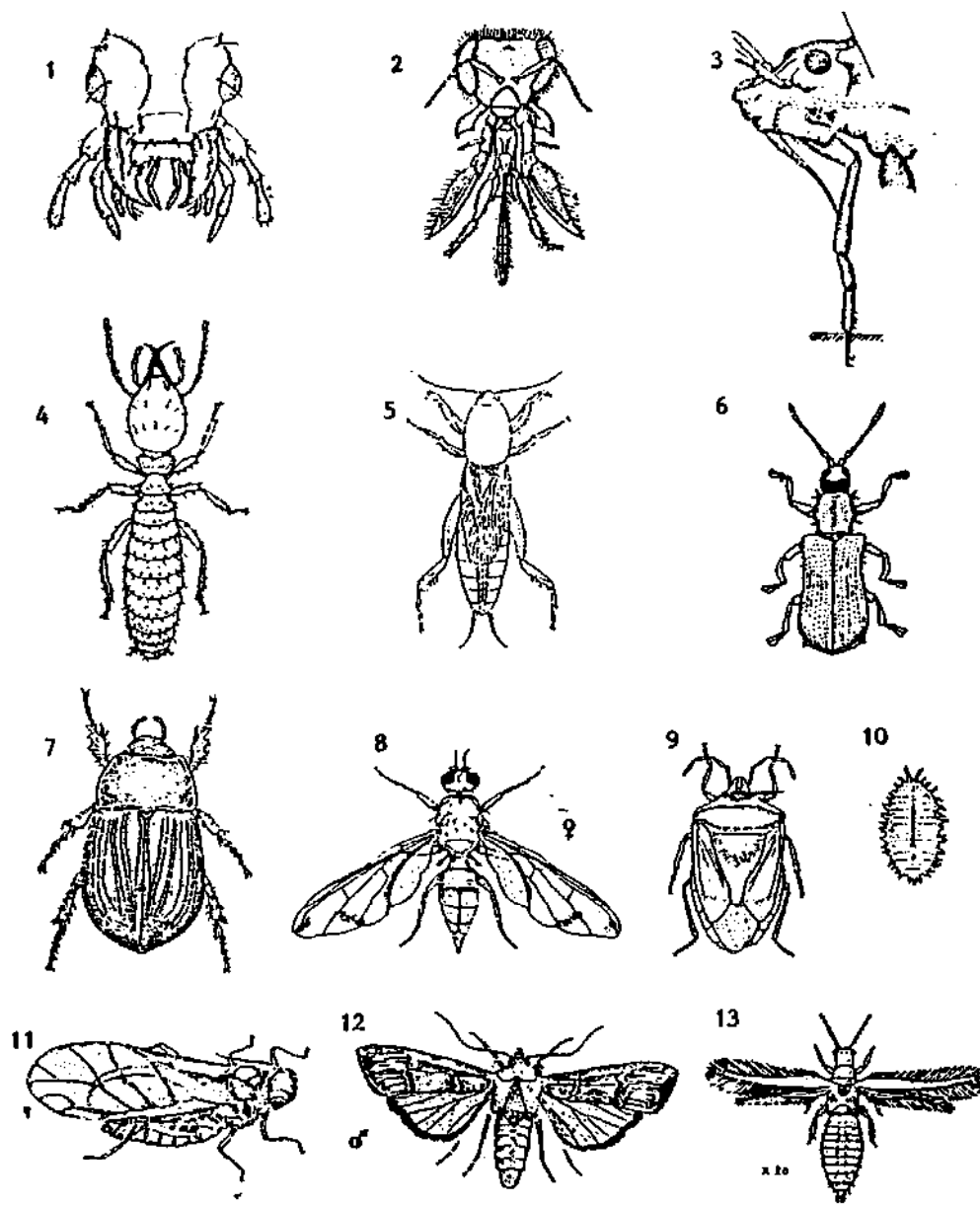

- | | |
|------------------------------------|-------------------------------|
| 1) Mouthparts-biting type | 8) Diptera |
| 2) Mouthparts-licking-sucking type | 9) Heteroptera |
| 3) Mouthparts-piercing type | 10) Homoptera (Scale insects) |
| 4) Isoptera | 11) Homoptera (Aphids) |
| 5) Orthoptera | 12) Lepidoptera |
| 6) Coleoptera (Chrysomelidae) | 13) Thysanoptera (Thrips) |
| 7) Coleoptera (Scarabaeidae) | |

Adapted from Appert, J. and Deuse, J., 1982. "Les ravageurs des cultures vivrières et maraîchères sous les tropiques"- by permission of the authors.

2. SPIDER MITES

Formerly of secondary importance, the spider mites are now amongst the most important of crop pests.

The class Arachnida is distinguished from that of Insecta by the fusion of the head and thorax into a 'cephalothorax', by the almost universal possession of four pairs of legs and the absence of wings and antennae. The mouthparts comprise appendages in the form of stylets, accompanied by maxillary palps, permitting the mites to suck sap from plant cells.

The multiple pricking of the leaf surface by the mites, and their general feeding activities result in poor growth, deformation, chlorosis, browning, etc. The leaf is often 'peppered' with tiny colourless points alongside the veins, which sometimes give an almost silvered appearance to the leaf.

Spider mites are very small and some species are invisible to the naked eye. Unlike the true spiders they have no 'waist' between the cephalothorax and the abdomen. A group known as the Eriophyidae present a long, narrow, soft body, with only two pairs of legs, for example, *Aculops lycopersici*. The other group comprises spider mites with round bellies: the Tetranychidae and the Tarsonemidae belong to this group.

Spider mites reproduce either sexually or parthenogenetically: they are either egg-laying or viviparous. There are generally four post-embryonic development stages: the larva (which often has three pairs of legs), the protonymph, deutonymph (sometimes a tritonymph) and the adult.

3. FUNGI.

Globally, phytopathogenic fungi cause heavy damage to plants. The majority are multi-cellular, non-motile organisms resembling plants in that their cells possess a rigid wall, but unlike plants they are completely devoid of chlorophyll, a condition which obliges them to depend upon organic carbon compounds for their basic nutrient requirements. Certain fungi, the facultative parasites, can develop either on living host tissue or on dead organic tissue; other fungi are able to develop only in the living tissue of the host, and are thus obligate parasites.

A typical fungal thallus is made up of numerous microscopic, tubular structures, known as hyphae, typically 6 to 10 μm . wide (1 μm . = 1/1,000,000 metre) which are lined with protoplasm and which branch more or less continuously as they grow.

Some fungi exhibit a complete life-cycle, during which they pass through two development stages, the 'imperfect' stage in which asexual spores are produced, and the 'perfect' stage which results in the production of sexual spores.

As well as their different modes of formation, fungal spores show a great diversity of form such as size, shape, ornamentation of surface, thickness of wall, presence or absence of septation, and colour, all of which may be used as taxonomic characters.

In a typical life-cycle the spore germinates to form a germ-tube which grows and branches and eventually penetrates into the plant tissue: some fungi penetrate directly into unwounded plant tissue whilst others, the wound - parasites, can only enter through wounds: yet a third type of

penetration is by means of natural openings such as stomata and lenticels. During the plant growing-season the fungus may pass through several asexual generations and produce vast numbers of asexual spores which effectively spread the disease, provided that prevailing climatic conditions favour the fungus. Towards the end of the season when the host-plant is maturing, the fungus may produce sexual spores.

Certain fungi do not have a 'perfect' stage and these are grouped together as the imperfect fungi (see below).

Symptoms. A plant which is being attacked by a fungus may exhibit one or more symptoms. In the earliest growth stage, an apparent lack of germination of seeds may be due to attacks by soil-borne fungi such as Pythium spp. or Phytophthora spp. "(pre-emergence damping-off)" or the same fungi may cause collapse of young seedlings by attacking them at soil-level soon after germination ("damping off"). Older plants may wilt due to root diseases or collar-rot; there may, however, be no external signs of rotting, in which case the symptoms may be due to a vascular wilt caused by such fungi as Fusarium oxysporum or, in cooler regions, Verticillium spp. The wilt symptoms can also be caused by water imbalance, or by the activities of bacteria or nematodes.

Various types of leaf-spot may be present, whilst diseases such as powdery mildews may rapidly cover the surface of leaves, stems and fruit with a mycelium bearing chains of powdery conidia (spores) imparting a white, powdery appearance to the plant.

Certain fungi cause necrotic areas on stems and foliage and examination may reveal the presence of minute dark-coloured circular structures, just visible to the naked eye, indicating the presence of a pycnidial fungus (see below). Pycnidial fungi can equally attack underground plant organs such as potato tubers and roots of various plants.

These and many other symptoms may give an indication of the identity of the fungal organisms responsible for causing the damage, but the only certain method is to obtain and examine the spores of the fungus.

Classification

Several systems of taxonomic arrangement or classification have been proposed, but the following simple outline highlights the most important information relating to the fungi involved in vegetable diseases in the region under study.

CLASS Phycomycetes: sub-class Oömycetes - the lower fungi. Mycelium coenocytic (i.e. without cross-walls), the sexual process resulting in the formation of a spherical oospore; asexual reproduction usually by zoospores formed in sporangia. The sub-class Oömycetes is divided into several orders, of which the Peronosporales contains numerous plant pathogens, including Pythium spp., Phytophthora spp., Peronospora spp., Pseudoperonospora spp.

The sporangia of Pythium spp., and Phytophthora spp. germinate either by germ-tubes or, when conditions are moist, by zoospores: sporangia of Peronospora germinate by germ-tubes, those of Pseudoperonospora by zoospores.

CLASS Ascomycetes. The mycelium is septate, the sexual spore is typically (though not invariably) one of eight, developed inside a small sac or ascus. In most genera the asci are borne on or in structures known

as ascocarps, which may be open (apothecia), completely closed (cleistothecia), or closed but with an exit pore (perithecia): in some genera the asci are borne directly on, or embedded within, the host tissue. Asexual reproduction is by conidia, which may be borne in various ways (see Fungi Imperfecti).

One of the most important Ascomycete families is the Erysiphaceae which comprises the powdery mildews, including the genera Erysiphe, Leveillula and Sphaerotheca: certain species of these three genera cause destructive diseases of vegetables. The sexual stages (cleistothecia) of these three fungi are rarely seen.

CLASS Basidiomycetes. The mycelium is septate; the perfect stage typically consists of four spores borne on a structure called a basidium. Basidiomycetes of particular interest to the vegetable grower are the rust-fungi (order Uredinales) which produce their orange-brown spores in small pustules or sori on the surface of leaves, stems and, in some cases fruits. Some rusts have a complex life-cycle (which in some species may take place on two distinct and unrelated hosts), involving the production of several different types of spores (spermatia, aeciospores, urediniospores = uredospores, teliospores = teleutospores, basidiospores).

CLASS Deuteromycetes (Fungi imperfecti). This is a large group of fungi, having septate mycelium, and apparently existing only as conidial stages which bear strong similarities to those of certain Ascomycetes. This class is divided into three orders, according to the way in which the conidia are borne:

1. Conidia produced in minute, round-to-flask-shaped structures called pycnidia - - - - - Sphaeropsidales
2. Conidia borne in acervuli, which are saucer-shaped structures often below the plant epidermis, through which the spores break at maturity - - - - - Melanconiales
3. Conidia borne in other ways - on exposed conidiophores (single or grouped) or directly on the mycelium - - - Moniliales.

Included also in the Deuteromycetes is the order Mycelia sterilia (Agonomycetales) subdivided into twenty-eight genera, in which no conidia are formed. Two of these genera, of importance to the vegetable grower are Rhizoctonia and Sclerotium.

Many of the numerous and diverse spore-forms of the Deuteromycetes are illustrated by Barnett and Hunter (1972).

Disease spread. The spread of fungal diseases can occur in a variety of ways. On a national and international scale, the shipping and transport of diseased plants has undoubtedly contributed to the spread of certain plant diseases, as also has the use of infected seed, whilst many fungal spores are small and light and are widely dispersed by the wind. Yet another method of disease-spread is in irrigation water and/or rain, whilst the passive carriage of fungal spores on farm machinery, on the hands or clothing of workers, on the coats of animals and by insects most probably plays a not inconsiderable role in the spread of plant diseases.

Fig. 3. SOME FUNGAL SPORES

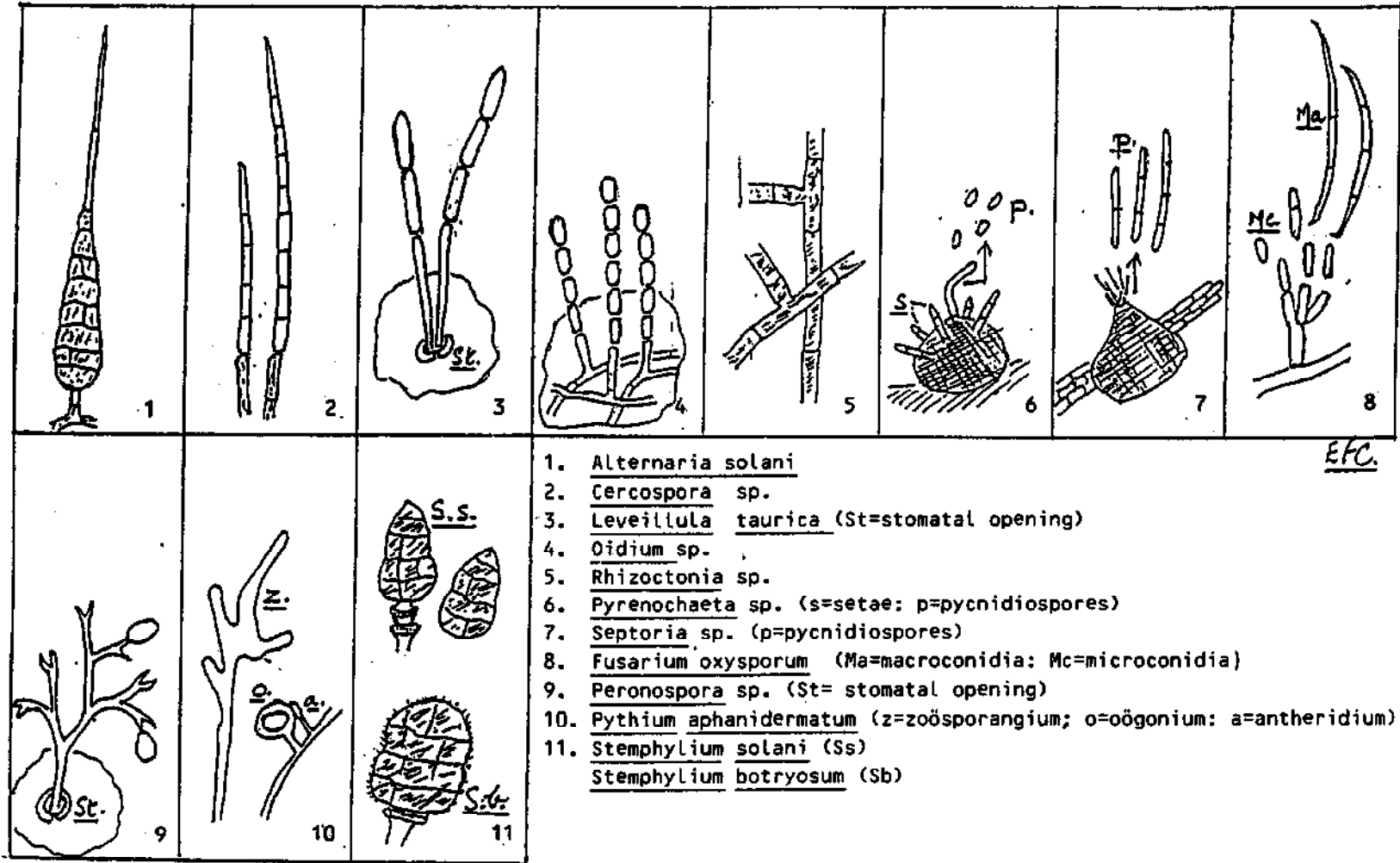

1. Alternaria solani
 2. Cercospora sp.
 3. Leveillula taurica (St=stomatal opening)
 4. Oidium sp.
 5. Rhizoctonia sp.
 6. Pyrenochaeta sp. (s=setae; p=pycnidiospores)
 7. Septoria sp. (p=pycnidiospores)
 8. Fusarium oxysporum (Ma=macroconidia; Mc=microconidia)
 9. Peronospora sp. (St= stomatal opening)
 10. Pythium aphanidermatum (z=zoösporangium; o=oögonium; a=antheridium)
 11. Stemphylium solani (Ss)
Stemphylium botryosum (Sb)
- Etc.

4. VIRUSES

Viruses may be described as infective, intracellular agents of minute size, so small in fact that they are beyond the limits of resolution of an optical microscope. They consist of particles of nucleic acid and in order to multiply must of necessity be inside an appropriate living cell. An electron microscope is used to demonstrate their form, which may be spherical (either single, or paired 'gemini' particles) or elongated, with either square, or rounded ends. The size of these particles is measured in nanometres (nm.=1/1000,000,000 m). The form and size of the particle can be an important aid towards identification.

Symptoms. The presence of virus particles in a cell causes a disturbance of the metabolism, and in plants may lead to the appearance of symptoms such as leaf-distortion, mottles and ringspots; also caused by viruses are certain colour-breaks in flower-petals and leaves, which may enhance the commercial value of particular plants.

Transmission. Several different types of virus transmission are known:

By seed: A limited number of viruses can be transmitted via the true seed: those infecting vegetable crops include lettuce mosaic virus (from 1 to 10% transmission), Phaseolus bean common mosaic virus, cucumber green mottle mosaic virus, southern bean mosaic virus, tomato mosaic virus, tomato ringspot virus, tomato spotted wilt virus.

Vegetative propagation: Where a virus is present systemically within a plant, then parts of that plant used for vegetative propagation will similarly be virus-infected: this is the situation with Potato virus Y and Potato leaf-roll virus where virus-infected tubers are produced from virus-infected plants. Using systematically infected plant material for grafting will likewise spread the virus.

Sap-transmission: Many viruses can be spread by inoculating infected sap into suitable species of healthy plants. With very contagious viruses such as tomato mosaic virus, transmission readily occurs during cultural operations when the sap can be spread on the hands or clothing of persons working in the crop, or even contact in the soil between healthy and virus infected roots.

Nematodes and Fungi: Tomato ringspot virus is spread by the soil-inhabiting, ectoparasitic nematode Xiphinema americana, whilst species of the fungus Olpidium are responsible for transmitting Lettuce big-vein virus and cucumber necrosis virus.

Insects: Aphids are the most important vectors of virus diseases: other insects involved include beetles, thrips and whiteflies. Eriophyid mites also transmit certain viruses. Viruses fall into three classes, according to their persistence in the insect-vector:

- a. **Persistent.** The vector may have to feed for up to several hours to acquire the virus, which may then remain active inside the insects body for a long period, possibly for the rest of the insect's life. Transmission of the virus may similarly require a feeding period of up to several hours.
- b. **Non-persistent.** Acquisition and transmission of the virus require only short periods, maybe only a matter of seconds; infectivity may be rapidly lost.
- c. **Semi-persistent.** Intermediate between the two categories described above.

5. MYCOPLASMA-LIKE ORGANISMS

Within the last sixteen years or so another group of organisms resembling the Mycoplasmas has been associated with a series of diseases generally known as 'yellows'. True mycoplasmas are possibly intermediate between bacteria and viruses: their size ranges from 200 to 500 nm., they lack the rigid wall of bacteria but (unlike the viruses) are capable of living independently, and some have been cultured in the laboratory. Many of the mycoplasma-like organisms infecting plants are transmitted by leafhoppers.

Symptoms. Various types of symptoms have been reported. One of the commonest is yellowing of the foliage, hence the name 'yellows disease'. Other symptoms are abnormal branching, stunting of growth, hypertrophy of flower buds, thickening of flower stalks, suppression of flowering and distortion and reduction of leaves. Many of these symptoms are found in the disease of tomatoes known as Stolbur, which can also attack eggplants.

6. BACTERIA

The plant-pathogenic bacteria are small, unicellular rod-shaped organisms with a rigid cell wall, but lacking chlorophyll: as a general indication of size, a bacterial cell might measure 1.5 μ m long x 0.5 μ m wide. Many species are motile by virtue of their flagella. The number and arrangement of these flagella are used as aids to identification: bacteria of the genus Xanthomonas, for example, have a single polar flagellum, Pseudomonas possesses several polar flagella, whilst in Agrobacterium, the flagella are variable in number and laterally inserted. The genus Erwinia has peritrichous flagella, i.e. the flagella are inserted all around the bacterial cell.

Bacteria normally gain entry via natural openings or wounds: Xanthomonas campestris, the casual organism of black-rot of crucifers, penetrates roots at the point where adventitious roots emerge: the fruit-canker phase of tomato bacterial leaf-spot is said to develop following penetration by Xanthomonas vesicatoria via broken hairs on the surface of the fruit.

Symptoms. The range of symptoms produced by plant pathogenic bacteria is very wide and includes - 'bird's eye' spots, blackleg, cankers, chlorosis, die-back, exudations, fasciations, galls (hyperplasia), halo blights, leaf-spots, 'shot holes', soft-rots, vein-blackening and wilting, etc.

Transmission. Bacterial diseases of plants are transmitted in various ways - man, insects, rain and wind all being important agencies. Infected seedlings transplanted into a crop will act as foci for spreading the disease. Several important bacterial diseases of vegetables are seedborne, including those of Brassicaceae, Cucurbitaceae, Leguminosae and Solanaceae. Of particular interest to the vegetable grower are the genera Pseudomonas, a species of which causes halo-blight or Phaseolus beans: Xanthomonas, responsible for leaf-spot and black-rot of crucifers: and Streptomyces (scabies) the causal organism of common scab of potatoes. The morphology of the bacterial cell, the number and arrangement of the flagella and the biochemical reactions of the organism are all used as aids to identification (see Bradbury, 1970).

7. PLANT PARASITIC NEMATODES

Plant parasitic nematodes are very small, worm-like creatures averaging up to 1 mm. or so in length. Of the numerous named species, some are free-living (ectoparasites) whilst other species pass part of their existence as endoparasites, living within plant-tissue. The mouth of plant parasitic nematodes bears a hollow stylet, a spear-like organ which enables the nematodes to pierce plant cells, in order to suck out the juices during feeding. Certain species of nematode lacking this spear are non-parasitic and associated with the breakdown of decaying organic matter, and are frequently encountered during microscopic examination of diseased plant material.

Of great importance to the vegetable grower, particularly in warm climates, are species of plant parasitic nematodes of the genus Meloidogyne, or root-knot nematodes: a soil temperature of 18°C, with an optimum of 26/28°C is highly conducive to the development of this parasite, particularly on light, sandy soils.

Symptoms. The feeding activity of Meloidogyne spp. within the roots causes enlargement of the nearby cells and the production of the familiar root-galls. Meloidogyne attacks not only roots, but also tubers such as potatoes; symptoms on potato tubers can vary from small nodosities to large, distorted outgrowths on the tuber surface.

Damage. As a result of infestation the plant metabolism is upset: there is a marked reduction in secondary root production, which means that the uptake of water and nutrients will be interrupted, to the detriment of growth.

Spread. Nematodes are capable by themselves of making limited progress through the soil; the most important method of spread, however, is in soil which adheres to the feet of workers and animals, to farm implements, etc., or is carried by wind or irrigation water. Nematodes can also be transported in soil which is carried on the roots of nursery transplants, etc., and this can lead to spread of nematodes either locally or on an international scale.

Species attacked. Meloidogyne has a very wide host-range, including, unfortunately, most of the commonly grown vegetables: some small differences exist, however, in their susceptibility of the different species to attack. As well as vegetables, a wide range of other plants is attacked, some 2 000 or so species having been recorded as susceptible, including many common weed species.

8. WEEDS

Weeds may be species of non-cultivated plants growing in a crop, or may be cultivated plants from the previous growing-season, developing in the current season's crop ('groundkeepers').

Weeds can have several undesirable effects on crop development. They compete for water, nutrients and light; the latter can be particularly serious in a crop such as onions, in which the initial rate of development is very slow. Weeds may also act as alternative hosts for pests, diseases and nematodes; for example Meloidogyne spp. can develop on a range of common weeds and make even more difficult the possibility of control by rotation. Groundkeepers can be particularly dangerous as they are often overlooked, yet may be infected with foliar disease and act as primary foci for disease-epidemics.

From an economic standpoint, hand-weeding of crops can be costly and very demanding in time, whilst the presence of weed-seeds as a contaminant in seed may pose particular cleaning problems in an effort to remove them.

A point in favour of weeds is that under certain circumstances they may have a beneficial effect in countering soil erosion.

In addition to the types of weeds mentioned above, there are a number of parasitic or semi-parasitic plants which may be partially or almost totally devoid of chlorophyll, and draw a varying amount of their nutrient requirements from their host-plants: The Dodders (Cuscuta spp.) and the Witchweeds (Striga spp.) are well-known examples.

9. NON-PARASITIC DISORDERS

The growth of plants can be impaired by disorders which are non-parasitic in origin, but which are related to environmental conditions, nutrition, etc. Important amongst these are the so-called deficiency diseases, resulting from a deficiency of major or minor nutrients. Recognizable symptoms are associated with some of these deficiencies, for example insufficient phosphate often manifests itself as a bluish-purple coloration of the leaves, whereas the symptoms of magnesium deficiency, well known to tomato growers show up as interveinal yellowing, especially on the older leaves. Amongst the minor nutrients, chlorosis of the youngest leaves is often associated with a deficiency of iron: a deficiency of boron can cause the well known heart - or dry-rot of beet, and is also responsible for a disorder of cauliflower resulting in a browning or brown-rot of the curd and its branches.

These nutritional disorders may result from a direct shortage in the soil of the element concerned: however, shortages often arise because of unavailability of the element, induced by the action of other soil-factors. Thus, iron deficiency is often related to an excess of lime ("lime-induced chlorosis"), whilst magnesium deficiency in tomatoes is said to be aggravated by the use of large quantities of potash, an important element in modern tomato-production techniques. The availability of nutrients is quite strongly influenced by soil pH, as shown diagrammatically by Nelson (1968).

The use of symptoms as a tool for diagnosing nutrient deficiencies has its limitations: some of the symptoms are difficult to diagnose correctly and may be similar or identical with those caused by certain parasites: a more precise method is to relate the symptoms to chemical analysis, where possible. O'Dell (1981) shows the range in concentration of ten plant nutrients which might be expected in the tissue of twenty-one different vegetable crops. Careful sampling, according to a recommended programme is essential for the success of this form of analysis.

Deficiencies of major elements can usually be corrected by applying suitable fertilizers. Correction of minor-element deficiencies is usually effected by either soil or foliar-application of the appropriate chemical; this operation can be fairly exacting, as the margin between correcting a minor-element deficiency and causing toxicity can be small in some cases. Recommended quantities of minor-element chemicals are often as low as 2 or 3 kg. per hectare, with possibly twice this quantity on organic soils: Lorenz and Maynard (1980) give a series of recommendations for the principal minor elements. Certain minor-element deficiencies may be reduced by correcting the pH of the soil, if this is outside of the optimum range for plant-growth (approx. 6.2 - 6.8).

Phytotoxicity. Certain plant species react adversely to the application of some pesticides (for example, cucurbitaceae/DDT and copper): however, in general most reputable pesticides, when applied according to instructions, are safe on crops, although some may exert a slightly adverse effect on yield which is difficult to assess. Excessive concentrations of fertilizer may cause root-damage and particles of fertilizer lodging on the plant foliage may cause scorching.

Soil reaction: Most species of vegetables will grow at a pH of 6.5, but certain species such as potato, shallot, sweet-potato and water-melon are fairly tolerant of acid conditions down to pH 5.0/5.5.

Salt concentration. The concentration of soluble-salts in the soil determines the ease by which plant roots extract water: with increasing concentration this extraction becomes more difficult. Plant species vary in their salt tolerance: for example, beans, lettuce, onions and peppers can tolerate only low salt concentrations, whereas beet, cabbage and tomatoes are more resistant. The 'total soluble salt' concentration is determined by first making an aqueous extract of the soil and then measuring its electrical conductivity by means of a conductivity bridge.

Water is one of the most important requirements for plant production; insufficient water leads first to a state of temporary wilting which, if it continues becomes permanent and the plant dies. Plants with large, thin leaves (for example cucumbers and melons) grown under semi-tropical conditions may wilt during the heat of the day, even when adequately supplied with water: in certain instances, however, wilting may be a sign of root or vascular disease. Excessive watering may lead to asphyxia of roots, followed by rotting, and thus lead indirectly to wilting.

Wind, sun, heat. Some species of plants such as Phaseolus beans have foliage which is easily damaged by wind: in windy locations it is usual to erect (or grow) suitable wind-breaks to prevent damage. Certain species are susceptible to damage by high temperatures during sunny weather: tomato fruits and fruits of sweet pepper are particularly sensitive. In climates with high sunshine levels, suitably adapted cultivars (for example, with adequate protective foliage) should be selected.

Other enemies of growing plants. In addition to the groups of organisms described above there are others which prey upon, or compete with, growing plants, or damage plant products: these include birds and rats which are not described in this chapter although limited notes on their control are given at appropriate points in the text.

C. CROP LOSSES

All of the pests, diseases and non-parasitic disorders described above have the potential to cause varying degrees of loss in crop production. Over the years, numerous attempts have been made to arrive at regional and global estimates of these losses in harvested crops, and also post-harvest losses. Thus Cramer (1967) suggests that global losses in vegetable production amount to 27.7% of which 8.7% is caused by insects, 10.1% by diseases and 8.9% by weed competition. He also states that the loss of potential vegetable production in Africa is of the order of 33.4% and gives figures of 24.8% and 13% for equivalent losses in North and Central America, and Europe respectively. Taylor (1967) quotes a figure of 10% of the total agricultural production of the USA being lost to nematode attacks, whilst Bridge and Muller (1984) speaking of agricultural development in Africa state that yield-losses in excess of 25% and often up to 50%

can be expected when Meloidogyne is allowed to build up in vegetable gardens. Other authorities put crop-losses in tropical countries as high as 50%, plus a further 20% loss due to post-harvest damage.

It is evident that loss-estimates can vary considerably, and that there are probably also fairly substantial regional differences: there may be differences also at local level, between the crops grown at research establishments and those grown by farmers, the latter being more truly representative of the area from the point of view of estimating actual production.

Losses fall into two broad categories, namely qualitative losses and quantitative losses. In qualitative losses the blemishes are often superficial, thereby spoiling the appearance of the product and leading to a reduction in market value, without necessarily reducing the actual crop yields. An example is common scab of potatoes, caused by Streptomyces scabies which attacks the tuber-skin and is normally removed when the potato-tuber is peeled: heavily-scabbed tubers will be downgraded for quality, with consequent loss of revenue on sale. Other examples of qualitative loss are light attacks of mole-cricket (Gryllotalpa africana) on potato tubers and Margaronia indica attacks on melon. Qualitative losses can also result from faulty handling at harvest time, bad packing, poor transport, etc. These topics are discussed in the section on marketing.

It is difficult to estimate the degree of loss caused by these quality defects: much depends on the type of market, i.e. the standards demanded by the local consumer as to whether a blemish is classed as a 'quality defect'. Also important is the abundance or otherwise of the product on the market, and in periods of shortage, produce otherwise considered as 'blemished' might find a ready sale.

Quantitative losses result from attacks by insects, fungi, etc. which, by destroying plant foliage or other parts of the plant bring about direct yield reductions. The extent of these reductions is often related to the rate of reproduction of the pest or pathogen which is in turn influenced by the levels of temperature and humidity. Quantitative (and qualitative) losses can also result from non-parasitic disorders.

Quantitative losses may be due to direct destruction of saleable parts of the plant, for example, damage to hot pepper fruits due to attacks by Ceratitis capitata, or loss of tomato fruits due to blossom-end rot. Such losses can be calculated either as a direct percentage of the number of fruits or as a percentage weight-loss. Alternatively, losses may be indirect, resulting for example from the destruction of foliage by a fungus or insect-pest, with a subsequent lack of development of tubers or grain. This type of loss can be calculated by comparing yields of untreated, unprotected plants with yields from plants which have been kept free from pests and/or disease by protecting them with appropriate pesticides. There may be more than one disease involved, or more than one pest, or a combination of pest and disease. The possibility cannot be ruled out that the pesticide itself may exert some effect, and thus one may not have the 'true' yield. Despite this limitation the method is useful for estimating losses from fungal, insect, etc. attack and for evaluating the potential yield of the crop when protected.

Since 1973 field trials have been carried out at the CDH to evaluate numerous techniques, including the use of pesticides, for the control of insect pests, plant pathogens, etc. Tables 2A to 2F show the estimated losses for several crop/pathogen combinations, most of them occurring over a period of several years: yields from the untreated control and the best yielding treatment are compared.

TABLES 2A - 2F: Crop losses in Senegal caused by insect pests, fungi and nematodes.		
Table 2A. <u>Heliothis armigera</u> on tomato.		
Year and best treatment	Untreated	Treated
1977. Deltamethrin 25 g.a.i./ha./week No. of sound fruits harvest/10 m ² (5m x 2m) - - - - - Percentage sound fruit - - - - - LOSS - - - - -	389 32.4 67.6%	1079 89.7 10.3%
1978. Fenvalerate 100g.a.i./ha./week No. of sound fruits harvested/8 m ² - Percentage sound fruits - - - - - LOSS - - - - -	333 59 41%	1316 98 2%
1979. Deltamethrin 16g.a.i./ha/week No. of sound fruits harveste/10 m ² - Percentage sound fruits - - - - - LOSS - - - - -	56 8.3 91.7%	1321 96.8 3.2%

Table 2B. <u>Plutella xylostella</u> on cabbage		
Year and best treatment	Untreated	Treated
1977. Acephate 750 g.a.i./ha./week Percentage commercialisable heads - - LOSS - - - - -	20 80%	100 0%
1978. Acephate 750 g.a.i./ha./week Percentage commercialisable heads - - LOSS - - - - -	48.9 51.1%	100 0%
1981. Chlorpyrifos-ethyl 480 g.a.i./ha/week. Percentage commercialisable heads Average weight per head (grammes) Weight commercialised/12 m ² (Kg) LOSS (number of heads) - - - - -	6 150 0.6 94%	99 877 62.3 1%
Yield from untreated area was less than 1% of that from treated area		

Table 2C. <u>Cryptophlebia leucotreta</u> on pepper.		
Year and best treatment	Untreated	Treated
1979. Deltamethrin 16 g.a.i./ha/week No. of sound fruits harvested /6 m ² - Percentage sound fruits - - - - - LOSS - - - - -	130 42.6 57.4%	298 97.1 2.9%
1981. Deltamethrin 19g.a.i./ha.week No. of sound fruits harvested /6 m ² Percentage of sound fruit - - - - - Weight of sound fruits/6 m ² (Kg) - - LOSS (number of fruits) - - - - -	161 41 8.9 59%	405 95 27.7 5%

Table 2D. <u>Meloidogyne</u> spp. on tomato. (one trial only)		
Year and best treatment	Untreated	Treated
1978. Metham-sōdium 473 Kg.a.i./ha. Weight of sound fruit /10m ² (Kg) - -	8	34.8
Yield from untreated area equivalent to 23% of that from treated area.		

Table 2E. <u>Leveillula taurica</u> on tomatoes.		
Year and best treatment	Untreated	Treated
1978. Triadimefon 156g.a.i./ha/2 weeks Weight of fruits / 10 m ² (Kg)	29.5	42.3
Yield from untreated area equivalent to 69.7% of that from treated area.		

Table 2F. <u>Pseudoperonospora cubensis</u> on melon.		
Year and best treatment	Untreated	Treated
1979. Metalaxyl. 300 g.a.i./ha/week Weight of fruit / 10 m ² (Kg)	13.2	29.8
Yield from untreated area equivalent to 45% of that from treated area.		

The above examples serve to indicate the extent of losses which are caused by certain insect pests, phytopathogenic fungi and nematodes. It should be borne in mind, however, that the yields shown represent the average production from experimental plots in the relevant trial. The calculated losses appear, unfortunately, to be quite representative of bigger exploitations, as was evident for example in Senegal some years ago, where the farmers in one area abandoned the culture of cabbage because heavy attacks by Plutella xylostella virtually destroyed the crop.

Results from a series of crop protection trials in Senegal suggest that insects and nematodes are more consistent in their attacks from year to year than are the majority of fungi, a situation which makes decision-taking more difficult in relation to anti-fungal protective measures.

D. THE EFFECT OF SOME ENVIRONMENTAL FACTORS ON INSECT PESTS AND DISEASES

1. ON INSECT PESTS

Environmental factors such as temperature, humidity and rainfall influence the evolution in time and space of insect populations: temperature for example determines the duration of development and the number of generations per year; each species has its preferred temperatures. It is important, therefore, to examine all entomological observations in terms of their climatological context, as the following examples illustrate.

Population dynamics of Plutella sp. on cabbage are influenced by the interaction of various environmental factors acting upon the several developmental stages of the insect. The work of Hardy and Kanervo might be summarized as follows:

Adult: death almost instantaneous at 50°C:
death occurring in 3 hours at 42°C: optimum longevity at 20°C
(14-28 days):
almost normal longevity at 35°C
egg-laying: maximum oviposition at 20°C:

oviposition almost zero at 15°C:
above 20°C, progressive diminution of oviposition with complete cessation at 35°C

Incubation: lethal temperature for eggs 40°C, even in an atmosphere with 100% humidity:
incubation period of 15 days at 15°C, of 2 days at 35°C, and a very long incubation period with 80% mortality at 10°C:

caterpillars: development in 20 days at 12°C (R.H. 80-90%), in 7 days at 24°C and in 6 days at 25°C.

These data place the optimum conditions for development of the different stages between 20 and 30°C, with the disappearance of the insect in dry zones with high summer temperatures.

P. xylostella produces a number of generations varying according to the length of the period favourable to its reproduction: its development is slowed down or stopped by a drop or an increase in temperature beyond the optimum.

The feeble population densities of P. xylostella encountered in the pre-sahelian and continental regions is explained by the high temperatures frequently found in these zones, lethal for both adult and eggs at 42°C and 40°C even with 100% relative humidity. By contrast, medium temperatures close to the optimum for development facilitate population explosions of the insect in more temperate zones bordering the sea (Bourdouxhe, 1983).

Spodoptera littoralis, another important pest of vegetable crops, has a similar distribution in time and space regulated by temperature (Cayrol, R.A., 1972). The mortality of eggs and young larvae exposed to a temperature greater than 34°C is significant: at 40°C, the eggs live for two days, the caterpillars from 22 to 50 hours; the chrysalids survive for two days at a temperature of 42.5°C.

Eggs and chrysalids of S. littoralis are not very sensitive to humidity, whereas the larvae are very sensitive. According to Janisch, the optimum relative humidity for caterpillars is between 90 and 95%, whilst Caresche states that dry heat causes a heavy mortality in young larvae. It is this which explains the feeble presence of this insect in the pre-sahelian zones with their high temperatures and low humidity.

Eggs of Agrotis ypsilon hatch in 3-4 days at 25°C, whilst a relative humidity lower than 77% hinders hatching (Appert, 1976). According to Bishara, the maximum threshold temperature is of the order of 36°C.

The gravid females look for an environment where the humidity of the air and soil is relatively high (Cayrol, R.A., loc. cit.).

As noted above for Spodoptera, the differences in population density between sahelian zones and more temperate zones can be explained by the low humidity and the high temperatures characterising the former.

Irrigation can modify quite markedly the population dynamics and the distribution in space and time of insects. The irrigated areas can thus be distinguished by densities of population very different from those of adjoining, non-irrigated zones.

Heliothis armigera, an important pest in cotton-growing zones during the hot, wet season, experiences explosions of population in vegetable (market-garden crops), grown under irrigation during the dry season. A further effect of the irrigation is to permit an increase in the number of generations per year of the insect, thereby increasing the chances of the emergence of resistant individuals in response to selection pressure exerted by certain insecticides.

The mode of irrigation can be important in influencing the distribution of insects by the micro-climate created within the crop. Overhead irrigation maintains a humidity level favourable to the development of Liriomyza trifolii, a leaf-miner, and under such conditions the females of this Diptera have a tendency to invade the vegetation of the entire plant: by contrast, in a drier environment with furrow irrigation, they confine themselves to the lower leaves (Vercambre, 1980: Bourdouxhe, personal observation).

These examples demonstrate that in view of the close relationship existing between environmental factors and insect development, observations carried out in a particular area must not be extrapolated without taking into account the local climates and microclimates.

2. ON FUNGUS DISEASES.

Nutrition. It is generally stated that application of excessive nitrogen or insufficient potash renders a plant more susceptible to disease: too much nitrogen might have the effect not only of producing excessively soft growth but also may result in the production of a large canopy, providing an ideal microclimate for the development of fungal disease: on the other hand, inadequate nutrition might render a plant more susceptible to disease attack, and Chupp and Sherf (1960) cite examples of this in relation to attacks by Alternaria solani on tomato. Conversely, nitrogen is toxic to certain fungi such as Sclerotium rolfsii (ammonium and nitrate nitrogen) and Fusarium solani f.sp. phaseoli (nitrate) and judicious applications of nitrogen might reduce attacks by these fungi. Deficiencies or excesses of other, including minor elements, may have

adverse effects on the plant's ability to withstand disease attack, and balanced nutrition, avoiding a build-up in the soil of soluble salts, should be the objective.

Temperature. As with insect pests, fungal and bacterial plant pathogens react in a specific manner to temperature, and the distribution of many fungal and bacterial diseases can be fairly well correlated with temperature. Some fungi do not thrive at high temperatures and may be absent from tropical or semi-tropical regions: this may partially explain why neither Verticillium albo-atrum nor V. dahliae have been found in Senegal, despite the presence of suitable host plants.

When plants are grown at temperatures in excess of their optimum, they may become susceptible to disease attack: it is possibly this situation which explains the heavy losses suffered in the earliest crops of dwarf (haricot) beans in Senegal CV. The beans are planted soon after the end of the rainy season when the soil temperatures are still very high (up to 34°C in October, 32°C in November at a depth of 5 cm) and thus beyond the optimum for this crop. Added to this is the fact that excessive irrigation is often the rule, presenting ideal conditions for Pythium aphanidermatum.

Another temperature-linked crop-loss situation is found in the north of Senegal, and occurs when irrigation of the late (April-maturing) potato crop is reduced or stopped altogether as the crop approaches maturity. The result is an increase in soil temperature which tips the balance in favour of the fungus Rhizoctonia bataticola (heavy losses up to 100% of potato tubers sometimes occur) and against the defensive ability of the potato tuber to resist attacks by this fungus (cf. Rudd-Jones et al., 1950). The phenomenon may also be associated to some degree with low-moisture stress.

Humidity and irrigation. Most, though not all fungal spores require high humidity, sometimes free water, not only for germination but to enable them to establish infection in their host-plant: by contrast, conidia of several species of powdery mildew (Erysiphales) can germinate in a relative humidity as low as 20%, and free water might, in fact, impair their germination.

In the arid and semi-arid areas, humidity may be so low as to effectively prevent spore-germination, and rain may be absent for the greater part of the year. In these areas irrigation is necessary to permit plant growth, and it is designed to give the plant an adequate and regular supply of water throughout the growing-period; if this is interrupted the plants may be under stress and be more susceptible to disease attack or physiological disorders (e.g. blossom-end rot in tomatoes) might be encouraged).

Excessive irrigation, be it soil- or sprinkler-applied undoubtedly enhances the attacks of soil-borne fungi such as Pythium spp. and Phytophthora spp.: when considering foliage parasites, however, important differences between soil- and sprinkler-applied irrigation are apparent. Roten and Palti (1969) summarize these as follows:

Furrow or subsoil irrigation, flooding or trickling: foliage and fruit not wetted, negligible effect on tissue temperature, no splashing of soil or inoculum, fungicides not washed off.

Overhead sprinkling: foliage and fruit wetted, pronounced effect on tissue temperature, much splashing of soil and inoculum, fungicides partly washed off.

One important effect of sprinkler irrigation mentioned above is to lower the leaf temperature, which in the case of several fungal species permits the infection process to go ahead. The amount of dew may be inadequate for the survival of certain thin-walled spores, and the presence after spore-dispersal of water-vapour from sprinkler-irrigation may be vital in preventing these spores from dying of desiccation: similarly, water-vapour may be necessary to permit the infection process to be completed. However, in dry, hot conditions the leaf-surface may remain wet for only a short time - sometimes for only several minutes.

Sprinkler irrigation undoubtedly has the additional effect of spreading inoculum within the plant canopy, and this applies particularly to certain bacterial diseases.

A reduction in the efficacy of pesticides is a consequence of their partial removal by sprinkler irrigation, and irrigation repeated regularly at short intervals, as practised by many local farmers is not compatible with pesticide application: the use of systemic pesticides may be one way of overcoming this problem. By contrast a possibly beneficial effect lies in the redistribution of pesticide on the leaf-surface.

Roten and Palti point out that under completely arid conditions the choice of the most suitable irrigation technique presents no problems from a phytopathological point of view, but suggest that under semi-arid conditions, where dew formation occurs during the night, the choice of surface irrigation, where practicable, will contribute more to disease-control than will chemical treatment. They suggest furthermore, if sprinkling is employed, that sowing (spacing) and fertilising should be such as to avoid excessive density of foliage, and that irrigation should be carried out at the longest intervals compatible with the avoidance of moisture-stress and at the time of day when sprinkling is least likely to aid the infection processes of the pathogen.

E. CONTROL OF PESTS AND DISEASES

Objectives. The principal objective of pest and disease-control programmes might be described as being to protect growing crops by maintaining the attacks of pests and diseases at acceptable levels, while ensuring that the increase in value of the crop resulting from pest and disease-control operations exceeds the cost of carrying out those operations. Only rarely is the eradication of the pest attempted - for example, to prevent the establishment of an exotic insect or disease. A second objective should be to ensure that the pest and disease-control operations are carried out with the least disturbance to, and the minimum contamination of, the environment.

It should be remembered that pesticide usage is only one, albeit probably the best known, of numerous methods available for pest and disease control. Indeed, in the absence of any active control measures, considerable biological activity occurs to maintain a 'biological equilibrium'. Thus, antagonism between different species of fungi probably prevents certain plant pathogenic soil-borne fungi from becoming dominant, whilst natural parasitism and predation amongst insects ensures that many potential major insect pests remain at a low level of importance. The importance of this consideration has been demonstrated in numerous instances in which the natural equilibrium has been upset, for example when the excessive use of wide-spectrum insecticides has resulted in the death of natural insect predators and parasites and permitted hitherto fairly insignificant insects to assume the role of major pests.

1. CONTROL METHODS NOT INVOLVING THE USE OF PESTICIDES

Non-pesticidal control measures include legislative measures and cultural control, as well as various physical and biological techniques for defence from parasites and disease vectors. Some of these methods are described below.

Legislation. Legislative measures at international level are used to regulate the movement of plant material, including seeds, into a country, with the object of preventing the introduction of exotic pests and diseases. These measures entail the inspection of imports of plant material by qualified inspectors at all points of entry, by air, land and sea. Plant material imports must normally be accompanied by a signed International Phytosanitary Certificate, certifying that the plant material was inspected by a qualified inspector in its country of origin and is believed to be free from all injurious pests and diseases. Inspection procedures may, in some cases, be extended to include aircraft, ships' holds and motor vehicles, to ensure that exotic pathogens are not accidentally introduced. The import of certain species of plants from specified countries, or at specified periods of the year, moreover, may be completely forbidden.

An importing country may insist upon certain pre-or post-entry pesticidal treatments of imported plant material or plant products, or may require that certain parts of the plant material be removed (e.g. the bark of trees). Some countries possess facilities for post-entry quarantine for more detailed examination of imported material before release and regulations are sometimes imposed on a national scale to regulate plant movement on a regional or inter-state basis.

These procedures are known generally as Plant Quarantine Control. However, no matter how skilfully plant quarantine regulations are drafted, their effectiveness is only as good as the regulatory apparatus for enforcing them and unfortunately, the lack of resources and trained personnel often results in less than adequate plant quarantine.

Cultural Control

Seedling production: It is essential that seedlings be completely healthy at the moment of transplanting. Thus, the seedbed should be sited on land that has not been planted to the crop in question for several years (see Rotation below) or on land that has been treated with a soil-sterilant. The seedbed should be shaded from the hot sun, but not excessively humid.

Careful cultural techniques at the seedling stage are of great importance for healthy growth.

Sanitation: Potentially infective material such as old roots from a diseased crop should be carefully removed and burned on non-cultivated ground. Care should be taken not to contaminate 'healthy' land either with infested soil carried on implements, boots, etc., or when transporting infested material for burning, although some contamination of healthy land almost certainly occurs due to wind-carried, infested soil. Any diseased or pest-infested plant material should be cleared from the field immediately after harvest and deeply buried, or destroyed.

Rotation: Rotation of crops has long been a cornerstone of farming programmes throughout the world: the main idea behind this practice is the hope that, by growing their host-plant only once every 3 or 4 years or so, certain soil-borne pathogens might be starved and die-out before their host

culture is grown again. By periodically including a root crop in the rotation, it also gave the chance to clean up the land - an operation which is now achieved by the use of herbicides.

There are certain limitations to the successful functioning of a rotation: it is most likely to succeed in the case of an obligate parasite, or with pathogens which have a very restricted host-range, but those organisms which can survive saprophytically will continue to thrive, and those which form chlamydospores or other types of resistant resting bodies will also have a good chance of surviving.

Recent research findings suggest that some species of following crops are more successful than others at reducing the inoculum of certain soil-borne fungi, whilst in certain instances, botanically unrelated following crops have actually appeared to increase inoculum levels!

A further limitation on the practice of rotation is that growers are often unwilling to reduce their most profitable crops.

The use of healthy seed: Seed which has not been correctly cleaned can be the carrier both of undesirable weeds and of numerous plant diseases, including many caused by bacteria, fungi and viruses, either carried on the outside of the seed or, in some cases, in the tissue of the seed itself. For certain diseases, very stringent standards have been set for seed health. For example, in the case of black rot of crucifers (*Xanthomonas campestris*), an essay on cabbage seed should show that *Xanthomonas campestris* is not present in a viable condition in a sample of 30 000 seeds (Williams, 1981). Whilst several treatments are available to eradicate certain infections from seeds, the primary objective must always be to obtain seed which has in the first place been harvested from healthy, disease-free plants. All too often the grower saves seed from fruit which has been left on a plant because for some reason it is unmarketable - an unhygienic practice which should be strongly discouraged.

Packeted seed from a reputable seed-house and with a genuine date-stamp is not likely to present problems, either as to trueness to variety or percentage germination, but the same cannot always be said of locally produced samples, which sometimes consist of new seed diluted with leftovers from the previous seasons.

Vegetative material: For some species of plant, such as strawberry and potato, various grades of vegetative planting material are available, the grade relating principally to the degree of expected freedom from disease in the stock, the purest and most healthy being the most costly. These stocks usually originate from individually-tested virus- and disease-free plants. The highest grades may be just a few generations away from the original 'foundation' plants, the lower grades have been further multiplied in the field and have less rigorous limits for disease content. It is for the grower to decide which grade suits his particular enterprise, but the highest categories are generally used for stock multiplication rather than for the production of commercial crops.

Another type of vegetative material is that produced by meristem culture which, when successful, assures the elimination of all types of disease (including those caused by virus), insects, mites and nematodes. Such a technique is used for the production of commercial strawberry plants, etc., but it could be valuable in other circumstances, for example, to ensure that desirable varieties of plants, even if imported from doubtful sources, are free from all pathogens before being planted out.

Rootstocks: In extreme cases, the use of seedling scions grafted on resistant rootstocks may be adopted as a protection from nematodes such as Meloidogyne spp. and soil-borne diseases such as Fusarium oxysporum f.sp. Lycopersici (patho-types 1 and 2).

Pyrenochaeta lycopersici and Verticillium spp., Messiaen (1974) gives information on rootstocks resistant to bacterial wilt (Pseudomonas solanacearum) - including CRA 66, Cranita and a variety of Solanum integrifolium for tomato, and S. torvum, S. integrifolium and Ceylan SM 164 for eggplant).

The use of resistant cultivars: Varieties of plants possessing resistance to disease, nematodes, insect pests and sometimes to adverse soil factors, such as high salt level, are widely used. Resistance may be determined by a wide range of factors, classed by Dickinson and Lucas (1982) as:

(a) Passive mechanisms, that is, anatomical or chemical barriers such as wax, cuticle, endodermis, enzyme inactivators, toxic compounds, etc., which are already present in the host before attack;

(b) Active mechanisms like callus formation, wound barriers, phytoalexins, detoxification mechanisms, etc., which are triggered off when the plant comes under attack.

The resistance of some plant cultivars to certain obligate parasites might conceivably be due to their lack of particular essential growth factors.

Resistance to plant disease may be classified as either 'Vertical' or 'Horizontal'. Vertical resistance is controlled by one or more identifiable major genes which can be manipulated by the plant breeder and which are active only against a limited number of pathotypes of a specific disease. Vertical resistance is usually of high intensity but has a 'narrow base', and can be overcome by a mutating pathogen. Exposure to a pathogen of a cultivar endowed with vertical resistance results in 'selection pressure', which is likely to induce the pathogen to overcome the resistance. An example of such a loss of vertical resistance was recorded in Senegal, when a pathotype of Fusarium oxysporum f.sp. lycopersici infected tomato cultivar 'UHN-11, which is normally resistant to this pathogen. (Collingwood and Defrancq, 1979).

Suggested strategies to delay the loss of vertical resistance include reducing the period of exposure to the pathogen by ensuring that there is a complete break between the end of one crop and sowing the next; using mixtures of cultivars within the same season and the use, if necessary, of legislation to prevent the planting of specific cultivars (Robinson 1971).

The incorporation of more than one gene for resistance may increase the level of protection against a pathogen and this strategy has been followed for example in an attempt to provide resistance to tomato mosaic virus by incorporating one, two, or in some cases, three factors for resistance into a single cultivar. Some pathogens (certain rust fungi, for example) produce new pathotypes or "races" with great facility, entailing a continuing plant-breeding programme to keep one or more steps ahead of the pathogen: a difficulty in such cases lies in finding new sources of resistance.

Horizontal resistance results from the collective action of numerous minor genes which confer a degree of resistance against several or all pathotypes of a specific parasite. This less-intensive resistance results

probably in a lower selection pressure which, in combination with the polygenic nature of the resistance, means that the latter cannot be overcome by the pathogen. Horizontal resistance is exploited by selecting from a population, over a number of seasons, plants which exhibit resistance to the disease concerned. It is probable that many of the locally-selected 'varieties' owe their success to horizontal resistance.

Good protection against certain diseases can sometimes be assured by growing F1 hybrids which, as a result of heterosis or hybrid vigour, often grow more vigorously and display enhanced disease resistance and an ability to outgrow certain pests.

The introduction into a region of reputedly disease resistant material from another part of the world sometimes yields rather disappointing results, and may be due to the fact that the introduced cultivar(s) are resistant to the pathotypes found in its country of origin, but may in fact be susceptible to the locally occurring pathotypes.

Numerous trials were carried out in Senegal to compare the resistance of a wide range of vegetable species and cultivars to various phytopathogenic fungi and bacteria, and root-knot nematodes: Defrancq (1984) gives the results of these trials. Some of the earlier trials underlined the fact that quite a number of cultivars which were most desirable from a commercial standpoint were very susceptible to some of the major diseases and could only be grown successfully with fungicidal protection (Collingwood *et al.*, 1975/80).

Disease escape: By growing the crop in a district where the environment favours the plant and is unsuitable for the pathogen is a method which can sometimes give satisfactory control of certain plant diseases without recourse to any other control measures. For example, Stemphylium botryosum on flower-stalks of onions grown for seed was successfully controlled by growing the seed crop in the north of Senegal where the climate is less humid than that of the Cap Vert region, in which losses from S. botryosum often exceeded 60%.

Heat Treatment of Soil by Solar Energy ('Solarization')

Conventional methods of controlling soil-borne fungal pathogens usually involve the use of rotations and chemical sterilants. These methods have their limitations, in particular the chemicals are often unpleasant to use, costly and, for the most part, phytotoxic. One method, that of mulching the soil with thin (25-30 μm .) transparent polyethylene sheets in order to raise the soil temperature, has been tried in several countries over a period of years. The ensuing 'greenhouse effect' ensures that a portion of the solar energy is trapped under the plastic sheets and the soil temperature rises: the method is particularly appropriate to warm climates. The operation is carried out pre-planting, and the plastic sheets are left in place for a period which may be from two to six weeks, to permit the process of heating and subsequent pathogen control to extend throughout the root-zone to a depth of about 20 cm: the soil should be moist at the time of treatment in order to activate the dormant stages of plant-pathogens and to improve heat-conduction in the soil.

The method has been used with successful results against a number of soil-borne pathogens, including Verticillium diseases of tomato, eggplant and potato; Rhizoctonia solani in potato and onions; Sclerotium rolfsii in peanut; Pyrenochaeta lycopersici in tomato; Pyrenochaeta terrestris on onion and Fusarium diseases of cotton, tomato and onion (Katan, 1980); disease control was accompanied in several instances by substantial yield-increases and in some cases, increased amounts of soluble minerals and

organic matter in treated soils. An additional benefit was the control of a range of weeds though attempts to control root-knot nematode, Meloidogyne spp. by soil-solarization have given variable results. Davis and Sorensen (1983) report that the beneficial results from plastic tarping (mulching) carried out in 1980 to control Verticillium dahliae on potatoes extended through to the 1981 and 1982 cropping, even though the mean-maximum soil-temperature attained at a depth of 15 cm after six weeks' mulching was only 41°C (non-mulched area 26°C).

Soil solarization appears to possess several desirable qualities as a possible method for controlling certain soil-borne pathogens; in particular, no toxic chemicals are involved and as a consequence there are no application hazards, whilst its cost-effectiveness is probably better than that of other methods of soil sterilization. It might, however, be prudent to monitor the situation to ensure that strains of parasites resistant to high temperatures do not evolve, particularly for those parasites in the lower part of the root zone.

Non-Pesticidal Methods for the Control of Insects

Physical methods effective against insects.

Mechanical barriers. Protecting young melon fruits against attacks by melon fruit-fly can be achieved by covering the fruits at a very young stage with newspaper or paper bags; the employment of a thin layer of acrylic wool has also been tried, with limited success. The fruits are usually safe from attack by the time they reach a diameter of about 7 cm.

Hand picking. This is a very ancient method of pest control, and is suitable for caterpillars such as Agrius sp. on sweet potato, Trichoplusia sp. on cabbage, Xanthodes sp. on okra; or for slow moving insects such as Pachnoda spp. on okra.

Pitfall traps (jam-jars buried in the soil up to their upper rim) are effective against mole-crickets (Gryllotalpa africana) which fall into the jars during their nocturnal movements.

Small pieces of wood, rigid cardboard etc. placed on the soil surface are used by caterpillars of Agrotis ypsilon as shelter during the day. The caterpillars can be collected and killed.

The four methods described above are suitable for use on small areas of crop.

Biological methods effective against insects

The use of disease-producing bacteria. Several species of bacterial have been used to produce disease in insects: the most widely used species is probably Bacillus thuringiensis which is effective against many Lepidopterous (and some dipterous) larvae. It is non-phytopathogenic, non-harmful to man and animals and relatively harmless to many insect parasites and predators. This rod-shaped, spore-forming bacterium forms a protein crystal at sporulation time: when ingested by the larva the protein is broken down by the alkaline juices in the gut of the insect, causing a paralysis and cessation of feeding. The spores may germinate, and the bacteria multiply. The spores and protein crystals are formulated and sold as a pesticide for spray application: this is compatible with a fairly wide range of fungicides and insecticides but not with alkaline materials. The bacteria do not appear to spread naturally, thus there is no contamination of the environment (The Pesticide Manual, 1983).

Results of several trials carried out at the CDH against Heliothis armigera, using several different formulations of Bacillus thuringiensis at up to 1500 g. product/ha applied weekly gave disappointing results (Collingwood et al, 1981). By contrast, against Plutella xylostella on cabbage, results were more satisfactory, although the net result was inferior to that obtained by using other pesticides, because other species of caterpillars, present along with the Plutella xylostella, were not controlled by the bacterial pesticide.

The use of fungi. Limited success has been achieved by using fungi of the genus Beauveria, (Deuteromycetes, Moniliales). Certain species of this fungus can sometimes be isolated from dead and dying insects: they act generally by penetration of the insect cuticle.

The use of virus diseases. The use of virus disease for insect control may understandably raise questions as to the possible dangers to man, animals and even plants, resulting from such a practice. However, of the numerous viruses attacking insects, those known as the Baculoviruses do not appear to have any connection with diseases of vertebrates or plants. Two groups within the Baculoviruses, the Nuclear polyhedrosis viruses, and the Granulosis viruses, include individual members which are active against Lepidoptera, including certain major economic plant pests: these viruses are fairly host-specific, and thus many useful insect parasites and predators remain unharmed when the viruses are applied to crops.

The viruses are formulated for spray application in a manner similar to chemical pesticides: several of these 'viral pesticides' are available commercially, for fairly specific usage.

'Biological control'. The term 'biological control' is used in the rather special sense signifying the use of parasites and predators for control of pests and diseases of plants. Naturally-occurring examples of biological control are not uncommon: at the CDH, for example, a hedge heavily parasitised by cottony cushion scale, Icerya purchasi, was completely cleared of the parasite by the natural intervention of a ladybird beetle, Rodolia sp., but not before the hedge had suffered noticeable damage. In another instance, 40% or more of the chrysalids of Plutella xylostella on a cabbage crop were found to be naturally parasitised by larvae of a small wasp, Apanteles litae var. opercullelae Nixon (Braconidae), but despite this high level of parasitisation, so rapid was the build-up of the pest that the crop was severely damaged. These two examples illustrate what can be a drawback of natural biologic control - it may be slow-acting.

Various techniques are used in the application of biological control. In the control of red spider mite of cucumbers and tomatoes in glasshouses, the predator (Phytoseiulus persimilis) is normally introduced once only, at the beginning of the season, and the red spider must be present throughout the rest of the growing season, albeit at a low level of population, otherwise the predator will die out. An alternative method, used in the field, is to introduce parasites or predators in fairly large numbers at regular intervals. This technique was adopted in Senegal, where eggs of Ephestia kuehniella parasitised by Trichogramma sp., and stuck to pieces of thin card, were introduced at a rate of 450 000 to 500 000 per hectare once per week in an effort to control Heliothis armigera. Control did not approach the level attained by the best of the chemical pesticides.

In the employment of biological control techniques, it is important that an active strain of the parasite or predator be used that will seek out its prey; it is also important to limit pesticide application when

biological control is being used - even certain fungicides may be inimical to predators. It is essential to have a detailed knowledge of the biology of the pest and its predator.

Use of sex pheromones. Sex-pheromones are chemicals which, when secreted by animals and released into the environment in minute quantities often exert an effect on animals of the opposite sex of the same species. Examples are the highly-specific sex-pheromones released by many female moth species to attract the males for mating. It is now possible to synthesize certain of these pheromones, and they have been employed in various ways to try and control certain pests. They are particularly useful in studies of population dynamics and have been used also as a means of reducing the population by luring the males into traps (mass trapping). In another technique, 'the confusion method', small fragments of pheromone-impregnated plastic are scattered in the crop to confuse the males and disrupt mating by saturating the atmosphere with pheromone, thereby negating its effect.

Non-Pesticidal Methods to Control Root-Knot Nematodes (*Meloidogyne* spp.)

Physical methods used against *Meloidogyne* spp.

Rotation. Reference to Table 3 shows that there are relatively few vegetable crops not attacked by *Meloidogyne* spp.: this limits the value of rotation and makes any benefits difficult to achieve. Onion is probably the most commonly grown of the resistant species, whilst *Amaranthus* and leeks are cultivated on a more limited scale. Both resistant and susceptible varieties of sweet potato and tomato occur. Cabbage, whilst more heavily attacked than onion appears, at least in Senegal, to be fairly tolerant.

Alternating onion, resistant sweet potato and resistant tomato varieties with susceptible plant species will help to reduce the nematode population in the soil. It may also be possible to introduce a non-susceptible, Gramineous crop such as Sorghum or maize into the rotation.

Care should be taken to use the resistant rotation crops with discretion, in order to prevent the build-up of other specific parasites, for example *Pyrenochaeta terrestris* on onion.

Flooding of cultivated land, such as occurs in the 'niayes' in certain African countries may reduce the population of *Meloidogyne* in the soil: in Senegal, however, this flooding has occurred but rarely during the last twelve years or so, and even when it did occur, sufficient *Meloidogyne* usually remained afterwards to cause heavy infection of subsequent vegetable crops.

Bare-fallowing during the dry season, provided that all weeds are eradicated as soon as they germinate, will reduce the population of *Meloidogyne*, though a proportion of the eggs may survive in the egg-masses.

Biological methods used against *Meloidogyne*

Resistant varieties. In some plant species, varieties exist which are resistant to *Meloidogyne*, for example the tomato, resistant varieties of which are designated 'N', 'VN', 'FN' or 'VFN' in seed catalogues.

Trap-crops. Certain plant species such as groundnut may act as a trap-crop: after penetrating into the roots of these plants, the young nematodes die, due to abnormal development, leading to a reduction of the population.

Table 3. Susceptibility of Vegetable and other Crops to Meloidogyne Attack (1)

Not Attacked	Seldom Attacked	Moderately Attacked	Heavily Attacked
Mint Strawberry ⁽²⁾	Garlic Leek Onion Sweet Potato (resistant cvs) Tomato (resistant cvs)	Amaranthus Bissap Cabbage Turnip Pepper (Hot) Pepper (Sweet) Roselle (<u>Hibiscus</u> <u>sabdariffa</u>)	Basil Carrot Courgette Eggplant Cucumber Indian Spinach (<u>Basella rubra</u>) Lettuce Melon Okra Parsley Potato Scarlet Eggplant (<u>Solanum aethiopicum</u>) Sweet Potato Tomato Watermelon
Citrus			Banana Baobab Guava Pawpaw

(1) List prepared in collaboration with Mr. Prot, Nematologist, O.R.S.T.O.M., Dakar, Senegal

(2) Meloidogyne javanica was occasionally observed by O.R.S.T.O.M.

Another crop - Digitaria exilis, known locally in Senegal as "Fonio" has given good results as a trap-crop.

Predacious fungi. The action of certain species of predacious fungi which trap nematodes in the soil has been known and studied for many years. At least one of these fungi, Arthrobotrys irregularis is available commercially as a mycelial culture for incorporation into the soil for control of Meloidogyne: it is recommended that this should be carried out at least one month before planting the crop. The success of the technique depends largely on how well the fungus is able to establish itself within the microflora of the soil. Such a technique must be carefully evaluated, locally, over a number of years before being generally adopted.

The incorporation of well-rotted organic manure into the soil is said to stimulate the plant and possibly alter the balance of micro-flora and fauna in the soil to the detriment of Meloidogyne.

Methods for Controlling Virus Diseases

The use of healthy, disease-free seed, or virus-free vegetative material (p. 167) is a basic requirement. Suitable virus-resistant cultivars should be used, if available.

Good cultural practices include the destruction of weeds which may act as alternative hosts to the virus and destruction of visibly-infected plants growing in the crop ('Rogueing').

Control of vector insects. One of the most widely-used and successful strategies is to locate the production of virus-free plant material in climatic areas where the environment is unfavourable for the insect vectors: seed potato production, for example, is often undertaken in areas where there is more or less continuous wind, which upsets the flight pattern of the aphid vectors of certain viruses. The use of insecticides may be successful if the virus is of the persistent type. Control of Tomato yellow leaf curl virus has also been achieved by spreading a straw mulch over the soil in the seedbed and the crop, leading to damage to the stylets of the vector, Bemisia tabaci. The use of reflective aluminium foil to repel aphids has been proposed with success in some instances, but is costly.

Some of the synthetic pyrethroids have an excitant effect on certain aphids and cause a proportion of them to fly off leaves before they have time to become infective or to transmit the virus, if already infective.

Methods of Possible Value for Controlling Mycoplasma-like Organisms

The application of insecticides to kill the vectors is a possible means of control. The selection and use of resistant crop cultivars is another possibility, whilst the taking of meristem cuttings may eliminate the pathogen. Application of tetracycline gives remission of symptoms during the course of the treatment, but is expensive and not recommended because of the dangers of phytotoxicity and of residues in edible crops.

2. USE OF PESTICIDES

When physical and biological methods of control are inadequate, recourse is usually made to the use of pesticides.

Pesticides are classed, first of all, according to their sphere of activity, the principal groups being acaricides, insecticides, fungicides, herbicides, nematocides and rodenticides.

Closer examination reveals a considerable diversity of action between the various products within each group. Insecticides, for example, may be stomach poisons (action following ingestion) or contact poisons, where action follows contact between the body of the insect and the insecticide. There is also another type of insecticide which inhibits the formation of the insects' cuticle. The insecticide may have a fumigant action, as is the case with several soil-insecticides, or it may have a repulsive action, repelling the insect and preventing or discouraging it from feeding. Whilst many insecticides remain on the surface of the plant after application, others are systemic, that is, they penetrate into the plant and may be carried around in the sap stream, with the advantage that the younger, newly developing tissue is protected from within, whilst the insecticide itself is protected from weathering. Systemic insecticides can thus exert a good effect against insects which suck plant sap, and at the same time preserve beneficial insects.

Most insecticides are based on synthetic inorganic and organic chemicals. However, various biological materials, both living (bacteria and fungi) and non-living (plant extracts) are currently used as insecticides.

Fungicides show a similar diversity of action and may kill the fungus and/or spores ('fungicidal') or may inhibit growth ('fungistatic'): other fungicides are 'genistatic', that is, they prevent spore formation. Biological fungicides, usually in the form of antagonistic fungi, are used in a limited number of situations for disease control. Fungicides may act as protectants, in which case they are applied to the plant before the onset of the fungal attack: or they may be curative, eradicating fungal organisms which are already present in the plant tissue. Other fungicides are sterilants, or fumigants, often used for treatment of soil or other 'non-plant' applications, because they may be phytotoxic.

Many of the new fungicidal materials are systemic, and move within the plant tissue, generally either in an ascending direction, or trans-laminar. However, not all systemic fungicides are curative in action.

Certain fungicides, particularly some of the copper-based products, show a marked bactericidal action, whilst others (including several of the sulphur-based products) have a useful acaricidal effect.

Spectrum of activity. Certain insecticides are described as 'wide spectrum', that is, they kill a very wide range of insects - a quality which may have undesirable consequences as it includes beneficial insects as well as insect pests: examples are DDT and dieldrin. At the other extreme, one finds products such as pirimicarb, which is used more or less as a specific for the control of aphids. In a similar fashion, there exist wide spectrum fungicides such as maneb, and more specific products such as metalaxyl and cyoxanil.

Toxicity of Pesticides

Pesticides, being designed to kill various types of organisms, are inherently toxic: they exhibit the following types of toxicity:

- a. Toxicity towards their target organism (insect, fungus, nematode, etc.). The effectiveness of the pesticide is directly linked to this type of toxicity.
- b. Phytotoxicity. Many pesticides are probably phytotoxic to some degree: this may be desirable, in the case of herbicides, but in other types of pesticide it may limit the usefulness of the product. Generally speaking, reputable makes of pesticide are not noticeably phytotoxic at recommended insecticidal and fungicidal concentrations. In some situations, inherent phytotoxicity can be circumvented; for example certain types of tar-oils and dinitro compounds can be used on fruit trees during the dormant season; whilst the use of phytotoxic nematicides and soil sterilants is permissible, providing that the application is made several weeks before planting, so that the phytotoxic vapour has completely disappeared by the time seeding or planting is carried out.
- c. Mammalian toxicity. The toxicity of certain pesticides to man can pose serious problems in relation to their manipulation: the danger may arise as a result of their high oral and/or dermal toxicity, or because the pesticide exists in a highly-toxic vapour phase (for example, methyl bromide).

Measurement of toxicity of pesticides. The measurement of toxicity to the target organisms is usually the subject of a comprehensive programme of trials by the manufacturers starting from small-scale tests at laboratory level up to field-scale trials under temperate and tropical conditions and extending over a number of seasons. During the course of these trials other factors such as phytotoxicity, and the ease of formulation and handling of the product will be evaluated. It is highly desirable also that the mammalian toxicity be evaluated, in order to establish whether the pesticide is potentially dangerous to the spray operative handling the material, and to the eventual consumers of the plant products on which the pesticide is sprayed. Some products have a higher dermal toxicity than oral toxicity and may be dangerous to handle, whilst others, in the form of a vapour, may pose a problem of inhalation toxicity.

Mammalian toxicity is estimated by feeding the test product to animals, often rats, in carefully controlled feeding trials designed to establish the quantity of active ingredient (a.i.) which causes the death of 50% of the test animals - the LD.50 (oral): this is expressed as the number of milligrams of active ingredient per kilogramme of animal body weight required to cause the above mortality rate. Thus, a product with an LD.50 of 100 mg/kg is ten times more toxic than a product with an LD.50 of 1000 mg/kg. A broad classification of hazard level for solid pesticides (oral toxicity) as proposed by WHO is:

Extremely hazardous	-	less than	5 mg/kg
Highly hazardous	-	" "	5 - 50 mg/kg
Moderately hazardous	-	" "	50 - 500 mg/kg
Slightly hazardous	-	more than	500 mg/kg

The LD.50 test is criticized because it is wasteful in its use of test animals and resources: because it causes unnecessary suffering to animals and because results often vary widely between test laboratories.

Many workers have questioned the legitimacy of extrapolating to man results which have been obtained on other animals. Current research is examining the possibilities of substituting animal cells or animal gut, or even tissue from human victims of fatal accidents, for living animals in pesticide toxicity tests.

Formulation: Examination of a list of commercial pesticides reveals many hundreds of names, and suggests a vast diversity of products. This situation becomes less overwhelming when it is realized that many of the names relate to the same basic product, i.e. the active ingredient of the pesticide. For example, 'maneb' is the active ingredient in at least twenty products, all bearing a different commercial name, but all based on the fungicide maneb. In addition, maneb is found as one of the active ingredients in over fifty other products containing more than one active ingredient: the active ingredient(s) in association with maneb may be fungicides, insecticides or both.

In most cases, the active ingredient in its pure form is not only unsuitable for use as a pesticide, but may be much too concentrated for the grower to measure out accurately, and too toxic to manipulate with safety: to make it convenient to handle and function correctly as a pesticide, the active ingredient is 'formulated' with other chemicals, which may be destined to dilute it to make it easier to handle (dilutents), to help it to stick more satisfactorily on leaves and stems (stickers), or to wet the surface of the plant (wettters), or to enable it to mix better with water (emulsifiers). The completed formulation may be presented for use by the grower in one of several forms:

- a. A 'wetable powder' (abbreviated to w.p.). In this type of formulation the active ingredient is insoluble in water: it is finely ground, and by the addition of appropriate wettters, stickers and other formulants it is made 'wetable', in which state it can be mixed with water: due to its fine state of division, it will remain in suspension, at least for a short period, in the sprayer-tank, though in many cases agitation is applied to the spray-liquid to improve and maintain suspension.
- b. Soluble powders, which dissolve completely in the spray-liquid. The disadvantages of (a) and (b) are that they are sometimes hygroscopic and thus liable to deteriorate in a humid climate and also some form of weighing device is required.
- c. Liquid formulations. These are frequently of the 'emulsifiable concentrate (E.C.) type, in which the active ingredient is dissolved in an organic solvent, and an emulsifier added to permit the product to be diluted with water to bring it to the correct concentration for application to the crop: these are relatively easy to measure out by volume. Another type of formulation which is semi-liquid or paste-like is, in fact, a thick suspension of the very finely-ground insoluble active ingredient. After shaking this suspension, the desired quantity of active ingredient can thus be measured out by volume. One disadvantage of this type of formulation is that certain products tend to settle in storage and may be impossible to re-suspend.
- d. Dusts. The finely-ground active ingredient is mixed and then ground with an inert filler or carrier, or impregnated on to the surface of a filler, so that it can be dusted on to the plant surface by means of an appropriate machine. Dusts may contain less than 5% of active ingredient, but in some instances, for example sulphur, the formulation may contain as much as 99% of the active principle. It is

important that dust formulations should flow freely inside the applicator, otherwise blockages may occur, resulting in irregular output. While dust formulations have the advantage that no water is involved in their dilution or application, they are less widely used than liquid sprays because they are easily removed from the foliage by rain, etc., added to which there may be handling hazards due to drift during application. Against this, dusts may be valuable in specific cases when, for example, it is required to carry out treatment in a seedbed without wetting plant foliage, to reduce the danger of spreading (bacterial) disease.

- e. Granules are small 'pellets' from 0.2-2 mm in diameter, made by impregnating an inert carrier with the active ingredient. They contain typically up to 5%, sometimes 10%, of the active ingredient, and generally offer a safe means of handling and applying toxic insecticides, soil sterilants, etc., and also virtually eliminate possible hazards due to drifting. Granules can be formulated either to break down quickly, or alternatively as slow-release pesticides, though under excessively dry soil conditions the availability of the active ingredient may be impaired. Granules should be free-flowing, dust-free and without any tendency to crack or break down.
- f. Seed dressing. These are special formulations of insecticides, fungicides or both which are applied to seeds to protect the young germinating plant from attacks by insects and fungi, or to protect the seeds themselves from attacks during storage. They are usually either special dust formulations with added sticker to enable the dust to adhere to the seeds, or liquid or 'slurry' formulations applied to the seeds at very low volume: they often incorporate a warning colour to indicate that the seed has been treated and is therefore unfit for human or animal consumption. Organo-mercurial products were widely used as seed-dressings at one time, and because of their slightly fumigant action were effective not only in destroying surface-borne spores, etc. but also in eradicating some of the less deeply-seated infections within the grain: however, mercury salts have to some extent been replaced by less toxic fungicides such as captan, captan, iprodione and thiram: and systemic fungicides such as carboxin and chloroneb. Of the insecticides, lindane is frequently used in seed-dressings and may be combined with a fungicide. Anthraquinone is incorporated into certain seed dressings as a repellent to birds.
- g. Baits. Certain insecticides, for example carbaryl, are formulated as baits, and applied to the soil surface to kill caterpillars of noctuid moths: alternatively, suitable baits can be prepared by the grower himself. Care should be taken to avoid using baits in the vicinity of villages or habitations, as there is a danger to poisoning domestic animals, fowls and game.

Difficulties and dangers in the use of pesticides

Danger to operators. The toxic nature of pesticides has prompted several countries to introduce legislation obliging spray operatives to wear prescribed clothing when handling certain pest-control products. Whilst this is possible in temperate climates, the high temperatures and humidities often encountered in the tropics and semi-tropics often precludes the wearing of any but the lightest clothing, whereas prescribed clothing for certain toxic products includes waterproof coats, respirators, rubber boots, etc.

A partial answer to this problem is to use only pesticides of low mammalian toxicity, and to wear, during all spraying operations, at least a lightweight jacket, a pair of lightweight trousers and rubber boots, plus rubber gloves when required. Unfortunately, even this minimum of protective clothing is beyond the resources of many farmers.

Another possibility is to organize a rotation of work for spray application, involving maybe three members of the family in a 'three days spraying, six days off' cycle.

Consumer protection. Given the toxic nature of many present-day pesticides, it is obvious that the consumer could be put at risk by eating vegetables contaminated by residues of these products. Several factors are important in determining this residue:

- a. The dosage of pesticide applied: the manufacturer's recommendation should always be followed, particularly in respect of maximum dose.
- b. The amount of weathering after application: sun, rain, humidity, irrigation, wind and abrasion will tend to reduce the residue.
- c. Culinary preparation: where vegetables, etc., are peeled before consumption, the amount of residue will tend to be reduced.
- d. The interval between application of the pesticide and harvesting. This is an important factor, and reference to pesticide manuals will show, for many of the more toxic pesticides, the number of days which should elapse between pesticide application and harvesting, i.e. the 'harvest delay'. Unfortunately, there is no international agreement on the extent of this delay and reference should be made to local regulations.

Several of the fungicides and some insecticides (certain of the newer pyrethroids, for example), have a 'zero or 1 day' harvest delay requirement. However, as a general principle, crops should be harvested as long as possible after pesticide application, to avoid unnecessary residues of any kind.

Destruction of insect parasites and predators. Insect parasites and predators play a useful role in maintaining certain potential pests at relatively low levels: this equilibrium can be upset by the excessive use of wide-spectrum insecticides. One way of reducing this danger is to attack the target organism with highly specific insecticides (which are relatively few in number); another method is to use soil-applied systemic insecticides in a granular form.

In any case, a thorough investigation of the life-cycle and population dynamics of the insect pests is essential, in order to ensure that valid decisions can be taken as to the correct timing of spray-applications hopefully leading to a reduction in the overall number required. In certain cases it may be found possible to delay the start of the insecticide campaign if initial damage is not excessive, in order to allow a certain build-up of parasites and predators. In certain historic cases, the decision has had to be taken to withdraw completely insecticide applications for a period in order to restore the parasite-predator/insect pest equilibrium.

Resistance to pesticides. Well-documented evidence is available showing the existence of numerous species of insects, fungi, spider mites and bacteria which have developed resistance to various pesticides. Several factors are considered to be necessary for resistance to occur, including:

- a. An insect pest or pathogen of which numerous generations are produced fairly rapidly, and whose population is not completely stable or uniform, genetically.
- b. A fairly prolonged exposure of the pathogen to the pesticide, in which case a selection pressure would be exerted on the pathogen, the most susceptible part of the population being killed, leaving the more resistant individuals as survivors. These resistant individuals, whose relative proportion might be expected to increase with each succeeding generation, may be kept in dominance only because of the selection pressure exerted by the pesticide, and might otherwise be 'unfit' or non-competitive.

Various strategies have been proposed to prevent or diminish the development of resistance to pesticides: these include:

- a. Alternation of pesticides in the spray-programme, the alternation entailing the use of two or more compounds having a different mode of action and acting on different 'sites' (i.e. biochemical functions) in the pathogen.
- b. The use of mixtures of fungicides, mixtures of insecticides, etc. In some cases, this is obligatory because, for example, certain 'site-specific' fungicides are commercialized only in mixtures with other fungicides of the 'multi-site' type.
- c. Reduction of exposure, that is restricting the use of the 'site-specific' material (either alone or in a mixture) to only part of the growing season of a crop.

Supply difficulties: The relatively limited size of many vegetable production projects, delays and difficulties in Customs and pesticides approval procedures and the cost of providing technical support, often discourage commercial organizations from attempting to import and sell pesticides. In countries where large-scale, government-sponsored crop production schemes exist, however, smaller enterprises may benefit from the spin-off from pesticides imported for use in the major schemes.

Lack of retail points within a country may also cause difficulties, representatives often being found only in fair-sized towns and consequently inaccessible to many rural growers.

Packaging. Standard packs of pesticides, often a minimum of 1 litre or 1 kg. may well exceed growers' requirements, and in many cases the cost will be beyond his financial means. Growers' cooperatives might help to overcome both supply and packaging difficulties by purchasing appropriate quantities of pesticides in standard packs for groups of growers.

Inadequate labelling and poor storage facilities are perennial problems. Labels are rarely comprehensible to the peasant farmer, and technical back-up by suitably trained local personnel is necessary for their interpretation. Facilities for storing pesticides in the home of the peasant farmer are invariably far from satisfactory, and here again, local technical officers must explain the potential hazards and suggest minimum precautions.

3. APPLICATION OF PESTICIDES

Numerous types of appliance are available for the application of pesticides to the plant or to plant products for post-harvest protection.

Soil-applied pesticides

Liquid nematicide is usually applied on small areas by means of a hand injector (Fig. 4. 1). The volume injected per stroke, and the depth of injection can be adjusted. At a dosage rate of 300 l/ha, with rows 30 cm apart and at 30 cm intervals in the rows, the volume injected per stroke should be approximately 2.7 ml (the calibration can be checked by measuring the output of say, 25 or 50 strokes of the pump). The depth of injection is usually 15 to 20 cm. The injection operation can be facilitated by indicating the proposed line of injection across the field by means of a thick cord marked at 30 cm intervals by means of paint spots. Holes made by the injector tube in the soil should be closed immediately. To avoid the too rapid loss of fumigant in hot conditions, treatment should not be carried out during the hottest part of the day. A water seal should also be maintained on the soil surface for 3 to 4 days after treatment by periodic light overhead watering.

The injector should be checked from time to time for correct functioning by placing the steel point on a stone on the soil surface, and gently pressing the striker button to ensure that liquid is emitted from all four exit-holes around the collar of the steel point. After use, a thin kerosene/oil mixture should be pumped through the machine to prevent corrosion of the valves, pistons, etc. The filter should always be maintained in place in the filler opening.

If an injector is not available, liquid nematicide can be applied in parallel furrows, about 15 cm deep and 30 cm apart, trickling the liquid directly into the base of the furrow from a small container, then closing the furrows immediately, compacting the soil slightly and moistening it, if necessary. When using the nematicide 'D-D' at a dosage rate of 300 l/ha, some 9-10 ml. will be required for each metre length of furrow.

For larger exploitations, injectors are available which can be mounted on a tractor, whilst others may be adapted for mounting on a tractor-drawn plough or cultivator.

At the CDH, treatment with D-D was usually carried out in late August/September when the rainy season was more or less finished: if D-D was applied at the beginning of the rainy season, difficulties were sometimes encountered in ridding the soil of D-D vapour.

At the time of carrying out the above treatment, the soil should be in a state equivalent to that prepared for seed-sowing - free from lumps and fairly moist. If necessary it should be well-irrigated a few days before the treatment. The soil should be well aerated about ten and fifteen days after the treatment, and an interval of three to four weeks or more should elapse before planting or sowing.

As a safeguard a 'cress-test' should be carried out to ensure that all the D-D vapour has disappeared: this is done by placing a representative sample (about 1 to 1½ kg) of the treated soil in an airtight (screw top) jar, sprinkling a small amount of cress seed on the surface, moistening if necessary then replacing the airtight lid. If the cress germinates satisfactorily after a few days it is an indication that the soil is free from D-D vapour. A 'control' jar of cress seed in untreated soil should be

set up at the same time, in case the cress is an old sample with a low germination capacity.

Liquid sterilants - Metham-sodium. This material is sometimes injected but gives good results if diluted in water and then applied to the soil surface, for example, by means of a watering can. The surface of the pre-moistened soil (see above) is raked over to break up any compaction, then marked out into areas of 2 sq.m., each of which is treated with 200-300 ml. of commercial metham-sodium diluted to 10 litres with water in a watering can: this is allowed to soak in for a few minutes and is then followed up by watering with 10 to 20 litres of water, to carry the metham-sodium down more deeply into the soil. The soil surface is then covered with clean plastic sheeting for six days or so, or a water-seal is maintained for a similar period. Subsequent treatment is the same as for D-D. Do not use brass, copper or zinc vessels when manipulating metham-sodium, and do not carry out the treatment in the hottest part of the day. Wear rubber boots and gloves when applying DD and metham-sodium.

Soil sterilants in powder form - Dazomet. This material is commercialized in the form of powder or very small granules. It should be evenly incorporated into the top 18 to 20 cm of previously finely-worked and moistened soil at a rate of about 50-60 g/sq.m. After treatment, a water-seal can be maintained or the soil surface covered with plastic sheeting for six days or so, after which the sheeting should be removed and the soil well worked to aerate it. Five to six weeks should elapse before sowing or planting, and as for the two previous treatments, the cress-test can be carried out as a check. Water the soil well before sowing or planting; Dazomet should only be used on light soils.

Granular pesticides - chlorpyrifos-ethyl, diazinon. On a small scale, these products can be spread by hand over a measured surface. The prepared land is measured out into blocks of say, 20 sq.m.: the product is measured out in aliquots each sufficient to treat 20 sq.m. of soil surface and subsequently incorporated into the top 12-15 cm of soil.

For the treatment of larger areas, knapsack-type applicators are available, some of these will also apply pesticides in dust form.

When handling and distributing granules, rubber boots plus rubber gloves which fit closely at the wrist should be worn, as should, for preference, a dust mask. Trousers should be worn on the outside of the rubber boots to prevent granules from falling down inside the boots. Gloves with open gauntlet tops should not be used.

APPLICATION OF PESTICIDES TO GROWING CROPS

The treatment of growing crops is effected either by spraying or dusting, spraying being the more widely used system.

There are various types of spraying machines: portable hand-operated knapsack sprayers and motor-driven, air-assisted models; tractor mounted hydraulic sprayers; battery-driven, spinning disc sprayers, and low-cost syringe-type sprayers. Hydraulic knapsack sprayers may be fitted either with piston pumps or diaphragm pumps (Figs. 4/2 and 4/3). Both types of pump work satisfactorily in practice, although the diaphragm pump takes rather longer to dismount for service. With both types of pump, there is an air-compression 'bell' or chamber to even out the pressure which is generated by pumping. A small supply of piston-pump washers should be kept on hand as these require changing periodically.

When spraying fully developed vegetable crops with a hand-operated knapsack sprayer, between 600 and 900 litres of spray liquid per ha per application will probably be required (up to 1 300 litres/ha for fully grown cucurbits), to ensure a thorough cover of both upper and lower leaf surfaces.

Tractor-mounted or tractor-trailed hydraulic sprayers exist in a great many types and capacities. The basic principle of operation is more or less the same as that for the hydraulic knapsack sprayer, but with a different type of pump and usually with a system of agitation in the reservoir which depends on the recirculation of a proportion of the liquid from the pump.

The height of the boom during spraying is important: the spray pattern from the nozzles is shaped like an inverted 'V', so that the spray from adjoining nozzles eventually overlaps. The spray-boom should be at a height such that the overlap point is a few centimetres above the top of the crop: if the boom is too low, the overlap point will be below the top of the crop, and some of the upper foliage will be left unprotected.

The capacity of tractor-mounted sprayers can be up to 750 litres or more, according to the weight and size of the tractor; wheeled sprayers are often very much larger. Application rate can be in the range of 250 to 450 litres per hectare. Some sprayers have a facility for cutting off the output to the spraybar and attaching instead one or more hand-lances for specialized spraying.

Nozzles. The object of passing spray-liquid through a nozzle is to break it up into fine droplets in order to distribute it more or less evenly over the leaf surface or other target: the size of these droplets varies widely according to the type of nozzle used, and may range from a diameter of less than 40 microns to over 200 microns. The very small droplets often float away in the air, evaporate and therefore never reach their target: conversely, the large droplets may coalesce, and run off the leaf on to a lower part of the plant, or on to the soil surface. Whereas droplets of less than 100 microns' diameter are generally regarded as suitable for control of fungi and insects, larger droplets of 200 microns' diameter or larger are generally recommended for herbicide application, in order to reduce drift. The discs which control the outputs of the nozzles should be examined periodically for wear, and compared against a new, unused sample. A small stock of replacement discs should be kept on hand.

Knapsack sprayers are sometimes fitted with a variable nozzle, by means of which the output can be varied from a wide cone to a long, narrow jet for spraying at a distance, or for tree-spraying, etc. Also widely used is the fan nozzle, the output of which is a thin, flat sheet of liquid: such nozzles when mounted on a spraybar are offset at a slight angle in relation to the spraybar, so that the spray from one nozzle does not touch (and break-up) that from the adjoining nozzle: a special spanner is usually supplied to ensure a correct setting angle.

In a third type of nozzle, known as an impact nozzle, the liquid comes out of a fairly large orifice and impacts onto a smooth, curved surface and is shattered into a sheet of uneven but rather large droplets. Such a nozzle is quite suitable for fitting to a hand-operated knapsack-sprayer for herbicide application, for which purpose fairly large droplets of over 200 μm are generally recommended in order to reduce dangers arising from drift. A well-known range of these nozzles is manufactured in plastic and colour-coded according to output.

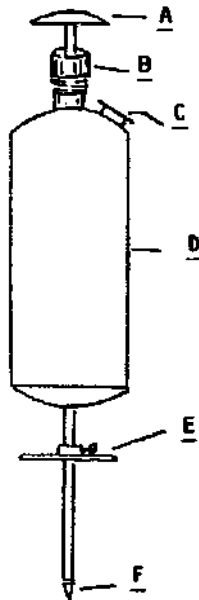

Fig. 4.1. Injector.

- A - Striker button
- B - Dosage regulator
- C - Filler cap
- D - Reservoir
- E - Depth regulator
- F - Steel point (renewable)

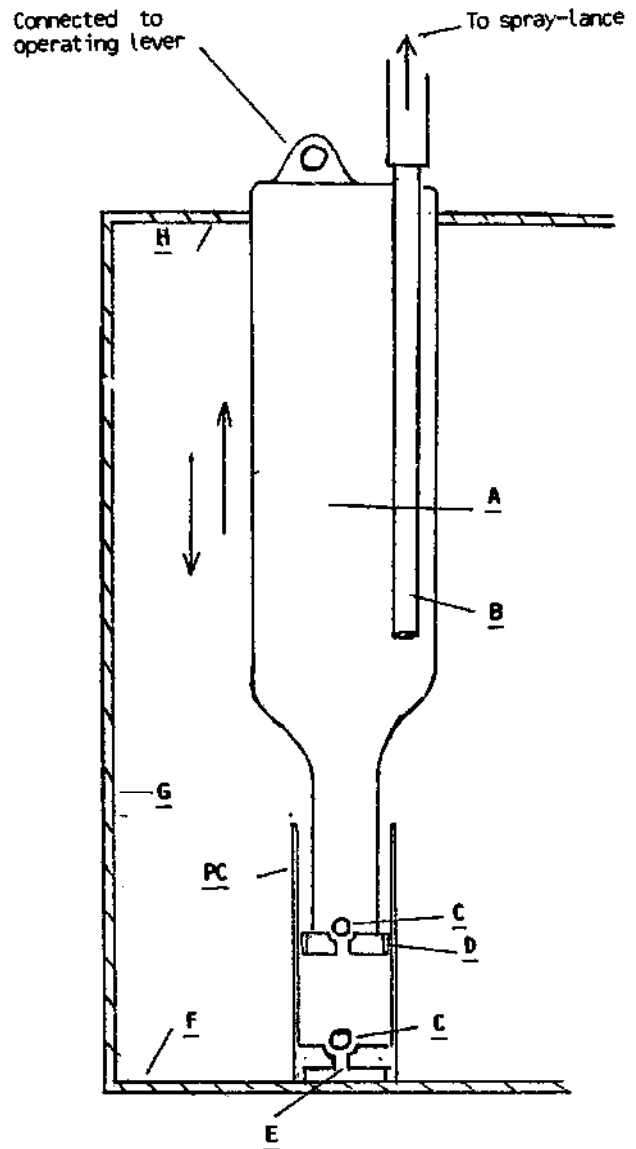

Fig. 4.2 Piston pump section

- A - Compression chamber
- B - Delivery tube
- C - Ball-valve
- D - Pump washer
- E - Inlet for liquid
- F - Sprayer base
- G - Side of reservoir
- H - Top of sprayer
- PC - Pump cylinder fixed to base of sprayer

Fig. 4. Injector and sprayers

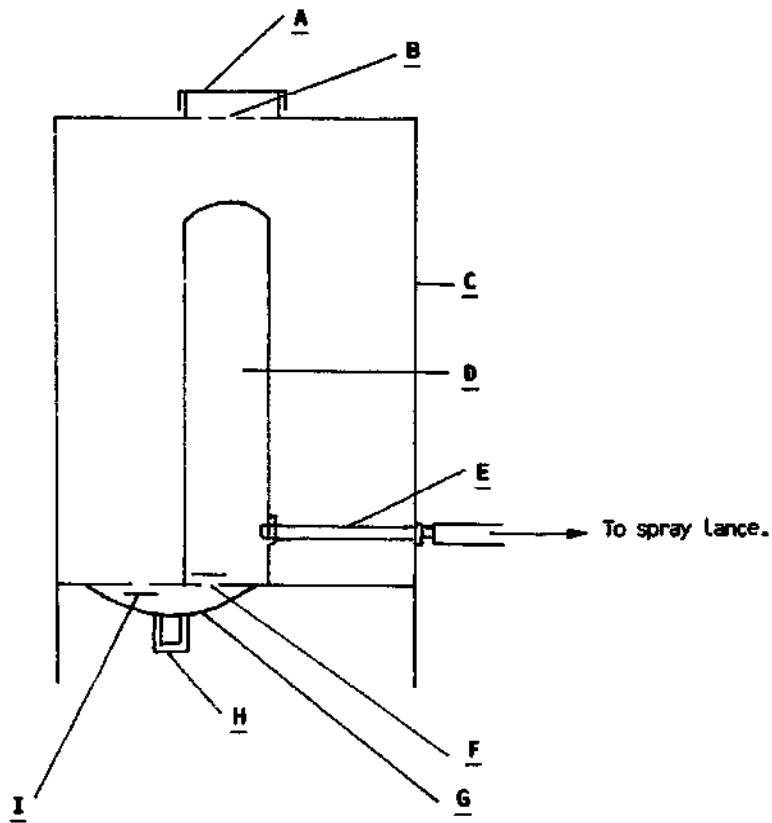

Fig. 4.3 Section through sprayer with Diaphragm pump.

- A - Cap
- B - Filter
- C - Reservoir
- D - Compression chamber
- E - Delivery tube
- F - Outlet valve
- G - Diaphragm
- H - Crank connected to operating lever
- I - Inlet valve

Motorised Knapsack Mistblowers: These portable machines are built around a small two-stroke engine of about 35 cc. (or larger) capacity which uses as fuel a petrol/oil mixture (ratio about 18:1 to 25:1), and is usually run at maximum speed (5000 rpm. or more) during spraying. This engine is directly coupled to a large, vertically-placed fan which drives large volumes of high-velocity air into a flexible, wide-bore horizontally-mounted rubber delivery hose. The spray liquid is contained in a horizontal, 10-litre (approx.) cylindrical reservoir mounted on top of the fan housing: the liquid is led from the reservoir via a small-bore flexible pipe, and is introduced into the high-velocity airstream near the open end of the wide-bore delivery hose, via a 'shear' nozzle: the large volume of air which blows directly over this nozzle shatters the liquid into droplets, which are carried out to the target in the airstream.

The flow of the liquid is assisted by having a slight positive pressure inside the reservoir: in some models this is effected by bubbling air into the reservoir via a short perforated tube, which has the secondary effect of agitating the liquid. To maintain this positive pressure in the reservoir, the lid must fit tightly over the filler-opening. The rate of flow of the liquid to the shear nozzle is controlled by a small, adjustable valve mounted externally on the delivery hose.

One advantage of a mistblower is that it can be used to apply pesticides at comparatively low volume: application-volumes of around 100 l/ha enables several types of pests to be satisfactorily controlled. Thus pesticide concentration in the reservoir of a mistblower may be eight or nine times more concentrated than that in a conventional knapsack sprayer, where the volume of pesticide/water mixture applied to a mature crop may be around 600 to 900 litres/ha.

When using a mistblower, the operator should walk along in the crop at a fairly slow pace with the motor running at full speed, manipulating the delivery hose gently in a lateral plane, or vertically, as required, so that the stream of droplets falls onto the crop foliage about two metres in front of him: spraying against the wind should not be attempted.

To stop the machine, the fuel should be turned off and the machine run until the carburettor is empty. This helps to avoid build-up of oil residues in the carburettor, which might make for difficult starting. Some makes of motorized knapsack mistblowers can be converted into dust or granule applicators and thus serve an additional role.

Spinning disc sprayers for Ultra-low volume (ULV) - application.

The spraying systems previously described use nozzles which produce droplets of varying size, including a fairly high proportion over 250 μm . in diameter, a situation which entails the use of relatively large volumes of water as a carrier. The spinning-disc sprayer is designed to overcome this situation by producing a large proportion of small droplets, generally ranging in size from about 70 μm to 90 μm diameter, thus permitting an adequate cover of the plant foliage to be obtained with volumes as low as 3 to 4 litres per hectare. With such small droplets and such a small volume, products for ULV application must be formulated in a carrier which resists evaporation and at the same time is non-phytotoxic; water is unsuitable.

The pressure element is lacking in this type of spraying, and the spray droplets are, in fact, carried along and distributed by air-currents. The desirable limits for wind speed are between 1.5 and 4 metres per second: the operator walks slowly (about 0.7 to 1 m per second) in a

direction more or less perpendicular to the direction of the wind, so that the droplet cloud will be blown away from his face and into the crop. Wind-speed can be measured by means of a small, hand-held anemometer, although, with practice, it is possible to judge whether wind-speed is suitable. If the intention is to adopt the ULV method as standard, some effort should be made, where possible, to plant the crop more or less perpendicular to the wind which is known to prevail at the period of the year when treatment is usually necessary.

The width of the crop which can be treated in one passage varies with the density of the crop and, to some extent, with the pest/active ingredient complex. At the CDH, for example, satisfactory control of Heliothis armigera on well developed tomatoes was achieved using cypermethrine, deltamethrine and fenvalerate at treatment widths of up to 3 m (i.e. two double rows of tomatoes). (Slight phytotoxicity noted with fenvalerate)

ULV formulations are normally sold 'ready for use' with the appropriate carrier already added, and it must not be overlooked that they are very concentrated, the four litres or so containing, in some cases, the same amount of active ingredient which would normally be applied in 700 or more litres in a conventional hydraulic knapsack sprayer. The sprayer must be carefully washed out after use, using a recommended solvent, otherwise the feed-tube and the disc notches may become blocked, a situation which would seriously impair droplet formation. It is also essential that the fine-bore air-bleed tube in the sprayer head is kept clean and open at all times. Intermittent treatment - 20 minutes spraying, followed by six or seven minutes during which the sprayer is switched off - will prolong battery life.

This spraying system has several advantages. The sprayer is light-weight, easy to manipulate, can be used in difficult locations and no water is required - a very important consideration in arid and semi-arid regions. Spraying can be carried out quickly (one hectare can be treated in about one-and-a-half to two hours), resulting in a saving of manpower and physical effort.

However, it seems that many pesticides may not lend themselves to ULV formulation and the number of products available is somewhat limited.

Certain makes of ULV machines are very fragile, the sprayer heads breaking off with great facility when the reservoir is removed or replaced. With such fine droplets there would appear to be potential dangers, both to the operators and the environment, especially when highly toxic active ingredients are used.

A current development attracting a great deal of attention is the possibility of imparting a positive charge to droplets, in order that they will be attracted by, and will adhere to plant foliage, which is naturally negatively charged; if this can be successfully accomplished it opens up the possibility of using very small droplets in the 50 um range, thereby reducing still further the volume of fluid used per hectare and, because of the improved distribution of the product on the plant foliage (both upper and lower leaf-surfaces) the possibility also of reducing the amount of active ingredient necessary for effective pest and pathogen control.

Double-acting syringes. These machines comprise a hand-held tube with a piston inside, and are amongst the simplest and cheapest of sprayers, being hand operated by a simple to-and-fro pumping action. The reservoir for the pesticide is separate - usually a bucket, and the liquid pesticide is transferred from the bucket to the sprayer via a rubber or plastic tube several meters long.

This type of sprayer is widely used in small farms in some areas, and has been successfully demonstrated for the control of certain insect pests of vegetables in Senegal.

Dust application: A variety of apparatus is available for dust application. The simplest is probably a hessian sack which is charged with the pesticide dust and is then simply held over the crop to be treated and the dust shaken out onto the foliage, sometimes assisted by 'beating' the sack lightly with a stick: this method is rather wasteful, and the operator's feet are usually heavily contaminated with dust in the process. Another simple piece of apparatus can be made by tying two layers of hessian over the open end of a tomato-paste or similar tin, having first half-filled the tin with the appropriate (low-toxicity) pesticidal dust: the dust is then shaken onto the plant foliage. It is not possible with either of the above methods to give any directional movement to the dust, most of which falls on the upper surface of the plant-foliage.

A slightly more sophisticated duster is in the form of a pair of bellows which are half-filled with dust, which is then puffed onto the foliage.

Various other small hand-operated dusters are available made in both metal and plastic and incorporating a rotary blower operated by a small crank handle: before purchasing a duster of this type it is important to make sure that the hopper contains a well-designed feed-mechanism/agitator to ensure a continuous output, without blocking or 'bridging' of the dust.

Already mentioned above are two further types of duster, the shoulder-mounted granule/dust distributor, and the motorised knapsack mistblower which can be converted for dust application.

Technique for herbicide application on onions using a hydraulic knapsack sprayer

This operation is carried out with the aid of an impact-type nozzle, mounted on an angled spray-lance. This nozzle produces a flat sheet of liquid in the form of an inverted 'V'. The width of this sheet of liquid (the swath width) as it hits the ground is controlled by the height of the nozzle above the ground: the higher the nozzle the wider the swath-width.

Suppose that the width of the onion bed is 1 metre, with 25cm pathways between beds. An impact nozzle capable of covering this width was selected, and by experiment it was found that with pumping at a pressure of approximately 1 kg/cm² a swath-width of 1.25m was obtained with the nozzle held 25 cm above the ground. The measured output of the nozzle at this pressure (measured into a large bucket) was approximately 2.4 l/min.

Thus, one has:

- pumping pressure	1 kg/cm ²
- output of nozzle	2.4 l/min.
- desired volume of application	600 l/ha

Therefore, area sprayable per minute is $(2.4 \div 600) \times 10\,000 \text{ m}^2 = 40 \text{ m}^2$: with a spray-width of 1.25m the operator will have to walk $(40 \div 1.25) = 32$ metres in 1 minute. The following points must be observed:

- a. The herbicide is added at the appropriate concentration (a dosage rate of 12 kg product/ha requires 400g/20 l.)
- b. The nozzle is fitted as shown in Fig. 5 and must be maintained at the correct height above the ground during spraying: this can be assured by fixing to the nozzle a piece of string of appropriate length (for the above example, 25 cm long), weighted down with a small metal bolt which is just allowed to touch the soil-surface during spraying.
- c. The operator must practise beforehand to achieve the correct walking speed (timing with a watch is necessary at first: small steps improve accuracy and stability when carrying a full sprayer). He must also achieve the correct pumping technique to provide the desired regular output: this latter can be facilitated by fitting a small pressure-gauge to the hand-lance, or setting the pump on the knapsack sprayer to an operating pressure of 1 kg/cm^2 .

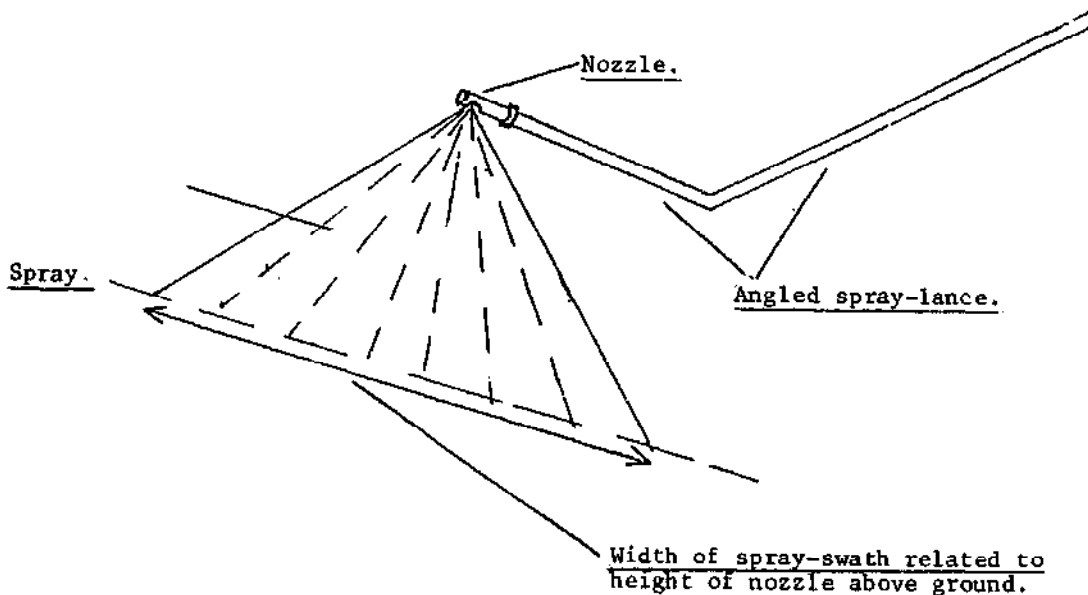

Fig. 5 : Herbicide application using Impact nozzle

Timing of Pesticide Applications

For many pest and disease control programmes the 'insurance policy concept' is adopted, whereby protective spraying is carried out at regular (often weekly) intervals over the period of the growing season when the pathogen or insect-pest is likely to be troublesome. This approach is often wasteful in time and material, may increase selection-pressure by prolonging the period of exposure to pesticides, and may increase the danger of killing beneficial insects: in certain situations, however, it may be the only system which is practicable.

This system can sometimes be refined to some extent by delaying insecticide spraying until the first insect-pests are seen on the foliage: similarly, with the advent of curative fungicides it is now possible with some diseases to wait until the first disease-symptoms are present on the foliage before spraying. Such an approach requires close monitoring.

It might be possible to retard even further the start of spraying operations if more information is available concerning the economic threshold level (the level of pest population at which control measures should be instituted to prevent the population building-up to a level causing economic damage to the crop - Sterr. et al): this might relate, for example to the number of insects per leaf on the two topmost leaves, or perhaps the number of moths of a particular species caught in a 24-hour period in a pheromone trap: on the other hand it may relate to a certain level of damage in the crop.

With a pest such as *Heliothis armigera* on tomatoes, the approach may be different: the young larvae penetrate into tomato fruits two or three days after hatching, and once inside the fruits are more or less protected from subsequent insecticide-sprays: thus, it might be decided that only a zero larval presence is permissible, and to start spraying operations as soon as *Heliothis* eggs are found on the tomato foliage.

The 'economic threshold level' may be difficult to interpret, due to factors similar to those described in determining qualitative losses (p. 159) and it is not possible to predict what total cash return will be obtained for the crop. In addition, where damage is caused to plant foliage, the potential loss is partially mitigated by the adjoining plants and leaves which compensate to some extent by increased growth: in early stages of insect attacks there may be less pressure to start insecticidal treatment if the attack is confined to parts of the plant which are not commercialized.

Many insect larvae are more susceptible to insecticides when they are young, thus, spraying at an early instar stage, when possible, should give a better kill.

It has been mentioned above that, if applying a protective fungicide for disease-control, it is usual to spray before the appearance of the first symptoms. In recommendations for spraying potatoes against blight (*Phytophthora infestans*) Gair and Humphreys-Jones (1983) introduce a degree of precision. They distinguish between 'high risk' and 'low-risk' areas: in high-risk areas, using metalaxyl-mancozeb mixtures the first application is made before the potato-haulm meets across the rows, whilst in low-risk areas the fungicide is not applied until the first blight-infection-period warning is issued (see below). In both areas the final spray should be made with a conventional protectant fungicide. An intensive potato-growing area, where blight-susceptible potato cultivars predominate, is likely to be a high-risk area. Whilst potato blight may not be a general disease problem

in the arid and semi-arid areas, the general principles of this approach to spray-timing can be applied to certain of the crop disease complexes found in the region.

A limit is eventually reached when it becomes uneconomic to continue to spray a crop: this may be because the crop is reaching maturity and consequently the rate of yield-increase is declining, or, in the case of a foliage disease, when the disease becomes fairly widely established throughout the crop.

To carry out assessments to aid in decision-making for spraying involves inspection and sampling in the crop. The whole crop must be covered during inspection, as frequently there are parts of the field where the micro-climate is more conducive to disease-development and which may contain primary foci. Sampling plans must be adequate, but not too complex and they also should cover the entire crop, which might, for example be divided up into several parts, with 5 plants from each of 2 'stations' sampled in each part; records of each pest and disease should be made, with a note of their stage of development and if required, the number of relevant insect-pests per plant.

In sampling fields for tomato-pests, one authority (Int. P.M. Project 1982) recommends at least weekly visits throughout the entire season, increasing the frequency of visits and the number of sampling stations when infestations are approaching a damaging level, and during periods when damaging populations are known to occur: both visual searches and 'beating' (shaking the insects off the plant onto a tray or sheet below) are employed. Fruit sampling should be added to the monitoring technique when green fruit develops on the plants.

Decision-making on the timing of spray-applications might be aided by two types of information - the forecasting of likely outbreaks of plant diseases, and early indications of the presence of certain insect pests in the crop.

Plant disease forecasting is based on the premise that disease outbreaks might be expected consequent upon the occurrence of certain weather conditions: forecasting thus demands a detailed knowledge of disease development in relation to temperature, humidity etc. and must also take into account local factors such as altitude, the intensity of production of the crop in question, the relative proportion of disease-susceptible varieties being grown, the stage of crop development, etc. With any warning system, the warnings should be communicated to the grower several days before disease-outbreaks are likely to occur, and today, even in remote communities it is possible to achieve this by radio.

Before the forecasting of a disease is undertaken, observations and 'trial runs' of a system are carried out over a number of years; with existing systems, criteria are constantly being updated and the systems refined. Amongst diseases of vegetables, potato blight (Phytophthora infestans) is the subject of disease forecasting in numerous countries, and to a lesser degree, downy mildew of cucumbers and melons (Pseudoperonospora cubensis).

The capture of insects by means of various types of suction traps and light-traps has been carried out over a number of decades: within the last few years, however, the synthesis of sex pheromones of numerous insect pests (e.g. Heliothis armigera, Spodoptera littoralis, Cryptophlebia leucotreta) has been accomplished, and these materials can be used to lure the male insects into simple traps - sticky traps, where the insect is captured when it sticks to a glued surface, or a water-trap, where it is

drowned in water. In each case, the pheromone is either contained in, or impregnated into the walls of a small plastic/cellulose capsule from which it diffuses continuously into the atmosphere at an intensity approaching that of a virgin female of the insect species. Pheromones have the great advantage of being specific in action, and pheromone traps are sensitive to low densities of insects. Such traps can be used as 'early warning indicators' of the presence of specific insect pests, and in addition might be used to give an indication as to when to commence spraying operations (when, for example, a certain number of moths, determined by experience, has been caught in a period of, say, 24 hours).

Other types of insects - aphids, *Dacus* spp. *Bemisia tabaci*, for example - are attracted to yellow-coloured surfaces (in some cases, the shade of yellow is highly critical) and may be captured by coating the yellow surface with glue (*Dacus*, *Bemisia*) or by filling yellow plastic saucers with water plus a drop of wetting agent (aphids).

4. INTEGRATED CONTROL

It is obvious from the foregoing that a large and varied selection of measures is available to control pests and pathogens, and that, in any case, too much reliance on any one method may have its dangers (resistance to pesticides, re-contamination of 'sterilised' soil, destruction of predators, etc.). It would seem that the most effective approach would be to use several methods at the same time: such an approach is known as 'integrated control'. At its most complex, such a programme might be dealing with the simultaneous control of several pests and pathogens, and care must be taken that all the different methods are compatible, and do not introduce unwanted side-effects. Again, if moving production of a crop to a new region to find an environment of unfavourable for a pathogen, one must be sure that the new environment does not have an equally adverse effect on the host plant. Similarly, 'rotation crops' should be used with prudence - excessive growing of onions in a rotation to reduce the population of *Meloidogyne* might lead to an undesirable build-up of inoculum of *Pyrenochaeta terrestris* in the soil.

REFERENCES

- APPERT, J. Les insectes nuisibles aux cultures maraichères au
1976 Sénégal. Dakar, 86 pp.
- BARNETT, H.L., HUNTER, BARRY B. Illustrated genera of imperfect fungi.
1972 3rd Ed. Burgess Pub. Co. SBN-8087-0266-1
- BOURDOUXHE, L. Dynamique des populations de quelques ravageurs importantes
1983 des cultures maraichères du Sénégal. Agronomie Tropicale
38 (2) 132-149.
- BRADBURY, J.F. Isolation and preliminary study of bacteria from plants.
1970 Rev. Plant Path., 49 (5) 213-218.
- BRIDGE, J., MULLER, R. Role of nematodes as constraints to agricultural
1984 development in Africa. In Hawksworth, D.L. (Ed.),
Advancing agricultural production in Africa. CAB,
Reading, UK. 454 pp.
- CAYROL, R.A. Spodoptera littoralis (Boisd) et Scotia ipsilon (Hfn).
1972 In Balachowsky, A.S. Tradite d'entomologie appliqué
à l'agriculture. Paris, Masson. Tome II, Vol. 2,
p. 1141-1423, 1292-1303.
- CHUPP, C., SHERF, A.F. Vegetable diseases and their control. John Wiley
1960 & Sons, ISBN 0-471-06807-1.
- COLLINGWOOD, E.F., BOURDOUXHE, L., DIOUF, M. Rapport des essais insecticides
1981 1980-1981. CDH, Cambérène, Dakar.
- COLLINGWOOD, E.F., DEFRANCO, M. Fusarium oxysporum f.sp. Lycopersici patho-
1979 type 2 on tomato in Senegal. FAO Plant Protection Bulletin
27, 22-23.
- COLLINGWOOD, E.F. et al. Rapport des essais fongicides et namaticides.
1975 CDH, Cambérène, Dakar.
- CRAMER, H.H. Plant protection and world crop production. Pub. Bayer AG,
1967 Leverkusen.
- DAVIS, J.R., SORENSEN, L.H. Carry-over effects of plastic tarping on
1983 Verticillium wilt of potato. 4th International Congress
of Plant Pathology, Melbourne. Abstract No. 627.
- DICKINSON, C.H., LUCAS, J.A. Plant pathology and plant pathogens.
1982 2nd Ed., Blackwell Scientific Publications. ISBN 0-632-00918-7.

- GAIR, R., HUMPHREYS-JONES, D.R. Pests and diseases of potatoes. In Scopes, N. 1983 Ledieu, M. (Eds.) Pest and disease control handbook, p. 189-224. ISBN 0-901436-78-X.
- INT. P.M. PROJECT Integrated pest management for tomatoes. Univ. of 1982 California, Agric. Science Pub. No. 3274. ISBN 0-931876-56-7.
- KATAN, J. Solar pasteurization of soils for disease control: status 1980 and prospects. *Plant Disease*, 64 (5) 450-454.
- LORENZ, O.A., MAYNARD, D.N. Knott's Handbook for vegetable growers. 2nd Ed. 1980 Pub. Wiley Interscience. ISBN 0-471-05322-8.
- MESSIAEN, C.M. Le potager tropical. ISBN 2-85319-008-8. 1974
- NELSON, L.B. (Ed.) Changing patterns in fertilizer usage. Soil Science 1968 Soc. of America. Madison. (Illustrated in Lorenz, O.A. and Maynard, D.N., 1980, Knott's Handbook for vegetable growers).
- O'DELL, C.R. Plant tissue analysis - a diagnostic tool to increase 1981 the yields of vegetable crops. *The Vegetable Growers News*, 36, 2-3. Virginia Truck & Ornamentals Research Station, Virginia Beach, VA 23455.
- ROBINSON, R.A. Vertical resistance. *Rev. Plant Path.*, 50 (5) 233-239. 1971
- ROTEM, J., PALTI, J. Irrigation and plant diseases. *Ann. Rev. Plant Path.*, 1969 267-288.
- RUDD-JONES, D., DOWSON, W.J. On the bacteria responsible for soft-rot in 1950 stored potatoes and the reaction of the tuber to invasion by Bacterium carotovorum (Jones). Lehman and Neuman. *Ann. Appl. Biol.*, 37 (4) 563-569.
- TAYLOR, A.L. Introduction to research on plant nematology. FAO, Rome. 1967
- THE PESTICIDE MANUAL. 7th Ed. ISBN 0-901436-77-1. Pub. The British Crop 1983 Protection Council.
- VERCAMBRE, B. Etudes réalisées à la Réunion sur la mouche maraîchère 1980 Liriomyza trifolii Burgess. *Rev. Agr. et Suc. de l'Ile Maurice*, 59, 147-157.
- WILLIAMS, P.H. Black rot: a continuing threat to world crucifers. *Plant 1980 Disease*, 64, 736-742.

CHAPTER V

SOME SPECIFIC PROBLEMS OF IRRIGATED VEGETABLE CROPS

by E.F. Collingwood , L. Bourdouxhe, M. D'Hondt

In the following pages, certain problems of vegetable crops are described, as well as methods for their control. Where possible, an indication is given of geographical distribution within the region: this information is taken from various sources but principally from the distribution maps prepared by the Commonwealth Mycological Institute and the Commonwealth Institute of Entomology in England. The abbreviations used to indicate names of countries are as follows:

AL = Algeria, An = Angola, B = Botswana, C = Cameroon,
Ch = Chad, E = Ethiopia, K = Kenya, Md = Madagascar,
Ml = Mali, Mu = Mauritania Na = Nigeria, Nb = Namibia,
Ni = Niger, Se = Senegal, So = Somalia, Su = Sudan,
U = Burkina Faso (ex-Upper Volta).

The relative economic importance of all the various problems in all of these countries is not known: however, to act as a guide, this information is supplied in respect of Senegal, where it applies principally to the Cap Vert region; symbols used are as follows:

+ = of little importance; ++ = moderately important; +++ = very important.

The addition of a symbol in parentheses indicates that from time to time the problem may be of greater than normal importance; for example, ++(+) indicates that a problem is moderately important but that it can occasionally be very important.

Several symptoms of pest and disease damage on plants are illustrated in this publication: for further illustrations, likewise in colour, see Collingwood, Bourdouxhe and Defrancq, 1984, 2nd Ed.

Whilst every care has been taken to ensure that control measures described in this Chapter are correct, in view of the very diverse conditions of climate, usage, etc., the authors/publishers cannot accept responsibility for any untoward results, loss, damage, accident, etc., arising from the use of the methods described.

The correct identification of an insect, fungus, nematode, etc., can be very difficult, and is often only satisfactorily carried out by a specialist, possibly at an Institute offering an identification service, such as the two Commonwealth Institutes mentioned above.

When an unfamiliar fungal or other organism is isolated from a diseased plant, it may be necessary, in order to prove that it is responsible for causing the disease, to inoculate similar plants with the organism, reproduce the disease symptoms and then re-isolate the same organism again, in order to satisfy Koch's postulates.

A. PROBLEMS COMMON TO SEVERAL CROPS

1. INSECT PESTS

Aphids (*Aphis gossypii*, *Myzus persicae*.) (Homoptera, Aphididae). These small insects are often globular in form, and exist generally in large colonies on the underside of leaves, on young shoots and on flower buds. The abdomen of the insect carries a pair of 'cornicules' - protruding tubes of which the form and size vary according to the species. The colour of the insect, likewise, can vary markedly according to the species and the stage of development, and can be ashy-grey, black, brown, green or yellow. Most of the aphids are without wings (apterous), but have winged generations at certain times in their development cycle. Aphids can colonise a crop within several days, usually attacking young tissue: they are sucking insects and, following their attacks, the young terminal leaves become distorted and shrivel up, leading to a growth check and reduction in the number and quality of fruits. Further damage may be caused by the development of sooty moulds on the leaf surface, following the production of sugary honeydew by the aphids. In addition to the above, aphids are notorious as vectors of many different virus diseases. In Senegal, they are particularly abundant from mid-March until about June. Several predators of aphids (Coccinellidae) have been noted in Senegal (Bourdouxhe, 1983).

Control. Spray the crop when leaf damage and colonies of aphids are noted, using acephate, dimethoate, endosulfan, malathion or pirimicarb; repeat the treatment if necessary. Pirimicarb is an aphicide and will not destroy useful predators and parasites.

Grasshoppers (*Pyrgomorpha* sp., *Oedaleus* sp. (Orthoptera). These insects have hind legs strongly developed for jumping: they are solitary, unlike the locusts which undergo periodical swarm phases. Their populations become important during the wet season. They can cause heavy damage to plants in seed-beds and to new transplants which they cut off at soil level. They will attack all species of vegetables.

Control. The most simple way to control these insects is to spread poison baits (see p.179) around the seed-beds, between the lines of seedlings or around transplants. Another method claimed to be effective is to dust the soil surface with 1% or 2% propoxur at a rate of 20 to 50 kg of commercial product per hectare. These treatments should be carried out in late afternoon or evening.

Leaf miner (*Liriomyza trifolii*) (Diptera, Agromyzidae)

Hosts: This small fly was first recorded in West Africa (Senegal) in 1980 (Bourdouxhe, 1982b) where it caused severe damage to dwarf beans, okra, potato, scarlet egg-plant (*Solanum aethiopicum*), tomato, *Vigna unguiculata* and watermelon.

Description: Eggs are laid in the leaf tissue. The larvae are about 1 to 1.5 mm long and feed on the leaves, in which they cause sinuous mines or galleries of progressively increasing diameter: in the case of high populations of larvae, this results in the drying out and death of the leaves. The adult fly is 1.4 to 2.3 mm long, blackish in colour with yellow markings around the eyes and on the antennae, the thorax and the abdomen. Active during the day, the female contributes substantially to the damage by puncturing the leaves at many points during feeding.

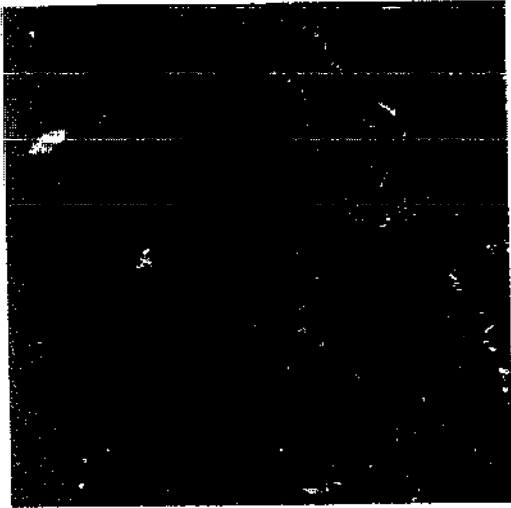

Liriomyza trifolii



Zonocerus variegatus

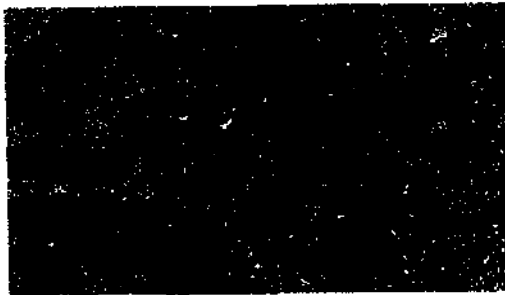

Aphis gossypii

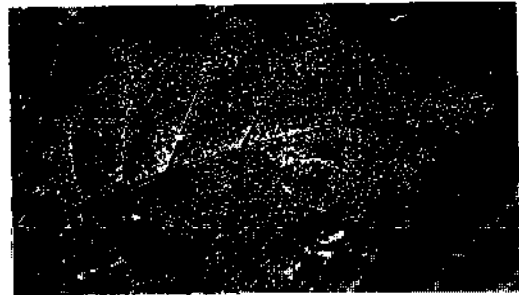

Tetranychus urticae

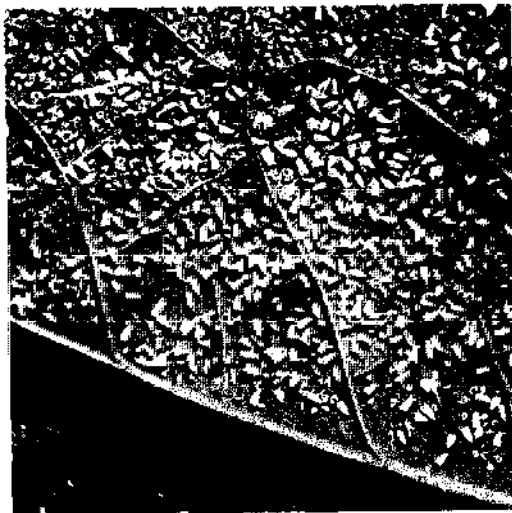

White fly

Fig.1 - Some pests which attack varied vegetable crops.

Control. Efforts to control this insect with pyrethroids, acephate or dimethoate appeared to make the situation worse, presumably by killing off the natural parasites, of which several species exist in Senegal and effectively parasitise 50% or more of the larvae. The population of *L. trifolii* built up to a maximum towards the end of May 1981, then diminished during the hot, wet season. During the year 1981-1982, the level of attack was less intense.

In a concept of integrated control, the search for tolerant cultivars, a study of the effect of different modes of irrigation and the use of biological insecticides should hopefully lead to an improvement in the situation created by the arrival of this new and potentially serious pest.

Mirids (*Halticus tibialis*) (Heteroptera, Miridae). This small, shiny black insect is a little more than 1.5 mm long: its hind legs are adapted for jumping. Adults and nymphs, by repeatedly piercing the foliage during feeding cause the enfeeblement of the plant and the appearance on the foliage of small, discoloured points. The insect is polyphagous and attacks dwarf bean, melon, potato, etc. Control is by the application of dimethoate.

Termites (Isoptera). These insects live in communities, which contain workers, soldiers and a queen: some species live in wood, some are subterranean, whilst others build the familiar 'termite mounds'. Termites sporadically cause damage to vegetable crops by attacking plants below soil level, causing yellowing of the plants and ultimately, collapse of the stems.

Control. To reduce the possibility of termite attacks, decomposing vegetable matter should be removed from the cultivated area. The application to the soil of chlordane, in countries where this product is authorized, can be effective in controlling these insects.

White-flies (Homoptera, Aleyrodidae). The adults are about 1 mm long, are rather moth-like in appearance with rather waxy wings: they are found generally on the underside of the leaves and are very active, quickly flying off when the plant foliage is disturbed but settling fairly quickly again nearby. By contrast, the nymphs, about 0.6 mm long and resembling scales, are fixed to the lower surface of the leaf and remain immobile.

Both adults and nymphs suck the sap from leaves and enfeeble the plant: both stages secrete honeydew, and attack cucurbits, dwarf beans, egg-plants, potato, sweet potato and tomato. These insects are additionally dangerous in that they transmit certain damaging virus diseases to several vegetable crop species.

Control. Treatment with acephate and dimethoate has given fairly good control, at least of the white-fly species *Bemisia tabaci* (see p.260). The lower surface of the leaf must receive particular attention.

2. SPIDER MITES

Tetranychus spp. (Acarina, Tetranychidae)

These small organisms inhabit the lower surface of leaves, and cause damage by making large numbers of minute punctures in the leaf and sucking out the sap: attacked leaves often have a silvery, 'peppered' appearance, particularly along the veins. The adults, about 0.5 mm long and just visible to the naked eye (p.150) are protected by the fine webs which they spin on the

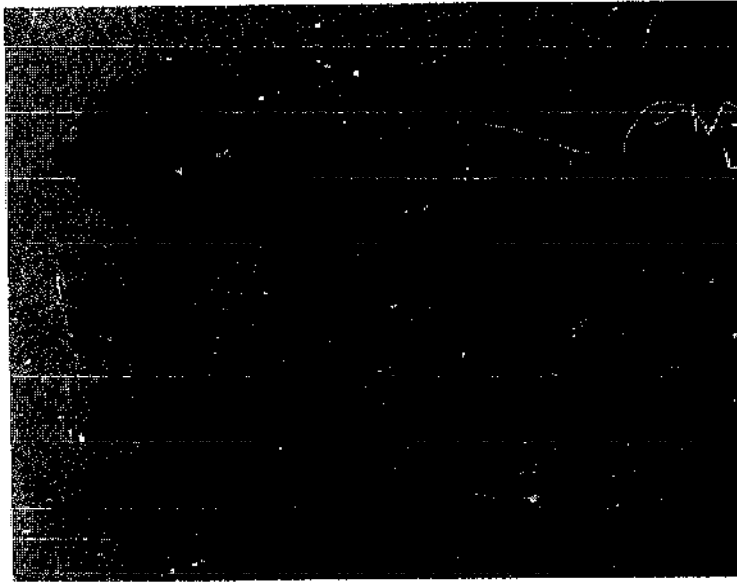

NEMATODE: on roots.
Meloidogyne

on potato tubers

Fig.2 - Examples of the effects of attacks of the nematode Meloidogyne.



Courgette



Potato

Fig.3 - Examples of the effects of sun burn and desert wind (Harmattan).

leaf surface. Crops most heavily attacked include dwarf beans, egg-plant and Solanum aethiopicum.

Control. Numerous acaricides exist, of which dicofol is active against eggs, larvae and adults: dimethoate also has an acaricidal effect, but its prolonged use may have an adverse effect on the natural predators of Tetranychus. Some new pyrethroids, at present under development, show very promising acaricidal action.

3. NEMATODES

The root knot nematodes, Meloidogyne spp., are truly polyphagous and attack a wide range of plant species. They have already been described on page 156.

4. DAMPING OFF

This is a widespread disorder which principally affects either germinating seeds (pre-emergence damping off) or young seedlings (post-emergence damping off). In either case, the causal organisms are soil-borne fungi, two of the most frequently implicated being Pythium aphanidermatum and Rhizoctonia solani. In addition, various species of Phytophthora cause damping off.

Symptoms: In pre-emergence damping off, the seeds fail to germinate, either because the seed itself has rotted away, or else because the young germ has been destroyed. In the post-emergence phase of the disease, the stem of the young seedling is attacked near or just below soil level, and the seedling usually collapses.

Pathogens: (a) Pythium aphanidermatum. (Phycomycetes, Peronosporales): Mycelium coenocytic, white; hyphae up to 7.5 μ m diameter. Zoosporangia with several lobes develop from hyphae and give rise to zoospores; oogonia up to 30 μ m diameter, antheridia 11 x 13 μ m. Optimum temperature for growth above 30°C, maximum 46°C. Zoosporangia will often be produced if a piece of suspect infected tissue is placed in water for 24 hours. Pythium butleri is generally larger and more robust, with more copious mycelium.

(b) Rhizoctonia solani is the non-sporing mycelial stage of the basidiomycete Thanatephorus cucumeris (also known as Corticium solani). The hyphae are robust, up to 12 μ m diameter, often coloured brownish-pink in host tissue and in culture. Hyphal branches bear a constriction at, and are cut off by septa, near to their point of origin.

Control.

(a) Cultural. Faulty cultural conditions such as dense seeding/overcrowding and overwatering in the seedbed often favour the development of damping off as may, in the case of Rhizoctonia solani, an erratic watering regime. Sowing too soon after the end of the hot, wet season when the soil temperature may be considerably above the optimum for germination and plant growth has led to heavy losses in certain crops. These cultural faults should be avoided, as should the application of large amounts of nitrogenous fertilizers.

(b) Chemical. Against Pythium spp., treatment of certain species of seeds with fungicides such as captan, drazoxolon and thiram will give protection: whilst drenching the soil around young plants with low concentrations of copper oxychloride or zineb (beware copper- or zinc-sensitive plants) or with propamocarb, is another method of protection.

In preliminary trials, the application of metalaxyl either to the soil, pre-sowing (2000 g active ingredient/ha) or foliar applications on seedling plants (5 x 250 g active ingredient/ha at five-day intervals) effectively reduced losses of tomato seedlings due to Pythium spp. (Defrancq et al., 1982).

Against Rhizoctonia solani, quintozone (= PCNB) (following crops should not include Cucurbitaceae) and a newer material, tolclofos-methyl, are both active, whilst the use of the systemic fungicide chloroneb as a seed dressing is said to give protection against this fungus.

The above chemicals are not universally applicable to all crops in all circumstances, and the manufacturers' recommendations should be closely followed.

5. VERTEBRATES

Birds and rats can cause quite substantial damage to growing crops.

Birds often attack ripening fruit such as tomatoes which have turned red, and they may also uproot young transplants in their search for grubs and insects. They may be attracted to the site in dry weather by pools of water left after irrigation. The surest way to prevent bird damage is by the physical presence of someone, walking the crops and making a noise by shaking stones in a tin, for example, at irregular intervals. Damage to tomatoes can be reduced by harvesting before the fruit turns red.

Rats can cause various types of damage, and are adept amongst other things, at uprooting potato tubers. Various anti-coagulants are available for the preparation of baits, or ready prepared baits in the form of small tablets, treated grain, etc., can be purchased. Rats in some areas are resistant to some of these anticoagulants.

A simple method, used effectively in most parts of the world, is to trap the rats in box traps, which can be purchased in most local markets or constructed quite easily. In Senegal, a most effective bait for use in these traps is prepared by coating small pieces of potato tuber with groundnut-paste (also available in the local market), and fixing this to the 'trigger' inside the trap.

B FRENCH BEANS - Phaseolus vulgaris.

1. INSECT PESTS

Heliothis armigera (p.260) **. The caterpillars of this insect sometimes attack the pods and damage developing seeds.

Maruca testualis - (Lepidoptera, Pyralidae) **

Distribution: An, K, Ml, Mu, Na, Ni, Se, So, Su.

Hosts: Leguminosae

Description: Eggs are laid on the buds, flowers or foliage. The larvae are about 15 mm long, pale greenish-yellow and with a brownish-orange head. Each segment bears small, dark, almost black spots, forming longitudinal rows down the back. The adult is about 13 mm long, with brown forewings bearing three white spots. Pupation takes place in a cocoon, usually inside the pod.

Damage: The caterpillar attacks the leaves, the buds and the pods, making holes in the latter and often destroying the developing seeds. Losses due to pod damage can at times be severe.

Control: The short persistence chemical insecticides proposed for Heliothis armigera (p.260) should be applied at the start of the attack.

Ophiomyia phaseoli - bean fly. (Diptera, Agromyzidae) *(*)

Hosts: Beans and other leguminosae

Description: Eggs are laid in the leaf tissue. The larvae, 2.5 and 3 mm long, spend their first few days mining the leaves, then pass down the stem via the petiole to the collar of the plant, where they remain and feed. The leaves may turn yellow, and the stem develops longitudinal cracks. Pupation takes place in the feeding areas, and the brownish, barrel-shaped pupae can be seen within the cracks. The adult is a small black fly about 2 mm long. The life-cycle spans about three weeks.

Damage: Attacked plants become unthrifty consequent upon damage caused by the feeding larvae. Feeding wounds and cracks also offer possibilities of entry to various soil fungi which may cause basal rots.

Control:

- (a) Cultural. Continuous cropping with beans should be avoided.
- (b) Chemical. Seed treatment with an insecticidal seed dressing is used to control this pest (Hill, 1978).

Plusia spp. (p.211) *(*) and Spodoptera exigua (p.245) *. Caterpillars of these two Lepidoptera sometimes damage leaves.

Thrips-Caliothrips impurus ** and Sericothrips occipitalis **, cause discoloration and some distortion of leaves and reduction in plant growth (see p.238).

Control: Apply malathion or dimethoate, if necessary.

2. RED SPIDER MITE

Tetranychus spp. *(*). This spider mite sometimes attacks beans and can cause a drying out of foliage, particularly if irrigation is neglected. See p.199 for a general description of this pest.

3. FUNGAL DISEASES

Isariopsis griseola - Angular leaf spot (Deuteromycetes, Moniliales).

Distribution: An, E, K, Na, Se, So, Su.

Symptoms: Angular spots on the leaves, limited by veins. On the underside can be seen small, dark-coloured fungal tufts or synnemata.

Pathogen: The synnemata are composed of dense tufts of dark conidiophores bearing, at their tips, cylindrical, straight or curved spores having three to seven cells.

Damage. This fungus has usually been found only on maturing crops and causes negligible damage in Senegal.

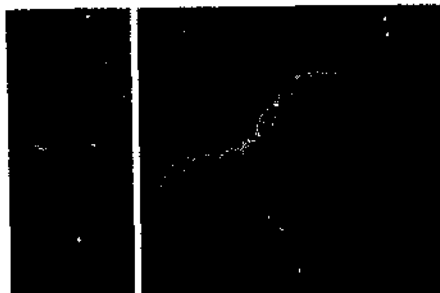

Right: Trichoplusia
Left: Maruca testulalis

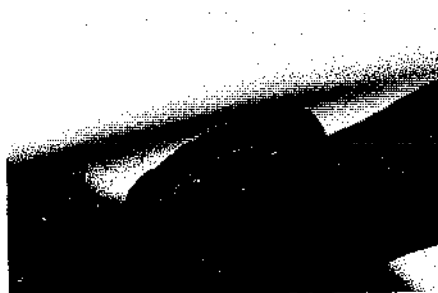

Spodoptera exigua



Mylabris sp.

Some pests of beans.

Pythium aphanidermatum, Fusarium solani and Rhizoctonia solani - Root- and crown-rot complex. ***

Symptoms: Young plants with only two leaves may wilt suddenly and die. Examination shows a soft, wet rot of the roots and crown (usually Pythium aphanidermatum), and/or reddish, longitudinal lesions (usually F. solani). A third fungus, R. solani, causes reddish cankers on the crown and stem usually on more mature plants, where damage appears to be less severe than that caused by the other two fungi.

Pathogen: For description of these three fungi see p.225, p.236 and p.253 respectively.

Conditions favouring development: High temperatures beyond the optimum for the growth of beans (24-26°C) accompanied by high humidity. Conditions such as temporary water-shortage, high salinity etc. causing growth-checks at a later stage may well favour the development of R. solani.

Damage: Heavy losses, sometimes involving the entire crop, can occur at the seedling stage. Losses due to R. solani are more difficult to evaluate and in many cases do not appear to be severe.

Control:

- (a) Cultural. Sowing beans not more frequently than once every three years on the same land, and under good cultural conditions - absence of excessive temperature and humidity, absence of high soluble salts in the soil - will help to reduce losses from this disease-complex. Seed should not be sown too deeply - about 2 cm. is the optimum - so that germination will be rapid and un-impeded. After seed-sowing, excessive irrigation should be avoided, and water used for irrigation should be low in soluble salts. Cultivars resistant to this disease-complex are described in the literature, but many of the commercial cultivars were susceptible in Senegal.
- (b) Chemical. Disinfection of the seed with thiram will generally give some protection against P. aphanidermatum: other fungicidal materials recommended in the literature as seed-dressings are draxolon which, if used should be handled with care because of its toxicity, and chloroneb, which also has some action against R. solani.

Rhizoctonia bataticola - Stem-rot. +.

Symptoms: A blackish rot develops on the growing point of seedlings, and also on the stem at the level of the cotyledons: the leaves wilt and the plant dies.

Pathogen: R. bataticola (p.253) is the casual organism, and the disorder is commonest under very hot conditions.

Damage: The disease is usually of limited extent.

Rhizoctonia solani - Pod-rot. +.

Symptoms: Small, (5-8mm.), depressed, round to oval cankers, pinkish-brown in colour, appear on the pods.

Pathogen: R. solani is responsible for this disease, with infection probably taking place from the soil.



Collar rot



Collar rot

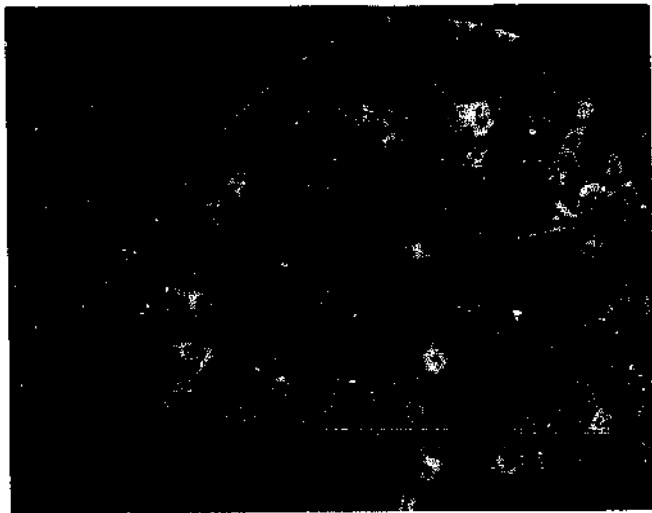

Uromyces appendiculatum

Fig.5 - Some diseases of french beans.

Damage: Losses are usually of limited extent.

Uromyces appendiculatus - Rust. (Basidiomycetes, Uredinales). +(+).

Distribution: Al, An, C, E, K, Md, Na, Ni, Se, So, Su.

Hosts: Phaseolus spp, Vigna spp.

Symptoms: Small whitish pustules or sori (1.5-2 mm.) appear on both upper and lower leaf-surfaces and more rarely on pods and stems: these sori, often surrounded by a narrow yellow border, rapidly develop powdery masses of rust-brown spores. Infected leaves dry-out, shrivel and die.

Pathogen: The spore-type found in Senegal is the uredospore, globular, unicellular, spiny (echinulate), about 18 x 28 μ m, pale yellowish-brown in colour and with two equatorial germ-pores. thick-walled, smooth teliospores are formed in some regions but were not seen in Senegal.

Conditions favouring development: Moderately high temperatures (18-22°C) with relative humidity exceeding 95% for extended periods are necessary for infection.

Damage: In Senegal, losses due to this fungus were generally light, probably because of lower than optimal levels of relative humidity.

Control.

- (a) Cultural. When planting haricot crops, low-lying, damp situations should be avoided. Resistant cultivars are available, but the situation is complicated by the fact that the fungus exists in many different races.
- (b) Chemical. Where necessary, preventive treatment using maneb, may be applied at bud-formation and flowering.

4. NON-PARASITIC DISORDERS

The foliage of Phaseolus beans is very susceptible to wind-damage, and beans should be protected where necessary by the provision of wind-breaks. Similarly, damage can arise from fertilizer-particles lodging on the foliage, and if overhead irrigation is available, its use immediately after fertilizer application will help to reduce this form of damage.

C CABBAGE (Brassica spp.)

1. INSECT PESTS

Agrotis Ypsilon (p.247) **. The larvae tunnel into the heart tissue and make large galleries inside, contaminated by faeces. Additional damage results from the cutting off of young plants at ground level.

Brevicoryne brassicae - Cabbage aphid (Homoptera, Aphididae) *(*).

Locally important pest.

Distribution: E, K, Md, Mu, Se, Su.

Description: Colonies of bluish-grey aphids approximately 2 mm long and covered with a waxy powder are found on the undersides of cabbage leaves and on stems and flowers.

Damage: The activities of these aphids can cause puckering, yellowing and distortion of leaf tissue, and can adversely affect development. The aphids are also vectors of several virus diseases.

Control: The use of a specific aphicide such as pirimicarb will control this insect, and will also permit the development of its natural parasites and predators. Other insecticides of use are acephate, dimethoate and malathion.

Crociodolomia binotalis *(*) . These slightly hairy, smallish (15 mm) caterpillars have orange heads, a creamy-yellow underside and a light green back with fine, longitudinal white lines. The sides of the body are brownish with three black spots on each segment. Up to 50 caterpillars may be found grouped together in a network of threads on a single cabbage. Adequate control is usually achieved by destroying the (usually) few cabbages which are being attacked.

Heliothis armigera (p.260). *(*) sometimes attacks cabbage and can destroy the hearts of young plants.

Hellula undalis - the Cabbage Borer (Diptera Pyralidae) +++

Distribution: An, C, E, K, Md, Mu, Na, Nb, Se, So, Su.

Hosts: Cabbage, Cauliflower, Turnip, Radish.

Description: The larvae of this insect attain a length of about 15 mm; they are pale cream to grey in colour, the head is dark brown to black and the body bears several narrow dark longitudinal stripes. The adult moth is small (up to 9 mm) with light brown wings. The life-cycle extends to about 4½ weeks.

Damage: The principal damage is caused to young seedlings and also to young cabbage and cauliflower transplants. On hatching from the egg, the young larvae destroy the young apical tissue and also bore into the base of the leaf-midribs, and hence into the stem, sometimes going down as far as the roots before emerging for pupation. Seedlings may be attacked by several larvae at the same time, and either die or develop into poor feeble plants. In the case of cabbage, seedlings often develop small, multiple distorted heads of negligible commercial value. Chinese cabbage is markedly more susceptible to attack than is the ordinary green cabbage (Bourdouxhe 1983). Particularly at risk are nursery seedbeds of cabbage and cauliflower which can be totally destroyed in a few days if surveillance and protection is inadequate. Danger from Hellula attack is particularly high during and immediately after the wet season.

Control: Seedlings in the nursery should be sprayed every four to five days with acephate or pyrethroid insecticides, preferably with the final treatment one or two days before transplanting. Young transplants may require one or two treatments after they have established themselves. A non-ionic sticker-spreader should be added to the spray.

Note. High temperatures and high humidity, such as would occur during and just after a rainy season, appear to favour the development of this insect (in Senegal CV from July to mid-November). Under such conditions it is imperative to inspect the nursery every one or two days. The critical period begins when the first true leaves are forming, and thorough spraying must be carried out about every four to five days.

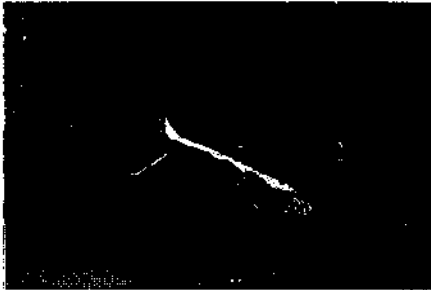

Plutella (adult)



Plutella(larva and pupa)



Plutella (damage)



Hellula



Agrotis

Fig.6 - Some insect pests of cabbage.

Plutella xylostella - Diamond-back moth (Lepidoptera, Teignidae) (A major pest of brassicae in both temperate and tropical areas.) +++

Distribution: Al, B, C, E, K, Md, Ml, Se, Su.

Hosts: a wide range of Cruciferae (including Brassica spp.)

Description: Caterpillars up to 12-13 mm. long, light green in colour, tapering somewhat towards each end: they feed on the underside of the leaf and if disturbed, writhe and twist vigorously, release their hold on the leaf and drop, but remain suspended on a thread. Pupation takes place on the underside of the leaf, the pupae being covered in a greenish cottony cocoon about 9 mm. long and fusiform in shape. The adult moth is small (12-13mm.) greyish-brown in colour with long narrow forewings bearing two triangular marks on the inner edge, forming diamond patterns when the wings are laid together. Life cycle - 3 to 4 weeks.

Damage: A rapid population build-up starts about mid-March, and the period of maximum danger extends until around mid-June. On hatching the young larvae spend their first 2 - 3 days as leaf-miners: later they emerge and feed on the outer parenchymatous leaf-tissue, the leaf showing the typical 'windows' where the caterpillars are feeding. They also destroy the young apical tissue of seedlings and young transplants. In a heavy attack, damage can be very severe and only the midribs and veins of the leaves remain.

In Senegal CV it is not uncommon to find 150 or more caterpillars per plant in an untreated crop - a situation which at one period led the local growers to abandon the culture of cabbage: by contrast relatively little damage occurs in the northern part of Senegal, a phenomenon which may be linked to the high temperatures in that region (Bourdouxhe 1983).

The seedling nursery is also at risk if sown during the active phase of P. xylostella and can be rapidly destroyed in the absence of adequate inspection and protection.

Control:

- (a) Natural (biotic) control. Heavy parasitisation of the pupae was observed, once the population of P. xylostella had become established. The parasite observed in Senegal CVT was Apanteles litae var. opercullelae Nixon (Braconidae). Often as many as 50% of the pupae were parasitised, but the build up of the population of P. xylostella was so rapid that, by itself, the parasite was inadequate, and additional control measures were necessary.
- (b) Chemical. The insecticides acephate, cypermethrin, deltamethrin and fenvalerate all with added spreader-sticker gave very good control of this insect for up to ten days or more after application. Bacillus thuringiensis gave satisfactory control, whilst endosulfan and dimethoate were generally unsatisfactory (Collingwood et al., 1981).

Note. In certain parts of the world, P. xylostella is developing resistance to certain pesticides. Liu et al. (1982) in laboratory tests in Taiwan, report resistance to cypermethrin, deltamethrin, fenvalerate and diazinon, and showed significant cross-resistance to all four compounds; whilst Winney (1983) remarks on the declining effectiveness of permethrin in field trials in Hong Kong, and of the ineffectiveness of phenthoate and diazinon.

Spodoptera littoralis (p.250). The larvae make large tunnels in the heart tissue, contaminating it with faeces in the process.

Trichoplusia ni - the false cabbage looper *, is a smooth, green caterpillar up to 35 mm long with a whitish line down each side, and the fore-part of the body slightly narrower than the rest. It walks in a typical 'looper' manner by arching its body. It makes large, irregular holes in the leaf tissue. Plant development can be retarded, and/or market quality reduced.

Control of the above caterpillar pests can be achieved by using the chemical treatments proposed for Plutella.

2. FUNGAL DISEASES

Alternaria brassicicola (Deuteromycetes, Moniliales) *(*) .

Distribution: E, Md, Na, Se, Su.

Hosts: Various cultivated brassica species.

Symptoms: Large brown zoned spots, 1 to 2 cm diameter, with a yellow halo and usually confined to outer, mature leaves. The fungus sometimes attacks seedlings in the seedbed.

Pathogen. Conidia dark brown, tapering to a small beak (though sometimes almost cylindrical) and often in chains. Several transverse, 0 to few longitudinal septa: 18 to 130 μm long, 8 to 20 μm wide at widest part.

Conditions favouring development: encouraged in seedbed by high humidity due to overwatering, dense seeding and heavy dew.

Damage: On mature crops, usually negligible, but seedling damage can be severe.

Control: Observe correct cultural conditions in seedbed. The fungus is seed-borne, and iprodione used as a seed dressing is reported to give good control. The same fungicide has given good control of foliage attacks.

Peronospora parasitica - downy mildew of brassicas (Phycomycetes, Peronosporales) +(+) .

Hosts: Various cultivated brassicas including Brussels sprouts, cabbage, calabrese, cauliflower.

Symptoms: Small yellowish patches develop on the leaves of young plants in the seedbed: on the underside of these patches may be found the rather sparse, whitish spore-bearing sporangiophores. Subsequently, necrotic areas appear in the yellow zones, which often have a speckled appearance. (Pl.7) Cotyledons also may bear a profuse growth of sporangiophores.

Pathogen: The dichotomously-branched sporangiophores grow out through the stomata and bear hyaline, elliptical sporangia, approx. 20 μm x 24 μm : some races of the pathogen are said to produce oospores which may be up to 45 μm in diameter.

Conditions favouring development: Cool nights with moderate daytime temperatures (the optimum for development is about 15 to 18°C) associated with high relative humidity - the latter being more likely to occur during periods of heavy dew, overhead irrigation and/or dense sowing.

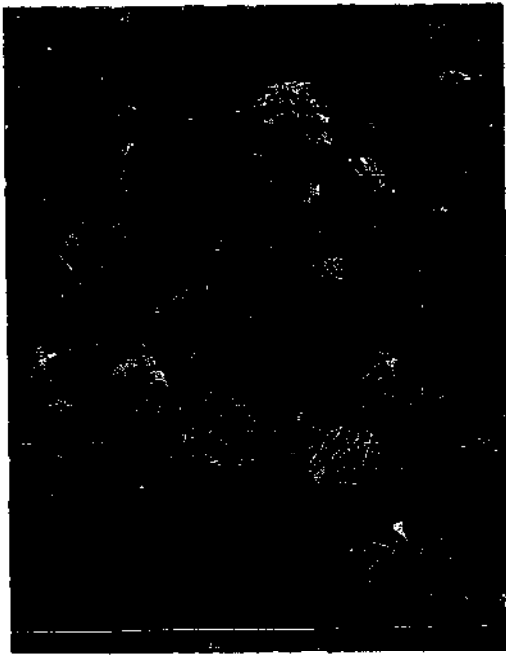

*Xanthomonas
campestris*

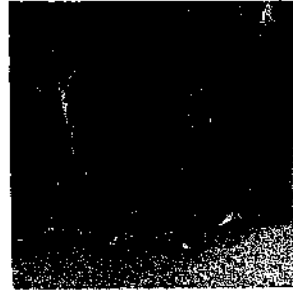

Peronospora parasitica

Fig.7 -Bacterial and fungal diseases of cabbage.

Damage: Severe growth-check may occur to seedling plants, though damage caused to mature plants in the field in Senegal was generally negligible.

Control: Cultural: Observe correct cultural conditions in the seedbed.

Chemicals: Apply a protective spray of zineb every five days or so: dichlofluanid is also reported to give good control (Channon and Turner 1970), although repeated use may lead to phytotoxic damage.

Defrancq (1984a) reports differences in varietal susceptibility in cabbage and cauliflower: cultivars of the latter, of Indian origin (Benarasi, Daccai, Maghi, Agrahyani and Pausali) were the most heavily attacked under Senegalese conditions.

Pythium aphanidermatum - Damping off. Young plants in the seedbed are sometimes attacked by this fungus. See p.225 for general description.

Rhizoctonia solani (basidial stage Thanatephorus cucumeris) - wirestem.

Symptoms: This widespread, soil-borne fungus may cause a dark brown to black, dry rot of the lower stem of young plants, just above soil level in the seedbed. This rot is limited to the cortex, and infected plants may remain more or less upright, but the foliage becomes flaccid, lustreless, often greyish-blue in colour. Infected transplants remain under-developed and usually die.

Pathogen: Microscope examination reveals the relatively coarse mycelium of R. solani within the rotted tissue (p.253).

Control. Avoid siting the nursery in a densely shaded or humid place. Observe correct cultural conditions and do not apply high doses of nitrogen. Dazomet and metham-sodium used as soil sterilants are both active against this fungus. Quintozene (PCBN) dust may be worked into the top 2-4 cm of soil before sowing to control the pathogen (there may be residual toxicity for cucurbit crops after such a treatment). In Senegal, a low percentage of attack was recorded, infected transplants being replaced by healthy seedlings.

3. BACTERIAL DISEASE

Xanthomonas campestris - black rot of crucifers.

Distribution: An, E, K, Se.

Hosts: All cultivated brassicas, radishes and numerous cruciferous weeds (Williams, 1980).

Symptoms: Infection commonly shows on cabbage leaves as yellow areas in the form of a 'V' at the leaf margin (with the point of the V inwards). Leaf veins often appear dark coloured and a blackened vascular ring may be seen on cutting the stem. Infected plants are stunted and may wilt and die.

Pathogen: Black rot is caused by a Gram-negative, non-sporing rod-shaped bacterium, 0.7-0.3 x 0.4-0.5 μm , which is motile with a single polar flagellum. Its optimum temperature for growth is 30-32°C, maximum 38-39°C (CMI/47, 1965). Infection of the plant is principally through the hydathodes, openings situated on the leaf margins, and sometimes via wounds in the root tissue.

The pathogen is readily spread by overhead irrigation, particularly in close-planted conditions as found in the seedbed. X. campestris is carried over on infested seed and in the soil, and is reported to survive on crucifer residues as long as they are not decomposed (perhaps up to two years or more). Soft-rot organisms associated with X. campestris often include Erwinia carotovora.

Damage: Discolouration, distortion and reduced crop production, particularly in fairly hot, wet conditions; in the absence of rain or overhead irrigation which spreads the disease, losses are much reduced.

Control: The use of non-contaminated seed is important, and heat treatment of cabbage seed by a water soak at 50°C for 25 minutes has long been recommended to kill the bacteria. A 3-year rotation in the seedbed should be followed, and irrigation techniques should be adapted to reduce the likelihood of spread in the seedbed. Some varietal resistance exists: a series of cabbages known as 'Badger Inbred' to X. campestris is being released (Williams, loc. cit.).

Soil temperatures as high as 39.1°C at a depth of 5 cm have been recorded in Senegal CVT in the hot season (Verdonck et al., 1983) which probably means even higher temperatures in other, hotter parts of the country and suggests that X. campestris in the soil, at least near the surface, would probably be killed out.

NEMATODES

Meloidogyne spp. Cabbage, though attacked by the root-knot nematode, appears to be fairly tolerant. No resistant varieties were found in comparative trials.

4. NON-PATHOGENIC DISORDERS

'Burning' of the upper surface of the cabbage heart by insolation on occasional plants was followed by growth of various fungi, amongst which predominated Stemphylium vesicarium (identified CMI, (1976)).

NOTES:

Fig. 8 illustrates two cabbage crops per year, so that the differences in pest-problems can be highlighted: this illustrates the situation in Senegal, CV, where the first crop is sown in early November, the second around February.

The subjects for forward planning are the seed, the seedbed and rotational requirements.

Seed. a) Alternaria brassicicola and Xanthomonas campestris are seed borne, and if either pathogen is troublesome in the region, appropriate seed-treatments should be carried out, or seed should be purchased ready treated, if available.

b) Resistant varieties. Cabbage varieties of the 'Badger' strain are reputed to be resistant to X. campestris, as are cabbage cultivars NHV 652 NVH 655 and NVH 656.

Nursery seedbed. To reduce problems due to R. solani and Meloidogyne a pre-sowing treatment with a soil sterilant may be carried out. Additionally, the seedbed can be sited on land which has not grown crucifers for three years or more.

Rotational requirements. The cabbage crop should be grown on a site which has not grown crucifers for at least two years, particularly where X. campestris has been a problem. Cabbage is usually fairly tolerant of Meloidogyne but should not follow a crop which has been heavily attacked by that organism.

Other considerations. Fig. 8 shows that, whilst the two cabbage crops have more or less the same exposure to diseases and nematodes, their pest problems are different. Thus, the major insect pest of the October/November-sown crop is Hellula undalis, against which treatments in the seedbed plus two treatments after transplanting, are recommended. This early-sown crop escapes most of the depredations of the other insect pests. By contrast the February-sown crop may be just early enough to escape attack in the seedbed by Plutella xylostella but will certainly require treatment after transplanting to protect it against this pest and against other Lepidoptera. Careful field observations should be undertaken to determine the timing of the first treatments so that the apical tissue is not destroyed: the earliest (outer) leaves are often discarded when cabbages are harvested, thus if they have been attacked by P. xylostella this may be of no great importance. Delaying the first spray, provided that the population is not allowed to get out of hand will reduce overall treatment costs and will also permit the build-up of natural enemies, which may be able to cope with at least the initial populations of P. xylostella. Decisions regarding spraying can only be made on the spot in relation to prevailing circumstances.

P. xylostella is susceptible (in Senegal) to B. thuringiensis which is unfortunately not very effective against the other species attacking the February cabbage crop, and rotations of other insecticides such as acephate and the synthetic pyrethroids will be necessary, it may, however be possible to use B. thuringiensis for the initial spray applications.

Growers must be prepared for the possible development of insecticide resistance in P. xylostella.

D. CARROT (Daucus carota)

1. DISEASES

Alternaria dauci - leaf-blight of carrot (Deuteromycetes, Moniliales)+

Distribution: An. E. K, Na, Se.

Hosts: Carrot and certain Umbelliferous weeds.

Symptoms: Lesions elongated to irregular, dark brown to black, sometimes with a narrow yellow margin occurring on leaves and petioles, usually on the more mature foliage: infected leaves may blacken and dry-out. The fungus is sometimes seedborne, in which phase it may cause damping-off of carrot seedlings.

Pathogen: Spores club-shaped, olive- to dark-brown in colour with up to eleven transverse and one or more longitudinal or oblique septa. The broadest end of the spore is the point of attachment to a conidiophore: the distal end tapers into a long fine hyaline appendage or beak, which may be up to twice the length of the spore. Dimensions: - spore 235 x 17 μ (150-320 x 12-20 μ): beak - 165 μ (125-250 μ) and approximately 2-3 μ in diameter.

Fig. 8: EXPOSURE OF CABBAGE TO ATTACKS BY INSECT PESTS, BACTERIA, FUNGI AND NEMATODES IN THE CAP-VERT REGION OF SENEGAL.

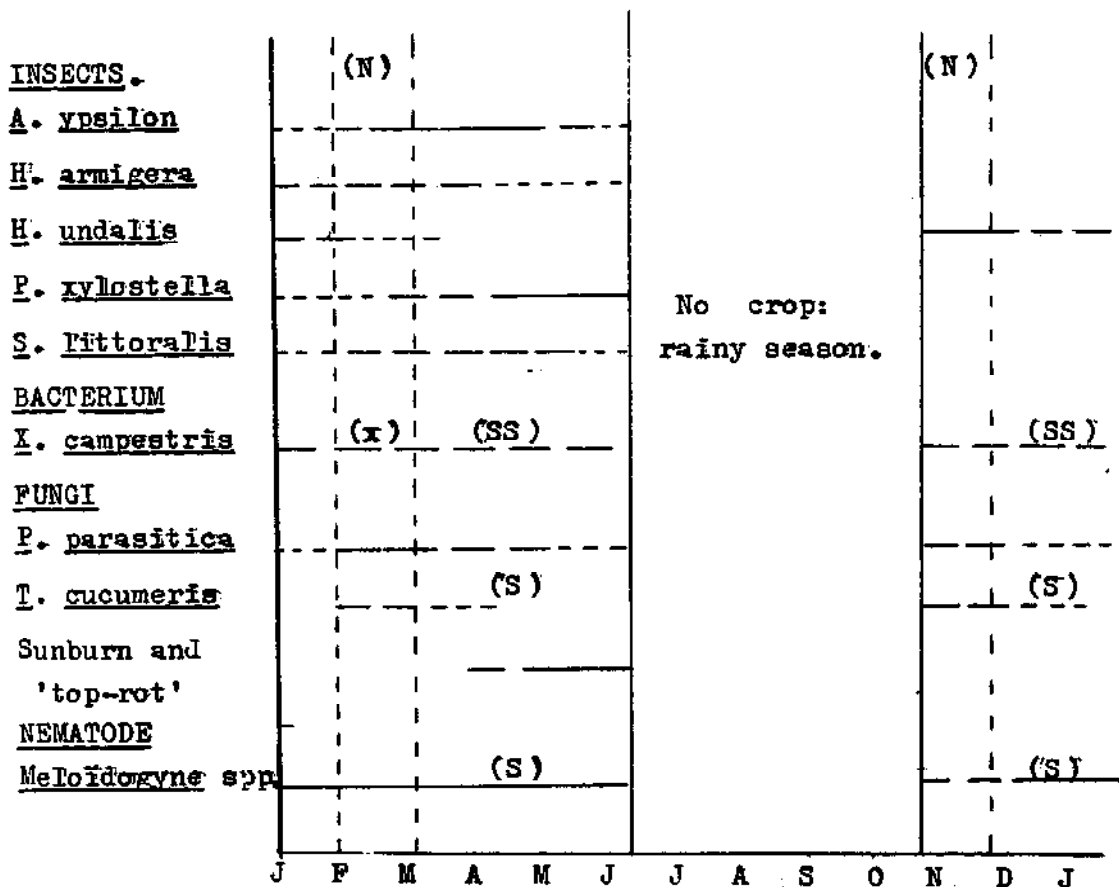

Legend:

- Heavy exposure.
- - - - - Medium exposure.
- Light exposure.
- No exposure.
- (S) - soil-borne.
- (SS) - possibly soil-borne after recontamination.
- (x) - seed-borne.
- (N) - nursery seed-bed.

The above plan assumes two crops per year, with sowing in seed-bed Feb/March, late Oct/November.

Recontamination in the sequence → Infected/infested seed -
 - - - diseased crop resulting from seed-borne infection - - -
 - - - soil contaminated from diseased crop.

Conditions favouring development: Humidity. Caused by irrigation and/or heavy morning dews: the disease is generally most important in Senegal between March and June when the temperature is increasing with the approach of the hot, wet season. The optimum temperature for infection is around 28°C.

Damage: Reduced root-development due to destruction of foliage.

Control:

- (a) Biological. Observations in Senegal suggest that differences in varietal susceptibility exist: cvs. 'New Kuroda' and 'Nantaise Améliorée' were less heavily attacked than others (Defrang 1984).
- (b) Cultural. A rotation of at least three years should be observed between successive carrot crops. All crop debris from an infected carrot crop should either be destroyed or deeply buried. The disease can be carried on the seed, and care should be taken to use only disease-free seed: the 'thiram-soak' treatment has been used to eliminate infection from the seed (the seeds are immersed for 24 hours in an aqueous thiram suspension - 2g/l. - at 30°C, after which they are gently dried in a current of cool air, out of the sun). Iprodione is also reported as giving promising results when applied as a seed-dressing.
- (c) Chemical. Maneb and zineb have been recommended for controlling this disease in areas of severe infection.

Cercospora carotae - foliar blight of carrots (Deuteromycetes, Moniliales +

Hosts: Carrot and other species of Daucus.

Symptoms: Circular to oval lesions, grey-brown in colour may form on all parts of the foliage and floral parts: those on the petioles may develop a dark margin. The symptoms are similar to those caused by A. dauci but C. carotae will attack foliage at a younger stage of development.

Pathogen: Spores are long, narrow, hyaline with many septa, 75μ (40 - 110μ) long x 2.5μ wide (approx.). They are borne on dark coloured conidiophores which emerge in groups through the stomata.

Conditions favouring development: High humidity with a temperature range between 20-28°C. The disease has been noted particularly in Senegal during the month of May.

Damage: Destruction of foliage leading to reduced root development.

Control:

- (a) Cultural. Observe a 3 year rotation. The disease can be seedborne, and the seed used should be free from the pathogen.
- (b) Chemical. See Alternaria dauci.

Erysiphe heraclei - powdery mildew (Ascomycetes, Erysiphales).+

Hosts: Carrot, fennel, parsley, parsnip and certain other wild and cultivated species of Umbelliferae.

Symptoms: Typical powdery-mildew symptoms (see p.224). The fungus is present on leaves and petioles, develops rapidly and finally covers all of the foliage.

Pathogen: Cylindrical conidia (average 40x 17 μ) develop, usually in chains on a superficial mycelium.

Conditions favouring development: Generally favoured by hot, dry conditions: most evident during the month of May in Senegal.

Damage. Loss of foliage leading to reduction in root development. However the fungus appears to attack maturing foliage at a rather late stage in the crop's development, so that losses are less severe.

Control:

- (a) Biological. Observation of 30 carrot cultivars in Senegal showed that 'Chatenay Longue' and 'Royal Cross' were least attacked, whilst 'Flakee de Colmar' and 'Parisienne à Forcer' were most heavily attacked.
- (b) Cultural. Any umbelliferous weeds which might act as hosts for the disease should be destroyed.
- (c) Chemical. Because of attacks late in the growing cycle in Senegal, chemical control was not generally considered necessary. In areas where attacks are more severe, systemic fungicides such as benomyl and thiophanate-methyl have been recommended for controlling this disease.

2. NEMATODES

The carrot is very susceptible to attack by Meloidogyne spp. Small rootlets may appear as wart-like protuberances. In heavy attacks, the main root may be deformed and forked, resulting in a complete loss of marketable produce.

Every effort should be made to ensure that carrots are grown on land which is free from this organism.

E. CUCURBITS (Courgette, cucumber, gherkin, melon, watermelon)

1. INSECT PESTS

Aphis gossypii - Cotton or Melon Aphid (Homoptera, Aphididae)** (p.197) may be present in large numbers on the underside of leaves, causing puckering and deformation of the young shoots and leaves and encouraging the development of sooty mould on the leaf surface (thereby interfering with photosynthesis) as a result of the production of honeydew.

Control: Application of dimethoate or pirimicarb should effectively control this insect. Ensure that the underside of the leaf is covered by the spray liquid.

Asbecesta cyanipennis and A. transversa (Coleoptera, Galerucinae) *(*) .

Description: Small insects, about 6 mm long; the first with blue-violet wing cases, the second with wing-cases yellowish-red with two black spots on each one.

Damage: Adults attack leaves and flowers; larval stage attacks stem base and roots.

Control: Where attacks appear potentially damaging, application of dimethoate or malathion should be made.

Note: Another related species, A. africana, may similarly cause damage.

Aspongopus viduatus - Melon bug (Heteroptera, Pentatomidae) *

Description: Adult about 18 x 10 mm, black in colour with the head, fore-part of body and the underside yellowish-brown. These insects often appear soon after the first rains.

Damage: Adults and nymphs pierce leaves, stems and fruits and suck the sap, causing wilting and sometimes fruit drop and the death of the plant. Damage is particularly heavy on watermelon.

Control: Collection by hand, or application of dimethoate on larger areas.

Aulacophora africana (= Rhaphidopalpa foveicollis) - Red Melon Beetle, (Coleoptera, Chrysomelidae) **

Description: The female lays her eggs at the base of the plant stem: the larvae are cylindrical, slender, ivory-coloured and up to 15 mm long. The adult is rather narrow, 7-8 mm long, bright orange-red in colour on the dorsal surface, black underneath; eyes dark-coloured.

Damage: The adults can cause severe damage to the leaves and may kill young plants. When the larvae hatch, they penetrate into the stem and sometimes down into the main root, often causing death of the plant. Where the attack appears potentially damaging, dimethoate or malathion should be applied, two treatments usually being adequate.

Bemisia tabaci - White-fly. (Homoptera, Aleyrodidae). This insect sucks the sap from plant tissue and may damage the plant in a manner similar to Aphis gossypii. Control, if necessary, by the application of dimethoate.

Cecidomyiidae - Midges. ++). The larvae of these tiny insects can cause stunting and distortion of the foliage and terminal growing-points. Damage can be severe on plants growing in the wet season.

Cerathothripoides cameroni - Thrips. (Thysanoptera, Thripidae). ++). This very small insect feeds on and deforms the apical growing-points and young developing leaves of the plants and prevents their development. It can be particularly serious on melon and watermelon during the wet season.

Dacus vertebratus (+++), Dacus ciliatus (+) - Fruit fly. (Diptera, Tephritidae).

Distribution D.ciliatus: An, B, C, E, K, Md, Mu, Na, Se, So, Su.

Hosts: Courgette, cucumber, gherkin, melon, watermelon.

Description: The adult is a small, greyish-coloured fly about 8-9 mm long with hyaline wings which have a dark stripe along their coastal (anterior) edge. The adult female lays her eggs in groups of ten or so just under the skin of the very young fruit. Immediately after hatching, the larvae (maggots) begin to bore into and eat the flesh, which may subsequently develop a soft, wet rot. The larvae are cylindrical, yellowish, about 10 mm long, pointed at one end and rounded at the other, and capable of jumping a distance of several cm by a sudden flexing movement. When fully grown they eat their way out through the skin of the fruit and enter the soil for pupation; their exit holes are visible in the skin of the fruit.

Damage: There may be considerable losses of fruit resulting from fruit-fly attacks. For example, in the Niayes of Senegal CVt, losses of up to 80% were observed in unsprayed crops of watermelons grown at the beginning of the wet season. Losses of 60 to 80% in other cucurbit species are not unusual.



MELON: *Dacus* sp.

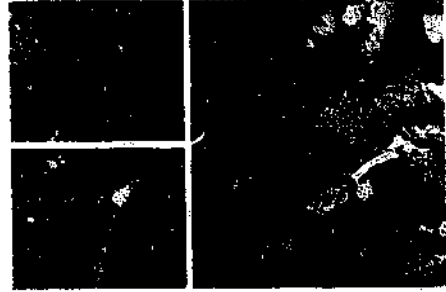

MELON: *Henosepilachna* sp.



MELON: *Pseudoperonospora cubensis*

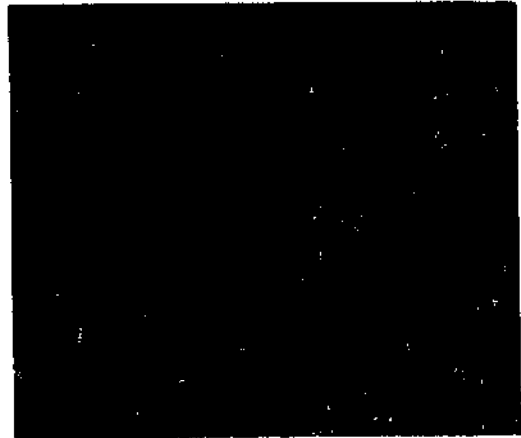

MELON: *Cercospora citrullina*

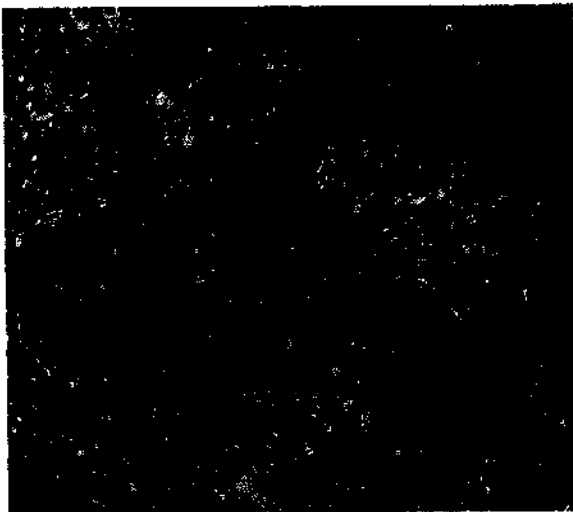

COURGETTE: *Oidium* sp.

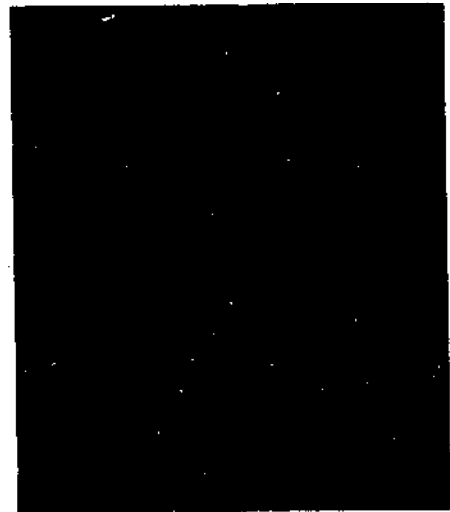

MELON: *Oidium* sp.

Fig.9 - Some pests and diseases of cucurbitaceous vegetables.

Control:

- (a) Mechanical barriers. Some protection can be given by covering very young fruits with paper, or fixing packets around them (this operation is feasible on small areas). The young melons become more or less resistant to egg-laying by the time they have reached about 7 cm or so in diameter.
- (b) Chemical. Because the eggs are laid under the skin of the fruit, the maggots are protected throughout their life from insecticides. This obliges the grower to try to kill the adult fly before egg-laying can take place and more or less requires the constant presence of insecticide on the plant surface; hence, frequent spraying - every week - is necessary, though such a spray programme may be economically unrealistic in relation to certain effective though expensive insecticides. In trials at the CDH, weekly applications of the following insecticides from the start of flowering gave significant control: (amounts of active ingredient/ha, and in decreasing order of effectiveness): deltamethrin 25 g, fenthion 500 g, trichlorfon 1500 g, formothion 500 g, dimethoate 400 g, malathion 1000 g. The above treatments reduced losses in watermelons from 80% (unsprayed) to an average of 23% of fruits (Collingwood et al., 1980). In another trial, spraying twice weekly with malathion instead of once per week did not significantly alter the result. Results obtained by applying trichlorphon, 1500 g.a.i./ha with a motorised knapsack mistblower (400 l/ha) and a hand-operated hydraulic sprayer (1500 l/ha) gave almost identical results.

During the day, the adult flies can often be found in 'live' wind-breaks (Pennisetum, maize, etc.) where they seek food (sugary exudates) or shelter from the sun: some degree of control of Dacus can thus be obtained by spraying the windbreaks with insecticide to which can be added attractants such as hydrolysed protein, but predators and parasites may also be killed.

Henosepilachna elateri (Epilachna chrysomelina) - Epilachna or ladybird-beetle (Coleoptera, Coccinellidae) ++).

Distribution: Al, B, C, E, K, Ml, Mu, Na, Se, So, Su, U.

Hosts: Cucurbits, particularly cucumbers and melons.

Description: The adult female lays clusters of oval, yellow eggs on the undersides of leaves: the larva which emerges about 4-5 days later grows to a length of 6-7 mm, is yellow, more or less long-oval in shape with longitudinal rows of dark-coloured spines on the back. The adult is hemispherical, orange-red in colour and has 12 black spots, arranged in transverse rows, on its back: its body is covered with very fine golden hairs. The life-cycle covers about 36-40 days.

Damage: Both adults and larvae damage the leaves by eating the soft outer tissue and leaving 'windows' (consisting of the tougher, middle lamella) in the leaves. In a heavy attack, young plants may be killed.

Control.

- (a) Physical. When the attack is moderate or on a limited area, hand-collection of the egg-masses and insects is an economic means of control.
- (b) Chemical. In case of heavy attacks, or a large area of crop, application of dimethoate or malathion is effective: the undersides of the leaves should be particularly well sprayed.

Leptoglossus australis (L. membranaceus) - Leaf-footed plant-bug.
(Heteroptera, Coreidae). +.

Distribution: An, B, E, Md, Se, So, Su, U.

Hosts: Citrus, cucurbits, groundnut.

Description: An elegant plant-bug, 20-25 mm long, brown-black in colour with long antennae having alternating orange and black zones. The tibial joint on the hindlegs is widened into a vaguely leaf-like, toothed structure.

Damage: The insect sucks the plant-sap, causing wilting and sometimes death of young shoots, sometimes dropping of young fruit.

Control: Not usually required.

Margaronia indica (Lepidoptera, Pyralidae). ++

Description. The larvae of this insect are 15-20 mm long, light green in colour with two almost shiny, white lines running the length of the body on the dorsal surface.

Damage: The caterpillars eat the leaf tissue, but possibly the most serious damage which they cause is to gouge-out hollows in the skin and outer flesh of melons, thereby reducing the quality: very often this damage is found at a place where a fruit is in contact with a leaf, or touching the soil.

Control: As soon as the young caterpillars are observed, particularly on young plants, treat if necessary with acephate, endosulfan or a pyrethroid insecticide. A single treatment is usually enough.

2. FUNGAL DISEASES

Alternaria cucumerina. (Deuteromycetes, Moniliales)

Hosts include courgettes, cucumbers, water-melons.

Symptoms: Small, rounded brownish spots about 1-3 mm diameter often surrounded by a lightish yellow halo; the centres of the spots often become whitish-grey.

Pathogen: Conidia usually solitary, pale brown, cylindrical, narrowing to an obtuse point at one end and tapering to a long fine beak at the other: beak often longer than the body. The body bears 6 to 9 transverse and usually several longitudinal oblique septa. Dimensions 170 x 17 μm (87-310 x 15-22 μm); beak approx. 1.5 - 2.5 μm . thick near point.

Conditions favouring development: Warm, humid conditions.

Damage: Very limited in Senegal.

Control: No control measures undertaken but if necessary, see products used to control A. solani.

Cercospora citrullina - Cercospora leaf-spot (Deuteromycetes, Moniliales)

Hosts: Melon (+): Water-melon ++

Symptoms: On the leaves of water-melon the disease shows as rounded brown spots (1-3 mm.) with a clear centre: these spots link-up, the leaves turn brown and dry out. Stems are also attacked and bear elongated grey spots, sometimes with brownish borders. On melon leaves the spots are round, brown with a clear centre and surrounded by a yellow halo.

Pathogen: Conidiophores emerging in groups from the stomata, greenish-brown: conidia long, narrow, tapering, almost needle-like, with many septa, hyaline, sometimes curved.

Dimensions: 175 μm . (35-300 μm) Long: + 4 μm . (2-5 μm .) wide around mid-point.

Conditions favouring development: Hot, wet weather: attacks are particularly heavy on water-melon grown during the wet-season.

Damage: Destruction of foliage.

Control.

(a) Biological. Some slight variation in the degree of susceptibility was noted between melon varieties ('Cantaloup Diamex' and 'Jaune Canaria' were respectively the least and the most heavily attacked). All watermelon cultivars observed were susceptible.

(b) Chemical. In trials at the CDH, weekly treatments with maneb (240 g a.i./hl) or captafol (240 g a.i./hl) or fortnightly treatments with benomyl (40 g a.i./hl) gave satisfactory control. Treatment with maneb was more efficacious than captafol treatment (Collingwood et al., 1975/80).

Note: Ellis (1971) states that C. citrullina is probably a synonym of C. apii.

Fusarium solani - Wilt. (Deuteromycetes, Moniliales).

Symptoms: A dry rot on the stem at soil level, followed by a wilting and general collapse of the plant, usually occurring just before harvest time.

Pathogens: F. solani (see p.230) has consistently been isolated from these stem lesions in Senegal. In addition, a bacterium, Erwinia tracheiphila has occasionally been isolated by the bacteriologist at ORSTOM (DuBerne, 1981) from the vascular tissue, but pathogenicity tests remain to be carried out.

Damage: Usually, the entire harvest of the affected plant is lost.

Control:

(a) Biological. 'Cantaloup Diamex' was less affected than 'Cantaloup Ido' and 'Romeo'.

(b) Cultural. observe a rotation of at least three years free from melons.

(c) Chemical. Ensure that the stems of melons are not attacked by insects such as Asbecesta spp. and Aulacophora sp. as their damage may provide a port of entry for the fungus and/or bacterium.

Leveillula taurica - Powdery Mildew (see p.246) was occasionally noted on leaves of cucumber in Senegal CVt.

Oidium spp. - Powdery Mildew (Ascomycetes, Erysiphales).

Distribution: Widespread.

Hosts: Courgette ***, cucumber **, gherkin **, melon **, watermelon *.

Symptoms: Small, white powdery spots appear on both surfaces of leaves, on stems and sometimes on the fruits. In courgette, the entire plant surface may be rapidly covered by the fungus. In cucumbers, gherkins and melons the onset of the attack is often denoted by the appearance of clear, light green spots visible on the upper surface of leaves, and this is rapidly followed by the development of the fungus on the underside of the spots. Infected tissue dries out, and young plants infected at an early growth stage may die. Watermelon is more resistant than the other cucurbit species.

Pathogen: The imperfect or Oidium stage consists of a superficial mycelium from which grow erect hyphae giving rise to chains of barrel-shaped spores (24-29 x 13-16 μ m). In the rare instances when cleistothecia are formed, they identify the fungi as belonging to the species Erysiphe (cichoracearum) or Sphaerotheca (fuliginea).

Conditions favouring development: Fairly hot (24-29°C) dry weather favours development. Conidia can germinate at an RH as low as 20%. On the other hand, it is not uncommon to find both Oidium spp. and Pseudoperonospora cubensis (see p.225) growing on the same leaf together. Plants appear to become particularly susceptible from the stage when the first fruits are forming.

Damage: Infection leads to the destruction of foliage, a reduction in the number of fruits and consequently a reduction in yield. In addition, fruit from infected plants suffer from lack of flavour (melons).

Control:

- (a) Biological. Cultivars selected for resistance to Oidium exist in commerce. Examples are:
Cucumber: 'Bresco', 'C461H', 'Fem Green', 'Green Gem', 'Harvest price 259', 'No. 18/06'.
Gherkin: 'Chipper', 'DP-90-H', 'DP-125-H', 'Eriko'.
Melon: 'Cantaloupe ido', 'Gulfstream', 'Homegarden', 'Ohgon', 'Romeo', 'Saticoy', 'Supermarket', 'Tom Dew', 'Vac 15-15'.
Watermelon: 'Fengshan No. 1', 'Grand Baby 123', 'Honey Red', 'New Sugar Baby 102', 'W615', '126H' (see also Defranq, 1984).

Note: A pycnidial fungus, Ciccinobolus cesati (syn. Ampelomyces quesqualis) was frequently found parasitising conidiophores of Oidium in Senegal.

Pseudoperonospora cubensis - Downy Mildew (Phycomycetes, Peronosporales).

Distribution. Al, E, K, Md, Na, Ni, Se, Su.

Hosts: Cucumber ***, gherkin ***, melon ***, watermelon *

Symptoms: Yellow-green angular spots, 10-15 mm, delimited by the leaf veins, are visible on the upper leaf surface. On the underside of these spots can be found a grey-brown to violet mould. The spots merge together, the tissue becomes brown, the leaves shrivel and die. The earliest visible symptoms in melons may be infection of the cotyledons. Courgettes are not attacked by P. cubensis.

Pathogen: The sporangiophores and sporangia en masse usually have a violet coloration. The sporangiophores, which emerge through the leaf stomata are almost transparent and dichotomously branched at acute angles. The branches

taper to fine tips on which are borne the ellipsoidal, thin-walled sporangia, 14-25 x 20-38 μm , with a small papilla at the distal end, and germinating typically by zoospores. In certain parts of Asia, oospore development has been reported.

Conditions favouring development: *P. cubensis* develops rapidly in conditions of high humidity, especially during periods of heavy dew and mist. The fungus develops over a range of temperatures from about 12-29°C, the optimum being around 20-22°C.

Damage: Under favourable climatic conditions, the fungus develops rapidly and causes heavy destruction of foliage, accompanied by a reduction in the number and individual weight of fruits (Defrancq et al., 1982).

Control.

(a) Biological. The least attacked cultivars noted in trials in Senegal were:

Cucumbers: 'Bresco', 'C461H', 'Fem Green', 'Green Gem', 'Harvest Price 259', 'High Mark II', 'New Market No. 1-252', 'Radar', 'Triple Mech', 'Victory, No. 18/06'.

Gherkins: most cultivars were more or less susceptible.

Melons: 'Diamex', 'Chilton', 'Georgia 47', 'Gulfcoast', 'Kogane Nashi Makua', 'Tom Dew'.

Watermelons: are fairly resistant.

(b) Cultural. Irrigation should be programmed so that it does not occur late in the day, thereby risking a prolonged period of high humidity in the crop if dew is present the following morning.

(d) Chemical. Fungicides giving satisfactory control in trials were (all in g active ingredient/ha, and applied every five to seven days, according to climatic conditions): mancozeb 140 g, mancozeb 140 g + curzate 12 g, maneb 200 g, chlorothalonil 200 g (Defrancq et al., 1982). In preliminary trials, metalaxyl applied every ten days at 25 g active ingredient/ha gave excellent long lasting control, but should be used in association with another fungicide, according to manufacturers' recommendations, to prevent the selection of resistant strains of the fungus.

Pythium spp. (amongst others, *P. aphanidermatum* and *P. butleri*), sometimes attack the stem, particularly of cucumbers, at soil level and at the leaf nodes in contact with the soil. This results in a soft rot followed by wilting and death of the part of the plant distal to the rot. The same fungi have also been identified as the cause of fruit rotting in watermelon, particularly during the wet season.

Control is difficult to achieve, but steps should be taken to avoid the presence of excessive water around the plants. The application of thiram did not control or prevent the stem-rot: it is not known whether materials such as propamocarb or metalaxyl would give satisfactory results.

Rhizoctonia solani sometimes causes fruit-rot when melons come into contact with the soil. Occasionally, also, *Colletotrichum dematium* has been isolated from large sunken spots on melon fruits. Excessive irrigation leading to prolonged wetting of the surface should be avoided.

3. VIRUS DISEASES

Cucumber Mosaic Virus (CMV)

Distribution: Worldwide.

Hosts: Cucumber, gherkin, melon, watermelon and a wide range of related and unrelated plants including carrot, pepper, tomato.

Symptoms: On cucurbits, particularly melon and courgette, the leaves show a distinct mosaic pattern with leaf curling in melon, whilst in courgette, the leaves are often puckered, reduced in size and deformed: fruits are mottled, with warted areas, symptoms being particularly pronounced in courgettes.

Pathogen: The virus particle is about 30 μm in diameter: the virus is spread by numerous species of aphids, including Aphis gossypii and Myzus persicae and is of the 'non-persistent' type. Damage can be very severe, with sometimes almost total loss of fruits, especially in courgettes.

Control: With insecticides is difficult because of the rapidity with which the virus is transmitted by aphids. Limitation in infection has resulted in some areas by growing the crop during a period of naturally low aphid population. Experimental control has included the use of reflective plastic to repel aphids, and spraying with oil to prevent infection.

4. NEMATODES

Meloidogyne spp. Cucurbits are generally very susceptible to attacks by Meloidogyne spp.

F. EGG-PLANT OR AUBERGINE (Solanum melongena)

1. INSECT PESTS

Bemisia tabaci White fly. This insect damages egg-plant by sucking the sap from the leaves (see p.260).

Daraba laisalis - Fruit worm (Lepidoptera, Pyralidae) **(*)

Hosts: Egg-plant, Solanum Aethiopicum, occasionally tomato.

Description: The larvae are up to 15-16 mm in length, pale pink in colour on the ventral surface, pale violet on the back. They develop inside the fruit, devouring the flesh, and very often there are virtually no external symptoms to indicate their presence until the fruit is cut open. The adult is about 12 mm long with a wing-span of 28-33 mm. The forewings are barred with white and brown, the rear wings are grey to pinkish in colour.

Damage: Very heavy losses may result from Daraba attacks. In one experiment at the CDH, counts at harvest showed 57.3% of fruits attacked on untreated plots. When the so-called 'healthy' fruits were examined again ten days later, a further 38% were shown to be infested, making a total loss of over 95% (Collingwood et al., 1980). Infested fruits may develop secondary rots. The level of infestation can be particularly high during the hot wet season - June to November.

Control: The insect is difficult to control as the larvae, being endocarpic, are protected from the effects of insecticides. Of several products tested, weekly applications (shown in g active ingredient/ha) of deltamethrine (19 g), cypermethrine (75 g) and fenvalerate (100 g) gave 10%, 22% and 28% of fruit attacked, respectively (untreated - 89% attacked). Application once every 14 days gave results much inferior to the seven-day cycle. Treatment with acephate, carbaryl, dimethoate, endosulfan and tetrachlorvinphos likewise gave inferior control. Insecticide application must start more or less at the flowering stage, once the presence of the insect has been noted.

In areas where egg-plant is subject to heavy Daraba attacks, careful evaluation must be made to decide whether the production of this crop is economically worthwhile in view of the losses which may be suffered, despite a costly weekly spray-schedule. It should be noted that the quantities of active ingredient of pyrethroid insecticides used to obtain the above results are in excess of those recommended for treatment of other Lepidoptera.

Eublemma olivaceae (Lepidoptera, Noctuidae). +

Description: The fully-grown larva is up to 15 mm long: the head is black, the body greenish-yellow with darker-coloured zones and seven grey, longitudinal bands carrying long upstanding hairs (Appert and Deuse, 1982).

Damage: The larvae feed on young leaves of aubergines which they fold together and join with silken threads.

Control: Damage is not generally severe enough to warrant specific treatment, but the caterpillars are sensitive to pyrethroid insecticides.

Jacobiasca Lybica - Jassids, or leafhoppers (Homoptera, Cicadellidae) +++.

Host: Several Solanaceae, okra.

Description. These insects are very active: the adult is about 2 mm. long, bright green to yellow-green in colour with shiny wings: the body tapers towards the rear end. The adults may be found on the foliage in large numbers, and move around by jumping, but fly very readily when disturbed. The larvae are smaller than the adults and wingless, and move around very rapidly, seeking refuge on the underside or the leaves if disturbed.

These insects suck the plant sap and cause the edges of the leaves to become yellow, with an upward rolling, giving a spoon-like appearance.

Damage: In the case of heavy attacks, the yellowed foliage turns brown and dies, and this can lead to a serious loss in production. The insect population is greatest during the hot, wet season (Bourdouxhe, 1983).

Control: As soon as the first symptoms are seen, or the insects become noticeable by virtue of their numbers, the crop should be sprayed with dimethoate, paying particular attention to the underside of the leaves. Two treatments with an interval of 30 days between are usually sufficient.

Myzus persicae - Peach-potato Aphid (*). This insect is sometimes present and occasionally troublesome on egg-plant (p.197).

Pachnoda spp. - Chafer Beetle * (p.234). These beetles sometimes attack the buds, flowers and young fruits of eggplant, after the first rains.



Jocobiasca lybica



Daraba laisalis



Aecidium habuquense

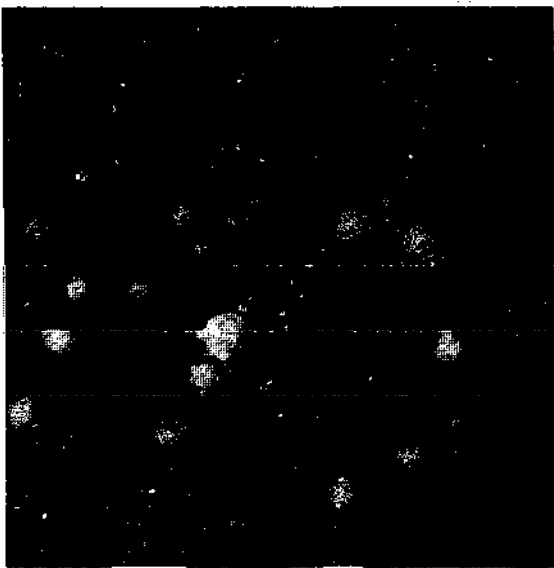

Aecidium habuquense

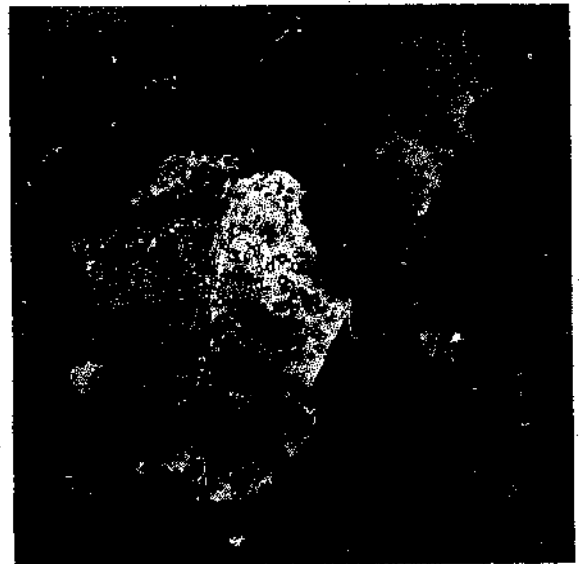

Stemphyllium solani

Fig.10 - Some pests and diseases of egg-plant.

Selepa docilis - leaf-eating Caterpillar. (Lepidoptera, Noctuidae) *(*) .

Hosts: several Solanaceae

Description: The larvae, which are covered by long, fine hairs, attain a length of about 15 mm when fully grown. The median dorsal part of the body is clear yellow or greenish-yellow in colour, with, on either side, a narrow greyish band at the fore-end of the body, darker towards the rear. A black mark in the form of a cross is visible on the first quarter of the body a short distance behind the head. The adult is characterized by its grey forewings, spotted with brown and bearing two or three black points. The rear wings are pearly-coloured, with brownish margins.

Damage: The caterpillars devour the leaves of egg-plant, and can cause severe damage to small plants, particularly when the caterpillars are young as they are often grouped in colonies on the foliage.

Control: Control measures are taken only if the larvae become numerous on young plants, using the same products as those used for the control of Heliothis (p.260)

Urentius hystricellus (Heteroptera, Tingidae) *(*)

Host: Egg-plant

Description: These small insects, 2.5-3.0 mm long, about 1.5 mm wide, are yellowish-brown in colour with a rather spiny dorsal surface. At each stage the insects live in colonies and suck the plant sap.

Damage: The attacked leaves are covered by numerous dark spots and become enfeebled and yellow, and may fall. Where high populations of the insect are present, the growth of the plant is retarded. The insect develops rapidly under hot, dry conditions, and is much more in evidence in the hot, dry region of northern Senegal than in Senegal CVt.

Control: Treat with dimethoate in areas subject to high populations.

2. SPIDER MITES

Polyphagotarsonemus latus ++ and Tetranychus spp. ++. These two pests attack egg-plant and cause varying amounts of damage: they are described on p.250 and p.199 respectively.

3. FUNGAL DISEASES

Aecidium habunguense - Rust (Basidiomycetes, Uredinales) +(+) .

Host: Egg-plant

Symptoms: Rounded yellow spots up to 1.5 cm diameter and slightly depressed are visible on the upper leaf surface: these spots are often covered on the underside by masses of orange-coloured spores.

Pathogen: Aecidium habunguense is an imperfect rust, no teliospores having been found. On the underside of the spots are groups of aecia, small structures which are bell-shaped in section and produce masses of catenulate (in chains) orange-coloured aeciospores, 20-23 x 20-26 μ m.

Conditions favouring development: Hot, humid conditions.

Damage: The rust is most dangerous if it occurs in the nursery, particularly during the hot wet season when the climatic conditions favour its development: damage to older plants is not usually of much importance.

Control: When necessary, plants can be sprayed with maneb. No particularly resistant cultivars have been observed in Senegal.

Alternaria solani Target spot. Egg-plant is fairly resistant to this disease, although attacks have sometimes been noted on young plants in the seedbed. For a description of the pathogen see p.239.

Fusarium solani - Basal Stem-rot (Deuteromycetes, Moniliales). ++

Host: Plurivorous (non-specialized).

Symptoms: Rotting of the stem at soil level, and the roots.

Pathogen: F solani produces three types of spores:

- (a) Hyaline microconidia which are usually cylindrical, often slightly curved, 0-1 septate, 9-16 x 2-4 μm : these microconidia are produced on fairly long conidiophores (40 μm long) as opposed to the short microconidiophores of F. oxysporum (about 10-15 μm).
- (b) Cylindrical macroconidia, with 3-5 septa, pointed at one end and with a 'foot cell' at the other, 40-100 x 5-7.5 μm .
- (c) Globose to oval, thick-walled chlamydospores, 10-11 x 8-9 μm , either terminal or intercalary.

Conditions favouring development: This disease is particularly prevalent on egg-plants during and just after the wet season, when the soil is saturated with water and the plant roots may be under stress because of insufficient aeration.

Damage: Under the above conditions, losses of plants may be heavy.

Control: The only control measure is to avoid the occurrence of the above situation by planting the crop on land where waterlogging is not likely to occur.

Leveillula taurica - Powdery mildew. +

Symptoms: Chlorotic spots are visible on the upper surface of the leaves with a whitish powder on the underside of the spots (p.246).

Control: Whilst egg-plants are frequently attacked by this fungus in Senegal, control by application of fungicides was rarely deemed necessary. Cultivars 'Barbentane', 'Black Beauty', 'Bonica' and 'Large Fruited H. No. 29' were the least attacked; 'Black Torpedo' and 'Fr. Lurki' the most heavily attacked.

Pseudocercospora trichophila (Deuteromycetes, Moniliales) *

Symptoms: Chlorotic spots are visible on the upper leaf surface; on the underside of these spots is a light, greyish mould with long needle-like conidia (90 x 3 μm). The fungus has been seen only occasionally in the seedbed at the end of the wet season.

Pythium aphanidermatum. This soil-borne fungus causes a soft rot of the collar region of the stem at soil level.

Rhizoctonia solani. This fungus is sometimes the cause of a dry, dark-coloured rot on the stem at soil level on young plants in the seedbed.

Sclerotium rolfsii (*). This fungus sometimes causes a collar rot of plants at soil level. It was occasionally important on egg-plant crops in the Casamance region.

3. NEMATODES

The egg-plant is susceptible to attacks by the root-knot nematode Meloidogyne spp. The commercial cultivars observed in Senegal did not differ greatly in their reaction to this pathogen (all were susceptible), with the possible exception of cultivar 'Prelane', which was very susceptible.

G. LETTUCE (Lactuca sativa)

1. INSECT PESTS

Caterpillars. + Lettuce may be attacked by several species of caterpillars, including Agrotis ypsilon, which cuts-off young plants at soil-level and also tunnels into the heart of older plants: Plusia spp. which eat the leaves and Heliothis and Spodoptera which tunnel into and destroy the plant heart.

This damage is in general secondary, and routine preventive sprays are not usually necessary: however, should protection be required, the occasional spray with one of the products recommended under Heliothis (p.260) will be suitable, bearing in mind that in the lettuce plant the foliage is consumed, and that an adequate interval should elapse between spray application and harvest.

2. FUNGAL DISEASES

Cercospora longissima. +

This fungus has occasionally been found on lettuce which has gone to seed and is probably a weak parasite: it causes irregular necrotic leafspots (up to 5mm): spores are $137 \times 3 \mu\text{m}$ ($75-220 \times 2.5-5\mu\text{m}$). The disease can be seed-borne.

Septoria lactucae - Leaf spot. (Deuteromycetes, Sphaeropsidales) +.

Distribution: An, E, K, Na, Su, Se.

Symptoms: The fungus causes rounded spots on the leaves, up to 10 mm diameter, brownish, with scattered black points - the pycnidia.

Pathogen. Pycnidiospores (produced in dark coloured, flask-shaped pycnidia) needle-shaped, $37 \times 3 \mu\text{m}$ ($30-42 \times 2.5-3 \mu\text{m}$) with up to 3 septa.

Control: The symptoms are usually seen on the outer semi-senescent leaves on lettuces which are more or less ready for harvest, or else on leaves of plants which have gone to seed. Under these circumstances, protective

spraying is not usually carried out, but should it be necessary, treat with maneb, allowing an interval of at least ten days between treatment and harvest. The disease can be seed-borne, so the use of good quality disease-free seed is imperative.

3. NEMATODES

Meloidogyne spp. Lettuce is very susceptible to root-knot nematode attacks.

H. OKRA, LADIES' FINGERS (Hibiscus esculentus, Abelmoschus esculentus)

1. INSECT PESTS

Aleyrodidae - Whiteflies ++. Both adults and nymphs suck the plant sap, and are often present in large numbers (p.260).

Aphis Gossypii - The cotton aphid ++. (p.197) these small insects exist in colonies, suck the plant sap and enfeeble the plant.

Cosmophila flava - Cotton semi-loopers. (Lepidoptera, Noctuidae). *(*)

Hosts: Cotton and other Malvaceae.

Description: Eggs are laid singly on the leaves. The larva, which attains a length of about 30 mm. has a slender body, light green in colour with several fine longitudinal lines along the dorsal surface. The adult moth is about 11 mm. long, with a wingspan of about 28-30 mm: the forewings are brown, darker coloured at their distal ends: the rear wings pale brown. Life-cycle 5-6 weeks.

Damage: The larvae eat the soft part of the leaves, leaving only the veins: in a heavy attack the plants may be defoliated.

Control: Treatment as recommended for Heliothis, if protective measures become necessary.

Earias biplaga and E. insulana - Spiny bollworm (Lepidoptera, Noctuidae) **

Distribution: E. biplaga: An, Ch, E, K, Md, Ml, Na, Ni, Se, So, Su.
E. insulana: At, An, C, Ch, E, K, Md, Ml, Mu, Na, Ni, Se, So, Su, U.

Hosts: Cotton and other Malvaceae.

Description: The eggs, which have a ribbed surface are laid singly on the plant. The fully-grown larvae reach a length of about 16-17 mm, are rather thick, fusiform in shape with alternating bands of colour going from dark brown to green: they are known as 'spiny bollworm' because of the rather fleshy spike-like appendages carried on the dorsal face of most of the segments. The adult has a wingspan of about 20 mm., yellowish forewings in the case of E. biplaga, greenish in E. insulana. Each forewing of the female of E. Biplaga carries a brown patch in the centre. the life cycle is 4-5 weeks.

Damage: The caterpillars perforate the capsules of okra.

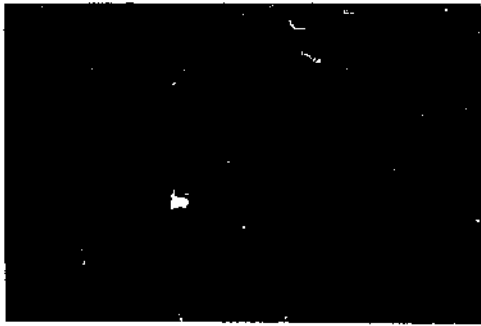

Earias sp.

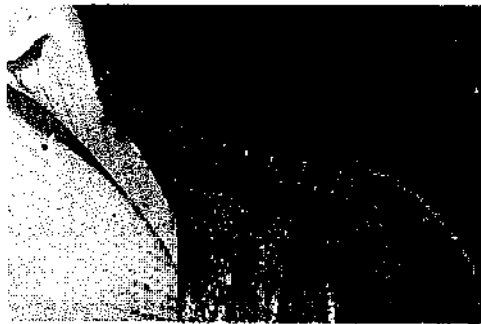

Xanthodes sp.



Nisotra sp.

Fig. 11 - Some insect pests of okra

Control: Treatment as recommended for Heliothis.

Heliothis armigera. ** (p.260). The caterpillars of this insect can cause severe damage by perforating the capsules of okra.

Jacobiasca Lybica - Leafhoppers **(*). Leafhoppers, or jassids, can cause the same type of damage on okra as they do on egg-plant.

Nisotra sp. (Coleoptera, Chrysomelidae, Halticinae) **(*)

Description: The adult is a small insect, about 3-4 mm long, elliptic in shape, and light orange-brown in colour.

Damage: Multiple small holes are pierced in the leaves and damage on young seedlings can be very severe, mainly during the hot wet season.

Control: application of dimethoate, as required.

Oxycarenus hyalinipennis - Cotton Seed Bug (Heteroptera, Lygaeidae) *(*)

Hosts: Cotton and other Malvaceae.

Description: The adult insect is about 4-5 mm long, dark brown in colour with translucent wings. The nymphs are similar in appearance though lacking wings and ocelli.

Damage: The adults and nymphs attack the grains in ripe, opened capsules. Control measures are not normally necessary.

Pachnoda spp. - Chafer Beetles (Coleoptera, Cetoniidae) *(**)

Hosts: Numerous species of plants.

Description: These Coleoptera are fairly large, up to 20 mm long, often dark brown in colour with a lighter-coloured lateral band around the body. They frequently appear after the first rains of the wet season.

Damage: They may be present in large numbers, eat leaves and stems and attack young capsules, causing deformed growth.

Control: On a small area of crop, control may be effected by hand-picking. If this is not practicable, dimethoate should be applied.

Pectinophora gossypiella - Pink bollworm (Lepidoptera, Gelechiidae) *(*)

Distribution: Al, An, C, E, K, Md, Ml, Mu, Na, Ni, Se, So, Su, U.

Hosts: Cotton and other Malvaceae.

Description: The larvae measure between 12 and 15 mm when fully grown. They have a characteristic colour - whitish with the dorsal surface deeply tinted with pink/red, hence the name Pink Bollworm.

Damage: The larvae attack and damage flower buds and young capsules, causing them to drop prematurely: they also penetrate into older capsules and feed on the developing seeds.

Control: Apply a pyrethroid insecticide, if necessary.

Sylepta derogata - Cotton leaf-roller (Lepidoptera, Pyralidae) *(*)

Populations of caterpillars of Sylepta are often effectively reduced by microhymenoptera (Braconidae, Apanteles sp.).

Xanthodes graellsii - Cotton leaf-caterpillar (Lepidoptera, Noctuididae) *(*)

Hosts: Cotton and other Malvaceae

Description: The caterpillars are green, with long hairs on each segment, and have either a single yellow band on the back, with small dark-coloured designs on each side, or else simply a pair of yellow points on each segment. The larvae can attain a length of 35-40 mm.

Damage: is caused by the destruction of foliage, the attacks being particularly important during the wet season.

Control: On small areas, removal of the caterpillars by hand may be possible. If not, treat with one of the products recommended for Heliothis control. Repeat the treatment only if necessary.

2. FUNGAL DISEASES

Cercospora abelmoschii - Cercospora Leaf-spot (Deuteromycetes, Moniliales) *(*)

Hosts: Several species of Hibiscus.

Symptoms. Yellowish-green or dark spots on the leaves, round (up to 1 cm) or sometimes angular and bounded by the leaf veins. On the underside of these spots can be found the sporing stage of the fungus, at first greyish, later becoming black and resembling soot.

Pathogen: Sporulation occurs principally on the underside of the leaves. The conidiophores are cylindrical, septate, sinuous; the conidia are $45 \times 6 \mu\text{m}$ ($27-50 \times 5-7 \mu\text{m}$) and often narrowed at the base.

Conditions favouring development: Hot, humid conditions.

Damage: Infected leaves roll-up, dry-out and drop. In Senegal the disease is generally of limited importance except in certain areas, Casamance for example, where it can cause severe damage to the okra crop during the period between June and December.

Control:

- a) Biological: some degree of varietal resistance has been noted: for example the cultivar 'Population 12' was much more susceptible to attack than was the cultivar 'Puso'.
- b) Chemical: application of fungicide is not usually undertaken to control this disease, but in case of necessity, the treatment proposed for Cercospora citrullina on water-melon would probably be effective.

Cercospora malayensis causes small, circular necrotic spots up to 3 mm diameter, surrounded by a violet-coloured margin and becoming grey at the centre.

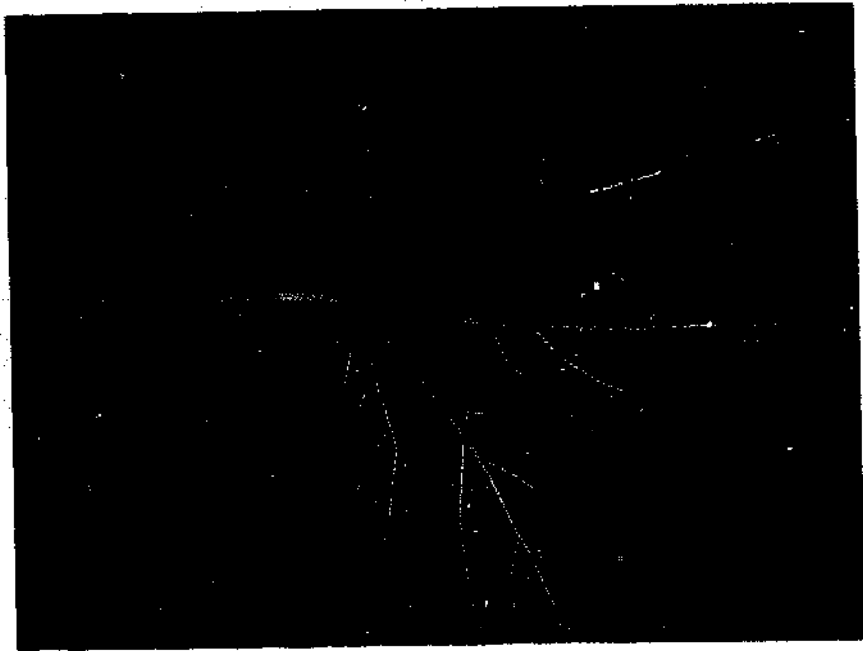

Cercospora abelmoshi

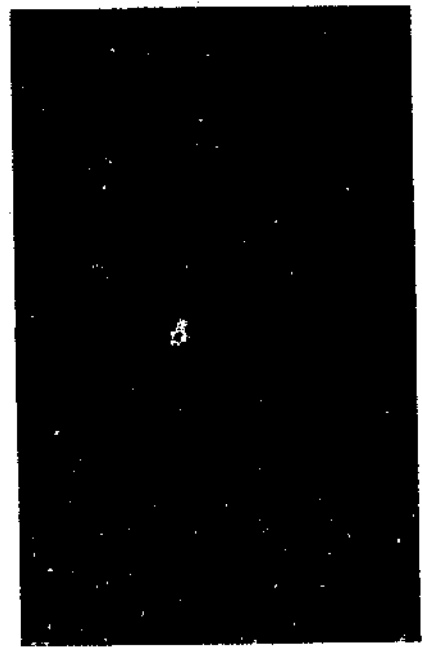

Oidium abelmoshi



Fusarium oxysporum
vasinfectum

Fig.12 - Some fungus diseases of okra.

Fusarium oxysporum f.sp. vasinfectum - Fusarium wilt (Deuteromycetes, Moniliales *(*)

Distribution: An, E, Se, So, Su.

Hosts include species of Gossypium, Hibiscus, Solanum, Vigna.

Symptoms: Leaves may become chlorotic, growth is retarded and the plant wilts and may die. On cutting the stem obliquely, a browning of the vessels can be observed.

Pathogen: For general characteristics of F. oxysporum see p.267.
Microconidia 0 to 1 septate; macroconidia 3, 4, 5 or 6 septate.

Conditions favouring infection: The optimum temperature for disease development is around 25°C: a low level of potash and a high soil acidity are also said to be conducive to disease development. The disease has been found in Senegal both during the dry and the wet season. Plants are susceptible at all growth stages.

Damage: The growth rate of infected plants is reduced, and the plant may die. In one experiment, a loss of 12.5% of plants due to F. oxysporum f.sp. vasinfectum was noted, whilst field infection as high as 75% was found (Defranq, 1984b).

Control: This fungus is soil-borne, and one of the most effective methods of controlling it would be by the use of resistant varieties: several breeding programmes are under way with this object in view. The two cultivars 'Puso' and 'Population 12', grown in Senegal, are both susceptible.

The disease is also stated to be seed-borne, and Ganopadhyay and Kapoor (1977) claimed that soaking seed in 0.3% w/v ziram at 45°C ± 1°C for half an hour effectively controlled Fusarium wilt.

A rotation of at least five years free from Malvaceae species should be observed on land infested with F. oxysporum f.sp. vasinfectum.

Leveillula taurica - Powdery mildew +

This fungus can infect okra, though the disease is of little importance. Small spots of whitish mould, often delimited by the leaf veins, may be visible on the underside of the leaf. The hyphae are largely endophytic (p.268). Control measures are not usually necessary.

Oidium abelmoschii - Powdery mildew ++

Symptoms: Powdery spots can be found on both the upper and lower leaf surface: the spots expand until the whole leaf surface is covered; the leaf then dries out and falls.

Conditions favouring development: This fungus is favoured by relatively warm, dry weather and in Senegal is most important during the dry season, from November to May.

Damage: Destruction of foliage causes reduced yields, and the quality of the fruit may be impaired.

Control: In a limited trial, sulphur (4000 g active ingredient/ha), triadimefon (75 g a.i./ha) and benomyl (500 g a.i./ha) all effectively controlled the disease which was not, however, of sufficient intensity to

cause a significant reduction in yield on the unsprayed control, compared with the treated plots (Defrancq, 1984b).

Differences in varietal susceptibility have been noted, the cultivars 'Dwarf Long Pod Green', 'Emerald Green Velvet', 'Puso' and 'White Velvet' being the least heavily attacked (Defrancq, 1984). (N.B.: 'Puso' is a local selection of 'Emerald Green Velvet').

NEMATODES

Meloidogyne spp. Okra is usually heavily attacked by root-knot nematodes when the latter are present in the soil.

I. ONION (Allium cepa)

Whilst globally, the onion is subject to a wide range of pest and disease attack, in the climate under discussion serious problems are fairly limited. In addition the onion possesses the great virtue of being highly resistant to attacks by the local species of root-knot nematode (Meloidogyne) which makes it a very useful 'rotation' crop, one of the few at the disposal of the vegetable grower.

The slow growth-rate of the onion in its initial stages, combined with its open growth habit means that competition from weed-growth can be very severe.

1. INSECT PESTS

Thrips tabaci - Onion thrips. (Thysanoptera, Thripidea) +++

Distribution: C, Ch, E, K, Md, Mu, Na, Nb, Se, So, Su.

Hosts: Polyphagous, particularly common in hot, dry climates.

Description: The adult thrips is a very small insect, about 1 mm long, brownish-yellow in colour with two pairs of long, narrow wings (the forewings are longer than the hind wings) both pairs of which are fringed around their edges with hair-like structures. The nymphs are pale yellow, similar to the adults but smaller and wingless. The insects can be found during the day at the base of the plant, on the inside of the leaf-axils. The life-cycle spans about three weeks.

Damage: Both nymphs and adults rasp the surface tissue of the leaves, causing wounds from which flows the sap on which T. tabaci feeds. The leaf surface of attacked plants bears fine, silvery-white mottling and flecks; the leaves may shrivel and the leaf-tips become dried-out and papery. In the case of a heavy attack, yield-losses can be serious, with stunted leaf-growth, reduced bulb size and in extreme cases, death of the plants. Damage appears to be somewhat less under sprinkler irrigation than when furrow irrigation is practised.

Control:

- (a) Biological. In trials carried out at the CDH, differences were found in varietal reaction to Thrips attack, and the following cultivars showed marked resistance (shown in descending order of resistance): 'Ben Shemen', 'Early Yellow Texas Grano 502', 'Beth Alpha As', 'Red Creole-H', 'Yaakar' (CDH selection from 'Roxa do Traviu'), 'Gros

Lisboa', 'Golden Creole H'. The resistance was associated with a reduced number of larvae and adults attacking the plants, from an average of \pm five larvae and adults per plant of 'Ben Shemen' (resistant) to \pm 100 larvae and adults per plant of the susceptible cultivar 'Violet de Galmi' (Collingwood et al., 1981).

- (b) Chemical. Control of Thrips tabaci can be successfully achieved by a wide range of chemicals, of which deltamethrine, bromophos, cypermethrin and acephate performed particularly well. Malathion and dimethoate are also efficacious. A non-ionic spreader-sticker may be added to the spray. High-volume application at 750 l/ha or more gave the best results.

Kisha (1979) working in the Sudan found that for successful control of Thrips on late-transplanted onions, initiation of spraying programmes was indicated when infestation levels reached 5-10 nymphs per plant.

Caterpillar damage. Several species of caterpillar, including Heliothis armigera, Spodoptera exigua, S. littoralis, occasionally attack onion and may be found inside the hollow leaves. Treatment is not usually necessary.

2. FUNGAL DISEASES

Alternaria porri - Purple Blotch (Deuteromycetes, Moniliales) *(*)
This fungus, which has an optimum temperature around 25-30°C, has been found occasionally in Senegal CVT, but is more common in the southern region of Casamance, where it causes more damage.

Symptoms: Sunken spots at first water-soaked but rapidly becoming violet/brown, and often zoned and with a yellow halo, appear on leaves and seed-stalks: under wet conditions these spots enlarge and elongate, destroying the leaf and stalk tissue. The fungus can also cause a rot of the bulb.

Pathogen: Conidia mid-brown, club-shaped, usually solitary: up to 12 transverse and 0 to several longitudinal or oblique septa. Dimensions 147 x 19 μ m (110 - 190 x 14 - 25 μ m at widest part) possessing a narrow tapering beak 75 μ m long (30 - 110 μ m) (Defrancq 1984).

Conditions favouring development: Temperature 25 to 30°C, with high humidity.

Damage: Yield-loss following foliage destruction, accompanied sometimes by rotting of the bulb.

Control: No control measures have been found necessary, but if damage is likely to be severe, weekly sprays with dithiocarbamate fungicides such as mancozeb and zineb are said to be effective. In Kenya 'Red Creole' and 'Yellow Creole' were very resistant; 'White Mexican' and 'Burgundy Red' showed some resistance. (CMI 1970).



Stemphylium cotryosum



Pyrenochaeta terrestris



Sclerotium rolfsii

Fig.13 - Some fungus diseases of onion.

Pyrenochaeta terrestris - Pink root disease (Deuteromycetes, Sphaeropsidales) +(++)

Hosts: Onion, leek, garlic and numerous other plant - species.

Symptoms: Yellowing and wilting of the outer leaves and slow development of the plant may be external symptoms of pink root disease: on carefully digging up the onion bulb, roots are found to be pink to red in colour or, in some cases, completely rotted. The plant attempts to 'compensate' for this damage by forming a succession of new roots.

Pathogen: The causal organism is a pycnidial fungus. Pycnidia are dark coloured, slightly beaked, up to 450 μ m in diameter and bearing a series of bristles, often around the ostiole. Pycnidiospores hyaline, ovoid, averaging 2.1x4.8 μ m. The formation of pycnidia by different strains of this fungus is very variable, and many strains do not form them either in nature or in artificial culture.

Conditions favouring development: A temperature of 25-28°C, and poor cultural conditions (high soluble salts, irregular irrigation, lack of adequate nutriment) appear to favour the development of this fungus.

Damage: Attacks on young seedlings may kill the plant or risk spreading the disease if infected transplants are used, whilst the longer-term effect is a reduction in yield.

Control:

- (a) Cultural control. Only healthy seedlings should be used as transplants: the same remark applies to the use of onion 'setts'.
- (b) Certain cvs of onion are said to be resistant to P. terrestris (indicated as 'PRR' - Pink Root Resistant). In laboratory tests in Senegal, cvs 'Yellow Granex' and 'Yaakar' were less susceptible than cvs. 'Egyptian', 'Violet de Galmi', and 'Early Texas Grano 502 PRR'. (Defrang, 1984).
- (c) Onions should preferably not follow a graminaceous crop, the roots of which may have been infected with P. terrestris.
- (d) Solar heating of soil (p.170) has given promising results in the control of P. terrestris and might be considered as a soil treatment, at least for the onion seedbed.

Note: The pink root situation is often complicated by the presence alongside P. terrestris of another fungus, Fusarium oxysporum. This is often the case in Senegal where both fungi have frequently been isolated from the same lesion. Whilst the pathogenicity of P. terrestris has been verified in laboratory tests in Senegal, this has not at the time of writing been accomplished for F. oxysporum, thus it cannot be said with certainty whether or not it is F. oxysporum f.sp. cepae. Bouhot (1965) describes F. oxysporum in Senegal as being one of the components in the complex causing rotting of the roots and root-plate in onion.

Cultures of P. terrestris from Senegal were identified by the Commonwealth Mycological Institute (CMI).

Leveillula taurica. Powdery mildew.+ Onion leaves may occasionally bear small, diffuse chlorotic spots which are covered with a whitish powder - the conidiophores and elongated conidia of the fungus (p.268). Damage appears to be negligible, and no control measures were deemed necessary in Senegal though the disease appears to be more important in the Cape Verde Islands.

Sclerotium rolfsii +. This fungus is sometimes responsible for the rotting of onion bulbs in the field: it is easily identified by its abundant mycelium and small sclerotia which resemble mustard seeds (p.254). The fungus is favoured by hot, humid conditions, and has usually given trouble in Senegal in very late-produced crops (i.e. approaching the hot, wet season), or in very early-produced crops when the soil is still warm and humid following the rainy season.

Stemphylium botryosum. (Deuteromycetes moniliales) (+++).

Symptoms: Dark-brown elongated spots up to 3-3½ cm long on the flower-stalks of onions grown for seed production: the weight of the seed-head causes the stalks to fold over at the point of the lesion.

Pathogen: Dark brown, almost rectangular conidia but with rounded ends: usually 3 transverse and 1 to 3 longitudinal septa, with slight constriction at the level of the median septum. 39 x 17µm (22-50 x 12-20µm).

Conditions favouring development: Warm, humid conditions, similar to those favouring A. porri but at lower temperatures, and possibly somewhat lower humidity.

Damage: The fungus can infect flower-stalks damaged by wind, insects etc. but attacks principally stems at an advanced stage of maturity but before the grain has fully ripened. The seed-head itself is sometimes attacked. Losses of grain can be very heavy - in many cases exceeding 50%.

Control:

- (a) Cultural control. Losses from this disease were particularly heavy when onion seed-production was attempted at the CDH, where the relative humidity in the area is fairly high throughout the growing season: however, a dramatic reduction in the level of S.botryosum attack resulted from transferring seed production operations to the northern part of Senegal where the relative humidity is consistently much lower.
- (b) Chemical control. Attempts to control the disease by the use of various types of fungicide and different methods of application were unsuccessful, due probably to the fact that the fungus was growing largely as a saprophyte, on more or less moribund tissue which was offering no host-resistance to the attack.

3. WEED CONTROL

Pre-emergence. The herbicide chlorthal can be used for this operation at a rate of 9 kg a.i./ha, applied as a pre-emergence spray to direct seeded onions, as soon as possible after seed-sowing: the soil should be moist at the time of treatment. On light sandy soils the dosage rate should be reduced by up to 3 kg/ha. Under the above conditions, annual gramineae were controlled quite well; results against Portulaca minutum and P. oleracea

were moderate. Perennial plants are resistant. Persistence of chlorthal in the soil may be up to three months.

Post-emergence. Limited trials were carried out at the CDH using ioxynil: this material was applied at a rate of 600 g.a.i./ha, the onions having reached the 3 true-leaf stage. At this rate of application, good control of the two Portulaca spp. was obtained, but Gramineae were resistant. A slight yellowing of the crop is sometimes seen but this does not appear to have any adverse effects. Ioxynil does not persist in the soil. Herbicide treatments should not be carried out in windy weather, or damage to adjoining crops may result, if these are susceptible species.

J. PEPPER (Bell or sweet, pepper and hot pepper) - Capsicum spp.

1. INSECT PESTS

Agrotis ypsilon - Greasy cutworm. (p.247) +(+).

The caterpillars of this noctuid cut the stems of young plants and transplants.

Control: The treatment recommended under 'potato' is equally efficacious for peppers.

Ceratitis capitata - Mediterranean Fruit-fly. (Diptera, Tephritidae)

Distribution: Al, An, E, K, Md, Ml, Na, Ni, Se, Su, U.

Hosts: Peach, citrus and a wide range of other fruits. Serious pest of hot peppers in Senegal (+++) much less important on sweet peppers (+).

Description: The female fly lays her eggs in groups under the skin of the fruit: after a few days they hatch and the maggots mine the interior of the fruit, which often begins to rot and/or may fall before it is fully developed.

The maggots, which eventually pupate in the soil, are whitish in colour and about 6-7 mm. long: by a sudden flexing motion they are able to jump a distance of several centimetres. The adult fruit-fly is about 5-6 mm. long with one pair of translucent spreading wings which are marked with irregular, orange-brown bands, some transverse, others oblique, and with a longitudinal band on the distal outer edge of the wing. The life-cycle spans about 4 weeks.

Damage: Infected fruits often contain several maggots, and usually rot and drop prematurely: substantial losses can be caused.

Control:

(a) Cultural: ensure that the developing maggots are killed by collecting and destroying all infested fruit.

(b) Chemical: As soon as attacks are noticed apply sprays of dimethoate, or melathion or tetrachlorvinphos or trichlorphon: during the harvesting period use only malathion and/or trichlorphon: as these two insecticides have a shorter 'harvest-delay' period.

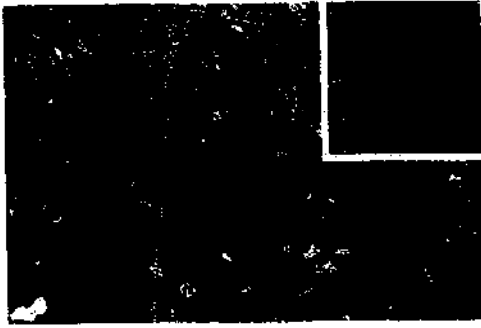

Ceratitis(adult)

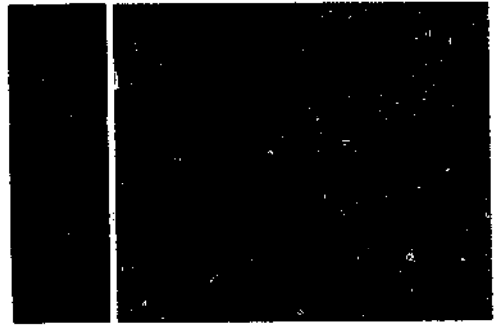

Heliothis

Cryptophlebia



Leveillula taurica

Fig.14 - Some pests and diseases of peppers.

Cryptophlebia leucotreta - False Codling Moth (Lepidoptera; Tortricidae).+++.

Distribution: An, C, Ch, E, K, Md, Ml, Na, Ni, Se, Si, Su, U.

Hosts: A wide range of wild and cultivated fruits.

Description: The whitish-coloured eggs are laid on the surface of fruits and hatch about 4-6 days later. The young larvae, whitish at first, pinkish-red at maturity penetrate directly into the fruit and remain inside, making tunnels in the flesh, leading often to secondary rotting caused by bacteria and fungi. At the moment of leaving the fruit for pupation in the soil they measure about 15 mm long. In Senegal CVt. They have been found attacking peppers from about mid-April until the end of December. Life-cycle 4-5 weeks.

Damage: Attacked fruits are worthless, and losses can be substantial - up to 60% of attacked fruits have been recorded on untreated crops. The situation is made more complex because it is sometimes difficult to know from the exterior whether a fruit has been attacked.

Control:

- (a) Cultural. All visibly attacked fruits should be removed immediately from the plants and destroyed or deeply buried.
- (b) Chemical. In trials carried out at the CDH, weekly applications of deltamethrin 12.5 g.a.i./ha; or cypermethrin, 75 g.a.i./ha gave satisfactory control of C. leucotreta. Larger dosage-rates of these two insecticides applied at 14-day intervals gave less satisfactory results. Trials with acephate, endosulfan and fenvalerate showed that these three materials were less effective than deltamethrin and cypermethrin. (Collingwood et al). *Pheromone traps were successfully used to study the population dynamics of this insect (Bourdouxhe, 1983).

Note. The persistent use of pyrethroids had the negative effect of permitting a build-up of aphids, probably due in part to the destruction of natural predators/parasites, and the use of an aphicide was necessary to reduce the aphid population.

Heliothis armigera ++ (p.260) sometimes penetrate into pepper fruit and cause not inconsiderable losses.

Myzus persicae ++(+). (p.250) sometimes attacks peppers and damages the foliage.

Nezara viridula + (p.250) causes the same damage as on potato.

Spodoptera exigua - Lesser Armyworm (Lepidoptera, Noctuidae) ++(+).

Distribution: Al, B, C, E, K, Md, Ml, Ni, Se, So, Su, U.

Hosts: Cotton, dwarf bean, pepper, potato, rice, tomato.

Description: The pale-green eggs, about 0.5 mm. diameter are laid in masses on the underside of leaves. The caterpillars, which measure up to 20-25 mm. are smooth, with a green dorsal surface and a lighter green ventral surface, the two areas being separated by a fine, whitish longitudinal line.

The adult is a brownish-grey moth with a wingspan of 25-30 mm.

Damage: The larvae devour the flower-buds and also the leaf-tissue. During their feeding, they sometimes migrate in 'swarms' from one plant to another.

Control: In Senegal measures for the control of this insect have rarely been necessary. If damage becomes serious, treat with acephate, endosulfan or pyrethroid insecticides.

2. SPIDER MITE

Polyphagotarsonemus latus +(+)¹ (p.250) sometimes attacks the young leaves of peppers, causing them to develop a 'feathery' aspect, as though virus-infected.

3. FUNGAL DISEASE

Leveillula taurica - powdery mildew (Ascomycetes, Erysiphales) +++.

(Distribution, Hosts, Pathogen - see p.267).

Symptoms: The first symptoms of this disease are chlorotic spots with an ill-defined margin, visible on the upper leaf-surface: these spots have on their underside a light, whitish powdery mould. As the fungus develops, scattered necrotic points appear within the tissue of the spots. Subsequently, there is often a heavy leaf-fall.

Conditions favouring development: The disease is favoured by warm (25-28°C) for hot pepper, 20-28°C for sweet pepper) and moderately dry (RH 50-75% conditions: however, L. taurica has been found infecting both hot and sweet peppers throughout the whole year in Senegal CVT. though it is most important in the dry season. Plants appear to become susceptible subsequent to the flowering stage.

Damage: An attack of L. taurica can result in a heavy loss of foliage which, despite the regrowth of leaves which often occurs, can nevertheless cause a substantial yield-loss.

Control:

(a) Biological. In Senegal, differences in varietal susceptibility were noted. For hot peppers, the least attacked cultivars were 'Kani Xegne' and 'Safi'; moderately attacked were 'Hungarian Yellow Wax', 'Jalapeno', 'Long Horn 407', 'Long Red Cayenne Thin', 'Piment Piquant', 'Santaka Siam Chili 409': whilst the most heavily attacked were: 'Fresno Chile Grande', 'Large Cherry', 'Long Red Cayenne', 'Pretty Red 408', 'Red Cherry Large'. For sweet peppers there is less distinction between cultivars but 'Clio', 'Gildor' and 'Harris Early Giant' were less severely attacked than the other cultivars (Defrancq, 1984).

(b) Chemical control. In a series of trials, several fungicides gave satisfactory control of L. taurica when applied every two weeks: these include triadimefon (12 g a.i./hl), fenarimol (3.5 g a.i./hl), diclobutrazol (10 g a.i./hl) and triforine (28.5 g a.i./hl. In addition, good control was obtained by applying (wetttable) sulphur at a rate of 400 g a.i./hl at weekly intervals (Collingwood et al., 1975/80).

BACTERIAL DISEASE

Xanthomonas campestris pv. vesicatoria - Bacterial Scab or Spot (*) (p.255)
This bacterium sometimes attacks peppers, causing small (1-2 mm) roundish dark-brown spots on the leaves. The centre of the spot is lighter coloured, and the spots are sometimes surrounded by a yellow halo. The leaves sometimes turn yellow and drop. Treatment is rarely necessary.

VIRUS DISEASE

Several virus diseases were seen in pepper crops during the course of several years. One notable crop of hot peppers, cv. 'Safi', was 100% infected. This virus was identified by Duberne (1981), virologist at ORSTOM, as Cucumber Mosaic Virus 1, which is a non-persistent virus spread by many species of aphids including Aphis gossypii and Myzus persicae. Other viruses noted were Potato Virus Y and Pepper Veinal Mottle Virus.

NEMATODES

Meloidogyne spp. Hot peppers and sweet peppers are generally moderately susceptible to Meloidogyne attack.

K. POTATO (Solanum tuberosum)

1. INSECT PESTS

Agrotis ypsilon - Greasy cutworm (Lepidoptera, Noctuidae) ++

Distribution: Al, B, K, Md, Ml, Mu, Se, Su, U

Hosts: Cabbage, lettuce, potato, peppers, etc.

Description: Caterpillar 35-40 mm long, rather thick; greyish-black, darker coloured along the dorsal surface, two white spots on the head, which is brownish. Body without hairs. The larvae are essentially nocturnal, and during daylight remain hidden in the soil, typically rolled up on themselves. They may often be found by scraping away the soil from around an attacked plant.

The adult has brownish-grey forewings the hind wings being whitish with a dark marginal band: the wing-span is 40-50 mm. The life-cycle extends to 40 days or more, according to the prevailing temperature. The insect is important in Senegal CVt. between February and May.

Damage: The young caterpillars feed on the leaves of a variety of crop plants: in the potato crop, the older caterpillars cut through the outer stems of the young potato plants, near or below ground level.

Control:

- (a) Cultural. The crop should be kept weed-free, as weeds attract the adult egg-laying female.
- (b) Chemical. Good control has been obtained by applying a pyrethroid insecticide on the soil around the plants during the evening, after damage is first noticed.



Gryllotalpa africana

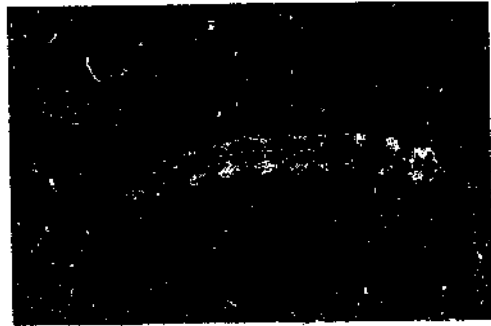

Spodoptera littoralis

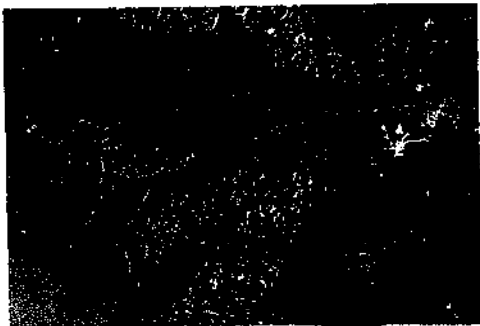

Polyphagotarsonemus sp.

Fig.15 - Some insects and mite pests of potato.

Dysmicoccus brevipes - Pineapple mealybug (Homoptera, Pseudococcidae) +

Colonies of this insect are occasionally found, particularly on badly drained soils, at the point of attachment of the tubers to the stem, and sometimes at the eyes in seed tubers: they do not appear to cause any damage. Another scale, Phenacoccus madeirensis, attacks the stored potato tubers. Spray applications of acephate reduced the population of this insect.

Gryllotalpa africana - African mole-cricket (Orthoptera, Gryllotalpidae) ++(+)

Distribution: A, An, B, E, K, Md, Ml, Mu, Na, Ni, Se, So, Su, U.

Hosts: A wide variety of plants is attacked

Description: The adult insect is 30-35 mm. long, brown in colour with lighter-coloured elytra: its forelegs are large and powerful and adapted for burrowing in the soil. The wings are short and cover about 1/4 to 1/2 the length of the abdomen. The insect prefers moist, medium-textured soil. Metamorphosis is incomplete and there is no distinct larval stage.

Damage: The insect makes large (1cm.) holes in potato-tubers during the course of its foraging in the soil, rendering them unsaleable or at best reducing the quality of the sample: in heavy attacks in Senegal C.Vt, 60% or more of the tubers have sometimes been attacked. Seedlings of other plants are uprooted during the insect's tunneling operations, or bitten-off in direct attacks.

Control:

- (a) Physical methods. Tomato-tins or glass jars, empty but for 2 cm or so of water, etc., may be buried up to their necks in the soil, the insects falling in during their nightly perambulations on the soil surface.
- (b) Baits - bran, etc. mixed with insecticide, spread over the soil-surface in the evening will help to reduce the population of Gryllotalpa.
- (c) Granular insecticides, mixed with the soil represent an effective way of controlling Gryllotalpa: three products which have given good results are chlorpyrifos-ethyl, diazinon and fonofos, and all three have a residual effect which extends more or less over the entire development period of the potato-crop, when currently applied at the recommended dose.

For potato-crops treatment may be effected in one or two ways. The soil may be treated before planting by spreading appropriate quantities of the product on the soil surface and mixing to a depth of about 12 to 15 cm. The second method is to spread the product along the rows of the growing crop, a few weeks after planting and incorporate it into the soil during the final ridging up operation. It is difficult to predict whether an attack might take place, because the insect is very mobile and may come in from an adjoining site. In such a case, the first method provides an 'insurance' against an attack, but adds a sizeable sum to the cost of production. It might be remarked that, on untreated soil of a type favoured by this insect, crop failure has been noted on several occasions due to destruction of the seed tubers by G. africana at a very early stage in the crop cycle, before any appreciable growth had taken place.

Heliothis armigera (*). Caterpillars of this insect sometimes attack potato foliage. Treatment is rarely necessary (see S. Littoralis below).

Liriomyza trifolii - Leaf miner (**), sometimes causes damage to potato foliage. The most satisfactory reduction in population has been achieved (up to 1984) by refraining from applying chemical insecticides, thereby permitting the build up of populations of natural parasites and predators.

Jassids or leafhoppers sometimes cause leaf damage *. See under egg-plant for symptoms and control.

Myzus persicae - Peach aphid **. Very heavy populations of this insect sometimes build up on the undersides of potato leaves, late April to June in Senegal CVT. The insect is a vector of numerous virus diseases.

Nezara viridula - Green stink bug (Heteroptera, Pentatomidae) *

Distribution: Al, An, B, C, Ch, E, K, Md, Ml, Mu, Na, Ni, Se, So, Su, U.

This insect, more or less shield-shaped, flat, about 8 X 15 mm and uniform light green in colour sometimes causes wilting of the apical part of young potato stems by sucking the sap. Whilst the insects are fairly numerous the damage which they cause appears to be insignificant. Apply dimethoate if necessary.

Spodoptera exigua (*) - Sometimes attacks potato foliage.

Spodoptera littoralis - Egyptian cotton leaf worm (Lepidoptera, Noctuidae) (**)

Distribution: Al, An, C, Ch, E, K, Md, Mu, Na, Ni, Se, So, Su, U.

Hosts: Polyphagous.

Description: Caterpillars 35-40 mm long, at first light green in colour with a darker head, they become brownish in colour with a light dorsal band, the body bearing on each side a series of dark triangular spots, with two black spots behind the head. The ventral side is greyish in colour. The adult has a wing-span of 35-40 mm, forewings yellowish-brown, the hindwings white.

Damage: The caterpillars of S. littoralis eat the foliage, leaving only the stems and large veins. In certain seasons damage is quite extensive. During the day, the older larvae can sometimes be found in the soil around the plant, or hidden under plant debris; they occasionally attack the tubers of the potato plant, making shallow holes with irregular borders.

Control: In the event that protective measures might be necessary, treat with acephate, cypermethrin, deltamethrin, endosulfan or fenvalerate.

2. MITES

Two species of mites, the Russet mite (Aculops lycopersici) ** (see p.262) and the Yellow Tea mite (Polyphagotarsonemus latus) **, attack potato foliage and can cause serious damage if not checked.

Description (P. latus). The adult mites are creamy yellow in colour, about 0.125 mm long, and are found on the underside of the leaf. A characteristic of the mite is the habit of the male in moving around quickly on the leaf, carrying a female pupa on the tip of the abdomen.

Damage: The mites attack the outer cells of the leaves, causing the foliage to dry up. Symptoms of Aculops attack are more specific - the leaves tend to stand out rigidly from the stem, the margins of the leaflets curl upwards and the whole plant has a 'staring' look. Meantime, the undersides of

the leaflets develop a shiny appearance, and eventually turn russetcoloured and dry out. Substantial yield loss can occur.

Control: As soon as the first symptoms are seen, the crop should be sprayed with either dicofol or dimethoate, ensuring that the undersides of the leaves are thoroughly treated. One application is usually adequate.

3. FUNGAL DISEASES

Alternaria solani - Early blight, Target spot ++

This widespread fungus is described under Tomato, (p.263).

Symptoms: Zoned spots up to 6-7 mm in diameter are visible on the upper surface of the older leaves some six weeks or so after planting: the diseased leaves eventually dry out and die. The fungus is also capable of attacking the tuber and causing a brown, corky rot, but this phase was seen infrequently in Senegal.

Pathogen: See description under 'Tomato'.

Conditions favouring development: A temperature of 24-28°C, accompanied by high humidity: susceptibility to attack appears to begin about six weeks after planting and increases as maturity approaches. In Senegal CVt, the potato crops planted in March and later are more heavily attacked, probably because temperature and relative humidity begin to rise as the wet season approaches.

Control:

- (a) Biological. Defrancq (1984) states that Alpha was the cultivar which was least attacked in Senegal, whilst the following were moderately attacked: 'Ajax', 'Arran Banner', 'Baraka', 'Cardinal', 'Claustar', 'Dani', 'Diamant', 'Desiree', 'Draga', 'Estima', 'Eureka', 'Feja', 'Kerpondy', 'Keswick', 'Mirka', 'Nicola', 'Radosa', 'Rosalie', 'Z62-7 Saida', 'Tobique' and 'Vittorini'. Most susceptible were: 'Bintje', 'Claudia', 'Jaerla', 'Ostara', 'Premiere', 'Sahel' and 'Spunta'.
- (b) Cultural. A rotation of 2 to 3 years without solanaceous crops should be observed.
- (c) Chemical control. Application of captafol or maneb can be made on susceptible cultivars growing in a 'high risk' situation, about six weeks or so after planting, and repeated every 7 to 10 days, if necessary.

Leveillula taurica - Powdery mildew.

Attacks by this fungus have occasionally been noted on potato, particularly on cultivar 'Bintje', but the pattern of attack has never been such as to require the application of fungicide.

Pythium aphanidermatum * This soil-borne fungus occasionally causes a wet rot of the stem at ground level and soft rot of potato tubers. It is favoured by warm, wet soil conditions.

Macrophomina phaseoline (Deuteromycetes, Sphaeropsidales) (***)
(syn. Rhizoctonia bataticola)

Distribution: Widespread.

Hosts: The fungus infects a wide range of host plants.

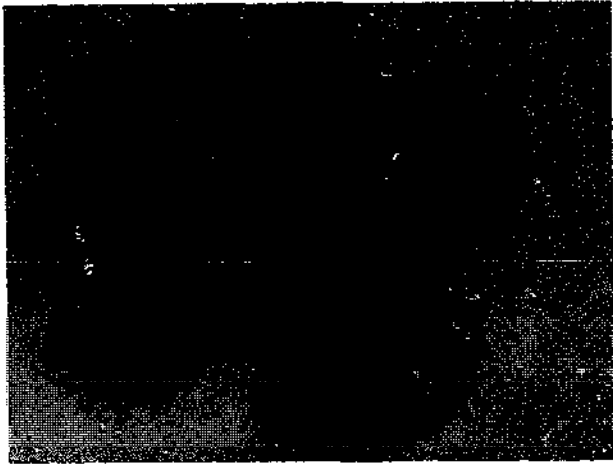

Streptomyces scabies



Alternaria solani

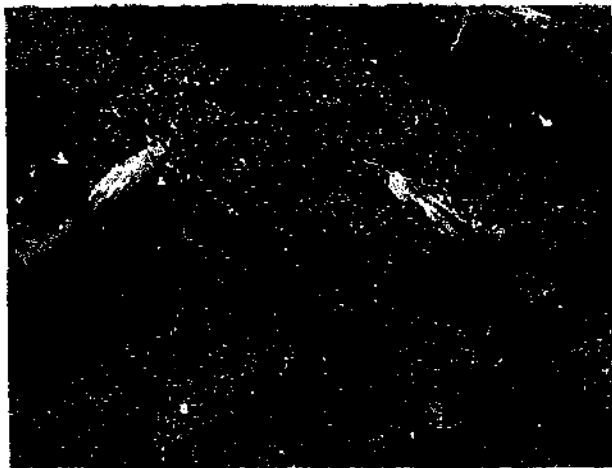

Sclerotium rolfsii

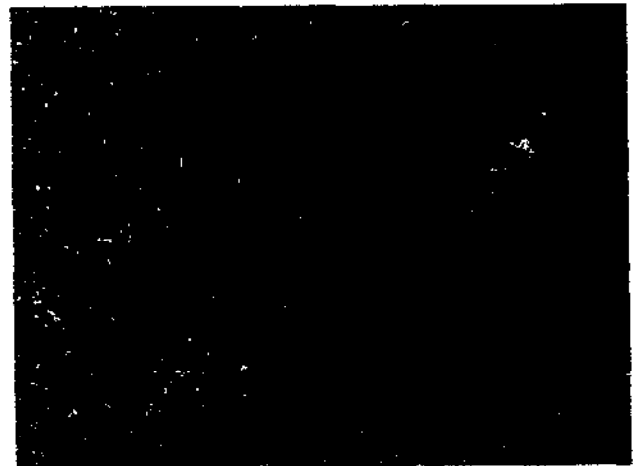

Rhizoctonia bataticola

Fig.16 - Some fungus diseases of potatoes.

Symptoms: A blackish-brown dry rot develops around the lenticels of the potato tuber: these rotted areas increase in size and join up, involving large parts of the tuber surface. The rot may penetrate up to 5 mm or more. Infected tubers are severely downgraded or unsaleable.

Pathogen: This fungus is complex in that it apparently comprises a sterile form, *R. bataticola*, and also a pycnidial form named *Macrophomina phaseolina* with large and very variable non-septate pycnidiospores up to 30 μm long. Only the sterile form was isolated from potato tubers: in culture on potato dextrose agar it produced thick (12 μm + diam.) blackish-brown hyphae and formed many blackish-brown, round to oval micro-sclerotia up to 600 μm diameter.

Conditions favouring development: This fungus attacks potato tubers growing in hot, dry soils. It is particularly in evidence towards the end of the culture, when the tops have died down and irrigation has been stopped.

Damage: Under the above conditions, failure to dig the crop after stopping irrigation has led to total loss of the crop, particularly in the hot, dry conditions in the north of Senegal.

Control: It is particularly important to dig the potato tubers when the crop is mature and irrigation has ended. In cases where this is impossible, a light irrigation to cool and moisten the upper layers of the soil is reported to limit the losses to some extent.

Rhizoctonia solani (Deuteromycetes, Mycelia Sterilia) **

Distribution: Widespread, existing in numerous different strains.

Hosts: The fungus attacks a wide range of plants.

Symptoms: A dark brown (initially) dry rot appears on the stem at soil level. The leaflets roll upwards and the attacked stem may die. A further type of symptom may sometimes be found on the surface of the tubers, where the fungus forms blackish-brown sclerotia in the form of thin, dry plaques or crusts.

Conditions favouring development: Infection appeared to occur most frequently when the soil was maintained continually moist, under daily irrigation. Temperature appeared to be of less importance, possibly reflecting the existence of different strains of the fungus. The presence or absence of sclerotia on the seed tuber surface did not seem to have any influence on the degree of infection. Symptoms often appeared a few days after ridging up, but this is not necessarily thought to indicate that infection occurred following wounding of the stem tissue due to cultural operations.

Damage: Attacked stems invariably died, and sometimes the whole plant was involved. Losses of up to 20% of the plants were recorded on occasion, though generally the attack was much less severe.

Control:

- (a) Biological. Differences in varietal susceptibility were observed; thus the least attacked were: 'Alpha', 'Desiree', 'Spunta'; whilst the most frequently attacked were: 'Baraka', 'Bintje', 'Cardinal', 'Claudia', 'Mirka' and 'Premiere'.
- (b) Cultural. Avoid excessive irrigation.

- (c) Chemical. Following numerous experiments, no clear-cut recommendation for the use of chemical pesticides emerged. Treatment of seed tubers by dipping before planting did not lead to any reduction in attack. Of the various treatments, iprodione (0.75 kg.a.i./ha) captafol (8 kg.a.i./ha.) or thiophanate-methyl (2 kg a.i./ha), applied as a spray to the soil-surface immediately before ridging-up, all gave significant control of stem infection, but without any significant increase in yield (the attack in all the numerous experiments was rather limited). Quintozene at 20 - 23 kg a.i./ha in soil application or pre-ridging-up application gave good control but in one instance caused russetting of the potato tubers, and some foliar phytotoxicity.

Sclerotium rolfsii - (Deuteromycetes, Mycelia Sterilia) + (+).

Hosts: plurivorous (non-specialized).

Symptoms: This soil-borne fungus causes a beige-coloured rot of the potato stem at soil level: the cortical tissue is destroyed, the leaves turn yellow and the plant dies. The fungus may also attack the potato tubers.

Pathogen: A copious cottony-white mycelium grows out of the invaded tissue and usually covers the soil surface around the stem: amongst the mycelial strands develop small spherical sclerotia, about the size of mustard seeds, whitish at first then becoming beige to dark brown as they mature. The mycelium is usually sterile but may sometimes produce basidiospores - the perfect stage Pellicularia rolfsii.

Conditions favouring development: The fungus thrives at high temperatures (30-35°C) and high soil-moisture/relative humidity; the presence of undecomposed plant debris in the surface soil, and a deficiency of nitrogen in the nutrition of the plant will also contribute to the perpetuation of Sclerotium rolfsii. Because high temperatures favour the development of S. rolfsii, it is generally the very early-planted (just after the hot, wet season) and the very late-planted (the last crop before the hot, wet season) potato crops which suffer most from the attacks of this fungus.

Control:

- (a) Cultural. Plant debris should be removed or deeply buried before planting potatoes. Despite the fact that S. rolfsii is a non-specialized fungus, less infection was noted when a 2-3 year rotation free from Solanaceae was adopted.
- (b) Chemical fertilizer should be applied to ensure that the crop is receiving adequate nitrogen: according to Henis and Katan (1975), a decrease in S. rolfsii infection resulted from the application of calcium nitrate to tomato, and both ammonium and nitrate nitrogen to sugarbeet. Other workers have shown that the addition of calcium may exert a beneficial effect in protecting crops from the effects of S. rolfsii.

The addition of certain pesticides such as quintozene to the soil is said to suppress S. rolfsii (see Rhizoctonia solani above); tolclofosmethyl also is specified for the control of S. rolfsii at dosage rates of 5-10 kg a.i./ha for soil incorporation; the manufacturer's recommendations should be carefully followed.

4. BACTERIAL DISEASE

Xanthomonas campestris pv. vesicatoria +

Symptoms: Small water-soaked, brownish, irregular spots on the underside of the potato-leaflets; later, they appear also on the upper surface, grow bigger (2-2.5 mm) and can lead to the drying out of leaf tissue.

Pathogen: In Senegal CVt, the bacterium on potato was identified in collaboration with ORSTOM (M'Baye, 1982) and confirmed by the CMI; however, pathogenicity trials were not carried out. This pathogen has been described under 'Tomato'.

Conditions favouring development: Symptoms were most noticeable when temperature and relative humidity were high; thus, very early and very late crops were most liable to be attacked.

Damage was usually limited, the organism did not appear to be very aggressive.

Control:

- (a) Biological. The cultivars 'Cardinal' and 'Desiree' were more freely attacked than were 'Alpha', 'Baraka' and 'Nataange'.
- (b) Chemical. The disease was never serious enough to warrant application of pesticides, but should such a situation arise, probably a copper fungicide, as used on tomatoes, would be efficacious.

5. VIRUS DISEASE

The potato is host to a large number of virus diseases. Despite this, the incidence of virus diseases, at least in Senegal, was fairly limited, possibly because, during the main cropping period, the populations of aphid vectors were not very high, the main build-up coming in May/June.

Virus Y was identified in potato crops in Senegal by Thouvenel and Fauquet in 1976. Virus Y is transmitted by aphids, the most important vector species being the peach aphid Myzus persicae. Virus Y is of the non-persistent type, thus insecticide spraying is of very limited value in controlling the spread of the virus from sources outside the crop.

6. NEMATODES

Meloidogyne spp. A general description of this organism has already been given (p.156).

Symptoms: Both roots and tubers of the potato plant are attacked by this nematode. Symptoms on roots are typical nodose swellings, whilst on the tubers, they vary from small nodules to large protuberances on the tuber surface.

Damage: Attacks on the root system can cause yield losses: however, the loss of revenue is often enhanced, because tubers attacked by root-knot nematode are usually subject to serious downgrading, quality-wise.

Control: General control measures for Meloidogyne spp. have already been discussed.

L. ROSELLE (*Hibiscus sabdariffa*)

1. INSECT PESTS

Roselle is attacked by more or less the same range of insect pests as is okra.

2. FUNGAL DISEASES

Leveillula taurica - Powdery mildew (p.267) causes symptoms similar to those found on okra. Development of the disease is usually limited, and warrants no action.

Oidium abelmoschii. Symptoms are similar to those found on okra, but the fungal attack usually takes place when the crop-plants are fully grown, towards the end of the cropping cycle.

3. NEMATODES.

Meloidogyne spp. Both red and green Roselle are attacked by Meloidogyne spp.: however, in a comparative trial, Roselle was found to be noticeably less susceptible than Okra (Defrancq, 1984).

M. SCARLET EGG-PLANT (*Solanum aethiopicum*)

1. INSECT PESTS AND SPIDER-MITES

Many of the insect-pests which attack aubergine (*S. melongena*) attack also scarlet egg-plant (*S. aethiopicum*): two exceptions, at least in Senegal, are *Eublemma olivacea* and *Pachnoda* spp., neither of which attack *S. aethiopicum* to any great extent. On the other hand, *S. aethiopicum* is preferred by *Myzus persicae*.

Scarlet egg-plant is also a preferred host of the leaf-miner, *Liriomyza trifolii*, and suffered severe damage from the attacks of this pest during the 1980-1981 season in Senegal (p.197).

Concerning the spider-mites, infestations of *Tetranychus* spp. are very common on *S. aethiopicum*. Damage caused by *Polyphagotarsonemus latus* is frequent, the young leaves in particular being attacked: their growth is distorted and they assume a feathery form, suggestive of a viral infection.

2. FUNGAL DISEASES

Aecidium habunguense - Rust +. Local selections of *S. aethiopicum* in Senegal were moderately susceptible to this fungus (p.229).

Leveillula taurica. Powdery mildew. +

Scarlet egg-plant is somewhat more susceptible than aubergine to attacks by this fungus. Attacks in Senegal were generally heaviest on crops which were approaching the stage of harvest, and were more or less confined to the dry season from November to June. In some areas, attacks were heavy enough to warrant control measures.

~~Pseudocercospora acromarginata~~
Symptoms: Rounded, chlorotic leaf-spots visible on the upper leaf-surface: on the underside of these spots is a light, brownish-black mould.

Pathogen: The conidia are long and tapering, $78 \times 3 \mu\text{m}$ ($52-105 \times 2.5-3.5 \mu\text{m}$). The disease is not serious and appears only occasionally.

Sclerotium rolfsii + This fungus sometimes causes a collar-rot of plants at soil-level.

Stemphylium solani. ++

Symptoms: Small, (up to 4mm) round to angular spots, grey-brown in colour and encircled by a dark brown margin are visible on the leaf, which turns yellow and falls.

Pathogen: See p.242 for description. Spores $49 \times 19 \mu\text{m}$ ($28-75 \times 12-25 \mu\text{m}$).

Damage: Plants are attacked both in the seed-bed and in the field: in the south of Senegal in the Casamance region, the disease is found all the year round.

Control: Preliminary results from field trials suggest that maneb, mancozeb and captafol applied weekly at a rate of around 1450 g.a.i./ha from the date of appearance of the first symptoms, will give satisfactory control of S. solani (shown in descending order of efficacy). (M'baye, 1983).

3. NEMATODES ++(+)

Scarlet egg-plant is susceptible to attacks by the root-knot nematode, Meloidogyne spp.

N. SWEET POTATO (Ipomoea batatas)

1. INSECT PESTS

Agrius convolvuli - Convolvulus hawk-moth (Lepidoptera, Sphingidae). ++(+).

Distribution: widely distributed throughout Africa.

Hosts: Sweet potato and other Convolvulaceae: occ. Phaseolus:

Description: The young caterpillars are light green in colour: they can attain 80 - 85 mm long when fully grown, and may remain green in colour, with darker green strips, or become brownish streaked with whitish lines. All the larval stages of this family carry a conspicuous 'horn' at the end of the abdomen. The adults have a wingspan of about 85 to 100 mm. and are greyish in colour with pink markings on the abdomen.

Damage: The caterpillars devour the foliage, and because of their size can cause considerable damage if they are numerous.

Control: A single application of a pyrethroid insecticide, if really necessary, is usually sufficient to control this pest. On a limited area, control by hand-picking is possible.

Aspidomorpha sp. - Tortoise beetle (Coleoptera Chrysomelidae)
(Cassidinae) +(+)

Host: Sweet potato.

Description: The larva is about 6 to 8 mm. long and has a flat, oval-shaped body bordered by spines: at the rear extremity it has a long, dark-coloured 'tail' which is carried arched over the back. The adult is about the same size, rounded to shield-shape in form, irridiscent greenish-gold in colour.

Damage: Both larvae and adults eat the foliage, which they pierce with irregular-shaped holes: the damage, which is more important during the wet season, rarely reaches serious proportions.

Control: In cases where this is deemed necessary, the plants should be sprayed with dimethoate, ensuring that the undersides of the leaves are particularly well treated.

Brachmia convolvuli. (Lepidoptera, Pyralidae) +.

Description: Caterpillars very slender and active; 10 mm long, brownish-black streaked with whitish lines: body narrowing towards the head.

Damage: The caterpillars eat the parenchymatous tissue of the foliage and roll the leaves, fixing them with silk threads.

Control: Apply one of the insecticides recommended for Heliothis control, but only in case of high populations.

Cylas puncticollis - Sweet-potato weevil (Coleoptera, Curculionidae) +++.

Distribution: C, Ch, K, Na, Se, So, Su.

Hosts: Sweet potato, Ipomoea spp.

Description: The larvae of this insect are white, legless maggots about 8 mm long which bore into the stem and also cause more serious damage by tunnelling into the underground tubers. The adult is a small (6-7 mm) black insect with a narrow head and thorax but a rather bulging abdomen, and bears a superficial resemblance to an ant: the adults attack the leaves, which they perforate with small holes. The life-cycle covers about 6 weeks.

Damage: The most serious damage is caused by the larvae during the wet season: by boring into the stems, they cause the death not only of leaves but often of young plants, whilst their tunnelling activities in the tubers often lead to secondary wet-rots which destroy the tubers entirely.

Control:

- (a) Cultural. An ample depth of soil should be maintained over the tubers, and the soil itself should be worked to avoid the formation of cracks, in order to prevent the females from reaching the tubers for egg-laying. After harvest, all Cylas-infested material should be gathered up and burnt. A two to three year rotation should be observed. Field observations showed that the stems of certain deeply-pigmented selections of sweet-potato were less heavily attacked than some of the lighter-coloured cultivars.
- (b) Chemical. Some degree of control can be achieved by spraying the foliage with dimethoate, to kill the adults.

Gryllotalpa africana - African mole-cricket. +

Makes shallow holes in sweet-potato tubers, similar to damage caused to potato tubers.

Description: See page 249.

Pinnaspis strachani - Scale insect (Homoptera, Diaspididae) ++.

Description: Small, white scale-insect which sometimes occurs in large numbers on the stems.

Damage: Growth is retarded due to loss of sap.

Control: Not generally necessary, but oil formulations of malathion are said to be effective against this type of pest.

2. SPIDER MITES

Tetranychus spp. + causes limited damage to sweet potato in Senegal.

3. FUNGAL DISEASES

Cercospora ipomoea occasionally causes roundish leaf-spots, greyish in colour with a red margin. Spores 80 x 3.4 μ m. (47 - 150 x 1.6 - 4.7 μ m).

4. VIRUS DISEASES

Unidentified diseases, apparently of viral origin can cause severe yield-losses in sweet potato crops in Senegal. The importance of this was underlined in a trial carried out in 1983/84 to compare the yield from healthy and virus-infected plants of the two cultivars N'Dargu and Walo: significant losses in yield resulting from virus infection were as follows:

Tubers: 78% for 'N'Dargu' and 28% for 'Walo'

Foliage: 52% for 'N'Dargu' and 25% for 'Walo'. (M'baye, 1983).

Thus, 'N'Dargu' is much more susceptible than 'Walo'.

Defrancq (1984b) observes that in the case of very susceptible varieties, as the virus-infected cuttings take root only with the greatest difficulty, this represents a form of natural selection which assures that principally only the virus-free plants will survive out of a mixed planting of healthy and virus-infected material.

5. NEMATODES

Sweet-potato is susceptible to attacks by the root-knot nematode (Meloidogyne spp.) However, important differences were shown to exist in the degree of susceptibility amongst the members of a series of clones locally selected in Senegal, and also amongst clones imported from Nigeria. These differences ranged from highly resistant; (e.g. 'Louga 5') to moderately susceptible (M'boro 3), represented by notations of 0.5 and 4.0 respectively on a scale of 0 (resistant) to 10. This suggests that it would be worthwhile to carry-out comparative tests for resistance to Meloidogyne spp.

O. TOMATO (*Lycopersicon esculentum*)

1. INSECT PESTS

Bemisia tabaci - Whitefly (Homoptera, Aleurodidae) + (++)

Distribution: An, C, Ch, E, K, Md, Mu, Na, Se, So, Su

Hosts: A wide range of plant species

Description: This small insect is about 1 mm long, silvery-white in colour and with wings of a rather waxy texture: it is found often on the underside of the foliage where it sucks the plant sap and enfeebles the plant. In many warm climates it also transmits a damaging virus disease of tomatoes - Tomato Yellow Leaf Curl (p.271).

Epicauta tomentosa - (Coleoptera, Meloidae) +(>). This small, greyish beetle, 12 mm long and 4 mm wide, can damage young plants by making large irregular holes in the foliage or by cutting off seedlings. Control, if necessary, is by the use of dimethoate or malathion.

Heliothis armigera - Tomato fruitworm or Cotton bollworm (Lepidoptera) +++

Distribution: Al, An, B, C, Ch, E, K, Md, Ml, Ni, Na, Se, So, Su, U.

Hosts: Polyphagous, attacks a wide range of plants including cotton, cereals and numerous species of vegetables.

Description: Eggs yellowish-white, almost spherical about 0.6 mm in diameter with the surface sculpted into longitudinal ridges: they are visible to the naked eye and are laid singly, usually on the upper surface of the young leaves, sometimes on the peduncles or on the fruit: as hatching approaches, they darken in colour. On hatching, the caterpillars feed on the young foliage but after about one day they bore into a suitable fruit where they continue their development. The fully-grown caterpillar may measure up to 35-40 mm long. The colour may vary from light green through brown to almost black: there are several pale longitudinal lines on the body, which also bears on the surface a series of very small dark-coloured spines. The adult moth is greyish-brown in colour with a wing span of 36-38 mm. The adults fly principally at dusk and during the night. The life-cycle covers about 4½ to 5½ weeks.

Damage: Leaves are damaged and flower-trusses are cut off, but the most serious damage is that caused by penetration of the fruit by the caterpillar, which may destroy several fruits in succession. When fruits are attacked in the very young stage they generally fall: older fruits may remain on the plant but in many cases they develop a soft-rot. Losses resulting from attacks of H. armigera in the Cap Vert region of Senegal often amount to 90% or more of the fruit.

Control: In field trials in Senegal, the following insecticides were shown to be effective against H. armigera - acephate, carbaryl, cypermethrin, deltamethrin, endosulfan, fenvalerate, tetrachlorvinphos. (Collingwood and Bourdouxhe, *1980. Collingwood et al, 1981, Bourdouxhe and Collingwood, 1982). Application should be made every 7 to 8 days in the case of a heavy attack: the first treatment should be carried out a few days after the appearance of the first eggs but before the young larvae have penetrated into the fruit (where they will be protected against insecticidal sprays). From two weeks before the first harvest, only pyrethroid insecticides, and

* 1979 and 1980

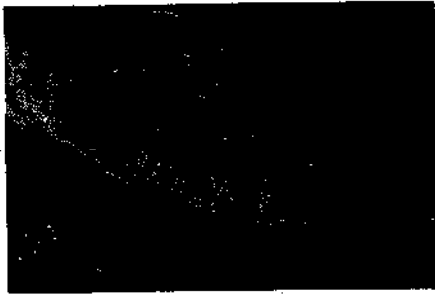

Heliothis sp.(larva)



Heliothis sp.(larva and eggs)



Blossom and rot



Sun burn



Xanthomonas vesicatoria

Fig.17 - Caterpillar,bacterial attacks,and physiological diseases of tomato.

possibly carbaryl, should be used, the harvest delay with the other products being longer than the intervals between successive harvests. Products of different chemical groups should be used alternately before the start of harvest to reduce the possibility of the development of resistance.

Note: In Senegal CV, H. armigera attacks the cotton crop which is grown during the July - October rainy season: with the onset of the dry season the insect returns to the vegetable-growing region and can be detected by means of pheromone traps from about mid-December until June/July (Bourdouxhe 1980, 1981a, 1983). Its arrival in the tomato crops is widely thought to coincide with the onset of flowering, but this is not a reliable indicator, and attacks before flowering have resulted in heavy losses of young flower-trusses.

Jacobiasca spp. - Jassids + sometimes cause discolouration to the leaves by sucking out sap: aphids also may cause distortion and damage to leaves.

Scrobipalpa ergasima (Lepidoptera, Gelechiidae) + (+)

Description: The larvae are translucent, with darker markings on the body, which attains a length of about 8 to 10 mm. The adult is a small moth, light-brown in colour with narrow wings.

Damage: The larvae bore into the fruit, often under the calyx, and make narrow galleries in the central 'plug' of the tomato. In Senegal CVt they have been observed particularly towards the end of the dry season.

Control: No control measures have been applied, but if deemed necessary, the same chemicals as used against Heliothis would probably be effective.

2. MITES

Aculops lycopersici (Vassates lycopersici) - Tomato Russet Mite.
(Acarina) +++.

Hosts: Tomato, potato.

Description: The mature mite is creamy white in colour and is about 250 μ m long - too small to be seen without the aid of a good hand-lens (x20 is required to see the mite with ease). It is more or less cylindrical in shape, tapering towards the rear end: at the fore-end are two pairs of legs.

Damage: Attacks by russet mites on the underside of tomato leaves leads to a drying-out and death of the foliage: the attack starts on the lower leaves of the plants, which at first appear shiny and reflective, later becoming bronze in colour and finally dry and brown: as the lower leaves dry out the mites move progressively towards the upper foliage. The mites tend to congregate around the midribs of the leaflets, where they can be very numerous - 100 to 200 per leaf is not uncommon: they attack principally the leaves and sometimes the main stem: occasionally the fruit is attacked, in which case the skin turns brown and dry and is covered by a network of very fine fissures. In hot weather the rate of reproduction is very rapid, and the attack progresses very quickly: medium-sized plants seem to be particularly susceptible, and may be killed by the attack.

Control: Treatment is by the use of suitable acaricides, and dicofol, dimethoate and endosulfan have given good results (the two latter being also insecticides). Endosulfan is one of the products recommended for control of H. armigera, and its use might simultaneously control the two

pests: similarly, sulphur used as a fungicide to control Leveillula taurica might exert a limited acaricidal effect. An acaricide should be applied as soon as bronzing of the lower foliage is noted and the presence of the mites is confirmed. Usually, one or two treatments are sufficient.

Note. On several tomato crops in Senegal, very heavy damage due to Aculops lycopersici has followed the indiscriminate use of synthetic pyrethroid insecticides: this misuse has presumably led to the destruction of the natural predators of Aculops and permitted an unchecked population build-up of this mite.

3. FUNGAL DISEASES

Alternaria solani - target spot, early blight. (Deuteromycetes, Moniliales)
++

Distribution: Worldwide.

Hosts: Tomato, potato, eggplant.

Symptoms: Three different phases of the disease are found on tomatoes:

- a) On young plants in the seedbed, elongated spots (sometimes zoned) on the lower stem.
- b) On the leaves - brown zoned spots, up to 8 mm. diameter, surrounded by a yellow halo: the stem and leaf axils may also be attacked.
- c) On the fruit - large, often zoned spots, up to 2 cm. diameter and often on the upper side of the fruit in the region of the calyx.

The leaves seem to become susceptible to attack in the field when the first fruits begin to ripen.

Pathogen: Conidia usually solitary, cylindrical, tapering at one end to a long beak which is equal to the conidium in length or slightly longer. The conidium usually has 8 to 12 transverse, and 0 to 3 longitudinal or oblique septa. Dimensions - 150-300 x 15-19 μ m.

Conditions favouring development: A temperature of 24 to 28°C, with a high humidity. In Senegal CVt, the heaviest attacks were noted as the temperature began to rise towards the start of the wet season (March - June).

Damage: There is a loss of young plants in the seedbed, plus the danger of spreading disease on transplants. Destruction of foliage enfeebles the plants, and reduces their yield-capacity. In addition, important losses occur as a result of fruit-infection: in a trial carried out at the CDH in 1979/80, losses in untreated plots amounted to 23% and 14% in cultivars UHN 11 and Hope No. 1 respectively.

Control:

- (a) Cultural. Seed should be sown in correctly-spaced lines, and watering of young plants in the seedbed should be completed before late afternoon so that they do not remain wet overnight. The fungus is seedborne, so healthy seed should be used. The spores are said to persist in the soil for 1 - 1½ years so a rotation should be practised. All debris from infected crops should be removed and destroyed by burning.
- (b) Chemical. Treatment every five to seven days with captafol if A. solani is a problem in the seedbed: weekly applications in the field of captafol, chlorothalonil, maneb or metiram-zinc should be made from the stage when the first fruits are well-formed, in crops which are likely to be at risk from this disease.

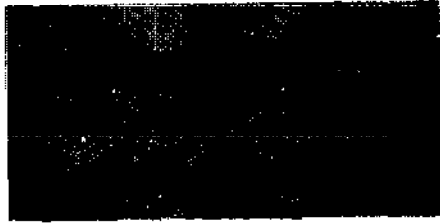

Alternaria solani

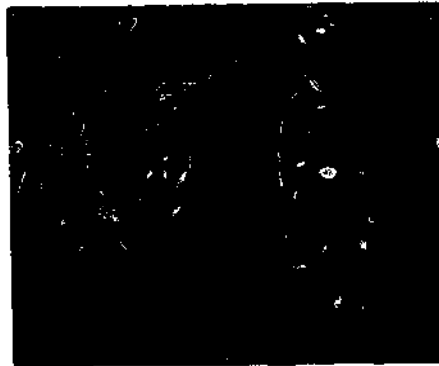
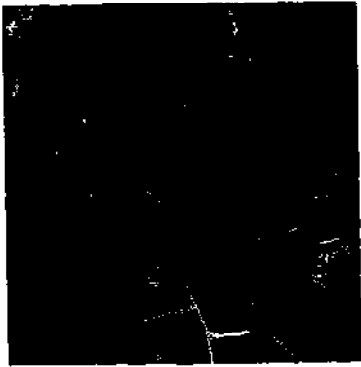

Stemphylium solani

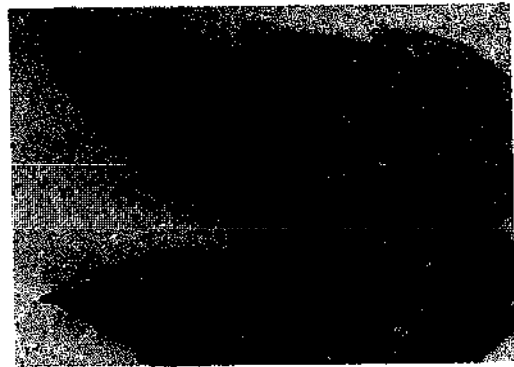

Fulvia fulva

Fig.18 - Fungus diseases of tomato.



Leveillula taurica

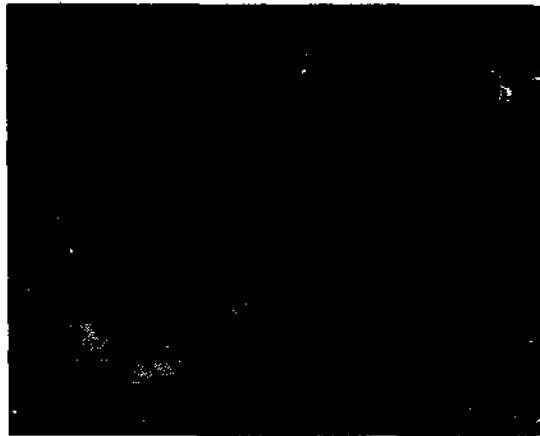

Rhizoctonia solani

Fig.18 - Fungus diseases of tomato.

Note: In general, a greater proportion of cultivars with round fruits were found to be susceptible to *A. solani* than was the case in cultivars with elongated fruits, such as 'Elsa 498', 'Hessoline', 'Roma VFN', 'Royal Chico', 'Slumac', 'Zevat' (Defrancq, 1979). However, it is interesting to note that in the trial mentioned above, of the two round varieties, 'Hope No. 1' was more resistant than 'UHN 11', and the combination fungicide + resistance ('Hope No. 1') gave relatively much better control than fungicide + susceptibility ('UHN 11').

Cercospora fuligena. (Deuteromycetes, Moniliales) (++) .

Symptoms: Circular chlorotic spots, up to about 5 mm diameter are visible on the upper leaf surface: on the underside of these spots is a brownish-black velvety mould, consisting of the conidiophores and conidia of the fungus.

Pathogen: Spores are long, narrow, hyaline structures with numerous septa, tapering somewhat from the base to the apex. Dimensions: 90 x 3.7 μ m (35-150 x 3.5-4.2 μ m).

Conditions favouring development: Optimum temperature 28°C: observed in Senegal during and just after the rainy season.

Damage: The disease results in destruction of leaf-tissue.

Control: The disease can be controlled by the use of maneb or benomyl. Differences in varietal susceptibility have been noted, amongst the least-attacked cultivars being 'Healani', 'Heinz 1370', 'Marsol', 'Master No. 3', 'Quatuor, 75/22'.

Colletotrichum phomoides - Anthracnose. (Deuteromycetes, Melanconiales) (++) .

Symptoms: This fungus attacks principally ripening tomato fruits. Roundish spots, 2-7 mm diameter cause depressions on the fruits: the centre of the spots darkens, the skin may eventually rupture and the pale, salmon-pink, gelatinous spore masses appear on the lesions.

Conditions favouring development of lesions are a temperature of about 25 to 27°C and the presence of ripening fruits in moist conditions.

Damage: Heavy losses of fruit may occur if conditions are favourable for the disease.

Control: Spraying with a dithiocarbamate fungicide plus a sticker has been recommended. The fungus is able to persist in the soil from one season to the next on infected debris, thus an adequate rotation is desirable. In Senegal, this disease has generally been of minor importance, and only one serious attack has been noted during the last few years.

Fulvia fulva. (Cladosporium fulvum) - leaf mould. Deuteromycetes, moniliales) + (+) .

Distribution: An, C, K, Na, Si, So, Su.

Host - Tomato.

Symptoms: Pale green yellowish spots with diffuse edges appear first on the upper surface of the lower leaves: on the underside of these spots can be found a downy, olive-green mould. As the lesions develop the leaves become brown and dry.

Pathogen: Conidiophores pale, olivaceous brown with swellings along one side giving the appearance of nodes. Conidia 0 to 3-septate, 12.5-38 x 5-10 μm , rather variable in shape.

Conditions favouring development: Optimum temperature 22°C, very high relative humidity required for rapid development, which more or less ceases when the RH drops to around 70%. The disease is sometimes found attacking field crops in Senegal CVT, more frequently in Casamance: it is also found on old seedbed sites, where unwanted plants have been allowed to grow on and are consequently crowded together, maintaining an ideal microclimate for the development of F. fulva.

Damage: Considerable destruction of foliage follows a heavy attack by this fungus.

Control: Applications of benomyl, thiophanate-methyl, mancozeb or zineb are effective (benomyl or thiophanate-methyl should be alternated with one of the other two). Defrancq (1984) has noted differences in susceptibility, and it must also be remembered that there are several different races of the fungus.

Fusarium oxysporum f.sp. lycopersici - Wilt (Deuteromycetes, Moniliales) *

Host: Tomato and certain other species of Lycopersicon.

Symptoms: Yellowing of the lower leaves, at first often on one side of the plant only, followed by wilting. The symptoms progress towards the top of the plant which grows badly, remains stunted and eventually dies. The vascular system shows a brown discolouration.

Pathogen: F. oxysporum is a soil-borne fungus which penetrates into the roots of the tomato plant. The fungus produces both microconidia, 0.1 septate (2.5-3.7 x 5-11 μm) and macroconidia, fewer in number, fusiform (spindle-shaped) often curved like a sickle (falcate) and with up to 5 septa (3-5 x 27-60 μm). Chlamydospores also are produced (8-12 μm). Cultures on potato dextrose agar usually produce a pale salmon-pink pigment.

Conditions favouring development include a temperature of 25-31°C, low pH, low potassium and low soil moisture.

Damage: Poor plant development, death of foliage and consequent loss of yield.

Control: Soil treatment on a field scale cannot be envisaged, and the disease is checked by the use of resistant varieties. A large series of varieties exist which are resistant to pathotype 1 of the fungus - indicated by F or VF in catalogues. However, pathotype 2 of the fungus, which has been identified in several parts of the world, including Senegal (see p.169) is capable of overcoming this resistance. Another, more limited series of tomato cultivars exists, resistant to both pathotypes and including cultivars 'Big Set', 'Caribe', 'Duke', 'Florida MM1' and 'Walter', and also the two tomato cvs. Romitel and Rotella, bred for tomato paste production and developed at the CDH in a joint programme with INRA (Defrancq and Laterrot, 1985). The pathotype 2 did not appear to spread very rapidly from the original points where it was found in Senegal.

Leveillula taurica - Powdery mildew (Ascomycetes, Erysiphales) ++.

Distribution: Al, An, E, K, Na, Se, Su.

Hosts: Tomato, pepper, plus many other minor hosts.

Symptoms: On the upper leaf surface - irregular yellow spots (5mm+) which develop scattered necrotic points: on the underside of these spots can be found a light growth of whitish, powdery mould: This mould is occasionally found growing on the upper surface of the leaves. Infected leaves turn yellow then dry out.

Pathogen: The imperfect stage, Oidiopsis taurica is the one usually found. The fungus is endophytic, growing within the leaf-tissue, the conidiophores growing out through the stomata and bearing usually two, rarely three almost rectangular-shaped conidia, the terminal one however narrowing towards the apex (57x18 μ m (42-72x12 -25 μ m.)

Conditions favouring development: The optimum temperature range appears to be around 20 to 28°C: the fungus can grow over a fairly wide range of relative humidity, from 50 to 80% being suitable. In the region of Podor in the north of Senegal, where the average relative humidity during the tomato growing season (Oct-April) rarely exceeds 40%, only traces of L. taurica are found in the crop, and then only in low-lying, badly-drained, more humid areas (Van Damme 1982).

Damage: Reduced yield following foliage destruction.

Control: Good control has been obtained by treatment with triadimefon, fenarimol, triforine, bupirimate and (wetttable) sulphur: the tomato appears to become susceptible to attack after the stage at which the first fruits begin to ripen.

Differences in varietal susceptibility were observed, the cultivars 'Atkinson', 'Elsa 498', 'Roma VFN', 'Ronita' and Rossol being least attacked.

Pythium spp. - damping-off

This widespread disorder is found most frequently in the seedbed where plants are often overcrowded and overwatered, and particularly when sowing is carried out very soon after the wet season, when the soil is still warm and moist. See p.151) for a general discussion on damping off.

Rhizoctonia solani - 'Soil Rot' or Fruit Rot (Deuteromycetes, Mycelia Sterilia)*(*)

Distribution/Hosts: The fungus is found throughout the world and attacks a wide range of plants.

Symptoms: In this particular disease of tomatoes, the symptoms appear as large, roundish, dark-brown spots on the surface of the fruits, particularly where they come into contact with the ground. The spots are usually zoned, and the skin above them often tears, resulting in radial cracks, this may be followed by rotting.

Pathogen: R. solani is the non-sporing mycelial stage of a Basidiomycete (p.253).

Conditions favouring development: Contact between the fruit and the ground, with a film of moisture present. It arises from this that cultivars with large round/flattish fruits are more likely to become infected than smaller, elongated fruits of the Roma type, because the shape and weight of the former bring them more readily into contact with the soil.

Damage: Fruit losses of up to 50% have been recorded in Senegal CVt.

Control: There is no easy method of control. Supporting tomatoes on canes, wires, etc., in order to keep them off the ground will reduce losses. So far as chemical treatment is concerned, application of captafol (200 g a.i./100 l) at weekly intervals during the fruiting period (trial with 2 cultivars) resulted in a significant reduction in the percentage of fruits attacked by R. solani (9.6% treated, 19.6% untreated: 2.6% treated, 8% untreated) (Collingwood et al., 1975/80). If Alternaria solani is a problem, the captafol treatment will help to control both diseases simultaneously. Excessive wetting of the soil surface should be avoided.

Sclerotium rolfsii- +(+)

See under potato for description of this soil-borne fungus, which sometimes attacks the stem at soil-level.

Septoria lycopersici. (Deuteromycetes, Sphaeropsidales) +

Symptoms: Small black spots on the leaves, increasing in size and becoming grey with a black margin and with minute black pycnidia embedded in the tissue of the spot.

Pathogen: Pycnidiospores filiform (thread-like), multiseptate: 71 x 3.2 μm (53-90 x 3.2 μm)

Conditions favouring development: Temperature of 25°C associated with a very high humidity.

Damage: destruction of foliage.

Control: S. lycopersici is an occasional parasite in Senegal and control measures were never required. Captafol and maneb etc. are generally effective against Septoria spp.

Stemphylium solani - Grey leaf spot (Deuteromycetes, Moniliales) *(*)

Distribution: An, Na, Se, Su.

Hosts: tomato, egg-plant, (pepper), Solanum aethiopicum.

Symptoms: small, (2-4 mm) irregular, greyish spots on leaves, often surrounded by a yellow halo. Infected leaves turn yellow and dry-out.

Pathogen: spores pointed, mid-brown with up to 6 transverse and several longitudinal walls: spores constricted at the median transverse septum. 47 x 17 μm (32-60x15-22 μm).

Conditions favouring disease: warm moist conditions, temperature 25°C+. The disease is only of importance on susceptible varieties during the period from February to June (Senegal).

Damage: Severe loss of foliage in a heavy attack, starting on the lower part of the plant. A 40% reduction in the number of harvested fruits and a loss of more than 50% of harvested weight was suffered in one trial using the tomato cultivar 'Polepak' (Collingwood et al., 1975/80).

Control

(a) Biological: Resistant varieties are available; these include: 'Atkinson', 'Big Set', 'Chef', 'Duke', 'Florida MH1', 'Hope No. 1', 'President', 'Romitel', 'Rotella', 'UHN 11', 'UHN52', 'VFN8' and 'Walter'. On the other hand, 'Roma VF', 'Roma VFN', 'Rossol', 'Sluma' and 'Small Fry' are fairly susceptible.

b) Chemicals: in trials at the CDH for the control of Stemphylium solani, application of the fungicides maneb, metiram-zinc, chlorothalonil and captafol resulted in significant yield increases with all four products at commercially-recommended doses, in the above order of efficacy.

4. BACTERIAL DISEASE

Xanthomonas campestris pathovar vesicatoria - bacterial scab or spot +(++).

Distribution: Na, Se, Su.

Hosts: Tomato, chilli pepper, sweet pepper, potato.

Symptoms: On leaves - small (1 to 3 mm) spots, at first water-soaked becoming black, surrounded by a yellow halo: the leaves turn brown and quickly dry-out. Corky irregular spots appear on sepals and peduncles whilst on the fruits the most damaging symptoms develop - small spots, at first water-soaked, whitish, becoming corky and increasing in size to 5-7 mm, remaining fairly superficial.

Pathogen: An aerobic, gram-negative rod, 0.6-0.7 x 1.0-1.5 μ m, motile with a single polar flagellum, yellow in the mass on agar. (CMI/20 1964).

Conditions favouring development: Optimum temperature 30°C, maximum temperature 40°C. The disease develops particularly rapidly under conditions of high humidity and is spread by overhead irrigation. Infection is said to occur through stomata on the leaves and stems and via damaged hairs and small wounds on the fruit. The pathogen is seed-borne. In Senegal CVt. and Casamance it is usually found from May to November, but has been noted as early as February.

Damage: Destruction of leaf tissue, and either loss of fruit or reduction in quality, depending on the degree of attack. Gross yield losses of 40% due to X. campestris p.v. vesicatoria were recorded in untreated tomatoes, compared with those receiving applications of copper oxychloride (M'baye, 1982).

Control:

- (a) Hygiene. Use healthy seed. Clear up all infected debris, on which the pathogen is said to survive for some time: observe a three-year rotation.
- (b) Cultivars showing some resistance are: 'Caribe', 'Duke', 'Rehovot 13', 'Roforto' and 'Rossol'.
- (c) Chemical. In a trial at the CDH, weekly treatment with a copperbased fungicide, starting three weeks after planting out, gave good control of this disease. Treated tomato fruits should be cleaned before sale.

5. VIRUS DISEASES

Tomato Mosaic Virus (TMV) *(*)

Distribution: Worldwide.

Hosts: Over 150 botanical species can be infected.

Symptoms: Infected leaves show a mottling or mosaic of light and dark areas, sometimes with distortion of the younger leaves. Fruits sometimes show bronzing.

Pathogen: The virus, which can be seed-borne, can persist on clothing, seed, plant debris in the soil, for many months. The virus is readily spread on hands, clothes, knives, etc.

Damage: Reduction in fruit size and number and consequent loss of yield.

Control: Cultural. Try to obtain and use seed which has been treated to free it from TMV. Observe a good rotation to avoid picking up TMV from infected soil-borne debris. If TMV is recognized in a section of the tomato crop, always harvest/manipulate the infected section last of all.

Tomato Yellow Leaf Curl Virus (TYLC) **(*)

Distribution: This serious disease is widespread in tomato-growing areas in the Middle East and Senegal, and has also been recorded in The Gambia, Mali and Mauritania.

Symptoms: Infected plants may be stunted, with rather erect, rigid foliage. The leaves remain small, the leaflets are rather spoon-shaped, rolled or curled, and with interveinal chlorosis.

Pathogen: TYLC is a semi-persistent virus, and is spread by the whitefly, Bemisia tabaci. The minimum acquisition and inoculation periods are 15 to 30 minutes, with a latent period in the vector of at least 21 hours (Cohen and Nitzany, 1966).

TYLC is thought to be caused by a gemini-virus, and recent studies of virus-infected tomato foliage from Senegal tend to confirm this view (Defrancq-D'Hondt and Russo, in press). These authors have shown that there is a direct correlation between the population of the vector, Bemisia tabaci and the level of infection of tomato plants: in Senegal CVt. populations show a peak in August/September, following the onset of the rainy season, a decline in October (due possibly to the high humidity), followed by a high peak in November/December and finally a decline in December/January with the onset of the cool, dry season. Incidence of TYLC was highest in tomatoes sown from September to February over a five-year period from 1979 to 1983. The virus is not transmitted mechanically.

Further studies showed that much of the initial infection occurred in the nursery seed-bed, and that plants so infected are efficient virus sources which greatly favour disease spread within the crop, after trans-planting.

Damage: The effect on fruit-setting and consequent yield is particularly severe if infection occurs before flowering. Yield losses of over 50% have been recorded in certain tomato-growing areas.

Control:

- (a) **Biological.** Control by the use of resistant varieties does not appear to be very promising at the moment: certain lines of Lycopersicon pimpinellifolium show some resistance to the disease and are currently being used in breeding programmes, as also is L. peruvianum (Makkouk and Latterot, 1983).
- (b) **Physical.** Cohen (1982) reports the effectiveness of straw mulches in preventing the spread of TYLC during the first eighteen days after germination: Cohen later substituted yellow polythene mulches for straw, and thus protected the tomato plants during their critical early growth-stage.
- (c) **Chemical control.** As mentioned above, TYLC is a semi-persistent virus, offering some possibility of control by killing the vector. Some degree of success was obtained in Senegal by spraying the

seedling tomato plants with acephate or dimethoate every five or six days before transplanting, followed by two treatments at weekly intervals after planting out: pesticides tested by other authors include malathion, methidathion, methomyl and pirimiphos methyl. The decision to carry out such a treatment must be determined after evaluating over a number of seasons the increased yield resulting from the treatment. Benisia tabaci seems to develop resistance to insecticides fairly readily.

6. NON PARASITIC DISORDERS

Blossom-end rot. This disorder usually appears on developing green fruits. The earliest symptom is a small brown spot at the 'blossom' end of the fruit; this spot gradually expands and becomes dark brown (sometimes greyish), sunken and leathery, finally appearing almost black in colour.

Blossom-end rot is generally agreed to be associated with a deficiency of calcium. It is aggravated by lack of water, irregular irrigation and also by high concentrations of soluble salts in the soil, which have the effect of reducing the plant's ability to absorb water. It is usually the fruits on the first trusses which are affected, and cultivars with elongated fruits are generally more susceptible.

Control of the disorder consist of avoiding the conditions which are conducive to the disease. Efforts should be made to assure regular and even irrigation, avoid planting on soils where the soluble salts are known to be high and avoid the application of excessive fertilizer. The incorporation of organic matter into the soil will aid in stabilizing the soil moisture.

Sunburn. Symptoms of this disorder show up as large sunken whitish patches, rather like parchment in texture, often invaded at a later stage by secondary organisms. This damage is caused by an excessive exposure of the fruits to the hot sun, which might follow defoliation by insects or as a result of foliar disease.

Control. In very sunny climates, tomato cultivars should be selected with foliage which is adequate to protect the fruit from sunburn: foliage should be kept in a healthy state by suitable protective measures.

7. NEMATODES

Meloidogyne spp. This pest and methods for its control have already been generally discussed but the following points relate more specifically to tomatoes:

- (a) In general, the tomato is very susceptible to attack by root-knot nematodes, but resistant varieties exist in commerce, and these are denoted in catalogues by N, FN, VFN.
- (b) In Senegal, a few cultivars said to be resistant have been attacked under field conditions: - 'Beefmaster', 'Bonus', 'Cantom B', 'Fortune 360', 'Pikopac'; by contrast, 'Camarillo' and 'Healani', classed as non-resistant, were not attacked by Meloidogyne spp. (Defrancq, 1984).
- (c) A pathotype of Meloidogyne, has been identified by Netscher (1977) in Senegal as capable of attacking resistant tomato cultivars; however, some degree of resistance was maintained.
- (d) When grown on soil where the temperature exceeds 28-30°C, there is some breaking of nematode resistance in the 'N' cultivars; however,

some resistance is maintained, and resistant cultivars should be chosen in preference to non-resistant ones, even under high temperature conditions.

(e) Indications are that, under conditions as in (d) above, 'fixed' cultivars maintain a higher level of resistance to Meloidogyne than do F1 hybrids.

8. Mycoplasma-like organisms

Stolbur. Tomato plants showing symptoms resembling Stolbur are encountered in Senegal. The plants are rather stunted, the flower stalks are thickened and the flower buds themselves are inflated; there is a suppression of flowering and a reduction in leaf surface. Stolbur is said to be transmitted by a species of leafhopper.

The proportion of plants showing the above symptoms in a crop is usually insignificant, generally not exceeding 0.05%

ANNEX A SOME PESTICIDES USED FOR PROTECTION OF VEGETABLE CROPS

Active ingredient (a.i.) and type of formulation	L.D.50 (mg/Kg-Rat)	Concentration/Percentage a.i. in typical product	Quantity of product for ten litres of spray liquid 1/	Minimum harvest delay (days)
INSECTICIDES				
Acephate (SP)	945	50%	15g.	15
Carbaryl (WP)	850	85%	18g.	7
Cypermethrin (EC)	251	100g/1	5ml.	7
Deltamethrin (EC)	130	25g/1	6ml.	1
Diazinon (EC)	300	600g/1	10ml.	15
Dimethoate (WC)	320	400g/1	10ml.	7
Endosulfan (EC)	80-110 (in oil)	350g/1	30ml.	15
Fenvalerate (EC)	450	100g/1	10ml.	7
Fenthion (EC)	190	500g/1	10ml.	15
Malathion (EC)	2 800	500g/1	20ml.	4
Pirimicarb (WP,SP)	147	50%	5g.	7
Tetrachlorvinphos (WP)	4 000	75%	20g.	15
Trichlorphon (WP)	630	80%	20g.	2
Bacillus thuringiensis (WP)	-	-	15g.	1
ACARACIDE				
Dicofol (EC)	809	480g/1	10ml.	7
FUNGICIDES FOR FOLIAR TREATMENT				
Benomyl (WP)	>10 000	50%	8g.	
Bupirimate (EC)	4 000	250g/1	10ml.	3
Captafol (WP)	5 000	8%	25g.	7
Chlorothalonil (WP)	>10 000	7%	25g.	3
Copper oxychloride (WP)	1 440	30%	45g.	3
Fenarimol (EC)	2 500	40g/1	6ml.	3
Maneb (WP)	6 750	80%	25g.	3 (10 for lettuce)
Metiram-zinc (WP)	>10 000	80%	25g.	5
Pyrazophos (EC)	151-778	295g/1	5ml	3
Sulphur (WP)	-	(80-85%)	50g. (85%)	1
Triadimefon (WP)	568	5%	20g.	3
Triforine (EC)	>16 000	190g/1	15ml.	3
Zineb (WP)	>5 200	70-80%	25g. (80%)	3
HERBICIDES				
Chlorthal (Pre-emergent application) (WP)	>3 000	75%	200g	
Ioxynil (EC)	110	250g/1	24ml. (1000 litres/ha)	7
SEED TREATMENT (Fungicidal)				
Thiram (May irritate mucus membranes) (WP)	800	80%	2g. product mixed dry with 1 kg. of seed 1/	

EC=emulsifiable concentrate: SP = soluble powder: WP = wettable powder.

1/ Footnote on next page.

(LD 50 values quoted principally from The Pesticide Manual (1983) and 'Index Phytosanitaire', ACTA, rue de Percey, Paris.

ANNEX A SOME PESTICIDES USED FOR PROTECTION OF VEGETABLE CROPS (CONTINUED)

Active ingredient (a.i.) and type of formulation	L.D. 50 (mg/Kg-Rat)	Concentration/Percentage a.i. in typical product	Dose/ha of product $\frac{1}{2}$	Minimum delay (treatment/sowing)
GRANULAR SOIL-INSECTICIDES				
Chlorpyrifos (ethyl)	163	5	75Kg.	No delay
Diazinon	300-350	10	100Kg	No delay
Fonofos	8-17.5	5	80Kg	No delay
NEMATOCIDES (Soil-treatment)				
Dazomet (granules)	640	98%	500Kg.	5-6 weeks.
Dichloropropene-dichloropropene	140	55% dichloropropene	300 litres	5-6 weeks.
Metham-sodium	820	334-510 g/l.	1000 l/ha of product with 330g/l conc.	5-6 weeks.

Notes.

- Wettable powders should be pre-mixed in a small quantity of water to form a thin paste or cream, before being finally diluted to spray volume.
- If nematocide soil-treatment is carried out when the soil is cold, the delay period between treatment and sowing should be increased.
- When applying granules or nematocides, protective clothing should be worn.

PREPARATION OF POISONED BAIT for control of grasshoppers and certain soil insects.

- 1 Kg. Bran
- 20 g. trichlorphon or carbaryl insecticide
- 40 g. sugar (optional)

Mix the above with a clean stick in a plastic bucket, slowly adding just enough water to moisten the mixture to make it hold together so that it is easier to handle. Spread the mixture around the foot of the plants or along the plant-rows. One Kg of the above bait is enough to treat about 100 sq. metres.

CONVERSION OF THE DOSE OF ACTIVE INGREDIENT INTO DOSE OF COMMERCIAL PRODUCT.

- If the commercial wettable-powder product 'XY' contains 30% of the active ingredient copper oxychloride, and the recommended dose is 15 g.a.i./10 litres, then the amount of commercial product required is $\frac{100 \times 15}{30} = 50$ g./10 litres.
- If the commercial emulsifiable concentrate product 'NM' contains 400 g./litre of the active ingredient dimethoate, and the recommended dose is 4 g.a.i./10 litres, then the amount of commercial product required is $\frac{1000 \times 4}{400} = 10$ ml/10 litres

$\frac{1}{2}$ Quantities and doses shown are indicative: refer to manufacturers' literature for detailed recommendations. For pesticides (acaricides, fungicides and insecticides) applied by means of a high volume knapsack sprayer, about 600 - 900 litres/ha of spray liquid will be required, according to type and stage of development of crop: fully-developed Cucurbitaceae may require more than 900 litres/ha.

REFERENCES

- APPERT, J., DEUSE, J. Les ravageurs des cultures vivrières et maraichères
1982 sous les tropiques. (Maisonneuve et Larise, Col.)
- BOUHOT, D. Les principales maladies des plantes cultivées au
1965 Sénégal. Deux Tomes, Grande Imprimerie Africaine, Dakar.
- BOURDOUXHE, L. Study of Heliothis armigera flights with synthetic
1980 pheromone traps in Senegal. FAO Plant Protection Bulletin
28 (3), 107-109.
- BOURDOUXHE, L. Comparison of two types of trap for the sexual trapping of
1982 a Heliothis armigera in Senegal. FAO Plant Protection
Bulletin, 30 (3/4), 131-136.
- BOURDOUXHE, L. The North American leaf-miner, Liriomyza trifolii Burgess
1982 b on vegetable crops in Senegal. FAO Crop Protection Bulletin
30 (2), 81-82.
- BOURDOUXHE, L. Dynamique des populations de quelques ravageurs importants
1983 des cultures maraichères du Sénégal. L'Agronomie Tropicale,
38 (2) 132-148.
- BOURDOUXHE, L., COLLINGWOOD, E.F. Efficacité de trois pyrethrinoides
1982 photostables à l'égard des principaux ordres d'insectes
et des acariens nuisibles aux cultures maraichères au
Sénégal. Agronomie Tropicale, 37 (4) 379-388.
- CHANNON, A.G., TURNER, M.K. Ann. Rep. Nat. Veg. Res. Sta., Wellingbourne, UK.
1969 102.
- CMI Description of pathogenic fungi and bacteria: No. 20 -
1964 Xanthomonas campestris p.v. vesicatoria.
- CMI Description of pathogenic fungi and bacteria: No. 47 -
1970 Xanthomonas campestris.
- CMI Description of pathogenic fungi and bacteria: No. 248 -
1970 Alternaria porri. Commonwealth Mycol. Inst., Kew, UK.
- COHEN, S. Control of whitefly vectors of viruses by color mulches.
1982 In Pathogens, Vectors and Plant Diseases. Academic
Press, Inc. ISBN 0-12-326440-5.

- COHEN, S., NITZANY, F.E. Transmission and host range of the Tomato Yellow Leaf Curl Virus. *Phytopathology*, 56 (10) 1127-1131.
1966
- COLLINGWOOD, E.F., BOURDOUXHE, L. Trials with decamethrin for the control of *Heliothis armigera* on tomato in Senegal. *Tropical Pest Management*, 26 (1) 3-7.
1980
- COLLINGWOOD, E.F., BOURDOUXHE, L., DEFRANCO, M. Les principaux ennemis des cultures maraichères au Sénégal. 2eme Ed., CDH, Cambérène, Dakar.
1984
- COLLINGWOOD, E.F. et al. Rapport des essais insecticides 1980-1981. CDH, Cambérène, Dakar.
1981
- COLLINGWOOD, E.F. et al. Rapport des essais pesticides. Premier partie - 1980 Insecticides. CDH, Cambérène, Dakar.
1980
- COLLINGWOOD, E.F. et al. Rapport des essais fongicides et nématicides. 1975/80 CDH, Cambérène, Dakar.
- DEFRANCO, MIA Quelques observations sur deux types de variétés de tomate; à fruits ronds et à fruits allongés. CDH, Cambérène, Dakar.
1979
- DEFRANCO, MIA Maladies des cultures maraichères au Sénégal et sensibilité variétale. CDH, Cambérène, Dakar.
1984 a
- DEFRANCO, MIA Rapport de phytopathologie 1982-1984 et synthèse des programmes d'amélioration de la tomate pour la résistance aux maladies. CDH, Cambérène, Dakar.
1984 b
- DEFRANCO, MIA et al. Rapport des essais pesticides en phytopathologie, 1980-1982. CDH, Cambérène, Dakar.
1982
- DEFRANCO-D'HONDT, MIA et al. Tomato Yellow Leaf Curl in Senegal. In press.
- DUBERNE, J. Personal communication.
1981
- ELLIS, M.B. Dematiaceous hyphomycetes. Publ. Common. Mycol. Inst., Kew, UK. SBN-85198-027-9.
1971
- GANGOPADHYAY, S., KAPOOR, K.S. Control of *Fusarium* wilt of okra with seed treatment. *Indian J. of Mycology and Plant Pathology*, 7 (2) 147-149.
1977

- HENIS, Y., KATAN, J. Effect of inorganic amendments and soil reaction on soil-borne plant diseases. In Bruehl, G. (Ed.) Biology and control of soil-borne plant pathogens (100-106). American Phyto. Soc., St. Paul, Minnesota.
1975
- HILL, DENIS Agricultural insect pests of the tropics and their control. CUP. ISBN 0-521-29441-X.
1978
- KISHA, J.S.A. Insecticides for the control of Thrips tabaci on onions in the Sudan. PANS, 25 (1) 19-24.
1979
- LIU, M.Y. et al. Insecticide resistance in the diamond-back moth. Journal of Economic Entomol., 75 (1) 153-155.
1982
- MAKKOUK, K.M., LATERROÏ, H. Epidemiology and control of Tomato Yellow Leaf Curl virus. In Plumb, R.T. and Thresh, J.M. Plant Virus Epidemiology. Blackwell Sci. Pub., Oxford, UK.
1983
- M'BAYE, A.A. Thesis "Identification et contrôle du Xanthomonas campestris p.v. vesicatoria sur tomate". CDH, Cambérène, Dakar.
1982
- M'BAYE, A.A. In Defrancq, Mia, 1984 b. loc. cit.
1983
- NETSCHER, C. Observations and preliminary studies on the occurrence of resistance-breaking biotypes of Meloidogyne spp. on tomato. Cah. ORSTOM Sér. Biol. XI, 1976, 173-176.
1977
- VAN DAMME, P. Rapport technique finale: La vallée du fleuve Sénégal. CDH, Cambérène, Dakar.
1982
- VERDONCK, R., De LANNOY, G. Rapport météorologique 1980 et 1981. CDH, Cambérène, Dakar.
1983
- WILLIAMS, PAUL H. Black Rot: a continuing threat to world crucifers. Plant Diseases, 64, 736-742.
1980
- WINNEY, R. Tactics for integrated pest management in vegetable crops. Proc. 10th Int. Congress of Plant Protection, Brighton, UK., Vol. 3, p. 1165-1172.
1983

CHAPTER VI

THE BREEDING AND IMPROVEMENT OF VEGETABLE CROPS

By G. de Lannoy

A. NATURAL EVOLUTION AND GENETIC VARIABILITY

One of the principal characteristics of the vegetable kingdom is the diversity of the individuals which compose it. The objective of systematic botany is to classify these individuals, that is to say, to arrange them according to certain criteria in an hierarchic system.

The species, which is the basic unit of this system, may be defined as an ensemble of rather similar individuals which have the capacity of sexual reproduction and of transmitting their similarity from generation to generation.

The different species are distinguished by series of discontinuities of morphological, physiological, biochemical and ecological character, but the essential criterion is genetic. In fact, species are separated from one another by a series of reproductive barriers, such as incompatibility and sterility, which preserve their integrity and normally prohibit the exchange of genes between individuals of different species.

Each species is constituted of a number of different populations, whose variability depends on the genetic composition of the constituent individuals. This variability can be considerable, particularly with cross-pollinated species, where no two absolutely identical individuals can be found, except in the case of monozygotic twins.

Under natural conditions, the observable characteristics of each individual are the result of the reaction of internal genetic factors and the external factors of the environment. In other words, this "phenotype" is the expression of the "genotype" under the external conditions concerned.

The genotype can rarely be seen, since its expression in the characteristics of the individual plant is never complete. One can only say that if the environmental conditions are identical, the appearance of phenotypic differences is probably the consequence of genetic differences. In the case of individuals of the same genotype, derived either from the same parent plant by asexual reproduction, or by sexual reproduction from one or two strictly homozygotic parents forming a "pure line", then any phenotypic variation can only be ascribed to the influence of the environment.

Genetic variability provides the basis for the differentiation of ecotypes, that is to say, the formation of races which are distinct ecologically. In fact, within their inhabited areas, the populations of each species develop under rather varied conditions, and the effects of natural selection encourage those individuals best adapted to each group of conditions. Among the numerous populations, therefore, various ecotypes emerge, and sometimes exhibit marked differences in their structure and function.

Genetic variability, (which may be termed polymorphism,) also provides the principle basis for the evolution of new species. However,

before this differentiation is fixed, these groups must not only acquire typical morphological characteristics and such chromosome structures and genes as will cause a sexual barrier, but must also be submitted to a process of isolation. In short, three conditions seem to be necessary before the mechanism of evolution of a new species becomes effective; first, the existence of variability, then the intervention of natural selection and finally the establishment of a sexual discontinuity, accompanied by genetic isolation.

Because of the recombinations between allelic genes, sexual reproduction is one of the important causes of hereditary variation, but nevertheless the principal cause is generally considered to be mutation. There are three main types of mutation: genetic, chromosomic and genomic.

Genetic mutations are characterised by chemical or structural modifications of genes. Individually they may alter one or several plant characteristics, but it is their cumulative effect which is responsible for marked phenotypic variation. Most of these mutations affect only one single gene and are recessive.

Chromosomic mutations consist of changes in the position of the genes on the chromosomes and such changes are known as "chromosome rearrangement".

As the effects of a gene sometimes depend on its relationship to adjacent parts of the chromosome (the position effect), these mutations, because they modify the order of several genes, can cause considerable phenotypic changes.

Genomic mutations. In this last category of mutations, no gene or chromosome is changed in its internal structure, but it is the whole complex of chromosomes, i.e. the "genome" that is changed. If the number of complete groups of chromosomes in the nucleus is more than two, it is a case of polyploidy and the number of groups may be indicated by the terms "triploid", "tetraploid", "pentaploid", "hexaploid", etc.

Hybridisation can, like mutation, bring about considerable increases in the genetic diversity of a population. It destabilises the genetic equilibrium and may occasionally lead to the retention of certain unfavourable alleles which could otherwise be eliminated. However, it may help to maintain a hetero-allelic condition, which may, in the long term, prove advantageous, especially if there is a change in ecological conditions.

While mutations and hybridisation tend to increase genetic diversity in a population, selection has the effect of reducing it. It results in a differential reproduction of the individuals in a population, the selective value of each genotype depending on its ability to survive and reproduce in any given set of conditions.

Natural selection, unlike mutation, does not react on the genes, but on the phenotypes.

However, when natural selection has eliminated a large number of new variants which have proved less adapted to the environment than others, a process of isolation is necessary to allow the creation of a new species. In fact, the differentiation of two distinct "types", originating from the same parent, is only possible if some obstacle comes to separate them and inhibits all exchange of genes between them. This obstacle can have an internal origin (atrophy of sexual functions, polyploidy, autogamy) or an external one (geographical or ecological isolation).

The preceding discussion is intended to show that species are the direct result of the general mechanism of evolution. They constitute, in general, the final expression of genetic variations, through mutation or hybridisation in populations of the same origin, after they have been submitted to the pressures of selection and have become isolated from one another. This isolation allows the development, not only of specific characteristics common to every individual of the new species and absent in those belonging to related species, but also of genes and chromosomic structures which ensure sexual separation.

B. DOMESTICATION AND THE DIFFERENTIATION OF LOCAL VARIETIES

The domestication of vegetable species started at about the same time as the evolution of agriculture. This is believed to have been about 9,000 years ago, when man started to cultivate and multiply a certain number of wild plants, which he had learnt to use as food.

These plants were subjected to gradual selection, causing a change in the complex of alleles and a considerable reduction in the variability of the natural populations.

In the course of his migrations and conquests, man also encouraged the expansion of some species at the expense of others, which he considered less useful. However, as the number of individuals transported was very small in proportion to the total populations, certain alleles became more common, while many others were lost completely. This phenomenon, which is known as "genetic drift", especially affects the rare recessive alleles.

In order to improve his food supplies, man chose the most suitable plants and those which gave the highest yield. The number of cultivated species therefore slowly decreased.

The greater part of the resources of vegetables available to mankind are now restricted to little more than 13 species, the majority belonging to the class of Dicotyledons. The most widely consumed species are members of the following great botanical families: Convolvulaceae (sweet potato), Alliaceae (onion), Euphorbiaceae (cassava) and Solanaceae (white potato, tomato and eggplant).

Other important families concerned are the Cruciferae (cabbage) and Compositae (lettuce) for leaf vegetables, the Leguminosae (French beans) for pulses, the Umbelliferae (carrot) for root vegetables and the Cucurbitaceae (watermelon, melon, cucumber) for a range of fruit vegetables.

Some agricultural practices, such as seed sowing and harvesting, did not only transform the environment for the plant kingdom in the course of history, but improved the selective value of the numerous genotypes occurring in spontaneous populations.

In the same way protection from all sorts of predators, tended to make acquisition of natural defences against diseases and parasites unnecessary. Numerous genes of resistance then disappeared and thus exposed the cultivated species to many serious risks.

Intensification of agriculture also involved a process of selection that produced, in numerous cultivated vegetables, an extraordinary development of certain organs, such as the enlargement of fruits (e.g. in tomato), larger and thicker leaves (e.g. in cabbage) or increased size of seeds (e.g. in beans).

Wild species were domesticated in a limited number of zones, which correspond in general to their primary centre of diversification - that is to say, in the zone where their spontaneous development took place. Some of these centres have also served as secondary centres of diversification for other species, deriving from a more distant region, as happened in Africa with the onion and Amaranthus.

The principal market garden species originated mainly in 10 centres of origin and domestication (Grubben, 1977): namely China and Japan (eggplant); Indo-China and Indonesia (cucumber); Hindustan (eggplant, cucumber, okra); Central Asia (onion, spinach, carrot); Middle East (onion); Mediterranean Basin (cauliflower, radish); Africa (eggplant, watermelon, sweet melon, okra, roselle); Europe and Siberia (lettuce); South America (tomato, cassava, potato, chili pepper); Central America and Mexico (tomato, chili pepper, French beans, amaranth, sweet potato).

As these centres all have a large reserve of genetic variability, it is still possible to find in these regions numerous genotypes with a high level of resistance to various parasites and environmental conditions, although this resistance may have totally disappeared elsewhere as a result of selections and migrations.

In this connection it is important to note the genetic importance of local varieties. They are generally the result of artificial selection and in fact, this process causes the division of species into a very large number of populations on which the environment then leaves its mark. These local varieties are characteristic of agricultural regions at a low level of development and when compared with varieties selected by more sophisticated methods, they exhibit a number of faults, such as low productivity, heterogeneity, etc. However, it is these varieties which provide the most promising material for crop improvement, since they show considerable genetic diversity and have a great capacity of adaptation.

C. OBJECTIVES OF BREEDING

After the long historical period of domestication of crop plants, in modern times a new process has become established, involving the practice of scientific crop improvement.

The first interesting results of the process began to appear in the 19th century, with the growth of botanical knowledge and the invention of appropriate techniques. However, it was not until the development of genetic science and its application to the processes of breeding and selection in the present century that spectacular progress was made, especially in the field of agricultural productivity.

Varietal improvement can have many objectives, but three approaches have called for particular attention: increase of yields, adaptation to environment and improvement of quality.

Of the various aims of the crop breeder, the improvement of yield is certainly one of the most important, since every new variety is expected to enable the farmer to obtain an appreciable increase in revenue. However, the yield of a variety does not only involve the element of productivity, that is to say, the potential yield of the variety in optimal conditions, but also the element of adaptability, i.e. the capacity to retain a high productivity under different environmental or cultural conditions.

Increases in yield result, in fact, from the interaction of various factors, including a favourable response to fertilizers, efficient movement

of the products of synthesis within the plant, resistance to diseases, etc. The truth is that high potential productivity can only be exploited under very favourable conditions and improved varieties have a tendency to be less productive under unfavourable conditions than most local ecotypes, because they are rendered incapable of using their full genetic potential. In many cases, a good capacity for adaptation to various conditions and a tendency to give regular yields are much more important than a high potential productivity, when this is allied to poor adaptability.

The efforts of the breeder must therefore be concentrated on the characters of adaptability and regularity, as well as on productivity. For these purposes, local varieties have an important part to play, since they are usually resistant or tolerant to parasites and to unfavourable conditions of soil, climate and culture.

Adaptation to the physical environment is the principal pre-occupation of much plant selection work in Africa, the general objective being to increase crop yields under certain definite conditions. For example, one may aim to improve the resistance of a given crop species, say tomato, to heat and humidity, or the tolerance of cassava to drought, the tolerance of okra to cool periods, or the adaptability to poor soils of sweet potato or, again, the ability of the onion to flower in the absence of winter vernalisation.

Adaptation to the biological environment, that is, resistance to pests and diseases, is also a fundamental problem in Africa. Such resistance may be obtained by selection either by exploiting the variability to be found within a population or by introducing genes of resistance from other related populations.

In this type of work, collaboration with a phytopathologist is often indispensable to the breeder. The pathologist will need first to identify the parasite responsible for the disease or damage to the crop, then to study its biology and finally to elaborate a technique for artificial inoculation and a simple method for recording symptoms. It must be added that improvements of resistance to parasites is a valuable means of increasing yield, but unfortunately it is often only effective under the conditions at the time of selection and may be rapidly reduced to zero by the appearance of new races of parasite.

Improvement of quality concerns many aspects of crop character, since it involves the demands of the consumer in matters of appearance, flavour, texture and nutritive value, as well as those of traders in resistance to transport and suitability for storage. In some cases, the needs of the processing industry concerning technological qualities, content of dry matter, etc., must also be considered. In efforts to improve quality, the breeder must thus bear in mind both commercial and consumer requirements. Industrial requirements are usually dealt with by the selection of special varieties suited to processing.

D. GENERAL PRINCIPLES

The terms "selection" and "improvement" often lead to some confusion, in fact, they represent two different processes. "Selection" means the choice from a given population of a series of individuals that possess favourable characteristics and then their multiplication separate from other individuals, so as to preserve those characteristics. The

process has limitations directly connected with the genetic potential of the selected individuals, which again depends entirely on the variability existent in the original population.

"Improvement", on the other hand, aims at the creation, via mutagenesis or hybridisation between several populations, of individuals with a new genetic constitution, superior to that of their parents.*

However, the techniques of selection and improvement are generally associated in practice in the process of creating and distributing new varieties. Selection also includes the process of maintaining the purity and preserving the original characteristics of a variety.

For the improvement of vegetables, the best plan is to approach the goal in several stages.

First of all, the objectives should be clearly defined and classed according to their relative economic importance, the difficulties likely to be encountered, etc. The next stage is a search among all available plant material for the desired characteristics. This includes prospection in local races of the vegetable species concerned, the preparation of a collection and the introduction of new varieties from comparable ecological zones elsewhere.

All these varieties should then be submitted to field trials with detailed observations on their growth and development, adaptation to the local environment and resistance to pests and diseases. If these studies reveal a variety or varieties which seem to have valuable characteristics but lack uniformity, a work of selection may be undertaken to improve their homogeneity. On the other hand, it may be concluded that no individual in the collection will yield a variety with the uniformity and qualities and it will then be necessary to enlarge the genetic variability through hybridisation or mutagenesis and to search for promising new combinations.

Mutagenesis consists of the use of ultraviolet and ionizing radiations, with the object of artificially changing the genetic potential of individual plants. It may provide solutions to particular problems, but its usefulness varies very much according to the species treated and, in fact, remains limited in scope.

Hybridization is used primarily to associate the characteristics of two or more varieties in the same genome. Preparations should include the collection of the maximum possible number of varieties possessing the desired characteristics and a study of the heredity and heritability of these characters. These studies should be coupled with careful observations of pollen mechanisms, the incidence of selfing, the occurrence of male sterility, the ability for crossing, etc.

The collection of genetic material of which the breeder disposes for the improvement of a given species, is known as a "gene pool". This includes modern varieties, primitive varieties, spontaneous forms and wild forms.

Modern vegetable varieties have been bred in various different parts of the world from a wide range of material and have a very mixed genetic character. As they have been subject to rigorous selection to meet the requirements of modern agriculture, they do not exhibit much variation.

* See calculations of the selection differential in Annex C.

They also have a high potential productivity and valuable commercial qualities. However, they are not very adaptable and sometimes, for example, prove unsuited to tropical African conditions.

The characteristics of primitive varieties and their value for crop improvement have already been discussed. Unfortunately, they have totally disappeared in many agricultural zones, although they may still be found in some isolated regions. Spontaneous forms may occur in all regions, however, and may provide useful genetic resources. When they derive from cultivated varieties, they may have achieved success under natural conditions due to regressive mutations which have restored their competitive qualities. Some spontaneous forms are, in fact, the result of natural cross-pollination between cultivated varieties and wild varieties growing nearby or mixed with the crop as weeds.

Finally, the genetic resources of a species may also be found in wild forms which have never been domesticated but which remain more or less closely related to the cultivated forms. Wherever they occur, they constitute an important source of variability, notably for characteristics of adaptability and disease resistance.

The genetic resources of a species exhibit a certain variability, so that it is usually convenient to make a subdivision into "subspecies", "varieties" and "forms". The word "variety", however, may vary in meaning according to the type of reproduction involved. If the plant is propagated through self-pollination, the "variety" is, in fact, a "pure line"; if it comes from allogamous parents, it constitutes a "population", but if it is propagated vegetatively, it constitutes a "clone". The term "variety" is now often reserved for natural botanical forms, whereas agricultural varieties derived from artificial selection and breeding are known as "cultivars".

Natural genetic variability is immense and is amply sufficient to cover the needs of varietal improvement. It is, however, threatened by the intensification of agriculture and the standardisation of varieties. In fact, the search for ever greater yields results in the creation of very demanding varieties, which often require intensive use of fertilizers and phyto-sanitary products. Moreover, by concentrating on a relatively small number of modern varieties, one risks the loss of a multiplicity of local material and, thus, of invaluable resources of crop quality and resistance. Measures such as the creation of specialised "gene banks" are needed to preserve this patrimony from genetic erosion.

The plant breeder working in Africa needs to take heed of the importance of the adaptability of his vegetative material to local conditions and traditional production methods. It may often happen that the security of food supply is more important than productivity (Bouharmont, 1980). This means that a certain heterogeneity should be conserved in varieties to facilitate their adaptation to different conditions and thus diminish the risks of loss from climatic changes and attacks of pests and diseases.

E. SEXUAL EXPRESSION AND THE CLASSIFICATION OF SPECIES*

Sexual reproduction in plants is conditioned by a cycle in which there are always successively a diploid phase and an haploid phase. The plant is formed of cells in which the nucleus is furnished with chromosomes in the diploid number (2n). In the reproductive organs, however, the pollen grains and the embryo sacs are characterised by the presence of the

* See Annex A

haploid chromosome number (n). The transformation of diploid into haploid cells is effected by meiosis and initiates the formation of the male and female gametes. The process is reversed during the double fecondation of the ovary by the male gametes, to produce, on the one hand, diploid cells in the embryo and, on the other hand, triploid cells in the albumen.

Vegetable crops may be classified biologically, according to the presence of functional male and female organs in their flowers, in three groups: hermaphrodite, monoecious and dioecious.

Hermaphrodite species are characterised by bisexual flowers, bearing both the male pollen grains in the stamen and the female embryo sacs in the carpels. Usually, the stamens and the carpels become functional at the same time and natural selfing is normal. However, in some species, there is a time-lag between the maturity of the male and female organs which prevents self-pollination. This may work in either of two ways: either the stigmas become receptive before the shedding of pollen, as in the strawberry, or the pollen is shed before the stigmas become receptive, as in the carrot and onion. Certain varieties of some species bear hermaphrodite flowers in which there is a partial or total sterility of one of the two sexes, and in some varieties, plants bear both bisexual and unisexual flowers at the same time.

Monoecious species are those in which each individual plant bears two sorts of flowers, the male and the female. This is the case with sweet melon, watermelon and cucumber.

Dioecious species are those in which there are two types of individual plant, the male and the female, as in asparagus and spinach. In such cases cross-pollination is, of course, absolutely necessary for seed production.

F. SYSTEMS OF REPRODUCTION IN VEGETABLE SPECIES

For plant improvement, it is obviously desirable to have a good understanding of the means of reproduction of the species concerned.

In the case of vegetable crops, it is first necessary to distinguish the species reproduced vegetatively from those reproduced sexually and amongst the latter, those self-pollinated from those cross-pollinated (see Annex A).

Vegetative reproduction may be spontaneous or artificial and is effected in different cases from various parts of the plant - root, shoot, stolon, rhizome, tuber, bulb, bulbil, offshoot, stem, etc., and the resultant individuals together constitute a "clone". The clone is thus composed of genetically identical individuals. This type of propagation is very useful where uniformity is required and is difficult to obtain by sexual reproduction, for example because of inbreeding depression in allogamous plants.

It is, in fact, used for many species for which sexual propagation can easily be effected but which results in important dissociations of characters and a very mixed progeny.

Although clones are genetically homogeneous, they are not usually homozygotic. In fact, they are usually strongly heterozygotic, i.e. they possess a variety of genes for contrasting characteristics, being the descendants of hybridization and often also of numerous mutations.

As vegetative propagation involves no genetic change, it is very stable - the only variability that can arise is from somatic mutations or from infection by virus or mycoplasma.

In autogamous (self-pollinating) species, the ovule is fertilized by pollen from the same flower or from another flower on the same plant. This is notably encouraged by physiological or morphological peculiarities which, although they may not always prohibit cross-pollination, considerably increase the chances of self-pollination.

In the French bean, for example, the lower petals of the flower are joined together in a keel which encloses the stamen around the pistil.

The same mechanism is found in the tomato, where the pistil has to traverse a tube formed by the stamens which are attached together in a ring. There is a similar staminal tube in the lettuce and in this case, although the stigma is not receptive during its passage through the tube, it is furnished with hairs which meanwhile sweep the pollen upwards.

To verify the autogamy of a plant, it is usually sufficient to isolate a number of flowers in bags and to observe if seed is produced - although this system does not work with parthenogenetic species (where seed is produced without pollination) or in cases where self-pollination requires the intervention of an insect.

One of the consequences of selfing is the formation of pure lines, i.e. of progeny which are homogenetic and stable, although a certain measure of heterozygosity may occur as a result of accidental crossings of spontaneous mutations. Unlike allogamous plants, these species can support repeated selfing or "inbreeding" without the slightest loss of vigour. On the other hand, they can be crossed with selected lines to produce hybrids. A species is considered strictly autogamous if the rate of cross-pollination does not exceed 1% under normal conditions. This applies only to a few species of vegetable, including the French bean, lettuce, pea and tomato.

The percentage of crossing in other autogamous vegetables is often fairly high and varies with variety, genotype, wind, density of planting and insect activity. In dealing with partially autogamous species, such as eggplant, okra, chili pepper and sweet pepper, it is important to have precise information on the percentage of crossing, so as to permit the breeder to take the necessary steps to protect the plants from exterior pollen.

Incidentally, it should be noted that autogamy is more frequent among cultivated plants, especially the annual crops, than amongst wild or spontaneous plants. This is presumably because the stable environment that crops enjoy is advantageous to pure lines, whilst the complex changes which occur under natural conditions favour the cross-pollinated species which are more heterozygotic and richer in genes and hence more adaptable.

In allogamous (cross pollinating) species, fertilization is mainly carried out by pollen from other plants and is favoured by the mechanisms previously described - namely the separation of the sexes, the time lapse in maturity between male and female sexual organs, male sterility, auto-incompatibility, etc.

Because of their exposure to different genetic influences, these plants show a very high percentage of heterozygous individuals. Furthermore, repeated selfing causes in some cases a reduction in vigour known as "inbreeding depression" which involves not only a loss in fertility but the evolution towards a homozygotic constitution. As far as possible therefore this "inbreeding depression" should be avoided.

G. BREEDING SELF-POLLINATED SPECIES

1. BASIC PRINCIPLES

As self-pollinated species stabilise genetically at a highly homozygous level, their natural populations tend to be constituted of a mixture of pure lines, with individuals in each pure line of identical genetic constitution.

In the case of local varieties, the selection pressures favour a certain degree of heterogeneity and there are always a mixture of many different pure lines. In the case of selected varieties, although they exhibit a relatively high degree of uniformity of the more obvious phenotypic characteristics, they rarely correspond to pure lines. In fact, the majority of these varieties are the result of hybridisation followed by a number of self-pollinations, which cause a certain stabilisation of the more interesting and visible characters, but does not prevent the separation of other genes.

Pure lines have the advantage of being stable and uniform. Their stability is useful to avoid the evolution of different populations within the variety through the influence of natural selection, whilst the uniformity is useful for various practical purposes: uniformity of maturity helps mechanised cultural operations, uniformity of shape and size helps grading and packing, and uniformity of flavour and colour is good for marketing.

The main disadvantage of pure lines is their lack of adaptability which, in the case of marked fluctuations in the climate or the occurrence of pests and diseases, even induce serious variations in yield.

When a population is relatively heterozygotic, a series of selfings can induce a change in the number of the various genotypes, according to a mechanism which depends primarily on the number of pairs of alleles to be segregated. In fact, in the course of successive generations, there is a progressive elimination of heterozygotes and this proceeds at a rate inversely proportional to the original number of heterozygotic pairs of alleles (see Annex B).

In an extensive collection of pure lines of the same species, it may be observed that, between certain lower and upper limits, some characteristics exhibit practically all the intermediate values. These so-called quantitative characteristics are generally controlled by the action of polygenes.

To each of these characteristics of each individual, one may assign a "phenotypic value", which is the sum of the "genotypic value" and the "environmental deviation", due to the variability of the environment. One may also subdivide the genotypic value of each individual in one locus into an "additive genetic value" and a "deviation of dominance". Anyway, individuals are chosen on their phenotypic value and the relationship of the phenotypic value with the additive genetic value is judged by the heritability.

In a population of autogamous plants, the different genotypes do not always contribute in an equal degree to the constitution of the following generation, because of differences in rates of multiplication. For example, if one plant produces a progeny of 20 and another only 14, one may express their relative influence on the next generation by saying that, if the first plant is assigned a "selective value" of 1, the selective value of the second plant will be 0.7.

In practice, artificial selection aims at the separation from the original population of certain individuals to be used for the propagation of the following generation, the rest of the population being conserved, if necessary, to evaluate later the quality of the selection. When dealing with relatively stable characteristics, the elimination of undesirable types is rather easy, because it is sufficient, starting with the F_2 generation, to harvest each genotype separately and to examine carefully all the F_3 descendants.

On the other hand, when dealing with fluctuating characters, whose precise genetic nature is usually unknown, selection is more difficult. Progress will depend, at the same time, on the additive genetic variance, the heritability and the intensity of selection.

2. MASS SELECTION

Mass selection is a method which probably dates back to the early domestication of each species. It is based on the phenotypic expression of the individuals within each population; its essential character depends on the fact that the seeds from the selected plants are mixed for the sowing of each succeeding crop. In this method, there is, therefore, neither control of pollination nor test of inheritance.

It is possible to apply the method in two different ways. In the first case, one chooses the most promising plants from the original population for one or several given characters, one harvests them separately and mixes their seed to sow for the next generation (positive mass selection). In the second case, one eliminates all undesirable types, that is to say, those which possess morphological characters that one wishes to avoid, and one harvests and mixes the seed of all the remaining plants (negative mass selection). The latter method is naturally more suitable when the proportion of plants to be eliminated is relatively small.

There is no precise rule for the determination of the number of individuals to select, it depends above all on the heritability of the characters sought. In principle, the better that the phenotype represents the genotype, the fewer selected individuals are needed. However, in most cases, it is various practical constraints that determine the proportion of plants retained from each generation.

The intensity of selection can have important repercussions on the evolution of the variety. If the intensity is moderate, the probability of improvement is small, whereas if it is too high, there is a risk that the population may deviate strongly from its original characteristics. It is therefore necessary to control the intensity of selection through trials of plant behaviour and yield, in which the initial population is compared with the selection fraction.

Valuable progress can be obtained if mass selection is repeated for several successive generations (Figure 1). The results depend, above all, on the stability or fluctuation of the characters concerned. For stable characters, whether dominant or recessive, as genetic improvement is rapid, it is often useless to continue the mass selection through several cycles.

Moreover, for quantitative characters, such as yield, there is a risk that repeated selection cycles, if continued too long, will rapidly become ineffective, because of the poor heritability of this type of character.

One must remember that repeated mass selection is also of little value in the case of modern varieties, since these are constituted of a

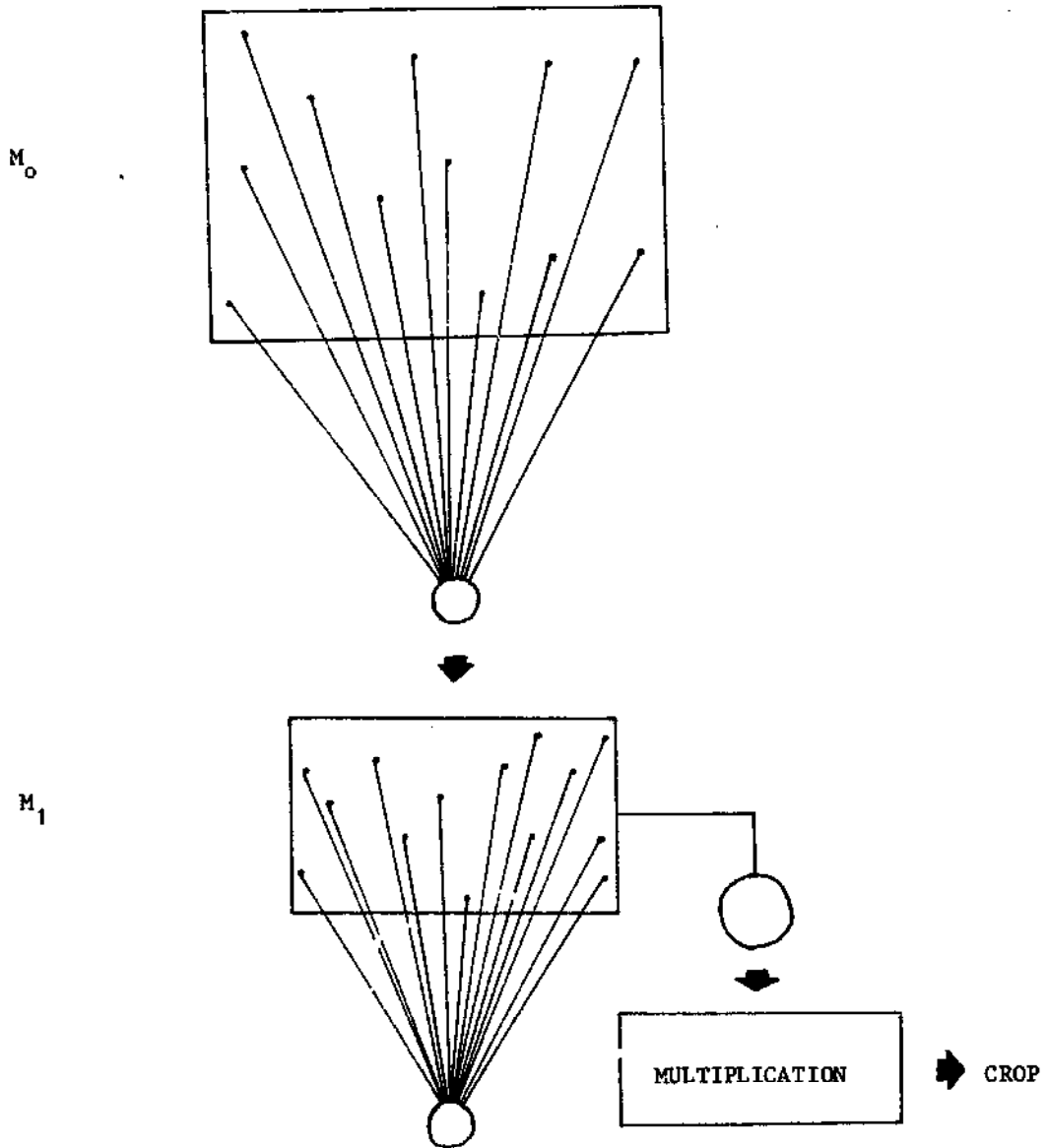

Figure 1 : Positive mass selection repeated through several generations.

restricted number of similar lines. When differences are observed, they are often the result of environmental influence and are not inheritable. Mass selection is really only of interest when there is a high proportion of heterozygotic plants resulting from cross-pollination in the initial population.

Mass selection can be useful in the process of seed production, for the purpose of maintaining varietal purity. It is a matter of negative selection, since the object is to remove, in the course of multiplication, all individuals of which the phenotype does not seem to correspond to the variety.

Finally, it must be emphasised that the efficiency of mass selection depends on the correlation between the different characters to be selected. In fact, if these consist of an ensemble of characters with a negative correlation, for example yield and quality, the method will prove entirely useless (Demarly, 1977).

3. PURE LINE SELECTION

This method, which is a variant of mass selection, makes it possible to record observations over two or three generations of the progeny of the individual plants selected. It consists in choosing a relatively large number of plants, representing the various desirable characteristics, and in sowing their seed in separate plots (Fig. 2).

In the course of the development of the seedlings, observations are recorded concerning the peculiarities and values of the different lines. The final choice from these pure lines is made on the basis of a series of comparative trials of their characteristics and yield carried out in the experimental station and, if necessary, also in different localities of the zone of commercial production.

4. GENEALOGICAL SELECTION

Genealogical selection is a longer and more complicated process than mass selection. Nevertheless, the results that can be achieved with this method are altogether more interesting because the individuals are not chosen for reproduction according to the phenotype, but according to the characteristics of the descendants. Moreover, it is possible to follow the results obtained by selfing separately, for each of the individuals chosen. The breeder can thus ensure that the characters on which his original choice was based are really transmitted to the progeny. Furthermore, the selected lines, in the course of successive generations from natural or artificial selfing (if this is found to be practicable), attain a progressively more homozygotic condition.

In this method, which is mainly used for selection after crossing, one chooses from the descendance of F_1 hybrid a number of plants with the desired characteristics (Fig. 3). The number should be ample (several hundreds of F_2 individuals), so as to lose nothing of the genetic potential of the progeny. Since many characters only appear at a certain stage of development, observations should be carried out throughout the vegetative cycle, before making the final selection. When the crop is mature, the selected plants are harvested and threshed separately, and a part of the seed of each is put aside, in case of accidents.

For the production of the next generation (F_3), the seed of the F_2 plants are sown in separate lines. As far as the number of plants and

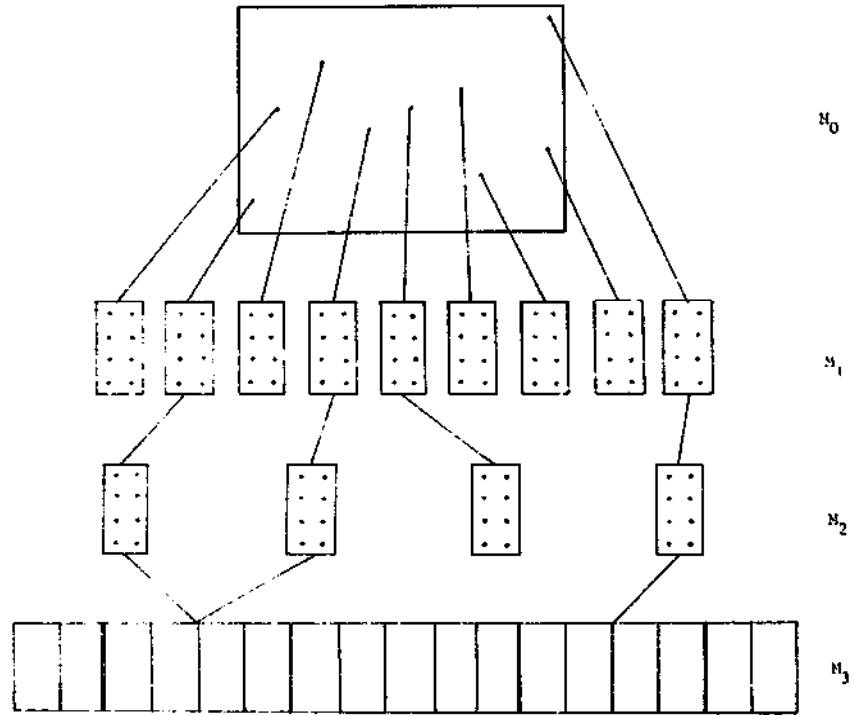

Figure 2 : Pure line selection.

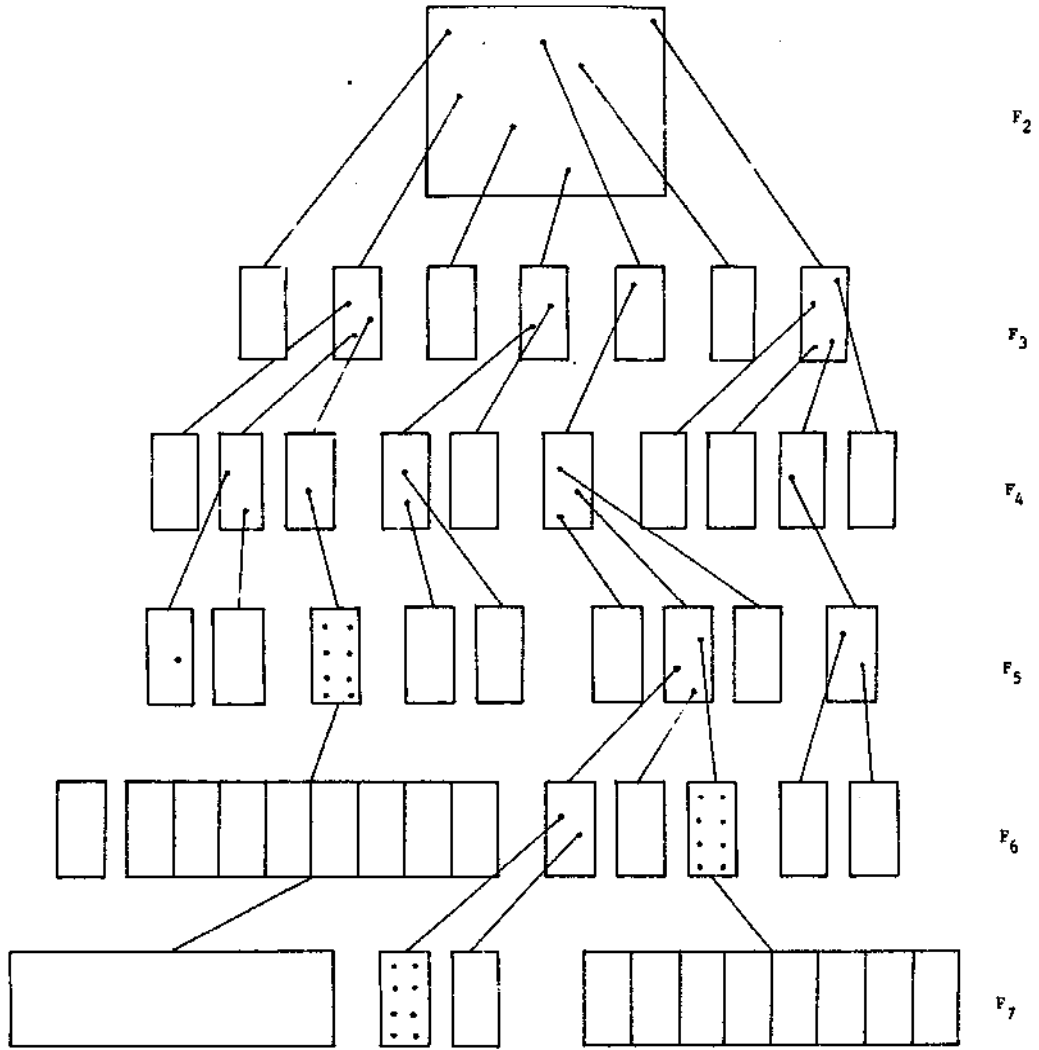

Figure 3 : Genealogical selection

lines to select is concerned, it is preferable to choose a large number of lines of a limited number of plants (10 to 50), than a limited number of lines of a large number of plants (100 to 200). A certain number of plants from each line is again harvested separately and a part of the seed is placed in reserve.

In the next step, the seed from each of the selected plants is sown in a separate plot and the different families compared. While the crop is developing, eliminations continue on an individual basis, but the general qualities of each family are henceforward taken into consideration.

In the course of the following generations, observations on homogeneity and corresponding eliminations may continue, but at a certain stage, normally F_6 or F_7 , one or the other of the lines may become homogenous because homozygous at least as concerns apparent characters. At that point, all of the individuals of the trial are harvested separately and their seed sown in lines, grouped by family, so as to ascertain the stability in each line and between the lines of each family. When a family is shown to be stable, it is considered that the individual from which it sprang was homozygous and the family is classed as a pure line. Following operations then consist in a simple conservation of homozygosity.

As soon as a certain uniformity starts to appear in the material being selected (F_5), the better families may be included in comparative trials of behaviour and yield. These trials yield valuable information to the breeder on the behaviour of his material under more or less normal conditions of culture. The genealogical selection may be continued for the families concerned via 10 or 20 plants harvested from a few selected lines of each. The seeds harvested from the rest of the plants from each family are then massed for subsequent comparative trials. As the selection progresses, the trials may be repeated on a larger scale, both on the research station and in various different localities within the zone of commercial production.

Genealogical selection demands a minimum of six generative cycles and thus requires more time than mass selection, although its efficiency is also largely limited by the heritability of the characters selected. On the other hand, from the fact that the progeny of each plant is followed separately for a certain number of generations, there is practically no risk of missing any of the interesting qualitative characters present in the descendants of the hybrid.

5. CROSS BREEDING

Once the genotypic variability in a population has been exploited, the breeder disposes, in principle, of a collection of pure lines. However, it is the general experience that no "pure line" in cultivation of whatever species, is perfect. In each, there is a certain number of faults, in addition to the valuable characteristics.

For further improvement, under these conditions, it is necessary to create new variabilities by intra-specific crossing, that is to say, crossing between two genotypes of the same species. The objective is then to combine a collection of useful characteristics, from among two or more different varieties, in a single pure line.

The process consists in crossing two pure lines from different populations or cultivars for the sake of the recombinations taking place at the meiosis of the different generations. Successive selfings will allow the development of a progressively homozygotic condition. If the

objectives cannot be reached using two varieties, polycrosses must be used. In this case, two lines are crossed and the resulting hybrid is then crossed with a third line or a second hybrid. This technique is very useful because of the new combinations of characters it makes possible.

For success in cross-breeding, a clear conception of the objectives and knowledge of the available material is essential. It is often necessary to make a close study of the descendants of a few hybrids, rather than to work with those from numerous crossings. The chances of success of selection after crossing depend also on the choice of parental genotypes and on the system used in selecting from the progeny (bulk population method, genealogical selection, etc.).

When choosing the parents, it may prove useful to employ the most popular variety in the region concerned and to try and add to its good qualities a limited number of characters from another variety. However, if there is no suitable variety in the region, the best solution is to choose one parent from an introduced high yielding variety and the other from a local well adapted variety.

When the particular weak point of a genotype is an easily observable character, its transfer should not be difficult. However, when it concerns a character with a complex genetic constitution, showing a high variability according to changes in environment, the problem becomes more complicated, particularly if it concerns yield. In such a case, the most efficient way of improving the production potential is through combining lines of high productivity originating from distant genealogical sources. In any case, the breeder must never forget that his work demands continual progress; he will never witness the success of a variety which shows improvements in some characters but a decline in others!

To make crosses, it is necessary, of course, that the female parent is receptive when viable pollen from the male parent is available. This can best be ensured by successive sowings. On the other hand, the seed produced must be sufficient for an F_2 progeny of several hundred plants; the multiplication coefficient of the species should, therefore, be borne in mind.

In the F_1 generation, the plants are all homogeneous, although, at the same time, they are heterozygous and therefore the carrier of numerous different characters. It would not be prudent, at this stage, to judge the results of a crossing by observations on the F_1 , since there may be certain characters which may be hidden because they correspond to recessive alleles. On the contrary, the success of a crossing may be judged by noting the presence in the hybrid of certain dominant mendelian characters from the male parent ("marker genes"). It should also be remembered that, as the whole F_1 generation is similar, it is useless to retain more of the hybrids than is really necessary to produce the next generation.

In the F_2 , one sees the explosion of variability induced by the crossing of the different qualities of the original parents. For a monofactorial character, the frequency of heterozygous genotypes is then 50%. Theoretically, the final result of a programme of improvement through hybridisation depends essentially on the number of F_2 individuals before selection. If the breeder only retains a restricted number of F_2 plants, it would be a miraculous chance that allowed him to find the ideal genetic combination. On the other hand, the number of F_2 individuals depends also on the differences existing between the parental lines.

If, for example, these differ in k pairs of alleles, the F_2 will include, theoretically, 2^k homozygotic genotypes. It will obviously be

necessary to have at least 4^k individuals available, if there is to be a reasonable chance for all the 3^k possible genotypes to appear, including heterozygotes as well as homozygotes. Thus, if there are 20 pairs of different alleles (which would correspond to the control of a few morphological characters with a simple genetic constitution), one would obtain approximately 35×10^8 different sorts of individuals, which would mean the cultivation of a population of at least 11×10^{11} plants to have one chance in two of finding a favourable genotype (either homozygote or heterozygote). Counting a planting density of 25 per m^2 , an area of 400,000 hectares would be occupied for 11 consecutive years by this F_2 , to have some chances of extracting the best genetic combination from only 20 pairs of alleles!

The breeder should not, therefore, try to isolate the ideal homozygous genotype in one generation, since, in any case, selfing tends to increase the percentage of homozygotes in the course of successive generations. One can only hope that certain F_2 plants will provide a chance for the desired genotype to appear in the F_3 or later generations. In this respect, the chances of an F_2 having k pairs of favourable alleles in a homozygotic or heterozygotic condition equals $(3/4)^k$; when $k = 20$, this means 3.2 %/oo. It will be seen that it is necessary for work on F_2 generations to be on an adequate scale to provide a statistically good chance of finding really useful genotypes.

In practice, the selection in the course of the F_2 generation after crossing aims at eliminating unfavourable genes and at preserving favourable genes expressed in the phenotypes. In that respect, the intervention of the breeder will be most effective if he has good means of judging his material. However, the selections that he makes involve a risk of error such as elimination of useful genotypes or conservation of mediocre ones. For this reason, an estimation of the mean value of the different lines is much surer than an evaluation of separate individuals.

For example, in the case of a gene with 2 alleles - A and a - if the breeder chooses "n" individuals of F_2 at random to produce "m" plants of F_3 , the probability of losing the gene in the F_3 can be calculated by the following formula (Valdeyron, 1961):

$$[1/4 + (1/2)^{2m+1}]^n$$

It follows that it increases in the value of "n" that permit reductions in probabilities of the loss of a gene in the recessive condition. To take the extreme case, probability would be reduced to the minimum by retaining the largest possible number of plants in F_2 and representing each of them in F_3 by one descendant.

So as to have the maximum possibility of bringing together useful genes, the most promising F_3 lines should be resown in considerable quantities the following year. In the F_4 generation, the frequency of heterozygotic genotypes should not then exceed 12.5%, in the case of monofactorial characters.

If possible, the fixation of homozygosity should be followed through the most promising descendants, even to the F_8 generation or further. However, as in successive generations, the number of alleles in heterozygotic condition diminishes progressively at the rate of 50% per generation, and as, moreover, the probability of finding descendants without loss of favourable genetic combinations also increases rapidly, the

number of plants per line can be progressively reduced. For any given generation, this number may correspond to the square root of the number studied in the preceding generation.

The genes which control the physiological characters are more difficult to fix by elimination of unsuitable lines than the genes corresponding to morphological characters, above all because they are more difficult for the breeder to identify. On the other hand, if there is a linkage between certain of these genes, a selection aimed at fixing the morphological characters inevitably involves a contingent selection for the physiological characters to which they are tied. The breeder should accordingly always concentrate his choice on principle objectives and by progressive elimination of the lines in disjunction for the more important morphological characters he can at least accelerate the apparent stabilisation of his material.

6. BULK POPULATION METHOD

This method consists in multiplying a mixture of the whole first generation after crossing, without effecting a selection and allowing homozygosity to establish itself naturally (see Fig. 4). A random sample is taken from a mixture of the seed of each generation for the next sowing. Normally the process is repeated as often as the breeder thinks necessary, but at least as far as F_5 . At this stage, certain plants may be chosen from the population and their progeny followed separately, according to the techniques of genealogical section.

The bulk population method is based on the elimination of genotypes of low selective value through natural selection. However, in self-pollinated species, there is not always a close correlation between the selective value of individuals and their productivity in commercial crops. Nevertheless, as the least competitive genotypes are usually the least useful from the agronomic point of view, experience shows that yields from successive generations tend to increase. This method also relies on the fact that, in the course of the first few generations after crossing, heterozygosity is at such a high level that no valid judgement can be made on polygenic characteristics.

It is possible to increase the efficiency of the method by making a mass selection of the progeny in disjunction. In this way, one can eliminate certain undesirable characters on which natural selection would have no effect, such as susceptibility to diseases, lateness of maturity, fruit quality, etc. This will help the population to progress more rapidly in the desired direction.

The principal advantages of the bulk population method are the ease of execution and the relatively low cost. The technique may, therefore, be useful at improvement stations with limited resources. It is especially effective in improving the yield and other quantitative characters and is very useful for the adaptation of varieties to local conditions. However, when the objective is the production of new pure lines, the efficiency of the method cannot be compared with that of genealogical selection, because the elimination of unfavourable genotypes is not nearly so rapid. At the same time, this method is slow, when the autogamy is partial and heterosis (hybrid vigour) gives the heterozygotes a superior competitive value. However, bulk populations have another important advantage, namely that when the material, even the F_2 , is distributed in several representative localities of a given region, it is able to continue its evolution under local conditions and produce several distinct varieties which make the best use of the potentials of the original hybrid material.

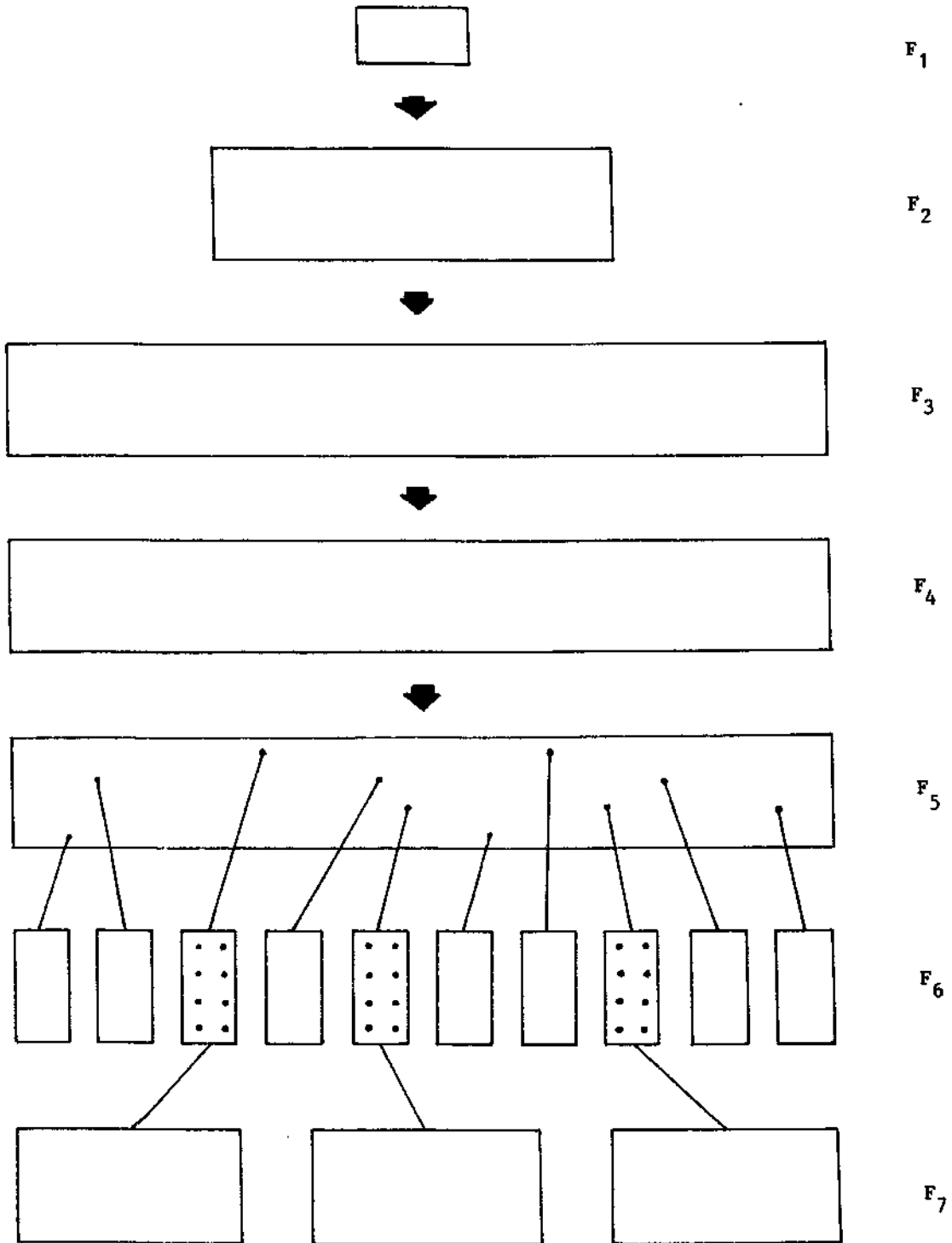

Figure 4 : Bulk population method.

7. OTHER METHODS OF BREEDING

Among other means of stimulating a larger variation in a given material, the breeder may make use of artificial mutagenesis, polyploidy, interspecific crossing and back-crossing.

The modifications induced in genes or chromosomes under the effect of different radiations or chemical substances could play an important part in the breeding of vegetables, but the use of these techniques to date remains very limited. In fact, although mutagenesis induces mutations at much higher frequencies than occur under natural conditions, it makes no difference to the proportion of favourable mutants.

The breeder can also induce changes in chromosome number, i.e. create a genomic mutation, notably in doubling the number by treatment with colchicine. In general, the polyploid individuals produced in this way have a somatic chromosome number ($2n$) more than twice the basic number (x) of the species; for tetraploids, $2n=4x$, for hexaploids, $2n=6x$, etc.

One of the difficulties with the use of colchicine is that it is only effective if applied to cell masses in active growth, such as those in germinating seeds and apical meristems. The technique of this treatment varies considerably for vegetable crops, according to the species and to the stage of development concerned. For tomatoes, the usual systems are soaking the seeds in a solution of colchicine or direct application of the alkaloid on shoot apices or floral organs.

The genomic mutations may appear either in the diploid tissues of the plant, i.e. as somatic mutations, or in the gametes, i.e. as germinal mutations. In the case of somatic mutations, a sectorial or periclinal chimera is usually produced and the resulting individuals then possess several levels of ploidy (mixoploids).

Interspecific crossing is used to increase the range of variability of progeny, so as to give the breeder a choice among a considerably larger number of phenotypes, sometimes including unexpected combinations. However, this exchange of hereditary material between genotypes of different species meets with numerous difficulties. In the first place, it is not always easy to effect crosses, because of certain natural barriers. For example, if one tries to cross Lycopersicon peruvianum as the female parent, bearing resistance to the Tobacco Mosaic Virus and to Meloidogyne sp., with Lycopersicon esculentum as the male parent, the pollen germinates normally but the growth of the pollen tube in the style is inhibited, i.e. there is an incompatibility. On the other hand, if the crossing is carried out in the opposite direction by the introduction of alleles from wild species into Lycopersicon esculentum as the female parent, the operation is easier but the F_1 must then be backcrossed, either as male parent with the cultivated tomato or as female parent with pollen from a wild species.

Interspecific crosses can also meet with physiological difficulties causing anomalies in the morphogenetic development of the hybrid. In the case of the tomato, incidentally, this can be overcome by in vitro embryo cultures.

Finally, even if the crossing of a wild with a cultivated species produces a viable hybrid, or if the incompatibility can be reduced artificially, a last obstacle remains to be overcome. It is necessary that the F_1 hybrid has an acceptable level of fertility and this means that the pairing of homologous chromosomes in meiosis must be regular. The fertility of interspecific hybrids implies, consequently, that the two parental species possess sufficient homology for bridging the gap. When the breeder

obtains a hybrid of sufficient fertility, the diversity of its progeny in F_2 can be remarkable and may include types very different from either of its parents. Nevertheless, despite the heterogeneity of the progeny, not all of the possible combinations will necessarily be found, because there may be a linkage effect. It may also happen that certain phenotypes may exhibit interesting characters which are linked with unfavourable ones. The breeder must then try to promote the largest number of crossings-over by recurrent selection.

The back-crossing method (see Annex D) is particularly useful when a vegetable variety is found to be excellent for most of its characteristics but deficient in one, or a limited number, of others. It is then necessary to search for another variety which has the missing good qualities, even if it is of little value for the ensemble of its characteristics, and to transfer these good qualities to the genetic structure of the variety to be improved, while avoiding the transfer of the disadvantages of the donor.

In such a programme, the variety to be improved is called the recurrent parent, while the other variety is known as the donor parent. Crossing between the recurrent and donor parents is followed by a series of back-crosses with the recurrent parent, indicated as BC_1 , BC_2 , BC_3 , etc. In the course of selection, one then tries to conserve the plants which possess the characters to transfer and are also of the phenotype of the recurrent parent. After several generations, the progeny become heterozygotic for the "genes to transfer" but homozygotic for the others. At the end of the programme, a final self-fertilization followed by selection should make it possible to obtain homozygotic individuals carrying the "genes to transfer" but with practically all remaining characteristics of the recurrent parent (see Annex B).

For this method to give good results, the recurrent variety should be one of good agronomic value and the "character to transfer" should be fully retained in the course of successive crossings, which can be difficult if several genes are involved. It is also necessary that the number of back-crosses should be sufficient for recovering practically all of the genes of the recurrent parent. However, this depends principally on the number of different alleles in the two varieties.

This method is, in fact, the only one that can give a foreseeable and repeatable result, but its objectives remain limited because it is only adapted to improving the initial variety by the addition of one, or occasionally several, interesting characters. Moreover, it is limited by the fact that the genes to transfer must be relatively independent from those which are undesirable and it also involves a rather slow procedure since crossings must be made for each generation. One must also note that if the "character to transfer" corresponds to a recessive allele, the breeder must follow each back-cross with a selfing to ensure that he has retained the heterozygotes carrying the useful genes. This, again, considerably prolongs the process of selection. All the same, contrary to other techniques, the number of plants to retain after each crossing need not be very great - a few hundred plants - since it is only necessary to ensure the presence of the character to transfer in the progeny.

B. BREEDING OF CROSS-POLLINATED SPECIES

1. BASIC PRINCIPLES

Cross-pollinated species are much more heterogeneous than self-pollinated species because they are composed of individuals which are heterozygotic for numerous genes. For this reason, the study of their phenotype only gives a partial indication of their genetic potential.

Under ideal conditions, a cross-pollinated population is composed of numerous individuals which reproduce in "panmixing", that is to say, when the pairing between the two sexes happens completely at random. Each ovule has the same chance of being fertilised by any one of the male gametes. Moreover, if there is no migration, mutation or selection, the frequency of the alleles for each gene, and also the frequency of the genotypes, remains constant from one generation to another. This is known as the "Hardy-Weinberg equilibrium".

Among the factors that may upset this equilibrium and modify the genetic structure of the population during the transmission of the genes to the next generation, are spontaneous mutations. These can affect the hereditary material, but are infrequent and their influence is often negligible.

The stability of the allogamous populations may also be modified by migration, that is to say, by the introduction of new genes. This usually results from the transport of pollen from another population by insects or the wind. It can cause unfortunate results, when a variety is grown near to some highly compatible spontaneous forms.

The "Hardy-Weinberg equilibrium" may, furthermore, be upset by selection, when some genotypes produce more offspring than others, thus affecting the proportion of genes and genotypes in the next generation. This selection may occur at the haploid stage, notably when pollen grains do not have the same vitality, or produce pollen tubes which develop at different rates. It may also take place at the diploid stage when genotypes have different levels of viability or fertility. It may come about either by natural selection or through the intervention of the plant breeder.

Lastly, the genetic equilibrium may be altered as a result of the size of the population, when this becomes too restricted. The range of genes transmitted by the gametes then diminishes; this causes random fluctuations in gene frequencies, and it thus becomes impossible to foresee the genetic structure of the succeeding generation. This is known as "random drift" and results in the creation of sub-populations of different characteristics, a loss of genetic variability and, finally, a progressive reduction in the proportion of heterozygotes in favour of homozygotes. The process, however, reaches a limit when, in any sub-population, the genetic frequencies of a single locus descends to 0 or 1. At this point, the allele of a frequency of one becomes fixed and that with a zero frequency is lost.

The variations which result from selfing are sometimes the cause of an unfortunate phenomenon for the breeder, known as "inbreeding depression". It should be noted that this phenomenon can also be caused by the use of restricted populations, in which the genotypes are closely related. Two related individuals have a greater chance of each having a copy of the same gene carried by one of their common ancestors. If they are crossed, their descendants may then have two identical genes in a given locus. Thus, the coefficient of inbreeding is a measure of the probability of homozygosity at a locus due to inbreeding.

Selfing is the most efficient means of increasing homozygosity. There are some species, such as carrots, where selfing causes loss in vigour, but in other species, like onions, it has less effect and in yet

others, like melon and cucumber, it has no effect at all. The latter species then produce lines through a series of consanguineous crosses which react more or less like autogamous plants.

Hybrid vigour is the reverse of "inbreeding depression". It is the expression of heterosis, and is due to several factors, including the presence of dominant alleles in the hybrid, the heterogeneity of the mitochondria, the interaction between different alleles (over-dominance) and between different genes (epistasis). Hybrid vigour may affect different organs and modify a large number of characters, including yield, earliness, climatic adaptability and disease resistance. It endows the hybrid with vigour and productivity superior to either of its parents, especially if these come from lines of relatively widely separated origins.

2. MASS SELECTION

Mass selection is used for the breeding of local varieties, cultivated varieties or populations resulting from hybridisation. The technique is comparable to that used for self-pollinated species; the seeds harvested from the plants retained by positive or negative selection are mixed for sowing the next generation. However, in this case, because of the strong heterogeneity of the population, selection should be followed for a longer time than for the self-pollinated species.

This method leads to a more or less rapid evolution, according to the nature of the character concerned. If this is controlled by a small number of major genes, the response to selection is more rapid than in the case of numerous minor genes whose individual effect on the phenotype is weak. The progress that can be made with this method is, therefore, considerable, provided that the selection concerns characters with a simple segregation, but it is much more limited when the characters are polygenic and strongly fluctuating.

As mass selection is practised on the basis of the phenotypic expression of the individuals, the breeder should rely primarily on characters with a high rate of heritability, that is to say, on those in which the genetic variance is, above all, additive, such as height of plants. Moreover, as cross-pollinated populations have a great diversity of genes with a variety of interactions, mass selection can be used both for creating new varieties and for conserving the varietal purity of the material selected. In fact, the two processes can take place simultaneously and continuously.

If the objective of the breeder is to totally eliminate a recessive undesirable gene, the method is ineffective. Nevertheless, it can lead to a frequency sufficiently low for the influence of the gene to become negligible.

Finally, if the gene concerned is partially or entirely dominant, a selection after cross-fertilisation normally makes it possible to reduce the frequency of the gene by 50% each generation. On the other hand, if the selection is made before cross-fertilisation, a single selection should suffice to obtain complete elimination.

3. SELECTION BY FAMILIES

In cross-pollinating species, each individual differs from the others to such an extent that it is practically impossible to appreciate the value of any genotype by simple observation of the phenotypes. This

difficulty can be overcome, however, by using a progeny test. The progeny of several dozen individuals furnishes, in fact, a better estimation of the value of a plant than the phenotype itself.

When it concerns an annual species, the original material is generally some population from which the breeder has selected a certain number of plants on the basis of their phenotypic value (Fig. 5). The pollination is free, but the seed of each selected individual is harvested separately. In the next generation, the progeny of each of the selected plants constitutes a family of individuals. The different families are tested separately, preferably in several replications, so as to make possible an analysis of variance but also so as to obtain cross-pollination nearer to panmixing. According to the yield obtained and the behaviour of the plants in the course of growth, the families are classified and the most promising are retained. Finally, all the seed of selected families is mixed to provide the material both for multiplication and further selection.

When a biennial species, such as turnip, radish, beetroot or onion, is concerned, the principal characteristics can be judged in the course of the first year of growth, i.e. before flowering. Various systems of selection are then possible (see Figs. 6 and 7). From the initial population, most often a cultivar, the breeder selects a few hundred mother plants among the bulbs or roots produced, basing his choice on important characters such as quality, shape, size and colour.

In the second year, the mother plants produce seed, which is harvested individually. At this point, it is possible to eliminate certain lines for reasons of susceptibility to disease or poor seed production. In the third year, the lines retained produce families of plants, which are used in comparative trials for behaviour and yield, followed by a classification of families. The best, say, 20 families are selected by the breeder for multiplication. Alternatively, a further selection of mother plants may be made in each family. In this case, if, say, 25 individuals are selected per family, the total of 500 mother plants are used for the continuation of the programme, whereas the remaining non-selected mother plants of the 20 families are grown for commercial seed production.

The method of selection by families has the advantage that it can be carried out over several successive cycles, with no risk of inbreeding depression. Various adaptations for different species can make it even more efficient. If it is a question of the total elimination of recessive homozygotic genotypes, and if it is carried out before flowering, it is more effective than mass selection. If, however, the characters to eliminate are more or less dominant, the two methods are of about the same efficiency.

Another variant of the selection by families is the system called "plant to row". This is also a phenotypic selection, based on a progeny test. One chooses the best individuals of a population and one sows a part of the seed from each, in separate lines, the following year (Fig. 8). The remaining part of the seed of the selected individual is kept apart and it is a mixture of the seed from the plants which have produced the best offspring which is used for the following generation.

The seeds which are used for the progeny test are generally from free pollination. In this case, the individuals are all from the same mother plant, but from extremely varied pollen sources and it is therefore known as "half-sib" selection. The characters of the selected plant may be masked by the influence of the unidentified pollinators. This difficulty can be overcome if the seeds are obtained by selfing but the

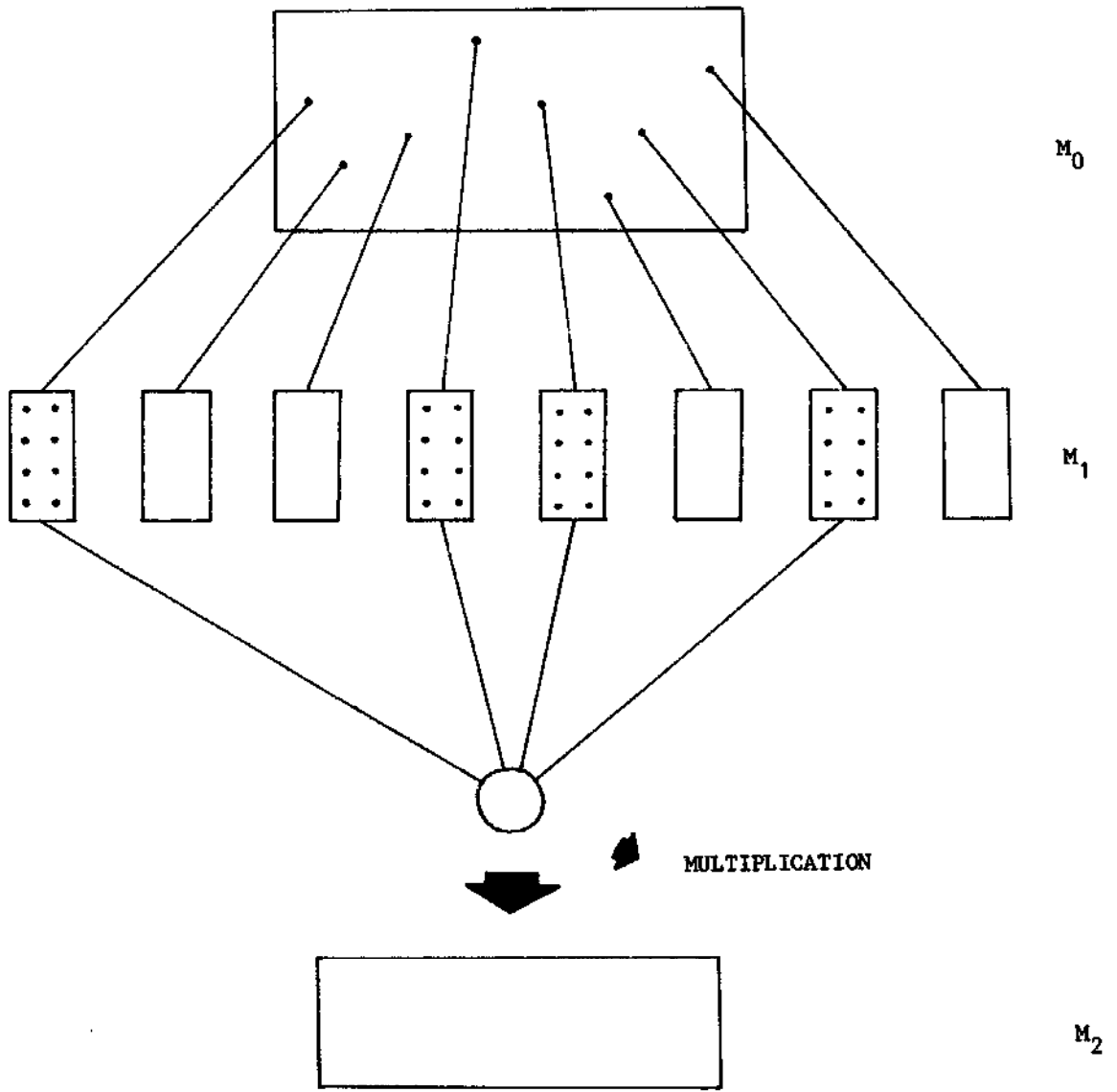

Figure 5 : Selection by families, for an annual species.

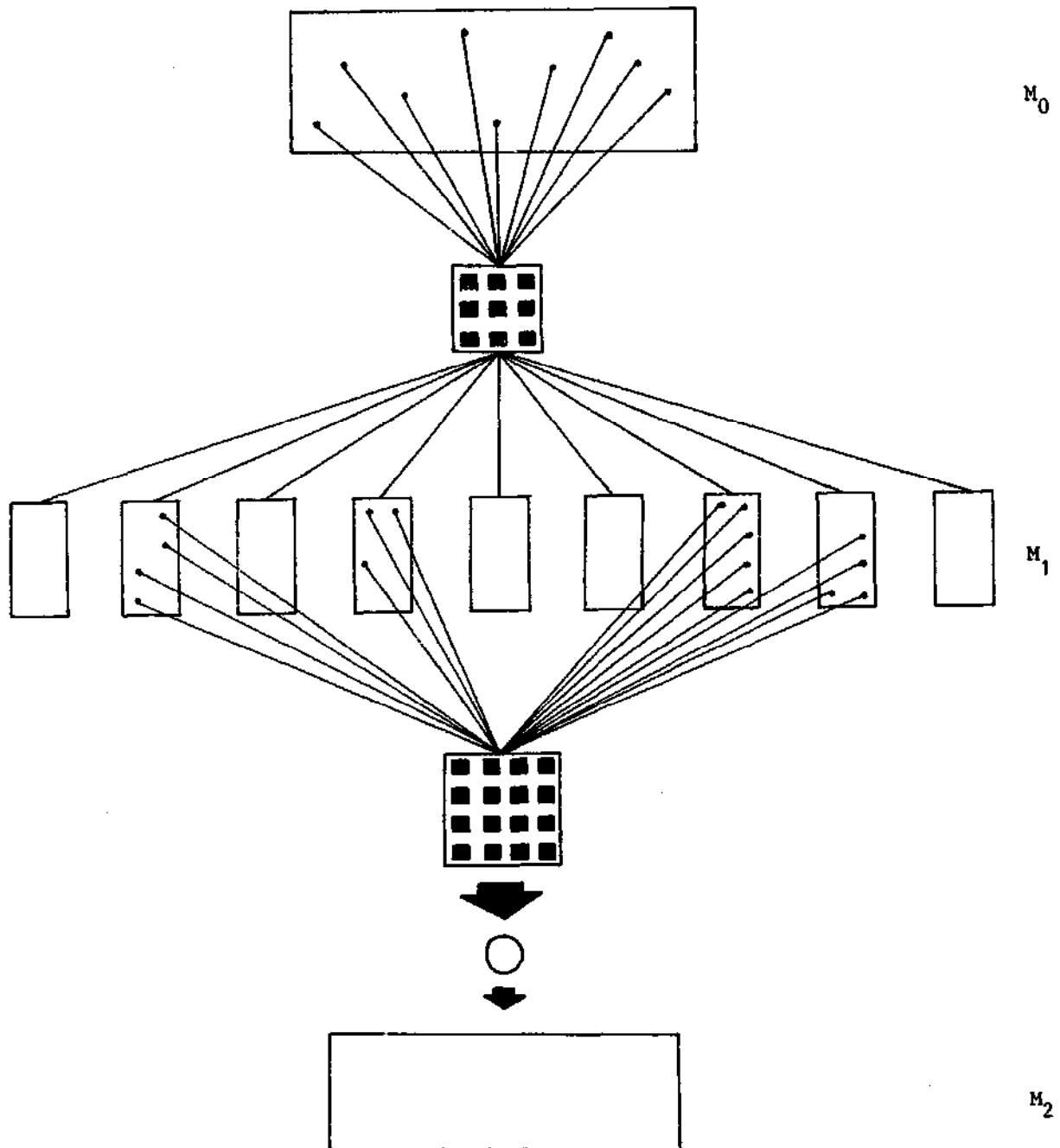

Figure 6 : Selection by families over 4 years, in the case of a biennial species whose principal characters can be evaluated before flowering.

- Production of roots or mother bulbs
- Seed production in open pollination

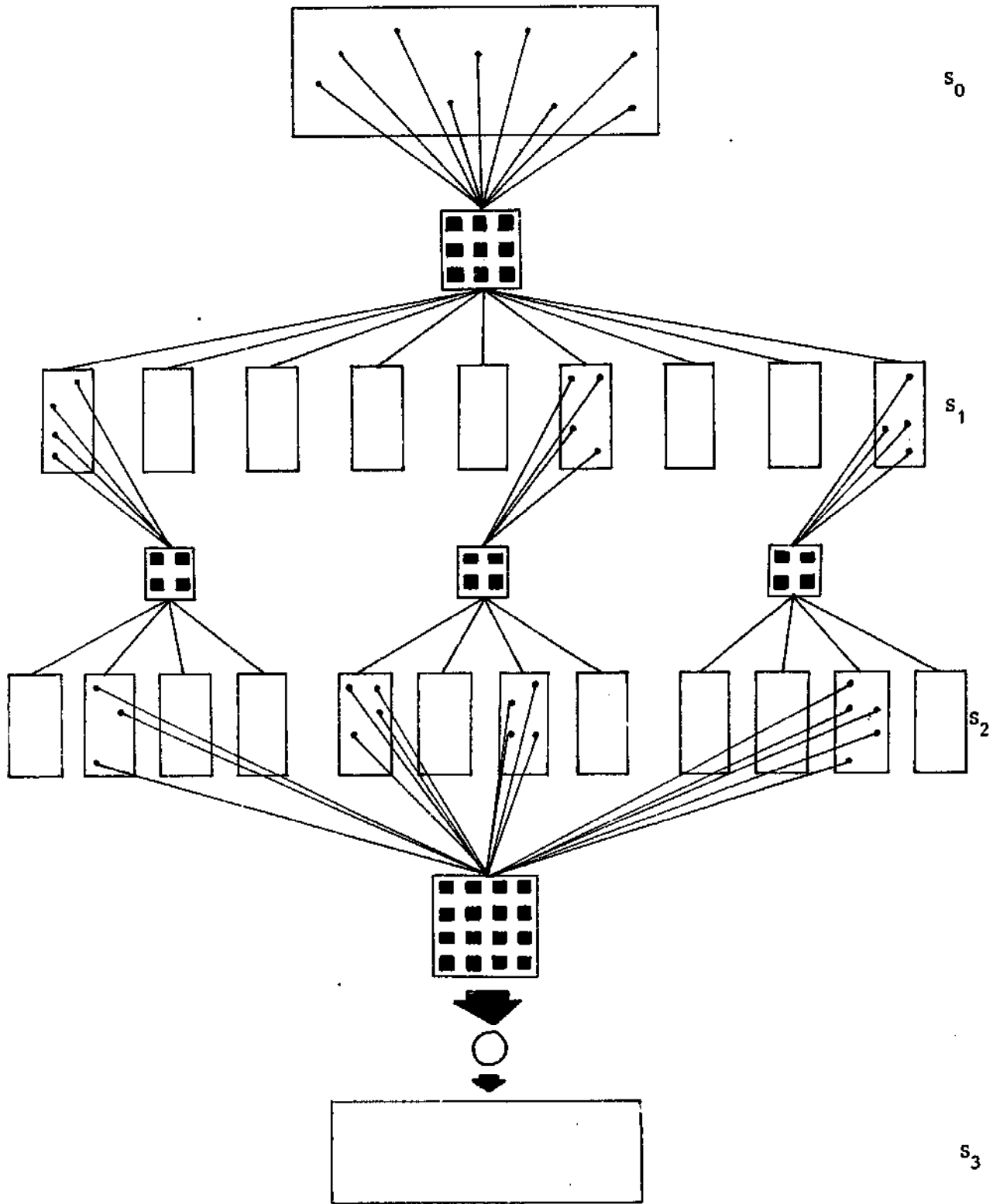

Figure 7 : Selection by families over a 6-year cycle, in the case of a biennial species whose principal characteristics can be evaluated before flowering.

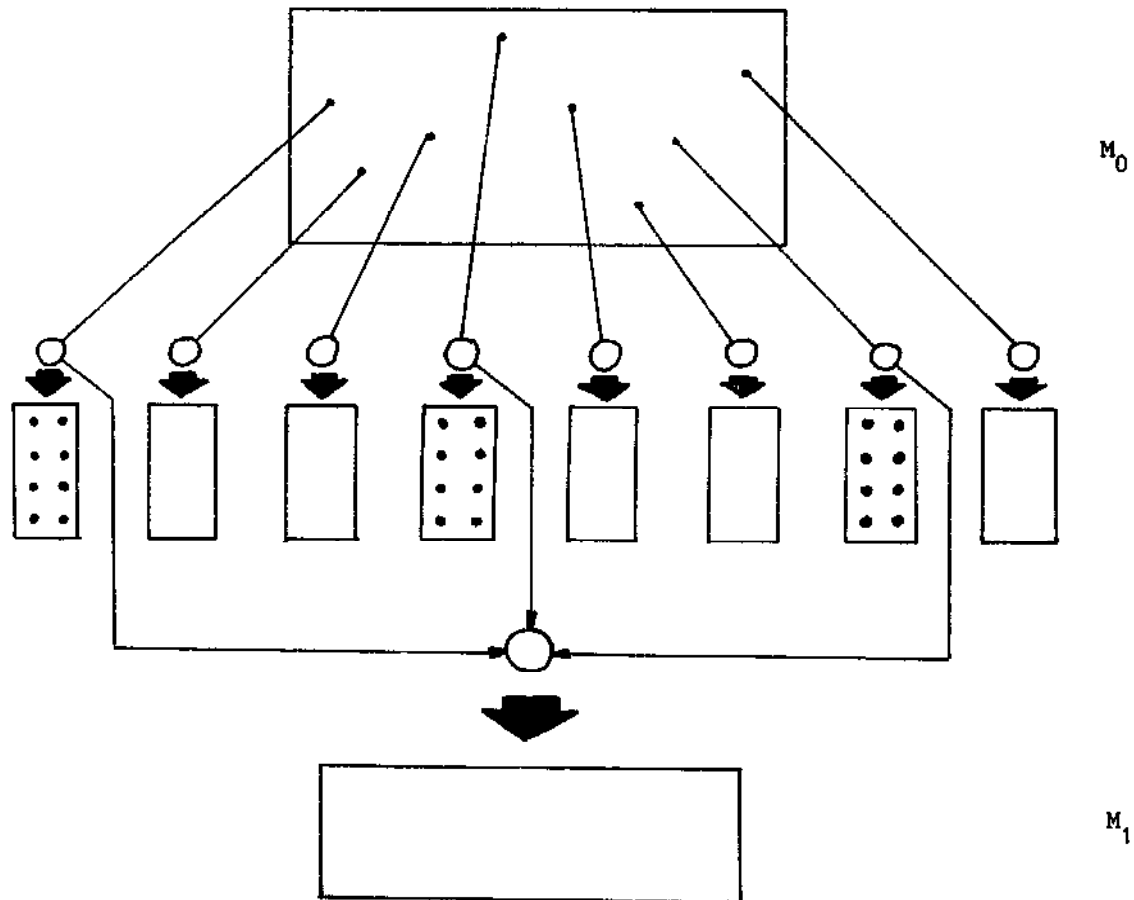

Figure 8 : Phenotypic selection of an annual species, based on a progeny test by the "plant-to-row" method.

technique, in this case, is only suited to qualitative characters, since the inbreeding depression involved considerably complicates the evaluation of quantitative characters like vigour and productivity. For this reason, the best solution is to make a "top-cross" by pollinating all the selected plants by the same genotype or by using these plants to fertilise the same "tester", in the process known as "full-sib selection".

4. SELECTION BY INBRED LINES

This method of selection is applied only to those cross-pollinated but self-fertile species which do not suffer too much loss of vigour from selfing. The main advantage of the method is in obtaining, via forced selfing, rapid homogeneous structures. However, in view of the danger of inbreeding depression, the breeder must always ask himself just how far he can go with homogenisation. This is especially the case with onions, where experience shows that it is better not to exceed two successive generations of selfing. In fact, after three selfings, the breeder should not be surprised if only 10% of the lines show a normal bulb conservation or a sufficient seed production for their propagation.

The diagram in Figure 9 illustrates a system of breeding for a biennial species in which selection can be made before flowering - either at the time of harvest or during storage of bulbs or roots. In this case, a rather large number of individuals, say, several hundred, are selected from the base population and are artificially self-fertilised during the second year of growth. Each self-fertilised plant initiates one first generation inbred line (I_1) and the progeny of each line is grown on separately.

In the course of the third year, numerous lethal and sub-lethal types are eliminated and a selection is made both between the lines and in the lines. Only the best plants of the best lines, with a minimum number of 25, are retained for the second seed crop. For the next generation, some of the flowers are self-pollinated and the remainder allowed open pollination. This progeny test makes it possible to judge the quality of the following generation both of the inbred lines (I_1) and of the families. The breeder can thus judge the value of the different lines from the point of view of their general combining ability and, at the harvest of the I_2 plants, he can also select the lines on the basis of the average performance of the corresponding families.

For the third seed crop, the breeder retains the best individuals of at least 25 lines, which he mixes and uses for multiplication with open pollination, in order to restore vigour through heterosis. The result of this type of selection is known as an "open pollinated variety" (O.P.V.).

5. CREATION OF HYBRID VARIETIES

The phenomenon of heterosis, following the restoration of heterozygosity after the crossing of lines obtained through artificial selfing is actually well-known in several cross-pollinated vegetable species - spinach, asparagus, beetroot, onion, carrot, courgette, cucumber and melon. Various causes are believed to contribute to the phenomenon; the accumulation of favourable complementary genes (dominance), the fortunate combination of certain alleles in different loci (over-dominance) and the interaction between genes at different loci (epistasis). The resulting hybrid vigour is observed to be most intense where the parental genotypes are most distant genealogically.

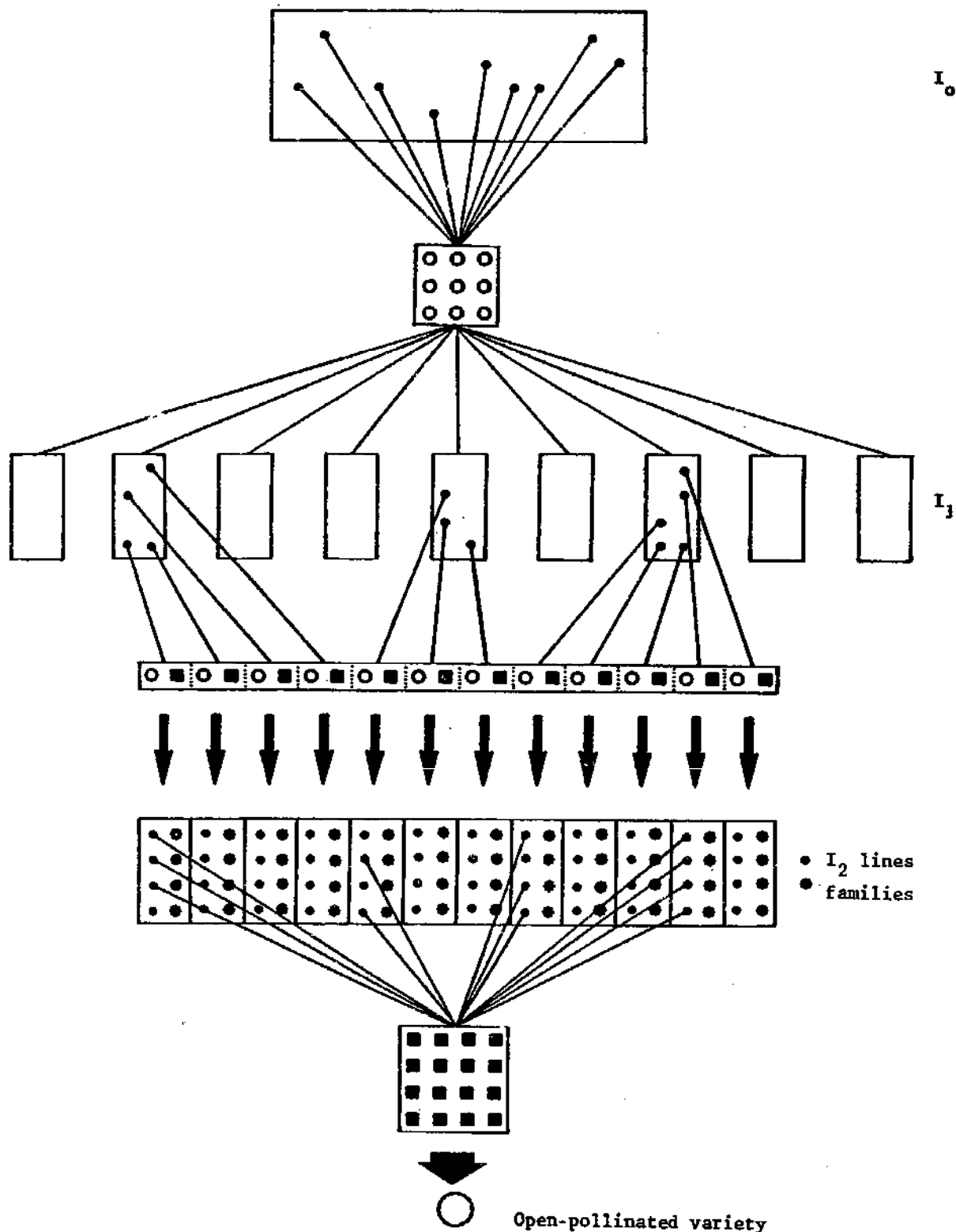

- ● roots or mother bulbs
- crops of seed bearers in free pollination
- crops of seed bearers in self pollination.

Fig. 9 - Selection by self-pollinated lines of a biennial, self-fertile species whose principle characters can be evaluated before flowering.

The principal objective of hybridization is the exploitation of heterosis in hybrid varieties of first generation, i.e. "F₁ hybrid varieties". If the crossing is made between inbred lines, the resulting hybrid is constituted of individuals which are genetically identical but which have progeny of instable heredity. That is to say, the first generation from the F₁ hybrid seed is homogeneous, but the hybrid seed must be reconstituted for each crop.

Hybrid varieties can be formed from the crossing between two lines or between two F₁ hybrids or between a line and an F₁ hybrid, giving rise respectively to a "single cross hybrid", a "double cross hybrid" or a "three-way cross hybrid".

The importance of double hybrids compared with simple hybrids is primarily the lower cost of the seed. This is due to the fact that the F₁ female parent can be used in smaller quantities as the volume of seed produced by the F₁ female is much greater than it would be from a homozygotic line. Moreover, the proportion of pollinators used can be notably reduced, due to the greater efficiency of the F₁ hybrid male parent.

Double hybrids also have the special advantage of allowing the combination of characters from four different parental lines; on the other hand, they have the major disadvantage that their descendants are not homogeneous. The diversity of the progeny is in proportion to the diversity of the four progenitors.

The classical method for creating a hybrid variety involves three stages: the preparation of suitable homozygotic lines, the search for the best combining ability between these lines and the production of the hybrid seed of first generation.

The preparation of the homozygotic lines is done by successive selfings and usually requires a fairly considerable number of plants. As there is always a large number of different genetic combinations in the initial population, this technique makes it possible to maximise the chances of fixing the most promising homozygotic ones. However, this inbreeding must be accompanied by a severe selection, since it favours the apparition of various unfavourable types connected with lethal or semi-lethal genes. When the lines have become sufficiently homogeneous - which is not necessarily to say homozygous - they are grown separately in isolated plots, leaving pollination open within each plot.

The second stage in the creation of an F₁ hybrid is the search for an optimal hybrid structure. For this, it is necessary to have valid estimations of the combining ability of the lines produced by selfing, and the best way to do this is by a diallelic design of crossings in which all lines are crossed in every possible combination and the hybrids compared. Thanks to a programme of hybridization of this sort, the breeder may discover the specific combining ability between certain pairs of progenitors and may select the pair whose progeny displays the greatest hybrid vigour.

The determination of the best combinations by diallelic crossings involves numerous hybridizations and, as the number of lines involved must exceed 100, it is a relatively laborious process. There is, however, a simpler method of identifying the good parent lines without loss of the best combinations. It is the method of "top-cross", by which one estimates the general combining ability, that is to say, the average value of each line according to the combinations in which it is a parent.

In a "top-cross" test, one crosses the different lines with a "tester", which is usually another open-pollinated population, in order to determine the average performance of each parent. As there is a good correlation between the productivity of the top-cross hybrids and that of the F_1 hybrids of inbred lines, the breeder can make a preliminary elimination of inferior lines without risk of losing valuable genetic material. Unfortunately, the "top-cross" method gives less precise information than the "diallelic design", and it is preferable not to use it for the final choice of parents.

In order to improve the potential of the lines obtained by selfing, it is sometimes useful to introduce one or two other morphological or physiological characters, using a method similar to that employed for autogamous species. When it is a question of introducing a gene for disease resistance or of incorporating the genotype of an inbred line with a male-sterile cytoplasm, the breeder may employ a "back-cross". On the other hand, when the principal objective is to increase the productivity of the hybrids, it is especially important to create some lines which have a better combining ability. For this purpose, the breeder must create inbred lines of second cycle by selfing among the descendants of those combinations which have shown the highest level of heterosis. He will thus obtain lines which are intrinsically superior and whose hybrids will be slightly better.

The last step in the process of creating a hybrid variety is the production of the F_1 seed. For this purpose, various different procedures are indicated, according to the sexual expression of the plants concerned.

First of all, for dioecious species, like asparagus, the operation is a very easy one, since it involves neither castration nor the suppression of flowers. Furthermore, the vegetative multiplication is, in this case, a great advantage that involves considerable reduction of the cost of production of hybrid seed.

If the species is monoecious, like sweet melon, watermelon and cucumber, hybridization is also easy, since castration is unnecessary. All that is required is the removal of the male flowers that appear during the flowering period of the female line.

When the species consists of plants which are self-fertile and whose flowers are hermaphrodite, like the carrot and the onion, the operation takes longer and is more costly, since castration is necessary. However, when the flowers are hermaphrodite but the plants self-sterile, as in the case of cabbages, castration is not required.

At the present time, male sterility is much employed for the production of hybrid varieties as it dispenses with the tiresome operation of castration. Male sterility occurs spontaneously in many species, at a frequency of 1% or more; in the onion it is 10%. It can be of three types: "functional", if the pollen exists but the stamens are indehiscent,, "pollinic", if the anthers produce little or no pollen, or "staminal", if the stamens abort or if androecium is malformed.

"Pollinic" sterility is usually controlled by a cytoplasmic factor associated with one or several nuclear genes. A well-known example is that of the onion, where the mechanism of male sterility is controlled by two alleles and two types of cytoplasm (see Annex E).

Sporophytic self-sterility can be used in the same way as male sterility in the production of F_1 hybrids, notably in the cabbage. In this case, although vegetative multiplication is often possible, the parent

lines are continued by sexual propagation, since artificial pollination of the flower buds before they open overcomes the self-sterility barrier.

A number of current research programmes are based on the creation of hybrid varieties, but so far these are far from yielding satisfactory results. In fact, these varieties demand considerable human and financial inputs. Moreover, the extensive distribution of hybrid varieties involves, at relatively short term, a risk of progressive disappearance of local varieties. Hybrid varieties may, indeed, be well adapted to modern types of agriculture, but are probably not the best suited to the relatively limited technical resources of most traditional African vegetable growers.

6. OTHER METHODS OF IMPROVEMENT

Besides the above, more or less classical, methods, other methods of improvement have been devised, in particular "recurrent selection" and the creation of "synthetic varieties".

The different systems of recurrent selection are of a non genealogical type because they always finish in a bulking of the retained genotypes; they are also of a cumulative type because they aim to concentrate in the same individual the maximum of useful genes. As they include a phase of selfing and a phase of crossing in each cycle, they have the advantage of recombining the genes and bringing about the maximum segregations.

Improvement by recurrent selection begins in the choice from an original population (P_0) of a certain number of plants, which are then self-pollinated. The resulting seeds are sown in lines and a series of crosses are made between the lines. The seeds from these crosses are harvested, mixed and sown to produce an improved population (P_1) which is still heterogeneous but has a higher frequency of favourable genes. A diagram of this simple recurrent selection is shown in Figure 10. The above genetic pool may serve as the departure for a new cycle of selection, resulting in a second improved population (P_2). It may also be used for the production of hybrids or synthetic varieties.

The value of the method of recurrent selection resides, primarily, in the fact that it is based on the best combination of the existing genes in a given group of plants, rather than on the phenotype of a single individual.

When yield constitutes the principle criterion for selection, the value of the plants selected from an initial population may be estimated from a preliminary test which, according to whether the tester chosen is a heterogeneous variety or a pure line, leads to a recurrent selection for the general or specific combining ability (Fig. 11). In this system, a proportion of the flowers of each plant is self-pollinated and the rest is crossed with the "tester". In the following generation, the progeny from crossings are compared with each other so that the breeder selects those which give the best performance. Lastly, the seed from selfing of the selected individuals is collected for the next generation. The normal duration for a cycle of recurrent selection with a test for combining ability is, therefore, three years.

There is another more elaborate technique, consisting in the selection of two populations, if possible with complementary qualities and of different genetic origin, then using them as testers, the one with the other (Fig. 12). In this case, the individuals selected from each group are submitted simultaneously to selfing and to crossing with the pollen

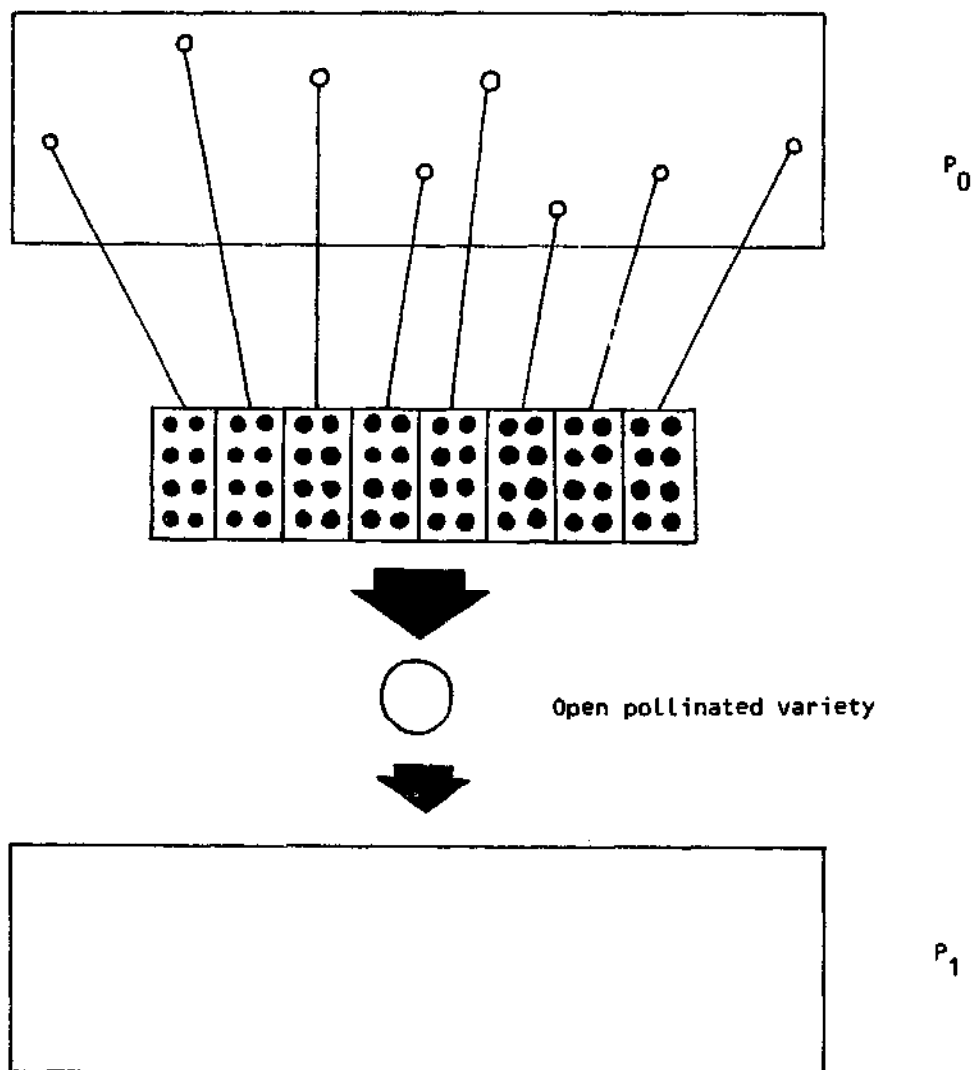

Figure 10 ; Simple recurrent selection of a self-fertile annual species

- Self pollination
- Cross pollination

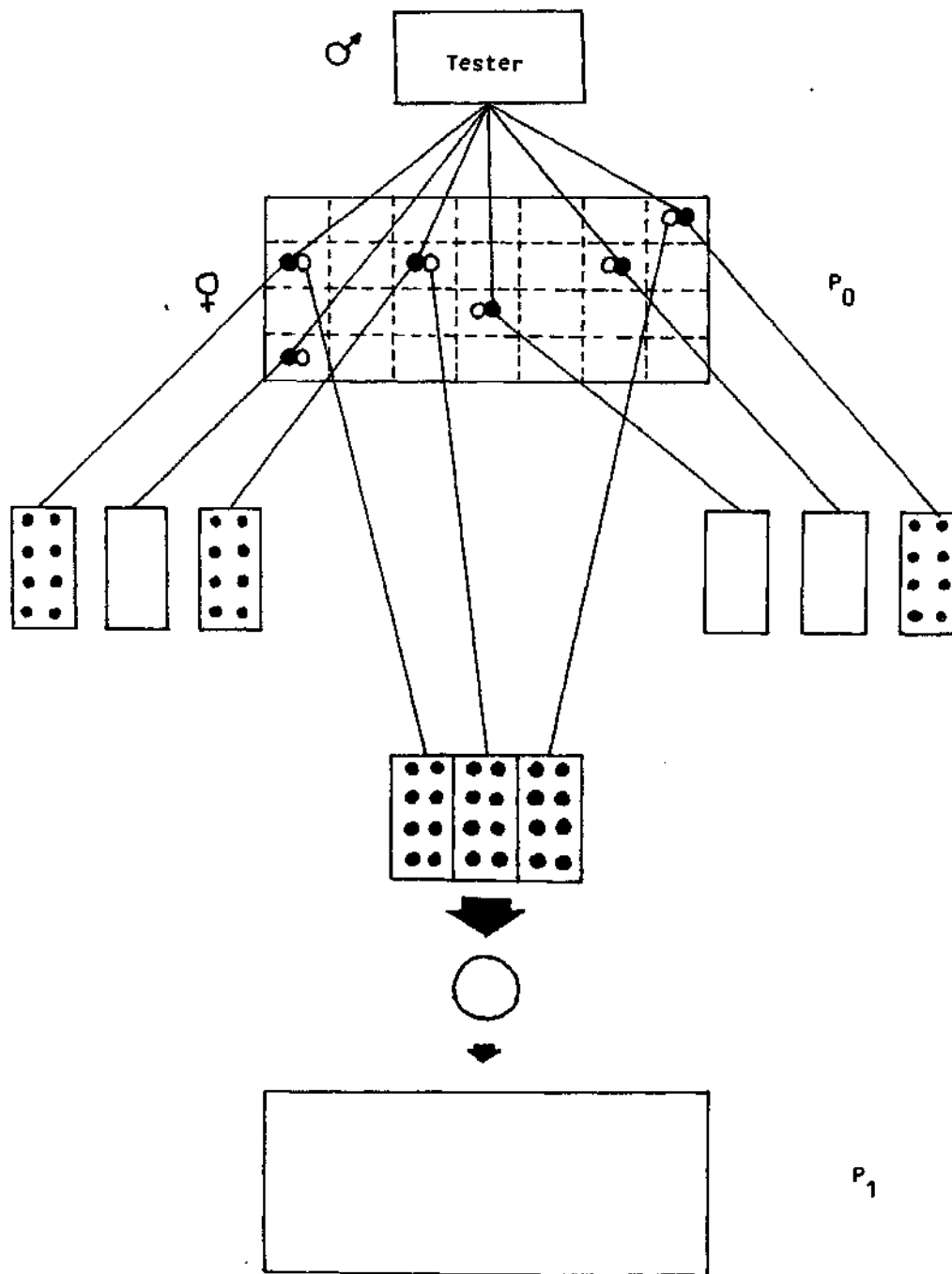

Figure 11 : Recurrent selection of a self-fertile annual species with a combining ability test.

- Cross pollination
- Self pollination

pool of the other population. The next selection concerns the value of the plants coming from each "top-cross" and, according to this value, one chooses the best descendants produced by selfing in the first year. The resulting seed is now used, via a general panmixing of each group, to produce two new improved populations, which can be the departure for a second cycle of "reciprocal recurrent selection".

The different methods of recurrent selection, contrary to the method of creation of hybrid varieties, all have the advantage of using the additive genetic effects to the maximum in order to gather those together; and, contrary to the genealogical methods, are able to maintain, thanks to the repeated crosses, a notable level of genetic variance.

When the production of hybrid varieties cannot be undertaken, for such reasons as the difficulty of castration, the absence of self-incompatibility, limitations in the production of homogeneous parental lines or insufficient production of seeds, the breeder may turn to the creation of synthetic varieties. This method is applicable to a number of market garden species, such as carrot, radish, onion and cauliflower. Its objective is to gather in a single variety a certain measure of heterosis, a good homogeneity between individuals and the fixation of useful characteristics.

In reality, a synthetic variety is the result of one or several multiplications, in open pollination, of a certain number of genotypes, which can be reproduced in a stable manner and tested for their combining ability. The individuals destined to constitute the nucleus of a synthetic variety must obviously be chosen from the genotypes which give good results when crossed with all the others. Evaluations can be made following open pollination or polycross.

The advantages of synthetic varieties are, on the one hand, their large genetic base, which confers on them a great suppleness of adaptation to different conditions of culture or variations in season and, on the other hand, the easy process by which they can be multiplied. In fact, the seeds can be produced without any particular technical difficulty and may be distributed after only two or three multiplications in the station.

For these reasons, the creation of synthetic varieties is considered more suitable for development in the tropical zones of Africa than the relatively long and costly production of F_1 hybrids.

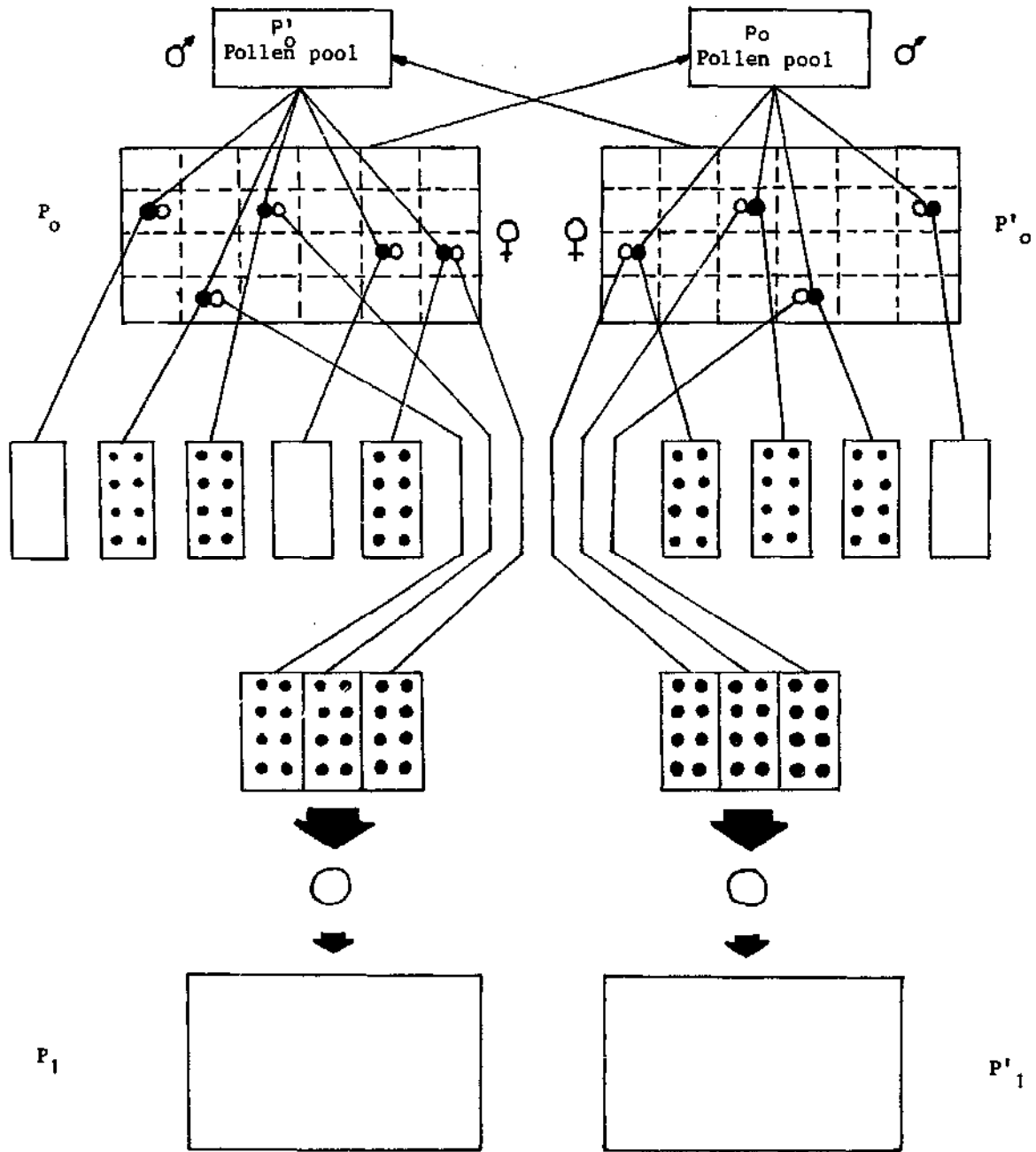

Figure 12 : Reciprocal recurrent selection of an annual self-fertile species

- Cross pollination
- Self pollination

I. IMPROVEMENT OF VEGETATIVELY PROPAGATED SPECIES

Vegetative propagation makes it possible to produce from one plant a progeny of individuals of the same genotype that is known as a "clone".

"Varieties" of potatoes, sweet potatoes and cassava, like 'varieties' of oranges and bananas, are in fact clones. These individuals have great genetic uniformity, but they are very heterozygotic, because they often originate from cross-pollinated species. As a result, the seedlings from a clone do not resemble their parents: there may even be such marked dissociations of character that it is impossible to find among them the original phenotype.

In principle, all mitotic divisions initiating this system of propagation produce cells of identical genetic constitution. However, new genotypes may appear through somatic mutation. In this way, a fair amount of genetic variability may appear in a clone. Mutations are uncommon in isolated individuals, but they become more frequent when the same genotype is represented by a large number of individuals.

These mutations may be of a qualitative, quantitative or physiological character. When they are of an undesirable type, of course, the breeder should eliminate them immediately, but favourable mutations occur which may improve the productivity, tuber colour, length of internodes or many other factors. In these cases, they should be multiplied and submitted to comparative trials. If the results are positive, the new clone may make a considerable improvement to the species.

To instigate genetic variability on a wider scale, the breeder has several means at his disposal. Artificial mutagenesis or induced polyploids may be used but the most common is still sexual reproduction.

The creation of a new variety through the latter process requires the deployment of a considerable number of seeds to obtain as large a segregation as possible. Several hundred or several thousand seeds may be needed, and this may oblige the breeder to make a succession of generations.

With some species, for example cassava, this can cause a considerable prolongation of the time required for selection. Furthermore, the evaluation of the selected genotypes may take several years.

In a programme of clonal selection of cassava or sweet potato, for example, the first generation of seedlings is usually subjected to a preliminary selection based on criteria of quality (Figure 13). The selected individuals are then multiplied vegetatively and comparative trials are carried out in small plots. Selection is then based on productivity, resistance to parasites and the quality of the crop. Finally, the best clones are tested in replicated trials, first on the station and then in trial plots under various environmental conditions. The trials should be repeated for several years, so as to obtain a true evaluation of the adaptability of the different clones.

The means of sexual reproduction used for these purposes may be of three kinds: open or semi-open pollination, selfing or hybridization. Open pollination with several pollinators, followed by harvesting the seed "in bulk", is certainly the easiest method but the procedure is not recommended as only the female parent is known. A preferable technique is by planting selected male and female parents in isolated plots and collecting the seeds from each parent after semi-open pollination.

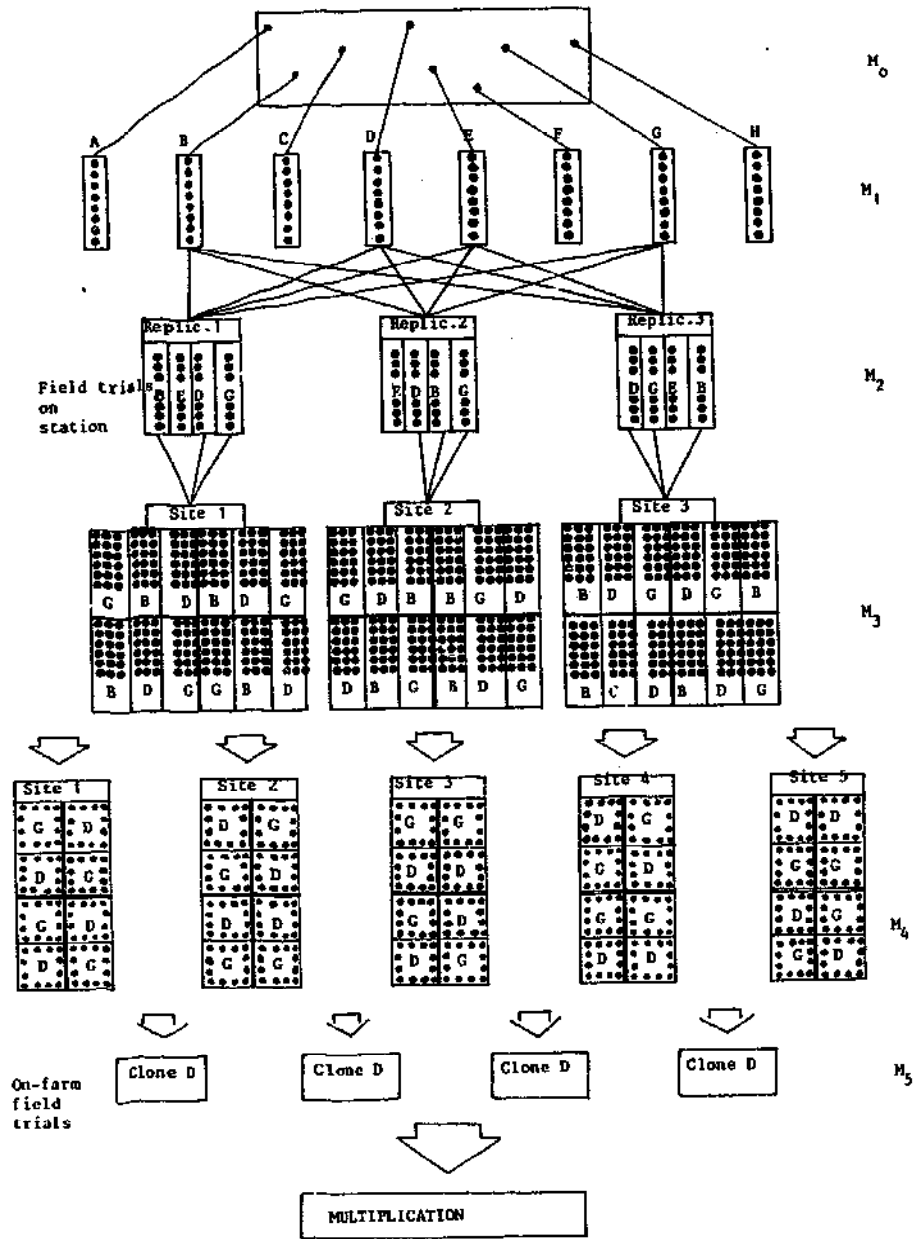

Fig.13 - Clonal selection of a vegetatively propagated species (cassava or sweet potato).

Selfing, when this is possible, gives results less subject to chance. It may be carried out either by natural interclonal pollination in isolated plots, or in an isolation cage, or manually by artificial pollination of the female flowers by pollen from male flowers of the same plant. If the species has a high level of heterozygosity, the selfing instigates a very great variability among the descendants caused by the segregation of different pairs of alleles, and this may bring about new genotypes superior to the original clone.

Hybridization is an efficient system which may be employed in either of two ways. In the first, the crossing is practised directly by natural pollination between two selected clones grown side by side in isolated plots, the seed being harvested separately from each of the two parents. If there is no male sterility or autosterility, a certain percentage of seed from self-fertilization may be expected. In the second case, the crossing between the two clones is carried out artificially. This makes it possible to obtain individuals of known parentage but it involves more work.

With hermaphrodite or monoecious species, the hybridization may be obtained easily by the castration of all the individuals of one of the clones and by manual fertilization of that clone with pollen taken from the second. Evidently, if the natural dispersion of pollen is adequate, the artificial fertilization is unnecessary. In dioecious species, a total hybridization can be obtained simply by planting the females of one clone mixed with the males of the other.

The crosses are normally between different varieties of the same species but inter-specific crosses are possible in some cases. They can prove very valuable but there are often considerable obstacles to such crosses because of chromosomic or genomic differences.

Whether natural populations or cultivars of allogamous and vegetatively propagated species are concerned, the different methods of improvement are all based on the additive effects of genes and the substitution of less valuable alleles by more valuable ones. They may, therefore, involve the employment of successive cycles of mass selection, of selection by families or of recurrent selection coupled with recombinations and evaluations. In fact, there is always a choice of individuals superior to the average of the population for any given character or characters, and they may be used in open, semi-open or controlled pollination. Then a fresh evaluation is made amongst the descendants and a new cycle of selection may be started.

J. SELECTION FOR RESISTANCE TO PARASITES

1. GENERAL PRINCIPLES

In the arid and semi-arid regions of tropical Africa, vegetable crops suffer heavy losses every year from attacks by pests and diseases. These parasites may be classed into three major groups:

Non-cellular (viruses),
Cellular (mycoplasma, bacteria and fungi),
Animal (nematodes, insects, mites).

As explained in Chapter IV, there are many methods of control. The use of pesticides remains the most important, but it has serious drawbacks.

Pesticides are not only expensive and liable to cause environmental pollution, but are often of limited effect. Above all, they tend to stimulate the evolution of resistant races of the parasites they are intended to control.

Genetic control, through the creation of resistant crop varieties, provides a notably economic and non-polluting alternative and is of potentially wide application. Nevertheless, the method has limitations in that it is not possible to find sources of resistance to all parasites in all circumstances; moreover, the parasites themselves may often develop new varieties capable of overcoming the genetic resistance in the crop.

The efficiency of any given genetic resistance depends both on the level of incompatibility between host and parasite and on the stability of this resistance.

Resistance may depend on a great variety of characteristics, effective at various different stages of development of the parasite. The characteristics may be of an anatomical or morphological nature, such as hairiness of leaves, or thickness of cuticle or cell walls, but they are more often biochemical factors such as the presence of certain tannins and alkaloids. There is also a whole series of defensive reactions in cells or tissues involving the liberation of antibiotic substances or the synthesis of phytoalexines.

When a parasite comes into contact with the cells of a resistant host, the level of response will depend on the type of mechanism involved.

There may be absolute resistance due to reactions of immunity or hypersensitivity. Immunity may be caused by the absence of suitable sites for the parasite to attack the host or, in the case of a virus, it may be due to the absence or inefficiency of processes which allow the multiplication of the virus. In either of these cases, no visible symptoms of attack will appear. A good example of immunity is the resistance of tomatoes to Cladosporium attack provided by the gene Cf-2.

Hypersensitivity is one of the most efficient resistance mechanisms in vegetable crops. It results in the stopping of infection through the premature necrosis of the contaminated cells and is brought about by a complex of cytological and biochemical reactions. It is accompanied by important metabolic changes in neighbouring cells causing ligneous deposits in the cortical parenchyma and tylosis in the vessels. Such mechanisms of hypersensitivity are found especially in peppers, where they are effective for TMV virus, in melons for Oidium, in French beans for Pseudomonas phaseolicola and in tomatoes for Meloidogyne sp.

Finally, there are the cases of partial resistance or "reduced sensitivity" which are principally the result of the reduction of the number of sites suitable for the parasite to attack the host, the prolongation of the period of incubation and a decrease in the number of infectious germs produced. The result is a slower progression of the disease in the plant and of the epidemic in the crop. It is important that the concept of "partial resistance" should not be confused with that of "tolerance" which is normally applied to plants which show the symptoms of a disease without suffering its effects on their growth, although the term 'tolerant' is also frequently used for plants which can support a high concentration of virus infection while presenting few or no symptoms of disease.

The stability of a case of absolute resistance can only be judged after the observations over a number of years, because the rapidity with

which a pathogen can develop adaptations to any given resistance is very variable. It depends on three essential factors: the probabilities of mutation of the genes controlling virulence, the number of genes concerned and the reaction of the characteristics of virulence with the characteristics of the host (Clerjeau et al., 1979).

However, there are some cases of resistance which have never been overcome or, even if sometimes overcome, remain effective under most conditions. Good examples are the resistance to Stemphylium solani and Tomato Mosaic Virus controlled respectively by the genes Sm and Tm-2. It is also notably the case in the control of certain of the less virulent or less widespread pathogens such as a race of Meloidogyne incognita, which is controlled by the resistance gene Mi in the tomato.

2. TYPES OF RESISTANCE AND THEIR GENETIC CONTROL

The genetic control of resistance and virulence depends on the existence of a "gene-by-gene" relationship because from each gene for resistance in the host, genes for resistance are most often dominant, while the genes for virulence are usually recessive. Under these conditions, if a crop variety does not possess several alleles for resistance it is, as a rule, subject to all the races of a given parasite. On the other hand, if the resistance gene is dominant, it will overcome all the races of the pathogen which do not possess the complementary recessive gene. Again, if the host has two dominant alleles for resistance, only races of the parasite which have both of the corresponding recessive alleles for virulence will be able to attack it. Thus, the virulence of a physiological race of a parasite depends on the number of genes for virulence that it possesses - in other words, on the number of genes for resistance that it can overcome.

The resistance of a host plant to any given pathogen may depend either on major genes or minor genes. The first are generally connected with an absolute resistance, but when they are employed for the creation of resistant crop varieties, the result is often a more or less sudden collapse of resistance following an adaptation of the parasite. In fact, crop varieties which are grown over large land areas create a selection pressure which favours the development of a variety of mutations and recombinations in the parasite which finally enables it to overcome resistance. This evolution is the more rapid the greater the genetic homogeneity of the crop. The resistance of crop varieties, through these major genes, may be classified as 'specific', 'differential' or 'vertical'.

Specific resistance, whether recessive or dominant, is not always controlled by one gene (monogenic), it may sometimes be controlled by several (oligogenic) as is the case with the oligogenic resistance to anthracnose in French beans. Nor is it always associated with hypersensitivity, as is shown by the Tm-1 gene against TMV in the tomato. It should also be noted that there are a certain number of dominant genes of resistance which have never yet been overcome by new races of the pathogen - for example, the gene Sm for resistance to Stemphylium solani in the tomato, and the gene I for resistance to common mosaic in the French bean.

For many years, breeders have been primarily interested in specific resistances, because of their dominance and simple pattern of heredity, which have been especially useful in first generation hybrids. However, in view of the serious risk of the appearance of pathotypes capable of attacking such resistant varieties, genetic research in this field should concentrate on the introduction of durable resistances.

Resistance due to the minor genes, whose individual or combined action confers a reduced sensitivity to disease attack, is generally more stable than that from the major genes and is termed 'non-specific', 'general' or 'horizontal'.

Plants which have no specific genes of resistance to a particular parasite exhibit an identical degree of sensitivity to all the races of that parasite, although this degree of sensitivity may vary between different varieties of the plant species concerned. While specific resistance is a qualitative character which may be identified by artificial inoculation, non-specific resistance is a quantitative character, generally dependant on numerous genes with additive effects; it is impossible to identify these genes separately unless they are combined with marker genes. This so-called 'horizontal' resistance is often imperfect and varies according to the age of the plant, the abundance of the inoculum and to ecological conditions more or less favourable to the parasite and its genotype.

The non specific resistance is dependant on a great variety of processes of a biochemical and mechanical nature and a parasite can never adapt itself fully because of the complexity of biological changes necessary and the great number of genes involved. It is not impossible, incidentally, that some minor genes originated as major genes which have been artificially overcome by a parasite, such as gene Cf-1 in the tomato which gives partial resistance to Cladosporium. In fact, the same genes may be involved in both 'horizontal' and 'vertical' resistance (Clerjeau et al., 1979).

Finally, it should be noted that some types of horizontal resistance are polyvalent against several different parasites - it has been shown, in tomatoes for example, that resistance to Pseudomonas solanacearum is associated with a high level of tolerance to two other vascular parasites - Fusarium oxysporum f. lycopersici race 2 and Corynebacterium michiganense (Kaan and Laterrot, 1977).

3. SEARCH FOR SOURCES OF RESISTANCE

The first phase in a programme of selection for disease resistance consists in tracing parent lines possessing the desired characteristics. The most common system is to make a selection of cultivars available in collections or gene-banks and to test them through artificial inoculation. Research may also be undertaken in the centres of origin and diversification of the species where, during the long process of co-evolution, a reciprocal adaptation has usually been established between the plant and its parasites. However, the populations which are found in such locations are rarely homogeneous in their resistance; they usually consist of a mixture of highly resistant, tolerant and disease susceptible plants. Of course, one may also find resistant plants among local crop populations when these have remained genetically heterogeneous. Finally, there is the possibility of selection from cellular in vitro cultures from protoplasts or vegetative organs.

The next phase in the selection programme is the testing of resistance through natural or artificial inoculations. The choice of technique is very important because, if the breeder uses an overly severe method to select an absolute resistance, he may lose valuable plants which exhibit partial resistance to the disease concerned. On the other hand, the use of natural infestations has a major disadvantage, in that they are too variable and unreliable for efficient selection. In fact, the development of centres of infection and the severity of the disease depend

on climatic conditions and are extremely variable. In these circumstances, when the potential level of inoculation is low, the breeder may be led to consider certain plants as resistant when they have merely been fortunate in escaping the attack of the parasite. Moreover, under natural conditions, the selection for resistance to a given disease may be hampered by the appearance of other unwanted diseases.

If inoculations in a glasshouse cannot be arranged, it is possible to reduce the difficulties attending natural infestations by a wider distribution of the inoculum through the trial plot - for example, by burying numerous pieces of infected root in the substrate when selecting tomatoes for resistance to Pyrenochaeta lycopersici. This technique, unfortunately, involves the risk of spreading the disease outside the station and, in any case, does little to expedite the programme of selection.

All considered, it is preferable to rely on artificial inoculation under controlled conditions in a glasshouse which will make it possible to distinguish clearly between resistant and sensitive plants. This technique, however, necessitates the use of genetically homogeneous stocks of parasites with a well defined level of virulence and the stabilisation of the inoculum by storing under refrigeration, freezing or lyophilisation.

The viruses which are not transmissible by mechanical means can only be preserved in a glasshouse on host plants and their inoculation can only be effected by the natural vectors. As for endoparasitic nematodes, such as Meloidogyne sp., they must be maintained on plants grown under aseptic conditions in vitro, or in a sterilised compost, to avoid infection by undesirable fungi such as Pythium, Rhizoctonia or Fusarium. Lastly, the raising of insect plant parasites must be carried out under special conditions on plants cultivated in cages or on artificial media.

In order to estimate the virulence of any given vector, and to control the efficiency of infection, it is useful to include in all resistance trials, control plants comprising a resistant and a sensitive cultivar. When dealing with a mechanically transmissible virus, the contamination is carried out by rubbing the leaves of the host plant with a suspension of the virus mixed with carborundum. When testing the resistance of tomatoes to TMV, through the hypersensitivity genes Tm-2 and Tm-2², a treatment of the cotyledons will reveal the susceptible individuals after ten days. However, when dealing with a virus that cannot be transmitted mechanically, the breeder will be obliged to use the natural vectors and to make an approximate evaluation of resistance on the basis of the percentage of successful infections.

In the case of certain bacteria which penetrate the aerial parts of plants via the stomata, artificial inoculation is carried out by spraying a bacterial suspension under high pressure or - if the breeder wishes to eliminate the role of stomata from the phenomena of resistance - by injection into the mesophyll.

For fungi which parasitize the aerial organs of the plant, spraying of the foliage with a suspension of the spores is used. With fungi, like Alternaria, whose fructifications are difficult to obtain in a culture, powdered mycelia may be substituted for spores in the suspension. The plants are then kept in a humid chamber at an optimum temperature for the development of the disease until a thorough infection has developed (Messiaen, 1981). If the fungus does not develop in the humid chamber, as may happen with Oidium, infected leaves are hung above the test plants.

When it is necessary to check the resistance of a plant to certain vascular parasites, such as Fusarium oxysporum f. sp. melonis and Pseudomonas solanacearum, the surest method consists in growing the seedlings in a sterile medium, then uprooting them and chopping up the root system. The pieces of root are then soaked in a suspension of the parasite organism and planted out in a sterile substrate under conditions favourable to the parasite.

Another task for the breeder may be to identify sources of nematode resistance, especially in the tomato. In this case, the best method is to remove the egg-masses from infested roots and to raise the nematodes on host plants grown in sterilized compost (Laterrot, 1969). One obtains perfect nematode galls which may be sliced into small pieces and mixed with a sterile compost to carry out the resistance tests.

In the case of checking resistance to insect attack, various methods of artificial infestation are available. Eggs or adult insects may be placed manually on the plants to be tested, or left with the plants in a cage, under controlled conditions.

Most partial resistances and some absolute resistances can only be expressed under certain limited conditions and it is, therefore, essential for the breeder to understand the effect of physical and physiological factors on the mechanisms of resistance.

Among the physical factors, temperature is one of the most important, especially in cases of hypersensitivity - for example, varieties of tomato resistant to nematodes of the genus Meloidogyne nevertheless form galls when the temperature exceeds 30 C. Again, insufficient illumination, due to the eliolation it causes, may discourage the expression of some resistances, such as that against Phytophthora infestans on some varieties of tomato carrying the resistance gene Ph-2. Similarly, levels of resistance may be modified by the mineral nutrition available to the host plant.

Physiological factors mainly affect the intensity of the reaction of protection mechanisms. The breeder therefore needs to take into account the parameters of resistance corresponding to the different physiological conditions of the host plant, and to exploit those favourable to maximum expression of resistance. Thus, in the case of resistances which are best expressed at a late stage of plant development, it is sometimes necessary to find techniques which will modify physiological states to expedite testing. Alternatively, it may be suitable to use less aggressive races of the parasite or to reduce the quantity of inoculum.

Non-specific resistances are sometimes masked in plants with characters of specific resistance. The breeder needs to remove such masks, either by placing the host plants in a temperature which annuls the specific resistance or by using virulent genotypes of the pathogen.

It is sometimes possible to ascertain whether a variety is resistant or susceptible by the inoculation of excised organs, which are kept alive in a controlled environment - as for the resistance to infection by Pseudoperonospora cubensis in cotyledons of melons and cucumbers. This method should be used, however, with prudence, because of the differential reactions which may be produced between the races of the inoculated parasite and the host tissues, according to the nature of the organ concerned, whether pieces of leaf or slices of stem, and so on.

In order to speed up programmes of selection for resistance to several different parasites or to several bio-types of the same pathogen, it is sometimes useful to employ mixed inoculations. Nevertheless, one must first be sure that this does not bring about induced resistance or induced susceptibilities provoking a different expression of resistance to that from separate inoculations.

When the objective of the breeder is to obtain a partial resistance to a parasite, the estimation of differences of susceptibility should be recorded on a scale established in advance of the trials. In most cases, a scale from 1 to 10 is used ('0' representing the absence of the parasite from the trial). Sometimes, scales from 1 to 9 may be used and the marks are then awarded for the following percentages of the foliage attacked by the disease:

1 = 0%; 2 = 0.1-4%; 3 = 4.1-15%; 4 = 15.1-30%; 5 = 30.1-50%
6 = 50.1-70%; 7 = 70.1-85%; 8 = 85.1-96%; 9 = 96.1-100%.

4. METHODS OF GENETIC IMPROVEMENT

The choice of a method of improvement depends not only on the system of reproduction of the species and the potential variability of the parasite and of the existing genes for resistance, but above all, on the type of resistance sought.

If it is wished to multiply the favourable genes in a population of strictly or strongly allogamous plants, a simple mass selection may be suitable. At the same time, a recurrent selection could also be used, especially for the combination in the same cultivar of resistance to diseases with agronomic qualities of yield, earliness, quality, etc.

When resistance to diseases is to be introduced to autogamous species, the method of back-crossing is the most useful. The recurrent parent should be a susceptible variety of good agronomic character and this should be crossed with a cultivar of proven resistance. This system is very efficient in the case of a dominant monogenic resistance, but if the gene is recessive, selfings must be alternated with the back-crossings.

In the case of non-specific resistance, whether oligo or polygenic, it is preferable to practice a back-crossing and a selfing simultaneously on the same plant. The breeder will then retain the back-cross corresponding to the self-fertilised progeny which shows the desired characters of resistance.

It sometimes happens that a source of resistance to a given parasite cannot be found in a crop species. One can then try inter-specific crossings or, if it proves impossible to cross a cultivated species directly with a wild one, 'genetic bridges' may be used. An example of this is the use of Capsicum frutescens as a bridge to transfer genes of resistance in Capsicum chinense to varieties of Capsicum annum.

The choice of the type of resistance to introduce in cultivated varieties varies according to circumstances. A 'qualitative' or specific resistance controlled by major genes is particularly indicated for urgent or dangerous epidemics, but should not be used to control an endemic disease. It may be useful, however, when climatic conditions are unfavourable to the parasite or when the spread of the disease is relatively slow.

One generally finds, when using plant varieties with specific resistance, that there is a selection pressure on the parasite for the development of greater virulence, but there is also a "stabilizing" selection which is sufficient to reduce the spread of the pathotype (Van der Plank, 1978). However, such resistant plants often prove to be extremely susceptible to new pathotypes which manage to overcome the major genes of resistance. The phenomenon may be explained by the fact that the major genes controlling the specific resistance sometimes mask the action of minor genes which operate at different stages in the progress of the disease.

In the course of selection work, there is therefore a considerable risk of losing the minor genes and observing the adaptation of the pathotypes to the major genes. To avoid the disastrous results of the 'Vertifolia effect' it is necessary to practise artificial inoculations first of all with a non-virulent race of the parasite respecting the gene for specific resistance that is to be preserved and afterwards with a virulent race of the parasite. Only the plants which have reacted favourably to both tests are retained.

A programme of breeding for 'horizontal' or non-specific resistance is not quickly completed and can only be successful if the minor genes concerned are submitted to selection pressure on the part of virulent strains of the parasite while the plants remain unprotected, either through pesticides or the action of major genes. Given the oligo- or polygenic nature of the horizontal resistance, the breeder must allow the maximum possibilities for recombination in the initial population. If the species concerned is autogamous, a satisfactory degree of heterogeneity may be obtained through polycrosses between several lines. Following this, the frequency of the alleles of resistance should be increased by the method of hybrid populations, retaining the individual plants which behave best in the presence of the parasite for each successive generation.

Recent work tends increasingly to concentrate on combined selection for horizontal and vertical resistances. Through the accumulation in the same variety, several genes with complementary actions of resistance, the breeder can considerably reduce the probability of adaptation of the parasites.

If the nature of the material makes it impossible to obtain a horizontal resistance, the proliferation of the parasite should be controlled by a diversification in space of the host. This can be arranged, for example, by growing 'multi-lines' of a crop composed of a mixture of isogenic pure lines which differ only in their genes for resistance to a given parasite.

K. EVALUATION OF VARIETIES

1. GENERAL PRINCIPLES

In any programme of breeding, a series of trials is required to determine, as efficiently and precisely as possible, the value of available plant material. Investigations should start with the preparation of a detailed experimental plan, including the following points: the objectives and conditions of the trial, descriptions of treatments, definition of the experimental units, observations to be recorded during the trial, choice of experimental lay-out and details of the practical operation of the trial (Dagnelie, 1981).

These trials usually have a single objective, as they consist in the comparison of the behaviour of different genotypes of a species with a control variety. The general conditions of the trial, however, vary greatly, according to whether it is executed within or outside an experimental station. In practice, trials in a station are carried out under well-controlled conditions, which make it possible to compare many genotypes and to use relatively small experimental plots. Trials outside the station usually involve the use of larger plots and a smaller number of genotypes.

In the first stages of selection, trials in the station can start with up to several hundred varieties. This preliminary screening can be effected on very small plots without replication, as these 'preliminary trials' or 'orientation trials' are qualitative in character and do not call for statistical analysis. The number of treatments is greatly reduced for the next stage, as only the most generally promising types are selected for the 'comparative trials', which are carried out in the station on larger plots, with several replications, so that genetical differences can be measured quantitatively and judged statistically.

Finally, the varieties which have given the best results in the comparative trials are subjected to 'multi-local trials' in various sub-stations representing the different climatic areas in which the crop is to be grown. These 'confirmation trials' are carried out, as far as possible, under optimum conditions of culture, including adequate fertilisation and crop protection. However, if the varieties are intended for use in the context of 'traditional agriculture', they should also be tested under village conditions. Further, due to the importance of annual climatic variations, the tests should be repeated for several years running, in the various sub-stations.

It is emphasised that, before recommending the diffusion of a new variety, the breeder should be sure that it represents a genuine improvement compared with the varieties usually grown in the regions concerned. Its superiority should have been clearly demonstrated in the comparative and multi-local trials in comparison with one or several suitable 'control' varieties, grown under exactly the same conditions.

2. CHOICE OF EXPERIMENTAL UNITS

In a field variety trial, the experimental unit is normally a certain number of plants grouped in a plot. The size of the plots should be as small as possible within practical limits. Where mechanical cultivation can be avoided, a few square metres are sufficient, provided that a minimum of 10-20 plants can be grown in each plot. However, to eliminate the 'border effect', the experimental plants in each plot should be

surrounded by border plants, which may either be of the same or a different variety from the experimental plants. As shown in the two examples in Figure 14, the useful area of the plots is much reduced by this requirement - in the examples quoted, it corresponds to 42.9 and 50.4% of the total.

The shape of the plots should be approximately square, when the land is relatively homogeneous, but when there is a 'fertility gradient' in the site, rectangular plots should be used and aligned with the gradient. If the soil is variable, this shape of plot is favourable for a better distribution of the variability related to irrigation, drainage, texture, or organic content of the soil, slope, exposure to wind and other factors.

Before decisions are made on the shape and dimensions of the plots and the number of replications, however, it is indispensable to obtain a rather precise estimation of the variability of the experimental material. This estimation may be made with the help of statistical tables (Claus-triaux and Rousseau, 1974; Garner and Weil, 1939; Ma and Harrington, 1940; Njos and Nissen, 1956). Alternatively, a relatively simple "pilot trial" will provide the information. This preliminary trial should comprise a restricted number of plots and, preferably, a small number of varieties.

In the preparation of the experimental play, it is also indispensable to define precisely the dates of observations, their periodicity and their distribution in the field.

3. CHOICE OF OBSERVATIONS

Essential observations for the required objectives may be quantitative, - recorded as the weight of tubers, weight and height of plants, number of fruits and number of insects; or qualitative, - such as hairyness, colour and shape. The categories of quality should be defined in advance, according to a classification on a numerical scale, for example, but there will not be any mathematical relation between the different values of the scale. For this reason, the analysis of such data depends not on the numbers themselves, but on the frequency of occurrence of each number.

Notwithstanding the above, semi-quantitative observations have a mathematical relationship. They depend on the use of a scale designed to define, for example, the degree of susceptibility to a disease, the intensity of colouration, etc. Such scales must be as precise as possible and should preferably be arranged in arithmetical progression.

Apart from these essential records, it is useful to make some subsidiary observations in the course of a trial. These may be planned and systematic, such as records of sowing or planting data, fertilisation, protection operations, harvest date, etc., or occasional, such as those concerning accidents, or unexpected difficulties. These observations are useful for the explanation of anomalies that may arise during the interpretation of results. For the recording of some factors, involving, for example, counting the numbers of certain insects, measuring the dry matter of fruits, and so on, it is impossible to make detailed records for each plant on every plot. Here, the experimenter must make use of a sampling technique with a precise procedure and the recording of the number and the size of samples taken.

4. DIFFERENT TYPES OF ERROR

Particular attention should be paid to any variability in trial results - for example, variations in yield of the same variety in different plots under identical conditions of cultural treatment.

When such variability can be traced to differences in environment or to genetic variations in the individual plants concerned, - or simply to a lack of precision in the observations - it corresponds to what is known as "experimental error", which can be evaluated and quantified by statistical analysis.

However, when the apparent variability is due to errors in measurement or to differences of judgement between several recorders, this type of "systemate error" cannot be detected by statistical analysis.

There may be a third type of complication due to "sampling errors". These are usually due to neglect of the rules for the random selection of samples - such as the use of statistics from neighbouring plots for the completion of missing data, mistakes in plot boundaries, etc.

5. CHOICE OF EXPERIMENTAL DESIGN

It is desirable to select an experimental design which combines adequate representation of the factors under study with simplicity and efficiency. The choice will, of course, be limited by the site, material and personnel available and by other practical constraints.

In order to increase the sensitivity and accuracy of the trials, local control of the variability of the experimental material should be carried out and the subjects under trial should be repeated on a sufficient number of plots to ensure an adequate level of statistical significance in the results. Within certain limits, there should also be a random distribution of the different subjects under trial.

The most practical experimental designs adaptable to most programmes of selection are:

- completely randomised plots,
- completely randomised blocks, and
- the latin square.

Completely randomised plots is the simplest lay-out to use (Fig. 15) if there is no gradient of fertility.

It is based on the principle of complete randomisation of the varieties in the different plots using, for example, tables of random numbers. This type of design has the advantage that it can be adapted for any number of varieties and replications and even for an uneven number of plots per variety. On the other hand, it has the disadvantage of being relatively inefficient when the different plots are not properly homogeneous one with another.

The interpretation of results for a completely randomised trial based on one factor is made by a one-way analysis of variance. This may be preceded by a normality test, a test of equality of variance or by a transformation of variables. It can be followed, if necessary, by multiple comparisons of mean values.

B	C	A	D	D
C	B	A	C	A
D	B	D	D	B
B	A	C	A	C

Sources of Variation	Degrees of Liberty
Differences between varieties Residual variation	$p - 1 = 3$ $p(n - 1) = 16$
Total	$pn - 1 = 19$

Fig. 15 - Example of a completely randomized lay-out for the comparison of four varieties replicated five times, plus the diagram for the corresponding analysis of variance.

If the site has a 'fertility gradient', as long as the number of subjects for comparison is less than 20, the most suitable experimental design is certainly in randomised complete blocks (Fig. 16). Before planting the trial, the site is divided into several blocks, each being formed of a group of contiguous plots, each block being as homogeneous as possible. Although differences of fertility within each block must be avoided, differences between the blocks is not of particular importance. Within each block, the distribution of the varieties within the different plots is completely randomised, for each block independently. As each variety is represented once in each block, the number of plots per block is normally equal to the number of varieties. The orientation of the blocks should preferably be perpendicular to the 'fertility gradient' which is normally equivalent to arranging the blocks perpendicular to the plots (Dagnelie, 1981).

The interpretation of the results of a trial of this sort based on one principal factor consists in a two-way analysis of variance, as in addition to the principal factor there is the subsidiary factor of the blocks.

Trials in randomised complete blocks have the advantage of being adaptable to a variety of situations whatever the number of varieties or replications. However, the number of replications should normally be the same for different varieties, except for the control, for which the number of replications per block can be a multiple of those of the other varieties.

This experimental design is a very robust one experimentally, as it allows the elimination of several blocks or several varieties in the course of the trial or during the analysis of results, if it proves necessary. Moreover, many problems due to the lack of data can be resolved by certain methods of estimation. The experimental design is also 'adaptable' as the blocks need not be contiguous nor necessarily of the same shape and the plots within the blocks need not necessarily be arranged in the same pattern. As long as the number of subjects does not exceed 20, and as long as the experimental material is not heterogeneous, randomised complete blocks are generally better and more efficacious than a completely randomised design.

When there are two 'fertility gradients' instead of one, and as long as the number of varieties is between five and eight, the latin square design is certainly the most suitable (Fig. 17).

If p is the number of varieties, there should be p^2 plots arranged in p lines and p columns. The distribution of the p varieties within the different plots should be arranged at random, but with each variety represented once only in each line and in each column. In this way, there is a double check on variation, since the different lines and columns form in a manner a double perpendicular series of blocks.

In this type of design, it is not necessary to have an experimentation field of a square shape; the breeder can arrange the plots in a linear manner.

The interpretation of the results of a trial in latin square based on one factor only is carried out by a three-way analysis of variance, of a special type: the fixed factor, represented by the varieties, and the two random, represented by the lines and the columns.

Gradient of Fertility

C	A	B	D	B
B	C	D	B	A
D	B	A	A	C
A	D	C	C	D

Block 1 Block 2 Block 3 Block 4 Block 5

Sources of Variation	Degrees of Liberty
Varieties	$p - 1 = 3$
Blocks	$q - 1 = 4$
Interaction	$(p - 1)(q - 1) = 12$
Total	$pq - 1 = 19$

Fig. 16 - Example of a lay-out in randomised complete blocks for the comparison of four varieties replicated five times, plus the diagram for the corresponding analysis of variance.

Line 1	B	A	E	C	D
Line 2	D	E	B	A	C
Line 3	C	D	A	E	B
Line 4	A	B	C	D	E
Line 5	E	C	D	B	A
	Column 1	Column 2	Column 3	Column 4	Column 5

Sources of Variation	Degrees of Liberty
Objects	$p - 1 = 4$
Lines	$p - 1 = 4$
Columns	$p - 1 = 4$
Residual variation	$(p - 1) (p - 2) = 12$
Total	$p^2 - 1 = 24$

Fig. 17 - Example of lay-out in a latin square, of five varieties replicated five times, plus the diagram for the corresponding analysis of variance.

The fixed factor is tested in comparison with 'residual variation' which includes all the variation which is not due to one or another of the three factors.

The latin square is generally more efficient than the other experimental designs mentioned because it gives control on the interacting effects of the two gradients of fertility.

It has the limitation, however, that the number of replications must always equal the number of varieties and it is, therefore, not suitable for trials involving a large number of varieties, although there should be at least five of them. However, in contrast to an experimental design in randomised complete blocks, it is not possible, in a latin square, to eliminate a single variety, a single line or a single column without upsetting the nature of the experimental design (Dagnelie, 1981).

L. MULTI-LOCAL AND/OR PLURIANNUAL TRIALS

Multi-local Trials

Before establishing the superiority of a new variety, the breeder should always confirm the results under various ecological conditions, according to the variations existing between the proposed production zones.

It is preferable for these local trials to be carried out on the same plan with the same number of replications and, naturally, using the same techniques. The distribution of the experimental varieties in each trial should, however, be made at random, independently, in each location.

Annual Repetitions

In order to verify the productive capacity of a new variety under the normal annual variations of climate, it is also necessary to repeat the trials for several years, until some reliable mean yield can be established. Under normal conditions, however, it is not usually possible to reduce annual variations in yield below 10-20% or more (Dagnelie 1981).

CLASSIFICATION OF THE MOST IMPORTANT VEGETABLE SPECIES
ACCORDING TO THEIR SYSTEM OF REPRODUCTION
AND THEIR SEXUAL EXPRESSION

<u>Vegetative Reproduction</u>	Chromosome Number
Asparagus (<u>Asparagus officinalis</u>)	2 n = 20
Cassava (<u>Manihot esculenta</u>)	2 n = 36
Sweet potato (<u>Ipomoea batatas</u>)	2 n = 90
Potato (<u>Solanum tuberosum</u>)	2 n = 48
 <u>Sexual Reproduction</u>	
<u>More or less complete autogamy</u>	
French bean (<u>Phaseolus vulgaris</u>)	2 n = 22
Lettuce (<u>Lactuca sativa</u>)	2 n = 18
Peas (<u>Pisum sativum</u>)	2 n = 14
Tomato (<u>Lycopersicon esculentum</u>)	2 n = 24
 <u>Partial autogamy</u>	
Eggplant (<u>Solanum melongena</u>)	2 n = 24
Okra (<u>Abelmoschus esculentus</u>)	2 n = 108 to 144
Chili and sweet pepper (<u>Capsicum spp.</u>)	2 n = 24
 <u>Complete allogamy (self-sterile)</u>	
<u>Dioecious</u>	
Asparagus (<u>Asparagus officinalis</u>)	2 n = 20
Spinach (<u>Spinacia oleracea</u>)	2 n = 12
 <u>Total self-incompatibility</u>	
Cabbage (<u>Brassica oleracea</u>)	2 n = 18
Turnip (<u>Brassica campestris</u>)	2 n = 20
Radish (<u>Raphanus sativus</u>)	2 n = 18
 <u>Partial allogamy</u>	
<u>Hermaphrodite</u>	
Carrot (<u>Daucus carota</u>)	2 n = 14
Celery (<u>Apium graveolens</u>)	2 n = 22
Onion (<u>Allium cepa</u>)	2 n = 16
Potato (<u>Solanum tuberosum</u>)	2 n = 48
 <u>Monoecious</u>	
Cucumber (<u>Cucumis sativus</u>)	2 n = 14
Cassava (<u>Manihot esculenta</u>)	2 n = 36
Melon (<u>Cucumis melo</u>)	2 n = 24
 <u>Partial self-incompatibility</u>	
Sweet potato (<u>Ipomoea batatas</u>)	2 n = 90

CALCULATION OF THE EFFECT OF A SERIES OF SELFINGS
ON THE EVOLUTION OF HOMOZYGOSITY
IN AN AUTOGAMOUS POPULATION

For k pairs of alleles in the heterozygotic condition, the level of homozygosity attainable after "n" generations of self-pollination is given by the formula:

$$\frac{2^n - 1}{2^n} k$$

Thus, if $k = 5$, 72% of the population can become homozygotic after four generations, while if $k = 50$, seven generations would not be sufficient to obtain a similar result.

The general picture of the rate of increase in homozygosity shown by applying this formula to different numbers of pairs of alleles (1, 5, 25 and 50) for a course of ten successive generations of selfing is shown in Figure 1.

Figure 1: Effect of selfing over ten successive generations on an autogamous population with different numbers of heterozygotic pairs of alleles (1, 5, 25 and 50).

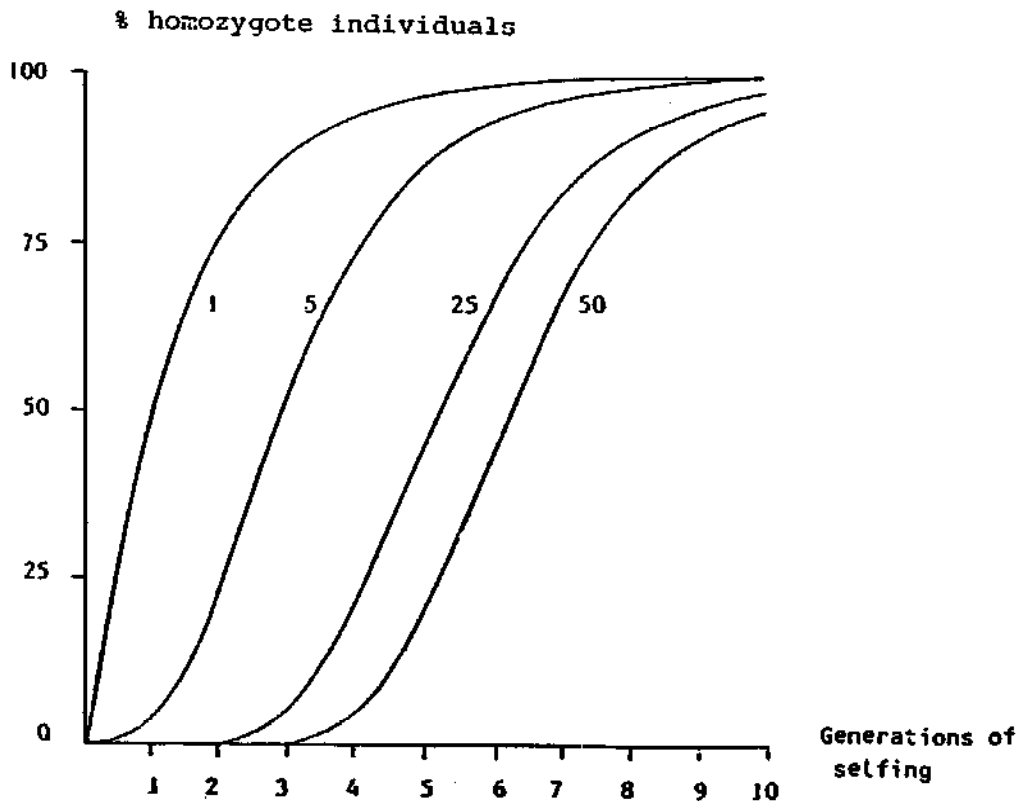

CALCULATION OF THE SELECTION DIFFERENTIAL
AND OF THE SELECTION RESPONSE

One usually measures the selection operated on a given population as the 'selection differential'. This represents the average superiority of the selected genotypes, compared with the average quality of the original population.

In a hypothetical initial population, with an average yield (m) of 157 kg/are and with an average variation in individual yield (p) of 16 kg/are, let us select the best yielding 10% (Figure 1) and suppose that these individuals all have average yields above a threshold (z) of 178 kg/are and together have an average yield (ms) of 185 kg/are.

In this example, the selection differential is then the difference between the average yield of the selections (ms) and the average initial yield (m), i.e. $185 - 157 = 28$ kg/are.

It is important for the breeder to know the repercussions of his selection on succeeding generations. For this, he must find out if the selected lines are really the most productive lines of the initial population (generation "n") by observing the average yields of their descendants (generation "n + 1").

He will then obtain the selection response (R) which is the difference between the average phenotypic value of the progeny of the selected lines and the average phenotypic value of the population before selection.

In the present example, $R = 165 - 157 = 8$ kg/are (Fig. 1).

The heritability (H) may then be defined as the ratio between the selection response (R) and the selection differential (S). In the present example: $H = \frac{R}{S} = \frac{8}{28} = 29\%$.

In the same way, the selection response (R) is the product of the heritability (H) and the selection differential, i.e.:

$$R = H \times s = \frac{29}{100} \times 28 = 8$$

The magnitude of the selection differential (S) depends on two factors: the proportion of the population included in the selected group and the standard deviation of the phenotypic values of the character concerned (Vp).

The relationship between S and these two factors is represented in Figure 2, which shows different supposedly normal distributions of phenotypic values with mean standard deviations between 0.5 and 2. These diagrams show clearly that each increase or decrease of mean deviation is reflected in a corresponding spread of the curve of probability.

On the other hand, considering the diagrams (1) and (2) of Figure 2 where only 10% of the individuals of the population are selected, it may be seen that the selection differential is greater when variability of the

character is greater. The same mechanism is shown in diagrams (c) and (d) with 20% of individuals selected.

Finally, if one compares diagrams (1) and (3), one sees that, for the same variability of phenotypic values ($V_p = 1$), the selection differential (S) decreases as the proportion of the population selected (q) increases.

If one expresses " s " in terms of the standard deviation of phenotypic values, S/V_p is a very generalised measure of the selection differential, called intensity of selection (i). This varies only with the proportion of the population selected and, as long as the distribution of phenotypic values is normal, it can be determined from tables established for normal distribution (Falconer, 1974).

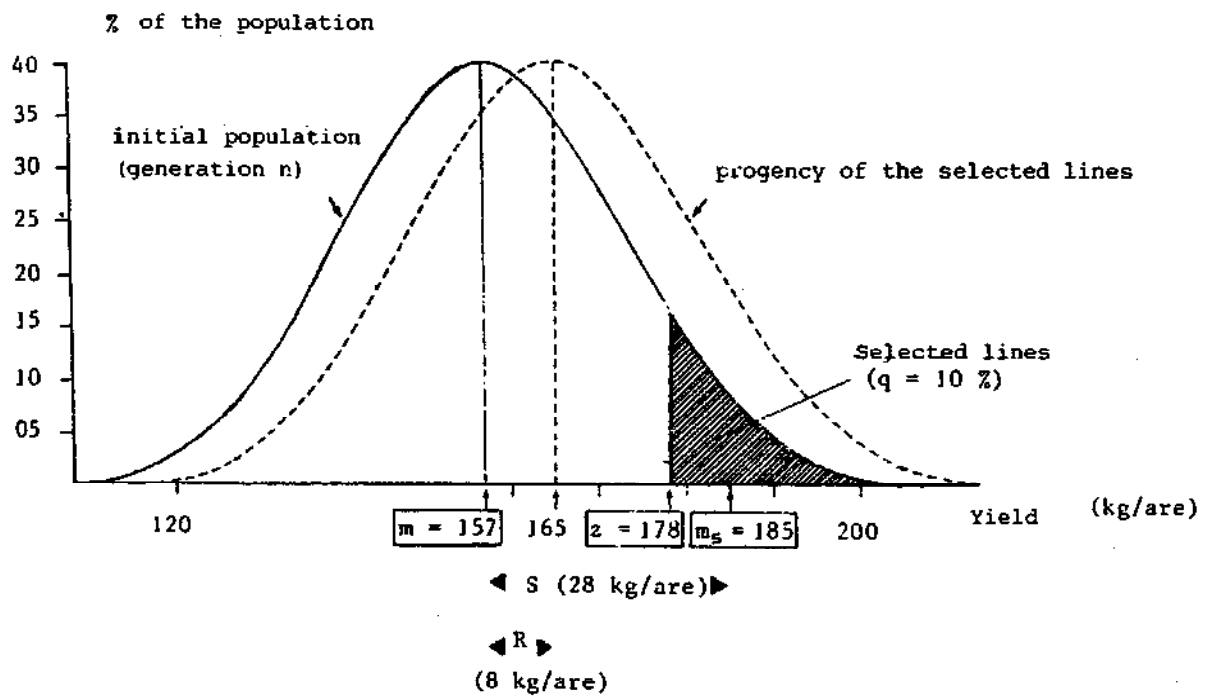

Fig. 1: Effect of selection on the yield of an imaginary autogamous population: Selection differential (S) and selection response (R)

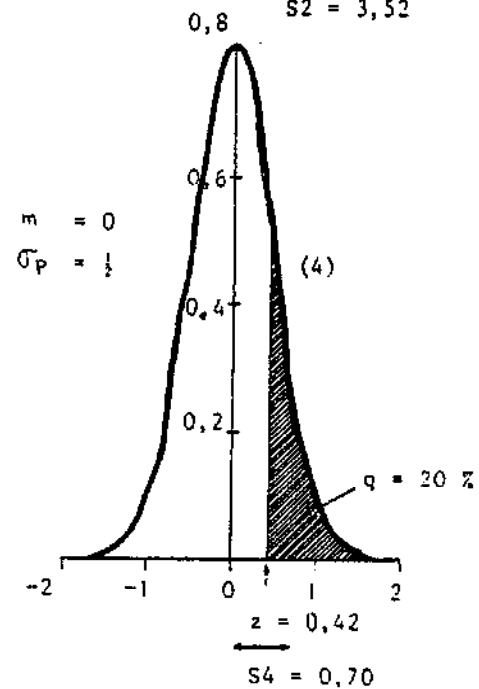
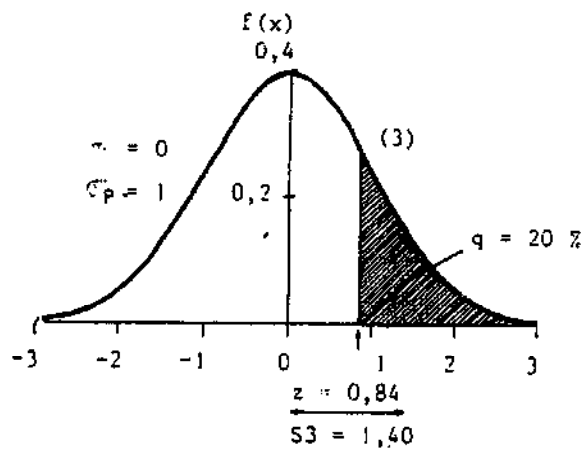
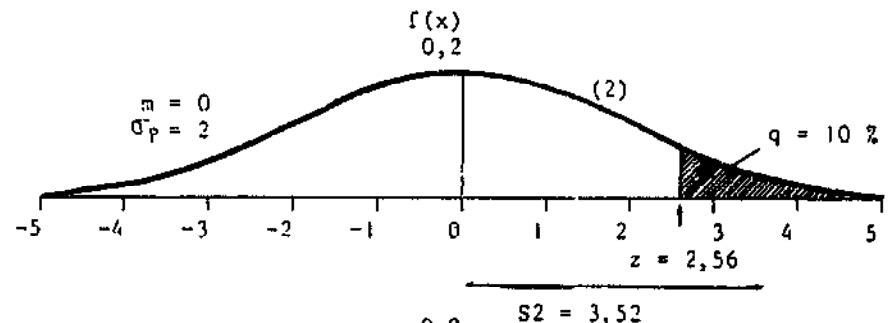
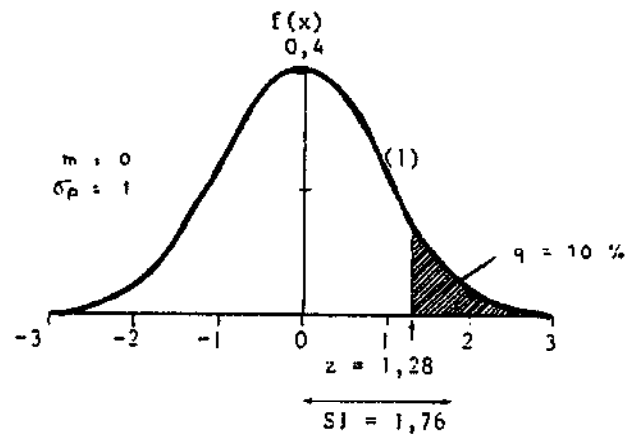

Fig. 2: Variation of the selection differential (s) in relation to the population selected (q) and the variability of "phenotypic values" (σ_p) of a character with normal distribution.

BACK-CROSSING TECHNIQUE

In the course of successive back-crossings, the breeder has to pay attention to various factors: the recuperation of the recurrent parent, the recuperation of the character to transfer and the elimination of genes tied to the locus transferred.

First of all, concerning the recuperation of the recurrent parent, it is important to take into account the evolution of the population under the influence of back-crossings. The process for a single locus is represented in Figure 1.

donor parent	x	recurrent parent
AA		aa
BC1		100% Aa x aa (F ₁)
BC2		<u>50% Aa + 50% aa</u> x aa
BC3		<u>25% Aa + 75% aa</u> x aa
BC4		<u>12.5% Aa + 87.5% aa</u> x aa
		6.25% Aa + 93.75% aa

Fig. 1 Evolution of a self-pollinated population after successive back-crosses on the scale of a single locus.

Normally, a population which is repeatedly back-crossed progresses to homozygosity at the same rate as it does with selfing and the curves of evolution are the same. Consequently, for k pairs of alleles, the proportion of homozygotes obtained after n generations is equal to:

$$((2^n - 1) / 2^n)^k$$

In the method of selection based on back-crossing, the progression of the material is towards a single homozygotic genotype which is that of the recurrent parent. However, as the varieties used have often numerous different characteristics, the evolution of the population will be more efficient if the breeder chooses the phenotypes most similar to the recurrent parent after each back-cross.

If the work of improvement aims at the transfer of a dominant monogenic character, the recuperation of this character can be obtained through the process represented in Figure 2.

donor parent		recurrent parent			
AA	x	aa			
BC1	100% Aa (F ₁)	x	aa		
BC2	<u>50% aa</u> eliminated	+	50% Aa	x	aa
BC3			<u>50% aa</u> eliminated	+	50% Aa
			25% aa selfing	+	selfing 50% Aa + 25% AA selfing

Fig. 2. Back-crossing technique in the case of a single dominant gene.

On the other hand, if the character to transfer is recessive, it is practically impossible to distinguish heterozygotes from homozygotes in the successive generations. In this case, the back-crosses must be alternated every other generation with selfings (Fig. 3).

When several characters are to be introduced in one improved variety, it is preferable to proceed with these transfers separately for each character and then to make crossings to incorporate them all in the same genotype. This is known as improvement by convergence.

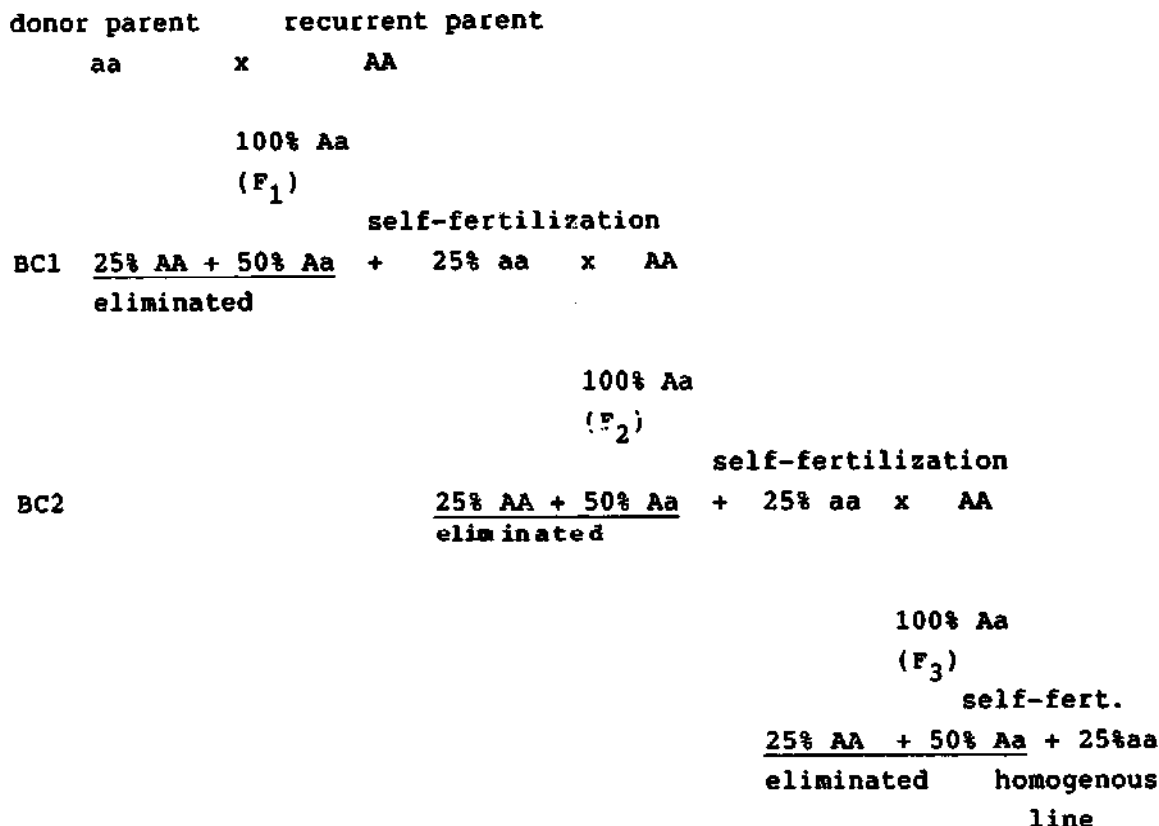

Fig. 3. Back-crossing technique on alternate generations in the case of a recessive gene.

Finally, it must be emphasized that in a back-crossing programme the most delicate operation is that of eliminating the genes responsible for the worst shortcomings and which are tied to the gene to transfer in the donor parent. This phenomenon of "linkage" is the most dangerous when it is connected with polygenes with little visible effect. In this situation, they are practically impossible to eliminate by selection. When the gene to transfer is linked to an undesirable gene in the donor parent, the probability of eliminating it can be calculated by the application of the following formula:

$$1 - (1 - p)^{m + 1}$$

where p is the number of crossings-over and m the number of backcrosses (Allard, 1960).

The probability of eliminating an undesirable gene tied to the gene to transfer is thus a function of the distance between the two genes and increases with the number of back-crosses performed. This means that, if the proportion of crossing-over is 25%, the separation of the genes will be attained in 76 lines out of 100 after a series of four back-crosses, while if the genes are only distant by one unit (1% of crossing over), the linkage can only be broken in five lines out of 100.

AN EXAMPLE OF THE PRACTICAL APPLICATION OF THE
MALE STERILITY TECHNIQUE IN THE CREATION OF
HYBRID VARIETIES OF ONION

Male sterility in this case is controlled by two alleles, M_s and m_s , which each display a classic mendelian heredity, and two types of cytoplasm, the one fertile (N) and the other sterile (S), both of which are transmitted by the oosphere.

The (S) m_s/m_s plants are male-sterile and constitute the A lines.

The (S) M_s/m_s and (S) M_s/m_s plants are male-fertile, the pollen fertility of the (S) plants being restored by the allele M_s .

After having researched numerous cultivated populations for the male-sterile character and having isolated certain (S) m_s/m_s plants, the breeder must obtain some sterility maintainers (N) m_s/m_s (B lines). For this it is only necessary to pollinate a male-sterile plant by a series of plants, retaining only those whose crossings yield 100% male-sterile offspring.

He must also choose maintainers which show a good general combining ability with sterile-males and must try to obtain their fixation and the isogeny of the lines A and B.

The next step consists in selecting pollinator lines (C lines) from the improved varieties, according to their specific qualities and their hybrid value with the isogenic couple A-B. The couple A-B is maintained by planting some lines of B among the lines of A, while the male sterile seed is harvested from the lines of A (Fig. 1).

Isolation of the parcels is necessary to permit the multiplication of B, without contact from C. For this there is no problem, since the B plants are male-sterile. The multiplication of the pollinator C can be carried out in parcels of A x C crosses and it is often preferable that these parcels are isolated.

Finally, the production of the F_1 hybrid seed A x C is performed in an isolated plot with 3 to 4 lines of A interplanted with one line of C. The seed is then harvested from the A lines.

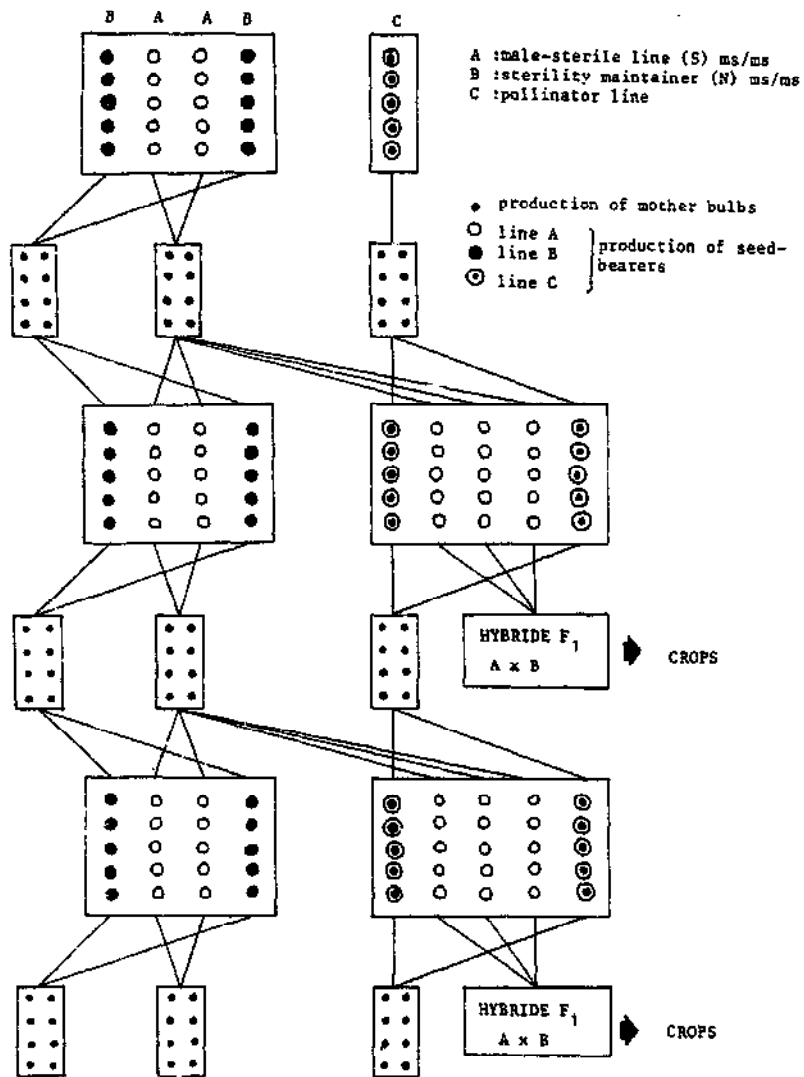

Fig.1 - Diagram of the production of an F₁ hybrid variety of onion by the use of genetic and cytoplasmic male sterility.

REFERENCES AND BIBLIOGRAPHY

- ALLARD, R.W. Principles of plant breeding, Wiley, New York
1960
- BOUHARMONT, J. Problèmes spécifiques d'amélioration des plantes en
1980 régions tropicales, Annales de Gembloux, 86: 137-151
- CLAUSTRIAUX, J.J. et ROUSSEAU, G. Analyse statistique des résultats
1974 d'essais à blanc, Biom. Praxim. 14, 57-79
- CLERJEAU, M., LATERROT, H., PITRAT, M. Création de variétés
1979 résistantes aux maladies chez les plantes maraichères,
Bulletin technique d'informations 337, 101-114
- DAGNELIE, P. Théorie et méthodes statistiques - Volume II, Les
1970 presses Agronomiques de Gembloux, 451 p.
- DAGNELIE, P. Principes d'expérimentation, Les Presses Agronomiques de
1981 Gembloux, 182 p.
- DEMARLY, Y. Génétique et amélioration des plantes, Masson, Paris
1977
- FALCONER, D.S. Introduction à la génétique quantitative, Masson,
1974 Paris
- GARNER, H.V. and WEIL, J.W. The standard errors of field plots at the
1939 Rothamsted and outside centres, Emp. J. Exp. Agric. 7, 369-
379.
- GRUBBEN, G.J.H. Tropical vegetables and their genetic resources,
1977 IBPGR, Rome
- HORN, M. Regarding the optimality of the formula $n/n = p$ for the
1979 ratio of sample sizes of a control and of p treated groups,
Biom. Z. 21, 407-412
- KAAN, F. et LATERROT, H. Mise en évidence de la relation entre des
1977 résistances de la tomate à deux maladies vasculaires : le
flétrissement bactérien et la fusariose pathotype 2, Ann.
Amélior. Plantes, 27, 25-34
- LATERROT, H. Contribution à l'amélioration de la tomate pour la
1969 résistance aux maladies, Thèse ingénieur DPE, 117 p.
- MA, R.H. and HARRINGTON, J.B. The standard errors of different
1948 designs of field experiments at the University of
Saskatchewan, Sci. Agric. 28, 461-474
- MESSIAEN, C.M. Les variétés résistantes - méthode de lutte contre les
1981 maladies et ennemis des plantes, I.N.R.A., Paris
- NJOS A. and NISSEN O. Standard errors of field experiments at the
1956 Farm Crop Institute, Agricultural College of Norway, Agron.
J. 48, 416-418
- VALDEYRON, G. Génétique et amélioration des plantes, Baillière, Paris
1961
- VAN DER FLANK, J.E. Genetic and molecular basis of plant patho-
1978 genesis, Springer Verlag Edit., 167 p.

CHAPTER VII

SEED PRODUCTION

by G. de Lannoy

1. INTRODUCTION

As soon as the superiority of a new variety has been established by a series of multi-locational trials, repeated for several years, multiplication of the seed should be undertaken as rapidly as possible.

It is not just a question of providing a regular supply to the market; the genetic stability and varietal purity of the material must also be assured. A seed-growing project involves careful planning and organization (see Annex A), and a strict system of quality control.

The propagation of seed is carried out in three stages - by the research station, the seed farm and the contract seed grower.

The role of the research station is to provide foundation seed, from the original breeder seed. The seed station multiplies the foundation seed to produce the first generation of certified seed (R_1), and may sometimes also produce the certified seed of the second generation (R_2). Further second generation seed is produced by contract growers.

In Africa, the place of individual contract growers is often taken by a group of farmers from a "seed growing village". It is obviously desirable that small scale seed growers should be grouped together, to reduce the risk of accidental mixtures for cross-pollinating species; moreover, the varieties should be kept in different zones to ensure isolation.

2. REGISTRATION, CERTIFICATION AND CLASSIFICATION

Registration: In any seed growing project, lists of recommended varieties should be regularly published, giving a detailed description of each variety (quality, performance and weak points), with precise information on the districts for which it is suited and the recommended crop production techniques. Alternatively, the users of the seed should be protected by official regulations on the designation of varieties based on a national seed catalogue issued by a technical commission which controls the description of certain standard characteristics for each variety. This system provides the most thorough control, since it involves a whole series of tests on identity, purity, stability and agricultural qualities which assures the seed user of the quality of the product.

Probably the best way of implementing such a system is by starting with compulsory registration of a few of the most important species and extending the list gradually, to cover the whole field of vegetable seeds (Simon, 1981).

Certification: It may also be necessary to establish a system of control for foundation and certified seed, involving regulations, covering seed beds, cultural methods and the quality of the seed produced, i.e. its varietal purity, power of germination, moisture content, freedom from foreign seed, pest infestation, disease infections, etc.

The standards must naturally be fixed at an attainable level. At the commencement of the certification project, it may be preferable to start with relatively low standards and to raise them progressively as the seed growers gain experience and improve their methods and equipment. Certification is limited, of course, to the species to which compulsory registration applies.

Finally, it must be remembered that a seed certification service must be well staffed and well equipped, both in the laboratory and on the seed farm, if it is to be effective.

Seed Classification: There are various different ways of classifying seeds at the different stages of multiplication. When a seed production industry is of recent establishment, it is best to use the simple classification, mentioned above, into the three classes: 'breeders' seed', 'foundation seed' and 'certified seed'.

Breeders seed is produced and controlled directly by the breeder or originator. It is usually available only in small quantities but is produced in such a way that the identity and genetic purity of the material are guaranteed. It consists of seed harvested from a certain number of individually selected plants.

Foundation seed is the first stage of commercial seed production. While the breeders' seed may be the result of several generations, the foundation seed is normally only the first generation after the breeders' seed. It is usually produced by the originator or his accredited representative, under careful control. As this seed will generate all future certified seed, plants showing symptoms of disease or any deviation from the varietal type must be eliminated with the greatest severity.

Certified seed is produced directly from foundation seed, but if it is grown on a large scale, in two successive generations, it should be classed as 'first' (R_1) and 'second' (R_2) generation - each being subject to the relevant standards for certification.

In most countries where seed production is of recent establishment, there is no system of certification. Seed produced at the level of 'certified seed' is known as "commercial seed" or "standard seed". It should, nevertheless, be subject to laboratory testing, to ensure the maintenance of adequate standards of quality.

Certification of seed tubers

Rules for certification have been established for some species of vegetable which are propagated vegetatively. 'Seed' potatoes are classified officially in two categories: foundation tubers and certified tubers.

The classification is established according to criteria covering the origin of the tubers, conditions of isolation, the 'roguing' practised during growth of the crop and the percentage of diseased, atypical or dwarf plants recorded.

Among the foundation tubers, two classes are distinguished: "Super Elite", normally consisting of tuber families not more than seven years old and "Elite", consisting exclusively of tubers of the first generation from "Super Elite". Certified tubers are also divided in two classes: "Class A", obtained directly from foundation tubers, and "Class B", obtained directly from "Class A" tubers.

3. PRODUCTION TECHNIQUES

The great diversity of vegetable species necessitates the use of different techniques for the production of seed from species of different families. This concerns cultural methods, harvesting, the extraction of seed and its cleaning.

In general, the cultural methods for the production of a seed crop are much the same as those used for an ordinary commercial vegetable crop. However, the biennial species naturally require a much longer period to produce seed. These species, moreover, except for especially adapted strains, need exposure to low temperatures before they can produce flowers in their second year of growth. For these biennials, careful preparation of the soil and careful fertilisation are called for. Planting distances also need to be studied, especially for cabbages and carrots, which have relatively large inflorescences. It is advisable to leave an extra large space between the lines and to reduce the spacing in the line as far as possible. In this way, the inflorescences are held erect and access to the crop for roguing plants and harvesting seed is facilitated.

For all species, successful seed production will depend on a suitable programme of irrigation, since the harvest should be taken during the dry season if the seed is to mature satisfactorily. All species will need regular irrigation, in the absence of rainfall, from sowing to flowering. For species with fleshy fruits, such as tomato, irrigation must be continued to fruit maturity. For species where the pods or fruit are harvested dry, irrigation must be stopped several weeks before the maturation of the seed - this applies to peas, cabbage, lettuce, French beans, onion, red beetroot, chilli pepper and okra.

It is emphasized that seed should be grown on very clean beds free from all weeds, seeds of previous crops and all dangerous pests and diseases. For this reason, suitable rotations must be observed between seed crops. The interval should be at least three years between Brassica crops, between Solanaceous crops and between Cucurbitaceous crops, and at least two years between crops of the Umbelliferae (Apiaceae), crops of the Alliaceae and those of the Compositae and Fabaceae.

Finally, particular attention should be given to the elimination of 'volunteer' plants, as these can cause seed contamination.

For the vegetative multiplication of healthy plant material of potatoes, sweet potatoes and cassava, the site must be situated far from any source of infection, especially as regards virus diseases. At the same time, the planting season should be chosen, as far as possible, so that the crop is growing when the climate is unfavourable to the activities of insect vectors such as white flies, jassids and aphids. If this is not possible, insecticides must be used to limit the dangers of contamination.

4. THE INFLUENCE OF CLIMATIC CONDITIONS

The most important climatic factors limiting seed production are day-length, temperature, rainfall and wind. They play the major part in decisions on the choice of site for propagation, which may be quite different from the sites most suitable for ordinary crop production.

This is especially the case for vegetables, like cabbage, which are grown for their leaves, for those, like carrots, grown for their roots, or like onions, grown for their bulbs, since they require special temperature conditions (vernalisation) to enable them to flower during their second year of growth.

On the other hand, species that are cultivated for their fruits, like tomatoes, chillies, eggplants and okra, or for their seed, like haricot beans require much the same conditions for seed production as for commercial crop production.

As for day-length, it should be remembered that for vegetables from the temperate regions, long days are usually necessary to induce flowering. Seed production in the tropics must, therefore, be limited to species or varieties whose photoperiodic requirements are "short day" or "day-length neutral".

Temperature requirements for flowering and fruiting must also be taken into consideration. In this respect, vegetables may be divided into three groups:

- those requiring temperatures between 7° and 13°C (cabbage, lettuce, onion and carrots)
- those requiring temperatures between 13° and 18°C (tomatoes and French beans) and
- those for which temperatures should be between 18° and 24°C (okra, roselle and sweetcorn).

There are further complications regarding the incidence of rainfall. For species requiring high temperatures, it is necessary to plan production so that the vegetative phase occurs during the rainy season and the flowering during the dry season, since heavy rainfall during flowering may hinder pollination and seed ripening and, in some cases, may even provoke premature germination of seeds within the fruits. Incidentally, it is often necessary to provide for artificial drying of the seed.

Finally, for certain species, notably tomatoes, which are tolerant of low night temperatures, it is preferable to limit seed production to a cool season, since the high night temperatures of the rainy season cause poor seed setting and a poor quality of seed.

Wind may also be harmful to seed production, particularly when, like the "harmattan", it is hot and dry and arrives during the season of flowering. For wind-pollinated species, like amaranth, maize, beetroot and spinach, the best results are obtained when there are no strong winds, as these affect the even distribution of the pollen. Similarly, for insect-pollinated species, like eggplants, chillies, radish, okra and onion, high winds discourage the activities of the pollinators and are thus unfavourable to seed setting. It is, therefore, advisable to install wind-breaks, if seed production is planned in exposed positions.

5. CONTROL OF POLLINATION

It is necessary to avoid all possibilities of contamination of pollen, if pure seed is to be produced, above all in the case of cross-pollinating varieties and most especially for the production of foundation seed (Annex B). This involves the correct isolation of the pollen-bearing plants.

When it is a question of only a limited number of selected plants, the isolation may be achieved by growing them in a cage or glasshouse. In that case, when cross pollination is entomophilous, suitable insects must be introduced at the time of flowering.

When seeds are produced on a large scale, however, isolation can only be achieved by separation of the seed crop from others of the same species, either by distance or by time. Isolation, in time, may be arranged even during the same season, if the flowering period is relatively short. Otherwise it will be necessary to limit seed production to only one variety a year for any given species.

The usual method of isolation of crops, for which there is a potential danger of cross pollination, is by planting them at a suitable distance from one another. For insect pollinated species (cabbage, radish, onion, carrot, chilli, melon, cucumber, courgette, etc.), the required distance depends on the character of the pollinating insect.

Hymenoptera (Apidae) are generally considered to be amongst the most effective agents, but certain Diptera (Calliphoridae) are important pollinators, notably for onions and chinese radish. The breeder may find it necessary to raise a collection of flies (of the genera Sarcophaga or Lucilia) for the pollination of plants grown in a cage or where the inflorescences are protected in bags.

Under conditions of open pollination, it is considered that the natural insect populations are nearly always sufficient to produce a good crop of seeds. Nevertheless, insect activity can be strongly diminished by inclement weather conditions, such as strong winds, low temperatures or prolonged rainfall. In many cases, it may be useful to plant a wind-break of trees around the seed growing area, to induce a more favourable microclimate. Care must also be taken to avoid the use of insecticides during the flowering period. Careful selection of plant protection preparations and reduction of the doses can also reduce the destruction of insect pollinators to a level compatible with normal seed production.

For wind pollinated species (amaranth, beetroot and maize), the problem of isolation can also prove difficult, as the pollen may, in some cases, be carried for great distances. The risks of contamination depend on the wind speed and on topography. Some defence in this respect is possible by aligning seed plots in a direction in line with the prevailing winds (George, 1980).

In general, accidental pollination occurs much more frequently on the borders of seed plots. It is therefore preferable to lay out these plots as near to a square as possible. For large plots, it is also possible to harvest the outside band of each plot separately, to a depth of 5 metres and then, according to the degree of impurity, either destroy those seeds or place them in an inferior category (George, 1982).

Finally, another means of reducing the spread of unwanted pollen is the use of barrier crops of another species grown round the seed crops. Maize, sorghum or sunflower are useful for this purpose and may also act as a wind-break and encourage insect pollination activity. Maize has the additional advantage of being anemophilous and, therefore, does not compete for the services of the insect pollination activity.

6. ROGUING

Roguing consists in the elimination from the seed plot of all plants which are diseased or which differ from the varietal standard and which might, therefore, affect the purity of the seed crop; such plants may include accidental crosses, mutations or other varieties. Roguing is

especially important for cross-pollinating species (cabbage, radish, onion and melon), because of their natural tendency to hybridisation. The destruction of undesirable plants must be carried out as soon as possible and, in any case, well before flowering.

The frequency and severity of roguing depends on the stage of multiplication. The production of breeders' seed or foundation seed calls for much more numerous and rigorous examinations than the production of commercial seed. (Incidentally, in the case of species grown for their fruits, it is not sufficient to discard the unsuitable fruit - the whole plant must be removed).

The seed plot must be laid out with sufficient paths between the rows to allow systematic examination of all the plants. Inspections should be carried out fairly early in the morning with, if possible, the sun at the back of the inspector (George, 1980).

It should be noted that weeds of species related to the crop may cause pollution of the seed crop and their seeds may be difficult to remove after harvest. For this reason, the crop should be hoed regularly and with great care.

The inspector should be provided with a precise description of the varietal type. The morphological characters, such as the shape and colour of the fruits, the shape and hairiness or otherwise of the leaves, usually provide an adequate basis for identification. There are, of course, some characteristics, such as the height of the plant, the colour of the leaves and the earliness of flowering, which can normally be ignored since they vary greatly with environmental factors.

Roguing must be carried out for each species according to the various stages of growth. It should be started as soon as the plants exhibit individual characteristics and repeated several times during the development of the crop (Annex C).

7. HARVESTING

The best moment for harvesting a seed crop is that which produces the highest yield and at the same time the best seed quality. However, most vegetable species have a prolonged period of fructification and there is a risk of serious losses if harvest is delayed until the last fruits mature. Harvests must, therefore, be timed as well as possible with this in mind, especially for species which are difficult in this respect, such as okra, tomato, African aubergines and chillies (Annex D).

Incidentally, the development of a single inflorescence may spread over several weeks and this complicates the task of timing the harvest so as to obtain the maximum yield with the minimum of losses from shattering. With onions, for example, it is generally recommended to harvest the umbels at the time that 10% of the capsules dehisce. The timing of harvest will even be affected by the system of irrigation employed; if this is by sprinkler, the harvest should be earlier than otherwise, since the risks of losing seed are greater.

The period during which a seed crop remains at a stage suitable for harvesting varies with the species and the climatic conditions. In general, hot dry periods accelerate maturity, but if both temperature and atmospheric humidity are excessive, the yield and seed quality will be reduced.

For the purposes of seed extraction, vegetables may be placed in three groups according to the condition of their fruits when mature for harvesting.

The first group includes the species whose seeds are enclosed in dry, non-fleshy fruits at the time of harvest: - the capsules of the onion, pods of peas and haricot beans, siliquas of radish and the achenes of lettuce.

The second group consists of the species whose seed is buried in the fleshy humid mesocarp of a fruit which is harvested at full maturity (i.e. much later than the stage of maturity chosen for the commercial fruit crop): - the 'berry' type fruits of tomato, African aubergine (Solanum aethiopicum), some chillies (Capsicum chinense), as well as the large fruits of the sweet melon, watermelon and cucumber.

The third group comprises those species whose fleshy fruits are harvested half dry and are then completely dried before seed extraction - the capsules of okra and roselle and the berries of some chillies (Capsicum frutescens). In this connection, care must be taken with the dark coloured seeds of okra and roselle never to expose them to full sunlight at temperatures over 40°C.

The choice of manual or mechanised harvesting will depend on the size of the crop, the cost of labour, the existence of suitable machines and the funds available. In general, manual harvesting is to be preferred, because most vegetable species do not mature their seed regularly at the same time. Their fruits, whether of the dry or fleshy kind, may best be harvested individually with scissors or secateurs. For some species, the plants may be harvested either by cutting them off at soil level (radish, lettuce and cabbage) or by pulling them out of the soil (peas, haricot beans). Mechanical harvesting, in fact, need not be considered unless the area of seed crops is very large or the cost of labour unusually high.

According to the results of a study of the cost of seed production of several vegetable species in Senegal (Van de Plas, 1984), it appears that local propagation of numerous varieties is quite profitable in comparison with the cost of seed on international markets.

In this region of West Africa, the production of seed of chillies and of the onion variety "Violet de Galmi" is of particular commercial interest, but for tomato, the cost of production depends mainly on the seed content of the variety concerned. (Only varieties like "Xewel 1" and "Nowet" give a profitable return). From a commercial point of view, the production of selected seed of okra, of African aubergine and of Capsicum chinense is only justified when there is a shortage of other supplies, or if the varieties available are not well adapted to local conditions.

8. EXTRACTION AND DRYING

As soon as the fruits or the whole plants have been harvested and dried, either in windrows (peas, French beans, radish, lettuce, etc.), or on drying frames (onion, okra), they should be threshed for the extraction of the seed.

This operation can, in some cases, be effected simply by rubbing the fruits between the hands (onion) or by banging them against a wall (lettuce) or by beating with a stick or a flail (radish). One can also drive cattle or a light tractor over the crop after spreading it in a fairly thick layer on a threshing floor. (The latter method is useful when

the seed crop has been grown on a large scale and better means are not available). Of course, if a threshing machine can be used, this is more convenient, but care must be taken to adjust the speed of rotation of the cylinder according to the species being treated, so as to avoid damage to the seed. For some species, such as onion, radish and chilli, one can also make use of a brush polisher to clean the seed.

The above operations apply to dry seed crops, but for species where the seed is enclosed in moist, fleshy fruits, extraction must be achieved with other techniques.

Thus, for tomatoes, the fruits are cut in two and pressed to extract the pulp. The pulp, which contains the seed, is collected in a container and left to ferment. A white skin of fungus will then form on the surface (*Geotrichum candidum*) and after about 24 hours, according to the surrounding temperature, the mucilage which surrounds each seed will disintegrate. The seed drops to the bottom of the recipient and can then be washed on a sieve, before being spread out to dry.

Alternately, seed may be separated from the pulp by treatment with hydrochloric acid, at 50 cc per kg of pulp. They are left to soak in the acid, with occasional shaking, for 30 minutes and must then be washed thoroughly with clean water before drying. This procedure has the advantage of protection from Tomato Mosaic Virus, which can otherwise carry infection on the exterior of the seed.

For the globular type of chilli (*Capsicum chinense*), the technique is to open the fruit and remove the placenta which bears the seed. The placentas are left soaking in water for 24 hours. It is advisable to add some disinfectant to the water (6 cc acetic acid per litre) to prevent transmission of bacterial diseases. After separation, the seed should be carefully washed and dried at a suitable temperature to reduce water content to the optimal level.

For African aubergines, the fruits are usually cut transversely in two and left to ferment in a recipient for 24 hours. The seed is then separated from the flesh and washed in water. They may be put to soak in a solution of gibberellic acid (1000 ppm) to cancel dormance, if they are required for immediate use. They are then dried in the sun or a seed drier.

Correct control of drying is essential, in all cases, to produce good quality seed. The temperature employed must be properly adjusted according to the species in order to retain the maximum power of germination. As a general rule, the higher the original water content of the seed, the lower should be the drying temperature. Thus, for very moist seed (over 18% moisture content), the temperature should generally not exceed 35°C. At lower humidities, seed can be safely dried at temperatures between 35°C and 40°C, and at moisture contents under 10%, temperatures may reach 45°C. Especial care is needed with sensitive species like onion and lettuce.

It is important to reduce the water content of the seeds to a suitable level whatever is to be the length of storage. The lower their water content, the lower is their rate of respiration, and hence the longer is their potential viability. In fact, for seeds containing between 5 and 14% of water, each reduction of one percent approximately doubles the potential viability (Harrington and Douglas, 1970). Moreover, correct drying prevents deterioration due to the development of bacteria and fungi in the interior or on the exterior of the seed.

If the harvest occurs during the dry season, seeds do not usually contain more than 13-18% of water, according to the species, and in this

condition, they are able to withstand the usual mechanical shock during cleaning and handling. Nevertheless, this water content is too high for storing and must be reduced to enable them to conserve their germinative capacity. A level of 6% is suitable for Chinese radish, 7% for tomato and African aubergine and 9% for onion, okra and roselle (Van de Plas, 1984).

As long as seed production remains on a modest scale, drying may be affected during the dry season by exposure to the sun on a drying floor. Provided the layer of material exposed is not too thick, the system offers no great problems, although it is not possible to keep precise records of temperatures.

When operations are on a large scale, artificial drying by exposing the seed to a current of hot dry air becomes necessary. This method is rapid and effective, although relatively costly, and allows for correct temperature control at any season.

The duration of the drying process, whether natural or artificial, depends, of course, on the nature and condition of the seed and the temperature and humidity of the air to which they are exposed. The seed of some species such as lettuce, watermelon and sweet melon, dries much quicker than others, for example cabbage, Chinese radish, onion, French beans and peas.

9. CLEANING, SORTING, GRADING AND DISINFECTION

After drying, the seed lots will still contain a certain percentage of impurities - particles of soil, plant debris, misshapen seeds and weed seeds - that must be eliminated. The quantity of the impurities varies a good deal between foundation seed, certified seed and commercial seed.

The first cleaning may be carried out by systems of winnowing, either in the open air or in a winnowing machine. The lighter material is removed in the machines either by air blowing or suction, or by a combination of both (Delhove, 1982).

The next operation is sieving, by which first the large impurities and then the fine impurities are removed. On a large scale this can be carried out in sorting and grading machines equipped with rotating cylindrical sieves. There are also combined winnowing and sieving machines known as "cleaners and separators". It is, in short, possible to obtain, by mechanical means, seed which is clean and almost standardized. Further refinements allow seed to be sorted according to shape and weight. Sorting by weight makes possible the mechanical removal of immature, damaged and diseased seeds.

Even after drying and cleaning, seed is capable of transmitting a variety of parasites and pathogens - fungal, bacterial and viral - and can thus be the source of infection of a whole crop in a whole neighbourhood.

Parasites are most often carried on the surface of the seed but, in some cases, may occur in the interior. The results of infections may be anything from irregular and weak germination to a crop epidemic. Disinfection of seed has, therefore, become a common and valuable practice which not only protects seed from damage during storage, but from losses after germination. Such treatments must, of course, be carefully controlled to avoid damage to the seed itself. Special commercial preparations are available for fungicidal or insecticidal purposes or both, and are applied in powder or liquid form or as fumigants. In all cases, the maker's directions must be followed carefully.

10. STORING

Even seeds which have been correctly harvested, dried and cleaned, rapidly lose their viability if the temperature and humidity during storage are not carefully controlled. Seeds, in fact, are hygroscopic and tend to gain or lose moisture according to the conditions of humidity in the store (Fig. 1). Normally, if the atmospheric humidity is at 65%, the moisture content of the seed will approximate to 12%, but for seed with a high fat content (carrot, lettuce, cabbage, radish, watermelon, cucumber), it will be between 8 and 10% (Grubben, 1978). On the other hand, the seed of some species (lettuce and onion) deteriorates rapidly under conditions of high temperature and humidity, while others (okra and tomato) survive longer under similar conditions.

Temperature has an important influence on the development of micro-organisms. Bacteria, fungi and insect development are all favoured at temperatures between 25 and 35°C.

Atmospheric humidity also has a marked effect on the growth of parasites; Aspergillus and Penicillium develop rapidly in an R.H. above 65%. Incidentally, insects are sensitive to the moisture content of seeds and cause most damage when this reaches 9% or more (Justice and Bass, 1978).

As a consequence of these peculiarities, for short-term storage up to one year, temperatures in a seed store should never exceed 25°C if the R.H. is at 50%.

For long term storage, under tropical conditions, it is recommended that vegetable seeds should be kept in a refrigerated store at temperatures between 4°C and 10°C and with an atmospheric humidity below 50%. The moisture content of the seeds should never be above 9%. (In fact, the life of seeds is probably doubled for each reduction of 5°C below a temperature of 30°C and for each reduction of 1% of the moisture content of the seeds (Harrington, 1972).

If refrigerated storage is not available, limited quantities of seed can be stored, after careful drying, in air-tight jars containing silicagel or calcium chloride, at the rate of 10% of the weight of the seeds to be stored. These hygroscopic substances have the advantage that they can be re-used after heating.

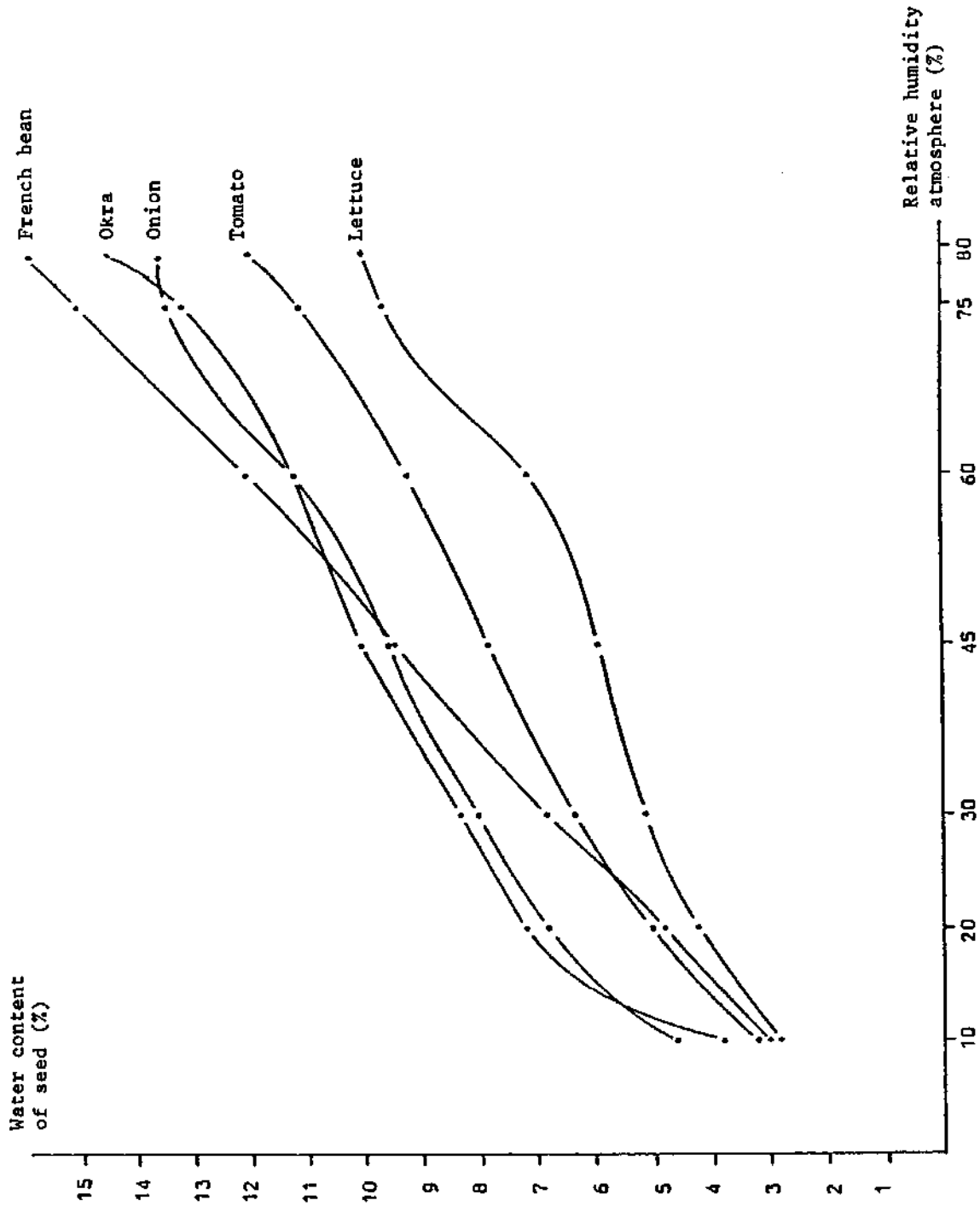

Fig. 1 Relationship of the water content of seeds of certain vegetable species to the atmospheric humidity, at 25°C. (After: Justice and Bass, 1978).

EXAMPLE OF A PROGRAMME OF SEED PRODUCTION OF A VARIETY OF ONION FOR THE PROVISION OF A LOCAL MARKET

1. BASIC DATA

Objective:	Production of 35 000 tons of onions for consumption in 1995.
Variety:	Violet de Galmi
Seed rate for commercial production:	6 kg/ha
Average yield of bulbs:	20 t/ha
Average yield of seed:	400 kg/ha
Quantity of mother bulbs planted per ha:	5 t
Spacing of seedlings for production of mother bulbs:	0.2 x 0.1 m
Planting density of seedlings:	355 000 plants/ha
Spacing of mother bulbs for the production of seed	0.5 x 0.2 m
Planting density of mother bulbs:	83 000 ha
Average weight of mother bulbs:	60 gr
Percentage of bulbs discarded before storage:	25%
Duration of storage of mother bulbs in ventilated store:	5 months (June-October)
Percentage of loss during storage:	15%
Duration of cycle for production of Bulbs:	110 days
Duration of cycle for production of seed:	150 days

2. PLAN FOR SEED PRODUCTION

Commercial onion production to achieve:	35 000 t in 1995
Net area of land required:	1 750 ha
Quantity of <u>commercial seed</u> required:	10 500 kg in 1994
Area of seed production required (with margin for safety):	30 ha
Quantity of mother bulbs to plant:	150 t in 1993
Quantity of mother bulbs to store:	176.5 t
Quantity of mother bulbs to harvest (with margin for safety):	240 t
Area to sow for production of mother bulbs:	12 ha
Quantity of <u>foundation seed</u> required:	72 kg in 1992
Area required to produce foundation seed (with margin for safety):	2 500 m ²
Quantity of mother bulbs to plant:	1 250 kg in 1991
Quantity of mother bulbs to store:	± 1.5 t
Quantity of mother bulbs to harvest (with margin for safety):	2.5 t
Area required for production mother bulbs:	1 250 m ²
Quantity of <u>breeders' seed</u> required:	750 gr in 1990
Area for production of above (with margin for safety):	25 m ²
Quantity of mother bulbs to plant:	12.5 kg in 1989
Quantity of mother bulbs to store:	± 15 kg
Quantity of mother bulbs to harvest (with margin for safety):	25 kg
Area to sow to produce above mother bulbs:	12.5 m ²
<u>Initial supply</u> of seed required:	7.5 gr in 1988

ANNEX B

CLASSIFICATION OF CERTAIN VEGETABLE SPECIES ACCORDING TO THEIR HEAT REQUIREMENT FOR FLOWERING, MODE OF POLLINATION AND DISTANCE NECESSARY FOR ISOLATION FOR SEED PRODUCTION

Heat requirements for flowering/Species	Predominant method of pollination	Required distance for isolation(m)	
		Foundation seed	Certified seed
<u>Species requiring cold for flowering (<13°C)</u>			
Onion(<u>Allium cepa</u>)	Cross/ento.	1.000	400
Red beet(<u>Beta vulgaris</u>)	Cross/anemo.	2.400	1.200
Carrot(<u>Daucus carota</u>)	Cross/ento.	1.000	400
Radish(<u>Brassica campestris</u>)	Cross/ento.	900	400
Cabbage(<u>Brassica oleracea</u>)	Cross/ento.	1.800	1.000
<u>Species with moderate heat requirements for flowering (13-18°C)</u>			
Tomato(<u>Lycopersicon esculentum</u>)	self-	50	15
French bean(<u>Phaseolus vulgaris</u>)	self-	50	10
Sweet pepper(<u>Capsicum annuum</u>)	cross/ento.	300	150
Eggplant(<u>Solanum melongena</u>)	cross/ento.	900	400
<u>Species with high heat requirements for flowering (>18°C)</u>			
Okra(<u>Abelmoschus esculentus</u>)	cross/ento.	1.000	400
Sweet corn(<u>Zea mays</u>)	Cross/anemo.	2.000	1.000

STAGE OF DEVELOPMENT FOR ROGUING AND CHARACTERISTICS TO OBSERVE DURING SELECTION

Okra	Before flowering	Plant habit.Shape and colour of foliage. Earliness of flowering.Colour of flowers. Shape(number of sides),size and hairyness of fruits.Development of branches.
	Flowering	
	Fruiting	
Onion	Bulb formation	Appearance and colour of foliage. Earliness of maturity of the plants. Absence of precocious flowering. Colour and shape of bulbs.Thickness of neck and development scale leaves.Absence of multiple bulbs. Resistance to diseases(Aspergillus, Sclerotium).Duration of dormancy.
	Pre-harvest	
	Harvest	
	Storage	
Chilli	Before flowering	Plant habit.Hairyness of leaves. Absence of infectious diseases(CHV, Xanthomonas). Date of first flowering.Position of pedicel and anthers.Colour of corolla. Length,shape and colour of fruits at maturity.
	Flowering	
	Fruiting	
Tomato	Before flowering	Plant habit.Size of leaves. Absence of infectious diseases(TYLCV, Xanthomonas,Alternaria).
	Flowering	
	Fruiting	

ANNEX D

CLASSIFICATION OF CERTAIN VEGETABLE SPECIES ACCORDING TO SEASON AND DURATION OF SEED HARVEST; CONDITION OF FRUIT AND SEED YIELD (UNDER THE CLIMATIC CONDITIONS AT CDH CAMBERENE; SENEGAL)

Optimum Condition for Harvesting /Species	Month of Sowing or Planting (onion)	Average Density (pl/ha)	Duration of harvest (days)	Total cycle (days)	Average seed yield (kg/ha)
<u>Fruits completely dry</u>					
Onion(<u>Allium cepa</u> , var. Violet de Galmi)	Nov.	100.000	20	155	350-450
Chinese Radish(<u>Raphanus sativus</u>)	Nov.	50.000	10	140	250-350
<u>Fleshy fruits with high water content at full maturity</u>					
Tomato(<u>Lycopersicon esculentum</u>)					
var. Xeevel I Nawet	Oct.	41.666	40	115	190-220
var. Nomitel	Nov.	23.529	15	135	55- 65
Chilli(<u>Capsicum chinense</u> , var. Safi)	Nov.	26.666	100	260	190-230
African aubergine(<u>Solanum aethiopicum</u> , var. Soxna)	Nov.	26.665	100	260	190-230
<u>Nearly dry fleshy fruit</u>					
Okra(<u>Abelmoschus esculentus</u> , var. Puso)	Aug.	25.000	60	150	500-700
Chilli(<u>Capsicum frutescens</u> , var. Salmon)	Sept.	33.333	10	155	320-380
Roselle(<u>Hibiscus sabdariffa</u> , var. Koor)	Sept.	27.777	20	130	1000-1100

CHAPTER VIII

THE PREPARATION OF CROPS FOR THE MARKET

by J. Delvaque

A. GENERAL CONSIDERATIONS

In the great majority of cases, the objective of vegetable production enterprises, whatever their dimensions, is profit. All the efforts that the farmer devotes to growing and protecting his crop are made with a view to selling it to his best advantage.

The preceding chapters have been primarily devoted to consideration of production and protection; the present and following chapter concern the harvesting, preparation and delivery of the crop to market and its sale; that is to say, they are concerned rather with the techniques of commerce than with those of agronomy.

Harvesting, incidentally, may well be defined as an agricultural operation, but it is convenient to discuss it in this section because it is the first operation in the process of preparation for market and because the success of all subsequent operations, prior to delivery to the consumer, depends on correct harvesting techniques. One might add that when, as is not uncommon in Africa, a merchant buys the unharvested crop as it stands in the field, harvesting becomes, literally, part of the marketing process.

We feel that a publication on vegetable growing of the present sort would be incomplete if the problems of marketing and preparation for market were not properly discussed. No modern grower, whatever might be the type of his farm and production, can afford to neglect this aspect of his business. All his work will be useless if he does not ensure that his produce is delivered to the consumer in good condition. In many circumstances, he will be best able to do this on a group basis and it will be of great value to him if, in addition to his activities as a grower, he participates in cooperative efforts in post-harvest and marketing operations.

B. CHARACTERISTICS OF VEGETABLE CROPS

Before discussing the various operations involved in preparing vegetables for the market, it will be useful to consider the remarkable variety of characteristics of the crops concerned. The characteristics of most importance from the commercial point of view are the following:

1. SEASONALITY

Each vegetable crop requires special climatic conditions to develop normally and to achieve a reasonably adequate yield. According to geographic locations, favourable cropping periods vary both in their duration and their particular annual seasons. For example, the growing of green "French" beans in Senegal, in the coastal regions between Dakar and St. Louis, is limited in season to the months from October to May. In Burkina Faso, however, the season is from October to March/April, while in Kenya and in Cameroon, the crop may be produced at different altitudes to provide a succession practically throughout the year.

Wherever vegetable crops are subject to severe limitations of season, there is often a marked excess production during the favourable period, followed by a shortage during the "off-season".

Such marked seasonality is often rendered more acute by a variety of uncontrollable climatic factors, such as drought, hail, rain-storms, gales and hot, dry desert winds. Insect attacks and diseases may also cause unexpected damage and between one trouble and another, crop forecasting and market organization may become difficult or even impossible.

2. SUSCEPTIBILITY TO DAMAGE

Apart from some exceptions, such as main crop potatoes, mature onions and root vegetables, harvested vegetable crops are greatly subject to damage, whether from mechanical shocks or climatic factors like atmospheric dryness, heat and cold. This sensitivity creates the need for a whole series of precautions in handling, storing, packing and transport. Tomatoes, French beans, lettuce, melons and many other products must be treated very carefully if their appearance is to remain attractive and their internal composition undamaged.

3. PERISHABILITY

Vegetables have a very high proportion of water in their composition and this renders them easily subject to chemical and physical change and hence to rapid deterioration. To maintain their fresh condition under the climatic conditions of most tropical African countries, requires great care and a good practical knowledge of their "post-harvest physiology". Only a proper understanding of these matters will ensure arrival of the produce at its final destination in a fit state for consumption.

4. DIVERSITY

The list of the various species and varieties of vegetables that can be grown in different locations of the semi-arid or arid tropics is a long one. They may be classed commercially in three major groups:

- Root vegetables (potatoes, radish, carrots, etc.)
- Leaf vegetables (lettuce, cabbage, spinach, etc.)
- Fruit vegetables (tomatoes, egg-plant, melon, cucumber, etc.)

However, there is not much similarity between the individual crops in each class, either from the botanical or agronomic points of view. A potato, for example, is quite different from a carrot morphologically; it belongs to a different botanical family and is propagated and cultivated in quite a different way. As a consequence of this diversity, each different species of vegetable needs, to a large extent, its own special treatment for packing, storing and all the other operations in preparation for marketing. There are even different practices in the actual business of marketing; some vegetables are sold by number, some by weight and others in bunches!

The great diversity between crops and treatments naturally complicates the organization of marketing. It is, in fact, carried out by a variety of operators with special experience in the various stages between harvesting and consumption. A good deal of professional ability is involved, if these operations are to be carried out rapidly and efficiently. Unfortunately, this condition is not always fully appreciated by farmers, agronomists and administrators concerned with commercial horticulture.

C. THE RELATIONSHIP BETWEEN PRODUCER, DISTRIBUTOR AND CONSUMER

To be successful, market gardening must be based on economic realities and be capable of supplying as satisfactory a revenue as possible to those engaged in it. To achieve this revenue, the final objective must be the satisfaction of the needs, tastes and gastronomic habits of the consumer. For the best chances of success, the market gardener should have, as near as possible, a perfect understanding of the qualities sought by his clients in the produce concerned, in shape, size, colour, taste, consistency, and so on. He should be able to adapt his production accordingly and choose the varieties which best approximate the market requirements. For example, in Senegal the onions most appreciated in the market are those with a strong flavour, a red or yellow colour and those which retain their shape well after cooking.

The nearer the farmers' produce approaches the qualities required by the consumer, the better his chances of obtaining a good price in the market and a good return for his labours. This is a good general rule, but it is not an absolute or invariable one and should not be allowed to paralyse new initiatives nor discourage new introductions. Tastes, like fashions, are in constant evolution and the introduction of new varieties and even new species to the market often meets a favourable response. One may quote the introduction of the onion "Violet de Galmi" on the markets of Senegal, and on a larger scale the arrival of the lettuce "Iceberg" on European markets. In both cases, the novel varieties had a lasting success.

Unfortunately, direct and regular individual contacts between producers and consumers are very difficult to establish. Both because of the physical distances which usually separate the places where they live and because the two parties are usually fully absorbed in occupations which have little regular inter-communication, producers and consumers are rarely, if ever, in direct contact.

The liaison of interests should normally be carried out by wholesalers, but here again the transmission of information is made difficult by the excessive number of intermediaries which accumulate between the farmer and wholesaler. That problem is resolved to some extent, nevertheless, when the producers are grouped in cooperatives or associations which can deal directly with the traders established in the vegetable markets.

We must however face the negative aspects of the relationship between producers and traders. In a good many countries, it is unfortunately true to say that, in agricultural circles, both among farmers and administrators, the trader is considered to be a person of somewhat doubtful honesty, whose main and constant objective is to obtain high, if more or less legal, profits at the expense of the producer. It is obvious that these conditions of mistrust do not lead to the establishment of particularly constructive relationships.

As in all human activities, some individuals may be found in agricultural commercial circles whose business ethics leave something to be desired, but it is dangerous and incorrect to generalise from these regrettable cases. It would be more true to say that the majority of traders are honest and respectable businessmen. A certain number of them, no doubt, achieve some enviable degree of wealth, but how many others, less fortunate or less capable, finish up in difficulties or disappear from the scene?

It should be clear that the commercial profession is the natural and direct complement of the agricultural profession. It is therefore highly desirable that the conflict between the two is resolved; there are plenty of examples of how this may be achieved with mutual benefit. Producers and distributors should be not adversaries or enemies and the persistence of such attitudes can only be harmful. It is the merchant who must provide the liaison between consumer and producer and who must advise the latter on his choice and scale of production. It is only in a climate of confidence, even of friendship, that the necessary information can be exchanged, and co-operation established, with profit to both sides.

D. HARVESTING

1. THE EFFECTS OF HARVESTING METHODS ON THE SUBSEQUENT CONDITION OF THE CROP

Whether "fruit vegetables", "root vegetables" or "leaf vegetables" are concerned, one may say that as long as they remain attached to the soil and in their natural habitat, to maintain them in good condition does not involve great difficulties. Harvesting, however, involves the separation of plants or plant organs from their natural support and may reasonably be considered a surgical operation. This operation is followed by a shock to the tissues which causes physiological reactions with important effects on the future condition of the crop. It should therefore be accompanied by certain well-established precautions, if the crop is not to be damaged. Unfortunately, these facts are not often understood by those responsible for harvesting operations and this applies to both growers and merchants.

If any vegetable is to arrive at the table in a state resembling its condition before harvest, that is to say before it was picked or uprooted, its vitality must be preserved. But, as it has been separated from its usual sources of nutrition which are essential to the life of its tissues, the food reserves contained in the vegetable must be drawn upon. It is exactly these food reserves which must be conserved, as far as possible, if good quality is to be maintained until the vegetable is eaten.

Once this situation is properly understood by those in charge of harvesting, preparation and marketing of the crop, it should be possible to conduct operations on a suitable technical basis.

2. RULES FOR GOOD HARVESTING

(a) Recognition of the point of optimum maturity is essential for successful harvesting of certain "fruit vegetables", such as tomatoes, sweet melons and water melons. For these species, it provides the basis for determining the best stage of development for harvesting, taking account of the subsequent physiological evolution of the crop. If such species are harvested too soon, the process of maturation is blocked and if harvested too late, the process is dangerously accelerated. In either of these cases, the product will be of mediocre quality and far from an optimum quality for consumption.

For harvesting certain other species of "fruit vegetables", such as egg-plant, courgette and French beans, and also for the majority of "leaf vegetables" and "root vegetables", the question of degree of maturity is less crucial. With these vegetables, the ideal stage for harvesting is variable, depending on the tastes and habits of the consumers served by the

market concerned. Different markets, in fact, vary considerably as to the size and degree of maturity preferred for each of these species. For every vegetable crop, a certain number of criteria have been established which enable the degree of maturity to be measured; the date of harvesting can thus be decided, without risk of error. Nevertheless, certain other considerations affect the date of harvest, namely:

- the delay involved in transport to the consumer, which normally depends on the distance separating the point of production from the retail market and the means of transport to be used;
- climatic conditions, above all the temperatures, to which the vegetables will be subjected during transport;
- the species and variety of vegetable involved.

(b) Correct handling is a crucial element in the harvesting operation, because of the fragility and perishability of most vegetables. The actual picking or lifting of the crop is best carried out manually, at least for those vegetables intended for consumption in the fresh state. No machine is capable of doing this work as delicately as the human hand, especially where it concerns those species whose maturity and harvesting extend over a certain time - that is to say, those crops which are harvested by several selected pickings.

(Other conditions may apply to so-called "industrial" vegetable crops, grown for canning or freezing. Tomatoes and peas grown for canning in Europe and North America are now sometimes harvested by machine and special varieties are grown whose fruit matures all at the same date. This applies to very large-scale production, however, and is not yet applicable to most African countries).

The personnel employed for harvesting should be selected according to their skill and dexterity and should be carefully trained to carry out their task delicately and rapidly and with an economy of movement. The grower must supervise the work and insist constantly that all rough handling is avoided. Every shock and every small wound, even if invisible, will shorten the life of the vegetable or cause later deterioration. Such damage may easily reduce its commercial value by the time it reaches market and seriously threaten its profitability. It must be emphasized that growers often consider these precautions unnecessary as long as the appearance of the harvest is good while it is on the farm. In many cases, in fact, the damage does not become apparent until later, when the produce reaches the consumer - who is then no longer disposed to buy it - above all, not at a high price.

In addition to care over the work of the harvesters, attention must also be paid to the weather. Heat, rain and dew may all damage the appearance of the crop after picking or lifting. In many cases, it is therefore necessary to limit harvesting to fine mornings or cool evenings. Carelessness over climatic conditions may lead, for example, to "skin discolouration" of tomatoes or courgettes harvested in the dew or while rain is falling; again, lettuce leaves may wilt rapidly if the crop is harvested during the hottest part of the day.

(c) The use of suitable harvesting containers is an essential element in preserving the quality of the crop. It is convenient to use some type of field box or basket to collect the crop and carry it to the packing shed prior to marketing, but it is important that such containers are suited to the crop concerned and will cause no damage.

Many farmers are careless on this point and use any old 5-kg boxes or 20-litre tins, which they never wash. One may even witness the use of ancient baskets mended with iron wire and with points of the wire sticking out in the interior - the list of unfortunate improvisations for this purpose seems endless! These make-shift containers often prove engines of destruction as far as the quality of the crop is concerned and should be banished from the farm.

It is protested in many tropical countries that materials for making suitable containers are rare and expensive, but this difficulty is more apparent than real. It is nearly always possible to find local material for constructing containers at little cost. The leaves of many palms and the pseudo-stems of bananas yield fibrous material which can be plaited and made into strong baskets with handles. Such baskets are long-lasting and provide ideal temporary containers of different sizes for a wide range of vegetables - tomatoes, egg-plants, cucumbers, melons, French beans, lettuce, okra, cabbage - that is to say, for almost any delicate crop.

For the collection of the less delicate root crops - potatoes, sweet potatoes, radish and carrots - ordinary sacks are quite suitable.

In all cases, however, meticulous cleanliness of containers should be the rule. The majority of the cases of disease appearing on crops after harvest are transmitted by dirty containers. In tropical countries, containers should be washed every two days, and in some cases every day, while in use. After washing, they should be soaked in disinfectant solution (e.g. 10% eau de Javelle) and dried in the sun.

The shape of the baskets should be carefully designed for their function - they should be easy to pack together and should remain stable while being filled. There should always be available a sufficient number of baskets, so that there is no temptation to over-fill them - a practice which is often the cause of serious crop damage in the course of harvest operations.

(d) Careful selection during harvesting is always required to avoid mixing vegetables unsuited for consumption with good produce. Not only is it a waste of time and space to put useless material in the picking basket, but diseased or damaged material may start infection in the healthy specimens. It is also desirable to eliminate from the harvest any mal-formed, immature, over-ripe or otherwise unmarketable material at an early stage.

It is therefore advisable to carry out the harvesting in three main operations. First, the complete elimination of all diseased or decayed specimens, which cannot be left on the plant or in the field. Second, the collection of all the healthy produce of good quality readily marketable. Third, the collection of produce of second quality with some minor damage or blemish or other fault which diminishes its market value.

The use of this method makes it possible to avoid grading the produce after collection, which is always a tiresome procedure and does not improve the condition of the crop. When the crop is sold "at the farm gate", this harvesting technique facilitates the immediate presentation of produce of superior quality and thus improves prospects of obtaining a good price.

(e) Period of recuperation. A number of vegetable crops require a certain period of "recuperation" after picking or lifting, if they are to maintain their freshness and quality. This important operation is unfortunately little understood or practised by many producers and merchants.

Nearly all the "fruit vegetables" - tomatoes, egg-plant, sweet pepper, melons and French beans especially - need a period of rest, which may vary in duration according to species and circumstances, but should always mean several hours in a cool, slightly humid, clean, fairly dark room. The crop should be carried to a suitable building immediately after picking or lifting and left there in the harvesting containers for the requisite period. This resting period often results in the appearance of a few small bruises or wounds on some fruits - which were previously invisible. It is then possible to remove these damaged specimens, which greatly improves the keeping quality of the rest of the crop.

E. STORING

In the case of perishable products like vegetables, what we mean by storing is the preservation of the crop, for shorter or longer periods, under conditions which permit conservation of good external and internal quality with all the characteristics required by the consumer. Storage may be necessary when the harvesting of the crop concerned cannot be sufficiently spaced out over the required marketing period. It is especially important for certain crops like potatoes and onions, which have to be cleared in the course of a single harvesting operation.

Temporary storage for short periods, usually not exceeding a week, may be needed at various points along the route from producer to consumer. It may concern the producer himself, when he needs to store his vegetables between harvesting and forwarding to a market or handing them over to a merchant. Temporary storage may also be involved before packing. Alternatively, or in addition, it may be necessary for a period after packing and before dispatch from packing house to distant markets. In the latter case, it most often concerns a wholesaler's operations. Temporary storage rarely concerns the retailer, unless he is trading on a very large scale.

According to the type of vegetable, the local climate, the point along the commercial chain involved and the length of storage required, different types of storage may be used.

In tropical countries, on small and medium scale farms, it is usually a question of storing under natural conditions in a well ventilated shady site. At a packing station or on a large farm however, under tropical conditions, where mean temperatures may exceed 25°C (77°F), refrigerated storage may be desirable. Wholesalers also may find refrigeration necessary, when holding consignments awaiting dispatch over long distances.

Nevertheless, we must here emphasize an important limitation. Refrigeration is a heavy consumer of energy. This usually means electricity, because of the efficiency and ease of installation, but this form of energy is not available everywhere and at the present time, it is very expensive. It follows that cold stores are not suitable in every case or in every place, and the number of species of vegetables which can be stored economically under refrigeration is limited. Obviously, the economics of the business limits the location both of production and of packing stations and in certain instances even the location of markets may be effected.

1. DIFFERENT TYPES OF STORE

a. Storage under naturally ventilated conditions

It is sometimes necessary to store produce for a considerable period, so as to space out the sales and avoid glutting the market. This

applies especially to vegetables for which harvest is effected in one operation, such as potatoes and onions. However, these products are generally sold at a rather modest price and it is therefore desirable to design and use a very economic type of store, if there is to be any hope of profit.

For this type of crop, the costs of storage must be calculated well in advance of production and marketing, so that the limits of expenditure are known from the start. It is clear that these limits will be rather narrow.

For successful use of natural ventilated storage, a suitable variety of the crop species, with good storage qualities, must be chosen. As the different cultivars usually show a wide range of characteristics, not only in this respect, but in season of maturity, flavour, size, appearance, resistance to disease, yield and so on, the choice is not always an easy one.

The site for the store should be relatively elevated and well exposed to the dominant winds. If possible, it should be located in the shade of a tree so that there is a constant flow of relatively cool dry air. The design of the store should be simple and adapted to the climate. It should be so constructed that the air enters the building at the lowest possible point near to soil level and should leave the building at the highest point under the roof (see Fig. 1). The crop should be spread out on well aerated, open racks, in a layer not exceeding about 20 cms in depth.

The store must be kept clear of all rubbish, or collections of sacks and boxes that could interfere with the free circulation of air and which might act as centres of disease infection. The racks should be separated by passages wide enough to allow easy loading and unloading and easy access for the necessary regular inspections.

The material used for building such stores should be, as far as possible, chosen from local resources, and therefore within the means of the small farmer, and it should be possible for the farmer to erect the store himself, with the help of his neighbours or family labour. It should not be necessary for him to employ a carpenter or builder.

The storage capacity of this type of building is relatively modest - about 15-20 kg per m² - and this is another reason that construction costs must be kept to the minimum.

Apart from considerations of cost, however, the larger the store, the better it functions, both from the point of view of convenience and for the efficiency of ventilation. The maximum duration of storage in these structures depends on various factors: species and variety of crop, local atmospheric conditions, and the care taken in selecting and handling the produce. Even for the more resistant species and varieties under average conditions, the period of storage should not exceed four months.

Losses due to dessication and deterioration increase progressively with the duration of storage. They may be estimated roughly as follows, under efficient management:

- First month - practically insignificant
- Second month - 2-4% by weight
- Third month - 3-8% by weight
- Fourth month - 7-20% by weight

(Ref.: Essais Conservation
Oignons, C.D.H., 1980/81)

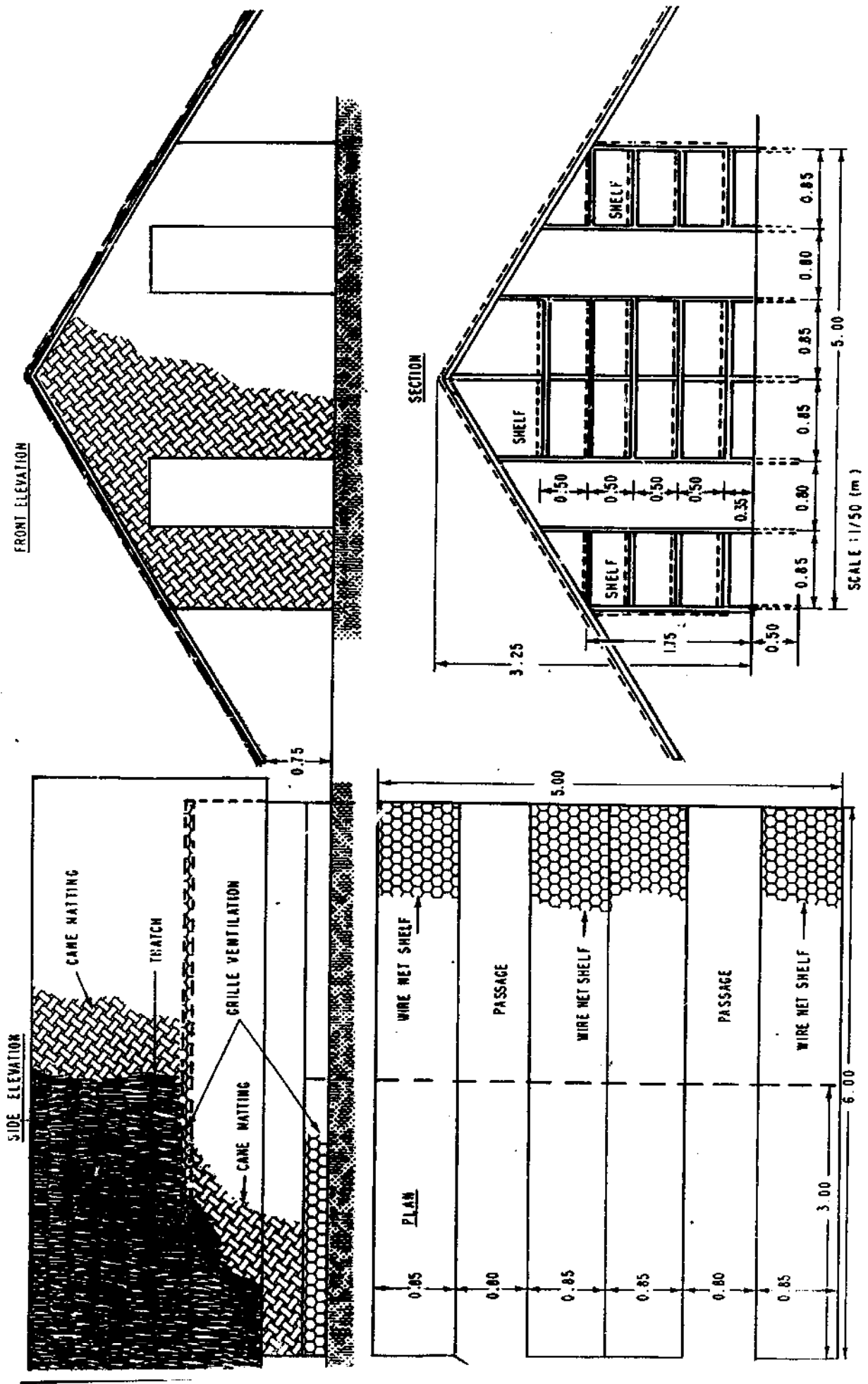

Fig 1 : Naturally ventilated onion store

The total costs involved in using this type of storage are difficult to establish, but are, in any case, very modest. In fact, depreciation costs for the building are almost insignificant in view of the low cost of construction and there is a total absence of expenditure for fuel and "consumable stores". There remains only the costs of upkeep and operation to account for, plus the losses incurred during storage. It is suggested that, if the latter exceed 20% by weight, the operation is not worthwhile.

This type of storage is, in general, the best adapted to the circumstances of the small farmer, both for temporary storage of produce awaiting delivery and for longer periods of storage to await better conditions of sale.

(b) Refrigerated storage

As explained above, the use of refrigerated stores is only advisable under certain economic conditions. In some circumstances, it is indispensable to preserve vegetables in a fresh and attractive condition but, normally, it can only be used when supplies are intended for sale to the wealthier urban classes.

Many vegetables only need to be stored for short periods and, for this purpose, the economic natural ventilated stores will usually prove adequate. Refrigerated storage may then be reserved to deal with unexpected delays and other commercial difficulties.

The type of cold store usually required is of medium size. It should be designed to meet the particular requirements of the vegetables concerned and should be adjustable to the necessary ranges of temperature for the different species.

Vegetables may be classified according to their temperature and humidity requirements under storage. As vegetables nearly always contain over 80% of water, they are obviously very sensitive to frost. Refrigeration temperatures are therefore usually above 0°C - normally somewhere between +1°C and +5°C for root vegetables, +6°C to +10°C for fruit vegetables, and +1°C to +3°C for leaf vegetables. (See table in Annex B).

Relative humidity is also an important factor and installations must be designed to provide humidities within the ranges indicated in the above mentioned table. The figures given in the table for temperatures and humidity, however, should only be taken as a general indication of levels. They are based on European conditions and it would be a mistake to apply them literally under tropical conditions, without careful trial. Adjustments are necessary, according to the nature and condition of the vegetables concerned and also according to local climatic conditions at the time of storage.

2. THE EFFECT OF COLD TEMPERATURES ON VEGETABLE QUALITY

When vegetables are kept under refrigeration, certain modifications in their metabolism occur. Most important, there is a reduction in the rate of transpiration under low temperatures. It is necessary to allow for these changes when the vegetables are removed from the cold store. The transfer to normal temperatures and atmospheric conditions causes an acceleration of physiological changes and makes them attain maturity more rapidly. The first exterior sign is the appearance of condensed moisture on the outer surfaces. This accompanies a marked increase in their susceptibility to damage which makes it dangerous to handle them. For this reason, when such produce has to be dispatched on a long journey, or has to be subject to a

long delay before sale, it must be retained in cold storage throughout all delays and all transport. This procedure is known as the "cold chain". Unfortunately, the operation of such a "cold chain" involves the use of expensive equipment and offers many difficulties. It is for this reason, in fact, little used.

3. THE COSTS OF INSTALLATION AND OPERATION

The cost of installation of cold stores is generally very high, both as concerns the construction of an insulated store and also the purchase and installation of the refrigerating unit. Naturally, the cost per m³ of a store is in proportion to its size - the smaller the store, the higher the cost per m³.

The cost of energy in non-oil-producing countries, is well known to be very high at the present time and it follows that great care should be taken over the insulation to achieve the greatest possible economy in energy consumption. The cost of operation of the store is obviously very variable, according to conditions and fuel costs in different countries. Experience in Senegal in the years 1974/75 gave some indication of the cost/kg/day of about 2.5 FCFA (= about 1 U.S. cent). This cost reached 3.5-4 FCFA (about 1.5 cents) in 1980/81 with the increased costs of energy. The use of refrigerated storage is therefore limited to products of a sufficiently high value to support such costs and then only for short periods, usually amounting to only a few days.

The stocking capacity per m³ varies according to the density of the produce concerned. Clearly the weight, for example, of potatoes per unit of volume is relatively high; allowing for the space required for air circulation, it amounts to 400-450 kg per m³. In contrast, for salads and many other vegetables, it is no more than 200-250 kg per m³ depending on the packaging.

The cost of storage is calculated according to the running costs, plus costs of depreciation of the store, the capacity used and the duration of storage and, finally, according to the losses in store due to dehydration. These losses can sometimes reach important levels - as much as 10% by weight for a storage of a few days, varying according to the type of vegetable and even according to the conditions under which it was grown and harvested. The latter point deserves careful observation; in too many cases, this aspect of the business is forgotten or neglected and causes some nasty surprises in the final accounts.

F. PACKING AND GRADING

The term "packing" covers a whole series of operations concerned with the preparation and protection of the product throughout the period immediately following harvest until final sale to the consumer.

It concerns the preservation of the produce in the best possible condition of freshness, appearance, hygiene and general attractiveness, and hence to the protection of its market value.

In many African countries, packing is reduced to elementary levels for the purpose of local markets and is only considered seriously for the sake of produce which has to make a long voyage to export markets. However, even if at present packing seems unnecessary for successful marketing in many tropical countries, it is as well to anticipate changes in conditions in the near future. The fact is that, even in Africa, the absence of proper

packing is already the source of considerable losses, especially affecting the more fragile and perishable vegetables and this often results in enormous increases in price for the better qualities. For second quality produce, sold at a lower price, poor grading and packing also cause loss as a result of the disappointment of customers when they find a high proportion of waste in their purchases. In these conditions, it is not always certain that the high cost of proper grading and packing is not compensated by a reduction in wastage and the greater satisfaction of the customer. These considerations eventually have important repercussions on the producer and the rewards he receives for his labour and initiative.

1. THE PRINCIPAL OPERATIONS IN PACKING

In tropical African countries, a distinction has to be made between packing produce destined for local or national markets and that destined for export to West European markets, where severe regulations impose special conditions before merchandise can be admitted for sale.

Packing for local or national markets

The different operations recommended may be summarised as follows:

- thorough cleaning of the vegetables;
- simple grading in two categories of quality;
- simple grading according to size;
- packing in boxes or baskets suitable for delivery to retailers.

(a) Cleaning

Most vegetables are not in a fit condition for marketing as they come from the field. There is always a certain proportion of the crop whose appearance is spoilt by dust, mud or chemical residues. Cleaning may either be done with a clean damp rag or sponge or, when the produce is very dirty by washing in a tub of clean water. This operation might appear superfluous to some farmers or merchants, who do not admit that it is essential to good marketing, but without it a good price will rarely be obtained.

(b) Quality Grading

Vegetables as harvested are never of uniform quality. Some will be nearly perfect - in shape, colour, maturity and freedom from blemish - but the rest will have some smaller or greater defect. In good commercial management, the principle should be to remove from the produce anything unfit for consumption before it is marketed, with especial care in the case of vegetables to be eaten uncooked or without special preparation.

The produce which is considered suitable for marketing should be sorted into two grades; "first quality" for the best and "standard quality" for the rest. It is general experience that prosperous customers do not hesitate to pay a high price for extra quality. The grower and merchant will thus usually obtain a greater total return by selling in two grades.

(c) Size Grading

The tastes and habits of customers are very variable. Some prefer large vegetables and some prefer those of medium or small sizes. (One might remember, for example, that it is easier to serve a large family if the vegetables in the dish are small!). It is therefore often useful to present the crop in two size grades, "large" and "small to medium" to give maximum

satisfaction to the customer. Incidentally, it has been found that some markets have a general preference for the smaller sizes of all vegetables and pay a better price for them.

(d) Packing for Sale

To fetch the best price, the produce must be presented in as attractive a way as possible. The containers used for harvesting must be suited to heavy wear for many years and are not available or suitable for sending to market. It is usually preferable to have special boxes or baskets for market purposes, as described later in this chapter.

2. PACKING FOR EXPORT

When preparing vegetables for dispatch to foreign countries, it is first necessary to obtain full information on the current regulations. For many countries now, in order to be allowed entry the produce must be packed in a certain way, and this and other rules must in all cases be respected. The simple operations described for local markets are then insufficient. In general, the following treatments are required:

- Cleaning (washing, brushing, disinfection);
- Pre-grading (in some cases);
- Quality grading;
- Protection;
- Size grading;
- Packing (export type).

(a) Cleaning

For export marketing, the quantities of vegetables to be treated in any one consignment are usually large and hand cleaning is therefore impractical. Especially designed mechanical apparatus is used. The vegetables are first tipped into large vats, in which the water is constantly renewed. They then pass on endless belts to the scrubbers, where they are brushed and sprayed and subsequently dipped in a bath of disinfectant, to free the outer surfaces from any pathogens. They finally pass through driers to the packing tables.

(b) Pre-grading

To facilitate rapid packing for certain types of contract, it is sometimes necessary to carry out a preliminary size grading immediately after cleaning. Three grades are employed: "small", "medium" and "large", which are then stocked separately and can be used when contracts specify different proportions of size grades - e.g. "20% large, 60% medium, 20% small"
- or "90% medium, 10% small"
- or "100% large."

(c) Quality Grading

At this stage of preparation, the produce should no longer include anything which needs to be discarded. It should all be "loyal and marketable", that is to say, suitable for sale and consumption. Certain importing countries, notably those of the European Economic Community, have enacted regulations defining the norms applicable to the quality of each particular vegetable. These categories of quality are precisely defined, in descending order, as "Extra", "Category I" and "Category II", plus, sometimes, "Category III" (an example is given of the qualifications for tomatoes in Annex D).

At present, the operation is carried out manually on a special type of bench - either the vegetables are carried along on a system of rollers, which make it easy to examine all parts of the produce - or they are conveyed on an endless belt. In either case, the packers, usually women, stand on either side of the belt or rollers and examine each vegetable carefully. According to its quality, each piece is either rejected or transferred to one or another belt, corresponding to its grade.

Of recent years, automatic sorting apparatus has been devised which is capable of grading by electronic means without human assistance. These machines are very expensive and are only used in the most advanced industrialised countries and in the largest establishments. Their maintenance, moreover, calls for the employment of specialists and the total cost of operation maintenance and depreciation can exceed the costs of manual labour. Very careful study and calculation is therefore desirable before investing in an apparatus of this sort.

(d) Protection

In some cases, in answer to competitive and market conditions, it may be desirable to undertake a further operation before or after quality grading. This usually has the triple objective of protection of the vegetables from infection by pathogens, avoidance of dessication and loss of weight and production of a brilliant shiny appearance, attractive to the customer.

The operation is always mechanised and can be effected either by immersion or by spraying with a volatile solution of waxy substances which cover the vegetable with a very fine protective coating. It is only used for a restricted range of vegetables, including peppers, tomatoes, egg-plants and courgettes. (It is also very commonly used for apples, pears and citrus fruits).

(e) Size Grading

This operation, which is carried out in a summary fashion for local markets, has to be very much more precise for exports. For this type of trade, the rules for standardisation are strict, giving exact limits of size for each species of vegetable.

It is clear that this operation can only be performed rapidly and efficiently by means of mechanical apparatus adapted to each product.

When dealing with vegetables of a regular and more or less globular shape, like tomatoes and melons, one can use apparatus based on "perforations", that is to say based on a series of endless belts perforated with holes of successively greater diameter - or alternatively, on a series of double belts which diverge from one another, leaving progressively greater spaces between them. (There are also other systems, using complex arrangements of belts and rollers).

For vegetables of a peculiar or irregular shape, such as cucumbers and peppers, machines based on differences in weight are employed. These generally consist of a series of plates carried on a travelling chain. The plates are each controlled by a counter-balance and are released progressively at different weight levels, as the chain moves forward. Feeding this type of grader is a rather slow business and the output per hour is correspondingly low.

For special cases such as the grading of French beans, a revolving cylinder provided with slots is used.

Technical progress is now having its effects even on the design of size grading machinery and electronic methods bid fair to provide a degree of perfection unattainable by mechanical means. Here again, as for quality grading, costs should be studied very carefully before deciding to purchase expensive equipment. Whatever sizing apparatus is used, each grade, of equal weight or volume, is delivered into a separate bin from which it is removed for final packaging.

(f) Packaging

This operation, the last in the chain of operations in the packing station, is carried out manually in most cases, each object being carefully placed in the box in a fixed pattern. This procedure, however, is not always applicable, especially for vegetables of an irregular shape. In such cases, one uses a loose pack of a standard weight, which can easily be controlled mechanically with the help of an automatic balance.

2. PACKING MATERIALS

There are a number of criteria governing the choice of packing material. The principle object of packing is to assure the protection of the contents during transport and handling. Packing of fresh vegetables is extra complex, since the produce is highly perishable and must be preserved in fresh condition until it reaches the consumer. Moreover, since it affects sales, the packing must be as attractive to the customer as possible. The various desirable characteristics of the packaging may be summarized as follows:

- (a) Resistance to damage;
- (b) Good aeration;
- (c) Absence of interior projections or rough surfaces;
- (d) Made of material which does not affect taste or odour;
- (e) Light in weight;
- (f) Price reasonable in relation to value of contents;
- (g) Shape adapted to stacking;
- (h) Shape allowing easy examination of contents;
- (i) Good general appearance

Some of the above qualities may appear to be contradictory, such as resistance to damage, lightness in weight and above all low cost. Priorities will vary with crop circumstances.

The European Economic Community has published standards on the subject of types and uses of packing material. In developing countries, however, this presents many problems, especially where there is a lack of forest products, wood being generally the most useful raw material involved.

The problem must be examined from the economic standpoint, starting from the question of re-useable boxes and packs.

It is clear from the foregoing that packing material represents a heavy charge on marketing produce. It is, however, indispensable, and one cannot escape the conclusion that the use of non-returnable containers is a waste, above all when used for internal markets. This is the reason that the decisions taken a few years ago in European countries on the enforced use of non-returnables have recently been modified.

It must be admitted that the system involved in the use of returnable boxes and packs - the keeping of records, the transport of empty

boxes, losses incurred and so on - offers many difficulties, but it is usually the best solution. It is not possible here to advise on the best system for each case, since the situation with different products in different countries is so variable, but with a little imagination and initiative it should always be possible to find a way of dealing with the problem.

(Very often developing countries are themselves importers of various horticultural products and the recuperation of the empty boxes and packs can provide a useful source of material for local trade - when, of course, the boxes are non-returnable! In some cases, local resources of raw material can be adapted for the making of suitable packs).

The main types of container used for packing vegetables

A considerable number of different types of container are employed, varying in size, shape and material used. They may be classified under three headings: sacks; baskets and straw/bamboo hampers; crates and trays.

(a) Sacks

The lack of rigidity of sacks means that they offer only a limited protection to their contents, and they are therefore only used for the most resistant vegetables - potatoes, onions, carrots, radish, cabbages and dry beans.

There is, unfortunately, a tendency to re-employ sacks used originally for cereals, but these are quite unsuitable for vegetables, because of their large size and close weave.

One should choose small sacks of a loose weave, of the type known as "nets", containing not more than 25 kg. This type of container is useful for consignments which do not need a great deal of handling because "nets" are not very strong. There is also the danger that porters tend to throw them, instead of putting them in place gently, thereby causing serious damage.

Sacks, however, are cheap and suitable for low-priced vegetables. They can be made either of jute or plastic thread. For some produce, such as early potatoes, sacks are lined with "kraft" paper, which makes them stronger and protects the contents from the effects of light.

(b) Baskets and Hampers

These were used for a long time in European markets but have now nearly disappeared, although they are still common in a number of developing countries. They may be woven from Rotan (Calamus), Palm-leaves, reeds, split bamboo, banana leaves, etc.; - in general from any vegetable material sufficiently supple and resistant.

Large baskets with handles are easier to transport and stronger than the light basket usually used in Africa for carrying on the head. Neither type of container is expensive, as a rule, and they are both resistant and long-lasting. Unfortunately, they are not always easy to stack and they are often too big. They are usually more suitable for use in harvesting than for sending to market.

Miniature baskets are used for marketing in special cases, for delicate and luxury articles like strawberries and mushrooms. In such cases, they are made on a small industrial scale either from thin wood slices or plastic material.

(c) Trays and Crates

These are the containers most commonly used for vegetables in western markets. They may be made from sawn timber, pressed timber, cardboard or plastic (polyethylene). Trays are square or rectangular boxes of shallow depth. Both trays and crates are covered with a lid. Their contents vary in weight from 3 to 5 kg for the flat trays to 20 kg for the deepest crates. Dimensions vary according to the country but they are now tending to uniformity to adapt them to the use of pallets, which are becoming more and more a standard implement for handling.

The most common sizes are on a base of 30 x 40, 50 x 30, or 60 x 40 cm. The height varies from 10 to 30 cms; construction varies according to the use for which they are intended and the product they are to contain. They must, of course, be of a tougher construction if they are to be used as returnables.

The choice of container depends very much on the shape, volume, density and fragility of the species of vegetable concerned. For example, for lettuces which are fragile, of a large volume, of a roughly spherical shape and of a very low density, one uses large trays, 60 x 40 x 25 cm, containing 4 - 5 kg and 12, 18 or 24 heads. These trays are made of thin strips of pressed or sawn wood, well spaced and reinforced at the corners. For tomatoes, which are also fragile but are of comparatively small volume, of a spherical shape and medium density, one uses shallow trays of sawn timber or cardboard, measuring 50 x 30 x 15 cm and containing 10 - 12 kg.

Table 1 THE PRINCIPAL TYPES OF PACKING USED FOR VEGETABLES

Vegetable	Small tray	Medium tray	Large tray	Sack
Egg-plants	x	x		
Carrots (bunched)	x			
Cabbages			x	3-30 kg net or returnable sack
Cauliflowers			x	
Cucumbers	x	x		
Courgettes	x	x		
Endives	x			
Spinach		x		
Broad beans				10-30 kg net
Strawberries (in punnets)	x			
French beans	x			
Haricot beans			x	10-30 kg net
Okra (Ladies fingers)	x			
Cassava				returnable sack
Lettuce			x	
Melon		x		
Radish (bunched)	x			
Radish (loose)				3-30 kg net
Onions (green)	x			
Onions (dry)				15-30 kg net
Chilli peppers	x			
Peas			x	10-15 kg net
Leeks	x	x		
Sweet peppers	x	x		
Potatoes (new)				10-30 kg net or sack
Potatoes (main crop)				returnable sack
Tomatoes	x	x		
Roselle		x	x	

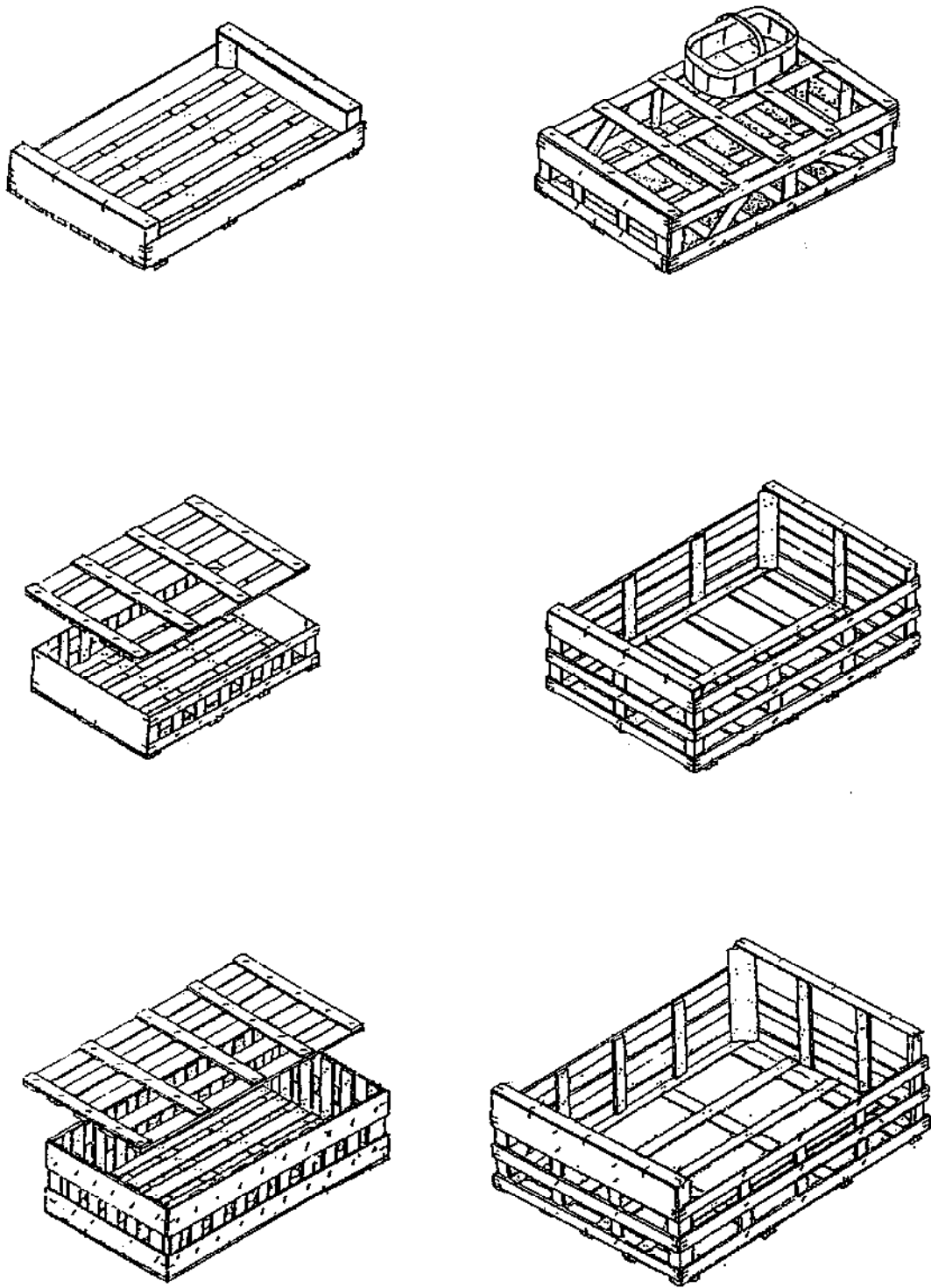
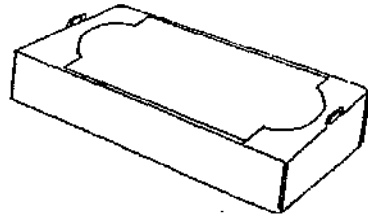
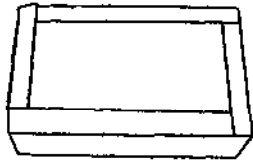
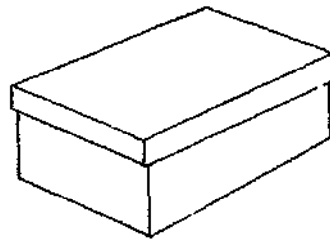
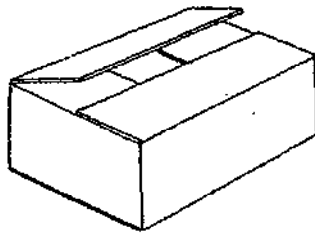
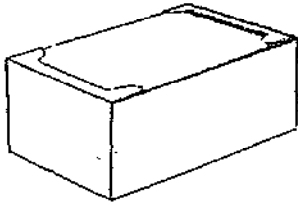

Fig. 2 - Packing for sale in wooden trays and boxes.

T R A Y S



B O X E S



C R A T E S

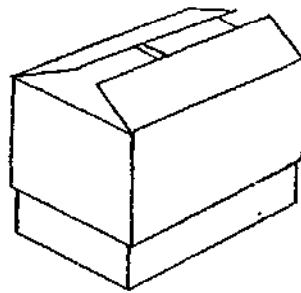
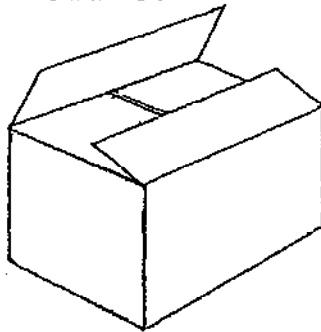
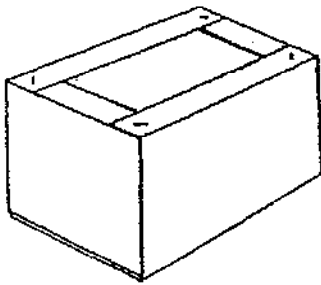

Fig. 3 - Packing for sale in cardboard containers.

The use of local resources

Vegetable producing countries, in particular those of the Sahel, are not always blessed with resources of timber, nor with facilities for manufacturing cardboard. They are thus obliged to import these materials - often at a high cost. On the other hand, they often possess local supplies of fibrous material from certain species of plants which can be used for making containers. These supplies should be surveyed and developed to make sure there are enough for packing requirements and a study should be made of the types of container that can be made from these materials and which would be suitable for the different kinds of vegetable produced. Local industries can be based on this work, creating new jobs in family and small enterprises.

Several instances of this sort of enterprise can be quoted, but they have not always been successful, because of a lack of perseverance and a neglect of quality and standardisation. Examples include the manufacture of baskets in Senegal for the export of French beans and the making of other types of basket for the delivery of mangoes to local markets in Rwanda. Baskets have also been made for the export of sweet peppers and small punnets to contain strawberries for local sale. Such enterprises are frequently spoilt by the excessive price demanded, but they are certainly worth taking up again, especially for interior markets. The materials available are not to be despised; the leaves of palm trees (*Borassus*) in Senegal, plaited reeds and bamboos in Rwanda, banana leaves in the Canary Islands - are all useful.

3. PACKING STATIONS

When the quantities to be processed reach a certain magnitude, it becomes necessary to collect the produce together in a centre - either at or near the place of production or at the centre for expedition - and to establish a packing station.

The station may either be attached to an agricultural organization (whether a large vegetable growing farm, an agricultural collective, or co-operative society) or to a group of otherwise independent growers; or to a commercial company.

The packing station is a working tool and should be designed as such - that is to say, it should be simple and functional. The architecture should be modest, but can be elegant within the limits imposed by the lowest cost for the essential facilities.

The station should be built on one level, as near as possible to natural ground level. The old idea of raising the floor level to the height of a truck or wagon to facilitate loading has been out-dated since the general use of fork-lifts, with considerable economies in construction costs.

The building itself is usually erected on a steel frame, with wide doors giving unobstructed entry for lorries. It should be at least 6.50 m high, as this makes it possible to install a mezzanine floor to accommodate stacks of packing material and other supplies, which are indispensable and nearly always voluminous. The exterior walls are made of the most economic material available and furnished with ample windows, to allow for natural illumination.

The dimensions of the building depend, of course, on the quantities of produce to be handled daily and the number of different species involved; each type or group of similar vegetables needing different treatments and materials. The total space required for all packing operations and related stores may be calculated as roughly 50 m² for each ton of produce treated daily. This figure covers the following space requirements:

- The space required for preliminary natural or refrigerated storage of harvested material before treatment. This can be calculated on the basis of 1 m² per ton of produce, if stackable harvesting boxes and fork lifts are used; otherwise, 1 m² will not provide accommodation for more than 300 kg. The area reserved for passages and ventilation, incidentally, should be equivalent to 30% of the area occupied by the merchandise.
- The space for the apparatus required for the various operations. (Where mechanical apparatus is used, this figure will be given by the suppliers).
- The space required for the various movements of goods.
- The space for natural or refrigerated storage of produce after packing and before dispatch.
- The space for storage of packing materials and other supplies.
- The space for washing, disinfection and repair of harvest boxes and baskets.
- Plus space for offices and a mechanics' workshop; toilets and changing rooms for personnel; collection of discarded material.

G. STANDARDISATION

1. GENERAL

Appreciation of quality tends to be subjective. Standardisation enables us to speak the same language by establishing definitions and laying down rules. Even when limited to the exterior appearance of a product, the judgement of a producer and a consumer, or of a seller and a buyer, can differ to a remarkable degree, as they do not ascribe the same values to the same criteria. Standardisation of vegetable quality is based on the establishment of clear and precise definitions concerning each of the main factors involved, such as shape, cleanliness, skin coloration, freedom from infection and infestation, degree of maturity and dimensions. This permits a rational classification in various categories ranging from virtual perfection to a level below which produce will not be authorised for sale.

Countries which adopt quality standards generally grade into four categories:

Category "Extra"	= superior
Category "I"	= good
Category "II"	= medium
Category "III"	= poor

This system puts grading on a rational basis, simplifies discussions between buyers and sellers and facilitates the organization of trade. In the case of a collective production group, it renders possible cooperative marketing with remuneration according to the quantities and grades of produce supplied by each unit of the group, which leads to greater efficiency and a progressive improvement of production.

From the commercial aspect, standardisation greatly facilitates agreement on prices, the criteria for each quality being well known to both buyers and sellers.

From the economic point of view, standardisation has the virtue of stabilising the market in relation to the best qualities instead of the poorest, through the elimination of unsatisfactory produce. It is generally recognized, in fact, that an influx of mediocre produce to the market provokes a depression in the general level of prices, which tend to sink towards the value of the poorer qualities to the detriment of returns for the better qualities. In addition, standardisation encourages more efficient running of a wholesale market by offering a possibility of regulating the balance between supply and demand through the suppression of excessive supplies of lower quality produce.

2. PRE-CONDITIONS FOR THE ESTABLISHMENT OF A PROGRAMME OF STANDARDISATION

For international trade, the exporting country must always respect the standards set by the importing country. In view of the competitive conditions, indeed, it is wisest to consider these standards as minima. On the large European markets, high quality is not only necessary to obtain the best prices, but is essential to ensure a sale. Given the high cost of putting produce on these markets, it is in the interest of the exporter to seek constant improvements in quality.

For trade on the national scale, the organization of a system of standardisation calls for several pre-conditions:

- In the first place, the availability of a sufficient volume of uniform produce, otherwise the work of grading will not be justified by the low returns.
- A considerable proportion of the clientele ready to pay a higher price for a standardised product.
- The presence of a well organized market, where all vegetables on offer are assembled at the same time and in the same place, to enable the clientele to compare the different qualities available.
- An organization centered at the wholesale market that is equipped to exercise an effective control on quality standards.

As already explained, a system of standardisation must be based on the enforcement of well defined regulations, but where this is not possible, for internal markets, it is still worthwhile to carry out a simple selection for quality and size. This will at least eliminate produce unfit for consumption, which is useless and only lowers the value of the whole consignment.

3. EUROPEAN ECONOMIC COMMUNITY STANDARDS

As innovations in this field are dangerous, it is advisable for anyone wishing to establish a standardisation scheme to model it on existing regulations, adapting where necessary to local conditions. The standards established by the E.E.C., which have been carefully elaborated and modified over a considerable period, can serve as a useful basis.

The first principle is to protect the interests of the consumer, without damaging those of the producer, and to create a general climate of confidence in transactions. Following the example of E.E.C., standards should be based on the definitions of the following minimal quality characteristics. The produce should be:

- **Whole, healthy and in good condition:** This excludes all vegetables which show traces of decomposition, wounds or open cracks and in general any sign of deterioration which may make the produce unsaleable.
- **Clean:** That is to say, free from foreign matter such as soil, dust, traces of chemicals, etc.
- **Free from abnormal exterior humidity:** This concerns produce which has been harvested during rain or excessively dampened (such as lettuce kept for several days in a pail of water). This rule does not concern the traces of condensation due to refrigerated storage.
- **Absence of strange odours and flavours:** This concerns the use of odourless packing materials, and storage and transport under clean, well managed conditions, where the produce is not mixed with other merchandise which could affect odour or flavour.
- **At a suitable degree of maturity:** This involves a knowledge of the final destination of the merchandise and the delays to which it may be subjected, so as to choose a suitable stage of development at which to harvest the crop.
- **In addition:** Certain produce of a very fragile character must be carefully harvested by hand, so as to preserve the natural condition of the produce for as long as possible.

Following these definitions of minimal quality characteristics, the classification of each category should be established: Extra, I, II and possibly III, with a list of the range of tolerances for each.

- Size grading

After quality norms are fixed, the maximum and minimum dimensions acceptable within each category are defined, including the maximum variation acceptable between the largest and smallest unit in the same package.

- Packing and appearance

The norms refer to packing and appearance, not merely to the quality of the produce. They concern especially the uniformity and protection of contents in each package and the quality of the packing materials - cardboard, wood and paper.

- Markings

With the object of holding the sender responsible for the description of the contents, the norms demand exterior marking of each package including the following information:

- o Name and address of sender.
- o Description of the produce
- o Zone of production
- o Commercial category and size grade

4. STANDARDISATION OF PACKING

The standardisation of produce should be completed by one for the packing. This offers the following advantages:

- A reliable protection for the product.
- A similar financial cost for packaging similar products and thus fair competition between them.
- A convenience in transactions conducted at a distance.
- A rational use of material.

The standardisation of packing defines:

- Nature of material used: wood, cardboard, plastic.
- Shape and dimensions and type of container.
- Details of construction of the container.
- Range of tolerance.
- Markings.

It is clear that, for packing as for produce, exporting countries must respect the norms laid down by the importing countries.

Before introducing such standardisation for internal markets, a careful study of conditions is necessary. If it is decided that it is feasible, a scheme should be preceded by careful instruction for the producers, packers and merchants concerned and the scheme should start with the rules as simple as possible and covering only a small number of important products. If a standard brand is introduced for a given product, every package containing that product and carrying that brand must conform to a certain number of well defined conditions concerning its appearance, size, colour, etc., and of course, the contents must be equally standardised according to Category.

In any case, such an innovation will create something of an uproar and meet considerable opposition, especially from those who produce and trade in the lower qualities of produce, because they will be the most penalised. Excessive attention should not be given to these protests! Standardisation is an instrument of progress and merits the support of all concerned.

5. SYSTEMS OF CONTROL

The application of any set of rules necessitates a system of control to protect the interest of those who respect the rules and to avoid fraud, whether involuntary or otherwise. To be effective, the control must be put in the hands of selected, trustworthy and competent officials, thoroughly trained and tested.

For the standardisation to be well applied and respected by all, the object of the inspectorate should be to inspire confidence rather than fear. Despite careful definition, there are always difficulties in interpretation of the rules. It is important to determine if an infraction is due to a mistake or misunderstanding - or a wish to cheat. Severe sanctions, such as the withdrawal of a consignment from sale or an instruction to repackage, should only be taken after careful consideration, as the financial blow to the consigner may be a heavy one.

Another important question is the location of the point of control. The most convenient is usually found to be the wholesale market, but at this stage the sanctions are particularly onerous, as the produce has by then incurred the maximum of expenses. It would be preferable to inspect the merchandise in the packing house just before dispatch, but when packing houses are widely dispersed, this may be impractical.

When exportation to distant markets is involved, it is usual to effect the control just before embarkation at the sea-port or airport or, in the case of consignments by road or rail, at the natural frontier (at the customs station or railway station); the wagons or lorries concerned are then locked and sealed.

The methods of control should be rapid and well adapted to the circumstances. The first step is to decide what percentage of packages to inspect; the technique of opening packages without damaging them is then established and the apparatus required for inspection, such as small wheeled tables with a basin for sorting produce, rings for testing size, colorimetric charts, etc., is obtained. Assistants responsible for opening and repacking the containers are assigned to each controller.

The sanctions for infringement of the regulations should include a whole range of penalties, starting from a simple warning and going as far as the rejection of the merchandise. Normally, they should be applied by the controller but, for serious cases, it is a good system to have the decisions of the controller ratified by an inspector and to allow the offender a means of defending himself. In some countries a commission is set up, composed of equal numbers of representatives of growers, merchants and the control service, to which appeal may be made. The commission gives a final verdict, after examination of the lot concerned and thus provides a safeguard against undue severity. Dangers of laxity are largely avoided by double control, that is at departure and arrival. This presents no difficulty in the case of exports, since importing countries always impose a control on arrival; it is then a simple matter of effective cooperation between the two control services concerned.

Financial support

Control operations constitute a protection for the sender against incorrect claims made by unfair buyers. It is generally considered, therefore, that the sender should bear the costs of the control service. A small tax per kg of produce forwarded is generally sufficient to cover this and does not constitute an excessive burden on the consignment.

Some countries have introduced special stamps, which are purchased by the sender and applied to each package dispatched. This is convenient where a consignment is to be divided into several lots, since the transmission of a certificate of control is impractical in such cases.

H. TRANSPORT

1. LOCAL AND NATIONAL TRANSPORT

At the stage of production and packing, transport is usually only required for short distances. Various vehicles suited to such purposes are available for the larger farms, including tractor-trailers and animal carts. On small holdings, of course, human portorage and push-carts are more usual.

It is at the level of marketing and distribution that the most difficult problems arise, because of the dangers of damage to vegetables when transported over long distances and on rough roads.

Road transport is the commonest and usually the most convenient means and there is a great selection of vehicles adapted to a wide range of loads and road conditions. In most countries there are now camionettes, small lorries and pick-ups capable of travelling on rough roads and providing connections to sites that were previously difficult to reach.

In hot countries, especially where the distances to be covered are long and journeys must be undertaken in daylight, special protection for the produce is necessary. In most cases, the use of insulation and an air-conditioning unit are sufficient to keep the vegetables fresh, and do not involve an excessive expenditure. For the more resistant species of vegetable, such as onions, potatoes, cassava, carrots and cabbages, good ventilation and an insulated bodywork are sufficient for the purpose.

Despite its numerous advantages, road transport is often more expensive than transport by rail, when the latter is available. Unfortunately, however, in many developing countries, the rail network is very limited in coverage and often does not serve the main vegetable producing regions. Moreover, the rail trucks are not often adapted for the transport of fresh produce and this, frequently accompanied by slow delivery, often makes rail transport unsuitable.

There are other disadvantages to rail transport. As is well known, direct connection is rarely available between sender and receiver and hence double or treble handling is unavoidable and dangerous to produce.

Sea and river transport are not often available and do not often offer the necessary facilities for local transport. There are exceptions, but the speed of transit and the frequency of collections are rarely convenient and, in practice, boats are only used for local transport in special circumstances.

It sometimes happens that production areas are far distant from the main markets and distribution centres in the same country and that no surface transport is available, or none suitable, for perishables. In these circumstances, the use of air-freight is unavoidable. Nevertheless, high charges make it uneconomic for any except vegetables of high value, usually delivered in small quantities. It is unusual that a clientele can be found with a purchasing power adequate to justify the transport of large tonnages at prices that justify internal air-freight.

2. INTERNATIONAL TRANSPORT

When the exporting and importing countries are situated on the same continent, surface transport may well be practicable.

Long-distance trains usually provide better rolling stock and faster transport than local trains. In this case, especially if modern refrigerated wagons are available, rail transport may well be recommended.

For long-distance road transport, powerful, rapid and very well equipped lorries of heavy tonnage are now available. They constitute a remarkable and reliable working instrument.

When the exporting and importing countries are on different continents, however, one is obviously obliged to use air or sea transport.

Air transport has undeniable advantages - speed and very good general facilities. This would be the ideal means for transporting vegetables, but for two obstacles which hinder its employment: in the first place, the freight charges, which are not adapted to the market value of a large number of vegetable products, and in the second place, the limitations of tonnage.

Despite the superior freshness of air-carried vegetables and the recognition of their greater value by customers, this type of commerce is limited to highly priced produce that cannot be delivered by other means. It usually involves only relatively modest quantities of off-season strawberries, melons, French beans, asparagus and (for a limited period) sweet peppers. Numerous efforts are nevertheless being made to develop this trade; refrigerated containers, special cargo flights at reduced prices and chartered cargo services are all made use of.

A certain prudence must be exercised in employing such expensive services. The planes used are generally large - the DC8 or Boeing 707 of 33 tons capacity or the Boeing 747C of 80 tons capacity, and it is therefore desirable to diversify the load for any one market or to consign a load of a single product to several markets. In fact, this is a speculative business which involves high risks. Even a slight excess in supply to a market may provoke a drop in prices which may - partly or entirely - neutralise the advantages expected from air transport and may even result in a heavy financial loss.

Under favourable circumstances and for certain products for limited seasons, such consignments may also yield high profits, but this tends to be exceptional.

Marine transport offers very different advantages and disadvantages, as compared with air transport. Ordinary cargo boats have much lower charges and can transport very large quantities of a fair variety of vegetables economically. However, despite the considerable improvements that have been made in the speed of these vessels and the availability of ventilated and refrigerated holds, normal cargo boats are only suited to produce which can withstand long delays in delivery and rough handling. Such conditions demand, moreover, the use of packaging which is stronger, heavier and more expensive than the sort adequate for air shipment; the proportion of net weight to gross weight of course also suffers.

To summarize: marine transport is still valuable for inter continental transport of vegetables, but calls for certain conditions and precautions:

- First of all, the service should be regular and as frequent as possible. The perishable nature of market garden produce makes it necessary to reduce delay between harvest and sale to the minimum; a frequent and direct service is therefore as important as speedy travel.

- The first condition implies a second - that the volume of production should be proportional to the capacity of the ships and the number of shiploads that can be dispatched per week.

- A carefully planned loading system must be established. The shippers must be aware of the special requirements for loading vegetables. The holds of the ship below the water-line should be used only for the most resistant species, that is, those with the lowest heat of respiration which can withstand a fairly high concentration of carbon dioxide, since these holds are the most difficult to ventilate. Carbon dioxide, being heavier than air, tends to collect in the lower regions of the ship. Certain fruits and vegetables, like oranges and cauliflowers, are easily damaged by the action of this gas, while other produce, like potatoes, is much less affected. Another factor to be borne in mind, in planning the loading, is that some produce, especially onions and melons, give off strong odours liable to be absorbed by other vegetables, which should not, therefore, be loaded in the same hold.

- Dock workers must carry out the loading according to well-known rules of seamanship. Out-of-season vegetables are usually dispatched during seasons of the year (the northern winter and spring) when rough weather and high seas are common. Careless loading can then lead to movement of the cargo and damage to produce.

- Handling of the cargo must also be severely controlled. When a consignment is dispatched in cases and crates, it must be handled altogether six or seven times between delivery at the port of embarkation and dispatch at the point of disembarkation. It is rare that a crate does not receive at least one heavy shock in the course of the rough handling caused by human carelessness and fatigue. This is one of the main reasons for "palletisation" and the use of shipping "containers".

- Hygiene. Before each loading, holds or containers must be thoroughly cleaned and disinfected. This is essential to preserve the merchandise in good condition, but it is often neglected.

Container ships have introduced a new type of marine transport during recent years. The demand for the carriage of merchandise in containers has led to the design of ships adapted to their use. The great advantage of this system is the elimination of a large proportion of the handling previously involved in loading and unloading. The sender can fill a container with vegetables for one or several customers at, or near, the same destination, and it can be delivered direct to his clients' addresses.

This attractive system of transport suffers at present from one grave disadvantage - its high cost. In many cases the various charges involved - for delivery to sender, filling, delivery to boat, loading, sea transport, unloading, delivery to consignee and maintenance, add up to something approaching the cost of delivery by air cargo. This has a marked influence on enthusiasm for container transport and makes air freight preferable in some cases, because of its greater rapidity. Containers, however, are preferable when they can serve an area near a sea-port which is far distant from any airport capable of receiving large freight-carrying planes.

Refrigeration, and sometimes humidity control, during long sea voyages is necessary for most vegetables and is required even on short journeys for the more delicate species. Most modern cargo ships are now fitted with refrigeration equipment. (See tables in Annex C).

THE HEAT OF RESPIRATION*

Being constituted of living cells, vegetables "respire", that is, consume oxygen and emit carbon dioxide. This exchange of gases is accompanied by a production of heat, which varies in amount according to species.

The following table gives indicative figures for the heat of respiration of different types of vegetable; the precise level depending on the physiological condition (maturity), variety and production conditions.

Species	Heat of respiration in Kcal/ton per 24 hours					
	0°C	2°C	5°C	10°C	15°C	20°C
Garlic	450	660	950	1450	2650	3150
Bunched carrots	1060	1200	1280	2050	3150	6500
Carrots without leaves	200-580	450-700	580-800	650-900	1500-2000	1850-2800
Cauliflowers	500-1300	720-1450	1100-1600	2550-2850	4000-5350	6300-8300
Cucumbers (long)	390-420	400-500	500-700	1050-1250	1950-2500	3250-4000
Broad beans in pod	400-600	730-900	1150-1550	2200-3000	3650-5100	6650-8100
French beans	1170-1450	1600-1700	2150-2500	3350-4250	5450-8500	8150-11900
Lettuce	650-800	700-900	850-1050	1450-2100	2250-3900	5200-7000
Melons	280-400	360-480	450-550	850-905	1100-1450	1950-2100
Onions	240-400	260-440	320-520	470-700	650-950	950-1200
Potatoes	220-540	220-500	250-400	350-450	400-750	500-900
Tomatoes	280-360	330-400	400-550	650-850	1100-1800	1650-2100

* From the "Institut International du Froid" (Paris) Recommended conditions for refrigerated storage of perishable products (1967)

TEMPERATURES AND HUMIDITIES FOR VEGETABLE STORAGE*

Species	Temperature °C	% Relative Humidity	Duration of Storage	Observations
Artichokes	-0.5 to 0	85-95	1-3 wks	
Asparagus	0 to 0.5	85-95	2-4 wks	Sensitive to frost
Egg-plant	7 to 10	85-90	10 days	Risk deterioration below 7°C
Bunched carrots	0 to 1	90	up to 2 wks	
Galery in bunches	0	over 95	8-10 wks	
Chicory Witloof	0 to 1	90-95	2-3 wks	
Cabbages	0	85-90	2-3 mths	
Brussels sprouts	-1 to 1	90-95	2-6 wks	Brisk ventilation
Cauliflowers	0 to 1	85-90	3-6 wks	Very sensitive to temps. below -1°C
Cucumbers	7 to 10	90-95	1-2 wks	
Courgettes	0 to 4.5	85-95	over 2 mths	
Broad beans in pod	0 to 1	85-95	2-3 wks	Brisk ventilation
French beans, 'filet'	2 to 7	85-90	10-15 days	
French beans 'mangetout'	0 to 6	85-90	1-3 wks	
Lettuce 'Butterhead'	0 to 1	90-95	1-3 wks	Sensitive to frost
Lettuce 'Iceberg'	0 to 1	90-95	4-6 wks	
Melons, 'Ogen'	2	85-90	1 week	
Melons 'Honeydew'	16 to 18	80	2-6 mths	
Watermelons	2 to 4-5	85-90	2-3 wks	
Cassava	0 to 2	80-90	6 mths	
Onions	-2 to 0	75-85	7-9 mths	
Sweet potatoes	11 to 13	85-90	13 wks	
Peas	-0.5 to 0	85-90	1-3 wks	Pre-refrigeration recomm.
Chilli peppers	0	85-90	4-5 wks	
Sweet peppers	7 to 10	85-90	8-10 days	
Potatoes, new	3 to 4	85-90	A few weeks	Stored in dark
Potatoes, ware	4.5 to 10	88-93	4-8 mths	" "
Potatoes, seed	2 to 7	85-90	5-8 mths	" "
Tomatoes, ripe	0	85-90	1-2 wks	Consume immed. after store
Tomatoes, green, turning	1.5 to 12	85-90	1-2 wks	

* Institut Internationale du Froid (1967)

TEMPERATURES AND HUMIDITY FOR THE TRANSPORT
OF VEGETABLES UNDER REFRIGERATION*

Species	Temperature °C	% Relative Humidity	Remarks
Egg-plants	7 to 10	85-90	
Bunched carrots	1 to 3	90	
Carrots without tops	2 to 4	85-90	
Cauliflowers	1 to 4	85-90	
Cucumbers	5 to 10	90-95	
Courgettes	2 to 10	85-95	
Lettuce	1 to 4	90-95	
Melons "Charentais"	Transport not recommended for more than five days		
Melons "Honeydew"	6 to 10	80	
Broad beans in pod	1 to 5	85-95	Vigorous ventilation, well ventilated packing
French beans, "filet"	Transport lasting over four days not recommended		
French beans, "mangetout"	0 to 6	85-90	
Watermelon	Stand 5 to 6 days in ventilated hold without refrigeration		
Peas in pod	Transport lasting over 4 days not recommended		
Dry onions	2 to 6	75-80	Vigorous ventilation. Not to be mixed with other types of vegetables.
Chilli peppers	1 to 4	85-90	
Sweet peppers	6 to 10	85-90	
New potatoes	3 to 8	85-90	
Ware potatoes	Refrigeration unnecessary. Ventilated hold.		
Tomato, coloured, firm	10 to 12	85-90	
Tomato, green, turning	1 to 5	85-90	Maturation 20°C.

* Institut Internationale du Froid (1967)

QUALITY STANDARDS FOR TOMATOES

I. DEFINITION OF PRODUCTS

The present quality standards refer to fresh tomatoes of all varieties of Lycopersicon esculentum Mill, destined for delivery to the consumer in the fresh condition and excludes tomatoes destined for processing.

II. QUALITY CHARACTERISTICS

A. General

The standards define the qualities of tomatoes at the stage of dispatch, after grading and packing.

B. Minimum standards

1. The tomatoes should be:
 - whole and undamaged,
 - healthy (within certain limitations allowed for each country),
 - clean and in particular free from all residues of sprays, dusts and other treatments,
 - free from all abnormal exterior moisture,
 - free from all strange odours or flavours.
2. The stage of maturity should be such as to allow the tomatoes to withstand transport and handling and to be maintained in good condition until delivery and to correspond to commercial requirements at place of destination.

C. Classification

1. Grade "Extra" - Tomatoes in this grade should show the typical characteristics of their variety. They should be free from all defects. Fruit with green shoulders are excluded. Three types of fruit are recognized: "round", "elongated", "square" (fruits with a "square" cross-section should show this characteristic only for one-third of the length of the fruit from the blossom end and should be of a regular shape).
2. Grade I - Tomatoes in this grade should be of good quality. They should be sufficiently firm, free from serious defects and show all the characteristics typical of their variety. They may show slight bruises. Fruit with fresh or healed cracks or splits, and fruit with noticeable green shoulders are excluded. Three types of fruit are recognized: "round", "elongated", "square" (fruits with a "square" cross-section should be of a regular shape).
3. Grade II - Tomatoes in this grade are those of marketable quality that cannot be included in the superior grades. They may be of irregular shape but should otherwise conform to the minimum qualities described above. They should be sufficiently firm and should have no fresh cracks. Healed cracks of no more than a maximum length of 3 cm are acceptable.

CHAPTER IX

COMMERCIAL ORGANIZATION OF PRODUCTION AND MARKETING

by J. Delvaque

A. TYPES OF PRODUCTION UNIT

1. PRODUCTION FOR MARKET BY INDIVIDUAL FARMERS

Small, independent market gardeners in many African countries are responsible for up to 85% of the total volume of vegetables produced. The size of their holdings is variable, but is mostly very small. Large market gardens run by a single family are rare. Those of about one ha would count as medium in size.

The number of these small market gardeners is often considerable; their produce is diversified and the quantity of each vegetable is only in the order of a few dozen kgs per crop. In Senegal, for example, there are reckoned to be over 10 000 of such holdings in the Cap Vert region alone, with an average area of not more than 1 500-1 800 m² each.

The large number of holdings and the small quantities each produces make marketing difficult. For every species of vegetable there is a mixture of varieties, qualities and sizes as well as seasons, which makes it almost impossible to assemble the produce in uniform grades. This individualism is one of the greatest obstacles to organization, either in cooperatives or in any form of growers' association which might improve their commercial situation.

Market gardeners are, moreover, usually people with well established habits that they are loth to change, and their conservatism often costs them dear when it comes to selling their produce.

The methods of sale they practice vary with the distance of their holding from the market. When they are within about 5 km from an urban centre, they deliver their goods themselves, either to a wholesaler or a shop, or they may even install themselves as retailers in the market or deliver direct to household customers. When they are far from the market centre, small producers are faced with difficulties of transport and this delivers them into the hands of dealers who possess a vehicle. Unfortunately, these dealers profit from their situation and the prices they pay do not always have much connection with market value.

The economic position of medium-size market gardeners, i.e. those with between about one and five ha of land, is much more favourable. They are more able to afford good equipment and inputs for cultivation, crop protection and storage and the larger holdings will permit some mechanization of cultivation and transport, although the size will still be sufficiently small to be managed by one family without the employment of labourers - except for seasonal work, such as harvesting of French beans or tomatoes.

This type of medium-sized market garden, however, is relatively uncommon in Africa. Families with sufficient capital usually prefer to invest it in other businesses, especially trade or real estate. The tendency is regrettable, since market-gardeners with a medium-sized holding

could deliver their produce direct to wholesalers without recourse to middlemen, with great improvements to the efficiency and prosperity of the industry. This might also lead to the evolution of crop specialists who could market graded produce under a trade name.

In Africa, large vegetable farms, covering several tens of hectares and owned by one family, are very rare. They would not be well adapted to the supply of local markets. Large holdings are usually agro-industrial businesses and are managed by companies or societies.

2. PRODUCTION BY COMPANIES OR SOCIETIES

There are many forms of collective organization, including cooperative societies, private companies, limited companies, and producers' groups.

Cooperatives is a title which has often been misused and abused. There are many instances of so-called cooperatives which have been formed under government pressure and operated under official control which have ended in failure, with the result that the very word 'cooperative' often causes a bad reaction amongst farmers.

Nevertheless, if it is properly understood and correctly applied, the cooperative system offers the best possibilities for the betterment of the small farmer. The first rule is that the cooperative must be a voluntary association controlled and administered by its members. The society should be governed according to statutes previously agreed by its members and should enable the smallholder to enjoy many of the advantages of medium or large-scale production, above all through dealing in large quantities of produce and thus resolving many of his marketing problems, as well as in making possible the use of mechanical equipment and adequate facilities for packing and storage.

The most serious disadvantage to producers cooperatives is the weight of work which falls on the members who accept responsibility for administering the society. This calls for great devotion to the collective cause and it is frequently difficult for a busy farmer to find time to attend to such duties. The problem is complicated by the fact that there is still a high proportion of illiteracy amongst African smallholders.

However this may be, the cooperative system offers important advantages and should be taken into consideration whenever conditions are favourable. The establishment of cooperatives is often assisted by grants and loans provided in proportion to the capital invested by the members and more or less on a long-term basis. It is also common for governments to allow exemption from certain taxes.

The chief constraint on the members is that they must agree to deliver all of their marketable produce to the cooperative, otherwise they may sell some of their crop privately in competition with the society, which will eventually endanger the existence of the organization.

In principle, producers' cooperatives should limit their activities to the production and sale of their members' crops and should not be entitled to undertake any other business. For this reason, some countries have encouraged the establishment of 'Agricultural Trading Societies' which undertake similar operations to private trading companies and are not exonerated from tax. In other cases, 'Agricultural Production Groups' have been created to assist groups of small farmers to acquire a suitable area of land to establish a farm of economic dimensions.

3. STATE FARMS OR MARKET GARDEN ESTATES.

These are nearer to being communal production entities than collective associations. The farmers own their crops but do not own the land. Production work is partly individual and partly cooperative. For example, the director of the farm may plan the production of a crop of sweet peppers from five ha and allots 500 m² to each of 100 families. The state farm undertakes the preparation of the land and the sowing of the crop over the whole of the five ha and then the 100 families look after the irrigation, weeding, general care and harvesting of each of their 500 m² plots.

The advantages of this system should lie in the homogeneity of the crop, the control of production according to estimated market demand and, in theory, the regularity of production techniques and quality of produce.

In practice, the grower does not feel that he is the owner of the crop as he has no direct financial involvement and hence he does not always care for it properly. Flagrant inequalities develop also, because of the inevitable variations in soil quality and land levelling; in the end, there are great differences in yield and quality of produce from the different plots. (Differences in soil texture and water supply can easily result in a plot yielding 50% of the general average, to the misfortune of the family concerned).

It is difficult to find an alternative to this way of operating a state farm. If the crop is not divided on a personal basis but regarded as communal, the lazy families will profit from the work of the more industrious - and so on.

Another problem that arises is one of scale. The area of such state farms should be adapted to local conditions. In some cases in Africa, they have been established on areas of several hundred hectares, which means the installation of several hundred families on one site. This results in a large and complicated administrative machinery and the control of operations at a satisfactory level of efficiency becomes difficult, if not impossible.

4. PRIVATE LIMITED COMPANIES AND MULTINATIONAL COMPANIES

These are also liable to suffer from problems of scale, caused by the desire for rapid expansion.

In a recent project in Senegal, for example, plans were made for the establishment of a vegetable and fruit growing organization covering over 3 000 ha, for the production of many tens of thousands of tons of crops for export to Europe. After several years of intense effort and great expenditure, the farms covered an area of about 600 ha and reached a maximum annual level of exportation of about 7 600 tons. Finally, the project had to be terminated, with heavy financial losses, because the operation has proved unprofitable.

This experience did not prove that large scale operations are impossible nor that exports of vegetables to Europe cannot, in some cases, be profitable. It did seem to show that such projects must be built up carefully and progressively and always within dimensions suited to available human resources.

Well conceived and economically operated projects of a certain size could indeed provide an example to the vegetable production industry, but it is likely that pilot projects in different locations, on the scale of 20 to 25 ha each, would prove more manageable and more constructive under African conditions than one mammoth project.

B. TYPES OF MARKETING ORGANIZATION

1. OFFICIAL MARKETING AGENCIES

At this point, it should be mentioned that some countries have set up agencies for the purchase and marketing of specified agricultural crops, and that normally these offices are given the monopoly of trade in the commodities concerned. The farmer, in effect, has to deliver the whole of his crop to the official agency, which remunerates him according to a tariff fixed independently from market prices and their variations. This system has not proved successful for horticultural crops, as it has not been possible to allow for the differences in quality and season and the changes in market conditions. In addition, accounts have often not been settled sufficiently rapidly and this has led growers to seek private sales.

2. MARKET CENTRES

Normal commercial circuits vary according to the relative geographical situation of the market garden and the market. When the region of production is far from the region of consumption, there is always a need for a wholesale forwarding market in the producing region. These markets are unnecessary when the market gardens are situated within a few kilometres of the final market.

The different commercial stages between producer and consumer may be summarized as follows:

Producer: to wholesaler: (sometimes both forwarding and receiving wholesalers): to greengrocer, supermarket or retail market (sometimes via a dealer): to consumer.

Wholesale forwarding markets vary greatly in size and activity according to the type of production in the region. When production is highly specialized and seasonal, permanent constructions are dispensed with. The essential feature is the establishment of a point of contact where growers and wholesalers can meet regularly at certain fixed hours and days of the week.

Wholesale receiving markets are usually situated in or near large urban centres. They have always proved necessary for the assembly of supplies and traders, especially for perishable foodstuffs, as they offer a number of commercial advantages. Above all, they establish an equilibrium between supply and demand, both as regards quantity and quality, and thus offer the possibility of fixing prices according to market requirements. Ideally, suppliers find the best possibilities of selling their produce and buyers have the best selection to choose from. Competition between these parties gives the best possibility of producing realistic prices and healthy economic conditions.

Wholesale markets also give the authorities the opportunity to control hygienic conditions, to impose rules concerning weights and measures, to encourage fair trading and to collect statistics on the

availability of food supplies. There are also problems and inconveniences resulting from the use of wholesale markets, although these are usually considered to be outweighed by the advantages.

Concentration of sales in a wholesale market often causes extra handling and transport costs and, moreover, involves supplementary payments to cover running and administrative expenses.

For these reasons, the decision to establish a regular wholesale market needs careful prior consideration and should be well discussed by municipal authorities with both farmers and merchants, so as to ensure a suitable location with easy road access, adequate space and installation and suitable rules and procedures. Extravagant expenditure on installations must be avoided, as these are likely to be reflected in high charges and discourage the use of the market.

3. MARKET OPERATORS

Traders may be wholesalers working on a profit margin or agents working on a commission. They obtain goods either direct from growers, from dealers or from other wholesalers working from a forwarding market. In general, wholesalers try to obtain a wide range of goods so as to satisfy all the requirements of their clientele. Some wholesalers, however, specialize in a certain type of produce - some, for example, in potatoes, cassava and onions, others in salad type vegetables and yet others in imported goods.

There is often a class of secondary wholesalers who purchase from the primary wholesalers and supply shops and retail markets. They frequently sell on credit to a clientele of retailers who cannot pay on delivery. They form an important link in the chain of distribution, and in some countries their trade association wields considerable influence.

Growers may also operate in the market. They are usually farmers who possess smallholdings in the district and some means of transport. They attend the wholesale market whenever they have sufficient goods for sale and thus obtain a comparatively good price and keep in touch with market requirements.

C. COMMERCIAL CONDITIONS IN AFRICA

In African countries, vegetables are not usually sold by auction as they are in some European wholesale markets. The usual type of sale is by mutual agreement after discussion between the seller and the buyer. These sales are common both between a grower and a merchant, between different merchants and between merchant and retailer. They may take place in the market or in the field and are often based on the price of a whole 'lot' or field plot rather than on weight or volume.

Moreover, there are many towns in Africa with no wholesale market, and in many regions, the wholesale marketing of vegetables is carried out in an informal way that may meet local conditions, but gives very poor returns to the small grower, unless he is fortunate enough to have his own means of transport and is near enough to a market to deliver and sell his goods personally. In most cases, he is obliged to sell to a travelling dealer who collects the produce from the farm and is able, to a large extent, to dictate the price. The dealer delivers his goods to one or another of several collection points according to his agreement with the wholesale merchants who transport the produce from collection points to the

urban centres, where they are sold in the street to retailers before the opening of the retail markets. These street sales take place without formalities or control and often in poor hygienic circumstances. Under these confused conditions, prices are variable and unstable; the net result is that there is no relation between the price paid by the consumer and the price received by the growers. Moreover, the poor conditions of packing and transport and the frequent handling of each consignment often results in the produce being delivered to the consumer in a bruised and dirty state.

These marketing arrangements represent a grave disadvantage to both producer and consumer. They hold back the development of the market gardening industry, increase the urban cost of living and damage the quality of diets and the people's health and wellbeing.

D. THE SYSTEMS OF SALE

As explained above, the methods of sale vary according to the type of merchant concerned and other circumstances.

In countries where trade is free but organized - that is to say, where the commercial circuits are well established and operated by professionals, both sellers and buyers - various types of transaction are currently practised.

The mechanism is nearly always the following: the producer, the packer, the cooperative or the wholesale sender makes an agreement with a wholesale receiver or importer installed in a centre of consumption, usually in a wholesale market.

Three main types of transaction are employed.

1. FIXED SALES

These are of two sorts: (a) the seller lives near the wholesale receiver and a direct transaction is made at the time of delivery of the merchandise. After examination of the quantities and qualities, the two parties come to an agreement on the price for the whole consignment. In general, payment is made immediately provided that the sum is available. Otherwise, a payment is made on account and the balance is settled within a few days. (b) The seller and the wholesale receiver live at some distance from one another: after preliminary discussion by mail or telephone, the partners decide on a price - either 'carriage forward' or 'carriage paid' - subject to certain conditions on quality, dimensions, colour, packing, quantity, date of delivery and mode of payment. This amounts, in fact, to a contract; it is obvious that in such cases standardisation of the produce is very useful.

In principle, this method of sale should give the seller a certain security and guarantee of price and payment, especially when the date of delivery is near to the date of contract. Unfortunately, in practice, everything goes well when the market is favourable, i.e. when prices are above those agreed, but when the market is unfavourable, disagreements and litigation are common.

It is almost impossible that all containers of the same lot are in strict conformity, especially in large consignments, and this offers an opportunity to profit from these differences to obtain a reduction on the initial agreed price. Moreover, these disagreements are often justified,

especially when the produce has had to suffer a long journey - senders are sometimes surprised to see the condition of their goods on arrival.

Contacts between sellers and buyers are sometimes arranged by brokers and this practice is tending to increase. Relying on a more or less substantial commission, which is always charged to the seller, these intermediaries, once they have received orders from buyers, make enquiries from a series of sellers to select their goods. Their services constitute an extra charge on the produce, and moreover, they usually provide no guarantee of payment. They are, however, useful when it is necessary to disengage from a contract.

This mode of sale, which offers only a relative security, is thus useful in some cases and may help in the control of large transactions. Some well-run firms of brokers, specialized in the business, do, in fact, offer certain guarantees, but the system is not one which provides the best financial returns and does not give the seller the best opportunity of following market developments.

2. SALES ON COMMISSION

In these transactions, the wholesale receiver is known as the 'commission agent'. Following an agreement with the seller on the nature, quality and quantity of the consignment, the agent arranges sale on the basis of a commission, which generally varies, according to the value and quantity of the merchandise, from 8 to 12% of the selling price.

The rules governing this type of negotiation are very strict. In particular, the commission agent must never himself purchase the goods which are entrusted to him.

In the past, this profession was normally exercised by specialists who never dealt in fixed sales. At present, difficulties in the business have led a good many agents to deal in both types of sale, which is not always a desirable development. In fact, when two or more consignments are of a similar produce, the agent always tends to favour those of which he is the owner, to the detriment of those which he is supposed to be selling on commission. This sometimes results in great differences in the prices received and disappointing results for the sellers.

Nevertheless, sales on commission, when properly managed, remain the best system, since they allow the sender to follow the business practically to the end of the commercial chain, to make the improvements that his customers require and thus progressively improve the quality of his goods. The system also provides the best returns, or at least the most realistic, since receipts, in general, follow the movement of the market. All the same, commission sales call for a long experience and good knowledge of the market on the part of the seller. He must understand how to dispatch his goods in a rational way, that is to say, by sending to each seller the right quantity to satisfy his clientele. Excessive deliveries which overload agents always result in a drop in market prices.

Of course, this principle of balancing supplies and demand is not easy to follow. Many agents tend to be over-optimistic and to request consignments beyond their normal requirements. The best results are usually only obtained after a long collaboration between seller and agent, leading to a correct mutual judgement of commercial possibilities.

3. SALES ON MUTUAL ACCOUNT

This system amounts to a compromise between a fixed sale and a sale on commission.

With the object of ensuring a certain degree of security, selling agencies, such as cooperatives or other collective societies, and also private companies of a certain importance, may make an agreement with their market agent on the basis of a 'threshold price', above which and below which the differences in receipts are shared.

There are many ways of arranging such contracts and of fixing the threshold prices. One can take as a basis the cost of production of a crop as harvested or packed, adding a margin that ensures a minimum return to the producer. Alternatively, one can fix the threshold on the basis of an average of prices received on fixed sales.

In some cases, a variant of this system is practised, when a minimum price is guaranteed to the sender by the receiver. Under such conditions, obviously, the price level is lower than under the above threshold system as, in effect, only the profits are shared, the losses being borne exclusively by the receiving agent. The method provides an excellent incentive to the latter, at the same time as assuring the security and preserving the interests of the sender. When the two partners know each other well and have confidence in one another, the results can give considerable satisfaction to both parties.

It must be added that, whatever formula is used, the profession of commerce in vegetable produce demands special abilities. The rapidity with which the produce must be moved and sold and the need for unfailing and regular supplies to the market demand the ability both to maintain up-to-the-minute commercial information and to make constant and rapid decisions. In the past, and even to some extent in the present, these conditions involved firm verbal contracts. In these days, however, the widespread use of the telex system greatly assists business.

E. SETTLEMENT OF ACCOUNTS

This is an important point of commerce, although not always discussed in publications on marketing. For each mode of sale there is, practically, a special system of settlement.

1. FIXED SALES

The contract should always include a special clause on the system of settlement, such as the following: "Part payment on dispatch, balance on arrival". In this case, the seller demands up to 80% at the departure of the lorry or train, the remaining 20% constitutes a guarantee for the buyer as to conformity of delivery with the other clauses of the contract.

This is probably the most satisfactory system of settlement, although not readily accepted by buyers. Buyers prefer "settlement on arrival", but in fact rarely settle immediately on delivery; delays of one month or sometimes two or three months, are common. It often happens that wholesale merchants do not dispose of enough ready cash for immediate payment and their retail clients also demand a period of credit. Moreover, these delays put the buyer in a strong position financially; finally he does not pay until after he is sure that the merchandise is up to standard

and often in fact not until after he has sold it. This system, in fact, is open to abuse and results in much argument and litigation.

2. SALES ON COMMISSION

As soon as the goods are sold, the commission agent should inform his supplier by telephone or telex. He usually waits for the close of the market and then quotes:- the quantities sold by price category, the balance unsold, market tendencies and estimated consignments required for the following days. he must then, as soon as possible, dispatch his "Bill of Sale" detailing the 'gross receipts', i.e. sales by quantity and price, from which is deducted commission and expenses, including correspondence, storage and transport, and (in the case of exports) the costs of transport and custom charges. The balance constitutes the 'net proceeds of sale' and should be provided in the form of a cheque attached to the Bill of Sale.

The delay, in principle, should not exceed a few days, but here again, if his clients are not prompt in payment, the commission agent may await his receipts before paying the sender. There are, unfortunately, some agents that practise regular delays in payment, not always for good reasons. The motive, often enough, is to avoid an easy comparison between the information on the Bill of Sale and market information on the day of sale. Regular delays in payment, therefore, give rise to doubts on the information supplied or, more seriously, on the correct reporting of receipts.

3. SALES ON MUTUAL ACCOUNT

Either of two methods of settlement may be used, according to contract:

- (a) On each delivery, only the threshold price is paid and the mutual accounts are settled at the end of the contractual period, or
- (b) Each delivery corresponds to a complete account, in which one adds to or subtracts from the threshold price according to the results of sale.

The second system is to be preferred.

F. SPECIAL SYSTEMS OF SALE

1. DIRECT SALE TO RETAILERS

This is a practice originating with the initiation of 'integrated commerce' (large or medium units) and the corresponding organization of 'buying centres'.

The representatives of these large societies can deal directly with the sender, thus short-circuiting the wholesalers, because of the size of their business.

In these cases, the transactions are always made in the form of fixed sales and at a distance, which necessitates standardization of produce. Sometimes the services of a broker are employed.

Packing in this trade becomes of secondary importance, as the large companies are nearly always equipped for the confection of 'sales units'. Their purchases usually concern a medium quality suited to their clientele.

2. SALES TO SPECIAL COMMERCIAL CIRCUITS

In countries characterized by an absence of well established free markets, organization tends to be inefficient or inexistant. It is clear that the modes of sale are very different from those previously described; the rules controlling business are not subject to the same necessities. One must add that, as many of both sellers and buyers are often illiterate, written contracts are impossible and most transactions are by verbal contract. The fact that most purchases are made without the benefit of scales, also means that they are usually carried out on an immediate cash basis.

Transactions on commission are not unknown in these circumstances, but are usually limited to partners who are old friends dealing on a comparatively large scale, but this is exceptional.

G. RETAIL TRADE

As for wholesale business, the systems of retail trade differ widely between countries where there is a normal commercial infrastructure and those where special commercial circuits are the rule.

In well organized markets, distribution to consumers is carried out through retail markets (covered or open air) and by various types of greengrocers, food stores, supermarkets and hypermarkets, as well as through the shops of cooperatives societies and other consumer groups.

The operators who supply the traditional retail outlets are classed according to the size of their daily trade and the markets they serve. Some supply fruit and vegetable markets and itinerant vendors, which only trade during certain hours of the day. Other traders supply the general food stores which have a relatively small turnover, and yet others specialize in supplying the greengrocers which are open all day and have a large turnover.

All of the above operators belong to a class of independent traders, working on an individual, self-financed basis.

Supermarkets, cooperative societies and other very large retailers, however, obtain their supplies through 'buying centres' who deal direct with producers, producer groups, and wholesale merchants. As they deal in very large quantities, they are able to obtain very favourable conditions of price and payment. Their system of trade is nearly always 'self-service' and this tends to emphasize standardization of goods rather than high quality, as compared with the business of independent traders, where the question of quality is critical.

In countries where the only commerce is through 'special circuits', retail trade takes a different form, although there are some points in common with that of more highly organized markets.

The main differences are in the size of transactions, the number of traders and the system of distribution. The retail structure is very different: although one finds both covered and open markets, their layout has little in common with those of developed countries - the number of traders is much greater and the space allowed to each is reduced to the strict

minimum. The retailers are divided in two classes: (a) those with an average trade of about 400 kg per day, who rent a market stall covering 100-120 m², and (b) those with daily sales of only up to 27 kg who install themselves on a small area of a few square metres.

In these countries, there are rarely any itinerant vendors and the merchants are generally not specialized. There are usually no greengrocers' shops, although some food stores sell a small range of fruit and vegetables. In the large towns and capital cities, however, the department stores and the supermarkets often stock a wide range of fresh produce and, moreover, mark the prices of all goods offered for sale.

H. THE EVOLUTION OF PRICES

In a free and organized market, prices are subject to constant variation. Changes occur practically daily and even continue between the opening and closing of the market. This extreme variability is caused by various factors. Unlike the prices of most non-perishables, the retail price of vegetables cannot usually be based on the cost of production, due to the number and variability of the costs of distribution, including packing and transport, and wholesale, semi-wholesale and retail trade costs and margins.

Fig. 1 illustrates the usual routes of distribution, which are much the same whether sales are fixed or on commission. In either case, the produce passes through the following hands between producer and consumer:

(1) wholesale sender, (2) wholesale receiver, (3) semi-wholesaler, and (4) retailer.

Whether the wholesale receiver is working on a profit or a commission, the most sensitive point of the chain concerns the sales between him and the retailer, because it is here that retail market conditions and the law of supply and demand are felt most keenly.

The producer will eventually have to suffer the following charges against his receipts:

- the commission for profits of wholesale sender and wholesale receiver;
- loss in weight of the produce;
- transport and handling costs;
- storage (when required);
- grading and packing costs

In the case of fixed sales, the price offered to the producer will always cover these elements and the buyer will also include a certain margin for security.

The retailer, in his turn, must charge a price to the consumer which covers the costs of delivery to his shop or market stall and allows him a profit, usually plus a margin to cover possible deterioration of the produce and loss of sales. The various costs and profits which are borne by the merchandise after it leaves the producer account for a large percentage of the price to the consumer.

The degree of variation of market prices is often large, notably as a result of King's Law, which states that a small excess of supply to the market causes a disproportional drop in market prices and, in consequence,

Fig. 1 The distribution of vegetables: routes between consumer and producer

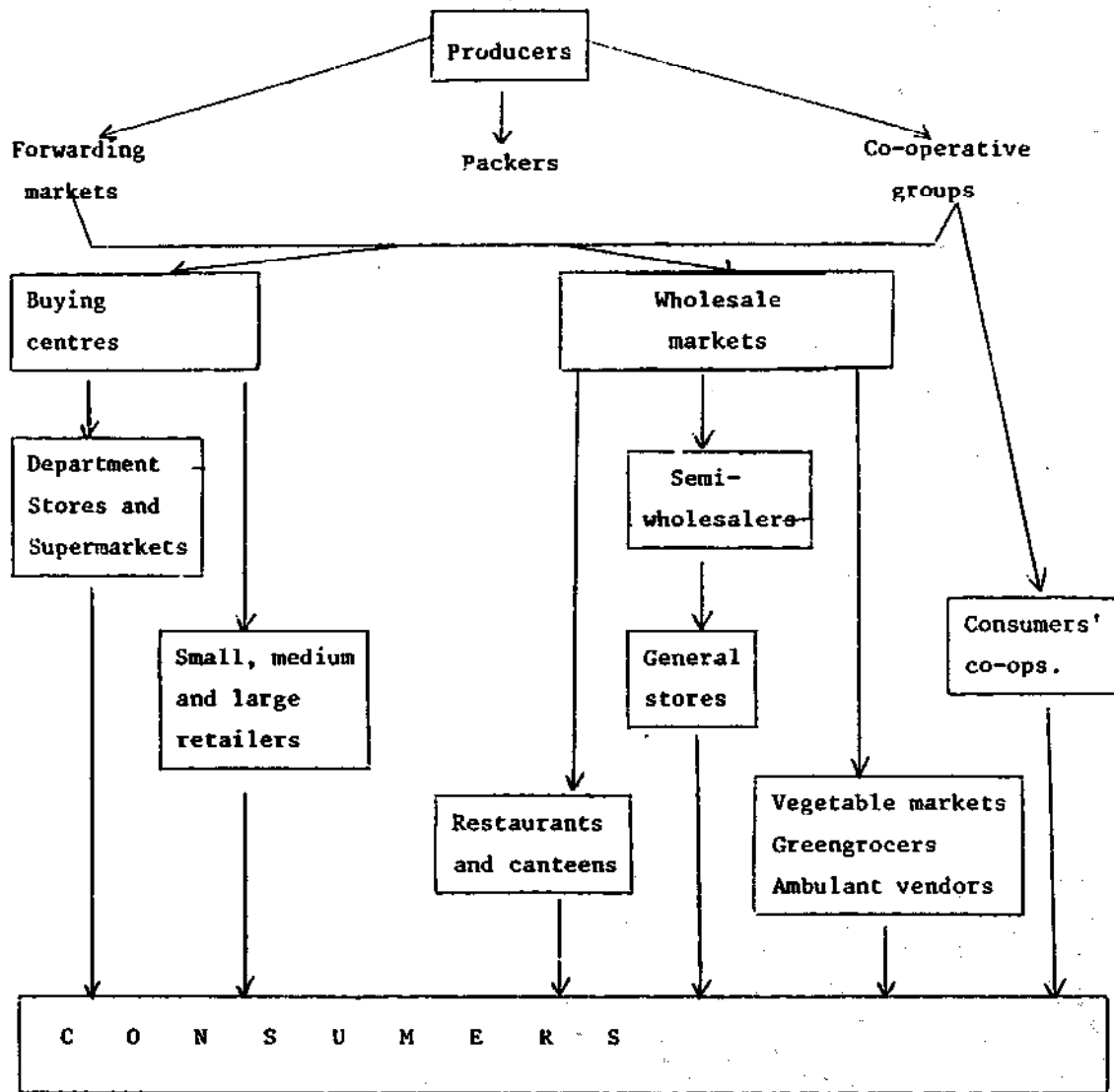

in prices paid to the producer. In addition, the price curve of horticultural produce, because of its seasonal nature, has a typical "saw-tooth" configuration. (Fig.2)

Fig.2 Theoretical Price Curve of Horticultural Products

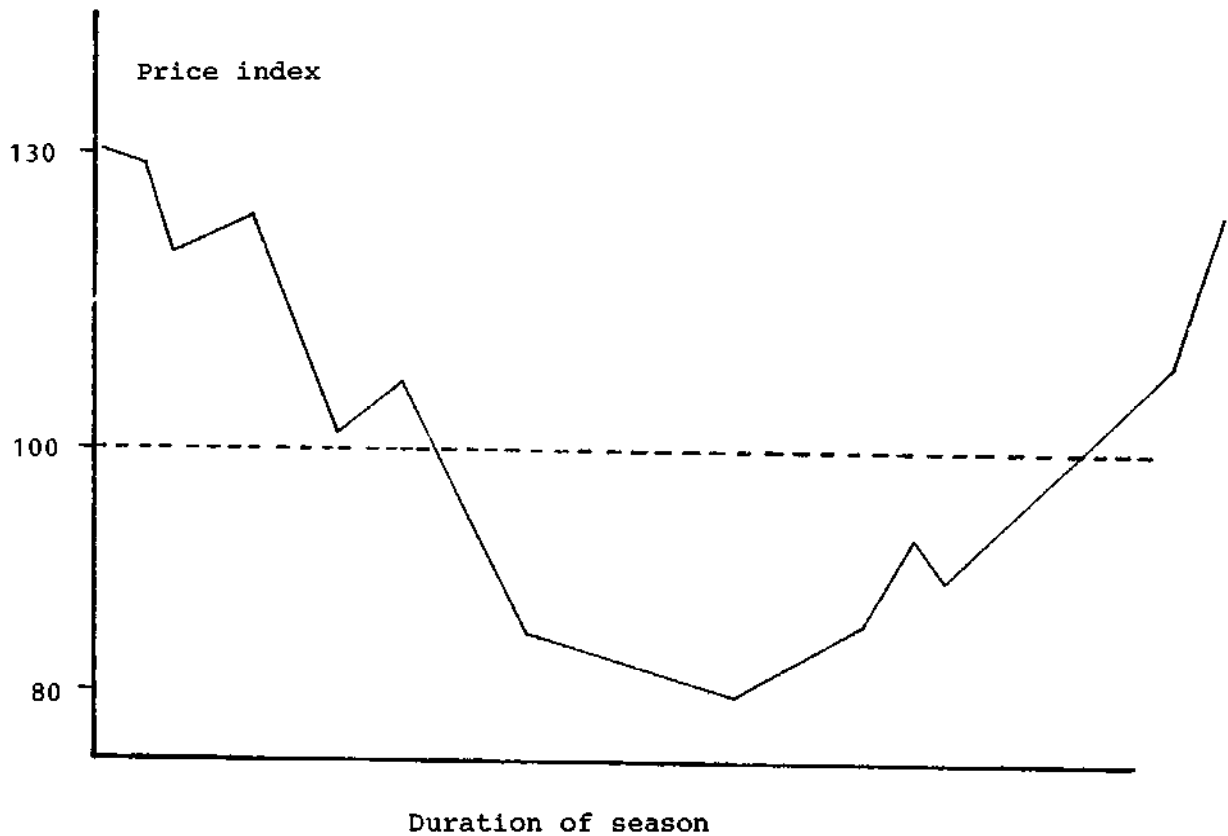

The following characteristics of the curve should be noted:

- the high prices at the beginning of the season;
- a subsequent progressive reduction in price with fluctuations until the period of full season is reached, where there may be a sudden drop (in severe market gluts, the produce may even become unsaleable);
- an increase in price towards the end of the season.

The market is also sensitive to numerous other factors over and above the usual variations in supply and demand, such as:

- Climatic conditions; for example, a heat wave causes an increase in the demand for melons and tomatoes, whereas a cool period causes a decrease.

- The appearance on the market of competitive species, e.g. an abundant supply of peas at a low price reduces the demand for French beans.

- Improvements in the quality of produce offered stimulates demand and deterioration of quality causes a reduction.

Price stabilisation

The sudden fluctuations of price, up or down, sometimes cause serious economic problems and give rise to a search for means of stabilisation. These are never completely successful, such is the difficulty of controlling the complex of variable factors involved. Even in the best cases, it has only proved possible to limit the degree of fluctuation.

It is clear that it is the producer who is most interested in obtaining a stabilisation of prices, since it is, in the end, always on his shoulders that the effects of variations fall, and nearly always in a negative sense; that is to say, that he only profits very partially from price increases, but a drop in market prices is reflected in its totality on the initial value of the product.

Various different systems of market control are possible:

Price control, by official regulation is often illusory unless it is accompanied by improvements in equilibrium between supply and demand. It is rare that the official price suits all the interested parties: producers, merchants and consumers. Many initiatives of this type have failed, even when governments have set up their own purchasing departments, since this type of organization seems to cause the automatic creation of an 'alternative' ('black') market, which makes matters worse.

The only measures that can bring about a more satisfactory situation involve improvement of equilibrium between supply and demand. It is usually an excess of supplies which causes a collapse in market prices. The following measures may be considered in such situations:

- a search for new market outlets,
- storage,
- industrial use,
- restriction of sales to certain categories of produce,
- temporary closure of markets.

These actions, especially the last two, should be employed only in serious crises which threaten the economic stability of agricultural production.

The search for new market outlets is the most simple measure. Sometimes, a new orientation and fresh information make it possible to route products to other under-supplied markets and this may often be sufficient to control a market glut.

Storage or industrial treatment are also good means of correction. For storage, however, it is necessary to study costs, to ensure that they do not exceed the gain in market price. Industrial treatment provides a valuable alternative, provided that suitable processing industries are available in the district and can absorb the quantities concerned.

The other measures - restrictions of sale or removal of produce from the market - are only applicable where standardisation of produce is already applied and a competent professional organization is established. Such measures involve the imposition of a strict control of supplies. Removal of produce usually amounts to its destruction and this requires a special organization and the payment of compensation to the producers. Even then, the results are not always satisfactory. The compensation can only be paid at a low rate and the procedure is rarely applied sufficiently rapidly or thoroughly. If the compensation is generous, there is also a danger that some producers may be tempted to produce large quantities of inferior material for destruction as an easy way out of their marketing problems!

In the end, one is bound to admit that any policy which involves production for the purpose of destruction is liable to give negative results.

I. EXPORT MARKETS

To have some chance of success in foreign markets, the exporter needs to have at his disposal sufficient quantities and qualities of produce available throughout the production season for this type of trade. It is usually only the larger production units and collective organizations that have the facilities for packing, transport and storage and the level of commercial organization necessary to provide regular supplies for export.

Although the possibility exists in theory for specialized dealers to collect supplies from numerous small farmers for participation in the export trade, efforts of this sort often fail through lack of experience and ability. Indeed, such failures seem to occur regularly nearly every year!

In the following paragraphs, some indication is given of the character and potentialities of foreign markets of interest to African producers.

1. AFRICAN MARKETS

The climatic variation in African countries results in a great difference in vegetable seasons which, to some extent, makes their import and export needs complementary.

According to local purchasing power and the available means of communication, there is thus some commerce in between African countries to supplement supplies during seasons of scarcity. So far, however, this trade has been limited in extent. The African countries most in need of supplies

of fresh vegetables are those in the centre of the continent, since their cropping season, because of temperature conditions, is a short one.

Some tropical coastal regions north of the equator, especially those in Senegal, have favourable conditions for production for a long season and are thus in a position to export. In tropical Africa, however, it is the countries with large highland cropping areas which have the most favourable ecological conditions, their climate being equable throughout most of the year. In West Africa, this applies especially to the highlands of Cameroun and Guinea, and in East Africa, to the highlands of Ethiopia, Kenya and Tanzania.

These climatic possibilities are often not exploited in fact, because of difficulties of communication. This frequently results in paradoxical situations. For example, the Ivory Coast imports cauliflowers and many other vegetables from France, at seasons when they can be produced in Senegal. Although the transit distances by sea or air between Abidjan and Paris are 3-4 times greater than Abidjan-Dakar, the services are much more frequent and adaptable and the capacity of transport available is much greater. One must add to this that the Ivorian merchants now have a long established relationship with French exporters which helps to explain the construction of this rather anomalous business.

In considering the future of African markets, it must be remembered that both the production and consumption of many vegetable species is a new development in tropical Africa. Vegetables that are not traditional in the African cuisine are not purchased when their price is high and imported vegetables - because of the high costs of packing, transport, profits and taxes involved - are usually expensive.

This situation is liable to change, however. In the larger cities tastes are changing rapidly and there is a growing awareness of the importance of vitamins and the value of a varied diet. As market garden production develops in the favourable regions, techniques and organization will improve and the costs of production will come down, which will open up new commercial possibilities. There is every reason why trade between African countries should be encouraged and the signs which herald changes in conditions of trade should be watched carefully.

Internal African trade is, at the moment, largely in the hands of merchants who are primarily engaged with commerce to and from Europe. It is not carried out on a regular basis, but rather as odd consignments when the occasion arises. The mode of sale and contract are always on a 'fixed sale' basis as already described. The only variation is that the sale may be F.O.B. (free on board) or C.I.F. (cost, insurance and freight). F.O.B. means that the payment covers the costs up to the completion of loading on boat or aeroplane; C.I.F. covers the costs up to delivery to destination, but not unloading.

2. WEST EUROPEAN MARKETS

The main markets of Western Europe for African produced vegetables are in France, West Germany and the United Kingdom, and to a lesser extent in Italy, Bénélux, the Scandinavian countries and Switzerland.

Most of the produce arrives by air as sea connections are too infrequent and, in any case, much of the production is not situated near an effective seaport. The most important European airports for the produce are

Paris, London, Brussels, Frankfurt, Geneva, Amsterdam and Milan. Consignments are sometimes forwarded from the larger airports to others less well served from Africa.

The large Western European markets are capable of absorbing several dozens of tons per day of the same product and, if the criteria of quality demanded by the clientele are rigorously maintained, the prices obtained are usually perfectly satisfactory to the sender. Nevertheless, the range of vegetables that command a final selling price that will cover all the intermediate costs, including the very heavy airfreight charges from Africa, are limited.

At the present state of the market, the species are mainly limited to French beans ('filets' or 'mangetout'), melons and chilli peppers. Okra may also be profitable if sent in limited quantities. Others, like sweet pepper and tomatoes, only find occasional market openings. In any case, it is indispensable to keep well informed of the mercurial market changes from day to day.

All the European markets remain rather unstable in their reactions to vegetable imports and the business necessitates great caution on the part of the exporters. Importers may often show undue optimism in their orders, especially in the case of sales on commission.

Conditions of Sale

Commission sales are arranged on the system described for internal markets.

Fixed sales under contract, may be arranged either F.O.B.* , C.I.F.* , F.O.T./F.O.R.* or delivered to shop. F.O.B. is often the simplest system, provided it is well understood by both parties. The sender has only to bear the expenses of transport to the boat or plane, plus loading and any taxes at the port of embarkation. He can be relieved of all responsibility for subsequent operations; some contracts arrange for payment to be made at a bank in the country of dispatch on presentation of the bill of lading.

Certain European importers seem to demand excessive guarantees and insist on payment of only 80% on embarkation and 20% on arrival. This practice should not be accepted as the receiver has the free choice of transport. - It leads to the suspicion that the buyer wishes to influence the price, playing upon market conditions to exercise pressure on the seller.

Incidentally, insurance may or may not be obligatory according to the country concerned. If the consignment is sent without insurance, the expression 'C.F.' (Cost and freight) is used instead of C.I.F.

Occasionally, contracts are made 'Free on Quay'. This means that all costs in disembarkation and customs at port of arrival are borne by the vendor. If the sale is made F.O.T./F.O.R. (Free on truck, free on rail), then costs of loading on truck or rail wagon are also included. Sales may even be made 'delivered to shop', which covers transport right up to the retailers.

* F.O.B. = Free on Board; C.I.F. = Cost, Insurance, Freight;
F.O.T. = Free on Truck; F.O.R. = Free on Rail.

3. EAST EUROPEAN MARKETS

In centrally planned European countries, international trade is controlled by an association known as COMECON ('Council for Mutual Economic Assistance'). In these countries, imports are accepted on the condition that they are matched by exports of an equal value of available goods. For example, one can export potatoes or bananas through COMECON if one agrees to import the same value in, say, timber, tractors, etc. This involves considerable administrative work, since it is necessary to ascertain which of the available goods it is useful to take in exchange, and that is not always easy.

4. RULES FOR EXPORT TO FREE MARKETS

The enormous distances which separate African vegetable producers from European markets involve many difficulties and dangers from delays in transport, breakage of crates, changes of climate and troubles in communication. Experienced exporters usually manage to deal with these problems, but accidents and losses still occur. They are very often due to the neglect of a few simple but essential rules.

The most important principle lies in the regularity, reliability and frequency of supplies to the 'target' markets, through the whole season of each product, both as regards quantity and quality.

The exporter is often misled by the size and wealth of the European market and the high prices often obtained for out-of-season vegetables. He may underestimate the strong competition from other sources, especially from crops produced under protection in Europe and North Africa. He must remember that the competition is fierce and many suppliers from other sources are well established in the market; it is therefore rare that a product succeeds in beating the opposition, if its appearance on the market is only sporadic.

The exporter must accept the fact that market prices fluctuate widely and cannot expect that he can benefit from the 'booms' in price without going through the 'bad patches'. Nevertheless, the question of quantity must always be watched. Despite the great volume of trade, these markets are very 'fragile'. It has been estimated, for example, that on the large market of Rungis near Paris, an excess or shortage of only 3% of a product can cause a fluctuation of 15-20% in the price.

With few exceptions, however, it may be expected that the best quality is always the first to be sold. A regular quantity at a high standard is, therefore, one of the best guarantees for success in a difficult business.

The contrast between wholesale and retail prices in Europe is often the subject of disagreement. The margins taken by retailers sometimes seem so high that they provoke official price controls, which can lead to difficult situations. Trade in perishables is, indeed, a complex affair requiring special experience and official intervention never seems to lead to a satisfactory solution. In the same way, excessive prices charged by shopkeepers have sometimes led producers or their associations to try to establish themselves as retailers, but the attempts have usually ended in failures. It is better for producers to accept that it is useless to judge market values by prices in the shops; the only prices that can be taken into consideration by exporter or importer are those reflected in the wholesale market.

Another cardinal rule is that successful operations between exporter and importer depend on a relationship of mutual trust; the best results, in fact, are obtained by partners who have known each other for a long time and have developed ties of friendship. It is very important that the importer informs his client promptly of conditions and tendencies of the market before and at the time of arrival of each consignment, and advises him in detail on all matters concerning the quality, grading and transport of his produce. If the sender deals in a variety of produce, it is usually advisable for him to choose several partners in each market, provided that each merchant is as keen to deal with a different product. Competition between different batches of the same product from the same sender must be avoided.

One of the best roads to success in export business is to adopt a trade-mark. This involves establishing the reputation of a mark which is an absolute guarantee of quality. It demands rigorous control and regular supplies; however, when the mark conquers the market, instead of the product seeking buyers, the situation is reversed. That can be called real success!

PRODUCTION COSTS

1. DEFINITION

The production costs of an agricultural product is the sum of all the expenses and charges which have been incurred during the production of a given crop on a given plot of land, divided by the number of units of weight (kg or lb) harvested from that plot.

2. THE VALUE OF CALCULATIONS OF PRODUCTION COSTS

(a) For the producer, the knowledge of the costs of production of a crop is an advantage for the following purposes:

- the calculation of profit as a proportion of the price received;
- the search for means of reducing the costs of production and hence of increasing profits;
- the planning of production to concentrate on the most profitable crops;
- the comparison of results, season by season, on an economic basis;
- the establishment of cost accounts as a defence against the imposition of excessive taxes.

(b) For the official of the national agricultural services, the knowledge of costs of production provides an essential basis for:

- the planning of research;
- the establishment of development priorities;
- the encouragement of new crops and new production areas;
- the improvement of production techniques;
- the direction of extension services in the best national interest.

In conclusion, it is clear that the calculation of production costs is essential to all serious financial and economic analysis. It is also clear that, to be valuable, the calculation must be as exact as possible and this frequently offers some difficulty.

3. THE COMPOSITION OF THE COST OF PRODUCTION

The various elements which must be taken into consideration to calculate costs and productivity include:

- in the first place, the exact location and area on which the crop is grown;
- the "inputs" - seed, water, fertilizer, pesticides, etc.;
- fuel - oil, petrol and, in some cases, electricity;

- labour - including permanent staff, family and seasonal labour;
- upkeep and amortization of equipment and, where applicable, of buildings, roads, etc.;
- financial costs (interest on loans) and general overheads.

4. CALCULATION OF PRODUCTION COSTS

Method

The calculation depends on the maintaining of proper accounts of expenses, for each of the constituents described above.

The procedure is relatively simple for certain of these, for example the inputs, since it consists of a simple multiplication of the quantities of each material used by the corresponding direct cost.

For calculations concerning personnel and labour, there are some complications; a work schedule must be fixed for each cultural operation and the proportion of personnel costs for permanent staff to be charged must be established.

The costs of irrigation also offers some problems; the real cost of the water must be based on the quantity delivered to the crop. This cost includes the cost per m³ of water at the crop location, plus the expenses related to the system of irrigation used - overhead, drip, etc. - which comprises amortization, energy and labour. It is difficult to calculate all these elements for one crop amongst the many grown. A rough simplification is to base calculations on the overall cost per m³ of water, including all related expenses. The number of m³ used by a crop is relatively easy to arrive at, via the output per hour of the irrigation system and the number of hours of application.

The same method can be used for costs of equipment. Before all other calculations, the cost per working hour of each machine plus implement is established (e.g. tractor-and-plough; tractor-and-harrow), including upkeep, amortization, fuel, materials, and labour. This is much more satisfactory than trying to allocate a fraction of global expenses to each crop.

The latter method, however, should be applied for general and overhead expenses, financial costs and administrative costs.

The final element in the calculation of production costs, i.e. the quantity of crop harvested, is often the one most subject to discussion. The important point is not to base calculation on the total gross yield but only on the weight of crop of good marketable quality produced.

The above methodology, taking into account all financial aspects of a farms work, is easily applied in the case of a business large enough to have a suitable accounting system from which all the necessary figures can be abstracted. In the case of medium-sized farms, run on a family basis, cost accounting is more difficult but is still possible.

For smallholdings, with an area of, say, less than 1 ha., the difficulties are very serious; the farmer is often illiterate and incapable of keeping precise accounts. In such cases, the only way of obtaining a useful costing is through the assistance of a suitable person - say, a bookkeeper working for the official agricultural services. The elements to consider are a little different, especially in the case of labour costs. If there is

no paid labour involved, it is a question of putting a value on the work time used by the farmer - which requires a different approach. The principal difficulty resides in the calculation of crop yields and particularly for those which are harvested on a series, over a rather long period (French beans, tomato, etc.), since the farmer often uses no scales, or standard measures of volume, and in some cases sells the standing crop without measuring the harvest. In such cases, the only way of making realistic estimates is with the help of a third person trusted by all parties concerned.

The following models of calculation of costs of cultivation and crop irrigation and of the inclusive costs of production of tomatoes and onions are presented as a general guide to suitable methods of accounting.

(a) Calculation of costs per hour of mechanical cultivation

The components of these costs are the net costs per hour of the tractor plus the net costs per hour of the implements it draws.

Calculation of net costs per hour of the tractor:

Costs of the following elements must be included:-

- Depreciation: Estimations of the number of hours worked per year may be difficult to arrive at. It may be more realistic to base depreciation costs on the working life of the tractor as estimated by the makers. This figure varies according to the model between 3 000 and 5 000 hours, at which point the makers estimate that repairs would be less economic than replacement of the machine.

- Upkeep: Generally speaking, the costs of upkeep amount to about the same as the costs of depreciation.

- Fuel, lubricants and hydraulic fluid: Rates of consumption/hour are available from records or makers' recommendations.

- Labour: Wages per hour of driver and (if required) assistant driver.

Calculation of net cost per hour of implements:

In all cases, costs of depreciation and upkeep must be included, and may be calculated on the same basis as for the tractor. The use of cultivating implements does not usually involve other costs, but for implements with independent power units, such as spraying and dusting machines, labour and fuel must be calculated.

Example (\$ costs rounded at 360 FCFA per \$)

Net costs per hour of tractor and plough

<u>- Tractor</u>		
Purchase price of tractor \$41 700 =		15 000 000 FCFA
Working life of tractor (estimated by makers) = 4 500 hours		
Depreciation per working hour of tractor	$\frac{41\ 700}{4\ 500}$	3 334 FCFA/hour
Upkeep of tractor per working hour		3 334 FCFA
Fuel and lubricants : diesel oil (150 x 10)		1 500 "
lubricating oil		500 "
hydraulic fluid		500 "
Labour (wages and charges)		<u>220 "</u>
		9 390 "
Unforeseen		<u>880 "</u>
	TOTAL (rounded)	<u>10 270 FCFA/hour</u>
<u>- Plough</u>		
Purchase price of plough \$6 944 =		2 500 000 FCFA
Working life of plough = 7 500 hours		
Depreciation per working hour of plough	$\frac{6\ 944}{7\ 500}$	333 FCFA/hour
Upkeep of plough per working hour		<u>333 FCFA</u>
	TOTAL	<u>666 FCFA/hour</u>
Net costs per hour of tractor and plough =		10 270 + <u>666</u>
	TOTAL (rounded)	<u>11 000 FCFA/hour</u>

Net costs per hour of tractor and cultivator

<u>- Tractor (as above)</u>		
		10 270 FCFA/hour
<u>- Cultivator</u>		
Purchase price of cultivator \$9 722 =		3 500 000 FCFA
Working life of cultivator = 6 000 hours		
Depreciation		580 FCFA/hour
Upkeep		<u>580 "</u>
	TOTAL	<u>1 160</u>
Net cost per hour of tractor and cultivator =		<u>10 270 +</u> <u>1 160</u>
	TOTAL (rounded)	<u>11 500 FCFA/HOUR</u>

(b) Calculation of costs of irrigation per m³ of water applied

The costs of the operation of irrigation are regarded as the costs of applying to the crop water which has already been delivered to the site at soil level. These costs are additional to such expenses as have been incurred to obtain supplies; whether the water has been pumped from a well, lake or river or has been brought from a society supplying individual holdings in an agricultural area.

The costs of the application of water to the crop may concern the digging and upkeep of canals or the installation and maintenance of a system of pipes. In addition, if water is not applied by gravity, there will be the costs of a motor pump to deliver under pressure and the costs of a system of overhead sprays or drip irrigation.

Of course, these latter installations will only be applicable to large or medium scale market gardens. Smallholdings will usually rely on manpower and water-cans or animal power and "Persian wheels".

Apart from the question of scale, the choice of irrigation systems will depend largely on the topography, type of soil, crops produced and the amount of water available. All systems have their advantages and disadvantages depending on the equipment required; the net costs per m³ of water delivered can vary considerably.

Gravity irrigation

This system, in which water is delivered to basins or furrows via irrigation channels, is the most inexpensive, since no supplementary energy is required to supply water under pressure. The necessary installations are all of a type that can be depreciated over a long period. One can practically base calculations on the "gross" cost per m³ of water, whether bought or pumped, plus the labour required for maintenance and irrigations.

Overhead sprinkler irrigation

The installation comprises the following elements:

- a central motor-pump, which can provide a pressure of 1.5 kg/cm² at the sprinklers,
- a movable system of pipes, capable of delivering water throughout the market garden,
- a suitable number of sprinklers.

The calculation of the net cost per m³ of the water delivered under pressure by the motor-pump is made in the same way as for the cost per hour of mechanical cultivation. the working life of the pump will be estimated by the makers at between 3 000 and 5 000 hours.

The movable system of pipes is subject to more rapid deterioration, because of the frequent handling which is required and the intensive use, amounting usually to over 2 000 hours per year. Sprinklers must also be depreciated over a more or less short period, depending on the quantities of water used.

Finally, calculations for manpower must include personnel for the operation and maintenance of the motor-pump and the handling and maintenance of pipes and sprinklers. These costs can also be relatively high.

Drip irrigation

This type of installation can prove very expensive, because of the high price of the equipment required - including pump, water filters, tubing and drip harness. Trained operators are needed, especially so as to avoid the blocking up of the dripper nozzles. (This also depends on the type of equipment used and soil concerned, but is frequently a problem).

Irrigation by water-can

For smallholdings in sandy soil, this is the system most commonly used in Africa, because of its simplicity and low capital cost. It is not, however, always the cheapest to operate. Studies in Cap-Vert, Senegal (Navez, 1980), showed that the cost per m³ of water can reach a level three times the cost of sprinkler irrigation.

Economic considerations

The net cost per m³ of water applied is not the only element to consider in calculating the costs of irrigating a crop. The quantity of water required for crop production can vary enormously according to irrigation methods, soil and other circumstances. A particular problem with gravity irrigation is the difficulty of measuring the quantity of water actually given to the crop. Heavy losses in water channels and over-generous applications by the operators may greatly reduce the economies offered by a low cost per m³.

Again, in sprinkler irrigation, losses due to evaporation, plus those due to the necessary overlapping of the circles of the crop watered by each sprinkler may involve the use of 60% more water than the crop really needs.

In contrast, the drip system permits nearly the maximum economy of water use, delivering to the plant little more than its precise needs. This partially compensates for the high net cost per m³ of water delivered by this method.

Irrigation by water-can is also economic in water use, since the quantity applied can be adjusted precisely according to the needs of the crop.

A series of trials was carried out at CDH, between 1975 and 1980, to study the costs of the two most common irrigation methods used on the local sandy soils - namely, those using water-cans and those using overhead sprinklers. The trials covered crop production over 80 days on areas of 1 000 m² and gave the following results:

Water-can

Water consumption =	560 m ³	
Net cost of delivery per m ³		87.78 FCFA (\$0.244)
Total net cost of irrigation per 1 000 m ²		49 156.00 FCFA (\$136.55)

Overhead sprinkler

Water consumption = 910 m³
(including losses)

Net cost of delivery per m³ 25 00 FCFA (\$0.069)

Total net cost of irrigation per 1 000 m² 22 750.00 FCFA (\$63.19)

It should be noted, however, that the main costs of irrigating by water-can, i.e. labour, has been reckoned at the official rate of 110 FCFA/hr, but the more usual rate at this period was 60 FCFA/hour. At this latter rate, the net cost of delivery would amount to 49.40 FCFA (\$0.137) and the total net cost of irrigation of 1 000 m² would be 27 664 FCFA (\$76.8), instead of 49 156 FCFA.

The conclusion was that, in practice, there was not a large difference in the costs of the two methods of irrigation, the cost of irrigating by water-can being only about 20% higher than by using sprinklers.

MODELS OF A METHOD OF CALCULATING NET PRODUCTION COSTS

I. Large Scale Production

In the case of large agro-industrial societies production areas may be in the tens or even in the hundreds of hectares. In this type of farm, the accounting figures are usually available and calculation of production costs is a question of allocating the proportion of costs to each crop concerned.

It is generally most convenient to consider these charges under the headings of "fixed costs" and "variable costs".

Fixed costs: include the relevant portion of the following costs chargeable to the crop concerned:

- Depreciation and maintenance of general facilities, including walls and fences, roads, electric installations, terraces, earth-works and levelling.
- Depreciation and maintenance of buildings, including offices, sheds, stores and (in some cases) living quarters.
- Salaries etc. of permanent staff including managerial, administrative, accountancy and clerical staff and guards.
- General administration expenses, including bank and fiscal charges, travel, telex and telephone

In most cases it is best to calculate the fixed costs of the crop concerned according to the proportion of the area it occupies in relation to the total area of crops grown on the farm. Allowance must be made for double or triple cropping - e.g. on a farm with 100 ha of cultivated land a total of 180 ha of crops may well be grown in the course of 12 months.

Variable costs: include all the specific expenses involved in growing and harvesting each particular crop, namely:

- Inputs, including seeds, fertilizers and phytosanitary products.
- Mechanical cultivations, including plowing, harrowing, seeding and hoeing.
- Spraying and dusting.
- Irrigation.
- Various manual operations, including pruning, training and hand weeding.
- Harvesting, including labour, equipment and transport.

Examples of production costs on a farm of 100 ha:

on which	75	ha.	are	used	for	early	vegetables
	55	"	"	"	"	"	main crop and late
	50	"	"	"	"	"	rainy season crops
	50	"	"	"	"	"	clean fallow

The total cropped area would thus be 180 ha (75 + 55 + 50).

Suppose the staff consists of the following:

1 Director
1 Accountant
1 Secretary
1 Farm Manager/Assistant Director
3 Section Chiefs for - equipment
 - irrigation
 - crops and cultivation
10 Foremen
35 Permanent field staff, including 30 labourers and
5 guards
150 Seasonal field workers.

Example A **Calculation of Net production costs of a crop of early tomatoes on 10 ha***

Technical notes

- Bush varieties, requiring no pruning or staking, are used.
- Seedlings are produced in a nursery covering about 2 000 m², over 2 periods of 30 days.
- Harvesting is spread over 40 days, with pickings every 3-4 days, according to the progress of ripening.
- In view of the area concerned, the degree of mechanisation, etc. the production may be classed as extensive rather than intensive i.e. priority is given to productivity rather than to high quality.
- The crop is produced for sale on the local market.

Harvest

The crop was graded as follows:

Category I	-	75 000 kg
Category II	-	250 000 kg
Category III	-	70 000 kg
Unsaleable	-	25 000 kg
TOTAL		<u>420 000 kg</u>

* All the figures quoted in these examples are hypothetical. They are given only to illustrate the method of calculation and are not for practical application. US Dollar equivalents have been reckoned at 360 FCFA/\$.

i.e. A total acreage yield of 42 T/ha.
A commercial yield of 40 T/ha (rounded)

Fixed costs of farm

Total 54 000 000 FCFA = \$150 000.

(a)	Depreciation and maintenance of general facilities (4% on an investment of 50 000 000)	= 2 000 000	
	Maintenance	= 1 000 000	
	Sub Total	<u>3 000 000</u>	= \$8,330
(b)	Depreciation & maintenance of buildings (5% on investment of 80 000 000)	= 4 000 000	
	Maintenance	= 4 000 000	
	Sub Total	<u>8 000 000</u>	= \$22 220
(c)	Permanent Staff		
	Director	- 6 000 000	
	Accountant	- 3 500 000	
	Secretary	- 1 800 000	
	Farm Manager	- 2 500 000	
	3 Section Chiefs (each - 1 500 000)	- 4 500 000	
	10 Foremen (each 750 000)	- 7 500 000	
	35 Workmen (each 360 000)	-12 600 000	
	Sub Total	<u>-38 400 000</u>	= \$106 670
(d)	General expenses	- <u>2 500 000</u>	= \$ 6 940
(e)	Contingencies	- <u>2 100 000</u>	= \$ 5 830

Calculation of part of total fixed costs of farm to be changed to the 10 ha of tomato crop.

54 000 000 X 10 = 3 000 000 FCFA = \$8 330

180

i.e. 300 000 FCFA/ha = \$833/ha.

Variable costs of crop

(Notes: Cost of plants. The nursery costs, including soil preparation, seed, sowing, manuring, phyto-sanitary treatments, and irrigation, total 315 000 FCFA equal to 31 500 FCFA per ha of crop.

Mechanization. It is assumed that, on a crop area of this size all cultural operations would be mechanized. Costs should be calculated as advised in the preceding chapter IX).

Total of variable costs per crop of 10 ha,
5 500 000 = \$15 280.

(a) Mechanized operations: Total 1 770 000 FCFA = \$4 920.

- Plowing (Tractor + plow)
20 hrs x 10 500 = 210 000
- Harrowing (Tractor + harrow)
10 hrs x 10 000 = 100 000
- Hoeing (Tractor + hoe)
3 x 10 hrs x 11 000 = 330 000
- Fertilizer applications (Tractor + spreader)
10 hrs x 10 500 = 105 000
- Organic manure applications (Tractor + spreader)
10 hrs x 10 500 = 105 000
- Planting (Tractor + planter)
15 hrs x 12 000 = 180 000
- 4 Phytosanitary applications (Tractor + sprayer)
4 x 5 hrs x 12 000 = 240 000
- Misc. Transport, including harvest (Tractor + trailer)
50 hrs x 10 000 = 500 000

(b) Inputs: Total FCFA 990 000 = \$2 750

- Plants (see note above) - 315 000
- Fertilizers - 350 000
- Organic manure
15T at 11 000 - 165 000
- Phytosanitary products - 160 000

(c) Irrigation (Overhead sprinkler system)

- 71 500 m³ at 25 FCFA = 1 787 500 = \$4 970

(d) Labour

- 550 hrs x 150 = 825 000 = \$ 2 290

(e) Contingencies

- 127 500 = \$350

Total variable costs per ha.

= $\frac{5\ 500\ 000}{10}$ = FCFA 550 000 = \$1 530

Inclusive total costs per ha.

Fixed costs 300 000

+ Variable costs 550 000 = FCFA 850 000 = \$2 360

Average net cost of production of early tomatoes

$\frac{850\ 000}{40\ 000}$ = 21,25 FCFA per kg = \$0.06 per kg.

Example B Calculation of net production costs of a crop of onions on 15 ha.

Technical notes

- Variety: Violet de Galmi (main season)
- Seed: sown in nursery (500 m²) on 15 December, transplanted in 45 days
- Plantation: 6 million seedlings planted 1 February, grown for 100 days
- No phytosanitary treatments necessary
- Harvest mid-May all bulbs lifted on same day
- Total yield: 675 T
- Average commercial yield: 45 T/ha.

Fixed costs

The same total per ha of fixed costs as for early tomatoes, i.e. 300 00 FCFA = \$830 per ha.

Variable costs

Notes

Cost of plants: Nursery costs are increased to 1100 000 FCFA including seeds, fertilizers, irrigation etc.

Mechanization: Planting and cultivation are all mechanized.

Irrigation: Stopped at 85 days after transplanting.

Total of variable costs - FCFA 6 400 000 = \$17 780

(a) Mechanical operations : Total FCFA 2 070 000 = \$5 750

1 Plowing	315 000	
1 Harrowing	150 000	
2 Hoeing	330 000	
Fertilizer applications		157 000
Organic manure application		157 000
Planting		360 000
Harvesting		
60 hrs x 10 000		600 000

(b) Inputs : Total FCFA 1 610 000 = \$ 4 470

Plants	1 100 000
Fertilizers	270 000
Organic manure	240 000

(c) Irrigation : Total 2 175 000 = \$6 040
87 000 m³ x 25

(d) Labour : Total 405 000 = \$1 130

Cultural operations	
450 x 150 = 67 500	
Harvesting	
2 250 x 150 = 337 500	

(e) Contingencies : Total 140 000 = \$390

Calculation of inclusive total costs per ha.

Fixed costs FCFA, 15 ha	4 500 000	=	\$12 500
Variable costs, 15 ha	6 400 000	=	\$17 780
Total costs, 15 ha	<u>10 900 000</u>	=	<u>\$30 280</u>
Total costs per ha	<u>10 900 000</u>	=	726 660 rounded to
	15		730 000 FCFA =
			\$ 2 030 per ha.

Average net cost of production of onions per kg.

$$\frac{730\ 000}{45\ 000} = 16.22\ \text{FCFA} = \$ 0.045/\text{kg}.$$

II. Medium Scale Production

Production on a medium scale is not generally common in tropical Africa. Where it is practised, the area would be from about 5 ha and would rarely reach 20 ha.

The management of such farms is in the hands of the individual proprietors, each assisted by members of his family and some permanent employees. There may be one or two foremen on the farm but usually no administrative staff.

The proprietor/farm manager only in rare cases obtains specialized assistance in accountancy.

- The calculation of costs in these circumstances is usually inexact.

Mechanized equipment adapted to the type of farm is commonly employed. In such cases the fixed costs are reduced to a minimum and are usually limited to the following elements:

- Depreciation and maintenance of general facilities
- Depreciation and maintenance of buildings
- Permanent staff
- General expenses

The above costs are extremely variable, according to the type and size of the farm and hence may have considerable influence on the net costs of production.

Variable costs for each crop include the same elements as for large scale productions. It should be noted that in this type of farm the range of crops grown is sometimes very large and varied and this tends to complicate the allocation of costs and the calculation of net costs of production for each particular crop.

Examples of production costs on a farm of 5 ha.

on which 3.5 ha are used for early crops
2 ha are used for main season and late crops
3 ha are used for early rainy season crops
2 ha are left fallow in rainy season

i.e. a total of 8.5 ha of crops are grown over the course of 12 months.

Mechanical implements are reduced to a minimum and consist of a motor-cultivator. Transport is carried out with animal drawn carts.

Management is in the hands of the proprietor and his two sons. They employ 2 permanent workers and about 20 seasonal workers.

Example A Net production costs of a crop of early tomatoes
on 0.5 ha

Technical notes

- Bush variety used
- Nursery production of seedlings on 70 m² for 30 days.
- Crop is grown for a total of 110 days after transplanting.
- Harvesting is spread over 40 days with pickings approximately every 4 days.
- In view of the small area concerned, the production is carried out under intensive conditions with frequent inspections, timely operations and careful harvesting.

Harvest

The crop was graded as follows:

Category I	13 500 kg
Category II	5 500 kg
Category III	2 000 kg
Unsaleable	500 kg
Total	<u>21 500 kg</u>

i.e. A total average yield of 43 t/ha
A commercial yield of 42 t/ha.

Calculation of costs

Fixed costs of farm, (Total FCFA 2 914 000 = \$8 100)

(a) Depreciation and maintenance of general facilities:

4% of investment of 1 000 000 =	40 000
Maintenance =	20 000
Sub total	<u>60 000 = \$170</u>

(b) Depreciation and maintenance of buildings:

5% on investment of 2 000 000 =	100 000
Maintenance =	100 000
Sub total	<u>200 000 = \$560</u>

(c) Permanent staff salaries etc.

Proprietor/ Manager	=	800 000
Two sons at 500 000	=	1 000 000
Two workers at 360 000	=	720 000
Sub total		<u>2 520 000</u> = \$7 000

(d) General expenses 130 000 = \$360

(e) Contingencies 4 000 = \$11

Fixed costs per ha of crops grown

FCFA = $\frac{2\,914\,000}{8.5}$ = 342 824

rounded to 340 000 FCFA/ha = \$940/ha.

Variable costs for total area of crop (0.5 ha)

Total FCFA 252 500 = \$700

(a) Mechanical operations = Total FCFA 28 000 = \$77

1 plowing	:	2.5 hrs x 4 000	=	10 000
1 harrowing	:	1.5 hrs x 4 000	=	6 000
2 hoeing	:	3 hrs x 4 000	=	12 000

(b) Inputs = total FCFA 49 250 = \$136

Plants	=	15 750
Fertilizrs	=	17 000
Organic manures	=	8 250
Phytosanitary products	=	8 250

(c) Irrigation (overhead sprinkler) Total FCFA 89 250 = \$248

3 570 m³ x 25

(d) Labour = Total FCFA 84 000 = \$233

Spreading fertilizer
10 hrs x 150 = 1 500

Spreading organic manure
10 hrs x 150 = 1 500

Planting
200 hrs x 150 = 30 000

Phytosanitary treatments
50 hrs x 150 = 7 500

Harvesting
280 hrs x 150 = 42 000

Transport
10 hrs x 150 = 1 500

(e) Contingencies = Total FCFA 2 000 = \$5.56

Calculation of net average cost of production of early tomatoes:

Fixed costs per ha 340 000. Costs per
0.5 ha = 170 000

Variable costs
0.5 ha = 252 000

Total costs
0.5 ha 422 000 FCFA = \$1 172

Net average costs production/kg tomato
= $\frac{422\ 000}{21\ 000} = 20.10$ FCFA = \$0.06/kg

Example B Net production costs of a crop of onions on 1 ha

Technical Notes

- Variety: Violet de Galmi (main and late season)
- Nursery production of 400 000 seedlings on 450 m² in 45 days (15 Dec. - 30 Jan)
- Crop is grown for 100 days after transplanting in mid May.
- No phytosanitary treatments necessary
- Harvest in one lifting of bulbs
- Yield, 46t/ha
- Mechanical operations with use of one motor-cultivator.

Fixed costs (1 ha)

Equal to those calculated for tomatoes
= FCFA 350 000 = \$970/ha

Variable costs (1 ha). Total FCFA 397 500 = \$1104

(a) Mechanical operations = Total FCFA 87 000 = \$242

1 cultivation	20 000
1 harrowing	12 000
3 hoeings	55 000

(b) Inputs = total FCFA 62 500 = \$172

Plants	28 500
Fertilizers	18 000
Organic manure	16 000

(c) Irrigation = Total FCFA 145 000 = \$403
5 800 m³ x 25

(d) Labour = total FCFA 99 000 = \$275

Manure spreading 3 000

Fertilizer spreading 3 000

Planting
450 hrs x 150 67 500

Harvesting
150 hrs x 150 22 500

Transport
20 x 150 3 000

(e) Contingencies = Total FCFA 4 000 = \$11

Total net cost of production per ha

350 000 fixed + 397 500 variable costs =
FCFA 747 500 = \$207/ha.

Net cost of production of onions per kg
FCFA $\frac{747\ 500}{46\ 000}$ = 16.25 = \$0.045/kg

III. Small Scale Family Production

Small scale farms are probably the category most often involved in vegetable production in the areas of Africa under consideration, especially in the green belts surrounding the big cities.

The individual farms are often very small, frequently amounting to no more than 2 500 m². They usually employ no machinery for cultivation although in some areas animals are used for draught and water lifting. Motor pumps are common in some districts, but where water is available near the surface, it is often lifted manually. In the majority of cases, the farmer employs no labour outside the members of his own family and as he is often partly or entirely illiterate, the question of his calculating the costs of production does not arise.

However, studies undertaken at CDH permitted the quantification of the main operations on small farms, in terms of hours of labour and necessary inputs, and thus to calculate costs of production in general terms on the lines of the following examples. It is clear that fixed costs are limited to the depreciation and upkeep of the few installations involved - mainly the well and means of water lifting. In the absence of machinery, buildings and salaried staff, a nominal sum may be used to cover the fixed costs. For the variable costs, the value of labour can be estimated on the same basis as in previous examples. (150 FCFA/hour).

Example A Net production costs of a crop of tomatoes on 500m²

Technical notes

- Variety: early maturing, bush types.
- Nursery production: 3 m², 30 days
- Crop is grown for 110 days after transplanting
- Harvesting is spread over 40 days with pickings every 3 or 4 days.

Harvest

The crop was graded as follows:

Category I	850 kg
Category II	850 kg
Category III	500 kg
Unsaleable	<u>200 kg</u>
Total	2 450 kg

Total yield at rate of 49 t/ha
Commercial yield at rate of 45 t/ha.

Fixed costs = Total (nominal) FCFA 2 500 = \$7

Variable costs = Total FCFA 40 375 = \$112

(a) Labour = Total FCFA 32 625 = \$90.6

Nursery Sub total: 2 175 = \$6

Preparation and seed sowing
2 hrs x 150 = 300

Upkeep = 1 125

Watering = 750

Crop Sub total: 17 250 = \$48

Planting
25 hrs x 150 = 3 750

Upkeep
(50 hrs) = 7 500

Harvest
(25 hrs) = 3 750

Various
(15 hrs) = 2 250

Irrigation Sub Total: 13 200 = \$37

(b) Inputs = Total FCFA 7 780 = \$21.6

Seeds = 180
(15 gr @ 11.8 per gr.)

Fertilizers = 4 200

Organic manure = 2 400

Phytosanitary
products = 1 000

Total costs per crop:

FCFA

Fixed costs = 2 500

Variable costs = 40 375

Total 42 875 = \$119

Net production costs per kg of tomatoes =

$\frac{42\ 875}{2\ 250}$ = FCFA 19.05 = \$0.05/kg

Example B Net production costs of a crop of onions on 1 000 m²

Technical notes

- Variety: Violet de Galmi (main season)
- Nursery: 50 m² 45 days (15 Dec - 31 Jan)
- Crop is grown for 100 days following transplanting (1 Feb - 15 May)
- No phytosanitary treatments required
- Harvest: all bulbs lifted on same day

Yield 5 500 kg (on 500 m²)

Fixed costs Total FCFA 5 000 = \$14
(as in Example A)

Variable costs Total 78 050 = \$217

(a) Labour Total 64 350 = \$179

Nursery Sub Total 11 850 = \$33

Preparation and seed sowing
10 hrs x 150 = 1 500

Upkeep
8 hrs x 3 x 150 = 3 600

Watering
45 hrs x 150 = 6 750

Crop Sub Total 27 750 = \$77

Planting
50 hrs x 150 = 7 500

Upkeep
65 hrs x 150 = 9 750

Harvest
50 hrs x 150 = 7 500

Miscellaneous
20 hrs x 150 = 3 000

Irrigation Sub Total 24 750 = \$69

(b) Inputs Total FCFA 13 700 = \$38

Seed
420 gr. x 8.6 = 3 612

Fertilizers = 6 485

Organic manure = 3 600

Total cost

Fixed costs = 5 000
Variable = 78 050
Total 83 050 = \$231

Net costs of production per kg of onions $\frac{83\ 050}{5\ 500}$

= 15.10 FCFA = \$0.04/kg

REFERENCES

- ARNAUD, D. Horticulture dans le Cap-Vert
1970
- CENTRE POUR LE DEVELOPPEMENT DE L'HORTICULTURE, DAKAR, SENEGAL. Various
1972-85 publications on horticulture in Senegal.
- CENTRE FRANÇAIS DU COMMERCE EXTERIEUR, PARIS. Annual Statistics of French
imports and exports.
- CENTRE SENEGALAIS DU COMMERCE EXTERIEUR, DAKAR. Annual commercial statistics
for Senegal.
- CENTRE TECHNIQUES INTERPROFESSIONNEL POUR FRUITS ET LEGUMES, PARIS. Various
1973-80 studies on marketing and distribution of fruits and vegetables
in France and certain other European countries.
- FAO, ROME Monthly statistical bulletins. Rome
1976-80
- INSTITUT INTERNATIONAL DU FROID, PARIS. Recommendations for refrigerated
1967 storage of perishable products.
- INSTITUT SENEGALAIS DE RECHERCHE AGRONOMIQUE. Various studies on vegetable
1973-78 crops.
- INSTITUT UNIVERSITAIRE DE TECHNOLOGIE, DAKAR. Study of consumption budgets
1975 of the inhabitants of Dakar.
- MINISTERE DE L'AGRICULTURE Information service on market conditions.
1976-80 Paris, France.
- MINISTERE DE L'ECONOMIE ET DES FINANCES. The economic situation in Senegal.
1978 Dakar, Senegal.
- MARCHES EUROPEENS DES FRUITS ET LEGUMES. Weekly publications. Paris
1976-80
- SOCIETE CENTRALE POUR L'EQUIPEMENT DU TERRITOIRE INTERNATIONAL. Project
1968 for vegetable and rice production in Sine Saloum, Senegal.