

Gasification: An Alternative Process for Energy Recovery and Disposal of Municipal Solid Wastes

by
Alexander Klein

Advisor: Professor Nickolas Themelis

Submitted in partial fulfillment of the requirements for the degree of
M.S. in Earth Resources Engineering

Department of Earth and Environmental Engineering
Fu Foundation School of Engineering and Applied Science
Columbia University
May 2002

Research project sponsored by the Earth Engineering Center

www.columbia.edu/cu/earth

Gasification: An Alternative Process for Energy Recovery and Disposal of Municipal Solid Wastes

Alexander Klein

Executive Summary

Many cities are confronted with the problem of how to dispose of large quantities of municipal solid waste (MSW). Currently, landfills are the primary destination of waste receiving about 60 percent. However, with landfill tipping fees rising and their proven negative environmental impacts, cleaner and less costly alternatives for municipal waste disposal should be identified and implemented. High temperature energy recovery from MSW, known as waste-to-energy (WTE), is one such alternative. Waste-to-energy reduces the amount of materials sent to landfills, prevents air/water contamination, improves recycling rates and lessens the dependence on fossil fuels for power generation. The two most commercially viable forms of large scale WTE are combustion and gasification. Combustion of wastes is a well-established practice, while gasification is still in its early stages as a large-scale commercial industry. The purpose of this study was to assess MSW gasification technology as an alternative to combustion and also to examine its potential role in a zero-emission waste-to-energy (ZEWTE) process.

Currently, 33 million tons of MSW are combusted annually in the US, accounting for the energy equivalent of 1.6 billion gallons of fuel oil. During combustion, dioxins/furans (PCDD/PCDFs) form in the flue gases as they leave the combustion chamber and cool to 650-300°C. These dioxin/furan emissions are the primary catalyst for political and environmental opposition to the expansion of the WTE industry. Over the past decade, progress has been made in reducing dioxin/furan release from U.S. WTE plants lowering them from 4000 g/year in 1990 to 400 g/year in 1999. The most effective capturing techniques have been adsorption on activated carbon and the use of baghouse filters instead of electrostatic precipitators.

Gasification is a process that devolatilizes solid or liquid hydrocarbons, and converts them into a low or medium BTU gas. There are more than 100 waste gasification facilities operating or under construction around the world. Some plants have been operating commercially for more than five years. Gasification has several advantages over traditional combustion of MSW. It takes place in a low oxygen environment that limits the formation of

dioxins and of large quantities of SO_x and NO_x. Furthermore, it requires just a fraction of the stoichiometric amount of oxygen necessary for combustion. As a result, the volume of process gas is low, requiring smaller and less expensive gas cleaning equipment. The lower gas volume also means a higher partial pressure of contaminants in the off-gas, which favors more complete adsorption and particulate capture according to chemical thermodynamics: $\Delta G = -RT \ln(P_1/P_0)$. Finally, gasification generates a fuel gas that can be integrated with combined cycle turbines, reciprocating engines and, potentially, with fuel cells that convert fuel energy to electricity more than twice as efficiently as conventional steam boilers.

During gasification, tars, heavy metals, halogens and alkaline compounds are released within the product gas and can cause environmental and operational problems. Tars are high molecular weight organic gases that ruin reforming catalysts, sulfur removal systems, ceramic filters and increase the occurrence of slagging in boilers and on other metal and refractory surfaces. Alkalis can increase agglomeration in fluidized beds that are used in some gasification systems and also can ruin gas turbines during combustion. Heavy metals are toxic and bioaccumulate if released into the environment. Halogens are corrosive and are a cause of acid rain if emitted to the environment. The key to achieving cost efficient, clean energy recovery from municipal solid waste gasification will be overcoming problems associated with the release and formation of these contaminants.

The two gasification plants compared in this study utilize unique gas cleaning and gasification technologies to produce a synthesis gas suitable as fuel in a combined cycle turbine. The first plant assessed was designed by TPS Termiska. This process uses partial combustion with air at atmospheric pressure in a bubbling fluidized bed, followed by a circulating fluidized bed vessel containing dolomite that catalytically “cracks” the tars. The TPS system has been operating using 200 tonnes of “refuse-derived fuel” per day (RDF) since 1993 in Italy, sending its product gas to a closely coupled boiler. Battelle-Columbus Laboratories designed the second plant examined in this study. This system is an indirectly heated atmospheric pressure gasifier that avoids nitrogen in the fuel stream and produces a medium BTU gas. The Battelle plant has been licensed by the Future Energy Resources Company and is near the commercial stage for biomass gasification with a capacity of 200 tons/day.

Finally, this paper speculates on the viability of two processes in which gasification takes place in a hydrogen rich environment, known as hydrogasification. The first process generates a

methane rich gas that can be transported to a utility and combusted in a gas turbine. The second process reforms the synthesis gas on-site into a relatively pure hydrogen stream that is then fed to a fuel cell stack. This system utilizes the formation of calcium carbonate to provide heat for reforming while capturing carbon dioxide emissions. Both of these processes result in zero emissions to the atmosphere at the plant site.

This thesis concludes that waste gasification is a viable and cost competitive alternative to the combustion of RDF. However, the dearth of commercial gasification plants, and the operational difficulties experienced at several pilot and large scale demonstration plants, indicate that improvements in operating conditions and in gas cleaning technologies are necessary before gasification can be considered a reliable, off-the-shelf solution to the waste disposal problems of large municipalities.

Acknowledgements

The author gratefully acknowledges the financial support of Columbia University's Department of Earth and Environmental Engineering (Harry Krumb's School of Mines), and the Energy Answers Corporation. Special thanks are due to my advisor, Professor Nickolas Themelis. Professor Themelis's support, advice and extensive technical knowledge were invaluable in the creation of this document. Also, the inputs of Professor Klaus Lackner, Dr. Hanwei Zhang, Joe Didio, Ko Matsunaga, Claire Todd and Shefali Verma are greatly appreciated.

Alexander E Klein

New York City, May 2002

Table of Contents

<u>Section</u>	<u>Page</u>
1. Introduction	6
1.1 Gasification Process	6
2. Gasifier Designs	7
2.1 Fixed Beds	7
2.1.1 Downdraft	7
2.1.2 Updraft	8
2.1.3 Slagging Fixed Beds	9
2.2 Fluidized Beds	10
2.2.1 Bubbling Fluidized Beds	11
2.2.2 Circulating Fluidized Beds	12
3. MSW as an Energy Feedstock	13
4. Product Gas	16
4.1 Tars	16
4.2 Halogens/Acid Gases	19
4.3 Heavy Metals	20
4.4 Alkalis	21
5. Power Generation	22
5.1 Integrated Gasification Combined Cycle (IGCC)	23
5.2 Fuel Cells	23
6. Description of Commercial Technologies Considered	25
6.1 TPS Termiska Processer – AB	26
6.2 Battelle Columbus Laboratories	27
6.3 Essex County, NJ	29
6.4 SEMASS, Massachusetts	30
7. Technoeconomic Comparison	30
7.1 Energy Comparison	31
7.2 Capital Costs	33
7.3 Operating Costs	34
8. Gasification Technologies for the Future	36
8.1 Hydrogasification of Waste with Methane Export	37
8.2 Zero Emission Waste-To-Energy	38
Conclusions	44
References	47

1. Introduction

Many cities are confronted with the problem of how to discard large quantities of municipal solid waste (MSW). Currently, landfills are the primary means of MSW disposal taking in approximately 60% of the residential garbage generated in the US (SCS Engineers, 1992). However, rising landfill tipping fees and their proven negative environmental impacts (Denison, 1996; Miranda and Hale 1999), have led to the search for cleaner and less costly alternatives for municipal waste disposal. High temperature energy recovery from MSW, known as waste-to-energy (WTE), is one such alternative. Waste-to-Energy reduces the amount of materials sent to landfills, can prevent air/water contamination, improves recycling rates and lessens the dependence on fossil fuels for power generation. The two most commercially viable forms of large scale WTE are combustion and gasification. Combustion is a well-established practice, while gasification is still in its early stages as a large-scale commercial industry. The purpose of this study was to assess MSW gasification technology as an alternative to combustion and also to examine its potential role in a zero-emission waste-to-energy (ZEWTE) process.

1.1. Gasification Process

Gasification is a thermochemical process that generates a gaseous, fuel rich product. Regardless of how the gasifier is designed, two processes must take place in order to produce a useable fuel gas. In the first stage, pyrolysis releases the volatile components of the fuel at temperatures below 600°C (1112°F). The by-product of pyrolysis that is not vaporized is called char and consists mainly of fixed carbon and ash. In the second gasification stage, the carbon remaining after pyrolysis is either reacted with steam or hydrogen or combusted with air or pure oxygen. Gasification with air results in a nitrogen-rich, low BTU fuel gas. Gasification with pure oxygen results in a higher quality mixture of carbon monoxide and hydrogen and virtually no nitrogen. Gasification with steam is more commonly called “reforming” and results in a hydrogen and carbon dioxide rich “synthetic” gas (syngas). Typically, the exothermic reaction between carbon and oxygen provides the heat energy required to drive the pyrolysis and char gasification reactions. (EREN, 2002)

The basic gasification reactions that must be considered are:



- 2) $C + H_2O \rightarrow CO + H_2$ +131 kJ/mol (endothermic)
- 3) $C + CO_2 \rightarrow 2CO$ +172 kJ/mol (endothermic)
- 4) $C + 2H_2 \rightarrow CH_4$ -74 kJ/mol (exothermic)
- 5) $CO + H_2O \rightarrow CO_2 + H_2$ -41 kJ/mol (exothermic)
- 6) $CO + 3H_2 \rightarrow CH_4 + H_2O$ -205 kJ/mol (exothermic)

(Krigmont, 1999)

All of these reactions are reversible and their rates depend on the temperature, pressure and concentration of oxygen in the reactor.

2. Gasifier Designs

The reactors used for the gasification process are very similar to those used in combustion processes. The main reactor types are fixed beds and fluidized beds.

2.1 Fixed Beds

Fixed bed gasifiers typically have a grate to support the feed material and maintain a stationary reaction zone. They are relatively easy to design and operate, and are therefore useful for small and medium scale power and thermal energy uses. It is difficult, however, to maintain uniform operating temperatures and ensure adequate gas mixing in the reaction zone. As a result, gas yields can be unpredictable and are not optimal for large-scale power purposes (i.e. over 1 MW). The two primary types of fixed bed gasifiers are updraft and downdraft.

2.1.1 Downdraft

Downdraft gasifiers (Figure 1) have a long history of use in cars and buses to produce a wood-derived gas for internal combustion engines. In a downdraft gasifier, air is introduced into a downward flowing packed bed or solid fuel stream and gas is drawn off at the bottom. The air/oxygen and fuel enter the reaction zone from above decomposing the combustion gases and burning most of the tars. As a result, a simple cooling and filtration process is all that is necessary to produce a gas suitable for an internal combustion engine. Downdraft gasifiers are not ideal for waste treatment because they typically require a low ash fuel such as wood, to avoid clogging. In addition, downdrafts have been difficult to scale up beyond 1MW because of the geometry of their throat section.

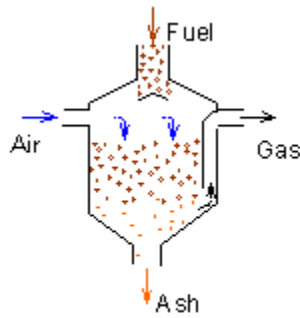

Downdraft gasifier

Figure 1

Source: Scottish Agricultural Web Site 2002

2.1.2 Updraft

In updraft gasifiers, the fuel is also fed at the top of the gasifier but the airflow is in the upward direction (Figure 2). As the fuel flows downward through the vessel it dries, pyrolyzes, gasifies and combusts. The main use of updraft gasifiers has been with direct use of the gas in a closely coupled boiler or furnace. Because the gas leaves this gasifier at relatively low temperatures, the process has a high thermal efficiency and, as a result, wet MSW containing 50% moisture can be gasified without any predrying of the waste. Moreover, size specifications of the fuel are not critical for this gasifier. Ash is removed from the bottom, where the gasification air and steam are introduced. However the product gas exits at low temperatures, (typically less than 500°C), yielding a tar rich gas. For heating applications, this is not a problem as long as blocking of pipes can be overcome. However, the high tar content makes this gasifier an unlikely candidate for power applications because of the extensive tar cleaning required.

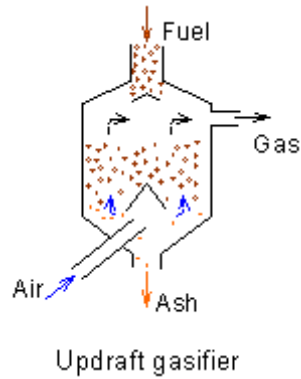

Figure 2

Source: Source: Scottish Agricultural Web Site 2002

2.1.3 Slagging Fixed Beds

One particular updraft gasifier that has commercial potential for gasifying MSW is the high-pressure, oxygen- injected slagging fixed bed (Figure 3). Originally developed for the gasification of coal briquettes, these units operate at a maximum temperature of around 3000° F, above the grate and at pressures of approximately 450 psi. In theory, the high temperatures crack all tars and other volatiles into non-condensable, light gases. Also under these conditions, the ash becomes molten and is tapped out, as is done in iron blast furnaces. Dynecology, Inc. has developed a version of the Lurgi/British Gas designed slagging gasifier for use with a briquetted fuel consisting of one part MSW and one part coal. This system was demonstrated at a pilot plant at Columbia University (Schultz, 2000). The potential problems for such a system are maintaining the furnace for extended periods of time at such high temperatures and pressures, overcoming blockages in the outlet by accretions, and tapping a slag from the bottom of the furnace.

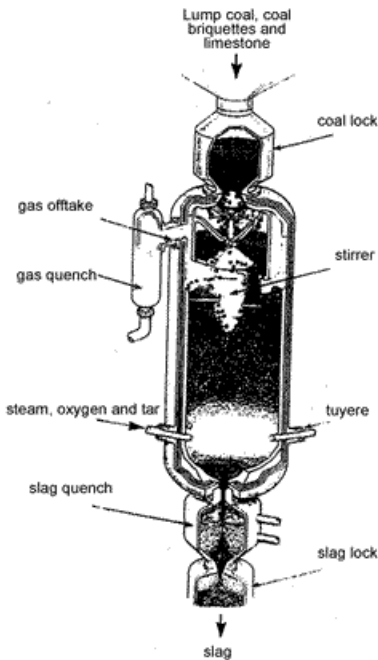

Figure 3. Lurgi Slagging Fixed Bed Gasifier for Mixed MSW & Coal
 Source: Schultz 2000

2.2 Fluidized Beds

Fluidized beds offer the best vessel design for the gasification of MSW. In a fluidized bed boiler, inert material and solid fuel are fluidized by means of air distributed below the bed. A stream of gas (typically air or steam) is passed upward through a bed of solid fuel and material (such as coarse sand or limestone). The gas acts as the fluidizing medium and also provides the oxidant for combustion and tar cracking. The fluidized bed behaves like a boiling liquid and has some of the physical characteristics of a fluid. Waste is introduced either on top of the bed through a feed chute or into the bed through an auger.

Fluidized-beds have the advantage of extremely good mixing and high heat transfer, resulting in very uniform bed conditions and efficient reactions. Fluidized bed technology is more suitable for generators with capacities greater than 10 MW because it can be used with different fuels, requires relatively compact combustion chambers and allows for good operational control (Morris, 1998). Fluidized bed gasifiers have been the focus of appreciable research and development and there have been several commercialization projects over the last ten years. The

two main types of fluidized beds for power generation are bubbling and circulating fluidized beds.

2.2.1 Bubbling Fluidized Bed (BFB)

In a BFB, the gas velocity must be high enough so that the solid particles, comprising the bed material, are lifted, thus expanding the bed and causing it to bubble like a liquid. A bubbling fluidized bed reactor typically has a cylindrical or rectangular chamber designed so that contact between the gas and solids facilitates drying and size reduction (attrition). The large mass of sand (thermal inertia) in comparison with the gas stabilizes the bed temperature (Figure 4).

The bed temperature is controlled to attain complete combustion while maintaining temperatures below the fusion temperature of the ash produced by combustion. As waste is introduced into the bed, most of the organics vaporize pyrolytically and are partially combusted in the bed. The exothermic combustion provides the heat to maintain the bed at temperature and to volatilize additional waste. The bed can be designed and operated by setting the feed rate high relative to the air supply, so that the air rate is lower than the theoretical oxygen quantity needed for full feed material oxidation. Under these conditions, the product gas and solids leave the bed containing unreacted fuel. The heating value of the gases and the char increases as the air input to the bed decreases relative to the theoretical oxygen demand. This is the gasification mode of operation. Typical desired operating temperatures range from 900° to 1000 °C.

Bubbling fluidized-bed boilers are normally designed for complete ash carryover, necessitating the use of cyclones and electrostatic precipitators or baghouses for particulate control.

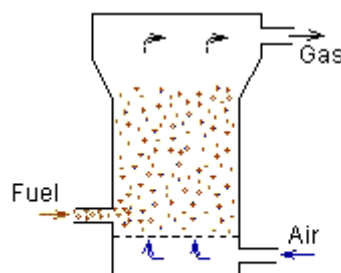

Bubbling fluidised bed gasifier

Figure 4

Source: Scottish Agricultural Web Site 2002

2.2.2 Circulating Fluidized Bed (CFB)

As the gas velocity increases in a turbulent fluidized chamber, the bed of solids continues to expand, and an increasing fraction of the particles is blown out of the bed. A low efficiency particle collector can be used to capture the larger particles that are then returned to the bed. This suspended-combustion concept is called a circulating fluid bed. A circulating fluid bed is differentiated from a bubbling fluid bed in that there is no distinct separation between the dense solids zone and the dilute solids zone (Figure 5). Circulating fluid bed densities are on the order of 560 kg/m, as compared to the bubbling bed density of about 720 kg/m (Babcock and Wilcox 1992). To achieve the lower bed density, air rates are increased from 1.5-3.7 m/s (5 - 12 ft/s) of bubbling beds to about 9.1 m/s (30 ft/s) (Hollenbacher 1992). The particle size distribution, attrition rate of the solids and the gas velocity determine the optimal residence time of the solids in a circulating fluid bed.

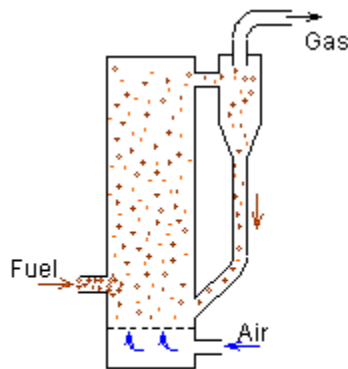

Circulating fluidised bed gasifier

Figure-5

Source: Scottish Agricultural Web Site 2002

A major advantage of circulating fluid bed boilers is their capacity to process different feedstocks with varying compositions and moisture contents. As with bubbling-bed boilers, bed agglomeration is a concern. High alkaline content fuels cause particles in the bed to agglomerate, eventually defluidizing the system.

In general, gasification technology is selected on the basis of available fuel quality, capacity range, and gas quality conditions. Table 1 shows the thermal capacity ranges for the main gasifier designs.

Table 1. Thermal Capacity of Different Gasifier Designs

Gasifier Design	Fuel Capacity
Downdraft	1kW – 1MW
Updraft	1.1MW – 12MW
BFB	1MW-50MW
CFB	10MW-200MW

Source: Morris, 1998

Larger capacity gasifiers are preferable for treatment of MSW because they allow for variable fuel feed, uniform process temperatures due to highly turbulent flow through the bed, good interaction between gases and solids, and high levels of carbon conversion (EREN, 2002).

3. MSW as an Energy Feedstock

MSW is a negatively priced, abundant and essentially renewable feedstock. Currently, about 220 million tons per year or 0.8 tons of MSW per capita are generated in the US. The composition of these wastes can vary from one community to the next, but the overall differences are not substantial. Table 2 shows two separate estimates of the typical US MSW composition.

Table 2. Comparison of US MSW Composition (%)

	Tchobanoglous, et al. 1993	EPA 530-S-97-015, 1997
Paper	34	33.7
Cardboard	6	5.5
Plastics	7.0	9.1
Textiles	2.0	3.6
Rubber, Leather, “other”	1.0	2.0
Wood	2.0	7.2
Yard Wastes	2.0	14.0
Food Wastes	9.0	9.0
Glass and Metals	17.5	13.1

Source: Columbia, 2001

The heat content of raw MSW depends on the concentration of combustible organic materials in the waste and its moisture content. On the average, raw MSW has a heating value of roughly 13,000 kJ/kg or about half that of bituminous coal (Smoot & Smith, 1985). The moisture content of raw MSW is 20% on average. Figure-6 shows how the heating values of MSW and its components change with moisture content. Points shown are experimental values, and solid lines show the thermochemical calculations for various organic compounds. (Themelis, Kim &

Brady, 2002). This table shows that mixed plastics and rubber contribute the highest heating values to municipal solid waste. Moist food and yard wastes have the lowest heating value and are better suited for composting, rather than for combustion or gasification.

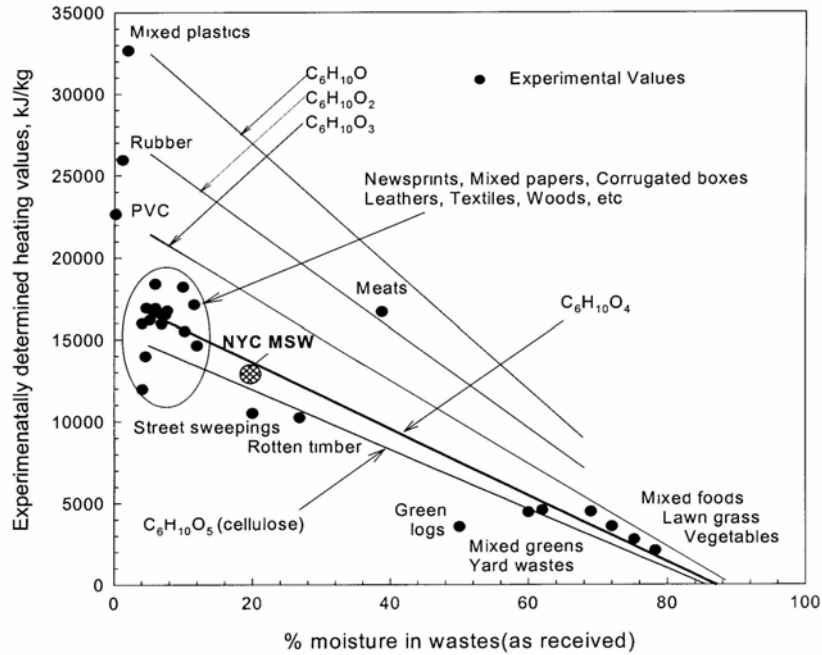

Figure 6. Effect of moisture on heating value of MSW materials

Source: Themelis, Kim & Brady 2002

Figure-7 shows the heating values of various feedstocks including raw MSW.

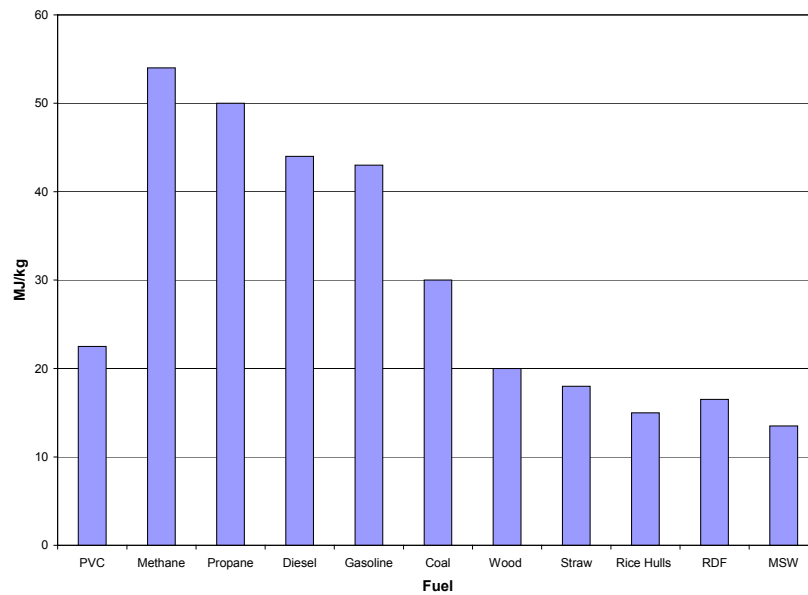

Figure 7. Heating Values of Various Fuels

Source: ECN Website (2002)

A study by Themelis and Kim (2002) modeled the thermodynamic properties of the combustible components of municipal solid waste. They calculated the following molecular formulas for the key components of MSW as follows:

Mixed paper:	$C_6H_{9.6}O_{4.6}N_{0.036}S_{0.01}$
Mixed plastics:	$C_6H_{8.6}O_{1.7}$
Mixed food wastes:	$C_6H_{9.6}O_{3.5}N_{0.28}S_{0.2}$
Yard wastes:	$C_6H_{9.2}O_{3.8}N_{0.01}S_{0.04}$

Based on the data shown by Tchobanoglous (1993) in Table 2, Themelis and Kim (2002) also showed that the hydrocarbon formula that most closely approximated the mix of organic wastes in MSW is $C_6H_{10}O_4$.

The ash composition and concentration of a fuel can result in agglomeration in the gasification vessel and that can lead to clogging of fluidized beds and increased tar formation. In general, no slagging occurs with fuels having an ash content below 5%. MSW has high ash content (10-12%), versus coal ash (5-10%) and wood wastes (1-5% ash).

Raw MSW can be converted into a better fuel for power generation by making it more homogeneous. Several waste-to-energy plants create a refuse-derived fuel (RDF), through the separation of inert materials, size reduction, and densifying. RDF plants remove recyclable or non-combustible materials and shred the remaining trash into a homogenous fuel. The densified material is more easily transported, stored, combusted and gasified than raw MSW. The size of a particle affects the time required to combust. Therefore shredded RDF, which typically has a diameter of 6 inches or less, reduces the required residence time in a fluidized bed and allows for more complete combustion. During gasification, the use of a RDF permits a lower air-to-fuel ratio and lowers bed temperatures. Under these conditions, a very large fraction of the organic refuse component breaks down into volatile components. In addition, the processing of MSW to RDF can include the addition of calcium compounds that reduce HCl emissions and may reduce trace elements concentration by one to two orders of magnitude.

Producing a true RDF cost-effectively remains one of the most difficult tasks in thermochemical conversion of solid waste. It involves a large amount of mechanical processing and close supervision, which greatly impact operating costs and can account for as much as 50% of the total plant capital costs. If too much metal and glass are allowed to pass through into the

gasifier, the heating value of the RDF decreases and there are constant operational problems and plant shutdowns making the plants costly and unreliable. Therefore, waste gasification will be most successful in communities where there is good recycling practice. It should be noted that energy recovery from waste is not in competition with recycling, but rather its complement in a sound waste management plan. Table 3 below shows the typical specifications of an RDF feed for a gasification system.

Table 3. RDF feed specifications for Gasification

Diameter	10 to 15 mm (.4 to .6 in)
Length	50 to 150 mm (2 to 6 in)
Bulk Density	500 to 700 kg/m ³ (31 to 42 lb/ft ³)
Net Calorific Value	16-18 MJ/kg (6980 to 7850 Btu/lb.)
Moisture	6-10 %
Volatile Matter	71.1 %
Fixed Carbon	11.4 %
Sulfur	.5 %
Chlorine	.4 to .6%
Total non-combustibles	11 %

Source: Niessen et al, 1996

4. Product Gas

The product gas resulting from waste gasification contains various tars, particulates, halogens, heavy metals and alkaline compounds depending on the fuel composition and the particular gasification process. The downstream power generating and gas cleaning equipment require removal of these contaminants. The specific fuel requirements for end-use technologies vary significantly and will be discussed in a later section.

4.1 Tars

When MSW is gasified, significant amounts of tar are produced (between .1 and 10% of the product gas, Milne & Evans, 1998). Tar is considered to be any condensable or incondensable organic material in the product stream, and is largely comprised of aromatic compounds. If tar is allowed to condense (condensation temperatures range from 200° to 600°C) it can cause coke to form on fuel reforming catalysts, deactivate sulfur removal systems, erode compressors, heat exchangers, ceramic filters, and damage gas turbines and engines.

Incondensable tars can also cause problems for advanced power conversion devices, such as fuel cell catalysts and complicate environmental emissions compliance.

The amount and composition of tars are dependent on the fuel, the operating conditions and the secondary gas phase reactions. Elliot (1998) classified tars into three primary categories based on the reaction temperature ranges in which they form (Table 4). This categorization is important for assessing gasification processes, as the effectiveness of conversion and/or removal schemes depend greatly on the specific tar composition and their concentration in the fuel gas.

Table 4. Categories of Tars

Category	Formation Temperature	Constituents
Primary	400-600°C	Mixed Oxygenates, Phenolic Ethers
Secondary	600-800°C	Alkyl Phenolics, Heterocyclic Ethers
Tertiary	800-1000°C	Polynucleic Aromatic Hydrocarbons

Source: Milne & Evans, 1998

The primary tars are mixed oxygenates and are a product of pyrolysis. As gasification takes over at higher temperatures, the primary products thermally decompose to lesser amounts of secondary and tertiary products and a greater quantity of light gases. Tertiary products are the most stable and difficult to crack catalytically. Provided that there is adequate gas mixing, primary and tertiary tars are mutually exclusive in the product gas. Both lignin and cellulose in the fuel result in the formation of tertiary tar compounds. However, lignin rich fuels have been shown to form heavier tertiary aromatics more quickly (Evans & Milne,1997).

Both physical and chemical treatment processes can reduce the presence of tar in the product gas. The physical processes are classified into wet and dry technologies depending on whether water is used. Various forms of wet or wet/dry scrubbing processes are commercially available, and these are the most commonly practiced techniques for physical removal of tar. Wet physical processes work via gas tar condensation, droplet filtration, and/or gas/liquid mixture separation. Cyclones, cooling towers, venturis, baghouses, electrostatic precipitators, and wet/dry scrubbers are the primary tools. The main disadvantage to using wet physical processes is that the tars are just transferred to wastewater, so their heating value is lost and the water must be disposed of in an environmentally acceptable way. Wastewater that contains tar is classified as hazardous waste; therefore, its treatment and disposal can add significantly to the over-all cost of the gasification plant.

Dry tar removal using ceramic, metallic, or fabric filters are alternatives to wet tar removal processes. However, at temperatures above 150°C, tars can become “sticky” causing operational problems with such barriers. As a result, such dry tar removal schemes are rarely implemented. Injection of activated carbon in the product gas stream or in a granular bed may also reduce tars through adsorption and collection with a baghouse. The carbonaceous material containing the tars can be recycled back to the gasifier to encourage further thermal and catalytic decomposition.

Chemical tar treatment processes are the most widely practiced in the gasification industry. They can be divided into four generic categories: thermal, steam, partially oxidative, and catalytic processes. Tars can be removed from the gas stream in the fuel reformer or by separate hot gas tar removal catalysts. Thermal destruction has been shown to break down aromatics at temperatures above 1,000°C. However, such high temperatures can have adverse effects on heat exchangers and refractory surfaces due to ash sintering in the gasification vessel. The introduction of steam does encourage reformation of primary and some secondary oxygenated tar compounds, but has little effect on tertiary aromatics.

The presence of oxygen during gasification has been shown to accelerate both the destruction of primary tar products and the formation of aromatic compounds from the phenolic compounds. Evans and Milne 1997 reported the amount of aromatics formed by thermal cracking increases in the presence of low oxygen environments (less than 10%) of the gas. Only above 10% was a decrease in the amount of tertiary tars observed. A net increase in the CO level could also be observed as the product from the oxidative cracking of tars. It was also shown that benzene levels were not affected by the presence of oxygen.

The most widely used and studied tar cracking catalyst is dolomite (a mixture of $MgCO_3$ and $CaCO_3$). Dolomite has been shown to work more effectively when placed in a vessel downstream from the gasifier and in a low carbon monoxide environment. When used in the gasifier, the catalysts accumulate a layer of coke rapidly causing them to lose their effectiveness.

The specific tar conversion and destruction schemes chosen depend on the nature and composition of the tars present, as well as the intended end-use equipment. For a closely coupled lime-kiln or well-designed combustion boiler, tar clean-up is not critical. However, advantages of tar cracking in the product gas include increased thermal-to-electrical efficiencies, lower emissions, and lower effluent treatment costs. The lack of effective and inexpensive tar

removal processes has remained the primary barrier to widespread commercialization of biomass and MSW integrated gasification combined cycle (IGCC) power generation.

4.2 Halogens/Acid Gases

The principal combustion products of halogens are either hydrogen halides, (i.e. HCl, HBr) or metal halides (i.e. HgCl) that leave the fuel bed along with the flue gases. In the gasification of pure MSW, HCl is the prevailing chlorine product. Bromine (Br) seems to accumulate to a greater extent in the bottom ash. Typical Br content in municipal solid waste, however, is very low (30 - 200 mg/kg), as compared to Cl (3,000-6,000 mg/kg). Chlorine is mainly transformed to HCl and bromine to HBr, both of which are easily removed in all modern scrubbing systems and hence cause no emission problems.

A significant advantage of gasification is that it takes place in a reducing atmosphere, which prevents sulfur and nitrogen compounds from oxidizing. As a result, most elemental nitrogen or sulfur in the waste stream end up as H₂S, COS, N₂ or ammonia rather than SO_x and NO_x. The reduced sulfur species can then be recovered as elemental sulfur at efficiencies between 95 and 99%, or converted to a sulfuric acid by-product. The typical sulfur removal and recovery processes used to treat the raw syngas are the same as commercially available methods used in other industrial applications, such as oil refining and natural gas recovery. One commonly used process to remove sulfur compounds is the selective-amine technology where reduced sulfur species are removed from the syngas using an amine-based solvent in an absorber tower. Physical solvents are also used. The reduced sulfur species removed in the solvent stripper are converted to elemental sulfur in a sulfur recovery process such as the Selectox/Claus process (Orr and Maxwell, 2000).

When MSW is gasified, nitrogen in the fuel is converted primarily to ammonia, which when fired in a turbine or other combustion engine forms nitrogen oxides, a harmful pollutant. Removal of ammonia and other nitrogen compounds in the product gas prior to combustion can be accomplished with wet scrubbers or by catalytic destruction. Catalytic destruction of ammonia has been studied with dolomite and iron based catalysts. This technique is of interest because tars are simultaneously decomposed (cracked) to lower weight gaseous compounds. Destruction of 99% of the ammonia in the gas stream has been demonstrated with these catalysts. If the product gas is cooled first, wet scrubbing with lime is also an effective ammonia removal

technique. Gasification processes that use pure oxygen, steam or hydrogen, will only have nitrogen contents brought in through the fuel stream. Typical MSW has a nitrogen content of less than 1% by mass.

4.3 Heavy Metals

Trace amounts of metals and other volatile materials are also present in MSW. These are typically toxic substances that pose ecological and human health risks when released into the environment. The mass balance in Table 5, based on fly ash and flue gas data collected at the SEMASS RDF plant in Massachusetts, shows that RDF contains approximately 1.25, 4.2, and 156 ppms of mercury, cadmium and lead (Pb) respectively. These values are consistent with other reports (Zevenhoven, Kilpinen 2001).

Table 5. A Mass Balance of 3 Trace Metals in MSW combusted at SEMASS

	Flue Gas	Fly Ash	Total in MSW	Removal %
Mercury*	.043	1.207	1.25	96.5
Cadmium*	.011	4.61	4.62	99.7
Lead*	.254	155.8	156.1	99.8

*kg per thousand tons of MSW

Data Reported by SEMASS, Rochester MA

This assumes Hg, Cd and Pb completely volatilize and do not end up in the bottom ash

Mercury found in the fly ash and flue gas is likely to be in the elemental form. In the event of oxidizing gasification reactions, the presence of HCl and Cl₂ can cause some of the elemental mercury to form HgCl₂ at 300-400 by:

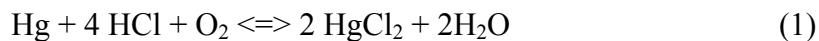

Volatilized heavy metals that are not collected in the gas cleanup system can bioaccumulate in the environment (Gregory, 2001) and can be carcinogenic and damage human nervous systems. For this reason, mercury must be removed from the product gas prior to being combusted. However, the MSW combustion industry has demonstrated extraordinary success removing heavy metals with activated carbon, baghouses filters and electrostatic precipitators. As shown in Table 5, removal efficiencies at the SEMASS plant exceed 95% using activated carbon injection and baghouse filters. Even greater removal can be expected from gasification

plants, because heavy metals will have a higher partial pressure in the product gas, which will encourage greater adsorption during cooling according to the thermodynamic relationship: $\Delta G = -RT \ln(P_1/P_0)$.

4.4 Alkalies

Alkali compounds in biomass and MSW gasification ash can cause serious slagging in the boiler or gasification vessel. Sintered or fused deposits can form agglomerates in fluidized beds and on grates. Potassium sulfates and chlorides have been found to mix with flue dust and condense on the upper walls of the furnace. The primary elements causing alkali slagging are potassium, sodium, chlorine and silica. Sufficient volatile alkali content in a feedstock that reduces fusion temperature and promotes slagging begins with a fuel concentration of 0.17 to 0.34kg/GJ. At higher levels, noticeable fouling occurs (Miles et al, 1996).

Alkali deposit formation is a result of particle impaction, condensation, thermophoresis, and chemical reaction. Unfortunately, most deposits occur subsequent to combustion and cannot be predicted solely by analysis of the fuel composition. A study by Korsgren et al, 1999, showed that there are two characteristic temperature intervals for alkali metal emission. A small fraction of the alkali content is released below 500°C and is attributed to the decomposition of the organic structure. Another fraction of alkali compounds is released from the char residue at temperatures above 500°C.

The presence of alkali metals in combustion and gasification processes is known to cause several operational problems. Eutectic alkali salts mixtures with low melting points are formed on the surfaces of fly ash particles or the fluidized bed material. The sticky particle surfaces may lead to the formation of bed material agglomerates, which must be replaced by fresh material. The deposition of fly ash particles and the condensation of vapor-phase alkali compounds on heat exchanging surfaces lower the heat conductivity and may eventually require temporary plant shutdowns for the removal of deposits.

The challenges of removing alkali vapor and particulate matter are closely connected, since alkali metal compounds play an important role in the formation of new particles as well as the chemical degradation of ceramic barrier filters used in some hot gas cleaning systems. The most straightforward way of reducing the alkali content from the fuel gas prior to the gas turbine is to cool the gas and condense out the alkali compounds. If the gas cooler is kept at 400-500°C,

the alkali concentration has been shown to approach the gas specifications for gas turbines, i.e. 0.1 ppm (wt) and below. Although effective, the energy loss makes this method less attractive. There has been extensive research on developing ceramic filters followed by high temperature “getter beds” that may be used for capturing alkali compounds while simultaneously removing other particulate matter from the hot product gas produced in high pressure, high temperature gasifiers. An ideal high temperature “getter” material would have the characteristics of rapid adsorption rates, high loading capacity, transformation of alkali into a less corrosive form, and irreversible adsorption to prevent the release of adsorbed alkali during process fluctuations. Such materials include bauxite (aluminium ore) and emathlite (roughly 70% SiO₂ and 10% Al₂O₃, with the remainder composed of smaller amounts (<5%) of MgO, Fe₂O₃, TiO₂, CaO, K₂O, and Na₂O), and have been shown to reduce alkali species below the specifications for the operation of gas turbines (Turn, et al 2000). However, more research needs to be done to determine the impact of carbonaceous tars on such “getter beds”. If tar concentrations are relatively high in the product gas they are likely to cause significant fouling. As a result, high temperature gas cleanup depends on sufficient tar cracking upstream.

Table 6. Alkali Concentration in Some Fuels (mg/kg, ppmw, dry)

	Coal	Scrap Tires	Wood Saw Dust	RDF	Straw
Sodium (Na)	100-500	200-600	40	3,000-5,000	100-5000
Potassium (K)	50-3,000	200-600	500	2,000-3,000	5,000-10,000
Chlorine (Cl)	Na	Na	Na	3000-6000	Na

Source: Zevenhoven & Kilpinen, 2001

Source of Chlorine: ASME, 2002

5.0 Power Generation

Power generating equipment that can be integrated with a MSW gasification process include steam boilers, reciprocating engines, combined cycle turbines and fuel cells.

Combustion boilers have the highest tolerance for tars and other impurities but are also the least efficient (about 31%) from the point of view of thermal energy conversion to electricity. In contrast, combined cycle turbines, reciprocating engines and fuel cells offer operational

efficiencies of 40%+. The following two sections describe combined cycle turbines and fuel cells as potential components in an integrated MSW gasification system.

5.1 Integrated Gasification Combined Cycle IGCC

The Integrated Gasification Combined Cycle (IGCC) concept is based on the combination of a gasification system with a gas turbine and a steam cycle and has the potential to provide thermal energy to power conversion efficiencies exceeding 40 %.

Critical for the success of the IGCC is the maintenance of the gas turbine. The IGCC turbine's lifetime can be limited due to erosion and high temperature corrosion caused by impaction of particles and deposition of impurities such as alkali metals in the product gas. Corrosion of the turbine blades is accelerated by formation of low melting eutectic salt mixtures, of which alkali sulfates are believed to be important constituents. Turbine manufacturers have set specifications for the maximum tolerable alkali metal concentration of the fuel gas to be less than 0.1 ppm of the fuel by weight. These specifications are often based on operating experience with fossil fuels (ETIS 2001).

Table 7. Gas Turbine Specifications for Trace Elements in a Product Gas

Element	Allowable Concentration	Motivation
Potassium	<1 ppm	Hot Corrosion
Sodium	<1 ppm	Hot Corrosion
Lead	1 ppm	Hot Corrosion
Zinc	1 ppm	Fouling
Tar	<0.5 mg/m ³	Hot Corrosion
Particulates	< 0.1 ppm	Fouling

Source: Spliethoff, 2001

5.2 Fuel Cells

The best type of fuel cell for integration with a MSW gasifier is the tabular solid oxide fuel cell (TSOFC) (Figure 8). The electrolyte used is a solid, nonporous metal oxide, usually Y₂O₃ –stabilized ZrO₂. The cell operates at 1000°C where ionic conduction by oxygen ions takes place. Typically, the anode is Co-ZrO₂ or Ni-ZrO₂ cermet, and the cathode is Sr-doped La MnO₃. The solid ceramic construction of the cell reduces the hardware corrosion problems characterized by the liquid electrolyte cells and has the advantage of being impervious to gas

cross-over from one electrode to the other. The kinetics of the cell are fast, and any CO left in the product gas is a directly useable fuel. At operating temperatures over 900°C, the syngas can be reformed within the cell. For TSOFCs, carbon does not deposit on the fuel cell electrode so the primary poisons are alkaline compounds and sulfur. SOFCs can tolerate only 1-ppm H₂S and 1-ppm halides in the fuel gases. Ammonia can be tolerated up to 0.5 vol% (Fuel Cell Handbook, 2000).

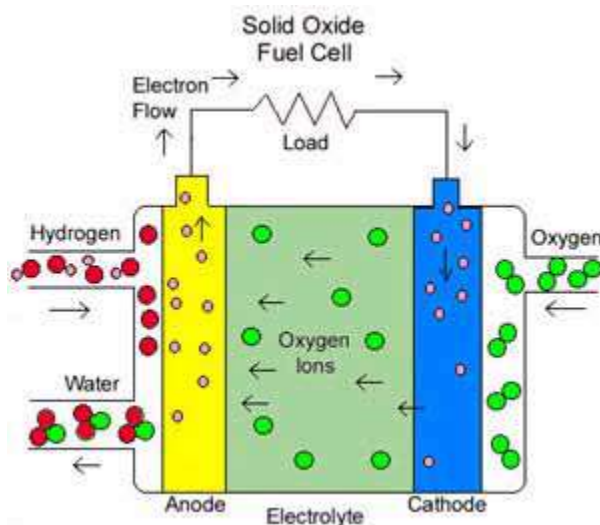

Figure 8

Source: americanhistory.si.edu/csr/fuelcells/images/sofc4.jpg

The disadvantage of TSOFCs, as compared to other high temperature fuel cells, is that sealing between cells is difficult in the flat plate configurations. The TSOFC also exhibits a high electrical resistivity in the electrolyte; this results in a lower voltage than the Molten Carbonate Fuel Cell (MCFC) by approximately 100mV (Fuel Cell Handbook, 2000).

Molten carbonate fuel cells (MCFCs) also offer a potential alternative for use with a MSW derived syngas. MCFCs operate at lower temperatures (500-700°C) than SOFC systems but offer similar fuel flexibility and tolerance to impurities. SOFC systems are tolerant of CO, CO₂, and hydrocarbons. Hydrocarbon fuels are usually reformed in an external reforming unit and coking of the Ni-based catalysts is a concern.

Because current gas cleaning techniques have been unable to capture 100% of the contaminants in the syngas, especially sulfur, an integrated waste gasifier fuel cell concept requires a fuel cell that can accept hydrogen with traces of sulfur, mercury, ammonia and other

chemicals from the feedstock. Such SOFCs have not yet been designed or manufactured for operation with synthesis gas. So, until more tolerant fuel cells or more advanced gas cleaning technologies have been developed, integrated waste gasifiers with fuel cells will be impractical.

Table 8. Product Gas Purity Requirements for Various Fuel Cells

Gas Species	Proton Exchange Membrane	Alkaline	Phosphoric Acid	Molten Carbonate	ITSOFC	Tabular Solid-Oxide
H₂	Fuel	Fuel	Fuel	Fuel	Fuel	Fuel
CO	Posion (50 ppm per stack)	Posion	Poison (<.5%)	Fuel	Fuel	Fuel
CH₄	Diluent	Poison	Diluent	Diluent	Fuel	Fuel
CO₂ & H₂O	Diluent	Posion	Diluent	Diluent	Diluent	Diluent
S as (H₂S & COS)	?	Posion	Poison (<50ppm)	Posion (<.5ppm)	Poison	Poison (<1.0 ppm)
Halogens (HCL)		Poison	Posion	Poison <1 ppm		Poison (<1 ppm)
Alkali Metals				Electrolyte loss 1-10 ppm		

Source: (Dayton, 2001)

6. Description of Commercial Technologies Considered

This paper compares the costs, environmental impacts and technical feasibility of the following advanced waste gasification and combustion technologies:

- 1) TPS Termiska- CFB atmospheric gasification with downstream dolomite tar cracker
- 2) Battelle indirectly heated gasifier
- 3) Essex County Mass Burn Combustion Plant
- 4) SEMASS RDF Combustion Plant

These technologies are considered to be amongst the most viable commercial technologies for converting MSW to energy on a large scale.

6.1 TPS Termiska Processer –AB

TPS Termiska is a Swedish research and development company that focuses on combustion and gasification of solid waste and biomass. TPS Termiska licensed its waste gasification technology to Ansaldo Aerimpianti SpA in 1989. In 1992, Ansaldo installed a commercial, two-bed unit in Greve-in-Chianti, Italy, which is operated by TPS. The gasification plant has a total capacity of 200 metric tons of RDF per day (Figure 8). The two units have a combined capacity of 30 MWth. The TPS technology uses a starved-air gasification process in a combined bubbling and circulating fluidized bed reactor operated at 850°C and near atmospheric pressure. RDF is fed to the fluidized bed. Air is used as the gasification/fluidizing agent. Part of the air is injected into the gasifier vessel through the bottom section and the remainder higher up in the vessel. This pattern of air distribution causes a density gradient in the vessel. The lower part maintains bubbling fluidization that allows coarse fuel particles adequate residence time for good gasification reactions. The secondary air introduced higher up in the vessel increases the superficial velocity of air through the reactor so that smaller, lighter particles are carried away in the gas flow.

The process gas from each gasifier passes through two stages of solids separation before being fed to a furnace/boiler. The flue gas exiting the boiler is then cleaned in a three-stage dry scrubber before being exhausted through the stack. Alternatively, some of the raw gas stream can be sent to a nearby cement factory, without cleaning, to be used as fuel in the cement kilns.

TPS Termiska has developed a patented catalytic tar-cracking system. Immediately downstream of the gasification vessel, a dolomite (mixed magnesium-calcium carbonate) containing vessel catalyzes most of the tars formed in the gasification process and breaks them down into simpler compounds with lower molecular weights and melting points. The dolomite also will absorb acids in the flue gas, including HCl and sulfur oxides. The product gas can then be cooled and passed through conventional scrubbing systems without operational problems. After cooling, the syngas can be compressed and is clean enough to be used with a combined cycle turbine. This gas cleaning technology has been demonstrated successfully at a biomass gasification plant as part of a joint venture with ARBRE Energy LTD in England (Morris, 1998). TPS Termiska has also been selected by the World Bank to build the first commercial power station in the world using wood-fuelled, combined gasification and gas turbine technology. This plant is currently being installed in the state of Bahia, in northeastern Brazil.

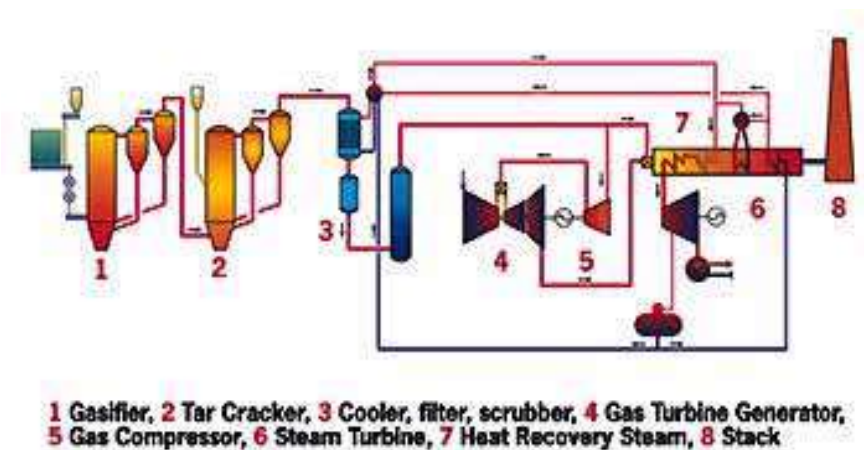

Figure 8. TPS Termiska Flow Sheet

6.2 Battelle Columbus Laboratories Indirectly Heated Gasifier

The Battelle gasification process is an indirectly heated, atmospheric pressure, circulating fluidized bed system designed to gasify wood, biomass and potentially MSW by reacting it with steam in a fluidized sand bed (Figure 9). Hot medium-BTU gas leaves the gasifier with the sand and a small amount of char. The sand is captured and recycled to the gasification vessel, while the char is combusted in a fluidized bed combustor that provides heat to reheat the sand, generate steam, and dry any wet feedstock. Because heat used during the endothermic gasification process is supplied externally from the sand circulating between the gasification vessel and the char combustor, the resulting fuel gas is free of nitrogen and has a heating value of 13-18 MJ/m³, using wood as the feedstock.

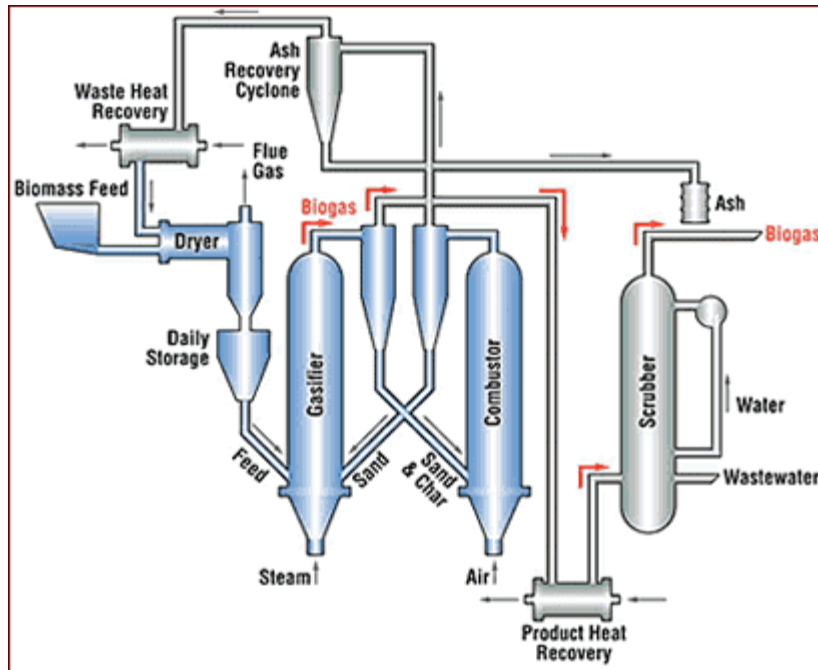

Figure 9. Battelle Indirectly-Heated Low Pressure Gasifier

Source: http://www.eren.doe.gov/biower/projects/ia_tech_gas4.htm

Battelle has experimented with a RDF feedstock in their Process Research Unit (PRU) which has throughputs between 0.22 and 9.1 Mg/d of dry RDF. The PRU has logged over 10,000 operating hours with a variety of feedstocks. The longest continuous operation with RDF was approximately 100 hours at 9.1 metric tons per day. It was concluded from these studies that higher through puts exceeding 19.5 Mg/h m², could be accomplished.

Figure-10 shows a mass and energy balance for Battelle’s indirectly heated gasifier based on figures reported in a study by the National Renewable Energy Laboratory (Niessen, 1996).

Battelle Material/Energy Balance 1000 kg basis of RDF

Input			Output		
	Material (Kg)	Energy (MJ)		Material (Kg)	Energy (MJ)
TO GASIFIER:			PRODUCT GAS:		
RDF	1,000.00	1,969	Ash	0.26	
H2O Liquid	290.33	0	N2	7.39	
Feed water	311.81	111	CH4	76.25	
Subtotal	1,602.13	2,080	C2H4	77.95	
TO COMBUSTOR:			C2H6	4.68	
N2	1,735.40		CO	305.42	
O2	461.30		CO2	123.55	
Subtotal	2,196.71	93	H2	9.72	
			H2O vapor	743.04	
			Subtotal	1,348.27	1,792
			FLUE GAS		
			Ash	60.26	
			N2	1,207.39	
			O2	45.60	
			CO2	599.81	
			H2O vapor	27.43	
			Subtotal	1,940.50	293
			Ash		
			H2O	188.21	
			H2	3.20	
			C	163.55	
			Subtotal	354.96	63
			Wastewater		
			H2O	266.14	
			N2	0.76	
			H2	0.47	
			C	3.78	
			Subtotal	271.14	21

Heat Loss Summary		
Heat Loss from Heat Exchange = 1.52 % of HHV		
Heat loss from Gasifier = .21%% of HHV		
Heat loss from Combuster = 0.37 % of HHV		
Heat loss from Cyclones 0.52 % of HHV		
Heat Loss from Piping = 1.3 % of HHV		
Heat Loss from other = 0.26 % of HHV		
Heat Loss Total = 4.27 % of HHV		

	Material	Energy		Material	Energy
Total Input:	3,798.84	2,172.7	Total Output:	3,914.87	2,169.2

Figure-10

Source: Niessen et al 1996

6.3 Essex County, Mass Burn WTE

The Essex County Mass Burn Waste-to-Energy facility is New Jersey's largest resource recovery facility and is owned and operated by American Ref-Fuel. The Essex facility combusts about 2800 tons of MSW per day and generates approximately 65 MW of electricity for sale. The facility does not shred or processes its waste into a RDF so the sizes of the items deposited to the combustion chamber can be large, and the rates of mass transfer and oxidation are relatively slow. As a result a very large combustion chamber and grate are required and the intensity of combustion is correspondingly low. Energy is generated via steam production from waterwall tubes and a superheater. Flue gas is cleaned with three DBA electrostatic precipitators and dry scrubbing systems. The stack height is nearly 300 feet high.

6.4 SEMASS RDF Combustion

The SEMASS resource recovery facility at Rochester, MA was developed by Energy Answers Corporation and is now owned and operated by American Ref-Fuel. This facility takes in about 3,000 short tons of waste per day by covered rail car and truck from communities within a 65-mile radius. There are three combustion units. The waste brought to the plant is loaded onto conveyors, shredded and exposed to overhead magnets that recover ferrous metals from the waste. The shredded RDF (also called Processed Refuse Fuel) is then sent into the combustion chambers through inclined chutes. A portion of the feed is burned in suspension, while the remainder falls onto a horizontal moving grate. The grate moves slowly and it takes materials approximately one hour to move from the front to the rear of the boiler. The feed rate can be adjusted automatically by installed temperature controls to provide maximum efficiency. Underfire and overfire air are introduced to enhance combustion. Waterwall tubes, a superheater and an economizer are used to recover heat for production of steam. Detailed operating data show that 650 kWh of electricity are generated per ton of MSW combusted. Of this amount, 100kWh are used in the plant operation and 550kWh are sold to an electric utility.

7. Technoeconomic Comparison

7.1 Energy Comparison

Table 8 below compares energy related characteristics for the four WTE systems mentioned above. Data for the Essex County mass burn plant were reported in the Handbook of Solid Waste Management (1994). Data for the SEMASS plant are from actual operating data as reported by Energy Answers Corporation. Data for the TPS Termiska and Battelle-Columbus plants are based on pilot-scale test data reported in a document published by the National Renewable Energy Laboratories (Niessen, 1996). The TPS Termiska system includes two circulating fluidized beds, with the downstream vessel containing dolomite for tar cracking and a combined cycle turbine. The Battelle system includes a circulating fluidized bed heated by and fluidized with steam combined with a circulating fluidized bed char and sand combustor that is fluidized with air. The Battelle plant generates power with a combined cycle turbine.

Based on the data presented, gasification demonstrates better efficiency in converting waste to electricity. The Battelle gasifier generates a product gas with a heating value greater than the TPS system because its indirect heating system prevents nitrogen from entering the

gasification vessel. As a result, the volume of gas generated by the Battelle process is also significantly lower than all the other plants.

The Essex County Mass Burn plant requires the least amount of electric energy to operate. This reflects the energy penalty associated with the pre-processing of MSW in an RDF plant. However, Essex also generates the least amount of electricity per ton of waste demonstrating that a cleaner and more homogenous feedstock results in more efficient combustion and gasification reactions.

Table 8. Energy Data for Various MSW Waste-To-Energy Technologies

All Tonnages are reported as Short Tons	*Temiska TPS	*Battelle-Columbus	**Essex County Mass Burn	***SEMASS RDF
MSW Processed per Year (Tons)	642,400	341,275	831,105	910,000
RDF Processed per Year (Tons)	506,255	239,075	N/A	N/A
HHV of Product Gas (MJ per cu. Meter)	7.5	18.6	N/A	N/A
HHV of Product Gas (GJ per Ton MSW)	6.8	7.1	N/A	N/A
Volume of Product Gas (cu. meter /Ton MSW)	906	396.5	6700+	6700
Gross Power Rating (MW)	74.5	47	76	78
Annual Gross Power Production (kwh/ton MSW)	781	703	501	660
Facility Power Needs (kwh/ton MSW)	130	70	23	110
RDF Plant Power Needs (kwh/ton MSW)	15	21	N/A	
Excess Power for Sale (kWh/ton MSW)	636	612	476	550

Sources: *Niessen et al, 1998
 **Handbook of Solid Waste Management, 1994
 *** Provided by Energy Answers Corp.
 All Tonnages are in Short Tons

The product gas compositions for the Battelle and TPS Termiska gasification processes are shown in Table 9. Battelle’s product gas composition is a prediction based on a simulation in ASPEN in which a Fortran subroutine controls the simulation of the gasifier. The equations in this subroutine that describe the component mass balance in the gasifier were developed on the basis of the experimental data from the Battelle Columbus Laboratory 10 t/day PDU (Craig and Mann, 2000). The values for the Termiska process are based on actual operating data from their plant in Greve, Italy (Morris, 1998). Adjusting the temperature, residence time and pressure within the gasifier can vary these product gas compositions. However, since both systems utilize similar temperatures, pressures and feedstocks, it is assumed the differences in their gas composition is due to the injection of steam in the Battelle process versus the addition of air in the TPS Termiska process. In order to assess this difference, the TPS Termiska molar gas concentrations were calculated excluding the moisture and nitrogen brought in with the air and are shown in the third column of Table 9. A comparison of this to the dry Battelle product gas indicates the addition of steam results in higher concentrations of CO and CH₄ formation and lower concentrations of heavy organic gases and carbon dioxide. So clearly, the addition of steam does encourage better gas quality, however this benefit must be judged against the energy penalty associated with water’s heat of vaporization (44 kJ/mol).

Table 9. Gas Concentrations Leaving Three Different Gasifiers (mol %)

	¹ Battelle (dry basis)	² TPS Thermiska	TPS Thermiska (Dry basis w/o N)
Gasific Temp	826	870	870
Pressure (MPa)	0.17	0.14	0.14
H₂	21.2	8.6	19.35
CO	43.17	8.8	19.80
CO₂	13.46	15.65	35.21
H₂O	N/A	9.5	N/A
N₂	N/A	45.8	N/A
CH₄	15.83	6.5	14.62
C_xH_y	5.85	4.9	11.02

Source: ¹Craig & Mann, 2000

²Morris 1998

7.2 Capital Costs

The gasification systems are less expensive per kW than the combustion plants because of their higher chemical to electrical efficiencies. Additionally, overall capital costs per daily ton are lower for the gasification plants. This is expected since gasification generates less product gas (from Table 8), which requires much smaller and less expensive gas cleaning equipment. Plants with lower capital costs are easier to finance, as there are less severe financial risks associated with plant shutdowns prior to start-up. This trend is evident in the traditional power markets. For example, investors favor natural gas plants over coal because of their lower up-front capital costs despite larger fuel costs during operation. Consequently, assuming comparable reliability, investors are likely to favor gasification plants over combustion plants.

The RDF processing is a significant capital cost of the gasification systems, accounting for nearly 40% of the total. The green field cost, including power generation system for an Integrated Biomass gasification system, typically varies between \$1,200 and \$2,000 per kW, installed. The extensive pretreatment process for MSW and necessary gas clean-up explains the higher cost of MSW gasification systems.

In order to normalize the data as much as possible, annuity payments were calculated at a constant 10% discount rate over an expected loan lifetime period of 15 years for all systems. Better project financing terms are likely as more acceptance and confidence is garnered towards this industry. All of the data reported in this thesis are based on engineering estimates. Variable operating and capital costs such as the price of land, tax rates and insurance were not taken into account for any of the systems compared.

Table 9. Capital Costs for Various MSW Waste-To-Energy Technologies

	Themiska TPS IGCCT	Battelle IGCCT	Essex County Mass Burn	SEMASS
Pretreatment / Shredding Costs (US\$)	\$62,800,000	\$37,000,000	N/A	N/A
Gasifier, Gas Treatment and Engineering Costs (US\$)	\$56,875,000	\$12,532,000	N/A	N/A
Power Generating Equipment (US\$)	\$51,000,000	\$31,000,000	N/A	N/A
Total Capital Costs (US\$)	\$170,675,000	\$80,532,000	\$259,003,776	\$286,712,323
Total Capital Costs (\$US/kW)	\$2,291	\$2,177	\$3,408	\$3,676
Total Capital Costs (US\$/ Ton MSW/day)	\$96,970	\$86,100	\$113,748	\$115,000
Annuity Payment at 15% over 15 year loan per ton of MSW	\$41	\$36	\$41	\$41

Source: Niessen et al, 1996
 Meeting with Steven Bossotti and Steve Goff, 2001
 Handbook of Solid Waste Management, 1994

7.3 Operating Costs

Table 10 shows the operating costs per ton of MSW for the four systems. Per ton of waste processed, operating costs are higher for the gasification plants. Gasification is a more complex technology requiring more labor and maintenance. As gasification designs improve, it is possible that operating costs will decrease. Based on reported data from the gasification companies, the Battelle system incurs a much greater ash disposal cost than TPS, due to a larger amount of ash disposal. It is not clear why this is the case. All systems were assumed to have a cost of disposal of \$50 per ton of ash. According to the report, for every ton of waste delivered, the Battelle plant disposes of 757 pounds of ash (37% of input), while the TPS Termiska plant only disposes of 405 pounds (20% of input) of ash.

Table 10. Operating Costs for Various MSW Waste-To-Energy Technologies per Ton of MSW Processed

	Themiska TPS IGCCT	Battelle IGCCT	Essex County Mass Burn	SEMASS
Labor, Admin, Maintenance	\$16	\$17	\$17	N/A
RDF Process	\$8	\$9	N/A	N/A
Waste Disposal Cost (50\$/ton)	\$12	\$22	\$10	N/A
Total Operating Costs (US\$/ Ton MSW)	\$36	\$48	\$27	\$30

Source: Niessen et al 1996
 Meeting with Steven Bossotti and Steve Goff, 2001
 Handbook of Solid Waste Management, 1994

Table 11 below shows the net cash flows for all four systems taking into account energy revenues. It was assumed that electricity would be sold at \$.04/kWh. There is little difference in the capital costs between gasification and combustion plants. However, the operating costs of the gasification plants are higher, for reasons discussed earlier. In regions where electricity prices are higher, gasification will be even more competitive, due to their potential for higher generation of electricity per unit of MSW processed.

	TPS Termiska IGCCT	Battelle IGCCT	Essex County Mass Burn	SEMASS RDF
Capital Annuity Payment	\$41	\$36	\$41	\$41
Total Operating Costs per ton MSW	\$36	\$48	\$27	\$30
Electricity Revenue Per Ton MSW	(\$25)	(\$25)	(\$19)	\$(22)
Break Even Tipping Fee	\$52	\$59	\$49	\$49

It should be noted that it is unclear whether the projections made for the gasification plants are achievable over long time horizons. TPS Termiska’s Greve plant has experienced problems with slag accumulation on the boiler tubes. This has caused a plant shutdown and longer-than-acceptable outages for boiler cleaning and rework. This result was in part caused by the boiler design, which was somewhat undersized and not well-configured for burning a high-ash fuel. Termiska TPS believes that a new revised plant will not have these problems and will allow long-term operation with a combined cycle turbine.

The longest test with RDF that Battelle has accomplished was 100 continuous hours of operation of a small turbine with a RDF fuel rate of 10 tons per day. The company concluded from these tests that it is likely that for long term operation with a combined cycle turbine, more work with feedstock preparation and gas cleanup will be necessary.

8.0 Gasification Technologies for the Future

In addition to the air blown and indirectly heated gasification technologies discussed above, other integrated waste gasification combined cycle turbine or fuel cell plants are possible in the future. Such technologies could include carbon dioxide capture, pure oxygen blown gasification, or integration with a series of small modular engines to burn the syngas. Alternatively, a methane rich syngas could be generated and piped to nearby utilities. These technologies will depend very much on reliable hydrogasification, cost effective carbon dioxide sequestration or disposal techniques, and low-cost production of industrial oxygen. Such innovations have yet to be operationally explored for waste gasification. Two possible zero

emission plants utilizing hydrogasification are explored below. The first process produces a methane rich gas and pipes it to a local utility. The second process uses a fuel cell and captures carbon dioxide and is termed “Zero Emission Waste-to-Energy” (ZEWTE).

8.1 Hydrogasification of Waste with Methane Export

Hydrogasification is an exothermic gasification process in which hydrocarbons are broken down into a methane rich gas in a hydrogen atmosphere. The main reactions are:



Hydrogasification has been experimented with since the 1930’s in Germany, the U.S., and Great Britain. For use with MSW, a RDF feed would be fed to a hydrogasifier that operates under pressure and at temperatures of approximately 800 °C. The resulting methane-rich, low-tar gas would be passed through a high temperature gas clean-up stage, where alkalis, acid gases and sulfur would be removed (Figure 10). Following the gas cleaning operation, a portion of the gas would be sent to a reforming vessel in order to generate enough hydrogen to sustain the hydrogasification reactions. Alternatively, hydrogen also could be purchased on the open market, and injected into the gasifier. The resulting methane rich syngas would be piped to a utility plant. Several utilities, including Duke Energy have expressed their willingness to purchase syngas generated at waste gasification plants (Conversation with Dr. Helmut Schultz, Dynecology, 2000).

The main goal of hydrogasification as a waste treatment process is to upgrade the organic wastes to a methane rich gas. The advantage of the hydrogasification process is that it forms a gas with low concentration of hydrogen and high concentrations of methane. As a result, there would be no need to change the conventional pipeline technology in order to transport this syngas to a nearby utility. Natural gas containing than 10% hydrogen by volume can be transported without any change in the current gas transport infrastructure (Mozaffarian and Zwart, 1999). Furthermore, a methane rich gas can be burned directly in a conventional combined cycle turbine without modification or air bleed. The advantage of generating a syngas product, rather than combusting the gas to generate electricity is that there would be zero atmospheric emission at the facility, so siting such a plant may receive less political and environmental opposition. From an environmental standpoint, syngas clean-up technologies

have already demonstrated the ability to scrub out the heavy metals, acid gases and particulates to be well below emission standards for power plants. To ensure good operation, the methane rich syngas could also be mixed with the natural gas that is already being burned at the utility.

Hydrogasification is an intriguing process for the destruction of MSW because it may greatly reduce the heavy organic tars produced during the gasification reactions. Uil et al, 1999 reported that the presence of excess hydrogen in the hydrogasifier, especially in combination with high operating pressures, might lead to a very low tar content of the produced gas. Feldmann, 1973 stated that in the hydrogasification of solid wastes no tar was formed at all (Uil et al 1999). As discussed earlier, minimizing tar greatly improves the effectiveness of gas cleaning technologies. Additionally, hydrogasification is an exothermic reaction; therefore, once it has been initiated, supplementary combustion of some of the waste may be unnecessary. Despite these advantages, hydrogasification of coal and biomass has not been explored extensively for commercial purposes because the cost of hydrogen was believed to be prohibitive.

A study by Mozaffarian and Zwart (1999) used the ASPEN plus model to simulate the hydrogasification of dry poplar wood which has the approximate chemical formula $C_6H_9O_{3.6}$ (ECN,2001). The material balances showed that the synthesis gas molar percent concentrations were 50.2%, 34.8%, 10.1%, and 4.3%, for methane, hydrogen, carbon dioxide, and carbon monoxide respectively. For MSW with the average chemical formula $C_6H_{10}O_4$, the corresponding hydrogasification reaction could be estimated as:

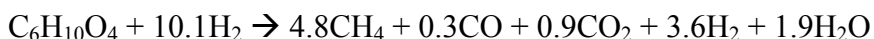

This syngas could then either undergo a second methanation reaction to convert the remaining CO and H₂ to CH₄, or a PSA could be used to capture the hydrogen and recycle it back to the gasifier.

8.2. Zero Emission Waste-To-Energy (ZEWTE)

The Zero Emission Waste-to-Energy concept is derived directly from a technology developed by the Zero Emission Coal Alliance (ZECA). ZECA is pursuing a concept originated at the Los Alamos National Laboratory. The technology is based on a coal hydrogasification system, which produces hydrogen and a stream of CO₂ suitable for mineral carbonate sequestration, or use with alternative CO₂ disposal processes. In the ZECA process, coal is

converted to a methane gas through an exothermic reaction with hydrogen (Eq. 1, below). The resulting methane synthesis gas is cleaned with sulfur removal systems and cyclones to remove particulates. The gas is then transferred to a second vessel where it is reformed at approximately 60 atm and 825°C to produce a relatively pure hydrogen stream through the use of a CaO carbonation reaction. The carbonation reaction removes the CO₂ and supplies the energy needed to drive the reforming reaction (Eq. 2). It is a fortunate coincidence of nature that the net resulting reaction of equations 1 & 2 are essentially energy-neutral (Eq. 3). Nonetheless, these two steps must occur in two separate vessels because silica, which represents about 15% of coal, reacts with CaO to create a slag and this would have deleterious effects on the gasification vessel.

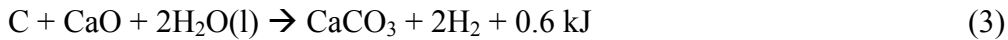
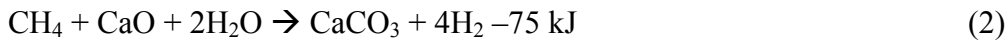

Electric power can be generated from the product hydrogen in a high temperature fuel cell. A calcination reaction, driven by excess heat derived from the high temperature fuel cell, regenerates the CaO from CaCO₃ (Eq. 4) and produces a stream of pure CO₂ (Yegulalp et al 2000).

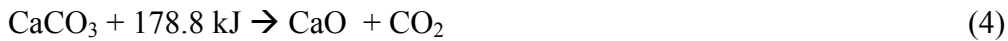

Although the ZEC process was designed for coal, a similar process could be conceived for other hydrocarbon feedstocks such as biomass or solid waste (Figure 11). MSW has a non-recyclable component comprising roughly 60% of its total, which has been shown to have the approximate hydrocarbon chemical composition C₆H₁₀O₄ (Themelis and Kim 2000). The net exothermic reaction from the simultaneous hydrogasification of this waste supplemented with calcium oxide can be expressed as:

ZEWTE:



Based on this equation, MSW with a moisture content of 50% would be in stoichiometric equilibrium, without the need for added steam. MSW offers a few potential advantages over coal as a fuel in the ZECA process. MSW has a higher moisture content than coal, which is needed to help the reforming reactions proceed. MSW has less sulfur than coal, reducing the likelihood of fuel cell poisoning from sulfur compounds; for example, the average Kentucky bituminous coal contains about 4% sulfur (Smoot & Smith 1985), whereas MSW only has around 1% sulfur. Furthermore, MSW is a negative cost feedstock with tipping fees of \$30-80 per ton. This compares favorably with coal, which in the US has a price range of \$8-30/ton (DOE, 2002).

Of course, there are also significant disadvantages to using MSW instead of coal. MSW is difficult to transport, has about half the heating value of coal, has a higher ash content, is extremely heterogeneous and contains relatively high amounts of chlorine, sodium and potassium which result in slagging and agglomeration of the bed material. MSW also contains higher contents of volatile heavy metals, which could cause fouling in downstream energy equipment and hinder the calcination reactions. Therefore, in order to be effectively hydrogasified with lime and integrated with a fuel cell, MSW would require extensive pretreatment. Currently, the development of this system is hindered by the lack of fuel cell technology capable of handling the impurities that end up in the syngas. As a result, commercialization of such a plant is not imminent.

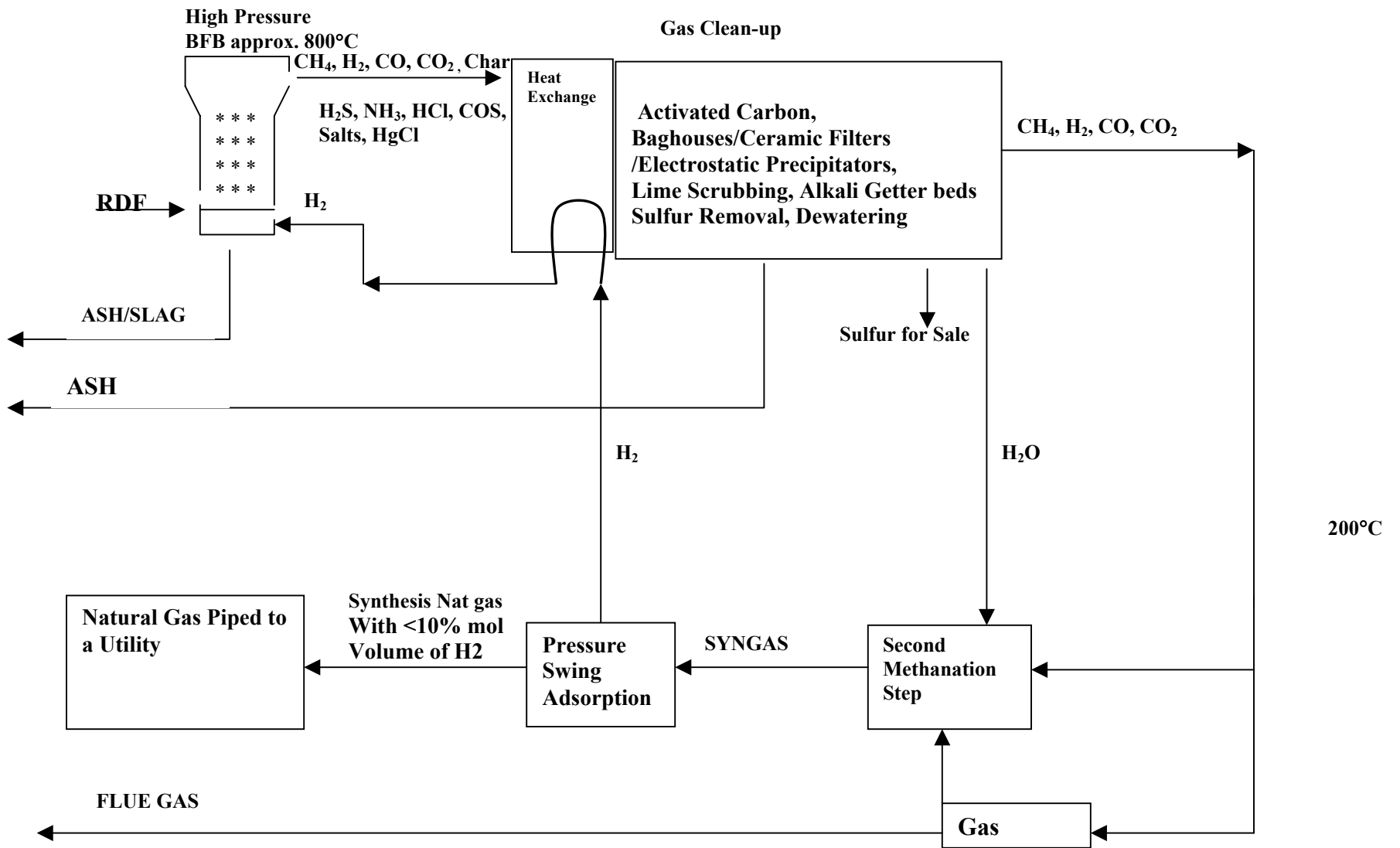

Figure 10. Natural Gas Production From Municipal Solid Waste

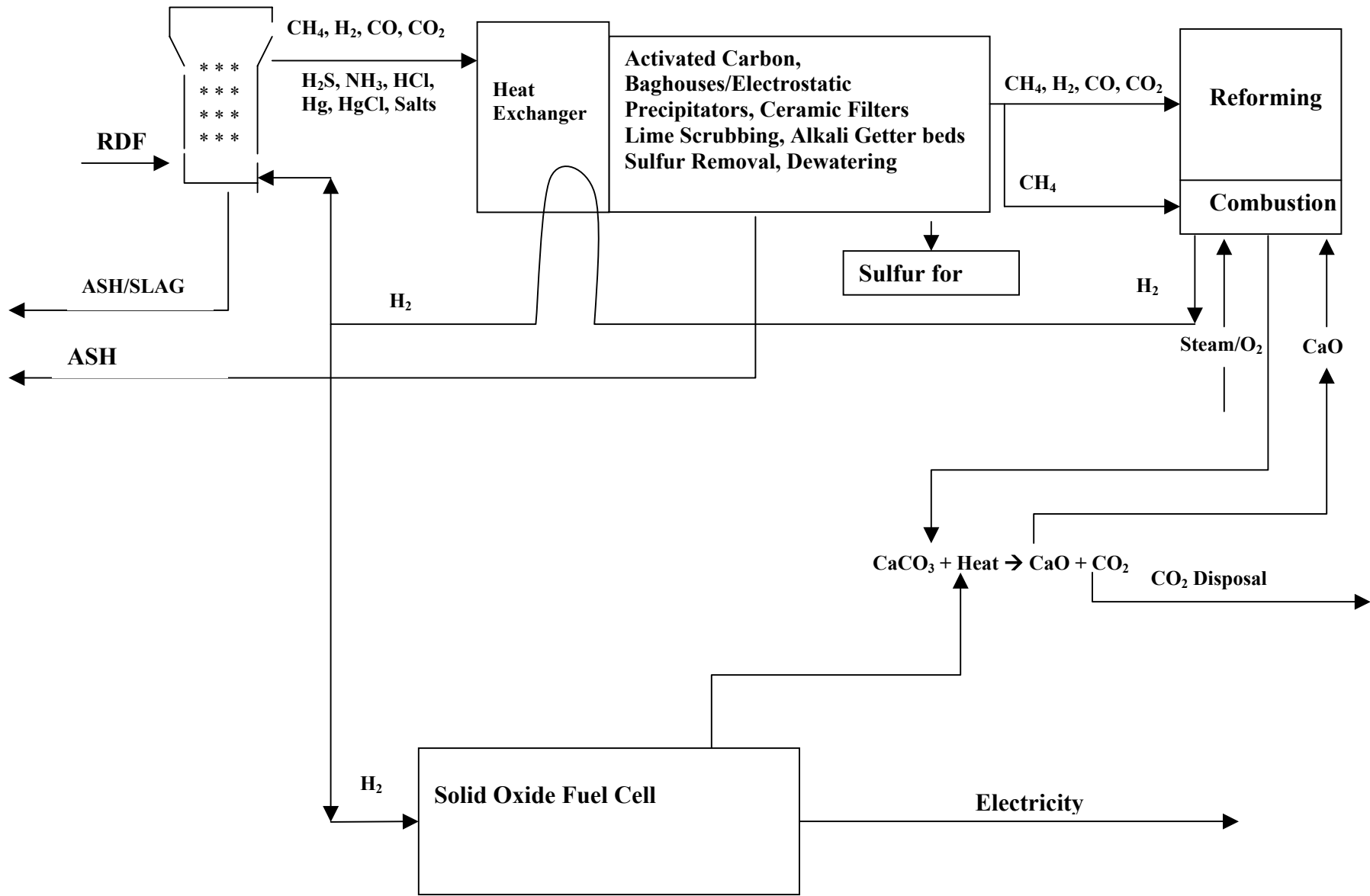

Figure 11. Zero Emission Waste-to-Energy Plant

9.0 Conclusions

A solution to the waste problems confronted by municipalities no doubt requires a strategy that integrates several technologies including, waste reduction, recycling, landfilling and waste-to-energy. According to the chemical composition of MSW, a maximum of 40% are paper, plastics, metal and glass suitable for recycling (Life After Fresh Kills, 2001). The remaining quantity that is not recyclable has a heating value roughly half that of coal. Yet most of this essentially renewable, negatively priced energy feedstock is transported to landfills, despite several studies that have shown conclusively that landfilling is the most environmentally degrading means to treat waste. Waste-to-energy, which converts the non-recyclable and combustible portion of the waste to electricity, reduces the amount of materials sent to landfills, prevents air/water contamination, improves recycling rates and lessens the dependence on fossil fuels for power generation. The two most viable forms of waste-to-energy are combustion and gasification.

Combustion is a well-established practice, currently handling 36 million tons of MSW annually in the US and generating electricity that would require the equivalent of 1.6 billion gallons of fuel oil (Life After Fresh Kills, 2001). If all of the MSW in the US were combusted, the total energy production would account for close to 3% of the total electricity supply in the US. During combustion, dioxins (PCDD/PCDFs) form as flue gases leave the primary combustion chamber and cool to 300-650 °C. Over the past decade, dioxin emissions from U.S. WTE plants have been greatly reduced from 4000 g/year in 1990 to 400 g/year (i.e. 11 grams per million tons of MSW combusted, in 1999, IWSA). Nevertheless, strong environmental and political opposition to any dioxin release remains and has stifled the further expansion of the industry considerably over the last decade. In NYC, for example, former Mayor Rudolph Guliani placed a ban on all new waste incinerators within New York City.

One alternative to combustion, as discussed in this paper, is MSW gasification. Gasification is a process that devolatilizes solid or liquid hydrocarbons, and converts them into a low or medium BTU gas. Gasification has several distinct advantages over traditional combustion of MSW. It takes place in a low oxygen environment that limits the formation of dioxins and large quantities of SO_x and NO_x. Furthermore, it requires just a fraction of the stoichiometric amount of oxygen necessary for combustion. As a result, the volume of process gas is low, requiring smaller and less expensive gas cleaning equipment. The lower gas volume

also means a higher partial pressure of contaminants in the off-gas, which will favor more complete particle condensation and capture according to chemical thermodynamics: $\Delta G = -RT \ln(P_0/P_1)$. Gasification also generates a synthesis gas that can be integrated with combined cycle turbines, reciprocating engines and potentially fuel cells that produce electricity more than twice as efficiently as conventional steam boilers.

Despite these benefits, there are significant concerns about gasification on a large scale. The most difficult operational problem results from the formation of heavy organic compounds referred to as tars. These tars cause significant fouling in downstream gas cleaning processes and energy conversion devices. As a result, finding cost-effective and thermally efficient gas cleaning techniques for the remaining syngas constituents that include halogens, acid gases, volatilized heavy metals and alkaline substances remain difficult.

A comparison of two commercially viable gasification technologies and two combustion technologies already in operation, indicate that gasification can be an environmentally superior and cost competitive technology with combustion. Per ton of waste treated, gasification generates more electricity, has a lower up-front capital cost and is more effective at reducing pollutants in the flue gas. Yet the high operational costs associated with maintaining gasification systems result in a slightly higher overall cost per ton of waste treated.

As gasification evolves as an industry there are several key areas that could potentially reduce capital and operating expenses and further reduce environmental impact. The most obvious way is to improve removal of the harmful constituents of the synthesis gas. Better catalysts and system designs that more thoroughly eliminate tars in the product gas will have several advantages. It will allow more reliability and longer operational ability of gasifiers and turbines. Furthermore, it will enable high temperature gas clean-up technologies that offer the benefit of increased chemical to electricity efficiencies, and result in increased energy revenues. Alternatively, high temperature gas cleaning technologies, such as improved alkali “getter beds” and more durable filters that can more readily tolerate tars in the product gas stream will also improve operational efficiencies.

Another area that would increase the viability of waste gasification is the improvement of waste sorting and pre-treatment methods. Processing of raw MSW to a more homogeneous RDF fuel with a lower non-combustible component permits a decrease in the overall bed air-to-fuel ratio below the stoichiometric point, lowering the bed temperature. Under these conditions, a

very large fraction of the organic refuse component breaks down into volatile components maximizing energy production. Creating a true RDF cost effectively remains one of the most difficult tasks in thermochemical conversion of solid waste. It involves a large amount of mechanical processing and close supervision, which greatly impact operating costs and can account for as much as 40% of the total plant capital costs. If too much metal and glass are allowed to pass through into the gasifier, the heating value of the RDF decreases and there can be constant operational problems and plant shutdowns making the plants costly and unreliable. If shredding and sorting of the waste can be made simpler and more effective, gasification would become even more advantageous. Similarly, waste gasification will be most successful in communities where there is good recycling practice. A better job of recycling glass and food wastes by city residents will improve the gasification reactions. It should be noted that energy recovery from waste is not in competition with recycling, but rather its complement in a sound waste management plan

In the future, gasification with pure oxygen or pure hydrogen (hydrogasification) may provide better alternatives to the air blown or indirectly heated gasification systems described in this report. This depends greatly on reducing the costs associated with oxygen and hydrogen production and improvements in refractory linings in order to handle higher temperatures. Pure oxygen could be used to generate higher temperatures, and thus promote thermal catalytic destruction of organics within the fuel gas. Hydrogasification is appealing because it also effectively cracks tars within the primary gasifying vessel. Hydrogasification also promotes the formation of a methane rich gas that can be piped to utilities without any modifications to existing pipelines or gas turbines, and can be reformed into hydrogen or methanol for use with fuel cells. The advantages and costs of piping CH₄ should be further explored in populated areas where siting and permitting of WTE plants are especially difficult.

Converting Municipal Solid Waste (MSW) to energy has the environmental advantages of reducing the number of landfills, preventing water/air contamination, and lessening the dependence on oil and other fossil fuels for power generation. Gasification is a WTE technology that can be cost competitive with combustion and offers the potential for superior environmental performance. However, before it can be considered to be a clear-cut solution for waste disposal in large municipalities, its long-term reliability must be demonstrated.

References

- ASME (2002). "An evaluation of the cost of incinerating wastes containing PVC".
<http://www.asme.org/research/imw/wastecost.pdf>
- Babcock and Wilcox (1992), "Steam", 40th ed. Chapter 16: Atmospheric Pressure Fluidized-Bed Boilers, Babcock and Wilcox, Barberton., OH.
- Bain, R. Overend, R., Craig, K. (1996), "Biomass-Fired Power Generation", National Renewable Energy Laboratory, Golden CO.
- Bridgwater, A.V. and Evans, G.D., 1993, "An assessment of thermochemical systems for processing biomass and refuse", ETSU B/T1/00207/REP
- Buekens A., Huang, H. (1998), "Comparative evaluation of techniques for controlling the formation and emission of chlorinated dioxins/furans in municipal solid waste incineration". Journal of Hazardous Materials.
- Columbia University (2001). Life After Fresh Kills: Moving Beyond New York City's Current Waste Management Plan. Policy, Technical and Environmental Considerations.
- Craig, K., Mann, M. (2002). "Cost and Performance Analysis of Three Integrated Biomass Combined Cycle Power Systems." National Renewable Energy Laboratory, Golden, CO.
- Dayton, D.C. (2001) "Fuel Cell Integration – A Study of the Impacts of Gas Quality and Impurities." National Renewable Energy Laboratory. Golden, CO. NREL/MP-510-30298
- Denison, R.A. (1996) "Environmental life-cycle comparisons of recycling, landfilling, and Incineration" Annual Reviews of Energy and Environment, Vol. 21 191-237.
- ECN Web site (2002). <http://www.ecn.nl/phyllis/>
- Elliott, D.C. (1988). "Relation of Reaction Time and Temperature to Chemical Composition of Pyrolysis Oils," ACS Symposium Series 376, *Pyrolysis Oils from Biomass*.
- EREN (2002). "Gasification Based Biomass"
http://www.eren.doe.gov/power/pdfs/bio_gasification.pdf
- ETIS Web site (1999). "Characterization of Alkali Metal Emission from Fuels and Samples Collected from Fluidized Bed Gasification." Paper No. FBC99-0125
<http://www.etis.net/balpyo/15icfbc/99-0125.PDF>

Evans, R.J., Milne, T.A (1997). "Chemistry of Tar Formation and Maturation in the Thermochemical Conversion of Biomass." *Developments in Thermochemical Biomass Conversion*, Vol. 2.

Feldmann, H.F. (1973) "A process for converting solid wastes to pipeline gas." US Patent 3,3773,187

Fuel Cell Handbook 5th Edition (2000). Report prepared by EG&G Services, Parsons, Inc. and Science Applications International Corporation under contract no. DE-AM26-99FT40575 for the U.S. Department of Energy, National Energy Technology Laboratory, October 2000.

Hollenbacher, R.H. (1992). "Biomass Combustion Technologies in the United States," Biomass Combustion Conference, Reno, Nevada, US DOE Western Regional Biomass energy Program.

Integrated Waste Services Association (IWSA) Web Site (2000). www.wte.org

Kreith, F. (1994). *Handbook of Solid Waste Management*. McGraw-Hill, Inc.

Korsgren, J.G. et al. (1999). "Characterization of Alkali Metal emission from fuels and samples collected from Fluidized bed gasification." Proceedings of the 15th annual conference on fluidized bed combustion. Savannah, GA.

Krigmont, H (1999). "IBGCC power generation concept: A gateway for a cleaner future. Allied Environmental Technologies." White Paper.
<http://www.alentecinc.com/papers/IGCC/ADVGASIFICATION.pdf>

Miles, T.R., et al., Alkali Deposits Found in Biomass Power Plants. (1996) "A preliminary Investigation of Their Extent and Nature." National Renewable Energy Laboratory, Golden, CO: NREL/TP-433-8142

Milne, T.A., Evans, R.J., (1998). "Biomass Gasifier Tars: Their Nature, Formation, and Conversions." National Renewable Energy Laboratory, Golden, CO. NREL/TP-570-25357.

Miranda, M., Hale, B. (1999). "Re-Covering All the Bases: A Comparison of Landfills and Resource Recovery Facilities in Puerto Rico." Nickolas School of the Environment, Duke University.

Morris, M. (1998). "Electricity Production from Solid Waste Fuels Using advanced Gasification Technologies." TPS Termiska Processor AB. www.tps.se

Niessen, W., Markes., C et al. (1996). "Evaluation of Gasification and Novel Thermal Processes for the treatment of Municipal Solid Waste." National Renewable Energy Laboratory, Golden, CO. NREL/TP-430-21612.

Orr, D., Maxwell, D. (2000) “A comparison of gasification and incineration of hazardous wastes.” Radian International, LLC. DCN 99.803931.02.
http://www.gasification.org/Radian_20Final_20Report.PDF

Reed, T.B., Gaur, S. (1998) “Survey of Biomass Gasification—1998,” Volume 1 *Gasifier Projects and Manufacturers around the World*, Golden, CO: The National Renewable Energy Laboratory and The Biomass Energy Foundation, Inc.

Schultz, H. (2000). “A Bright Future for Renewable Energy Based on Waste.” International Directory of Waste Management.
http://www.jxj.com/yearbook/iswa/2000/bright_future_schultz.html

Scottish Agricultural Website (2002)
<http://www.sac.ac.uk/envsci/External/WillowPower/Conversn.htm>

SCS Engineers. (1992) New York City Waste Composition Study, 1989-1990

Smoot, L.D., Smith, P.J., (1985). Coal Combustion and Gasification. Plenum Press, New York.

Spliethoff, H (2001). “Status of Biomass Gasification for Power Production.” IFRF Combustion Journal. Article Number 200109.
<http://www.journal.ifrf.net/library/november2001/200109spliethoff.pdf>

Tchobanoglous, G., Theisen, H., and Vigil, S. (1993) “Integrated Solid Waste Management” Chapter 4, McGraw-Hill, New York.

Themelis, N.J., Kim, Y.H., Brady M.H. (2002). “Energy Recovery from New York City Solid Wastes.” IWSA

Themelis, N.J. , Kim, Y.H (2002) “Energy & Material Balances in a large-scale aerobic bioconversion.”

Themelis, N.J., Gregory, A.F. (2001). “Sources and Material Balance of Mercury in the New York-New Jersey Harbor.” Report to the NY Academy of Sciences.

Uil, H., Mozafarriani, M., et. al. (2000) “New and Advanced Processes for Biomass Gasification.” Netherlands Energy Research Foundation (ECN).
http://www.ket.kth.se/rolando/paper/22_denUil.pdf

Yegulalp, T.M., Lackner, K.S., Ziock, H.J. (2000) “A review of emerging technologies for sustainable use of coal for power generation.” Environmental Issues and Management of Waste in Energy and Mineral Production.

Zevehoven and Kilpenin. (2001) “Trace Elements, Alkali Metals.” Chapter 8.
<http://www.hut.fi/~rzevenho/tracalk.PDF>

