

## Modeling for control of a biomass gasifier

Thijs Paes [0474218]

20th January 2005



# Contents

---

<b>Contents</b>	<b>3</b>
<b>Nomenclature</b>	<b>5</b>
<b>1 Introduction</b>	<b>6</b>
<b>2 Process description: the small scale fixed bed reactor</b>	<b>8</b>
2.1 Project aims . . . . .	8
2.2 Details of the updraft gasifier . . . . .	9
2.3 Solid substances in the process . . . . .	10
2.4 Gaseous substances in the process . . . . .	10
2.5 Heat notation . . . . .	11
<b>3 A static model for 1D biomass gasification</b>	<b>12</b>
3.1 Tests to be carried out . . . . .	13
3.2 Simulink model setup . . . . .	14
3.3 Boundary conditions . . . . .	15
3.4 Results . . . . .	16
<b>4 A dynamic model for 1D biomass gasification</b>	<b>20</b>
4.1 Tests to be carried out . . . . .	20
4.2 Physical equations used in the dynamic model . . . . .	21
4.3 Modeling in Simulink . . . . .	23
4.4 Evaluation of simulation results . . . . .	24
<b>5 Process control</b>	<b>28</b>
5.1 Study of control action effects . . . . .	28
5.2 Controller design and evaluation . . . . .	29
<b>6 Conclusions and recommendations</b>	<b>32</b>
6.1 Conclusions . . . . .	32
6.2 Experimental results . . . . .	32
6.3 Recommendations . . . . .	32
<b>References</b>	<b>34</b>
<b>A Overview installation</b>	<b>36</b>
<b>B First results dynamic model</b>	<b>38</b>



## nomenclature

$\alpha$	heat convection coefficient between solids and gasses	[W/m <sup>3</sup> K]
$\Delta Hr$	heat production during generation of $k$	[J/mol $k$ ]
$\rho$	density	[kg/m <sup>3</sup> ]
$A$	reaction rate	[1/s]
$A_{gasifier}$	gasifier cross area	[m <sup>2</sup> ]
$a_s$	Pre-exponential factor	[m <sup>3</sup> /kg s]
$c_p$	heat capacity	[J/kg K]
$C$	reaction constant	[1/s]
$D_{AB}$	binary diffusion coefficient	[m <sup>2</sup> /s]
$k$	thermal conductivity coefficient	[W/m K]
$E_R$	released energy from reactions	[J]
$E_{conv}$	convection of heat energy from gas to solid material	[J]
$E_s$	activation energy	[J/mol]
$g$	gravitational acceleration	[m/s <sup>2</sup> ]
$\dot{m}_g$	mass flow gas	[kg/s]
$mw$	molair weight	[g/mol]
$n_s$	stoichiometry term	[-]
$Q$	heat	[J]
$R$	universal gas constant	[J/mol K]
$T$	temperature	[K]
$t$	time	[s]
$u$	velocity	[m/s]
$\Delta x$	slice height	[m]
$x$	height	[m]
$Y$	concentration of each species	[-]
$\mathcal{D}_{AB}$	diffusion coefficient related to the diffusion of species A into B	[-]
$\mathcal{G}_h$	generation of heat in chemical reactions	[J]
$\mathcal{G}_Y$	generation of a reaction product	[1/s]

subindices:

$g$	gas
$i$	slice number
$k$	gaseous substance
$\ell$	solid substance
$pg$	product gas: all gas that leaves the gasifier
$s$	solid

### 1 Introduction

Gasification is a thermal conversion process in which a fuel is only partially oxidized. This is often done to turn biomass into manageable gaseous product gasses that can be used as a fuel. A disadvantage is the presence of tars in this product gas which can seriously harm the installation. A gasification setup is being built for a NOVEM project, studying the possibilities of tar removal. This is the PhD-project of ir. Dorus van der Hoeven.

This report focusses on a side project, describing the modeling of the experimental setup of a small scale fixed bed reactor, used for the PhD project. The type of this biomass reactor was not chosen because of it is often used in commercial energy production, but because it is much more easy to start up, measure and control for optimization for the research on tar removal. The results of the PhD-project could then be used also in more complex and more economical interesting gasification processes. Examples are larger fluidized bed gasifiers and the use of product gas in combustion engines.

In this report only the small scale, so-called updraft gasifier is regarded in order to control the gasification process.

One of the main drawbacks of the small-scale biomass combustion applications is the limited possibility to regulate the combustion process. In commercial gasifier installations efficient combustion process control is applied to minimize emission levels and to optimize the thermal efficiency. Several methods for biomass process control have been developed for economical use, mainly to reach higher efficiencies. In this study the control goals are a bit different, because the gasifier will be controlled for experimental use only.

First a start will be made by describing the process. After this a simplified static model will be derived. This model is very limited, time independent and needs strict boundary conditions. It will be used for the modeling of a dynamic model, which should better replicate the process in practice. This will be used for insight in the process and the possibilities to control it. Finally recommendations for design of a controller for the gasifier and for further research towards the model will be given.



## 2 Process description: the small scale fixed bed reactor

In this chapter the test setup of a gasifier for the PhD-project is discussed. A complete overview of the installation for this project is included in Appendix A. The subject of this report will only be the gasifier, which is a small scale type, having a design capacity of 22 kW, and can be seen as a batch reactor, because it will be filled with biomass before operation and during the operation the biomass will completely be burnt out.

In the reactor, air flows in from below and volatile biomass from upper levels sags into the reaction front. This type is therefore called an updraft or countercurrent gasifier, since fuel and oxygen move in opposite directions. More details on the process inside the reactor are discussed in § 2.2. Before going into details of the reactor, some general project aims will be disposed.

### 2.1 Project aims

The main project aim is to gather insight in the processes inside the test gasifier, and determine how it could be controlled. The understanding of the process is needed for:

- develop a reliable model for the prediction of (dynamic) behavior,
- predict process output in uncontrolled operations, and
- predict when the operation becomes dangerous or harmful, for instance when temperatures in the gasifier get too high.

After this research, the possibilities of control will be examined:

- safety can be guaranteed,
- constant process conditions can be achieved,
- the startup and shutdown of the gasifier can be simplified and quickened, and
- the type of control: a low-gain controller based on a good knowledge of the gasifier's behavior, or maybe model predictive control can finally be applied.

MPC is only possible with measured data from the gasifier to assure the variables used in the model and the model itself. In this case, the control scheme in Figure 2.1 shall be used. Here block  $C$  is the controller,  $P$  represents the real process and  $M$  the model that will be developed. Gathering measurements will not be done in this report and more research towards the gasifier will be needed to come to a model that is accurate enough to use MPC.

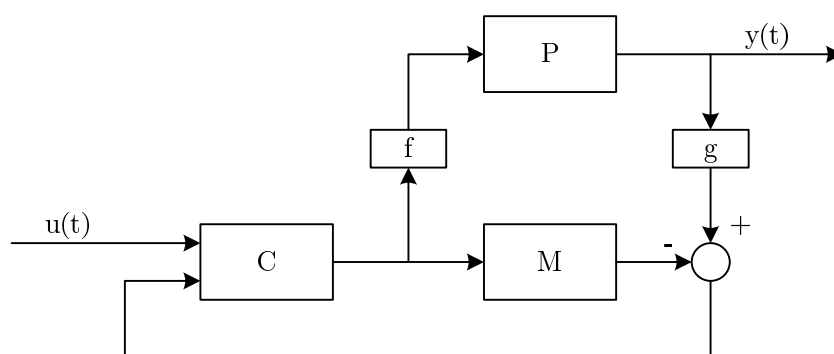

Figure 2.1: control scheme for the biomass gasifier.



## 2.2 Details of the updraft gasifier

A sketch of the updraft gasifier can be seen in Figure 2.3.  $O_2$  in the air coming from the inlet at bottom of the gasifier reacts with charcoal in the lower part of the gasifier.  $CO_2$  is generated by this reaction and on its turn, it reacts endothermically with the charcoal to  $CO$ , which is the main gasification product. Ash from the charcoal falls through the grate and the gas products flow upward.

The updraft gasifier is the most uncomplicated reactor type. It is largely self-regulating because one reactions after the other takes place along the gas flow. The heat required to accomplish gasification, is generated in the combustion zone and the heat flows upwards with gas, starting the gasification processes. This can be seen Figure 2.2, where also a division of the different reaction zones is made. These four different zones will largely overlap in practice, still their differences will take a prominent place in the development of a model for the gasifier.

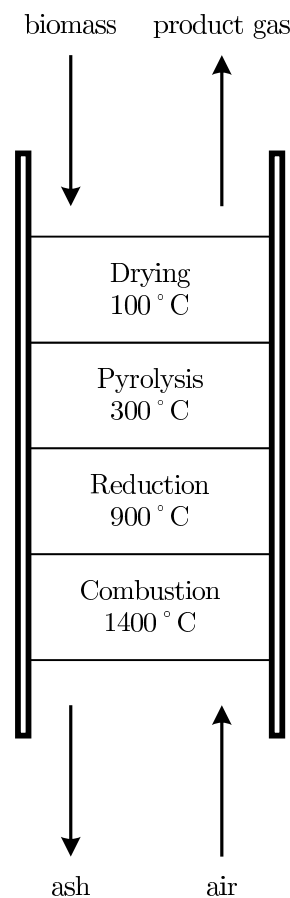

Figure 2.2: schematic cross-section of an updraft gasifier [7].

A description of the reactions that take place in each zone will be discussed next.

- **Combustion zone.** In the combustion zone, charcoal combusts with oxygen in the air from the inlet at the bottom of the gasifier.



Also some other reaction occur (treated in [2]), but at a much lower rate. The effects of these reactions are small and these will not be modeled.

- **Reduction zone.** By the release of  $CO_2$  and heat from the combustion, reduction occurs. The main reaction here is  $CO$  being formed from  $CO_2$ -molecules and charcoal. This is an endothermic reaction which hardly takes place at temperatures lower than  $800^\circ C$ .

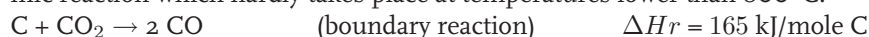

## Modeling for control of a biomass gasifier

- **Pyrolysis** In the third zone pyrolysis takes place. Pyrolysis is the degradation (lysis) of a material by heat (pyro). The absence of air in this zone, and the high temperature of the gas coming from underlying zones (between 200 °C and 500 °C) are needed for the gasification of the biomass. Apart from charcoal, also various gas products are formed, mainly CO, CO<sub>2</sub>, H<sub>2</sub>O, H<sub>2</sub> and CH<sub>4</sub>. However, in this project, the exact content of the product gas will be left aside.

The mechanism of pyrolysis is very complex and much research is done towards the weight reduction of a heated particle in thermogravimetric analysis (TGA) [6]. Results from these researches are not useful for the dynamic model that will be developed in this study. But they do indicate that it is reasonable to calculate the reaction rate of pyrolysis in the same way as the two chemical reactions.

One should mention that some inhomogeneities are not modeled this way, such as the effects of the cellulose in the material which will evaporate much slower than other structures in the solid material [2]. Also the geometries of the wood blocks will cause inhomogeneities in operation in practice.

- **Drying and heating zone** In the upper zone fresh biomass is partially dried by the hot gasses rising through the gasifier. The drying process does not change the particles chemically. It is possible to gasify fuels with moisture contents up to 50 % but of course, for a high efficiency a low moisture content is desired [2]. The drying process:

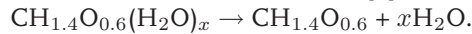

### 2.3 Solid substances in the process

Small wood blocks of 10 × 10 × 10 mm are used as fuel. The size and shape can affect the operation of the gasifier. In [1] it is assumed this size is small enough to provoke mechanical bridging and the bulk can be seen as homogeneous having a constant physical properties. The density, heat capacity, thermal conductivity of the biomass and charcoal will be discussed later, in section 4.3.

On the other hand, dimensions are large enough to provoke pressure drops in the gas flow through the bed.

In the pyrolysis zone, the wood blocks are carbonized. In the modeling of this process, the density reduces while the volume of the solid material remains the same, assumed that the structure of the solid material (the blocks and their position) remain intact [7]. Only in the combustion and reduction zone, where the charcoal in its turn is being consumed, the slice height will reduce.

Because the ash falls through a grate on the bottom of the reactor, the resulting slice height has no limitations and will go to zero by combustion.

### 2.4 Gaseous substances in the process

A 7-bar pressurized air connection is available in the cabin in which the gasifier is located. Air from this connection is fed into the gasifier by a mass flow controller. In [1] from the design capacity of 2 kW and the optimal equivalence ratio (equation (2.1)) for a small scale updraft gasifier of 2.5, the air flow was determined as 2.1 gr/s.

$$\phi = \frac{\text{actual quantity of air supplied}}{\text{quantity of air needed for combustion}} \quad (2.1)$$

The product gas consists of N<sub>2</sub> from the air inlet, and all gasses that have been produced in any of the three zones. These are CO<sub>2</sub> from the combustion zone, CO from the reduction zone and other compounds from the pyrolysis zone, where burnable gasses such as CH<sub>4</sub> and H<sub>2</sub> are added to the gas flow, and also O<sub>2</sub>. This gets no chance to burn up and flows directly to exit and the exact compounds that are present in the product gas will not need to be modeled.

All together, the incoming flow of 2.1 gr/s expands to 3.2 gr/s [1]. This and other principles that will be used in the model development are shown in Figure 2.3.

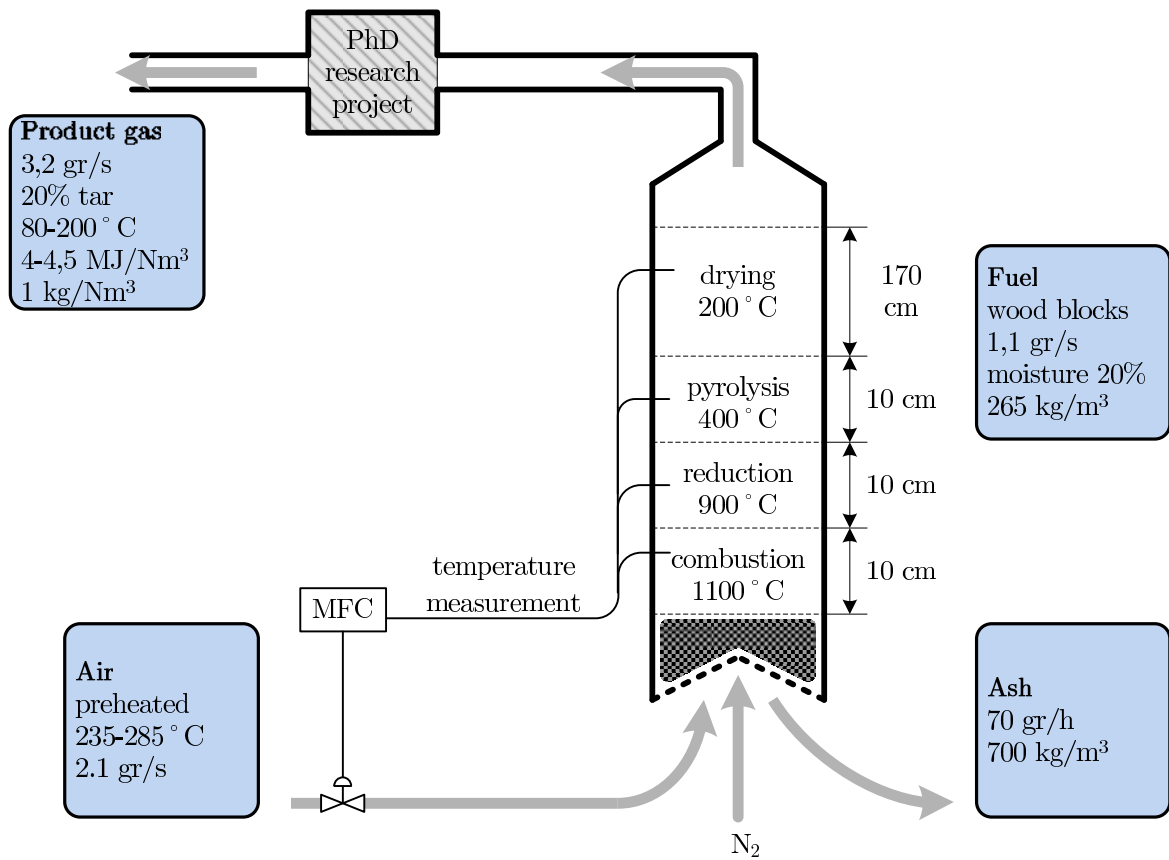

Figure 2.3: Sketch of the gasifier and information of flows.

### 2.5 Heat notation

In the heat balance diffusion and heat losses to the environment are assumed to be much smaller than the dynamic effect in the process. The gas flow and the effect of heat generation and consumption by chemical reactions are the only effects that will be modeled. An overview of the heat energy flows that will be in the model are showed in Figure 2.4.

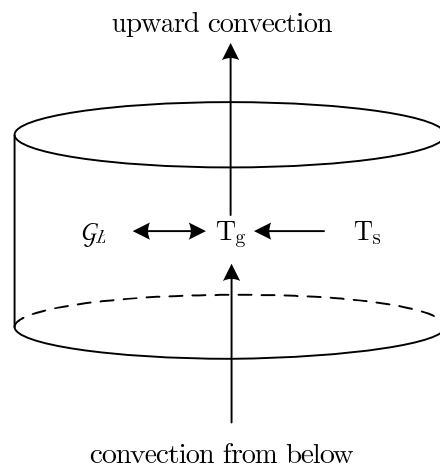

Figure 2.4: Heat energy flows to be modeled.

## 3 A static model for 1D biomass gasification

The modeling of the biomass gasifier will start with a static model, operating under normal conditions. This model will be used as a basis for further development to a dynamic model (section 4). In this section the main purpose is to find a way of modeling the static reaction equations and estimate all unknown values for this model.

The model can be one-dimensional and will consist of a number of horizontal slices in which the changes in concentrations and temperature over the length of the slice are calculated. Each slice will be regarded as perfectly mixed and all elements behave identically, so macroscopic integral conversion laws can be used for calculation of concentration, mass flow, and temperature profiles. A plan of the model is shown in Figure 3.1. The proportion of a slice is fixed by a certain amount of solid material. In the dynamic model, the reaction of solid material will cause reduction of slice height  $\Delta x$ . In this static model the slice height is constant.

The counting of slices is according upwinding: count in the direction of the gas flow.

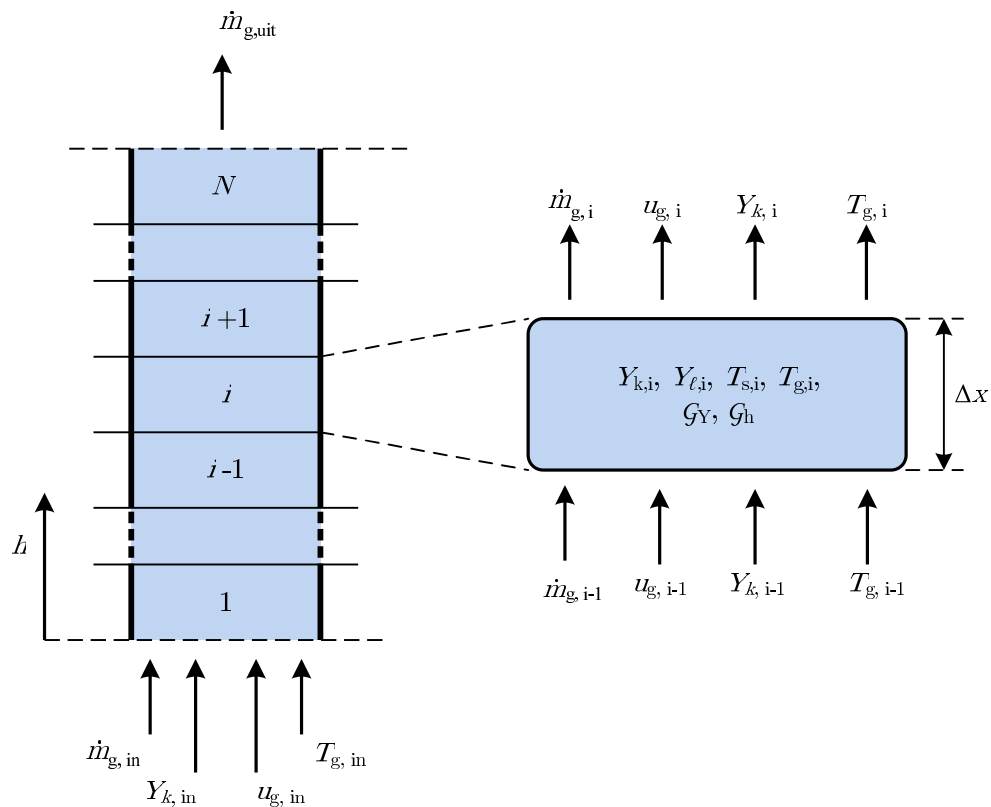

Figure 3.1: cross-section of the static SIMULINK-model.

The modeling will be done in SIMULINK to have the possibility of easily do tests with it and use the final model for on-line control. The model will become a finite-element approach of the gasifier. Later when a dynamic model will be derived, it will become clear that this model becomes to large to remain practical in SIMULINK. A recommendation for a possible future project is therefore to try to use an other way of modeling or to do model reduction.

The nomenclature that will be used to the describe the variables for all slices:

- For each slice **the appearance of any chemical element** is denoted by index  $k$  which signifies the

appearance of  $O_2$ ,  $CO_2$  and  $CO$  in the gas flow passing through any slice, or by index  $\ell$  which signifies either the appearance of volatile biomass in the solid content of a slice.

- The **inputs** of the model are mass flows of elements  $k$  and the inlet temperature.
- Each slice  $i$  has its **internal variables**:
  - $Y_{k,i}$  stands for the concentration of element  $k$  in the gas flow passing slice  $i$ .
  - $Y_{\ell,i}$  stands for the solid compound  $\ell$  in slice  $i$ .
  - $T_{g,i}$  denotes the temperature in the gas flow.
  - $T_{s,i}$  denotes the temperature of the solids in slice  $i$ .
  - Two different **generation terms**
    - \*  $\mathcal{G}_{Y_{k,i}}$ , denoting the generation of element  $k$  in slice  $i$  in [mol% /s], and
    - \* the heat generation term  $\mathcal{G}_{h,i}$  for the generated heat in slice  $i$  in [J].
- Each slice  $i$  has **external variables**:
  - the in- and outgoing mass flow of gasses  $\dot{m}_{g,i-1}$  and  $\dot{m}_{g,i}$ ,
  - the in- and outgoing flow velocities  $u_{i-1}$  and  $u_i$ ,
  - the concentrations of species from the underlying slice  $Y_{k,i-1}$  and of the current slice  $Y_{k,i}$  and
  - the temperature of the gas flowing in from the underlying slice  $T_{g,i-1}$  and the temperature of the gas in the current slice  $T_{g,i}$ .

In the whole report, the subscript  $s$  denotes the solid phase and the subscript  $g$  denotes the gaseous phase. The subscripts *in* and *out* are used for the flows in and out the gasifier, the subscript  $i - 1$  and  $i$  are used for flows in and out of slice  $i$ .

### 3.1 Tests to be carried out

Several tests will be carried out with the static model. The main aim is only to simplify the formation of a dynamic model. Issues of interest are:

- **Profile determination.** The first aim of the static model is to determine temperature and concentration profiles along the height of the gasifier in steady state operation. The way the different zones overlap and affect each other is unknown. The reliability of the derived simplified model must be discussed from its results.
- **Parameter sensitivity analysis.** A number of variables will have to be determined by estimation, for instance the reaction constants and heat conduction coefficients. For a great part reliability comes with a good choice of these unknown parameters. In the static model the effect of small deviations of these variables can be investigated. Of course the parameters that do affect the operation conditions must be determined and will need more attention, also when the model can be compared with the test setup in the TFE-lab.
- **Boundary conditions.** The influence of the boundary conditions will also be regarded. A test with little changes in the air inlet (temperature and quantity of the air flow) and one with another prescribed temperature profile can be done. With these tests an operation that is not under normal conditions can also be simulated. This can, for instance, give insight in the starting up and shutting down of the dynamic model.

### 3.2 Simulink model setup

The use of slices makes the model a finite element approach of the proces in the gasifier. Each slice is a subsystem-block in SIMULINK and consists of several parts, also modeled in separate subsystems for a better overview. One part deals with the chemical reactions. Here, the incoming gas flows and the steady-state temperature of the slice will determine the source rates for combustion, reduction and pyrolysis. It is necessary to compute the Arrhenius-equation in a slice for each of the three different source rates. In this way only the incoming concentrations  $Y_{k,i}$  and the temperature determine whether combustion, reduction or pyrolysis is the main reaction mechanism in the current slice. This part will be modeled in a SIMULINK-subsystem with three reaction mechanisms inside. Next the outgoing concentrations and the total mass flow are calculated in the second part and brought into the reaction

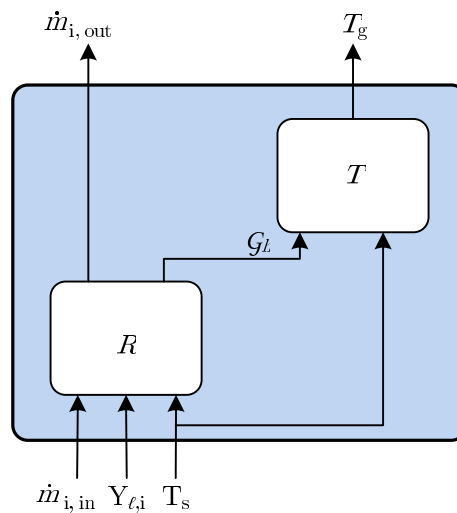

Figure 3.2: a slice in the static model.

equations of the next slice.

The description of the subsystems  $Y$  and  $T$  follows.

- The source rates  $R$  for the different reactions depend on the mixing and the availability of reactants, temperature and residence time. Reactions are modeled using first-order Arrhenius-equations [8]:

$$\frac{d[\text{product}]}{dt} = A[\text{fuel}][\text{oxidant}] \quad \left[ \frac{\text{kg}}{\text{s}} \right] \quad (3.1)$$

$$\text{where } A = a_s n_s \exp\left(\frac{E_s}{RT_g}\right) \quad (3.2)$$

The [oxidant] is the local concentration of the gas phase [-], this holds only for combustion and reduction. The concentration [fuel] is the concentration of biomass in solid material [-] in case of pyrolysis.

Because for all three reactions the pre-exponential terms  $a_s$  and  $n_s$  and also the activation energy  $E_s$  are unknown and will become the estimated constants  $C_1$  and  $C_2$  in case of combustion as in equation (3.3). For calculation of the rate of reduction the constants  $C_3$  and  $C_4$  are used and for pyrolysis  $C_5$  and  $C_6$ .

The pre-exponential terms for combustion and reduction will also include the effects of porosity of the solid material and the effective surface contact area of the carbonized woodblocks. This has a big influence on the source rates because it determines the chance of collisions between gaseous particles with C-molecules from the charcoal, which determines affects the source rate.

it is however impossible to compute this factor for the woodblocks in the model, and the only possibility is to include the phenomenon in the pre-exponential parameter. Therefore, this parameter must be tuned when the model is working.

$$R = C_1 \exp\left(-\frac{C_2}{T_g}\right) [\text{fuel}] [\text{oxidant}] \quad (3.3)$$

- The second part of the model calculates the Temperature variations, and is called  $T$ . In the static model, only the gas temperature will be calculated as in equation (3.4), where the temperature of the solids is a boundary condition. The equations for  $T_g$  are derived from the heat balance in Figure 2.4.

$$\begin{aligned} T_g &= \frac{E_R - E_{conv}}{c_{p,gas} m_g} \\ E_{conv} &= \alpha (T_s - T_g) \end{aligned} \quad (3.4)$$

- The proces is assumed to be isobar along the height of the gasifier, so the mass balance is instant.
- The way  $T$  and  $Y$  interact inside one slice, can be showed best in a figure where source rate  $R$  is plotted with different temperatures and concentrations. This is to be seen Figure 3.3.a for combustion and Figure 3.3.b for reduction.

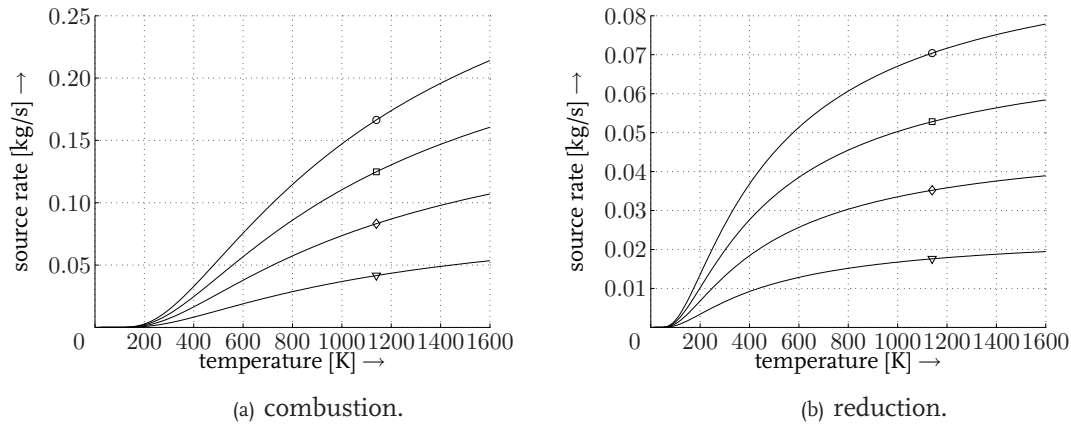

Legend	
○	$Y_{O_2} = 0.20$
□	$Y_{O_2} = 0.15$
◇	$Y_{O_2} = 0.10$
▽	$Y_{O_2} = 0.05$

Figure 3.3: source rate profiles for reduction and combustion.

### 3.3 Boundary conditions

The model operates in a fixed working point so boundary conditions are necessary to describe it. The air flow and air temperature from the inlet are determined in [1], as 2.1 [g/s] and 533 [K]. A temperature profile of the solid materials, known from [2], is needed for calculation of the source rates. From this  $T_g$  can be calculated and with this also the heat transfer between gas and solids. In the dynamic model this profile will be used as initial condition.

## Modeling for control of a biomass gasifier

The approximate temperature profile is used from [7]. And all used parameters in the static model, are listed in tabel I. When a value was estimated, a reference to the paragraph where the estimation was made, is given.

Table I: Settings in the static SIMULINK-model.

param.	value	unit	reference
$\alpha$	3	[W/m <sup>3</sup> K]	[4]
$\Delta x$	0.02	[m]	§ 3.4
$\rho_{air}$	1.25	[kg/m <sup>3</sup> ]	[11]
$\rho_{coal}$	25	[kg/m <sup>3</sup> ]	§ 4.4
$\rho_{biomass}$	500	[kg/m <sup>3</sup> ]	[9]
$A_{gasifier}$	0.1508	[m <sup>2</sup> ]	[1]
$c_{p,air}$	1464	[J/kg K]	[4]
$c_{p,coal}$	1260	[J/kg K]	[4]
$c_{p,biomass}$	2300	[J/kg K]	[4]
$dHr_{combustion}$	393800	[J/mol]	[10]
$dHr_{reduction}$	-16500	[J/mol]	[10]
$dHr_{pyrolysis}$	-5000000	[J/mol]	[10]
$m_{w,air}$	$28.96 \times 10^{-3}$	[kg/mol]	[8]
$m_{w,coal}$	$12.01 \times 10^{-3}$	[kg/mol]	[8]
$m_{w,productgas}$	$52.03 \times 10^{-3}$	[kg/mol]	[8]
$Y_{O_2,air}$	0.209	[-]	[12]
$Y_{CO_2,air}$	0	[-]	[12]
$Y_{CO,air}$	0	[-]	[12]

### 3.4 Results

The concentration changes in the two lower zones are the first results to show. The still values of parameters  $C_1$ ,  $C_2$ ,  $C_3$  and  $C_4$  must be estimated with these plots. In Figure 3.4 results with the tuned parameters is shown. In these figures the gasifier is laid down at its side, having the height position at the  $x$ -axis. The static model that was used consist of 20 slices forming a biomass bed of 40 cm height. The pyrolysis and the drying/heating zone zones were not jet modeled, so the gasses pass the combustion and reduction zone and flow directly to the exit afterwards.

Next three other variables can be determined when also the mass flow in a figure is plotted (see Figure 3.5). Here the Arrhenius terms  $C_5$  and  $C_6$  that together determine the generation of gasified wood, and the molair weight of the bulk of this gas are estimated. As reference for this estimation the profile of the total mass flow and the quantity of the mass flow at the exit, which is know from [1].

In Figure 3.5 the mass of gasses flowing through the gasifier is plotted. In the legend  $m_{g,k}$  denotes the mass flow when no pyrolysis is modeled and the increase in mass flow only is due to the formation of CO<sub>2</sub> and CO out of O<sub>2</sub>. The second profile in the legend called  $m_{g,pg}$  is the flow of product gas when als pyrolysis is modeled. The rate of pyrolysis depends on temperature and on the concentration of volatile biomass in the solid material of any slice which also is reflected in the figure (the right  $x$ -axis).



### section 3: A static model

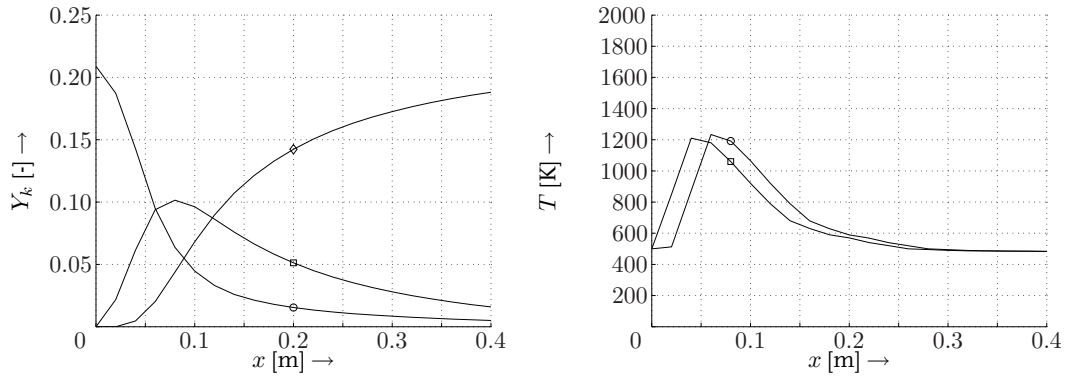

(a) concentration profiles in standard operation conditions. (b) temperature and concentration of biomass in standard operation conditions.

Legend	
left figure:	right figure:
○ $Y_{O_2}$	○ $T_g$
□ $Y_{CO_2}$	□ $T_s$
◇ $Y_{CO}$	

Figure 3.4: profile determination in static model.

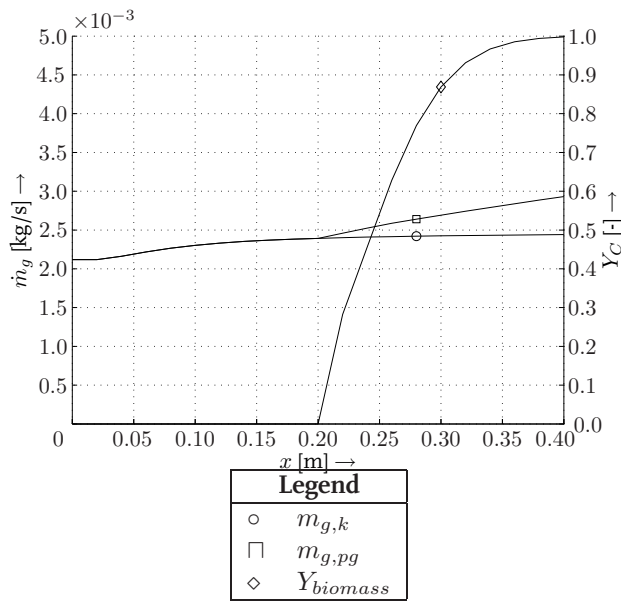

Figure 3.5: mass flow profile.

The influence of variations in variables that now have been estimated must be investigated.

## Modeling for control of a biomass gasifier

---

$C_1, C_3, C_5$	These pre-exponential terms in the Arrhenius-equations are roughly tuned by the knowledge that combustion and reduction mainly take place in the first 20 cm of the gasifier and pyrolysis in the next 10 cm. When the gasifier will be available for testing, product gas flows and temperature profiles must be used to check the reliability of these assumptions.
$C_2, C_4, C_6$	The values of these constants determine the activation energy of a reaction. In most cases these are unknown and were also estimated by examination of the resulting profiles in Figure 3.4. It would be better in future work to use the so-called $T_{max}$ -methode for determination of these constants as described in [1].
$\Delta x$	To test whether the slice height $\Delta x$ is small enough, the number of slices has been halved, resulting in a doubled slice height in a new simulation. When the results are plotted, the curves become jagged, but comparable with former results. For the concentration this means the slice height is small enough, but for the temperature calculation this test is little useful since a fixed temperature profile was needed as a boundary condition.
$T_{air,in}$	The change in input temperature can not be tested in this static model. Because of the boundary condition fixing the temperature profile, a test could never demonstrate the effects of different inlet temperatures. This test must be done with the dynamic model.
$Y_{O_2,air}, Y_{CO_2,air}, Y_{CO,air}$	The value of $Y_{O_2,air}$ is the only value that causes a significant different state because it is the factor to determine the rate of combustion, which establishes in its turn the warming up of the gas flow and the rate of the following reactions. But the concentration of oxygen in air is known and little variations should be anticipated.



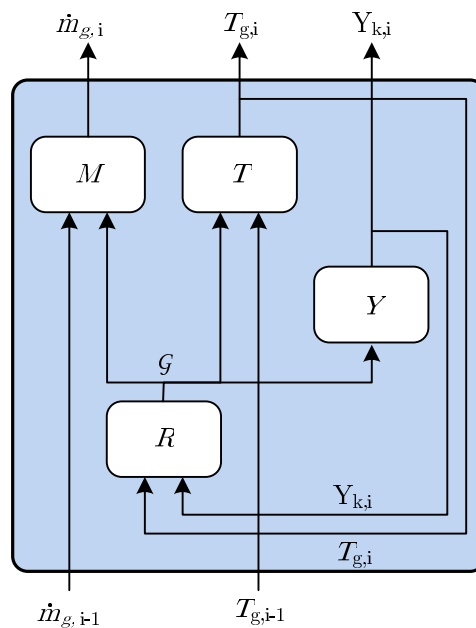

Figure 4.1: cross-section of the dynamic SIMULINK-model.

## 4 A dynamic model for 1D biomass gasification

In this section a dynamic model will be developed and it first will be tested under normal constraints, to check it for errors due to simplifications and design choices.

Now each slice consist of a certain amount of solid material. But here weight reduction of solid material must be calculated. It occurs in two different ways.

- In the pyrolysis zone burnable gasses evaporate from the volatile biomass. In the model this is manifested by a reducing concentration of biomass. There is no reduction in slice height due to pyrolysis, since the structure of the solids remains intact. If the concentration of biomass becomes zero, only charcoal is assumed to be left over.
- The charcoal that has been formed reacts with  $O_2$  and  $CO_2$  during combustion and reduction. Here the slice height will reduce, and even go to zero when all charcoal has reacted. All ashes are supposed to fall through the grate.

The scheme in Figure 3.1 has to be extended with a mass balance part  $M$ . Since the height of each slice is no longer constant, the quantity of solid and gaseous material in each slice will change and must be calculated. Som new equations will be formulated, dealing with the time varying temperatures, mass flows, biomass concentrations and slice height.

### 4.1 Tests to be carried out

With this dynamic model, other tests will be carried out for model evaluation and process insight.

- **Profile changes in time.** Does any of the profiles as seen in the static model change due to burning up the biomass and formation of ashes.
- **Profile changes due to varying  $\dot{m}_{g,in}$ .** This test has been carried out in section 3, but here the effects in the long run are regarded. Possible consequences of enlarging  $\dot{m}_{g,in}$  are the increase of combustion and reduction zone or to 'blow' these zones to higher slices. Also the effects on the quantity of product gas and the efficiency of the gasifier will be examined in this test.

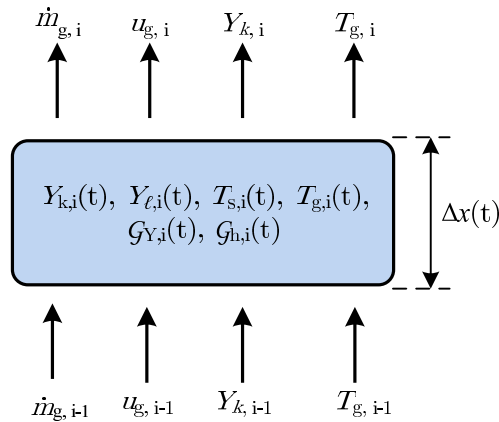

Figure 4.2: Internal and external values of a slice in the dynamic model.

- **Parameter sensitivity analysis.** Analysis of some variables that could not be tested in the static model ( $c_p$ ,  $\rho$ ) and analysis of already tested variables (effects on the dynamical behavior)
- **Step response test.** The objective is to determine steady state transfer gain, time to steady state, and comparison of the different time constants. Input is  $\dot{m}_{g,i-1}$  and as output  $\dot{m}_{g,i}$  and  $T_{g,i}$  will be regarded.
- **Start up and burn out.** If a reliable model is ready, also the start up proces can be investigated. Does the gasifier always start up, or does this strongly depend on it's initial temperature? Maybe using the model the start-up can be made faster. The examination of the burn out can be used to enlarge operation time by changing the air flow at the inlet (or maybe cooling the bulk/add extra wood).

## 4.2 Physical equations used in the dynamic model

For the notation, first reconsider Figure 3.1, where an extra term has to be added for the change to a dynamic model. Since the concentration  $\ell$  of charcoal in the solid part is no longer a boundary condition, a new generation term must be introduced.  $\mathcal{G}_{\ell,i}$  denotes the generation of charcoal, (or better: the conversion of biomass into charcoal) in the solid material due to pyrolysis in slice  $i$ . The nomenclature that is used in this extended dynamic model will be considered. See also the nomenclature that was given in Figure 3.1 for the static model

- The **inputs** of the model are mass flows, temperatures and velocities of the gasses and concentrations of gaseous elements  $k$ .
- Each slice  $i$  has different **concentrations** of species:
  - $Y_{k,i}$  stands for the concentration of element  $k$  in the gas flow passing slice  $i$ ,
  - $Y_{\ell,i}$  stands for the solid compound  $\ell$  in slice  $i$ ,
- different **temperatures**:
  - $T_{g,i}$  denotes the temperature in the gas flow, and
  - $T_{s,i}$  denotes the temperature of the solids in slice  $i$ .
- The variable **height** of any slice is denoted by  $\Delta x$ .
- Two different **generation terms**

## Modeling for control of a biomass gasifier

- $\mathcal{G}_{Y_k,i}$ , denoting the generation of element  $k$  in slice  $i$  in [mol% /s], and
- the heat generation term  $\mathcal{G}_{h,i}$  for the generated heat in slice  $i$  in [J].

First the physical equations will be deduced, from three conservation equations for mass balance, the balance for concentration of species and the temperature balance. The impulse balance will not be considered here, assuming the velocity changes are mainly determined by the mass generation due to either combustion, reduction or pyrolysis, and assuming the process is isobar. In subsection 4.3 the way these equations are placed into SIMULINK is explained.

- The first conservation equation is the **mass balance** or continuity equation:

$$\frac{\partial \rho}{\partial t} + \frac{\partial(\rho u)}{\partial x} = 0, \quad (4.1)$$

where  $\rho$  [kg/m<sup>3</sup>] is the density and  $u$  [m/s] is the velocity. This equation will be regarded instantaneously, and concerns the gas flows only. Because of the assumption of constant pressure, the first term becomes zero, the second term stands for the difference between incoming and outgoing mass flows. For slice  $i$ , the outgoing flow is the right hand side of equation (4.2); the incoming gas flows are at the left hand side, including the incoming gas flow from slice  $i-1$ , a generation term ( $\dot{m}_{\mathcal{G}_{Y_i}}$ ) and the result of the reducing slice height.

$$\dot{m}_{g,i-1} + \dot{m}_{\mathcal{G}_{Y_i}} + A_{gasifier} \rho \frac{dx}{dt} = \dot{m}_{g,i}. \quad (4.2)$$

- The **concentration of the gaseous elements**  $k$  where  $k$  stands for either  $Y_{O_2}$ ,  $Y_{CO_2}$ ,  $Y_{CO}$  or  $Y_{pg}$ . These are calculated from the general notation for the concentration:

$$\rho_g \frac{\partial Y_k}{\partial t} + \rho_g u \frac{\partial Y_k}{\partial x} = \rho_g \frac{\partial}{\partial x} \left( \mathcal{D}_{AB} \frac{\partial Y_k}{\partial x} \right) + \rho_k \mathcal{G}_{Y_g,i}, \quad (4.3)$$

where  $Y_k$  [-] is the concentration of species  $k$ ,  $\rho_k$  is  $\rho Y_k$  and  $\mathcal{G}_{Y_k}$  is the generation of species  $k$  in slice  $i$ . The second term in equation (4.3) represents the influence of an incoming flow with a different  $Y_k$ , this is the first term in the right hand side of equation (4.4). The last term is the generation of substance  $k$  within slice  $i$  in [1/s].

$$\frac{dY_k(t)}{dt} = \frac{u_{i-1}}{\Delta x} (Y_{k,i-1} - Y_{k,i}) + \mathcal{G}_{Y_s,i}. \quad (4.4)$$

Diffusion has a much smaller effect than the two others and will be neglected in the model, so the third term in equation (4.3) was eliminated.

In solid material, the concentration of charcoal will rise caused by the generation due to pyrolysis, the term that will be called  $\mathcal{G}_{Y_\ell,i}$ . This occurs while the sum of  $Y_{biomass}$  and  $C_{charcoal}$  remains always equal to one.

$$\frac{dY_\ell(t)}{dt} = \mathcal{G}_{Y_\ell,i}. \quad (4.5)$$

- The **temperature notation** is carried out for both gasses as solids. In general form:

$$\rho \frac{\partial c_p T}{\partial t} + \rho u \frac{\partial c_p T}{\partial x} = \frac{\partial}{\partial x} \left( k \frac{\partial T}{\partial x} \right) + \dot{m}''' \Delta Q + Q_{loss} \quad (4.6)$$

Temperature changes in the solid part of a slice are caused by the temperature difference with the gas only. So, only the first and the last term from equation (4.6), representing the instationair

term and a heat losses term (heat losses due to conduction), are significant for the temperature balance of solids. The convection of heat in the gas is supposed to be zero.

$$m_s c_{p,s} \frac{dT_s(t)}{dt} = \alpha(T_s - T_g) \quad (4.7)$$

Temperature changes of the gaseous part of a slice are also influenced by the in and out stream of gas and the generation (or loss) of heat energy by reactions. These are the second and third terms in equation (4.6). The differential equation that will be used to calculate the temperature of the gas part of slice  $i$  becomes:

$$m_g c_{p,g} \frac{dT_g(t)}{dt} = c_{p,g} \dot{m}_{g,i-1} (T_{g,i-1} - T_{g,i}) - \alpha(T_s - T_g) + \mathcal{G}_h \quad (4.8)$$

### 4.3 Modeling in Simulink

The mass balance will be modeled in SIMULINK as in Figure 4.3. This is the subsystem **M** inside a slice, representing the mass balance.

In this section the mass flow through a slice is regarded instantly, so the outgoing mass flow of gasses is the summation of the ingoing mass flow of gasses, the mass that is generated from any of the three chemical reactions, and finally the extra outgoing mass flow due to shrinkage of the slice height  $dx$ .

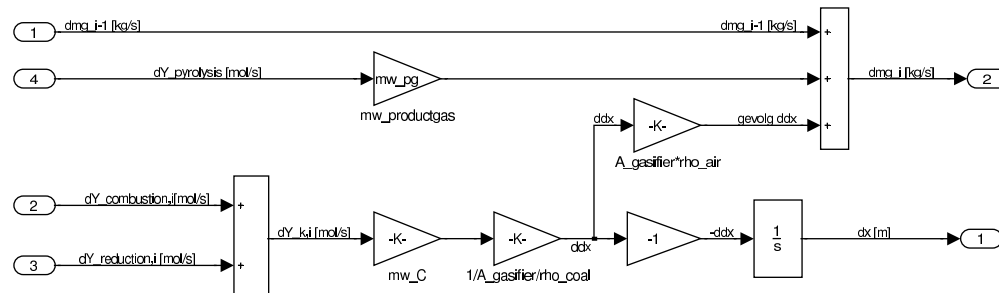

Figure 4.3: SIMULINK-subsystem  $M$  for mass balance.

Next the concentration of species will be modeled in a subsystem **Y** as in Figure 4.4. In Figure 4.4 only one of the species  $k$  is calculated. The right hand side of equation (4.4) is placed before an integration block which calculates the resulting  $Y_{k,i}$ . This term is the summation of a generation term  $[-/s]$  and the changes caused by the inflow from the underlying slice  $i-1$  with different  $Y_k$ .

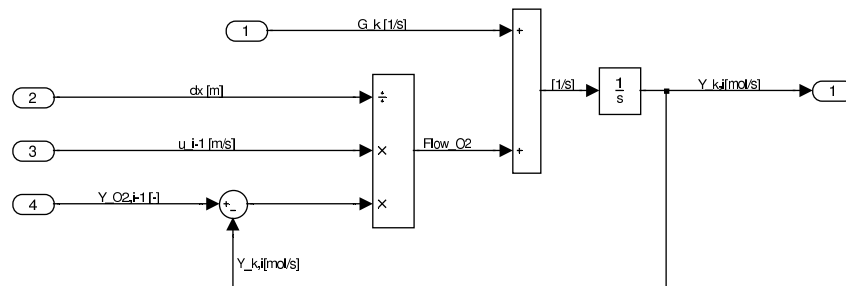

Figure 4.4: SIMULINK-subsystem  $Y$  for concentration notations.

The Arrhenius equations are modeled in a subsystem **R** where the concentration of species  $k$  is multiplied by the pre-exponential term  $C_1$  and the term  $\exp(-C_2/T_g)$  as in equation (3.3).

The temperature notation is found in a subsystem **T** where equation (4.7) (for solids) and equation (4.8) (for gasses) are converted to a SIMULINK-scheme, see Figure 4.5. The right hand side of equation (4.8) is the input for the upper integrator block which calculates  $T_g$ , and the right hand side of equation

## Modeling for control of a biomass gasifier

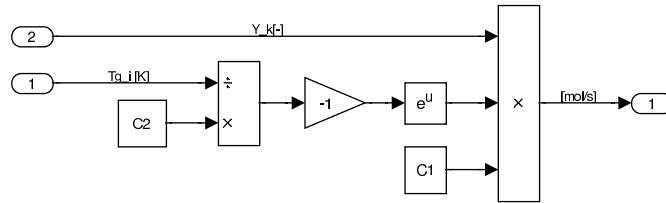

Figure 4.5: SIMULINK-subsystem  $R$  for reaction notations.

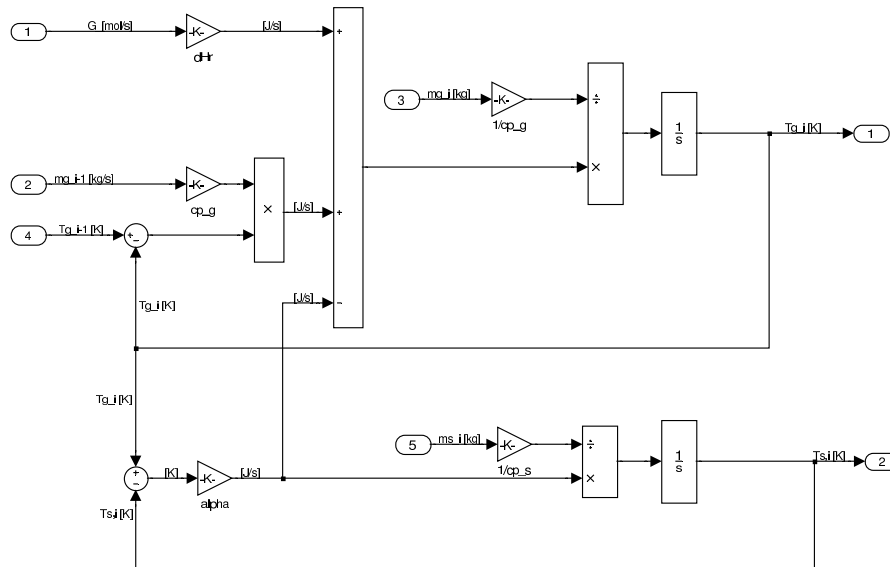

Figure 4.6: SIMULINK-subsystem  $T$  for temperature notations.

(4.7) is the input for lower integrator block, which calculates  $T_s$ .

From input block 1 the generation term from  $R$  is multiplied by  $dHr$ , giving the total amount of released or consumed heat by chemical reactions. The other two terms that influence the change in  $T_g$  are the inflow of gas from slice  $i-1$  having a different temperature, and the convection with solid material.

All used parameters that are used in this model are listed in table 1 in Section 3.

### 4.4 Evaluation of simulation results

The testing of the model in SIMULINK can be done when all these subsystems have been coupled. The model consists of 40 slices of each 2 cm in initial height. To solve the differential equations, the ode15s-method for stiff ode's is used with a relative tolerance of  $1 \cdot 10^{-3}$ . The duration period of one simulation is set to 10.000 s.

In the very first tests some simplifications were made, such as a very high  $\alpha$  to eliminate difference in temperatures  $T_s$  and  $T_g$ . The model was checked for errors during these first trial runs. Also the effects of estimated parameters could be checked.

Initial conditions that were needed, are profiles for  $Y_\ell$  and  $T_s$ . For  $Y_\ell$  the presence of 25 cm of charcoal on the bottom of the gasifier and for  $T_s$  a temperature peak were applied, both to start the combustion process. After starting the operation the zones establish themselves, having profiles that were seen in Figure 3.4, and the process is started up. The initial conditions and simulation results are to be seen in the figures of in appendix B.



In the sensitivity analysis first parameters  $C_1, C_2, C_3, C_4, C_5, C_6$  were considered. These reaction constants were tuned by the known characteristics of each zone already in the static model. Results hereby the height and temperature as described in [1] were used as reference for tuning. Also the density of the charcoal bulk in the combustion and reduction zone  $\rho_{coal}$  was unknown. The total operation time of the proces was found to be almost complete dependent of this variable. This is physically reasonable, since the parameters  $C_1$  and  $C_2$  did already fix the reaction profile of the combustion zone. Now  $\rho_{coal}$  is the only parameter to determines the burning time of the volume in which charcoal is present. Of coarse, the upper zones do not affect this and will stabilize along the combustion process behaves. It can be recommended that measurements form the gasifier in practice will be used determine the operation time to further precise this variable.

The reliability of the model will depend on these estimated values. As soon as measure data will be available, the outgoing mass flow and temperature output must be used for check the model. For now, little attention will paid to the reliability of the used values and the emphasis will lie on the dynamic behavior of the model.

Still, the evaporation of water is not modeled. It does effect the exit temperature, but when this temperature gets that high, that a control action is needed, evaporation will be largely extinguished.

In the beginning it seemed temperature measurement could be used for control. A maximum temperature is located at a fixed place on the top of the combustion zone, having an almost constant temperature. It would be very easy to measure  $T_{max}$  because it is found at a nearly fixed position in the gasifier. Although, after examination of this maximum temperature profile over time, the fluctuations prove to be bigger than expected, and even worse, this profile is very sensitive for changes of reaction constants in the Arrhenius-equations. In this simulation builds up during the first 4000 s, and after this time it starts lowering, as in Figure 4.7. From this can be concluded that the supposed steady state condition does certainly not hold for all measurable values.

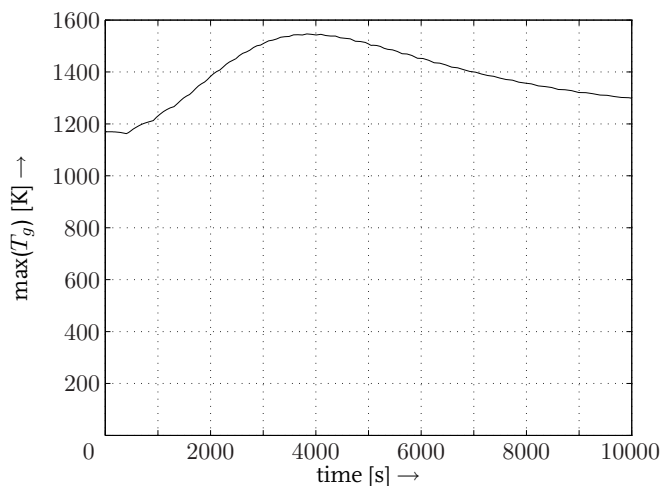

Figure 4.7: Maximum  $T_g$  during one run.

Other results that can be examined are shrinkage of the height of the bed and the outgoing mass flow. This last,  $\dot{m}_{g,out}$  (Figure 4.8) shows also a peak. However, both plots do not indicate that the temperature profile and the  $\dot{m}_{g,out}$  profile are coupled. The maximum temperature profile is the result heating up the bed, while the peak in  $\dot{m}_{g,out}$  proves to be almost completely due to the pyrolysis, when also the total outgoing pyrolysis products have almost the same curve (the dashed line in Figure 4.8). This peak must be provoked by pyrolysis in the top of the bed, were it was not expected to start already. This can be due to model errors; the assumption that pyrolysis is to be described by an Arrhenius equation might cause this phenomenon. Another possibility is that in reality this will happen also. An

## Modeling for control of a biomass gasifier

explanation would be that inside the batch reactor the biomass from the whole batch warms up in the beginning of the process, enough to start pyrolysis .

The main problem for control now is the output  $\dot{m}_{g,out}$  is very inconstant, without big changes on the profiles seen in appendix B. In measurements it should be checked if these are model errors by the assumption that pyrolysis can be described by an Arrhenius equation, or that this effect is still present in reality. In the following part of this report this is assumed, and a good controller must therefore be able to deal with this problem.

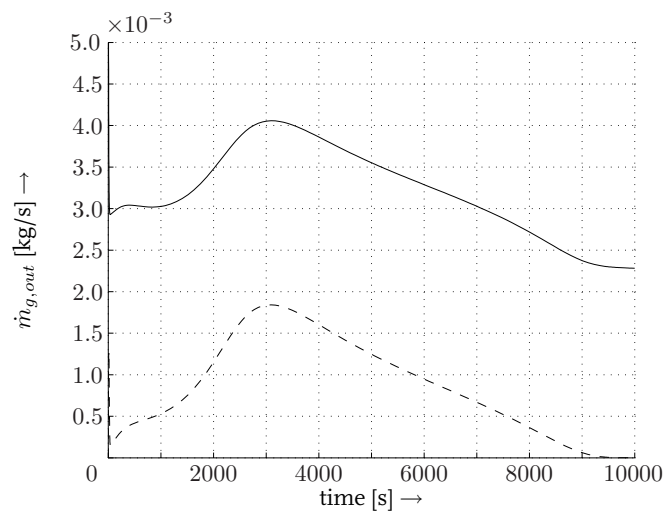

Figure 4.8: outgoing mass flow during one cycle,  $\dot{m}_{g,in} = 2.1$  [g.s].

At last, the front speed remains more constant as can be concluded from the rather constant lowering height of the bed as in Figure 4.9. This means combustion and reduction do not show this so-called batch-effect.

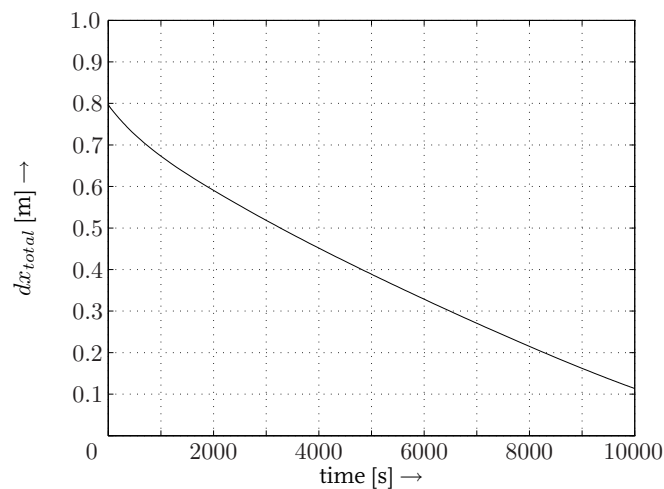

Figure 4.9: front velocity during one cycle,  $\dot{m}_{g,in} = 2.1$  [g.s].

Now the deviations of the supposed steady state have become clear. If a constant outgoing mass flow

is wished, this output must be measure directly. To control this output with temperature information seems impossible.

The first control aim was safety, so to maintain the limits of the gas temperature at the exit of the gasifier (maximum here is 600 K) and the minimum and maximum gas temperature inside the gasifier has priority (should be between 1300 and 1600 K). If the process meets these tolerances, a mass-flow controller can manipulate the inflow of air to control the outgoing flow  $\dot{m}_{g,out}$ . This way of control is possible in a cascade controller in which temperature controllers can overrule the mass flow controller at the exit.

## 5 Process control

In this section the effects of the possible control actions will be regarded and discussed into detail.

### 5.1 Study of control action effects

The study for control possibilities starts with a tests in which the controllable input has been varied in an (unrealistic) wide range. In Figure 5.1 this input was kept constant during a cycle, and varied from 1.4 to 2.7 gr/s in eight separate simulations.

When the input is set to a higher level to peak in  $\dot{m}_{g,out}$  comes sooner, so the settling time for this effect is shorter, but it is also relatively higher. The bed is sooner empty in this case, which can also be seen in the decrease of  $dx$ , which goes faster in Figure 5.1.b.

In the study of the concentration profiles, when the input flow is set higher, the profiles shift to right in general, as was to be expected.

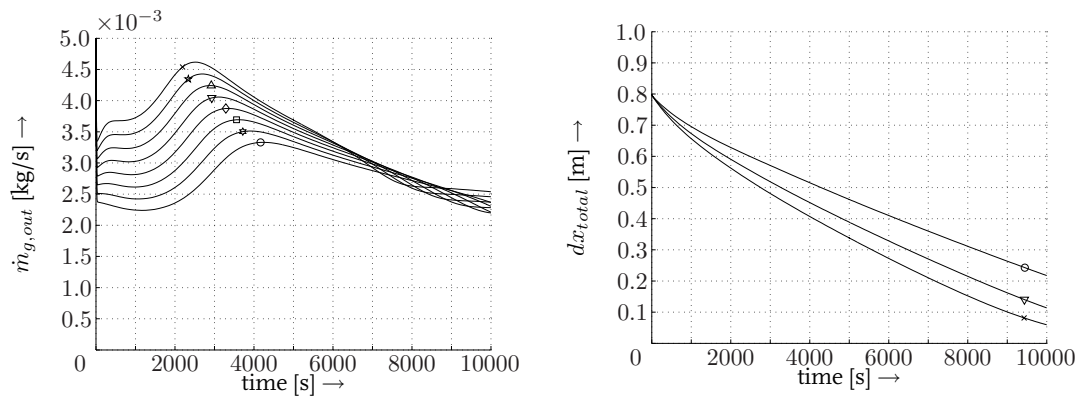

(a) front velocity measured on the top of the bed. (b) reduction height  $dx$  of the reactor bed.

Legend			
$\dot{m}_{g,in} =$			
×	1.5 gr/s	◇	2.3 gr/s
*	1.7 gr/s	□	2.5 gr/s
△	1.9 gr/s	○	2.7 gr/s
▽	2.1 gr/s		

Figure 5.1: results control action.

A second test to get more insight in the effect of control is to consider some different step responses. In a new simulation, the input starts at the normal operation value for the input signal  $\dot{m}_{g,i-1}$  of 2.1 gr/s, after 5000 s, this changes to either 1.6, 1.9, 2.1 or 2.4 gr/s. In SIMULINK this step causes a convergence problem but this can be remedied by tightening the relative tolerance from  $1 \cdot 10^{-3}$  to  $1 \cdot 10^{-4}$ .

These tests, in Figure 5.2 and 5.3 show an inverse response of temperature. When in Figure 5.2 the input is lowered, the resulting maximum temperature gets gradually higher. Clearly, the cooling effects (lower combustion rate) is compensated by the warming effects (also a lower reduction and pyrolysis rate). Now, due to lower flow velocities, the gas has more time to heat up in the combustion zone, and a higher maximum temperature results.

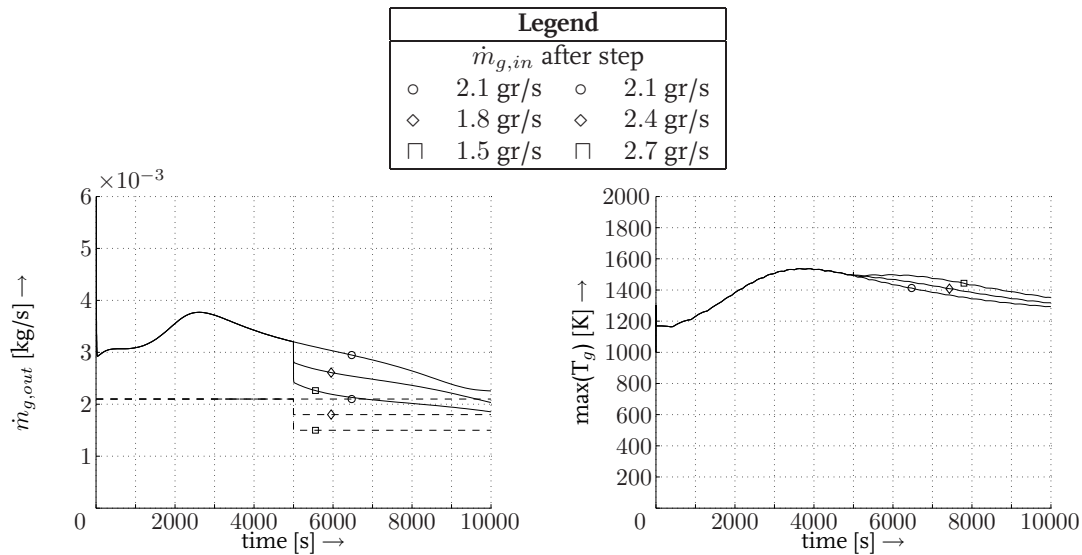

Figure 5.2: responds of  $T_g$  and  $\dot{m}_{g,out}$  on a downward step.

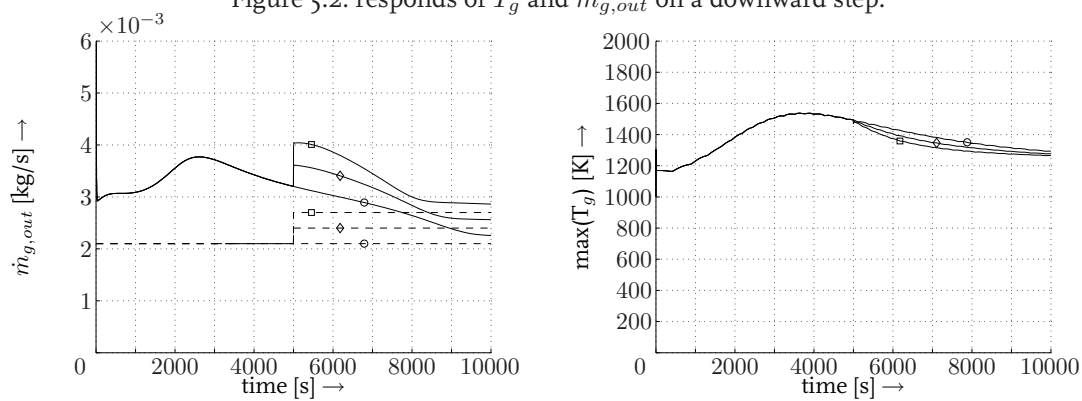

Figure 5.3: responds of  $T_g$  and  $\dot{m}_{g,out}$  on an upward step.

## 5.2 Controller design and evaluation

Control of  $\dot{m}_{g,out}$  in first stage of a cascade controller was proposed in Section 4. A control scheme for this is shown in Figure 5.4.

Control only affects the actual output  $\dot{m}_{g,out}$ . Therefore, it will not be possible to reduce the peak in the production pyrolysis gas. After applying a controller it turns out that the gas flow can be steadied by a simple PI-controller for the time window between 3000 and 10.000 s, but that the concentration of pyrolysis remains uncontrolled and still shows the same peak as the uncontrolled situation. The dashed line in Figure 5.5.a denotes the quantity of pyrolyzed gas. The temperature remains also quite constant and is shown in Figure 5.5.b. It is impossible to control both the concentration of pyrolysis product in the product gas as well as  $\dot{m}_{g,put}$  with only one controllable input  $\dot{m}_{g,in}$

In a new project the possibilities to smooth the pyrolysis profile could be studied, which also is important for a constant formation of tars in the product gas. This must be done with MPC which only is possible if the pyrolysis process is very well understood. A better tuned controller or other possibilities actuate must be considered.

Further the quickening of start up and a simulation of shut down procedure with  $N_2$  have not jet been tested.

## Controlling the model

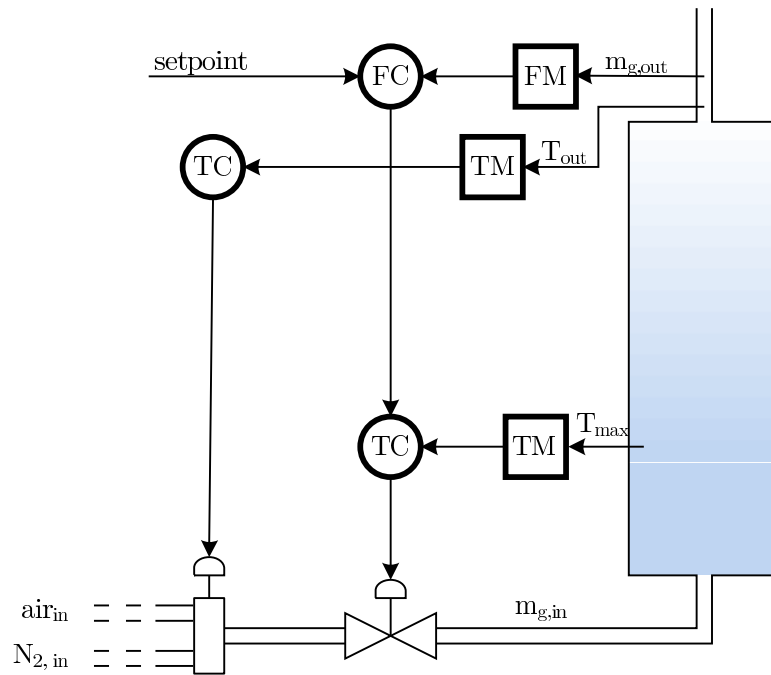
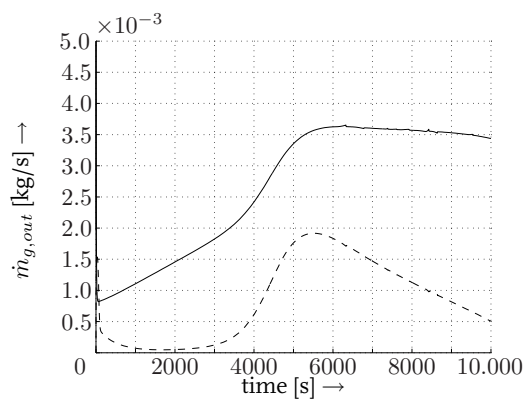
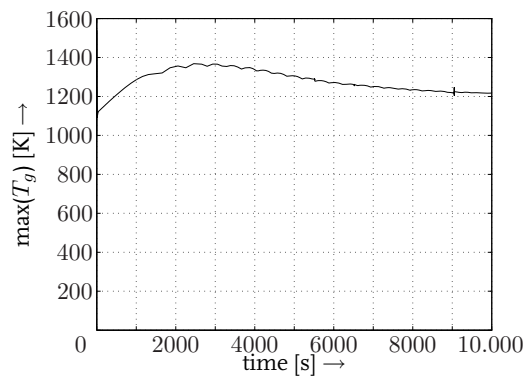

Figure 5.4: Cascade controller setup.



(a) outgoing mass flow during a controlled cycle.



(b) maximum gas temperature during a controlled cycle.

Figure 5.5: profile determination in static model.



## Conclusions and recommendations

---

### 6 Conclusions and recommendations

#### 6.1 Conclusions

The aim of the present work was the design of a model for the experimental test setup of a small scale updraft biomass gasifier, that is used for a PhD project on the removal of tars from the product gas of a gasifier. This has become a one-dimensional numerical model. A static as well as a dynamic model consisting of several horizontal slices have been developed in SIMULINK, after investigation of the processes inside the reactor.

All slices in the static model have been modeled in the same way, and the structure of one slice gives an idea how the model was built up. One slice consists of a reaction part and a temperature part in which the various calculations take place. To use the static model, boundary conditions on temperature and concentration profiles were needed. With the model all reaction constants for the modeled chemical reactions could be estimated.

The static model was then extended with a mass part, to calculate weight and slice height reduction, and a concentration part to model dynamic effects such as gas flows in the concentrations. The boundary conditions in the static model could be used as initial conditions in the dynamic model, for a smooth start-up in dynamic simulations.

The model was used to investigate its dynamic effects and to see in which way it can be controlled. Also a parameter sensitivity analysis has been carried out, concluding the influence of some estimated values in the model must be investigated in practice.

#### 6.2 Experimental results

With the dynamic model the behavior of the gasifier could be studied and the mass flow of product gas from the gasifier could be tested for control. An important factor to consider when a controller for the reactor will be designed, is the batch-effect due to pyrolysis that makes the mass flow inconstant during a gasification run.

A mass-flow controller was proposed to manipulate the inflow of air to control the outgoing gas flow. A cascade control setup with a temperature controller that can overrule the mass flow controller was needed, not to let the temperatures rise or lower too drastically due to the control actions.

After tuning a controller, which is only applicable for the model as it has been developed in this report, the gas flow at the exit could be controlled by a simple PI-controller for the time window between 3000 and 10.000 s. Although the concentration of pyrolysis remains uncontrolled and still shows the same peak as the uncontrolled situation. So having only one controllable input signal, only the output of product gasses can be stabilized and it will not be possible to reduce the peak in the production of pyrolysis gas. If this is a problem for the constant formation of tar, and thus for the possibilities to do measurements with the gasifier for the PhD-project, is not sure. When a controller as here has been described will be used, this must be tested.

#### 6.3 Recommendations

It was not possible to do comparable test runs in practice to reconsider estimated values and chosen model principles. When a controller will be derived with use of the model that has been developed, this reconsideration should first be performed when measurement data will become available.

Correctness of values of parameters for chemical reactions, must be investigated and also the used model for pyrolysis. For a better estimation for the activation energy the TGA-analyses can be used in combination with the  $T_{max}$ -method

Finally, the quickening of start up and a simulation of shut down procedure, for instance with  $N_2$  have not yet been tested, and leave possibilities for approving of test runs.





---

## References

- [1] As, A.J.H. van, *Design of an updraught gasification installation*, TU/e Eindhoven, 2003, afstudeerverslag 2003010
- [2] Hoeven, T.A. van der, *Basics of biomass gasification*, TU/e Eindhoven, 2004, WET 2003.08
- [3] Hoeben, M.P., *Ontwerp van een externe kraker voor teren in een biomassa vergasser*, TU/e Eindhoven, 1999, Afstudeerverslag WET 99.008
- [4] Janna, even op de bibsite checken
- [5] Jenkins, B.M. *Downdraft gasification characteristics of major California residue-derived fuels*, Research centre Finland, fuel and lubricant research laboratorium, Espoo Finland
- [6] Loo, S van, Koppejan, J, *Handbook of biomass combustion and co-firing*, Twente University Press, Enschede, 2002
- [7] Reed, T.B., Das, A. *Handbook of biomass downdraft gasifier engine systems*, Golden, Colorado
- [8] Scott Fogler, H., *Elements of chemical reaction engineering*, Prentice Hall, London, 1998
- [9] SERI, *Generator gas: the Swedish experience from 1939 - 1945* Solar Energy Research Institute, Golden, CO, SERI/SP 33-140,1979 33-140,1979
- [10] Susanto, H., Beenackers, A.A.C.M., Van Swaaij, W.P.M., *Moving bed gasifier with internal recycle of pyrolysis gas in: Energy from biomass*, Applied science publishers London, England, 1983
- [11] <http://hypertextbook.com/facts/2000/RachelChu.shtml>
- [12] <http://www.mistupid.com/chemistry/aircomp.htm>



## A Overview installation

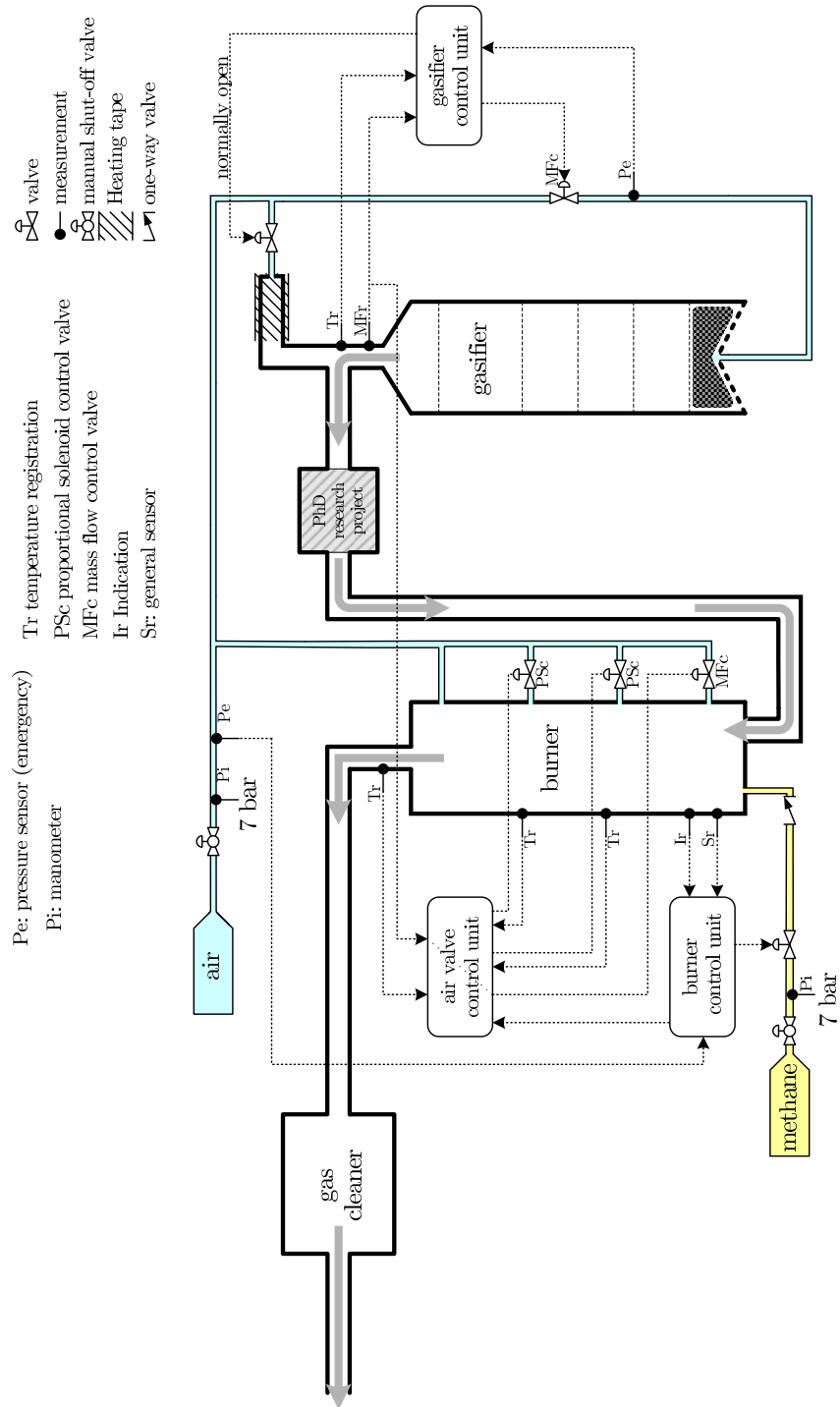

Figure A.1: complete overview control system and installation.



## B First results dynamic model

The first simulation results of the dynamic model. In the left figures, the change in concentrations of gaseous species  $O_2$ ,  $CO_2$  and  $CO$  is plotted. In the right figures the concentration of biomass in the solid material as well as both temperature profiles of gaseous materials as temperature profiles of solid materials are shown.

The reactor has been filled with biomass up to  $x = 0.8$  m and combustion has been monitored for 10.000 s. In the figures the reactor is again laid on its side (the  $x$ -axis indicate the height position). The chosen moments in time to plot are  $t = 0$ , which is the initial state,  $t = 200$  s, where all reactions and temperatures are risen to a kind of steady state,  $t = 5000$  and  $t = 10.000$  which is regarded as the end of the simulation, since almost all biomass has been consumed for pyrolysis.

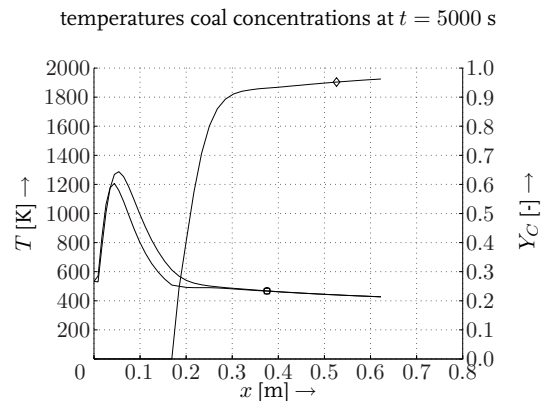
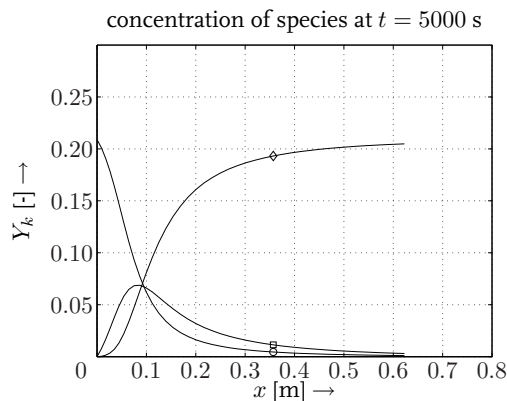
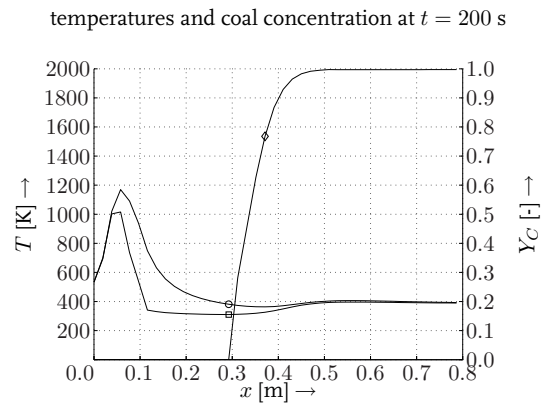
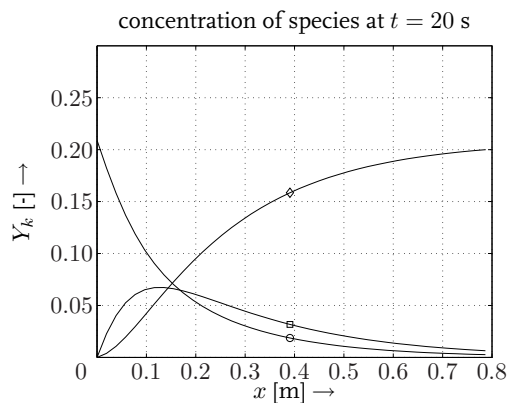
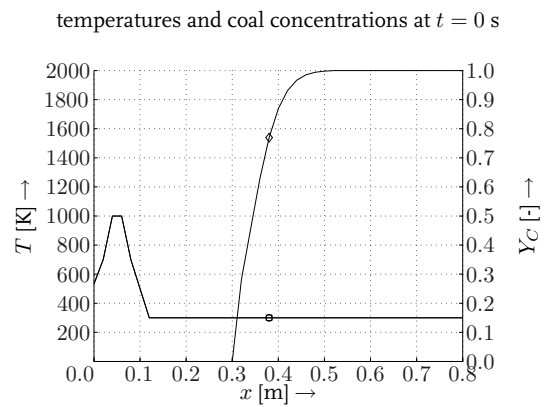
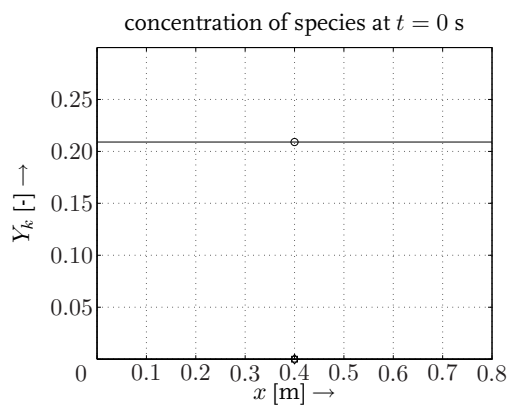

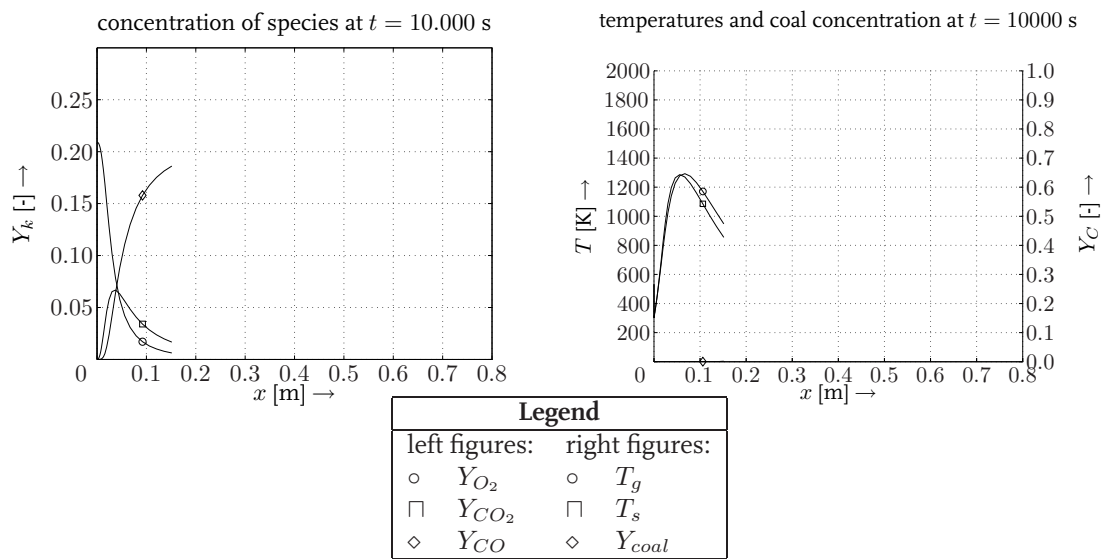

Figure B.1: profile changes during gasification.

