

AT MICROFICHE
REFERENCE
LIBRARY

A project of Volunteers in Asia

Proceedings of the Conference on
Energy-Conserving, Solar-Heated Greenhouses

by. John Hayes and Drew Gillett

Published by:
Marlboro College
Marlboro, VT 05344 USA

Paper copies are \$ 9; \$7.50 for readers in
developing countries.

Available from:
Marlboro College Greenhouse Conference
Marlboro College
Marlboro, VT 05344 USA

Reproduced by permission of Marlboro College.

Reproduction of this microfiche document in any
form is subject to the same restrictions as those
of the original document.

PROCEEDINGS

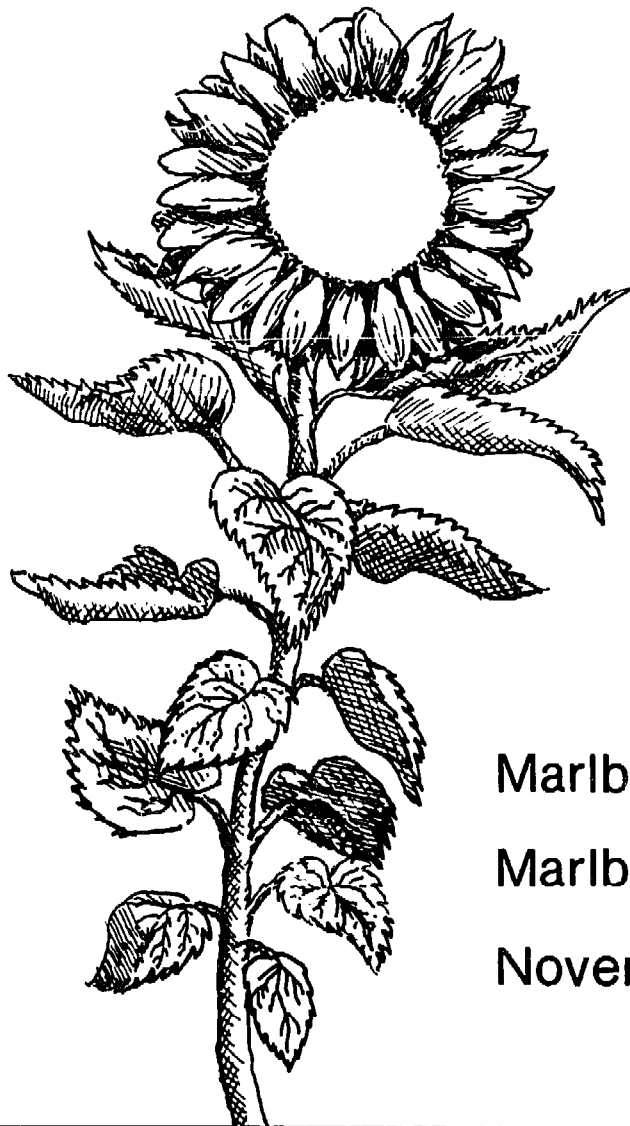

Marlboro College

Marlboro, Vermont

November 19-20, 1977

Conference on
Energy Conserving
Solar Heated Greenhouses

PROCEEDINGS OF THE CONFERENCE
ON ENERGY-CONSERVING, SOLAR-HEATED
GREENHOUSES

Edited by
JOHN HAYES & DREW GILLETT

Held at
MARLBORO COLLEGE
MARLBORO, VERMONT 05344

on
NOVEMBER 19 & 20, 1977

SPONSORING ORGANIZATIONS

TOTAL ENVIRONMENTAL ACTION
NEW ENGLAND SOLAR ENERGY ASSOCIATION
MAINE AUDUBON SOCIETY
ENERGY RESEARCH GROUP, MARLBORO COLLEGE
FRIENDS OF THE SUN
VERMONT RECYCLED GREENHOUSES
KALWALL CORPORATION
SOLAR TECHNOLOGY TRANSFER OFFICE,
BROOKHAVEN NATIONAL LABORATORY

ORGANIZING COMMITTEE

DAN SCULLY
JEREMY COLEMAN
JONATHAN GORHAM
ERIKA MORGAN
JIM STILES
JIM BURKE
DREW GILLETT
JOHN HAYES

These Proceedings are available
from Marlboro College for \$9.

TABLE OF CONTENTS

SECTION 1

PREFACE	1
ACKNOWLEDGMENTS	3
INTRODUCTORY LETTER by CHANDLER FULTON (Brandeis Univ.)	4

SECTION 2

WELCOME ADDRESS by Vermont Congressman JAMES JEFFORDS	10
KEYNOTE ADDRESS by THOMAS LAWAND (Brace Research Inst.) Solar Energy and Greenhouse Agriculture: The Challenge Ahead	12

SECTION 3

CHAIRMAN: DREW GILLETT
(Brookhaven National Laboratory)

WILLIAM YANDA (Solar Sustenance Project) - Solar Sustenance Project - Phase II Final Report.	16
NORMAN SAUNDERS (Circuit Engineering, Weston, MA) - The Overall Solution to Solar Heating	39
WILLIAM MAKOFSKE (Ramapo College) - Ramapo Aquaculture - Greenhouse System	44
WILLIAM MILBURN*, ROBERT ALDRICH & JOHN WHITE (Pennsyl- vania State University) - Internal and External Solar Collection and Thermal Storage for Green- house Heating	48
DOUG TAFF*, R.B. HOLDRIDGE (Parallax Corp.) & JOHN WOLFE (Dartmouth College) - Hybrid Passive Systems I. Design Considerations, Theoretical Predictions and Performance of an Attached Solar Greenhouse Used to Heat a Building	58
DOUG TAFF*, R.B. HOLDRIDGE - Hybrid Passive Systems II. Close Control Design Criteria Establishing Cost- Effective Solar Heating - The Hybrid-Delta Line	63
DOUG TAFF*, R.B. HOLDRIDGE & AL CONVERSE (Dartmouth College) - A Comparative Study Between the Thermal Efficiency of Window-Wall and Active Collector Systems	67
NED NISSON (Center for Ecological Technology) - Preliminary Report on a Free-Standing Solar Green- house in Western Massachusetts.	70
WILLIAM JOHNSON*, ARTHUR SEDRICK (Kalwall Corp.) & ANDREW SCOVILLE* (Dynamics Research Corp.) - Evaluation of Passive and Hybrid Temperature Control Methods for Greenhouses	79

SECTION 4
 CHAIRMAN: ERIKA MORGAN
 (MAINE AUDUBON SOCIETY)

DAVID MACKINNON (Rodale Press) - Light Levels in Solar Greenhouses: Some Recommendations	94
CARL LINDSTROM & ABBY ROCKEFELLER* (Clivus Multrum) - Greywater for the Greenhouse	101
CHARLES WING (Cornerstones) - The Maine Vocational Region Ten Hybrid Solar Greenhouse	109
DAVIS STRAUB* & EVAN BROWN (Ecotope) - A Preliminary Assessment of the Unique Features of a Parabolic Aquaculture/Greenhouse	114
ELIZABETH COPPINGER (Ecotope) - The Effect of Solar Energy on Aquaculture Support: A Preliminary Assessment	122
ECOTOPE GROUP - Evaluation of a Solar-Heated Greenhouse for the Environmental Farm Project, Canyon Park Junior High, Bothell, Washington.	127
ROBERT GINSBURG* (Southern California Institute of Architecture) & JACK PARK (Helion, Inc.) - Evolution of a Solar Greenhouse.	137
E.R. FREEMAN (Provider Greenhouses) - The Evolution of a Small Solar Greenhouse.	141

SECTION 5
 CHAIRMAN: DREW GILLETT

ED MACDOUGALL (Brookhaven National Laboratory) - A Home-Built, Low Technology Solar Greenhouse.	148
JOSEPH FREDA* & LEAFIE FREDA* - A Simple, Inexpensive Unheated Shelter for a Winter Garden at the North Shore Science Museum, Plandome Manor, NY	162
MICHAEL PISERCHIO, WILLIAM DUPONT, JOHN HAYES* (Marlboro College) & JEREMY COLEMAN (Total Environmental Action) - The Use of Retractable, Insulated, Reflective Shutters for Augmenting Radiation and Retaining Heat in Greenhouses.	166
CARLA MUELLER*, JOHN WHITE & R.A. ALDRICH (Pennsylvania State University) - The Growth and Response of Vegetables in Sub-Optimum Greenhouse Environments	180
EDWARD MAZRIA, STEVE BAKER, ERIC HOFF, DAVID JENKINS & JIM VAN DUYN (University of Oregon) - NOTI Solar Greenhouse	196
RICHARD MACMATH (Sunstructures, Inc.) - Passive Greenhouse Design in the Great Lakes Region: A Case Study	209
KATHI RYAN* & EARLE BARNHART (New Alchemy Institute) - Plant Response and Food Production in Solar Bioshelters.	216
EARLE BARNHART - Biotechnic Strategies in Bioshelters.	222

SECTION 6
CHAIRMAN: BRUCE ANDERSON
(Total Environmental Action)

RICHARD GOTTLIEB & BUZZ TENENBOM* (Goddard College) - Solar Greenhouse Experience at the Institute for Social Ecology.	229
MARK WARD (Cambridge, MA) - Some Observations on the Design and Construction of Greenhouses.	237
MARK HAHN (Ramapo College) - Greenhouse at Ramapo College	244
TAMIL BAUCH* (EGGE Research) & MORTON SCHIFF* (Energy Shelters) - Energy Conservation in Greenhouses.	251
ROBERT LIU (Light & Plant Growth Laboratory, USDA) - Spectrum Separation Chamber for Plant Growth.	253
REED MAES (Environmental Research Institute of Michigan) A Large-Scale Northern Climate Solar Garden	258
DAVID SNELL (Snell Nurseries) - A Solar Heated and Air Conditioned Greenhouse Using the Greenhouse as the Collector	262
TYRONE PIKE (Dubin-Bloome Associates) - Greenhouse at Cary Arboretum.	264
RAMON RUEDA (People's Development Corporation) - Program at the People's Development Corporation	266

SECTION 7

WILLIAM YANDA - SUMMARY SPEECH - Insurmountable Opportunities	268
CONRAD HEESCHEN (Dryden, ME) - A Closing Letter - Observations.	273
LIST OF PARTICIPANTS.	275



SECTION 1

- Preface
- Acknowledgements
- Introduction to the Conference, Chandler Fulton

PREFACE

This volume contains the papers which were delivered at the Conference on Energy-Conserving, Solar-Heated Greenhouses which was held at Marlboro College, Marlboro, Vermont, on November 19 and 20, 1977. Copies of these Proceedings may be obtained from Marlboro College at a price of \$9.

The decision to hold this conference was made by a small group of New Englanders who were attending the Second Annual Conference on Solar Energy for Heating of Greenhouses and Greenhouse-Residence Combinations, held in Cleveland, Ohio, in March of 1977. The group included Jeremy Coleman of Total Environmental Action, Harrisville, NH; Jonathan Gorham of the Maine Audubon Society; Jim Burke of Vermont Recycled Greenhouses; Jenny Greene, a greenhouse owner from New Hampshire; Mark Ward, a greenhouse recycler/builder from Cambridge, MA; Drew Gillett, then of the Kalwall Corporation of New Hampshire; and John Hayes of Marlboro College.

It was not that we thought then or think now that the government-sponsored approach as reported at Cleveland is inappropriate or invalid, but that we couldn't understand why greenhouse pioneers such as Bill Yanda, Tom Lawand, Steve Baer, Ed Mazria of NOTI, the New Alchemists, Doug Taff, then of Garden Way, Dave MacKinnon of Rodale Press, the Ecotope Group, Malcolm Lillywhite of the Domestic Technology Institute, and many others were conspicuously not in attendance. We felt the need for a conference, a truly national conference, which would include this group as well as the Cleveland presentors.

When we returned to New England, we formed an Organizing Committee which included Dan Scully of TEA, Jim Stiles of Friends of the Sun in Brattleboro, VT, Erika Morgan of Maine Audubon, Jim Burke, Jeremy Coleman, Jonathan Gorham, Drew Gillett and John Hayes. This committee, in its call for papers, invited the Cleveland presentors as well as all others whom we could find who were carrying out greenhouse research. It is interesting that only one group from Cleveland, the Penn State group, submitted papers for inclusion in this conference.

In the future, when we come together to discuss greenhouse research, we need to bring together three apparently disparate groups: the government-sponsored researchers, the independent researchers, and the growers. We all have important contributions to make, and we can and should all learn from each other.

Notes on this Conference

To say that our collective minds were boggled by the sheer amount of information presented during the day and a half conference would be an understatement. As originally planned, the conference was supposed to convene for a morning and an afternoon session. Because of the tremendous response to the

call for papers, two extra sessions were included. This 100% expansion of allotted time was still not enough. With the ever-growing interest in this exciting area of research, the organizers of the next conference should be prepared to be overwhelmed.

This enthusiasm for energy-conserving greenhouses is also shared apparently by a goodly number of people who did not submit papers. Who could have predicted with the really minimal amount of publicity that nearly 600 people would want to come to a day and a half conference in an out-of-the-way place such as rural southern Vermont? Unfortunately, because of limited facilities, registration had to be restricted, and, eventually, 375 people attended and the rest had to be turned away. The participants came from 25 states, 2 Canadian provinces and France.

Instead of attempting to explain here what went on at the conference, two letters are included which were sent to the organizing committee after the conference. The letter by Chandler Fulton serves as the Introduction, and the letter by Conrad Heeschen serves as the Conclusion. In addition to these two letters, it should be mentioned that Bill Yanda's closing address, more than anything this committee could write, captures the spirit, the excitement and the enthusiasm generated by this conference. Your help and support is needed to maintain this momentum.

ACKNOWLEDGMENTS

The organizing committee would like to thank all those who helped make this conference a success. In particular, the committee would like to thank the sponsoring organizations: Total Environmental Action, the New England Solar Energy Association, the Maine Audubon Society, the Energy Research Group of Marlboro College, Friends of the Sun, the Kalwall Corporation, Vermont Recycled Greenhouses, and the Solar Technology Transfer Office of Brookhaven National Laboratory.

There are many individuals who contributed to the success of this conference. They include the members of the Paper Review Committee: Bruce Anderson, Bill Shurcliff, Earle Barnhart, Bill Yanda and Tom Lawand. Thanks also go to the Chairmen who made the Sessions run smoothly: Drew Gillett, Erika Morgan and Bruce Anderson. Special thanks go to the speakers, Jim Jeffords, Tom Lawand, Bill Yanda and all the other presentors who consented to report on their work.

The people who helped run this conference are far too numerous to include here. We owe them very special thanks. At least a dozen members of the Marlboro College Energy Research Group were involved in running the lights, setting up chairs, registering participants, etc. Greg Gibbons and his crew did an excellent job in preparing meals during the conference. Piet van Loon, the college Business Manager, was instrumental in making sure all the proper equipment was available. Kim Gibbons and Maureen Little answered the many inquiries about the conference. Joanne Hayes did almost all of the typing and registration organization for the conference.

Special thanks are due Jack Ruttle, of Rodale Press, who offered much encouragement and many suggestions for organizing the conference, and Jim Williams, of the Brattleboro Design Group, who did all of the graphics for the registration flyer and these Proceedings.

Finally, we would like to thank the conference participants for their enthusiasm and lively discussion sessions. Without them the conference spirit would not have developed and our enthusiasm for greenhouse research would not be nearly as great as it is.

ON EXPERIMENTS TO COMPARE SOLAR GREENHOUSES

Chandler Fulton

Department of Biology
Brandeis University
Waltham, Mass. 02154

Through sophisticated and sensitive instrumentation we are searching for sign posts and keys to enable future tenders of bioshelters to do without expensive mechanical and electrical controls.

John Todd, 1977¹

As a biologist who makes his living doing experiments, I recently became an enthusiastic advocate of solar-tempered greenhouses, and I hope to build one next year. I came to the Conference to learn, and learn I did. It was an inspiring Conference, held at just the right moment for me and, I suspect, for the evolution of this thousand-year endeavor.

As the Conference came to an end, one recurrent theme began to worry me. That theme is the "scientific" comparison of solar greenhouses, in particular by measuring the growth and productivity of plants. The issue is to what extent, and under what conditions, one can do meaningful experiments to compare the performance of one solar greenhouse with another. After listening to the papers presented at the Conference, I concluded that I had an obligation to write an open letter to participants as well as readers of the published Proceedings. The letter is written while I am still full of excitement about and knowledge gained from the Conference, and the criticism it contains is intended as constructive rather than destructive.

* * *

In 21 years of research and research training, I have learned that experimental analysis is the most challenging of endeavors. It is reasonably straightforward to do an "experiment" and get "results." One can build an edifice of experimental results that are sufficient to convince the experimenter, and others, of a given conclusion. But all too often the "law of maximum unhappiness" (M.U.)² intervenes. Briefly stated, this law is that if an experimental result can deceive you, it will. Because of the law of M.U., genuine progress in the experimental analysis of a problem is extremely challenging. It is detective work, where the clues are numerous but the truth is elusive.

At the Conference, many interesting experiments using solar greenhouses were described, and provocative results were presented. In several cases, however, it is not certain what conclusions can be drawn from the results, and no amount of discussion can provide that certainty. The reason is that the experiments had too many variables. A major

challenge of experimental analysis is to single out the crucial variable or variables to test while at the same time keeping all other variables constant. This is difficult. Often it is difficult to create two systems -- a "control" and an "experimental" -- that differ only in the experimental variable. For example, if the variable is light, how is one to have the experimental (or control) in the light and the control (or experimental) in the dark without introducing any other change in the environments of the two systems -- such as a difference in the temperature, for example. Of course such experiments can be done, and many have been, but they require thoughtful and ingenious manipulation of the variables. Another difficulty is that sometimes not all the variables are known or anticipated. For example, one might have one system in the dark and the other in the light, and keep the temperature constant, but the rate of air movement in the two systems might be slightly different and this might have an unanticipated effect on the outcome of the experiment. Although such possibilities are obvious when stated, they can be very subtle in practice. The difficulty in designing decisive experiments increases as the number of potential variables increases. When there are many variables involved as when one is comparing the growth of plants in two greenhouses, the detective work becomes formidable.

One of the more interesting and exciting presentations at the Conference was given by Carla Mueller, who described a careful comparison of crop production in four greenhouses at The Pennsylvania State University. The results were most provocative. Her experiments indicated, for example, that the "double-walled acrylic greenhouse" -- Carla's "favorite" -- gave substantially earlier yields of tomatoes and other crops than the other greenhouses. Crop production was delayed in the two greenhouses glazed with fiberglass. The results presented were precise; the differences in plant behavior among the greenhouses were striking and clear. The experiments showed beautifully that plants handled similarly in four different greenhouses at the same latitude and longitude behave very differently. But which variables are responsible, I wondered?

As I was pondering this question during the coffee break that followed Mueller's talk, I was accosted by an authority on building greenhouses who told me I should use acrylic double glazing for my greenhouse -- because of the results just presented. No! Certainly I should consider this glazing, among others, but not for this reason. There is no way, on the basis of the experiments Mueller described, to guess whether the glazing was even an important variable.

The "variable" in this comparison was entire greenhouses. The four experimental greenhouses used at Penn. State were very different from one another -- in size, orientation, siting (including neighboring greenhouses), temperature ranges, and many other variables, including the glazing material and, presumably, infiltration, humidity, and so forth. Which variable was responsible for the differences in crop production? Perhaps it would be surprising if any one variable were responsible.

The difficulty in dissecting out important variables can be illustrated by considering two variables -- air infiltration and movement --

that are likely to be very important in solar greenhouses. These two variables were little discussed at the Conference, and I do not think any measurements were reported. As is well known, plants require carbon dioxide as the substrate for the photosynthesis of sugars, cellulose, and other organic compounds that make up most of their dry weight. There is little CO₂ per unit volume of air (300 ppm), but plant growth is absolutely dependent on extracting this CO₂ from the air. Even field-grown plants deplete the CO₂ in the air around their leaves unless there is a breeze.³ Twenty years ago, Went and his collaborators demonstrated that frequently changing the air in a greenhouse and maintaining reasonable air turbulence has a favorable effect on plant growth, due at least in part to providing a supply of CO₂ to the plants.⁴ More recently, Calvert reported that artificially increasing the concentration of CO₂ in the air of an experimental greenhouse increased the early crop of tomatoes by 90% and the total crop by 30%.⁵ Commercial growers provide sufficient CO₂ by drawing large volumes of outside air through their greenhouses. Conventional home greenhouses are leaky and have lots of air infiltration and drafts. But air infiltration, in the words of Fisher and Yanda, "cannot be tolerated in a solar greenhouse."⁶ It should be quite possible to create situations in a tight greenhouse where there is insufficient CO₂ and/or air turbulence to allow optimal plant growth. It is conceivable, for example, that the early yields of tomatoes in the double-walled acrylic greenhouse at Penn. State was influenced by the level of CO₂ or the air movement in this greenhouse. This is perhaps no more likely than that the glazing itself were solely responsible. But it becomes evident that measuring the temperature, humidity, light levels, and so forth in experimental greenhouses will not tell us whether any differences in plant growth might be due to CO₂, air movement -- or any other uncontrolled, unmeasured variable.

It would not be easy to devise good experiments to determine the effect of glazing on greenhouse performance, as separate from all other variables. The greenhouses would have to be replicates -- in size, shape, construction -- so sited that their exposure to sun and weather were equivalent. Different glazings would require different methods of mounting them to the frames; one would have to guard against differences in infiltration, etc., caused by this. If the greenhouses were in an east-west row in an unshaded field, one would have to be aware that the greenhouses on the ends would be subject to different environments than those in the middle of the row. Temperature would require a difficult decision. Would one allow the temperatures in each greenhouse to vary according to the glazing -- thereby adding a second known variable -- or control the temperatures in all the greenhouses artificially? Such an experimental approach would require sufficient funds to build all the greenhouses from scratch.⁷ Obviously this is not often feasible. One could also question whether such experiments are worth large investments. Suppose glazing A were found to be better than others tested in a well-controlled experiment. Would this apply to greenhouses of a different design? in another part of the world? used for growing different plants? Would it help one decide which glazing to use if glazing A cost \$5/ft² and a glazing that gave slightly poorer growth of the test plants cost \$0.50/ft²? A simpler approach may be to evaluate glazings directly, considering such parameters as light transmission, U values, cost, and

longevity. Several useful evaluations of this kind are available, including one by Tom Lawand.⁸ But the crucial issue is that if one wishes to evaluate the role of glazing, per se, in solar greenhouse performance by using experimental analysis, an experiment with as many variables as the one at Penn. State is unsatisfactory.

In Carla Mueller's defense -- if any is needed -- it should be noted that she did not draw undue conclusions from her results. Although she did describe the greenhouses by their glazing, she did not argue that this was the variable of major interest. Her primary concern was the growth and productivity of plants in the sub-optimum temperatures, etc., of energy-conserving greenhouses. She did, however, fall into traps of "scientific" comparisons. For example, in describing the series of experimental greenhouses set up for the 1977-78 growing season -- all very different, with solar collectors, thermal storage and thermal blankets, etc. -- she referred to a glass-glazed greenhouse as the "control." How can one greenhouse serve as a control for a series of completely different greenhouses? A control, at least as understood by this experimenter, differs from the experimental by one or more known variables.

One more example from the Conference warrants comment. At the final discussion, after we had all listened to a lengthy discussion of instrumentation for monitoring the environment of solar greenhouses, one participant suggested that we should use plants as more sensitive and reliable indicators. As a specific plant, he suggested we all use the tomato "Sweet 100," and that perhaps the wet weight of the plants could be used as the criterion. In this way we could all compare our greenhouses. A substantial discussion of which tomato variety would be suitable ensued. At first I was enthusiastic. Obviously tomatoes are better measurers of greenhouse performance than transistors. But no! Now I will have nightmares about the next solar greenhouse conference -- which otherwise I look forward to eagerly. Were this suggestion followed, we would be barraged with endless curves of the wet weight of "Sweet 100." We would learn that Dick (from Arizona) got bigger plants under a single layer of fiberglass than Jane (from Maine) got with triple layers of iron-free glass. But what of the insolation, the humidity, the soil, the soil temperature, the number and activity of earthworms in the soil -- not to mention the relative "green thumbs" of Dick versus Jane. Such a "scientific" comparison of diverse greenhouses could be a major setback for solar greenhouses.

Such experiments, considered in this light, are obviously unsatisfactory because of the number of undefined variables. Comparisons of plant growth within a single greenhouse are more straightforward. For example, suppose one were to compare the productivity of two varieties of tomatoes, grown side by side in the same greenhouse. Here if one were cautious the variables could be few, and one could have confidence in the conclusion that the productivity of variety A exceeded that of B. But could this conclusion be extrapolated to another greenhouse with a different environment and a different gardener? Even in this comparison the results can be useful only to the extent that the variables of the greenhouse environment and the growing conditions are clearly specified. When one wishes to compare between greenhouses, one must be even more

careful about the variables. Went⁴ and others have accomplished such comparisons, using carefully controlled greenhouse environments. The difficulty of comparison is compounded as the individuality of the greenhouses increases.

In general, experiments in solar greenhouses are of great value if their results are viewed as contributions to our collective experience rather than leading to "scientific" conclusions about the variables involved. It is important for us to learn from each other's experiences which varieties are good to try in our greenhouses. Observations such as Carla Mueller's that -- according to my notes -- "cucumbers just sit when it's cold; they don't get sick," are useful to all of us contemplating the temperature fluctuations of energy-conserving greenhouses. Uncontrolled experiments such as Abby Rockefeller's report at this Conference of the ingenious and very successful use of greywater for greenhouse irrigation leads us in a good direction. Solar greenhouses and bioshelters have much to offer, and sharing experiences such as these and many others described at the Conference will help guide us all.

In a more general sense, the comparison of plant growth in different greenhouses can be useful. Tom Lawand, for example, describes the comparison of the performance of the Brace Institute solar greenhouse with a conventional greenhouse.⁶ He points out that "It is by no means an easy task to maintain identical air temperatures and humidities, ventilation rates, soil temperatures, watering sequences, fertilizer applications, variety trials, etc." and that "it is difficult to draw too many hasty conclusions." He emphasizes that "the agronomic part of the greenhouse experiment was not seriously controlled." Yet the remarkable improvement in plant productivity in the Brace greenhouse as compared to a conventional greenhouse should help to convince us all that the longer energy-free growing season in solar greenhouses warrants their commercial as well as individual application.

For the individual "tinkerer" -- to use the warm word Bill Yanda used in his summary address -- evaluating how well his/her plants grow is important. Indeed, consideration of how well the plants (and animals) do in a greenhouse is crucial if we are not to lose sight of the role of a "greenhouse" in our enthusiasm about "solar." Sharing these experiences is also essential. But an attempt to give all this a scientific basis is likely to cause confusion, and perhaps to cause us to have false expectations or to turn in the wrong direction.

Our high-technology society has conditioned us to think that everything is amenable to, and requires, objective evaluation, with results that can be expressed in efficiencies (solar collectors), BTU outputs (wood stoves), and the like. Many of us, by our participation in this wonderful Conference, recognize that a return to individual, low-technology solutions offers a better hope for our lives, and especially those of our offspring, than do high-technology solutions. We recognize that as long as we compare cars solely by the gasoline they consume -- mpg -- and ignore the energy cost of continuing to produce millions of cars with short life spans, or the cost of emphasizing individual rather

than mass transportation, we are hiding behind a single variable -- mpg -- in a complex and potentially devastating problem. But as we return to low-technology approaches we must recognize that high-technology analysis is not always suitable. The builders of log cabins could share their experiences, and profit greatly therefrom. But imagine what it would be like if one attempted to compare log cabins as one does mass-produced, uniform, high-technology items. It is not always useful to apply objective criteria, and the approach of experimental analysis, to the low-technology things that perhaps should form the basis of our lives, be they friendships, communication, the taste of tomatoes, locally-grown foods, the art of gardening, or solar greenhouses. This applies whether these things are part of our homes or on a university campus supported by federal grants. We should rejoice in this. We should have the courage to integrate the wholeness of subjective experience with the dissection inherent in objective analysis. We should endeavor to integrate the high-technology and low-technology approaches -- to use, for example, our knowledge of physics, biology, and other sciences, of glazing materials and engineering, to wisely design and build and use solar greenhouses. But let us beware of the inevitable temptation to reduce our individualistic, low technology, experiential solutions and enterprises to nonsense by "objectively" comparing the wet weights of "Sweet 100" tomatoes grown in many scattered, individualistic greenhouses, managed by nearly as many individualistic gardeners. Perhaps we should solve this problem as the farmers do, by having a fair at the next conference and giving a prize for the best tomato or the biggest plant. Whatever we do, let us continue to share our experiences.

References

- ¹Todd, J. 1977 Tomorrow is our permanent address. *J. New Alchemists* 4: 85-106.
- ²Zinder, N.D. 1957 Personal communication.
- ³Leopold, A.C., and P.E. Kriedemann 1975 Plant Growth and Development, second edition. McGraw-Hill.
- ⁴Went, F.W. 1957 The Experimental Control of Plant Growth. Chronica Botanica No. 17 and Ronald Press.
- ⁵Calvert, A. 1972 The effects of day and night temperatures and carbon dioxide enrichment on yield of glasshouse tomatoes. *J. Hortic. Sci.* 47: 231-247.
- ⁶Fisher, R., and B. Yanda 1976 The Food and Heat Producing Solar Greenhouse. John Muir Publications.
- ⁷It appears that such experiments may be underway in Sweden, as briefly reported by W.L. Bauerle 1977 Conservation is the key. *Amer. Veg. Grower* 26 (11): 14, 45. The full report, which I have not yet seen, is contained in the proceedings of the Internal Symposium for More Profitable Use of Energy in Protected Cultivars, Agricultural University of Sweden, Box 55, S-230 53, Alnarp, Sweden.
- ⁸Lawand, T.A., et al. 1975 Solar energy greenhouses: operating experiences. Report R-112 of The Brace Research Institute, Macdonald College of McGill University, Ste. Anne de Bellevue, Quebec, Canada HOA 1C0.



SECTION 2

- Welcome Address, Congressman James Jeffords
- Keynote Address, T. A. Lawand

WELCOME ADDRESS
CONGRESSMAN JAMES JEFFORDS

Thank you very much; I appreciate the introduction. I really cannot take claim to all the (solar) legislation, but I have certainly been active in it. And looking at the numbers of states which are represented here today, I only wish that your congressmen could be here with me to share the enthusiasm which I see for this particular area of research. From our own poll results and from talking with people around the state of Vermont, people are way out ahead of government on recognizing the need for finding alternative sources to nuclear power and fossil fuel energy. The kind of response we have here today and the kind of response we read about around the country indicates that, although Congress has made dramatic steps forward in the last three years, unfortunately, the administration is way behind in understanding the capabilities and potentials of solar energy.

Being a layman myself, I am here with enthusiasm to learn, because I want to find out what the appropriate Federal role would be to help you with this important work.

I am going to talk briefly now about two things: first, I want to give you a short overview of where Congress is going and what may be available under the present legislation; and, second, to plea with you for help in balancing the priorities in this nation on the development of energy sources.

First, I would like to say that, fortunately, there has in Congress been a kindling of enthusiasm which can be seen in the votes as they grow each year in favor of solar energy. We have expanded our budget in solar technology from \$40,000,000 in fiscal year 1975 by some 940% to \$393,000,000 this year. The new energy budget is increasing, and we were successful just recently in conference committee in taking the higher Senate figures for the development of solar energy. But, as dramatic as that increase is in percentages, it is still way behind what we are spending on nuclear energy and half, for instance, what we are spending on fusion, which is off some time in the next century. Although we have made tremendous progress, much more needs to be done.

Let me talk specifically, though, about available funding for greenhouse research. There is substantial money available now. How much we can convince the administration to get money out to individuals and small businesses, which are really the ones I look to more than any other group to provide the answers, is somewhat difficult to assess. We are trying to get pressure on the development agencies to get money out to the people who are really doing the work and not to the giant corporations. But we have tremendous bureaucratic safety concepts to overcome first. It is a lot easier to give money to a giant corporation than it is to give money to John Smith, because, if something goes wrong,

why it is hard to blame me if I gave it to the corporation, whereas, if I gave it to John Smith, they are going to say I am wacky. We are trying to get over that philosophy, and I hope that some of the legislation which was passed last year will help accomplish that goal.

For instance, Congressman Brown and I were able to get on to the Farm Bill substantial funding for agricultural solar energy projects. There is an allotment of \$25,000,000 for agricultural solar energy systems, which is in effect as of October 1. This will provide loans and grants for the development of solar technologies in the agricultural field. Also, within the same bill, there is \$20,000,000 more so that each state may have at least one demonstration project.

The greenhouse concept seems to fit well within the definitions of what we were trying to do when we got this legislation passed. I mean that sincerely, because with the energy crisis approaching the way it is now, and the way it is affecting the northeast in particular, the cost of produce will rise with increasing costs of energy for transportation and with water allocation problems in the far west. We may then witness in the northeast a rebirth of agriculture such as the truck farming we saw years ago. With our short growing season it seems that greenhouses, with the kind of cost-effective use of solar energy which I have seen in some of the papers I have already read, make a lot of sense here. They may well be a key to the success of a rebirth of agriculture in our area.

Now I would like to look very briefly at what is happening and whether we are making the substantial progress I think we need to make in order to balance out our resources by developing alternative energy sources. Progress is being made, but there is so much more that needs to be done. I am now involved in a struggle with the Department of Energy on what kind of place they are going to give solar energy within their own structure. Unfortunately, we find, as in the past administration, that the new people being brought into that organization are very much skewed toward nuclear power. I am fighting right now the nomination of Mr. Thorne, who will have jurisdiction over solar energy, because his whole background and his whole emphasis, at least in California and other areas, has been in the nuclear field.

I mention this because we are working toward something for which I need your help. That is, next May 3rd, and I hope you will all note this day, we will be having around this nation, similar to Earth Day, what will be referred to as Sun Day. I would hope that each of you would find out who is in charge of movements in your state and help us all participate. If we can build the kind of enthusiasm and support for solar energy we see here today, we can, I think, alert this nation, the administration and the Congress that the future of this country more likely will lie in the sources of renewable energy than in the direction of nuclear energy and the other ways we are presently headed. I plea with you to participate in Sun Day. Thank you very much.

ADDRESS DELIVERED BY T. A. LAWAND
OF THE BRACE RESEARCH INSTITUTE
MACDONALD COLLEGE OF MCGILL UNIVERSITY

SOLAR ENERGY AND GREENHOUSE AGRICULTURE
THE CHALLENGE AHEAD

The field of solar energy is advancing on all fronts as conventional fuel costs continue to spiral and prospects for future plentiful supplies of fossil fuels appear, according to some quarters at least, to be somewhat doubtful. Inevitably man turns his attention to satisfying his basic necessities, and allocating his scarce resources, both energy and others, to meeting these demands. The necessities of life, food, water, shelter, etc. all require an energy input and nowhere are their operations more focused than in the greenhouse - an ancient contrivance of man to control the environment and hence be in a position to grow food (vegetables, fruits, etc.) continuously regardless of the season. References to greenhouses go back at least one thousand years, so it is difficult to envisage that there may be so much that is new in such an established process.

Actually, there is something which is claimed to be new - a curious family of structures called "solar greenhouses". In fact, this is the reason why we are gathered here today. The name, solar greenhouse, is an obvious misnomer. All greenhouses are, by definition, necessarily "solar" in that use must be made of the sun to trigger the photosynthetic reaction. That some greenhouses are more "solar" than others, is a matter of conjecture and definition.

Greenhouses were, no doubt, man's earliest solar collectors - they differ from most buildings in that a larger percentage of the shell envelope is generally transparent. The greenhouse industry has thrived, providing food and employment to millions of persons in various parts of the world. However, the recent dramatic increase in the costs of conventional fuel supplies has placed the greenhouse industry, particularly those segments located in colder and more temperate regions, into some jeopardy as heating costs have spiraled - increasing a factor of 2 to 5 over the past 6 years alone.

The greenhouse industry has not entirely been overlooked by the solar energy bandwagon that has been forming in some industrialized countries in recent times. However, it is fair to say that the attention paid by the solar energy profession to resolving the pressing problems of escalating fuel costs in the greenhouse industry, has been nonetheless negligible. The challenge really lies ahead.

One of the areas which has received some considerable attention, admittedly primarily by individual workers, has been what is colloquially come to be known (however erroneously) as the "solar greenhouse". This is generally a small structure, which at best might provide some food for part of a normal sized family. These "solar greenhouses" come in all shapes, sizes, configurations

and are often furnished with all variety of components such as fish ponds, for example, which the normal greenhouse grower has, to date, basically ignored. At least this is the case with greenhouse growers in my area of the country.

On the other hand, some of these solar greenhouse types have proven successful, and have been adapted to the needs of the commercial sector permitting their availability to a wider range of the community. Some large sized greenhouses of this type have been reported.

Suffice it to say, the veritable pre-occupation with these small, individual greenhouse types has rather masked some of the real problems.

These are:

- A. the need to address the requirements of the real farming community and to integrate the greenhouse potential into their overall operations. Particular attention should be paid to the needs of the small farmer, a vanishing breed in most parts of this continent.
- B. the need to develop systems to serve the bulk of the population, who in industrialized countries, live in large urban centres, where a new greenhouse industry might benefit from the availability of waste heat, manpower and the proximity of the marketplace.
- C. the need to assist and maintain the existing greenhouse industry so that it can continue to provide food and employment to the community at large.

As much as possible, future society will attempt to reduce the unnecessary transportation of goods, so as to conserve scarce fuel resources.

This attempt to readdress our priorities should not be misconstrued as a criticism of existing efforts. They should no doubt continue - but surely some more serious efforts should be directed to the target areas I have just mentioned, in order to bring some balance into these activities. The age of improving the effectiveness of solar energy utilization in greenhouses is dawning - if enough foresight can be had to recognise the real challenge that lies ahead.

Food, and employment, may well constitute some of the most serious problems that man has to face in the next few decades. The greenhouse and the improved utilization of solar energy for its lighting and heating have an important contribution to play in resolving these challenges.

It is essential that we integrate our work as much as possible with the work of agronomists and greenhouse growers. It is the only way that "solar" greenhouses will truly command respect and credibility. We must recall that the type of structure

and covering must always be subserviant to the primary purpose of a greenhouse - that is the growing of plants in a controlled environment.

It is not just the shape of the greenhouse that determines the energy consumption for the maintenance of optimum temperatures. Recently I had the pleasure of hearing a paper prepared by an agronomist colleague, Jean Luc Lussier of the Ministry of Agriculture of Quebec. Some of the points he raises, which deal primarily with the production methods within a greenhouse, as a mechanism for reducing energy consumption are listed (but not discussed in detail) for your reference. Each of these factors can significantly affect energy consumption.

- A. the location of the greenhouse
- B. Orientation of the greenhouse
- C. Overall dimensions and shape of the greenhouse
- D. Type and number of transparent covers used on the greenhouse
- E. Type of heating system used
- F. Improvements and maintenance of heating system
- G. Careful choice of fuel and its availability
- H. The variation of ambient air temperature within the greenhouse with respect to
 - day/night factors
 - solar radiation intensity
 - stage of development of the plants within the greenhouse
- I. Adequate control of ventilation - both internally and externally
- J. Better utilization of space within the greenhouse reducing aisle spaces, use of movable planters (reduces the cost of heating per square metre of effective growing area)
- K. Using moveable insulated night covers in greenhouse
- L. Using chimney heat recuperators
- M. Modifying Growing Techniques by
 - later transplanting of plants into the greenhouse (affecting growing conditions in the seedling house)
 - variation of seeds (using cold temperature varieties)
 - combined crop production
 - planting crops according to external climate conditions to maximize profitability
 - high density cropping
- N. Disinfecting soil in greenhouse during the autumn to save 2 to 3 weeks of heating
- O. Flood greenhouse soil to reduce salinity in autumn instead of spring to reduce heating costs
- P. If several free standing greenhouses are used, utilize space between houses for spring planting through temporary coverings
- Q. Insulate northern and end sections (in longer greenhouses)
- R. Utilize soil heating techniques
- S. Utilize moveable insulation (beadwall) between transparent covers
- T. Use of Solar Energy (?)

M. Lussier concludes with a look to the future - Solar Energy. Our associates in the area of greenhouse agricultural production are examining their energy consumption as this is becoming one of the prime costs of production. Surely it is the obligation of those working in the field of solar energy research development and applications to work closely with our colleagues involved in production to develop really appropriate greenhouse systems making better use of solar energy.



SECTION 3

- Saturday Morning
- Chairperson, Drew Gillett

SOLAR SUSTENANCE PROJECT PHASE II FINAL REPORT

**PREPARED FOR
THE ENERGY RESOURCES BOARD
STATE OF NEW MEXICO**

BY

WILLIAM F. YANDA
EXECUTIVE DIRECTOR • SOLAR SUSTENANCE REPORT
RT. 1 • BOX 107 AA • SANTA FE, NEW MEXICO 87501

The Solar Sustenance Project, Phase II is a direct action approach to some severe problems facing low-income families in New Mexico. The primary emphasis of the project is to measure heat savings/gain an attached solar greenhouse provides for a home. The twelve experimental units adjoin homes built of various materials in order to record the interaction of each with the greenhouse. In addition, thermally designed window box units (5) were built, tested and available for display.

A benefit derived from the original Solar Sustenance Project is that, because of the demonstration units built, over fifty similar greenhouses were built in north-central New Mexico with owner capital. Phase II expanded this factor by conducting statewide design, construction and operation seminars, utilizing the news media to further its goal. Exposure through media, education and demonstration guarantees major impact for the project.

Another important area of research is to maximize the food and income capabilities of the solar greenhouse. The low-income family has a "locked in" budget for food that escalates at a greater rate than a 1:1 ratio with rising energy costs. Any vegetable that goes directly from seed to table represents not only immediate family savings, but a measurable energy savings nationally.

Implementation Through the Workshop Approach

The Solar Sustenance Project was the first state supported program in the United States to take a participatory demonstration of solar energy directly into local communities. The emphasis was aimed at the low/fixed income sector, although people of all income and educational levels participated. The twelve demonstration units were assigned to the widely diverse geographical and climatological areas of New Mexico. We have units in areas of low degree days (Carlsbad-2700) up to high degree day locations (Taos-7000). In effect, the only area of the state not within seventy miles of a demonstration solar greenhouse is the extreme northeast (Raton).

The format of the project was as follows:

- Interested community organizations (Community Action Programs, local solar energy groups, social service organizations) were contacted by the director and informed of the project and its goals.
- A schedule was established.
- A package containing organizational plans, materials list, site criteria, media contact information, was sent to the local coordinators. A great deal of the responsibility for the success of the workshop was put into local hands. By doing this, local involvement was stimulated and many of the problems of "outside" inspired projects were avoided.
- At a public meeting, the principles and examples of working greenhouses were explained in an hour and a half lecture/slide show presentation. In five of the communities a representative of the New Mexico Solar Energy Association also made a presentation. These public meetings were attended by an average of 75 people in the course of the entire project. Besides general education, a primary function of the meetings was to inspire the audience to come out and build the greenhouse the following two days. An unplanned benefit of the public meetings was that in several of the locations (Gallup, Farmington, Portales) the nucleus of a local solar energy association and information exchange forum was established.

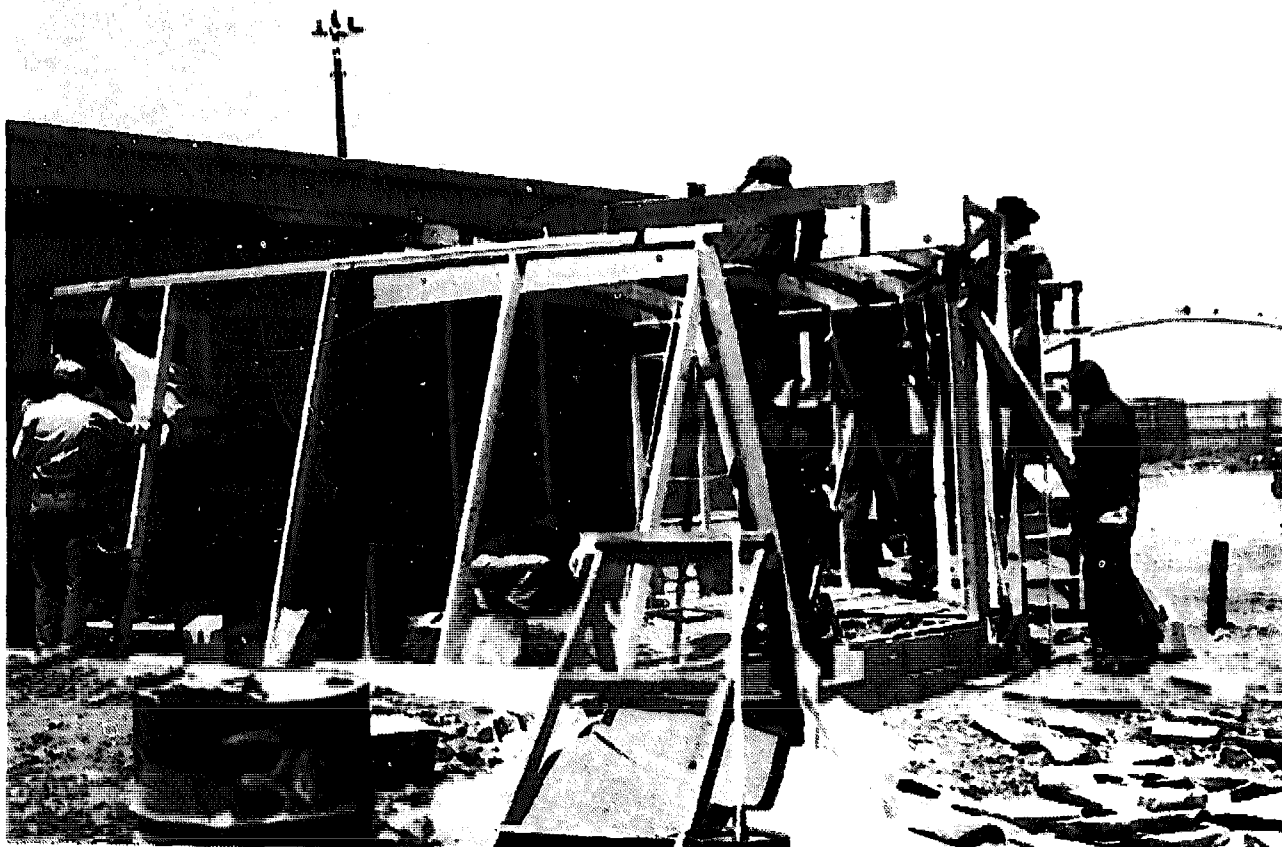

*—Building on the Navajo Nation—
Solar Energy Association "Outreach" Project*

Fig. 1

● The greenhouse was built by the participants in the community. During the two day building session many interested non-builders dropped by the site to ask questions and check on the progress of the workshop. As often as possible, the project obtained the names of all attendees. However, many were missed because of the myriad activities taking place simultaneously. It's estimated that an average of 90 persons attended each activity. That would be 1,080 New Mexico citizens directly involved in the program. The end of the two day building phase saw the demonstration units 75-98% complete. The owners of the greenhouses and interested friends completed finishing work, planting layout and planting.



A Clear Door under construction—Alamogordo Workshop

Fig. 2

It was not possible to locate a workshop in every community that wanted one. The communities of Roswell, Tierra Amarilla, Ramah, and Raton were not included in the Phase II Project. The director is working with coordinators in these communities for future, New Mexico Solar Energy Association sponsored workshops.

A Brief Survey

One of the primary purposes of the Phase II Project was to determine if a "multiplier effect" in the private sector can be obtained by government sponsored demonstration solar units being placed in communities. To accumulate data, 100 cards were sent to workshop participants chosen at random. From the return, a proportional sampling of the private building stimulated by the project has been evaluated.

Thank you for participating in the Energy Resources Board, Solar Sustenance Project this summer. To determine the impact of our greenhouse workshops we would appreciate your answering these questions.

Yes No

___ ___ I have built an attached greenhouse.
 It is _____ long and _____ deep.

___ ___ I plan to build one this year.

___ ___ I plan to build one when I can.

___ ___ I don't plan to build a greenhouse.

Questions, comments, problems: _____

Optional: (Name) _____ Thank you.
 (Address) _____ Bill and Susan Yanda

Survey Results

Total Sample=100 Total participants in project=1,080

Category	# of Responses	% of Total Responses	# X Sample Factor (10.8)
HAVE BUILT	13	31	140
PLAN TO BUILD THIS YEAR	9	21	97
PLAN TO BUILD WHEN THEY CAN	16	38	173
DON'T PLAN TO BUILD	4	10	43
TOTAL RESPONSES	42	100	453.

Some of the comments by respondees are enlightening:

- "I sincerely hope funds are allocated to provide more workshops. I feel this grass roots approach is right on target!" - Steve Meyer, Alamogordo.
- "The workshop provided an attempt to realize the practical realities of an attached greenhouse." - George and Maria Wallace, Sapello.
- "Please keep me informed about solar energy. Presently I am renting but I encourage homeowners to build greenhouses." - Reynaldo Romero, Las Vegas.
- "We are interested in solar heating on a scale suited to our modest income. Most projects are unrealistically high for us." - Ernest E. Shea, Alamogordo. (Plan to build category).
- "I am a slave to a garden all summer and decided I did not want to be one all winter." - No name given, obviously a non-builder.

Regardless of the sampling, it must be assumed that the actual number of privately built units is much higher. Many new greenhouse builders have no contact with the Solar Sustenance Project other than the two books that the director has published. It is estimated that over 300 solar greenhouses have been built in the state in the last year.

Another related effect of the workshops was increased interest by social service organizations in larger scale projects. The director has acted as a volunteer consultant to such groups as the Isleta Pueblo Senior Citizens Center, McKinley Area Services for the Handicapped, and the Cañones Community Association. These agencies realize the practicality of combining the multiple use greenhouse with solar heating for their new facilities.

Many persons, particularly elderly people, cannot build an attached greenhouse by themselves. It was a natural outcome of the workshop format that in several communities (Las Vegas, Alamogordo, Taos) participants who wanted to build for jobs were put in contact with participants who wanted greenhouses built. These small job builders learned greenhouse building techniques at the workshop and have contracted jobs in their own communities as a result of the project. At other workshops (Carlsbad, Shiprock, Albuquerque) C.A.P. winterization crews were trained for their own agencies' future projects.

One final direct result of the Phase II workshop format is that it has served as a model for other states. Nebraska, Idaho, Arizona, and California are using the workshop approach.



*Greenhouse on Mobile Home. Built in Workshop by
Mojave County Solar Energy Commission: Kingman, Arizona*

Fig. 3

Regardless of the sampling, it must be assumed that the actual number of privately built units is much higher. Many new greenhouse builders have no contact with the Solar Sustenance Project other than the two books that the director has published. It is estimated that over 300 solar greenhouses have been built in the state in the last year.

Another related effect of the workshops was increased interest by social service organizations in larger scale projects. The director has acted as a volunteer consultant to such groups as the Isleta Pueblo Senior Citizens Center, McKinley Area Services for the Handicapped, and the Cañones Community Association. These agencies realize the practicality of combining the multiple use greenhouse with solar heating for their new facilities.

Many persons, particularly elderly people, cannot build an attached greenhouse by themselves. It was a natural outcome of the workshop format that in several communities (Las Vegas, Alamogordo, Taos) participants who wanted to build for jobs were put in contact with participants who wanted greenhouses built. These small job builders learned greenhouse building techniques at the workshop and have contracted jobs in their own communities as a result of the project. At other workshops (Carlsbad, Shiprock, Albuquerque) C.A.P. winterization crews were trained for their own agencies' future projects.

One final direct result of the Phase II workshop format is that it has served as a model for other states. Nebraska, Idaho, Arizona, and California are using the workshop approach.



*Greenhouse on Mobile Home. Built in Workshop by
Mojave County Solar Energy Commission: Kingman, Arizona*

Fig. 3

Other Services and Activities

The Solar Sustenance Project with the help of the New Mexico Organic Growers Association constructed a functional, portable solar greenhouse. The 64 Ft.² (5.94 M²) unit is a colorful display that features signs explaining the principles behind the design. It breaks down into five panels which can be easily transported to schools, energy exhibits, and seminars. The greenhouse was first displayed at the New Mexico State Fair where it was examined by over 2,000 people. The visitors were given an explanatory sheet as they asked questions of the attendants. Its next exhibit was at the Energy Seminar at the Albuquerque Convention Center. Here it was shown to over 500 visitors by the project director. At both the State Fair and the energy conference, the unit attracted the attention of Albuquerque TV stations and was given air time in the news segment of their programming. KNME-TV did a 10 minute presentation of the greenhouse in its State Fair special coverage. It was shown at the University of New Mexico Energy Fair in Albuquerque, the Conservation Fair May 14th and 15th in Los Alamos, then at the C.A.P. winterization conference in Santa Fe. The portable greenhouse was in operation at the home of Ray Alfini in Albuquerque all winter, providing that family with free heat and vegetables.

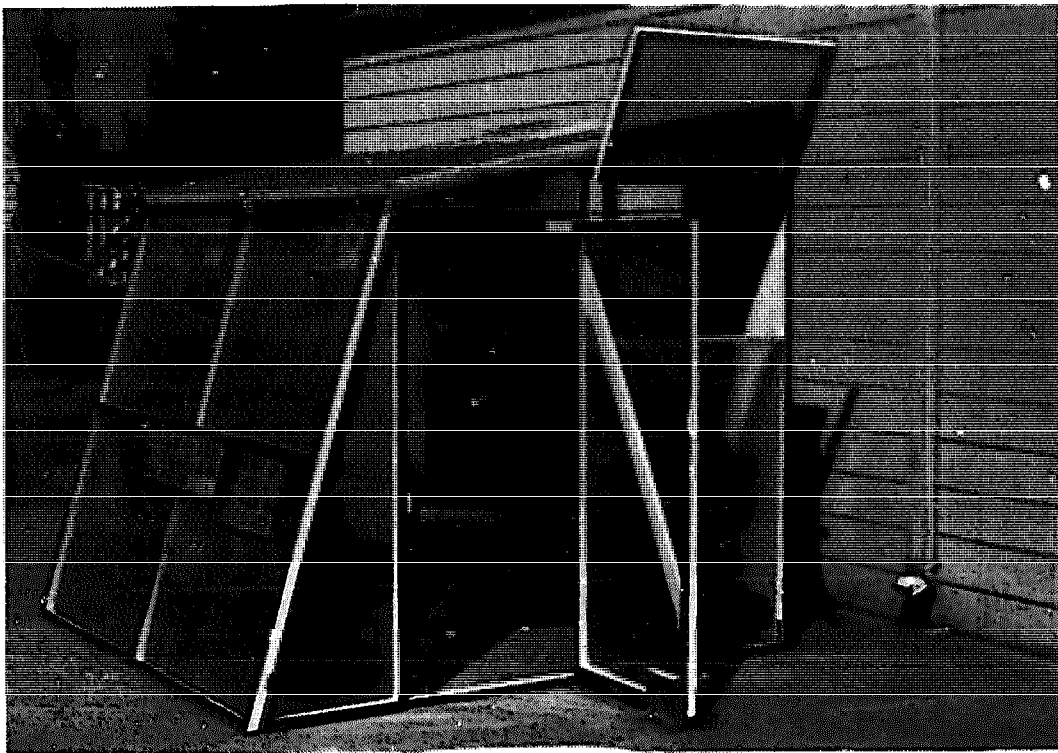

Portable Display Unit exhibited at State Fair

Fig. 4

The unit will be used by the New Mexico Solar Energy Association in its Outreach program.

The project director made himself available for free lecturing and consulting services for New Mexico organizations of many varied interests. Examples are: The Los Alamos Garden Club, Society of American Foresters, La Clinica de la Gente, and New Mexico Department of Development. Emphasis was also placed on the Solar Sustenance Project acting as a communications coordinator between organizations and individuals seeking professional help in solar applications and qualified engineers, architects, and builders.

One problem the potential greenhouse builder had was in obtaining greenhouse quality fiberglass, polyethylene and accessories. For that reason, the project established an outlet for these materials. The specialty items sold were not in competition with any existing private business and were sold for a small mark-up to cover the rental of the storage facility and distribution costs. It is interesting to note that since August 1st, 1976, 14,300 Ft.² (1328.5 M²) of fiberglass glazing have been sold. This amount, if the ratio of 1.76:1 (area clear: floor area) is used, would cover 8125 Ft.² (754.8 M²) of greenhouse, or, 51 greenhouses @ 160 Ft.² (14.86 M²) each. This is some indication of the amount of building going on in the Santa Fe area alone. There are now new private fiberglass distributors in Las Vegas, Silver City, and Albuquerque.

Produce from the Greenhouse

The owners of the eleven attached greenhouses built have all expressed great satisfaction with their greenhouse, though some have harvested much more produce from their unit than others. This has resulted from the fact that some owners took longer to learn the workings and operation of a greenhouse or were not able to spend as much time in it. The owners who had the most success spent an average of five to seven hours a week in the greenhouse. All have commented on the fantastic taste of a vegetable picked fresh in mid winter.

Though one person said her greenhouse 10' x 20' (3.05 x 6.10 M) produced all of the vegetables a family of four plus guests could eat, on the average each project greenhouse produced 40% to 60% of the family's vegetables. In two cases, the greenhouse supplied all of the family's vegetables throughout the winter. The highest monthly average of food production in the project was reported by the Alamogordo unit at a \$40.00 saving a month (1976-77 fresh food prices). An average for the total units in the project is \$25.00 a month. Though some owners did experiment with more exotic fruits and vegetables, on the whole, everyone in his first year with the greenhouse planted the more common ones: lettuce, spinach, Swiss chard, peas, broccoli, green onions, corn, radishes, beets, carrots, various herbs, and fruiting vegetables such as tomatoes, cucumbers and peppers.



*Dwarf corn in the Anton Chico Greenhouse, late April.
"I thought corn this sweet only grew in Iowa."—Rebecca Chavez*

Fig. 5

An important aspect of greenhouse growing, which cannot be overstated, is using the greenhouse throughout the summer period. Much of New Mexico, the Rocky Mountain area, and the northern Midwest experience a short growing season and very cool summer nights. These summer night-time temperatures, often into the low 50's (10 C) in New Mexico, are hardly conducive to high production from fruiting vegetables. The well run summer greenhouse not only avoids the ravages of hail and drought, but puts fruiting vegetables into an environment which can keep an optimum mid 60's (16 C) low temperature range.

The greenhouse must also be looked at in light of its water conservation over field crop conditions. Authorities report water usage for greenhouse crops to be 1/10 to 1/30 of the field crop.¹ Two of the project owners, Tom Rolf of Silver City and the Chavez family of Anton Chico, devised simple systems to trap rain water and snow melt from the roofs of their homes, drain it into tanks in the greenhouse, and gravity feed the water to their plants.

¹The Solar Greenhouse: A Means to Increased Food Production, by Lloyd Wartes, Solar Engineering Magazine, October, 1976.

".... less than $\frac{1}{4}$ of the energy consumed in the U.S. food system is used to actually produce the food. The remaining $\frac{3}{4}$ s are used to transport, process, preserve and distribute it."² There is not only a substantial money savings in growing one's own vegetables year round, which is important for low and fixed income as well as middle income people, there is also a substantial energy savings. It is important to realize that a dollar's worth of December tomatoes or lettuce produced in the home greenhouse garden is an actual 75¢ saving in petrochemical energy.



Albert Martinez displays lettuce from his Taos Project Greenhouse.

Fig. 6

Window Boxes

Five window boxes of various designs were built and displayed at the Albuquerque Energy Fair. The one pictured turned out to be the most successful design. In it, the owner figures she produced 60% of the vegetables she ate; this included a salad every day. Fruiting vegetables were put into the window box in February. The owner notes success with the following crops: Tiny Tim tomatoes, California Wonder bell peppers, Chinese cabbage, chop suey greens, spinach, Black Seeded Simpson lettuce, water cress, sorrell, parsley, rosemary, chives and basil.

The window box units, as they were built in the project, do not substantially provide more heat for the home than do the window they cover. However, they do give the owner space for a mini garden. One problem encountered in testing the units was that it is impossible to equip the hanging window box with enough thermal mass to prevent it from freezing on a cold winter night (without leaving the window to the home open). It is suggested that a clear enclosure could be built under and adjoining a ground floor window box. This small enclosure would have a double clear southern glazing and openings for air circulation to the window box above. Within it could be a black 55 gallon (208 liter) drum. This passive storage container would make the window box capable of sustaining low temperature winter nights without supplementary heat from the home.

²Food for People Not For Profit, Catherine Lerza and Michael Jacobson, editors, Ballantine Books, New York, 1972.

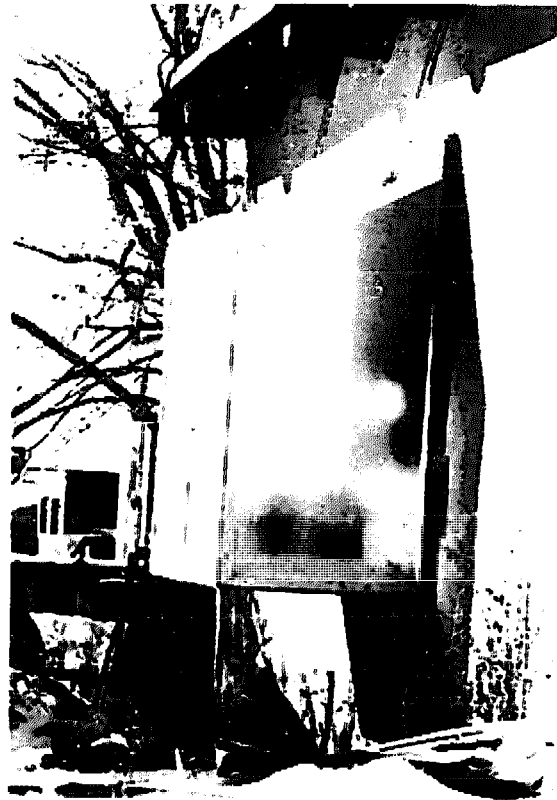

Window box in use at Santa Fe home.

Fig. 7

Economics and Cost Analysis

Many people, particularly senior citizens and families where both adults work, do not have the time resources to build their own greenhouses.

In an attempt to get a grasp on the economic impact of a contract-built, attractive greenhouse, the project had Mr. Michael Coca submit a simplified analysis prepared in conjunction with his economics class at Highlands University. The analysis was done independently of the Solar Sustenance Project, although some of our estimations were used. The data obtained "fit" our recorded examples in costs and heating potential of the small greenhouse. The vegetable production is slightly lower than we experienced. Note that interest rates are not included in the costs of building the greenhouse, but neither are increases in fuel costs. It is suggested that one might offset the other.

Excerpts from Mr. Coca's report:

"Questions most asked about this type of application are usually related to cost, curiosity about the point in time when accumulated savings in food and heat equal the total cost of the structure, and whether this solar application is a viable alternative to rising food and energy prices.

"A breakdown of cost on a greenhouse this size would look something like this:

Materials - @ \$2.50/Ft. ² (\$26.92/M ²) X 160 Ft. ² (14.86 M ²) =	\$400.00
Labor - 160 man hours @ \$4.00/hr. =	<u>640.00</u>
Total cost of greenhouse	\$1,040.00

"An analysis of heating fuel cost for the above home indicated an average monthly natural gas bill of \$30.00 per month or \$360.00 per year. It was estimated that the greenhouse would save approximately 30% or \$98.00 of yearly fuel cost.

"Food cost for a family of five runs about \$200.00 per month or \$2400.00 per year. Of this total, the following vegetables and herbs could be started in the greenhouse:

Description	Quantity Consumed in One Year	Total Yearly Cost
Lettuce	1 head per week @ \$.35	\$18.20
Tomatoes	2 lbs. per week @ \$.60	62.40
Chili (green)	50 lbs. @ \$10.00	10.00
Chili (red)	3 lbs. @ \$2.00 per lb.	6.00
Cabbage	\$.13 per lb. x 60 lbs.	7.80
Broccoli	\$.59 per lb. x 78 lbs.	46.02
Cauliflower	\$.59 per lb. x 78 lbs.	46.02
Spinach	\$.35 per bunch x 104 bunches	36.40
Misc. herbs		<u>20.00</u>
	Total	\$252.84

"In review, a greenhouse could supplement approximately 11% of the total yearly food expense for a family of five.

"A look at annual savings in fuel and food shows the following:

Annual savings in fuel	\$ 98.00
Annual savings in food	<u>252.84</u>
Total annual savings	\$350.84

"Projecting these savings and initial greenhouse cost onto a graph, we can see how many years it takes to break even on the initial investment of a greenhouse.

**Breakeven Point Between
Initial Total Cost of a Solar Greenhouse and
the Yearly Accumulated Savings**

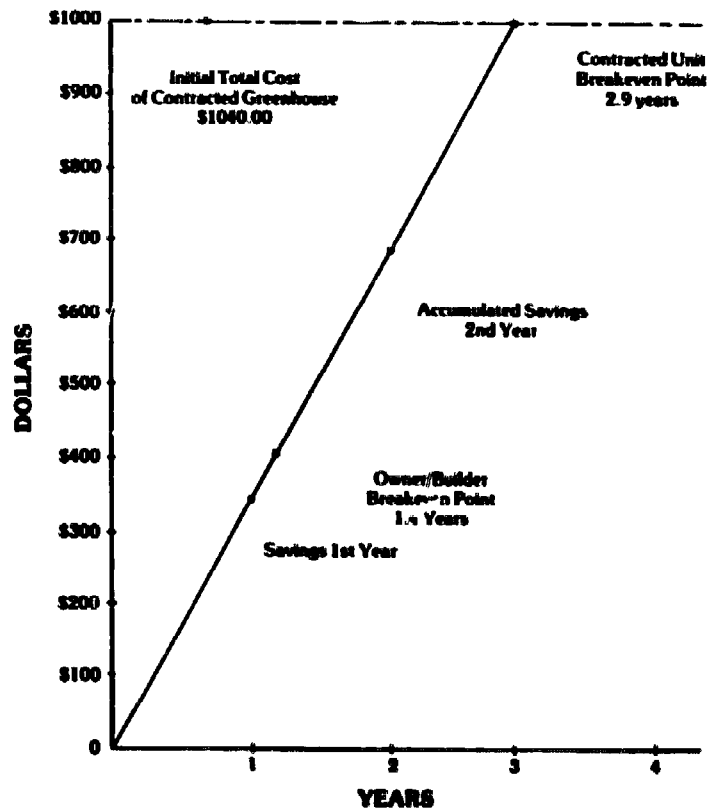

Fig. 8

"Reviewing the above graph, we find that by investing \$1,040.00 in an attached greenhouse, a family can accumulate enough savings in 2.9 years to pay for the structure. The breakeven point may be achieved sooner if we assume that food and fuel prices will continue to rise or if a family is willing to do the labor and thus save more than one-half of the cost."

Solar building impetus has been given to the New Mexico citizen by the State Legislature in the form of a tax credit for solar applications. A Passive System Workform is given in Appendix I, for the use of anyone who doesn't know of its existence and those readers in other states looking for help in constructing their own laws.

The actual materials costs of building the 12 demonstration units were compiled by totaling all of the local purchasing receipts and adding on the retail costs of the greenhouse glazings brought to the sites by the project. The total cost was \$6,473.32. The total square footage of the 12 project greenhouses was 2,064 (192 M²). This gives an average square foot cost of \$3.14 (\$33.76/M²). The range between low and high costing greenhouses (of the same 160 Ft.² size) was considerable. At the low end we have the Albuquerque unit with a total cost of \$394.61, or \$2.46/Ft.² (\$26.55/M²). At the high end was the Las Vegas greenhouse at \$651.74, or \$4.07/Ft.² (\$43.85/M²). This disparity was a function of: 1) local retail prices; 2) the ability of local coordinators to get bargains and astutely

use the suggested materials list to account for individual differences in their site. It should be mentioned that at all sites surplus building materials were left to be used in local projects relating to solar greenhouses. They are included in the average materials costs. Feedback from many owner/builders indicates that \$2.50/Ft.² (\$26.91/M²) materials cost is an accurate 1977 estimate of the passive, attached lean-to greenhouse. Unlike higher technology, mass produced systems, it is not expected that the cost of this type of application will drop in the future. It will rise reflecting inflationary trends in the building supplies industry. For example, the materials cost has risen 34% since we started building basically the same type units in 1974. The potential owner really has no excuse to wait for further developments.

The Griffin Home

The House

A 22 year old frame structure, 1115 Ft.² (103.6 M²), 2 x 4 walls with a flat roof of approximately R-8 insulation. The home has all steel sash windows. It is located in a residential area and has considerable tree and building cover from wind. Heating is by two independent floor furnaces. Owners have reduced thermostat settings by 2^o since March '74. Cooking, heating and domestic hot water are by natural gas.

Add-On Greenhouse

Located in a southeast corner of the building. It has an 11' long x 8' high (3.4 x 2.4 M) southerly clear wall. (All of the clear surfaces have outer fiberglass/inner polyethylene glazings.) East greenhouse wall is 12' long x 8' high (3.7 x 2.4 M) and is clear. Clear roof section faces south and is 6' x 11' (1.8 x 3.4 M). Total floor square footage of greenhouse is 120 Ft.² (11.14 M²). A 15' (4.6 M) high apricot tree is 5' (1.5 M) southeast of the southern corner of the greenhouse. The greenhouse covers 3 home windows and a standard size door, for a total of 42.5 Ft.² (4.0 M²) of openings to the home. The unit is operated in a "open to home during day/closed off from home at night" mode. The owner built the greenhouse entirely by himself for a total cost of \$127.55. He is a scrounger, par excellence.

Add-In Wood Stove

This is a "Contemporary Franklin" design. It is located in the living room in the western part of the home. The stove has a thermostatically controlled blower that cuts on at 150 F. (65.55 C) and blows hot air directly into the living room. It was purchased for \$227.36, a wholesale cost.

FUEL CONSUMPTION IN A SANTA FE HOME BEFORE AND AFTER ADD-ONS (SOLAR GREENHOUSE AND WOOD STOVE)

OWNERS—Jerry and Sandy Griffin: data recorded by Sandy Griffin.

Date	MCF Units	Date	MCF Units	Base Ave. MCF	Date	MCF Units	Reduction %		Date	MCF Units	Reduction %	
							from 73-74 base	from 73-74 base			from 73-74 base	from 73-74 base
11-73	9	11-74	7	8	11-75	7	12		11-76	6	25	
12-73	12	12-74	14	13	12-75	10	23		12-76	7	46	
1-73	19	1-74	26	22.5	1-75	17	24		1-76	13	42	
2-74	25	2-75	29	27	2-76	19	29		2-77	13	52	1
3-74	24	3-75	19	21.5	3-76	14	35		3-77	9	42	
4-74	18	4-75	17	17.5	4-76	11	37		4-77	8	54	
5-74	16	5-75	16	16	5-76	10	37		5-77	7	56	2
6-74	8	6-75	8	8	6-76	8	0		6-77	8	0	
7-74	5	7-75	6	5.5	7-76	6	-9		7-77	6	-9	
8-74	4	8-75	4	4	8-76	4	0		8-77	4	0	
9-74	4	9-75	3	3.5	9-76	5	-30		9-77	5	-30	
10-74	6	10-75	5	5.5	10-76	5	9		10-77	5	9	
	150		154	152.0		116	24			91	40	

- Add on Greenhouse
- Add in Wood Stove

1 Stove shut down.

2 End of recorded data.

Assume 75-76 readings.

SAVINGS AT MARCH 1977 PRICES:
 152-116 = 36 MCF x 1.74 MCF = \$62.64 (75-76)
 152-91 = 61 MCF x 1.74 per MCF = \$106.14 (76-77)

Fig. 9

Some Observations about the Chart

1) The first thing that becomes apparent when one examines the chart is the pattern of fuel consumption. Heavy usage begins in January and continues through May. May usage is higher than December usage. This is probably due to several factors: 1) the house, even though it is frame (not a massive structure) is carrying a "thermal charge" well into the heating season. It is a slab on grade and the earth below the home is, perhaps, still warm into January; 2) when the house loses its thermal momentum it takes a long time, into June, to regain it; 3) the high winds of springtime contribute more to the heat loss on this home than the cold temperatures in December. This pattern of fuel consumption should be examined and documented in great detail for the Southwest; it could be a critical factor in home design. We have been looking at degree days as a guide to design, and actual fuel usage and energy consumption may be more important and quite different.

2) When the heating load becomes heavy (February is consistently the highest month), the greenhouse is going into its own heavy surplus heat-available period.* That, of course, becomes greater as we go into March, April and May. It was noted by the owner that no fires were made after "late February", so we might consider the March through May reductions in '77 attributable entirely to the greenhouse and a milder spring than previous years. The owner stated that "in 1975-76 we only opened the greenhouse to the bedroom because we didn't think it would do that much. In 1977 the greenhouse was open through all windows and doors into June." The results of this operating mode are apparent in the March through May '77 fuel reductions.

3) Please note that this greenhouse is not in what would normally be considered an "optimum" location or geometry, i.e., it is southeast and "boxy" as opposed to due south and rectangular. To further complicate matters, it is partially shaded until noon in the winter by the apricot tree on its southeast corner. Its energy saving contributions are perhaps due to three factors:

- There is direct gain and continuous daytime airflow to the home.
- It covers 42.5 Ft.² (3.9 M²) of windows and a door of steel sash (and old) construction; if the greenhouse were not there, these surfaces would be contributing to high conductive and infiltrative losses; the greenhouse is also serving as an "air lock" to the home for 50% of the daily entries and exits.
- As the greenhouse is used as a garden, it is providing the home with high humidity air. The regular home furnaces and the wood stove are dry, forced air systems. The greenhouse is, in effect, providing the other heaters with air which has a greater capacity to store heat. This is an extremely important factor along with the "buffer effect" of the attached greenhouse. These two complicated effects must be thoroughly examined before anyone will truly understand what an attached greenhouse is doing for a home. There is much more than direct gain going on in these systems.

* See Spring Heating Surplus (fig. 19).

4) There are probably subtle lifestyle changes and energy awareness taking place in the family over the last several years. However, they were not given as "major" or even "notable" by the operators. Mr. Griffin stated, "We were energy conscious in 1973 before I ever heard of solar greenhouses."

Thermal Performance

Data used: Eversole greenhouse, Alamogordo, N.M., Jan. and Feb., 1977 -
 Chavez greenhouse, Anton Chico, N.M., Feb.3-7,
 Mar. 17-21, 1977 -
 Roger's heat loss analysis, Sept. 15, 1976

Table I summarizes the temperature record of the Eversole greenhouse. Several points of interest emerge. The greenhouse maintains a mean temperature 22 F (12.2 C) degrees above outside air temperature. However, the minimums are only 19 F (10.5 C) degrees higher, while maximums are 24 F (13.3 C) degrees higher. This is due to inadequate storage capacity. The greenhouse tends to overheat during the day, which increases the daytime heat loss; thus less heat is available to offset night-time heat loss. This pattern appears to be typical of many add-on greenhouses, indicating the need for more storage capacity in the system.

The amount of temperature variation or temperature range is an important characteristic of the system. The temperature range inside is 26 degrees F (14.4 C) while the outside air temperature range is only 21 F (11.7 C) degrees. This is also explained by the low storage characteristics of the system.

Table I
Eversole Greenhouse

January-February 1977
 AVERAGES

TEMPERATURE	MAX.	MEAN	MIN.	RANGE
INSIDE	78.8 (26)	65.6 (18.7)	52.4 (11.3)	26.4 (14.7)
OUTSIDE	54.5 (12.5)	43.8 (6.6)	33.2 (0.7)	21.3 (11.8)
INSIDE-OUTSIDE	24.3 (13.5)	21.7 (12.05)	19.2 (10.7)	5.1 (2.8)

Fig. 10

BERNARDO CHAVEZ - ANTON CHICO GREENHOUSE/HOUSE

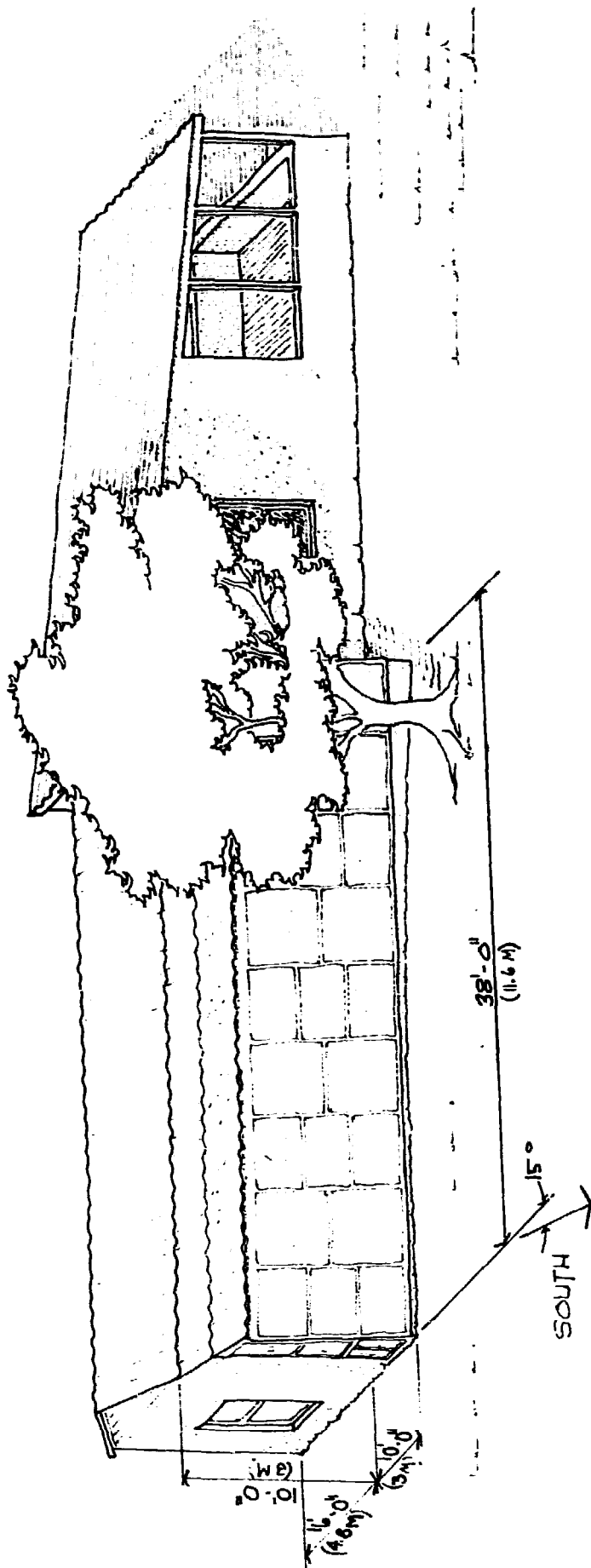
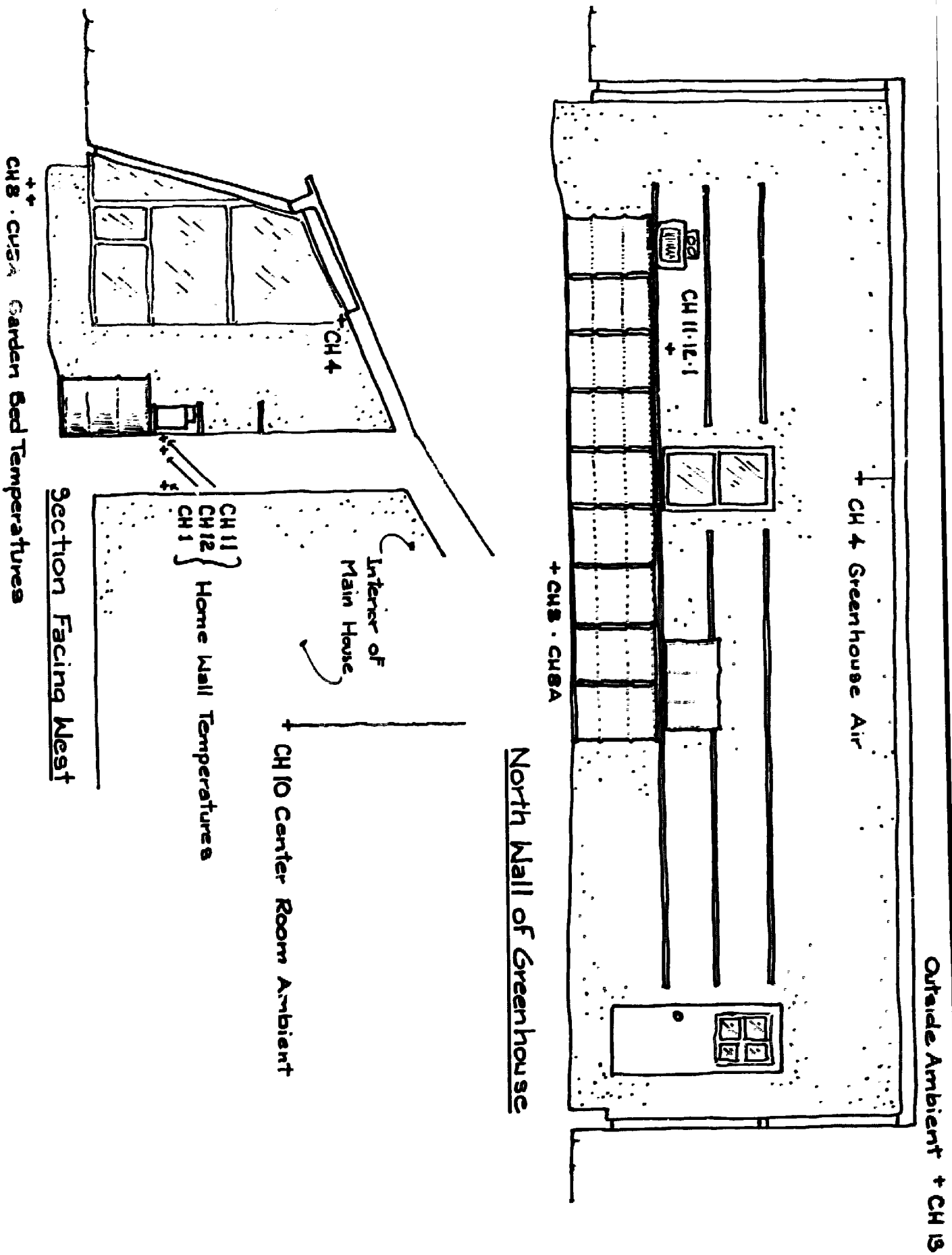

Fig. 11

The Chavez green house in Anton Chico, New Mexico, was monitored by Los Alamos Scientific Laboratories Solar Division with a 16 point hourly recording unit. The home is an old adobe structure with 16" (.4 M) thick walls. The greenhouse covers one window and one door. It is 36 Ft. (11 M) long. We can look at the structure before and after the addition of eleven 55 gallon (208 liter) water drums.



BERNARDO CHAVEZ GREENHOUSE

Fig. 12

Table II summarizes the temperature record of the Chavez greenhouse for the period February 3-7, 1977. This structure maintains a mean temperature 29 F degrees (16.1 C) above outside air. Comparison of internal and external maxima and minima reveals a very similar pattern to the Eversole greenhouse. During this period this greenhouse also tends to overheat during the day and underheat at night. The inside temperature range is 16 F (8.9 C) degrees, or 162% greater than outdoor air.

Table II Chavez Greenhouse

February 3-7, 1977 - No Storage
AVERAGES

TEMPERATURE	MAX.	MEAN	MIN.	RANGE
INSIDE	80.4 (26.9)	59 (15)	37.7 (3.2)	42.71 (23.7)
OUTSIDE	42.8 (6.0)	29.6 (-1.3)	16.4 (-8.7)	26.41 (14.7)
INSIDE-OUTSIDE	37.6 (20.9)	29.4 (16.3)	21.3 (11.9)	16.3 (9.0)

Fig. 13

Table III summarizes performance of the Chavez greenhouse during March 17-21, 1977. The pattern here is quite different. The temperature differences between inside and outside are 26 F (14.4C) for the maxima and 31 F (17.3C) for the minima, thus reversing the February data. The interior range is also less than the exterior range. This is explained by the addition of eleven 55-gallon (208 liter) drums of water for storage. The performance improves dramatically while maintaining the same temperature elevation.

Unfortunately, no hard data is available on the exact amount of heat transfer from the greenhouse to the house. Opening and closing of doors and vents to the exterior and opening and closing of doors and windows between the house and greenhouse were not recorded. It appears from the temperature records that both the Eversole and Chavez structures were operated with venting to the interior during the day which was closed at night.

Table III Chavez Greenhouse

March 17-21 11-Barrel Storage
AVERAGES

TEMPERATURE	MAX.	MEAN	MIN.	RANGE
INSIDE	82.2 (27.9)	66.3 (19.0)	50.3 (10.2)	31.9 (17.7)
OUTSIDE	56.7 (13.7)	38.2 (3.4)	19.7 (-6.8)	37.0 (20.6)
INSIDE-OUTSIDE	25.5 (14.2)	28.1 (15.6)	30.6 (17)	-5.1 (-2.9)

Fig. 14

Graphs for extracted data are shown in Figs. 15, 16, 17, and 18

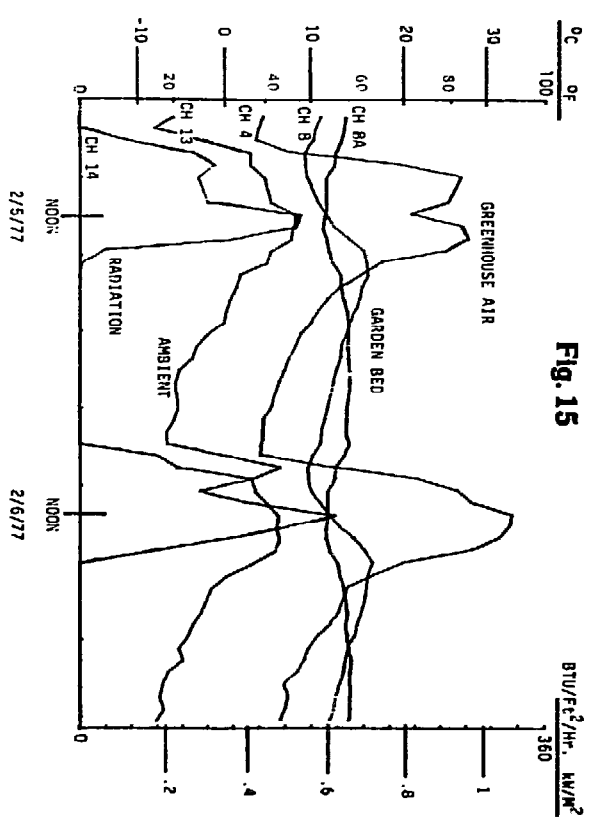

Fig. 15

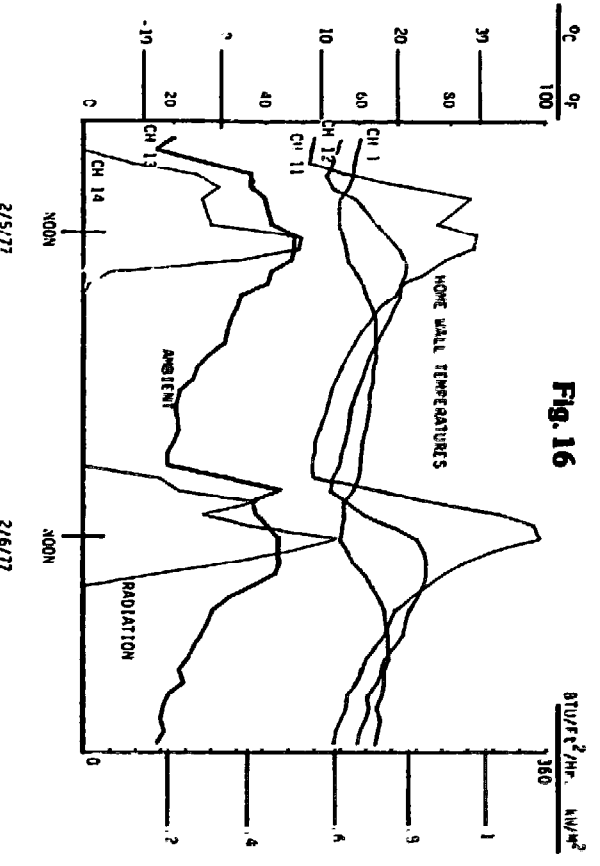

Fig. 16

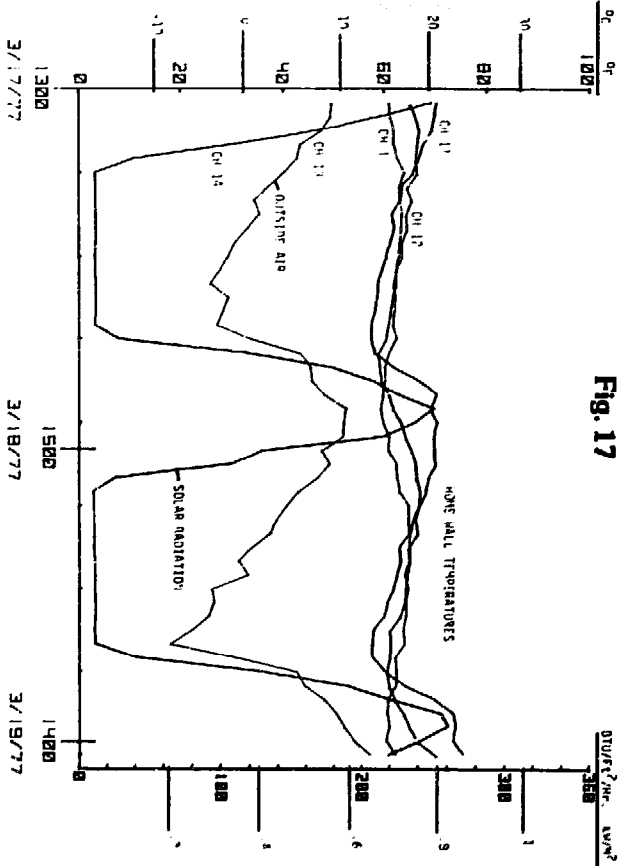

Fig. 17

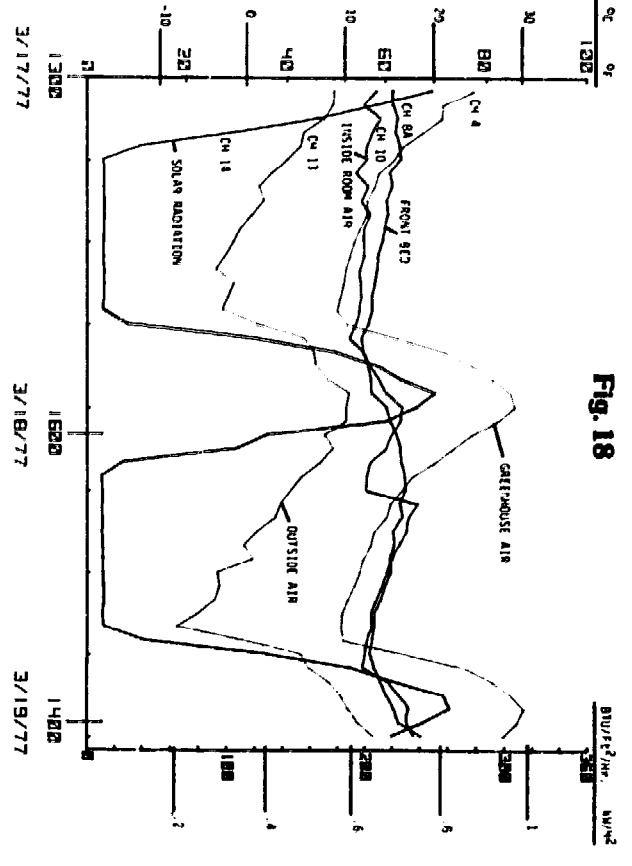

Fig. 18

BERNARDO CHAVEZ - ANTON CHICO GREENHOUSE

Several items become apparent when examining the graphs.

- Total solar radiation has increased 30-40% in the March period but the interior daytime high temperatures have not risen accordingly. This is explained by: 1) the increased thermal mass; 2) the geometry of the unit, i.e., the south face is reflecting the higher altitude sun and the partially clear roof is beginning to shade the back part of the greenhouse; 3) increased vegetation and water inside the greenhouse are having an evaporative cooling effect.
- The 'thermal wave' through the wall is flatter and more regular in the March reading. The interior channel, #1, has risen in average about 2° F (1° C). The occupants of the home are rarely using any supplemental heat within the dwelling. (See inside room air in Fig. 17). The greenhouse may be considered the sole heating unit for this part of the home. The massive contiguous wall is a radiant and conductive heater.
- In both measured periods the ground beds used for growing constitute thermal storage for the greenhouse. Whenever the interior air temperatures drop below the earth temperatures they help heat the space.

The Potential Heat Available from a Greenhouse

The amount of heat which would be available for transfer given optimum storage capacity may be estimated by determining the amount of absorbed solar energy and subtracting from it the heat lost from the greenhouse to the outside air. For a typical add-on greenhouse design using the dimensions 10' (3.04 M) deep by 16' (4.9 M) long and the clear area:floor area ratio of 1.78:1, total heat loss is about 4,200 BTU/Degree Day (7968 kJ/C Day). Data from The New Mexico Solar Resource for Albuquerque gives a heat loss of 126,000 BTU (132,804 kJ) and a heat gain of 277,000 BTU (291,958 kJ) with the greenhouse maintaining a 30° (16.7 C) temperature elevation and the house maintaining a 33° (18.3 C) temperature elevation. These are averages for the months of December, January and February. Thus, on the average, some 151,000 BTU (159,154 kJ) is available to the house providing that the heat can be stored when not needed, and released on demand.

Structure—Add on Greenhouse/Location—Albuquerque

- Roof glazing area = 4 x 16 = 64 Ft.² or 1.2 x 4.9 M = 5.9 M²
- South glazing area = 16 x 9.3 = 149 Ft.² or 4.9 x 2.8 M = 13.8 M²
- East and West area = 46 Ft.² (4.3 M²)
- Occlusion Ratio - 90%
- Load: Based on A.S.H.R.A.E. Heat loss calculations and 1 air exchange per hour = 4200 BTU/DD (7968 kJ/CD)
- Transmissivity - 77%
- 90% x 77% = 70% effective gain multiplier

Solar Availability Per Day

	FALL		WINTER		SPRING	
	BTU/Ft. ²	kJ/M ²	BTU/Ft. ²	kJ/M ²	BTU/Ft. ²	kJ/M ²
South 75° tilt:	1806	20,490	1870	21,215	1521	17,256
East & West:	887	10,063	697	7,908	1173	13,308
Roof 15° tilt:	1870	21,215	1521	17,256	2377	26,967

Solar Gains Per Day

	FALL		WINTER		SPRING	
	BTU	kJ	BTU	kJ	BTU	kJ
Total Available:	429,576	452,773	408,036	430,070	530,885	559,553
X .68 transmittance:	292,112	307,886	277,464	292,447	361,002	380,496

Greenhouse Loads Per Day

	FALL		WINTER		SPRING	
	°F. Aver.	°C. Aver.	°F. Aver.	°C. Aver.	°F. Aver.	°C. Aver.
Outdoor Mean	57.6	14.2	37.1	2.8	55.6	13.1
G.H. Mean	67.1	19.5	67.1	19.5	67.1	19.5
Δ T	9.5	5.3	30.0	16.7	11.5	6.4
Total Load	39,900 (BTU)	42,055 (kJ)	126,000 (BTU)	132,804 (kJ)	48,300 (BTU)	50,908 (kJ)

Surplus (For Home) Per Day

	FALL		WINTER		SPRING	
	BTU	kJ	BTU	kJ	BTU	kJ
	252,212	265,831	151,464	159,643	312,702	329,588

Will Heat

421 Ft.² (39.1 M²) - House load at 12 BTU/°F.D. - Ft.² (245 kJ/°C.D. - M²)
 631 Ft.² (58.6 M²) - House load at 8 BTU/°F.D. - Ft.² (163 kJ/°C.D. - M²)

Fig. 19

An add-on solar greenhouse of 160 Ft.² (14.8 M²) has the potential to heat some 400 to 600 Ft.² (37.2-55.7 M²) of living space on the average.

With light construction such as wood-frame or mobile home this is not possible without the construction of some storage element inside the house itself. For that reason, a greenhouse linked to thermal storage below a mobile home is shown in Appendix II.

This scheme would also work for a frame house with a crawl space beneath the living area.

There is a great need for measurement of the amount of heat transfer which actually occurs with window and door type openings and the improvement possible with use of fans and better storage devices which interface directly with the house itself.



*Survivors (builders and film crew) of the
New Mexico Solar Energy Association Workshop:
1372½ Cerrillos Road, Santa Fe
The Solar Greenhouse is available for public tours.*

Fig. 20

The Overall Solution To Solar Heating

Norman Saunders

Circuit Engineering

15 Ellis Road

Weston, Mass. 02193

Sun power is diffuse and intermittent. Heating needs are variable and require enormous amounts of energy. To heat with the sun we must reduce our heat energy requirement to the sun energy we can afford to capture and store. In winter we desire interior temperatures about twenty celsius degrees (36F°) higher than the mean outside temperature. In our area the sun's 1400 watts per square meter in space is reduced to an average of about 100 W/m² (32BTU/ft²hr) at the surface. Nights present the need for one day's storage while cloudiness and temperature variations extend the need to ten days. Further, the typical solar heating system, whether active or passive, delivers to the living space only 25% of the energy incident on it's glazing.

Insulation

If we take a conventional modern frame house (100m² or 1,000 ft² floor area) and halve it's heat loss we have something we can heat by the sun.

Roughly, ITEM	EXTENT	LOSS RATE
Ground	100m ²	10
Ceiling	100m ²	20
Walls	90m ²	30
Windows	10m ²	40
<u>Infiltration 2 hour change</u>		<u>50</u>

150 watts per celsius degree

The obvious places to search for improvement are in reduced air movement losses and in reduced window losses.

Solar Heating

Our house then has an average winter loss of 3 kilowatts (10,000 BTU/hour). It needs 120 square meters of collector and 720 kilowatt hours (2.6 gigajoules or 2,500,000 BTU) of heat storage (calculated from the above assumption). Glazing all of the southerly roof and a third of the south wall will let in enough sun. A depth of a fifth of a meter (8 inches) of water over the floor area will store enough heat.

How To Do It

We can get a working system: 1. If we glaze the entire south pitch so as to capture in the store more than fifty percent of the incident insolation; 2. Reduce the outward heat loss from the store through this glazing to less than 1 W/m²C°; and 3. Reduce the below ceiling heat loss in terms of floor area to less than 1 W/m²C°.

We can salvage heat that would otherwise be lost by Dynamic Insulation(TM). (See following text.) We can also reduce the heat loss through the glazing while maintaining sun transmission by geometric tricks and use of selective surfaces. Examples are the Solar Staircase (TM) and Translucent Insulation (TM).

To make solar heating worth doing we must probably hold the added initial cost to less than ten dollars per square foot of net-glazed area. This can be done by making the solar components replacements for, rather than additions to, the regular building components, and keeping the system as simple as possible.

Greenhouses

Some of the resultant solutions are more like greenhouses than conventional houses. Most of the techniques developed for houses can be used in greenhouses. Compared to a house the greenhouse permits lower night-time temperature, delayed morning warm-up, and larger temperature swing. It is time to adapt the successful solar heated house designs and devices to greenhouses.

"The Solar Staircase (TM) Applied to Greenhouses"

The Cambridge School in Weston has received much publicity for its installation of the first Solar Staircase (TM). This 1800 ft² (165m²) installation had an added cost of \$2.20/ft² glazing and saved about 6¢/ft² in oil heat and 32¢/ft² in electricity for lighting in its first year. An initial rate of return of 17% ("6 year payback") is good for a solar system.

The third solar staircase installation (470 ft²) was in Belmont. It is beautiful. David Johnson was the architect. The added cost was \$1.96 ft². It was completed this summer.

The fourth Solar Staircase (TM) installation in Vermont may do even better since it includes the inner glazing called for by Saunder's design. The Barre Hill Craft Cooperative has arranged with the National Center for Appropriate Technology to monitor the performance of its installation by using the simple and inexpensive (less than \$1,000 complete) Stereotronics data logger. Next year we should have performance data for you. Mark Crosley's detailing and construction supervision kept the cost to about \$5/ft² less the cost of the heating system replaced for thus letting the sun in through the 400 ft² of the southerly roof pitch.

Notice by how little these houses differ from greenhouses. The south roof is nearly fully open to the sun and so is the south wall.

How The Solar Staircase (TM) Works

The Solar Staircase (TM) was conceived of as a means of getting into a pitched roof the seasonal sun control of vertical south glass. The stepped vertical glazing alternates with horizontal mirrors which much of the year double the effective height to admit the sun and skylight. In June more than 80% of the direct sun is masked off or reflected out. The provision of overhead thermal mass for winter heat storage together with natural ventilation prevents summer overheating.

In spring and fall the sun is admitted not only to the extent of the vertical glazing but also nearly as much sun power again enters by double reflection in the horizontal mirrors. In December a height equal to about a third of the North-South extent of the staircase is effectively added to the actual vertical height to admit sun power. Figure 1.

An unexpected bonus (hence the patent applications) is that the mirrors redirect most any reflection from the inner glazing. Six sheets of glazing usually reflect out more than half the sun. With the Solar Staircase (TM) under the weather skin and inner glazing below it, the total reflection was in winter only a few percent more than that of the two sheets of glazing above the mirrors. By so treating the mirrors as to reflect room heat as well as sun power, the staircase itself traps heat as well as two layers of ordinary glazing would.

The Staircase plus inner glazing cuts the heat loss to the point that 100% solar heating is practical in Massachusetts and southward. The construction is simple enough so that the sun energy captured is worth the investment. However the design procedure in detail is quite intricate. No one has as yet fully mastered it. (Refer to previous papers and reports listed at the end.)

Solar Staircase (TM) and Greenhouses

The reduction of direct sun in the summer was the motivation for the development of the solar Staircase (TM). The unforeseen advantages make it a superior solar heating system. Where the contents of the greenhouse require summer shading the Solar Staircase (TM) is superior in summer as well as in winter. Liming or white washing the usual greenhouse roof is messy and takes time. Applications must be repeated and ultimately removed unless one is skilled in formulation, application and anticipating the rainfall for the coming summer. Moveable insulation is an improvement over the ordinary greenhouse. The Solar Staircase needs no daily nor even seasonal operator time.

If the summer shading by the Staircase is not tolerable, translucent insulation (TM) can be used instead. This is now undergoing evaluation and installation (of 600 ft² or more). Future reports on it are planned. Briefly it transmits about 80% of the incident sun power and has a thermal conductance of about 1 W/m²C° (i.e. about R 6).

Dynamic Insulation (TM) Applied to Greenhouses

The heat normally lost through the windows can be in part recaptured by preheating the incoming ventilating air. One such system is described in patent 3,952,947. (Figure 2). Since heat is being trapped by continuous movement, I call this Dynamic Insulation (TM). Other patent applications have been made upon other applications of this principle.

The drawings shown in the patent issued perhaps represent excessive effort. Spaced double glazing with an intermediate heat reflective foil has a conductance of about 1 W/m²C° (R 6). Controlled air flow can theoretically raise this single foil system to greater than R 25. Practically R 10 to 12 seems realizable. For 100 % solar heating the average permissalbe R value (including ventilation) for the entire house skin is an average of about 12. Windows doing this well are then adequate since the blinds, walls, etc. typically have a higher thermal resistance. The practical consideration is to balance benefits and costs for each part of the structure and between the parts.

How It Works

The major heat transfer between well spaced sheets of double glass (closer spacing gives greater heat loss) is by convection. The warm sheet of glass warms an air film which rises, crosses to the cold sheet, and gives up its heat to that cold sheet, and at the bottom crosses again to the warm sheet to repeat the process. Dynamic Insulation (TM) open-circuits the air flow by moving the warmed air inward and replacing it by the cold dry outside air. This also eliminates condensation throughout most of the year. The incoming ventilating air is not completely warmed but it has recaptured most of the heat the window would otherwise lose.

Tolerances Are Large

If we glaze all of all four walls and reduce the ventilation rate to one air change every three hours, we have a flow of only 0.04 m³/sec (80cfm) for our small tract house. Distributed uniformly over the 100 m² of glazing this would give an inward flow of 0.4mm/sec. (i.e. it would take the ventilating air six minutes to traverse the glazing.) However, the crack at the windows to admit this air is only 40m long by perhaps 3mm wide so that the velocity through the crack is about 1/3 m/s. or slightly greater than the glazing's internal convective film flow in velocity and thickness. With less of the wall area glazed, the forced air flow becomes more dominant over the convective air flow.

Mark Crosley and Andy Shapiro in their Maryland house demonstrated that such an all glass wall could be built for the same cost as a conventional stud wall with its ohly 10% windows.

The requisite air movement is brought about by reducing the air pressure within the building. Presently available devices for reducing the pressure and controlling the flow can be improved. The improved inexpensive and completely passive devices under development and upon which patent applications have been made will be reported on at a future conference.

For summer ventilation, as in greenhouses, thermally driven, temperature actuated devices are now on sale.

SOLAR ENERGY COLLECTION SYSTEM

NOTHING MOVES BUT THE HEAT.
 No fluids move. No beads, no shades, nor shutters move. The only adjustment is seasonal made by the sun itself

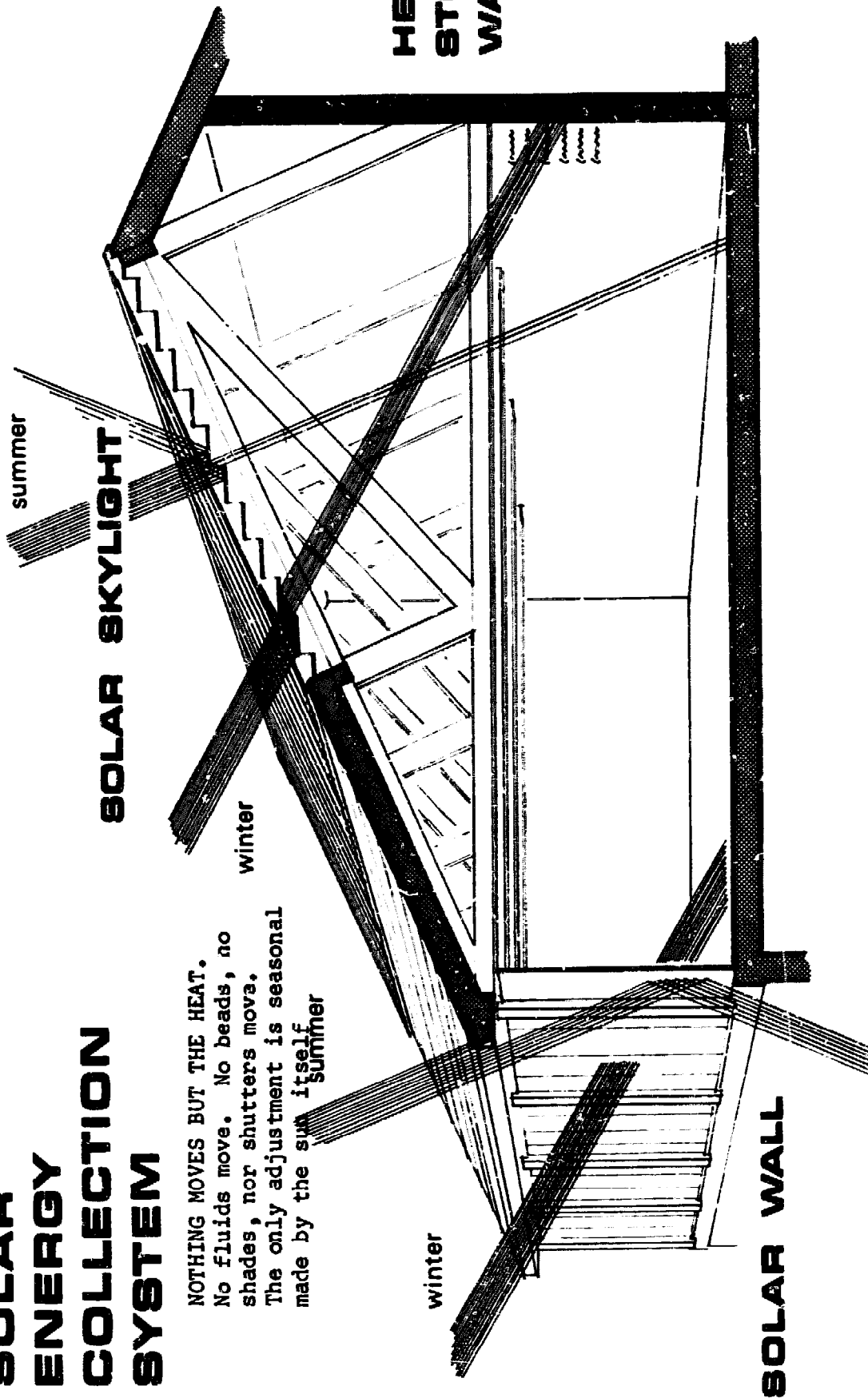

HEAT STORAGE WALL

SOLAR WALL

Solar Skylight, Heat Storage Wall, and Solar Wall are used as Auxiliary Heat Source at the CAMBRIDGE SCHOOL, Weston, Mass.
 Architects: DAVIES, WOLF, & BIBBINS, Cambridge, Mass.
 Solar Systems Consultant: NORMAN B. SAUNDERS, P.E., Weston, Mass.

References:

1. Saunders, N.B., Solar Heating Basics, 4th edition, Weston, MA 1976
2. Saunders, N.B., "Heating Papers - Selected Set", Weston, Mass. Nov. 1975
3. ERDA, "Performance of Solar Staircase (TM) Solar Heating Systems" Fourth Report, P.O.Wa-76-4974, July '76, 20 Mass. Ave. Wash. 20545
4. ERDA, Passive Solar Heating and Cooling, "One view"- N.B. Saunders Conference and Workshop Proceedings, p. 247, Albuquerque, New Mexico May 19, 1976
5. *Ibid*, p.IV, "Weston Residence"
6. NESEA (New England Solar Energy Association) "Decision Making in Solar Technology, p.427, N.B. Saunders, "Buildings: Proving the Solar Staircase (TM) Complete Passive Solar Heating Present Status" paper presented at the "Toward Tomorrow Fair", Amherst, Mass. June, 1976
7. NESEA, "Economic Results of Certain Passive Structures", Norman B. Saunders paper presented at the NESEA Better Thermal Utilization Conference, Hartford, Conn., Sept.8-11, 1977
8. NESEA, "Thermal Results of Certain Passive Heated Structures", N.B. Saunders paper presented at the NESEA Better Thermal Utilization conference, Hartford, Conn., Sept.8-11, 1977

The Ramapo Aquaculture-Greenhouse System

submitted by: Dr. William Makofske
Associate Professor of Physics
Ramapo College of New Jersey

Introduction

Two years ago, in response to a deteriorating world environment, a group of faculty and students at Ramapo College formed the Ramapo Alternative Energy Center. Its program consists of a multi-faceted approach to meet the energy-environment problem, and includes educational, research, and community action components. Among its activities include: the design and construction of a solar-heated aquaculture-greenhouse unit, the installation and integration of an 1.8 kw wind generator for electrical production for the aquaculture-greenhouse unit, a recycling program, and a soil reconditioning and organic gardening program. The present paper will concentrate on the physical design features of the entire system. The biological integration is currently undergoing a reanalysis and will only be briefly mentioned. The present design has evolved over a two-year period and further modifications are expected based on operating experience. Presently, the structure itself is essentially complete, the wind system is installed. Major remaining work consists of construction of the heating backup system and the completion of the aquaculture system.

Design Philosophy

The aquaculture-greenhouse system has been designed to provide a suitable environment for aquatic and plant life throughout the entire year in the Mahwah, New Jersey, climatic area by utilizing only renewable energy sources. The design tries to minimize material usage and to maximize natural energy inputs at the site, while still maintaining operating specifications, reasonable simplicity and economic viability. The basic design procedures and objectives were to:

- minimize heat loss through sufficient insulation and reduction of infiltration.
- provide 50 - 70% of the seasonal heating load from solar energy. The auxiliary system will provide the additional heating requirements.
- store heat through the auxiliary system for two average January days.
- maintain an overall temperature range of 50 - 80 degrees F by a judicious integration of solar windows, passive heat storage, auxiliary heating system with active heat storage, and ventilation systems.

Physical Description

The building is 25 feet long and 12 feet wide with 300 ft.² of surface area tilted at 60 degrees to the ground and 75 ft.² of vertical surface area, both facing south. This entire surface area consists of a double layer of glazing, the interior one being recycled glass pane windows from a local school, and the top one being a layer of Kalwall to give added protection from the weather and flying objects. Interior insulated shutters made of styrofoam are used over the windows at night during cold weather.

There are two additional double glazed windows on both the east and west sides of the building for added light intensity and summertime ventilation. The entrance consists of a door on the north side with an airlock for reduced infiltration. The outside of these windows are fitted with insulating shutters to reduce heat loss at night and during cloudy weather.

The building construction consists of wood framing on a concrete block foundation. The inside walls and ceiling are insulated with 6" of fiberglass insulation and 1" of styrofoam. The insulation is covered with exterior plywood and wood paneling in some instances. The overall design of the building is calculated to give an overall heat loss value of about 8 BTU/ft²/DD, which includes both conduction and infiltration losses.

On the north side of the structure, embedded 5 feet into the ground will be a rock heat storage unit of dimensions 3 feet wide, 16 feet long, and 8 feet high, insulated with 9" of fiberglass and styrofoam insulation. A forced air circulating wood stove inside the building will be connected directly to the heat storage unit and transfers up to 90,000 BTU/hr to the rock.

The system for providing electricity consists of an 1800 watt reconditioned Jacobs wind generator mounted on a 3-leg 50 ft. high tower sited 25 ft. from the NE corner of the building. The generator produces an output of 40 volts DC and 50 amps at a rated wind speed between 22 and 27 mph. The storage system consists of 12 - 6 volt deep cycle batteries divided into 2 sets of 6 each and connected in parallel. Total capacity is 360 amp-hr. A 500 watt 32 volt Wilmore inverter is used to obtain 110 volt AC electricity for operation of fans, pumps and a small amount of electric lighting. The system will probably be modified to dump excess electricity into resistance heating of water in the building.

System Operation

The primary heating system consists of direct solar input through the south facing window surfaces. Because of wood framing, the effective surface area is about 255 ft.². The typical heat loss of the structure over an average day in January (29 degrees F in Mahwah, New Jersey) is about 125,000 BTU.

On a typical sunny day in January the solar energy collected through the south solar windows is about 360,000 BTU. The basic heat storage mechanism consists of a passive distributed system of closed water containers, the cement block composing part of the front and back walls, and water contained in algae, fish tanks and storage pond (about 2000 gallons). These features will moderate the large solar input over the midday hours and allow the collected energy to be released at night and during cloudy weather. The amount of cement block thermal mass is about 5000 lbs. which would store about 30,000 BTU with the expected temperature range. Distributed water storage of about 150 gallons would provide an additional 25,000 BTU. Together with the aquaculture water, the building should be able to maintain itself without using the auxiliary heating system over a typical January night.

The backup heating system consists of an efficient wood stove placed inside the structure connected via closed ducts into a well-insulated 18 ton rock storage unit placed adjacent to the structure on the north side. The rock storage system is sized to supply the building for 2 average January days. A small blower circulates the heated air (150 degrees F) around the inside stove jacket and into the rock storage. This mode of operation requires a charging up of the rock storage over the coldest months and its recirculation back into the structure as needed, depending on weather patterns and temperatures. Some advantages of this system is that it allows the rock storage system to be conveniently heated over a relatively short time. It also maximizes safety since no unattended fire need be used. Wood is also a readily available renewable resource near the site since many trees cleared for other campus buildings are left in nearby woods.

The ventilation system for warm weather operation is primarily passive and consists of operable windows and east and west sides, a slit opening along the entire south wall, vents on the upper north wall and a screen door opening on the north side. The needed ventilation area was calculated based on a complete air change every 3 minutes or 20 air changes per hour. Based on a structure volume of 3375 ft.³, a volume flow of 1125 ft.³/min. is required. With a prevailing summer breeze of 2 mph, the outlet area was found to be 21 ft.². The north and east walls have a total vent area of 36 ft.². Inlet area can be adjusted by the east window openings to maximize velocity flow within the building. The chimney effect, provided by vents on the north side, will also supply additional ventilation without any wind velocity.

Even though natural cooling should suffice under most conditions, under the worst conditions (no wind velocity), it is necessary to have a backup system. This would consist of two small fans installed at the top of the east and west sides of the building. Each would need to exhaust about 600 ft.³/min. and would be operated off the wind generator-battery system.

The aquaculture system will consist of a below ground storage tank which will hold approximately 2000 gallons of water. The water will be pumped to an algae production tank and gravity feed to above ground fish tanks. The waste water will be circulated through a biological filtration system consisting of a series of shell cultures and emergent vegetation. In addition to the algae tank located on the rear wall (north) of the structure, food for the fish will be provided through an earthworm culture. Waste products from the fish will be recycled as fertilizer for plants. Most of the space in the building will be utilized as a greenhouse for production of vegetables for human consumption.

Acknowledgements

I am deeply indebted to the following people who have contributed to the design and construction over the past two years: Dr. Richard Graham, Associate Professor of Ecology, for project initiation and collaboration; Mr. Douglas Coonley and Dr. Martin Greenwald, Assistant Professor of Industrial Arts, Montclair State College, for design work and for teaching the Alternative Energy Workshop at Ramapo College; Mr. Robert Perna and Mr. John Caraluzzo, project coordinators for the Alternative Energy Center; Mr. Daniel Scully, for help in building design; and finally, but most importantly, to the many students who through their contributions of time and effort, have made this project possible.

RAMAPO AQUACULTURE-GREENHOUSE

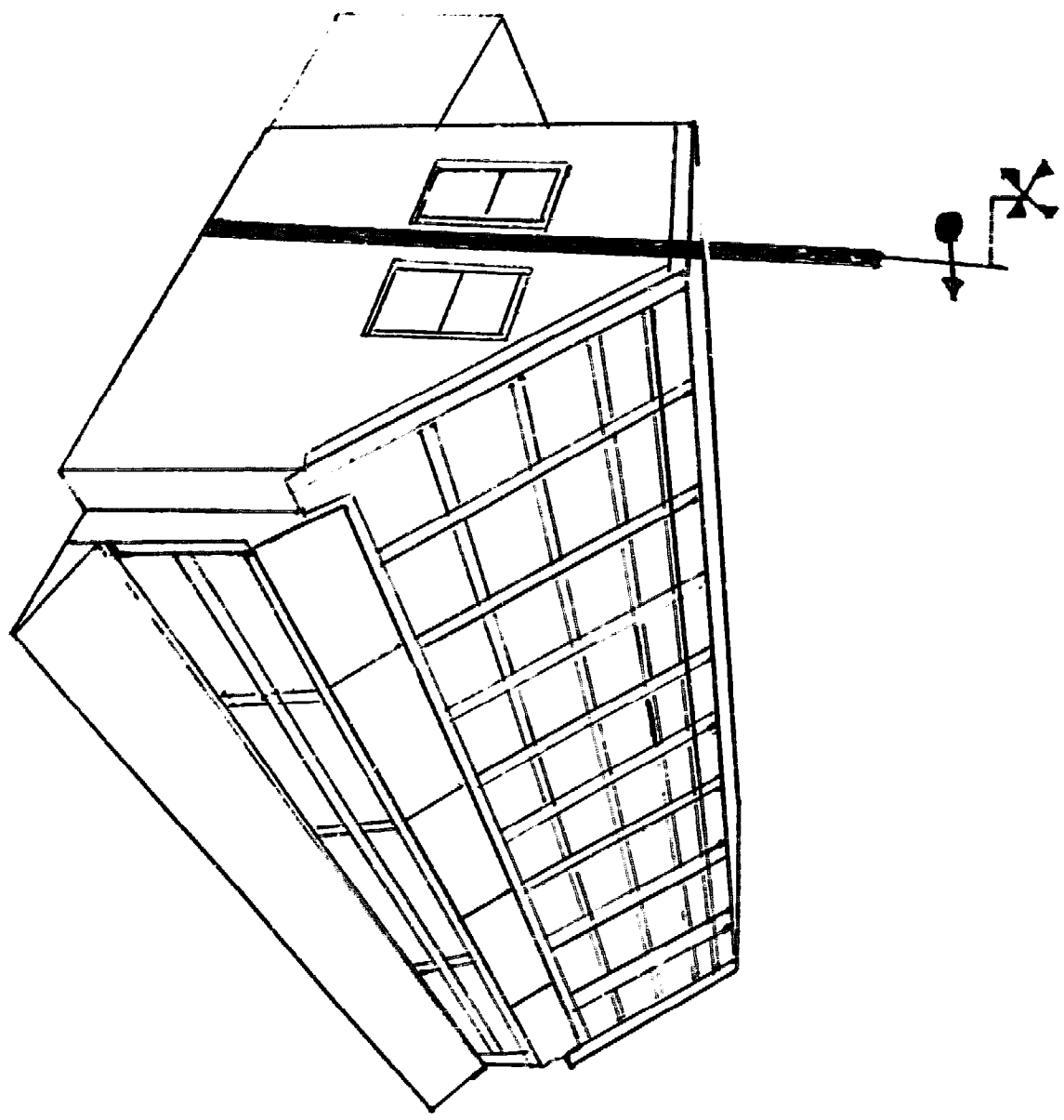

INTERNAL AND EXTERNAL SOLAR COLLECTION AND THERMAL STORAGE FOR GREENHOUSE HEATING

William F. Milburn, P.E.
Robert A. Aldrich, P.E.

Department of Agricultural Engineering

John W. White
Department of Horticulture
The Pennsylvania State University

ABSTRACT

Standard greenhouse construction materials and methods were used to assemble an air heating solar collection system. Design features are low initial cost, simplicity of installation and operation and high utilization factor. Initial results indicate that the system is suitable for "in-house" construction, installation and operation and that performance is equivalent to commercially available systems with approximately two to three times the initial cost.

OBJECTIVES

The type of solar systems which are currently evolving for use in heating residential and commercial buildings are too costly and in some cases too complex for use in the greenhouse industry.

It has been attempted, in this investigation, to design the solar collection and storage systems in such a way that they have a low first cost, are more adaptable to greenhouse application and can be assembled and installed (from plans) by people familiar with greenhouse maintenance.

SYSTEM DESCRIPTION

The system used in this investigation was somewhat different from one that would be used in a large commercial greenhouse because of the high ratio of surface area to ground area and, therefore, heating load per unit floor area. The external solar collectors, for example, were sized at 46 percent of the floor area of the experimental greenhouse. In a 200' x 200' greenhouse, however, only 25 percent of the floor area would need to be the area of the solar collectors for a similar annual contribution to the heating load. Likewise the heat storage unit would be proportionally smaller.

The greenhouse used in this investigation was 20' x 20' and was covered with a premium grade Tedlar* coated corrugated fiberglass. The sill line was 3' above grade. The wall below the sill extended approximately 12 inches below grade and was cement asbestos board bonded to 3/4" polyurethane foam. The inside of the wall was covered with 2" polystyrene bead board.

The interior collection system consisted of a fractional horsepower forward curved centrifugal cabinet fan which pulled air from the two ridge areas of the greenhouse through clear polyethylene ducts. The layout of the fan and ductwork can be seen in Figure 2. The air from the fan was discharged directly into the rock bed for storage or into the inlet of the heating fan if the crop zone thermostat was calling for heat (Figure 4).

*Registered trademark E. F. DuPont Co., Wilmington, Delaware.

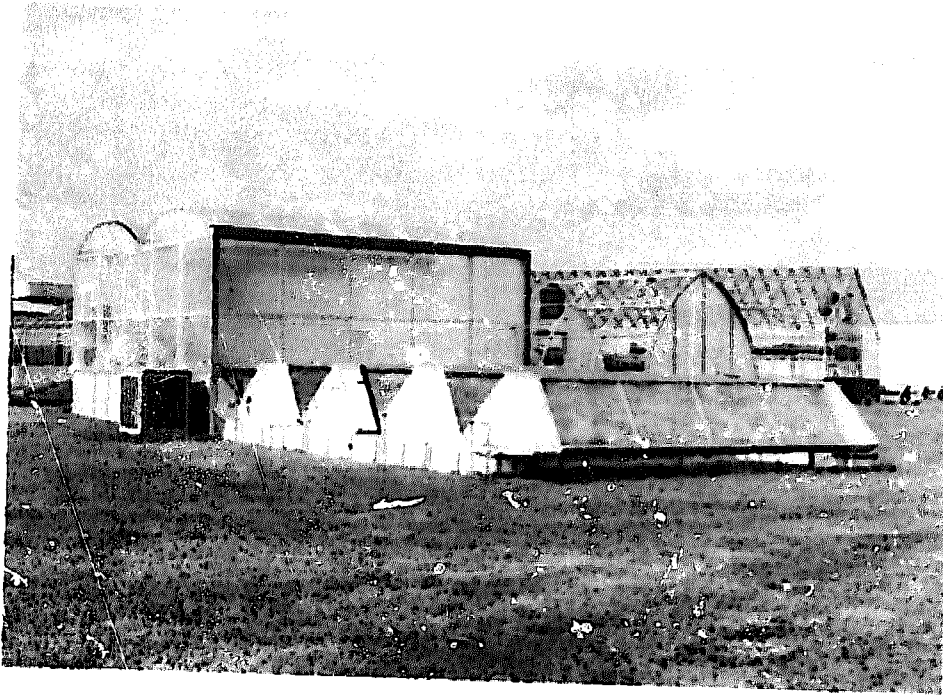

FIGURE 1



FIGURE 2

The external collection system was an array of four flat plate air heating collectors inclined at an angle of 58° above the horizontal. The absorber was of 28 ga. sheet steel with integral fins and was covered with an inexpensive high temperature flat black paint. All framing was of construction grade lumber and all insulation was foil faced polyurethane board. The glazing was flat fiberglass. A cross-sectional view in Figure 3 shows the layout. The absorber surface was 16' long as most building materials are available in 8' and 16' units. The materials cost for the collector was about $\$2/\text{ft}^2$ ($\$21.50/\text{m}^2$).

Figures 1 and 2 show the collector array and interior of the greenhouse.

All ductwork which supplied air to the collectors was insulated with 2" polystyrene bead board and a ductwork connecting the collector outlet with the greenhouse was insulated with 4" polystyrene bead board. Each collector had a forward curved-centrifugal fan which was mounted to draw through the collector. The air was discharged into the duct leading to the rock bed and was either directed through the rock bed for storage or into the inlet of the heating fan when the crop zone thermostat was calling for heat (Figure 4).

The heat from the two collection systems was stored in a rock bed 4.73m (15'-6") long and 0.48m (19") deep. It was divided into two sections. The internal system section was 1.6m (5'-3") wide and the external system section 2.12m (10'-3") wide. The material used in the rock bed was 4 cm ($1\frac{1}{2}$ ") crushed limestone. The approximate mass of rock was 10,500kg (23,300 lb) for the external system and 5,800kg (12,800 lb) for the internal system. The specific heat of limestone is about $9.085\text{E}02 \text{ J/kg-K}$ ($0.217 \text{ Btu/lb-}^{\circ}\text{F}$). The rocks rested directly on the soil and were separated from it by a polyethylene vapor barrier. The top and two sides of the rock bed were enclosed with an interior layer of polyethylene and a covering of plywood. There was no insulation. The air plenum spaces at either end of the rock bed were formed by the sidewall of the greenhouse, described previously, the soil, covered with a vapor barrier, and $\frac{1}{2}$ " of polystyrene bead board and an uninsulated plywood top.

RADIATION

All incident solar radiation was measured with Moll-Gorczyński type precision thermocouple pyranometers manufactured by Kipp and Sons. Insolation was measured at the collector face with the pyranometer in the plane of the collector and inside the greenhouse with the pyranometer horizontal and in a relatively unshaded location. The assumption was made that the horizontal floor area of the greenhouse would be considered the collection area for the internal system. Total direct insolation on a horizontal surface was also recorded. The values of incident versus collected and stored energy totalized over the applicable areas are shown in Figure 5. Although it is not shown graphically here, it is of interest to note that the insolation per unit area incident on the external collector surface and incident on the horizontal in the greenhouse were normally within 10 percent of each other for the month of May and both values were approximately 75 percent of the total direct insolation on a horizontal surface.

EXPERIMENTAL PROCEDURE

The temperature measurements were made with copper-constantan thermocouples. In the rock bed, these were located as shown by the data points on the horizontal scale of Figure 6 and at the vertical midpoint of the rock bed.

The crop zone temperature and control thermostats were located in an aspirated chamber. Collector leaving air temperatures were actually the entering air temperatures of the respective rock storage bed of the two systems. The energy

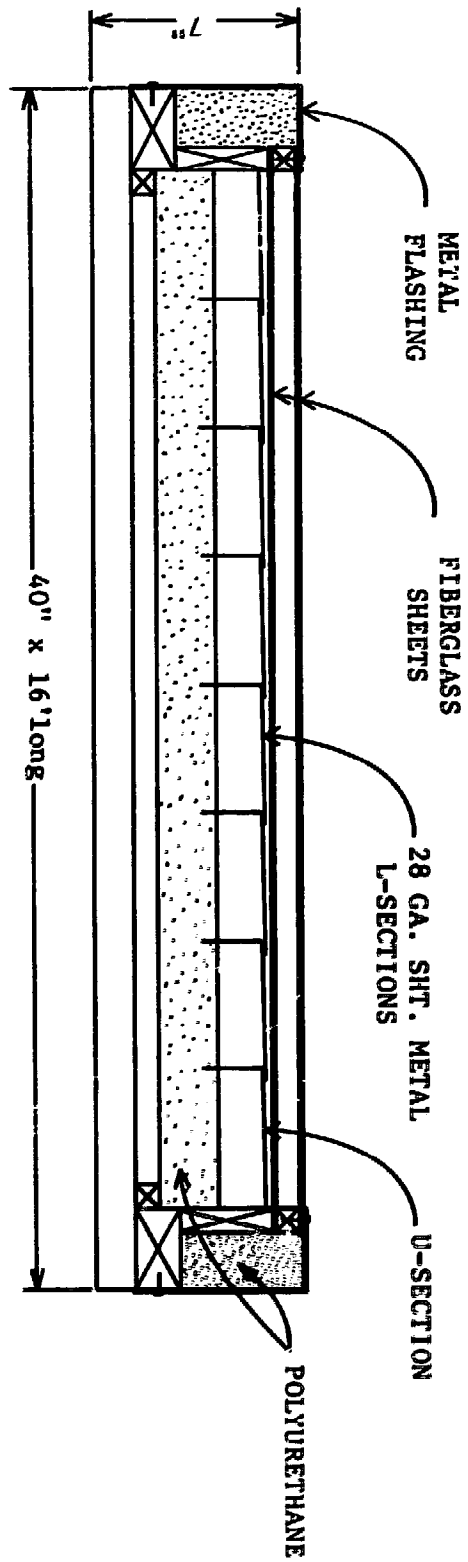

FIG 3 - SOLAR COLLECTOR CROSS-SECTION

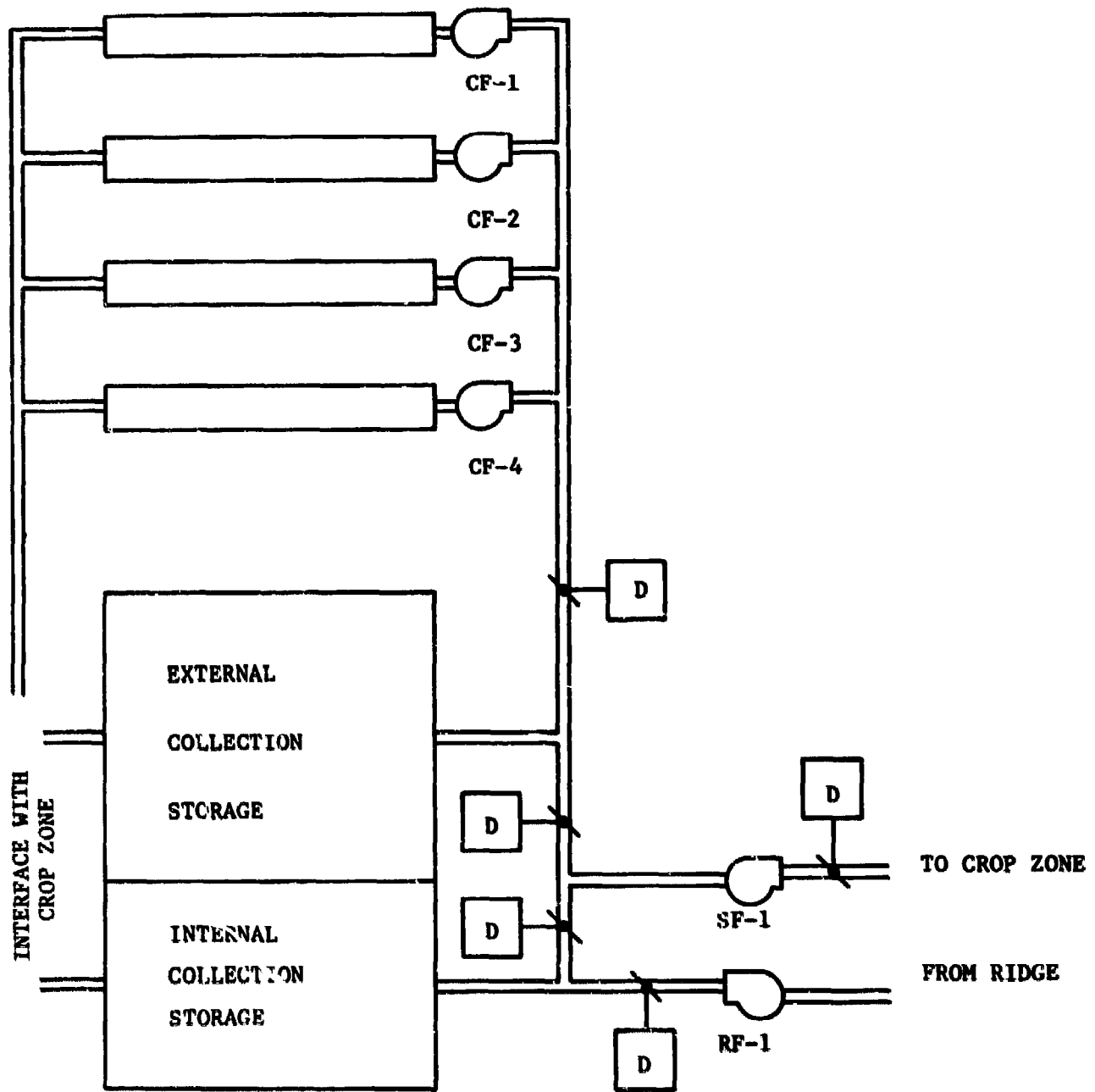

FIG. 4 - SCHEMATIC DIAGRAM OF COLLECTION, STORAGE AND DISTRIBUTION SYSTEM

which was both collected and stored was used for the system analysis. Sub-system efficiencies are not within the scope of this paper, however, they were measured. The running times of the various fans were obtained with an operations recorder (Figure 6). Measurements were made on a continuous basis over the time reported.

The system was operated on a fully automatic basis. The two collection systems were controlled by differential thermostats.* The temperature at the cold side of the respective rock storage bed was compared against plate temperature on the external system and ridge air temperature on the internal system. The heating fan was controlled by a two stage heating thermostat mounted in the aspirated chamber. The set point temperature was 20°C (68°F) with a 2°C (3°F) differential between stages. The stage one heating mode used heat from the internal collection storage bed since it was normally the cooler of the two beds. The stage two heating mode used heat from the external collection storage bed since it was the warmer of the two beds and could handle a large heating load.

DISCUSSION

The system was put into operation on May 7, 1977 and operated through the entire period of May 8, 1977, however, data was not taken for the first half of the 24 hour period. The data appearing in Table 1 for total energy collected and stored assumes a 20°C (68°F) initial bed temperature. This data is equivalent to the sum of lines two and three for the other three days. The operations of the systems appear to be somewhat variable over the three days May 27, May 28, and May 29, however, on closer examination the performance can be easily identified. The sum of lines two and three in Table 1 gives the total amount of energy stored at the end of the day. For all three days, the incident radiation on the external collectors was 3.1E08 J and the final energy stored was 1.5E08 J representing a possible operating efficiency of about 49 percent. The amount of heat retained in the rock bed simply reduced the apparent efficiency. The energy remaining in the rock bed in the morning was due, in part, to the unseasonably mild weather at the time. Another factor which contributed to this type of performance was the performance of both collection systems on crop zone for inlet conditions. The external collectors would benefit greatly here from a direct connection of the rock bed to the collector inlet. Cooler weather, of course, would have assured a continuous profile of 20°C through the rock storage.

A constant airflow rate of 0.57 m³/s (1200 cfm) was used through the external collector array and 0.13 m³/s (275 cfm) was pulled through the internal collection system. This would undoubtedly be a contributing factor in the overall seasonal operating efficiency of the system. It has been found in previous investigations and simulations (1,3) that this airflow rate will yield a high collection efficiency and low final temperature. It was selected because the low outlet temperature is necessary in a greenhouse heating system and the high collection efficiency is, of course, very desirable.

The performance of the rock bed seemed to be very good in relation to the collection system. The collected energy corresponded reasonably well to the stored energy from data taken on the individual components. Some heating at the outlet side of the bed occurred during the heating processes. This is normal and represents a good utilization of the storage capacity. This would probably fluctuate with velocity of air through the bed. The gross face velocity of the air entering the bed was 0.37 m/s (72 ft/min). This velocity is somewhat high but due to rock storage bed size limitations and the selected collector air flow

*Manufactured by Rho Sigma, Inc., Torrence, California

which was both collected and stored was used for the system analysis. Sub-system efficiencies are not within the scope of this paper, however, they were measured. The running times of the various fans were obtained with an operations recorder (Figure 6). Measurements were made on a continuous basis over the time reported.

The system was operated on a fully automatic basis. The two collection systems were controlled by differential thermostats.* The temperature at the cold side of the respective rock storage bed was compared against plate temperature on the external system and ridge air temperature on the internal system. The heating fan was controlled by a two stage heating thermostat mounted in the aspirated chamber. The set point temperature was 20°C (68°F) with a 2°C (3°F) differential between stages. The stage one heating mode used heat from the internal collection storage bed since it was normally the cooler of the two beds. The stage two heating mode used heat from the external collection storage bed since it was the warmer of the two beds and could handle a large heating load.

DISCUSSION

The system was put into operation on May 7, 1977 and operated through the entire period of May 8, 1977, however, data was not taken for the first half of the 24 hour period. The data appearing in Table 1 for total energy collected and stored assumes a 20°C (68°F) initial bed temperature. This data is equivalent to the sum of lines two and three for the other three days. The operations of the systems appear to be somewhat variable over the three days May 27, May 28, and May 29, however, on closer examination the performance can be easily identified. The sum of lines two and three in Table 1 gives the total amount of energy stored at the end of the day. For all three days, the incident radiation on the external collectors was 3.1E08 J and the final energy stored was 1.5E08 J representing a possible operating efficiency of about 49 percent. The amount of heat retained in the rock bed simply reduced the apparent efficiency. The energy remaining in the rock bed in the morning was due, in part, to the unseasonably mild weather at the time. Another factor which contributed to this type of performance was the performance of both collection systems on crop zone for inlet conditions. The external collectors would benefit greatly here from a direct connection of the rock bed to the collector inlet. Cooler weather, of course, would have assured a continuous profile of 20°C through the rock storage.

A constant airflow rate of 0.57 m³/s (1200 cfm) was used through the external collector array and 0.13 m³/s (275 cfm) was pulled through the internal collection system. This would undoubtedly be a contributing factor in the overall seasonal operating efficiency of the system. It has been found in previous investigations and simulations (1,3) that this airflow rate will yield a high collection efficiency and low final temperature. It was selected because the low outlet temperature is necessary in a greenhouse heating system and the high collection efficiency is, of course, very desirable.

The performance of the rock bed seemed to be very good in relation to the collection system. The collected energy corresponded reasonably well to the stored energy from data taken on the individual components. Some heating at the outlet side of the bed occurred during the heating processes. This is normal and represents a good utilization of the storage capacity. This would probably fluctuate with velocity of air through the bed. The gross face velocity of the air entering the bed was 0.37 m/s (72 ft/min). This velocity is somewhat high but due to rock storage bed size limitations and the selected collector air flow

*Manufactured by Rho Sigma, Inc., Torrence, California

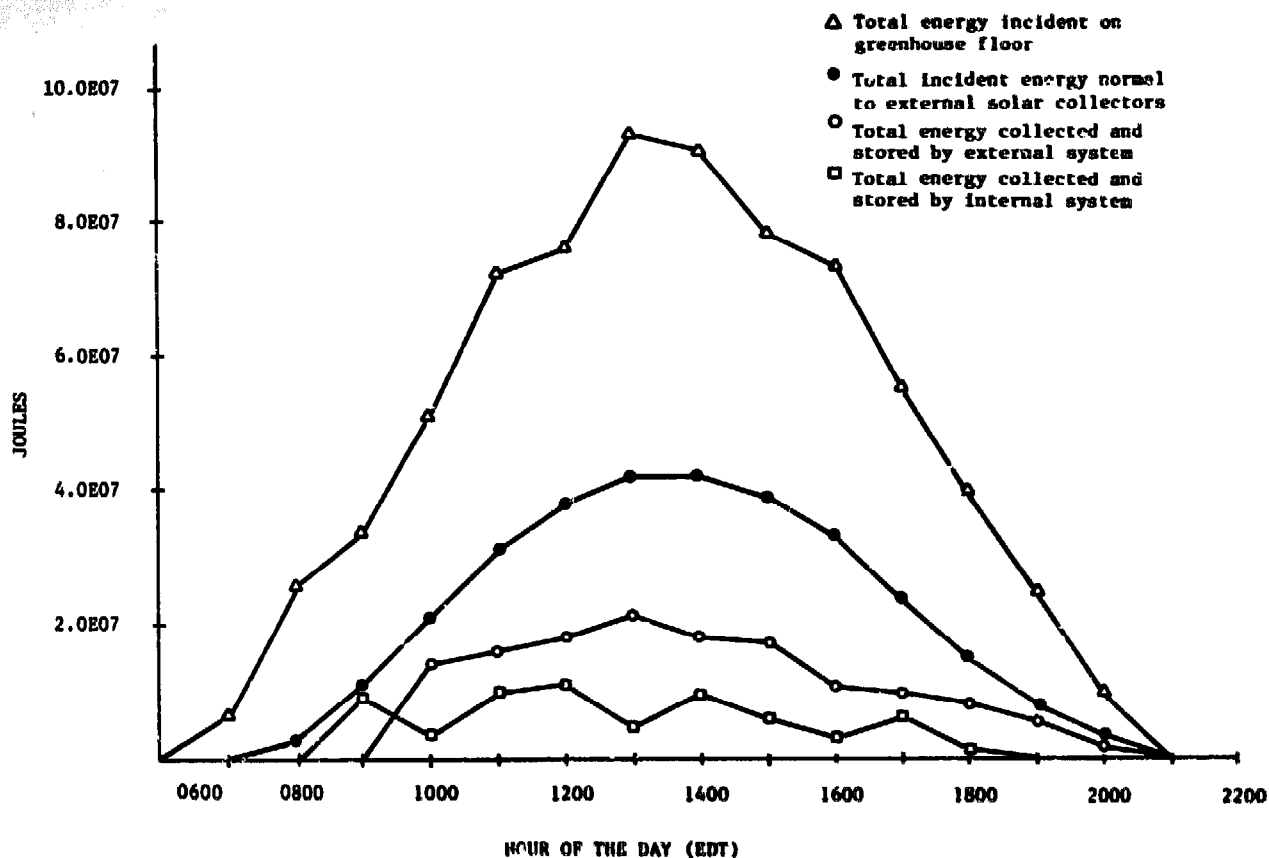

FIG. 5 - TOTAL INCIDENT AND COLLECTED ENERGY FOR 5/28/77

	5/8/77		5/27/77		5/29/77		5/29/77	
	External System	Internal System	External System	Internal System	External System	Internal System	External System	Internal System
Total incident energy on collector ^{1,3}	3.22E08	6.44E08	3.12E08	7.61E08	3.06E08	7.31E08	3.05E08	7.08E08
Initial energy level of storage ^{2,3}			6.79E07	2.72E07	1.27E07	8.78E06	8.11E07	3.60E07
Total energy collected and stored ³	1.24E08 ²	5.24E07 ²	6.32E07	3.95E07	1.32E08	5.44E07	7.29E07	3.50E07
Power consumed by collection system ³	8.60E06	2.99E06	1.03E07	3.85E06	1.14E07	4.03E06	1.05E07	2.95E06
Coefficient of performance = stored heat/pwr. cons. ⁴	14.4	17.5	8.08	10.26	11.67	13.49	6.94	12.63
Collection-storage efficiency = incident energy/stored energy ⁴	0.385	0.081	0.267	0.052	0.432	0.135	0.239	0.051

¹ Totalized for 17.09 m² external and 37.16 internal collector areas

² Calculated from a base temperature (zero stored energy) level of 20°C

³ Energy is given in joules

⁴ The values for the internal system would be de-rated by approximately 35 to 49% as explained in the text

TABLE 1 - DATA SUMMARY

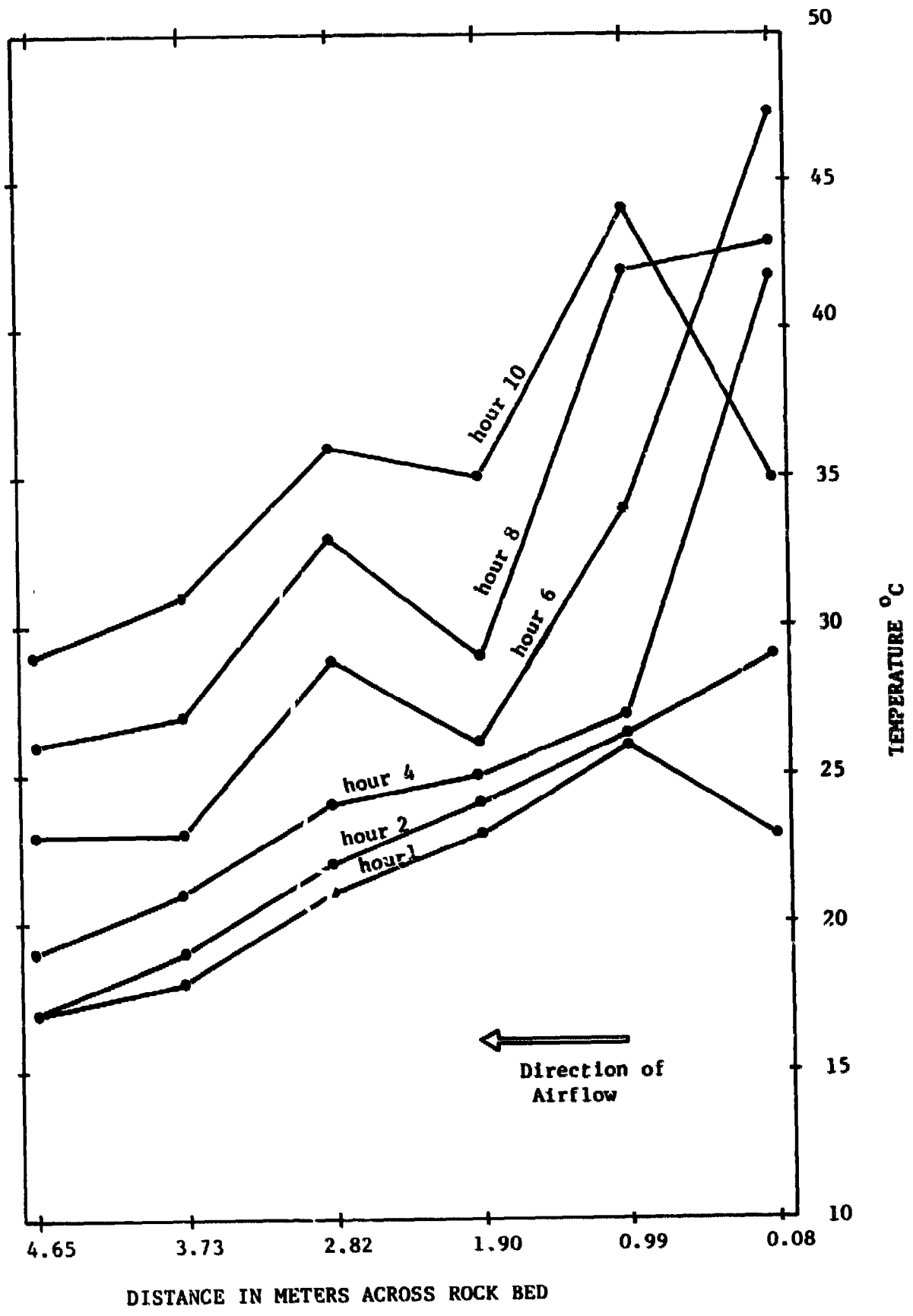

FIG. 6 - TYPICAL ROCK BED HEATING PROCESS

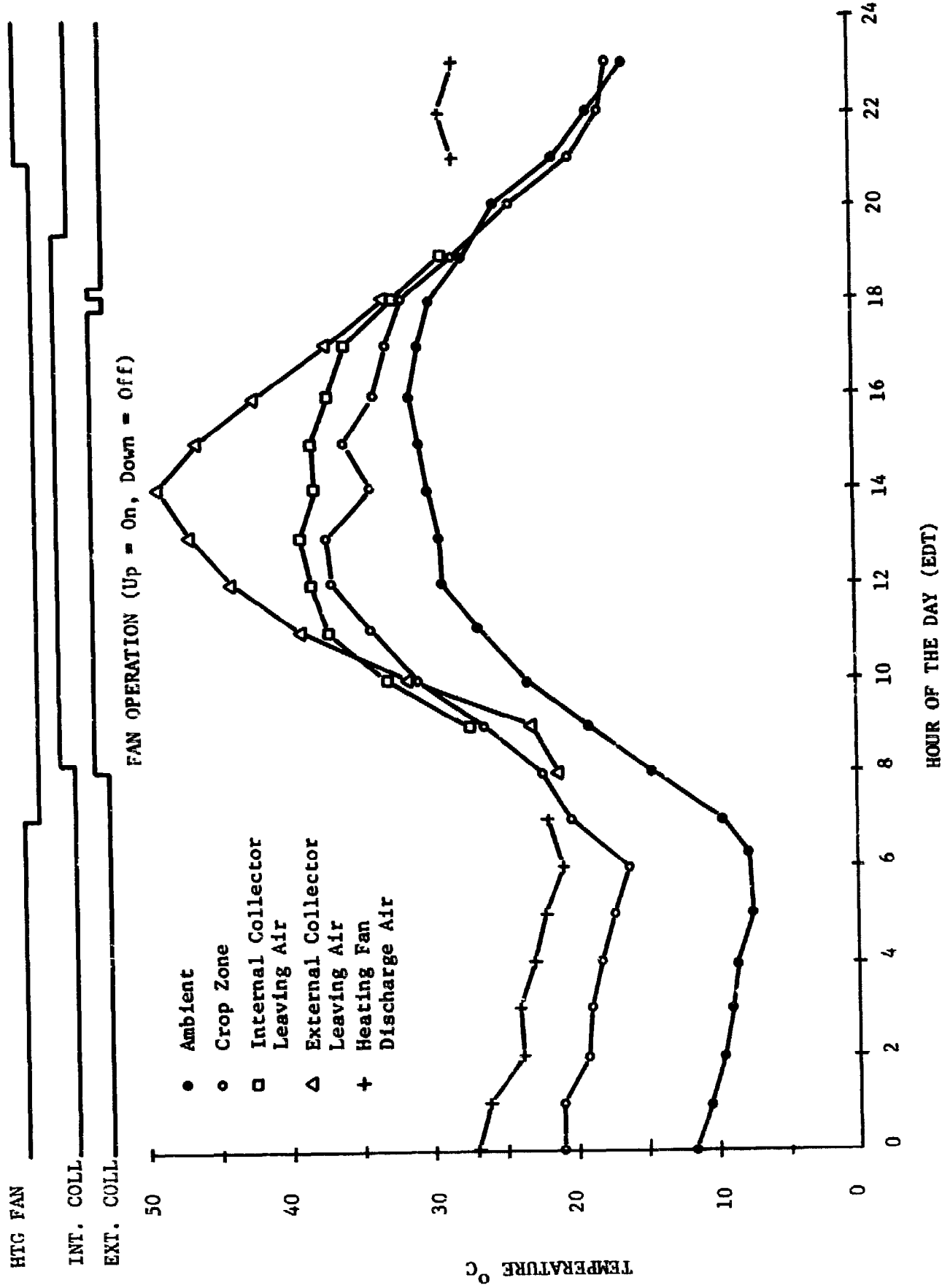

FIG. 7 - 24 HOUR TEMPERATURE PROFILE FOR 5/28/77

rate, the decision was made to operate the system with this higher velocity. The unusual temperature profile occurring in the middle of the rock bed in the direction of air flow (Figure 7) occurred regularly in the rock storage bed of both the internal and external systems. Channeling of the air above the rocks is a probable explanation. Removal of the cover from the storage bed revealed some localized settling of the rocks to a depth which could have initiated air channeling. The rocks have been sealed on top with a thin layer of concrete to prevent the possibility of any air channeling in the future.

CONCLUSIONS

The use of standard greenhouse construction materials and methods to assemble an air heating solar collection system has produced a system which appears to deliver a performance equal to commercially available systems for roughly one third to one half the cost of an equivalent commercial system. Since the initial performance tests of this system have been successful, refinement will be made in an attempt to increase operating efficiency and improve cost effectiveness. Annual operating data will be collected in order to verify performance predictions for other seasons of the year. It is felt that a system design such as this would have a very attractive payback period because of the low initial cost, simplicity of installation and operation and because of the high utilization factor resulting from the small relative size.

REFERENCES

1. Close, P.J., R.V. Dunkle, and K.A. Robeson. Design Performance of a Thermal Storage Air Conditioning System. Mechanical and Chemical Eng. Trans. I.E. Aust., May 1968.
2. American Society of Heating, Refrigerating, and Air-Conditioning Engineers, Inc. ASHRAE Guide and Data Book - 1974 - Applications. ASHRAE, New York, 1974.
3. American Society of Heating, Refrigerating, and Air-Conditioning Engineers, Inc. Applications of Solar Energy for Heating and Cooling of Buildings. ASHRAE, New York. 1977.
4. Lof, G.O.G. and R.W. Hawley. Unsteady State Heat Transfer Between Air and Loose Solids. Industrial and Engineering Chemistry, Vol. 40, No. 6, June 1948.

HYBRID PASSIVE SYSTEMS I

DESIGN CONSIDERATIONS, THEORETICAL PREDICATIONS, AND PERFORMANCE OF AN ATTACHED SOLAR GREENHOUSE USED TO HEAT A DWELLING

D. C. Taff, Ph. D.
Parallax Corp.
Hinesburg, Vt.

R.B. Holdridge, Arch.
Parallax Corp.
Hinesburg, Vt.

John Wolfe
Dartmouth College
Hanover, N.H.

ABSTRACT

Passive solar heating can be accomplished in a cost effective manner by attaching a thermally efficient greenhouse to the structure requiring heat. This paper presents the results of a monitoring study done on such a greenhouse in Hinesburg, Vermont. In this study, the greenhouse was used to heat part of a home. Simulation data is also presented which indicates design improvements required for structures to be thermally productive as well as self-sufficient. Calculations are also presented which indicate potential savings in home heating possible with attached greenhouses located in 12 U.S. cities.

INTRODUCTION

Greenhouses have been used for decades to provide out of season flowers and vegetables to a consuming public. Rising fuel costs have made their future existence questionable in light of a worldwide transportation network which allows for crop production under ideal conditions far from the consumer. On the other hand, fuel costs contribute to the cost of field grown vegetables in the form of spiraling transportation costs. It can be argued that those transportation costs will escalate faster than the fuel costs to heat locally sponsored greenhouses if those greenhouses are designed to be thermally efficient.

Solar heating has been sold to the public as a new, technology loaded with promise as well as complication. They have been told repeatedly of the need for steep roofs covered with expensive collectors, large storage masses which fill basements and \$10,000 installation bills. They have not been educated in the basics, even though a simple collector, i.e., a window, is a common part of their lives. Complication and expense have had serious negative impacts on the market acceptability. Passive solar heating systems incorporating control technology can provide the market acceptability required to give solar heating a significant impact in the National Energy Program. Passive systems in commercial as well as residential greenhouses promise

even greater impacts.

Various designs already exist for solar greenhouses, i.e., those greenhouses optically designed for maximum solar energy transmission, absorption, and storage. Most rely on south facing transparent surfaces which are angled in such a way to be as close to perpendicular to the noon midwinter sun as possible. North walls are usually insulated. All rely on systems of thermal storage to minimize interior temperature fluctuations and to optimize plant growth. Preliminary studies by Lawand et al (1), Yanda (2), Kusanovich (3), and Nash (4), have established the feasibility of thermally self-sufficient greenhouses using passive energy storage systems. This paper reports on the monitoring of a prototype greenhouse located in northern Vermont and used to heat a home. Simulation studies are also presented here to support the authors' contention that similar structures can provide cost effective solar space heating at a low capital expense. It has also been found that consumer acceptance and desire for solar heating is substantially increased because such multi-purpose structures, i.e., greenhouse-solarium-passive solar heaters, can provide solar heating as well as additional living space, home equity, and potentially, food.

Although this particular structure was designed primarily as a passive solar heating system for retrofit and new home construction, the strong possibility exists that optimized greenhouse design, new methods of passive thermal storage, computerized control and new refractive glazing materials could rejuvenate a struggling commercial greenhouse industry.

THE HINESBURG, VERMONT SOLAR GREENHOUSE

Greenhouses can be divided into three major classes. The first two (Figure 1A, 1B) are classic designs with all surfaces transmitting solar radiation. Depending on climate and cloud cover, they may be oriented on an east-west or north-south axis. Both designs are subject to high rates of heat loss during colder months as well as over heating in warm

months. They were designed and exist because of low fuel costs. For the twenty-first day of February in northern Vermont (44.5 N Lat.), assuming clear sky, a -18°C (0°F) outside temperature and a 13°C (55°F) inside temperature, the heat loss calculated over twenty-four hours for the single glazed, $2.4 \times 3.7\text{m}$ ($8' \times 12'$) design (Figure 1A) will approximate 163 kW-hrs. The solar gain after reflection and absorption will approach 48 kW-hrs. The net loss over 24 hours will approximate 115 kW-hrs. Adding an additional layer of rigid glazing can reduce the net heat loss to 21 kW-hrs. (infiltration losses included in calculation) (Figure 1B).

The third class of greenhouse holds the most promise for homeowners as well as large commercial applications. Figure 1C illustrates one design typical of this class and illustrates the greenhouse built as a prototype, monitored and simulated in this paper (Table 1). For the same day used in comparison to the greenhouses in Figures 1A and 1B, the total heat balance calculated over twenty-four hours will approach a positive gain of 14 kW-hrs.

As detailed in Table 1, the Hinesburg solar greenhouse is attached to an older home of some 167m^2 (1800ft^2) floor area. The express purpose for its design is to produce supplemental heat for the house. A typical greenhouse contains so much transparent surface that winter heating becomes a major problem. To achieve a low heat loss, two techniques have been used. All transparent walls (windows) have been double glazed to cut losses by a minimum of 50%. The north wall, north roof, and half of the east and west walls are insulated. The immediate effect is to cut the heat loss of the solar room-greenhouse by 80% compared to single glazed and 48% compared to double glazed plastic greenhouses of similar size. The net effect is that when you combine insulation with good optics, you create a system which produces more heat than it consumes. As a greenhouse, it becomes practically self-supporting and as an attached passive solar heater, it becomes an efficient and inexpensive means of providing solar heating to the rest of the house.

In most greenhouses, excess heat is vented to the outside and lost. In the Hinesburg greenhouse, heat is conserved via thermal mass. Four drums provide the containers for 787.4 liters (208 gallons) of water. This volume has been demonstrated by Michel (5) and by our results (Figure 2) to provide adequate thermal mass to avoid erratic temperature fluctuations. Correct sizing of thermal mass is a function of solar aperture and the heat loss coefficient of the greenhouse. For this case 787.4 liters provide $3.70 \times 10^5 \text{ J/m}^2 \cdot ^{\circ}\text{C}$ ($18.09 \text{ BTU/Ft}^2 \cdot \text{F}$) heat capacity.

The controls for this greenhouse consist of one differential thermostat and two $204\text{m}^3/\text{hr}$ ($7200\text{ft}^3/\text{hr}$) room-to-room fans. One fan is installed at ceiling height and blows warm air from the solar room into the house. The second is installed at floor level and pulls cool house air into the solar room for heating and return to the house. The differential thermostat continuously senses the solar room temperature against the house temperature. As soon as the temperature of the solar room exceeds the house by 2.5°C , heat is pumped into the house and therefore reduces fuel consumption. If the house is warmer or within 1.7°C of the greenhouse, then the fans remain off. By using this control method, radical highs have been avoided and surplus heat supplied throughout the winter.

RESULTS OF MONITORING

The greenhouse has been monitored continuously since November, 1976. Data collected has included day, time, highs and lows of both the interior and outside ambient temperatures, running time on the fans, precipitation and continuous recording of the interior air temperatures of the greenhouse prior to ejection into the house. Data for February and March is presented in Figure 2. It is significant to note that the daily greenhouse low temperatures never fluctuate more than a few degrees above and below 13°C (55°F) even though the greenhouse is sealed and insulated from the house and subject to frigid nighttime temperatures. The continuous recording curves are presently being integrated and actual heat delivery rates should be available shortly. Pyranometer recordings will be taken on a second and larger prototype being constructed.

SIMULATION RUNS FOR AN ATTACHED SOLAR GREENHOUSE

Perhaps the most useful application of a simulation model is examining design variables. By far the most sensitive variable proved to be the main house heat load coefficient, which determines how much solar heat is useful before overheating occurs. Decreasing the coefficient from $12.6 \times 10^5 \text{ J/Hr} \cdot ^{\circ}\text{C}$ ($662 \text{ BTU/Hr} \cdot \text{F}$) to $3.8 \times 10^5 \text{ J/Hr} \cdot ^{\circ}\text{C}$ ($200 \text{ BTU/Hr} \cdot \text{F}$) decreased the net solar gain from 1307 kW-hr to 96 kW-hr. If a heat load coefficient of 200 reflects the load for the house, it would be senseless to increase heat load in order to increase the efficiency of the greenhouse. Instead, one would try to increase the thermal storage and thermal storage transfer rates in the design and perhaps encourage the building's inhabitants to tolerate moderately high temperatures before venting off access air. Since the solar room design is meant primarily as an addition to an existing structure, it should be pointed out that the investment would be most worthwhile for large, open buildings.

The effects of meticulous construction details which minimize heat losses from the greenhouse were also examined. Cutting infiltration₃ from 109m³ (1176 cu. ft.) to 46m³ (500 ft³) and better insulation will decrease the heat loss coefficient from $1.89 \times 10^5 \text{ J/hr}\cdot\text{C}$ ($99.3 \text{ BTU/Hr}\cdot\text{F}$) to $1.52 \times 10^5 \text{ J/hr}\cdot\text{C}$ ($80 \text{ BTU/Hr}\cdot\text{F}$). Cutting losses by that amount increases the annual net solar gain from 1307 to 2158 kW-hr (Figure 3).

Going even further, and adding a night shutter to the solar room's collector face that has an R-factor of 6.25 (when in place before sunrise and after sunset), will increase the net gain to 2919 kW-hr. More importantly, such a system yields a net gain in heat from the solarium for even the coldest months of the heating season.

A second simulation run covering the same model greenhouse constructed in 12 cities throughout the U.S. is presented in Table 2. Significant fuel savings can be realized by this design. Simulations such as this can be used to pinpoint target areas where the maximum solar gain can be accomplished at maximum return on investment. It is interesting to note that the city having the cloudiest and coldest weather in the U.S., i.e., Burlington, Vermont, still displays a result that indicates the possibility of building a structure with a net positive heat gain over the heating season, and that the structure will pay for itself in a reasonable period of time in saved fuel. (The total greenhouse cost without instrumentation but with exterior and interior finish was \$ 891 in late 1976).

CONCLUSIONS

This paper illustrates how passive solar heating can be accomplished in a cost effective manner. Although the monitoring and simulation programs are by no means complete, several conclusions can be suggested.

- (1) Solar heating systems need not be expensive to be significant.
- (2) Solar retrofits are possible with passive solar greenhouse systems.
- (3) Greenhouses do not of necessity have to be energy wasteful but designs must be subject to stringent controls around lowering heat loss while maintaining insulation levels.
- (4) Modest solar greenhouses can be used to heat homes.
- (5) Monitoring data has shown that thermal storage subsystems can stabilize maximum and minimum interior temperatures even when subjected to variable outdoor temperatures and increasing monthly (Feb. - March) average temperatures.

- (6) The heat load coefficient of the house is critical in determining the net useable energy gain from the greenhouse.
- (7) Reducing the net loss out of the greenhouse via night shutters can have a significant impact on the net yearly solar gain produced by the greenhouse.

REFERENCES

- (1) Lawand, T.A., Alward, R., Saulnier, B., and Brunet, E., "The Development and Testing of an Environmentally Designed Greenhouse for Colder Regions," U.S. Section of International Solar Energy Society, Fort Collins, Colorado, U.S.A., August 21-23, 1974.
- (2) Yanda, W.F., "Solar Sustenance Project," International Solar Energy Congress, July 28-August 1, 1975, Los Angeles.
- (3) Kusiarovich, J., "Solar Heated Greenhouse with a One Year Payout," International Solar Energy Congress, July 28 - August 1, 1975, Los Angeles.
- (4) Nash, Robert T., and Williamson, John W., "Thermally Self Sufficient Greenhouses", American Section of the International Solar Energy Society and the Solar Energy Society of Canada, Inc., August 15-August 20, 1976, Winnipeg.
- (5) Michel, Charles, "Glazed Area, Insulation, Thermal Mass in Passive Solar Design," Proceedings of the First Annual Conference of the New England Solar Energy Association, July, 1976, Amherst, Mass., P. 295.

Table 1
CHARACTERISTICS OF CLIMATE AND GREENHOUSE

- * Glazing -- South face only, 60 tilt to horizontal, $U = 9038 \text{ J/m}^2 \cdot \text{hr}\cdot\text{C}$ ($0.45 \text{ BTU/ft}^2 \cdot \text{hr}\cdot\text{F}$)
Material -- rigid double fiberglass with 3.2cm (1.25") air space.
- * All opaque walls have U of $1055 \text{ J/m}^2 \cdot \text{hr}\cdot\text{C}$ ($0.0538 \text{ BTU/ft}^2 \cdot \text{hr}\cdot\text{F}$). Floor and ceiling $U = 665 \text{ J/m}^2 \cdot \text{hr}\cdot\text{C}$ ($0.0338 \text{ BTU/ft}^2 \cdot \text{hr}\cdot\text{F}$)
- * Surface area = 41.6 m^2 (448ft²)
- * Total volume = 25.0 m^3 (884ft³)
- * Infiltration = 1 air change per hour
- * Heat loss coefficient for greenhouse = $1.48 \times 10^5 \text{ J/hr}\cdot\text{C}$ ($77.78 \text{ BTU/hr}\cdot\text{F}$)
- * Thermal storage = 4 barrels (black) containing 787.4 liters (208 gallons of water).
- * Air flow rate of fan = $204 \text{ m}^3/\text{hr}$ (7200ft³/hr).
- * Local climate, degree days = 7865
Percent possible sunshine: October - 43, November - 26, December - 25, January - 34, February - 44, March - 48, Yearly average - 51.
Latitude = 44.5 N

Figure 1
AN EXAMPLE OF ONE DAY'S NET HEAT BALANCE FOR THREE GREENHOUSE DESIGNS

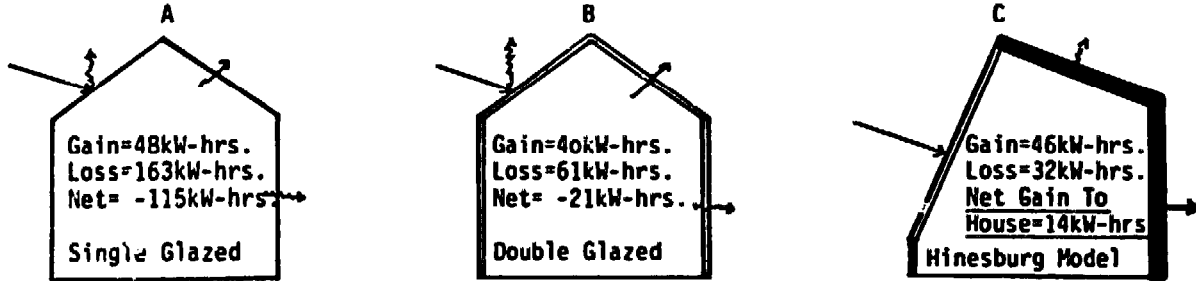

Clear, -18 C, February 21st, Burlington, Vermont

Figure 2

DAILY RECORDING FROM THE HINESBURG GREENHOUSE

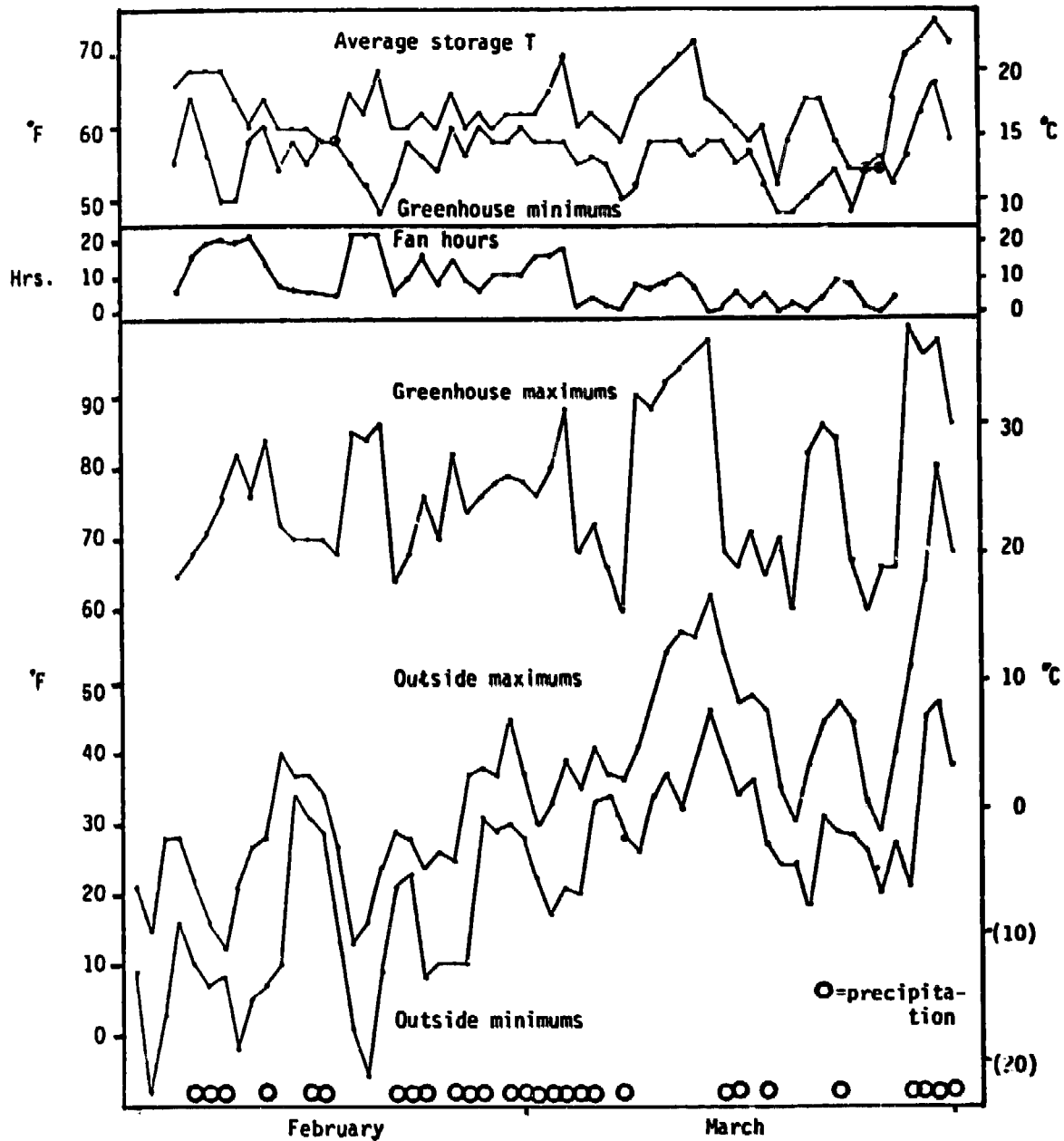

Figure 3
SIMULATED MONTHLY PERFORMANCE OF A PROTOTYPE GREENHOUSE
IN BURLINGTON, VT., USED TO HEAT A HOUSE

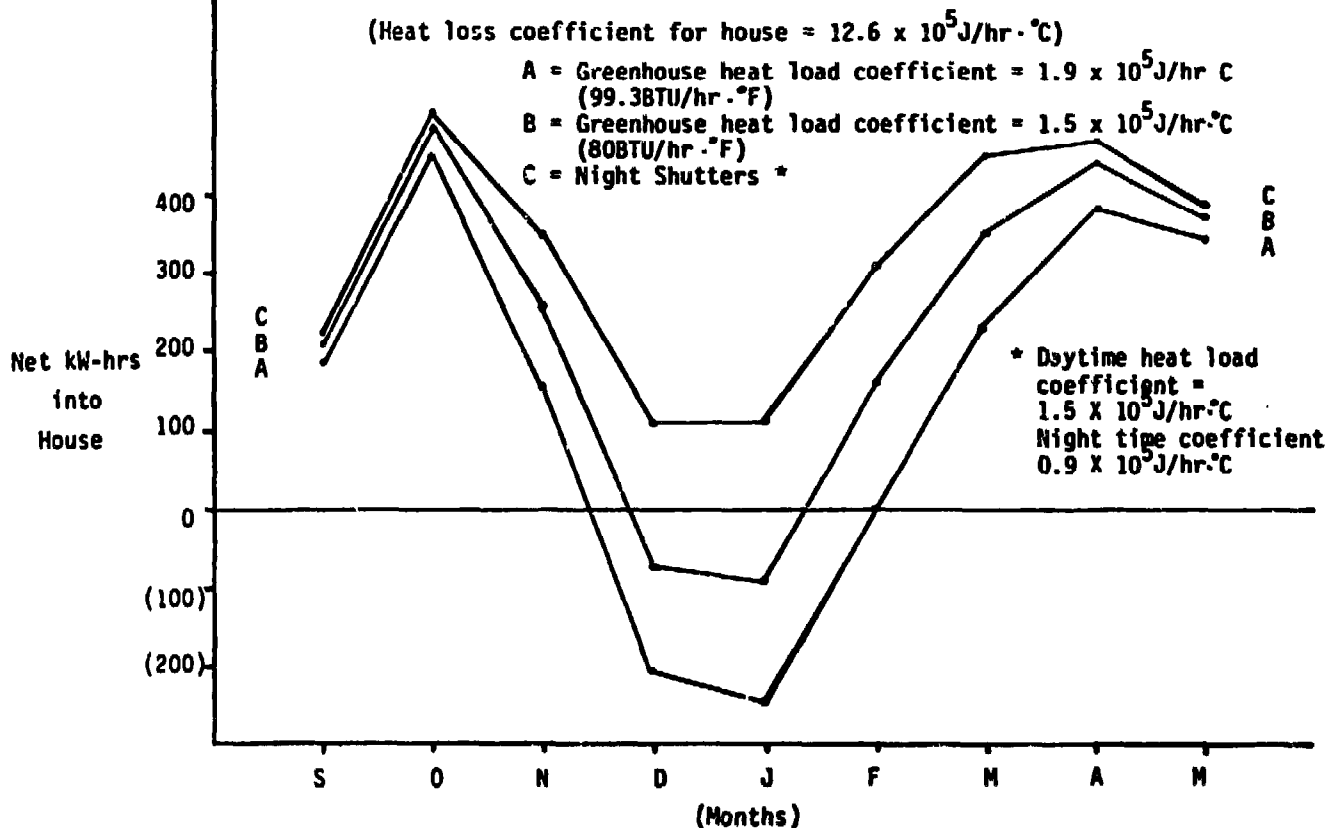

Table 2

FUEL REDUCTION CONTRIBUTED BY AN ATTACHED SOLAR GREENHOUSE ***

City	65 Degree Base	Solar Heat Produced by Greenhouse* (kW-hrs)	Heat Loss of Greenhouse (kW-hrs)	Ratio of Heat Gain to Heat Loss	Fuel*** Reduction (%)	Savings**** (\$)
New York, NY	4871	5652	2007	2.8	32.1	324.85
Boston, MA	5634	5592	1856	3.0	28.5	227.90
Burlington, VT	7865	4476	2931	1.5	8.4	77.25
Philadelphia, PA	5251	5452	1548	3.5	32.0	206.91
Baltimore, MD	4654	4818	1414	3.4	43.5	156.58
Chicago, IL	6155	4993	2159	2.3	19.8	130.36
Springfield, IL	4561	5754	1821	3.2	37.0	173.05
Milwaukee, WI	7205	5965	2735	2.2	19.2	125.97
Denver, CO	6283	7897	1996	4.0	40.3	224.24
Dayton, OH	5597	4803	2042	2.4	21.1	99.40
Cincinnati, OH	4870	5003	1356	3.7	32.1	124.00
Duluth MN	10000	6809	3968	1.7	12.2	-----

* Energy available after transmission and reflection losses subtracted

** Based on 55° nighttime setback and materials as described in Table 1

*** Dwelling is assumed to use 2.33 kW-hrs. per degree day (base 65). This quantity of heat is typical of an average U.S. home.

**** Value of energy is based on available electrical costs during January, 1976.

HYBRID PASSIVE SYSTEMS II
CLOSE CONTROL DESIGN CRITERIA ESTABLISHING COST EFFECTIVE
SOLAR HEATING - THE HYBRID-DELTA LINE

D. C. Taff, Ph.D.
Parallax Corp.
Hinesburg, Vt. 05461

R. B. Holdridge, Arch.
Parallax Corp.
Hinesburg, Vt. 05461

ABSTRACT

One of the major design problems associated with passive solar architecture is a lack of close temperature control within the conditioned space. Although passive designs are often simpler and more cost effective than active systems, any lack of control effects their thermal efficiency as well as their market acceptance. Hybrid systems containing both the passive collector - storage subsystems as well as the close electronic control of active systems offer marked advantages over either alone. Early work by Lawand (1) and latter studies by Gillett (2) have established the solar greenhouse as an effective hybrid passive system. Further work by Taff, Holdridge and White (3) discussed the design parameters of a solar greenhouse used to heat a home. This paper will show that the very act of adding close control enhances the climate reliability of the structure and allows the designer/builder the obvious advantage of predicting, within fair limits, future performance.

RESULTS AND DISCUSSION

In a previous paper (3) the results of a monitoring program on a solar greenhouse used to heat a home were reported. The structure included 96 ft.² of double glazed ($u=0.45$) window-wall, thermal storage (18.1 BTU/ft.² aperture x °F), and two differentially controlled fans delivering 120 ft.³ per minute of exchange air to the house.

A linear regression analysis by month of the maximum and minimum daily ambient as well as daily greenhouse temperatures yielded extremely interesting results. As expected the ambient regressions maintained similar positive slopes as summer approached (Figures 1 and 2). March was warmer than normal in Vermont, hence the regression line for the minimum March temperature is higher than normal, but still with reasonable limits

The interesting features of this data come after examining the daily greenhouse minimum and maximum temperature regressions and the relationship of the ambient regressions to the greenhouse regressions as a whole. The greenhouse minimum temperatures increased by month (Figure 2), but at a slow rate (5°F over 90 days). Additional data has shown that this rate is stable only up to the point where the ambient minimum and greenhouse minimum regression lines cross. At this intersection, control of the greenhouse minimums become a function of the increasing ambient temperature. The stability of the greenhouse minimum temperature prior to intersection is predictable and a function of thermal storage size within the structure.

Figure 2 illustrates the daily maximum greenhouse regression by month. The April analysis produced a line with a negative slope indicating that the average maximum temperature during April was actually decreasing. Such a negative slope can only be caused by two factors: 1) geometry

and/or 2) front surface reflection losses. And, only if close electronic fan control is exercised over the interior space temperature, would you ever expect to see such a negative slope. Without the differentially controlled fan the regression for April would remain positive because of trapped, stagnant air. The greenhouse would begin to overheat, without ever fulfilling its potential to produce energy for a home still requiring heat in April to maintain comfort. Overheating or decreased air flow out of the greenhouse has the same effect as running an active collector system without adequate coolant -- lost efficiency, decreased cost-effectiveness, higher maintenance. The same logic can be applied to an unaided Trombe wall with inadequate flow. Close control of the coolant flow i.e. differential control of the fans in this case, determines the average maximum greenhouse temperature and ultimate solar collection efficiency of the structure in the same way the average minimum greenhouse temperature is controlled by the radiating area and size of the thermal mass.

Under ideal conditions, when storage is properly sized and the air flow adequate, the temperature differences by month between the maximum ambient and greenhouse temperatures and minimum ambient and greenhouse temperatures should be identical.

Using Figures 1 and 2 as an example, the average temperature difference between the greenhouse minimum temperature and the ambient temperature for February is 45 degrees F. (Figure 2) You would predict that for the same month the average maximum greenhouse temperature would be 45 degrees warmer than the ambient maximum temperature. Comparing the listed differences in Figures 1 and 2 shows this hypothesis appears correct. When the differences alone are compared by month in graphic form, they form a straight line (Figure 3) indicating a potential average temperature difference between the greenhouse and ambient temperatures for January of 60+ degrees and only a 2+ degree difference for June (i.e. essentially turned off). The line (Hybrid-Delta Line) generated in Figure 3 describes the average temperature by month for any passive-hybrid structure built under similar standards and climatic conditions. Its importance lies in the fact that given any average monthly temperature and correcting for local climatic conditions and building variables, any engineer can predict not only the collector efficiency but also the ultimate temperature within the conditioned space. Climate, thermal mass aperture, etc., are all design variables which must be included if Hybrid-Delta Lines (Figure 3) are to be useful. Their ultimate utility, however, rests in their simplicity as a design tool, enabling accurate sizing of hybrid-passive architecture from homes to high schools.

1. Lawand et al, "The Development and Testing of an Environmentally Designed Greenhouse for Colder Regions," U.S. Section ISES Meeting, August 21-23, 1974.
2. Gillett et al, "Solar Greenhouses," Proceedings of the First Annual NESEA Conference, July, 1976.
3. Taff et al, "Hybrid Passive Systems I," Proceedings of the Second Annual NESEA Conference, September 1977.

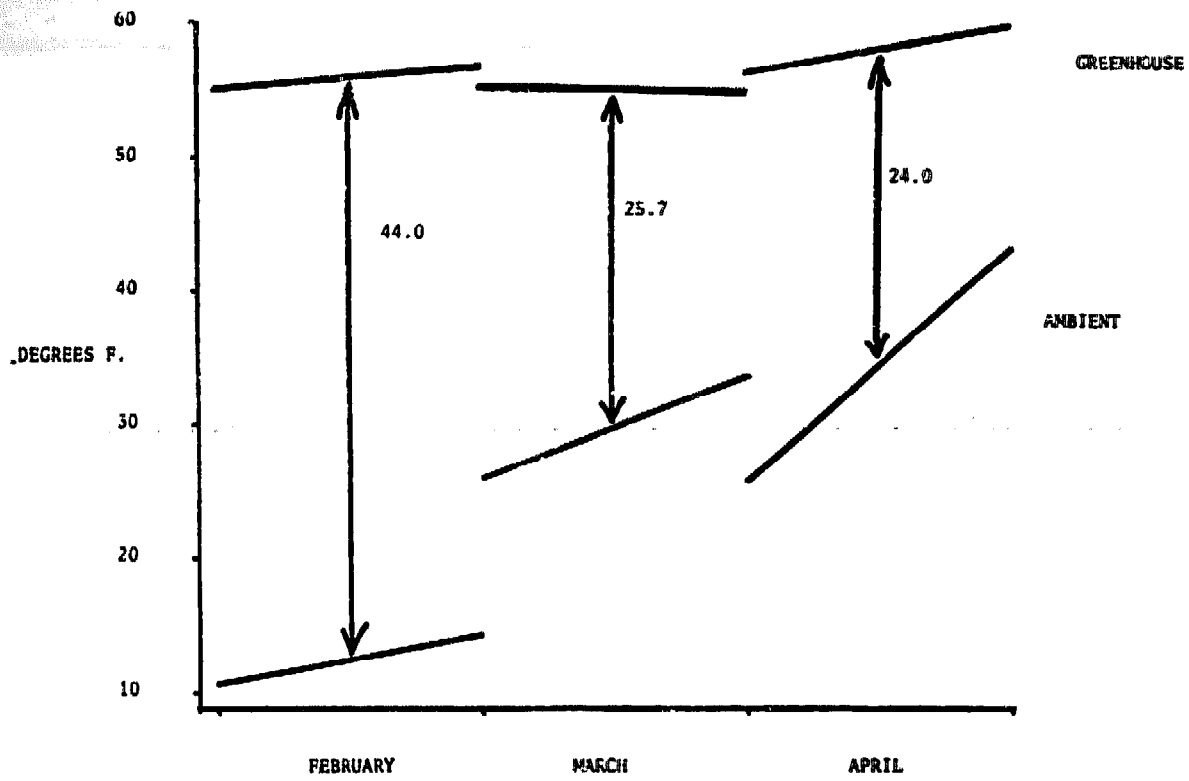

COMPARISON OF AMBIENT AND GREENHOUSE DAILY MINIMUM TEMPERATURES BY MONTH

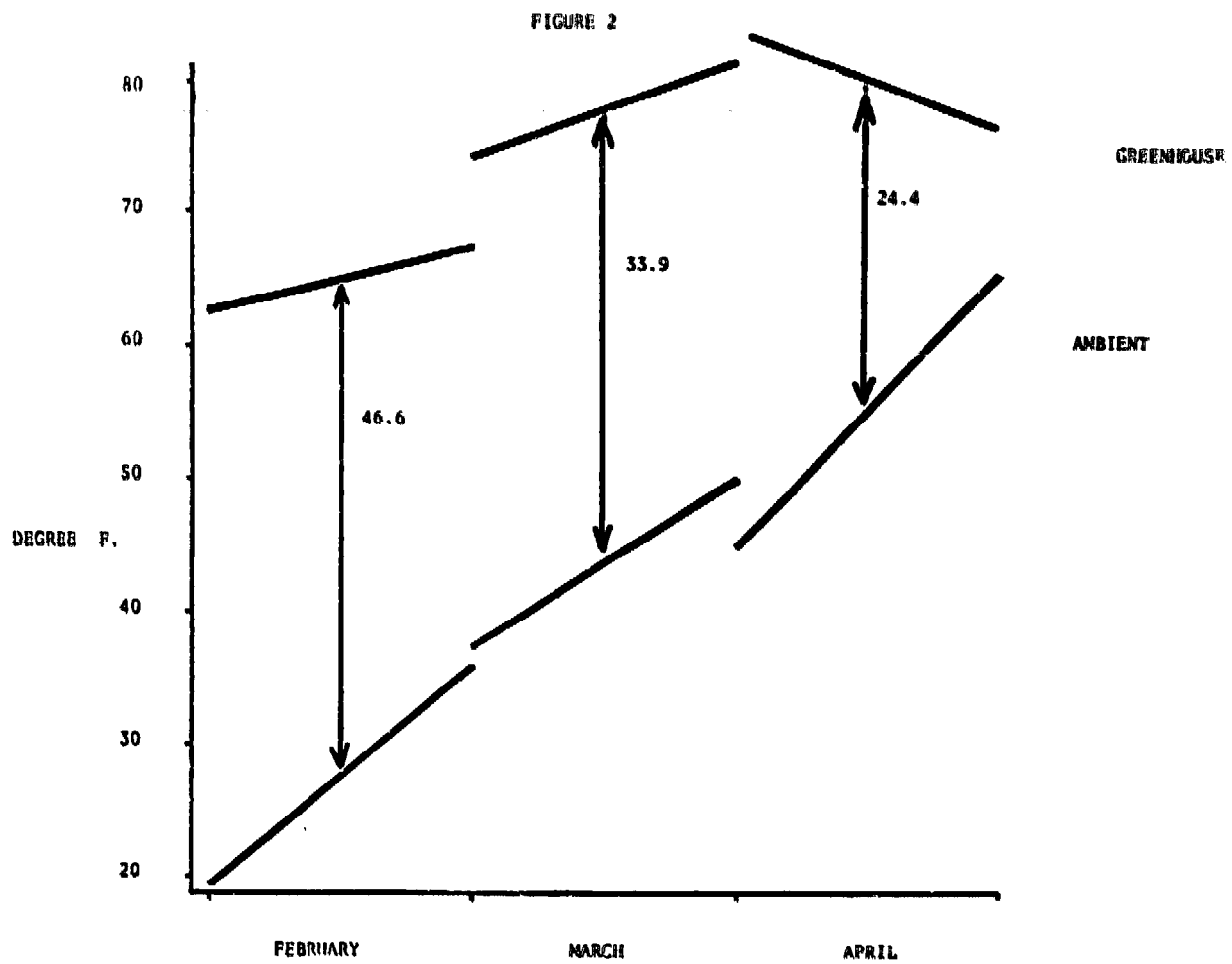

COMPARISON OF AMBIENT AND GREENHOUSE DAILY MAXIMUM TEMPERATURES BY MONTH

FIGURE 3

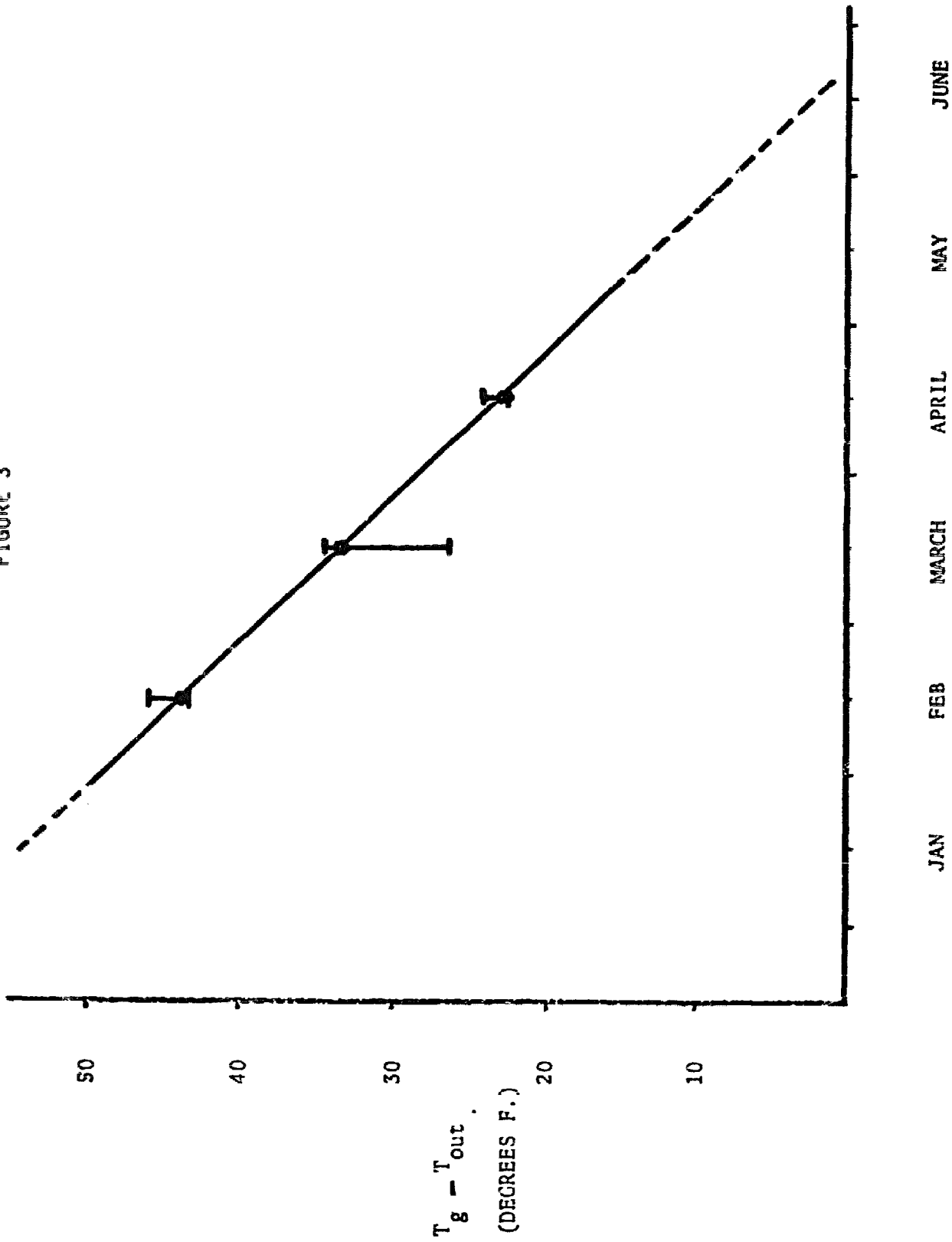

AVERAGE AMBIENT AND GREENHOUSE TEMPERATURE DIFFERENCE BY MONTH

**A COMPARATIVE STUDY BETWEEN THE THERMAL EFFICIENCY
OF WINDOW-WALL AND ACTIVE COLLECTOR SYSTEMS**

**D. C. TAFF
Parallax, Inc.
Hinesburg, V.T.**

**R. B. Holdridge
Parallax, Inc.
Hinesburg, V.T.**

**A. O. Converse
Dartmouth College
Hanover, N.H.**

ABSTRACT

Solar collection via windows is of course a simple and inexpensive means of heating a living space or volume directly. However, the efficiency of this collection process has been largely overlooked in response to the development of seemingly more efficient active collector/solar panel systems. Storage has always been recognized as a necessary component of any active or passive solar heating system although the match of a direct gain, volume collection system, (i.e. window-wall direct to living space) to a low temperature thermal storage system has been largely ignored as inefficient.

Direct gain systems are usually flawed by their tendency to overheat at inappropriate times, although this can be controlled by mass sizing. Conversely, active systems are flawed by high capital as well as life-cycle costs.

It is the purpose of this paper to examine the yearly solar collection efficiencies and capacities of window-wall systems and to compare capacities to active collector systems which have been intensely monitored by a team at Dartmouth College.

Burlington, Vermont is located at 45°N latitude and winters are characteristically cold (8000 degree days) and cloudy (24% sun in December). Active systems are not generally cost-effective in this climate because of the thermal delivery problems of collectors operating under high temperature differences, because of high maintenance costs, and because the high first capital cost for the collectors dictate a high fixed cost for any solar input delivered to space to be heated. Windows operate at a much lower thermal difference during daylight hours although nighttime heat losses must be controlled if they are to act as "effective" collectors. In addition, window-walls are only moderately expensive, inherently long lived, and subject to low maintenance costs. Active systems installed in areas north of 45°N latitude consistently demonstrate design and life-cycle cost problems directly related to cold and cloudy climates. It is

therefore extremely important to create a data base which analyzes the thermal efficiencies of typical window-wall systems and compares them to active collector systems both in terms of their total yearly solar thermal delivery capacity and their life-cycle cost. The attached chart illustrates one such study for Burlington, Vermont. Six window systems are listed, as well as, six active collector systems. Each system is designed with thermal storage. The active systems have been monitored in actual operation and the data presented has been adjusted for Burlington's climate.

The data presented indicates quite clearly (for window-walls) that increased efficiencies, delivery capacities and lower costs can be generated by adding additional layers of glazing, night drapes, and inclining the glazing to optimize for sun geometry. The active system data is presented and lists the type of system, glazing detail, tilt angle, absorber plate design, and coating.

Two important bits of data are found in this chart: 1) For Burlington, Vermont a double glazed window system, with adequate storage and a nighttime drape will be as effective as most active collector systems, but at a lower cost. 2) The same system as above, but inclined to take advantage of the sun's geometry, was shown to perform better or equal to any of the active systems tested---even those containing solar assisted heat pumps. Such inclined, double glazed, and draped walls are commonly found in solar greenhouses. They are twice as cost-effective as solar assisted heat pump systems and almost three times better than conventional active collector systems.

The present cost of electric and oil heat in Burlington, Vermont are \$14.64 per 10^6 BTU (\$3.70 per 10^6 Kcal) and \$5.10 per 10^6 BTU (\$1.29 per 10^6 Kcal) respectively. The active systems are barely competitive with electric heat if maintenance is ignored. (Maintenance is not factored into the chart.) Window-wall systems, especially if night draped and optimized for geometry, are competitive with present day oil prices. If one also accepts the idea that windows last much longer than 20 years and that during their useful life maintenance is minimal, then the life cycle cost of a window-wall used to collect solar energy appears even more inviting.

An explanation will be given in the complete paper of those methods used in this study and the comparative table will be expanded to include target cities along the northern tier of the United States, Europe, and Canada.

A COMPARISON BETWEEN EFFECTIVE COLLECTORS*

COLLECTOR SYSTEM	EFFICIENCY (%)	BTU/FT ² .YR (kcal/m ² .yr)	\$/10 ⁶ BTU.YR
WINDOW-WALL			
SINGLE GLAZED (u = 1.13, t = .88)	0	negative (----)	-----
DOUBLE GLAZED (u = .55, t = .77)	8.7	12,722 (34,502)	22.60
TRIPLE GLAZED (u = .38, t = .68)	17.4	25,189 (68,312)	14.64
DOUBLE GLAZED PLUS NIGHT DRAPE (u = .55/.17, t = .77)	27.3	40,163 (108,922)	9.96
DOUBLE GLAZED AT 60° (u = .55, t = .77)	24.8	50,620 (137,281)	5.68
DOUBLE GLAZED AT 60° PLUS NIGHT DRAPE (u = .55/.17, t = .77)	39.6	80,928 (219,477)	4.94
ACTIVE COLLECTOR			
AIR SYSTEM - DOUBLE GLAZED (vertical, finned, selective)	29.2	42,908 (116,367)	18.06
AIR SYSTEM - DOUBLE GLAZED (vertical, corrugated, paint)	28.4	41,764 (113,264)	17.79
AIR SYSTEM - DOUBLE GLAZED (60°, flat plate, paint)	21.5	43,797 (118,777)	12.50
LIQUID SYSTEM - SINGLE GLAZED (45°, flat plate, paint)	28.8	57,615 (156,252)	13.02
LIQUID SYSTEM - SINGLE GLAZED PLUS HEAT PUMP (45°, flat plate, paint)	44.2	88,510 (240,039)	10.59
LIQUID SYSTEM - DOUBLE GLAZED PLUS HEAT PUMP (45°, flat plate, paint)	37.7	75,507 (204,775)	9.84

*DATA SET FOR BURLINGTON, VERMONT

PRELIMINARY REPORT ON A
FREE STANDING SOLAR GREENHOUSE IN WESTERN MASSACHUSETTS

Ned Nisson,
Center for Ecological Technology

The free-standing solar greenhouse described in this paper was built during the winter of 1976-1977 to test the applicability of a passive solar heated greenhouse for single family vegetable production in western Massachusetts. The greenhouse was designed and built by Center for Ecological Technology, Pittsfield, Massachusetts and donated to the Berkshire Garden Center, Stockbridge, Massachusetts.

SITE CONSIDERATIONS AND CLIMATE

Stockbridge lies in the Berkshire hills in western Massachusetts. The average winter temperature (October 1 - June 1) is 35.4° F. and the average winter has 7600 degree days. In the Berkshires, two factors which make passive solar design very exacting are clouds and mountains. With only 45% possible sunshine, one can only tolerate a limited amount of solar obstruction by mountains or trees at a potential building site before it becomes futile to install the large glazing areas necessary for passive solar design.

The site chosen for this greenhouse is a flat field with a clear view to the East, a few deciduous trees reaching up to about 30° altitude in the South, and a small wooded hill to the West. Since the eastern exposure offered more potential sun, the structure was pointed thirteen degrees east of true South.

DESIGN CONSIDERATIONS (see Figure 1)

In order to prevent over-heating during late spring and early fall, the north roof was designed to shade the water storage from direct sunlight from mid-April to September.

Calculations show that the slope of the front roof can vary up to 25° without significantly affecting solar transmission. We used a slope of 45° because it fell within the optimum range and because it conformed well to available lumber dimensions.

The short knee wall was designed to take advantage of reflected radiation from the flat field to the South.

COST

The cost for materials was about \$2000. Labor was volunteer. We estimate that the commercial cost of this type of structure should run about \$15 to \$20 per square foot.

CONSTRUCTION

Foundation

The original design called for a frost wall with perimeter insulation extending four feet down the outside of the wall. Due to the extremely high water table at the site (18"), the design was changed to a post foundation, using pressure treated posts. The overall dimensions are 16' x 16'.

Framing

The frame was built using full dimension 2" x 8" lumber for the wall studs and roof rafters. Both studs and rafters were placed 24" on center. The original design called for planting directly in the existing ground. Due to the foundation change, the soil beds were raised 6" off the ground onto a plywood floor supported by 2" x 4" floor joists. Insulation was placed under this floor as described below.

Insulation

The floor is insulated with 3" of ureaformaldehyde foam laid over a sheet of 6 mil polyethylene which was laid directly on the ground and stapled up onto the inside walls of the structure to form an air and water tight seal.

The walls are insulated with 8" of ureaformaldehyde foam. A 6 mil polyethylene sheet was applied to the inside wall as a vapor barrier. After the foam dried, we noticed considerable shrinkage around all the edges between the studs. The polyethylene was removed and the cracks were stuffed with fiberglass. A new sheet of polyethylene was then applied to the walls.

The north roof was insulated in the same manner as the walls.

Glazing

A double layer of Kalwall 0.040" Premium "Sunlite" fiberglass was applied to the south slope, south knee wall, and two small side panels on the east and west walls. The 49½" wide sheets were applied lengthwise along the rafters and were sealed with rope caulk between each layer. The two layers of glazing were held apart using 1½" wood spacers. The glazing assembly, consisting of two layers of fiberglass, 1½" spacer, and top batten, was bolted down to the rafters using lag bolts. The holes in the fiberglass were oversized to allow for thermal expansion and contraction.

This attempt to prevent buckling by allowing for thermal expansion was contradictory to the need for tightening down the assembly to minimize air infiltration. Despite this apparent problem, buckling was very minimal during the hot summer months.

Floor and soil beds

Floor construction consisted of the following: (1) a layer of 6 mil polyethylene laid on existing gravel; (2) 3" of ureaformaldehyde foam insulation; (3) 2" x 4" floor joists, supported by the sill at the ends and by cement blocks in the center; (4) ½" plywood floor, sloping toward the central path for water drainage; (5) polyethylene lining in the soil boxes; (6) 3" of crushed stone in the soil boxes; (7) 12" of top soil. The floor section along the north wall is heavily reinforced to support the water tanks.

Doors and vents

There is one door, one sliding vent, and one "pop-out" vent. The door is 6" thick with a beveled closing edge and is filled with ureaformaldehyde foam. The adjustable sliding vent on the east wall is used for winter ventilation on sunny days. It has a maximum opening of 3.6 square feet and is manually operated. The "pop-out" vent in the west wall is used only for summer ventilation. There are no peak vents.

The interior surfaces are finished with rough cut pine on the east and west walls and aluminum builder's foil on the north roof and north wall. The builder's foil was used to reflect sunlight down onto the barrels and onto the soil beds. It was not intended to act as thermal insulation since the surface would probably not retain sufficient reflectivity to reflect long wave infrared radiation.

The outside of the building is sheathed with ½" plywood and sided with rough cut board and batten. All structural seams were originally caulked with latex caulk. After three weeks, we noticed considerable degradation of the caulk, so it was removed from most seams and replaced with silicone caulk.

THERMAL STORAGE

The main thermal storage consists of eleven black 55 gallon drums filled with water and stacked two high along the north wall. This supplies a storage capacity of 5046 BTU/°F. The other storage component is the soil beds. Using a specific heat value of 0.33 Btu/lb-°F and a density of 100 lbs/ft³, the total heat storage capacity of the soil beds is 5049 Btu/°F. This estimate requires some qualifications: (1) The heat capacity and conductivity of soil will vary considerably with moisture content. For example, the specific heat of an average loam soil with a moisture content of 20% is 0.33 Btu/lb-°F, compared with 0.20 Btu/lb-°F for dry soil; (2) The depth to which thermal exchange

takes place over a diurnal cycle is variable. For example, due to the increased conductivity, moist soil will undergo thermal exchange to a greater depth than dry soil. Last winter we measured soil temperatures at 3" and 6" depths and found significant diurnal temperature fluctuations at the 6" depth. This winter we will monitor at 9" and 12" also. The value given above for total thermal storage of the soil (5049 Btu/°F) assumes 20% moisture content with heat exchange to a depth of 12". For practical purposes, we are assuming a total storage capacity of half that amount or 2525 Btu/°F.

MONITORING

The monitoring system was put in place gradually during February and March and consisted of the following:

1. A YSI Model 67 pyranometer placed inside the greenhouse on top of the barrels at the center of the north wall. The probe was mounted to measure insolation on a vertical surface.
2. A Taylor recording thermometer measuring indoor air temperature at plant canopy level.
3. A YSI telethermometer with thermistor probe measuring water temperature in the barrels.
4. Soil thermometers measuring soil temperatures at 3" and 6" depths in the front and rear sections of the growing beds.
5. A series of thermometers measuring inside air temperatures at heights of 6", 2', 4', and 6' above the soil level.
6. A U.S. Weather Service maximum-minimum thermometer measuring outdoor air temperatures.
7. A Taylor humidity instrument.
8. A 24-hour clock wired in parallel to the electric backup heater to monitor elapsed heater operation time.

THERMAL PERFORMANCE FROM FEBRUARY 20 TO MARCH 18, 1977

Indoor temperatures (Figure. 2)

During the period from February 20 to March 18, indoor air temperatures ranged from the low 40's at night to the 60's and 70's during the day. Maximum indoor air temperature was limited to 80° by manually operating the sliding vent during peak temperature periods. The electric heater was set to turn on at 40° but was not needed during this time period.

Thermal storage temperatures

The maximum amount of heat picked up by the water storage was 75,700 Btu on March 3. The maximum overnight loss from storage was 45,400 Btu on March 18. During that night, the system maintained an indoor-outdoor temperature differential of 39° (45° indoors, 6° outdoors). The theoretical heat loss under those conditions is 4914 Btu/hr. This data suggests that the actual heat loss from the structure may be greater than the calculated theoretical loss.

The equilibrium air temperature at any moment is a combined function of the heat loss through the building skin, heat gain from storage, and heat gain from solar radiation. At night, heat given off from the water storage is greater than from the soil beds due to (1) higher water temperature; (2) higher conductivity of the water and barrels, and; (3) greater surface area of the barrels. The water storage is, then, a faster reacting system while the soil is a slower reacting system with greater tempering ability. If the heat exchange rate of either storage were increased, the ability of the system to maintain higher minimum temperature in the greenhouse during the early morning hours may be improved. This, of course, would result in greater depletion of the storage at night and would pose a problem during periods of cold nights and cloudless days. However, this same storage system would also pick up heat faster during the day and could store some of the excess heat which was otherwise vented out. Further experiments and modelling are needed to optimize the design heat exchange rate between storage and heated space.

One experiment planned for this winter is to block off the solar radiation entering the south wall, artificially maintain a constant indoor temperature, and calculate the heat loss based on the energy required to maintain the constant indoor temperature. Integrated with that experiment will be a study of the heat transfer dynamics between the thermal storage and heated space.

AIR TEMPERATURE STRATIFICATION

One design consideration for solar greenhouses is whether to try to capture the heat contained in the warm air which collects in the peak. Does the energy obtained justify the cost of a system to bring that warm air down to storage or elsewhere?

Most of our temperature measurements were taken before and after the sunlit part of the day. At those times, we saw little or no temperature stratification from 6" to 6'. The maximum temperature differential measured during mid-day was 9°F . Although further data is needed, we feel that for this type of structure, a mechanical air transport system is not cost-justifiable.

THERMAL CURTAIN

This greenhouse was built without any provision for insulating the south wall at night. Since 86% of the calculated heat loss is through that surface (R-2.17), it is obvious that adding an insulating shutter or curtain would significantly lower the overall heat loss and raise the minimum indoor night time temperature. For practical application, any moveable insulating device must be inexpensive, highly durable, and easy to operate. We are now installing a sliding thermal curtain in a similar solar greenhouse and will report the results from that experiment in a later paper.

CONCLUSIONS

1. Although final evaluation must await the results of a full year's testing, present data indicates that this basic design can be successfully applied to domestic vegetable production in the Berkshires with a minimum amount of auxiliary fuel.
2. The heat exchange rates of the thermal storage systems could affect certain aspects of the structure's thermal dynamics, particularly minimum night time temperature. Further work is needed in this area.
3. Soil moisture content can significantly affect the depth and rate of heat transfer into and out of the soil. The time of watering is an operational parameter which could be used to affect the thermal dynamics of the structure: watering in the morning will increase heat transfer into the soil; watering at night will increase transfer out of the soil.
4. The addition of a tight fitting thermal curtain or shutter will reduce the overall heat loss up to 40%.

TABLE 1

CET SOLAR GREENHOUSE PARAMETERS

Width: 16'

Length: 16'

Enclosed floor area: 210 ft²

Enclosed volume: 1910 ft³

Walls:	East and west sides (opaque):	246 ft ²	R-42.4
	(glazed):	18 ft ²	R- 2.17
	North side :	128 ft ²	R-42.4
	South knee wall (glazed):	32 ft ²	R- 2.17

Roof:	North slope :	144 ft ²	R-42.4
	South slope (glazed):	192 ft ²	R- 2.17

Glazing: Double layer of Kalwall 0.040 Premium "Sunlite" separated with a 1½" air space.

Vents: 1 sliding vent on east wall for winter ventilation; maximum opening - 3.6 ft².
1 "pop-out" vent on west wall for summer ventilation; area = 9.8 ft².

Thermal mass:
- Eleven 55 gallon drums filled with water and painted black.
- 153 ft³ of soil.

Total heat storage capacity:
Water - 5046 Btu/°F
Soil - 5049 Btu/°F*

*Assuming specific heat of 0.33 Btu/lb-°F and effective thermal exchange to a depth of 12"

Heat loss:
Conduction - opaque walls: 9.2 Btu/hr-°F
- glazed surfaces: 111.5 Btu/hr-°F
Infiltration : 8.6 Btu/hr-°F **

Total theoretical heat loss : 129.3 Btu/hr-°F

**Assuming a rate of 0.25 air changes per hour

thermal storage in shade
from April 21 to August 21

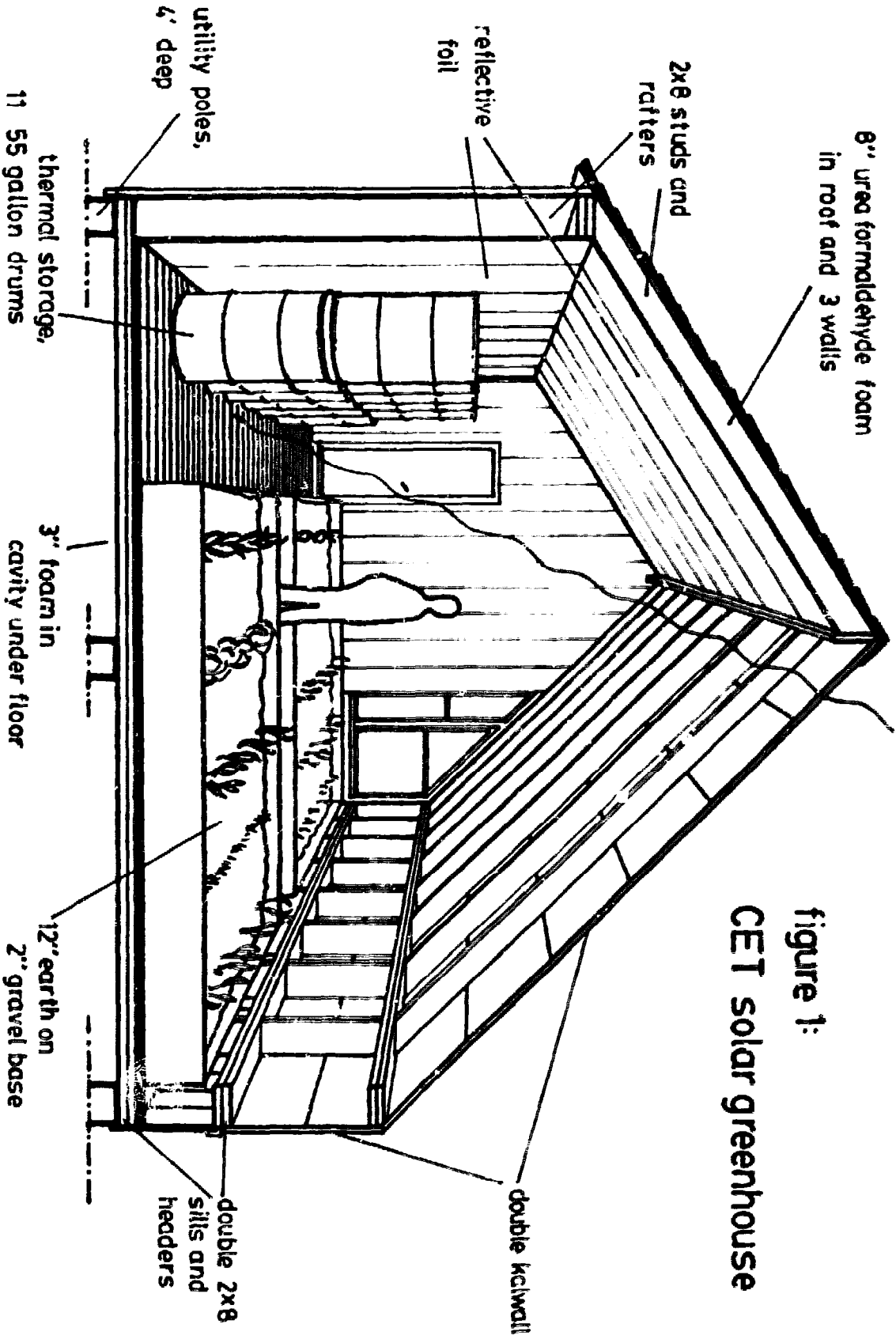
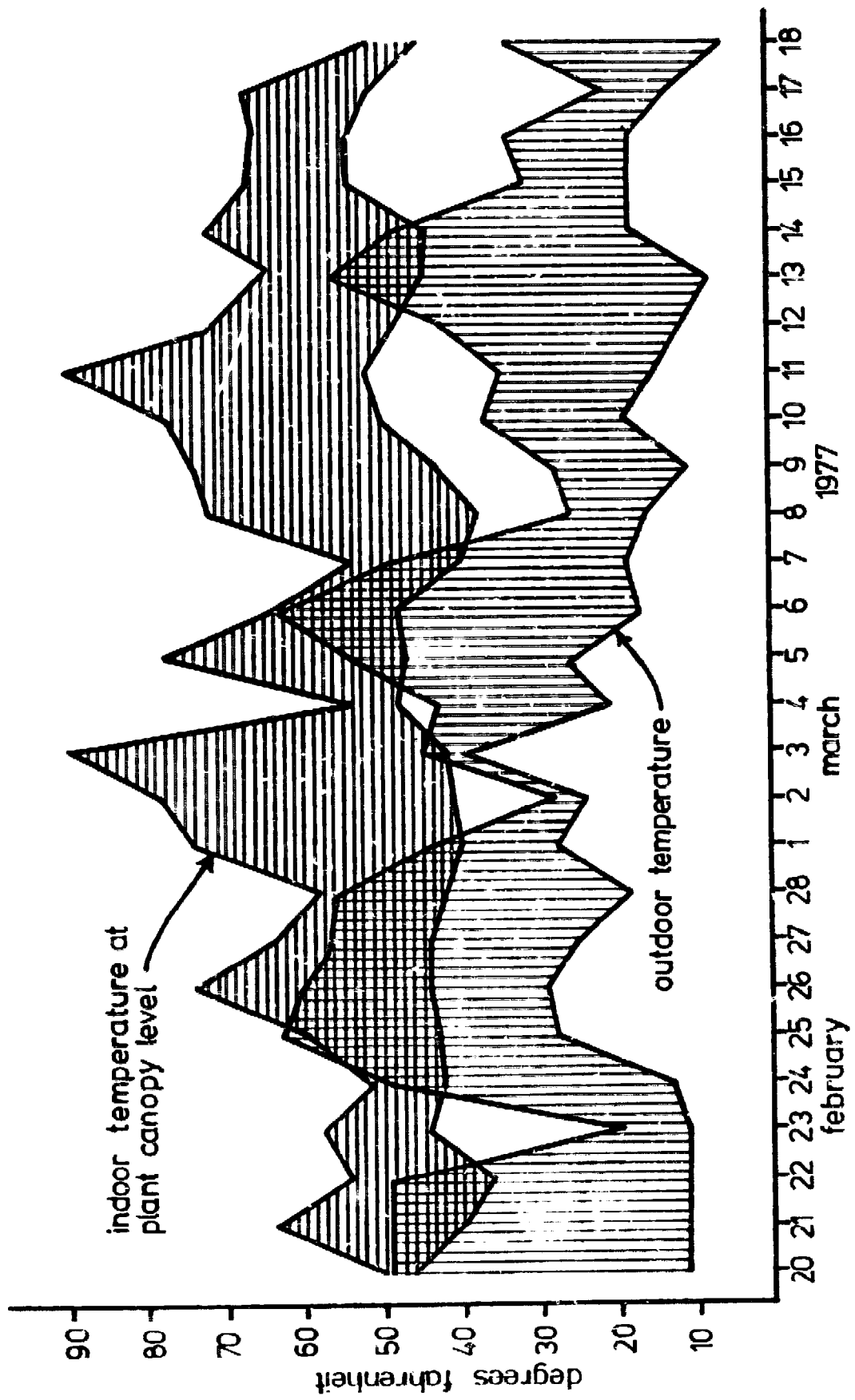

figure 1:
CET solar greenhouse

figure 2: indoor and outdoor temperature extremes
 CET solar greenhouse



EVALUATION OF PASSIVE AND HYBRID
TEMPERATURE CONTROL METHODS FOR
GREENHOUSES

William C. Johnson +
Andrew E. Scoville *
Arthur V. Sedrick +

ABSTRACT

The effects of using thermal mass storage and insulation as low cost methods for regulating greenhouse temperatures are investigated. Results of extensive tests of three experimental greenhouses operated in Manchester, New Hampshire, during the winter of 1976-1977 are presented. A simplified simulation technique, suitable for use with a programmable calculator, has been developed to analyze key greenhouse design factors and to predict performance. From test and simulation results, it is concluded that thermal mass, a fan for aiding heat transfer to the air, and insulation in a greenhouse are effective and low cost means of regulating greenhouse temperatures.

INTRODUCTION

Passively solar heated greenhouses have existed since the first greenhouse was built. The concept of incorporating Kalwall's Solar Storage Tubes as massive thermal storage has been developed and tested over the past three years. Mr. Drew Gillett initiated Kalwall's passive greenhouse testing program in 1973. Results of this work were presented in 1976 in the paper entitled Solar Powered Greenhouses (Ref.1). This current paper is a progress report of data and performance of the greenhouses which are still operational, based on the 1976 paper.

Thermal mass storage tempers the interior air temperatures of the greenhouse by providing a heat sink for added thermal storage of solar energy or by creating a cold sink thereby assisting in summer time cooling. Thermal mass storage provides a more stable temperature environment and reduces or eliminates the need for auxiliary heating.

Greenhouse performance data are presented for some of the critical months of the winter of 1976-1977.

+Kalwall Corporation, Solar Components Division, Manchester, NH, 03105

*Dynamics Research Corporation, Wilmington, MA, 01887

The average air temperature in greenhouse #1 (Figures 2 and 3) was between 4° - 5°F above the average ambient temperature during the sunny days of this period. During the cloudy days the average air temperature followed ambient very closely. The high and low temperatures for this period were 83° and 35°. The maximum temperature swing in one day was 48°. There was the tendency at night for the interior air temperature to drop below ambient due to radiational cooling.

The average air temperature in greenhouse #2 was between 10° - 20°F above the average ambient temperature during the sunny days of this period. During cloudy days the average air temperature was 1° - 2° above ambient. The high and low temperatures for this period were 85° and 11°. The maximum temperature swing for one day was 34°. The effect of the black absorbing surface producing heat for both water and air heating is evident here. The nighttime cooling effect is evident and can be attributed to the lack of insulation, double glazing and air circulation.

Greenhouse #3, as was to be expected, displayed the highest average air temperature of 20° - 30° above ambient during the sunny days. During the cloudy days the average air temperature stayed between 8° - 10° above ambient. The maximum temperature swing for one day was 33°. The air temperature was closer to the water temperature at all points in greenhouse #3 than in #2. Water temperatures were an average of 10° warmer in #3 than in #2 over the 12 day period. The air temperatures in #3 were an average of 12° warmer than in #2 for the period. The closely related air and water temperatures for greenhouse #3 can be attributed to: the circulating fan which greatly enhances the transfer of heat between the air and tubes; the north, east and west wall insulation and the double glazing.

NOVEMBER 1976

The first of November saw snow on the ground which has the effect of reflecting more solar energy into the greenhouses, increasing the air and water temperatures over what would be expected without snow. The results for a sunny three day period show the real importance of dual glazing, insulation and powered circulation.

The average temperatures of greenhouses #1 and #2 (Figures 4 and 5) varied very little from each other during this time even though the water temperature in #2 was considerably higher than the air temperature. From the data it can be seen that #1 actually got colder than ambient at night due to radiational losses and about 10° - 30° warmer than ambient during the major portion of the day. Greenhouse #2 remained 5° - 12° above ambient during the night and 10° - 20° warmer during the day. It is evident here that the thermal mass of #2 lowered the peak air temperature by providing a heat sink for the elevated air temperatures and released this stored heat during the night.

The average air temperature for greenhouse #3 remained between 51° and 62° for the three day period or 25° to 38° above ambient. Even with the north, east and west wall insulation, dual glazing and powered circulation the interior air temperature dropped to the 30's during the night. It would seem that this time of year is border line for complete passive greenhouses in this climate.

MARCH 1977

The insolation values of March are slightly higher than those of October but in southern New Hampshire there are approximately twice the heating degree days in March as there are in October. From Figures 6 and 7 of the daily performance for March 20 and the performance for the period of March 17-21, it can be seen that all the greenhouses performed better in October than in March.

The average air temperature of greenhouse #1 was 5° - 10° above ambient during a typical day. The temperature swings during the day were much smaller for March than for any other month (7° - 10°) analyzed.

The effect of thermal mass and the black absorbing surface gave greenhouse #2 an average air temperature 7° - 14° above ambient air. The low ambient air temperature and lack of insulation still dictates the performance to a great degree overcoming the effect of the thermal mass storage.

Again the north wall insulation and dual glazing increased the performance of greenhouse #3 to a point where its average air temperature is a consistent 10° warmer during the night than #2. Average air temperatures follow the average tube water temperatures within 2° - 3°F showing the effect of the fan in transferring thermal energy.

APRIL 1977

A very sunny 6 day period was examined in this month. The ambient temperature seldomly dropped below 50°F during this period. Greenhouse #1 was not attached to the monitoring equipment.

The average air temperature inside greenhouses #2 and #3 during a sunny day very quickly exceeds 100°F. The ambient air temperature is not so low that the storage of large quantities of thermal energy is important. The thermal mass storage now could be used as a cold sink to lower the air temperatures during the day by ventilation at night to lower the water temperatures. This is the point when the insulation and dual glazing becomes a deterrent to healthy plant growth. The same effect is true with even the uninsulated single glazed unit #2. (Figures 8 and 9).

PERFORMANCE SIMULATION

The advantages of modeling the three greenhouse configurations, simulating their operation by repetitive use of the model equations, and finally comparing the results of the simulations with actual test results are:

- 1) Good correlation insures that all significant factors are known.
- 2) Changes made to the model, while carrying out the reconciliation of the model results with the actual results, represent a learning process about the factors influencing the operation.
- 3) It provides empirical determination of values in the model that would be difficult to determine analytically.
- 4) Once confidence is gained in the model, then it allows extension to larger greenhouses with fewer errors in design.
- 5) It facilitates initial checks of suggested design changes.

Useful modeling of physical systems and subsequent simulation of the dynamics and long term operation of a system requires that the system be basically understood qualitatively and to some degree quantitatively. It is also necessary that an adequate computation capability is employed to execute the equations. Then one of two basic approaches to modeling any system must be selected:

- 1) Initially include all factors and influences by complete and rigorous modeling and derivation of equations, later simplify to make the simulation practical as various smaller effects can be proven negligible.
- 2) Start with a simplified model, try it out and later add additional factors as they are proven significant.

The first approach is ideal, but the second is often more practical and was used by the authors.

The basic model for simulating the greenhouse is shown in Figure 10 by an electrical analog and the equations. A microcomputer (or programable calculator) such as a Texas Instrument SR-52 or a Hewlett Packard HP-67 is barely adequate and requires several manual operations. A Texas Instrument SR-59 in conjunction with a printer is perhaps the best match of the computational requirement and capability; of course, anything more powerful can be employed.

The process of determining realistic values for the constants of a model can be done by various means or a combination:

- 1) Measurement.
- 2) Calculations from the measurements and the physical laws involved.
- 3) Running the program with estimates, comparing the results with actuals, refining the estimates, repeating and converging ("trial and error").
- 4) Sophisticated methods, such as Kalman filters and optimization criteria.

The approach employed was a combination of (1), (2), and (3). Generally the constants that were known most precisely were inserted and then the simulation was run to pinpoint others (empirically). Additional logic had to be employed to facilitate this process. Examples:

- * To determine the effective thermal inertia (or heat capacity) of greenhouse interior surfaces it was advantageous to use configuration #1, which does not include water tubes with their large thermal inertia.
- * To determine the effect of solar insolation impinging on the opaque ends, it was advantageous to use data from mornings (8am and 9am) and afternoons (3pm and 4pm).

The one factor which was originally left out of the basic model but which proved to be significant and had to be added was the solar effects on the east and west "ends" of the greenhouses. The east and west components of insolation had to be incorporated despite the ends being opaque.

This need was observed in the first trial runs by noting a divergence between the simulation model and actual data for the morning and late afternoon. The greenhouses ran hotter than the models for these periods. The first cut or "basic model" was adequate for simulation of mid-day and nighttime operation, but had to be improved with east and west insolation and side parameters to achieve full 24 hour accuracy.

Figure 11, presents the results of both the actual greenhouse measurements and the simulation for greenhouse #3 for ease of evaluating the success of the model.

DISCUSSION OF RESULTS

Thermal mass storage, double glazing insulation, and venting, all contribute to an environment in which plants will flourish. The relative merits of these in conjunction with greenhouses #1, #2 and #3, are discussed below.

Greenhouse #1 displays characteristics such as severe overheating and severe cold that would prevent it from being a useful year round growing environment. The lack of venting causes overheating which at times reaches the 140°F level and the absence of thermal storage and insulation cause a tendency to follow the ambient air temperatures during the periods of no sun.

Greenhouse #2 with its 1200 lbs of thermal mass storage reduces overheating to some extent and carries the solar energy gain into the night. The lack of air movement past the warm tubes severely hampers any heat transfer that might help keep the average interior air temperature sufficiently above ambient to create a healthy growing climate. The October data shows that thermal mass storage temperature remained higher above the average air temperature in greenhouse #2 than in #3 which bears out the theory of lower heat transfer coefficients. In November the lack of a double glazed cover and north side insulation explains the average air temperature's tendency to become very close to ambient during severely cold weather. During warm weather there was again the problem of severe overheating which could be solved by either shading and or ventilation.

During all the periods examined greenhouse #3 out-performed #2 by a substantial margin due to it's double cover, insulation and forced air movement. Greenhouse #3 has a better heat transfer coefficient than #2 has due to the circulating fan which pushed the warm air from the top of the greenhouse over the tubes creating a smaller difference between average air and average water temperatures.

In November the data was taken during an unusually cold spell when the night time temperatures dropped to the 10°F level. At this point the environment inside the greenhouse exhibited temperatures that hardy plants could withstand without auxiliary heat, assuming sunny conditions.

This greenhouse displayed the most even temperature gradient throughout all the testing periods. After reviewing the data it becomes evident that this type of greenhouse could operate (with summer venting) for 9 months out of the year with little or no auxiliary heat.

FUTURE RESEARCH

The results up to this point have shown consistently that there is a critical need for summer time venting and for higher heat transfer coefficients between water and air.

There is simple equipment available which could be used to passively control vents in the ends of the greenhouse. These actuate between 68° - 73° and could be used in both the lower and upper portion of the greenhouse to create a thermosyphoning effect for cooling during April - September. This cooling mode if carried out during the night would create a cold sink by cooling the storage water thereby cooling daytime air temperatures.

A sheet of Sun-Lite fiberglass sheeting attached to the front of the tubes (straight across the front from end wall to end wall) with continuous openings along the top and bottom would help create a natural convection current past the tubes thus increasing heat transfer rates. The insulation should be upgraded to 2" of styrofoam to cut down heat loss as much as possible.

Unfortunately the months of December, January and February were omitted from the readings, the three most critical months for determination of the total annual heat required from auxiliary to provide a continuous growing season.

CONCLUSIONS

- 1) Incorporation of thermal mass and insulation is of utmost importance in the design of any greenhouse structure along with the coupling of this mass to the air.
- 2) Products are currently available that make the building of new greenhouses or retrofitting old greenhouse structures with both massive storage and venting procedures, technically and economically feasible.
- 3) A well designed solar greenhouse incorporating the correct blend of currently available passive solar technologies will provide food, heat, and satisfaction for years to come.

SUMMARY

Results from extensive monitoring of three experimental greenhouses and the mathematical simulation of greenhouse performance confirm the theories and conclusions presented in Kalwall's original paper on solar powered greenhouses. The results clearly show the value of incorporating the following elements in greenhouse design:

- 1) Thermal mass storage devices such as Kalwall's Solar Storage Tubes.
- 2) Insulating glazings such as Kalwall's Sunlite.
- 3) A means of circulating air around the thermal mass storage devices to increase heat transfer.

The inclusion of these low cost elements will provide a more constant temperature and controllable growing conditions. Additional modifications to be considered are the use of vents and night cooling to lower summer air temperatures, and methods of increasing heat transfer rates both into and out of the thermal mass storage.

REFERENCES

1. D.A. Gillett, "Solar Powered Greenhouses", a paper presented at the New England Solar Energy Association First Annual Conference, "Decision Making in Solar Technology," University of Massachusetts, Amhurst, Massachusetts, June 24-27, 1976.

FIGURE 1
TEST GREENHOUSE #3
(Mailbox Design)

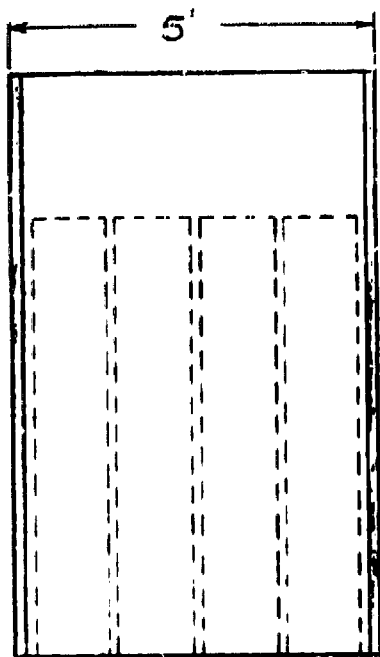

FRONT ELEV.

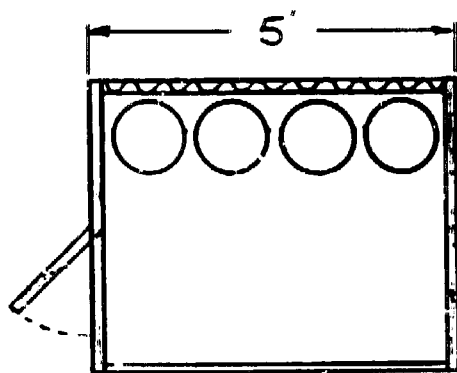

PLAN

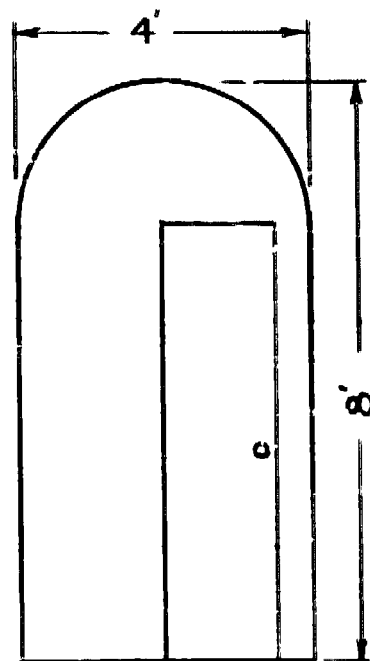

SIDE ELEV.

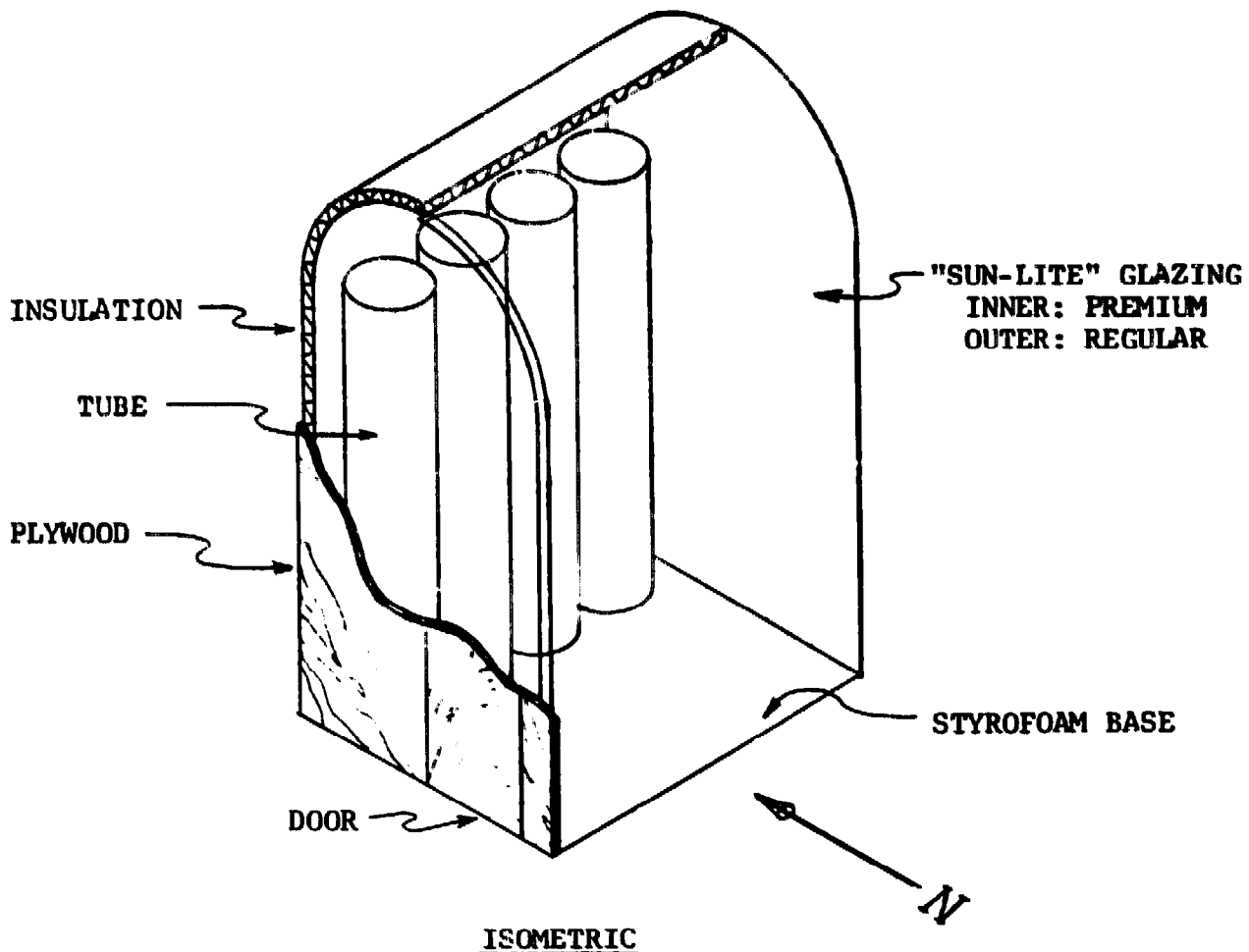

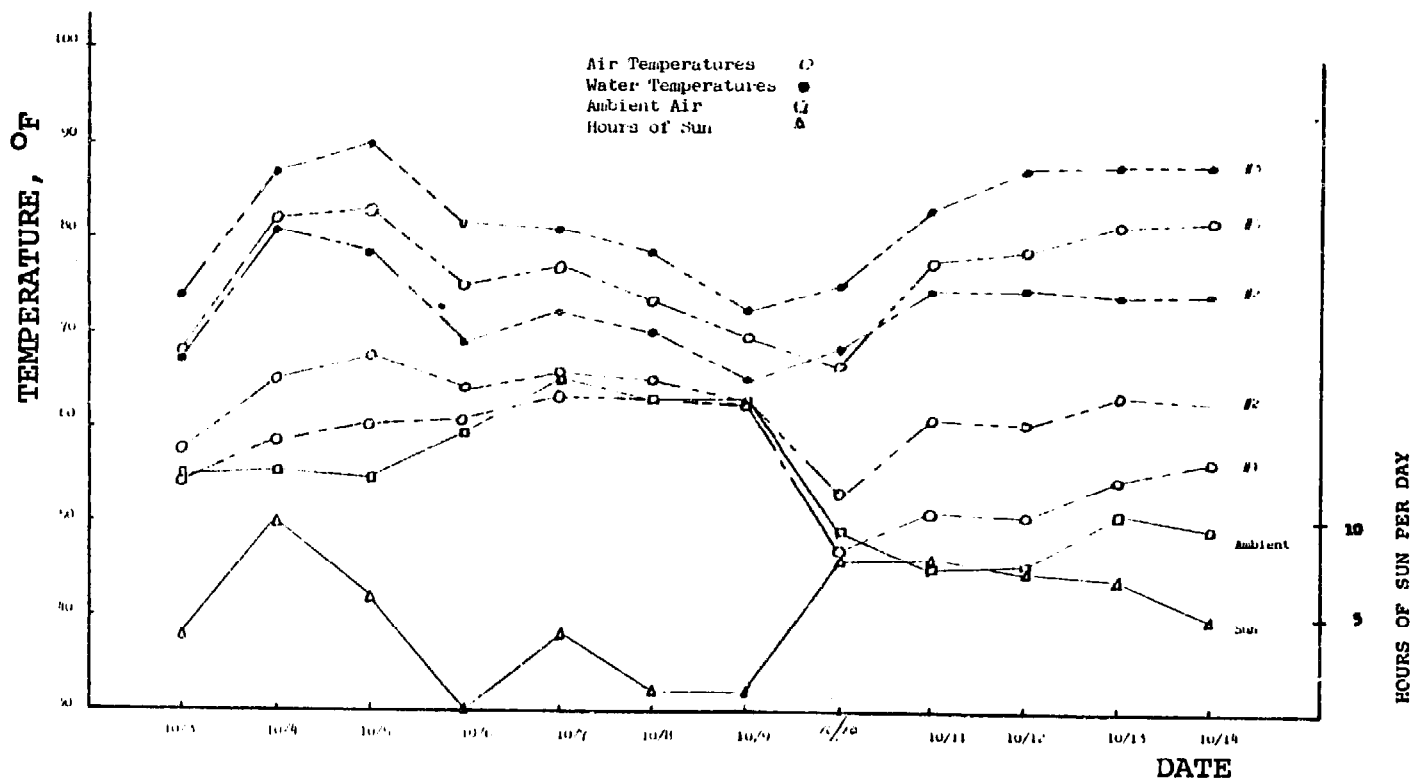

FIGURE 2 TEST RESULTS, OCTOBER 1976

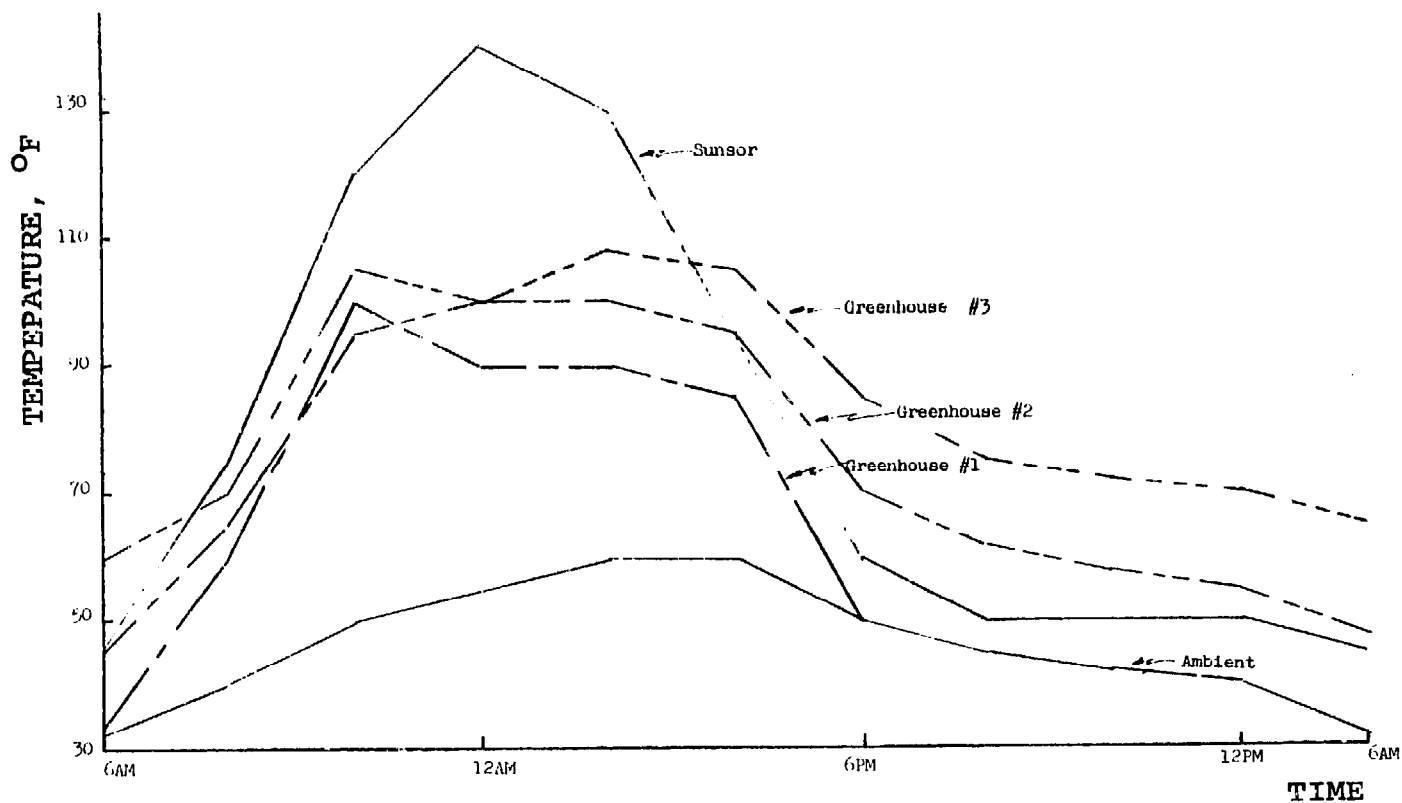

FIGURE 3 TEST RESULTS, OCTOBER 11, 1976

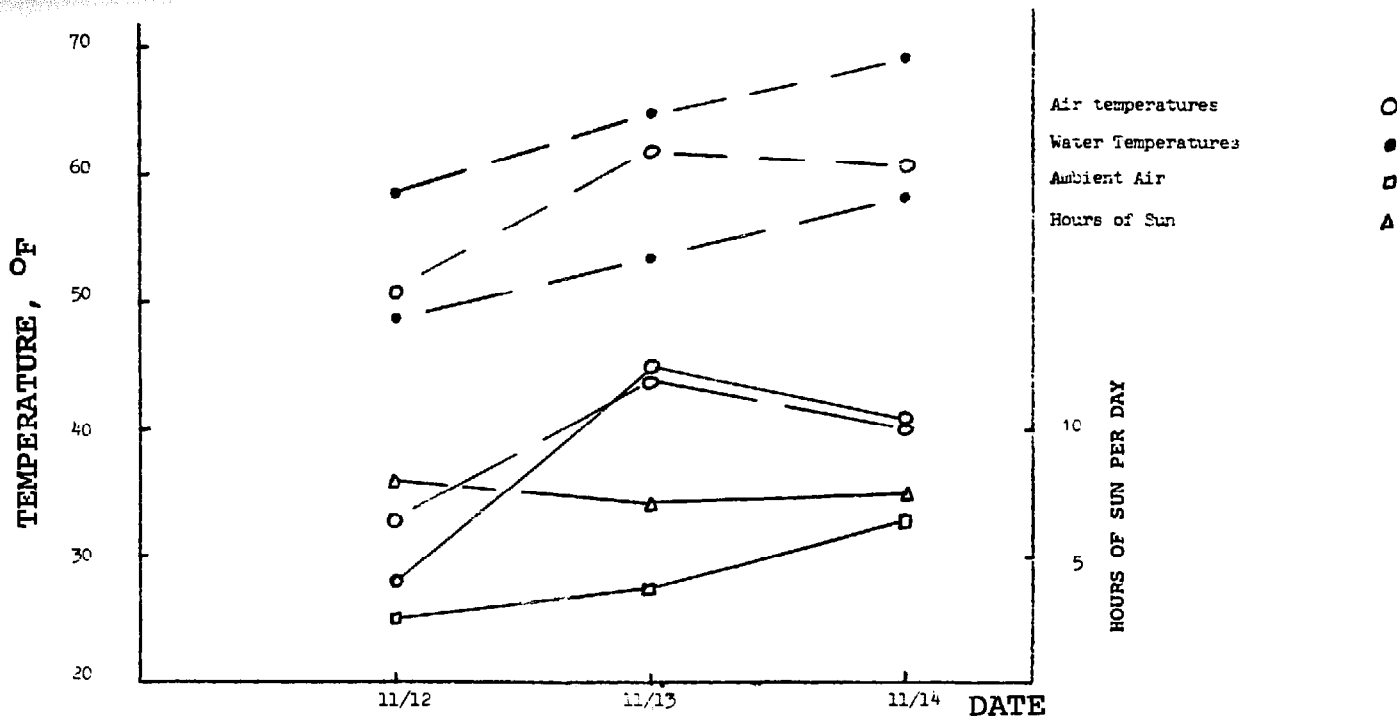

FIGURE 4 TEST RESULTS, NOVEMBER 1976

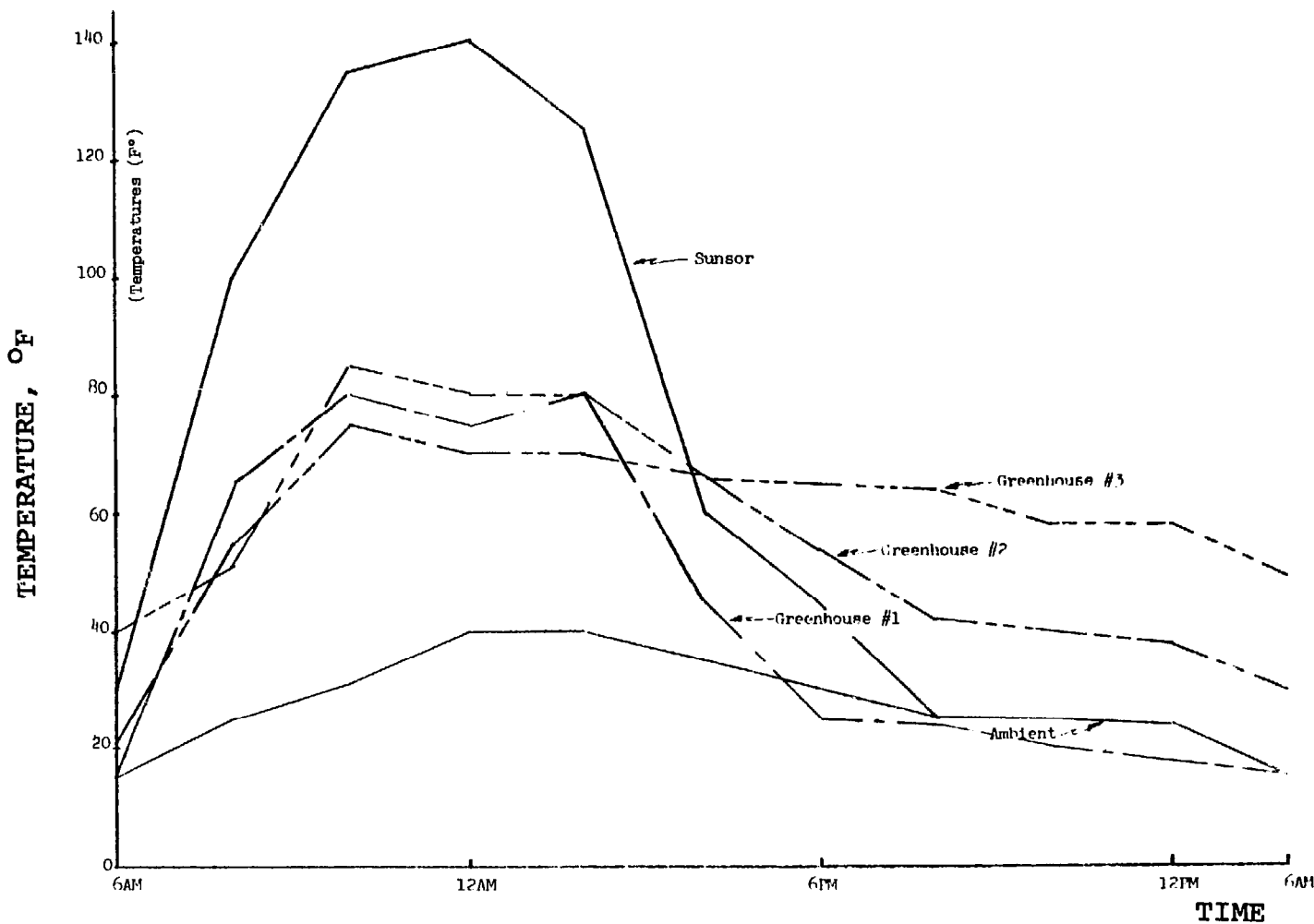

FIGURE 5 TEST RESULTS, NOVEMBER 12, 1976

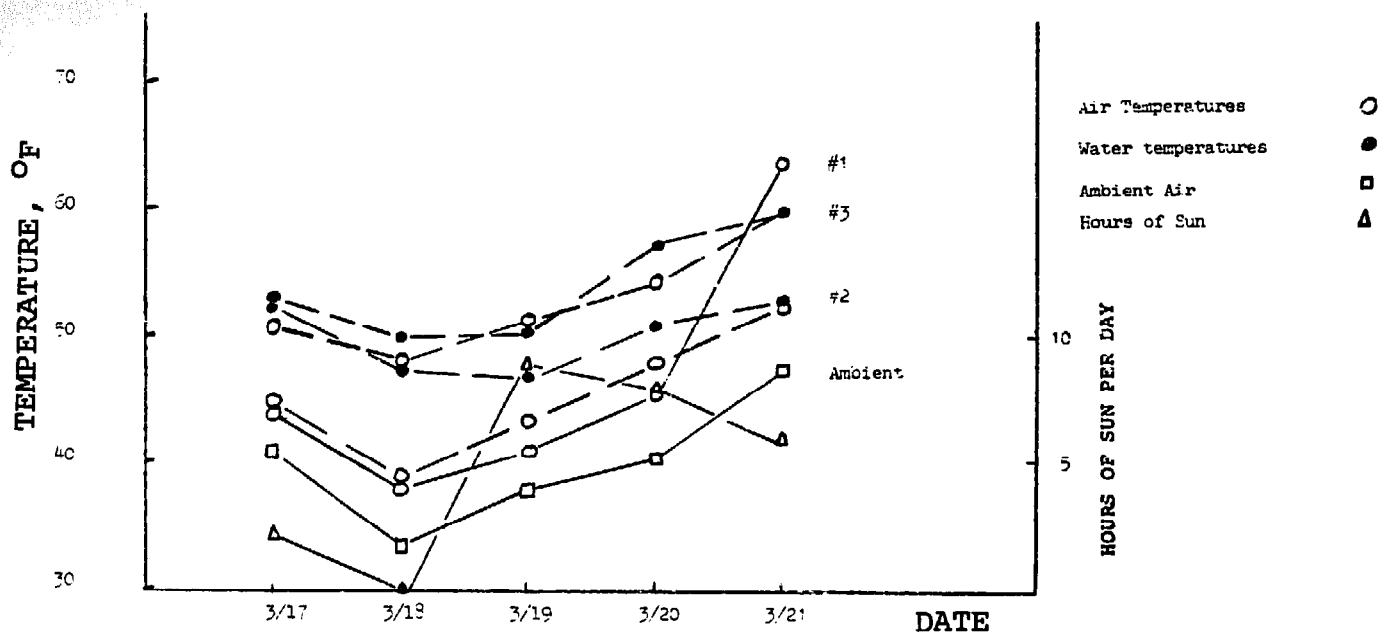

FIGURE 6 TEST RESULTS, MARCH 1977

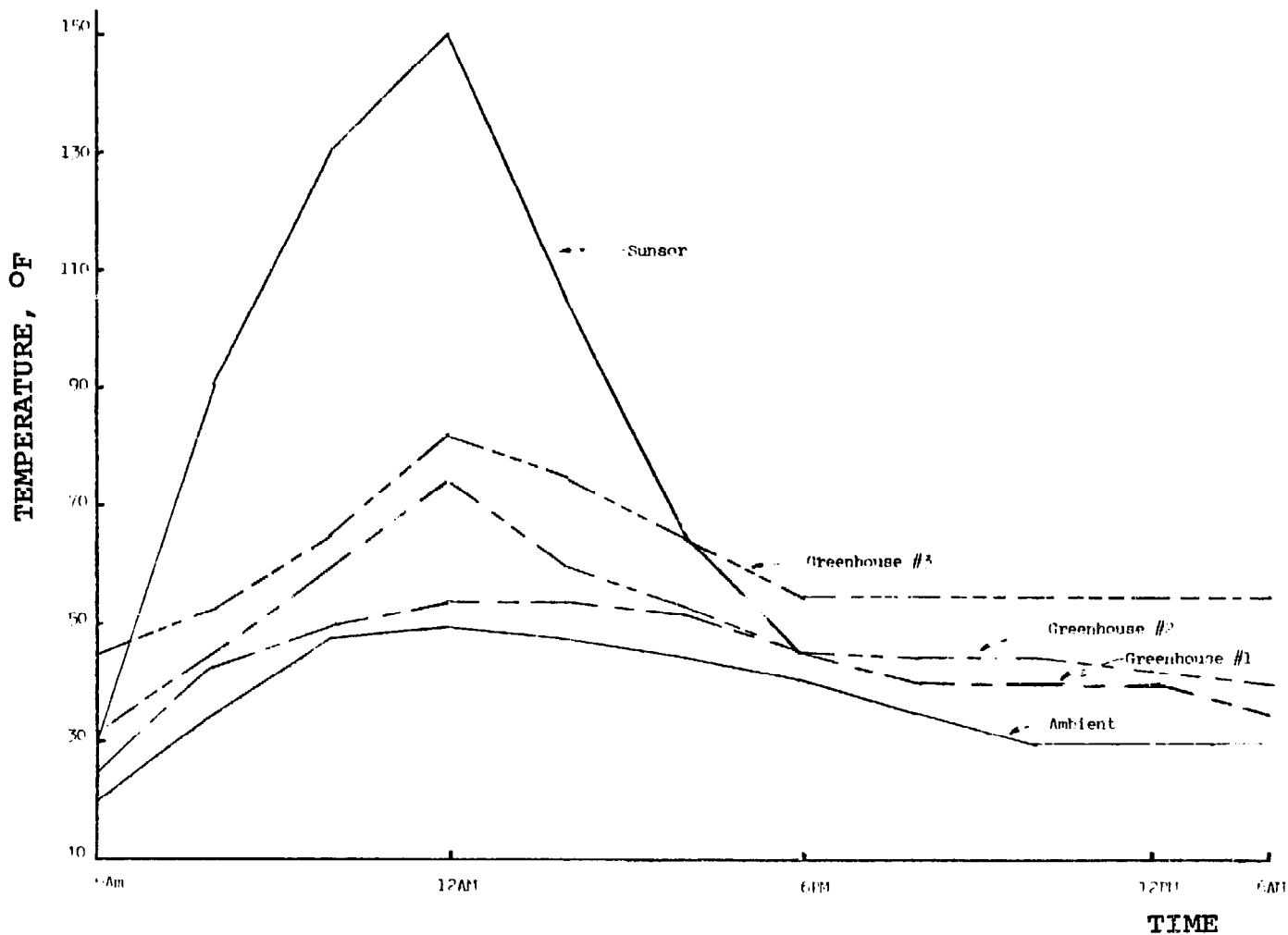

FIGURE 7 TEST RESULTS, MARCH 20, 1977

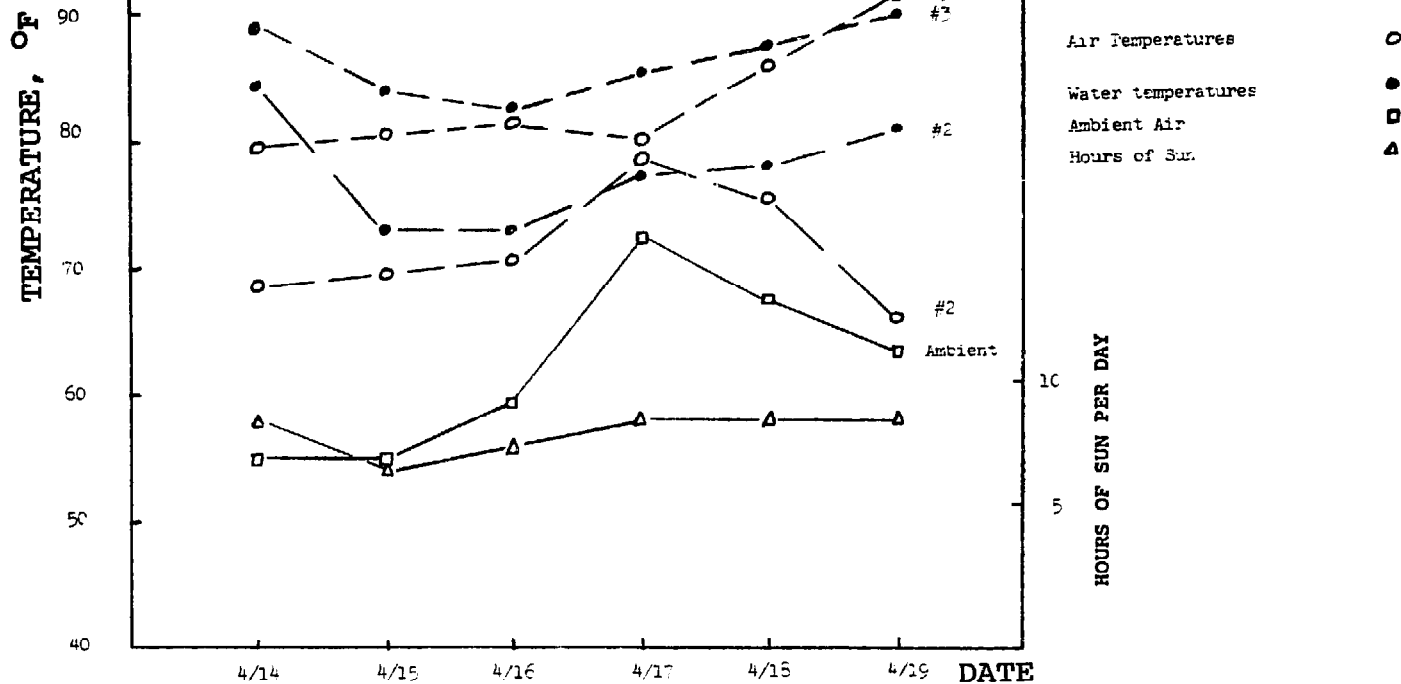

FIGURE 8 TEST RESULTS, APRIL 1977

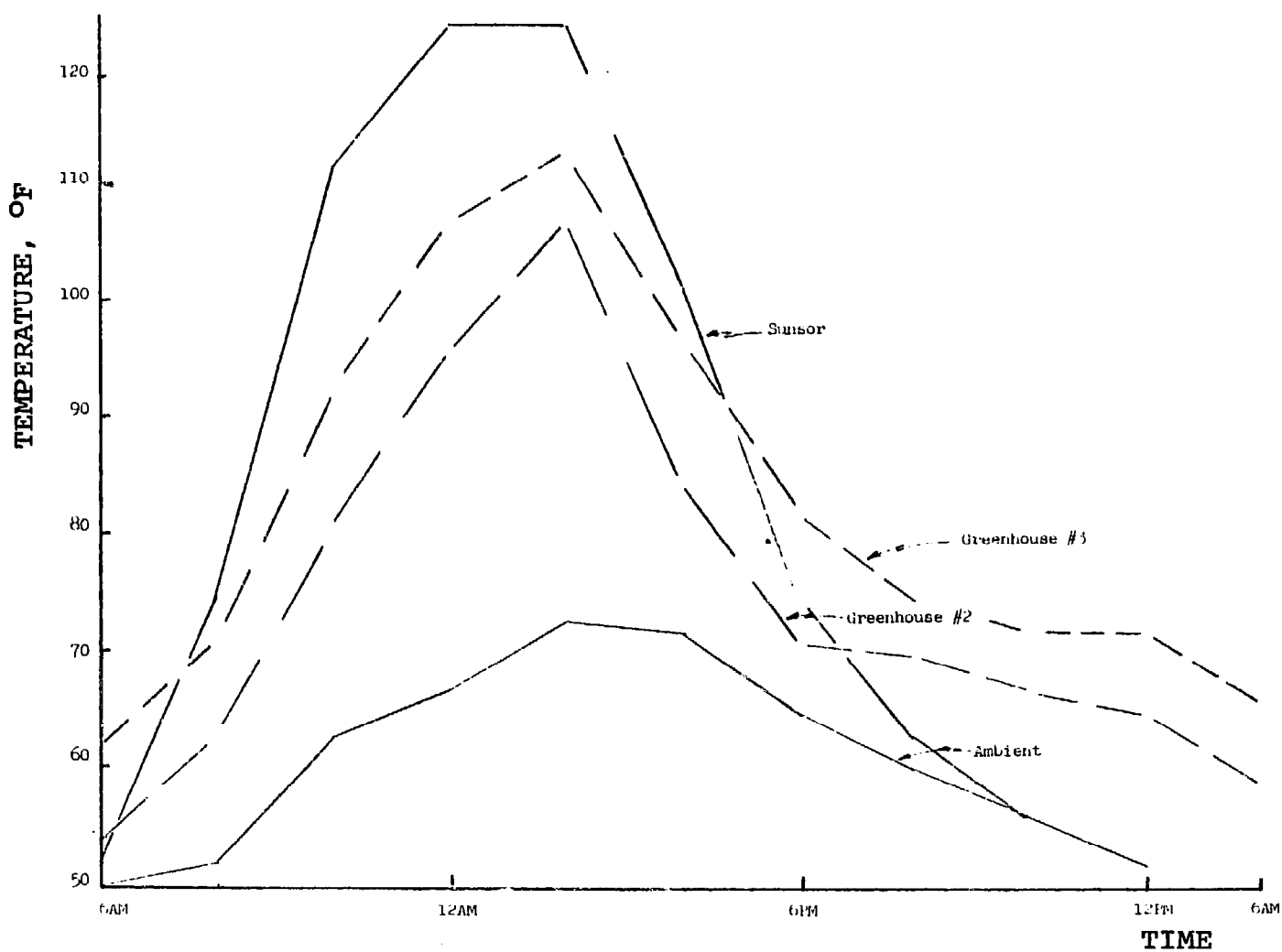
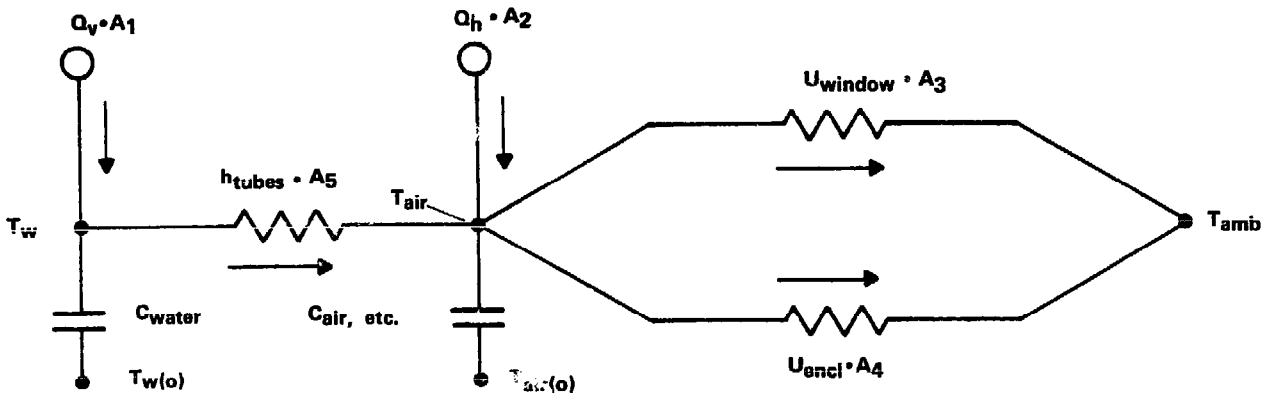

FIGURE 9 TEST RESULTS, APRIL 16, 1977

FIGURE 10 BASIC SIMULATION MODEL FOR TEST GREENHOUSES

ELECTRICAL ANALOG



EQUATIONS

- #1 $\Delta Q_{water} = Q_v A_1 - (T_w - T_{air}) h_{tubes} A_5$
- #2 $\Delta T_w(\text{new}) = T_w + Q_{water} / (C_{water} N)$
- #3 $\Delta Q_{air} = Q_h A_2 + (T_w - T_{air}) h_{tubes} A_5 - (T_{air} - T_{amb}) (U_{window} A_3 + U_{enc1} A_4)$
- #4 $\Delta T_{air}(\text{new}) = T_{air} + Q_{air} / (C_{air, etc} N)$

DEFINITIONS

- Q_v = hourly insolation, vertical component
- Q_h = hourly insolation, horizontal component
- ΔQ_{water} = heat energy added (or subtracted) to water tubes
- ΔQ_{air} = heat energy added (or subtracted) to greenhouse interior, air
- A_1 = vertical, front facing area of tubes
- A_2 = horizontal floor area, illuminated portion
- A_3 = window area
- A_4 = enclosure area minus windows
- A_5 = effective heat transfer area of water tubes to interior air
- T_w = temperature, water
- T_{air} = temperature, interior air and surfaces
- T_{amb} = temperature, outside ambient
- $T_w(o)$ = initial water temperature
- $T_{air}(o)$ = initial greenhouse interior air temperature
- C_{water} = heat capacity of water in tubes
- $C_{air, etc}$ = effective heat capacity of interior air and surface skins
- h_{tubes} = heat transfer coefficient from tubes to interior air
- U_{window} = heat transfer coefficient, glass portions of enclosure
- U_{enc1} = effective or weighted U-factor for other portions of enclosure
- N = number of iterations per hour

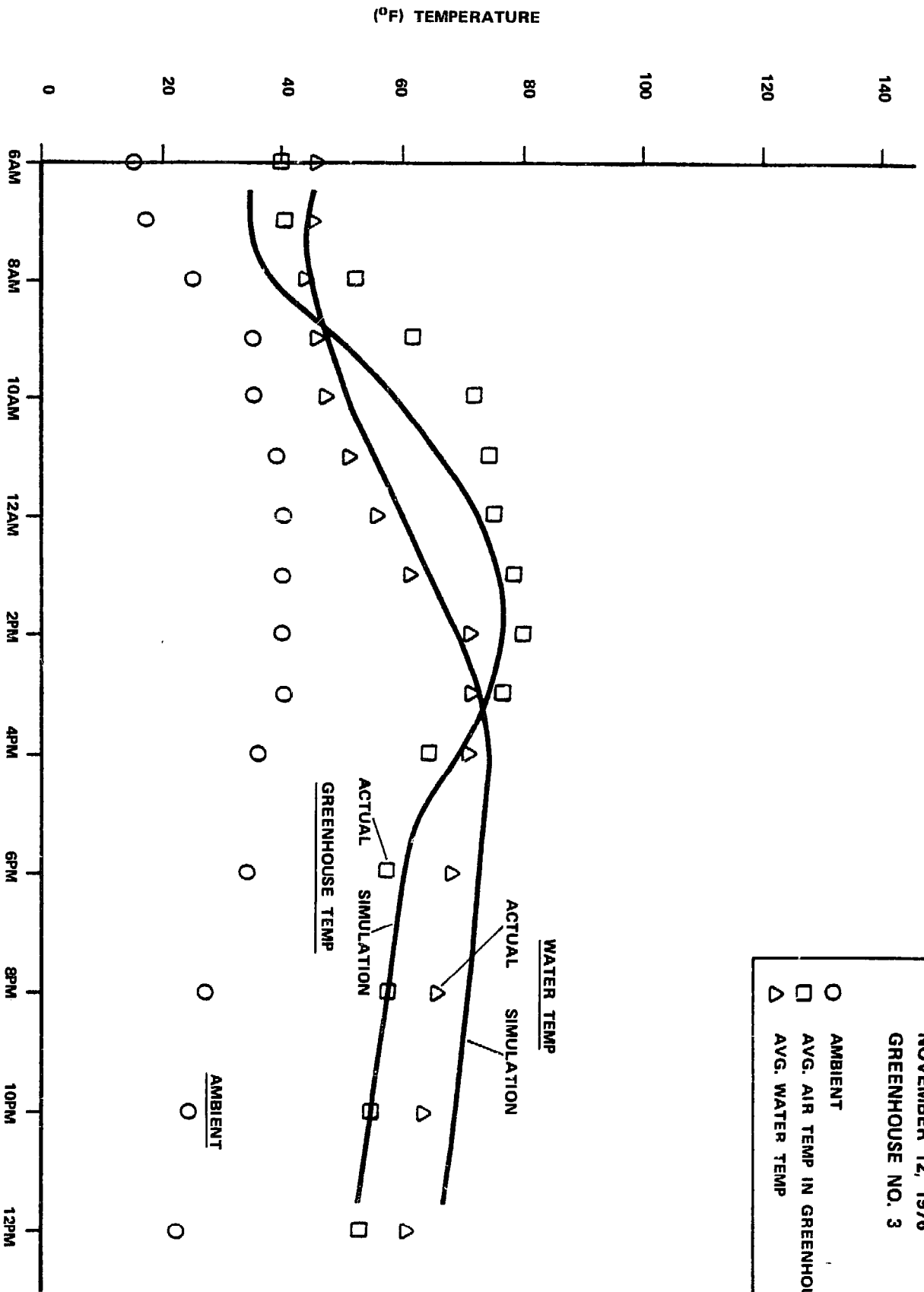

NOVEMBER 12, 1976
 GREENHOUSE NO. 3

- AMBIENT
- AVG. AIR TEMP IN GREENHOUSE
- △ AVG. WATER TEMP

FIGURE 11 COMPARISON OF INITIAL SIMULATION RESULTS WITH TEST RESULTS



SECTION 4

- Saturday Afternoon
- Chairperson: Erika Morgan

LIGHT LEVELS IN SOLAR GREENHOUSES:

Some Recommendations

By

David J. MacKinnon*

Introduction

My interest in the light levels in solar greenhouses increased this summer (1977) when I noticed that the plants in Rodale's Flagstaff greenhouse grew slower (with some phototropism) than similar outside plants. The Flagstaff greenhouse was designed with only the south facing surface transparent not only to maximize winter light collection and heat storage, but to reduce summer overheating by limiting light levels. But this approach to reduce overheating may not be best. Just how much does this design limit summer light and how does it affect plant growth? Furthermore, if the opaque walls severely limit light during the summer, then what are their effects during the rest of the year?

In this paper I provide tentative answers to these questions. Using data developed by Sellers (1965) and contained in the Ashrae Handbook of Fundamentals (1972), I calculated the daily total of direct radiation (Btu per square foot) that would pass through single glazed surfaces (double strength glass) on the south and north facing roofs, and the east and west side walls for various times of the year. The direct radiation passing through these walls was further broken down into amounts striking selected points on the greenhouse floor (horizontal). The shading effects of wall supports (2 x 4 studs, for example) are not included.

I have not included quantitative analyses of diffuse and reflected light levels in this paper. This, however, will not affect the major conclusions. Nevertheless, I discuss qualitatively some problems and solutions concerning diffuse and reflected light in solar greenhouses.

* Dave is working as a research scientist for Rodale Press, Inc. in the H. S. Colton Research Center at the Museum of Northern Arizona in Flagstaff.

Procedure

Sellers (1965) gives complete geometric equations describing the sun's path across the sky. These equations can in turn be modified to describe the sun's path across an arbitrarily oriented flat surface with respect to an arbitrary point in space. These modified equations can then be simplified to describe the "rising" and "setting" of the sun with respect to any point on the greenhouse floor for each of the surfaces composing the greenhouse structure. The direct radiation striking a point on the greenhouse floor, then, is the sum of the light contributions from each surface during the period of illumination between "sunrise" and "sunset".

The light contributions from each surface depend on the angle at which the sun strikes the surface and the transmission properties of the glazing. Moreover, the amount of sunlight striking the surface depends on the solar constant, the transmission properties of the atmosphere, time of day, time of year, and latitude.*

Rodale's Flagstaff greenhouse is 20 feet in the east-west direction and 12 feet in the north-south direction. At the midpoint along the north-south direction, the greenhouse peak rises to approximately 9 feet. The transparent south facing glazed surface (roof) slopes away at 56 degrees to a vertical 1 foot high kneewall at the greenhouse front. An opaque, insulated north facing surface (roof) slopes away at 44.5 degrees to a 4 foot high vertical kneewall at the back. The kneewalls and (vertical) side-walls are opaque and insulated.

Results

Using the previously defined equations, methods and greenhouse dimensions, I calculate the direct radiation passing through the various surfaces (some opaque surfaces are assumed transparent) and illuminating specified points on the floor at selected times of the year. The results are presented in Tables 1 through 6 as the amount of light energy per unit area or light flux striking the floor. The exact positions from the southwest corner are denoted by the numbers along the X and Y axes of the tables. The flux at these points is given as a percentage of the outside values.

* The transmission properties of the glazing and the (clear sky) atmosphere, and the solar constant were obtained from the Ashrae Handbook of Fundamentals (1972).

	0	2	4	6	8	10
12	43.3	55.5	67.0	74.2	79.1	80.2
10	43.3	58.7	70.4	78.1	82.3	83.7
8	43.3	61.9	74.4	81.1	84.1	85.9
6	43.3	66.2	79.3	84.7	86.5	86.6
4	42.9	72.8	83.9	85.9	85.9	85.9
2	34.3	68.6	68.6	68.6	68.6	68.6
0	0.0	0.0	0.0	0.0	0.0	0.0

Table 1-- Calculated percent of the outside total daily direct beam solar radiation (BTU per square foot) passing through the south sloping surface (56 degrees) at selected points on the Flagstaff greenhouse floor on December 21. The calculated outside total daily direct beam radiation on a horizontal surface is 875 BTU per square foot at latitude 35 degrees. The numbers along the perimeter of the Table locate the floor position in feet from the Southwest corner at (0,0).

	0	2	4	6	8	10
12	39.5	49.0	55.1	59.9	63.0	63.9
10	40.5	51.3	59.0	64.9	67.6	68.6
8	41.3	54.3	63.3	69.7	72.7	73.9
6	41.7	58.0	68.8	74.7	77.5	78.6
4	41.9	63.6	75.7	79.5	81.6	82.1
2	42.0	72.9	81.3	83.2	83.7	83.8
0	0.0	0.0	0.0	0.0	0.0	0.0

Table 2-- Same as Table 1 except for March 21 and the outside total daily horizontal surface radiation of 1789 BTU per square foot.

	0	2	4	6	8	10
12	0.0	0.0	0.0	0.0	0.0	0.0
10	0.0	0.0	0.0	0.0	0.0	0.0
8	5.7	11.5	11.5	11.5	11.5	11.5
6	31.9	44.1	52.6	58.3	61.9	64.3
4	36.0	52.3	61.7	66.4	68.3	69.0
2	36.7	60.5	68.7	71.3	72.1	72.4
0	4.5	7.8	8.6	8.7	8.8	8.8

Table 3-- Same as Table 1 except for June 21 and the outside total daily horizontal surface radiation of 2178 BTU per square foot.

	0	2	4	6	8	10
12	32.0	49.8	63.1	63.9	63.9	63.9
10	39.1	51.1	62.1	70.3	76.5	78.2
8	34.9	39.0	46.8	54.6	65.3	69.7
6	8.6	8.6	8.2	5.7	3.2	0.0
4	3.7	3.7	3.7	0.0	0.0	0.0
2	1.0	0.0	0.0	0.0	0.0	0.0
0	0.0	0.0	0.0	0.0	0.0	0.0

Table 4-- Same as Table 1 except for June 21 and a north sloping surface(44.5 degrees).

	0	2	4	6	8	10
12	36.3	34.4	30.2	26.4	24.3	22.8
10	35.1	32.2	26.4	21.4	19.5	17.9
8	34.2	29.5	22.2	16.4	13.6	12.7
6	33.5	26.3	18.2	11.1	8.6	7.2
4	33.1	21.5	10.5	5.9	3.8	3.2
2	33.0	12.5	3.8	1.6	0.9	0.7
0	0.0	0.0	0.0	0.0	0.0	0.0

Table 5-- Same as Table 1 except for March 21 and a vertical West side wall.

	0	2	4	6	8	10
12	34.2	14.1	0.7	0.0	0.0	0.0
10	34.2	28.9	20.8	10.5	2.6	0.0
8	34.2	30.9	24.5	17.4	12.2	10.8
6	34.2	29.3	22.1	19.6	19.0	20.7
4	34.4	29.2	21.2	17.1	15.1	14.5
2	36.6	23.2	13.6	10.2	8.8	8.7
0	35.8	6.7	4.7	4.1	3.9	3.9

Table 6-- Same as Table 5 except for June 21.

Tables 1 through 3 give the flux distribution for the south sloping surface only for winter (Dec. 21), spring (Mar. 21), and summer (June 21), respectively. Table 4 gives the flux for the north sloping surface during summer only (time of maximum illumination). Tables 5 and 6 include the sum of both sidewall contributions only for spring (Mar. 21) and summer (June 21), respectively. Individual contributions from each surface can be added to arrive at the total contribution. In all the data, the kneewalls are assumed to remain opaque.

Analysis of Results

I anticipated two results. First, the effect of the glazing (single layer, double strength sheet glass) in causing shading losses by reflection and absorption beyond a normal 10 percent or so is not very significant. Second, most of the greenhouse shading is caused by the structural members (opaque walls, support pieces). More importantly, Tables 2 and 3 show the transparent south face severely limits light during the spring (fall) and summer months along the back and side perimeter of the greenhouse. In this connection, spring light levels can be significantly improved by creating transparent sidewalls. At this time, a transparent north slope does not add to the interior light levels. However, summer light levels (June 21) are significantly improved by adding a transparent north roof.

Discussion of Results

The results immediately suggest that if maximum year around vegetable production is desired, the solar greenhouse should have certain flexible design components. The first is opaque insulated walls that can be made transparent. The second is transparent walls that can be modified to allow more ventilation as light levels increase.

The first can be achieved by building a greenhouse with almost all transparent surfaces, and then installing removable insulation as the seasons change. The second can be achieved by removing large sections of the transparent insulation for free air flow, and adding screen if insects are a problem.

Additional Considerations

The results in these tables do not include the effects of reflected and diffuse light. The reflected light from interior surfaces becomes important in winter months when such light contributes significantly to the total light at plant level. The diffuse

light from external sources increases the total light slightly, more or less uniformly, over the greenhouse floor. If the glazing is diffusing as well, then the uniform illumination totals increase. By its very nature, this glazing prevents some external light from passing into the greenhouse initially. However, the glazing would improve the poor distribution of light during the summer from south and east-west facing surfaces.

In cold, cloudy regions, where most of the winter light is diffuse, there is no clearly defined design for the solar greenhouse: opaque walls reduce the light levels, clear walls increase the heat losses. In general, when the outside light levels are diffuse and low, the plant growth may not be much better in a greenhouse with mostly clear walls than with mostly opaque walls.

Another slightly paradoxical situation occurs with interior reflecting surfaces. Diffuse surfaces (painted flat white for example) give uniform illumination to plants. Specular surfaces (aluminum foil, for example) can create non-uniform illumination and hot spots. Yet, a large fraction of the intercepted light can be reflected back out of the greenhouse from diffusing surfaces. But specular surfaces generally reflect light to interior absorbing surfaces such as plants, ground, or heat storage systems. Thus the advantage of the specular surface is that little light leaves the greenhouse.

Obviously, something with the desirable properties of both types of reflecting surface is needed. Figure 1 shows a configuration of reflecting surfaces called a specular diffuser. Such a device, if placed properly along interior greenhouse walls, would provide maximum uniform plant illumination with little loss of reflected greenhouse light.

One final note: house attached greenhouses have the significant advantage over freestanding units in that excess heat can easily be piped into the house. On the other hand, a freestanding unit with removable opaque walls may collect more light in the summer months than a house attached unit, thus providing greater vegetable production.

Acknowledgements

I appreciate the confidence and push (which I need) from John Haberern, Chuck McCullagh, and Jack Ruttle.

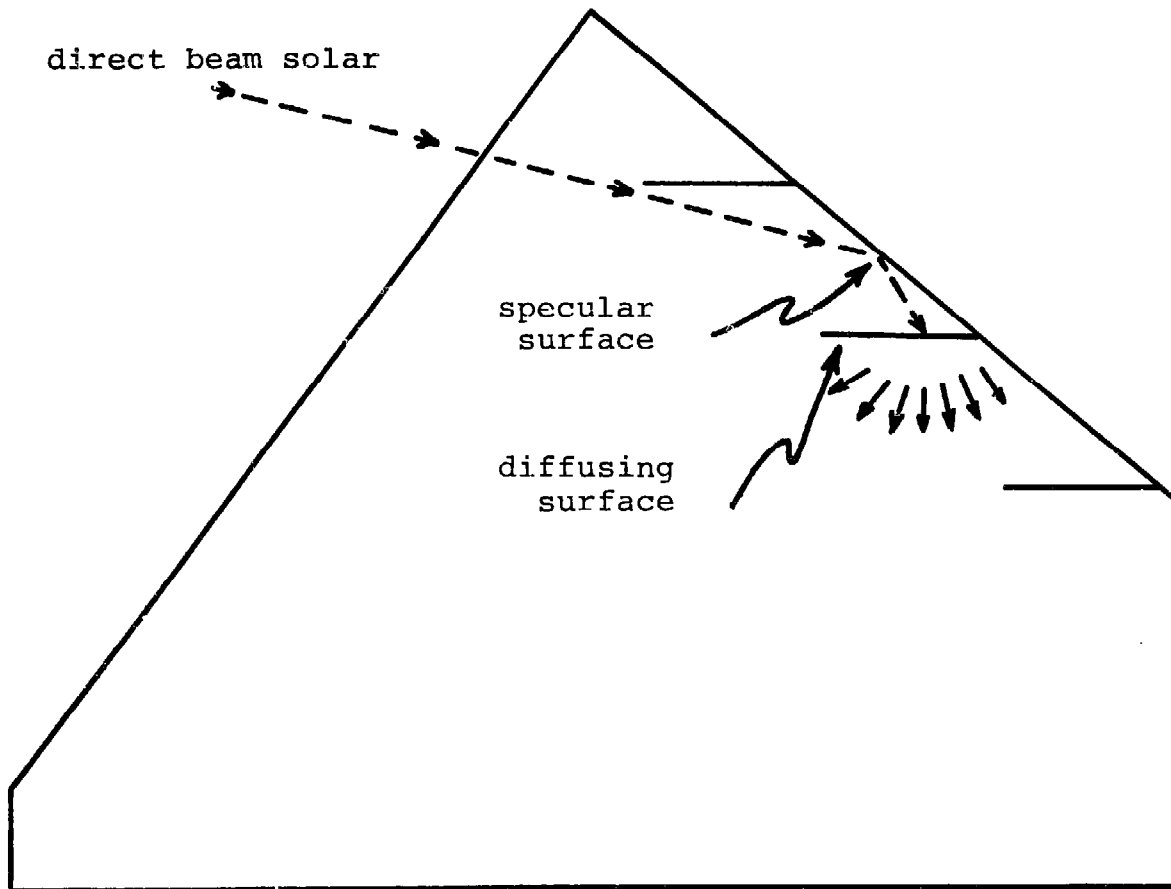

Figure 1-- One possible configuration of specular and diffusing surface forming a so-called specular diffuser. The spacing and length of diffusers depend on roof angle and latitude. The surface area of the diffuser exposed to points external to the greenhouse is small, therefore the amount of light scattered out of the greenhouse is negligible.

References

1. Sellers, W.D., 1965. Physical Climatology, The University of Chicago Press, Chicago.
2. ASHRAE Handbook of Fundamentals, 1972. George Banta Co., Inc., Menasha, Wisconsin.

Greywater For The Greenhouse

by

CARL LINDSTROM and ABBY ROCKEFELLER

The greenhouse we will describe here is one which, combined with the effects of a Clivus Multrum composter and a greywater roughing filter, closes the cycle of waste conversion/water purification/food production in the home. Having a practical, ecological means of keeping kitchen and toilet wastes out of the water - the Clivus - was the inspiration to experiment with a greywater-irrigated greenhouse. The reason for this is that toilet wastes and, when there is a garbage grinder, food wastes as well, constitute the most troublesome pollution load to the water leaving the house. As long as that water is burdened by these wastes, there can be little incentive to separate, and wisely treat, the greywater (water which has been used for washing only). However, once the combined toilet and kitchen wastes are turned to an advantage by composting, the opportunities for making final good use of the remaining wastewater in the course of its purification are inviting, if not compelling.

It is a simple matter to prepare greywater for use as an irrigation and nutrient source for gardens and greenhouses. Since it carries only small particles such as lint, hair, and bits of food from the kitchen sink, it can be passed through a roughing filter instead of a septic tank. (It is toilet paper and feces whose large size and slow degradation makes the septic tank necessary as the conventional means of pretreating combined sewage.) The effluent from this filter will be relatively aerobic as compared to the perfectly anaerobic effluent from septic tanks. This is an advantage to its use as irrigation water in garden soil. (Septic effluent may promote anaerobic processes that would be harmful to the plant roots.) Greywater has advantages - in addition to the smaller size and greatly reduced quantity of particles - that improve its potential use for irrigation purposes: there is 40% less of it than total combined sewage (the flush toilet accounts for roughly 40% of total water use in the home), and the character of the organic and nutrient content is such that its breakdown (and therefore potential use by plants) is much more rapid than is the case in combined sewage. It is also probably of positive significance that most of the nitrate and sodium salts are deposited in the Clivus Multrum (between 85% and 90% of the nitrogen produced as a waste product in the home are concentrated in the urine). Most of the nitrates in the Multrum will be stabilized into organic compounds for slower release in the garden. If most of the domestic nitrogen were present in the washwater, some of it, in the form of nitrates, might be wasted by leaching rapidly through the soil.

It was our idea that a greenhouse would for several reasons make an ideal leaching bed at the same time as the greywater would serve the nitrification and irrigation needs of the growing plants. It would provide a sheltered and therefore stable area for the purification of the wastewater. Ordinary leach lines are, at least in the northern latitudes, laid at least 2 feet below ground level because of freezing. In the greenhouse these perforated pipes could be laid as close to the surface as desired (ours are 2 inches below the surface). This means several favorable things: 1) Access to them for inspection or cleaning is very convenient; 2) The relatively warm and stable climate favors the activity of the decomposer organisms responsible for purification. In contrast to the outdoor leachfield these

creatures will be active year round; 3) The lines being near the surface are in the topsoil where by far the greatest activity of not only bacteria, but the whole ecosystem of invertebrates, takes place. These help greatly in metabolizing the organic particles deposited by the wastewater and, by their tunneling and chewing activities, keep the soil aerobic even directly around the leach pipe. Conventional leach lines are laid deep in the subsoil where the biological community is likely to be less diverse than that near the surface. 4) Perhaps most important of all is the fact that with shallow distribution, the plant roots have an opportunity to take up the nutrients prepared for them by the micro-organisms. At the time when the conventional leaching fields were designed, the sanitary engineers were not concerned with protecting groundwater, but rather only protecting public health from surface water and well water contamination. It is now important to recognize that soils unaided by plant uptake have a limited capacity to absorb nutrients and that even the best laid conventional leachfield is designed to eventually cause groundwater pollution because few plant roots can reach these nutrients.

In order to satisfy the requirements of greenhouse-as-leach bed it was necessary to make one significant modification: Namely, instead of using shallow (usually 9 inch deep) benches, we made soil boxes 3 feet deep. This is because the shallow bench would have no chance to purify the amount of greywater produced in the home. The greenhouse we used is the English one from Burpee of the lean-to variety with only a window leading into the house. It is raised up on a 3 foot concrete block foundation, and its dimensions are 6' x 12'. With 2 foot wide soil boxes (one L-shaped at the end) there is only 54 sq. ft. of growing space. There are 6 cu. yards of soil. This soil is entirely a mixture of half commercial topsoil and half backyard-made leafmold. It was our thought that it should be as organically rich as compatible with plant growth, contrary to the sanitary engineers practice of favoring an organically poor medium such as sand in the belief that percolation would be better. They are probably right for the first week the leach field is used. But in a very short period of time a slime layer builds up in soils where nutritious water is regularly delivered, and it is only the invertebrates such as earthworms, springtails, and mites that penetrate and metabolize it. We have dug our leach lines twice in the year that we have been using this greenhouse, once in May and once in November. At neither time was there a trace of anaerobic odor or bacterial slime, even directly beneath the perforations in the leach lines. Earthworms, potworms and springtails were present in startling numbers especially around the leach pipes. It appears certain that it is they who are responsible for the sweet smelling and slime-free nature of the soil, and the excellent percolation.

These deep soil boxes have turned out to be beneficial in several ways to the vegetable producing function of this greenhouse as well as to its water purification function. For example, root depth ceases to be a limiting factor in what can be grown. We raised salsify successfully last winter as well as carrots, beets and turnips. In a larger area shrubs or small fruiting trees, whose perennially deep roots would retrieve the deeper nutrients, could be grown. The volume has itself a stabilizing influence on temperature, moisture, pH, and the greenhouse ecosystem. Temperature: Greywater is between 10 and 15 degrees higher than sewage containing toilet water. A good proportion of its heat is retained in the soil which acts as a heat recovery or exchange medium. This is especially significant in the winter when, if there is a sudden drop in the air temperature, the relatively slow-changing soil protects the plants. Moisture. In a similar way the plants are protected from

the intense drying effects of the sun by the deep moisture reserve which induces them to send their roots downward rather than to develop a shallow root system as they might do where insufficient top-down watering is practiced. Because of this one can leave a greenhouse such as this one unattended for well over a week without watering. pH. The large volume of soil acts also as a buffer to sudden changes in the pH of the greywater. Ecosystem. And, finally, a diverse and balanced population of soil invertebrates can thrive in this environment as it could not do in shallow bench whose micro-environment is subject to too great fluctuations of the factors described above. Earthworms, for example, must be able to retreat to deeper, moister levels when threatened by dehydration from above. The stability of this environment provides a habitat for the predators of greenhouse pests as well as to the decomposer organisms so necessary to maintenance of soil health and water purification. This soil is well populated by rare beetles, ground beetles, predatory mites, centipedes and jumping spiders. The natural parasitic and predatory enemies of whitefly, aphids, and two-spotted mites can also thrive. It appears that mass of soil is as important a criterion to the stability of the greenhouse as it is to the compost heap. Low maintenance is the sum of the benefits arising from the stability of the greywater irrigated greenhouse with deep soil boxes.

An initial question we had was what the implications would be to both plant growth and water purification when all the wastewater (excluding laundry) from two to three people is pumped into the growing boxes. Before investigating this question, let us give some elementary facts and figures pertaining to the wastewater and receiving medium: The dosing occurs whenever any of the washing facilities are used. After any particles which would cause plugging in the leach lines have been filtered out by the roughing filter, the greywater is pumped automatically to the greenhouse where it is distributed along the length of both growing beds through 1½" pipes with ¼" perforations at every foot. The rich, absorbant soil acts both as storage and flywheel: If not already saturated, it will hold some portion of the dose; what it cannot hold, although introduced rapidly, will exit slowly. One 30 gallon shower will dribble out the bottom drain for over an hour. The soil boxes have drains at the lower end of their slightly sloping bottom. A 2" layer of 2-3" crushed rock at the bottom helps the drainage.

From the point of view of water purification, it is self-evident that the more greywater is introduced per cubic yard of soil per day and the faster its rate of percolation the less effective the treatment will be. Conversely, the slower the water percolates through the soil, the better will be its treatment. On the other hand, for the plants well-being, a more critical factor than either the volume of rate of water passed through each cubic yard per day is the oxygen level in the growing medium. The slower the percolation rate in the soil the more oxygen will be consumed, and the plants could be correspondingly harmed if anaerobic conditions prevail. (We observe here again that where a septic tank is used as the pretreatment for greywater, the effluent from it will be thoroughly anaerobic.) In our greenhouse, however, the percolation rate is rapid because of the high organic content of the soil, and therefore, although there is considerably more water introduced than either the soil can hold or the plants can evaporate, the oxygen content of the soil is high. The set-up consists in this respect of a hybrid between conventional irrigation and hydroponics. But we feel it combines

the advantages of both: The stability of the soil as growing medium (e.g., diseases are spread less rapidly in soil than in water, and soil makes the whole range of micro-nutrients available to the plants), and the nutritious irrigation and aeration of the rapidly moving effluent.

Preliminary tests on the post-greenhouse effluent show it to be free of fecal coliform bacteria. Total coliforms were only 1% as many as found in average greywater. The BOD was high in the first test when the soil hadn't yet settled, but down to secondary sewage effluent on the second test. It is rendered biologically stable at least to the extent that it will not develop foul odors after being stored in a tight container. The pre-greenhouse, post-roughing filter effluent, by contrast, has a characteristic greywater odor, and when stored even for a day becomes fully septic.

Experience with the effects of this set-up on plant growth is so far encouraging. Last winter we grew a wide variety of greens and root crops. All grew luxuriantly. There was only one case of disease in which the centers of a variety of Chinese cabbage rotted slightly. There were enough salad greens throughout the winter for three hearty salad eaters. In the summer we grew eggplants, melons, peppers, cucumbers and tomatoes. The cucumbers and eggplant produced a good crop. The variety of tomato plant set no fruit. In the middle of the summer a severe outbreak of two-spotted mites nearly decimated the crop. We introduced the predatory mite Phytosalis persimilis and within three weeks there was no more sign of the two-spotted. Other pests, aphids and white-fly, have been kept under good control by the presence of indigenous enemies. It is significant that in the summer we neglected the greenhouse entirely. Without attention to either cooling, venting or watering, growth was abundant which, whether we ate anything from it or not, was good for the water treatment aspect.

We will say something about the heating and cooling of this greenhouse the elements of which, although not innovative, have contributed substantially to its demanding so little maintenance. The floor consists of a 2" concrete slab (the soil boxes sit on top of this) under which is a rock storage the same dimensions as the greenhouse and 3 feet deep. This serves as a thermal "storage battery" to temper both highs and lows. The hot solar-heated air from near the peak is drawn down an opening in one end of the slab and through the rocks by a thermostatically controlled fan. The cool ground air is simultaneously blown up into the growing area. A most important consequence of this arrangement is that venting in the winter is not necessary: It is a closed ventilation system which stores, instead of loses, the captured solar heat of the day, and returns it by radiation through the floor at night. We should note that we tried charging the rock storage with heat from supplementary solar panels, but found that for this size rock storage and in relation to this size greenhouse, at least, the loss in the cooling effect too much outweighed the benefit of the extra heat. Moreover, we found that the waste heat from the central gas heater, when blown directly into the greenhouse instead of up the chimney, made a very satisfactory source of heat for nighttime and cloudy days. The high CO₂ content was certainly partly responsible for the rapid plant growth in the winter. Of course, if one does this, the gas furnace must be well tuned to avoid carbon monoxide production.

NOTE: Even more important is that the waste gases must not be returned in a loop to feed the gas combustion, because if the combustion air contains more than 1% CO₂, the production of CO will take a sudden leap up to lethal levels.

There are a number of questions which experience with this system raises and which only time, careful observation, and regular testing will answer. Some of these are: (1) What is the optimal amount of water that should pass through each cubic yard of soil from the point of view both of satisfying the needs of the plants and the purification of the water? Approximately 80 gallons/day pass through our greenhouse soil. If the water moves too fast and if there is too much of it, will it carry too many nutrients away? On the other hand, if it moves too slowly and there is too little, will nitrate and sodium salts build up in the soil to toxic levels? (2) Is pathogen contamination of plant roots a danger with greywater irrigation? It seems likely that the risk here is much slighter than when total sewage is used raw to fertilize or irrigate vegetables. But little work has been done in this particular area (indeed, the very idea of "greywater" is in its infancy), and it is known that there are fecal coliforms in greywater (though what this really says is hardly certain). (3) Will the soil in the greenhouse boxes eventually go anaerobic and plug up? The soil, of course, will settle and the organic particles in it will eventually become mineralized; this will have implications for purification and irrigation, and therefore on the question of whether the soil will need to be replaced.

In conclusion, our experience to date suggests that the greywater-irrigated greenhouse indeed constitutes a good integration of waste conversion, nutrient recovery, water purification and vegetable production; that it can be built and maintained economically on the small urban or suburban lot as well as in rural areas. (The one described is in a city on a lot less than a quarter of an acre.) We were not interested in optimizing any one factor, either solar heat, plant growth, or water purification. Rather, we wanted to solve in an aesthetically, psychologically and environmentally satisfying way whatever household functions were compatible with the greenhouse environment. Regarded in isolation many household functions are troublesome both to the homeowner and to the environment. Rational combinations, however, can have the synergistic effect of doing no environmental harm, of producing positive benefits to the household, and of involving minimal maintenance, a psychologically important factor. This greenhouse has demonstrated to us again, what should be obvious - that what is waste treated one way is a resource treated another, and that such transformations do not require complex or centralized technologies.

A Low Entropy Waste Conversion,
Water Purification, Food Production
System for the Home

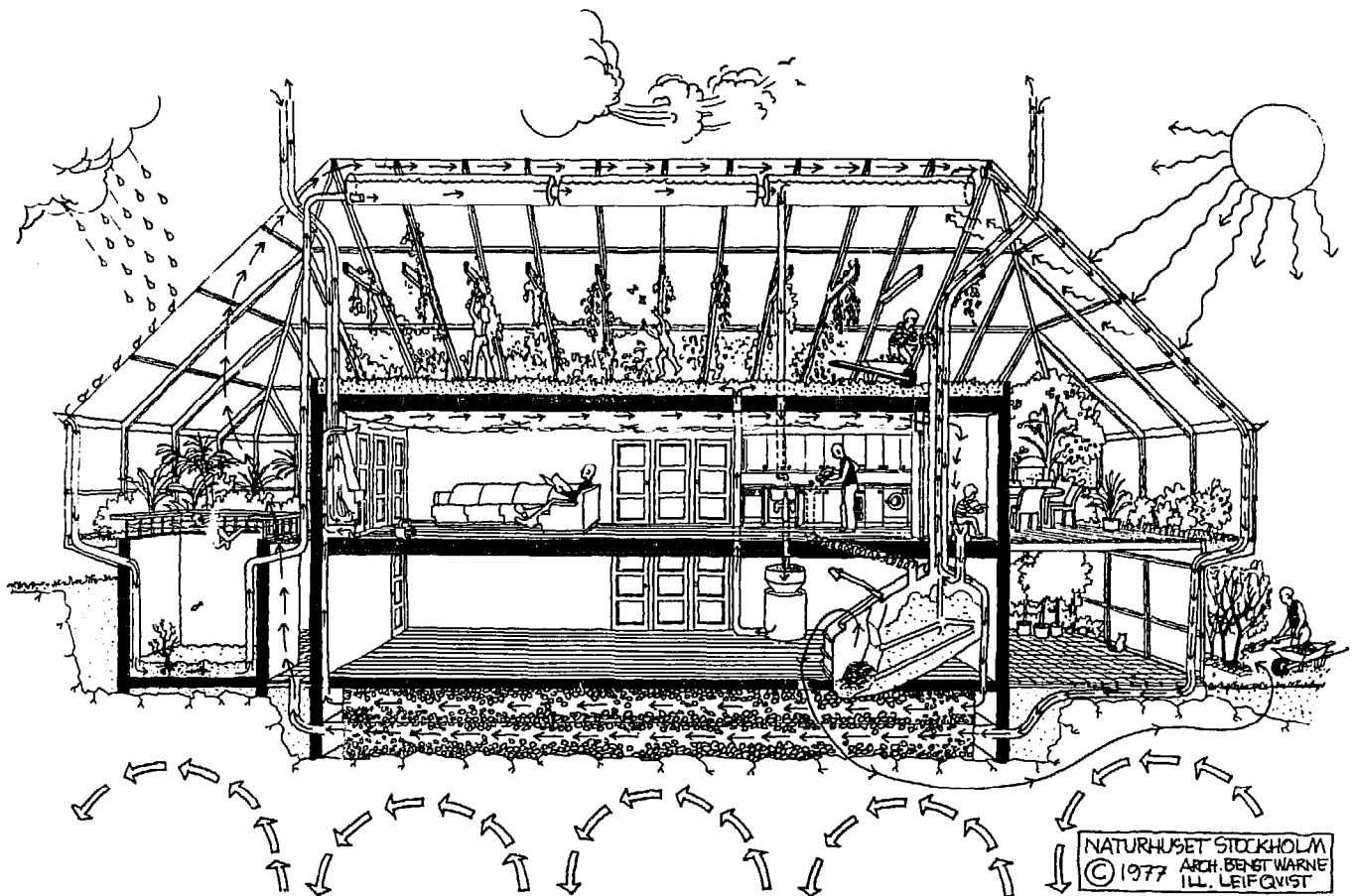
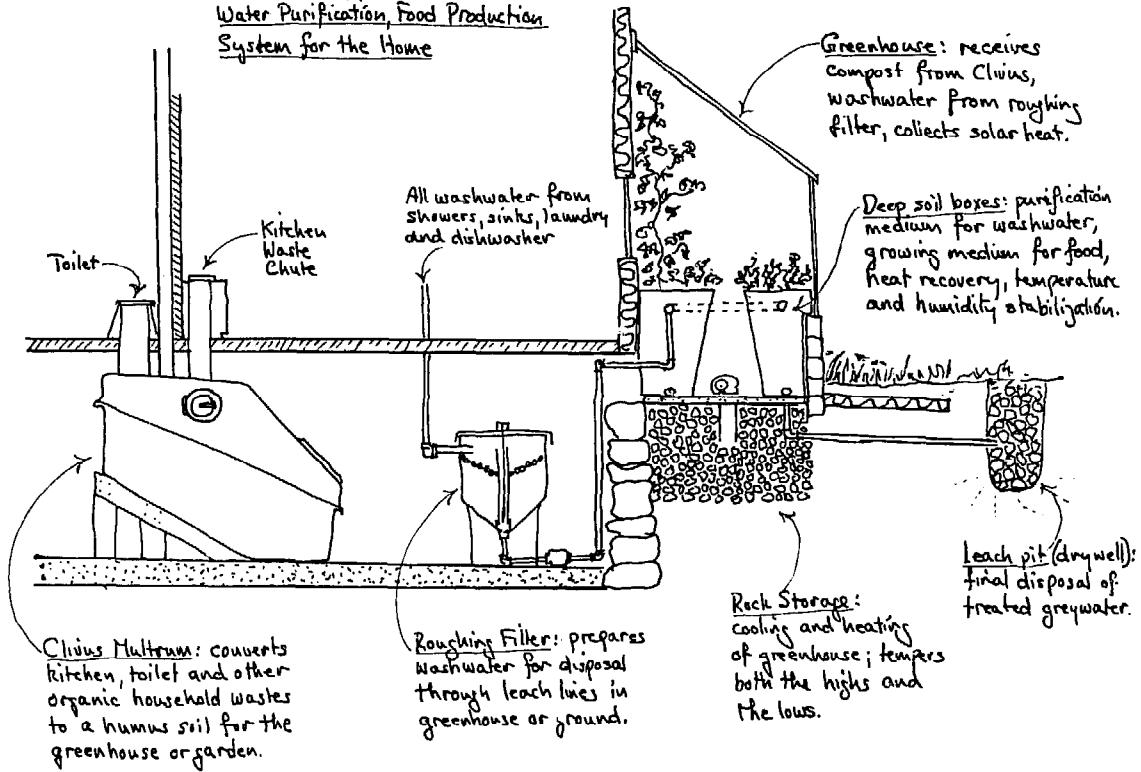

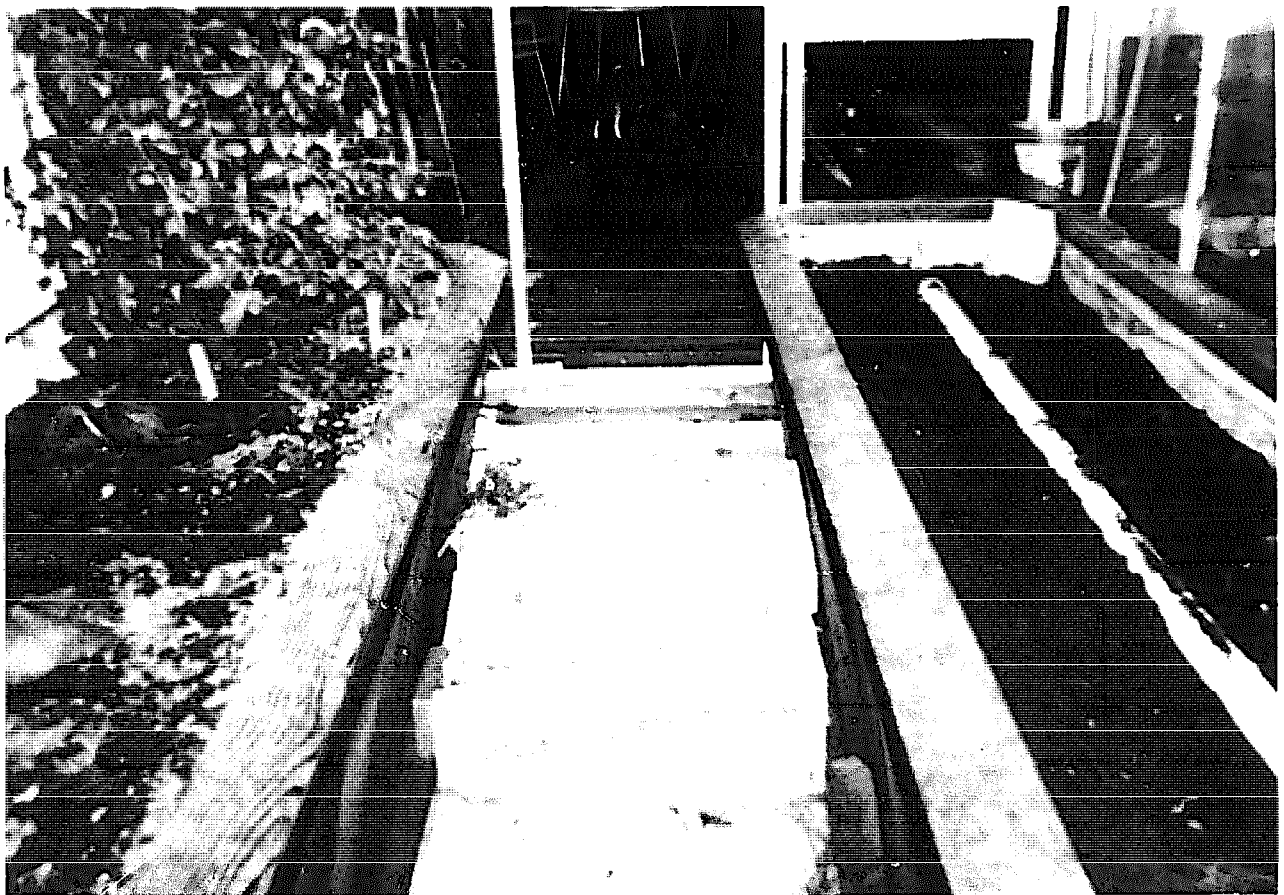
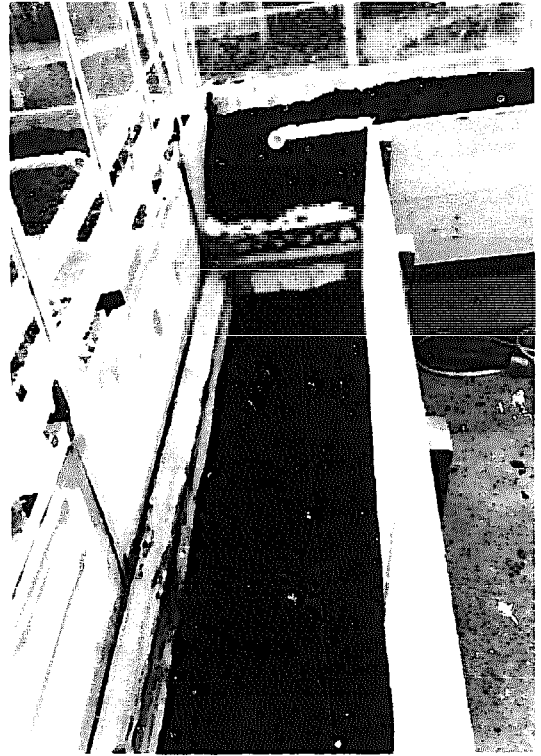
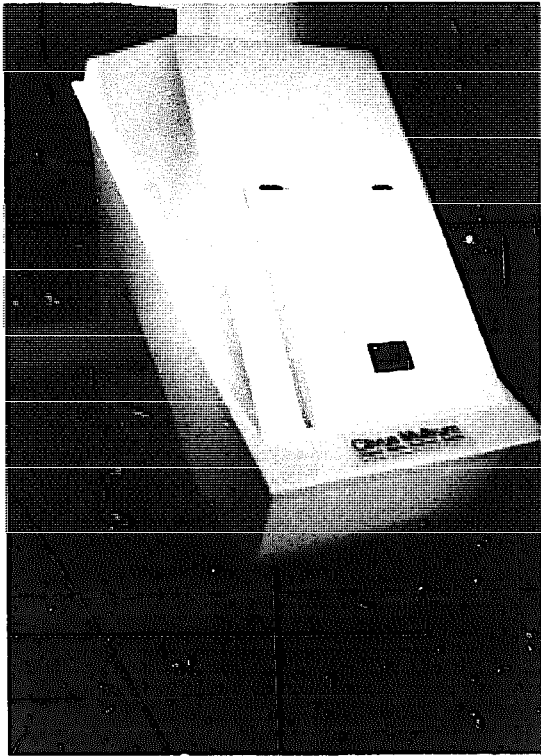

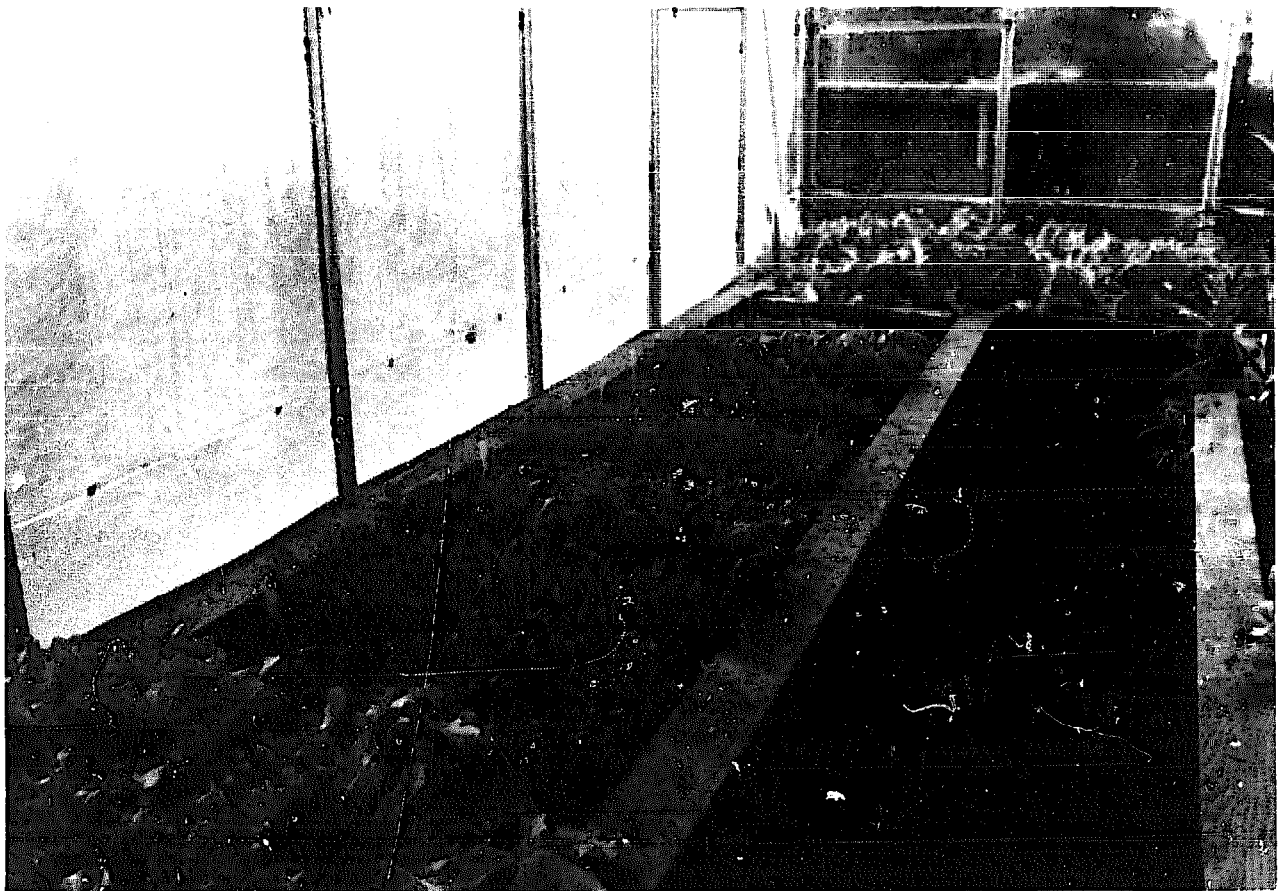
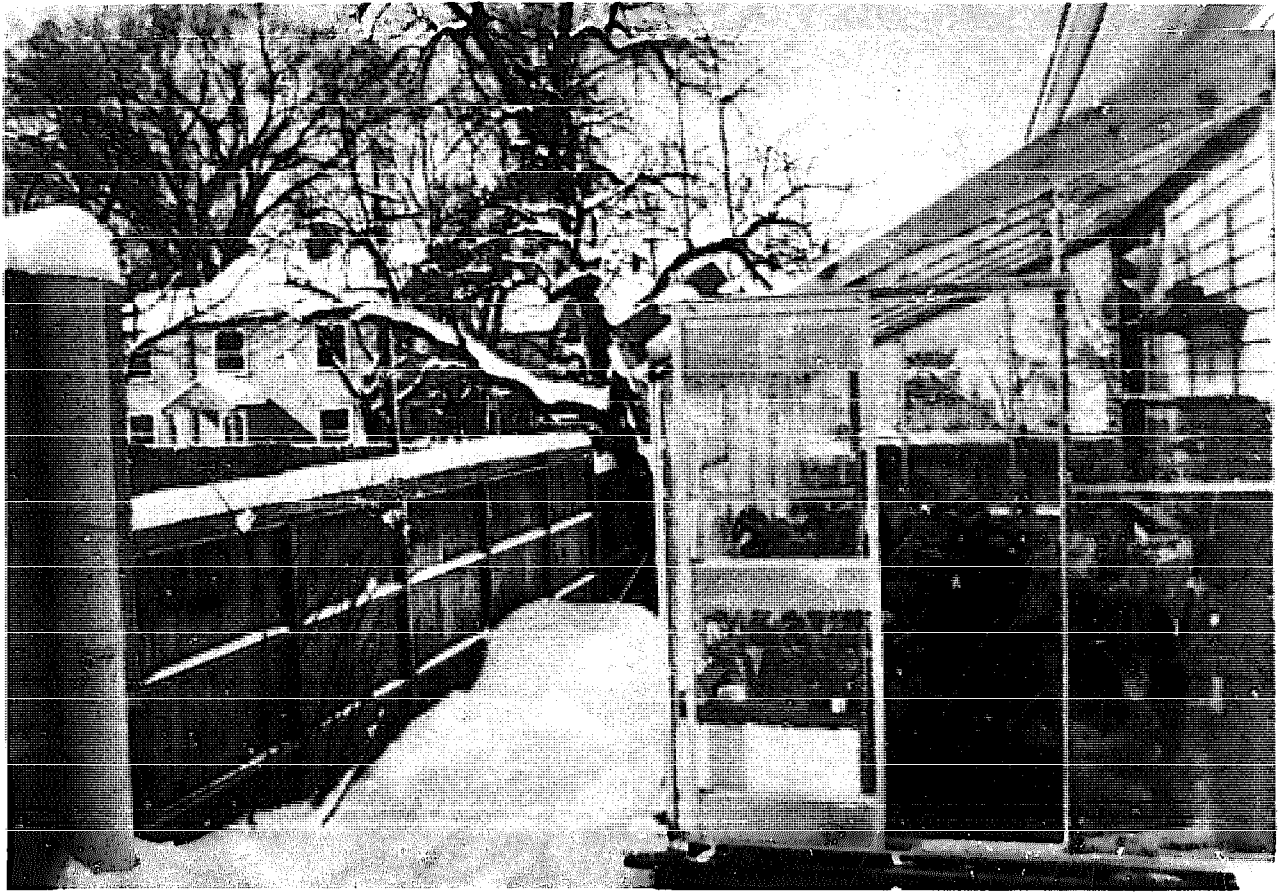

THE MAINE VOCATIONAL REGION TEN HYBRID SOLAR GREENHOUSE

Charles G. Wing

INTRODUCTION

Although Maine has only a small amount of commercial greenhouse business (36 acres under glass), it became apparent several years ago to the Maine State Department of Education that future horticulturalists would benefit from, if not require, some training in solar energy. In the spring of 1977, the Maine Audubon Society contracted to develop a solar horticulture curriculum for Maine's vocational schools. Cornerstones School for Energy Efficient Building in Brunswick, ME, was engaged to design and supervise construction of a "solar greenhouse" for the use of a pilot program at Vocational Region Ten in Topsham, ME. The students in the masonry and horticulture programs constructed the 12' X 32' hybrid solar structure in May and June of 1977, under the direction of Cornerstones teacher, John Crowley. The structure will be extensively monitored this winter as a prototype for vocational greenhouses to be built throughout the state.

THE DESIGN PROBLEM

The design program was the construction of a "solar greenhouse":

- . by vocational school students and teachers.
- . for use Monday - Friday, 9 AM - 3 PM, excluding summer.
- . with maximum flexibility as to temperature regime.
- . to use no auxiliary fuel through a Maine winter.
- . to be freeze-proof over weekends with no attendance.
- . located against the south wall of an existing horticulture program building.

The program therefore dictated that the greenhouse not require exotic materials or exceptional skills in construction and that it have a very high level of thermal performance. These contradictory requirements pointed toward a hybrid solar structure. An active system would have required skills not available; a totally passive system would not have had the required thermal performance.

Few of the construction details are unique: (Figure 1) concrete perimeter wall insulated outside with two inches of styrofoam to frost depth, lean-to construction using one-half of an APA rigid-frame design, framing of 2" x 6", 24" on-center, R-19 fiberglass insulation in opaque walls, double-glazing of Kalwal outside and Monsanto 602 polyethylene inside. The only unique features were the 4' x 8' exterior shutters constructed of Simplex Thermoply® and the use of 500-5 gallon polyethylene government surplus sonobuoy cases for thermal storage. Detailed blueprints are available through Maine Audubon Society or Cornerstones.

A review of the literature on existing greenhouses revealed extensive material on construction details but almost nothing on quantitative thermal design procedures. The single exception was a paper by Michal¹ of TEA in which an equation for the dynamic thermal response of a solar collector is presented. In the particular form given below, the equation demonstrates clearly the separate influences of glazed area, received radiation, thermal resistance, and thermal mass. It is in a form easily programmed on a calculator and can be used to predict the temperature inside the greenhouse as a function of time, incoming radiation and outside temperature. We used the equation as a design tool to select glazing area, insulation R-values, size of thermal mass, and blower requirements.

THE EQUATION

The equation, as we used it, is:

$$\Delta T_{IN} = [1 - e^{-\frac{A_g U_e t}{mC}}] [\frac{S}{U_e} - (T_{IN,START} - T_{AMB})]$$

where: T_{IN} = temperature inside greenhouse, °F
 ΔT_{IN} = change in inside temperature in the time interval t, HR.
 T_{AMB} = average outside temperature during interval
 A_g = area of glazing, Sq. Ft.
 S = radiation transmitted by glazing, BTU/Sq.Ft.Hr.
 C = specific heat of mass m, BTU/F°Lb.
 M = mass coupled to greenhouse air, Lb.
 U_e = heat loss coefficient of building envelope normalized to A_g .

The two outstanding features of the equation are:

- 1) The iterative form whereby the temperature change can be calculated in any desired increment of time. (We most commonly used increments of one hour, as this was the form of available radiation and temperature data.)
- 2) The ease with which design parameters are separated as will be elaborated below.

¹Glazed Area, Insulation and Thermal Mass in Passive Solar Design. C. J. Michal, Total Environmental Action; Harrisville, NH 03450

USING THE EQUATION

A. AVERAGE TEMPERATURE. If we wish to find the average temperature for a 24 hour period, we simply set ΔT_{IN} equal to zero. That is, if daily temperature and radiation conditions were identical for successive days, we would expect T_{IN} to be the same each day at the corresponding hour, or $\Delta T_{IN,24HR} = 0$. For this to be true, one or both of the brackets must also equal zero. For the left bracket to equal zero, the exponential term must equal unity which requires either the heat loss coefficient to be zero (zero heat loss) or the thermal mass to be infinite. While desirable, neither is possible, leaving the right bracket. Therefore:

$$(T_{IN,START} - T_{AMB})_{24HR} = \frac{S}{U_e}$$

In other words, the average temperature difference between the inside of the greenhouse and the outside air is the transmitted radiation averaged over 24 hours, divided by the average value of normalized greenhouse heat loss coefficient.

B. THERMAL TIME CONSTANT. The exponential term is of the form $e^{-t/\tau}$ so often encountered in nature. τ is the time constant, or time in hours required for an initial difference between inside and outside temperature to decay by 63%. During a second time constant the temperature difference will decay 63% of the remaining difference and so on. We can therefore easily calculate the time required for the greenhouse to reach freezing, given any starting temperature and any average outside temperature. We used this particular term to predict that the Region 10 greenhouse could be left unattended starting from 70°F during average January weather for at least three days before freezing.

C. TEMPERATURE SWING. The inside temperature can be calculated hour by hour by iterating the full equation: Iterating means

$$T_{IN,HOUR 2} = T_{IN,HOUR 1} + \Delta T_{IN}, \text{ etc.}$$

We calculated T_{IN} for January days having clear radiation, average radiation, and 25% of average radiation. Hourly values of S were obtained from ASHRAE solar radiation tables and hourly T_{AMB} from Brunswick Naval Air Station computed averages.

As Michal pointed out, use of the equation assumes that the thermal mass and the greenhouse air are perfectly coupled, i.e. the storage mass and the greenhouse air are always at the same temperature. In a totally passive structure this assumption is dubious. However, in a hybrid system where greenhouse air is cycled through a large thermal mass of large surface area, the

approximation can be made arbitrarily good. Calculations for the Region 10 greenhouse show the thermal mass (2500 gallons of water stored in containers with a 1 sq. ft./gal. surface to volume ratio) and air temperature tracking to less than 5°F .

RESULTS

Figure 2 shows the predicted thermal performance of the greenhouse through 24 hours of average January clear sky conditions. Curve A is the outside ambient temperature, ranging from a low of 17°F just after sunrise to a high of 27°F at 2 PM. Curve B shows the temperature record of a greenhouse of identical construction, but without insulating shutters or any thermal mass beyond that of the structure and furnishings (estimated $mC = 3000 \text{ BTU}/^{\circ}\text{F}$). This greenhouse exhibits unacceptable temperature excursions from below freezing to over 100°F even though it has less glazing and more insulation than conventional commercial structures. Curve C demonstrates the effect of adding shutters of R value 10. The shutters increase performance in two ways. During the day the top reflective surface increases the received radiation by an estimated 30%. At night the shutters reduce heat loss through the glazing by a factor of 5. In general, the effect is simply to raise the average operating temperature. The temperature swing is still undesirable. On a really cold night the temperature would still dip below freezing without auxiliary heat. The upper temperature on all of the curves is clipped at 80°F representing venting of excess heat. Curve D shows the effect of increasing the thermal mass from $3000 \text{ BTU}/^{\circ}\text{F}$ to $24,000 \text{ BTU}/^{\circ}\text{F}$ by installing 500 - 5 gallon water-filled sono buoy cases under and behind the rear plant bench. A $1/3$ HP blower forces air from the top of the greenhouse over the container surfaces. The air exits at floor level. Curve D seems, at first glance, to have a very high level. In fact, its average value is less than that of curve C, disregarding venting. The effect of the additional thermal mass is thus simply to prevent temperature extremes - not to raise average temperature. Curve E combines insulating shutters and thermal mass and is the predicted performance of the Region 10 greenhouse as built. The effect of incorporating both shutters and mass is to raise the average temperature to an acceptable level and then to keep it there.

Of course not all days are clear days. In fact, received radiation is sometimes as low as 5% of the clear day value. With radiation values of this order there is little point in opening the shutters, and plant growth will simply slow in the cool dark periods.

Received radiation and ambient, inside air, and thermal mass temperatures will be monitored simultaneously this winter. Hopefully, the results will show that Michal's equation is a powerful design tool for hybrid solar buildings.

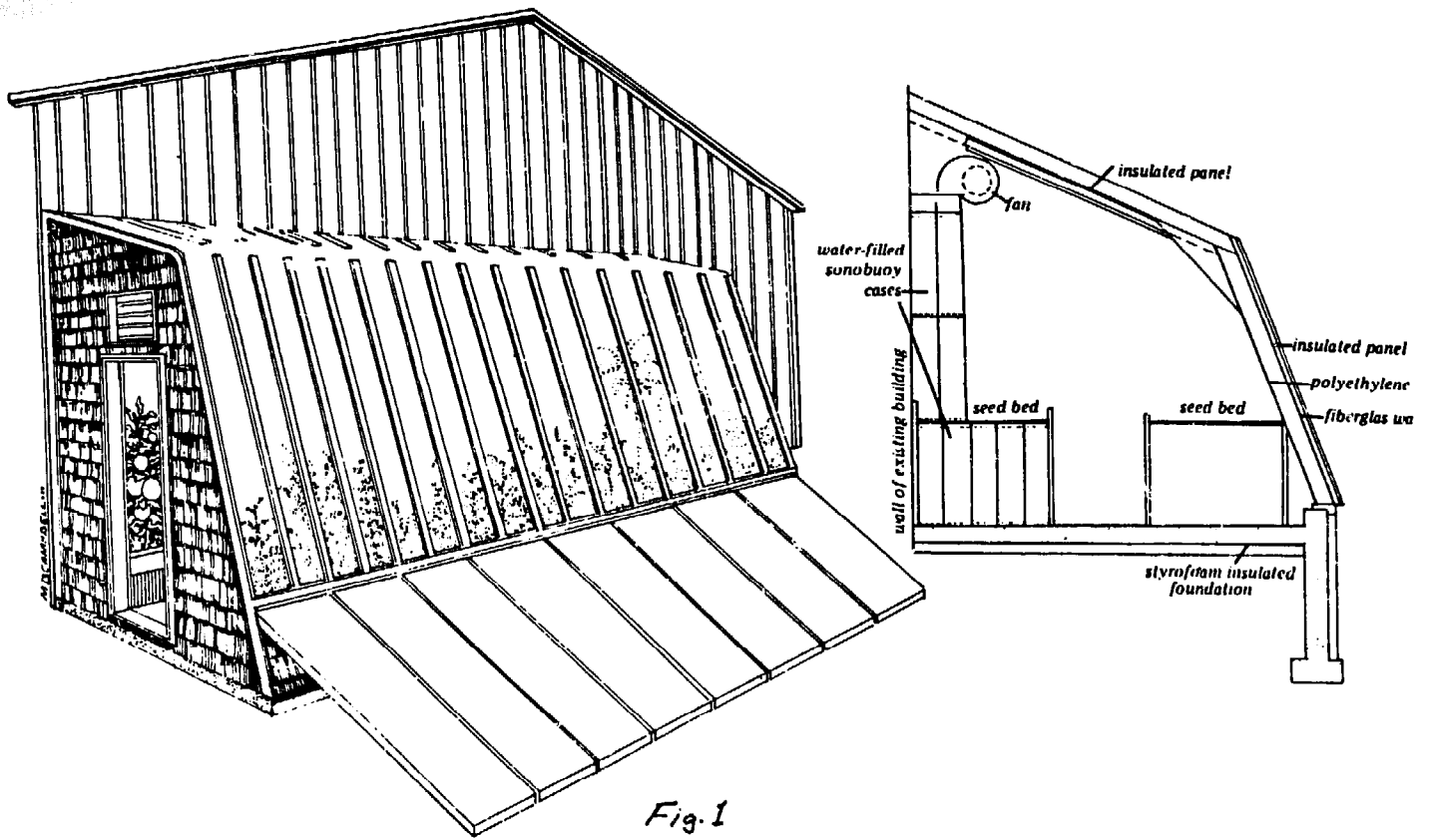

Fig. 1

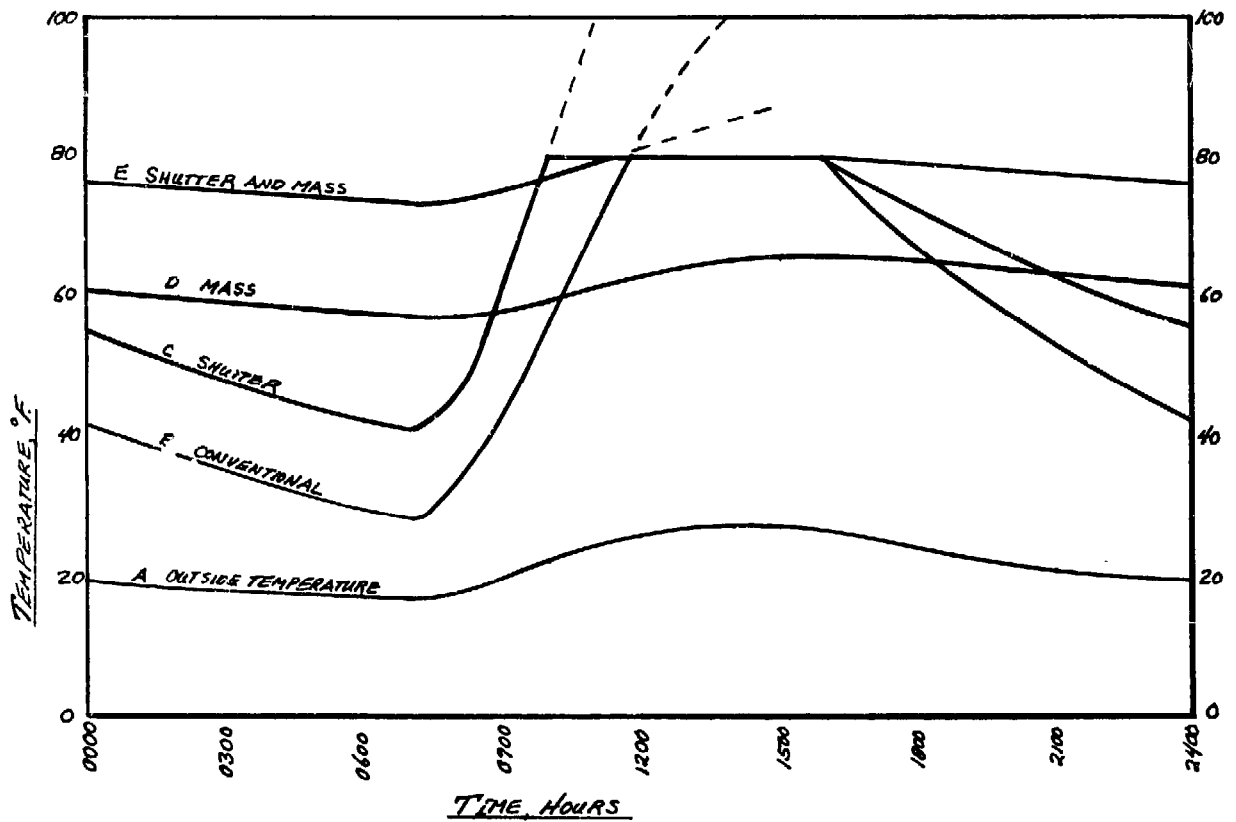

Fig. 2. PREDICTED TEMPERATURE INSIDE A HYBRID SOLAR GREENHOUSE ON AN AVERAGE JANUARY CLEAR DAY, BRUNSWICK MAINE, USING COLLECTOR EQUATION.

A PRELIMINARY ASSESSMENT OF THE UNIQUE FEATURES OF A PARABOLIC AQUACULTURE/GREENHOUSE

by
Davis Straub

Evan Brown
ECOTOPE GROUP
Seattle, Washington

ABSTRACT. The unique features of the parabolic aquaculture/greenhouse at Pragtree Farm are enumerated and described. The importance of each feature is analyzed using the framework developed by Balcomb, et al. Data taken from the greenhouse is analyzed to determine the performance of the design and to point to further research objectives. The data collection system developed for monitoring aquaculture/greenhouse performance is also described.

Current research work with the aquaculture/greenhouse systems at Pragtree Farm is being conducted under a Cooperative Agreement between Ecotope Group and the United States Department of Agriculture, Agriculture Research Service "Solar Heating and Cooling of Greenhouses and Rural Residences" program.

Ecotope Group is presently carrying out research on two aquaculture/greenhouses located at Pragtree Farm in Arlington, WA. These two greenhouses, named for their primary forms -- the parabolic and the small rhombicube octahedron, have been built in

SOLAR AQUACULTURE/GREENHOUSE (SECTION) FIG. 1

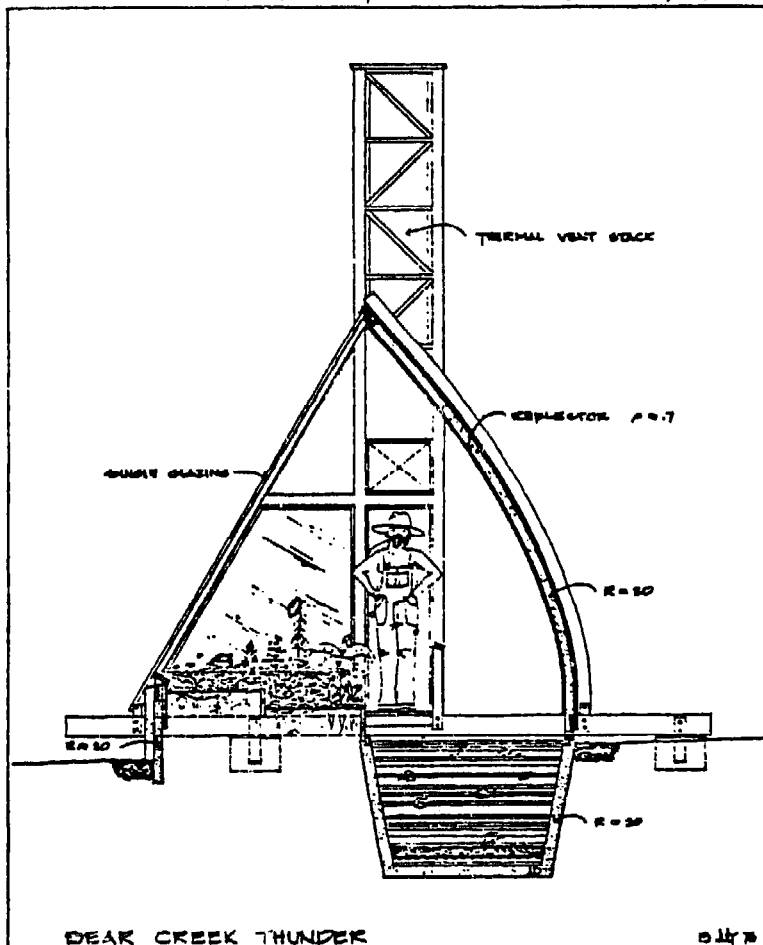

cooperation with Bear Creek Thunder of Ashland, OR, designers of the parabolic.

The parabolic greenhouse (Figure 1) incorporates a number of design features which are unique in passive solar design and as such have received scant documentation. We expect our research to determine the efficacy of each of these features, as well as validate or/and improve our design methodology. The design features of the parabolic greenhouse are:

1. Interior concentrator -- direct coupling of solar radiation incident on the south face to thermal storage mass with a parabolic-shaped reflector formed by the north wall of the greenhouse.
2. High thermal storage mass-to-aperture ratio -- 104 Btu's storage per square foot of aperture.
3. Restricted thermal coupling of heat storage mass to interior space.
4. Heavily insulated north, east and west walls ($R=20$).
5. Tight construction to minimize infiltration.
6. Options for double glazing with interior vinyl covers and for night shuttering with polystyrene doors to further reduce heat loss.
7. Solar chimney to provide ventilation of overheated interior air, passively operated by a heat motor.

Douglas Balcomb and his associates in New Mexico have provided the clearest and most accessible documentation of simulation and experimentation on passive design (Balcomb, et al., 1975, 1976, 1977). Using their simulation analysis, one can describe the parabolic greenhouse as a variation on the direct-gain passive solar building in which "storage is placed in the room in the direct sun but loses heat only to the room." This is their Case #4 (1975). This model is differentiated from others where the storage mass is not in direct sunlight (picking up its heat from the warmed interior air) or the mass is near the glazed area (losing heat directly to the outside). It is the solar building modeled as Case 4 that is most effective in capturing solar energy.

In the parabolic greenhouse, direct sunlight is focused by a reflective north parabolic-shaped wall into a 4800-gallon heat storage tank. This allows a direct coupling between the sunlight and the interior

thermal storage mass as envisioned in Balcomb's simulation.

INTERIOR CONCENTRATOR

The north wall of the parabolic greenhouse is heavily insulated and its interior side is covered with an 8 mil vinyl backed with aluminized mylar and surfaced with 1/2 mil Tedlar. This reflector is attached to 2-foot wide styrofoam (TM) boards and does not provide a sharp focus but a more diffuse one (Figure 2). Both the east and west walls are reflectorized to further enhance the light in the tank and growing areas.

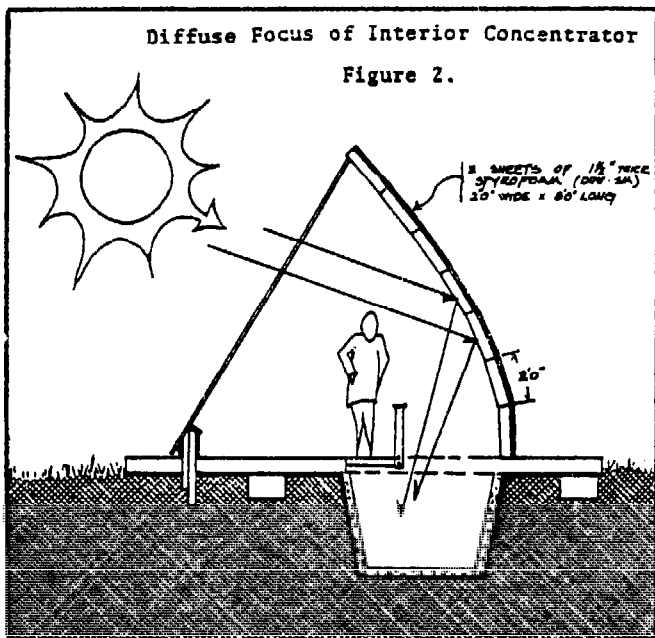

There are three aspects of the interior concentrator which are basic to its function: the tilt of the axis of the parabola, length (or height) of the parabola, and the south facing glazing.

Tilt of the Axis. The axis of the linear parabolic reflector forms a 15° angle with the horizon, as shown in Figure 3. This 15° tilt corresponds to an average solar elevation of 15° at 47.5° N latitude for the three hours about solar noon on the winter solstice. At this time, the sun's rays are parallel to the parabola's axis. The rays are focused into the tank four feet south of the north wall.

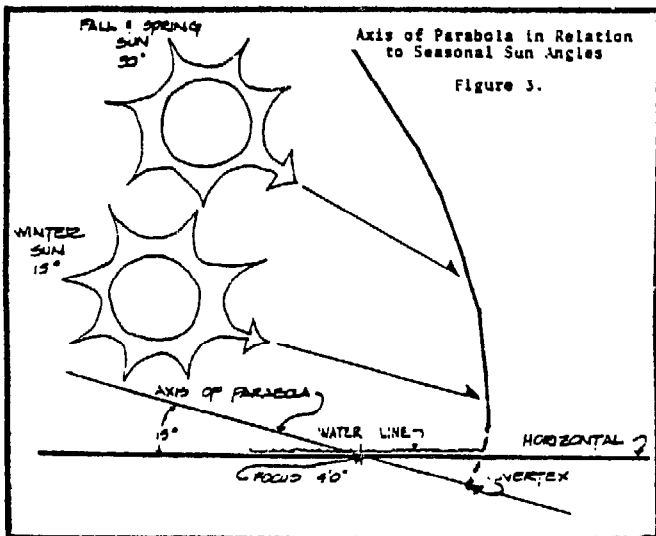

As the elevation of the sun rises through the seasons, the rays are no longer parallel to the parabola's axis. The focus becomes increasingly diffuse and shifts to the north of the tank. Only when the sun is below 15° elevation and in the southern sky would the focus shift into the plant-growing area south of the tank.

Length (Height) of the Parabola. The placement of the ridge (the meeting of the aperture and reflector) is determined by four conditions: (1) June 21 noon sun should hit the north side of the tank so that shading is minimized, as shown in Figure 4. (2) The south face/aperture should optimally be normal (i.e., perpendicular) to the late fall and early spring sun.

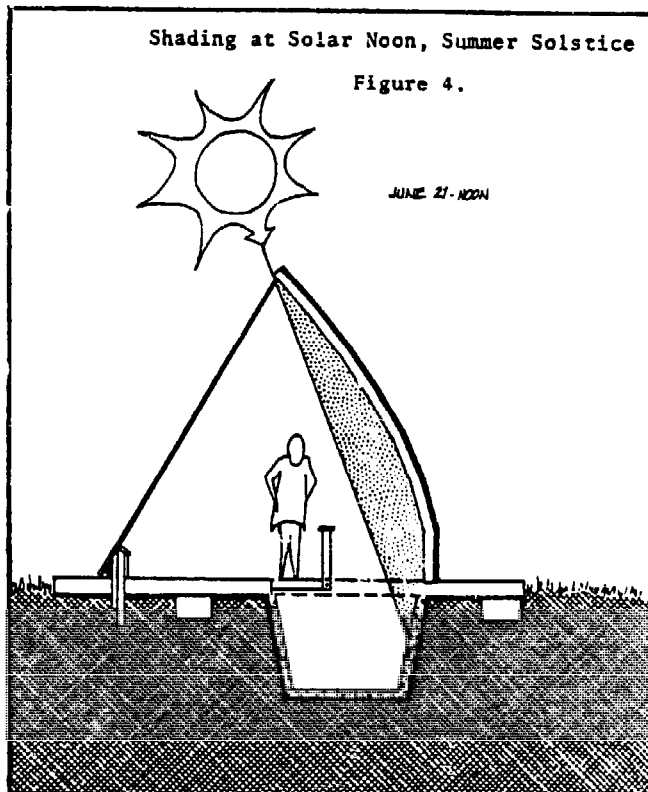

(3) The length of the parabola should be limited because increasing the height progressively yields less increase in light to storage while considerably expanding the volume and surface area of the structure. At the vertex, the parabola wall is perpendicular to its axis. As we move away from the vertex along the curve, the parabola is increasingly parallel to its axis. Therefore, the longer the curve of the parabola, the less effective are the end points of the curve at intercepting solar radiation.

If we take an example in which the pitch of the south face is fixed, then as this face is moved south, widening the north-south width of the greenhouse, both the height of the greenhouse and the length of the curve of the parabola increase. This increases less useful vertical space within the greenhouse, increases heat losses through the enlarged glazed area, and makes progressively less effective use of the parabolic curve.

(4) The focus of the parabola should be placed to maximize growing area. As the focus is moved south, the area needed for water storage (and fish raising) increases. As the focus moves north, more plant growing area is available.

On the parabolic greenhouse, the first condition

ECOTOPE GROUP

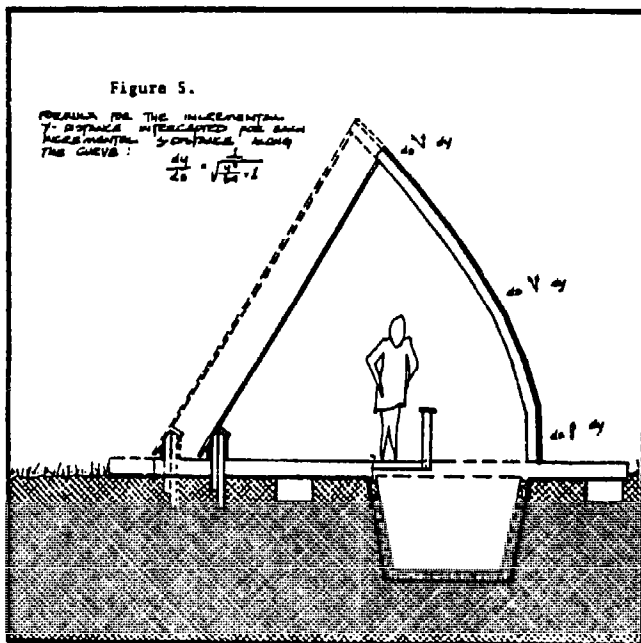

Figure 5.

RESULTS FOR THE INCIDENTAL 7-DIGIT 1-10 CAPTURED FOR EACH HOUR: THE CURVE: $\frac{dy}{dx} = \frac{1}{\sqrt{1-x^2}}$

is not precisely met -- one foot of the water tank on the north side is shaded at noon on June 21. The south face is steeply pitched at 60° to meet the second condition. Conditions 3 and 4 are roughly met in this prototype.

In a further refinement of the design (Barnes and Reichmuth, 1977), a 45° pitch of the aperture and decreased height of the parabola are incorporated into the design. As most glazings, and particularly glass, exhibit wide acceptance angles, the pitch of the south face is not as crucial as the other factors in optimizing solar gain. However, lowering the pitch would increase the interior growing space.

South Face Glazing. A transparent (not translucent) glazing is necessary to preserve the coherency of the sunlight so it can be focused into the tank. The south face (aperture) of this greenhouse consists of reused glass and mullions taken from an abandoned greenhouse. The small (16"x18") glass and considerable number of light-blocking mullions, while low in initial cost, are not to be preferred to large sheets with wider spaced supports.

The problem with direct gain solar heating is that the sun may have a hard time reaching storage as we live and work between the aperture and the storage. In this case, we noted that tall plants in the south growing beds have the potential of blocking radiation to the pond. Tall tomato plants did that to some extent this summer. Low-lying crops are usually grown in the fall and spring and should not interfere with radiant coupling to storage.

In order to accurately assess the solar energy input into the greenhouse interior and storage, both direct and diffuse radiation need to be measured. In the design phase, average solar radiation calculations by Baker (1975), using data from the University of Washington meteorological station, determined solar radiation incident upon a 60° south wall for this latitude. Actual values were measured December 1976 to August 1977 in the horizontal plane by a Kipp & Zonen solarimeter wired to a Lambda LI-500 integrator. Figure 6 compares these actual values with the predicted horizontal values from Baker. Reasonable correlation between predicted and actual average radiation is noted.

While this to some extent validates our use of these calculations, measurements of actual radiation entering the interior and storage compared with measured incident radiation will validate the predictions used in the design (Reichmuth, 1976).

THERMAL STORAGE MASS

The 4800 gallon fish tank occupying half of the interior horizontal space has a thermal mass ratio of $104 \text{ Btu}/\text{ft}^2$ of aperture. This is a particularly large thermal mass in terms of its relationship to both interior volume and to aperture area. The high thermal mass of water (1 Btu/lb) and its transparency contribute to its effectiveness as thermal storage. Rapid internal convection, considered a benefit in water wall designs where the south wall is cooled by convection, leads to temperature stratification in the parabolic tank.

Large solar inputs and low heat loss rates are required to charge this thermal storage up to temperatures necessary to sustain optimal fish growth. Such a large mass provides a relatively stable thermal environment for a fish population.

The usefulness of such a large thermal mass is called into question by Balcomb, et al. (1975), who imply that 30 Btu's of storage per square foot of aperture is optimal. Balcomb, et al. (1976) have further calculated that a model home in Seattle with a Trombe wall of $30 \text{ Btu}/\text{ft}^2$ aperture receives 67% of its heating from solar radiation striking the wall.

Howard Reichmuth (1976) in his preliminary design analysis for the parabolic greenhouse indicates that:

The thermal storage must be large enough to redistribute the energy occurring on above average solar days to the below average ones. The distribution of the above average and below average days has been found by Liu and Jordan (1960) to be fairly reliably associated with the cloudiness index, K_t . This distribution associated with K_t is the basis for a rough estimate of the thermal storage requirements in the Northwest. A typical Northwest winter K_t of .3 implies a thermal storage of six times that supplied by a typical Southwest winter K_t of .7. Passive systems studied by Balcomb (1975) for $K_t = .7$ show good performance for a thermal storage of $30 \text{ Btu}/\text{ft}^2$ of aperture. Therefore, the starting estimate for the Northwest $K_t = .3$ is $180 \text{ Btu}/\text{ft}^2$ aperture.

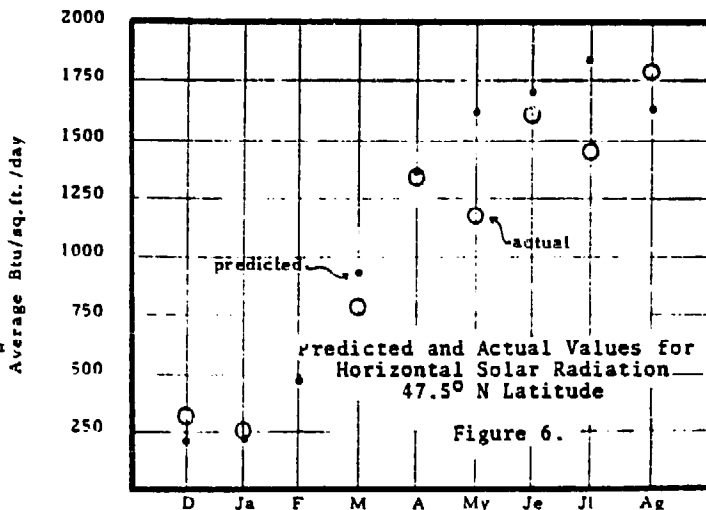

Figure 6.

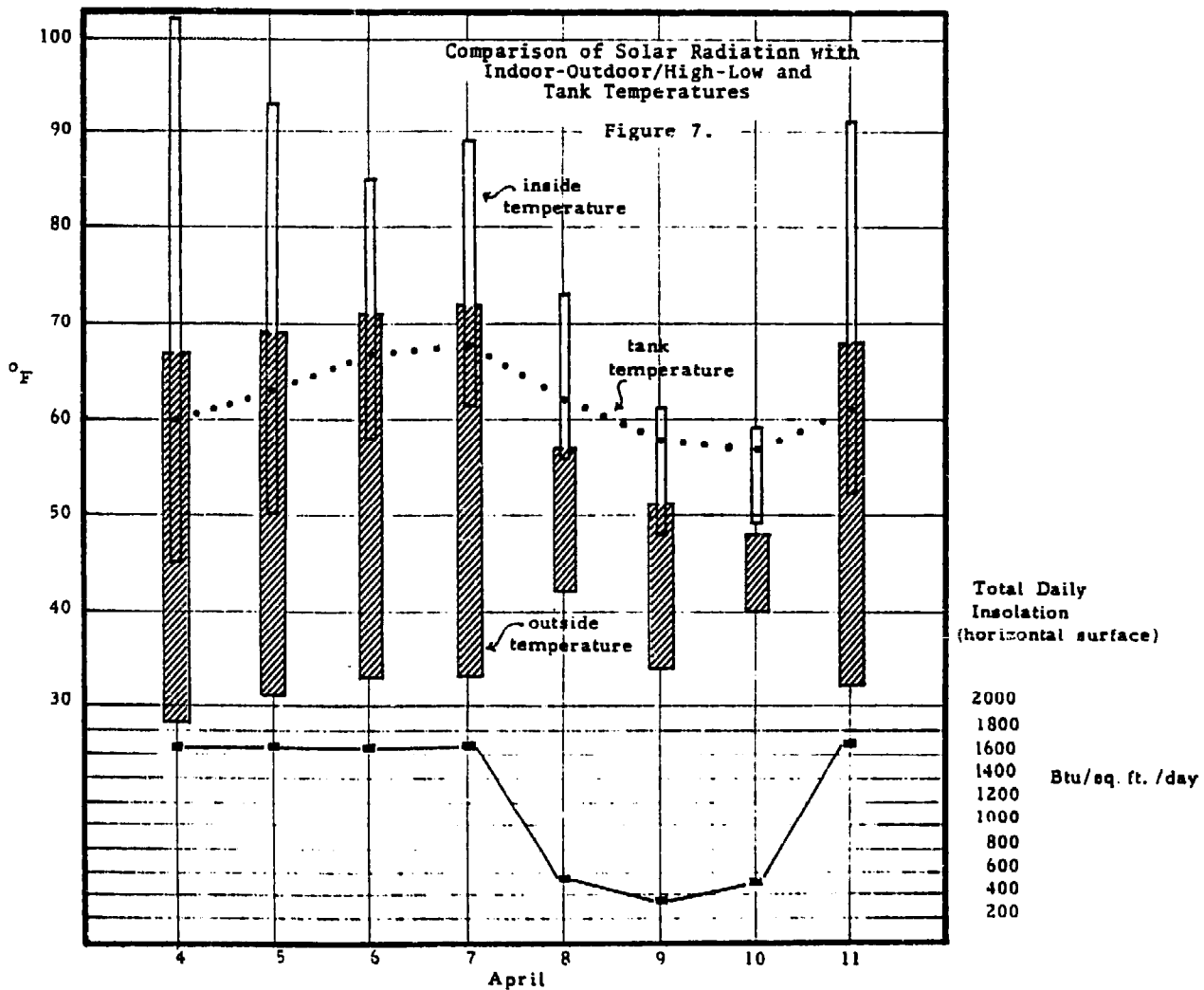

Figure 7 indicates the tank's ability to store solar radiation from a sunny day for use on the next day. Excessive heat losses from the building muted this effect. Further experimentation will take place which will indicate whether the tank is able to provide long term storage. Performance of the tank to date is discussed in the following sections.

THERMAL COUPLING

Decoupling the storage from the space provides for both high storage temperatures and longer term storage. The design U_i (coupling rate between storage and interior) for the parabolic is quite low: a range from 2.0 Btu/ft² aperture for an uncovered tank to .86 Btu/ft² aperture for the tank covered with clear vinyl lily pads (Reichmuth, 1976).

There are two reasons for this low coupling coefficient. One is the 2:1 ratio of aperture area to tank surface area afforded by the interior concentrator. The other is the small storage surface area in contact with the interior as compared, for example, with 55-gallon drums.

Balcomb, et al. (1975) show that a low thermal coupling coefficient (U_i) correlates to a high utilization of solar energy by the passively heated building, particularly in Case 4 which corresponds to the parabolic greenhouse. Balcomb further states, "Case 4 is unrealistic for low values of U_i because the sun

must shine through the room to reach storage and this implies transparent insulation." Through the use of an interior concentrator, we are partially able to simulate transparent insulation.

In spite of the low design U_i , early measurements indicated that the tank was losing heat too rapidly to the interior (Figure 8). Hourly data was gathered for a night to determine heat loss rate from tank to interior (Figure 9). The tank t dropped 2° overnight, indicating a thermal coupling coefficient of about 3 Btu/ft² aperture. Vinyl covers were installed in July 1977 in order to raise tank temperature to a level sufficient for fish growth by reducing U_i .

Four options for control of U_i are possible: (1) leave the tank uncovered; (2) the present situation, vinyl covers to be removed on sunny days; (3) swimming pool covers (bubble packing) lying directly on the water surface; and (4) floating styrofoam covers taken off during the day.

The present vinyl covers have substantial leaks and are prone to fogging, although this may be cleared up through the use of Sunclear. Bubble packing material will restrict oxygen diffusion into the water. The styrofoam covers are susceptible to degradation and require a good deal of attention as well as storage space.

Further experimentation will be carried out in the coming year to determine the thermal coupling coefficient under a variety of conditions and with a number of pond coverings.

ECOTOPE GROUP

Figure 7 indicates that the tank was able to absorb enough solar energy to both heat the greenhouse interior at night and have carry-over to the next day. When solar radiation decreased, the tank quickly lost heat. It clearly was not providing storage between intermittent solar influzes. This was considered to be due in great part to the high heat loss of the building (discussed below). Further experimentation after the installation of the data collection system will test the usefulness of the large thermal mass when the building heat loss is controlled.

HEAT LOSS REDUCTION

The problem of maintaining adequate tank temperatures may be solved in an entirely different manner than through control of thermal coupling. Lower than predicted interior and tank temperatures have been recorded throughout the operation of the greenhouse (see Figures 8, 10). These have preliminarily been attributed to high infiltration rates.

Recorded data is somewhat contradictory. While lower-than-predicted outside temperatures have been consistently recorded, the differences between interior

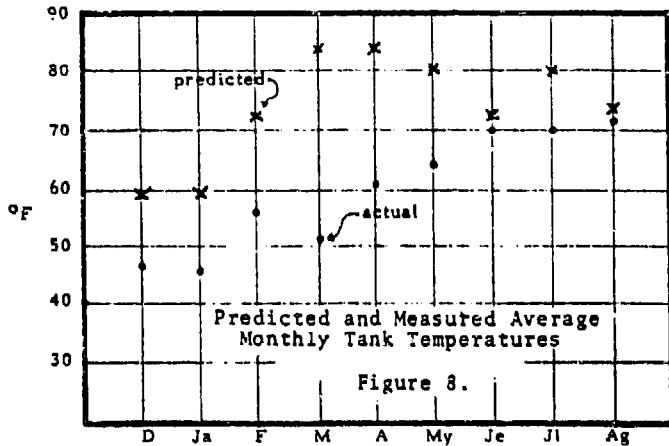

Figure 8.

and exterior temperature was about that predicted (11°F from January through August 1977). It was decided to record hourly temperatures (interior and exterior) and tank temperature over one night to determine the amount of heat given up by the storage to the interior and consequently the heat loss rate to the exterior (see Figure 9).

Data was collected with handheld thermometers, making accuracy somewhat less than satisfactory. It was determined from the data, however, that the building heat loss rate was twice that predicted. Consequently, the east and west doors were weatherstripped, all possible cracks siliconed, the south wall caulked and siliconed at the lap joint, and small holes patched. No hourly data has yet been taken to determine efficacy of these improvements.

The data collection system about to be installed is particularly suited to measure heat loss rates from the building and from storage to the interior. Numerous experiments will be carried out after its installation to determine the heat loss rates under various modes of operation.

VENTILATION

The parabolic aquaculture/greenhouse does not transmit all the incoming radiation into storage. More incoming radiation is directed to storage in winter than is directed to the plants. In summer this ratio is reversed, with more solar input going to the growing beds, less to storage. In addition, the reflector is not perfect (estimated reflectivity of 70%) and the pond covers are not totally transparent. This situation leads to unstored thermal energy overheating the greenhouse even in winter.

A solar chimney has been designed to deal with overheating. It rises 24 feet above the ground, about 12 feet above the top of the greenhouse. The pressure differential caused by the rising warm air in the chimney pulls air from the greenhouse. Solar energy penetrating the glazed south surface of the solar chimney adds heat to the rising air, causing it to rise even faster.

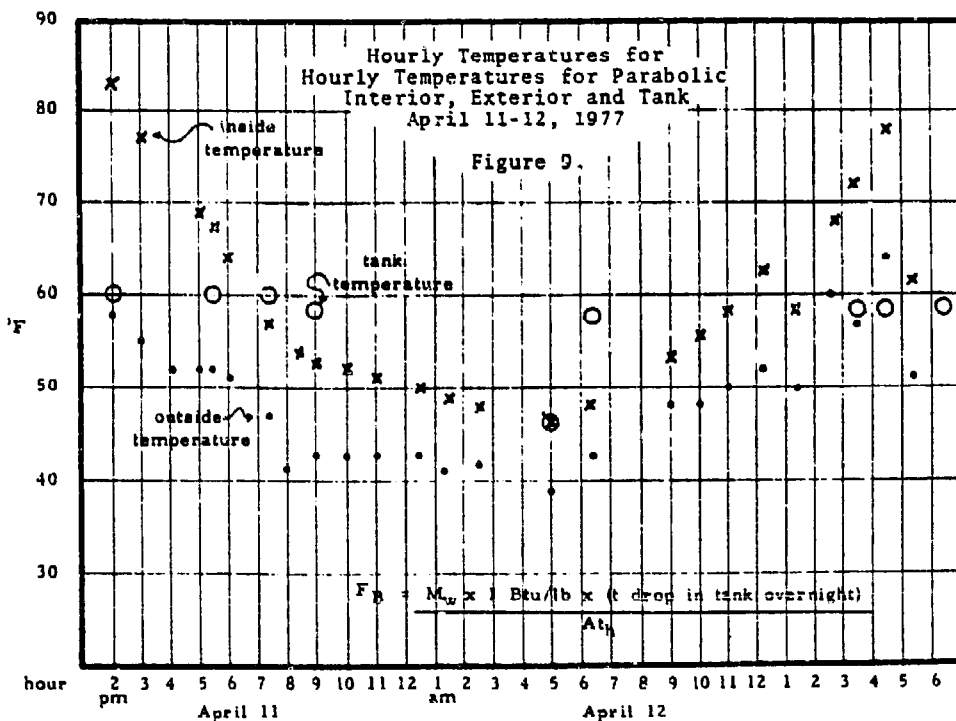
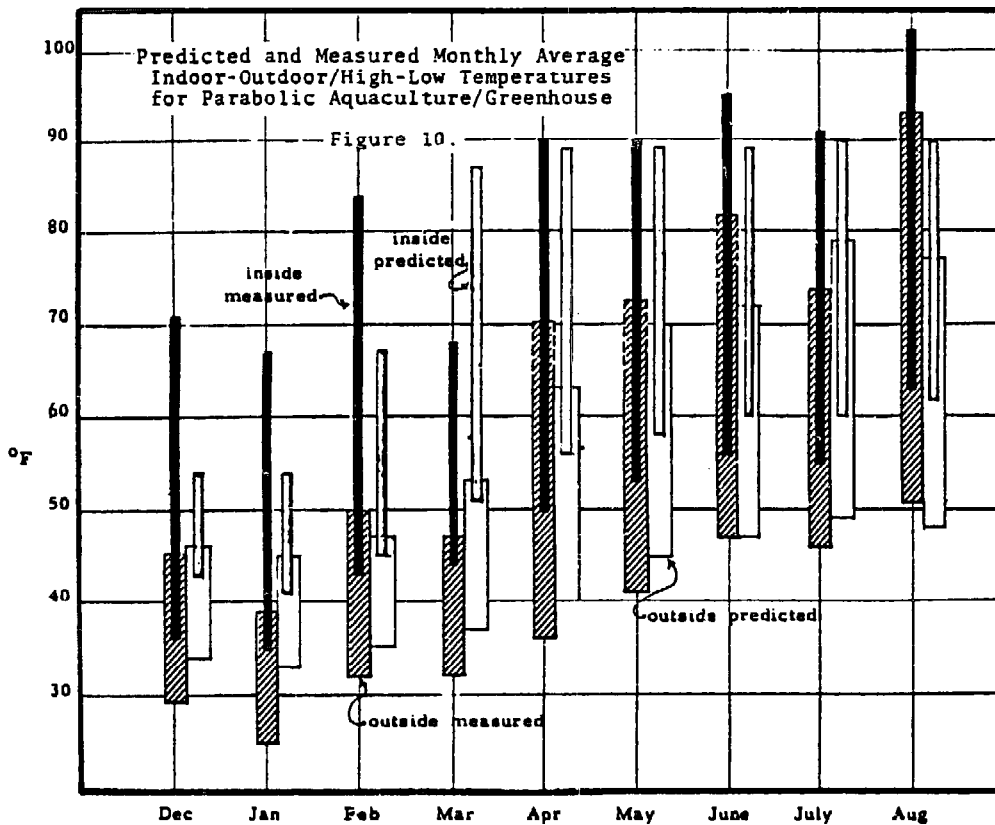

Figure 9.



At the bottom of the chimney is a 2'x2' styrofoam door opened by a heat motor. The heat motor consists of a tube of paraffin encasing a rod which is pushed out when heat in the greenhouse air expands the paraffin. The door closes with a spring.

The performance of this ventilation system is predicted by the equation:

$$Q = 8.4 \cdot A \sqrt{H \Delta t}$$

where:

Q = the quantity of air moved (cubic feet/minute)

A = the cross section of the stack

H = the height of the stack

Δt = the effective temperature difference between the ambient temperature and the temperature in the stack

For this design, we expect air movements up to 900 cfm on sunny days.

This heat loss to the solar chimney represents an inefficiency. Many experimental commercial solar greenhouses utilize a ridge fan to suck hot air from the ridge and place it into rock bin storage. A similar process is possible here: the air lift pump could draw warmed air down and bubble it through the tank, the air releasing its heat to the water. At night the pump could recirculate air from underneath the pond covers with some holes left for oxygen diffusion. Interruptions in use of the pump for tank aeration would disrupt this plan.

DATA COLLECTION SYSTEM

The long term efficacy of the design decisions will be tested and monitored by the data system. The principal research questions at this point are: the effect of the interior concentrator, the necessity and performance of the large thermal storage mass, the optimum thermal coupling between the tank and the greenhouse interior, the thermal performance of the building shell, and the effectiveness of the thermal stack.

To monitor the performance of the parabolic aquaculture/greenhouse, continuous measurements need to be collected over a period of time to establish the relationships between solar input and heat absorption in water and soils, as well as heat loss and thermal chimney ventilation rates. The accuracy and length of time needed for data collection indicate the need for a collection system that would have the following features:

1. Accuracy of at least $\pm 0.1^\circ\text{C}$.
2. Flexible data sampling rates for each sensor.
3. On-site direct readout of temperatures.
4. Recording of data (including channel numbers and time) and transmission of recorded data into local university computer for analysis and graphic output.
5. Back-up power supply to maintain data collection during power interruptions.

A market survey of available data collection systems indicated that most products were either too expensive (\$5,000-\$10,000 and up) or were too time-consuming (such as reading raw data from a multi-point strip chart recorder, also costing several thousand dollars). A micro-computer (\$2000-\$4000) could have been used to collect voltages given off by existing solar and temperature measuring devices. Considering the size and complexity (and low budget) of the task at hand, this was considered to be inappropriate.

The hardware selected for the job is a "bare bones" microprocessor system (Motorola MC 6800 D2 Evaluation Kit) containing a minimum amount of memory and interface hardware. One of the important features of this Evaluation Kit is its ability to record data on an inexpensive audio cassette tape recorder.

Several factors influencing the decision to develop a low cost, flexible programmable data collection system include the comparatively good support software and the Evaluation Kit cost: \$235. Also, expertise

ECOTOPE GROUP

is available to Ecotope Group for assembling the hardware and developing the programming software. Total cost for hardware for the system is about \$500.

System Operation

Voltages generated from either thermistors, solarimeters, or wind speed generators are directed by the microprocessor to pass through an Analog to Digital converter. The digital data is stored in a memory buffer. When the buffer is full, the tape recorder is activated and the data is transcribed to the tape (30 seconds recording time).

The microprocessor controls the flow of data and allows the user to select the sampling rate (i.e., from one sample per minute to one sample every four hours) for each channel. For information such as solar radiation, the processor will function as an integrator, summing up data sampled every minute and outputting an integrated value for a specified time period such as fifteen minutes. Temperature data will be changing more slowly. This can be integrated using longer sampling rates or recorded directly.

After several days of data are collected on a cassette tape, this will be transported to Seattle and fed into a University of Washington CDC computer. The format of the tape (Kansas City standard) is not compatible with the CDC input format. Therefore, another Evaluation Kit will be used to feed in valid data over the phone lines. This kit will also be able to further assemble the data for clear presentation of time and channel outputs, as well as carriage return and line feed.

The powerful CDC, with its full complement of support software and graphics hardware, will perform necessary computation and interactive development necessary for thorough data evaluation.

Solar radiation is measured with three Kipp & Zonen CM-5 solarimeters ($\pm 5\%$ accuracy), also known as pyranometers. Two solarimeters are mounted at 60° tilt (aperture angle) to the south. A shadow band

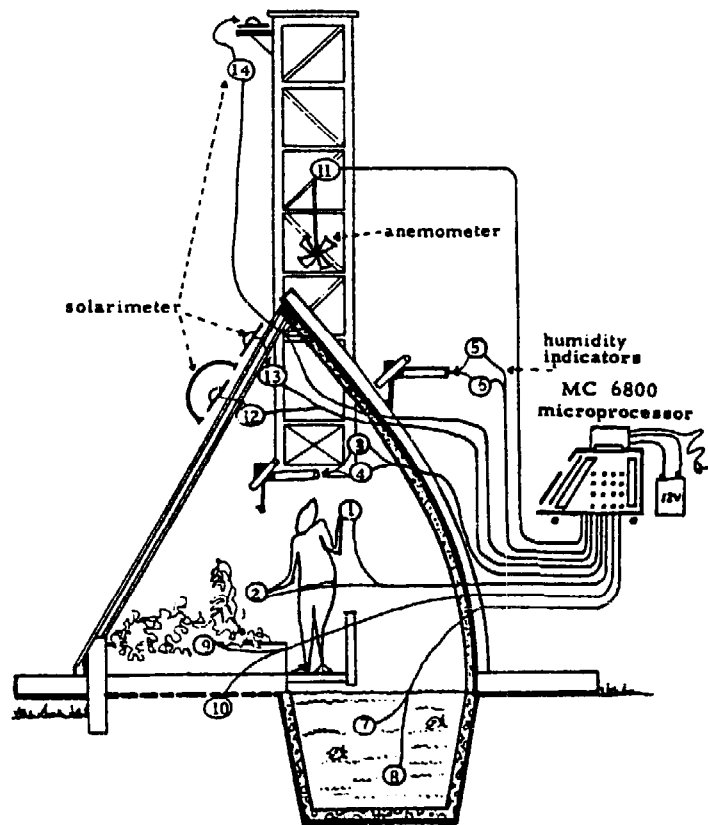

Placement of Sensors for Greenhouse Data Collection System

Figure 11.

DATA COLLECTION MICROPROCESSOR

SENSORS

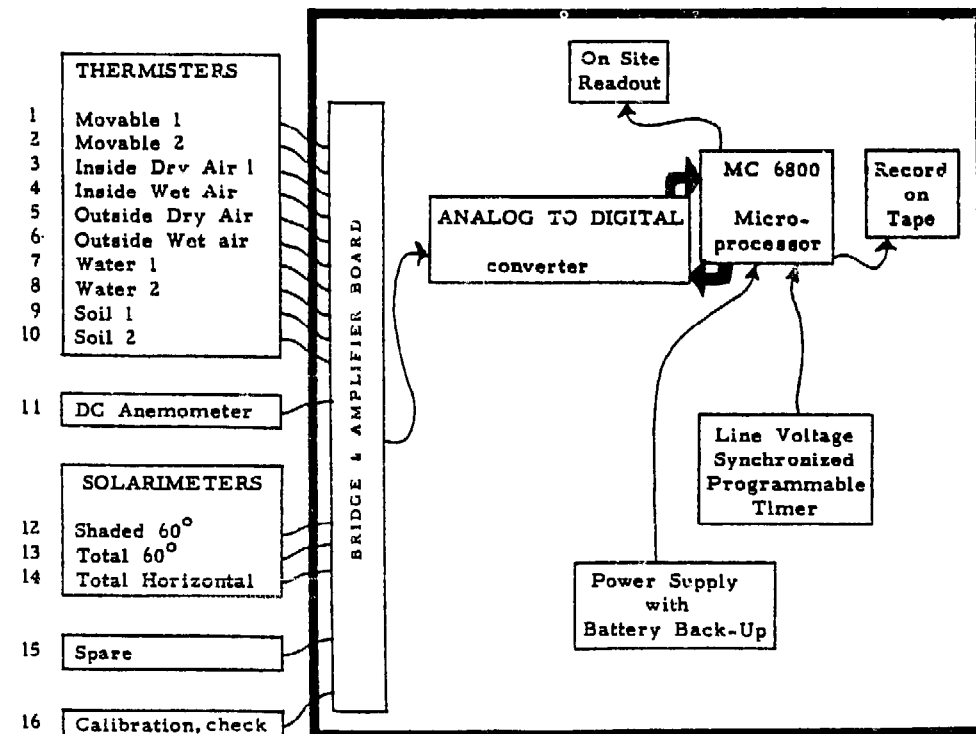

PARABOLIC AQUACULTURE/GREENHOUSE

DATA PROCESSING

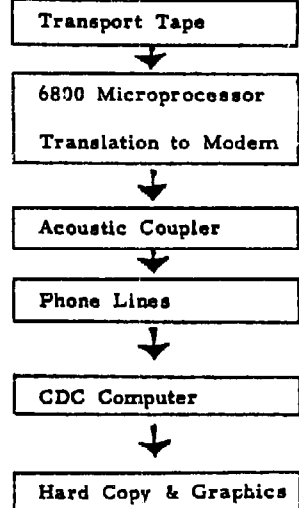

Data Collection System

Figure 12.

(adjusted weekly) on one allows only measurement of diffuse solar radiation. The other measures total radiation. The difference between the two (total minus diffuse) is the direct radiation incident upon the greenhouse. This is important because it is the direct beam component of solar radiation that is reflected by the parabolic mirror into the greenhouse's aquaculture tank.

The third solarimeter is oriented at the horizontal position for a comparison with world-wide standard solar radiation measurements. An analysis will be made of the relationships between horizontal and 60° direct and diffuse radiation measurements. Solarimeters will from time to time be placed inside the building to determine the amount of light at plant canopy, at focus, in the water (using a submersible pyranometer) and at other locations.

Temperature measurement is made with thermistors. Yellow Springs Instrument Thermalinear Thermistors are a two-thermistor composite that produces a linear output ($\pm 1^\circ\text{C}$) over a specified range. When connected in an appropriate Wheatstone bridge network with precision resistors, the millivolt output is the same as the temperature in $^\circ\text{C}$. This produces an on-site readout and direct recording of the temperature without having to use any processor time or memory to calculate the temperature.

A thermal stack will be used to ventilate in periods of overheating. The low air velocity traveling up the stack (estimated at only 20 cm/second) will be measured with a propeller anemometer made from lightweight polystyrene. Rotation of the propeller will induce a voltage in a tiny DC generator which can be sensed when sampled by the processor.

110 volt power will be transformed to the ± 5 volt needed for the processor. The standard 60 cycles per second line frequency will be used to synchronize a programmable timing clock that will output the day, the hour and minute. Back-up timing, in case of power failure, will be provided by a crystal oscillator. Small power "glitches" are absorbed in a large capacitor. Temporary brownouts or blackouts will cause power to flow from the 12 volt lead-acid battery back-up.

CONCLUSION

To date the parabolic has operated well in spite of its incomplete construction. Two crops have been grown as of August 1977 with good yields and fast growth recorded. Much more refined data collection and experimentation is expected to begin in the last quarter of 1977. It is expected that the contribution of all the features of this unique greenhouse will be evaluated and that the design data will be confirmed or corrected, thereby pointing to possible future direction in design strategy and analysis.

REFERENCES

- Baker, M. Steven and John S. Reynolds, 1975, "Insolation on south facing tilted surfaces: Pacific Northwest locations." A publication of the Center for Environmental Research, School of Architecture and Allied Arts, University of Oregon.
- Balcomb, Hedstrom, 1975, Simulation Analysis of Passive Heated Buildings: Preliminary Results, ERDA Contract W-7405-Eng-36, Los Alamos Laboratory, University of California, Los Alamos, New Mexico.
- Balcomb, Hedstrom, McFarland, 1976, "Simulation as a design tool," Passive Solar Heating and Cooling, Los Alamos Scientific Laboratories, University of California, Los Alamos, NM.
- Balcomb, J.D. and D.D. McFarland, 1977, "Simulation analysis of passive solar heated buildings -- The influence of climate and geometry on performance," Proceedings of the 1977 Annual Meeting of the American Section of ISES, June 1977, pp. 11-1/4.
- Balcomb, McFarland and Moore, 1977, "Simulation analysis of passive solar heated buildings -- Comparison with test room results," Proceedings of the 1977 Annual Meeting of the American Section of ISES, June 1977, pp. 11-5/9.
- Reichmuth, Howard, 1976, "Description and analysis of a novel passive solar heated aquaculture/greenhouse complex near Seattle, WA," Sharing the Sun: Solar Technology in the Seventies, Volume 10, American Section of ISES, Cape Canaveral, FL.
- Reichmuth, H. and Jeffrey Barnes, 1977, "Passive solar heating systems of the interior concentrator type," Proceedings of the 1977 Annual Meeting of the American Section of ISES, June 1977, pp. 11-26/30.

THE EFFECT OF SOLAR ENERGY ON AQUACULTURE SUPPORT: A PRELIMINARY ASSESSMENT

by
Elizabeth Coppinger
ECOTOPE GROUP
Seattle, Washington

ABSTRACT. The potential of solar energy to meet the aeration and waste treatment requirements of aquaculture systems is examined. The two greenhouse configurations and their filtering systems at Pragtree Farm are described and related to their impact on water quality. Simple tests to determine aeration and waste treatment needs are described.

Current research work with the aquaculture/greenhouse systems at Pragtree Farm is being conducted under a Cooperative Agreement between Ecotope Group and the United States Department of Agriculture, Agriculture Research Service "Solar Heating and Cooling of Greenhouses and Rural Residences" program.

INTRODUCTION

Water, which has one of the highest heat capacities of any liquid, is an ideal storage medium for solar energy. A large quantity of water directly coupled to the sun also provides an excellent medium for fish production. Integrating aquaculture with a solar greenhouse allows the space devoted to storage to also be used for food production.

Ecotope Group and Bear Creek Thunder have constructed two solar heated aquaculture/greenhouses at Pragtree Farm near Seattle, WA. Both structures use water as a heat storage medium, passively heated by a direct light couple.

One structure is a small rhombicube octahedron constructed of poles and plastic. This dome-like structure has a circular 2500 gallon tank in the center which is used for experimental aquaculture.

The second structure is a solar greenhouse with a parabolic mirror on the north wall which focuses low angle winter sun into a 4800 gallon aquaculture tank. This well-constructed and well-insulated structure provides a year-round growing environment for both fish and plants.

NATURAL VS. HIGH DENSITY AQUACULTURE

Most current aquaculture research has focused on issues associated with high density fish cultures. These systems which attempt to maximize fish production intensify certain problems associated with fish culture. Two of these, gas exchange and waste treatment, can significantly impact the energy use of the systems.

The normal gas exchange rate between still water and the atmosphere is not sufficient to remove carbon dioxide (CO₂) and replenish oxygen (O₂) to the water. As a result, if some aeration system is not available, fish can die from either too little O₂ or from a build-up of CO₂. Excess feed and fish wastes pollute the medium in which the fish feed and respire; therefore, the water must be continuously flushed or recirculated through a waste treatment system. These support systems, necessary for high density fish culture, can represent a significant energy input.

Obviously waste treatment and gas exchange do occur naturally; however, these processes cannot serve an unlimited number of fish. Once the capacity of the natural processes is reached, additional energy inputs are needed. Each increment of fish added requires an additional increment of energy.

The basic premise of a passively heated solar greenhouse is to free food production from electricity and fossil fuel energy dependence. It is far more in keeping with the nature of solar greenhouses to design an aquaculture system which can have as many of its needs as possible met by solar energy.

Aeration and waste treatment will most likely be needed at times in any aquaculture system. However, intelligent judgments can be made as to when and how often they are needed. A tank of warm water which has direct solar input provides a reaction vessel in which the treatment of waste products can occur simultaneously with and complementarily to the production of these wastes. An aquaculture system need not be tied to out-

side energy sources to be productive.

In a natural system, when organic wastes enter a stream there is a proliferation of heterotrophic bacteria which will convert wastes to CO_2 , ammonia (NH_3) and to nitrates if sufficient O_2 is available. Much of the CO_2 and NH_3 produced by the bacteria are lost to the atmosphere. Soluble nutrients, such as nitrates, will cause a bloom of microalgae and higher plants somewhere downstream, provided there is sufficient light and warmth.

In the process of photosynthesis, algae use CO_2 and produce O_2 , measured in a system as dissolved oxygen (DO). The O_2 produced by algae will most likely also be lost to the atmosphere like the bacterial CO_2 . The algae can then provide food for herbivorous fish and zooplankton. The waste products from the fish will begin the cycle again. By allowing all of these processes to occur simultaneously, the waste products from one process can be used as nutrients for another.

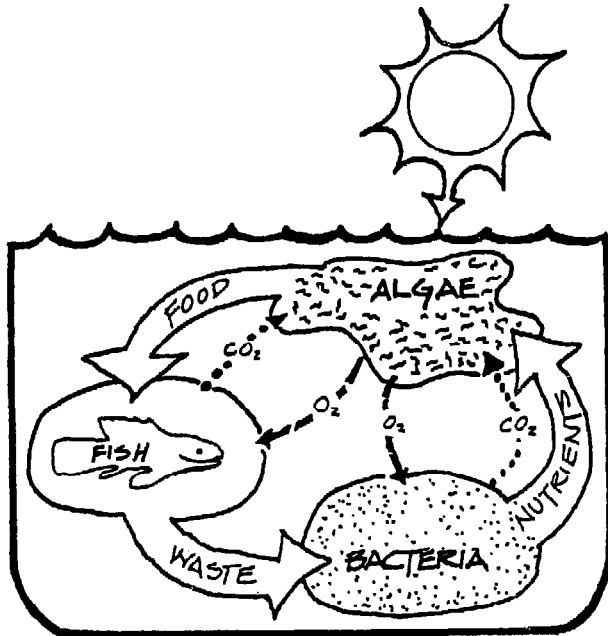

Figure 1.

Since solar energy is the driving force behind photosynthesis, the amount of oxygen produced is directly related to the amount of solar input. The capacity of any greenhouse/aquaculture system will be dependent upon solar input to the tank.

EXPERIMENTAL AQUACULTURE

The greenhouses at Pragtree Farm differ significantly in their tank configuration. The solar gain for the rhombicube approximates the average monthly insolation for a horizontal surface at 47.5° N latitude (Baker, 1975) multiplied by the surface area of the

tank and by a factor to account for the transmission of the polyethylene.

The solar gain of the parabola, on the other hand, varies both according to the insolation and the reflection effects. The concentration by the reflector increases the solar gain in the spring, fall and winter. In the summer, however, when the reflector does not contribute, the solid north wall partially shades the tank and a walkway and railing obstruct the light path. Figure 2.

A variety of tests were performed on the water in the rhombicube and parabolic throughout the summer. A LaMotte water quality test kit was used for weekly measurements of pH, dissolved oxygen (DO), CO_2 , NH_3 , nitrate, phosphates, calcium and magnesium ions, and alkalinity.

The results of the testing showed high DO and an absence of NH_3 throughout the summer. Therefore, no supplemental aeration or filtration was used.

Since dissolved oxygen is an essential consideration in fish culture, as well as a solar sensitive variable, we hope to include a DO sensor in our data collection system. Using this parameter as a biological indicator, more accurate relations between solar input and its impact on water quality can be derived. Although our water quality data consists of instantaneous readings taken once a week, inferences about the correlation between DO and solar can be drawn.

Our measurements began in late March 1977, by which time the solar gain of the rhombicube was already ahead of the parabolic. The DO levels in the rhombicube rose faster and stayed consistently higher throughout the summer. The difference in the tanks' DO levels in late July and early August was dramatic, with the rhombicube at time showing DO levels of greater than 20 ppm. The highest level recorded for the parabolic was 12 ppm.

By the middle of August, the DO levels in the rhombicube began a sharp drop. The levels of the parabolic also began to decrease, but much more gradually. Measurement from August 21 and 28 showed DO levels in the parabolic higher than those in the rhombicube for the first time. From that time on, DO levels in the two greenhouses stayed approximately the same. This corresponds quite well to the predicted intersection between the decrease in solar gain to the rhombicube and the increase in solar gain to the parabolic due to seasonal interior light reflection.

The rhombicube is most suited to a high density, fast-growing fish population. It can support more fish per cubic feet in the sum-

ECOTOPE GROUP

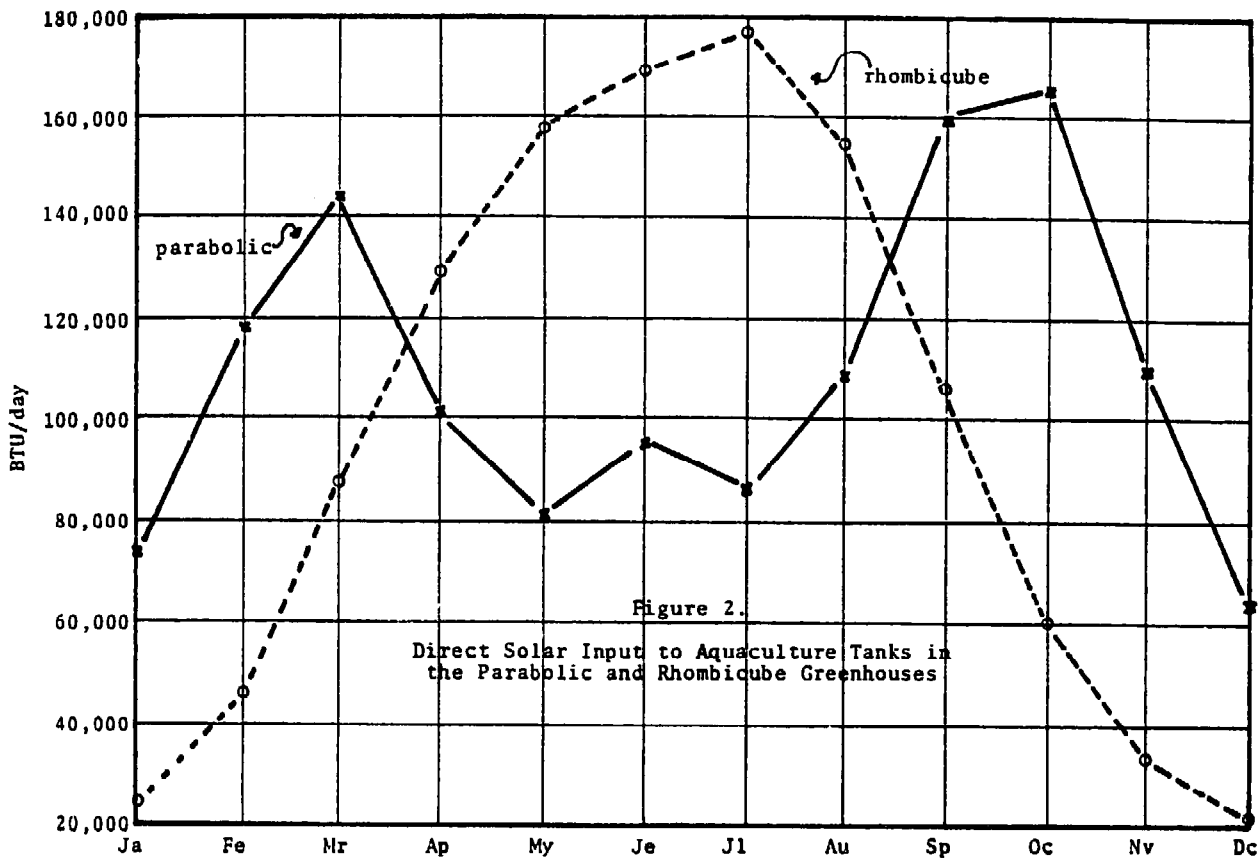

Figure 2.
Direct Solar Input to Aquaculture Tanks in the Parabolic and Rhombicube Greenhouses

mer than can the parabolic, but its fish-growing season is very limited. The parabolic was designed to support fish growth throughout the year. Predicted solar gain for the parabolic should maintain a respectable level of algae photosynthesis through 10 months of the year.

During the fall, winter and spring in the Pacific Northwest, a stretch of overcast days is not uncommon. Consequently, there will be times when supplemental aeration and waste treatment methods are needed. Providing intermittent aeration is a simple matter, provided that the aeration method is separated from the filtration system. Pumping air through air stones, or pumping up water and letting it cascade back to the tank will provide needed aeration with a minimum of problems.

Intermittent filtration, however, does present certain problems. A filter bed must remain "conditioned," even when not in use, so that it will be able to provide filtration when needed. A conditioned filter bed has an active population of the bacteria necessary to ensure that the conversion of wastes to NH_3 and nitrates occur simultaneously. If not, a build-up of ammonia occurs which inhibits the nitrification process and is toxic to fish.

AQUACULTURE SUPPORT

At Pragtree Farm we have two different types of filtration systems in our greenhouses. The first one built was a two-stage biological filter external to the tank. Water with dissolved wastes is pumped from the tank through a 10" layer of gravel and oyster shells where the wastes are oxidized. The water then flows to the second stage, where small aquatic plants are grown. After passing through the two stages, the water is aerated as it flows down a trickle collector and splashes into the tank.

This filter system has proven to be very adaptable to intermittent use. Since the filter is external to the tank, it deals only with dissolved wastes and whatever solids remain in suspension. Therefore, the waste handled is proportional to the amount of water which flows through the filter. When the pump is not circulating water through the filter, there is no waste accumulated on the filter. The tank is shallow enough to allow the filter bed to remain predominant aerobic even when not in use. " This is evidenced by the lack of H_2S odor when the pump is again started.

During those times when the solar input is sufficient to provide the high levels of O_2 necessary for nitrification of suspended wastes, the filter is able to remain aerobic.

Solid wastes which sink to the bottom of the aquaculture tank may become anaerobic, but this will not be a problem unless the bottom is stirred up. In the case of an external filter, that situation would exist whether or not the filter was running.

The filter system in the parabolic greenhouse differs significantly from that in the rhombicube. The entire bottom area of the tank contains a layer of gravel and oyster-shells on a perforated fiberglass floor. Lift tubes extend from the space beneath the fiberglass floor to a point above the water's surface. Air is pumped down each of these tubes and released through air stones. The aerated water rises to the top of the lift tubes and splashes back down to the surface of the water. Water is thus circulated through the gravel bed, where the necessary purification processes are then conducted by the filter bacteria.

The advantage of this type of filter over that in the rhombicube is that its large filter area in intimate contact with the water allows for a more rapid and uniform breakdown of nitrogenous wastes. Its disadvan-

tage, in terms of our interest in intermittent use, is that it continues to accumulate wastes via sedimentation, even when the filter is not in operation. If an excess of nitrogenous wastes are accumulated without sufficient oxygen, ammonia cannot be converted to nitrites and nitrates. This results in a build-up of toxic NH_3 which may inhibit nitrification bacteria.

Even when sufficient oxygen is available, effective oxidation of nitrates cannot occur in the filter bed. As the waste build-up continues, the filter bed can eventually become anaerobic. An anaerobic bottom is not an uncommon occurrence in pond cultures. It becomes a problem when the bottom is disturbed and the toxic metabolites are released into the water. Unfortunately, when the pump is turned on in this filter configuration, the toxic gases are sucked out of the filter bed and released throughout the system.

SYSTEM OPERATION

The operator of an aquaculture system must develop a familiarity with the system

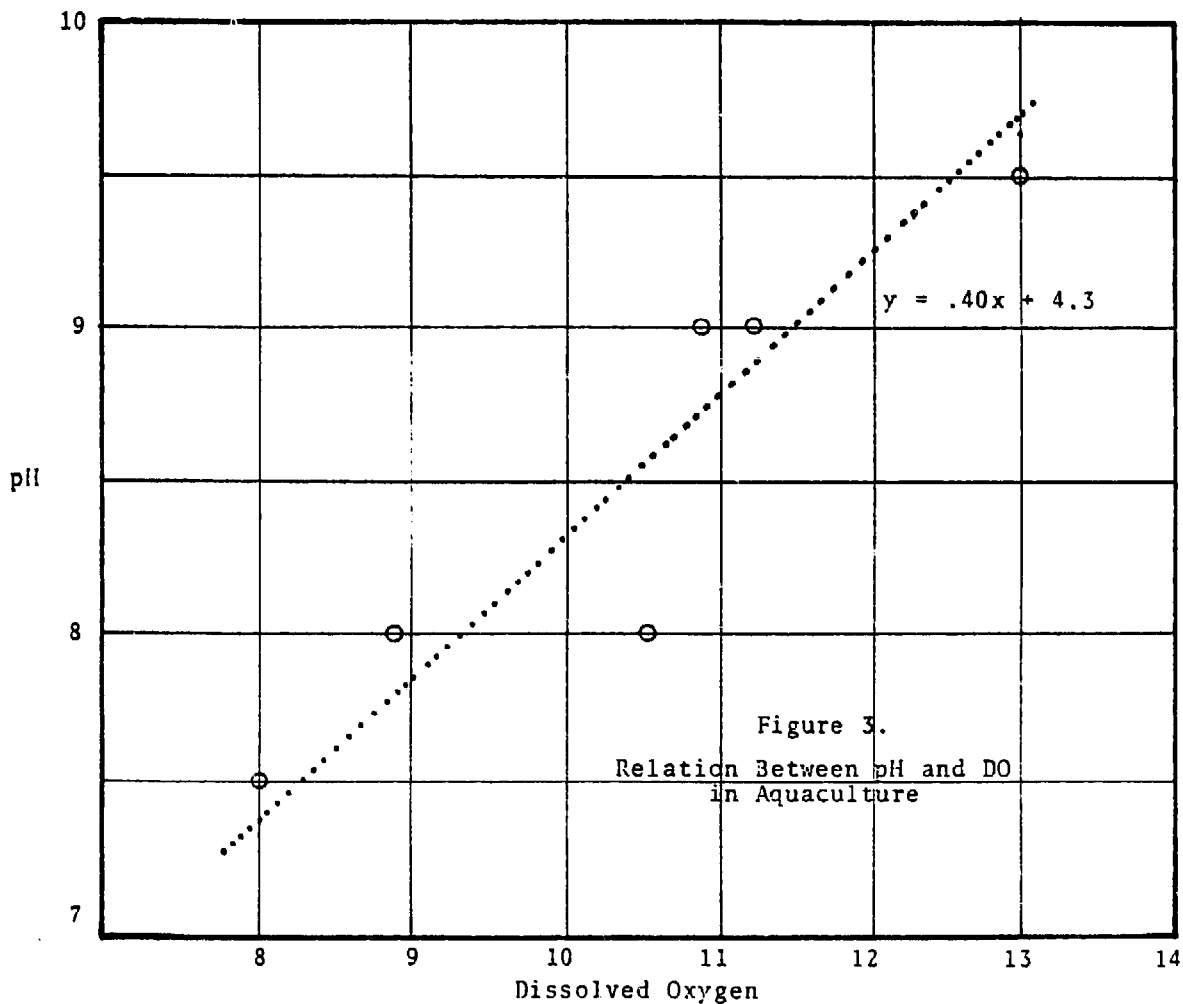

to determine when aeration is needed. Obviously, a full range of water quality tests could be run daily to monitor the health of the system. However, by becoming sensitive to certain changes in the tank, an operator can make intelligent choices about actions needed with nothing more than pH paper, a secchi disc, and an eye toward the sun.

The pH of water gives some very useful information. If there is a strong algae bloom, the algae may extract all of the dissolved CO₂ from the water. CO₂ is then extracted from bicarbonate ions in the water to leave hydroxide ions. $\text{HCO}_3^- \rightarrow \text{CO}_2 + \text{OH}^-$. This production of hydroxide ions will raise the pH of the water to above normal.

In early summer, as the pH of the water was on the rise, the following relationship between pH and O₂ was recorded at Pragtree Farm (see Figure 3).

However, there is not a direct relationship between pH and O₂ concentration at all times. For instance, we found the pH of the system began to fall due to a decrease in solar input, the O₂ level did not fall off at a rate consistent with the decrease in pH. Likewise, at a pH of 7, O₂ concentration ranged between 1 and 8 parts per million.

On the average, a pH of above 8 indicates a sufficient O₂ level. Once the pH reaches 7, aeration may be necessary. If the pH drops below 7, this indicates a build-up of CO₂ which reacts with water to form carbonic acid. $\text{CO}_2 + \text{H}_2\text{O} \rightarrow \text{H}_2\text{CO}_3 \rightarrow \text{H}^+ + \text{HCO}_3^-$. Aeration should definitely be used in such cases.

A secchi disc is a wood or metal disc 8" in diameter painted with alternating quarters of black and white. It is attached to a cord which is marked in inches or centimeters. The disc is lowered into the pond until the black and white quarters become indistinguishable.

These measurements indicate the density of algae present. If a decrease in the amount of algae is noted without any noticeable decrease in solar input or temperature, additional fertilizer may be necessary. During periods of heavy sunlight, the algae growth can become nutrient-limited. Because of this, we fertilized our water with manure a number of times during the summer to keep the phosphate level up.

The most important parameter to watch is the solar input. A few days of cloudy weather will certainly decrease the amount of oxygen being produced. However, during that time, CO₂ will be building up so that algae will be able to resume a high rate

AQUACULTURE SUPPORT

of O₂ production on the next sunny day. During the fall and winter, a decrease in pond temperature will likewise decrease the photosynthetic activity. At lower pond temperatures, O₂ deficiency will occur even more rapidly during cloudy weather.

CONCLUSION

In nature, solar energy meets the aeration and waste treatment needs of all fish growth. In tank culture, many of these needs can also be met for low and moderate fish densities -- provided that there is sufficient solar input.

A greenhouses' aquaculture system can be designed around the amount of solar gain received by the tank and the resultant O₂ produced. By allowing the capacity of the natural system to determine the amount of fish to be raised, supplemental aeration and waste treatment will be needed only occasionally -- if at all.

An aquaculture system's supplemental aeration and waste treatment must be adaptable to intermittent use. The system's operator can easily learn to recognize when the supplemental system is needed. Through Ecotope Group's ongoing research at Pragtree Farm, it is hoped that the relationship between solar input and water quality can be clearly determined in a closed aquaculture system. Research should also lead to description and analysis of the relationship between solar input, stocking densities and fish growth.

REFERENCES

- Baker, M. Steven and John S. Reynolds, 1975, "Insolation on South Facing Tilted Surface: Pacific Northwest Locations." Center for Environmental Research, University of Oregon, Eugene.
- Deryckx, Woody and Becky Deryckx, 1976, Two Solar Aquaculture-Greenhouse Systems for Western Washington: A Preliminary Report. A Tilth Publication, Arlington, WA.
- Huet, M., 1970, Textbook of Fish Culture: Breeding and Cultivation of Fish. Fishing News Books, Ltd., Surrey, England.
- McLearney, W.O. and John Todd, 1974, "Walden II: A Complete Guide to Backyard Fish Farming." The Journal of the New Alchemists II. Woods Hole, MA.
- Oswald, W.J., 1973, "Productivity of Algae in Sewage Disposal." Solar Energy 15: 107-117.
- Oswald, W.J., 1973, Fish and Invertebrate Culture: Waste Management in Closed Systems. John Wiley and Sons, Somerset, NJ.
- Stumm, W. and J.J.Morgan, 1970, Aquatic Chemistry. John Wiley and Sons, Somerset, NJ.
- Zweig, Ronald D., New Alchemy Institute, Personal Communication, July 1977.

Evaluation of a Solar Heated Greenhouse
for the Environmental Farm Project
Canyon Park Junior High
Bothell, Washington

ECOTOPE GROUP
Seattle, Washington

The greenhouse at Canyon Park Junior High School is one of several experiments conducted by Ecotope Group to verify the concept of solar heated greenhouses for the Puget Sound region of Western Washington. The Canyon Park greenhouse is a component of the "Energy, Food & You" program and is jointly funded by a grant from Environmental Education and the Washington State Office of Public Instruction. Greenhouse materials were purchased with money collected from classes offered by the program for teachers.

The Canyon Park greenhouse will demonstrate that a greenhouse can operate without auxiliary energy inputs and will show the feasibility of local, year-round vegetable production with fossil fuel conservation resulting from the decreased transportation of food. Vegetables and flower seedlings produced in the greenhouse will be distributed to schools with teachers participating in the program for use in each school's organic garden.

Solar Greenhouses vs. Conventional Greenhouses

Solar greenhouses were distinguished from conventional greenhouses by T.A. Lawand (1974). He documented the improved performance of greenhouses given a well-insulated north wall covered with a reflective surface. This configuration cut heat loss and still maintained adequate light at the plant canopy.

A further distinction drawn by Lawand was the orientation of a greenhouse. Conventional greenhouses have been oriented on a north-south axis with the majority of the glazing facing east-west. Optimizing solar exposure requires the greenhouse to be oriented on an east-west axis with the majority of the glazing facing due south for optimum solar exposure.

A final distinguishing characteristic of solar greenhouses is the use of interior mass to store solar heat and modulate the interior greenhouse temperatures. The impact of this technique has been documented by several researchers, including Reichmuth (1976, 1977), Mazria and Baker (1977), and Wilson and Price (1977).

Thermal mass performs a two-fold function for the greenhouse. First, it acts as a storage medium to provide heat when the primary heat source -- sunlight -- is not available.

SOLAR GREENHOUSE BOTHELL

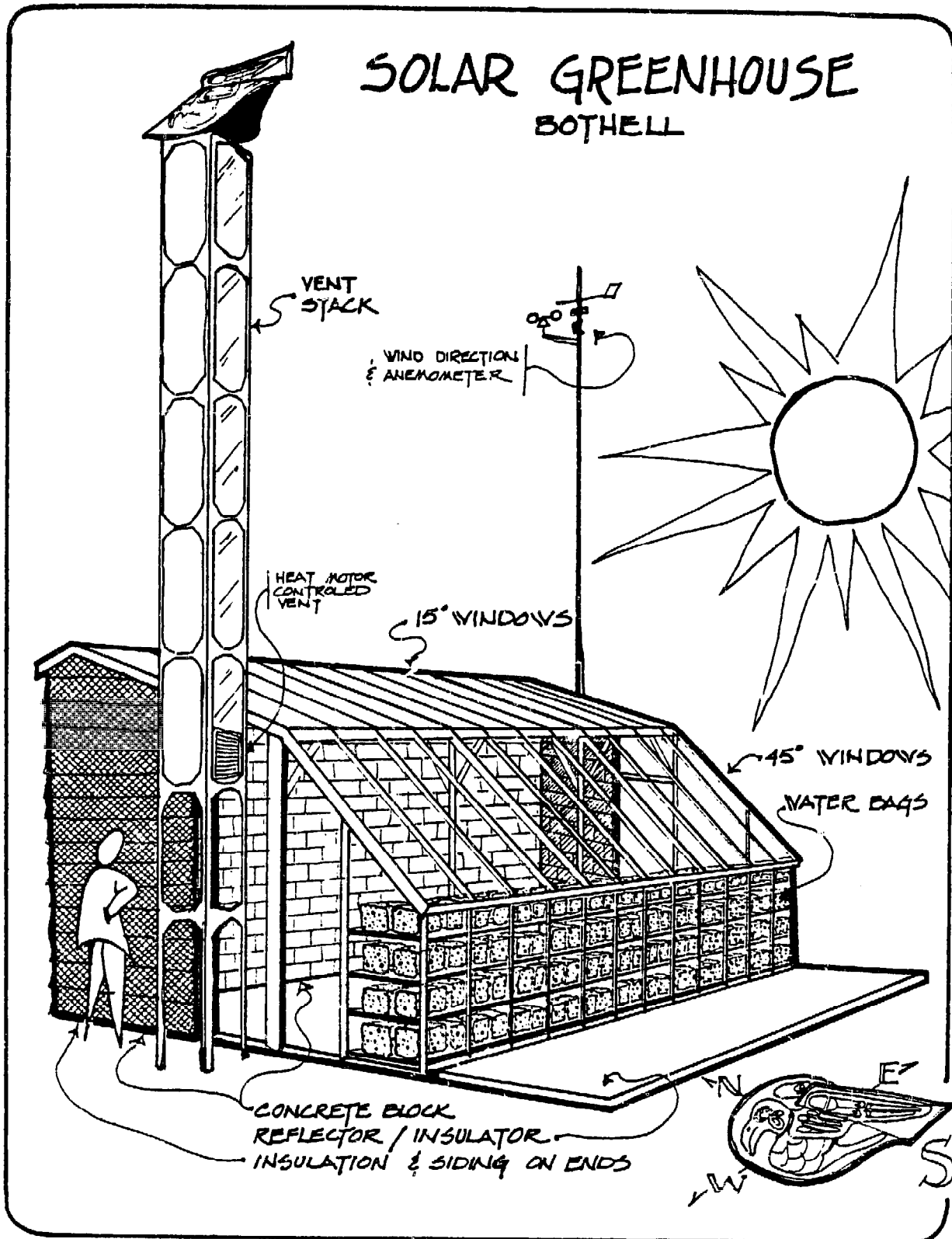

Thermal mass is most effective when it receives direct illumination from solar radiation. Direct coupling of light to the thermal mass allows for maximum collection and absorption of solar energy. Solar heat can also be absorbed indirectly through convection from trapped hot air within the greenhouse by forcing the hot air over the thermal mass.

The thermal mass also acts as a moderator of air temperature by storing the excess heat during sunny days when overheating would otherwise require ventilation. Mazria and Baker (1977) have clearly described the function of thermal mass for moderation of interior temperature in direct gain collection of solar radiation.

Conceptual Design

The energy/heat requirements of a greenhouse are determined by the interaction of desired design temperatures, local weather conditions, solar input, the contribution of heat from the earth, the rate at which the building materials lose heat, and the ability of the greenhouse to store heat.

Although there is some question concerning the effectiveness of solar heated greenhouses in the cloudy coastal zone of the Pacific Northwest, the concept has been verified for Western Oregon by students from the Department of Architecture, University of Oregon. The Noti Greenhouse maintained interior temperatures above 45°F while outside temperatures dipped into the low 20's. This was accomplished without auxiliary heating (Hoff et al, 1977).

The Canyon Park greenhouse was conceived as a passive solar heated greenhouse. The term "passive" describes solar heating systems which rely, for the most part, on natural forces in the building. This generally means that the building envelope is used as the collector rather than externally attached solar collection devices. "Active" systems use external devices such as flat plate or concentrating solar collectors. These require distribution systems with elaborate controls for collection and utilization of solar heat in the space.

The Canyon Park greenhouse is designed to incorporate the important features of a passive solar heated greenhouse. These features include the following elements:

1. STORAGE. This greenhouse has three distinct and independent storage systems:

a. The first is an opaque north wall built of concrete blocks forming the 26-foot long by 12'-6" high north wall, and the 4-foot long by 11"-6" high portions of the east and west walls. The 16" x 12" x 8" concrete blocks are filled with pea gravel and concrete to provide a total storage of 9502 Btu/°F in 408 cubic feet of concrete block and gravel. These walls are also insulated to R-20 to reduce heat losses.

b. The second storage system is a translucent "water wall." One thousand gallons of water is stored in 200 clear polyethylene cubes measuring eleven inches on each side. These are stacked two deep on four metal shelves directly behind the four-foot tall southern glass wall. The polyethylene cubes

serve a dual purpose -- allowing light to enter the greenhouse and offering a medium for heat storage. Total water wall storage is 8803 Btu/°F. It is assumed that the water will collect 30% of the light passing through it as heat. The water wall receives additional sunlight from a reflective shutter which is opened to a horizontal position during sunlight and closed as an insulating wall if direct gain is not possible (at night or on cloudy days). Lowndes & McDaniels (1975) indicate a 25% enhancement in incident solar radiation in the winter using horizontal reflectors.

c. The third storage medium is the earth itself. The floor is subterranean, recessed 18" below grade for storage of heat and for heat contribution from constant earth heat. Most of the heat storage during the winter will be a result of direct solar gain from the water storage wall and the block wall. It is assumed that the earth will provide stored heat to the greenhouse when interior temperatures dip below 50°F. (The constant temperature of the earth is considered to be 50°F at a depth of 18". Further research will be done to verify the ground heat contribution.) The total heat capacity for this depth is 29,160 Btu/°F using a floor area of 300 ft² and a density of 108 lb/ft³ (42% moisture) with a heat capacity of 0.45 Btu/lb. See Table 1.

2. GLAZING. The east-west orientation of the Canyon Park greenhouse gives the glazed surface maximum exposure to direct solar gain. The glazed area includes a three-faceted wall facing south and east/west end walls (see illustration). All surfaces, except the south vertical wall, are double glazed. The exterior layer of glazing is glass recycled from a salvaged greenhouse, and the interior layer is 4 mil clear vinyl. The glazing is supported by recycled 1" x 2" cedar mullions.

The facets of the south-facing glazed area are arranged in the following way:

a. A 100 ft² vertical glass wall is located in front of the metal racks which hold the plastic water containers. A movable, exterior shutter, the same size as the vertical wall, is hinged to the wall at the bottom. The shutter is constructed with two lengthwise sections of 2' x 2' frame holding 1½" Styrofoam SM (trademark) rigid board insulation. The inside of the shutter is painted with glossy white latex paint for reflection.

b. A 45° double glazed surface extends from the vertical wall to a 2" x 8" structural beam. This surface is 150 ft². It exposes the block wall and greenhouse floor area to a maximum year-round southern direct gain while providing structural integration between the vertical and overhead horizontal glazing.

Table 1.
 Temperature Performance of Canyon Park Greenhouse Elements
 at 20°F Exterior Temperature

HOUR	t_i interior	t (wall)	$t_{n=6}$ wall temperature	$t_{n=9}$	$t_{n=12}$	t_s (water)	t_{gnd} (ground)
0	44.22	50	50	50	50	50	50
1	43.55	48.68	50	50	50	50	49.62
2	43.18	48.26	49.25	50	50	49.23	48.66
3	42.80	47.66	49.11	50	50	48.84	48.22
4	42.52	47.38	48.54	49.55	49.75	48.45	47.84
5	42.21	46.93	48.45	49.09	49.64	48.07	47.51
6	41.97	46.72	47.95	49.04	49.33	47.69	47.21
7	41.69	46.34	47.87	48.58	49.16	47.32	46.94
8	41.47	46.15	47.40	48.51	48.83	46.95	46.68

HOUR	ground temperature							
	$t_{n=6}$	$t_{n=9}$	$t_{n=12}$	$t_{n=15}$	$t_{n=18}$	$t_{n=21}$	$t_{n=24}$	
0	50	50	50	50	50	50	50	
1	50	50	50	50	50	50	50	
2	49.79	50	50	50	50	50	50	
3	49.54	49.94	50	50	50	50	50	
4	49.29	49.85	49.98	50	50	50	50	
5	49.05	49.73	49.95	49.99	50	50	50	
6	48.82	49.61	49.90	49.98	50	50	50	
7	48.60	49.97	49.84	49.96	49.99	50	50	
8	48.39	49.33	49.77	49.94	49.98	50	50	

c. The overhead glazing is 200 ft² on a 19° slope and is double glazed. It extends from the 2" x 8" beam to the top of the north wall.

d. The end walls are double glazed and each is approximately 50 ft². These surfaces join the end block walls with the vertical glass wall. The east has a door and the west end supports a thermal ventilation structure.

The 19° sloped glazing was placed over the greatest portion of the plant growing area to allow maximum use of diffuse light. Because of the large percentage of diffuse light in the Pacific Northwest, it is felt that the additional glazing will be beneficial for plant growth. The tradeoff, of course, is the net benefit of diffuse light for plant growth vs. increased loss of heat from the glazed surface. Preliminary thermal analysis indicates, however, that the addition of thermal mass coupled to direct sunlight could offset the losses.

3. VENTILATION. Greenhouse ventilation is typically controlled by one of two methods -- manual-opening windows or mechanical ventilation by electric fans. The Canyon Park greenhouse uses a chimney, applying the stack effect through natural convection. In addition to the stack effect, there is a solar boost created by the chimney's south face which is glazed, causing it to act as a solar collector to increase the temperature in the insulated stack. This increases the ventilation in phase with solar heat gain. The chimney ventilator avoids the construction problems and expense of large area vents which usually extend the total length of a greenhouse at the peak and ground level.

The cross section of the chimney is 2.2 ft². The chimney rises approximately 25 feet above the ground and 14 feet above the greenhouse vent opening. It is made with a 2" x 2" square frame stabilized with plywood gussets. Board insulation (1½" Styrofoam) is nailed and glued onto three sides of the frame. The fourth side is covered with a layer of 4 mil Tedlar clear glazing. To absorb solar radiation, the inside is painted with black flat latex paint. The air flow in the ventilation stack increases when the temperature rises from increased insulation. Expected performance of the stack is given in Table 1.

Ventilation will be controlled by either manual operation of the opening or by a passive phase change motor. The phase change motor resembles a hydraulic door closing machine. A tube containing paraffin changes from solid to liquid when heated. The expansion causes the vent to open by pushing a piston which is attached to a rod on the door of the vent.

The formula which describes the stack effect through natural convection is given below:

$$Q = 8.4 A \sqrt{h(t_i - t_o)}$$

where:

Q = air flow in ft³/minute
 A = area of vents
 h = total height of venting system
 t_i = inside temperature
 t_o = outside temperature

Table 2.

Expected Performance of Solar Chimney

(t _i - t _o)	ft ³ /min	estimated equivalent electric fan
1	92.4	1/100 hp
4	184.8	1/70
9	277.2	1/70
16	269.6	1/70
25	462.9	1/70
36	554.4	1/70
49	646.8	1/70
64	739.2	1/40
81	831.6	1/30
100	924.0	1/20

Greenhouse Performance

The greenhouse performance is determined by the interaction of solar heat gain, storage mass, interior temperature and exterior temperature. This interaction is described by the general formula:

$$F_b (t_i - t_o) = \sum F_s (t_s - t_i)$$

where:

F_b = building heat transfer coefficient
 F_s = heat transfer coefficient, storage mass to interior air
 t_s = temperature of storage wall
 (where heat loss equals heat gain)

Average measured insolation data recorded at the University of Washington was used for performance analysis. This data was adjusted for estimated angular effect of the three tilted surfaces using a program developed and published by Baker and Reynolds at the University of Oregon (1975).

By comparing insolation adjusted for transmission losses with skin (conduction) and lung (infiltration) losses for the building, we can predict the performance of the greenhouse. Since this greenhouse presents a complex set of storage conditions, an arbitrary standard of 65° day temperature and a 40° night temperature was chosen to compare against monthly average highs and lows. The results of this analysis is summarized in Figure 1. This suggests that the performance of the greenhouse will be adequate in the context of monthly average temperatures if the greenhouse is able to store most of the insolation.

The performance of the storage is analyzed for a single 8-hour period in which the exterior temperature remains at 20°F and the interior storage temperatures begin at 50°F (Table 1). For purposes of the analysis, the water wall is assumed to be isothermal (i.e., is losing heat equally from the entire mass). The remaining masses are divided into 3" layers, the surface layer losing heat to the interior, the next "layer" losing heat to the surface "layer," and so on. The storage wall is divided into four 3" layers. The ground storage is assumed to be eight 3" layers to a depth of 24".

In this analysis, the temperature for the surface given an interior temperature is:

$$T_g' = t_g - f_g(t_g - t_i) \div Q_g$$

where:

- T_g' = the temperature of the mass at the conclusion of the hour
- t_g = the temperature of the mass at the beginning of the hour
- f_g = transfer coefficient between the ground and the air
- Q_g = the heat capacity of the surface layer in Btu/°F

For each succeeding layer, the temperature is given by:

$$K(t_n - t_{n+1}) - K(t_{n-1} - t_n)$$

where:

- K = the conductivity of the storage
- t_n = the particular 3" "layer" of earth

Table 1 was derived using these equations for the concrete wall and the earth, and assuming the water wall to be approximately isothermal.

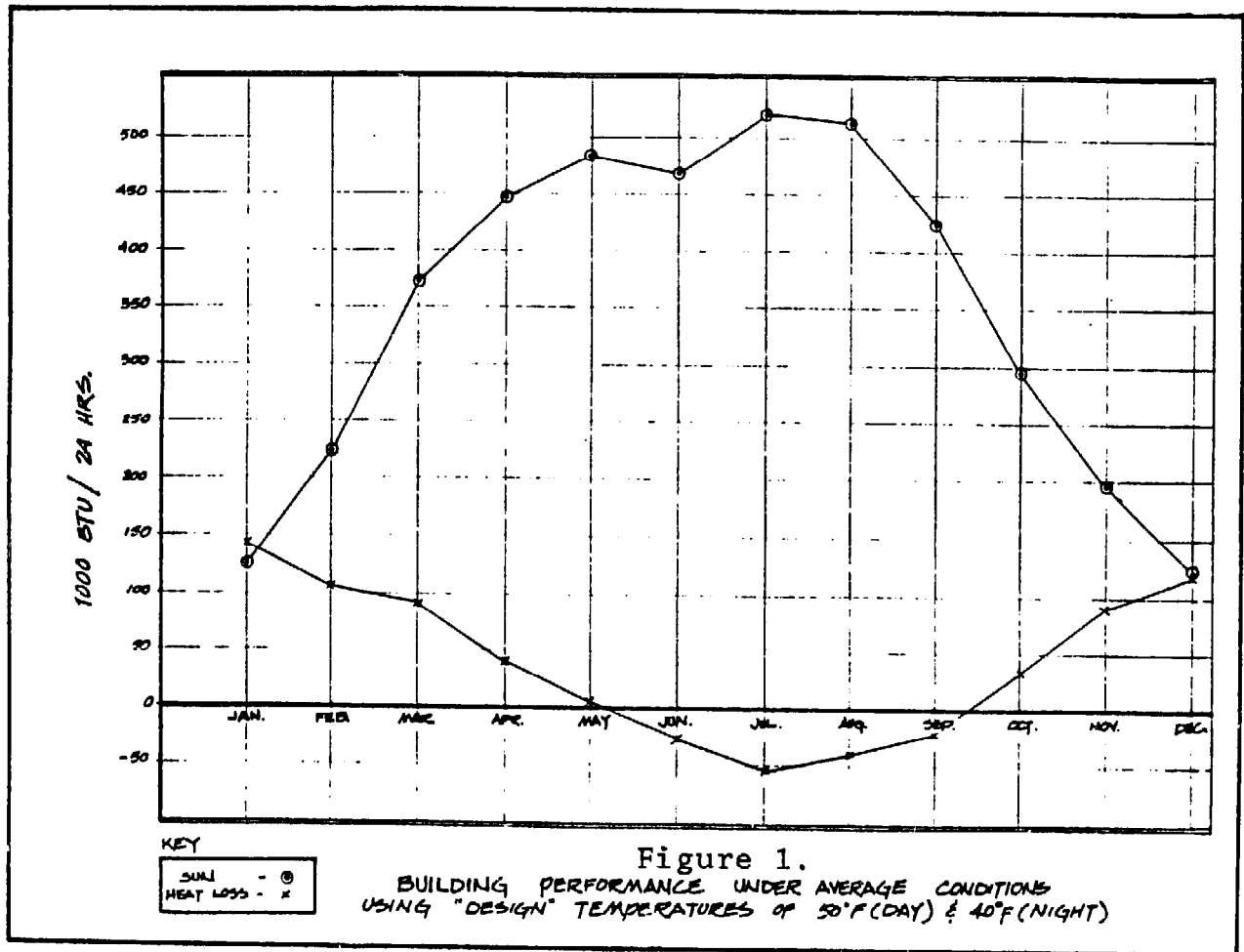

Conclusion

The Canyon Park greenhouse was completed and put into operation in September 1977. As yet insufficient data has been collected to validate any of the overall performance calculations. However, the analysis presented here indicates that the greenhouse should maintain an adequate growing environment through a typical Pacific Northwest winter. If the storage temperature can be brought to 50°F, even under unfavorable circumstances a substantial heat demand can be accommodated by the storage without the greenhouse temperature falling below 40°F. The heat storage systems perform adequately and provide a variety of opportunities to analyze the effectiveness of the storage masses and the interaction of storage masses.

References

ASHRAE Handbook of Fundamentals (1976).

Baker, M. Stven and John S. Reynolds (1975) "Insolation on South Facing Tilted Surfaces: Pacific Northwest Locations," Center for Environmental Research, University of Oregon, Eugene.

Hoff, Eric, David Jenkins, and Jim Van Duyn (1977) "Noti Solar Greenhouse -- Performance and Analysis," Center for Environmental Research, University of Oregon, Eugene.

Lawand, T.A., R.Atward, B. Saulnier, and E. Brunet (1974) "The Development and Testing of an Environmentally Designed Greenhouse for Colder Regions," Brace Research Institute, McGill University, Ste. Anne de Bellvue, Quebec.

Lowndes, D.H., D.K. McDaniels, and H.D. Kaehn (1975) "Geometrical Analysis of Reflector - Solar Thermal Collector Combinations," Paper presented to International Solar Energy Society.

Lui, Benjamin and Richard Jordan, "The Interrelationship and Characteristic of Direct, Diffuse and Total Solar Radiation," Solar Energy v.4#3 (1960).

Mazria, Edward, M.S. Baker and F.C. Wessling (1977) "Predicting the Performance of Passive Solar Heated Buildings," Center for Environmental Research, University of Oregon, Eugene.

Wilson, G.E., D.R. Price, L.D.Albright,N.R. Scott, R.W.Langhans, Pitam Chandra, "Experimental Results of a Greenhouse Solar Collection and Modular Gravel Storage System," A report of research of the Cornell University Agricultural Experiment Station, Ithica, NY (1977).

U.S. Department of Commerce, "Meteorological Data for the Current Year, 1973, Seattle-Tacoma Airport."

EVOLUTION OF A SOLAR GREENHOME

Robert Ginsburg
Southern California Institute of Architecture
Santa Monica, CA

Jack Park
Helion, Inc.
Brownsville, CA

Solar Greenhome has its roots in the works of Day Charoudi, the New Alchemists, Ken Kern, and all of the common sense one discovers when one realizes that it is possible to live inside a solar collector, and remain comfortable, and happy. Solar Greenhome is a term coined by Helion to use as a descriptor for completely integrated solar greenhouse/dwelling structures.

The Solar Greenhome to be briefly described here is a passively tempered structure of approximately 1400 square feet size, with 400 of that allocated to the greenhouse portion. It was designed as a student project at Southern California Institute of Architecture, at Santa Monica, California. The author served as energy consultant (he is a member of the teaching staff) and he and his wife acted as client in the traditional architect/client mode. Before discussing certain features of this Greenhome - which is to be built at Brownsville, it would be well to briefly relate some of the steps leading to the concepts evolved in the creation of this dwelling.

Helion's original project in Solar Greenhouses was the alteration of a domestic swimming pool at the author's home to become root-cellar/solar greenhouse (figure 1). Thermal problems arose owing to a lack of sufficient mass to temper the structure; structural considerations with the pool roof structure limited the weight allowable for this purpose. Accordingly, some early crops were subjected to heat stress, and resulting failure. Elliott Freeman joined the project with several ideas for low mass passive tuning by airflow. Improvements were made and the structure began to perform much closer to desired. Higher mass would no doubt improve it as it stood, but Helion moved to a ranch in Northern California to explore concepts of domestic autonomy.

A new greenhouse was built similar to the first, but using structural concepts advanced by Elliott's new company, Provider Greenhouses*. The structure was built as a validation of the working plans he now offers to the hobby greenhouse do-it-yourselfer. The curved membrane north wall was conceived as a quasi-focusing reflector. Painted white, it illuminates the growing chamber during winter months and is shielded from intense summer sun light by an overhanging roof Elliott has added to the structure. At this writing planting has begun, and evaluation of thermal mass and venting schedules is in process.

Need for an immediate dwelling at the new ranch has resulted in procurement of an ancient mobile home. In preparation for the forthcoming cold winter, a small wood-burning stove was added to the structure, along with a new insulated roof, and a lean-to solar greenhouse patterned after those constructed by the Solar Sustenance group. Immediate summer benefits included cooler day-time dwelling temperatures (the gas refrigerator stopped defrosting every day), and a nice evening spot was created to enjoy

* Provider Greenhouses - Box 49708, Los Angeles, California 90049

mint juleps without bother of the usual entourage of ranch flies. If we go no further, the structure was worth the effort. It includes solar heaters for domestic water, a water storage tank (to be added) on top of the tower (see figure 2), and a composting toilet.

North wall of the greenhouse is a white-painted south trailer wall, and now includes a Trombe wall/brick planter with moist soil. The mass has changed again the qualitative climate and fall evenings which now cool quickly to the lower 50°F range are passively tempered inside well past bed-time to the 70°F range. At this writing, the structure is nearing completion. Owing to building codes, additions such as this greenhouse cannot be attached to our mobile home; many air leaks must be sealed before thermal performance is entirely relevant. All of the Brownsville ranch projects have been started since February, 1977, and no amount of magic seems to complete them overnight.

Figure 3 is a diagram of the Solar Greenhome as it is conceived by the author and its designers, Debi Strozier, Jon Massaro, Terry Rainey, and Bob Ginsberg. The diagram illustrates the structure configured for winter heating. The greenhouse is isolated structurally from the dwelling, but thermally, not so. Windows from the sleeping loft and office level open into the greenhouse area and direct heated airflow from a Trombe wall into the dwelling. A north block wall and soil berm serve as a thermal sink to draw heated air in a south to north loop flow. Cooler air returns from the north wall, through a plenum below the office level to the Trombe wall where it re-enters the greenhouse environs, completing the loop. An enormous thermal mass stands within the dwelling, serving as a structural housing for shower, stove, and fireplace; its thermal purpose is to dampen any temperature swings brought on by inappropriate attention by the occupants or computer to the configuration of the structure. Insulated reflective doors slide down from above to insulate and isolate the greenhouse from outside heat loss, or heat gain. The Greenhome was designed as part of a statement by Helion on its concept as an appropriate technology, and as part of the ongoing autonomous dwelling experiment. It was designed with occupant operation and configuration control intended; humans are at least as sensitive to their environment as, say, a Honeywell thermostat. A computer control system is planned as part of the project, as a parallel monitor and control mechanism.

Indeed, with computer monitoring as cheap as it is today, the Greenhome structure will contribute greatly to the emerging body of understanding of passive structure design. Appropriate monitors would seem to be the plants, themselves. The Solar Greenhome described here is planned to be a part of the experiments necessary to guide us in such an appropriate direction.

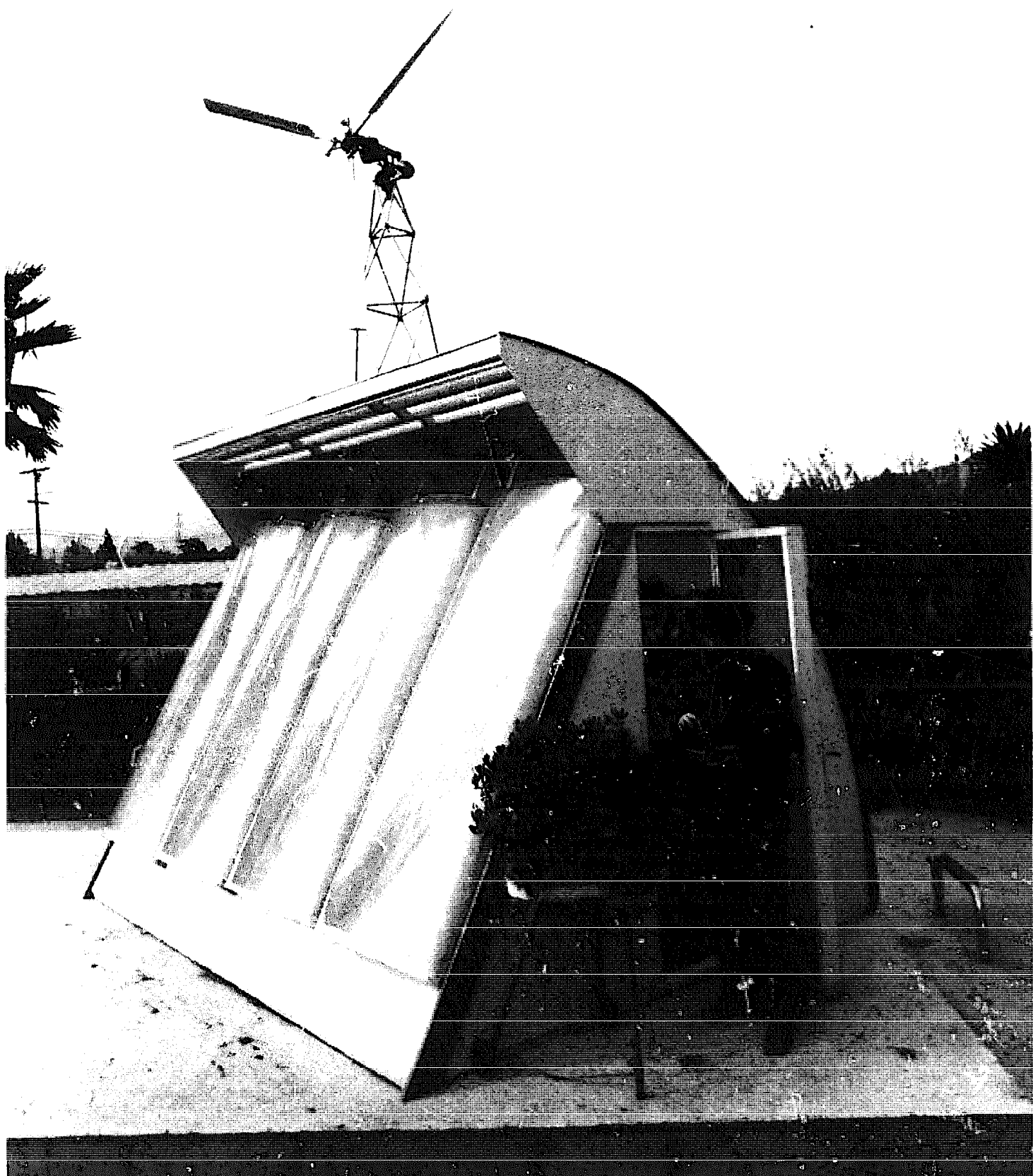

Figure 1
Helion Prototype Solar Greenhouse
with Modifications by Freeman

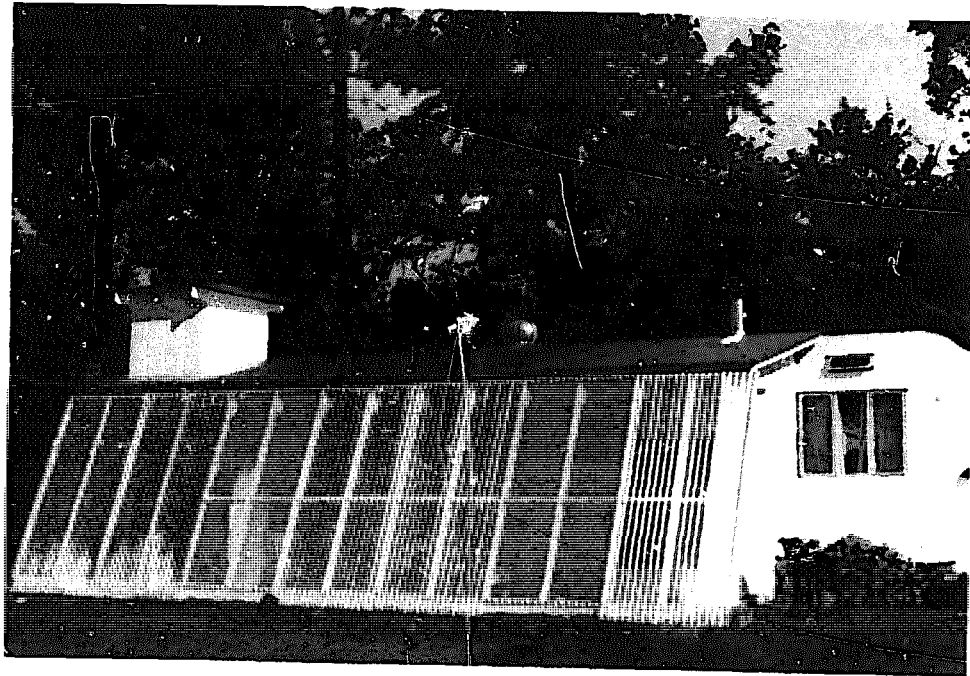

Figure 2
Solar Greenhouse Attached to
Mobile Home by Author

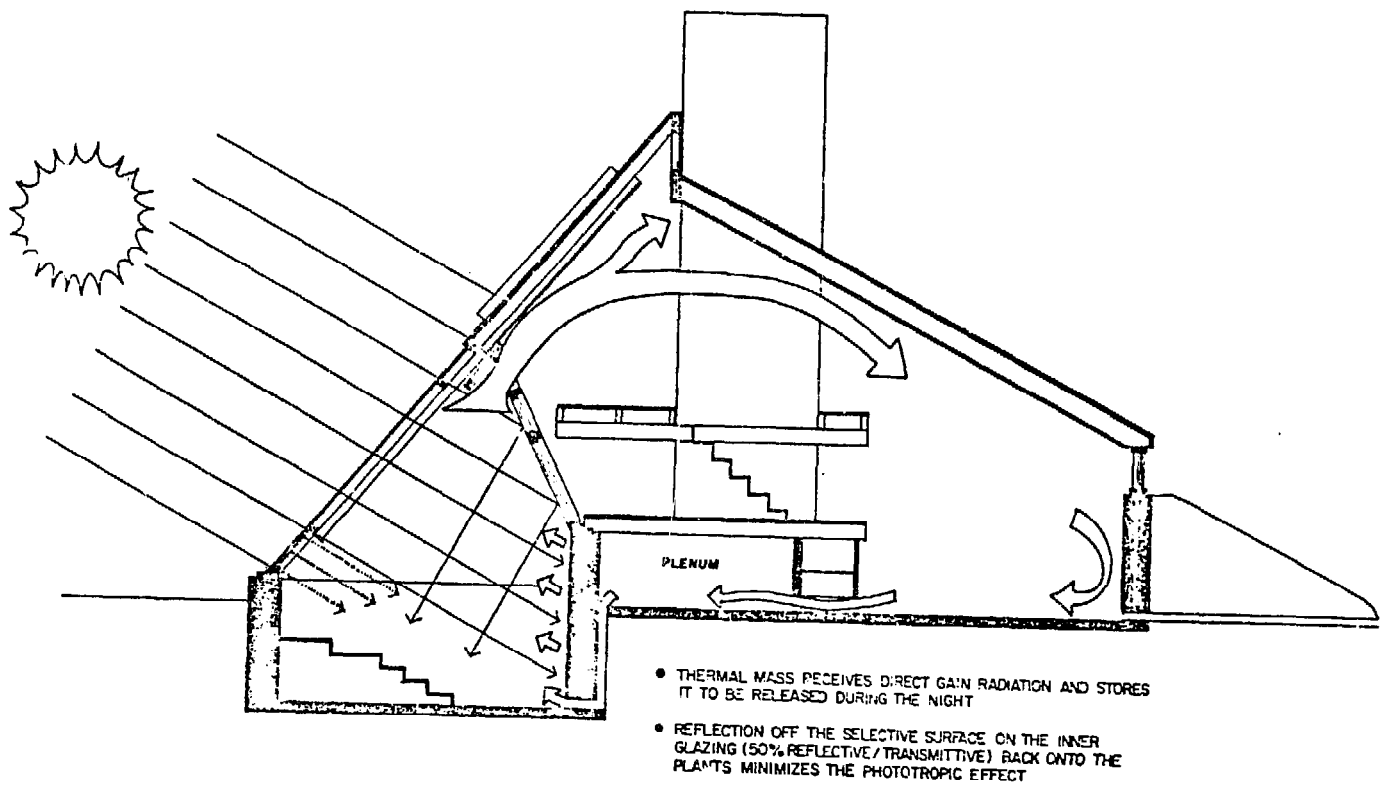

Figure 3
Diagram of Helion Solar Greenhouse
Showing Winter Heating Configuration.

THE EVOLUTION OF A SMALL SOLAR GREENHOUSE

E. R. Freeman

Provider Greenhouses, Box 49708, Los Angeles, Ca 90049

Abstract-This paper reports the evolution of a small solar greenhouse being developed for commercial sale. The greenhouse requires little or no energy other than direct solar energy to provide a year round environment for healthy plant growth. The design process and prototype construction are described. Also the results of evaluation and the modifications which precipitated from the evaluation are discussed.

INTRODUCTION

The greenhouse as originally developed by Helion Inc., Brownsville, California is a small greenhouse designed to provide a healthy environment in which to grow plants using natural processes and a passive system to regulate temperature, sunlight entry, air circulation and humidity. Reliance on natural processes would eliminate or greatly reduce the need for increasingly expensive and scarce fuels to power equipment which maintain environments in conventional greenhouses.

DESIGN

The structure shape which was chosen is one with a curved rear or north wall. The side walls are vertical and the front or south wall is at a 60° slope. This angle provides excellent sunlight penetration during winter months when the sun is at a low angle. The angle is also relatively easy to lay out during construction and allows for efficient use of interior floor space. This sloped, south wall is the only glazed surface allowing sunlight entry. The rear and side walls are opaque and insulated. The insulated walls will help maintain warmth within the structure during cold periods and reduce sunlight entry when it is desirable to do so during summer months when the sun is at high angles.

The curved rear wall of the greenhouse offers additional features: one being that it encloses maximum space with minimum exposed surface further reducing heat loss. In addition, the interior wall reflects sunlight into the growing area at low sun angles focusing more light on the growing area when it is most needed.

PROTOTYPE CONSTRUCTION

The prototype was constructed in southern California in the San Fernando Valley. Its size was approximately 8 feet by 12 feet and the structure was fabricated with 2x4's, plywood and Masonite. The side walls had a 3/8 inch plywood exterior and a Masonite

interior surface separated with 2x4's. A door was installed in the east wall. The two side walls were supported upright and separated along the curved, outer edge with a series of 12 foot 2x4's acting as stringers similar to aircraft fuselage construction. Over these 2x4's, 3/8 inch plywood was curved and attached to form the exterior surface of the north wall. Masonite was again used for the interior surface. For both the north wall and side walls, blanket fiberglass was used for insulation.

The bases on which construction materials were selected were that they should be inexpensive, readily available and renewable. An additional goal was to design a greenhouse which could be assembled with basic tools.

Glazing on the south wall consists of a double layer of thin, flat sheets of fiberglass cut from rolls. Rigidity is provided by an outward bow in each of the four sections of the fiberglass. The double layer provides an insulating air gap. Fiberglass was chosen over glass for several reasons including strength, weight, light transmission characteristics and cost. Another characteristic of fiberglass which is advantageous is its ability to diffuse incoming light.

INITIAL EVALUATION

Initial evaluation of the greenhouse indicated that, in spite of attenuation of direct sunlight in summer months, light which did enter was diffused sufficiently to eliminate heavy shadowed areas and allow healthy plant growth.

Further evaluation of the greenhouse made one thing very apparent: that a good ventilation system is indeed a necessity, especially in a southern California location. As a result, some design changes were incorporated.

MODIFICATION

Vents were added at the base of the rear wall and above the glazing on the south wall. In the prototype, rather than trying to actually modify the rear wall, the rear vents were approximated by installation of a large screened opening in the side door. In addition, an extension of the rear wall curve was made over the front glazing in the form of louvers. This provided additional shading at high sun angles and it was thought that the louver arrangement would assist in discharging hot air through the upper vents when an outside breeze was present. Figure 1 is a cross-section of the greenhouse showing the basic design concepts and the prototype greenhouse is shown in Photograph 1 with the modifications incorporated.

These modifications were made for the purpose of cooling the inside of the greenhouse. They seemed to help tremendously as the maximum temperature within the structure dropped 10 to 15°F.

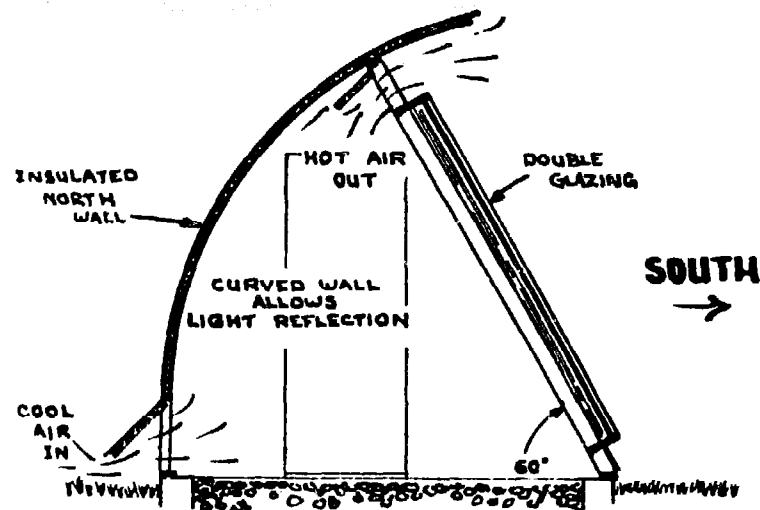

Cross-Section, Provider Greenhouse
Figure 1

At this point the shape of the greenhouse was proven. Adequate light was available to the greenhouse interior and a ventilation system was developed to reduce temperatures in the greenhouse to tolerable levels. It was desired though to modify the fabrication method for marketing purposes. It would be advantageous if the greenhouse could be assembled in modules. The components could be manufactured at one central location and marketed in kit form and company or owner assembled at the site. In addition, the length of the greenhouse could be changed to suit individual needs merely by adding a sufficient number of modules. The greenhouse could also be expanded in scale, not only increasing the length but also expanding widthwise without drastically changing the design and construction method.

The rear wall was redesigned by Provider Greenhouses into sections of curved sandwich panels each 4 feet wide. The exterior surface is 1/4 inch plywood; the interior surface is 1/8 inch Masonite with a 2 inch core of polyurethane foam separating the two. The foam provides rigidity to the structure in addition to its outstanding insulating characteristics.

The side wall components are designed as one piece, pie-shaped units with one wall having the door opening cut out. The side walls are also sandwich type construction similar to the rear panels.

CONSTRUCTION

A second greenhouse was constructed; the size, 8 feet by 12 feet, similar to the prototype but incorporating the new construction methods. All components were prefabricated and the greenhouse assembled at a Helion, Inc. site in northern California.

The curved panels were manufactured using a jig arrangement and a series of clamps. The inner and outer panel surfaces were separated with curved, laminated pine beams manufactured previously on the jig. These pine beams were arranged in the panels in a tongue and groove fashion for the subsequent assembly of the panels

into the rear wall. The jig and several clamps are shown in Photograph 2. The foam core was poured in place, allowed to expand and set while the panel was clamped to the jig.

Component pieces of the sidewalls were laid out on plywood sheets, cut and assembled into the sidewall pie-shape with 2x2's. The foam core was applied using a different method than with the curved panels. The foam was poured between the 2x2's and allowed to expand while the Masonite for the interior wall was being attached to the 2x2's. Photograph 3 shows the two side walls prior to application of the foam and Masonite. The fabrication of the vents and door was done in a similar manner.

With all the components now fabricated, assembly began with the fitting together and attachment of the rear panels using the tongue and groove arrangement. Once mated together, the rear wall was raised on the foundation and temporarily supported with 2x4's. The procedure is depicted by Photograph 4. With the limited, temporary support the rear wall showed a satisfying amount of rigidity indicating that increased greenhouse length and expanded scale would be possible with this construction method. At this point the side walls were moved into place and fastened to the rear wall curved edge. The basic greenhouse shape was now apparent and the vents and doors were installed with off-the-shelf hardware.

The final step in completing the greenhouse was installation of the glazing and glazing supports. In this design, corrugated fiberglass sheets were used. As in the prototype, a double thickness was employed and the glazing was bowed outward for strength. Unlike the prototype there were only three sections of glazing, a one-to-one ratio to the rear wall panels.

During this installation process and also during the assembly of the larger components it was found that the prefabricated components were dimensionally correct. In other words, things went together pretty much according to plan. This was very satisfying since, eventhough this was a prototype of the construction method, it gave validity to the prefabricated concept for this greenhouse. The completed greenhouse is shown in Photograph 5.

FINAL EVALUATION

The Provider Greenhouse was completed in early July of this year and proved the construction method but the question remained, "Will it work?". As yet, of course, no information has been obtained relating to the greenhouse's ability to retain heat. That will have to wait until the winter has come and gone; however, the northern California location will provide a good test. Through the summer and into the autumn healthy plant growth took place. The venting system has been effective in eliminating excessive heat build up in spite of very high temperatures outside and no effort to provide additional cooling. Inside temperatures could be reduced further with some simple steps: one being to use the vent design most effectively by providing extensive shade behind the structure. This

shade will help to cool the air entering through the rear vents.

FUTURE MODIFICATION

As evaluation of the Provider Greenhouse continues it is anticipated that some modifications will be made to the design. The purpose of some of these modifications will be to improve performance; others will be made to attempt to meet individual customers' needs. As stated earlier the greenhouse size can be increased by increasing the scale or by simply adding more rear panels and glazing sections to lengthen it. Automatic controls can be added to operate the vents, opening and closing them at predetermined temperatures. Other materials will be investigated which might be better suited to mass production, shipping and on site assembly. The greenhouse can also be attached to a building and configured to provide space heating.

CONCLUSION

Most of the basic concepts of the greenhouse design have been proven. Enough sunlight for healthy plant growth enters in spite of shading by the rear wall during summer months. Shading and the venting system keep temperatures at tolerable levels during summer months and the prefabrication and on site assembly method has proven viable. What remains to be proven are the heat retaining capability and the number of adaptations which can be incorporated in this structure to fully utilize the capabilities which exist for solar greenhouses.



Side Wall Panels Prior to Application of
the Foam Insulation and Interior Surface
Photograph 3



Raising of Rear Wall on Foundation
Photograph 4

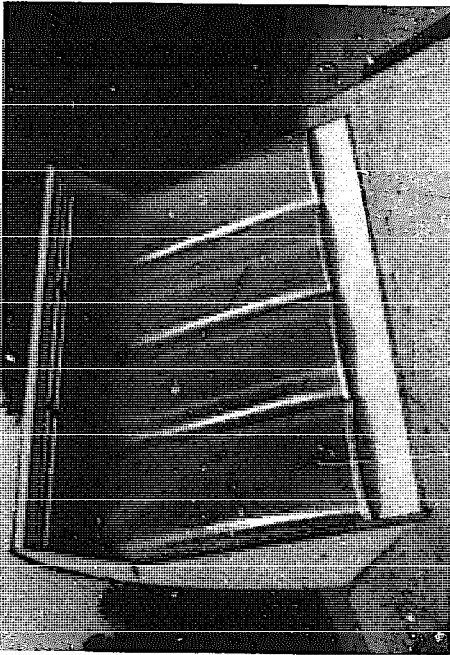

Modified Prototype Greenhouse
Photograph 1

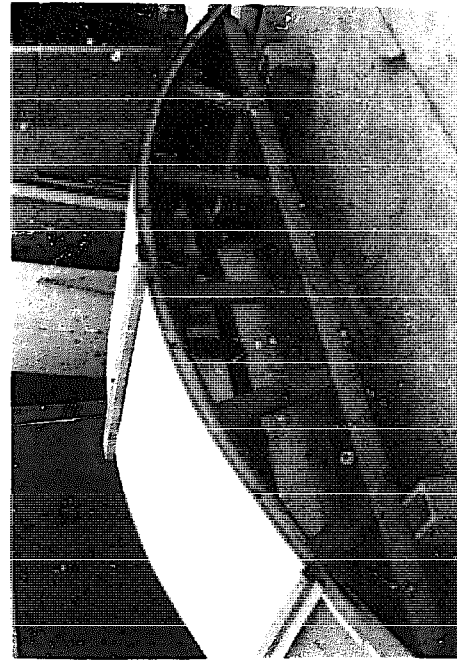

Curved Panel Being Assembled on Jig and Clamp Arrangement
Photograph 2

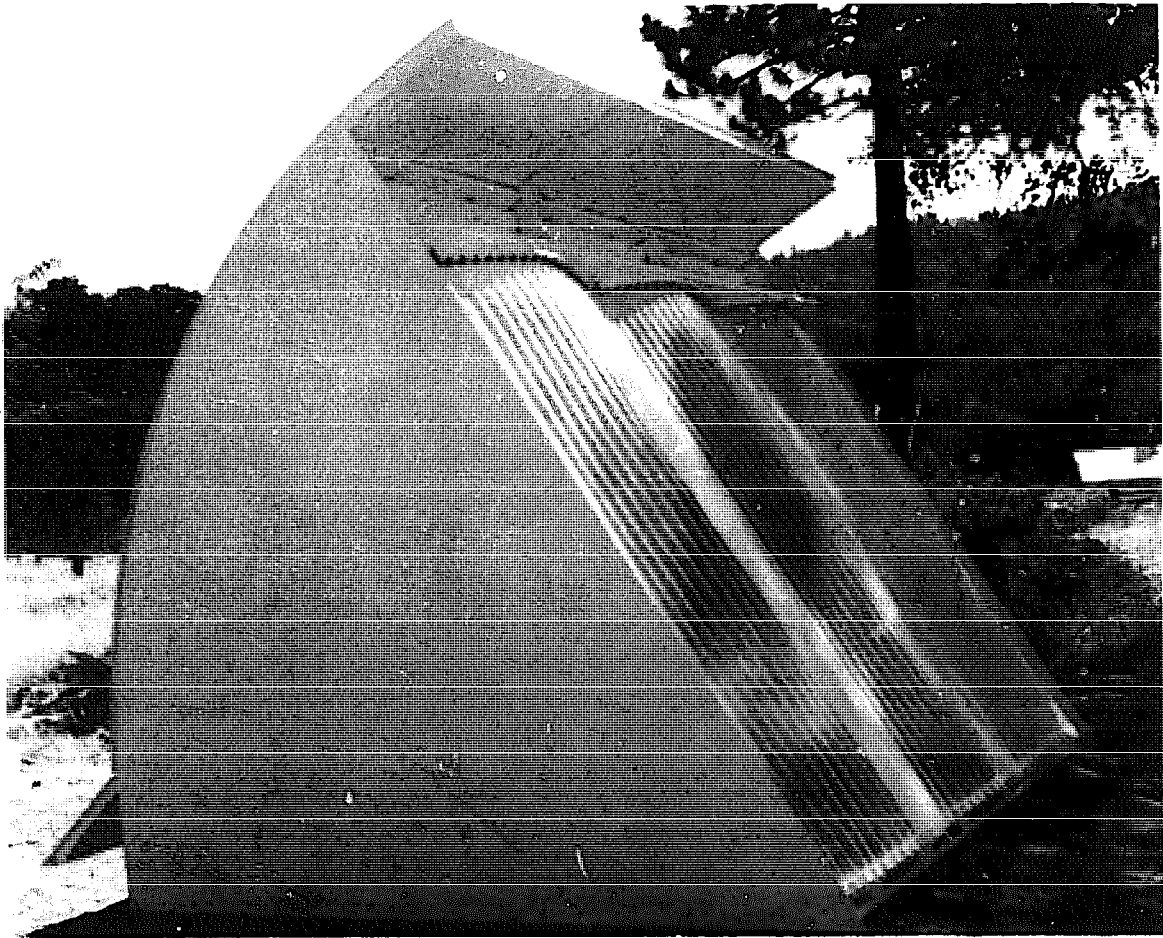

Completed Provider Greenhouse at Helion, Inc.
Site in Brownsville, California
Photograph 5



SECTION 5

- Sunday Morning
- Chairperson, Drew Gillett

A Home-Built, Low Technology Solar Greenhouse

Ed MacDougall

*Brookhaven National Laboratory

Introduction

Greenhouses for the homeowner have long been useful for raising flowers and vegetables in cold weather and starting plants early in the spring.

With the price of utilities rising, solar greenhouses become more attractive economically since a good deal of the heating is done by the sun. Rising utility costs also make power ventillation of excess heat in the greenhouse more costly. New ideas in using this excess heat are needed.

This paper describes the construction and operation of an owner built greenhouse and also describes how the excess heat is used to preheat the domestic hot water of the owner's house.

Description

The solar greenhouse is located in Bellport, L. I., N. Y., and is situated in an open area 30 feet east of the house. Figure 1 shows the greenhouse as it appears from the house.

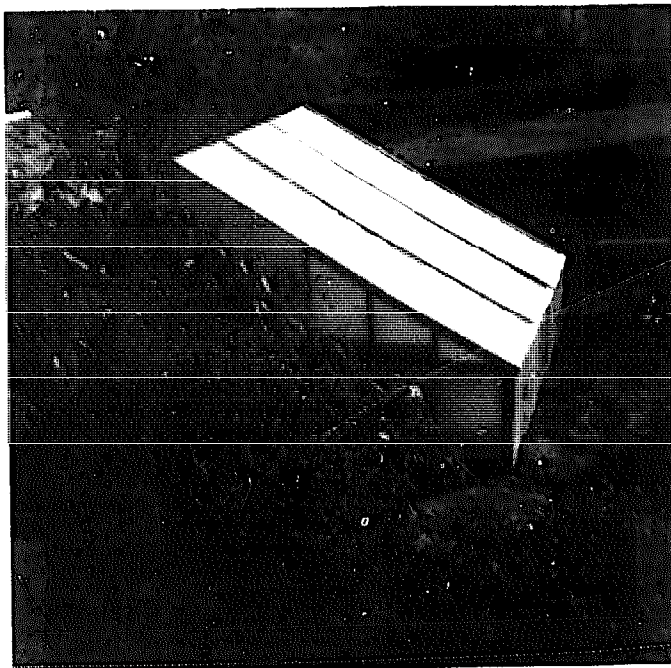

FIGURE 1

*Work performed by the author privately at Bellport, L.I., N.Y.

The greenhouse is of standard wood frame construction with Homosote sheathing and 2" styrafoam insulation. Where the sun light strikes most of the day (the top, the south and parts of the west side), Kalwal plastic .025 inches is used. Beneath this with 1 inch wood separators are 2 layers of 4 mil polyethylene. The footing is insulated with 1" styrafoam, 12" deep around the entire perimeter. Figure 2 shows an elevation from the west side.

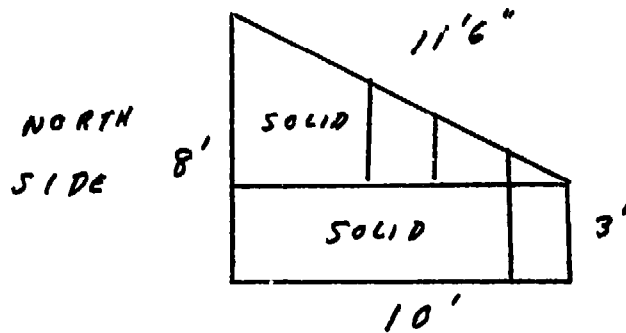

FIGURE 2

The door is located on the North side and is a screen door with 2" styrafoam insulation.

The storage medium is water and is contained in 5-55 gallon drums set vertically 1 foot into the earth along the south wall. In addition, a 40 gallon water tank 16 inches by 48 inches high is located 30 inches above the ground in the northeast corner.

The greenhouse is 12 ft. long and 10 ft. wide; the area is 120 sq. ft. and the volume 660 cubic feet.

The heat loss has been calculated by ASHRAE methods to be 7560 BTU-2.22 KW including an infiltration loss of 300 BTU and a perimeter loss of 264 BTU.

Solar Energy Available

The monthly estimates of total solar energy available in BTU per sq. ft. are shown in Appendix A. The single day of the month figures were multiplied by the days of the month to get the amounts shown in Col. 8. The yearly total is 562,092 BTU/sq.ft.

The exact amount of solar energy that will be available for growing in the solar greenhouse is not known since an efficiency study has not been completed.

Since a typical efficiency for a solar water collector might range from 25-50% and since the greenhouse has a good triple light emitting area and is well insulated all around, it

is conservatively estimated that the greenhouse has a 25% efficiency. The annual solar energy captured by the greenhouse is computed as: 562,092 BTU/sq. ft. x .25 = 140,523 BTU/sq. ft. The sloped area of the greenhouse that is covered by Kalwal is 138 sq. ft.; therefore, the total estimated solar energy captured is:

$$140,523 \text{ BTU/sq. ft.} \times 138 \text{ sq. ft.} = 19,392,000 \text{ BTU} = 5680 \text{ KWH}$$

All of the BTU's listed above would be available to the area where the greenhouse stands even without the structure. Obviously, the plants would freeze without an enclosure and heat. The solar greenhouse appears to be the logical way to keep the earth warm enough to grow plants year round while using a minimum amount of utility energy.

Storage Design

In designing the storage of solar energy, the objective was to have enough storage to minimize the use of commercial power and at the same time to maximize the space for growing vegetables and starting plants in the spring.

In the selection of a storage medium, water was chosen over rock to reduce the space required for heat storage. Rock requires about 2.7 times as much volume as water (Ref. 3).

The amount of water was computed from (Ref. 4) as follows:

$$1.00 \text{ cu. ft. rock/sq. ft. of collector} = 1.00 \times 11.5' \times 12' \\ = 138 \text{ cu. ft. Conversion to water (Ref.3): } 138 \div 2.7 = 51 \text{ cu. ft.}$$

The containers for storing the water are 55 gallon drums 3 ft. high and 2 ft. in diameter. The volume of each is 9.4 cu. ft.; the total number of drums therefore is:

$$51 \text{ cu. ft.} \div 9.4 \text{ cu. ft.} = 5+ \text{ drums.}$$

An alternate method of computing storage volume required is as follows: (Ref. 5).

$$\text{Water Heat} = \frac{\text{C.A.} \times 20}{62.4} = \frac{138 \times 20}{62.4} = 44 \text{ cu. ft.}$$

Where C.A. = Collector Area
20 = Constant
62.4 = BTU/cu. ft./degree F of water

This method requires slightly less than 5 barrels.

The five barrels were placed upright in the south end and a 40 gallon tank was set in the northeast corner with its base 30 inches above the ground.

Temperature readings showed water at the top of the barrel to read 58 degree F when the water at the bottom of the barrel read 40 degree F (see Figure 3).

It appears that better heat transfer to the earth would have resulted from laying the barrels on their 3 ft. side, but less space would then have been available for growing plants.

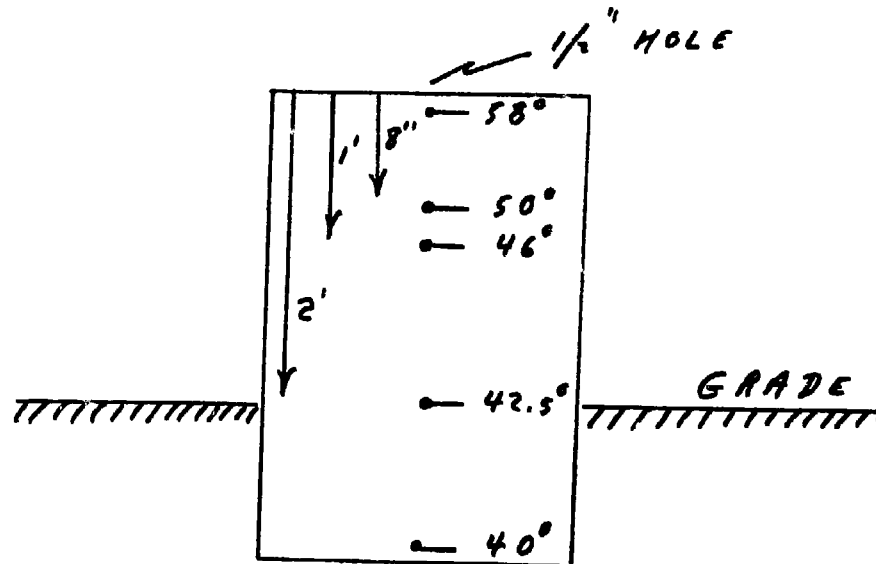

FIGURE 3

Greenhouse Operation

In general, cold weather vegetables have been grown during the winter months. The most successful have been lettuce, swiss chard and spinach; others that have not done so well are peas and beets. During one summer, tomatoes were grown, but there were few good tomatoes with many having green growth on stems and leaves.

For the winter months, a 200 watt thermostatically controlled heating tape was set to maintain a minimum of 40 degrees earth temperature. The earth temperature was measured 3 inches below the surface in the center of the greenhouse. The heating tape was installed 6 inches below the surface around the entire perimeter. In addition, a thermostatically controlled 1320 watt heater was placed in the greenhouse and set so that the air temperature would not go below freezing.

Figure 4 shows how dramatically the temperature of the greenhouse rises on a typical warm sunny day. When the sun came onto the structure at about 10 A.M. the temperature went from 70 degrees F to a peak of 158 degrees F at 1 P.M.

SUNNY DAY 8/27/75

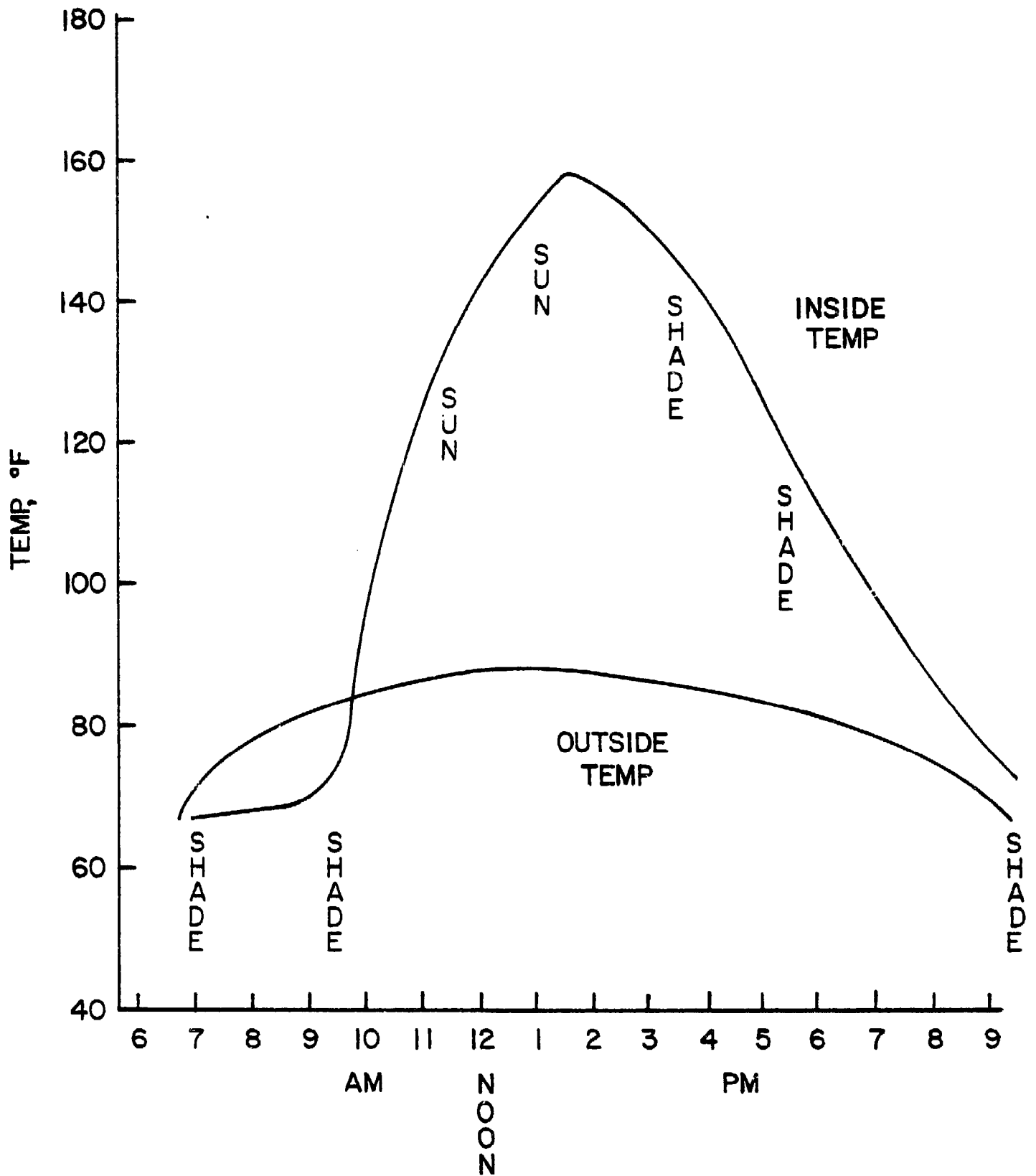

FIGURE 4

Figure 5 shows a series of temperature curves for the greenhouse air, the water tank set in the N.E. corner and the water temperature in the center drum. These temperature readings were also taken on a single warm summer day.

Figure 6 shows mean temperature over the initial water warm up time 7/31-8/22 with some weather notations. The above grade storage tank has been consistantly warmer than the in-ground barrels; the inside air follows the outside air temperature quite closely.

Figure 7 shows more recent temperatures taken at 7 A.M. each morning on the days shown.

The operations have been successful in that the cold weather vegetables have been available all winter. However, at a 40 degree F earth temperature the plant growth has been slow on the very cold weeks.

Domestic Water Heating

Since the need for the greenhouse decreases sharply as the outside temperature rises, and since considerable power would be required to reduce the inside summer temperature, it was decided to use the greenhouse as a water preheater in the warmer months.

Figure 8 shows the layout of the piping system. The tubing is 3/4" P.V.C. It runs from the existing cold water supply around the 5-55 gallon drums to the raised 40 gallon tank then back to the oil fired furnace.

Figure 9 shows furnace connection. The friction loss for the 130 ft. of P.V.C. was figured at 13 ft. and the house pressure system raised to make up for this loss. If additional pressure is needed, a Grundfos model 25-42SF will be installed. This pump in turn will be controlled by an Hawthorne Industries H-1510 Varifly Controller. To date neither has been required.

Table 1 shows various possible fuel savings with solar preheating based on 330,034 BTU/sq. ft. which is the available insulation on Long Island for the months April through September. Since the efficiency has not yet been determined, various efficiencies are shown.

The water temperature in the raised 40 gallon greenhouse tank has run as high as 105 degrees F (See Fig. 6). However, when connected to the domestic water heating system, the tank temperature ranged from 72 to 90 degrees F.

SUNDAY 7/18/76

AIR TEMP IN GREENHOUSE
WATER TEMP OPEN BARREL
WATER TEMP TANK

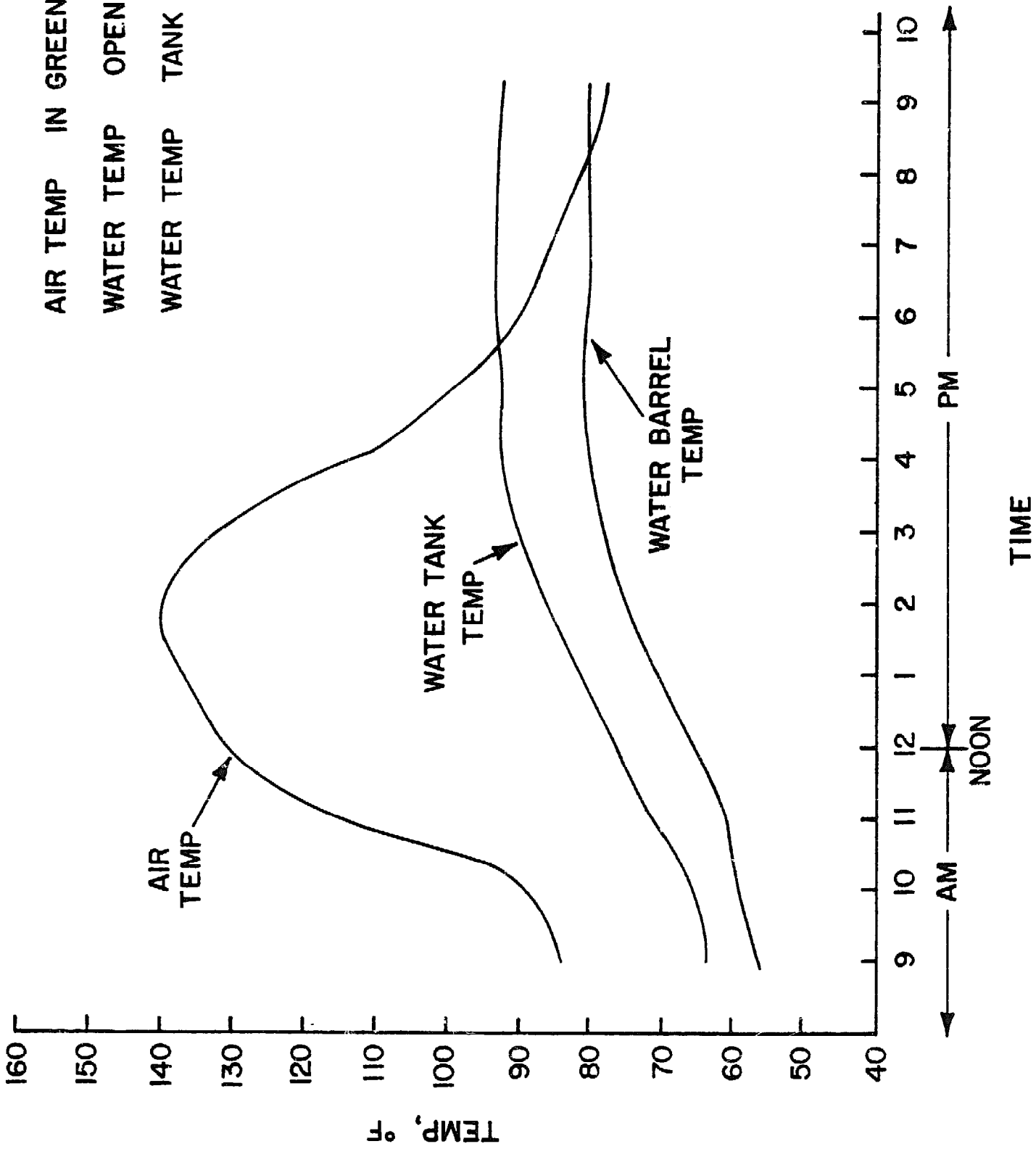

SOLAR GREENHOUSE

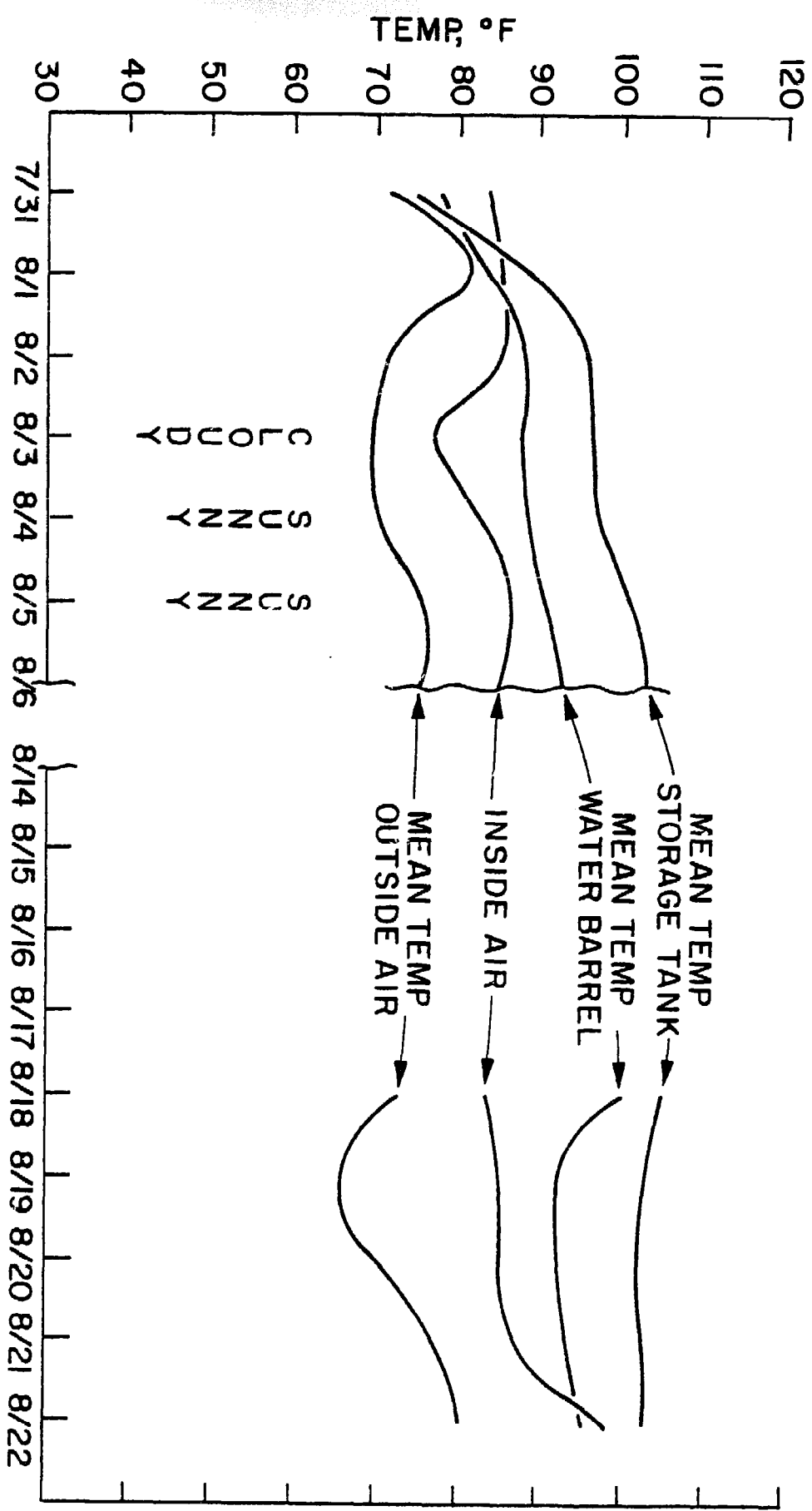
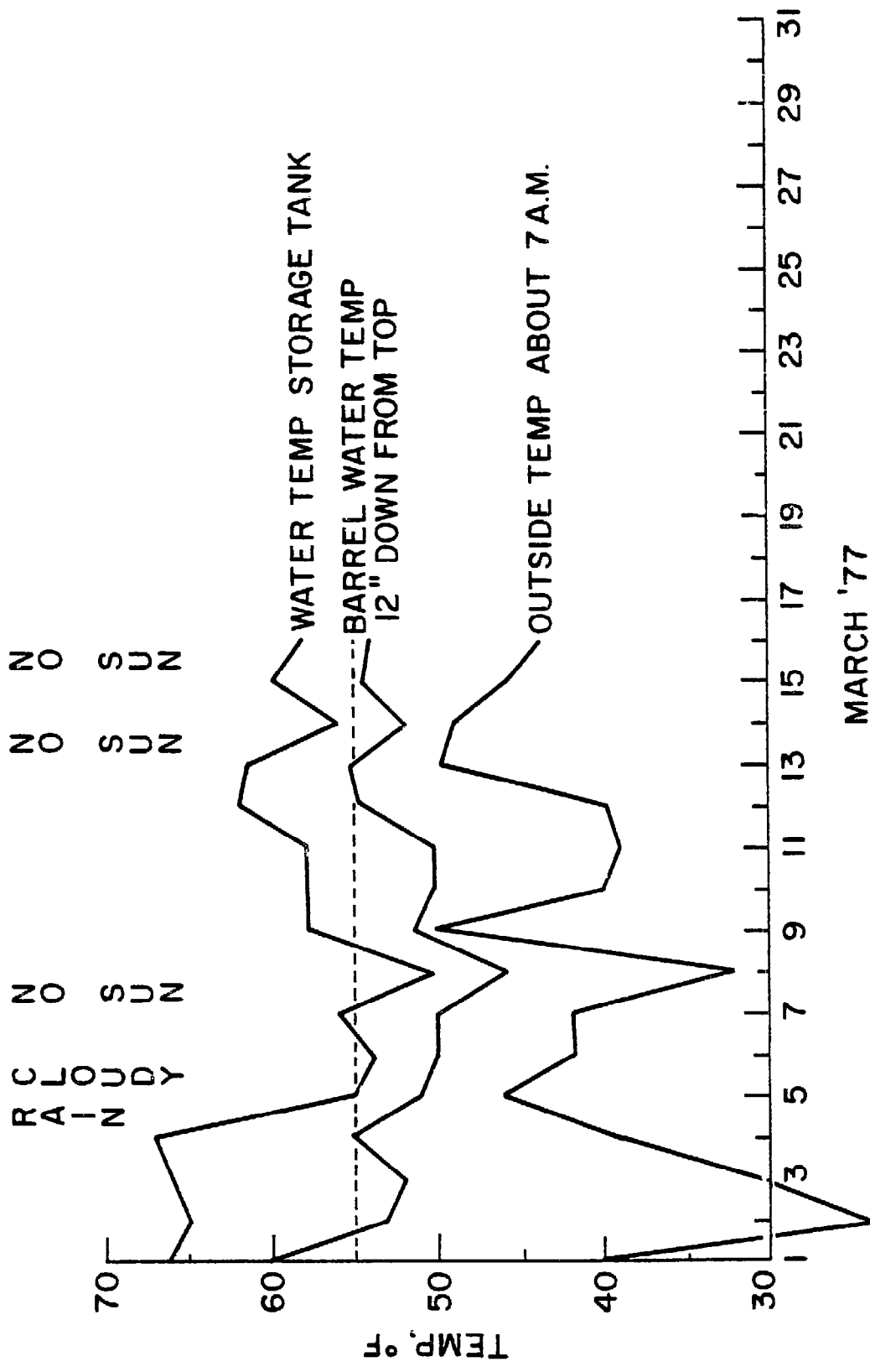

FIGURE 6



MARCH '77

FIGURE 7

FLOW DIAGRAM SOLAR GREENHOUSE USED AS WATER HEATER

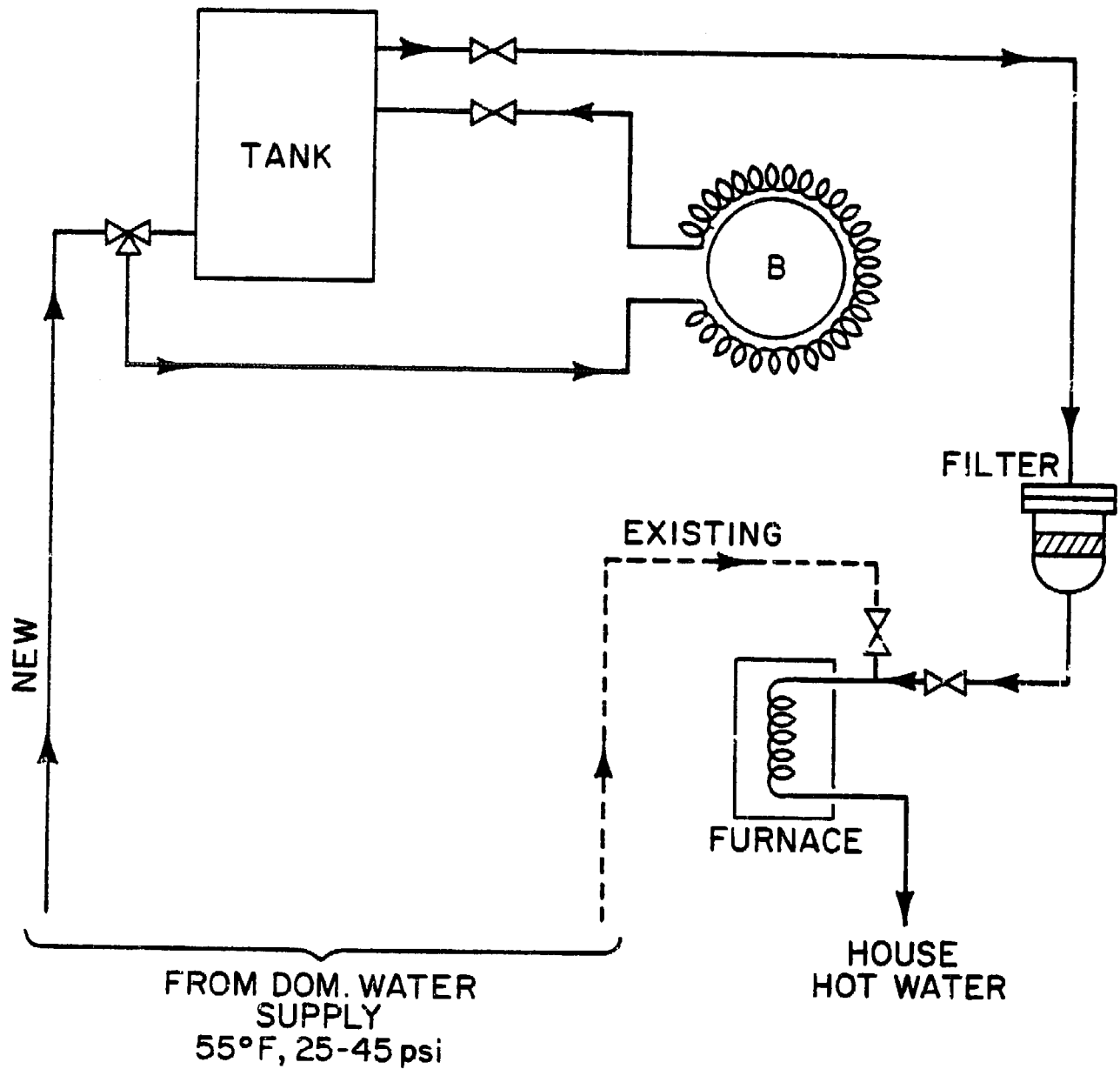

(B) = 5 BARRELS

NORMAL FLOW - DOMESTIC WATER DIRECT TO BARRELS
THEN TO TANK - THRU FILTER TO HOUSE HOT WATER
HEATER

FIGURE 8

<u>Est. Eff.</u> <u>%</u>	<u>Energy to Water</u> <u>(BTU)</u>	<u>Equiv. Gal.</u> <u>#2 Oil</u>	<u>Gals. Oil</u> <u>138 sq. ft.</u>
15	49,505	.35	48
20	66,007	.47	65
25	82,509	.58	80
30	99,010	.70	97
35	115,512	.81	111
40	132,014	.93	128

TABLE 1

The water temperature in the raised 40 gallon greenhouse tank has run as high as 105 degrees F (See Fig. 6). However, when connected to the domestic water heating system, the tank temperature ranged from 72 to 90 degrees F.

Costs

The material for the original structure was approximately \$160 in 1975. The additional cost for the material necessary to use the greenhouse for a water preheater was approximately \$80. Most of this expense was for PVC tubing as neither a pump nor special controls were necessary.

The energy used by the 200 watt heating tape was figured by timing the hours of use with an electric clock and reading the data daily during certain cold periods. The eleven day period from Jan 24 '77 to Feb. 3 showed the soil cable on for 69 hours.

$$69 \text{ Hrs.} \times .2 \text{ KW} \times \$.05/\text{KWH} = \$.70$$

This projects to about \$2.10/month. It should be noted that this was an extremely cold time with readings as low as 2 degrees F outside. A similar 11 day period was checked when the outside temperature dipped to zero. This showed a projection of \$3.00 per month.

Table 2 shows readings of the 1320 watt heater during the first half of March.

The projected yearly operating cost of the electric heater is about \$22 based on the following:

$$\text{Est. Cost} = 12 \text{ KWH} \times \$.05 \times \frac{4811 \text{ annual degree days}}{131 \text{ degree days}} = \$22.00$$

COST FOR OPERATING 1320 WATT HEATER

1977 Date	Out Temp 7 AM	In Temp 7 AM	Degree Days	KWH Used	Cost \$
2/28	30	40	22	.13	.01
3/1	30	32	30	4.82	.24
3/2	24	40	33	5.61	.28
3/3	30	40	24	1.45	.07
4	39	40	<u>22</u>	none	
5	46	50			
6	42	52			
7	42	42			
8	32	32			
9	39	39			
10	40	40			
11	39	39			
12	40	50			
13	50	50			
14	49	49			
15	46	46			
16	44	50			
			131	12.01	\$.60

TABLE 2

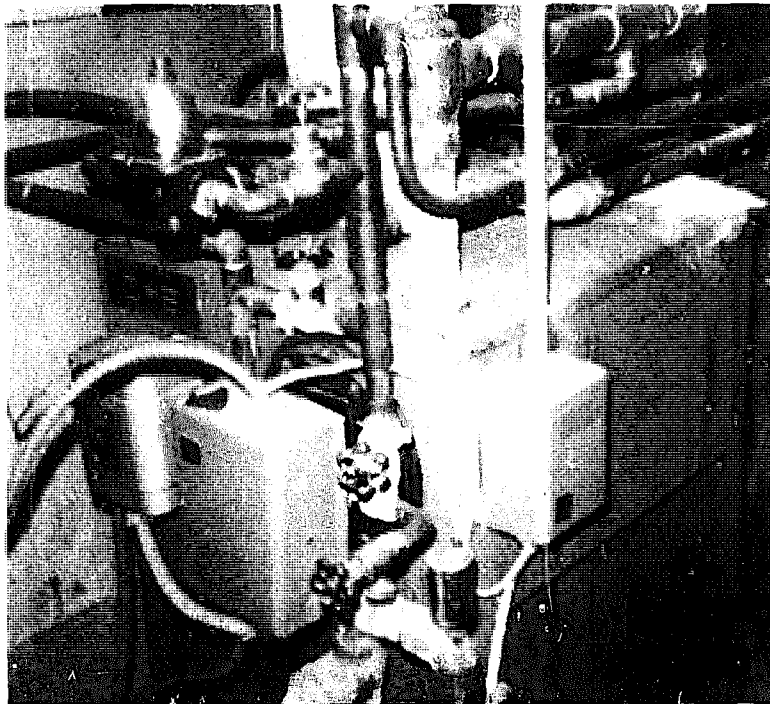

FIGURE 9

Conclusion

This solar greenhouse has proven to be a worthwhile project and has served as a means to produce a small amount of fresh vegetables in the winter months. It has also been useful as a place to start vegetables and flower plants early in the spring. In addition, it has the potential to supply a small amount of domestic water preheating during the summer months.

All of the above has been done at very little cost in comparison with initial and operating costs of similar commercially available greenhouses.

References

- (1) John I. Yellott, ASHRAE, Chapter 59, "Solar Energy Utilization for Heating and Cooling," 1974 Application Handbook.
- (2) National Oceanographic and Atmospheric Administration (NOAA), "The Climatology Atlas of the United States."
- (3) Jim Junk, Solar Engineering, Pg. 32, September 1977.
- (4) J. D. Balcomb, J. C. Hedstrom, B. T. Rogers, "Design Considerations of Air Cooled Collectors/Rock Bin Storage Solar Heating Systems," ISES 1975.
- (5) Henry Landa, Solar Energy Handbook, 1974.

APPENDIX A

Solar Irradiation - Bellport, N.Y.

MONTH	South Facing						
	DAILY I ⁽¹⁾ BTUh/sq ft. * - 0°	DAILY I ⁽¹⁾ BTUh/sq ft. * - 30°	RATIO $\frac{I-30}{I-0}$	MEAN DAILY SOLAR RAD. LANGLEYS (2)	MEAN DAILY SOLAR RAD. BTU/sq. ft.	MEAN DAILY SOLAR RAD. BTU/sq. ft. 30°	MEAN MONTHLY SOLAR RAD. BTU/sq. ft. 30°
Jan.	948	1660	1.75	160	590	1033	32023
Feb.	1414	2060	1.46	249	918	1340	37520
Mar.	1852	2308	1.25	335	1235	1544	47864
Apr.	2274	2412	1.06	415	1530	1622	48660
May	2552	2442	.96	494	1821	1748	54188
June	2648	2434	.92	565	2083	1916	57480
July	2534	2409	.95	543	1998	1898	58838
Aug.	2244	2354	1.05	462	1703	1788	55428
Sept.	1788	2210	1.24	385	1419	1848	55440
Oct.	1348	1962	1.46	289	1065	1555	48205
Nov.	942	1636	1.74	186	686	1194	35820
Dec.	782	1480	1.89	142	523	988	30628
Avg.	1776	2114	1.31	352	1298	1540	46841

*21st of month - clear day

A SIMPLE, INEXPENSIVE UNHEATED SHELTER FOR A WINTER GARDEN
AT THE NORTH SHORE SCIENCE MUSEUM
PLANDOME MANOR, NEW YORK

Joseph And Leafie Freda

There is obviously a great deal of on-going research into the design and performance of energy-conserving greenhouses and similar structures. Much of this research has been devoted to solid, well-constructed *buildings* for large-scale operation, where a high initial cost may be acceptable.

The objectives of our experiments at the North Shore Science Museum are, on the contrary, to achieve a design that will not be considered a building at all by the tax assessors, that will be inexpensive to construct, that will cost nothing at all to maintain, and that will permit the raising of certain vegetables throughout the coldest winters that are likely to be experienced on Long Island. We want something that can be recommended to the gardeners in our area, most of whom have relatively small growing areas and are not prepared to erect a structure that will be costly or will add to their already high taxes.

It is to be hoped, therefore, that this paper will meet the sponsor's suggestion that "...any papers stressing low-impact solutions which are simple, inexpensive and appropriate would be welcomed."

We call our structure a winter shelter rather than a greenhouse because it really does form a shelter over a 9' x 23' garden plot and because it consists of an uncovered frame for a portion of the year. All vegetables are planted in the soil of this plot in late summer when the frame is not covered, and nothing is raised in containers.

During winter and early spring the edifice may seem, at first glance, to be nothing more than a quite ordinary plastic-covered greenhouse. On closer examination, however, it will be found to incorporate several novel ideas, some of them borrowed from the experimental greenhouses and "arks" constructed at the Rodale Experimental Farm in Pennsylvania and at the New Alchemists on Cape Cod. These structures will undoubtedly be described in other papers of this collection.

FOUNDATION AND SUPERSTRUCTURE: There is really no foundation at all. The frame for the plastic covering is made of two by fours, and this frame is supported by wooden posts sunk into the ground. A cement foundation could be easily constructed but this would lead to the classification of the structure as a building by the tax collectors. The absence of a solid foundation does make more difficult the problem of keeping some of the ground inside the shelter from freezing during the coldest winter months. This will require some improvised solutions.

THE SHAPE: The most obvious element borrowed from the structures at Rodale and the New Alchemists is the *shape* of the shelter. Our very first shelter was a simple A-frame made of two by fours covered with a single layer of plastic. After visiting the Rodale Farm and the New Alchemists we modified the structure by removing the slanted beams on the north side of the frame and erecting perpendicular beams to form a perpendicular north wall and gently-sloping north roof when the plastic covering is in place. The great advantage of this shape is that it makes possible additional insulation (besides the plastic covering) of the north wall and the north roof by one of several methods, some of them inexpensive. It also enables us to place along the inside of the north wall some heat storage units such as black-painted cans filled with water. We have proven to our own satisfaction that

this shape is just as functional in a simple plastic-covered shelter as it is in the more elaborate buildings to be found at Rodale and the New Alchemists. It certainly has prevented a great deal of the heat loss characteristic of conventionally designed plastic greenhouses.

The illustration below shows the basic shape of the modified structure.

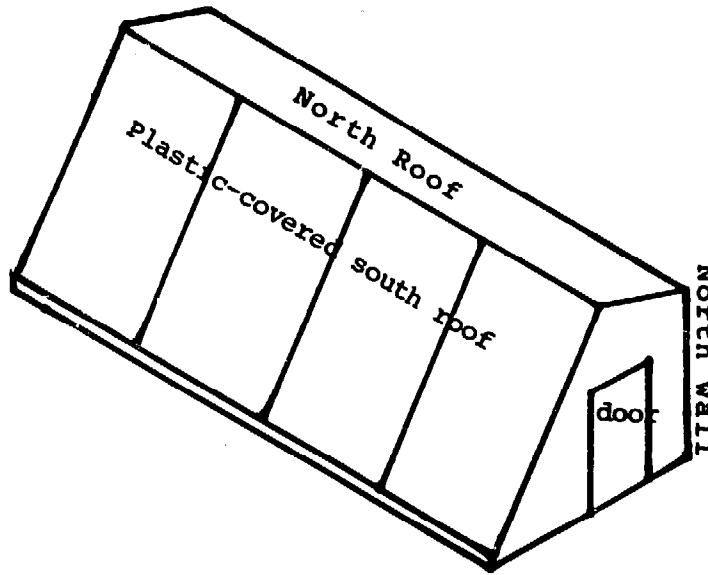

(This would be illustrated in a slide talk)

INSULATION: Having rejected a solid foundation and superstructure because of cost and tax considerations, we could not expect to achieve the kind of insulation such a design would provide for the north wall and roof, so we had to improvise.

During cold weather, the present shelter is covered with two layers of plastic. The outer layer is 6-mil polyethylene. The inner layer is Aircap, the bubble type of plastic ordinarily used in packaging. Insulation and protection of the north roof is provided by loosely nailed sheets of plywood put in place before the plastic is installed and painted white on the inside. Bags of leaves, of which there are plenty on Long Island in the autumn, have in the past been piled against the outside of the north wall. This year we expect that the outer layer of polyethylene will extend about a foot beyond the north wall and another layer will be attached to the frame. The space between these two layers of plastic will be filled with loose, dry leaves. The leaves will thus be protected against rain and snow.

Insulating the ground inside from freezing is a more difficult operation because of the absence of a foundation. Our present plan is to dig a trench bordering the outside of the shelter and fill this trench with styrafoam. We will report at another time on the effectiveness of this solution.

HEAT STORAGE AND DISTRIBUTION: It was planned to have ready for the winter of 1976-77 an array of black-painted, water-filled cans to be placed along the inside of the north wall to absorb the sun's heat during sunny days and reradiate the heat to the interior of the shelter at night. We did not have enough cans ready for that winter. They are now ready for the coming winter and it is expected that they will contribute measurably to the effectiveness of the shelter. At the suggestion of Earl Barnhardt of the New Alchemists, the cans will be stacked in such a way as to leave spaces between them.

Also at the suggestion of Mr. Barnhardt, we are planning to design and install near the ceiling of the shelter a large fan powered by a rotor-type windmill on top of the structure. This, it is hoped, will circulate the warm air that rises to the ceiling area.

VENTILATION: This is provided by a door at each end of the shelter. A more sophisticated system of ventilation will be considered for later installation.

WHEN IT IS NEITHER A SHELTER NOR A GREENHOUSE: Probably the most unconventional thing about the Museum's shelter is that during the late spring, the summer and the early fall it is not a shelter at all. From the beginning of our experiments, the plan has been to start a garden growing on the plot some time in August to get good growth before the frosts arrive. This cannot be done if the shelter is covered during this period. The plastic covering is on the shelter only during the coldest months, largely to protect the growth that has already occurred. Here on Long Island the covering is attached about the middle of October. In late Spring the interior will get too warm, so the plastic coverings are then removed. With careful handling, we have been able to get two years of use from the plastic in spite of this putting up and tearing down.

WHAT GROWS IN THE SHELTER: During the coldest months the shelter will protect only those vegetables which are inherently fairly hardy but which still cannot be grown without some protection. The hardy leaf vegetables we have grown are lettuce, spinach, kale, kohlrabi, parsley, cabbage, collard, chard, celery and dandelions. The root vegetables are leeks, onions, carrots, beets, oriental radishes. This summer (1977) we did plant some warmth-loving plants, not so much with the idea that they would grow through the winter, but to see just how far we could extend their season into the colder period. These include tomatoes, egg plants, peppers, cucumbers and some flowers.

A SEASONAL CHRONOLOGY: The following is a list of suggestions we make to gardeners who have built or will build a structure similar to the Museum's shelter. We are including it unchanged in this paper, even though there is some repetition of what has already been said, because it summarizes the basic procedure in using the shelter from a somewhat different angle.

Summer: We start off with summer because if one is building such a shelter for the first time it must be ready for summer planting and will not yet be covered with the plastic. If the shelter has been used before, the plastic will have been removed some time during the spring. Summer is the time to plant the garden inside the frame. One does not expect vegetables to really grow during the coldest part of the winter, so the idea is to get good growth before the onset of very cold weather. You will then be able to keep harvesting until the deep freeze is over and warmer weather comes back again. We found August to be the most appropriate planting time. As noted before, we plant directly in the ground, not in containers of any kind.

Fall: Some time about the middle of October (this is for Long Island, remember) the north roof is covered with plywood and the entire frame is covered with the two layers of plastic. At this time or somewhat later the north wall will be insulated with bags of leaves on the outside, and the fluid-filled cans will be placed along the inside of the wall. You will have had good growth up to this time; and with the structure prepared for the winter, growth may continue well into November, depending on the weather. On warm days, the gardener must remember to ventilate.

Winter: There is not much that can be done in the winter except to repair any damage that may be done by storms. Weeds will not be a problem. Watering will not generally be necessary, though a bucket of water should be kept in the shelter after the outside water has been turned off, just in case you might want to transplant something.

Spring: As soon as the coldest depths of the winter are past, the vegetables will begin to grow again, and by the beginning of March, long before anything much is growing outside, growth will be luxuriant in the shelter. You will enjoy harvesting a rich crop of tasty food when others are just beginning to think about what they will put in their gardens. The shelter is also an ideal place to harden off the seedlings of warm-weather plants which you started in a warmer environment. It can act, after all, as something of a large cold frame. In late spring the plastic covering is removed and put aside for use in the next season.

RESULTS: The winter of 1976-77 could be regarded as a definitive test of an enclosed shelter without complete insulation. It was the coldest winter in a century in the New York area and it is doubtful that anything at all could have been saved in the original A-frame shelter. For the final test of what can be accomplished when we have installed the "works", we shall have to wait (not very anxiously, we must tell you) for another such winter. During this bitterly cold winter we did lose quite a bit of our planting when the temperature dropped at times to around zero and stayed below ten degrees at night for quite a continuous stretch. What amazed us was how much we did *not* lose. Visitors to the Museum were tremendously impressed with what we were harvesting in the depths of the winter. Color photographs taken on January 18, 1977 leaving people who see them murmuring "incredible". There was absolutely no time during the winter when we were not harvesting some vegetables for the table of our own family and that of Peter Rickert, the grounds caretaker who does most of the growing in the shelter. About the middle of February the plants began growing again and by the end of March the inside of the shelter was a lush jungle of all kinds of goodies, long before anything was growing outside.

MAYBE WINTER IS THE ONLY TIME YOU CAN GROW: Many Long Island plots are so densely covered with trees that nothing much can be raised during the normal growing season when the trees are in leaf. So it strikes us that it might be possible for the owners to raise a vegetable garden only in the wintertime. With the leaves off the trees, it should be possible in many cases to situate a winter shelter properly to get enough winter sunlight for good growth. An unusual, but not necessarily impracticable, idea.

THE USE OF RETRACTABLE, INSULATED, REFLECTIVE SHUTTERS
FOR AUGMENTING RADIATION AND RETAINING HEAT IN GREENHOUSES

Michael Piserchio, William DuPont and John Hayes, Energy Research
Group, Marlboro College, Marlboro, VT 05344

and

Jeremy Coleman, Total Environmental Action, Harrisville, NH 03450

The purpose of this paper is two-fold:

1. To briefly describe two energy-conserving greenhouses which have been constructed at Marlboro College, and
2. To present an abbreviated, very simple method for estimating the added solar gain on vertical south surfaces through use of equal-area, horizontal, specular reflectors.

PART ONE: GREENHOUSE DESCRIPTIONS

Physical Descriptions

Drawings of the two greenhouses are included in Figures 1,2 and 3. Both greenhouses have 12' x 18' outside dimensions and face about 15° east of due south, because this is the orientation of the Marlboro College science building to which they are attached. The walls are insulated to R=20 and the opaque portions of the roofs to R=30. The frost walls and the undersides of the concrete floors are insulated to R=10. The main differences between the two greenhouses are outlined below:

	Greenhouse #1	#2
Height of vertical glazing	8'	5'
Length of roof glazing	5'	8'
Roof angle	15°	30°
Reflective, insulated, retractable shutter	Yes	No
Interior wall surfaces reflective	Yes	No
Removable insulation under roof glazing*	Yes	No

*Installed in November and removed in March. Thus, during the winter, all exposed glazing is covered with insulation at night.

Insolation

The average amount of direct and diffuse solar radiation falling on the external glazing of the two greenhouses is given below for

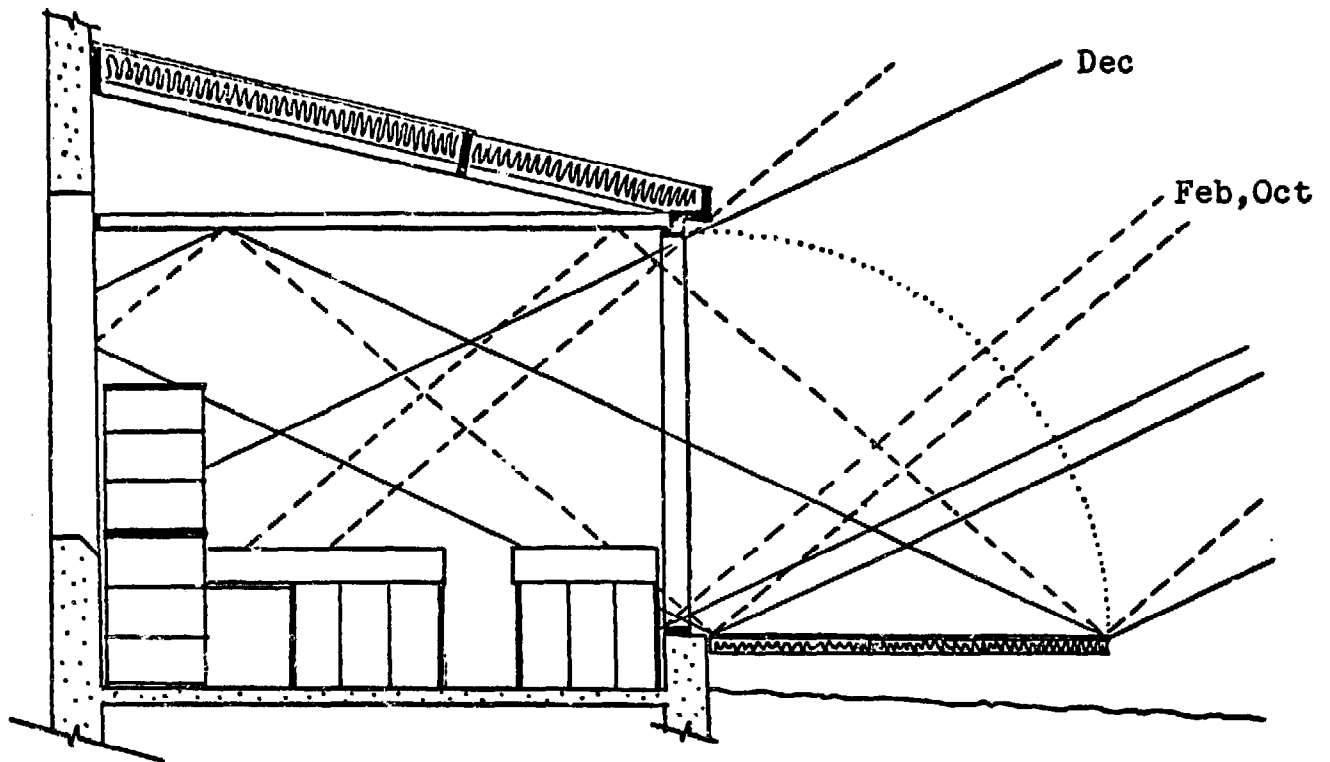

Figures 1 & 2. Greenhouse #1, cross-section facing east.
 Scale: $\frac{1}{4}$ " : 1'. Sun angles for solar noon are
 given for the 21st day of Feb, Apr, Jun, Aug, Oct
 & Dec. Use of reflectorized shutter and remov-
 able roof insulation is indicated.

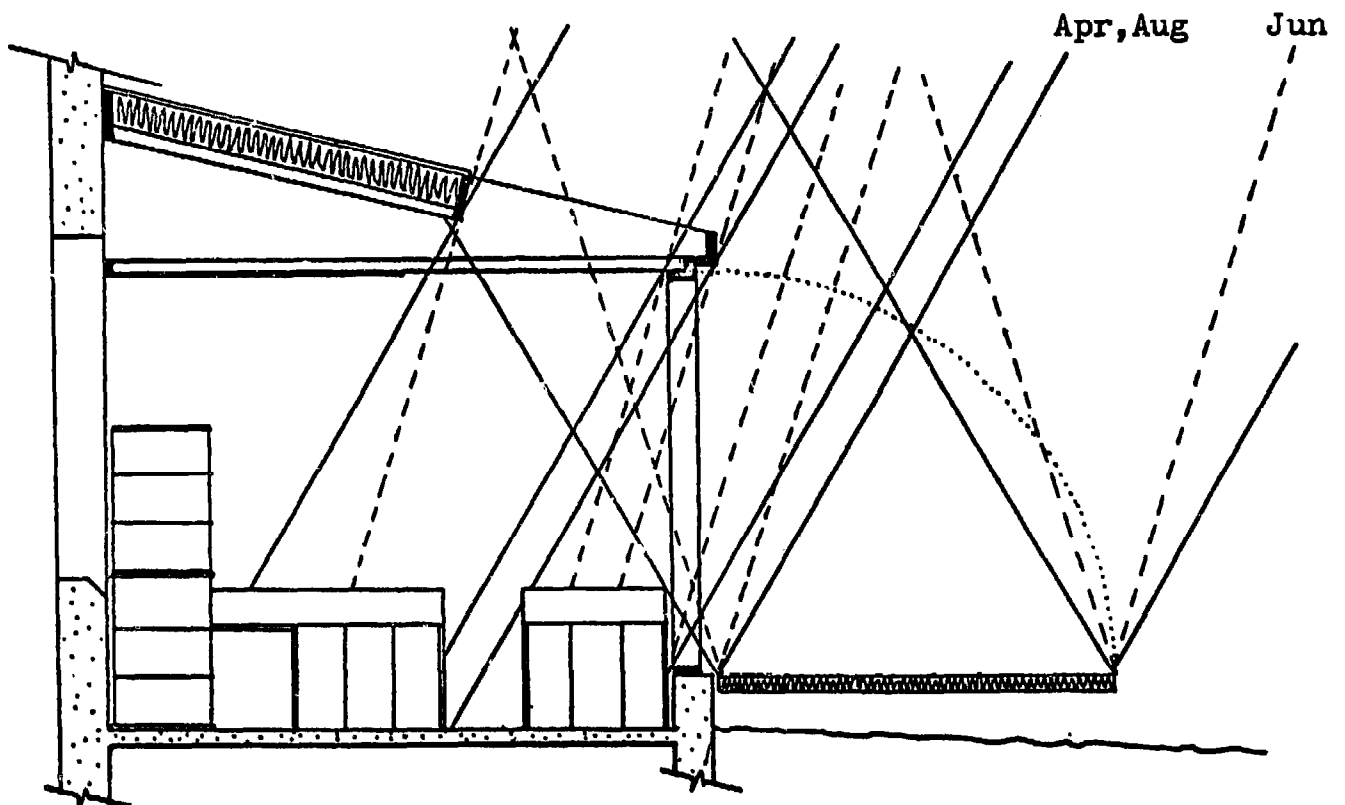
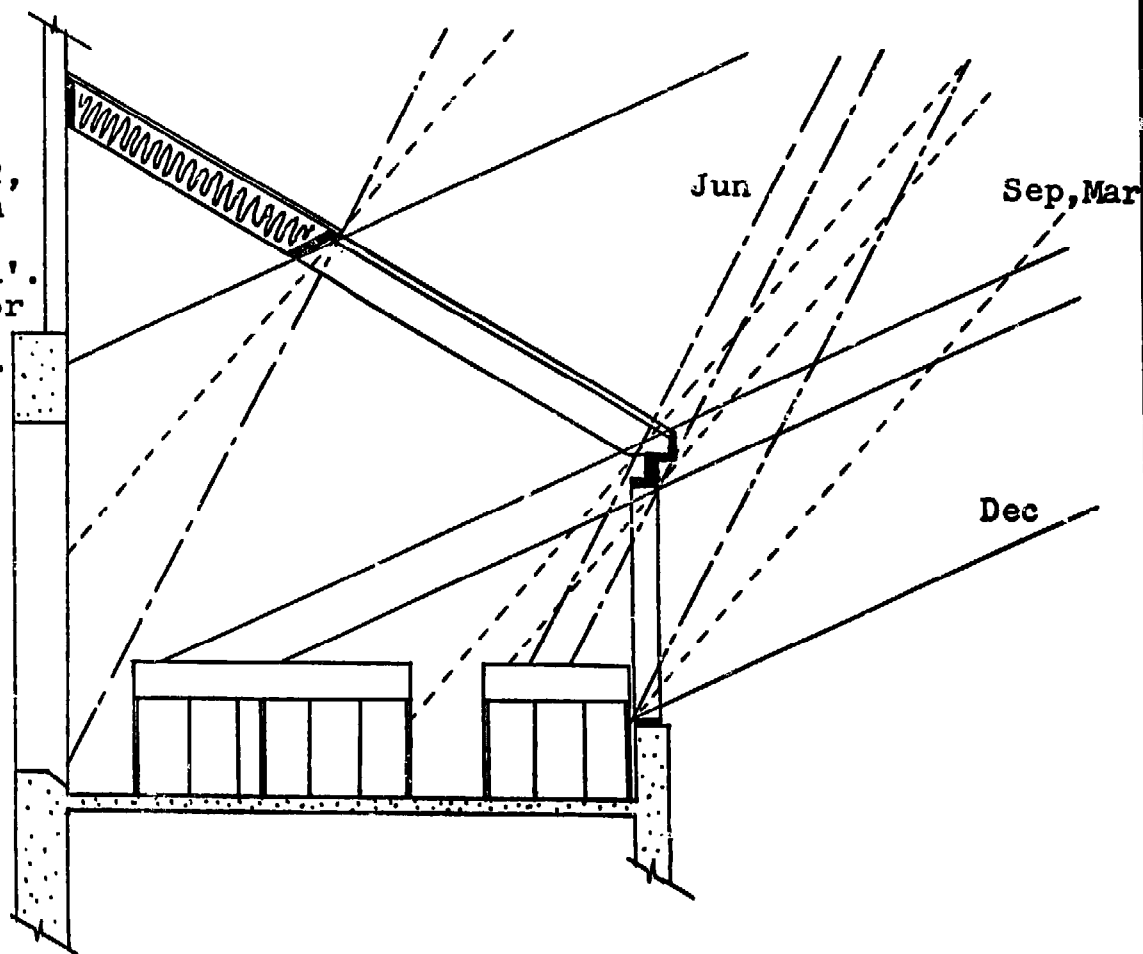

Figure 3.
Greenhouse #2,
cross-section
facing east.
Scale: $\frac{1}{4}$ " : 1'.
Sun angles for
solar noon
are given for
the 21st day
of Mar, Jun,
Sep & Dec.



the 15th day of each month (1,2). It is estimated that with reflection losses and absorption by the glazing about 75% of this radiation will enter each greenhouse. The contribution from the equal area specular reflector on greenhouse #1 has been added, but the added increment caused by reflected radiation from the immediate environment has been neglected for both greenhouses.

Table 1: Average insolation values for the 15th day of each month. Values are given in thousands of BTU/day.

<u>Day</u>	<u>#1</u>	<u>#2</u>	<u>Day</u>	<u>#1</u>	<u>#2</u>	<u>Day</u>	<u>#1</u>	<u>#2</u>
Jan 15	156*	178	May 15	211	252	Sep 15	218	242
Feb 15	181*	225	Jun 15	213	256	Oct 15	223	231
Mar 15	220	241	Jul 15	217	260	Nov 15	159	157
Apr 15	208	238	Aug 15	225	263	Dec 15	124*	132

*Insulation under roof glazing 24 hours per day for these months.

Identical plant growth experiments are being carried out in each greenhouse in order to determine any deleterious effects of eliminating roof glazing in the winter in greenhouse #1. As can be seen from the lighting diagrams (Figures 1,2 & 3), precautions have been taken to insure that light reaches the rear of greenhouse #1.

Mass

In order to effectively use for heating the extra radiation which the plants do not use, it is necessary to provide the greenhouse with storage mass. Effecting this transfer to storage presents special problems in greenhouses, especially when that transfer takes place passively, as in the two greenhouses being described. The problem arises because the plants, under maximal growing conditions, will effectively block most direct transfer to storage. While it is true that some of the light reflected off the plant leaves will eventually strike and be absorbed by storage, the efficiency of this transfer would be virtually impossible to calculate.

Consequently, over the winter, we will attempt to determine experimentally the optimal storage mass for our greenhouse conditions. We expect to begin experimentation with approximately the equivalent heat capacity of 40 pounds of water per square foot of greenhouse floor area. In addition, storage mass will not be placed in any position where it would block plant access to direct sunlight.

Heating and Cooling

Table 2 contains the results of heat loss calculations for five 200ft² greenhouses. The first two values represent predicted values for greenhouses #1 and #2. The last three values are for hypothetical single, double and triple-glazed conventional greenhouses. The values are calculated using 8,000 and 6,000 heating degree-days/season and one air change per hour. The heat loss values have been adjusted by subtracting the heat loss for the existing wall which is covered. Thus, the listed value is for the increment above the former heat loss. The R value for the existing wall is assumed to be 14.

Also in Table 2 are predicted transmitted-insolation values for greenhouses #1 and #2 for the heating season only. The values are calculated from data in Table 1.

It can be seen that greenhouse #1 is expected to provide to the building the equivalent of 47 and 93 gallons of fuel oil, depending upon the number of degree-days. Although the insolation values for the three conventional greenhouses were not calculated, it can be inferred that all three would suffer rather large net heat losses, even at 6,000 degree-days.

Table 2. Comparison of predicted transmitted insolation with predicted heat loss. Values in millions of BTU.

	<u>Greenhouse #1</u>	<u>Greenhouse #2</u>	<u>Single Glazing</u>	<u>Double Glazing</u>	<u>Triple Glazing</u>
Heating Season Insolation	23.9	26.3	-	-	-
8,000 D·D Heat Loss	19.2	35.5	132.3	76.7	55.7
6,000 D·D Heat Loss	14.6	26.8	101.4	59.7	43.9

Daytime excess heat in the winter is transferred to the building by means of a small fan mounted high on the back wall. Make-up air then enters the greenhouse from a vent low on the opposite end of the back wall. This same arrangement serves to transfer heat into the greenhouse at night. Summer time cooling of the greenhouses is accomplished with a natural convection arrangement which will not be described further.

Performance

As was mentioned previously, agriculture experiments are being carried out to determine the effect of vertical glazing with an equal-area specular reflector on plant growth. In addition, the thermal performance of both greenhouses is being monitored. Data are being recorded on a Leeds & Northrup Speedomax G recorder; solar insolation data are being recorded with an Eppley pyranometer.

PART TWO: THE REFLECTOR

This section is devoted to a description of the method for calculating solar gain on vertical surfaces through use of horizontal, specular reflectors. This is a simplified treatment taken from more rigorous treatments described elsewhere (3-9). In addition, although little space in this paper is devoted to this issue, it is assumed that the reflective shutter, when cranked to the vertical position, is an effective heat barrier. This, of course, assumes that a good seal has been achieved.

Simplifications

Using geometry and trigonometry, the performance of any reflector/collector combination can be predicted, but the resulting calculations are not easily performed. These calculations can be greatly simplified, so that only simple arithmetic is required, if some of the design parameters are given the following specifications:

1. The reflector is perfectly horizontal.
2. The wall (collector) is perfectly vertical.
3. The wall is oriented due south.
4. The reflector and wall are of identical size.
5. The measurement is made only for the winter months (actually, the measurement is made only when the solar altitude is 45° or less; when the altitude is greater than 45° , some reflected radiation will skip over the top of the wall).

For a detailed explanation of solar altitude as a function of date and latitude, as well as for a description of sun angles and insolation values, Chapter 59 of the ASHRAE Handbook and Product Directory (10) should be consulted.

Orientation

The optimal orientation for collectors and reflectors has been analyzed by McDaniels, et al. (7). Their findings suggest that the collector should be tilted between 70° and the vertical and that the reflector should be perpendicular to the collector plane (if the reflector must be fixed). A few degrees (+ or - 10%) deviation from the perpendicular gives small changes in reflector enhancement.

Definitions

- \bar{H}_o ** Monthly average daily total extraterrestrial radiation (6)
- \bar{H} ** Monthly average daily total radiation on a horizontal surface (11,12)
- \bar{D} *** Monthly average daily total diffuse radiation on a horizontal surface
- \bar{T} *** Monthly average daily total radiation on a tilted surface
- \bar{K}_t ** Cloudiness index: $\bar{K}_t = \bar{H}/\bar{H}_o$ (11)
- \bar{R} *** Tilt ratio: $\bar{R} = \bar{T}/\bar{H}$
- *
 \bar{R}_b Tilt ratio for beam component only
- S ** Angle of tilted surface (measured from the horizontal)
- P ** Ground reflectance (3,13)
- * Values in this paper
 ** Values easily available
 *** To be calculated

Monthly average daily total radiation is obtained by adding up the total radiation on a surface for each day, summing the values for a month, and dividing by the number of days in the month. The other symbols are pretty much self-explanatory. Values for each parameter are obtained from the indicated references.

Procedure

The number to be calculated is, of course, the sum of the total radiation, \bar{T} , on the vertical surface and the contribution from the horizontal specular reflector. \bar{T} is obtained from,

$$\bar{T} = \bar{R} \times \bar{H} \quad (\text{Eqn 1})$$

\bar{H} is known for many weather stations at different latitudes. \bar{R} is obtained from the following equation,

$$\bar{R} = \text{BEAM}/\bar{H} + \text{DIFFUSE}/\bar{H} + \text{REFLECTED}/\bar{H} \quad (\text{Eqn 2})$$

where, $\bar{T} = \text{BEAM} + \text{DIFFUSE} + \text{REFLECTED}$

This expression can be expanded into,

$$\bar{R} = (1 - (\bar{D}/\bar{H}))\bar{R}_b + (\bar{D}/\bar{H})(1 + \cos S)/2 + P(1 - \cos S)/2 \quad (\text{Eqn 3})$$

Equation 3 is not as formidable as it now appears, when it is applied to a vertical surface, because S in that case is 90° . The cosine of 90° is zero. Thus, the equation reduces to,

$$\bar{R} = (1 - (\bar{D}/\bar{H}))\bar{R}_b + (\bar{D}/\bar{H})/2 + P/2 \quad (\text{Eqn 4})$$

Values for \bar{R}_b are in the Appendix to this paper, because the existing tables are incomplete (see, for example, reference 6). The value for \bar{D}/\bar{H} is available from the following equation,

$$\bar{D}/\bar{H} = 1.390 - 4.027\bar{K}_t + 5.531\bar{K}_t^2 - 3.108\bar{K}_t^3 \quad (\text{Eqn 5})$$

Sample Calculation of \bar{T} for
Schnectady, NY (43°N) in December

- Approach:
1. Calculate \bar{D}/\bar{H} .
 2. Substitute \bar{D}/\bar{H} into Equation 4 and calculate \bar{R} .
 3. Substitute \bar{R} into Equation 1 and calculate \bar{T} .

The values of $\bar{K}_t = 0.331$ and $\bar{H} = 356 \text{ BTU/ft}^2/\text{day}$ are obtained from the Climatic Atlas (11). $\bar{R}_b = 1.73$ is obtained from the Appendix. $P = 0.7$ is used for reflectance off snow (3,13). Then, from Equation 5, \bar{D}/\bar{H} is calculated to be 0.550. \bar{R} , from Equation 4, is calculated to be 1.84. Then, $\bar{T} = \bar{R} \times \bar{H} = 655 \text{ BTU/ft}^2/\text{day}$.

Effect of Reflector

We know the value of \bar{H} on the reflector. That value can be divided into diffuse and beam components. The reflected diffuse radiation on the vertical surface is due to both the snow and the reflector. Technically, the diffuse component from the snow arriving on the vertical surface, which was calculated as the third term of Equation 4, should be modified by subtracting out the contribution from the area which is now covered by the reflector. This is not easy to do. It is also not easy to calculate the contribution on the vertical surface of the diffuse component coming from the reflector.

To simplify the calculation, it is assumed that the diffuse contribution from the snow field is equal to the diffuse contribution from the reflector and can replace that value in the calculation. Since the reflectivity of the reflector is greater than that of the snow, this will lead to a slight underestimation of the value of the reflector.

Since this calculation is being made for the winter months with a solar altitude restriction of 45° maximum, the only reflector loss which must be taken into account is end loss. At all times other than solar noon, some reflected radiation will not intersect the vertical surface. Obviously, end losses will be greatest when the solar azimuth angle is large, i.e., during early morning and late afternoon hours. (Solar azimuth is defined as the angle between the projection on the earth's surface of the earth-sun line and its intersection with a north-south line at the observer. (10))

This end loss based on total reflectivity is higher when the ratio of reflector length (east-west) to width (north-south) is small. For infinitely long reflectors end loss is negligible. Thus, longer east-west axis reflectors give proportionately lower end losses. This can be seen quantitatively in Table 3.

Table 3. Table of end loss.

Azimuth	Percent Loss				
	<u>L = W</u>	<u>L = 2W</u>	<u>L = 3W</u>	<u>L = 4W</u>	<u>L = 5W</u>
0	0	0	0	0	0
10	9	4	3	2	2
20	18	9	6	5	4
30	29	14	10	7	6
40	42	21	14	11	8
50	58	30	20	15	12
60	71	43	29	22	17
70	82	64	46	34	27
80	92	82	73	64	56
90	100	100	100	100	100

Next, the end loss has to be subtracted from the horizontal radiation. This is somewhat a laborious process, since it must be done for all times of the day. It can be simplified by subtracting end loss for each hour of the day, starting with the hour centered around 8:30 and continuing with 9:30, 10:30 and 11:30. End loss for the afternoon hours parallels exactly the losses for the morning so they do not have to be directly calculated.

Recall that the beam component, \bar{H}_b , is the value to be calculated. The fraction of \bar{H} which occurs during any hour of the day is approximately known (3.14) and is given in column 3 of Table 4. Similarly, values for \bar{D} are also given in Table 4.

Table 4. Calculation of the beam component on the specular reflector for Schenectady in December (43°N).

Hour Inter-val Centered at:	Azimuth	%-age of \bar{H}	Available \bar{H} (BTU/ft ² /hr)			
8:30	48	0.05	17.9			
9:30	35	0.11	39.3			
10:30	22	0.16	57.1			
11:30	8	0.18	64.3			

Hour	%-age of \bar{D}	Available \bar{D} (BTU/ft ² /hr)	$\bar{H} - \bar{D} = \bar{H}_b$ (BTU/ft ² /hr)	Area (ft ²)	\bar{H}_b (for Total Area) (BTU/hr)
8:30	0.06	11.8	6.1	92.5	564
9:30	0.12	23.5	15.8	105.5	1670
10:30	0.15	29.4	27.7	115	3190
11:30	0.17	33.3	31.0	123.5	3830
					9250

When the hourly percentage values for \bar{H} are multiplied by \bar{H} (356 BTU/ft²/day broken down into hourly components), the hourly available radiation can be obtained. Previously, \bar{D}/\bar{H} was calculated to be 0.550; using the value of \bar{H} , \bar{D} is 196 BTU/ft²/day. Thus, in just the same way as \bar{H} , the hourly available \bar{D} can also be calculated. The beam component, then, for each hour is $\bar{H} - \bar{D} = \bar{H}_b$.

Using the end-loss percentages from Table 3 for a reflector with $L = 2W$ and an area of 128 ft² (8' x 16'), effective collector areas at each hour may be calculated. Finally, by multiplying the hourly beam component, \bar{H}_b , by the effective area, the total hourly radiation, \bar{H}'_b , can be calculated. The total contribution from the reflector, \bar{H}''_b , is twice the sum of the \bar{H}'_b values, or 18,500 BTU/day.

This value assumes a reflectance of 1.0. Thus, \bar{H}''_b needs to be multiplied by the actual reflectance. For the purposes of this

calculation, this value is assumed to be 0.95. A discussion of reflectance values is included in the Appendix.

Multiplying 18,500 BTU/day by 0.95 and 31 days/month, a value of 546,000 BTU/month is obtained. This must be reduced by subtracting that fraction which does not get through the glazing. If we assume an average value of 75% transmittance, the amount of radiation from the reflector which actually enters the greenhouse will be 410,000 BTU/month for December.

Table 5 contains a summary of the calculations for Schenectady in the winter. It can be seen that the enhancement factor ranges from a low of 21% in December to a high of about 40% in October, March and April. Overall, the average enhancement is 32%. At 43°N latitude in April, during some parts of the day the altitude gets larger than 45°. In order to keep the reflected radiation from skipping over the top of the vertical wall at solar noon, the reflector is raised above the horizon by 11°.

Table 5. Calculation summary for Schenectady (43°N).

Month	\bar{H} BTU/ft ² /day	\bar{K}_t	Reflector BTUx10 ⁻⁶	\bar{T} BTUx10 ⁻⁶	Total BTUx10 ⁻⁶	% enhance- ment
Oct	820	0.420	1.02	2.66	3.68	38
Nov	436	0.309	0.45	1.65	2.10	27
Dec	356	0.331	0.41	1.96	2.37	21
Jan	488	0.406	0.66	2.77	3.43	24
Feb	753	0.441	0.95	3.20	4.15	30
Mar	1026	0.433	1.27	3.54	4.81	40
Apr	1272	0.413	1.06	2.50	3.56	42
			5.82	18.28	24.10	32

Acknowledgments

We are greatly indebted to Tom Bibby, Cherie Brown, Jane DeLisa, Sarah Edwards, Kathleen Goff, Gene Kistler, John MacArthur, Norman Paradis, Victoria Reck and Lilliana Vitelli, members of the Marlboro College Energy Research Group, without whose participation this project would have been impossible.

We are also indebted to the National Science Foundation for a grant (#SMI77-05278) which supported portions of this project. In addition, we are indebted to the U.S. Army Cold Regions Research and Engineering Laboratory for loan of monitoring equipment. Friends of alternate energy research, who are far too numerous to mention here, have also supported this project with ideas, encouragement and financial support.

References

1. Design, Construction and Preliminary Evaluation of a Solar-Wood Heating System for New England, Energy Research Group, Marlboro College, Marlboro, VT 05344 (1975).
2. Jeremy Coleman, Estimation of Average Long-Term Daily Radiation Striking Tilted Surfaces, Total Environmental Action, Harrisville, NH 03450 (1976).
3. B. Liu & R. Jordan, The Interrelationship and Characteristic Distribution of Direct, Diffuse and Total Solar Radiation, Solar Energy 4, No. 3 (1960).
4. B. Liu & R. Jordan, Daily Insolation on Surfaces Tilted Toward the Equator, Trans. ASHRAE 526-541 (1962).
5. B. Liu & R. Jordan, The Long-Term Average Performance of Flat Plate Solar Energy Collectors, Solar Energy 7, 53-74 (1963).
6. S. Klein, Calculation of Monthly Average Insolation on Tilted Surfaces, Solar Energy 19, 325-329 (1977).
7. D. McDaniels, D. Lowndes, H. Mathew, J. Reynolds & R. Gray, Enhanced Solar Energy Collection Using Reflector-Solar Thermal Collector Combinations, Solar Energy 17, No.5 (1975).
8. S. Seitel, Collector Performance Enhancement with Flat Reflectors, Solar Energy 17, No.5 (1975).
9. S. Grassie & N. Sheridan, The Use of Planar Reflectors for Increasing the Energy Yield of Flat Plate Collectors, Proceedings of the 1976 Joint Conference of the American & Canadian Sections of ISES, Winnipeg, Manitoba.
10. Solar Energy Utilization for Heating & Cooling, ASHRAE Handbook & Product Directory, Chapter 59 (1974). (Available from the American Section of ISES as a reprint.)
11. Climatic Atlas of the United States, Environmental Data Service, U. S. Department of Commerce, Washington, DC (1968).
12. J. Krieder & F. Kreith, Solar Heating and Cooling: Engineering, Practical Design & Economics, Hemisphere Publishing, Washington, DC (1975).
13. B. Hunn & D. Calafell, Determination of Average Ground Reflection for Solar Collectors, Solar Energy 19, 87-92 (1977).
14. J. Duffie & W. Beckman, Solar Energy Thermal Processes, Wiley, New York (1974).

Appendix

Table 6. Values for \bar{R}_b .

Date	Latitude (°N)	Tilt Angles						
		0°	15°	30°	45°	60°	75°	90°
Jan 15	20	1	1.24	1.40	1.46	1.43	1.29	1.07
	25	1	1.29	1.49	1.59	1.58	1.46	1.25
	30	1	1.34	1.60	1.74	1.77	1.67	1.46
	35	1	1.42	1.75	1.95	2.02	1.96	1.76
	40	1	1.52	1.94	2.22	2.36	2.33	2.15
	45	1	1.65	2.19	2.59	2.80	2.82	2.66
	50	1	1.85	2.57	3.11	3.45	3.54	3.40
	55	1	2.20	3.25	4.08	4.63	4.86	4.76
Feb 15	20	1	1.17	1.25	1.26	1.17	1.01	0.78
	25	1	1.20	1.33	1.36	1.30	1.15	0.92
	30	1	1.25	1.41	1.47	1.44	1.31	1.08
	35	1	1.30	1.50	1.61	1.61	1.49	1.28
	40	1	1.36	1.62	1.78	1.81	1.72	1.58
	45	1	1.44	1.78	2.00	2.08	2.02	1.83
	50	1	1.55	1.99	2.30	2.45	2.44	2.26
	55	1	1.71	2.30	2.73	2.98	3.02	2.86
Mar 15	20	1	1.08	1.08	1.01	0.87	0.67	0.48
	25	1	1.10	1.13	1.08	0.96	0.77	0.58
	30	1	1.13	1.19	1.16	1.06	0.88	0.66
	35	1	1.17	1.25	1.26	1.17	1.01	0.78
	40	1	1.21	1.33	1.36	1.30	1.15	0.93
	45	1	1.25	1.42	1.49	1.45	1.32	1.10
	50	1	1.31	1.52	1.64	1.64	1.53	1.32
	55	1	1.31	1.52	1.64	1.64	1.53	1.32
Apr 15	20	1	0.99	0.92	0.79	0.60	0.37	0.13
	25	1	1.02	0.97	0.85	0.68	0.45	0.21
	30	1	1.04	1.01	0.91	0.75	0.54	0.30
	35	1	1.07	1.06	0.98	0.84	0.64	0.39
	40	1	1.09	1.11	1.05	0.92	0.73	0.49
	45	1	1.12	1.16	1.13	1.02	0.84	0.61
	50	1	1.15	1.22	1.21	1.12	0.96	0.73
	55	1	1.19	1.29	1.31	1.24	1.09	0.87
May 15	20	1	0.94	0.81	0.63	0.42	0.18	0.00
	25	1	0.96	0.85	0.69	0.48	0.26	0.05
	30	1	0.98	0.89	0.75	0.55	0.34	0.11
	35	1	1.00	0.93	0.80	0.63	0.41	0.18
	40	1	1.02	0.97	0.86	0.70	0.49	0.26
	45	1	1.04	1.02	0.92	0.77	0.57	0.35
	50	1	1.06	1.06	0.98	0.85	0.66	0.43
	55	1	1.08	1.10	1.05	0.92	0.75	0.52
Jun 15	20	1	0.91	0.76	0.57	0.34	0.12	0.00
	25	1	0.93	0.80	0.62	0.41	0.18	0.01
	30	1	0.95	0.84	0.68	0.47	0.26	0.05

		0°	15°	30°	45°	60°	75°	90°
	35	1	0.97	0.88	0.73	0.54	0.33	0.11
	40	1	0.99	0.92	0.79	0.61	0.40	0.18
	45	1	1.01	0.96	0.84	0.68	0.47	0.26
	50	1	1.03	0.99	0.89	0.74	0.55	0.33
	55	1	1.05	1.03	0.95	0.81	0.63	0.41
Jul 15	20	1	0.92	0.79	0.60	0.38	0.15	0.00
	25	1	0.94	0.83	0.66	0.44	0.22	0.02
	30	1	0.96	0.86	0.71	0.51	0.30	0.08
	35	1	0.99	0.90	0.77	0.58	0.37	0.15
	40	1	1.01	0.94	0.82	0.65	0.44	0.22
	45	1	1.03	0.99	0.88	0.72	0.52	0.30
	50	1	1.05	1.03	0.94	0.79	0.60	0.38
	55	1	1.07	1.07	1.00	0.87	0.69	0.46
Aug 15	20	1	0.97	0.88	0.73	0.52	0.29	0.07
	25	1	0.99	0.92	0.79	0.60	0.37	0.14
	30	1	1.02	0.96	0.85	0.67	0.45	0.22
	35	1	1.04	1.01	0.91	0.75	0.54	0.30
	40	1	1.06	1.05	0.97	0.83	0.63	0.39
	45	1	1.09	1.10	1.04	0.91	0.73	0.49
	50	1	1.12	1.16	1.12	1.01	0.83	0.60
	55	1	1.15	1.21	1.20	1.11	0.94	0.72
Sep 15	20	1	1.05	1.02	0.92	0.77	0.56	0.31
	25	1	1.07	1.07	0.99	0.85	0.65	0.41
	30	1	1.10	1.12	1.07	0.94	0.75	0.51
	35	1	1.13	1.18	1.15	1.04	0.86	0.63
	40	1	1.16	1.24	1.24	1.16	0.99	0.76
	45	1	1.20	1.32	1.35	1.28	1.13	0.90
	50	1	1.24	1.40	1.47	1.43	1.30	1.08
	55	1	1.30	1.51	1.62	1.61	1.50	1.29
Oct 15	20	1	1.13	1.19	1.17	1.06	0.89	0.65
	25	1	1.17	1.26	1.26	1.18	1.01	0.78
	30	1	1.21	1.33	1.36	1.30	1.15	0.93
	35	1	1.25	1.41	1.48	1.45	1.32	1.10
	40	1	1.30	1.52	1.63	1.63	1.51	1.30
	45	1	1.37	1.64	1.80	1.84	1.76	1.55
	50	1	1.45	1.80	2.03	2.12	2.07	1.88
	55	1	1.57	2.03	2.35	2.52	2.51	2.33
Nov 15	20	1	1.22	1.36	1.40	1.35	1.21	0.98
	25	1	1.26	1.44	1.52	1.50	1.37	1.15
	30	1	1.31	1.54	1.66	1.66	1.56	1.34
	35	1	1.38	1.67	1.84	1.89	1.81	1.60
	40	1	1.47	1.84	2.08	2.18	2.14	1.94
	45	1	1.59	2.06	2.40	2.57	2.57	2.39
	50	1	1.75	2.37	2.84	3.11	3.17	3.01
	55	1	2.01	2.89	3.57	4.01	4.17	4.05
Dec 15	20	1	1.26	1.44	1.52	1.50	1.37	1.15
	25	1	1.31	1.54	1.66	1.66	1.56	1.34
	30	1	1.38	1.66	1.83	1.88	1.80	1.59
	35	1	1.46	1.83	2.07	2.17	2.12	1.93
	40	1	1.58	2.05	2.38	2.54	2.54	2.36
	45	1	1.72	2.33	2.78	3.04	3.09	2.93
	50	1	1.98	2.82	3.47	3.89	4.04	3.91
	55	1	2.41	3.67	4.67	5.35	5.67	5.60

Reflectance of Materials

The value for the reflectance of 0.95 used in the calculations is somewhat idealized, and it is only used because it probably represents about the best that can be obtained. The measurement of accurate reflectance values is extremely difficult, because there are variables which change reflectivity under actual use conditions. The best that can be hoped for is some sort of average value.

Some of the confusion over reflectance values arises because in the literature distinctions are not made between specular and diffuse reflection. When a beam of light is shined at a reflective material, the light will be reflected in all directions but may be more concentrated in a certain direction or aperture. The total reflection is called hemispherical and the reflection with the directional component is called specular. Thus, when reflectivity is mentioned, the aperture of measurement should be mentioned.

As was mentioned previously, some other variables must also be specified. Reflectance varies with wavelength of the light, the angle of incidence, and oxidation or dirt accumulation. In the case of a silver mirror, 30% of incident red light is reflected, whereas 98% of violet light is reflected. (E. Hect & A. Zajac, Optics, Addison-Wesley, pp. 88-89 (1973)) As far as angle of incidence is concerned, with white light silver has a reflectance of 0.9 at normal incidence and a reflectance of 1.0 as the angle approaches 90°. (ibid.) An approximation method for reflectance calculations for incident angles other than normal is given in O. Heavens, Optical Properties of Thin Solid Films, Dover, New York.

Reflectance values for various materials are given in a Sandia Laboratory report. The values for these materials were obtained using the solar spectrum. (R. Pettit & B. Butler, Solar Total Energy Materials Support: Mirror Materials and Selective Coatings, Sandia Labs (1976))

In summary, be wary. But recall that as the angle of incidence moves away from the normal, the better the reflectivity. These shallow angles are precisely the ones most frequently encountered with flat reflectors. Polished aluminum, which is the most common reflector material, can have a reflectance of 0.95 at those shallow angles. The question remains, though, what fraction of the 95% hemispherical reflectance is specular?

THE GROWTH AND RESPONSE OF VEGETABLES IN SUB OPTIMUM GREENHOUSE ENVIRONMENTS

Carla Mueller, J.W. White and R.A. Aldrich¹

Introduction

In response to fuel cost problems confronting conventionally designed and operated greenhouse businesses, Penn State University Horticulture Department is developing an extensive solar and energy conservation research project for greenhouses at its Rock Springs facility. Six small collection and/or conservation structures have been completed for autumn and winter testing. The performance of each design will be compared to a control glasshouse. Also, the performance of selected greenhouse crops of established potential market value will be tested. Some experimentation, designed to observe the behavior of commercially grown greenhouse crops cultivated in sub-optimum greenhouse environments, was completed between February 15 and June 16, 1977. This paper will examine and discuss the results of this work.

Materials and Methods

Many vegetable and flower crops grown commercially today may not grow optimally in "solar energized" environments. This may be due to lower or fluctuating temperatures, and reduced incoming solar insolation from glazing materials or "thermal blankets". Four experimental structures were used to grow vegetable crops requiring disparate optimum temperatures, light, humidity, and nutritional requirements. Basically, variations in house glazing material, internal temperatures, humidity and internal levels of insolation should produce problems associated with growing currently popular commercial crops in noncontrollable, "solar energized" environments.

Houses*

#1. 12' x 16' lapped glasshouse in conventional gable roof design (Glass-6).

#2. A 20' x 20' two-ridge, gable-roofed house, glazed with a double-walled acrylic paneling² (Acrylic 3).

#3. One 20' x 20' two-barrel vault fiberglass house, one of two newly built in the summer and fall of 1976 (Fiberglass-2).

#4. Another similar fiberglass house containing facilities for the collection of excess solar heat from the ridges, and storage in rocks under the growing benches. Collection started when temperatures were about 75°F; supplemental heat was supplied when internal night temperatures fell below 60°F (Fiberglass-1).

Temperatures

Each house was supplied with heat by a hot water-to-air exchanger located on the north end of each house. Although a base temperature of 70°F day and

¹Graduate assistant; Professor of Horticulture; Professor of Agricultural Engineering respectively. Special thanks to P. Ferretti Extension Specialist of Small Fruits and Vegetables.

²Manufactured by Rohm of Darnstadt

60°F night was given as the best compromise for the crops grown, temperatures fluctuated on occasion from 40°F to 104°F, depending on the house. On February 23, temperatures reached a minimum of 43°F and 38°F, while on March 30, temperatures reached a minimum of 42°F and 40°F in Fiberglass 1 and Fiberglass 2, respectively.

A hygrothermograph located at plant level in each house was used to record day-night temperature cycles and relative humidity.

Table 1 summarizes temperature maximums measured between March 2 to June 3. Chart data were not available for the first two weeks of the experiment, but temperatures were noted on a standard thermometer every other day at 10:30 a.m. and 2:00 p.m. Averages of both times for a two-week period are as follows:

Fiberglass-1	70°	Acrylic-3	75°
Fiberglass-2	70°	Glass-6	80°

Table 1. Temperature Maximums and Minimums. (March 2 to June 3)

Dates	Fiberglass-1		Temperature (°F) Fiberglass-2		Acrylic-3		- Glass-6	
	max.	min.	max.	min.	max.	min.	max.	min.
3/2-3/11	76	51	77	74	77	52	98	74
3/19-3/26	71	41	84	53	80	54	85	77
4/17-4/25	81	58	99	65	75	52	96	61
4/26-5/4	78	54	89	64	73	51	91	53
5/26-6/3	89	57	100	57	90	51	107	55

Expressing temperatures as maximum and minimum averages does not express the fact that fiberglass houses 1 and 2 were cooler longer in the morning, and cooled off quite quickly in the afternoon; acrylic-3 and glass 6 warmed up gradually, then stayed warm longer as outside temperatures declined. Although fiberglass 2 shows quite high daytime temperature peaks, this house was the most consistently cool.

Relative humidity curves usually followed inversely those for temperature. Graph 1 shows how maximum and minimum humidity averages changed as day lengths increased in the spring. In March, day humidities were lower, and there was less night-day differential. Starting in April, night values climbed, and day humidities were relatively low. House covering material was probably a major contributor to such large variability in humidities between houses.

Choice of covering also greatly influenced both solar and thermal transmission into the houses. The following chart summarizes data obtained from Aldrich and Rotz (1978) and manufacturer's specification. (4)

Material	% Solar Transmission	Thermal Transmission* (watts/m ² /°c)
Glass (2)	90	6.4
Fiberglass (2)	78	5.7
Double-walled acrylic (4)	83	3.12

Crops

Three benches, each holding 8" of soil mix, were constructed in each house. All were supported about 3' off the ground from the top edge, then filled with a pasteurized 1:1:1 mixture of mushroom casing soil, sphagnum peat and perlite. Single superphosphate, potassium nitrate and magnesium sulfate were added as recommended by soil test results. Fertilizing was done manually; each bench received a complete analysis solution every two weeks until about the end of April, after which ammonium nitrate and potassium nitrate were given weekly on an alternating basis. This fertilizer schedule was insufficient to maintain the crops at optimum fertility levels, probably because of extensive leaching when beds were watered. Twin-wall soaker type irrigation hose, stretched the length of each bed, was used for irrigation.

All crops were germinated and grown to transplant size at the Penn State floriculture greenhouses, then transplanted at Rock Springs. The north bed in each house was divided into three sections; the two end areas held "La Reine" gynoecious cucumber vines, which were trained up twine attached to overhead supports in an inverted "V" pattern, or attached to side walls. The middle bed had one row of "9102 M", an experimental field tomato developed at Penn state, and one row of "Small Fry" cherry tomato plants. The far bed contained 1½ rows each of Bibb and Buttercrunch lettuce, and 3 cultivars of "Cherry Belle" radishes, directly sown. This paper will summarize and discuss data on yield and quality of each crop excluding the radishes.

Field Tomato - 9102 M

Both tomato varieties were selected because they are not usually grown in a commercial greenhouse; the response of commonly used varieties such as "Vendor" or "Super M" has been widely observed in many experimental environments. "9102 M" had large-leafed, coarse foliage and grew with a sprawling habit not suited to single-stem training. Seeds were sown on December 6; seedlings were transplanted into peat pots on the 28th, and placed in the Rock Springs house February 19 to 26. Table 2 documents earliness of yield and plant performance. All plants were terminated on June 8.

Table 2. Tomato 9102 M: Plant and Yield Characteristics.

	Fiberglass 1	Fiberglass 2	Acrylic 3	Glass 6	6a
Date transplanted	2/20	2/26	2/20	2/19	-
Date of first yield**	4/30	5/3	4/19	4/12	-
Days transplanted to yield	70	66	58	49	-
# Harvest days	35	37	51	46	303
Total fruit picked	299	127	339	168	280
Total fruit sampled	247	77	326	14	23
# Culls	52	50	13	30.15	50.25
Est. pounds produced***	36.37	11.82	52	5.02	5.02
Est. pounds produced/plant***	3.64	1.18	5.20	30.3	-
Ave. # fruit/plant	29.9	12.7	33.9	3.06	-
Ave. size fruit weight	3.13	2.58	3.07		

*6a: values are estimates for 10 plants; only 6 plants were grown in glasshouse 6.

** .5 lbs. fruit harvested.

*** does not include what was originally graded as "culls".

The data in Table 2 shows that tomato plants in glass-6 yielded the earliest, followed by those in acrylic 3, a week later. Plants in both fiberglass houses began yielding two weeks later than those in glass-6. In Pennsylvania the average main season field tomato begins yielding fruit about 75 days after transplant; field varieties currently recommended require from 64 to 85 days (11). The total number of fruit harvested at consecutive dates is shown in Fig. 2. By June, branches from glasshouse 6 were flowering for a second cycle of fruiting. Numbers of mature tomatoes available from fiberglass-2 peaked on June 2, then sharply decreased; plants bore heavily around this time, but most were either of very small size or deformed. An unfavorable growing environment in house 2 was probably responsible for reduced fruit equality; besides reduced light and low average air temperature during early spring, soil temperatures were about 60°F, 10° lower than in all other greenhouses. Mature fruit was being picked in large quantities by May 26 in Fiberglass 1 (Fig. 2). Both tomato varieties in both fiberglass houses had yet to reach peak harvest when plants were removed.

In determining fruit quality, 9102 M had to be compared to criteria established for field tomatoes in Pennsylvania. It should be kept in mind that field varieties are not selected for greenhouse cultivation.

Table 3. Tomato 9102 M: Fruit Quality.

<u>Fruit weight/oz.</u>	<u>Fiberglass-1</u>	<u>Fiberglass-2</u>	<u>Acrylic-3</u>	<u>Glass 6</u>	<u>6a*</u>
1-3.5 oz.	219	73	218	129	215
3.6-6 oz.	25	7	79	35	58
6 oz	1	0	2	3	5
<u>Fruit diameter/oz</u>					
0-1.9 in	59	23	55	28	47
2-2.9 in	183	128	172	48	80
3-3.9 in	3	6	57	11	18
4 in	1	0	15	0	0
<u>% culls in total</u>	.17	.39	.04	.08	.13
<u>% harvested with defects</u>	.77	.51	.34	.18	.30

*6a: values are estimates for 10 plants; only 6 plants were grown in glasshouse 6.

The fruit was harvested and graded at the "Red Stage", with 90% of the surface red. Individual tomatoes were examined initially as is common practice for greenhouse fresh market tomatoes. Almost all fruit would fall in the "small" category as described in U.S.D.A. Agricultural Handbook #382, and a large percentage would be discarded as culls, due to insufficient size or damage. However, it may be more accurate to treat 9102-M as a field tomato grown in Pennsylvania, out of season.

According to the Fruit and Vegetable Division of the Pennsylvania Department of Agriculture, private company specifications following USDA grade guidelines for process grade tomatoes are most often used. An increasingly popular trend is to divide tomatoes into two categories, "useable" and "culls". Criteria for useability

depends on its intended use, ie. paste, juice (11). Grades for fresh market field tomatoes follow the four categories established by the USDA to be used as specifications at shipping point. In order of best quality, categories include U.S. #1, U.S. combination, U.S. #2 and U.S. #3 (19). It was arbitrarily decided that "serious damage" included catfacing, extreme blossom end rot, heavy stolor scaring, anther scaring or extremely malformed fruit. "Minor damage" included slight blotchy ripening, slight blossom end rot scaring, some "ribbing" on tomatoes, triangular or oblong shaped fruit, and minor sunscald. Using either classification scheme, all 9102-M tomatoes, including all but a very few culls, could be called "usable"; or except for house #2, all tomatoes would have been graded as U.S. #1.

This experimental field tomato yielded quite well at the same planting density in the greenhouse when compared to yield in tons per acre for field grown fruit for Pennsylvania and Canada. Keep in mind that the poundage recorded for each house does not include the "culls", nor were tomato plants in houses 1 and 2 allowed to realize their yield potential.

Table 4. Average Yield of field tomatoes - (Tons per Acre*)

<u>Field - Grown Crops</u>	
Canada: (fresh market)	8 ½ - 10
high yield	18
Pennsylvania:	20 - 25
high yield	30 - 40**
<u>Greenhouse Soil-Mix Culture</u>	
fiberglass-1	24.75
fiberglass-2	8.05
acrylic-3	35.39
glass-6	36.42

*Varies by picking method and severity of grading.

**Up to 60 tons per acre or more have been harvested in experimental plots in Pennsylvania (var. "Royal Cheko")

In summary, plants from the acrylic and glass houses performed similarly in earliness of harvest; total poundage and number of fruit in each size category. The acrylic house tomatoes had the lowest percent "culls", but along with the glass house had nearly the same relative percent fruit harvested with defects. Although fruit from plants in fiberglass-1 had the highest percent defects, most damage was quite minor in comparison to that of fiberglass-2.

Small Fry

The cherry tomato has traditionally been considered as a field and home garden crop. However, after observing the cultivar "Small Fry" in the greenhouse, it appears that this type tomato has great potential both commercially and in non-optimum greenhouse environments. In general, plants in all houses were vigorous, heavy bearers even with varying temperature conditions, heavy white fly infestation in May, water or heat stress and little pruning of lateral shoots. Sowing and transplanting dates were identical to those for "9102 M".

Table 6. "Small Fry" Yield and Plant Characteristics

	Fiberglass 1	Fiberglass 2	Acrylic 3	Glass 6	6a*
Total days, seed sowing to maturity	114	116	102	93	-
Harvest period	5/3-6/2	4/26-5/21	4/19-6/8	4/12-6/1	-
# Harvest days	31	27	51	52	-
Est. pounds produced/house	80.41	48.00	87.83	30.00	50.00
Est. pounds produced/plant	8.04	4.80	8.78	5.00	5.00
Total # fruit harvested	1927	1163	2386	922	1537
Total # samples**	59	56	70	50	-
Ave. diameter in inches	1.25	1.30	1.34	1.30	-
Ave. weight in oz.	.67	.67	.63	.60	-
Est. tons/acre produced	54.73	32.67	59.78	36.24	-

*6a Values are estimated for 10 plants

** Fruit measured for weight and diameter.

Plants from glass-6 had the earliest harvest index, yet the estimated total pounds produced was only slightly higher than that from fiberglass-2 with 21 days for harvesting, and peak potential not yet achieved. Acrylic-3 plants had matured fruit nearly as early as those in the glass house, plus they had the highest estimated total poundage and number of fruit. Plants in fiberglass-1 and 2 quickly caught up to an initial two week lag behind the others once average day temperatures warmed up. Yields were well on the way to surpassing those of houses 4 and 6 when plants were pulled. Five fruit from each quart harvested were sampled for weight and diameter. Samples from fiberglass 1 and 2 had the highest averaged weights; average diameters varied no more than .2 cm between all houses, but there was a general decrease of tomato diameter across the season, particularly in fruit from the acrylic and glass houses. This may have been a reflection of soil nutrient depletion earlier in the season, and/or increasing water and heat stress as spring progressed.

There were no data available for yield of cherry tomatoes in the field, but this variety seems to have done quite well and might be a potential replacement for the more culturally demanding table tomato. The fruit is not prone to the physiological or morphological deformities to which larger tomatoes are susceptible. In North Carolina, an important greenhouse tomato producing state, the best growers reported average yields of 20 lbs. fruit per plant (7). Obviously the Rock Springs crop did not match these commercial yields but may have produced more fruit with more lateral pruning, adequate nutrition, and slightly extended growing season. Besides plant vigor and high percentage of quality fruit production, cherry tomatoes are in great demand on the fresh market.

In the State College area this past spring, greenhouse grown, large tomatoes wholesaled for between 50 and 54¢ per pound, depending on the grade (13). For the week of October 1 to 8, 1977, vine ripe tomatoes from California were selling for between 30 to 45¢ per pound wholesale. For the same period, prices on cherry tomatoes were between 92¢ and 1.04 per pound (or per pint) wholesale. Prices during the year on cherry tomatoes can vary as much as \$5.00 above or below average wholesale prices, but in general stay higher than those for large tomatoes by 30 to 80¢ per pound or more (20) (13). Hence, there are good reasons to grow this variety in the greenhouse. Plants are easy to maintain and vigorous; their uniform, high quality fruit production, the ease of harvest packing and shipping, plus the strong possibility of receiving higher prices per pound than for conventional tomatoes, might make cherry tomatoes, a safe-risk crop for a grower.

Cucumbers

"La Reine" gynoecious cucumbers were direct sown January 21 in peat pots at the Penn State greenhouses. On February 27, ten plants were placed in each house, while the smaller glass house received eight. Seedlings were spaced at about two feet on center and trained up binder twine by the "main stem" method as described in Grower magazine (5). Due to growing space limitations, vines were terminated before lateral growth progressed. Flowers were pinched off for only the first 2½ to 3 feet of vine, instead of the recommended 4½ feet for the same reason (16). Table 7 lists specifics on the fruit yields.

Table 7. "La Reine" Cucumber: Yield Characteristics:

	<u>Fiberglass</u> <u>1</u>	<u>Fiberglass</u> <u>2</u>	<u>Acrylic</u> <u>3</u>	<u>Glass</u> <u>6</u>	<u>6a*</u>
Harvest dates	5/21-6/10	5/14-6/10	4/19-6/10	4/19-6/10	-
# Harvest days	21	19	56	53	-
Total # recorded	64	62	83	58	73
Total # sampled	57	46	63	45	56
Pounds sampled	92.68	89.62	105.40	79.40	98.80
Est. total lbs. produced	104.01	120.79	138.86	102.34	128.80
Est. lbs/plant produced	10.41	12.08	13.89	12.79	12.88
Ave. fruit length (in)	15.87	16.93	16.23	15.75	-
Ave. fruit diameter (in)	2.21	2.24	2.24	2.32	-
Ave. fruit weight (oz)	26.8	27.8	28.1	28.0	-

*6a: Values are estimates for 10 vines.

Possibly due to higher temperatures and better light transmission into the houses, plants in acrylic-5 and glass-6 commenced harvest earlier by 33 to 26 days, and were past peak performance by the time those in fiberglass-1 and 2 began. Given more time, warm temperatures and long days, plants in the fiberglass houses may have out produced the others. Note the following chart, which compares the Rock Springs yields to trials done at Stockbridge House EHS (5).

<u>Greenhouses</u>	<u># fruit</u> <u>per plant</u>	<u># per</u> <u>1/100 acre</u>	<u>% Class I Fruit</u>
Fiberglass-1	6.4	662	100
Fiberglass-2	6.2	643	100
Acrylic-3	8.3	859	98
Glass-6	5.8	575	98
EHS main stem method	24.7	861	63

The performance of cucumbers in all houses was limited by a number of experimental factors. First, seedlings are often grown for two weeks under 24 hour fluorescent lights; this suppresses flowering and encourages vigorous vegetative growth (6). Also, many growers use up to 1500 ppm CO₂ to raise their yields up to 20% more; no CO₂ was available at Rock Springs (6) (15). Due to lack of room, vines were limited to roughly half their potential length. The plants stopped production after the first heavy fruit set, and did not start again until all the first cucumbers were picked (12) (15). Also, the fruit matures only 7 to 10 days after flowering. By delaying a day or two, it is easy to harvest fruit too large to sell at a price which would cover decreased production potential from fruit abortion. According to the Ontario Greenhouse

Vegetable Producers Marketing Board Spring 1975 standards, cucumbers in all houses were harvested at the large (38-43 cm) to extra large (greater than 43cm) length and 1 to 2 cm larger diameter than the recommended 4 to 4½ cm (16). By making an effort to harvest fruit of slightly smaller diameter and length in fiberglass-1, the amount of fruit set increased. Gynococous cucumbers are a good indicator plant for measuring growth response to the greenhouse environment. Preferred temperatures are around 80° to 85°F air temperatures on sunny days, with 75 to 80% humidity and 70° soil temperatures. Night temperature should be around 65° to 70°F, depending on the weather (15) (25). Temperatures in the houses were often below these requirements. Plants would simply stop growing without any visible adverse effects until warmth and light was available. Favorable response to warmer, brighter conditions is reflected in the earlier harvest dates of houses acrylic-3 and glass-6. However, vines in houses 1 and 2 were catching up quickly in total production because of longer and more sunny days.

In general, fruit quality was excellent for all the houses, with very few curved fruit or rotted ends. Foliage was most prolific and vigorous, with largest leaf areas in the acrylic-3 house, probably because this house gave the best diffused light, highest day humidities and least extreme temperature cycles. This labor-intensive crop has great potential as a luxury item, as already noted by growers in Europe, and somewhat now in the U.S.

Lettuce

Seeds of Bibb and Buttercrunch lettuce were sown on December 28 and transplanted to cell packs on January 5. Thirty to thirty-one seedlings of each variety were placed in the larger houses, 20 to 22 in the glass house, all at an 8" x 8" spacing for a total of three rows. Fifteen harvested heads from each house of each variety were measured for head diameter and weight. Both varieties showed quite a variation between houses for fresh and dry weights and diameters. Separate samples of inner and outer foliage were taken to test for differences in nutrient accumulation. Table 9 documents yield characteristics.

Table 9. Yield Characteristics of Bibb & Buttercrunch Lettuce

	Fiberglass-1		Fiberglass-2		Acrylic-3		Glass-6	
	Bibb	Buttercr.	Bibb	Buttercr.	Bibb	Buttercr.	Bibb	Buttercr.
Days from sow to harvest		101		101		89		87
Total pounds (15)	7.80	7.35	7.21	8.27	7.12	6.56	6.94	5.00
Ave. lbs. per head	.52	.49	.48	.55	.48	.43	.46	.34
Ave. diameter (In.)	5.91	6.05	4.85	6.04	8.06	12.28	7.43	8.32
<hr/>								
3/9 leaf fresh wt. (g)	2.65	3.74	1.65	3.49	3.13	4.84	2.87	2.59
4/3 leaf fresh wt. (g)	11.98	9.13	7.16	13.19	9.73	14.19	--	12.93
3/9 leaf dry wt. (g)	0.11	0.45	.13	.28	.34	1.00	--	.12
4/3 leaf dry wt. (g)	0.64	0.49	.32	.60	.51	--	.34	--

Tissue samples from fiberglass-1 had a substantially heavier fresh and dry weight for the March 26 sampling of Bibb, than all others. Possibly much of the variation in pounds produced and fresh and dry weights originates in house environments encouraging larger or smaller leaf areas, or greater and lesser intake of water and nutrients.

The physical appearance of the lettuce varied greatly from house to house. Bibb in house 6 and 1 had a tendency to bronze at the outer foliage. This generally occurs when extra carbon dioxide is added with cool temperatures; however, no extra provision for CO₂ was made during this experiment (24). House 3 lettuce was larger leafed and looser in head formation than the other houses.

In general, Buttercrunch was of better quality in all houses than Bibb, especially from the fiberglass houses, perhaps due to lower average temperatures and less light or heat stresses. However, the heads were mature about 1 week later than those grown in warmer houses with increased solar transmission.

Time needed to grow to maturity was in keeping with established times for spring crops of lettuce or even a little early (3). Harvest was delayed 1 to 2 weeks to observe plant response to the stress of lengthening days and higher day temperatures. At prime time for harvest there was no evidence of tipburn, stem elongation or bolting.

Some days later, Bibb lettuce in particular showed evidence of elongation and bolting, the earliest and most severe in house 6, then 3. Except for lettuce raised in fiberglass-2, all heads of both varieties developed "normal dry burn" (22). This type of damage occurs especially in spring, during sunny or dry days and can develop within the space of a day. Leaves enclosing the head, just underneath healthy-looking outer foliage, develop brown margins. Incidence of injury is also raised by soil being too dry, or salt content being too high. There was also some occurrence of tip burn of the innermost foliage only, with mottling and severe necrosis of leaf edges (22) (12). Percent leaf burn damage by variety and house is summarized in the following table.

Table 10. Effect of Environment on Degree of Leaf Burn on Bibb and Buttercrunch Lettuce.

	Fiberglass-1		Fiberglass-2		Acrylic-3		Glass-6	
	Bibb	Buttercr.	Bibb	Buttercr.	Bibb	Buttercr.	Bibb	Buttercr.
Percent Tip burn	0	13	13	0	7	0	5	59
Percent Dry burn	37	50	0	0	7	48	95	100

Soil conditions may have contributed to the lettuce's lowered quality and predisposition to burning. Soil pH was 5.6; Wittmer, Honma and Robb claim poor growth results if pH is less than 6. Leaf lettuce is also sensitive to high salts. Leaf sodium values of 2427 to 4497 ppm for leaf lettuce, and correlate high sodium to interaction with water of potassium uptake only (9) (17).

A good yield for spring sowings of greenhouse lettuce grown in central Pennsylvania is .71 pounds per square foot (18). Values for the houses are as follows (Table 11); these can be compared to figures obtained by Wittmer, Honman and Robb for Bibb lettuce yields grown with various combinations of CO₂ and nitrogen supplement from February 20 to April 2, 1964(24).

Table 11. Yield of Bibb and Buttercrunch Lettuce in Four Experimental Greenhouses (pounds).

	Fiberglass-1	Fiberglass-2	Acrylic-3	Glass-6
Pounds Bibb/ft ²	.98	.90	.90	.86
Pounds Buttercr. per ft ²	.92	1.03	.82	.67
Pounds Bibb/10 heads	5.2	4.8	4.8	4.6
Pounds Buttercr./10 heads	5.9	5.5	4.3	3.4
W.H.&R. Standard Bibb/10 heads	normal*	+CO ₂ **	+CO ₂ +N***	
	1.8	2.0	2.6	

* 300 ppm CO₂
 ** 1200-1800 ppm CO₂
 *** 100 lbs NH₄NO₃/acre weekly

Except for Buttercrunch in house 6, yield, were better than sufficient. However, the lettuce accumulated more mass due to the lateness of harvest. It is not known why values for pounds Bibb/10 heads were higher than those obtained by the other researchers. But perhaps by harvesting earlier at a lower fresh weight, growers can avoid problems with burning. In general, leaf lettuce has been a traditional cool house crop in Europe, and to a lesser extent in the U.S. for many years. There is no reason why a grower using a solar heated greenhouse should exclude this versatile crop. Based on personal experience, fresh leaf lettuce in March seems very popular.

Phase II

Experimentation with crops on a more controlled level was begun on September 15, 1977. The size structures used have been constructed with combinations of energy conserving materials, bed placement and solar energy collection, storage and reuse systems as follows: (23).

- House 1: Fiberglass covered, two barrel vault design, thin thermal blanket, internal solar energy collector, heat storage and recovery from rocks.
- House 2: Fiberglass covered, two barrel vault, thick thermal blanket commercial external hot water solar collector, heat storage and recovery from water tanks.
- House 3: SDP 16 mm acrylic covered, two-ridge gable roof, thin thermal blanket, "Rutgers" external hot water solar collector, heat storage and recovery from a gravel floor. Three ground beds lined with heavy plastic are used to hold crops.
- House 4: Fiberglass covered, two barrel vault, thick thermal blanket, internal and external hot air solar collectors, heat storage and recovery from rocks.
- House 5: Polycarbonate covered, two-ridge gable roof, thin thermal blanket, "Rutgers" type external hot water solar collector, heat storage and recovery from a gravel floor. Soil heated ground beds are used.
- House 6: Lapped double strength glass, gable roof, no thermal blanket, no solar collector or storage. This control house will be 12 x 16 feet.
- House 7: This house will not be ready for growing in until January. It is multi: barrel vault covered with a double layer of it is equipped with a thin thermal blanket, "Rutgers" external hot water solar collector, and will have heat storage and recovery from a gravel floor.

Hot water heat will be used as a backup and supplemental heat source. Kerosene space heaters will be used as a secondary backup heat source.

Supplemental heat use is being measured with water flow meters; pyrheliometers and light meters are measuring solar radiation incident on a horizontal surface both inside and outside used for the houses. Wet and dry bulb temperatures are being monitored with thermocouples at locations within the houses, in the soil and outside.

Data will be summarized by a data logger, computer integration system, and results will be related back to crop performance in each house.

Crops were selected for their compatibility with cool temperatures, and possible market value as an alternative to more heat-demanding products. The following selections have either already been moved into beds, or are in the process of being moved.

Vegetables

1. Chinese Cabbage: "Early Top #16", an early season variety, "Michilili", midseason, and "Winter Giant", a late type. It takes 80 to 90 days for a cabbage crop; 50° to 60° day temperatures are optimum.
2. Tomato: An experimental cultivar is being grown from seeds obtained from Dr. E.A. Kerr of Ontario, Canada. This new hybrid may perform well in low light and low temperatures.
3. Spinach: Various "Longstanding" varieties such as "Winter Bloomsdale" will be set out by November. Plants do well at 50-60° temperatures, and can tolerate brief periods down to 15-20° F.
4. Lettuce: More Bibb and Buttercrunch leaf lettuce will be bedded. These varieties are grown at 45-50° F in England, or even with frost protection only.
5. Brussel Sprouts: Widely grown in Europe as a greenhouse crop. Depending on the variety, sprouts mature from 15 to 19 weeks after seeding. The plants do best in a cool house and ground beds.
6. Leeks: Also popular in Europe as a cool house crop and demands allow for luxury prices in the U.S. Depending on the variety, leeks sown from seed take 21 to 22 weeks to marketable size.

Flowers

1. Mysotis: Annual varieties bloom in late spring to mid-summer when sown after frosts are over. The flower is the familiar blue "Forget-me-not" once used by florists widely; it grows best in a 50° house.
2. Lupine: A leguminous plant with palmate leaves and a spike of keeled flowers. If sown in September it blooms in January. A 48° night and 55° day is best.
3. Delphinium: "Giant Pacific strains" can be sown by August 1 to bloom for Mother's Day until July. The plant sends up tall, stately spikes of large, blue lavender or white hues.
4. Centaurea: A naturally spring blooming plant. It does best in a 50° house and produces vivid blue and purple single blooms on tall stems.
5. Calendula: If sown in August and pinched once, these plants will bloom continuously through April. These large, orange and yellow sunflower-like blooms do best in a 45° to 50° house.

6. Snapdragons: Once grown quite widely in the U.S. and still in good demand, snapdragons are fairly easy to grow in a cool house and are available in a kalidoscope of color for each season.
7. Chrysanthemums: "Princess Anne Superb" is normally grown as a standard size mum. However, this time cuttings have been placed in 4" pots, pinched and given two sprays of B-9. Mums usually are grown at 55° to 65° F night and 65° to 75° F days.
8. Strawberries: Two varieties of ever-bearing strawberries were planted out for the summer on Penn State's trial grounds, then transplanted to hanging baskets in early September. Fruit production, if any, will be monitored through the winter.
9. Stock: Has cultural requirements similar to Calendula. If sown August 1, flowers are ready for January harvest. Its available in a variety of colors. One advantage is their ability to be grown at a close 3" x 7" spacing.

It should be realized that the crops being grown at Rock Springs represent a small sample of vegetables and flowers which might have the capability of performing well both in cool houses and in the market place. Therefore, the sort of experimental exploration that suits the new solar greenhouses is that which seeks out the crops best suited to growing conditions with larger fluctuations in temperature or finds the best combination of heat collection and conservation systems for plant growth. Growers with crops demanding 70° F days in winter now must meet soaring costs of 90 to 95¢ per square foot for the 1977 heating season (8). Hence, there is sound economical reason for pursuing new crops for new greenhouse environments. In this respect, we would benefit greatly from the expertise of northern European growers, who have pursued the problems of growing in cool houses and with low light for a number of years. But, in general, the discipline of developing cultivation techniques and crops for the "solar energized" age has remained an open-ended, broad and largely unexplored subject.

Literature Cited

1. Aldrich, R.A. 1977. Personal communication on solar and thermal transmission of double-walled acrylic panels.
2. Aldrich, R.A. and C.A. Rotz, 1978. "Greenhouses That Hold Heat", Presented at the National Tropical Foliage Short Course, Orlando, Fla.
3. Anonymous. 1972-73. Greenhouse Vegetable Production in Ontario. Publication #526, Ontario Dept. of Agriculture and Food, Toronto, Canada.
4. Anonymous, 1977. Manufacturer's Specifications on SDP-Panels, CY/RO Industries.
5. Anonymous. 1972. New cucumber training method should suit old-style houses. The Grower. 78 (6):243.
6. Anonymous. 1974. The bug switch. European cukes replace tomatoes. American Vegetable Grower. 22(11):13-15.
7. Anonymous. 1976. Venturing in greenhouse tomatoes. American Vegetable Grower. 24(11):17-18.
8. Ball, V. 1977. You can control fuel costs! Grower Talks. 40(12).
9. Bert, J.S. and S. Honma. 1975. Effect of soil moisture and irrigation method

on tipburn and edgeburn severity in greenhouse lettuce.
J. American Society of Horticulture Science. 100(3):278-282.

10. Duncan, and J.N. Walker. 1973. Greenhouse Coverings. University of Kentucky Cooperative Extension Service Publication AEW-10.
11. Ferretti, P.A. 1977. Personal communication of field tomato production in Pennsylvania. Extension agent for small fruits and vegetables. The Pennsylvania State University.
12. Honma, S. and J.S. Bert. 1978. Trucking down tipburn. American Vegetable Grower. 23(11):24-26.
13. Houtzdale Produce Co. 1977. Wholesale grocers, Philipsburg, Pennsylvania. Personal communication on tomato prices.
14. Jensen, M.H. 1971. Take a look at seedless cukes. American Vegetable Grower. 19(11);20-22, 58-60.
15. Loughton, A. 1974. Growing European seedless cucumbers. Ontario Ministry of Agriculture and Food Factsheet #72-135.
16. Loughton, A. 1975. The how-to of European cucumbers. American Vegetable Grower. 23(11):16-18, 58-60.
17. Lunt, O.R. 1965. Sodium, Chapter 27, Diagnostic Criteria for Plants and Soils. H.D. Chapman, editor. p. 409-411. Quality Printing Company, Inc.
18. Mertz, Boyd. 1977. Yield in pounds for greenhouse grown lettuce, from Spring sowings. Personal communication with commercial grower.
19. Miller, C. 1977. Pennsylvania Department of Agriculture, Section of Bureau of Foods and Chemicals, Fruits and Vegetable Division. Personal communication on field tomato grades for Pennsylvania and the United States.
20. Nelson, J.E. and Sons. 1977. Food broker, shippers and distributors. Altoona, Pennsylvania. Personal communication on tomato prices.
21. Stoner, A.K. 1971. Commercial productions of greenhouse tomatoes. Agriculture Handbook #382. Ag. Research Service, U.S.D.A.
22. Termohlen, G.P. and A.P.v.d. Hoevan. 1966. Tipburn symptoms in lettuce. Acta Horticulturae. 4:105-111
23. White, J.W., R.A. Aldrich, J.L. Duda, S.M. Rebeck, J. Tesca, C.A. Rotz, and A. Merbaum. 1977. "Energy conservation systems for greenhouses." Presented at Solar Energy Workshop Conference, Tucson, AZ.
24. Wittmer, S.H. Honma and W. Robb. 19. Practices for increasing yields of greenhouse lettuce. Michigan State University. Agricultural Experiment Station Research Report #22. East Lansing, Michigan.
25. Zuinkels, I. J.H.M. 1973. Personal communication on cultivation of gynoecious cucs, to R.F. Fletcher, Extension Vegetable Crops Specialist, Penn State University.

RELATIVE HUMIDITY: MAXIMUMS & MINIMUMS

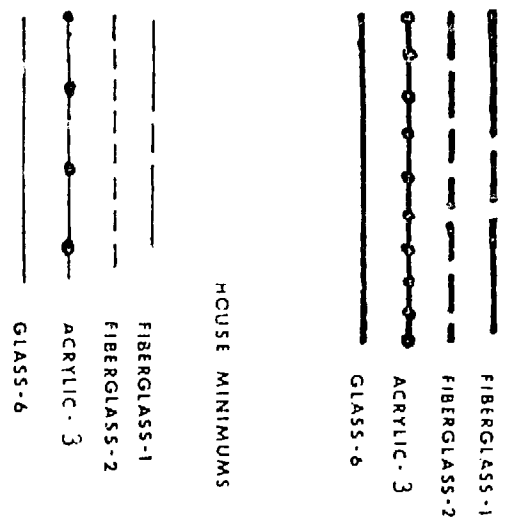
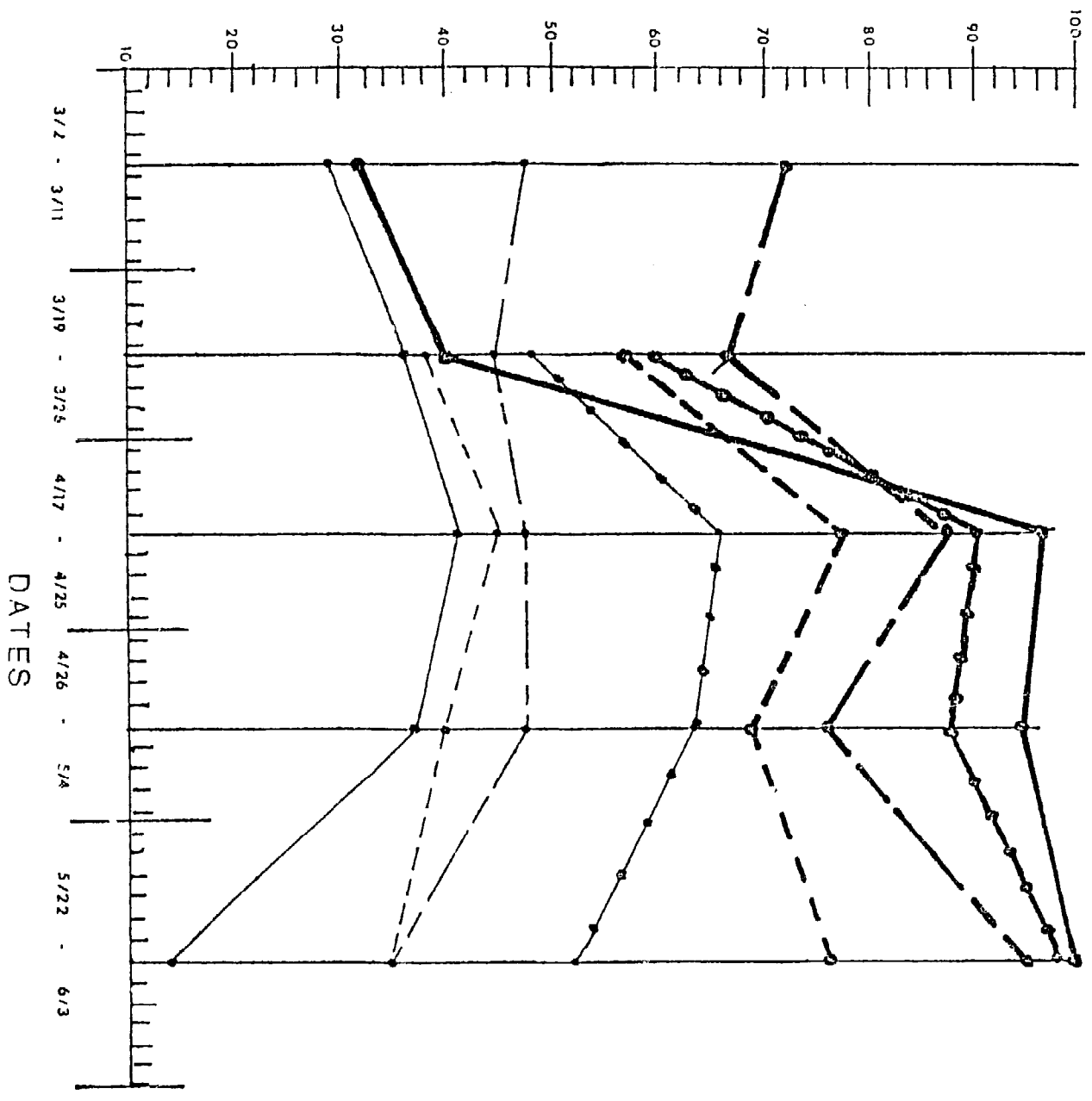

SPRING 1977 'SMALL FRY' YIELD
GENERALIZED CURVE

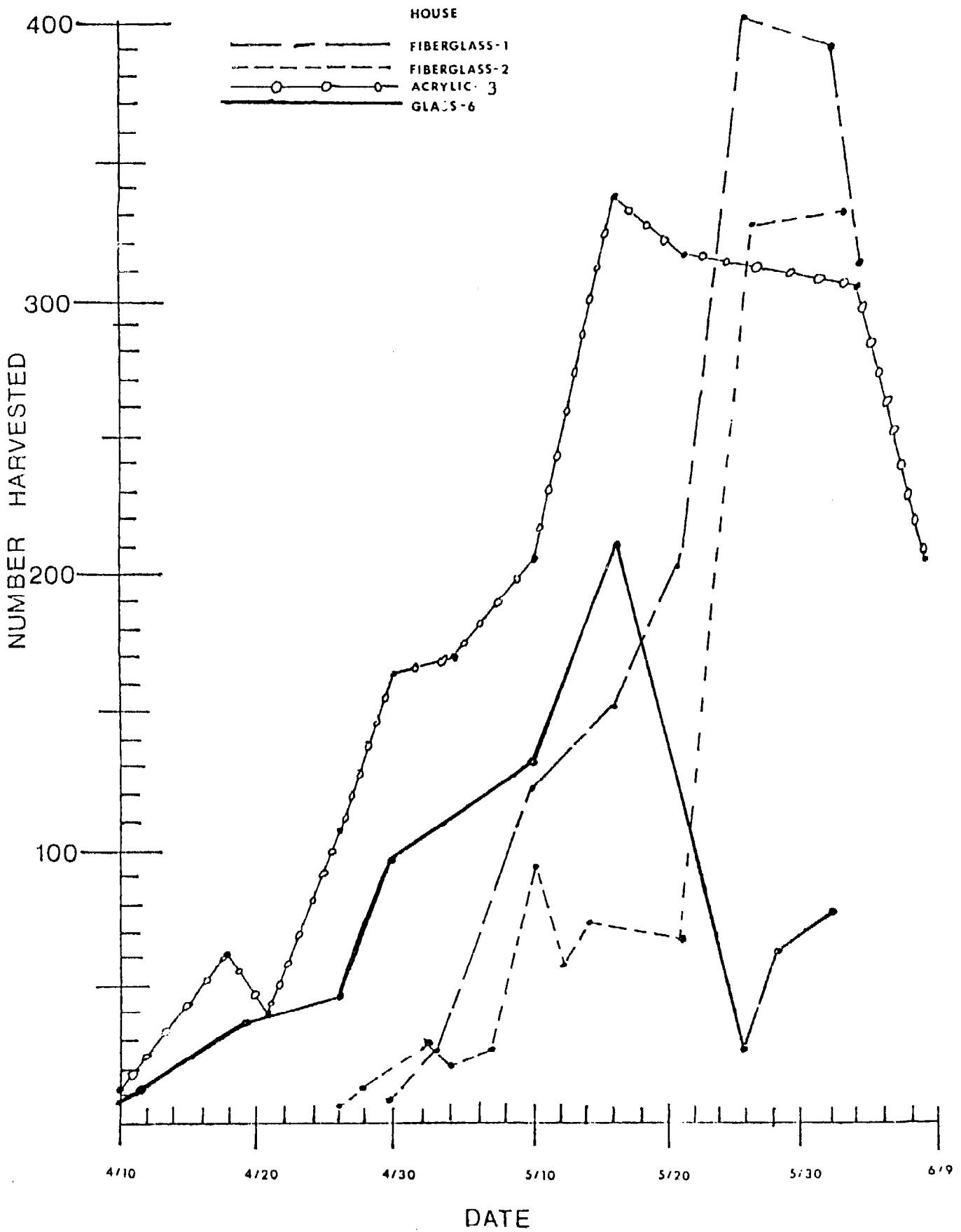

SPRING 1977 9102-M YIELD
GENERALIZED CURVE

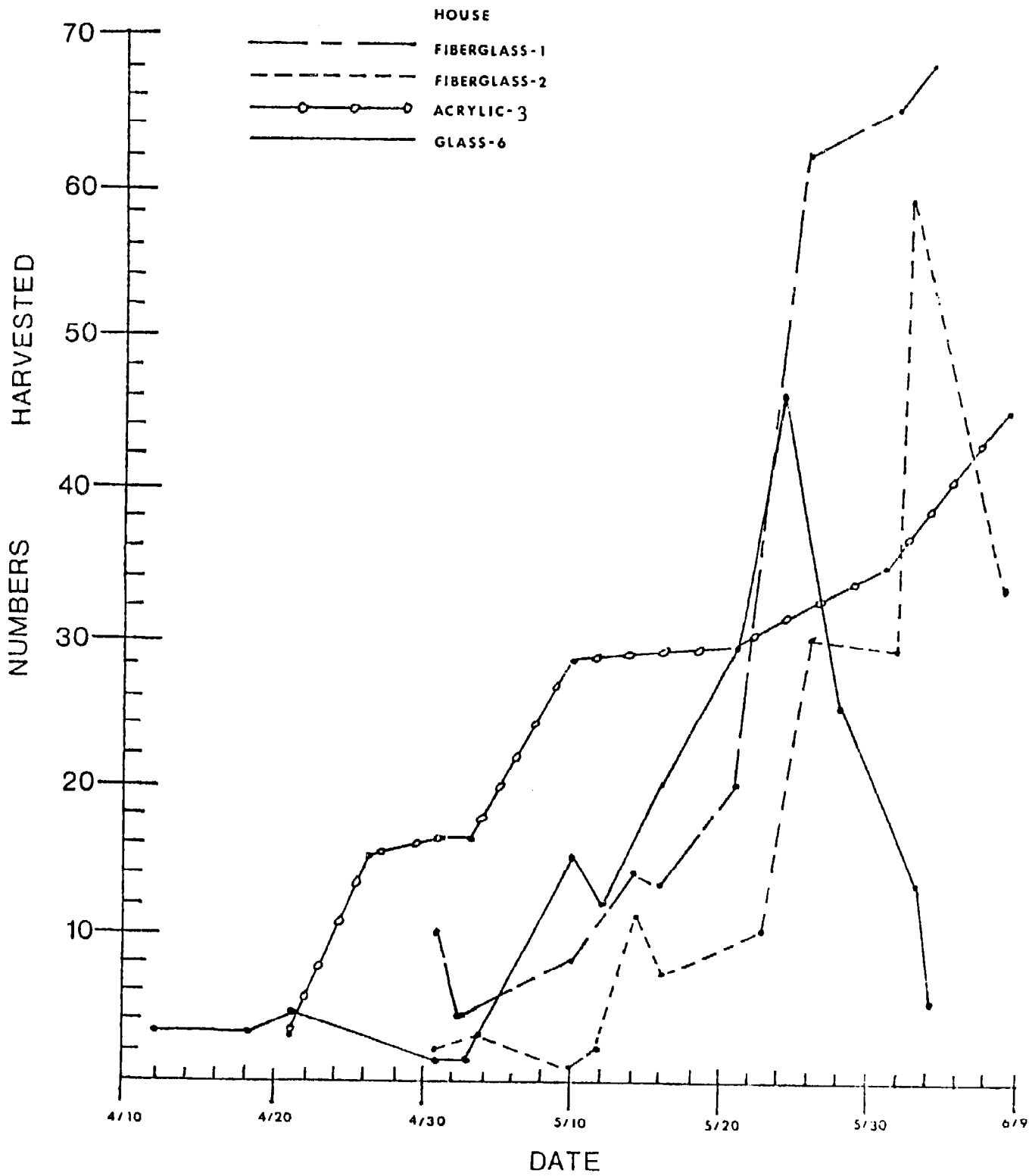

NOTI SOLAR GREENHOUSE

Performance and Analysis

by Edward Mazria, Steve Baker,
Eric Hoff, David Jenkins
and Jim Van Duyn

Rising energy costs have provided the incentive to reduce energy consumption through the design and application of alternative energy sources. In order to have wide-spread application it is necessary that this technology be inexpensive and simple in concept to use. Passive solar energy systems offer such an alternative. The Noti greenhouse demonstrates the feasibility of passive systems as a major heating source for buildings in the Pacific Northwest, an area thought to be unsuitable for solar energy utilization. THE GREENHOUSE HAS OPERATED SUCCESSFULLY THROUGH ITS FIRST WINTER WITH THE SUN AS ITS ONLY HEATING SOURCE. The design and performance of the greenhouse is presented with the expectation of generating further applications of passive solar systems as an appropriate alternative to present building design and construction.

The passive solar-heated greenhouse at Noti, Oregon, situated in the Willamette Valley 25 miles northwest of Eugene, is owned by Ernie O'Byrne and was designed and built by three students from the School of Architecture at the University of Oregon, Andy Laidlaw, Jim Bourquin, and John Hermansson, in consultation with Professor Edward Mazria and Steven Baker.

The use of solar energy coupled with recycled and locally available materials indicates the interest of the designers in appropriate and ecologically sound technologies. The greenhouse took two months to build, was completed in the spring of 1976, and has the following specifications.

Exposure: Due south

Floor Area: 12' x 17' = 204 sq. ft. (greenhouse)

Ceiling Height: Maximum, 12 ft.; minimum, 8 ft.

Volume: 2,000 cu. ft.

Wall Construction: Standard 2 x 4 framing with 3½" of fiberglass insulation. The interior walls are finished with ½" Cedar; the exterior is sheathed with Fir 2 x 8 Tongue & Groove decking.

Structure: Fir pole post and beam. The poles were obtained locally by salvaging them from land previously logged.

Thermal Mass: "Rip-rap", basalt quarried locally and broken into fist-sized pieces. The stone also serves as a retaining wall and is placed in a cavity between earth fill and chicken wire stretched between laterally braced columns. The thermal mass forms the north wall and part of the east wall of the greenhouse. Weight = 28,000 lbs.

Floor: 8,000 lbs. of gravel on a clay base (also acts as a thermal mass)

Windows: Salvaged operable residential windows (36 sq. ft.) with a polyethylene sheet attached to the frames for double glazing (winter).

Doors: A salvaged walk-in freezer door with excellent insulating properties is installed on the east with a salvaged residential exterior door on the west wall.

Auxiliary Heating Systems: Under particularly harsh outdoor conditions, a wood-burning stove in an attached sauna provides warm air to the base of the thermal mass (stone wall) in the greenhouse. The sauna, located on the southwest exposure of the greenhouse, provides protection from prevailing winter winds. The sauna has not yet been installed.

Roof: The south slope of the roof is 120 sq. ft. of double glazed Filon with a ½" air space. The north slope consists of 2 x 4 decking, a ½" layer of homosote, 60 lbs. building paper, a sheet of 6 mil plastic, and 12" of sod.

Cost: ± \$900.00 (labor donated)

Solar heating of the greenhouse is accomplished by the direct coupling of solar radiation with a thermal mass (rock wall). Solar radiation entering the greenhouse through glazed openings in the south wall and roof strikes the surfaces of the north rock wall and gravel floor (thermal mass), heating these masses (Fig. 3). Part of this heat is transferred into the mass (by conduction) and stored; the remaining part heats the air in the greenhouse. As the temperature of the air in the greenhouse rises, it is taken by a duct located near the west end of the roof ridge and released inside (at the base) the rock wall. This warm air rises and transfers its heat to the rocks in the rear of the wall. This insures that the entire wall is used efficiently as a heat storage mass. At night (Fig. 4), as temperatures in the greenhouse drop, the stored heat in the mass wall is released to the interior space.

The effect of a thermal mass is to stabilize interior temperatures by absorbing solar radiation during the daytime, converting it to heat, and releasing it at night when temperatures drop. This process is beneficial in all seasons. For example, it assists in avoiding overheating during the summer months by absorbing heat during the day and releasing it at night, moderating both daytime and nighttime interior temperature. As a further precaution against summer overheating, the thermal mass is shaded by the roof, receiving no direct solar radiation. When there is a heat build-up (Fig. 5), hot air is vented by opening doors and windows and operating an exhaust fan located on the east wall of the greenhouse.

In January, the coldest month of the year in the Willamette Valley, outdoor temperatures vary from 15° to 55°F on clear days and from 35° to 55°F on cloudy days. The Noti greenhouse was designed and built to maintain a temperature range between 50° and 70°F during this month without the use of ANY external energy source. During extended periods of cloudy weather, typical of January, in the Willamette Valley, the indoor air temperature of the greenhouse was expected to stabilize between 50° and 60°F, daytime, and 45° and 50°F, nighttime. Clear or only partly cloudy weather was expected to produce relatively greater interior temperature variations, daytime highs of 60° to 70°F and nighttime lows of 50° to 55°F.

In summary, indoor temperatures were expected to fluctuate between 45° and 70°F, never dropping below 45°F even during periods of completely cloudy weather.

MONITORING GREENHOUSE PERFORMANCE

To measure actual performance, test equipment was installed in the greenhouse from January 12 to February 8, 1977. A Pyronometer, placed on the exterior at the ridge of the roof, recorded solar radiation and a Chart Recorder with five sensors, located inside the greenhouse, recorded the following temperatures.

1. Indoor Air, in the center of the greenhouse, five feet above the floor level.
2. Outdoor Air, at the east end of the roof, shaded from direct sun.
3. Gravel Floor Temperature, two inches deep, near the east entrance.
4. North Wall (thermal mass) Surface Temperature, five feet above the floor level at the center of the wall.
5. North Wall (thermal mass) Interior Temperature, five feet above the floor level at the center of the wall, twelve inches deep.

During the four weeks of observation (January 12 to February 8), the Willamette Valley was experiencing a highly unusual weather pattern: long periods of clear days with little cloud cover or precipitation. January 11 through 13 were the only consecutive completely overcast days during the four-week period. January 13 is selected for closer observation as a consecutive cloudy day; January 28 as a consecutive clear day.

Because of an equipment failure from January 30 through February 2, high and low indoor and outdoor temperatures were recorded by direct observation from maximum/minimum thermometers placed both inside and outside the greenhouse. More specific data is not available for that period.

GREENHOUSE PERFORMANCE ANALYSIS

Figure 6 provides an overview of greenhouse indoor temperatures relative to outdoor temperatures over the 28-day period. Temperatures ranged from 16° to 63°F outdoors and from 47° to 73°F indoors. As expected, both indoor and outdoor temperature fluctuations were greater during clear days than cloudy days (January 28 vs. January 13). The lowest indoor temperatures occur on clear days but never fall below 47°F.

Figures 7 through 10 demonstrate the relationship of solar radiation to outdoor and indoor air temperatures. Solar radiation curves (at the bottom of the charts) that are relatively high and smooth indicate clear or only partly cloudy days (for example, January 28); curves that are low and less smooth indicate days of extended cloud cover (for example, January 13). Maximum outdoor air temperatures are reached two to three hours following maximum solar intensity (12 Noon) and indoor air temperatures peak approximately one to two hours following outdoor air maximums. At night, indoor temperatures decline less rapidly than outdoor temperatures, demonstrating the dampening effect of the thermal mass.

On cloudy days there is little solar radiation but greenhouse heat loss is also small (as compared to clear days) because outdoor air temperatures are higher. In the winter, during long periods of cloudy weather, indoor temperatures stabilize between 55°F, daytime, and 50°F, nighttime.

THE CLEAR DAY CYCLE

Figure 11 shows temperature readings over a 24-hour period following several consecutive clear days, January 28. Because it is in direct sunlight, the wall surface exhibits the highest temperature extremes. The wall interior exhibits the most stable temperature levels (56° to 58°F), slowly storing heat as interior temperatures rise and releasing this heat as interior temperatures fall. When the indoor air temperature is lowest, 51°F in the early morning, the wall's interior temperature is still at 57°F. The mass wall will supply heat to the space until its temperature equals or is exceeded by the indoor air temperature.

During the daytime indoor air temperatures rise rapidly. This occurs because a portion of the solar radiation that enters the greenhouse heats the air directly by heating plants and other non-massive objects (the wood construction, for example). After warming during the day, the greenhouse cools slowly because the heat stored in the thermal mass is released slowly over time. A comparison of beginning and ending temperatures for the 24-hour period indicates that slightly higher temperatures are carried forward to the following 24-hour interval.

THE CLOUDY DAY CYCLE

In contrast to the clear day cycle, Figure 12 shows temperature readings over a 24-hour period corresponding to a third consecutive cloudy day, January 13. During extended periods of cloudy weather, the greenhouse stabilizes as a system with ending temperatures for the period no different than beginning temperatures. Interior temperatures fluctuated no more than 5°F over the entire day.

COMPARISON OF ACTUAL GREENHOUSE PERFORMANCE WITH A COMPUTER SIMULATION MODEL

Professor Edward Mazria and Dr. Francis Wessling of the University of New Mexico have developed a dynamic computer simulation model to predict solar greenhouse performance under various climatic conditions.

Figure 13 is a representation of a computer model simulating both a solid mass stone wall and an isothermal* mass (rubble stone wall) similar to the thermal mass in the Noti greenhouse. Weather conditions at Noti on January 28 were used for the analysis.

As can be seen by the comparison of actual performance with the simulation curves, the thermal mass at Noti is more closely represented as an isothermal mass. The rubble wall approximates an isothermal wall due to its large exposed surface area and the constant circulation of indoor air through the interior of the rock wall.

* An isothermal wall is a mass that heats uniformly (infinite conduction) as opposed to a solid masonry wall whose mass is heated non-uniformly.

CONCLUSIONS

The environment of the Noti greenhouse has proven suitable for plant growth. Conditions are predictable and provide the opportunity to grow vegetables, potted foliage, and potted flowering plants year around. Throughout the winter the greenhouse maintained a temperature range of 50° to 70°F. On consecutive cloudy days, temperatures stabilized in the 50's. The greenhouse has proven to be extremely effective, operating through its first winter WITHOUT any heat source but the sun.

While the addition of supplementary heating can make a temperature range of 60° to 70°F available with extremely low operating costs, the Noti greenhouse, as is, demonstrates the viability of passive solar heating in cold climates.

Edward Mazria, Assistant Professor of Architecture at the University of Oregon is currently writing a book titled, "The Passive Solar Energy Book" which will illustrate in detail the design and calculation of passive solar systems. The book will be published by the Rodale Press in March-April 1978.

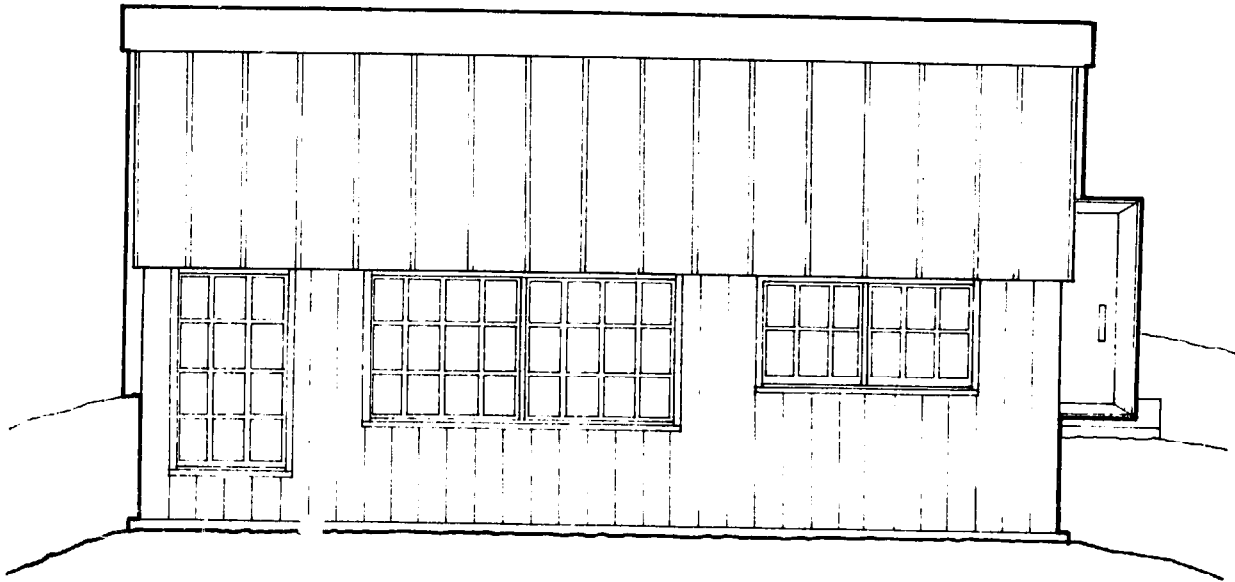

SOUTH ELEVATION

Fig. 1

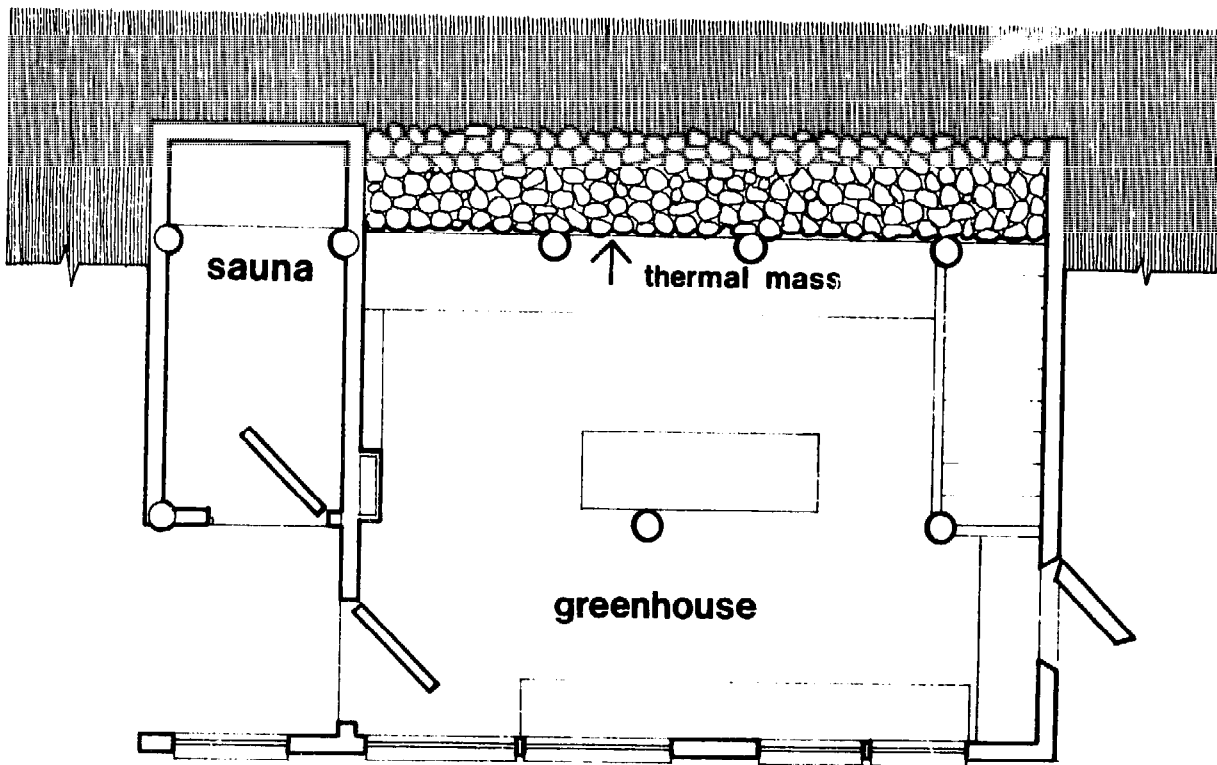

PLAN

↑ north

Fig. 2

GREENHOUSE SCHEMATICS

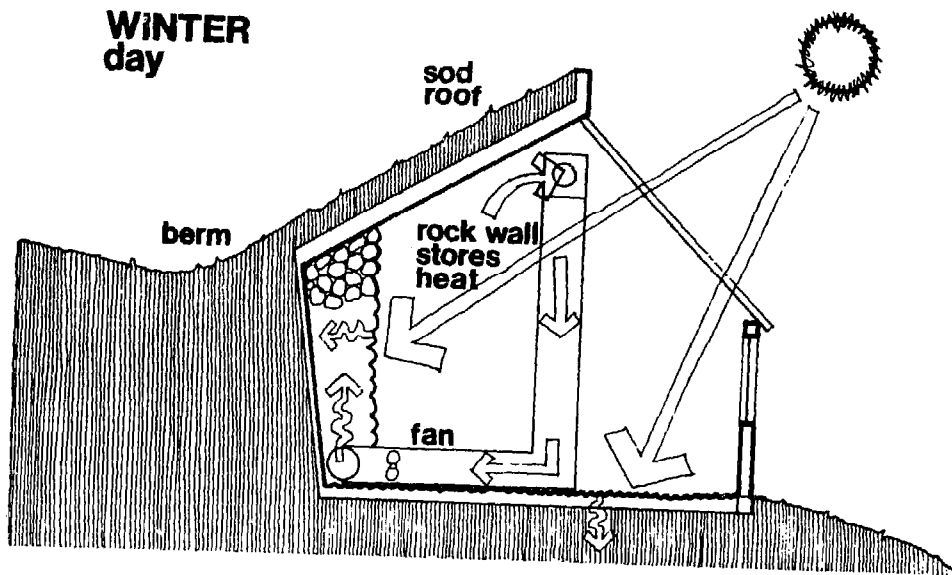

Fig. 3

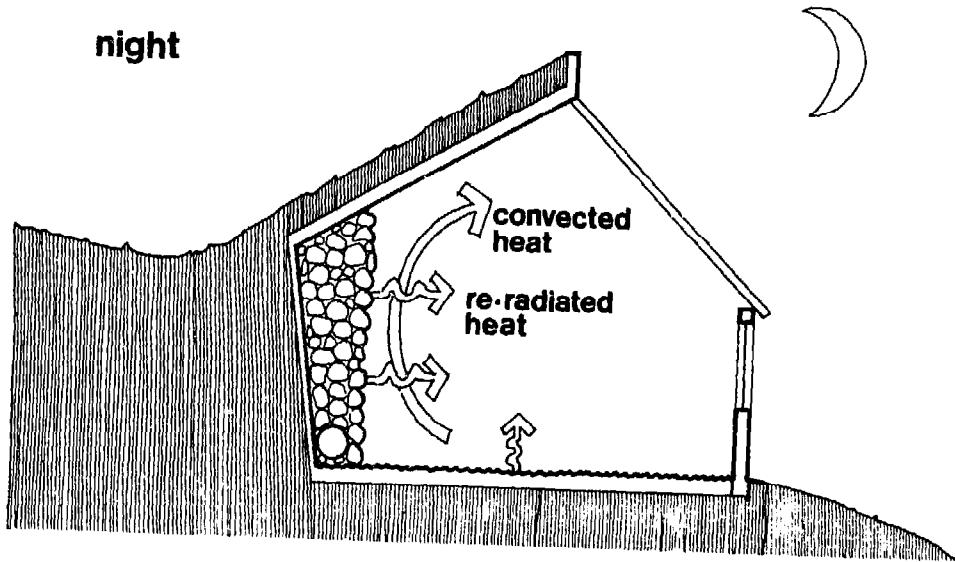

Fig. 4

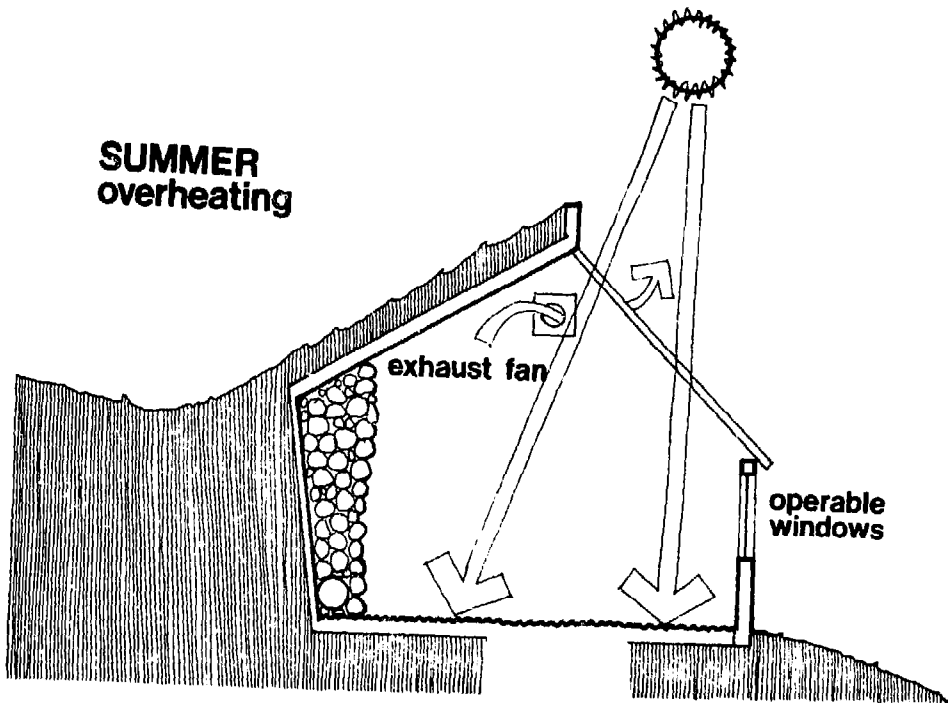

Fig. 5

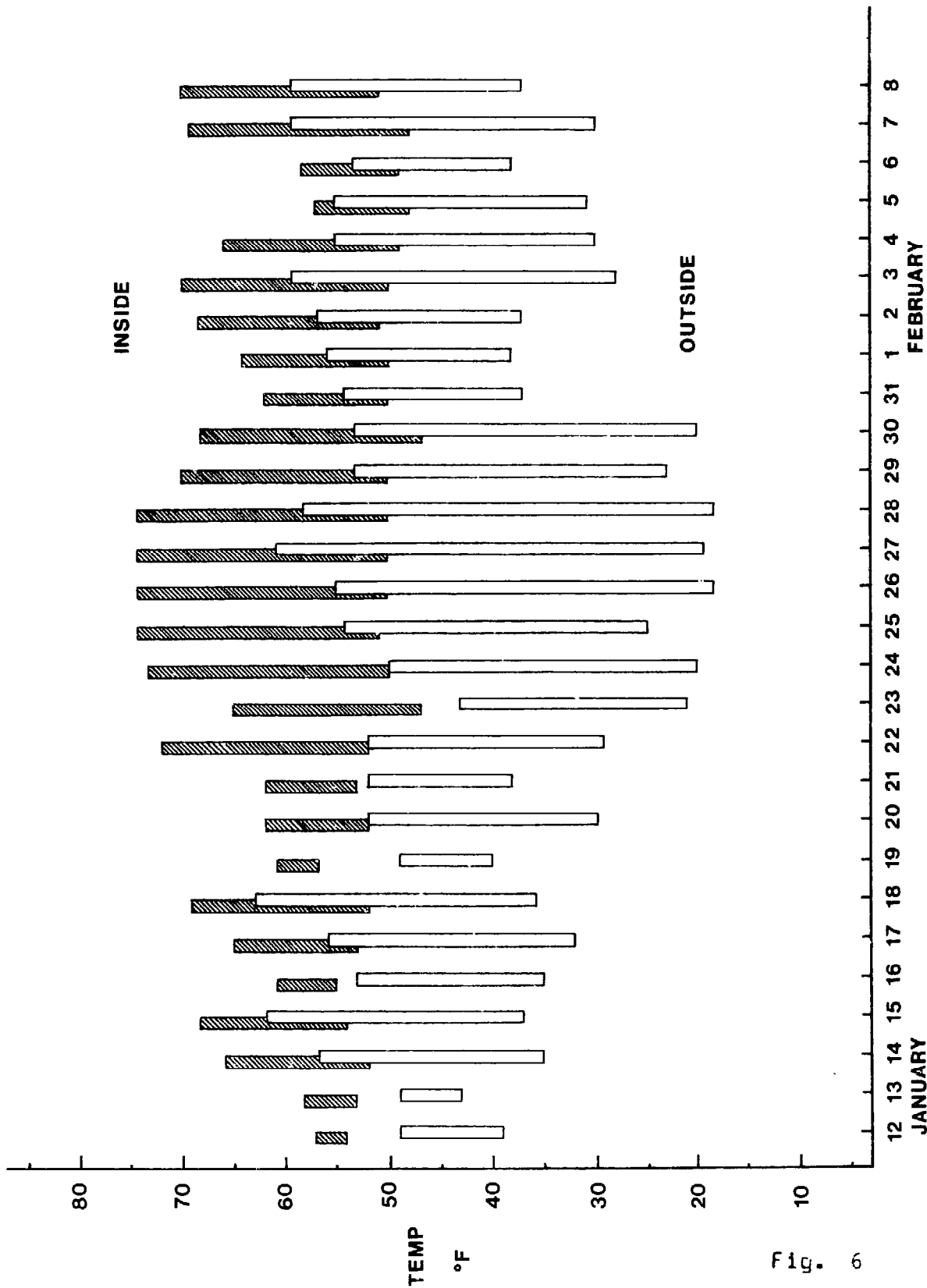
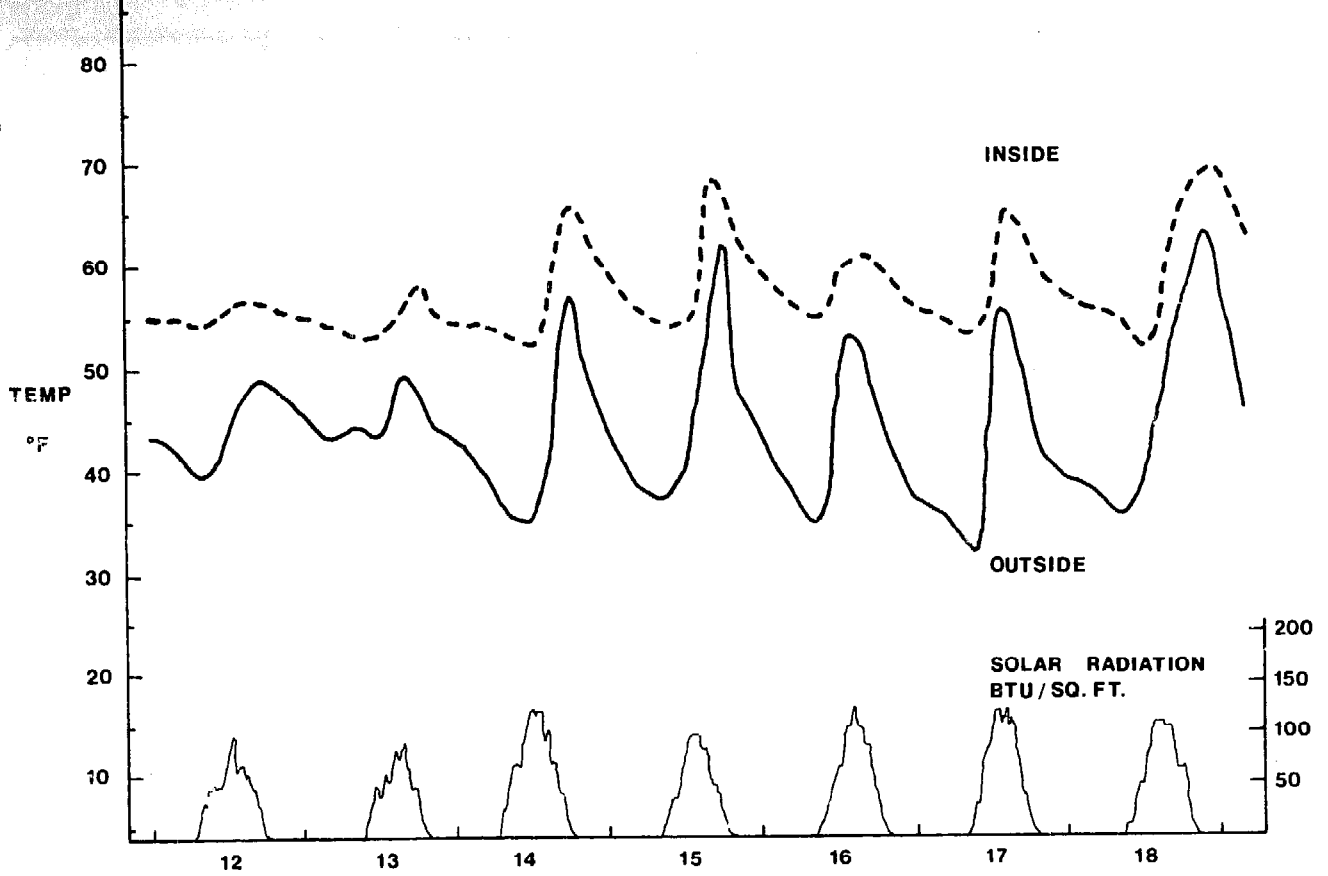
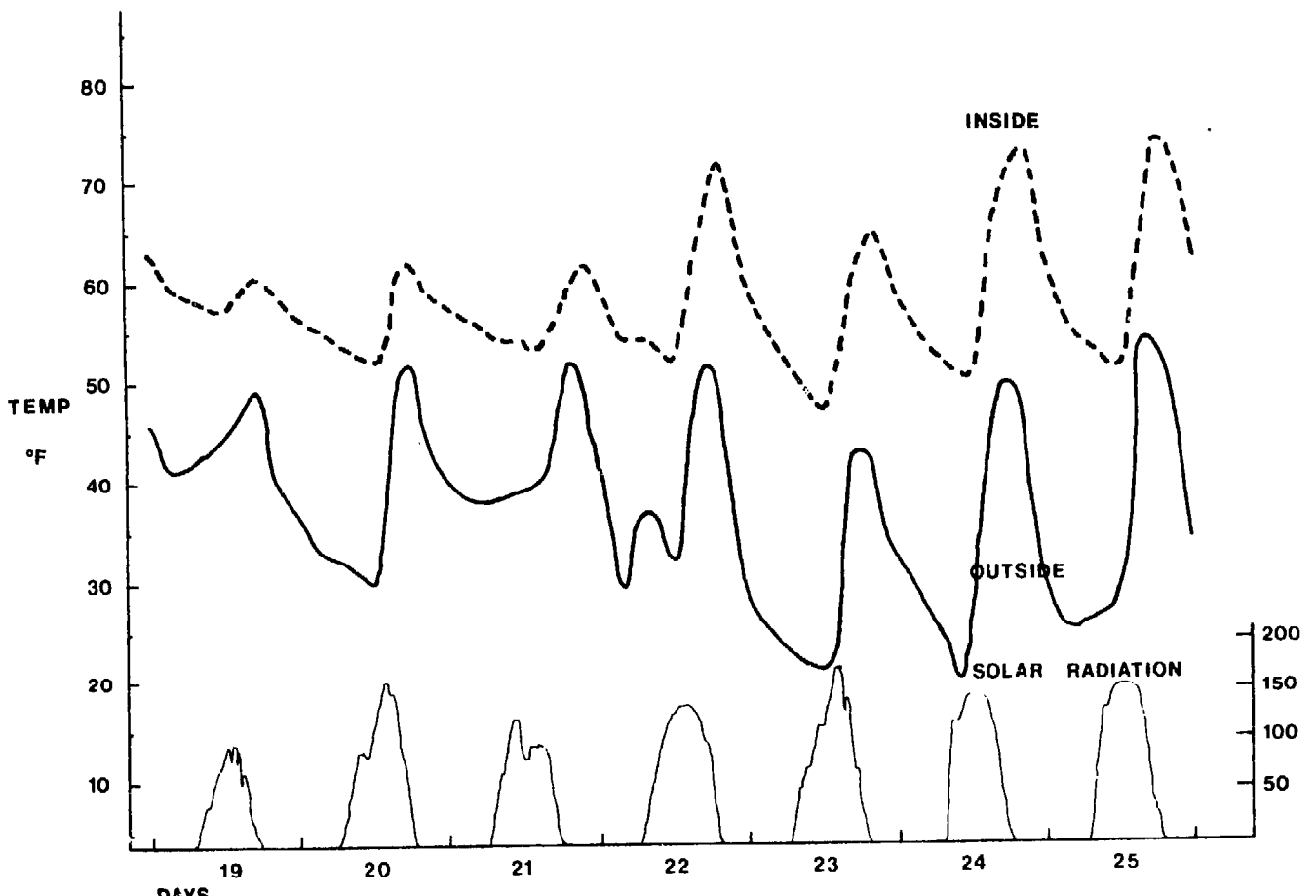

Fig. 6



WEEKLY HIGH & LOW JANUARY

Fig. 7



WEEKLY HIGH & LOW JANUARY

Fig. 8

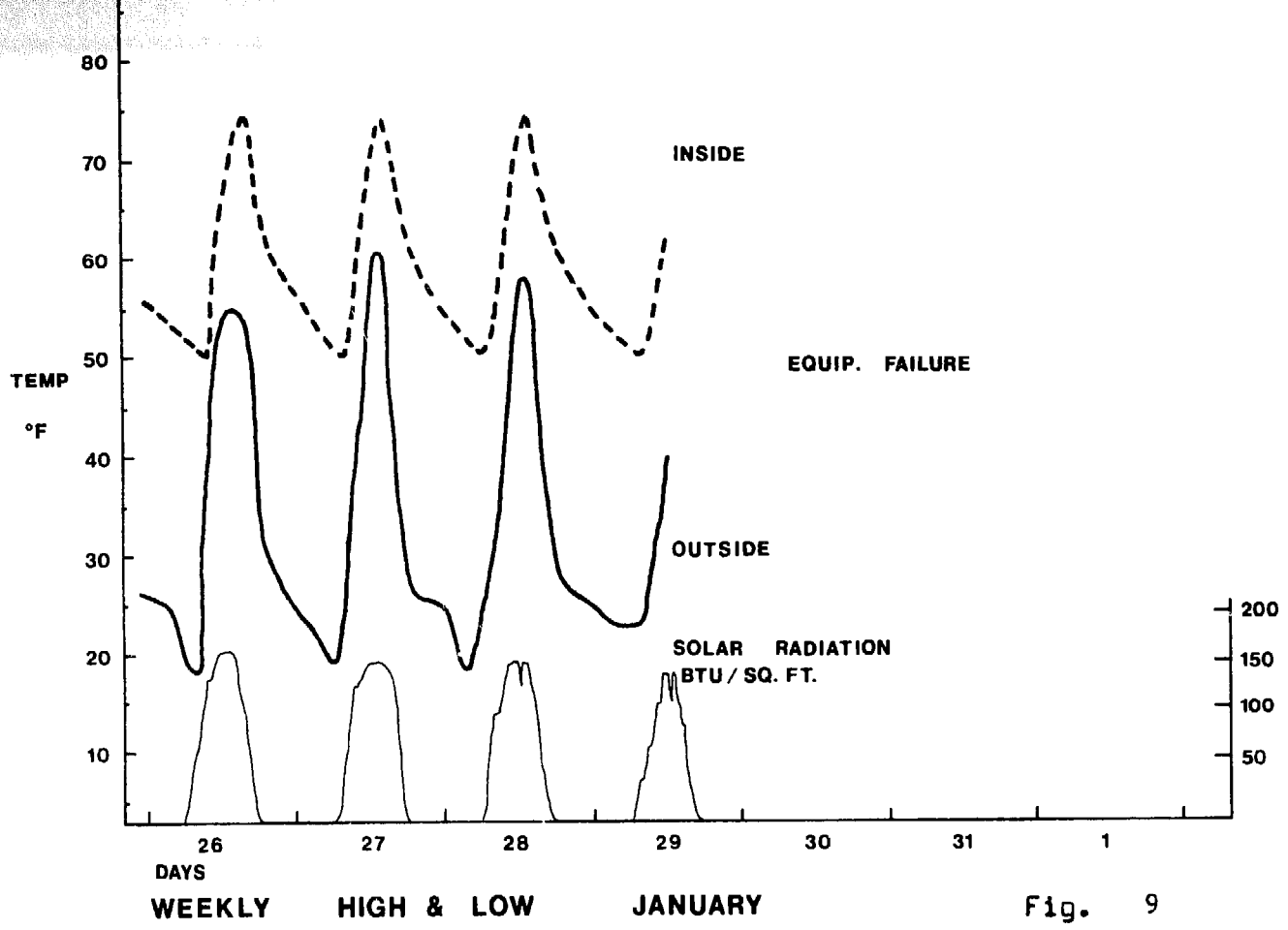

Fig. 9

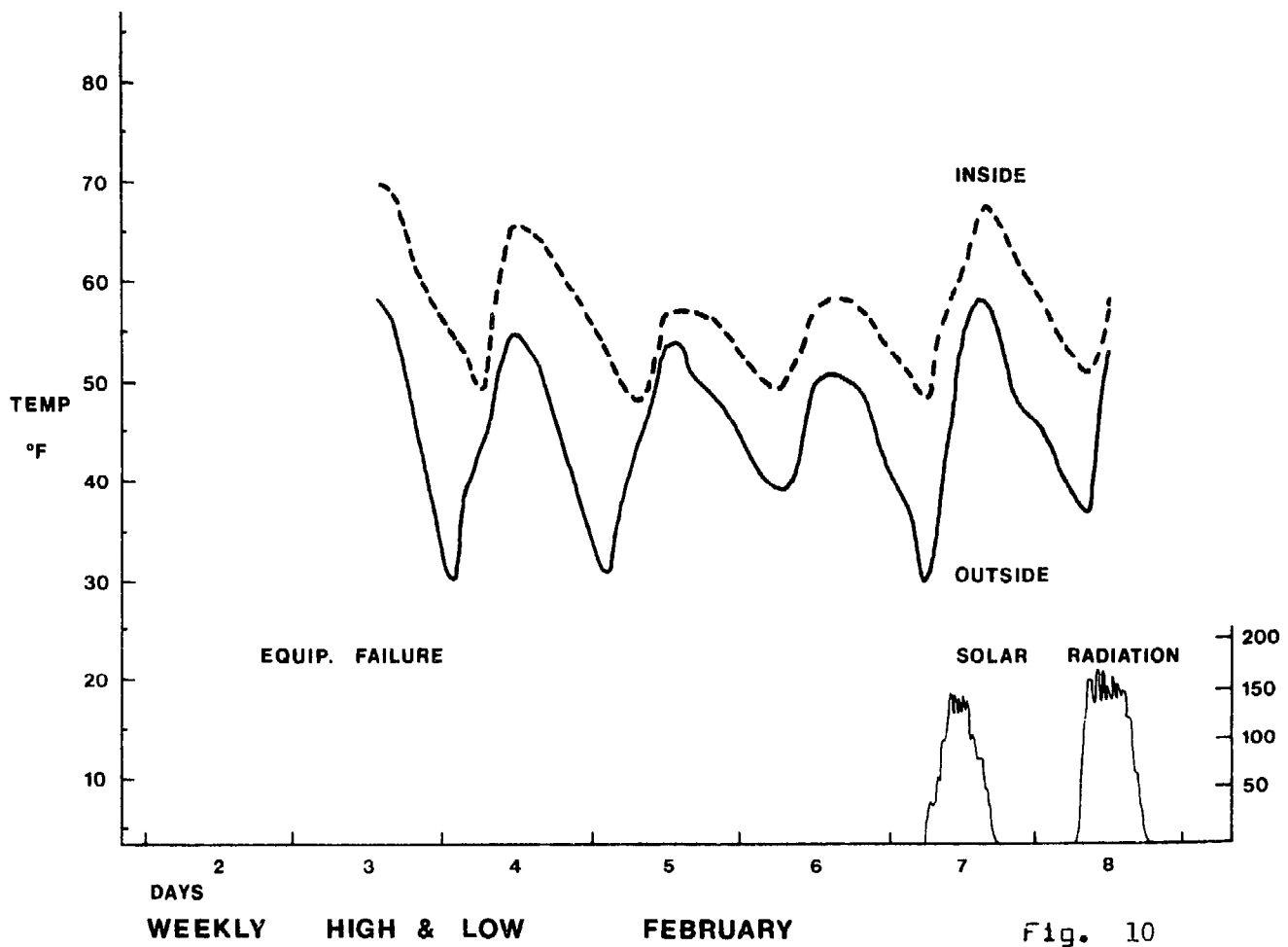
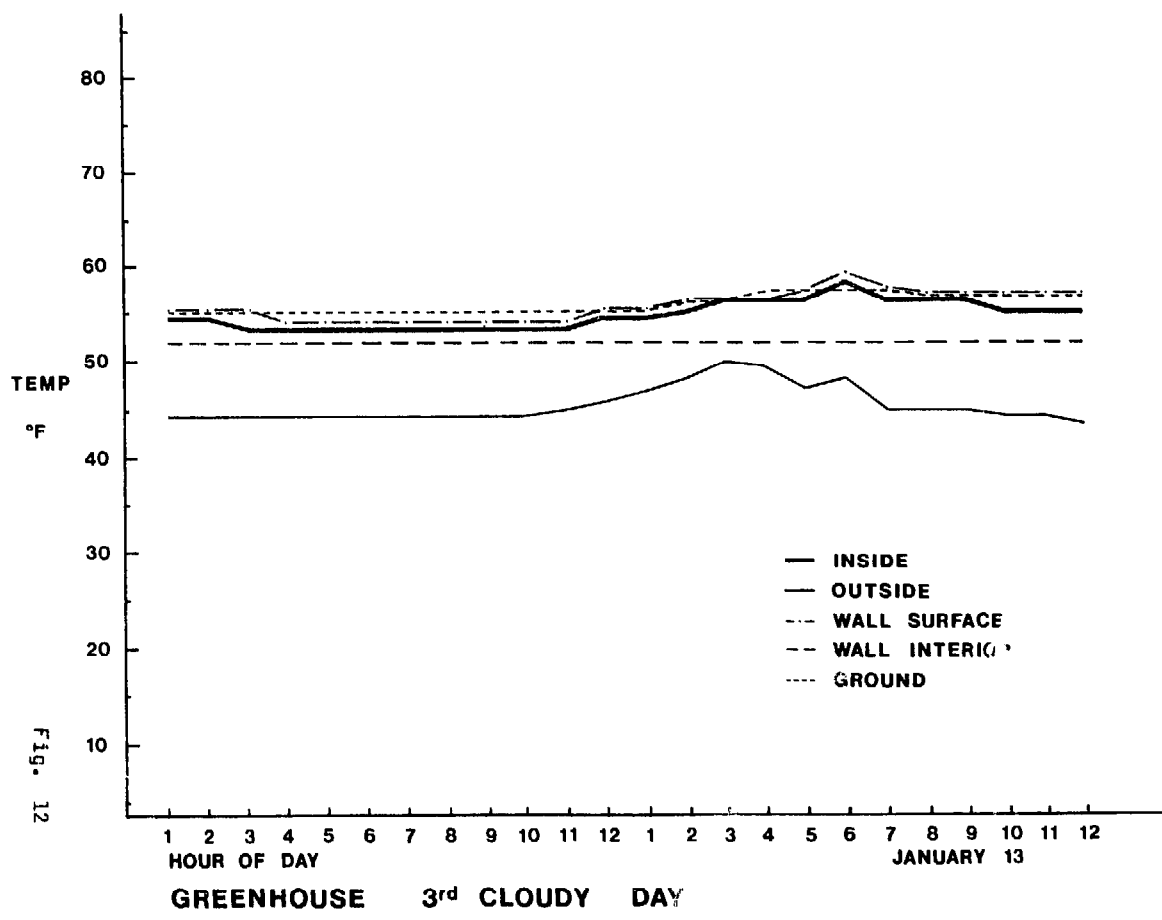
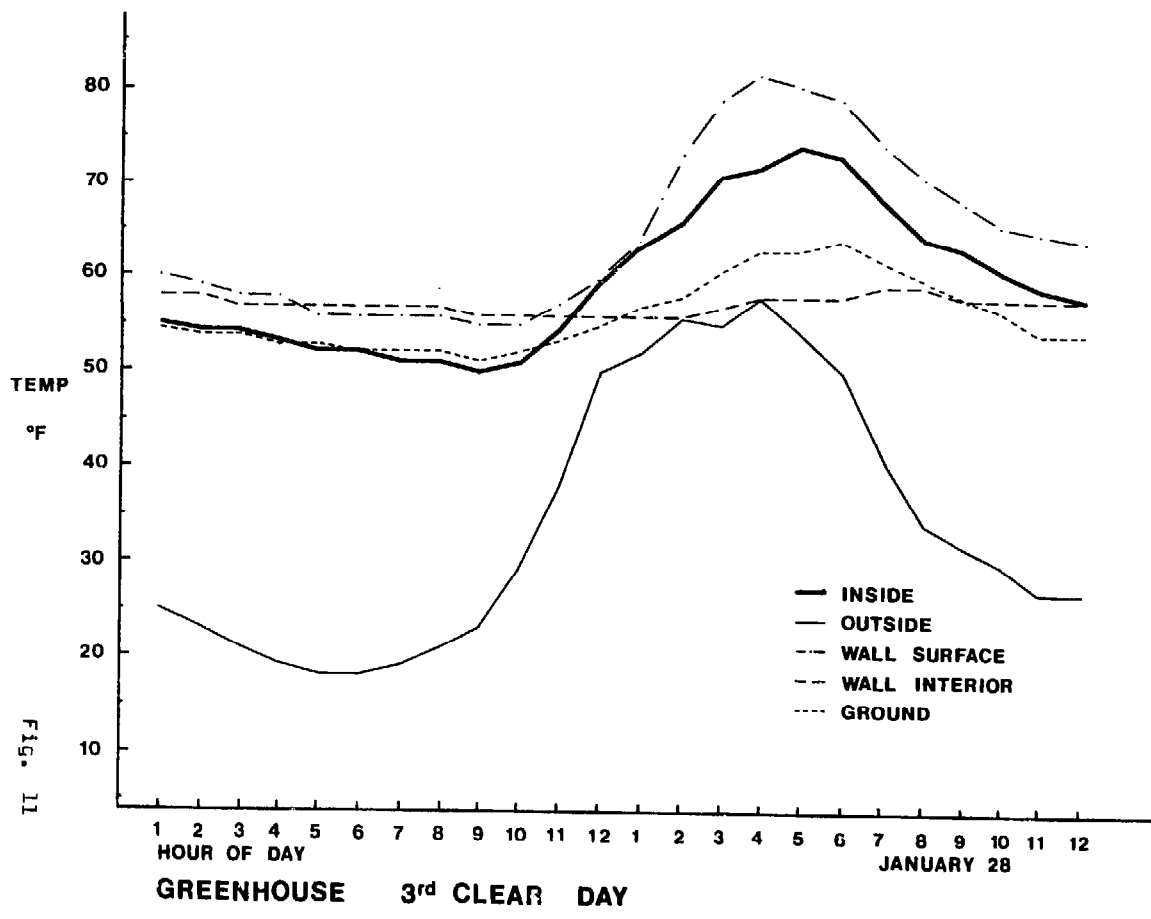

Fig. 10



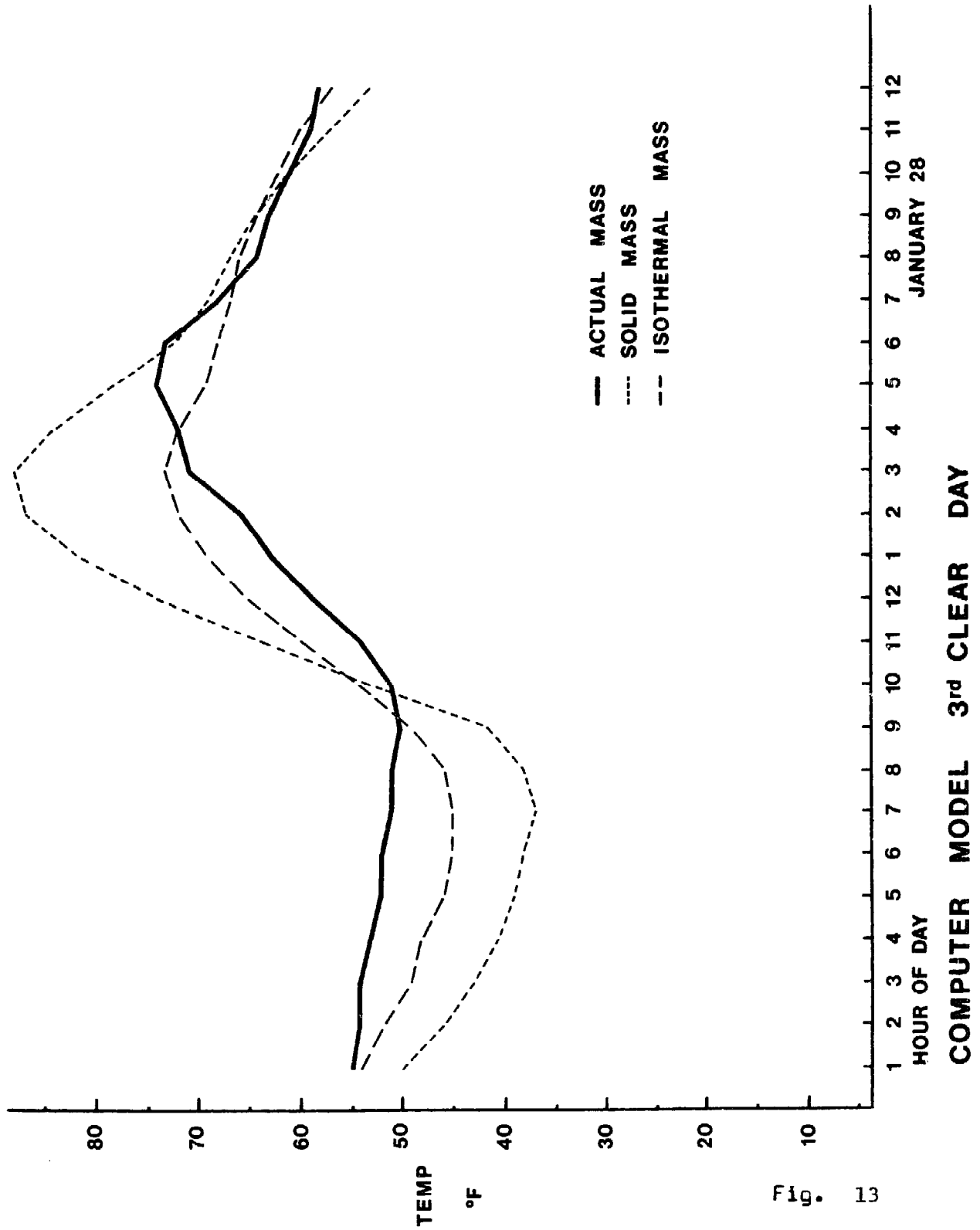

Fig. 13

PASSIVE GREENHOUSE DESIGN IN THE GREAT LAKES REGION: A CASE STUDY

Richard MacMath, Sunstructures, Inc.

ABSTRACT: A 2200 sq. ft. greenhouse addition to an existing nature center in Kalamazoo, Michigan, has recently been completed (October, 1977). The design incorporates both passive solar heating and energy conscious building techniques. Auxiliary heating is provided by the existing system with an additional air handler unit. Designed for one of the most severe areas in the country in terms of solar heating, 6900 degree days annually and only 48% annual possible sunshine, the project will help to determine the potential of passively heated and energy conserving greenhouses in the region. Simulated performance calculations yield an expected contribution of 26-45% of the total annual heating load being provided by passive means, depending on the condition analyzed.

BUILDING AND SITE DESCRIPTION: The new greenhouse addition is adjacent and directly connected to the existing "Interpretive Center". It provides space for exhibits, demonstrations, workshops, and classes, as well as being an example of an energy conscious building to the 150,000 people who visit the Nature Center each year.

Design of the building was determined primarily by energy conscious techniques (listed below), an attempt to "blend" with the form and materials of the existing building and site constraints (see site plan). The building site is restricted by the existing building to the west, parking to the north, and vegetation to the south and east which the staff at the Nature Center wished to preserve. These constraints limited the possibilities of the form, placement, and orientation of the new addition.

Kalamazoo is located in southwestern Michigan, approximately 40 miles east of Lake Michigan, and its climate is naturally influenced by the lake. The lake "tempers" the area's climate, having a cooling effect until late spring, and a warming effect in the fall. During the winter excessive cloudiness occurs, especially during the months of November through January. This cloud cover occurs less frequently in late winter.

ENERGY CONSCIOUS DESIGN TECHNIQUES: The greenhouse addition was designed to both maximize solar heat gain during the daylight hours and minimize heat loss during the nighttime hours of the heating season.

Optimum solar heat gain is obtained by means of large glass areas extending the entire length of the building--oriented 30° east of south. This heat gain will be minimized during the summer months by deciduous vegetation to the south, and a fabric mesh shading blanket mounted on the exterior of the glass surface. Cooling will be aided by operating vents and an exhaust fan when necessary.

Of the many energy conscious techniques employed to reduce the building's heat loss, the most effective are the following:

1. Earth berms: the north wall will be buried 5 feet and the south wall 3 feet below grade to minimize exposed surface area and reduce losses.
2. Site placement and landscaping: the existing building and surrounding vegetation provide shelter from wind to reduce infiltration losses.
3. Glazing: minimum north window area (for ventilation only); double glazing throughout.
4. Ventilation: operating windows and vents on the north and at the bottom and ridge of the vertical and sloping south glass will permit cross ventilation during the summer months.
5. Design transmission coefficients: the building envelope was designed to have as low a heat transmission coefficient as is practical within conventional construction practices. The brief summary below lists the total R factor for each building component.

COMPONENT	R TOTAL	U VALUE
Brick veneer wall	20.74	0.048
Block wall (below grade)	17.96	0.056
Sod roof	53.55	0.019
Glazing	1.54	0.650

PASSIVE HEATING PERFORMANCE: Due to site constraints, the greenhouse is oriented 30° east of south, an advantage in terms of summer cooling, but a disadvantage in terms of expected solar heating performance. Solar heat gain will be achieved by direct radiation transmitted through 950 sq. ft. of vertical and sloping southeast facing glass. Thermal mass for storage is obtained by one of the simplest means possible--a gravel and stone floor. Perimeter insulation below grade prevents edge losses from the floor, and losses down to the earth are considered to be small in proportion.

The passive solar heat gain and storage designs were analyzed for a number of different weather conditions to estimate the contribution of passive heating to the overall annual heating load. In summary, the table below shows this contribution in terms of the percentage of the total monthly heating load, assuming negligible storage losses to the ground.

MONTH	AVE. TEMP. OF	AVE. % POSSIBLE SUNSHINE	% OF TOTAL MONTHLY HTG. LOAD, WORST YEAR	% OF TOTAL MONTHLY HTG. LOAD, BEST YEAR
Jan	26.0	26	15.6	19.4
Feb	26.4	37	23.4	37.2
Mar	35.7	48	42.3	52.2
Apr	48.4	54	58.3	99.9
May	59.8	60	60.4	99.9
Oct	53.5	50	48.5	99.9
Nov	40.0	31	16.9	31.0
Dec	29.0	22	8.4	16.0
ANNUAL		48	26.3	41.2

List of Figures:

1. Site plan
2. Floor plan
3. View from southeast
4. View from east

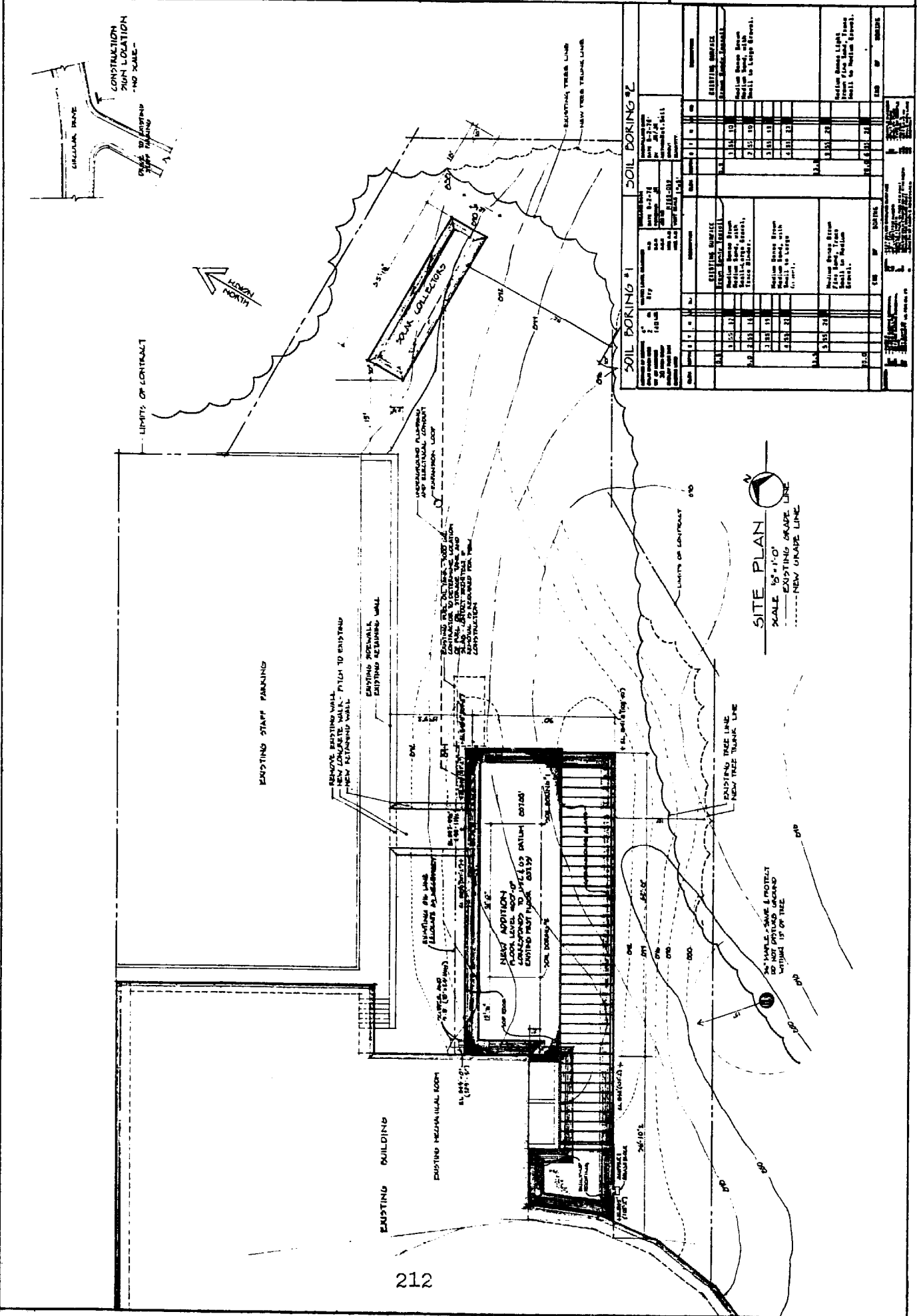

SOIL BORING #1

DEPTH (FEET)	SOIL TYPE	REMARKS
0.0 - 1.0	GRAVELLY SAND	
1.0 - 2.0	SAND	
2.0 - 3.0	SAND	
3.0 - 4.0	SAND	
4.0 - 5.0	SAND	
5.0 - 6.0	SAND	
6.0 - 7.0	SAND	
7.0 - 8.0	SAND	
8.0 - 9.0	SAND	
9.0 - 10.0	SAND	
10.0 - 11.0	SAND	
11.0 - 12.0	SAND	
12.0 - 13.0	SAND	
13.0 - 14.0	SAND	
14.0 - 15.0	SAND	
15.0 - 16.0	SAND	
16.0 - 17.0	SAND	
17.0 - 18.0	SAND	
18.0 - 19.0	SAND	
19.0 - 20.0	SAND	
20.0 - 21.0	SAND	
21.0 - 22.0	SAND	
22.0 - 23.0	SAND	
23.0 - 24.0	SAND	
24.0 - 25.0	SAND	
25.0 - 26.0	SAND	
26.0 - 27.0	SAND	
27.0 - 28.0	SAND	
28.0 - 29.0	SAND	
29.0 - 30.0	SAND	
30.0 - 31.0	SAND	
31.0 - 32.0	SAND	
32.0 - 33.0	SAND	
33.0 - 34.0	SAND	
34.0 - 35.0	SAND	
35.0 - 36.0	SAND	
36.0 - 37.0	SAND	
37.0 - 38.0	SAND	
38.0 - 39.0	SAND	
39.0 - 40.0	SAND	
40.0 - 41.0	SAND	
41.0 - 42.0	SAND	
42.0 - 43.0	SAND	
43.0 - 44.0	SAND	
44.0 - 45.0	SAND	
45.0 - 46.0	SAND	
46.0 - 47.0	SAND	
47.0 - 48.0	SAND	
48.0 - 49.0	SAND	
49.0 - 50.0	SAND	

SOIL BORING #2

DEPTH (FEET)	SOIL TYPE	REMARKS
0.0 - 1.0	GRAVELLY SAND	
1.0 - 2.0	SAND	
2.0 - 3.0	SAND	
3.0 - 4.0	SAND	
4.0 - 5.0	SAND	
5.0 - 6.0	SAND	
6.0 - 7.0	SAND	
7.0 - 8.0	SAND	
8.0 - 9.0	SAND	
9.0 - 10.0	SAND	
10.0 - 11.0	SAND	
11.0 - 12.0	SAND	
12.0 - 13.0	SAND	
13.0 - 14.0	SAND	
14.0 - 15.0	SAND	
15.0 - 16.0	SAND	
16.0 - 17.0	SAND	
17.0 - 18.0	SAND	
18.0 - 19.0	SAND	
19.0 - 20.0	SAND	
20.0 - 21.0	SAND	
21.0 - 22.0	SAND	
22.0 - 23.0	SAND	
23.0 - 24.0	SAND	
24.0 - 25.0	SAND	
25.0 - 26.0	SAND	
26.0 - 27.0	SAND	
27.0 - 28.0	SAND	
28.0 - 29.0	SAND	
29.0 - 30.0	SAND	
30.0 - 31.0	SAND	
31.0 - 32.0	SAND	
32.0 - 33.0	SAND	
33.0 - 34.0	SAND	
34.0 - 35.0	SAND	
35.0 - 36.0	SAND	
36.0 - 37.0	SAND	
37.0 - 38.0	SAND	
38.0 - 39.0	SAND	
39.0 - 40.0	SAND	
40.0 - 41.0	SAND	
41.0 - 42.0	SAND	
42.0 - 43.0	SAND	
43.0 - 44.0	SAND	
44.0 - 45.0	SAND	
45.0 - 46.0	SAND	
46.0 - 47.0	SAND	
47.0 - 48.0	SAND	
48.0 - 49.0	SAND	
49.0 - 50.0	SAND	

SITE PLAN
 SCALE 1/8" = 1'-0"
 --- EXISTING GRADE LINE
 - - - - - NEW GRADE LINE

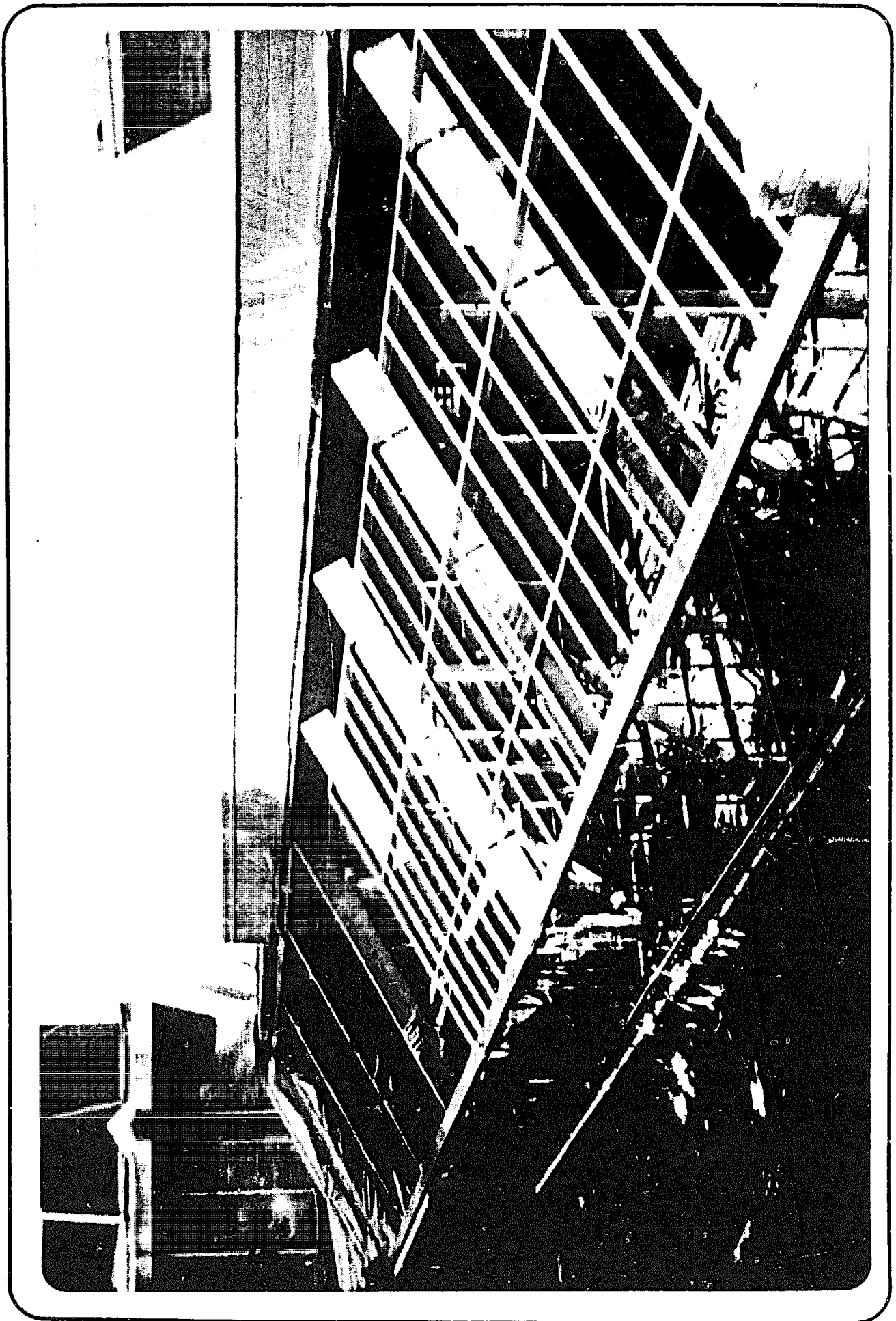

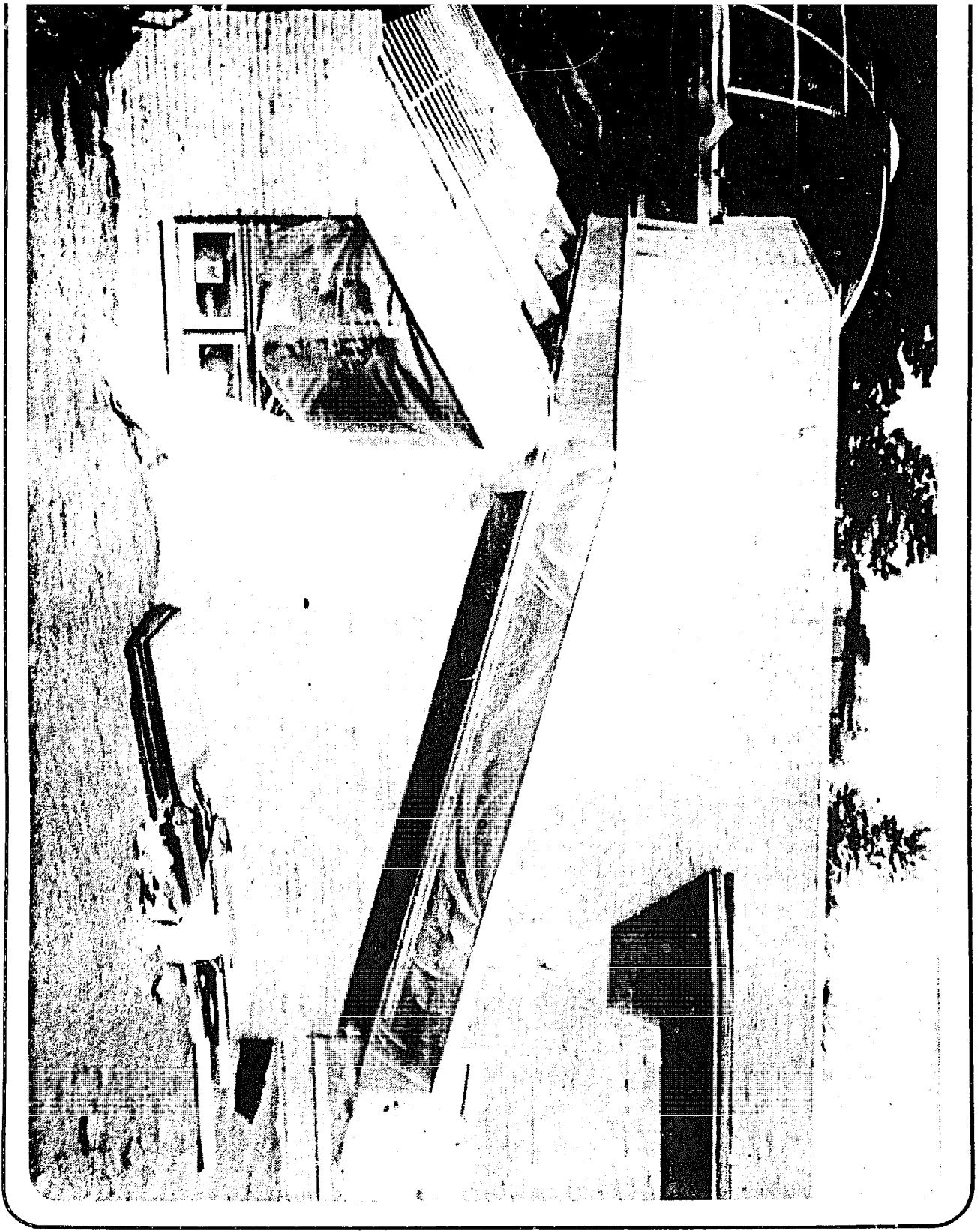

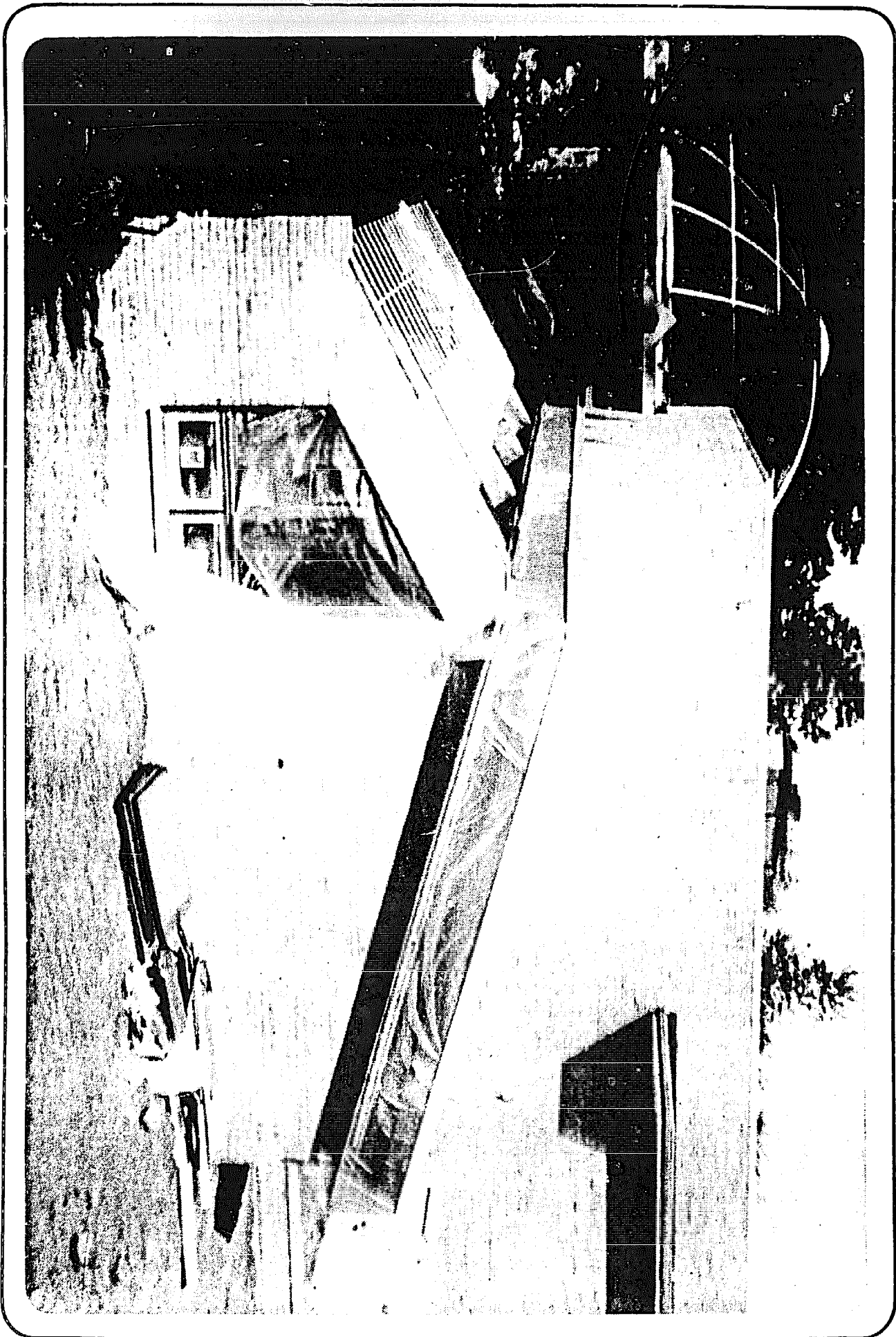

OBSERVATIONS OF PLANT RESPONSE AND FOOD PRODUCTION IN SOLAR BIOSHELTERS

by

Kathi Ryan
Director of Bioshelter Horticulture

and

Earle Barnhart
Director of Energy Research

The New Alchemy Institute
P.O. Box 432
Woods Hole, Massachusetts 02543

INTRODUCTION

The New Alchemy Institute's solar greenhouses are designed to grow a wide variety of food plants. The internal environment is a modified version of normal outdoor temperature and light cycles. The growing areas include several different microclimates so that many different vegetables can grow simultaneously in slightly different habitats. By creating a polyculture of mixed plants and animals, the gardener obtains a more constant and interesting diet and makes better use of the unique growing conditions of the solar greenhouse.

GREENHOUSE CLIMATE EFFECTS ON PLANTS

Plants growing in a greenhouse are affected by several conditions different from the normal outdoor garden. Differences include altered light quality, reduced wind, greater relative humidity and absence of normal pests and predators. Vegetables which have been selected and bred to do well when grown outdoors are affected by these unusual conditions. Some of the detrimental effects can be minimized by careful design of the greenhouse, while others may require the development of special strains of vegetables for solar greenhouse use.

Light quality inside a greenhouse is affected by the type and thickness of glazing. Various types of materials have been shown to exclude infra-red, ultraviolet, or other wavelengths of normal radiation. Several layers of glazing can significantly reduce the intensity of sunlight entering the building. Finally, the length of day perceived by a plant is altered if the morning and evening light is excluded by solid walls. These effects place some limits on the range of plants which can be grown.

Reduced wind has several subtle effects. Air movement across the surface of leaves helps exchange gases during photosynthesis and respiration. Gentle shaking by normal wind keeps

many plants more sturdy and compact than in still air. Condensed morning dew which may encourage fungus growth is evaporated quickly by air movement, and some plants require wind for successful pollination.

The benefits of high humidity are unclear. Plants have been shown to grow normally in very high humidity, but may need easy transpiration for daytime cooling. Relative humidity in our greenhouses is often 100% from evening until morning, but drops to 40-60% during sunny days.

The effect of air temperature on plants is very complex and varies with each species. In discussions of greenhouse temperatures, careful distinctions must be made of where the measurement was taken. Air temperature experienced by a person may be very different than a simultaneous temperature near the ground among the plants. Soil temperature and heat radiation upward affect plant growth in ways not obvious from wall temperature measurements. Most plants have optimum growth conditions but can tolerate a great range of temperature without damage.

We have observed that some vegetable production can be limited by high temperatures (such as lettuce) and some by low temperatures, such as eggplants. A microclimate which averages a few degrees higher than another often can promote higher production by warmth-loving plants such as peppers or greenbeans. We are gradually discovering the best light and heat zones within the greenhouse for the many vegetables we want to grow.

Insect pests outdoors have many natural predators, such as birds, toads and other insects. In a greenhouse many of these predators are absent and pests can spread rapidly. Winter frosts and soil freezing is also absent, which allow some pests to maintain constant active populations. Biological pest control that simulates garden processes is one alternative to the use of pesticides in a greenhouse.

1977 CAPE COD ARK AGRICULTURAL REPORT

Construction of the Cape Cod Ark was completed in the fall of 1976. Our first winter's crops were primarily transplants from the Institute's summer gardens. Warm, fertile, fish pond water from an aquaculture project inside the Ark provided irrigation water throughout the winter.

The first winter in the bioshelter provided lettuce, kale, swiss chard, spinach, parsley, endive, onion tops, beet greens, turnip greens and assorted herbs. Most of these plants produced throughout the winter with a slower growing period from mid-December to mid-January. This lull was primarily due to the lower angle of incoming sunlight and the shorter daily photoperiod. Less hardy plants, on the other hand, such as tomatoes and peppers did not fare as well. The only exception was a pepper plant that benefited from proximity to a solar algae pond.

In addition to food production we conducted varietal testing of lettuce to see which types would do best in the indoor environment of the Ark. Problems related to our first winter's experience curtailed this experiment.

Despite the severity of the 1976-77 New England winter, the plants in the Ark never froze. Temperatures did get down to freezing one night in early February. This was due to a combination of factors. First, a winter gale blew off the roof top vent. This was followed by a week of continuous and heavy rains. The combination of frozen ground and an incompletely landscaped exterior caused flooding of the building. Auxiliary heat was provided by a woodstove during that week. Towards the end of February, day-length increased and temperatures began to rise in the Ark. Even on partially cloudy days noontime temperatures would be in the high 70's and 80's and venting would be necessary. Moments after opening doors and vents, honeybees would fill the Ark, attracted by the scent of nasturtiums and herbs in flower.

PESTS AND INTEGRATED PEST MANAGEMENT

Pest problems during that first winter were limited to slugs and a handful of whiteflies. The whiteflies harmlessly inhabited the nasturtium during the colder months. Whitefly activity increased around mid-April when the minimum temperatures averaged 55°. Aphids and cutworms appeared in the early spring but generally caused less damage than the whiteflies. Control of the cutworms consisted mostly of handpicking. Marigolds acted as trap plants for this pest. Although handpicking 500 cutworms for one hour per day was a somewhat arduous task, it proved to be effective.

Aphids were controlled naturally by the many predators that co-habit the Ark. I observed spiders to be the most effective insect predator and each morning several webs could be found containing up to 100 whiteflies. Other predator insects in the Ark include damsel flies, praying mantises, lacewings and a variety of insect colonizers from the outside. Chameleons, toads and snakes were introduced and served as effective components of our pest management program.

The whitefly is a pest common to commercial greenhouses due to constant and relatively high temperatures. Whitefly productivity is at its peak between 58° and 65°F. Besides sucking juices from the plants the whitefly secretes a sticky honeydew on which a mold grows. Black sooty mold prevents photosynthesis and causes unhealthy plants. Most commercial greenhouses use large amounts of poisons to try to eliminate the whitefly. Hybridization and adaption to these pesticides have allowed the whitefly to persist. We believe that integrated biological controls are the only long-term effective solution.

In early July I introduced parasitic wasps (Encarsia formosa) as a control for the whiteflies. This tiny tropical

wasp parasitizes by ovipositing an egg inside the third larval stage of the whitefly. Within four days the larval scale turns black. With optimum climatic conditions an adult wasp will emerge from the black scale approximately 28 days after parasitization. At the end of July we observed 50% parasitization and Encarsia had eliminated the whiteflies by early September.

I believe that a further understanding of greenhouse pests and of the careful timing for initiating controls, will lead to a productive and ecologic balance. Basically the grower needs to know which pests are common to greenhouses and at what temperatures do each of these insects reproduce. Which plants are attractive to these pests is another important factor in dealing with biological control. With careful monitoring and the use of integrated pest management, one can eliminate the use for pesticides and their according hazards.

Biological controls and integrated pest management were the major focuses of this past summer's research. Not knowing how traditional garden plants would respond to the high summer temperatures in the Ark, I planted a variety of crops for observation purposes. It was late May before the soil temperatures were warm enough for summer varieties such as melons, peppers, okra and tomatoes.

Seedlings were planted in April and most either died of root rot or remained dormant until the soil temperatures increased.

Most plants grown in the Ark this summer produced an abundance of foliage but very little fruit. The overall health of the common garden vegetables was not good, due, I think, to the intensity of heat and the whitefly damage. Even with maximum venting the building would reach temperatures of 100°F and higher on windless, sunny days.

The tropical fruit trees, of course, did very well in this hot and humid environment. They were relatively unaffected by pests and grew rapidly. Malabar spinach, a tropical vegetable, gave tremendous yields from mid-summer to the beginning of October. This plant climbed trellisses and poles and produced large amounts of excellent tasting spinach.

This winter we are again experimenting with varietal testing of lettuce. Five varieties of greenhouse lettuce are being grown in comparison to five varieties of outdoor lettuce. We are measuring food production per square foot and are monitoring the effects of different organic fertilizers as well as the effects of different light levels. We will continue experiments with hydroponics in the fish tanks. Reflectors are being used to determine the importance of light for the growth of plants. We are planning to heat soils and to compare concurrent plant growth rates. Maximum space utilization and microclimates are other areas presently in focus.

Thoughts for the future are optimistic. We plan to make use of the high temperatures during the growing season for tropical fruit production and mist propagation of trees. I believe we are successfully replicating productive outdoor ecosystems. Mother Nature seems to be approving as our second generation of chameleons have recently entered our greenhouse community.

REFERENCES

- Geiger, Rudolf. 1965. "Climate Near the Ground." Harvard University Press. 611pp.
- McLarney, W. O. 1974. "Irrigation of Garden Vegetables with Fertile Fish Pond Water." THE JOURNAL OF THE NEW ALCHEMISTS, No. 2: pp. 73-76.
- THE JOURNAL OF THE NEW ALCHEMISTS, No. 4. 1977. Bioshelter Section: "Tomorrow is our Permanent Address." John H. Todd; "Bioshelters as Organisms." Ron Zweig; "Bioshelter Primer." Earle Barnhart; "The Six-Pack: A Backyard Solar Greenhouse." Laura Zuck-Engstrom.
- Mitchell, Cary. 1977. "NASA Launches a New Experiment to Explore How Plants React to Stress." Horticulture, September 1977, pp. 10-13.
- Ott, John. 19 . "Health and Light." Devin-Adair. 198pp.

ACKNOWLEDGMENTS

Investigation of winter food production discussed in this paper was supported in part by research grants from The Massachusetts Society for Promoting Agriculture, Wenham, Massachusetts, and The Jessie Smith Noyes Foundation, New York. Research was conducted by several New Alchemy staff, including Susan Ervin, Laura Zuck-Engstrom and Hilde Maingay.

CAPE COD ARK MINIMUM TEMPERATURES

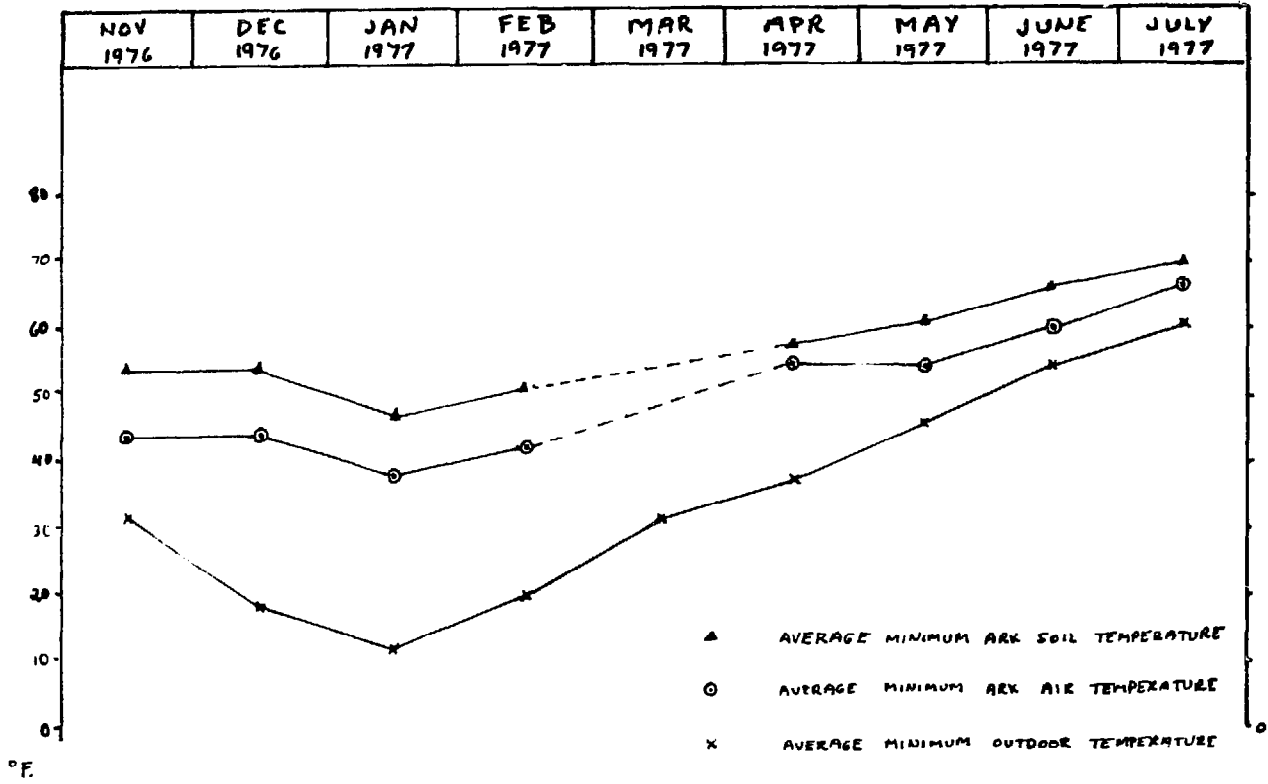

CAPE COD ARK TEMPERATURES AND EVENTS

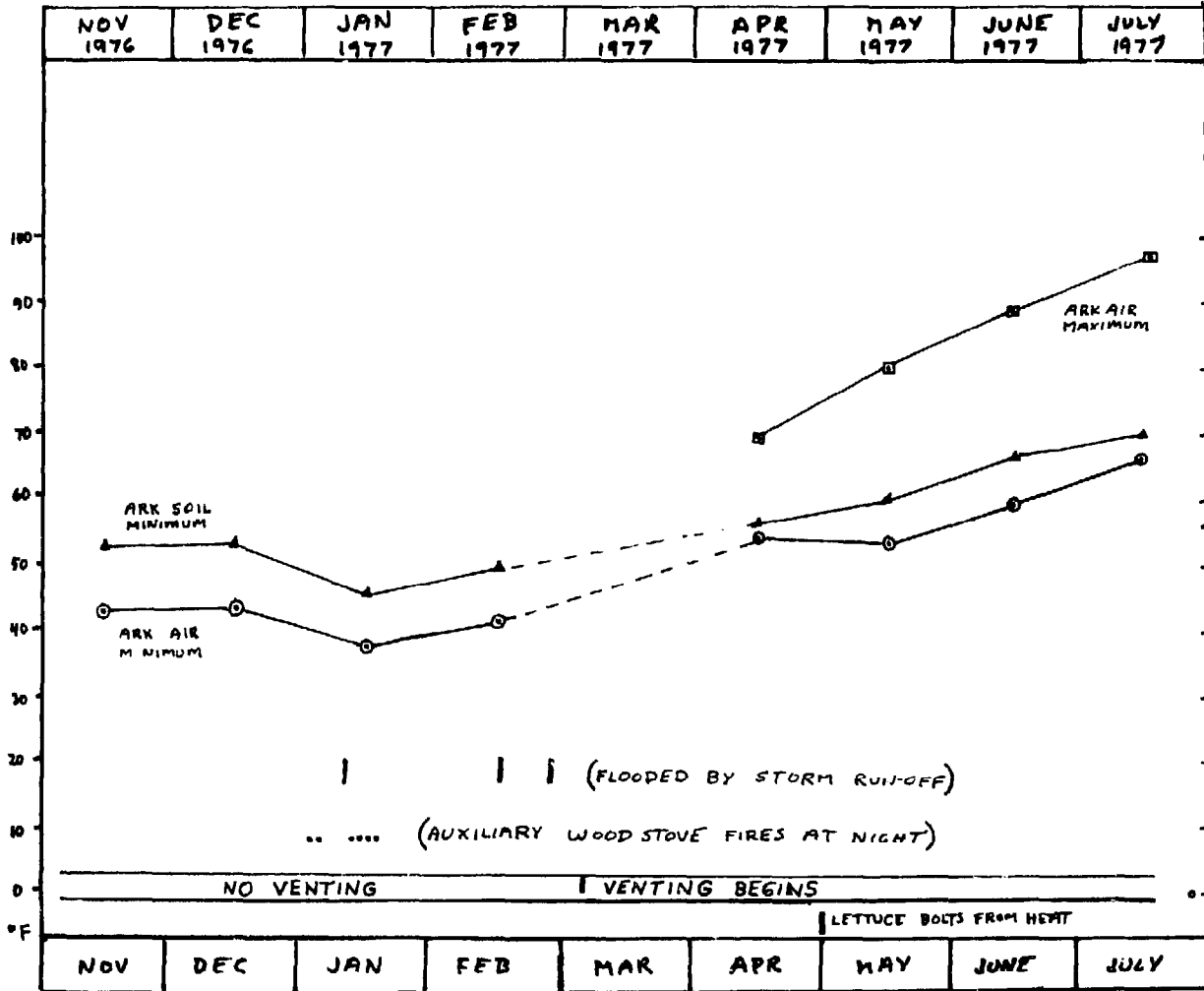

BIOTECHNIC STRATEGIES IN BIOSHELTERS

by

Earle Barnhart

The New Alchemy Institute
P.O. Box 432
Woods Hole, Massachusetts 02543

ABSTRACT

The New Alchemy Institute is developing ecologically-derived forms of energy, agriculture, aquaculture, housing and landscapes. Bioshelters are advanced solar greenhouses which contain gardens, aquaculture ponds and human habitation in a single integrated ecosystem. The two main functions of greenhouse architecture - channeling solar energy and nurturing a food-producing ecosystem - are discussed as parts of a single design strategy.

ELEGANT ENTROPY

From the recent surge of solar oriented architecture, design principles are emerging which are similar to biological strategies found in natural living systems. Both systems are a response to the fundamental dilemma of maintaining biological processes driven by fluctuations of incoming energy. Component members of living systems have developed mechanisms of collection and storage to cope with fluctuations of energy supply. Plants generally absorb daily sunlight and store energy chemically as sugars, starches or other materials in their structure. Many animals periodically ingest food energy but use it only gradually. Warm-blooded animals have the additional strategy of conserving the heat of their energy use with fur or feathers and other forms of seasonal insulation. Whole communities of organisms living in a cold region have evolved heat-conserving surface area to volume ratios, and many species develop special nighttime and winter behavior such as hibernation. On the ecosystem level where plant and animal strategies co-evolve, ecosystems gradually develop a structure to reduce the effects of extreme fluctuations of temperature, humidity, wind, and other environmental parameters. One important result of the interacting community is a mutual reduction of physiological stress on its members.

In a mature ecosystem trees, shrubs, grasses and other plant structures affect climate largely by reducing wind velocity and restricting radiant heat loss. Within a forest or meadow reduced wind stabilizes air temperature, evaporation and soil moisture. In turn, a gaseous membrane of air, water vapor and CO₂ near the ground affects incoming and escaping radiation. The quantity of energy involved in evaporation and condensation is a significant factor in daytime cooling and nighttime heat release. These combined environmental buffering effects create relatively stable microclimates and new habitats for organisms within the ecosystem. As the ecosystem gradually becomes more diverse, it

becomes more efficient at capturing available sunlight, produces more food, and becomes capable of supporting still more organisms.

Generally, then, a terrestrial ecosystem partially buffers environmental extremes and gradually diversifies to become more efficient at capturing diurnal and seasonal pulses of sunlight. The solar energy captured as both heat and food is conserved and slowly expended in biological activity before being finally lost as thermal radiation back to the heavens.

ARCHITECTURE AND BIOTECHTURE

"Ultimately the natural and technological solutions will be indistinguishable."

Jono Miller

Solar greenhouses and more complex bioshelters are architectural forms designed to protect and nurture living plants, animals and people. Successful solar greenhouses must include many of the principles found in successful ecosystems. Greenhouse architects should remain aware that biological systems are a source of potential strategies useful in solar design. Solar greenhouses must perform a unique blend of the energy collection function of a plant, the heat conserving process of a warm-blooded animal and the micro-climate formation of an ecosystem. The architect must combine effective solar orientation and thermal storage so that chosen food crops have optimum ranges of temperature, light and moisture.

Much traditional building design and even some solar greenhouse design confines analysis of energy dynamics of a structure to its outer "shell", calculating energy inputs of sunlight and radiant heat and losses of reflection, radiant heat and infiltration. The more subtle dynamics of how input energy is passively absorbed, stored and channeled within the structure are only beginning to be investigated and understood. We know that the best of the passive solar buildings can orchestrate light, thermal mass and convection and can create a zone of very stable temperatures. This type of sophistication is important in designing spaces where several different species interact, yet each species has specific environmental requirements. A bioshelter must reflect these needs in its design. Ideally, the architectural design of a successful agriculture will interact until architectural form merges with ecological function.

In a home greenhouse food crops are the major ecosystem components. An internal light and temperature regime suitable for a mixture of fruits and vegetables is the primary goal of the architect. To cope with pest species which soon immigrate to the crop, successful ecological management of an outdoor garden suggests that an alternative to persistent biocides is a permanent population of associated predators within the structure. It is not known how few species or organisms can comprise a human-dominated, permanent food-producing garden ecosystem which is self-regulating without need for pesticides. One solution is to duplicate as nearly as possible the ecological patterns of a

successful outdoor garden. Each of the plants, pests and predators requires a slightly different range of temperature, light, moisture and habitat. The challenge to the greenhouse designer is to create many microclimates which allow this highly diverse life to coexist.

DESIGN PRINCIPLES

"In wildness is the preservation of the world."
Henry Thoreau

Concepts of ecological architecture and ecological engineering have recently begun to be intensively investigated in relation to agricultural systems. Principles of design that are useful to the architect are strategies that encourage greenhouse systems to become self-adapting without having to thoroughly understand the biological intricacies involved. The following examples are general rules of biological design in solar greenhouses.

I. Architectural forms should create microclimates that nurture a diversity of different plants and animals.

Microclimate should be created to include zones for major crop plants, minor crop plants including herbs and flowers, maintenance organisms such as predatory, parasitic and pollinating animals, soil organisms for decomposition and recycling, and, if possible, aquatic communities which interact with the terrestrial community. Microclimates are created by intentionally shaping the solar greenhouse and interior structures to create variations in sunlight intensity, air temperature, soil types, moisture conditions and types of habitat surfaces. Specific structures that can be used include terrace levels, raised or lowered beds, stone walls, passive thermal walls, vertical arbors and tiny ponds.

II. Fill every available ecological niche and habitat with chosen organisms.

a. Soil and soil organisms from a normal garden should be added to the crop growing area. This soil will introduce bacteria and microorganisms adapted to the culture of vegetables. Common surface animals such as crickets, spiders and beetles should be included, as well as samples of other types of soil from fields, meadows and forest floor. Compost and earthworms can be distributed in all beds. The goal is to assemble many types of soil organisms which may adapt to the different microclimates.

b. Major and minor food crops will occupy much of the growing area. Food crops can be changed as the seasons change. Many plants have an optimum season of production based on day length, while others are affected by temperature. Test plots and close observation will indicate which food plants are productive in a particular area through the seasons. Mixed species of food plants give a more interesting and continuous human diet, and will act to gradually create many insect habitats and food sources for both pest and predators.

c. Create permanent ecological islands to harbor populations of regulatory organisms. Predators, parasites and pollinators, which help maintain the agriculture, need special soil and plant associations. Predators include toads, frogs, chameleons, spiders, beetles, damsel flies and other insects. Parasites include microscopic trichogama wasps, and pollinators include wasps, flies and bees. These ecological islands are protected zones undisturbed by seasonal mass harvests, removal of crops and soil cultivation. These permanent zones allow cumulative diversification of the ecosystem by harboring unintended colonizers from the outdoor ecosystem. Permanent populations of many organisms may be essential for ecological succession and self-regulation within the bioshelter. Attempts should be made to preserve a wide range of natural diversity because we do not always know which species are necessary for long-term function. Ecological islands can take many forms such as permanent herb plots, an area of meadow sod or forest litter, a rotting log, a rough stone wall, a tiny pond or a permanent tree or vine.

III. Encourage adaptation and succession.

A solar greenhouse environment, however well designed, differs from the outdoor environment in many respects. Altered light quality, higher humidity levels and lack of bird predation are among these parameters. Over several years populations of soil microorganisms, insects, and even larger predators will adapt to the new environment. Pests and predators will become established, will find ecological niches, and will develop new relationships. The process is a gradual development of new food chains based on new associations of crops, pests, predators, parasites, pollinators and decomposers. The designer can facilitate succession by providing for maximum interaction and travel among microclimates. Soil connections between growing beds permit earthworms, soil organisms and surface animals to move freely. Tiny ponds at the soil level give animals access to moisture. Ecological islands in corners and near crop areas provide convenient shelter for predators. A second method is periodic reintroduction of outdoor soil, insects and potential predators. As permanent plants become established, new habitats develop which were unavailable previously. A third method is to permit two-way migration between the outdoors and the greenhouse in the warm season.

Another general adaptation may occur when an aquaculture pond is used to recycle weeds or plant wastes and in turn supplies fertile irrigation water for the crops. The aquatic nutrient loop can eliminate the survival of some plant diseases which might carry over in plant wastes, and bacterial and biochemical changes will occur to utilize the exchanged nutrients in both aquatic and terrestrial systems.

IV. Stimulate gaseous exchange.

Air movement by winds and local convection plays an important role in the exchange of water vapor, oxygen and CO₂

across leaf surfaces. This air movement speeds evaporative cooling, brings CO₂ for photosynthesis and removes waste O₂. In nature a large part of CO₂ supply comes from respiring soil organisms' decomposing organic matter. Whereas a greenhouse using sterile soil can become depleted of CO₂ without an outside supply, a greenhouse with fertile soil of organic matter and microbes has a slow-release CO₂ reservoir. Nutrients which are removed from the system as food must be periodically resupplied by adding compost.

V. Avoid cumulative toxins and biocides.

Some pesticides used in agriculture and indiscriminately lethal to multitudes of organisms. Even Rotenone, considered relatively mild, is toxic to many cold-blooded animals such as toads and fish. Pesticides, herbicides, fungicides, wood preservatives and some paints contribute toxins or heavy metal compounds which pass through food chains and accumulate in top predators, including humans. Organic matter such as grass clippings, sewage sludge or food wastes should be evaluated as possible sources of biocides.

NEW ALCHEMY INSTITUTE'S RESEARCH AND DEVELOPMENT

New Alchemy Institute has for several years been investigating the synthesis of sun, wind, biology and architecture in gardens, aquaculture ponds, solar greenhouses and bioshelters. Our interest is the development of permanently sustainable food-producing ecosystems based on patterns found in nature. Bioshelters are advanced solar greenhouses which contain agriculture, aquaculture, and human habitation in a single integrated system. Bioshelter sub-elements we have investigated thus far include:

a. Solar ponds are semi-closed aquatic ecosystems for fish protein production. These solar ponds provide food, indoor nutrient cycling of greenhouse plant wastes and enriched irrigation water. Equally as important they serve as passive solar collectors and thermal storage mass for climate moderation.

b. Agricultural ecosystems of vegetables, herbs, seedlings, tree cuttings, ornamentals, dwarf fruit trees and associated pests and predators.

c. Integral human habitation for operators of bioshelters, where people live within the structure, exchanging heat, food and waste materials with the greenhouse environment.

d. External components including reflective solar courtyards for sunlight concentration, rainwater collection from the rooftop as a supplemental water supply and living plants for winter windbreaks and summer shading.

Other bioshelter concepts yet to be developed include:

e. Agricultural hydroponics on solar ponds which would utilize a potential niche which is stable and has a constant water and nutrient supply.

f. Human waste and water recycling which are biological processes and should return nutrients to a locally productive use. Throughout the world aquatic ecosystems are used for rapid cycling of many organic waste materials. In Canada the Prince Edward Island bioshelter uses a Clivus Multrum for solid human wastes. Treated grey water is being tested for irrigation in California. Conceivably, a linked aquaculture/hydroponics/irrigation system could recycle human wastes locally.

g. Selection of crops specially adapted for solar greenhouse conditions.

h. Water distillation from condensation on glazing. A significant fraction of solar energy absorbed by a plant evaporates water. On cool nights as energy is lost from a solar greenhouse, vapor condenses on the inner glazing surface, producing a small fresh water supply.

i. Seasonal multi-use of greenhouse structures:

- i. Winter vegetable production and sale.
- ii. Winter supplemental home heating.
- iii. Spring seedlings for outdoor agriculture.
- iv. Summer solar drying of surplus garden food.
- v. Domestic hot water pre-heating.
- vi. Water distillation.
- vii. Tree propagation.

EPILOG

"We are faced with insurmountable opportunities."
Pogo

The design principles I've described are examples of ecological concepts in which architecture is one of many factors. The sun, soil, plants, animals and water are equally important. In the microcosm of a solar greenhouse everything is truly connected to everything else: the architecture to the sun and the plants, the plants to the season and the soil, the soil to the people and their habits and people's habits to the region and their needs. We at New Alchemy are carefully contemplating these relationships in the hope that with better understanding of how nature works, we might gain a greater respect for our place in it.

REFERENCES

- Geiger, Rudolf. 1965. "Climate Near the Ground." Harvard University Press. 611pp.
- THE JOURNAL OF THE NEW ALCHEMISTS, No. 4. 1977. "Bioshelters." pp. 85-125.
- Odum, Eugene P. 1971. "Fundamentals of Ecology." W. B. Saunders Co., Philadelphia, Pennsylvania. 574pp.
- Serle, J. A. 1973. "Environment and Plant Life." Faber and Faber, London. 278pp.



SECTION 6

- Poster Session
- Chairperson, Bruce Anderson

SOLAR GREENHOUSE EXPERIENCE AT THE INSTITUTE FOR SOCIAL ECOLOGY

by

Richard Gottlieb and Buzz Tenenbom

ABSTRACT

From the inception of the Social Ecology Program in June 1974, to the present time, construction, use, evaluation and modification of Hybrid and Passive Solar Greenhouses have been undertaken. Two Hybrid Greenhouses and one Passive Greenhouse exist at present.

This paper describes the experience with the latest Hybrid: the Solar Heated Windpowered Aquaculture Greenhouse Complex; and the design and predicted performance of the Passive Solar Greenhouse now nearing completion: the Biological Generator.

In July 1975, construction was begun of a Hybrid Solar Greenhouse: the Solar Heated Windpowered Aquaculture Greenhouse Complex. Construction was completed in May 1976. A side section of the Complex is shown in Figure 1 and a front elevation in Figure 2. Figure 1 contains pertinent information about the Complex. No attempt has been made to show plumbing, electrical, wood heat back up system, growing areas, potting areas or aquaculture systems. The building has undergone progressive changes which are described in the text and Figure 1.

Despite a harsh 1975/1976 winter with the building under construction, the solar and wind systems functioned satisfactorily. Direct gain in the greenhouse and heat supplied by the collectors accounted for approximately 20% of the heat load in December, January and February, with wood heat supplying the remainder.

The summer of 1976 was occupied with reworking the plumbing part of the open water flat plate collectors, conducting experiments with local and southern varieties of crayfish and activating the filtration system for aquaculture work in the large concrete tank. Fingerling Tilapia were introduced in late July 1976, and were successfully grown into the late fall. A very successful experiment having to do with selecting the most hearty variety of cabbage adapted to Vermont's short growing season was carried out. Detailed results of all the above may be found in References 1, 2 and 3.

By late November 1976, despite the introduction of a heat exchanger from the solar reservoir to the aquaculture tank, evaporative heat losses in the aeration system requiring excessive cold make up water prevented the maintenance of desired temperatures for fish growth. The Tilapia were wintered over in the Gate Farm house. The Complex was run and monitored until February 1977, when it was decided to change the interior physical set-up.

DESCRIPTION

- LOCATION: CATE FARM, GODDARD COLLEGE PLAINFIELD, V. 44° 1' N LAT. 72° 1/2' LONG.
 371,634 sq ft
 180,634 sq ft
 1312,000 gal
 2543.20 gal
- Building : 1 Ground Floor Area Including Tank Tops
 2 First Floor Area
 3 Concrete Tank Capacities
- Small :
 Large :
- 4 Bed Growing Area
 5 Greenhouse Glazing (Acrylic Outside, 1/8" Acrylic Inside) East and West Faces : 264' 00" ft
 Night Insulation : Manually Operated 2" Beadboard Sliding Panels For South Face , 2" Beadboard Nightwall For East And West Faces Of Greenhouse
 6 Night Insulation : Manually Operated 2" Beadboard Sliding Panels For South Face , 2" Beadboard Nightwall For East And West Faces Of Greenhouse
 7 Collector System : Flat Plate Open Flow Double Glazed. Collector Material: Aluminum, Flat Black
 Collector Glazing: 401.25 sq ft Sunlite .040" Pyrexium Pump and Reservoirs : Various, See Item 10
 8 Thermal Back Up: Wood stoves, Various, See Item 10
 9 Electrical: 110 V AC 60 ~ 20 AMP SERVICE 32 V DC 16 2 Volt Cells, 12 KW Storage Coupled To 1800 Watt Jacobs Wind Generator
 10 Physical Changes: Spring 1976: 110 V AC 1/2 HP Myers Pump Replaced By 1/2 HP Teel Centrifugal Pump. Fall 1976: Inner Glazing Added To Greenhouse. Winter 1976: 668 Air Tight Stove Replaced With Similar Size Ashley Spring 1977: Ground Floor Raised To Level Of Tank Tops By Addition Of Gravel. Solar Reservoir And Aquaculture Tank Interchanges. Fall 1977: 1/2 HP DC Motor Added To Myers Pump And Piped In Parallel With 1/2 HP Teel Used As Back Up.

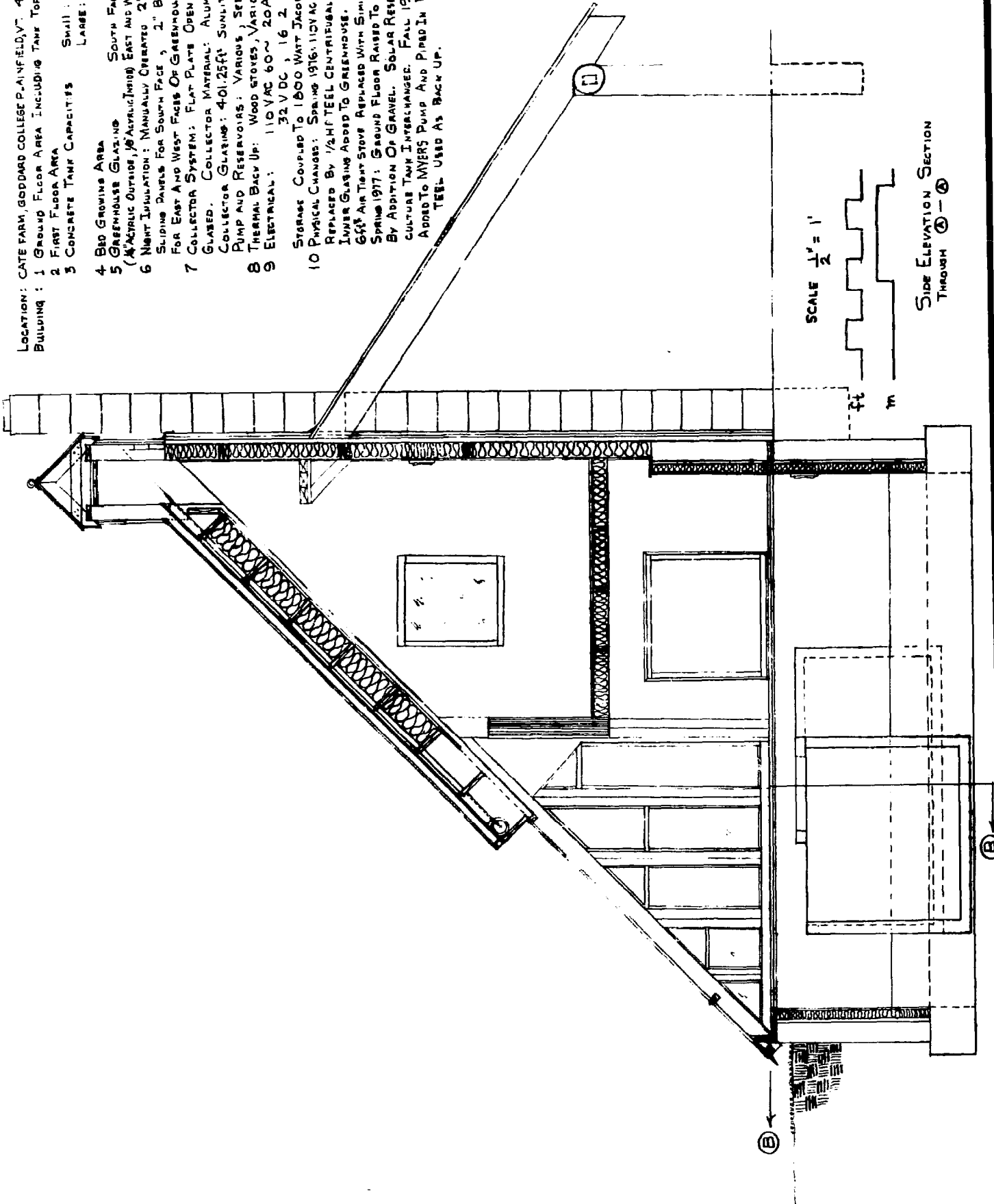

Solar Heated Windpowered Aquaculture
 GREENHOUSE Complex
 INSTITUTE FOR Social Ecology
 GODDARD COLLEGE
 PLAINFIELD, VERMONT 05667
 DRAWING: Robert Lyell

FIGURE 1

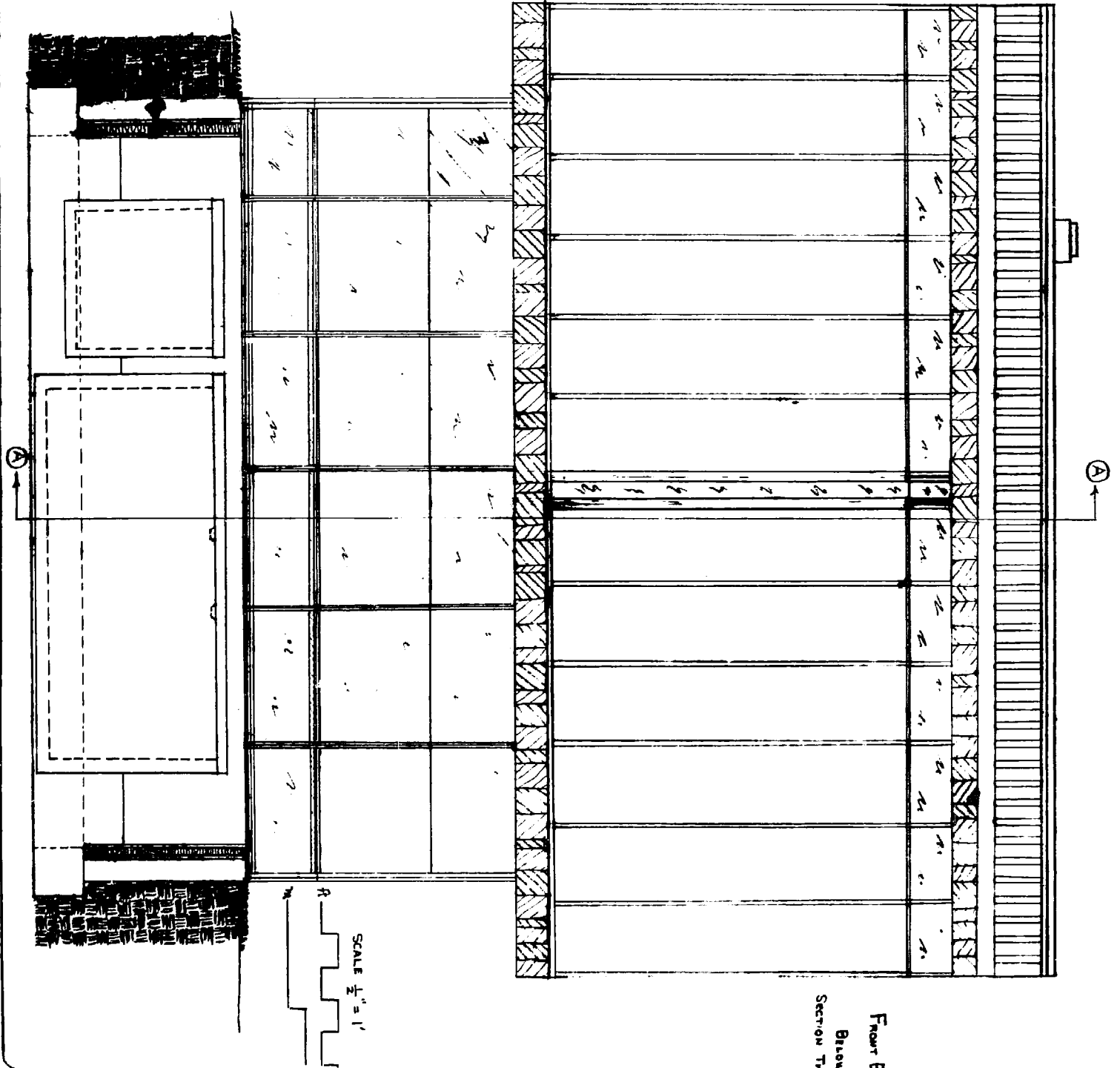

FRONT ELEVATION
 BELOW GRADE
 SECTION THROUGH (A)-(A)

FIGURE 2

SOLAR HEATED WINDPOWERED AQUACULTURE
 GREENHOUSE COMPLEX
 INSTITUTE FOR SOCIAL ECOLOGY GODDARD COLLEGE
 PLAINFIELD, VERMONT 05667 DRAWING: *Richard G. ...*

LETTER TO: TEVENBOM
BUZZ BOX 55
PLAINFIELD, VT 05667

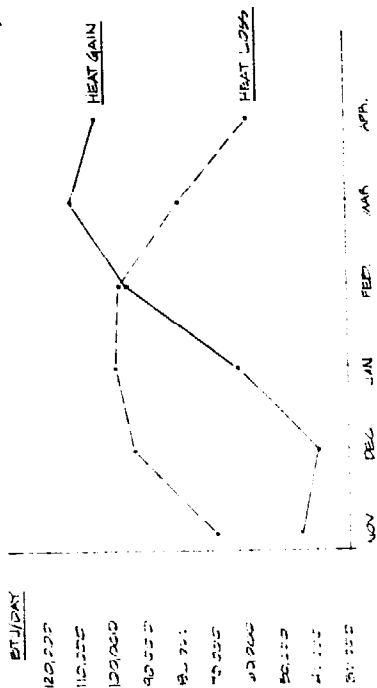

LIST OF DRAWINGS

1. BUILDING DESCRIPTION
2. PLAN & ELEVATIONS
3. FOUNDATION PLAN
4. FLOORING PLAN
5. SECTION-BUILDING
6. SECTION-VESTIBULE
7. DETAILS-WALL SECTIONS
8. USING THE BUILDING

DETAIL KEY

1. DETAIL/SECTION NUMBER
2. LOCATION SHEET NUMBER

SUMMARY - SOLAR BIO-LOGICAL REVEALS

LOCATION: SATELITA VERMONT COLLEGE 41°N LAT. 72°W LONG. BUILDING: 230 SQ FT FLOOR AREA + 90 SQ FT VESTIBULE. 87 SQ FT PLANT BEDS + 20 SQ FT CONCRETE. HEATING: 400 GALLONS WATER + 200 GALLONS WATER + 400 GALLONS WATER + 400 GALLONS WATER. NOTE: THIS BUILDING WAS DESIGNED TO COMPLY WITH THE NATIONAL HANDICAPPED STANDARD (AMBI ACT) - 1968.

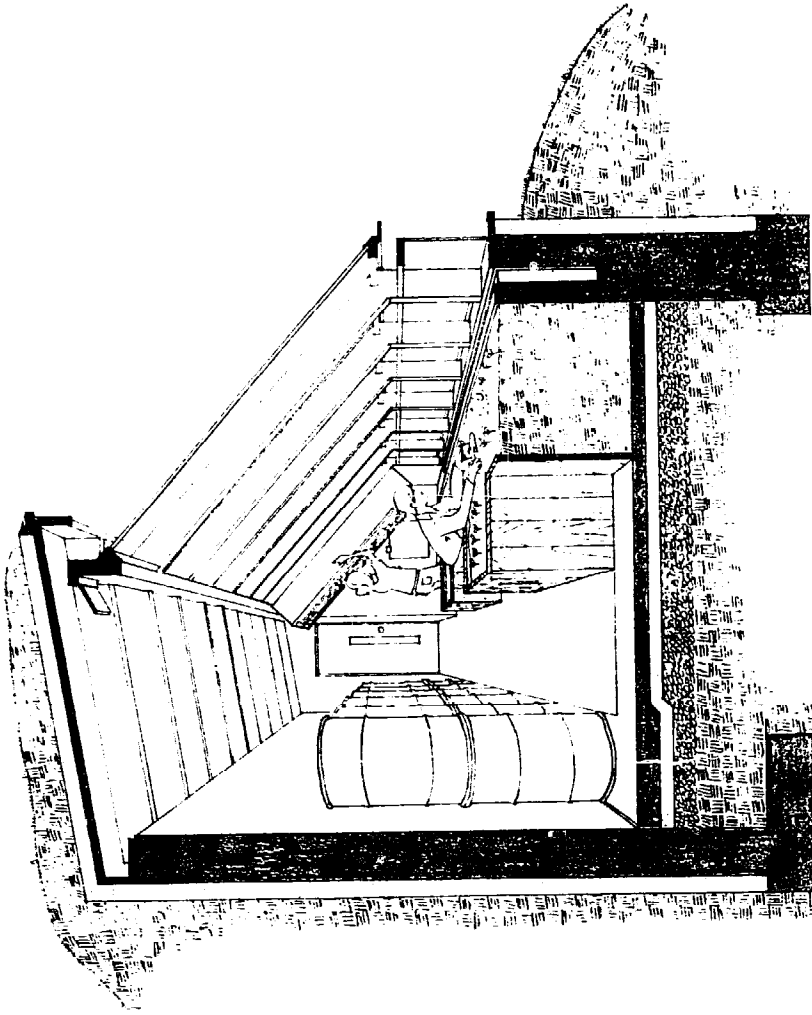

WORK BEGAN THIS SUMMER ON A BIOLOGICAL REVEALS FOR THE INSTITUTE FOR SOCIAL ECOLOGY AT SATELITA VERMONT COLLEGE. THE REVEALS IS A BIOLOGICAL REVEALS AND PLANT BEDS WHICH THE ENERGY OF THE SUN CONVERTS TO FOOD. THE SYSTEMS VARIOUS BIOLOGICAL REVEALS TO GROW. THE STRUCTURE IS DESIGNED WITH 180° FLOORING AND WALLS ALLOWING THE BUILDING TO ACT AS A PASSIVE COLLECTOR. THE WALLS ARE INSULATED WITH 50 GALLONS OF WATER AND 100 GALLONS OF WATER. THE PLANT BEDS AND CONCRETE WALLS INSULATING SHUTTERS WILL BE OUT TO COVER THE GLAZING AT NIGHT. PLANT BEDS WILL PROVIDE A YEAR-ROUND GROWING MEDIUM. VISIONS HAVE BEEN MADE FOR AN INTEGRAL COOPERATIVE SYSTEM TO MINIMIZE OUTSIDE INPUTS OF ENERGY DURING THE FIRST 5 YEARS.

FACULTY ADVISOR: BUZZ TEVENBOM
STUDENT: JOHN SHELL, D.W. MATTHEWS, BARBARA JOHNSON, JERRY GORDON, AND OTHERS OF THE SOCIAL ECOLOGY PROGRAM, SUMMER, 1977.

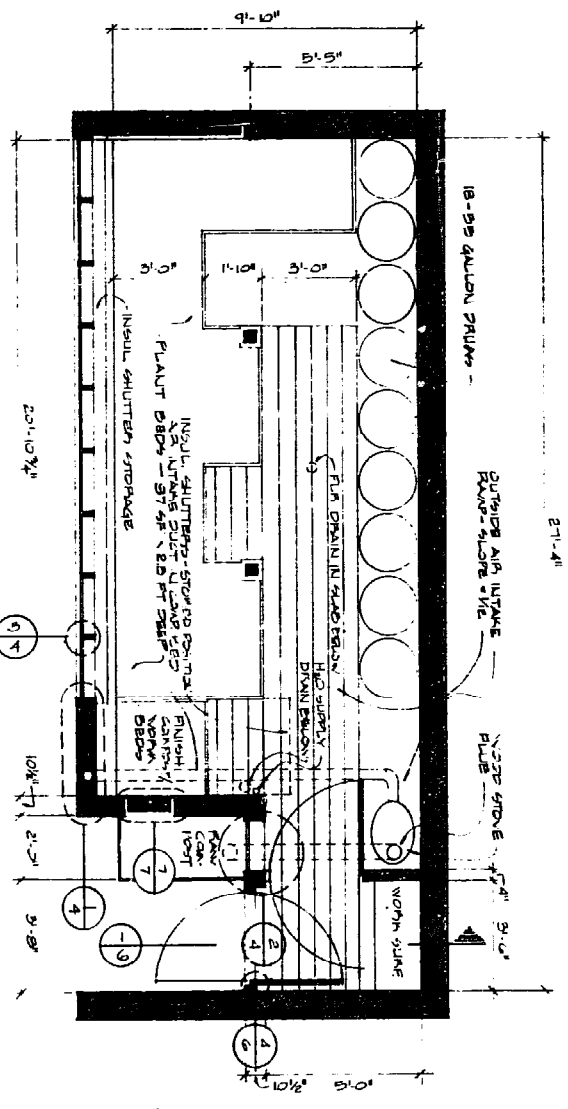

FLOOR PLAN
SCALE: 3/8" = 1'-0"

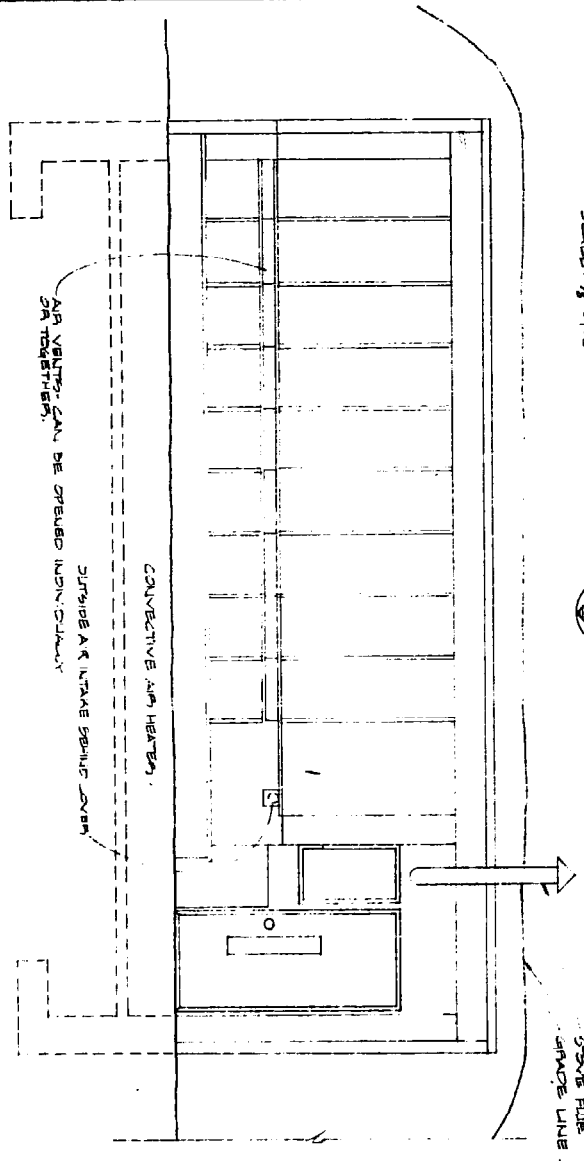

FRONT (SOUTH) ELEVATION
SCALE: 3/8" = 1'-0"

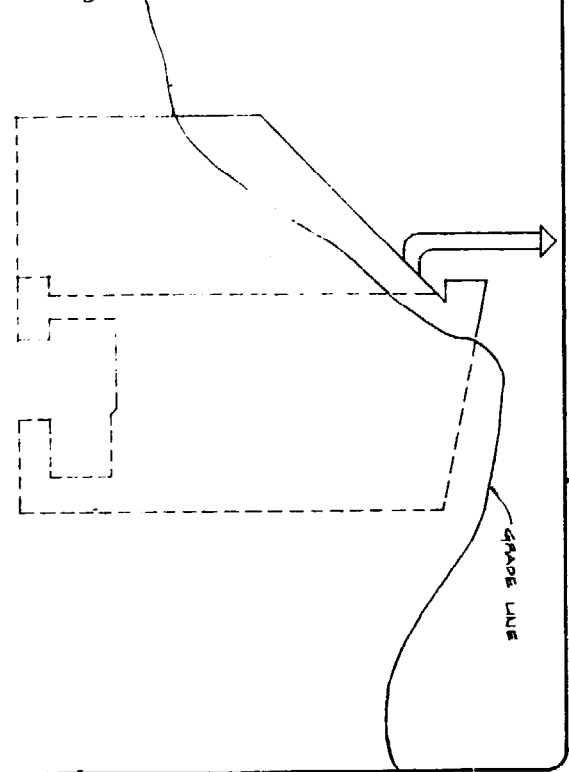

EAST ELEVATION
SCALE: 3/8" = 1'-0"

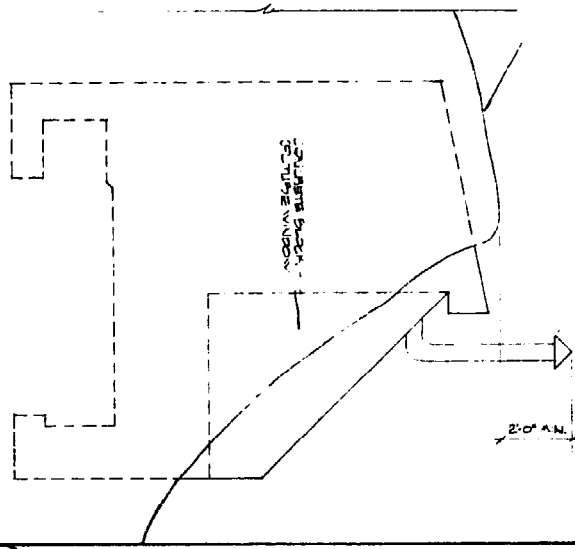

WEST ELEVATION
SCALE: 3/8" = 1'-0"

PLAN & ELEVATIONS

INSTITUTE FOR SOCIAL ECOLOGY GODDARD COLLEGE
PLAINFIELD VERMONT SUMMER, 1977

FIGURE 5

2

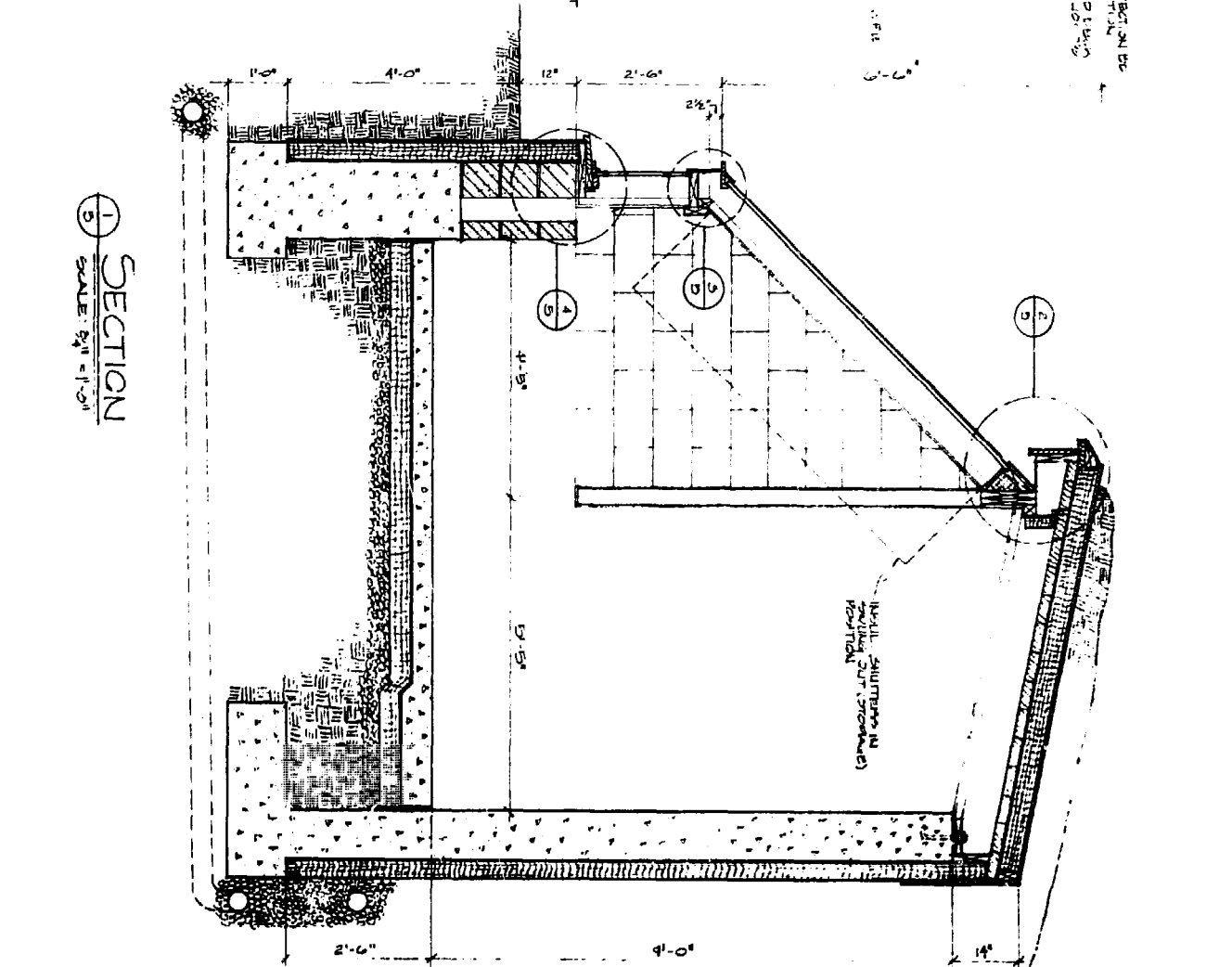
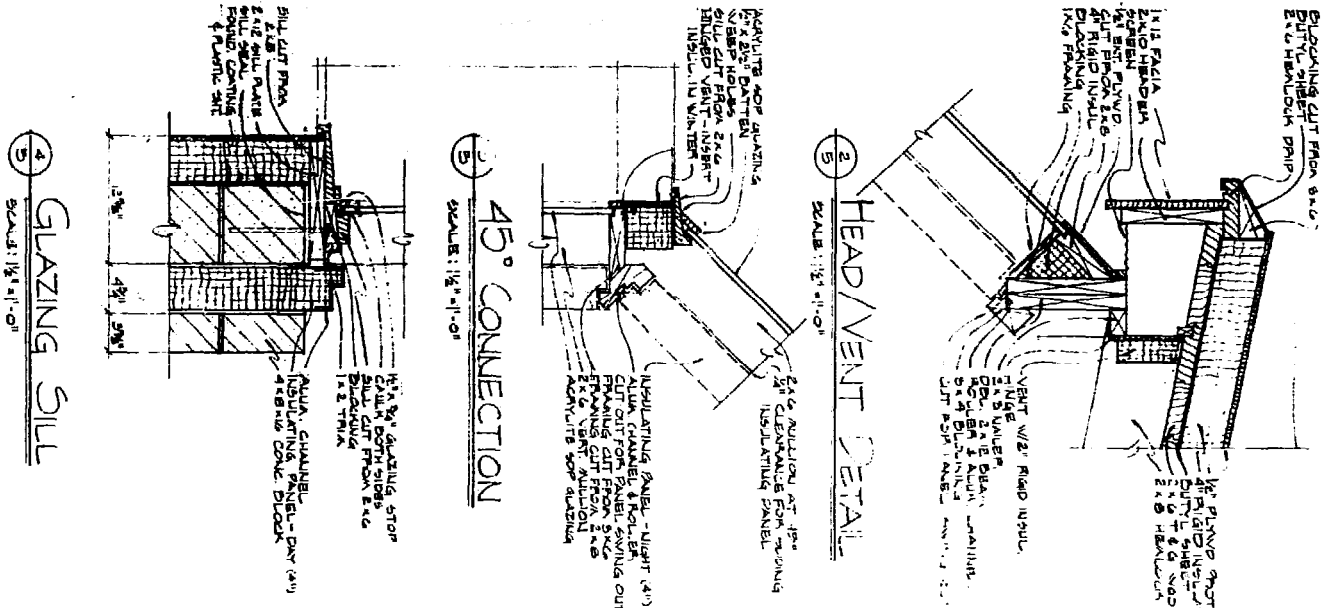

SECTION - BUILDING

INSTITUTE FOR SOCIAL ECOLOGY GODDARD COLLEGE
PLAINFIELD, VERMONT SUMMER, 1977

Figure 7

SOME OBSERVATIONS ON THE DESIGN AND
CONSTRUCTION OF GREENHOUSES

Mark Ward, Cambridge Mass.

Any undertaking benefits from the experiences, mistakes, and successes of those who have come before. It is important to understand that greenhouses have been with us for a very long time, and that conventional or commercial designs represent the end result of an evolution of design based upon several hundred years' experience. Until recently, the prime focus of this design process was on plant productivity and ease of maintenance. Now with the relatively high cost of fuel, the thermal efficiency of the greenhouse has become an important factor, leading some to design greenhouses with heat efficiency as the exclusive design consideration. If we are seriously thinking of producing plants and food with "solar" greenhouses we should pay attention to the factors that make conventional designs efficient plant producers and try to retain those in new designs that are efficient heat producers as well. In addition, attention to the choice of material, construction detail, and other factors that contribute to a more durable structure well suited to a very wet environment are important if the greenhouse is intended to last for more than a few years.

As a greenhouse recycler/builder I have learned much about what lasts in a greenhouse environment. Together with Jim Burke of Vermont Recycled Greenhouses I have dismantled about 50,000 square feet of glass greenhouses in the Boston area ranging in age from 25 to 75 years old, mostly old carnation houses driven out of business by the price of oil, labor, and competition from the South. They are typically located on valuable suburban property, a factor which hastens their removal.

We have recycled the material into numerous smaller greenhouses, representing a wide range of function and solar efficiency. Most are attached to homes, although we have done some small commercial greenhouses. We both work in all aspects of design and construction as well as supply materials and aid to owner/builders.

From my perspective, the "solar" greenhouse that serves as its own heat collector represents a design compromise between growth efficiency and heat efficiency. That compromise has a different result for a person who wants to get some heat and winter greens from an attached greenhouse than it does for a commercial grower trying to produce on a schedule. Different priorities lead to different designs but I suspect that designing "solar" greenhouses to be thermally efficient in the months of January and December can lead to plant growth problems. Light levels in the North are too low during those months to support growth in many plants, and the tradeoffs made for thermal efficiency often end up compromising the ability of the greenhouse to produce in February, March, and April when light levels are higher.

Of the design factors related to plant productivity, light levels are the most widely overlooked. In many "solar" designs, the use of

large-dimension, closely-spaced, non-reflective framing; multiple glazings; and black body heat storage significantly reduce light levels, in some cases retarding plant growth. Reducing the proportion of glazed area to growing area in order to accomplish year round solar self sufficiency often has the same effect.

Minimal light obstruction is a very clear objective in respect to framing. Framing in commercial greenhouses is as minimal as possible in order to maximize light transmission. Double polyethylene houses, the most widely used new greenhouse construction, often use one-inch pipe for framing, spaced on four foot centers, resulting in virtually no light obstruction. This style house is very popular among growers from a production standpoint.

In woodframed houses where the spacing is smaller, the framing is of relatively small dimension and is painted white in order to reflect as much of the obstructed light as possible. Often, productivity is noticeably increased after a paint job.

Framing dimensions and requirements vary according to the weight and width of the glazing, roof pitch, length of unsupported span, and other structural considerations, but minimal light obstruction should be a design objective.

However, on the issue of multiple glazings and heat storage, the objectives are not as clearcut. There is no question that many glazings retain heat better than fewer, but there is also no question that they block more light. In addition, placing black barrels of water or other dark thermal mass in the greenhouse is very convenient for the passive absorption of heat, but those black bodies are in direct competition with the plants for light. There is no one solution to these problems but the growth implications of various choices should be explored. There are many design variations possible in "solar" greenhouse design depending upon the location and function required.

Ventilation both for CO₂ replenishment and for cooling is another factor that must be accounted for. In the winter this ventiation can be accomplished in many different ways as have been reported in other papers presented here. However, if the greenhouse is to be used in the late spring or summer, then some provision for venting to the outside should be made. If this is to be accomplished without the use of fans, then large vents both at the peak and at ground level are required in order to establish good convection flow.

The choice of materials and construction details that contribute to durable greenhouses is another area overlooked in the design of "solar" greenhouses. No matter what a greenhouse is glazed with, no matter what its shape, size, roof pitch, or other design features, its frame has the same problem with water condensation and high humidity. A greenhouse is a very adverse climate for most standard building materials, many of which are susceptible to rot and corrosion. Almost all commercial greenhouse construction now is either aluminum or galvanized steel, chosen for their resistance to corrosion and low maintenance requirements. Wooden frame greenhouses were made primarily of cypress and later redwood, both woods that resist rot. The material used is the key to longevity

in a greenhouse and should be chosen to suit the long-term expectations of the project. A discussion of the comparative longevities of glass and fiberglass without considering the lifespan of the frame is purely academic.

In order of durability and resistance to rot, some materials for framing are: aluminum, galvanized steel, cypress, redwood, locust, white oak, cedar, hemlock, followed at the end of the list by fir and pine. Pressure treated lumber looks promising although I do not know if the chemicals used are compatible with plants. There are other, often more important factors governing selection of material such as cost, availability, ease of fabrication, etc., but the factor of durability should be understood. Pine and fir, for example, will last as long as 20 years if treated with cuprinol and painted well, although I have seen some, especially old storm windows, that have rotted in as little as 5 years. Cypress, on the other hand, has a virtually unlimited lifespan for practical purposes. There are greenhouses approaching 150 years of age that have cypress frames. Aluminum and galvanized steel have not been used as long but should fall into the same category.

Other aspects of durable design are the details of construction in which the prime focus is upon the ability to shed water from both inside and out, and to resist corrosion. When using wood, as most "solar" greenhouses seem to, care must be taken to avoid any places where water can collect on the frame, especially at the sill and eave which are the first areas to deteriorate. If a greenhouse has an eave it is often advisable to have a gutter on the inside for condensation. Sills should be either sloped or bevel cut to shed both interior condensation water and external rain. In addition, bolting through exposed sills should be avoided if possible as water will find its way down the hole rusting the bolt and rotting the wood. Often eaves and sills in wood frame houses are made from galvanized steel or cast iron, eliminating many of these problems.

The fasteners (nails, screws) used should be corrosion resistant. Hot dipped galvanized fasteners are well suited for most purposes and well worth the extra cost. Electro-plating or cadmium plating, a cheaper form of galvanizing, does not protect nearly as well and should be avoided if possible. In screws, brass, aluminum, or stainless are best but are far more expensive and will typically outlast the frame, particularly if common lumber is used. If redwood is used, corrosion resistance is very important as redwood is very acidic and reacts with unprotected steel, destroying the fastener and the wood around it in a matter of a few years.

For more information on these areas, I have listed two books on construction that give a good description of basic framing techniques. In addition, I would recommend visiting several different kinds of greenhouses and studying how they are assembled. It is not my intention to discourage people from building, but only to point out some problems that do arise in greenhouses. It is important to get things built and projects underway, but it is also important to make intelligent choices between alternatives, particularly in regard to the lifespan of the structures and the life costs.

Food production in greenhouses will become increasingly important in cold climates and energy should be focused on improving the solar efficiency of the entire spectrum of greenhouse use, from private to commer-

cial. However, care must be taken so as not to seriously compromise the production aspect of greenhouses in the name of solar heat self sufficiency. In addition, as long as the energy is being expended to build structures, care should be taken to build them well, so that they last for a meaningful period of time.

As a means of accomplishing the second of these objectives, it seems fitting that we can re-use the materials from the previous generation of greenhouses which, in many areas, are no longer economically viable and are being destroyed. The materials and construction techniques are designed for greenhouse use, have been proven over time, are readily available in many areas, and provide an excellent source of inexpensive materials for the new generation of "solar" greenhouses. I would like to support Tom Lawand in his speculation that there is not much new under the sun. Much can be learned by studying the wheels already invented.

Books on construction

American Greenhouse Construction, Richard T. Muller,
A.T. De La Mare Co., Inc., New York. 1927.

Greenhouses; Their Construction and Equipment, W.J. Wright,
Orange Judd Publishing Co. Inc., New York. 1946.

Others of interest

The Unheated Greenhouse, K.L. Davidson,
George Newneds LTD and Country Life LTD, London. 1907.

This book is primarily concerned with flower production but covers the management of cold (down to 35° F.) greenhouses.

A Description of a Patent Hot House which Operates Chiefly by the Heat of the Sun without the aid of Flues or Tan bark or steam for the purpose of Heating it, James Anderson,
London. 1803.

This seems to be of curiosity interest only.

These books and many others are in the Massachusetts Horticultural Society Library. Agricultural Schools and agricultural extension services are other sources of similar material.

The following pages show some examples of the work that I have been doing with attached greenhouses, while the last page depicts some very interesting 19th century material.

The greenhouses shown here are constructed of used material from large commercial greenhouses using primarily glass and cypress. The framing is of relatively small dimension, the size dependent upon the length of unsupported span. Some standard sizes are outlined below. The greenhouses on this page were intended for growing purposes. Numbers One and Three are of a post construction, using heavy steel posts in the side-wall every 8 ft supporting a galvanized steel eave and sill. As a result there is no need for wooden structural members in the sidewall. In number One, the sidewall is one continuous vent, hung from the eave and opening outward.

#One - Redford Mass.

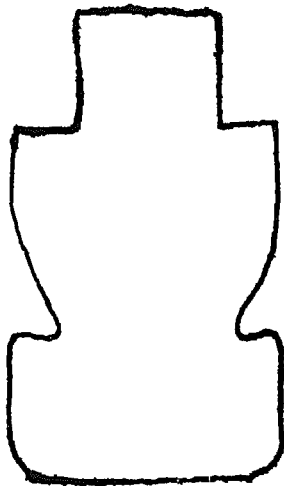
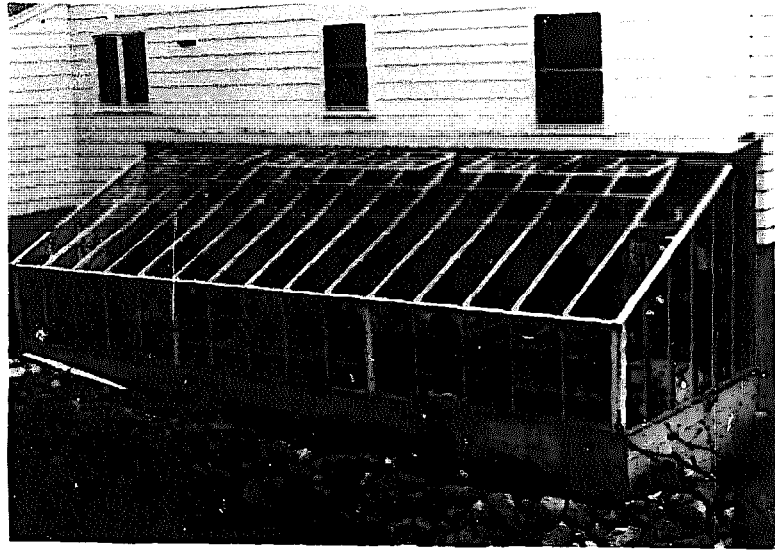

7ft span

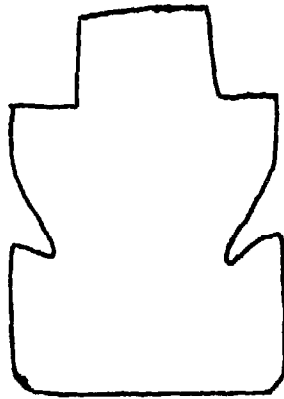

6ft

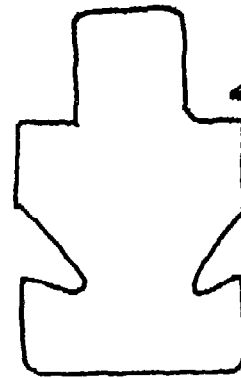

← Glazing bed

← Condensation gutter

5ft

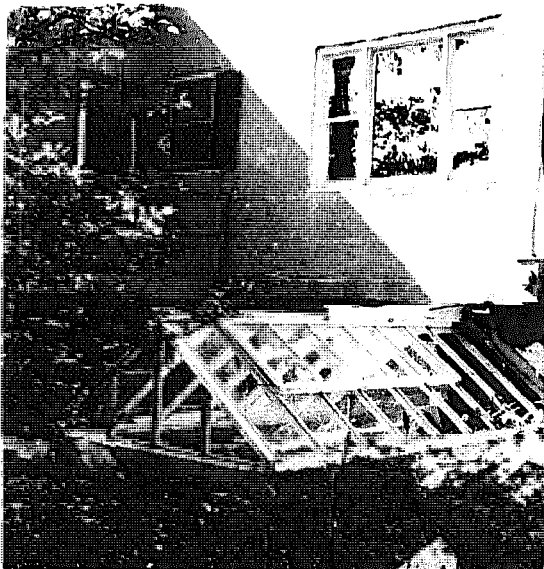

#Two - Newton Mass.

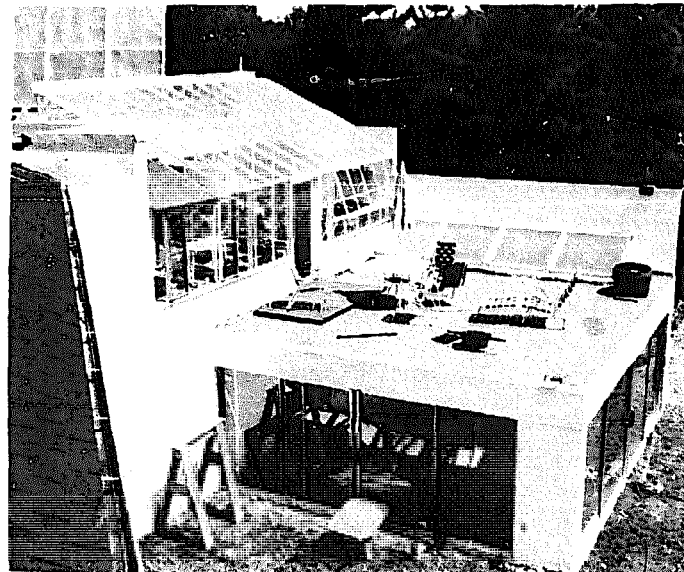

#Three - Lexington Mass.

The two examples here are greenhouses not expressly intended for growing. Example Four is a glass entry-way that is used in late spring for starting plants that will be moved to an outdoor garden. Number Five was designed as a walk-in solar collector. Heated air will be drawn off the top and circulated through rock storage under the main house. This is a "semi-steel" construction using a heavy steel frame to support thin cypress mullions in order to minimize light obstruction. In this case, a 16ft span without posts or supports was possible, facilitating the use of interior insulating curtains if desired at some point in the future.

#Four - Boxboro Mass.



#Five - Cohasset Mass.

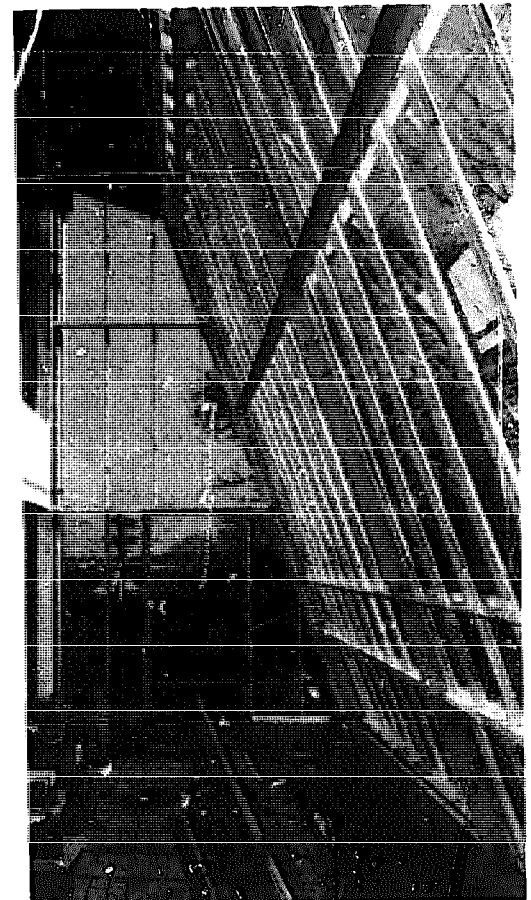
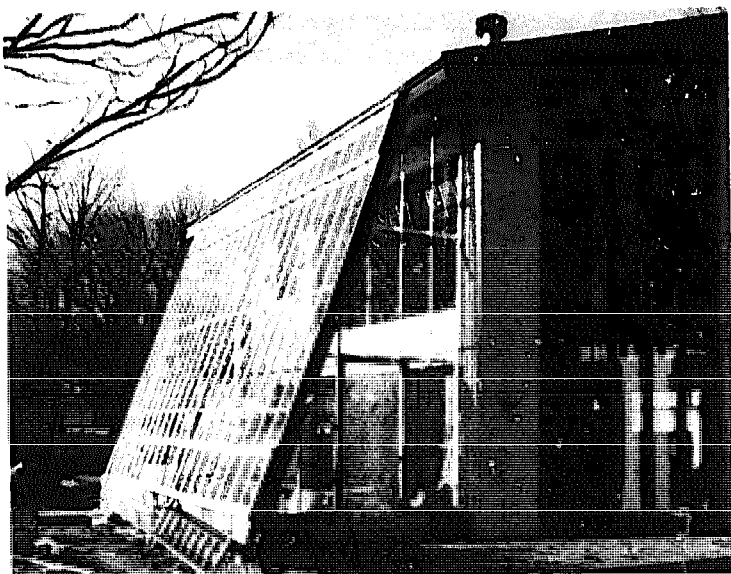

Some drawings from

Bau und Einrichtung der Gewächshäuser: ein handbuch für gärtner und baumeister. von Carl David Bouché und Julius Bouché. Bonn, E. Strauss, 1886.

(Building and stucturing the growth-house: a handbook for gardener and builder.)

I am struck by the resemblance of these designs to many "new" solar designs. In particular note the bottom example (floor plan on right). The drawing shows a 25' by 15' greenhouse with a 6" insulated? north roof and 6" insulated? north, east and west walls, with an airlock type entry on the north. The text of this book is in German so that I do not know much more about these designs for the moment. However I would imagine that there is much valuable information in material of this kind, particularly those relating to small scale vegetable and fruit production which was popular at the turn of the century. This book is in the Mass. Horticultural Soc. Library, which is an excellent resource center.

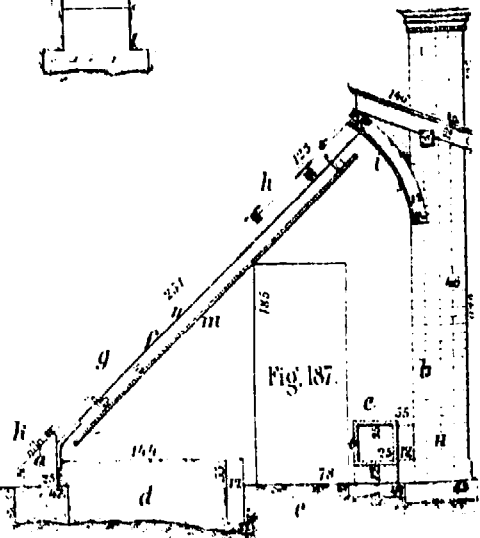
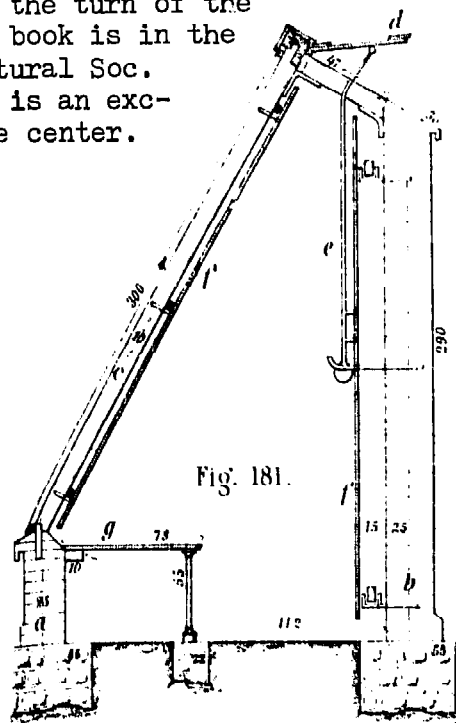
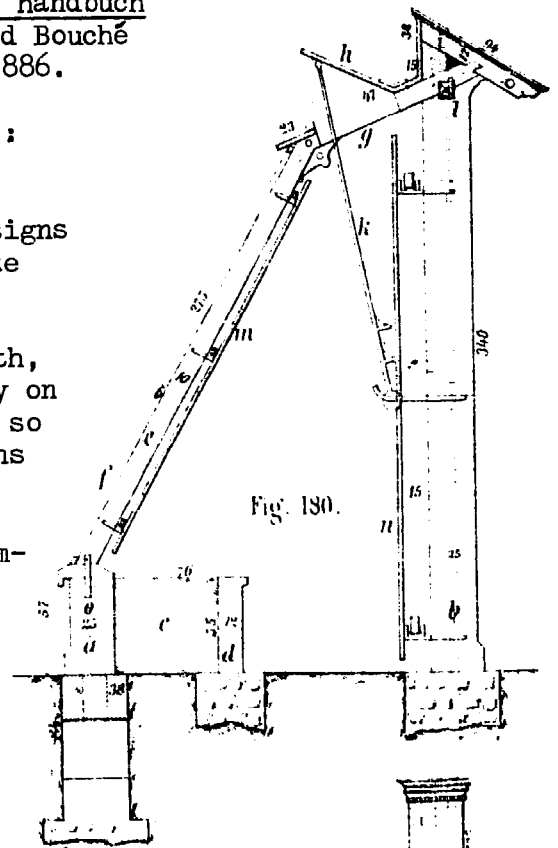

Quer Profil nach A B in Fig. 197.

Fig. 197 Grundriss

zu Fig. 183

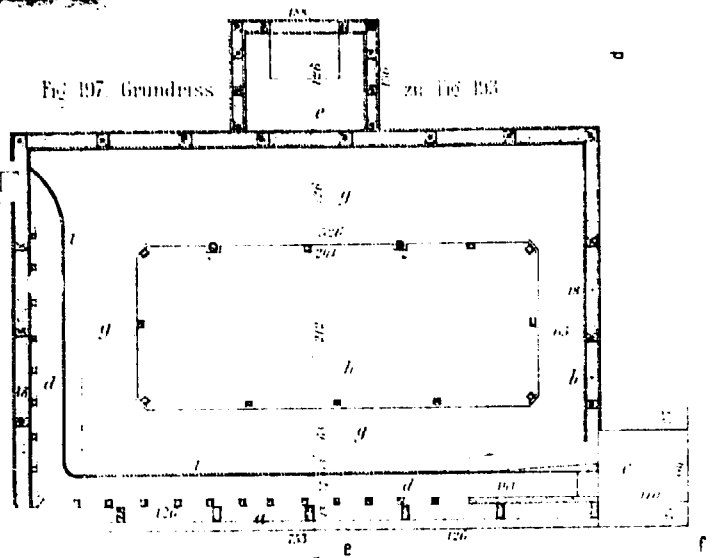
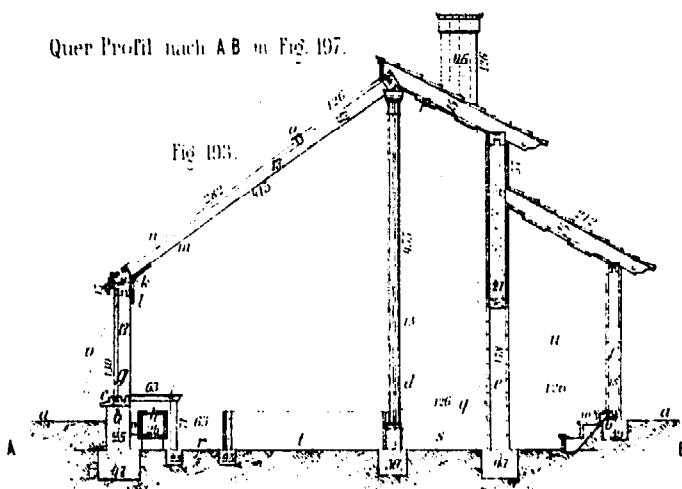

Mark R. Hahn
Ramapo College of New Jersey

GREENHOUSE AT RAMAPO COLLEGE

The greenhouse shown here is now halfway constructed. The center of the design is a small (7' x 9') aluminum and glass greenhouse, which I purchased to house my cactus collection. When I became interested in solar heating, I designed the following system to fit this particular greenhouse.

The structure is divided into three separate sections:

1. A "Cool" greenhouse which serves as a vestibule to the second section.
2. A "Controlled" greenhouse.
3. An active air-transfer solar heating system.

The structure contains four separate heating systems:

1. The vestibule is passively designed, with 100 gallons of water and an insulated block foundation acting as thermal storage.
2. An excess solar heat gain storage system, with passive distribution.
3. A propane backup for the "Controlled" greenhouse.
4. The active solar heating system.

This active system has 64 square feet of homemade collectors. The thermal storage consists of crushed stone and the mass of the insulated block foundation. The active system will provide heat for the 63 square feet "Controlled" greenhouse. It will supply an estimated 27% of the total seasonal heat loss, while direct solar heat gain to the greenhouse will supply an estimated 43%. The propane will make up the rest. The percentage supplied by the sun will be greater if the greenhouse is allowed to get colder than the design temperature of 60°F.

At the minimum design temperature of -20°F, the "Controlled" greenhouse will lose an estimated 13,000 BTU/hr.

Mark R. Hahn

June 4, 1977

Heating System Load

Note: (A) = 3,840 Btu/DD = The heat loss rate through the structure.

(B) = 3,050 Btu/day = The heat loss rate through the floor.

Month	(G) Degree Days per Month <u>DD</u> <u>mo</u>	(L) Heat Loss (structure) <u>Btu</u> <u>mo</u> (G) x (A)	(D) Days per Month <u>Days</u> <u>mo</u>	(M) Heat Loss (floor) <u>Btu</u> <u>mo</u> (B) x (D)	(N) Total Heat Loss <u>Btu</u> <u>mo</u> (L) + (M)	(K) Solar Heat Gain <u>Btu</u> <u>mo</u>	(P) Heating System Load <u>Btu</u> <u>mo</u> (N) - (K)
Sept	25	96,000	30	91,500	187,500	1,415,650	0
Oct	240	921,600	31	94,550	1,016,150	1,333,950	0
Nov	500	1,920,000	30	91,500	2,011,500	938,115	1,073,385
Dec	845	3,244,800	31	94,550	3,339,350	868,525	2,470,825
Jan	995	3,820,800	31	94,550	3,915,350	887,770	3,027,580
Feb	860	3,302,400	28	85,400	3,387,800	1,039,660	2,348,140
March	695	2,668,800	31	94,550	2,763,350	1,319,665	1,443,685
April	395	1,516,800	30	91,500	1,608,300	1,242,835	365,465
May	125	480,000	31	94,550	574,550	1,423,135	0
Yearly	4680	17,971,200		832,650	18,803,850		10,729,080

Monthly Energy Collection and Usage

Month	(R) Col. Area (ft ²)	(S) Daily Surface Totals ($\frac{\text{Btu}}{\text{day-ft}^2}$)	(D) # days per Month (days)	(T) % Possible Sunshine (decimal)	(U) Insolation Incident on the Collector ($\frac{\text{Btu}}{\text{mo}}$) (R)x(S)x(D)x(T)	(Q) Estimated Collector Efficiency (decimal)	(V) Energy Collected (Btu/mo) (U) x (Q)	(P) Heating System Load ($\frac{\text{Btu}}{\text{mo}}$)	(W) % supplied by the Collector (%) (V)/(P)x100%
Nov	64	1,908	30	.50	1,831,680	.58	1,062,375	1,073,385	99
Dec	64	1,796	31	.49	1,746,000	.53	925,380	2,470,825	37
Jan	64	1,944	31	.45	1,735,605	.52	902,515	3,027,580	30
Feb	64	2,176	28	.50	1,949,695	.52	1,013,840	2,348,140	43
March	64	2,174	31	.52	2,242,870	.56	1,256,010	1,443,685	87
April	64	1,956	30	.52	1,952,870	.60	1,171,720	365,455	100
Yearly Totals					11,458,720		6,331,840	10,729,080	

FOUNDATION

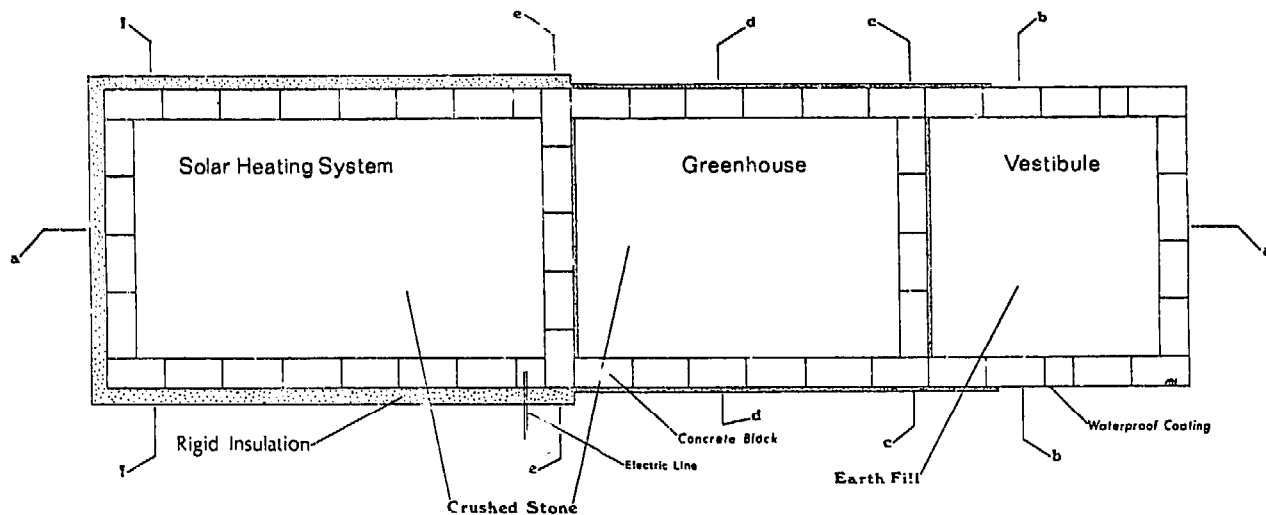

Scale 1:16

Cross Section at the Fourth Course

Mark R. Hahn

7-1-77

VESTIBULE

Section b-b

Scale 1:16

Mark R. Hahn

7-2-77

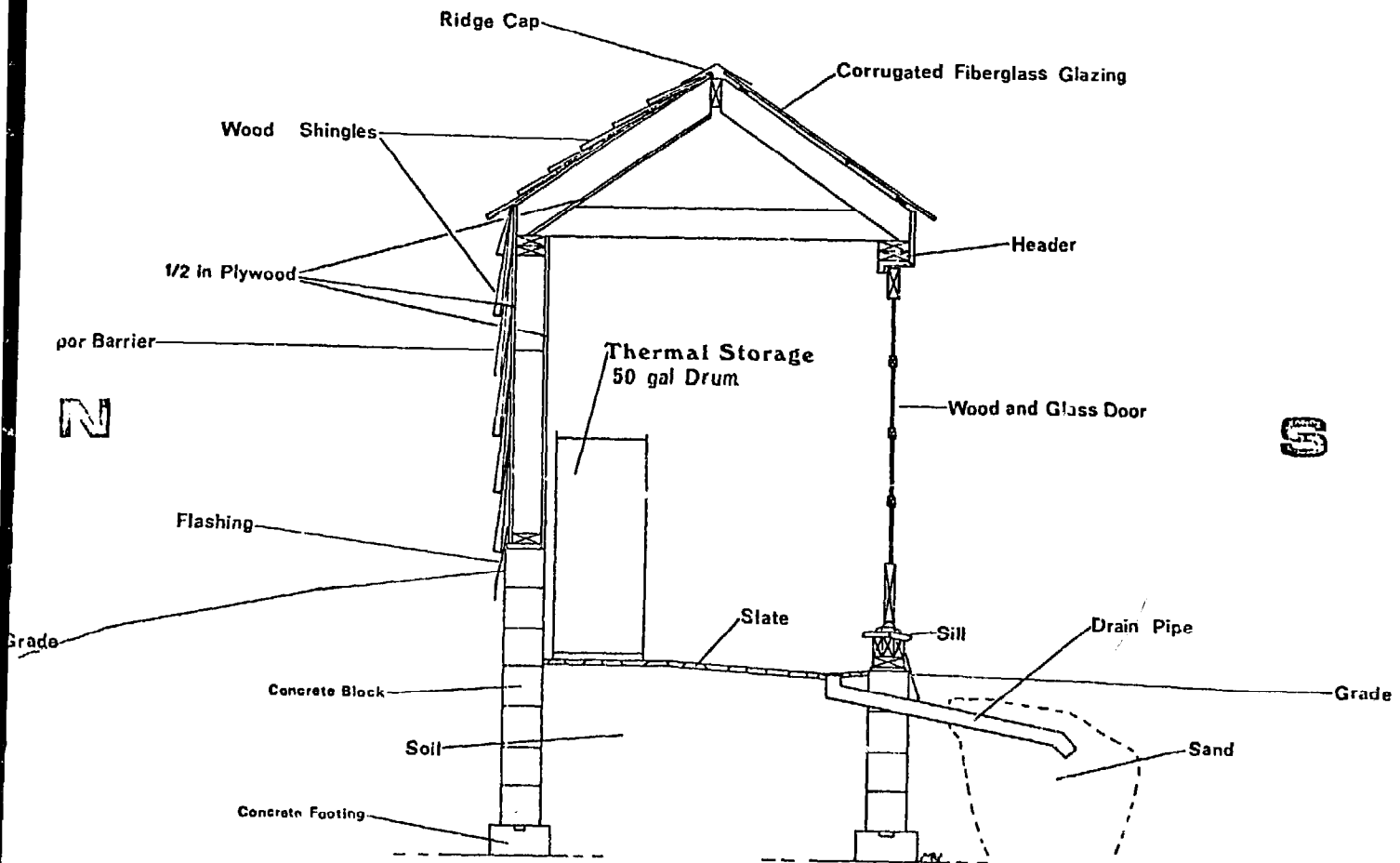

GREENHOUSE

Section d-d

Scale 1:16

Mark R. Hahn

7-5-77

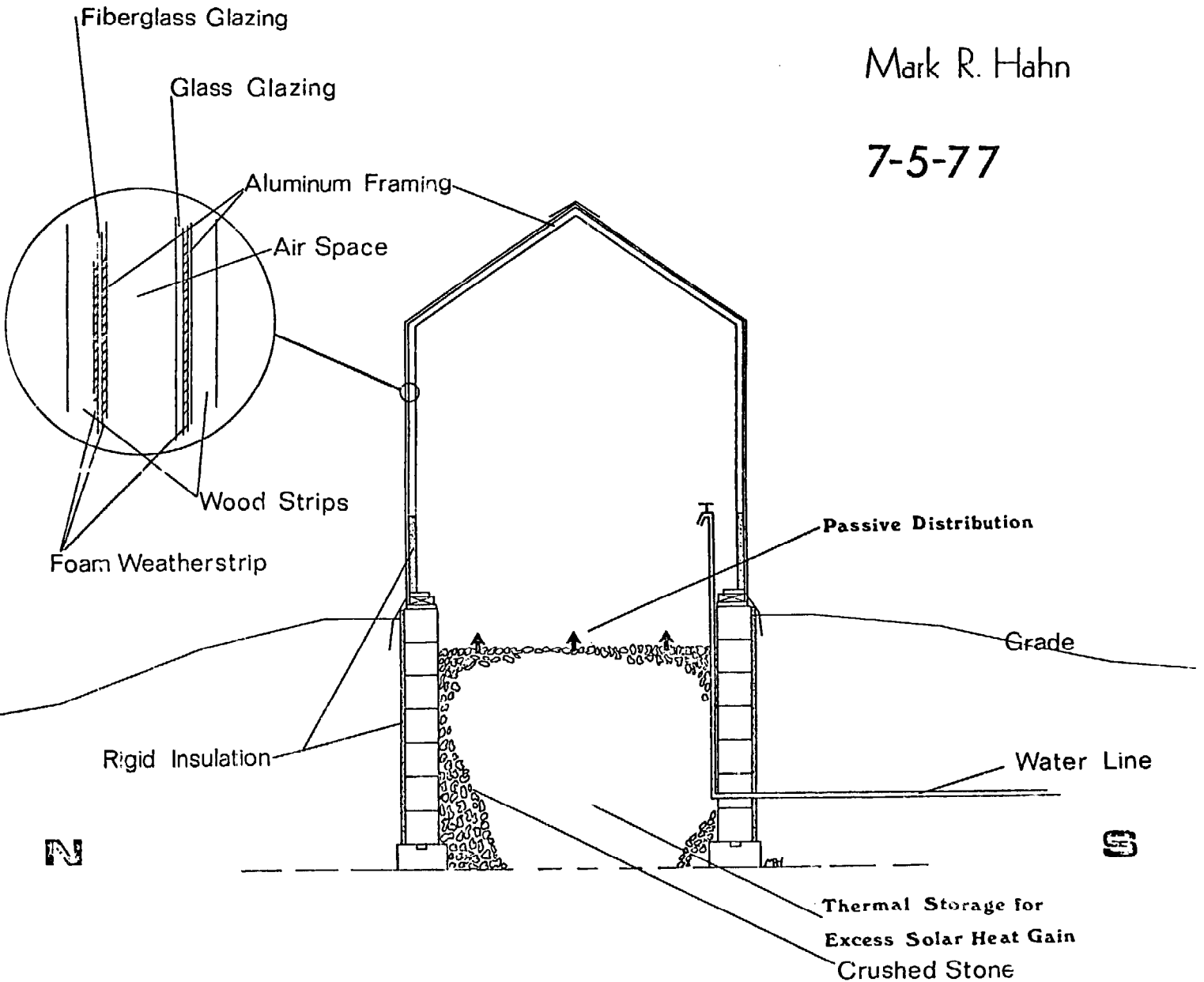

GREENHOUSE

Section c-c

Scale 1:16

Mark R. Hahn

7-4-77

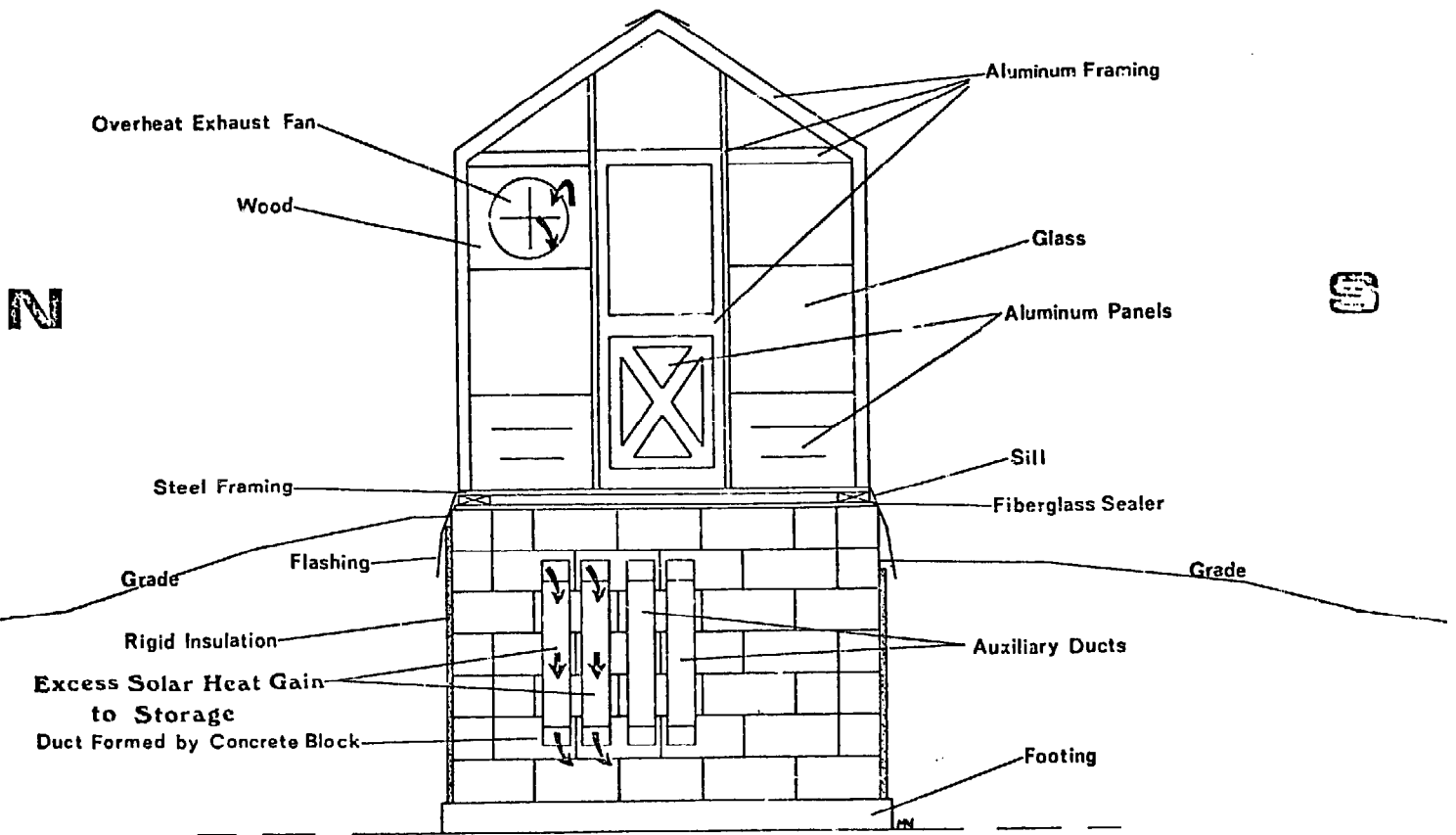

SOLAR HEATING SYSTEM

Section f-f

Scale 1:16

Mark R. Hahn

7-6-77

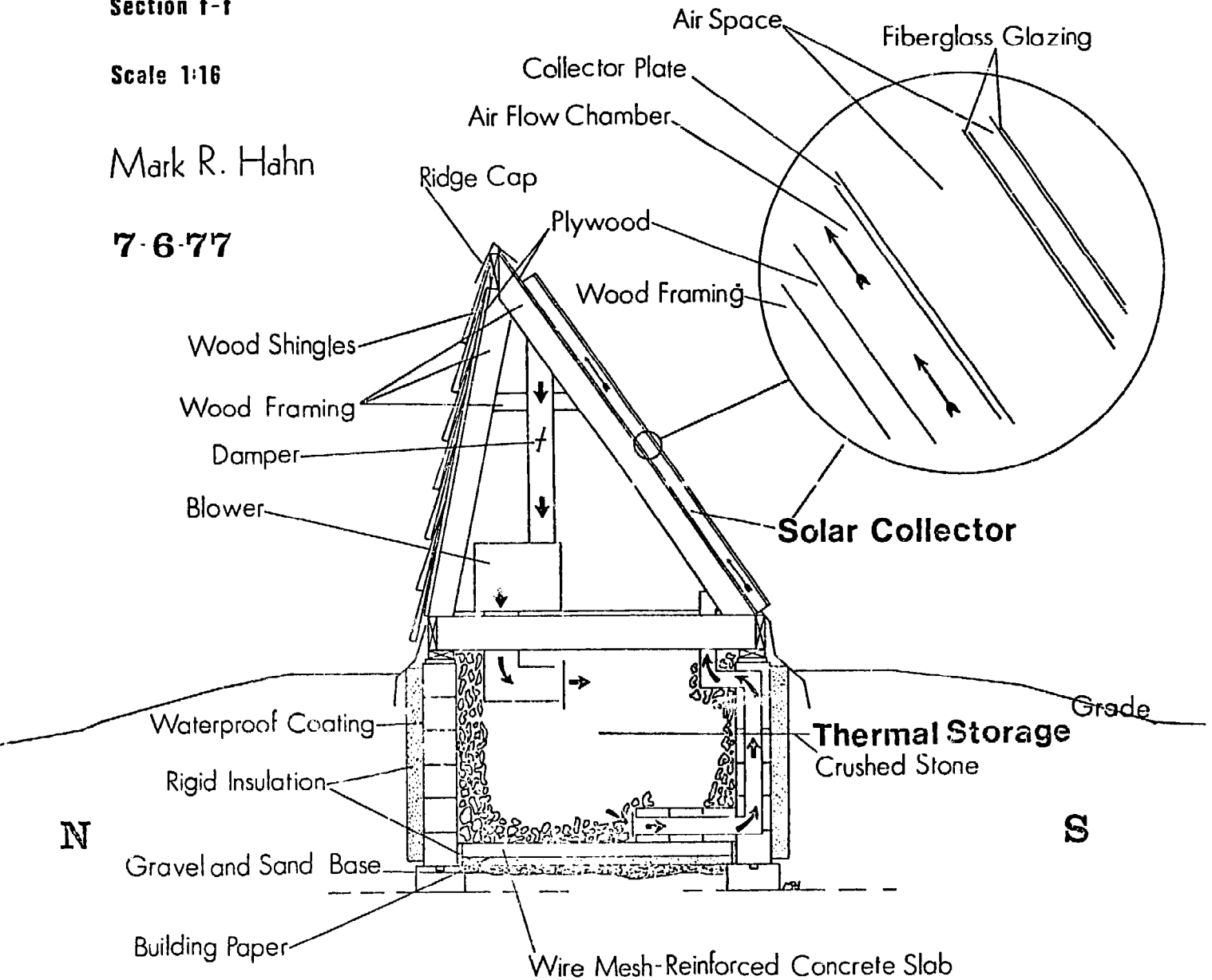

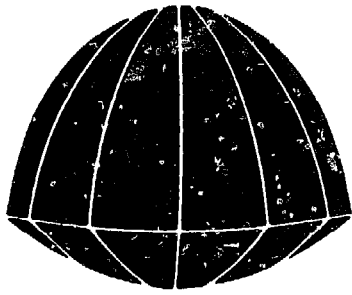

EGGE RESEARCH

Tamil Bauch

ENERGY

SHELTERS
INC.

Morton Schiff

A JOINT VENTURE -- OFFERING DESIGN, CONSULTING AND PRODUCTION SERVICES FOR SOLAR HEATING AND ENERGY CONSERVATION. THIS BROCHURE DESCRIBES SOME OF OUR MORE UNIQUE PRODUCTS AND SERVICES.

FIBER CEMENT BUILDING PANELS

This is a low cost, energy conserving building material system that can be custom designed to meet varying situations. The panels are molded to the required shape with a unique joining and sealing system (patent applied for) molded into the panel. Electrical conduit, windows, doors and vents can also be molded into the panel. The sandwich construction technique (which provides greater structural strength with less material than other fabrication techniques) is used with the composite section containing four different layers of material. Each material has several functions. Starting from the exterior the layers are:

1. An exterior layer (1/8 - 1/4 inch) of colored glass fiber reinforced cement (GFRC) which is both a structural component and the exterior finish.
2. The light weight structural core of urethane foam (1-6 inches), which also provides the insulation.
3. A layer of light weight cellular cement (1/2 - 3/4 inch) which also is part of the structural core and provides fireproofing.
4. The interior structural layer of GFRC (1/8 - 1/4 inch) which provides a smooth (or textured, if desired) surface for the interior finish. The GFRC which uses polymer modified cement is extremely resistant to aging and will retain its color, structural integrity and waterproof quality for upwards of 50 years with no maintenance. The cost of complete panels ranges from \$3 to \$8 per square foot depending on size, shape and volume of production.

BEADWALL INSTALLATIONS

We are designing and installing Beadwall (U.S. Pat. No. 3,903,665) Installations under license from the Zomeworks Corporation. We have developed some unique hardware and building techniques to make the Beadwall installation attractive and economical. Beadwall is a mobile insulation system using a double glazed window with a 4 inch wide cavity between the layers of glazing. At night the cavity is filled with styrofoam bead insulation. During the day the beads are sucked out of the window cavity and stored. When used in a south-facing window you will have a very efficient collector for a passive heating system. In other situations you will be able to conserve energy; e.g. north-facing windows, display windows, store fronts, office buildings and greenhouses. This concept has been in use since 1972 and offers many possibilities for passive heating and energy conservation. The blowers which move the beads can be operated automatically or manually, and they consume very little electricity, about one kwh per week costing about 5 cents per week, for each 120 square feet of Beadwall area. Installation costs are about \$10 to \$12 per square foot of window area. The R-value empty is about 1.5 and the R-value full is about 15.

SOLAR GREENHOUSE

This greenhouse structure can be used in two ways. The first is a passive system. A large water storage is provided in one section at the rear of the structure, at the focal point of the curved section of the north wall. The rest of the water is stored under the growing beds. The inside of the north wall is coated with a reflective film so that it is a specular reflector, and the entire structure becomes a walk-in focusing collector. The entire south wall is a bead wall so that the collection system can be turned on and off as required. Of course when the bead wall is full, the structure is highly insulated, the heat loss rate is approximately 75 BTUH/°F (1800 BTU/D.D.). Sufficient energy can be stored in the water tanks to handle a large part of greenhouse heating requirements. An exhaust blower is included to handle excessive heat gains particularly in the summer and fall. Automatic controls are provided which monitor the sun's energy and temperature, and to make the required adjustments.

The second approach is to use the greenhouse as an active collector. There is an advantage in using the greenhouse in this mode. If a solar retrofit is desired, one can add on this greenhouse, rather than just using simple collectors. In the active mode sufficient energy can be collected to heat both the greenhouse and the retrofitted existing house. A greenhouse has its own value above and beyond collectors. As an active collector, the north wall is painted white, so that it is a diffuse reflector and there is no exposed water storage as in the passive system. Solar energy is captured and stored in a water tank located below the greenhouse floor. To capture the solar energy, a combination of the plant leaves and heat pump is used. A mature, or fruiting plant exposed to solar energy will transevaporate. (Transevaporation is a process where a plant uses solar energy to convert liquid water to water vapor.) A heat pump is then used to dehumidify and maintain the proper temperature and humidity in the greenhouse; the reject energy from this process goes into storage (see Fig. 1).

If tomatoes are grown, better than 50% of the incident solar energy goes into transevaporation. As long as the heat loss of the greenhouse does not exceed the sensible heat gain of the greenhouse, the energy in the water vapor can be collected by dehumidification and stored for use as required. The active solar greenhouse then becomes a collector whose efficiency approaches 50% over a wide range of conditions and can provide a large percentage of the energy required to heat a house.

FIG. 1

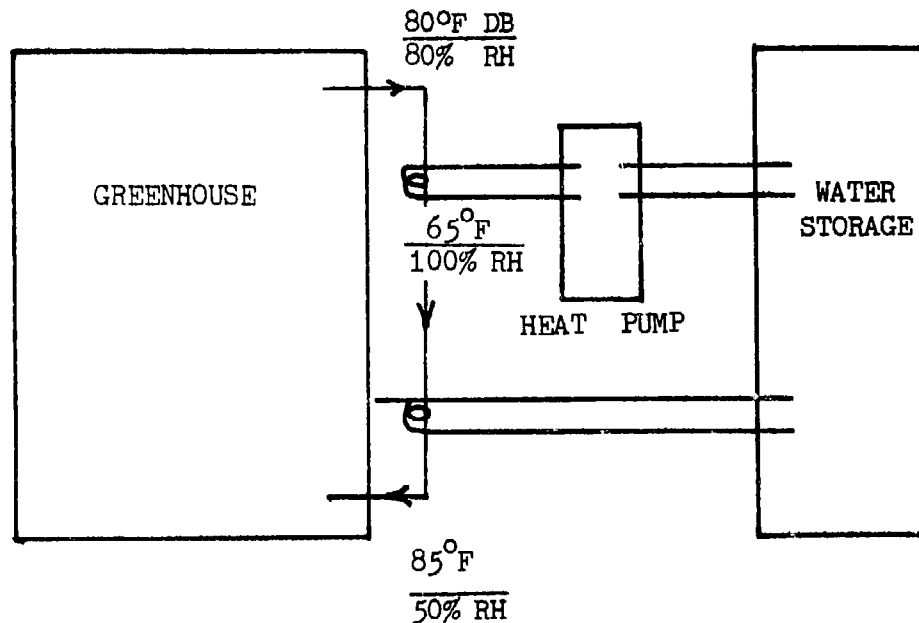

For further information, you may contact either:

EGGE RESEARCH, Box 394B, RFD 6, Kingston, New York 12401

ENERGY SHELTERS, Inc., 2162 Hauptman Road, Saugerties, New York 12477

914-336-5597

914-246-3135

SPECTRUM SEPARATION CHAMBER FOR PLANT GROWTH

Robert C. Liu, Agricultural Engineer
Plant Physiology Institute, U.S.D.A., Beltsville, MD

Plant response to solar radiation is limited only to a small portion of the spectrum ($350 < \lambda < 760 \text{ nm}$). More than 50% of the spectral energy is in the infrared region, $\lambda > 760 \text{ nm}$, and it does not contribute directly to plant growth. These portions of the spectrum should be maximized for growth and modification of the environment in greenhouse operations.

Spectrum separation can be accomplished by differential absorption and transmission or by differential reflection and transmission. Curcio and Petty, 1951, presented the spectral transmission characteristics of liquid water at various path lengths. To achieve a cut-off point at $\lambda = 760 \text{ nm}$, approximately 90 cm of path length is needed. Withrow and Price, 1953, published the spectral transmission of copper sulfate solutions of varying concentrations in a 10-cm path length. We constructed a plexiglass double-wall plant growth chamber with a 7-cm path length. Cut off at $\lambda = 760 \text{ nm}$ required a 0.2% solution of $\text{CuSO}_4 \cdot 5\text{H}_2\text{O}$. This chamber, shown in Figs. 1 and 2, will be used to observe the response of soybean plant growth to various spectral conditions, and to evaluate its physical characteristics and performance in control and modification of the ambient environment.

Duguay and Edgar, 1977, proposed the use of directed beams of sunlight for lighting of buildings as an economically attractive and practical option for solar energy. Ideal, cool-lighting up to 1 million lux is obtained by using cold mirrors to separate the visible (VI) and infrared (IR) portions of the solar spectrum. The IR can be used to generate electricity and usable heat in solar cells. I have adapted Duguay's concept for use in a nonconventional greenhouse. The VI portion is directed to the growing area where it is used for plant growth, while the IR portion is absorbed by a heat transfer medium and then transferred to storage as shown in Fig. 3. This can be accomplished by the use of a copper sulfate liquid lens system which is arranged to transmit VI and to absorb IR from optically directed beams without the use of cold mirrors, Fig. 4. The roof and walls of the structure are opaque and well insulated. They could serve as the means of heat storage transfer. This nonconventional greenhouse will be limited to areas with abundant direct radiation.

The principle of spectrum separation should also be applied to modified conventional type greenhouses. Availability of appropriate materials and research limits application at this time.

In a greenhouse the transparent barrier is the key component. New concepts and innovative application are essential to the economic survival of the greenhouse industry in this day of escalating energy costs.

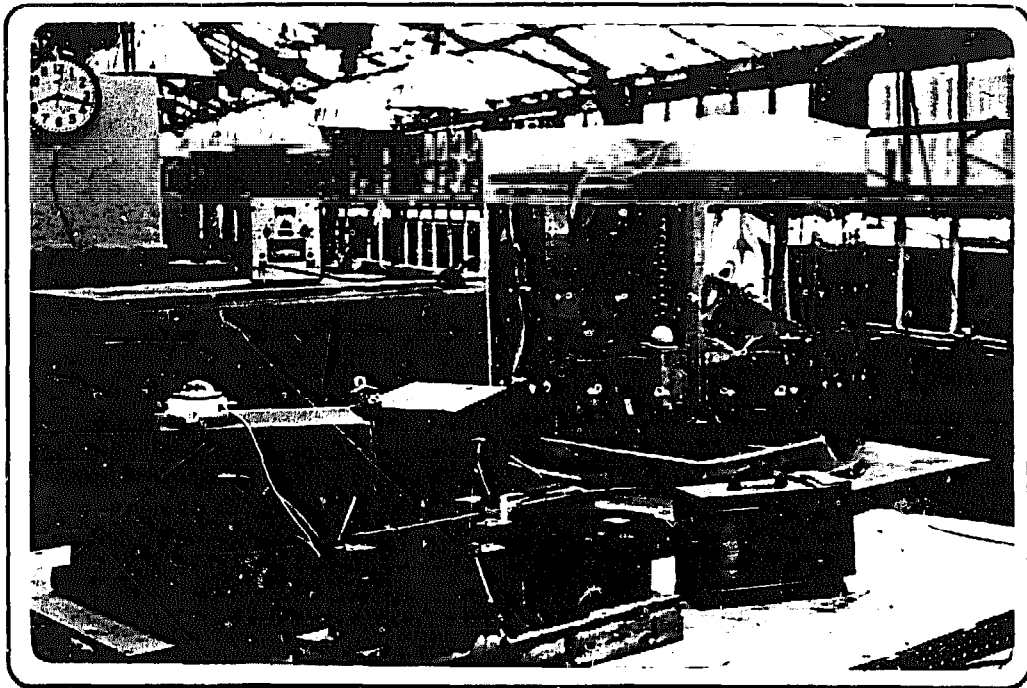

Fig. 1

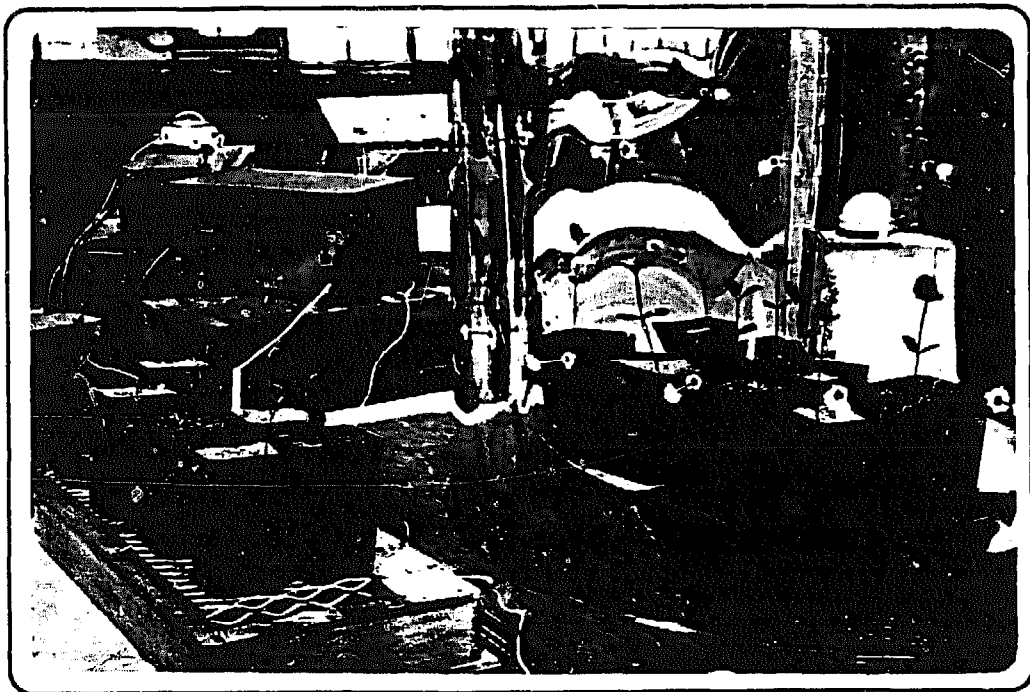
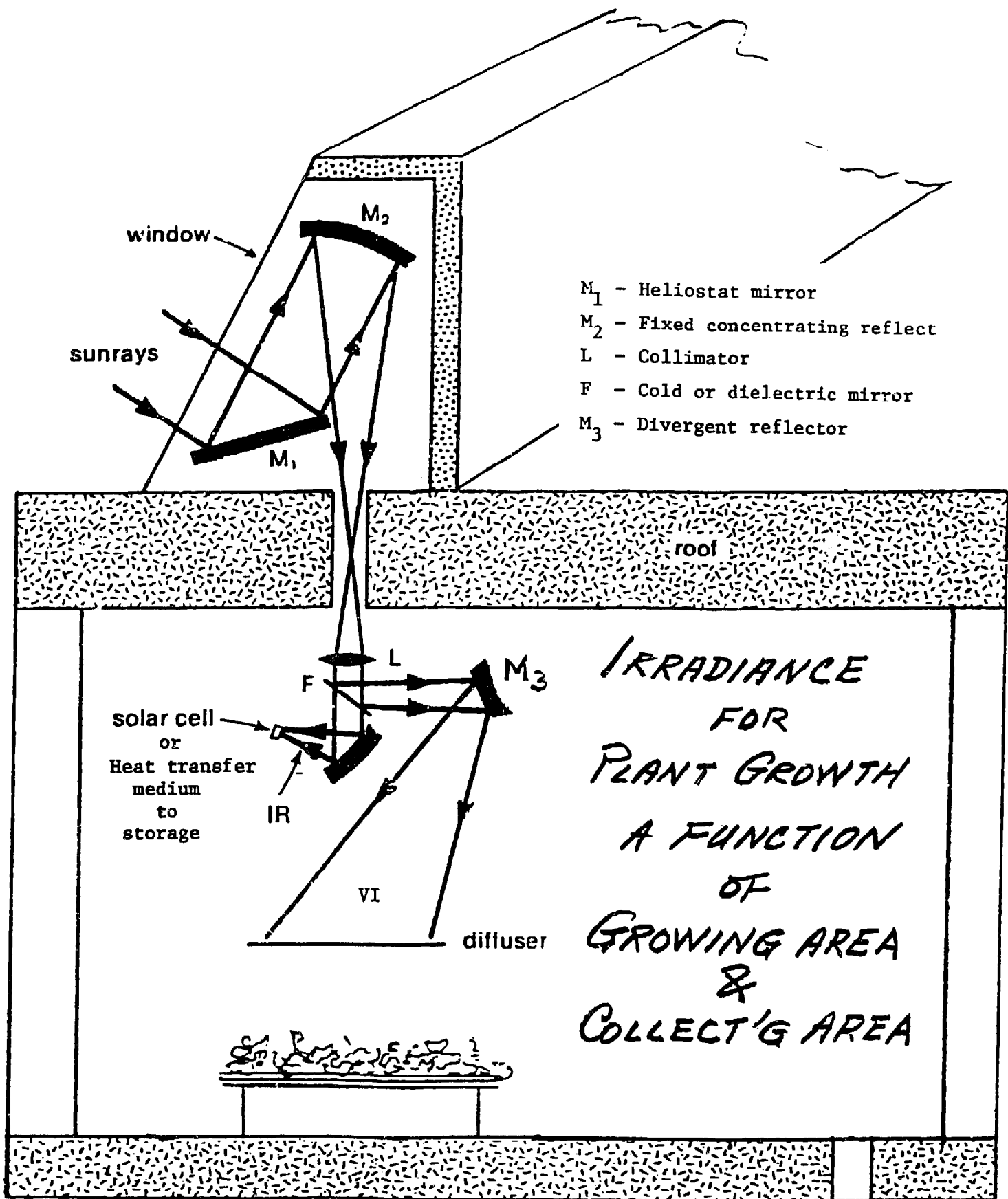
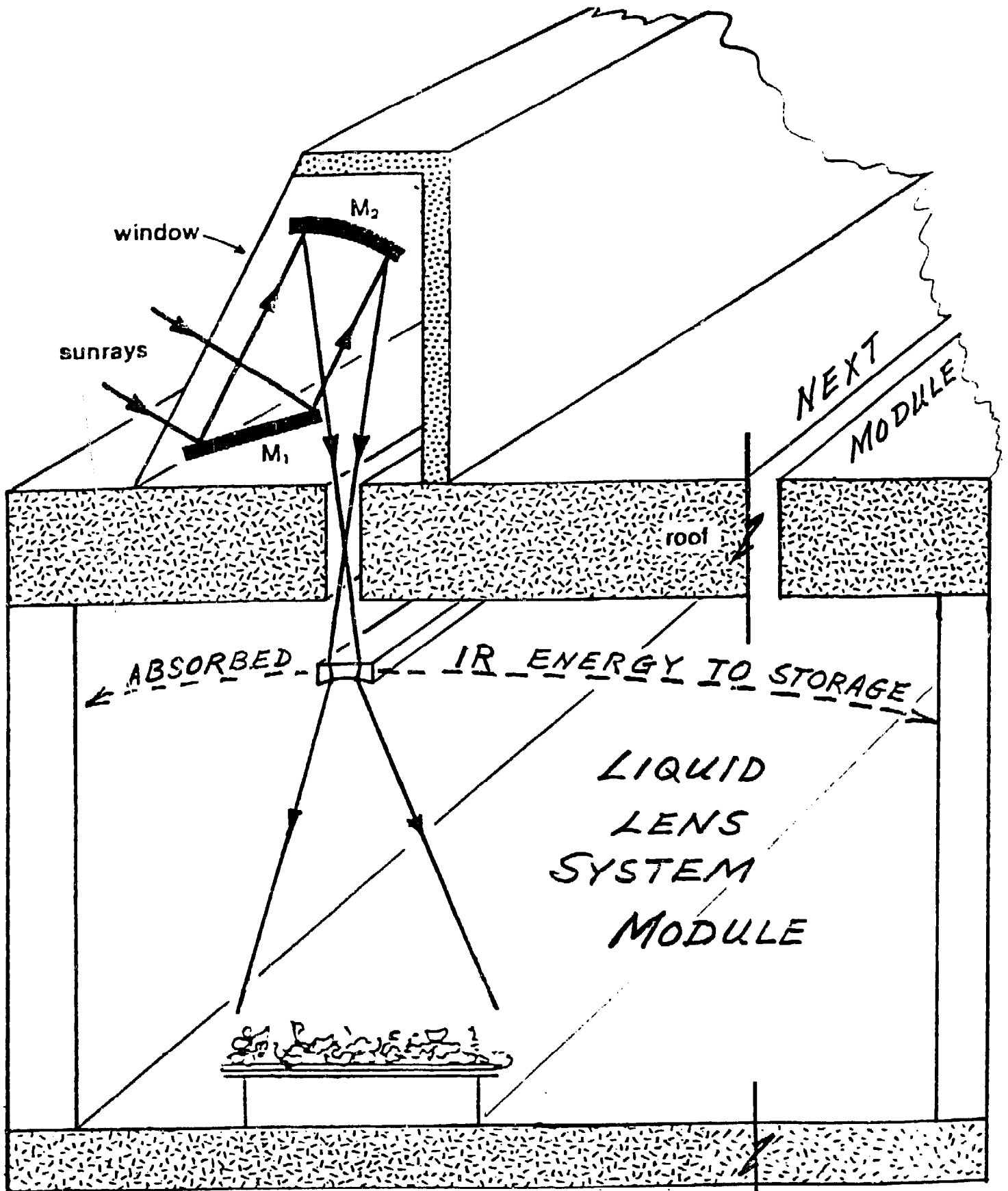

Fig. 2



Modified from Duguay

Fig. 3



MODIFIED FROM DUGUAY

Fig. 4

A LARGE SCALE NORTHERN CLIMATE SOLAR GARDEN

R.E. Maes
Environmental Research Institute of Michigan
Ann Arbor, Michigan 48107

INTRODUCTION

A structure has been designed and built using modified greenhouse principles that will allow an extended growing season in Northern climates with a minimum requirement for external energy. The objective is to develop an agricultural ability to grow fresh vegetables and produce on a year round basis at a reasonable cost.

The typical greenhouse is glass on all sides to take advantage of all available light. The disadvantage of the all glass house is that glass is a very poor insulator and heat losses on cold days and nights are quite dramatic. In addition to this, the available light level in winter months is inadequate for many plants. Thus, there are three principle requirements for a Northern climate greenhouse. It should provide extra light in the winter, it should be well insulated to reduce heat losses, and it should have the capability to retain extra heat for later use. These features are incorporated in the present design by using pivoted insulator-reflector curtains that reflect extra light during the day and close at night to insulate the roof. Heat storage is accomplished by circulating hot air through rock storage in the ground and also by accumulating heat in solar heated 55 gallon drums filled with water.

The term "Northern climate solar garden" is used to represent a concept that implies more than a greenhouse structure with a south-facing glass wall that grows flowers and plants. The intent is to describe an agricultural system that is compatible with diminishing energy supplies. It is a system designed to provide fresh vegetables and produce on a year round basis in the northern climates. These agricultural systems would be locally based, employ local labor, and would rely on the sun as the primary energy source. Northern states would benefit greatly because they would be less dependent on external circumstances like the California droughts and the Florida freezes.

This application of solar energy is practical with present technology and has many redeeming features in its overall impact on society and energy use. The system uses low-grade replenishable solar energy as a substitute for high grade expendable energy that is required to transport these out-of-season vegetables and produce from remote southern locations. The second redeeming feature is the geographic independence that is achieved by a community that produces its own food with its own labor base. The economic and social implications of this type of independence are far-reaching. A state like Michigan, that imports 95 percent of its energy needs, must have innovations of this type to guarantee its long-term viability as a place to live.

Winter solar gardens can take three forms and all three play an important role in the energy crisis. The first form is an attached greenhouse which can be incorporated with the family living quarters to supplement the heating requirements of the house and add beauty and fresh produce to the home. The second form is a small free standing greenhouse where for various reasons it is not practical to attach it to the house but a greenhouse is still desired. This second form is not usually as cost effective as the first unless it can be constructed quite inexpensively, since excess heat cannot be utilized as well.

The third form of winter solar garden is the large scale greenhouse that is a commercial enterprise equivalent to truck garden farming. In this instance, the solar garden is large enough to merit the use of small tractors and other mechanized equipment required for efficient food production. They can and should be located in and around urban areas to provide local employment and generally reduce transportation and distribution costs for the consumer. It is this third form of solar garden that is still largely undeveloped, and its economic and social impact can be significant.

DESIGN, CONSTRUCTION AND OPERATION

Two large scale winter gardens have been constructed. The first was built in the fall of 1976 and was a quonset type building of 1200 ft². It had a tubular frame covered with two layers of polyethylene. The north wall and ceiling had 6" foil faced fiberglass sandwiched between the two layers of plastic. The south wall was transparent during the day and was covered with a tiltable insulating curtain at night. The aluminum foil surface on the north wall provided some light gain, and thermal storage was obtained by circulating air through two 8" diameter ducts buried 2' underground that ran the length of the garden. No external heat was added throughout the winter and on two occasions when outside temperatures reached -10° f the garden temperature dropped to 28° f. Winter crops consisted of lettuce, peas, chinese celery and New Zealand spinach whereas the tomatoes finally ripened in June.

The second solar garden was designed during the summer of 1977 with construction continuing through the fall. The design is quite different in that the solar garden is of an A frame construction that provides a work area beneath an insulated ceiling that gets transformed to a light reflecting north wall during daylight hours. The insulator-reflector is lowered at night and raised during the day. The physical configuration is shown in Figure 1. Figures 2 and 3 show inside and outside views, and Figure 4 shows the 12' x 200' insulator-reflector curtain in the open position.

The winter garden is 200' long in the east-west direction to take advantage of the winter sun and is 30' wide.

The raised reflector yields a direct illumination light gain of approximately 2.5 during the low sun angle of the winter months. On cloudy days, however, the diffuse illumination available to the garden is only two-thirds the light intensity when compared to an all glass house.

The A frame is basically 2 x 4 wood construction using 24' lengths for the long triangular members. The lower 8' contains most of the framing while the upper level only supports the polyethylene cover and the venting mechanism. The lower third of the south wall uses transparent fiberglass on the inner surface and when this is coupled with the outer layer of plastic it results in a loss factor of about R = 1.5. The ceiling is constructed of 2" thick foil faced polyurethane sheets that have an R value of about 16. The north wall uses standard construction materials and also has a loss value equivalent to R = 16. Therefore, the only high thermal loss surface of the garden is the 8' high south wall which results in heat losses less than 25% of a similarly sized conventional greenhouse.

With the above ground values of heat loss reduced to a reasonable level, it is also necessary to reduce below ground losses around the edges of the garden. An insulated footing of 2" thick styrofoam sheeting was installed to a 4" depth. This insulated footing is especially important in a low energy greenhouse because the ground is an important source of stored heat and adds considerably to the thermal capacity of the garden.

Two techniques are employed to add to the thermal storage of the garden. The first is the use of 55 gallon drums of water installed against the north wall. The second is a covered gravel trench extending the length of the garden with circulating fans placed at 50' intervals. The gravel bed is used to store excess heat of the day and return it at night as required.

The A frame design has the advantages of being able to shed fairly heavy snow loads and is stable in fairly strong winds. In its present configuration the polyethylene cover must be replaced on a periodic basis.

The garden area was planted with lettuce, broccoli, garlic, onions, and tomatoes in October. The crops are doing quite well even though construction is still continuing. The Michigan fall has been very cloudy with only a few sunny days. The inside temperatures have ranged from 40° to 110° whereas the outside temperatures have dropped as low as 17°. Venting is required on most sunny days because the excess heat cannot all be adequately stored.

In summary, it is expected that with light gain and insulating properties of the present winter garden that successful in-ground vegetable crops can be grown through the winter with very little added heat energy.

T.A. Lawand, et al, Development and Testing of an Environmentally Designed Greenhouse for Colder Regions, Solar Energy, Vol. 17, pp. 307-312

R. Fisher and W. Yanda, Solar Greenhouse Design, Construction and Operation, John Muir Publications, Santa Fe, NM

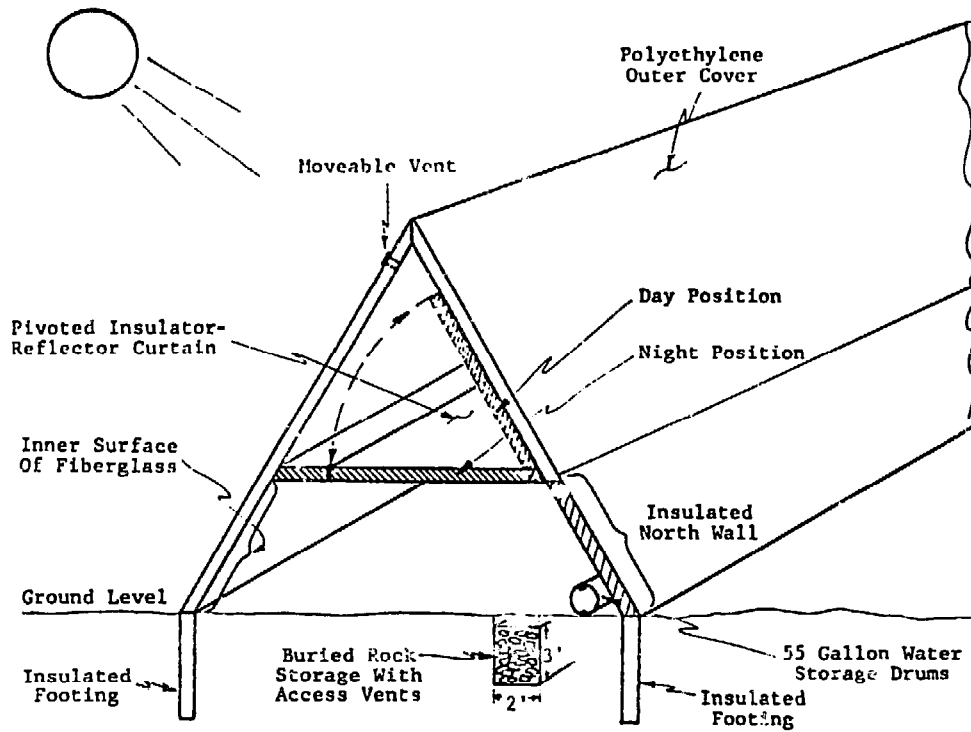

Figure 1. Light Gain-Insulated Winter Garden Design Layout



Figure 2. Inside View of Growing Area

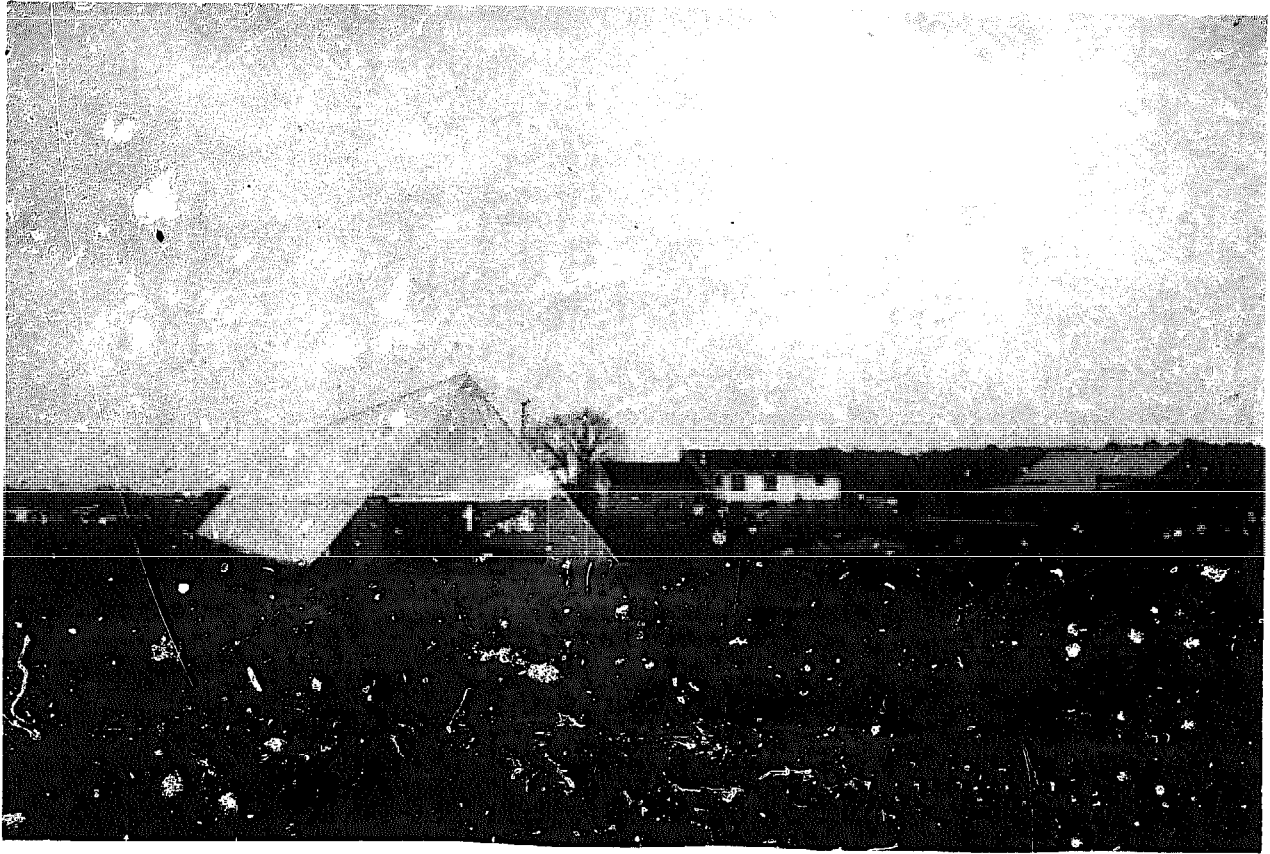

Figure 3. Outside View of Completed Solar Garden



Figure 4. View of Insulator-Reflector in Raised Position

A SOLAR HEATED AND AIR CONDITIONED GREENHOUSE
USING THE GREENHOUSE AS THE COLLECTOR

DAVID SNELL

DAVID H. SNELL NURSERY
RT. 6, BOX 128, RUNKLES RD.
MT. AIRY, MD 21771

THE SYSTEM

Actual costs for construction using my plans would be much lower than the costs listed below because several changes have been made in the system. Heat is exchanged from air to water storage, which consists of 6000 gallons of water, or 6 gallons per square foot of greenhouse floor area.

The system will store 372,000 BTU for each one degree F rise in storage temperature. The best test of the storage system was on November 14 (see Table) after seven consecutive days of cloudy, rainy weather. The exterior temperature the previous night went to 19°F, drawing the storage temperature from 59°F to 56°F. The low in the greenhouse was 49°F. Because the 14th was sunny, storage temperature went back up to 59°F. The 3°F temperature rise means that about 1,116,000 BTU were stored that day.

No other source of heat has been employed in this system, under these conditions in Maryland. Inquiries about this system would be welcomed.

THE COST

Greenhouse area 10' x 100' =	1000 ft ²
Material cost	\$2210
Labor cost	\$1480
Total cost	<u>\$3690</u>
(\$3.69 per ft ²)	

TABLE 1

LOG OF DATA FOR 10/16/77 TO 11/16/77

NITE	inside air temp		Water storage temp 5:00pm-9:00am	sunny day	cloudy day	outside air temp		Air temp		12:00 am Date	
	low	high				low	high	inside 12:00am	outside 12:00am	Water stor	Temp
60	65	64	62		✓	36	50	65	50	63	10/16
54	80	64	60		✓	32	50	75	60	62	10/17
53	82	63	61	✓		38	65	65	60	62	10/18
62	88	64	63		✓	46	60	72	55	64	10/19
58	88	64	62	✓		32	72	80	72	64	10/20
56	92	67*	62*	✓		32	84	86	80	65	10/21
58	98	67	64	✓		40	86	88	86	66	10/22
59	90	68	64	✓	✓	40	70	88	70	68	10/23
56	84	69	66	✓	✓	40	72	82	69	68	10/24
58	88	69	65	✓		40	78	82	74	67	10/25
58	80	69	66		✓	40	62	68	62	66	10/26
60	82	68	65		✓	40	65	72	64	66	10/27
62	100	71	67	✓		32	88	82	79	69	10/28
55	96	71	68	✓		28	75	80	68	70	* 10/29
53	94	69	66	✓		28	73	92	73	68	10/30
54	83	66	65		✓	40	58	70	54	65	10/31
64	80	66	65		✓	40	70	75	64	65	11/1
66	77	67	64		✓	50	65	70	62	66	11/2
67	73	66	66		✓	50	67	82	65	66	11/3
68	79	68	66		✓	50	74	70	72	68	11/4
67	92	69	68	✓		50	72	79	64	68	11/5
65	74	68	67		✓	50	61	71	59	68	11/6
62	69	67	67		✓	40	63	69	62	67	11/7
65	66	65	66		✓	40	66	65	63	66	11/8
62	73	66	65		✓	38	66	70	64	65	11/9
54	77	66	65		✓	36	68	66	65	63	11/10
52	68	63	63		✓	28	50	64	47	61	11/11
50	65	61	60		✓	28	46	63	46	59	11/12
49*	70	59	58		✓	19*	45	64	43	59	11/13
50	64	59*	56*	✓		30	55	68	50	58	11/14
54	70	59	57	✓		29	55	70	55	58	11/15
54	94	62	58	✓		40	65	75	66	61	11/16

GREENHOUSE AT CARY ARBORETUM

Tyrone Pike
Dubin-Bloome Associates
42 West 39th Street
New York, N.Y. 10456

MALCOLM WELLS, ARCHITECT AND DUBIN-BLOOME ASSOCIATES ARE DESIGNING A SOLAR GREENHOUSE ADDITION TO THE SOLAR HEATED CARY ARBORETUM ADMINISTRATION BUILDING, IN MILLBROOK, NEW YORK. THE PRELIMINARY DESIGN FOR THE GREENHOUSE INCLUDES A "DUCKWALL" - A MOVEABLE THERMAL SHADE MADE OF "POLARGUARD", NYLON, AND ALUMINIUMIZED NYLON, A HOT AIR RECOVERY SYSTEM FOR CHARGING THE KALWALL TUBE STORAGE AND THE AUXILIARY HEAT IS SUPPLIED BY THE EXISTING BUILDINGS SOLAR SYSTEM.

SECTION
(HORIZONTAL)
SCALE 1/8" = 1'-0"

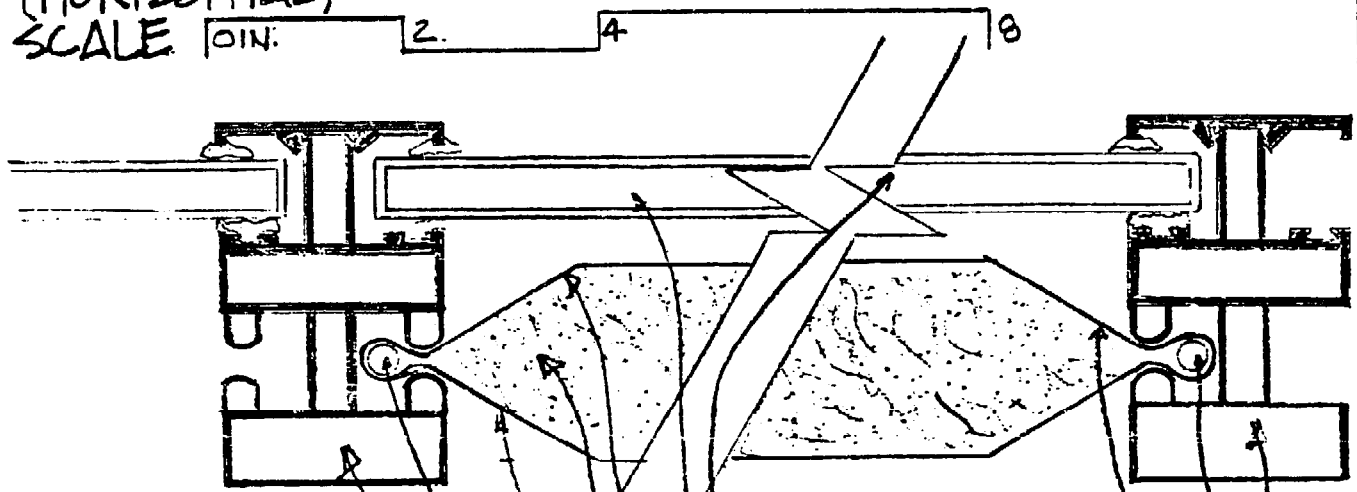

SECTION
(VERTICAL)

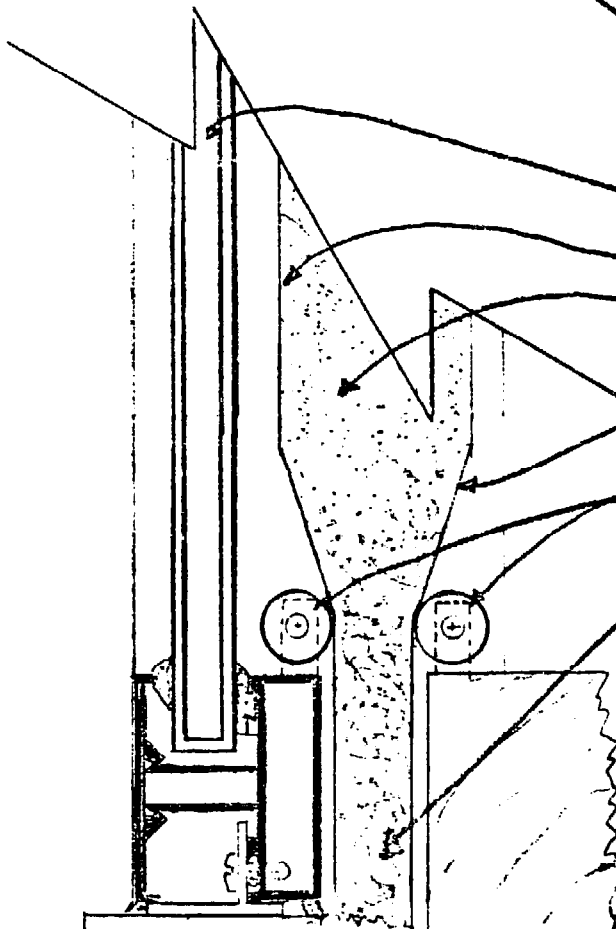

DOUBLE GLAZING
NYLON FABRIC
"POLAR GUARD"
ALUMINUMIZED NYLON
NYLON LINE
ALUMINIUM BUILT-UP
MULLION.

DOUBLE GLAZING
NYLON FABRIC
"POLAR GUARD"
ALUMINIZED NYLON FABRIC
ROLLERS
SLOT FOR COMPRESSED
"DUCKWALL"

265

title CART SOLAR GREENHOUSE "DUCKWALL" DETAILS - PRELIMINARY	scale AS NOTED	dwg. no.
	date 4/17/1977	
	drawn by TYRONE PIKE	page no.

THE PEOPLE'S DEVELOPMENT CORPORATION

Editor's Note: During the Evening Session, Ramon Rueda of the People's Development Corporation made a very eloquent plea to us and to everyone concerned with the development of alternate energy sources. Very simply, he reminded us that, in fact, people live in cities, sometimes in very large cities such as New York. We should not forget, as we carry out our research in mostly rural areas, that in order for our greenhouse research to be truly successful it must be adaptable to the urban environment. We should, then, be working with groups such as the People's Development Corporation to explore ways to incorporate our structures into that type of built environment.

Ramon has invited anyone who is interested in this problem or who is interested in the work of the People's Development Corporation to visit them at 1186 Washington Avenue, New York, NY 10456 (212 292-8131). The rest of this paper consists of excerpts from the October 6, 1977, New York Times, which explains briefly some of the projects being undertaken by this organization.

A Loan and Some 'Sweat Equity' Create an Oasis Amid Desolation

By MICHAEL STERNE

Three years ago, the tan brick apartment house at 1186 Washington Avenue in the Morrisania section of the Bronx looked so much a part of the square miles of desolation around it that city officials were loath to lend \$310,000 to the young people who wanted to restore it.

But today, after getting the loan and investing many of thousands of hours of their own labor, called sweat equity, in the six-story building, the young people have shown what some

urban homesteaders can do in neighborhoods so decayed many people are ready to write them off as hopeless.

Twenty-eight attractive new apartments with carrying charges ranging from \$96 to \$240 a month have been created, and that achievement won the interest and praise of President Carter during his surprise tour of the Bronx on Wednesday.

But to the young members of the

Continued on Page A22, Column 1

Loan From City and 'Sweat Equity' Create an Oasis

Continued From Page A1

Peoples Development Corporation, the group that organized and did the work, those new apartments are more than apartments. They are the base for a much larger goal—to fill the empty lives of thousands of slum youths with a sense of collective purpose, to give them jobs, training, hope and confidence in their ability to change the world for the better.

"By strengthening neighborhoods, by taking offenders off the streets and by serving as an example for others, we think we are building the solutions to the problems of the '70's," said Ramon Rueda, executive director of the corporation.

"Obviously, we can't do it all on our own," Mr. Rueda said. "But we are providing the most important thing, showing people how they can transform their own lives."

While working toward that objective, the group has completely transformed 1186 Washington Avenue. Only the outer walls and about half the beams were left after the group cleared away rotted partitions, rusted pipes, frayed wiring and tons of congealed garbage

from the cellars and rear yards of the abandoned building.

Then, working with plans the future tenant-workers themselves drew up with the help of a professional architect, the group began the slow job of reconstruction. Skilled craftsmen were hired to train and work along with the unskilled neighborhood youths who were doing the bulk of the labor.

The craftsmen were paid their regular wages. The trainees began at \$2.40 an hour and worked up to \$3.25. They worked 40 hours a week for pay and then worked at least 10 hours more a week without pay as their investment in the project. The extra hours were the sweat equity that enabled them to become owners of their apartments without making the down payments that ordinarily would be required in a cooperative.

The building is now 98 percent complete, the tenant owners have moved in, and the new heating system is getting its shakedown on these chill October mornings. The halls are bright with fresh paint and murals, one of them an accomplished copy of Picasso's well-known cubist work "Three Musicians."

Most of the apartments still lack

their final coat of paint and it will be a long time before the tenants can afford to furnish them completely. But even in their still-raw state, they are comfortable living spaces. They range in size from small studios to two-bedroom duplexes with dining rooms.

Human Development, Too

For Victor Merced, a 20-year-old who emerged from Theodore Roosevelt High School two years ago with a diploma but no skills he could turn into wages, 1986 had provided much more than ownership of his one-bedroom apartment. The two years of labor he has invested in the project, the first nine months of them at no wages, have given him a purpose for his life.

"First I did demolition work here," said Mr. Merced as he sat in his apartment and scratched the ear of a stray gray cat he is sheltering. "Then I learned carpentry, plumbing, how to read blueprints. Now I am a construction supervisor, and that's the work I want to do in rehabilitating buildings around here and in other parts of the Bronx."

Work Set on 7 Buildings

At the moment, Mr. Merced and most of the other tenants in the building are unemployed and are living on unemployment insurance. They are however getting seven other buildings in the neighborhood ready for rehabilitation that the corporation expects to begin on Jan. 1.

Because of the success of the 1186 project, the group has won a Federal mortgage commitment of \$3 million to restore five of the seven buildings. Temporary financing will be provided by four banks, Morgan Guaranty, Chemical, Bankers Trust and Bowery Savings.

Other financing for these and the other two buildings will come from the Community Development and Comprehensive Employment and Training programs.

"We're especially pleased to have the banks involved in these projects because we think it's a way of leading them into further investments in decaying neighborhoods," said Meagan Charlop, another of the corporation's leaders.



SECTION 7

- Summary Address, William Yanda
- Closing Comments, Conrad Heeschen
- List of Participants

INSURMOUNTABLE OPPORTUNITIES
Summary Speech for the Marlboro Solar Heated
Greenhouse Conference

Bill Yanda

Insurmountable opportunities. It's rather difficult to deliver a summary speech when the last speaker, Mr. Earle Barnhart of the New Alchemy Institute, said it all. Perhaps it would be beneficial to examine these insurmountable opportunities in light of the diversification of research and similarity in philosophy of the papers presented here. From that perspective, we might all get a glimpse of the future that our field, the solar greenhouse, might hold.

And a broad field it is, too...

The solar greenhouse has the ability to fulfill two basic human needs: food and shelter. Few, if any, other scientific pursuits can make claim to that statement. None of us needs to be reminded of how critical these two areas are to the majority of the people now living in this world. What we differ on then is simply the method of dealing with these two basic needs.

Recent trends in agriculture and shelter design have used highly technological, energy intensive, and ecologically unsound methods in meeting these problems. I like to think of it as the 'Pump-In' technique. The routine is totally analogous to most aspects of life in industrialized nations. When the car gets low on fuel, pump in more! If more corn is needed, pump in more fertilizer! If the house is too cold, pump in more heat! The shelter or the land is never thought of as more than a framework--a shell for technicians to adjust until it 'gets right'. This was fine, of course, until someone mentioned that the pump was running dry.

Enter Us

How did all of you people get here? I bet there's not a licensed Agricultural Botanical Chemical Architectural Engineer in the whole lot of you. Are you sure you're not in over your collective heads? What do you mean you grew fresh food throughout last winter in Maine and helped heat your home at the same time? That's outrageous. Nobody, at least nobody in the Financial District of Manhattan, believes that. You're a bunch of tinkers, that's what you are. Same school as that nut Edison and those crazy bicycle builders who thought they could fly. Any fool knows that three months schooling and a stint on the Grand Trunk Railroad doesn't make lightbulbs.

I believe we're all coming from very different places.

At this conference we've certainly become aware of the insurmountable. As Mr. Lawand so aptly outlined, there are seventeen separate energy saving techniques a commercial greenhouse owner can employ before even considering solar

applications. Add in all of the improved growing techniques, humidity control and insect and soil management and you become aware of two things: 1) There's a lot of work to be done, 2) No one's going to build a perfect solar greenhouse very soon. These are encouraging and stimulating conclusions.

Could I Xerox Your Proposal?

Naturally, in a field as vital as this there are going to be duplications of effort. My first reaction is to assume that's bad. After all, every alternate energy proposal worth its recycled paper has to have "and to prevent duplication of efforts" somewhere in the introduction. However, after considering the infinite number of variables in solar greenhouse design and operation and the necessity to pound media people over their heads with facts, I've changed my mind. I would love to duplicate Ms. Rockefeller's or the University of Pennsylvania's valuable work. I'd change a few details, add a couple of licks of my own and suddenly...new experiment, new results.

To me, the most important consequence a conference like this can have is in leading others into duplication of efforts. I expected to find one or two exciting areas of research here, and I found twenty. The work is too vast. It cannot be truly duplicated. My only fear is that we might become compartmentalized, too specialized, and overlook the broad-based and varied applications our discipline encompasses. Conferences like this should speak generally of concepts and specifically of research results. Our time together is too valuable to get hung-up in comparing transmission ratings of glazings or subjective definitions of the solar greenhouse, unless through submitted papers.

The Great My Sky's Cloudier Than Yours Syndrome

Wherever you go in the United States you will find that once you get there it is the most unique place you've ever been. This is true. Hence, if you speak with a resident of Lame Deer, Montana, you'll learn that, "It once got so cold here in July, boy, that the trout you pulled out of the crik hit the bank freeze dried. Now, how's your solar greenhouse gonna like that, hey, boy?" This same delightful uniqueness reads through greenhouse proposals, projects and papers.

Every single town, every square foot (meter) of the globe is different and unique. One of the most exciting aspects of solar utilization is that the field lends itself to regional diversity in design and application. However, we're at a point where we can now apply some rules of thumb to both small and larger scale solar greenhouses which enable us to fairly accurately predict performance. Good examples of this are found in Dr. J. Douglas Balcomb's "Rules of Thumb for passive Solar Heating in Northern New Mexico" and D. C. Taff, et al., "Design Considerations, Theoretical Predictions, and Performance of an Attached Solar Greenhouse Used to Heat a Dwelling." Both papers are studies based on particular local climate conditions but both contain data which are applicable in all other parts of the

country. The point is, we don't have to start at 'Go' to convince a client or a community that certain performance is attainable.

A good working example is the commercial solar greenhouse, The Herb Shop, located in Santa Fe, New Mexico. Ms. Joan Loitz, the owner and builder, adapted the greenhouse work of the Brace Institute to Santa Fe's conditions. The only major change in the design was the tilting of the north wall to correspond to the sun's altitude on the summer solstice at 36°N. latitude. In addition, she added water drum storage under the planting tables, and a cold frame along the south wall which is used as a hardening-off area for seedlings. Ms. Loitz built the greenhouse in 1974 for \$3.40 a square foot total costs. The structure is 70-75% solar heated and the back-up heating costs an average of \$.09 a square foot per season compared to \$.30-.50 a square foot for a conventional greenhouse in Santa Fe. She could have waited until now to build a solar greenhouse and, perhaps, achieved 5-10% additional solar heating. In the interim, building prices for the materials in the structure would have at least doubled and she would have paid an extra \$2,340 by the end of this winter for heating a traditional greenhouse. There is a great deal to be said for the 'Do it Now' ideology which business people will grasp if it is presented to them in language they understand.

If you are working in the field and wish to see your ideas implemented by a greater number of people, you need to be armed with many informational tools. Two of the most important are rules of thumb which can be applied to any situation and working examples to back up what you say. Without those, you're on shaky footing and your work will only reach a small, and highly adventurous, audience.

To Get Their Attention...Throw Tomatoes At Them

A good friend of mine, B. T. Rogers, a consulting engineer to Los Alamos Labs Solar Division, has said, "The only sensible way to use a totally non-depletable resource is extravagantly." This is a rather novel concept and one I believe we need to foster. In the midst of national agitation over future energy supplies solar utilization is often viewed as an ultimate extremity, a begrudgingly necessary step to be taken if all conventional technologies fail. This image is best conveyed in a phrase often seen in national publications in articles written by a 'recognized expert', a 'professional'. "Of course," this person will say, "we must continue to explore the exotic energy options which may become available in twenty or thirty years." The theme is also used ad nauseum in advertising campaigns by energy companies. This has a devastating effect on the solar industries. Imagine...if you are a homeowner out of the mainstream of alternate energy information, are you going to seriously explore an 'exotic' energy option? Of course not, you're going to wait.

To counter this erroneous notion we must show both the immediate practical benefits and the long range improvement

in lifestyle a soft technology path can provide. Here again, we have an increasing number of models to draw upon.

Several nights ago I was in the new Doug and Sara Balcomb residence designed and built by Susan and Wayne Nichols of Santa Fe. To my knowledge it is the most unique and successful solar home in the country. 95% of the heating is supplied by a solar greenhouse. The temperature range of the interior rooms, summer and winter, is between 68-72°F. The south facing greenhouse is surrounded by a two story structure of frame construction. A massive adobe wall (it could be block or brick in other parts of the country) is the interface between house and greenhouse. There is an active fan and rock storage beneath the home but, as Dr. Balcomb explains, this is really a minor feature of the home. The majority of the heating is conductive and radiative through the massive wall.

It's difficult to describe the psychological impact of this structure. Anyone who enters the house for the first time gauks for several minutes. People will wander through the rooms for a tour but naturally gravitate to the greenhouse for socializing. You feel right...there. Because the space was well-designed for living, as well as solar performance, a person is comfortable wherever he or she ends up in the home. I've been there in mid-August when outdoor temperatures were pushing 100°F and the interior rooms are delightfully cool. In the warm months the greenhouse maintains temperatures 10-12°F below outdoor ambients with only passive venting. This home stands as a contradiction to all popular conceptions of how a solar structure should look, feel, and perform. The fact that the residence hasn't rated a segment on '60 Minutes' or one of the Energy Specials demonstrates the ignorance of the national media to the actual state of the art and underscores our failures to make inroads in the translation of our own technology.

Jobs...politicians and national policy makers like to talk about JOBS. Do we have models, hard examples, to point to?

Susan and Wayne Nichols, the solar builders mentioned previously, recently had a party for their crews. There were forty people there, men, women, children...forty mouths fed by a small solar building company in Santa Fe. What would be the employment impact of a major rehabilitating campaign that emphasized food and heat producing greenhouses and soft technologies in the urban setting? Is there work to be done there? Could people find self-satisfying work building life support systems in the midst of urban decay? Could part of the national energy drain and the de-humanizing tragedy of urban unemployment be stopped with meaningful steps toward food and energy self-sufficiency? I think it could if persons of vision took the lead in establishing long term policy. We don't need unimaginable sums of money spent to reach some distant atomic society. We need realistic and humanistic programs which employ people in meaningful work.

I speak from experience. In Santa Fe, where there has been great interest and emphasis in solar building, there is no lack

of work for those with even the most meager solar experience. Designers and builders (many of the best are women) are backlogged for as long as a year on their jobs. They can't find enough competent workers for their crews.

Throw tomatoes at them! When a sceptic questions the national impact of your 200 square foot greenhouse, don't be bashful. If a neighbor complains about the price of heating domestic hot water, invite the whole family over for a bath in your solar hot tub. When bureaucrats doubt the long range employment possibilities of solar energy, show them the list of jobs you've turned down and offer them higher paying employment with your firm. Be noisy for a change! Make waves!

A Vision With Substance

We do constitute an exceptional assembly of talents at a unique point in history. There is an opportunity available to us to effect, by our research and by our demonstration, major change in the welfare and economic well-being of citizens of the world. We have some choices to make...some of us have already made them. If we chose, we could pursue maintaining traditional food and energy production and distribution patterns, simply substituting solar for petrochemical input into the equation. We could establish per square foot productivity as our goal and entirely bypass the real issues.

Amory Lovins has stated, "The most important, difficult, and neglected questions of energy strategy are not mainly technical or economic but rather social and ethical." If those are the questions, I've heard some answers at this conference. I've seen social and ethical methods of feeding, sheltering, and employing people described here.

In the future, I see revitalized cities that don't draw upon the countryside like so many cancers but sustain their food needs while they employ citizens in rewarding occupations. I taste vegetables which are fresh and nutritious because they've been grown down the block in the community solar greenhouse and not shipped, processed and plasticized from half way across the continent. I walk into a public building and smell the fragrance of life instead of the curing of concrete.

If this conference has been the first step, we can make that goal our destination.

OBSERVATIONS: A CLOSING LETTER

Conrad Heeschen
Dryden, Maine 04225

Although the Marlboro Greenhouse Conference was, in general, a success, because time was limited there were several potentially important issues which were touched upon only tangentially. Since they came mostly from the audience it is unlikely that these issues would otherwise appear in the proceedings; thus, I wish to take the liberty to summarize some of them here.

Most of the solar greenhouse designs presented placed great emphasis on optimizing the slope of the glazing for winter (or fall/spring) conditions, but always in terms of direct beam radiation. The resulting configurations would appear to be more appropriate for parts of the country with a high percentage of direct radiation, yet most of the greenhouses were from regions with a rather high proportion of diffuse radiation. Since 40-50% of the total radiation in the Northeast is diffuse, one might have expected to see more design recognition of this fact. Perhaps when we get more information on plant growth in these greenhouses we will find out whether the configuration is a real problem.

We do need to see more work on plant growth in solar greenhouses, since that is the true measure of greenhouse success (in combination with energy conservation). So much attention has been given to solar greenhouses as heat producers and solar greenhouses that it often appears that food production is of secondary importance. This may be only a ploy to lure people into growing their own food in a live-in solar collector, but large growers have indicated that plant growth is their key criterion. Exploration of the effects of the light regime as well as the temperature regime in solar greenhouses will do much to help us determine the practical as well as theoretical success of solar greenhouse configurations.

Just how to measure the success of a solar greenhouse is another area which requires work. A plea was raised from the audience, requesting suggestions for low-cost instrumentation for greenhouses, but the ensuing discussion quickly got off into \$500 and up micro/macro processors and multichannel recorders. This was probably far from what the original questioner had in mind; under \$100 would be much more like it. It was suggested that a comparative study might be possible if one or two particular varieties of plants were grown by many people, but some records and observations of the greenhouse microclimate would still be necessary. Perhaps one or two thermometers (max-min, if possible) for air and soil temperatures and maybe a psychrometer would be all the instrumentation necessary, if good notes were taken on greenhouse activity as well. The primary purpose of the records ought to be to enable the greenhouse grower to adapt plants and growing schedule to

the greenhouse rather than just to monitor the greenhouse in the abstract, like a solar collector.

The urban situation certainly was not addressed directly by the conference, but just because the designs presented happen to have been built in rural areas does not mean that they cannot be adapted to urban areas. Physical integration of solar greenhouses into the built environment of urban areas may be a challenge, but it is surely one that can be fairly met, while the potential for energy conservation and social interaction with creation of community scale greenhouses is significant. In most instances today, city organic wastes are lost from the food chain, because of the isolation of the city as consumer from rural areas as producers. Urban greenhouses could help bring these wastes back into the system.

In a similar vein I would like to conclude with a personal plea to solar greenhouse growers - wherever possible do not build your greenhouse on otherwise prime agricultural land. Try to use marginal or unproductive plots and create your own soil within the greenhouse. Our objective should be to supplement regular agriculture rather than to replace it, and the odds are that a properly maintained plot of cropland will long outlast our greenhouses.

GREENHOUSE CONFERENCE PARTICIPANTS

Douglas Athart
Department of Plant
and Soil Sciences
Bowditch Hall
University of Massachusetts
Amherst, MA 01002
(Research)

Susan Aulisi
Adirondack Alternative Energy
Edinburg, NY 12134
(Low energy requirement buildings)

Diana Ayers
Maine Vocational Region 10
35 Union Street
Brunswick, ME 04011

Earle Barnhart
New Alchemy Institute
Box 432
Woods Hole, MA 02143

Susan Allen
294 Plain Street
Stoughton, MA 02072

Bud Bartra
Box 861
Red Lodge, MT
(Builder)

Rick Bartra
Red Lodge, MT

Tamll Bauch
EGGE Research
Box 394B RFD 6
Klingston, NY 12401

Michael Beattie
13 Center Street
Rutland, VT 05701
(Solar architecture/
community greenhouses)

William Beck
80 Alpine Street
Cambridge, MA 02138

Peter O. Ashley
Natural Energy Co., Inc.
Box 5
Ogunquit, ME 03907
(Food production)

May Bedding
Box 51
Mill River, MA 01244

Crayton Bedford
59 Phillips Street
Andover, MA 01810

Jane Benitez
1186 Washington Avenue
Bronx, NY 10456
(People's Development Corp.)

Andrew Bergen
Marlboro College
Marlboro, VT 05344

Pleter Bergen
New Alchemy
536 Main Street
Amherst, MA 01002
(Education)

Allison Berry
Project Wintergreen
219 Amity Street
Amherst, MA 01002
(Plant environment)

Tom Bibby
Marlboro College
Marlboro, VT 05344

Barbara Blotta
50 Miller Road
Newark, NY 14513
(Vegetable production)

Michael Bissonet
264 Kelton Street
Allston, MA 02134
(Research, design,
building)

Richard Blazej
Grassy Brook Village
Brookline, VT

Don Booth
Community Builders
Canterbury, NH 03224
(Design and construction
of wood and passively
heated solar homes)

Steve Booth
Community Builders
Canterbury, NH 03224

C. Bovi
850 McEachran Avenue
Outremont, Quebec
(Passive solar greenhouse)

Vaughn Bradshaw,
Consulting Engineer
Dublin-Bloome Associates
42 West 39th Street
New York, NY 10018

Barbara Brandt
21 Burnside Avenue
Somerville, MA 02144
(Urban community organizer)

Richard Brigham
15 Harcourt Street
Boston, MA 02116

Peter S. Brock
Princeton Energy Group
245 Nassau Street
Princeton, NJ 08540
(Alternative energy design research)

Charlie Brown
Marlboro College
Marlboro, VT 05344

Dan Brown
Cary Arboretum of the
New York Botanical Garden
Box A8
Millbrook, NY 12545

Bruce Brynes
New England Coalition
Putney, VT

Jason J. Burbank
Department of Mechanical Engineering
University of Massachusetts
Amherst, MA 01003
(Modeling of passive solar systems)

Jim Burke
Vermont Recycled Greenhouses
Vernon, VT

Tom Burns
Bellows Falls, VT
(Solar greenhouses as heat source)

Tracy Calvan
Box 432
New Alchemy Institute
Woods Hole, MA 02143

Lowell E. Campbell
USDA-ARS
Agricultural Equipment Laboratory
Beltsville, MD 20705

John Caraluzzo
Ramapo College of New Jersey
Mahwah, NJ 07430

Bruce Anderson
Total Environmental Action
Church Hill
Harrisville, NH 03450

Mattia Angelou
3 Old Farm Circle
Weyland, MA 01778

Michael Ankuda
Pratt Institute
335 West 21st Street
New York, NY 10011
(Design)

Peter R. Anstutcher
Dartmouth College Library
1 South Balch Street
Hanover, NH 03755
(Vegetable production)

Alvin Atlas
Institute for Social Ecology
Cate Farm
Plainfield, VT 05667
(Biological agriculture/
aquaculture)

Neal Chamberlain
Box 145A
RD 1
(Construction of underground structures)

Tom Chappell
50 Miller Road
Newark, NY 14513
(Vegetable production)

Mark Cherniak
Energy Office
University of Massachusetts
Box 459
Amherst, MA 01002

Kent Christman
Boston Wind
2 Mason Court
Charlestown, MA 02129
(Solar architectural design)

Theodore Claffone
1610 Olive Street
Scranton, PA 18510

Tito Cintron
1186 Washington Avenue
Bronx, NY 10456
(People's Development Corp)

Jeremy Coleman
Total Environmental Action
Church Hill
Harrisville, NH 03450

A. O. Converse
Thayer School of Engineering
Dartmouth College
Hanover, NH 03755
(Analysis and monitoring)

Scott Coledge
38 York Street
Lexington, MA 02173
(Solar application to commercially grown vegetables)

Elizabeth Coppinger
233 E. Madison
Seattle, WA 98112
(Ecotope)

Ernest Costen
Southwest Corridor Farm
81 Fort Avenue
Boston, MA 02119
(Boston urban agriculture)

Linda Costen
Southwest Corridor Farm
81 Fort Avenue
Boston, MA 02119

Thomas Cowing
Box 76
Lyndon Center, VT 05850

Columba Coyne
Weston Priory
Weston, VT 05161

Sam Cravotta
Star Tannery Design Studio
One Design Inc
RFD 1 Box 23
Star Tannery, VA 22654
(Solar design/solar equipment manufacturing)

Peter K. Crone
Appalachian Advertising
Box 376
Lee, MA 01238

Jack Crowl
Department of History and Political Science
RPI
Troy, NY 12180

John Crowley
Maine Times

Rose Crowley
Marlboro College
Marlboro, VT 05344

David M. Culp
Community Action Against Poverty
Planning and Evaluation
HEAF Project
930 S. Warren Avenue
Indianapolis, IN 46221

Scott Cunningham
61 Salisbury Street
Winchester, MA 01890

C. G. Currin,
Energy Technology Manager
Dow Corning Corporation
Midland, MI 48640
(Greenhouse materials)

Mrs. C. G. Currin
c/o C. G. Currin
Dow Corning Corporation
Midland, MI 48640

John G. Dean
Dean Associates
Eindale Road
North Scituate, RI 02857

Jane DeLisa
Marlboro College
Marlboro, VT 05344

David Deppen
557 Pelham Road
Piula, PA 19119

Pauline Deppen
557 Pelham Road
Piula, PA 19119

Kevin Dudley
602 W. Olive Street
Long Beach, NY

John Duffy
2 Weaver Circle
North Haven, CT 06473

Larry Dumoff
Smokey House Project
RFD Box 257
Danby, VT 05739
(Demonstration greenhouse)

Willie DuPont
Marlboro College
Marlboro, VT 05344

William W. Durrell
Old Route 132
Barnstable, MA 02630

Lisa L. Farina
Total Environmental Action
Church Hill
Harrisville, NH 03450

Laurie Feine
P.O. Box 25
Virginville, PA 19564
(Rodale Press)

John Ferrantino
4 Lakeview Drive
Farmington, CT 06032

Phil Ferraro
Phoenix Nest
South Acworth, NH 03607
(Design research)

Rebecca Flyer
CREF - Canadian Renewable Energy Foundation
331 James Street
Ottawa, Ontario K1R 5M8
(Public information)

Ted Finch
Energy Task Force, Inc.
156 3th Avenue
New York, NY 10010

Robert G. Fiske
Vershire, VT. 05079
(Building contractor, specializing in solar heated installations)

Robert Flower
Eco-energy Association
342 Franklin Street
Alburtis, PA 18011
(Solar heating education/solar system temperature monitoring)

James Fothergill
Techniturf
South Berlin, MA 01549

Margaret C. Frantz
80 Courtland Street
Holliston, MA 01746
(Public information)

Mr. and Mrs. Joseph E. Freda
North Shore Science Museum
1526 North Plandome Road
Plandome Manor, NY 11030

Walter H. Friend
 Ornamental Horticulture Department
 State University of New York
 Alfred, NY 14802

Karen Frost
 Marlboro College
 Marlboro, VT 05344

Chandler Fulton
 Department of Biology
 Brandeis University
 Waltham, MA 02154

Tom Gaucher
 2 Berkshire Heights
 Great Barrington, MA 01230

Larry W. Gay
 The Stove Works
 Marlboro, VT 05344

Timothy H. Gillespie
 137 Horseneck Road
 South Westport, MA 02790

Drew Gillett
 319 Holbrook Road
 Bedford, NH 03102
 (Brookhaven National Laboratory
 Solar Technology Transfer Office)

Robert Ginsburg
 Southern California Institute of
 Architecture
 1800 Berkeley Street
 Santa Monica, CA 90404

Ernest K. Glaban
 Department of Horticulture
 101 Tyson Building
 Penn State University
 University Park, PA 16802
 (Horticulture/site planning design)

Jennie Gladding
 Marlboro College
 Marlboro, VT 05344

Kathy Goff
 Marlboro College
 Marlboro, VT 05344

Henry Golba, Architecte
 Brace Research Institute
 Ville de Montreal
 Division des Edifices Municipaux
 200 Rue Bellechasse
 Montreal, Canada (Quebec)

Edward Goodell
 New Alchemy Institute
 Box 432
 Woods Hole, MA 02143
 (Plant varieties)

Mark Gordon
 283 Carl Street
 San Francisco, CA 94117

Richard Gottlieb
 c/o Friends of the Sun
 210 Main Street
 Brattleboro, VT 05301
 (Energy conservation)

Stephen Green
 Charдавogne Solar Consultants
 Box 606
 Florida, NY 10921
 (Contractor and consultant)

Jon Greeg
 Eden Design Associates
 Eden, VT 05652

Keith B. Gross
 Box 204
 Lincoln Road
 Lincoln, MA 01773
 (Edward Colwell Collins Architect
 Associates)

Mark R. Hahn
 146 Boonton Avenue
 Kinnelon, NJ 07405

Robert Hamburg
 Waste-to-Energy Systems
 Box 137
 Sudbury, MA 01776

Joanne M. Hayes
 Marlboro College
 Marlboro, VT 05344

John W. Hayes
 Marlboro College
 Marlboro, VT 05344

Ronald Hays
 Charдавogne Solar Consultants
 Box 606
 Florida, NY 10921

Paul S. Hazelton
 Evog Associates Inc.
 Box 36
 Hebron, NH 03241

Conrad Heeschen
 Dryden, ME 04225
 (Researcher)

Michael Hennessey
 80 Alton Street
 Manchester, CT 06040

David Hewitt
 Rt 1
 Wheeler, VT 54772
 (Energy planner)

Carol H. Hicks
 Center for Local Self-Reliance
 1008 Grant Street
 Madison, WI 53711

Scott Hicks
 Center for Local Self-Reliance
 1008 Grant Street
 Madison, WI 53711
 (Landscape architecture)

Nerla Higgins
 58 Cedar Street
 Wellesley, MA 02181
 (Passive solar space heating)

Gary Hirschberg
 P. O. Box 432
 New Alchemy Institute
 Woods Hole, MA 02543
 (Education/writing)

Milo Hochstedler
 hochstedler Insulation, Inc.
 RR 5
 Kokomo, IN 46901
 (Building solar integrated
 systems)

Ruth Hochstedler
 Hochstedler Insulation, Inc.
 RR 5
 Kokomo, IN 46901
 (Designing passive solar
 systems)

Terry Holland
 c/o John Duffy
 2 Weaver Circle
 North Haven, CT 06473

I. W. Hollingshead
 RD 4
 Boyertown, PA 19312

Richard Holt
 Evog Associates Inc.
 Box 36
 Hebron, NH 03241

Hank Huber
 RFD 1, Box 137
 Peterborough, NH 03458
 (Designer/builder)

Karen Huenink
 Marlboro, VT 05344

Tom Huenink
 Marlboro, VT 05344

Mike Hurley
 Citizens for Citizens
 264 Griffin Street
 Fall River, MA 02724

Cheryl Hutto
 c/o Valerie Ann Locher
 Rt 23
 Monterey, MA 01245

Tessa Huxley
 Brooklyn Botanic Gardens
 1000 Washington Avenue
 Brooklyn, NY

Dennis Jaehne
 Montachusett Community Action
 Agency
 Box 336
 Townsend, MA 01469

Ronald Jahoda
 Strawberry Fields Nursery
 Starks Road
 New Sharon, ME 04955

James M. Jeffords
 Congressman
 U. S. House of Representatives
 Washington, D.C.

Paul H. Jennings
Department of Plant and
Soil Science
Bowditch Hall
University of Massachusetts
Amherst, MA 01002

Borne Jerald
4 Joel Road
Marblehead, MA 01945

Craig Johnson
52 Monument Avenue
Charlestown, MA 02129
(Designer and director of
TV film and slide-tape
programs)

Eric P. Johnson
140 Hess Avenue
Woodbury, NJ 08096
(architecture/aquaculture)

Ken Johnson
Canadian Greenhouses
Beansville, Ontario L0R 1B0

Roy Johnson
The American Baptist Extension
Corporation
Box 188
New Windsor, MD 21776

William Johnson
Kalwall Corporation
Box 237
Manchester, NH 03101

Bill Jones
Jones Nursery
Rt 1 Box 129A
Charlestown, WV 25414
(Low cost greenhouse heat)

JP Jourdan
Rhône-Poulenc-Petrochimie
25 Quai Paul Doumer
F92408 Courbevoise
France
(Chemical products for solar
collectors and greenhouses)

Lucy Kelly
Dubin-Bloome Associates
42 West 39th Street
New York, NY 10018

Charles Kelsey
Department of Biology
McGill University
1205 McGregor Avenue
Montreal, Quebec H3A 1B1
(Research plant ecologist)

Carl Kelson
North Adams State College
Murdock Hall, G-1A
North Adams, MA 01247

Robert Kendall
Energy Resource Group
West Tisbury, MA 02575

Mr. and Mrs. Richard Ketchum
Country Journal
139 Main Street
Brattleboro, VT 05301

Robert Kiernan
Weston Priory
Weston, VT 05161

Mary Jane King
Rt 1, Box 276
Millbrook, NY 12545

Robert M. King
RD 2, Box 226
Hill & Dale Farm
Putney, VT 05346
(Bio-dynamic gardener)

Ron King
Piper Hill Road
Loudon, NH 03301

Alan D. Kiphut
Center for Solar Energy Applications
San Jose State University
San Jose, CA 95192

Jim Kirby
Solar Alternative
30 Clark Street
Brattleboro, VT 05301

Gene Kistler
Marlboro College
Marlboro, VT 05344

Peter Kitchell, Architect
6 Main Street
Amherst, MA 01002
(Solar greenhouse and home combinations)

Miriam Klein
National Center for Appropriate
Technology
P. O. Box 3839
Butte, MT 59701

Thomas H. Koehnlein, Architect
1427 North 3rd Street
Phoenix, AZ 85004
(Commercial greenhouse design
and redesign)

Joe Kohler
Total Environmental Action
Church Hill
Harrisville, NH 03450

Tasha Kotliar
Organic Gardening Club
Ramapo College of New Jersey
Mahwah, NJ 07430

Karen Krohnengold
Box 176A RT 3
Putney, VT 05346
(Food grower)

Brent R. Lamb
CREP - Canadian Renewable Energy
Foundation
331 James Street
Ottawa, Ontario K1R 5M8
(Public information)

D. Bruce Langmuir
9 Bent Brook Road
Sudbury, MA 01776
(Residential and commercial
Greenhouses)

John Laudermilch
Brethren Service Center
New Windsor, MD 21776

Jim Laukes
Acorn News
Governors State University
Park Forest South, IL 60466

Tom Lawand
Brace Research Institute
Ville de Montreal
Division des Edifices Municipaux
200 Rue Bellechasse
Montreal, Canada (Quebec)

Barry Lawson
Long Island Appropriate Technology
Group
230 Woodbury Road
Huntington, NY 11743
(Solar engineer)

Russ Lawson
Old County Road
Eastport, ME 04631

Daniel C. Lewis
Mechanical Engineering Department
University of Massachusetts
Amherst, MA 01003

Lawrence L. Lindsey
Princeton Energy Group
245 Nassau Street
Princeton, NJ 08540

Carl Lindstrom
Clivus Multtrum, USA
14A Elliot Street
Cambridge, MA 01238

Robert C. Liu
Light and Plant Growth Laboratory
USDA-ARS Building 046-A
Beltsville, MD 20705

Mrs. Robert C. Liu
3112 Chapel View Drive
Beltsville, MD 20705

Ms. Valerie Locher
Inner Spaces
Rt 23
Monterey, MA 01245
(Horticultural design and
consultation)

David Longland
New England Wildflower Society
Garden-in-the-woods
Framingham, MA 01701
(Propagating rare and endangered
plants)

Harvey R. Lorber
Sol-Air Design
Sylvandale
Etna, ME 04234

Chuck Lubbers
Box 141
Waterbury Center, VT 05677

Barbara Lucas
32 Abbott Street
Greenfield, MA 01301

David Lyle
Scandinavian Stoves, Inc.
Box 72
Airstead, NH 03602

John R. MacArthur
Marlboro College
Marlboro, VT 05344

Ken MacClean
"Waste-to-energy systems"
Box 137
Sudbury, MA 01776
(Ecological disposal of waste)

Garyl MacDougall
9 Academy Lane
Bellport, NY 11713

Edward A MacDougall
9 Academy Lane
Bellport, NY 11713

David MacKinnon
Museum of Northern Arizona
Flagstaff, AZ 86501

Reed Maes
Erim Company
923 Sheridan
Ypsilanti, MI 48197

William Makofske
Ramapo College of New Jersey
Mahwah, NJ 07430

Peg Matla
Project Wintergreen
Department of Environmental Science
Marsh Hall
University of Massachusetts
Amherst, MA 01002
(Biological soil management)

Dennis Mallett
Mackin Energy Systems
Old Gill Road P.O. 667
Greenfield, MA 01301

Tom Maloney
One Design Inc
Mt. Falls Route
Winchester, VA 22601

Mickey Marcus
Marlboro College
Marlboro, VT 05344

Jerry Mark
Jefferson Greenhouses
RT 1 Box 151
Kearneyville, WV 25430

Jim Markstein
Organic Gardening Club
Ramapo College of New Jersey
Mahwah, NJ 07430

Henri de Marne
RR 1 Box 139B
Waitsfield, VT 05673
(Solar greenhouse as part of living
space of house)

Diane Matthews
Podale Press, Inc.
33 East Minor Street
Emmaus, PA 18049

Charles McClintock
Center for Studies in Food Self-
Sufficiency
Vermont Institute of Community
Involvement
90 Main Street
Burlington, VT 05401

Michael McClintock
Boston University Energy Office
195 Baystate Road
Boston, MA 02115

Anne M. McCormick
Solar Shelter Developers
Route 5, Box 80A
Menomonee, WI 54751

Lee McDonald
3 Reed Street Court #2
Cambridge, MA 02140
(Moveable insulation systems)

Robert F. McGrath
Box 840
Salem, MA 01970

Mary McKenna
Box 417
Norwich, VT 05055

Don McKinney
Maine Audubon Society
Falmouth, ME

Russell McLean, Sr.
Hardy Street
Dunstable, MA 01827

Mr. and Mrs. Samuel Meek
720 5th Avenue
New York, NY 10019

Dave Merker
Organic Gardening Club
Ramapo College of New Jersey
Mahwah, NJ 07430

Charles Michal
Total Environmental Action
Church Hill
Harrisville, NH 03450

William F. Milburn
249 Agricultural Engineering
Building
Penn State University
University Park, PA 16802

Dean L. Mims
Box 25
Virginville, PA 19564

Clare F. Moorhead
Conservation Concepts
802-297-1816
617-547-0495

Erika Morgan
Maine Audubon Society
Gislard Farm
118 Old U.S. Rt. 1
Falmouth, ME 04105

Carla Mueller
Department of Horticulture
Penn State University
University Park, PA 16802

Glenn Munson
Pawlet, VT 05761

Eliyn Murphy
National Center for Appropriate
Technology
Box 3838
Rutte, Mt. 59701
(Theater - Energy caravans for
education)

John Murphy
Old Stone Mill
Fitzwilliam, NH 03441

Catherine Murray
Office of Energy Resources
55 Capitol Street
Augusta, ME 04130
(Community and school centered
greenhouses)

Sharon Nagle
Organic Gardening Club
Ramapo College of New Jersey
Mahwah, NJ 07430

Ron Nash
Hornbeck Road
Harpersfield, NY 13786
(Theater - dramatic statements on
solar energy)

Bruce E. Neely
84 Lakeshore Drive
Oakland, NJ 07857
(Ramapo College of New Jersey)

Lynn Nelson
Environ/mental
1518 Sixth Street
Berkeley, CA 94710

Rudy Nelson
122 Lancaster Street
Albany, NY 12210

Shirley Nelson
122 Lancaster Street
Albany, NY 12210

John G. New, Chairman
Department of Biology
State University College
Oneonta, NY 13820
(Alternate life styles)

Betty New
c/o Department of Biology
State University College
Oneonta, NY 13820

Nancy New
c/o Department of Biology
State University College
Oneonta, NY 13820

Abby Rockefeller
Clivus Multtrum USA
14A Elliot Street
Cambridge, MA 01238

Don Prowler
2216 St. James Street
Philadelphia, PA 19103

Larry Purcell
Brattleboro Design Group
63A East Orchard Street
Brattleboro, VT 05301
(Architectural design and
graphic arts)

Francis Parkman
Earth Stewards, Inc.
Box 76, RFD 3
Putney, VT 05346

Paul Newlin
Project Wintergreen
82 Pondview Drive
Amherst, MA 01002
(Low income community
Greenhouse projects)

Helen Parkman
Earth Stewards, Inc.
Box 76, RFD 3
Putney, VT 05346

Barbara Putnam
Box 29
Harrisville, NH 03450

Joseph A. Perazzelli
X. S. Smith, Inc.
Rcd Bank, NJ 07701

Stan Noffsinger
Regional Director
Church World Service - CROP
Box 188
New Windsor, MD 21776

Roger Peters
240 Fifth Avenue
Ottawa, Ontario, Canada K1S 2N3
(Waste for compost)

Gary W. Norton
Box 93
Norwich, VT 05055
(Plant retailer)

Jan Pfuler
Associates of Lee Porter Butler
3375 Clay Street
San Francisco, CA 94118
(Architecture. Total passive heated
and cooled buildings)

Jennie C. O'Brien
35 Longview Road
Reading, MA 01867

John A. O'Brien
35 Longview Road
Reading, MA 01867
(The MITRE Corporation)

Sandra Oddo
Solar Age
Hurley, NY

Debbie Oscar
46 Cottage Street
Newton Highlands, MA 02164

David Osmond
Raiph S. Osmond, Co.
Custom Builders
3 Old Farm Circle
Wayland, MA 01778

Christine Ostlund
Ramapo College of New Jersey
Mahwah, NJ 07430

Reed Parish
Old Stone Mill
Fitzwilliam, NH 03441

Phillip Pommier
190J Cullen
Austin, TX 78757

Paul B. Popinchalk
Aeonic Energy
Box 182
Westminster, MA 01473

Ramon Rueda
Peoples Development Corporation
1186 Washington Avenue
Bronx, NY 10456

Grace Ruth
RR 1 Ormstown
Quebec, Canada

Jack Ruttle
Rodale Press, Inc.
33 East Minor Street
Emmaus, PA 18049

Lanie Ruttle
Rodale Press, Inc.
33 East Minor Street
Emmaus, PA 18049

Kathi Ryan
New Alchemy Institute
Box 432
Woods Hole, MA 02143

Tom Sabatini
Richmond Road, RD 2
Brandon, VT 05733
(Grower)

Rob Szadinsky
Box 432
New Alchemy Institute
Woods Hole, MA 02143

Norman Saunders
15 Ellis Road
Weston, MA 02193
(Teaching, development, consulting)

Andrew Schaper
Weston Priory
Weston, VT 05161

Alain Ratheau
Solar Alternative, Inc.
30 Clark Street
Brattleboro, VT 05301

Sharon Reynolds
344 West Germantown Pike
Norristown, PA 19401

Mark Riley
Pollution Probe - Ottawa
54-53 Queen Street
Ottawa, Ontario, Canada K1P 6C3
(Greenhouse design, composting,
recycling of waste)

Catherine Riseng
6200 Carpenter Road
Ypsilanti, MI 48197
(Greenhouse operator/botanist)

Victoria Reck
Marlboro College
Marlboro, VT 05344

Diana Reiss
1186 Washington Avenue
Bronx, NY 10456
(People's Development Corpora-
tion)

David Reynolds
344 West Germantown Pike
Norristown, PA 19401

Sharon Reynolds
344 West Germantown Pike
Norristown, PA 19401

Mark Riley
Pollution Probe - Ottawa
54-53 Queen Street
Ottawa, Ontario, Canada K1P 6C3
(Greenhouse design, composting,
recycling of waste)

Catherine Riseng
6200 Carpenter Road
Ypsilanti, MI 48197
(Greenhouse operator/botanist)

Morty Schliff
Energy Shelters, Inc.
2162 Hauptman Road
Saugerties, NY 12477
(Energy systems in greenhouses)

John Schnebly
New England Solar Energy
Association
High Street
Brattleboro, VT 05301

Jack Schultz
Solar Utilitics Company
406 North Cedros Street
Solana Beach, CA 92075

Rob Schultze,
Agricultural Consultant
Hanover Consumer Cooperative
Society
Hinman Box 728
Dartmouth College
Hanover, NH 03755

Frederick A. Schwartz, President
Vegetable Factory, Inc.
100 Court Street
Coplaque, NY 11726

Mrs. Frederick Schwartz
Vegetable Factory, Inc.
100 Court Street
Coplaque, NY 11726

Andrew E. Scoville
Dynamics Research Corporation
30 Canterbury Hill Road
Topsfield, MA 01983

Dan Scully
Total Environmental Action
Church Hill
Harrisville, NH 03450

Vic Sedrick
Kallwall Corporation
Box 237
Manchester, NH 03101
(Glazing, hybrid/passive
solar thermal storage)

Cathy Satterlin, Director
Green Chimneys Farm Center
Putnam Lake Road
Brewster, NY 10509

Andy Shapiro
National Center for Appropriate
Technology
P. O. Box 3838
Butte, MT 59701

Betty Shaw
New England Solar Energy Association
Box 541
Brattleboro, VT 05301

Jack Sheehy
84 Lakeshore Drive
Oakland, NJ 07436
(Ramapo College of New Jersey)

Bill Sherry
Penn State University
University Park, PA 16802

Robert Shortreed
National Center for Appropriate
Technology
84 Westford Road
Stafford Springs, CT 06076

Chuck Silver
Innovative Studies
S.U.N.Y. College of New Paltz
New Paltz, NY 12562

Art Silverman
Vermont Public Radio
Box 323A
Charlestown, NH 03603

Richard Slaybaugh
Maple Leaf Gardens
147 Clinton Street
Concord, NH 03301

Brian Slopey
Saranac High School
Saranac, NY 12981

Greg Smith
Barratt Hill Farm
Wilton, NH 03086

Prudy Smith
Oak Street
Brattleboro, VT 05301

Robert O. Smith
Robert O. Smith & Associates
55 Chester Street
Newton, MA 02161

Caroline Smilgson
National Center for Appropriate
Technology
P. O. Box 3838
Butte, MT 59701

David H. Sneli
David H. Sneli Nursery
Box 137 Kunkles Road
Mt. Airy, MD 21771
(Alternative methods of
heating greenhouses)

Ara Snyder
Snyder Associates, Inc.
Box 98
Essex, CT 06426

Jean Snyder
Snyder Associates, Inc.
Box 98
Essex, CT 06426

Leonard P. Sohacki
Department of Biology
State University College
Oneonta, NY 13820

Thomas Southin
Biology Department
McGill University
1205 McGregor Avenue
Montreal, Quebec, Canada H3A 1B1
(Construction of domes as
greenhouses and homes)

R. Elias Stein
76 Lindale Street
Stamford, CT 06902

Mark Steinke
211 Charles
Ann Arbor, MI 48104

Fred Sterner
Addronack Alternate Energy
Edinburg, NY 12134

Lincoln Stevenson
Pine Island Nurseries
Pine Island Road
Rye, NY 10580

Douglas Stewart
Olde Madbury Lane Apartments
Apt. 38
Dover, NH 03820
(Forestry technician)

Jim Stiles
Friends of the Sun
Main Street
Brattleboro, VT 05301

Ann Talbot Stone
Seventy Acres Road, RD 3
West Redding, CT 06896

Davis Straub
Ecotope
233 E. Madison
Seattle, WA 98112

Paul Sullivan
Sullivan's Solar Systems
93 Halcyon Road
Newton Center, MA 02159

Lowell B. Symmes
Evog Associates, Inc.
Box 36
Hebron, NH 03241

Victor Szymanski
105 Maple Avenue
Shrewsbury, MA 01545

Betsy Taff
Parallax, Inc.
Box 180
Hinesburg, VT 05401

Doug Taff
Parallax, Inc.
Box 180
Hinesburg, VT 05401
(Architectural engineering)

David N. Talbot
Talbot's Herb and Perennial Farm
RRI
Hartland, VT 05048

Buzz Tenenbom
Cate Farm
P. O. Box 55
Goddard College
Plainfield, VT 05667
(Design - construction of passive
homes and greenhouses)

Hugh M. Tomb
Eibart Manufacturing Co.
127 W. Main Street
Millsbury, MA 01527

Lavinia Tomb
Eibart Manufacturing Co.
127 W. Main Street
Millbury, MA 01527

John H. White
Department of Horticulture
Penn State University
University Park, PA 16802

Betsy Williams
Box 932
Wellfleet, MA 02667

David Williams
Long Island Appropriate
Technology Group
230 Woodbury Road
Huntington, NY 11743

James Williams
Brattleboro Design Group
P. O. Box 235
Brattleboro, VT 05301

Nathaniel E. Williams
41A High Street
Old Town, ME 04468

Paul F. Williams
Box 932
Wellfleet, MA 02667

Peter Williams
RFD 1
Brattleboro, VT 05301

John W. Williamson
School of Engineering
Vanderbilt University
Nashville, TN 37235
(Mechanical engineering research
in energy systems)

Charles G. Wing
Cornerstones
54 Cumberland Street
Brunswick, ME 04011

Marshall Winkler
South Street
Rockport, MA 01966
(Grower)

Marshall K. Wood
Box 27
Castine, ME 04421

Rob Traver
Moravian Academy
4313 Greenpond Road
Bethlehem, PA 18017

Gene Troia
Institute for Social Ecology
Gate Farm
Plainfield, VT 05667
(Greenhouses as solar heaters)

Ron Vidal
Canadian Greenhouses
Beamsville, Ontario L0R 1B0

Lillie Vitelli
Marlboro College
Marlboro, VT 05344

Dave Vreeland
Project Wintergreen
231 Montague Road
Leverett, MA 01054
(Greenhouses for low income
communities)

Mark R. Ward
9 Greenough Avenue
Cambridge, MA 02139
(Greenhouse recycling)

Norman Weiner
Long Island Appropriate
Technology Group
230 Woodbury Road
Huntington, NY 11743
(Passive solar retrofit &
college based low-cost
food production program)

Eileen Weinstein
RD 1
Alburtis, PA 18011

Marvin and S. Weiss
Energynomics Corporation
Box 239
Main Street
Stockbridge, MA 01262

Bob Woodruff
Energy Resource Group
West Tisbury, MA 02575

Betsy Woodward
Box 421
Essex, CT 06426

Greg Worden
The Brattleboro Reformer
Main Street
Brattleboro, VT 05301

Ginger Worthington-Paca
RD 1 Box 326
Troy, NY
(Solar architectural design)

William Yanda
RT 1 Box 107
Santa Fe, NM 87501

Peter Yellin
38 Lakeside Drive
New Rochelle, NY

Regi Young
Box 113
New Tripoli, PA 18066

Ronald Zabliaski
Northeastern University
Boston, MA

Dorian Zachai
RFD 3
Richmond, NH 03470

Carl Zipner
Eco-Energy Association
201 Greenwood Avenue
Madison, NJ 07940
(Solar education)

Gerrit Zwart
25 Lancaster Street
Cambridge, MA