

## **Compendium in Small Hydro**

# Compendium in Small Hydro

**Selected & Edited by John Furze. 2000/2002**  
**Holme Bygade 12, 8400 Ebeltoft Denmark**  
**Fax: + 45 86 10 07 86**  
**E-mail: <furze@post.tele.dk>**  
**University of Aarhus, Faculty of Political**  
**Science, Law & Economics.**

**NB:**

**It should be noted that this Compendium is for the express use of students, workers, research and production engineers and technicians, and for political decision-makers at all levels - concerned with development of production capability.**

**It does not intend nor imply any infringement of any of the copyrights of any of the authors quoted.**

**Indeed, this Compendium is intended and presented in grateful thanks, and to perhaps bring these authors to a wider public.**

## CONTENTS - Page of first quote:

- 10: **The Power Guide:** W. Hulscher & P. Fränkel. 1994. ISBN 1 85339 192 1. IT Books. London UK - University of Twente. The Netherlands.
- 24: **Machinery's Encyclopedia Vol. VI:** [Chas. L. Hubbard]. The Industrial Press. 1917. New York USA / London UK.
- 40: **Energy Primer:** Portola Institute. 1974. ISBN 0 914774 00 X. Portola Institute. 558 Santa Cruz Ave. Menlo Park. California 94025. USA.
- 51: **Solar Living Source Book:** J. Schaeffer et al. 1994. ISBN. 0 930031 68 7. Chelsea Green Pub./Real Goods. Ukiah California. 95482-3471. USA.
- 63: **Energy from Nature:** P. Pedals. 1993. Rainbow Power Company. 1. Alternative Way. Nimbin. New South Wales 2480. Australia.
- 77: **Handbook of Homemade Power:** Mother Earth News. 1974. Bantam Books. 666 Fifth Ave. New York. N.Y. 10019. USA.
- 105: **Harnessing Water Power for Home Energy:** D. McGuigan. 1978. Garden Way Publishing. Pownal. Vermont 05261. USA.

### Water Wheels:

- 115: **Energy Primer:**
- 123: **Field Engineering:** P. Stern [F. Longland - 1936/1942]. 1983/1993. ISBN. 0 903031 68 X Intermediate Technology Publications. London. UK.
- 125: **Liklik Buk:** Melanesian Council of Churches. 1977. ISBN 0 86935 0244. Lae Papua New Guinea.
- 128: **Shelter:** distributed by Random House Publishing. USA 1973. 0-394-70991-8.
- 129: **Soft Technology Magazine # 21.** ATA 247 Flinders Lane Melbourne Australia.
- 137: **D.I.Y. - Plan 7 - Timber Waterwheel:** CAT. 1977. Center for Alternative Technology. Machynlleth. Powys. Wales. UK.
- 145: **Handbook of Homemade Power:**
- 147: **Eco-Tech:** R.S. de Ropp. 1975. Dell Publishing. 1. Dag Hammarskjold Plaza. New York. N.Y. 10017. USA.
- 148: **Handbook of Homemade Power:**

### Gearing and Elementary Electrical Power Generation:

- 163: **Handbook of Homemade Power:**
- 164: **Other Homes & Garbage:** J. Leckie et al. 1975. ISBN 0 87156 141 7. Sierra Club Books. 530 Bush St. San Francisco. California 94108. USA.
- 166: **Windmills & Wind Motors:** F.E. Powell. 1910 /1985. ISBN 0 917914 27 9. Lindsay Publications. Bradley IL. 60915 USA.

**170: Forsøgsmøllen - Vol IV. [The Danish Wind Mill Experimental Station Report - [1900-1903] Poul La Cour. 1903. Det Nordiske Forlag Copenhagen Denmark.**

**Pelton and Turgo Wheels:**

**172: Energy Primer:**

**174: Homemade Power:**

**185: Harnessing Water Power:**

**Michel/Banki Turbines:**

**189: Energy Primer:**

**191: Producing your own Power: C.H.Stoner. 1974. 0-394-71440. Rodale/Vintage Books-Random House. New York USA.**

**195: Energy Primer:**

**196: Harnessing Water Power.**

**202: Michel/Banki Turbine: W.R.Breslin. 1980. 0-86619-066-X. VITA. USA.**

**220: Soft Technology Magazine # 35,37,26. ATA Melbourne Australia.**

**Hydro Plants:**

**234: Energy Primer:**

**235: Soft Technology Magazine # 31. ATA 247 Flinders Lane Melbourne Australia.**

**240: Ultra Low-head Hydro. Home Power Magazine # 23. USA 1991.**

**245: Mini-Hydro: J. McPhee. "The New Yorker" Magazine - # 23 February 1981. "New Yorker" Magazine. 25 West 43rd. Street. New York. N.Y. 10036. USA.**

**Appendix: Small-scale Dam Construction, Pipes and Fittings, Tables etc:**

**258: Permaculture: B. Mollison. 1990. ISBN 1 55963 048 5. Island Press Washington DC. USA / Australia.**

**272: Energy Primer:**

**286: Ben Meadows Catalogue 1994-1995: Ben Meadows Company - Equipment for Natural Resources. 3589 Broad Street. Atlanta. Georgia 30341. USA.**

**290: Forestry Suppliers, Inc. - Jackson. MS. USA. - [www.forestry-suppliers.com](http://www.forestry-suppliers.com)**

**294: Nano Hydro. Home Power Magazine # 15. USA 1990.**

**297: Village Technology Handbook: VITA. 1975. VITA. 3706 Rhode Island Ave. Mt. Rainier. Maryland. USA.**

**339: Model Water-turbine: A. Nielsen. Museum of Natural History Århus Denmark.**

**Extra Titles: - Construction Manuals & Reference Books.**

**Micro-Centrales Hydrauliques:** J-B. Maucor & S. Maucor. 1984. - available from: MilieuBook. Plantage Middenlaan 2 H. Amsterdam The Netherlands.

**Micro-Hydro Electric Power:** R. Holland. 1983. ISBN 1 85339 363 0. IT Books. - available from: IT Bookshop. 103-105 Southampton Row. London WC1B 4HH. UK. [orders@itpubs.org.uk].

**Micro-Hydro Power:** P. Fraenkel et al. 1991. ISBN 1 853339 029 1. IT Books. London UK.

**Micro-Hydro Design Manual:** A. Harvey et al. 1993. ISBN 1 85339 103 4. IT Books. London UK.

**Micro-Hydropower Sourcebook:** A.R. Inversin. 1986. ISBN 0 94668 848 6. NRECA Books. - available from IT Bookshop. London UK.

**Small Hydro Power in China:** Hangzhou Regional Center for Small Hydro Power. 1985. ISBN 0 946688 46 X. - available from IT Bookshop. London UK.

**Motors as Generators for Micro-hydropower:** N. Smith. 1995. ISBN 1 85339 286 3. IT Books. London UK.

**Pumps as Turbines:** A. Williams. 1995. ISBN 1 85339 285 5. IT Books. London UK.

**Water Current Turbines:** P. Garman. 1986. ISBN 0 94668 827 3. IT Books. London UK.

**Young Mill-Wright & Millers Guide:** Oliver Eyans. 1850/1972. - available from Metastasis, PO-Box 128. Marblemount. Washington 98267. USA.

**Treatise on Mills & Millwork:** Sir William Fairbairn. 1861/1878. Longhams Publishing. London UK.

**Electricity for the Farm:** F. Andersen. 1915. Macmillan Publishing Co. USA.

**Power for the Farm from Small Streams:** US Dept. of Agriculture. Jan. 1925. Washington DC. USA.

**Water Power Development - Vols I & II:** E. Mosonyi. 1960/1967. Hungarian Academy of Science. BudaPest Hungary.

**English/British Watermills:** L. Syson. 1965. Batsford Publishing. London UK.

**Overshot Water-Wheel - Design & Construction Manual:** VITA. 1979. VITA. 3706 Rhode Island Ave. Mt. Rainer. Maryland. USA.

**The Micro-Hydro Pelton Turbine Manual:** J. Thake. 1999. ISBN 1 85339 460 2. IT Books. London UK.

**Banki Water Turbine:** Mockmore & Merryfield. 1949. Bulletin Series Number 25. 1949. School of Engineering. Oregon State University. Corvallis. Oregon 97331. USA.

**Crossflow Turbine Type - BYS 7:** SKAT. 1986. - available from Swiss Center for App. Technology. Vadianstrasse 42. CH-9000 St. Gallen. Switzerland.

**Multi-Purpose Power Unit:** A.M. Nakarmi & Backmann. 1982. Sahayogi Press. Tripureshwar. Kathmandu. Nepal.

**Low-cost Development of Small Water-Power Sites:** H.W. Hamm. 1967. VITA. 3706 Rhode Island Ave. Mt. Rainer. Maryland. USA.

**Mini-Hydropower:** T. Jiandong et al. 1996. ISBN 0 471 96264 3. UNESCO - John Wiley & Sons Publishing. London UK.

**Field Engineering:** P. Stern [F. Longland]. 1936/1993. ISBN 0 903031 68 X. IT Books. London UK.

**Home Power Magazine:** PO-Box 520. Ashland 97520 OR. USA.

**Waterlines Magazine:** IT Books. London UK.

**Compendium in Hydraulic Ram-Pumps:** J. Furze. 1995/1996.

**Compendium in the Integrated Farming System:** J. Furze. 1996/1997/1998.

## Glossary

axial flow	A term for hydraulic machinery, pumps, turbines, in which the water flows parallel to the power shaft (axis of rotation) as in a propeller pump.
center of curvature	That spot where the point of the compass is stuck when drawing an arc or circle.
cfm.	Water flow rate, cubic feet per minute.
cfs.	Cubic feet per second.
control gate	See gate.
design flow	That flow rate for which the turbine is designed.
fps = feet/second	Velocity in feet per second. Also: (fps)(60) = feet/minute - feet per minute.
flume	An old term for a wooden or metal box channel: an aqueduct.
gate	In a sluice or canal, a structure of vertical sliding boards or metal that controls the flow of water (as in a "watergate").
gpm.	Gallons per minute (there are 7.48 gallons in each cubic foot).
head	The elevation of water that is available and so, a measure of the energy of the water. In some cases the pressure in a pipe may be indicated by the head in feet of water. The law of conservation of energy in water flow is given by the equation: $\frac{v^2}{2g} + \frac{P}{\alpha} + \frac{\text{(elevation)}}{\text{in feet}} = \text{a constant along a continuous flow.}$ v = velocity in feet/second 2g = 64.34 feet per second <sup>2</sup> $\alpha$ = 64.4 lbs. per cubic foot P = pressure in lbs. per square foot
headwater	The static head (without velocity) usually behind a dam, sluice, or weir.
HP	Horsepower. A measure of power, equivalent to 745 watts.
hydraulic radius	A concept used in analysis of water flow in channels. Equal to the cross-section area of the flow divided by the wetted perimeter.
penstock	A pipe to carry water to the turbine, usually under a high pressure.

percent grade	% Grade. The slope of ground, creek, or canal—in feet per 100 feet or meters/100 meters. (Not the same as the channel flow equations “s.”)
psi	Pounds per square inch. A pressure measurement, equivalent to .433 foot of head (of water).
Q	Symbol for flow rate, usually in cubic feet per second or liters per second.
radial flow	For hydro machinery, pumps and turbines; where the water flows radially out from the power shaft; as in a centrifugal pump, or radially as in a Francis wheel.
radius of curvature	The distance from the center of curvature to the arc.
rim speed	The velocity of a point on the rim of a rotating wheel or turbine = $(\text{rpm})(2\pi)(\text{radius})$ .
rpm	Rotation, revolutions per minute.
slope	In channel flow calculations: slope, $s$ = feet of drop per 1000 feet of horizontal distance (or meters drop per kilometers).
tailrace	The channel that carries the tailwater flow.
tailwater	The water surface elevation immediately downstream of a water-wheel or turbine (see various wheel illustrations).
torque	Something that produces or tends to produce rotation or torsion and whose effectiveness is measured by the product of the force and the perpendicular distance from the line of action of the force to the axis of rotation.
tuberculation	The pits and lumps of rust and corrosion in steel and cast-iron pipe.
weir	An exact opening (rectangular, triangular, or trapezoidal) used to accurately measure water flow rates.
wetted perimeter	A concept used in flow analysis. It is that portion or length of the channel cross-section that is in contact with the flow (measured perpendicular to the flow). For a circular pipe flowing full, the wetted perimeter would equal the circumference of the pipe.



# Applications of water power

*Type of motion in machine*

*Type of prime mover in water*

*Work done*

*Process, eg.*

Reciprocating:  
cam or piston

Horizontal axis  
wheel

Sawing  
Air bellows  
Water pumping

Timber reduction  
Blast-furnance in iron or glass works.  
Mining, land drainage and irrigation;  
industrial processes involving cleaning  
or cooling  
Forge; crushing ore, clay  
Trimming metal tools

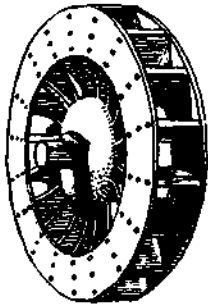

(a)

Rotary with  
direct horizontal  
drive

Horizontal axis  
wheel

Tumbling

Tumbler-mixing of eg. concrete; stone  
polishing; laundry  
Water supply for irrigation or manufacture

Rotary with  
gearing to  
horizontal axis  
drive (a)

Horizontal axis  
wheel

Raising water  
'Noria'

Roller milling

Paper manufacture; metal rolling mills

Grinding

Tool manufacture;  
Wire drawing  
Textile weaving; fulling cloth  
Metal and wood lathes  
Pipe and tube making  
Electricity generation  
Wire coil and rope making

Turning

Boring

Dynamo

Winding

'Turntable'

Potter's wheel; wood turning

Grinding

'Mortar and  
Pestle'

Corn-grinding; flour mill; crushing aggregate

Grinding powders

Forge; crushing ore, clay

Beating out metals

Pumping

Rotary with right-  
angle gearing to  
vertical drive (b)(e)

Horizontal axis  
wheel

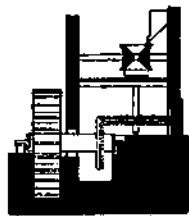

(b)

'Intermittent  
counterpoise'

Tilt-hammer

Vertical axis  
rotation (c)(f)

Submerged  
'panemone' or  
reaction turbine

Direct or geared  
drive for most of the  
above purposes

Corn-grinding, etc. in small amounts

Vertical axis  
rotation (d)

'Norse mill' type

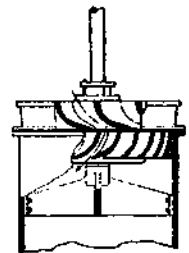

(c)

(d)



(e)

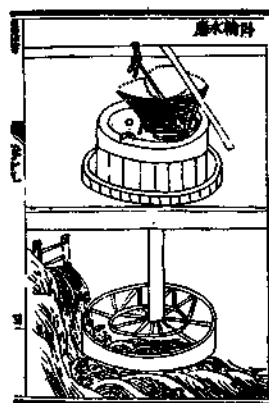

(f)

# 3 Water power

Water power, or hydro power, are terms given to power which can be extracted from falling water, or from the energy in fast flowing streams or rivers. Three categories of water power devices are covered here; water turbines, water current turbines and hydraulic ram pumps. All use the same basic energy source, but in different ways.

Large hydro-electric schemes often have outputs measured in hundreds of megawatts. In this chapter schemes of up to 300kW are described. The most common means of producing water power at this scale are small water turbine schemes, often called micro-hydro schemes.

Micro-hydro schemes have been in use for some 2000 years. Water-wheels (Figure 1) and the vertical axis Norse wheel or ghatta (Figure 2) were the most common. They were made from wood, with a few wearing parts made from metal or stone. The most common use was for milling grain, but water pumping for irrigation and water supply was also widespread. Later, water-wheels were used to drive the air bellows which charged the furnaces of the industrial revolution.

These simple wooden machines were gradually developed to quite high efficiencies. Tens of thousands of traditional machines are still in use, in Africa, Asia and South America, for milling grain, and sometimes for powering pumps or lathes. Most are designed to power only one machine, which can limit their economic viability, as they may not be in use all the year round.

Rising energy prices, combined recently with concerns about the environment, have led to increased interest in micro-hydro as a safe, low-cost energy source, particularly in more remote areas. Technological developments have accompanied the revival of this power source. Traditional machines have been improved, using modern materials, so that they can power a number of different machines. The advent of power electronics has allowed electronic load control to replace complex hydraulic governors; PVC and



Powerhouse at Cajamarca (IT)

other plastic pipes are replacing cast iron and steel; and modern high-speed alternators and bearings have reduced weights and costs.

Hydraulic ram pumps (hydrams) and water current turbines are also covered in this chapter. Hydrams are water power devices which can only be used for pumping water. They are typically used for low-power applications such as drinking water supply. Water current turbines (also called river current turbines) are used for extracting power from fast-flowing streams and rivers, without the use of a significant fall in levels.

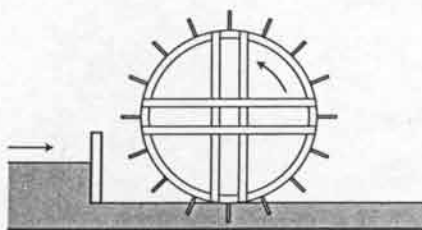

(a) The undershot water-wheel

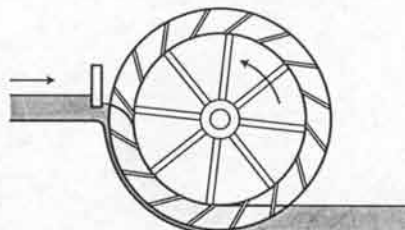

(b) The breastshot water-wheel

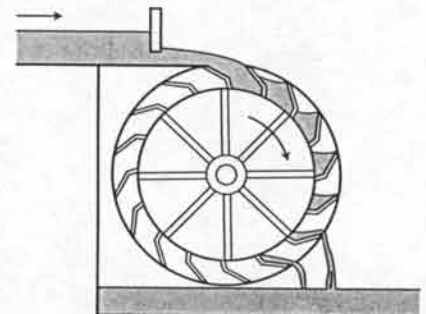

(c) The overshot water-wheel

Figure 1. Water-wheels

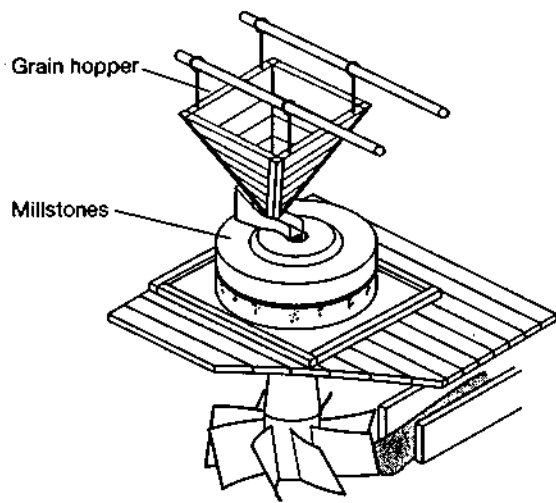

Figure 2. Norse wheel or ghatta, used for milling

Here are some of the advantages and disadvantages of using water power which, along with the rest of this chapter, should help you to judge its relevance to your needs.

The main advantages of water power are:

- Power is produced at a fairly constant rate so that there is little need for storage batteries, and power is available at any time.
- The technology is easily adapted for manufacture and use in developing countries and remote areas.
- No fuel is required and maintenance costs are low.
- The technology is simple and robust, leading to lifetimes of over 20 years without major new investment.
- Overall costs can in many cases undercut all other alternatives.

- There are no large dams, so that problems faced by large hydro, such as resettlement and reservoir silting, are avoided.

- Schemes emit no carbon dioxide (CO<sub>2</sub>) or other hazardous by-products, little noise and little waste heat.

Micro-hydro schemes and hydrams have the additional advantage of using old, well-established technology.

The main shortcomings are:

- It is a site-specific technology, and suitable sites are required close to locations where power is needed.

- On the small streams normally used, the maximum power is limited and cannot be expanded as demand grows.

- In some cases, power output is reduced or even zero during the dry season.

- Droughts and changes in water use and land use can reduce power output.

- In many areas, the potential market is not large enough to support the engineering knowledge and equipment needed for easy implementation.

- In many areas, water power is unknown, and the engineering skills needed are expensive to acquire.

- As with many other renewable energy technologies, the capital intensive nature of the technology makes it sensitive to the economic climate.

This chapter does not set out to provide the knowledge necessary to design a scheme and select equipment. For this, further reading is required and, for most people, some advice or training from manufacturers, consultants, or organizations specializing in this area. Manufacturers are listed in the catalogue section, and many can offer consultancy advice, or lead the enquirer to an experienced company. Some

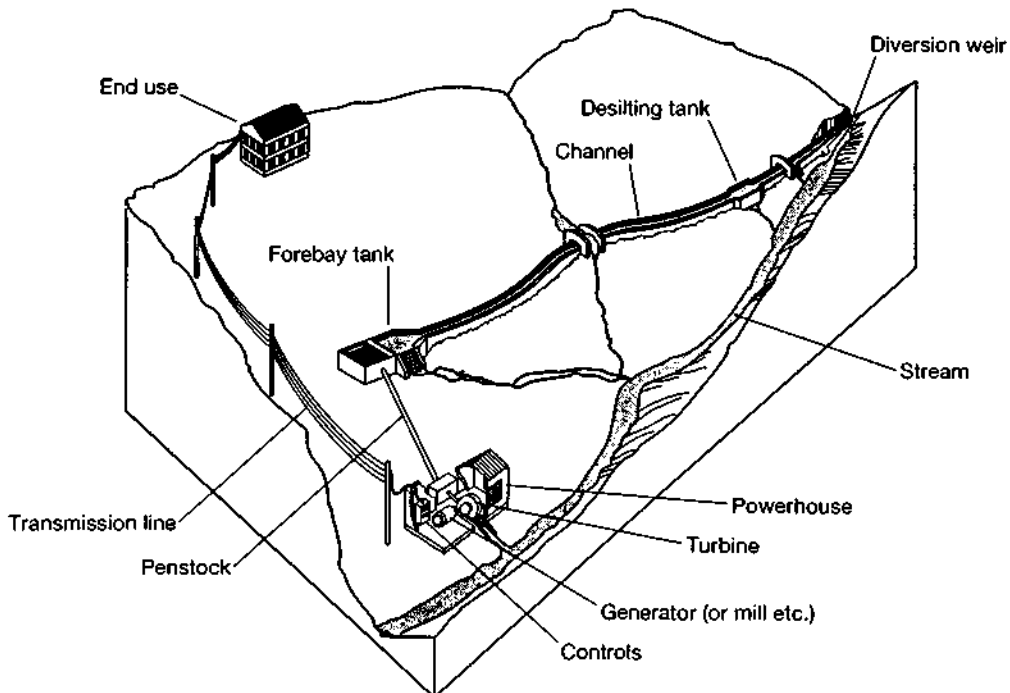

Figure 3. Components of a micro-hydro scheme

of the organizations specializing in micro-hydro power are listed at the end of this section.

This introduction does, however, give sufficient information to allow careful consideration of the micro-hydro option when a small-scale energy source is needed, along with information on suppliers worldwide, and some ideas as to how to go about obtaining further help.

## GENERAL PRINCIPLES

The three categories of water power devices covered here are: water turbines (used here to mean conventional turbines using falling water), water current turbines and hydraulic ram pumps.

### Water turbines

If water falls or is led from a higher level to a lower level, then the resulting flow of water can be used to do some work. Normally, a pipe (or penstock) is used to lead the water down a slope, and this results in a flow of water under pressure. If the water is allowed to move some form of turbine, then the pressure is converted into mechanical power and can be used to drive a generator or a grain mill or some other useful device (Figure 3).

To calculate the amount of power generated, you first require two measurements:

- The vertical height difference through which the water falls is called the 'head'. It is usually measured in metres or feet.
- The flow rate in the pipe is the other important quantity and is usually measured in cubic metres per second or cubic feet per second.

The power output is simply a product of head, flow, and the gravitational constant,  $g$ . In practice, some of the energy is lost as heat (Figure 4), so an efficiency is introduced,  $e$ .

The formula, in SI units, is therefore:

$$\text{Power output (W)} = \text{Mass flow (kg/s)} \times \text{Head (m)} \times g \times e$$

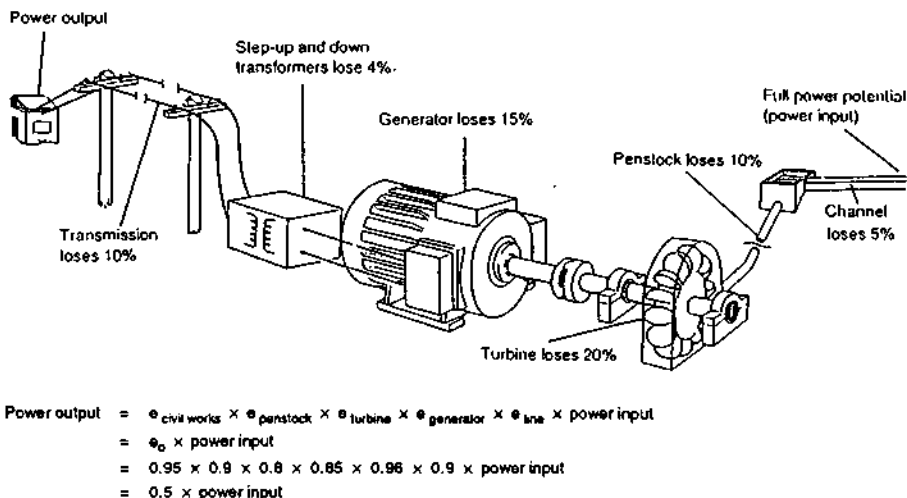

Figure 4. Typical efficiencies in a hydro system generating electricity (direct-drive mechanical applications have fewer inefficiencies)

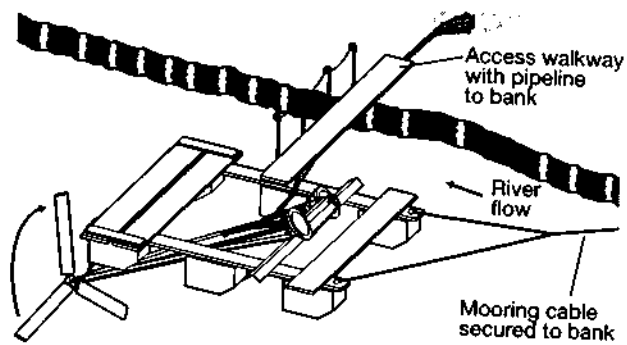

Figure 5. Submerged propeller water current turbine

One cubic metre of water weighs 1000kg and 1kW is 1000W, so we can rewrite the equation:

$$\text{Power output (kW)} = \text{Flow (m}^3/\text{s)} \times \text{Head (m)} \times g \times e \quad (\text{m/s}^2)$$

For initial calculations, an overall efficiency of 50 per cent is a good approximation, and  $g$  can be taken as 10, giving:

$$\text{Power output (kW)} = \text{Flow (m}^3/\text{s)} \times \text{Head (m)} \times 5$$

### Water current turbines

Water current turbines (Figure 5) use the kinetic energy of fast-flowing streams or rivers. A large head is not required. Power is dependent on the area of the turbine impeller which is exposed to the flow (the swept area), the velocity of the river current, and a coefficient of performance. This can be simplified to the following formula:

$$\text{Power output (kW)} = K \times \text{Swept area (m}^2) \times [\text{Velocity (m/s)}]^3$$

$K$  is a factor which includes efficiency and should be available from manufacturers. It usually lies in the range 0.03 to 0.08.

## Hydraulic ram pumps

The hydraulic ram pump or 'hydram' combines the functions of a turbine and a water pump into one simple unit. Water is led down a pipe as in the case of most turbines, but the resulting flow is periodically stopped by means of the impulse valve. This rapid valve closure causes a pressure surge, known as water hammer. Another valve called the delivery valve opens near the peak of this pressure surge and allows a small portion of the water through to the high pressure side of the device. From here the water is led by the delivery pipe to the higher point where the water is required.

The pressure surges limit the size of hydrams to a few hundred watts per unit, but units can be operated in parallel for larger outputs. At powers of under 500W, hydrams are generally cheaper to buy and maintain than the equivalent pump-turbine set, and will operate at similar or better efficiencies.

The overall efficiency of most commercially available hydrams is at least 50 per cent. Therefore, if the pumping load is found in kilowatts, the general water turbine power output formula given above can be used to see what flow is needed to drive the hydram (or hydrams), given the head available at the site. Hydram manufacturers generally supply tables which allow simple selection of a machine.

## COMPONENTS OF WATER POWER SCHEMES

Micro-hydro, water current turbine and hydram schemes share many common components. As micro-hydro schemes incorporate most of the shared components, these are covered first in this section.

### Micro-hydro schemes

The components of a micro-hydro scheme are usually split into two categories: the civil works, which are the



Hydraulic ram pump

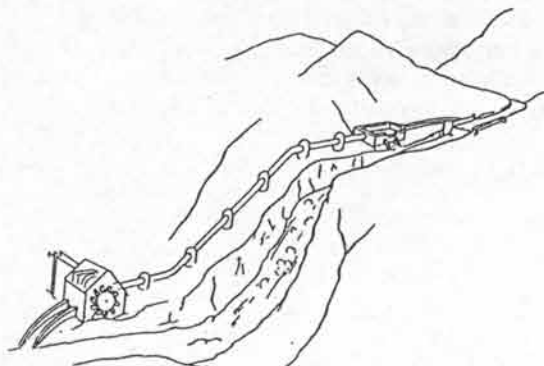

(a) High head with no channel

Figure 6. Common layouts for micro-hydro schemes

buildings and structures, and the electro-mechanical parts, which are the machines and electrical equipment. Figure 6 shows some common layouts of schemes.

### Civil works

#### Weir or dam

Dams store water for long periods, whereas weirs divert water directly from the stream to the intake (Figure 7). Dams are usually relatively high structures, while weirs simply seal and regularize the stream bed to allow water to be diverted. In rocky streams natural weirs are often used for micro-hydro intakes.

Dams are rarely built for micro-hydro alone, but sometimes a small dam is used to integrate micro-hydro power generation with flood control and irrigation schemes, as is often the case in China. In some cases, micro-hydro schemes are fitted to irrigation or water supply dams, or used to provide 'compensating' flow – the minimum flow specified by the regulatory boards to safeguard fish and plant life downstream of the dam.

#### Intake

This is the structure which takes water from the weir or dam and leads it to the next component, usually the headrace channel. It has to regulate flow – usually by gates and spillways – in all conditions, including floods.

#### Settling tank

Also called the desilting tank, this removes sand and stones from the water. These will otherwise cause blockages and wear. In certain layouts, settling occurs in the reservoir or in the forebay tank (see below), and the settling tank can be omitted.

#### Channels

Also called canals, leats, or headraces, these are often earth-lined, but difficult terrain or soil conditions may dictate that concrete-lined channels be used. Locally available irrigation technology and expertise is often adapted and used in building channels. Figure 8 shows some channel types.

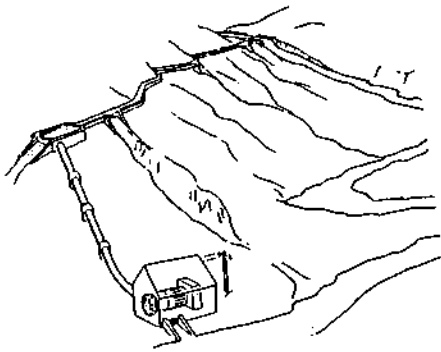

(b) High head with channel

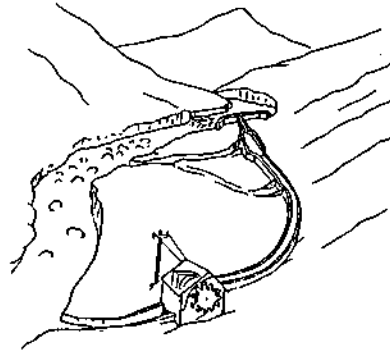

(c) Low head with channel

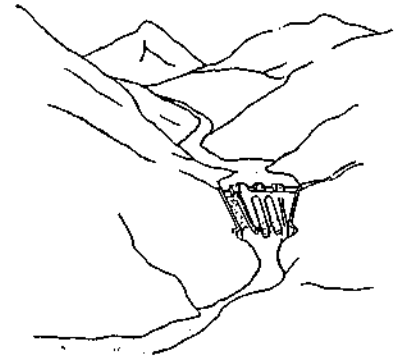

(d) Low head river barrage

### Forebay tank

This is the name given to the tank which connects the channel to the top of the penstock. It can be as small as a one metre cube, but in most cases it incorporates desilting, as with a settling tank, and a trash rack, or leaf screen, which removes floating debris such as leaves and twigs. A typical size for a  $0.1\text{m}^3/\text{s}$  flow is approximately 4m long, 2m deep and 1m wide.

### Penstock

This is the name given to the pressure pipe which carries water to the turbine. On small, high-head schemes it can be more than 30 per cent of the total cost, making correct design important. Common materials are steel, cast iron, plastics (PVC and HDPE) and concrete. In micro-hydro, diameters vary from around 50mm to around 600mm.

### Powerhouse

The powerhouse contains the turbine, the generator (or grain mill or other driven machine), and the control equipment. It is normally situated just above the

flood level of the stream. On very small schemes (less than 1kW) this often takes the form of a box with a removable lid. On larger schemes it might be a building with two or three rooms, housing the electro-mechanical equipment, and providing accommodation for the operators. The penstock leads the water into the powerhouse, and a channel, often concrete-lined at its start, leads water away from the powerhouse and, in most cases, directly back to the stream.

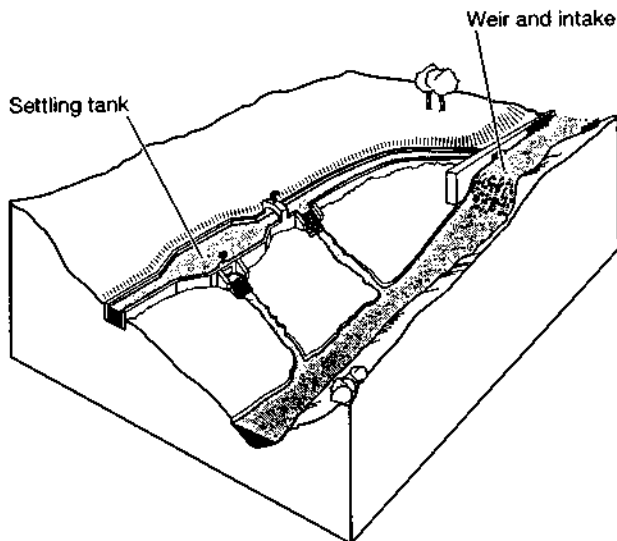
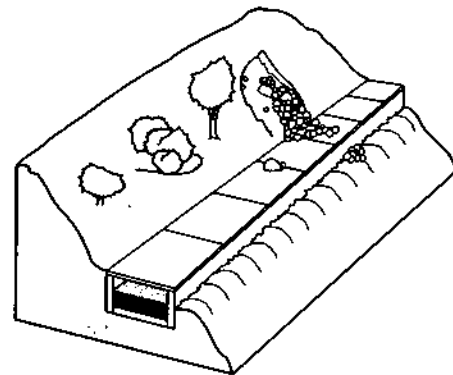
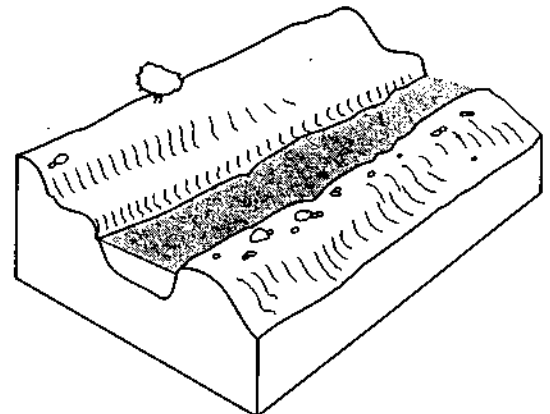

Figure 7. Weirs divert water directly from the stream to the intake and settling tank



(a) Concrete channel with concrete slab covers for protection against falling debris



(b) Earth channel, or unlined channel

Figure 8. Channels may be unlined where conditions allow

## Electro-mechanical equipment

### Turbines

The turbine is the most specialized piece of equipment listed here and the main subject of the manufacturing lists in later pages. The following brief descriptions include comments on ease of manufacture, and efficiencies at the maximum design flow (full flow) and at flows below this (part flow), which may be encountered in drier periods in some systems. Many schemes are designed to use less than the minimum flow of the stream, making part-flow efficiency irrelevant.

The turbines are listed in order of their suitability for different heads of water, starting with a 'zero head' machine, the water current turbine, and ending with the highest-head type of machine, the Pelton.

Large turbines are designed to established engineering guidelines, as each machine is purpose built. Micro-hydro turbines, on the other hand, are often produced in batches, and one type of turbine can become popular in a certain area. Thus a crossflow machine might be selected in Nepal, while a Pelton machine would be chosen in Sri Lanka for the same head and flow. The choice of machine is therefore often left up to the manufacturer (see Figure 10). It is wise, however, to be aware of the characteristics and limitations of the various machines.

### WATER CURRENT

Various machines are made to extract power from the current of fast-flowing streams without the use of diversion weirs. This is an attractive solution for many situations, but performance is heavily dependent on the water velocity. Output powers are usually modest (less than one kilowatt) and often used for water lifting or battery charging. All designs take the form of either a modified undershot water-wheel, or a submerged propeller (see Figure 5, page 125).

### WATER-WHEELS

Water-wheels fall into three groups – overshot, undershot and breastshot wheel (Figure 1). Overshot machines tend to have the highest efficiencies, which can be as much as 60 per cent. Water-wheels move slowly,

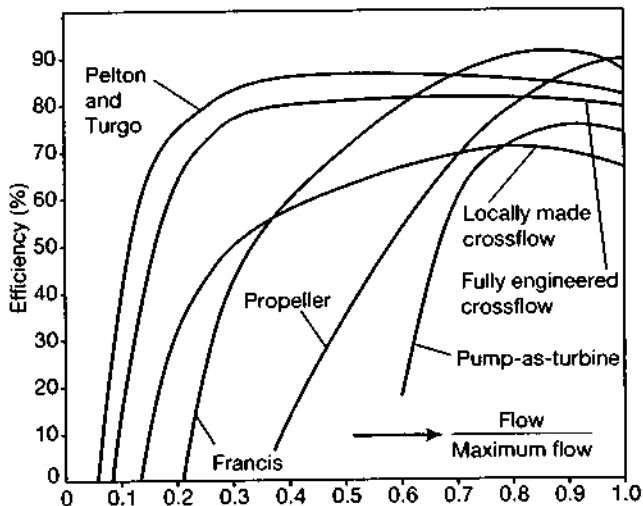

Figure 9. Part-flow efficiency of various turbines, assuming turbines can vary water flow rate at constant head

generating modest powers but high torques (turning forces), which tend to lead to massive transmission systems. Where low-speed machines such as mills are used, this is not a problem but, for modern, high-speed machines such as alternators, water-wheels are often ruled out because of the cost of the mechanical transmission. Advantages are ease of manufacture, simplicity, and tolerance of silt and debris. Typical heads range from 0.5m to 3m.

### PROPELLER AND KAPLAN

Also called axial flow turbines, these machines consist of a propeller-shaped runner rotating in a tubular case. The rotating part of a turbine which is in contact with the water is the runner. The propeller turbine is the more simple variant. It is termed a fixed-geometry machine because neither the propeller blades nor the guide vanes pivot.

The Kaplan is a propeller with movable guide vanes and pivoting blades. A Semi-Kaplan has movable guide vanes or blades and performance characteristics between those of propellers and full Kaplans. Peak efficiencies and part-flow efficiencies of Kaplans are good, but those of fixed geometry machines are less good. The cost and complexity can be high, but there are simplified designs on the market and under development. A draught tube is always used. This is a specially shaped tube which leads the flow from the runner to the tailrace (the channel leading water away from the turbine). Various configurations are possible, as shown in Figure 11. For micro-hydro, heads usually range from 2m to 10m. Good control of silt and debris is necessary to avoid wear and blockages.

### FRANCIS

The Francis or radial flow turbine can be designed to cover a wide range of head and flow conditions. Heads, for example, can range from 4m to 70m. The runner is fully immersed in water and both the pressure and the velocity decrease from inlet to outlet. Movable guide vanes are used to direct the flow correctly under a range of flow conditions (Figure 12). Machines are sometimes arranged as double entry (or exit) or 'back to back' turbines. Peak efficiency

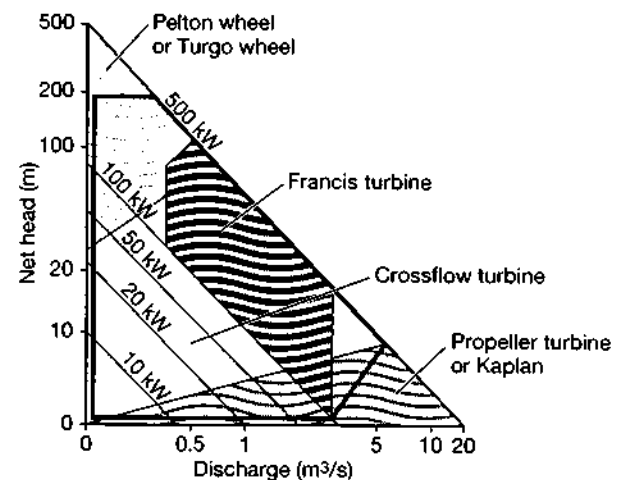

Figure 10. Typical manufacturer's selection chart (each manufacturer will have different ranges for different machines)

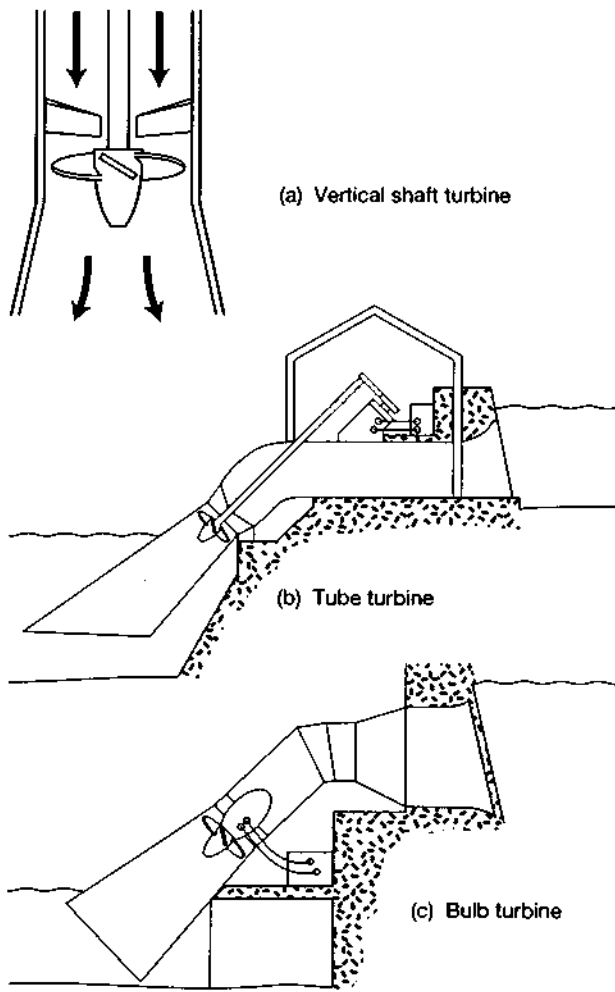

Figure 11. Axial flow turbines

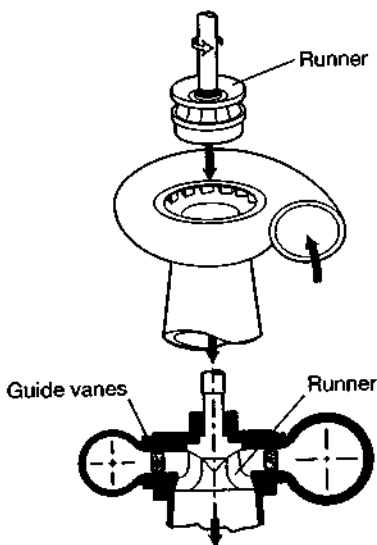

Figure 12. The Francis or radial flow turbine

is usually high and part-flow efficiency can be good down to 50 per cent, but usually falls off sharply at lower flows on small machines (Figure 9).

Construction is not simple and usually involves complex castings, which makes small machines uncompetitive in some countries. Francis machines are often designed specifically for one site, a practice which makes them expensive, but which usually has the advantage of allowing direct drive to the alternator, eliminating the need for a belt drive or gearbox. Small clearances in the machine mean that reliable silt and debris control are required to avoid rapid wear.

#### CROSSFLOW OR MICHELL-BANKI

These machines are widely used in micro-hydro, mostly because of the ease of manufacture and access to designs. No casting is needed for most designs, and machines are commonly built in simple workshops. Crossflows tend to have moderate efficiencies at peak flow, with part-flow efficiencies dependent on the particular design used.

Water enters via a rectangular nozzle, usually regulated by a valve (Figure 13). The jet of water then flows through the runner. Draught tubes are sometimes used. Typically, heads range from 7m to 60m.

#### PUMPS-AS-TURBINES (PATs)

Also called reverse pumps, PATs are centrifugal pumps used as turbines. Many manufacturers have run test programmes on their pumps and can supply them as turbines. It is also possible to predict the performance of a given pump.

Advantages are availability, low cost and compact layout. Servicing can be carried out by pump suppliers, who are usually far more numerous than turbine suppliers. Direct coupled motor pumpsets can be run as turbine generator sets, by arranging the motor to be run as a generator. Peak efficiencies range from low to quite high, falling off sharply with reduced flows (Figure 9). Heads in the range 15m to 80m are most common.

#### TURGO

This machine is quite close to the Pelton in characteristics, but runs a little faster in any given situation,

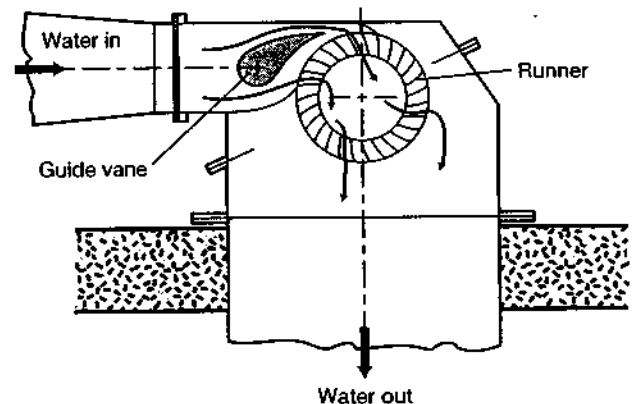

Figure 13. Crossflow turbine



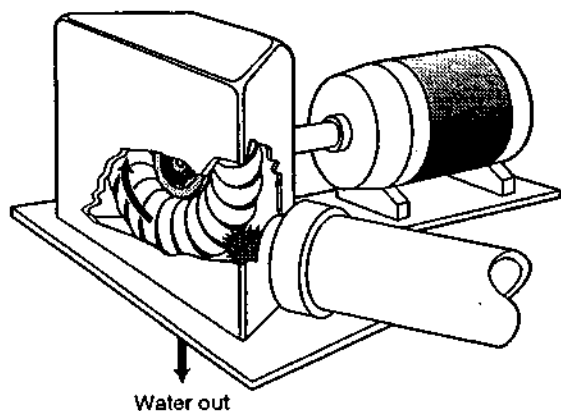

Figure 14. Turgo turbine

making it more suitable for lower head sites. Heads range from 20m to 100m. Traditional vertical axis water mills use an early version of this design. Water flows across the runner, as shown in Figure 14, at an angle of around 20 degrees. One- or two-jet machines are common. Flow control is by a spear jet valve which can be omitted to save cost where not needed – for example, where there is always enough water available and load control governing (see below) is used. Traditionally, runners are made from a single complex casting, but approximations to the Turgo have been successfully fabricated in Nepal and are being copied elsewhere. Peak efficiencies are quite high, with good part-flow performance.

#### PELTON

This machine is used where there are high heads. The water jet strikes the concave side of a pair of spoon-shaped buckets and is exhausted on either side of the wheel. The buckets are cast and fixed to the hub, or the wheel is cast in one piece. Traditionally, a spear valve was used to vary flow while maintaining the shape of the jet. With the advent of load control governing, multi-jet machines with horizontal and vertical axes have become common. These designs do not use spear valves for flow control as, by opening various

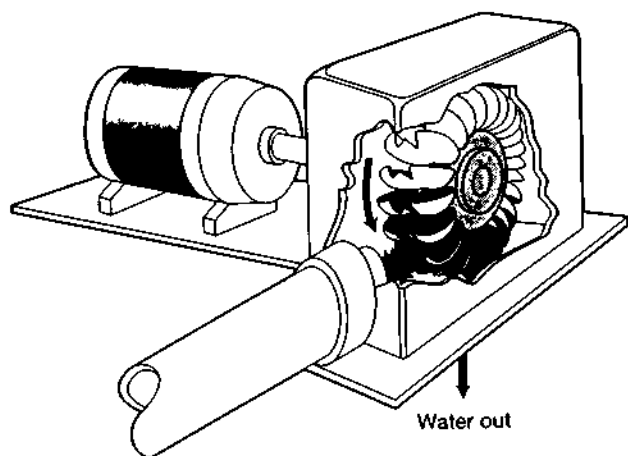

Figure 15. Single-jet Pelton turbine

combinations of jets, sufficient flow control is available. This reduces cost and makes for ease of local manufacture. Multi-jet machines are used on heads down to 20m. For heads above 100m, single-jet machines are more commonly used (Figure 15).

Peak and part-flow efficiencies are among the best for small machines (Figure 9). Peltons are relatively robust and more tolerant of silt and debris than most designs.

#### Governors

Without a governor, the system is subject to speed variations with changes in load. Some systems, such as battery chargers and grain mills, function well un-governed. Most larger systems and most AC electrical systems require their speed to be kept more or less constant under all conditions, and so use governors.

There are two main types of governors – flow control and load control. Flow controllers alter the flow of water to match power demand. Load controllers maintain speed by varying the amount of power fed to a ballast or dump load. A ballast load usually consists of a bank of water-cooled elements, capable of absorbing the full power of the system when no other load is connected. Load controllers can only be used with electrical systems. As a general rule, they are used where possible because of the advantages of cost, accuracy, and reliability. Where significant water storage is built in to a system, flow control should be considered.

Electrical schemes normally use automatic cut outs, fuses and trips to protect users and equipment. Lightning protection is often needed.

#### Driven machines

There are, of course, various machines connected to micro-hydro turbines, most commonly agro-processing equipment such as mills, expellers and hullers. Catalogues to help with the purchase of this equipment are available. Many systems are used to produce electricity by driving a generator, and a brief outline of these machines is given here.

There are three common types of generators used in micro-hydro.

#### VEHICLE ALTERNATORS

Vehicle alternators are often used in very small installations (under one kilowatt), designed for battery charging. They are easily available and well understood, but are not designed for continuous operation and so can have limited lives.

#### SYNCHRONOUS ALTERNATORS

This is the conventional choice for any AC system which is not connected to the grid. Advice must be taken from literature or from turbine and alternator manufacturers to make sure that the alternator is suitable for use with the overspeed (the runaway speed reached by the system should the governor fail), humidity, altitude and control system of a proposed installation.

#### MOTORS AS GENERATORS (MAGs)

Also called induction generators, these are standard or modified induction motors used as generators. In many cases, they are used for schemes connected to the grid, and recently, with developments in Induction

Generator Controllers, they have become useful for stand-alone schemes. MAGs are very robust and widely available and, up to around 20kW, often the cheapest option.

### Transmission lines

There is often a need to transmit the electrical power generated from the powerhouse to a particular place (the load centre), which may be a village or a factory. This is usually counted as part of the micro-hydro system.

Electrical transmission is either by overhead line or by underground cable. Overhead is usually cheaper, but can involve significant maintenance costs. Transmissions over distances of more than a few hundred metres sometimes use transformers to increase the voltage along the line, and so reduce the cable size and cost.

### Hydraulic ram pump schemes

Hydrum systems (Figure 16) have broadly the same weirs or dams, intakes, settling tanks, channels, fore-bay tanks and penstocks as micro-hydro schemes. Hydrum penstocks are generally termed 'drive pipes', however, and are designed on different criteria. They need to be sufficiently rigid and strong to transmit water hammer pressure surges.

The hydrum unit is fitted to the end of the drive pipe. From here most of the water will be exhausted into a tailrace, but a proportion will be diverted into the high pressure side of the pump, and from there to the delivery pipe, which is the name given to the pipe connecting the hydrum to the point of use of the pumped water. There will normally be a storage tank at this point.

### Water current turbines

Water current turbines have to be placed in a canal, stream or river at a point where the flow velocity is high. Normally this is done by floating the turbine on a raft, and anchoring this to the shore. The raft and turbine are sold as one unit. The driven machine, a pump or a generator, is mounted on the raft, and the water or electricity delivered to the shore by a pipe or cables.

## APPLICATIONS

In order to demonstrate the application of small water power systems, a selection of work in various countries is described here.

### China

China has long been the world leader in terms of the number of modern micro-hydro systems installed. Around 80000 systems have been installed in recent years, with an average power of around 40kW. They are used mainly for generating electricity in rural areas, which in turn is used largely for agro-processing and domestic lighting. The machines tend to be heavy, and to make use of castings for the major components. Since the early 1980s, Chinese machines have appeared on the international market, and this exposure has led to the development of electronic load control governing, and technology transfer packages.

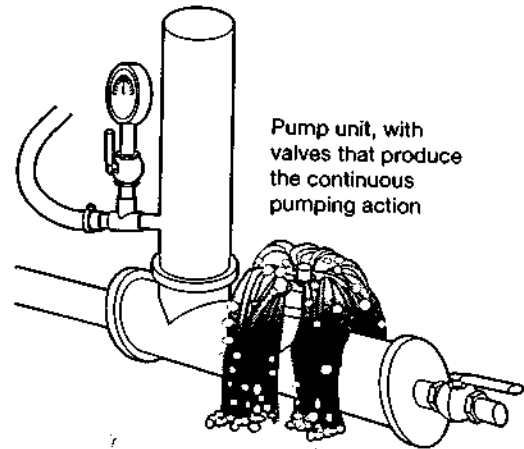
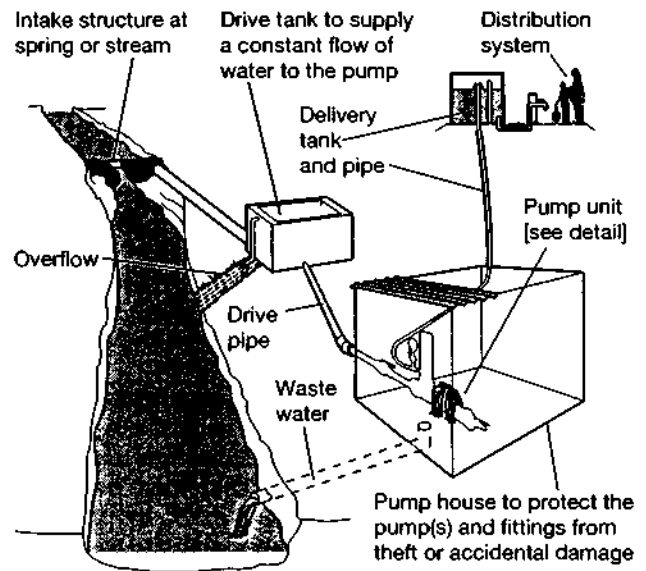

Figure 16. Components of a hydraulic ram pump scheme

Load control governing has not been widely used in China, partly because of poor availability of power electronic components, and partly the result of a policy of using manual control initially for small schemes and then linking them in to local 'mini-grids' as soon as they are developed.

### Nepal

There are several thousand vertical axis Norse (Himalayan) water mills in Nepal. Since the mid 1970s larger, modern machines have begun to appear. As well as taking advantage of modern materials and designs, these machines, which are mostly crossflow and Turgo devices, have been able to drive a number of different machines. Most older designs can only accomplish one task, such as grain milling. This limits the plant factor (see Economics on page 134) and thus the profitability of these machines.

One more recent successful machine is known as the multi-purpose processing unit, or MPPU, to emphasize this capability. The crossflow machines are made by around nine local manufacturers and are mostly used to drive oil expellers, rice mills, and grain

mills, via interchangeable belt drives. Since the early 1980s, alternators have sometimes been added to the systems, and more recently, all-electric schemes, where all loads are electrically powered, have become popular.

This process has been helped by initiatives from national and international organizations who have supported training, technology transfer, technology development and subsidy and credit schemes. This has helped the infant industry to develop, and to compete with other forms of rural energy which are often either subsidized or, as in the case of fuelwood, not costed financially.

Hydraulic ram pumps have been manufactured in Nepal in small numbers since the early 1980s, benefiting from technical development mechanisms similar to those used by micro-hydro. They have been used mainly for domestic water supply in the mountainous regions of the country. Unlike electricity or milling services, water is not traditionally sold in Nepal, so the issues of ownership and maintenance are less straightforward. Over the years, the market has concentrated more on higher head devices, usually delivering water to heights of at least 100m, and sometimes 180m, above the pump. These sites save considerable amounts of time for villagers, which provides a strong incentive to ensure good maintenance.

## Peru

Peru has a widely scattered population, many of whom have access to good micro-hydro sites. Experience with small diesel sets is marred by maintenance problems and so there is a general willingness to consider alternatives.

Like Nepal, Peru has several thousand traditional

vertical axis mills, and countless other slightly larger machines driving coffee processors, textile mills and other rural industrial activities. Many of these larger machines did not survive the land reform of the 1970s, and the small mills now have to compete with mills powered by cheap local diesel fuel. However, recent developments have led to more manufacturers becoming involved in hydro power generation and some new designs being transferred and adapted. Electronic load controllers have become more common, and manufacturers, benefiting from modern, low-cost designs made possible by these governors, and from Peru's excellent casting facilities, are supplying to small co-operatives and to local governments. The harsh economic climate has not yet allowed these developments to become widespread, however, and many schemes depend on development organizations for access to capital.

## ESTIMATING THE POTENTIAL OF A SITE

The first step in deciding whether water power is a good option is to estimate the hydraulic power available and then to compare this with the demand.

Estimation of demand is covered in the introductory sections of this catalogue. Hydro often cannot be expanded to meet a demand which is expected to grow with time, so this aspect should be checked carefully, along with the characteristics of the load. The next section covers some of the economic implications of powering various loads with hydro.

To estimate the available water power it is necessary to find values for head and flow for micro-hydro and hydrams, and the speed of the flow for water current turbines.

## CASE STUDY: ELECTRIFICATION OF BARPAK

Bir Bahadur Ghale is a 22-year-old entrepreneur who lives in the village of Barpak, which is two days' walk from the road, in the Himalayan foothills of West Nepal. A few years ago he began to get tired of the way that success in his village was judged in terms of recruitment by a foreign army. Bir Bahadur resolved to do something in his own village and built a 60kW hydro plant to provide electric power to Barpak.

The village has more than 600 houses and is inhabited by Gurungs and Ghales, clans that have a tradition of enlisting in the Gurkha Brigades of the British and Indian Army.

The plant has been running since July 1991. To construct it Bir Bahadur used:

a grant from the government:	Rs 500 000
a loan from the Agricultural Development Bank of Nepal:	Rs 1 500 000
and made a personal investment of:	Rs 800 000
to make a total of:	Rs 2 800 000

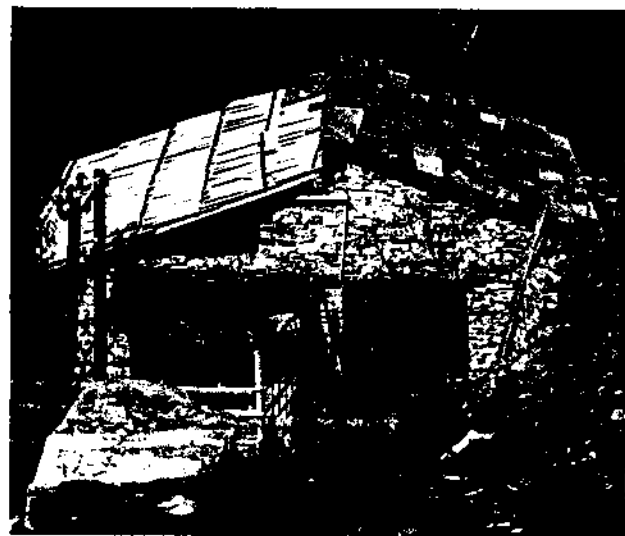

*The powerhouse at Barpak*

## Head measurement

There are many methods for measuring head. Conventional surveying methods can be used but may be rather slow and expensive for initial surveys.

For heads greater than 50m, a large-scale map is often the best starting point as it allows the scheme to be laid out, perhaps looking at one or two different options for the position of the various components. Where this is not available, an inclinometer or Abney level is a good option. Surveying altimeters give fast results, but experience is required to obtain reliable results.

For measuring heads of less than 50m, builders' levels become feasible. One of the most foolproof methods is to attach a pressure gauge to a 20m length of flexible tubing. This is then filled with water and laid out along the proposed penstock route. The gauge can be calibrated by using a tape and a suitable drop (a stairway or a balcony, for example) for more accurate work. If none of these methods is well known, then consult more detailed literature or resort to a professional survey.

## Flow measurement

Unlike head, flow varies with time. In many cases an indication of the minimum flow in the stream under consideration is enough for the initial viability assessment.

The float method for flow measurement is a quick way of getting a first approximation (see Figure 17). If this result does not immediately invalidate the site, then it is necessary to look at the hydrology of the stream. A basic step is to check whether there is a long dry season. A measurement taken towards the end of this period will give more information to help choose a design flow. Another step is to talk to irrigation

engineers and hydrology departments. There will often be a tried and tested method, perhaps based on catchment area and rainfall or on comparison with larger gauged streams nearby. A gauged stream or river is one which has a flow measuring station or gauging station somewhere along its length.

Information from people living near the stream should also be taken into account, but interpreted with care as enthusiasm can distort memories.

## Current speed measurement

In the case of a water current turbine installation, only the speed of the stream or river needs to be found. This is best done by float tests at the proposed site in the season when the machine is to be used. This involves using floats to determine speed, exactly as in the float method (Figure 17).

## Power estimation, micro-hydro and hydram

With an estimate of head and of flow it is possible to produce a figure for power by using the simple equation described earlier:

$$\text{Power (kW)} = 5 \times \text{Flow (m}^3/\text{s)} \times \text{Head (m)}$$

## Power estimation, water current turbine

The equation for water current turbines is:

$$\text{Power (kW)} = K \times \frac{\text{Swept area (m}^2\text{)}}{\text{(m}^2\text{)}} \times \frac{[\text{Velocity (m/s)}]^3}{\text{(m/s)}}$$

The performance coefficient  $K$  must be obtained from manufacturers, but a figure of 0.07 can be used for initial estimates.

The swept area is that area of the rotor which is at right angles to the water flow.

He has distributed 30kW so far and is in the process of extending his transmission line to include the remaining houses. He runs a mill powered by a 5kW motor at his own house. The mill runs for 18 hours a day and earns him as much money at present as his sales of electricity.

With an interest rate of 18 per cent, the income from milling and sales of electricity is just enough for him to pay the interest and some of the capital on his loan to the bank after covering his running costs. Bir Bahadur hopes that with the extension of his transmission line will come increased sales of electricity, and the returns on his plant will further improve.

The plant was built by Kathmandu Metal Industries (KMI) and Nepal Power Producers (NPP), micro-hydro equipment manufacturers and installers in Kathmandu. It uses a gross head of 100m and a flow of 0.12m<sup>3</sup>/s. The turbine is a two-jet Pelton manufactured in Kathmandu. Controls on the system are an electronic load controller, over- and under-voltage trips, and a jet deflector, all assembled in Kathmandu. The alternator was imported from India. The overhead transmission line runs at 11kV, using trans-

formers from another company in Nepal. Bir Bahadur constructed the canal, the intake and the other civil structures that were necessary. KMI and NPP erected the penstock, installed the turbine and alternator, erected the transmission line and distribution lines, and commissioned the plant.

In addition to lighting and milling, Bir Bahadur has plans to use the power from his mill for making rice paper in his village – an activity that has not been practised before in the village because of the large amount of firewood that is required to make paper. He also wants to start a furniture factory for more efficient use of timber in the village. More ambitious plans include a ropeway to reduce the village's transport costs from the road head which is four days' portering distance away.

Demand for electricity in the village seems likely to keep growing for some time. When the power from this plant becomes a constraint, Bir Bahadur has an additional 100m of head below this power plant which is expected to produce another 60kW.

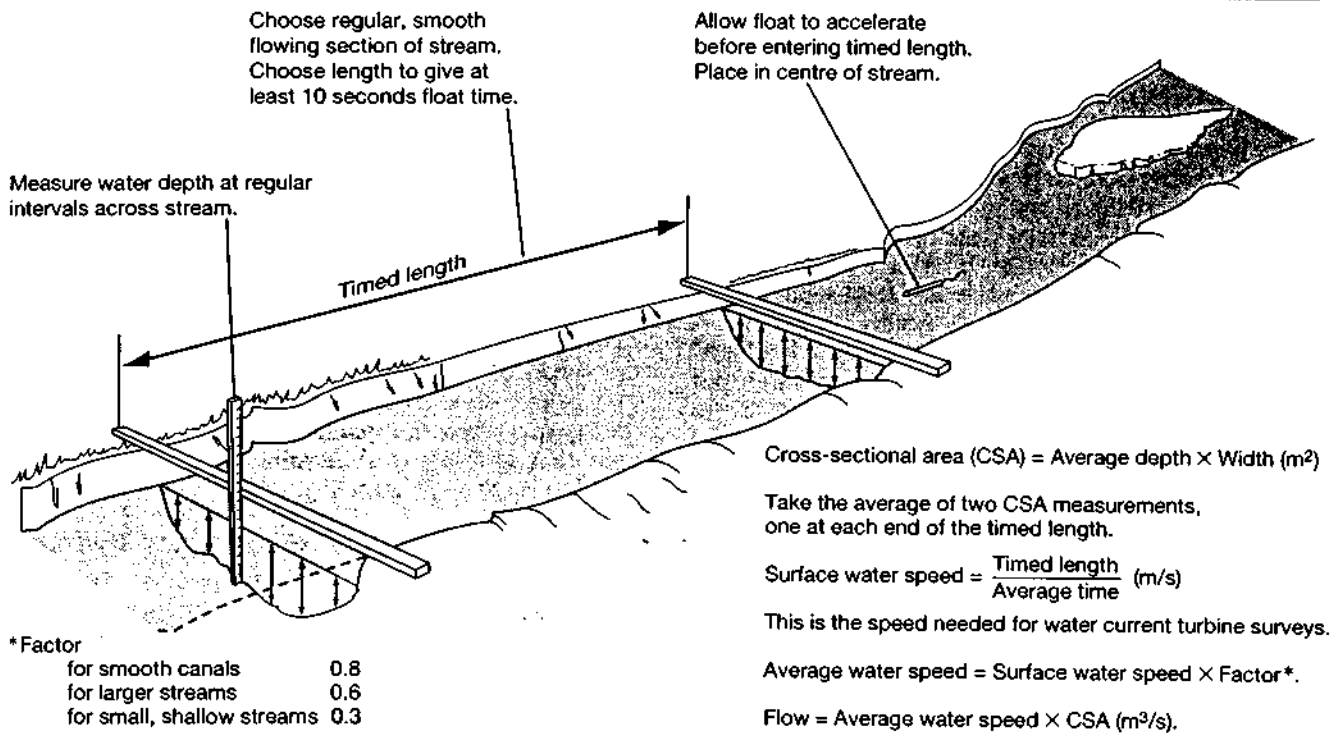

Figure 17. The float test

The next step is to estimate the cost of the scheme and to compare both capital cost and running cost with the various alternatives available.

## ECONOMICS

While it is difficult to provide precise data, it is possible to show some general approaches and relationships to help the analysis of the costs and benefits of water power schemes.

### Scale effects of micro-hydro

Experience has shown that while costs per kilowatt for large hydro begin to rise steeply for installations of below 1MW, the cost/kW of micro-hydro follows a different pattern (see Figure 18).

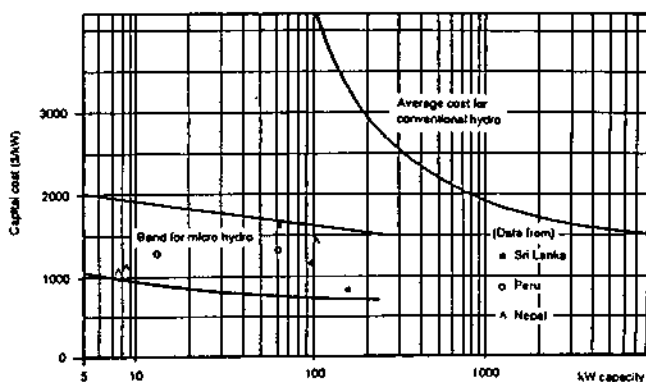

Figure 18. Micro-hydro's economy of scale: overall costs of a number of micro-hydro schemes compared to larger schemes

The fixed costs, such as surveying, designing, specifying and supervising the installation of micro-hydro schemes, are not very sensitive to changes in power within a range of, say, 20–50kW. In areas where expertise is expensive, these fixed costs can be significant – up to 25 per cent of total cost. This can lead to a significant economy of scale effect, where a doubling of power installed may only increase costs by, say, 30 per cent.

Where expertise is relatively cheap, then fixed costs may be only 10 per cent of the total (see Figure 19). Most of the hardware costs of micro-hydro schemes are strongly dependent on installed power. Penstock costs, transport costs, transmission line costs and channel costs are all very sensitive to changes in installed power, for example. Turbines, drives, alternators and control systems do exhibit an economy of scale effect, particularly at powers below 100kW. Table 1 shows the approximate cost of turbines calculated from data in this catalogue. These costs are for turbines only, without governors, alternators or drive systems.

Table 1. Costs of turbines (US\$'000)

Power output (kW)	Crossflow	Pelton	Pump-as-turbine	Francis
1	0.5–1	0.5–1	0.4–1	3–6
5	1–4	1–5	0.8–2	8–12
20	2–10	3–15	4–10	10–15
100	5–40	15–60	10–40	20–60
300	12–120	30–130	50–130	60–150

In general, where the site allows, it is worth costing an alternative with a larger power than is immediately necessary to allow for future expansion. Mistakes have been made, however, when the part-flow efficiency of the scheme has not been considered. A 100kW installation may not cost much more than a 70kW installation, but it may produce only 30kW in the dry season where the smaller machine, working at a different part of its efficiency curve, may produce 40kW.

### Scale effects of hydam and water current systems

Hydam systems are similar in this respect to smaller micro-hydro schemes, and in many cases suffer relatively high fixed engineering and installation costs, as hardware costs can be low. Hardware costs do increase with installed power, however, and this may become important in countries where engineering costs are generally low.

Water current systems require far fewer engineering inputs than the other forms. Survey work is very simple for assessing the resource, and installation is simply a matter of final assembly and launching of the raft unit. Costs tend to increase in rough proportion to the size of the turbine runner, but the cost/kW depends very much on the strength of the current at the chosen site.

### Load characteristics

Once a water power scheme is installed, the running costs do not vary with the amount of energy used. Indeed, most electrical schemes suffer effects such as condensation and corrosion more when they are shut down than when they are in use. This is why uses such as milling, battery charging or tea processing, which provide a steady load, often for 24 hours a day, are more common than carpentry shops or crop driers, which provide more intermittent loads.

The characteristic of a load can be expressed as a plant factor. This is the percentage of energy available which is actually used (see Figure 20).

Typical plant factors for mills or tea factories are in the 40 to 50 per cent range. When the plant factor

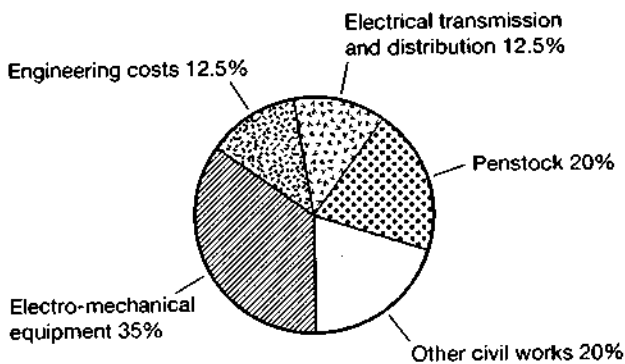

Figure 19. Cost breakdown of typical micro-hydro scheme

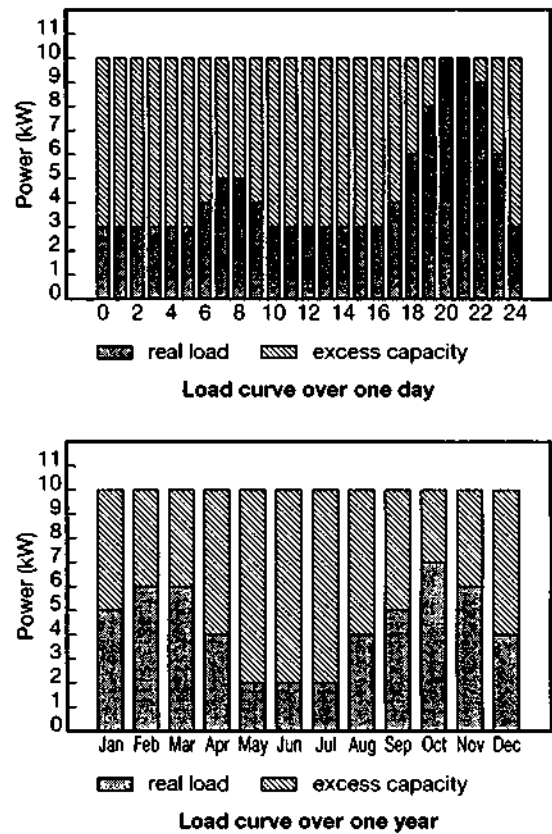

Figure 20. Plant factor: the relative amount of energy which is generated in relation to the total which could be generated over a certain period

drops below 15 per cent it is rarely viable to use micro-hydro, and diesel engines become a cheaper option.

It is sometimes possible to influence plant factors, much as the big utilities do in many countries, by introducing split tariffs. These encourage the use of energy at 'off peak' times, when demand for energy is low. This leads to the use of timers and storage heaters in some systems. In less complex systems, the rearranging of loads (load management) is equally effective. Milling is stopped during the evening when domestic loads are high, for example, or factories work two shifts rather than increase their capacity. In the case of hydam systems, or any water pumping scheme, careful sizing of the storage capacity at the point of use is important in keeping plant power low and plant factors high.

### Running costs

Although there are no fuel costs in water power, and often only a few moving parts, their remote location and small numbers in many cases lead to unexpectedly high running costs. This is especially true of rehabilitated micro-hydro schemes, where repairs tend to be expensive. A figure of 10 per cent of the total capital cost per year is a safe starting point.

Labour costs have exceeded revenue in some micro-hydro schemes, due to over-staffing. This is particularly common where schemes are run by large,

---

centralized organizations, who might use staffing structures designed for larger schemes. Most electrical schemes below 100kW do not justify having any full time staff, and are best designed to be unattended.

### **Hydrams – special considerations**

Hydrams present a different set of economic constraints, in most cases, as the end product, water supply, is often not metered or sold. Viability is usually tested against other alternatives, such as gravity fed systems, or hand-pumps. Hydrant systems are often very simple to maintain but, in common with many other small water supply systems, maintenance is often difficult to arrange, and emphasis on this is needed for hydrants to succeed alongside more familiar technologies.

Hydrants have proved particularly successful in systems with high delivery heads, where the labour or cost savings made by the system are significant enough to support a good maintenance programme.

-  
*Andy Brown,  
Dulas Engineering, UK*

# WATER-WHEELS AND TURBINES

**WATER-WHEELS AND TURBINES.** A water-wheel or water turbine may be defined as a prime mover in which the potential energy of a body of water is transformed into mechanical work. The water-wheel, also commonly called a *hydraulic motor*, is in its various forms one of the simplest devices for the development of power, and dates from prehistoric times. While improvements have been made from time to time to meet the requirements of changing conditions, the most important advancement along this line has taken place within the last few years, due to the rapid increase in the number and size of hydroelectric plants.

**Preliminary Considerations.**— Before taking up the construction of the hydraulic motor, it is necessary to become familiar with the principles involved in the changing of stored energy into work. These principles, to a certain extent, are common to all prime movers, and are described in detail in the articles relating to STEAM ENGINES and STEAM TURBINES. As the subjects of *potential* and *kinetic energy, action, reaction*, etc., apply to the operation of water-wheels and turbines in much the same way as they do to steam turbines, the article on STEAM TURBINES should be referred to in this connection.

**Available Power.**— The available power in any given case depends upon the fall or *head*, and the *volume* of water, and is given by the equation:

$$\text{H.P.} = \frac{W \times h}{33,000}, \quad (1)$$

in which

H.P. = available horsepower;

$W$  = weight of water flowing through the flume per minute = cubic feet  $\times$  62.4;

$h$  = height of fall, or head, in feet.

In case the water is utilized for the development of power by passing through a water motor, the efficiency of the latter must be taken into consideration, as it is impossible to utilize the full amount of energy stored in the water, the same as it is impossible to utilize all of the energy of the steam, in the case of an engine or turbine. Introducing the efficiency of the turbine, the following working formula applies to any type of water motor:

$$\text{B.H.P.} = \frac{Q \times 62.4 \times h \times E}{33,000} = \frac{Q \times h \times E}{529} \quad (2)$$

in which

B.H.P. = delivered or brake horsepower;

$Q$  = cubic feet of water passing through the motor per minute;

$h$  = head, in feet;

$E$  = efficiency of motor.

For approximate work, it is customary to assume an efficiency of 80 per cent ( $E = 0.8$ ), which gives:

$$\text{H.P.} = \frac{Q \times h}{661}. \quad (3)$$

**Measurement of Available Power.**— From the foregoing, it is evident that the first step in determining the available power of a proposed hydraulic development is to ascertain the amount of water, which, in general, should be based upon the minimum discharge for an average year at the point where the wheel is to be located. In the absence of definite information, this may be estimated roughly from the area of the water shed. For example, in New England, the water flow may be approximated by assuming 1.5 cubic foot per second per square mile. This will vary in different parts of the United States, depending upon the average rainfall and the character of the surface, presence of forests, etc. The possibility of storage should always be considered, especially if the wheel is to be run only a portion of the time. For instance, if the



**Table I. Horsepower Due to Certain Head of Water**

(The table gives the horsepower of 1 cubic foot of water per minute, and is based on an efficiency of 85 per cent.)

Heads in Feet	Horsepower	Heads in Feet	Horsepower	Heads in Feet	Horsepower	Heads in Feet	Horsepower
10	0.0161	220	0.354	430	0.692	1050	1.690
20	0.0322	230	0.370	440	0.708	1100	1.771
30	0.0483	240	0.386	450	0.724	1150	1.851
40	0.0644	250	0.402	460	0.740	1200	1.932
50	0.0805	260	0.418	470	0.757	1250	2.012
60	0.0966	270	0.435	480	0.773	1300	2.093
70	0.1127	280	0.451	490	0.789	1350	2.173
80	0.1288	290	0.467	500	0.805	1400	2.254
90	0.1449	300	0.483	520	0.837	1450	2.334
100	0.1610	310	0.499	540	0.869	1500	2.415
110	0.1771	320	0.515	560	0.901	1550	2.495
120	0.1932	330	0.531	580	0.934	1600	2.576
130	0.2093	340	0.547	600	0.966	1650	2.656
140	0.2254	350	0.563	650	1.046	1700	2.737
150	0.2415	360	0.580	700	1.127	1750	2.818
160	0.2576	370	0.596	750	1.207	1800	2.898
170	0.274	380	0.612	800	1.288	1850	2.978
180	0.290	390	0.628	850	1.368	1900	3.059
190	0.306	400	0.644	900	1.449	1950	3.139
200	0.322	410	0.660	950	1.529	2000	3.220
210	0.338	420	0.676	1000	1.610	2100	3.381

plant is to be operated only 12 hours per day, the capacity may be doubled by constructing a storage reservoir of sufficient size to accumulate the water which flows through the stream during the night. In case the wheel is run continuously, the only effect of storage is the accumulation of water for use during those parts of the season when the supply falls below the normal requirements.

For definite calculations of power, the flow of the stream must be measured under standard conditions. In the case of streams up to 40 or 50 feet in width, having a maximum depth of from 3 to 4 feet, the *weir* method is the simplest and the most accurate. The general construction of a weir dam is shown in Fig. 1. It should be so proportioned that all of the water will flow through a space the length *A* of which shall not exceed two-thirds of the width of the stream. The bottom and ends of the open section, or *notch*, as it is called, should be beveled on the down-stream side, in order to give a sharp edge for the water to flow over. A short distance up-stream, a stake should be driven into the earth with its top on a level with the bottom of the notch. This may be done either by the use of a spirit level or by adjusting the stake when the water has risen to a height just sufficient to spill over the weir. When the water has reached its full height, the depth above the bottom edge of the weir can be accurately measured by placing the end of a scale upon the top of the stake. If the measurement were made at the weir, it would be impossible to obtain an accurate result, owing to the curvature of the water as it flows over the edge.

In constructing a weir, it is important that the banks of the stream be parallel

for a distance of several feet above it, and also that there be sufficient space at the sides, and sufficient depth below the notch, in order that the water may approach it quietly and without eddies. The volume of water passing over a weir is determined by a *weir table*. (See Table II.) The first column at the left corresponds to the depth of the water flowing over the weir, in inches, while the fractions of an inch appear at the

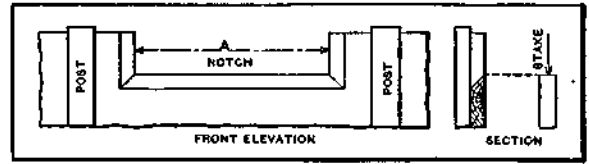

**Fig. 1. Construction of Weir**

top. The figures in the body of the table give the cubic feet of water, per minute, passing over the weir for each inch in length.

*Example:* — A weir has a notch 60 inches in length, and the depth of the water passing through it, as measured at the stake, is 20½ inches. What is the flow of the stream?

From Table II, find the number corresponding to this depth, which is 36.48; hence, the total flow is 36.48 × 60 = 2189 cubic feet per minute.

Where it is impossible to construct a weir, owing to the size of the stream, the simplest method is to determine the average velocity of flow, in feet per minute, and the sectional area, in square feet, and multiply the two together. This gives the flow of the stream in cubic feet per minute. The velocity of flow varies in different parts of a stream, being highest near the surface at the center, and lowest near the banks and bottom, due to frictional resistance.

The average velocity for the entire stream may be determined approximately by measuring it at the surface near the center and multiplying the result by 0.83. In taking measurements of this kind, a point should be selected where the width and depth are as nearly uniform as possible for a considerable distance. A light body is then thrown into the center of the stream and the time noted

**Table II. Weir Table**

Inches	0	¼	½	¾	1	¾	¾	¾
0	0.00	0.02	0.05	0.09	0.14	0.20	0.26	0.33
1	0.40	0.48	0.56	0.65	0.74	0.83	0.93	1.03
2	1.14	1.24	1.35	1.47	1.58	1.71	1.82	1.96
3	2.08	2.21	2.35	2.48	2.63	2.76	2.90	3.06
4	3.20	3.36	3.51	3.67	3.82	3.98	4.15	4.31
5	4.48	4.65	4.81	4.99	5.16	5.35	5.52	5.71
6	5.89	6.06	6.26	6.44	6.64	6.83	7.01	7.22
7	7.41	7.62	7.82	8.03	8.23	8.42	8.64	8.85
8	9.07	9.27	9.48	9.71	9.92	10.15	10.36	10.60
9	10.81	11.03	11.27	11.49	11.74	11.96	12.18	12.43
10	12.66	12.91	13.14	13.39	13.63	13.86	14.12	14.36
11	14.62	14.86	15.10	15.37	15.61	15.88	16.13	16.40
12	16.65	16.90	17.18	17.43	17.71	17.97	18.22	18.51
13	18.77	19.05	19.31	19.60	19.87	20.13	20.43	20.69
14	20.99	21.26	21.53	21.83	22.11	22.41	22.68	22.99
15	23.27	23.55	23.86	24.14	24.45	24.74	25.02	25.34
16	25.62	25.92	26.23	26.55	26.85	27.14	27.46	27.76
17	28.08	28.38	28.68	29.01	29.31	29.64	29.95	30.28
18	30.59	30.89	31.23	31.54	31.88	32.19	32.50	32.85
19	33.16	33.51	33.82	34.17	34.49	34.81	35.16	35.48
20	35.84	36.16	36.48	36.84	37.17	37.53	37.85	38.22
21	38.55	38.88	39.24	39.57	39.94	40.28	40.61	40.98
22	41.32	41.69	42.03	42.41	42.75	43.09	43.47	43.81
23	44.19	44.54	44.89	45.27	45.62	46.00	46.35	46.74
24	47.09	47.45	47.84	48.19	48.58	48.94	49.30	49.69

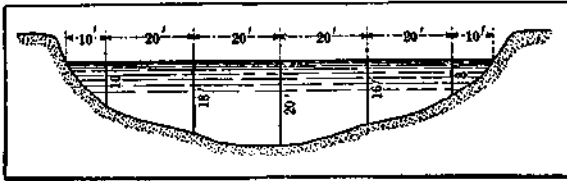

Fig. 2. Section of River

which it takes to float over a known distance. Several trials of this kind should be made, and the average of the series used in making the final computations. The sectional area of a stream is measured by driving a number of stakes into the bottom, an equal distance apart, except the two outer ones, which should be spaced one-half this distance from the shore, as shown in Fig. 2. The depth at each stake is then measured, the results added, and the sum multiplied by the full space between the stakes, which will give the sectional area of the stream.

*Example:* — A float requires 5 minutes to pass between two points at the center of a stream located 1000 feet apart. Measurements for sectional area are as shown in Fig. 2. What is the volume of flow?

$$\text{Average velocity, } \frac{1000 \times 0.83}{5} = 166 \text{ feet per minute.}$$

Sectional area,

$$(10 + 18 + 20 + 16 + 8) \times 20 = 1440 \text{ square feet,}$$

from which the flow is found to be:

$$1440 \times 166 = 240,000 \text{ cubic feet per minute, approximately.}$$

**Classification of Hydraulic Motors.** — Hydraulic motors may be divided into three general classes:

1. Current and gravity wheels, which utilize either the impact of the current or the weight of the water.

2. Impulse wheels and turbines, which utilize the kinetic energy of a jet at high velocity. These are commonly employed in connection with a limited volume of water under a high head, which, in practice, may vary from 300 to 3000 feet.

3. Reaction turbines, which utilize both the kinetic energy and the pressure of the water. These are employed for conditions the reverse of those under (2), that is, with a large volume of water under a low or medium head. In practice, reaction turbines are used under heads ranging from 5 to 500 feet.

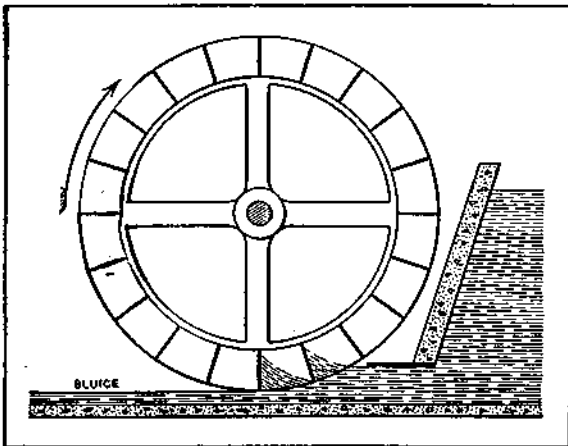

Fig. 3. Undershot Water-wheel

**Current and Gravity Wheels.** — These are the earliest type, and their use is practically obsolete in the United States, with the exception of the overshot wheel. Current and gravity wheels include the *undershot*, *Poncelet*, *breast*, and *overshot* wheels.

*Undershot Wheel.* — The principle of the undershot wheel is shown in Fig. 3, power being obtained by confining a current of water in a sluice, into which the floats extend from the underside of the wheel. Only a small

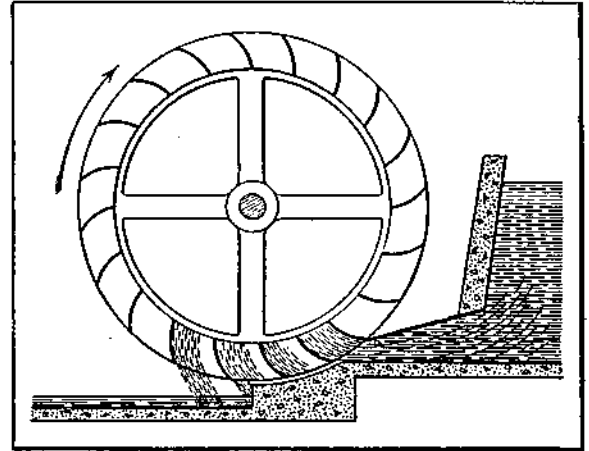

Fig. 4. Poncelet Water-wheel

proportion of the energy of the water is utilized in this way, the efficiency of the wheel, under practical conditions, rarely averaging more than 25 per cent. Wheels of this type were in general use up to about the year 1800.

*Poncelet Wheel.* — This is an improved form of the

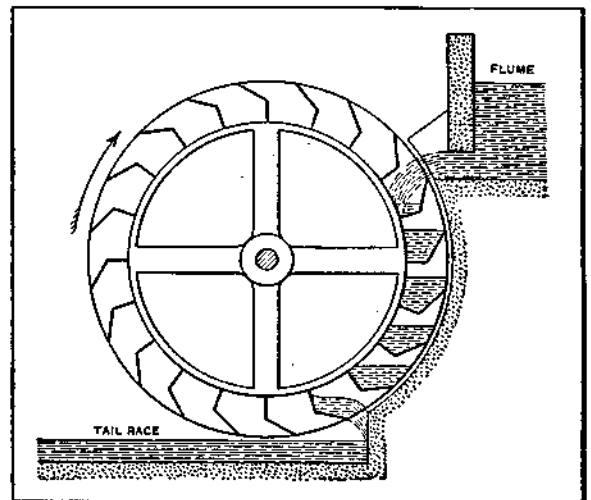

Fig. 5. Breast Type of Water-wheel

undershot wheel, in which the floats are curved so that the water enters without shock and is discharged in a direction nearly at right angles to the circumference of the wheel (see Fig. 4). This arrangement increases the impulse effect and practically doubles the efficiency.

*Breast Wheel.* — The breast wheel is a modification of the undershot wheel, in which the water is admitted to the floats at a considerable height, and retained during their descent by a casing or breast, as shown in Fig. 5. There are two forms of this wheel, the *high breast*, in which the water is delivered to the buckets above the center of

the wheel, as in Fig. 5, and the *low breast*, where it is delivered below the center. In the first arrangement the power developed is due principally to the weight of the water in the floats or buckets on the breast side of the wheel, while in the second case the power is produced partly by impulse, as the water falls from the flume or head-race

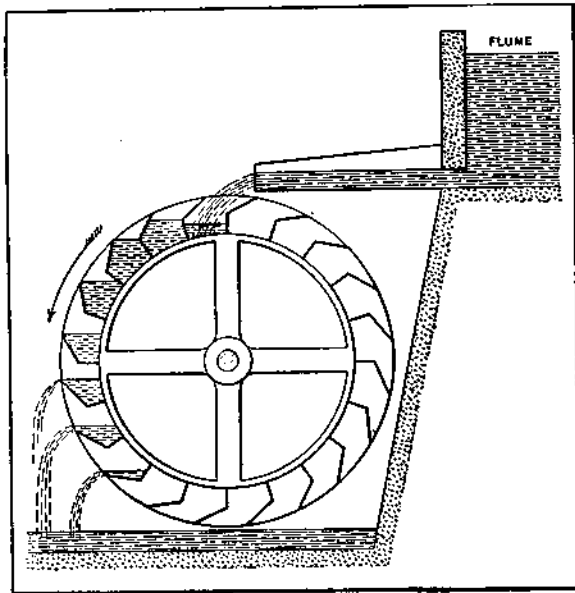

Fig. 6. Overshot Water-wheel

into the buckets. The efficiency of the breast wheel commonly varies from 50 to 80 per cent, depending upon its size and construction. This type of wheel, owing to its higher efficiency, continued in use for about fifty years after the undershot wheel.

*Overshot Wheel.* — This is a more recent type of the gravity wheel, and is still in use to a considerable extent. It is simpler in construction (see Fig. 6), and has an effi-

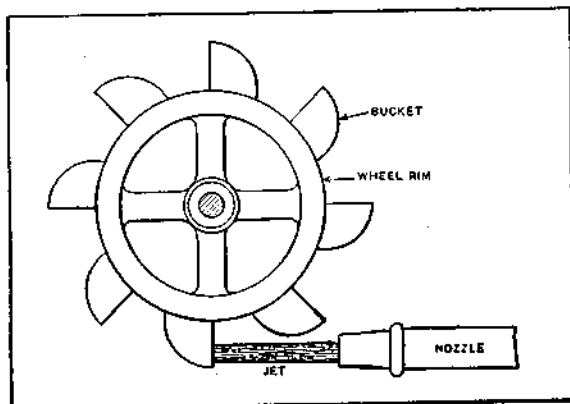

Fig. 7. Pelton Wheel

ciency of from 70 to 85 per cent, which is practically the same as that of the modern turbine.

*Impulse Wheels and Turbines.* — Modern impulse wheels are a modification of the older form of current wheel in which the sluiceway is replaced by a jet of water from a nozzle, at high velocity. The best known types of the impulse motor are the *Pelton wheel* (in the United States) and the *Girard turbine* (in Europe).

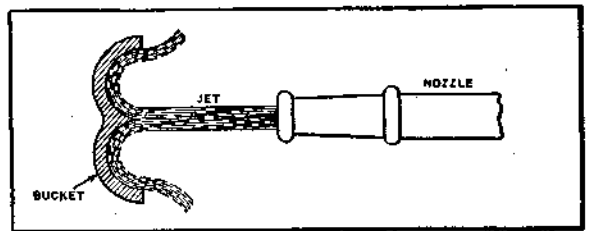

Fig. 8. Form of Buckets of Pelton Wheel

*Pelton Wheel.* — The principle of the Pelton wheel is illustrated diagrammatically in Fig. 7. The wheel consists of a series of buckets attached to the rim of a wheel, against which a jet of water is discharged at a high velocity from a suitably located nozzle. The form of bucket is shown in Fig. 8, and is such as to divide the jet and deflect the two streams thus formed through an angle of nearly 180 degrees. If the jet could be completely reversed, the theoretical efficiency of the Pelton wheel would be 100 per cent. In practice, however, it is necessary to deflect the reversed jet sufficiently to clear the adjacent bucket, and this, in connection with frictional losses, reduces the efficiency to about 80 per cent for average conditions. The Pelton wheel, together with other types, is described in detail in another section of this article.

*Girard Turbine.* — This turbine is shown in both horizontal and vertical sections in Fig. 9; *A* is the inlet, *B* the nozzles, and *C* the vanes or blades of the runner, the latter being shown in section in both views. In operation, water enters *A* under pressure and is discharged through the nozzles *B* against the blades *C*. As the

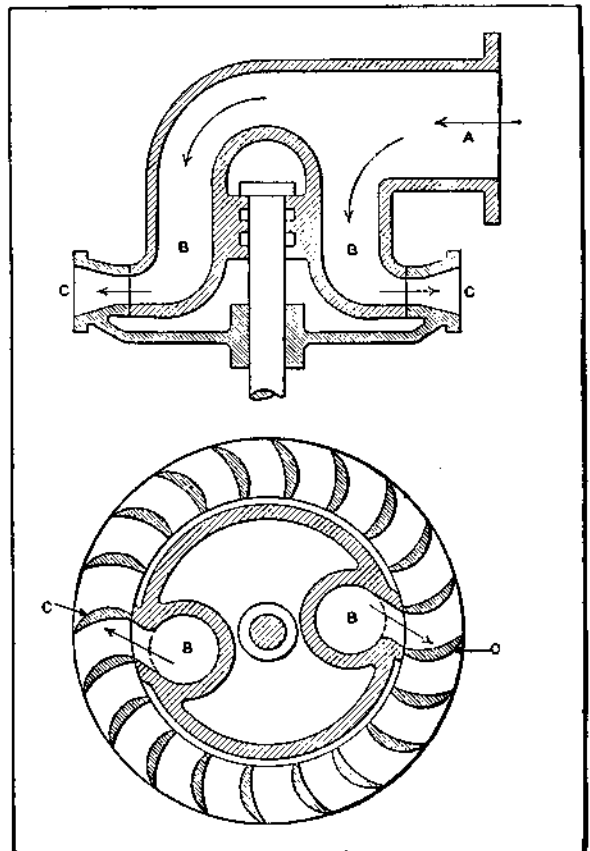

Fig. 9. Girard Turbine

velocity of the water at the inner ends of the blades is greater than at the outer, it is necessary to flare the blades toward the tips, in order not to obstruct the passage, as shown in the vertical section. The Girard turbine has been manufactured in the United States under the trade name "Victor High-pressure Turbine." The efficiency commonly varies from 70 to 80 per cent, depending upon the design and size.

**Reaction Turbine.**—The principle of the reaction turbine is described in the article on STEAM TURBINES. In the impulse wheel, the energy is entirely kinetic, while in the reaction type it is partly kinetic and partly pressure energy. Reaction turbines are subdivided into *radial outward flow*, *radial inward flow*, *axial flow*, and *mixed flow* turbines, according to the direction in which the water passes through the wheel.

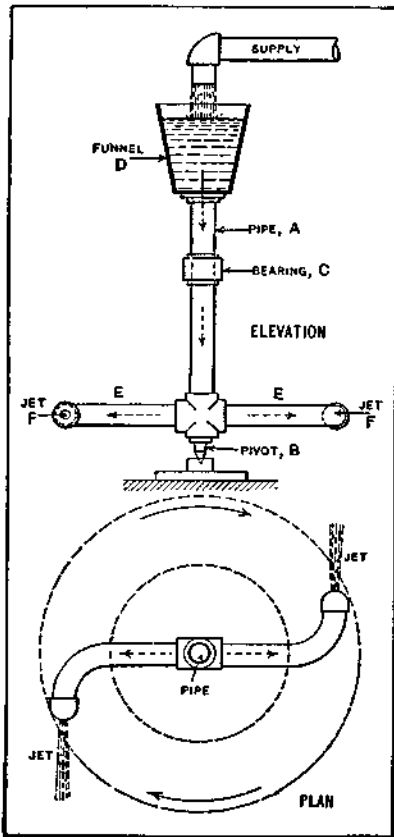

Fig. 10. Scotch Mill Reaction Turbine

**Development of the Turbine.**—The reaction turbine in its present form was developed from the Scotch mill by increasing the number of arms until it finally became a complete wheel, the jet-openings being separated by curved blades. The use of stationary guides for directing the water from a central pipe into the vanes of the wheel or runner was first employed by a French engineer named Fourneyron, and the turbine designed by him is shown in diagram in Figs. 11 and 13. Here *A* is a central chamber supplied with water under pressure; *B* shows the stationary guides; and *C*, vanes upon a runner rotating upon the shaft *D*. In operation, the chamber *A* and the spaces between the guides and vanes are completely filled with water, which is passing outward in the form of solid jets, thus causing the wheel or runner to rotate in the direction indicated by the arrows. The action here

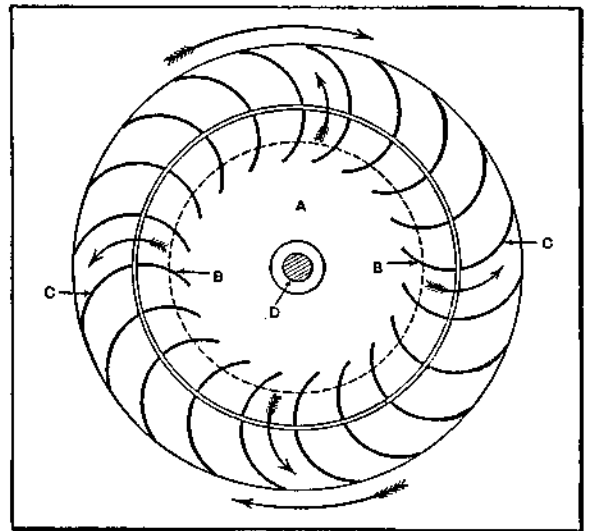

Fig. 11. Fourneyron Reaction Turbine

**Scotch Mill.**—

One of the simplest forms of the reaction turbine is the Scotch mill, shown in Fig. 10. This type serves to illustrate the action of the modern machine. It consists essentially of a vertical pipe *A*, closed at the bottom and resting on a pivot *B*, being free to turn in the bearing *C*. A funnel *D* is attached to the top of the pipe *A*, and two curved pipes *E* extend from a point near the bottom, as indicated. In action, water is supplied to the funnel and flows downward through the central pipe and is discharged at the openings in the ends of the curved pipes *E*. The pressure head is that due to the height of the water in the funnel, and the reaction of the jets *F* issuing in opposite directions causes the arms and central pipe to rotate in the direction indicated by the arrows. The Scotch mill is simply an improved form of Barker's mill, in that, in the former, the jets of water are discharged from the ends of curved arms instead of through holes drilled in the sides of straight ones, as in Barker's mill.

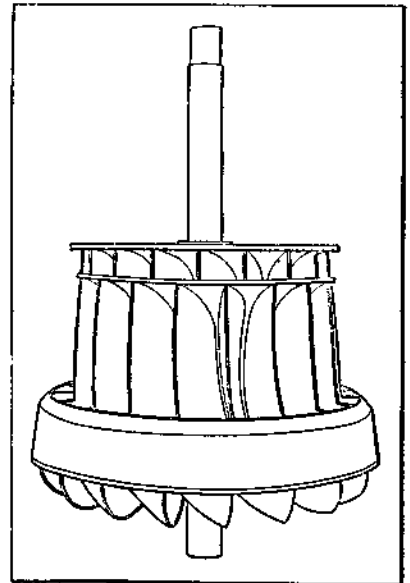

Fig. 12. Mixed-flow Turbine

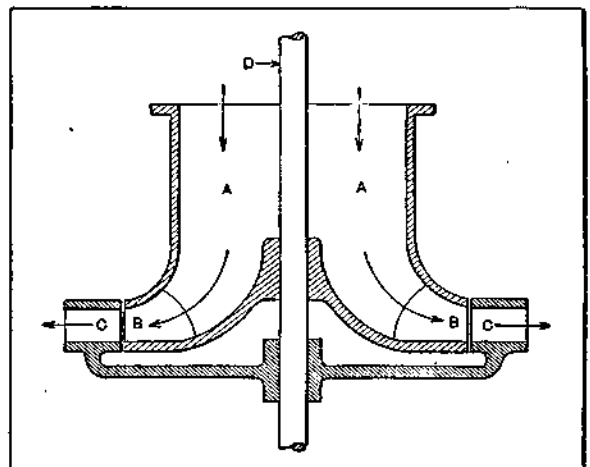

Fig. 13. Section of Fourneyron Reaction Turbine

is precisely the same as in the case of the Scotch mill, and is due to the reaction of the jets of water against the vanes *C* as they issue at the periphery of the wheel. The Fourneyron turbine represents the radial outward flow type.

Following this was the Jouval type, designed upon the parallel or axial flow principle, and shown diagrammatically in Fig. 14. The lettering of the different parts is the same here as in the preceding illustration, and the action is practically the same, except for the direction of flow, which is indicated by the arrows.

The form shown diagrammatically in Fig. 15 was designed by the noted American hydraulic engineer, J. B. Francis, and is known as the Francis type. This is an in-

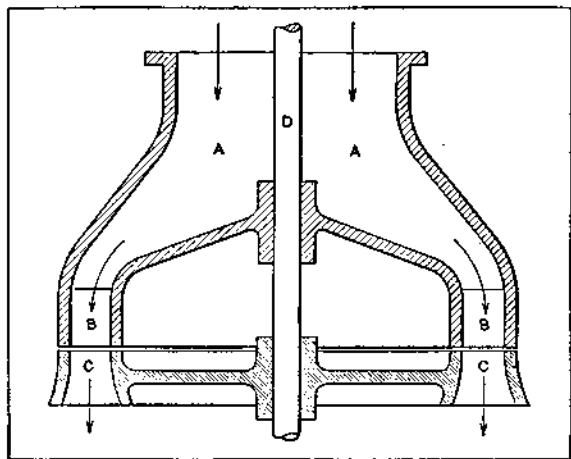

Fig. 14. Jouval Reaction Turbine

ward radial flow turbine with the vanes so formed that the water leaves them at an angle of about 45 degrees downward from the horizontal, as shown by the arrows. The lettering in this case has been made uniform with Figs. 11 and 14. Water enters between stationary guides *B* surrounding the entire periphery of the wheel, then passes through the spaces between the vanes *C*, and is discharged at an angle downward toward the center.

**Types of Runners.** — The wheel together with the vanes or blades is called the *runner*, and is the vital part of a turbine. In American practice, the two forms of turbines in general use are the *impulse* and the *radial inward flow*

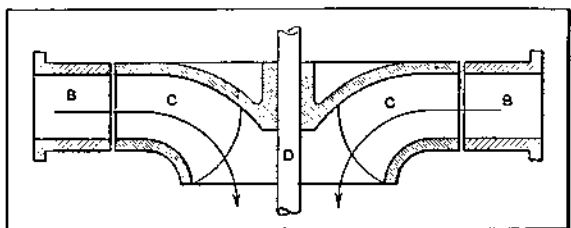

Fig. 15. Francis Reaction Turbine

reaction types. A typical impulse runner is shown in Fig. 16. This is equipped with the Pelton-Doble bucket, each half of which is ellipsoidal in form, with a portion of the outer lip cut away to clear the jet when coming into action. This special form permits the water to impinge without shock, and to be discharged from the entire surface.

A horizontal reaction runner of the Francis type, as employed in the Trump turbine, is shown in Fig. 17. In-

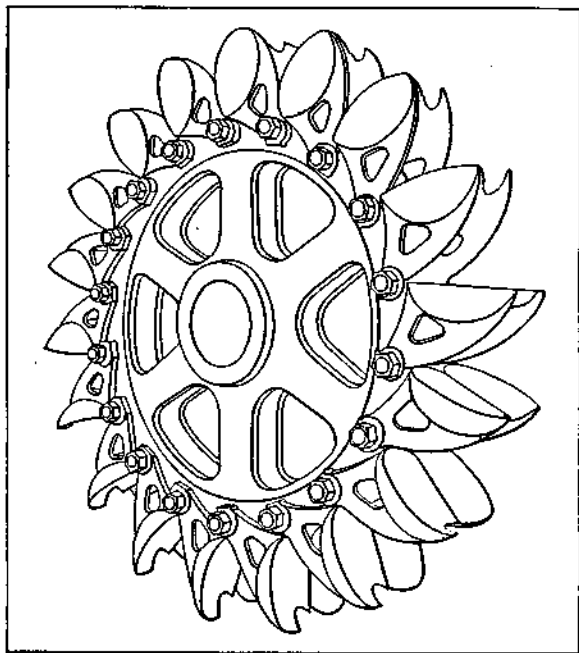

Fig. 16. Pelton Impulse Turbine Runner

ward-flow runners are enclosed in a casing with specially formed guide vanes, which distribute the water evenly to the entire periphery. Runners of the Francis type are especially adapted to heads ranging from 100 to 500 feet, the limit, at the present time, for the head of reaction turbines being 600 feet.

A form of runner widely used in the United States is known as the *mixed flow* or *American* type. This is a modification of the Francis type, and is designed for high speed and power under low heads. Higher speed can only be obtained by reducing the diameter of the runner, which reduces the power, if other features of the design remain the same. This is offset by increasing the width of the runner, using fewer vanes and extending them further toward the center. In order to increase the dis-

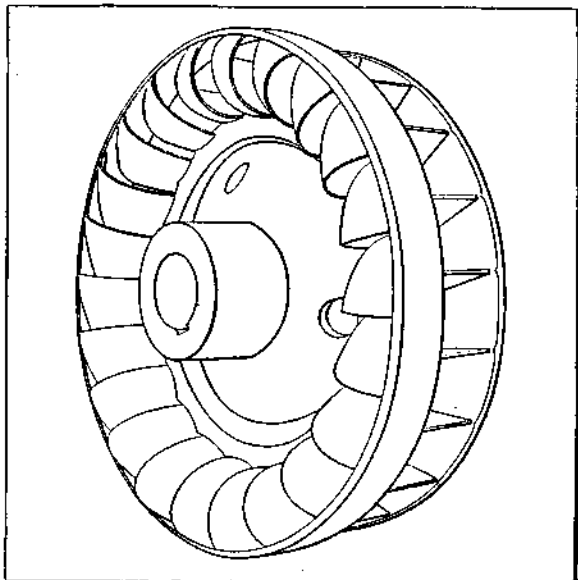

Fig. 17. Francis Reaction Turbine Runner

charge area, the wheel is flared, and the vanes so curved as to discharge axially. As the water enters *radially*, and passes out *parallel* to the axis of rotation, it is called a *mixed-flow* turbine. A vertical runner of this type is shown in Fig. 12. Mixed-flow runners are equally well adapted to the horizontal position. Runners of the general type shown in Fig. 12 are adapted to heads ranging from 5 to 150 feet.

**Classification of Runners.** — The classification of runners and the methods of determining the best type to employ under different conditions will now be considered. The basis of classification for turbine runners is known as the *type characteristic* or *characteristic speed*, and is the speed, in revolutions per minute, which would be attained by the runner if it were reduced in all dimensions to such an extent as to develop 1 horsepower when operating under 1 foot head. This is commonly expressed by the symbol  $N_s$ , and is given by the equation:

$$N_s = \frac{n \times \sqrt{\text{H.P.}}}{h^{\frac{5}{4}}}, \quad (4)$$

in which

- $N_s$  = characteristic speed;
- $n$  = revolutions per minute;
- H.P. = horsepower;
- $h$  = effective head, in feet.

Table III. Fifth Power of Fourth Roots

Head, in Feet, $h$	$h^{\frac{5}{4}}$	Head, in Feet, $h$	$h^{\frac{5}{4}}$
10	17.78	110	356.3
20	42.3	120	397.1
30	70.2	130	438.9
40	100.6	140	481.5
50	133.0	150	525.0
60	166.8	160	569.1
70	202.3	170	613.9
80	239.2	180	659.3
90	277.2	190	705.3
100	316.2	200	752.0

*Example:* — It is desired to develop 500 horsepower from a stream by means of a turbine running at 300 R.P.M. under a head of 80 feet. What will be the characteristic speed?

$$N_s = \frac{300 \times \sqrt{500}}{80^{\frac{5}{4}}} = \frac{300 \times 22.36}{239.2} = 28.04.$$

The characteristic speed is used for determining the type of runner for varying conditions. For different values of  $N_s$ , the following types are generally used:

$N_s$	Type of Turbine
1 to 5	Impulse — Single nozzle
5 to 10	Impulse — Multiple nozzles
10 to 20	Reaction — Low speed
20 to 50	Reaction — Medium speed
50 to 80	Reaction — High speed
80 to 100	Reaction — Very high speed
Over 100	Reaction — Multiple runners

From a study of the table above, it is evident that a reaction turbine of medium speed is called for in the example given.

When multiple nozzles are employed, the required speed varies as the square root of the number of "multiple" used.

*Example:* — Suppose an impulse wheel, using a single nozzle, must run at a speed of 350 R.P.M. to develop a given horsepower. If the power is divided between two nozzles, at what speed must it operate?

$$350 \times \sqrt{2} = 350 \times 1.4 = 490 \text{ R.P.M.}$$

If four nozzles were used, acting on two runners, the required speed would be:

$$350 \times \sqrt{4} = 350 \times 2 = 700 \text{ R.P.M.}$$

The method employed in dividing the power between two or more runners in the case of a reaction turbine is illustrated by a practical example under the heading *Runner Tables*, given later in this article.

**Speed Limit.** — The most efficient speed for a given diameter of runner may be checked by the equation:

$$\frac{3.14 \times d \times N}{60 \sqrt{h}} = C, \quad (5)$$

in which

- $d$  = entrance diameter of runner, in feet;
- $N$  = speed of runner, in R.P.M.;
- $h$  = head, in feet;
- $C$  = a factor called the *speed constant*, and which, in the case of a reaction turbine, cannot exceed 7 without a loss of efficiency.

**Diameter of Runner.** — The diameter of the runner may be determined approximately by the formula:

$$d = \frac{153.5 \times a \times \sqrt{h}}{N}, \quad (6)$$

in which

- $d$  = diameter of runner, in inches;
- $a = \begin{cases} 0.6 \text{ for high head;} \\ 0.7 \text{ for medium head;} \\ 0.8 \text{ for low head;} \end{cases}$
- $h$  = head, in feet;
- $N$  = speed of runner, in R.P.M.

**Runner Tables.** — So-called "runner tables" are prepared by manufacturers, giving the principal characteristics of their stock runners, and are used in the selection of a type to meet any given set of conditions. These, however, are to be used only in preliminary calculations; but before types and sizes are definitely settled upon, the problem should be referred in all its details to the makers of the apparatus it is proposed to use. Table IV has been abridged from one of the bulletins of the Allis-Chalmers Co., and will be used in solving a practical example. The working formulas for use with this table are as follows:

$$N = n \times \sqrt{h}, \quad (7)$$

$$\text{H.P.} = (\text{H.P.})_1 \times h \sqrt{h}, \quad (8)$$

$$n = \frac{N}{\sqrt{h}}, \quad (9)$$

$$(\text{H.P.})_1 = \frac{\text{H.P.}}{h \sqrt{h}}, \quad (10)$$

in which

- $N$  = revolutions per minute required;
- H.P. = horsepower required;
- $h$  = head, in feet;
- $n$  = revolutions per minute for 1 foot head;
- $(\text{H.P.})_1$  = horsepower developed for 1 foot head.

*Example:* — A proposed hydraulic development has a flow of 3600 cubic feet per minute and a fall of 60 feet. What horsepower may be developed? What type of run-

ner should be used? At what speed should the turbine operate?

From Formula (3):

$$\text{H.P.} = \frac{60 \times 3600}{66t} = 327,$$

or, approximately, 325 horsepower.

From Formula (10):

$$(\text{H.P.})_1 = \frac{325}{60 \sqrt{60}} = \frac{325}{465} = 0.7.$$

From Table IV, this is found to correspond closely to an 18-inch, type "F," runner, which has values of 0.704 and 86.8 for  $(\text{H.P.})_1$  and  $n$ , respectively. Substituting the

From Table IV, it is found that a 40-inch, type "F," runner meets the requirements, with a small margin to spare, with a speed of  $39.1 \times \sqrt{30} = 214$  R.P.M.

In the case of twin runners:

$$(\text{H.P.})_1 = \frac{600}{2 \times 30 \times 5.48} = 1.82,$$

calling for two 28-inch, type "F," runners, at  $55.8 \times 5.48 = 306$  R.P.M.

In Table IV, the values of  $(\text{H.P.})_1$  for the different types overlap one another somewhat, which might prove confusing in the selection of a runner for a given value. When the approximate value of  $(\text{H.P.})_1$  is found under

Table IV. Runner Table

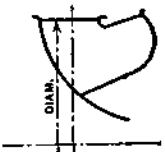
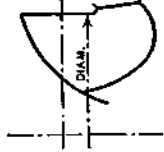
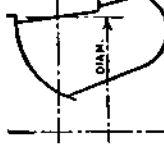
Type "D" Runner			Type "E" Runner			Type "F" Runner		
								
$N_s = 40.7$			$N_s = 51.7-60.5$			$N_s = 71.4-79$		
Diameter, Inches	$n$	$(\text{H.P.})_1$	Diameter, Inches	$n$	$(\text{H.P.})_1$	Diameter, Inches	$n$	$(\text{H.P.})_1$
15	85.7	0.226	14	98.4	0.277	14	111.5	0.410
18	71.4	0.324	16	86.1	0.367	16	97.7	0.541
21	61.3	0.442	18	76.5	0.471	18	86.8	0.704
24	53.6	0.577	20	69.0	0.597	20	78.1	0.912
27	47.6	0.731	22	62.6	0.731	22	71.0	1.133
30	42.8	0.902	24	57.4	0.883	24	65.1	1.375
34	37.8	1.158	26	53.0	1.055	26	60.1	1.62
38	33.9	1.444	28	49.2	1.243	28	55.8	1.93
42	30.6	1.765	30	46.0	1.436	30	52.1	2.20
46	28.0	2.12	32	43.0	1.65	32	48.8	2.55
50	25.7	2.50	34	40.5	1.89	34	46.0	2.82
55	23.4	3.04	36	38.3	2.15	36	43.5	3.14
60	21.4	3.61	38	36.3	2.42	38	41.1	3.52
65	19.8	4.22	40	34.4	2.75	40	39.1	3.93
70	18.4	4.90	42½	32.4	3.09	42½	36.8	4.33
.....	.....	.....	45	30.6	3.53	45	34.7	4.92
.....	.....	.....	47½	29.0	4.01	47½	32.9	5.66
.....	.....	.....	50	27.6	4.45	50	31.2	6.13
.....	.....	.....	52½	26.3	4.95	52½	29.8	6.75
.....	.....	.....	55	25.1	5.52	55	28.4	7.50
.....	.....	.....	57½	24.0	6.10	57½	27.2	8.16
.....	.....	.....	60	23.0	6.80	60	26.0	8.94

latter value in Formula (7), the required speed is found to be:

$$86.8 \times \sqrt{60} = 673 \text{ R.P.M.}$$

The value of  $N_s$  for this type of runner comes between the limits of 71.4 and 79, according to Table IV, which corresponds to the limits previously given for a high-speed reaction turbine (50 to 80).

Checking for speed limit, from Formula (5):

$$C = \frac{3.14 \times 1.5 \times 673}{60 \times \sqrt{60}} = 6.8,$$

which comes within the required limit.

*Example:*—A water power has a head of 30 feet and a sufficient flow to develop 600 horsepower. Determine the type, size, and speed of runner for a single turbine; also for twin turbines.

$$(\text{H.P.})_1 = \frac{600}{30 \sqrt{30}} = \frac{600}{30 \times 5.48} = 3.65.$$

two or more types, the selection will depend upon the particular conditions it is desired to fulfill. For example, a type "F" runner is designed for maximum power and speed, with the least possible sacrifice of efficiency to meet these requirements. Type "E" is designed to give maximum efficiency with the least sacrifice of power and speed, while type "D" has about the same efficiency as "E," but is slightly lower in power and speed, and is applicable to the higher range of speed.

**Details of Construction.**—The general methods employed in the construction of modern water motors are best shown by means of diagrams illustrating typical forms of the latest design, together with brief descriptions. Selections have been made with reference to bringing out special features, and the omission of any well-known make from the list has no bearing upon its excellence of design or importance as compared with those included.

**Overshot Wheel.**—The Fitz wheel, an installation of which is shown in Fig. 18, is a good illustration of this type which is quite extensively used in certain parts of the United States for the development of small powers. It has a high efficiency, is simple in construction, and may be built in single units up to 60 feet in diameter, having a width sufficient for a capacity of 3000 cubic feet of water per minute. These wheels are constructed entirely of steel, and, on account of their slow speed, are connected by means of gearing to the machinery which they are to operate.

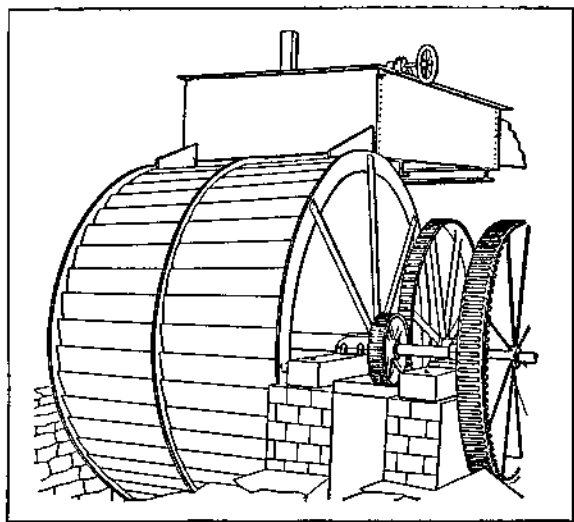

Fig. 18. Installation of Fitz Overshot Wheel

**Impulse Wheels.**—This type is illustrated by the Pelton wheel, the runner of which has been shown in Fig. 16. A section through the nozzle, illustrating the method of varying the size of the jet, is shown in Fig. 20. This device consists of an adjustable needle of special form which may be forced into the orifice or withdrawn from it, thus changing the volume of discharge without breaking the jet. The needle is adjusted by a handwheel, and is used for proportioning the power developed to the load. As the momentum of the water in the pipe line is very great, due to its high velocity, any sudden reduction in the size of the jet would produce a dangerous shock or water hammer; hence, any adjustment of this kind must be made by hand, and very slowly. Automatic speed regulation, which must take place quickly, is obtained by means of a deflector which diverts a portion of the jet away from the buckets into the tail race without doing work. This device is controlled by the governor and operates independently of the needle adjustment. In another form of combined needle and deflecting nozzle, a hinged deflector is not provided, but the entire jet is raised and lowered, the nozzle being attached to the supply pipe by means of a ball-and-socket joint. This movement is automatically controlled by the governor. It is evident that regulation by means of a deflector is wasteful in the use of water, and in cases where it is necessary to economize in this direction, control should be secured by needle adjustment. This can be done without shock by means of a by-pass arrangement which opens temporarily when the jet opening is reduced in size, and gradually closes afterward.

Pelton wheels of the impulse type are enclosed in cast-iron casings. They are made in all sizes from the small laboratory motor up to 18,000 horsepower.

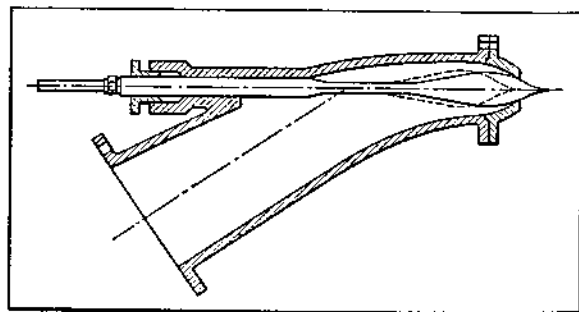

Fig. 20. Sectional View of Pelton-Doble Needle Nozzle



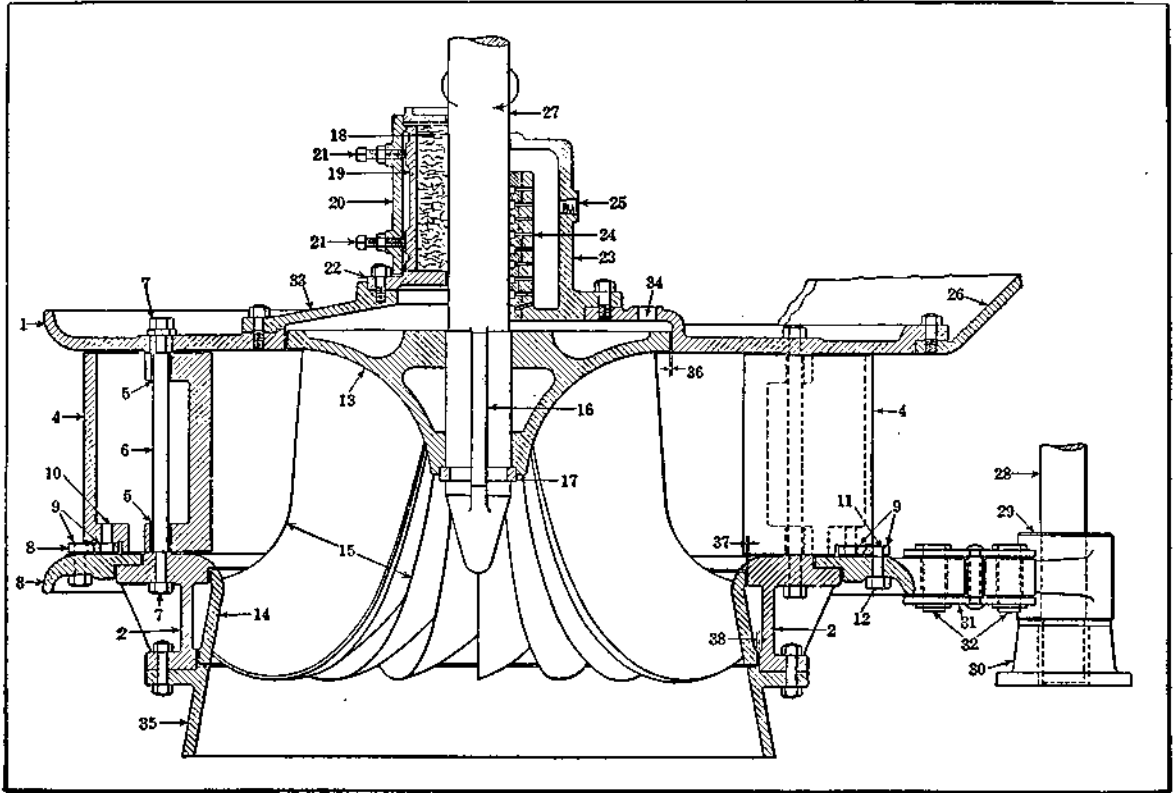

Fig. 19. Section through Reaction Turbine with Names of Principal Parts

**Reaction Turbines.**— A section through a reaction turbine of the mixed-flow type is shown in Fig. 19, in which also the different parts are numbered. The names generally used are as follows:

*Guide Casing:*

1. Crown plate.
2. Curb plate.
3. Shifting ring.
4. Speed gate.
5. Gate bushing.
6. Fulcrum bolt.
7. Fulcrum nut.
8. Link.
9. Link bushing.
10. Gate pin.
11. Shifting ring pin.
12. Shifting ring pin nut.

*Runner:*

13. Hub.
14. Rim.
15. Bucket vane.
16. Main-shaft key.
17. Keeper ring.

*Bearing:*

18. Lignum vitæ block.
19. Block holder.
20. Adjusting plate.
21. Bronze Adjusting Screw.
22. Bearing casting.
23. Hydraulic stuffing-box.
24. Babbitt or bronze bushing.
25. Drain to draft tube.
26. Casing head.
27. Main shaft.

*Speed-gate Regulating Parts:*

28. Regulating shaft.
29. Lever or bellcrank.
30. Bearing.
31. Connecting-rod.
32. Connecting-rod pin.

*Miscellaneous:*

33. Cover plate.
34. Pressure relief connection.
35. Base ring.
36. Hub clearance.
37. Upper rim clearance.
38. Lower rim clearance.

Runners of the reaction type are enclosed in cast-iron casings, the guides for directing the water into the wheel being pivoted in such a way as to be adjustable and serve as speed gates. Runners of the reaction type may be used either in the vertical or horizontal position, as most convenient.

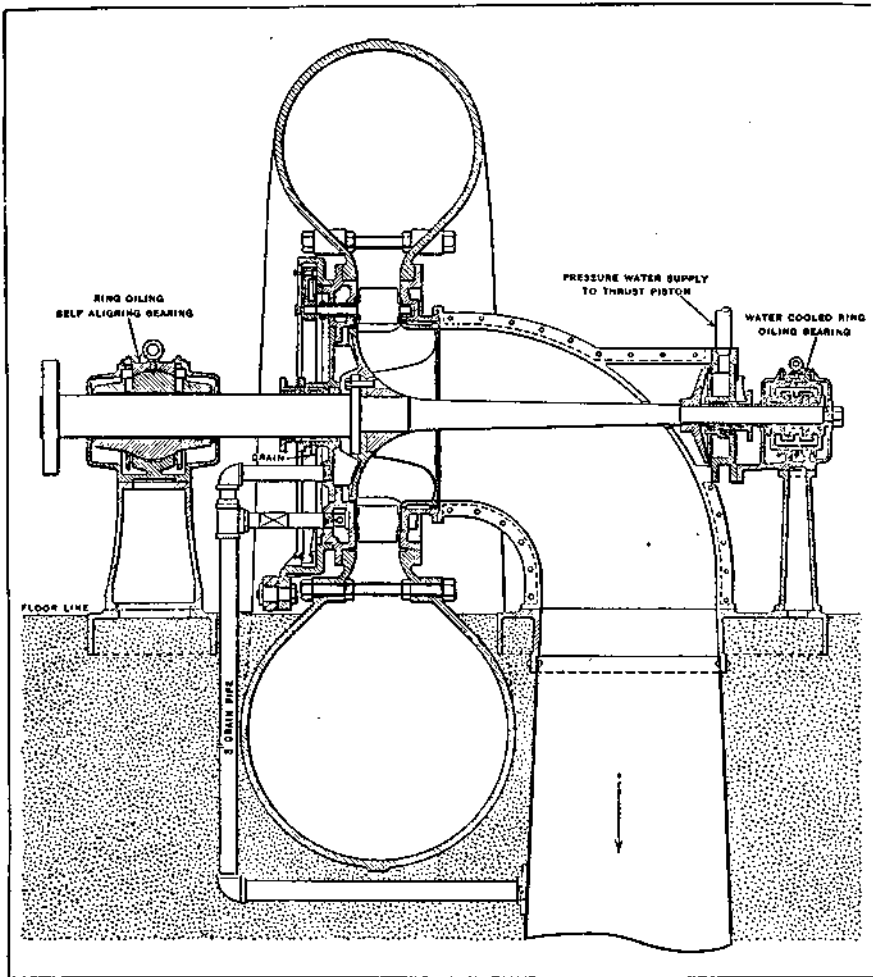

Fig. 21. Single-runner Turbine with Circular Form of Casing

In the case of high heads, where the water is brought to the wheel through pipe lines or penstocks, the circular form of casing is used, as shown in section in Fig. 21, and side elevation in Fig. 24. The first of these represents a single-runner machine, and is typical of this general class. The runner and sections of the speed gate are clearly indicated. The pipe line connects tangentially with the casing, and the water is discharged from the center, as shown by the arrow. Fig. 24 shows the form of casing used with the Francis type of runner.

**Governors.** — Two general types of governors are employed for the regulation of water-wheels and turbines. In the first of these, the transmission of energy from the governor to the speed gate or nozzle, as the case may be, is brought about mechanically, by means of levers or gearing. The governor may be of the fly-ball type, so arranged that a movement of the spindle acts on a reversing clutch, which, in turn, engages with a train of gearing attached to the regulating shaft, thus opening or closing the gate, as may be required. Motive power for rotating the balls and operating the gearing is obtained from the main shaft by means of a belt and pulleys.

The other form of governor is known as the "oil-pressure" type, in which oil, under air pressure, acting on a piston, furnishes the motive power for operating the gate or nozzle mechanism. This type is illustrated by the Pelton

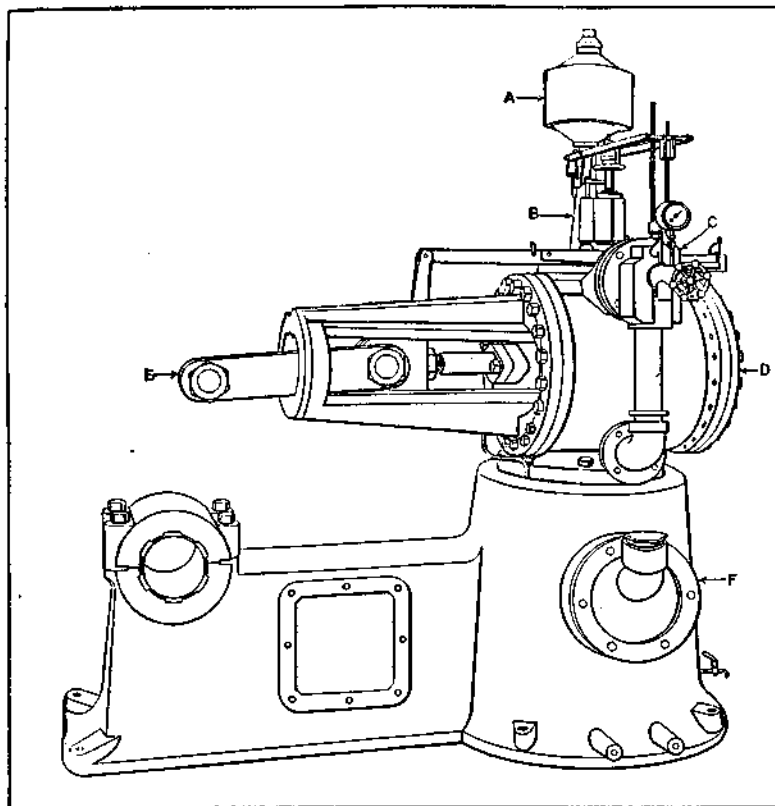

Fig. 22. Pelton Oil-pressure Governor

oil-pressure governor, shown in Fig. 22. Here, *A* is a case containing a weighted centrifugal governor; *B* is a pilot valve, actuated by the centrifugal governor, and which, in turn, operates a control valve *C*, thus admitting oil under pressure to the cylinder *D*. This valve contains a piston, any movement of which is transmitted to the gate or nozzle mechanism through the connecting-rod *E*. A sufficient oil pressure for operating the device is maintained by means of a rotary pump *F*, located in the base of the governor and driven from the main shaft by means of bevel gearing.

In large hydraulic plants, containing a number of units, the oil pressure is maintained by an independent pumping outfit driven by a belt, or preferably by an independent water-wheel or electric motor. In case a system of this kind is used, both the motor and the pump should be in duplicate, in order to guard against accident.

**Head Gate Apparatus.** — There is a great variety of apparatus for the operation of head gates. Equipment of this kind must be very rigid in construction and designed for heavy lifts by means of back gearing. Head gates are designed for operation both by power and by hand, according to local conditions. A typical hoist for hand operation is shown in Fig. 23.

**Plant Arrangement.** — The form of runner casing, and arrangement with

reference to the flume and tail race, may be widely varied to suit local requirements and must be designed for each special case. A number of typical arrangements are shown in Figs. 25 to 36, and will be found useful in working out a general scheme in the design of a new plant.

Fig. 25 shows a common form of vertical turbine placed in an open flume, and is one of the simplest forms in use. A horizontal turbine is shown in Fig. 31. In this case the shaft is brought out through the side of the flume and may be direct-connected with a generator placed upon the same level, or belted to one above. A vertical turbine with twin runners is illustrated in Fig. 27, and a horizontal machine with four runners in Fig. 33. These four cases are adapted to a low head, the turbine being placed somewhat above the level of the tail race and provided with a draft tube. Vertical and horizontal turbines provided with circular iron casings are shown in Figs. 29 and 30. In this arrangement, the water is admitted to the casing tangentially and is discharged at the center from both sides.

A vertical turbine, provided with circular concrete casing and curved draft tube, is illustrated in Fig. 36, and is similar in all respects to that in Fig. 29, except in the construction of the casing. Both of these units are direct-connected to a vertical generator placed at a higher level. A horizontal turbine with twin runners enclosed in a metal chamber is shown in Fig. 34.

The turbines shown in Figs. 29, 30, 34, and 36 are connected with pipe lines or closed flumes and are especially adapted to high heads. More complete lay-outs are

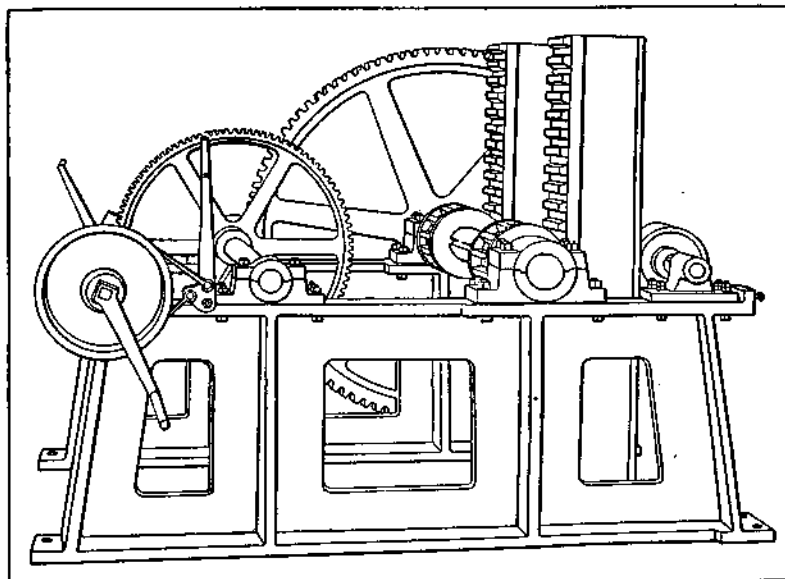

Fig. 23. Hand-operated Head-gate Hoist

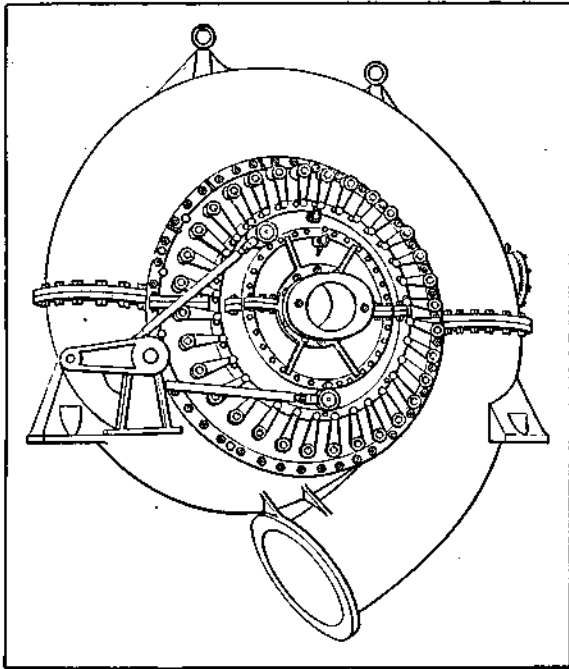

Fig. 24. Casing for a Francis Turbine

shown in Figs. 26, 28, 32, and 35, which include the head gates, flumes, turbines, and generators. Figs. 26 and 35 are adapted to low heads for both horizontal and vertical machines with direct-connected generators. Figs. 28 and 32 show similar arrangements for higher heads.

**Testing Turbines.** — Turbines are tested for power and efficiency at different percentages of gate opening, by measuring the pressure head, the speed, and the quantity of water discharged by the wheel per unit of time. The brake horsepower developed is usually determined from the speed by means of a Prony brake or other form of absorption dynamometer, the same as in an engine or steam turbine test. If the machine is direct-connected to an electric generator, the power developed may be computed from the electrical output.

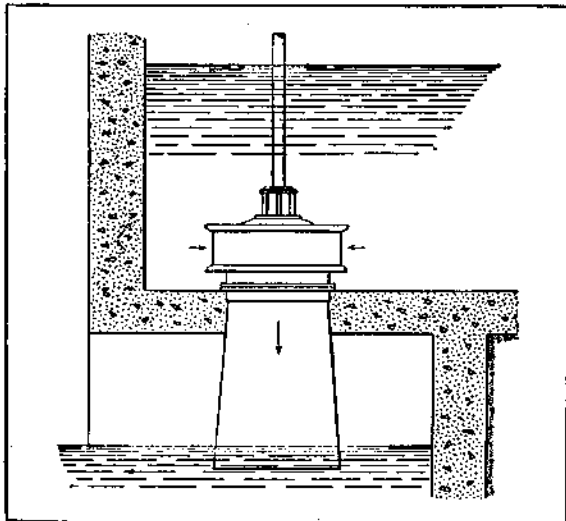

Fig. 25. Vertical Turbine placed in Open Flume

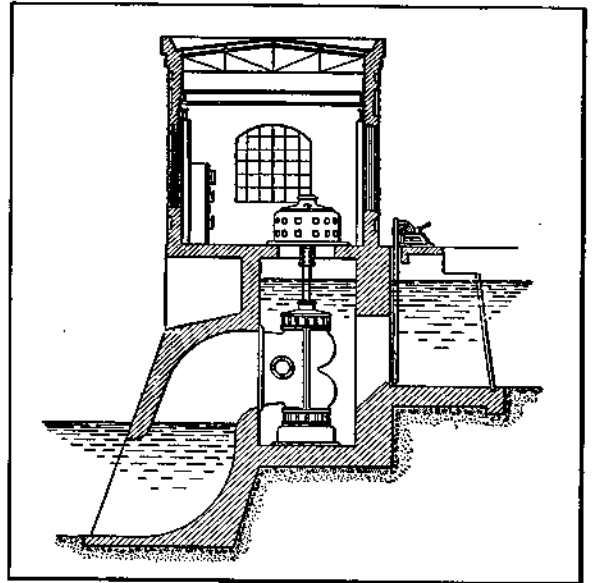

Fig. 26. Low-head Vertical Turbine Installation

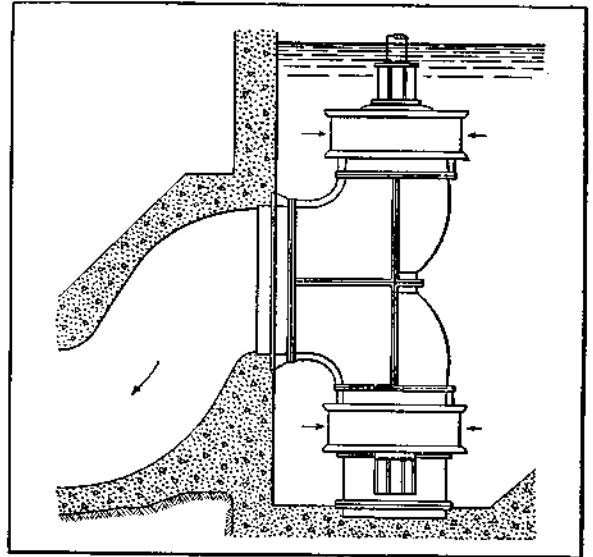

Fig. 27. Vertical Turbine with Twin Runners

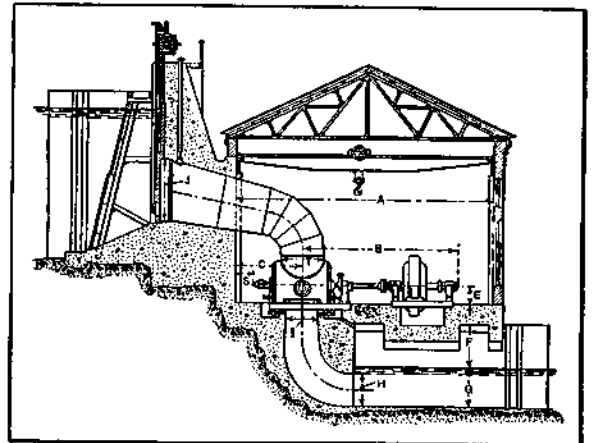

Fig. 28. High-head Horizontal Turbine Installation

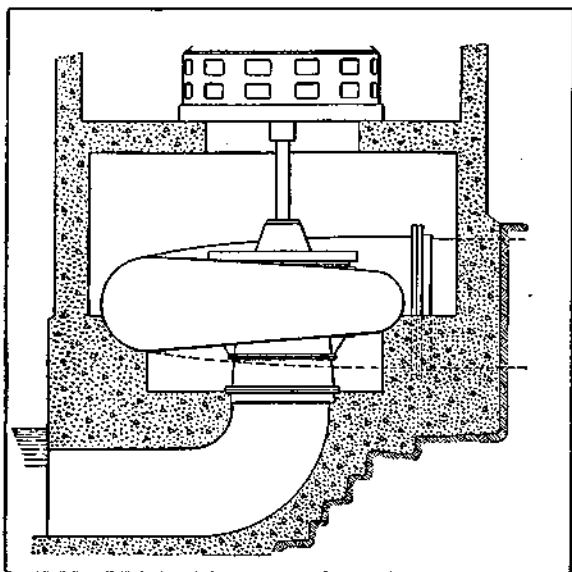

Fig. 29. Vertical Turbine with Circular Iron Casing

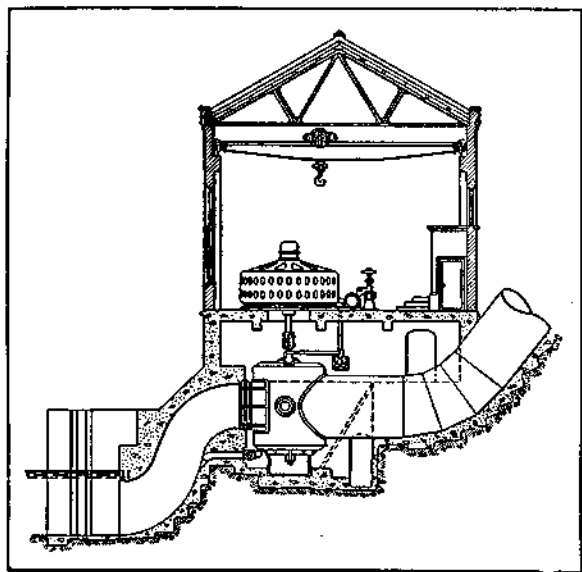

Fig. 32. High-head Vertical Turbine Installation

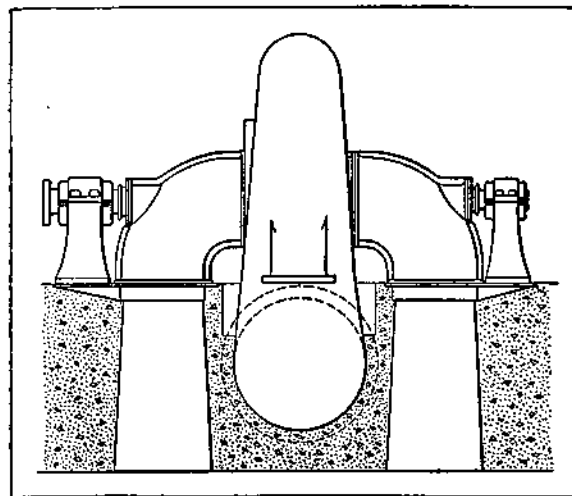

Fig. 30. Horizontal Turbine with Circular Iron Casing

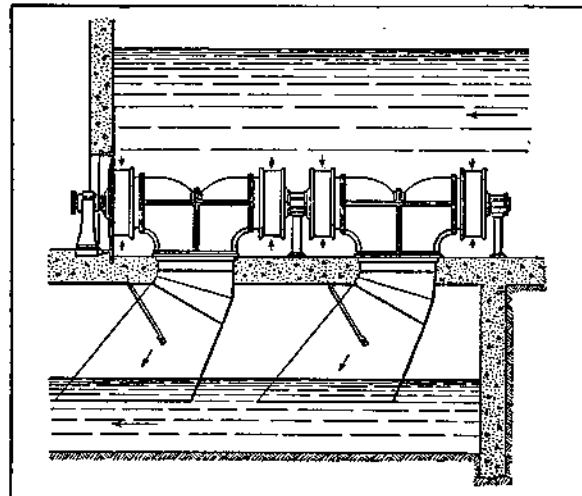

Fig. 33. Horizontal Turbine with Four Runners

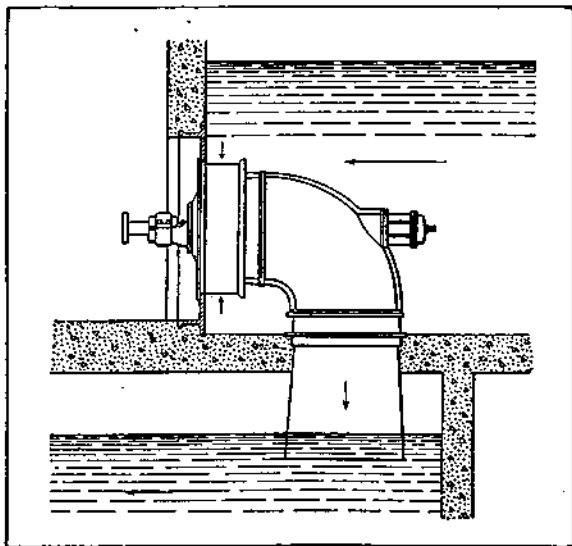

Fig. 31. Horizontal Turbine placed in Open Flume

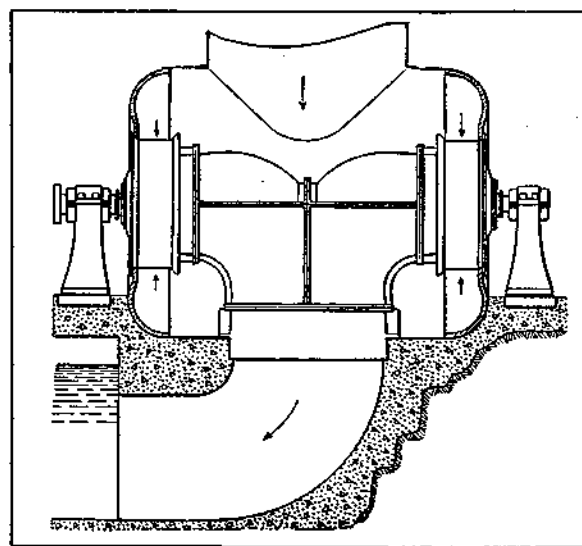

Fig. 34. Turbine with Twin Runners in Metal Casing

**Efficiency.** — The efficiency of a turbine is the ratio of the delivered or brake horsepower to the theoretical horsepower of the water supplied, due to its weight and fall. The latter quantity, according to Formula (1), is:

$$\frac{W \times h}{33,000}$$

or, according to Formula (2):

$$\frac{Q \times h}{529}$$

in which

$Q$  = cubic feet of water passing through the wheel, per minute;

$h$  = head, or fall, in feet.

Therefore, the efficiency is found to be:

$$E = \text{B.H.P.} \div \frac{Q \times h}{529} = \frac{\text{B.H.P.} \times 529}{Q \times h} \quad (11)$$

**Example:** — A turbine using 4500 cubic feet of water per minute, under a head of 30 feet, develops 200 brake horsepower. What is its efficiency?

$$E = \frac{200 \times 529}{4500 \times 30} = 0.7837, \text{ or } 78.37 \text{ per cent.}$$

The efficiency of a turbine varies with the load and falls off somewhat at the lower gate openings, although runners may be designed for a considerable range with a fairly high efficiency. For example, a test of a reaction turbine, made by the Hydraulic Turbine Corporation, showed the results in Table V, when running at a constant speed of 220 revolutions per minute, under 28 feet head.

**Methods of Comparison.** — In order to determine the power of a turbine under conditions of head and speed differing from those of a given test, it is necessary to reduce the results to a standard basis. This is taken as the corresponding speed and power which would be developed

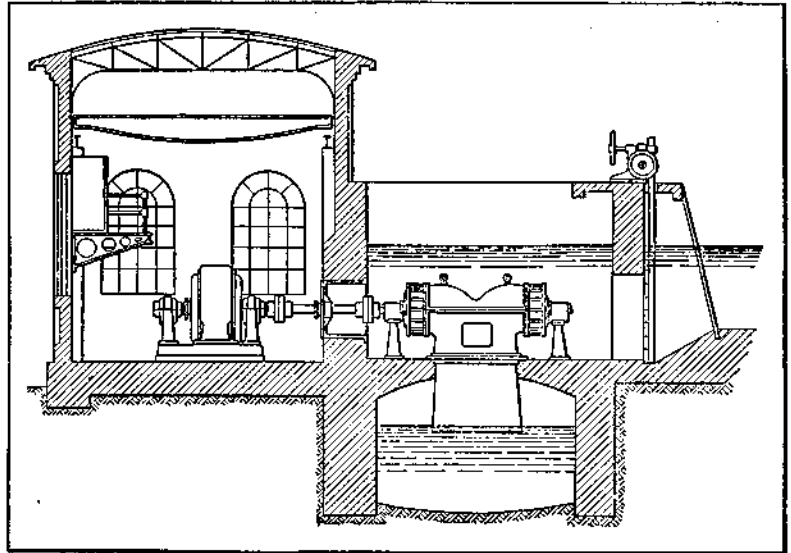

Fig. 35. Low-head Horizontal Turbine Installation

under a head of one foot, called the *specific speed* and *specific horsepower*, respectively. The observed speed may be reduced to specific speed by dividing by the square root of the head, while the actual horsepower developed is reduced to specific horsepower by dividing by the square

Table V. Results of Tests of Reaction Turbine

Gate Opening, Inches	B.H.P.	Efficiency, Per Cent
2.25	218	83.0
2.60	264	87.2
3.00	300	88.2
3.50	330	86.0
4.00	348	83.8
4.50	360	81.5

root of the third power of the head. Expressed in the form of equations:

$$\text{Specific speed} = \frac{\text{R.P.M.}}{\sqrt{h}} \quad (12)$$

$$\text{Specific horsepower} = \frac{\text{B.H.P.}}{h^{3/2}} \quad (13)$$

in which

R.P.M. = observed speed;

B.H.P. = developed or brake horsepower;

$h$  = head at which test is made.

Values of  $\sqrt{h}$  may be taken from regular square-root tables, while values of  $h^{3/2}$  may be taken from Table VI.

Table VI. Square Roots of Third Powers of Numbers

Head, in Feet, (h)	$h^{3/2}$	Head, in Feet, (h)	$h^{3/2}$
10	31.62	60	464.75
20	89.44	70	585.66
30	164.31	80	715.54
40	252.98	90	853.81
50	353.55	100	1000.00

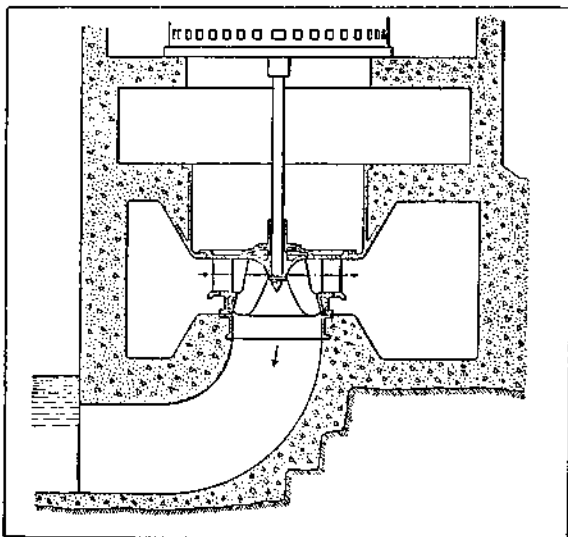

Fig. 36. Vertical Turbine with Circular Concrete Casing

*Example:* — A given wheel under test develops 350 horsepower with a head of 20 feet, running at 200 R.P.M. What speed and power will it develop when working under a head of 50 feet?

$$\sqrt{20} = 4.47, \text{ and } 20^3 = 89.44.$$

Hence:

$$\text{Specific speed} = \frac{200}{4.47} = 45.$$

$$\text{Specific horsepower} = \frac{350}{89.44} = 3.9.$$

Further,

$$\sqrt{50} = 7.07, \text{ and } 50^3 = 353.55.$$

Hence, under a head of 50 feet, the speed will rise to  $45 \times 7.07 = 318$  R.P.M., developing  $3.9 \times 353.55 = 1370$  B.H.P.

Turbines may be tested in special testing flumes constructed for this particular purpose, or after erection in their permanent locations. A large amount of work of this kind is done at the testing flume of the Holyoke Water Power Co., Holyoke, Mass., which is the only flume of its kind devoted exclusively to this particular purpose. Turbines are tested at this plant by nearly all builders, and, as the results are obtained under uniform conditions, they afford an excellent basis of comparison of the different types and designs.

C. L. H.

# **WATER**

## **HARNESSING THE POWER OF WATER**

**Robin Saunders  
Mechanical Engineer**

Most everyone has witnessed the destruction caused by torrential floods, the subtleties of weathering or erosion, the power of wave motion, the strength and mystique of grand rivers, or the gentleness and swiftness of small streams. The power of water has the capacity for destruction and useful work.

Essentially water power is a form of solar energy. The sun begins the hydrologic cycle by evaporating water from lakes and oceans and then heating the air. The hot air then rises over the water carrying moisture with it to the land. The cycle continues when the water falls as precipitation onto the land, and the potential energy of the water is dissipated as the water rushes and meanders its way back to the lakes and oceans.

The potential of water at an elevation above sea level is one of the "purest" forms of energy available. It is almost pollution free (when not contaminated) and can provide power without producing waste residuals. It is relatively easy to control and produces a high efficiency. From 80% to 90% of controlled water energy can usually be converted to useful work. This is dramatic when compared with the 25% to 45% efficiencies of solar, chemical and thermal energy systems. As a result, large and small rivers around the world have been dammed and waterwheels and water turbines installed to capture the energy of water.

Here, we will be concerned with small hydro-plants that can service the needs of individuals and small communities. In many cases even very small streams can be harnessed to produce power. The power that can be developed at a site is calculated as the rate of flow of water (measured in cubic feet per minute) multiplied by the "head" or vertical distance (measured in feet) the water drops in a given distance. It is these two quantities which must first be measured to see if they are adequate to develop a hydro-plant.

Most hydro-power installations will require the construction of a dam. A dam can increase the reliability and power available from a stream. It can also provide a means by which to regulate the flow of water and can add to the elevation of the water (by making it deeper) thus providing greater head to operate the wheel or turbine.

Both waterwheels and turbines deliver their power as torque on a shaft. Pulleys, belts, chains or gear boxes are connected to the shaft to deliver power to such things as grinding wheels, compressors, pumps or electric generators.



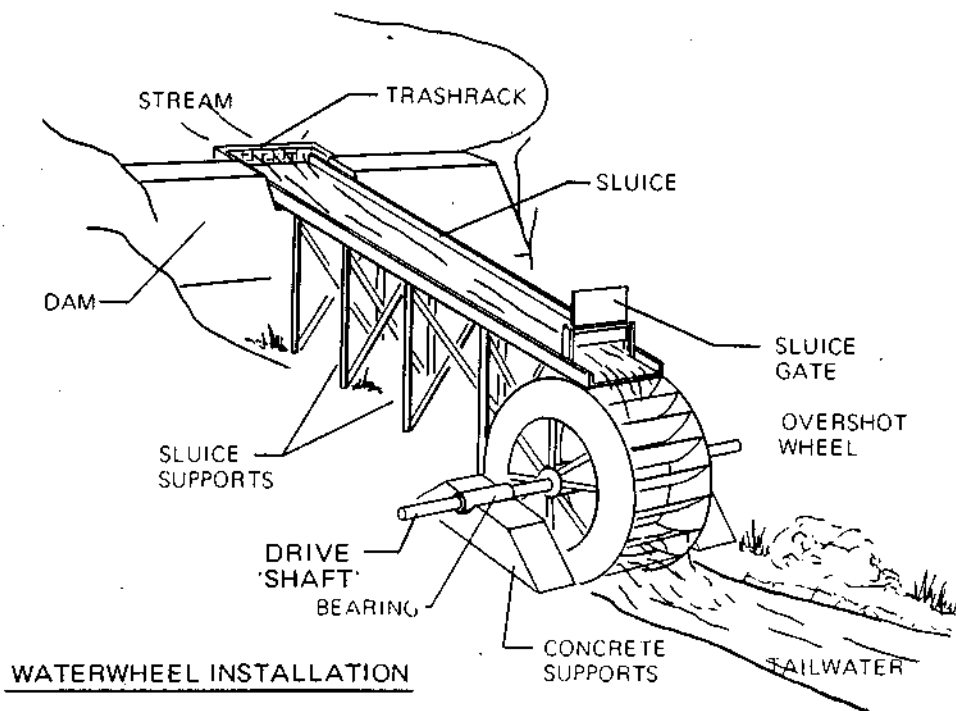

Waterwheels are the old-style, large diameter, slow turning devices that are driven by the velocity of the weight of the water. Because they are slow turning they are more useful for producing mechanical power for grinding and pumping than electrical power. The mechanical power can be connected by pulleys and belts to drive saws, lathes, drill presses and other tools. Waterwheels can provide a small amount of electric power (up to 10 HP) but it involves complex and expensive "gearing up" to produce the necessary speeds to actuate an electric generator.

Water turbines are preferable for producing electricity from the stream. Turbines generally are small diameter, high rpm devices that are driven by water under pressure (through a pipe or nozzle). When coupled with a generator, even relatively small turbines can provide electricity for most homestead needs.

## Economics

Perhaps the greatest stumbling block to utilizing water power will be cost. Purchasing a manufactured waterwheel or turbine will obviously be more expensive than building your own. (In the Reviews/Water section a few companies and their relative costs are reviewed.) However, only a few of the many different types of waterwheels and turbines should be attempted by the home-builder. This includes most of the lower technology waterwheels but only one of the turbines. The Banki Turbine can with some time and perhaps some technical assistance be home-built. The Pelton Wheel and the Reaction Turbines are probably best left to the manufacturer. A home-built unit could be inefficient as well as downright dangerous. The cost of the waterwheel or turbine is only a portion of the over-all cost of installing a hydro-power system. Building dams also costs money. Here, the expense can be small if you use indigenous materials but if concrete and steel reinforcing are used the cost can be much greater. Then comes the expense for pipe or sluice to carry the water to the wheel or turbine. Depending upon the amount of flow and the distance involved this could be a very minor expense or a considerable one.

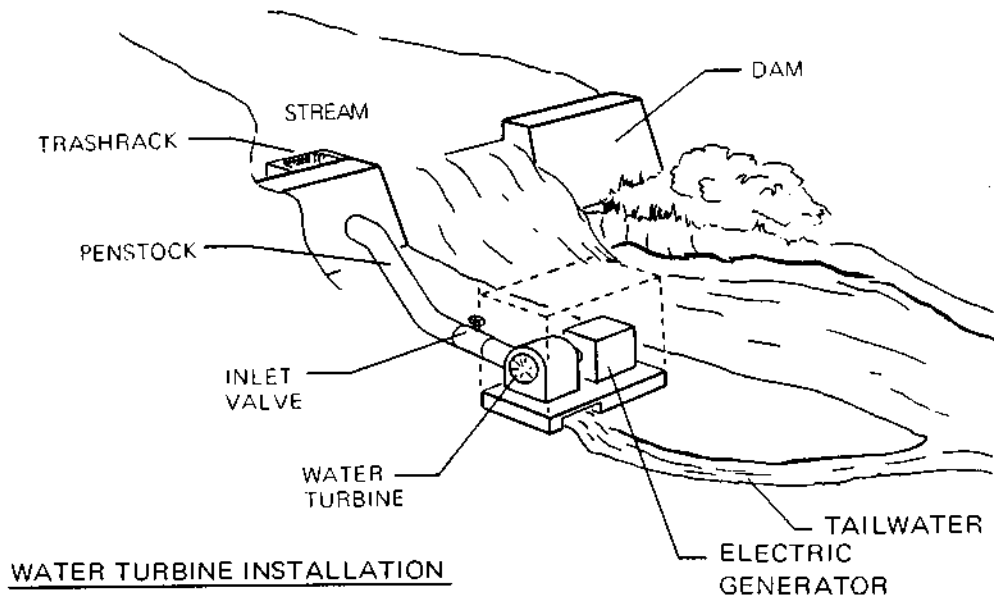

Probably the largest expense besides the wheel or turbine itself will be the gears or pulleys, the shafting and the electrical generator. A 1 KW generator should be obtainable for under \$200 new and considerably less if surplus or used. A new 10 KW unit should start in the \$800 range. The pulleys, drive belts and chains or gears needed to "gear up" the power of the waterwheel or turbine should be rather inexpensive.

The cheapest electrical generating hydro-power system that could be installed, dam, generator, turbine and all would cost a minimum of \$500, and more likely \$1,000. On the other end of the scale, a manufactured turbine, with dam and piping being constructed by the owner could cost from \$3,000 to \$10,000.

It is difficult to determine the long range cost of building or buying a hydro-plant, as opposed to hooking up with the local utility company. At present it is probably cheaper to go with the utility. But as the age of cheap utilities and the promise of something-for-nothing from nuclear power is disappearing, building an independent power source will become a more economical investment.

## Environmental Considerations

Waterwheels and turbines in and of themselves have a negligible effect on the environment. However, the damming of a river or stream, a necessity with most installations, has an important and sometimes irrevocable effect upon the long-term ecological balance of that particular environment. Certainly dams can create a better environment for some animals and plants, and they can and do prevent natural disasters such as floods and severe erosion. But it is important to know that by building a dam, you are also creating a pond or lake where a stream or river used to exist; that you are flooding an already existing river ecosystem, encouraging the accumulation of silt, and perhaps providing a breeding ground for mosquitoes. The resulting pond or lake behind a dam also usually raises the water table behind the dam (as a result of seepage) and lowers it below the dam. Innumerable other changes are effected by the construction of a dam, and it is generally fair to say that the larger the dam the greater the changes. It is therefore of primary importance to foresee the ecological impact of installing a hydro-plant, and if necessary, to forego that particular site plan or the entire project.

## MEASURING AVAILABLE WATER POWER

Assuming that you have overcome any legal, economic or environmental problems on your property you can now begin planning your hydro-power plant by calculating how much power is available from your stream. The amount of horse-power possible is determined by; (1) what quantities of water are available (the flow), and (2) what the drop or change in elevation (the head) along the water course is.

### Measuring Flow

The volume of water flowing is found by measuring the capacity of the stream bed and the flow rate of the stream. Accurate measurements of the water flow are important for decisions about the size and type of water power installation. You will want to know; (a) normal flow and (b) minimum flow. If a unit is built just on the basis of normal flow measurements, it may be inefficient or even useless during times of low flow. If it is built just on the basis of minimum flow measurements, which usually occur during the late summer, the unit may produce considerably less power than possible. All water courses have a variation of flow. There are often daily as well as seasonal differences. The more measurements you make throughout the year, the better estimate you will have of what the water flow really is. Once you know the stream's varying flows, a system can be built to operate with these flows.

### The Small Stream

$$Q = \frac{V}{S} \quad \text{where} \quad \begin{array}{l} Q = \text{flow rate in cubic feet per second (cfs)} \\ V = \text{volume of bucket in cubic feet} \\ S = \text{filling time in seconds} \end{array} \quad (\text{Eq. 1})$$

The easiest way to measure the flow rate of a small creek or stream with a capacity of less than one cubic foot per second is to build a temporary dam in the stream. Channel all of the water flow into a pipe or trough and catch it in a bucket of known volume. Measure the time it takes to fill the bucket and use Eq. 1 to find the flow rate.

### The Medium Stream: The Weir Method

$$Q = T \times W \quad \text{where} \quad \begin{array}{l} Q = \text{flow rate in cubic feet per second} \\ T = \text{flow value in cubic feet per second per foot of} \\ \quad \text{width of the weir, read from a standard table} \\ \quad \text{(Table I)} \\ W = \text{width of the weir in feet} \end{array} \quad (\text{Eq. 2})$$

The weir method is used for measuring flows of medium streams with a capacity of more than one cubic foot per second. Basically a kind of water meter, a weir is usually a rectangular notch of definite dimensions, located in the center of a small dam. By measuring the (1) depth of water going over the weir and referring to standard tables, and measuring (2) the weir width, the volume of flow can be accurately calculated.

In order for standard tables to apply, the weir must be constructed of standard proportions. Before you build the dam, measure the depth of the stream at the site. The depth of the weir notch "H" (see Fig. 1A) must equal this. The weir notch must be located in the center of the weir dam (see Fig. 1B) with its lower edge at least a foot above the downstream

water level. The opening must have a width at least three times its height (3H), and larger if possible. The notch will then be large enough for the water to pass through easily to measure the large flows, and yet not too large so that it cannot also accurately measure the small flows.

The three edges of the opening should be cut or filed on a 45° slant downstream, to produce a sharp edge on the upstream side of the weir. The sharp edges keep the water from becoming turbulent as it spills over the weir, so that measurements will be accurate.

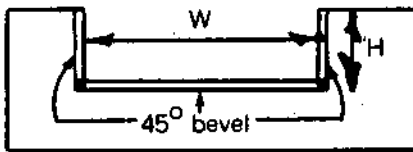

FIG. 1A WEIR

W SHOULD BE ABOUT 3 TIMES H. THE THREE SIDES ARE CUT TO A 45° BEVEL; SHARP EDGE PLACED UPSTREAM

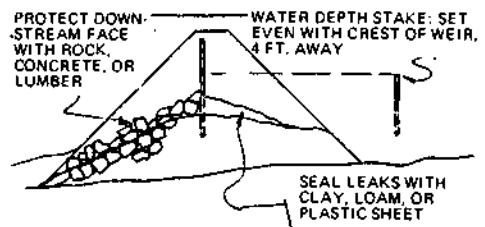

FIG. 1C WEIR DAM CROSS-SECTION

The weir dam need not be permanent, although if left in, it is convenient for continuously monitoring stream flow. The temporary dam can be made simply from logs, tongue and groove lumber, scrap iron, or the like. The dam must be perpendicular to the flow of the stream. And, when the weir is installed, be certain that the sides are cut perpendicular to the bottom, and that the bottom is perfectly level.

All water must flow through the weir opening, so any leakage through the sides and bottom of the dam must be sealed off. Side and downstream leakage can be stopped with planks extended into the banks and below the bed of the stream. Upstream leakage can be sealed off with clay or sheet plastic.

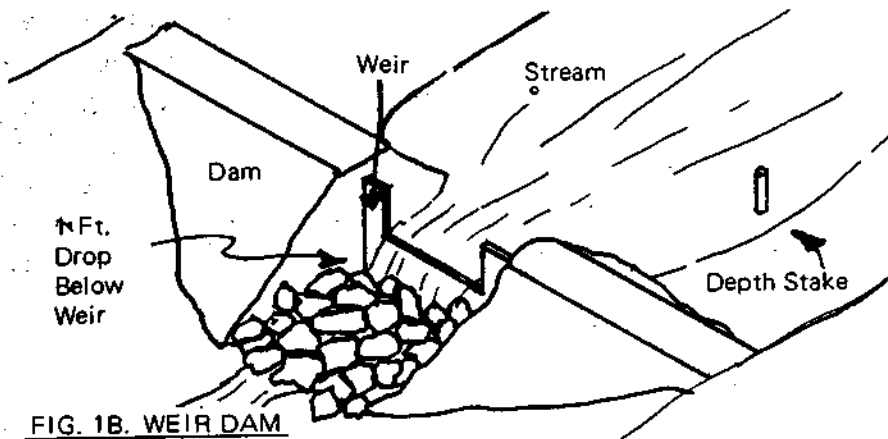

FIG. 1B. WEIR DAM

The accepted method of measuring the water depth over the weir notch (in lieu of putting a ruler in the weir notch) is to drive a stake in a spot accessible from the bank and at least four feet upstream from the weir. The reason for placing the stake at this distance is that the level of the water begins to fall as it nears the weir, where the water forms a crest. Four feet is a safe distance away from the weir to avoid measuring this lower water.

Pound the stake down until the top of the stake is exactly level with the bottom of the weir opening. A level can be established by placing a plank between the bottom of the weir opening and the stake, and using a car-

penter's level. To measure the "head" (depth) of water flowing over the weir, allow the stream to reach its maximum flow through the weir, and place a ruler on the stake. Then directly measure the depth in feet of water over the stake.

Having measured the depth of the water, refer to the Flow Rate Weir Table (Table I) for the flow rate for that depth labelled "H" for Head. The flow rate in Table I is given in cubic feet per second for each foot of width of the weir. It is necessary to multiply the flow rate by the width of the weir in feet, to find the actual flow rate. For example: If the depth (H) of the water is 1 foot then the given flow rate from Table I is 3.26. To find the flow over a weir that is 4 feet wide, multiply 4 x 3.26 which equals 13.04 cubic feet per second.

### The Large Stream: Float Method

The following method is not as accurate as the previous two. It is impractical to dam a larger stream and measure it for preliminary study, but with large amounts of water, a precise measurement is probably not so important.

**TABLE I – FLOW RATE WEIR TABLE**

Table for rating the flow over a rectangular weir.  
Flow (Q) is in cubic feet per second per foot of width of the weir.  
Multiply the flow value given times the width of the weir in feet  
to find the actual flow rate.

<u>H, head</u> <u>(feet)</u>	<u>Q, flow</u> <u>(cfs)</u>	<u>H, head</u> <u>(feet)</u>	<u>Q, flow</u> <u>(cfs)</u>	<u>H, head</u> <u>(feet)</u>	<u>Q, flow</u> <u>(cfs)</u>	<u>H, head</u> <u>(feet)</u>	<u>Q, flow</u> <u>(cfs)</u>
.05	.037	1.05	3.51	2.05	9.37	3.05	16.66
.10	.105	1.10	3.76	2.10	9.71	3.10	17.05
.15	.193	1.15	4.01	2.15	10.05	3.15	17.45
.20	.297	1.20	4.27	2.20	10.39	3.20	17.84
.25	.414	1.25	4.54	2.25	10.73	3.25	18.24
.30	.544	1.30	4.81	2.30	11.08	3.30	18.65
.35	.685	1.35	5.08	2.35	11.43	3.35	19.05
.40	.836	1.40	5.36	2.40	11.79	3.40	19.46
.45	.996	1.45	5.65	2.45	12.14	3.45	19.87
.50	1.17	1.50	5.93	2.50	12.51	3.50	20.28
.55	1.34	1.55	6.23	2.55	12.87	3.55	20.69
.60	1.53	1.60	6.52	2.60	13.23	3.60	21.10
.65	1.72	1.65	6.83	2.65	13.60	3.65	21.53
.70	1.92	1.70	7.13	2.70	13.97	3.70	21.95
.75	2.13	1.75	7.44	2.75	14.35	3.75	22.37
.80	2.34	1.80	7.75	2.80	14.73	3.80	22.79
.85	2.57	1.85	8.07	2.85	15.11	3.85	23.22
.90	2.79	1.90	8.39	2.90	15.49	3.90	23.65
.95	3.02	1.95	8.71	2.95	15.88	3.95	24.08
1.00	3.26	2.00	9.04	3.00	16.26	4.00	24.52

$Q = A \times V$  where  $Q$  = flow rate in cubic feet per second (cfs)  
 $A$  = average cross-sectional flow area in square feet  
 $D(\text{depth}) \times W(\text{width})$   
 $D$  = the average depth of the stream  

$$\frac{(d_0 + d_1 + d_2 + d_3 + \dots + d_n)}{n}$$
 which is the sum of the depths at  $n$  stations  
 of equal width, divided by  $n$   
 $W$  = the width of the stream  
 $V$  = the velocity in feet per second of a float

(Eq. 3)

Choose a length of stream that is fairly straight, with sides approximately parallel, at least 30 feet long (the longer the better), that has a relatively smooth and unobstructed bottom. Stake out a point at each end of the length, and erect posts on each side of the bank at these points. Connect the two upstream posts by a level wire or rope (use a carpenter's line level). Proceed the same way with the downstream posts (see Fig. 2).

Divide the stream into at least five equal sections along the wires (the more sections, the better), and measure the water depth for each section. Then average the depth figures by adding each value and dividing by the number of values. For example, if you have 7 readings of equal width, add  $\text{depth}_0 + \text{depth}_1 + \text{depth}_2 + \text{depth}_3 + \text{depth}_4 + \text{depth}_5 + \text{depth}_6 + \text{depth}_7$  and divide by 7. Since Fig. 2 shows  $d_0$  and  $d_7$  at the edge of the stream, their depths are zero, they are not included in the calculation, and the sum of the values is divided by 5. For other situations, Eq. 4 should be used.

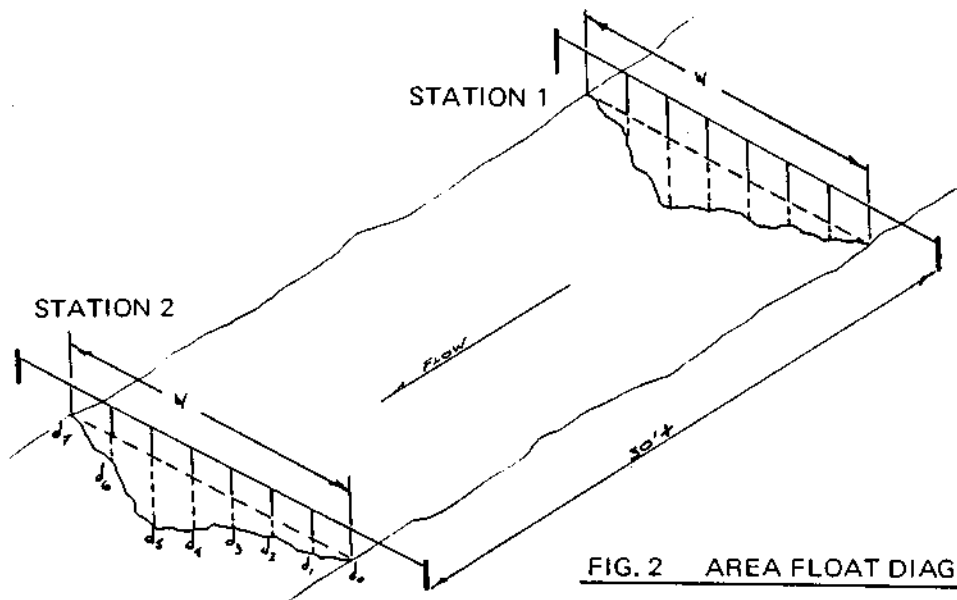

FIG. 2 AREA FLOAT DIAGRAM

$$A = \frac{(d_0 + d_1 + d_2 + d_3 + \dots + d_n)}{n} \times (W)$$

where A = average cross-sectional flow area in square feet  
 d = the depth at each reading  
 n = the number of readings taken along the stream's width  
 W = the width of the stream

(Eq. 4)

Now to find the stream's cross-sectional area, multiply the average value of the depth times the stream's width (the length of the wire or rope as in Eq. 4.)

Remember that you are trying to find the average area of a section of the stream, so you must take the value of (A) for each station, add them together and divide by two.

Your next step is to measure the stream's velocity in order to determine Q (the stream's flow rate). Make a float of light wood, or use a bottle that will ride awash. A pennant can be put on the float so that its progress can be followed easily. Now set the float adrift, in the middle of the stream, upstream from the first wire. Time its progress down the stream with a stop watch, beginning just when the float passes the first wire, and stopping just as it passes the second wire. Since the water does not flow as fast on the bottom as it does on the surface, you must multiply your calculations by a coefficient to give you a more accurate estimate of the stream's velocity.

$$V = \frac{D}{T} \times .8 \quad \text{where } V = \text{velocity in feet per second (fps)}$$

D = distance in feet  
 T = time in seconds  
 .8 = coefficient

(Eq. 5)

Having determined the area and velocity of the stream, Eq. 6 gives the flow rate of the stream.

$$Q = A \times V \quad \text{where } Q = \text{flow rate (cfs)}$$

V = velocity (feet per second)  
 A = cross-section area in square feet

(Eq. 6)

## Measuring Head

The "head" or height of fall of the water determines what kind of waterwheel or turbine you will choose. Commonly, this distance is measured in feet. Head produces a pressure . . . water pressure. Basically the weight of the water at a given head exerts a pressure that is proportional to that head . . . the greater the head the greater the pressure. Pressure is usually measured in pounds of force per square inch (psi). Pipes, fittings, valves and turbines may be rated either in head or psi. The relationship between the two if you need to know head, and the equipment is rated in psi and vice versa, is:

1 ft. head = .433 psi      .water weighs 62.4 lbs. per cubic foot  
    .there are 144 square inches (in<sup>2</sup>) per square foot  
    .thus  $\frac{62.4\text{lbs/ft}^3}{144\text{in}^2/\text{ft}^2} = .433 \text{ psi/ft of head}$

An elevation of head will produce the same pressure, no matter what the volume or quantity of water is in that distance. If the head or depth of water is 20 feet the pressure of that water will be  $(20 \times .433) = 8.7$  psi whether there is a whole reservoir of water 20 feet deep or a 2 inch pipe filled with water 20 feet high.

You can get a rough estimate of head on your land from a detailed topographic map. The U.S. Geological Survey prints topographic maps of the entire U.S., with elevation contour intervals of 40'. They are available directly from the USGS (see page 68) or from some local sporting goods stores. These maps are useful for making note of particularly choice sites. However, since they only give an approximation of slopes and elevations, for a more accurate measure of head it will be necessary to take a level survey.

Level surveying is a relatively easy process. A good description of a poorman's survey using a carpenter's level can be found in *Cloudburst* (see page 66). Also included in that publication is a critique that recommends the all-purpose hand level. The hand level is a metal sight tube with a plain glass cover at each end and a prism, cross hair, and spirit level inside the tube. In most cases the hand level will be the simplest and least expensive surveying transit or a surveyor's level) but they will probably not be needed for these basic measurements.

*Measuring the vertical difference in elevation between point A and point B.*

1. Basic Eyeball Method with Handlevel: How High is Your Eye?

Measure the distance standing upright from the bottom of your feet to the middle of your eye. Stand at the lower point (point B) and sight through the level at the top of an object or at the ground next to an object so you know where to go next. Go stand at that spot and sight again, always working towards point A. With a pole in the ground at point A the elevation of the final sighting can be marked and subtracted from the total. By simply multiplying the elevation of the eye by the number of sightings (minus the extra elevation in the last sighting) the vertical elevation change from point A to B is determined.

2. With surveying Rod and Handlevel

Attach a tape measure to a pole with the zero end at the bottom. Have one person hold the rod while another sights through the handlevel. This does require some conversation between the "rod-man" and the "instrument man" about where the "level point" is on the rod and what the value of that point is.

The instrument man must tell the rod man where the level point is on the rod (indicated with a pointing finger) and the rod man must read off and write down the value on the tape of that point. The instrument man stays put while the rod man moves on towards point B to some notable point where a new reading is taken. Then the instrument man "leap-frogs" downhill past the rod for a new reading and so forth. Add up the differences of readings for each time the instrument man moves past the rod man; the total of these differences will be the elevation change from point A to point B.

The head is then the change in elevation between point A and point B. It is desirable to obtain the greatest amount of head possible. This can be accomplished in several ways. First, you can choose a site for the turbine where the greatest drop in the stream occurs in the shortest distance.



Secondly, the amount of head can be increased with the construction of a dam (see Dams). Most hydro-power systems will require a dam anyway, and the higher the dam can be built, the greater the head will be. Finally, the head may be increased by the use of a channel or sluice. The channel or sluice will be downstream from the dam to carry the water to a place where a steeper drop occurs. Other determining factors must be considered in trying to realize the greatest amount of head. The most basic are cost, property lines, construction laws, soil condition and pond area in back of the dam.

## Calculating Power

We can define power as the ability to do work. In order to determine if the hydro-power installation will meet your needs, the amount of available power must be calculated. The amount of this power is proportional to the head available and the flow rate of the water. Waterwheels and water turbines generate mechanical power (however, turbines are usually hooked up to an electrical generator, and the mechanical power generates electrical power). The mechanical power is usually measured in horsepower.

$$\text{THP} = \frac{Q \times H}{8.8} \quad \text{where} \quad \begin{array}{l} \text{THP} = \text{theoretical horsepower} \\ Q = \text{flow rate in cubic feet per second (cfs)} \\ H = \text{head in feet} \\ 8.8 = \text{correction factor for the units} \end{array}$$

(Eq. 7)

Eq. 7 illustrates the theoretical horsepower available from the head and flow of a stream. Eq. 8 below refines the calculation of this available power. There are losses in the amount of head due to friction in the channel or pipe which carries water from the dam to the wheel or turbine. Thus, actual head is the amount of head loss (due to friction) subtracted from the total head available. A discussion of the head loss in pipes and canals can be found in the Channels, Sluices and Pipes section.

Another loss factor that Eq. 8 accounts for is the efficiency of the devices (turbine, generator, and any mechanical connection between the two: belts, gears, chains, pulleys) used to harness the power. In the case of water power, efficiency is an indicator of the conversion performance of the machinery used to harness the water power. It is usually measured as a percentage. Each machine or device will have its own efficiency percentage, and they must be multiplied together in order to obtain the over-all efficiency:

$$\text{NHP} = \frac{Q \times H \times E}{8.8} \quad \text{where} \quad \begin{array}{l} \text{NHP} = \text{net horsepower} \\ Q = \text{flow rate in cubic feet per second} \\ H = \text{actual head in feet} \\ E = \text{efficiency of all the devices multiplied} \\ \quad \text{times one another} \\ \quad \text{(i.e. } 75\% \times 85\% \times 80\%) \\ 8.8 = \text{correction factor for the units} \end{array}$$

(Eq. 8)

## POWER TRANSMISSION

In many cases the power available from a hydro-power installation will not supply the amount of power desired. In those cases it will probably be necessary to re-define your needs or fill them on a priority basis. Some needs can also be filled by another source of power. It is thus useful to think in terms of an integrated power systems approach from the outset.

It is probably pretty obvious that the operating speeds of the water wheels and turbines will not exactly match the speeds required to drive the generator or compressor. The common design of A.C. generators requires a particular rpm in order to produce the proper voltage and frequency of electricity. For the 60 cycle frequency common in the U.S. and Canada, the minimum input of a two-pole generator is 3600 rpm. Four pole generators are slightly more expensive, but operate at 1800 rpm. Six and eight-pole generators are also available (with proportionately slower operating speeds of 1200 rpm and 900 rpm) but these are specialty items that can be hard to find and are quite expensive besides. Even the speediest turbine of them all, the Pelton wheel, would require a head of more than 2000 feet to drive a 12 inch wheel at the 1800 rpm that is needed for a four-pole A.C. generator.

At the other extreme in power sources, the overshot wheel would turn at about 10 rpm (for a 16 foot wheel); the gearing up to get the speed necessary for electric generation would require a gear ratio of over 1-to-100. This sort of speed change would, in itself, cause some considerable loss in the overall efficiency of the system.

D.C. generators and alternators are available throughout the world for use in autos. They can operate at most any rpm above their minimum (that is, something faster than about 700 rpm); also, they are usually equipped (in an auto) with some sort of voltage regulator to avoid over-charging the batteries. This sort of flexibility in operation, along with their ready availability and their bargain prices, make them attractive for use in small scale generating plants (for windmills, as well as waterwheels). The D.C. technology developed for automotive systems can be applied for some household uses: D.C. storage batteries, light bulbs, radios, tape players and small motors are available. The biggest problem in converting a household to D.C. use are those motors in appliances and power tools. Most are designed for the common 60 cycle A.C. power source at 120 volts and would be completely useless for a 12 volt D.C. power supply.

Most installations use belts and pulleys to transfer the power from turbine to generator and, at the same time, obtain the needed rpm along the way. Larger installations, or those with high torques (like the waterwheels) need to have some sort of metal gearing or drive chains to handle the loads. Ready-built gear boxes and speed changers are usually available at surplus or used machinery dealers. And, of course, the neighborhood auto junk yard has a plentiful supply of rear axles, already complete with roller bearings and wheel mounting bolts. These can be arranged to provide a gear ratio of from 3:1 to almost 9:1. (Of the three rotating parts, that is, the two wheels and one drive shaft connection, one must be fixed in order for power to be transferred through the other two.) To check the gear ratio of any gear box in question merely turn one shaft and count the resulting turns of the other shaft.

## HYDROELECTRICITY

If you could choose any renewable energy source to use, hydro is the one you want. If you don't want to worry about an energy-efficient lifestyle, always nagging the kids to turn off the lights, watching the voltmeter, considering every appliance not on appearance or function but on energy efficiency. Well then, you had better settle next to a substantial year-round stream! Hydropower, given the right site, can cost as little as a tenth that of a PV system of comparable output. Hydropower users are often able to run energy-consuming appliances that would bankrupt a PV system owner, like mass-produced refrigerators and electric space heaters. Hydro may require more effort to install, but even a modest hydro output over 24 hours a day, rain or shine, will add up to a large cumulative output. Hydro systems get by with smaller battery banks because they only need to cover the occasional heavy power surge rather than four days of cloudy weather. So, now that we have you all enthusiastic, what makes a good hydro site and what else do you need to know?

### *What is a "Good" Hydro Site?*

The Columbia River in the Pacific Northwest has some great hydro sites, but they aren't exactly homestead-scale (or low-cost). Within the hydro industry the kind of home-scale sites and systems we deal with are called *micro-hydro*. The most cost-effective hydro sites are located in the mountains. Hydropower output is determined by the water's volume times its vertical fall (jargon for the vertical fall is *head*). We can get the same power output by running 1000 gallons per minute through a 2-foot drop as by running 2 gallons per minute through a 1000-foot drop. In the former scenario, where lots of water flows over a little drop, we are dealing with a low-head/high-flow situation, which is not truly a micro-hydro site; turbines that can handle thousands of gallons are large, bulky, and extremely site-specific. At the homestead level, low-flow/high-head systems are perfect for a small Harris turbine which can handle a maximum of 120 gallons per minute and which requires a *minimum* 20-foot fall in order to make any useful amount of power. In general, any site with more than 100 feet of fall will make a good micro-hydro site. The more head, the less volume will be necessary to produce a given amount of power. Check the output chart on the facing page for a rough estimate of what your site can deliver.

The following charts give a rough idea of how much output in watts to expect from the Harris turbines at specific head and flow rates, and which voltage or output options are in order. If your site will exceed the wattage limits for the standard alternator, you will need to order the high-output option. The high-output option can increase wattage output for some sites, particularly low-head/low-speed sites. The precise output curves aren't easily graphable, so if you have trouble figuring it out from the following charts, give our technical staff a call and we'll talk it over.

These output charts are based on actual output measurements from a working site. We try to err a little on the conservative side for most applications. Multiply this number by 24 to get daily watt-hours generated. Our Hydro Site Evaluation program will also size the water pipe and wiring and factors in any losses from pipe friction or wire loss.

A typical micro-hydro system.

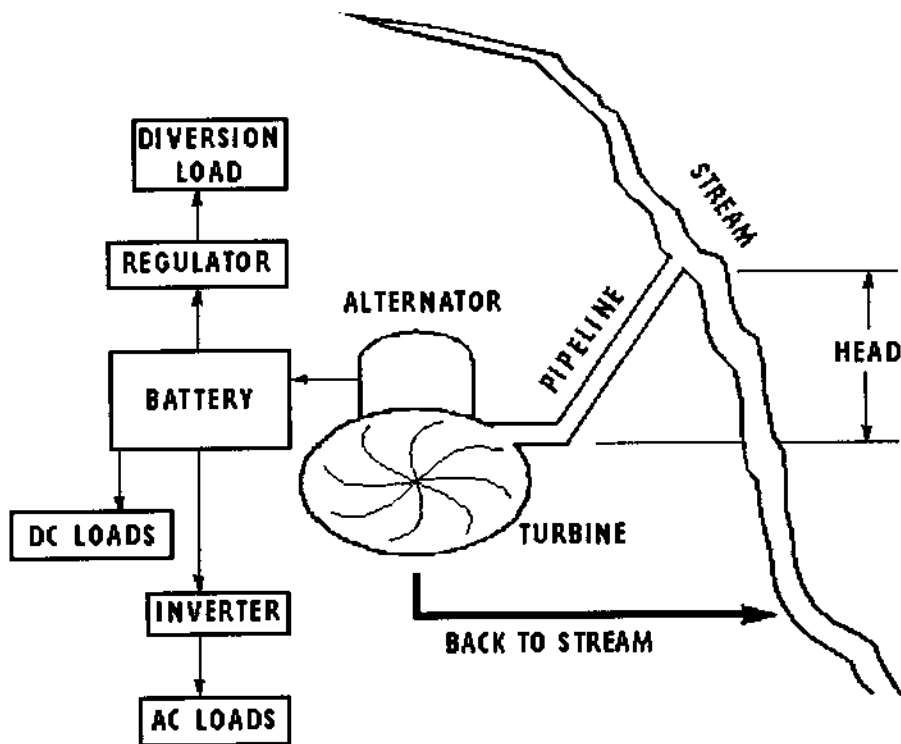

A hydro system's fall doesn't need to happen all in one place. You can build a small collection dam at one end of your property and pipe the water to a lower point, collecting fall as you go. It's not unusual to have 2000 to 4000 feet of pipe in a hydro system with only a few hundred feet of head.

#### *What If I Have a High-Volume/Low-Head Site?*

You are in the catbird seat for sure, but the variables are beyond the scope of this book. Apart from very significant engineering issues, there are also likely to be regulatory hurdles. Contact the National Appropriate Technology Assistance Service at (800)523-2929 for more free information than you ever thought was possible on low-head hydro.

**PROJECTED STANDARD HYDRO TURBINE OUTPUT  
(IN WATTS)**

GPM	Feet of Head						
	25	50	75	100	200	300	600
3	-	-	-	-	25	60	125
6	-	-	-	10	80	110	250
10	-	-	35	65	140	225	450
15	-	40	60	105	225	350	600
20	25	65	100	150	300	450	-
30	45	100	175	230	450	550	-
100	140	350	500	650	-	-	-

Wattage output figures based on actual measurement with standard output alternator. The fan option must be used on all systems producing over 20 amps (280 watts @ 12V, 560 watts @ 24V).

**PROJECTED HIGH-OUTPUT HYDRO TURBINE PRODUCTION  
(IN WATTS)**

GPM	Feet of Head						
	25	50	75	100	200	300	600
3	-	-	-	-	40	70	150
6	-	-	10	20	100	150	300
10	-	15	45	75	180	275	550
15	-	50	85	120	260	400	800
20	25	75	125	190	375	550	1100
30	50	125	200	230	580	800	1500
100	200	425	625	850	1500	-	-

Wattage output figures based on actual measurement with high output alternator option. The fan option must be used on all systems producing over 30 amps (420 watts @ 12V, 840 watts @ 24V).

**ALTERNATOR OUTPUT LIMITS**

	12-Volt	24-Volt
Standard	375 watts	750 watts
High-Output	750 watts	1500 watts

## HOW DOES A HYDRO SYSTEM WORK?

The Harris turbine is the simplest and most appropriate micro-hydro generator we have encountered. A cast silicone-bronze Pelton wheel is mated with a low-voltage DC alternator, which produces plenty of power for charging batteries and running household appliances. By using a DC charging system and batteries a couple of important advantages are gained. First, the battery system allows the user more energy over a short time than the turbine produces, so we can start and run larger appliances, motors, and tools. There is no problem with washing machines or power tools, so long as the inverter/battery system is sized to handle them. Secondly, DC charging means that precise control of alternator speed is not needed, as it would be to produce a 60 Hz output. This saves thousands of dollars on control equipment. The Enermaxer controller that is especially designed for hydro systems simply takes any surplus power beyond what is needed to keep the batteries charged and diverts it to a secondary load, often a water- or space-heating element, so extra energy heats either domestic hot water or the house.

The alternators used for the Harris are the world's most common models: vintage 1960s and 1970s Delco or Motorcraft units with windings that are customized for each individual application. (*For us to customize the windings correctly, it is very important for you to fill out one of the Hydro Site Evaluation forms when ordering.*) Parts that wear out, brushes and bearings, are commonly available at any auto parts store, making maintenance for these units easy anywhere in the world. Bearings and brushes require replacement at intervals anywhere from annually to once every five years depending on how hard the unit is working.

A disadvantage of this system can be difficulty of transmission from the turbine to the batteries. Low-voltage power is difficult to transmit. The turbine should be as close to the batteries as is practical. Transmission distances of more than 500 feet require expensive large-gauge wire or technical gimmickry. A typical installation has the batteries at the house *on top* of the hill, where the good view is, and the turbine *at the bottom* of the hill, where the water ends its maximum drop. With longer distances we sometimes install the batteries and inverter at the turbine site; please consult with the Real Goods Technical Staff about this option. Longer transmission distances are possible, but this drives system prices up.

Depending on the volume and fall at your micro-hydro site, Harris turbines will produce from 1 kWh (1000 watt-hours) to 30 kWh per day. The typical American home consumes 10 to 15 kWh per day with no particular energy conservation, so with a good site it is fairly easy to live a totally conventional lifestyle with hydropower.

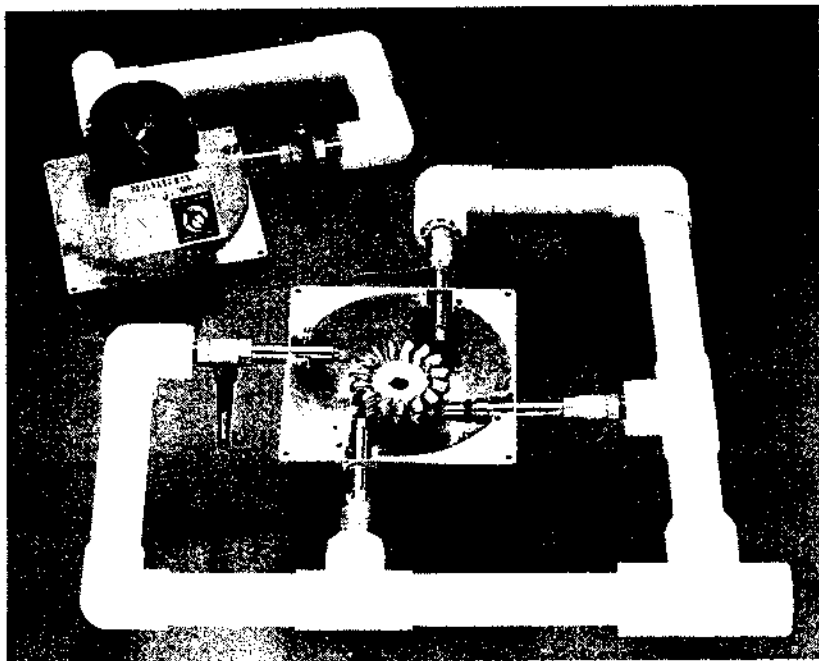

*A two-nozzle and four-nozzle (shown upside down) hydro turbine.*

Hydro turbines can be used in conjunction with any other renewable energy source, such as PV or wind, to charge a common battery bank. Many of us have seasonal creeks with substantial drops, but that only flow in the winter. This is when our power needs are often at their highest level and PV input is certainly at its lowest, and so we count ourselves lucky. Small hydro systems are well worth developing, even if you can only use them a few months out of the year.

### *How Many Nozzles?*

The Pelton wheels which turn falling water into rotational power for a generator have from one to four nozzles. The maximum flow rate for any single nozzle is 30 gallons per minute, so if you have 40 gallons per minute (gpm) to work with at peak flow and want to use it all you will need to use two nozzles. Many folks buy two or four nozzle turbines, so that individual nozzles can be turned on and off to meet variable power needs or water availability. Three-nozzle turbines are not commercially available. The nozzles are replaceable (because they wear out, especially if there is grit in the water) and come in 1/16-inch increments, from 1/16 inch through 1/2 inch. (*This is another reason you must fill out the Hydro Site Evaluation form, so we can advise you well on what sizes to order.*) The first nozzle on any turbine doesn't have a shutoff valve, while all nozzles beyond the first one are supplied with ball valves for easy, visible operation.

### *Site Evaluation*

Okay, you have read everything about hydro up to here, you have a fair amount of drop across your property, you have enough water flow, and you think microhydro is a definite possibility. What happens next? Time to get outside and take some measurements, then fill in the necessary information on the Hydro Site

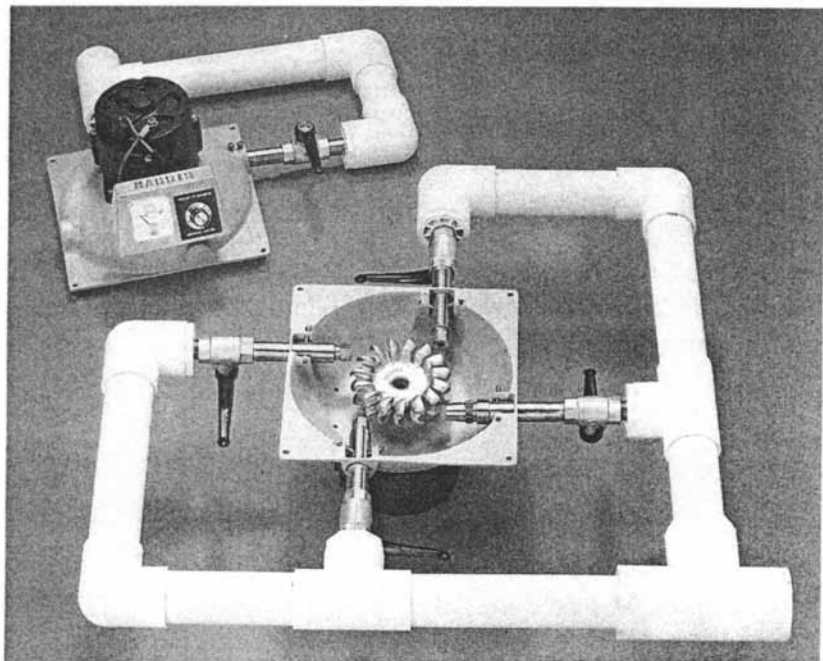



Evaluation form. By looking at this completed form we here at Real Goods can calculate which turbine and options will best fill your needs, as well as what size pipe and wire and which balance-of-system components you require. Then we can provide you with some hard numbers on paper, such as: what your system will cost, and what you can expect to gain. In the end, you will have what you need to decide if it is all worth the work.

**Distance Measurements.** Keep the turbine and the batteries as close together as practical. As discussed earlier, distances greater than 500 feet get expensive. The more power you try to move, the more important distance becomes.

## MEASURING HYDROPOWER

### *Fulminations from a Real Goods Applications Engineer*

Why is it that we in the United States are so steadfast in our refusal to adopt the metric system? Our obstinacy leaves us nearly alone in the world and brings us nothing but grief as we attempt to participate in the new global economy. One would think that the young and iconoclastic renewable-energy industry would have jumped headfirst into the warm and rational clutches of metrification years ago, but noooooo . . . Instead, the Powers That Be cling to the archaic terminology of an era that has proven to belong on the ash heap of history.

This is particularly true when the subject is small-scale hydroelectric power. Converting feet and gallons per minute to watts requires tremendously complicated conversions between units inherently at odds. Trying to figure out the logic of the fudge factors used in these unit conversions can be very frustrating when all you really want to figure out is how much power is available. To this end, I present the following to those curious few who would like to be able to estimate power output from a hydroelectric site. I submit that the metric system allows us to easily and accurately make use of simple math and physics concepts to arrive at a conclusion which is both reasonable and comprehensible.

### *Analysis of Hydropower Potential*

The potential energy available from falling water can be derived from the general equation describing the potential energy of an elevated object:

$$\text{Potential Energy} = m \times g \times h$$

where:

m = mass

g = gravitational acceleration

h = height

A given mass of water at rest a given height above the ground will embody a potential energy expressed in *joules*, the metric unit of energy measurement.

We need to know the distance from the proposed turbine site to the batteries (how many feet of wire), and from the turbine site to the water collection point (how many feet of pipe). These distances are fairly easy to determine.

**Fall Measurements.** Next, we need to know the vertical fall from the collection point to the turbine site. This measurement is a little tougher. If there is a pipeline in place already, or if you can run one temporarily and fill it with water, this part is easy. Simply install a pressure gauge at the turbine site, turn off the water, and make sure the pipe is full. Read the static pressure (which means no water movement in the pipe) and multiply the psi (pounds per square inch) reading by

---

We are not interested so much in this absolute potential under static (not moving) conditions, but rather in the *rate* of power production with a given flow rate of water.

Therefore, our rate of power production is based upon the *mass per second* which can fall this distance, which yields the rate of power production expressed as *joules/second*, otherwise known as *watts*.

In other words:

$$\text{Wattage}(\text{maximum theoretical}) = (\text{mass}/\text{sec}) \times g \times h$$

or

$$\text{Wattage} = \text{kilograms}/\text{second} \times (9.8 \text{ meters}/\text{second}/\text{second}) \times h \text{ (in meters)}$$

**Example:** What is the potential wattage available from 5 liters/sec falling 100 meters?

Water has a density of 1 gram/cubic centimeter, so 1 liter has a mass of 1 kilogram. Therefore:

$$\text{Wattage} = 5 \text{ kg}/\text{sec} \times (9.8 \text{ m}/\text{sec}/\text{sec}) \times 100 \text{ m} = 4750 \text{ watts}$$

To relate this to a practical hydroelectric system, certain inefficiencies must be accounted for. The turbine will not convert all of the available potential energy into mechanical energy. The electric generator or alternator will not convert all of the mechanical energy into electrical power. Our Pelton wheel alternator units have an overall efficiency of about 40%, and so, to estimate the power produced, multiply theoretical yield by .40. Using the example cited above, multiplying 4750 watts by our efficiency factor of 40% results in a theoretical maximum output of 1900 watts (1.9 kilowatts). There will also be friction losses in the supply pipe which reduce the effective "head," but ignoring them does not compromise our reasonable baseline estimate for the site.

The 5 liters/second of water processed would be equal to (for those who must have English units) 79.25 gallons per minute (1 liter/second = 15.85 gallons/minute), and 100 meters is equal to 328.1 feet.

2.31 to obtain the vertical drop in feet. If the water pipe method isn't practical, you'll have to survey the drop or use a very accurate altimeter.

The following instructions represent the classic method of surveying. You've seen survey parties doing this (and have doubtless always wanted to attend a survey party), so this is your big chance to get in on the action. You'll need a carpenter's level, a straight sturdy stick about six feet long, a brightly colored target that you will be able to see a few hundred feet away, and a friend to carry the target and make the procedure go faster and more accurately. (It's hard to party alone.)

Stand the stick upright and mark it at eye level (five feet even is a handy mark that simplifies the mathematics, if that's close to eye level for you). Measure and note the length of your stick from ground level to your mark. Starting at the turbine site, stand the stick upright, making sure your carpenter's level is level, then sight uphill toward the water source along the level. With hand motions and body English, guide your friend until the target is placed on the ground at the same level as your sightline, then have your friend wait for you to catch up. Repeat the process, carefully keeping track of how many times you repeat. It is a good idea to draw a map to remind you of landmarks and important details along the way. If you have a target and your friend has a stick (marked at the same point, please) you can leapfrog each other, which makes for a shorter party. Multiply the number of repeats between the turbine site and the water source by the length of your stick(s) and you have surveyed the vertical fall. People actually get paid to have this much fun!

**Flow Measurements.** Finally, we need to know the flow rate. If you can, block the stream and use a length of pipe. Time how long it takes to fill a 5-gallon bucket. Dividing the time by five yields seconds per gallon. Divide 60 seconds by this seconds/gallon figure, and you have calculated the flow in gallons per minute. If the flow is more than you can dam up or get into a 4-inch pipe, or if the force of the water sweeps the bucket out of your hands, forget measuring; you've got plenty!

## CONCLUSION

Now you have all the information needed to guesstimate how much electricity your proposed system will generate based on the Projected Hydro Turbine Output charts on page 125. This gives a rough indication as to whether your hydro site is worth developing, and which alternator option is best. If you think you have a real site, fill out the Hydro Site Evaluation form, and send it and \$10 to us here at Real Goods. We will run your figures through our computer sizing program, which will figure how much head is lost to pipe friction, how much wattage is lost in transmission, and a myriad of other calculations necessary to design a working system. You can find a worked-out sample on the facing page.

Because Harris turbines are customized for each installation, it is absolutely essential that you either fill out the Hydro Survey Form on that follows the sample and mail it in, or give the data to a member of the Real Goods Technical Staff over the phone before ordering a turbine.

# REAL GOODS HYDRO-ELECTRIC SITE SURVEY FORM

Name \_\_\_\_\_

Address \_\_\_\_\_

Phone # \_\_\_\_\_ Date \_\_\_\_\_

Pipe Length: \_\_\_\_\_ (from water intake to turbine site)

Pipe Diameter: \_\_\_\_\_ (only if using existing pipe)

Available Water Flow: \_\_\_\_\_ (in gallons per minute)

Vertical Fall: \_\_\_\_\_ (from water intake to turbine site)

Turbine to Battery Distance: \_\_\_\_\_ (one way, in feet)

Transmission Wire Size: \_\_\_\_\_ (only if existing wire)

House Battery Voltage: \_\_\_\_\_ (12, 24, ??)

## *Alternate estimate (if you want to try different variables)*

Pipe Length: \_\_\_\_\_ (from water intake to turbine site)

Pipe Diameter: \_\_\_\_\_ (only if using existing pipe)

Available Water Flow: \_\_\_\_\_ (in gallons per minute)

Vertical Fall: \_\_\_\_\_ (from water intake to turbine site)

Turbine to Battery Distance: \_\_\_\_\_ (one way, in feet)

Transmission Wire Size: \_\_\_\_\_ (only if existing wire)

House Battery Voltage: \_\_\_\_\_ (12, 24, ??)

For a complete computer printout of your hydro-electric potential, including sizing for wiring and piping, please fill in the above information and send to Real Goods along with \$10. Refundable with system purchase.

# CALCULATION OF HYDROELECTRIC POWER POTENTIAL

Copyright © 1988 By Ross Burkhardt. All rights reserved.

## ENTER HYDRO SYSTEM DATA HERE:

PIPELINE LENGTH: 1300.00 Ft.  
PIPE DIAMETER: 4.00 INCHES  
AVAILABLE WATER FLOW: 100.00 G.P.M.  
VERTICAL FALL: 200.00 Ft.  
HYDRO TO BATTERY DISTANCE: 50.00 Ft. (1 way)  
TRANSMISSION WIRE SIZE: 2.00 AWG #  
HOUSE BATTERY VOLTAGE: 24.00 VOLTS  
HYDRO GENERATION VOLTAGE: 29.00 VOLTS

Customer: Meg A. Power

## Power produced at hydro:

49.78 AMPS  
29.00 VOLTS  
1443.53 WATTS

## Power delivered to house:

49.78 Amps  
28.20 VOLTS  
1403.59 WATTS

Four nozzle, 24v, high output w/cooling turbine required

## PIPE CALCULATIONS

HEAD LOST TO PIPE FRICTION: 7.61 Ft.  
PRESSURE LOST TO PIPE FRICTION: 3.29 PSI  
STATIC WATER PRESSURE: 86.62 PSI  
DYNAMIC WATER PRESSURE: 83.33 PSI  
STATIC HEAD: 200.01 Ft.  
DYNAMIC HEAD: 192.40 Ft.

## HYDRO POWER CALCULATIONS

OPERATING PRESSURE: 83.33 PSI  
AVAILABLE FLOW: 100.00 GPM  
WATTS PRODUCED: 1443.53 WATTS  
AMPERAGE PRODUCED: 49.78 AMPS  
AMP HOURS PER DAY: 1194.65 AMP HOURS  
WATT HOURS PER DAY: 34644.83 WATT HOURS  
WATTS PER YEAR: 12645362.71 WATT HOURS

## LINE LOSS (USING COPPER)

TRANS. LINE ONE WAY LENGTH: 50.00 FEET  
VOLTAGE: 29.00 VOLTS  
AMPERAGE: 49.78 AMPS  
WIRE SIZE #: 2.00 AMERICAN WIRE GAGE  
VOLTAGE DROP: 0.80 VOLTS  
POWER LOST: 39.95 WATTS  
TRANSMISSION EFFICIENCY: 97.23 PERCENT  
PELTON WHEEL RPM WILL BE: 2969.85 AT OPTIMUM WHEEL EFFICIENCY

This is an estimate only! Due to factors beyond our control; construction, installation, incorrect data, etc., we cannot guarantee that your output will match this estimate. We have been conservative with the formulas used here and most customers call to report more output than estimated. However, be forewarned! We've done our best to estimate conservatively and accurately, but there is no guarantee that your unit will actually produce as estimated.

# HYDRO-ELECTRIC

## Hydro Site Evaluation

In order to accurately size your hydro-electric system some specific site information is needed. Your site information is fed into our computer for our custom hydro sizing analysis. Send us the following information with an SASE and \$10 and we'll evaluate your potential site and recommend a system for you. Allow two weeks processing time. See form on page 131.

1. Head, or drop in elevation from source to turbine site.
2. Flow in gallons per minute. (120 gpm is maximum usable)
3. Length and size of pipe to be used. If existing pipe will be used, list type & condition of pipe.
4. Distance from turbine to point of power use.

17-001 Hydro Site Evaluation

\$10

## Harris Hydroelectric Turbines

When calculated on a cost-per-watt basis, a hydro-electric generator can cost as little as one-tenth as much as a photo-voltaic (solar) system of equivalent power, and sometimes can be cheaper than grid power. Solar only generates power when the sun is shining; hydro generates power 24 hours a day. The generating component of the Harris turbines is an automotive alternator (Delco or Motorcraft, depending on system requirements) equipped with custom-wound coils appropriate for each installation. The rugged turbine wheel is a one-piece Harris casting made of tough silicon bronze. There are hundreds of these wheels in service, with no failures to date. The aluminum wheel housing serves as a mounting for the alternator and up to four nozzle holders. It also acts as a spray shield, redirecting the expelled water into the collection box. Harris Hydroelectric turbines are available in several different nozzle configurations to maximize the output of the unit. The particular number of nozzles that you need is a function of the available flow in gpm and the existing pipe diameter.

Here is a chart with some general rules for sizing the number of nozzles on the system you will need, but bear in mind that we need to size your system exactly. *All turbines have custom windings, we need the Hydro Site Evaluation information to properly assemble a turbine for your site!*

GPM	Number of Nozzles
5 to 30	1
30 to 60	2
60 to 120	4

Here is a chart with the output limits for Standard and optional High Output alternators. Please note that if your site will exceed the wattage limits for the Standard alternator, you will need to purchase the High Output option.

Alternator output limits	12 volt	24 volt
Standard:	375 watts	750 watts
High Output:	750 watts	1500 watts

You may also wish to install the High Output alternator to produce more wattage from your site. We have approximate output charts a few pages back for both alternators. If your site is marginal the High Output option may make the difference you need.

•17-101	1 Nozzle Turbine	\$769
•17-102	2 Nozzle Turbine	\$885
•17-103	4 Nozzle Turbine	\$1,055
•17-131	High Output Alternator	add \$185
•17-132	24-Volt Option	add \$59
•17-133	Low Head Option (less than 60')	add \$39
•17-134	Extra Nozzles	\$5

## Pelton Wheels

For the small hydro-electric do-it-yourselfer, we offer the same reliable and economical Pelton wheel used on the complete turbines above. Harris silicon bronze Pelton wheels resist abrasion and corrosion far longer than polyurethane or cast aluminum wheels. These are 5" diameter high quality castings that can accommodate nozzle sizes of 1/16" through 1/2". Designed with threads for Delco or Motorola alternators.

•17-202	Silicon Bronze Pelton Wheel	\$269
---------	-----------------------------	-------

# Hydro Power

## Hydro-Electric Systems

If you have a good hydro-power site it will be more cost effective in terms of dollars per watt than either solar or wind power. The average hydro-electric generator costs only ONE TENTH as much as a solar (photovoltaic) system of equivalent power. Hydro power has a major advantage in terms of continuity of supply. Solar only generates power when the sun is shining; hydro generates power 24 hours a day.

With only occasional rains, the water is stored, over the long term, in the water catchment areas. This water is released slowly to keep creeks and streams flowing continuously over quite a long period. This continuity means that a large battery bank (for storage) may not be necessary because the hydro power can provide a constant charge to the battery bank 24 hours per day.

Hydro-electric power systems fall into four main areas:

1. **High head:** Using a high head allows the extraction of a greater potential energy from the same quantity of water. This is dependent on a fall in excess of 20 metres but it needs a relatively small flow rate. The water is piped down to the hydro plant to create the necessary head (pressure). The Turgo and the Pelton wheel are high head turbines.

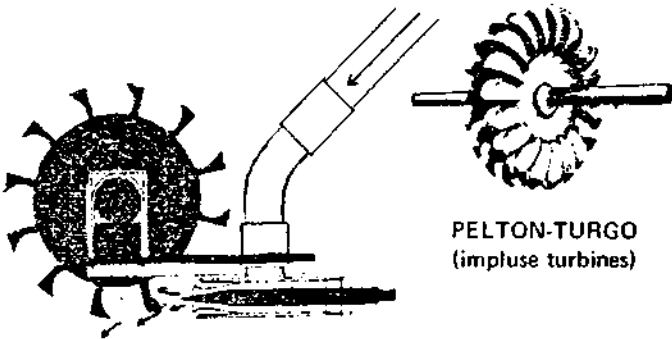

PELTON-TURGO  
(impulse turbines)

2. **Medium head:** With a lower head, a greater volume is required to produce the same power. The Francis (reaction) turbine is a medium head turbine which is a good turbine for small scale applications. It is basically a centrifugal water pump run in reverse which can be used as a cheap but inefficient turbine.



FRANCIS (reaction turbine)

3. **Low head:** A low head turbine requires a relatively large volume of water in order to extract a useful amount of power. It is also much more limited, due to difficulties in finding an appropriate site for the turbine which invariably needs to be located in or at the edge of a creek or stream. A Kaplan (propeller) turbine is an example of a low head turbine.

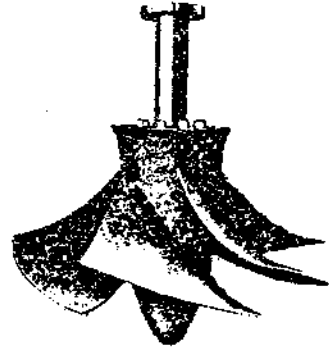

KAPLAN (propeller type)

4. **Flow of the stream turbine:** Where there is a fast flowing stream but virtually no head a floating propeller driven turbine may be used. See page 68 for more details.

A gear pump can also be used as a turbine. Gear pumps have high frictional and leakage losses, but are otherwise suitable for small scale hydro power applications. Gear pumps used as turbines need a medium to high head.

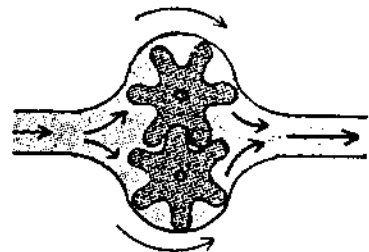

GEAR PUMP/ turbine

Banki (cross flow) turbines can be used for heads as low as 1 metre, up to heads as high as 200 metres. They can be manufactured in the back-yard workshop and are good for small scale hydro power applications. A Banki is, in effect, a two stage turbine.

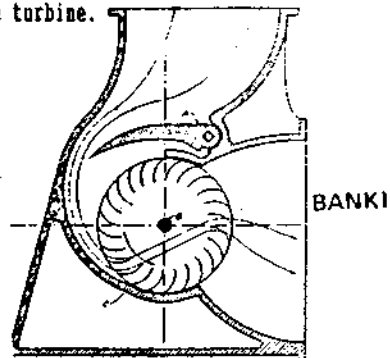

BANKI

## What is Head of Water?

To determine the power potential of water flowing in a river or stream it is necessary to determine both the flow rate of the water and the head through which the water can be made to fall.

### Flow Rate

The flow rate is the quantity of water flowing past a point in a given time. This is usually measured in litres per second.

### How to Measure Flow Rate

An easy method for measuring flow rate is with a common 10 litre bucket and a stop watch. The litres per second flow rate would then be exactly one tenth of the time it took to fill the 10 litre bucket. This method can be employed if you have a narrow opening through a weir or a pipe operating at its maximum flow rate.

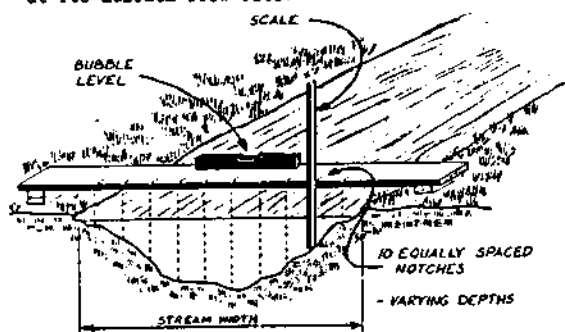

If you wish to ascertain the flow rate of a stream, when the 10 litre bucket method cannot be employed, you can get a rough idea by measuring the size (cross section) and average flow rate of the stream. For this method the speed of the mid-stream surface water is measured by timing a float. Choose a part of the stream where the cross section is regular. Measure the cross section by finding the average depth as shown, and the width. Time the float over a short distance to obtain the speed. The average speed of the whole stream can then be calculated by multiplying the measured speed by:

- 0.8 for a concrete channel
- 0.7 for an earth channel
- 0.5 for a rough hill stream

For streams less than 150 mm average depth, the factor becomes unpredictable and can be as low as 0.25. The flow rate is then equal to the distance that the float travelled multiplied by the correction factor and multiplied by the average depth and width of the stream and then divided by the number of seconds for the float to cover that distance. If the measurements are taken in metres and the float is timed in seconds, then the result multiplied by 1000 will give you the litres per second flow rate. Overall accuracy of this method is +/- 80%.

The water flow will always vary widely with the seasons and in some cases by a factor of several hundred. It is therefore essential to obtain as clear a picture as possible of the flow pattern and in particular the lowest flows experienced in the dry season.

The head is the vertical height in metres from the turbine up to the point where the water enters the intake pipe (which may be at a creek, stream, dam or weir).

The horizontal distance or the length of the pipe-line does not create an increase in pressure. It is the vertical distance which determines the maximum pressure that can be created in a length of pipe. This vertical distance or difference in altitude is called 'head'. Because hydro-electric systems depend on water pressure to generate electricity, it is important to be able to work out either the existing or potential water pressure.

Remember that the more pressure you have, the less flow you need to create the same amount of power.

### How To Measure Head

You can measure or gauge your head by one of several means:

1. **Pressure Gauge:** If you already have a pipeline installed with water flowing, it is just a matter of connecting a water pressure gauge (available from the Rainbow Power Company) to measure the pressure. The head in your situation can be worked out from the pressure that is measured. This pressure must be measured with the pipe completely filled with water (from the water source down) without any air pockets in the pipe and no water flowing in the pipe. If you have water flowing in the pipe due to taps turned on, leaks etc you will be measuring the pressure drop due to the friction in the pipe rather than your potential water pressure.
2. **Contour Map:** Locate the water source and the potential site for your hydro on a reasonably accurate contour map.
3. **Using a Level:** Another method of measuring head is to use a dumpy level or a transparent water container (eg a glass jar). With a glass jar you can get a rough idea of level and make use of this to measure head. Here is how:
  - a. starting at the lowest point (eg where the hydro may be situated)
  - b. viewing a point at eye level (horizontal) on the ground ahead by viewing through the glass over the level surface of the water to a point that you can walk up to
  - c. walking up to that point (and count the number of times you walk up to the next point)
  - d. placing your feet on that point
  - e. repeating b., c. and d. until your eyes are level with the water source (where the pipeline would begin)
  - f. Multiply the distance between your feet and your eyes by the number of times you walked up to the next point (including the final sighting)



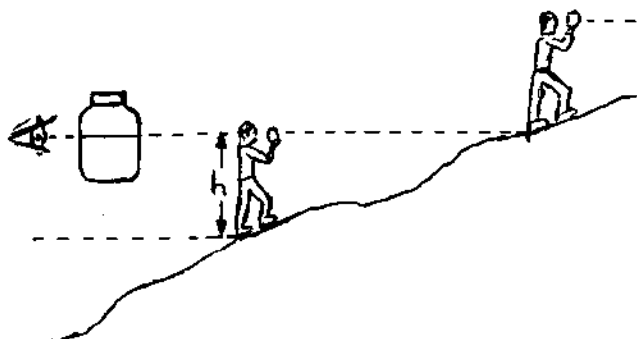

## The Power of Water

The formula for calculating the power of flowing water is:

$$\text{Power} = 9.8 \times L \times H$$

(power measured in watts)

where L = Litres per second

H = Height the water falls in metres

A good installation will convert about 30% of this into electricity.

You can improve on this way of measuring head by viewing across the level surface of a spirit level or using a long clear plastic tube filled (bar a few inches) with water. With both of these techniques you follow the same procedure as above except that you need a second person to either hold the spirit level or the other end of the plastic tube. With the plastic tube technique you can place your thumb over the end of the tube when you need to move. You may still need to carry extra water to refill the tube to counteract inevitable spillage.

## Monitoring of Water Pressure

Once you have laid down a water line it is worth while to get an accurate pressure reading by installing a water-pressure meter so that you can get a reading both when there is water flowing and when there is not. This will also give you an idea if there is a problem with the water line (eg low pressure due to blockage, air pockets or loss of siphon).

The friction of the wall of the water-pipe will cause a reduction of water pressure when there is water flowing. The amount of pressure reduction will depend on the diameter of the pipe and the flow rate (and very slightly by roughness of the inside wall of the pipe). The larger the pipe and/or the less the flow rate, the less the pressure loss you will encounter.

## Pipe Size to Match the Power

It is inevitable that some head is lost due to pipe friction. It is acceptable to allow up to 10% loss due to friction. It depends of course on whether you are intending to get maximum efficiency out of your turbine or maximum cost effectiveness. To obtain maximum efficiency for the turbine may be prohibitively expensive on water pipe. The maximum power that can be obtained from any particular size of pipe is when 25% of the total head is absorbed by friction. Refer to page 67 for tables to calculate loss of head.

## Losing the siphon

If the level of the pipe-line is any higher at any point than the top of the water at the water source it will be a problem if any air ever enters the pipe. You would need to fill the pipe completely with water before submerging the top of the pipe into the water source. This exercise is referred to as regaining the siphon. The siphon is created by the weight of the water column below the water level pulling the water over the high point. Because air is highly elastic a relatively small amount of air can cause a significant problem.

You can minimize on potential problems and ensure a constant flow of water from a dam or weir by raising the level of the wall to a level higher than the highest level of the pipe-line. The pipe-line would then be coming out through the wall rather than over the top of it.

## Electric Cable

Refer to wire section to help choose the suitable cable size. The electric cable may be inserted into poly-pipe and buried between the turbine and the house. To feed the cable into the poly-pipe it helps to stand at the top of a slope and feed the wire into the pipe downhill whilst whipping, wriggling and shaking the pipe to encourage the wire to keep sliding through.

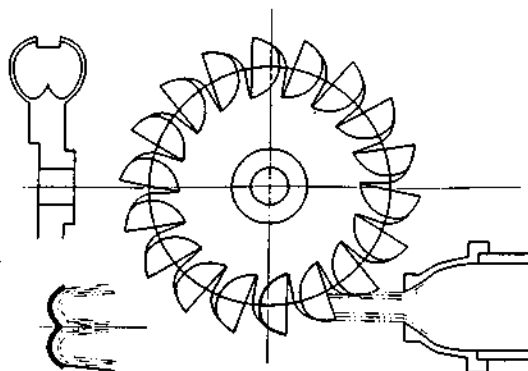

# Soma Turgo Hydro

Approximate Power Outputs

Nett Head (metres)	Water Flow (litres per second)	Continuous Output (watts)
5	3	50
	6	100
	15	250
	23	425
8	3	90
	6	200
	9	300
	15	450
15	1.5	80
	3	180
	4.5	300
	7.5	450
30	1	80
	1.5	180
	2.5	300
	4	500

N.B. Nethead = Physical head — Pipe friction losses.

Wherever there is a stream with a reliable flow of water, there is the potential for power generation by Micro Hydro.



## The SOMA WATTER micro hydro turbine

A medium head turbine utilizing a 12 pole, 3 phase permanent magnet alternator to generate a useful voltage at low revs. The Alternator is completely encapsulated in high temperature epoxy resin to provide protection from the wet environment in which it operates.

The prime mover is the 'TURGO' wheel which operates at high efficiency under varying conditions of flow and pressure. One or more jets of water are directed at the Turgo wheel.

The Soma Watter has been designed to extract cost effective power from streams previously thought to have insufficient water flow and head.

Nozzle size varies between 6mm (high pressure) and 25mm (low pressure) depending on the head and flow of the water supply. Requires between 5 metres and 30 metres of head and a flow rate (depending on head) of between 1 litre and 20 litres per second. Can have one or more nozzles.

A Control Box, which can be situated up to 300 metres from the turbine, rectifies the AC output from the alternator and regulates the current going into the battery bank.

The Soma Watter is supplied mounted on a fibreglass housing with one nozzle, gate valve, pressure gauge and connection point for the input pipe. Extra equipment required includes plastic pipe of appropriate size to channel the water supply to the hydro unit, electrical cable to go from the micro hydro to the batteries and the battery bank itself.

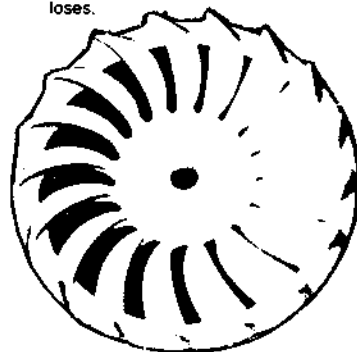

TURGO WHEEL



CONTROL PANEL

### SPECIFICATIONS

<b>General</b>	
Maximum output	500 watts
<b>Alternator</b>	
Type	Brushless, direct drive, rotating magnetic field
Stator	12 pole 3 phase
Voltage	12 or 24 volt
Charge controller	Voltage controlled relay with rectifier and dummy load
<b>Turbine Wheel</b>	
Type	Turgo wheel
Operating speed	300-3000 RPM
<b>Housing</b>	
Material	Glass reinforced Plastic
<b>Shipping</b>	
Weight incl. packing	40kg
Dimensions	500mm x 500mm wide 350mm high

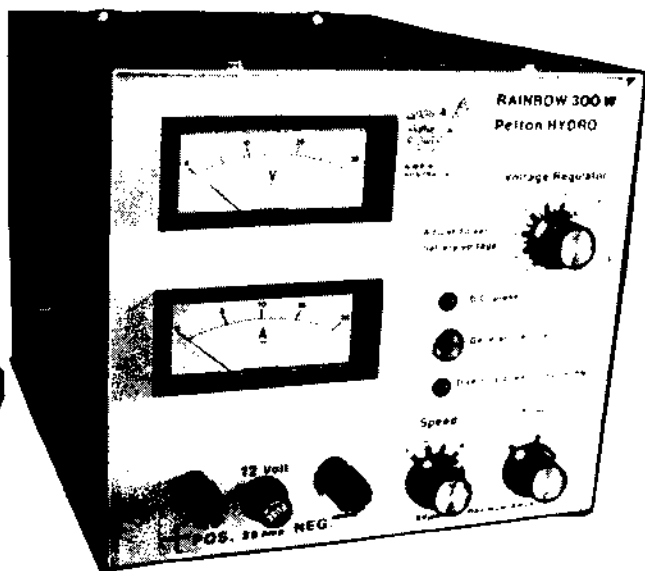
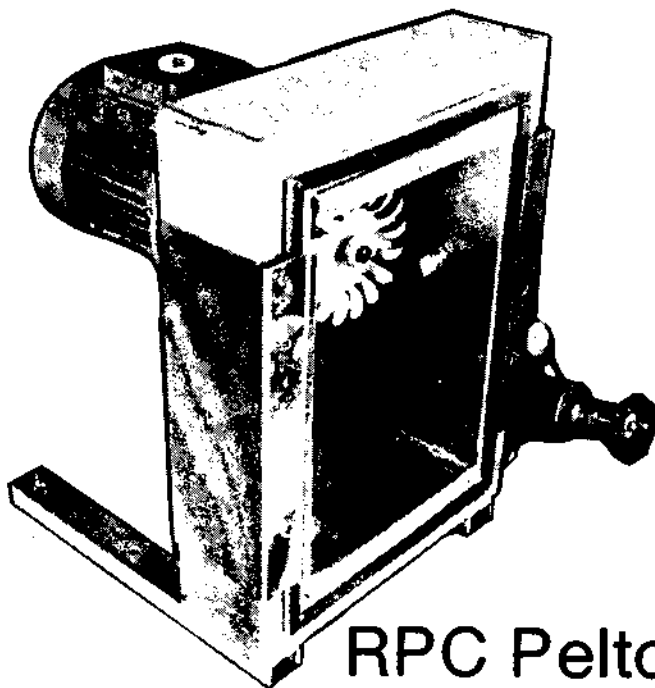

## RPC Pelton Wheel

### The Rainbow Micro Hydro Hydro Electric Generator

(RAPAS approved)

Hydro-electric systems make an ideal back-up to solar electric systems, or vice versa according to the dependability of the water supply.

No fuel cost!  
Low capital cost!

If you have the water flow and the head you can have Abundant Power with low overheads.

1 Micro Hydro can equal 20 Solar Panels in power output and at 20% of the cost!

In most circumstances there is no need for a large battery bank because the Rainbow Micro Hydro will produce power continuously, day and night.

### Little Maintenance, Long-Life, Economical

There is only one moving part on two standard 6204 bearings which are easily replaceable. There are no brushes or any other wearing components in the generator unit. All parts are made of non-corrosive materials and are readily available. All plumbing is of corrosion-resistant brass and high grade aluminium.

The Rainbow Micro Hydro represents a revolution in the production of electricity from small streams. It has been designed entirely by the technical staff of the company to meet specifications arrived at through more than a decade of personal experience in the field. The unit incorporates state of the art design and materials throughout, resulting in a machine with an exceptional service life but requiring minimal maintenance.

### Power Output

The Rainbow Power Pelton Wheel will produce useful amounts of power from either as little as 0.2 litres per second or as low as 5 metre head. It will produce up to 20 amps at 12 volt (10 amps at 24 volts) with head (pressure) more than 10 metres altitude and sufficient flow rate.

### Power Transmission Over Distance

Power transmission over distance is possible because the generator puts out a high voltage before being transformed to a low voltage. If long distance transmission is required, the installation will need to be done by a licensed electrician.

### Optimized Output

By varying the size of the nozzle, and the two dial settings, the Rainbow Micro Hydro can be optimized to suit the parameters of the site.

### Choice of Nozzles

Flow rate is controlled by a choice of nozzle sizes. These nozzles can be changed by the customer in less than a minute, without tools. Seasonal variation of flow is catered for by selecting between four installed nozzles or them on together.

### Easy to Install

Installation is easily carried out by the customer who needs only a water supply pipe and transmission wires. Adequate filtration on the water supply is essential. Thereafter, the only maintenance required is an occasional cleaning of the intake screen which sometimes becomes clogged with leaves. The Rainbow Micro Hydro should then provide years of trouble free service, with no further cost.

# RPC Pelton Wheel

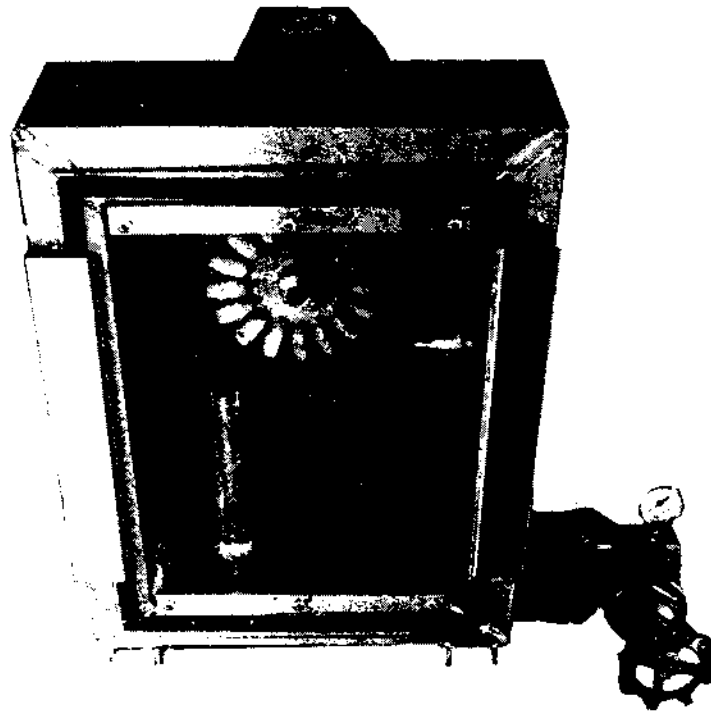

## Special Maintenance Free Generator

The heart of the machine is a highly efficient three phase induction generator. Having no slip-rings or carbon brushes, this device is completely maintenance-free for the life of the two ball-bearing races supporting the rotor, its only moving part. The generator is totally enclosed in a finned aluminium casing. Cooling is provided by a fan mounted directly onto the shaft.

## The Turbine/Impeller

The turbine operates over a large range of heads and flow rates. It is constructed of a modern high-strength epoxy resin composite chosen for its rigidity and resistance to abrasion. It is mounted directly onto the shaft. Water is prevented from leaking along the shaft to the bearings by the use of a slinger. There are no seals to wear out or contribute to friction losses.

## Aluminium Turbine Housing

The turbine housing case and mounting frame is constructed of aluminium. This makes the turbine corrosion and impact resistant and light enough to be carried by one person.

## The Battery Charger

Associated with the generator is a module which houses an exciter and battery charger. The exciter controls the generator, allowing its speed to match the optimum turbine speed for the specific installation. It is adjustable over four ranges, for heads of less than fifteen metres up to more than forty metres. Another adjustment sets the operation of the exciter for the correct power level. This has three ranges. The aim of both adjustments is simply to achieve maximum current as shown on the built-in meter.

The battery charger converts the high voltage produced by the generator into a suitable form to charge either a 12 volt or a 24 volt battery. This charger has several special features. The design is fundamentally efficient, featuring the use of high efficiency mosfet transistors.

## Inbuilt Regulator

There is no need to purchase a separate regulator. It comes supplied with an adjustable regulator.

## The RPC Pelton Wheel Manual

This manual is a goldmine of information covering such topics as: How to set it up a hydro system - water filtration, size of water-pipe, how to connect up the plumbing and the electricals; How to maintain it; Fault finding; etc. It was written specifically for the RPC Pelton Wheel and the cost of the manual will be deducted from the purchase of a RPC Pelton Wheel if you purchased a manual before hand. The manual is also normally provided with the RPC Pelton Wheel.

# RPC Pelton Wheel

## Performance Characteristics

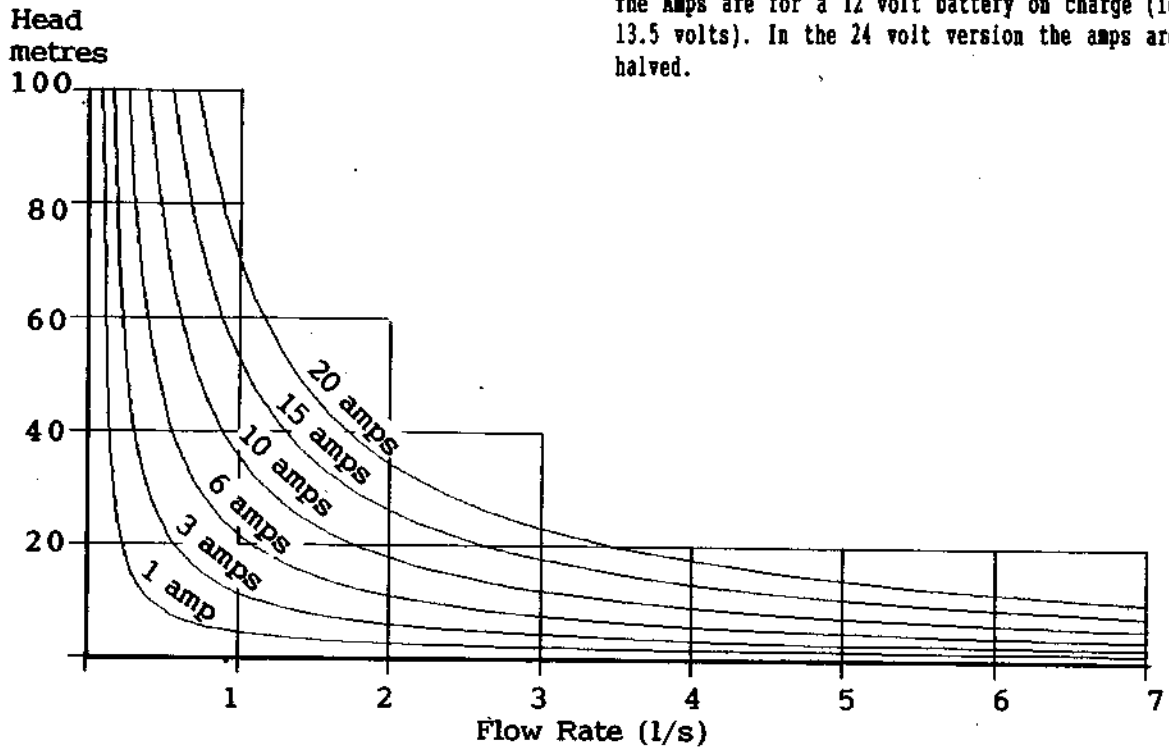

NB: The head (Dynamic Head) is measured at the machine and may be considerably less than the geographical height (Static Head) if too small a pipe is used.

The Amps are for a 12 volt battery on charge (ie 13.5 volts). In the 24 volt version the amps are halved.

Imperial pipe size is measured by internal diameter whereas metric pipe is measured by external diameter.

The Rainbow Power Company has a computer model which will give you optimum pipe size, power output and flow rate. All we need from you is the head, the pipe length and the flow rate.

The following is an example only! These graphs will vary considerably as head, pipe length and pipe diameter are varied.

## Friction Losses

Power output may be limited by pipe friction! Choosing a larger pipe diameter can make all the difference. Below are some performance curves of an installed pelton wheel with 50 metres of static head and 200 metres of pipe. The only difference between the three curves is the diameter of pipe used. The peak followed by a downward slope in figures 1 is 2 are due to pipe friction. In figure 3, a 50 mm diameter pipe was used, which in this example, enables the pelton wheel to be operated at the maximum power output.

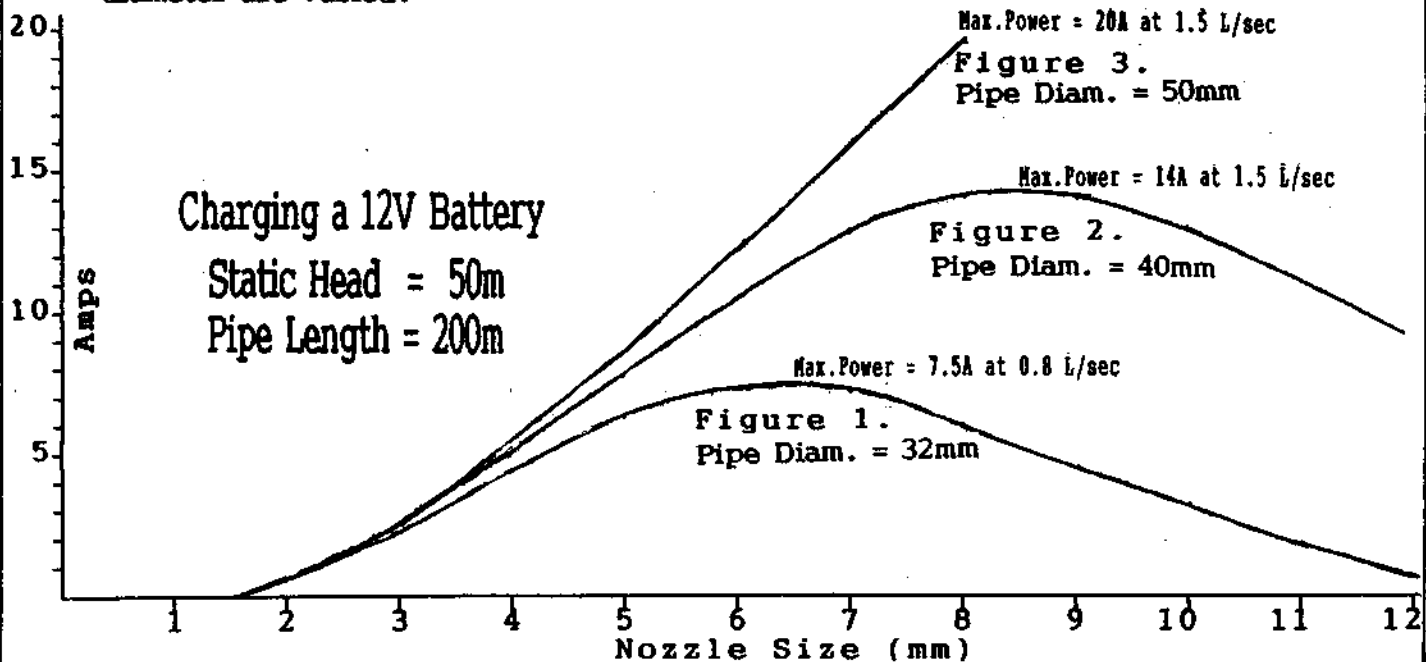

## Suggested Pipe Diameters (OD) for RPC Pelton Wheel

Pipe Length (metres)	Head (metres)													
	10	15	20	25	30	35	40	45	50	60	70	80	90	100
40	100	63												
50	100	75	63											
60	100	75	63	50										
70	100	75	63	63	50									
80	100	75	63	63	50	50								
90	100	75	63	63	50	50	50							
100	100	100	75	63	63	50	50	40						
120	100	100	75	63	63	50	50	50	40					
140	125	100	75	63	63	50	50	50	50	40				
160	125	100	75	63	63	63	50	50	50	40	40			
180	125	100	75	75	63	63	50	50	50	40	40	40		
200	125	100	75	75	63	63	50	50	50	40	40	40	32	
250		100	100	75	63	63	50	50	50	50	40	40	40	32
300		100	100	75	75	63	63	50	50	50	40	40	40	32
350			100	75	75	63	63	63	50	50	50	40	40	40
400			100	75	75	63	63	63	50	50	50	40	40	40
450				100	75	63	63	63	63	50	50	40	40	40
500				100	75	75	63	63	63	50	50	40	40	40
600					75	75	63	63	63	50	50	50	40	40
700						75	75	63	63	63	50	50	40	40
800							75	63	63	63	50	50	50	40
900								63	63	63	50	50	50	40
1000									63	63	50	50	50	50
1500											63	50	50	50
2000												63	50	50

### Note

All the above pipe diameters are in millimetres (outside diameter) class 'B' polyethylene. The sizes are to give between 90% and 100% of maximum 300 W performance.

Where near maximum performance from the pelton wheel would never be required, a pipe diameter of one size smaller may be selected. Never select a pipe diameter of two sizes smaller as this may render the pelton wheel virtually useless.

One size bigger in pipe diameter is more effective than two pipes operating in tandem. A section of smaller diameter pipe can undo most of the benefit of the larger pipe before and after it.

Between 5 metres and 10 metres head 300 W is not achievable regardless of nozzle size and pipe size. Despite not being able to operate at close to maximum power the hydro would still be a valuable asset at these low heads.

Pipe sold in metric units is usually measured in outside diameter (OD) whereas pipe sold in imperial units is measured by inside diameter (ID).

### Internal Diameter

Obviously it is the inside diameter (ID) of a pipe which affects its friction to the water. Pipe measurement has been utterly confusing because of conflicting conventions between ID and OD measurements and "soft" and "hard" metric conversions. Many botched installations have resulted from this confusion. We recommend you actually measure the ID of the pipe to be used, and any fittings which the water must traverse.

A factor often forgotten is that many plants and animals can cling to the walls inside the pipe. These make it thinner and rougher and can easily halve the output of the machine. To get an indication of this effect look at stones in the creek bed. If there is a crust then this thickness must be added to the pipe radius.

Pipe friction is very counter-intuitive. The effect of diameter is fifth power, which means too small a pipe is much worse than you think. Also it means that a short section of thinner pipe or fittings with narrow ID will cost you more than you think in head.

# Pressure Conversion

# Head Loss

10 KPa = 1 metre elevation    100 metres = 328 feet  
 † litre/second = 15.85 gal/min

### Imperial/Metric Pressure Conversion

metres	PSI	ft. head	metres	PSI	ft. head	metres	PSI	ft. head
1.0	1.5	3.4	4.0	5.8	13.4	7.0	10.2	23.5
1.1	1.6	3.7	4.1	5.9	13.7	7.1	10.3	23.8
1.2	1.7	4.0	4.2	6.1	14.1	7.2	10.4	24.1
1.3	1.9	4.4	4.3	6.2	14.4	7.3	10.6	24.5
1.4	2.0	4.7	4.4	6.4	14.7	7.4	10.7	24.8
1.5	2.2	5.0	4.5	6.5	15.1	7.5	10.9	25.1
1.6	2.3	5.4	4.6	6.7	15.4	7.6	11.0	25.5
1.7	2.5	5.7	4.7	6.8	15.8	7.7	11.2	25.8
1.8	2.6	6.0	4.8	7.0	16.1	7.8	11.3	26.1
1.9	2.8	6.4	4.9	7.1	16.4	7.9	11.5	26.5
2.0	2.9	6.7	5.0	7.3	16.8	8.0	11.6	26.8
2.1	3.0	7.0	5.1	7.4	17.1	8.1	11.7	27.1
2.2	3.2	7.4	5.2	7.5	17.4	8.2	11.9	27.5
2.3	3.3	7.7	5.3	7.7	17.8	8.3	12.0	27.8
2.4	3.5	8.0	5.4	7.8	18.1	8.4	12.2	28.2
2.5	3.6	8.4	5.5	8.0	18.4	8.5	12.3	28.5
2.6	3.8	8.7	5.6	8.1	18.8	8.6	12.5	28.8
2.7	3.9	9.0	5.7	8.3	19.1	8.7	12.6	29.2
2.8	4.1	9.4	5.8	8.4	19.4	8.8	12.8	29.5
2.9	4.2	9.7	5.9	8.6	19.8	8.9	12.9	29.8
3.0	4.4	10.1	6.0	8.7	20.1	9.0	13.1	30.2
3.1	4.5	10.4	6.1	8.8	20.4	9.1	13.2	30.5
3.2	4.6	10.7	6.2	9.0	20.8	9.2	13.3	30.8
3.3	4.8	11.1	6.3	9.1	21.1	9.3	13.5	31.2
3.4	4.9	11.4	6.4	9.3	21.4	9.4	13.6	31.5
3.5	5.1	11.7	6.5	9.4	21.8	9.5	13.8	31.8
3.6	5.2	12.1	6.6	9.6	22.1	9.6	13.9	32.2
3.7	5.4	12.4	6.7	9.7	22.5	9.7	14.1	32.5
3.8	5.5	12.7	6.8	9.9	22.8	9.8	14.2	32.8
3.9	5.7	13.1	6.9	10.0	23.1	9.9	14.4	33.2

metres	PSI	ft. head	metres	PSI	ft. head	metres	PSI	ft. head
10	15	34	40	58	134	70	102	235
11	16	37	41	59	137	71	103	238
12	17	40	42	61	141	72	104	241
13	19	44	43	62	144	73	106	245
14	20	47	44	64	147	74	107	248
15	22	50	45	65	151	75	109	251
16	23	54	46	67	154	76	110	255
17	25	57	47	68	158	77	112	258
18	26	60	48	70	161	78	113	261
19	28	64	49	71	164	79	115	265
20	29	67	50	73	168	80	116	268
21	30	70	51	74	171	81	117	271
22	32	74	52	75	174	82	119	275
23	33	77	53	77	178	83	120	278
24	35	80	54	78	181	84	122	282
25	36	84	55	80	184	85	123	285
26	38	87	56	81	188	86	125	288
27	39	90	57	83	191	87	126	292
28	41	94	58	84	194	88	128	295
29	42	97	59	86	198	89	129	298
30	44	101	60	87	201	90	131	302
31	45	104	61	88	204	91	132	305
32	46	107	62	90	208	92	133	308
33	48	111	63	91	211	93	135	312
34	49	114	64	93	214	94	136	315
35	51	117	65	94	218	95	138	318
36	52	121	66	96	221	96	139	322
37	54	124	67	97	225	97	141	325
38	55	127	68	99	228	98	142	328
39	57	131	69	100	231	99	144	332

HEAD LOSS IN POLYETHYLENE PIPE - TYPE 50-CLASS 6 (m/100m)						
FLOW RATE	32 mm 1.25 inch	40 mm 1.5 inch	50 mm 2 inch	63 mm 2.5 inch	75 mm 3 inch	
l/sec	Head Loss	Head Loss	Head Loss	Head Loss	Head Loss	
0.04	0.03	0.00	0.00	0.00	0.00	
0.06	0.06	0.02	0.00	0.00	0.00	
0.08	0.11	0.04	0.00	0.00	0.00	
0.1	0.16	0.05	0.02	0.00	0.00	
0.2	0.60	0.20	0.06	0.02	0.01	
0.3	1.26	0.41	0.14	0.04	0.02	
0.4	2.15	0.70	0.23	0.07	0.03	
0.5	3.25	1.07	0.35	0.11	0.05	
0.6	4.56	1.49	0.49	0.15	0.06	
0.7	6.06	1.99	0.65	0.20	0.09	
0.8	7.76	2.54	0.83	0.26	0.11	
0.9	9.66	3.16	1.04	0.33	0.14	
1.0	11.74	3.85	1.26	0.40	0.17	
1.1	14.00	4.59	1.50	0.47	0.20	
1.2	16.45	5.39	1.77	0.56	0.23	
1.3	19.08	6.25	2.05	0.65	0.27	
1.4	21.89	7.17	2.35	0.74	0.31	
1.5	24.88	8.15	2.67	0.84	0.35	
1.6	28.04	9.19	3.01	0.95	0.40	
1.7	31.37	10.28	3.37	1.06	0.44	
1.8	34.87	11.43	3.74	1.18	0.49	
1.9	38.55	12.63	4.14	1.30	0.55	
2.0	42.39	13.89	4.55	1.43	0.60	
2.1	46.40	15.20	4.98	1.57	0.66	
2.2	50.57	16.57	5.43	1.71	0.72	
2.3	54.92	17.99	5.90	1.86	0.78	
2.4	59.42	19.47	6.38	2.01	0.84	
2.5	64.09	21.00	6.88	2.17	0.91	
3.0	89.84	29.44	9.65	3.04	1.27	
3.5	100.00	39.17	12.83	4.04	1.69	
4.0	100.00	50.16	16.44	5.18	2.16	
4.5	100.00	62.39	20.44	6.44	2.69	
5.0	100.00	75.84	24.85	7.82	3.27	
5.5	100.00	90.48	29.65	9.34	3.90	
6.0	100.00	100.00	34.84	10.97	4.59	
6.5	100.00	100.00	40.40	12.72	5.32	
7.0	100.00	100.00	46.35	14.59	6.10	
7.5	100.00	100.00	52.67	16.58	6.94	
8.0	100.00	100.00	59.36	18.69	7.82	
8.5	100.00	100.00	66.41	20.91	8.75	
9.0	100.00	100.00	73.83	23.25	9.72	
9.5	100.00	100.00	81.61	25.70	10.75	
10.0	100.00	100.00	89.74	28.26	11.82	
11.0	100.00	100.00	100.00	33.71	14.10	
12.0	100.00	100.00	100.00	39.61	16.57	
13.0	100.00	100.00	100.00	45.94	19.21	
14.0	100.00	100.00	100.00	52.70	22.04	
15.0	100.00	100.00	100.00	59.89	25.05	
16.0	100.00	100.00	100.00	67.50	28.23	
17.0	100.00	100.00	100.00	75.52	31.58	
18.0	100.00	100.00	100.00	83.95	35.11	
19.0	100.00	100.00	100.00	92.80	38.81	
20.0	100.00	100.00	100.00	100.00	42.68	

# Tamar Hydro-Electric Turbines

Tamar manufacture all metal construction Pelton, Turgo, Francis, Kaplan and Axial Flow turbines. Power outputs are from below 1kW to over 1MW. These units include battery charging units (12V, 24V, 48V or 110V DC) with no governor required and 240VAC and 415V 3 phase units with governor.

## 240V & 415V Turbines

### Optional Equipment:

**Flow Control.** Automatic or manual flow control enables the generator output to vary according to load and water available. This feature is standard on some control systems and is particularly useful in drier months when water may be in short supply.

**Governors.** The governor controls the frequency to either 50Hz or 60Hz and can supply heating for hot water or space heating. Electric governors can also be used to control turbine power output by controlling the water flow through the turbine.

**Auto-start-on-demand.** This system is designed for sites where water is in short supply, particularly during the dry season. The turbine only operates when a load is switched on. Start up and shut down are automatic. A head pond acts as storage and supplies sufficient power for peak loads. An electric governor helps to conserve water by controlling water flow through the turbine. Any excess power is shunted away to produce heat for hot water or space heating.

## How Much Power is Available?

Power from water depends on the pressure and amount of water going through the turbine. Use the following graph as a guide to how much power you could expect from a generator for various site conditions. Notice that less water is required for the same power if the nett head can be increased.

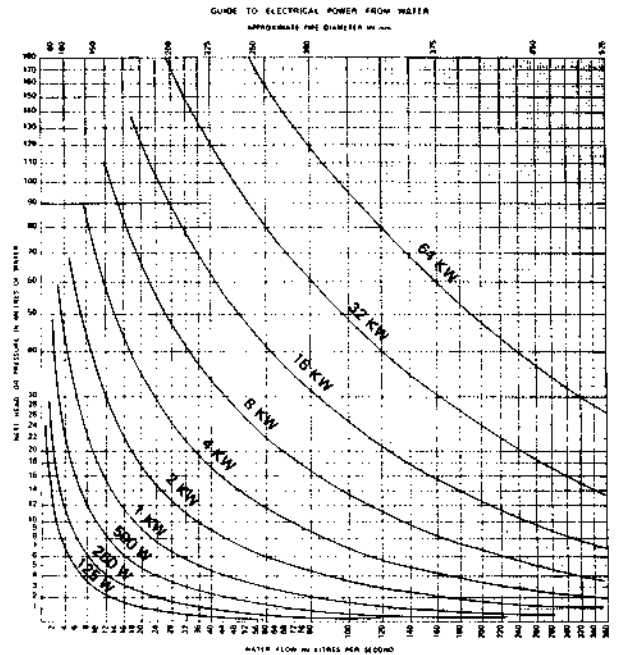

**Note:** For an accurate quote the site will need to be PROPERLY surveyed.

Diagram of a typical 240VAC hydro electric installation

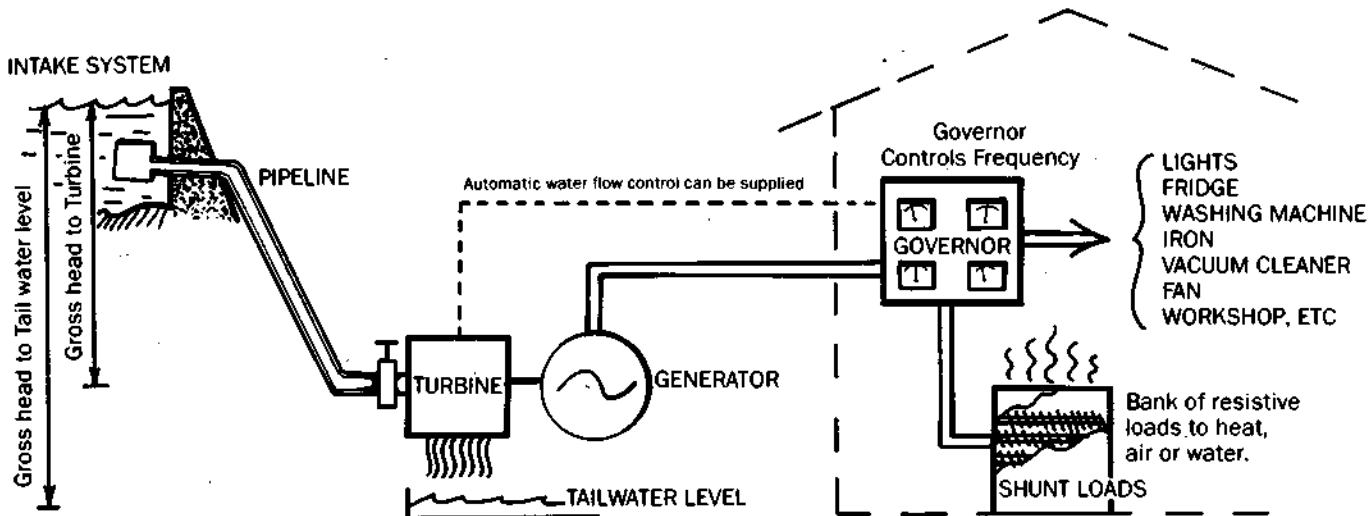



# New Products

The Tyson Turbine is a floating power-house which is moored in a fast flowing river or stream to either produce electricity (see page 68) or to pump water (see page 102).



**TYSON  
TURBINE**

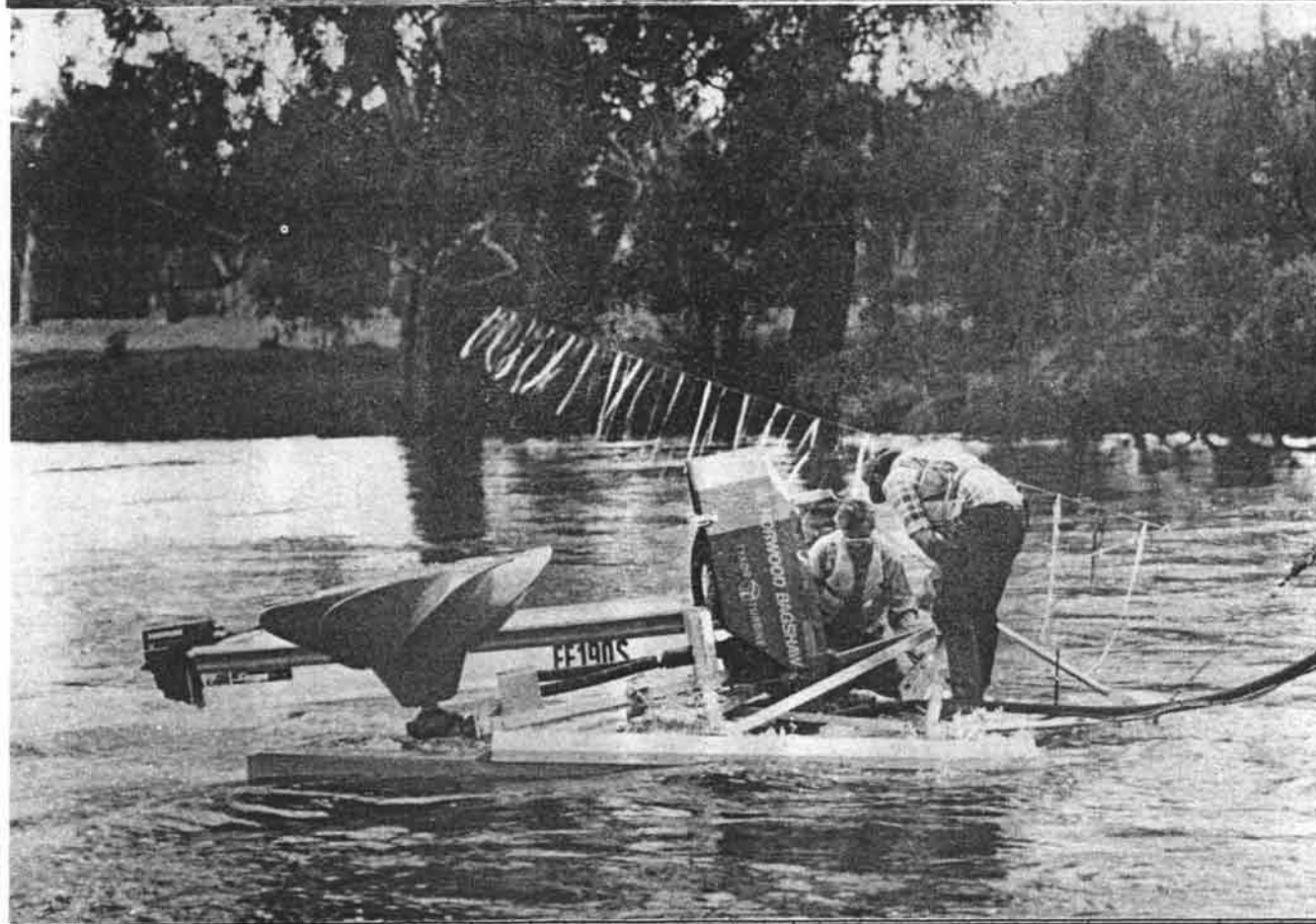
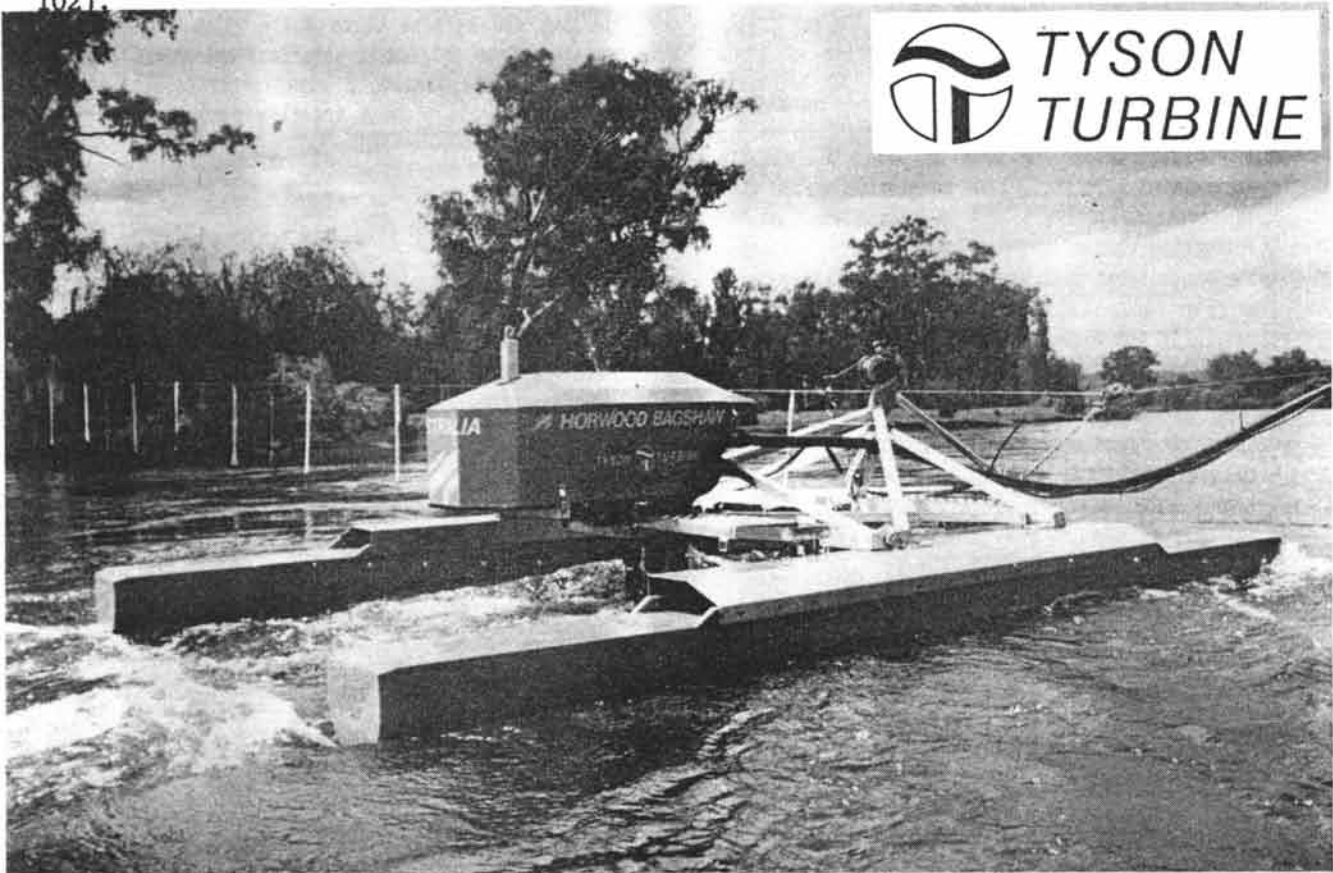

# Flow of the Stream Turbine

The Tyson Turbine is ideally suited for fast flowing rivers and streams, without dams or restrictions, or requiring steep terrain to generate electricity.

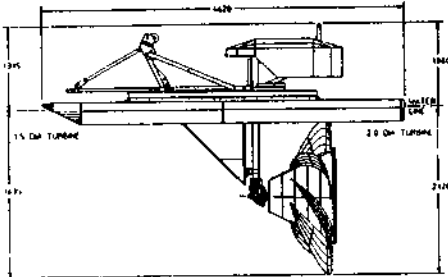
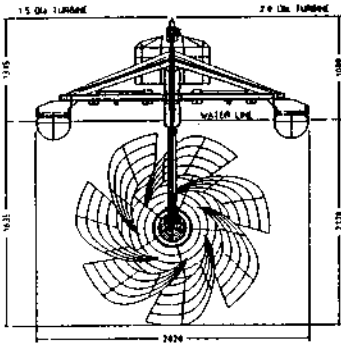
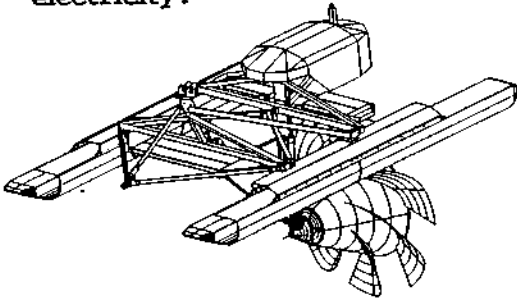

TYSON TURBINE ELECTRICAL PERFORMANCE PREDICTIONS

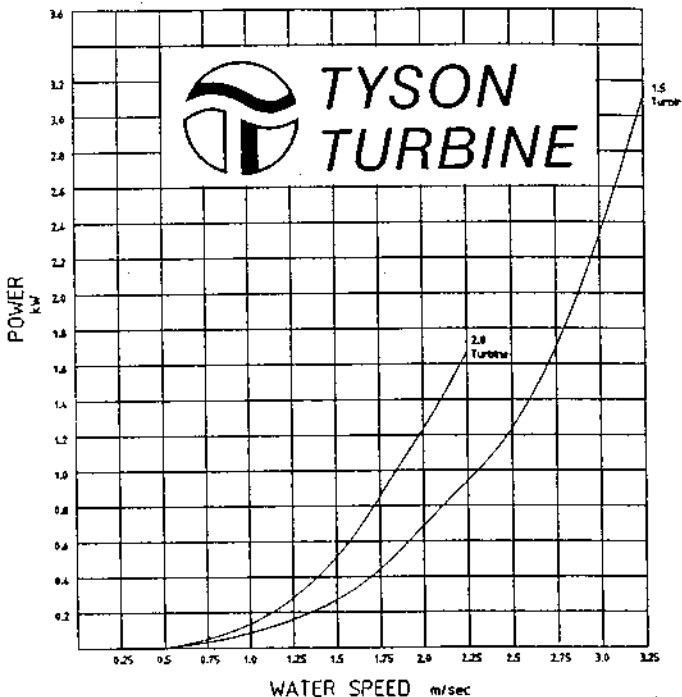

## Floating Turbine

The Tyson Turbine is suspended in the water by two pontoons. This is then tethered in the stream or river by means of a steel cable spanning the river, or a mooring from a bridge, pier or from the bank. The flow of the water rotates the submerged turbine head which is attached to a right angle gear box. The gearbox transmits the power above water level to an electric generator via a pulley.

## Electricity Generation

The Tyson Turbine can be used for generating low voltage DC for charging batteries or higher voltages to transmit power over distances of up to 5 kilometres. This power can be unregulated AC which is transformed and rectified to low voltage DC where the power is required. Outputs of up to 1500W can be generated depending on water flow speeds. Power generation and water pumping can be performed simultaneously when the combined power consumption does not exceed the available turbine power.

Power output (depending on water speed):

130 amps at 12 volt OR 65 amps at 24 volts

(using automotive alternator or permanent magnet DC generator)

## Relocation

The Tyson Turbine can be relocated by winching the turbine head out of the water, unhooking the machine and towing it to a different location with a small boat.

## Manufacturing & Materials

The machine is manufactured from light weight, corrosion resistant, high strength materials. The bearing life is in excess of 40,000 hours with virtually maintenance free gear box and main shaft operation. The chassis frame and panels are made of marine grade aluminium and stainless steel fasteners.

## Low Maintenance

The turbine is self-cleaning, and requires little maintenance. It can be easily maintained and operated by unskilled labour.

## Air Pumping

The Tyson Turbine may be used to drive an air compressor with a storage tank on land or to drive a high volume low pressure pump for fish tank or pond aeration.

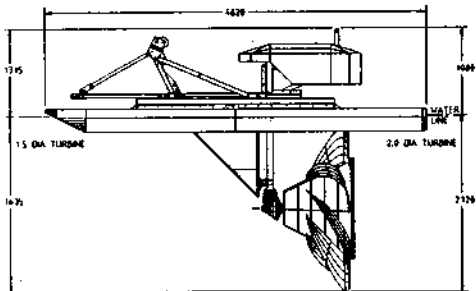
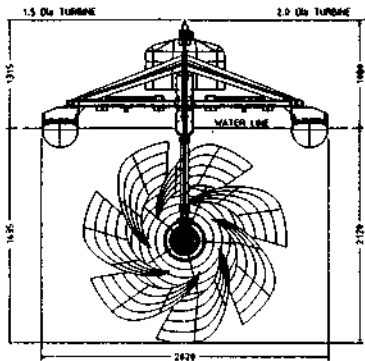

TYSON TURBINE ELECTRICAL PERFORMANCE PREDICTIONS

# Utilizing Flow of the Stream to Pump

The Tyson Turbine is ideally suited for fast flowing rivers and streams, without dams or restrictions, to pump water using the energy of the stream.



## Floating Turbine

The Tyson Turbine is suspended in the water by two pontoons. This is then tethered in the stream or river by means of a steel cable spanning the river, or a mooring from a bridge, pier or from the bank. The flow of the water rotates the submerged turbine head which is attached to a right angle gear box. The gearbox transmits the power above water level to a pump via a pulley.

## Pumping Capacity and Operation

The pump is a positive displacement pump which incorporates a unique repetitive hydraulic cycle to safeguard against abrasive contamination from the water supply.

It is available with an 82.5mm diameter barrel which delivers reliably up to a 100m head or with a 108mm diameter barrel for a head up to 60m and low level high volume flows.

Drive to the pump is by means of an adjustable crank attached to the gearbox output drive shaft. The pump stroke is variable from 0 to 190mm to optimise the power available to the pumping application.

A minimum river flow rate of .75 metres per second or 2.7 kms per hour is required for effective pump operation.

By matching the river flow, barrel size, turbine size, and pumping application, high performance output can be achieved.

### Relocation

The Tyson turbine can be relocated by winching the turbine head out of the water, unhooking the machine and towing it to a different location with a small boat.

## Manufacturing & Materials

The machine is manufactured from light weight, corrosion resistant, high strength materials. The bearing life is in excess of 40,000 hours with virtually maintenance free gear box and main shaft operation. The chassis frame and panels are made of marine grade aluminium and stainless steel fasteners.

## Low Maintenance

The turbine is self-cleaning, and requires little maintenance. It can be easily maintained and operated by unskilled labour.

## Air Pumping

The Tyson Turbine may be used to drive an air compressor with a storage tank on land or to drive a high volume low pressure pump for fish tank or pond aeration.

1.5m TYSON TURBINE - WATER OUPUT PREDICTIONS

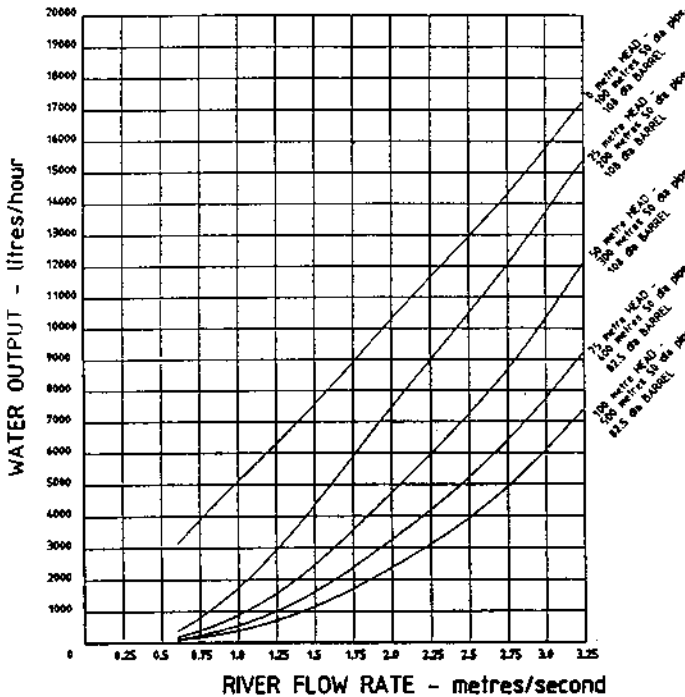

2.0m TYSON TURBINE - WATER OUPUT PREDICTIONS

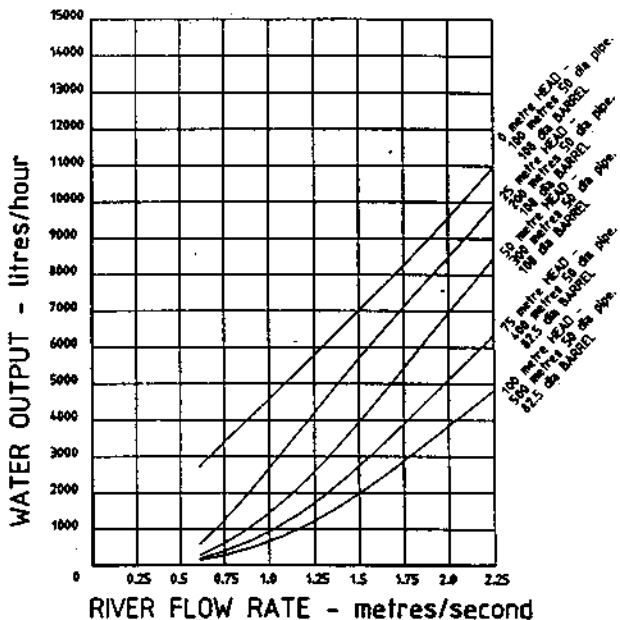

## Electricity Generation

See hydro power section (page 68) for electric power production.

**C. D. BASSET:**  
**BUILD YOUR OWN**  
**WATER**  
**POWER**  
**PLANT**

*Reprinted courtesy of  
Popular Science Monthly.  
© 1947 Popular  
Science Pub. Co., Inc.*

# **PART ONE: THERE'S ENERGY IN THAT STREAM!**

Many farms, ranches and other fair-sized tracts of land embrace at least one brook within their limits. In most cases, the idea that a small stream can provide a useful source of power has never occurred to the property owner or—if it did—has been rejected as silly. The fact remains, nevertheless, that impressive advantages can spring from small water power installations.

Electricity can be generated for general use, for pumping water and for standby or emergency purposes; and the pond that is usually created can serve additionally as a means for watering livestock in dry times, for fire fighting, as a swimming pool, as a place to raise fish for sport or as a "crop" . . . and for landscaping or scenic purposes.

Power can be obtained from any flowing stream, no matter how small. Whether it's desirable to harness this power depends on two factors. First, does water flow all the year round, even in the late summer months? Second, does enough water flow to make the harnessing of it economically sound? The first factor is, of course, known to the property owner by observation; the second may be determined by simple measurements.

What's the least amount of power that is worth developing? There is in this country at least one water wheel manufacturer who makes a line of small-capacity units, and this company's smallest hydroelectric unit develops 1/2 kilowatt. From this it can be inferred that, in this company's experience, it is not economically wise to harness a stream that will not develop at least 500 watts dependably at the switchboard. Half a kilowatt will light 10 fair-sized lamps or supply 2/3 hp to operate, say, a deep-well pump. With this figure in mind as a criterion, the reader can make a preliminary reconnaissance of the water power available on his property. The chances are he will be surprised; even a seemingly insignificant stream can deliver many times this minimum.

The power available at the site of a water wheel (that is,

before deductions for inefficiencies in the wheel and generator) is expressed in this formula:

$$H_p = \frac{62.4 \times Q \times H}{33,000}$$

Here Q is the cubic feet of water passing through the wheel in one minute, H is the "head" or vertical distance in feet through which the water falls, 62.4 is the weight in pounds of 1 cu. ft. of water and 33,000 the number of foot-pounds per

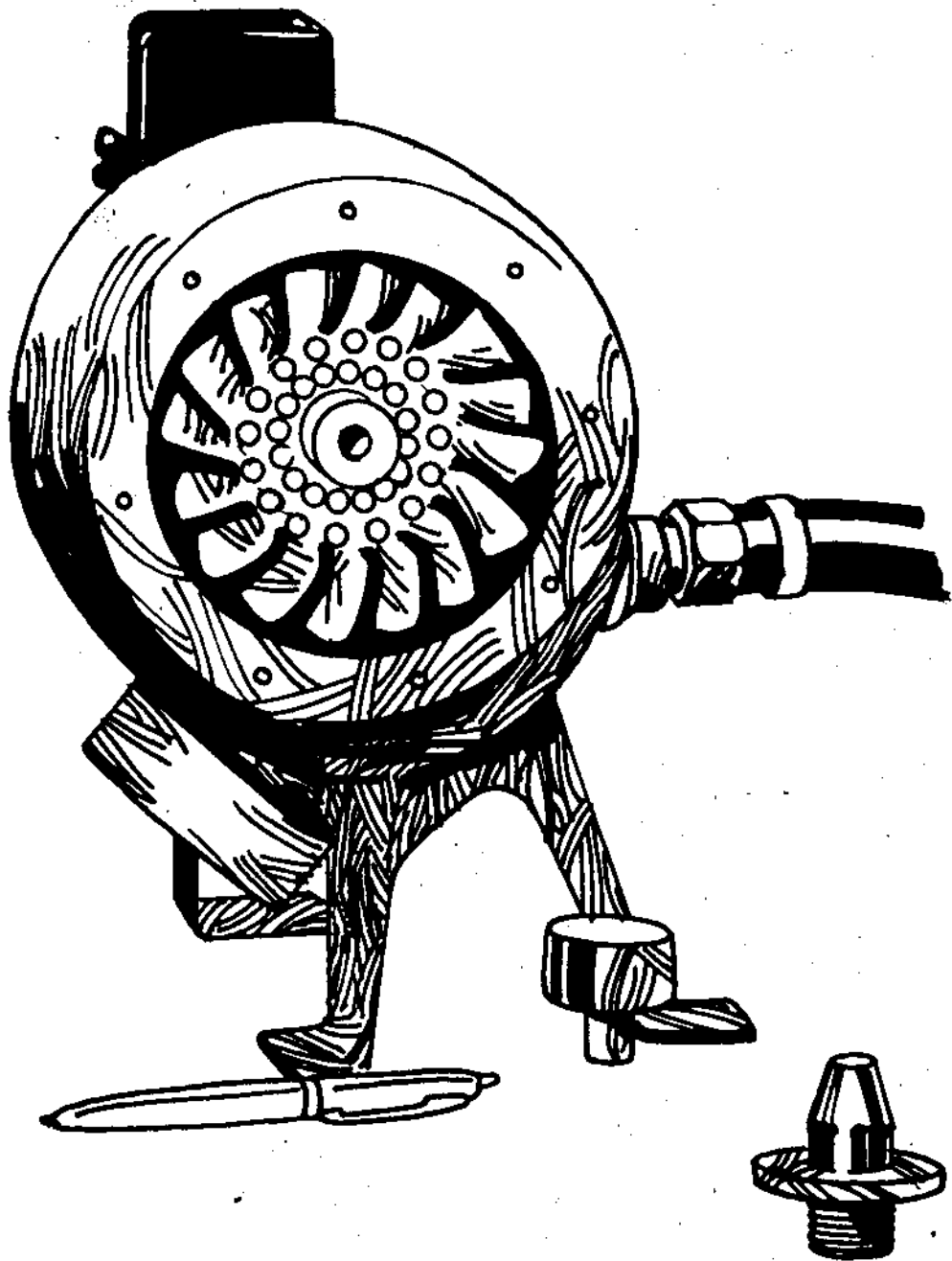

*This 4" impulse wheel, built for war requirements, was direct-connected to a small generator. It can be run off an ordinary water faucet. Note the removable nozzle and the tiny bucket, lower right.*

IF LOCATED AT A WATERFALL, RIGHT, A DAM WILL OFTEN BE SMALL AND INEXPENSIVE AND THE TOTAL HEAD FAIRLY LARGE.

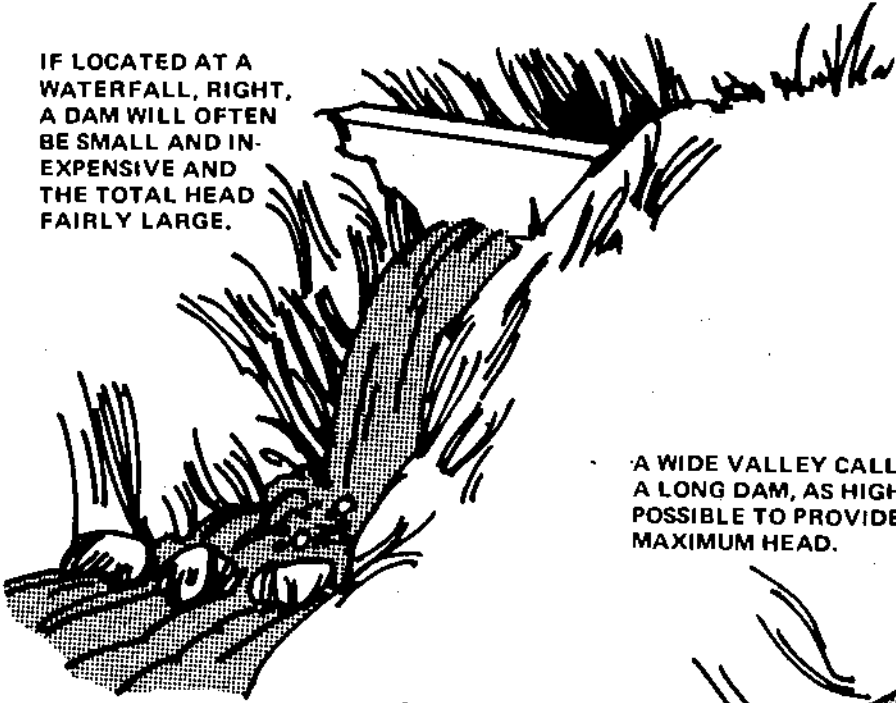

A WIDE VALLEY CALLS FOR A LONG DAM, AS HIGH AS POSSIBLE TO PROVIDE THE MAXIMUM HEAD.

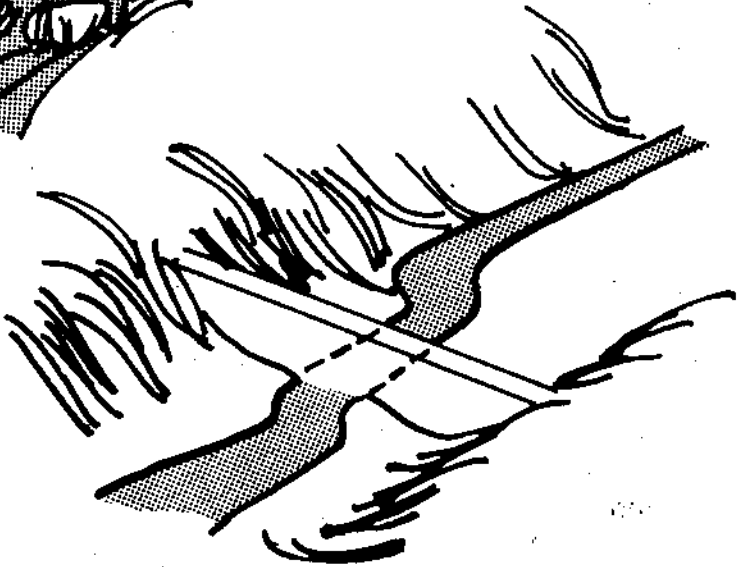

SWAMPY MEADOWLAND INDICATES THE PRESENCE OF A NATURAL RESERVOIR. PLACE THE DAM AT THE NARROWEST POINT WHERE THE BROOK LEAVES.

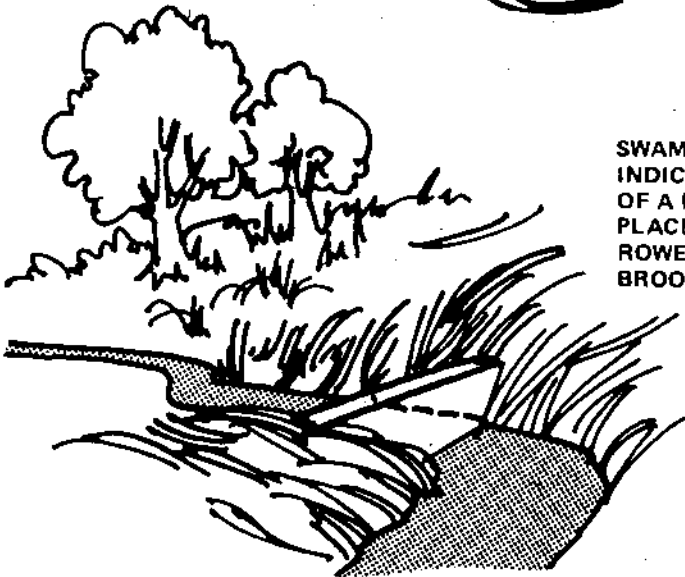
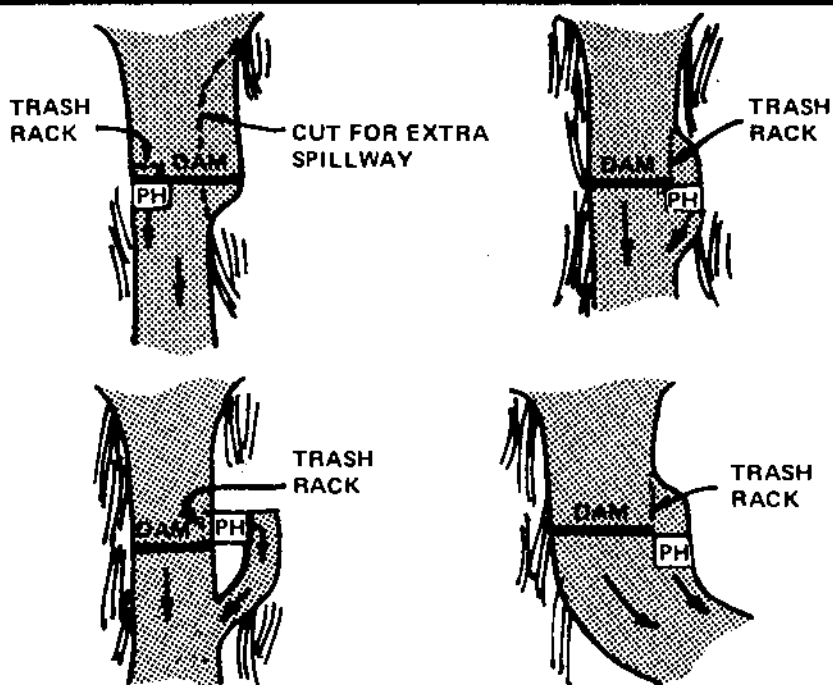

FIGURE 1

*You can cut your water power installation costs noticeably if you locate your dam [1] where the greatest fall can be realized in the shortest distance and [2] at the narrowest part of a stream.*





TYPICAL LAYOUTS WITH THE POWERHOUSE AT THE DAM, A LOCATION THAT USES ONLY THE ARTIFICIAL HEAD.

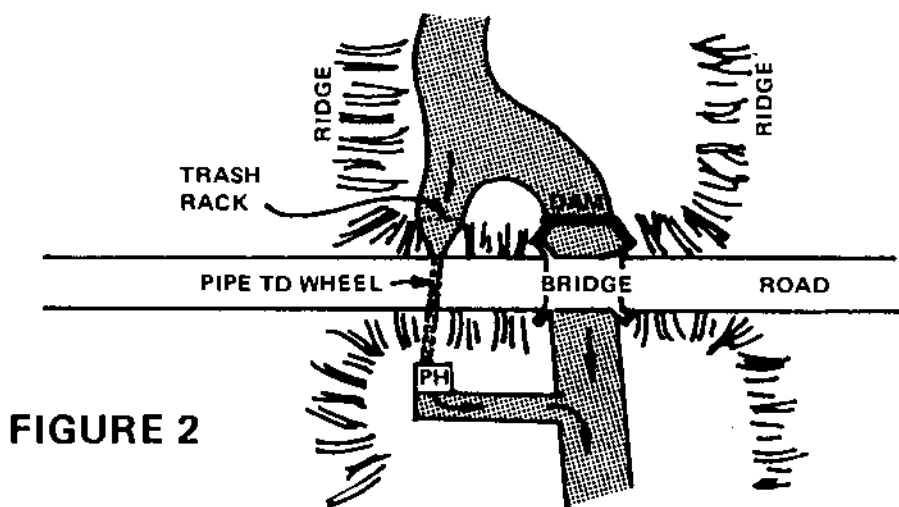
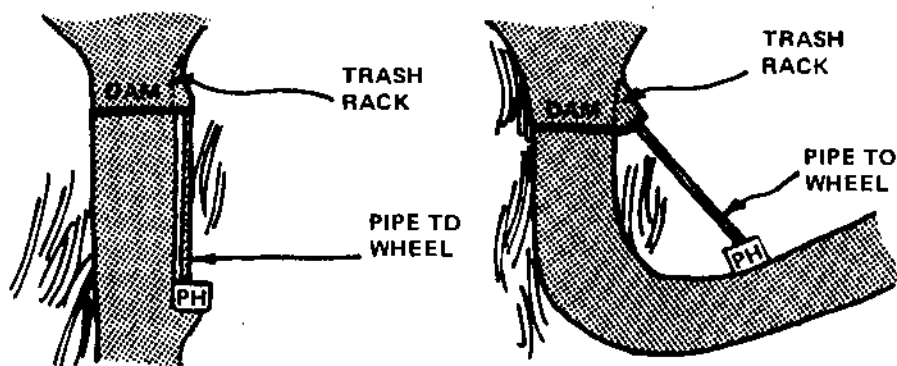

FIGURE 2



TYPICAL "DIVIDED-FALL" LAYOUTS, WITH THE WHEEL BELOW THE DAM, WHICH ADD THE NATURAL TO THE ARTIFICIAL (DAM) HEAD.

*A water wheel may be situated either right at a dam or some distance below it. Either location has advantages and disadvantages.*

minute in 1 hp. A number of methods exist by which the variables  $Q$  and  $H$  can be determined, but—before considering them—it's well to examine first the possible sites for the dam and wheel, since they will necessarily affect the amount of head secured.

The location of the dam, as suggested in Fig. 1, should be governed by two principles. It should be placed where the greatest useful head is obtainable . . . that is, where the greatest fall occurs in the shortest length of stream. Such a site is often indicated by a natural waterfall, by a conspicuously steep slope or by the swiftness of the current. The second locating principle is a simple matter of cost: a dam should be placed where it can be smallest and still impound the most water. This means, in general, that it should be placed where the stream valley or cut is narrowest.

The site of the water wheel, Fig. 2, may be either at the dam or some distance below it. The former location is the more common, being simpler to build and eliminating the need for a pipe or penstock to deliver water to the wheel. Disadvantages include the fact that the spillway must be of ample capacity to protect the powerhouse in time of high water, and the fact that only the "artificial head"—that created by the dam itself—is available. In cases where the ground falls away abruptly below the dam site, the "divided-flow" layout may be desirable, for it greatly increases the head.

Another preliminary calculation should be made as to the height of the proposed dam. This is restricted, as a rule, only by the height of the valley walls at the site, and by the materials, equipment and money available for building it. The higher it is, the greater the head and the larger the pond that will be created. "Pondage"—water stored for use in times of peak demand—is an important factor in water power calculations. Power is rarely needed 24 hours a day, and construction of a dam of sufficient height to provide water storage will greatly increase the power available at the time of day required.

If, for example, a wheel is to be run for 16 hours a day, and if a dam is built that will impound all water flowing into the pond during the idle eight hours, the power capacity will be increased by 50 percent. Don't neglect to distinguish between "live storage"—the volume of water represented by the difference in height of the spillway flashboards and the wheel

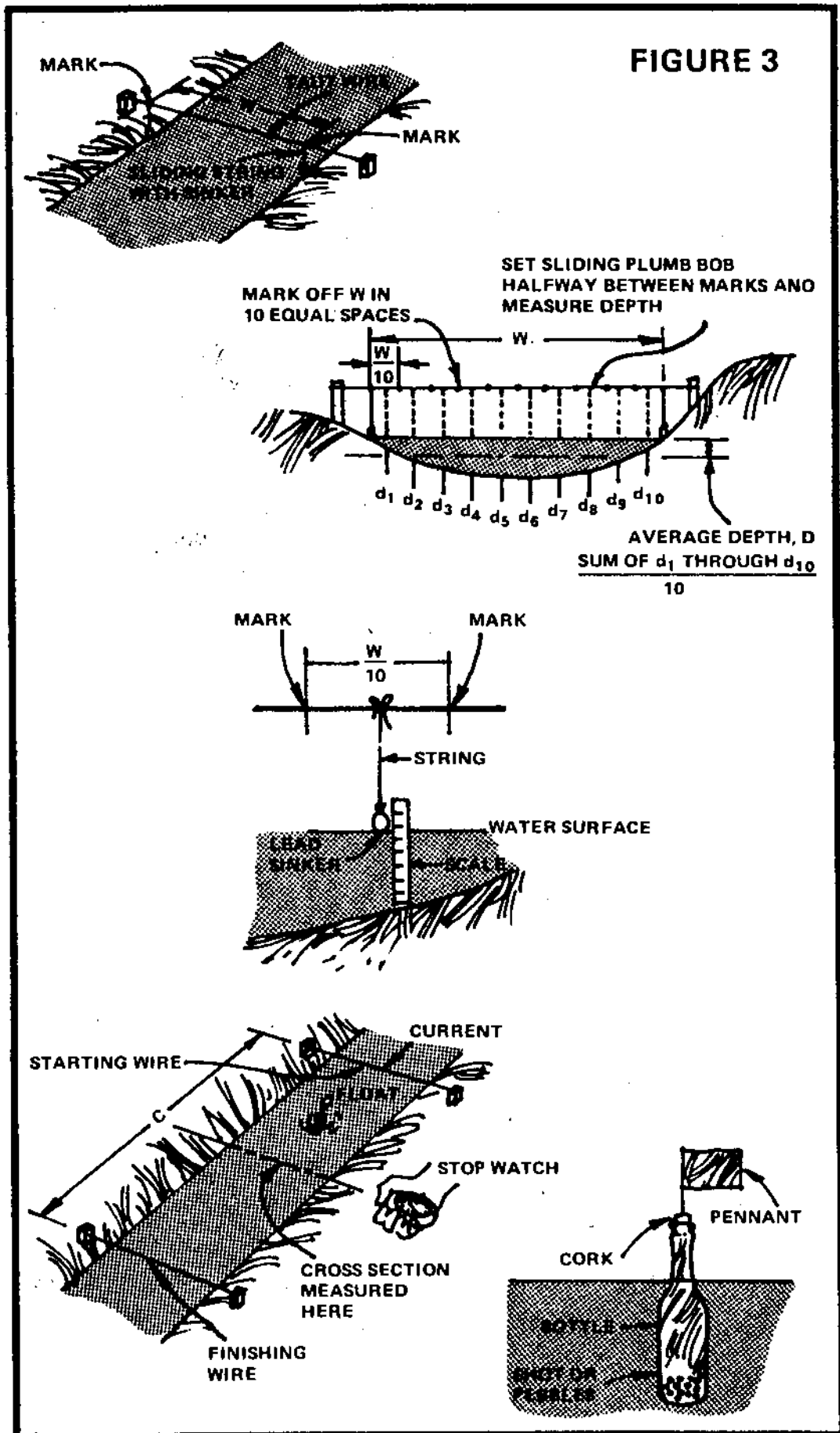

*One of the easiest methods of measuring the flow of a stream is with a float. (See full explanation in the accompanying text.)*

intake—and “dead storage”: the volume of water below the level of the wheel intake. The former is power-banked against a time of need; the latter is worthless, powerwise.

Once the dam and powerhouse are tentatively sited, and the height of the first is provisionally set, it is time to measure the power available. Assume that all water flowing in the stream can be made to flow through the wheel, which is a fair assumption on small installations. This flow ( $Q$  in the power formula) can be determined by the “weir method”, which involves constructing a temporary dam of controlled proportions and which will be detailed in a subsequent installment, or by the “float method”, which is theoretically a trifle less accurate, though still quite satisfactory.

The float method (Fig. 3) involves the formula:

$$Q = A \times V \times 60$$

in which  $Q$  is the volume of water flowing in cubic feet per minute,  $A$  is the cross-sectional area of the stream in square feet at the site, and  $V$  is the average velocity of the stream at this point, expressed in feet per second.

Select a length of the stream that is fairly straight, with sides approximately parallel, and unobstructed by rocks or shoals for a distance of about 100 feet. Stretch a taut wire squarely across the stream near the middle of this length and measure the width of the stream here in inches. Mark this width off on the wire and divide it into ten equal divisions. From the center point of each division, measure the depth of the water in inches. Then average the depth figure by adding each value and dividing by 10. The cross-sectional area of the stream,  $A$ , is now secured by multiplying this average depth by the width, and dividing the result by 144 to obtain the answer in square feet.

Your next step in determining  $Q$  is to measure the rate of flow. Using a steel tape, mark off a course along the bank that is 100 feet long; the midpoint of this course should be at the line where the cross section was measured. Stretch wires or rope tautly across the stream at each end of the course, and make a float by filling a bottle so that it rides awash. Provide it with a pennant so that you can follow it easily. Then set the float adrift in the middle of the stream, timing its progress over the course with a stopwatch, beginning just when the pennant

passes the first wire and stopping just as it passes the second.

Make a series of runs, averaging the results. The speed of the float in feet per second is then the length of the course divided by the average time. This result is not, however, suitable for immediate use in the flow formula, since not all the water in a stream flows as rapidly as that in the center and near the top. If you multiply the float speed by the coefficient 0.83, the resultant value will serve as  $V$  in the flow formula.

Given an estimate of the amount of head to be present at the wheel, you can now make a rough determination of the horsepower your stream can provide. It's worth emphasizing, though, that this figure is necessarily only as accurate as the measurements that produced it, and that the power indicated is that present *at the time of measuring*. A single stream-flow value is not of itself particularly useful unless it is obtained at the time of lowest water, usually in the late summer months. Moreover, even if you have measured the flow at slack-water time, the figures should if possible be supplemented by others secured during maximum springtime flow . . . so that you can calculate the size of spillway needed to prevent damage to your installation in times of high water.

It's a good practice—for backyard engineers as well as for professionals—to refine, cross-check and test your measurements by all means at your disposal. Such checks will not only reduce the chance of disappointment in the final result, but will also permit calculated economics in construction and greater efficiency in operation.

Your estimate of the head present at the wheel, for instance, should be carefully checked, since head is a vital element in the efficiency of any water power project. Several methods for determining the head rather precisely will be given in the next installment, together with the weir method for measuring flow. Subsequent installments will consider types of dams, methods of construction, wheels best suited to small plants and plans for building them.

Before you begin even a preliminary reconnaissance of water power on your property, the writer suggests you secure a loose-leaf notebook to be devoted solely to the project. Develop the habit of neatly entering all data as it is obtained, not forgetting to note dates and stream conditions at the time measurements are made. Such a record is a great help in performing sound calculations and producing excellent results.

# PART TWO: PUTTING WATER TO WORK

Inches Depth over Stake, D	1/8 in.	1/4 in.	3/8 in.	1/2 in.	5/8 in.	3/4 in.	7/8 in.
1 inch	.40	.47	.55	.65	.74	.83	.93
2 "	1.14	1.24	1.36	1.47	1.59	1.71	1.83
3 "	2.09	2.23	2.36	2.50	2.63	2.78	2.92
4 "	3.22	3.37	3.52	3.68	3.83	3.99	4.16
5 "	4.50	4.67	4.84	5.01	5.18	5.36	5.54
6 "	5.90	6.09	6.28	6.47	6.65	6.85	7.05
7 "	7.44	7.64	7.84	8.05	8.25	8.45	8.66
8 "	9.10	9.31	9.52	9.74	9.96	10.18	10.40
9 "	10.86	11.08	11.31	11.54	11.77	12.00	12.23
10 "	12.71	12.95	13.19	13.43	13.67	13.93	14.16
11 "	14.67	14.92	15.18	15.43	15.67	15.96	16.20
12 "	16.73	16.99	17.26	17.52	17.78	18.05	18.32
13 "	18.87	19.14	19.42	19.69	19.97	20.24	20.52
14 "	21.09	21.37	21.65	21.94	22.22	22.51	22.70
15 "	23.38	23.67	23.97	24.26	24.56	24.86	25.16
16 "	25.76	26.06	26.36	26.66	26.97	27.27	27.58
17 "	28.20	28.51	28.82	29.14	29.45	29.76	30.08
18 "	30.70	31.02	31.34	31.66	31.98	32.31	32.63
19 "	33.29	33.61	33.94	34.27	34.60	34.94	35.27
20 "	35.94	36.27	36.60	36.94	37.28	37.62	37.96
21 "	38.65	39.00	39.34	39.69	40.04	40.39	40.73
22 "	41.43	41.78	42.13	42.49	42.84	43.20	43.56
23 "	44.28	44.64	45.00	45.38	45.71	46.08	46.43
24 "	47.18	47.55	47.91	48.28	48.65	49.02	49.39

*The table above will allow you to very quickly and easily calculate the quantity of water passing over a rectangular weir in cubic feet per minute (cfm) for each inch of notch width. Depth D is read as a combination of the lefthand column and the top row. For example: If the depth over your stake is 5-3/8", follow over the 5 (fifth row) to 3/8" (fourth column), and read the value as 5.01 cfm. That's the volume of flow for each inch of notch width. To find the total flow for your weir, multiply this figure by the notch's width in inches.*

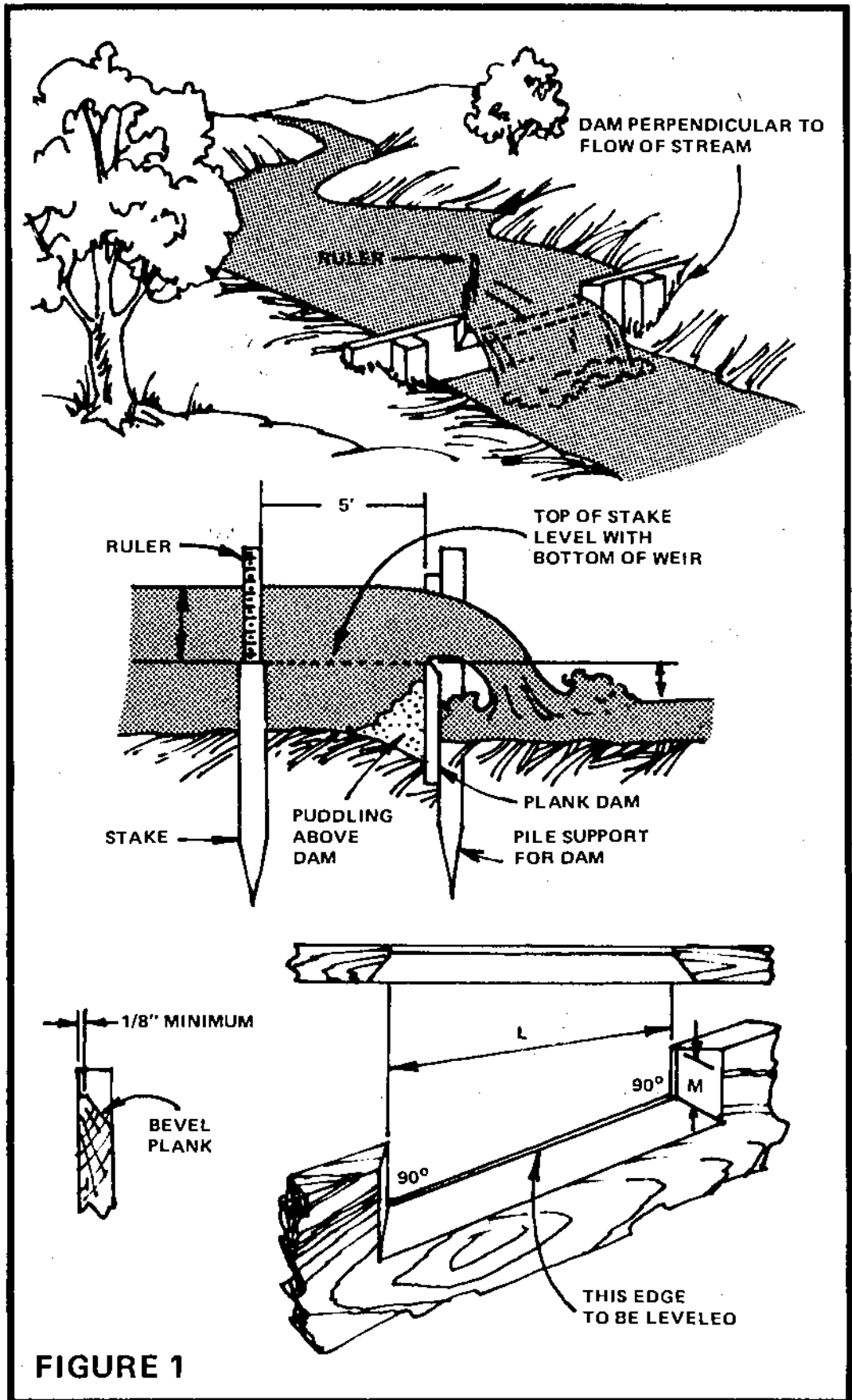

*It's more trouble to measure the flow of a stream with a weir than with a float . . . but it's also more accurate. The weir method of calculation, it should further be noted, is especially handy for figuring the flow of a stream that is shallow or already has a dam.*

Measuring the flow of water in the stream or brook on your property is the logical first step in planning a small water power project. The float method of making this measurement, described in part one of this article, is generally the easiest to perform and—if done carefully—is accurate enough for most purposes. If, however, a stream is so shallow at low-water time as to impede the progress of a weighted float, the weir method of measuring flow has advantages. Essentially a kind of water meter, a weir is a rectangular notch or spillway of carefully controlled proportions located in the center of a small, temporary dam. Two simple measurements permit the volume of flow to be accurately calculated.

Before constructing the dam, measure the depth of the stream at the site . . . the depth of the weir notch,  $M$  in Fig. 1, should equal this. Since the dam need not be permanent, simple plank or tongue-and-groove lumber will serve adequately. No water must flow except through the weir, so care should be taken to seal the ends and bottom of the dam by extending planks into the banks and below the bed of the stream. Clay or loam puddling on the upstream side will stop minor seepage. Be sure the dam is perpendicular to the flow of the stream.

The weir should be located in the center of the dam, with its lower edge not less than 1 foot above the surface of the water below the dam. This lower edge should be accurately leveled. Both this and the vertical edges of the weir should be beveled with the sharp edge upstream (a  $1/8$ " flat on the bevel will keep the edge from breaking down). Proportion the weir so that its length  $L$  is not less than  $3M$ , and larger if possible.

Drive a stake in the streambed at least 5 feet upstream from the weir, pounding it down until its top is exactly level with the bottom edge of the weir. Allow the stream to reach its maximum flow through the weir and then measure with a ruler the depth in inches of water over the stake. Referring to the table on page 77, you can now read the number of cubic feet per minute of water for each inch of  $L$ , the weir width. If you multiply the figure from the table by  $L$ , the result is the total amount of water flowing in cubic feet per minute, which is  $Q$  in the horsepower formula given last month.

If your stream is already dammed, there is no need to construct another dam just to measure flow. It is quite possible to employ the existing dam, using its spillway as a weir, provided that all water can be made to pass through the spillway. Con-



struct a wooden or metal frame to fit the spillway and seal it in place snugly. The center of this frame should incorporate a properly proportioned weir notch. As before,  $M$  should equal the depth of the water flowing through the spillway before the weir is installed, and  $L$  may in most cases be half the width of the spillway.

To get an accurate estimate of available horsepower, you will need a precise figure for  $H$ , the head of water that will be present. "Head" may be defined as the vertical distance in feet from the surface of water in the pond behind the dam to the surface of the stream below the dam at the site of the wheel. This figure may be obtained by any of several methods in cases where a dam is already present, and with scarcely greater difficulty at the site of an unbuilt dam.

Measuring a difference in elevation can be quickly and accurately done with an engineer's transit and leveling rod. But—since not everyone has access to these instruments, and since those who do would not need instruction on so simple a job as running a level—we'll pass on to other methods.

Fig. 2 illustrates a very simple way of measuring a vertical distance. The equipment required is a carpenter's level, a folding rule or steel tape, a 1" by 2" by 6' board with two edges planed parallel, two wooden pegs, a stake and a C-clamp. These are items that can be found in almost any home . . . and certainly on any farm. Though the method can be somewhat tedious if the difference in elevation is large, the results will be quite accurate with ordinary care in leveling and measuring. Note in the drawing that in the case of a pre-existent dam, one or more measurements needed to carry around the edge of the dam are subtracted from—rather than added to—the total.

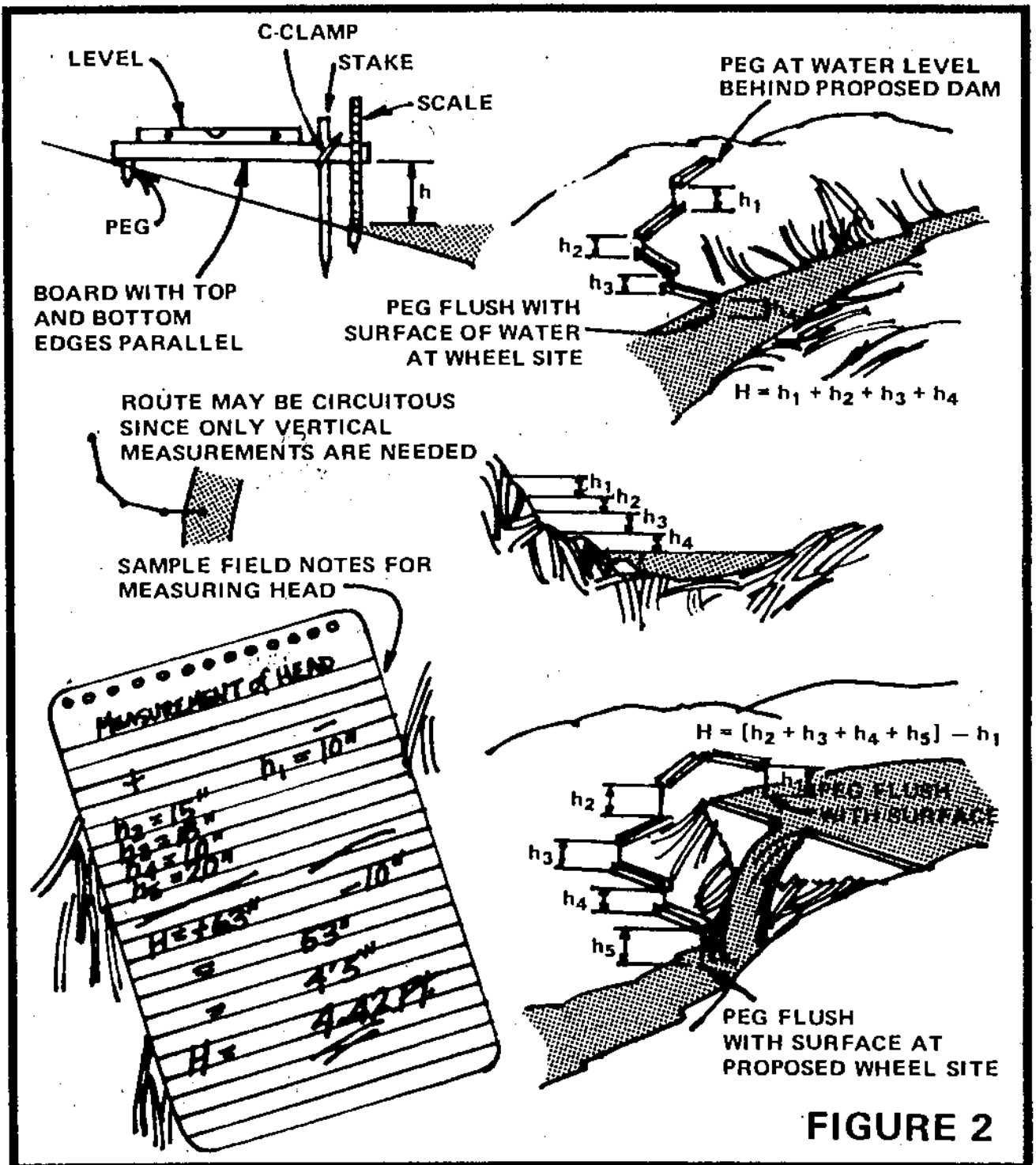

The information above illustrates how to measure a stream's head with a carpenter's level, straightedge and pegs. Best of all, the calculations can be made either before or after a dam is built.

Less practical in most cases, though still of occasional special value, are two other ways to determine head. Elevations can be measured quite readily by the techniques of photographic surveying. For those who are familiar with the procedure, it is a simple matter to take the required pictures in the field and then scale the required elevation at the desk from the developed photographs. Another method involves the use of a barometer, either mercury or aneroid, to indicate differences in height. However, this method is useful only where the head to be measured is considerable, say more than 25 feet, and calls for special techniques to hold the probable error down to acceptable proportions. Except in unusual circumstances, the writer recommends that the method in Fig. 2 be employed, inasmuch as it requires little special equipment and with ordinary care gives good results.

With sound figures for both H and Q, you are now ready to calculate the available horsepower of your installation with the formula given in the first installment. If the power is found to be sufficient to warrant continuing with the project, say 2/3 hp at the least, your next step is to determine the nature of your power requirements. Here individual variations are so many as to make it difficult to outline a specific procedure. It's possible, however, to suggest factors you should consider in planning your power plant.



*A simple method of measuring head. With a straightedge held level, the vertical height between a pair of pegs is read off and noted.*

Some of the uses to which small-capacity installations are successfully put include directly powering pumps, mills, machine tools or other small-demand machinery and driving a generator to supply electricity for either lighting or power purposes. The latter type of installation is, of course, the more flexible and generally useful. Determine, then, the uses you propose for your water power, and tabulate the horsepower required after each item. In the case of electric motors or appliances rated in amperes or watts, remember that watts are volts times amperes, and that 746 watts are equal to 1 hp.

From this tabulation, the peak load can be determined. This is the sum of the power demands made by different pieces of equipment that may probably be in use at one time. Knowing power and load, you can now determine if the proposed installation will be on a sound basis.

Do not use your available horsepower figure directly, since deductions should first be made for losses in the water wheel . . . and in the generator, if one is to be used. For small installations, assume wheel efficiency to be 75 percent. (Many small wheels will better this, but the assumption will provide leeway for possible optimism in measuring H and Q.) Generator efficiency can be assumed to be 80 percent . . . a figure that will also be bettered in many cases, but is on the safe side. Thus,

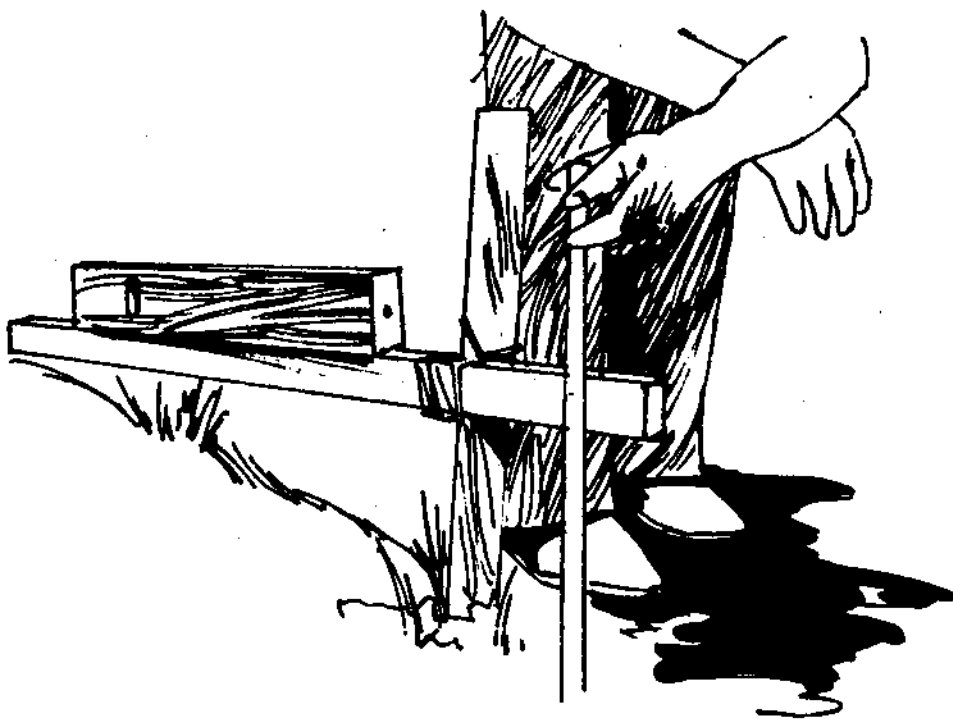

*Your last measurement, when using this method of calculating head, should be to the surface of the water at the power wheel's site.*

switchboard power may be expressed at  $.75 \times .8 \times \text{hp}$ , or .6 of the available horsepower.

At this stage of the game, it's well to mull over the possible variations and combinations, rather than to proceed with specific construction plans. Consider for example the decision required if the indicated switchboard power will seemingly handle the peak load . . . whether to build a dam just large enough to do this job, or to build one substantially larger to handle possible future increases in power requirements. The former choice will be obviously cheaper at first but may not be so in the long run, since power demands have a way of growing and since it is rarely satisfactory to increase the structure of an existing dam.

If the peak load is apparently too high, various possibilities should be considered. Will "pondage"—water stored behind the dam overnight or in slack periods—help out? Can the use of equipment be dispensed with? Is the project necessarily a year-round enterprise or can the low-power characteristics of the dry season be ignored? A word of caution on these points may not be amiss: it's far better to plan an installation that will provide more power than you need than one which doesn't supply enough.

Whether, in the event that you decide to generate electric-

### FIGURE 3

AN OVERSHOT GRAVITY WHEEL IS ROTATED IN PART BY IMPULSE BUT PRINCIPALLY BY THE WEIGHT OF THE WATER.

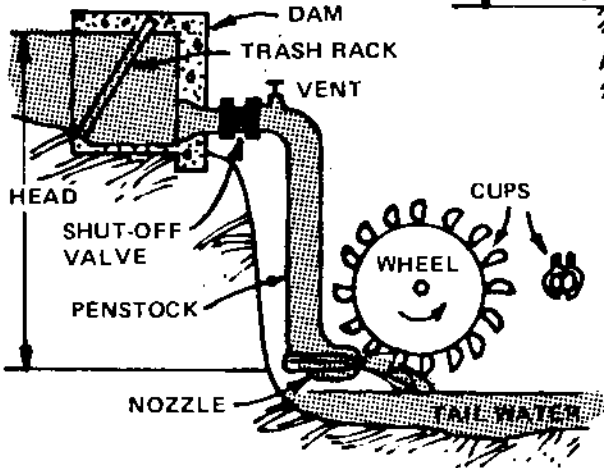
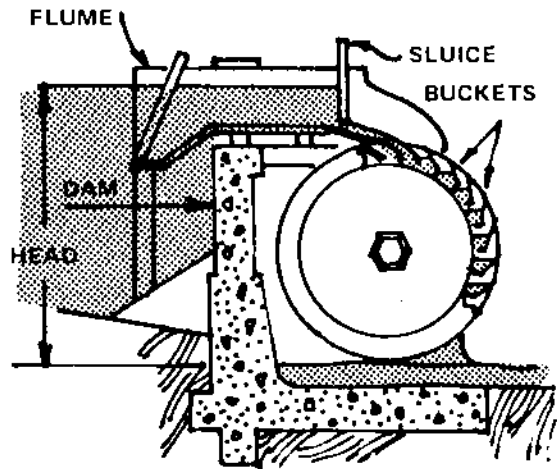

AN IMPULSE (PELTON) WHEEL IS TURNED BY THE FORCE OF A JET FROM THE NOZZLE AS IT HITS WHEEL CUPS.

THE PROPELLER REACTION WHEEL IS MOVED BY CURRENT FLOW ON A HIGH-SPEED HORIZONTAL-PLANE RUNNER.

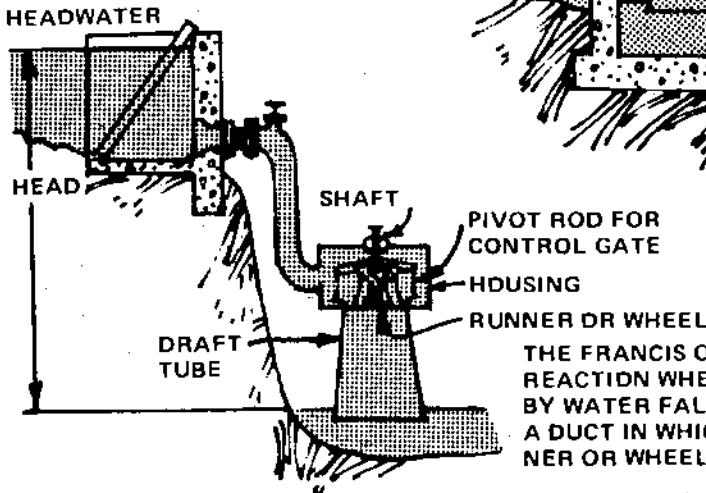
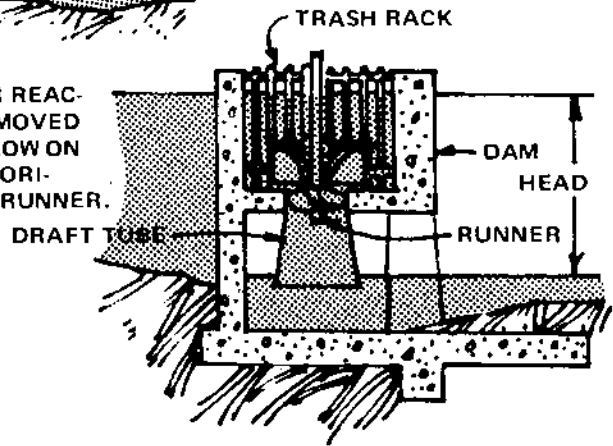

THE FRANCIS OR AMERICAN REACTION WHEEL IS TURNED BY WATER FALLING THROUGH A DUCT IN WHICH THE RUNNER OR WHEEL IS CONFINED.

*If you install a water power system, you'll probably use one of these four wheels to convert the fluid's energy to useable work.*

ity, to use AC or DC is another decision to make. In circumstances where the generator must be located some distance from the load, AC is the only choice, for DC transmission losses would be too high (amounting in small installations to a

prohibitive percentage of switchboard power). If your buildings and equipment are already wired to receive one type of current, it would obviously be sensible to fix on the same type of power. If, for example, your farm is already wired for a battery-type lighting system, there would be little reason to revamp the installation for AC. If on the other hand you are starting from scratch, the writer recommends the use of DC wherever possible. An AC generator must be closely regulated at or slightly above synchronous speed, and close regulation requires complicated governing equipment that is tricky to build or expensive to buy. A compound-wound DC generator, on the other hand, provides inherently close voltage regulation over a wide speed range . . . and even a shunt-wound DC generator with a direct-acting field-rheostat regulator would be satisfactory.

Selecting the right wheel for your plant is perhaps the final step in your preliminary planning. There are three general types of water wheel—impulse, reaction and gravity—and several fairly common varieties of each type. However, for small plant purposes, it's possible to narrow the number down to those shown in Fig. 3. Note that two types of reaction wheels—the Francis and the propeller—are shown, and but one variety of gravity wheel, the overshot one.

The impulse or Pelton wheel, operated exclusively by the force of the water from the jet, includes among its advantages very slight leakage and friction losses, good efficiency under varying flows and a sufficiently high shaft speed to drive a generator. It is more resistant to pitting by water containing sand, silt or minerals than the reaction type. Its disadvantages include the fact that it cannot use all the available head, is larger than a reaction wheel developing the same power and will wallow in high tail water. It must be mounted as close to the tail water as possible.

The reaction wheel, either the Francis or propeller type, is turned by the fall of water through a duct or pipe in which the wheel is confined. It is the most compact of all wheels for a given power, uses all of the available head and operates at a satisfactory speed for direct coupling to a generator. It is an efficient wheel over a wide range of conditions, and it can be mounted at any convenient height above tail water. Disadvantages include rapid corrosion with silted water and relatively high leakage and friction losses, especially in small units.

Finally, there is the overshot gravity wheel, which is turned largely by the weight of the water and partly by impulse. It has good efficiency under varying flow and is unaffected by sand, silt or minerals in the water. Gravity wheels turn at a low speed, which is undesirable for driving a generator or high-speed machinery, but suitable for some pumping and grinding applications. Such a wheel will wallow in high tail water, is the largest wheel for a given power and will be obstructed by ice in winter unless housed.



# **PART THREE:**

## **DAMS TURN WATER INTO KILOWATTS**

Concrete, though desirable, isn't necessary for damming a small stream. Beavers have gotten by for years without it. Suitable materials can be found on almost any farm. Logs, rough-hewn timber, rock, masonry, planking, gravel, sand and clay are all useful. Choose the materials most readily available on your property, or the least expensive if you must obtain them elsewhere.

You will have determined, on the basis of the first two installments of this series, the height and width of the dam you will need to convert your stream to power. The summer months provide an ideal time for its construction, for then most brooks are at their lowest level and the water will not impede the progress of work.

Four basic types of small dams are shown in the accompanying drawings. All are adaptable in general to the kind of materials likely to be on hand and also to the head of power desired.

There are two basic principles of design to bear in mind no matter which you build. First, a dam should be sealed both above and below its foundation to prevent the seepage of water through or under it. Seepage through a dam, if permitted, weakens the structure and will eventually break it; that under a dam will undermine its foundation. Then, too, some means must be provided to prevent undermining of the dam

by the water that flows or spills over it.

In addition, you should check with your local authorities and possibly file plans for your dam with them. States have widely varying regulations, some extremely lenient and some fairly strict. In most, general supervision comes under the state board of health, but a visit to your local county offices will give you correct guidance.

Fig. 1 illustrates the earth dam, which blends well with its surroundings and hence is particularly suited where landscaping or scenic qualities are to be considered. Sealing this type of dam is most important since seepage will literally carry it away if allowed to progress. The seal is put in first and the dam built around it. How far down it should go depends upon the kind of soil. A sand foundation, for instance, requires the seal to extend deeper than clay. If planking is used, it would be well to apply a protective coat such as tar or creosote.

A general pattern for depositing the earth fill is shown in the drawing, but it is not necessary to follow it unless different types of earth are available. Deposit the fill by layers, rolling and tamping each layer well. Then protect the waterside surface from erosion by covering it with a matting woven from brush. Plant turf on the top and downstream side to hold the earth.

Such a dam obviously cannot have water spilling over its crest since this action would wash it away. Two suggestions for handling the excess water are shown. The spillway must be of some material—such as masonry or planking—resistant to the erosion of rushing water, and the sides must protect the open ends of the earth dam from spillage water. An alternative method of handling runoff water is with drain tiles instead of a spillway. Some means must be provided for shutting them off. A simple cover on the upstream end would serve.

Fig. 2 shows the framed dam, which likewise can be easily built, particularly on a farm where lumber in any form from logs to planks is abundantly available. Each frame consists of one joist on which the surface timber is laid and one or more struts. Once the height of the dam is determined, the size of individual frames will vary depending on the contour of the gully (those frames located at the lowest part being the largest). The frames are spaced according to the support the surface timber needs . . . that is, the thinner the surfacing the more supports.

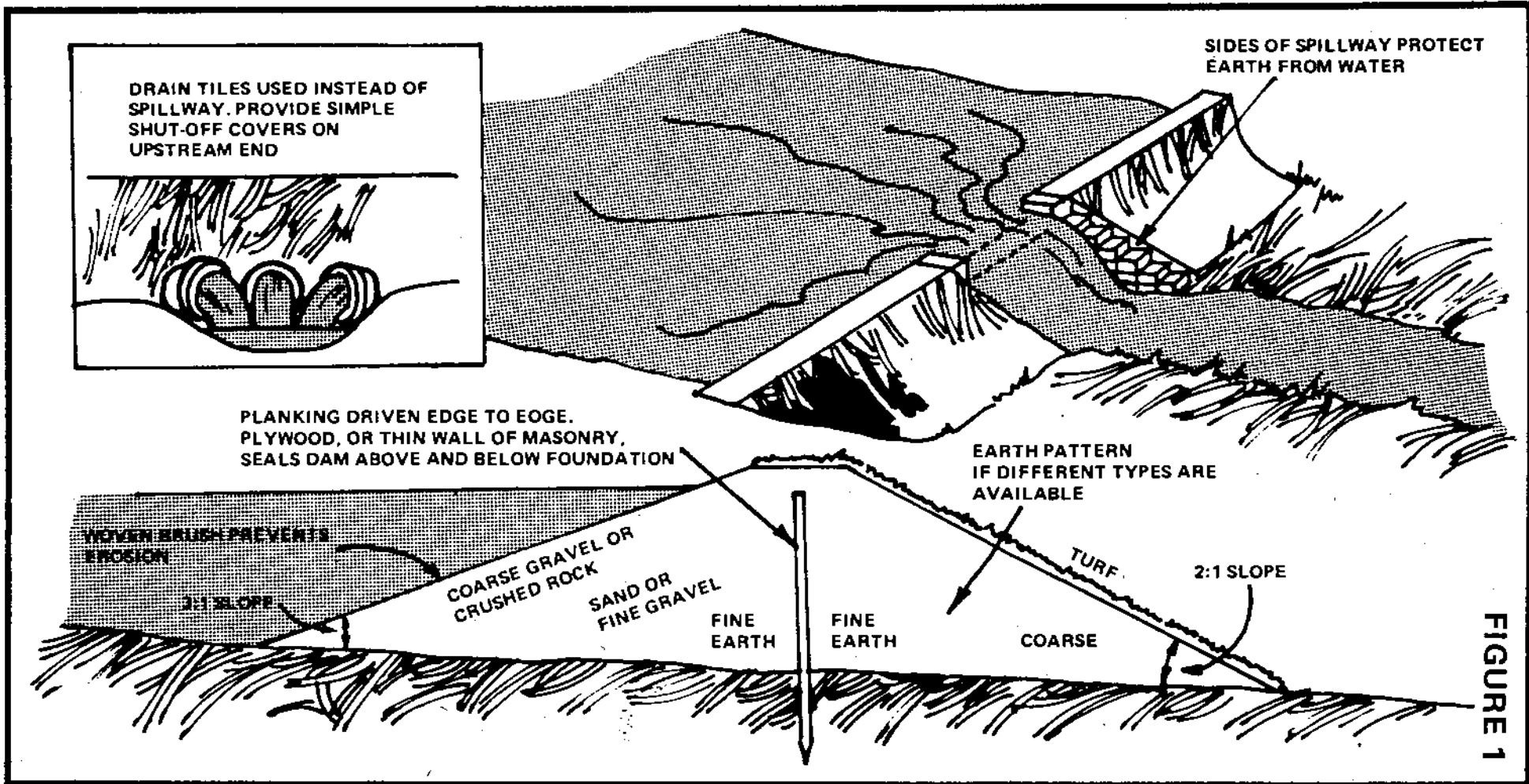

*There's more to the design and fabrication of an earth dam than meets the eye . . . as the above illustration clearly shows.*

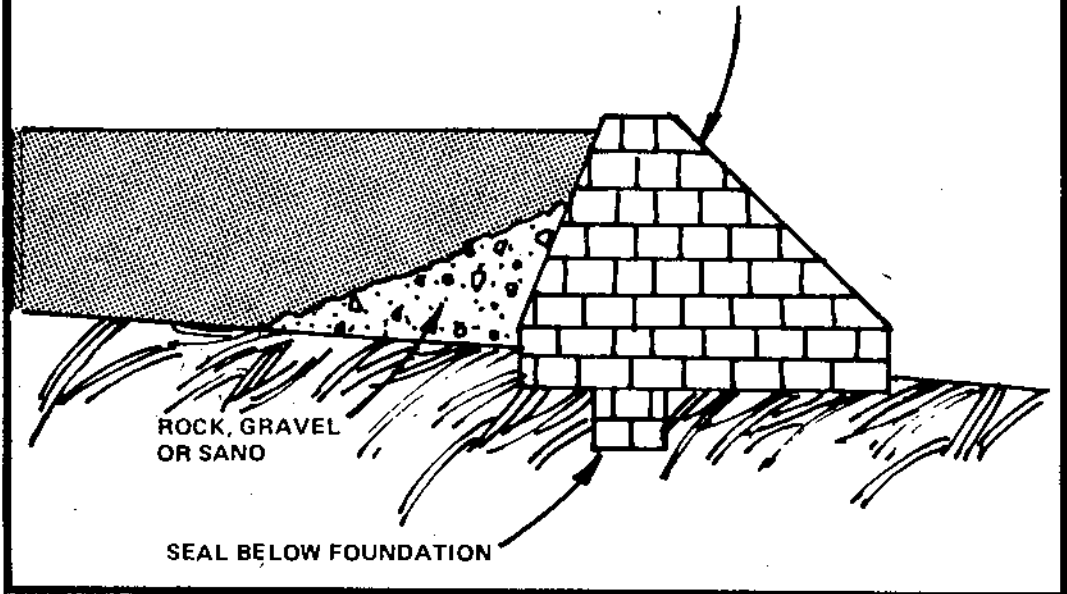
**FIGURE 3**BRICK, CONCRETE BLOCK, CINDER  
BLOCK, BROKEN PAVEMENT OR  
FIELDSTONE

*The gravity dam is relatively complicated to construct. It relies upon brute weight and the binding of its mortar for its stability.*

Lay the planking surface or rough-hewn timber horizontally and edge to edge across the frames, and bolt or spike each in place. Caulk the joints and apply a protective coating. Fill is put in behind the downstream side. Build the spillway entirely of planking or similar material.

The gravity dam (shown in Fig. 3) relies upon its weight for its stability. This dam would be most feasible where large rocks or fieldstones abound. Bricks, concrete or cinder blocks—and even chunks of broken concrete pavement—are also excellent materials. The dam is strictly a masonry type, each block being laid with mortar.

Length is not a critical factor for any of these three dams, but it *is* important for the arch dam illustrated in Fig. 4. The placement of such a dam in a gully is limited not only to the point of least width but also to the point where the banks are highest. Otherwise, this dam would impound little water. It would seem unwise to build one to span more than a width of 10 feet. If the heavy timber is used only as a frame on which to spike or bolt a surface of planking, as shown in one of the drawings in Fig. 4, the number of timber arches will depend on the strength of the planking and also on the height of the dam.

Only earth foundations are considered in the drawings, but you may be fortunate enough to have a solid rock foundation on which to build. In that case, a seal below the foundation

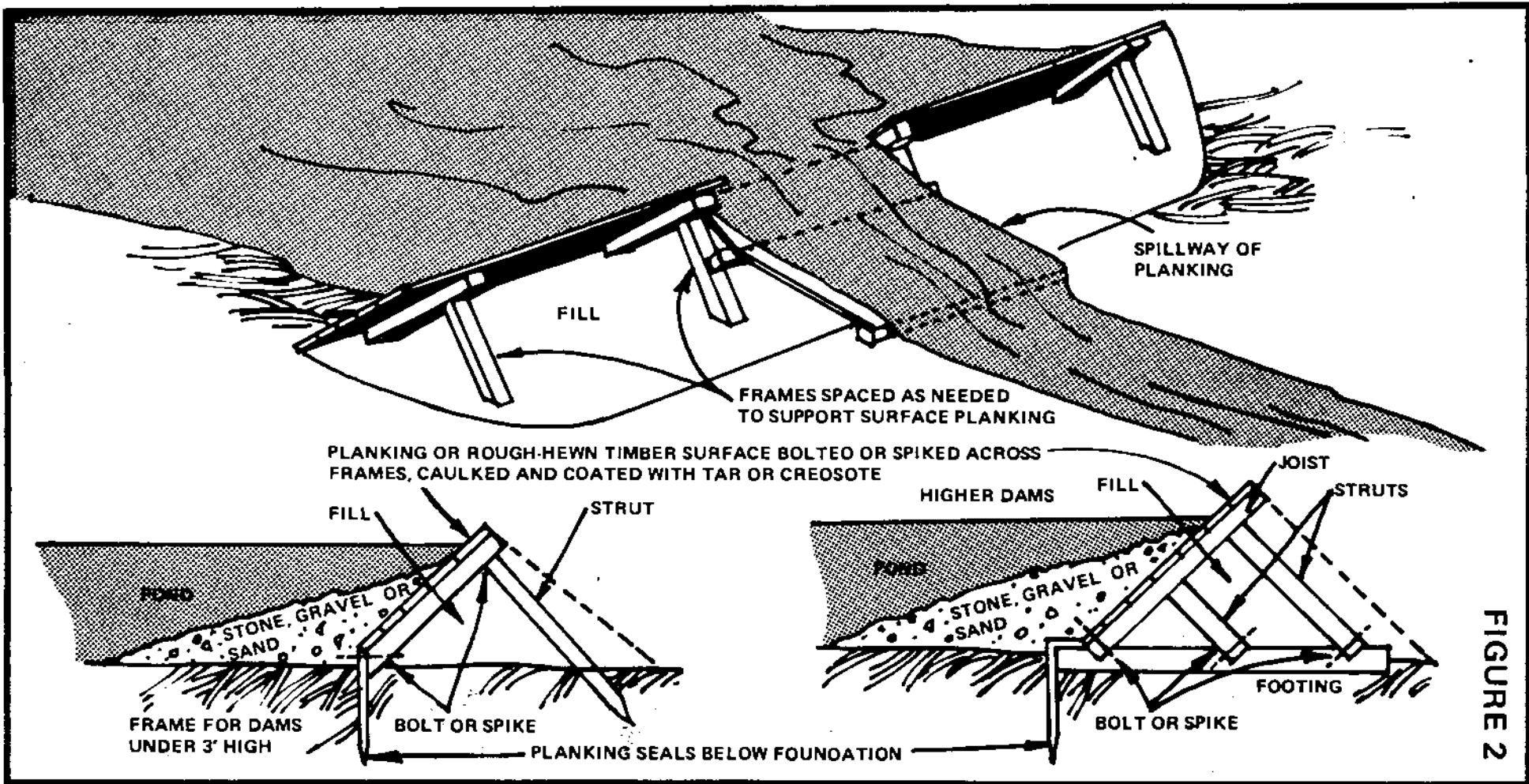

FIGURE 2

*Framed dams are fairly easy to construct, but are seldom used . . . quite possibly because their planks can rot away in time.*

will not be necessary, but some means must be provided to anchor the dam to the rock (such as with anchor bolts in the case of either the framed or gravity dam). Likewise the dam should be sealed at the rock foundation to prevent seepage under it.

In most instances it will be found best to restrict the width of the spillway for excess water to some part of the total length of the dam. This will always be necessary in the case of an earth dam to prevent washing. The spillage water may be allowed to pour over the entire length of framed, gravity and arch dams, however, if the precautions shown in Fig. 5 are taken.

If the downstream side of the dam, or of the spillway, is a curved hard surface of masonry or timber approximating the natural curvature of the water flowing over, it will guide the spillage water so it will be directed downstream without actually falling. Such a curved spillway surface is particularly satisfactory for an earth dam. Large rocks, bricks or other hard objects placed on the downstream side of a spillway not having a curved surface will break the force of the free-falling water and prevent erosion.

The spillway in its simplest form takes the shape of a rectangular depression in the crest of the dam. It should usually be large enough to carry off sufficient excess water so that impounded waters will not top the dam at any season of the year. This, of course, is quite a problem, since accurate determination of spillway capacity requires a knowledge of the total area drained by the creek being dammed plus data on the amount of rainfall at all seasons.

However, most of us will know whether or not the creek we are damming stays within its banks during the year. If it does, then a safe rule to apply would be to make the area of the spillway equal to the cross-section area of the creek at the dam when it is brimful or just ready to flood. The formula is illustrated in Fig. 6.

If the stream does flood, then either construct a dam that in an emergency can allow water to top its full length or build some sort of floodgate into the dam so it can be opened when necessary. One form such a floodgate could take is a group of drain tiles through the dam, as shown in Fig. 1.

The height of the dam you build will be determined by the area of the land to be covered by the impounded water. In

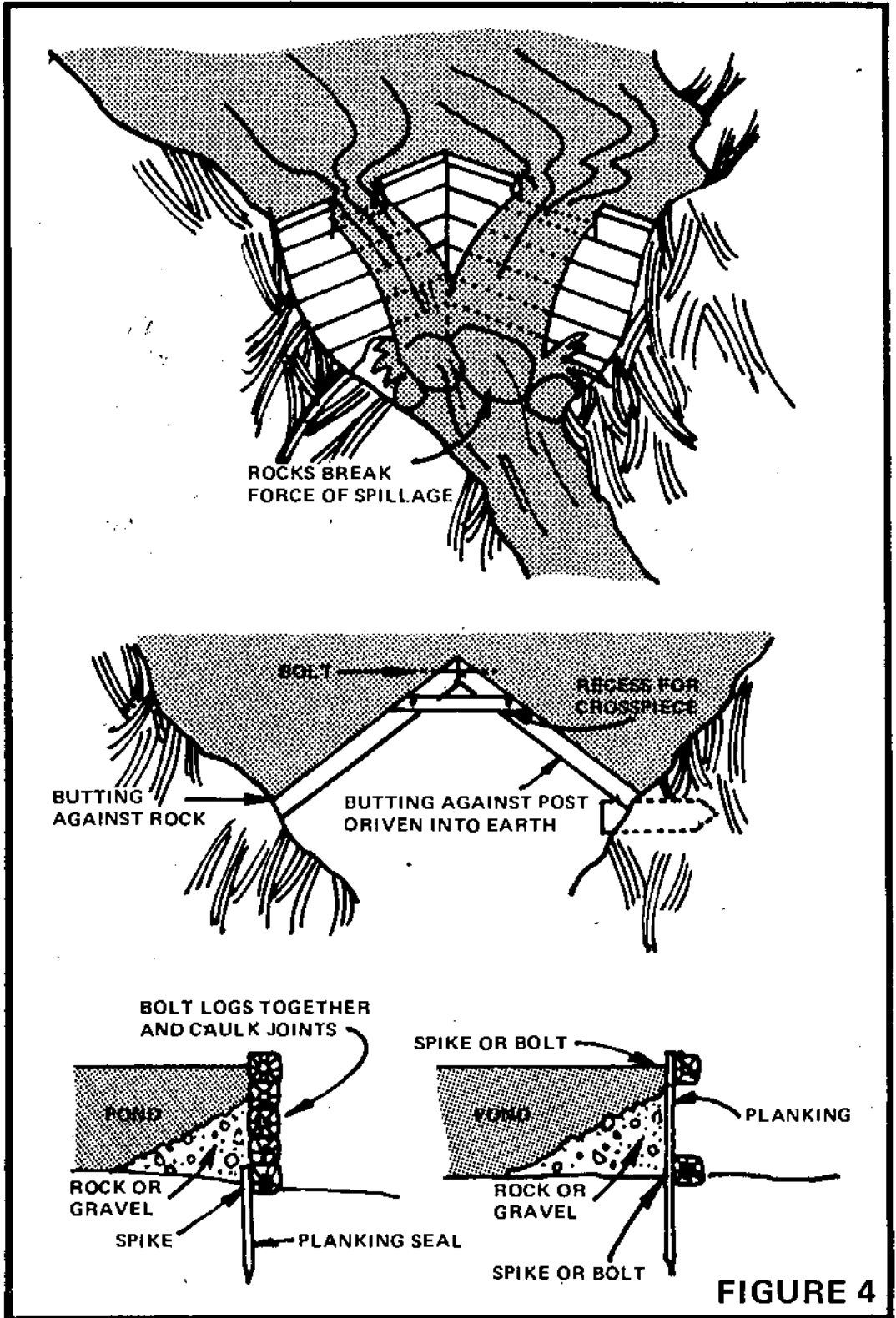

*The arch dam shown here is relatively easy to fabricate, but does have some severe limitations. It's best kept less than ten feet long.*

general, the higher the dam, the greater the area covered by water above it.

All vegetation, brush, floatage and the like in the area to be flooded and for about 15 feet around it should be burned out or otherwise cleared before the dam is built. This keeps down

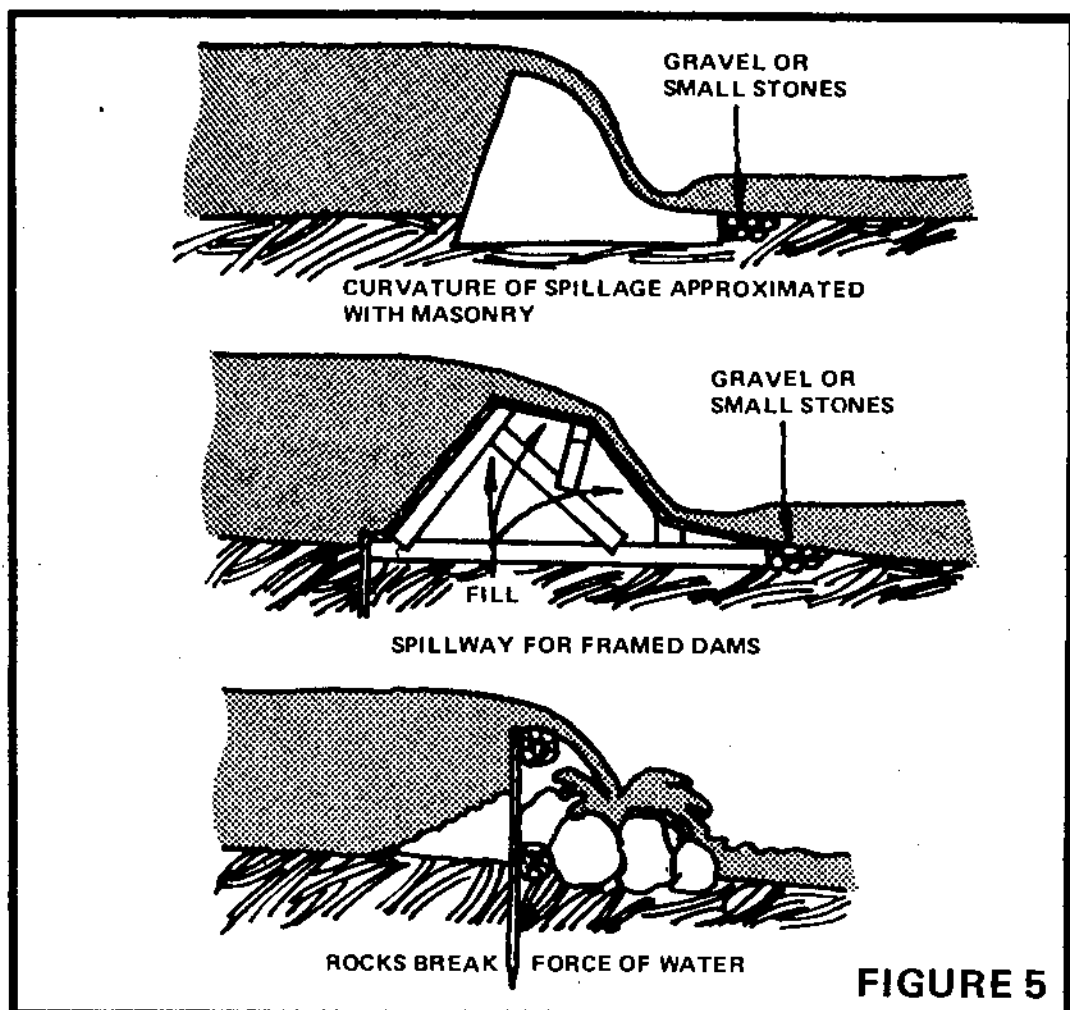

*Improperly handled spillage water can quickly undermine a dam and the methods shown above are a few ways to prevent such a mishap.*

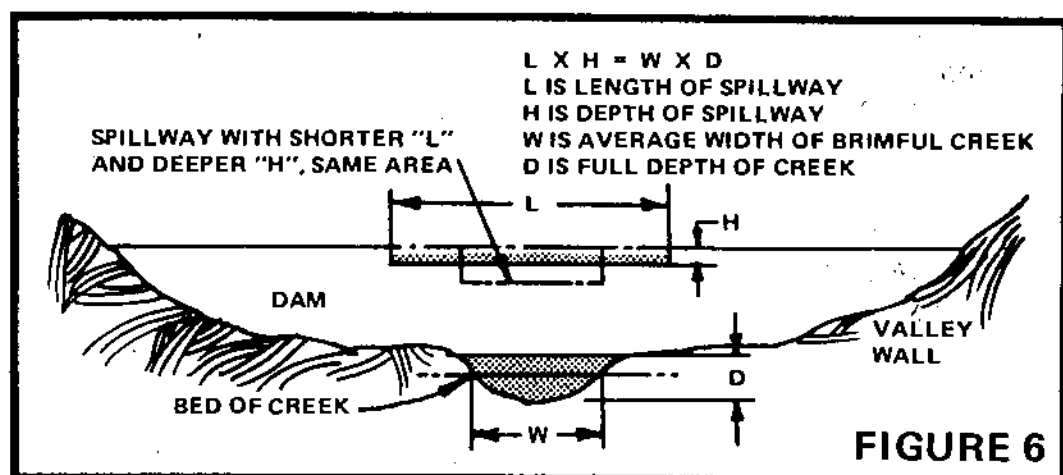

*A water power system's spillway can be just as important as the dam it protects and here's how to determine the spillway's size.*

the breeding of mosquitoes and helps retard pollution. It is required in the regulations of some states and is a wise precaution even when not covered by law. In addition, all trees in the area to be flooded should be cut reasonably close to the ground.



# HOW TO MEASURE FLOW AND HEAD

To determine feasibility for developing a water power system, this is where you must start.

This is a job which takes time and care. Its importance is based on the fact that a lot of money may be invested on the basis of the figures. In order to gain an understanding of a stream, one should really spend time with it, absorbing its detail, watching it flow, so that the most appropriate site for the installation can be found. Ideally the flow of the potential power source should be measured for a year before any hardware is purchased. If this is done, then two important facts are known:

1. The lowest and highest seasonal flows — the extremes.
2. The average, dependable flow per month.

With a firm knowledge of the flow figures and the available head, then a turbine can be installed with the certainty that it will produce a given amount of power each month.

The purpose for which the turbine is being installed should then be examined. For example, if it is to supply domestic power requirements, then how much power is needed and when? When you know what the river can supply, and the domestic demand, you can then plan accordingly.

The power in any stream is purely a function of the available flow ( $Q$ ) and the head ( $H$ ). Therefore power ( $P$ ) is equal to  $Q \times H$ . Some people are fortunate in that a local water authority has kept detailed readings of the river flow, but for those who are not so lucky there are three ways to find the value of  $Q$ .

# Flow Measurement

## Container Method

This method is only suitable for small mountain streams. Build a dam, divert the whole stream into a container of known size and time how long it takes to fill. It may not be necessary to build a dam, a groove could be built into the stream bed where the flow gathers at the point of a fall and a pipe inserted into the groove to draw off the flow into the container.

**Example:** *A 60 gallon tank is used, and it takes 30 seconds to fill. Therefore  $Q$  equals 120 gallons a minute, which is equal to 16 cubic feet per minute (cfm).*

## Weir Method

This is the most accurate method of measuring the flow in medium sized streams. The weir is built like a dam across the stream, which causes all the water to flow over a rectangular notch of known dimensions, see figure below. The weir is best constructed with timber and made watertight with sandbags, sods or clay.

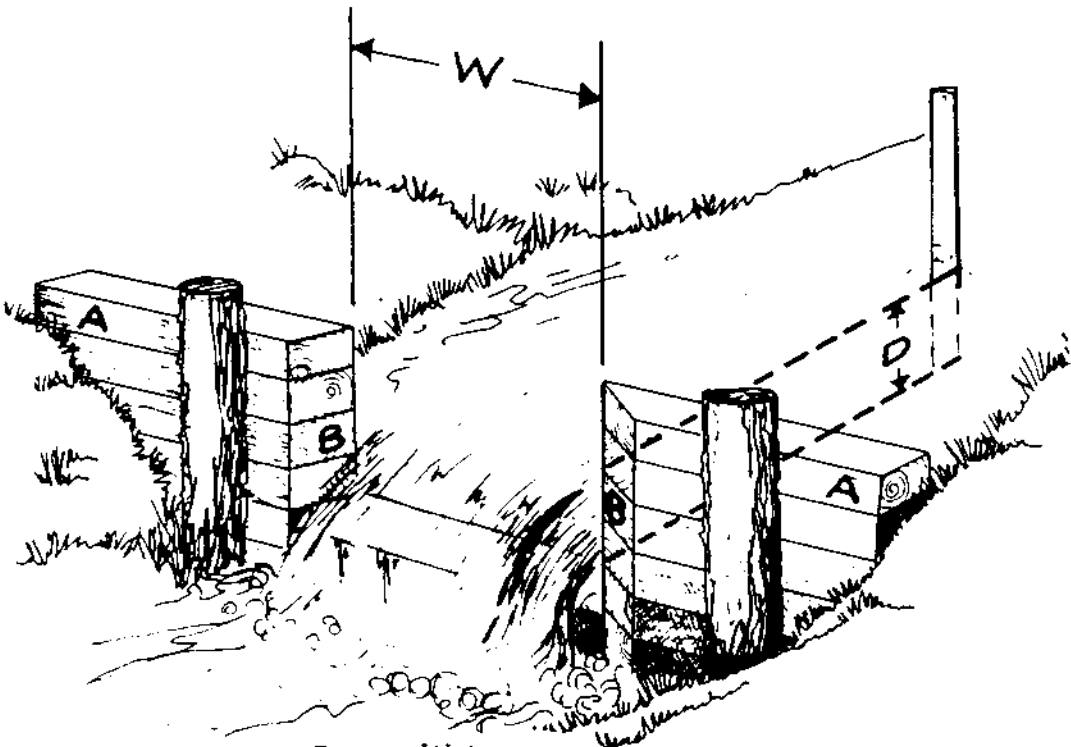

Fig. 1. Weir

Before building the weir, take an approximate measurement of the stream, and see that the overflow notch is sufficient to take maximum flow. The notch should have a width to height ratio of at least 3:1, and be perfectly level and sharp-edged.

To measure the depth of water flowing over the weir, drive a stake in the stream bed three or more feet upstream from the weir, to a depth such that a mark on the stake is exactly level with the bottom of notch "B." Measure the depth "D" in inches of water over the mark, and read the volume of flow in cubic feet per minute per inch of notch width from the table below. Multiply this volume by the notch width in inches, to obtain the total stream flow in cubic feet per minute.

WEIR TABLE

<i>Depth on stake in inches.</i>	<i>Cubic ft. per min. per inch length.</i>	<i>Depth on stake in inches.</i>	<i>Cubic ft. per min. per inch length.</i>
1	0.4	10	12.7
1.5	0.7	10.5	13.7
2	1.1	11	14.6
2.5	1.6	11.5	15.6
3	2.1	12.5	16.7
3.5	2.6	12.5	17.7
4	3.2	13	18.8
4.5	3.8	13.5	19.9
5	4.5	14	21.1
5.5	5.2	14.5	22.1
6	5.9	15	23.3
6.5	6.6	15.5	24.5
7	7.4	16	25.7
7.5	8.2	16.5	26.9
8	9.1	17	28.1
8.5	10.0	17.5	29.4
9	10.8	18	30.6
9.5	11.7	18.5	31.9

**Example:** *A weir is 3 ft. 6 in. wide and the depth of water at the stake is 10 inches. The flow in cubic feet per minute is therefore  $42 \times 12.7 = 533$  cfm. Once the weir is constructed (easier said than done) it is a simple matter to take frequent readings.*

## Float Method

This method is not as accurate as the two above. The flow in cfm or cubic feet per second (cusecs) is found by multiplying the cross-sectional area of the stream by its velocity.

Mark off a section of the stream, at least 30 feet, where its course is reasonably straight and smooth. Choose a windless day to take the measurements. Place a float upstream of the first marking and time its passage over the known distance. A bottle, partially filled, and submerged to the 'shoulders,' makes an excellent float. Repeat the procedure and find the average time. Reduce this time by a correctional factor of 0.8 for a stream with a smooth bed and banks, and by 0.6 for a rock strewn hilly stream.

Next, the average depth of the river between its banks must be ascertained. This is done by taking a number of depth measurements across the bed of the river, at equal intervals, adding up all the readings and dividing the total by the number of measurements taken. The cross-sectional area, in square feet (or whatever), is then found by multiplying the depth by the width of the river.

Having ascertained the velocity and the cross-sectional area, the flow is found by multiplying the two.

**Example:** *A float on a river, with smooth bed and banks, takes 75 seconds to travel 50 feet. Thus the velocity is equal to:*

$$\frac{50 \times 0.8 \times 60}{75}$$

*or 32 feet per minute. Ten cross-sectional readings were taken, giving a total figure of 14.5 feet. When divided by 10 this gives an average depth of 1.45 feet. The width of the river is 12 feet, so the cross-sectional area is  $12 \times 1.45$  or 17.4 sq. ft. Therefore the flow is  $32 \times 17.4$  or 557 cu ft/minute.*

## Measuring Head

The head (H) is the height the water falls from the headwater to the tailwater. The head exerts a pressure which can be turned into useful power. On high-head installations an indication of the head can sometimes be gained from detailed maps, but for a more correct measurement any of the following methods may be used:

1. Borrow or rent standard surveying equipment. The job re-

quires two people, one to hold the rod and the other to read through the transit. For the sake of accuracy it is wise to have someone on hand who has had experience with such equipment.

2. Use a hand level. A hand level is basically the looking glass part of a surveyor's transit. The tripod is replaced with a human body, of known height, so instead of using a staff one merely walks to the spot sighted through the level and then takes another sighting, and so on until the head is measured.

3. If you have time on your hands a good, though tedious method, is to tie a carpenter's level to a piece of straight board or light metal. Place the board horizontally (check with level) at the headwater, measure the vertical distance between the tip of the board and the ground, and keeping a record, repeat the process until the tailwater level is reached.

Having measured the gross head, we must now take into consideration the various losses which will result in a figure for the net head. There is always some loss of head on an overshot wheel installation as the wheel must run free of the tailrace. With impulse turbines, the Pelton and Turgo, there is loss of head for two reasons. First, there must be a gap between the nozzle jet and the tailwater. Second, head losses occur in pipelines due to friction. With PVC piping the friction is very low and even on installations with long pipelines I have rarely found the head loss to exceed 8 per cent. Any PVC pipe manufacturer ought to be able to give you a flow chart which will clearly show the head losses and also indicate the most appropriate pipe diameter to be used. Trying to cut down the capital costs by reducing the size of pipeline may ruin an otherwise excellent scheme. Steel, iron and concrete pipe all cause very high head losses, and as they cost more than PVC they are, at present, of little concern. Any pipeline with a large number of bends and undulations will have a bad effect on the flow and thus reduce the effective head considerably. The obvious choice for a water power site is where the highest head or fall is available in the straightest possible line, and within the shortest distance. Open chamber cross-flow, Francis and propellor turbines with draft tubes have little or no head losses. Those with pipelines suffer losses as above.

The net head ( $h$ ) is the actual head or pressure available to drive the turbine or waterwheel when useless losses have been deducted from the gross head ( $H$ ). Thus:

$h = H -$  pipeline friction at full load and drop from turbine nozzle center line to tailwater level (impulse) or rise in tailwater level at full load (reaction).

### Head Loss for Plastic Pipe

Flow cfm	3	6	12	18	24	30	36	42	48	54	60	66	72	78	84	90	120	150
Pipe Size	(Head loss per 1,000 ft. of pipe)																	
2"	18	63	230															
2½"	6	21	75	161	274													
3"	2	9	30	64	110	166	234	312										
4"	½	2	7	15	26	40	56	74	95	118	144	172	201	230	268	305		
6"	0	¼	1	2	4	5	7	10	13	16	19	23	27	30	36	40	69	105
8"	0	0	¼	¼	½	1¼	1¾	2⅓	3	3¾	4½	5⅓	6⅓	7⅓	8½	9½	16	25

(Steel pipe in fair condition will have about twice the head loss shown above.)

With very low head turbine installations, say from 5 to 10 feet, the rise in tail water level must not be ignored. Even with a tailrace only a few hundred feet long, the tail water level at full load may easily rise 1 foot or more. Thus with an open type turbine in a pit, when the gross head is 6 feet from head water level to standing tail water level, the power from any type of turbine with 'h' reduced to 5 feet will be reduced by 24 per cent.

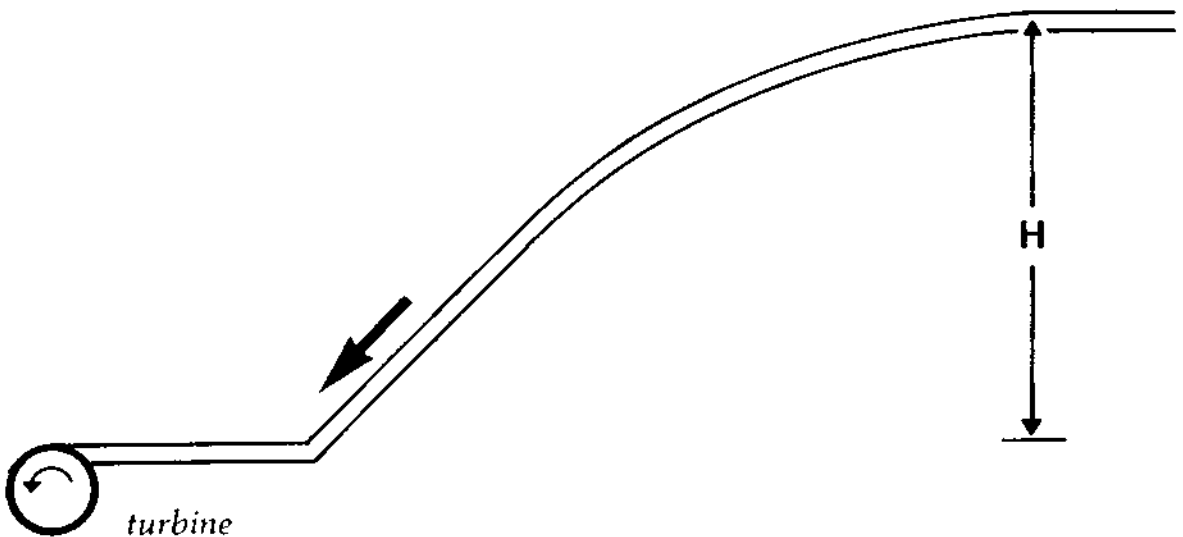

Fig. 2. "H" shows the head

# How to Compute Theoretical and Net Power Output

Having calculated the flow (Q) and the net head (h) it is a simple matter to calculate the theoretical output (T) in kilowatts:

$$T.kW = \frac{Q \times h}{708} \quad \text{or} \quad = \frac{Q \times h}{11.8}$$

where Q = flow in cfm                      or = flow in cusecs (cu ft/sec)  
       h = head in feet                        = head in feet  
       708 = const. factor                    11.8 = constant factor

The following equation is for those who have gone metric:

$$T.kW = \frac{Q \times h}{102}$$

where Q = flow in liters per second  
       h = head in meters  
       102 = constant factor

These equations show us the power available in flowing water if equipment with a 100% efficiency were available to tap it. However, as we haven't got that far yet, we must calculate according to available efficiencies. The maximum to be expected for a small water turbine is 80% efficiency; the figure drops to 65% for overshot water wheels.

Power transmission manufacturers are now claiming a 97% efficiency for their belt drives, so a turbine with one belt drive to the alternator will have a 97% transmission efficiency, with two belt drives a 94% efficiency and with three belts 91%. Gear-box manufacturers claim a 95%, or higher, efficiency. The efficiency of second-hand gear-boxes, bevel gears and motor vehicle back axles will vary slightly. A good alternator should have an efficiency of about 80% over a wide range of outputs. There is one on the market today with an 88% efficiency and another with a mere 71%.

From the above we can calculate that the overall efficiency for a water power installation using a turbine with a one belt drive and a good alternator will be 0.8 (turbine) × 0.97 (belt) × 0.8 (alternator) = 62%. The overall efficiency for an overshot water-wheel with a gear-box, 2 belt drives and an alternator will be 0.65 (water-wheel) × 0.95 (gear box) × 0.94 (2 belt drives) × 0.8 (alternator) =

46.5%. This indicates the two extremes in efficiency within which most installations fall. The high figure of 62% (which can be increased rarely in practice) is generally found on high-head, high-speed Pelton or Turgo impulse turbines. As the runner weight increases and its speed decreases on low-head installations, so the efficiency drops. Further information on efficiencies is given throughout the book in the description of each installation. It should be said that the efficiency of a turbine or water-wheel will fall if the flow or head for which it was designed decreases. If the shaft power to an alternator falls below 50% of its rated output its efficiency will begin to decrease. These efficiency figures for turbines and alternators are available from the manufacturers.

**Example 1:** *The flow on a mountain stream is found to be 90 cubic feet a minute and the available net head is 180 feet. An impulse turbine with a single belt drive to the alternator is considered best, therefore the overall efficiency will be about 60%. The net output will be:*

$$\frac{90 \times 180 \times 0.6}{708} = 13.7 \text{ kW}$$

**Example 2:** *A low-head reaction turbine with a gear-box and one belt drive is to be installed on a river with a 10 foot head and a flow of 50 cusecs (cfs). The net output will be:*

$$\frac{50 \times 10 \times 0.58}{11.8} = 24.5 \text{ kW}$$



WESTWARD MOULDINGS LIMITED,  
 GREENHILL WORKS,  
 DELAWARE ROAD,  
 GUNNISLAKE, CORNWALL, ENGLAND.

Westward Mouldings Ltd. manufacture a range of fiberglass water-wheels as follows:

Wheel diameter	8 feet	16 feet	20 feet
Number of buckets	16	32	40
Bucket capacity	3.6 cu. ft.	4.8 cu. ft.	7.2 cu. ft.
Max. advised rpm	15	10	6/8
Max. output (approx.)	3.6 kW	11 kW	25 kW
Price	\$1,200	\$3,200	\$4,800
Price of home-assembly kit		\$2,400	\$3,600

(Suitable for importing)

The maximum output in kilowatts shown above is based on a 65% water-wheel efficiency with the buckets filled to 70% of capacity, the figures exclude the increase in power which may result from the installation of an apron on the lower quarter of the wheel. The output relates to shaft power only, from which should be deducted generator and gear losses.

The calculations are based on the following equation:

$$\text{Output (kW)} = \frac{D \times B \times \text{B.no} \times \text{rpm} \times 0.65}{708}$$

where

D = wheel diameter from bucket centers

B = working bucket capacity (0.7 of total capacity, approximately)

B.no = number of buckets

rpm = revolutions per minute

0.65 = efficiency factor

708 = kW conversion factor

**Example:** *A 16 ft. wheel with buckets filled to 70% capacity, 3.36 cu. ft., revolves at 8 rpm. Therefore its output is as follows:*

$$\begin{aligned} \text{Output} &= \frac{14 \times 3.36 \times 32 \times 8 \times 0.65}{708} \\ &= 11 \text{ kW shaft power.} \end{aligned}$$

## Examples

### Mission Hospital

1. Requirements: 10 kilowatt light and power plant.
2. 10 kilowatts is  $13\frac{1}{3}$  horsepower.
3. The gross power required is then about 27 horsepower.
4. A stream in hilly territory can be dammed up and the water channeled through a ditch  $\frac{1}{2}$  mile long to the power plant site.
5. A penstock 250 feet long will take the water to the turbine.
6. The total difference in elevation is 140 feet.
7. Available minimum flow rate: 1.8 cubic feet per second.
8. The soil in which the ditch is to be dug permits a water velocity of 1.2 feet per second.
9. Table 7 gives  $n = 0.030$ .
10. Area of flow in the ditch =  $1.8/1.2 = 1.5$  square feet.
11. Bottom width = 1.5 feet.
12. Hydraulic radius =  $0.31 \times 1.5 = 0.46$  feet.
13. Figure 11 shows that this results in a fall and head loss of 1.7 feet for 1,000 feet. The total for the half-mile (2,640 feet) ditch is 4.5 feet.
14. The fall that is left through the penstock is then:  $140 - 4.5 = 135.5$  feet. Figure 13 gives 5.7 inches as the required penstock diameter for 1.8 cubic feet per second flow at 10 feet per second velocity.
15. Head loss in the penstock is 10 feet for 100 feet of length and 25 feet for the total length of 250 feet.
16. For the water turbine: Net head =  $135.5 - 25 = 110.5$  feet.
17. Power produced by the turbine at 80 percent efficiency:  
net power =  $\frac{\text{minimum water flow} \times \text{net head}}{8.8}$   
 $\times$  turbine efficiency =  $\frac{1.8 \times 110.5}{8.8}$   
 $\times .80 = 18$  horsepower.

## WATER WHEELS AND WATER TURBINES

So far we have been discussing ways to measure available water power, build dams and construct channels and sluices. Now we shall turn our attention to the actual devices, the waterwheels and turbines that turn water power into useful work. The choice of turbine or wheel is probably the biggest decision in building a hydro-power plant. The main factors that will determine your choice are:

1. *Flow rates*: minimum to be available, maximum to be utilized and maximum to be routed through the dam.

2. *Available head*: elevation difference in feet or meters between head waters and tail waters.

3. *Site sketch*: an elevation or topographic map with dam and power locations indicated.

4. *Soil conditions*: determines the possibility of erosion and the size and slope of a canal; also a consideration in dam construction.

5. *Pipe length*: required from dam or end of canal to powersite.

6. *Water conditions*: clear, muddy, sandy, acid, etc.

7. *Tailwater elevation*: the maximum and minimum water level immediately below the turbine.

8. *Air temperature* : annual maximum and minimum, particularly amount of exposure to freezing temperatures.

9. *Power generation*: a waterwheel if you want mechanical energy, or a turbine for electrical energy, and how much of each type of energy is needed.

10. *Cost/Labor*: pre-packaged vs "home-built."

11. *Materials*: use of native or purchased materials to suit the design and use.

12. *Maintenance*: some assessment of reliability and ease of repair.

We will discuss those waterwheels and water turbines that are appropriate for the small scale projects that individuals and communities might reasonably consider. There are really too many designs, devices and inventions associated with hydro-power to describe in this limited space. Further research has led us to conclude that construction instructions for wheels that may be "home-built" are adequately treated in other publications. Consequently we will not take the time here to rehash what is already available, and the reader should refer to p. 69 *Reviews/Water* section. For the more technically minded, the discussion of each wheel and turbine has *some* detailed and geometric coverage of construction.

TABLE IV WATERWHEEL AND WATER TURBINE SPECIFICATIONS

Wheel or Turbine Type	Range of head (feet)	Wheel or runner diameter (feet)	Optimum rpm	Efficiency %	Ability to handle changing:		Technology of construction	Materials
					Q flow	H head		
Undershot Wheel	6'-15'	(3)(H)	$\frac{42.1 \sqrt{H}}{D}$	35-45%	good	fair	low	metal/wood
Poncelet Wheel	3'-10'	2H-4H ( $>14'$ )	$\frac{42.1 \sqrt{H}}{D}$	60-80%	good	fair	medium	metal/wood
Breast Wheel	6'-15'	(H)-3(H)	dependent on design less than overshot	40-70%	good	fair +20%H	low	metal/wood
Overshot Wheel	10'-30'	(.75)(H)	$\frac{41.8}{\sqrt{D}}$	60-85%	good	none	low	metal/wood
Michell (Banki)	15'-150'	1'-3' +	$\frac{862 \sqrt{H}}{D, \text{ in}}$	60-85%	good	good	medium	welded steel
Pelton Wheel	50'-4000'	1'-20'	$\frac{76.6 \sqrt{H}}{D}$	80-94%	good	fair	medium/high	steel, cast iron or bronze
Francis	100'-1500'	1'-20'	dependent on design	80-93%	poor	poor	high	cast or
Kaplan	14'-120'	2'-30'	50-220	80-92%	poor	good	high	machined
Propeller	8'-200'	2'-30'	50-220	80-92%	poor	poor	high	steel

H = head in feet

D = diameter of wheel in feet

# WATERWHEELS

Waterwheels are particularly useful for generating mechanical power. This power is taken off the center shaft of the wheel and usually connected, via belts and pulleys, to machinery. Waterwheels generally operate at between 2 and 12 revolutions per minute (rpm) and are appropriate for slow speed applications such as turning grinding wheels, pumping water and sometimes running lightweight machinery and tools (i.e. lathes, drill presses and saws). Waterwheels may be used to generate electric power but because of the slow rotational speeds, difficulties are often encountered. Waterwheels will operate in situations where there are large fluctuations in the flow rate. The changing flow will bring about a change in the rpm of the wheel.

## Undershot Wheel

The most basic design (and simplest concept) in waterwheels is the old-style undershot wheel. The earliest design for the undershot wheel was a simple paddle wheel, immersed in the stream flow, that splashed along with the current. This sort of wheel powered the fountains of Louis XIV's Palace of Versailles. A number of undershot wheels, each 14 meters in diameter, powered the fountain's pumps with an overall efficiency of only 10%.

The refinements that were developed to improve the efficiency of the undershot wheel included better controls on the water in order to increase the velocity of the water as it hit the paddles, and to limit the amount of water so the paddles would not get bogged down in the backwater.

Since the really significant loss of energy in the paddle-type undershot wheels came from the shock and turbulence as the water hit the flat paddles, around 1800 the shape of the paddles was changed to reduce this loss. The end result of this change, the curved blades of the Poncelet undershot wheel, is still the last word in the design of the undershot waterwheel.

## Poncelet Wheel

These "low-technology" wheels are best suited for heads ranging from three feet up to ten feet and flows ranging from three cubic feet up to whatever is available. They generally operate at a low rpm (for example 7.4 rpm for a 14 foot diameter wheel with a six foot head) as determined using the appropriate formula from Table IV. Poncelet wheels usually develop a high torque; this coupled with their low rpm make them best suited for mechanical work rather than electrical generation. Poncelet wheels are usually made of wood with reasonably heavy timbers being used for the spokes. The buckets or vanes are usually made of sheet-steel.

A well designed Poncelet wheel utilizes the impulse of the water jet as it strikes the vanes at the bottom of the wheel. The vanes are curved so that they allow the water to enter the buckets with a minimum of shock (which would cause some energy loss). The water then "runs up" the curve of the bucket vane, exerting a force on the wheel. As the energy of the water is transferred to the wheel and the wheel rotates, the water falls back and drops from the wheel to the tailwater with nearly zero velocity. The Poncelet is 70% to 85% efficient.

The diameter of the wheel is largely a matter of preferred use and limitations in materials, usually with a minimum diameter of 14 feet up to a maximum of four times the head. For the same output the smaller wheels will turn much faster and with less torque than the larger wheels.

The bottom of the sluice under a Poncelet wheel must be made in a close-fitting breast for an arc of  $30^\circ$  ( $15^\circ$  on either side of bottom-dead center) see Fig. 10. *Breast* or *breast works* may be defined as a structure that is formed to fit close to the rim of the waterwheel, usually intended to help the wheel retain water in its buckets. A breast should be made of concrete or other easily-formed durable materials. It should fit as close as possible to the wheel but not so close that the wheel could rub or bind as it rotates. The tailrace beyond the breast should be deepened and widened to insure that the backwater does not hinder the rotation of the wheel.

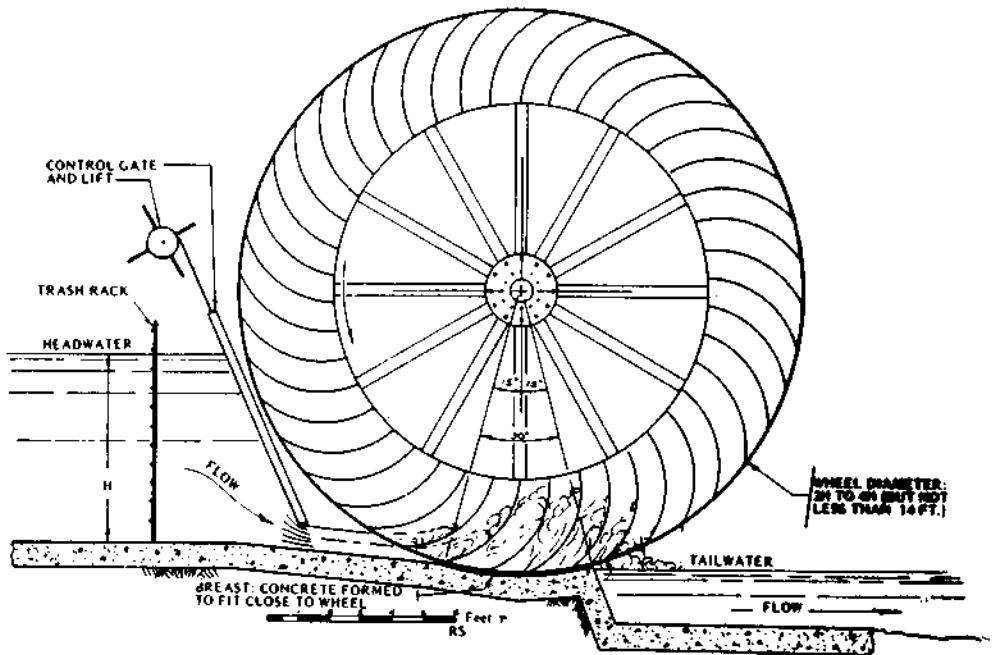

FIG. 10 PONCELET WHEEL

## Breast Wheel

Breast wheels can be used for heads between 5 and 15 feet; however, since they are not quite as efficient as overshot wheels for similar heads, they are generally only considered for heads under 10 feet. They are more difficult to construct than the other types of basic water wheels, in that they require a close-fitting breast works (similar to the one pictured in Fig. 10) to keep the water in the buckets along the lower half of the wheel. These breast works further complicate matters since the wheel must be protected from rocks, logs, and debris, to prevent the wheel being jammed and damaged.

When the water enters the wheel at about the elevation of the center shaft, it is considered a "breast wheel;" when the entrance is below the center shaft, the wheel is a "low-breast;" when above, it is a "high-breast."

From late 19th and early 20th century records of American and European practice (still pretty much the state-of-the-art for these wheels) it is evident that the efficiency will vary with the type of breast wheel: about 35% to 40% for low-breast wheels, little better than a simple undershot; about 45% to 55% for midrange; and for "high-breast," about 60% to 65%, approaching that of the overshot wheels.

Not only do breast wheels have complicated, curved breastworks and entrance gate, but the buckets must be "ventilated" to allow air to escape to the next higher bucket as each fills. It seems that considering the operating inefficiencies, maintenance problems, and difficulty of construction, it would make more sense to build an overshot wheel. And for the same effort in design and construction, a Poncelet wheel can give a higher efficiency than the medium or low-breast wheels.

## Overshot Wheel

Overshot wheels have traditionally been used for falls (heads) of 10 to 30 feet. They have sometimes been used with higher falls, but because of the size of the wheel needed, there are usually more practical ways to harness the energy. In an overshot wheel, a small portion of the power is a result of the impact of the water as it enters the bucket. Most of the power is from the weight of the water as it descends in the buckets. The wheel should be designed so that the water enters the buckets smoothly and efficiently so that the greatest amount of power is produced with the least amount of waste. The efficiency of this wheel, if well constructed is anywhere from 70% to 80%.

When the supply of water is small, during dry times, the wheel still operates, even though the buckets are only partially filled. This, of course, reduces the power output, and yet the efficiency is increased since less water spills from a less-full bucket. The corollary to this would seem to be that a wheel with an excess carrying capacity would operate at a higher efficiency. However, this increases the construction cost and usually the efficiency gained is not worth the extra expense.

Fig. 11A shows an overshot wheel with curved steel buckets. The water, controlled by the sluice gate at G, flows along a trough or sluice, A, to a drop at the crown of the wheel at C. The end of the sluice is slightly curved toward the wheel and placed such that the water enters at (or slightly after) the vertical center-line of the wheel. The sides of the sluice are extended just enough to fill several buckets at a time, without losing water over the sides of the wheel.

The supply of water as it is regulated by the sluice gate, is usually limited to under an 8 inch depth (see Fig. 11A). In most cases this flow would be controlled by hand, although with a little mechanical ingenuity, the gate could be regulated by an automatic governor.

## Overshot Construction

Suppose that the total fall or head available is 20 feet. To insure that the centrifugal force from the water in this head filling the buckets will not cause too much spilling, the rim speed,  $U$ , should not be too great. The rim speed is the velocity of the outer edge of the wheel, usually expressed in feet per second. One value for  $U$  has been given in an engineering handbook (c. 1930) as  $U = 2D$ . With the curved buckets in common usage (as shown in Fig. 11A), a better value of  $U = 1.55\sqrt{2D}$ , where  $D$  is the diameter of the wheel.

As a first approximation, assume the wheel diameter is 16 feet. Then  $U = 1.55(\sqrt{2} \times 16) = 8.8$  feet per second. The rim velocity should be between 50% to 70% of the velocity of the water, the best being about 65%. If the rim speed is much faster than this, the back of the buckets will tend to "throw" the water out and away from the wheel.

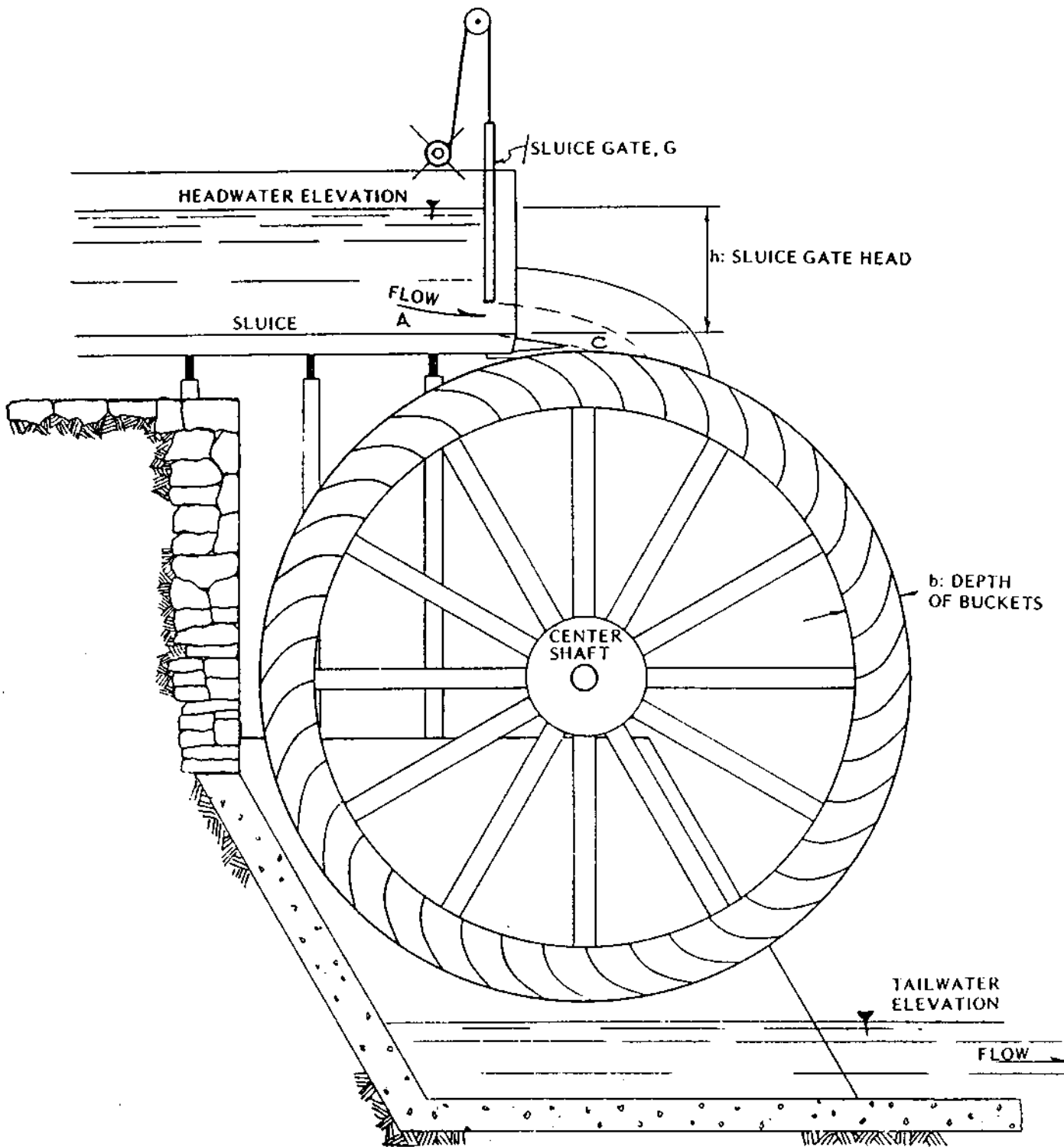

FIG. 11A OVERSHOT WHEEL



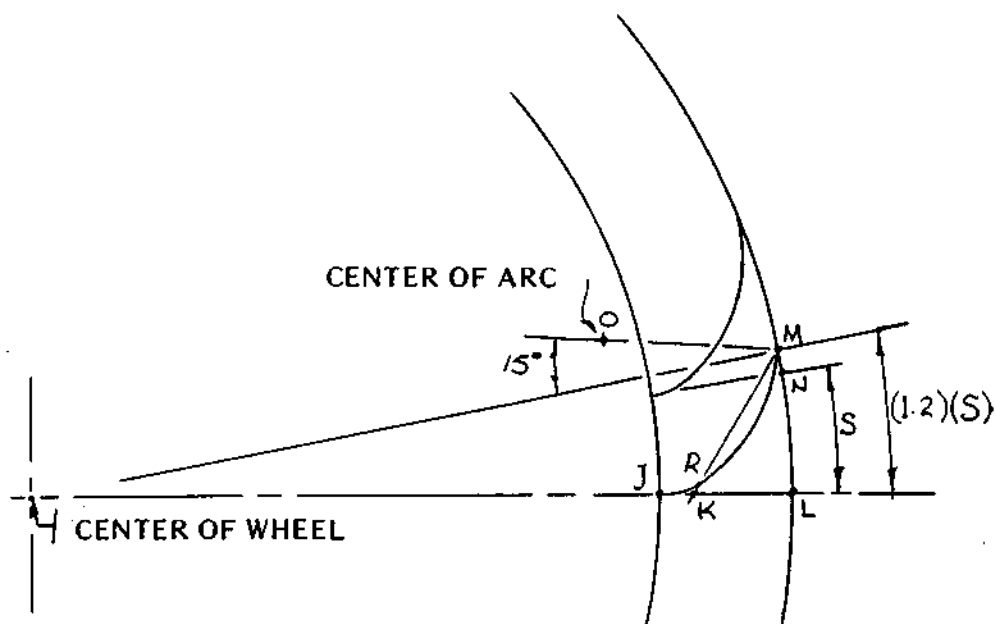

FIG. 11B OVERSHOT WHEEL: BUCKET CONSTRUCTION

The particular depth chosen for the buckets is rather subjective. One source says the depth should be  $.3\sqrt{D}$  to  $.5\sqrt{D}$  where narrower wheels are desired." Another says simply that "spacing and depth should be the same" and the spacing should be ".10 inch to .18 inch."

From the usual practice in the 19th century, it seems that a reasonable number of buckets for a wheel should be about  $2.5D$  (where  $D$  is in feet). This has to be a whole number so that the buckets are equally spaced around the wheel. The spacing,  $s$ , would be  $s = \frac{\pi D}{n}$  where  $n$  = number of buckets. Or, to find the angle in degrees between each bucket, divide the full circle,  $360^\circ$  by  $n$ .

To find curvature of the buckets for an overshot wheel (see Fig. 11B), set the distance  $J$  to  $K$  equal to  $1/3 b$  and the distances  $L$  to  $M$  equal to  $(1.2)$  times the circumferential pitch or bucket spacing,  $S$ . A bucket chord line is drawn from  $M$  to  $K$  with a point,  $R$ , found near to  $K$  (the length of  $K$  to  $R$  is about  $1/4$  the length of  $J$  to  $K$ ). The center of the arc from  $R$  to  $M$  is set at  $O$  on a line that is offset  $15^\circ$  from the radius. The arc from  $M$  to  $R$  should be "rounded" into the radial line  $J.K$ .

During construction of this wheel, the job of placing the buckets would be much easier with a template or jig already cut to the exact bucket curvature. If the jig were set up to include the center of the wheel, it could be moved rather quickly around the wheel to indicate the placement of each bucket.

For our example in which the rim speed is 8.8 feet per second, the velocity of the water entering the buckets would be  $8.8 \div 65\% = 13.5$  feet per second.

The headwater behind the sluice gate required to produce this velocity is:

$$h = \frac{v^2}{2g} \quad \text{where } h = \text{head in feet (at the sluice gate)}$$

$v = \text{velocity of water entering buckets in feet per second}$

(Eq. 13)       $g = \text{acceleration of gravity, } 32.2 \text{ feet per second}^2$

Then,  $h = \frac{13.5^2}{2 \times 32.2} = 2.82$  feet. Because of loss of velocity in the sluice and gate due to friction, another 10% should be added to the 2.82 feet to give a required gate head of about 3.1 feet. At best, only half of this velocity is useful work, i.e. contributing to the torque of the wheel. The rest, say 1.6 feet, is lost in the turbulence as the buckets fill.

At this point the initial estimate of wheel diameter can be evaluated. The sum of gate head (3.1 feet), wheel diameter and tailwater clearance (about .5 feet, sufficient so that the wheel does not "hit" the tailwater and get slowed down while it is rotating), should be the total head difference between headwater and tailwater. In this case the total head of 20 feet, minus the gate head (3.1 feet), wheel diameter (16 feet), and tail water drop (about .5 feet), leaves only .4 foot error in the initial estimate of wheel diameter. This is well within the accuracy of the design.

The 16 foot example wheel would operate best at about 10 rpm (from Table IV). Some care should be taken to keep the wheel running at the design rpm by manually regulating the flow with the sluice gate.

Once the wheel diameter and the rim speed are known then the rpm can be calculated with Eq. 14.

$$\text{rpm} = \frac{(U)(60)}{C} \quad \text{where} \quad \text{rpm} = \text{revolutions per minute}$$

$U = \text{rim speed in feet per second}$

$C = \text{wheel circumference in feet } (\pi \text{ diameter})$

(Eq. 14)

It is necessary to determine the volume of the buckets that is available to be filled with each revolution of the wheel. An approximate formula for this is a product of the area of the buckets (the width times the depth) times the circumference of the wheel at mid-depth of the buckets (that is  $\pi$  times the diameter of the wheel minus half the depth of the buckets).

$$\text{Volume per revolution} = \pi[(D - b)] \times [(\text{width of buckets}) \times (\text{depth of buckets})]$$

(Eq. 15)

The buckets are only assumed to be partially full, because a full fill would cause losses due to spilling with no net power gain. Assume then that wooden buckets will be filled approximately 50% and metal buckets approximately 67%. The flow (Q) needed to fill these buckets at the optimum rpm can now be determined using:

$$Q = (\text{volume per revolution}) \times (\text{rpm}) \times (\% \text{ fill}) \quad \text{where } q = \text{flow in cfm}$$

Figure 7.3 shows the proportions of the buckets in overshoot and high breast wheels. Overshot wheels have diameters up to 7.5 m. The diameter should be as nearly as possible equal to the height of the fall, or head, available, if the wheel is to be efficient.

The depth of the shrouding is from 300 to 400 mm. The number of buckets to a wheel = 7–8 times the diameter of the wheel in metres (see Figure 7.3).

Table 7.3 gives the appropriate power in kilowatts of well-constructed iron overshoot wheels of various diameters. Figure 7.4 shows an undershot wheel.

FOR WHEELS UP TO 7.5 m DIAMETER

$$b = 300 - 400 \text{ mm}$$

$$a = \frac{1}{2} b, \quad c = b$$

$$d = \text{ABOUT } 0.9 c$$

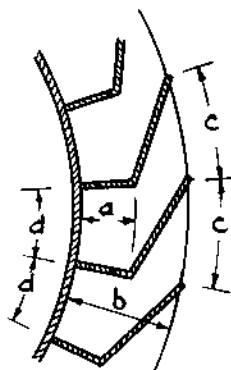

Figure 7.3 Bucket proportions for overshoot and breast wheels.

Table 7.3 Output of overshoot wheels (kW).

Width of wheel (m)	Discharge (l/sec)	Diameter of wheel (m)					
		1.0	2.0	3.0	4.0	5.0	6.0
0.6	100	0.66	1.31	1.97	2.63	3.28	3.94
0.9	200	1.31	2.63	3.94	5.26	6.57	7.88
1.2	300	1.97	3.95	5.91	7.89	9.86	11.82

### 7.4.3 Turbines

Turbines are more efficient than water wheels, but cannot be made locally as easily as water wheels can.

There are two types:

- Impulse or pressureless turbines.
- Reaction or pressure turbines.

In (a) above the water is passed through fixed guides or nozzles, to

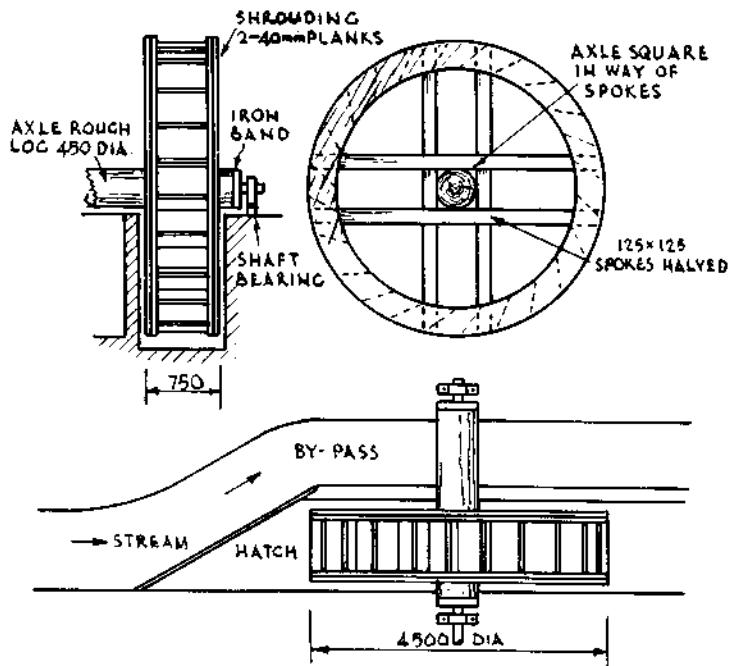

Figure 7.4 Undershot wheel.

discharge as a free jet, impinging on curved vanes mounted in a wheel, thus causing the wheel to revolve.

In (b) above the water passes through fixed guides as in (a) above but its pressure is used to react on moving blades to cause rotation. The wheel passages must always be full, whereas in (a) above they need not be filled. A reaction turbine will work equally well if it discharges into the atmosphere or in water.

The power developed by a turbine can be calculated from the formula in section 7.4.1. The maximum overall efficiency to be expected from a small water turbine is about 60-70 per cent. The power output of a turbine depends upon its operating head, flow of water and speed of rotation, and machines are manufactured to meet a wide range of conditions. Speeds of rotation for different machines may be from 100 r.p.m. or less to over 1000 r.p.m.

## WATER WHEEL

The use of water power has wide potential in many mountain communities. The initial difficulty is to build the wheel to convert the energy of the falling water to work that is useful to man.

The overshot water wheel is most efficient, but it requires damming a river so that the water will be able to flow on top of the water wheel.

More than a year ago an overshot water wheel was installed at Zafilio village, near Finschhafen, to drive a No 2½ Bentall coffee pulper. The total cost of all materials was K100.

### Materials required:

- 2 x 2m length of 100 x 100mm hard wood post
- 1 x 1.25m length of 1" pipe
- 30 metres of 75 x 25mm dressed hardwood
- 4 sheets 900 x 1800mm (3' x 6') flat iron
- 1 sheet 900 x 1800mm (3' x 6') ¼" marine ply
- glue, nails, screws, paint and solder or rivets
- 2 Vee pulleys of about 250mm diameter
- 1 Vee belt to suit pulleys
- 2 flanges to attach shaft to wheel.

Dimensions in the drawing are given in Imperial measurements because the ratios in the original design are simple numbers.

There are 24 buckets in the design, all made of flat iron. This will make a well balanced wheel by having three buckets per section.

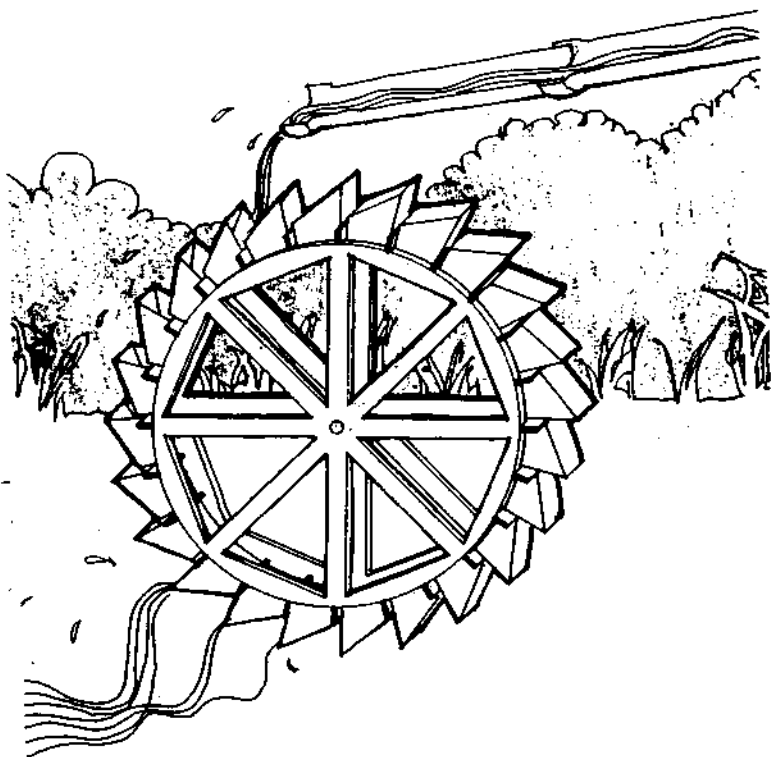

An alternative design is to make the buckets out of dressed 150 x 25mm (6" x 1") hardwood, using the same dimensions of height but slightly narrower buckets. On a five foot wheel 27 wooden buckets are required.

The design is built to operate at 40rpm on a flow of water of 250 litres (50gal) per minute. If the wheel is made very much smaller, it will not be big enough to do very much work; if it is bigger, these materials will not be strong enough.

The life expectancy of the wheel in constant use is about 3 years without maintenance if well built and painted.

After boring the hole in the hardwood posts for the shaft, place the end of the posts with the hole in a bucket of warm engine oil for several days, so the shaft will turn easily.

Editors note: There are many details missing here. The critical point of this design is the way in which the wheel and the pulley are attached to the shaft. Welding is an easy solution if available, but it may not be available to most of our readers. If you use a bolt through the shaft, don't use one larger than 6 mm (¼"), as it will weaken the shaft.

Initial contributor: I.M. Bean, DPI Rural Development Centre, Pindiu, MP.



Overshot water wheel (above) and generator (below) at the Swiss Mission near Minj, WHP. Power is transmitted through a counter shaft in order to increase the rpms.

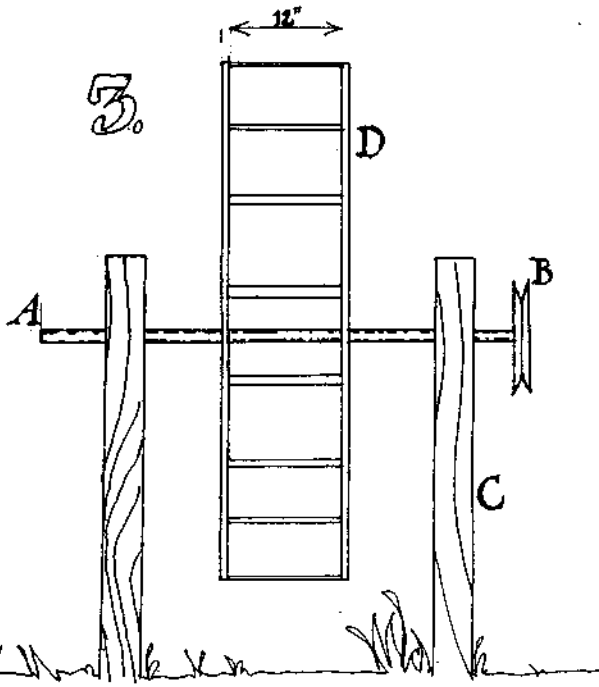
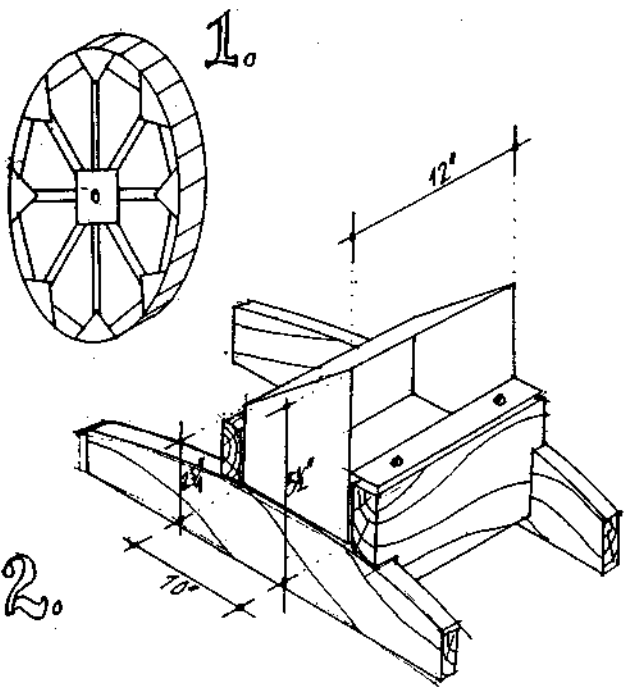
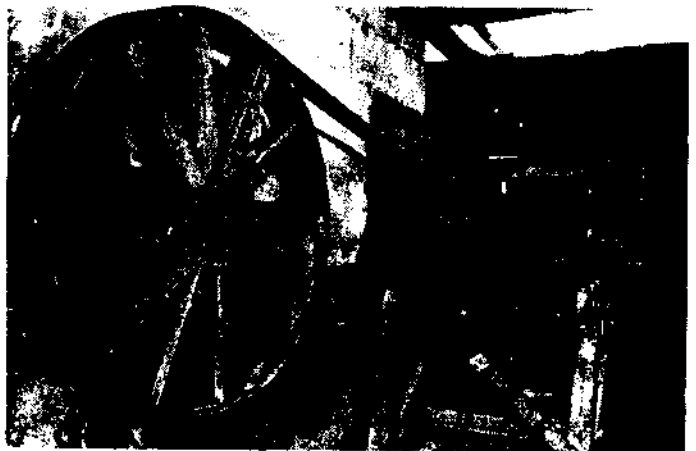

Figure 1: shows glued plywood cleats fixing together wheel frames of 3" x 1" dressed hardwood used throughout.

Figure 2: shows bucket construction of soldered flat iron screwed or nailed to frame.

Figure 3: A. 1" galvanized water pipe  
 B. 250 mm vee pulley  
 C. 100 x 100 mm kwila hardwood posts  
 D. Water wheel on its mounting

NOT TO SCALE



*Overshot water wheel (above) and generator (below) at the Swiss Mission near Minj, WHP. Power is transmitted through a counter shaft in order to increase the rpms.*

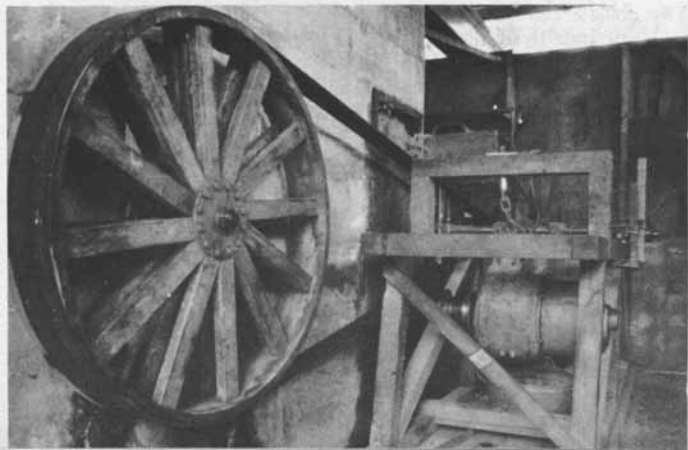



COKE CARTON WATERWHEEL.



# LOW TECHNOLOGY WATERWHEEL

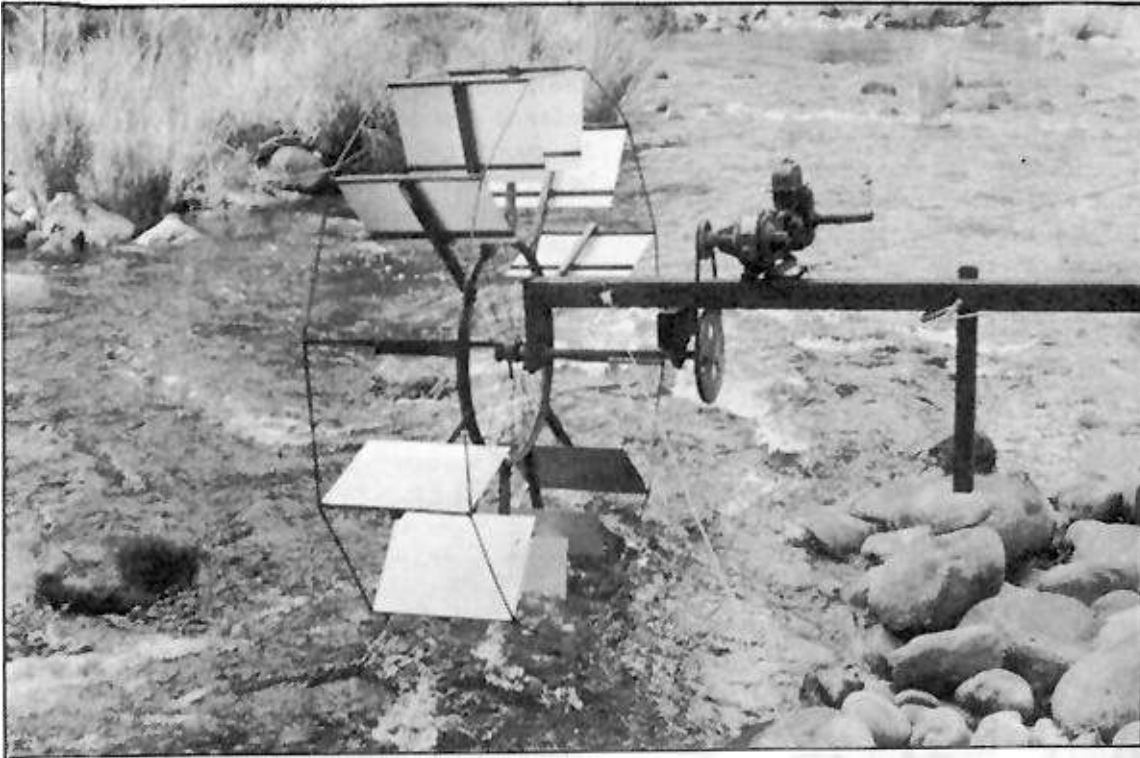

The waterwheel and pump in operation on the Mann River in Northern New South Wales. It is all done with old bicycle wheels and scrap metal.

Here is one approach to building a simple waterwheel from an old bicycle wheel. When Zeb King found he needed extra water for the garden of his house near the Mann River in Northern New South Wales, the river itself was the logical place to get it from. However, how was he to get the water from the river to his home about 500 metres away. Well the river also provided the solution.

So it was that this undershot waterwheel was built. The river provides the power to push the paddles and turns the wheel. This then turns a small pump which pumps the water up to his house.

It's simple, with little to go wrong and because of its small size has no adverse environmental impact on the river.

## How it was built

The waterwheel is based on a bicycle wheel (the source of many good home made gadgets). Because the wheel was too small to get much usable power it was extended by the addition of extension shafts made of square section steel (3" x 3" R.H.S., rolled hollow section).

On the end of these extensions go the 12 paddles which are 10 inches square and made of 24 gauge galvanised iron. Smaller pieces of square section steel (1" x 1" R.H.S.) strengthen the paddles by running along the top and bottom of each paddle. These smaller pieces of steel are welded to the larger pieces which are in turn welded to the bicycle wheel.

The paddles themselves are pop-riveted to the steel. Two strips of steel run around the outside of the wheel adding strength and stability to it.

All put together this makes a wheel five and a half feet in diameter, but which is very light and quite strong. The bicycle wheel was a 28" with a heavy duty rim. It needed to be heavy duty to take the welding. The wheel sits on a 1" shaft which transfers power to the pulley. Two standard bearing blocks allow the shaft and wheel to turn freely.

From the wheel power of 1/4 to 1/3 horsepower, goes via a 10" pulley through a "V" belt to a 4-1/2" pulley at the pump. The pump is double acting piston pump with a 1-1/2" bore and a 1-1/2" stroke.

#### **How about floods**

Probably the worst enemy of waterwheels are floods. To get over this problem Zeb

mounted his waterwheel on a hinged pole. With the use of an old winch fixed to a tree, Zeb can hoist his waterwheel out of the river until it is 3 metres above the normal water level.

The whole thing is fixed onto a steel pole which is concreted onto some very large river rocks sitting in the bed of the river.

The winch came from the tip, and Zeb believes any reasonably heavy winch could do the trick. He uses 6mm cable for the raising and lowering of the waterwheel. Two other cables (both 5mm) are secured to trees upstream and downstream from the wheel. When the wheel is lowered these cables (which are attached close to the end of the supporting arm), give added strength to the whole structure; an extra protection against flood or high water.

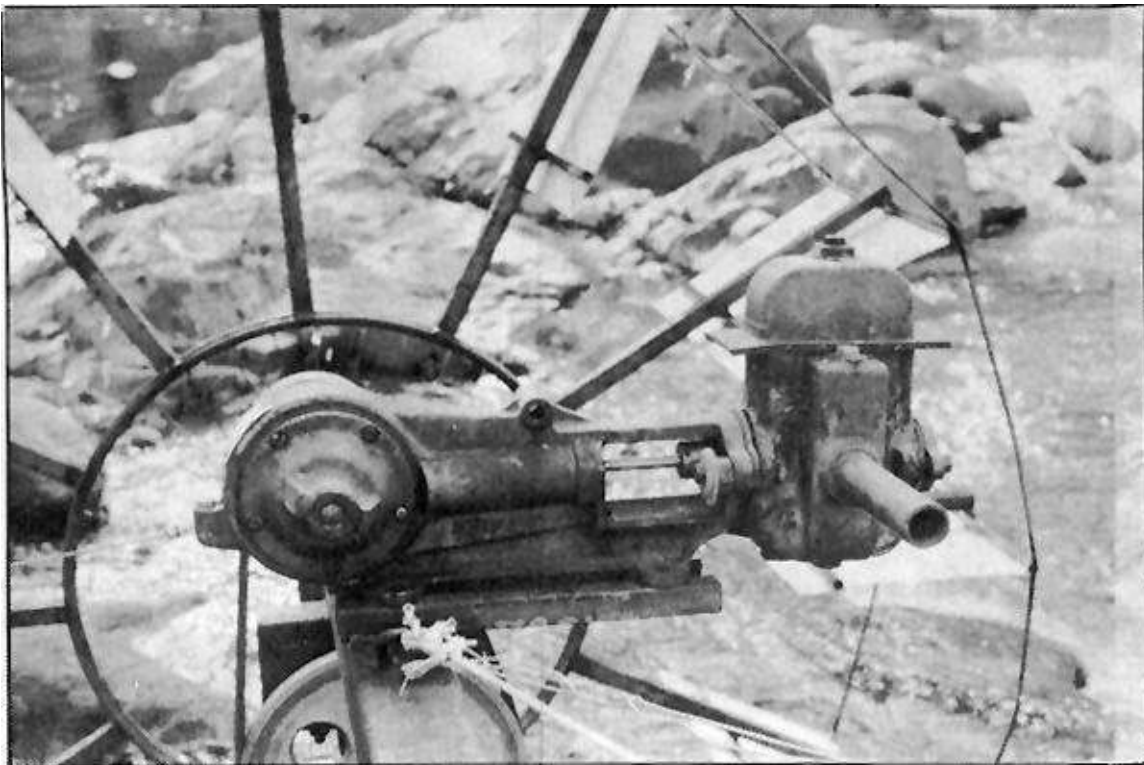

### How Well it Works

The waterwheel which turns at a sedate 16 R.P.M. can pump 40 gallons an hour. Zeb uses this to top up his dam. It works well but after some thought a number of ways to improve the wheel have suggested themselves and now Zeb plans to build a bigger and better wheel. There is certainly enough water and stream flow' to build a larger undershot wheel and maybe even a breast wheel, where the water enters half way down the wheel rather than at the bottom.

This wheel certainly proves one thing. That is that you don't have to have a lot of fall to get a usable amount of water power.

MICK HARRIS



Hoisting the waterwheel out of the river to avoid flood damage.

# SOLAR SEEKER

## “We made it !”



The solar car crosses one of the cattle grids after boards have been carefully put in place to make the crossing easier.

Last issue we reported on the preparations of a group of school students planning to take a solar car across Australia from North to South. The trip has now been successfully completed and we report on how it went.

For much of 1985, students and staff of Warrigal Technical School in Eastern Victoria, spent their time building a lightweight solar car and preparing for an epic trans Australian journey.

The car left for the Gulf of Carpentaria by truck on September 27th. Some last minute hitches which included the



When Lawrie Lang decided to build a water wheel on the creek at the end of his property he found he had an uphill battle. Experts told him it could not be done. The creek did not have enough water, it didn't have enough fall. So he went off to find printed information to help, only to find the little information that was available was inaccurate, contradictory and confusing and more a hindrance than a help.

In the end, ignoring "expert" advice and "authoritative"\* publications and working from basic principles, Lawrie found it was possible to generate several kilowatts of electrical power from a breast water wheel on his creek.

#### Construction

Because fabrication of the components of the water wheel would have been difficult and expensive Lawrie chose to use what materials were readily available. He obtained the basic wheel, pulleys and shafts from an old derelict timber mill for \$10.00. He bolted on some additional metal work and timber paddles (which were made of old floor boards). This increased the diameter of the wheel

from 6 ft. to 9 ft. To increase the speed of the output shaft gearing was used to take the speed from about 12 r.p.m. at the water wheel up to about 3,000 r.p.m. at the generator. This gearing was done in three steps; 8 to 1, 5 to 1 and 6 to 1 giving a total of 241 to 1. The belts running between the gear wheels were made of "Habasit" nylon.

The alternator was "Marcon", 240 volt AX. with a maximum output of 2.5 kilowatts. It gives 1.8 kW when the water wheel is running with a flow of 12 cu.ft./sec. It was specially re-wound to tolerate a 50% increase in rated speed.

The system uses an electronic governor which varies the speed of the water wheel according to the load. When more power is generated than is needed the excess electricity is used to heat water. Because the water wheel supplies power at 240 volts and runs throughout the year (assuming no droughts) no batteries are needed to store the power; unlike wind and solar electric systems where batteries are essential.

Because he had a limited head of water, Lawrie chose to use a breast

# WATER POWER

wheel, that is a water wheel in which the water enters halfway down the wheel.

At its deepest point, the dam is about 5 ft. deep. Water enters the buckets about 4½ ft. from the bottom of the wheel; half of its 9 ft. height.

The paddles of the wheel do not have sides, This is because the paddles run through a close fitting concrete sluice. The sluice has a maximum of about 1/8th of an inch between the wooden paddles and the concrete. This minimizes turbulence and water leakage both of which would reduce efficiency. The sluice was made of a coarse grade of cement with the last two centimeters finished with a layer of fine cement rendering. A scraper attached to the wheel was used when the concrete was drying to get the initial shape. The almost perfect shape was achieved by allowing the wooden paddles to actually rub against the newly formed concrete sluice until the concrete and wooden paddles had worn into a perfect fit,

The dam spillway is made from heavy removable boards which are slotted into position, These can be removed to lower the level of the dam in the event of flooding.

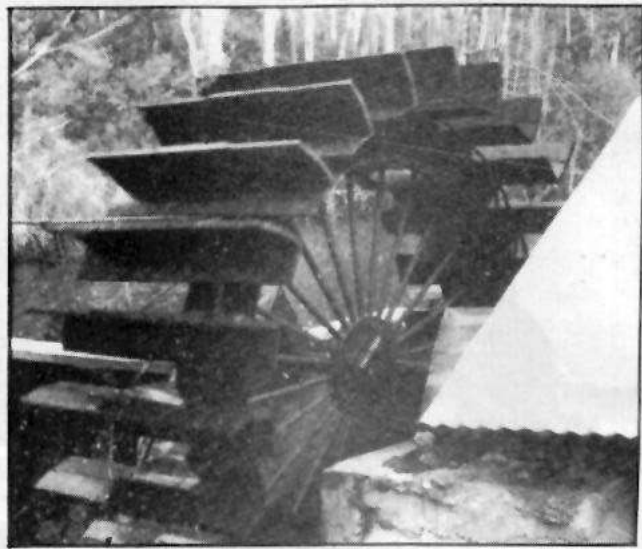

*All the wheels and pulleys were purchased for \$10.00.*

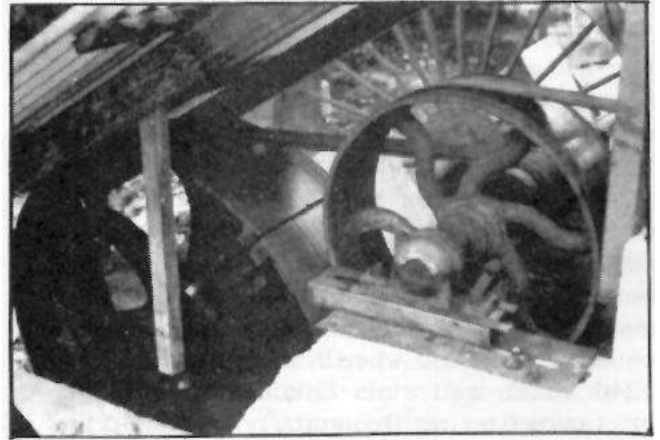

*The water wheel in action generating about 1.8 kilowatts.*

## Getting There

The water wheel was the evolution of several years work. The original wheel was somewhat different. However when the initial design proved impractical changes were made until the current design was evolved.

Originally a Dunlite alternator (costing \$500) was used, but after burning out twice, this was disposed of. The Dunlite alternator could not cope with continuous running. The replacement Marcon generator which was obtained from Tamar Design has proven much more reliable.

## Facts and Figures

The overall system is 65% efficient when it finally reaches the appliances in the house. The cost of the system is as follows:

Steel in paddles of wheel.....\$300  
Marcon alternator.....\$300  
Main shaft pulley 6" x 8"  
on 2" shaft.....\$ 80  
Pulleys, wheel and shafts.....\$ 10  
Concrete for dam and sluice....\$300  
Governor and control system...\$1200

Total cost of 240 volt, 23 kW system, excluding wiring and appliances..\$2220.

# Finding the Flow

To work out how much power you can get from your stream, the first thing you must do is find its flow. This can be done by three methods.

- 1) The container method is only suitable for small mountain streams and involves diverting the whole stream into a container of a known size and seeing how long it takes to fill.
- 2) The Weir method is the most accurate method for medium sized streams. A weir is built like a dam across the stream, which causes all the water to flow through a rectangular notch of known dimensions. The notch should have a width to height ratio of at least 3 to 1 and capable of taking the maximum flow of the stream.

To measure the depth of water flowing over the weir, drive a stake in the stream bed three or more ft. upstream from the weir, to a depth such that a mark on the stake is exactly level with the bottom of notch "B". Measure the depth "D" in inches of water over the mark, and read the volume of flow in cubic feet per inch of notch width from the table. Multiply this volume by the notch width in inches, to

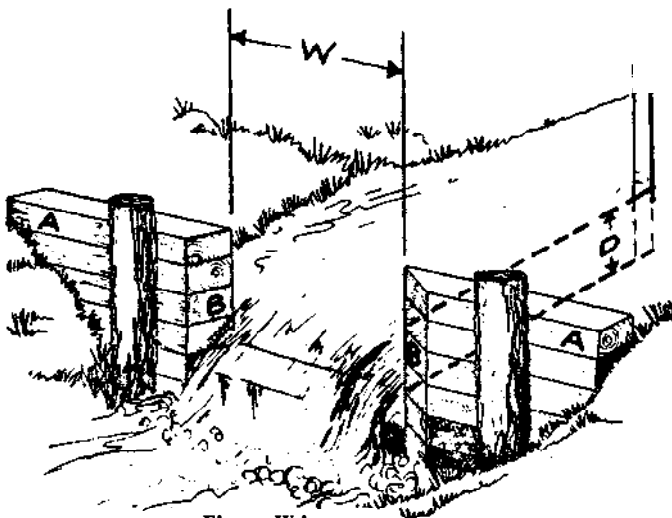

Fig. Weir;

obtain the total stream flow in cubic feet per minute.

WEIR TABLE			
Depth on stake in inches.	Cubic ft. per min. per inch length.	Depth on stake in inches.	Cubic ft. per min. per inch length.
1	0.4	10	12.7
1.5	0.7	10.5	13.7
2	1.1	11	14.6
2.5	1.6	11.5	15.6
3	2.1	12	16.7
3.5	2.6	12.5	17.7
4	3.2	13	18.8
4.5	3.8	13.5	19.9
5	4.5	14	21.1
5.5	5.2	14.5	22.1
6	5.9	15	23.3
6.5	6.6	15.5	24.5
7	7.4	16	25.7
7.5	8.2	16.5	26.9
8	9.1	17	28.1
8.5	10.0	17.5	29.4
9	10.8	18	30.6
9.5	11.7	18.5	31.9

**Example:** A weir is 3 ft. 6 in. wide and the depth of water at the stake is 10 inches. The flow in cubic feet per minute is therefore  $42 \times 12.7 = 533$  cfm. Once the weir is constructed (easier said than done) it is a simple matter to take frequent readings.

- 3) The float method is the easiest but also most inaccurate method of finding a stream's flow. Mark off a section of the stream (at least 10 meters) where its course is reasonably straight and smooth, On a windless day throw the float in the stream and time how long it takes to cover the distances. A bottle partly filled and submerged to its "shoulders" makes a good float. Repeat the procedure several times and average the time. Reduce this time by multiplying by a correction factor of 0.8 for a stream with a smooth bed and 0.6 for a rocky bed. Divide the distance covered by the time taken for the float to cover this distance, then multiply by 60 to get meters travelled per minute. Find the average depth and width of the stream. Multiply the width and depth together to find the streams cross sectional area. Next multiply the speed by area to get the flow.

Source: Harnessing water power for home energy. Dermot McGurgon.

# WATERPOWER

When you consider it would cost \$5000-\$10,000 for a wind or solar powered system of a similar capacity, this water wheel system is very cheap. Water power systems have a number of advantages that cannot be ignored.

While solar and wind systems are likely to produce power less than half the time due to unreliability of the sun and wind, a water power system will generate power 24 hours a day, 7 days a week for the whole year. This means

**(Continued page 23)**



## How Much Power Can You Get ?

Once you have worked out the flow the only other thing you need is the head. That is the amount of fall.

There are a number of ways this can be found, You can use a surveyors level and pole, build a small dam (you could do this as part of method 2 of measuring flow). Perhaps the easiest is to get a long length of plastic pipe, fix it just below the water level at what you anticipate will be the upper reaches of your dam. Run the pipe down stream along the bottom of the bed of the stream making sure there are no air bubbles in the pipe. Take the other end of the pipe out of the stream where you plan to have your water wheel, Assuming there are no air bubbles in the pipe,

water will continue to flow out of this end of the pipe as long as its height is lower than that of its top end. Lift the pipe out of the stream until water stops flowing. Measure the height of the pipe above the water in the stream; this will be your head.

The power of the stream in kilowatts is the water flow (in meters cubed per second) multiplied by the head (in metres) multiplied by a constant of 9.8. If you want to express this as a formula you can write it like this  $P = 9.8 Q H$

where P = power in kilowatts

Q = flow in meters cubed per head

H = head in meters

and 9.8 is the constant.

# WATER POWER (Continued from page 10)



*Lawrie Lang stands on the dam wall near his water wheel.*

you can have a much smaller power system. For example a 2 kilowatt water power system could be roughly equivalent to a 4 kilowatt solar electric system. With a water power system you can often generate 240 volts AC, which means you do not need an expensive inverter. Also because power is likely to be available 24 hours a day all year round you don't have to use storage batteries. Not needing storage batteries and an inverter substantially reduces your costs.

Small scale water power is potentially one of the best sources of domestic electricity if you have a suitable site. It only takes a moderately sized stream to supply a significant amount of power. Even if this is only seasonal, it could still be well worth while investigating.

MICK HARRIS

**WINGO**  
WIND GENERATORS  
200w & 450w Sizes  
12 & 24 Volts

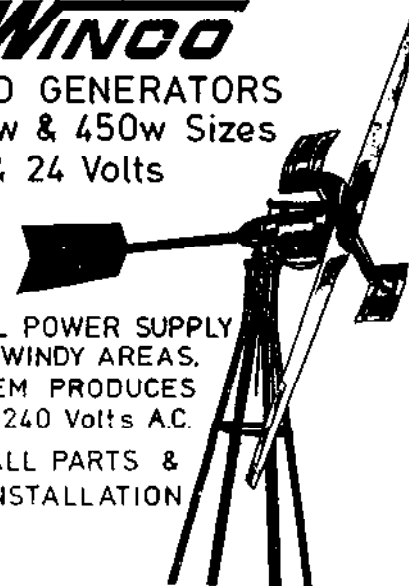

IDEAL POWER SUPPLY  
FOR WINDY AREAS.  
SYSTEM PRODUCES  
240 Volts A.C.

ALL PARTS &  
INSTALLATION

**SURVIVAL  
TECHNOLOGY**  
66 Maroondah Hwy  
CROYDON Vic 3136  
Phone 03 7255550



# D.I.Y. PLAN 7

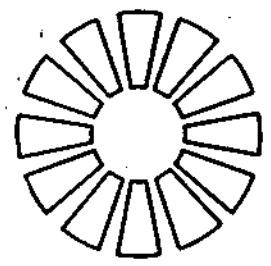

## TIMBER WATERWHEEL

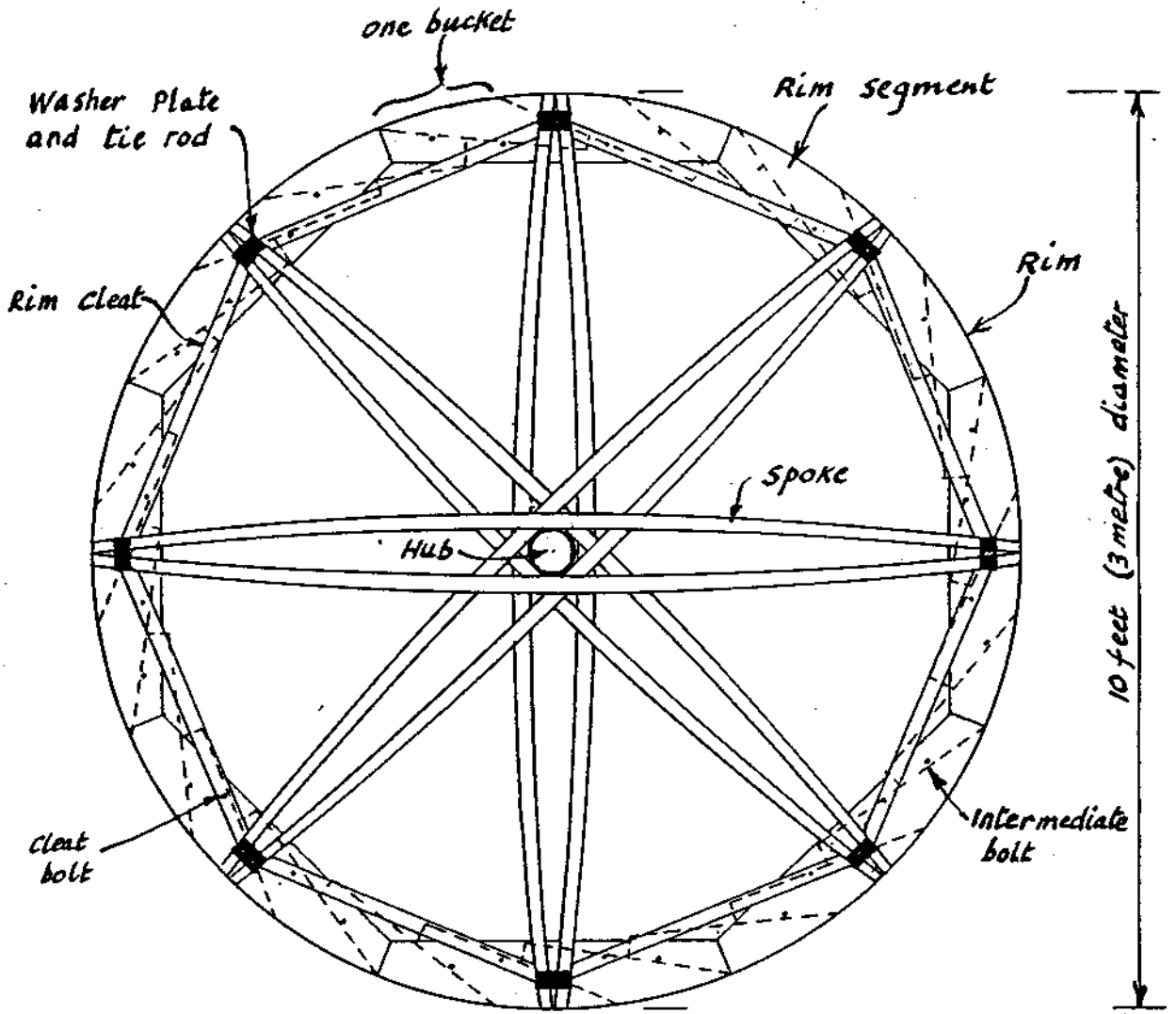

ELEVATION : scale  $\frac{1}{2}'' = 1'$

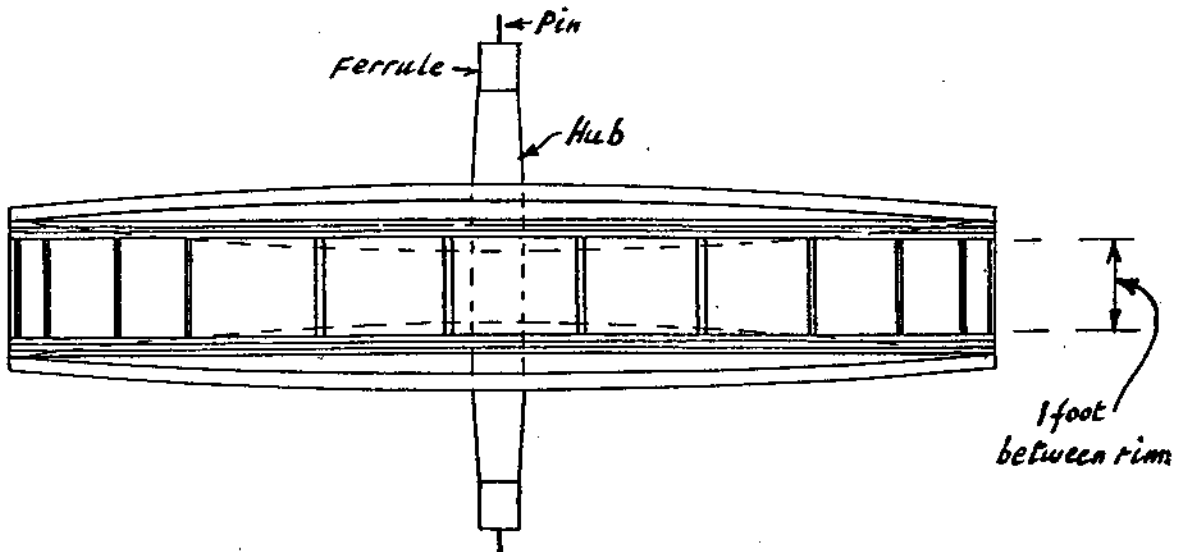

PLAN : scale  $\frac{1}{2}'' = 1'$

## Introduction:

The design and construction of waterwheels reached its topmost quality about 70 years ago; we realised that if our wheel was to be as successful or better than these, we would require cast iron, steel or aluminium, or good quality timber (possibly all of these) combined with the expertise and equipment of the foundry, the steel fabricator (blacksmith) or the wood machine shop (wheel-wright). This would limit construction to professionals only, and take the project out of range of D.I.Y.; the cost would also soar from £10s to £1000s.

We have therefore sacrificed the wheel's performance by reducing the design to simple timber engineering using hand tools on cheap (possibly recycled) materials, assembled anywhere large enough to fit the diameter of the wheel.

In this report we have described in detail the construction and cost of the wheel which we built. However, from our experience we can recommend that this method of construction is applicable to overshot (possibly undershot) wheels of diameter varying from 5ft. to 25ft. and width from 1ft. to 5ft.. Some design guides are given for establishing the size of wheel, and there are recommendations as to member sizes and method of assembly. Final choice of members would have to be found by experiment, or dictated by the availability of materials.

## Size of Wheel:

The overshot waterwheel is not an "impulse wheel" - i.e. its movement does not depend on the energy of moving water hitting the wheel, it relies on the weight of the water filling the buckets on one side of the wheel only, causing an out of balance force which rotates the wheel until the water pours out of the buckets at the bottom. Therefore, the more water that can be introduced and held in the buckets and the greater the height of fall from the point of filling to the point of emptying, the more energy will be available from the turning wheel. Hence the design for a given power (or rate of energy) supply for a specific purpose, with a fixed quantity of water available, the wheel diameter can be varied, with the bucket size remaining constant to suit the flow of water. Conversely for a limited head of water the quantity and hence bucket size can be varied and the wheel diameter varied up to a maximum to fit the available space.

The theoretical horse power available is given by  $H.P. = hQ/530$  where 'h' is the wheel outside diameter (ft.) and 'Q' the flow of water (cubic ft. per minute). However, in practice not all the water flowing remains in the buckets from the top to the bottom of its fall and the efficiency of the wheel could only be about 50%. Hence, as a guide, actual  $H.P. = hQ/1000$ . (Note: 1 gallon = 1/6 cu.ft. approx.)

The velocity of the wheel will vary with the load imposed upon it - e.g. no load - fast, maximum load - slow, but for any setting of a sluice gate controlling the flow of water, the water is flowing at a constant rate, and therefore it is impossible to efficiently fill the buckets in every working condition. If the number of buckets is 'n' and the wheel is rotating at 'w' revs. per minute, then the speed at which the buckets will pass the water supply is  $wn$  buckets per minute; hence to fill a bucket from a water flow of  $Q$  cu.ft. per minute, the bucket volume must be  $Q/wn$  cu.ft..

The velocity of the water supply can be roughly calculated as being the quantity flowing divided by the cross sectional area of the water supply i.e.  $V = Q/a$  where 'a' is the area of cross section of

of the pipe or channel. In practice, for efficient working the peripheral velocity of the wheel should be about 9/10 of this. In a limited space the wheel diameter may have to be reduced allowing for some fall on the feed pipe or channel to increase the velocity of water entering the wheel. The best peripheral velocity of a wheel is roughly  $2 \times \sqrt{\text{diameter ft./sec.}}$ .

Having chosen the dimensions of the wheel to suit your purpose, you will need the following timber:

Wide, thin boards, or thick plywood for the rims, thick boards for the buckets, a short piece of straight grained log for the axle and some thin poles for the spokes.

To give a good example of the materials and problems involved in the construction of this type of waterwheel we will describe the wheel that we built for the Centre for Alternative Technology.

#### Stages in Construction:

1. Setting out the Wheel: On a flat, smooth, hard surface such as a boarded floor or sheets of plywood laid out on the ground, we drew an accurate 10ft. diameter circle using compasses improvised by lashing a pencil to a batten nailed down at the centre. With a straight edge, we divided the circle into eight equal sections, by first making four quarters, then splitting each quarter into half (a larger wheel may need more divisions, say 12, but there must be an even number).
2. Making the pattern for a rim segment: We laid a 9 inch wide rim board on the outside of a segment, such that its outer edge was equidistant from the centre at each side of the sector. With compasses and straight edge, we reproduced the circle and sector edges on the pattern, and carefully sawed out the pattern leaving the pencil line just visible. (You may need to smooth the edges of this as it has to be drawn round. Hardboard or thin plywood may be more convenient for this.)

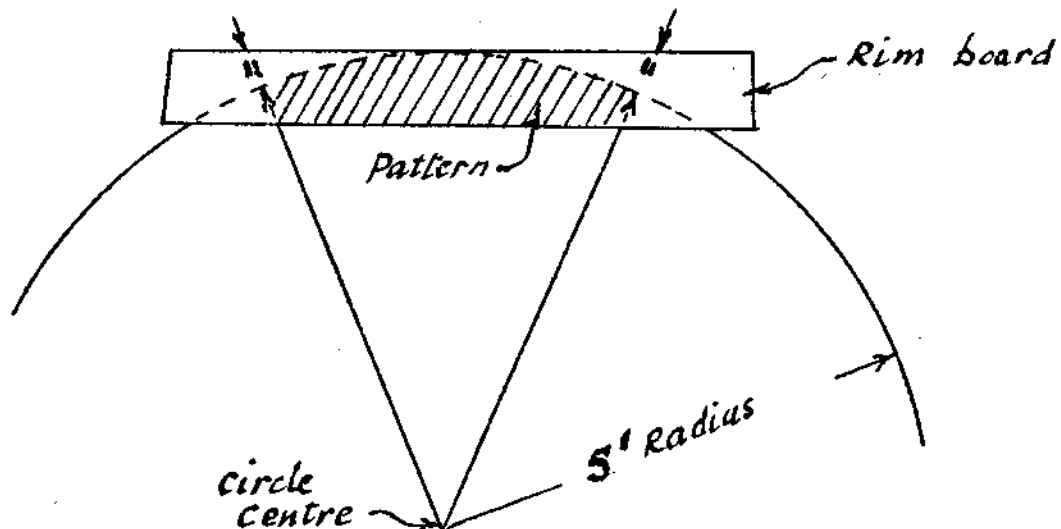

#### **MARKING OUT THE PATTERN FOR RIM SEGMENT $\frac{1}{2}'' = 1''$**

3. Construction of the rim: Each of the two rims consisted of three layers of eight segments, therefore we sawed out forty-eight. Accurate cutting of these is essential; we checked this by fitting the first layer onto the circle. We nailed the second layer onto the first, lapping the joints half way, and the third layer onto the second, in line with the first. 2 inch nails are suitable for this, clenched over afterwards if they protrude.

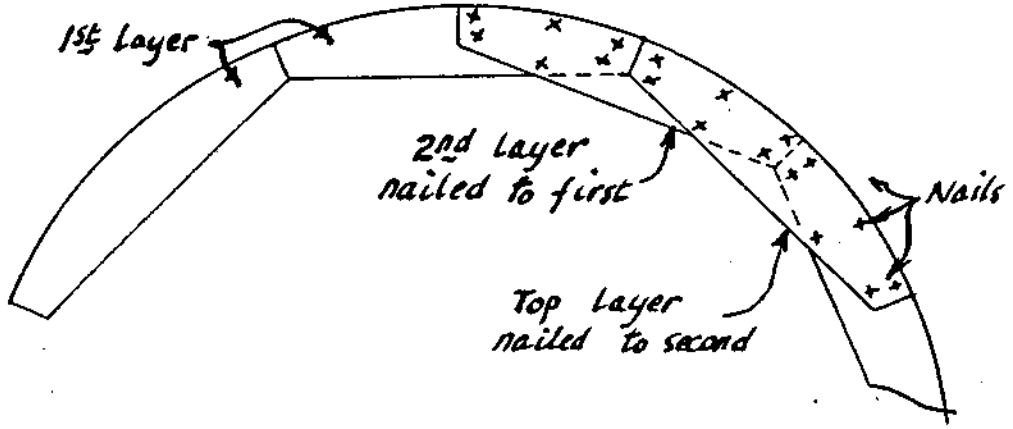

**NAILING THE RIMS TOGETHER  $\frac{1}{2}'' = 1''$**

We then bolted 2 inch square by approximately 4 ft. long cleats to the rim, with the ends roughly meeting as shown in the sketch. This procedure was repeated for the second rim.

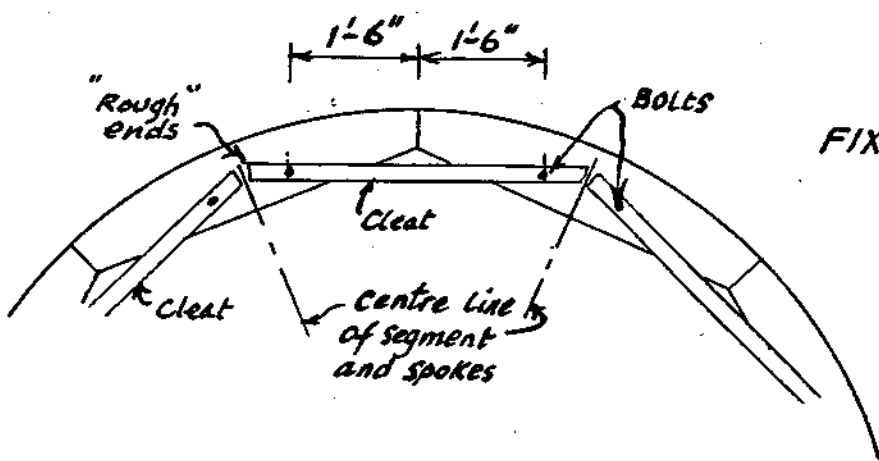

**FIXING THE CLEATS  $\frac{1}{2}'' = 1''$**

4. Marking out the bucket positions: For the 24 buckets required in our wheel, we laid the rims face to face, so that the segments were opposite one another, and divided each segment into three equal lengths round the circle. We cut out a complementary pattern to fit round the rim, and nailed it to a strip, equal to the width of a bucket board in the direction shown:

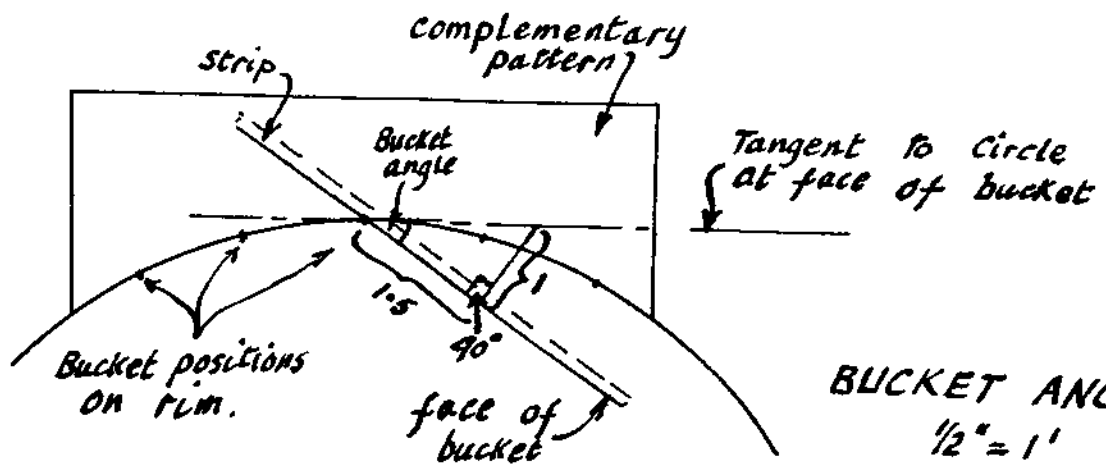

**BUCKET ANGLE :  $\frac{\Delta}{1.5}$   
 $\frac{1}{2}'' = 1''$**

At this stage, while the rims were together, we drilled the  $\frac{9}{16}$  inch diameter holes for the main tie rods as shown.

Then we laid each rim face up on the ground, fitted the pattern to the circle, and marked along both sides of the strip at each bucket position (note the strip must be nailed on to the opposite hand for the opposite rim). The buckets must not coincide with the main tie holes.

5. Bucket assembly: We laid the rims face to face, spaced apart by the thickness of the 12 inch wide buckets. Having cut the boards to length with a chamfered cut on the outside to match the rim, we nailed the buckets in with three 4 inch nails, through the rim each side, into prebored holes.
6. The spokes: The spokes are fixed in pairs, bent from one side of the wheel, round the hub, to the other fixed at each end by a common tie bolt and two cleats. They are also bent in the other plane because they overlap at the hub (see sketch). It is therefore important that the spokes are sufficiently flexible to allow this amount of bend without splitting, yet be stiff enough to firmly grip the hub and maintain the strength of the wheel. In the case of our wheel, the spokes were 10 ft. long and had to be bent 3 inches at the centre in the plane of the wheel and 1 inch or 3 inches at the centre at right angles to this plane.

Sawn timbers with even the very straightest grain have fibres 'breaking out' of the sawn edges, usually to a considerable extent; a pole, by its nature, as a growing tree, has all its fibres 'growing' along its length, and is much more flexible. We used conifer poles - forestry thinnings, and tested them by supporting them at their ends and checking whether they would deflect the required amount - i.e. 3 inches each way or  $4\frac{1}{2}$  inches total.

We chose 16 suitable poles and roughly tapered them with an adze and saw so that they were about 2 inches square at the centre and  $1\frac{3}{4}$  inches square at the ends. Note it was not necessary to make the poles square anywhere except at the ends where they are fastened with a bolt; however a tree is thicker at its base and to curve evenly each side of the axle it may be necessary to reduce the thicker end to roughly the same size as the thinner end.

7. The hub and its bearings: This can be made of any softwood tree trunk about 6 inches diameter and long enough to allow about 4 to 6 inches of bearing length beyond the spokes; additional length must be provided between the spokes and the bearing if a pulley fixing is required.

As the wheel is of fairly crude construction the hub need not be turned on a lathe; hand planing is adequate. After rough shaping it is useful to insert a pin (say  $\frac{3}{8}$  inch diameter) at the centre at each end. The log can then be set up between centres on the bench, and quickly rotated for the final accurate planing.

We drove a 4 inch diameter steel tube (4 inches long) ferrule on each end of our hub. The bearings are half circular open topped, made from yew or similar. We left the centering pins at each end to give frictionless restraint against lateral movement, the other end of the pins bearing against a stone. N.B. These bearings must always be kept well greased. In practice roller bearings may be required.

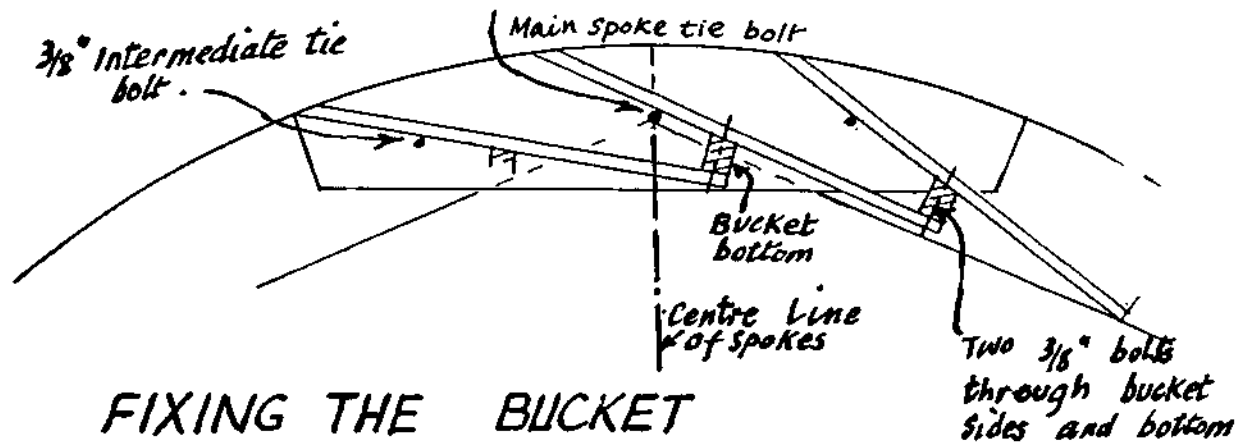

**FIXING THE BUCKET  
BOTTOMS**       $\frac{1}{2}'' = 1'$

8. Fixing the spokes: With the wheel horizontally on the ground and the hub propped up in the middle, put the spoke fixing bolts through their holes and put a nut and washer plate on the lower end (nearest the ground). Lay a pair of spokes with one pair of ends in their correct position on each side of the bolt, mark where to cut the ends of the cleats so that the spoke ends will fit snugly round the bolt; repeat this for all the other spoke ends, numbering positions to avoid confusion. Saw all the cleat ends off to the correct size (in position). Put one end of the first pair of spokes into position and fit the washer plate and nut tightly, then bend the spokes round the axle and fix the other end. Repeat this for the second pair of spokes at right angles to the first. Note the spokes become increasingly hard to bend as more are fitted; the third and fourth pairs will require two pairs of hands, strong feet and possibly cramps or a Spanish windlass.

Turn the wheel over to the same position the other way up and fit the other set of spokes exactly the same way, except that before each spoke position is marked out on the cleat, the nut and washer plate have to be removed, and this can only be done by cramping the spokes on the opposite side to the far rim so that they don't spring out when the bolt is loosened.

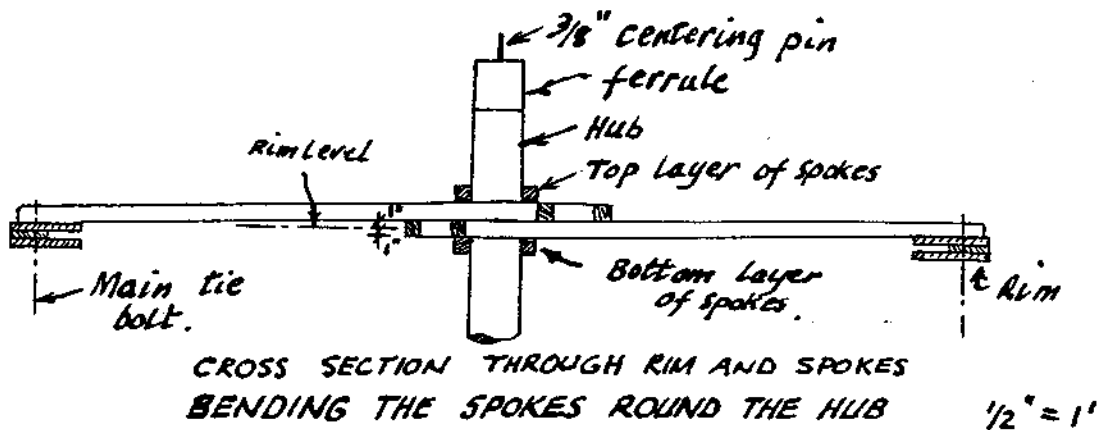

9. Truing the wheel: For this the wheel must be set up in its final bearings or in temporary bearings so that it can be turned. Fix a pointer on an immovable datum so that when the wheel is spun, its movement out of true can be observed. Push the wheel sideways into its correct position; at this stage it should still be sloppy enough to stay where it is pushed, but if it is not, fit temporary pairs of wires in the appropriate direction diagonally across the diameter inside and twist up as a 'Spanish windlass' until the wheel stays in 'shape'.

When the wheel spins reasonably true, fit and insert the plugs of wood which form the bottoms of the buckets and bolt right through from one bucket to the other, with two bolts each.

Insert an additional 3/8 inch diameter intermediate tie rod between the two rims alongside the bucket walls that haven't already a main spoke tie beside them.

Fix each spoke to the hub with a large nail (galvanised) say 4 or 5 inches long. The wheel will now remain tight.

The following is an ideal specification for the timber in a wheel to be built and used in the British Isles:

1. All timber must be dry (below 22% moisture content), free from dirt and bark.
2. Shape timber to final size.
3. Take all timber to timber merchant to be treated with preservative by vacuum pressure impregnation to 'specification for motorway fencing' (treatment plants in most towns throughout the country, cost per wheel £8 - £10).

This treatment will permanently protect timber against fungal decay; otherwise it must be brush treated with creosote every 4 to 5 years and only when the wood has been allowed to dry out thoroughly.

4. Allow timber to re-dry after treatment by stacking it carefully so as to allow good air movement, but out of direct sunlight. Separate sawn boards with  $\frac{1}{2}$  inch thick spacers 2 ft. apart and weight the top board down to avoid distortion.

Any subsequent cross cut faces to be liberally brush treated with creosote.

5. Suggested species:

Buckets and rims: Elm, shuttering plywood  
Cleats - softwood: Scots pine, Larch, Douglas fir  
Spokes - forest thinnings: Scots pine, Douglas fir, Larch  
Bearing blocks: Yew, Ekh, Greenheart - all quarter sawn

The cost of a 10ft. diameter wheel as at August 1976 (assuming new materials)

$\frac{3}{8}$ " and $\frac{1}{2}$ " nuts and washers	£ 4.80
32 off 110mm x 6mm coach bolts and washers	3.06
32 off 5" x $\frac{3}{8}$ " coach bolts and washers (should be 5 $\frac{1}{2}$ " )	5.99
2 kg 4" galvanized nails	2.27
Bolts and bearing sleeve by blacksmith	9.00
24 tie rods at say 90p each	21.60
Sawn elm	44.95
Hub	0.86
Spokes and cleats	<u>33.84</u>
	£ <u>126.37</u>

.....

This D.I.Y. plan has been prepared for the Centre for Alternative Technology by C.L. Wallis and R.G. King © 1977.

The information contained in this leaflet has been given in good faith and is believed to be accurate at the time of printing. However, both the author and the National Centre for Alternative Technology decline all responsibility for errors or omissions.

Other D.I.Y. plans, information sheets and books are available from the 'Quarry Bookshop' at the Centre. Please enclose a s.a.e. with all correspondence as we are a charity. Visitors are welcome.

Centre for Alternative Technology, Machynlleth, Powys, Wales  
Telephone: Machynlleth 2400

100% recycled paper

April 1977



# **PART FIVE:**

## **BUILDING AN OVERSHOT WHEEL**

Often seen beside a picturesque rural mill, an overshot water wheel possesses two excellent characteristics . . . considerable mechanical efficiency and easy maintenance. Many have remained in service for decades and now lend a nostalgic charm to their surroundings.

Operated by gravity, the overshot wheel derives its name from the manner in which water enters the buckets set around its periphery. Pouring from a flume above the wheel, the water shoots into buckets on the down-moving side, overbalancing the empty ones opposite and keeping the wheel in slow rotation.

Since such a wheel may be located near but not actually in the stream, it offers endless landscaping possibilities for a country home where a stream with sufficient flow is available. If a site on dry ground is chosen, the foundation may be constructed dry and the water led to the wheel and a tailrace excavated. With very little effort, the scene may be turned into an attractive garden spot, the wheel becoming both a landscaping feature and a source of power.

It should be noted, however, that an overshot wheel is practical only for a small-capacity output. How much power it will produce depends upon the weight of water the buckets hold and its radius, or lever arm. Expressed in another way, the output depends upon the weight of water transported and the height (or head) through which it falls while in the buckets. For maximum efficiency, the wheel must use the weight of the water through as much of the head as possible. Therefore, the buckets should not spill or sling water until very near tail water.

### **POWER INCREASES WITH WIDTH**

Although of simple construction, an overshot wheel is cumbersome in size. For this reason, before attempting to build one, be certain you have the facilities to move and lift it into place when completed. Also allow yourself plenty of working

FIGURE 1

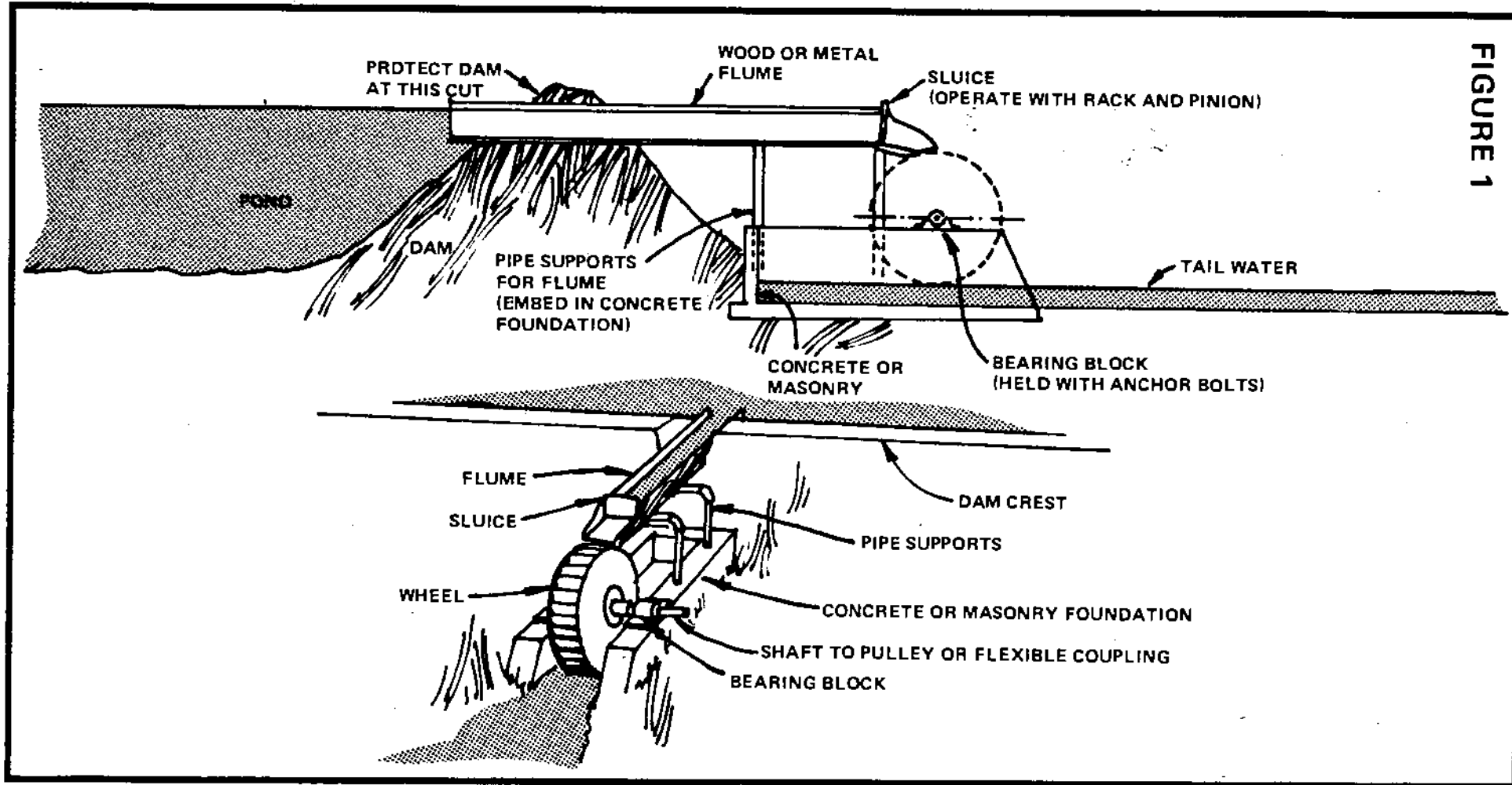

*As the head of a water power system rises or falls, the sluice gate may be adjusted to meter the correct flow to the wheel.*

In an overshot wheel such as the one shown in fig. 39 (also taken from the articles in *Popular Science Monthly*) the power developed is dependent on the size of the buckets and the diameter of the wheel. The wheel shown is 5 feet in diameter but its power can be raised from ½ to 1 horsepower by increasing the bucket width from 16 to 32 inches and the flume width from 13 to 29 inches. Before deciding on wheel size you will need to know the value of Q (flow rate of water). The value of H is fixed for this wheel at 6 feet 3 inches. To obtain 1 horsepower the value of Q would have to be about 100 cubic feet per minute.

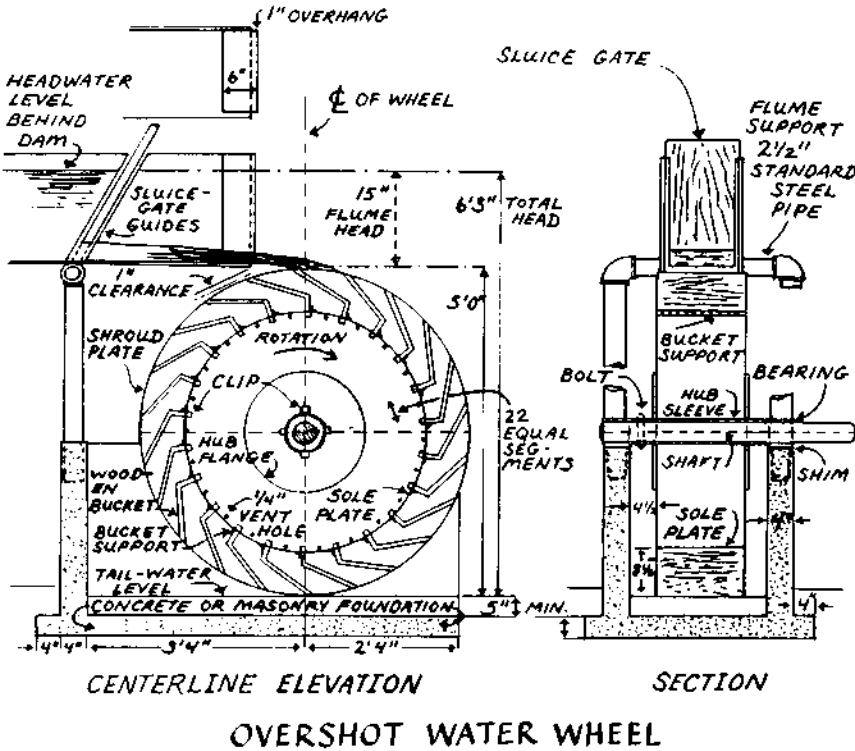
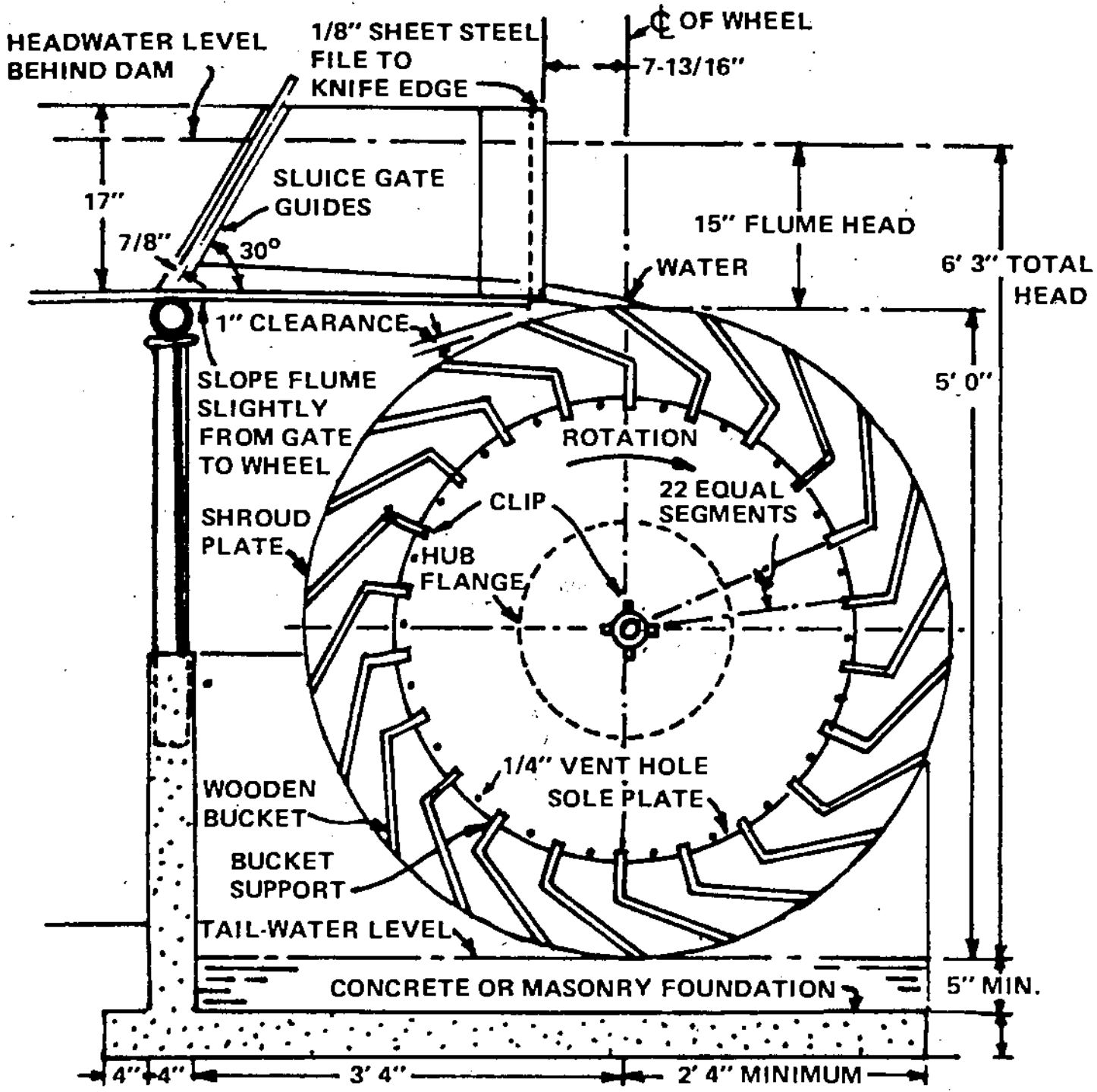

FIGURE 39

Water is led to the wheel in a wooden flume, which should be carefully bedded in concrete where it enters the dam. Rate of water flow is controlled by a sluice gate operated by a rack and pinion. The wheel itself can be constructed from 1/8-inch sheet steel. It consists of the following parts: (1) two shroud plates in the form of 5-foot discs; (2) a sole plate continuously welded to each shroud plate; (3) two 1/4-inch steel hub flanges to which the shroud plates are continuously welded; (4) 22 buckets, which can be sheet steel or wood; (5) one shaft turned from 3-inch-diameter steel; (6) one hub sleeve of 3-inch steel pipe; (7) two bearings with renewable liners and oilers.

The wheel turns slowly (10 rpm) but is heavy and runs constantly, so good lubrication is essential.



FLUME—3/4" SEASONED  
HARDWOOD

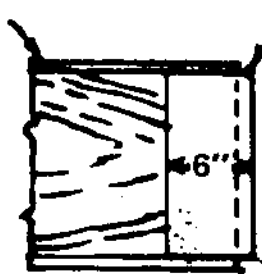

1" OVERHANG

C-1/8"

C

SLUICE GATE  
3/4" X C-1/8" X 20" SEASONED  
HARDWOOD. LOCATE AT ANY  
CONVENIENT PLACE ALONG  
FLUME

FLUME  
SUPPORT—2-1/2"  
STANDARD  
STEEL PIPE

SHROUD  
PLATE—  
1/8" X 5' 0" DIA.  
SHEET STEEL

BUCKET  
SUPPORT

HUB  
SLEEVE

HUB FLANGE  
1/4" X 20" DIA.  
SHEET STEEL

BOLT

BEARING

SHAFT

SHIM

SECTION

CENTERLINE  
ELEVATION

AS REQUIRED  
TO PLACE  
FOOTING ON  
SOLID EARTH

4-1/2"

4"

SOLE PLATE  
1/8" X B X 11' 3"  
SHEET STEEL

8-1/2"

4"



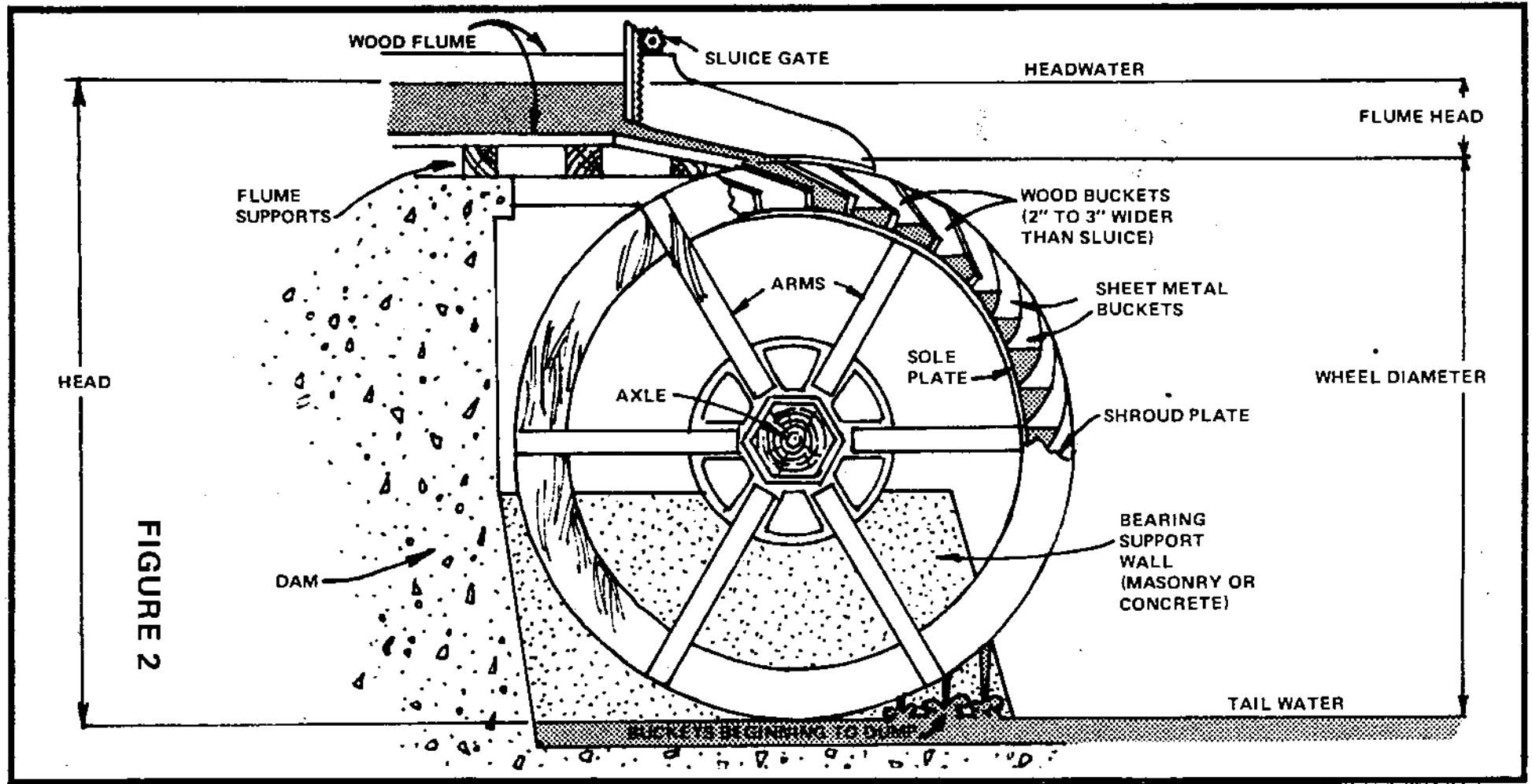

FIGURE 2

*For highest efficiency, the buckets of a water wheel must carry their load almost to tail water before beginning to spill.*

floor space. It must be understood, too, that such a wheel is a sizable project and requires a lot of material and time. Extreme care in cutting and assembling the parts is not essential, however, because the wheel—operating at slow speed—need not be accurately balanced.

Accompanying this article are drawings that illustrate the construction of a small wheel suitable for a water head of 6' 3". The wheel itself has a diameter of 5 feet, leaving a flume head of 15 inches to propel the water into the buckets. As you will note in the table shown on page 107, you may build the wheel to give a power output ranging from 1/2 hp to 1 hp at 10 rpm. All dimensions remain the same except the width, the horsepower increasing as this is increased. For 1/2 hp the wheel should be 15-31/32" wide. For 1 hp it should be 31-29/32". Before deciding on the wheel size, you'll want to make a survey of the power available in the stream (refer to parts one and two of this article).

Virtually all large wheels are built with wood or steel arms (as in the drawing below) and have a shroud plate only around the outer edge, but you may find it simpler and more satisfactory to build the drum-type wheel described here. In this case, each shroud plate is a disk of 1/8" sheet steel. Each disk is braced by a 1/8" sheet steel soleplate to which it is continuously welded, by the buckets, by one of the two large-diameter 1/4" steel hub flanges to which it also is continuously welded, and by the long hub itself.

## LARGE SHEET REQUIRED

If preferred the shroud plates may be made of wood. If so, care should be taken to bolt them securely to the hub flanges. Bushings pressed into the wood for the bolts will give the wheel a longer life expectancy.

Sheet steel for the disks may be ordered direct from several large steel companies in case your local supply house is unable to furnish it. Ordinarily, such steel comes in standard 48-inch widths, so you may have to weld together two or more sheets to get the required 5-foot diameter using either a butt weld or a backing plate. This will produce some distortion or ripple, as will the welding on of the numerous clips required. So long as distortion is local, however, and the main lines of wheel and shaft remain true, this will do no harm.

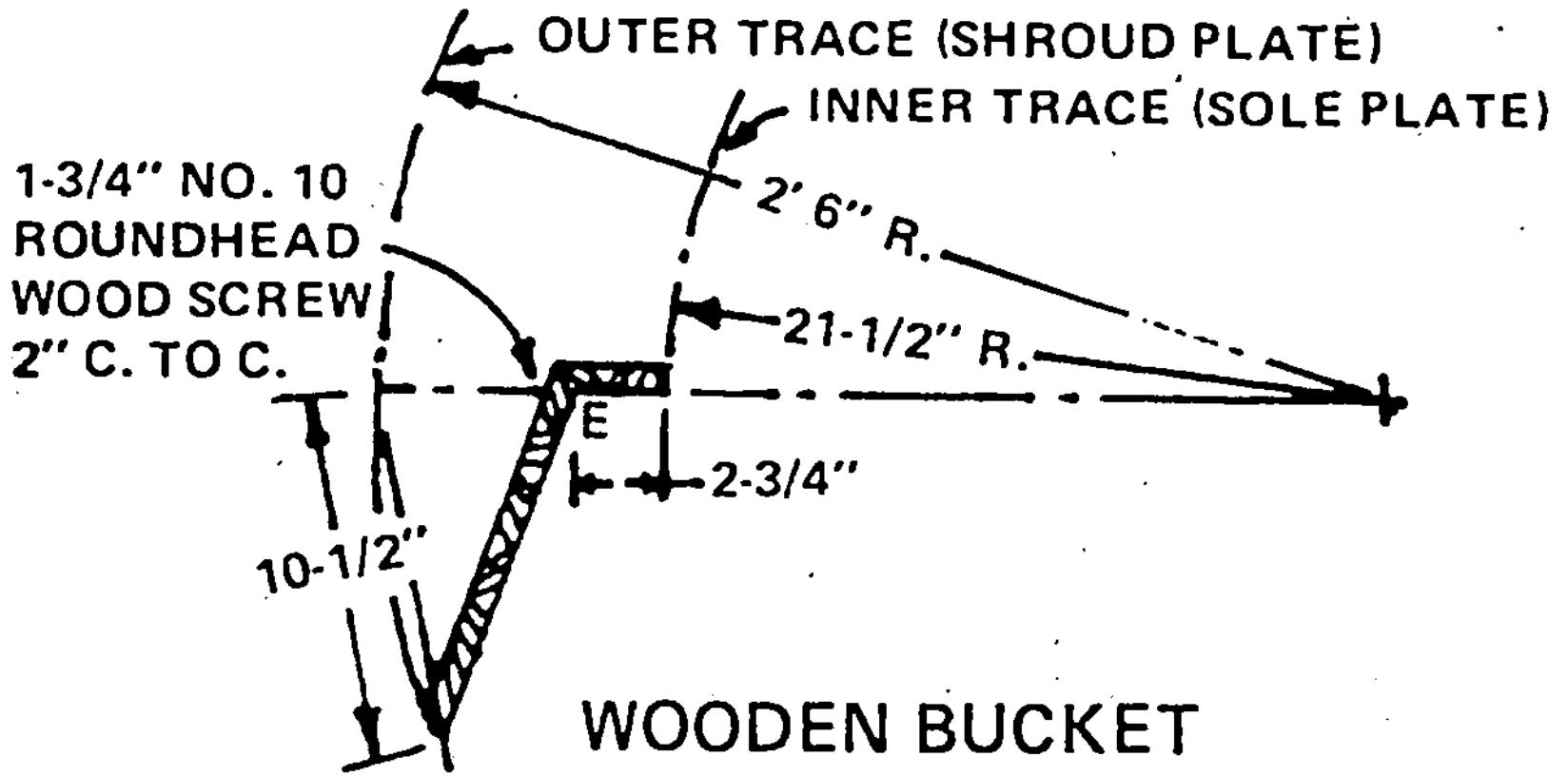

## WOODEN BUCKET LAYOUT

22 BUCKETS REQUIRED  
MAKE FROM 3/4" SEASONED  
HARDWOOD



After the sheet has been prepared, scribe a 5-foot circle on it and cut it with the cutting flame of a gas welding torch. With ordinary care, this method should give sufficient accuracy. Vent and drainage holes should be drilled as indicated around each disk to lessen corrosion with the drum.

## GOOD BUCKETS IMPORTANT

The buckets are the most important element of the wheel. To give maximum efficiency, they must be formed so that the water enters smoothly at the top of their travel and remains in them until just before they reach the bottom. For this reason, the bucket form indicated on the facing page should be followed faithfully. Either sheet metal or wood is an acceptable material, but metal is better suited to cold climates since wood is damaged when absorbed water freezes. Because the buckets are subject to wear from the water and sediment that it carries along, you may want to install them so they can be easily replaced.

In laying out and making wooden buckets, follow these steps:

Using a common center, strike off two arcs, one with a 21-1/2" radius and the other with a 2' 6" radius. Then draw a radius line intersecting these arcs.

From the point where the radius crosses the inner arc, measure 2-3/4" farther along the line and mark the point *E*.

From the point where the radius crosses the outer arc, draw a chord 10-1/2" long and from the new point where this intersects the outer arc draw a line to point *E*. You now have the inner trace of the bucket.

Take a piece of the bucket stock and lay it along the upper edge of this inner trace, and you have a cross section through the bucket. Cut your stock accordingly, making the length equal to *B* in the table of dimensions.

## STEEL BUCKETS REQUIRE JIG

Steel buckets are only slightly more difficult if you follow these steps:

Using a common center, strike off two arcs on a piece of plywood, one with a 21-1/2" radius and the other with a 2' 6" radius.

Draw a radius line and then a tangent to the inner arc,

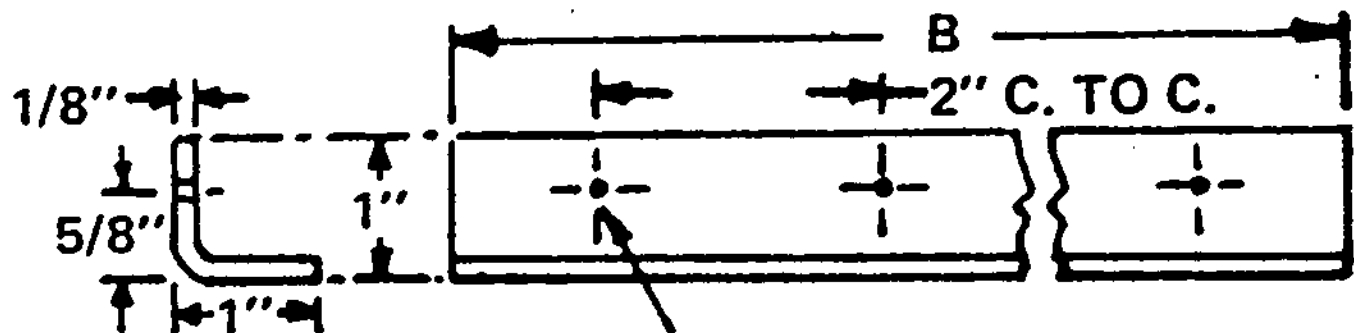

WHEEL WITH WOODEN  
BUCKETS: DRILL  $13/64$ "  
WHEEL WITH STEEL BUCKETS:  
NO. 8 SELF-TAPPING SCREWS

## BUCKET SUPPORT

SHEET STEEL (22 REQUIRED)

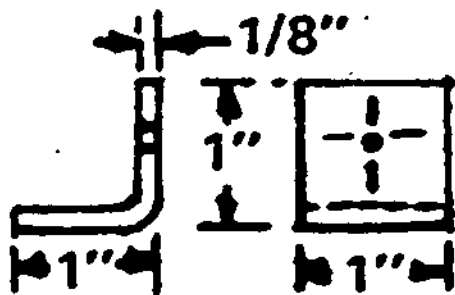

## CLIP

**52 REQUIRED FOR WHEEL  
WITH WOODEN BUCKETS;  
272 REQUIRED FOR WHEEL  
WITH STEEL BUCKETS;  
MAKE FROM SHEET STEEL**

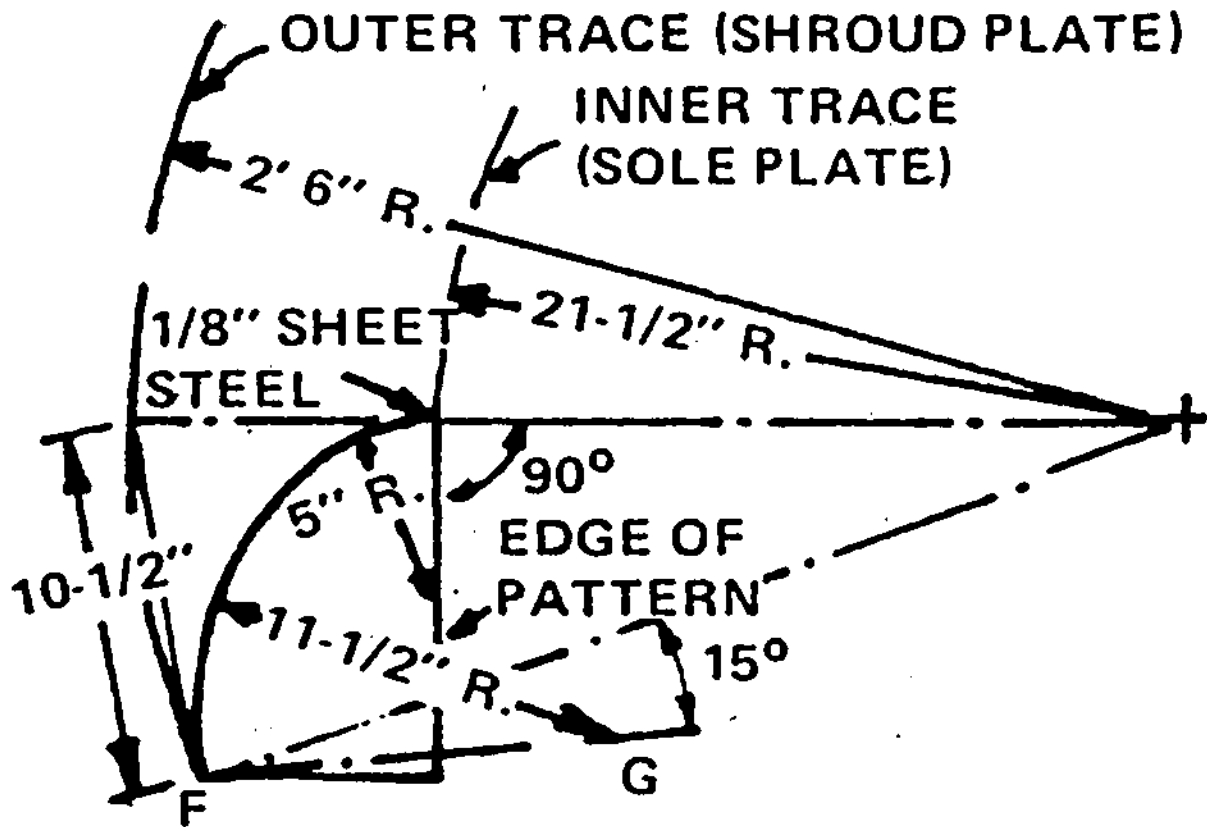

**STEEL BUCKET LAYOUT**  
**22 BUCKETS REQUIRED**

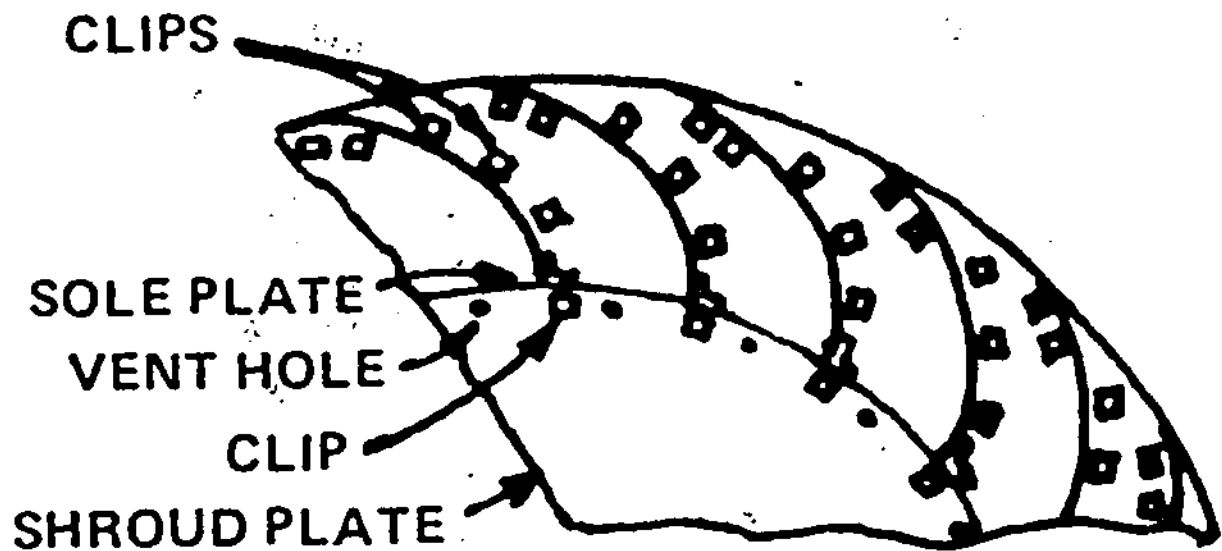

**SEGMENT OF WHEEL  
SHOWING STEEL BUCKETS**

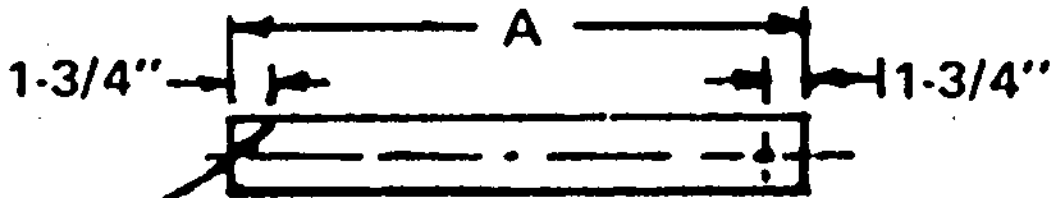

**DRILL TWO 3/8"  
HOLES AT RIGHT  
ANGLES TO EACH OTHER**

**HUB SLEEVE**

**3" EXTRA-STRONG STEEL PIPE**

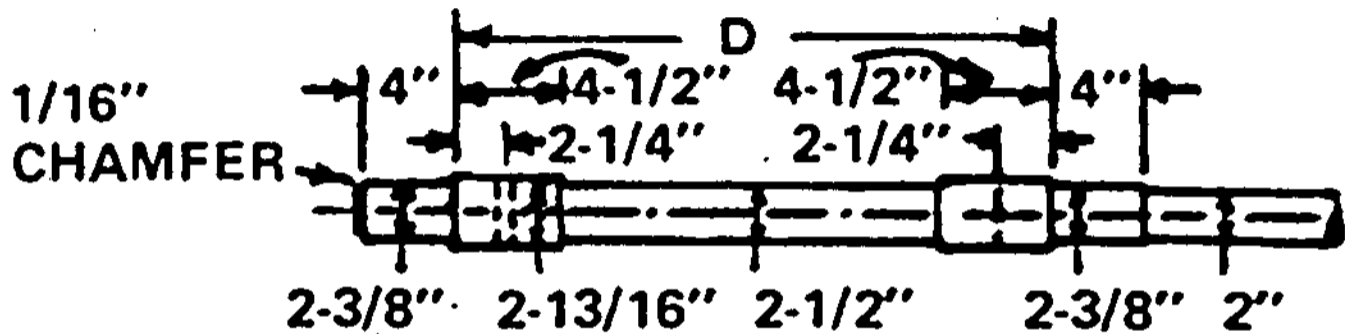

SHAFT

TURN FROM 3" DIA. STEEL

## DIMENSIONS

SYMBOL	A	B	C	D
1/2 HP	24-7/32"	15-31/32"	13"	25-7/32"
2/3 HP	29-9/16"	21-5/16"	18"	30-9/16"
3/4 HP	32-1/4"	24"	21"	33-1/4"
1 HP	40-5/32"	31-29/32"	29"	41-5/32"



making it vertical to the radius. From the point of tangency, measure 5 inches along the tangent. Mark this point.

Using this mark as a center, strike off an arc with a 5-inch radius. This is part of the inner trace of the bucket.

At the point where the original radius line (Step 2) crosses the outer arc, draw a chord 10-1/2" long, and at point *F* (where this chord intersects the outer arc) draw a new radius line. Also at point *F* measure off 15 degrees below the new radius and draw line *FG* 11-1/2 inches long.

Then, using *G* as a center, strike an arc with a 11-1/2" radius. This forms the rest of the inner trace of the bucket.

Cut the plywood along this line and along the lines that form a quarter ellipse. Using this as a pattern, cut several more quarter ellipses from scrap. Nail these to stretchers to make a bending jig around which the buckets may be formed.

## WELD WHEEL PARTS

Welding of the various parts of the wheel produces an exceptionally strong construction. After getting together or making all the required parts, begin the assembly by welding four clips to each end of the hub sleeve. Then weld the required number of clips to the shroud plates for the soleplate, and weld the shroud plates to the clips on the hub sleeve. After welding both hub flanges to the shroud plates and the sleeve with a continuous weld, attach the soleplate to the clips on the shroud plates with No. 8 self-tapping screws. Also weld the soleplate to the shroud plates with a continuous weld, and the bucket-support angles to the soleplate.

Attach wooden buckets to the supports with 3/4" No. 10 roundhead wood screws, and then drill holes 2 inches from center to center through the shroud plates for 1-3/4" No. 10 roundhead wood screws. If you use steel buckets, rivet or screw 10 clips to each side of each bucket and attach the buckets to the angles with No. 8 self-tapping screws. Then drill holes through the shroud plates in the way of the clips for the same type of screws.

## LUBRICATE BEARINGS WELL

Using locknuts and washers, fasten the hub sleeve to the shaft with two 3/8" by 4-1/2" bolts, placed at right angles to each other. Two bearing mountings having 2-3/8" renewable

liners with shoulders should be bolted to the foundation. Place shims about 1/4" thick under the bearings.

Standard bearing mountings, variously called pedestals or blocks, may be bought complete with wick oiler or cup oil reservoir and with built-in self-aligning features. Standard bronze bearing metal liners or inserts likewise may be bought from any machine component supplier. Babbitt liners are equally satisfactory.

Although the wheel turns slowly, it is heavy and will be running almost constantly, so good lubrication of the bearings is essential. To this end, care should be taken to insure that the bearing liners are finished to the correct fit. Porous inserts or inserts containing graphite are excellent for this application, but may cost more than regular bearing inserts.

It is important that the foundation be carried deep enough so that water falling from the buckets will not undermine it. Avoid a long flume if possible, in order to keep the construction as simple as possible. Strengthen it along its entire length with an exterior frame and support it well from dam to wheel with pipe uprights.

## SLUICE GOVERNS WHEEL

The sluice gate may be located at any convenient place along the flume. Since it is the governing mechanism of the wheel, its installation should be anything but slipshod. If it is installed at an angle as shown on page 106, water pressure will keep it at any desired position. If installed vertically, some mechanism (such as a rack and pinion) should be provided to keep it in place.

Adjust the sluice so that the buckets will run one-quarter full. This will give a wheel speed of 10 rpm. If the buckets are allowed to run more than one-quarter full, the efficiency of the wheel will drop for two reasons. Because of the increased speed, centrifugal force will throw water from the buckets. They also will begin to spill before approaching tail water. Although this practice does waste water, it may be profitably employed during a freshet to increase the power output, for at such times the excess water would be wasted anyway. ●

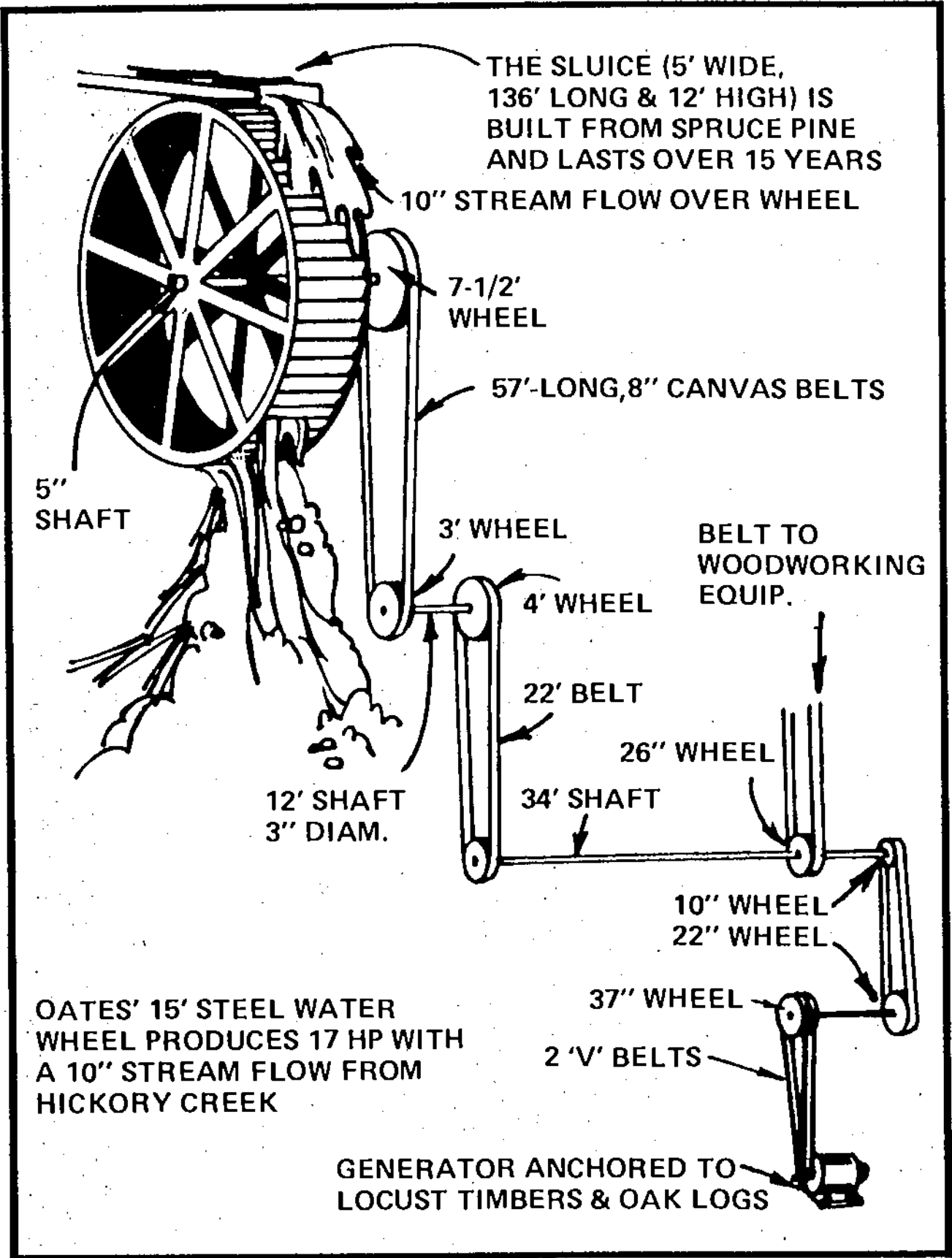

*Oates uses a series of canvas belts and nine drive pulleys to transfer power from his water wheel to a generator and other equipment.*

## Waterwheels, Turbines, and Generators

The energy in our stream of water is converted into mechanical, rotational energy by means of a waterwheel or a turbine. Waterwheels have the advantage of being rather "low technology"; they can be built without much in the way of special skills, materials, or tools. The shaft of a waterwheel can be coupled by means of belts and pulleys directly into such low-speed mechanical loads as saws, lathes, water pumps, and mills; but their low turning speed makes it difficult to couple them into electrical generators. A typical waterwheel turns at something like 5 to 15 rpm and, since an automobile generator needs 2000 to 3000 rpm to put out much current, a gear ratio of about 300:1 would be required. Such high gear ratios are quite difficult to attain, which severely limits the usefulness of the waterwheel-automobile-generator combination. There are generators, used in commercial wind-electric plants, which put out significant power at lower rpms; however they are considerably more expensive.

To speed up the rotation of a shaft, pulleys and belts can be used, as shown in Figure 3.29. The ratio of the speeds of the shafts is equal to the ratio of the diameters of the pulleys:

$$\text{E. 3.15} \quad \frac{N_2}{N_1} = \frac{D_1}{D_2}$$

To obtain a speed increase of, say, 20 to 1, the diameter of one pulley would have to be 20 times the diameter of the other. For large speed increases, the step-up should be done in stages, as shown in Figure 3.29. In this case, the total increase in speed is equal to the product of each pulley ratio:

$$\text{E. 3.16} \quad \frac{N_4}{N_1} = \frac{D_1}{D_2} \times \frac{D_3}{D_4}$$

In spite of the difficulty, it is possible to use waterwheels for generating electricity: Thomas Oates, for example, has described a four-stage belt-drive system which he uses to step up a waterwheel rotating at 15 rpm to a generator rotating at 800 rpm (in *Mother Earth News A Handbook of Homemade Power*

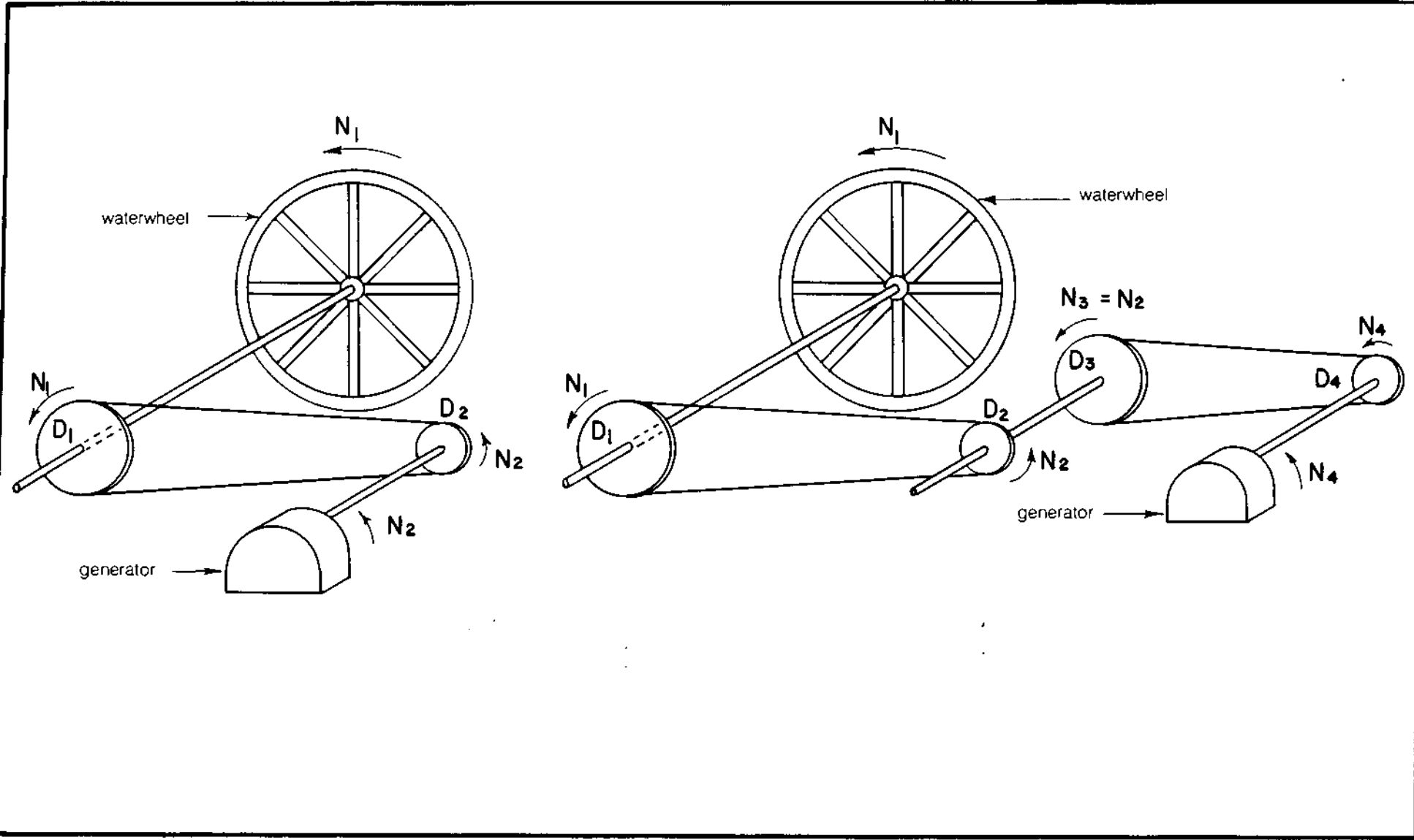

Matching the slow speed of a waterwheel to the high-speed requirements of a generator by belts and pulleys.

The following suggestions are based entirely on the excellent work recently done and published by Prof. P. la Cour in Denmark on behalf of that Government, which has in that particular placed itself ahead of other countries—considerably to the advantage of many of its villages and isolated dwellings. The reader must be prepared to experiment a little—not indeed in principles but in details of apparatus to suit his own case—but may rest absolutely assured that the method is quite practical and satisfactory.

There are two main difficulties in applying a power so variable and intermittent as wind to the production and supply of electricity. There must, first, be a means of automatically switching on the dynamo to a set of accumulators whenever the former is in a position to deliver current, the same apparatus cutting it out when the power falls away. Secondly, means must be adopted whereby an increase of wind-power beyond the normal amount required to just work the dynamo shall not affect the output by increasing either voltage or current. Both these ends have been attained by La Cour with the simplest apparatus imaginable.

A consideration of the second question raised will show why it is necessary to decide on a definite wind-velocity as being that at which any given windmill shall supply its "normal" output. By rating it low, say a wind of 9 miles per hour, it is possible to keep a dynamo working nearly every day in the year and for twelve hours out of the twenty-four. But the power of the wind at 9 miles an hour is only a quarter of that at 15 miles an hour, and although the latter only blows about half the total number of days in a year, and then for only about nine or ten hours a day, its total output is greater than the other. Another point to be considered is that a very small dynamo is much less efficient, so that a double loss is experienced if too much constancy of work is aimed at. Of course, in a large installation these points have less emphasis, and it becomes desirable to run the plant at a lower wind-rating (in other words, use a comparatively large mill), the only limiting factor being the initial cost of the plant.

In a wind-driven generating plant the following points should be noted. The windmill itself should be self-regulating (as, for example, that described in Chap. V.), and fitted with tail so as to turn to face all possible winds. The dynamo should be shunt-wound, so that an increase in the external resistance tends to raise the terminal voltage. If necessary, this tendency may be increased by having one or two resistance coils in series with the shunt-winding, these coils being automatically cut out as the external resistance rises and current falls. A low-speed machine is certainly preferable, the speed of a windmill being rather low itself. The accumulator is a vital point: it should have a large

capacity, as on this depends its ability to maintain a supply over a longer period of calm; yet as it is undesirable for any accumulator to remain long at a low state of charging, care must be taken to avoid draining it—especially if a spell of calm weather seems likely.

The whole of the electrical apparatus is shown diagrammatically in fig. 73, the only part needing much description being the automatic switch, further illustrated in three views in fig. 74. This consists of two electro-magnets, EM, each like an ordinary bell-magnet, and wound with fine wire, but with an extra winding of a few turns of thick wire, exactly like a compound-wound dynamo field magnet. A horse-shoe permanent magnet, PM, is suspended so that its poles lie opposite and near to the poles of the electro-magnets, and swings by means of the pivot screws which work in a *brass* (or non-magnetic) block, B. This block also carries the copper rod CR, each end of which turns downward into the wooden cups 1 and 2, containing mercury, matters being so arranged, however, that the end 1 is always in the mercury whichever way PM is swung, while 2 only touches the mercury when that end of CR is drawn downwards.

The switchboards present no special features. By following out the connections it will be seen that any agreed number of cells can be switched on to the dynamo, while any independent number can be caused to supply the lamps. This latter arrangement is desirable to allow for drop of voltage during discharge, also to provide for losses in mains and for an extra cell or two in case of accident to others.

The action of the automatic switch is as follows: Assuming the dynamo to be still, or running at too low a speed to furnish current, it will be seen that the battery is energising the electro-magnets EM through the fine wire-coils, the current passing also through the armature of the dynamo. The winding of EM is such that the current in this direction attracts the poles of PM to the right and so raises the end, 2, of CR out of the mercury. Only a very small current is required, or allowed, to be thus wasted. Supposing now the wind to increase sufficiently to raise the speed of dynamo so much as to be able to supply current, the first effect will be to reduce the current in EM to nil and then to reverse it, altering the polarity of the electro-magnets and throwing the lower end of magnet PM over to the right. This, by dipping the end 2 of CR into the mercury, makes connection between the dynamo and accumulator, the charging of which at once begins. The effect of the thick-wire coils on EM is to hold the magnet switch more securely during charging. The opposite action—that of throwing out the dynamo when the speed fails—is obvious on inspection.

There would be twelve accumulator cells, each of from 150 to 200 ampere-hour capacity, which would be easily capable of dealing with the full current for twenty-four hours' continuous charging. The capacity mentioned is the maximum suitable for the given plant, but the minimum may be anything down to twelve pocket-batteries, if so desired. Within the limits given, the greater the capacity the more the independence of conditions of wind.

With regard to the automatic switch, a little experimenting and adjusting will be needed to ensure its correct working. The electro-magnets may be two ordinary bell-magnets, wound with No. 36 wire, the bobbins being about  $1\frac{1}{2}$  inches long and 1 inch diameter outside. A resistance may be needed in series with this winding, or the effect may be tried of connecting up only six of the cells to these coils, the six on the left-hand side in fig. 73 being, of course, selected. All four bobbins will be joined in series. Over the fine wire on each bobbin will be wound from six to twelve turns (to be determined by experiment) of No. 16 or 14 gauge cotton-covered wire, the winding being in same direction as the fine wire in each case, so that the current is a reinforcing one when being supplied from the dynamo. The balance of the permanent magnet can be adjusted by moving the copper rod CR either to right or left.

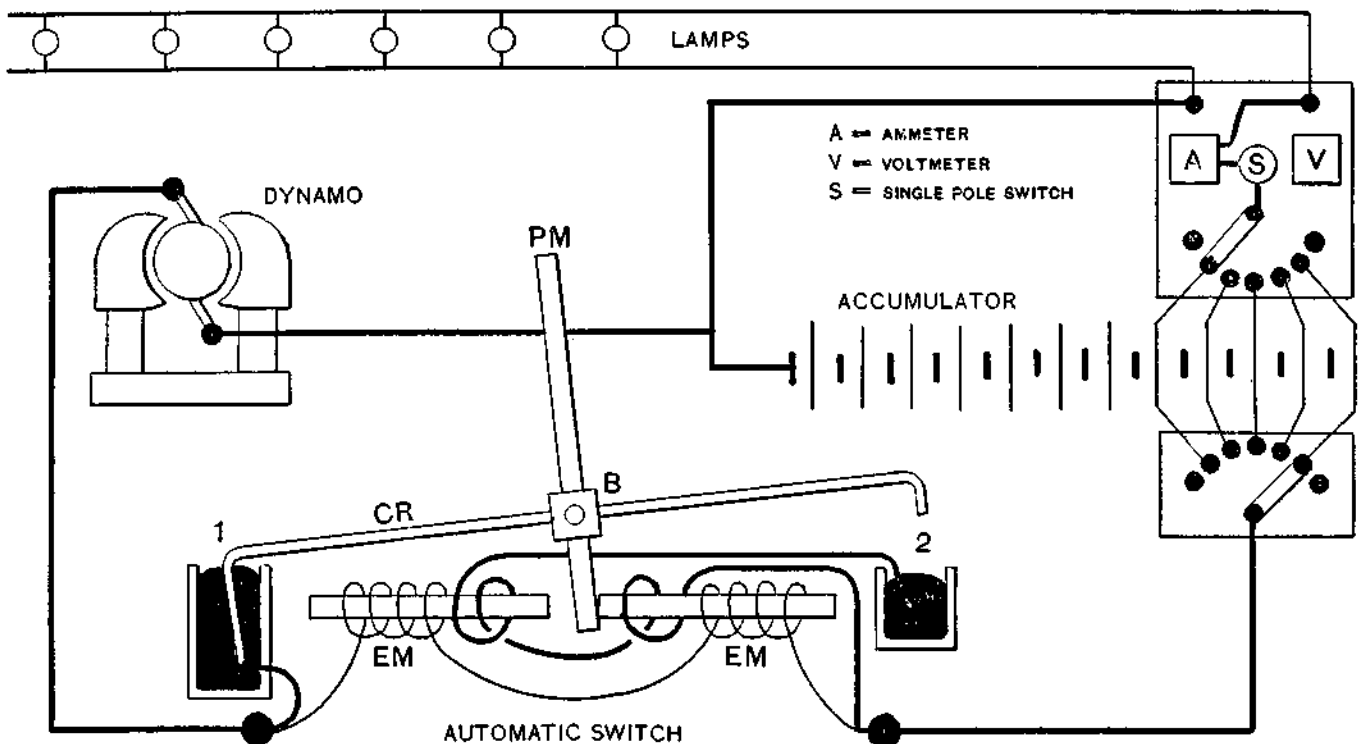
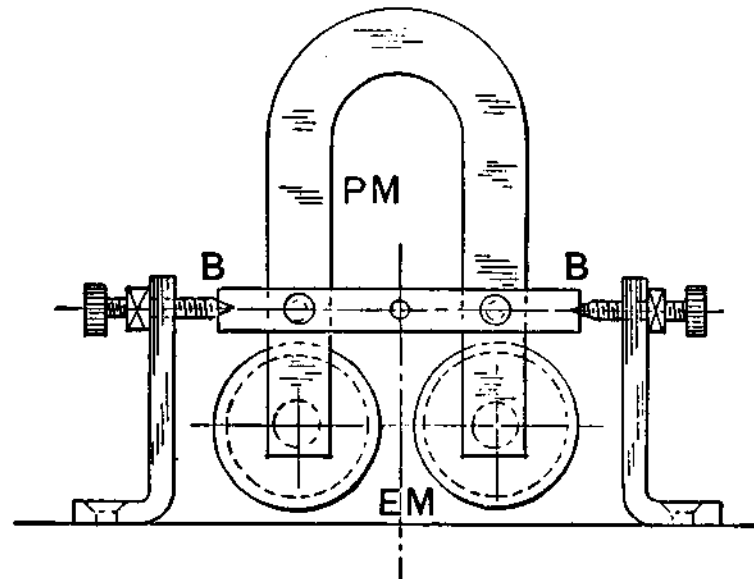
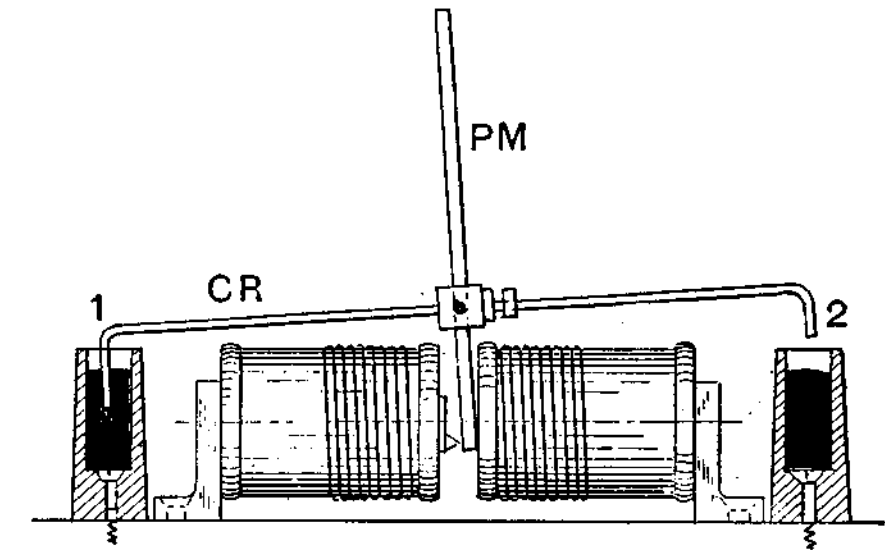

Fig. 73. — Diagram of Connections for a Wind-driven Electrical Installation.



NOT TO SCALE

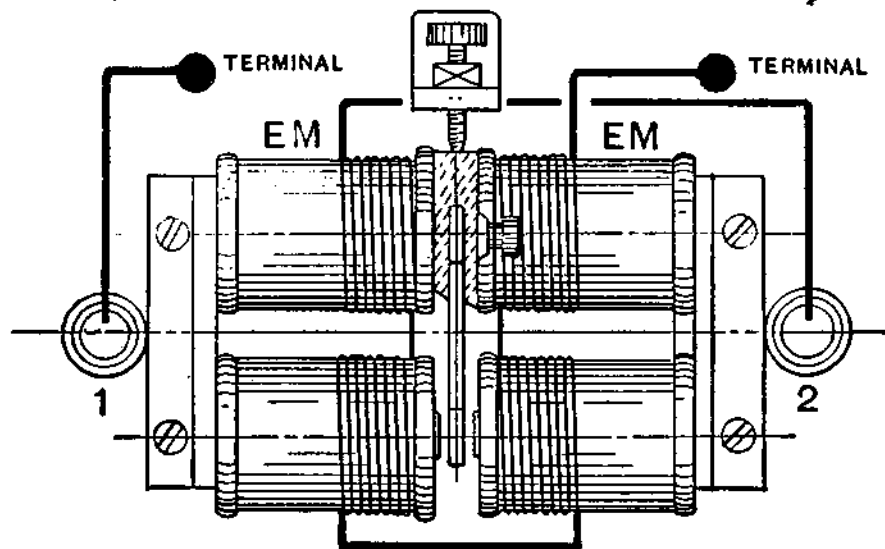

Fig. 74.—Automatic Switch for Wind Electrical Plant.



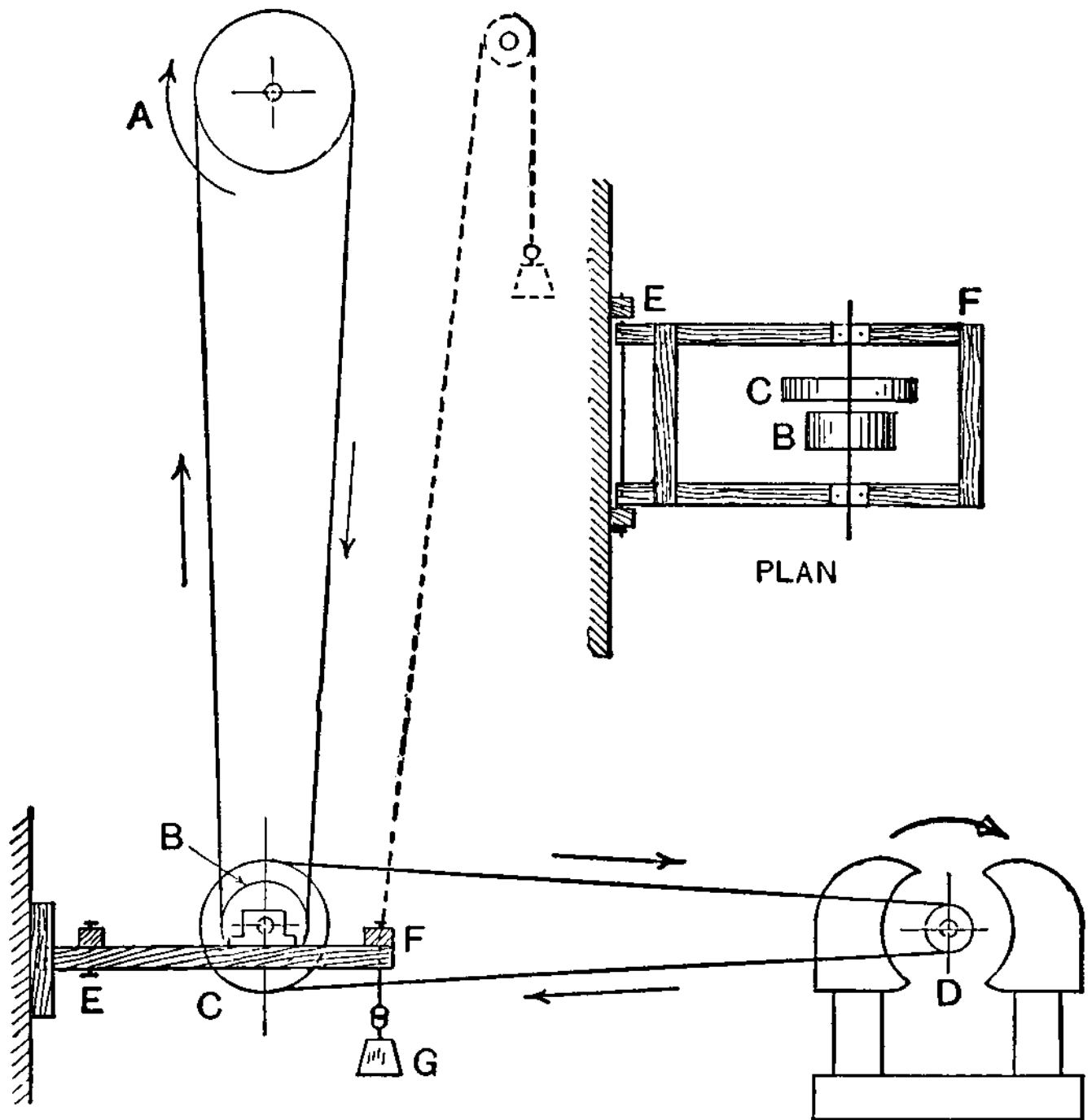

FIG. 75.—Driving Belt Arrangement for Wind Electrical Plant.

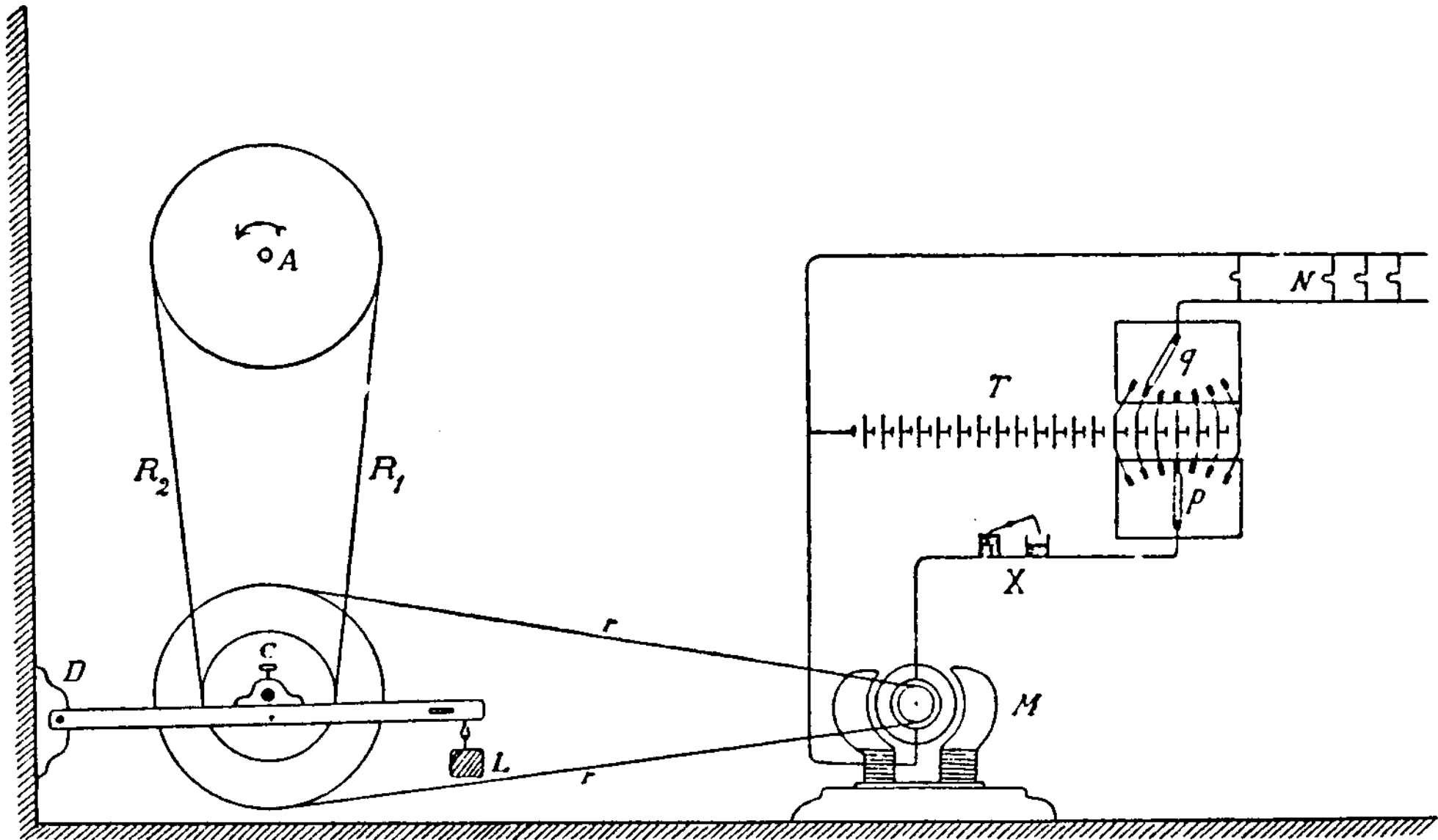

Fig. 5. Konstant elektrisk Ström.

The apparatus required to maintain the dynamo at the right speed when that of the mill itself ranges too high is a system of belts and pulleys, shown in fig. 75. Here A is an ordinary pulley with the usual curved face; B, a rather wide, flat-surfaced pulley; C and D, again, ordinary pulleys; C and B being fast on one shaft. This shaft is carried on the light timber frame EF, hinged at E, and carrying a weight G at the other end.

It will be seen that this arrangement provides for a constant pull on the belt between A and B. It may be found that this pull is too great even without the weight G, in which case a cord (shown dotted) takes its place, and, by means of a pulley overhead and another weight, takes off some of the load.

The belt CD has no special feature beyond being thin, supple, and even. That between A and B, however, must be specially smooth on its running surface, and must in addition be thoroughly well oiled. On this depends the peculiar result to be obtained. It is found that when the weight G has been properly adjusted, and other details of current supply, etc., decided upon by experiment, no matter how much faster than normal A is compelled to run by the wind, the speed of B remains constant or with just sufficient variation to meet the slightly varying conditions required by the dynamo, the belt slipping on B at the higher speeds. The principle, of course, is not new; but its application in the present instance, together with the automatic switch, is an excellent example of mechanical adaptation.

The details of the whole of the apparatus must necessarily be worked out by individual requirements: the following suggestions, however, are added as an example, the instance chosen being the 10-foot windmill described in the last chapter. This windmill, working in a

15- or 16-mile breeze, should have an output of about  $\frac{1}{4}$  H.P. Allowing for losses in dynamo, gearing, and belts, it may be assumed that a dynamo of 100-watts output would be the right machine for the available power. The voltage chosen might well be 25, this being its lowest rate at normal speed, which may be assumed at 1500 revs. per minute.

Under these circumstances, and assuming pulley A (fig. 75) to run at 200 revs. per minute (by whatever gearing used), A might be 12 inches diameter  $\times$  2 inches width; B, 6 inches  $\times$

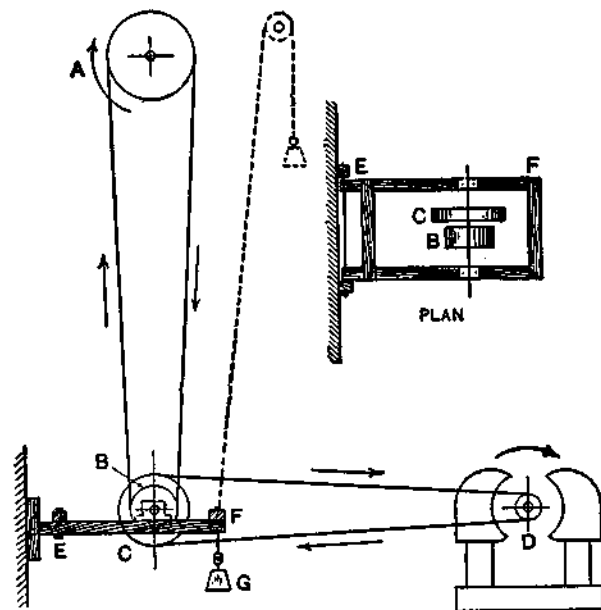

FIG. 75.—Driving Belt Arrangement for Wind Electrical Plant.

3; C, 8 inches  $\times$  2; and D, the dynamo pulley, 2 inches  $\times$  2 inches. This gives a rather higher ratio than is required—an error on the right side. The belt between A and B should be  $1\frac{1}{2}$  inches  $\times$   $\frac{3}{16}$  inch, the pulleys being about 6 feet centres, and belt CD 1 inch wide  $\times$   $\frac{1}{8}$  inch thick, also with about 6 feet drive.

# PELTON WHEELS

Written with the Assistance of Guy Immega

The Pelton wheel is an important type of impulse water turbine because with an adequate head it can develop a high rpm useful for A.C. power generation. A Pelton wheel is usually small in diameter with specially shaped bucket cups mounted on the perimeter. Water is directed into the cups by a nozzle. Characteristically, a Pelton wheel requires a very high head of water (over 50 feet), delivered at a small volume of flow through a pipe. This makes the Pelton wheel particularly useful for a small mountain stream. A Pelton wheel turns at high speed (up to 1000 rpm) which makes it attractive for use as a power source for electrical generators (which usually require 1800 or 3600 rpm). The efficiency of a Pelton wheel with polished cups can be up to 93%.

The selection of Pelton wheels is dependent upon the site available, and the power required. With a higher head, the power can be obtained from a smaller wheel, with a smaller volume flow rate. A lower head will require a larger wheel at a greater volume flow rate, for the same power. At the same head, smaller wheels turn at higher rpm's.

To lay out a site for a Pelton wheel, the volume flow of the stream and available head must be determined. A "worst case" approximation for the head at the wheel should allow for 1/3 head loss; the stream flow calculations can be made as described previously.

## Pelton Construction

Aside from the wheel itself, the most important part in a Pelton wheel installation is the feed pipe. Generally, to obtain a high head of water, many hundreds of feet of pipe are required. With this length of pipe, a primary concern is the friction of the water flowing in the pipe. Pipe friction is generally expressed in loss of head per 100 feet of pipe. If the pipe feeding a Pelton wheel is too small, then the pressure of water at the nozzle is reduced (effective head reduced).

Friction will be great in a narrow pipe. As the pipe diameter gets larger, the friction in the pipe decreases. But at some point, the high cost of a large diameter pipe outweighs the advantage of less friction. The general rule-of-thumb is that "maximum power-per-dollar invested is extracted from a pipe at 1/3 head loss. . ." This means that a 1/3 head loss gives the highest efficiency at the lowest price. Pipes with diameters allowing less than 1/3 head loss are more "efficient," but are prohibitively expensive.

Head loss may be determined by the use of the pipe flow nomograph (Fig. 9). For instance, suppose the pipe feeding a Pelton wheel must be 100 feet long and will have a static head of 200 feet. (Static head is the pressure inside a pipe filled with water, when the water is not flowing; in this case the pressure is equal to 200 feet of head.) Then the maximum tolerable head loss is 1/3 of 200 feet, or 66 feet. That leaves 134 feet of effective head at full flow. Expressed differently, the head loss must be less than 6.6 feet per 100 feet of pipe.

Suppose also that the stream is less than 6 inches wide and 6 inches deep, and the volume flow is about 32 cfm (.534 cfs), and that the entire stream is fed into the pipe. From the pipe flow nomograph, a 4 inch pipe is found to be more than sufficient to carry the flow, within the allowed 1/3 head loss.

Equation 20 is for finding the speed of the jet of water at the nozzle.

$$V = \sqrt{2gH} \quad \text{where } V = \text{nozzle velocity, when maximum power is taken from the feeder pipe}$$
$$g = \text{acceleration of gravity, 32 feet per second}^2$$
$$H = \text{effective head at full flow}$$

(Eq. 20)

The nozzle size is set by either the design flow rate of the system or the capacity of the wheel, whichever is less. At any point in the pipe or nozzle, the flow is a product of the velocity of the water through a particular cross-section.

$$Q = (V)(A) \quad \text{where } Q = \text{flow} \\ V = \text{velocity} \\ A = \text{cross-sectional area} \quad (\text{Eq. 21})$$

Since the nozzle velocity is known from Eq. 20, and the design flow (Q) is known, the theoretical nozzle opening can be found:

$$T.A. = \frac{Q}{V} \quad \text{where } T.A. = \text{theoretical nozzle opening (area) in inches squared} \\ Q = \text{flow in cfs} \\ V = \text{velocity in feet per second} \quad (\text{Eq. 22})$$

$$\text{With the above example, the area} = \frac{534}{92.6} (144 \text{ inch}^2/\text{foot}^2) = .83 \text{ inch}^2$$

However, to find the actual flow through a given nozzle the theoretical area must be divided by a "nozzle coefficient" ( $C_n$ ).  $C_n$  is .97 for a plain nozzle without controls. To find the necessary area for delivering the design flow:

$$\text{Area required} = \frac{\text{theoretical area}}{C_n} \\ A = \frac{.83}{.97} = .855 \text{ inch}^2 \quad (\text{Eq. 23})$$

Then, using simple geometry, the radius and diameter of the proper nozzle can be found.

$$r = \sqrt{\frac{A}{\pi}} \quad \text{where } r = \text{radius of the nozzle in inches} \\ A = \text{area required for delivering the design flow}$$

$$\text{then } r = \sqrt{\frac{.855}{3.14}} = .522 \text{ inch}$$

$$\text{And since diameter} = 2 \times \text{radius, } D = (2) \times (.522) = 1.044 \text{ inch} \quad (\text{Eq. 24})$$

The 4 inch feed pipe we selected on the basis of pipe flow will be more than adequate for this 1 inch diameter nozzle.

When the nozzle is delivering water so that the wheel can achieve maximum power, the rim speed of the wheel will be 1/2 the velocity of the nozzle jet.

$$U = .5 V \quad \text{where } U = \text{rim speed of the wheel (Pelton wheel)} \\ V = \text{velocity of the jet of water from the nozzle} \quad (\text{Eq. 25})$$

In the case of the 12 inch wheel with a 1 inch nozzle, the circumference of the wheel is:  $C = \pi D$ , or  $C = \pi \frac{12 \text{ inches}}{12 \text{ in/ft}} = 3.14 \text{ feet}$ .

From Eq. 20  $V = \sqrt{2gH}$ , we know that with the available head of 134 feet, the nozzle jet velocity will be 92.6 feet/second. Therefore, from Eq. 24, the rim speed will be half the velocity, or 46.3 feet/second.

To find rpm use Eq. 14 (from Overshot wheels):

$$\text{rpm} = \frac{\text{rim speed}}{\text{circumference}} = \frac{46.3 \text{ ft/sec}}{3.14 \text{ ft/revolution}} = 14.74 \frac{\text{revolutions}}{\text{second}} \times \frac{60 \text{ sec}}{\text{minute}} = 885 \text{ rpm}$$

If the wheel is overloaded, the speed will be slower and the power will drop. If the wheel is underloaded, the speed will be greater, but water will be wasted.

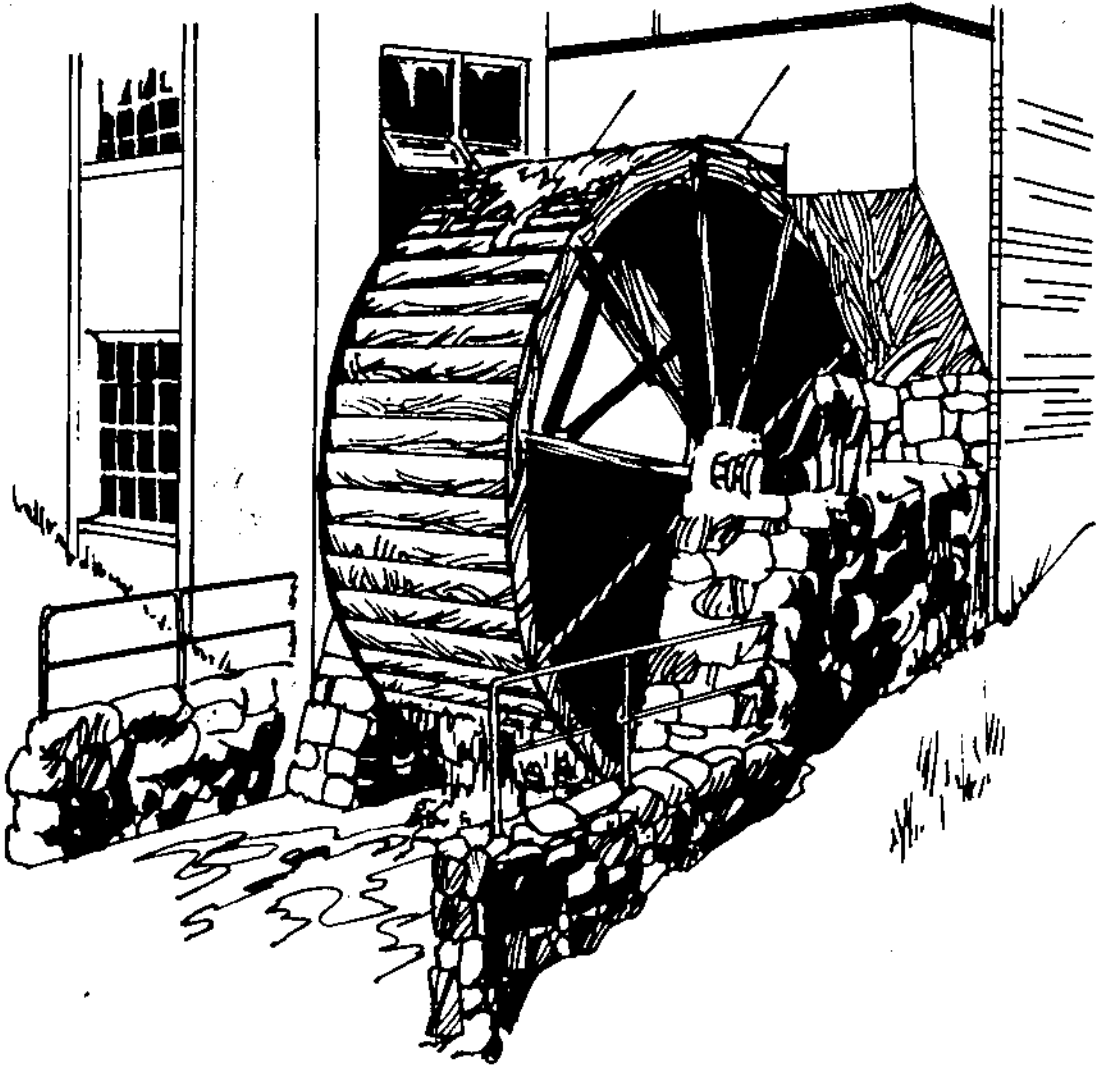

## **PART FOUR: HOMEMADE WHEEL DELIVERS OVER 3 HP.**

Though one of man's oldest prime movers, a water wheel is still a fascinating piece of machinery. Perhaps this is because it appears comprehensible at a glance (although an efficient wheel is actually a product of subtle and inconspicuous design refinements), and because it seems to be a way of getting power for nothing. The homemade wheel described here was especially designed for this series on harnessing small streams and will reward a careful craftsman by delivering years of constant service. It's particularly suited for an installation having a moderate head (25' to 60') and relatively small flow (.45 to .75 cubic feet per second). Subsequent installments will

describe the construction of wheels suited for lesser heads of water and other varied conditions.

As is apparent from the drawings, this is an impulse wheel, driven by the impulses produced as water strikes revolving blades or buckets. In a perfectly designed wheel, the water strikes at high speed, exhausts its energy in driving the wheel to which the bucket is attached and then falls free of the wheel.

Known as a Pelton wheel, this type was developed from the "hurdy-gurdy", a paddle wheel used in California by the forty-niners. The hurdy-gurdy was a wheel that rotated in a vertical plane, had flat vanes fixed around its circumference and was driven by the force of water striking the vanes. It was not an efficient machine, but it was simple to construct. Then an engineer named Lester Pelton substituted a cup-shaped, divided bucket for each of the vanes, and by that step added a high degree of efficiency to the wheel's other virtues.

No single wheel will meet all operating requirements, but some will perform under a reasonably wide range of conditions. The following table indicates the rpm and horsepower output that will be delivered by this wheel under given conditions of head and flow. The latter is measured in cubic feet per second:

HEAD	FLOW	RPM	HP
25'	0.43	350	1.0
30'	0.51	390	1.3
40'	0.59	450	2.0
50'	0.66	500	2.8
60'	0.73	550	3.75

Thus, if a survey of your stream indicates a head and flow close to these values, this Pelton wheel will fit neatly into your plans.

Strictly speaking, a water wheel is an engine powered by water, just as an automobile engine is powered by gasoline. The important power-producing elements of the wheel are the buckets and the nozzle . . . and considerable care should be exercised to see that these parts are made correctly. The nozzle meters the correct amount of water to the wheel, and forms and directs the jet against the buckets. Both the inside diameter and the location of the nozzle with respect to the

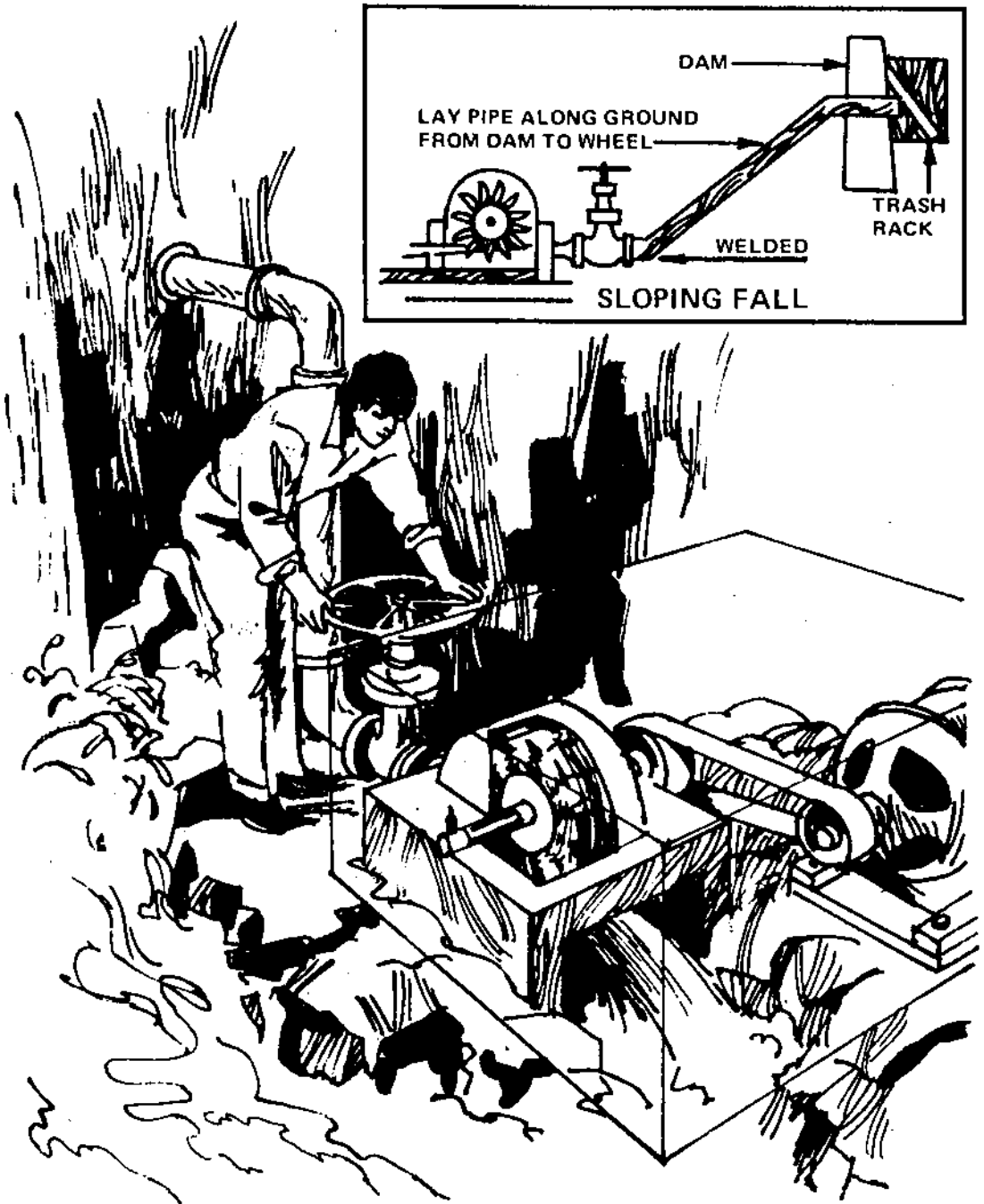

*While the penstock may be set up to provide either a precipitous or sloping fall, it should be of as large a diameter as possible, have minimum bends and hold down flow friction to the least amount.*

wheel are very important, since the jet must impinge upon each bucket at the correct wheel radius or lever arm. It must also be divided equally by the center ridge of each bucket.

The function of the bucket is to convert the energy of the jet—represented by its high speed—into mechanical energy at the wheel shaft. To do this it must slow the water from its high speed in the jet to practically zero speed when it drops into the tail water. Maximum efficiency with this wheel will be obtained if the buckets have the form and size shown in the



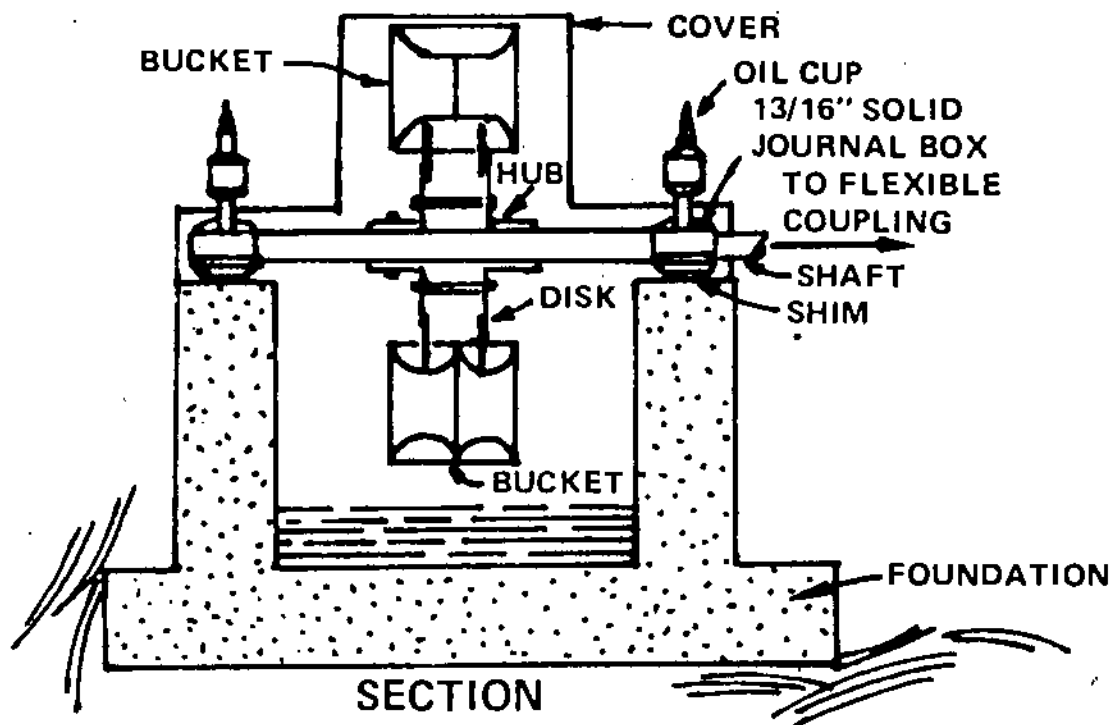
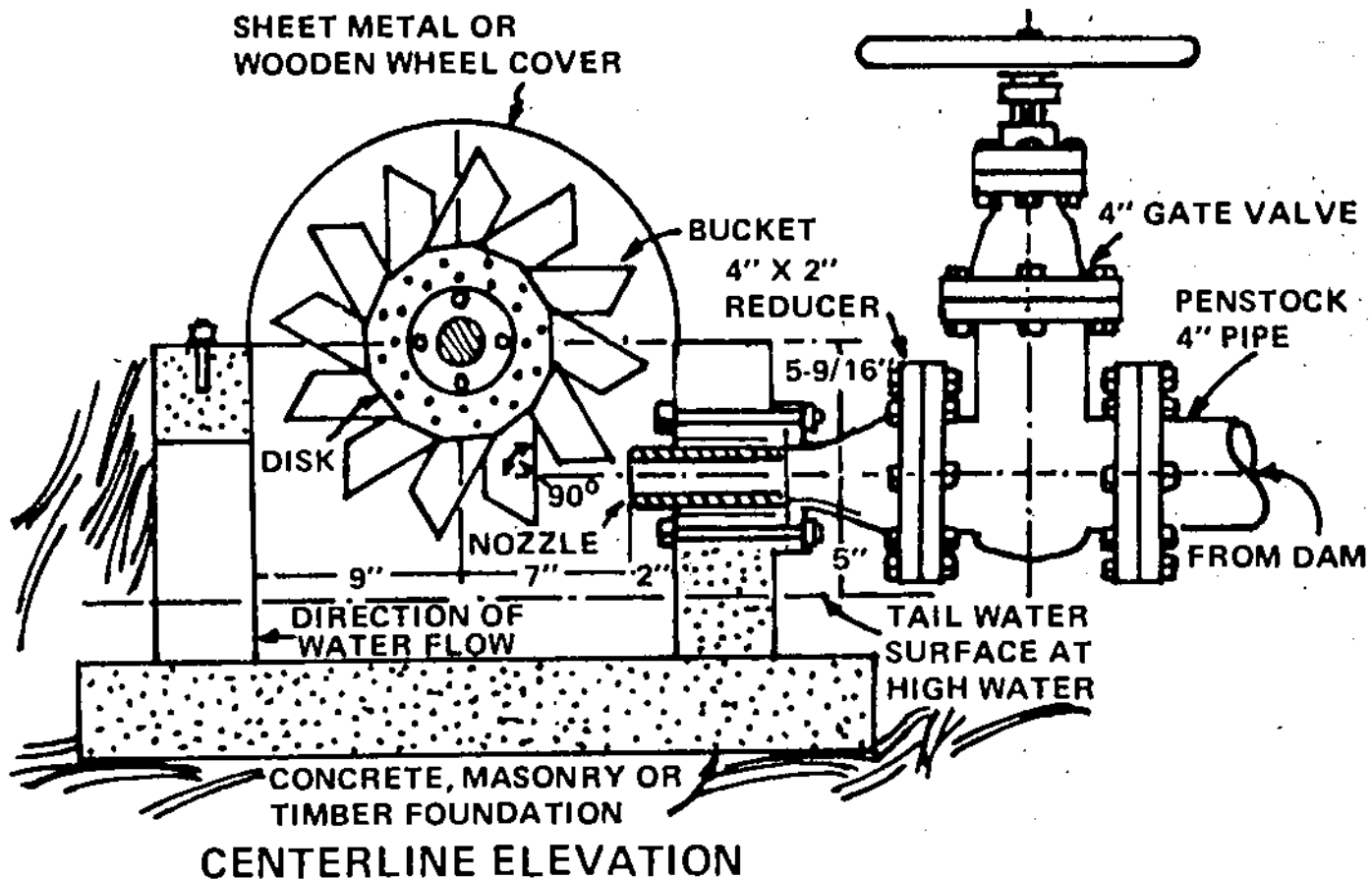

drawing. This shape acts to slow the jet by turning it smoothly through 180 degrees. The surface of each bucket must be as smooth as possible. A mirror finish is desirable on the inside, and even the back of each bucket should be ground and polished to minimize spray.

Important also is the correct orientation of the bucket to the jet. When the full jet strikes, the bucket should be perpendicular to it. Both the nozzle and the buckets will wear under the action of the high-speed water—at a rate determined by the silt content—and should therefore be made easily removable for replacement.

Above all, buckets must be uniform. If you can get access to a metal-cutting band saw, cut the blanks according to a single pattern. This pattern can be shaped so as to form the end bevels automatically when the blanks are bent, and the bending itself can be done in a jig or hammering form. This jig may be made of a piece of pipe of about 2 inches outside diameter mounted in hardwood end plates. Also provide a holding fixture that will slide in the table groove of the band saw to assure that the slots for the end lugs are cut and spaced uniformly. A holding jig should also be made to line up the lugs and buckets for welding. On completion, balance the wheel by laying weld beads along the backs of any light buckets. Beads should be laid carefully and ground smooth.

Ball bearings may be employed, but are not necessary since the wheel turns at comparatively low speeds. If the builder prefers to use plain bearings, it will simplify machining the shaft, which should present a shoulder to the inside of the bearing so that the wheel may be positioned. If plain bearings are employed, babbitted linings are satisfactory, provided provision is made for proper lubrication.

One vital job that the foundation must do is hold the wheel and the nozzle in correct relative positions. It should be placed on firm ground or piling so that it will not settle unevenly, and must, of course, take advantage of all the head possible. The penstock from the dam should have easy access to the nozzle, and the tail water easy escape to the stream. If possible use 4-inch or larger pipe for the penstock and lay it out to hold frictional losses to a minimum. The width of the foundation is such as to allow the water to fly clear of the buckets. The removable cover over the upper half of the wheel may fit more closely, since no water sprays from the buckets through this

# BUCKET—

12 REQUIRED. MIRROR  
FINISH-WELDED 1/8"  
SHEET METAL

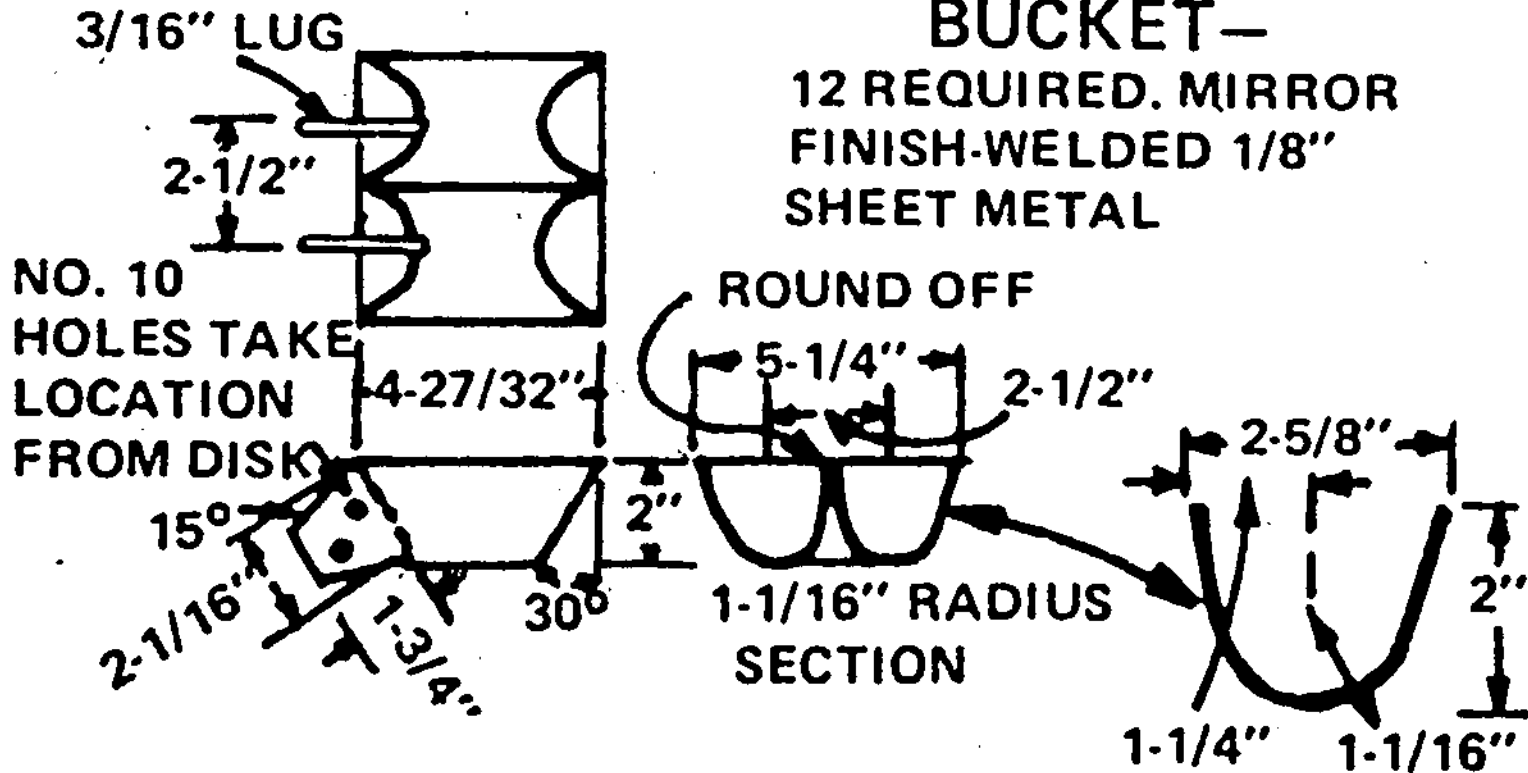

**DRILL 24 HOLES  
FOR NO. 10 BOLTS**

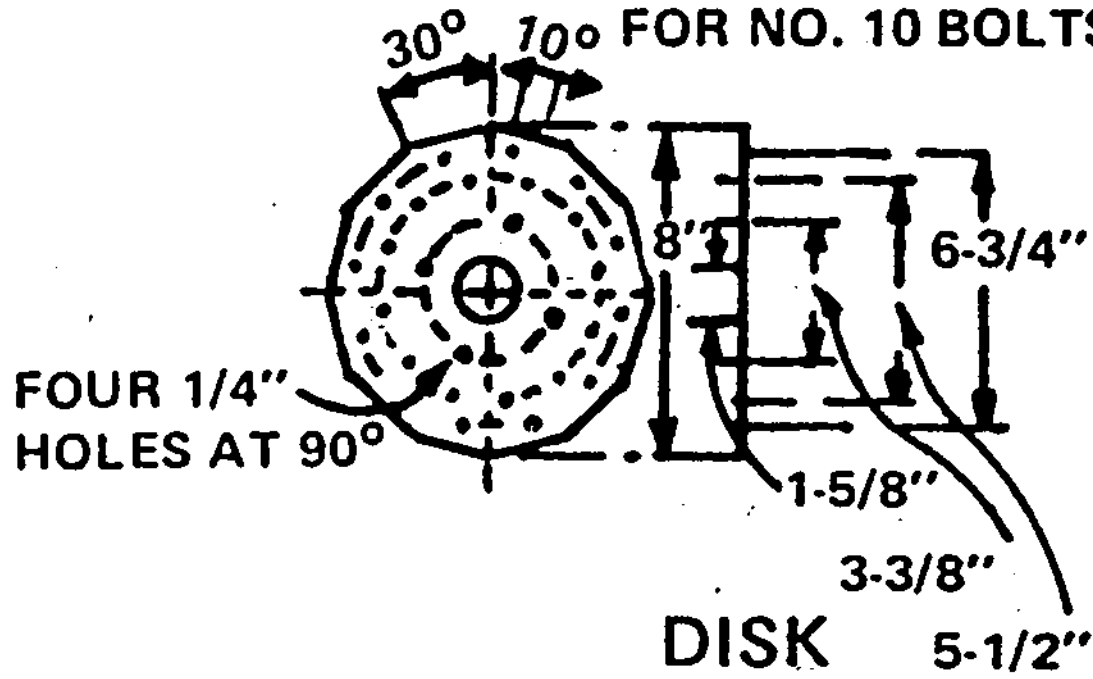

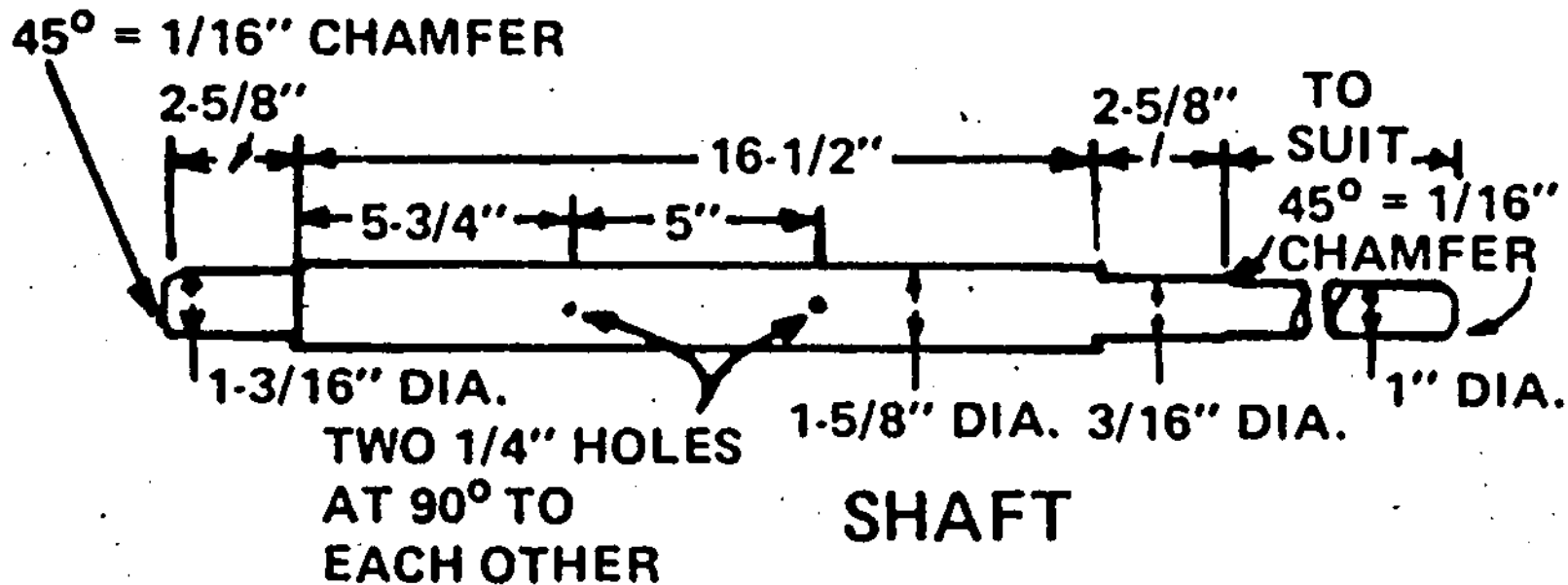

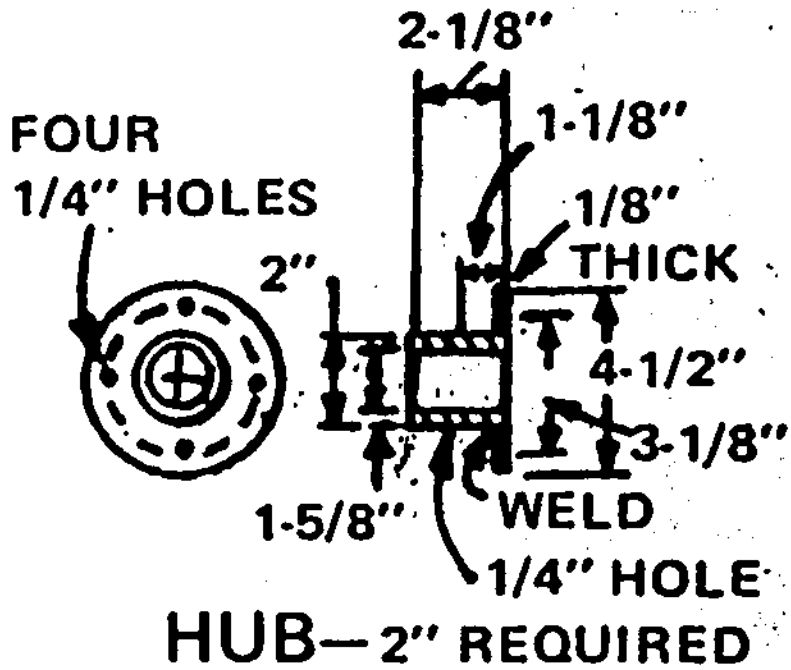

2.575" O.D.

1.476"

1.470" 2" FLANGE

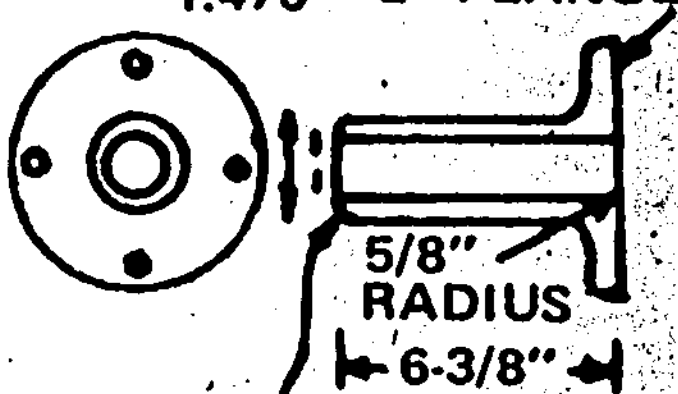

45° = 1/4

CHAMFER

NOZZLE

half of the revolution.

The foundation may be made of such materials as timbers in a framework, masonry or concrete (so long as it fulfills the above requirements). The wheel and the machinery being driven may then be housed in any suitable, inexpensive shed.

It's not wise to dispense with a gate valve, which is used to cut off or to throttle the water supply to the wheel. Since a gate valve cannot be operated rapidly, it is the best type, eliminating the risk of dangerous water hammer in the penstock. It is also well suited for throttling because fine adjustment is obtainable through the long operating screw. In throttling, the gate valve should be used together with a tachometer or revolution counter connected to the wheel shaft to secure the optimum speed and horsepower for the stream condition and load. Either fasten a tachometer permanently to the shaft, or keep a revolution counter handy in the wheel shed.

Generally the head and volume of water flowing to the wheel will remain constant, resulting in a constant output. If the machinery driven by the wheel has a level power demand there will be little need for constant adjustment of the valve.

The requisite piping, pipe fittings, steel sheet and rod and the bolts, nuts and gaskets are available at building supply houses or steel distributors. Machine screws, lock nuts, bearings and the like may be purchased from good-sized hardware distributors or mail-order houses.

One final point to keep in mind in making your calculations: head is defined as the vertical distance between the water surface behind the dam and the tail-water surface at the wheel. For an impulse wheel, however, which cannot operate submerged, the available head is measured from headwater to the center line of the nozzle. As shown in the construction drawing, there is only 5 inches difference between the two definitions, but this can make some difference in output when working with the moderate heads for which this wheel is designed.

While many details can be altered, the reader should beware of any that will affect operating characteristics. Thus, stainless steel buckets and antifriction bearings would improve performance, involving only some extra work in building the wheel. Changes in the nozzle diameter, wheel radius or effective head, however, should be undertaken only after careful consideration of the probable effect on performance.



# TURGO IMPULSE WHEEL

The Turgo runner is basically an improvement on the Pelton. It was designed in 1920 by Eric Crewdson, then the managing director of Gilbert Gilkes and Gordon Ltd.

With the Turgo, the jet is set at an angle to the face of the runner, strikes the "buckets" at the front, and discharges at the opposite side. The basic difference between the Turgo and the Pelton will be clear from Figure 12.

Any impulse wheel achieves its maximum efficiency when the velocity of the runner at the center line of the jet is half the jet velocity. Hence for maximum speed of rotation the diameter of the runner should be as small as possible, and so the ratio of the runner diameter to the jet diameter is critical. The Pelton has a minimum runner to jet ratio of 9:1.

Crewdson set out to design a runner which would operate on a reduced ratio and thus increase the speed. The successful outcome of his endeavors was the Turgo, with a minimum runner-to-jet ratio of 4:1. In effect the Turgo runs at twice the speed and is only half the diameter of the Pelton. Therefore the necessity for gears to the generator is greatly reduced, as is the manufacturing cost of the runner itself. It can be served by one or two jets, has an efficiency of over 80% with a high part-gate efficiency and is suitable for use on heads of 40 feet or more. The Turgo is in use all over the world and has established a good reputation for trouble-free operation.

**Example:** *Assuming a net head of 100 ft. the nozzle velocity ( $v$ ) will be the square root of:*

$$2 \times 32 \times 100 \text{ ft. sec.} = 80 \text{ ft. sec.} = 4800 \text{ ft. min.}$$

*(Water, streaming out of a nozzle at the end of a pressure pipeline, has the same velocity as if it had fallen from the height of the water level. The velocity rises in proportion to the square root of the height.) Runner rim speed =  $0.5 \times v = 0.5 \times 4800 = 2400 \text{ ft. min.}$*

	Pelton	Turgo
	Runner diameter 16 inches	Runner diameter 8 inches
	Circumference =	Circumference =
	$\frac{3.14 \times 16}{12}$	$\frac{3.14 \times 8}{12}$
	= 4.18 ft.	= 2.09 ft.
rpm	= $\frac{\text{rim speed}}{\text{circumference}}$	
	= $\frac{2400}{4.18}$	= $\frac{2400}{2.09}$
	= 574 rpm	= 1148 rpm

Pelton

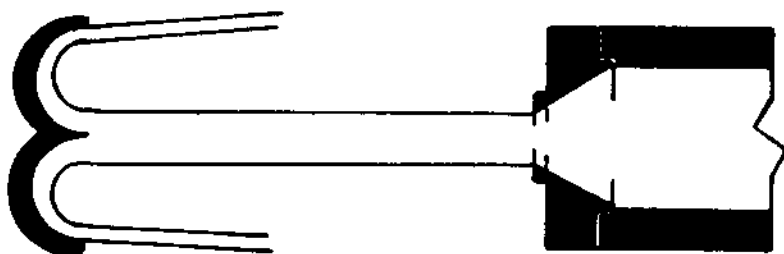

Turgo

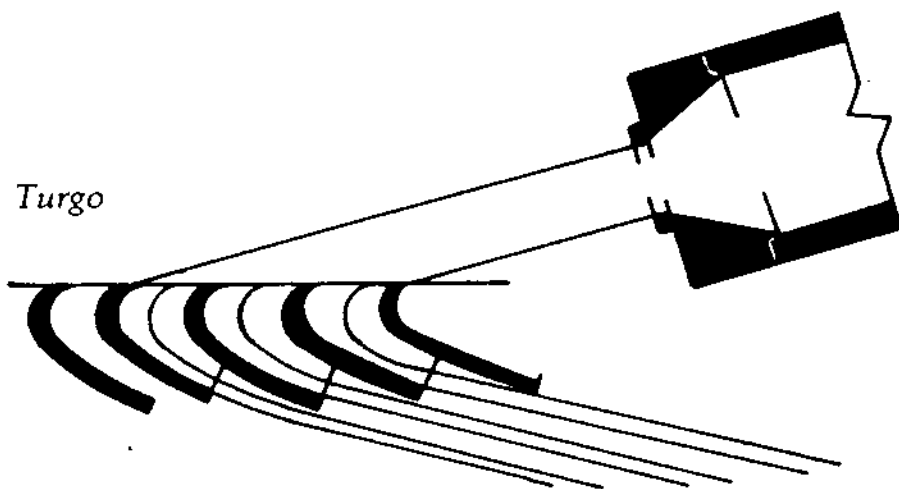

Fig. 12. Turgo and Pelton turbines contrasted. The jet on the Turgo strikes three buckets continuously, whereas on the Pelton it strikes only one. A similar speed increasing effect can be had on the Pelton by adding another jet or two.

# The Hydec Turbine Set

This is a recent and welcome addition to the group of turbines available today. Within its range on medium to high heads it is competitively priced against the Francis and Pelton turbines. Its design and construction is simple, as is the installation and maintenance of the unit. The efficiency of the Hydec is about 80%, which is average for most small turbines. The runner is the Gilkes Turgo Impulse Wheel. The wheel and its casing are both made of cast iron. The shaft is steel and the governor is an oil spring-loaded type which operates a stainless steel jet deflector. The inlet valve is a manually operated butterfly valve. Its output range is from 5 kW under heads as low as 40 ft. up to 150 kW under a head of 350 ft.

## Cost

Mean Diameter of Runner	Single Jet	Twin Jet
7.5 in.	\$7,840	\$9,300
10.5 in.	\$9,760	\$11,500
13.0 in.	\$11,200	\$13,000
16.5 in.	\$12,500	\$14,700

These prices include the wheel, complete with casing, governor, inlet valve and inlet pipe. Suitable governors and control panels can be supplied at additional cost. But, to quote an example, a 16.5-in. twin jet unit developing 25 kW on a net head of 40 ft. was recently sold, complete with generator and switch panel, for \$19,200.

The Hydec is available from:  
Gilbert Gilkes and Gordon Ltd.,  
Kendal, Westmorland,  
England.

Gilkes was founded in 1856 and they are the oldest manufacturers of water turbines in the world. They have kept a record of every turbine manufactured by them and can tell just what head and flow each was designed to operate under. In fact, they still have the original design for their turbine No. 1, a 4 kW Thomson Vortex, built in 1856, and which operated for over a century. May the same be said a hundred years hence of their new Hydec range.

They also manufacture a complete range of Francis and Pelton turbines to order. Unfortunately they tend to be very expensive per installed kilowatt as compared to the Hydec. They are also developing an electronic load governor.

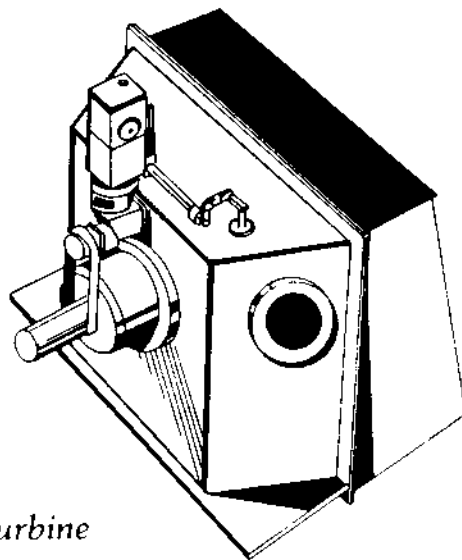

*Fig. 13. The Hydec turbine*

## WATER TURBINES

Water turbines are used for producing either direct current (D.C.) or alternating current (A.C.) electricity. Turbines can be classified into two types; (1) impulse, and (2) reaction. Impulse turbines include the Michell (Banki) and Pelton types. They are vertical wheels that utilize the kinetic energy (or momentum) of a jet of water which strikes the buckets or blades. The buckets or blades are so shaped that they turn the flow of water through as near 180° as possible and move at a speed which results in the spent water falling straight to the bottom of the wheel housing, which is mostly full of air. The Michell (or Banki) turbine is simple to construct, while the Pelton wheel is more complicated.

Reaction turbines are horizontal wheels that are moved at high speeds. Unlike the impulse wheels, they are encased in a housing which is completely filled with water, and the continuation of the outlet below the machine results in the formation of a slight vacuum, which both increases the total head and reduces turbulence. These are really too "high-tech" to consider "home-building" and should be purchased from a manufacturer.

### Michell Turbine (Banki Turbine)

There is some confusion in this country about the origin of this style water turbine. In the early part of this century an English engineer, A.G.M. Michell, wrote a discussion of the "cross-flow" turbine. Later European references usually mention Michell as the source. It was, however, a paper by Donat Banki, "Neue Wasserturbine," that introduced the concept to America. A study published in 1949 by the Oregon State College (now the University) included a "free translation" of Banki's paper, along with their test results (see page 68). Subsequent references to this type turbine usually have called it a Banki Turbine, although the European manufacturers list their products as the "Michell cross-flow turbine."

The Michell turbine is probably the best choice for most small hydro-power installations. It is fairly simple to construct, requiring some welding, simple machining and a few amenities in the workshop. The steel parts can be cut from stock sheet and standard steel pipe. The design is essentially the same for a very wide range of flows and head. For installations with variations in flow rates, the rotational speed for top efficiency will remain the same (for a constant head) over a range of flows from 1/4 of the flow to full design flow. A 12" diameter wheel with a head of 15 feet will operate at about 280 rpm. One speed change of approximately 6.5:1 will give the rpm necessary to generate A.C. power. A flow of 0.9 cfs would be required for one horsepower output at this head.

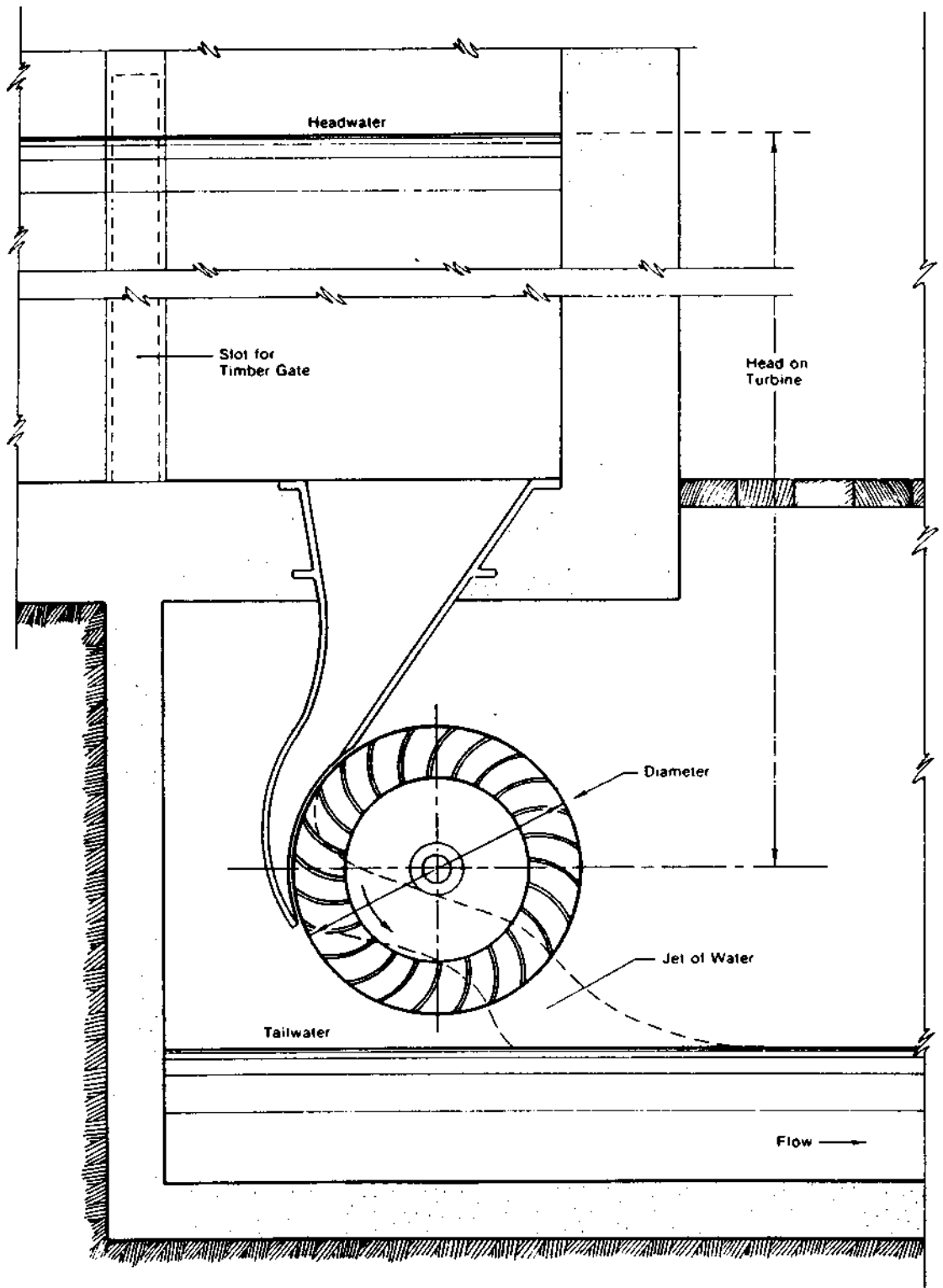

FIGURE 28. Arrangement for a Michell (Banki) turbine for low-head use without control (A).

## MICHELL (BANKI) TURBINE

The Michell (or Banki) turbine is simple in construction and may be the only type of water turbine which can be locally built. The two main parts of the Michell turbine are the runner and the nozzle. Both are welded from plate steel and require some machining. Welding equipment and a small machine shop like those often used to repair farm machinery and automotive parts are all that are necessary.

Figures 28 and 29 show the arrangement of a turbine of this type for low-head use without control. This installation drives a DC generator with a belt drive. Because the construction can be a do-it-yourself project, formulas and design details are given for a runner with a 12-inch outside diameter. This is the smallest size that is easy to fabricate and weld. It has a wide range of applications for all small power developments with head and flow suitable for the Michell turbine.

Different heads result in different rotational speeds. The proper belt-drive ratio gives the correct generator speed. Various amounts of water determine the width of the nozzle ( $B_1$ , Figure 29) and the width of the runner ( $B_2$ , Figure 29). These widths may vary from 2 inches to 14 inches. No other turbine is adaptable to as large a range of flow as this one is.

The water passes through the runner twice in a narrow jet before discharge into the tailrace. The runner consists of two side plates, each  $\frac{1}{4}$  inch thick with hubs for the shaft attached by welding, and 20 to 24 blades. Each blade is 0.237 inches thick and cut from a 4-inch standard pipe. Steel pipe of this type is available virtually everywhere. A pipe of suitable length produces four blades. Each blade is a circular segment with a center angle of  $72^\circ$ .

The runner design, with dimensions for a 1-foot-long runner, is shown in Figure 30; Figure 31 gives the nozzle design and dimensions. The dimensions can be altered proportionally for runners of other sizes. The shape of the nozzle can be made to suit penstock pipe conditions upstream from the nozzle discharge opening of  $1\frac{1}{4}$  inches.

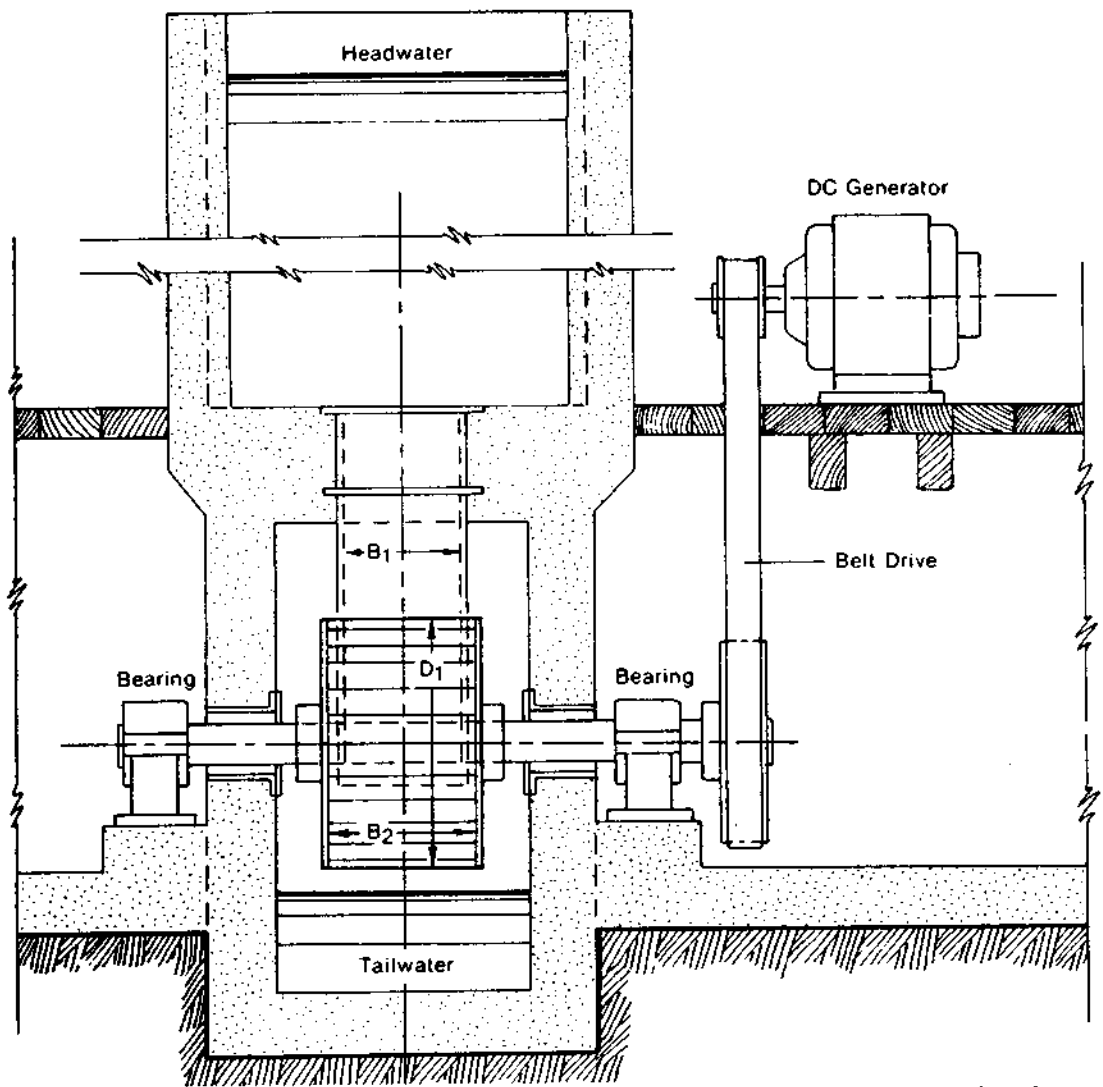

**FIGURE 29.** Arrangement for a Michell (Banki) turbine for low-head use without control (B).

The efficiency of the Michell turbine is 80 percent or greater, and therefore suitable for small power installations. Flow regulation and governor control of the flow can be effected by using a center-body nozzle regulator (a closing mechanism in the shape of a gate in the nozzle). A governor is expensive, but necessary for running an AC generator.

The application of Figures 28 and 29 is a typical example. For high heads the Michell turbine is connected to a penstock with a turbine inlet valve. This requires a different type of arrangement from the one shown here. As mentioned before, the Michell turbine is unique because its  $B_1$  and  $B_2$  widths can be altered to suit power-site traits of flow rate and head. This, its adaptability, simplicity, and low cost, make it the most suitable of all water turbines for small power developments.



To calculate the principal turbine dimensions:

$$(B_1) = \text{width of nozzle (inches)} = \frac{210 \times \text{flow (cubic feet per second)}}{\text{runner outside diameter (inches)} \times \text{head (feet)}}$$

$$(B_2) = \text{width of runner between discs} = (B_1) + 1.0 \text{ inch rotational speed (revolutions per minute)} = \frac{862 \times \text{head (feet)}}{\text{runner outside diameter (inches)}}$$

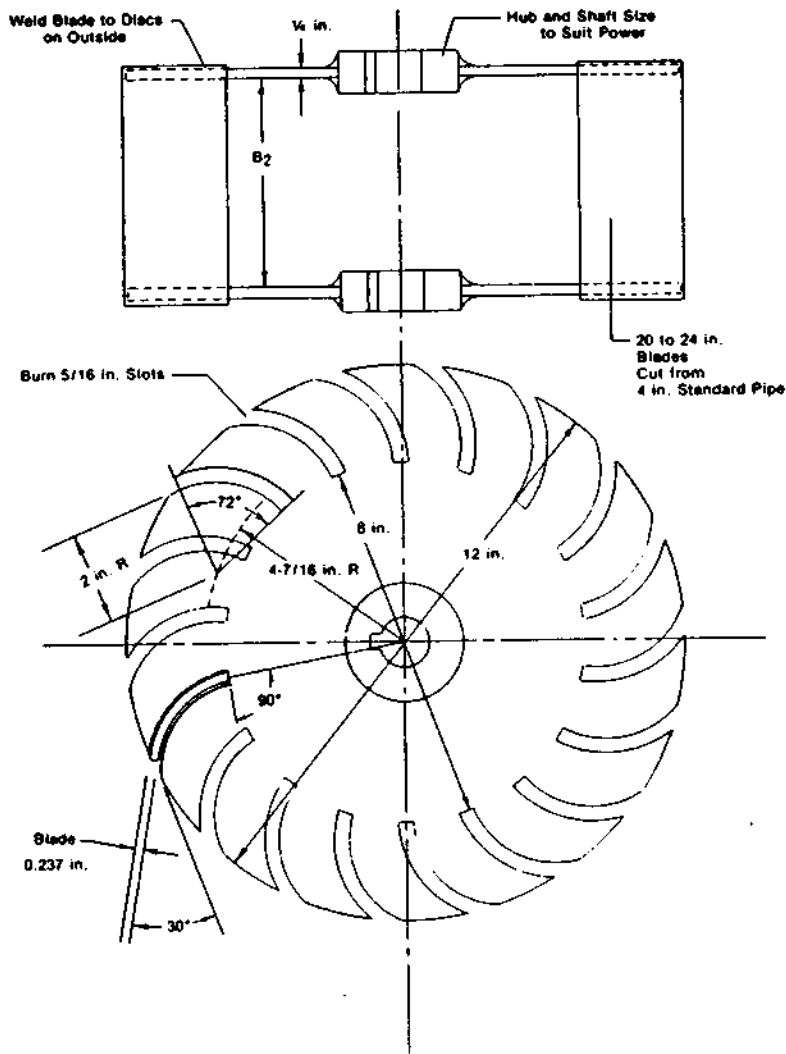

FIGURE 30. Detail of Michell runner, 12-inch size.

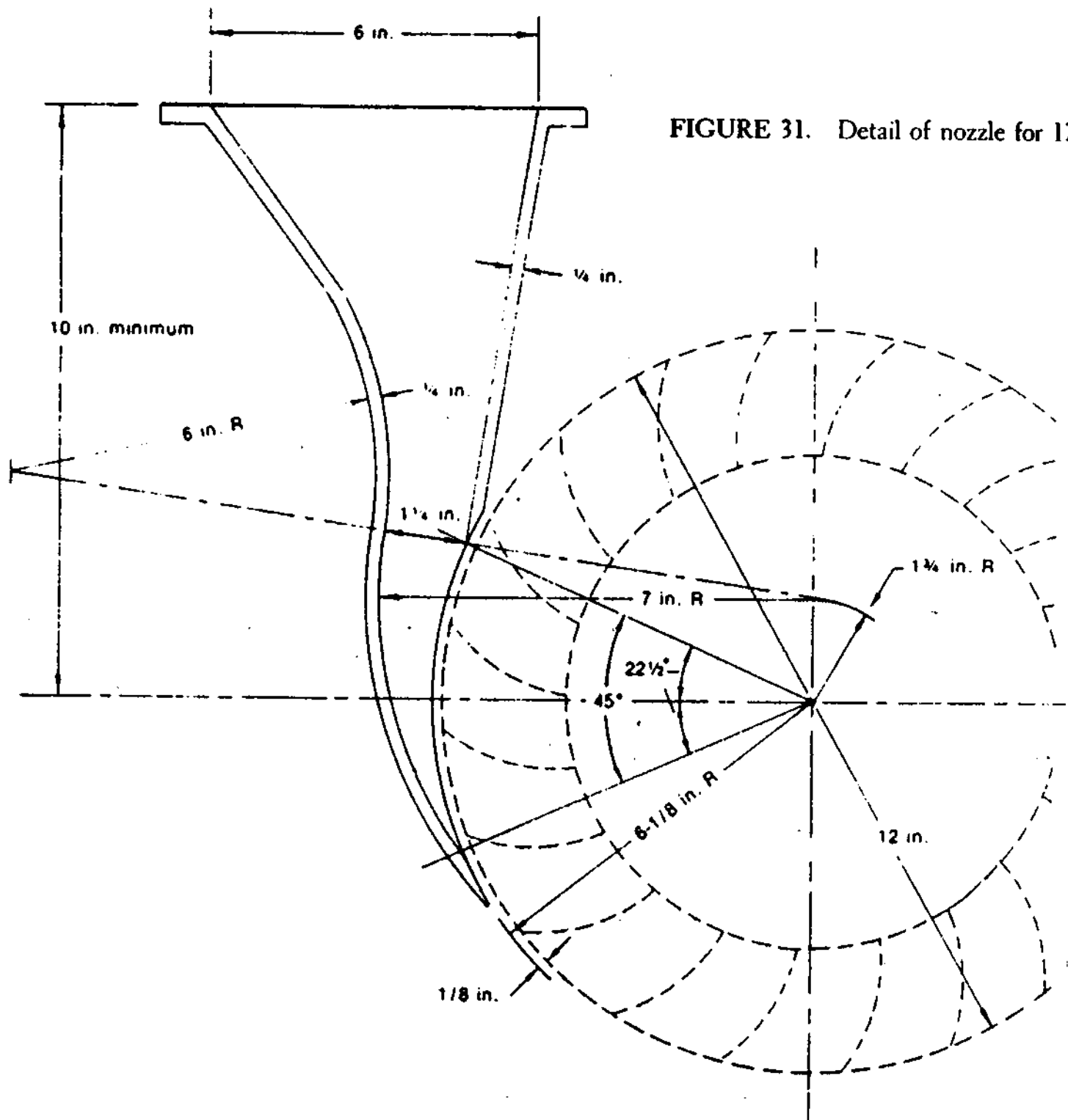

FIGURE 31. Detail of nozzle for 12-inch Michell runner.

The *Michell Construction* section has a brief description of the theory of this unique turbine; further, more technical discussion can be found in the Oregon State study. Basically there are two parts, a nozzle (Fig. 12A) and a turbine runner (Fig. 12B). The drum-shaped runner is built of 2 discs connected at the rim by a series of curved blades. The rectangular nozzle squirts a jet of water at an angle of approximately  $16^\circ$  across the width of the wheel; the water flows across the blades to their inner edge, flies across the empty space within the drum, strikes the blades on the inner side of the rim and exits from the wheel about  $180^\circ$  from the first point of contact. About  $3/4$  of the power is developed in the first pass through the blades, the remaining  $1/4$  in the second pass. With a well designed set-up with smooth nozzle surfaces, as well as thin, smooth blades, the maximum possible efficiency would be 88%; the Oregon State test in 1948 with a "home-built" turbine managed a respectable 68%; the German machines are rated at 84%.

The cost of materials to construct a Michell turbine is really rather insignificant, especially when compared with the other types of manufactured water turbines. The big expenses will be for the electrical generating equipment, the piping, and, should you need it, the cost of having some machine shop put the wheel together. The Michell turbine is undoubtedly the best power source (where the head is appropriate, in the range of 15 feet to about 100 feet) for the limited budget and those with a desire to be able to do-it-themselves. No other wheel or turbine is quite as versatile, easy to build, and still useful for power generation.

For constant speed regulation (something essential for running an A.C. generator), a slide gate valve would have to be added to the nozzle, plus a centrifugal governor to actuate the valve. (This little mechanism could cost as much as all the other materials combined.) For high heads, the entrance works would be connected directly to a pipe.

Design equations for Michell Turbine:

$$\text{(Eq. 16) Width of nozzle} = W_1 = \frac{(210)(Q)}{(D)(\sqrt{H})}$$

$$\text{(Eq. 17) Inside width of turbine} = W_2 = W_1 + 1 \text{ inch}$$

$$\text{(Eq. 18) Length of blades} = W_2 + 3/4 \text{ inch}$$

$$\text{(Eq. 19) Optimum rpm} = \frac{(862)(\sqrt{H})}{(D)}$$

where Q = flow rate in cubic feet per second

D = wheel diameter in inches

H = head at the wheel in feet

$W_1$  = outside width of turbine runner

$W_2$  = inside width of turbine runner

The specific details of assembly of the wheel and nozzle can be best understood from the drawings (Figs. 12A, 12B and 12C).

## A Small Owner-Built Cross-Flow Turbine

The photograph shows a cross-flow turbine being built from the Oregon University paper (see Bibliography). The actual blades of the runner were cut with a band-saw from 4-in.-diameter mild steel pipe, four blades to each length of pipe. The two 12-in. diameter end discs were flame cut from ¼-in. mild sheet steel. The slots in the discs for the blades and the central holes for the 1-in. steel shaft were cut with a milling machine. The blades were brazed into place. The rough edges on the outside of the rim were then ground smooth. The clamps on the shaft, which fit inside the bearings, are to stop the shaft from floating. The manually adjusted water intake will be made from sheet metal or resin and fiberglass.

The speed of the runner is about 300 rpm, which is taken up to 1800 rpm to the generator through a V-belt and pulley with a ratio of 6:1. The turbine operates on a 15 ft. head with a flow of 60 cfm, giving an output of 0.75 kW at an overall efficiency of 59%. Output from the slightly overrated generator is currently on a constant DC water heating load, and so no governor is required.

Some time in the future a battery system will be used to store the daily output of 18 kWh for peak domestic needs, such as cooking, lighting, etc. Meanwhile the owner is hunting around for old and new DC appliances, the idea being to try and avoid the expense of a DC-to-AC inverter. Plans are also afoot to install solar panels for summer water heating and a wood burning boiler for winter space and water heating.

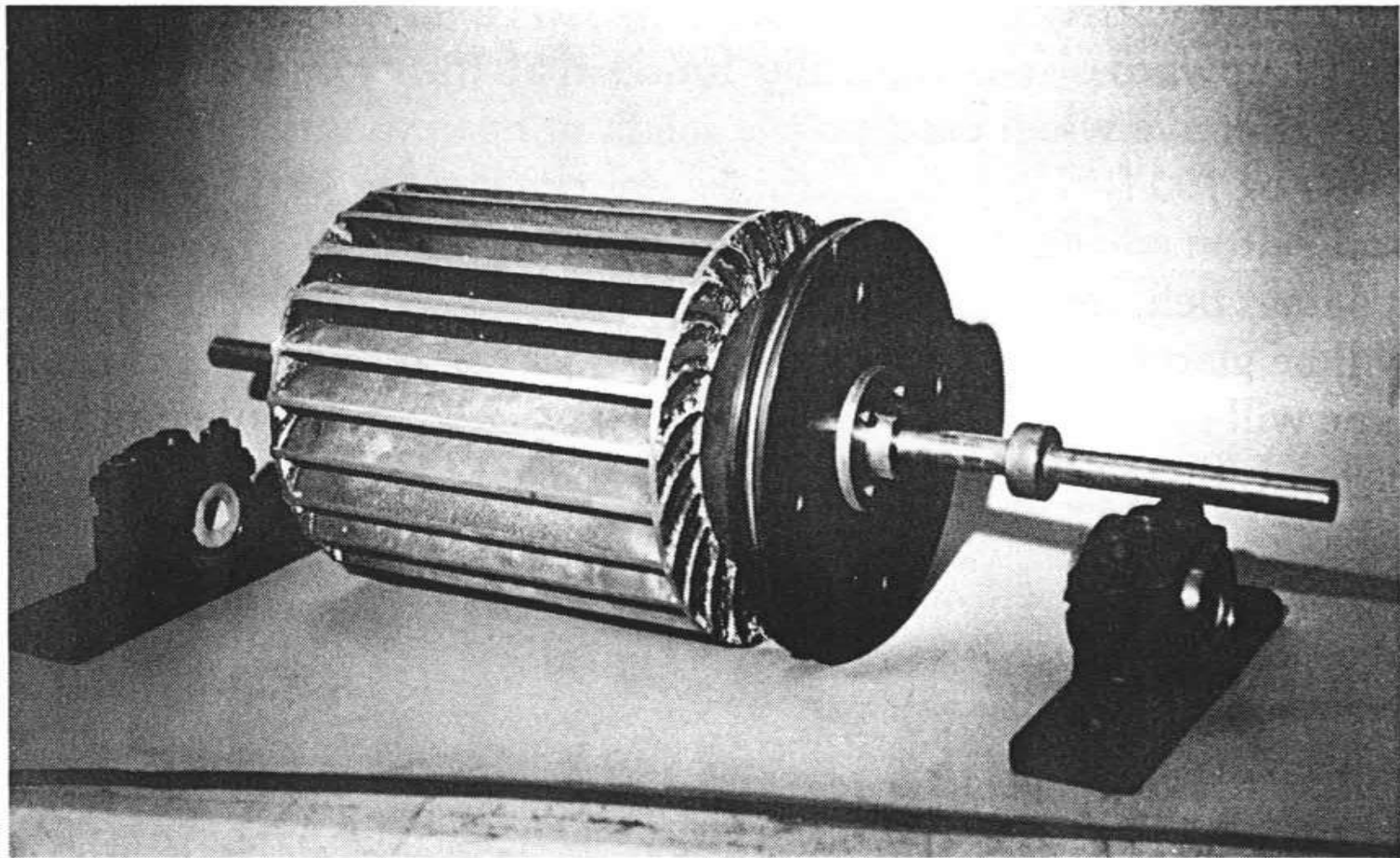

*Photo 14 — Cross-flow runner with shaft, pulley and bearings*

## Michell Construction

The following data is for construction of a 12" diameter wheel. The dimensions for wheel diameter and blade curvature can be changed proportionately for larger wheels though the angles will remain the same.

The end plates are 1 foot diameter discs, cut from 1/4 inch sheet steel, with keyed hubs welded in to fit a suitable sized shaft (this is dependent on power requirements). The blades are cut from standard 4 inch steel water pipe (wall thickness is .237 inch). Each blade is cut for a  $72^\circ$  arc; this can be measured at 1/5 the circumference of the pipe (for a 4" pipe the distance along the arc would be 2.83 inches, or .236 feet). Each length of pipe suitable for blade pieces will make only 4 blades (each piece 1/5 the pipe's circumference); since there is some loss of material with each cut, there would not be enough left over after 4 blades and 5 cuts to allow a 5th blade.

The length of each blade must be 3/4 inch longer than the inside width of the wheel ( $W_2$ ) to allow enough to stick out beyond each side plate for a 1/8 inch welding tab. The slots on the side plates can be cut with a welding torch. This should require about a 5/16 inch wide cut. For a more accurate job, the slots could be milled out with a .25 inch mill-bit, assuming a milling machine is available. Every center-of-radius for the arc of each cut will fall on a circle of 4.47 inch radius as measured from the center of the wheel (again, this is for a 12 inch wheel). If the wheel is to have 24 blades, each blade will be placed every 15 degrees around the wheel (i.e. every  $360/24$  degrees); and so, each center-of-radius will be 15 degrees apart around the 4.47 inch radius circle. Once the centers are located for the arc of each blade slot, the arcs are drawn at 2 inch radii, and the slots can be cut.

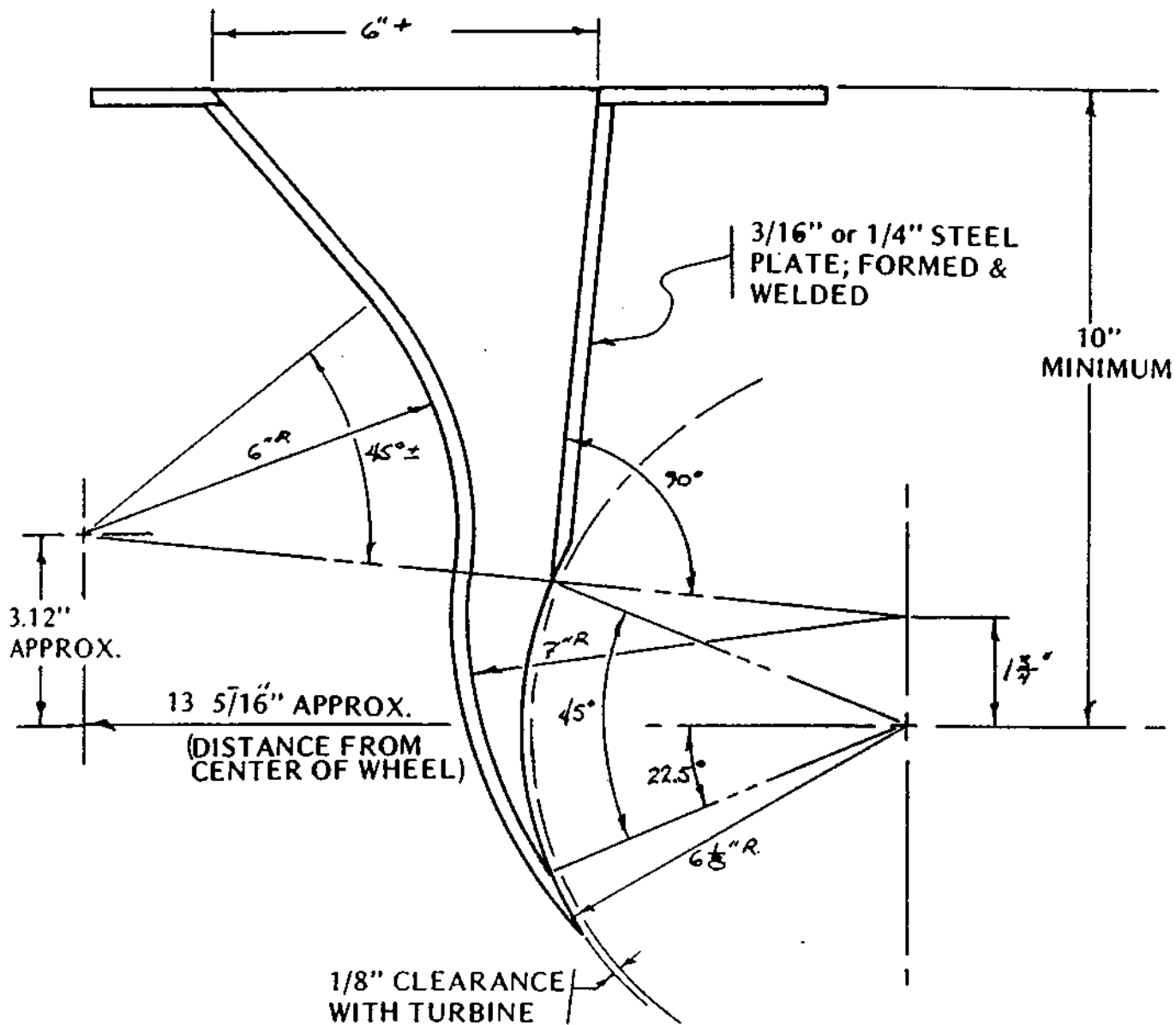

FIG. 12A NOZZLE FOR MICHELL TURBINE (BANKI)

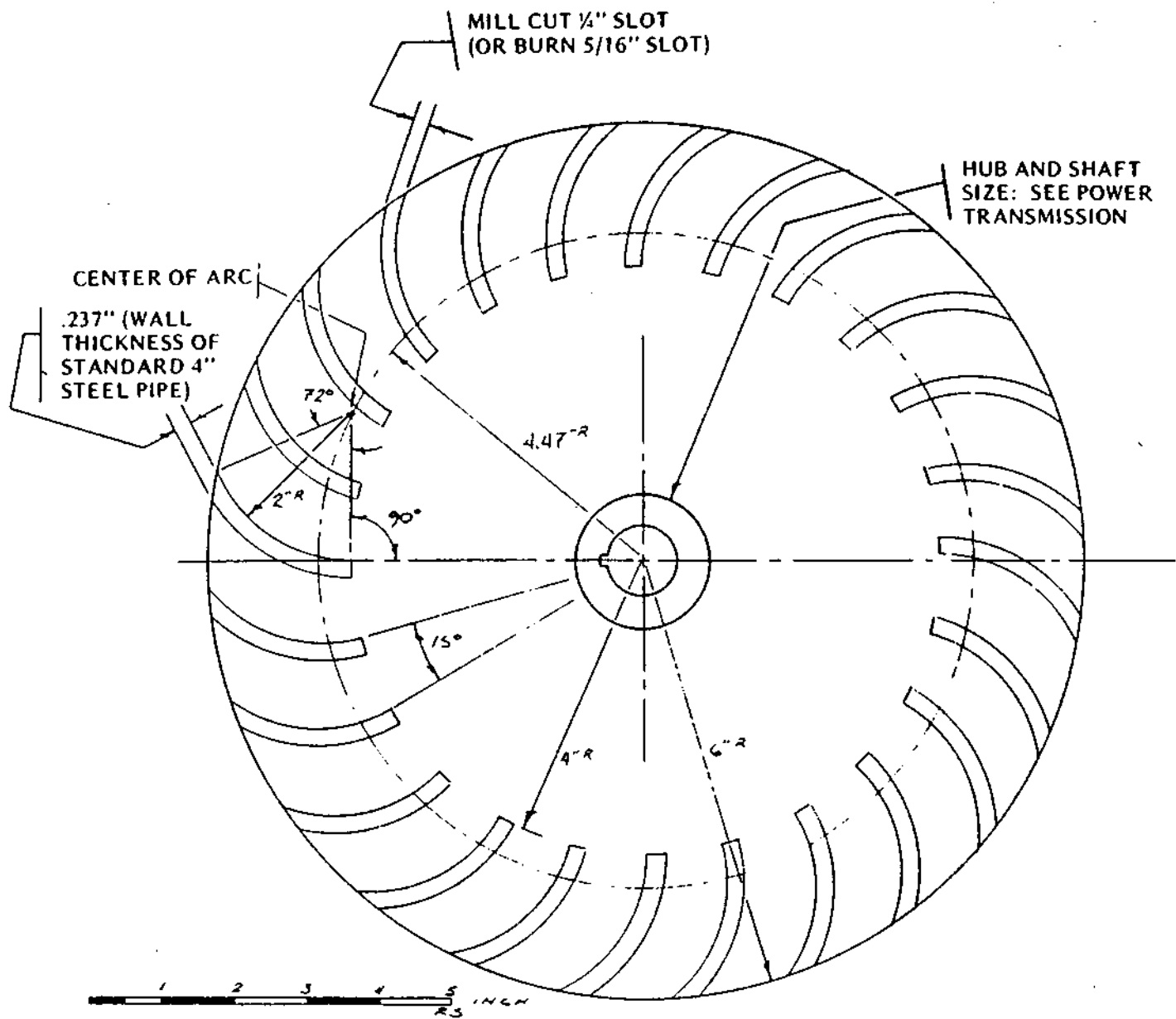

FIG. 12B 12" WHEEL WITH 24 BLADES FOR MICHELL TURBINE



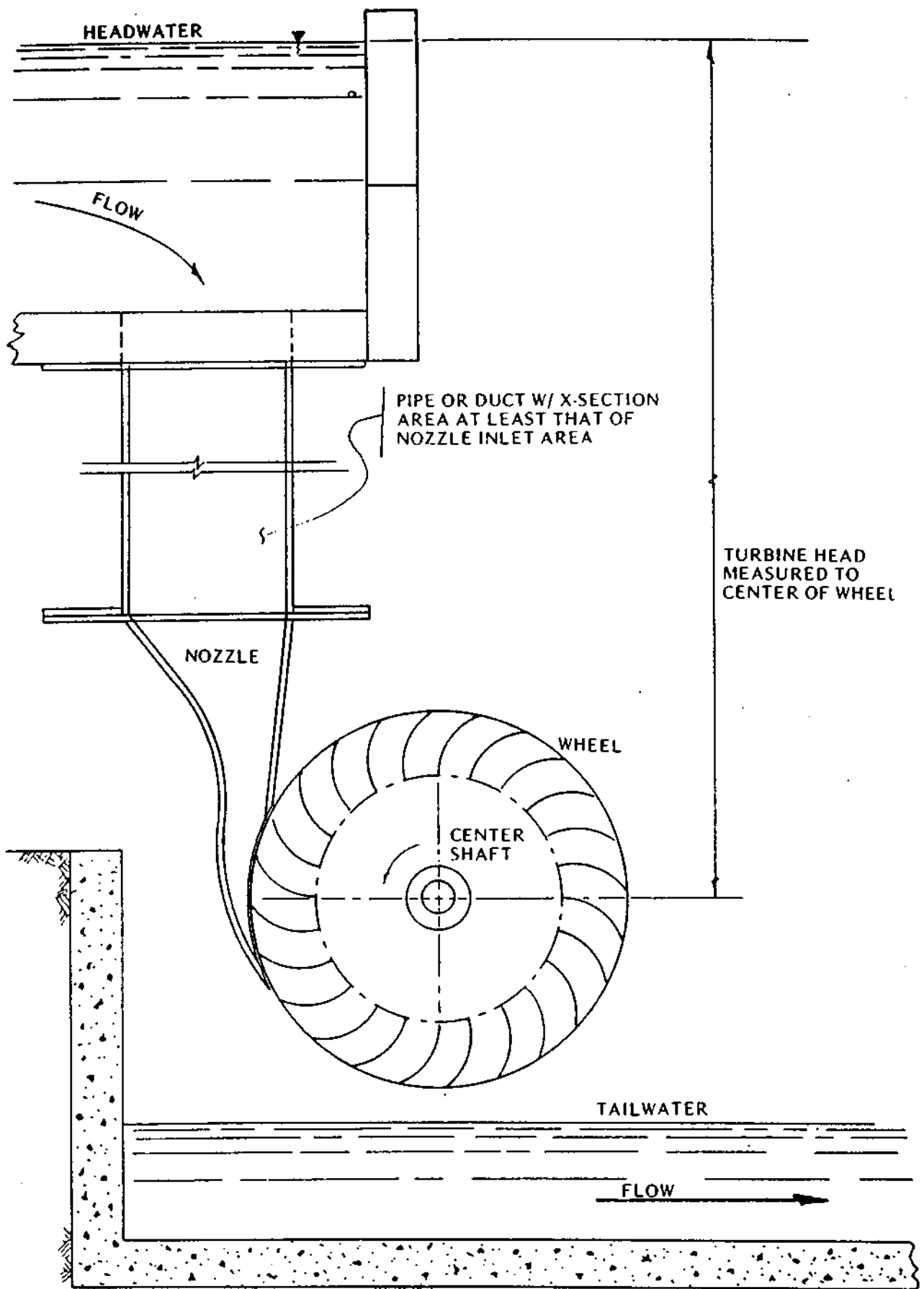

FIG. 12C ASSEMBLY AND INSTALLATION FOR MICHELL TURBINE (BANK I)

## **V. CONSTRUCTION**

### **PREPARE THE END PIECES**

An actual size template for a 30.5cm turbine is provided at the end of this manual. Two of the bucket slots are shaded to show how the buckets are installed.

Figure 4 shows the details of a Michell runner.

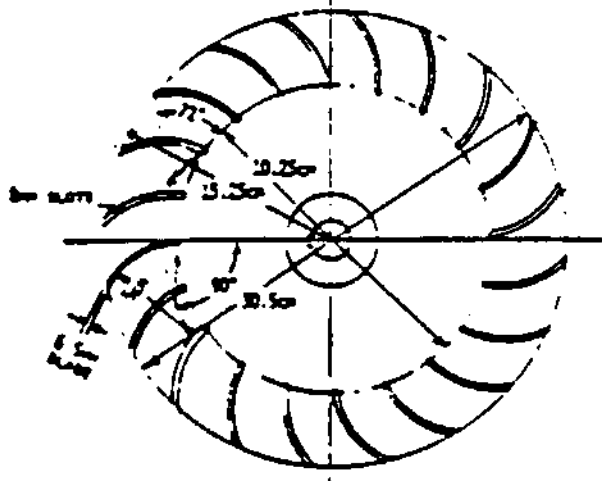
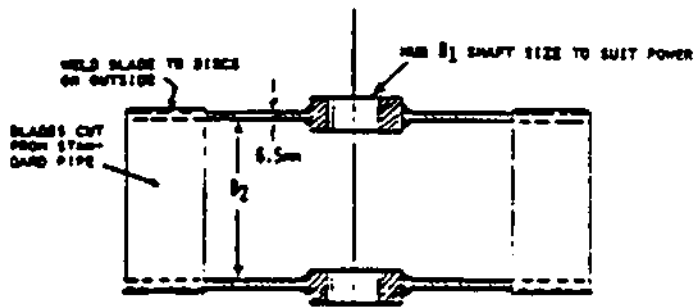

## Materials for 30.5cm diameter Michell turbine:

- . Steel plate 6.5mm X 50cm X 100cm
- . Steel plate 6.5mm thick (quantity of material depends on nozzle width)
- . 10cm ID water pipe for turbine buckets\*
- . Chicken wire (1.5cm X 1.5cm weave) or 25mm dia steel rods
- . 4 hub flanges for attaching end pieces to steel shaft (found on most car axles)
- . 4.5cm dia solid steel rod
- . two 4.5cm dia pillow or bush bearings for high speed use. (It is possible to fabricate wooden bearings. Because of the high speed, such bearings would not last and are not recommended.)
- . eight nuts and bolts, appropriate size for hub flanges

## TOOLS

- . Welding equipment with cutting attachments
- . Metal file
- . Electric or manual grinder
- . Drill and metal bits
- . Compass and Protractor
- . T-square (template included in the back of this manual)
- . Hammer
- . C-clamps
- . Work bench

---

\*Measurements for length of the pipe depend on water site conditions.

- . Cut out the half circle from the template and mount it on cardboard or heavy paper.
- . Trace around the half circle on the steel plate as shown in Figure 5.

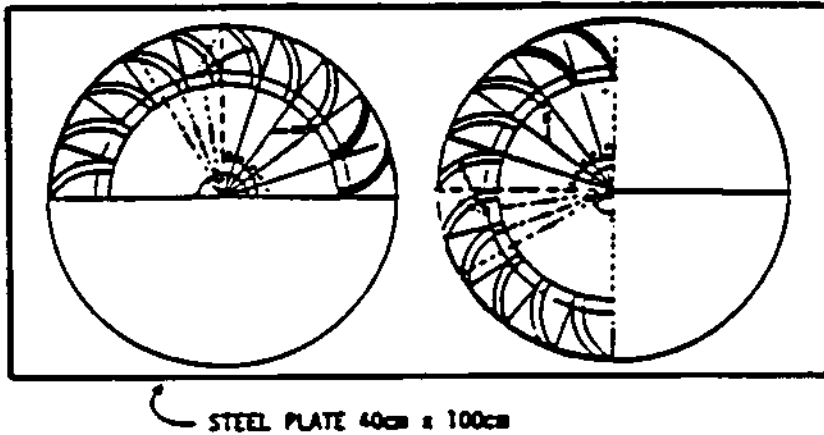

Figure 5. Trace Template on Steel Plate

- . Turn the template over and trace again to complete a full circle (see Figure 6).

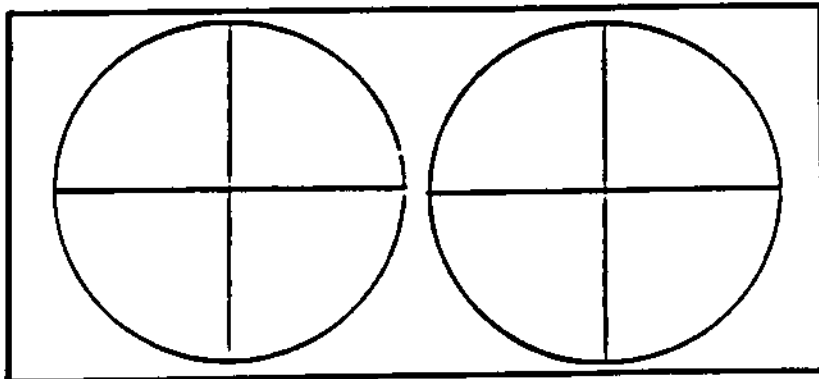
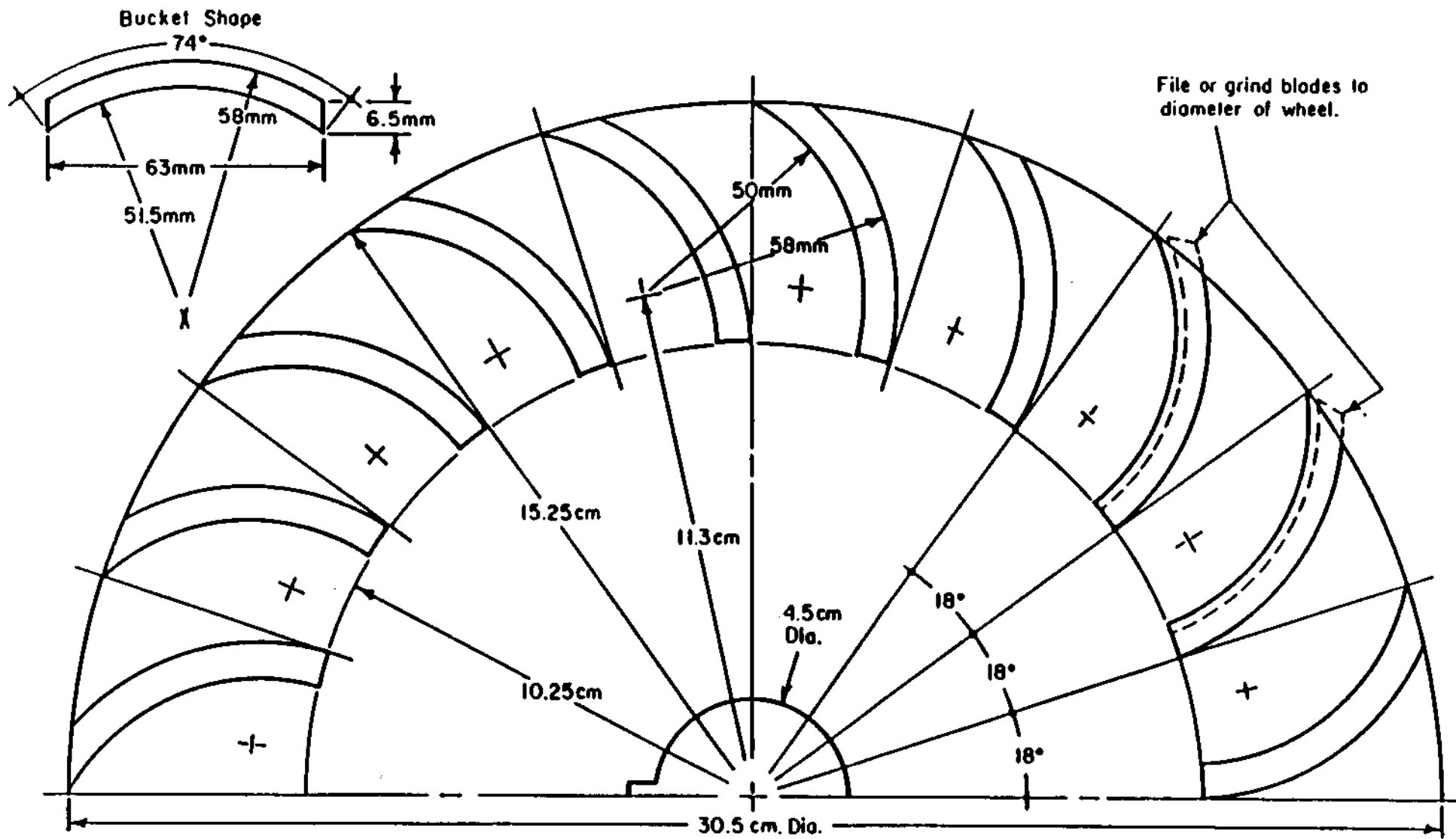

Figure 6. Trace Two Even Circles



- . Draw the bucket slots on the template with a clockwise slant as shown in Figure 7.

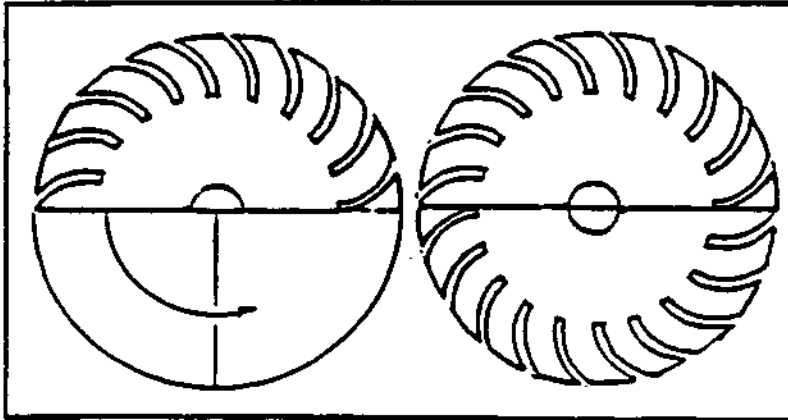

Figure 7. Bucket Slots on Template

- . Cut out the bucket slots on the template so that there are 10 spaces.
- . Place the template on the steel plate and trace in the bucket slots.
- . Repeat the tracing process as before to fill in the area for the shaft (see Figure 8).

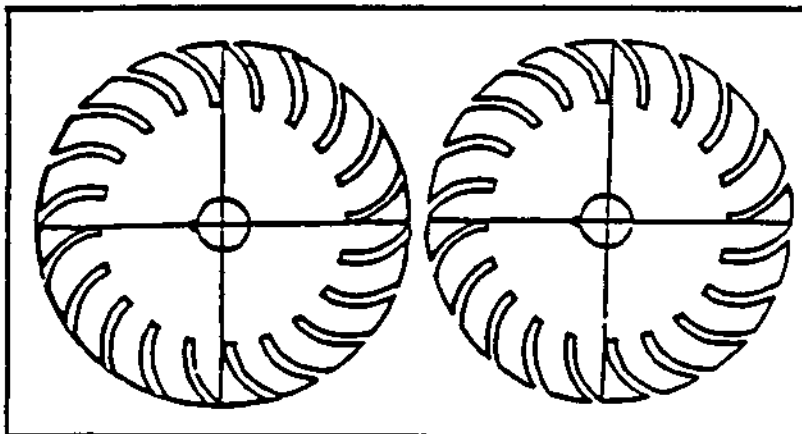

Figure 8. Bucket Slots on Steel Plate

- Drill a 2mm hole in the steel plate in the center of the wheel where the cross is formed. The hole will serve as a guide for cutting the metal plate.

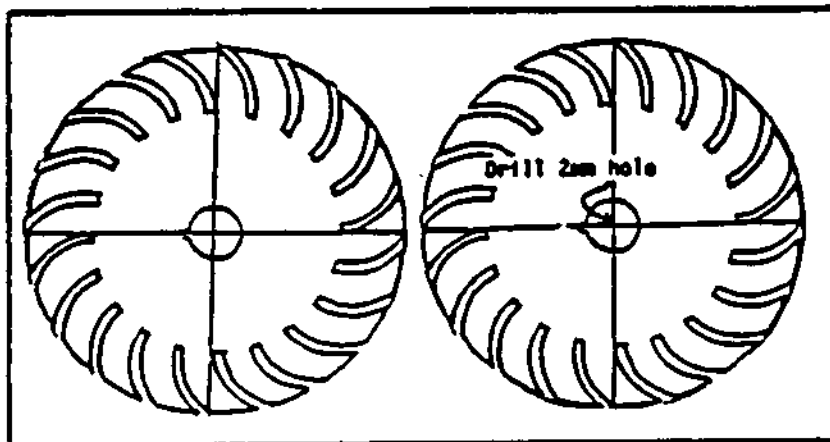

Figure 9. Center Hole

- Take a piece of scrap metal 20cm long X 5cm wide. Drill a hole the width of the opening in the torch near one end of the metal strip.
- Drill a 2mm dia hole at the other end at a point equal to the radius of the wheel (15.25cm). Measure carefully.
- Line up the 2mm hole in the scrap metal with the 2mm hole in the metal plate and attach with a nail as shown in Figure 10.

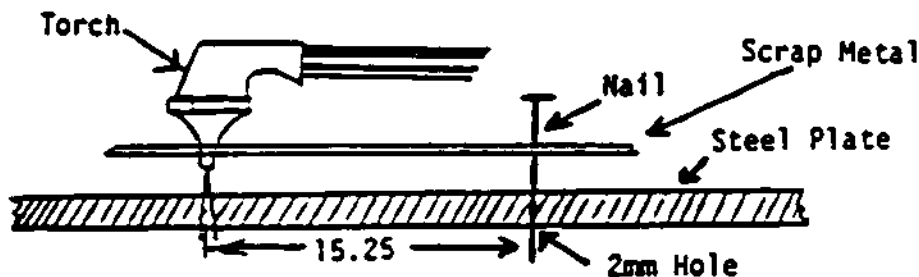

Figure 10. Cutting the End Plates



- . Cut both end plates as shown (in Figure 10) using the torch.
- . Cut the bucket slots with the torch or a metal saw.
- . Cut out a 4.5cm dia circle from the center of both wheels. This prepares them for the axle.

### CONSTRUCT THE BUCKETS

Calculate the length of buckets using the following formula:

$$\text{Width of Buckets Between End Plates} = \frac{210 \times \text{Flow (cu/ft/sec)}}{\text{Outside Diameter of Turbine (in)} \times \sqrt{\text{Head (ft)}}} + (1.5\text{in})$$

- . Once the bucket length has been determined, cut the 10cm dia pipe to the required lengths.
- . When cutting pipe lengthwise with a torch, use a piece of angle iron to serve as a guide, as shown in Figure 11. (Bucket measurements given in the template in the back of this manual will serve as a guide.)
- . Pipe may also be cut using an electric circular saw with a metal cutting blade.

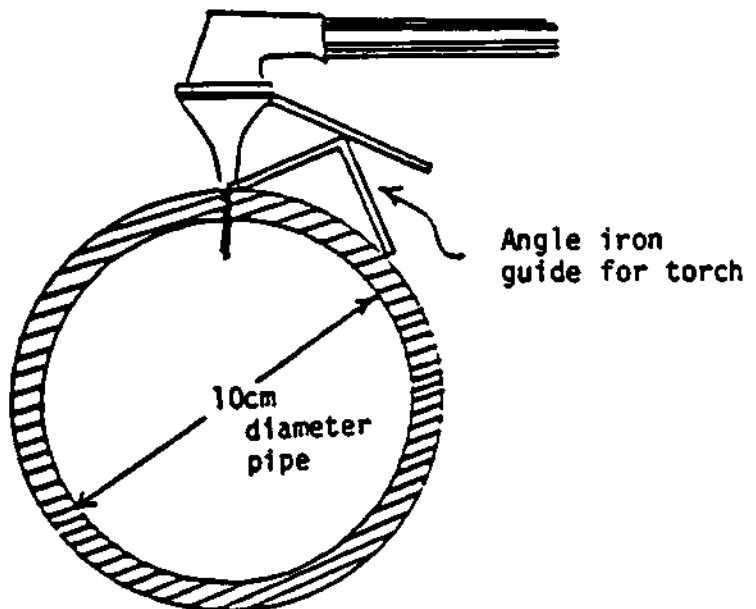

Figure 11. End View

- Cut four buckets from each section of pipe. A fifth piece of pipe will be left over but it will not be the correct width or angle for use as a bucket (see Figure 12).

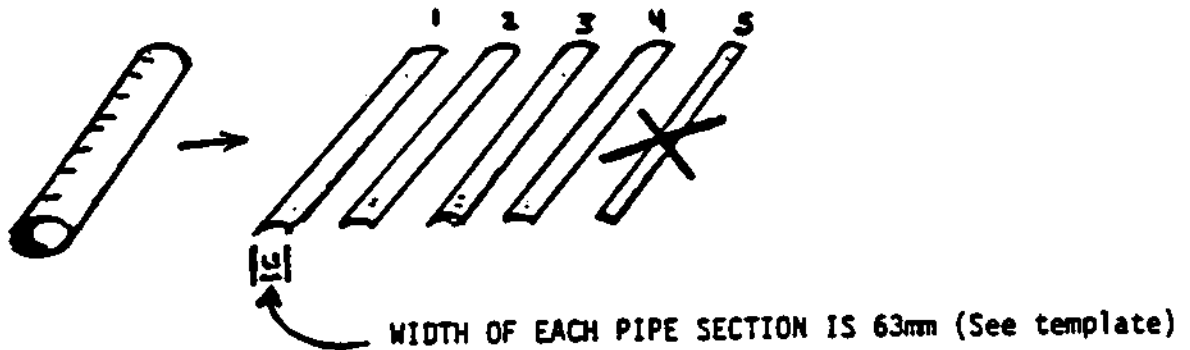

Figure 12. Buckets

- File each of the buckets to measure 63mm wide. (NOTE: Cutting with a torch may warp the buckets. Use a hammer to straighten out any warps.)

### ASSEMBLE THE TURBINE

- Cut a shaft from 4.5cm dia steel rod. The total length of the shaft should be 60cm plus the width of the turbine.
- Place the metal hubs on the center of each end piece, matching the hole of the hub with the hole of the end piece.
- Drill four 20mm holes through the hub and end piece.
- Attach a hub to each end piece using 20mm dia X 3cm long bolts and nuts.
- Slide shaft through the hubs and space the end pieces to fit the buckets.

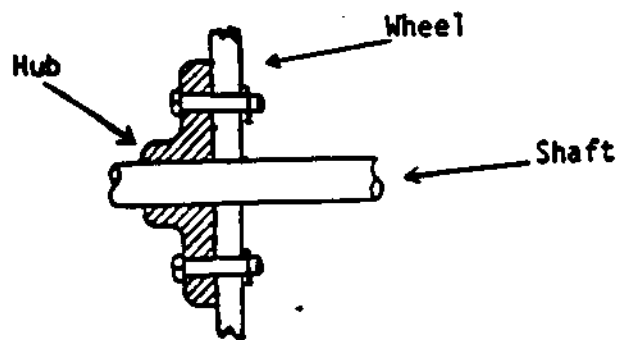

Figure 13. Hub Placement

- . Make certain the distance from each end piece to the end of the shaft is 30cm.
- . Insert a bucket and align the end pieces so that the blade runs perfectly parallel with the center shaft.
- . Spot weld the bucket in place from the outside of the end piece (see Figure 14).

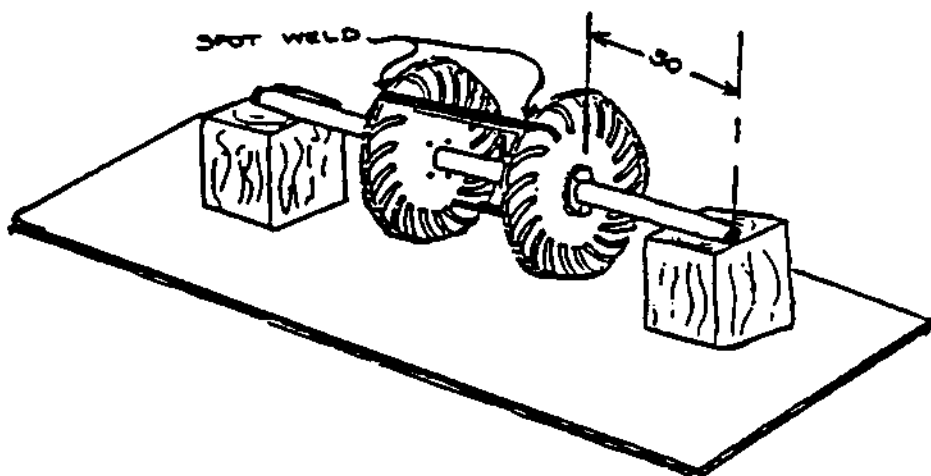

Figure 14. Blade Alignment

- . Turn the turbine on the shaft half a revolution and insert another bucket making sure it is aligned with the center shaft.
- . Spot weld the second bucket to the end pieces. Once these buckets are placed, it is easier to make sure that all the buckets will be aligned parallel to the center shaft.
- . Weld the hubs to the shaft (check measurements).
- . Weld the remaining buckets to the end pieces (see Figure 15).

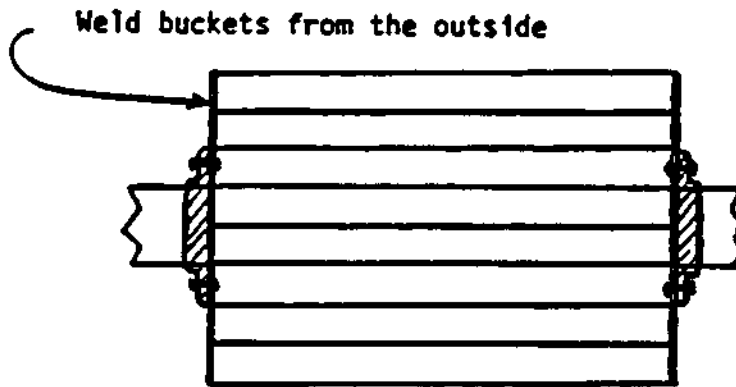

Figure 15. Bucket Placement

- Mount the turbine on its bearings. Clamp each bearing to the workbench so that the whole thing can be slowly rotated as in a lathe. The cutting tool is an electric or small portable hand grinder mounted on a rail and allowed to slide along a second rail, or guide (see Figure 16). The slide rail should be carefully clamped so that it is exactly parallel to the turbine shaft.

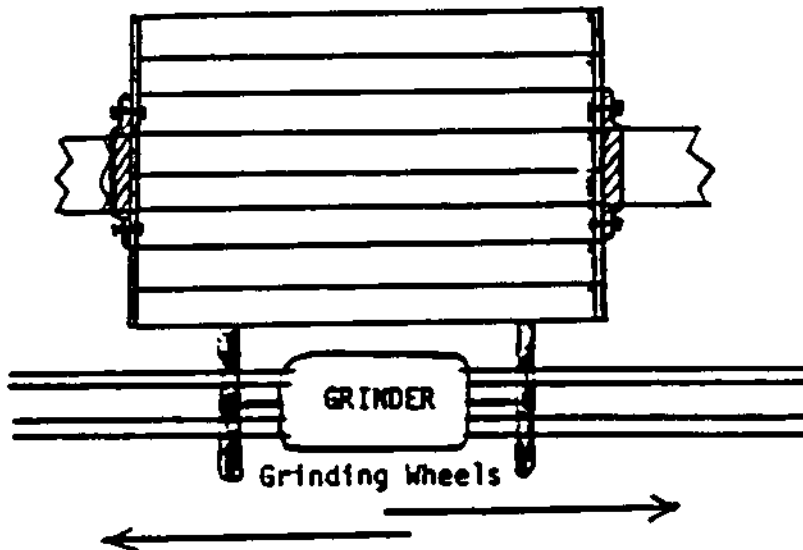

Figure 16. Top View of Turbine

- . Grind away any uneven edges or joints. Rotate the turbine slowly so that the high part of each blade comes into contact with the grinder. Low parts will not quite touch. This process takes several hours and must be done carefully.
- . Make sure the bucket blades are ground so that the edges are flush with the outside of the end pieces.
- . Balance the turbine so it will turn evenly (see Figure 17). It may be necessary to weld a couple of small metal washers on the top of either end of the turbine. The turbine is balanced when it can be rotated in any position without rolling.

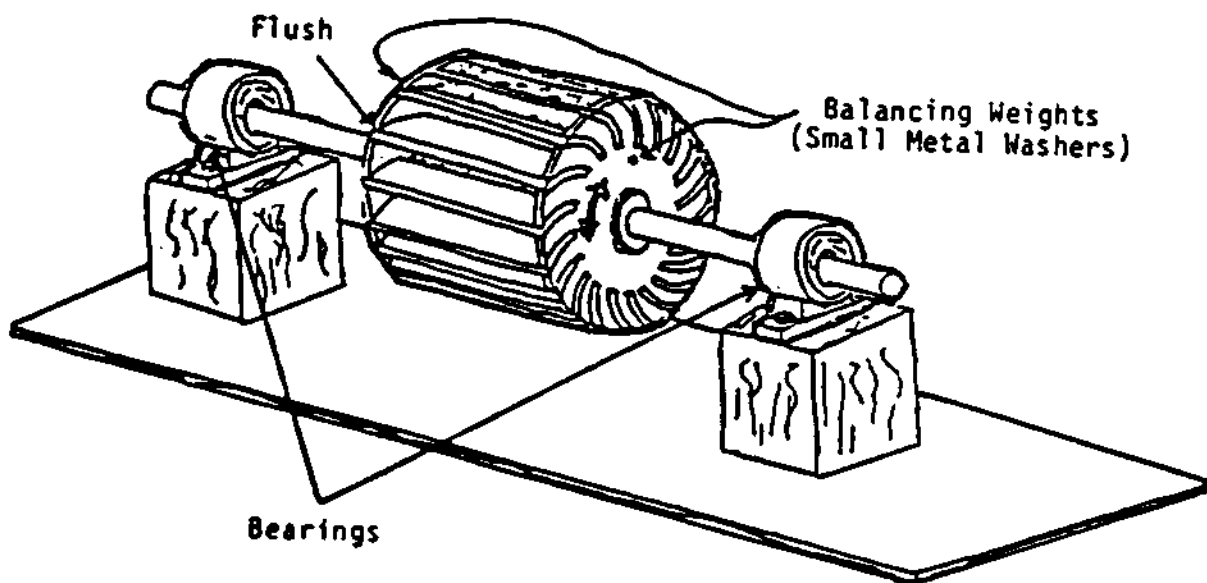

Figure 17. Turbine in Balance

## MAKE THE TURBINE NOZZLE

- Determine nozzle size by using the following formula:

$$\frac{210 \times \text{flow (cubic feet/second)}}{\text{runner outside diameter (in)} \times \sqrt{\text{head (ft)}}$$

The nozzle should be 1.5cm to 3cm less than the inside width of the turbine.

Figure 18 shows a front view of a properly positioned nozzle in relationship to the turbine.

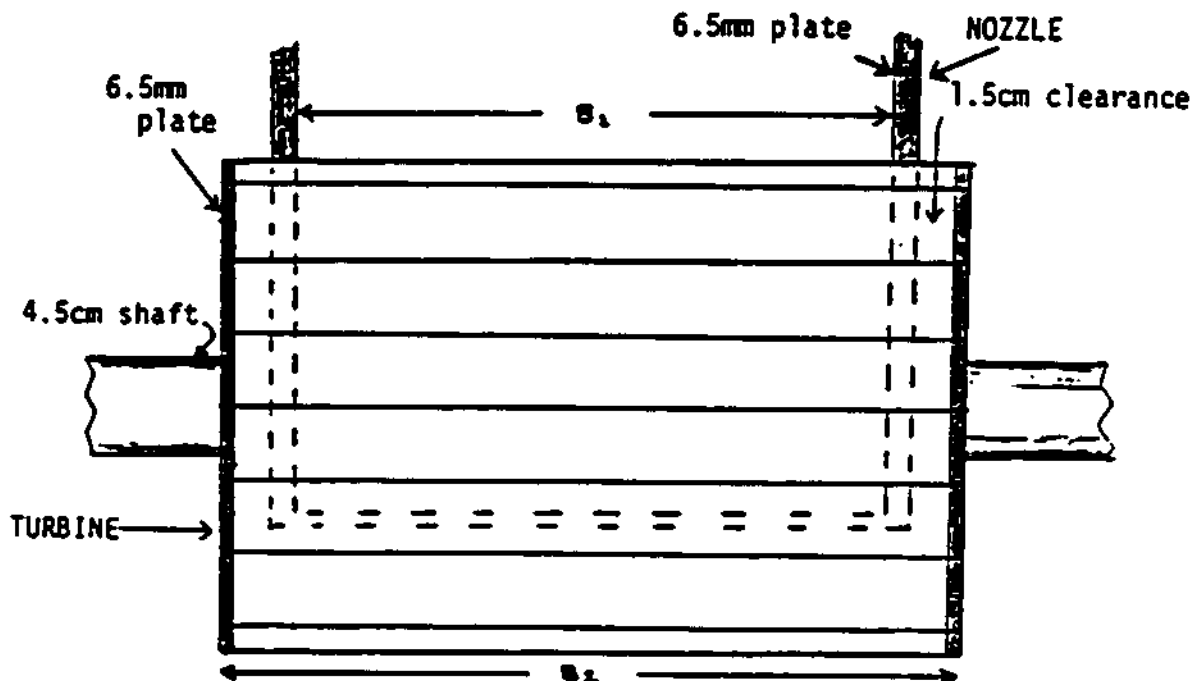

Figure 18. Turbine and Nozzle--Front View

- From a 6.5mm steel plate, cut side sections and flat front and back sections of the nozzle. Width of front and back pieces will be equal to the width of the turbine wheel minus

1.5 to 3cm. Determine other dimensions from the full-scale diagram in Figure 19.

- . Cut curved sections of the nozzle from 15cm (OD) steel pipe if available. Make sure that the pipe is first cut to the correct width of the nozzle as calculated previously. (Bend steel plate to the necessary curvature if 15cm pipe is unavailable. The process will take some time and ingenuity on the part of the builder. One way of bending steel plate is to sledge hammer the plate around a steel cylinder or hardwood log 15cm in diameter. This may be the only way to construct the nozzle if 15cm steel pipe is unavailable.)
- . Weld all sections together. Follow assembly instructions given in "Turbine Housing" on page 29.

The diagram in Figure 19 provides minimum dimensions for proper turbine installation.

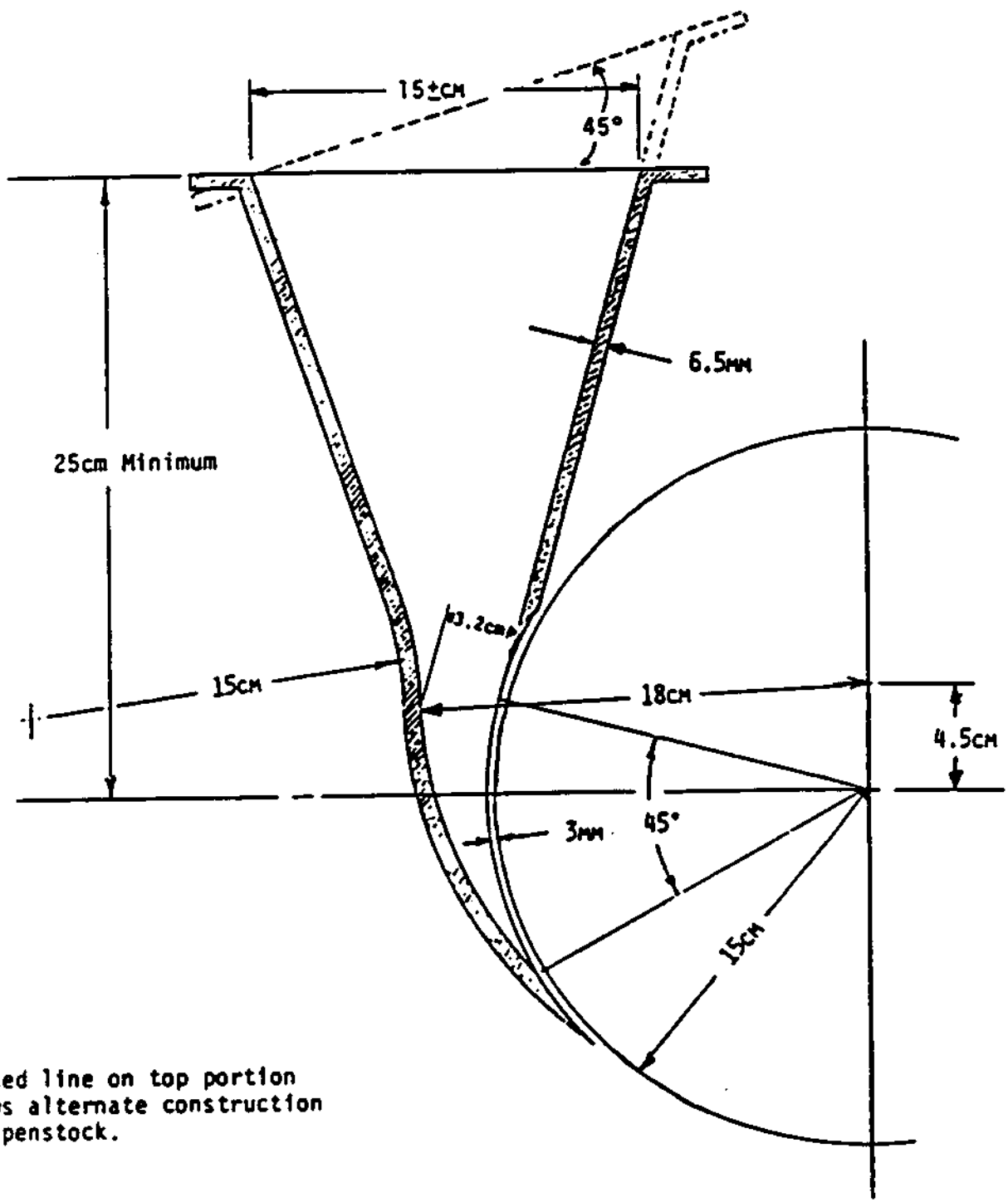

Dotted line on top portion shows alternate construction for penstock.

Figure 19. Details of Michell Nozzle



## TURBINE HOUSING

Build the structure to house the turbine and nozzle of concrete, wood, or steel plate. Figure 20 shows a side view and front view of a typical installation for low head use (1-3m). Be sure housing allows for easy access to the turbine for repair and maintenance.

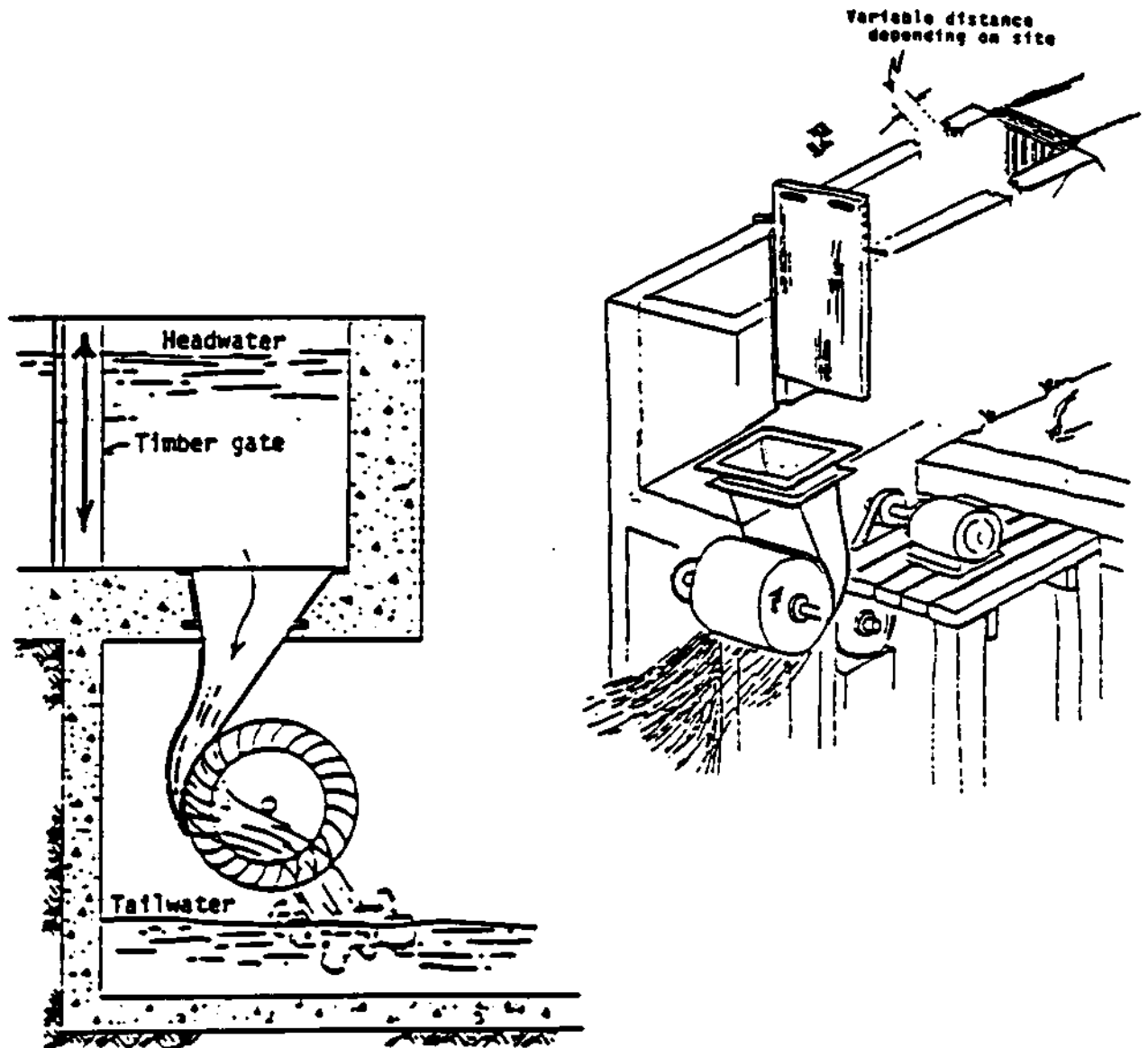

Figure 20. Unobstructed View of The Nozzle and Timber Gate

- . Attach the nozzle to the housing first and then orient the turbine to the nozzle according to the dimensions given in the diagram in Figure 19. This should ensure correct turbine placement. Mark the housing for the placement of the water seals.
- . Make water seals. In 6.5mm steel plate, drill a hole slightly larger than the shaft diameter (about 4.53cm). Make one for each side. Weld or bolt to the inside of the turbine housing. The shaft must pass through the seals without touching them. Some water will still come through the housing but not enough to interfere with efficiency.
- . Make the foundation to which the bearings will be attached of hardwood pilings or concrete.
- . Move the turbine, with bearings attached, to the proper nozzle/turbine placement and attach the bearings to the foundation with bolts. The bearings will be on the outside of the turbine housing (see Figure 21). (Note: The drive pulley is omitted from the Figure for clarity.)

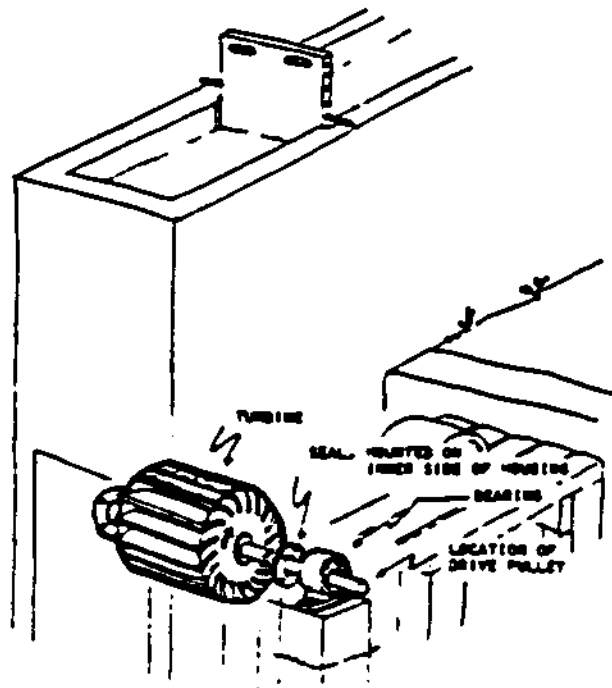

Figure 21. Unobstructed View of The Turbine, Seal and Bearing

The Michell (Banki) turbine is relatively maintenance-free. The only wearable parts are the bearings which may have to be replaced from time to time.

An unbalanced turbine or a turbine that is not mounted exactly will wear the bearings very quickly.

A chicken wire screen (1.5cm X 1.5cm weave) located behind the control gate will help to keep branches and rocks from entering the turbine housing. It may be necessary to clean the screen from time to time. An alternative to chicken wire is the use of thin steel rods spaced so that a rake can be used to remove any leaves or sticks.

# Cross-flow Turbine Design

---

by Ian Scales

---

The cross-flow water turbine is an efficient and robust flow machine that works under a wide range of head and flow conditions. The efficiency curve of a cross-flow is roughly flat from half to full flow, giving around 60 to 70% of the available stream energy to the turbine shaft across a wide range of flow conditions. The main purpose of this article is to provide the standard engineer's algorithm (i.e. recipe) for hydraulic design of such a machine, accessible to all including those with minimal maths and engineering skills. The algorithm is called XFLOW. The effort to use such an algorithm is well worth the effort in terms of greatly increased efficiency over a 'cut and try' approach.

## Introduction

There are definite advantages to the use of a cross-flow turbine over quite a range of head and flow conditions. They will serve heads of 2 to at least 40 m, and flows of 0.02 m<sup>3</sup>/s (20 litres/second) to thousands of litres per second. One needs to be conscious that at high head/low flow extremes, a Pelton wheel may be more appropriate, and at very low head/large flow extremes an axial flow reaction turbine suits better (one ought to determine this on the basis of specific speed -using XFLOW will give you a clue). However, cross-flow turbines suit a very wide range of conditions, are relatively insensitive to flow variations, are among the cheapest and simplest of turbines to construct, need little in the way of site works - and are self cleaning! Debris entering the turbine blades tends to be washed out one-half revolution later, when, from the point of view of the blades, the flow is reversed.

The name, cross-flow turbine, gives some clue as to its nature. In general terms it is an impulse type turbine; water is fed

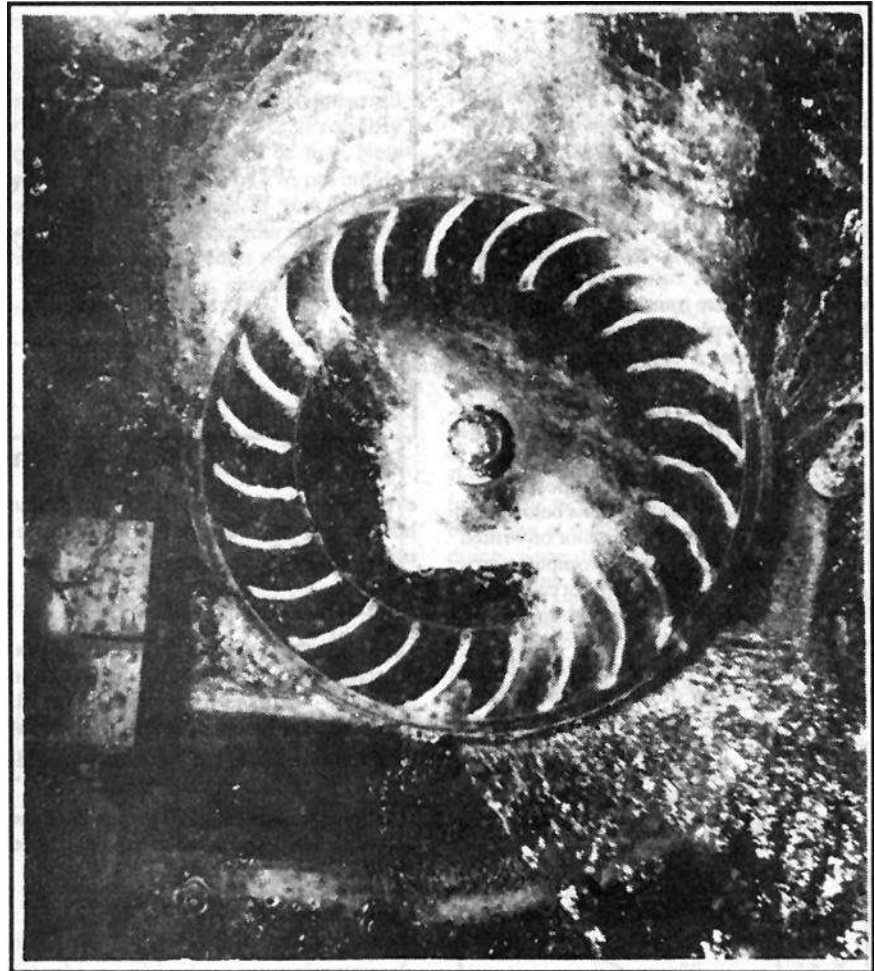

The APACE see-through experimental cross-flow turbine. The typical flow pattern at rated speed is exhibited.

under pressure through a nozzle (where pressure energy converts to kinetic energy) into the turbine mechanism, which is open to the air. The jet of water issuing from the nozzle hits the blades and so does work in spinning the turbine around. Ideally, all energy contained in the water is converted to mechanical energy at the turbine shaft, and the water drops from the turbine quite spent.

The peculiarity of the cross-flow turbine is that the jet passes through the blades once, passes across the diameter of the water wheel (rotor) and then hits the blades again just prior to exit. Hence 'cross-flow'. The first stage develops about 70-80% of the power, and the second stage the remaining 20-30%. You will see this turbine variously referred to as a Michell turbine (after the Australian engineer who patented it in 1903), a Banki turbine (after the Hun-

garian who developed it between 1912 and 1919), or a Michell-Banki turbine. Essentially the same machine is used in reverse as a cross-flow fan, most commonly found in domestic electric blow heaters. Pull one of these apart, and train a hose on the fan. It definitely works as a turbine - it can sound like a tiny jet engine; but you will notice water sprays everywhere. We can do a little better with a few calculations.

## Design Algorithm

The purpose of publishing this algorithm is to fill a gap in the literature as to design of cross-flow turbines. Existing treatments of the subject have not provided a full algorithm. The XFLOW algorithm has been patched together from a number of sources. It first existed as a computer program, receiving various refinements along the way. It has been transcribed almost verbatim from the program listing; and as you may appreciate, a computer will not run anything that is not complete to the last detail. And so XFLOW is a useful algorithm for people who primarily possess mechanical fabrication skills with little maths background - despite the listing's appearance!

The calculations and diagrams below may be worked with a hand calculator or written as a computer program. A computer program is useful if you want a robot calculator. By transferring the equations into a computer code, it is possible to perform experiments quickly and so more easily understand the effects of different parameters on turbine geometry. Calculator or computer, the equations below are presented in sequential order, interspersed with essential commentary. All one needs to do is work through them one after the other. Double or

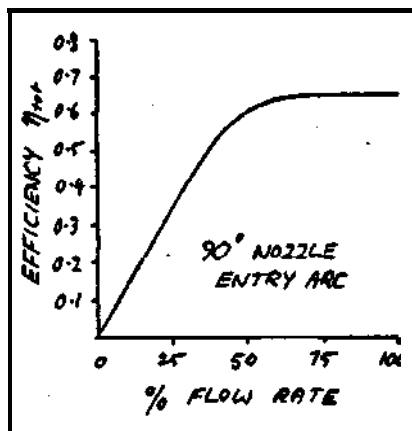

1. Efficiency curve of cross-flow turbine

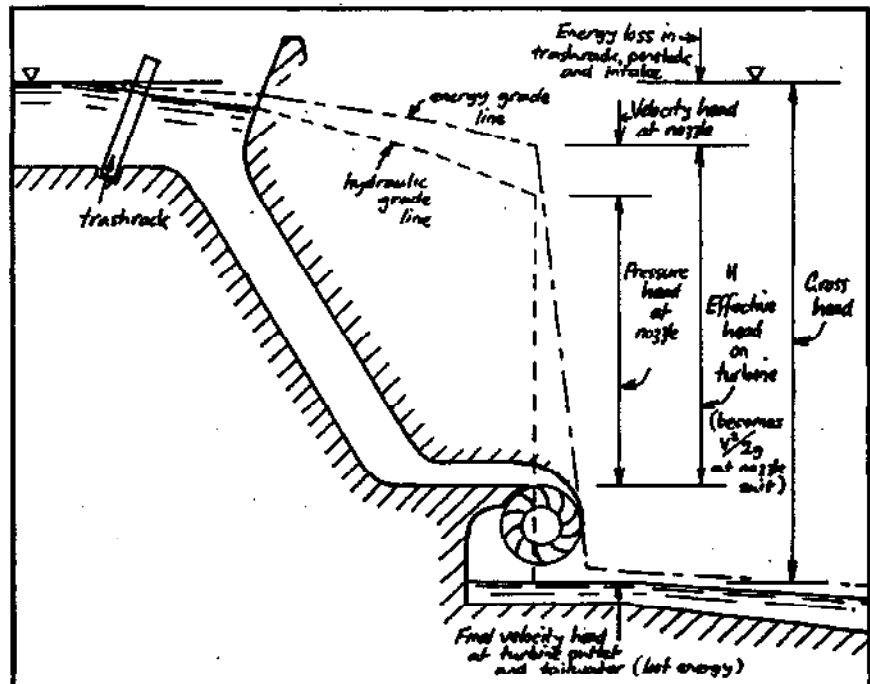

## 2. Determination of net head at turbine

even triple-check your calculations (some hours apart) - it is very easy to make unconscious mistakes.

### Listing

All lengths are measured in metres, velocities in metres/second, and angles in degrees unless otherwise stated. Trigonometric functions arctan, etc. are inverse functions, i.e.  $\tan^{-1}$  etc. on your calculator. The dots in equations mean times. Fractional powers, e.g.  $H^{0.75}$  means  $H$  to the power of 0.75. and as such can be entered into a scientific calculator.

### Constants

$$\pi = 3.14159$$

$$g = 9.81 \text{ ms}^{-2}; \text{ acceleration due to gravity}$$

$$\gamma = 1000 \text{ kg m}^{-3}; \text{ specific gravity of water}$$

### Input

Enter net head at turbine,  $H$

$$H = ?$$

This is the net head available at the site minus head loss in the distance between turbine runner (measured from its lowest point) and tailwater level, and hydraulic losses in penstock, penstock intake, and headrace, if there is one, etc.

Enter flow,  $Q$  ( $\text{m}^3/\text{s}$ )

$$Q = ?$$

This is the rated flow, which will be the design point for the turbine - you will need to choose some sort of average over the year with the aim of optimising annual energy extraction.

Enter estimated net efficiency of turbine,

$$\eta_{tot}$$

$$\eta_{tot} = ?$$

$\eta_{tot}$  is the turbine efficiency expressed as a decimal coefficient (i.e. 65% becomes 0.65).  $\eta_{tot}$  includes hydraulic losses in the nozzle and blades, and mechanical losses in shaft bearings. You will simply have to guess this, because there is no way in the world of accurately predicting  $\eta_{tot}$ . A figure of 0.65 would be safe to assume if the fabrication work is of good quality, 0.70 if you think you are able to do a really good job (e.g. accurately curved blades, balanced rotor, hydraulically smooth surfaces, etc.). 0.60 or less is a safe figure if your work will be a bit ...ah. rustic. Once you've built your treasure, you can get to know how well you guessed, but the above figures are common experience. None of the university

laboratory results (see bibliography) give higher than 70% peak efficiency.

### Parametric equations

Here we set the major variables determining the size and speed of the turbine.

Estimated Power output, P (kW)

$$P = \frac{\eta_{\text{est}} \cdot g \cdot \gamma \cdot Q \cdot H}{1000}$$

Choose type of speed input;

1. Rotational speed, N (rpm)
2. Specific speed, Ns

To begin, design the turbine to rotate at a speed in simple ratio with the generator speed; e.g. if you are using a 1500 rpm synchronous alternator, then choose a 1:3

ratio to make buying pulleys easier, and so try out the equation for specific speed for the turbine at 500 rpm to see if the corresponding specific speed is O.K. Specific speed is a standard measure of speed of all sorts of turbines under common conditions - it is useful for selection of the right sort of turbine for a particular site, and for setting guidelines for design of a particular type of turbine irrespective of its size and power rating. In the case of a cross-flow, specific speed should be between (depending on who you believe) 20 and 80 (Khosrowpanah et. al. 1984), or 40-200 (Hothersall 1985) to work at its best. Probably anywhere in this range will be fine. Note these values are in terms of kW, not metric horsepower or PPS units. If you find the specific speed suitable for your site is below this range, choose a Pelton wheel, while if it is above this range, choose a reaction turbine.

Specific speed, Ns

$$N_s = N \cdot \frac{\sqrt{P}}{H^{5/4}}$$

Rotational speed, N (rpm)

$$N = N_s \cdot \frac{H^{5/4}}{\sqrt{P}}$$

Peripheral velocity of Row at turbine exit,  $V_{u4}$ , is zero, indicating the perfect condition where the turbine absorbs maximum energy.

$$V_{u4} = 0$$

Work coefficient of turbine,  $\Psi$

$$\Psi = \frac{\Delta VU}{U} = \frac{V_{U1}}{U_1} = 2.0$$

This condition is commonly assumed for impulse turbines as this implies the degree of reaction is zero. In actual fact, a cross-flow turbine where the nozzle is in close proximity to the turbine rotor will not be operating at the inlet stage under this condition, since the fluid enters the turbine at some value above atmospheric pressure. (cf. Eck, 1973:161-63, Inversin 1986:179, Durali 1976:21)

Hydraulic efficiency of nozzle,  $\eta_h$

$$\eta_h = 0.95$$

Flow geometry of inlet stage

Inlet absolute flow angle,  $\alpha_1$   
(conventionally set at 15° or 16°)

$$\alpha_1 = 15^\circ$$

Velocity of flow from nozzle,  $V_1$

$$V_1 = \eta_{h_n} \cdot \sqrt{2 \cdot g \cdot H}$$

Tangential component of absolute inlet velocity,  $V_u$

$$V_u = V_1 \cdot \cos \alpha_1$$

Radial component of absolute inlet velocity,  $V_R$

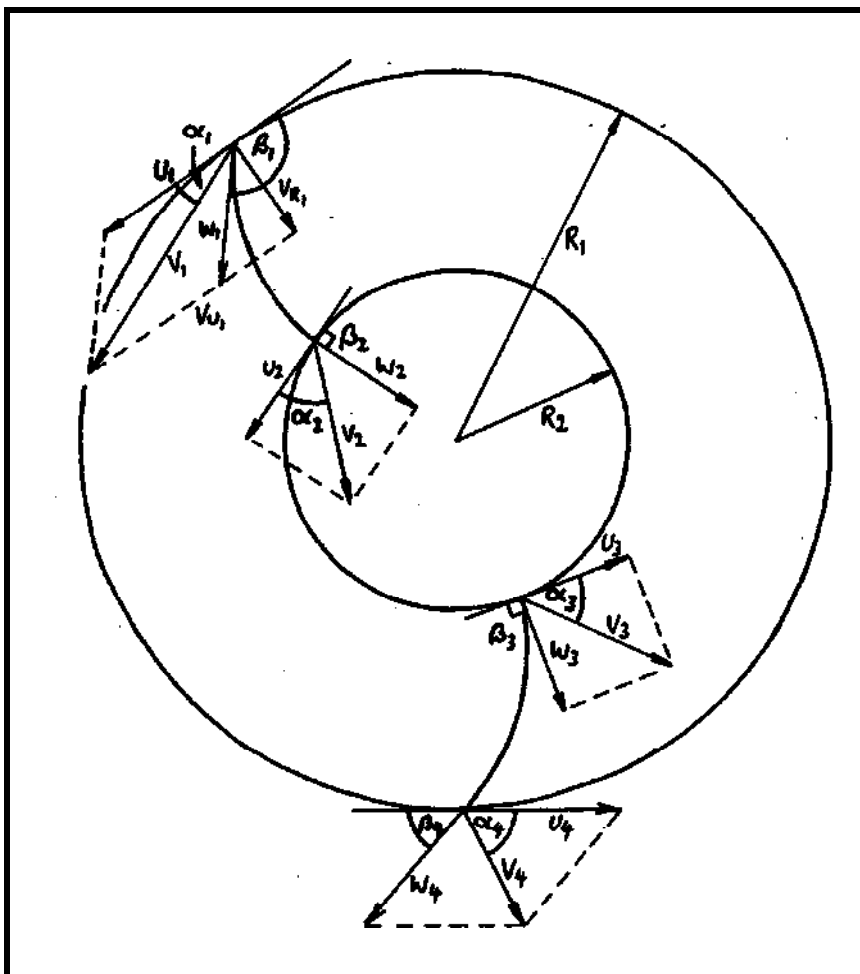

3. Flow geometry of rotor

$$V_{R1} = V_1 \cdot \sin \alpha_1$$

Tangential flow velocity at inlet,  $U_1$

$$U_1 = \frac{V U_1}{\Psi}$$

Relative flow angle at inlet,  $\beta_1$

$$\beta_1 = 90 + \arctan \frac{V U_1 - U_1}{V_{R1}}$$

Relative flow velocity at inlet,  $W_1$

$$W_1 = \frac{V U_1 - U_1}{\sin(\beta_1 - 90)}$$

General rotor geometry

Angle subtended by nozzle arc,  $\delta$   
(somewhere between  $70^\circ$  and  $110^\circ$  with optimum  $90^\circ$ )

$$\delta = 90^\circ$$

Diameter ratio (ratio of rotor blade outer diameter to inner diameter),  $M$  (normally  $\frac{2}{3}$  or  $0.7$ )

$$M = \frac{D_2}{D_1} = 0.7$$

Outer diameter of rotor,  $D_1$

$$D_1 = \frac{60}{N} \cdot \frac{U_1}{\pi}$$

Inner diameter of rotor blade annulus,  $D_2$

$$D_2 = M \cdot D_1$$

Outer radius of blade annulus,  $R_1$

$$R_1 = \frac{D_1}{2}$$

Inner radius of blade annulus,  $R_2$

$$R_2 = \frac{D_2}{2}$$

Radial width of blade annulus,  $a$

$$a = R_1 - R_2$$

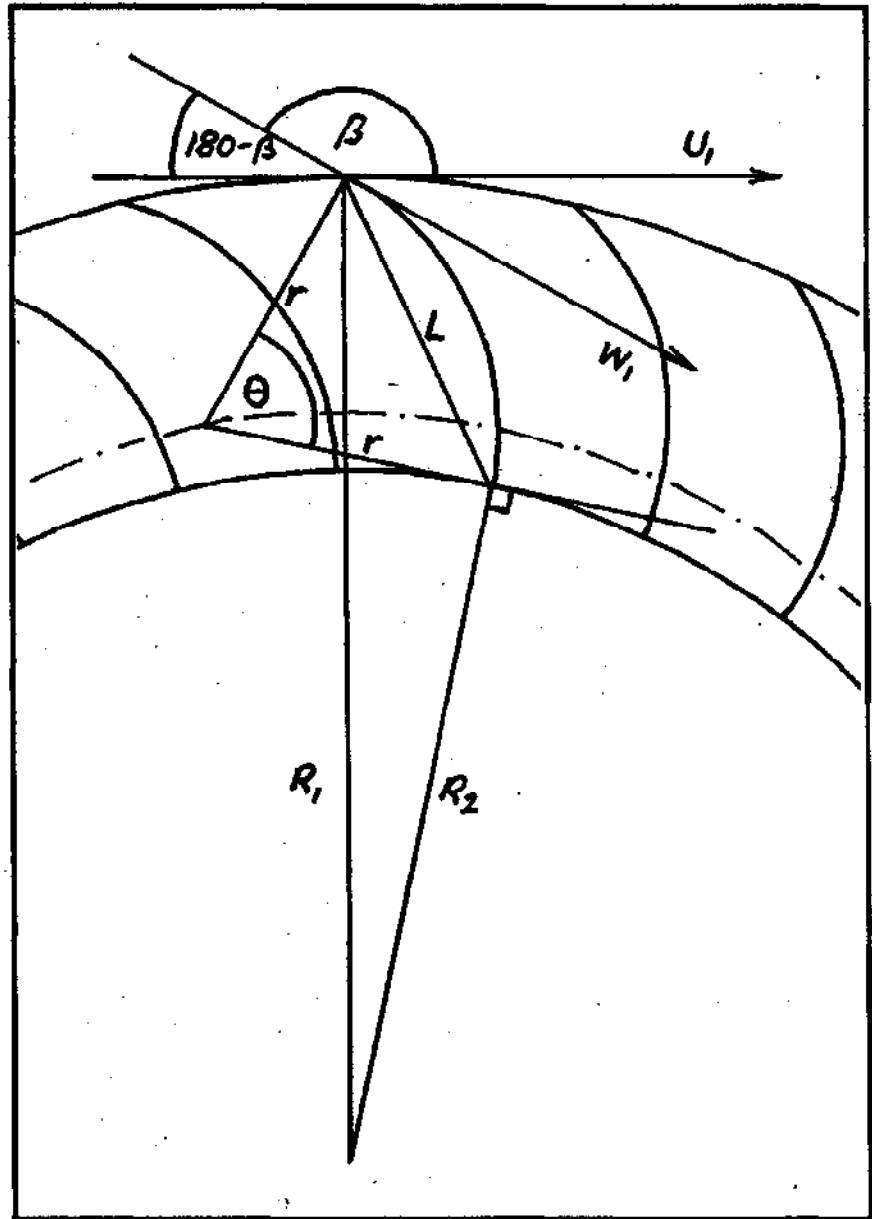

#### 4. Layout of blades

Spacing between blades around circumference of rotor (i.e. blade pitch),  $t_1$   
(from Khosrowpanah et al. 1984:43)

$$t_1 = 1.03 \cdot a$$

Number of blades,  $Z$   
(rounding off to nearest whole number)

$$Z = \frac{\pi \cdot D_1}{t_1}$$

Number of active inlet ducts,  $I$

$$I = \delta \cdot \frac{Z}{360}$$

Axial length of rotor,  $B$

$$B = Q \cdot \frac{Z}{I} \cdot \frac{1}{\pi \cdot D_1 \cdot V_1 \cdot \sin \alpha_1}$$

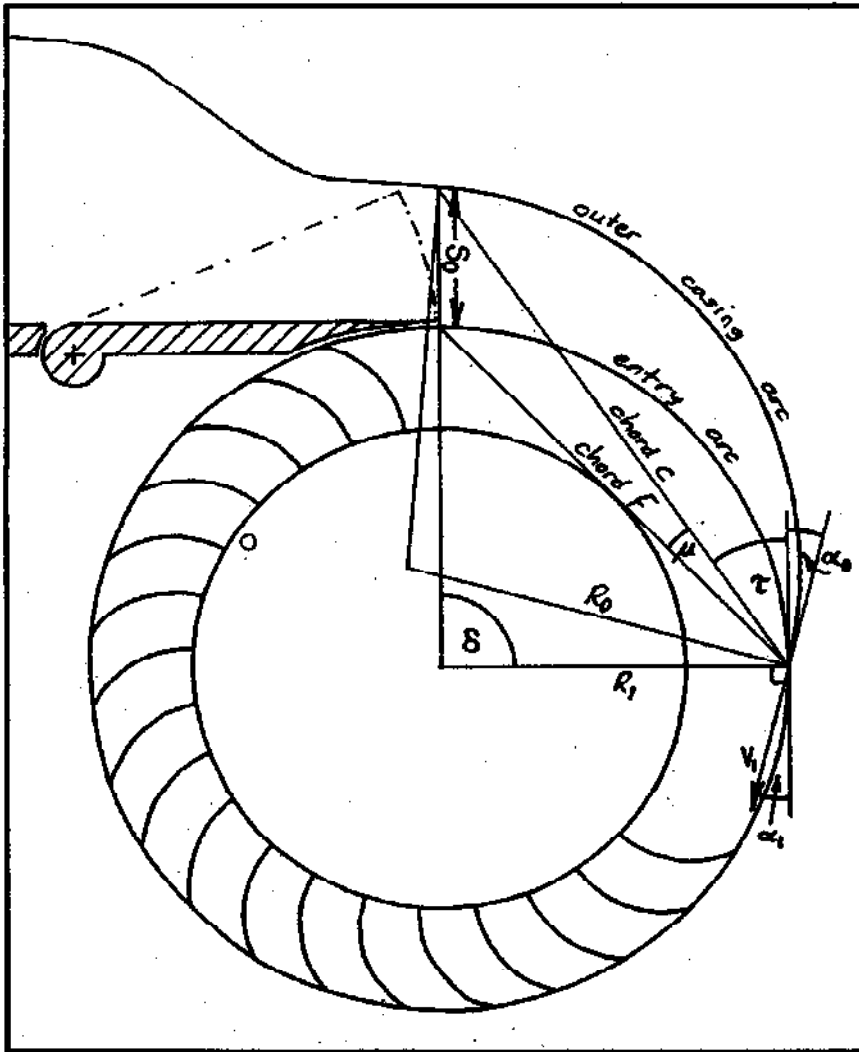

5. Layout of nozzle

Aspect ratio of rotor,  $B/D_1$   
(should approach value of 3 only for very large flows in respect to head)

$$0.5 \leq \frac{B}{D_1} \leq 3$$

**Flow geometry of intermediate rotor stage**

The intermediate stage of the cross-flow constitutes the fluid discharge from the first row of blades and its entry to the second stage. These are calculated together because it is a characteristic of the machine that the conditions of first stage discharge translate to those of second stage entry - i.e. they are almost the same.

Angle of absolute fluid discharge from first stage,  $\alpha_2$ ; angle of absolute fluid entry to second stage,  $\alpha_3$

$$\alpha_2 = \alpha_3 = \arctan \left[ \frac{1}{M} \cdot \cos (180 - \beta_1) \right]$$

Tangential flow velocity of rotor intermediate stage,  $U_2, U_3$

$$U_2 = U_3 = U_1 \cdot M$$

Relative flow angles,  $\beta_1, \beta_2$   
(assumed to be  $90^\circ$ , i.e. radial flow)

$$\beta_2 = \beta_3 = 90^\circ$$

Relative flow velocities of intermediate stage  $W_2, W_3$

$$W_2 = W_3 = U_2 \cdot \tan \alpha_2$$

Absolute flow velocities of intermediate stage  $V_2, V_3$

$$V_2 = V_3 = \sqrt{U_2^2 + W_2^2}$$

**Flow geometry of rotor outlet**

At this point water is discharged from the turbine.

Relative outlet flow angle,  $\beta_4$

$$\beta_4 = 180 - \beta_1$$

Tangential flow velocity at outlet,  $U_4$

$$U_4 = U_1$$

Relative flow velocity at outlet,  $W_4$

$$W_4 = W_1$$

Tangential component of absolute flow velocity at outlet,  $V_{U_4}$  (theoretically zero)

$$V_{U_4} = U_4 - (W_4 \cdot \cos \beta_4)$$

Radial component of absolute flow velocity at outlet,  $V_{R_4}$

$$V_{R_4} = W_4 \cdot \sin \beta_4$$

Absolute outlet flow angle,  $\alpha_4$  (theoretically  $90^\circ$ )

$$\alpha_4 = 90 - \arctan \frac{V_{U_4}}{V_{R_4}}$$

**Blade Geometry**

Having now determined the flow conditions within the turbine, we can calculate the physical dimensions of the rotor. When you go to draw out the plans for the turbine based on these figures, you will find some of the information redundant. However, all variables have been calculated to allow alternative layout procedures and cross-checking.



Blade spacing (pitch) at inner radius,  $t_2$

$$t_2 = \pi \cdot \frac{D_2}{Z}$$

Blade pitch arc angle,  $\Phi$

$$\Phi = \frac{360}{Z}$$

Radius of blade curvature,  $r$

$$r = \frac{R_1^2 - R_2^2}{2 \cdot R_1 \cdot \cos(180 - \beta_1)}$$

Blade curvature arc angle,  $\Theta$

$$\Theta = 2 \cdot \arctan \frac{\cos(180 - \beta_1)}{\sin(180 - \beta_1) + M}$$

Chord length across blade,  $L$

$$L = 2 \cdot r \cdot \sin \frac{\Theta}{2}$$

Rotor solidity at inner diameter,  $\sigma$

$$\sigma = \frac{L}{D_2 \cdot \sin \frac{180}{Z}}$$

## Nozzle Shape

The nozzle of a cross-flow turbine is as wide as the axial length of the rotor, and its arc follows the circumference of the rotor with as little clearance as possible in order to diminish leakage. The outline of the casing remains to be determined. To close approximation, the geometry of most efficient flow in the nozzle casing determines an outline calculated by logarithmic relationship, as this reflects the conditions of vortex flow. However, it has been found that a circular arc will do as an outer casing with virtually no loss in efficiency (Nakase, et. al. 1982). Hence we will follow this procedure for simplicity.

Nozzle throat width,  $S_0$

$$S_0 = \sin \alpha_1 \cdot R_1 \cdot \frac{\delta \cdot \pi}{180}$$

Chord length of nozzle outer casing,  $c$

$$c = \sqrt{(R_1 + S_0)^2 + R_1^2}$$

Angle between nozzle entry arc and nozzle entry chord,  $\tau$

$$\tau = \frac{\delta}{2}$$

Chord length of nozzle entry arc,  $f$

$$f = 2 \cdot R_1 \cdot \sin \tau$$

Angle between nozzle entry chord and nozzle outer casing chord  $\mu$

$$\mu = \arccos \frac{f^2 + c^2 - S_0^2}{2 \cdot f \cdot c}$$

Angle between nozzle entry arc and nozzle outer casing arc,  $\alpha_0$

$$\alpha_0 = \alpha_1 = 15^\circ$$

Angle between nozzle entry chord and nozzle outer casing arc,  $\phi$

$$\phi = \alpha_0 + \tau - \mu$$

Radius of nozzle outer casing,  $R_0$

$$R_0 = \frac{c}{2 \cdot \sin \phi}$$

## Fabrication

The subject of fabrication of a turbine is another full article, and in any case there are many ways of tackling the problem. The guides by SKAT, GATE (both in bibliography below), among others, give intricate documentation of specific designs. Here are some general pointers.

It is important to provide a slinger on the turbine shaft between turbine rotor and bearing; this is a metal disk of approx. 150 mm diameter. Its function is to throw off, by centrifugal action, any water creeping along the shaft toward bearing and pulley mechanisms.

Remember to curve all flow passages and round off any sharp angles or changes in direction for the fluid: optimum efficiency is reached by elimination of all eddies in the flow. Be particularly scrupulous at changes in pipe diameter, and at the entrance to the nozzle. Everything should have smooth and flowing lines. This isn't just mechanics, it's art.

Many of the construction manuals written by various AT (appropriate technology) or-

## Example

Here are the results for a sample turbine

<b>H = 3 m</b>	<b>D<sub>1</sub> = 134 mm</b>
<b>Q = 0.05 m<sup>3</sup>/s</b>	<b>D<sub>2</sub> = 94 mm</b>
<b><math>\eta_{me} = 0.65</math></b>	<b>Z = 20 blades</b>
<b>N = 500 r.p.m.</b>	<b>B = 251 mm</b>
<b>N<sub>s</sub> = 124</b>	<b>r = 19.3 mm</b>
<b>P = 0.956 kW</b>	<b>S<sub>0</sub> = 27.4 mm</b>
<b><math>\delta = 90^\circ</math></b>	<b><math>\mu = 9.64^\circ</math></b>
<b>M = 0.7</b>	<b>R<sub>0</sub> = 75 mm</b>

organisations suggest welding of the blades to metal end-disks. Although this is the standard procedure, it can cause stresses and eventual blade failure at the points of attachment. The AT group APACE at University of Technology, Sydney, are experimenting with cast polyurethane end-disks.

The same organisation has found that pressing blades into an arc preferable to the technique whereby a water pipe is cut lengthways into blades. This is because water pipe is rough on the inside, and takes a long time to cut accurately. The press is a steel cylinder of correct diameter and length, which screws up into a length of steel angle (the die).

If possible, weld the turbine from stainless steel components. Hot dip galvanising is an alternative. The rotor shaft may pass through the rotor without greatly affecting hydraulic performance, and is preferable for mechanical strength.

Scheurer et. al. (1980:39) give a table of blade thicknesses and number of intermediate disks as a function of head and flow. Other than very large head/flow combinations (c. 100 kw), blades of 2.5 mm thick steel are satisfactory. Flows over 85 L/s require one intermediate disk, over 125 L/s - two disks, over 155 L/s - three disks, over 180 L/s - four disks, etc.

When the rotor is completed, statically balance it on knife edges, and, if you get the chance, turn it down on a lathe. Possibly a pronounced lack of balance will set up fatiguing low frequency vibration.

As to electrical systems, DC consumer-side systems are much easier to control than direct AC systems, which require a complex and expensive electronic load controller. A simple DC system essentially consists of a generator trickle-charging a battery. The battery buffers the turbine from load changes.

## Efficiency

A turbine dimensioned according to XFLOW will exhibit a fairly flat efficiency curve above about 50% maximum flow. Part flow efficiency is improved with a flow regulation vane in the nozzle which channels available flow to less inlet ducts, i.e. effectively decreases the nozzle entry arc. The measured maximum hydraulic efficiency of 60% to 70% (as measured at the shaft), is about as good as you'll get with a micro-hydro set (say 2 kW to 20 kw). In this power range, be suspicious of claims for higher efficiencies unless the turbine is made by a sophisticated manufacturer; their turbines just may have the finish and accuracy (not necessarily any difference in geometry - they are all designed with the same sort of equations) to touch 75% or even 80% efficiency at optimum design-point rating.

These higher efficiencies are attained also by the use of a draft tube (see below). Without the draft tube, the cross-flow is not quite as efficient as the main alternatives; the Francis (radial) and propeller (axial) reaction turbines. Particularly in the larger size range (say over 100 kW) the reaction machines become markedly more efficient, but in the micro scale (say around 10 kW) they suffer from high hydraulic friction losses and do little better than the cross-flow. The efficiency curves of the reaction turbines are not so flat, either; so although their peak efficiency may be higher, over a year they will deliver less energy overall than the cross-flow. This has been demonstrated (cf. Haimerl 1960).

## Variations

Cross-flow turbines may be enhanced by provision of a draft tube below the turbine runner. This is a tube full of water into which the turbine discharges, which extends into the tailwater. The effect is to increase the head somewhat by provision of a certain amount of suction as a result of the weight of the water in the draft tube creating a negative pressure. If the water column in the tube is 1m high, this adds 1m of net head to the turbine, discounting friction losses, and losses due to aeration of the water. The turbine must operate in air, so an air valve is provided in the otherwise fully-sealed unit to prevent the runner becoming submerged. Further information is provided in Inversin (1986) and Haimerl (1960).

A further improvement in the efficiency of the cross-flow turbine is the division of the length of the turbine runner into two

sections, one one-third segment and a two-thirds segment. Separate nozzle vanes are provided for each segment, so it is possible to cut off flow from one or the other segment, hence providing a three-step flow regulator allowing the turbine to operate at design flow in the still-operating segment. The nature of the cross-flow turbine is that speed of the unit does not alter as a result of flow variation, hence no speed regulation is required

## Final word

Use of this algorithm allows assessment of the potential of a cross-flow turbine for a particular site, and of course the vital dimensions for its construction. At the assessment stage, however, be aware that a natural limit is imposed on their use when, as a result of following the calculations, it becomes evident that the dimensions of the machine become unwieldy - either the whole machine is far too small to build (only 50 mm across, for instance), or runs too slowly within the allowable range of specific speed.

The XFLOW algorithm is largely based on the theoretical coverage in Haimerl (1960) Mockmore and Merryfield (1949) and Durali (1976). Nozzle shaping is based on Nakase (et. al.) 1982. Djoko Sutikno, postgraduate student at University of Technology, Sydney, provided the equations for number of ducts and rotor length, and also verified results of the computer program I wrote, on which this article is based. It is on the basis that the computer program produced the exact dimensions of Djoko's already-built experimental turbine that I have confidence in the procedure; and it is due to Djoko's work that we have a good idea of turbine efficiencies based on this design algorithm.

The XFLOW algorithm is not the last word in cross-flow turbine theory. Upon observation of Djoko's rig, it is clear that the above 'classical theory' of the cross-flow needs empirical correction, particularly as to the question of degree of reaction due to incomplete conversion of pressure to velocity head at the nozzle entry, and so the modified kinematics of flow under these circumstances. Clarification of the range of suitable specific speed would be desirable

A bug-free, virus-free version of the XFLOW program for IBM-type PC's written in standard BASIC is available on a 5¼" floppy disk, upon receipt of \$15, from the author c/o Alternative Technology Association.

And for the desktop publishing freaks, I set the maths in this article with Ventura Professional Extension.

## Bibliography

Durali, M., 1976. *Design of small water turbines for farms and small communities*. Technology Adaptation Program, Massachusetts Institute of Technology, Cambridge, Massachusetts. (VITA microfiche)

Eck, B., 1973. *Fans*. Pergamon Press, Oxford.

Haimerl, L.A., 1960. The Cross-flow turbine. *Water Power*, v.12 no.1, pp. 5-13.

Halmos, L., 1959. Jet thickness and radial blading width of Banki turbines. *Acta Technica Scientiarum Hungaricae* v. 27, pp. 147-156.

Hothersall, R., 1985. A review of the cross-flow turbine. Proceedings, *Waterpower 85 Conference*, American Society of Mechanical Engineers, September 1985.

Inversin, A.R., 1986. *Micro-hydropower sourcebook*. NRECA International Foundation, Washington, D.C.

Khosrowpanah, S., Alberton, M.L., and Fiuzat, A.A., 1984. Historical overview of cross-flow turbine. *Water Power and Dam Construction*. v.36 no.10 pp. 38-43.

Mockmore, C.A., and Merryfield, F., 1949. *The Banki Water Turbine*. Engineering Experiment Station, Oregon State College, Corvallis, Bulletin Series No. 25.

Nakase, Y., Fukatomi, J., Watanaba, T., Suetsugu, T., Kubota, T., and Kushimoto, S., 1982. A study of cross-flow turbine (effects of nozzle shape on its performance). In Webb, DR. et al. (eds.) *Small Hydro Power Fluid Machinery 1982*. Winter Annual Meeting A.S.M.E., Nov. 14-19, pp. 13-18

Scheurer, H., Metzler, R., and Yoder, B., 1980. *Small water turbine; instruction manual for the construction of a crossflow turbine*. German Appropriate Technology Exchange (GATE), Eschbom, Germany.

SKAT, n.d. *Crossflow turbine BYST3*. Swiss Centre for Appropriate Technology, St. Gallen, Switzerland.

Steller, K., and Reymann, Z., 1987. Some test results on Banki turbines. *Proceedings of the Eighth Conference on Fluid Machinery*. Akademiai Kiado, Budapest, v.2, pp. 793-801.

Sutikno, D., forthcoming. Unpublished, Masters Thesis, University of Technology, Sydney.

# Further comments on Cross-flow Turbine Design

---

**Ian Scales**

---

This brief note gives some additional comments to the article on cross-flow turbine design in *Soft Technology* 35 based on some research work that has come to light, and makes a small correction to the previous article.

## Some additional design considerations

Khosrowpanah et. al. (1988) performed a series of experiments on small cross-flow turbines and found some useful results. *Runaway speed* was seen to decrease as the nozzle entry arc increased, with the highest *ratio* of runaway speed/speed at max. efficiency equal to about 3, and usually about 2.5. An *aspect ratio*  $B/D_1$  of 0.5 was found to be more efficient than an aspect ratio of 1.0, attributed to the tendency of water to rotate around the shaft in the smaller diameter rotor.

Some further interesting experimental results are detailed in Fiuzat and Akerkar (1991). They found that the average contribution of the first and second stages of the turbine to the shaft power developed is about 55% and 45% respectively when the nozzle arc is  $90^\circ$ . They found that the contribution to output by the second stage increases as shaft load increases and turbine speed decreases. These results show a much greater contribution from the second stage than the previous theoretical predictions, and one implication of the new results is that interference by the shaft with the flow passing between stages may cause significant losses

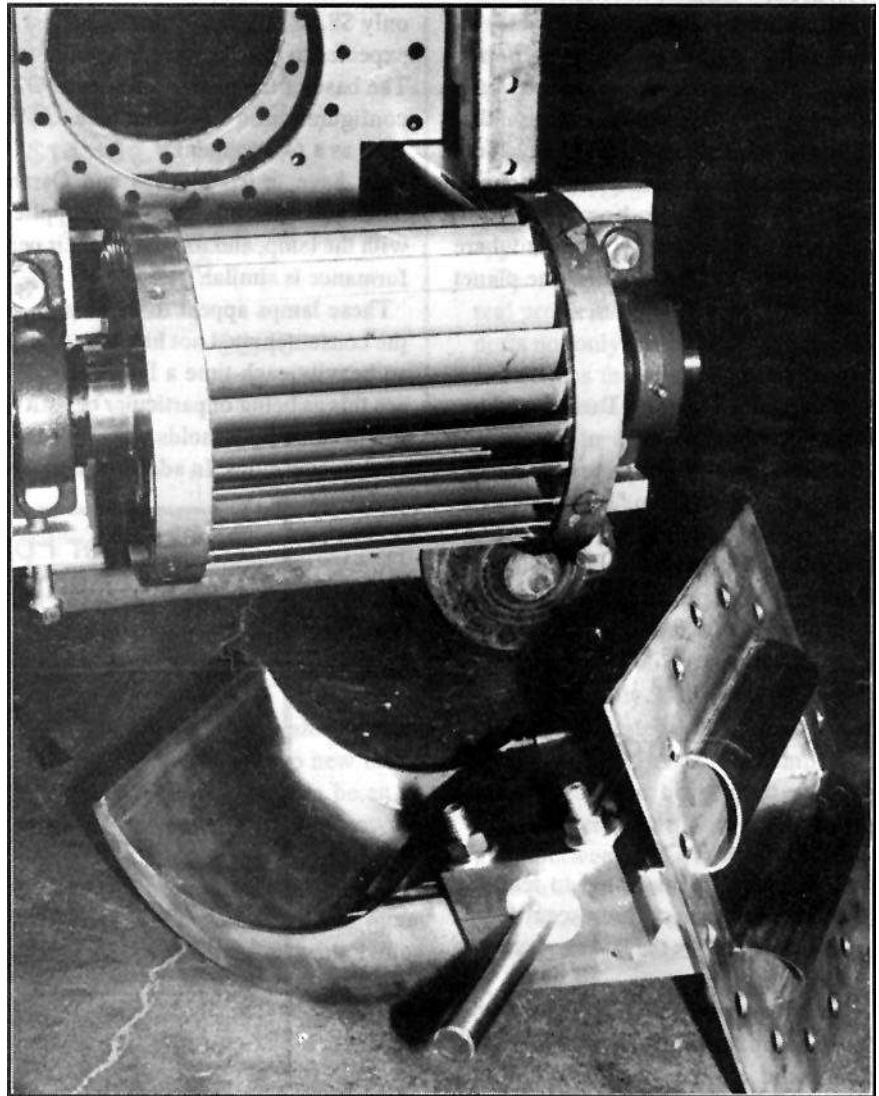

Cross-flow turbine under construction in the workshops of the School of Mechanical Engineering, University of Technology Sydney. At top are the supporting frames for the circular plenum tube receiving water from the penstock, at centre the runner, and in the foreground the nozzle/throat assembly with a guide vane. Notice the bell-mouthing on the throat entrance.

(however, the shaft is necessary for mechanical strength and should remain).

Some general observations as to the characteristics of the cross-flow turbine should be made. The speed of rota-

tion depends on the velocity of the free jet issuing from the nozzle, according to the relation

$$V = \sqrt{2g \cdot H}$$

It follows that an increase in head will be compensated by either increasing the rotor diameter or alternatively, in order to keep generator speed constant, by changing the gear ratio on the shaft. Flow variations will not be compensated by altering the diameter of the rotor, but by altering its length or changing the nozzle arc angle (i.e. altering the cross-sectional area of the nozzle).

### Correction to blade spacing

Further investigation has shown that the empirically-based equation used to determine the number of blades for the cross-flow turbine rotor should be revised. I previously defined the equation for blade spacing as:

$$t_1 = 1.03 \cdot a$$

where

$$a = \frac{(D_1 - D_2)}{2}$$

and

$$t_1 = \frac{\pi \cdot D_1}{Z}$$

There is a compound error in this equation. The value of 1.03 was reported as empirically derived by Khosrowpanah et. al. (1984 - see ref. in previous article). The first error in the equation I supplied was to *multiply* *a* by the value 1.03, rather than divide. Khosrowpanah et. al. stated the optimal blade spacing in their experiments was

$$t_1 = \frac{a}{1.027}$$

This conclusion was reiterated in the more detailed paper by Khosrowpanah and Albertson (1985), and again by Khosrowpanah, Fiuzat and Albertson (1988). However, on reworking their equations and experimental data, it appears the statement is incorrect by their own methods of analysis. Their highest-efficiency test turbine was 305

mm in diameter with  $D_2/D_1 = 0.68$  and a nozzle arc of  $90^\circ$ . On this model they tried 10, 15 and 20 blades. Their experimental data shows that 15 blades gave the highest efficiency. This result supports the conclusion that the optimum blade spacing is

$$t_1 = \frac{a}{0.764}$$

which is different to the equation supplied by Khosrowpanah et. al. The validity of this latter equation is justified by reference to the two equations relating the number of blades to the value  $\sigma$  that are supplied by those authors:

$$t_1 = \frac{\pi \cdot D_1}{Z}$$

and

$$\sigma = \frac{a}{t_1}$$

where  $\sigma$  is defined as solidity and is the label for the values 0.764 and 1.03 referred to above. The difference in efficiency was quite marked. Although the experiments were not perfect because head varied between the turbines over a range of 0.44 to 0.74 m, efficiency varied between 63% for 10 blades, 70% for 15 blades and 66% for 20 blades. As with Djoko Sutikno's experiments (Sutikno 1991), efficiency increased as the nozzle entry arc was increased to  $90^\circ$ . It is interesting to note, however, that blade number may not be too critical, because data collected by Hothersall (1985) from different machines show good efficiencies with up to 32 blades and diameter ratios of about 0.66 to 0.68.

### Sundry comments

A further point relates to the Soft Technology article referred to above. The photograph of flow through a cross-flow turbine on the first page was reproduced upside-down. The photographed turbine was undergoing tests in the hydraulics laboratory in the School of Mechanical Engineering,

University of Technology, Sydney last year. It achieved a peak efficiency of 68% (Sutikno 1990). Note it has 24 blades and a solidity  $\sigma$  of 1.26.

The computer program mentioned in the previous Soft Technology article is now updated to XFLOW version 2.0 (still GW-BASIC), and is obtainable from the author via the ATA for \$20 to cover costs.

Response to the cross-flow article has been good and demonstrates the potential popularity of these machines. Future articles are planned to cover details of other aspects of micro-hydro systems, including electrical systems and water supply.

### References

- Hothersall, R., 1985. A review of the cross-flow turbine. *Proceedings, Water Power '85 Conference*. ASME, New York
- Khosrowpanah, S., and Albertson, M.L., 1985. Experimental study of the cross-flow turbine. In Waldrop, W.R. (ed.) *Hydraulics and Hydrology in the Small Computer Age*, v.1. Proc. of the Specialty Conference, Hydraulics Division of the American Society of Civil Engineers. Lake Buena Vista Florida, August 12-17 1985. ASCE, New York: 644-649.
- Khosrowpanah, S., Fiuzat, A.A. and Albertson, M.L., 1988. Experimental study of cross-flow turbine. *Journal of Hydraulic Engineering* 114 (3): 299-314.
- Fiuzat, A.A. and Akerkar, B.P., 1991. Power outputs of two stages of cross-flow turbine. *Journal of Energy Engineering* 117 (2): 57-70.
- Scales, LA., 1991. Cross-flow turbine design. *Soft Technology* 35: 33-39.
- Sutikno, D., 1990. *Experimental Study of the Cross-flow Turbine*. Master's Thesis (unpub.), Faculty of Engineering, University of Technology, Sydney.

# **WATER POWER with an axial flow turbine**

The head on my site is only one metre and I have seen five metres of flood water over it on some occasions, Obviously, the traditional water-wheel in this situation would be far from satisfactory. Thus the 3 main advantages of turbines over water-wheels, are firstly that they can be built to handle submergence in flood prone streams, secondly they are generally more efficient due to their faster running speed, and thirdly higher speeds means less gearing.

Water turbines as a means of either pumping water or generating electricity remain very much unknown and uncommon amongst alternative technologists. I would like to suggest that the AXIAL FLOW (or propeller) turbine can be most efficient and well worth installing as an alternative to the common water-wheel. At least now that I have made a turbine and have had it functioning for a few months, I can share some useful ideas with those who may be interested.



The pump and turbine were unaffected by this flood which totally submerged them both. The top half of the pump box is visible in the centre of the photo.

The four basic turbine types are AXIAL FLOW, (Propeller) CROSS FLOW (Michell/Banki), MIXED FLOW (Francis) and the PELTON and TURGO RUNNERS. The first three are (most commonly) used in low, to medium head situations, whereas the Pelton and Turgo runners are generally used in higher head situations. The Francis Turbine is both extremely difficult to manufacture in a home workshop due to its spiral castings, and extremely expensive to purchase.

So in my case I had to choose between the axial flow and the cross flow. After considerable research into both of these, I decided to make, believe it or not, one of each! Axial flow turbines are the least commonly used small water turbines in Australia; in fact after two years of research I have yet to come across another one in operation, apart from the one described in the last issue of Soft Technology. (If anyone knows of one I would be most interested.) However, the cross flow turbine has two advantages over the axial flow; one, it is the easiest turbine to make in the home workshop, and two, it is able to maintain its relative high efficiency at part flow. That is, when the flow rate is reduced to as low as one sixth of full flow the efficiency remains much the same, This flow regulation is made possible by a pivoting guide vane and/or two hinged gates. Flow regulation is sometimes referred to as "throttling". Due to the nature of axial flow turbines, any form of throttling reduces its efficiency considerably, especially when the head or water volume drops below 30%.

My reason then, for making an axial flow was to have a turbine which would 'extract five horsepower whenever the river's flow was over 600 litres per second, (generally over 8 months of the year). At times when the flow rate falls below 500 l/sec, the axial flow is turned off and the cross flow operates alone, - until the water drops off to below 10 l/sec. (this very rarely occurs).

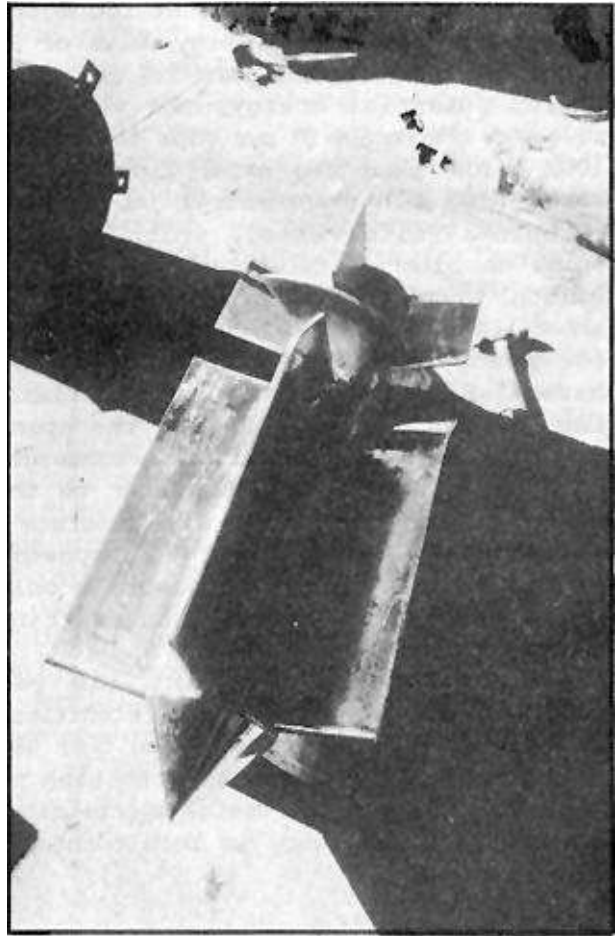

Photo showing the contents of the turbine pipe and the angle on the trailing edge of the prespinning guide vanes.

#### How the System Operates

The existing axial flow turbine is connected to a triple diaphragm pump via a 5/8 inch pitch chain and sprockets. This pump has a continuous output of 1 l/sec. (18,000 gallons per day) to a head of 100 metres. (pump pressure = 135 p.s.i.). The reservoir receiving this water is a 200,000 litre (44,000 g) concrete tank. Using a stationary petrol motor driving the same pump, it would cost \$50 in fuel to fill the tank, now it fills in 2 1/2 days - FREE!!!

This volume of water, at 100 metre head has an equivalent energy value of 35 kilowatt hours. In order to use this stored potential energy, the water is released through a 3" pvc pipe to a point 100m below (near the axial flow turbine site.) Here a high pressured jet is used to spin a Pelton wheel, which in turn spins an alternator. Actually, I have 2 Pelton wheels, one bronze wheel for generating 240V AC and one plastic wheel for generating 12V DC. Tamar Design now have 4" Plastic Pelton wheels available for \$60. The tail water from the spent water jet is used to backflush a submerged sand filter which supplies water to the diaphragm pump. The system will generate a maximum of 5 kVA of 240 V AC power; although, this amount of power is only required in short bursts when starting induction motors or welding.

The greatest problems (as yet unsolved) is in matching the electrical load with the water jet size, so that all the water coming down from the tank is being used to generate useful electricity, and that the frequency is held constant, (i.e. its RPM).

#### **Building the System**

Our river looks spectacular and is untouched along our frontage, so that any construction had to be done with great care. Having had formal education in ecology rather than hydrology, I was determined to minimise any disturbance to the natural environment. The final result was just that. The 1 m weir increased the normal water level by only 70 cm and the overall effect of flooding was negligible. The fish pass works perfectly. If I had no concern about the environment I would have made a 2 m concrete weir and had twice as much power; and if I had a very inefficient house and did not care about squandering electricity I probably would have flooded the Franklin.

The weir took some six weeks to build. It is composed of 3 cubic metres of concrete and 100 metres of 12mm re-bar and

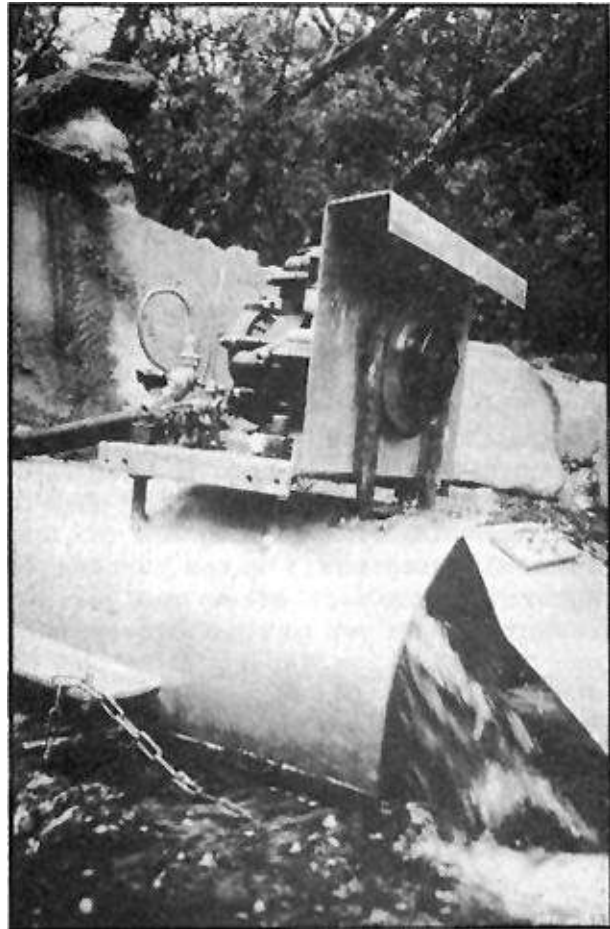

**The pump-turbine unit with the pump protection box removed. The diaphragm pump is happily pumping 1 litre/sec to 100 metre head.**

is made to withstand severe flooding. The visible surfaces are finished with natural rock, making the structure appear less conspicuous. The 10 m long wall is arched for extra strength and the vertical re-bars are hammered into holes predrilled into the bed rock at 15 cm spacings.

The axial flow turbine took a further six weeks to make. It is composed of a 1.2 metre length of 18" diameter pipe. The guide vanes, propeller, bearings and shaft are built into this section, whereby their fabrication and mounting in the pipe used up some 7 kg of welding rods. The concrete weir has a 500 mm length of this 18" pipe embedded in its base and the two pipes are

simply bolted together. The pump is mounted above the end section of the turbine as shown in diagram, and is covered by a rigid metal box to guard against floods. The turbine propeller drives a 50 cm long, 5 cm diameter, hollow stainless steel shaft. The speed of this shaft is 280 RPM, and the gearing ratio of the turbine to pump is 1 to 1. The effect of driving a chain underwater continuously is still being monitored. The propeller was the most time consuming component, taking hours of design work before any fabrication began. With great determination I was able to cut, bend and weld 10 mm plate steel to fabricate the 3 bladed propeller, the 6 inch hubs housing the bearings, and the 2 sets of guide vanes supporting the 2 hubs. (one each side of the propeller).

The clearance between the blades of the propeller and the inside wall of the pipe was a maximum of 1 mm. The bearings

are a special bearing plastic, lubricated with super filtered water, under pressure from the pump. The water is directly fed to each of the three bearings, (two cylinder types 100 mm long and one thrust,) through the centre of the shaft.

The whole unit, less the pump, chain and sprockets, and stainless steel shaft was galvanised to maximise its life. It cost only \$80 to galvanise 280 kg of steel. I am now convinced that this method of rust proofing is the most cost effective.

I should also mention that the reasons for driving a pump off the turbine instead of a generator are:

1. Flooding is frequent and a water tight box for a generator is difficult to incorporate and risky.

2. Water has priority over electricity. That is, electricity at 240 V AC is really only a luxury whereas water is an essential we cannot do without.





As our overall system is quite complex, I am unable to give a complete description of its workings in this article. Once the Pelton wheels are working I will write Part 11 of our water and power system. Stay tuned to Soft Technology.

**Costing of pump and turbine system**

Turbine; raw materials	\$700
Lathework; by Gippsland	
Energy Alternatives	\$300
Plumbing	\$200
Galvanising	\$100
Imovili diaphragm pump	\$450
Dam wall (steel-reo. & cement)	\$200
	\$1950



John and Robyn Hermans  
 C/- Bairnsdale Wholefoods  
 6 Service Street  
 Bairnsdale 3875  
 Phone: 051-526544

P.S. we sell Soft Technology magazines too!

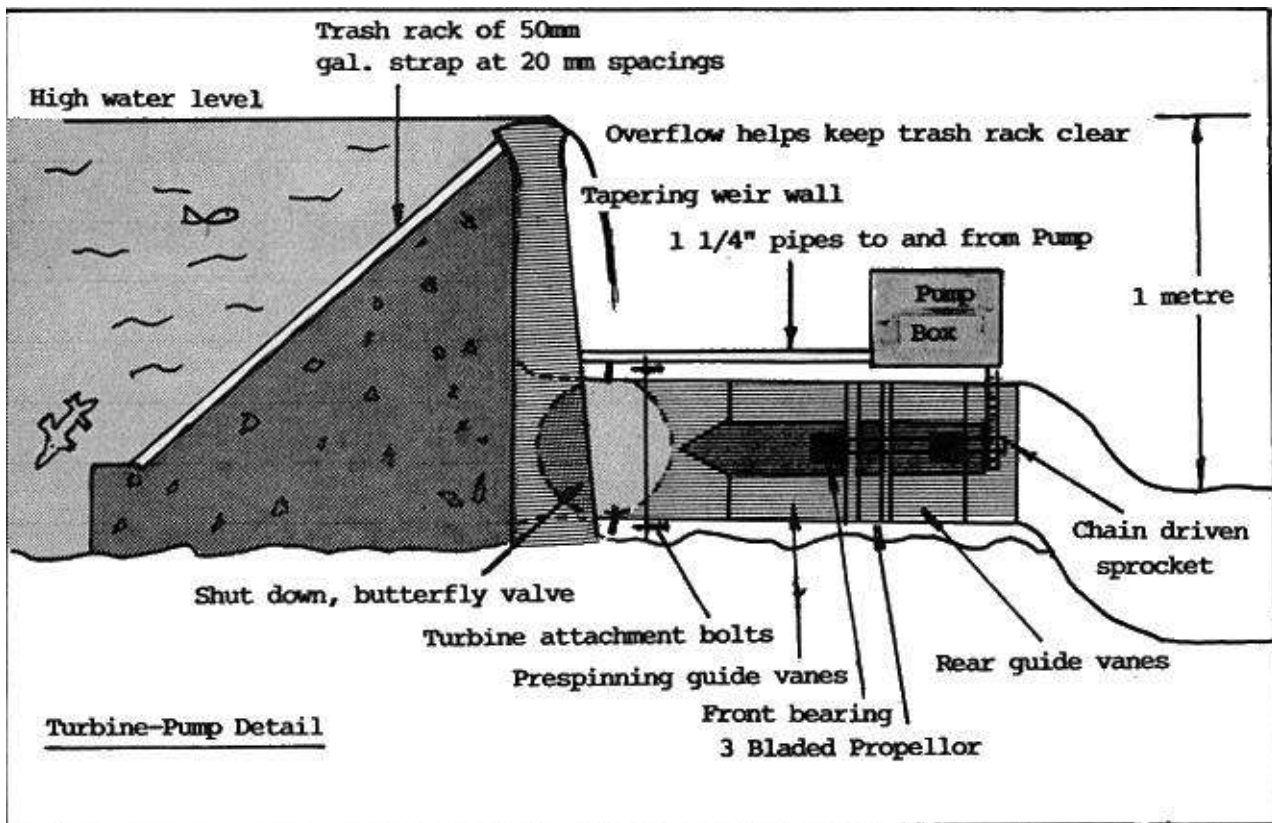

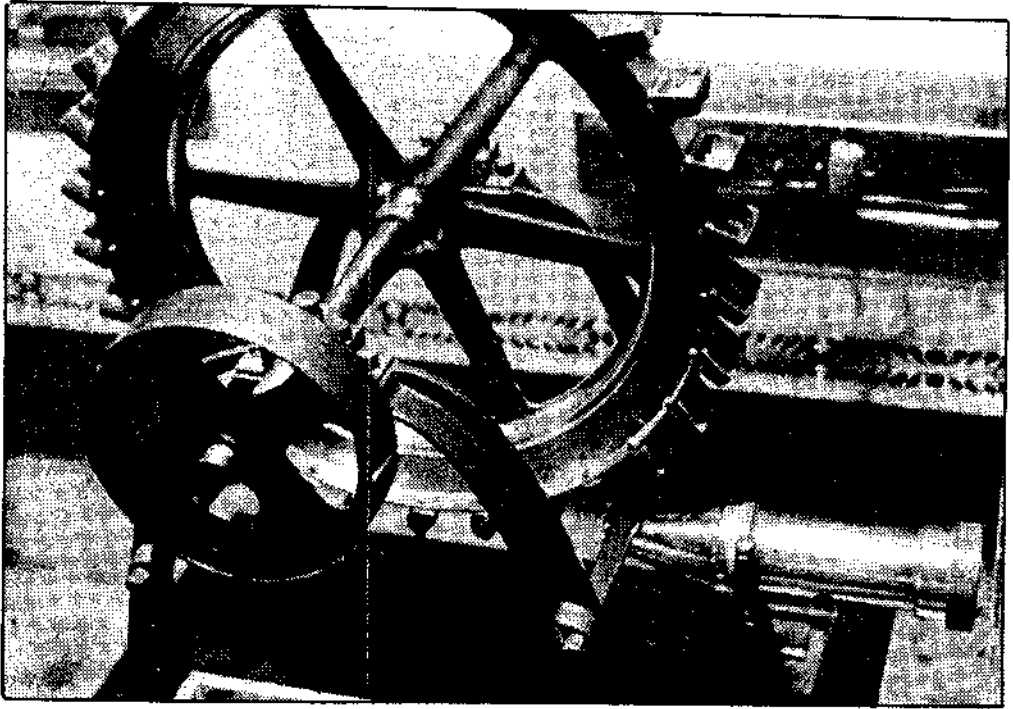

**SCALE MODEL OF A PELTON WHEEL:** Showing nozzle on right and pulley on left. Normally the cups on the wheel would be notched in the center so that water shooting out the nozzle would hit more than one cup at a time.

---

### **Reaction Turbines: Francis Wheel, Kaplan Turbine, Propeller (and others)**

Some people may come into possession of one of this class of reaction turbines. These consist of a number of curved and convoluted vanes or runners arranged around a central shaft. The water flowing through these vanes causes the wheel to rotate by the "reaction" or pressure of the water. These turbines require careful engineering to operate properly and must be purchased from a manufacturer rather than be home-built.

Reaction turbines are usually designed for a limited range of flow and head conditions, and are not suitable for other than their design specifications. They are very efficient when properly regulated for load and flows (up to 93%) and turn at a high rpm. The high rpm makes them ideal for driving an electrical generator. Because of their shape and structure they are expensive, but it is possible to find used or surplus turbines at bargain prices (be sure to check the specifications of head and flow as the turbine may be useless if it doesn't fit the situation).

The only knowledge that is needed for installing a turbine of this class is its rating for head and flow rate, operating speed, and of course all the basic information about the site at which the turbine will be placed.

The James Leffel Company manufactures a complete package unit for small hydro-power sites (see page 69). Leffel's design, a Hoppe turbine, a variation of the Francis is available for heads of 3 to 25 feet with an electrical output of 1 to 10 kw.

# The Segner Turbine.

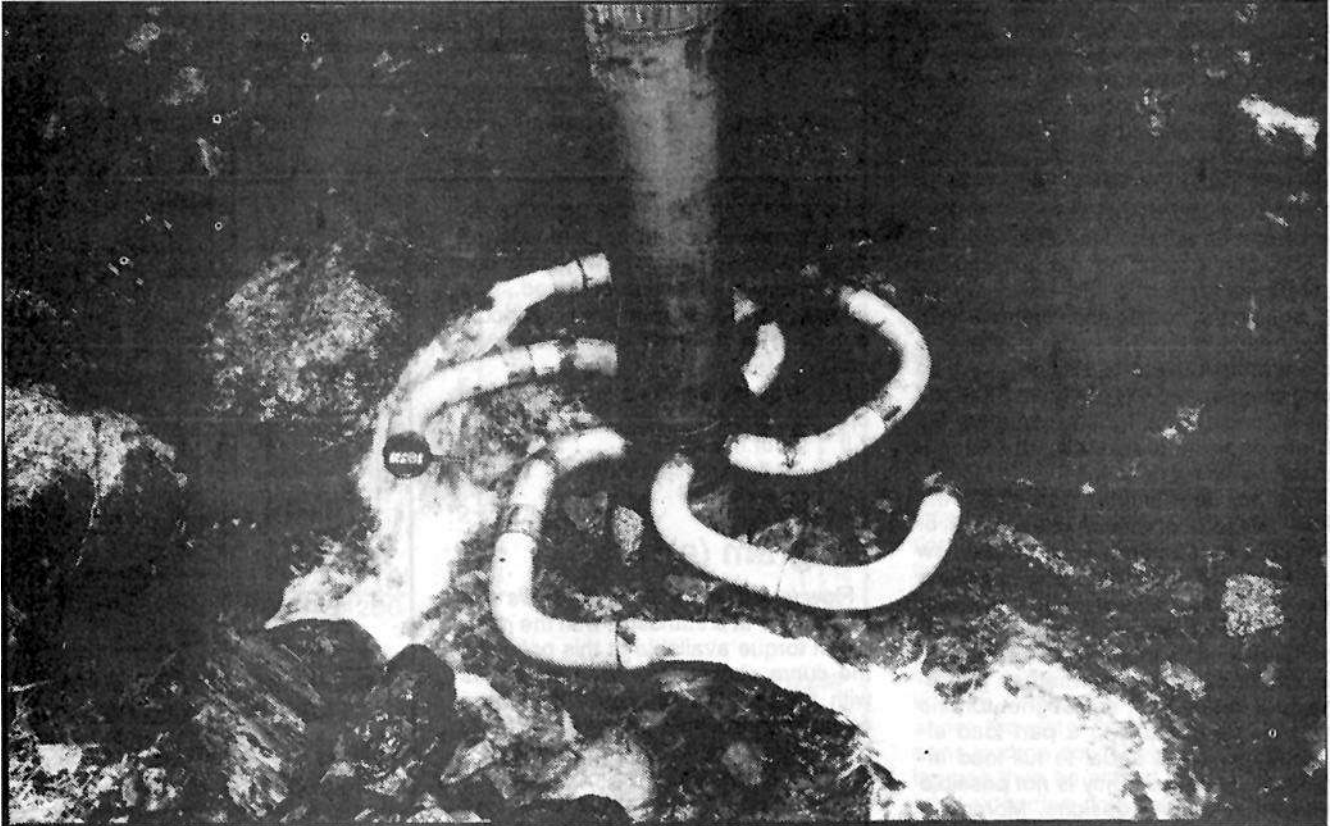

## An easily constructed low head water turbine.

by Alan Hutchinson  
(from a publication by  
SKAT)

Many different designs of water turbine have been developed since humans first harnessed water power to their energy needs. Varying head, flow and power requirements will make one design more preferable than another in a given situation. Here we present details of a design which, although not as efficient as some others, is a lot easier and cheaper to construct with

limited facilities and can be more readily adjusted for variations in flow.

The Segner turbine was invented in 1750 by J.A. von Segner probably on the basis of Bernoulli's work in 1738 on the water jet reaction effect. It uses the reaction effect : if you squirt a jet of water out of a nozzle, the nozzle tries to move in the opposite direction to the water. Its the exact opposite of the Pelton wheel which is a pure -turbine. It was used to power some mills in Germany and America until it was forgotten as other ideas came along. Its still used today in things such as garden sprinklers (the type with bent arms

which rotate) and helicopter blades (with compressed air).

### Basic Design

The Segner turbine consists of an inlet channel(1) [see Fig 1] with a cylindrical funnel through which water enters a vertical pipe (2). At the bottom of this pipe, two (or more) radial pipes (3) are provided with bends, to which nozzles (4) are fixed. This arrangement is done in such a way, that a water jet through these nozzles has an exactly tangential direction. The vertical pipe is held in place by a shaft (5) with spokes (6) which is supported by an upper and lower bearing (7), so that the vertical pipe with the radial arms at the bottom is

# CONSTRUCTION

free to rotate around its axis. A pulley (8) serves as the power take-off element.

The water consumption (Q) of the Segner Turbine depends on the head (H) under which the unit works, the total nozzle cross sectional area and the circumferential speed of the nozzles. For a determined working condition, outflow through the nozzles is thus given. Inflow is then adjusted with the help of a simple sliding gate (9) in the inlet channel in such a way that the vertical pipe remains completely filled. The operator can easily find this out by watching the top of the inlet funnel: optimally the funnel should very slightly overflow and the gate can be adjusted to achieve this.

You can determine the appropriate rotational speed of the machine by choosing the nozzle pitch diameter (D). For heads in the 3-5 metre range, D is standardised at about 1.5m giving an operating speed (N) of about 100 RPM (at a head of 3m). Pulley diameters are then chosen to match this to the machine being driven.

The nozzle diameter (d) defines the flow rate (Q) and is made smaller or larger to correspond to the actual flow available at the inlet. The machine works just as well with only one water jet. For a flow of 50% of the design flow rate, one nozzle may simply be capped, which enhances dry weather performance. In this way, the Segner turbine may be operated with a part load efficiency which is equal to full load efficiency. This, incidentally is not possible with other turbine designs. Moreover, the machine has good self-regulating characteristics.

## Operating characteristics.

Fig 2 shows the relevant characteristics of the Segner Turbine in operation. For better understanding, a grain milling situation is used as an example.

Performance characteristics at full design flow and at reduced flow may easily be found for optimal loading at the highest efficiency point, maximum power output, overloading of the machine and runaway conditions at no load. The operating points found for all these situations confirm that the Segner Turbine indeed gives excellent performance in mill applications.

For each of the two operating conditions,  $Q = 300$  l/s and  $Q = 150$  l/s, two

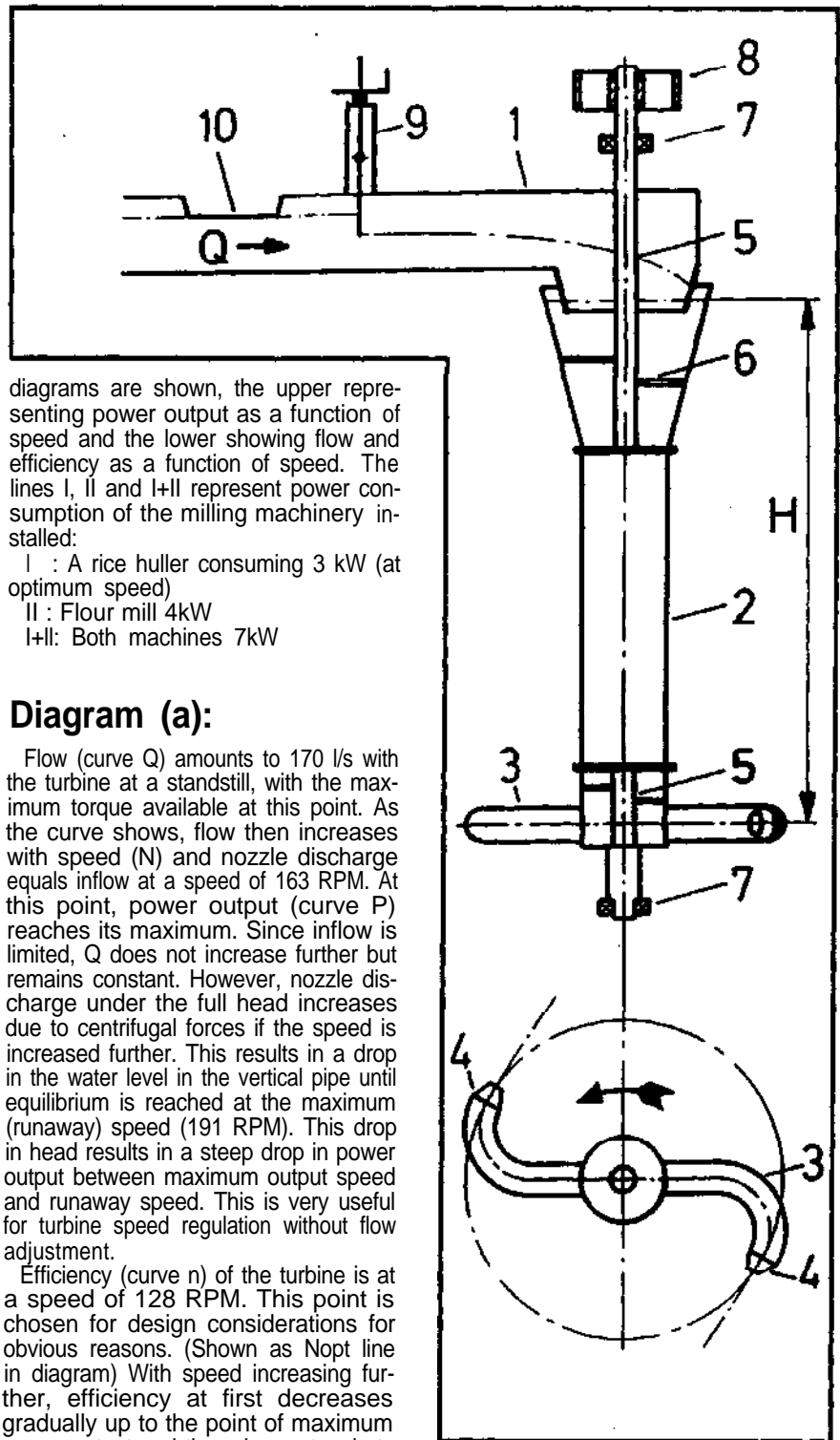

diagrams are shown, the upper representing power output as a function of speed and the lower showing flow and efficiency as a function of speed. The lines I, II and I+II represent power consumption of the milling machinery installed:

- I : A rice huller consuming 3 kW (at optimum speed)
- II : Flour mill 4kW
- I+II: Both machines 7kW

### Diagram (a):

Flow (curve Q) amounts to 170 l/s with the turbine at a standstill, with the maximum torque available at this point. As the curve shows, flow then increases with speed (N) and nozzle discharge equals inflow at a speed of 163 RPM. At this point, power output (curve P) reaches its maximum. Since inflow is limited, Q does not increase further but remains constant. However, nozzle discharge under the full head increases due to centrifugal forces if the speed is increased further. This results in a drop in the water level in the vertical pipe until equilibrium is reached at the maximum (runaway) speed (191 RPM). This drop in head results in a steep drop in power output between maximum output speed and runaway speed. This is very useful for turbine speed regulation without flow adjustment.

Efficiency (curve  $\eta$ ) of the turbine is at a speed of 128 RPM. This point is chosen for design considerations for obvious reasons. (Shown as Nopt line in diagram) With speed increasing further, efficiency at first decreases gradually up to the point of maximum power output and then drops steeply to zero at runaway speed.

fig. 1 Basic design of a Segner Turbine

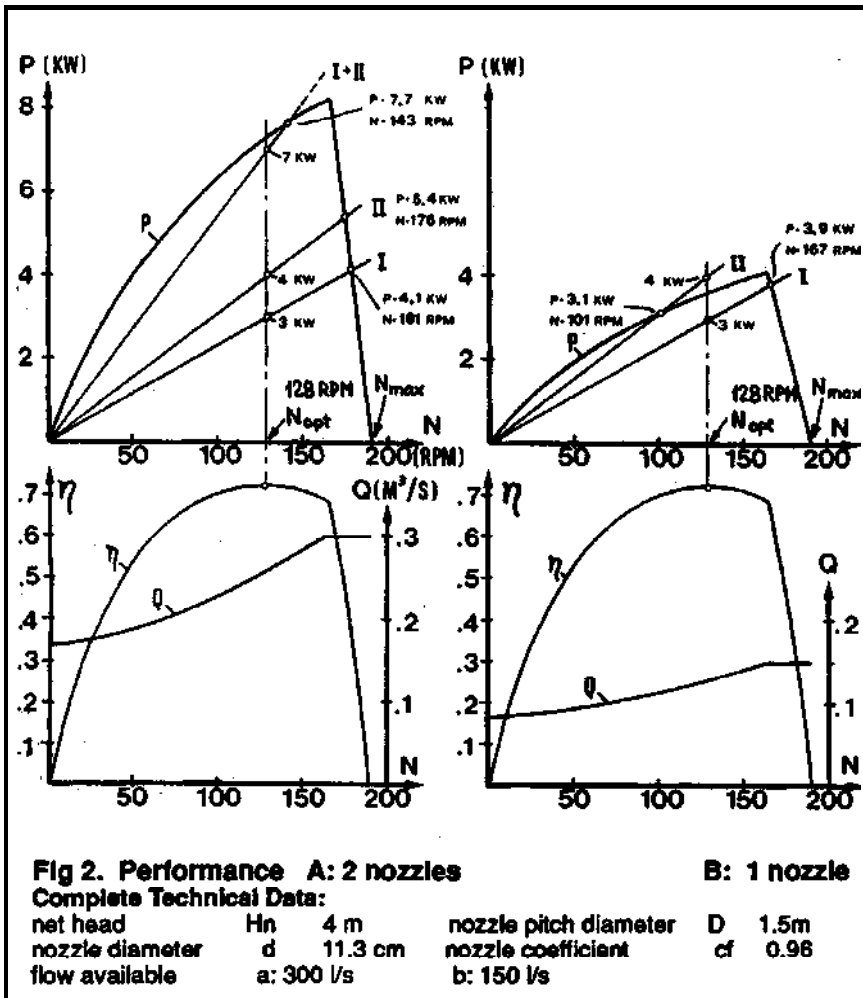

## Diagram (b):

Here the turbine is adapted to an inflow of 50% of full flow and nozzle discharge is cut to half simply by putting a cap on one of the nozzles. (Note that no imbalance is caused by this since the capped arm remains full of water.)

The efficiency curve remains the same as with full flow. So do optimum speed and runaway speed, while flow and power curves reach exactly 50%.

## Installation components.

The components of a typical Nepalese milling installation are shown in fig 4.

If two sizes of nozzle are used, the smaller being 60% of the cross-section-

al area of the larger, then the flow rate variations shown the table in fig 3 are possible.

The application diagram in fig 3 shows power output curves as a function of operating head and flow rate.

## Construction.

The shaft is supported at the top by an ordinary flange mounting radial ball bearing and at the bottom by a specially sealed taper roller bearing (to take the trust due to the weight of the column).

A lower power version could be made with somewhat narrower pipe. The main requirement is that the head lost due to flow down the central column is small (ie the velocity head is small relative to the static head).

In 1983, 3kW machines were available in Nepal for less than \$800 complete.

## Why publish an article about this sort of turbine in Australia?

I think that smaller units built could be built very cheaply from plastic plumbing fittings without sophisticated construction equipment. It would be interesting to see the results of local experiments with low head versions. With this design there are no tight tolerances to be met and the only real problem, that of sealing the bottom bearing, can be dealt with by raising the bearing 30-40 cm above the water level and allowing the arms to drop down below it. The bearing can then be placed inside a plastic tube extending downward to keep the water off it. As an aid to would be ex-

fig 3. Application Diagram

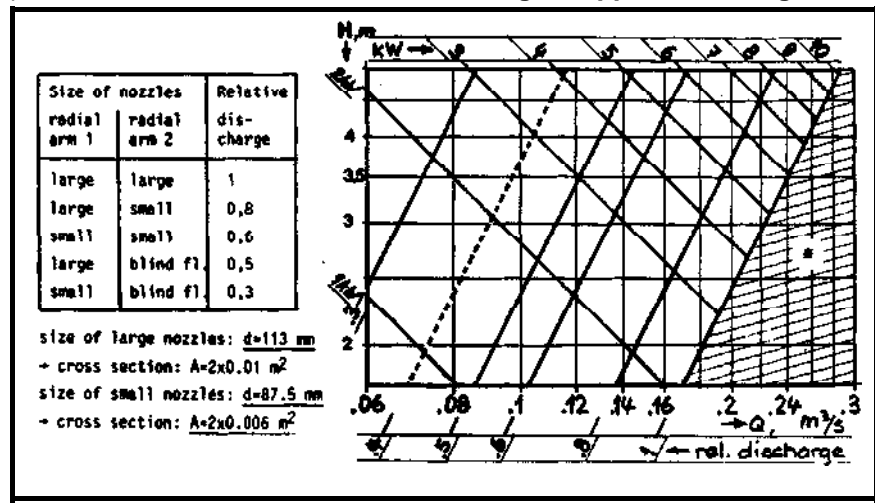

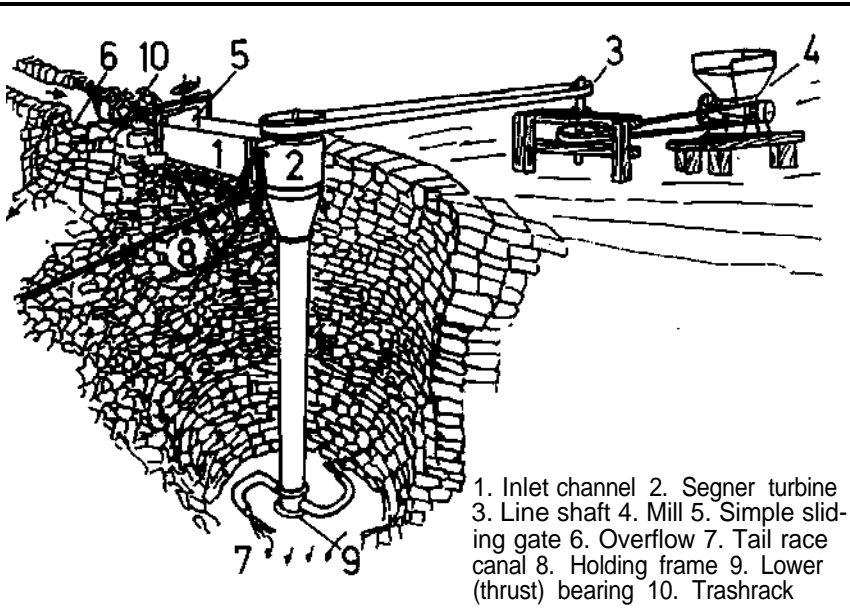

1. Inlet channel 2. Segner turbine  
3. Line shaft 4. Mill 5. Simple sliding gate  
6. Overflow 7. Tail race canal 8. Holding frame  
9. Lower (thrust) bearing 10. Trashrack

perimenters, we have included the basic design formulae (see box). One interesting advantage of the Segner Turbine is that its a particularly open design which is less likely to jam on obstructions which swim into it like eels or frogs!

*The material in this article is culled from a publication called The Segner Turbine : a low cost solution for harnessing water power on a very small scale by Ueli Meier, Markus Eisenring and Alex Arter. It was published by SKAT (Swiss Centre for Appropriate Technology at the University of St. Gall) about 1984. The ATA has a copy if you want to have a look at it.*

## PERFORMANCE CALCULATIONS

### Symbols used

H [m]	available head
Q [m <sup>3</sup> /s]	available water flow
D [m]	nozzle pitch circle diameter
d [m]	nozzle diameter
Z	number of nozzles
cf	nozzle coefficient efficiency
n	rotary speed
N [rpm]	rotary speed
P [kW]	shaft power
T [Nm]	shaft torque
A [m <sup>2</sup> ]	nozzle cross sectional area
u [m/s]	circumferential velocity
w [m/s]	relative velocity
g [m/s <sup>2</sup> ]	gravitational constant
r [kg/m <sup>3</sup> ]	density (of water)

### CALCULATION EXAMPLE

#### Given parameters:

$$H = 4.0\text{m}, Q = 0.15\text{m}^3/\text{s}, cf = 0.96$$

hence:

$$\eta_{\max} = 1 - \sqrt{1 - cf^2} = 0.72$$

$$P = Q.H.r.g.\eta_{\max}.10^{-3} = 4.24 \text{ kW}$$

(the turbine is to operate a 4kW oil expeller with a turbine speed in the range of 100 to 150 rpm.)

$$N_{\text{opt}} = 120 \text{ rpm (selected)}$$

$$\text{so } D = (60/[N_{\text{opt}}.\pi]) \sqrt{gH[(1/1 - cf^2) - 1]} = 1.6\text{m}$$

### BASIC FORMULAE:

$$P = Q.H.r.g.n.10^{-3} = \text{hydraulic power}$$

$$A = z.d^2.\pi/4 = \text{nozzle cross section}$$

### SEGNER FORMULAE:

$$Q = z.d^2.(pi/4).cf \sqrt{2gh+u^2} = \text{dis-charge}$$

$$P = A.w.u.(w-u).r.10^{-3} = \text{power output}$$

$$T = A.w.(D/2)(w-u).r = \text{shaft torque}$$

With given inflow, the working head (water level in vertical pipe) remains constant up to a certain speed ( $N_{\text{limit}}$ ). In the case of higher speed, working head will be decreasing. This is reflected by formulae for  $N_{\text{limit}}$  and  $N_{\text{max}}$ .

$$P = T.\pi.N/30 = \text{rotary power}$$

$$N = u.60/(D.\pi) = \text{rotary speed}$$

$$u = D.\pi.N/60 = \text{circumferential velocity}$$

$$\eta = [u/(g.H)](cf \sqrt{2gh+u^2} - u) = \text{efficiency}$$

$$\eta_{\max} = 1 - \sqrt{1 - cf^2} = \text{max. efficiency}$$

$$w = cf \sqrt{2gH + u^2} = \text{relative velocity}$$

$$N_{\text{limit}} = (60/[D.\pi]) \sqrt{(Q/[cf.A])^2 - 2gh} = \text{speed limit for full head}$$

$$N_{\text{max}} = 60.Q/(D.\pi.A) = \text{runaway speed}$$

$$N_{\text{opt}} = (60/[D.\pi]) \sqrt{gH[(1/1 - cf^2) - 1]} = \text{speed at max. efficiency}$$

$$u_{\text{opt}} = D.\pi.N_{\text{opt}}/60 = 10.05 \text{ m/sec}$$

$$A = Q/(cf \sqrt{2gH + u_{\text{opt}}^2}) = 0.0117 \text{ m}^2$$

so

$$d = \sqrt{A.4/(z.\pi)} = 0.086 \text{ m (z=2 selected)}$$

Check for the acceptability of runaway speed:

$$N = 60.Q/(D.\pi.A) = 154 \text{ rpm}$$

Available torque at operating speed:

$$T = (D/2) . A.w.(w-u).r = 336.75 \text{ Nm}$$

# Dear Editor ...

## Segner Turbine

I am writing to you concerning the "Segner Turbine" article by Alan Hutchinson in Soft Technology no. 31. There are a couple of errors in the formulae given which would pose problems to anyone attempting to design a turbine for their own application.

In the "calculation example" on page 14, the nozzle pitch diameter is calculated by the formula

$$D = (60/[N_{opt} * \pi]) * gH ([1/1 - Cf^2] - 1)$$

giving D=1.6 m. This is a misprinted formula. Using it would give D=3.4 m. The correct formula reads

$$D = (60/[N_{opt} * \pi]) * gH ([1/1 - Cf^2] - 1)$$

which gives D=1.6 m. A similar misprint occurs in the Basic Formulae table. Here the correct relationship is

$$N_{opt} = (60/[D * \pi]) * gH ([1/1 - Cf^2] - 1)$$

Obviously the omission of the inner square root makes quite a difference to the size of the turbine diameter! The designer would be annoyed and frustrated when his or her turbine runs with an optimum 56rpm rather than the required 120 rpm!

A less significant error occurred for  $N_{max}$ . It should read:

$$N_{max} = 60 * Q / (D * \pi * Cf * A)$$

which is the result if h becomes zero in the  $N_{limit}$  formula.

I did enjoy the magazine and will keep reading it.

Yours faithfully,  
**Tom Kirchner,**  
 Flemington, Vic.

## Z-Axis Drive, 32 volt systems

Received the October 89 issue yesterday (No32/33) and am writing to say what an excellent issue it was. Good, meaty, practical stuff and I thoroughly enjoyed it all!

Question no.1. I would very much like to get in touch with Greg Clitheroe to ask some

question about his low voltage modifications and also, if possible, to buy a copy of his book *Backyard Electrical Systems*?

The letters section carried a letter from W. Wadsworth of Northcote, Victoria. The gear system he mentions is called Z - Axis Drive and I enclose photocopies of some relevant information which you may copy for the association's files and forward on to Mr. Wadsworth. I would also like to write to Mr. Wadsworth concerning this matter if you can manage this?

Keep up the great work!

Yours sincerely,

**Terry Jameson,**  
 Woodford, N.S.W.

## Low-head Hydro

I read with interest the article on John Hutchinson's low-head turbine (Soft Technology 32/33). I have some questions to raise about that article.

- 1) What range of frequencies does the generator operate between?
- 2) What controls the frequency?
- 3) What frequency can you go down to?
- 4) What is the efficiency of the system, in terms of hydraulic and electric component losses?
- 5) Am I right in assuming the generator was rated at 2.2 kW because the computer program gave an estimated output of 1.8 kW at 100% efficiency. or was there another reason for using an overrated motor?

I must say I enjoyed the magazine . . I wait in anticipation for more!

Yours faithfully,  
**Richard Feynman,**  
 Preston, Vic.

## Soft-tech October Issue

Thanks very much for the October issue. It not only reminded us to re-subscribe but also featured the very useful "Solar Water Heater Buying Guide". Just what we needed!

Also good was Bill Keepin's article. Heard him speak at a People for Nuclear Disarmament A.G.M. He presented solid facts against nuclear power and for energy efficiency.

Thanks,  
 C. Newton  
 Mt. Hawthorn W.A.

## Does anyone know . . .

Would you have any ideas on how to convert a table/bench mounted "mangle" (wooden rollers type) into a grape press/roller please, some descriptive literature would be appreciated.

Thank you,  
**B. Marschner,**  
 Pt. Pirie Sth, S.A.

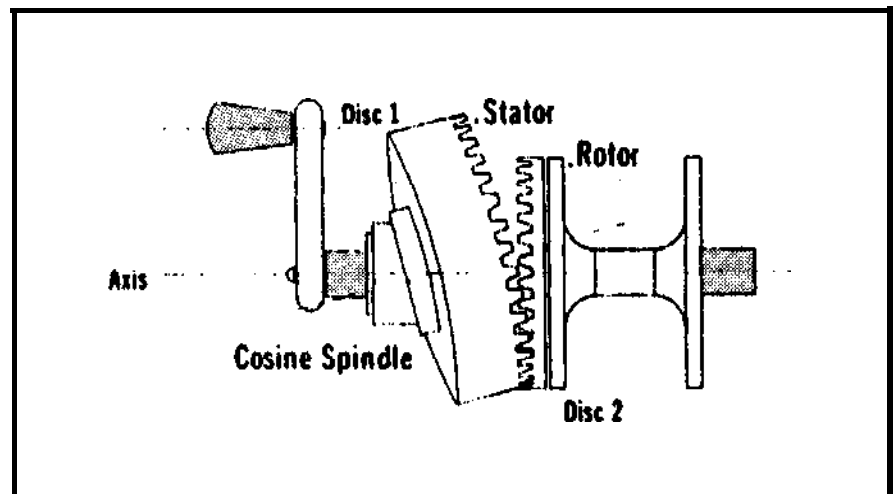

Z-axis drive winch (Tool Master Inc.)

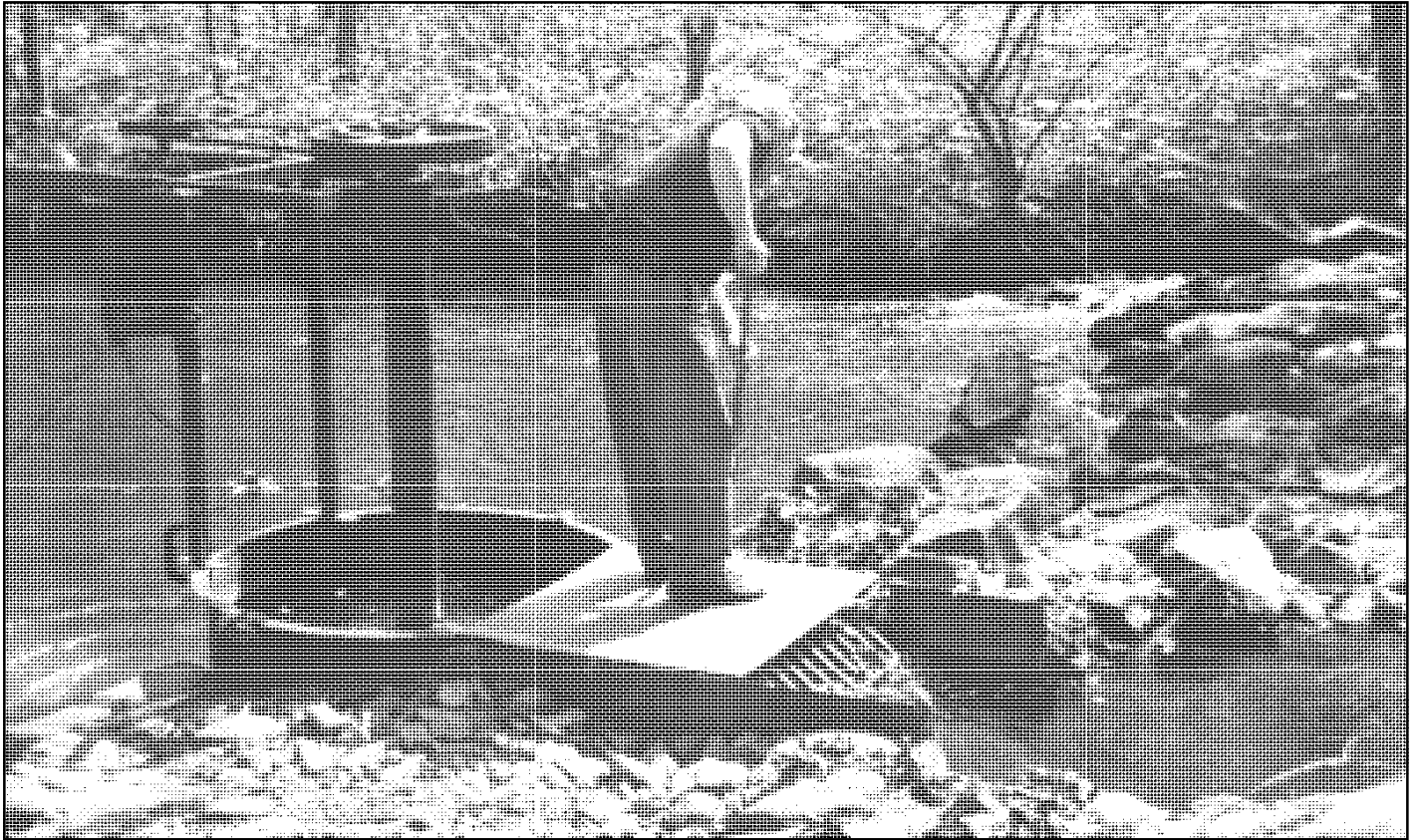

Above: Abe Lewisburger cleans out the trash racks of prototype "Portable" low head hydroelectric plant. Turbine Specs: 22 inches of head drives a 24 inch diameter C.M.C -Fitz vertical axis francis turbine developing 3 Amperes at 130 Volts DC or 9,360 Watt hours per day. This turbine discharges 520 cubic feet of water per minute at 70 RPM. Photo by Cameron MacLeod.

## Ultra-Low Head Hydro

Cameron MacLeod, N3IBV

©1991 Cameron MacLeod

**O**ne hundred years ago low-head hydro wasn't just an alternative; it was the best alternative. Unlike high-head sites, low-head sites are everywhere, and often closer to population centers where the power is needed. Power sources were valuable and sought after, because cheap power wasn't delivered through silent wires down every street. Local wars were fought over water rights.

### The History of Low Head Hydro

Times have changed, but the weight of water and gravity remain the same. Once we had over two hundred makers of small water turbines in the U.S.A. Some of them built, by 1875, equipment that was 80% efficient. They built and inventoried turbines as small as four inches in diameter that made one horsepower on ten feet of head. Turbines that ran on two feet of head and made from one to fifteen

horsepower were common. Some were excellent machines that ran with little maintenance for years. The know-how and hardware were everywhere. In the eastern part of America, the power of the small streams near populated areas was developed and put to work. All the way from the hills to the sea, this water was used over and over again wherever topography supplied enough head. One large stream in the east had dams and still has



pre-revolutionary deeded water rights wherever early settlers found three feet of head.

When ships landed on the east coast, surveyors and mapmakers headed inland to discover natural resources. All the old maps denoted power sites as "Mill Seats" long before settlers arrived. This was before the successful use of stationary steam engines, so we know that they were referring to hydro power. Later, towns grew because of this power. Virtually every sort of agricultural and industrial work was once aided by the water. It is sad that the water source of power is often blamed today for the mess that industry left behind. In this age of environmental awareness, we should not throw out the turbine with the wash water.

Back when power was valuable, men moved hundreds of tons of earth and rocks with just their backs, mules or oxen. Often they made this investment & did this work with their bodies for the sake of one or two horsepower. Wow! Think about it. Something was going on there. If you think they were nuts, then look at the size of the manor houses and mills that were energized with those one or two horsepower. Then think about what clean renewable power in your backyard is really worth to you - and your children - and your grandchildren - and on and on - forever.

Of course power has gotten cheaper and cheaper in the last hundred years. By burning non-renewable fossil fuels at the expense of the earth and our futures, they practically give it away. I can hear you now - what's this jerk talking about. The only ones that really know the value of power are the people who have tried to make power for themselves. If your goal is to supply your daily energy needs; you either know how cheap commercial power is or you're going to find out. My position is not to discourage you, just to warn you. Pursue your dream. If you can't visualize it it will never happen.

Over the past ten years, I've helped to develop twenty or so small hydro sites. I've gone on to bigger megawatt hydros now, because I need to make a living. The small sites range in power from 300 Watts to 100 kW. Almost all of this work has been under fifteen feet of head. The power has

been utilized to run homes and small businesses or more commonly, large farms. All the projects were former sites with dams in one state of repair or other. The legal aspects of these undertakings have been handled by the owners and often represent the greatest problem.

### Hydros and Red Tape

If your home power system isn't on federal land, doesn't hook to the grid, and doesn't make power from a navigable stream; then you may not need a federal license. There is no legal way to avoid dealing with a state agency. Watch out - often this destroys dreams. You had better base your work on an existing dam or a pile of rocks no more than 36 inches high called a diversion wier. Remember not a dam, but a wier. That diversion had better not be long in either case if you hope to stay within environmental laws. In all cases you had better own both sides of the stream. These problems will vary from state to state. You must learn through research. Have enough sense to keep your own council (keep your mouth shut about plans) until you figure out which way the water flows.

### Low-Head Hydroelectric Turbines

My goal here is to let home power people know that under just the right circumstances low head hydro is possible. Practical - that's your judgement. It will depend a lot on what you consider to be valuable. That is to say, your values. How much your alternatives cost matters too.



Above: a 30 inch Trump turbine operating at 36 inches of head. This turbine produces 35 Amps at 130 Volts DC or 4,550 Watts of power. It has been in operation since 1981. Photo by Cameron McLeod.

Despite all this red tape nonsense many people have successfully established low-head hydro systems. I'll detail a couple of sites to whet your imagination. First, you should understand that very little has been written about low-head hydro in the last fifty years. By 1915, development had shifted from small diverse sources of power to large centralized systems based on alternating current and high voltage distribution. Giant government-backed utilities were beginning to carve up the country into dependent territories. Starting with the cities and industrial areas they stretched their wires out into the country. By the 1930s, rural electrification was well under way. Many utilities forced their customers to take down their wind machines and remove their turbines before they could hook up. Big customers were bribed with no cost changeovers from D.C. to A.C.. Along with the gradual loss of public self-reliance, the end result for the hydro power machinery business was that the market for small turbines disappeared. So did the manufacturers. Several companies made the transition to giant utility grade equipment into the 1950's. Now they are gone too. None of the biggies are U.S. owned.

There are a few crazies like myself who still build small machines. Most backyard operations concentrate on pelton and crossflow turbine which are only suitable for high head (depending on power requirements). I build Francis and Propeller type turbines. They are expensive, hand-built machines that don't benefit from mass production. They will, however, last a lifetime with only bearing changes. This is a tall order because everything must be constructed just right. I approve all site designs before I'll even deliver a turbine. I personally design most systems.

Often a better way to go involves rehabilitating old equipment. Some hydros were junk the day they were built. Other makers really knew their stuff. Their quality and efficiency are tough to match even today. These machines are usually buried under mills or in the banks of streams. Go look, you'll find dozens. The trick is to know which one you want, so do your homework before buying an old turbine.

### **A Low-Head Hydro System**

One site that depends on a rehabilitated machine belongs to a farmer named George Washington Zook. George decided not to use commercial power in 1981. He had deeded water rights and the ruin of a dam on his property. Best of all he had lots of water, and incredible determination, common sense, and know-how. He only has thirty-six inches of head. I supplied him with a thirty

inch diameter vertical axis Francis type turbine. This turbine was built by Trump Manufacturing Co. in Springfield, Ohio around 1910. One of the good ones. George was 25 years old when he finished the project.

George got all the required permits and built a sixty foot long, 36 inch high, log dam with a wooden open flume for the turbine at one end. He installed the turbine with a generator mounted on a tower to keep it dry in high water (never underestimate high water). Four months later his dam washed out. One year later he re-built and started generating 130 Volt D.C. power. Yes, high voltage D.C.. His machine develops 35 Amps @ 130 Volts or 840 Ah/day or 109.2 kWh/day. Discharge is 2358 c.f.m. (lots of water) @ 96 r.p.m.. He has a 90 series cell, 240 Amp-hr. nicad battery pack. This represents an incredible amount of power for any home power system. That is 32,760 kWh a month. Hey, that's enough power to run three to five average American homes. All of this on 36 inches of head. Yeah, that's right, and his battery pack lets him meet 20 kW peaks. Here is what his load looks like : three freezers( two for the neighbors),a refrigerator, refrigeration to keep the milk from twenty cows cold, a vacuum system to milk these cows, two hot water heaters, all lighting in home, barn and two shops, occasional silage chopper use, wringer washer, water pump, iron and farm workshop machines. I'm afraid it still goes on, his nephews put in a complete commercial cabinet shop two years ago. They have all the associated equipment including a 24-inch planer. Well, now what do you think about low-head hydro?

There are a few key differences between George's system and most you read about. There isn't an inverter on the property. At 120 volts D.C., line losses are at a minimum (We have some 220 volt three wire systems operating). All of the equipment and machinery on the farm was converted to 120 volt D.C. motors, including refrigeration. The high efficiency of this approach makes all the difference.

### **AC versus DC Hydros**

Stand alone A.C. is a possibility, but it requires a larger turbine and more year round water to meet peak loads. The cost of an electronic load governor and the inefficiency of single phase induction motors are two of the drawbacks to consider. Backup generator cost is also a factor. You'll need a big one to meet A.C. peak loads. With batteries to meet peak a small generator will suffice.

Remember, if you can meet 20 kW. peak loads with batteries it only takes one horsepower 24 hours a day to run the average American home. This is a tiny turbine that

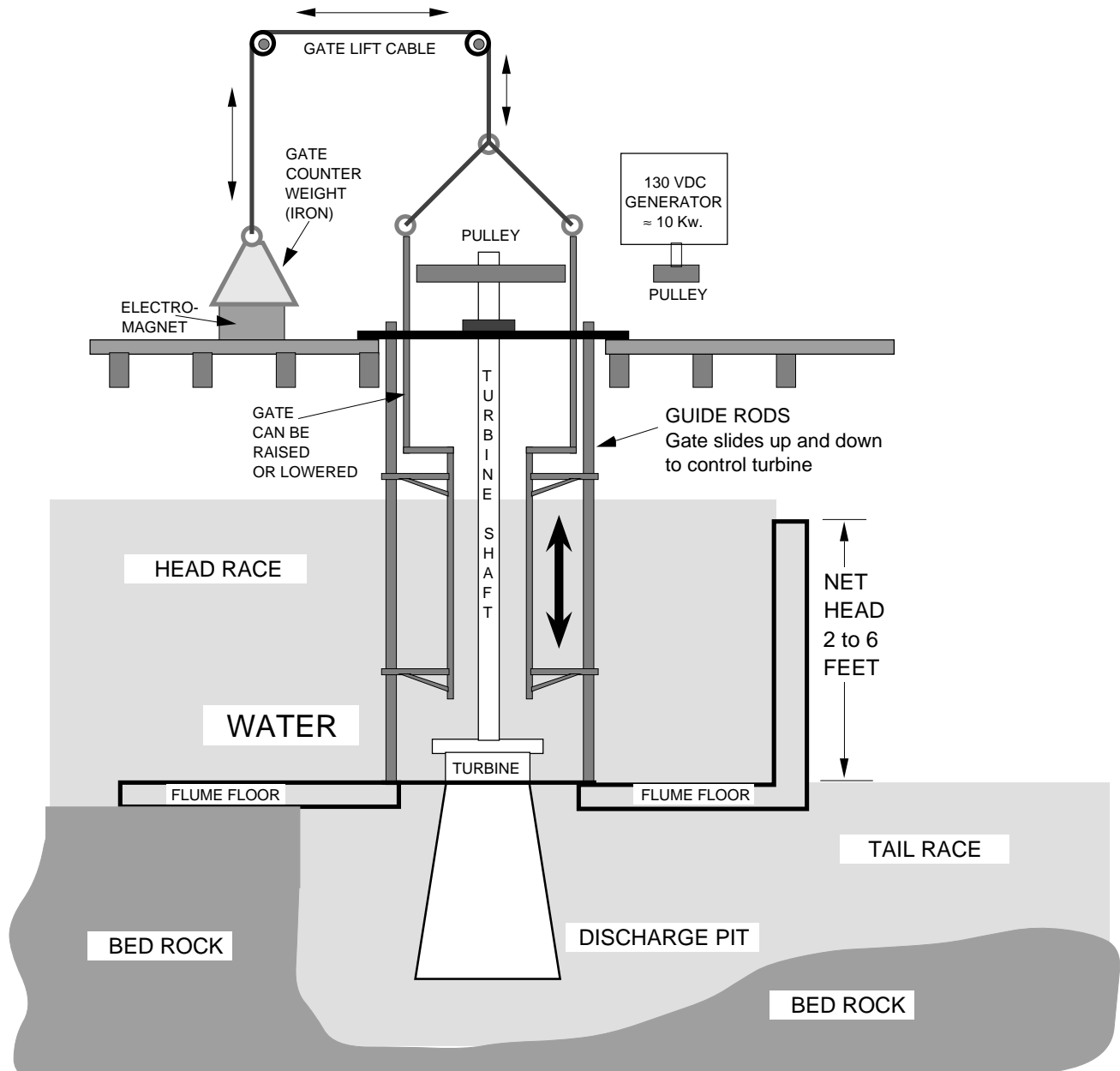

uses little water when compared to the 40 horsepower turbine on the same head that would be needed to meet the same peaks on conventional A.C.. Forget it - there is no comparison. The big machine would cost a fortune and require massive amounts of water. Hey, it is possible, I've built them.

The best of both worlds would have the lighting and heavy motor loads on 120 Volt D.C. for efficiency. It would have a switching power supply running on 120 Volts D.C. putting out high-current 12 or 24 Volts D.C. to run an inverter for specialized A.C. loads like TVs and stereo systems.

**Some Low-Head Hydro System Specs**

Here are the pertinent details on some-stand alone D.C. low-head hydro sites that I've been involved with:

**System 1**

5 feet of head - 8 inch MacLeod-built C.M.C. vertical Francis-type turbine develops 3 Amps @ 130 Volts or 72 Ah/day or 9.36 kWh/day. Discharge is 72 cubic feet of water per minute @ 335 r.p.m.. Note: The term vertical implies a vertical main and gate shaft which extends above flood level to protect generator and electrics.

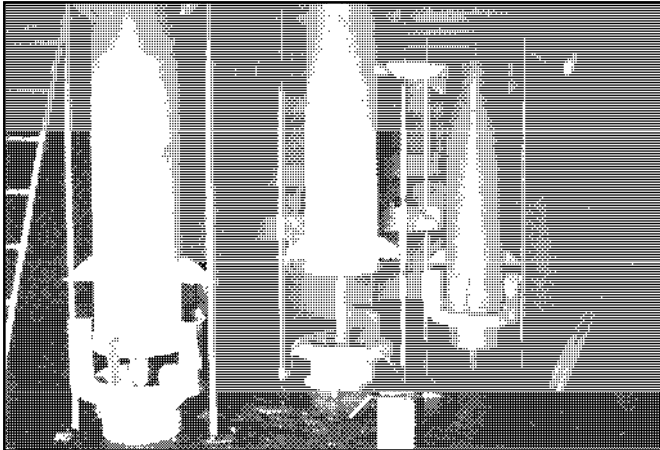

Above: three Conastoga propeller turbines that operate on 7 feet of head. Each turbine produces 5,000 Watts at 470 RPM. This photo shows the head race which is filled with water when operating. Note the Gates and Gate Rods.

Photo by Cameron McLeod.

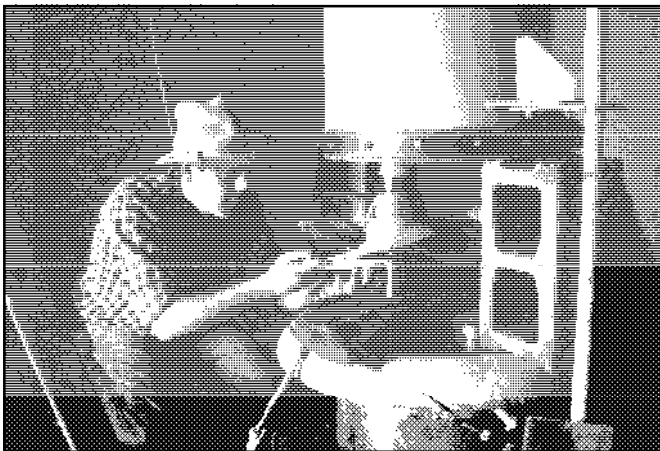

Above: Cameron McLeod inspects the propeller on one of the Conastoga turbines.

#### System 2

22 inches of head - 24 inch C.M.C -Fitz vertical francis develops 3 Amps @130 Volts or 72 Ah/day or 9.36 kWh/day. Discharge is 520 c.f.m. @ 70 r.p.m..

#### System 3

Three feet of head - 30 inch Trump Vertical francis turbine develops 35 Amps @ 130 Volts or 840 Ah/day or 109.2 kWh/day. Discharge is 2358 c.f.m. @ 96 r.p.m..

#### System 4

Fifteen feet of head - 8 inch MacLeod built C.M.C. vertical Francis turbine develops 12 Amps @130 Volts or 288 Ah/day or 37.4 kWh/day. Discharge is 130 c.f.m. @ 580 r.p.m..

#### System 5

Four feet of head - 27 inch S. Morgan Smith vertical Francis turbine develops 28 Amps @ 250 Volts or 672 Ah/day or 168 kWh/day. Discharge is 2190 c.f.m. @123 r.p.m..

#### System 6

Ten feet of head - 12 inch C.M.C. vertical Francis turbine develops 15 Amps @130 Volts or 360 Ah/day or 46.8 kWh/day. Discharge is 244 c.f.m. @ 320 r.p.m..

#### Low-Head Hydro Information

Getting info on low-head hydro isn't easy. Virtually nothing of any technical merit has been published since 1940. Watch out for crazies and experts who try to re-invent the wheel. It is un-necessary and wrong-minded. It has all been done and done well. Go find the data. Rodney Hunt Manufacturing published some of the best information between 1920 and 1950. They also built great machines. They no longer build turbines. Their books are out of print. Find them in engineering school libraries or museums that specialize in early industrial technology. Turbine makers catalogs from 1880 to 1920 were in fact engineering manuals, some better than others. Look for them. I haunt the old book stores. Go for it.

#### Books to look for :

Power Development Of Small Streams, Carl C. Harris & Samuel O. Rice, Published 1920 by Rodney Hunt Machine Co., Orange Mass.

Rodney Hunt Water Wheel Cat. #44 - THE BEST. Check out the Engineering section.

Any catalogs printed by : James Leffel Co., S. Morgan Smith Co. , Fitz Water Wheel Co., Holyoke Machine Co., Dayton Globe Manufacturing Co..

Construction of Mill Dams, 1881, James Leffel and Co. Springfield, Ohio. Reprint; 1972, Noyes Press, Park Ridge N.J.,07656.

#### Some words of encouragement...

Well people, I hope I've opened the door to stand-alone, low-head hydro for a few of you. If you really want the details you've got some long hours of research ahead of you. If you are determined to get on line, I wish you the best. Watch out, it is harder than building a house from scratch. It can be a real relationship buster. I believe it has as much merit as any effort at self-reliance one can undertake. Good Luck!

#### Access

Author: Cameron MacLeod N3IBV, POB 286, Glenmoore, PA 19343 • 215-458-8133.



# A REPORTER AT LARGE

## MINIHYDRO

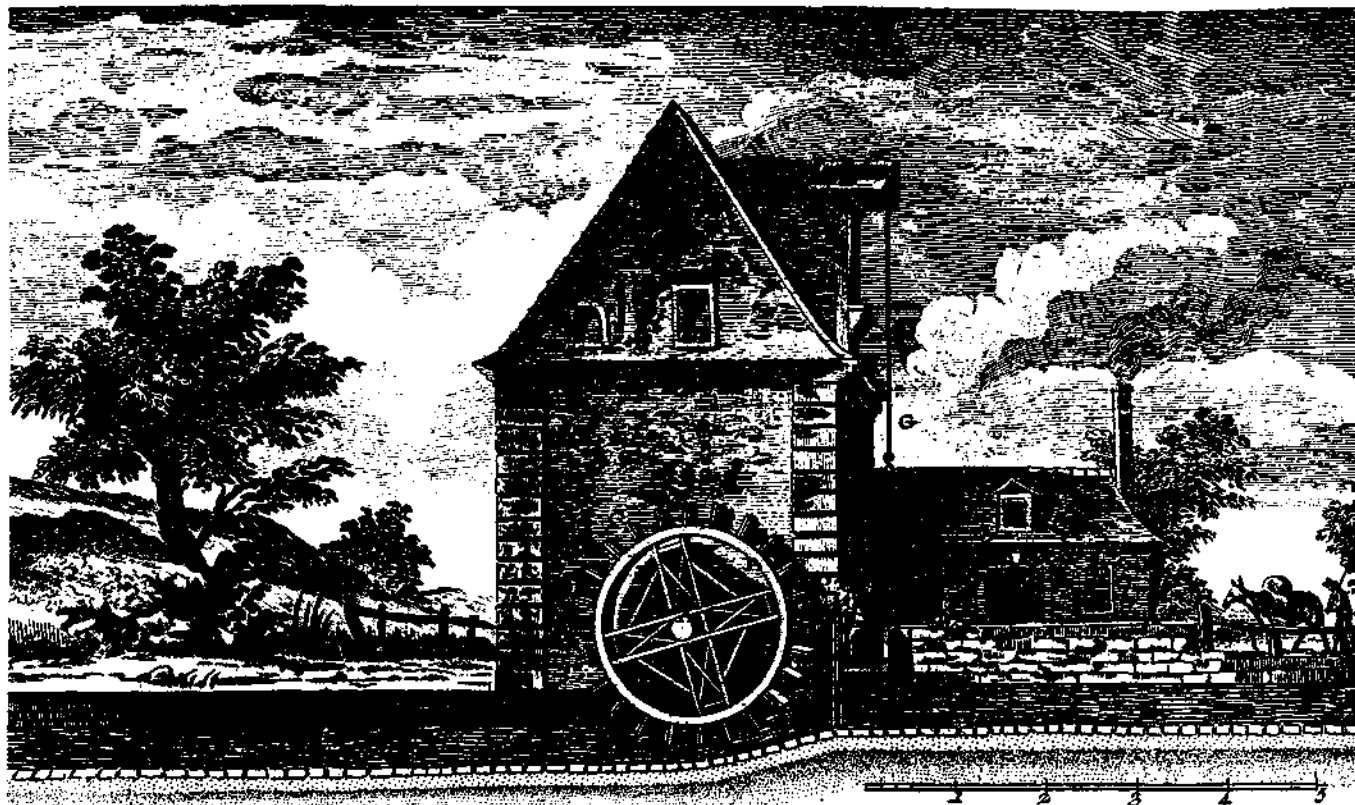

**A**FTER twenty prodigiously successful years, Paul Eckhoff sold his resin plant. There would be a six-year payout. He was fifty-six. He had good health, a tinkerer's unrelenting mind, a wife, five daughters. Taking into account his own needs and theirs, he contemplated what to do with his growing pile of money. Before long, he was exploring a "track," as he called it—a swath of country as much as a hundred and fifty miles wide and lying between his North Shore home on Long Island and his two retreats in the Adirondacks, on Lake George. In person or through deputies, he intended to visit any town on the track which contained in its name the word "falls." Haines Falls. Hoosick Falls. High Falls. Hope Falls. He had several deputies. Primarily, they were his daughter Mary and her friend Peter Houghton. Mary was an artist—a potter. Peter was a carpenter, a sawyer, a rufous-bearded nascent writer of fiction. The couple, at the time, were adoptive Vermonters. With no driveway, they lived upward of a mile from the nearest road. They skied to and from their home. As a graduate stu-

dent, Peter had been a literary scholar, but he was not much attracted to the academic world, and in the years that followed he had been experimenting unsuccessfully with other working milieus that might complement and stabilize a writer's life. Mary, Paul, and Peter searched for many months, in 1978 and 1979, making long erratic journeys on cambered rural roads, following stream courses, appraising the infrastructures of small river towns. They were looking for places where the power of falling water had for one purpose or another been utilized in the past. They were looking for falls and weirs and minor dams, abandoned power sheds, abandoned mills, with sluiceways, penstocks, and turbines that had been used, say, to crush pulpwood or to light the streets and houses of whole country towns. In the middle years of the century, electricity generated by big utilities had become cheap to the point where small-scale hydroelectric facilities were costing more in maintenance than their productive worth. An era that had begun with undershot and overshot nineteenth-century waterwheels ended with the outright aban-

donment of many thousands of relatively sophisticated impulse and reaction turbines, not to mention the generators that might be connected to them, the governors that kept things under control—all the works electrical and civil that collectively make power at dams. Corrosion, vandalism, desuetude rapidly made an eyesore of almost every one of the places where turbines had turned. River-borne debris piled high, neglected, at headgates and trash racks. Buildings stood vacant, the targets of stones, winds blowing through them over teeth of shattered glass. Dams rotted, spalled, cracked, breached, and began squirting water in high arcs—the hydrodynamic equivalent of death rattle. Some of these sites had belonged to the big utilities. Many were mills that had used the power for their own purposes. Others, privately owned, had made electricity and sold it to the utilities, but at rates that fell faster than water. In a subdivision of the legislation that became known as the National Energy Act of 1978, Congress decided that if someone wanted to make power at a small-scale hydroelectric facility and sell it for absorption into the regional

grid, then the territorial utility—Central Hudson Gas & Electric, New York State Electric & Gas, Niagara Mohawk—would be compelled to buy the electricity, and at handsome rates conditioned by the rising price of oil. It is possible that in 1897 less action was stirred by the discoveries in the Yukon. There was a great difference, of course. The convergence on the Klondike was focussed. This one—this modern bonanza—was diffused, spread among countless localities in every part of the nation. As a result, it was a paradox—a generally invisible feverish rush for riches.

In the past, most utilities had refused to buy power from private sources. Those that did had paid sums that would embarrass Volpone. Niagara Mohawk, for example, paid as little as six-tenths of one cent a kilowatt-hour, take it and like it or bring on the vandals. Now, after the National Energy Act, the State of New Hampshire was promising eight and two-tenths cents as the price of a kilowatt-hour from a small-scale installation. Paul Eckhoff imagined that small producers in New York State might be given as much as eight cents, and surely five. Under the provisions of the act, prices were to be set by March of 1981, and they would vary according to regional economics, but in all instances the price could be expected to multiply the sum that had been paid before. Minihydro, as it is sometimes called, would be saving oil, and in effect it would be paid by the barrel.

One did not have to be a theoretical physicist to figure out that if water was falling, say, twenty-five feet where the annual average flow was four hundred cubic feet per second, it could turn modest turbines that could turn small generators that would earn, at six cents a kilowatt-hour, about two hundred thousand dollars a year. All you had to do was find and acquire a comely little waterfall or an unbreached dam. You would need a functional conduit for the water—a power canal or sluiceway or flume, usually leading into a pressure penstock (an inclined pipeline)—to take the water from above the dam and down through a powerhouse and out through a tailrace back to the stream. Ideally, you hoped to find a turbine, a generator, a gearbox standing idle in the basement of the Mill on the Floss. You would take over the place. Kick out the artists and sculptors. Minus a

little rust, you would be ready to go. Possibly some of the components would be past repair, or missing. Possibly the penstock would have been sucked flat like an old straw. The powerhouse might be canting on its way into the river. The dam could be bleeding from a thousand wounds. You would address yourself to these problems. Some sites were definitely more viable than others—"viable," the magic word of minihydro, the vernacular synonym for "colors of gold." Every site was unique, each calculation "site specific," as would be anything that depended on the size, age, and condition of many expensive parts in addition to the drop and volume of the available water. Drop and volume varied greatly from river to river, drainage to drainage, region to region, waterfall to waterfall, dam to dam.

In Stuyvesant Falls, New York, twenty-five miles southeast of Albany, Peter and Mary went into the post office one spring day in 1979. They had just crossed a bridge over Kinderhook Creek, a tributary of the Hudson River. Beside the tumbling water they had seen a penstock running downhill into a powerhouse in an evident state of disuse. They wondered who might be the owner. The answer was "Niagara Mohawk." As scouts, they knew they could forget about Stuyvesant Falls. Niagara Mohawk was not going to part with a hydroelectric plant, even a small and dead one. For Peter and Mary, it was just another drawn blank. At Victory Mills, near Saratoga Springs, they had found an old paper mill, now used as a warehouse, wherein every hydroelectric component seemed in such good condition that the power could simply be turned on. The owner liked the warehouse and had no inclination to sell. They had been impressed by a former glass-blowing factory near Lake Placid, but it was taken. In Troy, they had found another fine old mill, ideal in many respects, but the penstock was under the city. Now they were about to leave the post office in Stuyvesant Falls. Perhaps there were other facilities nearby. Well, nothing much, said the clerk behind the counter, only the old cardboard-box factory down the road. Down the road were red barns and white silos and freshly planted open fields. Kinderhook Creek had deeply cut its bed and could not be seen from the fields. Suddenly, as the road began to descend, there protruded into

this Arcadian scene an industrial smokestack of great height. It seemed to rise from the farmland like a finger. Then, with further descent, a water tower came into view beside the smokestack, and, below the tower, a factory hideous beyond the province of decay (Munich, 1945; Reims, 1918)—an apparently bombed-out, shell-crazed ruin, with gaping holes in masonry walls that had been desiccated and disintegrated by fire. There was a sign. "FOR SALE." They would learn that the price was eighty-five thousand dollars. The place was not small. The rubble ran along the river more than six hundred feet. There was a beautiful waterfall at the upstream end, more than eight metres high, a hundred yards across, and falling over cap rock of dark, limy shale. It had been heightened six feet by a concrete weir. Over the top came a greenhouse curve of water clear as glass. It turned to cotton on the face of the rough black shale. Chittenden Falls. In all, the water spilled thirty-four feet—a thirty-four-foot "head," in the terminology of the science. The average annual flow there was four hundred and forty-two cubic feet per second, measured since the nineteen-thirties by the United States Geological Survey. There were wooden headgates rotting under years of river trash—trees, automobile tires, lumber, and plastic, in a matrix of mud and gelatinous slime. There was an elevated sluiceway, part wood, part concrete: porous, pocked, inutile, filled with silt and more debris. The penstock was rusted thin and in some spots rusted through. The powerhouse was precipitously ailt. The generators were gone. The turbines were rusted in place. By almost anyone's standards, the scene as a whole was repulsive, depressing, defeating. To Paul Eckhoff, when he saw it, it looked like a four-ton nugget.

ON a bluff above Chittenden Falls stands a Victorian stone mansion with a full-length front veranda, tall symmetrical windows, a mansard roof, and a cupola. In its obvious request for attention, it easily exceeds the home of Martin Van Buren, a few miles away, as one might expect of a structure that was built to house the president of a box company. All mullions, muntins, sashes, glass are long since gone from the windows, however, and snowdrifts form in the parlor. The veranda has collapsed. The roof is rent. The ma-

sonry is grouted with daylight. The lawn is bearded with saplings. For all of that, the old house retains its position of view and command, and sends out faint proprietary signals. Eckhoff intends to restore it—"to correct the masonry, put on a new roof, shutter the windows, and wait until someone in the family wants it. Someone will."

One method of finding old hydro sites is to look for decayed mansions in the sumac of river hills. Look up from the banks of the Grasse, for example, in Pyrites, New York—across the Adirondacks, a hundred and seventy miles northwest of Chittenden Falls—and see a stairway winding upward into the forest to the remains of another Chartwell. It is beyond restoration—a condition that describes almost all the facilities that once stood below. This was the DeGrasse Paper Company, in its time the largest paper mill in northern New York, built around 1900, closed in 1930, reabsorbed now by the forest. The eroded walls of the DeGrasse Paper Company can be traced around a grove of fifty-year-old trees. The stream, nearby, picks its way through a gorge of Precambrian amphibolite—bends left, right, right again, left—and drops a hundred feet in half a mile. Its turns are not the smooth meandering arms of letters "S" but sharp deflections that indicate with rapids the strife between the rock and the river. Two small dams were built to enable the DeGrasse Paper Company to exploit this memorable scene—one of them diversionary at the top of the gorge and the other to block the diverted water, to keep it from trying to make a new gorge by spilling untidily downhill through the woods. Instead, the DeGrasse people caused it to pour through a penstock a distance of seven hundred linear and seventy-six vertical feet. At the bottom is a small powerhouse, size of a garage, where a turbine and a generator long ago began to turn. They are turning again now. On a bad day, they produce twenty-five thousand kilowatt-hours of electricity. On a good day, twenty-eight. There is a meter on an inside wall. It is the reverse of the meters attached to private homes. It records, in effect, what Niagara Mohawk will pay.

For the most part, the powerhouse functions on its own, unattended, humming in the woods a couple of hundred yards from the river. At least

once a week, someone comes along to listen to the hum—today a young man with a lumberjack look, boots, blue-jeans, a sandy mustache. Mark Quallen. "Every machine is an individual," he says. "A turbine is a symphony of noise. You listen. You know if something is missing. Being able to listen to a waterwheel is something that is not in the books. This place was a mess, a disaster. We rebuilt it from one end to the other." He wears a mustered-out, threadbare military jacket with an emblematic patch: a hand holding a fistful of lightning bolts. The utility, not yet constrained by the government's coming rates, is paying 2.23 cents a kilowatt-hour for the electricity, a figure that is somewhat above the skinflint level but not as high as cheapskate. "Skimpy" is the word for it elsewhere in the industry. Even so—even at 2.23 cents a kilowatt-hour—the old turbine is making six hundred dollars a day. Quallen has drilled a row of vertical holes in the top of each dam. In the holes he has set galvanized pipes. Up against the pipes are planks of yellow pine. Pressing against these flashboards, as they are called, the ponded river has risen a foot. The additional foot is worth eight thousand dollars a year.

In 1978, Mark Quallen was an undergraduate at the University of Massachusetts, majoring in finance. He had served as a radio technician in the Strategic Air Command. He was older than most of his classmates and was therefore a little more than routinely interested in a course in entrepreneurial activity offered by Professor Robert I. Glass—how to get going in a small business, how to choose one in the first place, how to put a foot on the ladder to the sky. Glass, with a degree from the Wharton School of Finance and Commerce at the University of Pennsylvania, had made an enviable fortune as a small manufacturer, an investment banker, a builder of suburban malls. First, assess the needs of the society, he lectured. Ask yourself what is *not* being done. Look closely at the three "T"s: taste, transition, technology. Look for changes in taste, changes in technology. Such changes have economic impact.

With a headful of that, Quallen went out looking. One assignment in the course was to find and analyze an entrepreneurial opportunity. Suggested by Glass were multiple possibilities in

food, insurance for the young, the crisis in energy. Quallen and others chose energy. Remember, said Glass, you've always got to ask yourselves what *you* can succeed in doing. You are not going to compete with Exxon and Mobil, or with experimenters in synthetic fuels. You need something manageable and small.

In Millers Falls, Massachusetts, fifteen miles up the road, a wood-crib dam had been built in 1865, in the Millers River. The late Millers Falls Tool Company had used the head to generate electricity for its own use. Civil and electrical, the works were still there, preserved, after a fashion, in accumulated guck.

You must study the site, said Professor Glass, and ask yourselves if it is possible *at prevailing rates* to make a profit there in low-head hydro.

This was before the National Energy Act, and while the act may have been anticipated, the Professor's perhaps conservative point was that an intelligent entrepreneur would not base calculations on the hope or expectation of future high rates, would not depend on unvoted legislation, but would determine if a profit could be turned under conditions already prevailing. Given the rates being paid at the time for electricity produced by private sources, new sites and equipment seemed beyond conversation. Costs of labor were prohibitive, too. The only way to make a go of minihydro would be to refurbish an old site at the lowest possible cost—in short, to do it yourself.

Before long, Mark Quallen was at Millers Falls, up to his armpits in polluted silt. A company had been formed: Robert I. Glass, president; Mark Quallen, vice-president in charge of operations. In other words, Quallen was the company sandhog. He had a fire hose draped over his shoulder. Hydraulically, he exposed the old equipment, washed away the mud from flaking surfaces of rust. Right there by Bridge Street, he was working in a fairly public place. He fielded questions.

"What are you going to do with that junk? Cut it up and sell it?"

"No, we are going to make electricity with it."

"Yayup. Hah!"

While exhuming the facility, Quallen read everything he could find on hydroelectric power. In six or seven months, he had two turbines turning.

That was in the winter of 1979. Some generating tests were successfully conducted. An application was filed for a grant from the Department of Energy, the purpose being "to secure the dam." Then breakup came, and ice began to move in the river. A jam developed just upstream. Water ponded behind it. The ice jam continued to build—ten, twenty, thirty feet high, a natural dam in itself, a plug of enormous tonnage, dwarfing in every respect the fragile dam below it. The ice wall at last exploded, and drove the wooden dam in splinters to Long Island Sound.

Quallen's knowledge, of course, survived, and so did his enthusiasm. A few days later, he went to a New York State Energy Research and Development Authority conference on small-scale hydro and learned of not one

but a whole aggregation of available sites where streams coming off the Adirondacks flow north and west—Black River, Oswegatchie River, Grasse River. At Pyrites, twenty-five feet of debris had piled up at the dam and fallen over onto the penstock. It looked like the lodge of an extremely large beaver. The penstock, sixty years old, was in part rusted through and sagging out of round. Niagara Mohawk, asked for its opinion, had estimated a hundred and sixty thousand dollars as the cost of restoring the penstock alone. Glass and Quallen and a couple of young colleagues did the job for forty thousand dollars. Somewhere in Connecticut, they found a junkyard full of used underground fuel tanks, and

hauled them to Pyrites, where they sliced off the ends of the tanks and welded the tubes together: penstock. They spent sixty thousand dollars strengthening dams and spillways, twelve thousand fixing up the turbine. In all, their expenditures amounted to less than a tenth of what has become in the minihydro industry the average cost per unit of producible power. For a hundred and twelve thousand dollars, they had refurbished the Pyrites power station. They got twelve hundred kilowatts—one and two-tenths

megawatts—in return.

At Dexter, on the Black River, at Fowler and Hailesboro, on the Oswegatchie, there are waterwheels to listen to as well. Glass and Quallen and company have four sites in operation. They are restoring others. Headquarters, machine shop, and four working turbines are at Dexter—half a mile upstream from Lake Ontario—and the company is now called the Hydro Development Group. Its evident profitability is in large measure the result of a short personnel list (fourteen now), long working hours, and a wide-ranging search for used parts. In an old powerhouse in Mechanicville, near Albany, they found six turbines that had been standing there idle for twenty years, caked, crusted, swaddled in iron oxide, in flaking leaves of rust. Hydro Development bought them all, and they are now strewn around outside the machine shop, looking like sunken-ship parts brought up by divers after decades on an ocean floor. "We cannot afford new equipment," Quallen says. "We have to use used. There's nothing wrong with it. It's just frozen up and encrusted. We take it off with chisels. We sandblast." They bought a generator out of a power plant in Pennsylvania that had been crippled by a hurricane. By mail and phone, they have located much-needed components as far away as California. "We make a respectable return," Quallen continues. "A person approaching this sort of project in a more conventional manner would be hard put to it to make any money at all. A new waterwheel can cost five hundred thousand dollars."

At Pyrites, Dexter, Fowler, and Hailesboro, the company is generating thirty-five million kilowatt-hours a year. Overhead at any one site is reduced by the fact that there are many sites, and a thirty-mile radius sweeps them all. On operations and maintenance, the company is spending a quarter of a million dollars a year, and that is not a third of what is coming in.

**N**EAR Copenhagen, New York, in farm and forest country, the Deer River takes a wild

plunge, a hundred and sixty feet into a hidden gorge. It is a black-spruce-and-white-water mentholated scene—too beautiful to have come so near the end of the world in an undebased state of nature. Mark Quallen got out of his pickup one day to walk through a field and have a closer look. A wooden penstock ran down the side of the falls. There was an empty powerhouse in the gorge below. Fifty years before, the waterfall had lighted Copenhagen. And now, by the Hydro Development Group, power will be made there again.

In the same region, I wandered from site to site one day with David Wentworth, who works in Albany for the state, and we went out of our way to make a pilgrimage to Talcottville, a village so amazingly small and compact that it appears to be half a block of Utica standing in an open plain. There, quite near the intelligent stone home of Edmund Wilson, white water falls down stairs of Sugar River limestone of Ordovician age. "What a beautiful site!" said Wentworth, who describes himself as "the small-hydro program" of the New York State Energy Office. But no one had ever built a dam in Talcottville.

Among the tens of thousands of old hydro sites, few would be pictured on a wall calendar. Few are in country villages, few at sylvan mills. The majority are in fetid little cities half consumed by acid rains—rheumy-eyed, decrepit, semi-vacant, bypassed towns. Small dams, small turbines are vestiges, after all, of a lapsed prosperity, of a time that came and went, and they tend to be in places where boards cover windows, where rivers are fronted with century-old brick, where haircuts are cheap. One of the side effects of the rush to small-scale hydro is that in town after town more than power will be restored.

Wappingers Falls, New York, for example, was a wonder of industrial promise—shining like nearby Poughkeepsie—fifty and sixty years ago, when the Dutchess Bleachery was at the zenith of its days. The bleachery was actually a compound of buildings on the two sides of Wappinger Creek



at the foot of the long pitch from which the town took its name: Wappingers Falls, a fifth of a mile of urban cascades falling over slate toward the Hudson. Like so many textile mills in the Northeast, the bleachery bleached itself out of existence. But it used the creek for hydropower, and the old penstock is still there—a great, rusted entrail nine feet in diameter coming down from the dam and sluiceway at Wappinger Lake and dropping with elaborate prominence straight through the center of town. The central and focal intersection in Wappingers Falls is where the Main Street bridge crosses the penstock. The big pipe is raised on high piers above the streambed, and runs through the air like a pneumatic tube built for an unusual message. At the upper end of the town, impounded by a twenty-foot dam, is the artificial lake, its frontage crowded with identical houses that were built long ago by the bleachery. At the lower end of town are the mill complex—now full of job printers, electronics people, and insulation experts—and the old brick powerhouse, connected to the distant lake by the great umbilical penstock. Wappingers Falls' penstock may be the only one in the country that is lined with shops. It is a thousand feet long. The head is eighty-four feet. The annual average flow of Wappinger Creek is two hundred and fifty cubic feet per second. The figures work out to something more than a megawatt of power. At the height of the spring runoff, the flow can get up to a thousand cubic feet per second—thirty tons in every second, falling over the dam and pounding the bedrock slate. The pounding is hard enough to shake the town. The tremors move through the rock in waves, which trough and crest, and rattle only the structures whose basements they intersect. Bricks loosen in the walls of one building, nothing is disturbed in the next eight, plaster falls in the one after that. At winter's end, when breakup comes, the term is ambiguous in Wappingers Falls.

In Wappinger Lake, across the years, trash has piled up against rotting headgates. The concrete sluiceway, which connects the dam and the penstock, is in large part in shards. The power-plant windows, high

above the creek, have all been knocked out by vandals throwing rocks. Young people walk the penstock, down from the center of town—an act high enough to dare the devil—and some years ago they learned to keep going at the bottom, to climb from the penstock to the roof of the vacant powerhouse, and to go in through a cupola to smoke their joints. A spray-painted message on the penstock says, "CURB ALL DARKIES." Another one says, "I THINK ALL OF THE FEMALE DIMARCOS ARE EXTREMELY BEAUTIFUL."

Five engineers—electrical, mechanical, construction engineers—have undertaken to alter this picture: to restore power to the powerhouse, renovate the headgates, repair the sluiceway, give a fresh coat of paint to the penstock. They call themselves Electro Ecology, Inc., and they chose the site because it was the best among twenty or thirty they studied. Its dam was not breached. The turbines were in place. The penstock was all but undamaged. The eighty-four feet of head suggested the thunder of falling coins. William Hovemeyer, the president of the company, has for more than thirty years been an associate in research at the engineering school of Columbia University. He is a trim man with gray hair still touched with blond. He wears a tie clip among solid colors and grays, and he looks a little less like a professor than like the president of a utility. He has served as a consultant at Oak Ridge. He once engineered an electrical system involving pulse-power generation of a million amperes for twenty thousandths of a second. And now he is going to spruce up Wappingers Falls. "I calculated that our one small power plant will save twelve thousand nine hundred barrels of oil a year," he said one day in his office at Columbia. "Get something like that going across the country and think how much oil you could save. Moreover, as engineers, we all have a nostalgia for hydroelectric-engineering science. We have a great interest in it, beyond the fact that it could be a money-making scheme. In 1970, no one thought about it. In the past five years, things have mushroomed. People are all over the place looking for sites. New York is one of the more aggressive states. The activi-

ty is very intense. Our idea is to operate the plant by telephone modem or telemetry. We can design that sort of thing ourselves. We are going to automate Wappingers Falls."

And they are going to do so while spending scarcely a nickel of their own. Paul Eckhoff put down eighty-five thousand dollars of his resin money to acquire ownership of his invaluable ruin. Mark Quallen and Robert Glass have learned that one way to expand without much liquid capital is to come to terms with a site owner and then ask if they can reactivate the site before money changes hands. When the site is ready to hum, it is shown to a bank. Most bankers are able to multiply head times flow times efficiency and do the rest of the arithmetic that suggests kilowatt-hours on their way through a meter to the bank. The bank makes a loan to pay the owner of the site. The falling water pays off the loan. The simple ingenuity of such an arrangement is, however, not in a class with what might be described as the Columbia method, the financial *modus operandi* of Electro Ecology, Inc. The five engineers are renting Wappingers Falls. They are renting the dam from the town, renting the water of the lake. They are renting the crumbling sluiceway—with a promise to rebuild it in a manner meant to calm the tremors that rock the city. They are renting the powerhouse, from a real-estate company that has styled the old bleachery an "industrial park" and is the landlord of the ephemeral print shops. From the Marine Midland Bank, Electro Ecology, Inc., has obtained money necessary for the restoration of the civil works, and from the New York State Energy Research and Development Authority the funds for everything electrical. As engineers, Hovemeyer and his colleagues need no consultants, no ten- and twenty-thousand-dollar feasibility studies. They do their own. "We do our own engineering. We do our own wiring of control boards and switch gear. Our generators are being rewound, renovated, and insulated according to our own specifications."

When Electro Ecology was about to close its deal with Wappingers Falls and all points appeared to have been argued and agreed on, the Village Board insisted on one more stipulation. They want a fireplug to protrude from the penstock at the corner of penstock and Main.

A BIG tractor trailer crosses Kinderhook Creek and—in an act of apparent absurdity—backs up to a loading platform at Paul Eckhoff's rubbed factory. Paul is absent. His author-in-law—his daughter Mary's friend Peter—is present as usual and more or less in charge. He is assisted by Don Morse, a New York state trooper who lives across the creek and frequently daylights for Eckhoff's Chittenden Falls Hydro Power corporation before reporting for work in the afternoon. Morse wears a red checked shirt. He is youthfully middle-aged. He has crewcut gray hair, the light movements and taut body of a twenty-year-old athlete, and eyes that could make a driver's license shrivel and burn. He is a radar patrolman on Interstate 90. Welding, carpentering, or just removing junk, he has labored hard on this project. He shovelled and wheelbarrowed at least a hundred tons of muck out of the old penstock and the turbine housings. When Paul bought the place, he was advised to expect considerable vandalism, because vandalism, as everywhere, had become significant among the problems of Columbia County. With Don Morse working for the company and living just across the stream, there has been no vandalism at all.

In the tractor trailer are two Kato Revolving Field A.C. generators, mint new. The larger weighs two and a half tons. Their nameplate capacities add up to five hundred and fifty kilowatts, and they have come from Mankato, Minnesota. "The big one is worth about fifty thousand dollars," says Peter. "But I'm not sure of the figure. When you see him, you can ask Paul." Peter and Don hook come-alongs to the generators, and within an hour's inching they have pulled them off the truck. The arrival of the machines is anticipatory, a little premature. Out by the river, the old penstock is lying around in discarded flakes, and a new one is in place, its interior freshly lined with a heavy gum of Paul's invention—an anticorrosive whose ingredients include roofing tar and varnish. The powerhouse has

been jacked back to plumb, the tailrace has been bulldozed free, the headgates have been strengthened and repaired. But the sluiceway, of concrete and yellow pine, is only about half restored. It runs like a cornice along a high outcrop above the edge of the stream. The old trash racks, meant to stop debris at the mouth of the penstock, are completely gone, and new ones are not yet in place. The company, in short, is one or two hundred thousand dollars into the recapturing of power at Chittenden Falls, with tens of thousands to go.

Eckhoff regards himself as thrifty. He looks upon his budget as something of a shoestring. His style of spending on this restoration appears to be a little more freewheeling than the style of some people in the business, if considerably less so than others'. The new generators from Mankato bespeak an operation which, at the very least, seems to be advancing on a shoestring with silver tips. A Galion crane will soon arrive here; Chittenden Falls Hydro has bought its own crane. Mounted on a new balloon-tired hay wagon, standing near the mouth of the penstock, is a smart-looking Hobart welder, which Peter and Don now start into action. Helmets on their heads, torches in their hands, they weld steel bars in close rank to a frame at the mouth of the penstock.

Noon, and Don goes off to chase speeders. Peter gives up the welding and turns to carpentry. He is framing the walls of a machine shop that will stand on high ground close by the penstock, with a full view of the falls. In Vermont, when Peter used to ski off his property, with the Presidential Range over his shoulder and the Adirondacks before him, he went over the dry snow seven miles to work at a sawmill, which had a penstock, a Francis turbine, a small generator, and a belt that drove the saw. He cut softwood—rough lumber, planks for farmers. The owner had a big sugar bush, and Peter had begun his employment there and had gradually worked his way into the mill. To this day, on his Datsun pickup there is a sticker that says, "WOOD IS WONDERFUL." Mary, a classics graduate from Colby College, was a caseworker for the Vermont Department of Social Welfare. The long ski or hike into and out of home was less wonderful than the wood or the welfare, however, and Mary is now in law school, and Peter is here. He works this place with affec-

tionate hands. And no task is done more dreamily than the carpentry he is doing at the moment. Peter is about thirty. He once had polio and spent some months in a wheelchair. He went to college in the late nineteen-sixties, and, active and protesting, became a scion of his time, the mark of which may linger in his abiding gentleness somewhat more than in his air of faded anger. When Don Morse, inside the penstock, raised a hammer over the head of a mouse, Peter rebuked the trooper and saved the life of the mouse. He wears a railroad engineer's cap. His hair is extremely thin under the cap but tumbles out around it over his ears. He wears Vibram-soled boots, blue corduroy trousers, a pink checked button-down shirt over a green turtleneck, a Norwegian sweater full of holes. He is an antic figure with his full beard and gold-rimmed glasses that change in tint as they move in the light—now blue, now brown, now pink, now green, now gold. He is the author of short stories, poems. He is particularly fond of the carpentering of this machine shop, because he has persuaded Paul to let him add a second story—a twelve-by-twelve room with light on four sides and the prospect of the falls. "After we get the restoration finished and the turbines going, the amount of time necessary to make this place run as a business will be less than two hours a day," he says. "You check the turbines. You clean the trash racks, so the debris doesn't slow up the water going through the penstock. Then you're free. Someone who runs a hydro plant can do something else, too." While the turbines in the powerhouse (shut away from earshot) are steadily earning their hundreds of thousands of dollars, he imagines himself up in the cabin over the machine shop with a desk, a typewriter, a daybed, and the eternal sound of falling water. "My original dream was maybe to have a farm or an orchard and write. But you could have a hydro plant and write. That would be even better." It would indeed.

Peter is not sure of the direction his writing may take. He could, if he pleased, tell tales of the terrain just around him, for it was Mohican country, and it became a sleepy hollow with its own legends—of a red-lipped girl in a glass coffin, of a murdered violinist whose music is heard in the night, of pump organs played by the dead, of a woman in black with a mummy's parchment face who sometimes walks

the narrow local roads, where everyone who has so much as said hello to her has died before the sun fell. Henry Hudson, in 1609, brought the Half Moon into the creek and spent a pleasant afternoon with the Mohican braves. In the nineteenth century, people named Stott became so rich on woven cloth that they kept a barrel full of cash in the office of their mill for the convenience of everyone in the family, according to the tattle of the time. The first mill at Chittenden Falls was built in 1767; the last is Chittenden Hydro. The Philips Spiral Cornhusker Company sold stuffing to local mattress factories. George Chittenden was the first Town Supervisor, 1834. Vrooman Van Rensselaer became Town Supervisor in 1864. Vrooman Van Rensselaer was the valley's best-known storekeeper. His twentieth-century counterpart is Clayton Clum. Mills along the creek started out making banknote paper and ended up making cardboard. A factory that made looms in the nineteenth century grew mushrooms in the twentieth. The Universalist Church, 1853, is now a barn. Apparently, there is no way to stop progress.

Whatever settings Peter as an author may choose, the setting he is fashioning beside Kinderhook Creek cannot seem other than utopian to the rest of the writing profession. To be a colleague of a turbine that undemandingly brings in a couple of hundred thousand a year is surely an El Dorado for the ink-stained world. As a maker of fictions, Peter may bring upon himself in living form the words of Keats' own epitaph: "Here lies one whose name was writ in water."

**W**HEN the gold-seekers in their thousands rushed to the north, a very few made great strikes, almost everyone else came up with little or nothing, and the merchants who sold them their pans, grub, and shovels made good solid incomes year after year. Leroy Napoleon (Jack) McQuesten, for example, who established trading posts near all the major finds along the Yukon, actually anticipated the gold rush and went up there years before. Intending to become a helpful consultant, he learned all he could about the geology and geography of the region. Then he laid in a store of goods and waited for the customers to come. In Pointe Claire, Quebec, fifteen miles upriver from Montreal, is the Jack McQuesten of minihydro—

or, at any rate, a man whose lively intentions and early involvement would not argue the comparison. Black eyebrows, a massive head, a fringe of silver hair—he sits in the executive office of a modern manufacturing facility, dressed with the dark elegance of a Düsseldorf banker. There is about him more than a suggestion of gold—brushed-gold cufflinks, gold-framed spectacles, a Givenchy tie in navy blue and gold. He smiles benignly and lights a Craven "A." He is not only tall; he is a physical giant who has eaten extremely well—F.W.E. Stapenhorst, the king of seals.

Seals in this conversation are rings of carbon that surround the shafts of turbines. Long before he ever gave a thought to minihydro, Stapenhorst was making them on a grand scale. They block water. They allow a shaft to operate in wet and dry adjacent spaces—allow a propeller shaft, for example, to enter a ship. And because the shaft is spinning while surrounded by the stationary seal, an all but infinitesimal gap must be crafted to extraordinarily close tolerances, to withstand water pressures that exceed, at certain hydroelectric stations, a hundred pounds per square inch.

"That is quite an achievement. In this business, I am leading in the world, I suppose."

His English is Germanic, thinly accented, eloquent, slow. He grew up in Saxony. Some of his seals embrace spinning turbine shafts that are larger in diameter than the Alaska pipeline. His seals are on Spruance Class destroyers. They are in big hydroelectric installations in Bay d'Espoir, Newfoundland; Mactaquac, New Brunswick; Wreck Cove, Nova Scotia; Churchill Falls, Labrador—not to mention nations around the world. In the new facilities at James Bay, they seal the big shafts of Hydro-Québec. With its many turbines at three installations there, Hydro-Québec can make ten million kilowatts of power. I go into this mainly to suggest that in the light of his principal endeavors, of his close involvement with large-scale hydroelectric generation, Stapenhorst's absorption with small-scale hydroelectric generation seems all the more significant. It began on a trip to Bay d'Espoir fourteen years ago, and since then he has given it an ever higher percentage of his time. The contrast could not be greater if a conceptual designer of nuclear explosives were to take up the science of

swatting flies.

Stapenhorst smiles benignly. He lights another Craven "A." The smile seems to say, "We have come to a point in history when it is time to harvest flies."

To back up his reputation, Stapenhorst travels extensively to observe *in situ* his enormous seals. On that visit to Bay d'Espoir in the nineteen-sixties, he was told by the operators of the provincial power dam that they needed a small-scale generator to provide current in emergencies, and while such units were customarily run on diesel engines, they wanted to set up this one for water. They asked for his assistance in choosing the components, and he set about studying minihydro. The first waterwheels were undershot, their paddles dipping into streams. They have been in use for thousands of years. They are not very efficient. They capture about a quarter of the energy of flowing water, and oftentimes less than that. A Roman figured out that if you were to build a diversionary trough of some kind and carry water high to one side of such a wheel, you could direct the water into buckets that would empty at the bottom. With gravity's assistance, the wheel would turn faster. By the nineteenth century, overshot wheels had been improved to efficiencies of eighty per cent. Still, they were cumbersome—they were as much as eight stories high—and slow. In the eighteenth-century, designers learned that there were greater speeds and comparable efficiencies in a very different kind of wheel—totally immersed in fast-flowing water and reacting to it something like a windmill to a breeze. The water pressure could be greatly increased by the use of dams, penstocks, related works; and the wheels—usually encased, and a few feet instead of a few stories in diameter—would spin at unprecedented numbers of revolutions per minute. The Europeans called them turbines. Americans preferred not to drop "waterwheel" from their vocabulary, and to this day use the terms synonymously. Turbines constructed like chambered nautilus were developed in the United States by an engineer named J. B. Francis, and Francis turbines—for the most part produced by James Leffel & Company, of Springfield, Ohio—became the predominant waterwheel in late-nineteenth-century and early-twentieth-century American mills. (Those were Francis turbines standing in rust in

Mechanicville. Francis turbines are to turn at Wappingers and Chittenden Falls.) They achieve notably high rotation speeds, but not under all conditions of head and flow. There being so many variable factors, it is axiomatic that each small hydro site is unique, like a thumbprint. If you see one you have not seen them all. And no single size or kind of turbine can ever be in application even vaguely universal. During the California gold rush, the Pelton wheel was developed to answer the particular conditions in the dry foothills of the Sierra—high available pressure heads and low supplies of water. The Pelton wheel is struck and turned by high-pressure jets from nozzles, and thus, like the old water-wheels, is a so-called impulse turbine, and is not, like the immersed Francis, a reaction turbine. Over impulse turbines the Francis has the added advantage that it uses not only the water pressure coming down upon it from above but also the suction created by the water after it passes through the turbine and falls below. Hence, without losing any of the power represented by the total head a Francis turbine can be installed far enough above the riverbed to avoid damage in a flood. Stapenhorst nonetheless decided that Francis turbines were too complicated, and, on behalf of the Newfoundland and Labrador Hydro Corporation, went looking for something else.

Four times annually, in those years, he made visits home to Germany, and always to the town where he grew up. Oddly enough, he compares it to Cornell University, where he has recently been engaged to set up a small-scale hydroelectric facility. "The name of the town is Hamelin," he says. "Have you heard of the Pied Piper? Hamelin is equivalent in size to Cornell University, which is a little city in itself." On one journey, he also went down to Weissenburg, in Bavaria, to make the acquaintance of Karl Ossberger, whose small cross-flow turbines were very different in design from any turbines that Stapenhorst had ever seen. Cross-flow turbines were invented in Australia and were brought to world prominence by Ossberger, who had made more than five thousand of them and had shipped them to nearly every country in the atlas. Within an Ossberger turbine is a spinning drum. It suggests a cylindrical venetian blind, consisting of many blades. Water hits the blades twice—first as it rushes into

the drum, and then as it goes out—giving up a handsome percentage of its energy to the spin. The machine cleans itself. Bits of trash that might get past the racks and become stuck in the blades are pushed out as the water leaves. Looking beyond the needs of the Newfoundland dam and on into the general potentialities of a revival of small-scale hydro, Stapenhorst could see that in most situations there would not be consistent flow. A high dam could make its own consistency, with a hundred miles of reservoir backed up behind it, but the dams of minihydro would generally be low, the ponds shallow, the upstream drainages modest in area. As a result, water would arrive from hour to hour, season to season, in extremely erratic pulses. A cloudburst in Quebec could change the flow three hundred percent, not to mention the wider differences between figures for August and May. Turbines designed for low-flow situations would be wasteful in times of high water. Turbines designed for high efficiency at, say, five hundred cubic feet per second might be ineffective in times of low water. Under certain conditions, turbines can go into a state of cavitation, wherein vaporizing water creates bubbles that implode on the metal and riddle it with tiny holes. The ideal turbine for a little mill up a creek somewhere in inconsistent country would be one that was prepared to take whatever might come, to sit there and react calmly in any situation, to respond evenly to wild and sudden demands, to make the best of difficult circumstances, to remain steadfast in times of adversity, to keep going, above all to press on, to persevere, and not vibrate, fibrillate, vacillate, cavitate, or panic—in short, to accept with versatile competence what is known in hydroelectrical engineering as the run of the river. Stapenhorst believed that he discerned these qualities in the Ossberger turbine. The drum was segmented, so that part of it could be idle while the rest was engaged. The guide vane, which controlled the incoming stream of water, was in parts that could be played like the pedals of an organ. An Ossberger was, in effect, several turbines in one, and—high head or low, from trickle to torrent—it achieved great efficiency

across an extraordinary spectrum of flow. Stapenhorst shook hands with Ossberger and ordered one for Bay d'Espoir. Ossberger was signally pleased. He had never before sold a turbine in North America.

Stapenhorst explains, "If anyone wanted a small turbine in North America, they went to James Leffel, you see. Ossberger sold them everywhere else—Paraguay, New Guinea, Rwanda, Gabon, Burundi. I call them missionary turbines. The missionaries have a little money in the jungle and they buy a little power. He could make a hundred, a hundred and fifty turbines a year, there in Weissenburg. Weissenburg is a pretty little place. The whole population is as much as Cornell."

Stapenhorst volunteered to be Ossberger's North American representative, and he had brought two or three dozen cross-flow turbines into Canada when the so-called energy crisis began to spread its form of panic across the United States. From his close post of observation in Pointe Claire, Quebec, Stapenhorst watched with rising interest and some amusement the scramble to the south. The situation was obviously

less acute than chronic. It demanded multiple solutions. A return to small-scale hydro would surely be one. When the United States Army Corps of Engineers published a study listing thousands of existing dams where hydroelectricity could be generated, Stapenhorst decided that the mighty American utilities would soon be rediversifying in that manner. He tried to sell his turbines to them. The utilities were not interested in midget operations. When the National Energy Act was written and passed and private entrepreneurs began to multiply and swarm, he prepared to service them. He was still ahead of his time. For the most part, the entrepreneurs were busy with feasibility studies, and no one was buying new turbines.

"As yet, there is no market in the States. It's all talk. Everybody is after feasibility studies. It has cost me a cool half a million dollars to answer the questions of people preparing feasibility studies. That's where the activity is. They think there's a little gold rush. There are federal loans, forgiv-

able if the project doesn't go. Meanwhile, I tried to sell my hardware. I could not sell my hardware. So I thought I would sell some to myself."

The Susquehanna River, in upstate New York, is a meandering brook with a flow in some seasons twenty times greater than in others. Not far from its beginning, it has had imposed upon it an aneurysmal bulge called Goodyear Lake. The lake is actually a shallow pool, two miles long and held in place by a thirty-foot dam, which was built in 1907 and later acquired by the New York State Electric & Gas Corporation. In 1969, NYSEG closed the facility. The civil works were deteriorating. Six people worked there for an aggregate salary approaching a hundred thousand dollars a year. It would cost a great deal more to keep the place going than to lay off the people and burn cheap oil. There remained the inconvenient dam. With its lake, it was an attractive nuisance. It was a liability to its owner, and it would become a much greater one when geologic forces destroyed it with time. NYSEG wished to rid itself of the property. In the nineteen-sixties in this country, an old dam was about as negotiable as an old grapefruit rind. The company decided upon a simple and utilitarian solution. It announced its intention "to dewater the lake." Goodyear Lake, as it happened, was surrounded by a couple of hundred year-round and vacation homes. It was a one-motel lake, not a Seneca, Oneida, Otsego, or George. However modest, it was a resort nevertheless, set in what Canadians call cottage country, with a mountain behind it in evening light. Never mind that the mountain's name was Crumhorn. Lakeshore public versus public utility: the confrontation that followed was raucous and bitter—and unresolved—when Frederick William Elias Stapenhorst came walking down the lake. He had heard the story, and he thought it fitted his needs. It was a run-of-the-river situation, with no significant storage in the lake. The stream was high in its watershed and would therefore be particularly erratic. With the thirty-foot head, there was enough expectable runoff to make seven or eight million kilowatt-hours a year. Electric heat aside, that would meet the needs of five hundred homes. There could scarcely be a more appropriate place to demonstrate the Ossberger turbine.

"So I stepped in and became the savior of the area," Stapenhorst reports, with a smile, lighting another cigarette before continuing the story. NYSEG agreed to sell the works to him and to buy his electricity at a starting rate of three cents a kilowatt-hour. Stapenhorst filed for a license, imagining the process to be a simple formality, since the plant had been in operation scarcely ten years before. Stapenhorst was Continental, and based in Canada, and not attuned to American ways. In the end, the documents that were prepared in support of his license application weighed about as much as he did. Many represented the gilt research of lawyers. A large part had to do with impact on the environment, notwithstanding the fact that the dam already existed. Conservationists worry that when dams are under repair streambeds and banks will be disturbed, sending clouds of silt downstream. They worry about alterations in flow regimes and about changes in temperature as cool water from above a dam is added to warmer water below. Pollutants from industry—mercury, cadmium, lead—may be resting quietly in the sediments behind inactive dams. If dredging is done in the reservoir, the pollutants can be released into the stream. Conservationists hate dams, no matter how large they are, and in the eyes of an arch-conservationist if there is a sight more appealing than the Jungfrau in alpenglow it is a dam with a settling crest, a dam with a bulging toe, a dam that is breaking down under the forces of nature and insanely squirting water in arcs. An improvement on a dam is a rapid that was a dam. When water goes over a dam, especially if the dam is cracking to pieces, oxygen is mixed with the water. When water goes down a penstock, there may be no oxygenation. Fish going upstream to spawn swim right across an old, broken dam. If the dam stands firm, they need a ladder.

"We now know all the species of reptiles, summer birds, winter birds, mammals, fish," Stapenhorst says. "We have a list, for instance, of every type of salamander in the area, the color of its skin, the number of its toes. I realize, of course, the importance of protecting the environment, and now we have to pay for the devastation of previous years."

Whatever he is paying, Stapenhorst does not go cabin class. He hired Stone

& Webster to assist his engineering. For four months, he spent a thousand dollars a day doing dental work on the concrete of his dam, on the crumbling walls of his power canal. When he raised a million dollars through a bond issue, his agent was Lehman Brothers Kuhn Loeb. He is reluctant to reveal the cost of Ossberger turbines. His desire is not so much to sell them individually as to install them himself and do the rest of the electrical and civil works as well. He prefers to quote over-all figures. Pressed, he mentions a small Ossberger that went for thirty-five thousand dollars, and five times that for a pair of larger ones. He says sites are so varied that costs can be anywhere from three hundred dollars to twenty-five hundred dollars a kilowatt installed—figures that include repairs to powerhouses, penstocks, and dams. At Cornell University, where Fall Creek comes out of Beebe Lake to go crashing through the campus and over Ithaca Falls, he is about to install a package comparable in output to the one at Goodyear Lake, which is on line and humming now. It was dedicated in 1980 in a shower of splintered glass and champagne. The cottage owners contributed twenty-five thousand dollars. The Department of Energy, according to Goodyear Lake the status of a "demonstration site," contributed two hundred and forty-five thousand dollars. The largest Ossberger in the world sits there in automated quiet, drinking what comes. A smaller Ossberger stands beside it. The Goodyear Lake Low-Head Hydroelectric Power Project, as it is called, came in at twelve hundred and fifty dollars a kilowatt. Translated into over-all cost, that is one million seven hundred thousand dollars.

JOHN and Jim Dowd, on the other hand, bought a sixty-foot dam in excellent condition in a deep and beautiful chasm, a serene two-acre storage pond, an attractive fieldstone powerhouse containing a spiral-cased Francis turbine in working condition, a steeply angled penstock for the most part in need of no repair, functioning headgates (with gatehouse), trash racks prepared to stop timbers and twigs, eighty-seven feet of head, a reliable supply of thundering water, chasmsides of five-hundred-million-year-old sandstone in bedded blocks so orderly they seem to be cathedral walls, and (on the high ground

above) some dozens of shipmast white pines rising through stands of hemlock—forty-five acres in all—for one dollar. Chateaugay Chasm, as it is named, is in the St. Lawrence Valley, roughly two hundred miles north of Goodyear Lake, four miles south of Canada. Its sheer walls contain and concentrate power as they contain and concentrate beauty—an appearance that yields little to the celebrated splendors of Ausable Chasm, forty-five miles away. Chateaugay Chasm is so narrow that the dam, forty by sixty feet, is higher than it is wide. It was built in 1902, without effective objection, by a group of local entrepreneurs who called themselves the Chasm Power Company. The town of Chateaugay, an elaborated crossroad, has not grown since then. It has, in fact, dwindled. In the words of John Dowd, “It’s a one-light town.” He and Jim grew up there—in a family of eight children. Their father teaches music in the regional school. The light hangs over the intersection where River and Depot come together at Main. It puts a red glow on four bars, on the old wooden Chateaugay Hotel. When the light was installed, it received current from the chasm, as did all of Chateaugay, and dairy farms around, and Burke, six miles away. The Chasm Power Company, however, had sold out to Plattsburgh Gas & Electric, and, through other changes of hands, the powerhouse and all that went with it now belonged to NYSEG. When John Dowd was a teen-ager, in the early nineteen-sixties, he worked there, at the bottom of the chasm. He assisted Bill Stevenson, the plant supervisor, who went around with Windex spraying the dials on the machinery and giving them lustre. The big turbine was in a brown case. It had the gleam of cordovan leather. The governor, which as metallic sculpture might not have embarrassed a museum, was a harmonious assemblage of abstract shapes in what appeared to be freshly minted brass. Railings surrounding these objects kept visitors at a distance. Please do not touch. The floors were white-glove clean. In 1964, NYSEG shut the place down, sold the chasm and its structures to the town. It was cheaper to burn a little more oil somewhere else than to underwrite Stevenson and his Win-

dex. Stevenson, who was close to sixty, wept.

In no time at all—in a matter of months—the facility seemed headed for ruin. Vandals attacked it like buzzards from the sky. Boulders were heaved from the cliffside to crash through the gatehouse roof, and campfires were made using pieces of the building. Some of the fires were made inside, on the wooden floor. Down the chasm, all the windows of the powerhouse were splintered. Whoever stripped and stole the generator’s copper burned the rubber insulation to get at it. The interior walls of the once gleaming powerhouse are black to this day from that fire. Young John Dowd went before the Town Board in 1967 and complained. He was twenty-two. He accused the community leaders of negligence, of indolently allowing an attractive and valuable common property to be willfully destroyed. Chateaugay, in transalpine New York—“up here in no man’s land where no one really gives a damn about things”—is the sort of town where men in rubber boots sit in the hotel windows on the stoplight corner and stir when anything moves. And now John Dowd had moved.

“I said something should be done. They said, ‘If you’re so concerned about it, you take over. You just take it over. We’ll sell it to you.’ I said, ‘I don’t have the money or I’d buy it.’ They said, ‘All right—you’re so smart—we’ll sell it to you for what we paid for it. Put up or shut up. We paid one dollar.’”

There was a deed restriction. NYSEG had denied to future owners the right to use the site to make power. Since hydroelectricity could not be generated without generating a lawsuit as well, the Dowd brothers developed a very different plan. The powerhouse, at the bottom of the chasm, with a twenty-five-foot ceiling and ten big windows, would make a superb restaurant—wild water foaming past the windows, its thunder muted by the thick stone walls. The chasm had obvious recreational appeal. Traceable in the hemlock forest were the moss-covered foundations of a resort hotel that had been levelled by fire at the turn of the century. The brothers planned to construct a campground near the rim somewhere. For upward of a decade, though, they did not actually do any-

thing, emulating the town fathers. The Dowds had other preoccupations. Jim was a high-school physics teacher. John was a NYSEG lineman. He gave up the job, and for several years travelled the United States as a skilled laborer, building powerhouses and substations wherever he might hear of such work—Pennsylvania, Ohio, Florida, Minnesota, Idaho. He returned, at the age of twenty-eight, to go to college in Plattsburgh. Increasingly, as the brothers kept planning the future of the chasm, they thought about using it for power, and wondered how to circumvent or defeat the deed restriction. Congress did it for them in 1978, by declaring such stipulations everywhere invalid.

The restaurant and the campground faded backward in the priorities of the imagination as the brothers turned to minihydro. They could hardly afford tens of thousands of dollars for lawyers’ and consultants’ fees, so they worked their own way through permits and license applications. They shopped for new components, and when prices came back in six figures they arranged for the rebuilding of components they had. Like the Mark Quallens and the Paul Eckhoffs, they learned the business from the damage up. They spent two hundred dollars for a year’s subscription to *Hydro-Wire, the Newsletter of the Small-Scale Hydroelectric Industry*. As months went by, their conversation narrowed until it included almost nothing not related to the project. Their idea of relaxation on a summer holiday was to picnic by the edge of the chasm. They expect to restore the station for a hundred and eighty dollars a kilowatt, and to have it turning by summer. They have received no assistance from state or nation—only from the Marine Midland bankers in nearby Malone. When the power is turned on and again comes out of the chasm, they intend that Bill Stevenson be there to throw the switch. He is now seventy-four years old.

A year or so ago, the Dowds were visited by a man who inspected the site and asked them how much they were going to be spending to restore it. They said they figured about two hundred and fifty thousand dollars.

“How would you like a check for two hundred and fifty thousand dollars free and clear right now?” the man said. “We would like to buy the property from you.”

The Dowds had been offered a twenty-five-million-per-cent return on their original investment, and they turned it down. The offer was made in behalf of a corporation set up in the aftermath of the National Energy Act to acquire as many viable small-scale hydroelectric sites as its agents could find. There are at least half a dozen such companies, consisting mainly of lawyers, engineers, and financiers: for example, the American Hydro Power Company, of Villanova, Pennsylvania; the Noah Corporation, of Aiken, South Carolina; Hydro Development, Inc., of Los Angeles; Essex Development Associates, of Lawrence, Massachusetts; the Mitchell Energy Company and the Continental Hydro Corporation, of Boston. They are service companies. They serve as tax umbrellas, among other things. Forming little companies around single sites or clusters of sites, they attract investors' money and keep a part of the ownership. In the way that diamond traders have gathered on Forty-seventh Street and wholesale florists on Twenty-eighth, the white-collar world of minihydro tends to colonize. Continental Hydro and other companies set up in business at 141 Milk Street in Boston, for example, home of the New England River Basins Commission (which has produced, in eight extensive volumes, a study called "Potential for Hydropower Development at Existing Dams in New England"). The newsletter *Hydro-Wire* was also established at 141 Milk Street, by C. Sherry Immediato, editor, Harvard Business School student, who worked awhile for Continental Hydro and then started the letter to help pay her way through school. One day between dams, I talked with her over a salad in the Parker House—a small, trig woman with dark hair, bright eyes, and gold earrings, whose pleasant and articulate voice occasionally sounded as if it were reading a textbook. "Changing economic phenomena, natural and contrived, have focussed new attention on this investment in energy," she said. "'Natural' refers to the oil crisis. 'Contrived' means that small-scale hydroelectric projects have been segmented for special consideration by the federal government through loan programs, tax incentives, power bought at rates equivalent to the replacement of oil. It has allowed people to look to investments made a long time ago and revitalize them. For people who like to

tinker, it's just wonderful—an interesting business venture for frustrated engineers. There are good rainfall figures. You can predict your flow of money fairly well. That attracts investors. Banks like it, because they look good for being in alternative energy resources."

In small-scale hydro, obtaining a preliminary permit from the Federal Energy Regulatory Commission is the equivalent of staking a claim in the search for gold. A preliminary permit ties up a site for a time, and in order to apply for such a permit one need not own the site. She pointed out that any number of non-hydroelectric federal dams—irrigation dams, flood-control dams, municipal-reservoir dams—have attractive heads and other potentialities for hydroelectric generation on a significant scale. Anyone can file for preliminary permits and licenses to work such dams. Many of them already have penstocks, built into them when the dams were constructed by federal engineers who thought a day of need might come. "The Department of the Interior and the Army Corps of Engineers are being somewhat obstructionist about it," she said. "Which is unfortunate. It's an immense public resource sitting there untapped." The Federal Energy Regulatory Commission has certain rights of eminent domain. If someone obtains a preliminary permit on a little waterfall in a neighbor's garden—or on any minihydro site on which an acceptable feasibility study is submitted—the government can in effect force a reluctant owner to sell to the applicant. Speculation in small-scale hydro—with hundreds of applications filed, many in competition for a single site—has been intensified by the rule that one need not be an owner to apply. "However, that factor can be overstated, because you might very well be dead by the time all the paper was processed—it's a real sticky matter to use the right of eminent domain to favor one private interest over another."

It was New Hampshire that turned a promising bet into a national boom. "New Hampshire really did it, in terms of getting people's adrenaline flowing, when the state set its rate at eight cents a kilowatt-hour. People reasoned that if New Hampshire did it, it could happen anywhere." She said she knew at least ten people offhand who, in the commotion, had "jumped from govern-

ment to the private sector"—people from the Corps, people from the F.E.R.C.—and in one New England state "the energy staff working on hydro went off and bought their own dam." She drew a breath and ate a bit of salad. "Pragmatically, people who get into this—in a small or a large way—are idealistic," she continued. "It's quite a gamble, given the current political and economic environment. There is a danger in people becoming real excited about hydro and buying equipment and services that are much too high. To write a permit, architecture and engineering firms charge ten thousand dollars, which is insane. You could write one in a day if you had some statistics about the site. To spend sixteen per cent of project costs on that sort of thing is outrageous. It's like people buying houses, fixing them up, and saying, 'We'll get it all back.' They have no sense of the time value of the money. Someone like your friend Paul Eckhoff may be right to put his money in small-scale hydro, but I wonder if he wouldn't be better off buying a municipal bond. On the other hand, if someone has a chasm somewhere and a facility he got for a dollar, I guess that's a pretty good deal."

A winter day with snow on the ground and warm dark clouds collecting, John and Jim Dowd and I walk down the penstock, with John Dowd leading the way. "Watch yourself!" John says. "Watch your footing! Don't slip! The liability-insurance papers have not yet been signed." The words are all but inaudible. Tons of water are crashing beside us at the rate of fifteen a second. The Chateaugay River, after falling down the face of the dam, caroms into the space of the chasm in violent agitation, licking at the penstock, raging white from wall to wall. Hugging the sandstone, the penstock is beside the torrent. The penstock is seven feet in diameter and is covered with snow and ice. John kicks the ice, making steps. Heavyset but not fat, he is unarguably agile, at ease here on this tubular chute, with a lineman's sense of place. He and his brother are both handsome men in their thirties with a demeanor that suggests the out-of-doors. Each of them has light-brown hair that almost covers his ears, and a timber cruiser's guileless mustache. Jim wears a red-and-black wool jacket, John a loose brown parka. He worries about my shoepacs.

The rubber may slide on the ice. When NYSEG abandoned the chasm, they scuttled the penstock, suddenly cutting off the water and thereby making a vacuum of such implosive force that it crumpled the upper end. Pipe companies want twenty-one thousand dollars for a new segment of penstock. The Dowds, with used material, will build it on their own. Gatehouse to powerhouse—dam to turbine—the penstock is two hundred feet long. "Don't slip!" John says again, and once more he mentions the insurance. He kicks new steps into the ice. I glimpse a hand protruding from the cataract. It is mine, however, and it goes away.

The powerhouse does not call to mind a restaurant. Its beautiful windows are cold and vacant, and spring water pours through cracks in the fire-grimed walls. The turbine stands in place, its cordovan polish long absent, its substance intact.

"To a person whose eye is not tuned to machinery, this old Francis here may look like a piece of junk!"

"But to us it looks like a million dollars!"

The brothers seem pleased to be shouting. The higher they have to raise their voices, the more valuable the tympanics outside.

"The river is running at five hundred cubic feet per second today. Sometimes it goes a lot higher than that."

The penstock forks to a well for a second turbine. The plan is to get the existing one going, and later install another.

"The plant will be semi-automatic. It will shut itself down but not start up."

"When we finish here, we want to help other people do the same kind of thing. We have done a lot of bush-kicking, a lot of door-knocking. We are now in a position to sell that knowledge. We went over and drank maple wine with a man in Vermont who had a nice little twenty-five-foot head. We may be working for him."

"We'll take on anything up to five thousand kilowatts, but mainly we are interested in places much smaller than this one—three hundred and below. We're not going to say no to someone who has a ten-kilowatt potential."

"If all the old sites like this in New York State were put to work again, they would equal three nuclear power plants."

"Ten per cent of our gross income

will be more than enough to maintain this place. That is very conservative. It could easily be three to five per cent."

"The dam is only forty feet across. We'll put two feet of flashboard on it, and that will be worth five thousand dollars in net income a year—all for a hundred dollars' worth of plywood."

"I'm going to build myself an electrically heated house looking out on the pond through the hemlocks."

"There are a lot of dairy farmers around here who are so rich they can plunk down forty thousand dollars for a new tractor, forty-five thousand for a silo. But we won't have to worry about milking our turbines."

**P**AUL ECKHOFF, in blue overalls and a hand-knit white tam-o'-shanter, got into a small boat and slowly rowed the quiet pool above his dam, to see what or who was going to be disturbed if he put flashboards on the crest. "Nothing" and "no one" were his conclusions, and he rowed back to shore. At the end of the Pacific war, he was given command of the United States naval base on Saipan, and now he was in charge of a ruined box factory beside an abandoned dam—with no apparent mitigation of his sense of executive wherewithal, of his accumulated practical skill in lining up a complicated operation for smooth and efficient execution. A graduate of the Harvard Business School and also of Duke University Law School, he had built, for himself and for other companies, all the resin plants that a man in one lifetime should build, and now he was invigorated by something new. "There is a time to shift gears," he remarked on that autumn day. "And for me this is it. This is the time to bring all the experience of thirty years together in one impossible project." He looked around at the crumbling walls, the fire rot, the water tower corroding overhead. "We have champagne tastes and a beer pocketbook," he said. "Therefore, we have this place. But the same is true of many sites. You get a lot of junk with your head."

Not long ago, Brooklyn Polytechnic Institute made a study of the Chittenden Falls site, concluding that five hundred and eighty-nine thousand dollars would be required to restore it. Eckhoff prefers not to say how much he expects to spend, perhaps in part because it is not in an employee's dis-

cretion to speak of such things when the president of the Chittenden Falls Hydro Power corporation may not have been made aware of the numbers. The president is Paul's wife, Adelaide. His daughter Nina is the secretary of the corporation. She is also a fashion model. His daughter Karen is vice-president, Mary is treasurer, and so on down to Vicky, who is a student at the New York University College of Business and Public Administration, and Sally, who is on the staff of the *Village Voice*. "We absolutely have to do it for a great deal less than five hundred and eighty-nine thousand," Eckhoff says. "It's the family pocket. My wife calls this project my toy."

"And you don't want to buy it at F. A. O. Schwarz?"

"Exactly."

"How much did the new generators cost, the gearboxes, the sluiceway work, the new penstock, the switch gear, the substation, the governors, the reconditioning of the turbines?"

"You are asking me for my innermost secrets. I will say this: In the electrical field, there are very, very substantial discounts. You have to qualify to enjoy those discounts."

Listening to Paul Eckhoff, I have the sudden fancy that I am almost hearing the voice of someone in my own clan, who is also a lawyer and of about the same age. He has fared well in his profession, and he has an oil well somewhere and an interest in an office building in downtown Washington, but when he goes out in his Audi on weekend afternoons he comparison-shops for dog food. He knows every live discount in the District of Columbia—in Bethesda, in Alexandria, too. He is especially sensitive to discounted discounts, for which he will undertake long transurban journeys to outposts of Dart Drug. Looking at the crow's-feet in Eckhoff's rugged and handsome face, and into his steady blue eyes, I develop a familiar sense of deep discount. My guess is that if Brooklyn Poly thought five hundred and eighty-nine thousand dollars would do the job, Eckhoff can cut that in half.

"Whatever capabilities I have developed over the years, this project is draining them all the way down," he says. "You just cannot afford a consultant for everything. You can learn this business, though. You can learn. In the Navy, you know, there is a manual for everything. There are



manuals in hydro, too. I think our site is typical of many old mill sites. Just about everything has had to be replaced except the turbines, the turbine cases, and the concrete that supports the powerhouse. With vertical turbines, we had a choice. We could seek out vertical generators or we could go for horizontal gearbox right-angle drives and conventional horizontal generators. Here is where a few unwelcome surprises entered the scene. No U.S. company makes vertical generators small enough for our purposes. No U.S. company makes very slow-speed generators, vertical or horizontal. The cost of a European vertical slow-speed generator for our larger turbine was quoted at no less than two hundred and twenty-three thousand four hundred dollars, plus freight. So I started down the route of right-angle gearboxes and horizontal generators. It took a lot of reading and a lot of consulting with engineering friends to know what to look for. We could not use eighteen-hundred-r.p.m. generators—which are the cheapest—because they are not rated for a two-to-one overspeed in the event the system loses its electrical load and goes into a runaway condition. Big costs are involved, incidentally, in avoiding overspeed. When it happens, turbines can tear themselves apart and generators can burn up. I have invented a scheme to deal with overspeed. I think savings will result. The next-best generator was a twelve-hundred-r.p.m. But now consider the difference in gearbox quotes. When the generator speed is decreased—from eighteen hundred to twelve hundred r.p.m.—the cost of the gearbox soars from around twelve thousand dollars to forty-three thousand dollars. There is about a two and a half per cent efficiency loss from introducing a gearbox into the power train; however, by going horizontal we not only got new, reliable, compact generators but also gained the future capability of driving the generators from the other end by diesel engine if we want backup when the water is low. A wide price range in something like a gearbox doesn't mean they're ripping you off, by the way. A sixty-four-thousand-dollar gearbox could be for a tugboat but not for a powerhouse.

"For the electrical center, with its meters and switch gear, we were quoted a hundred and twenty thousand dollars, fifty-nine thousand, and thirty-six thousand—all on the same

specs. We finally did it the hard way, by shopping, and came up with a figure of approximately ten thousand dollars. This is a combination of some new and some used equipment—but all pre-tested and carrying new-equipment guarantees.

"Nights, I have made engineering drawings for the necessary replacement parts for the turbines. So far, eighty-three drawings. Three different machine shops have been turning out the parts. With this approach, we have been able to make, for example, gate bolts in stainless steel instead of ordinary carbon steel, and at a cost less than the cost quoted on carbon-steel bolts by James Leffel & Company, the original maker of the turbines. Leffel's prices were fair enough. We just could not afford them. We did buy a new runner from Leffel, and it is a first-class piece of work. One of the older engineers at Leffel is in his eighties and has been enormously helpful. His letters are classic in their detail and clarity. More than that, they reflected such good spirit and encouragement that I just could not succumb to the not so occasional suggestion that I back out of the whole thing and realize that I had bitten off more than I could cope with."

The suggestion may have come from the president of Chittenden Hydro.

"We're going to recover seventeen thousand five hundred square feet of the box factory," Eckhoff continues. "We've been romancing a European company to come and set up here. They make micronized hard wax, and it's ideal for them. They use quantities of compressed air, and it can be made off the turbine with the cold water.

"The smokestack is two hundred and fifty feet high. The draft produced by a thing like that is the equivalent of two hundred horsepower. If we wanted to run a boiler, we could clean-burn various fuels. We may set up a pilot plant for making ethanol from Columbia County corn. The problem in making ethanol is that you get ten per cent ethanol and ninety per cent water, and you have to get the water away. If you have a two-hundred-and-fifty-foot smokestack, you're off to a good start.

"For twenty-five years, I made complicated polymer resins. None of my daughters wanted to enter the business. It is not a woman's business. Peter is not right for it, either. Peter is a literary person—a writer of short

stories, a novel. If you have a decent site like this, and you can see your way through the engineering and building phase, you should do well in small hydro. It is a good business for women. A chemical business would be difficult for them. This is a business they can run until hell freezes over. It's a woman's world, man. You know that. We're engineering for the future development of a woman's world. In the resin business, you have to invent something new about once a year. In this business, you don't have to reinvent the kilowatt. You have no lab. You have no inventory. No receivables. No payables. You don't have to have salesmen running around. The utility is your one and only customer. You have a watt-hour meter that tells them what you have generated, and there is no question about their paying their bills. The raw materials are for free. As the price of oil inflates, the utility will be paying us more, but the creek will still be free. Moreover, there should be quite a bit of satisfaction in producing electricity and producing it clean. Putting small hydropower back on the line is basically something good to do."

—JOHN MCPHEE

## EARTHWORKS FOR WATER CONSERVATION AND STORAGE

For the serious small dam and earth tank builder, there is no substitute for such comprehensive texts as that recently compiled by Kenneth D. Nelson (1985). This small classic deals with catchment treatments, run-off calculations, soils, construction, outlets, volume and cost estimates, and includes detailed drawings for most adjunct structures.

However, like most engineers, Nelson concentrates mostly on valley dams (barrier or embankment dams), and less on the placement of dams in the total designed landscape. Few dam builders consider the biological uses of dams, and the necessary modifications that create biological productivity in water systems.

A second essential book for water planning in landscape is P. A. Yeomans' *Water for Every Farm/The Keyline Plan* (1981)<sup>5</sup>. This very important book, written in 1954, is without doubt the pioneering modern text on landscape design for water conservation and gravity-fed flow irrigation. As it also involves patterning, tree planting, soil treatment, and fencing alignment, it is the first book on functional landscape design in modern times.

There are two basic strategies of water conservation in run-off areas: the diversion of surface water to impoundments (dams, tanks) for later use, and the storage of water in soils. Both result in a recharge of groundwater. As with all technologies, earthworks have quite specifically appropriate and inappropriate uses. Some of the main productive earthwork features we create are as follows:

- Dams and tanks (storages);
- Swales (absorption beds);
- Diversion systems or channels; and
- Irrigation layouts, and in particular those for flood or sheet irrigation.

### SMALL DAMS AND EARTH TANKS.

Small dams and earth tanks have two primary uses. The minor use is to provide watering points for rangelands, wildlife, and domestic stock; such tanks or waterholes can therefore be modest systems, widely dispersed and static. The second and major use is to contain or store surplus run-off water for use over dry

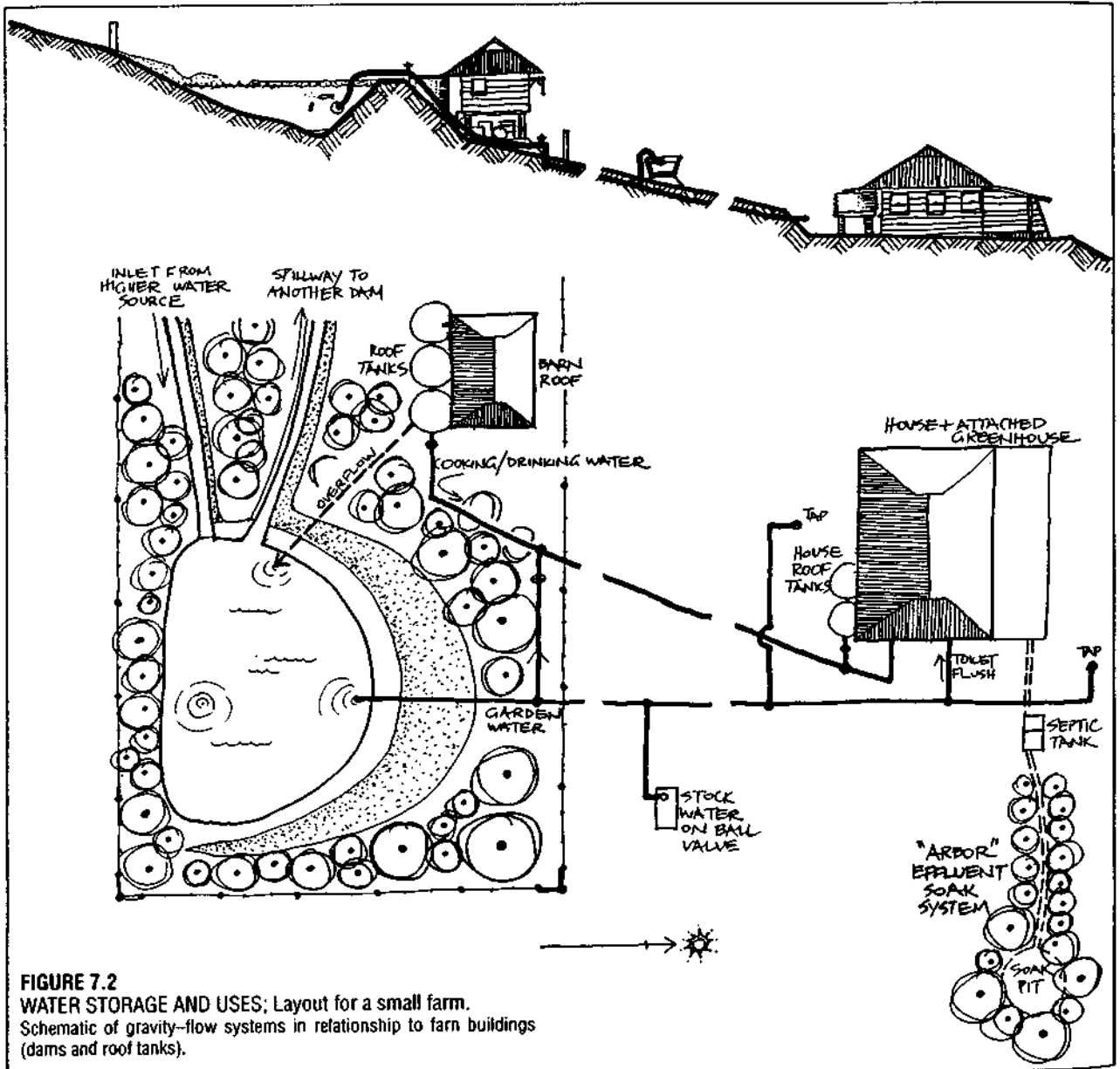

**FIGURE 7.2**  
**WATER STORAGE AND USES; Layout for a small farm.**  
 Schematic of gravity-flow systems in relationship to farm buildings (dams and roof tanks).

periods for domestic use or irrigation. The latter storages, therefore, need to be carefully designed with respect to such factors as safety, water harvesting, total landscape layout, outlet systems, draw-down, and placement relative to the usage area (preferably providing gravity flow).

A separate category of water storages, akin to fields for crop or browse production, are those ponds or wet terraces created specifically for *water crop* (vegetation or mixed polycultural systems of aquatic animal species).

Open-water (free water surface area) storages are *most appropriate in humid climates*, where the potential for evaporation is exceeded by average annual rainfall. There is a very real danger that similar storages created in arid to subhumid areas will have adverse effects, as evaporation from open water storages inevitably concentrates dissolved salts. Firstly, such salty water can affect animal health. Secondly, the inevitable seepage from earth dams can and does create areas of salted or collapsed soils downhill from such storages. And in the case of large barrier dams, so little water may be allowed to bypass them in flood time that agricultural soils, productive lakes, and estuaries may lose more productive capacity by deprivation of flush-water and silt deposits than can be made up (at greater cost) by irrigation derived from such lakes.

Dryland storage strategies are discussed in Chapter 11. What I have to say here is *specifically addressed to humid areas and small dams* unless otherwise noted.

Earth dams or weirs where retaining walls are 6 m (19 feet) high or less, and which have a large or over-sized stable spillway, are no threat to life or property if well-made. They need not displace populations, stop flow in streams, create health problems, fill with silt, or block fish migrations. In fact, dams or storages made anywhere *but* as barriers on streams effectively add to stream flow in the long term.

Low barrier dams of 1-4 m (3-13 feet) high can assist stream oxygenation, provide permanent pools, be "stepped" to allow fish ladders or bypasses, and also provide local sites for modest power generation. While almost all modern assessments would condemn or ban large-scale dams (and large-scale power schemes) on the record of past and continuing fiascos, a sober assessment of small water storages shows multiple benefits.

Given the range of excellent texts on small dams (often available from local water authorities, and by mail order from good bookstores), I have therefore avoided specific and well-published construction details, and have here elaborated more on the types, placement, links to and from, and function of small dams in the total landscape. Yeomans (*pers. comm.*, 1978) has stated that he believes that if from 10-15% of a normal, humid, lowland or foothill landscape were fitted with small earth storages, floods and drought or fire threat could be eliminated.

Not all landscapes can cost-effectively store this

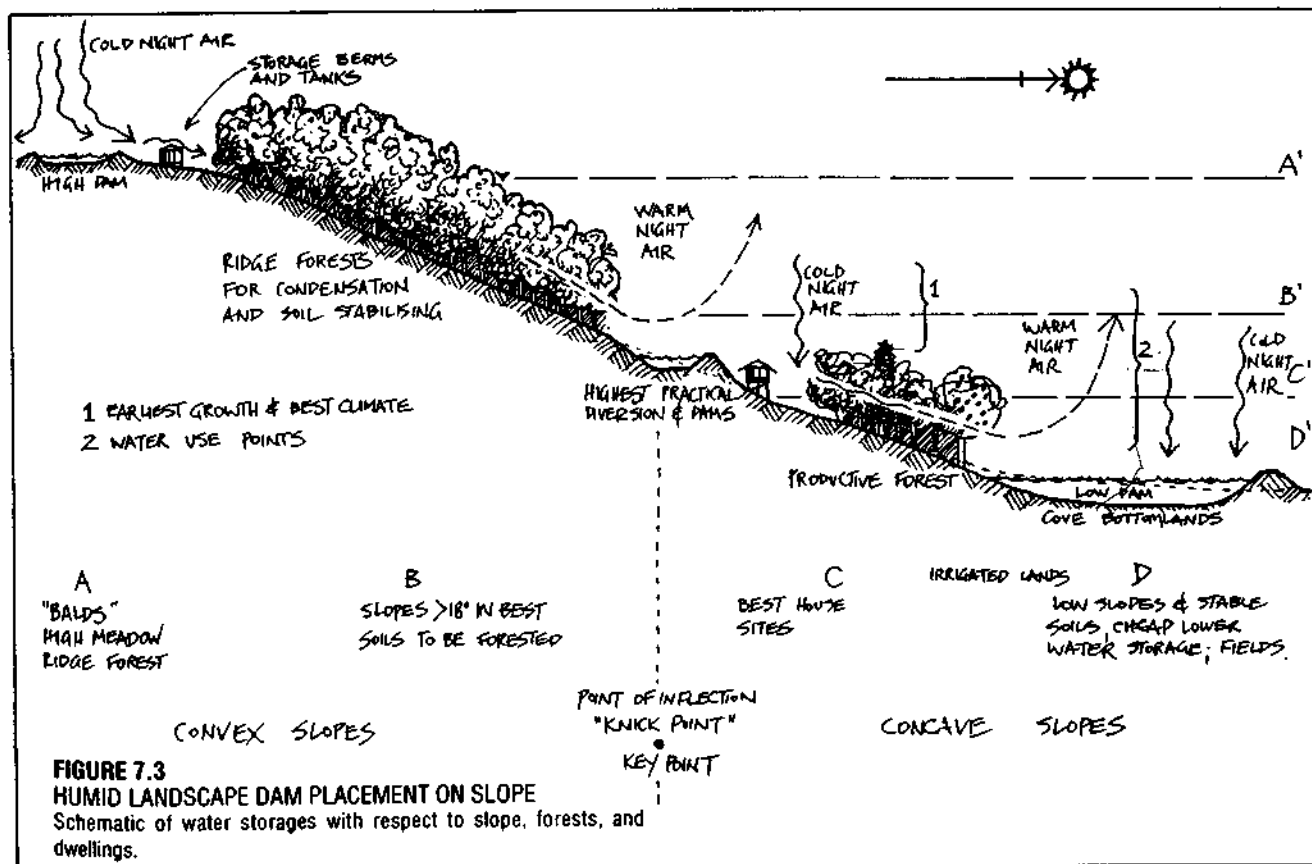

proportion of free surface water; some because of free-draining soils or deep or coarse sands. Other areas are too rocky, or of fissured limestone, and yet others are too steep or unstable. But a great many productive areas of clay-fraction subsoils (40% or more clay fraction) will hold water behind earth dams, below grade levels as earth tanks, or perched above grade as "turkey's nest" or ring dams. There are very few landscapes, however, that will not store more soil water if humus, soil treatment, or swales are tried; the soil itself is our largest water storage system in landscape if we allow it to absorb.

Almost every type of dam is cost-effective if it is located to pen water in an area of 5% or less slope. However, many essential dams, if well-made and durable, can be built at higher slopes or grades, made of concrete, rock-walled, or excavated if water for a house or small settlement is the limiting factor. Each and every dam needs careful soil and level surveys and planning for local construction methods.

#### DAM TYPES AND LOCATIONS

There are at least these common dam sites in every extensive landscape:

**SADDLE DAMS** are usually the highest available storages, on saddles or hollows in the skyline profile of hills. Saddle dams can be fully excavated below ground (grade) or walled on either side of, or both sides of, the saddle. They can be circular, oblong, or "shark egg" shaped with horns or extensions at either end (Figure 7.4).

Uses: wildlife, stock, high storage.

**RIDGEPOINT DAMS** or "horseshoe" dams are built on the sub-plateaus of flattened ridges, usually on a descending ridgeline, and below saddle dams. The

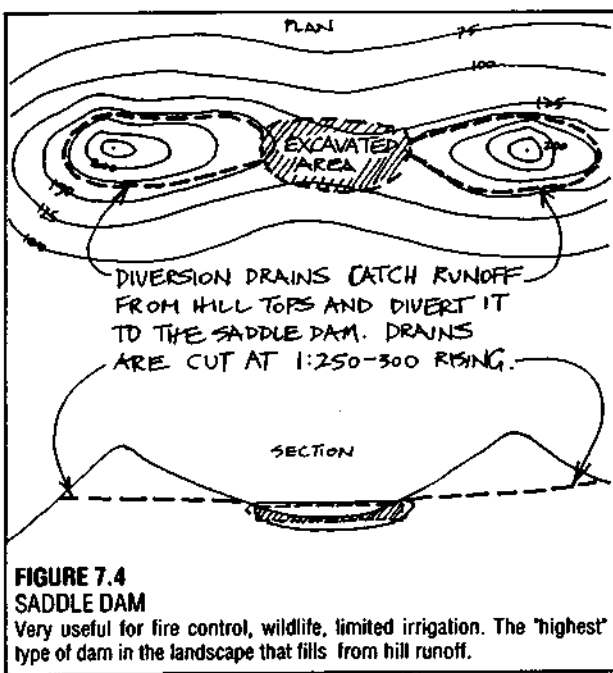
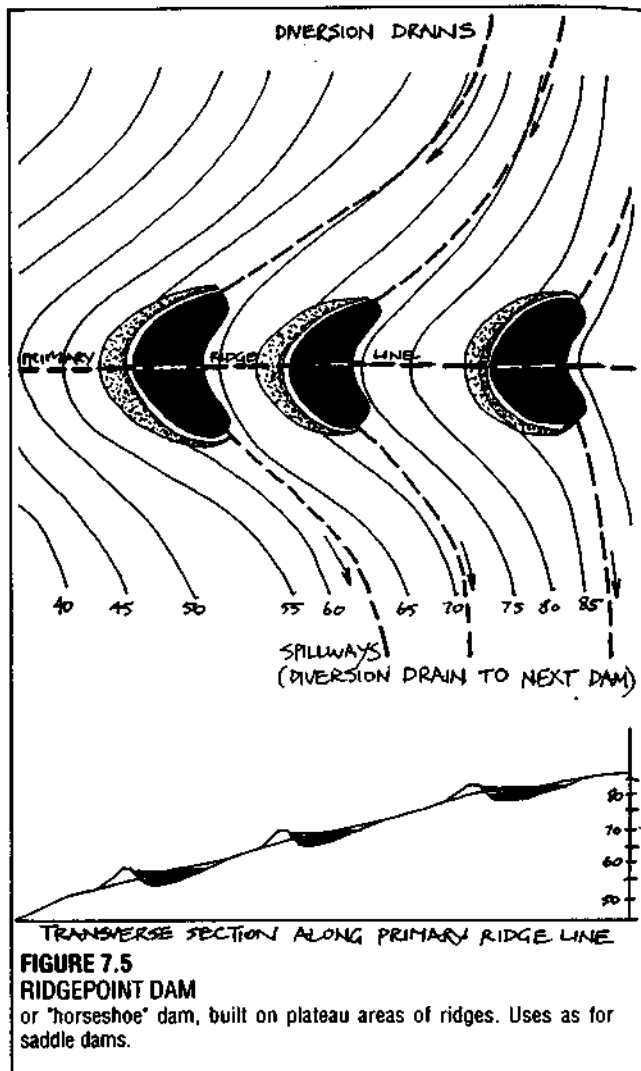

shape is typically that of a horse's hoof. It can be made below grade, or walled by earth banks (Figure 7.5).

Uses: As for saddle dams. Only of limited irrigation use, but very useful for run-off and pumped storages. Note that both saddle and ridge dams can act as storages for pumped water used for energy generation.

**KEYPOINT DAMS** are located in the valleys of secondary streams, humid landscapes, at the highest practical construction point in the hill profile, usually where the stream profile changes from convex to concave; this place can be judged by eye, and a descending contour will then pick up all other keypoints on the main valley (Figure 7.6).

Uses: Primarily to store irrigation water. Note that a second or third series can be run below this primary series of dams, and that the spillway of the last dam in a series can be returned "upstream" to meet the main valley, effectively spilling surplus to streams.

**CONTOUR DAM** walls can be built on contour wherever the slope is 8% or less, or sufficiently flat. Contours (and dam walls) can be concave or convex to the fall line across the slope (Figure 7.7).

Uses: Irrigation, aquaculture, or flood-flow basins in

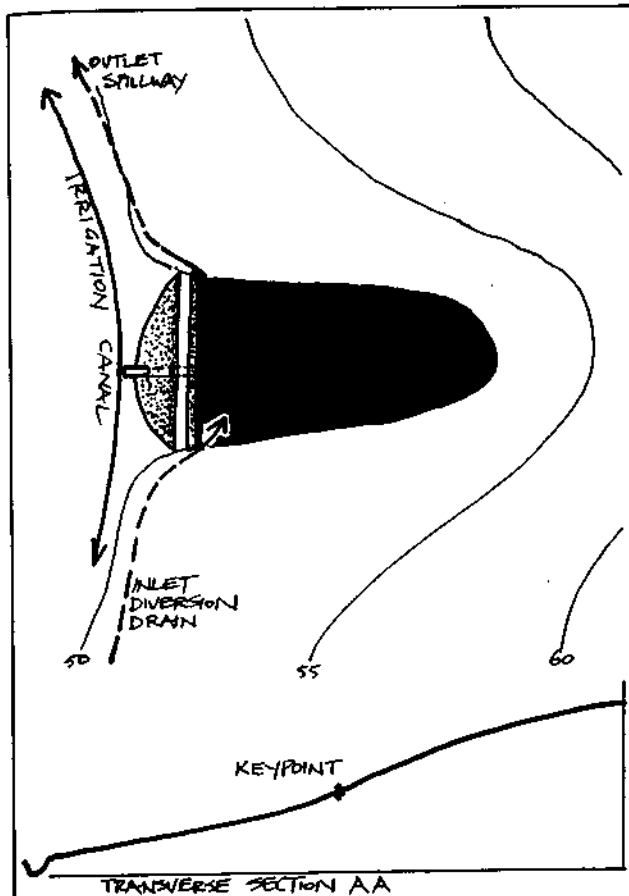

**FIGURE 7.6**  
**KEYPOINT DAM**

A. If used in series, no spillway is built and the overflow goes to the next dam, and eventually to a stream. Fitted for irrigation on lower slopes.

B. The keyline (heavy dashes) links keypoints in primary valleys.

semi-arid areas.

**BARRIER DAMS** are always constructed across a flowing or intermittent stream bed. These dams therefore need ample spillways, careful construction, fish ladders on biologically important streams, and are made most frequently as energy systems, but are also used for irrigation if they are constructed well above the main valley floors where crops are grown (Figure 7.8).

**TURKEY'S NEST DAMS** or above-grade tanks; water has to be pumped in to these, often by windmill or solar pump. They are common in flatlands as stock water tanks or for low-head irrigation (Figure 7.9).

**CHECK DAMS.** There are many forms of barrier dams not intended to create water storages, but to

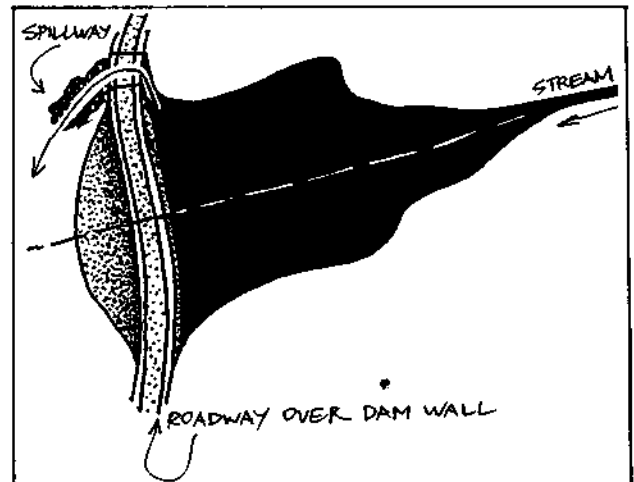

**FIGURE 7.8**  
**BARRIER DAM**

"The engineer's dam." Can affect fish, migration, and be difficult to spill; works well as part of a keyline series only.

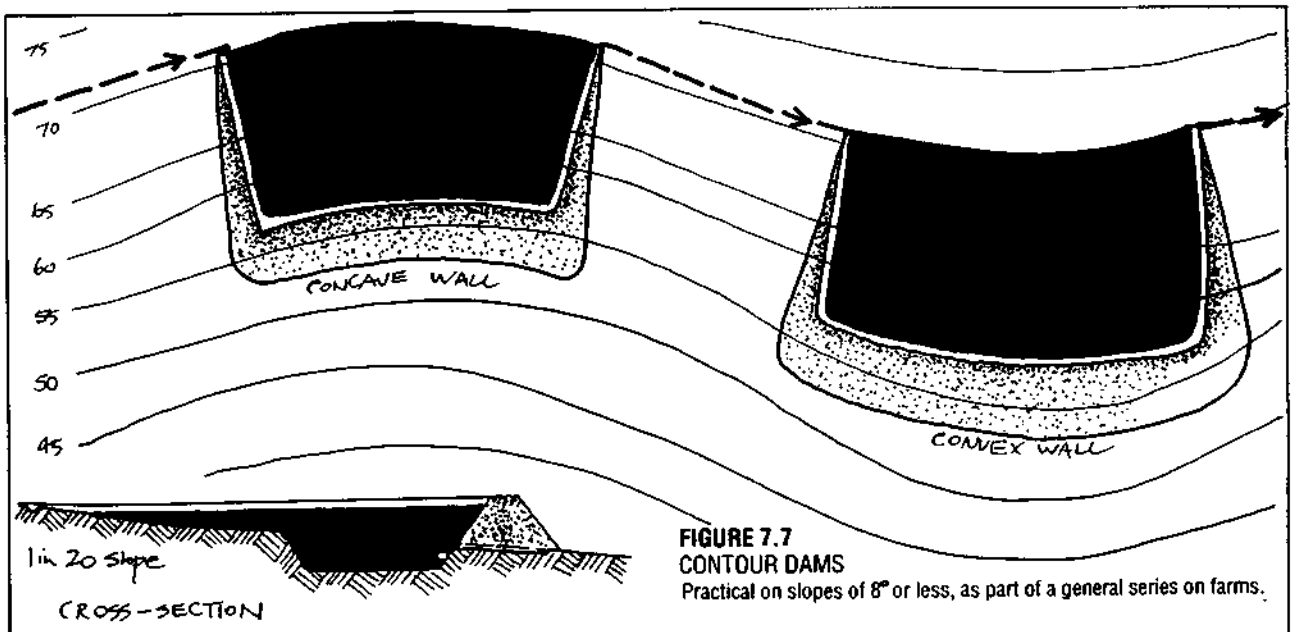

**FIGURE 7.7**  
**CONTOUR DAMS**

Practical on slopes of 8° or less, as part of a general series on farms.

regulate or direct stream flow. Even a 1–3 m (3–10 foot) wall across a small stream gives enough head to drive an hydraulic ram, to fit a waterwheel, to divert the stream itself to a contoured canal for irrigation, or to buffer sudden floods. Dams intended to regulate flood crests may have a base pipe or fixed opening in the streambed which allows a manageable flow of water downstream while banking up the flood crest behind the dam itself, so spreading the rush of water over time. The base opening allows silt scour and so keeps the dam free of siltation (Figure 7.10–13).

**GABION DAMS.** In drylands, permeable barriers of rock-filled mesh "baskets" (gabions) will create silt fields and water-spreading across eroding valleys. The

scale of these dams varies, but for farm construction, walls 0.5–2 m (2–6.5 feet) high are usual. As with Figure 7.12, the purpose is not to store free surface water, but to create a flat area where silt loads can usefully deposit, and so form absorption beds in flood conditions.

We can see the landscape (as though sliced into layers through contours) as a set of catchment, storage, usage, and revitalisation zones. (Figure 7.15)

### BUILDING DAMS

Although we can build dams or tanks on *any* site, given enough material resources, commonsense dictates that storage dams be carefully located with respect to:

- Earth type (core out a sample pit for assessing clay fractions);
- Grade behind wall (lower slopes give greatest

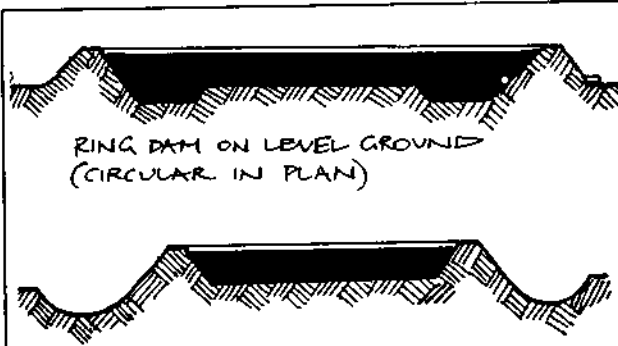

**FIGURE 7.9**  
**RING AND TURKEY'S NEST DAM.**  
Hold water pumped in by a windmill and provides a low head in flat landscapes; can be pipe-filled from a large roof or from parking areas.

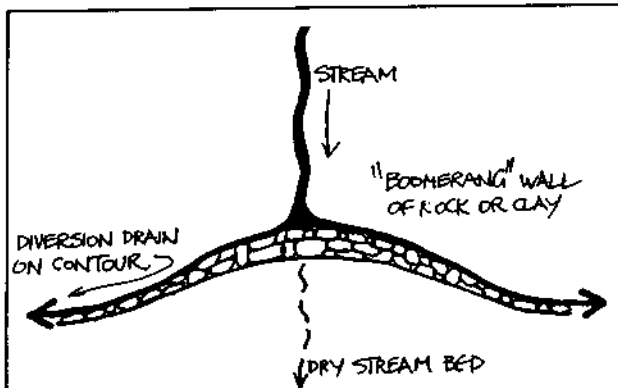

**FIGURE 7.10**  
**DIVERSION CHECK DAM**  
Diverts intermittent flow to ridges, storages, or canals on contour.

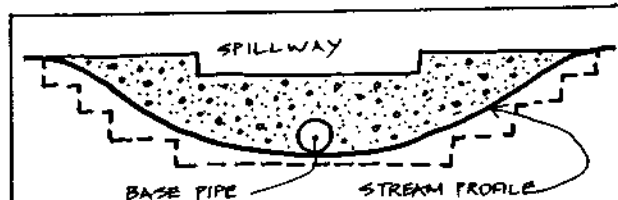

**FIGURE 7.11**  
**CONCRETE FLOOD CHECK DAM**  
Allows normal flow to pass, retards floods, and prevents rapid flood discharge.

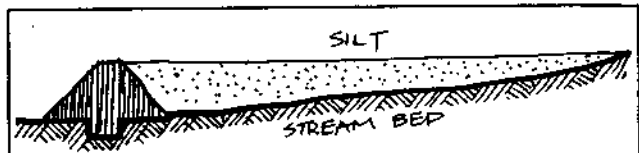

**FIGURE 7.12**  
**SILT CHECK DAM**  
Earth or concrete walls or gabions hold silt fields, spread water, reduce silt load in streams.

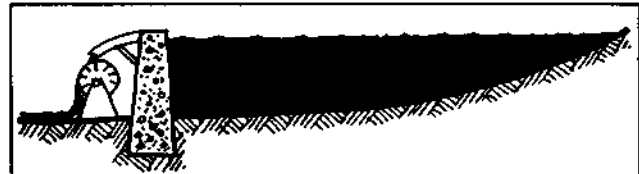

**FIGURE 7.13**  
**CHECK DAM FOR RAM PUMP OR WATER WHEEL**  
Only 1–3 m of head enables modest energy use for mechanical power, lift pumps, or diversion to canals.

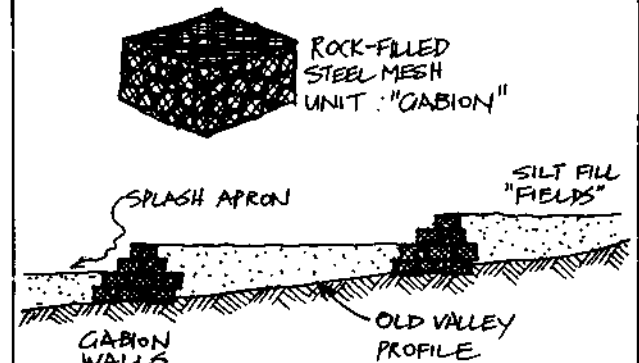

**FIGURE 7.14**  
Eroding gullies are best stabilised using strong wire baskets to contain stones or shingle; these resist floods well.

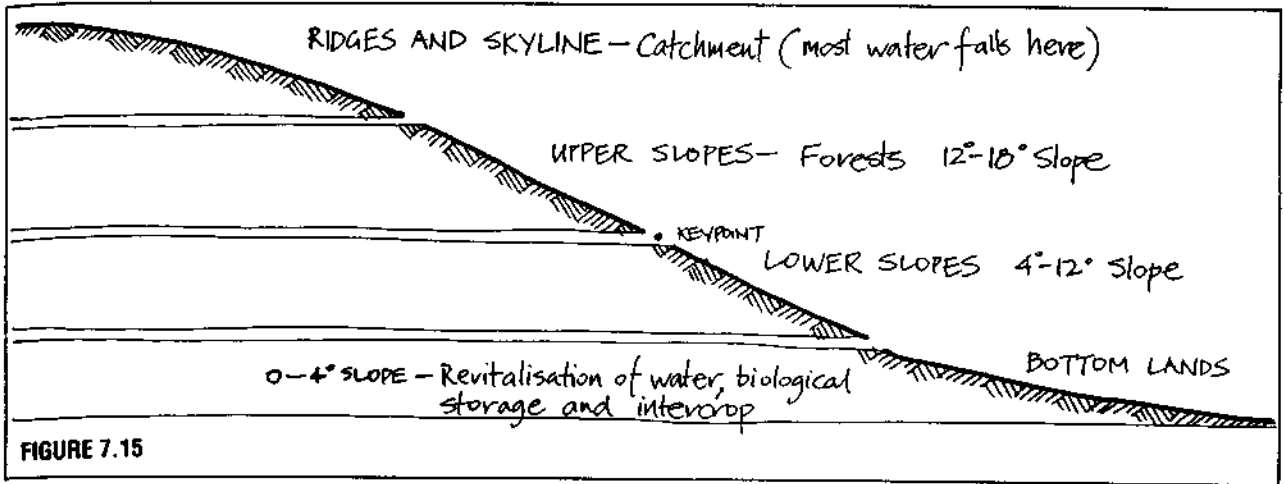

FIGURE 7.15

capacity);

- Downstream safety of structures and houses (a key factor in large dams);
- Height above use points (gravity flow is desirable);
- and
- Available catchment or diversion.

Tamped earth with some clay fractions of better than 50% is a waterproof barrier up to heights of 3.6 m (12

feet), not counting the holes behind such walls caused by their excavation. Therefore we speak of depths of 4.5-6 m (15-20 feet) for small earth dams. Few of us will want to build farm dams higher, and we must get good advice if we wish to do so.

Slopes to crest should be concave, and every 25 cm (10 inches) a machine such as a roller, or the bulldozer tracks themselves, should ride along and tamp down

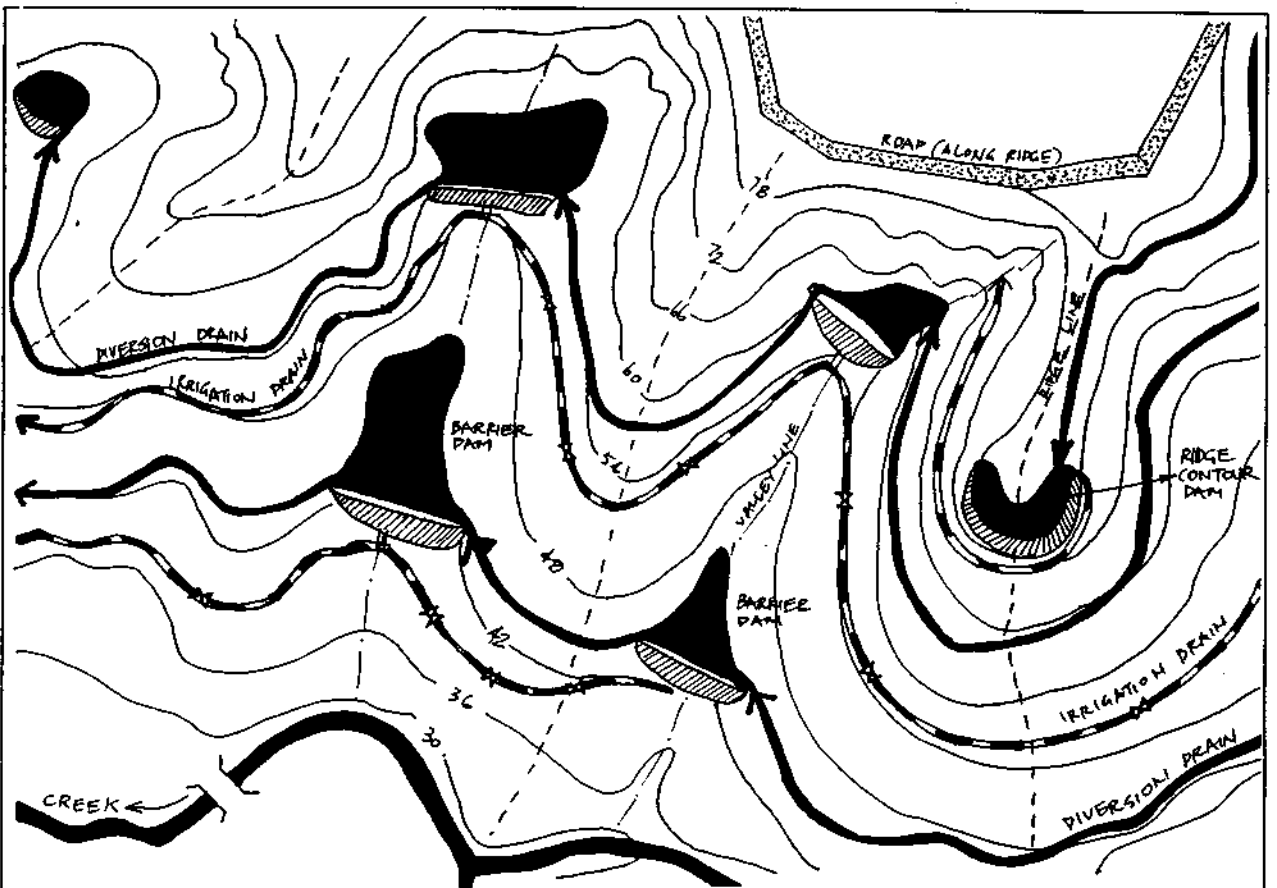

FIGURE 7.16.A

P. A. Yeomans' 'Keyline' system provides drought-proofing for farms with very low maintenance and operating costs; his was the first book

in English on total water design for foothill farms, access, tree belts, soil creation, low tillage, and creative water storage.

TRM	m <sup>3</sup> 1000's	imp. gall. 1000's	US gall. 1000's
1	25	5.5	6.6
2	37	8.1	9.8
3	31	6.8	8.2
4	20	4.4	5.3
5	15	3.3	4.0
6	74	16.3	19.5
7	31	6.8	8.2
8	39	8.6	10.3
9	15	3.3	4.0
10	22	4.8	5.8
11	49	10.8	13.0
12	55	12.1	14.5
13	136	30.0	35.9
14	61	13.4	16.1
15	25	5.5	6.6
16	80	17.6	21.1
Tot.	715	157.3	188.9

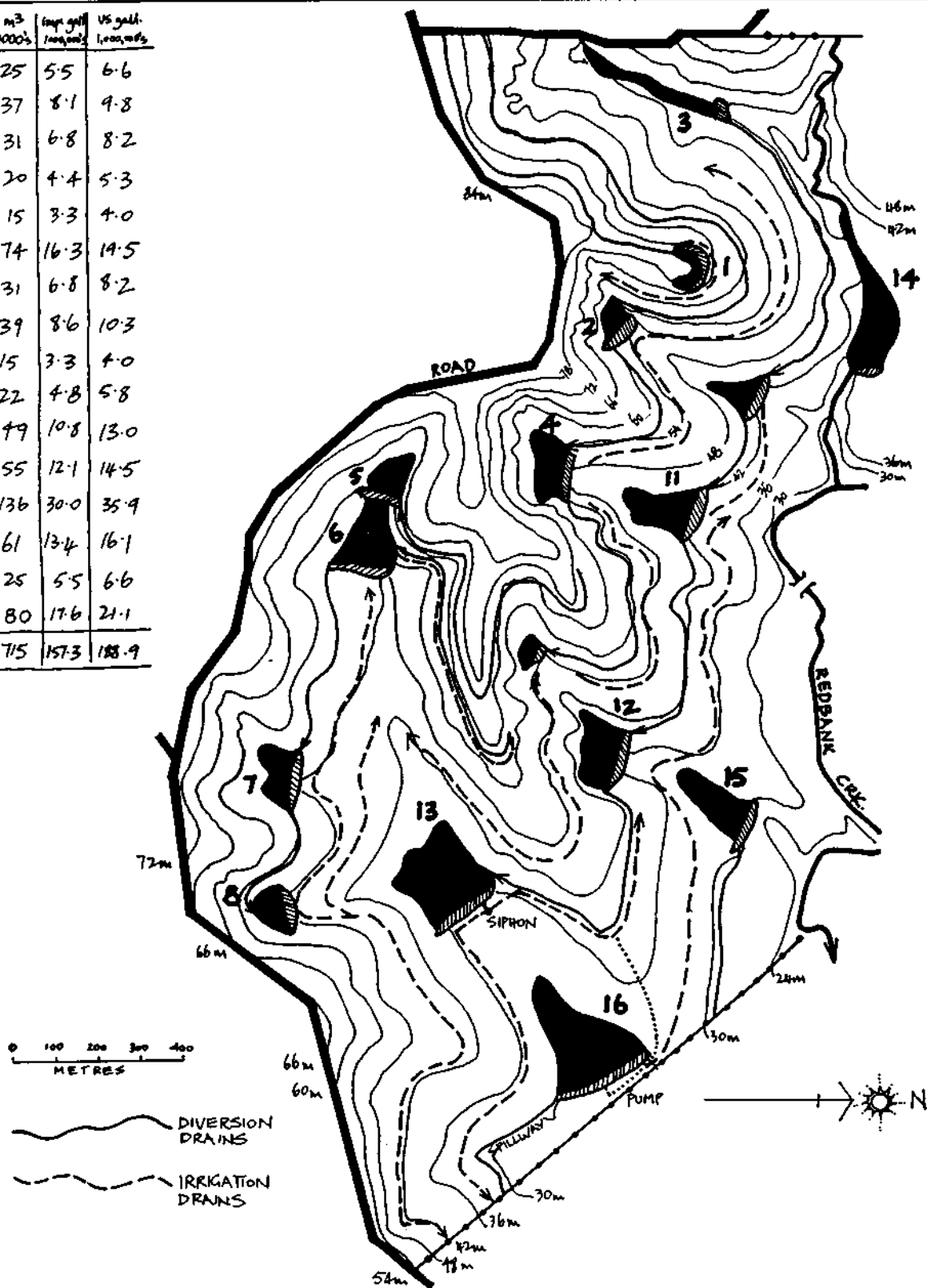

FIGURE 7.16.B

A MAP OF ONE OF P.A. YEOMANS' PROPERTIES.

P. A. Yeomans' former property "Yobarnie", after 17 years of keyline irrigation development, covering about 307 ha (758a.). The road on

the southern edge of Yobarnie is located along a main ridge. Note the primary valleys and primary ridges falling to Redbank Creek to the North. For further information and photographs see Yeomans<sup>(5)</sup>.



the earth. This, like the exclusion of boulders and logs, grass clumps and topsoil, is critical to earth stability (shrinkage of well-compacted dams is less than 1%). Earth so rolled should be neither so dry as to crumble nor so wet as to slump or squash out under the roller.

A key should be cut to prevent shear and cut off any base seepage. This is needed on all walls 1.8 m (6 feet) or more high, otherwise the base should be on a shallow clay-filled ditch. Slopes are safe at a ratio of 3:1 (inner) and 2 or 2.5:1 (outer), freeboard at 0.9 m (3 feet), key at 0.6-0.9 m (2-3 feet) deep. In suspect soils, the whole core can be of carted clay (Figure 7.17).

The wall can curve (out or in), but if carefully made as diagrammed and provided with a broad spillway, should be stable and safe forever, barring explosions or severe earthquakes.

The SPILLWAY base should be carefully surveyed at 1 m below crest and away from the wall or fill itself (don't try to judge this, measure it), and a SIPHON or

BASE OUTLET pipe fitted with baffle plates placed to draw off water (Figure 7.18).

The efficiency in capacity of dams depends on the flatness of the area behind the wall. A "V" valley or "U" valley, plateau, or field should be as level as can be chosen for greatest efficiency. The key to efficiency is the length of the dam wall, compared with the "length" of water dammed. If the back-up is greater than wall length, then this is a measure of increasing efficiency of energy used or earth moved for water obtained. A careful survey of grade plus dam length gives this data before starting the wall. Some dam sites are very cost-effective, especially those short dams at constricted sites where the valley behind them is flattish.

Small dams of this nature are a jewel in the landscape. Fenced and planted to 30-60 m of forest and fruit surround, they will provide biologically clean, if sometimes muddy, water, and if the topsoil is returned,

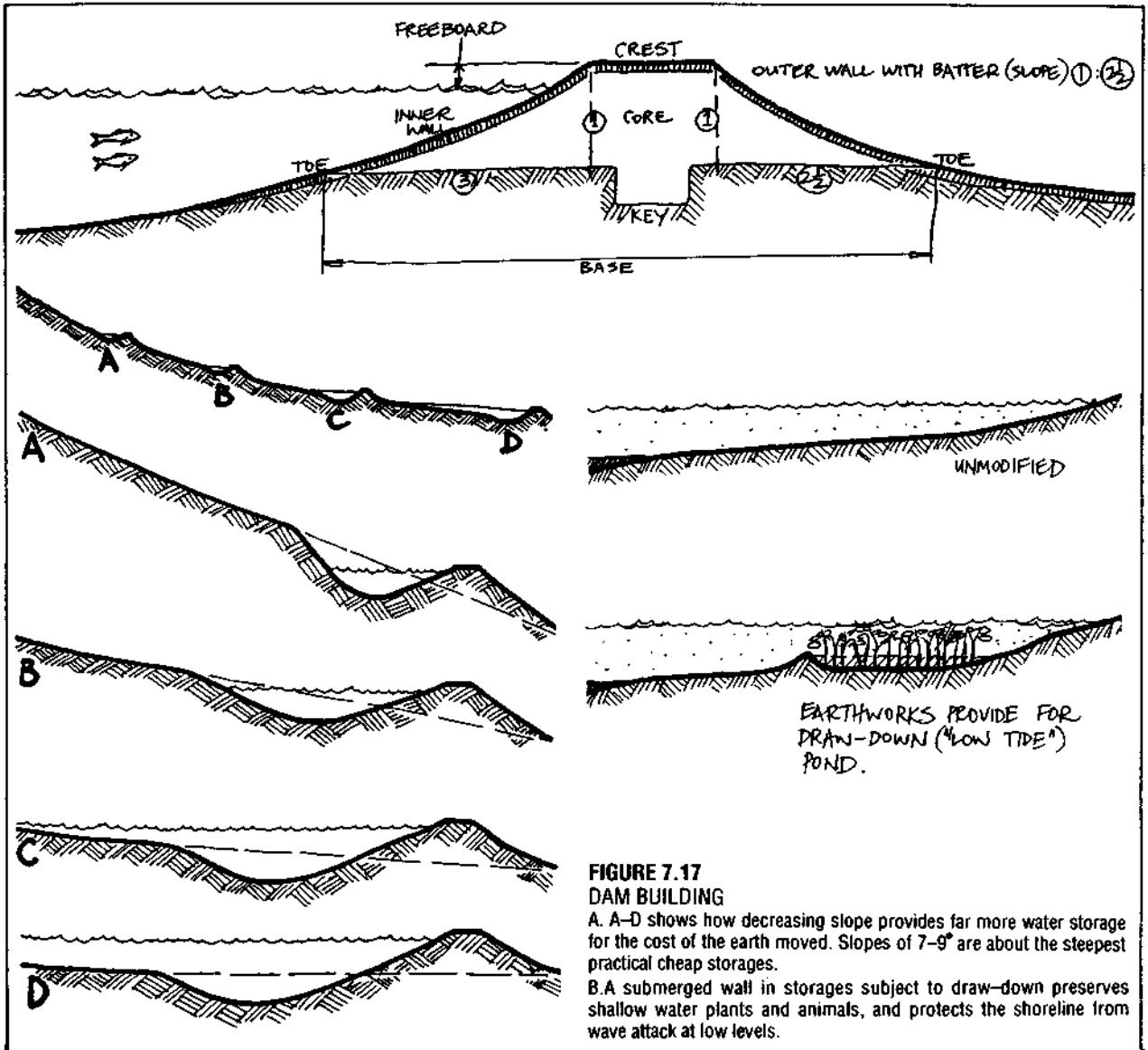

**FIGURE 7.17**  
**DAM BUILDING**

A. A-D shows how decreasing slope provides far more water storage for the cost of the earth moved. Slopes of 7-9° are about the steepest practical cheap storages.

B. A submerged wall in storages subject to draw-down preserves shallow water plants and animals, and protects the shoreline from wave attack at low levels.

lime used, and edges planted, mud will decrease and eventually clear. For water cleanliness and parasite control, cattle, sheep, and other animals should be watered at spigots or troughs, not directly at the dam. Troughs are easily treated with a few crystals of copper sulphate to kill snails and parasitic hosts; dams stocked with fish will do the same job.

Crests can be gravelled and safely used as roads to cross valleys or bogs, and special deep areas, islands, peninsulas, and shelves or benches made inside the dam for birds, plants, and wild-fire-immune houses.

### SEALING LEAKY DAMS

There are several ways to seal leaking dams:

- Gley;
- Bentonite;
- Explosives;
- Clay; and
- Impermeable membranes.

GLEYS are a layer of mashed, wet, green, sappy plant material sealed off from air. Although the very green manure of cattle is preferred, shredded, sappy vegetation will also work. It is carefully laid as a continuous 15-23 cm (6-9 inch) layer over the base and gently sloping sides (ratio of 1:4) of a pond, and is

covered *completely* with earth, cardboard, thick wet paper, plastic sheets, or rolled clay, and allowed to ferment anaerobically. This produces a bacterial slime which permanently seals soil, sand, or small gravels. Once ferment occurs, the pond is pumped or hosed full of water, and the paper or plastic can be later removed. I have used carpets and odd pieces of plastic sheets overlapped with good results. In cold areas, ferment can take a week or two, in tropics a day or so. Lawn or second-cut grasses, papaya and banana leaves, vegetable tops or green manure all serve as the base layer. I believe that in very good soils, especially in the tropics, it may be possible to grow the gley as a mass of *Dolichos* bean and just roll it flat before sealing it (Figure 7.19).

Modifications are:

- To pen and feed a herd of cattle in the dry dam until the bottom is a manurial pug; occasional watering assists this process.
- To strew bales of green hay and manure on ponds that leak slightly, producing algae which seal minor cracks.
- To sow down green crop in the dry dam, spray irrigate and feed it off regularly with cattle.

BENTONITE is a slippery clay-powder derived from volcanic ash. It swells when watered and will seal

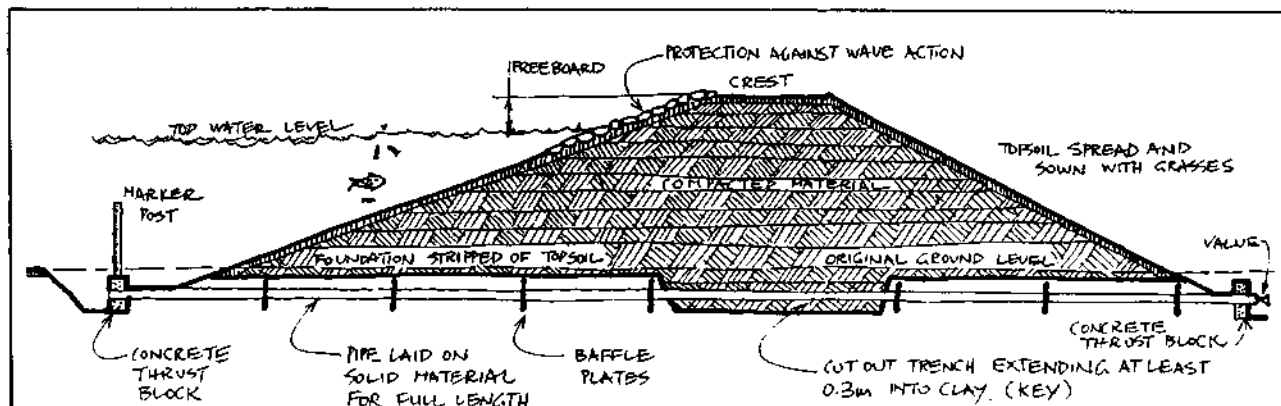

**FIGURE 7.18**  
DAM WITH LOCK PIPES.

A large earth dam feeding irrigation canals in the Keyline system can

be fitted with a base pipe. Smaller dams use siphon over the dam wall to gardens and houses.

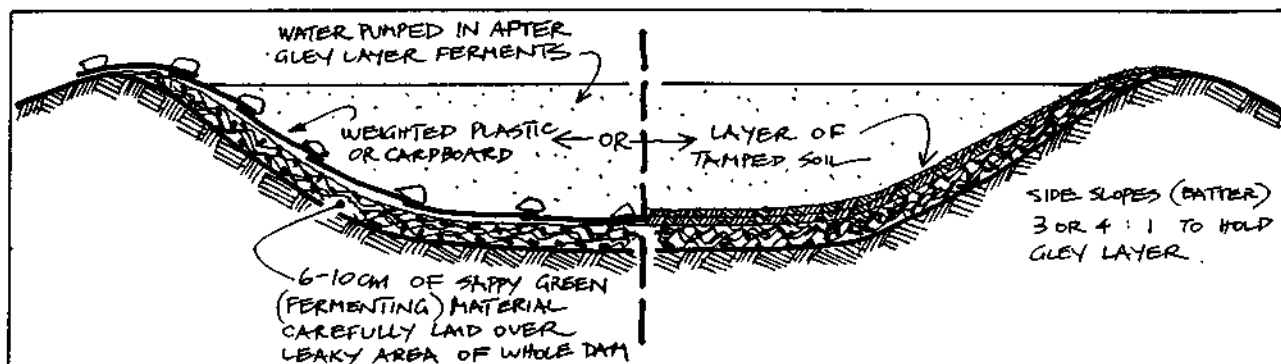

**FIGURE 7.19**  
GLEYSING A POND

With great care taken to slope side and place ferment material, this

technique will seal ponds in sands, gravels, shales, or leaking substrates.

clay-loams if rototilled in at 5-7 cm (2-3 inches) deep and rolled down. However, it is expensive and doesn't always work. Cement and tamping plus sprinkling might be preferable, or a bituminous spray can be rolled in after tilling. In clay soils, salt or sodium carbonate can have the same effect.

EXPLOSIVES are sometimes used to compact the sides of full dams, and consists of throwing in a 3-5 stick charge of dynamite. This works well at times, but is dangerous if you own a retriever, or if the dam wall is poorly compacted to start with.

CLAY is expensive if it has to be carted in, but it is often used to seal dams near a clay pocket. The clay is spread and rolled 23-30 cm (9-12 inches) thick over suspect areas.

IMPERMEABLE MEMBRANES can be of welded plastic, neoprene, or even poured concrete. Impermeable membranes are too expensive to use on any but critical dams, which may mean a guaranteed water supply to a house or garden in very porous areas. Using membranes enables banks to be steeper than in any other earth-compaction or gley system, so that more water can be fitted into smaller space. It is not "biological" unless a sand or topsoil floor is also added over the sealing layer, when fish or plants can be added.

Earth storage is now the cheapest, easiest, and most locally self-reliant method of water conservation. Unless both cities and farms use such methods, clean water will deservedly become known as the world's rarest mineral, ill-health will be perpetuated, and droughts and floods alike become commonplace. None of these are necessary.

Costs vary greatly; as a rough guide, water stored in soil and humus is the cheapest and of greatest volume, surface dams next cheapest, and tanks dear, but still much less expensive than piped water from mains supply. I can only urge all people of goodwill to promote, fund, and investigate water and water storage, water energy and water cleanliness, as the chlorinated, metallic, asbestos-fibred, poisonous water

of modern centralised systems is producing such epidemic disease and illness as cancer, bone marrow failure, and gastrointestinal disorder.

If a 22,500 l tank costs 20 units of money, the same units in a sensible earth storage pays for 2,500,000 l, or about 100 times as much water. Up to 135,000-2,500,000 l tanks get cheaper, as less concrete is used for more water. That is, a large tank is relatively cheaper than a small tank. Above 22,500 l, such tanks are usually poured on site; below this, they are carted from a central manufacturing site.

Dams, in contrast, begin to cost more as the height of the wall rises. About 3 m (10 feet) of retaining wall is the limit of cheap dams. Above this, costs rise rapidly as greater skills, more expensive and massive materials, more complex controls of levels, and much greater environmental risks take their toll.

As noted, "cheap" water in dams depends on the choice of site, so that very low dams on well-selected sites impound 20-100 times more water than the same earth used on steeper sites, where every unit of earth moved equals a unit of water. However, even earth tanks excavated below grade are at one-tenth the price of concrete tanks above grade.

Where are tanks, modest dams, and massive dams appropriate? Tanks are appropriate on isolated dwellings, in flatlands, and everywhere in cities and urbanised areas. Dams of from 22,500 to 4.5 MJ are best built on any good site in country and parkland areas. Massive dams are appropriate hardly anywhere but the the rock-bermed or glaciated uplands of solid and forested hills, subject to low earthquake risk and then only for modest domestic (not dirty industrial) power generation.

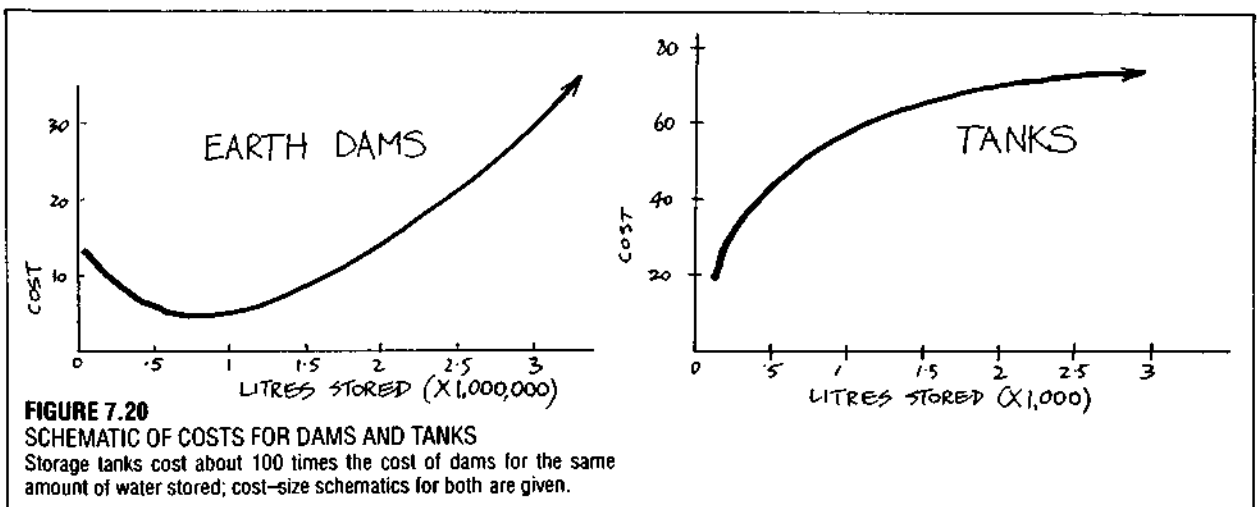

## STRUCTURE OF DAMS

There are effective approaches to the structural effectiveness of dams. The first is to make the dam itself as a deep conical section, so that as the level falls, surface area is also rapidly reduced (as the square of the radius). Much of the same effect is achieved in "V"-shaped valley storages.

Secondly, deep and shaded valley sites are far better protected from sun and wind than shallow valleys, and if choice is possible a shaded east-west valley is best.

Thirdly, a simple strategy of creating a series of 3-5 storages, each able to be drained by gravity flow to the next lower dam is very effective (far more so than a single storage of the same surface area). The system needs active management so that the use sequence is from the top down; the top dam is drained into the others just when they can take any residual water. As each is emptied, evaporative surface reduces by one-third, one-fourth, one-fifth and so on. Obviously, *the shorter the series the better the result*. It is better to create two series of 3 dams rather than 1 series of 6 dams. Like much else in the desert, the scale of operations decides efficiency, and in this case smaller is more efficient (Figure 11.46).

Despite all the potential problems with salted soils and water, there are many sites in desert or dryland foothills where freshwater springs and groundwater (less than 200 ppm salt) are available, where shaded valleys can be safely dammed, and where soils are open and free-draining. Endless problems and expense are avoided if such sites are carefully identified and selected wherever local long-term food provision is of an over-riding concern.

Many ideal sites lie in the inner valleys of spaced fold mountains, where deep sands over clay hold many millions of litres of freshwater run-off from the hills, and all that is needed is a reliable windmill or solar pump to raise this water to a mesa or nearby hill. As frost rarely exceeds the 12-20 m level in warm deserts, a raised tank will irrigate "sub-tropical" crop on the upper hill slopes, and deciduous plants needing a chill factor are planted on the lower slopes. This situation is common in hill country with restricted cold uplands. If all surplus run-off is used in wet years to set out forest trees held in nurseries, such situations quickly become not only sustainable but self-reliant and far less subject to serious drought effect. It is all a matter of careful site choice, responsible behaviour, and modest scale.

**FIGURE 11.46**

### THREE DAMS IN SERIES REDUCE EVAPORATION.

Evaporation loss can be as little as 40% of a single dam of the same capacity; all desert dams are ideally conical in section.

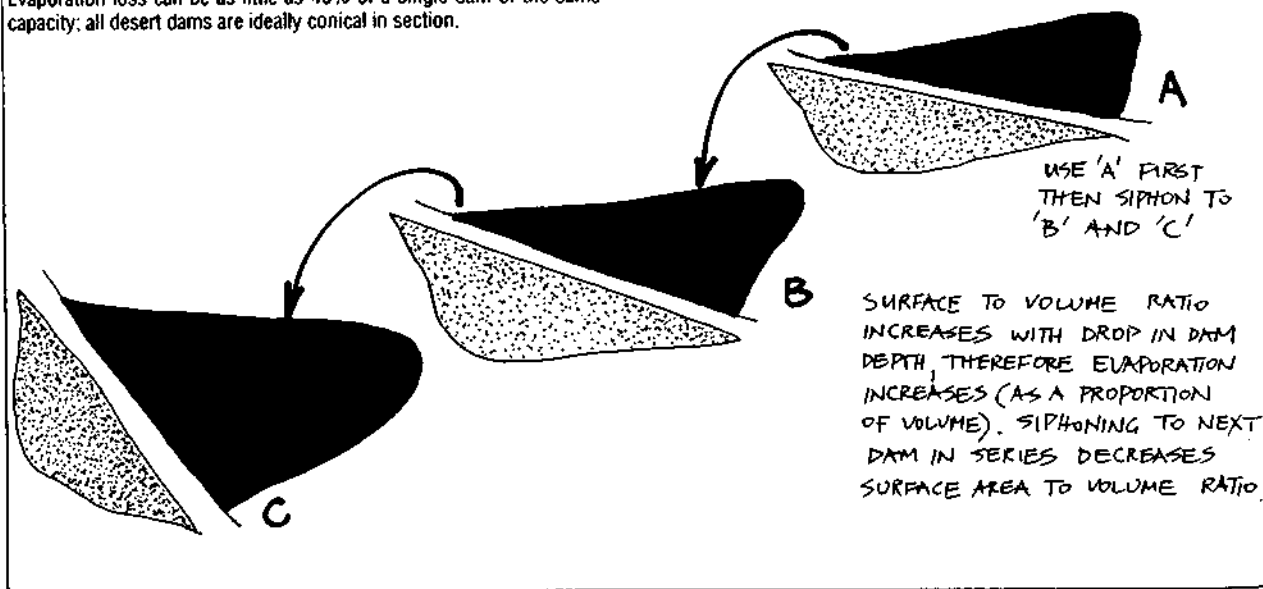

BARRIER DAM SECTION

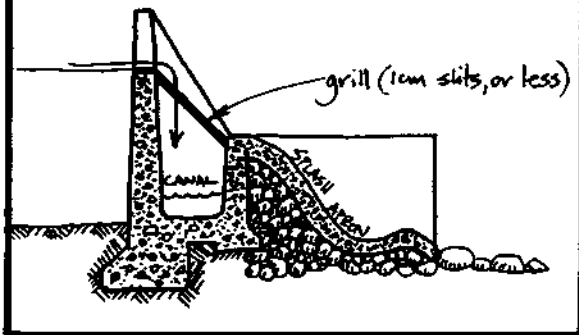
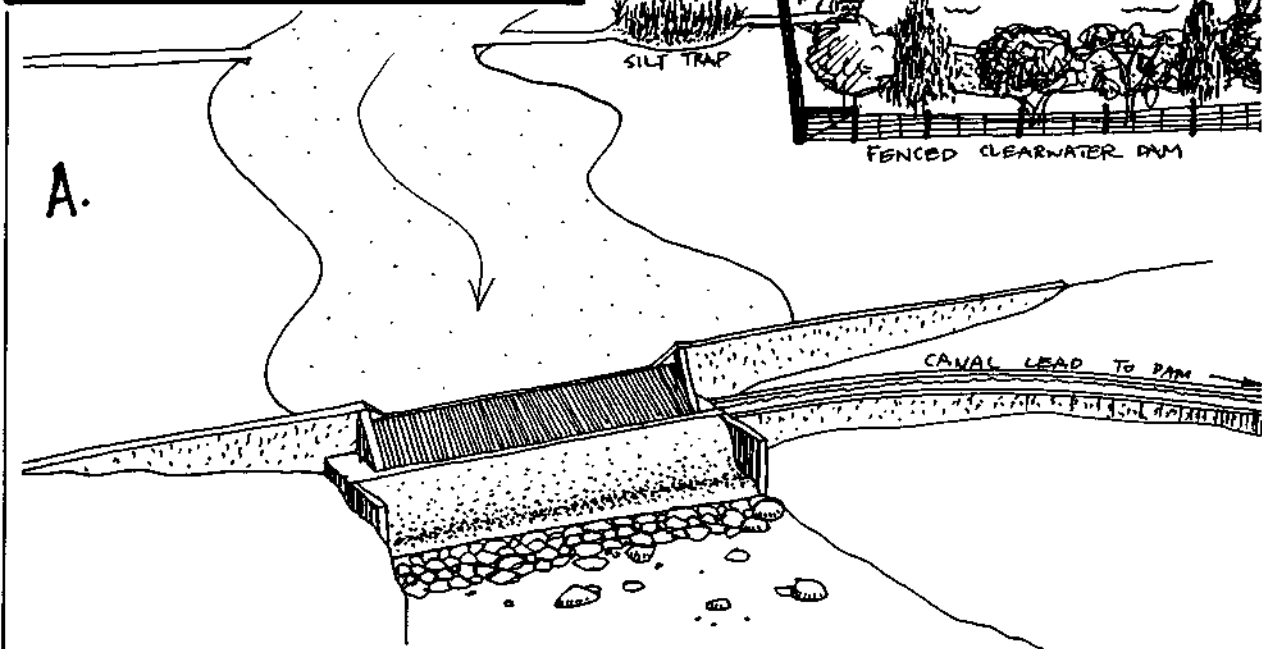

FIGURE 11.45

CLEARWEATER DAM BLEED OFF SANDTRAP.

A. A weir and grill allows water from a minor stream to be diverted to a clearwater dam (or long swale) via a silt trap.

B. Dry rivers in folds may develop very different tree species on each bank; the river is eroding on one side, depositing silt on the other; trees should be selected for site preference.



B.

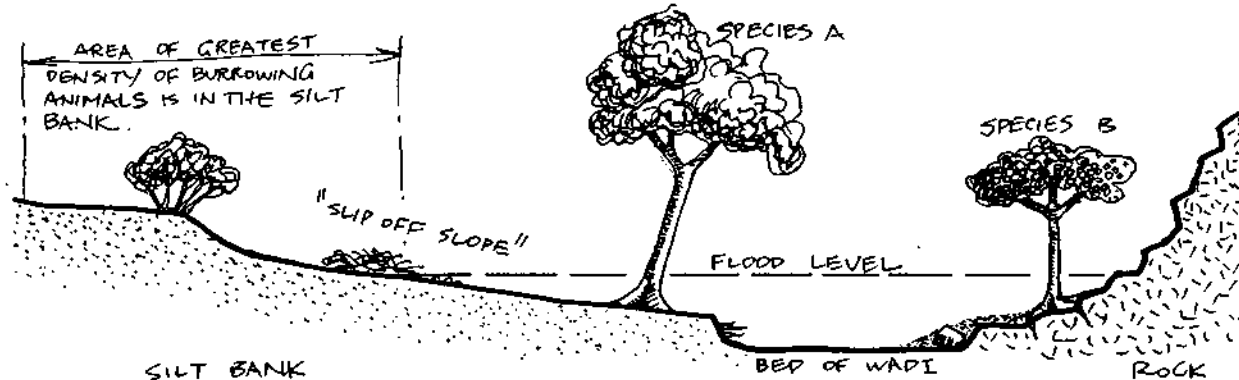
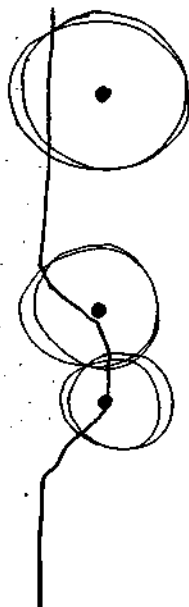
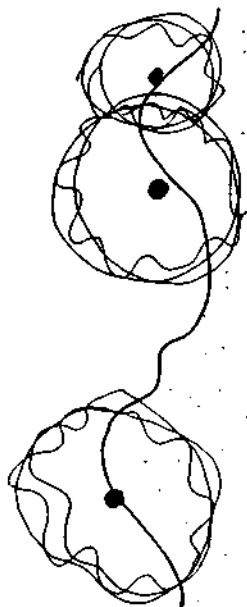

## CONSERVATION OF WATER IN TRANSIT

The transmission of water (as with any fluid or gas) needs great care. More water can be lost in canals, especially in loose soils or shattered rock, than is lost in use. Even open concrete channels can lose great quantities of water to air. There is really no substitute for long runs of pipe, and in small systems extruded PVC (flexible or rigid) pipe is most effective. Runs of 100 m or more can be made in one length; there are now long rolls of collapsible pipe for surface use, which can be unrolled as needed.

There is one other way to store water from opportunistic run-off, and that is in tough plastic or neoprene bags. These can, like swales, operate from fixed-diameter pipe inlets, much as the feeder drains operate from a head drain. The swale in this case is provided with a rolled container, which fills and unrolls as water fills it, and forms a "sausage" along the swale. Precisely the same technique can be used to capture fresh water flowing into salt lakes, so that the freshwater sausage floats, and is available as unmixed water on demand. This can be a much bulkier article, with greater depth/width ratio, as there is no substantial head pressure on an immersed bag. In swales, or as a series in swales, such bags would need fencing protection from large animals, but would otherwise be evaporation-free storage, preferably silvered above to reflect light, and trellis or vine-shaded to further reduce light and heat. Bags in salt water can be towed to other locations, or pipelines led across lakes to fill storage bags near villages.

There are these basic approaches to reducing evaporation in water storages in deserts:

- Underground and in-earth storage;
- Surface treatment of dams; and
- Storage configurations.

Any reduction in total evaporation of water is of interest in areas where this factor may reach 180 cm in a rainfall of 30 cm. Water is an expensive resource in any situation, and more so in deserts.

Several cultures in deserts (Peru, Iran, Afganistan, Canary Islands) have avoided gross evaporation loss by conveying water to desert farms via many kilometres of underground galleries (the *quanats* of Iran) and by storing the water in clay or cement-sealed caves. This is certainly an effective strategy, only superseded in

modern times by the development of extruded and leak-proof pipes and concrete tanks, by bores in headwater aquifers, and by the well and windmill systems widely used in Australia.

Water absorbed as rapidly as possible into soil is also safely out of the sun's rays, but to be efficiently stored, it is necessary to ensure that just enough water to soak the soil is admitted to swales or fields (that excess does not in fact escape to the groundwater at depth). A loose cover or mulch should be kept on the soil to prevent excess evaporation, and a crop established to use the water effectively. A 10–15 cm surface layer of loose gravel or volcanic cinder is widely used in the Canary Islands for crop and trees; coarse mulch has the same shading and insulating effect. If impermeable clays or rock lies at 2 m or so, trees can retrieve all water so stored, and desert trees penetrate to 30 m in free soils.

In view of the evaporative effect of winds, any exclusion of wind from dams greatly reduces surface loss. The exclusion can be by tree windbreak, artificial mesh windbreak, or even by building trellis or shade structure over small dams, as Australian Aborigines would do with gnammas (open rock pools). Gnammas up to a few metres across would be completely covered with a wooden frame covered with thick spinifex, thus providing both shade and wind protection. Covered tanks are likewise protected from wind losses, although vapour pressure can cause some loss in unshaded tanks. Roofed earth tanks are still widely used in Australia.

For more extensive water systems, strategies have ranged from floating rafts of wax, to the more permanent and effective strategy used in South Africa, where hexagonal floats of white-surfaced "light" concrete (a slurry of cement, sand, fine gravel and polystyrene beads) are floated out until the entire catchment surface is covered. This is very effective where water is rare or expensive. Larger and lighter rafts could be made of sealed pipe floats and thin panels, but the concrete is durable and simple; blocks are tar-sealed below, and their specific gravity is 0.8, so that they float deep enough to resist wave effect. Corners are rounded to allow air to the water.

## DAMS

In developing water power, dams are needed for three functions: (1) to divert the stream flow to the waterwheel or turbine, (2) to store the energy of the flowing stream, and (3) to raise the water level (head) to increase the available power. In addition to being used to help develop power, a dam may be useful in providing a pond for watering livestock, for fire protection or for irrigation needs. However, keep in mind the possibility of ecological harm involved in damming a stream, and forego the construction if necessary.

There are four basic criteria for deciding possible sites for the dam and powerhouse: (1) the ease of building the dam, considering the width of the stream and the stability of the soil; (2) maximizing the amount of possible storage volume behind the dam without damaging the ecological balance; (3) minimizing the distance to a good powerhouse site in order to lower the difficulty and the expense of moving the water; and at the same time (4) finding a place where the greatest amount of head is available.

Once a site has been chosen the size and type of dam needed will largely depend upon the stream course and surroundings as well as your needs for power. An assessment must be made of basic requirements for power (both mechanical and electrical) and some estimate of future needs. This could be as simple as adding up the power needs for lighting and refrigeration, but could also include assessing needs for machinery, power tools, or appliances. Essentially then, the size and type of dam will depend upon the size and type of waterwheel or turbine that will be needed to fill power needs, and also upon the flow rate of the stream, the head available, the local restrictions on size and permanency, and the money available.

### Diversion Dam

When there is a creek with a continuous flow and a natural drop that together will provide sufficient power for your needs, a small diversion dam will suffice. This can simply be a log placed up against some projecting rocks, with rocks, gravel and earth placed upstream to stop the underflow. Even a temporary dam of a few rows of sandbags will serve well (at least until the first flood comes) and can be cheaply and easily replaced. All that is necessary is a sufficient dam to divert the water into a sluice or pipe intake which carries the water to the turbine (see Channels, Sluices and Pipes).

Small diversion dams have the advantage of easily "washing out" during large flows thus preventing possible damage downstream which the washing out of a larger more permanent dam might cause. Also, diversion dams may be useful for running some of the stream's water into an off-stream storage location.



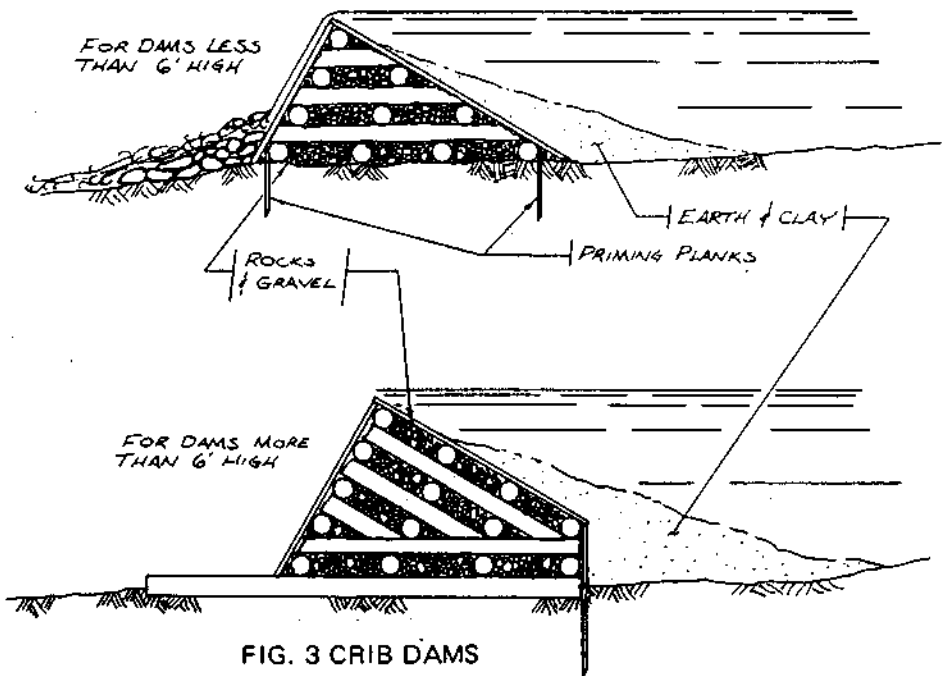
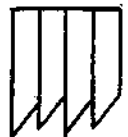

FIG. 3 CRIB DAMS

The need for storage is one of the dam's primary functions, but during times of large flow or flood can cause potentially dangerous situations. Normally the water would be stored directly behind the dam in the stream's course. However, if a diversion were used to divert the water to a side canyon or hollow, the need for storage would be met, while avoiding the danger of a flood washout. When large flows occurred the diversion dam could either be easily taken down or allowed to wash out by the stream's force; both situations leaving the off-stream storage facility full and intact. When the large flow subsided, the dam could simply be rebuilt.

### Low Dams of Simple Construction

These can be built by adding to the diversion dam's structure. Instead of one log, use several stacked together log cabin style, or like a corn-crib—hence the term "crib dam." The crib dam (see Fig. 3) consists of green logs or heavier timbers stacked perpendicular to each other, spaced about 2 or 3 feet apart. These should be spiked together where they cross, and the spaces in between filled with rocks and gravel. The upstream side, especially the base, should be covered with planks or sheets of plastic to prevent leakage, and then further covered with earth or clay to seal the edges. Priming planks should be driven into the soil approximately two to three feet deep at the upstream face to limit the seepage under the dam (particularly on porous soils). Priming planks are wooden boards, preferably tongue and groove, with one end cut to a point on one edge. They are driven into the soil so that the long pointed side is placed next to the board that was previously driven. Then as each successive board is driven into the soil it is forced up snug against the preceding board as a result of the angle of the bottom cut.



PRIMING PLANKS

The downstream face of the dam must be protected from erosion or undercutting wherever water will spill over. This is most important at a time of large flows! The spillways can be made of concrete, lumber, or simply a pile of rocks large enough to withstand the continual flow. Crib dams can be built with the lower cross-timbers extended out to form a series of small water cascades downstream. Each cross-timber step should be at least as wide as it is tall.

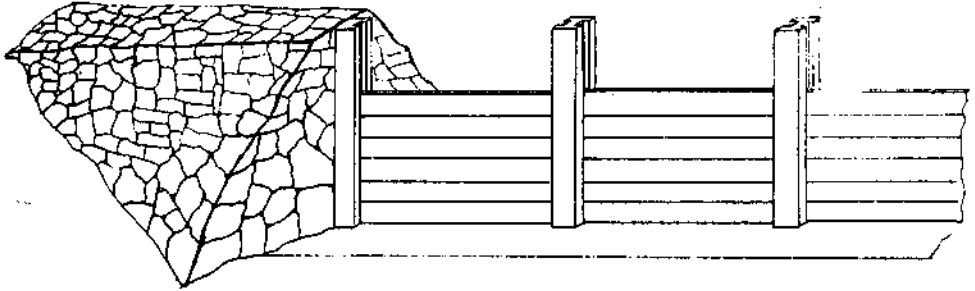

FIG. 4 PLANK BOARD DAM

## Earth-Fill Dam

This is the cheapest kind of dam if earth moving equipment is available. Sometimes these can be small gravel dams (under 5 feet) that can wash out with each season's flood, and can be rebuilt when necessary. For larger earth dams (in California anything more than 6 feet high or 5 acre feet or storage) a registered civil engineer will have to be consulted, and some soil studies should be made to determine the method of construction. For more information on the structure, placement, and suitability of earth fill dams, see the USDA Handbook No. 387, "Ponds for Water Supply and Recreation," page 67.

## Plank Board Dam

Much like a plank-board overflow spillway, a small dam can be constructed from wooden planks supported by posts set in a concrete foundation (see Fig. 4). The posts can be wood 4 x 4's (or larger) with steel channel or angle-iron attached to the sides, or the posts could be steel I-beams set directly in the foundation. The wooden planks can be dropped into the steel slots to form as much of a dam as is needed (up to the height of the posts). The upstream face of a plank board dam will often need to be sealed with plastic sheeting to prevent leakage. The planks (2 x 6 or larger) can be either added or removed to vary the height of the dam and can be completely removed during the flood season.

## Rock Masonry Dam

With a plentiful supply of rocks and stone nearby, a good rock masonry dam can be built of uncut rock laid in cement mortar. This style should be built with a base at least 8/10 the height. With a masonry dam more than 8 feet high some engineering consultation would be important (and may even be required). Many soil factors can threaten the stability of the dam.

## Concrete Gravity Dam

One of the more common building materials for containing water is good old concrete. A 1925 USDA Bulletin: "Power for the Farm From Small Streams," recommends a mixture of one part Portland cement, 2 parts sand, and 4 parts gravel or broken stone. Large boulders can be thrown in, but they should be well set in the concrete and should not exceed 30% of the total volume. The dam with dimensions shown in Fig. 5 should not be more than 50 feet long.

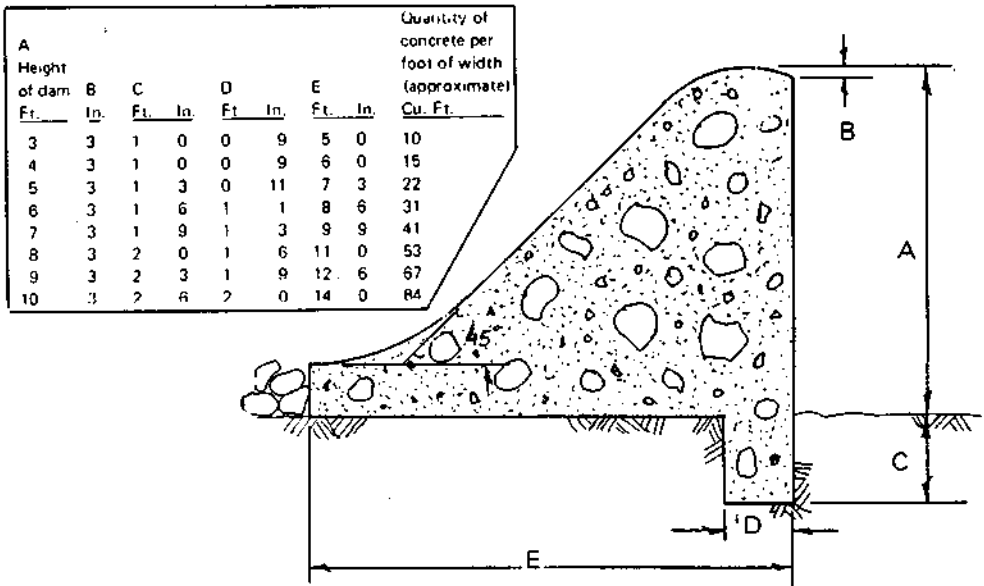

FIG. 5 CONCRETE GRAVITY DAM

## Concrete Block Dam

For simpler construction, and considerably less volume of concrete mix, a structure can be built of manufactured standard concrete blocks. The blocks will need to be reinforced with re-bar, placed on a firm concrete footing, and protected on the downstream face with a pile of sizable rocks. The construction of this type dam is very similar to retaining walls used to hold back earth for buildings. The re-bar must be placed first, then the footing concrete poured, and the first row of blocks placed on the wet concrete. After that has set, the other rows of blocks can be placed (with mortar joints) around the vertical bars; the horizontal bars can be placed where needed, and then the holes in the block should be filled with poured concrete.

## LARGE AND SMALL FLOWS

The process of developing a water power installation is complicated by variations in the quantity of stream flow. Large flows can wash out dams, destroy waterwheels and turbines and create dangerous situations downstream. It is important to know what the possible large flows for the particular stream will be and how best to prepare for them.

The maximum expected flow in a stream cannot always be measured directly; it could happen at 3 am on a cold rainy night. Nor can flows be determined by the regular high-water marks along the banks, or by old timers who remember the "big rains of ought-8." The "Big Flood" for a

particular drainage will come as the result of the right combination of strength and intensity of an exceptional storm as well as the soil conditions, moisture content, vegetation, and the physical structure of the drainage area around that stream. Hydrologists, local flood control people, soil conservation agencies, or water districts can often offer assistance in predicting the flood flows for small drainages. Another source, where these agencies are not available, is a US Department of Agriculture handbook (No. 387) "Ponds for Water Supply and Recreation" (see page 67).

For all types of dams there must be some provision to handle the maximum flows that can come with a severe rain storm; otherwise the sides, foundation, and the structure of the dam can be weakened. This is particularly true for earth dams, since any flow that exceeds the capacity of the spillway will erode the dam with frightening ease. As this would occur at a time when the stream is already at flood stage, the added volume of water from a washed out dam could be exceptionally dangerous downstream and the owner of the dam could be legally liable for the damage.

With small dams, especially earth dams, the best way for large flows to safely pass downstream may be to allow them to wash out the dam. With larger dams this method may be impractical, costly and dangerous. In these situations it will be necessary to use a culvert or weir for the large flows to pass through.

An opening can be made with a large culvert placed through the dam. The *Water Measurement Manual*, page 67, will aid in determining the capacity for a given length and size of pipe. The face of the dam should be protected from the downstream outflow of the culvert, or, if you have one long enough, the culvert can be extended beyond the footing of the dam to the natural stream course. The problem with pipes and culverts is that they are easily plugged by brush and trash. They must be watched almost continuously during storms or the water back-up may overflow the dam. Because of this problem, culverts do not make good spillways; so, there should be some additional spillway provided. However, pipes and culverts can be useful to control the flow rate downstream, a simple "gate valve" (of a sort) can be made by placing a piece of plywood over the upstream end of the pipe. The flow rate can then be controlled by adjusting the plywood to allow the proper opening.

A sufficient flood flow capacity can be provided by one or more rectangular openings in the dam. These could be built like large rectangular weirs to provide a continuous measure of the flow rate, as well. (Use Table 1 to find the size weir required to handle the flood flows). Such an opening would not be easily plugged by trash, and the flow could be regulated by placing planks flat across the upstream side of the opening to raise the spill level.

Plank board dams are well suited to handle floods. During times of large flow the planks may simply be removed to allow more water to pass downstream (see Dams).

Small flows do not present the potential danger that large flows do. They may, however, be of insufficient quantity to operate the waterwheel or turbine. Although it may be desirable to store water behind the dam in order to gain a larger flow for the wheel or turbine, it may not be possible or necessarily advisable. Water right laws in many cases will prohibit halt-

ing the flow downstream even if you plan to let it flow later in the same day. Also, during times of low flow, the intermittent storage and release of water will cause some erosion in the stream course above and below the dam. In short, it is probably best to design your hydro-power installation to operate at the minimum seasonal flow rate, rather than attempting storage during that time. This suggestion should not be taken as advice against storage of water during times of normal or average flow, but here too, care should be taken and the laws should be investigated.

## CHANNELS, SLICES AND PIPES

Every hydro-power installation (with the possible exception of an undershot wheel) will require a means to carry the water from the stream to the waterwheel or turbine. In most cases a dam will have been constructed and the task will be to take all or part of the water and run it to the wheel or turbine. In many cases there will be a considerable distance from the dam to the turbine and it will be important to consider the various possibilities and compare the costs of both materials and labor. Most of the lower technology waterwheels will be best serviced by an open channel or sluice. The Pelton wheel, Banki, Propeller, Kaplan and Francis turbines will almost always require piping. Discussion of how each of these units operate will follow in the Waterwheels and Water Turbines section.

Basically, there are two ways to move water from one location to another—either with unpressured flow along an open channel (e.g. a canal, sluice or a natural stream) or with flow under pressure contained in a pipe. Each has advantages in the appropriate situation.

A canal is simply a ditch dug out along the ground, that will maintain a nearly constant elevation (with a very gradual down grade slope) and carry water at a low velocity with a minimal amount of head loss. The head loss will be the same as the loss of elevation along the canal.) The size (i.e. the cross-section area) of the canal that will be required to carry a given amount of flow will depend on the roughness of the canal, the amount of vegetation growing in the canal and the slope of the canal. Canals are more often used for irrigation than for a hydro-power plant, although the two needs, power and agriculture will often be compatible—a dam and canal can divert water for both purposes. In short, a canal will move water with a minimum of both cost and head loss.

The sluice is really another type of open channel. The difference being that a canal is usually dug out of the ground, whereas a sluice is an elevated structure or open box channel, somewhat like the old Roman aqueduct or gold-miners flume. They are useful for carrying water over or around obstacles where a ditch would be impractical (e.g. rocky ground, side canyons, or very steep hillsides). The overshot water wheel requires a sluice to carry the water out over the structure of the wheel.

The sluice itself can be made from wood or metal. The sluice must be supported by a strong structure. Remember that water weighs 62.4 lbs. per cubic foot, so a 2' x 4' box channel would have to carry *500 lbs. per foot of length*, or each four feet of sluice would hold a ton of water!

## Channel Flow

There are several objectives in channel design: to (1) move the water with as little head loss as possible; this means a gradual slope, slower velocity, and an adequately large channel; (2) do the job as cheaply as possible, avoiding any undue construction complications, and keeping the channel as small and as short as possible; and (3) move as much water as is available within the above constraints. Some compromises must be made along the way, since it is unlikely that all these criteria can be met in any one design.

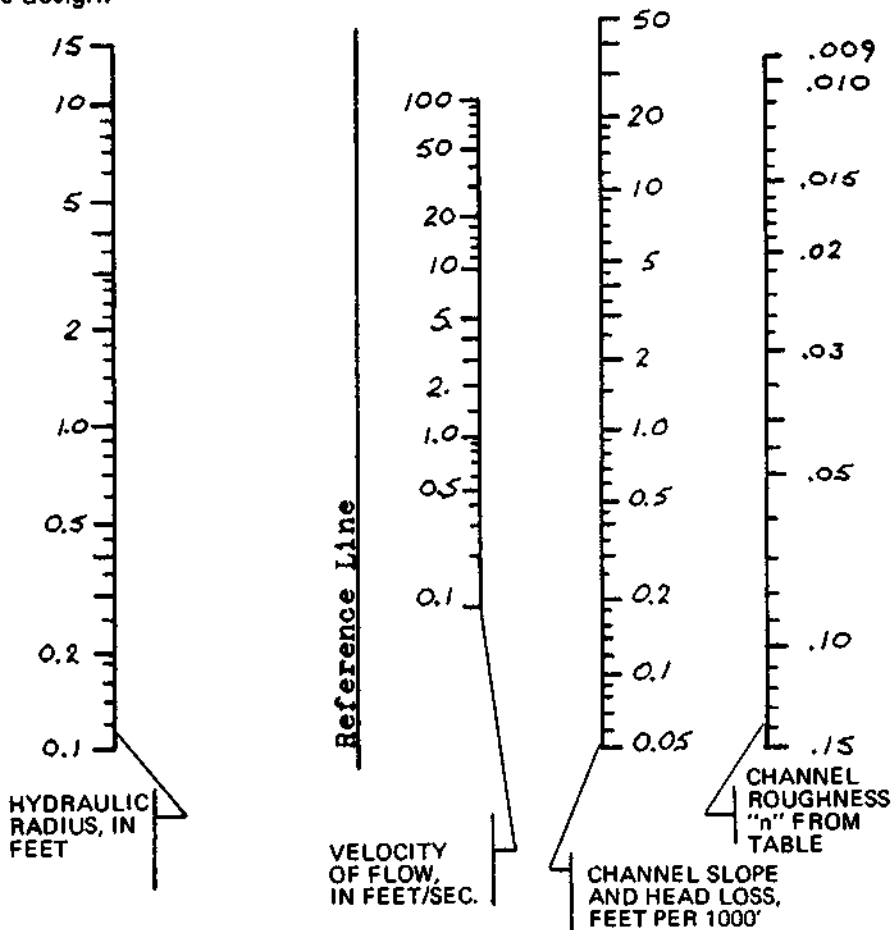
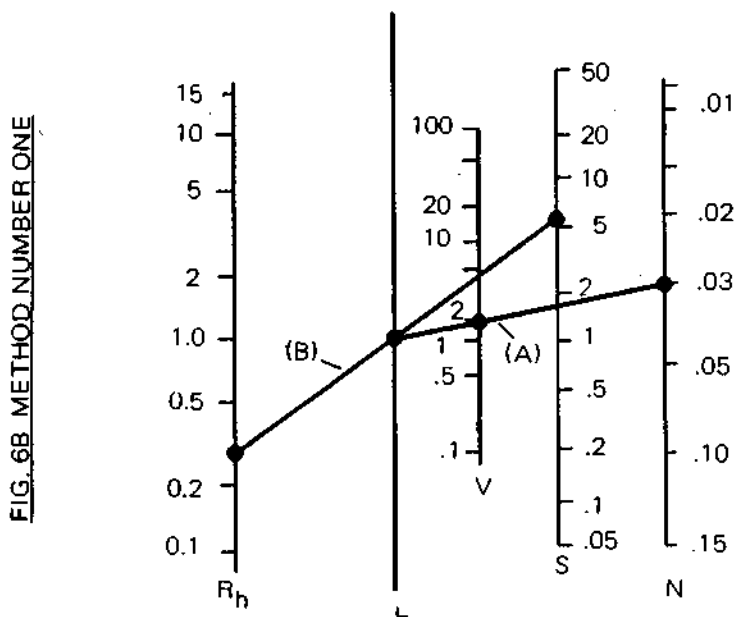

FIG. 6A CHANNEL FLOW NOMOGRAPH

**USE OF THE NOMOGRAPH:** Draw a straight line from the appropriate value for "n" through the velocity of flow desired, to Reference line; this sets the pivot point. Then a second line is drawn from the hydraulic radius (determined by the size and shape of the channel) through the pivot point to the head loss scale; this gives the slope required to overcome the head loss in a given channel for water moving at a given rate.

To find the channel size and slope needed to meet the above requirements involves the use of a "Channel Flow Nomograph" (Fig. 6A). The two following methods will describe how to use it. In order to avoid complications in the examples, we are assuming a uniform channel cross-section, a steady flow rate of water, and a constant slope along the channel.

**Method Number One** involves the use of a chart called a "nomograph" (Fig. 6B) to determine the required slope of the channel. First, determine the amount of water that must be diverted to the channel; this depends on the amount of flow available from the stream, and the wheel or turbine requirements (see *Waterwheels and Water Turbines*). Now consult Table II to find the maximum allowable velocity for the water to move through the channel. For example, if the flow is 1 cfs, and the channel were dug in soil with about 40% clay content, the maximum water velocity without causing erosion in the channel would be 1.8 feet per second.



The next value that needs to be known in order to work with the nomograph is the channel roughness ( $n$ ). This is also read directly from Table II and in this example would be .03.

Last, we must find the hydraulic radius in feet. The hydraulic radius is equal to a proportion of the channel through which the water flows. The first step is to find the minimum channel cross-sectional area that is required to carry the stream's flow (see Eq. 9).

$$A = \frac{Q}{V} \quad \text{where} \quad \begin{array}{l} A = \text{cross-section area of the channel in square feet} \\ Q = \text{flow in cubic feet per second} \\ V = \text{maximum water velocity in feet per second} \\ \text{before erosion begins (from Table II)} \end{array}$$

(Eq. 9)

Continuing with our "example" stream, using Eq. 9, "A" would equal 1 cfs divided by 1.8 fps or 0.56 ft<sup>2</sup>. Once the channel area is figured, the channel shape is chosen. The shape is largely a function of the materials found or used. Channels made of timber, masonry, concrete or rock should have walls constructed perpendicular to the bottom (see Fig. 7). The water level height should be one half of the width. Earth channels should have walls built at a 45° angle (see Fig. 8). Design them so that the water-level height is one half that of the channel width at the bottom.

# CHANNEL ROUGHNESS

TABLE II

<u>Composition of channel wall</u>	<u>Maximum water velocity (ft/sec) before erosion begins</u>	<u>Channel roughness (n)</u>
fine grained sand	0.6	0.030
coarse sand	1.2	0.030
small stones	2.4	0.030
coarse stone	4.0	0.030
rock	25.0	0.033
earth:		
sandy loam, 40% clay	1.8	0.030
loamy soil, 65% clay	3.0	0.030
clay loam, 85% clay	4.8	0.030
soil loam, 95% clay	6.2	0.030
100% clay	7.3	0.030
earth bottom with rubble sides	(use one of above factors for earth)	0.033
concrete with sandy water	10.0	0.016
concrete with clean water	20.0	0.016
wood	25.0	0.015
metal	no limit	0.015

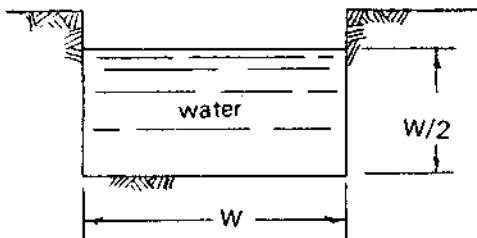

FIG. 7 RECTANGULAR CHANNELS:  
For timber, masonry, or rock

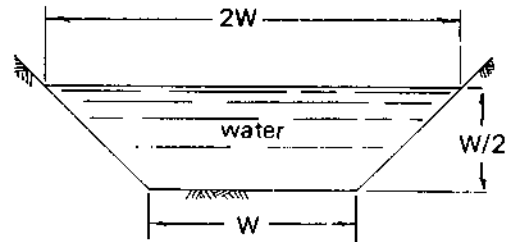

FIG. 8 TRAPEZOIDAL CHANNEL  
FOR EARTH

Now we must solve for (W) the width across the bottom of the channel which will enable us to find the hydraulic radius, the last value we must know to use the nomograph.

For Rectangular Channels: Timber, Masonry, Concrete or Rock Lined

$$\text{Area} = \frac{W^2}{2} \quad \text{so } W = \sqrt{2A}$$

$$\text{Hydraulic Radius } (R_h) = (0.25)(W) \quad (\text{Eq. 10})$$

For Trapezoidal Channels: Earth

$$\text{Area} = (.75)(W^2) \quad \text{so } W = \sqrt{\frac{A}{.75}}$$

$$\text{Hydraulic Radius } (R_h) = (0.31)(W) \quad (\text{Eq. 11})$$



To find the (W) of our example stream, use  $W = \sqrt{\frac{A}{.75}}$ . We know  $A = .56 \text{ ft}^2$ , then  $W = \sqrt{\frac{.56}{.75}} = \sqrt{\frac{.56}{.75}} = 0.86 \text{ ft}$ . Now the hydraulic radius can be calculated using the formula  $R_h = (.31)(W)$ .  $R_h = (.31)(.86) = 0.27$ . The hydraulic radius is then .27 ft.

To continue with the example, we have found the flow (1 cfs), the velocity (1.8 fps), the channel roughness (.03), and the hydraulic radius (.27 ft) and now need to find, using the nomograph, the channel slope required to move 1 cfs at a maximum velocity of 1.8 fps.

Using the nomograph (Fig. 6B), locate the point .03 on the *channel roughness scale* (N) and locate 1.8 fps on the *velocity scale* (V). Draw the line (A) through these two points to the *reference line* (L). Then locate the .27 on the *hydraulic radius scale* ( $R_h$ ). A second line (B) drawn from .27 through the point at which line (A) intersects the reference line will intersect the *channel loss/head loss scale* (S) at approximately 7.6. The channel slope/head loss is then 7.6 feet per thousand feet. Evaluating this outcome to see if this is the channel to construct will depend upon the length of the channel and the amount of head needed to operate the wheel or turbine.

In most cases the head loss and slope found in this manner will be too great for the requirements of the site, and so some redesign will be necessary. To redesign for a lesser, more gradual slope, a larger channel (with a larger hydraulic radius) will be necessary to move the same amount of water since the velocity would then be less.

*Method Number Two* begins with an assumed velocity much less than the maximum allowable. If we use the same flow rate, 1 cfs, it might be logical to choose a velocity of 0.5 fps. The channel area can then be found using Eq. 9. The example would require an area  $2 \text{ ft}^2$ . The corresponding hydraulic radius for a trapezoidal earth channel would be 0.51 calculated using  $(0.31) \times \sqrt{2 \text{ ft}^2} / .75$ .

Using the nomograph (Fig. 6C) and plugging in the appropriate values gives a channel loss/head loss of only .25, a drop of about 3 feet per thousand feet of channel length.

If the slope is still too great, the channel design can be changed by: (a) assuming a slower velocity, with either a larger channel or a smaller flow, or (2) reducing the channel roughness by removing vegetation or otherwise "smoothing out" the channel.

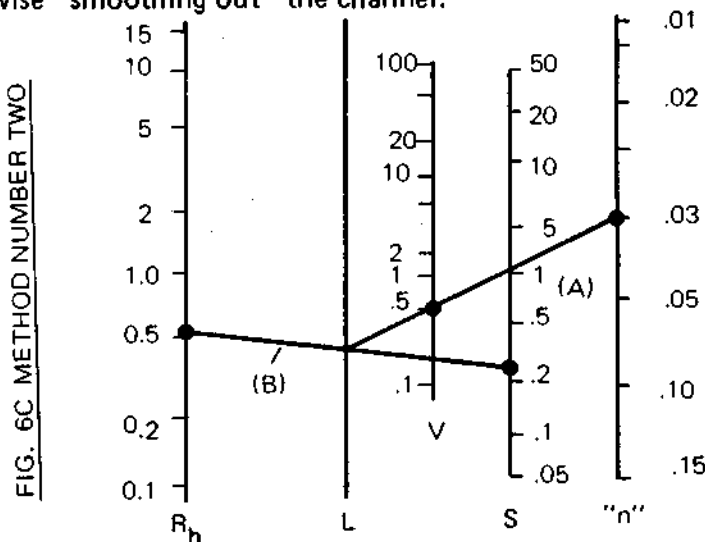

## Pipe Flow

The other alternative for water flow, besides the open channel flow, is the pressure flow of water contained in a pipe. This type of flow could exist over a very wide range of conditions: from the large volume of low pressure water flowing in a culvert (as under a road) to the small volume, high pressure flow of water in a pipe. Both cases can be analyzed with the pipe flow nomograph (Fig.9). It is important to find the proper diameter and strength of pipe to handle the required flow without undue expense or excessive head loss. Although water pipe is expensive (particularly, the high pressure steel pipe) it is the only way to deliver water under pressure.

Pipe flow nomographs are used to find head flow loss in pipes. The use of the nomograph in Fig. 9 is relatively easy. One line is drawn through the proper values on the flow rate (Q) scale and pipe size (D) scale, and will indicate the water velocity in the pipe and the corresponding head loss per 100 feet of pipe.

For example, to use a 4" steel pipe to move a flow of 1 cfs, draw a line from the 4" mark on line "D" on the nomograph through 1.0 cfs on the "Q" line. This will give a value on the head loss line "H<sub>L</sub>" of 20 feet of head loss per 100 feet of pipe. In most instances this would be too prohibitive a loss, and so some larger pipe would be required. To use a 6" pipe for the same flow rate (1 cfs) would mean a head loss of only 3 feet per 100 feet. This is a much more reasonable size of pipe for the 1 cfs flow.

This nomograph (Fig. 9) is only for the use of steel pipe. Steel is relatively rough compared with other kinds of pipes, with a roughness coefficient (C) of 100. It is possible to find the head loss and velocity in pipes other than steel (as long as the flow rate "Q" and pipe diameter are known). By finding the C value of the pipe (Table III) and using Eq. 12; the velocity, flow rate and head loss can be found.

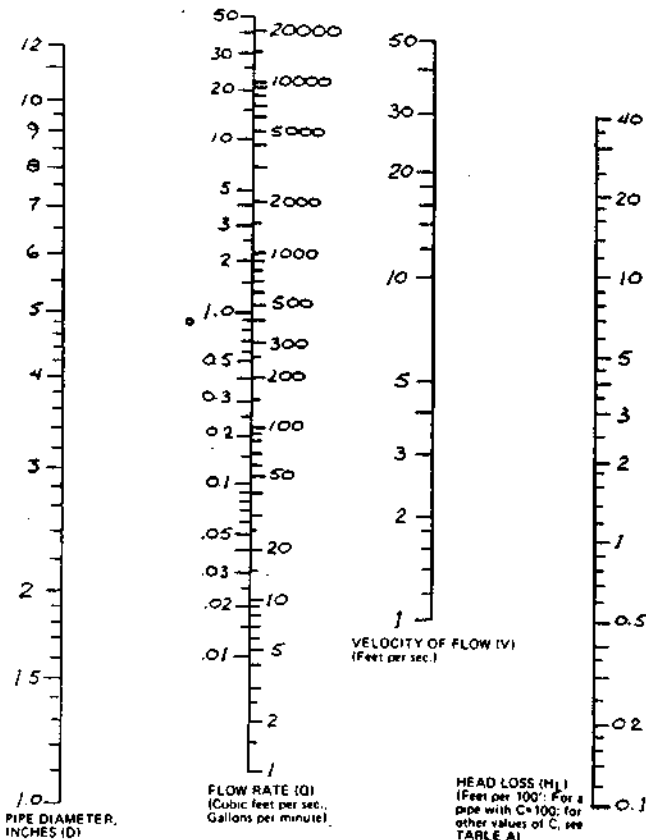

FIG. 9 NOMOGRAPH FOR HEAD LOSS IN STEEL PIPE (C=100)

$V = (V_N) \frac{C}{100}$  where  $V$  = velocity of water through a pipe other than steel

(Eq. 12A)

$V_N$  = velocity of water read from nomograph, when  $Q$  and  $D$  are known

$C$  = pipe roughness coefficient (Table III)

$Q = (Q_N) \frac{C}{100}$  where  $Q$  = flow rate of water (cfs) through pipe other than steel

(Eq. 12B)

$Q_N$  = flow rate value read from nomograph

$C$  = pipe roughness coefficient (Table III)

$$H_L = (H_{LN}) \left( \frac{100}{C} \right)^{1.85}$$

where  $H_L$  = head loss per 100 feet of pipe

$H_{LN}$  = head loss read from nomograph

$C$  = pipe roughness coefficient (Table III)

(Eq. 12C)

To take  $\frac{100}{C}$  to the 1.85 power, it is necessary to use logarithms. Either consult a friend, textbook or slide rule for assistance.

For example, using a new pipe lined with bitumastic enamel, and the same flow rate (1 cfs) and diameter pipe (6 inches) then:

$$V = 5 \text{ (fps)} \left( \frac{145}{100} \right) = 7.25 \frac{\text{feet}}{\text{second}}, \text{ a faster } V, \text{ as a result of smoother pipe}$$

$$Q = (1 \text{ cfs}) \left( \frac{145}{100} \right) = 1.45 \text{ cfs}$$

$$H_L = (3\text{ft}) \left( \frac{100}{145} \right)^{1.85} = (3)(.512) = 1.54 \text{ feet per 100 feet}$$

**TABLE III PIPE ROUGHNESS TABLE  
VALUE OF C\* FOR USE WITH PIPE-FLOW NOMOGRAPH**

<u>Pipe</u>	<u>C*</u>
New tar-coated	130
New cement-lined	150
New cast-iron, pit cast	120-130
New cast-iron, centrifugally cast	125-135
Cement lining, applied by hand	125-135
Bitumastic enamel, hand brushed	135-145
Bitumastic enamel, centrifugally applied	145-155
Ordinary tar-dipped cast-iron, 20 years service in inactive water.	110-125
Ordinary tar-dipped cast-iron after long service with severe tuberculation	30-40
Ordinary tar-dipped cast-iron; average tuberculation;	
new	135
5 years old	120
10 years old	110
15 years old	105
20 years old	95
30 years old	85
40 years old	80
New bituminous enamel-lined	150
Transite	140+
Poly-vinyl chloride (PVC)	130

\*C is a smoothness coefficient which gives a numerical value for how smooth the pipe and fittings are. A rougher pipe with a lower value increases the head loss in the pipe.

## USE OF WEIRS AND FLUMES IN STREAM GAUGING

### WATER MEASUREMENT MANUAL

Since water is such a precious commodity, some sort of accounting is usually necessary for measuring and metering the distribution of the wealth. This is particularly true for those situations where a large volume of water must be purchased from some local water utility, (e.g. irrigation) or for a community of water users to meter each individual outlet. These are needs that require some accuracy in measurement; but there is no need to resort to expensive mechanical devices. These two books discuss those means or "artificial controls" that can be used to measure the water flow rate with a great deal of accuracy and a minimum of expense and maintenance. The World Meteorological Organization book is primarily concerned with stream flow measurement made with open flow weirs and flumes. The Water Measurement Manual is a standard in the water resources business; it catalogues all sorts of possibilities for flow measurement with pipes, gates, and orifices as well as the standard weirs and flumes. For the money and the information the Water Measurement Manual is really the best bargain.

—Robin Saunders

## DESIGN OF SMALL DAMS

This is the definitive text on the design and construction of earth fill dams. The dams discussed and illustrated are medium sized or large by most standards. With considerable information on ecological impacts, soil geology, soil placement, construction techniques and the like this book has become part of the reference library of most civil engineers working in the field.

—Robin Saunders

Design of Small Dams  
Dept. of the Int.  
1973; 816 pp

**\$12.65**

from:  
Sup't of Documents  
U.S. Gov. Printing Off.  
Washington, D.C. 20402

or **WHOLE EARTH  
TRUCK STORE**

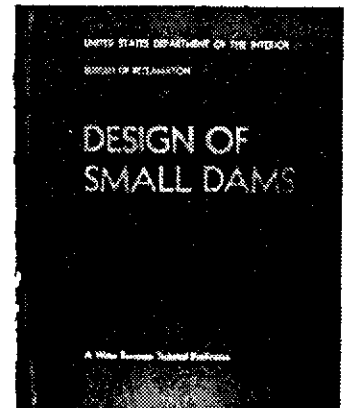

Ponds for Water Supply  
and Recreation;  
Agriculture Handbook  
No. 387, Soil Conservation  
Service, U.S. Dept. of  
Agriculture, 55 pp

**\$1.25**

from:  
Sup't of Documents  
U.S. Gov. Printing Office  
Washington, D.C. 20402  
or **WHOLE EARTH  
TRUCK STORE**

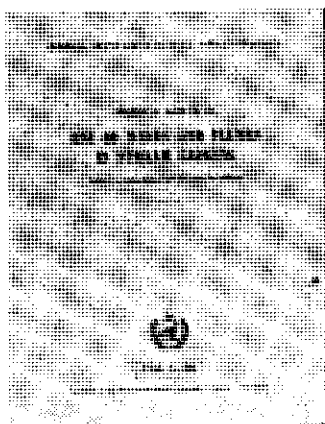
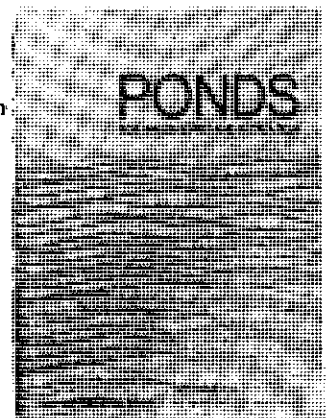

Use of Weirs and  
Flumes in Stream  
Gauging:  
Technical Note  
No. 117, 1971,  
55 pp **\$4.50**

from: World  
Meteorological Org.  
Publications Ctr.  
P.O. Box 433,  
NY, NY 10016

Water Measurement  
Manual: Bureau of  
Reclamation, 1967;  
323 pp **\$2.50**

from: Sup't of Documents  
U.S. Gov. Printing Office  
Washington, D.C. 20402  
or **WHOLE EARTH  
TRUCK STORE**

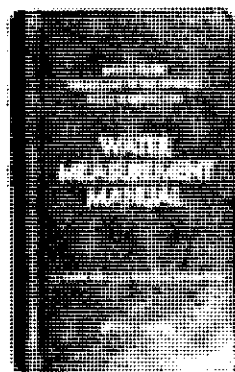

The Water Measurement Manual has been prepared to make available to designers, system operators, and water users the information needed for measuring irrigation, municipal, and industrial waters. The manual is primarily intended for personnel working on Bureau of Reclamation projects. However, it is just as appropriate for use by other groups or individuals, either in the United States or in foreign countries, who are engaged in designing or using water distribution facilities.

# HAND-HELD FLOWMETERS

ELECTRONIC  
FLOWMETER SOLD  
COMPLETE WITH  
STANDARD OR LOW  
SPEED IMPELLER PLUS  
PROGRAMMABLE  
FLOWMETER DISPLAY.

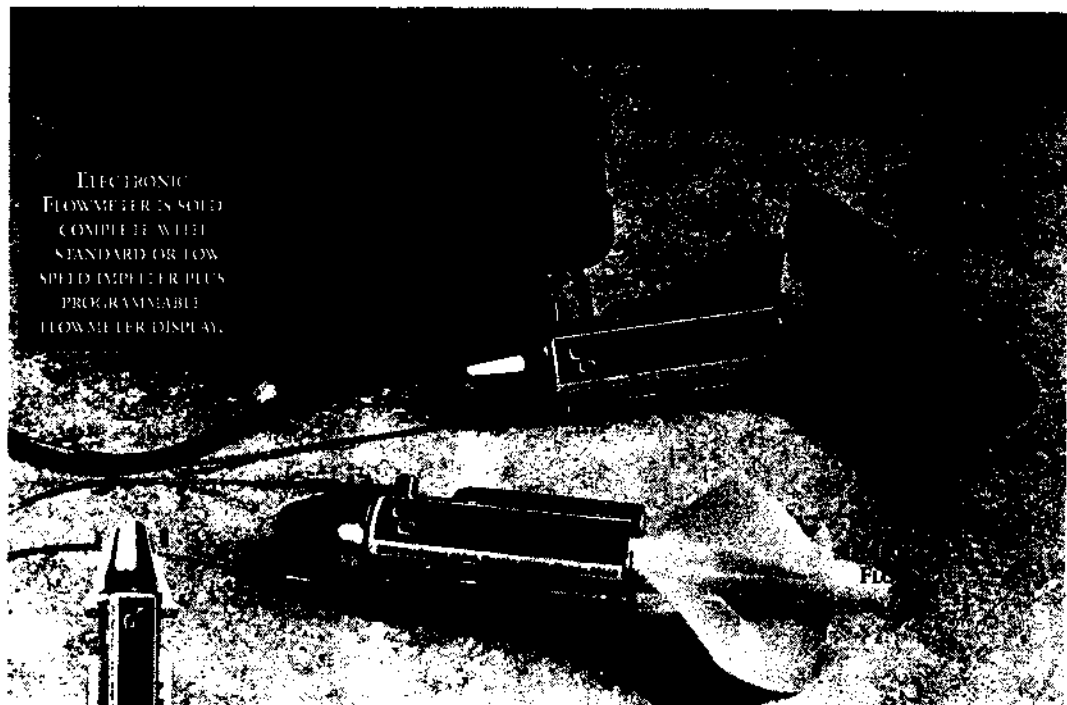

◀ LOW SPEED  
MECHANICAL  
FLOWMETER

General purpose instrument for flow measurements in rivers, estuaries, canals, sewerage outfalls and offshore applications. The Flowmeter is properly balanced to maintain horizontal position when suspended from the towing line. Meters begin rotating as soon as they enter the water and continue until unit is removed. The Flowmeter has a precision molded rotor coupled directly to a counter which registers each revolution and displays it on an odometer. Each Flowmeter is made with a brass nose cone and clear polycarbonate body.

## MECHANICAL OR ELECTRONIC

**THE MECHANICAL FLOWMETER** comes with a standard impeller suspended by a stainless steel tow line. After sampling, remove meter and record reading and time. Subtracting first reading from the second gives you your average speed over the sampling time. Complete system includes 11" long Flowmeter, 18" stainless steel tow line with copper bridle and stainless steel connecting axle pin.

**THE ELECTRONIC FLOWMETER** is equipped with an electronic sensor and underwater cable for remote reading, the cable connects directly to a Programmable Electronic Display to give constant current readings. The complete system includes 11" long Flowmeter, electronic sensor, 3-conductor cable, and programmable read-out display (additional description below).

## PROGRAMMABLE ELECTRONIC FLOWMETER READOUT

**DISPLAY**—Sold with the electronic flowmeter. The electronic flowmeter features 64K of memory and a RS232 port for connection to a PC. The unit is sold complete with Data Translation Software on a 5-1/4" floppy disk. Battery operated waterproof unit displays current velocity in cm/sec., ft./sec., m/sec. or knots. The two line LCD also gives total distance traveled or volume in cubic meters or can store information for downloading. Uses three 9-volt transistor batteries and comes with 10m cable.

## YOUR CHOICE OF IMPELLERS:

**STANDARD IMPELLER**—For use in oceans, rivers, canals, open channels or with towed nets. Measures current speeds from 10 cm/sec through 790 cm/sec. Comes with 6-digit counter that measures 999999 counts which is equal to approximately 14.5 nautical miles. 3/8" diameter plastic impeller.

**LOW SPEED IMPELLER**—Same as above, except features a 7" wide two-blade gray impeller that has more surface area so it senses slower currents. Measures currents from 2 cm/sec to 100 cm/sec. Designed for use in water that appears to be stagnant or along dams. Available with either 6 digit counter which measures 999999 counts which is equal to approximately 14.5 nautical miles or 7 digit counter where 9999999 is equal to approximately 145 nautical miles. (Mechanical version only)

Replacement Low Speed Impeller converts standard Flowmeter to low speed.

**EXTENDABLE WADING ROD**—3 ft. aluminum rod extends to 8 ft. to measure currents from river banks, bridges or any areas where it is difficult to reach. Connects directly to Flowmeter by the stainless steel axle pin. Unit has three 3-ft. aluminum sections.

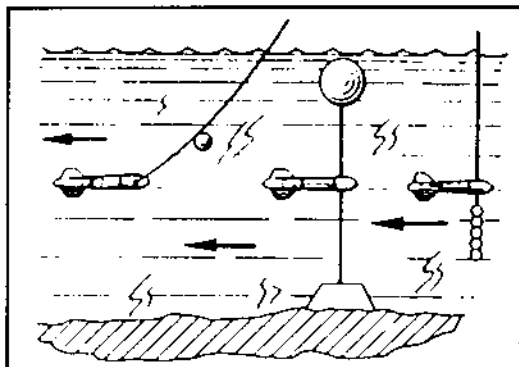

▲ FLOWMETERS IN OPEN AREAS

▲ EXTENDABLE  
WADING ROD

CAT. No.	DESCRIPTION	SH. WT.	PRICE EACH
<b>MECHANICAL FLOWMETERS COMPLETE</b>			
113040	Standard Impeller—6 digit counter	1.0 lb.	\$250.00
113041	Low Speed Impeller—6 digit counter	1.3 lb.	285.00
113044	Low Speed Impeller—7 digit counter	1.3 lb.	290.00
113042	Replacement Low Speed Impeller	0.8 lb.	89.00
<b>ELECTRONIC FLOWMETERS COMPLETE</b>			
113048	Standard Impeller—6 digit counter with programmable display	2.0 lb.	\$2,295.00
113049	Low Speed Impeller—6 digit counter with programmable display	2.0 lb.	2,345.00
113042	Replacement Low Speed Impeller	0.8 lb.	89.00
<b>EXTENDABLE WADING ROD</b>			
113043	Use with mechanical and electronic flowmeters	3.5 lb.	\$78.00

# SWOFFER 2100 HAND HELD CURRENT VELOCITY METER

- Measure stream velocity from 0.1 to 25 feet per second.
- Read in feet or meters per second.
- 90 second averaging.
- Weather-proof housing.
- ±1% accuracy.

An extremely portable instrument for measuring open stream velocities. The Model 2100 meter uses a 2" propeller to transmit velocity where it is immediately displayed in feet or meters per second. Hand-held meter displays maximum/minimum velocity, along with averaging. Stop/start button allows it to be used for interval testing. Housed in a weatherproof case, the unit is ideal for use in all open streams.

Fiber optic sensors on wands are not affected by conductivity, temperature fluctuations, suspended particulates or air bubbles. When the propeller is clogged, the sensor will automatically turn off to prevent false readings. Sensor wands are available in three models.

## 1 2100 METER WITH TELESCOPING TUBE TYPE WAND

- For relatively shallow (3-4 ft.) water.

Designed primarily for use in conduit types of open streams, sewers, plant outfalls, irrigation canals, fishways, etc. The adjustable depth probe provides stability as well as repeatability of sensor placement when taking readings in multiple locations. Both models contain an extendable wand, propeller on 8" boom and 3 ft. adjustable depth probe. Unit is shipped in two packages.

CAT. No.	MODEL No.	DESCRIPTION	WEIGHT	PRICE EACH
113030	2100-STDX	Meter w/wand that extends 2 to 9½ ft.	8.0 lbs.	\$1,780.00
113032	2100-LX	Meter w/wand that extends 4 to 19¼ ft.	11 lbs.	1,895.00

## 2 2100 METER WITH 6/10 DEPTH RODS

- For depth and velocity measurement.

Designed for forest management personnel hiking to remote mountain streams, it can also be used when wading in natural streams. The operator can both measure depth and place the sensor accurately at ¼ of the depth from the stream surface. Shipped in two packages.

CAT. No.	MODEL No.	DESCRIPTION	WEIGHT	PRICE EACH
113033	2100-12	Meter w/2¼ ft. wading rod	6.0 lbs.	\$1,710.00
113034	2100-13	Meter w/3¼ ft. wading rod	7.0 lbs.	1,765.00
113035	2100-14	Meter w/4¼ ft. wading rod	8.0 lbs.	1,825.00

## 3 2100 METER WITH GRADUATED WAND

- Ideal for use in hard to reach areas.
- Graduated in feet and tenths for depth and velocity measuring.

For use from bridges, boats, manholes or while wading. They are graduated in feet and tenths for depth measuring. The sensor can be locked along any position on the wand. 1" diameter tube provides more stability when working at greater depths. Unit includes meter with 20 ft. cable and four 3 ft. aluminum tubes that thread together for a 12 ft. overall length. Shipped in two packages.

CAT. No.	MODEL No.	DESCRIPTION	WEIGHT	PRICE EACH
113036	2100-1514	Meter w/graduated wand	13 lbs.	\$2,150.00

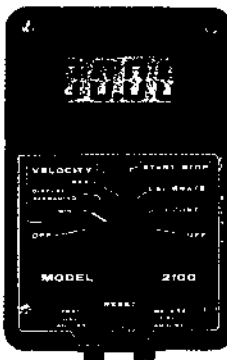
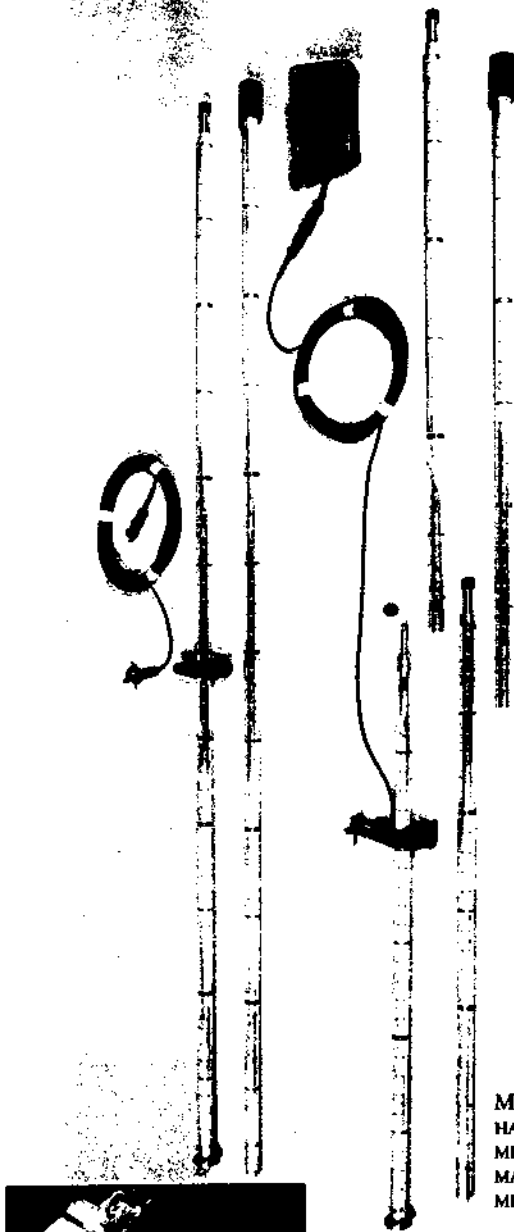

MODEL 2100 ▲  
HAND-HELD  
METER DISPLAYS  
MAXIMUM/  
MINIMUM VELOCITY.

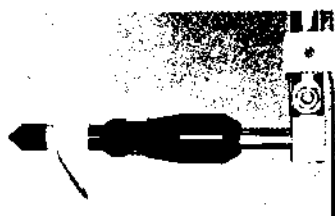

▲ 2" PROPELLOR  
TRANSMITS VELOCITY WHERE IT IS  
IMMEDIATELY DISPLAYED IN FEET  
OR METERS PER SECOND.

◀ MODEL 2100-12 IS IDEAL FOR  
MEASURING DEPTH IN STREAMS.





▲ WATERPROOF DIGITAL READ-OUT



▲ PROPELLER

## Global Water Flow Probe

- Reads from 0.3 to 25 FPS
- Digital read-out of instantaneous and average velocity

Easy to use, this lightweight flow probe (about 2 lbs.) is a highly accurate water velocity meter that is excellent for measuring flows in open channels and partially filled pipes.

The telescoping handle expands from 3 feet to 6 feet and features a unique, free rotating turbo-prop propeller sensor protected inside a 2" diameter PVC housing. The digital read-out, located on the top of the handle, displays instantaneous velocity as well as true average velocity. The digital read-out is waterproof and will run for about 2 years off replaceable internal watch batteries.

The Flow Probe is shipped complete in a padded carrying case.

Dimensions: Carrying Case: 9"W x 4"H x 4"L

Flow Probe: 2" wide x 3 feet long expandable to 6 feet long

113098	Water Flow Probe	10 lbs.	\$750.00
--------	------------------	---------	----------

SPECIFICATIONS:	RANGE	ACCURACY
	• 0.3 -25 FPS	• Average velocity: 0.1 FPS
		• Instantaneous velocity: 0.5 FP

## TELEDYNE-GURLEY CURRENT PYGMY METER OUTFITS

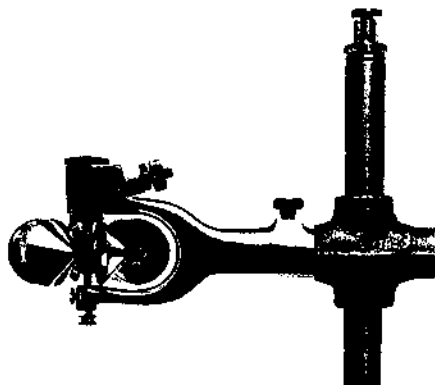

▲ PYGMY FLOW METER

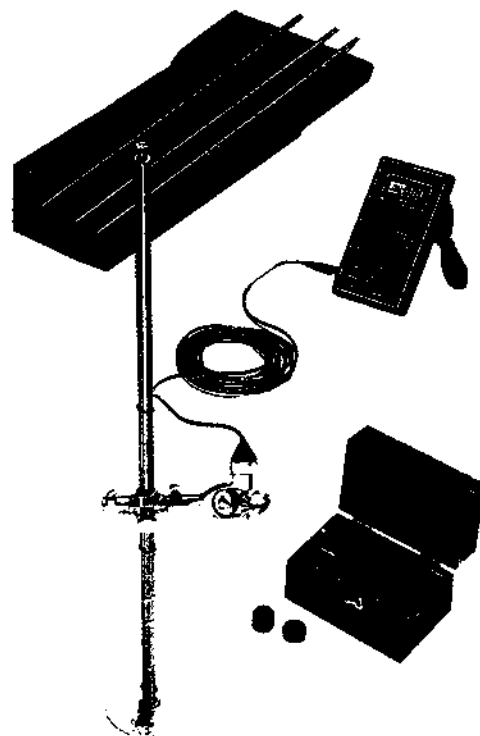

### No.625 Pygmy Type Current Meters

ROD SUSPENDED FLOW METERS USED WITH HEADPHONES OR DIGITAL FLOW INDICATOR

- Downsized from Price models to measure slower velocities.
- Indicates velocities at 0.05 ft. per second.

For measuring the flow of water in shallow streams, flumes and canals where depth of water or the velocity is extremely low. Sensitive to low velocities, starts indicating at flows of 0.05 ft. per second. The velocity in feet per second equals the revolution of the bucket wheel.

The unit consists of four 2 ft. long steel rods, graduated 0.1 ft., reading 8 ft. from the plane of the bucket wheel. Also includes a double end hanger, wading base, upper binding post, wire connections with double-contact plug connector, 8 spring clips to hold sensor wire to rod and one extra pivot with adjusting nut and lock screw. Meter fits in mahogany case, wading rods have a canvas carrying bag.

The headphone unit clicks with each revolution of the bucket wheel, while the digital flow indicator pulses with each revolution.

CAT. No.	MODEL	DESCRIPTION	WEIGHT	PRICE EACH
113020	625-F	Pygmy Flow Meter With Headphones	15 lbs.	\$1,320.00
113023	D625-F	Pygmy Flow Meter With Digital Flow Indicator	15 lbs.	2,556.00

▲ PYGMY FLOW METER WITH DIGITAL FLOW INDICATOR



# TELEDYNE-GURLEY CURRENT METERS

*American made instruments for standard hydrological velocity determinations.*

GURLEY hydrological instruments are used primarily to measure water velocities in open rivers, channels or oceans. Their rugged, durable construction ensures many years of trouble free, accurate operation even under the most difficult of field conditions. All the instruments are completely portable and self contained for field use.

WATER CURRENT METERS

## TWO STYLES AVAILABLE:

- 1 PRICE METERS MEASURE 0.1 TO 11 FEET PER SECOND. THEY CAN BE CABLE OR ROD SUSPENDED FOR USE FROM BRIDGES, WASTEWATER SYSTEMS, BOATS OR SHALLOW STREAMS.
- 2 PYGMY (COMPACT) METERS ARE EXTREMELY SENSITIVE TO LOW VELOCITIES IN SHALLOW STREAMS. ROD SUSPENDED METERS INDICATE VELOCITY STARTING AT 0.05 FT. PER SECOND.

## No. 622 Price Current Flow Meters

- Cable or rod suspended units depending on access to flow
- Economical! headphone models or digital models for unattended monitoring
- Direct reading indicator in feet and meters per second
- Measurements can be taken in deep rivers, shallow streams, tidal water, irrigation ditch, etc.

Designed for general purpose stream gauging, the ruggedly built Price meter is extremely simple to use in the field. It features two main components for taking measurements; a bucket wheel and either a pair of headphones or a hand-held digital flow indicator. The bucket wheel instantly starts rotating when it is lowered and registers as audible clicks in the headphones or as pulses to the digital flow indicator. There are two models available: Headphone and Digital Flow Indicator.

### HEADPHONE MODEL

The economical headphone model clicks with each rotation of the bucket wheel. This clicking can be adjusted to each revolution or every fifth revolution, either manually through the headphones or mechanically with the optional revolution counter offered on page 195. Using this table, velocity can be read directly over a range of 1 to 200 revolutions or 0.1 to 11 feet per second. The headphone model can be retrofitted with digital flow meter at later date.

### DIGITAL FLOW MODEL

The digital flow indicator consists of a hand-held computer that displays velocity in a range of 0 to 25 feet per seconds. Powered by a 9-volt battery, data is transmitted from the bucket wheel to an electro-optical sensor that displays findings within 4 seconds. It features three user selectable modes, built-in function and low voltage indicator.

Each unit includes headphones or digital flow indicator, mahogany case, instrument oil, screwdriver, cleaning cloth, extra pivot with adjusting nut and lock screw, weighted hanger screw, weighted pin and insulating bushing. Rating tables are printed inside the mahogany case.

### ROD SUSPENDED OUTFITS

Bucket wheel is attached to a graduated rod to take measurements in ditches, sewers or shallow streams. Rod is graduated to the nearest inch. The wading rod set consists of four graduated 2 ft. section poles reading eight feet from plane of bucket wheel, double end hanger, wading base, rod adapter with clamping nut, upper binding post, wire connections with double contact plug connector and 8 spring clips to hold sensor wires, all in a 24" canvas carrying case.

### CABLE SUSPENDED OUTFITS

Ideal for general stream gauging, it can be suspended from an overhead bridge or from a boat for measuring river currents. All accessories included with cable unit plus a 15 lb. lead weight to reduce side movement in currents.

CAT. No.	MODEL	DESCRIPTION	SUSPENSION	WEIGHT	PRICE EACH
113005	622-F	Flow Meter with Headphones	Rod	15 lbs.	\$1,839.00
113021	622-E	Flow Meter with Headphones	Cable	15 lbs.	1,889.00
113084	D622-F	Flow Meter with Digital Flow Indicator	Rod	20 lbs.	2,940.00
113080	D622-E	Flow Meter with Digital Flow Indicator	Cable	30 lbs.	2,990.00

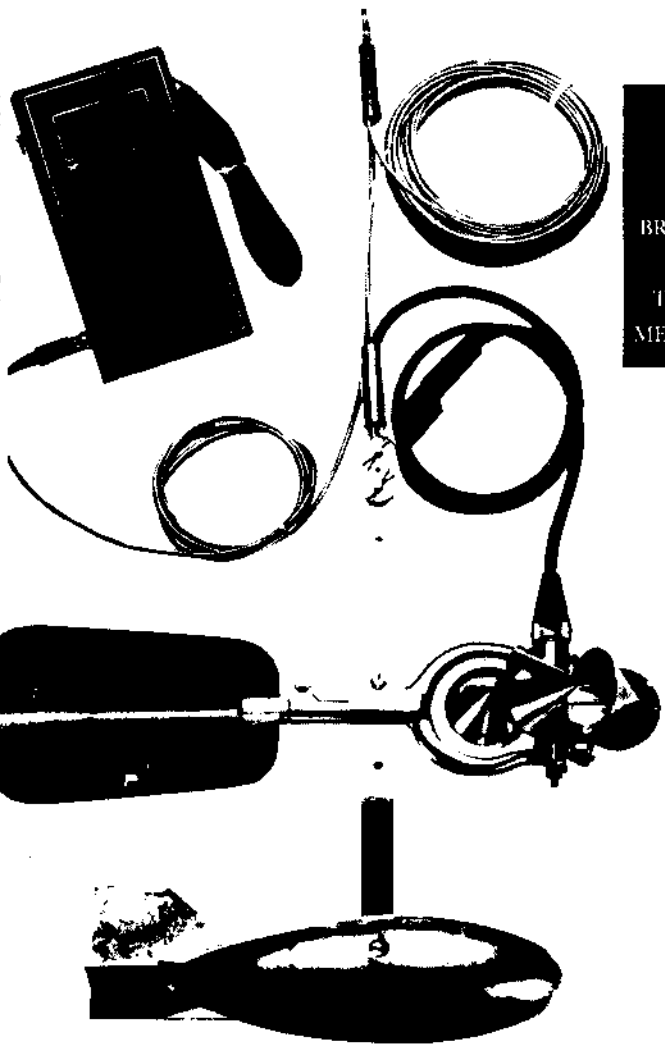

▲ CABLE SUSPENDED OUTFIT CAN BE SUSPENDED FROM BRIDGES OR BOATS FOR MEASURING RIVER CURRENTS.

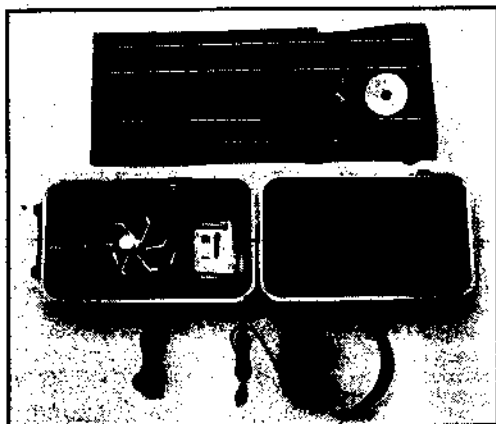

▲ ROD SUSPENDED OUTFIT TAKES MEASUREMENTS IN DITCHES, SEWERS, OR SHALLOW STREAMS.

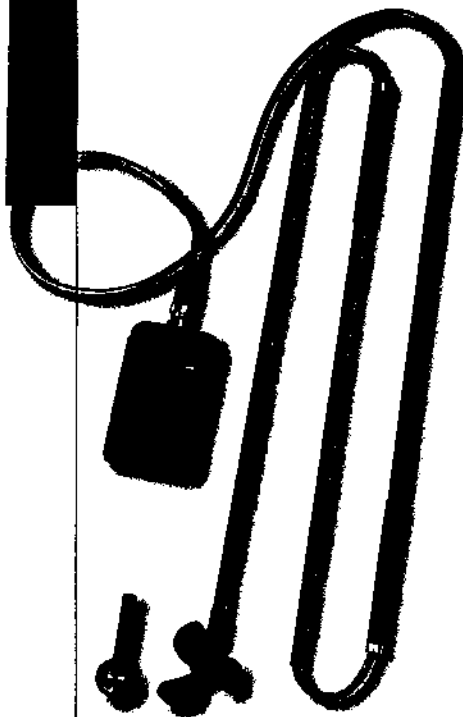

**1 Speedtech Flowmeter**

This affordable and compact flowmeter is ideal for educational use as well as for work in remote locations. The probe folds down into 3 separate sections measuring 16" each. This collapsible design allows you to easily pack the flowmeter in a backpack. Flow measurements can be taken in knots, km/h, mph, and m/s. The meter can also take temperature measurements, including minimum and maximum temperature and current temperature. Temperature readings can be taken in either °F or °C. The basic unit includes meter, foldable probe, standard flow sensor and carrying case. An optional wind speed impeller (sold separately) allows you to take air velocity and wind chill measurements. To take flow measurements from a bridge or other elevated location, use the optional flow sensor with 15 meter cable (sold separately). The unit automatically turns itself off after 36 hours. **Power:** CR2032 Lithium battery (included).

	Accuracy	Resolution	Minimum	Maximum	Sampling	Response
<b>Current Wind Speed</b>	±3%	0.2 knots	2.2 knots	27 knots	1 sec	3 sec
		0.2 mph	2.5 mph	31 mph		
		0.3 km/h	4.0 km/h	50 km/h		
<b>Current Water Speed</b>	±3%	0.1 m/s	1.1 m/s	14 m/s	1 sec	3 sec
		0.2 knots	0.5 knots	27 knots		
		0.2 mph	0.6 mph	31 mph		
<b>Average Speed</b>	±3%	0.3 km/h	1.0 km/h	50 km/h	-	-
		0.1 m/s	0.3 m/s	14 m/s		
		0.1 knots	0	27 knots		
<b>Temperature</b>	±0.7°C ±1.25°F	1°C	-25°C	100°C	1 sec	5 min
		1°F	-13°F	160°F		
<b>Wind Chill Factor</b>	-	1°C	<-25°C	>100°C	1 sec	-
		1°F	<-13°F	>160°F		

- 94356 Flowmeter 1 lb. **\$309.00**
- 94357 Optional Wind Speed Impeller 2 oz. **\$41.50**
- 94358 Optional Flow Sensor With 15 Meter Cable 1.25 lbs. **\$239.00**
- 02190 CR2032 Lithium Replacement Battery 1 oz. **\$1.75**

**2 Hondex™ Digital Depth Sounders**

Measure the depth of any body of water with these portable, digital depth sounders. Available in two models, one features a built-in transducer and the other features an external transducer on a 12' cable. Waterproof to a depth of 150' (50m) both sounders measure depths in feet or meters in a range of 1.8' to 260' (0.6m to 79m). (To switch from feet to meters, remove the front cap and push the small white switch back for meters, forward for feet.) The transducer operates by sending high frequency pulses to the bottom of a body of water where these pulses are reflected back and converted to electrical pulses that are amplified and displayed on the easy-to-read LCD. The 7-digit LCD is backlit for night use. These compact depth sounders transport easily and store conveniently - they will even slip into a shirt pocket! Powered by a 9V DC dry cell battery (included), the sounders have a battery life of approximately 500 uses and automatically shut off after 10 seconds. A wrist lanyard is included. **Minimum Depth:** 1.8' (0.6m). **Maximum Depth:** 260' (79m). **Accuracy:** ±1%. **Frequency:** 200KHz (Beam angle: 24°). **Backlight:** Filament light. **Dimensions:** 1.7" x 7.8". **Weight with battery:** 10 oz.

- 90100 Digital Depth Sounder w/Built-in Transducer 1 lb. **\$169.00**
- 90101 Digital Depth Sounder w/External Transducer 1 lb. **\$198.00**
- Accessory Kit for 90101 - includes a Velcro® strap for attaching transducer to a pole and a suction cup bracket for mounting transducer outside a boat's hull.
- 90102 Accessory Kit for 90101 4 oz. **\$29.25**

**3 Flow Probe Hand-held Flowmeter**

Combines performance with portability making it ideal for storm run-off studies or flow measurements of rivers, streams, canals, and sewers - just to name a few. And, it also incorporates true velocity averaging for the most accurate measurement possible.

The probe shaft is available in lengths that extend from 3' to 6' and from 5' to 15' allowing studies of a variety of situations and depths. Located on the bottom tip is a protected Turbo-Prop sensor which uses the most advanced positive displacement technique available. For minimal friction, this 2" Turbo-Prop sensor rotates freely on a bearing shaft with no mechanical interconnections. Magnetic material in the propeller carries a pickup coil in the housing producing electrical impulses. These electrical impulses are then carried by wire to a readout display located on top of the handle. As this readout display receives the signal, it amplifies and converts the signal into feet/meters per second readings. Instantaneous velocity and true average velocity is then displayed. Plus, a unique two-button keypad allows other functions to be displayed which include maximum velocity, time-of-day, stop watch, totalizer for batch flows, and RPM for accurate low velocity measurement. Features include a padded gun-type carrying case and long life watch-type batteries for readout display (no battery required for Turbo-Prop). Probe can be extended up to 25' with standard PVC pipe and electrical extension cable.

**Specifications - Range:** 0-25 FPS (0-8 MPS). **Accuracy:** average velocity ±0.1 FPS, instantaneous velocity ±0.5 FPS. **Averaging:** true digital running average. **Display:** LCD. **Sensor Type:** protected Turbo-Prop propeller with electromagnetic pickup. **Weight:** 2 lbs. **Size:** probe expands from 3' to 6', sensor housing is 2" in dia. x 3"L. **Materials:** PVC handle and propeller housing, anodized aluminum shaft, brass bearing. **Power:** Internal replaceable watch-type batteries with one-year life. **Operating temperature:** 0°F to 120°F.

- 94303 3' to 6' Expandable Flow Probe 8.25 lbs. **\$695.00**
- 94307 5' to 15' Expandable Flow Probe 10 lbs. **\$790.00**

Ⓢ Combination English and Metric

Flowmeters & Depth Sounders

Environmental Science

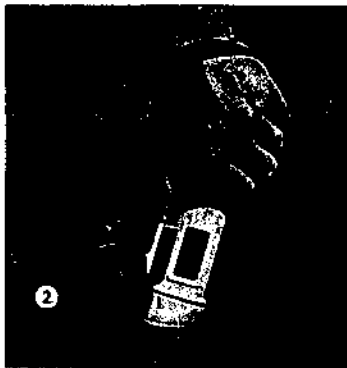

**1 General Oceanics Mechanical Flowmeter**

Use in rivers, estuaries, canals, sewer outfalls, pipes, and harbor entrances to determine velocity and distance information or use with plankton nets to determine water volume associated with each tow. Both models incorporate precision molded rotors coupled directly to six digit counters which record each rotor revolution. Supplied with a standard calibration curve (number of counts/unit time vs. velocity) sealed inside transparent body. A single pin and lanyard system located ahead of the lateral center of mass allows the flowmeter to maintain correct dynamic alignment with the fluid flow in which it is immersed.

**Materials:** Celcon rotor, nickel-plated brass nose piece, poly-carbonate body, stainless steel main rotor and idler gear shafts, Delrin idler gears, and Delrin and nylon digit wheels.

**Dimensions:** Overall length is 8-3/8" with a 1-9/16" dia. body.

**Depth rating:** Unlimited (free flooding).

**Data readout:** Six 10-digit counter wheels read 000,000 to 999,999; 10 counts per rotor revolution, non-resetting; read by noting difference in start and end readings (counter advances through 000,000).

**Six-digit full scale count:** 999,999 counts equal approximately 14-1/2 nautical miles (1,852 meters/nautical mile).

**Mounting:** Universal bridle allows single point connection for towing or two point connection within net mouth.

**Response with standard 3" dia. rotor:** Threshold approx. 10 cm/sec. (1/5 knot).

**Range:** Approx. 10 cm/sec. (1/5 knot) to 7.9m/sec. (15 knots).

**Weight:** 8 oz. in air, 4 oz. in water.

**94460 Model 2030R** – Flowmeter with standard 3" dia. rotor (10 to 790 cm/sec.), SS axle pin and towing bridge 2 lbs. **\$299.00**

**94463 Model 2030R2** – Flowmeter with gray PVC slow speed, low velocity (2 to 100 cm/sec) 6-3/4" dia. rotor 2 lbs. **\$329.00**

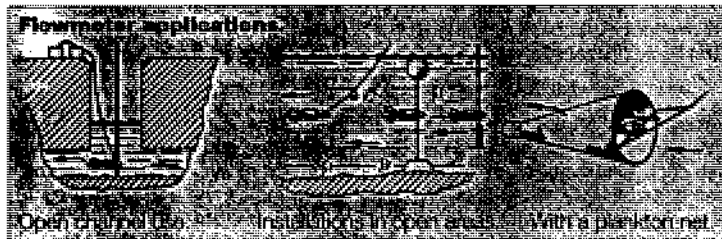
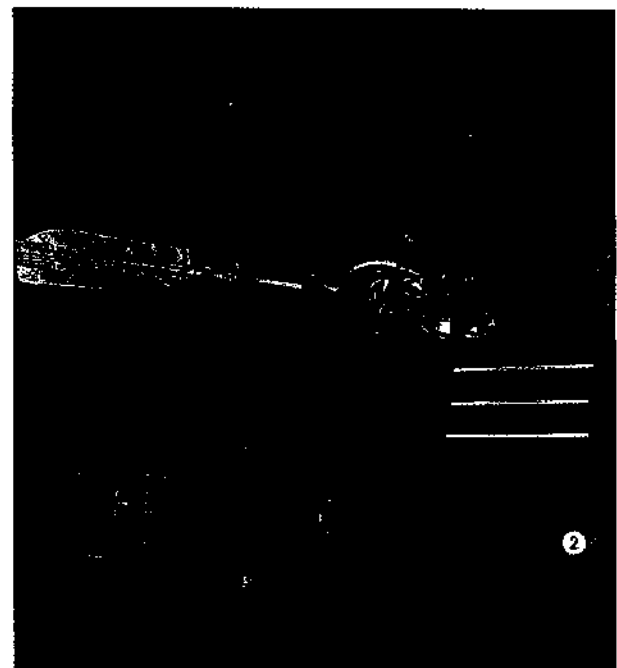
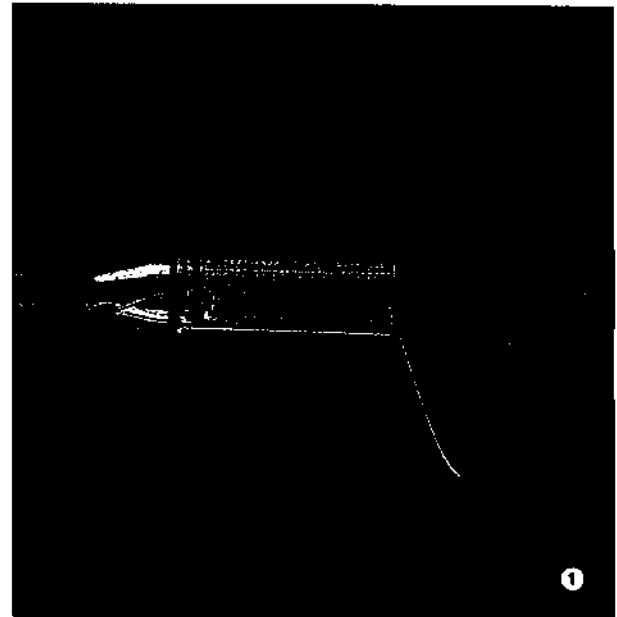

**2 WATER\*MARK® Model 6200FD Rod-Suspended Water Current Meter**

Measures velocity in shallow streams, irrigation ditches, canals, water supply conduits, and sewers. Suspended on an 8-foot wading rod, the bucket wheel revolves in flowing water. The circuit is closed each revolution or each fifth revolution. Separate binding posts permit selection of the count desired. Digital Flow Indicator provides direct digital display of flow velocity in feet or meters per second ranging from 0.2 to 32 ft. per second or 0.06 to 7.6 meters per second.

**Components**

**Type AA Current Meter:** With meter case, rating table, instrument oil, screw driver, and cleaning cloth.

**Spare Parts:** Extra pivot with lock nut, hanger screw, tailpiece screw, insulation bushing.

**Meter Case:** Holds meter, spare parts, accessories, and telephone set. Rating Table.

**Headphone Set:** Includes batteries.

**Top Setting Wading Rod:** 1.2 meter or 4' as required with vernier handle and two-plug connector.

**94961 Components** 55 lbs. **\$2,115.00**

**Optional English Top Setting Wading Rod**

Securely position a current meter to any depth while wading a stream with this 4' top setting rod. Attach current meter and tail fins to sliding support on the base of the aluminum rod which slides vertically for rapid positioning of the meter. Includes electrical connections for use with a headset or counters.

**95002 4' Top Setting Wading Rod** 9 lbs. **\$381.00**

**M** Metric **C** Combination English and Metric

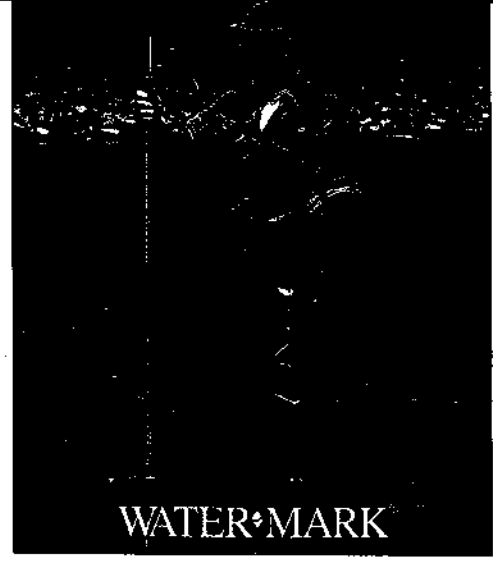

Mechanical Flowmeter & Current Meters

Environmental Science

**Swoffer Model 2100 Series & 3000 Series Open Stream Current Velocity Meters**

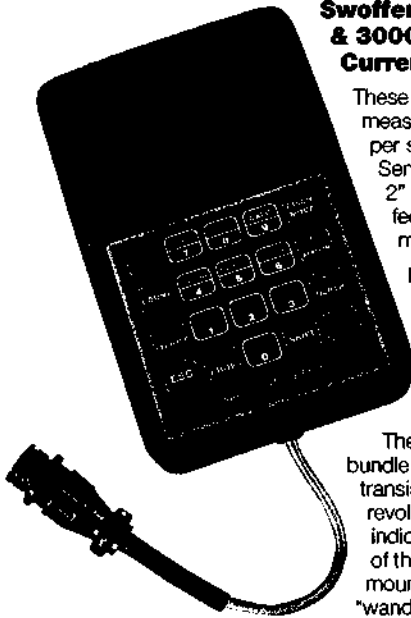

These meters provide a portable, reliable, easy means of measuring open stream velocities in the range of 0.1 to 25 feet per second or 0.03 to 7.5 meters per second (selectable). Sensor has a propeller-driven, photo-fiber-optic device with a 2" propeller sweep diameter. Measurements can be read in feet or meters on your choice of two digital readout indicator models. Both with better than 1% accuracy.

Each meter includes a meter indicator in either the 2100 or 3000 model, a shoulder strap and snap ring, and a PVC shipping/storage tube for the sensor. 2100 Series includes a 9V transistor battery, and the 3000 series includes four "AA" batteries.

**Sensor**

The sensor uses a 2" propeller which rotates a fiber-optic bundle to create a signal from a photodiode to a photosensitive transistor. This signal is produced at a rate of four pulses per revolution and is transferred via flexible electrical cable to the indicator where it is processed to display velocity. Resolution of the display is to hundredths. The propeller is swivel mounted (for storage) at the foot of the handle. The handle, or "wand" carries the cable to its upper end from which the cable extends to the indicator. A quick-disconnect, waterproof cable

connection is located at the indicator.

The electricals of the sensors are permanently encapsulated in epoxy resin and housed in chemically inert acetal-resin fittings. All parts of the sensors are readily and inexpensively replaceable and are available separately. The sensor wands are aluminum alloy with stainless steel fasteners. The propeller is glass impregnated nylon and all other plastic sensor parts are acetal-resin (Delrin or Celcon).

**Model 2100 Indicator**

The 2100 accommodates all types of open stream flows - three selectable, pre-set display update times allow up to 90 seconds of averaging. In extremely turbulent flows, otherwise unreadable data is electronically averaged and can be used without interpolation. Self-calibration feature enables you to check accuracy of instrument while in the field. A compartment in the back of the indicator houses the battery and has space for one spare. The Feet/Meters switch is located in this compartment. The liquid crystal display features one line with 0.7" high digits.

**Model 3000 Indicator**

A datalogging version of the 2100, the 3000 records depths, width, velocities and angles along with time and date of measurements. It figures the "Q" and can upload all information in spreadsheet-acceptable format to your PC via RS232. Simple file transfer software and a DB9 serial connection cable are provided. Designed for the measurement of open channel velocities and the on-site computation of stream discharges, the 3000 replaces the dial-style control of the 2100 with a keypad. Choose from 1 to 999 seconds of averaging. Velocities can be a single averaged measurement or the accumulated average of as many measurements as desired. As many as 1,000 "stations" in 1 to 100 stream cross-sections can be acquired and stored in memory. Angles of velocity other than perpendicular to the stream cross-section can be input by keypad. Use 0 key to change from feet to meters. Simple, accurate user-accomplished calibration is possible in the field. Features a two-line, 16-character LCD which prompts user through all operations. Compatible with all Swoffer instruments.

**Indicator Construction**

Weatherproof indicator cases are vacuum-formed ABS plastic with a clear acrylic lens over the LCD and measure just 6" x 4" x 2". The electricals of the indicators are sealed against moisture.

<b>94178 Model 2100-12</b> - for 6/10 depth method. 3' Wand easily measures stream depth to 2-1/2' then places the sensor 6/10 of the stream depth from the surface. Primarily used when wading, it is lightweight enough to be carried on a backpack. Shipped in two pieces; one weighs 2 lbs., the other 3 lbs.	Ⓞ	3 lbs.	<b>\$1,700.00</b>
<b>94031 Model 3000-12</b> - same as 2100-12, except includes the 3000 series indicator.	Ⓞ	6 lbs.	<b>\$2,295.00</b>
<b>94160 Model 2100-13</b> - same as Model 2100-12, except for 3-1/2' wading rod. Shipped in two pieces; one weighs 2 lbs., the other weighs 3 lbs.	Ⓞ	5 lbs.	<b>\$1,765.00</b>
<b>94032 Model 3000-13</b> - same as Model 2100-13, except includes 3000 series indicator.	Ⓞ	6 lbs.	<b>\$2,355.00</b>
<b>94179 Model 2100-LX</b> - Wand extends from 4' to 19-1/2'. Propeller is on 10" boom which swivels 120° for reaching up into lateral conduits. A 3' adjustable table depth probe is supplied. Shipped in two pieces; one weighs 2 lbs., the other 7 lbs.	Ⓞ	7 lbs.	<b>\$1,895.00</b>
<b>94033 Model 3000-LX</b> - same as 2100-LX, except includes 3000 series indicator.	Ⓞ	9 lbs.	<b>\$2,495.00</b>
<b>94161 Model 2100-1514</b> - Similar to the Model 2100-12 and 2100-13, but more versatile. The 2100-1514 can be used from bridges, boats, manholes, or while wading. Meter comes complete with four 3' sections that offer the option of adjusting the sensor. <b>Weight:</b> meter - 8 lbs.; four 3' sections packaged together - 2 lbs. each.	Ⓞ	10 lbs.	<b>\$2,175.00</b>
<b>94034 Model 3000-1514</b> - same as 2100-1514, except includes 3000 series indicator.	Ⓞ	10 lbs.	<b>\$2,770.00</b>
<b>94162</b> Optional 3' extension for 2100-1514		2 lbs.	<b>\$115.00</b>
<b>02179</b> 9V Battery		3 oz.	<b>\$3.15</b>
<b>02182</b> One "AA" Cell Battery - four needed		2 oz.	<b>\$95</b>

Ⓞ Combination English and Metric



Water Current Meters

Environmental Science

**1 WATER+MARK® USQS Type Current Meters**

These current meters feature a precisely balanced bucket wheel which is mounted on a vertical pivot and is rotated by water flow. The rate of rotation is proportional to water velocity. Velocity is determined by counting the number of revolutions of the bucket wheel over a given period of time. Revolutions can be monitored by headset or a digimeter (both sold separately). The headset is used to manually count the revolutions via an audible tone produced every revolution. The number of revolutions over a period of time are compared to a rating chart (included) which determines water velocity. The digimeter is a digital counter that electronically monitors the revolutions and time, calculates the water velocity, and displays it for the operator.

Two separate binding posts on the contact chamber allow the operator to set unit to selectively count either every revolution or every fifth revolution for use in fast moving water.

The meters are constructed of stainless steel, brass, and bronze with chrome-plating where required.

**Model 6200 "AA" Current Meter**

Measures velocity from 0.1 FPS to 20.0 FPS. May be suspended by wading rod (sold separately) or cable from a bridge board (sold separately 95007). Furnished with a foam-cushioned carrying case, rating chart, tail fin assembly, screw driver, assorted spare parts, special lubricant, and operation and maintenance manual. **Dimensions:** 8-3/4" x 5".

**95000** Model 1210 "AA" Current Meter 6 lbs. **\$749.00**

**Model 6205 "Mini" Current Meter**

Available for use in shallow water or where water velocity is between .05 FPS to 3.0 FPS. Its small size allows it to be suspended by wading rod (sold separately) only. Furnished with foam cushioned carrying case, rating chart, assorted spare parts, and special lubricant. **Dimensions:** 3.735" x 2".

**95001** Model 1205 "Mini" Current Meter 2 lbs. **\$545.00**

**Accessories for Model 6200 and Model 6205**

**95002** 4' Top Setting Wading Rod 9 lbs. **\$381.00**

**95003** 6' Top Setting Wading Rod 10 lbs. **\$418.00**

**95004** 1.2 Meter Top Setting Rod 9 lbs. **\$402.00**

**95005** Headset Readout for Current Meters 3 lbs. **\$68.00**

**95006** Digital Readout Unit for Current Meters 2 lbs. **\$950.00**

**2 WATER+MARK® Model 4200 Bridge Board**

Use this free-standing support with a sounding reel (sold separately) to raise or lower a current meter or sediment sampler over bridge railings. The vertical leg is adjustable to match rails of 12" to 48" heights. The 4' boom extends past the bridge railing to lower the instrument into the water below. Recommended maximum weight of the instrument being lowered is 30 pounds. The bridge board is constructed of aluminum with stainless steel hardware. Folds for easy transportation and storage.

**Dimensions (collapsed):** 48" x 12" x 6".

**95007** Bridge Board 16 lbs. **\$262.50**

**A-Pak Sounding Reel**

Optional sounding reel is equipped with 45' of sounding cable, a digital counter depth indicator, pressed sleeve connector, and heavy-duty carrying case. Mounts to bridge board with three wing nuts (included). Constructed of aluminum, brass, bronze, and stainless steel. Electric terminals, connected to the cable, are provided for sending or receiving electrical signals to or from a current meter.

**95008** A-Pak Sounding Reel 15 lbs. **\$950.00**

**15 lb. and 30 lb. Sounding Weights**

Optional sounding weights hold current meters against the flowing water. The 15 lb. sounding weight is solid bronze, and the 30 lb. sounding weight is lead. Each weight is furnished with the required weight hanger and weight hanger pin.

**95009** 15 lb. Sounding Weight 18 lbs. **\$219.00**

**95010** 30 lb. Sounding Weight 34 lbs. **\$273.00**

**3 Water Flow Calculator**

Use this instrument for calculating water flow through steel, cast iron, non-ferrous, plastic, asbestos, cement, concrete, vitrified and coated pipes and also open channels in earth, rock, concrete, metal, and wood. One side of the calculator solves the rational formula for water flow in pipes and ducts of circular sections with a flow range of 1.5 to 1,000,000 gpm and a diameter range of 0.5" to 240". The reverse side solves the Manning formula for the flow in open channels with a flow range of 50 to 5,000,000 gpm and a channel area of 0.7 to 2,000 sq. ft. Flow can be read in U.S. gallons/minute, million U.S. gallons/day, cu.ft./second, or cu. meters/second. Also determines velocity in pipes running full. This 7-5/8" diameter calculator is constructed of non-warping, heavy perspex acrylic and is engraved in black, red, and green lettering. Unit is supplied with instructions and vinyl case with snap closure.

**34259** Water Flow Calculator (8 oz.) **\$109.95**

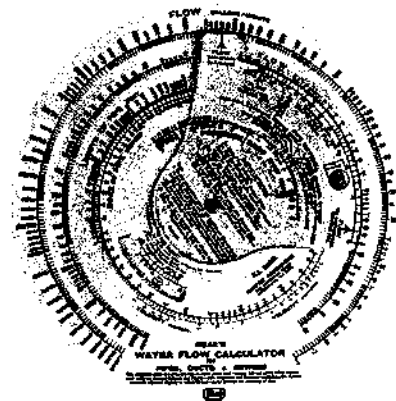
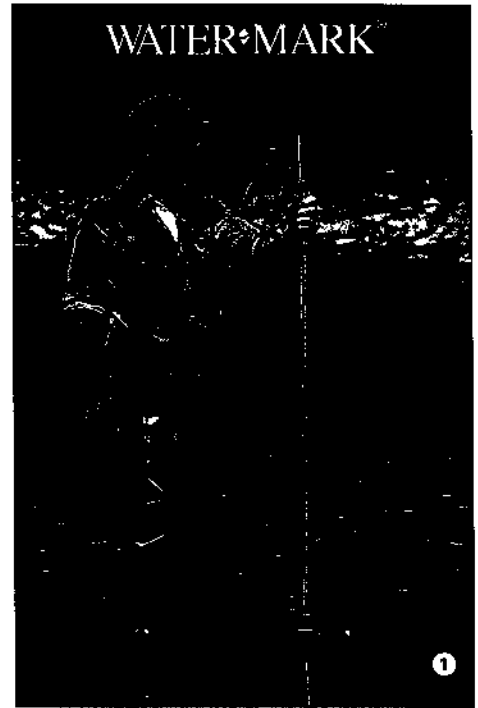

## MicroHydro Specialists

*10+ yrs. living with MicroHydro*

### Makers of "Lil Otto" Hydroelectric Systems

*"He's a hard worker who doesn't drink very much!"*

Lil Otto is a permanent magnet hydroelectric generator. He works with as little as 1.2 GPM or Heads as low as 20 feet. 12 or 24 VDC output, up to 5 Amps. Comes complete with manual and right nozzle for your site.



**\$395. shipped free in Continental USA**

CA residents add 7.25% sales tax.

Dealer inquiries invited.

**Lil Otto Hydroworks! Bob-O Schultze KG6MM**

**POB 203, Hornbrook, CA 96044 • 916-475-3401**

# Siting for Nano-Hydro- A primer

Bob-O Schultze KG6MM

**N**ano-Hydro is the ability to generate 3 Amps or less of hydropower at least some of the year. An amazing number of rural, and especially mountainous, homesites have this capability. Most anyone who has a couple of acres in the mountains somewhere has seen the phenomenon of little springs popping up everywhere after a couple of good rains or during snowmelt. True, most of them seem to pop up in the driveway somewhere or worse, in the cellar, but since most folks tend to build toward the base of the hill rather than the top, a lot of those seasonal creeks or springs can be harnessed to provide power during a time of year when the PV's aren't exactly boiling the batteries! The really fun thing is that as long as the water flows, you're producing power-24 hours a day and the sun doesn't have to shine at the time.

## Why Nano-Hydro?

There are some nice advantages to a nano-hydro system. In most micro and larger hydro installations half of the cost of the system is the pipe. Usually, somewhere between 2" - 6" PVC is used in order to get enough water to the wheel without incurring horrendous pressure losses. Priced any 6" PVC pipe lately? Whew! With a nano system, 2" pipe would be the high side with most systems running 1-1 1/2" pipe. I've seen a fair number of set-ups get away with 3/4" and even one which used 1/2" poly but that guy was really into low-ball!

Another factor is the lack of a need for any kind of regulation in most systems. At  $\pm 3$  Amps/hr, that's only a C/33 charge rate for a 100 A-hr battery and less than C/100 for a set of Trojan L-16's. Not much chance of warping the plates there!

## Have you Hydro?

As with any hydro situation, what you get depends mostly on the pressure and volume of water you can deliver to the generator. Of the two, pressure-whether you call it Head, Fall, or PSI-is the bigger factor. Up to 100 PSI (225' Head) or so, the more you have the better you'll like it.

Exact measurements are not important unless you have very little or very much Head. As a rule, anything between 25' and 250' will work to some degree or another. Below 25' gets dicey unless you have a lot of water-say...20GPM or better, and even then the output may not be worth the investment. At 250' of head or better, you'll have hydro up the wazoo, but you may have to invest in heavier duty pipe to handle the pressure and unless you have lots of water, (in which case you should be thinking about a larger, possibly automotive alternator-based system) you'll need a very small nozzle to restrict the flow enough to keep your pipe full. A very small nozzle, in turn, means very good filtration at the intake to keep clogging down to a minimum. None of these things are insurmountable, just factors to consider before you buy your components.

## Figuring Head

Figure if you've got a drop that's clearly twice the height of your house or better, you're in the ballpark. If you need or want to know a more exact figure, I like the garden-hose method. You'll need two people (it's possible to do this with one, but frustrating and not nearly as much fun), a 25' length of hose, a tape measure, something to write with and on, and unless it's summertime, raingear and gumboots-kinky!

One person starts at the water source with one end of the hose and the other person goes down the hill with the other end and the tape

measure. Fill the hose (getting the air out) and have the downhill person elevate the hose just until the water stops flowing. Measure from the hose end straight down to the ground and record your finding. Make a mark on the ground so the uphill person can find it, both put their thumbs over the hose ends, walk down and measure another station. **Note:** you'll have to top off the hose a little each time to be accurate, so if you're not following a live streamcourse, the uphill party should have a jug of water along for this purpose. Continue down until you reach your proposed generator site, add 'em up, and there you are. Keeping track of the # of stations will also tell you how much pipe to buy.

## Measuring G.P.M. (Gallons Per Minute)

Since we're not dealing with massive amounts of water here, the bucket method works as well as any with a lot less hassle. You'll need- a 4 or 5 gallon plastic bucket, materials to make a temporary dam at the source (plastic sheeting, a tarp, rocks, maybe a shovel), a piece of pipe large enough to handle all the flow of your spring or creek & long enough to get the bucket under, a couple of sticks and string to support the pipe, and a watch capable of measuring seconds. (If you've wondered when you'll ever get a chance to use the stopwatch feature on your digital, Eureka!)

Before you head up the hill, dump exactly 1 gallon of water into the bucket and mark the level. Dump another gallon in and mark the 2 gallon level, etc,etc, until the whole bucket is marked. Set your test up something like this:

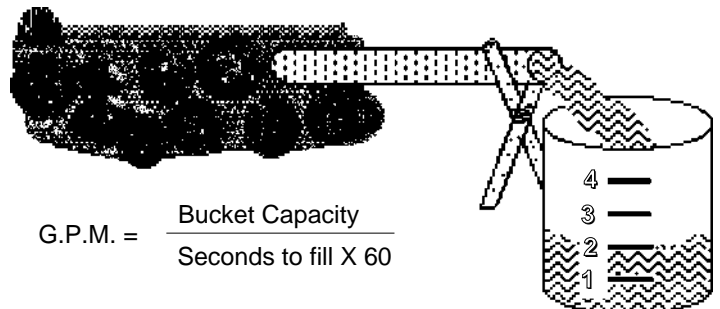

## So, now what?

OK, at this point you should have a handle on three things: Head, GPM, and length of pipe needed. Now, measure the distance from your hydrogenerator site to your batteries. Given these four factors, any reputable hydroplant dealer should be able to advise you on: 1) the kind of systems he has available suited to your site 2) the right diameter of pipe to buy, and 3) a close estimate of the amount of power you can generate.

## Hydro

### Equipment

What sets nanohydro systems apart from other hydrogenerators is the use of permanent magnet generators for the power source. The advantage to this is that no power is fed back into the machine to electrically generate a magnetic field, as is the case with most alternators, so all of what you produce you get to stuff into the batteries. The disadvantage of a PM set-up is that the maximum output is limited by the inherent strength of the magnets. Normally that's not a problem in a nanohydro situation because your GPM and/or Head are too marginal for a larger, more powerful system anyway. Depending on which system you buy or build, that **might** limit the amount of power you can generate at maximum run-off periods.

### Access

As of now, there are only three manufacturers of permanent magnet nano-hydro generators that I know of.

#### Lil Otto Hydroworks!

POB 8  
Forks of Salmon, CA 96031  
916-462-4740

#### Energy Systems & Design

POB 1557  
Sussex, N.B. Canada E0E 1P0  
506-433-3151

#### Photocomm Inc.

POB 649  
North San Juan, CA 95960  
916-292-3754

Shop around. There are Nanohydro systems available that produce meaningful power down to 1.2 GPM @ 50' Head, while others work as low as 3' Head but need lots of water. Once you know the capabilities of your site and what's available and suitable, you're armed with the right ammo to make intelligent decisions and choices. Good Luck and **Happy hydro!**



## MicroHydro Specialists

*10+ years living on and with MicroHydro*

### Makers of 'Lil Otto' Hydroelectric Systems

Complete line of RE Products:

Kyocera • Heliotrope • Trace • Lil'  
Otto • Powerhouse Paul's  
Turbines • Harris Hydro • Sun  
Frost • Flowlight • Aquastar •  
Sibir • ARCO • Trojan • Honda  
Sales - Installation - Service  
PV powered repeater &  
Radiotelephone experience

Jonsereds Chainsaws • Shindaiwa Brushcutters • Oregon Acc.  
for all your firewood and fire protection needs.

Professional Timber Felling- PV shading & hazard tree expert

**Ham Radio spoken here**

## Lil Otto Hydroworks!

Bob-O Schultze  
POB 8

Forks of Salmon, CA 96031 • 916-462-4740

Canyon  
Industries  
ad

## Pump your water with Sunshine!

*It's easy with SOLARJACK'S new*

### SUBMERSIBLE PUMP KIT

Kits come with EVERYTHING!  
Included are:

- Submersible Pump
- 1 or 2 PV Panels
- Power & Charge Controls
- PV Mounting Rack
- Wiring & Splice Kit
- Pump Drop Pipe
- Rope, Clamps, & Well Seal

SOLARJACK'S SDS submersible will pump up to 120 gallons per hour from 5 feet depth, to 30 gallons per hour from 230 feet depth. It can be powered by one or two 47+Watt PV panels. Complete kits start at \$1,447.50. Pump Kits W/O PVs start at \$985. 2 Year limited warranty on SDS pumps.



**QUALITY FIRST!**

**SOLARJACK**™

SOLAR PUMPING PRODUCTS  
325 E. Main, Safford, AZ 85546  
602-428-1092



## ESTIMATING SMALL STREAM WATER FLOW

A rough but very rapid method of estimating water flow in small streams is given here. In looking for water sources for drinking, irrigation or power generation, one should survey all the streams available.

If sources are needed for use over a long period, it is necessary to collect information throughout the year to determine flow changes--especially high and low flows. The number of streams that must be used and the flow variations are important factors in determining the necessary facilities for utilizing the water.

### Tools and Materials

Timing device, preferably watch with second hand

Measuring tape

Float (see below)

Stick for measuring depth

The following equation will help you to measure flow quickly:  $Q = K \times A \times V$ , where:

Q (Quantity) = flow in liters per minute

A (Area) = cross-section of stream, perpendicular to flow, in square meters

V (Velocity) = stream velocity, meters per minute

K (Constant) = a corrected conversion factor. This is used because surface flow is normally faster than average flow. For normal stages use  $K = 850$ ; for flood stages use  $K = 900$  to  $950$ .



FIGURE 1

## To Find A (Area) of a Cross-Section

The stream will probably have different depths along its length so select a place where the depth of the stream is average.

1. Take a measuring stick and place it upright in the water about 50cm from the bank.
2. Note the depth of water.
3. Move the stick 1 meter from the bank in a line directly across the stream.
4. Note the depth.
5. Move the stick 1.5 meters from the bank, note the depth, and continue moving it at 50cm intervals until you cross the stream.

Note the depth each time you place the stick upright in the stream. Draw a grid, like the one in Figure 2, and mark the varying depths on it so that a cross-section of the stream is shown. A scale of 1cm to 10cm is often used for such grids. By counting the grid squares and fractions of squares, the area of the water can be estimated. For example, the grid shown here has a little less than 4 square meters of water.

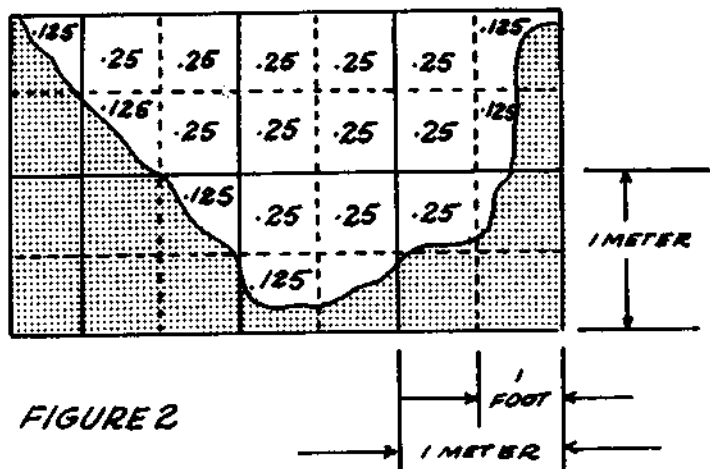

## To Find V (Velocity)

Put a float in the stream and measure the distance of travel in one minute (or fraction of a minute, if necessary.) The width of the stream should be as constant as possible and free of rapids, where the velocity is being measured.

A light surface float, such as a chip, will often change course because of wind or surface currents. A weighted float which sits upright in the water will not change course so easily. A lightweight tube or tin can, partly filled with water or gravel so that it floats upright with only a small part showing above water, will not change course so easily and makes a better float for measuring.

## Measuring Wide Streams

For a wide, irregular stream, it is better to divide the stream into 2 or 3 meter sections and measure the area and velocity of each. Q is then calculated for each section and the Qs added together to give a total flow.

Example (see Figure 2):

Cross section is 4 square meters

Velocity of float = 6 meters traveled in 1/2 minute

Stream flow is normal

$$Q = 850 \times 4 \times \frac{6 \text{ meters}}{.5 \text{ minute}}$$

$$Q = 40,800 \text{ liters per minute.}$$

or

$$680 \text{ liters per second}$$

## Using English Units

If English units of measurement are used, the equation for measuring stream flow is:  $Q = K \times A \times V$ , where:

$Q$  = flow in U.S. gallons per minute

$A$  = cross-section of stream, perpendicular to flow, in square feet

$V$  = stream velocity in feet per minute

$K$  = a corrected conversion factor: 6.4 for normal stages; 6.7 to 7.1 for flood stages

The grid to be used would be similar to the one in Figure 3; a commonly used scale is 1" to 12".

Example:

Cross-section is 15 square feet

Velocity of float = 20 feet traveled in 1/2 minute

Stream flow is normal

$$Q = 6.4 \times 15 \times \frac{20 \text{ feet}}{.5 \text{ minute}}$$

$Q = 3800$  gallons per minute

Source:

Design of Fishways and Other Fish Facilities by C. H. Clay, P. E. Department of Fisheries of Canada, Ottawa, 1961.

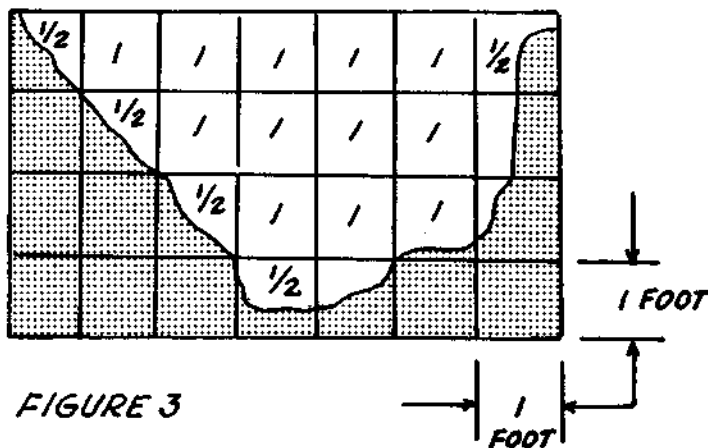
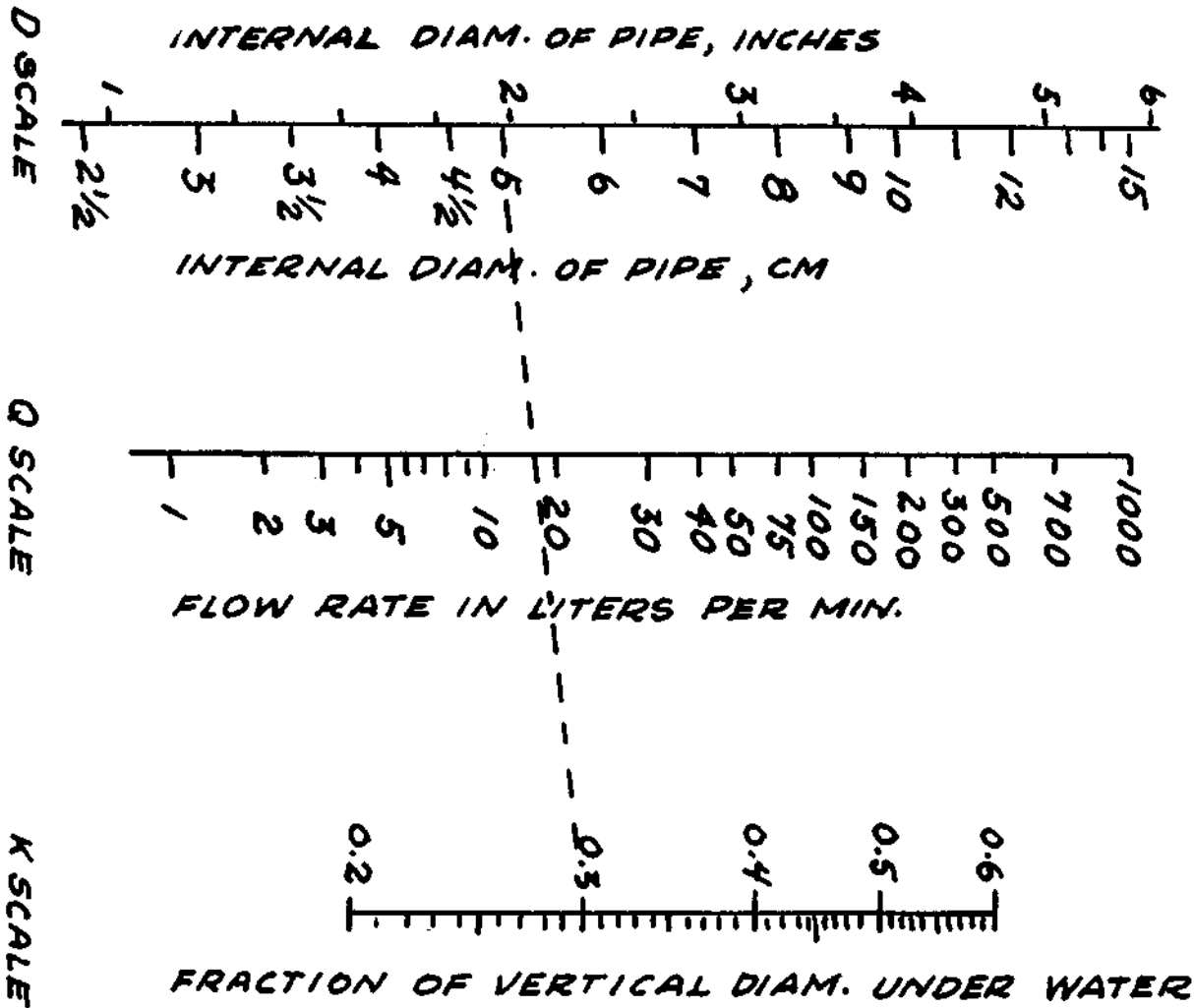

FIGURE 2



## MEASURING THE FLOW OF WATER IN PARTIALLY FILLED PIPES

The flow of water in partially-filled horizontal pipes or circular channels can be determined--if you know the inside diameter of the pipe and the depth of the water flowing--by using the alignment chart (nomograph) in Figure 2.

This method can be checked for low flow rates and small pipes by measuring the time required to fill a bucket or drum with a weighed quantity of water. A liter of water weighs 1kg (1 U.S. gallon of water weighs 8.33 pounds).

### Tools and Materials

Ruler to measure water depth (if ruler units are inches, multiply by 2.54 to convert to centimeters)

Straight edge, to use with alignment chart

The alignment chart applies to pipes with 2.5cm to 15cm inside diameters, 20 to 60% full of water, and having a reasonably smooth surface (iron, steel, or concrete sewer pipe). The pipe or channel must be reasonably horizontal if the result is to be accurate. The eye, aided by a plumb bob line to give a vertical reference, is a sufficiently good judge. If the pipe is not horizontal another method will have to be used. To use the alignment chart, simply connect the proper point on the "K" scale with the proper point of the "d" scale with the straight edge. The flow rate can then be read from the "q" scale.

q = rate of flow of water, liters per minute 8.33 pounds = 1 gallon.

d = internal diameter of pipe in centimeters.

K = decimal fraction of vertical diameter under water. Calculate K by measuring the depth of water (h) in the pipe and dividing it by the pipe diameter (d), or  $K = \frac{h}{d}$  (see Figure 1).

### Example:

What is the rate of flow of water in a pipe with an internal diameter of 5cm running 0.3 full? A straight line connecting 5 on the d-scale with 0.3 on the K-scale intersects the q-scale at a flow of 18 liters per minute.

### Source:

Greve Bulletin, Purdue University (12, No. 5, 1928, Bulletin 32).

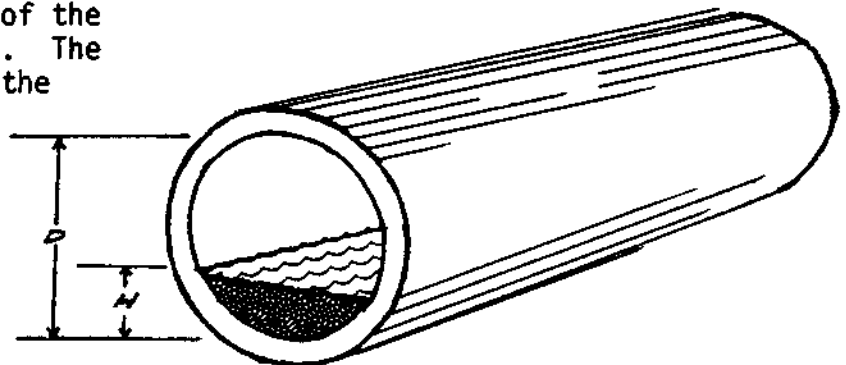
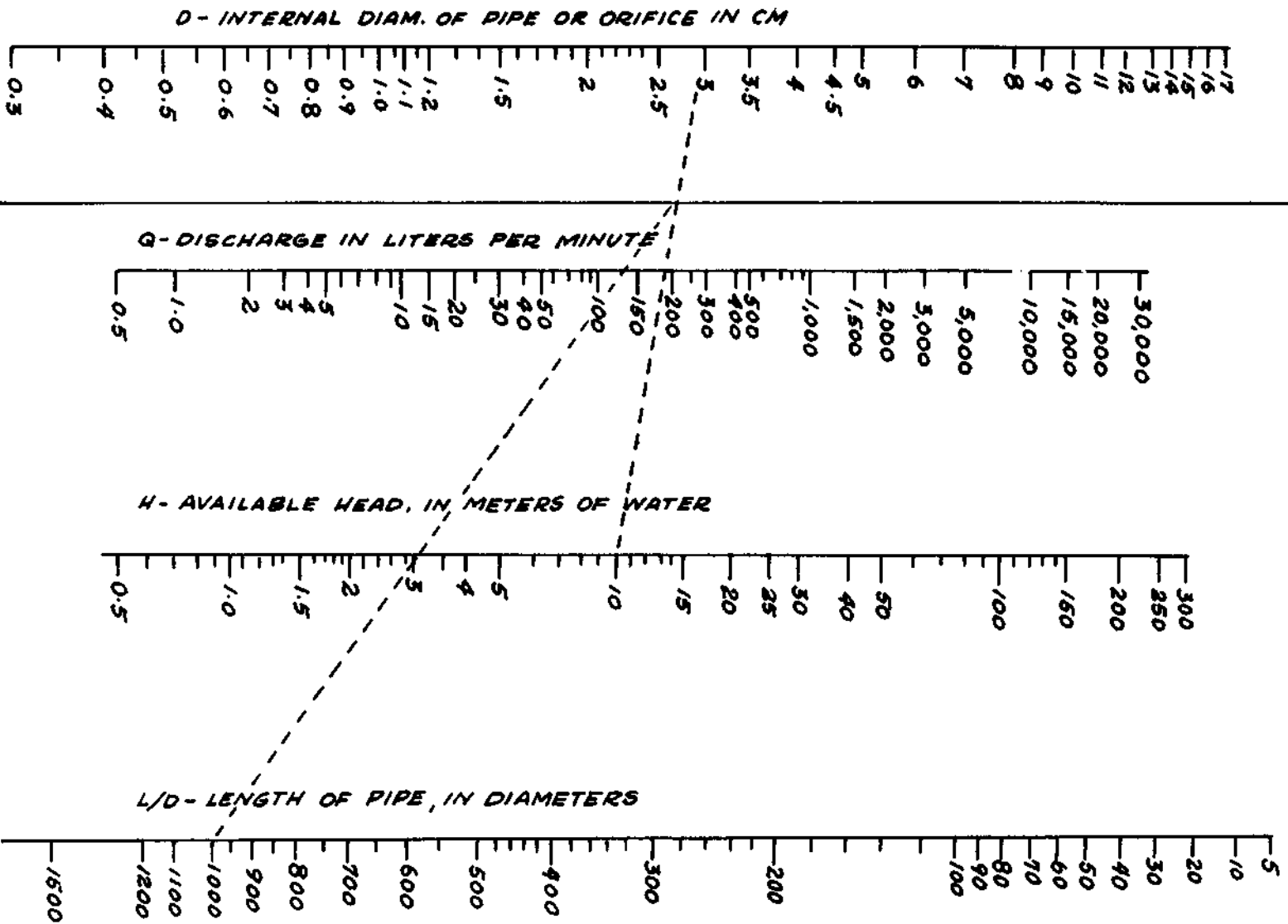

FIGURE 1

FIGURE 1

INDEX SCALE



Alignment chart for determining probable water flow with known reservoir height and size and length of pipe.

## DETERMINING PROBABLE WATER FLOW WITH KNOWN RESERVOIR HEIGHT AND SIZE AND LENGTH OF PIPE

The alignment chart in Figure 1 gives a reasonably accurate determination of water flow when pipe size, pipe length and height of the supply reservoir are known.

The example given here is for the analysis of an existing system. To design a new system, assume a pipe diameter and solve for flow-rate, repeating the procedure with new assumed diameters until one of them provides a suitable flow rate.

### Materials

Straight edge, for use with alignment chart

Surveying instruments, if available

The alignment chart was prepared for clean, new steel pipe. Pipes with rougher surfaces or steel or cast iron pipe which has been in service for a long time may give flows as low as 50 percent of those predicted by this chart.

The available head (h) is in meters and is taken as the difference in elevation between the supply reservoir and the point of demand. This may be crudely estimated by eye, but for accurate results some sort of surveying instruments are necessary.

For best results, the length of pipe (L) used should include the equivalent lengths of fittings as described in handbook entry "Flow Resistance of Pipe Fittings," p. 80. This length (L) divided by the pipe internal diameter (D) gives the necessary "L/D" ratio. In calculating L/D, note that the units of measuring both "L" and "D" must be the same, e.g.: feet divided by feet; meters divided by meters; centimeters by centimeters.

### Example:

Given Available Head (h) of 10 meters, pipe internal diameter (D) of 3cm, and equivalent pipe length (L) of 30 meters = 3000cm.

$$\text{Calculate } L/D = \frac{3000\text{cm}}{3\text{cm}} = 1000$$

The alignment chart solution is in two steps:

1. Connect Internal Diameter 3cm to Available Head (10 meters), and make a mark on the Index Scale. (In this step, disregard "Q" scale)
2. Connect mark on Index Scale with L/D (1000), and read flow rate (Q) of approximately 140 liters per minute.

### Source:

Crane Company Technical Paper #407, pages 54-55.

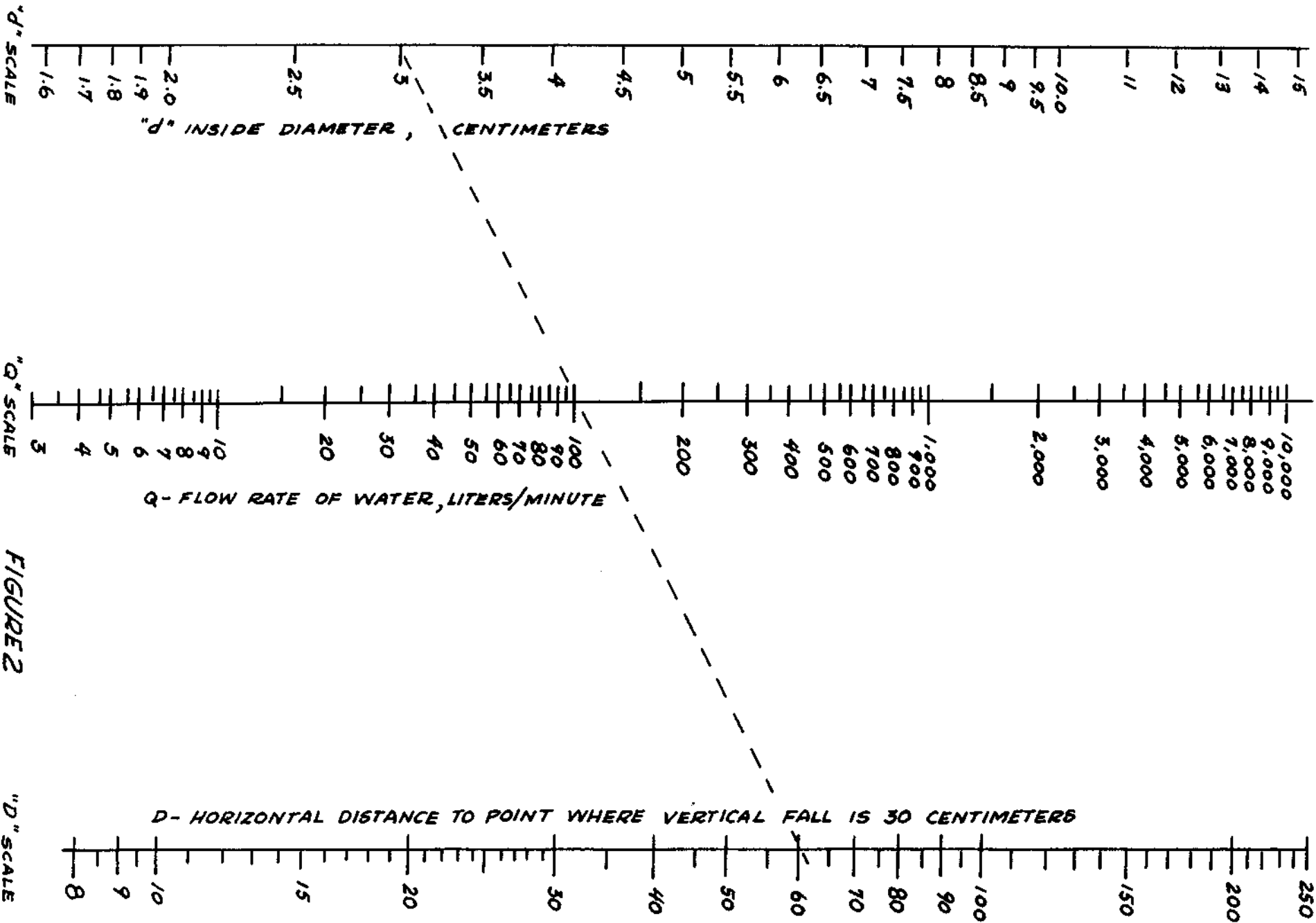

FIGURE 2



## ESTIMATING WATER FLOW FROM HORIZONTAL PIPES

If a horizontal pipe is discharging a full stream of water, you can estimate the rate of flow from the alignment chart in Figure 2. This is a standard engineering technique for estimating flows; its results are usually accurate to within 10 percent of the actual flow rate.

### Materials

Straightedge and pencil, to use alignment chart

Tape measure

Level

Plumb bob

The water flowing from the pipe must completely fill the pipe opening (see Figure 1). The results from the chart will be most accurate when there is no constricting or enlarging fitting at the end of the pipe.

### Example:

Water is flowing out of a pipe with an inside diameter ( $d$ ) of 3cm (see Figure 1). The stream drops 30cm at a point 60cm from the end of the pipe.

Connect the 3cm inside diameter point on the "d" scale in Figure 2 with the 60cm point on the "D" scale. This line intersects the "q" scale at about 100 liters per minute, the rate at which water is flowing out of the pipe.

### Source:

"Flow of Water from Horizontal Open-end Pipes," by Clifford L. Duckworth, Chemical Processing, June 1959, p. 73.

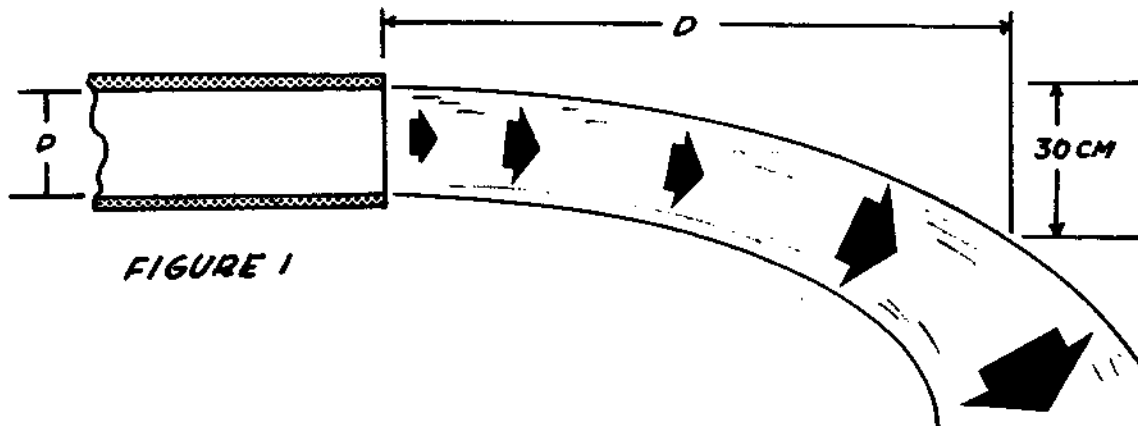

FIGURE 1

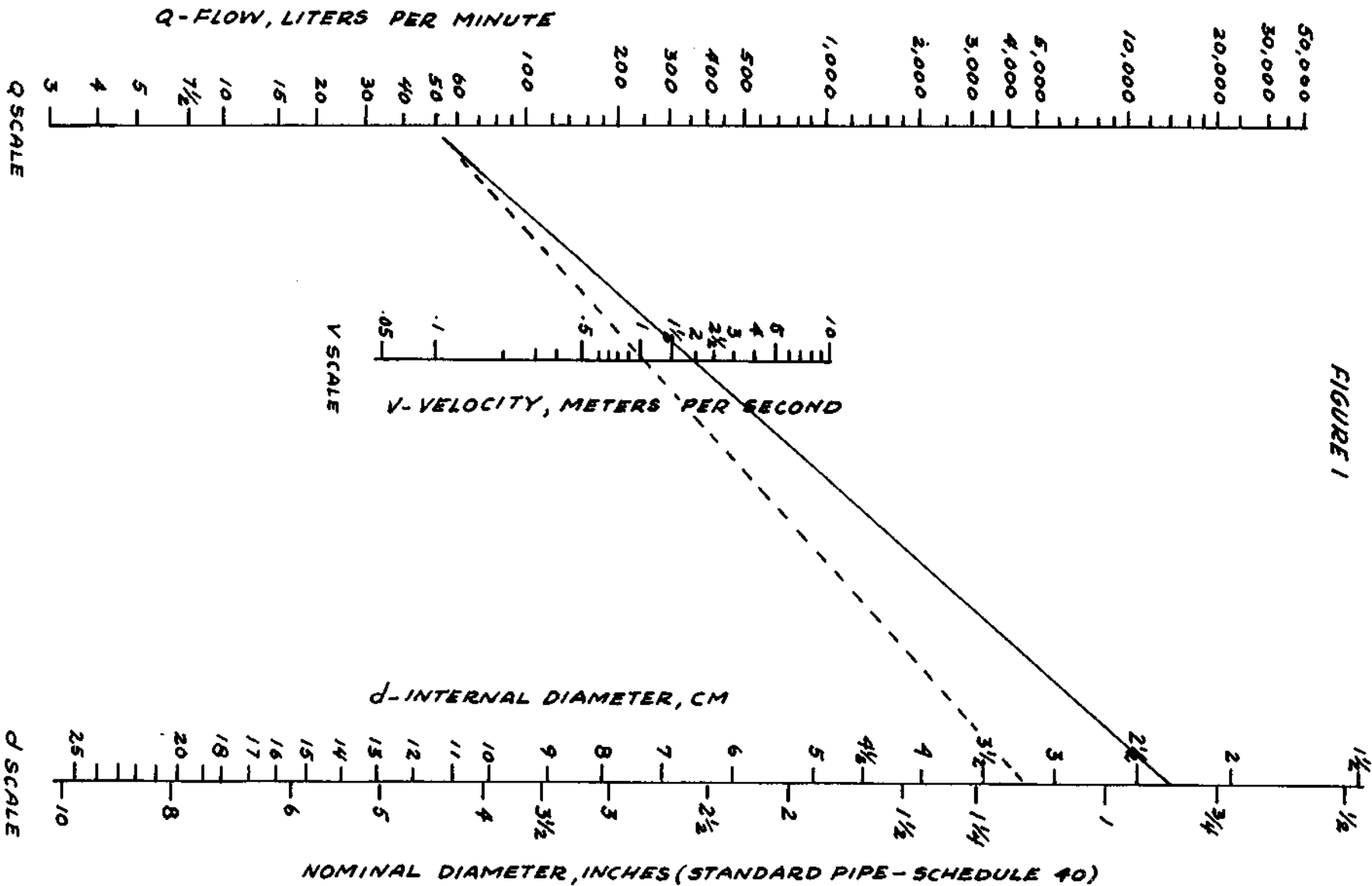

FIGURE 1

## DETERMINING PIPE SIZE OR VELOCITY OF WATER IN PIPES

The choice of pipe size is one of the first steps in designing a simple water system.

The alignment chart in Figure 1 can be used to compute the pipe size needed for a water system when the water velocity is known. The chart can also be used to find out what water velocity is needed with a given pipe size to yield the required rate of flow.

### Tools and Materials

Straightedge and pencil

Practical water systems use water velocities from 1.2 to 1.8 meters per second. Very fast velocity requires high pressure pumps which in turn require high pressure pumps which in turn require large motors and use excessive power. Velocities which are too low are expensive because larger pipe diameters must be used.

It may be advisable to calculate the cost of two or more systems based on different pipe size. Remember, it is usually wise to choose a little larger pipe if higher flows are expected in the next 5 or 10 years. In addition, water pipes often build up rust and scale reducing the diameter and thereby increasing the velocity and pump pressure required to maintain flow at the original rate. If extra capacity is designed into the piping system, more water can be delivered by adding to the pump capacity without changing all the piping.

To use the chart, locate the flow (liters per minute) you need on the Q-scale. Draw a line from that point, through 1.8m/sec velocity on the V-scale to the d-scale. Choose the nearest standard size pipe.

### Example:

Suppose you need a flow of 50 liters per minute at the time of peak demand. Draw a line from 50 liters per minute on the Q-scale through 1.8m/sec on the V-scale. Notice that this intersects the d-scale at about 2.25. The correct pipe size to choose would be the next largest standard pipe size: e.g. 1" nominal diameter, U.S. Schedule 40. If pumping costs (electricity or fuel) are high, it would be well to limit velocity to 1.2m/sec and install a slightly larger pipe size.

### Source:

Crane Company Technical Paper #409, pages 46-47.

# Resistance of Valves and Fittings to Flow of Fluids

**FIGURE 1**

EXAMPLE 1 - SOLID LINE  
EXAMPLE 2 - BROKEN LINE

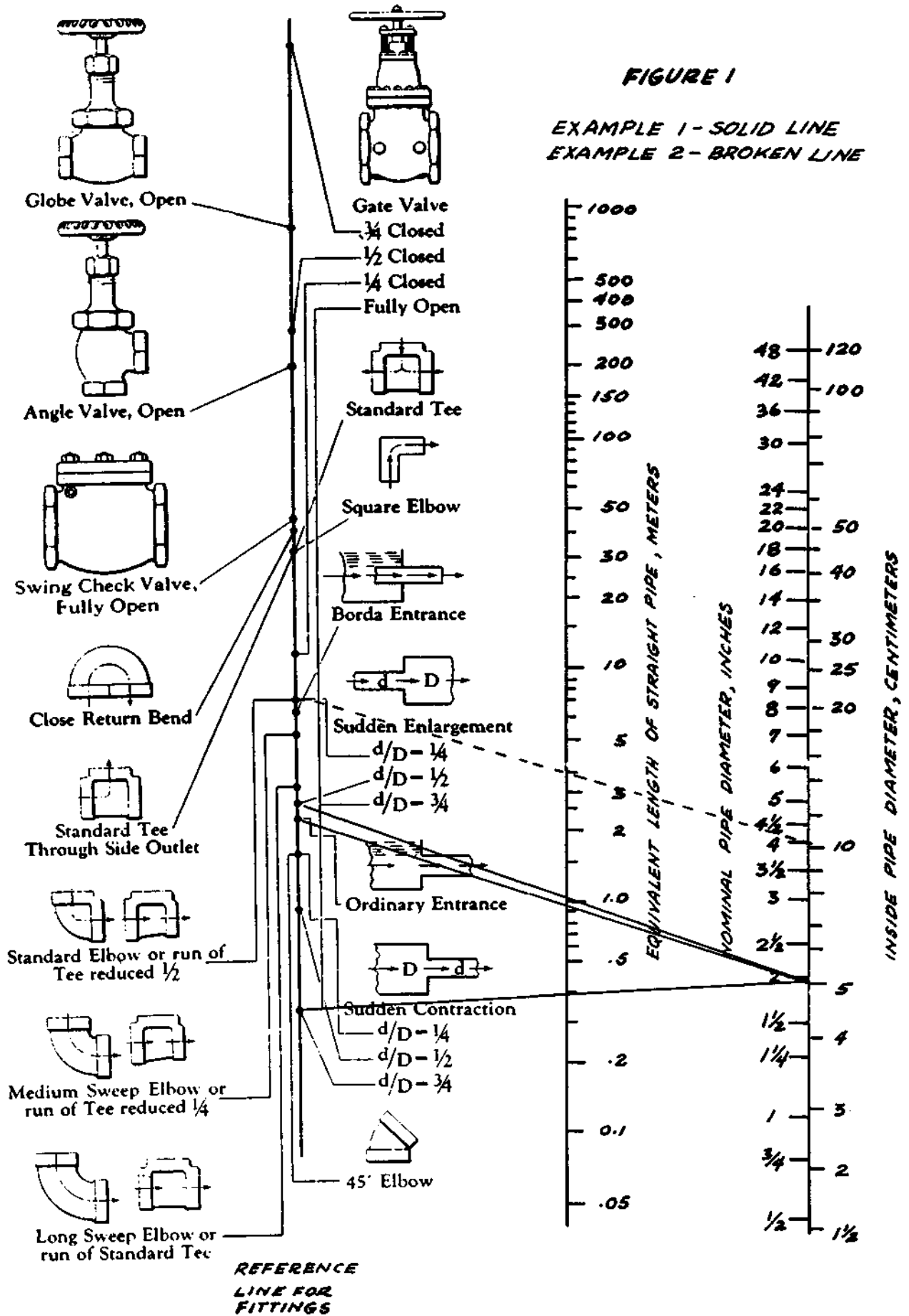

## ESTIMATING FLOW RESISTANCE OF PIPE FITTINGS

One of the forces which a pump must overcome to deliver water is the friction/resistance of pipe fittings and valves to the flow of water. Any bends, valves, constrictions or enlargements (such as passing through a tank) add to friction.

The alignment chart in Figure 1 gives a simple but reliable way to estimate this resistance: it gives the equivalent length of straight pipe which would have the same resistance. The sum of these equivalent lengths is then added to the actual length of pipe: this gives the total equivalent pipe length, which is used in the following entry, "Determining Pump Capacity and Horsepower Requirement," to determine total friction loss.

Rather than calculate the pressure drop for each valve or fitting separately, this chart will give the equivalent length of straight pipe.

Valves: Note the difference in equivalent length depending on how far the valve is open.

1. Gate Valve - full opening valve; can see through it when open; used for complete shut off of flow.
2. Globe Valve - cannot see through it when open; used for regulating flow.
3. Angle Valve - like the globe, used for regulating flow.
4. Swing Check Valve - a flapper opens to allow flow in one direction but closes when water tries to flow in the opposite direction.

### Fittings

Study the variety of tees and elbows: note carefully the direction of flow through the tee. To determine the equivalent length of a fitting, (a) pick proper dot on "fitting" line, (b) connect with inside diameter of pipe, using a straight edge; read equivalent length of straight pipe in meters, (c) add the fitting equivalent length to the actual length of pipe being used.

### Source:

Crane Company Technical Paper #409, pages 20-21.

### Example 1:

<u>Pipe with 5cm inside diameter</u>	<u>Equivalent Length in Meters</u>
a. Gate Valve (fully open)	.4
b. Flow into line - ordinary entrance	1.0
c. Sudden enlargement into 10cm pipe ( $d/D = 1/2$ )	1.0
d. Pipe length	<u>10.0</u>
Total Equivalent Pipe Length	12.4

### Example 2:

<u>Pipe with 10cm inside diameter</u>	<u>Equivalent Length in Meters</u>
a. Elbow (standard)	4.0
b. Pipe length	<u>10.0</u>
Total Equivalent Pipe Length	14.0

## DETERMINING PUMP OUTLET SIZE AND HORSEPOWER REQUIREMENT

With the alignment chart in Figure 2, you can determine the necessary pump size (diameter of discharge outlet) and the amount of horsepower needed to power the pump. The power can be supplied by men or by motors.

A man can generate about 0.1 horsepower (HP) for a reasonably long period and 0.4 HP for short bursts. Motors are designed for varying amounts of horsepower.

### Tools

Straight edge and pencil for alignment chart

To get the approximate pump size needed for lifting liquid to a known height through simple piping, follow these steps:

1. Determine the quantity of flow desired in liters per minute.
2. Measure the height of the lift required (from the point where the water enters the pump suction piping to where it discharges).
3. Using the entry "Determining Pipe Size or Velocity of Water in Pipes," page 78, choose a pipe size which will give a water velocity of about 1.8 meters per second (6' per second). This velocity is chosen because it will generally give the most economical combination of pump and piping; Step 5 explains how to convert for higher or lower water velocities.
4. Estimate the pipe friction-loss "head" (a 3-meter "head" represents the pressure at the bottom of a 2-meter-high column of water) for the total equivalent pipe length, including suction and discharge piping and equi-

valent pipe lengths for valves and fittings, using the following equation:

$$\text{Friction-loss head} = \frac{F \times \text{total equivalent pipe length}}{100}$$

where F equals approximate friction head (in meters) per 100 meters of pipe. To get the value of F, see the table in Figure 1. For an explanation of total equivalent pipe length, see the preceding entry.

5. To find F (approximate friction head in meters per 100m of pipe) when water velocity is higher or lower than 1.8 meters per second, use the following equation:

$$F = \frac{F_{\text{at } 1.8\text{m/sec}} \times V^2}{1.8\text{m/sec}^2},$$

where V = higher or lower velocity

### Example:

If the water velocity is 3.6m per second and  $F_{\text{at } 1.8\text{m/sec}}$  is 16, then:

$$F = \frac{16 \times 3.6^2}{1.8^2} = \frac{16 \times 13}{3.24} = 64$$

6. Obtain "Total Head" as follows:  
Total Head = Height of Lift + Friction-loss Head

Pipe inside diameter:	cm	2.5	5.1	7.6	10.2	15.2	20.4	30.6	61.2
	inches*	1"	2"	3"	4"	6"	8"	12"	24"
F (approximate friction loss in meters per 100 meters of pipe)		16	7	5	3	2	1.5	1	0.5

Figure 1. Average friction loss in meters for fresh water flowing through steel pipe when velocity is 1.8 meters (6 feet) per second.

\*For the degree of accuracy of this method, either actual inside diameter in inches or nominal pipe size, U.S. Schedule 40, can be used.

- Using a straight edge, connect the proper point on the T-scale with the proper point on the Q-scale; read motor horsepower and pump size on the other two scales.

Example:

Desired flow: 400 liters per minute

Height of lift: 16 meters, No fittings

Pipe size: 5cm

Friction-loss head: about 1 meter

Total head: 17 meters

Solution:

Pump size: 5cm

Motor horsepower: 3HP

Note that water horsepower is less than motor horsepower (see HP-scale, Figure 2). This is because of friction losses in the pump and motor. The alignment chart should be used for rough estimate only. For an exact determination, give all information on flow and piping to a pump manufacturer or an independent expert. He has the exact data on pumps for various applications. Pump specifications can be tricky especially if suction piping is long and the suction lift is great.

Conversion to Metric Horsepower

Given the limits of accuracy of this method, metric horsepower can be considered roughly equal to the horsepower indicated by the alignment chart. Actual metric horsepower can be obtained by multiplying horsepower by 1.014.

Source:

Nomographic Charts, by C. A. Kulman, McGraw-Hill Book Co., New York, 1951, pages 108-109.

FIGURE 2

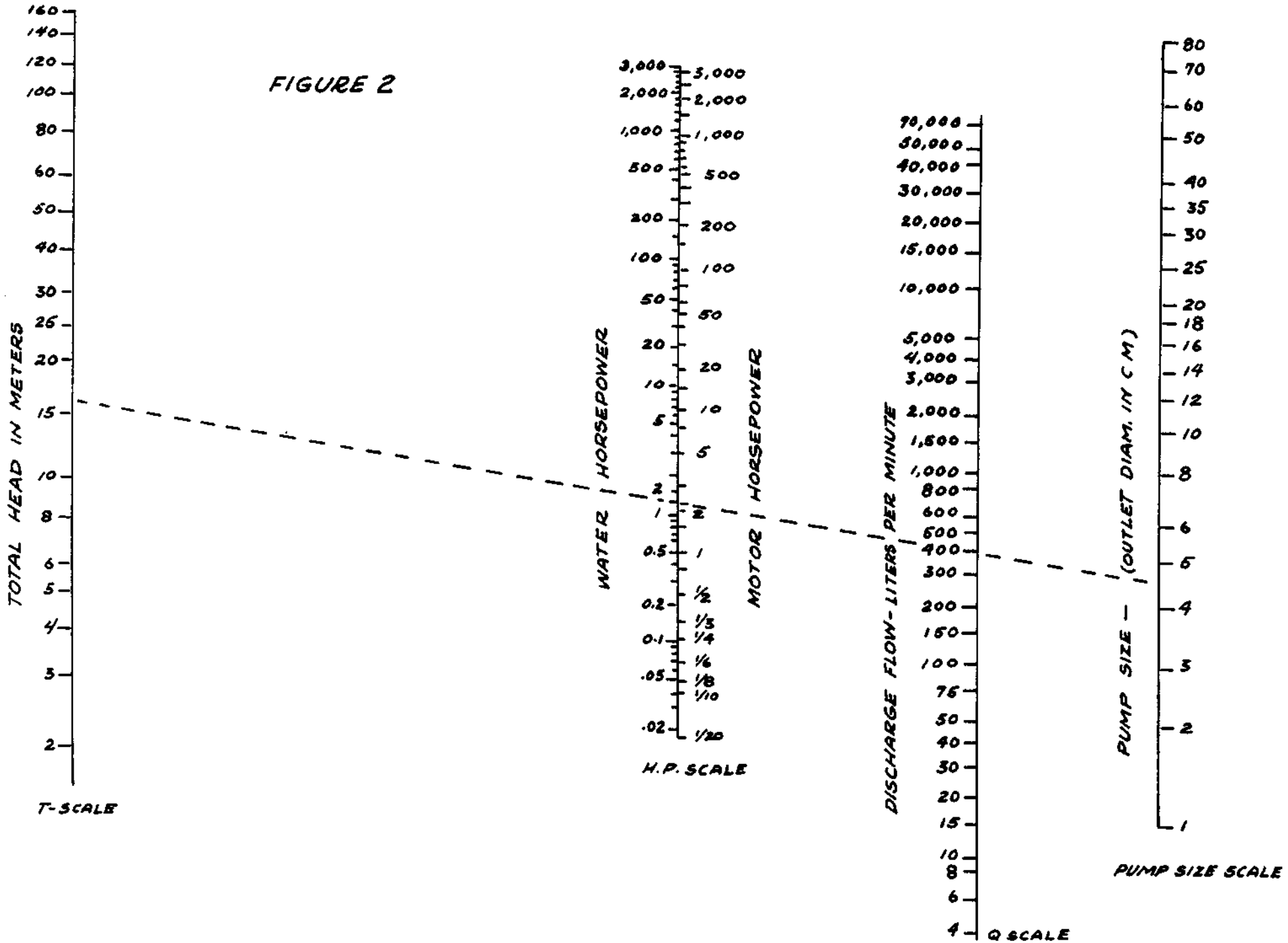



## DETERMINING LIFT PUMP CAPABILITY

The height that a lift pump can raise water depends on altitude and, to a lesser extent, on water temperature. The graph in Figure 1 will help you to find out what a lift pump can do at various altitudes and water temperatures.

### Tools

Measuring tape

Thermometer

If you know your altitude and the temperature of your water, Figure 1 will tell you the maximum allowable distance between the pump cylinder and the lowest water level expected. If the graph shows that lift pumps are marginal or will not work, then a force pump should be used. This involves putting the

cylinder down in the well, close enough to the lowest expected water level to be certain of proper functioning.

The graph shows normal lifts. Maximum possible lifts under favorable conditions would be about 1.2 meters higher, but this would require slower pumping and would probably give much difficulty in "losing the prime."

Check predictions from the graph by measuring lifts in nearby wells or by experimentation.

### Source:

Mechanical Engineer's Handbook, by Theodore Baumeister, 6th edition, McGraw-Hill Book Co., New York, copyright 1958. Used by permission. (Adapted.)

### Example:

Suppose your elevation is 2000 meters and the water temperature is 25C. The graph shows that the normal lift would be 4 meters.

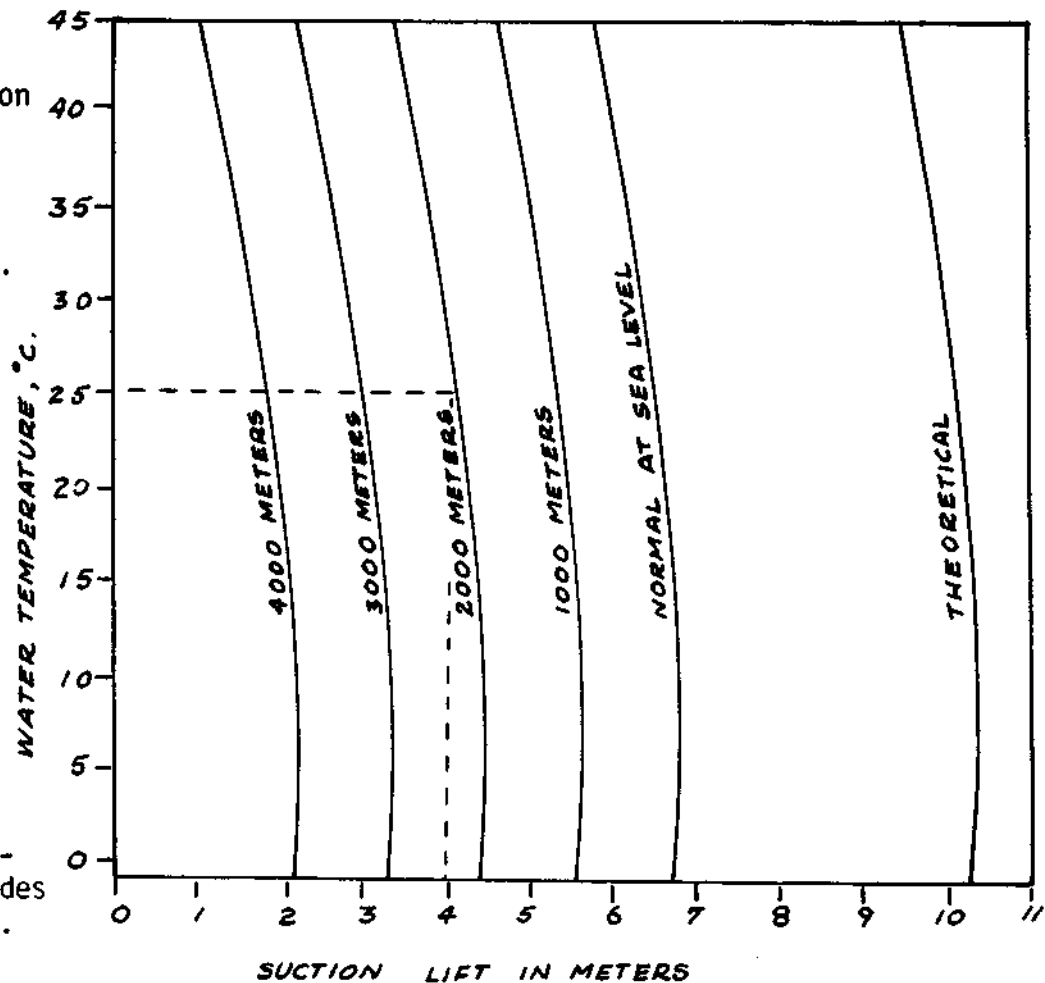

Figure 1. Graph showing lift pump capabilities at various altitudes and water temperatures. Broken lines indicate example given in text.

FIGURE 1

## RECIPROCATING WIRE POWER TRANSMISSION FOR SMALL WATER WHEELS

A reciprocating wire can transmit power from a water wheel to a point up to 0.8km (1/2 mile) away where it is usually used to pump well water. These devices have been used for many years by the Amish people of Pennsylvania. If they are properly installed, they give long, trouble-free service.

The Amish people use this method to transmit mechanical power from small water wheels to the barnyard, where the reciprocating motion is used to pump well water for home and farm use. The water wheel is typically a small undershot wheel (with the water flowing under the wheel) one or two feet in diameter. The wheel shaft is fitted with a crank, which is attached to a triangular frame which pivots on a pole (see Figure 2). A wire is used to connect this frame to another identical unit located over the well. Counterweights keep the wire tight.

### Tools and Materials

Wire - galvanized smooth fence wire

Water wheel with eccentric crank to give a motion slightly less than largest stroke of farmyard pump

Galvanized pipe for triangle frames:  
2cm (3/4") by 10 meters long (32.8')

Welding or brazing equipment to make frames

Concrete for counterweight

2 Poles: 12 to 25cm (6" to 10") in diameter

As the water wheel turns, the crank tips the triangular frame back and forth. This action pulls the wire back and forth. One typical complete back and forth cycle, takes 3 to 5 seconds. Sometimes power for several transmission wires comes from one larger water wheel.



WATER METER  
→

DAILY BARN  
Barn, N. Y.  
Barn, N. Y.

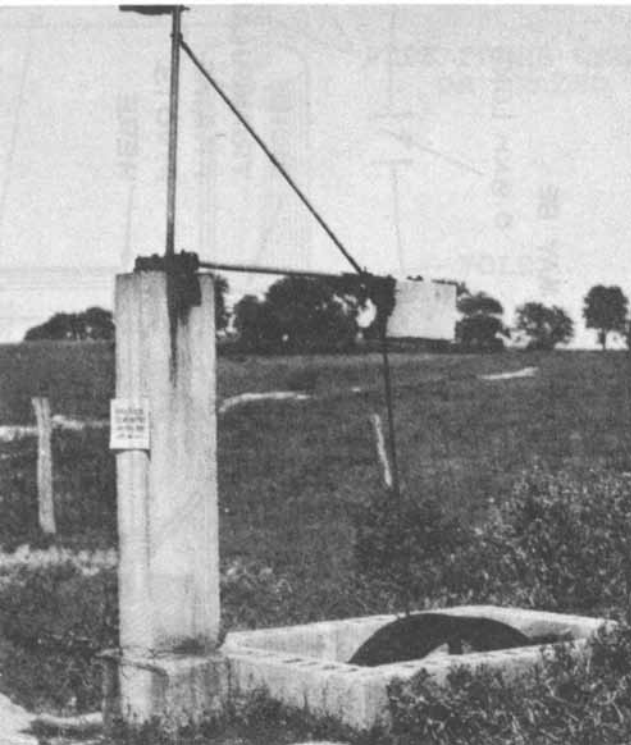

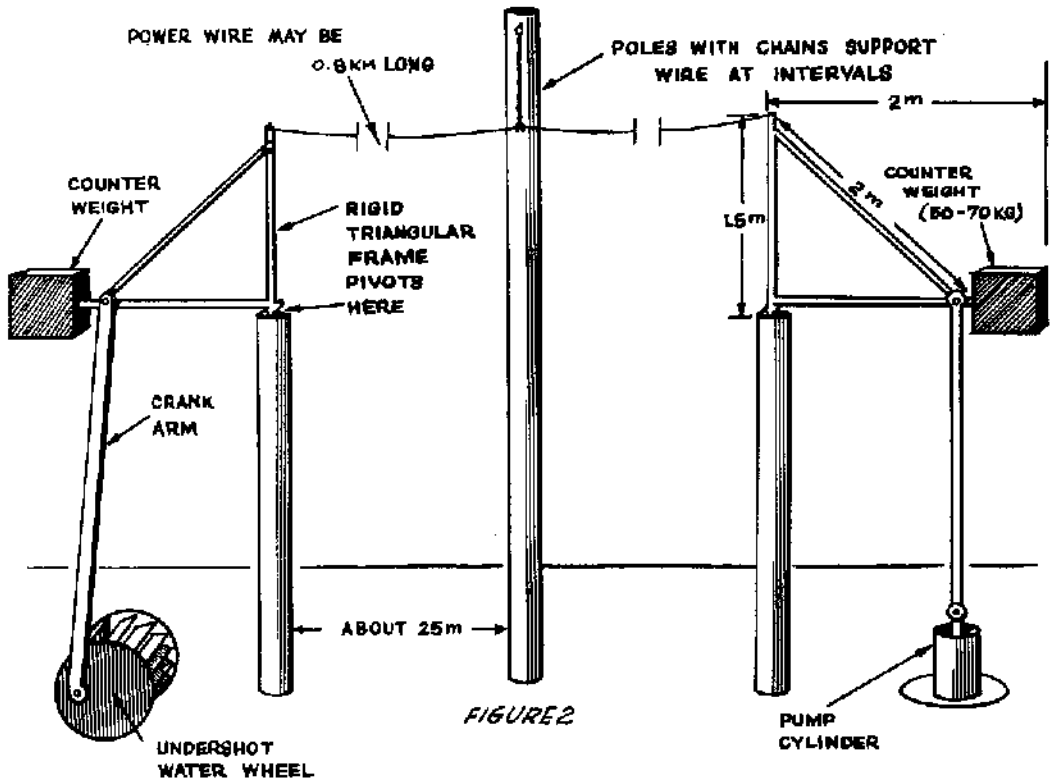

FIGURE 2

Turns can be made in order to follow hedgerows by mounting a small triangular frame horizontally at the top of a pole as shown in Figure 4.

Water Wheel

Figures 5, 6 and 7 show how to build and install a small water wheel made from wood and bamboo.

Source:

New Holland, Pennsylvania VITA Chapter.

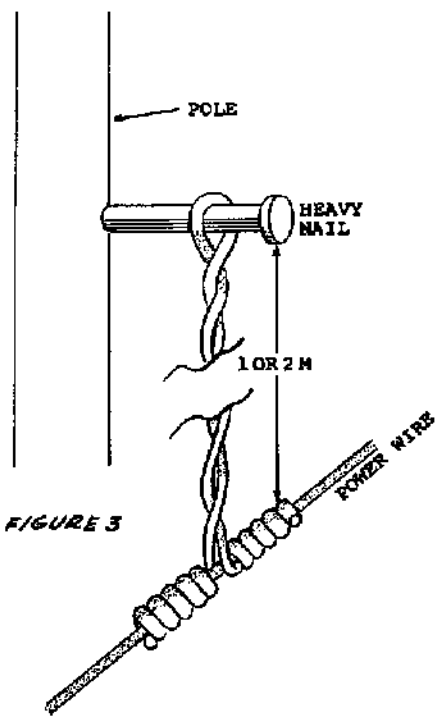

FIGURE 3

The wire is mounted up on poles to keep it overhead and out of the way. If the distance from stream to courtyard is far, extra poles will be needed to help support the wire. Amish folks use a loop of wire covered with a small piece of garden hose attached to the top of the pole. The reciprocating wire slides back and forth through this loop. If this is not possible, try making the pole 1-2 meters higher than the power wire. Drive a heavy nail near the pole top and attach a chain or wire from it to the power wire as shown in Figure 3.

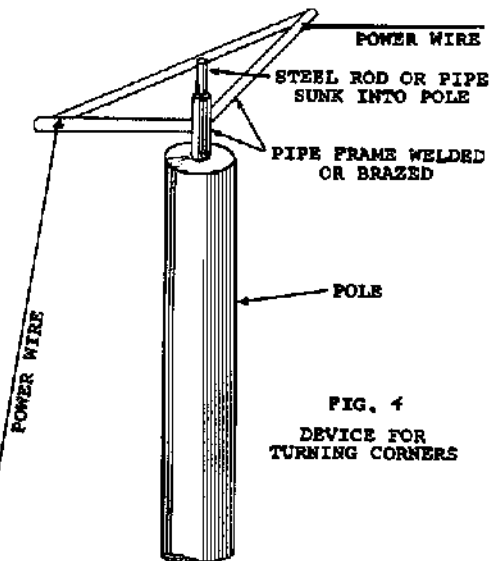
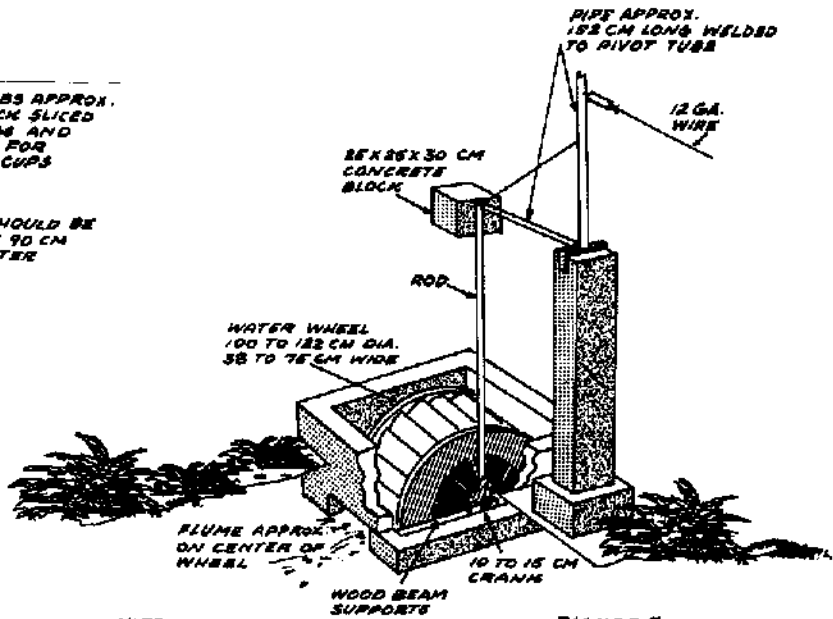
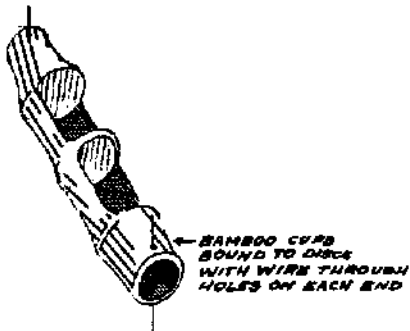
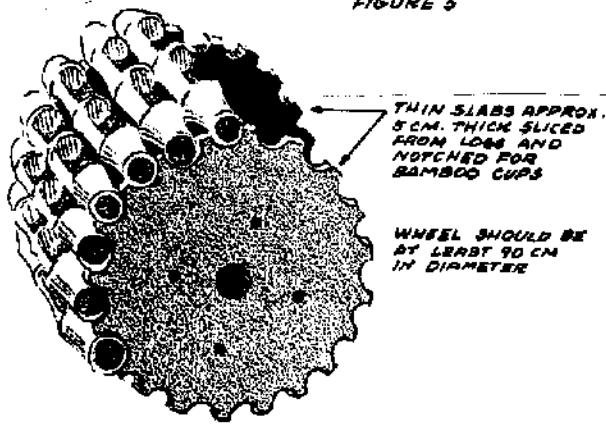

FIG. 4  
DEVICE FOR TURNING CORNERS

FIGURE 5



NOTE: CRANK CAN BE ADDED TO OTHER END OF SHAFT AT 90° ANGLE TO FIRST CRANK TO ATTACH MORE POWER TRANSMITTING WIRES

FIGURE 7

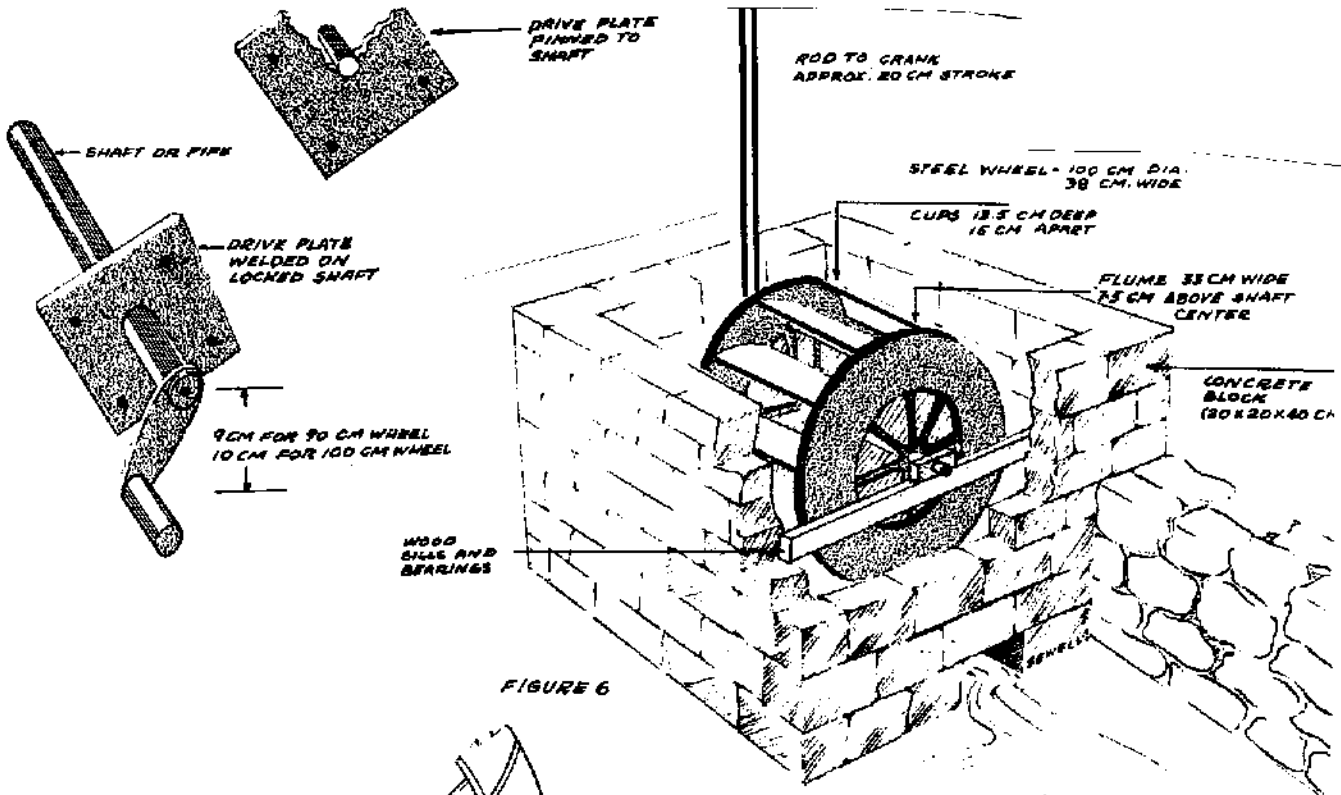
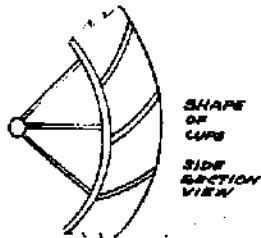

FIGURE 6



**WATER, PRESSURE AND FLOW.** Water is composed of two gases, hydrogen and oxygen, in the ratio of two volumes of the former to one of the latter. Water boils under atmospheric pressure at 212 degrees F. and freezes at 32 degrees F. Its greatest density is at 39.1 degrees F., when it weighs 62.425 pounds per cubic foot. The pressure in pounds per square inch of water that is not moving, against the sides of any pipe, vessel, container, or dam is due solely to the "head" or height of the surface of the water above the point at which the pressure is considered. The pressure is equal to 0.433 pound per square inch for every foot of the head, at a temperature of 62 degrees F. For higher temperatures, the pressure slightly decreases in the proportion indicated by the table "Weight of Water per Cubic Foot at Different Temperatures." The pressure per square inch is equal in all directions, downwards, upwards, and sideways. Water can be compressed only in a very slight degree, the compressibility being so slight that, even at the depth of a mile, a cubic foot of water weighs only about one-half pound more than at the surface.

**Flow of Water in Pipes.**—The quantity of water that will be discharged through a pipe depends primarily upon the head and also upon the diameter of the pipe, the character of the interior surface, and the number and shape of the bends. The head may be either the actual distance between the levels of the surface of water in a reservoir and the point of discharge, or it may be caused by mechanically applied pressure, as by pumping, in which case the head is calculated as the vertical distance corresponding to the pressure. One pound per square inch is equal to 2.309 feet head, or 1 foot head is equal to a pressure of 0.433 pound per square inch.

All formulas for finding the amount of water that will flow through a pipe in a given time are approximate. The formula below will give results within 5 or 10 per cent of actual results, if applied to pipe lines carefully laid and in a fair condition.

$$V = C \sqrt{\frac{hD}{L + 54D}}$$

in which

- $V$  = approximate mean velocity in feet per second;
- $C$  = coefficient from table;
- $D$  = diameter of pipe in feet;
- $h$  = total head in feet;
- $L$  = total length of pipe line in feet.

Values of Coefficient C

Diameter of Pipe		C	Diameter of Pipe		C
Feet	Inches		Feet	Inches	
0.1	1.2	23	2.0	24	57
0.2	2.4	30	2.5	30	60
0.3	3.6	34	3.0	36	62
0.4	4.8	37	3.5	42	64
0.5	6.0	39	4.0	48	66
0.6	7.2	42	5.0	60	68
0.7	8.4	44	6.0	72	70
0.8	9.6	46	7.0	84	72
0.9	10.8	47	8.0	96	74
1.0	12.0	48	10.0	120	77
1.5	18.0	53	.....	.....	.....

*Example.*—A pipe line, 1 mile long, 12 inches in diameter, discharges water under a head of 100 feet. Find the velocity and quantity of discharge.

From the table, the coefficient  $C$  is found to be 48 for a pipe 1 foot in diameter; hence:

$$V = 48 \sqrt{\frac{100 \times 1}{5280 + 54 \times 1}} = 6.57 \text{ feet per second.}$$

To find the discharge in cubic feet per second, multiply the velocity found by the area of cross-section of the pipe in square feet:

$$6.57 \times 0.7854 = 5.16 \text{ cubic feet per second.}$$

The loss of head due to a bend in the pipe is most frequently given in the equivalent length of straight pipe, which would cause the same loss in head as the bend.

Weight of Water per Cubic Foot at Different Temperatures

Temp. Deg. F.	Weight per Cubic Foot, Pounds	Temp. Deg. F.	Weight per Cubic Foot, Pounds	Temp. Deg. F.	Weight per Cubic Foot, Pounds	Temp. Deg. F.	Weight per Cubic Foot, Pounds
32	62.42	180	60.55	320	56.66	470	50.2
40	62.42	190	60.32	330	56.30	480	49.7
50	62.41	200	60.12	340	55.94	490	49.2
60	62.37	210	59.88	350	55.57	500	48.7
70	62.31	212	59.83	360	55.18	510	48.1
80	62.23	220	59.63	370	54.78	520	47.6
90	62.13	230	59.37	380	54.36	530	47.0
100	62.02	240	59.11	390	53.94	540	46.3
110	61.89	250	58.83	400	53.50	550	45.6
120	61.74	260	58.55	410	53.00	560	44.9
130	61.56	270	58.26	420	52.5	570	44.1
140	61.37	280	57.96	430	52.2	580	43.3
150	61.18	290	57.65	440	51.7	590	42.6
160	60.98	300	57.33	450	51.2	600	41.8
170	60.77	310	57.00	460	50.7	.....	.....

Volume of Water at Different Temperatures

Degrees F.	Volume	Degrees F.	Volume	Degrees F.	Volume
39.1	1.00000	104	1.00767	167	1.02548
50	1.00025	113	1.00967	176	1.02872
59	1.00083	122	1.01186	185	1.03213
68	1.00171	131	1.01423	194	1.03570
77	1.00286	140	1.01678	203	1.03943
86	1.00425	149	1.01951	212	1.04332
95	1.00586	158	1.02241	.....	.....

Experiments show that a right-angle bend should have a radius of about three times the diameter of the pipe. Assuming this curvature, then, if  $D$  is the diameter of the pipe in inches and  $L$  is the length of straight pipe in feet which causes the same loss of head as the bend in the pipe, the following formula gives the equivalent length of straight pipe that should be added to compensate for a right-angle bend:

$$L = 4D \div 3.$$

Thus the loss of head due to a right-angle bend in a 6-inch pipe would be equal to that in 8 feet of straight pipe. Experiments undertaken to determine the losses due to valves in pipe lines indicate that a fully open gate valve in a pipe causes a loss of head corresponding to that in a length of pipe equal to six diameters.

## APPENDIX: Conversion Factors

To convert from:	To:	Multiply by:
<i>Length</i>		
centimeters (cm)	inches	0.394
feet (ft)	centimeters	30.5
inches (in)	centimeters	2.54
kilometers (km)	miles	0.621
meters (m)	feet	3.28
meters (m)	yards	1.094
miles (mi)	kilometers	1.609
millimeters (mm)	inches	0.0394
yards (yd)	meters	0.914
<i>Area</i>		
acres	hectares	0.405
acres	sq. meters	4047
hectares (ha)	acres	2.47
hectares (ha)	sq. meters	10,000
sq. centimeters (cm <sup>2</sup> )	sq. inches	0.155
sq. feet (ft <sup>2</sup> )	sq. meters	0.0929
sq. inches (in <sup>2</sup> )	sq. centimeters	6.45
sq. kilometers (km <sup>2</sup> )	sq. miles	0.386
sq. kilometers (km <sup>2</sup> )	hectares	100
sq. meters (m <sup>2</sup> )	sq. feet	10.76
sq. yards (yd <sup>2</sup> )	sq. meters	0.836
<i>Volume</i>		
barrels (petroleum, bbl)	liters	159
cubic centimeters (cm <sup>3</sup> )	cubic inches	0.0610
cubic feet (ft <sup>3</sup> )	cubic meters	0.0283
cubic inches (in <sup>3</sup> )	cubic centimeters	16.39
cubic meters (m <sup>3</sup> )	cubic feet	35.3
cubic meters (m <sup>3</sup> )	cubic yards	1.308
cubic yards (yd <sup>3</sup> )	cubic meters	0.765
gallons (gal) US	liters	3.79
gallons (gal) Imp.	liters	4.545
gallons (gal) Imp.	gallons, US	1.20
<i>Weight</i>		
grams (g)	ounces, avdp.	0.0353
kilograms (kg)	pounds	2.205
ounces avdp. (oz)	grams	28.3
pounds (lb)	kilograms	0.454
tons (long)	pounds	2240
tons (long)	kilograms	1016
tons (metric)	pounds	2205
tons (metric)	kilograms	1000
tons (short)	pounds	2000
tons (short)	kilograms	907

continued



To convert from:	To:	Multiply by:
<i>Pressure</i>		
atmosphere	grams/sq.cm	1033
atmosphere	pounds/sq.in	14.7
pounds/sq.in (psi)	grams/sq.cm	70.3
<i>Energy</i>		
British thermal units (Btu)	kilojoules	1.054
calories (cal)	joules	4.19
ergs	joules	$1 \times 10^{-7}$
kilojoules (kJ)	Btu	0.948
joules (J)	calories	0.239
kilowatt-hours (kWh)	megajoules	3.6
megajoules (MJ)	kilojoules	1000
gigajoules (GJ)	megajoules	1000
terajoules (TJ)	gigajoules	1000
<i>Energy Density</i>		
Btu/gal	joules/cm <sup>3</sup>	0.27
Btu/ft <sup>3</sup>	kJ/m <sup>3</sup>	36.5
<i>Power</i>		
horsepower (hp)	Btu/min	42.4
horsepower (hp)	horsepower (metric)	1.014
horsepower (hp)	kilowatts	0.746
kilowatts (kW)	horsepower	1.341
watts (W)	Btu/hour	3.41
watts (W)	joules/sec	1
<i>Miscellaneous</i>		
liter petrol	megajoules	35
kilogram oil	megajoules	43.2
barrel oil equivalent	gigajoules	6.1
ton coal equivalent	gigajoules	29.3
ton coal equivalent	barrels oil equivalent	4.8
pounds/acre	kilograms/hectare	1.1

## SI units and conversion factors

### Basic SI units, prefixes, and most common derived SI units used

#### Basic SI units

Quantity	Basic unit	Symbol
Length	metre	m
Mass	kilogram	kg
Time	second	s
Electric current	ampère	A
Temperature	kelvin	K

#### SI prefixes

Prefix	Symbol	Factor	Prefix	Symbol	Factor
exa	E	10 <sup>18</sup>	deci	d	10 <sup>-1</sup>
peta	P	10 <sup>15</sup>	centi	c	10 <sup>-2</sup>
tera	T	10 <sup>12</sup>	milli	m	10 <sup>-3</sup>
giga	G	10 <sup>9</sup>	micro	μ	10 <sup>-6</sup>
mega	M	10 <sup>6</sup>	nano	n	10 <sup>-9</sup>
kilo	k	10 <sup>3</sup>	pico	p	10 <sup>-12</sup>
hecto	h	10 <sup>2</sup>	femto	f	10 <sup>-15</sup>
deca	da	10 <sup>1</sup>	atto	a	10 <sup>-18</sup>

#### Most common derived SI units

Quantity	Unit	Symbol
Area	square metre	m <sup>2</sup>
Volume (contents)	cubic metre	m <sup>3</sup>
Speed	metre per second	m/s
Acceleration	metre per second, squared	m/s <sup>2</sup>
Frequency	hertz	Hz (= s <sup>-1</sup> )
Pressure	pascal	Pa (= N/m <sup>2</sup> )
Volume flow	cubic metre per second	m <sup>3</sup> /s
Mass flow	kilogram per second	kg/s
Density (specific mass)	kilogram per cubic metre	kg/m <sup>3</sup>
Force	newton	N (= kg.m/s <sup>2</sup> )
Energy/heat/work	joule	J (= N.m)*
Power/energy flow	watt	W (J/s)
Energy flux	watt per square metre	W/m <sup>2</sup>
Calorific value (heat of combustion)	joule per kilogram	J/kg
Specific heat capacity	joule per kilogram kelvin	J/kg K
Voltage	volt	V (= W/A)

\* NB The joule can also be written in the form watt second (1J = 1W.s)

#### Conversion of non-SI units to SI units

Although academic scientists and engineers may be strict in their use of SI units for their calculations, a number of non-SI units are still in everyday use. For example, engines are still sold by cc (cubic centimetres) and hp (horse power), and water-pumping windmill manufacturers often quote in terms of cubic feet of

the same type of equipment there is not always consistency. In order to be able to compare different manufacturers' products, therefore, it is important to be able to convert the different data to a common unit. The following tables give some useful conversion factors for many of the common non-SI units.

## Conversion factors

### Length

Unit (symbol)	millimetre (mm)	metre (m)	kilometre (km)	inch (in.)	foot (ft)	mile (m.)
1		0.001	$10^{-6}$	0.0394	0.0033	$5.4 \times 10^{-7}$
1000		1	0.001	39.4	3.28	$5.4 \times 10^{-4}$
$10^6$		1000	1	39360	3280	0.5392
25.4		0.025	$2.5 \times 10^{-5}$	1	0.083	$1.4 \times 10^{-5}$
305		0.305	$3.0 \times 10^{-4}$	12	1	$1.9 \times 10^{-4}$
$1.6 \times 10^6$		1609	1.609	63360	5280	1

### Area

Unit (symbol)	square metre (m <sup>2</sup> )	hectare (ha)	square kilometre (km <sup>2</sup> )	square foot (ft <sup>2</sup> )	acre -	square mile (sq. m.)
1		$10^{-4}$	$10^{-6}$	10.76	$2.5 \times 10^{-4}$	$3.9 \times 10^{-7}$
10000		1	0.01	$1.1 \times 10^5$	2.471	$3.9 \times 10^{-3}$
$10^6$		100	1	$1.1 \times 10^7$	247.1	0.386
0.0929		$9.3 \times 10^{-6}$	$9.3 \times 10^{-6}$	1	$2.3 \times 10^{-5}$	$3.6 \times 10^{-6}$
4047		0.4047	$4 \times 10^{-3}$	43560	1	$1.6 \times 10^{-3}$
$2.6 \times 10^6$		259	2.590	$2.8 \times 10^7$	640	1

### Volume

Unit (symbol)	litre (l)*	cubic metre (m <sup>3</sup> )	cubic inch (in <sup>3</sup> )	US gallon (gal)	Imperial gallon (gal)	cubic foot (ft <sup>3</sup> )
1		$10^{-3}$	61.02	0.264	0.220	0.0353
1000		1	6102	264	220	35.31
0.0164		$1.6 \times 10^{-5}$	1	$4.3 \times 10^{-3}$	$3.6 \times 10^{-3}$	$5.8 \times 10^{-4}$
3.785		$3.8 \times 10^{-3}$	231.1	1	0.833	0.134
4.546		$4.5 \times 10^{-3}$	277.4	1.201	1	0.160
28.32		0.0283	1728	7.47	6.23	1

\* L in some countries

### Mass

Unit (symbol)	gram (g)	kilogram (kg)	tonne (t)	pound (lb)	ton -
1		0.001	$10^{-6}$	$2.2 \times 10^{-3}$	$9.8 \times 10^{-7}$
1000		1	0.001	2.205	$9.8 \times 10^{-4}$
$10^6$		1000	1	2205	0.984
453.6		0.4536	$4.5 \times 10^{-4}$	1	$4.5 \times 10^{-4}$
$10^6$		1016	1.016	2240	1

### Velocity

Unit (symbol)	metres per second (m/s)	kilometres per hour (km/h)	feet per second (ft/s)	miles per hour (mph)	knots (kt)
1		3.60	3.28	2.237	1.942
0.278		1	0.912	0.621	0.539
0.305		1.097	1	0.682	0.592
0.447		1.609	1.467	1	0.868
0.566		1.853	1.689	1.152	1

### Frequency

Unit (symbol)	hertz (Hz)	revolutions per minute (rpm)	radians per second (rad/s)
	1	60	6.283
	0.0167	1	0.1047
	0.159	9.549	1

## Conversion factors

### Flow rate

Unit (symbol)	litres per minute (l/min)	cubic metres per second (m <sup>3</sup> /s)	Imperial gallons per minute (gal(imp)/min)	cubic feet per second (ft <sup>3</sup> /s)
1		$1.7 \times 10^{-5}$	0.220	$5.9 \times 10^{-4}$
60000		1	13206	35.315
4.546		$7.6 \times 10^{-5}$	1	$2.7 \times 10^{-3}$
1699		0.0283	373.7	1

### Force

Unit (symbol)	newton (N)	kilonewton (kN)	kilogram force (kgf)	tonne force (t)	pound force (lbf)	ton force —
1		0.001	0.102	$1 \times 10^{-4}$	0.225	$1 \times 10^{-4}$
1000		1	102	0.102	225	0.100
9.807		0.010	1	0.001	2.205	$9.8 \times 10^{-4}$
9807		9.807	1000	1	2205	0.984
4.448		0.004	0.5436	$4.5 \times 10^{-4}$	1	$4.5 \times 10^{-4}$
9964		9.964	1016	1.1016	2240	1

### Torque

Unit (symbol)	newton-metre (Nm)	kilonewton-metre (kNm)	foot-pound (ft.lb)
1		0.001	0.738
1000		1	738
1.365		$1.4 \times 10^{-3}$	1

### Work/heat/energy (smaller quantities)

Unit (symbol)	calorie (cal)	joule (J)	watt-hour (Wh)	British Thermal Unit (BTU)	footpound force (ft.lbf)	horsepower-hour (hp.h)
1		4.182	$1.2 \times 10^{-3}$	$3.9 \times 10^{-3}$	3.088	$1.6 \times 10^{-6}$
0.239		1	$2.8 \times 10^{-4}$	$9.4 \times 10^{-4}$	0.7376	$3.7 \times 10^{-7}$
860.4		3600	1	3.414	2655	$1.3 \times 10^{-3}$
252		1055	2.93	1	778	$3.9 \times 10^{-4}$
0.324		1.356	$3.8 \times 10^{-4}$	$1.3 \times 10^{-3}$	1	$5.0 \times 10^{-7}$
$6.4 \times 10^5$		$2.6 \times 10^6$	745.7	2546	$2.0 \times 10^6$	1

### Work/heat/energy (larger quantities)

Unit (symbol)	kilocalorie (kcal)	megajoule (MJ)	kilowatt hour (kWh)	British Thermal Unit (BTU)	horsepower-hour (hp.h)
1		$4.2 \times 10^{-3}$	$1.2 \times 10^{-3}$	3.968	$1.6 \times 10^{-3}$
239		1	0.2887	947.8	0.3725
860.4		3.600	1	3414	1.341
0.252		$1.1 \times 10^{-3}$	$2.9 \times 10^{-4}$	1	$3.9 \times 10^{-4}$
641.6		2.685	0.7457	2546	1

## Conversion factors

Power						
Unit	watt	kilowatt	metric horse-power	foot-pound per second	horse-power	British Thermal Units per minute (BTU/min)
(symbol)	(W or J/s)	(kW)	(CV)	(ft.lbf/s)	(hp)	
	1	0.001	$1.4 \times 10^{-3}$	0.7376	$1.3 \times 10^{-3}$	0.0569
	1000	1	1.360	737.6	1.341	56.9
	735	0.735	1	558	1.014	41.8
	1.356	$1.4 \times 10^{-3}$	$1.8 \times 10^{-3}$	1	$1.8 \times 10^{-3}$	0.077
	746	0.746	0.9860	550	1	42.44
	17.57	0.0176	0.0239	12.96	0.0236	1

### Power flux

Unit (symbol)	watts per square metre (W/m <sup>2</sup> )	kilowatts per square metre (kW/m <sup>2</sup> )	horsepower per square foot (hp/ft <sup>2</sup> )
	1	0.001	$1.2 \times 10^{-4}$
	1000	1	0.1246
	8023	8.023	1

### Calorific value (heat of combustion)

Unit (symbol)	calories per gram (cal/g)	megajoules per kilogram (MJ/kg)	British thermal units per pound (BTU/lb)
	1	$4.2 \times 10^{-3}$	1.8
	239	1	430
	0.556	$2.3 \times 10^{-3}$	1

### Density (specific mass) and (net) calorific value (heat of combustion) of fuels

	Density (kg/m <sup>3</sup> )	Calorific value (MJ/kg)
LPG	560	45.3
Gasoline (petrol)	720	44.0
Kerosene	806	43.1
Diesel oil	850	42.7
Fuel oil	961	40.1
Wood, oven-dried	varies	16-20
Natural gas	—	103m <sup>3</sup> at 1013 mbar, 0°C = $39.36 \times 10^9$ J

NB These values are approximate since the fuels vary in composition and this affects both the density and calorific value.

### Replacement values

When trying to compare different fuel options, energy planners often use replacement values, which indicate in a specific situation how much fuel it would take to replace another one. For example, the tonne coal

equivalent (tce) would be used to say how much coal it would take to replace a given quantity of oil or natural gas. The table below gives some of the most common equivalence values.

Fuel	Unit	Tonnes of coal equivalent (tce)	Tonnes of oil equivalent (toe)	Barrels of oil equivalent (boe)	GJ*
Coal	tonne	1.00	0.70	5.05	29.3**
Firewood (air-dried)	tonne	0.46	0.32	2.34	13.6
Kerosene	tonne	1.47	1.03	7.43	43.1
Natural gas	1000m <sup>3</sup>	1.19	0.83	6.00	34.8
Gasoline (petrol)	barrel***	0.18	0.12	0.90	5.2
Gasoil/diesel	barrel***	0.20	0.14	1.00	5.7

\* GJ/tonne is numerically equivalent to MJ/kg

\*\* The energy content of 1 tce and 1 toe varies. The values used here are the European Community norms:

1 tce =  $29.31 \times 10^9$  J and 1 toe =  $41.868 \times 10^9$  J

\*\*\* 1 barrel of oil = 42 US gallons =  $0.158987$ m<sup>3</sup>

## Conversion factors

### Power equivalents

	<i>Mtoe/yr</i>	<i>Mbd</i>	<i>Mtce/yr</i>	<i>GW<sub>th</sub></i>	<i>PJ/yr</i>
<i>Mtoe/yr</i>	1	0.02	1.55	1.43	45
<i>Mbd</i>	50	1	77	71	2235
<i>Mtce/yr</i>	0.65	0.013	1	0.92	29
<i>GW<sub>th</sub></i>	0.70	0.014	1.09	1	32
<i>PJ/yr</i>	0.02	$4.5 \times 10^{-4}$	0.034	0.031	1

*Mtoe/yr* = Million tonnes of oil per year

*Mbd* = Million barrels of oil per day

*Mtce/yr* = Million tonnes of coal equivalent per year

*GW<sub>th</sub>* = Gigawatts thermal (see page 203 for further information)

*PJ/yr* = Petrajoules per year

# Conversions: length

Use of the table: the number of inches to be converted, which is made up by the number of inches at the head of a column and the fraction at the side of a line, is converted to the number in the position where line and column meet.  
For example, 1 1/64 in = 1 in + 1/64 in = 25.797 mm

## Inches and fractions of an inch to Millimetres

1 in = 25.4 mm

in →	0	1	2	3	4	5	6	7	8	9	10	11	← in
↓	mm	mm	mm	mm	mm	mm	mm	mm	mm	mm	mm	mm	↓
0	0.000	25.400	50.800	76.200	101.600	127.000	152.400	177.800	203.200	228.600	254.000	279.400	0
1/64	0.397	25.797	51.197	76.597	101.997	127.397	152.797	178.197	203.597	228.997	254.397	279.797	1/64
1/32	0.794	26.194	51.594	76.994	102.394	127.794	153.194	178.594	203.994	229.394	254.794	280.194	1/32
3/64	1.191	26.591	51.991	77.391	102.791	128.191	153.591	178.991	204.391	229.791	255.191	280.591	3/64
1/16	1.588	26.988	52.388	77.788	103.188	128.588	153.988	179.388	204.788	230.188	255.588	280.988	1/16
5/64	1.984	27.384	52.784	78.184	103.584	128.984	154.384	179.784	205.184	230.584	255.984	281.384	5/64
3/32	2.381	27.781	53.181	78.581	103.981	129.381	154.781	180.181	205.581	230.981	256.381	281.781	3/32
7/64	2.778	28.178	53.578	78.978	104.378	129.778	155.178	180.578	205.978	231.378	256.778	282.178	7/64
1/8	3.175	28.575	53.975	79.375	104.775	130.175	155.575	180.975	206.375	231.775	257.175	282.575	1/8
9/64	3.572	28.972	54.372	79.772	105.172	130.572	155.972	181.372	206.772	232.172	257.572	282.972	9/64
5/32	3.969	29.369	54.769	80.169	105.569	130.969	156.369	181.769	207.169	232.569	257.969	283.369	5/32
11/64	4.366	29.766	55.166	80.566	105.966	131.366	156.766	182.166	207.566	232.966	258.366	283.766	11/64
3/16	4.762	30.162	55.562	80.962	106.362	131.762	157.162	182.562	207.962	233.362	258.762	284.162	3/16
13/64	5.159	30.559	55.959	81.359	106.759	132.159	157.559	182.959	208.359	233.759	259.159	284.559	13/64
7/32	5.556	30.956	56.356	81.756	107.156	132.556	157.956	183.356	208.756	234.156	259.556	284.956	7/32
15/64	5.953	31.353	56.753	82.153	107.553	132.953	158.353	183.753	209.153	234.553	259.953	285.353	15/64
1/4	6.350	31.750	57.150	82.550	107.950	133.350	158.750	184.150	209.550	234.950	260.350	285.750	1/4
17/64	6.747	32.147	57.547	82.947	108.347	133.747	159.147	184.547	209.947	235.347	260.747	286.147	17/64
9/32	7.144	32.544	57.944	83.344	108.744	134.144	159.544	184.944	210.344	235.744	261.144	286.544	9/32
19/64	7.541	32.941	58.341	83.741	109.141	134.541	159.941	185.341	210.741	236.141	261.541	286.941	19/64
5/16	7.938	33.338	58.738	84.138	109.538	134.938	160.338	185.738	211.138	236.538	261.938	287.338	5/16
21/64	8.334	33.734	59.134	84.534	109.934	135.334	160.734	186.134	211.534	236.934	262.334	287.734	21/64
11/32	8.731	34.131	59.531	84.931	110.331	135.731	161.131	186.531	211.931	237.331	262.731	288.131	11/32
23/64	9.128	34.528	59.928	85.328	110.728	136.128	161.528	186.928	212.328	237.728	263.128	288.528	23/64
3/8	9.525	34.925	60.325	85.725	111.125	136.525	161.925	187.325	212.725	238.125	263.525	288.925	3/8
25/64	9.922	35.322	60.722	86.122	111.522	136.922	162.322	187.722	213.122	238.522	263.922	289.322	25/64
13/32	10.319	35.719	61.119	86.519	111.919	137.319	162.719	188.119	213.519	238.919	264.319	289.719	13/32
27/64	10.716	36.116	61.516	86.916	112.316	137.716	163.116	188.516	213.916	239.316	264.716	290.116	27/64
7/16	11.112	36.512	61.912	87.312	112.712	138.112	163.512	188.912	214.312	239.712	265.112	290.512	7/16
29/64	11.509	36.909	62.309	87.709	113.109	138.509	163.909	189.309	214.709	240.109	265.509	290.909	29/64
15/32	11.906	37.306	62.706	88.106	113.506	138.906	164.306	189.706	215.106	240.506	265.906	291.306	15/32
31/64	12.303	37.703	63.103	88.503	113.903	139.303	164.703	190.103	215.503	240.903	266.303	291.703	31/64
1/2	12.700	38.100	63.500	88.900	114.300	139.700	165.100	190.500	215.900	241.300	266.700	292.100	1/2
33/64	13.097	38.497	63.897	89.297	114.697	140.097	165.497	190.897	216.297	241.697	267.097	292.497	33/64
17/32	13.494	38.894	64.294	89.694	115.094	140.494	165.894	191.294	216.694	242.094	267.494	292.894	17/32
35/64	13.891	39.291	64.691	90.091	115.491	140.891	166.291	191.691	217.091	242.491	267.891	293.291	35/64
9/16	14.288	39.688	65.088	90.488	115.888	141.288	166.688	192.088	217.488	242.888	268.288	293.688	9/16
37/64	14.684	40.084	65.484	90.884	116.284	141.684	167.084	192.484	217.884	243.284	268.684	294.084	37/64
19/32	15.081	40.481	65.881	91.281	116.681	142.081	167.481	192.881	218.281	243.681	269.081	294.481	19/32
39/64	15.478	40.878	66.278	91.678	117.078	142.478	167.878	193.278	218.678	244.078	269.478	294.878	39/64
5/8	15.875	41.275	66.675	92.075	117.475	142.875	168.275	193.675	219.075	244.475	269.875	295.275	5/8
41/64	16.272	41.672	67.072	92.472	117.872	143.272	168.672	194.072	219.472	244.872	270.272	295.672	41/64
21/32	16.669	42.069	67.469	92.869	118.269	143.669	169.069	194.469	219.869	245.269	270.669	296.069	21/32
43/64	17.066	42.466	67.866	93.266	118.666	144.066	169.466	194.866	220.266	245.666	271.066	296.466	43/64
11/16	17.462	42.862	68.262	93.662	119.062	144.462	169.862	195.262	220.662	246.062	271.462	296.862	11/16
45/64	17.859	43.259	68.659	94.059	119.459	144.859	170.259	195.659	221.059	246.459	271.859	297.259	45/64
23/32	18.256	43.656	69.056	94.456	119.856	145.256	170.656	196.056	221.456	246.856	272.256	297.656	23/32
47/64	18.653	44.053	69.453	94.853	120.253	145.653	171.053	196.453	221.853	247.253	272.653	298.053	47/64
3/4	19.050	44.450	69.850	95.250	120.650	146.050	171.450	196.850	222.250	247.650	273.050	298.450	3/4
49/64	19.447	44.847	70.247	95.647	121.047	146.447	171.847	197.247	222.647	248.047	273.447	298.847	49/64
25/32	19.844	45.244	70.644	96.044	121.444	146.844	172.244	197.644	223.044	248.444	273.844	299.244	25/32
51/64	20.241	45.641	71.041	96.441	121.841	147.241	172.641	198.041	223.441	248.841	274.241	299.641	51/64
13/16	20.638	46.038	71.438	96.838	122.238	147.638	173.038	198.438	223.838	249.238	274.638	300.038	13/16
53/64	21.034	46.434	71.834	97.234	122.634	148.034	173.434	198.834	224.234	249.634	275.034	300.434	53/64
27/32	21.431	46.831	72.231	97.631	123.031	148.431	173.831	199.231	224.631	250.031	275.431	300.831	27/32
55/64	21.828	47.228	72.628	98.028	123.428	148.828	174.228	199.628	225.028	250.428	275.828	301.228	55/64
7/8	22.225	47.625	73.025	98.425	123.825	149.225	174.625	200.025	225.425	250.825	276.225	301.625	7/8
57/64	22.622	48.022	73.422	98.822	124.222	149.622	175.022	200.422	225.822	251.222	276.622	302.022	57/64
29/32	23.019	48.419	73.819	99.219	124.619	150.019	175.419	200.819	226.219	251.619	277.019	302.419	29/32
59/64	23.416	48.816	74.216	99.616	125.016	150.416	175.816	201.216	226.616	252.016	277.416	302.816	59/64
15/16	23.812	49.212	74.612	100.012	125.412	150.812	176.212	201.612	227.012	252.412	277.812	303.212	15/16
61/64	24.209	49.609	75.009	100.409	125.809	151.209	176.609	202.009	227.409	252.809	278.209	303.609	61/64
31/32	24.606	50.006	75.406	100.806	126.206	151.606	177.006	202.406	227.806	253.206	278.606	304.006	31/32
63/64	25.003	50.403	75.803	101.203	126.603	152.003	177.403	202.803	228.203	253.603	279.003	304.403	63/64







# Fractions to Decimals

Fraction	Decimal equivalent	Fraction	Decimal equivalent	Fractions						Decimal equivalent					
				1/2's	1/4's	8ths	16ths	32nds	64ths	(all figures are exact)					
1/2	0.5	1/32	0.031 25						1	0.015 625					
1/3	0.333 333	1/33	0.030 303					1	2	0.031 25					
1/4	0.25	1/34	0.029 412						3	0.046 875					
1/5	0.2	1/35	0.028 571				1	2	4	0.062 5					
1/6	0.166 667	1/36	0.027 778						5	0.078 125					
								3	6	0.093 75					
1/7	0.142 857	1/37	0.027 027						7	0.109 375					
1/8	0.125	1/38	0.026 316			1	2	4	8	0.125					
1/9	0.111 111	1/39	0.025 641												
1/10	0.1	1/40	0.025						9	0.140 625					
1/11	0.090 909	1/41	0.024 390					5	10	0.156 25					
									11	0.171 875					
1/12	0.083 333	1/42	0.023 810				3	6	12	0.187 5					
1/13	0.076 923	1/43	0.023 256						13	0.203 125					
1/14	0.071 429	1/44	0.022 727					7	14	0.218 75					
1/15	0.066 667	1/45	0.022 222						15	0.234 375					
1/16	0.062 5	1/46	0.021 739						16	0.25					
				1	2	4	8	8	16						
1/17	0.058 824	1/47	0.021 277						17	0.265 625					
1/18	0.055 556	1/48	0.020 833					9	18	0.281 25					
1/19	0.052 632	1/49	0.020 408						19	0.296 875					
1/20	0.05	1/50	0.02				5	10	20	0.312 5					
1/21	0.047 619	1/51	0.019 608						21	0.328 125					
								11	22	0.343 75					
1/22	0.045 455	1/52	0.019 231						23	0.359 375					
1/23	0.043 478	1/53	0.018 868			3	6	12	24	0.375					
1/24	0.041 667	1/54	0.018 519												
1/25	0.04	1/55	0.018 182						25	0.390 625					
1/26	0.038 462	1/56	0.017 857					13	26	0.406 25					
									27	0.421 875					
1/27	0.037 037	1/57	0.017 544				7	14	28	0.437 5					
1/28	0.035 714	1/58	0.017 241						29	0.453 125					
1/29	0.034 483	1/59	0.016 949					15	30	0.468 75					
1/30	0.033 333	1/60	0.016 667						31	0.484 375					
1/31	0.032 258			1	2	4	8	16	32	0.5					
									33	0.515 625					
									17	34	0.531 25				
									35	0.546 875					
								9	18	36	0.562 5				
									37	0.578 125					
									19	38	0.593 75				
									39	0.609 375					
									40	0.625					
						5	10	20	40						
									41	0.640 625					
									21	42	0.656 25				
									43	0.671 875					
								11	22	44	0.687 5				
									45	0.703 125					
									23	46	0.718 75				
									47	0.734 375					
									48	0.75					
									49	0.765 625					
									25	50	0.781 25				
									51	0.796 875					
								13	26	52	0.812 5				
									53	0.828 125					
									27	54	0.843 75				
									55	0.859 375					
									56	0.875					
						7	14	28	56						
									57	0.890 625					
									29	58	0.906 25				
									59	0.921 875					
									15	30	60	0.937 5			
									31	61	0.953 125				
									62	0.968 75					
									63	0.984 375					
									64	1					
									2	4	8	16	32	64	1

Note. For the decimal equivalent of other fractions with 1 as numerator, and a number from 0.01 to 100.9 as denominator, see reciprocals, pages 144-147.

Triangulation is an application of the principles of trigonometry to the calculation of inaccessible lines and angles.

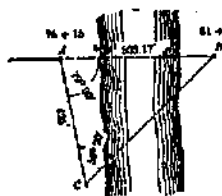

FIG. 1.

A common occasion for its use is illustrated in Fig. 1, where the line of survey crosses a stream too wide and deep for actual measurement. Set two points  $A$  and  $B$  on line, one on each side of the stream. Estimate roughly the distance  $AB$ . Suppose the estimate is 425 ft. Set another point  $C$ , making the distance  $AC$  equal to the estimated distance  $AB = 425$  ft. Set the transit at  $A$  and measure the angle  $BAC =$  say,  $79^\circ 00'$ . Next set up at the point  $C$  and measure the angle  $ACB =$  say,  $56^\circ 20'$ . The angle  $ABC$  is then determined by subtracting the sum of the angles  $A$  and  $C$  from  $180^\circ$ ; thus,  $79^\circ 00' + 56^\circ 20' = 135^\circ 20'$ ;  $180^\circ 00' - 135^\circ 20' = 44^\circ 40' =$  the angle  $ABC$ . We now have a side and three angles of a triangle given, to find the other two sides  $AB$  and  $CB$ . In trigonometry, it is demonstrated that, in any triangle the sines of the angles are proportional to the lengths of the sides opposite to them. In other words,  $\sin A : \sin B = BC : AC$ ; or,  $\sin A : \sin C = BC : AB$ , and  $\sin B : \sin C = AC : AB$ .

Hence, we have  $\sin 44^\circ 40' : \sin 56^\circ 20' = 425 : \text{side } AB$ ;

$$\sin 56^\circ 20' = .83228;$$

$$.83228 \times 425 = 353.719;$$

$$\sin 44^\circ 40' = .70298;$$

$$353.719 \div .70298 = 503.17 \text{ ft.} = \text{side } AB.$$

Adding this distance to  $76 + 15$ , the station of the point  $A$ , we have  $81 + 18.17$ , the station at  $B$ .

Another case is the following: Two tangents,  $AB$  and  $CD$  (see Fig. 2), which are to be united by a curve, meet at some inaccessible point  $E$ . Tangents are the straight portions of a

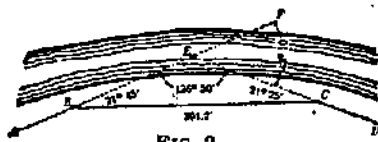

FIG. 2.

line of railroad. The angle  $CEF$ , which the tangents make with each other, and the distances  $BE$  and  $CE$  are required. Two points  $A$  and  $B$  of the tangent  $AB$ , and two points  $C$  and  $D$  of the tangent  $CD$ , being carefully located, set the transit at  $B$ , and backsighting to  $A$ , measure the angle  $EB C = 21^\circ 45'$ ; set up at  $C$ , and, backsighting to  $D$ , measure the angle  $EC B = 21^\circ 25'$ . Measure the side  $BC = 304.2$  ft.

Angle  $CE F$  being an exterior angle of triangle  $EBC$  equals sum of  $EB C$  and  $EC B = 21^\circ 45' + 21^\circ 25' = 43^\circ 10'$ ; angle  $BE C = 180^\circ - CEF = 136^\circ 50'$ . From trigonometry, we have:

$$\sin 136^\circ 50' : \sin 21^\circ 45' = 304.2 \text{ ft.} : CE;$$

$$\sin 21^\circ 45' = .37056;$$

$$.37056 \times 304.2 = 112.724352;$$

$$\sin 136^\circ 50' = .68412;$$

$$\text{side } CE = 112.724352 \div .68412 = 164.77 \text{ ft.}$$

Again, we find  $BE$  by the following proportion:

$$\sin 136^\circ 50' : \sin 21^\circ 25' = 304.2 : \text{side } BE;$$

$$\sin 21^\circ 25' = .36515;$$

$$.36515 \times 304.2 = 111.07863;$$

$$\sin 136^\circ 50' = .68412;$$

$$\text{side } BE = 111.07863 \div .68412 = 162.36 \text{ ft.}$$

A building  $H$ , Fig. 3, lies directly in the path of the line  $AB$ , which must be produced beyond  $H$ . Set a plug at  $B$ , and then turn an angle  $DBC = 60^\circ$ . Set a plug at  $C$  in the

line  $BC$ , at a suitable distance from  $B$ , say, 150 ft. Set up at  $C$ , and turn an angle  $BCD = 60^\circ$ , and set a plug at  $D$ , 150 ft. from  $C$ . The point  $D$  will be in the prolongation of  $AB$ . Then, set up at  $D$ , and backsighting to  $C$ , turn the angle  $CD D' = 120^\circ$ .  $DD'$  will be the line

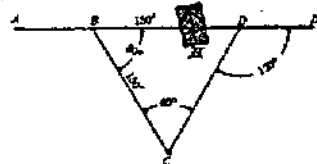

FIG. 3.

required, and the distance  $BD$  will be 150 ft., since  $BCD$  is an equilateral triangle.

$AB$  and  $CD$ , Fig. 4, are tangents intersecting at some inaccessible point  $H$ . The line  $AB$  crosses a dock  $OP$ , too wide for direct measurement, and the wharf  $LM$ .  $F$  is a point on the line  $AB$  at the wharf crossing. It is required to find the distance  $BH$  and the angle  $FHG$ . At  $B$ , an angle of  $103^\circ 30'$  is turned to the left and the point  $E$  set 217' from  $B$  = to the estimated distance  $BF$ . Setting up at  $E$ , the angle  $BE F$  is found to be  $39^\circ 00'$ .

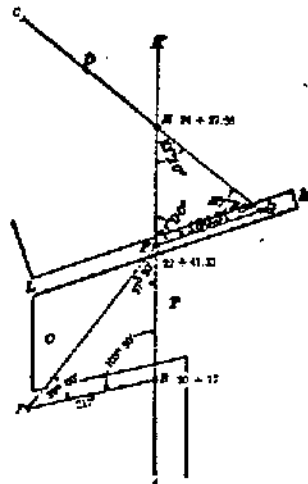

FIG. 4.

Whence, we find the angle

$$BFE = 180^\circ - (103^\circ 30' + 89^\circ) = 37^\circ 30'.$$

From trigonometry, we have

$$\sin 37^\circ 30' : \sin 39^\circ 00' = 217 \text{ ft.} : \text{side } BF;$$

$$\sin 39^\circ 00' = .62932;$$

$$.62932 \times 217 = 136.56244;$$

$$\sin 37^\circ 30' = .60876;$$

$$\text{side } BF = 136.56244 \div .60876 = 224.33 \text{ ft.}$$

Whence, we find station  $F$  to be  $20 + 17 + 224.33 = 22 + 41.33$ . Set up at  $F$  and turn an angle  $HFG = 71^\circ 00'$  and set up at a point  $G$  where the line  $CD$  prolonged intersects  $FG$ . Measure the angle  $FGH = 57^\circ 50'$ , and the side  $FG = 180.3$ . The angle  $FHG = 180^\circ - (71^\circ + 57^\circ 50') = 51^\circ 10'$ . From trigonometry we have

$$\sin 51^\circ 10' : \sin 57^\circ 50' = 180.3 : \text{side } FH.$$

$\sin 57^\circ 50' = .84650$ ;  $.84650 \times 180.3 = 152.62395$ ;  $\sin 51^\circ 10' = .77897$ ; side  $FH = 152.62395 \div .77897 = 195.93$  ft.; whence we find station  $H$  to be  $24 + 37.26$ .

X	0'	8'	12'	18'	24'	30'	36'	42'	48'	54'	Δ	ADD				
	0°·0	0°·1	0°·2	0°·3	0°·4	0°·5	0°·6	0°·7	0°·8	0°·9		1'	2'	3'	4'	5'
	0°	0·0000	0017	0035	0052	0070	0087	0105	0122	0140		0157	18	3	6	9
1	·0175	0192	0209	0227	0244	0262	0279	0297	0314	0332		3	6	9	12	15
2	·0349	0366	0384	0401	0419	0436	0454	0471	0488	0506		3	6	9	12	15
3	·0523	0541	0558	0576	0593	0610	0628	0645	0663	0680		3	6	9	12	15
4	·0698	0715	0732	0750	0767	0785	0802	0819	0837	0854		3	6	9	12	14
5	0·0872	0889	0906	0924	0941	0958	0976	0993	1011	1028		3	6	9	12	14
6	·1045	1063	1080	1097	1115	1132	1149	1167	1184	1201		3	6	9	12	14
7	·1219	1236	1253	1271	1288	1305	1323	1340	1357	1374		3	6	9	12	14
8	·1392	1409	1426	1444	1461	1478	1495	1513	1530	1547		3	6	9	11	14
9	·1564	1582	1599	1616	1633	1650	1668	1685	1702	1719		3	6	9	11	14
10	0·1736	1754	1771	1788	1805	1822	1840	1857	1874	1891		3	6	9	11	14
11	·1908	1925	1942	1959	1977	1994	2011	2028	2045	2062		3	6	9	11	14
12	·2079	2096	2113	2130	2147	2164	2181	2198	2215	2233	17	3	6	9	11	14
13	·2250	2267	2284	2300	2317	2334	2351	2368	2385	2402		3	6	8	11	14
14	·2419	2436	2453	2470	2487	2504	2521	2538	2554	2571		3	6	8	11	14
15	0·2588	2605	2622	2639	2656	2672	2689	2706	2723	2740		3	6	8	11	14
16	·2756	2773	2790	2807	2823	2840	2857	2874	2890	2907		3	6	8	11	14
17	·2924	2940	2957	2974	2990	3007	3024	3040	3057	3074		3	6	8	11	14
18	·3090	3107	3123	3140	3156	3173	3190	3206	3223	3239		3	6	8	11	14
19	·3256	3272	3289	3305	3322	3338	3355	3371	3387	3404		3	5	8	11	14
20	0·3420	3437	3453	3469	3486	3502	3518	3535	3551	3567		3	5	8	11	14
21	·3684	3600	3616	3633	3649	3665	3681	3697	3714	3730		3	5	8	11	14
22	·3746	3762	3778	3795	3811	3827	3843	3859	3875	3891		3	5	8	11	13
23	·3907	3923	3939	3955	3971	3987	4003	4019	4035	4051	16	3	5	8	11	13
24	·4067	4083	4099	4115	4131	4147	4163	4179	4195	4210		3	5	8	11	13
25	0·4226	4242	4258	4274	4289	4305	4321	4337	4352	4368		3	5	8	11	13
26	·4384	4399	4415	4431	4446	4462	4478	4493	4509	4524		3	5	8	10	13
27	·4540	4555	4571	4586	4602	4617	4633	4648	4664	4679		3	5	8	10	13
28	·4695	4710	4726	4741	4756	4772	4787	4802	4818	4833		3	5	8	10	13
29	·4848	4863	4879	4894	4909	4924	4939	4955	4970	4985		3	5	8	10	13
30	0·5000	5015	5030	5045	5060	5075	5090	5105	5120	5135	15	3	5	8	10	13
31	·5150	5165	5180	5195	5210	5225	5240	5255	5270	5284		2	5	7	10	12
32	·5299	5314	5329	5344	5358	5373	5388	5402	5417	5432		2	5	7	10	12
33	·5446	5461	5476	5490	5505	5519	5534	5548	5563	5577		2	5	7	10	12
34	·5592	5606	5621	5635	5650	5664	5678	5693	5707	5721		2	5	7	10	12
35	0·5736	5750	5764	5779	5793	5807	5821	5835	5850	5864		2	5	7	9	12
36	·5878	5892	5906	5920	5934	5948	5962	5976	5990	6004	14	2	5	7	9	12
37	·6018	6032	6046	6060	6074	6088	6101	6115	6129	6143		2	5	7	9	12
38	·6157	6170	6184	6198	6211	6225	6239	6252	6266	6280		2	5	7	9	11
39	·6293	6307	6320	6334	6347	6361	6374	6388	6401	6414		2	4	7	9	11
40	0·6428	6441	6455	6468	6481	6494	6508	6521	6534	6547		2	4	7	9	11
41	·6561	6574	6587	6600	6613	6626	6639	6652	6665	6678	13	2	4	7	9	11
42	·6691	6704	6717	6730	6743	6756	6769	6782	6794	6807		2	4	6	9	11
43	·6820	6833	6845	6858	6871	6884	6896	6909	6921	6934		2	4	6	8	11
44	·6947	6959	6972	6984	6997	7009	7022	7034	7046	7059		2	4	6	8	10
45	0·7071	7083	7096	7108	7120	7133	7145	7157	7169	7181		2	4	6	8	10
46	·7193	7206	7218	7230	7242	7254	7266	7278	7290	7302	12	2	4	6	8	10
47	·7314	7325	7337	7349	7361	7373	7385	7396	7408	7420		2	4	6	8	10
48	·7431	7443	7455	7466	7478	7490	7501	7513	7524	7536		2	4	6	8	10
49	0·7547	7559	7570	7581	7593	7604	7615	7627	7638	7649		2	4	6	8	9

X	0'	6'	12'	18'	24'	30'	36'	42'	48'	54'	Δ	ADD					
	0°-0	0°-1	0°-2	0°-3	0°-4	0°-5	0°-6	0°-7	0°-8	0°-9		1'	2'	3'	4'	5'	
	50°	0.7660	7672	7683	7694	7705	7716	7727	7738	7749		7760	11	2	4	6	7
51	.7771	7782	7793	7804	7815	7826	7837	7848	7859	7869	2	4		5	7	9	
52	.7880	7891	7902	7912	7923	7934	7944	7955	7965	7976	2	4		5	7	9	
53	.7986	7997	8007	8018	8028	8039	8049	8059	8070	8080	2	3		5	7	9	
54	.8090	8100	8111	8121	8131	8141	8151	8161	8171	8181	10	2	3	5	7	8	
55	0.8192	8202	8211	8221	8231	8241	8251	8261	8271	8281		2	3	5	7	8	
56	.8290	8300	8310	8320	8329	8339	8348	8358	8368	8377		2	3	5	6	8	
57	.8387	8396	8406	8415	8425	8434	8443	8453	8462	8471		2	3	5	6	8	
58	.8480	8490	8499	8508	8517	8526	8536	8545	8554	8563	9	2	3	5	6	8	
59	.8572	8581	8590	8599	8607	8616	8625	8634	8643	8652		1	3	4	6	7	
60	0.8660	8669	8678	8686	8695	8704	8712	8721	8729	8738		1	3	4	6	7	
61	.8746	8755	8763	8771	8780	8788	8796	8805	8813	8821		1	3	4	6	7	
62	.8829	8838	8846	8854	8862	8870	8878	8886	8894	8902	8	1	3	4	5	7	
63	.8910	8918	8926	8934	8942	8949	8957	8965	8973	8980		1	3	4	5	6	
64	.8988	8996	9003	9011	9018	9026	9033	9041	9048	9056		1	3	4	5	6	
65	0.9063	9070	9078	9085	9092	9100	9107	9114	9121	9128		1	2	4	5	6	
66	.9135	9143	9150	9157	9164	9171	9178	9184	9191	9198	7	1	2	4	6	7	
67	.9205	9212	9219	9225	9232	9239	9245	9252	9259	9265		1	2	3	4	6	
68	.9272	9278	9285	9291	9298	9304	9311	9317	9323	9330		1	2	3	4	5	
69	.9336	9342	9348	9354	9361	9367	9373	9379	9385	9391		6	1	2	3	4	5
70	0.9397	9403	9409	9415	9421	9426	9432	9438	9444	9449	6	1	2	3	4	5	
71	.9455	9461	9466	9472	9478	9483	9489	9494	9500	9505		1	2	3	4	5	
72	.9511	9516	9521	9527	9532	9537	9542	9548	9553	9558		1	2	3	4	5	
73	.9563	9568	9573	9578	9583	9588	9593	9598	9603	9608		5	1	2	2	3	4
74	.9613	9617	9622	9627	9632	9636	9641	9646	9650	9655	1		2	2	3	4	
75	0.9659	9664	9668	9673	9677	9681	9686	9690	9694	9699	4		1	1	2	3	4
76	.9703	9707	9711	9715	9720	9724	9728	9732	9736	9740	1		1	2	2	3	3
77	.9744	9748	9751	9755	9769	9763	9767	9770	9774	9778	4	1	1	2	3	3	
78	.9781	9785	9789	9792	9796	9799	9803	9806	9810	9813		1	1	2	2	3	3
79	.9816	9820	9823	9826	9829	9833	9836	9839	9842	9845		1	1	2	2	3	3
80	0.9848	9851	9854	9857	9860	9863	9866	9869	9871	9874		3	0	1	1	2	2
81	.9877	9880	9882	9885	9888	9890	9893	9895	9898	9900	0		1	1	2	2	
82	.9903	9905	9907	9910	9912	9914	9917	9919	9921	9923	0		1	1	1	2	
83	.9925	9928	9930	9932	9934	9936	9938	9940	9942	9943	2		0	1	1	1	2
84	.9945	9947	9949	9951	9952	9954	9956	9957	9959	9960		0	1	1	1	1	
85	0.9962	9963	9965	9966	9968	9969	9971	9972	9973	9974		1	0	0	1	1	1
86	.9976	9977	9978	9979	9980	9981	9982	9983	9984	9985			0	0	1	1	1
87	.9986	9987	9988	9989	9990	9990	9991	9992	9993	9993	See Table below.						
88	.9994	9995	9995	9996	9996	9997	9997	9997	9998	9998							
89	0.9998	9999	9999	9999	9999	1.000	1.000	1.000	1.000	1.000							
90	1.0000																

Sines of Angles near 90°

86 48	↙	0.9985	↘	86-80	87 46	↙	0.9993	↘	87-7
86 54	↙	0.9986	↘	86-91	87 56	↙	0.9994	↘	87-9
87 01	↙	0.9987	↘	87-02	88 05	↙	0.9995	↘	88-0
87 09	↙	0.9988	↘	87-13	88 16	↙	0.9996	↘	88-2
87 15	↙	0.9989	↘	87-25	88 29	↙	0.9997	↘	88-4
87 22	↙	0.9990	↘	87-37	88 43	↙	0.9998	↘	88-7
87 30	↙	0.9991	↘	87-50	89 00	↙	0.9999	↘	89-0
87 38	↙	0.9992	↘	87-63	89 25	↙	1.0000	↘	89-4
87 46	↙	0.9992	↘	87-78	90 00	↙	1.0000	↘	90-0

The values in the centre columns represent the sines for all angles lying between the successive ranges shown in the outer columns. Thus sin 87° 20' is 0.9989. For inverse use, the best angle for a given sine is the one lying midway between the adjacent ranges; if the difference is odd, choose the angle nearer 90°. Thus if sin x = 0.9988, x = 87° 12'.

For tabulated angles read the sine value in the half-line above; e.g., sin 87° 38' = 0.9991.

x	0'	5'	12'	18'	24'	30'	36'	42'	48'	54'	$\Delta$	SUBTRACT				
	0°-0	0°-1	0°-2	0°-3	0°-4	0°-5	0°-6	0°-7	0°-8	0°-9		1'	2'	3'	4'	5'
0°	1.000	1.000	1.000	1.000	1.000	1.000	0.9999	0.9999	0.9999	0.9999		See table at foot of page.				
1	0.9998	9998	9998	9997	9997	9997	9996	9996	9995	9995						
2	9994	9993	9993	9992	9991	9990	9990	9989	9988	9987						
3	9986	9985	9984	9983	9982	9981	9980	9979	9978	9977	1	0	0	1	1	1
4	9976	9974	9973	9972	9971	9969	9968	9966	9965	9963		0	0	1	1	1
5	0.9962	9960	9959	9957	9956	9954	9952	9951	9949	9947		0	1	1	1	1
6	9945	9943	9942	9940	9938	9936	9934	9932	9930	9928	2	0	1	1	1	2
7	9925	9923	9921	9919	9917	9914	9912	9910	9907	9905		0	1	1	1	2
8	9903	9900	9898	9895	9893	9890	9888	9885	9882	9880		0	1	1	2	2
9	9877	9874	9871	9869	9866	9863	9860	9857	9854	9851	3	0	1	1	2	2
10	0.9848	9845	9842	9839	9836	9833	9829	9826	9823	9820		1	1	2	2	3
11	9816	9813	9810	9806	9803	9799	9796	9792	9789	9785		1	1	2	2	3
12	9781	9778	9774	9770	9767	9763	9759	9755	9751	9748		1	1	2	2	3
13	9744	9740	9736	9732	9728	9724	9720	9715	9711	9707	4	1	1	2	3	3
14	9703	9699	9694	9690	9686	9681	9677	9673	9668	9664		1	1	2	3	4
15	0.9659	9655	9650	9646	9641	9636	9632	9627	9622	9617		1	2	2	3	4
16	9613	9608	9603	9598	9593	9588	9583	9578	9573	9568	5	1	2	2	3	4
17	9563	9558	9553	9548	9542	9537	9532	9527	9521	9516		1	2	3	3	4
18	9511	9505	9500	9494	9489	9483	9478	9472	9466	9461		1	2	3	4	5
19	9455	9449	9444	9438	9432	9426	9421	9415	9409	9403		1	2	3	4	5
20	0.9397	9391	9385	9379	9373	9367	9361	9354	9348	9342	6	1	2	3	4	5
21	9336	9330	9323	9317	9311	9304	9298	9291	9285	9278		1	2	3	4	5
22	9272	9265	9259	9252	9245	9239	9232	9225	9219	9212		1	2	3	4	6
23	9205	9198	9191	9184	9178	9171	9164	9157	9150	9143	7	1	2	4	5	6
24	9135	9128	9121	9114	9107	9100	9092	9085	9078	9070		1	2	4	5	6
25	0.9063	9056	9048	9041	9033	9026	9018	9011	9003	8996		1	3	4	5	6
26	8988	8980	8973	8965	8957	8949	8942	8934	8926	8918		1	3	4	5	6
27	8910	8902	8894	8886	8878	8870	8862	8854	8846	8838	8	1	3	4	5	7
28	8829	8821	8813	8805	8796	8788	8780	8771	8763	8755		1	3	4	6	7
29	8746	8738	8729	8721	8712	8704	8695	8686	8678	8669		1	3	4	6	7
30	0.8660	8652	8643	8634	8625	8616	8607	8599	8590	8581		1	3	4	6	7
31	8572	8563	8554	8545	8536	8526	8517	8508	8499	8490	9	2	3	5	6	8
32	8480	8471	8462	8453	8443	8434	8425	8415	8406	8396		2	3	5	6	8
33	8387	8377	8368	8358	8348	8339	8329	8320	8310	8300		2	3	5	6	8
34	8290	8281	8271	8261	8251	8241	8231	8221	8211	8202		2	3	5	7	8
35	0.8192	8181	8171	8161	8151	8141	8131	8121	8111	8100	10	2	3	5	7	8
36	8090	8080	8070	8059	8049	8039	8028	8018	8007	7997		2	3	5	7	9
37	7986	7976	7965	7955	7944	7934	7923	7912	7902	7891		2	4	5	7	9
38	7880	7869	7859	7848	7837	7826	7815	7804	7793	7782	11	2	4	5	7	9
39	0.7771	7760	7749	7738	7727	7716	7705	7694	7683	7672		2	4	6	7	9

## Cosines of Small Angles

cosine	cosine	cosine	cosine
0 00	1.0000	0 0	2 13
0 34	0.9999	0 5	2 21
0 59	0.9998	0 9	2 29
1 16	0.9997	1 2	2 37
1 30	0.9996	1 5	2 44
1 43	0.9995	1 7	2 51
1 54	0.9994	1 9	2 58
2 03	0.9993	2 0	3 05
2 13	0.9993	2 2	3 11
			0.9992
			0.9991
			0.9990
			0.9989
			0.9988
			0.9987
			0.9986
			0.9985
			0.9984
			0.9983
			0.9982
			0.9981
			0.9980
			0.9979
			0.9978
			0.9977
			0.9976
			0.9975
			0.9974
			0.9973
			0.9972
			0.9971
			0.9970
			0.9969
			0.9968
			0.9967
			0.9966
			0.9965
			0.9964
			0.9963
			0.9962
			0.9961
			0.9960
			0.9959
			0.9958
			0.9957
			0.9956
			0.9955
			0.9954
			0.9953
			0.9952
			0.9951
			0.9950
			0.9949
			0.9948
			0.9947
			0.9946
			0.9945
			0.9944
			0.9943
			0.9942
			0.9941
			0.9940
			0.9939
			0.9938
			0.9937
			0.9936
			0.9935
			0.9934
			0.9933
			0.9932
			0.9931
			0.9930
			0.9929
			0.9928
			0.9927
			0.9926
			0.9925
			0.9924
			0.9923
			0.9922
			0.9921
			0.9920
			0.9919
			0.9918
			0.9917
			0.9916
			0.9915
			0.9914
			0.9913
			0.9912
			0.9911
			0.9910
			0.9909
			0.9908
			0.9907
			0.9906
			0.9905
			0.9904
			0.9903
			0.9902
			0.9901
			0.9900
			0.9899
			0.9898
			0.9897
			0.9896
			0.9895
			0.9894
			0.9893
			0.9892
			0.9891
			0.9890
			0.9889
			0.9888
			0.9887
			0.9886
			0.9885
			0.9884
			0.9883
			0.9882
			0.9881
			0.9880
			0.9879
			0.9878
			0.9877
			0.9876
			0.9875
			0.9874
			0.9873
			0.9872
			0.9871
			0.9870
			0.9869
			0.9868
			0.9867
			0.9866
			0.9865
			0.9864
			0.9863
			0.9862
			0.9861
			0.9860
			0.9859
			0.9858
			0.9857
			0.9856
			0.9855
			0.9854
			0.9853
			0.9852
			0.9851
			0.9850
			0.9849
			0.9848
			0.9847
			0.9846
			0.9845
			0.9844
			0.9843
			0.9842
			0.9841
			0.9840
			0.9839



x	0'	6'	12'	18'	24'	30'	36'	42'	48'	54'	Δ	ADD					
	0°-0	0°-1	0°-2	0°-3	0°-4	0°-5	0°-6	0°-7	0°-8	0°-9		1'	2'	3'	4'	5'	
0	0-0000	0017	0035	0052	0070	0087	0105	0122	0140	0157	18	3	6	9	12	15	
1	-0175	0192	0209	0227	0244	0262	0279	0297	0314	0332		3	6	9	12	15	
2	-0349	0367	0384	0402	0419	0437	0454	0472	0489	0507		3	6	9	12	15	
3	-0524	0542	0559	0577	0594	0612	0629	0647	0664	0682		3	6	9	12	15	
4	-0699	0717	0734	0752	0769	0787	0805	0822	0840	0857		3	6	9	12	15	
5	0-0875	0892	0910	0928	0945	0963	0981	0998	1016	1033	19	3	6	9	12	15	
6	-1051	1069	1086	1104	1122	1139	1157	1175	1192	1210		3	6	9	12	15	
7	-1228	1246	1263	1281	1299	1317	1334	1352	1370	1388		3	6	9	12	15	
8	-1405	1423	1441	1459	1477	1495	1512	1530	1548	1566		3	6	9	12	15	
9	-1584	1602	1620	1638	1655	1673	1691	1709	1727	1745		3	6	9	12	15	
10	0-1763	1781	1799	1817	1835	1853	1871	1890	1908	1926	20	3	6	9	12	15	
11	-1944	1962	1980	1998	2016	2035	2053	2071	2089	2107		3	6	9	12	15	
12	-2126	2144	2162	2180	2199	2217	2235	2254	2272	2290		3	6	9	12	15	
13	-2309	2327	2345	2364	2382	2401	2419	2438	2456	2475		3	6	9	12	15	
14	-2493	2512	2530	2549	2568	2586	2605	2623	2642	2661		3	6	9	12	16	
15	0-2679	2698	2717	2736	2754	2773	2792	2811	2830	2849	19	3	6	9	13	16	
16	-2867	2886	2905	2924	2943	2962	2981	3000	3019	3038		3	6	10	13	16	
17	-3057	3076	3096	3115	3134	3153	3172	3191	3211	3230		3	6	10	13	16	
18	-3249	3269	3288	3307	3327	3346	3365	3385	3404	3424		3	6	10	13	16	
19	-3443	3463	3482	3502	3522	3541	3561	3581	3600	3620		3	7	10	13	16	
20	0-3640	3659	3679	3699	3719	3739	3759	3779	3799	3819	20	3	7	10	13	17	
21	-3839	3859	3879	3899	3919	3939	3959	3979	4000	4020		3	7	10	13	17	
22	-4040	4061	4081	4101	4122	4142	4163	4183	4204	4224		3	7	10	14	17	
23	-4245	4265	4286	4307	4327	4348	4369	4390	4411	4431		3	7	10	14	17	
24	-4452	4473	4494	4515	4536	4557	4578	4599	4621	4642	21	4	7	11	14	18	
25	0-4663	4684	4706	4727	4748	4770	4791	4813	4834	4856	22	4	7	11	14	18	
26	-4877	4899	4921	4942	4964	4986	5008	5029	5051	5073		4	7	11	15	18	
27	-5095	5117	5139	5161	5184	5206	5228	5250	5272	5295		4	7	11	15	18	
28	-5317	5340	5362	5384	5407	5430	5452	5475	5498	5520		4	8	11	15	19	
29	-5543	5566	5589	5612	5635	5658	5681	6704	5727	5750	23	4	8	12	15	19	
30	0-5774	5797	5820	5844	5867	5890	5914	5938	5961	5985	24	4	8	12	16	20	
31	-6009	6032	6056	6080	6104	6128	6152	6176	6200	6224		4	8	12	16	20	
32	-6249	6273	6297	6322	6346	6371	6395	6420	6445	6469		4	8	12	16	20	
33	-6494	6519	6544	6569	6594	6619	6644	6669	6694	6720		25	4	8	13	17	21
34	-6745	6771	6796	6822	6847	6873	6899	6924	6950	6976		4	9	13	17	21	
35	0-7002	7028	7054	7080	7107	7133	7159	7186	7212	7239	26	4	9	13	17	22	
36	-7266	7292	7319	7346	7373	7400	7427	7454	7481	7508		27	5	9	14	18	23
37	-7536	7563	7590	7618	7646	7673	7701	7729	7757	7785		28	5	9	14	19	23
38	-7813	7841	7869	7898	7926	7954	7983	8012	8040	8069			5	10	14	19	24
39	-8098	8127	8156	8185	8214	8243	8273	8302	8332	8361	29	5	10	15	19	24	
40	0-8391	8421	8451	8481	8511	8541	8571	8601	8632	8662	30	5	10	15	20	25	
41	-8693	8724	8754	8785	8816	8847	8878	8910	8941	8972		31	5	10	16	21	26
42	-9004	9036	9067	9099	9131	9163	9195	9228	9260	9293		32	5	11	16	21	27
43	-9325	9358	9391	9424	9457	9490	9523	9556	9590	9623		33	6	11	17	22	28
44	-9657	9691	9725	9759	9793	9827	9861	9896	9930	9965	34	6	11	17	23	28	
45	1-0000	0035	0070	0105	0141	0176	0212	0247	0283	0319	36	6	12	18	24	30	
46	-0355	0392	0428	0464	0501	0538	0575	0612	0649	0686		37	6	12	18	25	31
47	-0724	0761	0799	0837	0875	0913	0951	0990	1028	1067		38	6	13	19	25	32
48	-1106	1145	1184	1224	1263	1303	1343	1383	1423	1463		40	7	13	20	27	33
49	1-1504	1544	1585	1626	1667	1708		1792	1833	1875	42	7	14	21	28	35	



## NATURAL TANGENTS

19

X	0'	8'	12'	18'	24'	30'	36'	42'	48'	54'	Δ	ADD				
	0°-0	0°-1	0°-2	0°-3	0°-4	0°-5	0°-6	0°-7	0°-8	0°-9		1'	2'	3'	4'	5'
	50°	1-192	196	200	205	209	213	217	222	226		230	5	1	1	2
51	-235	239	244	248	253	257	262	266	271	275		1	2	2	3	4
52	-280	285	289	294	299	303	308	313	317	322		1	2	2	3	4
53	-327	332	337	342	347	351	356	361	366	371		1	2	2	3	4
54	-376	381	387	392	397	402	407	412	418	423	5	1	2	2	3	4
55	1-428	433	439	444	450	455	460	466	471	477		1	2	3	4	5
56	-483	488	494	499	505	511	517	522	528	534		1	2	3	4	5
57	-540	546	552	558	564	570	576	582	588	594	6	1	2	3	4	5
58	-600	607	613	619	625	632	638	645	651	658		1	2	3	4	5
59	-664	671	678	684	691	698	704	711	718	725		1	2	3	5	6
60	1-732	739	746	753	760	767	775	782	789	797	7	1	2	4	5	6
61	-804	811	819	827	834	842	849	857	865	873		1	3	4	5	6
62	-881	889	897	905	913	921	929	937	946	954	8	1	3	4	5	7
63	1-963	971	980	988	1-997	2-006	2-014	2-023	2-032	2-041		1	3	4	6	7
64	2-050	059	069	078	087	097	106	116	125	135	9	2	3	5	6	8
65	2-145	154	164	174	184	194	204	215	225	236	10	2	3	5	7	8
66	-246	257	267	278	289	300	311	322	333	344	11	2	4	6	7	9
67	-356	367	379	391	402	414	426	438	450	463	12	2	4	6	8	10
68	-475	488	500	513	526	539	552	565	578	592	13	2	4	6	9	11
69	-605	619	633	646	660	675	689	703	718	733	14	2	5	7	9	12
70	2-747	762	778	793	808	824	840	856	872	888	16	3	5	8	11	13
71	2-904	921	937	954	971	2-989	3-006	3-024	3-042	3-060	17	3	6	9	11	14
72	3-078	096	115	133	152	3-172	191	211	230	251	19	3	6	9	13	16
73	-271	291	312	333	354	376	398	420	442	465	21	4	7	10	14	18
74	-487	511	534	558	582	606	630	655	681	706	22	4	7	11	15	18
75	3-732	758	785	812	839	867	895	923	952	981	24	4	8	12	16	20
76	4-011	041	071	102	134	4-165	198	230	264	297	27	4	9	14	18	22
77	4-331	366	402	437	474	511	548	586	625	665	29	5	10	14	19	24
78	4-705	745	787	829	872	4-915	4-959	5-005	5-050	5-097	31	6	11	17	22	28
79	5-145	193	242	292	343	5-396	396	449	503	558	33	6	12	18	24	30
80	5-671	5-730	5-789	5-850	5-912	5-976	6-041	6-107	6-174	6-243	36	7	14	21	28	35
81	6-314	6-386	6-460	6-535	6-612	6-691	6-772	6-855	6-940	7-026	39	7	14	21	28	35
82	7-115	7-207	7-300	7-396	7-495	7-596	7-700	7-806	7-916	8-028	42	8	15	23	31	38
83	8-144	8-264	8-386	8-513	8-643	8-777	8-915	9-058	9-205	9-357	46	8	17	26	33	42
84	9-514	9-677	9-845	10-02	10-20	10-39	10-58	10-78	10-99	11-20	50	9	18	28	37	46
85	11-43	11-66	11-91	12-16	12-43	12-71	13-00	13-30	13-62	13-95	55	10	20	30	41	51
86	14-30	14-67	15-06	15-46	15-89	16-35	16-83	17-34	17-89	18-46		11	23	34	45	56
87	19-08	19-74	20-45	21-20	22-02	22-90	23-86	24-90	26-03	27-27		13	25	38	50	63
88	28-64	30-14	31-82	33-69	35-80	38-19	40-92	44-07	47-74	52-08		14	28	42	57	71
89	57-29	63-66	71-62	81-85	95-49	114-6	143-2	191-0	286-5	573-0						
90	∞															

Differences vary too rapidly for interpolation by P.P.s. See table on page 22.

P.P.s for differences exceeding 14, if not shown on this page, should be taken from the inside end cover of the book. For angles between 72° and 82° P.P.s based on actual differences should be used.

**B: ENERGY. #**

**Solar:**

- A: Solenergi. / Sunshine Revolution [book, - video also available]. - Harald N. Røstvik, Stavanger Norway/USA 1991 82-91052-01-8 / 82-91052-03-04 / Video - 82-91052-02-6
- B: Practical Photovoltaics. E.J. Komp, Antec Pub. Ann Arbor Mich, USA 1981/82 0-937948-02-0
- C: Strom aus der Sonne. Bernhard Krieg, Blektor Verlag Aachen Germany 1992 3-928051-05-9
- D: Sol.tech.3-7723-7792-0/Sol.anlag.3-7723-4452-6/Sol.energ.3-7723-7932-X Hannus, Franzis' De.
- E: Thermische Solarnergie. Müller, Franzis' Verlag 85622 Germany [De.] 1997 3-7723-4622-7
- F: Compendium in Solar-cookers & Food-dryers. J. Furze 1996
- 1: SolEnergiCenter Denmark Tel: +45 43 50 43 50 E-mail - www.solenergi.dk
- 2: EDRC-Univ. of Cape Town S. Africa E-mails - edrc@engfac.wct.ac.za chn@engfac.wct.ac.za

**Wind:**

- A: Forsøgsmøllen Rapport 1-4. Poul La Cour, Denmark 1900/1903
- B: Wind Power for Home & Business. Paul Gipe, Chelsea Green Pub. USA 1993 0-930031-64-4
- C: Wind Power Plants. E.Hau, Springer Verlag Berlin Germany 1997/98 3-540-57064-0
- D: Windgeneratoren Technik. B.Hannus, Franzis' Verlag 85622 Feld. Germany 1997 3-7723-4712-6
- E: Wind-turbine Blade Design and Praxis. J. Furze, 1993/94
- F: Compendium in Low-cost Wind-mills. J. Furze, 1993/95

**Bio-Mass Energy and Fiber Technology:**

- 1: a: Danish Energy Agency. b: Prof. H. Carlsen Danish Technical University. c: S. Hornmøller E-mail - hornmoller@dk-technik.dk d: Bio-Eaf, Bornholm Denmark.
- 2: Prof. H. Stassen, BTG University of Twente Netherlands.
- 3: Humb J. Gijzen, IRE Delft University Netherlands. [University Call Columbia]
- 4: Prof. T. Reed, Bio-Mass Energy Foundation Golden Co. USA. E-m. ReedTB@Compuserve.com
- 5: Prof. J.E. Moreira, MEGAWATT/BDN São Paulo SP Brazil Fax: +55 [011] 535 30 77
- 6: Dr. A. Borroto, CEMA University of Cienfuegos Cuba.
- 7: Dr. P.R. Bogue, CETA University Santa Clara Cuba. E-mail - ceta@central.quantum.inf.cu
- 8: Prof. E.W. Williams, Center for Energy & Environmental Studies, Princeton University USA.
- A: Biolog. Paths to Self-Reliance. R.E.Anderson, Van Nostrand UEA/Sweden 1979 0-442-20329-2
- B: Energie aus Bio-Mass. Flaig, Mohr. Springer Verlag Berlin Germany 1994 3-540-57227-9
- C: Bioenergy for Development. Woods, Ball. FAO-Rome 1994 92-5-103449-4

**Bio-Gas Energy. - [ Digesters ]:**

- For Large Systems: - Danish Energy Agency, Copenhagen DK Fax: + 45 3311 4743
- For Medium-size Systems: - "Danish Bio-Energy" Issue nr. 28/1996 p.10. - nr. 30/96 p.12. A nr. 32/97 p.10. E-mail - biopress@post4.tele.dk
- Dipl.Ing. E.Schneider/Bundschuh Schillerstr.34,80336 München Ge.
- Prof. H. Stassen, BTG University of Twente Netherlands.
- For Small Low-cost Units: - Prof. Zhong, Guangzhou Inst. of Geography China.
- [Plastic-bag digesters, - University of Agriculture & Forestry, Thu Duc HCM City Viet Nam, & Integrated Farming]. <<http://ourworld.compuserve.com/homepages/utaf>> <100013.3330@compuserve.com>
- Dr. Bo Gøhl F&P: E-mail - fepzim@harare.iafrica.com
- Dr. E. Murguettio: E-mail - cipav@cali.cetcol.net.co
- Prof. Preston: E-mail - thomas.preston@arec.kifs.plants@ox.ac.uk
- F. Dolberg: E-mail - frands@po.is.dk
- Prof. G. Chan: E-mail - 100075.3511@compuserve.com

**Plant-oil Engines for Transport and Power-generation. - [ cold-pressed non-refined plant oil ]:**

- 1: Elsbett Technologie. Industristr.14, 91161 Hilpoltstein/Mfr. Germany Fax: +49 09174 2111
- 2: Verein. Werkstätten f. Pflanzenöltech. Hauptstr.33,92342 Freyst.-Bulzk.Fax:+49 09179 90562

**Wave Power:**

- 1: Danish Energy Agency. Att. Jan Bünger Tel: + 45 3392 6700 E-mail - jbu@ens.dk
- 2: Erik Skaarup, Wave Plane Int. Cph. Denmark Tel: + 45 3917 9833 / Univ.of Cork Ireland.
- A: Power from the Waves, D. Ross Oxford University Press UK 1981//1995/1997

**Water-treatment, HydroPower, Water-pumps - etc.:**

- 1: Prof. Thomas L. Crisman, University of Florida Gainesville Florida USA
- 2: Prof. P. D. Jensen, Agricultural University of Norway E-mail - petter.jensen@itf.nln.no
- 3: Beth Josephson, Center for East. of Waters Falmouth Ma. USA E-mail - bjosephs@mb1.edu
- 4: Angus Marland, Watershed Systems Ltd. Edinburgh Scotland Fax: +44 [0]31 662 46 78
- 5: Alexander Gudimov, Murmansk Marine Biological Inst. Russia E-mail - vladim@fiffo.hsf.no
- 6: François Gigon, NATURA Les Remsilles Switzerland Fax: +41 [0]32 97 43 25
- 7: Aleksandra Drizo, Univ. of Edinburgh Scotland E-mail - a.drizo@ac.ed.ac.uk
- 8: Prof. Ole Mander, Institute of Geography Univ. of Tartu Estonia E-mail - ylo@math.ut.ee
- A: Field Engineering. F. Longland - [P. Stern, ed.], UK 1936//93 0-903031-68-X
- B: Mini HydroPower, T. Jiandong et al. UNESCO/John Wiley & Sons UK 1996 0-471-96264-3
- C: Compendium in Hydraulic Ram-pumps. J. Furze, 1995

- # NB: It should be noted that a comprehensive multimedia program on renewable energy on 3 CD's, is issued by the Danish Technological Institute. E-mail - infovc@dti.dk
- The Danish branch organization for heat and ventilation: CD - "Multi-Sol", showing mounting/assembly work processes for solar-collectors. <http://www.vvsu.dk>
- During 1998, a CD on access to wind-energy info. - should be issued under a common EU project, with as the coordinating Danish partner; - Handelskøjskole in Århus DK.
- A CD with a database on Renewable Energy is available from UNESCO-Publishing Paris.
- An energy/development CD-library is available from Belgium. E-mail - humanity@innet.be <http://www.oneworld.org/globalprojects/humcdrom> Also check: - //www.creat.org

- Plugs: - Rainbow Power Company Catalogue, Nimbin NSW 2480 Australia. Fax: + 61 66 89 11 09.
- Catalogue from Real Goods Co. Ukiah CA 95482-3471 USA. Fax: + 1 707 468 94 86
- E-mail - realgood@well.sf.ca.us
- Home Power Journal, Post-box 520 Ashland OR 97520 USA. Fax: + 1 916 475 3179.

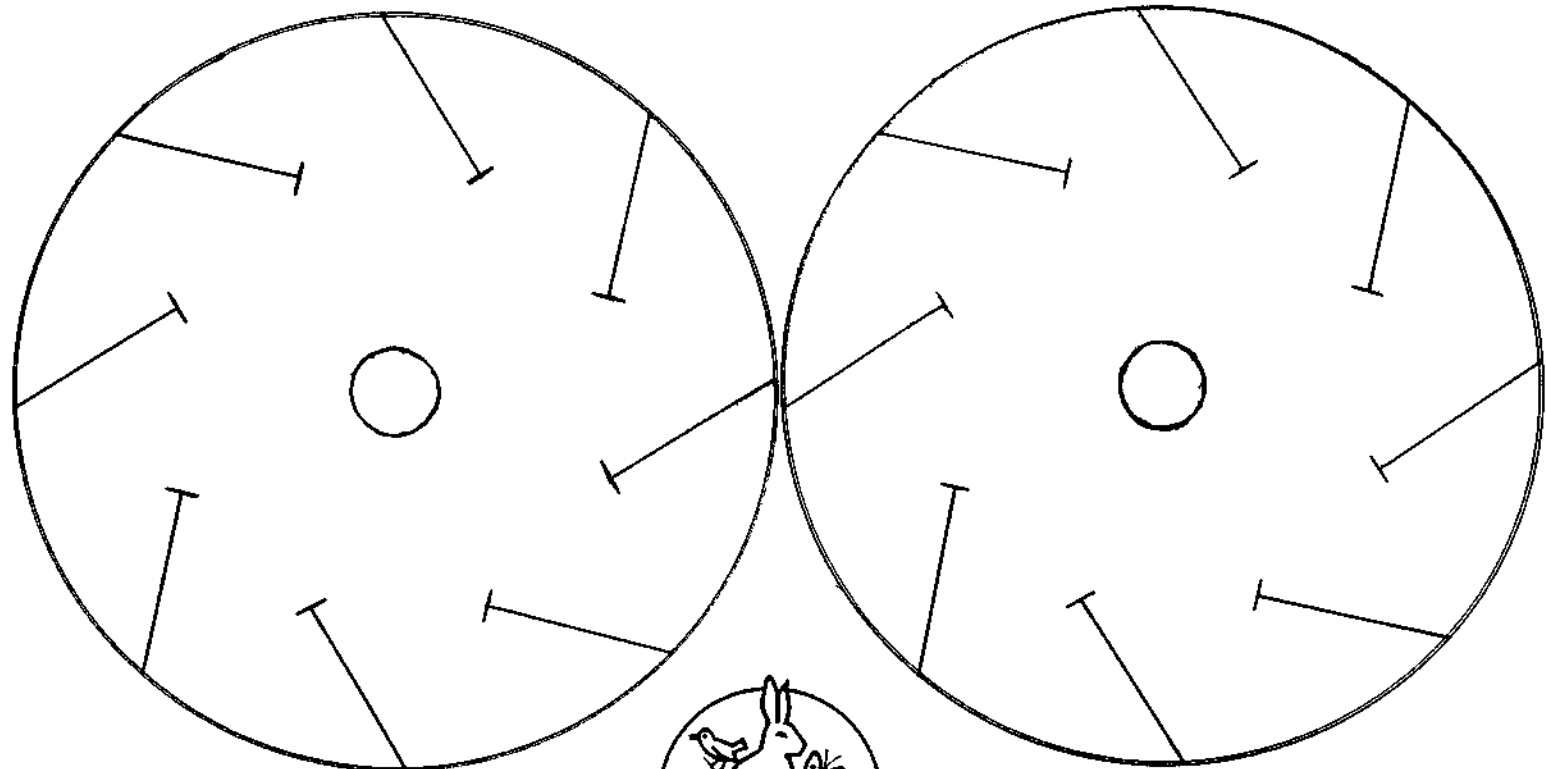
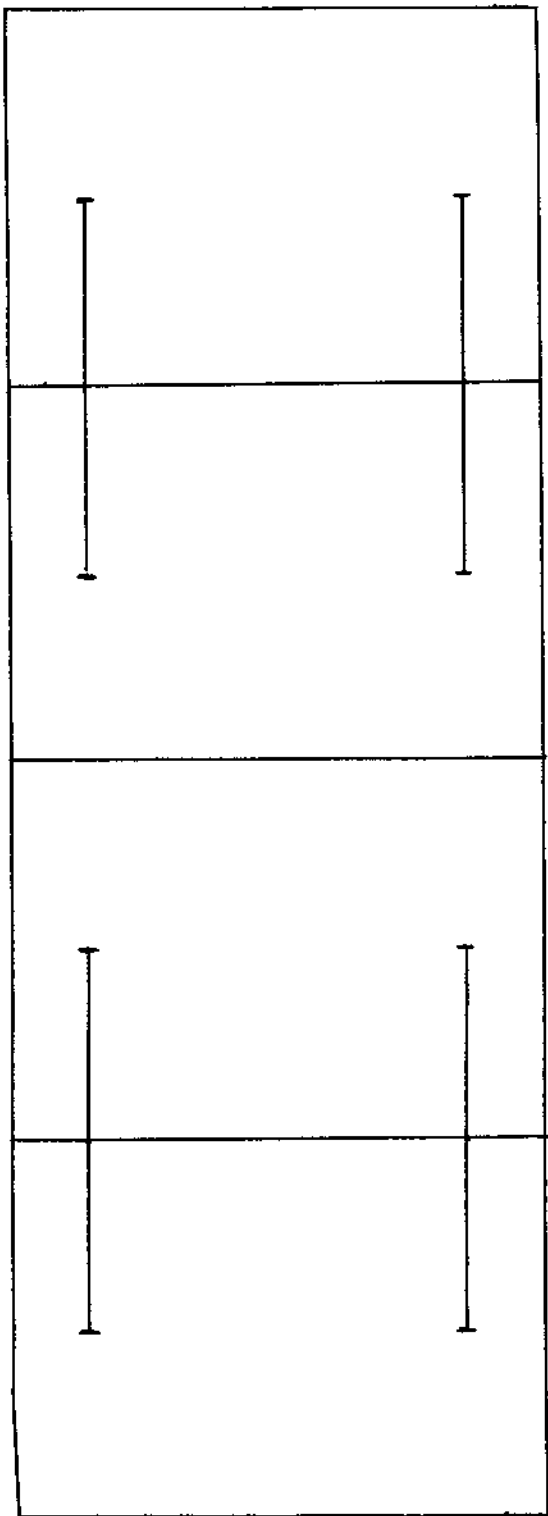

Design  
 Allan Nielsen, Naturhistorisk  
 Museum, ÅRHUS

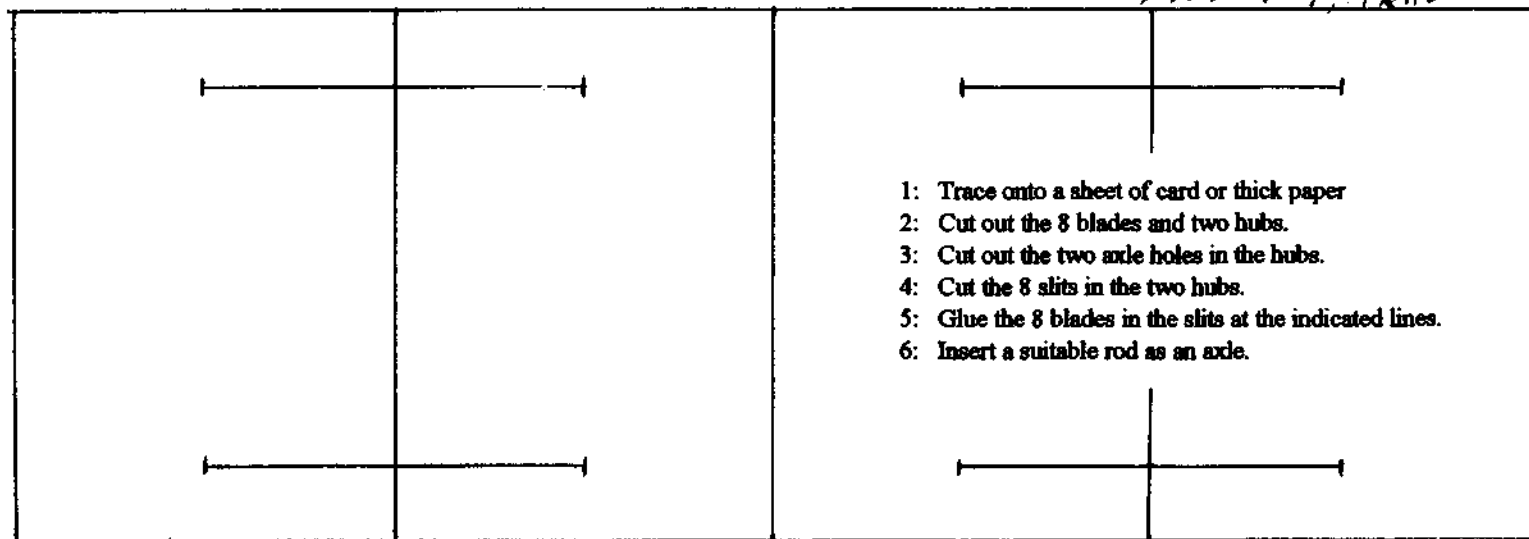

- 1: Trace onto a sheet of card or thick paper
- 2: Cut out the 8 blades and two hubs.
- 3: Cut out the two axle holes in the hubs.
- 4: Cut the 8 slits in the two hubs.
- 5: Glue the 8 blades in the slits at the indicated lines.
- 6: Insert a suitable rod as an axle.