

AT MICROFICHE
REFERENCE
LIBRARY

A project of Volunteers in Asia

Directory of Manufacturers of Small Hydropower
Equipment

by Allen Inversin

Published by:

Small Decentralized Hydropower Program
International Programs Division
National Rural Electric Cooperative Assn.
1800 Massachusetts Avenue N.W.
Washington D.C. 20036
USA

Available from:

same as above

Reproduced by permission.

Reproduction of this microfiche document in any
form is subject to the same restrictions as those
of the original document.

Directory
of manufacturers of
small hydropower equipment

NRECA Small Decentralized Hydropower (SDH) Program



Directory of manufacturers of small hydropower equipment
Third edition

Allen R. Inversin

January 1984

**Sponsored by the United States Agency for International
Development under Cooperative Agreement AID/DSAN-CA-0226**

**Small Decentralized Hydropower (SDH) Program
International Programs Division**

**National Rural Electric Cooperative Association
1800 Massachusetts Avenue N.W.
Washington, D.C. 20036**

Small decentralized hydropower program

This publication is one of a series that fosters the effective use of small decentralized hydropower systems. This series is published by the Small Decentralized Hydropower (SDH) Program, International Programs Division, National Rural Electric Cooperative Association (NRECA). NRECA operates the SDH Program under the terms of Cooperative Agreement AID/DSAN-CA-0226 with the Office of Energy, Science and Technology Bureau, U.S. Agency for International Development.

Under the agreement, begun in May 1980, NRECA provides a broad range of technical assistance to developing countries. NRECA provides assistance by:

- designing and implementing regional workshops in Africa, Asia, and Latin America;
- developing and conducting in-country resource surveys and site assessments;
- providing engineering, supervision, and specialized assistance;
- developing specialized publications such as state-of-the-art reports, inventories of manufacturers, and assessment methodologies;
- conducting special studies on issues pertaining to finance, management, evaluation, and other subjects;
- providing training services in such topics as operation and maintenance, resource assessment, equipment fabrication, and institution building;
- carrying out specialized services such as tours of U.S. manufacturing plants and small hydro sites and seminars on private-sector involvement; and
- creating specialized products such as productive-use plans for energy from small decentralized hydropower.

For more information on the SDH Program, please contact:

Training and Information Coordinator
Small Decentralized Hydropower Program
International Programs Division

National Rural Electric Cooperative Association
1800 Massachusetts Avenue N.W.
Washington, D.C. 20036

Telephone: 202-857-9622
Telex: 64260
Cable: NATRECA

CONTENTS

INTRODUCTION, 1

- Scope of directory, 1
- Costs, 1
- Cost-reduction techniques, 2
- Information required to obtain quotes, 5
- Application charts, 7
- Summary of application charts, 7

TURBINE MANUFACTURERS, 13

- Allis-Chalmers Corporation (USA), 13
- Atlantic, Gulf & Pacific Company of Manila, Inc. (Philippines), 17
- Balaju Yantra Shala (Pvt.) Ltd. (Nepal), 19
- Butwal Engineering Works (Pvt.) Ltd. (Nepal), 23
- Byron Jackson (USA), 25
- C.CH.LG. Ltda. (Colombia), 27
- C.V. Sukaradja (Indonesia), 29
- Canyon Industries, Inc. (USA), 31
- Combustion Engineering/Neyrpic Hydro Power, Inc. (USA), 33
- Cornell Pump Co. (USA), 37
- Energy Research & Applications, Inc. (USA), 39
- Essex Turbine Company, Inc. (USA), 41
- Gilkes/Border Contractors, Inc. (USA), 43
- Hayward Tyler Pump Co. (USA), 45
- Hydro Energy Systems, Inc. (USA), (see Combustion Engineering/Neyrpic Hydro Power, Inc.)
- Hydro-Watt Systems (USA), 47
- Hydro West Group, Inc. (USA), 49
- The James Leffel & Co. (USA), 51
- Jyoti Ltd. (India), 53
- Layne & Bowler, Inc. (USA), 55
- Little Spokane Hydroelectric (USA), 57
- McKay Water Power, Inc. (USA), 59
- New Found Power Co., Inc. (USA), 61
- Ossberger/F.W.E. Stapenhorst, Inc. (Canada), 63
- Schneider Engine Co. (USA), 65
- Small Hydroelectric Systems and Equipment (USA), 67
- Total Energy Corporation (Puerto Rico), 69
- Worthington/McGraw-Edison Co. (USA), 71

INTRODUCTION

Scope of directory

This directory has been prepared to provide some basic information both on companies which manufacture hydraulic turbines in the 1-1000 kW power range and on their product lines. An attempt has been made to include all packaged units which **satisfy source requirements** set by the U.S. Agency for International Development (see AID Handbook 1, Sup. B, Chapter 5). However, if the potential purchaser of a specific packaged unit containing some components made overseas is restricted by these requirements, it is advisable for him to verify that that unit does indeed satisfy these requirements.

Inclusion in this directory does not imply an endorsement of either the companies or their products. Some of those included have, through years of experience, built a reputation for quality and, with up-to-date design, test, and manufacturing facilities, continuing quality is probably assured. Other companies have only recently entered the arena and, though their equipment may be unique in certain aspects, they are not far beyond the R&D stage. With increasing worldwide interest in small hydropower, these companies and others, many very small, have moved in to fill the resultant demand. Prospective buyers must be alert to claims of, for example, high efficiency, unusual performance, durability, or low cost made by suppliers. Reputable suppliers will furnish lists of their past customers on request.

Future editions of this directory will not only update present entries but will also provide the reader with information on other manufacturers. This publication will also ultimately include manufacturers of load controllers and other basic components of small hydropower systems.

Costs

The term "standardized packaged turbo-generating unit" conjures up the idea of pre-assembled units laid out on a shelf, each with a price tag attached, ready to be shipped out at a moment's notice. However, virtually every hydroelectric scheme is unique—many of the physical characteristics of the site, as well as the demands imposed on the system's operation and performance, are different. In meeting all these constraints through a "standardized package," a supplier can select from a wide range of generally standard components, some off-the-shelf, others designed but awaiting orders before fabrication. Packages with different components can have substantially different costs. For this reason, except in cases of specific turbines or well-defined packaged units, specific cost figures have been omitted in this directory. Though these would undoubtedly be of interest to the reader, any cost figures, beyond those described above, could easily misrepresent the actual equipment cost for a specific site.

In addition to further details on both the equipment available from, and the experience and qualifications of, prospective suppliers, more precise costs for equip-

ment are clearly essential in order to decide among the equipment available. For this purpose, it is best if complete specifications for a particular site(s) are furnished to potential suppliers who will then provide the specific cost figures needed.

However, several general comments can be made regarding trends in costs. One of the major factors which affects the final cost of turbo-generating equipment is the magnitude of the operating (net) head. For a given power output, as the available head increases, the required flow decreases. This then leads to a smaller turbine and a higher operating speed, both of which contribute to reduced costs. As an example of this trend, one source¹ has computed the cost per kilowatt under a range of heads for packaged units of several hundred kilowatt capacity from several manufacturers. As the operating head increased from 4 m to 15 m, costs decreased from the \$500-\$1300/kW range to the \$200-\$700/kW range. In addition to reduced equipment costs, the scale, complexity, and cost of civil works generally also decreases with increasing head. For these reasons, hydro sites with higher heads will have generally lower equipment and civil costs.

The capacity of the actual unit being considered is another factor affecting the final cost. Costs incurred in the manufacture of turbines do not rise in proportion to their capacity. In addition, the cost of the generator and governor for small units is nearly independent of capacity. Therefore, for a given operating head, the cost per kilowatt generally decreases with increasing power outputs. For these reasons, if adequate water resources exist, it may be best to purchase sufficient excess generating capacity to cater to future needs. This is especially true if income-generating end uses are to be included since these would increase the economic viability of such small schemes.

Cost-reduction techniques

Load control. One principal method of cost reduction is to design the system so that a constant flow of water is consumed by the turbine. If this can be done, cost reductions are gained because:

- no adjustable flow-control devices (e.g., guide vanes, wicket gates, propeller runner blades, or needle valves) are required, and,
- no speed-control governors and hydraulic actuators for the above devices are then necessary.

A design to reduce costs can be achieved in several ways. When it is possible to tie into a large existing grid, induction generators may be used. In such cases, governors and ancillary devices are not required anyway for speed or frequency control since the grid itself performs this function. On the other hand, in remote decentralized installations, synchronous generators are generally used. In conjunction with these generators, speed-sensitive governors and flow-control devices have conventionally been required. These permit the turbine speed to be regulated by automatically matching the water power available to the turbine to the varying power drawn from the turbine (due to varying electrical load). Only water which is required to meet the power demand at that time is used. The most

¹ "Report on Turbogenerating Equipment for Low Head Hydroelectric Developments," Stone & Webster Engineering Corp., April 1978.

efficient use of the water consumed by the generating plant can then be made. However, more recently, a reverse approach, whereby turbine speed is regulated by matching the power drawn from the turbine to the water power available to the turbine, has been adopted. In this case, a constant flow of water passes through the turbine and all flow-control devices are replaced by less costly electrical devices which maintain the power demand from the generator (and turbine) at a constant level to match the constant water power available to the turbine.

With small isolated schemes, where governors and actuators can be to a major portion of the overall cost of the equipment, a number of suppliers have adopted this option by using a less costly electronic device commonly called a "load controller." This device can be inserted virtually anywhere in the electrical network and insures a constant electrical load on the turbo-generating unit to match the constant water power available. Any excess power available over that actually used by the customers is sensed electronically and dissipated in ballast resistors or the equivalent. This power can be dissipated at the powerhouse or anywhere in the distribution network. These load controllers are more commonly used on plants of less than 100 kW capacity.

With its larger units, Neyrpic is one company which has taken a slightly different approach to maintaining constant load on its turbine. In this case, any unused (excess) power which is available from the turbine is sensed electronically but is dissipated through an eddy current brake which is an integral part of the generator drive shaft. Cooling water is circulated through this braking mechanism to remove heat generated by the brake.

In applying this cost-reducing option for synchronous electricity generation, it must be kept in mind that the most efficient use of the water power available is not generally being made. A constant flow of water passes through the turbine irrespective of the electrical load. Any shortfall in user load over the water power available to the turbine is dissipated and potentially lost (though with proper design this power might be put to productive use). Therefore, though the total cost of equipment might be significantly less, especially in the smaller installations, the overall scheme might be less economical than an installation using conventional flow-control devices and a governor. Each installation must be considered on its own merits.

In all cases, a reliable device is necessary for both starting and stopping the unit. In general, to prevent runaway of the turbine, hydraulically-operated intake gates or valves are required to assure shutdown in the event of loss of load.

Pumps as turbines. Another method for reducing the cost of a hydropower installation which is gaining popularity is to use pumps in reverse as turbines. Pumps, of generally small capacity, have been used for years in industrial applications to recover energy otherwise wasted in industrial applications. On the large scale, pump/turbines have been used around the world with pumped storage hydropower schemes.

Use of pumps provides several advantages. Because these are often mass-produced by numerous manufacturers, costs are reduced. Since they are standardized and available off-the-shelf, delivery times are minimized. There is no question whether pumps can be used as turbines. Rather, the concern is with their efficiency, cavitation characteristics, and operating range.

One major difference between pumps and turbines is that the former are designed to operate under a single set of conditions. There is no efficient way of controlling flow through a pump. On the other hand, hydraulic turbines conventionally have efficient flow controls, but this is one of the major factors for their increased cost.

Using pumps where constant head and flow conditions are available presents no difficulties. It is for this reason that they are used in industrial applications where process energy has to be dissipated. This is also the case at hydropower sites where a unit is sized to utilize less than the minimum streamflow found in a stream. Under these circumstances, constant flow can pass through the turbine year-round. A constant power is generated which can either be fed into a larger grid or, in an isolated application, can be controlled by means of a load controller. More frequently with hydropower schemes, there is a need to harness the variable flows found in a stream and, therefore, the use of a pump for power generation is not as usual. By using at least two pumps, preferably of different capacities, it is possible to harness a significant portion of the energy available in varying flows.

For example, let the shaded area on the flow duration curve in Fig. 1 represent the flow which is available for power generation at a particular site. Assuming that a hydraulic turbine can make use of all this flow, this area is also proportional to the energy which can be generated. On the other hand, if two pumps, with a capacity of $0.10 \text{ m}^3/\text{s}$ and $0.20 \text{ m}^3/\text{s}$, respectively, were used as turbines, Fig. 2 illustrates the energy which would then be available. For low flows, only the smaller turbine would be put into operation. For higher flows, only the second turbine would operate. For still higher flows, both units would be operated. In this case, the energy generated by the pumps used as turbines is approximately 80% of the energy available from a more sophisticated hydraulic turbine. Whereas a single larger turbo-generating unit is usually used rather than two smaller units because of economies of scale, the relatively low cost of pumps still permits the economical use of multiple units for power generation.

Integrated uses. Whereas this approach is not strictly a means of reducing the cost of the turbo-generating equipment itself, it does permit reducing the overall cost of a hydropower scheme. This involves incorporating a power generation scheme as a component of another water project such as an irrigation scheme or a

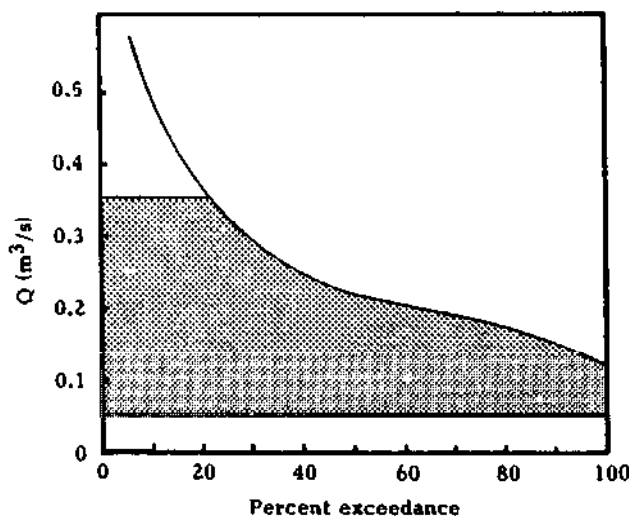

Fig. 1. Energy output from a turbine.

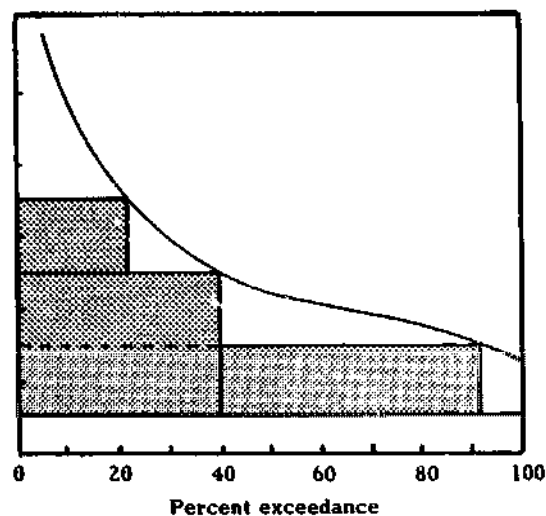

Fig. 2. Energy output from two pumps used as turbines.

water supply system. By so doing, cost of components required by both projects can be shared, effectively reducing the cost of each component.

An example of this is the use of a turbine in a municipal water supply system where high pressures have to be reduced before distribution to customers. Fig. 3 illustrates how this has been done in the city of La Habra, California, where a pressure-reducing valve was formerly used to dissipate the energy in the main high-pressure pipeline and reduce the pressure for household and commercial users. In the new installation, a turbine was placed in parallel with an existing pressure-reducing valve and the scheme was designed so that the water supply would not be disturbed with the addition of the turbine.

At its rated flow and head, it generates approximately its rated 110 kW of power. If less than the turbine's design flow is required, a flow-control valve before the turbine throttles the flow. Less pressure appears across the turbine and less water passes. If more flow is required than can be accommodated by the turbine, a flow-control valve placed in a pipe bypassing the turbine permits water in excess to that flowing through the turbine to be fed into the distribution system.

This scheme is of interest because not only is it integrated with another existing end use but costs were further reduced by using a pump. A Worthington pump was used as a turbine in this case.

Information required to obtain quotes

In requesting price quotations from suppliers of hydraulic turbines and packaged units, it is important, when available and applicable, that as much of the following information as possible accompany each inquiry:

- customer's name, address, and telephone number or cable address;

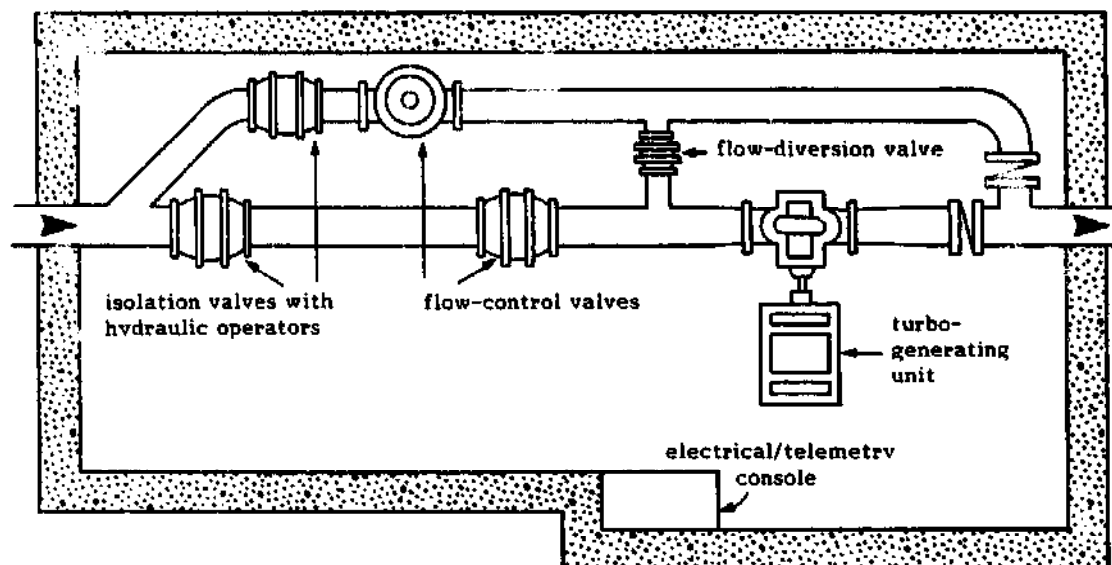

Fig. 3. Generating power on a municipal water supply system.

- an indication of whether only an estimate is desired or whether a full detailed proposal or bid is required; and,
- if possible, a map and/or sketch showing the layout of the proposed site; drawings and photographs of existing structures and/or foundations are particularly important and useful.

In addition, for quotes on hydraulic turbines, the following information should be submitted to the supplier:

- average gross head and/or net head available. For low-head sites, if the head varies noticeably with the flow, also include the minimum and maximum heads.
- water flow available to the turbine. If virtually the entire stream is to be used, include a flow duration curve based on as many years of data as possible or, if unavailable, provide some indication of flow variation during a typical year.
- total output power desired or needed. Indicate whether this value represents generator or turbine output. How many units are contemplated to produce this power?
- type of machine to be driven? Is there a required rpm?
- altitude of powerhouse site.
- if water to the turbine is to be supplied by a penstock, the actual or proposed length, internal diameter, and material used in its construction.
- if the powerhouse is already built, the distance from tailwater to the powerhouse floor (minimum, maximum, and the average), flume and tailrace dimensions, as well as water elevations.
- accessibility of site by rail, truck, boat, air, or on foot? What constraints might this place on the size of the equipment which can be transported to the site?

In addition to the above, for quotes on packaged units for electricity generation, the following would also be useful:

- required electrical output (a.c. or d.c., voltage, number of phases, frequency);
- kind of operation envisioned (manual, semi-automatic, automatic, or remote control);
- whether the plant is to operate separately or in conjunction with an existing power system? If the latter, give approximate installed capacity of this system.
- whether a control panel and protective equipment including switchgear and metering cubicle are to be included? If so, their design requires a definition of transmission and distribution schemes. Unless specified, suppliers usually provide a standard system to comply with minimum standards.

Application charts

Accompanying the description of most of the manufacturers included in this directory is an application chart. These are included to provide the user with an idea of the range of power and head covered by their respective lines of equipment. These charts are based on information provided by each manufacturer, and an effort was made to ensure that these are as representative as possible of actual equipment available. More precise, site-specific information should be obtained directly from the manufacturers by the site developer.

To determine the approximate flow (Q) needed by a turbine to produce the desired power (P) under a given net head (H), any of the following equations can be used:

$$\begin{aligned} Q &= \frac{P(\text{kW})}{7 H(\text{m})} \text{ m}^3/\text{sec} \\ &= \frac{150 P(\text{kW})}{H(\text{m})} \text{ liters/sec} \\ &= \frac{17 P(\text{kW})}{H(\text{ft})} \text{ cusecs} \end{aligned}$$

An overall conversion efficiency of 70% was assumed in deriving the previous equations.

Summary of application charts

A summary of all the application charts in this directory is included beginning on the following page to serve as a guide for quickly directing the user of this directory to the manufacturers of equipment suitable for a particular site under consideration. By locating the point of operation for the particular site on the application chart, a brief review of these charts will indicate which manufacturers may have suitable equipment available. In the case of a few smaller companies, insufficient information was available to complete such charts.

For example, if turbo-generating equipment is required for a site with a head of 2.5 m and a power output of 30 kW, the operating point would be located as shown. By reviewing the application charts which follow, it is apparent that Allis-Chalmers, Atlantic, Gulf & Pacific, Energy Research & Applications, and several other firms could provide quotes for equipment suitable for that site. For those companies for which application charts are incomplete, an indication of whether they might have appropriate equipment can be inferred from the written descriptions.

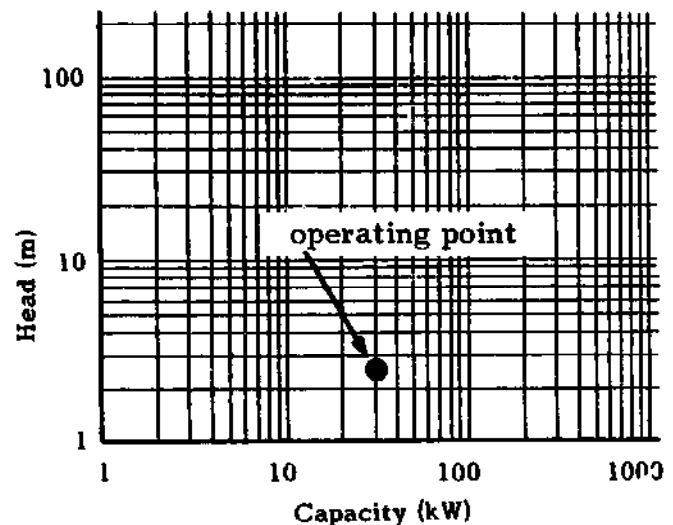

It should be kept in mind that it might be advantageous for several reasons to use multiple units at a site. In that case, other manufacturers might manufacture equipment which would be suitable. For example, although Little Spokane Hydro does not manufacture a turbine capable of generating the required 30 kW under a 2.5 m head, two smaller units manufactured by this company could be used in parallel to meet this need.

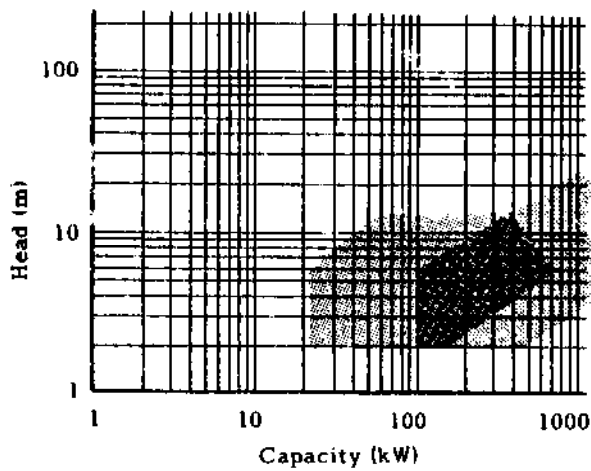

Allis-Chalmers Corporation

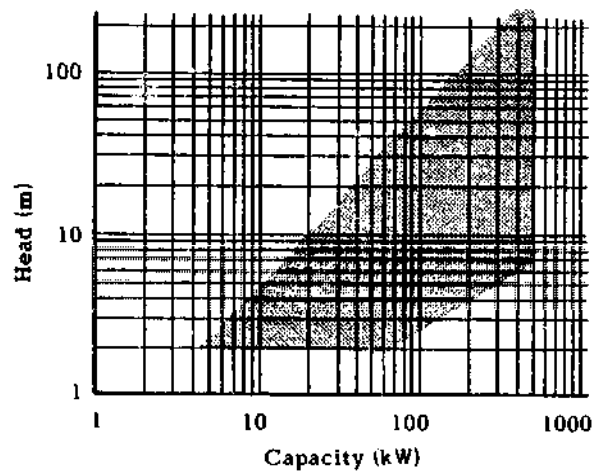

Atlantic, Gulf & Pacific Company of Manila, Inc.

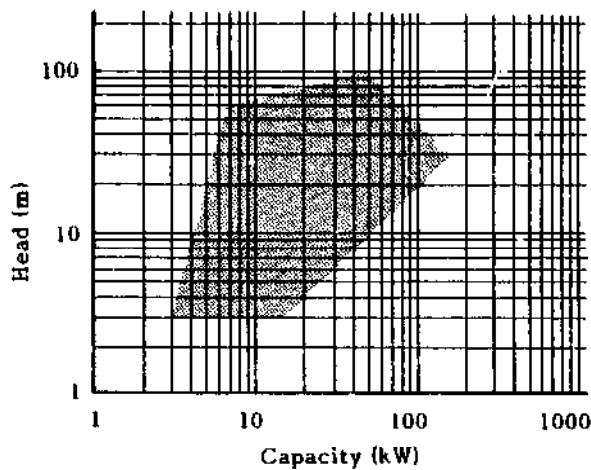

Balaju Yantra Shala (Pvt.) Ltd.

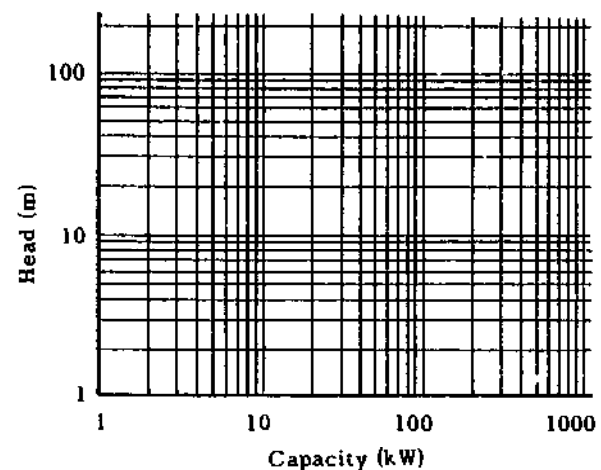

Butwal Engineering Works (Pvt.) Ltd.

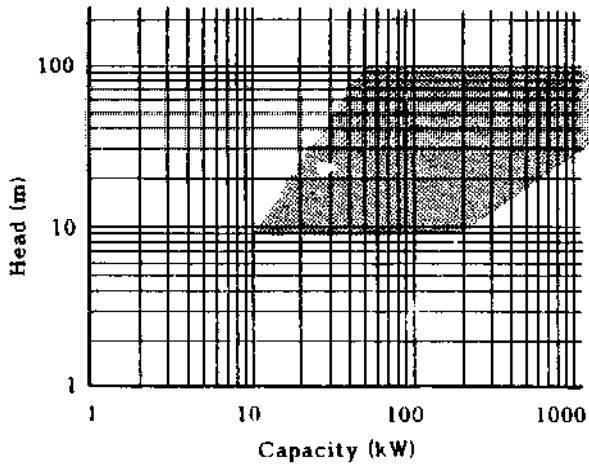

Byron Jackson

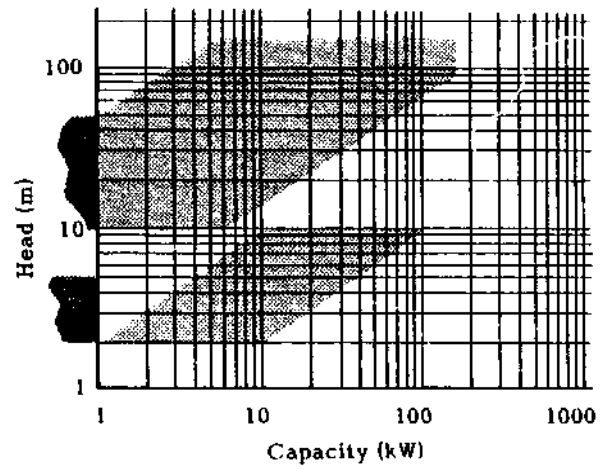

C.CH.LG. Ltda.

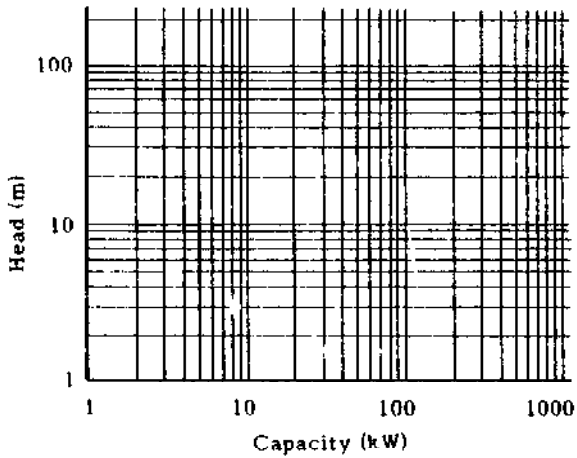

C.V. Sukaradja

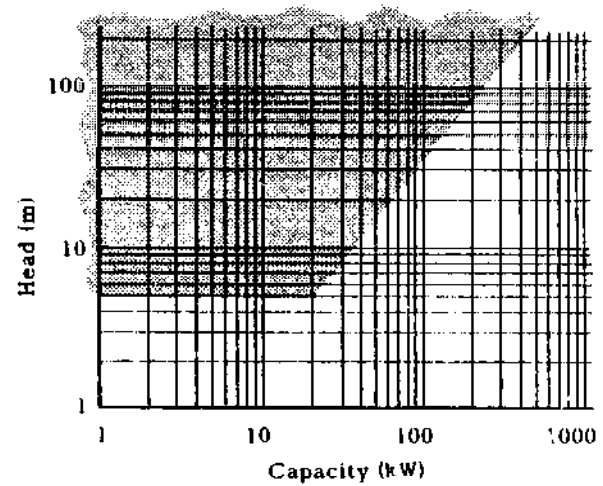

Canyon Industries, Inc.

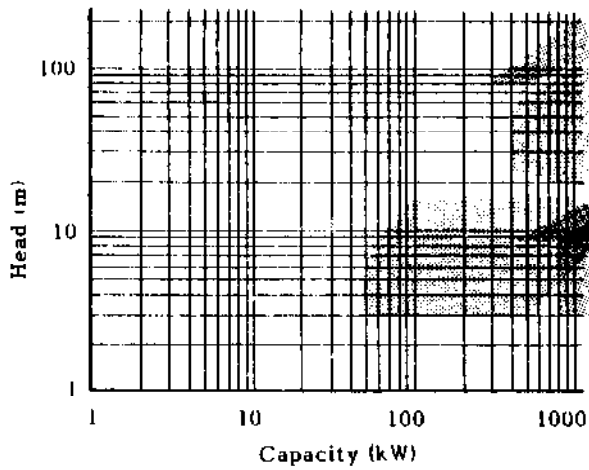

**Combustion Engineering/
Neyrpic Hydro Power, Inc.**

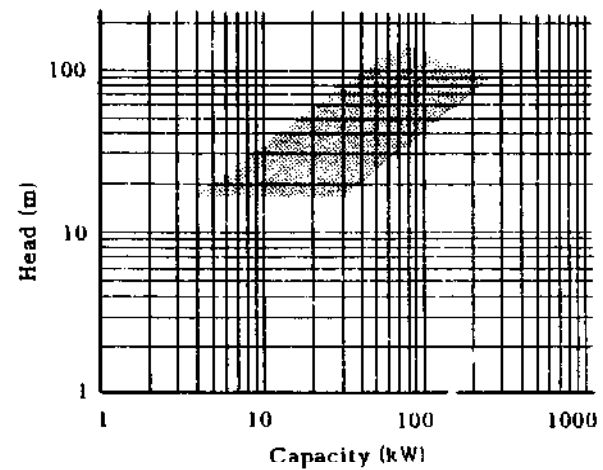

Cornell Pump Co.

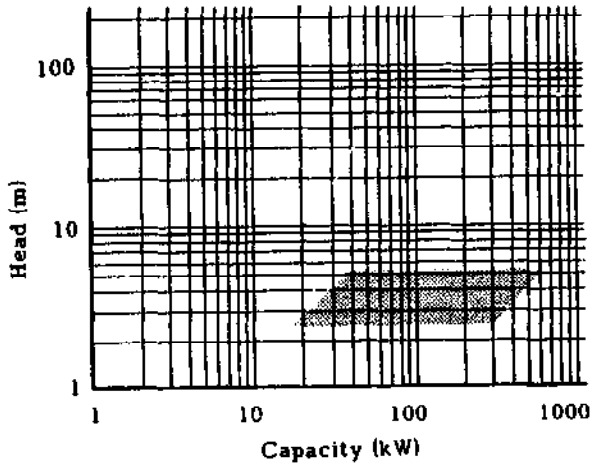

Energy Research & Applications, Inc.

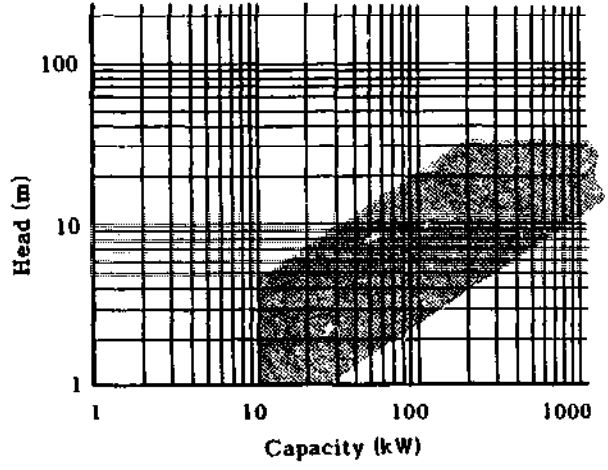

Essex Turbine Company, Inc.

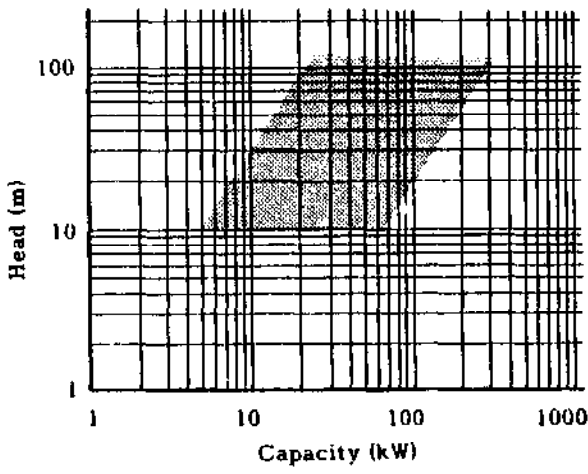

Gilkes/Border Contractors, Inc.

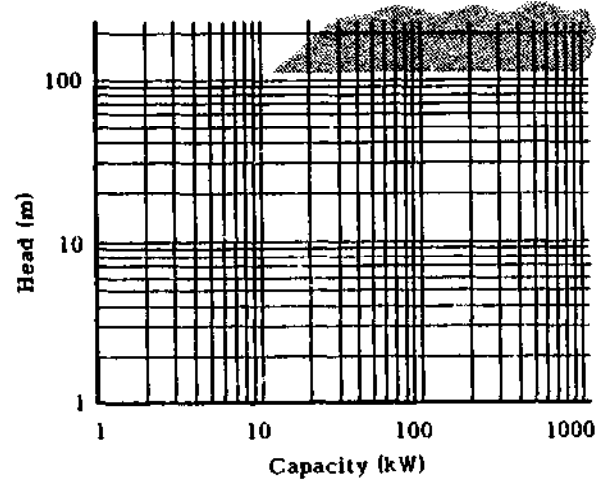

Hayward Tyler Pump Co.

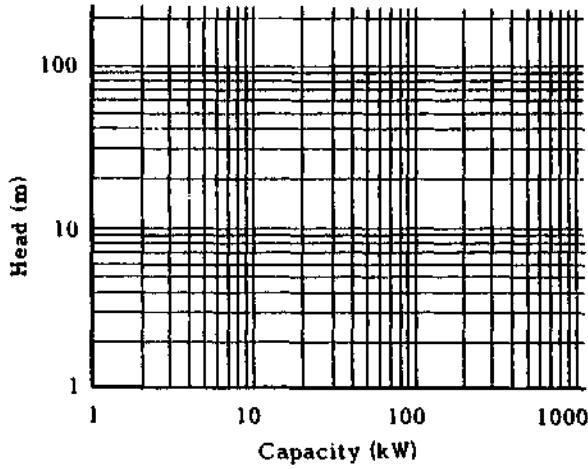

Hydro-Watt Systems

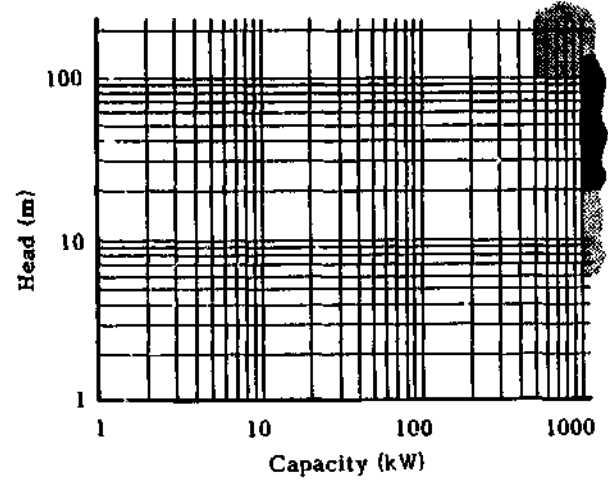

Hydro West Group, Inc.

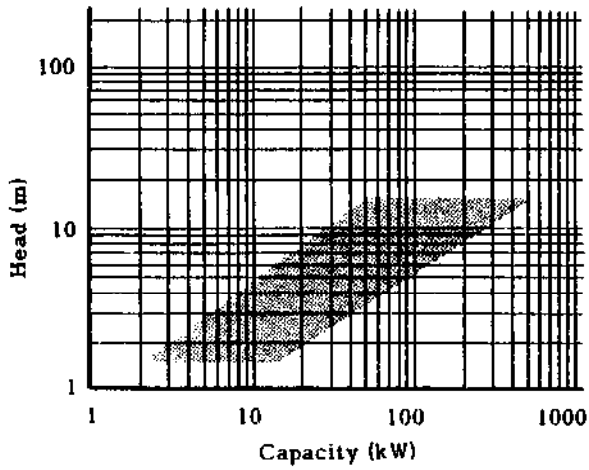

The James Leffel & Co.

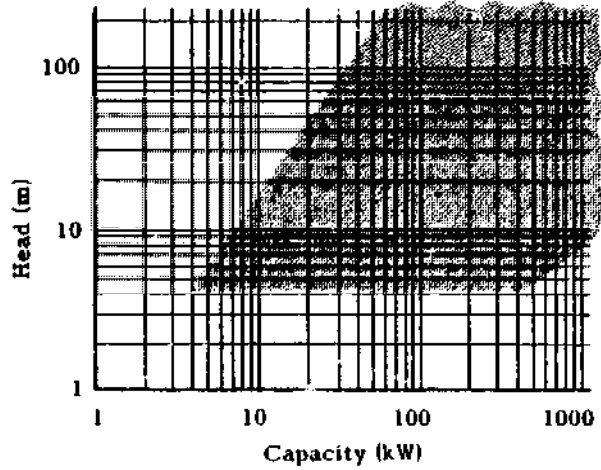

Jyoti Ltd.

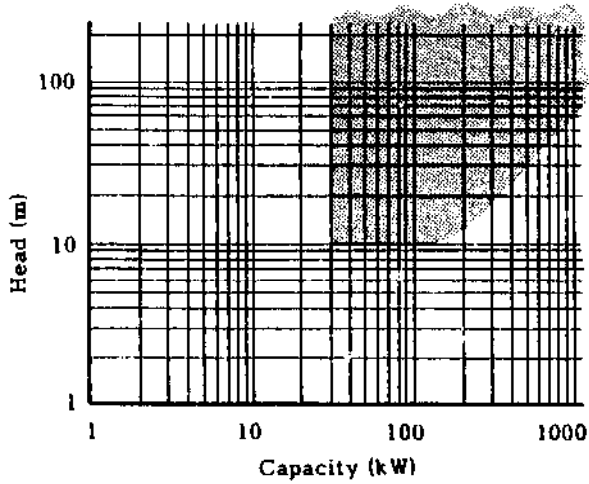

Layne & Bowler, Inc.

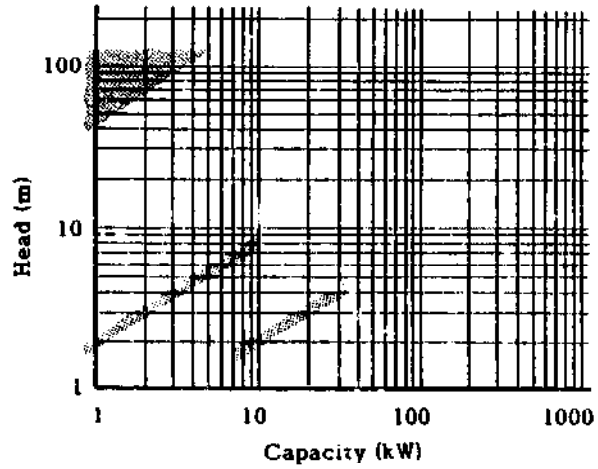

Little Spokane Hydroelectric

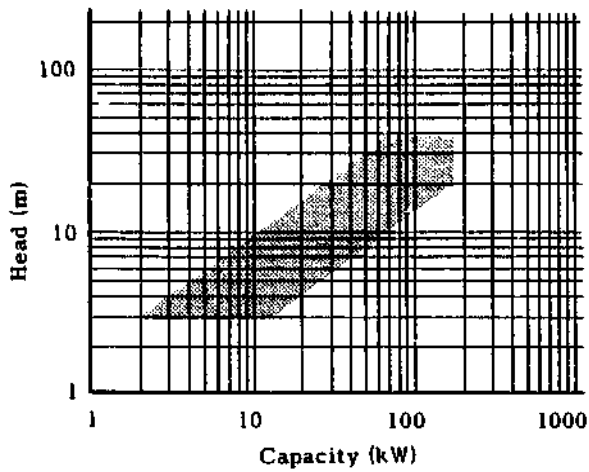

McKay Water Power, Inc.

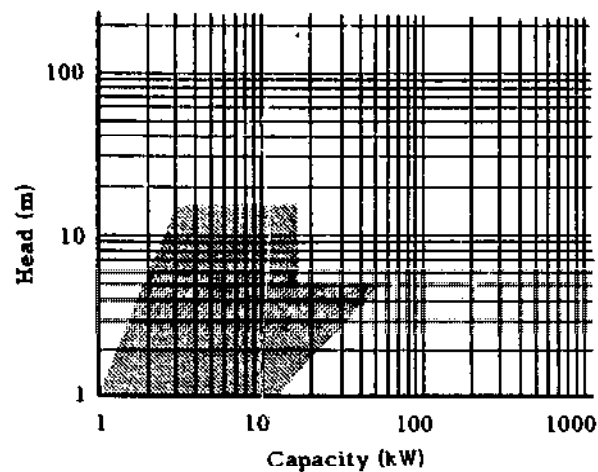

New Found Power Co., Inc.

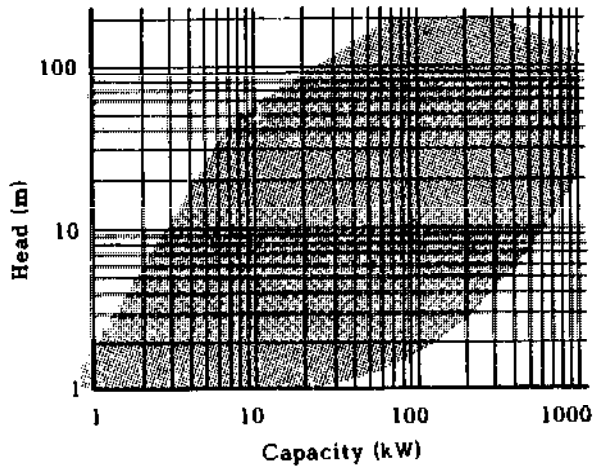

Ossberger/F.W.E. Stapenhorst, Inc.

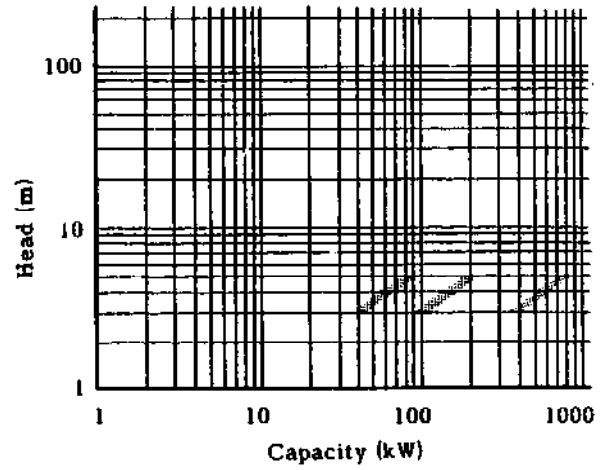

Schneider Engine Co.

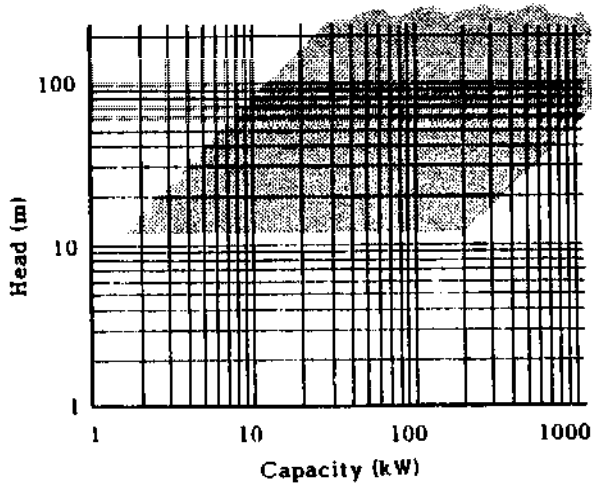

**Small Hydroelectric Systems
and Equipment**

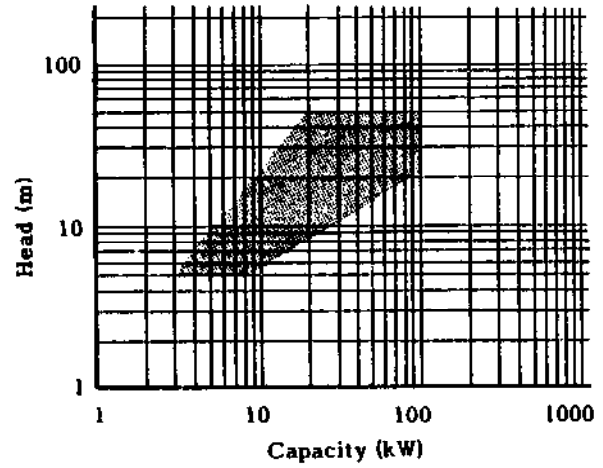

Total Energy Corporation

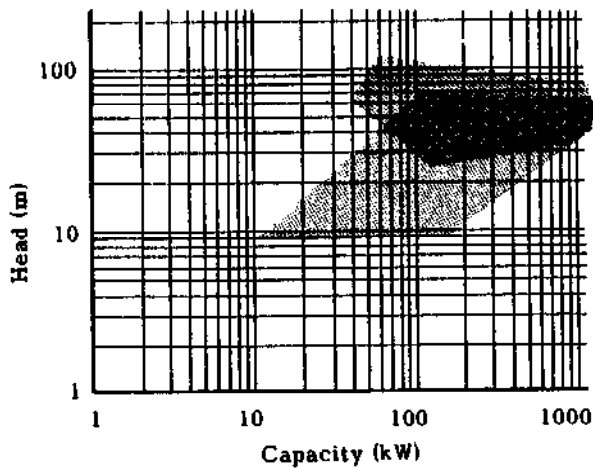

Worthington/McGraw-Edison Co.

TURBINE MANUFACTURERS

ALLIS-CHALMERS CORPORATION

Hydro-Turbine Division
P.O. Box 712
York, Pennsylvania 17405

Phone: (717) 792-3511
Telex: 840435

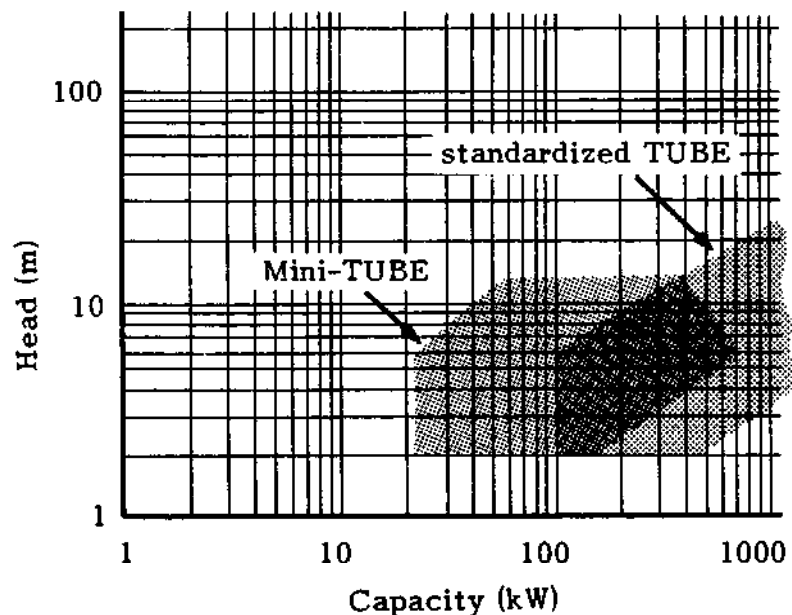

Background

For a century, Allis-Chalmers has designed and manufactured all types of hydraulic turbines—impulse, Francis, propeller, and reversible pump-turbines. This major U.S. manufacturer also designs and fabricates all types of water-control equipment including spillway gates, inlet and control valves, free discharge and bypass valves, and centrifugal as well as axial-flow pumps. At its York plant, it has extensive design, model testing, and manufacturing facilities.

For several decades, Allis-Chalmers has been developing and manufacturing TUBE turbines and axial-flow (propeller) turbines with the generator located outside the water passage and connected to the turbine by a direct drive shaft or through a geared speed increaser. To more economically tap the low-head water resources in the 100-6000 kW power range, it has recently made available standardized TUBE turbine packages including horizontal and vertical shaft arrangements.

To more economically address the lower power range, Allis-Chalmers has fallen back on its pump and pump/turbine experience with axial-flow and centrifugal pumps. It is presently incorporating modifications in existing designs of standard commercial pumps. Low-head axial-flow turbines with an inclined shaft have been built and are operating successfully. These mini-TUBE turbine units are the first-phase approach to smaller low-head applications. For higher heads, centrifugal pumps may be recommended where there is a constant flow or where two units of unequal size can adequately meet variable flow conditions. The technology is available to modify standard commercial units to provide good efficiency. Model test data, based both on conventional pumps operated in the turbine mode as well as on reversible pump-turbines, provides a basis for modification recommendations.

Equipment

Standardized horizontal-shaft TUBE turbine packages, as well as standardized vertical-shaft axial-flow turbine units are available in ten sizes from 100-6000 kW. They are adaptable for upgrading existing low-head plants for making previously uneconomical sites attractive, or for new power

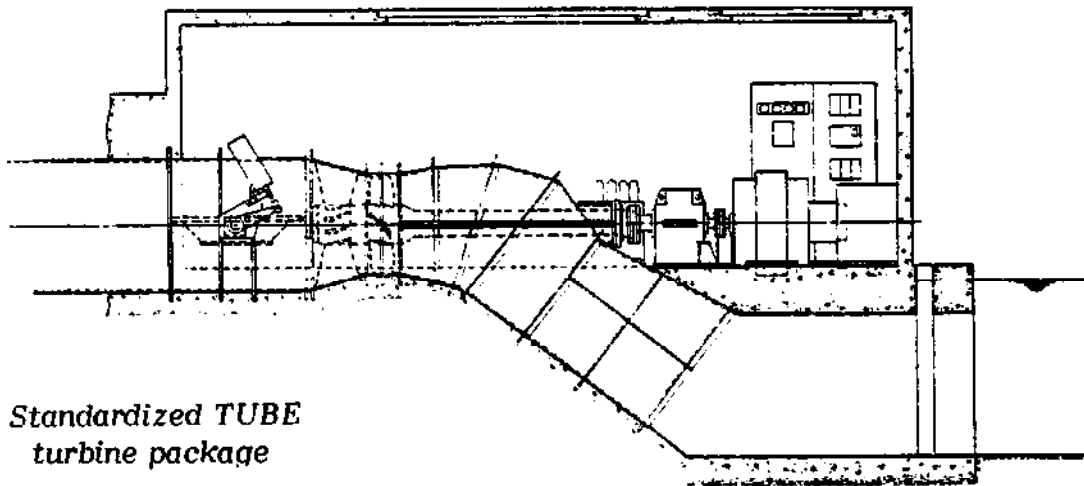

installations. These packages include the turbine water passageways (including draft tube) with intake gate or butterfly valves, fixed guide vanes, and fixed-or adjustable-blade turbine runner (with hydraulic controller for blade pitch control for the latter), geared speed increaser, generator, electrical controls and low voltage switchgear. They are available as complete packages. For installations overseas where local suppliers might furnish certain components, Allis-Chalmers can work with these suppliers to insure a properly integrated design. The lead time for units is approximately 9-12 months. The package can be extended to include the main power transformer, high voltage switch, and substation if desired.

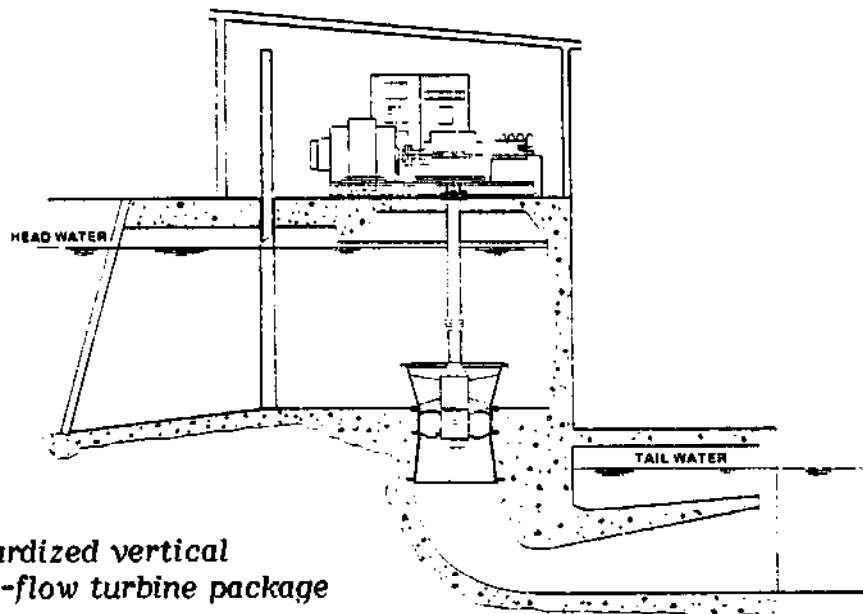

The **mini-TUBE turbines**, with a power output in the range of 25-1000 kW, are designed to be included in an economical and convenient package. Available in 12 runner diameters from 12"-72", the turbine package includes turbine water passageways and draft tube with fixed-blade propeller runner and guide vanes, generator with either belt or geared speed increaser and electrical control and switch-gear. A butterfly valve with hydraulic operator is provided for units operating in the higher head range and where a penstock is required. With a short intake, a hydraulically operated gate will be more economical and is particularly applicable to the larger units at lower heads. This gate or valve controls turbine speed as the unit starts up and until it reaches the normal operating speed. A hydraulic power system is used to provide stored energy for tight shutoff and emergency closure. By designing a unit which can be bolted down and need not be set in concrete and by mounting the belt driven generator on the housing, foundation and building costs are significantly reduced. Aside from protecting the generating and control equipment from the weather, a building is virtually unnecessary. If a geared speed increaser is used, this as well as the generator would then have to be mounted on the concrete foundation.

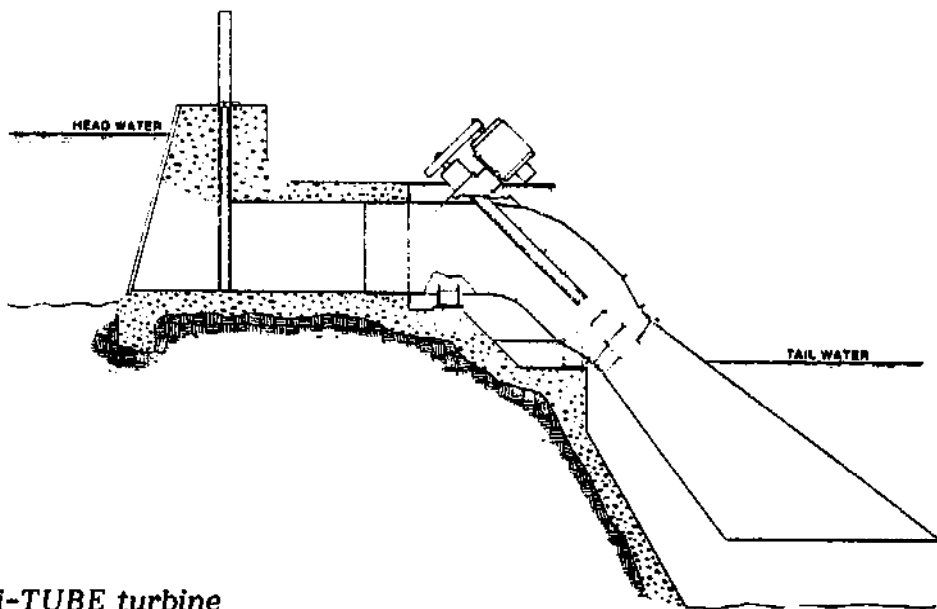

Mini-TUBE turbine

ATLANTIC, GULF & PACIFIC COMPANY OF MANILA, INC.

P.O. Box 69 MCC
Makati
Metro Manila, Philippines

Phone: 85-79-76
Telex: 45554 (Globe
Mackay-ITT)
ATGUPAC
22502 (RCA)
AGP PH
Cable: Dredging Manila

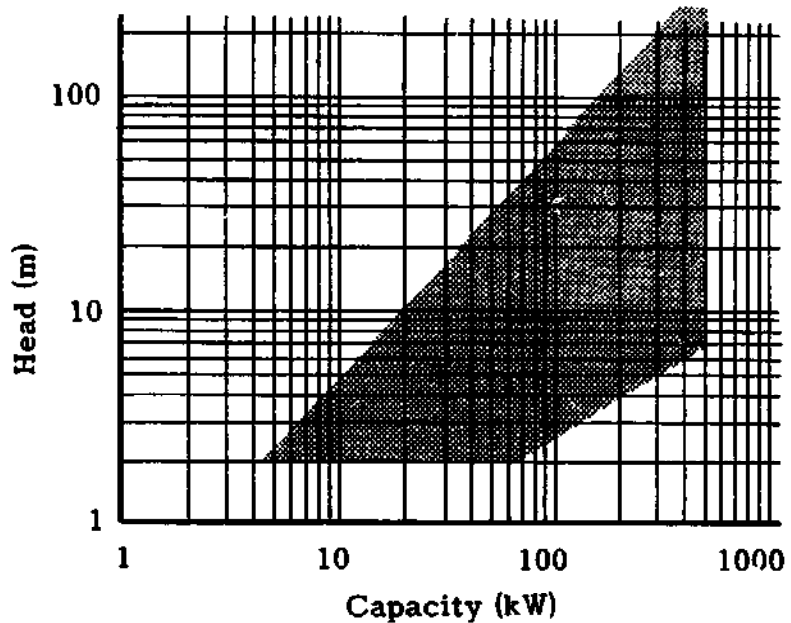

Background

Atlantic, Gulf & Pacific Company of Manila, Inc. (AG&P) was established in 1900. Through the years, AG&P has emerged as a leader in heavy industrial plant construction, design and fabrication of land and marine structures, foundry castings, preservation of lumber, and manufacture and supply of machinery, equipment, and industrial supplies.

In response to the government's search for alternative energy sources, AG&P entered into an agreement with the People's Republic of China for the transfer of mini-hydro turbine manufacturing technology. This agreement with the China National Machinery and Equipment Import and Export Corp. (CMEC) and Hangzhou Electric Equipment Works covers small hydro turbines with capacities ranging from 100-5000 kW. It is designed to augment AG&P's technical capability in the manufacture of turbines in a progressive manner.

Equipment

AG&P manufactures Francis, Pelton, and propeller turbines in the 100-5000 kW range.

The **Francis turbine** is suitable for heads ranging from 30-120 m. The spiral casing and the runner are of welded construction from steel plates with the labyrinth seal made of stainless steel. The rim of the flywheel is fitted with a shutdown brake to prevent possible bearing damage at low speed. The generator is connected directly to the turbine by means of a flexible coupling.

The **Pelton turbine** has a runner of cast-and-welded construction. The turbine is fitted with a needle valve and a deflector for regulating water flow. The needle valve and nozzle are made of stainless steel. The turbine is equipped with a sliding bearing lubricated by circulating oil. A flexible coupling connects the impulse turbine directly to the generator.

The **propeller turbine** manufactured by AG&P has a vertical-shaft configuration with an open flume intake.

The price of the turbines range from \$500-\$800/kW, depending upon the head.

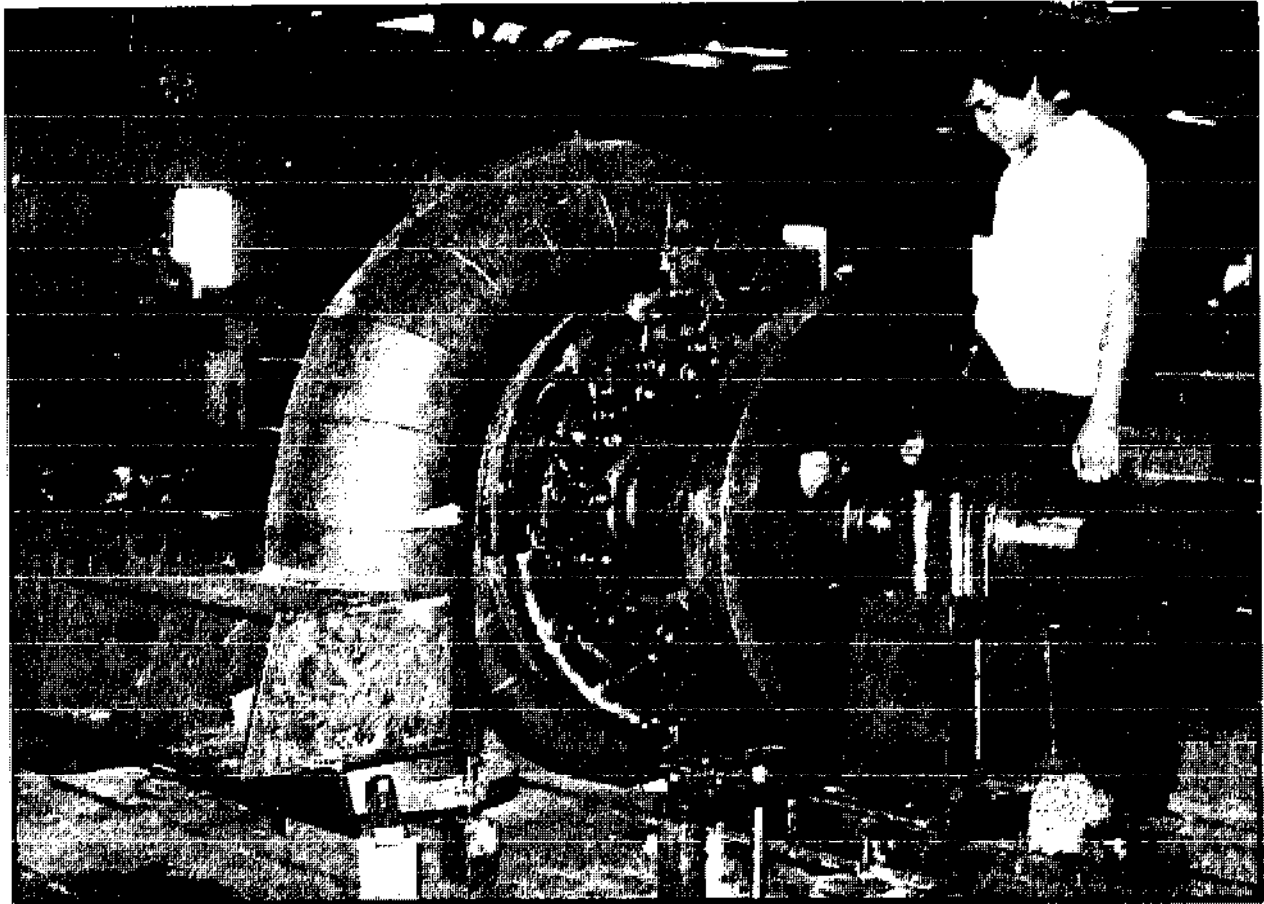

A fully assembled Francis turbine and flywheel are shop-assembled to ensure proper alignment and fitting of parts.

BALAJU YANTRA SHALA (PVT.) LTD.

Post Box 209
Kathmandu, Nepal

Phone: 14809, 13379, 13296
Cable: BYS
Telex: 2245 (Attn. BYS)
SATA NP

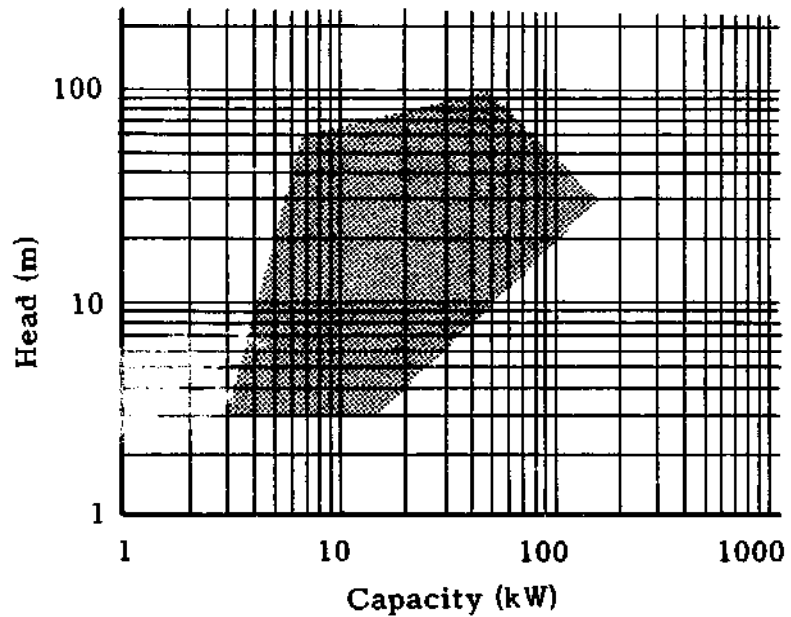

Background

Balaju Yantra Shala (Pvt.) Ltd. (BYS) is an organization initiated jointly by the Swiss Association for Technical Assistance (SATA) in Nepal and the Nepal Industrial Development Corporation (NIDC). It has a well-equipped mechanical workshop with modern machine tools obtained primarily from Switzerland. It has a staff of five mechanical and electrical engineers and a well-qualified staff of about 120 machine tool operators. It also has a mechanical design and drawing section. Since its inception in 1960, it has been producing suspension bridge parts, large oil storage tanks, overhead water tanks and trestles, concrete mixers,

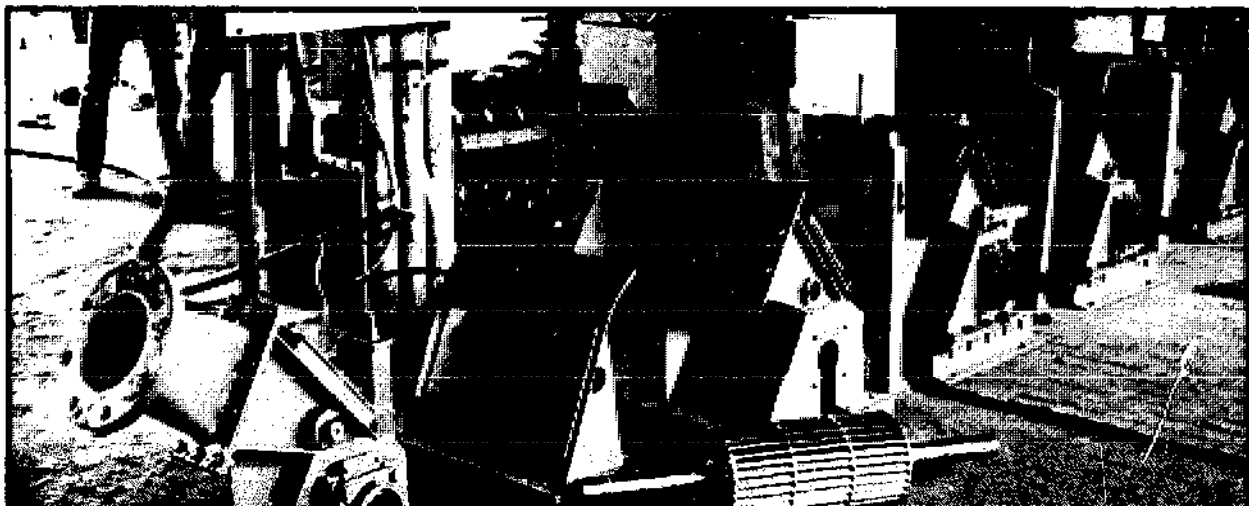

mechanical equipment, spinning and weaving machines, steel structures for factories and buildings, and crossflow turbines.

In 1973, a fabricated prototype of a crossflow turbine was developed for BYS and several dozen were then installed. These are primarily used for agro-processing although some are used for electricity generation and lift irrigation. Several turbines have already been sold overseas. Another version was developed and tested in Switzerland and put into production at the end of 1980.

Equipment

The turbine manufactured by BYS is a **crossflow turbine** of fully welded construction. In addition to the turbine and housing, it includes a guide vane which can be used to regulate the flow into the turbine either manually or hydraulically, an adapter between the penstock and the rectangular turbine inlet, and a draft tube, if required.

To facilitate transporting this unit on foot into remote areas, units are fabricated to permit carrying individual parts to the site where they can then be assembled. Assembling the unit with bolts permits ease in repair or replacement of individual parts if necessary.

To cover a wide range of flows, the crossflow turbine is available in 11 standardized widths. Turbines can essentially be custom designed. Because of a smaller runner diameter than the original design, the runner speed ranges from 300-1500 rpm, depending on head; therefore, less gearing is required for electricity generation. Efficiency of the unit averages about 75%.

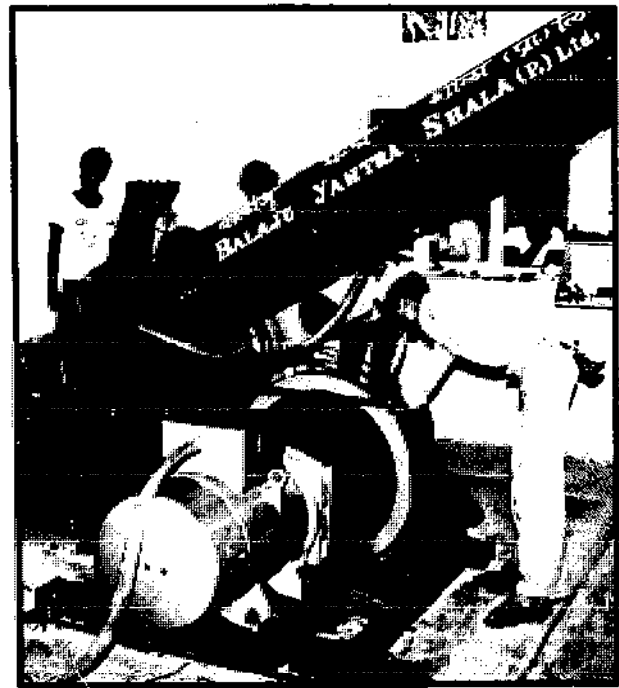

An isolated, 30 kW plant at Dhankuta, Nepal, using a BYS turbine and governor.

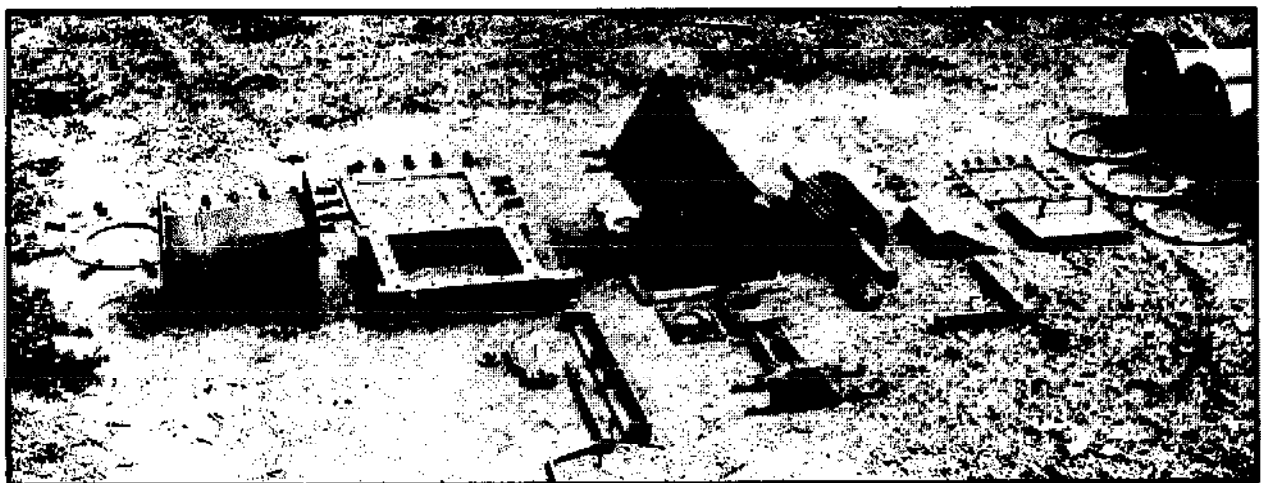

A disassembled BYS turbine with transition piece between nozzle and penstock.

Ex-factory prices for the turbine range from \$650/kW at a very low head (3m), to \$200/kW at medium heads (20 m), and down to \$110/kW at high heads (up to 100 m).

For the generation of electricity, hand regulation of the turbine is possible. BYS has a mechanical, water-hydraulic proportional-type governor available with speed regulation of $\pm 5\%$ -10%, adequate for most situations. Water, under the head available at the installation, is the working fluid and there is, therefore, no need for a pump. Research undertaken in Switzerland, coupled with experience gained from field work by BYS in Nepal, contributed to the final design.

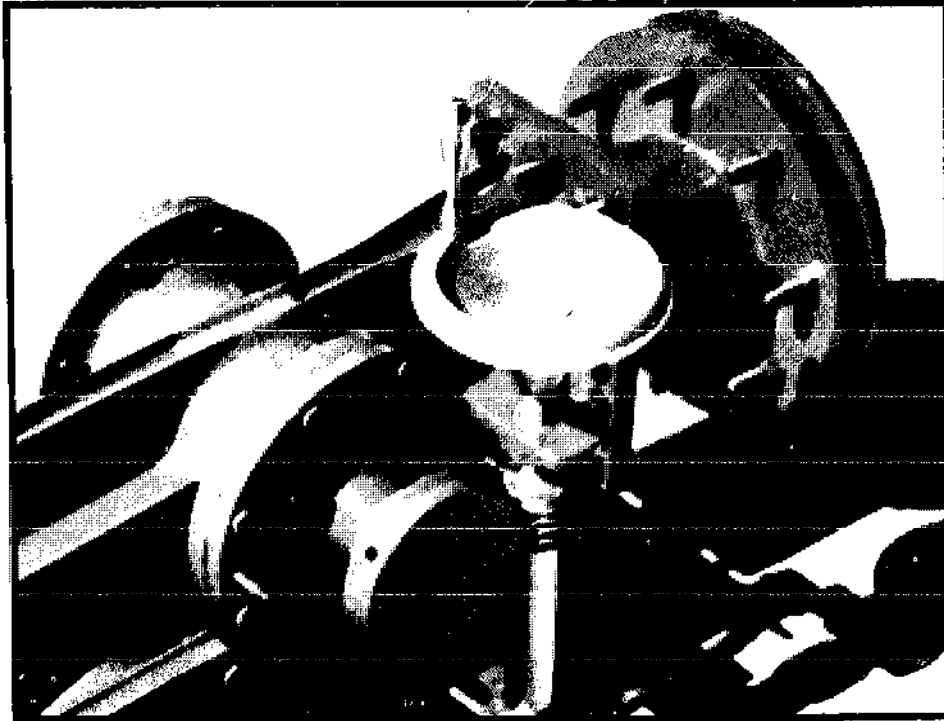

A small turbine for an installation in Irian Jaya, Indonesia, with manual flow regulation.

BUTWAL ENGINEERING WORKS (PVT.) LTD.

Post Box 1
Butwal, Lumbini Zone
Nepal

Cable: BEW

Background

In 1963, the United Mission to Nepal (UMN), in cooperation with the Department of Cottage Industries, started the Butwal Technical Institute (BTI). In 1977, the mechanical workshop of BTI became a private limited company, Butwal Engineering Works (Pvt.) Ltd. (BEW), controlled by BTI. It has one of the best-equipped mechanical workshops in the country, with mechanical tools to handle a wide range of tasks.

BEW has a staff of four engineers, seven supervisors, and about 25 machine tool operators. In addition to its workshop, it has a mechanical design section and a well-equipped site for testing its turbines and other hydraulic equipment. It fabricates a variety of products, including suspension bridges, transmission towers, irrigation gates, water and fuel tanks, penstock pipes, and crossflow turbines. BEW originally fabricated a high-head Pelton unit. After it became apparent that low-head sites were more prevalent and appropriate in the Nepali context, BEW quickly switched over to a crossflow turbine design more suitable for lower heads.



Fabricating a penstock bifurcation at the BEW workshop.

In cooperation with BEW, Development and Consulting Services (DCS), another UMN enterprise, handles the installation of BEW turbines in the field. To date, about 100 turbines have been installed. It also participates in research on other kinds of equipment which can be utilized in conjunction with micro-hydro installations. These include (1) a mechanically-driven air heater for drying agricultural produce (10 kW and 25 kW units already having been built by BEW), (2) rice-processing equipment, and (3) storage cookers which more efficiently use the capacity of small hydroelectric plants for cooking. With assistance from the Swiss Association for Technical Assistance (SATA) and the Centre for Electronics Design Technology (CEDT) of Bangalore, India, efforts are underway to simplify an electronic load controller, originally designed in Switzerland, to permit local assembly using Indian components.

Equipment

Fully welded **crossflow turbines** of two diameters are available. Type 405 has a 400 mm diameter runner and a nozzle 50 mm across. A more recent design, Type 205, has half that diameter which is more appropriate since it results in lower overall size and turbine costs and increased shaft speed. These turbines come in ten standardized widths to cater to the power required or flow available at a specific site. Turbine cost ranges from \$120-200/kW, depending on head.

BEW has developed a hydraulic governor suitable for small turbines and several are being tested in the field. In addition, an electronic load controller is under development. These units may be commercially available shortly.



A small crossflow turbine directly coupled to a generator.

BYRON JACKSON

Borg-Warner Corporation
200 Oceangate Boulevard, Suite 800
Long Beach, California 90802

Phone: (213) 721-4511
Telex: 181105

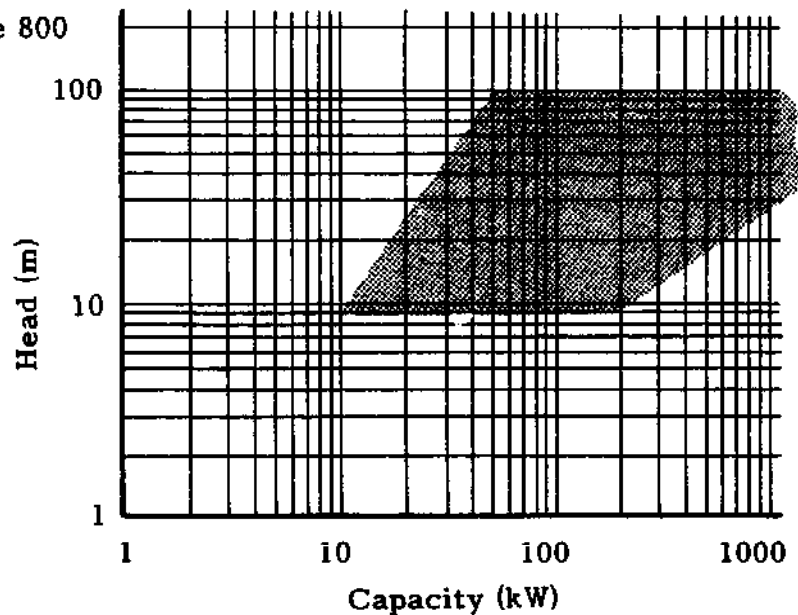

Background

Byron Jackson is an international division of Borg-Warner Corporation which has manufactured pumps and related products since 1872 for the power, petroleum, and general industries. It now offers a full line of vertical, horizontal, and submersible pumping equipment.

Byron Jackson has supplied a number of pumps which operate in reverse, as turbines, to recover waste hydraulic energy. These pumps work well in constant-flow situations; but the company was approached by municipal and industrial customers to develop a turbine that was more appropriate for wide variations in flow conditions. The company used its extensive hydraulic experience to develop the TKW turbine.

Byron Jackson has service centers and warehouses worldwide to provide quick turnaround on repairs and parts' delivery. Technicians are available to handle installation, repairs, start-up, and field services.

Equipment

Byron Jackson's TKW turbines are **semi-axial-flow turbines** with adjustable wicket gates to handle flow variations in the range of 50%-120% of design flow. They have been thoroughly tested for power output, efficiency, NPEH, and runaway speed and flow. The turbine is constructed with Ni-Alum-Bronze wicket gates and runner case, with a runner of cast Ni-Alum-Bronze or 304 stainless steel. The runner is axially adjustable from the operating floor level to restore original running clearance to the runner case by means of the adjustable turbine/generator coupling without removing the unit.

The TKW has been designed to maximize standardization and avoid complex controls. The simplified, compact design reduces site preparation and cost. The cost of this turbine and generator ranges from \$400-\$800/kW and delivery is within 4-8 months.

Byron Jackson's VKW (reverse running pumps) are fixed-geometry turbines with many components that are interchangeable with the Byron Jackson line of pumps. They are particularly suitable where head and flow are not too variable. Multiple units are usually required to absorb large flow variations.

Byron Jackson completed an extensive test program to generate a complete set of performance curves for use in the application of the VKW turbines. Each VKW type has been thoroughly tested for power output, efficiency, NPEH, runaway speed, and flow. The VKW turbine cost ranges from \$250-\$500/kW and delivery is within 3-8 months.

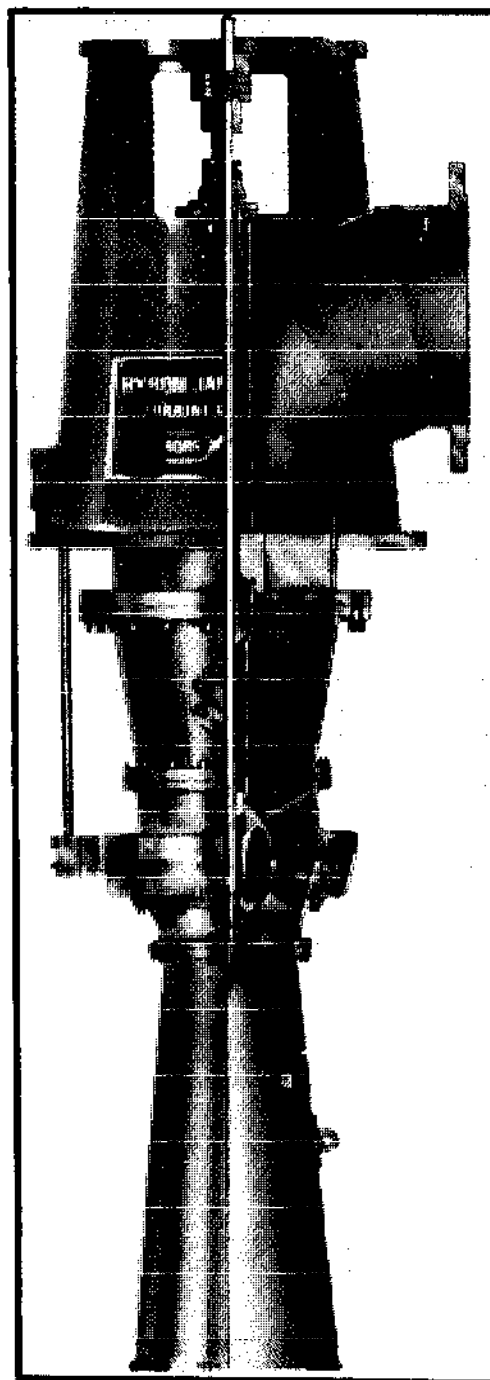

C.CH.LG. LTDA.

Apartado Aereo 316
Bogota D.E., Colombia

Phone: 258-6503

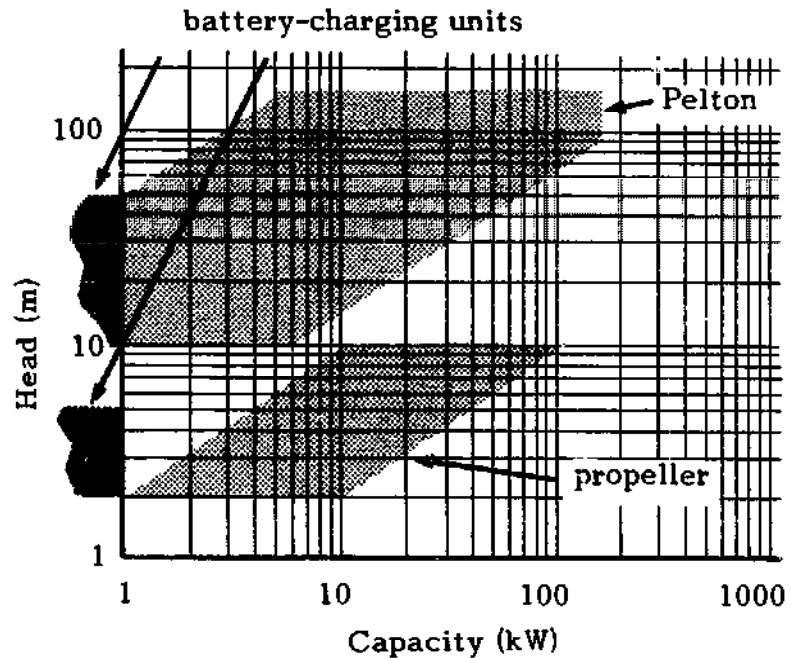

Background

C.CH.LG. Ltda. started in 1978 manufacturing tailor-made turbines for small scale hydropower units and providing technical assistance in hydropower developments for communities and private agro-industrial companies. C.CH.LG. Ltda. has been involved in various integrated hydropowered projects providing equipment for sawmills, rural industries, and rural electrification. The technology used in its design ensures that the community or client will take an active role in the development of the plant and operation of the equipment.

Equipment

"Microturbo" is C.CH.LG.'s trade name for a standard hydroelectric battery charging unit that operates with heads of 10-50 m to provide enough energy for the daily electric power demand of a rural home. The unit comprises a 2-jet **Pelton turbine** and alternator with adaptable features for best efficiency point operation and sells for \$500 excluding freight.

C.CH.LG. manufactures single casting, aluminum alloy Pelton runners for power under 10 kW and welded fabrication, alloy steel runners for power outputs of 10-150 kW. Speed regulation is provided accurately with elec-



The complete two-jet Microturbo battery-charging unit with penstock bifurcation piece.

tronic ballast load controls or approximately by using passive regulation with a back flow hood that brakes the runner, avoiding excessive overspeed.

The firm also manufactures **propeller turbines** with vertical shaft for heads of 2-8 m. Blade angles are fixed during the operation of the turbine but can be manually adjusted when the plant is shut down.

Except for the Microturbo, all units previously mentioned are engineered to specific site conditions on order. Costs of the units depend on the characteristics desired. For example, an 18 kW, two-jet Pelton turbine running at 1500 rpm under a head of 100 m will cost about \$2000. An axial turbine with the same capacity operating under a head of 2.5 m will cost about \$4500.

C.V. SUKARADJA

Jl. Kom. Ud. Supadio (Jatayu) 98
Bandung, Indonesia

Phone: (022) 615885, 611637

Background

C.V. Sukaradja, a metal workshop and engineering firm established in 1961, manufactures various kinds of machines and equipment needed by local industries.

In 1977, with the assistance of Dutch engineers within a framework of intergovernmental cooperation, C.V.

Sukaradja researched and developed a crossflow turbine design. Having recently completed fabrication of a 400 kW turbine, Sukaradja can now manufacture crossflow turbines in the 5-500 kW range. Sukaradja makes all components for the turbine. The generator, electric controls, and other components are either assembled in Indonesia under license from Japan or imported.

Equipment

Output from the **crossflow turbine** manufactured by Sukaradja is controlled manually by use of a guide vane. These units operate under heads of 5-50 m and are coupled by belts to the alternator. Efficiencies range from 65%-70%.

Complete packaged units, including turbine, generator, and load controller, are available. In the 5-50 kW range, the cost for the turbine only is about \$400/kW.

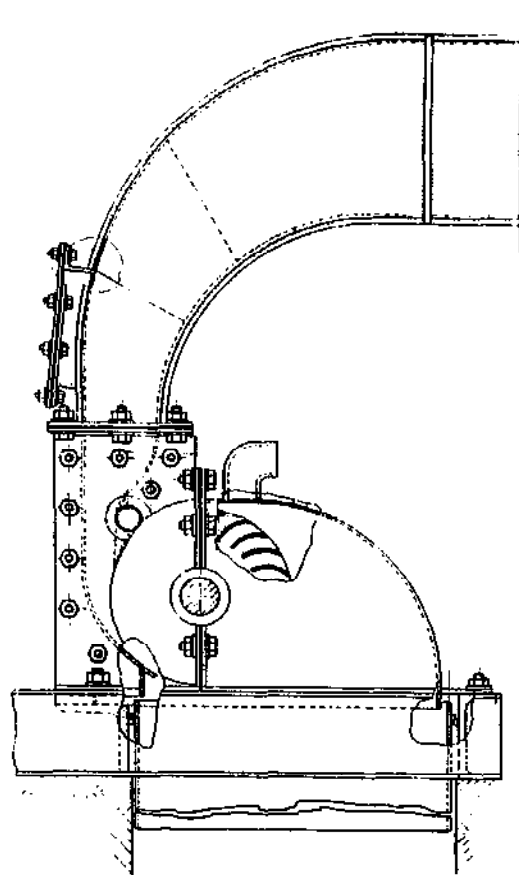

CANYON INDUSTRIES, INC.

5346 Mosquito Lake Road
Deming, Washington 98244

Phone: (206) 592-5552

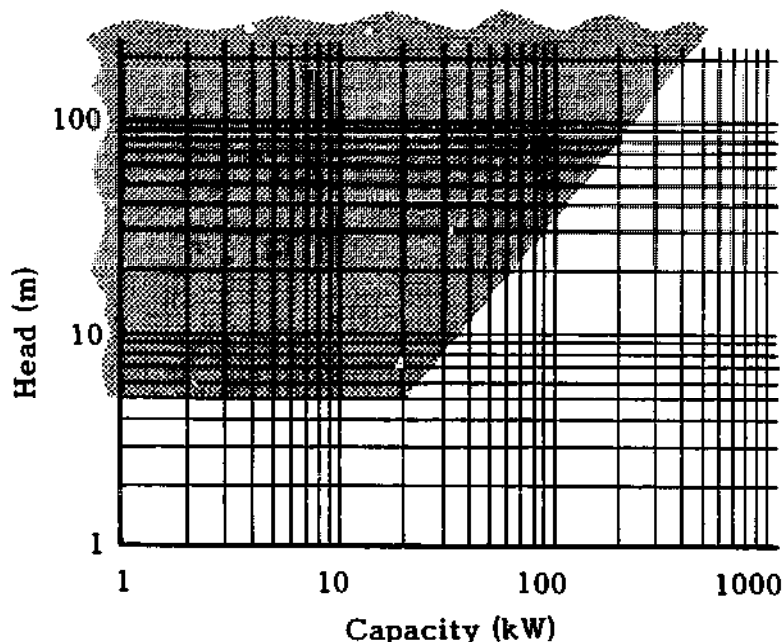

Background

Canyon Industries has been manufacturing small hydroelectric turbines since 1976, focusing on crossflow and Pelton turbines under 1000 kW. Complete machining and fabrication facilities are the center of Canyon Industries' operations, which include design pattern-making, light foundry, and testing capabilities. This small company is located about 100 miles north of Seattle.

Canyon Industries utilizes power from its own 24 kW small hydroelectric system installed in 1965. Experience and daily use of a micro-hydroelectric system has influenced the simple and dependable design stressed by Canyon Industries. It has manufactured equipment for over 50 sites, roughly half of which operate as independent systems.

Equipment

Canyon turbines include both high-head Pelton and medium-head crossflow turbines. The company focus is on custom-designed turbines, offering complete systems to operate in either stand-alone or grid-interconnected modes.

Pelton turbines made by Canyon Industries operate under heads over 30 m and generate power in the 1-1000 kW range. Runners are generally integrally cast (single piece) in manganese-bronze or stainless steel.



Housings are heavy plate steel, with internal jet deflectors, needle nozzles, labyrinth seals, and spherical roller bearings. The efficiency of the turbine approaches 90%.

Crossflow turbines range from 1-250 kW utilizing heads from 5-60 m. Runners are fabricated in steel or stainless steel. Full, infinitely variable flow control is standard on each custom-designed crossflow turbine.

Costs vary according to site conditions, available head, turbine size, and inclusion of available options. Both complete systems and turbines only are offered, along with various power-control options. Complete system costs for units under 100 kW range from \$180-\$1000/kW. For units over 100 kW, costs range from \$140-\$700/kW.



A complete turbo-generating package incorporating a crossflow turbine.

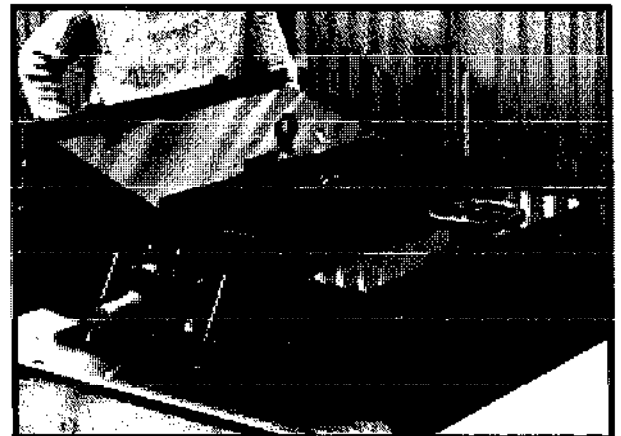

A crossflow turbine.

COMBUSTION ENGINEERING/NEYRPCIC HYDRO POWER, INC.

969 High Ridge Road
Box 3834
Stamford, Connecticut 06905

Phone: (203) 322-3887
Telex: 643920 (U.S.)
6819258 (int'l)

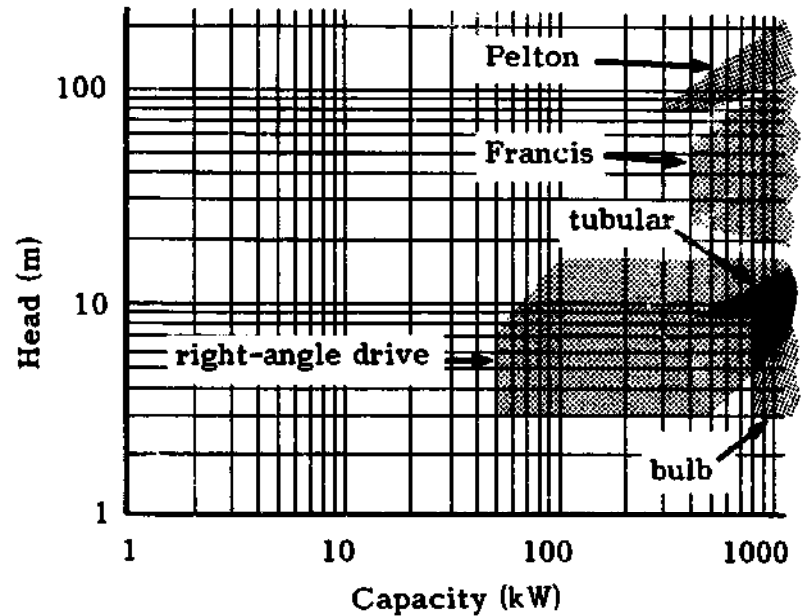

Background

Combustion Engineering, Inc. (C-E), formed in 1912, is a multi-national company serving energy-related industries worldwide. Today, C-E offers equipment and services, nationally and internationally, for the following markets: utility and industrial power generation; oil and gas exploration and production; environmental control; energy conservation; and renewable resource technology.

Neyrpcic, a major French turbine manufacturer, has been developing, designing, manufacturing, installing, and servicing all types of turbines and related components for over 130 years. Its equipment has been incorporated in over 1000 projects worldwide, with a total generating capacity in excess of 76,000 MW.

In May 1981, Combustion Engineering/Neyrpcic Hydro Power, Inc. (C-E/Neyrpcic) was formed as a subsidiary of C-E, licensing technology from Neyrpcic. Hydro Energy Systems, Inc. is a wholly-owned subsidiary of C-E/Neyrpcic, offering the small low-head turbines described below in some detail. As a wholly-owned subsidiary which shares the same location as its parent company, all inquiries should be directed to C-E/Neyrpcic.

In addition to its own staff, C-E/Neyrpcic is supported by engineering resources of both C-E and Neyrpcic. There are more than 6250 employees at facilities used by C-E/Neyrpcic at over 500 locations worldwide. With access to detailed theoretical (fundamental studies and computation) and experimental (test rigs and laboratories) research, which uses C-E production facilities in Chattanooga (Tennessee), Wellsville (New York), and Newington (New Hampshire), in addition to Neyrpcic's Grenoble (France) plant. It offers a complete product line encompassing Kaplan, Francis, Pelton, and pump turbines as well as gates, valves, and penstocks.

The C-E/Neyrpic line of small turbines has been developed with attention to maintaining the economic feasibility of small-scale projects. The design of its low-head standardized turbines is based on development and testing of the hydraulic profiles and complete detailed designs of the standardized units.

Small high-head turbines must meet the same requirements as the larger units, but their design and manufacture must be modified in order to reduce the cost per kilowatt. C-E/Neyrpic has achieved this by modifying certain design factors, choosing materials carefully, and performing the necessary tests.

Equipment

Right-angle drive turbines can accommodate outputs of 50–1500 kW with seven runner diameters. They are designed for heads of 3–20 m. Complete packages are available which include a trashrack, stoplog, and upstream butterfly valve or roller-type tail gate (hydraulic cylinder, gate leaf, embedded frame) which comes fully assembled for shipping. The turbo-generating unit incorporates a speed increaser, generator (a synchronous alternator with ballast load for isolated operation), mechanically driven oil pump, and fixed distributor.

One of the major advantages of this unit is its very compact design which minimizes the size and cost of civil works. The turbine-mounted generator eliminates the need for a generator foundation. The simplified construction involved is particularly appealing for isolated locations.

The design includes fixed-pitch runner blades and guide vanes with an integrated right-angle drive and speed increaser. Although use of such fixed-pitch units has conventionally been restricted to induction generation into a main grid, Neyrpic has engineered a device which permits the use of this right-angle drive unit in remote areas, away from the grid, to generate synchronously up to 1000 kW. If less electric power is consumed than the design power available from the generator, the excess power is sensed electronically and is dissipated by means of an eddy-current brake on the generator shaft. Excess heat generated in the process is dissipated by circulating cooling water. In this manner, the potential power available from the water is always matched to the total power consumed (by both the end-use consumer and the brake) and the runner speed is maintained constant.

All auxiliary items, such as lube oil pumps, are directly driven by the main shaft. The entire package can, therefore, be designed for isolated locations and minimum maintenance.

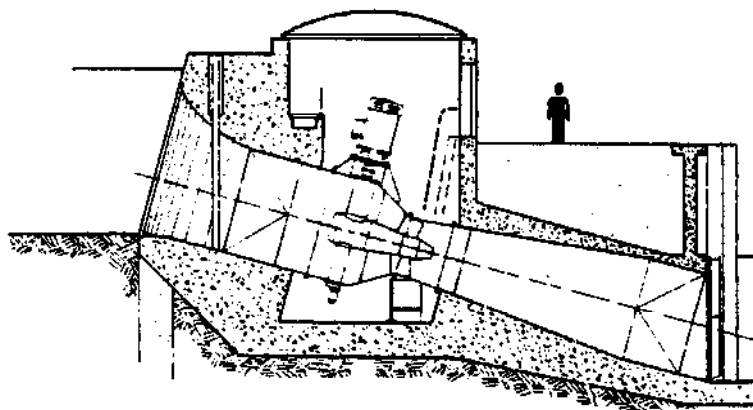

Right-angle drive unit

The standard **tubular unit** is available in four standardized horizontal arrangements for heads of 3-20 m and outputs of 500-5000 kW and features an upstream elbow design for better efficiency and cavitation characteristics.

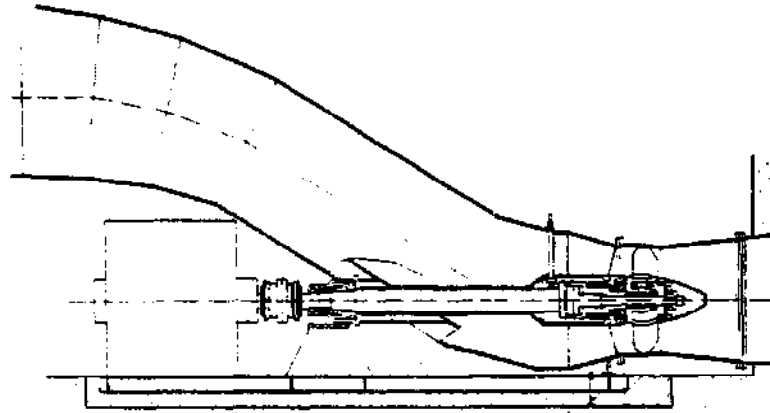

Tubular unit

Standardized **bulb turbines** are designed for heads of 3-20 m and outputs of 500-5000 kW. Seven runner diameters are available. Two configurations are available: fixed distributor with adjustable runner blades or fixed distributor with fixed runner blades. A total package would include a trashrack, upstream control gate or stoplog, speed increaser, generator, and fully assembled roller-type tail gate. In an isolated network, speed is governed continuously by the blades, while transitory variations are absorbed by a patented ballast load.

While bulb turbines are generally more expensive than other hydraulic turbines, their compact design and straight-through configuration provide numerous advantages particularly in civil works areas, such as less excavation, lower superstructures, and reduced higher cost of the turbine. In addition, the compact design characteristics of bulb units with their rational layout of flow passages can provide better performance under selected site conditions.

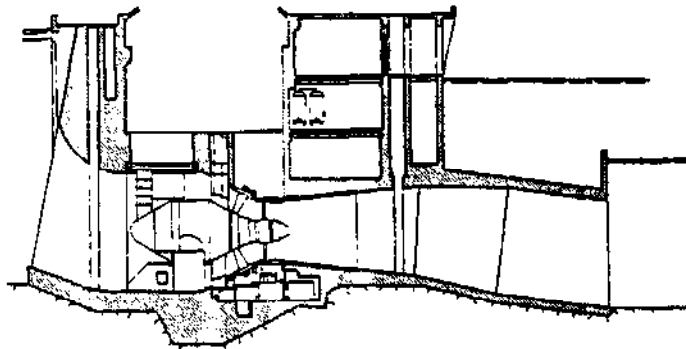

Bulb unit

The small **Francis turbines** are available for medium heads ranging from 20-150 m. For low output, the main shaft is generally horizontal, although vertical shaft units are also available.

Small **Pelton turbines** are available for high heads ranging from 100-1000 m. They are generally designed with horizontal shafts and can incorporate one or two nozzles.

30 Turbine manufacturers

CORNELL PUMP CO.

2323 S.E. Harvester Drive
Portland, Oregon 97222

Phone: (503) 653-0330
TWX: 910-453-8377
CORNELL PLT

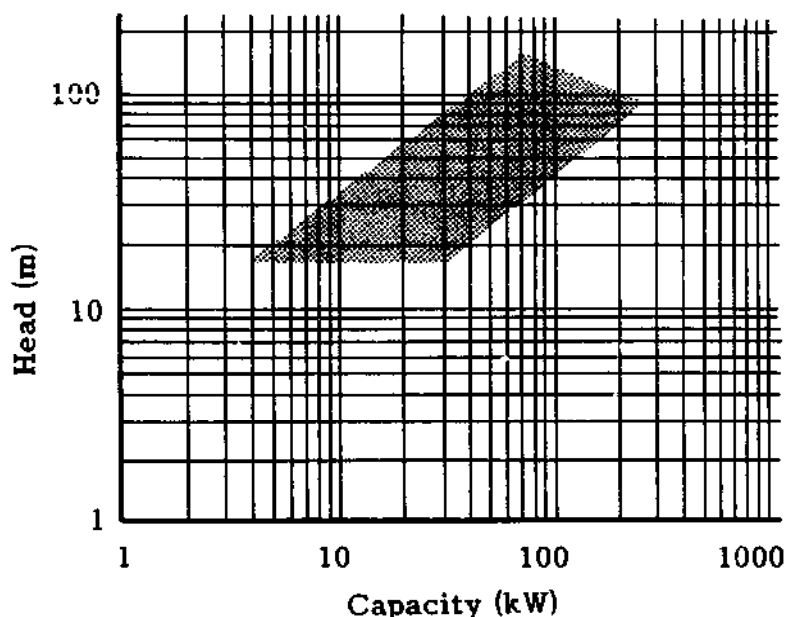

Background

Cornell Pump Co. has been manufacturing pumps and related products since 1946. Its current line of pumps, in the range of 1-200 hp, is used for a variety of purposes including irrigation, food product handling, commercial refrigerant circulation, domestic and industrial sewage handling, and industrial water and waste handling.

Based on its experience with irrigation projects, Cornell Pump observed that diesel generation units were supplying power for irrigation equipment at an ever-increasing operating cost. Yet, at a number of sites, available irrigation water had surplus head and energy which had to be dissipated across an orifice or valve. To harness this energy, Cornell Pump decided to modify its standard pumps as reversible pump-turbines to drive small generating units.

In October 1981, Cornell Pump put its first unit into operation in Oregon where it harnesses the energy available as irrigation water drops 150 m from an upper to a lower canal. During the months when surplus water is available, it generates up to about 170 kW into the local grid.

Equipment

Cornell Pump **reversible pump-turbines** are modifications of its end-suction, single-stage centrifugal pumps. Standard units are constructed of cast iron and bronze, although special units are made of a variety of materials.

Cornell Pump can provide a complete turbo-generating package with controls. For isolated systems in the lower power range (5-20 kW), it would generally supply a synchronous generator with its own load controller. For larger systems, it would propose induction generation, with appropriate controls, into the local grid.

Prices for these packaged units range from \$1000-\$1200/kW in the 10-15 kW power range to under \$500/kW for units over 100 kW.

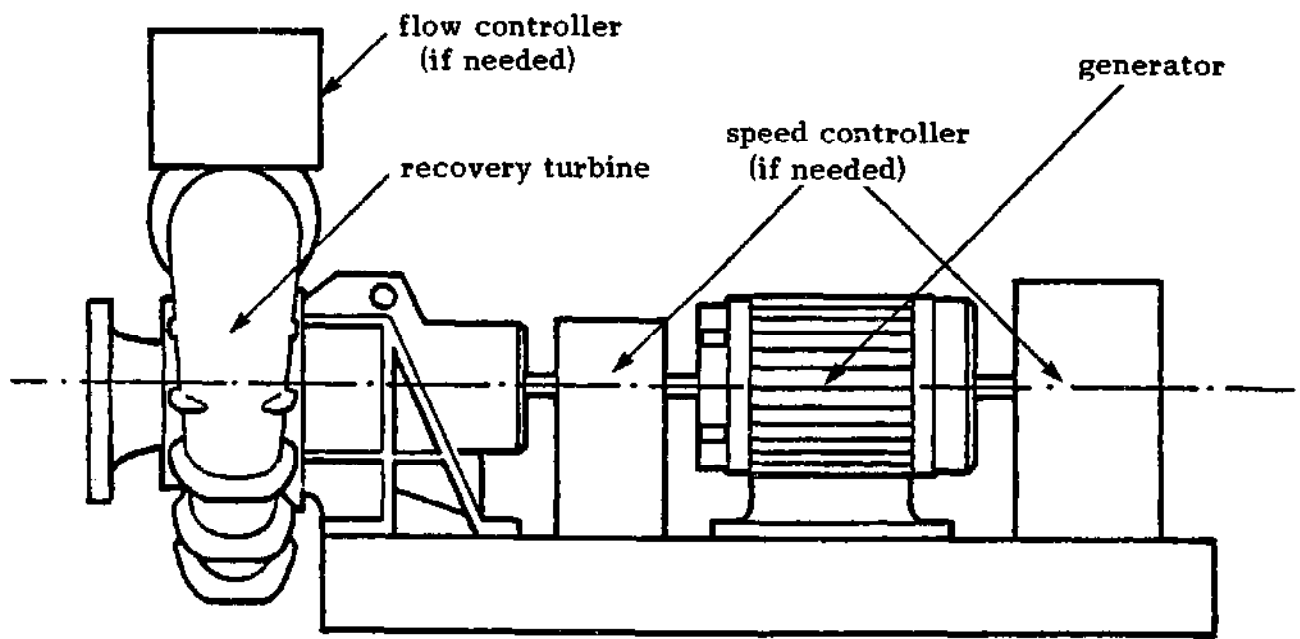

ENERGY RESEARCH & APPLICATIONS, INC.

1820 Fourteenth Street
Santa Monica, California 90404

Phone: (213) 452-4905

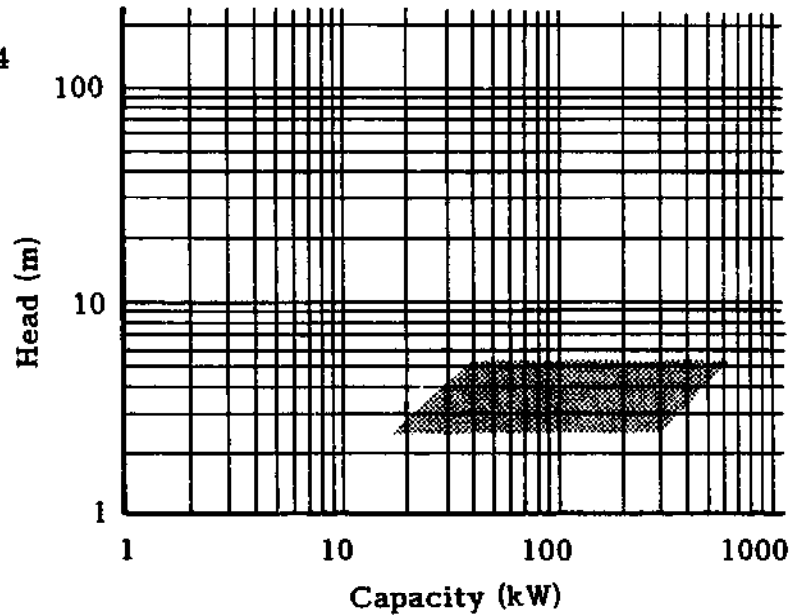

Background

Energy Research & Applications, Inc. (ER&A) was formed in 1976 with the specific charter of undertaking engineering and research projects in renewable energy technologies. ER&A specializes in innovative equipment, engineering designs, and installations for hydroelectric power generation. It is also involved in biogas-fueled cogeneration.

In its original engineering design work, ER&A was faced with the high cost of commercially available hydro-generating equipment for low-head application. To reduce these high costs and increase the attractiveness of developing low-head sites such as those commonly found at irrigation drops, it has developed its own line of ultra-low-head hydropower packages. The first 400 kW prototype was partially funded under U.S. Department of Energy (DOE) contracts and installed in 1982 in a canal in a central California irrigation district. An additional 100 kW unit has been installed and will be operational in early 1984 on a diversion structure at a fish hatchery in Oregon. Both units are grid-connected.

In addition to selling packaged units, ER&A is staffed and organized to provide complete site engineering and turnkey installations for its hydropower packages.

Equipment

Eleven standardized packages, consisting of a **propeller turbine**, coupling, and generator, have been designed to operate under heads of 2.5-5 m to generate 15-700 kW. Turbine efficiency is 70%-80%. An induction generator is standard in the package; synchronous generators can also be provided, usually at additional cost. For use with a synchronous generator as an isolated unit, a load controller was also designed as part of the original DOE contract. This has not been developed further because there has been no market for it in the U.S.

Key to reducing the cost of the ultra-low-head turbine is the use of a modified marine thruster as the prime mover. Other components have also been identified and developed on a cost-performance basis with the goal of minimizing overall equipment costs.

The package designs provide for vertical, horizontal, or syphon installations depending on particular site configuration. Additional civil works requirements or modifications for package installation are minimal. This was one of the design goals as part of the cost-reduction effort. The units are designed as constant-flow turbines, suggesting multiple-unit installations to accommodate seasonal or other variable flow conditions.

The complete package price ranges from \$50,000-\$250,000, with a delivery time of 6 months.

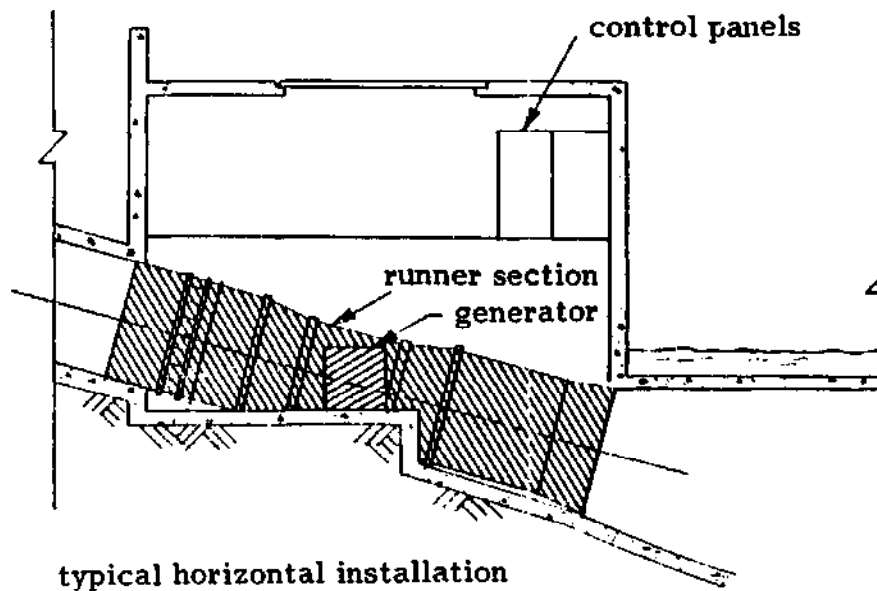
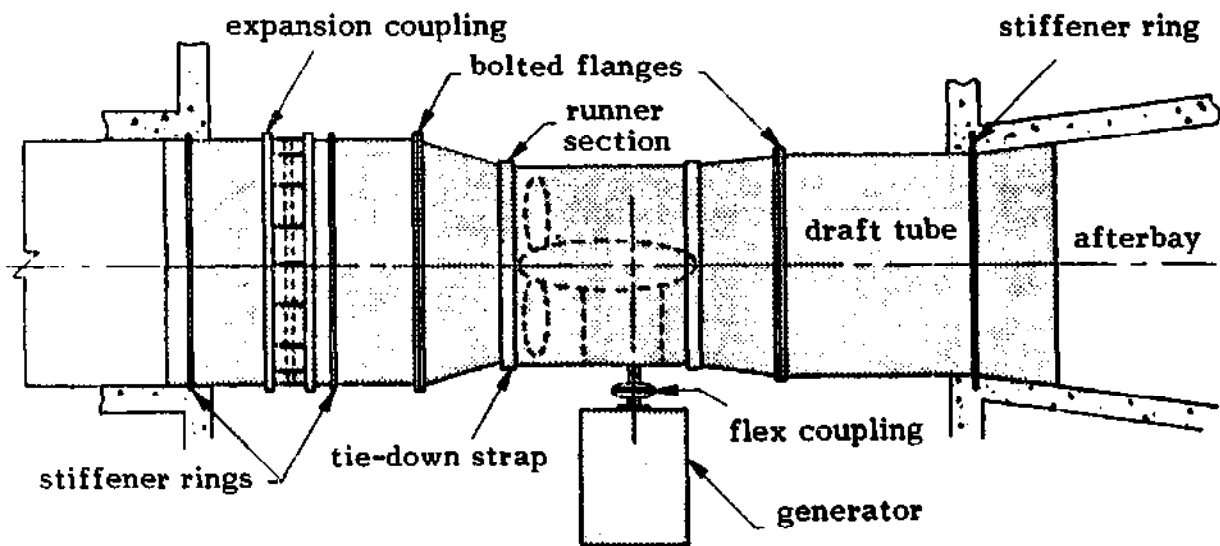

Standard ultra-low-head package and installation.

ESSEX TURBINE COMPANY, INC.

Kettle Cove Industrial Park
Magnolia, Massachusetts 01930

Phone: (617) 525-3523

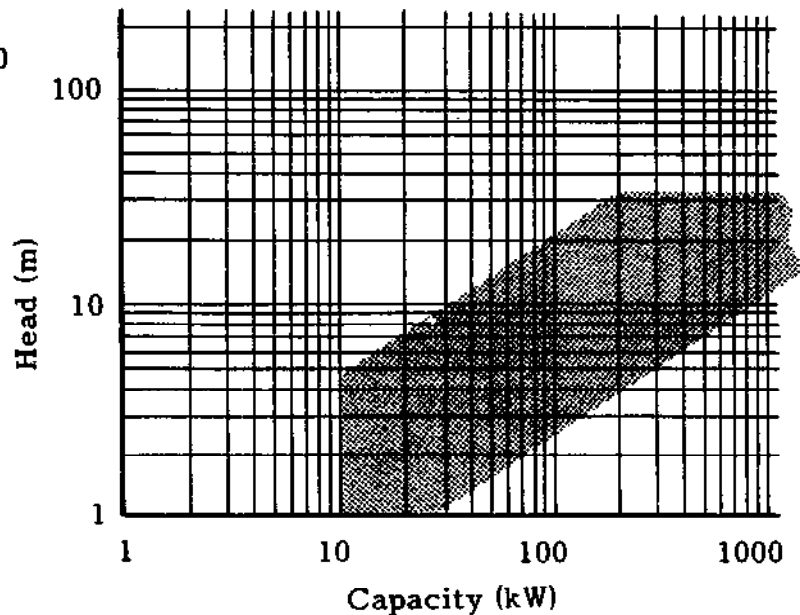

Background

The Essex Turbine Company, Inc. was founded in 1980 by six engineers with over 100 years of combined experience in turbo-machinery design and manufacturing. The company operates a 225 kW hydraulic test facility in Massachusetts and will have some 15 units ranging from 75-330 kW on-line by early 1984. Work is underway on an adjustable-pitch runner design with a prototype currently being installed in New Hampshire.

Essex also offers consulting services for the small hydro industry using the latest turbo-machinery theory, hydraulic structure analysis, and computer design concepts.

Equipment

Essex manufactures a compact fixed-geometry **bulb turbine** in six sizes suitable for heads in the 2-30 m range. Conservatively designed and ruggedly built using ductile iron runners and casing, the machines employ a planetary speed increaser to drive an induction generator for interconnection to an existing utility grid. The mainshaft and gearbox/generator sections are sealed from the water passage by multiple mechanical face seals. Each machine in the Essex series can be removed, disassembled, inspected or overhauled, and returned to service in two days by competent local mechanics.

Installation directly in the water passageway eliminates the need for a powerhouse and reduces civil costs proportionately. The Essex turbine is adaptable from horizontal through vertical installations and thus is well suited to retrofit into existing flumes or canal drops. Low specific speed and flow velocities reduce cavitation potential and minimize submergence and excavation requirements.

Costs for the Essex series turbines, including gearbox, generator, and draft tube range from approximately \$300/kW for the largest turbine operating under a 6 m

head to \$1000/kW for the smallest turbine under a 9 m head. Electrical controls, protection relaying, and water control apparatus can be quoted separately for specific site requirements.

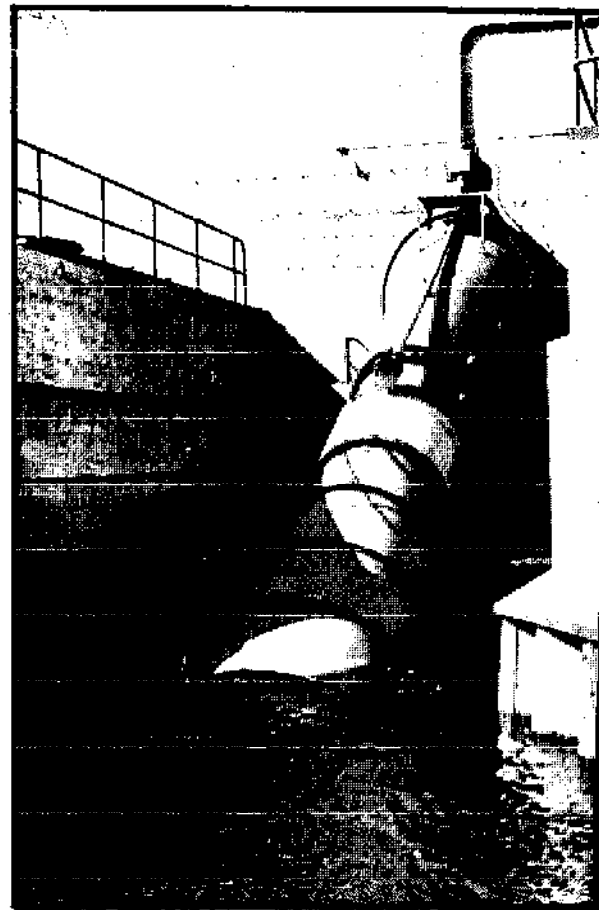
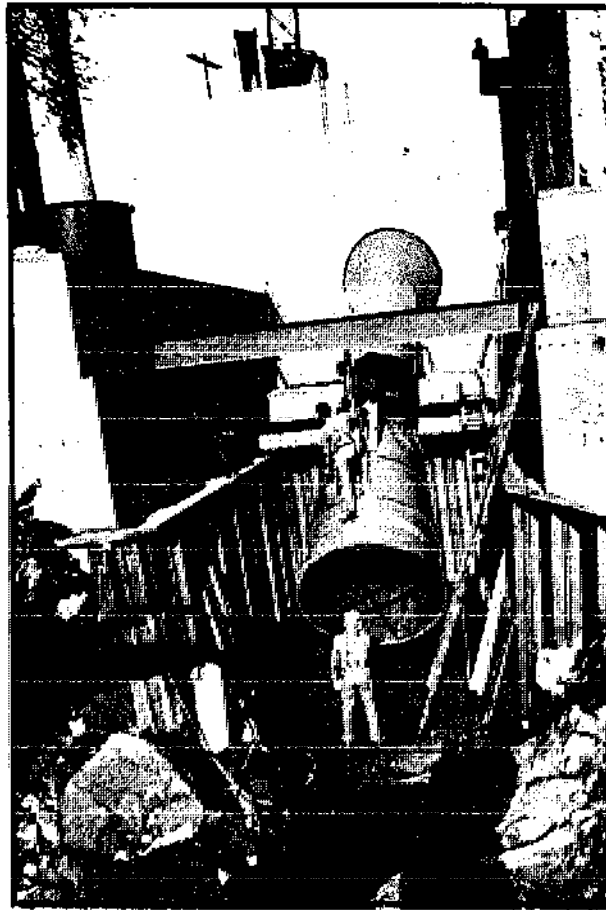

An installation utilizing a bulb turbine under construction and in operation.

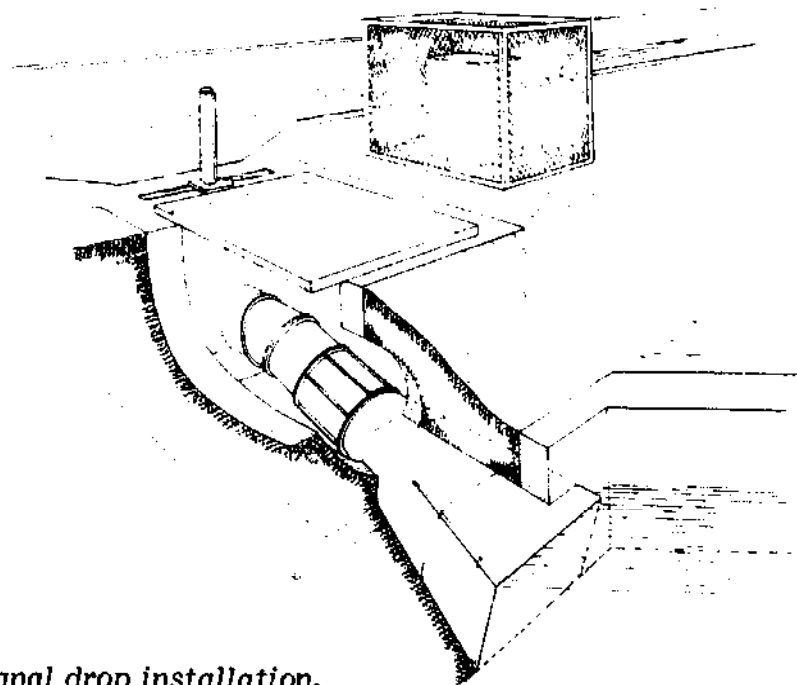

A closed-pit canal drop installation.

GILKES/BORDER CONTRACTORS, INC.

4600 Shipyard Road
Blaine, Washington 98230

Phone: (206) 332-5545

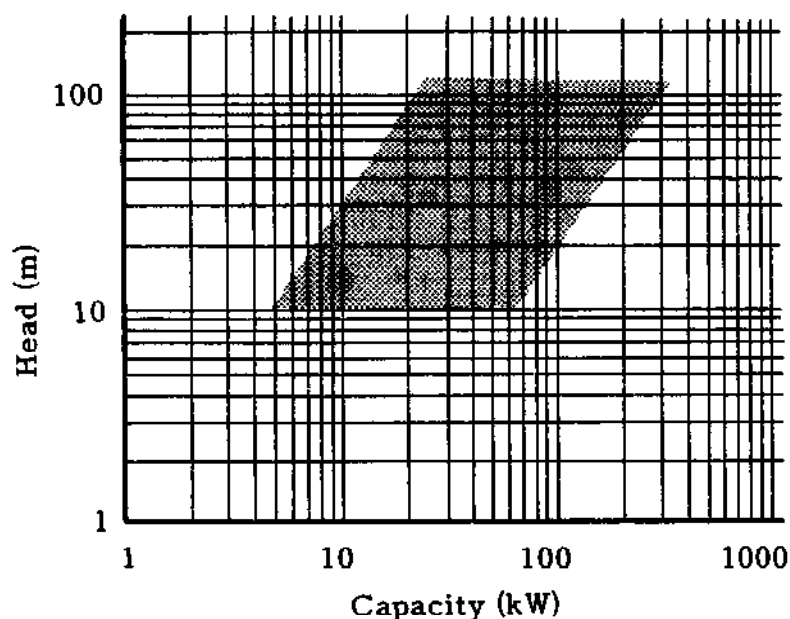

Background

Gilbert Gilkes & Gordon is an English firm which has manufactured water turbines and pumps for over a century. Manufacturing Francis as well as Pelton and Turgo impulse runners, its equipment covers a wide range, from fractional kilowatt units to the 10 MW range. A large number of its turbines have been installed overseas.

Border Contractors, Inc. is the sole representative of Gilkes in the U.S. At present, the turbine runner, cast housings if necessary, and some specialized components are imported from England. Fabricated housings, generators, governing equipment, and other components are either fabricated by Border Contractors according to Gilkes' engineering drawings or else purchased locally.

Equipment

The Hydec is Gilkes' answer to demand for a small standard turbine for use under medium and high heads. It incorporates a single- or twin-jet **Turgo runner** with a stainless steel deflector for each jet. Usually the twin-jet models are equipped with only one needle valve which permits control over the quantity of water used by the unit. Turbine speed is regulated by means of a Woodward governor which controls the deflector(s) and thereby controls the portion of water actually available to the runner. The Hydec is available in four sizes with outputs ranging from 5 kW under a 10 m head to 300 kW under a 90 m head.

A packaged unit includes the Hydec with governor, generator, belt gearing (if necessary), butterfly valve, and inlet pipework between the butterfly valve and nozzle(s).

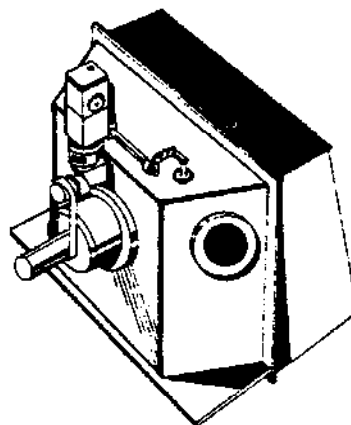

Hydec turbine with governor.

The cost of such a packaged unit, with Woodward governor but without generator, ranges from \$270/kW for a high head (80 m) and high power (300 kW) up to \$5400/kW for a low head (10 m) and low power (6 kW). As is often the case, cost can be reduced by appropriate design. At the high end of the cost per kilowatt range, for example, the governor, which could under certain conditions be omitted, accounts for about 20% of the cost. A further reduction in cost might, for example, be effected by eliminating the relatively costly needle valve.

The Turgo runner, manufactured only by Gilkes, has all the advantages of a Pelton runner but in addition, for a given head and power requirement, it can have a smaller diameter and, therefore, can attain a higher speed than a Pelton runner. This can reduce or eliminate the need for gearing between the generator and turbine.

HAYWARD TYLER PUMP CO.

P.O. Box 492
Burlington, Vermont 05402

Phone: (802) 863-2351
Telex: 954646

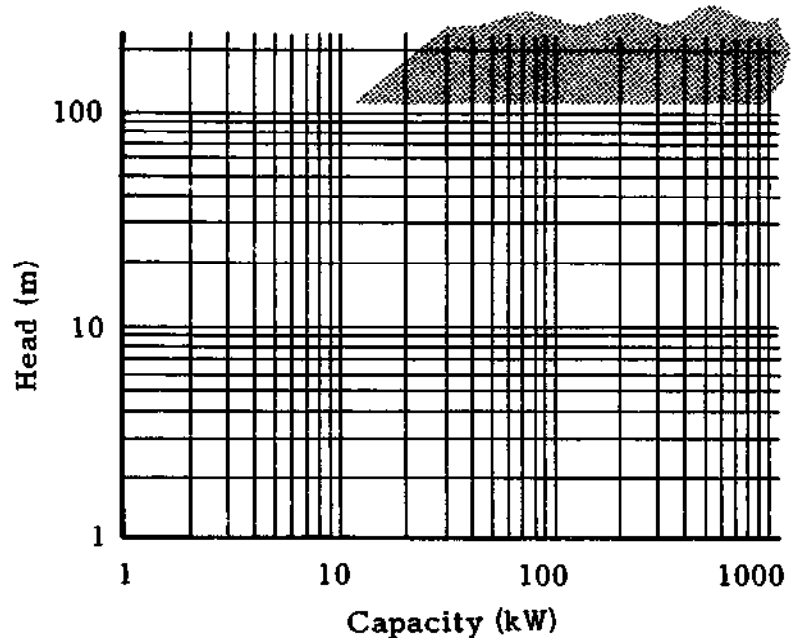

Background

Hayward Tyler Pump Co. designs, manufactures, sells, and services a wide range of centrifugal and mixed-flow pumps from 5-3000 hp. In addition, in order to recover energy from industrial applications or reverse osmosis plants, it has developed the Energy Recovery Turbine (ERT), also available for small hydro-power applications. It has over 50 years of experience, with offices throughout the U.S. and representatives in the Middle East and Asia. Half of its turnover is shipped overseas. Hayward Tyler also provides field services and supplies replacement parts for existing hydro installations.

Equipment

The standard Hayward Tyler ERT incorporates a horizontal **Pelton runner**, normally of aluminum-bronze, or stainless steel, generally with one or two nozzles. Either a manually operated handwheel or pneumatic or electric actuator may be used to activate the needle valve. The actuators can be adjusted by a controller which is programmed to follow forebay level or system demand. Vertical units with more than two nozzles can also be supplied. Because of its initial use to recover energy from high-pressure industrial processes, the turbine is designed to operate under relatively high heads. Options include overspeed sensors with jet deflectors and baseplate to accommodate turbine, generator, and auxiliary equipment.

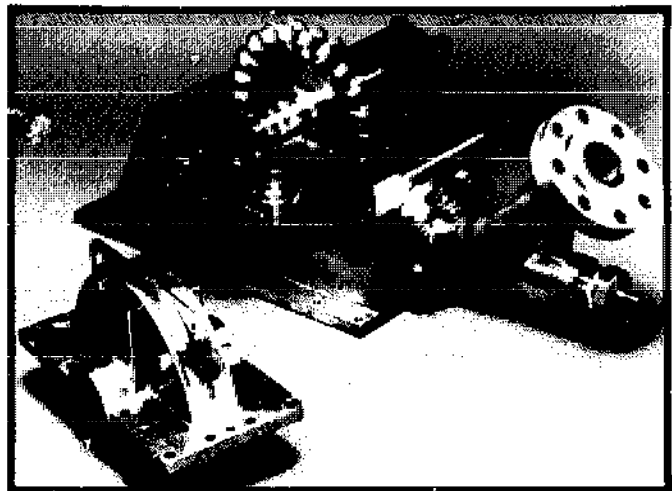

HYDRO-WATT SYSTEMS

146 Siglun Road
Coos Bay, Oregon 97420

Phone: (503) 267-3559

Background

After seven years of operation, Hydro-Watt Systems has hydropower units operating in the U.S., Africa, and South America. Through the use of computer-aided design and manufacture, it can tailor a plant to a specific site while still maintaining the advantage of standardization. It provides assistance in equipment selection and offers a site-evaluation service.

Equipment

Hydro-Watt Systems manufactures **Pelton, crossflow, Francis,** and small **propeller turbines** which can generate 5-1000 kW under 1-300 m heads. Runners are machined in a variety of possible materials, including stainless and alloy steels, non-ferrous alloys, and plastics, and not cast.

Packaged units can be designed for grid-interconnected or isolated systems. Simple systems and controls for areas with little technical service capability are available as are more complex systems to meet specialized functions such as remote control, automatic switching, and computer monitoring. Whereas Hydro-Watt Systems can sell individual components, it prefers to sell a complete

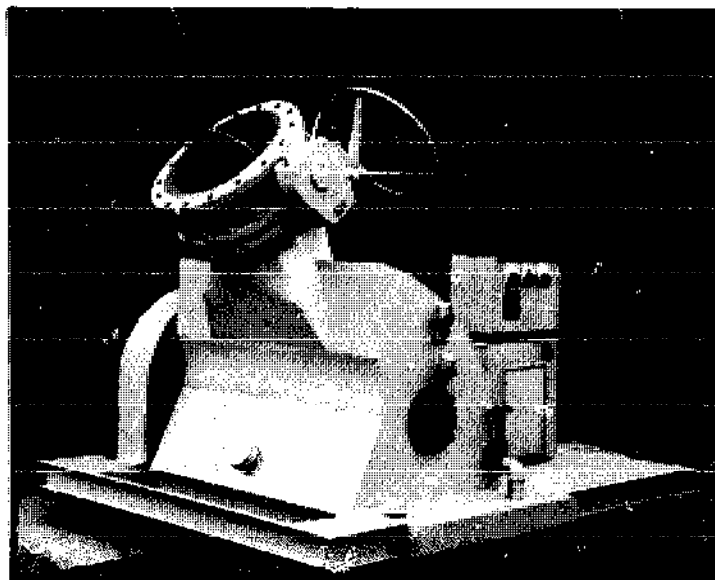

Crossflow turbine to operate under a 15 m head.

package to ensure proper integration of all components and closer production control.

Delivery times depend on workload and application but are approximately 3-4 months for small units and 6 months for larger units. Units for shipment overseas are pre-assembled and crated for export. Shop drawings and installation plans can be sent 2-4 weeks after receipt.

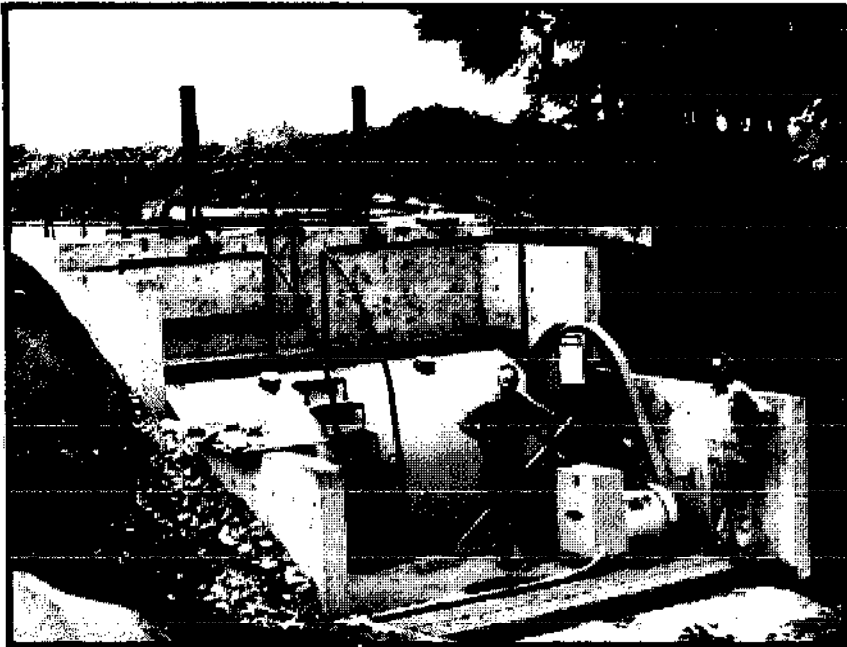

A large crossflow turbine operating under a 3 m head.



A small vertical Pelton turbo-generating unit.

HYDRO WEST GROUP, INC.

12659 N.E. 73rd
Kirkland, Washington 98033

Phone: (206) 822-7444

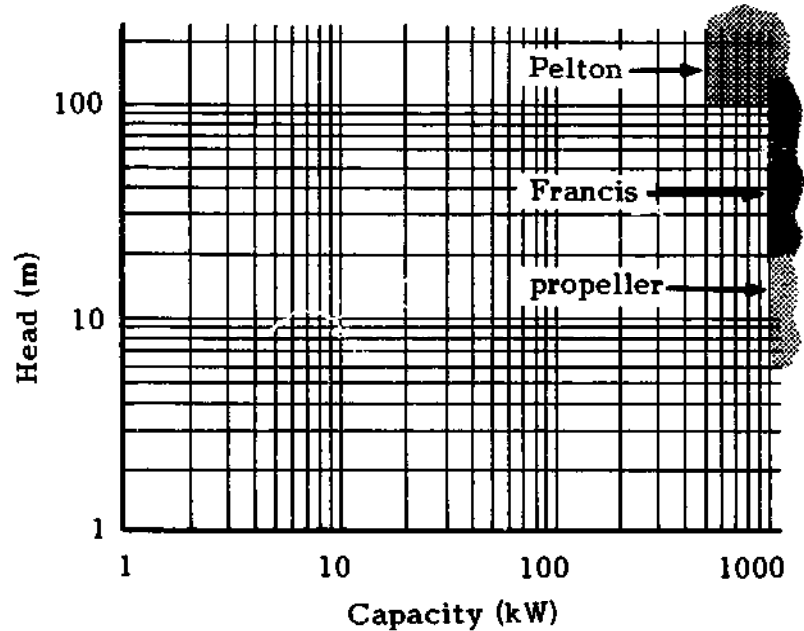

Background

Since 1980, Hydro West Group, Inc. has been involved in manufacturing, servicing, and uprating hydro-generating equipment throughout the western third of the U.S. Four of its turbines have been installed as of January 1984.

Equipment

Hydro West manufactures **Pelton, Francis, and propeller turbine** packages with capacities beginning at the upper limit considered in this Directory. Its standard packages include turbine, generator, exciter, voltage regulator, and switchgear, all assembled on a common steel base. Turbine and generator-rotating elements are designed and manufactured to withstand continuous maximum runaway speed. The standard package has manual start-up and synchronization with automatic shutdown in case of trouble. The switchgear includes all the necessary relaying to protect the generator from electrical faults.

Options also include isolated operating capability, remote supervisory control, hydraulic or motor-operated main valve, and turnkey installations.

Typical costs for its standard package range from \$400-\$900/kW. Delivery time is about 8-10 months.

THE JAMES LEFFEL & CO.

P.O. Box 1607
Springfield, Ohio 45501

Phone: (513) 323-6431

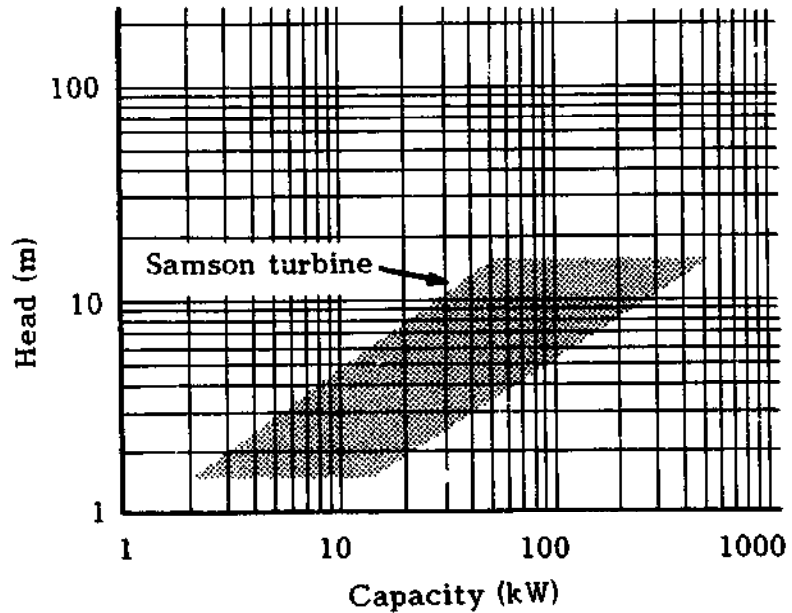

Background

The James Leffel & Co. manufactures Francis and small propeller turbines covering a wide range of power outputs. Leffel also repairs and overhauls old turbines and rehabilitates existing sites.

In addition to generating electrical power, a number of Leffel turbines have been installed to provide direct motive power to pumps, factory equipment, and paper, textile, flour, and feed mills. In all, over 10,000 Leffel turbines have been installed in the U.S. since 1862 and several hundred more have been installed overseas.

In October 1979, Leffel became affiliated with Tampella, a Finnish manufacturer of large-scale waterpower equipment for over 100 years. The Tampella turbo-generating equipment complements the traditional Leffel equipment.

In November 1983, Leffel closed its machine shop and fabricating facilities. Local sub-contractors continue to do this work, with assembling of the equipment still done by Leffel.

Equipment

Leffel's Samson turbines are **Francis turbines** which operate under heads of up to 15 m. They are available in nine standard runner sizes to cover the lower end of the range for small hydro turbines. These are installed in vertical configuration, either directly in an open flume or in a steel pressure flume, with either manual control or automatic governing.

In addition to the Samson units, Leffel manufactures submerged-gate Francis turbines, submerged-gate fixed-blade propeller units, and both horizontal- and vertical-shaft spiral-cased Francis turbines. Other propeller turbines, such as tubular or bulb turbines are available from Tampella through Leffel.

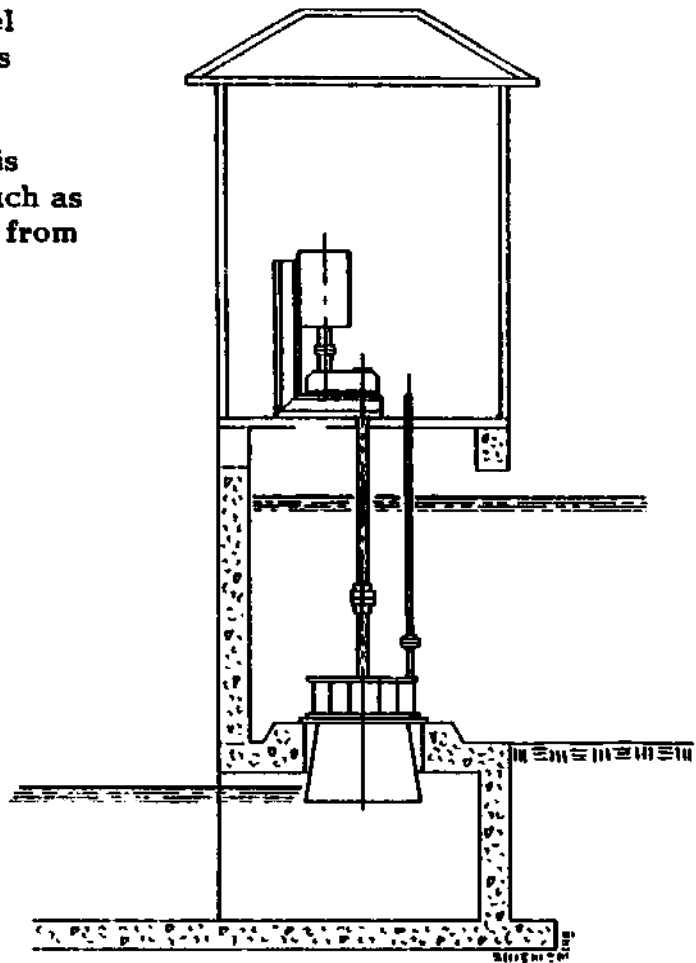

One of the many possible powerhouse configurations.

JYOTI LTD.

Bombay Shopping Centre
R.D. Dutt Road
Vadodara 390 005
India

Phone: 63503-4-5-6
Telex: 0175-215
JMP IN
Cable: JYOTISALES

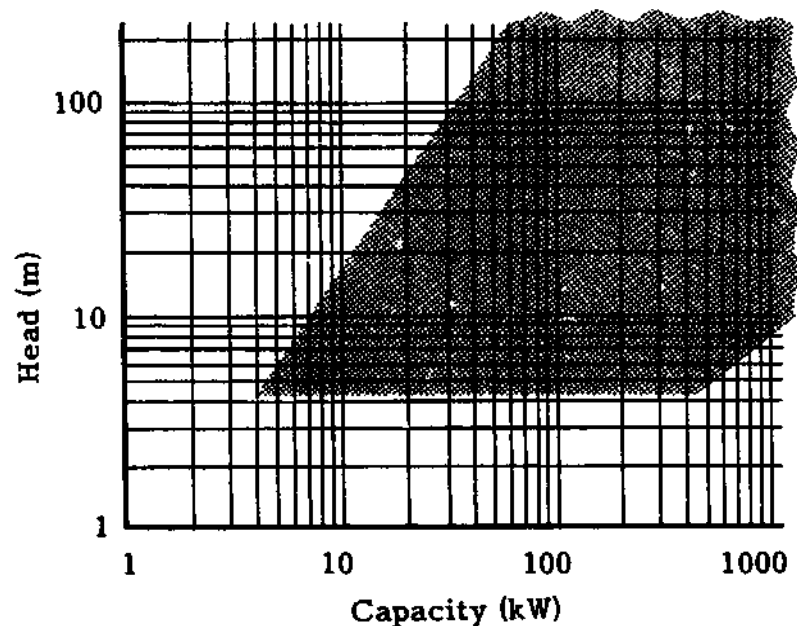

Background

Jyoti Ltd. has been in the field of hydraulic and electrical engineering for the last 35 years and is a leading manufacturer in India. Today, it has a staff of well over 5000, of which scientists and engineers constitute a high percentage. It also has its own research and development center and testing facilities. Adopting a systems approach toward schemes, Jyoti designs and manufactures all the components required for hydropower schemes under one roof—turbine, hydro-mechanical governor, butterfly valve, synchronous and induction generators, control panel, and all associated pipe and accessories.

Jyoti also offers expertise in site surveys, feasibility studies, and project reports. For after-sales service, it has experienced erection and commissioning engineers. It has supplied well over 350 micro-hydro plants not only to India but also to Afghanistan, Nepal, Papua New Guinea, Malaysia, Indonesia, and other countries.

Equipment

Besides all other components of the system, Jyoti manufactures several turbine types:

- **tubular turbines** for low-power applications such as pumping and direct-drive applications in addition to electricity generation which generate 8-25 kW under 4-10 m; tubular turbines for higher-power applications which generate 50-2500 kW under 5-15 m head are also available;
- **Francis turbines** generally utilized under a head of 30-100 m to generate 50-500 kW;
- **Turgo impulse turbines** for intermediate heads of 60-200 m generating 50-500 kW; and

- **Pelton turbines** which generate 50-1000 kW under higher heads of 100-300 m.

Jyoti can also supply equipment to suit other site conditions.

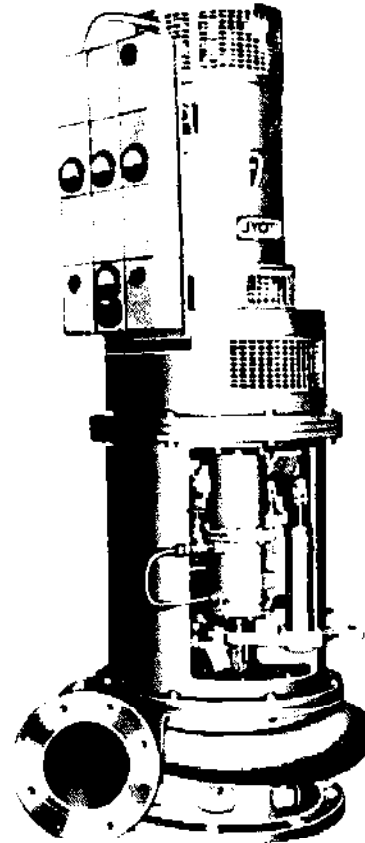

Micro-hydel unit with output ranging from 5-25 kW under heads of 3-12 m.

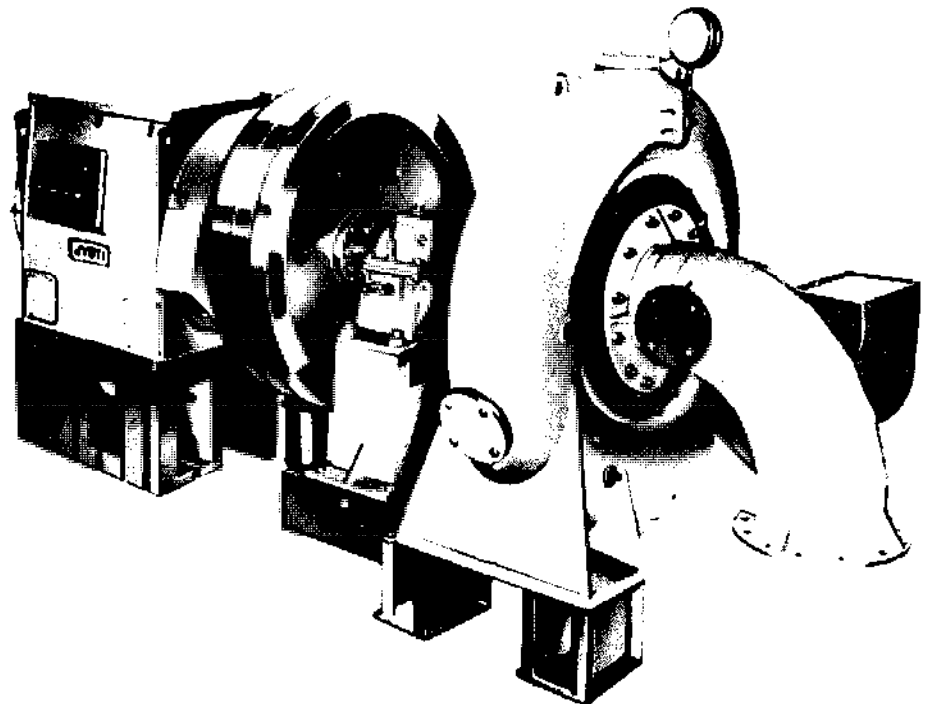

This horizontal configuration can accommodate a Francis, Turgo, or Pelton runner.

LAYNE & BOWLER, INC.

Box 8097
Memphis, Tennessee 38108

Phone: (901) 278-3800
Telex: 53920
LAYNE PUMP MFS

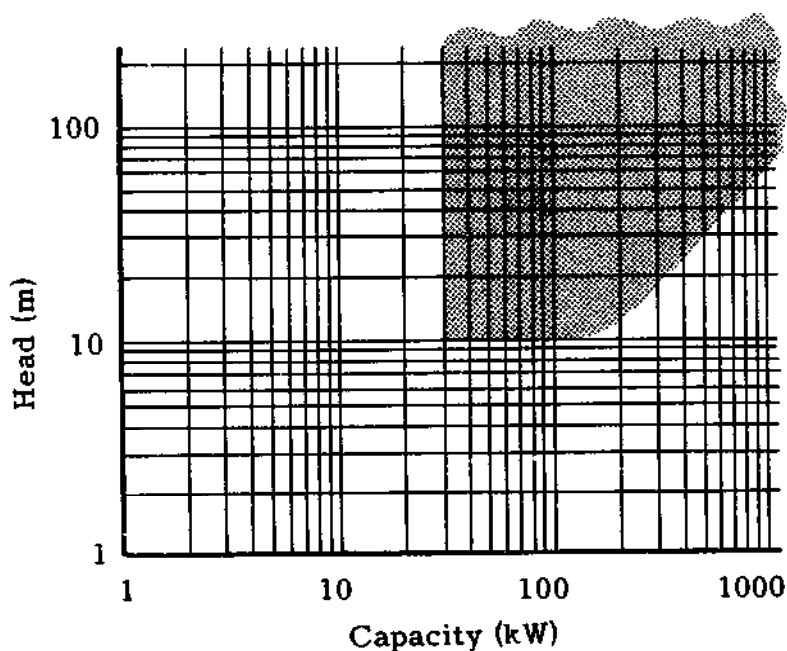

Background

Layne & Bowler, Inc. is a major supplier of vertical turbine pumps. Its manufacturing facilities include an iron foundry, a brass foundry, a machine shop, a steel-fabrication shop, and a hydraulic test lab.

In 1982, a comprehensive test program was started to determine the performance of Layne & Bowler pumps when operated in the turbine mode. As a result of this testing, several pump models were deemed appropriate for use as hydro turbines.

Equipment

The equipment Layne & Bowler offers is basically a standard vertical **turbine pump** operated in the turbine mode. Several models are available. Case diameters range from 6"-44" with outputs in the range of 15-1000 kW. Heads of up to 300 m can be accommodated. Multi-staging is routine, making the units ideal for high-head, low-flow applications. Standard units have cast-iron cases and bronze runners. A variety of materials is available.

Utilization of a conventional pump operating in the turbine mode offers several advantages. The units are readily available, usually at a lower cost than custom-designed turbines. Repair parts are readily available; many are in stock. The equipment is relatively simple and utilizes technology that has been well established by many years of pump operation.

The units are shipped in major sub-assemblies, which can be bolted easily in place, requiring a minimum amount of civil

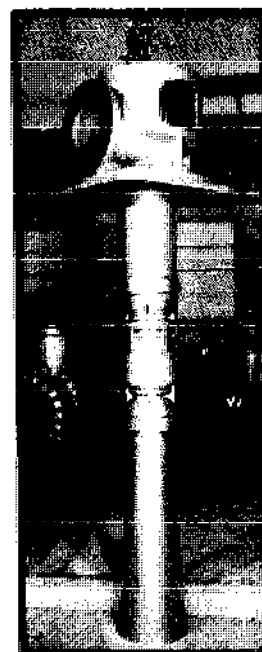

construction. The vertical axial-flow arrangement requires very little space for mounting.

Performance guarantees are usually based on test results obtained by testing a full-size unit rather than extrapolating data from a model test. Performance testing in the lab prior to delivery is available.

LITTLE SPOKANE HYDROELECTRIC

P.O. Box 82
Chattaroy, Washington 99003

Phone: (509) 238-6810

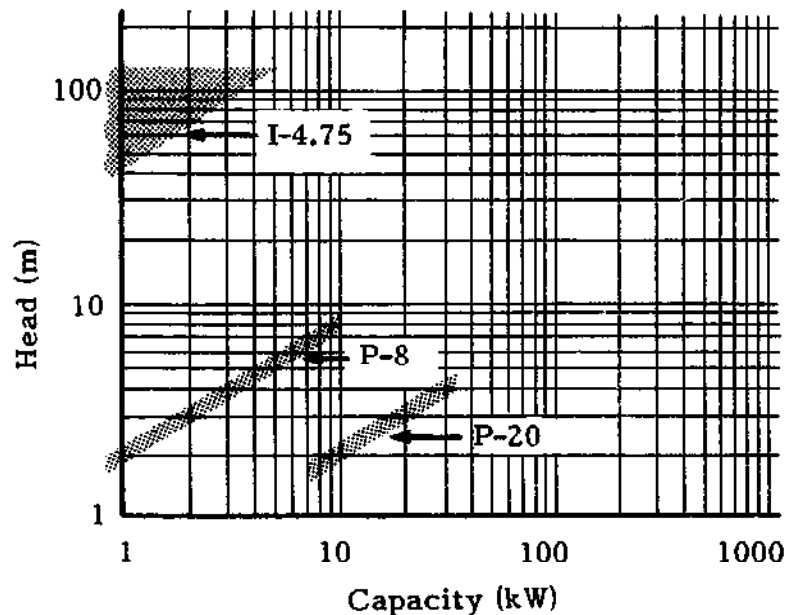

Background

Little Spokane Hydroelectric was formed in 1978 as a manufacturer of small-scale hydroelectric equipment. A complete range of activities, from pattern making to turbine testing, is possible at its facilities. This small company is unique in that the power used to manufacture the equipment (except for casting) is produced at its own low-head site. Little Spokane Hydro has been involved in over 20 small-scale hydro projects in U.S. and developing nations. Under contract to the U.S. Department of Energy, it also completed a report in December 1982 on a simple blade-adjustment mechanism for Kaplan turbines and has a prototype in operation.

Equipment

One of the standard units available from Little Spokane Hydro is a small **Pelton** package (Model I-4.75) for d.c. generation which operates under heads of 15-120 m with corresponding outputs of 100 W to approximately 2 kW (with one nozzle). Provision is made for including up to four nozzles. It is constructed with a bronze runner, a cast-aluminum housing, and is supplied with a heavy-duty d.c. brushless alternator in a range of voltages. The cost for the basic package is about \$900.

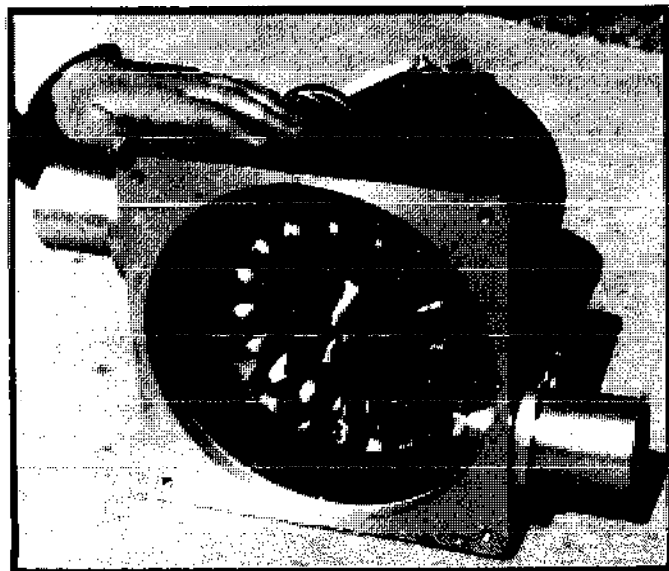

A 4.75" Pelton battery-charging unit.



An installed P-8 propeller turbine.

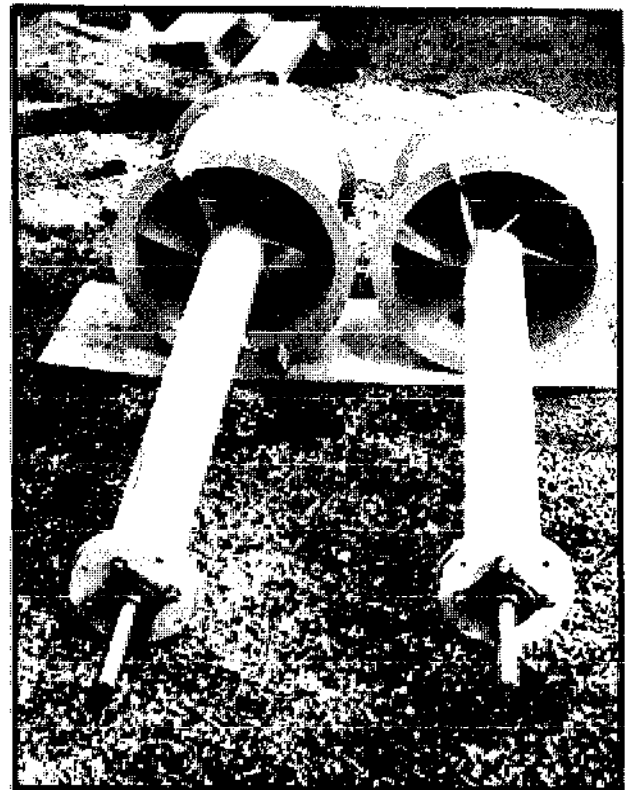

P-20 propeller turbines.

The other two standard units are low-head **axial-flow turbines**, Model P-8 and Model P-20:

- Model P-8 operates under a head of 2-8 m, with a corresponding output of 0.6-10 kW. This is a bronze propeller runner in a cast-aluminum housing which couples directly onto a standard 10" flange. This unit can be supplied as is or as a complete generating system engineered to specific site conditions. The cost of the turbine with draft tube is about \$2000.
- Model P-20 operates under heads of 1.5-4.5 m, with a corresponding output of 7-35 kW. This is a open flume, 20"-diameter propeller turbine. It is constructed with a bronze runner and has an epoxy-coated steel draft tube with regulation valve. The cost is approximately \$5500.

Little Spokane Hydro can supply larger equipment which includes both Pelton and axial-flow turbine units on a site-specific quote basis. Pelton runners are available in 6", 9.5", 12", 16", and 24" diameters.

A 12 kW Pelton turbine with 9.5" runner destined for Irian Jaya.

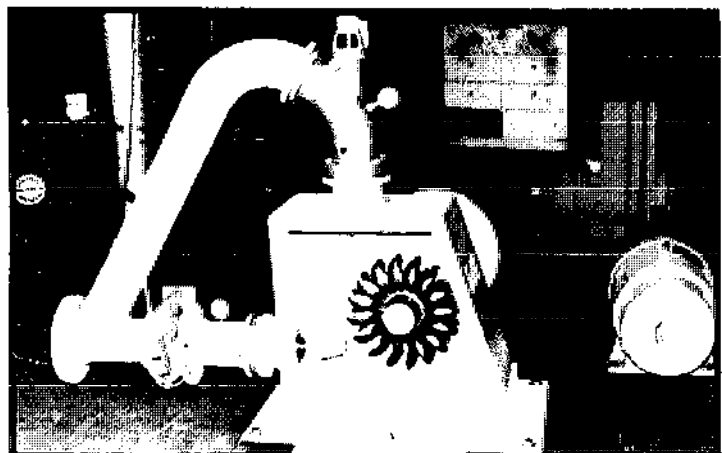

McKAY WATER POWER, INC.

P.O. Box 221
West Lebanon, New Hampshire 03784

Phone: (603) 298-5122
Telex: 95-3111

MCKAY WP WLBN

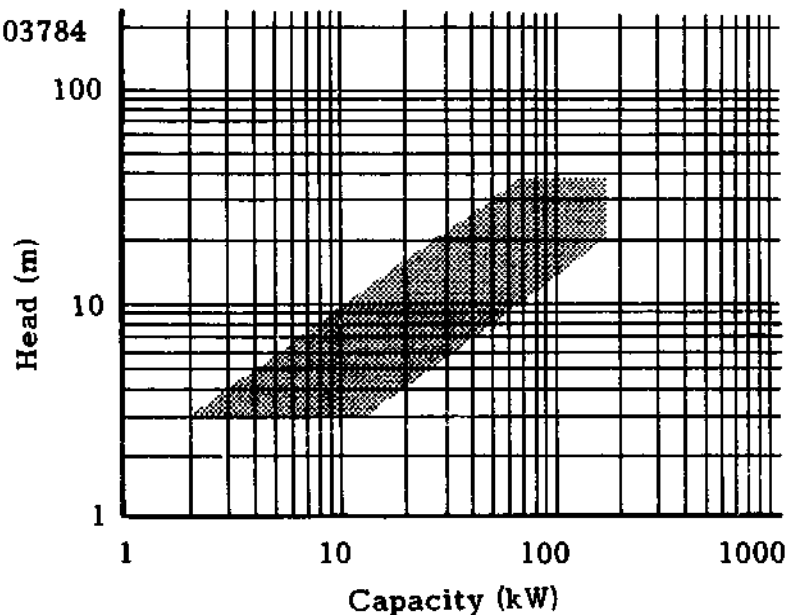

Background

McKay Water Power, Inc. began about 10 years ago to assist its clients to develop small-scale hydroelectric systems. In addition to using turbines manufactured by others, it began manufacturing its own line of equipment, the HYDROPAC turbine, designed for small users, about three years ago. Four of these units are already operational. The company is currently extending its equipment line to include a Pelton unit to operate under a head of up to 250 m to generate a maximum of 500 kW.

McKay Water Power can provide a complete package of equipment tailored to meet the needs of its clients, including whatever technical assistance and training are required to complete the project. In 1983, the company formed the Industrial Maintenance Service Division to provide maintenance services to owners of power plants, mill production areas, wastewater treatment plants, and hydro sites, including supplying replacement parts and repairing damaged components.

Equipment

McKay Water Power manufactures its HYDROPAC turbine which incorporates a **Francis** runner. Because it uses fixed stay vanes, each turbine accommodates a single, constant flow determined by its runner diameter and operating head, generates a constant power, and, consequently, requires a load controller if it is to be used as an isolated unit. By making the turbine available in seven sizes, a wide selection of head and flow combinations can be accommodated to generate power in the range of 2-150 kW. A generator, pump, or other mechanical load is usually coupled by a timing belt but can be directly coupled if the turbine's speed—which depends on head and runner diameter—is the same as that required by the load.

The HYDROPAC turbine comes complete with knife-gate inlet valve, draft tube, and belt drive for coupling to the generator. Its price ranges from \$8,000-\$35,000

for the belt-driven unit to \$6,000-\$27,000 for the directly driven unit. The reason for the significant cost difference between belt-driven and directly coupled units is that, with directly coupled units, the runner is mounted on the generator shaft and the bearing housing and two bearings are eliminated. Installing the plant in the powerhouse is also made easier. McKay Water Power can also supply an electronic load controller, if the unit is to be operated in isolation, as well as basic controls, switchgear, and generators.

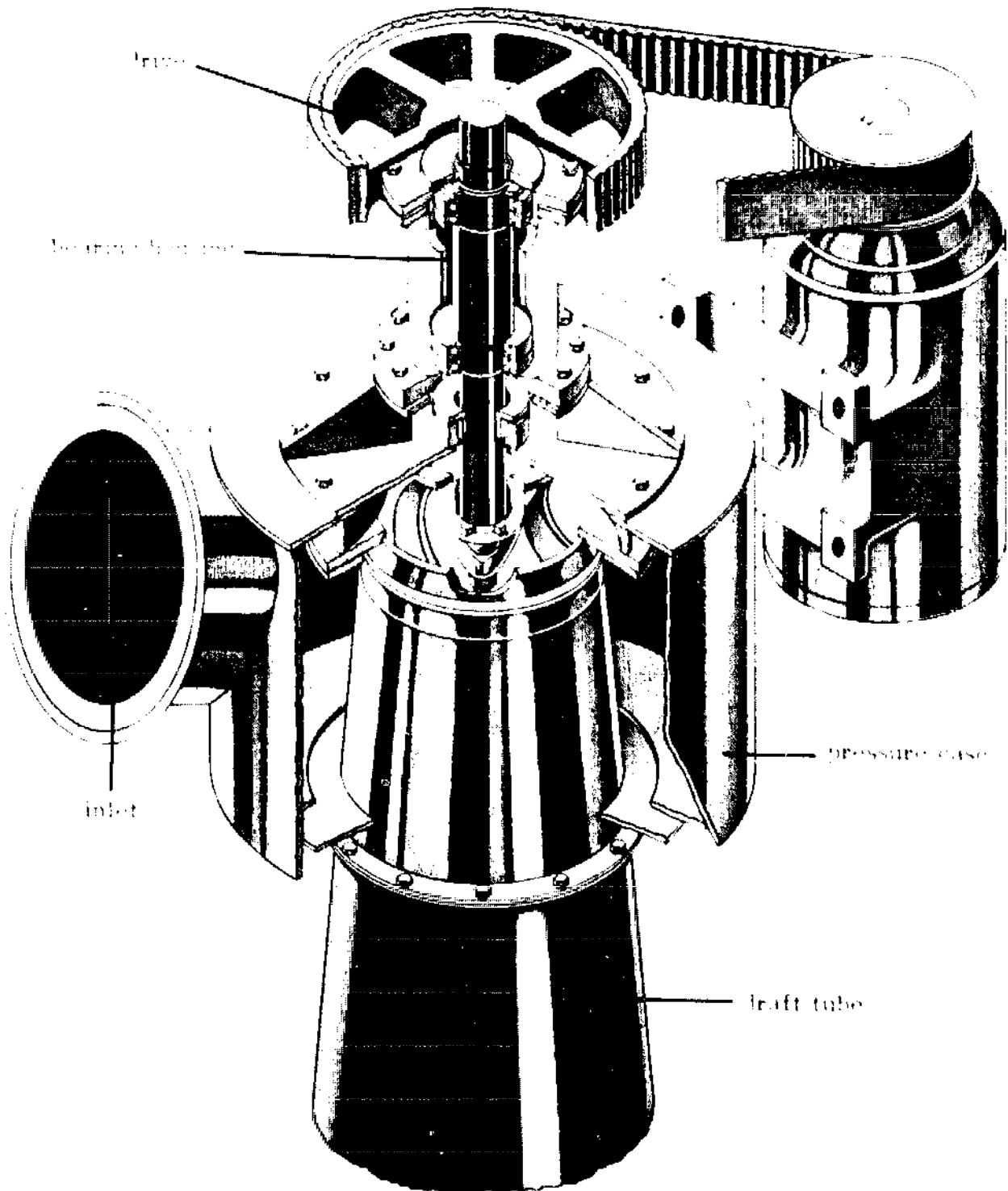

NEW FOUND POWER CO., INC.

Box 576
Hope Valley, Rhode Island 02832

Phone: (401) 539-2336

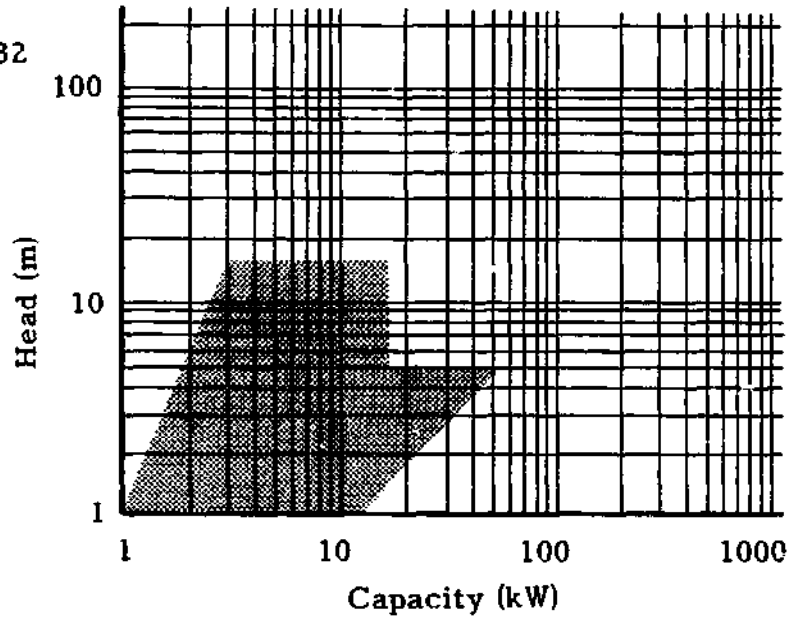

Background

New Found Power is a small group which is the outgrowth of a project supported by the U.S. Department of Energy in 1980-81 to improve the cost-effectiveness of low-head hydroelectric equipment. The project involved model testing and materials research to modify the crossflow turbine specifically for use in low- and ultra-low-head sites. Several prototype machines in the 5-25 kW range were built and tested. Although units constructed to date can generate up to 50 kW under suitable heads, work is now proceeding on turbines to generate up to 250 kW under heads up to 30 m.

Up to the present, New Found Power has produced machines only for use in electrical generation but has a great interest in mechanical uses for the power, especially agro-processing, pumping, and driving heat pumps. New Found Power utilizes its own low-head waterpower site to meet most of its electrical requirements.

Equipment

New Found Power manufactures only **crossflow turbines**, in a wide range of sizes for heads of 1-30 m and outputs of 1-250 kW. Either turbines or complete systems with U.S.-made gearboxes (where necessary) and generators are available. The runner can be fabricated of either stainless steel or epoxy-graphite composite. The casing and vane are of high-strength engineering plastics or steel construction. The movable vane, which is

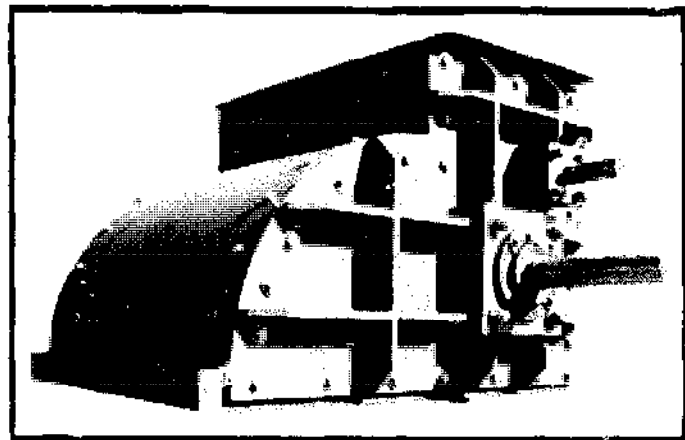

A 12" crossflow turbine with steel frame and composite case for 6 m head.

standard on all but the smallest turbine, can be used to completely shut off flow. The split vane, which is also available on some units, permits efficient operation of the turbine over a broader range of flows.

Systems for single-phase a.c., three-phase a.c., or d.c. are available for either stand-alone or grid-interconnected operation. Control can be either manual or simple 12 V electrical/hydraulic for semi-automatic operation. Also available are packages of protective relays to meet interconnection requirements of power companies and automatic control packages for unattended operation.

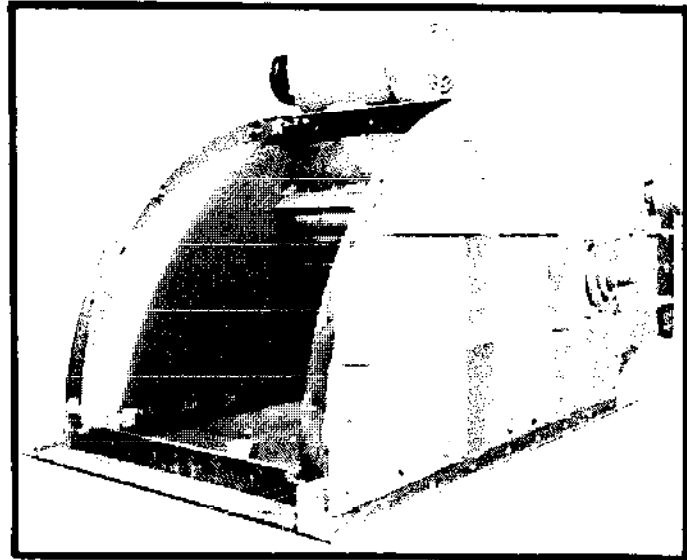

An 18" turbine for a 4 m head.

Turbines are available as skid-mounted bare turbines, with or without an inlet elbow and draft tube or as complete turbo-generating packages which include all necessary pulleys, belts, gearbox if required, and generator. The cost of a typical package, complete with induction generator, to generate 50 kW under a 6 m head is \$40,000. Turbines come with a two-year limited warranty covering materials and workmanship.

For those interested in local fabrication of single or multiple units, kits are available for the turbine runner or the complete turbine. The runner kit includes completely machined stainless-steel components, which require only welding to complete, and drawings for simple nozzles.

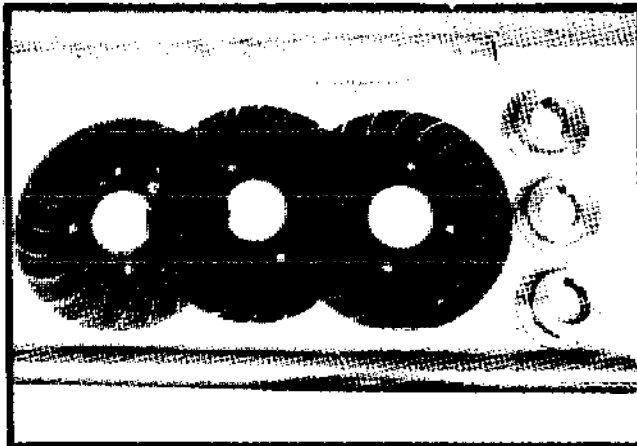

A 12" runner kit.

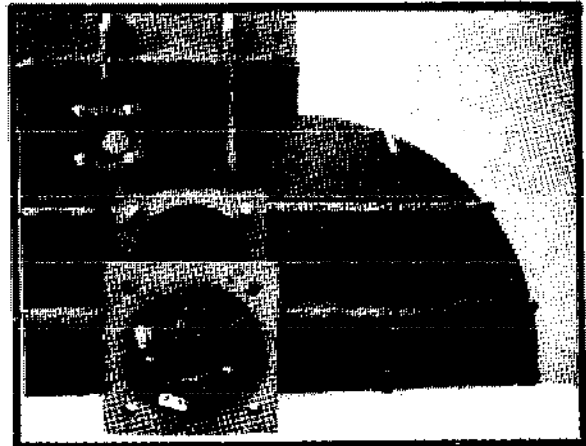

Side cover and bearing from a complete kit for a 12" turbine.

OSSBERGER/F.W.E. STAPENHORST, INC.

F.W.E. Stapenhorst, Inc.
283 Labrosse Avenue
Pointe Claire, Quebec H9R 1A3
Canada

Phone: (514) 695-8230
Telex: 05-823597

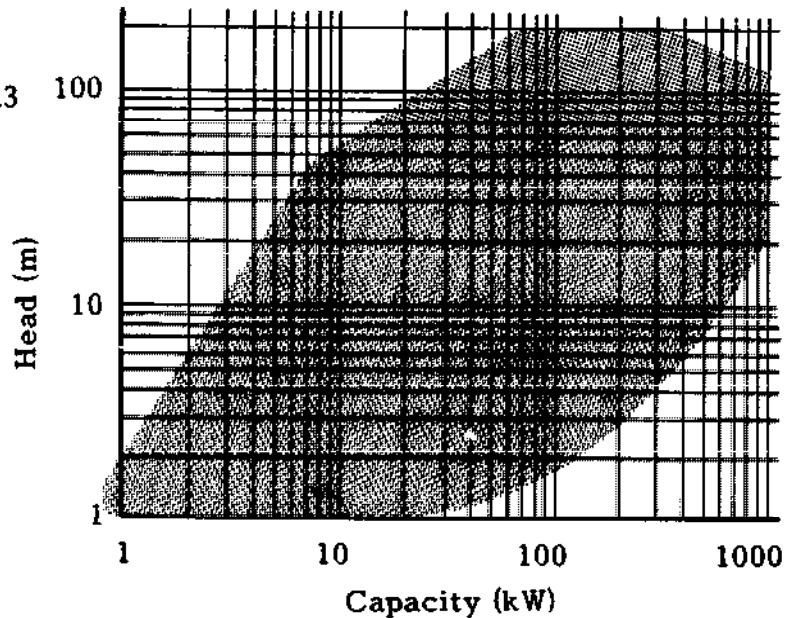

Background

Ossberger-Turbinenfabrik is an exception among the major hydraulic turbine manufacturers. For over half a century, it has concentrated solely on the research and development of a single type of turbine--the Michell (Banki) crossflow turbine--with power outputs up to 1000 kW. It is the only major manufacturer of this type of turbine in the world. Ossberger turbines, many under 75 kW, are serving small isolated systems in remote areas in many parts of the world.

F.W.E. Stapenhorst, Inc. is the sole representative for Ossberger in North America and is restricted to supplying only U.S.-funded projects. Although the crossflow turbine, housing, and guide vanes are manufactured in Germany, the generator, governor, electronic controls, and other components can be made in the U.S. to Ossberger specifications. Its complete packaged units may, therefore, satisfy U.S. source requirements.

In the state of New York, F.W.E. Stapenhorst, Inc. owns and operates the Good-year Lake Station, which contains two crossflow turbines with auxiliary U.S. equipment. Operating under a head of nearly 10 m, the two turbines, rated at 860 hp and 1140 hp, can generate a maximum of 1400 kW into the grid. Interested parties may visit the site by appointment.

Equipment

A significant advantage of the **crossflow turbine** manufactured by Ossberger is its relatively high efficiency (80%-85%) over a wide range of head and flow variations. By manipulating two simple guide vanes, its efficiency remains flat from full flow down to about a quarter of that flow. Up to $\pm 20\%$ variation in head results in no significant changes in efficiency. Only the Kaplan, or variable-pitch propeller, turbine can approach this level of efficiency over a wide range of flow conditions at low or medium heads (at the cost of substantially more complexity). However, efficient use of the available water may not be important in

isolated run-of-river schemes. Therefore, the possibility of high efficiency with off-peak loads available with the crossflow turbines might be inconsequential in such schemes.

In addition to the turbine housing with draft tube and guide vanes, generating sets include a standard governor, speed increaser, generator, and transition piece between penstock and turbine. The turbine is completely assembled and mounted on a frame ready to be bolted to the floor. The draft tube and transition piece are

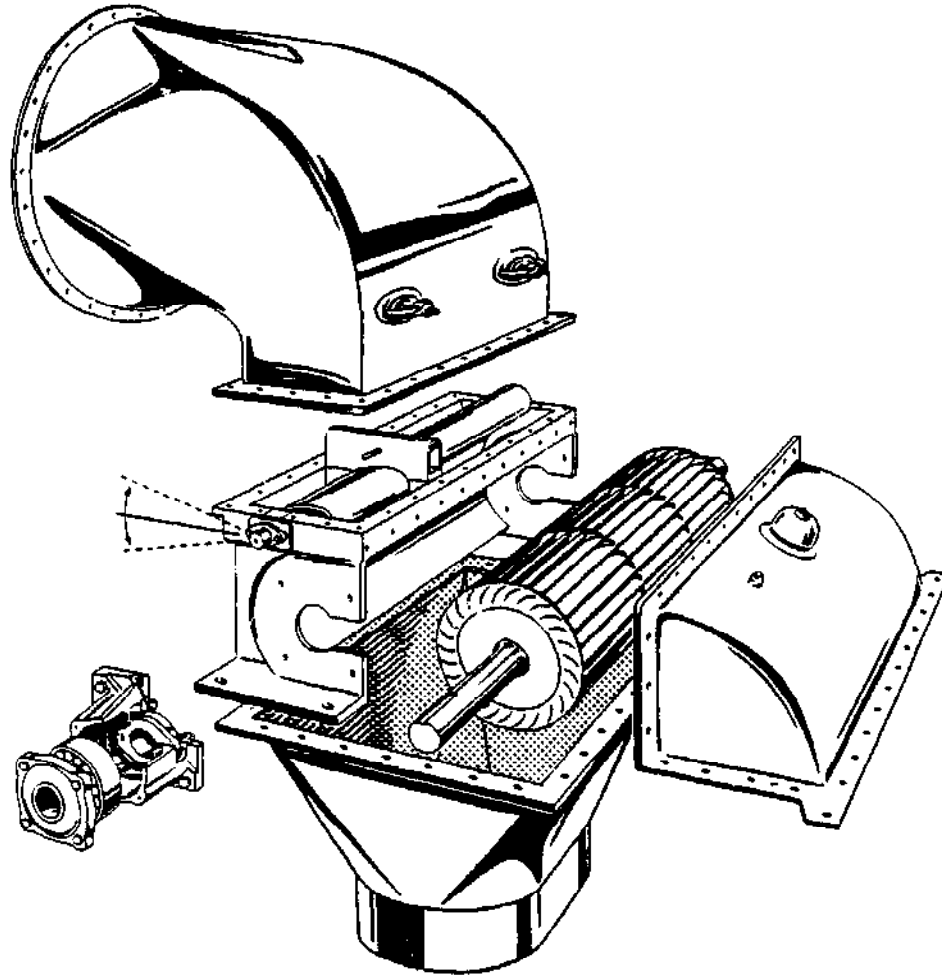

bolted to the assembly during installation. For generating sets up to about 75 kW, the complete unit, including the generator, is mounted on a common frame to facilitate installation.

Small standardized units, UNIVERSAL Types A and B, for low flows and heads and power outputs of 1-9 kW are available with either manual control or governors. However, even a complete package probably does not contain sufficient U.S.-made components (depending on the final configuration) to satisfy U.S. source requirements.

SCHNEIDER ENGINE CO.

Rt. 1, Box 81
Justin, Texas 76247

Phone: (817) 648-2293
TWX: 910-893-4000
SCHNEIDER JUXT

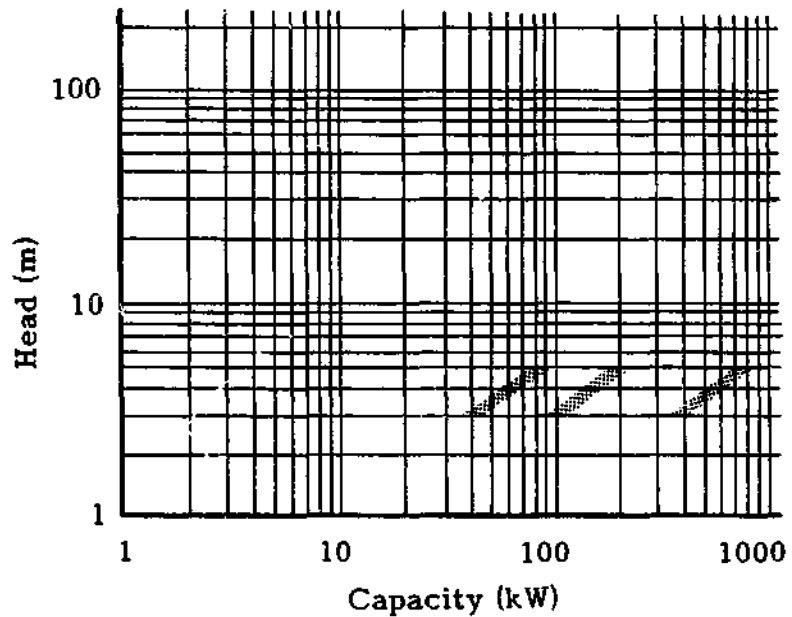

Background

Over the past decade, the Schneider Engine Co. has sought to apply aerospace technology to a turbine designed to harness hydropower at low-head sites. From this research emerged the Schneider Hydroengine, a unique design among hydro-power turbines. The first field testing was performed at an irrigation canal drop in 1980. Since then, additional units have been installed at sites in California and Asia. Tests are underway with support from the U.S. Department of Energy and several international groups to assess the durability, reliability, and cost-effectiveness of the turbine. These installations will lead the way to the development of larger pilot projects.

Equipment

The Schneider Hydroengine incorporates a series of lifting foils mounted between two continuous chains, similar to a continuous belt of venetian blinds running over a pair of parallel axles. Three models--rated at 90, 200, and 750 kW under a 5 m head--are currently being manufactured and the line is to be expanded in 1984 to include three more models--rated at 260, 1600, and 2100 kW at 2.5, 5, and 10 m respectively.

Schneider provides these standard models together with complete water conduit kits, including debris screens, gates (radial, roller, or butterfly) with actuator gear, entry tubes,

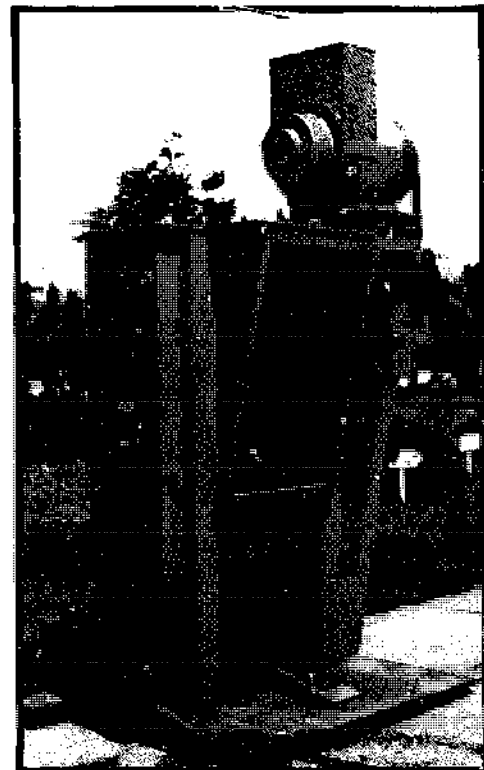

and draft tubes. Also supplied are generators (induction or synchronous), switch-gear, controllers, and transformers.

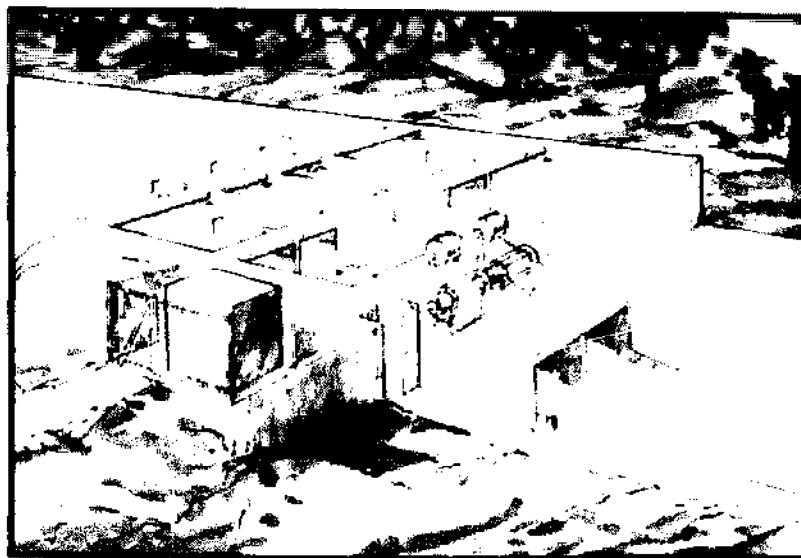

Possible installation of a Hydroengine at an irrigation drop.

SMALL HYDROELECTRIC SYSTEMS AND EQUIPMENT

5141 Wickersham Street
Acme, Washington 98220

Phone: (206) 595-2312
(206) 595-2225

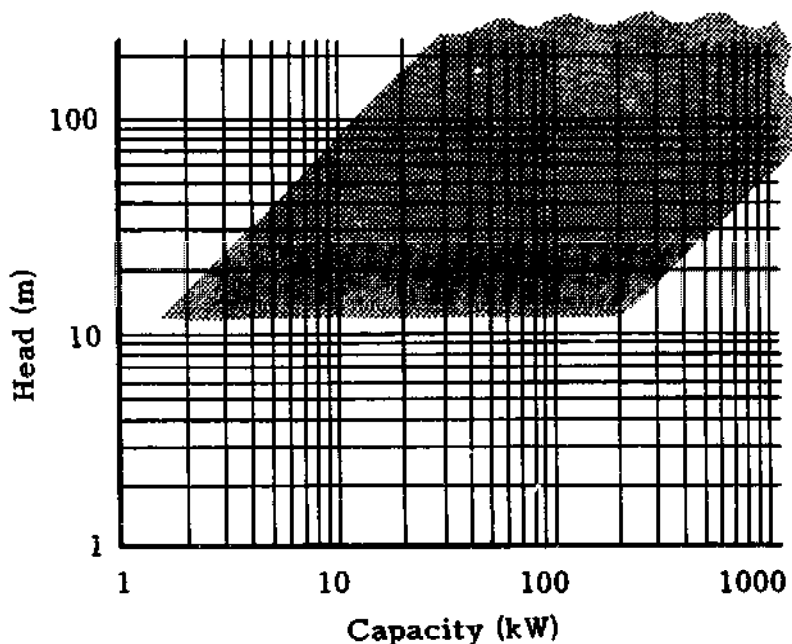

Background

One of the several groups to recently enter into the manufacture of small hydroelectric units, Small Hydroelectric Systems and Equipment (SHSE) now specializes in packaged units which appear under the trade name of "Peltech." The runner is a high specific-speed Pelton runner, designed by SHSE, which is prepared as an integral casting of stainless steel or bronze. All aspects of the fabrication of its units, except the pouring of the runners, are handled in its new facilities. Peltech, units with capacities of up through 400 kW, have been manufactured.

Equipment

SHSE sells **Peltech** units, either single or double jet, horizontal axis, or up to six jets, vertical axis **Pelton turbines**. The runner is available in five pitch-diameters, from 4.875"-19.5". With a pitch-circle-to-jet diameter ratio of 6 to 1, the Peltech runner design permits higher runner speeds than most Pelton designs under a given head. The speed increase required for proper alternator operation can, therefore, be reduced or possibly eliminated. A 30" runner is also available. Though needle nozzles can be incorporated with most of its units, they may not be necessary depending on site requirements. Even without spear valves, some flow control can be exercised by closing individual nozzles; further control can be achieved through adjustment of deflectors. Peltech units can be furnished with either a hand wheel for manual control, a Woodward governor which activates deflectors, or an electronic load controller. The alternator is mounted on a common frame with the turbine.

The cost of specific hardware is available on demand. The cost of a single-jet Peltech turbine ranges from \$1000 with the smallest diameter, bronze runner to \$24,000 with the 19.5" stainless-steel runner. Operating head is a major factor which influences turbine cost per kilowatt. For example, for the popular 9.75" Peltech runner, costs per kilowatt range from about \$1500/kW for low-head (20 m), low-flow (a single nozzle with a 4 kW output) turbine to below \$200/kW for

a higher-head (60 m), higher-flow (two nozzles with about a 40 kW output) turbine.

SHSE can also provide custom-built units, and has, for example, recently provided a 30" runner with single jet to generate 400 kW into the grid. It also has recently designed and manufactured an impulse runner of the Turgo design with a 6.5" pitch-circle diameter. Since this is available with a pitch-circle-to-jet diameter ratio of 4 to 1, the smaller diameter runner means that higher speeds are available than from a Pelton runner with the same power output. In addition to complete units, SHSE can sell Peltech runner castings, as cast or machined, and other components for incorporation in units which are fabricated overseas. Basic drawings are available for its Peltech units.

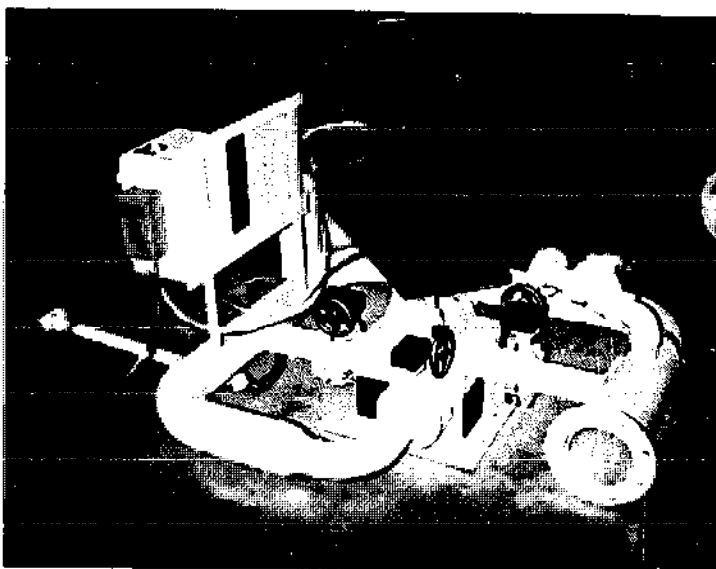

A four-jet, vertical-axis Peltech turbine.

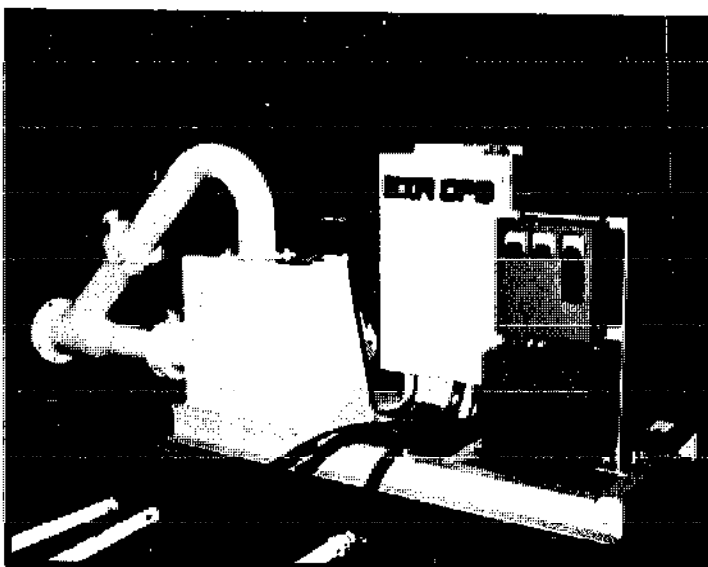

A two-jet, horizontal-axis Peltech turbine.

TOTAL ENERGY CORPORATION

P.O. Box 20868
Rio Piedras, Puerto Rico 00928

Phone: (809) 781-0025
Telex: 3654370
ROJITO

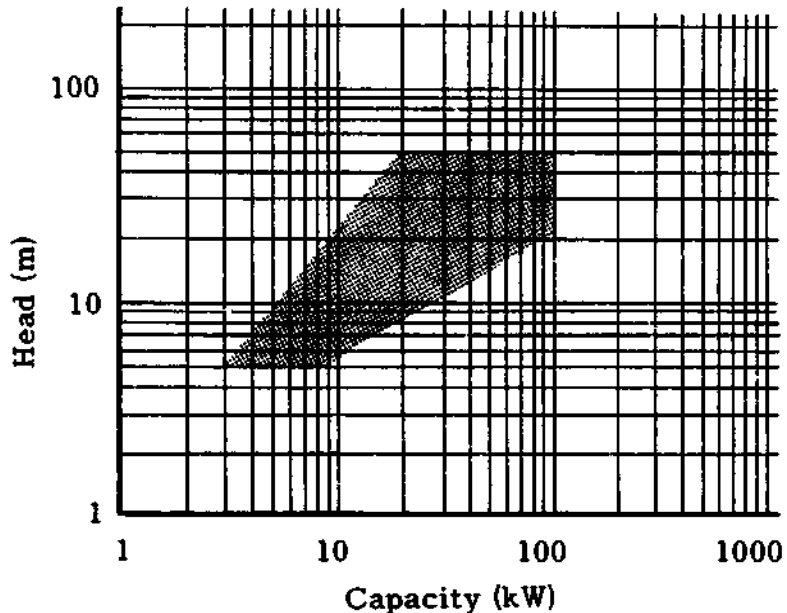

Background

Total Energy Corporation is a division of Empresas Rojo, Inc., a large firm involved in developing housing projects since 1961 in Puerto Rico and, earlier, in Cuba. In 1982, Total Energy Corporation was created to design and manufacture a micro-hydro turbine which would be simple and economical. The result of this is the Galo micro-hydro turbine. Besides an operational prototype unit in Puerto Rico, four turbines are in production—one 30 kW unit for the Dominican Republic, one 40 kW unit for Panama, and two 20 kW units for Puerto Rico. While the units are currently being manufactured in one of Puerto Rico's largest steel mills, a manufacturing operation is being established in San Juan.

Equipment

Galo micro-hydro turbines are fixed-geometry, **tubular turbines** of stainless-steel construction capable of generating 5-100 kW under a head of 4-50 m. They are available in three sizes with runner diameter ranging from 11"-37".

This design is unique because the turbine is coupled to the generator with hoses, with hydraulic fluid serving to transfer the energy from the turbine to the generator. The turbine unit pumps the fluid to the generator house where a hydraulic motor converts this energy back in rotational motion to drive a generator. Because of this design, the turbine can be placed directly in the streambed and the generator placed well out of reach of any flooding. The turbine can function fully immersed. In isolated situations, this hydraulic system serves as a governor, maintaining generator speed in spite of variable loads, thereby eliminating the need for an electronic load controller or governor. The efficiency of the turbine itself is approximately 80%, with overall efficiency for the turbo-generating unit about 50%.

Another unique feature is a float at the intake to the penstock which senses the height of the water there and mechanically transmits this information to the

turbine where the flow through the turbine is regulated. This gate permits using all the available flow, up to turbine capacity, for power generation.

The price range for the turbine, generator, and all components except hydraulic hoses is \$700-\$2000/kW. Delivery time is about 12 weeks. The manufacturer's guarantee covers all parts, some for several years.

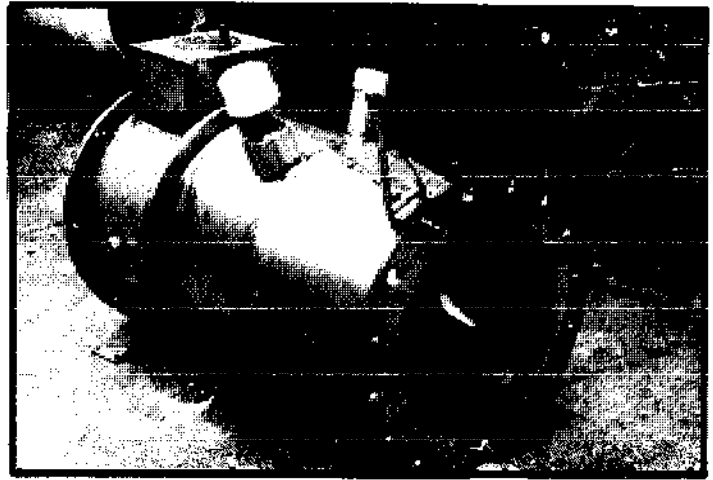

A Galo Micro-hydro turbine.

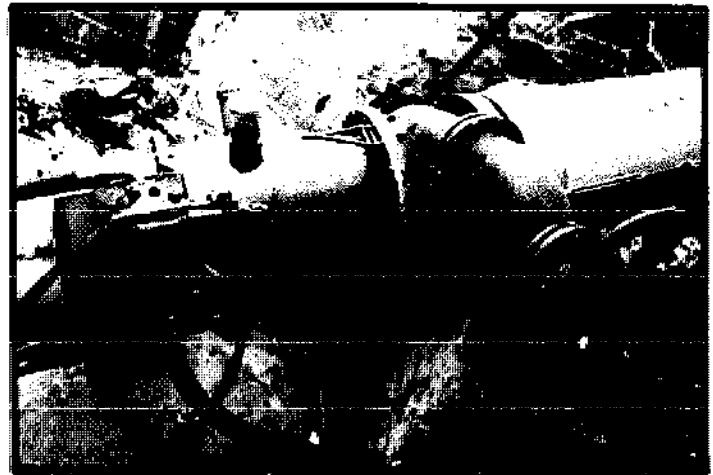

A Galo turbine installed downstream of a gate valve. Hydraulic hoses convey the energy generated by the turbine by means of hydraulic fluid under pressure.

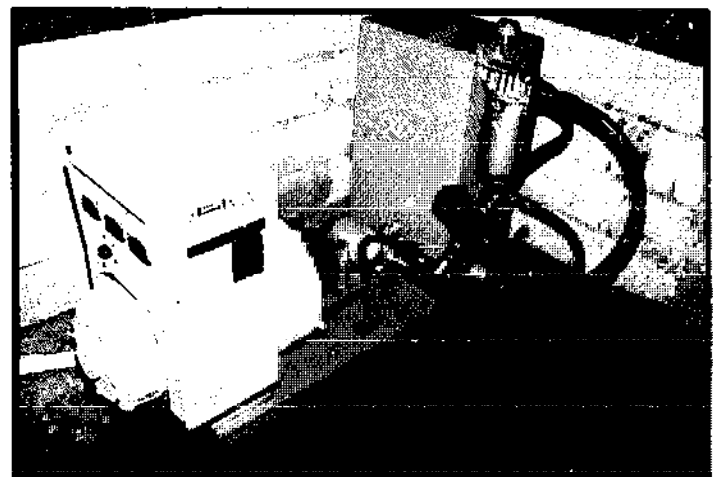

The energy in the hydraulic fluid is converted to rotational motion to drive a generator in the powerhouse.

P.O. Box 91
Taneytown, Maryland 21787

Phone: (301) 756-2602

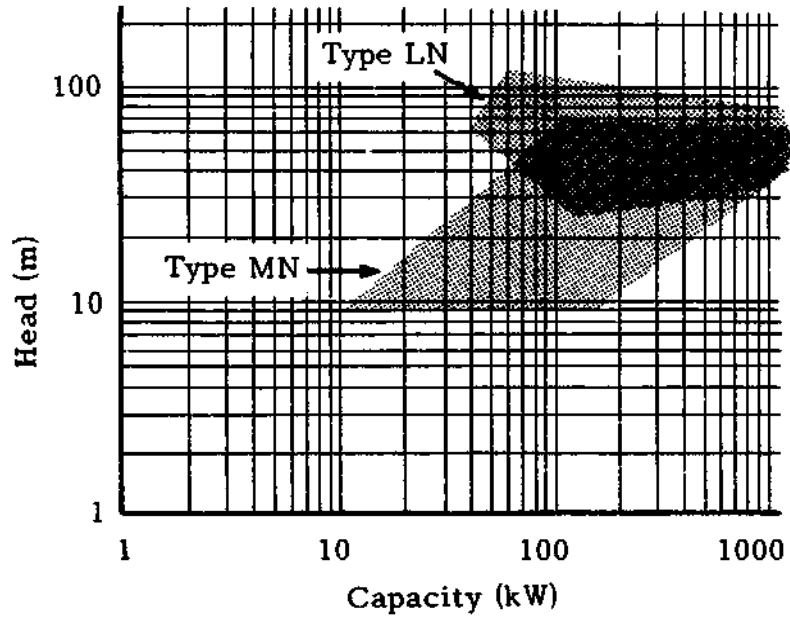

Background

The Worthington Division of McGraw-Hill Company is a worldwide manufacturer of a broad line of pumps, compressors, and steam turbines with over 100 years of experience with hydraulic machinery. It has plants in 15 countries around the world which manufacture a wide variety of pumps. Thirty years ago, by incorporating only slight mechanical modifications, it began applying its standard line of water pumps for reverse operation as hydraulic turbines.

Equipment

Worthington has all types of equipment configurations to suit the needs of turbine plant designers. These include **axial-flow, mixed-flow, and radial-flow pumps as turbines**, in horizontal- or vertical-shaft configurations, and wet- or dry-pit installations. Its broad range of pumps can be adapted to generate up to 1500 kW under heads of 10-120 m. With its turbine, Worthington can provide either an induction or synchronous generator and complete controls for operation. The turbine can also be coupled to another pump to move fluids.

By supplying standard, production-designed water pumps to be operated in reverse as turbines, equipment is immediately available for small hydropower generation.

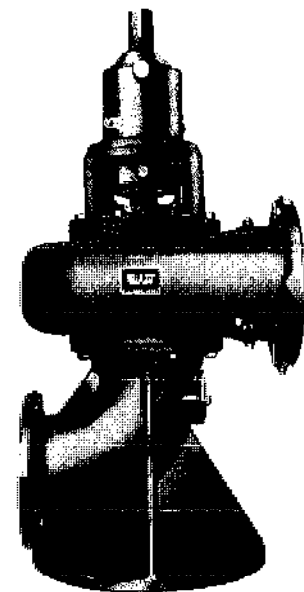

Type MN vertical end-suction centrifugal pump for use as a turbine.

**International Programs Division
National Rural Electric Cooperative Association
1800 Massachusetts Avenue, N.W.
Washington, D.C. 20036**

Telephone: 202-857-9622

Telex: 64260

Cable: NATRECA



NRECA International Programs Division