

# **AT** MICROFICHE REFERENCE LIBRARY

A project of Volunteers in Asia

The Dhading Micro-Hydropower Plant: 30kWe

by: Ueli Meier

Published by:

Swiss Center for Appropriate Technology  
14 Varnbuelstrasse  
CH-9000 St. Gallen  
Switzerland

Paper copies are \$ 4.50.

Available from:

Swiss Center for Appropriate Technology  
14 Varnbuelstrasse  
CH-9000 St. Gallen  
Switzerland

Reproduced by permission of the Swiss Center for  
Appropriate Technology.

Reproduction of this microfiche document in any  
form is subject to the same restrictions as those  
of the original document.

---

 THE DHADING MICRO-HYDROPOWER PLANT: 30 kWe
 

---

Equipment specifications with special reference to the BYS MH/P-governor  
(mechanical water-hydraulic proportional governor)

by U. Meier

Contents:

	page
<b>A: GENERAL INFORMATION</b>	
1. Technical specifications	1
2. Plant performance	2
3. Transient state tests	2
4. Sensitivity tests	2
5. Description of performance & operation	3
6. Plant safety	5
7. Maintenance	6
<b>B: DIAGRAMS AND PHOTOGRAPHS</b>	
1. Hydraulic profile of BYS Cross-Flow Turbine T1/250	7
2. Schematic of governor hydraulics	8
3. Proposed hydraulic damping arrangement	9
4. Photographs of equipment installed	10
<b>C: COMPONENT MATCHING PROCEDURE FOR GOVERNOR DESIGN AND TUNING</b>	
1. Instructions	14
2. Explanatory comments	15
3. Working diagrams & summary of data (Forms B1-B10)	18

St. Gall, June 1983

**SKAT**

SKAT  
Schweizerische Kontaktstelle für Angepaßte Technik am ILL,  
Institut für Lateinamerikaforschung und Entwicklungs-  
zusammenarbeit an der Hochschule St.Gallen

SKAT  
Swiss Center for Appropriate Technology at ILL,  
Institute for Latin-American Research and for Development  
Co-operation, University of Saint-Gall

Varnbuelstraße 14, CH-9000 St.Gallen,  
Switzerland, Tel. 071 23 3481

SKAT  
Centre Suisse pour la Technologie Appropiée à l'ILE,  
Institut de Recherche sur l'Amérique Latine et de  
Coopération au Développement, Université de Saint-Gall

SKAT  
Centro Suizo de Tecnología Apropada a el ILL,  
Instituto de Investigación sobre América Latina y  
de Cooperación al Desarrollo, Universidad de Sankt-Gallen

A: GENERAL INFORMATION

DHADING MICRO-HYDROPOWER PLANT

Rated Plant Output: 30 kWe

1. Technical specifications:

Turbine: BYS X250/CF1

with new cylindrical valve  
 $Q_s = 0.26$ ,  $H_{net} = 21$  m, 460 RPM  
 $Q_{max} = 300$  l/s  
 $P_{max} = 43$  kW,  $\eta = 0.7$

Alternator: MARKON make

self-excited, self regulated 50 HZ, 1500 RPM,  
65 kVA, 230/400 V

Governor: BYS/MWH/P-governor

Servo-cylinder:

$\varnothing$  125 x 200 (stroke)  
BIBUS/DU 125/200 1/32 706  
Adapter 1/32 700/023

Throttle/control-valve:

$\varnothing$  18 mm/special design (see enclosure)

Closing spring:

BAUMANN NR. 207  
Outside  $\varnothing$  118 mm, wire  $\varnothing$  8 mm  
free length 400 mm, compr. length 84 mm  
c-rate: 0,37 kgf/mm

Flyball assembly:

type BYS, directly mounted on turbine shaft  
 $\Delta f_f = 0.49$  kgf/mm, at 460 RPM (constant)

Flyball spring:

FBS 03, c-rate 0,23 kgf/mm  
Outside  $\varnothing$  38, wire  $\varnothing$  3 mm  
free length 90 mm, max. length 210 mm

Connecting lever:

H = 100 mm (constant)  
K = 130-190 mm (variable)  
L = 300-400 mm (variable)

Transmission:

6 x c-section vee-belt drive, single stage  
460/1500 RPM,  $i = 3,26$

Flywheel:

$\varnothing$  700 mm, weight approx 120 kg,  $GD^2$  approx 20 kg m<sup>2</sup>  
mounted in line with alternator axis (1500 RPM)  
and connected with semi-flexible coupling

Switchboard:

equipped with V, A, kW, kWh, Hz, h meters, on/off  
switches, excitation switch, phase selector  
switch and main line connector switch. Protected  
by fuses and overvoltage relay.

Filter and supply pipe:

- Basket strainer type filter with stainless steel gauze
- Storage tank 100 l with adjusting valve and overflow pipe 40 mm providing a constant head of 17 m
- G.I. 2" pipe along penstock with stop valve above the filter, 1" drain valve above the filter and stop/operating valve (1 1/2") above the governor in the power house.

Connecting pipe to servo-cylinder and control-valve flexible  $\varnothing$  40 mm (rubber) pipe. Governor discharge pipe:  $\varnothing$  80 mm x approx 3 m length.

2. Plant performance:

(as per commissioning tests 27.5.83)

Output:  $P_{el} = 34$  kW (under full head)

speed deviation: + 10 % at no-load

(static) - 6 % at rated-load (30 kW)

- 20 % at full-load

Overall plant efficiency: 0.58 for:  $H_n = 21$  m

$Q = 250$  l/s

$P_{el} = 30$  kW

3. Transient state tests:

Load rejection:	acting time	transient overspeed
25 %	5,2 seconds	9 %
50 %	5,5 seconds	13 %
75 %	6 seconds	23 %
100 %	7 seconds	26 %

rated no-load speed is reached after 20 seconds

Rated load acceptance:	5 seconds	underspeed 26 %
------------------------	-----------	-----------------

47 HZ static rated load speed is reached after 14 seconds.

4. Sensitivity test:

at:	required magnitude of load switched to initiate governor action
no-load	+ 0.6 kW
25 % load	+ 1.5 kW (10 %)
50 % load	+ 1.5 kW
rated-load	+ 2.0 kW (7 %)

## 5. Description:

### Performance:

The performance of the plant, observed during initial testing and during commissioning of the equipment, is satisfactory but better than specified by BYS for SHDB.

Static speed deviation is + 10 % at no-load (which is not of any adverse consequence since no consumers are connected) and remains within very acceptable  $\pm 4\%$  in the output range from approx. 10 to 25 kW, while deviating to  $\pm 6\%$  at rated load.

Rated load is achieved with 86 % turbine gate opening while at 100 % opening; peak power output is 34 kW.

It is however not advisable to run the plant at peak power output. The virtue of providing rated load at less than full turbine opening is rather that rated load can be maintained even under reduced head. This is likely to occur during operation at rated load for periods of more than one hour during the dry/irrigation season. In this period, rated load discharge is likely to be higher than forebay inflow, thus slowly draining the storage. Producing rated power output of 30 kW is possible with a head reduced by upto 2 meters, i.e. 19 m.

Voltage regulation of the alternator is such that voltage remains constant in the entire range from no-load to rated load. Higher/lower voltage occurs in transient state and at peak load only.

Transient speed deviation occurs during short periods of approximately 5 seconds to the extent of less than 15 % in normal switching (on or off) of 50 % of the load or less. In the unlikely event of rated load rejection or acceptance, transient speed deviation is in the region of 25 % (specified maximum is  $\pm 30\%$ ), returning to the steady state within a maximum of 20 seconds.

Governor action is quick but a closing time of about 7 seconds is maintained, giving a pressure rise in the penstock of 25 % which is within design limits of penstock strength. Faster closure and thus a higher pressure rise may occur at sudden loss of governor supply pressure. This can be induced by very fast and careless manual closure of the operating valve. Even in this case, penstock rupture is very unlikely and operators are instructed to avoid such wrong manipulations.

Observation of the plants performance during the first week after commissioning (early June, 83) has shown no deviation from the performance data obtained during initial testing and commissioning, and no malfunction. Operational load connected varied from 8 kW to 22 kW, indicating that for the time being full rated capacity is not yet connected.

Operation:

The procedure is as follows for starting-up of the plant.

1. Adjusting governor water supply
2. Opening on/off valve of the governor supply line in the power house
3. Switching-on excitation
4. After steady no-load speed is reached, connection of the line.

Shutting down:

1. Disconnection of the line
2. Slow closure of the governor supply valve (on/off valve).

Alternatively, the governor supply valve may be closed as a first step. The line will automatically be disconnected at approx. 100 Volts phase/neutral voltage.

Adjusting water supply:

The water discharge of the governor varies according to the position of the control-valve. Highest discharge occurs at no-load speed, lowest discharge at full-load speed. The problem of adjusting the governor water supply consists therefore in providing a constant head. To achieve this, the storage tank must overflow at all times. Adjustment is done best at no-load, providing very little overflow. The overflow pipe must have a sufficiently large diameter to keep a head increase at full-load, due to higher overflow discharge and subsequent pressure build-up, within limits. The overflow pipe provided is of  $\varnothing$  40 mm and approx. 3 m length. Adjustment of the 2" valve between filter and storage tank is an opening of 3 full revolutions opening from the fully closed position. This position needs not to be changed. The hand wheel of this valve has therefore been removed. The stop valve above the filter on the other hand is opened fully for operation and is shut-off for filter cleaning.

Starting up:

Except for filter cleaning, no manipulation of the adjusting and stop valve near the filter and storage tank is required after initial adjustments as described. Normal plant operation is possible from within the powerhouse. The following procedure has been found to be convenient:

- Slow opening of the on/off valve by approx. one revolution of the valve handle. Pressure in the servo-cylinder builds up and the turbine gate starts opening.
- While the generating set is speeding up, the excitation push button is pressed down until excitation is on, as soon as speed and therefore voltage reach a sufficiently high level.
- Immediately thereafter, the on/off valve is opened fully. In the process, speed will go up to above no-load speed (transient) and will return to no-load speed.

- The line may now be connected by the main switch.

Shutting down:

The equipment takes care of full-load rejection well within acceptable limits of speed increase. Irrespective of the load connected, shutting down is effected by:

- Disconnection of the line by operating the main switch
- Slow closure of the on/off valve.

The plant comes to a standstill without the need for a brake and without the need to close the penstock gate valve.

All manipulations described may conveniently be done by a single operator.

**6. Plant safety:**

Tests and operation so far have shown that in normal operation, no dangerous conditions occur. Permissible overspeed for the alternator is 40 % as specified by the manufacturer, while not more than 26 % overspeed occurs for short periods in normal operation.

In the case of governor malfunction, the system is in principal self-protecting, i.e. in the case loss of pressure, the turbine is shut down automatically.

Pressure loss can have the following causes:

- lack of water supply due to insufficient filter discharge due to blockage.
- rupture or leak of flexible (rubber) pipes

While the former may occur in case of operator's negligence, the latter is most unlikely.

Jamming of the control-valve, due to foreign particles (which would indicate that the filter is not good enough), would cause the governor to malfunction. Safety is not likely to be endangered since at overspeed the flyball assembly develops forces in the range between 20 - 30 kgf. These are very likely to move a stuck control-valve.

Two critical components of the governor system are the closing spring and the connecting link between the operating lever and the control-valve (turn-buckle). If one of these components should break, serious damage to the alternator may occur. However, breakage of the closing spring can be ruled out as a possibility. Removal by force of the ball joint/turn buckle is basically possible. This would have to be considered a serious act of sabotage.

## 7. Maintenance:

The revision of the governor design was done with the aim of reducing maintenance requirements. The result is a reduction of lubricating points and better protection of moving parts against dust and corrosion:

- the control-valve pushrod is fully sealed in its brass bearing from water with a rubber bellows. A single drop of oil needs to be put into the lubrication nozzle every few days.
- the flyball assembly is fully sealed and is also provided with a bellows at the pushrod extension. Grease lubrication applied initially is expected to last for at least 500 operating hours.
- the control-lever bearing consists of two permanently greased ball bearings and is sealed with a rubber cap.
- a brass friction disk is fitted between the point of the flyball pushrod and the control-lever pressure plate. One drop of oil must be applied daily at the point of contact of friction disk and pressure plate. Care must be taken not to remove the friction disk from its correct position.
- the bearing at the turbine gate lever to which the servo-cylinder is connected, is provided with a grease nipple to which grease must be applied occasionally by grease-gun.
- the same applies for the bearings of the turbine gate.
- proper attention must be paid to the condition of the governor filter. It is expected that under normal conditions, cleaning has to be done at least weekly. However, during and after heavy rains, more frequent cleaning is necessary due to heavy particle load of the water.

### Procedure:

- closure of main valve above the filter
- removal of filter basket by removing the filter lid
- draining of the filter housing by removing the drain-screw at the bottom
- cleaning of the filter basket by brushing its outside with a steel brush and subsequent flushing
- flushing out of the filter housing
- replacing drain-screw, filter basket and lid
- re-opening of the main supply-valve.

Maintenance requirements specified here can not be complete since there is no long term operating experience. Additional requirements will need to be specified based on such operating experience.

16 June 1983/ME



Part B

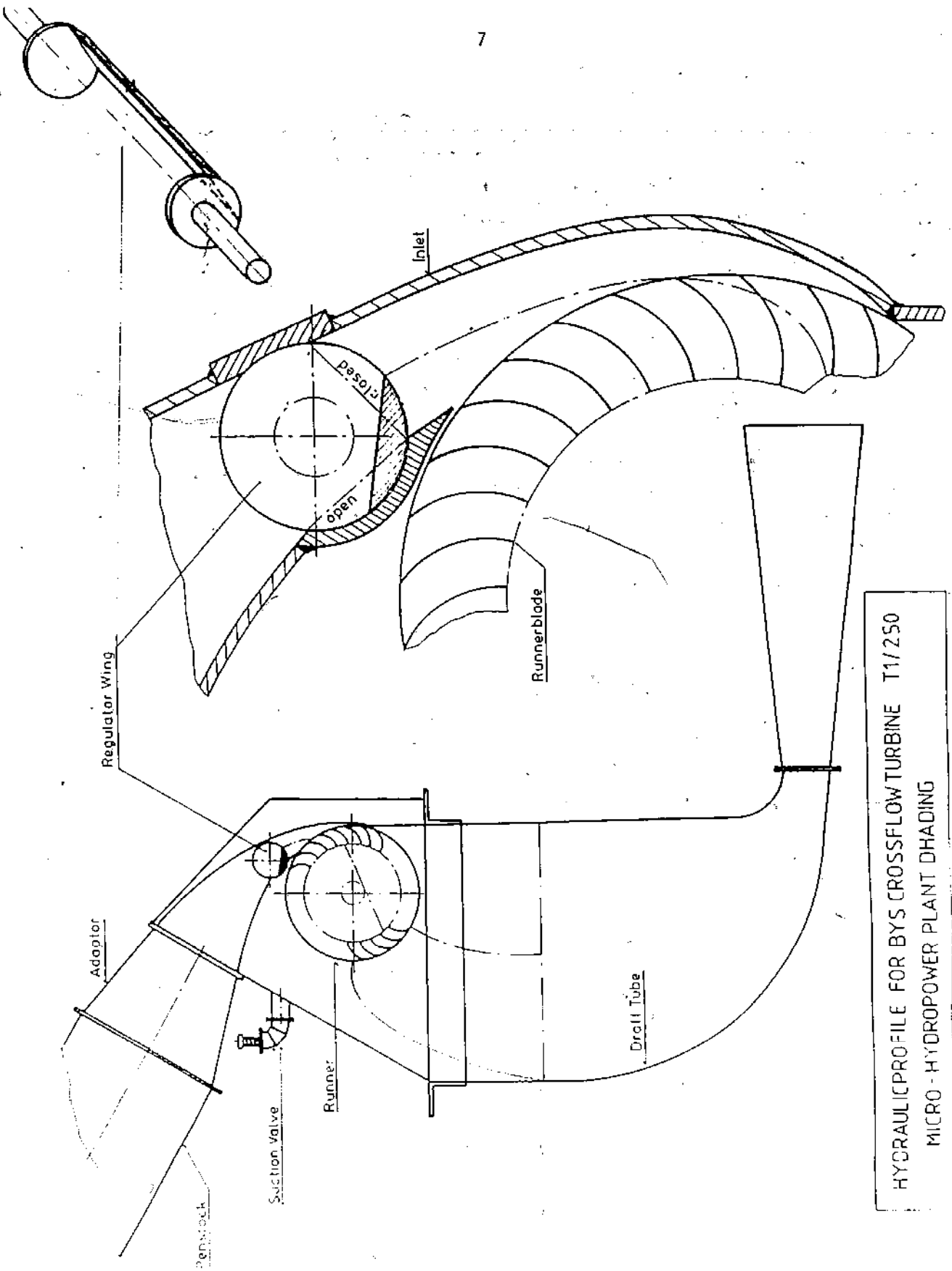

HYDRAULICPROFILE FOR BYS CROSSFLOWTURBINE T1/250  
MICRO - HYDROPOWER PLANT DHADING

SCHEMATIC OF MWH GOVERNOR HYDRAULICS  
"DHADING" MICRO HYDRO PLANT

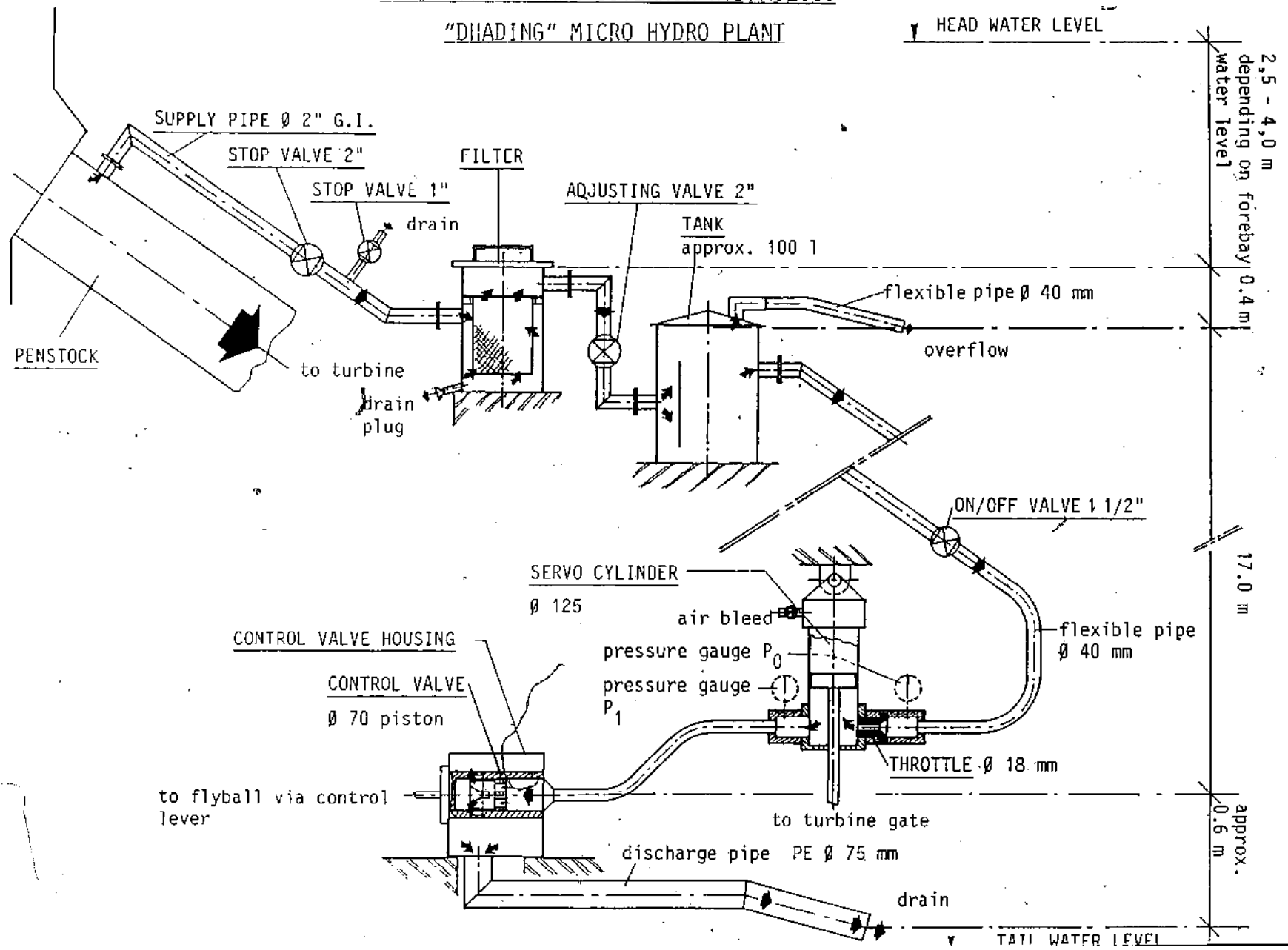

21.6.83/1/2

DAMPING ARRANGEMENT FOR  
MWH/P-GOVERNOR (SCHEMATIC)

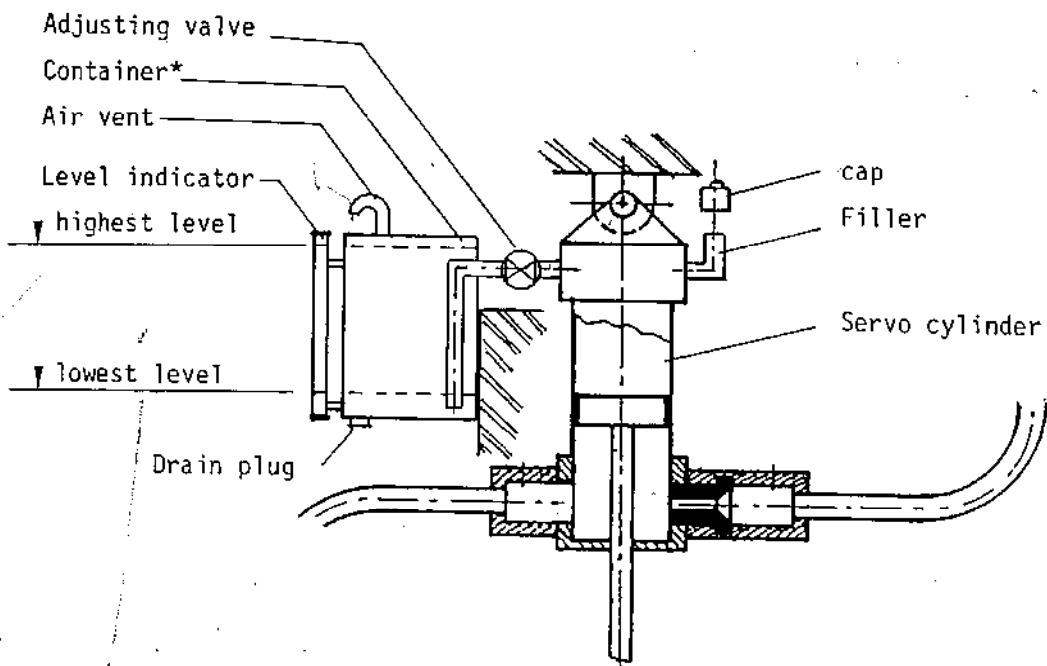

\* required container volume:

Servo cylinder ∅ / stroke	Liters (approx.)
80/150	1,0
80/200	1,2
100/150	1,4
100/200	1,8
125/150	2,0
125/200	2,7

BYS EQUIPMENT INSTALLED AT DHADING

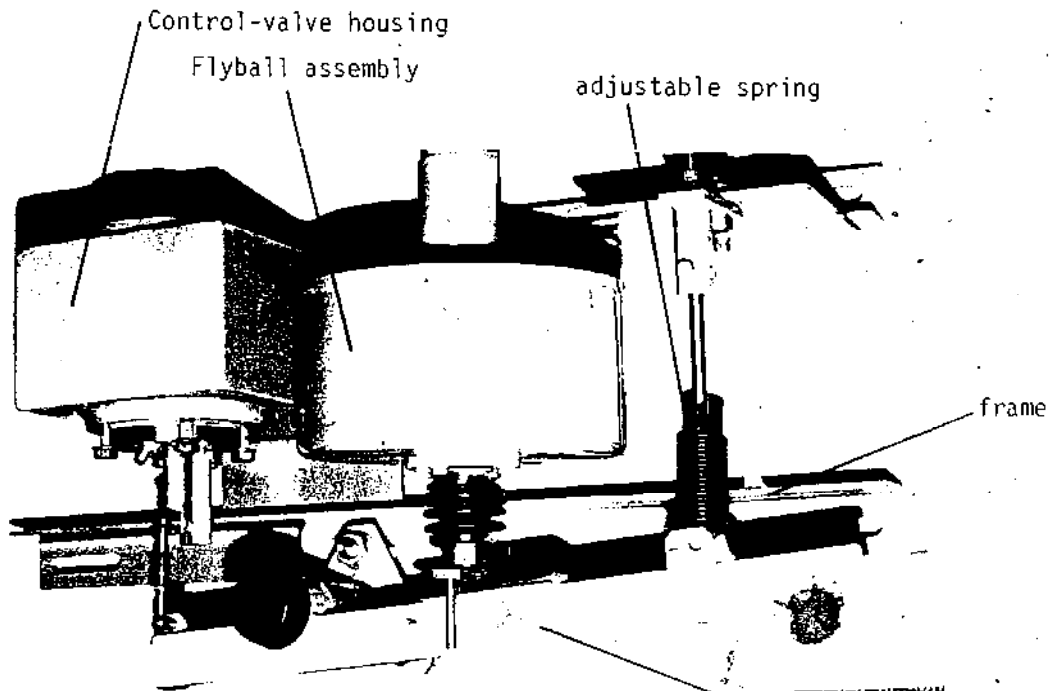

View of control unit  
MWH/P-Governor

Control lever

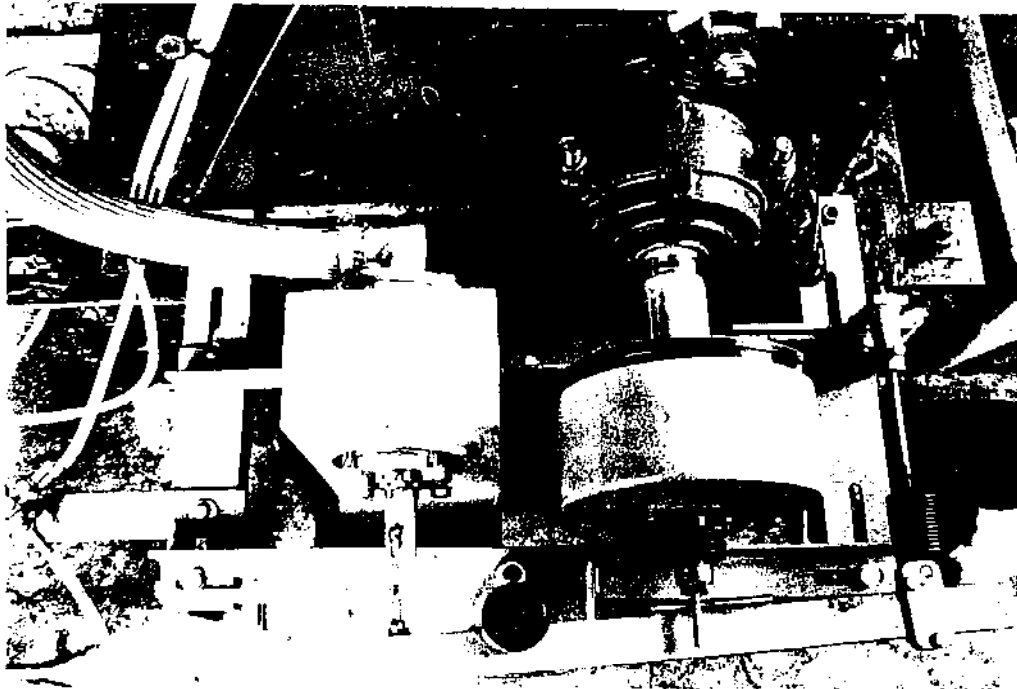

Control unit mounted on frame

Connecting pipe between  
servo-cyl. & control valve

Flyball  
Control-valve

- Servo-cylinder

Supply pipe

Closing spring

Turbine gate lever

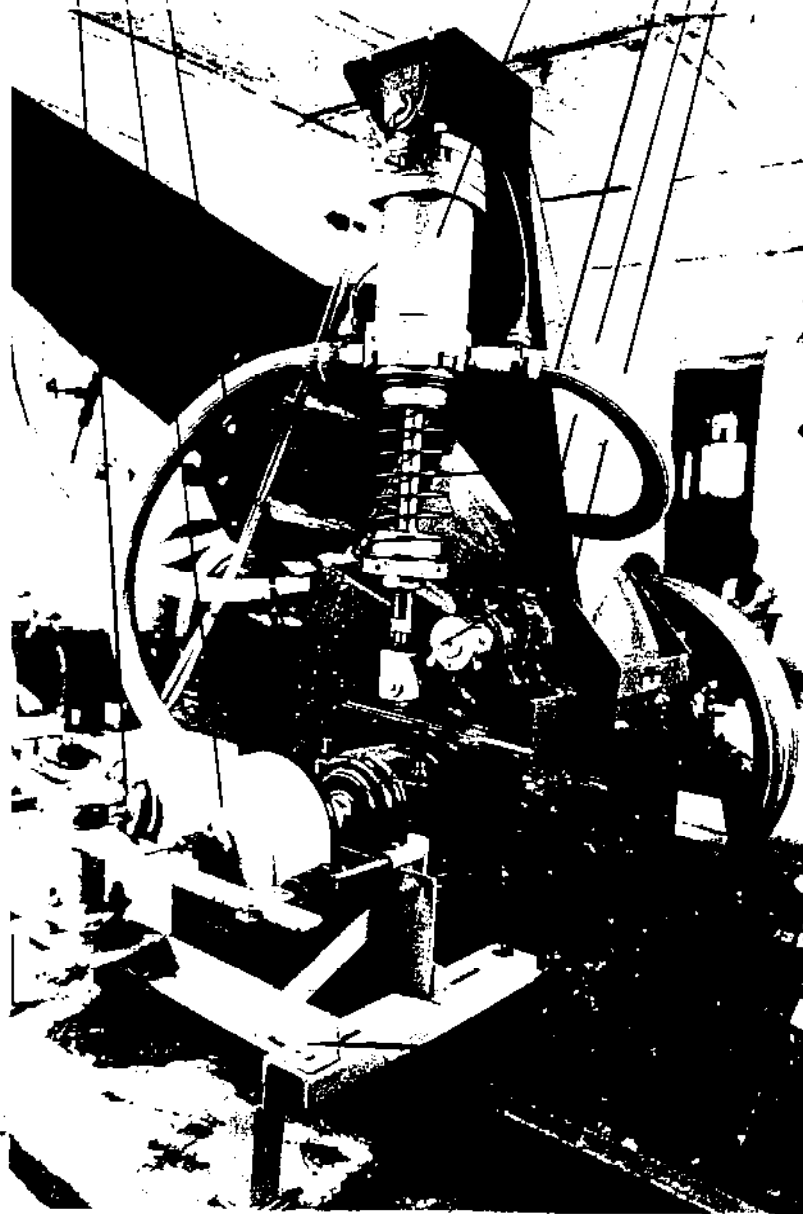

control  
unit frame

Overall view of Mill governor/Cross-Flow turbine assembly

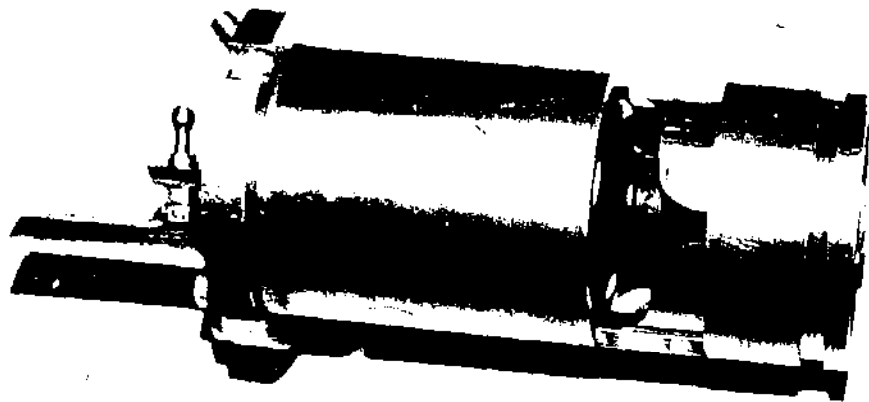

Detail: Control-valve assembly

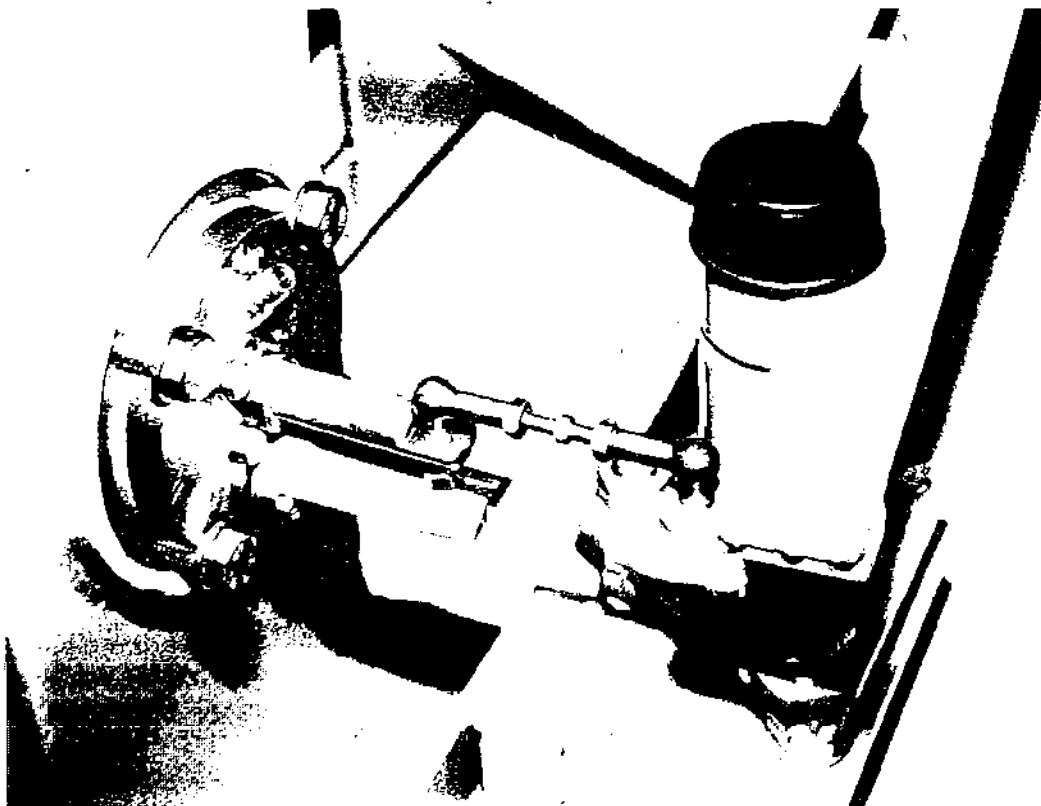

Pipe adapter with  
pressure gauge  
nipple & plug

Adapter and throttle  
assembly

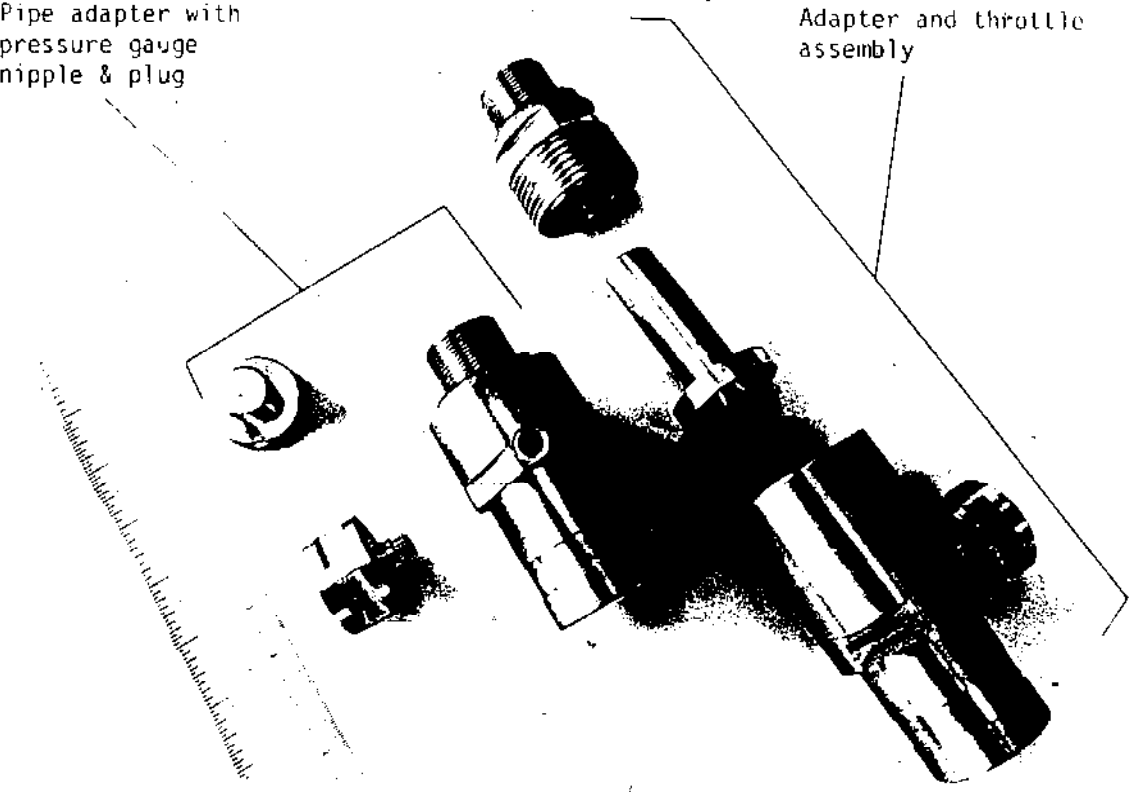

Detail: Pipe/servo-cylinder adapter parts

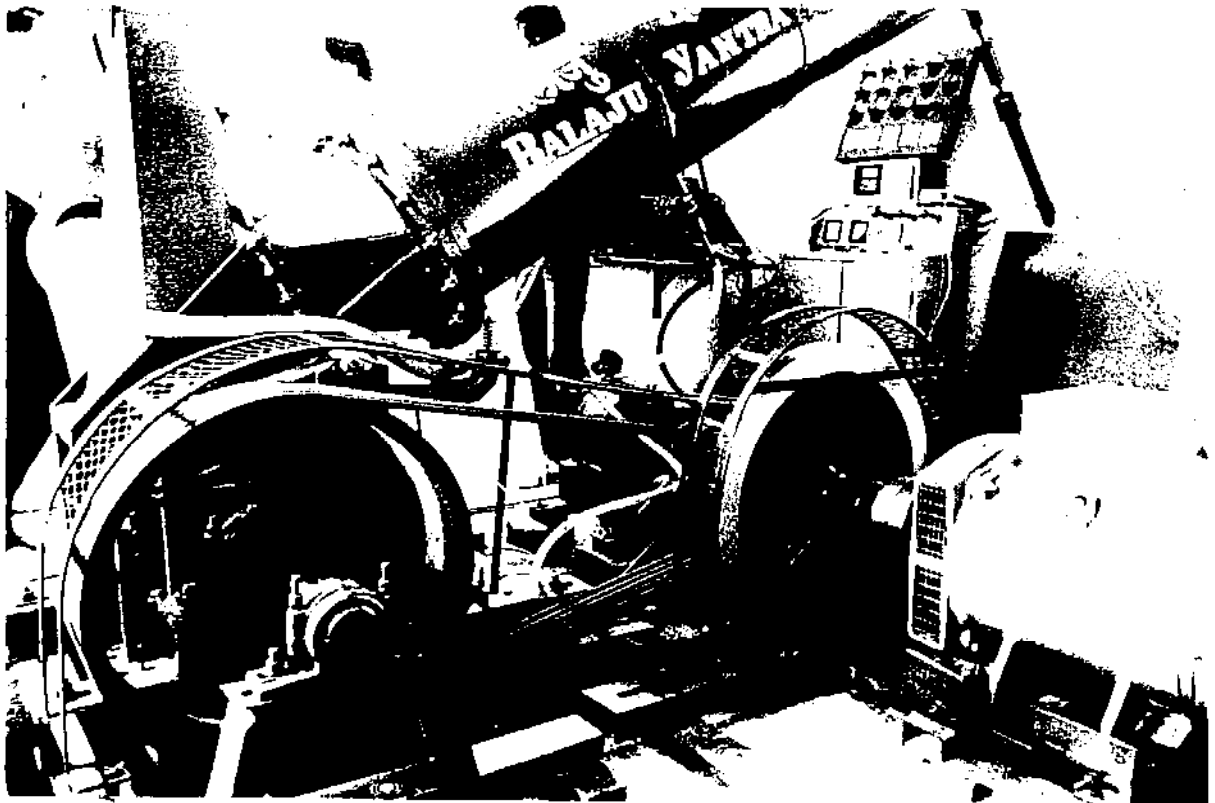

Two-belt transmission for alternator



Part C

1. INSTRUCTIONS  
Mechanical Governor

Component matching procedure:

A: Determine characteristics

1. Flow regulator forces (gate characteristic) including length of gate pushrod stroke between no-load and full-load (use form B1)
2. Flyball characteristic by using form B2 and B3
3. Throttle/control-valve characteristic by using form B4
4. Available working pressure  $P_0$  by using form B5

B: Select servo-cylinder diameter (Fig. 21, page 28)  
(use form B7, B8 as a worksheet)

1. Calculate effective cross-sectional piston area
2. Calculate available piston force at no-load and full-load points of gate (i.e. at  $P_1/P_0 = 0,3$  and  $0,7$  respectively). Draw piston characteristic on form B6
3. Add up gate, servo-piston and friction forces to determine required closing spring forces
4. Calculate closing spring characteristic

C: Select most suitable spring from the available range

1. Determine working points of spring at no-load/full-load
2. Calculate spring loading at full-load
3. Correct piston force  $F_{p_2}$  required and determine new value for full-load point of control-valve as well as stroke  $z$

D: Match flyball stroke length (17 mm) with control-valve stroke  $z$ , and flyball-pushrod forces with flyball spring

1. Calculate lever length K
2. Select suitable flyball spring
3. Calculate lever length L
4. Calculate amplification factor for flyball forces
5. Calculate flyball spring deflection at working points

E: Closing the control loop

1. Fill in design data (form B9)
2. Draw component characteristics in quadrant diagram (form B10)

## 2. EXPLANATORY COMMENTS

The component matching procedure with working diagrams B1 - B6 are used together with calculating sheets B7 & B8 to determine theoretically correct governor adjustments. The turbine gate characteristic and the flyball characteristic have to be measured to start with. Flyball pushrod forces are easily determined by operating the flyball assembly on a lathe machine at constant speed. Pushrod forces are measured in different positions by measuring the deflection of a spring (with known c-rate) which keeps the pushrod in the desired position. If this is repeated for a number of different constant speeds, the characteristic for any other desired speed may be calculated.

The gate characteristics must be measured under actual operating conditions, i.e. in the actual installation. The throttle/control-valve characteristics has been determined by the design of the control valve piston previously. It is now sensible to verify this by actual measurements at site, because manufacturing inaccuracies will have an influence. With the data obtained for the control-valve, graph B5 and subsequently graph B6 may also be completed.

The calculating sheet B7 is then used to determine control-valve working points and the setting of the closing spring. Subsequently, lever lengths and setting of the flyball spring are calculated. All data obtained are entered in form B9 which is used for executing governor adjustments.

Corrections of these preliminary settings have most likely to be done during trial runs, to obtain specified governor performance. Once this is achieved (by using the tuning procedure), adjusted values are entered in the respective column in form B9. The entire control-loop diagram can then be drawn in form B10. For full understanding of the interaction between the governor components, it is essential to find out the reasons for deviations of adjusted settings from design values. In case of such deviations, one or more of the initially assumed component characteristics must have been inaccurate or wrong.

Deviations of initially assumed characteristics from actual characteristics (which were derived from the final control-loop) are shown in the matching procedure for "Dhading". Reasons are explained in the following:

### a) Gate forces:

Initial measurements were not done in the actual installation but at the BYS test plant only. Due to a new gate design and a lack of appropriate measuring instruments, practically no forces could be measured. The gate was consequently wrongly assumed to be hydraulically balanced. From the setting of the closing spring and the positions of the control valve, actually occurring forces could be derived. As shown on graph B1, deviations are considerable, leading to deviations in other components of the system.

## b) Pistion forces:

Due to the apparent opening forces at no-load, the actually required piston force at this point is much smaller (20 kgf instead of the calculated 52,5 kgf). At full-load on the other hand, apparent closing force of the gate is higher than assumed. The required piston force is therefore higher than calculated (132 kgf instead of 122.8 kgf).

## c) Closing spring setting:

The closing spring is to counteract the total of opening forces. The corrective calculation of required spring setting, by using values of the apparent gate forces (form 7a) yields a required deflection of 162 mm, while the actually adjusted value is 160 mm. Spring deflection is higher than calculated initially 298 mm according to the corrective calculation and equal to the actual adjustment.

## d) Control-valve working range:

Due to the greater difference between required piston forces at no-load and full-load points, the working range of the control-valve needs to be greater than as per the initial design calculations. The results of corrective calculations (form B7a) agree with actual working points at no-load and full-load, indicating that all other deviations so far have been correctly understood.

## e) Flyball/connecting lever:

The working range of the control-valve was increased, requiring greater control-valve piston travel. The flyball pushrod travel is increased in proportion. The corrective calculation (form B8a) shows that this results in practically the equal lever length  $K$ , which agrees with the actual adjustment.

Effective flyball forces deviate considerably from design calculations— as could be derived from actual flyball-spring deflection. The reason for this are hydraulic forces of the control-valve piston which counteract flyball forces and which were neglected initially. Form B3 shows this correction and the length for lever  $L$  is recalculated on form B8a. According to this calculation,  $L$  should be equal to 382 mm whereas the actual adjustment is 378 mm. This seems to be a slight adjusting error but is apparently of no consequence.

Tuning of the governor was done by initially adjusting all components to the values resulting from design calculations. A first trial run showed quickly, that performance was erratic and that corrective adjustments had to be done. The cause was soon traced to forces apparently existing in the turbine gate. Since no accurate measurements were possible, a series of assumptions were made. The entire desing matching procedure was done and redone with each new assumption until satisfactory performance was achieved.

It may be concluded that the entire matching procedure proved to be suitable in attaining good governor performance. All deviations of actual adjustments from initial design adjustments can be understood and corrective calculations, give results which agree with actual final adjustments. It is important, however, to point out that the approach in correcting adjustments must be systematic and coherent, at all times backed by the respective calculations with formulae given.

Form : B1

Installation: Dhading ...

turbine type: CE11X250 ...

H<sub>net</sub> : 21.m ...

**F<sub>g</sub>** [kgf]  
in closing  
direction

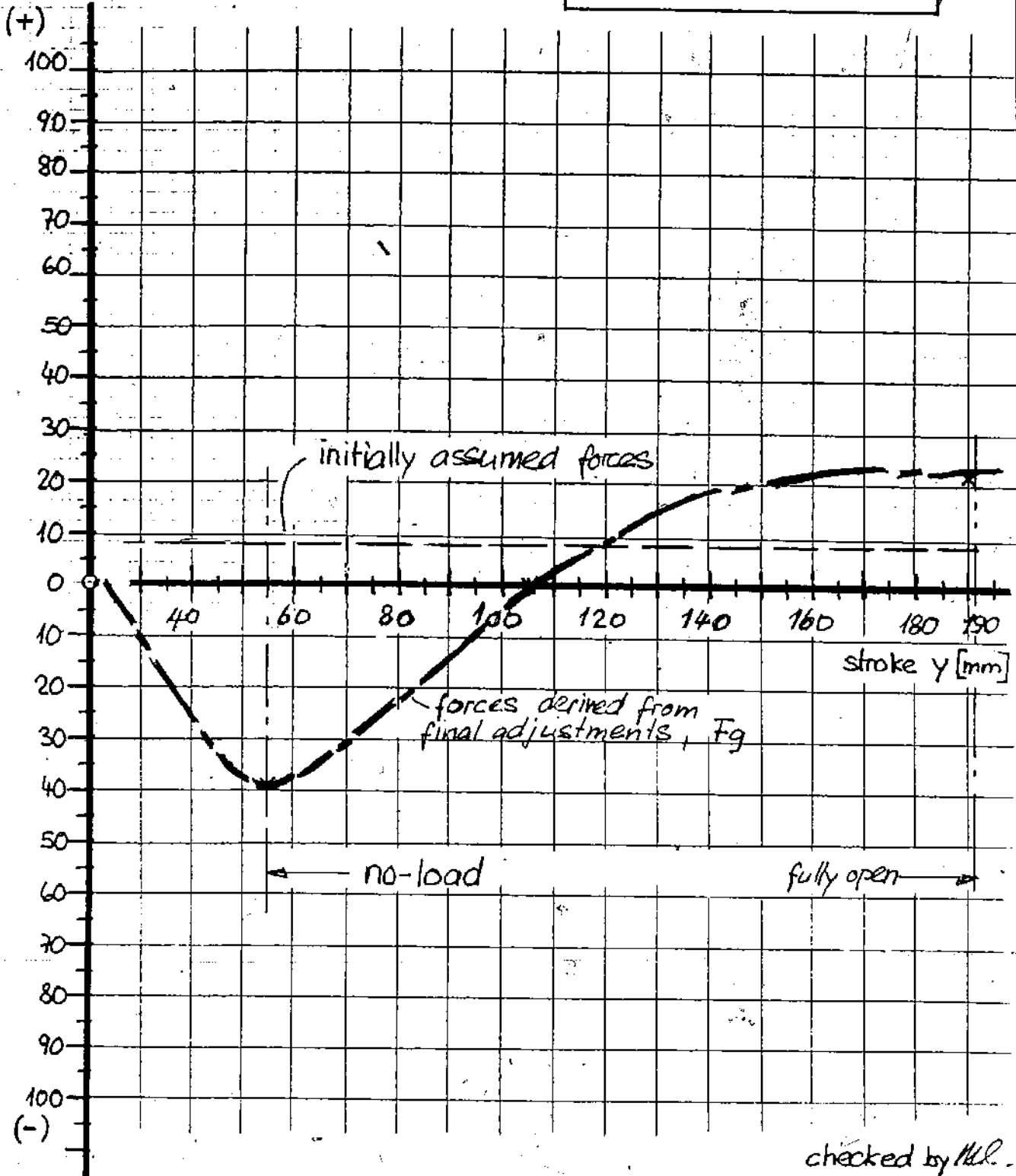

in opening  
direction

FLOW REGULATOR (GATE) FORCES

- define and mark no-load, full load positions

checked by MLL  
Date: 3.6.83

Form: B 2

Installation: Dhading.....

checked by: *Nel*.....

Date: 13.5.83/4.6.83

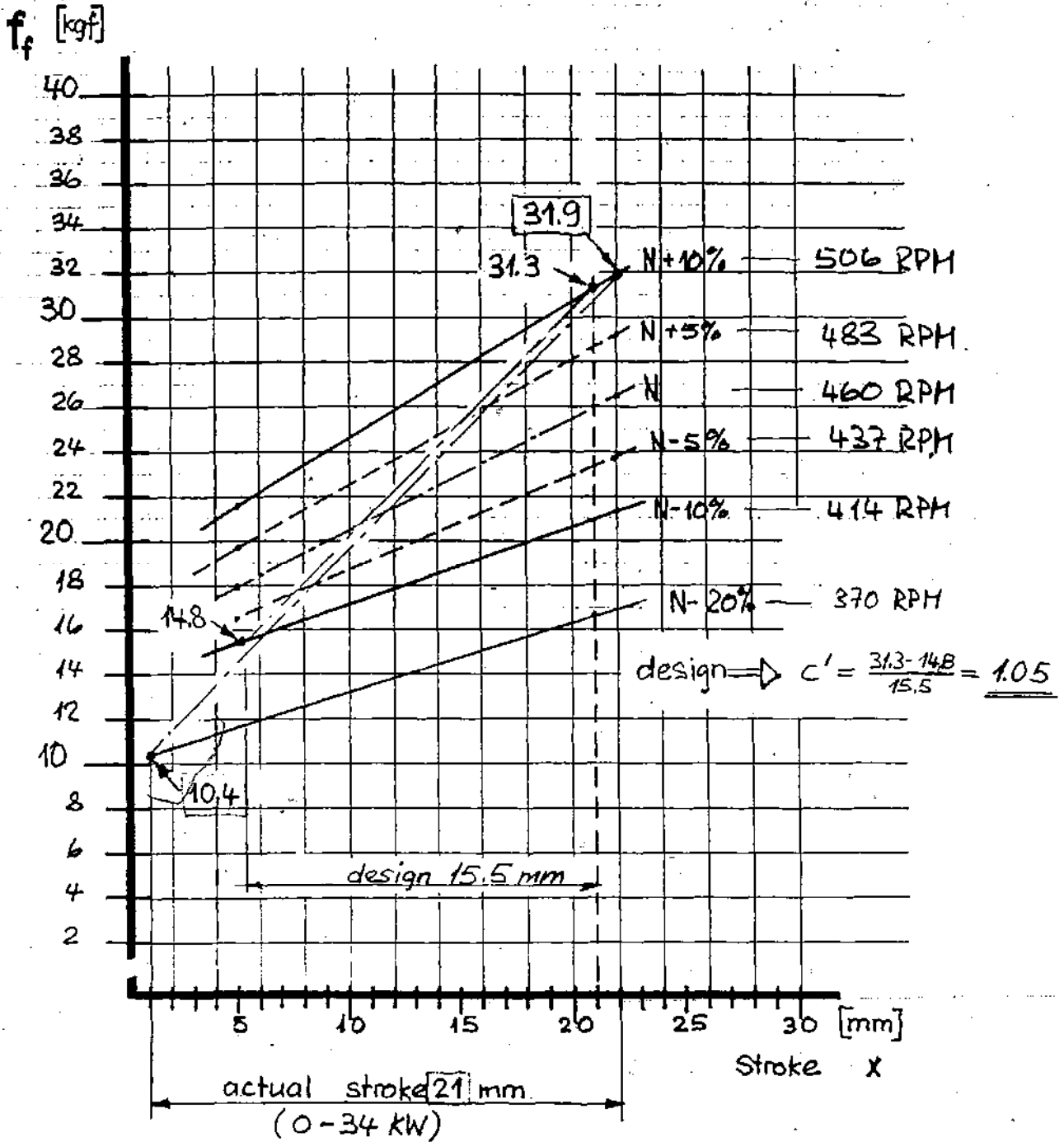

CENTRIFUGAL PENDULUM CHARACTERISTIC,  $f_f$

- establish characteristic for speeds: N, N+5%, N+10%, N-5%, N-10%
- calculate rate  $c'$  of imaginary flyball spring

Form: B 3

Installation: ... Dhading ...

checked by: ... KLP ...

Date: ... 6.6.83 ...

$f_s$  [kgf]

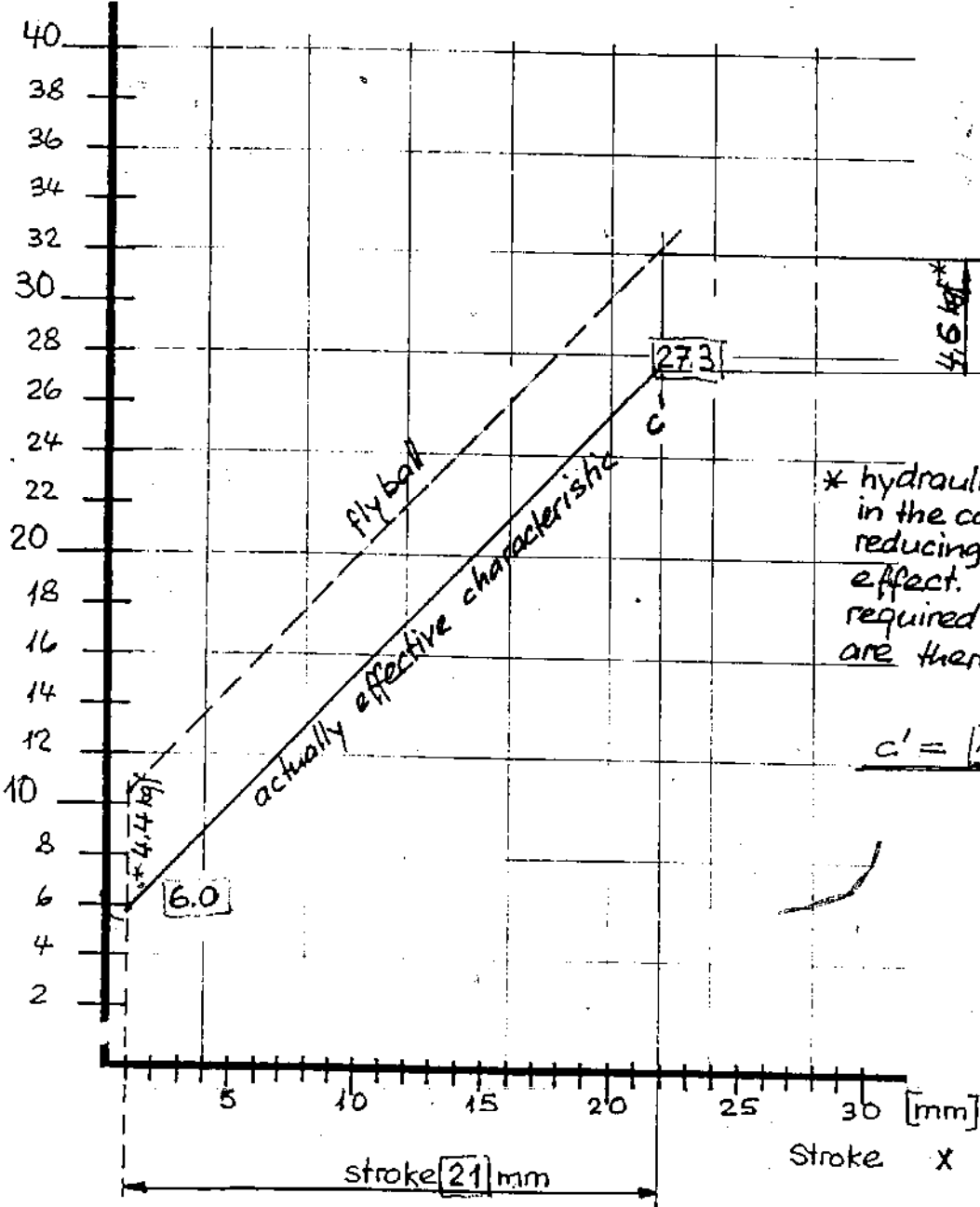

FLYBALL SPRING FORCE / STROKE DIAGRAM.



Form: B4

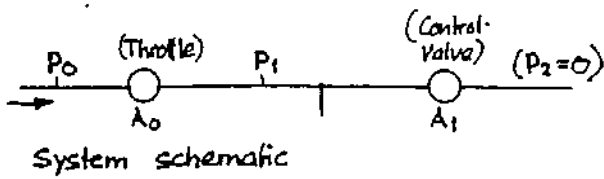

Installation: ... Dhading ...

throttle diameter:  $\phi$ .18 mm.

control-valve design: SPEC....

checked by: .. W. ....

Date: .. B.S. / 27.5.83 ...

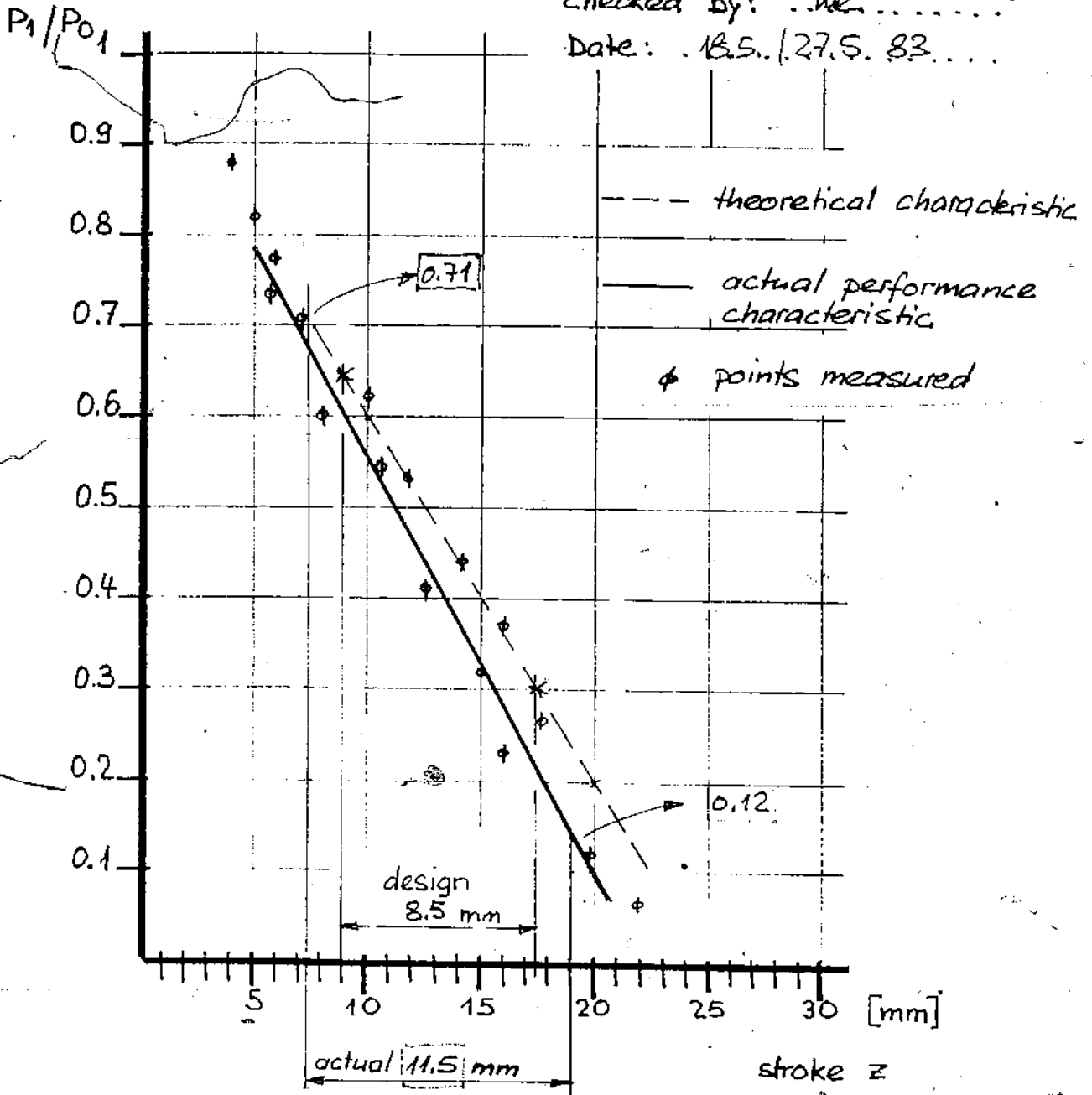

THROTTLE/CONTROL-VALVE CHARACTERISTIC

Form: B5

checked by: *NR*

Date: *6.6.83*

Installation: *Dhading*

H governor: *17m*

Throttle  $\phi$ : *18mm*

control-valve design: *SPES*

supply-pipe  $\phi$ : *2"* length *~50m*

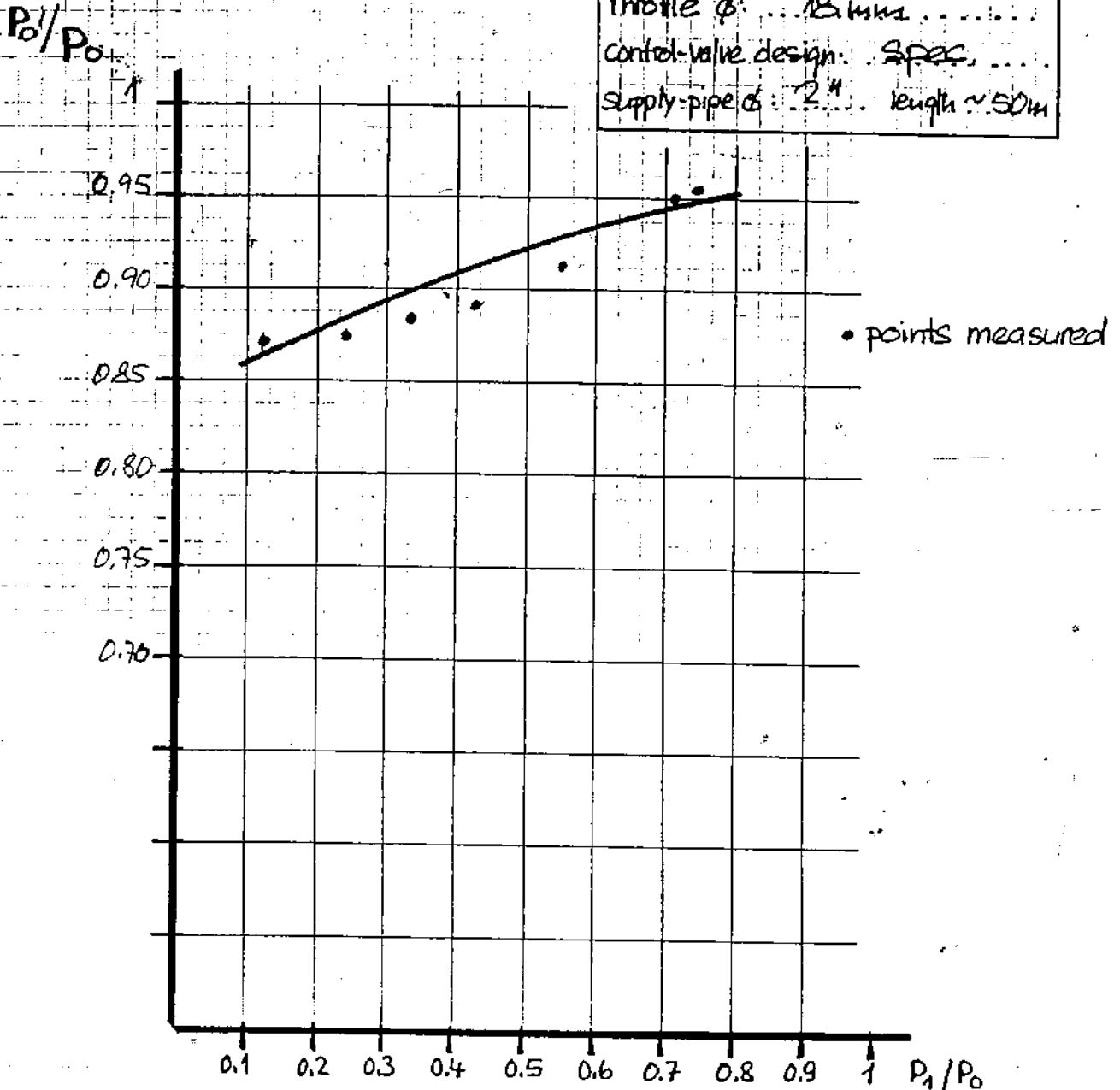

AVAILABLE WORKING PRESSURE  $P_0'$

$$P_1 = P_0 \cdot (P_0'/P_0) \cdot (P_1/P_0)$$

$P_0$  static = 17m

(measure at servo-cylinder inlet at zero flow).

Form : B 6

Installation: ... Dhading
Servo - piston $\phi$ : .. 125/30
eff. piston area: 11565 Piston <sub>des</sub> 17m

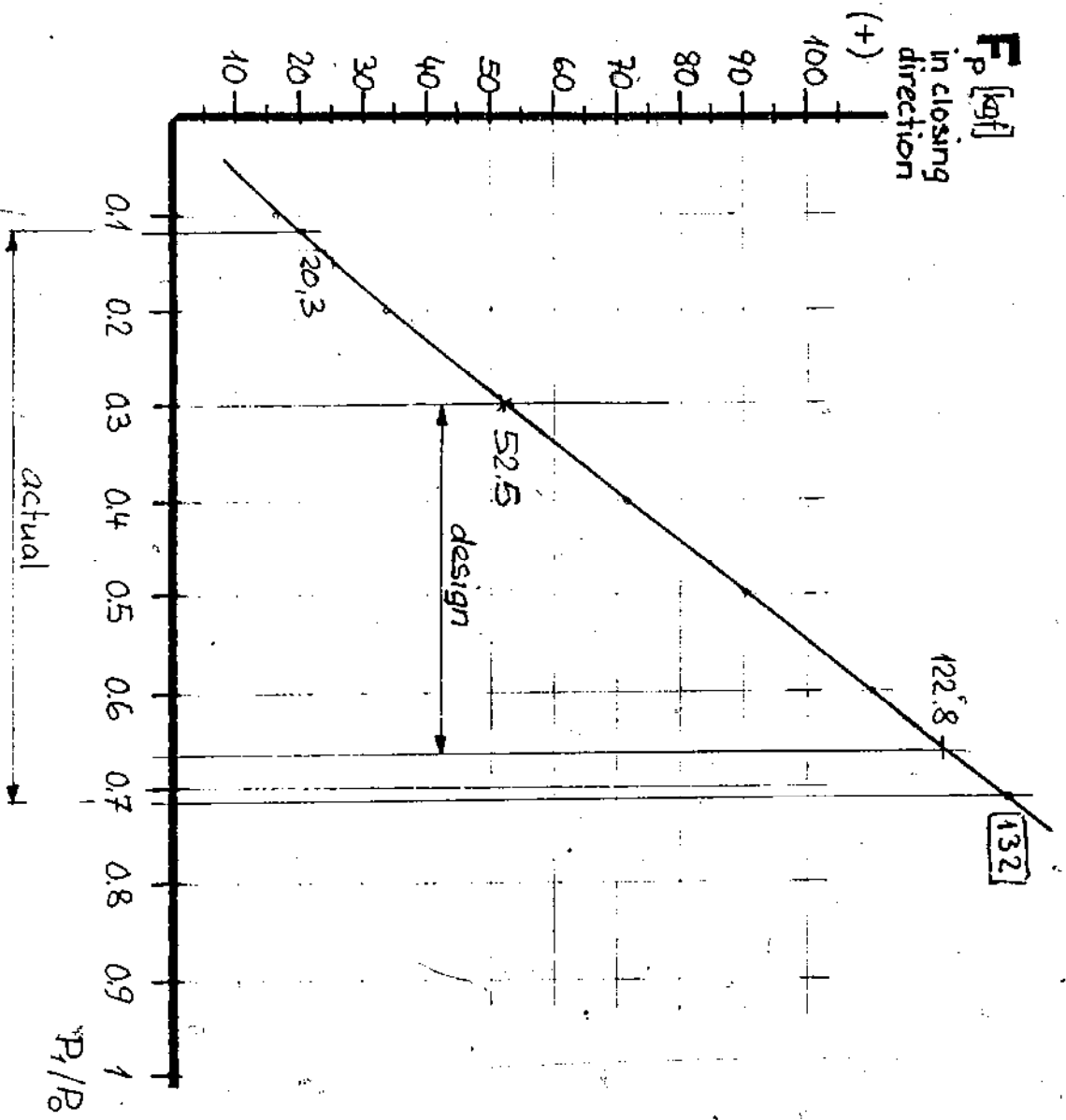

SERVO-PISTON FORCES,  $F_p$

$F_p = P_1 \cdot A_{eff}$

checked by: WE  
Date: 6.6.83

Form: B7

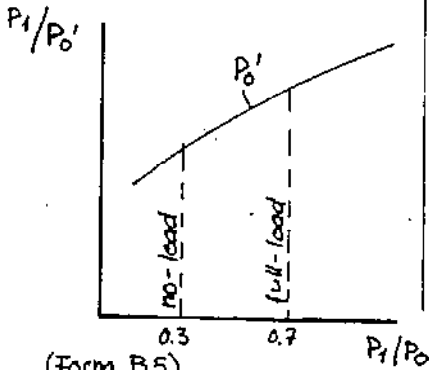
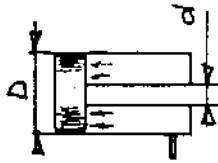

(Form B5)

Note:

Total of accumulated forces is in the opening (-) direction. Counterbalancing spring forces are in closing direction (+).

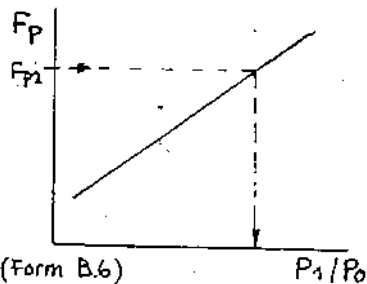
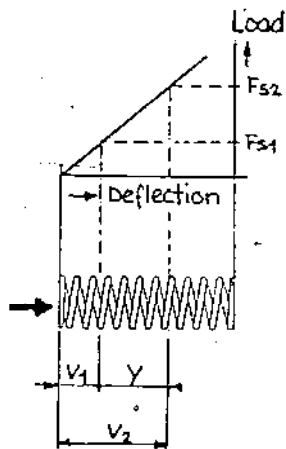

(Form B.6)

checked by: NR

Date: 27.5.83

Installation: Dhoding

ⓑ SERVO-CYLINDER

1. Effective piston cross-sectional area:  $A_p = (D^2 - d^2) \frac{\pi}{4}$

$A_p = 115.65 \text{ cm}^2$

2. Available piston force:

at no-load:  $F_{p1} = P_0' \cdot 0.3 \cdot A_p$   
 $F_{p1} = 0.99 \cdot 0.3 \cdot 1.7 \cdot 115.65 = 52.5$   
 at full-load:  $F_{p2} = P_0' \cdot 0.7 \cdot A_p$   
 $F_{p2} = 0.94 \cdot 0.7 \cdot A_p \cdot 1.7 = 129.4$

3. Accumulated forces:

	① no-load	② full-load
gate (form B1), $F_g (\pm)$	+ 8	+ 8
servo-piston, $F_p$	- 52.5	- 129.4
friction, $F_r$	- 10 kp	+ 10 kp
Required closing spring forces: $F_s$	- 54.5	- 111.4

4. Closing spring characteristic:

c-rate:  $c = \frac{F_{s2} - F_{s1}}{y} = \frac{111.4 - 54.5}{136} = 0.42$

ⓒ CLOSING SPRING

selected spring:  $c = 0.37$

1. Working points of spring:

initial deflection (at no-load):  $v_1 = \frac{F_{s1}}{c} = 147.3 \text{ mm}$   
 deflection at full-load:  $v_2 = v_1 + y = 283.3 \text{ mm}$

2. Spring loading at full-load point:

$F_{s2} = v_2 \cdot c = 283.3 \cdot 0.37 = 104.8 \text{ kgf}$

3. Correction of piston force  $F_{p2}$ :

$F_{p2} = F_r + F_{s2} = 10 \text{ kp} + 8 + 104.8$   
 $F_{p2} = 122.8 \text{ kgf}$

→ corrected value of  $P_1/P_0 = 0.66$

Form: B7a

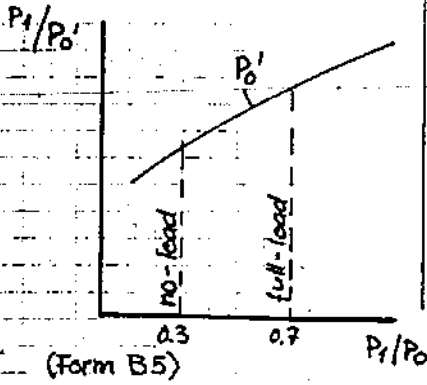
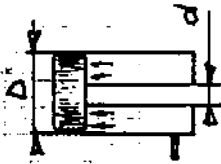

Note:

Total of accumulated forces is in the opening (-) direction. Counter-balancing spring forces are in closing direction (+).

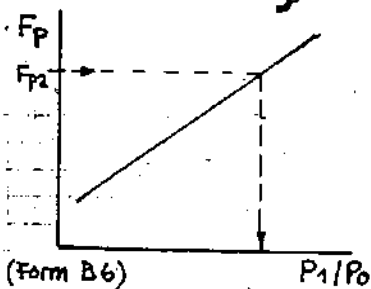
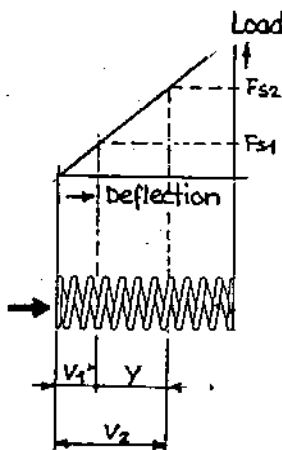

Corrective calculations

checked by: HUL

Date: 6.6.83. Installation: Dhading

**(B) SERVO-CYLINDER**

1. Effective piston cross-sectional area:  $A_p = (D^2 - d^2) \frac{\pi}{4}$

$A_p = \dots$

2. Available piston force:

at no-load:  $F_{p1} = P_0' \cdot 0.3 \cdot A_p$

data from form B10:  $F_{p1} = 20 \text{ kgf} \triangleq P_1/P_0 = 0.12$

at full-load:  $F_{p2} = P_0' \cdot 0.7 \cdot A_p$

$F_{p2} = 132 \text{ kgf} \triangleq P_1/P_0 = 0.71$

3. Accumulated forces:

	① no-load	② full-load
gate (form B1), $F_g (\pm)$	- 40	+ 22
servo-piston, $F_p$	- 20	- 132
friction, $F_r$	10 kgf	10 kgf
Required closing spring forces: $F_s$	- 60 kgf	- 110 kgf

4. Closing spring characteristic:

c-rate:  $c = \frac{F_{s2} - F_{s1}}{y} = \frac{110 - 60}{136} = 0.37$

**(C) CLOSING SPRING**

selected spring:  $c = 0.37$

1. Working points of spring:

initial deflection (at no-load):  $v_1 = \frac{F_{s1}}{c} = \frac{60}{0.37} = 162 \text{ mm}$

deflection at full-load:  $v_2 = v_1 + y = 298 \text{ mm}$

2. Spring loading at full-load point:

$F_{s2} = v_2 \cdot c = 298 \cdot 0.37$

$F_{s2} = 110 \text{ kgf}$

3. Correction of piston force  $F_{p2}$ :

$F_{p2} = F + F_{s2} = 22 \text{ kgf} + 110 \text{ kgf}$

$F_{p2} = 132 \text{ kgf}$

→ corrected value of  $P_1/P_0 = 0.71$

Form: B8

(contd. from B6)

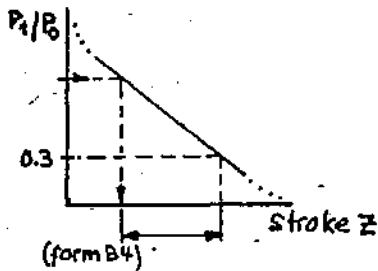

(form B4)

checked by: *Wol*

Date: *2.6.83*

Installation: *Dhading*

→ control-valve stroke:  $z = 8.5 \text{ mm}$

① MATCHING WITH FLYBALL

1. Lever length K:

$$K = \frac{H \cdot x}{z} =$$

with:  $H=100, x=15.5, K = \frac{100 \cdot 15.5}{8.5} = 182 \text{ mm}$

2. select flyball spring:

(according to flyball speed)

→ type selected: *FS 03*

c-rate: *0.23 kgf/mm*

3. Calculate lever length L:

$$L = \sqrt{\frac{K^2 \cdot c'}{c}}$$

where:  $c'$  = rate of imaginary spring (from form B2)

$c$  = rate of spring selected.

$$L = \sqrt{\frac{182^2 \cdot 1.05}{0.23}} = 388 \text{ mm}$$

4. Amplification factor for flyball forces:

$$(f_s \cdot L) - (f_f \cdot K) = 0$$

$$\therefore i = \frac{K}{L} = \frac{183}{388} = 0.47$$

5. Calculate flyball spring deflection:

at full-load:  $w_1 = i \cdot f_{f1} = 30.2 \text{ mm}$

at no-load:  $w_2 = i \cdot f_{f2} = 63.9 \text{ mm}$

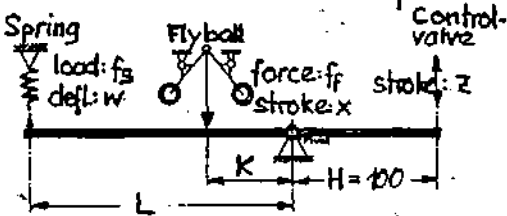

1	2	3	4	5	6	7	8	9	10	11	12	13	14	15	16	17	18	19	20
1	2	3	4	5	6	7	8	9	10	11	12	13	14	15	16	17	18	19	20

Table III, page 26

Note: if L calculated is near minimum or maximum of possible length, choose different spring.

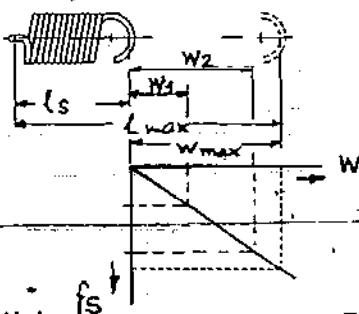

Note:

If  $w_2$  is near  $w_{max}$ , select a different spring.

Form: B8a

(contd. from B6)

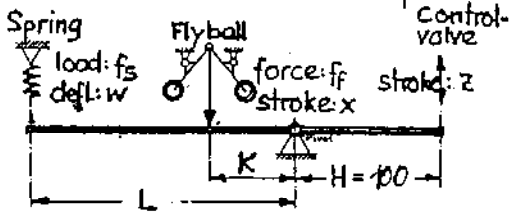
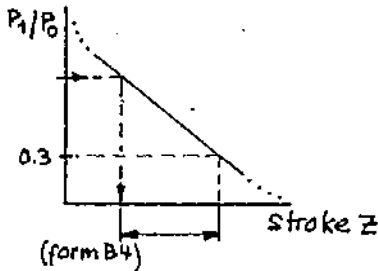

Spring No.	Spring Rate (N/mm)	Spring Force (N)	Spring Deflection (mm)	Spring Length (mm)	Spring Weight (g)	Spring Material	Spring Type
1	100	100	1	100	100	Steel	Coil
2	200	200	1	100	100	Steel	Coil
3	300	300	1	100	100	Steel	Coil
4	400	400	1	100	100	Steel	Coil
5	500	500	1	100	100	Steel	Coil
6	600	600	1	100	100	Steel	Coil
7	700	700	1	100	100	Steel	Coil
8	800	800	1	100	100	Steel	Coil
9	900	900	1	100	100	Steel	Coil
10	1000	1000	1	100	100	Steel	Coil

Table III, page 26

Note: if L calculated is near minimum or maximum of possible length, choose different spring.

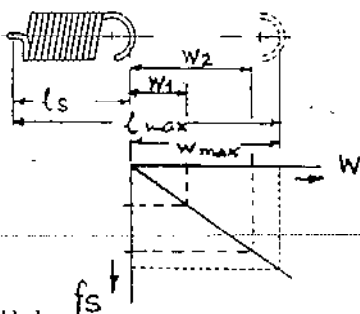

Note:

If w2 is near Wmax, select a different spring.

Corrective calculations

checked by: me

Date: 6.6.83

Installation: Dhading.....

→ control-valve stroke: z = ... 11.5 mm

(D) MATCHING WITH FLYBALL

1. Lever length K:

$$K = \frac{H \cdot x}{z} =$$

with: H=100, x=21,  $K = \frac{100 \cdot 21}{z} = 182.6 \text{ mm}$

2. Select flyball spring:

(according to flyball speed)

→ type selected: FBS 03

c-rate : ... 0.23

3. Calculate lever length L:

$$L = \sqrt{\frac{K^2 \cdot c'}{c}} \quad \text{where: } c' = \text{rate of imaginary spring (from form B2)}$$

c = rate of spring selected.

$$L = \sqrt{\frac{182.6^2 \cdot 1.01}{0.23}} = 382 \text{ mm} \dots$$

4. Amplification factor for flyball forces:

$$(f_s \cdot L) - (f_f \cdot K) = 0$$

$$\therefore i = \frac{K}{L} = \frac{183}{378} = 0.48 \dots$$

5. Calculate flyball spring deflection:

at full-load:  $w_1 = \frac{i \cdot f_{f1}}{c} = \frac{0.48 \cdot c}{0.23} = 12.5 \text{ mm}$

at no-load:  $w_2 = \frac{i \cdot f_{f2}}{c} = \frac{0.48 \cdot 27.3}{0.23} = 56.9 \text{ mm}$





Legend:

- F : piston force
- z : control-piston stroke
- x : flyball pushrod stroke
- ff : flyball " force
- y : turbine opening

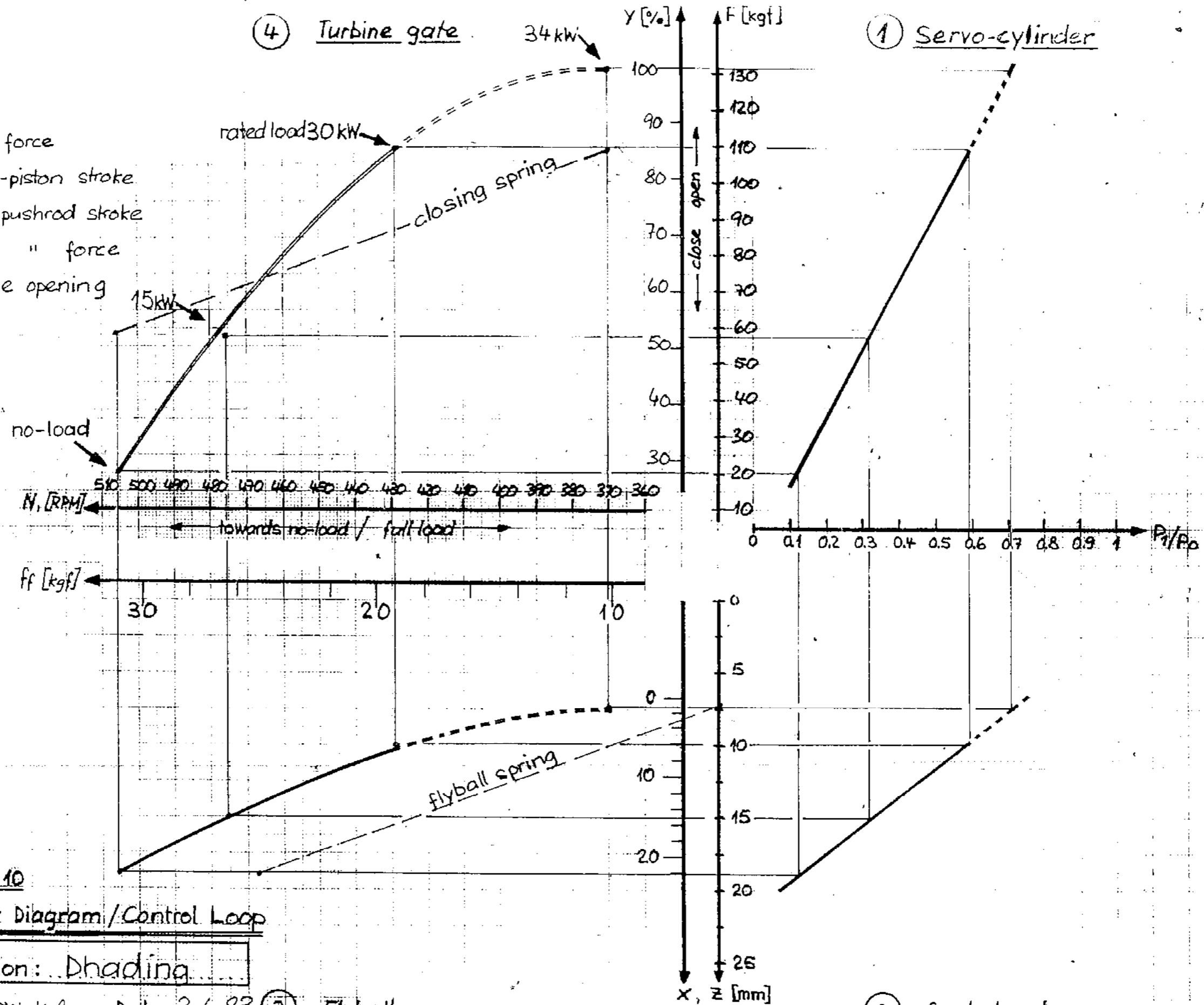

Fermi: B.10

Quadrant Diagram / Control Loop

Installation: Dhading

checked by: *kl*... Date: 3.6.83 (3) Flyball

(2) Control-valve