



How hard is it to make a working Hydro Turbine generator? This one probably didn't take more than 40 minutes.

The shaft opening is standard pipe thread, this makes it easy to cut a hole in a piece of stock, cut the same pipe threads in the stock and screw the mount on with a short threaded connector. The motor has two studs that stick through the mounting plate. The drive shaft was made out of a threaded piece of stock, one end slips over the automotive DC motor shaft (threaded hole with Allen set screw), the other engages the slot in the plastic turbine wheel.

I hooked it to the garden hose and powered a boom box (radio), I then run a 12 volt automotive tail light; not bad for our wimpy water pressure. What is most impressive is the low volume of water it takes to spin the turbine. Maybe a good way to explain this is... turn the garden hose on, and adjust the water down to where you would drink from the hose, this is all the water this turbine needs to produce a low voltage!

Something like this would be great for a site with a hundred or more feet of head, even if the

volume was VERY low, this mini turbine could still keep your batteries charged.

George B.





## How to contact me

We will become more SOPHISTICATED some day... but for now.

To help reduce Spam, the following email address contains **XXX's** that must be removed before attempting to send same...

send email to [George B.](#) <<<< click on the name

If you're emailing me to ask for a price list of all the things I might sell, the shipping weights, warranties and the likes, you're probably attempting to do business with the wrong person. I like to work with people from a needs basis, I don't care if you have no clue where to start, but addressing a need or desire is far more pleasant from my perspective. In addition, don't expect me to try and sell you something, if you don't sell yourself, you won't find me trying to twist your arm, this is my hobby, not my means of making a living.

If you send me email and don't think it's important to share you name, it may not make it through my sophisticated Spam filter, don't take it personal, but the software seems to get annoyed with minor omissions like that... You can lie about your name; just pick one and the software won't get offended.

If you send an email asking me to call, know that I do not have a good long distance rate and would find it easier to accept your call, ....just ask for a number in your email. I take calls from 0900-2200 PST most days.

I'll try and set up email return notification and let you know when I'm in the field, I do spend time off the grid and in the deep weeds, so if your email isn't answered right away, don't think I'm ignoring you.

All the best,

George B.



## Devoted to Intelligent AE Solutions

**Alternative energy solutions, with a focus on equipment you can maintain and rebuild yourself!**

**If you can't maintain and repair it with basic tools, we probably won't like it. If you like to 'DIY', you might enjoy our pages.**

**At present, our focus is on building back up power, identifying reliable and cost effective small diesels, continuous duty generator heads and drive systems, and deploying them efficiently. If it can burn Green fuels, we like it even better. We believe in slow RPM, the slower it is, the longer it lasts. [We usually have Listeroids and the Mighty Changfa singles in stock.](#)**

Utterpower is different, we openly share information with our customers and do all we can to support the DIY philosophy. This site will continue to evolve as a resource for DIYers and the products we like. It is our goal to build on resources and provide parts and service. When we find alternative sources, we often post them for our customers, this builds your independence, and your ability to keep running in hard times. If you bought a similar product elsewhere and found they have no clue how it works; or how to repair it, we'll still do what we can to help. Our pages are living documents, they change often as we learn and evolve.

We have readers and customers from many countries with years of hands on experience, our younger readers are often professional people who hold engineering positions, our mean audience are folks in their fifties who have a lifetime of knowledge and experience and grew up understanding the value of DIY. We do our best to learn from this incredible resource; and pass on useful information to our readers. Knowledge is power, it is the primary focus of utterpower.

[An important reminder](#)

[How to contact me](#)

[Engines](#)

[Generator Heads](#)

[Products](#)

[4 sale pages](#)

[shipping info](#)

[Articles](#)

[Utterpower's Project page](#)

[People](#)

[Show Quality Listeroid Generator plants](#)

[Our off grid Lab](#)

[Travel](#)

[Favorite links](#)

[Wanted](#)



[ST Generator Heads](#)

Custom designed for the DIY crowd? you can do almost any repair yourself! 4/29/02 utterpower.com to carry replacement [parts for ST gen heads](#)



[Changfa Diesel Engines](#)

Simple, efficient, and cost effective one cylinder diesels

Simple, efficient, and cost effective one cylinder diesels

[Sea Pump](#) A complete cost effective water system for your cabin?, you can afford this one.

[Utterpower Project Page](#) take a look at some of the

## things we're doing.



**The Listeroids arrive!**

**They are like a magnet!**

**7/19/2003 ...They'll go fast, order your 6/1 Listeroid now**

## **MISC ITEMS 4 SALE**



**Useful Information related to DIY POWER**

**Unforgettable Folks** Not everyone follows the beaten path.

**This site is under construction. While we're setting up a few pages, take a look at the following sites:**

Visit Steve Gray's [oldengineshed](http://oldengineshed.com), you'll be amazed!

The internet is full of sites that dispense useful information about home made wind turbines. Hugh's site is a must and an excellent place to start.

<http://homepages.enterprise.net/hugh0piggott/>

Want to learn a few things? Check out [windstuffnow.com](http://windstuffnow.com), Ed has something new brewing all the time, and has some interesting products.

Inverters, if you are thinking about buying a modified sign wave inverter, you must visit [donrowe.com](http://donrowe.com) before you purchase anything! I couldn't find a better price, and you won't find better service or nicer people to do business with. Count on it!

Greg Weinfurtnner turns discarded stuff into useful power plants, learn about converting induction motors into generators and how to make gas powered battery chargers. It's a fun

Generator Heads, Generator Ends, Homemade generator, DIY Generato..., Asian Diesels, off grid power, custom pulleys, custom sheaves,  
place to visit.

**30656**



**We usually have engines in stock, if not, there's usually a new shipment inbound, send me email if you wish to purchase or have questions about engines.**

**Modern engines of the WESTERN World are often 'throw aways'. If they are rebuildable, the cost is often Prohibitive.**

**Our Focus: Is 'off grid' or 'mission critical' power. If you appreciate either, you are a rare individual, you probably fall into a percentage of the population too small to measure State Side, and you can be sure that the big marketing companies won't be spending a lot of time studying your buying habits or needs.**

**We view the world as a complex place where trade offs and compromises are necessary, we know that single cylinder diesels are NOT the perfect prime movers for AC generators..... but they fully meet our needs.**

**What is foremost in our minds, is a dependable generator. We'd give up light weight, mobility, name brands, fancy art work, and more to assure it will run and produce power when required.**

**Shipping expenses are factored into every product you buy in North America. When you visit Home Depot and look over the consumer generators, you will note the use of alloys, plastic, air cooling, and all the other wondrous things that make a portable generator appealing, manageable, and more cost effective to ship to the 99 plus percent of the population that they are designed for. If you decide to use these generators often, you may have problems.**

**The stuff we like is 'heavy', you will pay higher shipping costs in many cases to move them to your site. Once there, you will want this stuff on wheels if mobility is important to you. Part of the pay off is the simple design and ease of maintenance. If you are even half way mechanical, you could overhaul one in an afternoon for a very small investment. These engines were designed from the ground up to run for long periods of time and to be maintained by the mechanically challenged, having simple tools.**

**The following engines have massive cast iron heads with thick decks like we haven't seen since the 50s and early 60s in American products. Valves have massive stems, with valve guides having twice or more the surface area as you would find in a 'modern' engine. Efficiency is important in these designs as well, fuel prices and fuel quality is not always good where they are typically deployed.**

**Following are engines and designs we like! Sometimes we know where you can buy these engines new, other times we can put you on a waiting list or put you in touch with the seller of a good used engine. Parts are easy to come buy, we stock some, we can**



[order the others.](#)

**German designed, Chinese built**, they come in a number of sizes. I like the units with counter balance shafts, 185=9HP, 195=13.38HP, 1115= 22HP, these engines all have the same design and layout. The counter balance shafts provide very smooth running at 1800 RPMs. We have developed a direct drive coupler for these engines and feel they are well suited for driving generators and pumps. **Changfa is a Multi-National Company making use of superior parts from countries outside China. This is an important difference.**



[The Changfa Pages](#)

British designed, Indian built Lister 6/1s (Singles) and 12/2s (Twins). These are legendary 650 RPM work horse engines. They are massive, the 6HP single weighs around 750 pounds. Here's an engine that was designed from the ground up to be rebuilt in place! Actual tests have produced **.125 Gallons of biodiesel per KWH** using the efficient Allmand drive, and the ST head.



[The Listeroid Pages](#)

[Inside the lister](#)

[Drive System for Listers](#)

Purchase a Listeroid, email [George B.](#)

British Designed, Indian built **Petters**. These engines are more compact and higher speed

than the Listers. They produce their power at 1500 to 1800 RPMs. Singles and Twins are available.

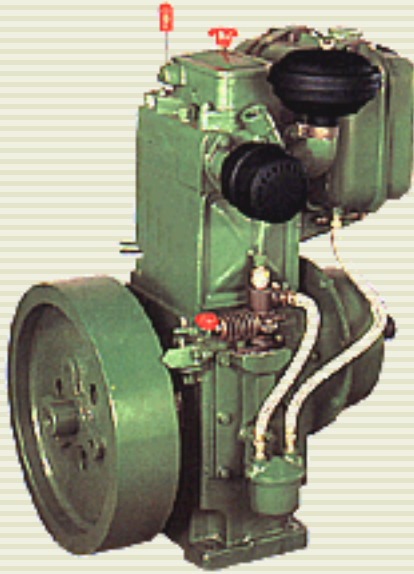

### The Petter Pages

This engine has a totally enclosed valve train and a pressure oil system, this is another durable, time tested design that should perform when you need it. Mine starts the first compression stroke every time.



What makes a Changfa different from other Chinese diesels? they have become a Multi-National Company sourcing superior parts from Partners outside China.



[Purchase a German Designed, Chinese Diesel](#)

[Parts for Changfa engines](#)

### **General Design Overview**

Changfa makes large volumes and types of Diesels, they are cast iron, heavy, and built to last. There's a number of standard engines in China and a large degree of parts interchange between the engines that different Manufacturers in China make. The **195** and **1115** are my favorites, they are German designed, and have two counter balance shafts, they run very smoothly at rated speed. These engines make 13.38 and 22 HP at rated RPMs, I run them at 1800 RPMs for direct drive and longevity.

Some of these engines are hopper cooled, others have radiators, fans, belts, and little DC alternators designed to charge a start battery and power a head light. These are popular on two wheeled tractors that are sometimes used to pull carts to market. The belt is something that can fail, the condensers are sized to work with the fan. If you use an adapter plate, and thermo siphon cooling setup with an auto radiator, you've eliminated a number of failure points, if the radiator is large enough, the fan will not be running, and you will run more efficiently when you are NOT running that extra belt, pulley, and fan..

**I have some regular visitors that are kind enough to point out things that will be of value to our readers; following is a snippet From Andris V.**

[I could never reconcile their conversions from Hp to kW. They always seemed to be a little off. Then I remembered there are at least four different definitions of Hp \(rounded to five places\):](#)

1 International Hp = 745.70 Watts

1 Electric Hp = 746.00 Watts

1 Metric Hp = 735.50 Watts

1 Water Hp = 746.04 Watts

We Americans use the Electric Hp number of 746 W/Hp but Changfa (China being a metric country) uses the Metric number of 735.5 W/Hp. Now their published conversions make sense! It might help your customers if you mention this on your web site.

Here's a link to my first [Changfa powered generator](#).

Harry's Changfa powered generator [Harry Anderson](#)

[7X24 Duty!](#) A great story in progress.

Put a Changfa on your [Garden Tractor?](#)

The belt driven setup fits up against the wall nicely, it doesn't require any walk around room, and all maintenance can be done from the front of the unit. The two heavy belts may last a life time, we'll see.

The Changfa comes with a standard pulley that mounts to the flywheel, If you want to direct couple to something, it can be done fairly easily. I like to do the job with junk parts or standard parts, when possible, read on for my approach.



First let's look at the stock pulley, the ring cut on the back side 'centers' the pulley into grooves cut in the flywheel face.



Here's a Changfa 195 flywheel facing a ST 10KW Generator shaft. Notice the three raised mounting tabs, the inward side is machined to receive the pulley, this arrangement 'centers' the pulley.



Above is a picture of our first direct drive adapter. The three holes drilled in the rotor face are used to mount the unit to the flywheel. This work was done by Randy Allmand in Kent, WA... Thanks Randy !!!



And here's the back side, notice the lip around the inside, go back up and compare this to the stock pulley cut, this is what the direct drive adapter will CENTER on.





Here's a picture of the coupler mounted, note that the stub shaft is Just the right length to accept the Love joy coupler. In the right side frame, you see the Lovejoy (half) mounted. Go up a few frames and see the large fastener holding on the flywheel. That is why the center of the adapter is raised.

June 7, 2002

And now for the final fitting, but first I should share how I chose to mount the engine and generator.

If you look at the engine in the first picture of this page, you will see that it comes stock with legs. I choose to mount both the Changfa Engine and ST Generator directly onto a frame made of two 4 inch high eye beams tied together with square tubing. The four inch height of the beams allowed me to unbolt the legs and mount the engine directly to the top of the eye beams. The oil pan sets between the 'I' beams and has adequate clearance from the floor.

Cross ties were welded between the beams to align with the mounting holes in the bottom of the generator. The top of these ties match the deck height of the eye beams.

Once the engine and generator were set in place, it became obvious that the distance from the deck to the centerline of the shafts was different. After measuring closely, a smile came across my face; The center line of the engine crank shaft was sitting EXACTLY .375" lower than the generator shaft centerline!

Three Hundred and Seventy Five Thousands..... the thickness of a good ole common piece of 3/8th flat bar stock. I located a piece and cut two lengths to match the width of the legs I just removed. I used the legs to match the hole spacing and then drilled two 1/2 inch holes in each piece of bar stock. I unbolted the engine, added these to each side as shim stock, and bolted it back together.



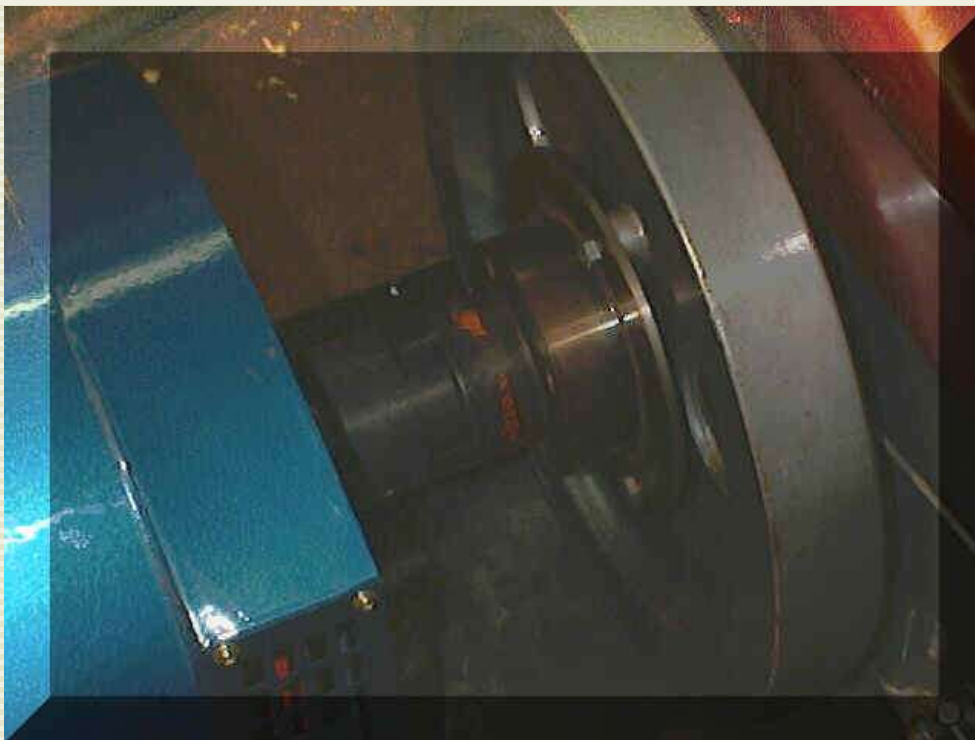

This is not the best picture, but the 3/8 material makes for a perfect alignment height !



This picture is a little busy, but it gives you some idea how easy it was to make a direct drive gen set. I'll call it the ChangYanGen. I think it will work well.

Don't forget the oil drain plug. If you mount it as I have, the drain plug will be difficult to reach. BUT... there's an easy fix.... see below.



Look closely, and you can see a standard pipe fitting TEE fitted to the drain plug. I used a TEE knowing I could tighten it with twice the precision of a 90 degree elbow. The other side of the TEE is plugged. As you can see, the pipe is brought out to a place where the oil can be easily drained. The other side of the TEE can be exploited later to effectively extend the sump, more on this later. This picture also shows the 3/8 inch stock used as a shim, and you can see how the engine is bolted to the 'T' beam.

## **MORE ON ADAPTERS**

**09/16/02** 2nd generation direct drive adapter is ready for shipping.

**12/01/02** 3rd generation direct drive adapter nearing completion.



**Above is the purpose built casting before any machine work..**

One of our Associates has fallen in love with this German designed single. In a short amount of time he has collected a 195, and two larger engines. We have exchanged numerous emails and telephone calls and have decided to work together to make available several parts that we feel are needed for these engines. Since Mike is an Engineer, owns a foundry and machine shop, it's not difficult for him to design and build parts from the ground up verses the previous ones we've made from existing donor parts. The third Generation drive adapter can be made to fit 185s, 195s, 1100s and maybe others with a little machine work. Mounting Love Joy couplers, Chain couplers, drive yokes for drive shafts all become easy with this part. We can supply you the part finished to your spec. Send me [email](#) if you are interested in this part.

**If you have a Hopper Cooled Chinese diesel**, you may have become envious when you saw one with a built in radiator. If your application allows, you can adapt your engine to radiator cooling and come up with a superior cooling system! Make use of a Junk auto heater core and fan, or... If you think you really need more cooling.. use the auto radiator out of a compact junk auto; with the massive cooling area, you probably won't need the fan.



**This picture is of a raw casting right out of the mold.**

**The conversion kit is designed to create a good thermal flow from the block to the radiator.** The holes receive standard pipe threads, and other parts are fitted to assure a rapid and positive thermal siphon. Note the raised surface around the one hole.. if you wish to use the small block Chevy goose neck and thermostat to properly control your engine coolant temp, it's ready to go. The third hole is designed to accept a sending unit or be capped off. The conversion kit comes with instructions that will steer you clear of common mistakes made in thermal siphon systems. Write me if you'd like to convert your hopper cooled engine to a real cooling system, conversion kits will be available in Jan 2003.

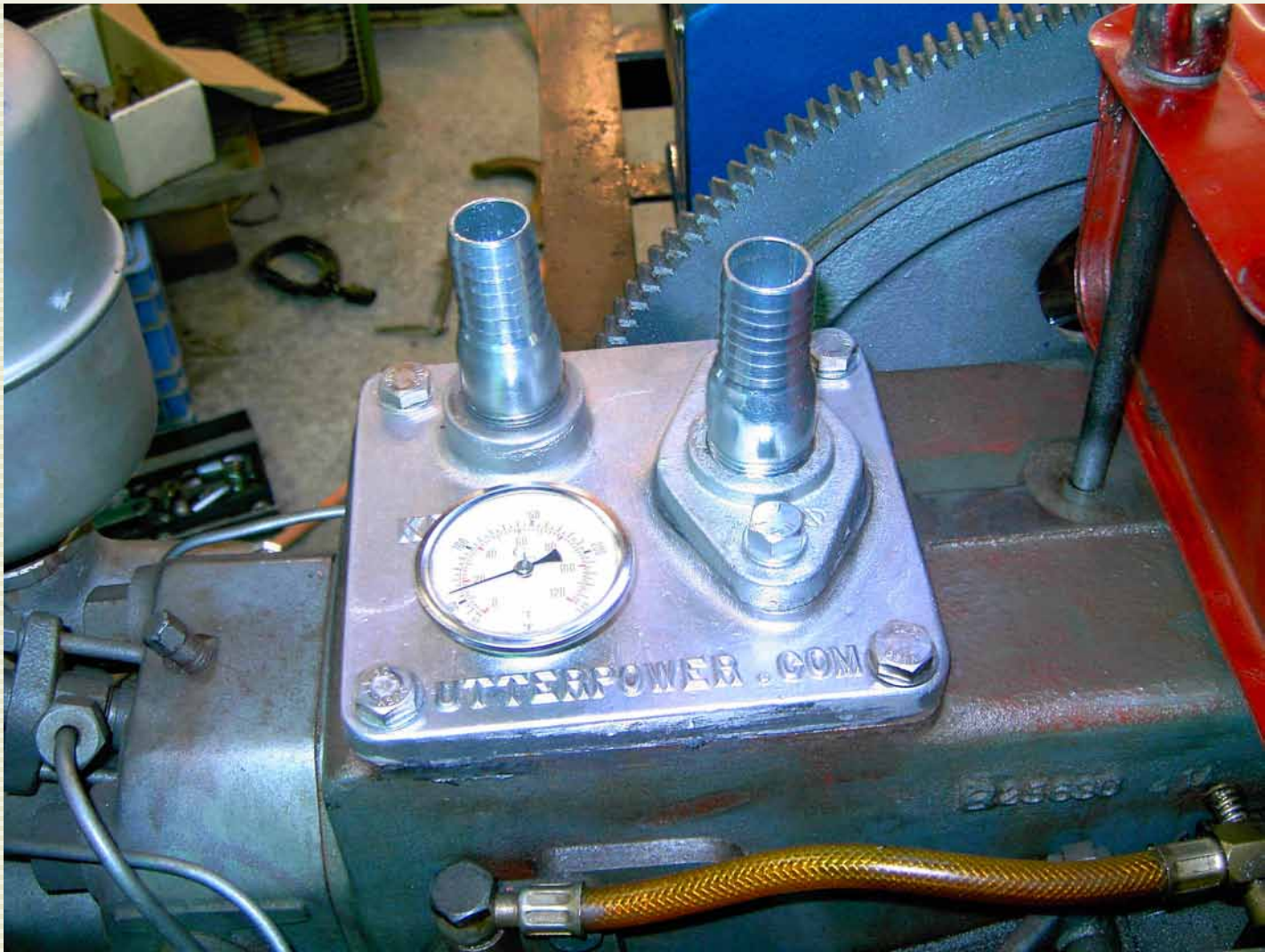

Above is a real poor picture of a hopper conversion for the 195 engine. Note the nipple on the right, this houses the thermostat. I use the NAPA part number 253 under the combination flange and nipple.

[Email George B.](#)

[Home](#)



Chinese single cylinder diesels may be the equivalent to the 'small block Chevy' of China, Vietnam, Cambodia, and other countries. At this point, I like Changfa's engines best and believe they are one of the more progressive engine building companies in Mainland China. They are now a multinational concern building engines with superior key components purchased from outside China.

I do not recommend engines without counterbalances. The 185 is the smallest engine I recommend, it's about 9 HP. The 195 is a little over 12 hp and the mighty 1115 is 22HP. these are very efficient engines. There are sizes in between, but these are my favorites from experience. The 1115 has a lower exhaust note and less of the diesel RAP, It make gobs of power, and is the quietest Chinese single I've had experience with, not as quiet as a 650 RPM Listeriod, but few diesels are.

[We usually have engines in stock ready to ship](#), unlike some outfits, we won't send you all the way to China for warranty, help, or advice. Email me if I can be of service.

[Email George B.](#)

[Home](#)



## DIY CHANGFA Diesel powered Generator Set

Some people love diesels; other people hate them.

They're noisy and they stink (My wife says)

On the 'pro' side, they seem to live long lives, and run with far greater efficiency than gas powered generators. Maybe equally important, the fuel keeps longer than gas, I have at least 12 gas powered devices, and it is a real chore keeping fresh gas in them, I've had to take several carbs apart and de-varnish them. the smell of oxidized gas stays with you for a week.

Over the last few days; I've been hand starting a 195 Chinese built-German designed 12HP single with amazing ease. People often refer to this engine as 12hp, but the information on the tag claims 9.98 kW at 2000 rpms which amounts to about 13.38 hp. We can get into elevation and it's effect on horsepower, but as we all know, the higher the elevation the less horsepower. My tests are being conducted at around 300 feet above sea level and at about 50 degrees F.



The generator head is rated at 10KW continuous and weighs 265 pounds (ST10), we know this device is not 100 percent efficient, we know the belts and pulleys are going to cost us some horsepower as well, so how much rubber can we put to the road?

AS of 2/2002, the new diesel engine is being retrofitted with a new cooling system, Pictures will be posted later

**12/02/2002 NOTE:** Utterpower is offering a cast iron conversion kit, this will convert a hopper cooled Chinese diesel to a radiator cooled unit. see the **4Sale** page for more info.



**Above is a picture of the raw casting.**

March 1, 2002

I have chosen to use two 4 by sixes (wood) as the 'base' for the generator set. It's taken some time to come up with the initial set up, but I think it will work well. The home made adjusters allow for an exact alignment when tensioning the belt. Having them on opposite sides of the generator head where one adjuster pulls the head away from the engine on the belt side, and the other adjuster pulls the gen head toward the engine is key.

March 6, 2002

The cooling system is very important, the amount of useful power and the longevity of the engine have a lot to do with maintaining the engine at the proper temp. If you have a hopper cooled engine beware of minerals in the water, if you continue to add water as required, you could create enough deposits to develop hot spots around the cylinder and ruin your engine.

The other day I had my electric space heater plugged into the Gen. set, I plugged in my 2 hp chop saw and stalled the motor. The generator didn't seem to notice the load! Sounds like I need to make up a good test load. Stay tuned for the results and more pictures. Just how conservative were they when they rated this engine?



The picture above is the home made generator head adjuster. It is nothing more than a piece of threaded rod purchased from the hardware store, and a scrap piece of flat steel bar. Simply hit the center of each surface with a punch and drill the proper sized hole, and run the tap for threads. I found 1/2 inch bolts work well to fasten the head to the mounts.



Here's a view of an 'adjuster' installed inside the square tube. The adjusters provide very accurate alignment of the belts and pulleys and provide a means to apply the proper tension. Once the alignment and tension are correct, tighten the 1/2 inch bolts and the head will stay put.





This is a picture of the home made adapter plate. After removing the stock water tank, I used the gasket to manufacture a plate to cover the hole. The goose neck houses the thermostat, the 190 degree unit seems to be doing the job. The hoses will eventually be replaced with high temp (flexible) hose. **Note:** the cold water side has a specially fabricated pickup to assure proper thermal siphon. The hot side enters just below the plate. After so trial and error, the volume of water moved is pretty amazing.



Here's a picture of a manual gauge installed, note the gauge is reading a little below 210, this was just before the thermostat opened. You can place your hand on the hose just above the thermostat and feel the thermal start when the valve does open. In this test set up, the temp in the head is held between 190 and 200 degrees F.



Above is the cooling tank, The two larger hoses run back to the gen set, the thermostat goes to the top connection, cold water return to the bottom. The hot water connection (at the top of this tank) is left open for expansion. During final installation, the tank will be fitted with an overflow tank like that found in a car and it will become a pressurized system for the higher elevation where it will be installed. the smaller hose was used to monitor the height of the water in the tank while it was being filled via the stock drain valve at the bottom of the tank. You can easily substitute an auto radiator for the tank and tilt it at a slight angle to encourage the air to 'thermal' through the radiator. If the radiator is sized correctly, you won't need a fan.

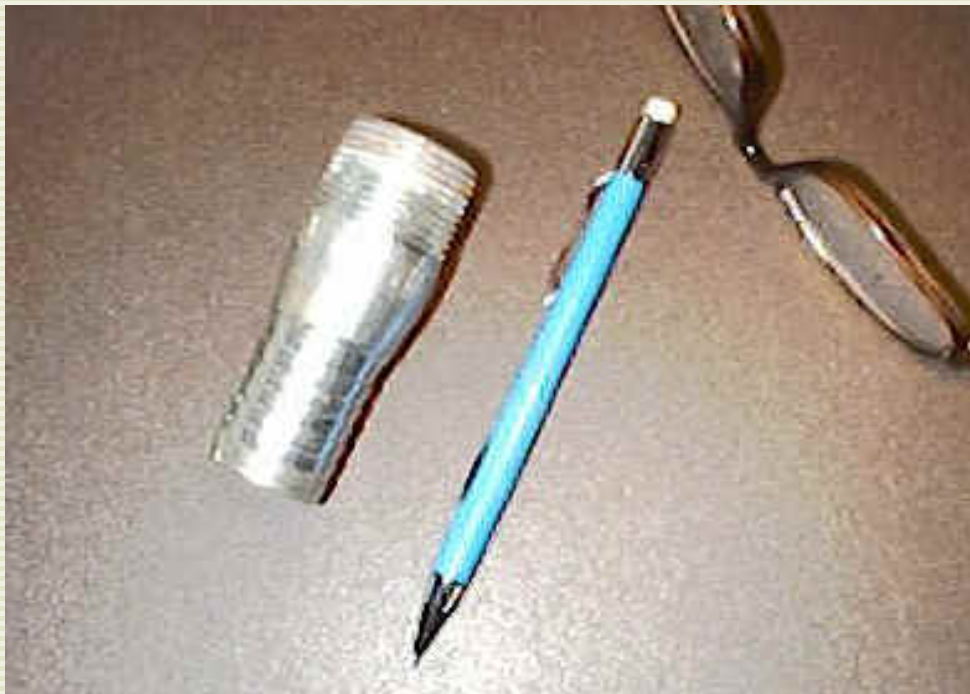

Of possible interest is the above **fitting**, it's barbed on one end and has pipe threads on the other. This fitting screws into the standard threaded holes used to hold the electric heating elements in a standard hot water tank. In addition, you can use a two part epoxy to 'bond' this fitting into the Chevy thermostat housing making for a simple connection. the barbed end makes a tight connection to the hose, adding a stainless steel hose clamp makes for a leak proof trouble free connection even when the system is pressurized.

Of course you could use a heater core and fan, but there's less to go wrong when you eliminate parts and sensors. Using this waste heat for domestic hot water could be an added bonus. I shut down the engine at 8:00 PM last night, the tank was still 100 degrees this AM (no insulation), This would beat a cold shower any day, and we all know there's a way to store this energy with less loss.



Here's a view of the stock pulley that comes with the 195 diesel, and the pulley mounted on the generator head. The ratio sets the engine at 2000 rpms when the head is turning at 1800 rpms which is required to make 60 cycle AC at the FULL rated RPM/HP of the engine. I learned to buy decent belts! Don't buy your them at a discount automotive parts store. Go to a parts house that carries industrial stuff and buy common back belts if you need more than a single belt to effectively transfer the power. a "common back" belt is two or more belts with a common backing, one advantage is they are the same size and always share the load equally. Mark in PA emailed me the other day and explained that the two belts he got were slightly different sizes and couldn't be used, he went back for the common backs at the suggestion of his supplier. The individual belts below are high quality and work well, but I think the common backs will live longer and do a better job.

If you're wondering if a person might be better off dropping the speed of the engine 200 RPMs and driving the head with a coupler, so am I... the belt driven unit goes up against a wall and takes up little space, the exhaust can be plumed right out the same wall. The coupler layout is not so tidy, it requires more 'walk around room and would fit best in a corner. I will build both sooner or later and learn the real pros and cons of both.

**Note added 12/2/02**, Utterpower now supplies a nifty cast iron adapter to direct drive an 1800 RPM generator head! see the 4Sale page for more information.



Good alignments reduce losses and reduce belt wear. Note the straight edge in the above photo of Harry Anderson's Generator set.

Here's something I think works well....., when you are placing your major components, mount your engine and then align the generator head in a way where it is easy to check alignment. In this application, the belts will be next to the back wall of the "power shed", enough room will be left to replace belts and to bend over and check alignment.

The mounts with the slotted holes were set in position when the back side of the head fell in line with the edge of the fly wheel. Once this alignment was made, the pulley on the gen head was adjusted and locked into place to be exactly in line with the engine pulley. Adjustments are precision and quick as follows.

1. back off the four bolts at the gen head base,
2. Apply the proper tension by tightening the back tensioner.
3. Lay the straight edge across the back of the fly wheel and gen head and adjust the front tensioner until the edge makes even contact along the fly wheel and the back of the head.
4. Recheck the belt for proper tension,
5. Tighten the four Gen Head base bolts..... You're done!



And here's the dummy load. This is a 10 kW electrical element out of a forced air electric furnace. The generator feeds the test load through a circuit breaker.

So what happened you ask? How much load can a 195 make? The answer is still not clear. The furnace coils have a thermal sensor that opens the circuit if they get too warm, as you can see I have no air blowing across them so I have a limited time to conduct the test before the thermal switch is triggered.

Here's what I did observe.

After warming the engine, I brought it to the governor speed (2000 rpms) which is 1800 Rpm for the generator head. After the engine had run at this speed for a minute or so I slammed the 5.7 ohm load across the 220 volt output. I watched the 'read out' of my FLUKE volt meter bounce off 210 volts and start heading upwards. At 221 volts the thermal protection fired and I lost my load. I'm thinking the voltage would have continued to climb, but who knows for sure. Another factor is the engine, it is new and not yet fully broken in. It might become more efficient after another few hundred hours of running?

Doing the math, it looks like we were handling an honest **8570 watts** when the load kicked out. The engine was NOT smoking black at the time and the voltage was climbing, this may be an indicator that the engine would continue to carry this load ?

If we take the rated 9.98 kW output of the engine and compare it to the observed output of the gen set we would see that 86% of that ((RATED)) output found it's way to the load. A loss of only 14 percent is a little too much to wish for... ( I think).

I end up wondering...

**What is the real horsepower of this engine ?**

**What are the typical losses found in a generator?** As of March 30th, I have torn down the ST head, it has 'very' fine laminations and a fairly tight airgap, this could be partially responsible for the

efficiency I think I'm seeing.

**What's typical in the way of losses for Vee belts and pulleys?** Seems like it's enough to investigate using a cogged belt like the Harley Davison uses.

Did I forget to factor something? **YES I DID!**

**April 18th 2002 Update:** I received a nice email from Darryl Phillips today, Darryl pointed out that Nicrome wire will create more resistance as it heats. This means that my test was junk! As you can see from above.. I was skeptical of what I was seeing, and now we know I had reason to be. I recently bought a clamp on amp meter, next test, I'll put the fluke and the clamp on amp meter in a place where I can snap a picture of the readings, we'll have a better idea of the 'real' load at that time, might as well set up for the frequency too. I will leave this information here for a while so others don't make the same mistake.

**If we look back at my observations, I saw an initial 210 volts, so it is possible that the engine was only carrying 7736 watts. When it's fully broken in, I'd bet we'll see the full 8 KW.**

I will fit the test load with a blower to keep the coils cool (so the load doesn't kick out) and retest this genset once the engine is fully broken in, (probably this summer), What's your guess on the final output? If you have suggestions or comments; please [email](#) me.

Come back and visit, I'm building a controller for this genset that will handle auto start, and all kinds of things you might find fun or interesting, there's no rush, but I do plan to get it done before [Harry Anderson](#) gets his piper in the air:-)

May 16th 2002

As of this date, I've had time to play with Petters and Listers, although they have their strong points, nothing I've played with in the way of one cylinder diesels comes close to being as smooth or refined as the Changfa. I'm sure it has a lot to do with the counterbalance shafts in the design, bring it up to speed and it is far smoother than the others.

After checking out some other installations, I noticed the exhaust systems get kind of twisty and turnie, you'd think this could affect peak power and the ability to start that really big load? How about making a straight shot out of the exhaust port... straight out the wall? In doing so, you eliminate two 90 degree bends in the stock system.





This flange is made of 1 1/2 inch black iron pipe commonly used to plumb natural gas. the flange was cut from some flat stock using the stock flange as a guide. Since you have plenty of room, leave an additional .100" of an inch margin over the stock flange.

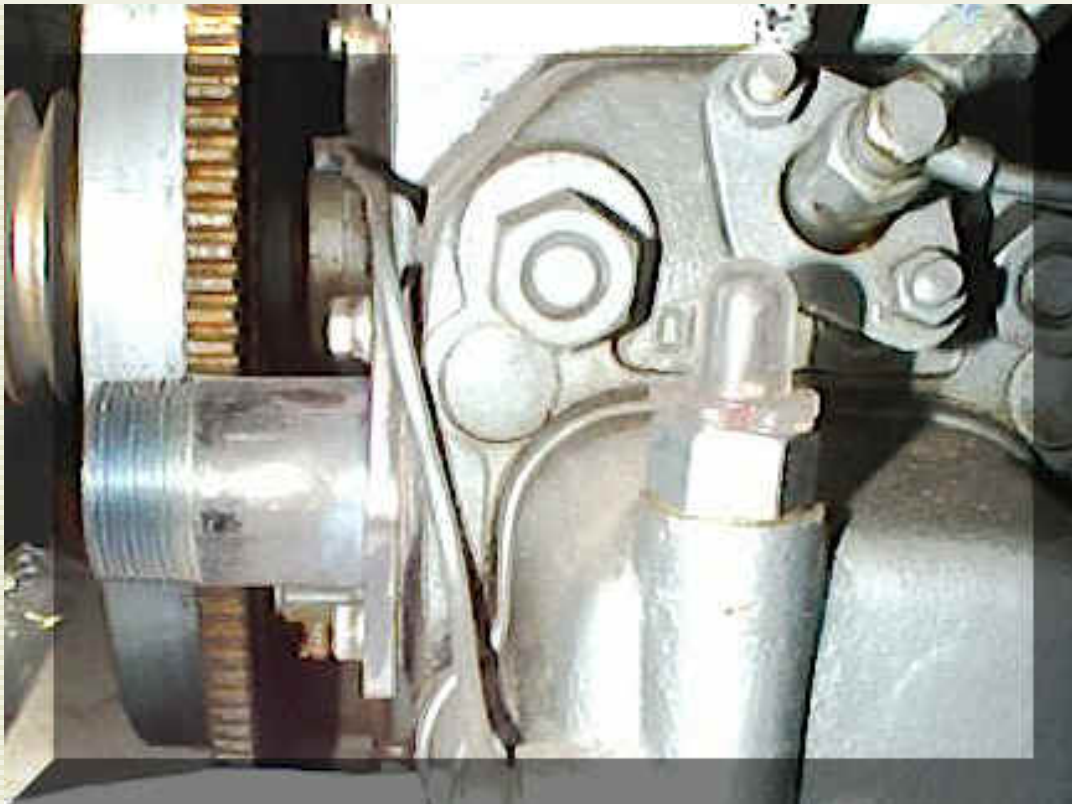

I used a cheap 1 1/2 inch hole saw with lots of oil for lube on the drill press to cut the hole in the flange. Butt the pipe up to the flange, center it, and weld it from the inside. The pipe is slightly larger than the stock exhaust, and should help make more peak power.

George B.

Home Page









**.....Scroll to the bottom of this page for FAQs, purchase info, and more.....**

---

**ST type gen heads are built by different manufacturers, but have the same general construction.** The other day I received an email from a fellow DIYer who was shocked to find that his 5KW ST generator did NOT have both windings coming out of the generator housing! His unit was constructed with a center tap that limits the genset to 1/2 it's output to any single 120 volt load. Another ST generator owner was surprised to read that many of the ST generators came with dual brushes per slip ring, "his had only a single brush". About the time I started advertising that our stuff was better, I discovered that our *previous* supplier had shorted us a few features without telling us of the changes. The learning curve has been fairly steep for us, I think we have finally found the right Company to do business with, and we have developed a 'spec' that the manufacturer will build to. We have a relationship with an a great company who will most likely do all they can to improve the product verses cut corners as two previous manufacturers did. they are now wondering why we don't order from them any longer....but guess what, there's others vendors who still do buy them. They pay a little less for these units than we pay, but we don't feel guilty selling the stuff we sell.

To tell you all of the things that makes our heads different will also tell our competition what we're doing. We don't really want them to know, but I will tell you this, the Fu King brand has the following basic features and more...

-  **115 or 115/230 volt operation... (this could be more important than you realize), don't be fooled!**
-  **Dual Brushes per ring on 5KW and up models**
-  **Sealed bearing on the fan end**
-  **All hot connections inside the box where they belong!**
-  **voltmeter , with nicely insulated leads. One person who bought another brand had a fire when the poor quality insulation broke down and fried a component.**
-  **all leads are brought out to soldered posts that are firmly supported, verses the soft copper, unsoldered terminals that often fall off the leads before you get things hooked up.**

**Look for the Fu king Brand!**

**We are committed to providing the best Fu King generators made.**





## After a few years of tearing ST heads, you learn what to look for, I'll share just a few, the others you might discover on your own.

ST generator heads are built like tanks, the main ingredient is cast iron. If you read a lot, you probably know that cast iron really is a wonder metal. Where weight is not the principle concern, it is hard to beat its performance. The downside is the shipping weight, you will end up paying for Cast Iron.

6/2003 Note added, we have just formed a relationship with a shipper that can save you 50% on shipping, this is dock to dock, and has a few restrictions, but it works well for most North Americans.

Some ST designs use dual slip rings, they provide the same function as the rings and brushes used in Autos around the world. In the early to mid sixties; Manufacturers gave up generators that used commutators when cost effective, compact, and reliable diodes became available. This technology is still the standard in the automotive industry. I think this is a strong endorsement that slip rings and brushes like those in the ST design do the job in a reliable, durable, and repairable way.

The ST I have experience with uses two brushes per ring, this makes for a redundant and quiet transfer of excitation Current. Each brush is carrying a tiny 55 watts. My Honda EM5000, (which is the workhorse of choice for many contractors) only uses one set of brushes per ring!

The ST design is simple and time tested, farmers and untrained persons in the field have managed to keep these heads running year after year in areas that have next to nothing in the way of repair material and spares.



Above is a picture of the rotor, it's a hefty piece at 72 pounds on the bathroom scale. or about as much as the complete consumer type head! The rotor laminations are 1mm thickness. Notice that fan, high tech plastic? Not a chance; it's real

cast metal, and it's held in place with a real spring steel 'C' clip. On the left is the slip rings, in the center is the four poles that allow the generator to function at the lower speed of 1800 RPMS versus 3600 RPMS of the typical 2 pole head used in consumer Generators.



Here's the inside, notice the housing, it is also made of good ole cast iron, the ends are precision machined and fit snugly into the stator housing, This allows for a nice tight air gap which adds a generous amount of efficiency to the design. I didn't measure the gap, but it's plenty close. The laminations in the stator were .5mm thick, which should add to the efficiency of the design.

Notice that all the windings are copper....

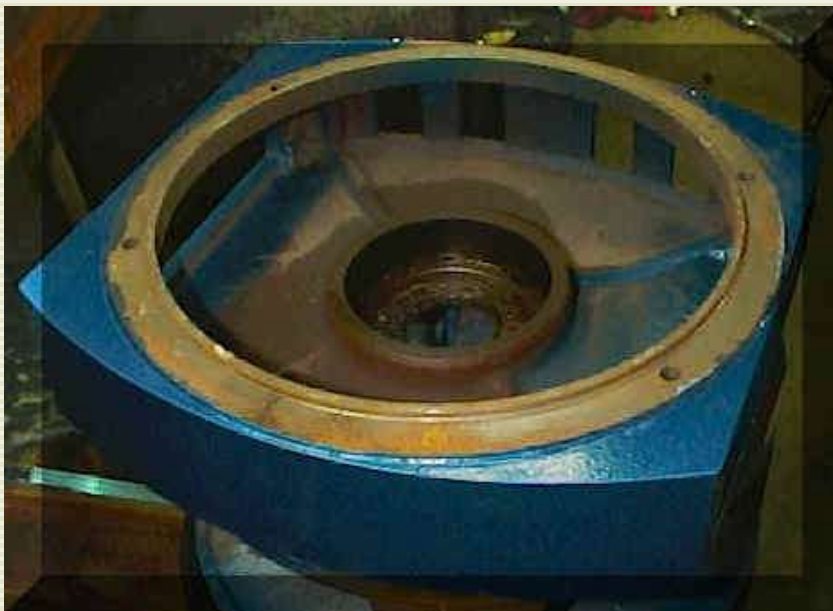

Here's the end bell for the shaft and fan side, notice the generous openings for cooling and access on each side. Keep the screens in place to keep mice and other critters out, consider adding a screen across the bottom section for the same reason. Mice; their nesting material, and their urine can wipe out machinery in no time.



Here's the 'slip ring side' bell housing, yes this is cast iron too. There's a bearing cover on the inside to assure that no grease finds it's way into the electrical windings and rings, it doubles as a sturdy mount for the brushes, I'll get a picture of this part soon. Note the size of these openings! The cover is removed with one positive clasp, no matter how big your hands are, you can get them inside the slip ring end.



The stock bearings are of the 'open' type; the shaft side has a massive standard 6310 bearing, the slip ring side has a smaller 6309 standard bearing. Most bearing houses will have these on the shelf. I compared the bearing size of the ST 12KW to a well known 'upper end' 12KW 3600 RPM head, the ST bearings are twice the size!

Note: One of the leading causes of electric motor and generator head failure is over greasing. The builders of the ST heads must know this, there is no external means over grease bearings. More often than not, this is a good thing, but adding a grease fitting would be easy. I did tear down one brand of ST 12KW head and found the bearing on the fan side was open to the elements towards the fan . If you bought an ST with this situation, you might rig up a cover for that side or replace the bearing for a sealed one. the fan provides quite a bit of cover for the bearing, so I don't know how bad the problem could be unless you're running the head in a dusty environment.

As for the shaft size, the ST10 and ST12 have 42mm shafts, this is a standard, you should have little problem ordering a

bushing through the bigger parts houses in North America. 42 mm is about 1.635 inches. You can compare it to 1 5/8 inches which is 1.625 inches. If you're really bothered by metric, you could pull the rotor and have your local machine shop turn the rotor to 1 5/8, a simple job for them to perform. The ST15, uses a massive 48mm shaft, (about 1.9 inches) although I haven't ordered bushings and pulleys for a 15 yet, I'd bet they're in the warehouse in North America as well.

**For those that have a few years under their belts, we remember a time when things were built to be repaired. To throw something out just because it quit working was unheard of. The ST Generator Heads are from our past; "when people bought things and expected them to last their life time". There's nothing inside you can't figure out or replace when it breaks. If you're off the grid, or you just want to be independent, the old way is worth a look.**

Closing thoughts? Any generator head is heavy, this will make a 'repair and return' expensive. Being able to fix it yourself, or have it rewound locally could be a major cost savings over time.

I have received several emails explaining that replacing the diodes in a brushless head requires one to pull the rotor because they are mounted on the rotor! In the ST design, they are in the control and wiring box on top of the machine for easy access.

**This is not the most sophisticated generator head in the world, it's really a step backwards into our past. Some of us will welcome the simple non-electronic design, others won't. In simple terms, it runs everything from my induction motors to my DSS dish and TV, it's all I need.**

**In closing.... Have you heard of an EMP? Electro Magnetic Pulse ? Some folks think that the use of EMP tactical weapons becomes more likely everyday. One EMP could wipe out all the electronic devices, your car wouldn't work, your microwave, TV, radio, etc; would be junk... How about that solid state ignition system on your trusty Briggs and Stratton? It would most likely be junk too.**

**But... a generator built like the ST, powered by a small diesel with no electronics could be brought back on line in the matter of minutes. Does it make a person radical to think about these things? Today.... I don't think so.**

I would appreciate any constructive [feedback](#) you might offer regarding this page or other pages at utterpower, [email](#) me any time.

## Additional info:

### ST FAQ

[>>>>How to buy an ST Generator head<<<<<](#)

[Shipping information](#)

[Panel Meters](#)

[How to trouble shoot the ST Gen Head.](#)

[ST Voltage Excitation \(How it works\)](#)

[How to inspect or replace a bearing in a ST Head](#)

[Recommendations for ST Head Installation.](#)

[Parts](#)

[What about the insulation class?](#)

[Installing brushes](#)

[ST Owner's Installations](#)

[Playing with power](#)

[Converting center tapped heads for full output at 120 volts!](#)

[HOME](#)





I was talking to a retired guy who spent most of his working years in a motor/generator rewind shop. He explained that he could look at motors and generators and accurately judge which one would never come back for a rewind. There was a direct correlation between mass and the KW or Horsepower rating. The heavier the motor, the less likely it was to need rewinding.

I have thought about this and think the cast iron helps to keep the temperature more constant than the light weight frames. The more rapid heating and cooling probably helps break down the insulation in the windings. Heating expansion creates movement, so it would stand to reason that it doesn't help matters, the higher the mass, the slower the movement... this is also a good thing in electrical and electronic circuits.

ST style heads shouldn't be your first choice if you are going to take it camping and expect to haul it out of the trunk of your car. But if you are looking for stationary power, or something to mount on wheels, something simple to work on and easier to understand, this may be for you. If you're in search of the most technically advanced generator... keep looking.

[Home](#)



**This is a living document, expect content to be added ongoing. What's posted here reflects the kind of questions we receive.**

**Question: What about a warranty?**

**Answer:** I have come across outfits that are selling generator heads and sending their customers all the way to China for warranty and repair work. I'm sure you won't be happy with that arrangement (if something goes wrong). Make sure the folks that sell you the product are going to be involved in the repair and warranty work, if they aren't; you should expect to be on your own. You might ask... who do I call if it doesn't work properly? If they tell you to look in the box for the warranty, you should suspect that you're going to be calling a number in Shanghai...and it isn't going to be a 1-800 number.... you can bet your donkey on that.

**Question: How much does it normally cost to ship a head?**

**Answer:** Between \$50 and \$400, use the following weights for quotes.

NEW, [we have a shipping page](#) ,Check it out.

Size	Weight in lbs.
3kw=	150
5kw=	205
7.5kw=	285
10kw=	305
12kw=	340
15kw=	420
20kw=	440
30kw=	560
40kw= (3phase)	620
50kw= (3phase)	760

**Question:** Does it matter which direction I rotate the generator head ?

**Answer:** No, you may turn it clockwise, or counter clockwise.

**Question:** Is there any penalty when running a 3 phase head verses a single phase head?

**Answer:** Yes! Without adding special equipment, you can only direct 1/3 of the total output to any **single** 120 volt load. You can only direct 2/3 of the total output of the generator to any **single** 220 volt load. Since some folks don't understand this statement, we'll continue, "stop reading when you get it". ... Lets' say you have a 20KW 3 Phase generator, and you have three 5000 watt 120 volt loads, you can run them all by plugging each one into one of the three phases. If you had a single 120 volt 15KW load, you wouldn't be able to power it with this generator, but where would you find a single load this big? When you get into high wattage loads, they usually become 240 volt appliances because this exact condition exists in your home. You can only use 1/2 of the total power coming into your house for a **SINGLE 120 volt appliance**. This QA was really placed here for readers to grasp the concept of 3 phase, not to suggest there's a problem with them. **Volts times Amps equals Watts**, do the math, you'll have no problem running your toaster on most 3 phase heads.

**Question:** How much horse power do I need to produce the full rated output of my generator?

**Answer:** Use the following continuous ratings. make sure you deduct 3 percent per 1000 feet of elevation for any normally aspirated engine. Example: my Cowiche cabin is at 4500 foot elevation, I should expect to get 8.65 horsepower out of my 10 horsepower engine.

Size-Horsepower

3kw= 6.5

5kw= 12

7.5kw= 15

10kw = 18

12kw = 20

15kw = 23

20kw = 31

30kw = 46

40kw = 60

50kw = 75

[Question: Does the ST come with a twist Lock plug and other plug ins ?](#)

Answer: No, these heads are for DIY people who would go to the hardware store and round up these pieces if required. If you are not comfortable doing this, you should seek some help locally. Generally, you can pick up these items inexpensively at a big box hardware store.

[Question: How much chrome plate does the ST have? Does it have enough bells and whistles to impress my friends?](#)

Answer: The ST generator looks like it came out of the 1950s. It's basic and sturdy. It's everything it needs to be for emergency power with none of the plastic, impressive art work and stuff kids like. If you order one, you better like, painted cast iron, and sheet metal. If you're looking for fancy plated Allen head fasteners, lots of flashing lights, digital read outs, perfect sine waves, do buy a different head.

[Question: My friends tell me to be careful running a computer off a generator. They explain that computer power supplies are highly sensitive and will blow up at the drop of a hat; is this true?](#)

Answer: Computer power supplies like the IBM PC Clones, and Apples are "switching" type power supplies, they were designed to provide nice clean power to the computer even when the AC power is not the best. Computer power supplies are often the most tolerant of them all. They survive on inexpensive UPS power that often looks far worse than any generator could make, I think the computer power supply will do well on the ST head, but I have not run one for days at a time...

**Sept 16, 2002**

I am still looking for a generator that is designed so badly that I can't watch TV, listen to the radio, or run my computer on the power it develops. I've owned some real junk, and the worst generator I've found still runs my DSS receiver and allows me to watch several hundred channels of flawless programming without ANY problems.

Some of you will allow the marketing guys to convince you that a high degree of voltage regulation is necessary, they might even tell you your generator needs to run at 60.00000 HZ to watch TV. Fact is, it's just not that critical, even the power company accepts plus or minus 10% for being acceptable in the voltage department.

Please send me examples of any generator you find that makes lousy AC. For the most part, the difference you'll notice is the ability to carry loads, longevity, and efficiency; not whether it's going to run your common household appliances.

[Question: How do I produce the charging voltage necessary for my start batteries, my engine doesn't have an alternator.](#)

Answer: Simply buy an off the shelf battery charger and plug it in as you would at home.

[Question: I think I have the wrong voltage coming out of my generator, what do I do to](#)

[correct it?](#)

[See the voltage REG page for additional info.](#)

There are a number of generator configurations, so I'll try and address this problem in a general way. If you consider that you have no voltage coming out of a generator that is not turning, we can safely say that the voltage is affected by the speed in most all generators no matter who made the darned thing.

We can safely start with the fact that 60HZ generator heads are usually 2 or 4 pole heads, the 4 pole ST heads need to turn at 1800 RPMs to produce exactly 60HZ. Some people get caught up with a need to run at 60.00000000 HZ, I believe you're fine at 59-61 for all the things I want to do. The days of using the sine wave for a timing reference is over.. you may have an old oscilloscope or something that demands it, but let's be honest... most of us won't be using our generator to run an antique oscilloscope.

Start by getting your generator set up to put out 120 volts, then plug in a frequency meter, and set the speed for 60HZ, watch the voltage as you adjust the speed.. if it gets higher than 130 volts (on the 115 volt leg), or 260 volts (on the 230 volt leg) while you're increasing the speed, **STOP**... suspect that something is wrong. It is far better to run the correct voltage and be off on the frequency, than run too high a voltage and the correct frequency... you'll fry fewer test loads this way.

There's a great and inexpensive device called the 'KILL A WATT', do a basic search and you'll find it for as little as \$29 dollars. This device plugs in like an appliance and gives you Power factor, frequency, voltage, and total KWH usage into loads up to 15 amps! This is a must have tool for a person who is going to use a generator more than once or twice. Just don't plug it in when the voltage is too high!

Plug the Kill A Watt in, or a frequency meter, and adjust the frequency to achieve 60hz, check your as you go. if it's 110-125, you have something useful. This may be a time to tell you how much the power companies voltage varies... I see about 126 volts in my shop, I've been on farms in the Midwest, where it's barely 110 volts. so don't get too excited if your output isn't text book perfect, the power company isn't perfect either.

For those of you who are running excessive voltages, you may have purchased a head that needs the field voltage adjusted, this is fairly easy to do. Identify the source of field excitation voltage, place a rheostat in series with this output and 'tune' in a little resistance to cool off reduce the voltage. This will in turn lower the current in the field of your generator and and lower it's output. As of 10/2003, we will be stocking rheostats to do this for our customers.

We have received a few call from folks that have ST heads that produce around 150 volts at 60 Hz, I would guess that a 5 ohm resistor rated at 50 watts would get the field current pretty close to correct, but using the rheostat will allow you to tune it. Another benefit of this adjustable field is you can crank up the voltage to compensate for a long extension cord, or a long run between your generator and load, simply place a volt meter across the appliance when it's running and adjust the rheostat for a decent voltage.

More to follow...

Best Wishes,

George B.

[Home](#)



## SHIPPING INFORMATION

As of 10/2003

**Click here to see [The shipping damage policy](#)**

We strive to provide the best shipping rates possible, if you can manage to pick up your goods in one of the following cities, we can usually provide you a great rate. The depot will place your goods into your pickup, or trailer.

Try this for a fairly accurate guess at shipping rates.

If the code is west of the Mississippi, start with \$50... add \$25 per 100 pounds of goods. If it's east of the Mississippi, start with \$75 and add \$25 per 100 pounds. And if you're really east Like NY or PA, it's going to be around \$30 per hundred. I can get a firm bid, but this gives you a good idea as to what it'll be.

Prices subject to change, some items have modest load fees...

Here's the static list, if you find typos, please let me know, note the city code, and use it in your correspondence. **Also see the bottom of this page for more complete shipping coverage.**

AIRPORT CITY	STATE
ALB ALBANY	NY
ATL ATLANTA	GA
AUS AUSTIN	TX
BDL HARTFORD	CT
BHM BRIMINGHAM	AL
BNA NASHVILLE	TN
BOS BOSTON	MA
BTR BATON ROUGE	LA
BUF BUFFALO	NY
BWI BALTIMORE	MD
CAE COLUMBIA	SC

CHS	CHARLESTON	SC
CLE	CLEVELAND	OH
CLT	CHARLOTTE	SC
CMH	COLUMBUS	OH
CVG	CINCINNATI	OH
DAY	DAYTON	OH
DEN	DENVER	CO
DFW	DALLAS	TX
DSM	DES MOINES	IA
DTW	DETROIT	MI
ELP	EL PASO	TX
EVV	EVANSVILLE	IN
EWR	NEWARK	NJ
FWA	FORT WAYNE	IN
GEG	SPOKANE	WA
GRR	GRAND RAPIDS	MI
GSO	GREENSBORO	NC
GSP	GREENVILLE	SC
HSV	HUNTSVILLE	AL
IAD	WASHINGTON DC	DC
IAH	HOUSTON	TX
IND	INDIANAPOLIS	IN
JAX	JACKSON	FL
JFK	NEW YORK	NY
LAS	LAS VEGAS	NV
LAX	LOS ANGELES	CA
LEX	LEXINGTON	KN
LIT	LITTLE ROCK	AR
LRD	LAREDO	TX
MCI	KANSAS CITY	KS
MCO	ORLANDO	FL
MDT	HARRISBURG	PA
MEM	MEMPHIS	TN
MGM	MONTGOMERY	AL
MIA	MIAMI	FL



MKE	MILWAUKE	WI
MOB	MOBILE	AL
MSN	MADISION	WI
MSP	MINN	MN
MSY	NEW ORLEANS	LA
OKC	OKLAHOMA CITY	OK
OMA	OMAHA	NE
ORD	CHICAGO	IL
PDX	PORTLAND	OR
PHL	PHOENIX	AZ
PHX	PHOENIX	AZ
PIT	PITTSBURG	PA
PNS	PENSACOLA	FL
RDU	RALEIGH	NC
RIC	RICHMOND	NC
ROC	ROCHESTER	NY
SAN	SAN DIEGO	CA
SAT	SAN DIEGO	CA
SBN	SAN ANTONINO	TX
SDF	LOUISVILLE	KN
SEA	SEATTLE	WA
SHV	SHREVEPORT	LA
SMF	SACRAMENTO	CA
STL	ST LOUIS	MO
SYR	SAYRACUSE	NY
TOL	TOLEDO	OH
TPA	TAMPA	FL
TUL	TULSA	OK
TUS	TUSCON	AZ
TYS	KNOXVILLE	TN
YVR	VANCOUVER	BC
YYZ	TORONTO	ONTARIO

Try this link for a list of addresses and telephone numbers for all Depots ,the above list is static, this link may show new depots added.

Ok, you've decided you need something closer to home. Following is a contact for Troy, a person who has provided good service for me in the past.

You must remove the leading XOXO before sending the email, this will help stop some of the Spam that might be sent his way. Please don't bother Troy unless you can give him 48 hours to reply with a quote (usually quicker), M-F, weekends don't count. Make sure you give him the To: and From:, the weight, and product description if possible, he is familiar with most of the items we like.

[XOXOtwilliams@integritylogistics.com](mailto:XOXOtwilliams@integritylogistics.com)

Troy Williams

Regional Manager

Integrity Logistics

1-800-294-3744

1-503-582-4499 fax



## Shipping Damage Policy

==Shipping damage/return/refund policy==

We are confident that we have some of the best warehouse and shipping people in the business; material doesn't leave unless it's in good condition. We usually arrange to have pictures taken for a shipping record on all motor freight/high dollar items.

Because of unfortunate abuses by a very few customers, the following is our return/refund/damage policy.

If you have not had items shipped to you before, please be aware that once an item leaves our warehouses it is yours; whether it leaves via USPS, UPS, motor freight, or other means.

We will NOT ship any item without insurance. If insurance is absolutely unacceptable to you, you may ship at your expense however you wish, and we will help as we are able.

Motor carrier (semi-truck) insurance is \$1.50 per hundred weight. That means, for example, that an item weighing 400 pounds will cost \$6.00 to insure. The insurance cost is already added into the shipping quote we give you.

UPS insurance is VERY inexpensive, and, like motor carrier insurance, is already added into your shipping quote.

If an item arrives damaged, or in unacceptable condition, we will assist in rectifying the

problem, provided:

- **YOU** notify us
- **YOU** make the damage claim
- **YOU** ship it back to us OR return it to the carrier, with all paperwork completed

If you return it to the carrier, and do NOT do the paperwork, we reserve the right to NOT issue credits, replace merchandise, or refund your money.

We will not replace non-functional equipment until it is returned to us.

When shippers attempt to deliver damaged goods to you, refuse them and note the damage, **or**, if it's something you think you can live with at the time, get them to make notations on your copy of the paper work and call us. PLEASE NOTE: if you do nothing at this point, **nothing will happen!** You will NOT get the problem taken care of. Photos are always nice; a picture of the damage is worth a thousand words.



Sorry,

This page is under construction



## Panel Meters, Frequency, Amps, Volts, Power Factor, and More

A while back, I thought those big ole panel meters were really cool, after working with generators a bunch, they have lost some their appeal, just another thing to find room for, t mount, and to fix when they break. If you have some antique gauges, and you are displaying them for the Vintage appeal, that's still cool; if you just want to know what's going on, that's a whole different matter.

the 'Kill A Watt' plug in meter is throw-a-way cheap, many of us can get by on this and enjoy some outstanding features. One of the things I like most is you can plug it in where you use the power, and monitor generator performance where you most likely are. For a typical price of \$29.95; some of us can afford to plug one in at the generator room, and one at the load, if one breaks, we have the other for backup.

After my experience with this device, I wouldn't be without it, and I wouldn't spend a dime more for instrumentation for my generator systems.

Click on the thumbnail below to see the manufacturer's info, do a search on 'kill A Watt' to learn where you can order this handy device.





## P4400 Kill A Watt™ Operation Manual

Congratulations on your purchase of the Kill A Watt™ Power Meter. Cared for properly, this unit will provide you with years of service.

1. The LCD shows all meter readings: Volts, Current, Watts, Frequency, Power Factor, and VA. The unit will start to accumulate KWH and powered duration time (hour) after power is applied.
2. Press Volt Key for true RMS Voltage (Volts) display.
3. Press Amp Key for true RMS output current (Amps) display.
4. The Watt/VA Key is a toggle function key. Press the Watt/VA key once to display Watt meter, then press key to display VA meter. The LCD will display Watts as the active power, where VA is the apparent Power. (VA=Vrms Arms)
5. The HZ/PF is a toggle function key. Press the HZ/PF key once to display the frequency (Hertz), then press key to display the Power Factor. HZ is the Frequency of output Voltage, where PF is the Power Factor (PF=W/Vrms Arms).
6. The KWH/Hour is a toggle function key. Press the KWH/Hour key once to show the cumulative energy consumption since power was applied to the unit. Then press key to display the cumulative time since power was applied to the unit.
7. Consumption will be displayed in Kilowatt-Hours (from 0.01 KWH to 9999 KWH). Time will initially be displayed as Hours:Minutes (from 00:00) and switch to Hours (to 9999). Counters will recycle to zero when they reach their maximum. To reset, remove power from unit momentarily.

**WARNING:** Do not exceed maximum ratings as detailed on label.

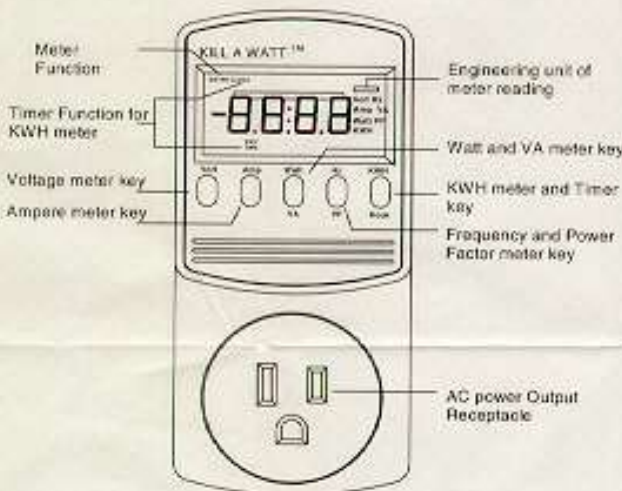

### P3 INTERNATIONAL CORPORATION LIMITED WARRANTY

P3 INTERNATIONAL CORPORATION ("P3") warrants to the original retail purchaser only, that its product is free from defects in material or workmanship under the condition of normal use and service for a period of six (6) months from the date of purchase. In the event that a defect, malfunction or failure occurs or is discovered during the warranty period, P3 will repair or replace at its option the product or component part(s) which shall appear in the reasonable judgment of P3 to be defective or not to factory specifications. A product requiring service is to be returned to P3 along with the sales receipt or other proof of purchase acceptable to P3, and a statement describing the defect or malfunction. All transportation costs shall be borne by the owner and the risk of loss shall be upon the party initiating the transportation. All items repaired or replaced thereunder shall be subjected to the same limited warranty for a period of six (6) months from the day P3 ships the repaired or replaced product. This warranty does not apply to any product that has been subject to misuse, tampering, neglect, or accident or as a result of unauthorized alterations or repairs to the product. This warranty is void if the serial number (if any) has been removed, altered, or defaced. This warranty is in lieu of all warranties expressed or implied, including the implied warranties of merchantability and fitness for a particular purpose which are expressly excluded or disclaimed. P3 shall not be responsible for consequential, incidental or other damages, and P3 expressly excludes and disclaims liability for any damages resulting from the use, operation, improper application, malfunction or defect of any P3 product covered by this limited warranty. P3's obligation is strictly and exclusively limited to the replacement or repair of any defective product or component part(s). Some states do not allow the exclusion or limitation of incidental or consequential damages, so the above limitation or exclusion may not apply to you. P3 does not assume or authorize anyone to assume for it any other obligation whatsoever. Some states do not allow limitation on how long an implied warranty lasts, so the above limitations may not apply to you. It is the customer's responsibility to comply with local, state, or federal regulations, if any, that may pertain to P3 products or their use. This warranty gives you specific legal rights, and you may also have other rights which vary from state to state.

If you experience difficulty in the operation of your unit, or if your unit requires repair please contact:

P3 INTERNATIONAL CORPORATION  
TECHNICAL SUPPORT  
71 West 23rd Street  
Suite 1201  
New York, NY 10010-4102  
Tel: 212-741-7289  
Fax: 212-741-2288

Email: [techsupport@p3international.com](mailto:techsupport@p3international.com)



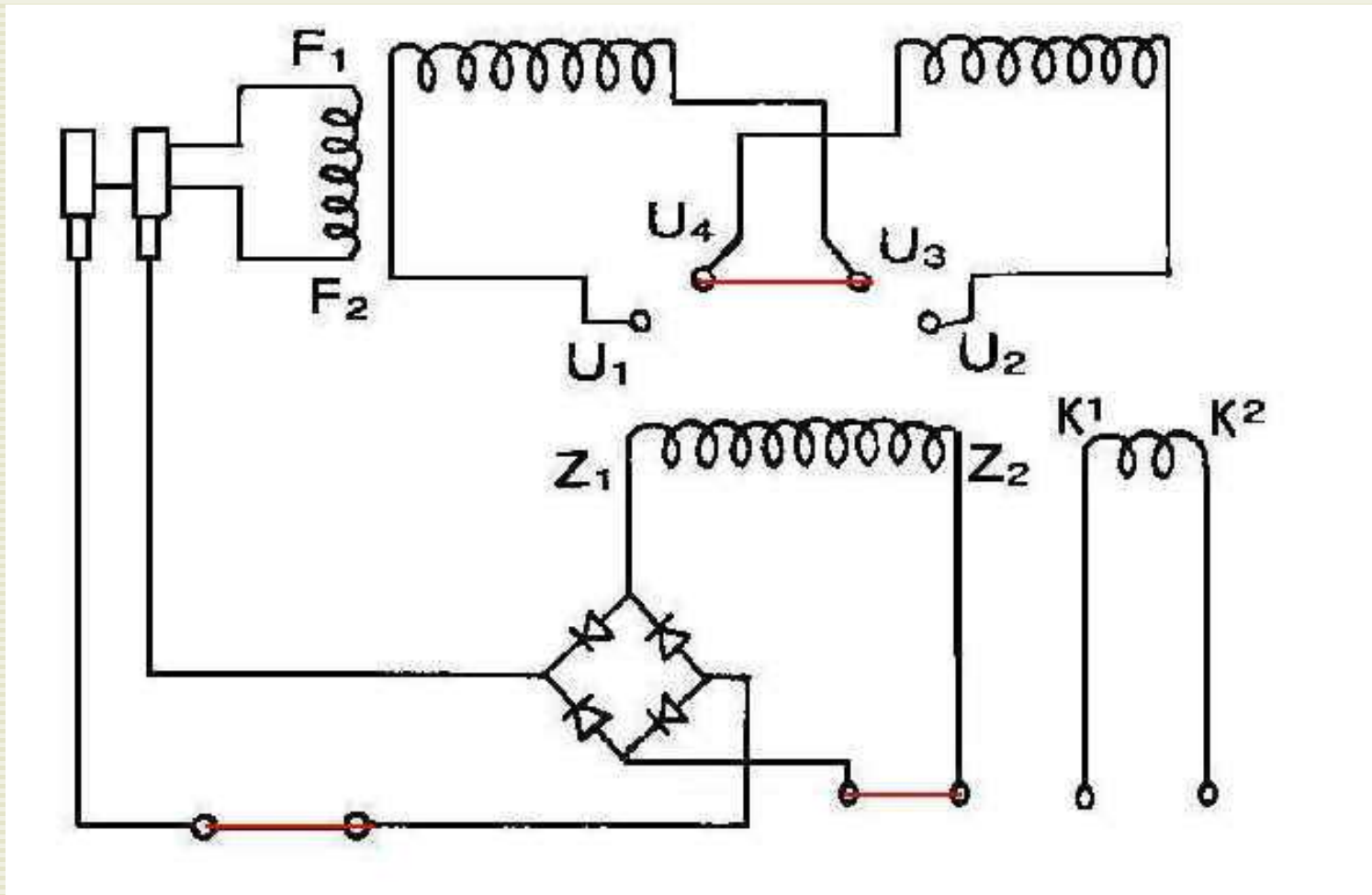

Manufacturers might change their wiring at any time, consider this an example only.

Update! April 2002, Some manufacturers have changed their wiring! Newer heads have what they think is a handy terminal strip on the side of the dog house. The new heads don't have the K winding that was used to support the 50HZ standard. Other than this AND some lead designations, they are the same. It is important to note that the newer documentation doesn't explain the option and advantage of wiring your head for 115 volt only use. Does this mean they will move from four leads to three out of the stator?

12/02/02 added note, this indeed has happened, some will welcome the changes, but on the smaller heads, you should understand the potential limitations of center tapping verses bringing out both windings for 120 only verses 120/240 operation.

12/15/02 Another note, the Chinese appear to be 'tuning' their gen heads to meet the expectations of the western world... or so they think. I have found that most of the STs coming into this country (at this moment) are center tapped. The Chinese have top down management, they still don't have a clue what competition is (IMHO), they don't ask, they just do it. Most folks won't care unless you're buying a small head.

I'm changing my website to reflect changes and things I am learning, soem things will be rewritten, in other areas, I will add a dated note to reflect when these things are discovered.

The first step in trouble shooting is to assume nothing. Verify that your head is indeed wired as above. If you find it is wired different, you might consider making a note of how it is wired now and then wire it as above

**for the purpose of testing. Note: if you have a center tapped head, it will be just like the drawing above.**

**There is a piece of test equipment called a 'megger', it's nice to have for testing electrical appliances. The one I had experience with in the NAVY had a hand crank, you'd hook it to the windings and then to the case or the ground terminal on a gen set and crank it up. This performed a high voltage test between the windings and ground. If the insulation was failing or breaking down, you'd see it. If you can get your hands on such a tester, do so, if not use the good ole multi meter like most of us, and proceed.**

**Use these test procedures at your own risk, this information is for educational purposes only!** We'll assume your generator head is dry and clean and that you have grounded the head to earth ground to protect yourself. We'll also assume that it's hooked to the engine and that you can spin it up to 1800 RPMs. We also must assume that you have a good idea where 1800 rpms is, or that you have a device like a mechanical tachometer to verify that the speed is correct. (It's a lot of assumptions!) If all this is true, proceed to step one. **Remember! the following readings were taken off the 10KW head**, I'll post actual readings of the other heads time permitting.

**1.** Remove the slip ring cover, lift both sets of brushes off the slip rings, a little messing around and you'll see they stay up on their own when lifted up far enough. Make a tool out of a paper clip to pull the spring back over the top of the brush when you wish to seat them again.

Place your ohm meter across the slip rings and take a reading on the R times 1 scale, you should see around 17 ohms. If true, **goto step 2**. If you find a different resistance, the field is suspect, consider pulling the rotor, you'll find four windings in series, inspect the solder joints, and connections to the slip rings. Open the individual windings and compare them using the ohm meter. Check the field to the shaft, you should read **infinite (OPEN)**. Once you have corrected problems here or have proven it good, goto step two.

**2.** Place the meter on the ohms times one scale, and place it across the Z1 and Z2 leads when they are removed from the diode bridge. g. The reading should be around 5 ohms, if true **goto step 3**. If not, Investigate the harmonic winding in the stator, and replace it if bad.

**3.** connect the volt meter across the Z1 and Z2 leads. Set the meter for AC volts, 100 volt scale. Start the engine and bring the set to 1800 rpms. You should read approx 53 volts AC, if true **goto step 4**. If your reading was different, verify you are turning 1800 rpms, if true, investigate stop the unit, take a 12 volt battery and FLASH the field with the brushes lifted on one ring, put the brushes back on the rings and repeat step three.

**4.** With the set stopped, re connect the Z1 and Z2 leads to the diode bridge. Start the engine and verify the set is running at 1800 RPMs connect your meter to the two screws that normally connect the two leads going to the slip rings, and note the DC voltage. It should be around 69 volts DC. If this reading is good **goto step 5**. If it is off, replace the diode bridge and retest.

**5.** If you got this far, you've proved you have a correct voltage from the Z winding, that it is being converted to DC by the diode bridge, and that you have a proper resistance in the field winding. If you have an amp meter that can accurately measure 2 amps AC, place the meter in series between the lead Z1 and the diode bridge terminal screw. Check all the brushes, slip rings and connections. Start the set and run it up to 1800 rpms. The meter should read approx 2.1 amps if true, **goto step 6**. If your reading was different, verify your meter, the RPMs, and the field excitation circuit, also look at the diode bridge for a flaw. read out the diodes with the ohm meter and prove it good.

**6.** You've proved that everything is working on the excitation side. The only thing left is the output side. Continue to **step 7**.

**7.** Verify that all test leads are removed and all the leads in the field excitation circuit are tight. Set the ohm meter on the R times one scale, place one test lead on the U1 terminal and the other on U2, you should see a very low resistance, .02 thru .06 ohms. If not verify that the strap is in between U3 and U4. Using the ohm meter, measure between u1 and ground, the reading should be infinite, if true **goto step 8**. If there is any reading other than infinite (open) to ground look at both windings further, replace if necessary.

**8.** Place your voltmeter across leads U1 and U2, set on a scale to read 230 volts AC. Start the engine and set at 1800

RPMs, if you're reading is not close to 230 volts AC, you most likely have a problem with your RPMs, your meter, or your U windings or associated leads. Get a megger and test all the windings with it. If you got here and didn't clear your problem, you are one unlucky person.

Please [report](#) any errors or omissions you might find in this text.



## Voltage Excitation

**This is a living document, expect things to be inserted as we learn and receive feed back.**

**It seems there are a good number of us who are concerned about voltage regulation, voltage droop, etc. Many of us want to know what the ST design deliverers and we don't have a clue what the majority of consumer Generators deliver. I strongly advise that you buy a Kill A WATT, these simple and inexpensive devices plug in anywhere and give you frequency, voltage, power factor, and will even allow you to track KWH usage of an appliance. This is a great product for a generator owner, a device sold for less than \$30 with a very nice LCD readout.**

**For those of you that have Kill A Watts, please consider plugging it into your consumer generator head, and noting the voltage and [email me](#).**

**It is a common practice to set a small generator up for 61 HZ no load, when the load is applied the governor often regulates speed at less than 61 Hz, and this allows for more accurate loaded regulation through out the load range.**

**When we get into this subject, remember the power company has no problem with plus or minus 10% in the voltage they deliver you. It's nice to set your machine up so the **no load** voltage is near the high acceptable limit, this way any droop between no load and your heavy loads will be acceptable.**

**I plugged my Kill a WATT into my Neighbor's Briggs and Stratton 5KW gen set.**

**At 61HZ, I observed 134 volts **no load**, At 60HZ, I saw 125 volts **no load**.**

George,

I have a Generac 5500XL. Using a Kill a Watt I observed 128 volts at 61 HZ no load and 126 volts at 60 HZ no load (It was bouncing back and forth.) At Approx 1000 watts load the voltage falls to 119 and 59 HZ. At approx 2400 watts the voltage falls to 114 and 57 to 58 HZ. This is approx. 125 feet from the generator to the load with 8 gage wire used to carry the current. ( I couldn't figure out how to keep it at 60 hz under load). The genset is 3 years old with approx 500 hrs service. Hope this data helps out.

David Robert

Note: I think David's machine has a lazy governor, but his readings give us some comparative figures. We need more readings, keep them coming! thanks David!

**Please consider taking the same readings and forwarding them to me, we'll then build a page with this info. If you have the equipment, it would be great to increase the load and take voltage readings at 60HZ as the load is increased. If we get enough data points, we might display this info via graphs.**

Alternators that provide access to the field winding allow an end user to control the voltage **INDEPENDENT** of the frequency. The ST head provides this kind of access. ST's come from the factory with "harmonic excitation", this is a simple self exciting system that uses the Z winding in the stator for a supply voltage. This winding is connected to a full wave bridge, ( a group of diodes) that (rectifies) or converts this AC voltage into a DC voltage. The DC voltage is then connected to the field (rotating winding) providing the voltage that will 'excite' the generator.

When the head is at 1800 RPMs, the "Z" winding is producing around 53 volts AC. at 2.1 amps, or only 111 watts. This AC is connected to a full wave bridge array of diodes that converts the excitation voltage to DC. At this point you will read 69 volts DC at the output of the

diode bridge. these measurements were made with simple FLUKE multimeter and may not represent true voltages or power. But.. it is most likely what you will have to test with, and it is what I had...

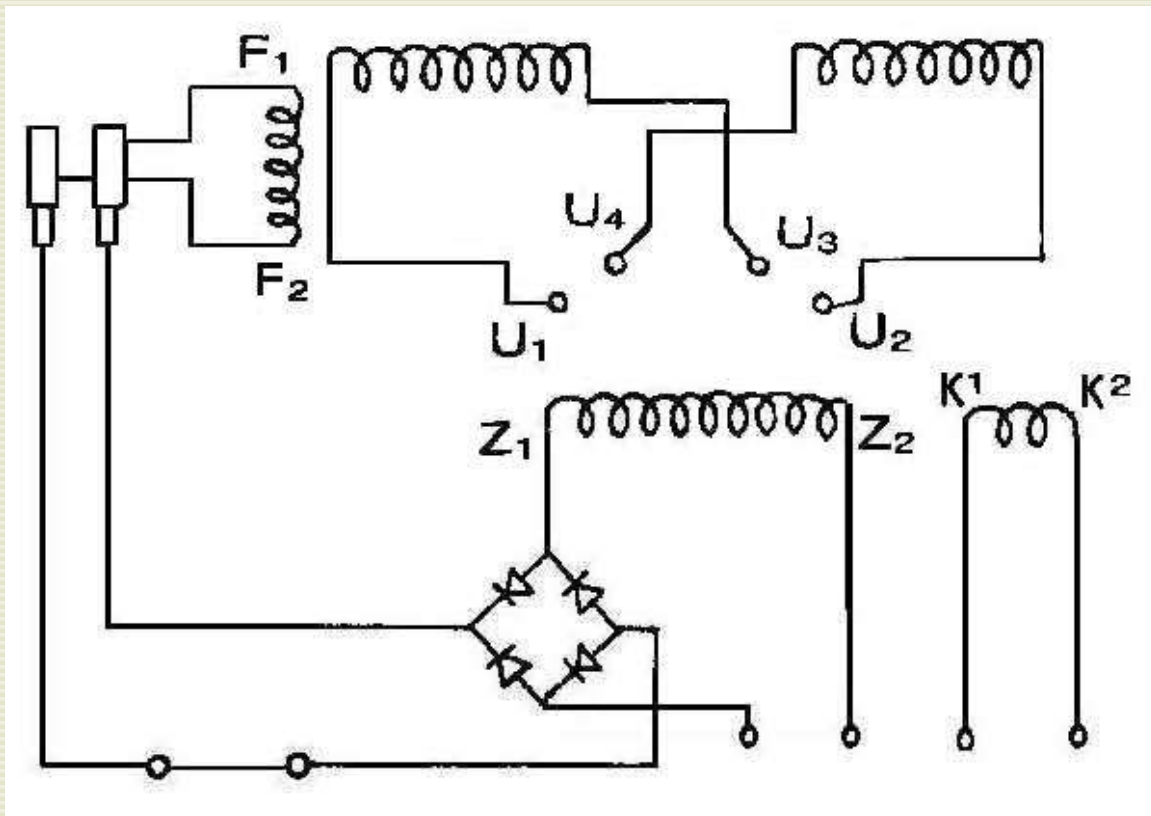

**Drawing Above: (ST Heads).** This system is simple to trouble shoot, and you could replace their diode bridge with one from radio shack or a hundred other places if something were to go wrong with it. What you have is three windings, a diode bridge, and some slip rings, that's it! The volt meter, light bulb, and switch are typically wired across the output of the generator for quick reference. I got an email suggesting that the switch and light bulb were a little misleading since they really didn't do anything. I guess the light tells you that voltage is present, and if the light bothers you, the switch turns it off....so if you're expecting something more than this, you'll be disappointed.

If your generator fails to make juice, simply remove the cover to gain access to the diode bridge, the leads to the field winding and the harmonic winding can be accessed here. The screw terminals allow you to lift the leads and properly isolate them for testing. Use an ohm meter to verify that both the Field winding F1-----F2, and the harmonic winding (Z1-----Z2) read properly. It might be a good idea to read these windings with your meter when you are installing the head and write down their resistance values on the inside of the cover. The actual stator windings that provide the power for your load come off of windings U1-----U3 and U2-----U4. The ST heads I have allow the end user to quickly wire the head for either 120 volt only loads, or 120, and 240 loads. Some generators are set up for both 120 & 240 only, this means that you can only use 1/2 of the generator's rated output to get your 'hard to start' 120 load going, this can be a problem, know what you're buying!

**The Following comments regard Generators in general, not just the ST units.**

**The following paragraph inserted 11/2003**

**If you look at the field winding above, you'll notice a strap and two terminals not designated. Following is an example why you might mess with this strap and how to do it.**

**Lets' say you bought a 'Kill A Watt' (do a web search if you don't know what this is), and you are measuring a little higher voltage than you are comfortable with at 60 or 61 HZ. I mention 61 Hz because lots of us set up Gen sets at this frequency (no load) with the expectation that the load will pull the genset down to 60hz and that we will get some advantage with the expected voltage droop. To help you figure your voltage, I'll mention that the power company typically regards plus or minus 10% to be in compliance. There will be no need for you to worry about decimal places. If you really want something to worry about, think of Ted Kennedy and what all that alcohol is doing to his liver.**



The above part is a ceramic 50ohm, 50 watt resistor, the center tap can be used to adjust the resistance downward. This is a good example of a part you can use to adjust voltage, but there are many.

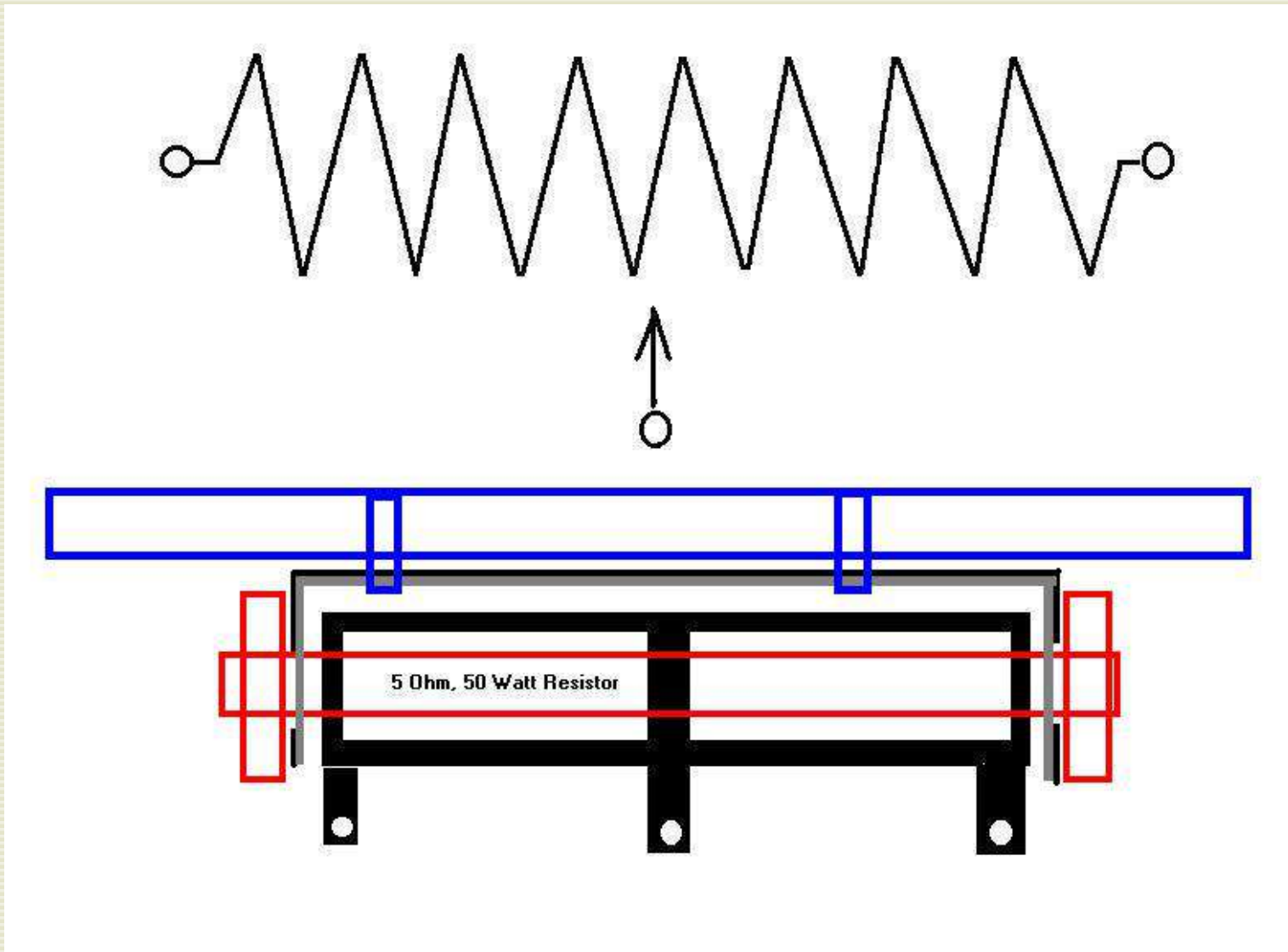

Above are drawings of the same part. Note that this device gets hot and requires a mount. The lower drawing attempts to demonstrate a typical mounting for OHMITE D50K5R0, Blue represents the side of the dog house or other suitable mounting place where the part can get some air for cooling. Gray represents a piece of metal strap bent at the ends with holes drilled to act as a mount. Red represents a bolt and bolt head, and nut inserted in the ceramic resistor to mount it. DIYers recognize that ceramic materials crack and break if you reef on them, so treat it like a glass part, and make sure the connections are clear of any metal near the mount.

Once you have properly mounted the resistor, place it in series with your field winding. Use washers, and loc-tite, or other means to assure things don't come undone. Fire up your Gen set and adjust to 61HZ, adjust the voltage to the highest voltage setting you'll want to see. Measure this voltage at your load, not at the head. If your loads are 300 feet from the generator head, measure the voltage there and adjust this part to provide that voltage. Once the center tap is adjusted, tighten it firmly.

It may be helpful to note that a generator's output voltage is in relation to the current in the field winding. Since this is a series circuit, the voltage drop created by this resistor will lower the current. Current is common throughout the circuit in a series circuit.

**With all this said, here's how you hook it up**

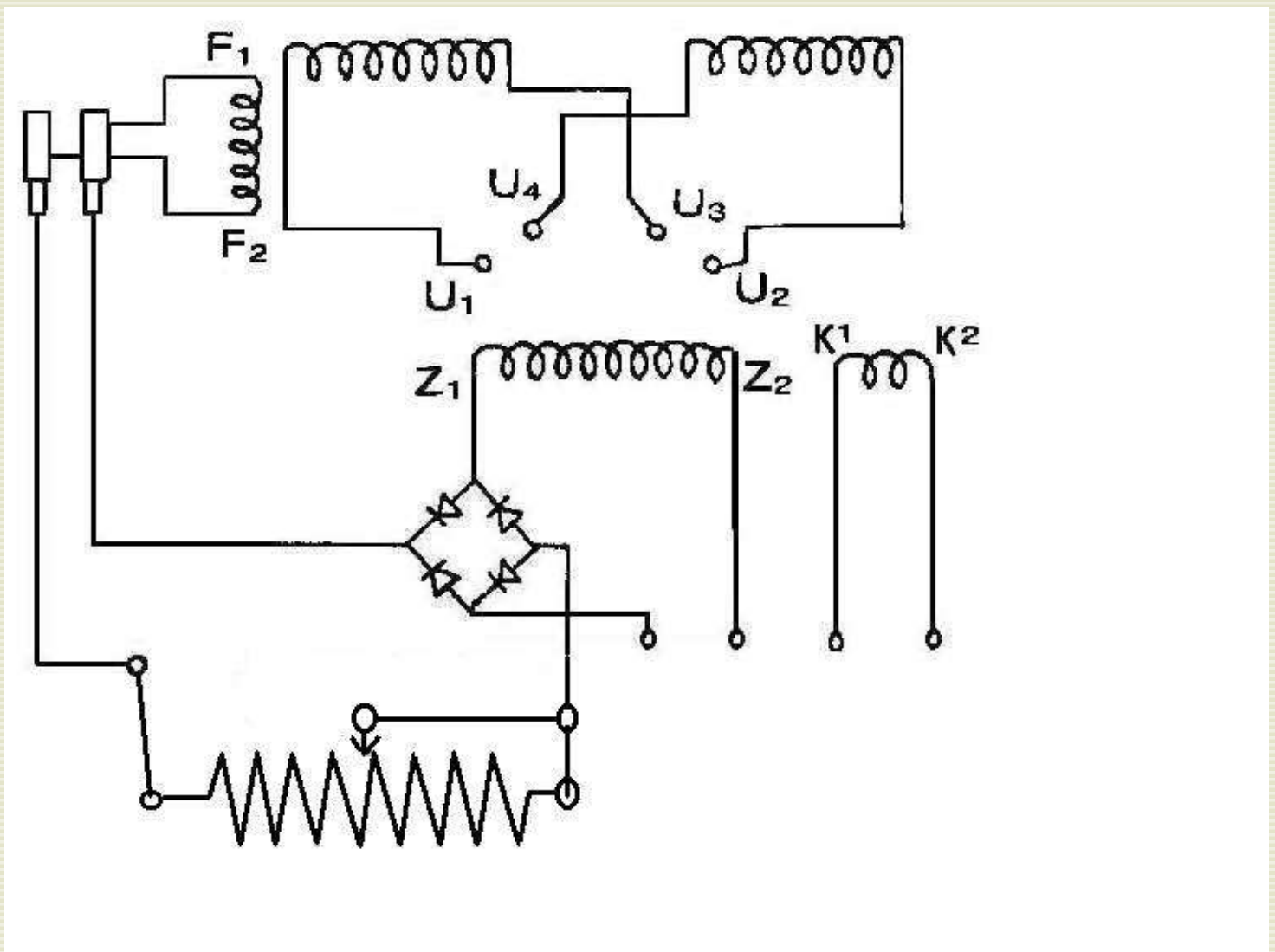

If you look at the drawing above, you'll note that there is a strap between one end of the resistor and the center tap. How you hook things up can make a difference. If you do it as I have drawn it, the lead between the tap and the end effectively 'masks' part of the resistor, should the center tap loosen or if the centertap wire breaks, the resistor will be fully inserted into the circuit. Other configurations could generate severe swings in voltage if the tap loosened or a wire broke.

Please note that the wire used should be very fine stranded and flexible.

End of 11/2003 insert.

Although the stock Voltage excitation will serve my needs entirely (and most likely yours too) you could add more components or a complete sophisticated voltage regulator if you like. To date, I don't know the best way to do it.

**At this point, I have found nothing that doesn't work fine when it's powered by a stock ST.** I've had one gas generator that had a carb problem and surged, the speed would vary widely and the voltage along with it. You could see the size of the picture get bigger and smaller, lighter and darker with each surge on the color TV. But you can't blame the generator head for that.

**Noise...** when it comes to this subject, you will hear it all. On a **rare** occasion you might run into something you want to use that might be of poor design or has a bad component, you might see a line on the TV, or a slight wine through the speaker of an old radio, the quickest fix is sometimes eliminating the signal at it's source verses fix the appliance. This might mean you add an inexpensive capacitor between your diode bridge and the field winding in your generator, or apply some other typical remedy to accommodate a 'low end' appliance or one that has developed a problem. The dual brush rigging in the ST's seem to take care of noise problems all together, but you may have some other head around that you can apply this fix to.

**Load... (This may be a worst case example)** A friend of mine recently bought an expensive Onan autostart generator. What kind of voltage regulation it had, I don't know, but it's a natural gas unit in a box and is rated at 8Kw. This particular unit was installed to support a glass blowing shop. The critical load was a blower motor rated at 2 horse power. This induction motor is a 3750 RPM unit; attached to the motor shaft is a fairly high mass blower fan, which means it takes a bit of time for the motor to come up to speed. After the glass blowing

shop replaced the blower motor for the second time, they became concerned and hired an electrical shop to investigate. They found that the motor starting windings were being 'cooked' and burning up! Further investigation proved that this Onan 8KW generator was actually too small to start this motor! The high mass of the blower, and the fact that this is a higher RPM induction motor means that it requires more of a generator to start it and get it up to speed fast before the start winding overheats and cooks! After calling the Onan Rep, the glass shop learned that the generator was clearly too small to handle such a load. Thanks to the Salesman and the assumption that an 8KW Generator would start any 2HP induction motor, they bought the wrong thing and have to buy it over again.

Superior voltage regulation would not have helped start this unusual and large load, **the root problem is the generator is too small.**

**The important lesson is: Induction motors are demanding loads to start, and can take up to 3 to 5 times the POWER (watts) to start than it takes to run!** When the shaft is at zero rpm, the motor windings have little impedance (opposition to current flow). Some Designers count on the motor to 'spin up' in a certain amount of time to keep from burning up the motor start windings. As the motor picks up speed, it generates a force called 'counter electromotive force' that opposes the incoming current. This quickly reduces the amount of current the motor draws. Now consider this blower motor in the glass shop, it has a huge blower fan made of cast, it weighs a bunch and acts as a flywheel when starting, AND it is trying to push air as well. The motor has to lug all this along as it tries to come up to speed. It would be my bet, that the start windings are only good for a few hundred starts when power is adequate! Add an under sized generator set, and you have a recipe for fried motor.

With this in mind, you can look at the motor you want to run and see what kind of load it carries with it when it tries to start. A big motor with no load is going to be easier for a smaller generator to bring up to speed. If you can load it after it's brought up to speed, you have the better situation.

Don't confuse skill saws, chop saws, vacuum cleaners, and all the other universal motors with induction motors. Universal motors are MUCH easier to start and don't have start windings, but they have more 'wear parts' and won't last nearly as long in continuous service.

## Added 11/03/2003 Understanding the Salient Rotor used in the ST design.

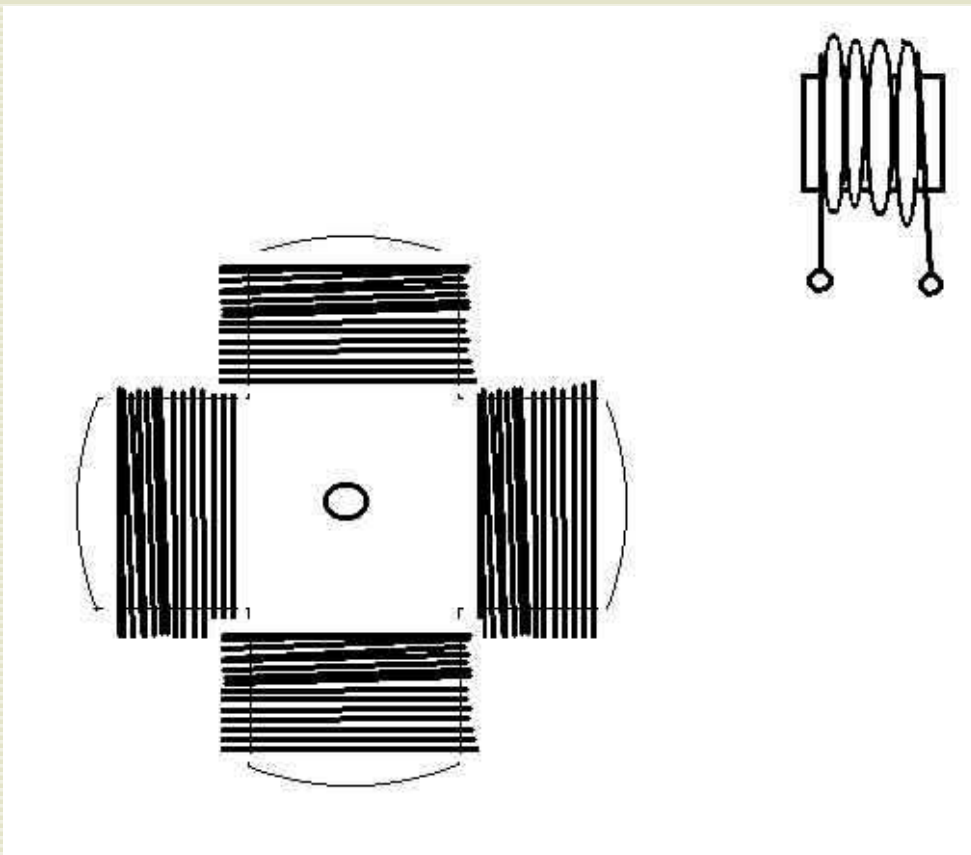

If you look at the above sketch, it somewhat represents the Salient rotor design found in the ST design. Here you can clearly see the 'four poles' in the rotor. Each winding is like a wound bobbin of copper wire. The standard rotor has all four bobbins connected in series. The winding above and to the right is a representation of each bobbin. If you were to take a reading with your ohm meter and divide by four, you should have the value of each winding's resistance.



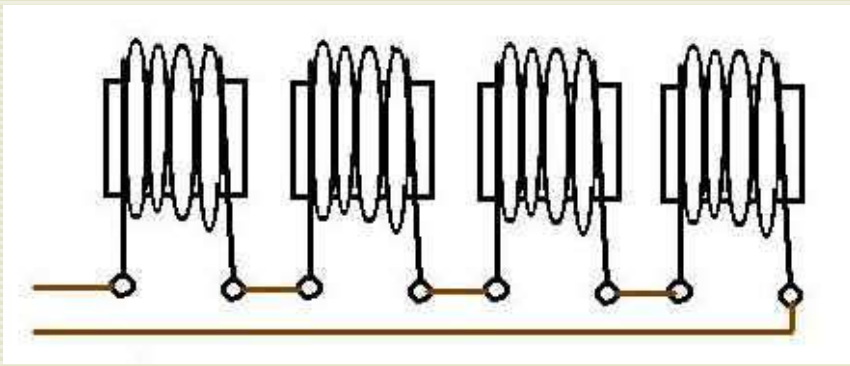

If we look at the above drawing, we see the coils connected as it is stock.

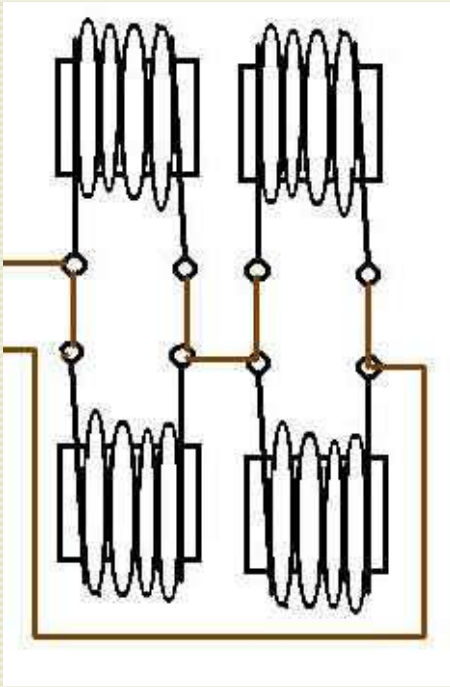

Above we see the same bobbins on the salient rotor wired series parallel, in this configuration, you could use a source of DC at 1/2 the voltage and produce the same output voltage of your generator.

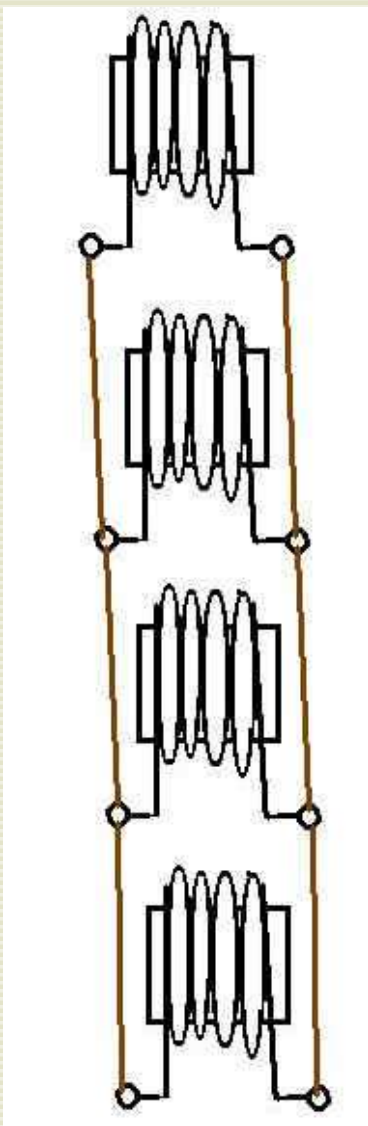

Above is the same four bobbins on the salient rotor wired in parallel, if you use 1/4 of the voltage to power the salient rotor (Field), wired as you see it here, you will produce the same output voltage as stock.

So why do you care?

Some folks use an external source for their field excitation. If you have a battery bank, you have a superior source of field current that is clean and pure, bottom line, batteries supply the cleanest DC power. Consider this.. 48 volt battery strings are becoming more popular. The telephone company has been using this voltage for about a Century, so it isn't anything new. The higher voltage allows a designer to reduce wire size and eliminate some pretty heavy resistive losses in an off grid power design. More and more off grid designs use this voltage, versus 12volts or 24 volts. if you decide to invest in solar, or a battery string and inverter, look into the advantages of the 48 volt system.

Lets make note of the float voltage of a 48 volt battery plant, it's around 52.2 volts depending on the type of batteries and other design criteria. You will note that this is pretty darned close to what we saw when the stock harmonic winding was powering the field in this ST head.

So why do I care?

Lets' say Ted Kennedy was messing with your stuff (drunk as usual), and messed up your generator. You do some basic trouble shooting and find that the rectifier is shot, or maybe he's managed to spill some Brandy into your generator head and smoked the harmonic winding. If you were to pull out the rectifier, and tape up the harmonic winding leads, you could use your battery string voltage to power the field by attaching it to the slip rings or to the same wires marked (plus and minus) that you pulled off your rectifier.

Also note, you could drop a cell and lower your field voltage by approx. 2 volts, this could give you some voltage adjustment, and most likely an even better sine wave.

But I don't have a 48 volt battery plant!

Well, take a look at the alternate ways one can wire the bobbins on the rotor, do you have 24 volts? Do you have 12 volts? these

voltages could be used to power the field as well.

If you're off grid, or if you're on grid house is cold and dark, it's always nice to know how you could Jerry rig your Gen set into making some juice if some component failed.

One more thing that might be handy to know, if you cut off two rotor tips and just had two tips with their bobbins spinning around, you'd have a two pole generator. You would need to spin the rotor double speed to make 60HZ, and I would imagine the bobbins would come flying off and grind your generator to shreds at that speed. 3600 RPM generators use a turbine design verses the heavy salient design, don't try tuning it faster than it's rated speed.

Please email me with your "Hands On" experience or ideas.

[George B.](#)

[Home](#)



The following info is intended as an introduction for fellow do it yourselfers who understand the value of making their own repairs and the independence and piece of mind it brings, © March 15, 2002. **If you don't believe in personal responsibility, please do not attempt a repair of any kind.... call the Repairman.**

Most of my tear down experience is around the ST10. At the moment I have a 12 and 15 in my work shop as well. They appear identical in construction; where the 10 and 12 share the same size shaft (42mm), and the same exterior dimensions. The ST15 has a larger diameter shaft (48mm) and the generator body is larger.

**Bearing inspection and replacement are straight forward in this head.**

**Tools Required for inspection:** Medium sized rubber hammer, 10mm & 14mm box end wrenches.

Additional tools for bearing replacement: Bearing puller, properly sized pipe to be used as bearing seater.

**Start by removing the slip ring inspection cover.** If it is trapped under the instrument housing, loosen the screws inside the housing and remove the inspection cover completely. Next... carefully pull the brushes from their seats and trap the brush where it no longer makes contact with the ring.

Remove the three 10mm (head size) bolts located around the shaft on the slip ring end. These hold the slip ring cover which doubles as a rigid mount for the slip rings. Once the bolts have been completely removed, back the cover off the bearing being careful NOT to apply force to the brush rigging. Move the cover and rigging inboard along the shaft away from the end bell.

Remove the four 14mm bolts securing the bell housing to the rotor housing. You'll notice there's generous amounts of room to swing a rubber hammer to back the bell housing (end housing) off the 'stator' or main housing. Go from side to side and slowly force the bell housing off the shaft, then remove it completely. The bearing could have remained on the shaft, but most likely it is still in the bell housing. Put a piece of clean paper over the bearing and set it aside where the bearing and grease will not become contaminated.

**WARNING...** take note, the rotor weights 72 pounds on the ST10 and more for the larger heads! ST heads have pretty tight air gaps and very fine laminations. Be careful so you don't scrape the rotor and stator together.

Now it's time to remove the screens on each side of the shaft end bell housing, Grab your 14mm box end wrench and remove the four bolts that hold the bell housing in place. Use your rubber hammer to drive loose the shaft end bell housing. Once it starts backing off, go

side to side and gently move the bell housing off the shaft completely. The shaft side bearing is most likely still on the shaft, at this point, you have access to both bearings for inspection and greasing.

**If you find it necessary to replace the large bearing**, it is best to remove the rotor, to do this get help! Prepare a soft place to lay the rotor once removed, I placed mine on a pile of rags on an old padded chair I have in the shop.

Now, remove the slip ring brush rigging and tie them out of the way. Position a person on each end of the rotor. Carefully lift the rotor and remove it through the slip ring end. This will give the person on the shaft end more to hold onto as the rotor passes through the stator. Go slow and try to eliminate as much contact as possible.

Once the rotor is out, get a decent bearing puller. I used one with three hooks. The screw goes in the end of the shaft and you tighten it up till the bearing moves. This is not always easy unless you know a few tricks. Spray some WD40 between the shaft and bearing. Tighten up the extractor bolt a bunch, if the bearing doesn't move hit it from the side, if this doesn't allow it to move, get your propane torch out and carefully add some heat to the inner race, tap on the end of the extractor bolt until the bearing starts to move.

**When you replace the new bearing, it is very important not to apply force anywhere other than the inner race. If you don't have proper tools to drive on the new bearing try the following.**

The seating surface for the bearing is larger than the shaft, it's also just wide enough for the bearing. This allows you to use the old bearing as a tool to drive on the new bearing.....

place the new bearing on the shaft, put the old one on top of it and find a piece of pipe that just fits over the shaft, **the pipe must rest on the inner race of the old bearing for driving!**

It is best to place the rotor shaft on a piece of wood and have someone hold it vertical while you drive on the new bearing. You'll feel the bearing seat against the shoulder on the shaft.

Once this operation is complete, reverse the procedure to put it back together and you're on your way.

[George B.](#)

[Return Home](#)





**This will be a living document, your feedback will add to the content.**

First, if you have ever lost equipment to mice, you will NEVER forget how much damage their urine, chewing, and bedding can cause over time. I have a tractor ring gear with the teeth corroded away because someone didn't put the cover back on the bottom of the bell housing access hole for greasing the throw out bearing. Mice moved in; damage was extensive, the throw out bearing, clutch, and pressure plate all look pretty sad.

**You need to add a screen to the bottom of the fan housing**, it will be obvious that mice can enter here. Simply remove one of the side covers for access. I'd use a piece of wire mesh with squares tight enough to keep a mouse out. You can drill some small holes and firmly attach it with flat washers and small machine screws. A five minute job that could save your head!

Many of us that are interested in a generator of this type will be installing it in a shed or some place where we can do some 'noise abatement' for the power source. My approach is to place the generator shed just over the hill where it can't be heard.

## **Wiring the head for your needs:**

**Some potential DIYers ask... "How many outlets are built into this generator, and what types are they?"** If you are asking yourself this question, you may be better off with a consumer type head. These units are heavy, less portable and are not equipped with plug ins. Most DIYers that are attracted to this type of head will buy a \$14 circuit box at Home Depot and put two five dollar breakers in it. They will mount a box on the generator frame where they want the plugs and wire from the generator head, to the breakers, to the plugs..." if they want them there". Again, if you are inclined to ask this question, you might be better off with something else.

Many of these heads will be set up stationary, where the generator powers a summer cabin off grid, or the output of the generator passes through breakers and then onto a transfer switch or "Interlock" assuring that the operator will perform the transfer of power safely.

**Always check the local code for wiring requirements, they may be different. Always include grounding in your wiring scheme. The case of the gen head should be tied to a good ground. If you don't have one, drive a ground rod. It's a good idea to tie this ground to the engine and all the metal within reach of the gen set. If you wire to a service panel, make a connection between the generator head and the panel ground as well.**

Not everyone understands that there are pros and cons to wiring your head for both 115 and 230 volts, the fact is, you can only direct 1/2 of the rated power output to any single 115 volt load when it is set up this way. **If you really think about it, this is exactly the same as the power panel in your home, 115volt loads are split, the electrician made the effort to BALANCE the loads between the two legs coming into your house.** Whatever power you can deliver to a 230 volt load, only half of that can be used for any SINGLE 115volt load.

**Wire the head for 115 volts only; UNLESS you have 230 volt loads to support. You can change it later if you find you have the need.**

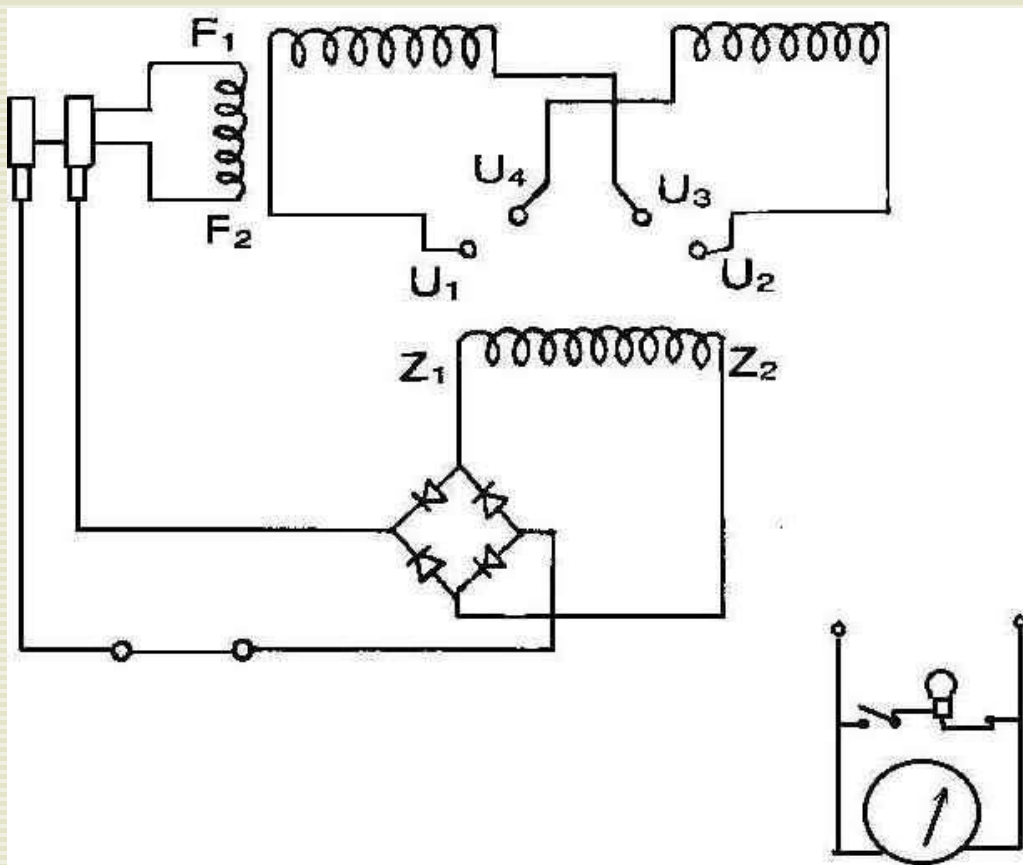

The picture above shows the basic ST setup, verify that your head is not different before you wire anything! the light bulb doesn't do much, people wonder why they bothered with the switch, it can be useful for trouble shooting, and it is what it is.

For **230 volt** operation, strap U3 and U4 together, take the 230 volt load off U1 and U2, use another wire coming off U3/U4 for the return path some times call the 'neutral' lead.

For **120 volt** only operation, Strap U1 and U4. Strap U3 and U2. Take the load from U1 and U2.

Following are two different presentations of the wiring:



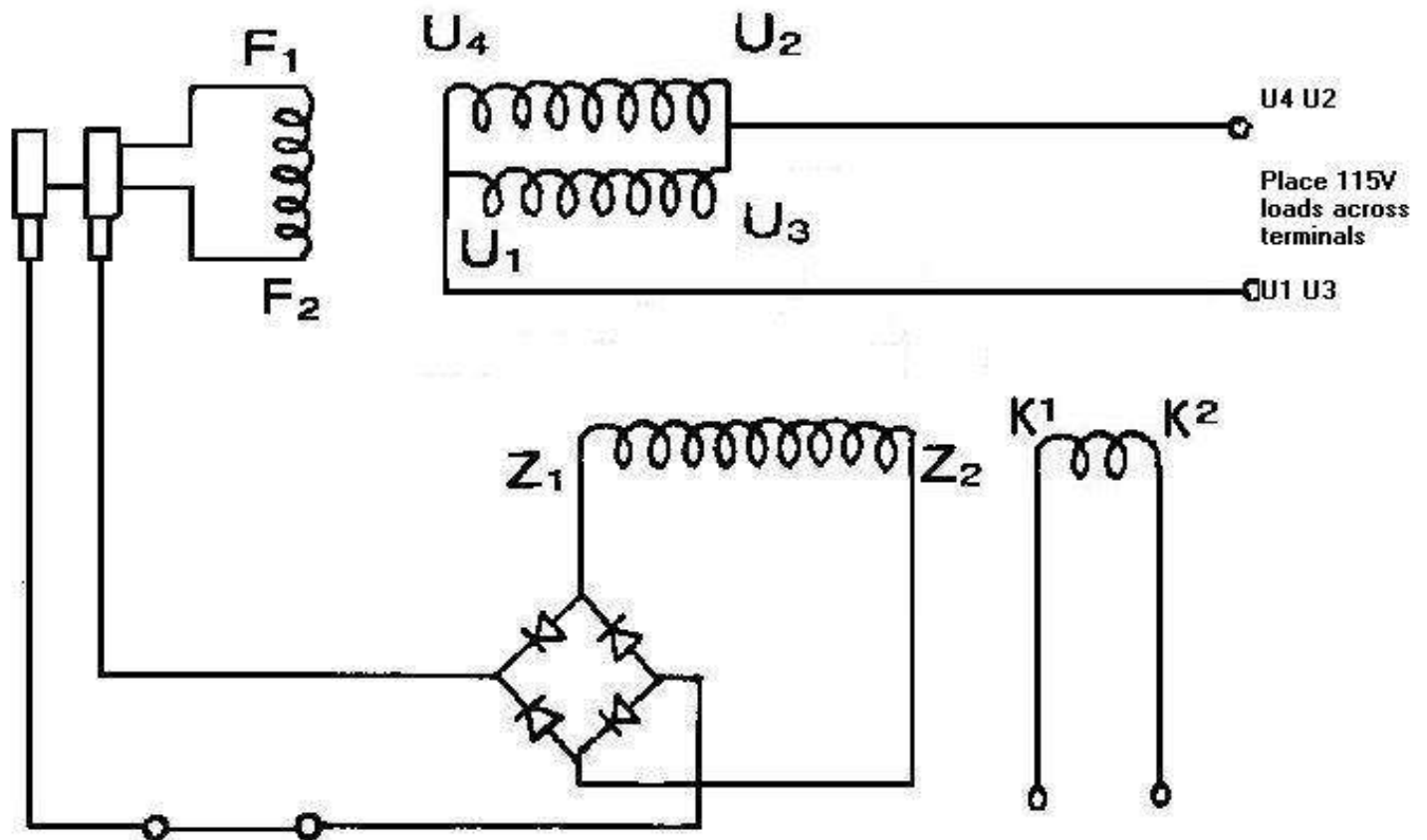

utterpower.com  
 Stator winding in parallel  
 115 volt only

Advantage: 100 percent of the  
 capacity can be utilized for  
 individual 115volt loads.

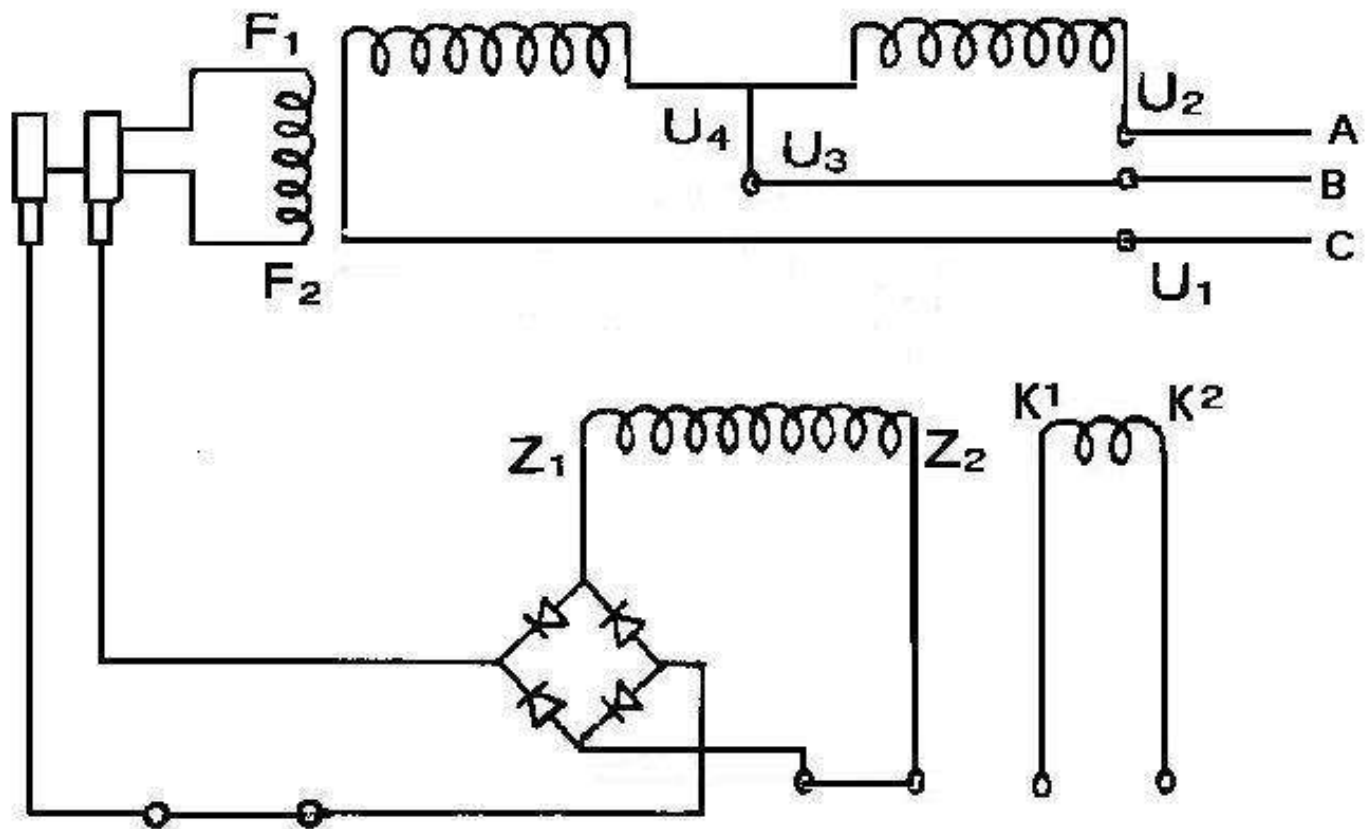

utterpower.com  
Stator wired in series for 230 volts

Advantage: both 230V and 115V outputs

Dis-advantage: 1/2 of the rated output is available to a single 115V load.

wire A - C for 230V  
wire A - B for 115V 50% of rated output  
wire B - C for 115V 50% of rated output

Some folks like the above drawing because it more readily explains why only 1/2 of the rated output can be directed to any single 115V load. If you follow the path back into the generator, you see that only one coil is providing the current. The other winding is not able to help out because it is assigned the task of making juice for the other leg, or other phase.

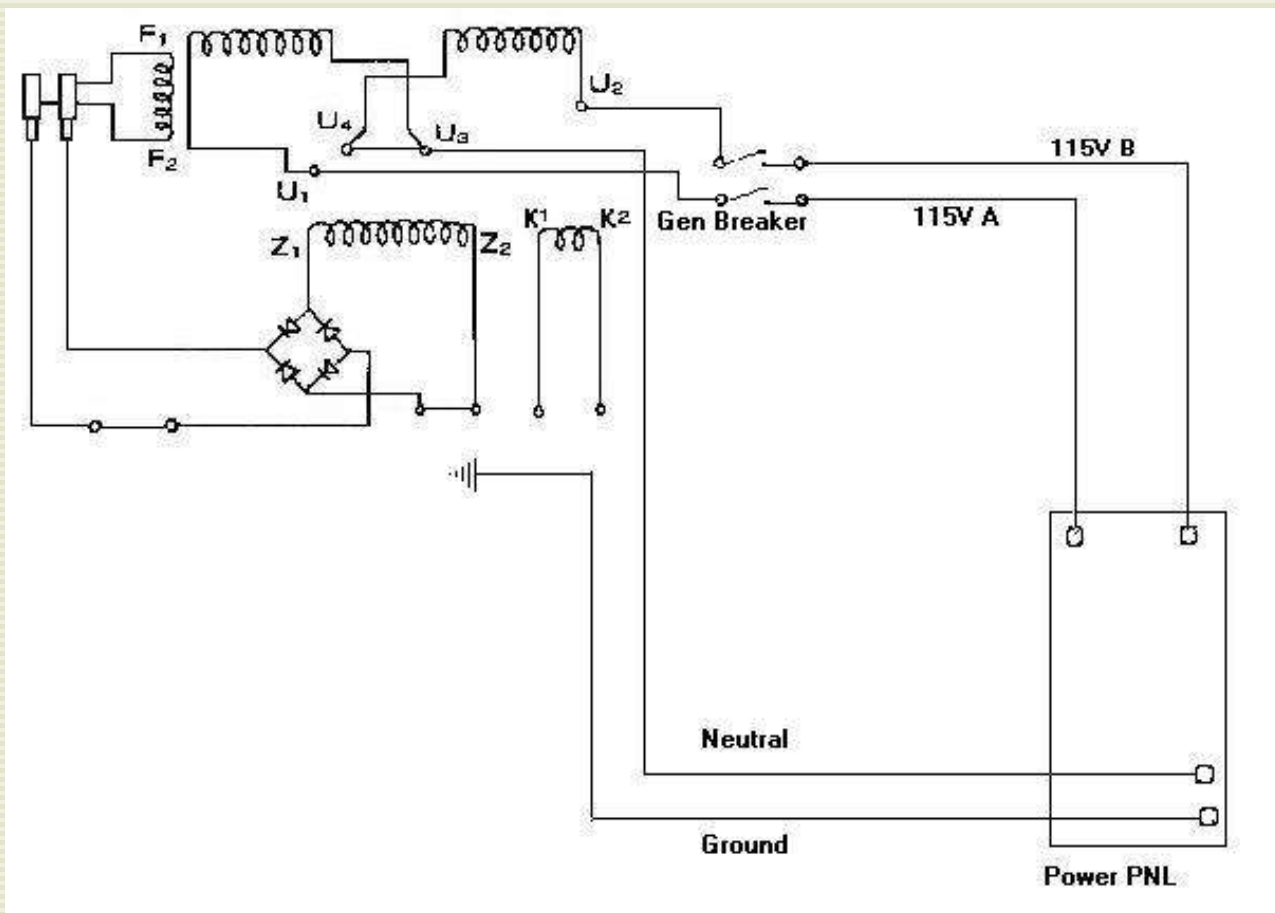

The above picture shows the ST head wired for 230V/115V to a common service panel. the Neutral and ground bus are often bridged. Make sure you sink a ground rod and attach it to a ground lug on the panel. If you have access to a well casing, or metal water pipe, consider making it part of your ground plane as well. Note the ground lead in the above drawing, this is picked up from the case of the gen head, make sure you get a good solid electrical connection. The power panel is typically fitted with circuit breakers to fit your individual needs. Readers sometimes write and say I need to put a diagram on my pages that shows how to wire to a panel. Here it is, and I changed the color to red so it's easier to find.

#### 6/2002 Addendum

I have received several emails asking if one could use the case of the generator as neutral. My answer is NO. If you follow the diagram above you will see that the neutral is wired to the center tap of the windings designated as U4/U3 in this particular head.

If you study the wiring in your house, you'd find that most of them use white for neutral and black for the the so called 'hot' side. If you study a house style electrical outlet, you will see that the white wire should always fit in one side, the hot in the other.

Also note that the home electrical panel is often set up with the neutral and ground connections 'bridged' or tied together. This could cause you to believe that it is OK to use generator case ground for neutral. Ground connections are for carrying fault current, you should never use these connections to carry current for a normal load. Think of them in this way..... 'if they're busy carrying normal loads, they may not have the capacity to protect you when trouble strikes'.

### A verbose rant on making connections to your gen head.

As stated in other places on this WEB SITE, we are all about cost effective solutions for DIYers. Sometimes cost effectiveness includes doing it right the first time, or removing the potential problems before they cause you trouble. During my life, I've witnessed thousands of hours spent on finding troubles with poor electrical connections, in one case, I saw a poorly crimped connection cause intermittent trouble in analog periphery of a computer. This one bad connection cost the company a fortune in trouble shooting to find; not to mention the down time of the equipment. There are lug terminals that can be installed with an expensive die that makes excellent connections, to place a lug on the end of a wire and crimp it on with pliers or a set of side cutters is asking for trouble. If you are building a generator that could be used for emergency back up, why would you make inferior connections? If you know Murphy, he'll assure the inferior connection fails when you need the genset the most.

The construction of the ST heads looks pretty good in most areas. But like most equipment, I can always find something to complain about. In the case of the ST heads, I think their terminal lugs and the method they used to attach them sucks. The lugs themselves are copper, they are far too soft to maintain a good connection with the wire. the fix is simple, you either replace the Lugs and properly crimp them on, or you solder what is there. It's a quick job, and all the leads I've looked at are plenty long enough to cut off the existing lugs if you wish. The other item I take care of is the leads to the volt meter, and indicator in the doghouse. I sleeve these leads, and place a dab of silicone in places to assure they don't rub on something. In fact, it's a good idea to sleeve all the leads and place a dab of silicone in areas where you think rubbing could occur. Another thing I'd consider, "why not by pass those handy external terminals"? Do it the old tried and true way, make your connections directly to the leads, and take them out of the doghouse via conduit or a proper portable cord through a standard grommet. If these things sound a little too much to deal with, get a friend with electrical knowledge to help you.

You'll note that crimp on connectors are used in all sorts of things, some were put on with the proper tools, some weren't. I know a few folks who have junked their old motor homes simply because they couldn't clear the electrical problems fast enough. Poor grounds, and those poorly crimped lugs can create a nightmare. Many of these motorhomes and trailers use the skin as ground. Sometimes you find steel screws, used to attach a wire lug to the alloy skin, dissimilar metal unions assure jobs for countless automotive electricians, I never thought about it, but this whole thing could be part of a left wing secret jobs program :-)

Another example... There's a company who builds small trailers including small tandems with electric brakes. A friend bought one of these and several years later, the electric brakes seemed to work on one side only... not the best of things to happen when you're towing something heavy. When I crawled under the trailer to trace the wiring, I found wire nuts like those used in house wiring. One connection was full of mud, it was wet and green and wide open. In my opinion, this is a connection that's guaranteed to fail sooner or later in the open environment. For all we know, an assembler thought he had a better and quicker idea, and decided to use this connector on his own, but the fact is, he was creating a condition that could put people and equipment at risk.

To 'sum up' this whole subject, [run proper ground leads, and when in doubt, solder all connections with electrical solder, plumbing solder is different, and will guarantee a problem. Pay attention to these things and you'll eliminate three quarters of electrical problems.](#)

**Important:** make sure the generator head gets fresh air . Don't cut off cool air to the head in your attempt to make the power plant quiet!

Look over the [Changfa/ST setup](#) and note how the alignment is done, consider doing something similar if you are going to belt drive the head.

## What about driving the gen head with a coupler verses a belt?

if you have an engine that will be turning 3600 RPM and a head that needs to turn 1800 RPM, you have little choice. But what about the Changfa that is rated at 2000 RPM, if you run the head with a belt, you can get a ratio where the head is at 1800 and the engine is at 2000, but there are more losses using a belt verses a coupler. What if you lower the speed of the engine to 1800 RPM,s and couple drive the head? which one would carry more load? I'd bet the direct drive would be nearly the same with less maintenance.

Look under ARTICLES for more information on direct drive couplings. If you have an engine with a very heavy flywheel, a direct drive coupling can be more cost effective and less trouble than a belt system. The more mass you add to the Gen Head side, and the more you decrease the flywheel mass, the more capable the coupler has to be; (read expensive). At this time, I think the L series Love Joys will do the job and reduce the coupler costs on small gen sets. When you go above the 1115, you need to look at more expensive couplings. I swap email with folks who are exploring cost effective solutions for VW diesels, and other small 3 and 4 cylinder engines. If you choose to go belts, you must understand that many of these engines were NOT designed to take a side thrust, so a belt drive system may not hold up without modification. these are things that can easily be overcome, understanding the requirement is key.

I offer aircraft engines verses automotive engines as a thought provoking example. The aircraft engine is designed to handle high side thrusts at the prop end. If you were to machine an adapter for that prop and attach it to an automotive engine, you could be in for some real trouble. There are plenty of examples of automotive engines that are modified for aircraft use, this can be a primer for your understanding.

Whether you decide to drive your gen head with belts, or a direct drive system, there are things to consider, as with most things in live, there are trade offs. No matter what we learn, there's always more to learn, these pages will continue to grow and

Installation

[change.](#)

[George B.](#)

[Home](#)



**04/29/02 utterpower.com announces it will stock parts for the ST Generator heads. these parts include**

**Dog House Front Panel and Meter, switches, rectifiers, brushes, complete brush rig assemblies, Keys for the shaft, etc, We do have a few bearings, but these are stock items you can order through Emerson Bearing, or Applied Industrial, or almost any other bearing house. These bearings are as common as they come, and we encourage you to buy it from common sources.**

**Did you buy it here? Did you buy it from a entity we support? Please send along your customer number, or if you've done business prior, we'll have you in the database.**

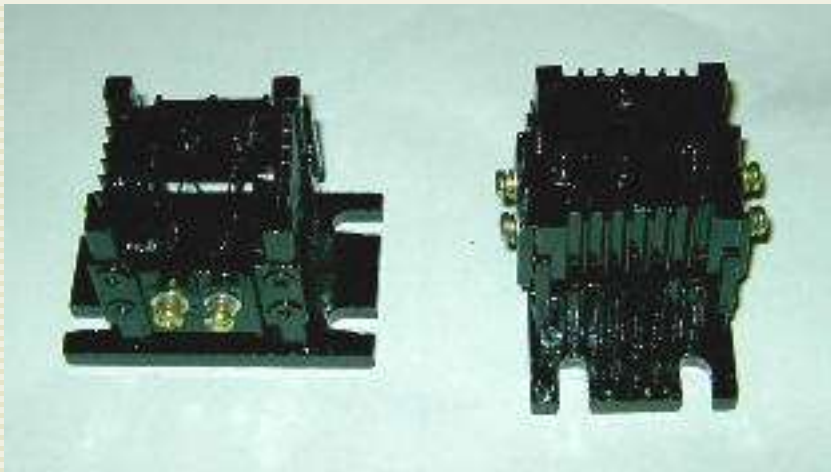

**Above: Part # ST\_rectifier**

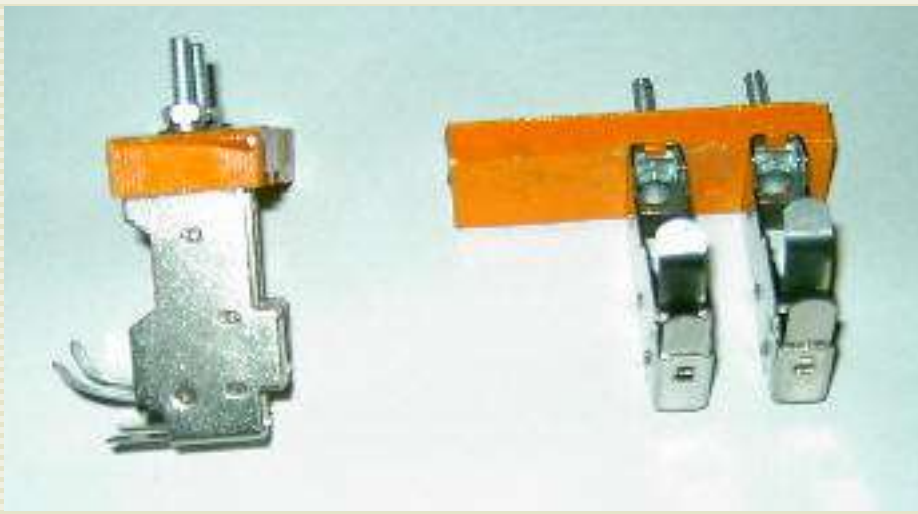

**Above: Part # ST\_ Brush holder**



**Above: Part # ST\_BRUSH SET**

**Parts contact: George B.**

**How do I get this unit up and running fast if something breaks?"**

**Let's look at the makeup of this genset, you'll see there's not much we can't do for ourselves.**

Cast Iron center housing, cast iron bell ends, rotor, stator, slip rings, brush rigging, brushes, bearings, 11 bolts, a volt meter, a rocker switch, a full wave bridge (diodes).

There's really only a hand full of parts you'll need to call on us for. It is my goal to find a 2nd source for most parts in these heads. At present, I am certain that everything can be replaced

with stuff you can find locally. I've decided to stock brushes, switches, volt meters, diodes and that sort of thing here, we'll do our best to keep prices reasonable, but it's easy to find a substitute part locally.

The bearings have the common number right on them, you can go to a bearing house and give them that number, they'll probably have them on the shelf. There are a number of discount bearing houses on the internet. Emerson Bearing is a great one. Bearings usually give you some warning that they are developing a problem, this may give you time to order a new one before it gets really bad. If you want to be prepared for anything, you might stock a spare set?

There really isn't anything else in the head that should wear out. If a winding were to fail, you should be able to locate the problem with an ohm meter, if you are reasonably handy, you might replace it yourself. If not, the local rewind shop should have no trouble working on this head. If a winding is damaged, the shop would remove it, match the wire gauge, form a new winding matching the number of turns and solder it into the rest of the circuit.

### **11/2003 an added note..**

As of this date, I have experienced one failure of a stock diode rectifier bridge. I have also received two requests for this part from other ST head owners. At this point, I'd say the rectifier is the most likely part to fail in the head, there just isn't much else in the design other than the brushes. This does not mean to say that this is a flaky part, we suspect that these failures resulted when prodding and poking around, and possibly shorting out the field lead or worse.

What I've done below is fit a standard North American rectifier bridge verses using a Chinese unit, you can buy them for \$5 to \$14 depending on the supplier. I do this because to demonstrate that you are not dependent on me or anyone else for parts. The field current and voltage is listed on the tag of ST Gen sets, this should be all you need to assure that the full wave bridge rectifier you select is adequate to handle the voltage and current, If I find a good place to order, I'll list same here, but this is a real standard part, and shouldn't be hard to find. Radio shack used to stock them.





Above is a picture of an older style head with the modification in place.

The little square device bolted to the inside of the case with the four leads is the new North American style rectifier. You should get four female spade connectors to match the male connectors on the new part. If you don't have a proper crimper, borrow one!

Note that this part uses the dog house as a heat sink, so make a good clean connection, and consider using some heat conductive paste between the part and the dog house, I have used a little anti seize for this connection, but I'm not positive it's anywhere close to the real thing. do note that this part is found in lots of consumer heads, I have replaced one in my Coleman generator, and there was no conductive past used there...maybe that's why it failed?



To the right of the screw driver is the Chinese style bridge rectifier, we will stock them, but understand you can use the American part if these are not available.

A gen set with a bad bridge will often have zero output. Pull the rectifier from the circuit, and use an ohm meter to read the Harmonic winding, if it looks good check the field winding and brushes, if they're good, suspect the rectifier.

Note that Fu King heads, look different than the head above, they are similar, but we think they're made with a little more quality and often better insulation on some of the wiring.

[See our trouble shooting page.](#)

[George B.](#)

[Home](#)



## Insulation

What does a higher insulation class buy you? You can run higher temperatures inside the generator head and still maintain a decent service life... that's what.

Common STs have insulation as follows:

Stator insulation is class 'E', the Rotor is class B.

**Note: Class E is a European spec, 120 C or 248 F maximum temp.**

Their approach to service life and longevity is building a unit with a massive frame, large ventilation openings, big fan, and wiring that is done in a way where the windings could be pulled and re-done in the field. The windings are not all glued in and sealed up, this means they don't have the highest insulation class. This appears to be part of their philosophy, a generator that can be rebuilt in the field if necessary.

What they've given up in this design is light weight, and compact size. The ST head should be the last head on your list if you plan to lug it around by hand every day. But it should run cooler than a compact unit by a whole bunch requiring less of an insulation class. I would also suggest you find another head for use outdoors in the weather, even though they claim the enclosure is 'drip proof' if you're planning to leave it outside in the rain, take the generator to a rewind shop and pay them to raise the insulation class.

Whatever head you buy, "no matter who makes it", remember the cooler you run it, the longer it will last. Never block the ventilation, if you install it in a shed, make sure it has adequate ventilation. I have heard stories of 10 kW ST heads making 13 or 14kw for a number of hours, seems to me this could shorten it's life. You should consider installing an amp meter if you are going to drive it with an engine that will allow it to be overdriven to this degree.

**A last thought on this insulation class issue**, I have a Honda EM5000, the engine never fails to start on the 1st or 2nd pull, but the head doesn't make juice anymore. The field winding has less resistance than it should. The cost of correcting this problem (according to the service center) is greater than the value of the generator.

I was reading a page from the ST "Operation and maintenance book". (Troubles and their elimination) section. **I quote:**

Problem: Open or short may occur in harmonic winding      Solution: "replace winding" and they mean it!

Let's face it, the Honda is lighter, and far better suited to dragging around..., but mine might

as well be a boat anchor...., if it was an ST , even I could fix it.

Please [send me your comments](#) regarding this page.

[George B.](#)

[Home](#)



## How to install new brushes the right way.

If you're going to change brushes in your head, take the time to do it right. In fact, the factory probably didn't do it right, so do it now.

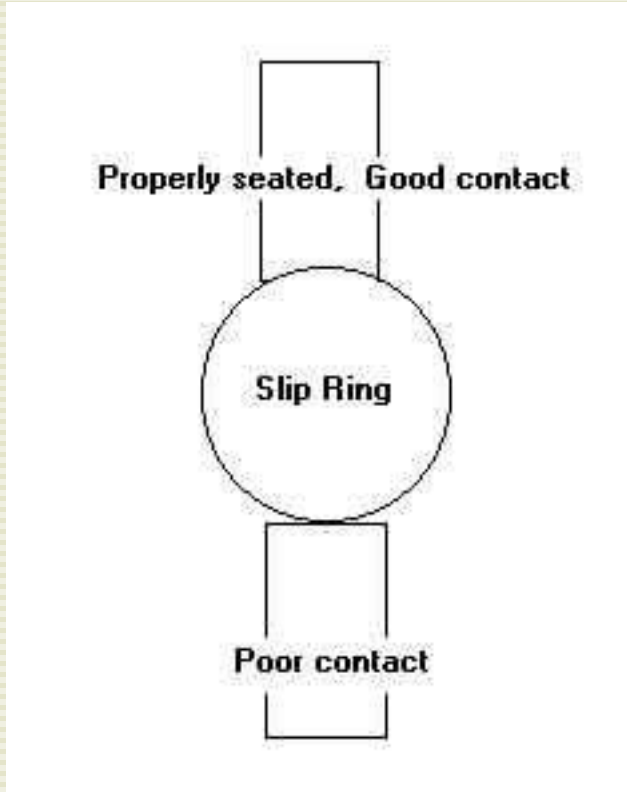

The image above represents an exaggerated slip ring with two brushes riding on it. The lower brush was put in with no adjustment, the top brush was seated and its contact end matched to the slip ring using 300 grit sand paper. Simply cut a strip of sand paper a little wider than the slip ring, lift the brush and fit the sand paper grit side towards the brush. Drop the brush against the sand paper and slip the paper back and forth till the end of the brush makes full contact with the slip ring. This will assure a better contact and will assure the full field current is delivered to the field.



## ST DIYer's projects

Mark's PTO Driven ST Head.

**UPDATED** Mike's 4Cyl Diesel Gen set.

**NEW** Wayne's PTO Driven ST head , a great idea for simple and cost effective setup, (if you have a similar tractor).

Phil P. out of the Chicago area shares the following, he says it runs like a Deer, I plan to post an article on Phil's design, and his methods to set up couplers. Phil has fun when the old times come by and scratch their heads...."Hmmm, I don't recall John Deere Making a genset like that".







Above is Mike McCarrol's welder rig, Mike is more than pleased with the fuel economy and power. Note that mike has used one of our hopper conversion plates to install a radiator and is using our direct drive verses belts. As of the posting of this second picture, Mike has put many hours on this welding set up and brags about the fuel economy.

The generator base is made of heavy gauge sheet metal bent to Mike's specifications and bolted together. Mikes radiator is equipped with a fan, the design relies on thermal siphon and stays cool even in HOT weather.



# Utterpower.com

Mark emailed me not long ago about making use of the small tractor he has to run the ST head. He noted that the PTO on his tractor had a speed of 950 RPMs at full throttle. He reasoned that he could cut it back a little and drive the head 2:1 and get the required 1800 RPMs. Following are pictures he sent me along with a snippet from his email explaining things.

Hi, George. Mark of PA. Here is a few notes about generator. The PTO. runs 900 rpm., pulley ratio is 2 to 1 which makes 1800 rpm. for generator. PTO shaft was found at tractor supply. Drive shaft was custom made to my specs by machine shop. , pillow blocks and pulleys came from a sawmill supply. The cart and 3 point hitch were my own ideas, made from odds and ends lying around, just used what was available. Put wheels on it, makes it nice to move around the shop. 3 point hitch makes it mobile, for when you need portable power. Put welder outlet on unit, to run small welder, works good. Can take welder any where now. Power cord for house uses same outlet.  
That's all for now . Mark



Notice the adjusters, Mark laid them out where they're easy to get at.



Mark has mounted and wired in a breaker box, It looks like he has also attached some metal boxes to the side of the breaker box to house some plug ins, also note his ground wire.

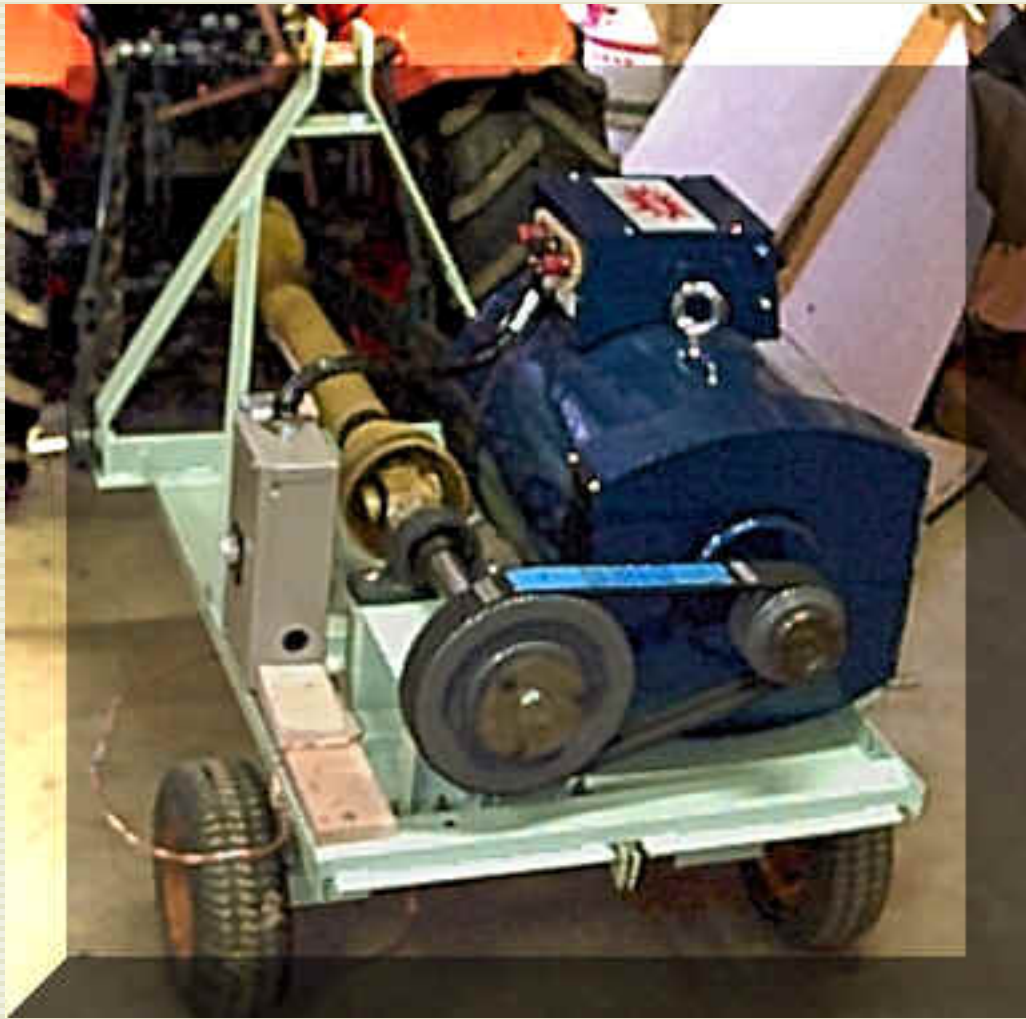

Thanks for allowing me to share your work Mark!

## Mike's 4 cylinder Kubota/ST20

**You'll work hard to top this effort!**

Hello George,

This is my generator project using a 20KW ST head. First I found an old boat trailer and cut the tongue down to the length I needed. I then found a 50-gallon fuel tank that had been used on one of those forced air torpedo type, shop heaters. Then I went to my local steel supply and ordered a light I-beam with a height that would allow me to drop the fuel tank inside. I welded the I-beam together creating the base, the fuel tank fit like a glove. I power the unit with a Kubota V1902 Diesel engine, about 39 H.P. I used a new radiator (electric cooling fan) designed for a Massey Ferguson 135-farm tractor, this since I have a tractor like this to spec. from. The drive couplings are made from "off the shelf" agriculture end yokes, the shaft for the generator measures out at 1-5/8 with a 3/8 key, I just had to hunt around till I found someone who carried them. I had a machine shop make my flywheel plate, which I welded one of the end yokes too. Other items, oil bath breather, remote mounted oil filter, fuel filters, and battery. Full engine gauges with tachometer from Kubota. Large 5-1/2" panel meters, amp and volt, still trying to find a frequency. Breaker box with 2-50amp 220volt and 2-20amp 110volt breakers, Eight-110volt plugs and Two-220volt 50 Amp plugs. Full metal enclosure with some help from my local fabricator.

Mike, Nashville TN







I think the enclosure is an amazing transformation... but notice that Mike has put larger wheels and fenders on his rig as well. I'd like to see a nicer looking rig, something tells me it'll be a while.

AS of FEB 2003, Mike shared he's had a 100 amp load on the set and it carries it with no problem.

Thanks for sharing your handy work with us Mike!

George B.

[Home](#)



## Wayne's PTO

There's a number of small tractors that have arrangements to drive something off the front. Wayne has taken advantage of the higher RPM of his PTO to engineer a simple and cost effective solution. Instead of speeding up the PTO speed, Wayne's problem was slowing it down to provide the required 1800 RPMs. This allowed him to use a rather large pulley right out of the Grainger catalog and a single vee belt.

Wayne can tell the story best, so here's some cut a paste from his emails. Do note that metric bushings are available right off the shelf for this pulley. Grainger might stock same, Applied Industrial does for sure.

Hi George,

I am going to send you some photos on separate emails so I am sure that you receive them. My generator project is almost complete except for the voltage control that we discussed. The tractor that you will see in the photos is a 22 HP diesel. The power take off pulley in the front of the tractor runs approximately 4500 RPM. I had to use a rather large pulley on the generator to obtain 1800 RPM. I got the pulley from Grainger and the **Grainger stock number is 2L292**. The bushing for the pulley is a 1 5/8" ID bushing and the stock number is 2L250. I had to have it machined out to accommodate the 42mm shaft on the generator. The bushing had a 3/8 keyway so I just machined 1/2 of the key to fit the keyway. The rest of the project is rather straight forward. The electrical box mounted on the frame is an outdoor box with breakers installed for both the 120 V and 220 Volt outlets. I put 2 120 outlets on one side of the winding and 2 outlets on the other side in order to divide the load. I will mostly use the 220 outlet because that matches my input to the house.

When we started it up it worked without a hitch. In fact, my wife was watching TV with all of the lights on in the living room. The furnace blower was running and all of the lights were on in the basement. I started the generator and went in the house and threw the transfer switch and my wife didn't even know that anything happened because the TV didn't even flicker.

All of the equipment for this tractor (including the generator now) attaches in about 30 seconds. You just drive into the equipment and it snaps in place. Then you attach the belt and you are ready to go. I didn't show you in the photos but the generator assembly raises up, by hydraulic, about 12 inches for transporting.

The bottom line is that the generator worked perfectly.

Thanks again for all of your help. If you want to use any of this material feel free to do so.

Wayne Thomas

3501 Hanover Pike

Manchester Maryland 21102

PS. You may want to look at our WebPages located at [www.thomastreefarm.com](http://www.thomastreefarm.com)







Wayne,

Thank you for sharing your project with us, after seeing your work, I remember a Bolens tractor I had where you could take power off in the same way. I think your set up would have worked well on that little tractor too. Your project will spark ideas for other readers, and I learned something new too.

George B.





**Anything you read here is for educational purposes only. Remember... this stuff is dangerous and could kill you or somebody else.**

So you want to do something with that new generator set? maybe set up a room in the house that can be fed with the generator when the power goes out? Before you do anything... remember this, that big ole transformer out on the pole works both ways, it's a step down coming into your house and it's a step up leaving.

With that said, **make sure you isolate your household from the grid before you try and power anything!**

I've seen people pull their power meters to accomplish this, other people wire in transfer circuits that automatically isolate the load from the commercial power with a double pole double throw switch. Our rec room backs up to the garage, the plug ins, and overhead lights in both the kitchen and rec room are all on the same breaker. I went to the wall between the rec room and garage and removed the wall outlet assembly. I got a piece of 12/3 wire and pig tailed onto the outlet and used this source to power a new outlet on the other side of the same wall "in the garage". There's a special box, called an "old work box" that can be mounted in a wall anywhere without being nailed up against a stud, easy to do. With this accomplished, I made up an adapter with back to back male plug ins.

When the power goes out, I go to the power box and OPEN the circuit breaker marked for the rec room. Next I place the generator next to the garage where it can annoy the neighbors the least. I run an extension cord into the garage and plug it into the adapter and then into the wall outlet that feeds the rec room. We watch TV, run the coffee maker, the microwave, and enjoy the outage. This worked quite well for me, it's probably not legal, and probably less safe than it should be. I've noticed that the transfer switches designed for this sort of thing are becoming reasonable, big hardware stores usually have them in stock, not to mention electrical supply houses.

Remember reading that little ad in the back of magazines..... **How to make your power meter run backwards.** For the most part it's true and can be legal. Following is basically how one accomplishes this. I have one of those fancy new meters, don't know if we can spin it backwards, maybe I'll try someday?..... Here's how it works....

But first a warning.... let's say you have two cars heading towards each other at 60 miles an hour, when they hit, there's a big bang and lots of damage. The same cars moving at the same speed in the same direction can touch with little or no damage. So it is with electricity.

You fire up your generator and try to "co-phase" it with the commercial power, you throw the breaker and **bang**, the breaker blows or you get smoke. Your generator has to be "in step" with the commercial power to accomplish this.

If you were to take two 115 volt light bulbs and put them in series across one leg of your generator and one leg of the commercial power, you would have a way of telling when they were "in phase" with one another. you would simply change the speed of the generator until the lights blinked slower and slower. Once you got things adjusted where the light went completely out for a second or more at a time you could "co-phase" the two. You would throw the generator breaker when the light is out.

Once you've accomplished this, your generator is LOCKED in step with the commercial power generators. The next step is to raise the voltage of your generator to force the current to flow out of the generator and back into the grid, If your power meter is the type that can run backwards, you will see it happen as you slowly raise the voltage, (excitation voltage) (Note: changing the voltage is not possible in most of the brushless consumer heads!) If you have a consumer type generator, you probably can't raise the voltage, if you have an ST style head, or one that allows you to adjust the field voltage, it would be a snap. In any case, you need to pay attention to the load and not overload your generator. I've left out a bunch here, but you will get the idea.

Some people view the power grid as a battery, you run your generator when you want and spin the meter backwards. Then you use the power from the grid to power your home spinning the meter forward to where it was when you started.

When you attempt to co-phase a generator, there's things that are nice to have, An amp meter is a big one.

Comments regarding content are always welcome, send me an [email](#).

George B.

[Home](#)



Generator Head Wiring, a verbose page on the difference between a center tapped head, and a four wire head.

This page shares information that is typical of many gen heads, not just ST types. This is educational only... never play with electricity, in today's world it's never your fault. Attorney's love left thinking.... opps.. I forgot, we were talking gen heads...

I've seen some generator heads being sold that are 3KW and center taped. A single phase generator head sold as a 120/240 volt head often has only three wires. If the head is sold as a (120 or 120/240) volt head, it should have four wires. This provides more options and flexibility.

*So what's the big deal?*

In my humble opinion, it's no big deal as long as the head provides about twice the KW as you might use for a >SINGLE< 120 volt load. Let's take a 10KW head, half of that would be 5KW. and that's plenty for a skill saw or most of the single 120 volt loads we might wish to run.

A center tapped 3KW head will deliver only 1500 watts to a single 120 volt load. This would be pretty wimpy power for a direct drive skill saw, and there's bound to be at least one guy who bought a small head thinking he was going to run one. If the head isn't set up properly (fused or breakered at the proper amperage), you could smoke the gen set, or possibly damage the skill saw. Some folks might even think they can pull the full 3000 watts of one winding.... they'll be plenty unhappy when the winding goes, and it will if they didn't put a proper fuse or breaker in the circuit.

So what do you do if you bought a center tapped head and it's not going to meet your needs? If you have average skills, and a little patience, you can often disassemble the gen head and convert it to deliver full power into a single 120 volt load. I'll also show you how you can flip a switch and get the 240 volts when you need it.

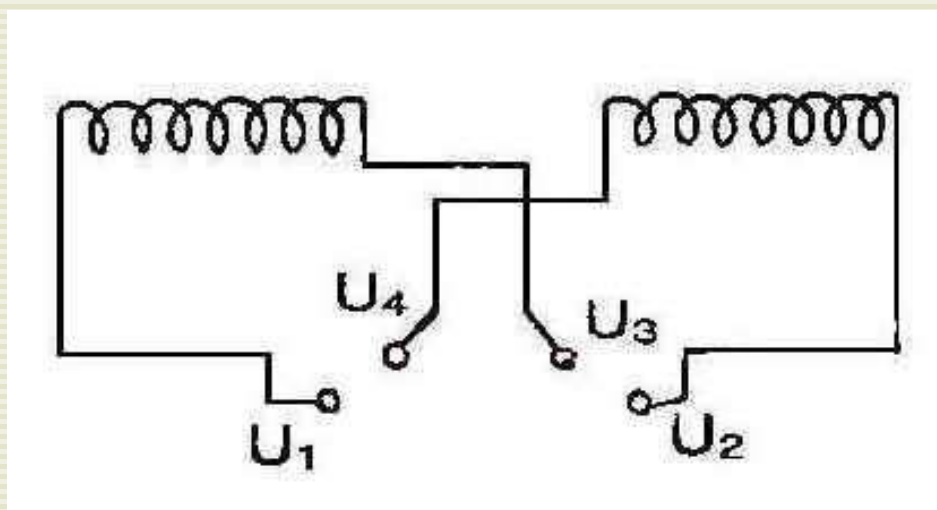

The above schematic shows the stator windings with four leads. If U3 and U4 are tied together, you will provide 240 volts across U1 and U2, and you'll see 120 volts between U1 and U4/U3, and 120 volts between U2 and U4/U3. If you wire the head where U2/U3 are strapped together and U1/U4 are also strapped together, you will have 120 volts across the connections, and you can provide the full rated output of the head into a SINGLE 120 volt load. 240 volts is not available in this set up, and some folks don't need it or want it.

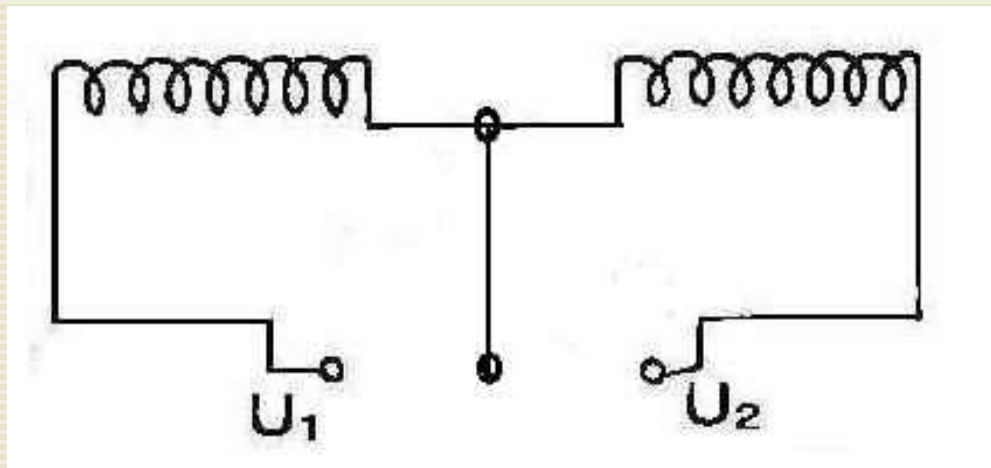

The above schematic shows a center taped head, note there's just three wires. the center tap is often labeled N for neutral. What should be obvious here is you have no choice as to whether you're going to have 240 volts or not. It's going to be here whether you want it or not. This is fine if you have a larger capacity head. At three KW or less, it's a poor choice (IMHO).

So now you know the difference. If you are one of those people that bought a 3KW or 5KW head and discovered the limitations only after you bought it.... and you think the limitation is far too severe, read on at your own risk; I'll show you how to modify it. I have heard that the typical charge for this mod is about \$125; if you can find someone to do it. Of course, we're going to teach you to do it for free, and we're going to tell you how to properly fuse or breaker your head as well.

But first, you should know how to solder, you need a soldering iron, you need to know what heat shrink is and you need some patience. It's not hard, it's just a tiny bit tedious.

Of course we'll be talking about the ST head, but the concept is the same for heads of different makes.

The first step is to get into the head to make the changes, it is best to pull the rotor and get the brushes out of the way. these are all simple things on an ST head, don't be intimidated, my daughter could have taken this apart at six years old, and put it back together too.

Take off the vent covers, and the slip ring cover.

1. remove the four bolts with **10mm** heads on the end bell, this releases the bearing retainer/brush holder post.
2. remove the four bolts that hold on each bell end..... '8 bolts total'. **14mm**
3. pull the brushes up in their holders so they clear the slip ring.
4. Use a rubber hammer to loosen the slip ring bell housing.
5. Remove the slip ring assembly
6. Grab the rotor shaft and carefully guide the other end of the shaft out through the stator housing. Find a safe clean place to set your loose parts!
7. Turn the wiring end, (slip ring end) towards you on a sturdy work bench. Get some decent light to work under.

**Now for the fun!**



Here's what you should be facing. You'll have to carefully trace the (N) lead down through the lacing. Use an exacto blade or something that will carefully cut lace without nicking enameled wire, it's pretty easy if you go slow. Don't be afraid to move other wires out of the way and to prod and pry a little as long as you're careful.

If you look at the wiring below, you'll see a pig tail right in front of the needle nose pliers, this is where stator windings are joined, and sheathing is placed over them, this is not something we'll need to mess with. To the right of that is the CENTER TAP we are going to split. You can see two groups of wire coming out of the stator and being terminated to the (N) lead forming the center tap.

Use your exacto blade to carefully remove the sheath and expose the solder connection.



As you can see above, I've carefully removed the splice, cleaned the varnish off the wires with 300 grit sand paper and re terminated the Neutral lead to one side of the splice. Although it's not clear, I've divided the stranded wire and soldered half to each of the varnished wires coming out of the stator. Make sure you use a big enough soldering iron and that you do your bending on the stranded side verses bend and kink the varnished wires. Always make a good mechanical connection before you solder wiring. check the color of your solder joints, they should be shiny, not dull. At this point, I made another lead up of similar stranded wire and terminated it to the remaining group of wires coming out of the stator (on the left above) using the same methods.

Now it's time to slip heat shrink of the proper size over your solder joints, be generous and overlap on each side a good amount. shrink it with a BIC lighter or other heat source, and lay the wiring back into the stator the way you found it. look around and see if you can find some lacing similar to what you've cut out. when it's all in place, you can paint on some electrical varnish and let it dry. Maybe finger nail polish would work? cut off the excess lacing.

Now it's time to 'ohm out' your work. Make sure you have continuity between U1 and U3.. and U4 and U2. Check that you are on the meg ohm scale between U3, and U4, it should be open. Re label your leads from U1, N, U2 to .....

U1-----U3    U4-----U2

**And finally, we should talk about adding breakers or fuses. It would be a shame to smoke your head when something gets shorted out; but first, let's take an imaginary trip to your household fuse (breaker) box,**



A typical fuse box is set up where every other breaker is feed from a different phase. If you have a typical box, you may see two breakers in the same housing. When the electrician plugs in a double breaker, each side is automatically feed from a different 120 volt leg (phase). Put your volt meter across the red and blue and you'll get 230 volts maybe higher or lower in your area.

Now for the fun. Lets say each breaker is 15 Amps, And both red and blue breakers feed (separate) 115 volt loads, they'd need to around 1725 watts (15 amps) to blow.

If you use these two breakers to feed a 230 volt circuit, you'd have twice the voltage and you would need to trip out at the same amperage to protect your equipment. In this case, you can see that the voltage travels through both breakers and one or the other will trip first. the breakers don't care if you are going to use 115 or 230 volts, they will perform their function at the specified amperage.

Best wishes,

[George B.](#)

[Home](#)



## Making your own power

**I** met him in the early 70s, He wore his hair close cropped and didn't pay much attention to what was in style. He was always clean and close shaven, but he didn't have electricity or running water. We'd visit at a mutual friend's house and Harry would talk about breaking ice down at the spring house where he took his morning shower.

Through the years I've come to know Harry pretty well, He's mentioned more than once the story about the local power company wanting to charge him an arm and a leg to bring the power into the OLE homestead where he hangs his hat. It's probably not more than 1000 feet off a paved road, but the cost of bringing in power was more than Harry was willing to pay.

Visiting his place is always fun, when you turn up his drive, you travel through a marsh area that provides privacy and a buffer from the road,



you turn left and side hill up about 75 feet above the stream. Tall Douglas firs, and big Cedar trees grow here,



there's a thick carpet of moss in places, and well worn animal trails leading down to the stream.



Harry has several acres cleared where fruit trees grow, and a garden is planted, the sunlight finds it's way through the clearing performing its magic.

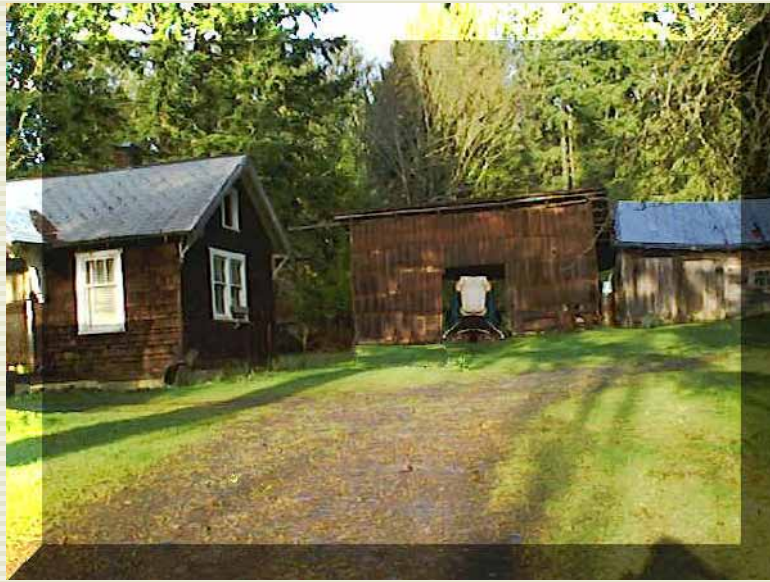

The old cabin looks no different than the first time I saw it thirty years ago, To the right of the cabin is a shed made of hand split cedar boards. The frame is made of poles peeled long ago. The doors of the shed haven't been fully closed for some years, Harry's old Piper Cub doesn't quite fit, the cowling and wheels hang out the front looking totally out of place. . Harry is going to get around to fixing it some day.... but I think he's just as likely to pay an electric bill as finish putting the Piper together, Harry is full of surprises, so I'm not placing any bets.



Behind the cabin is an old Merc, with a 63 plate, Harry's Brother "John" parked it here when he went into the Service, I think he always planned on getting back to pick it up, but you know how things go, a guy gets busy and just never gets around to it. To the right of the clearing is a Ford pickup, although its covered with moss, it only has 77,000 miles on the odometer, Harry parked it during a gas crunch, and bought a foreign car. I don't think it's moved since.



Dropping over the side of the hill towards the marsh, you find a short trail lined with stepping stones, at the end of the path, you find what's left of the homestead spring house and a shower house. Harry had a boat wench that raised a drum full of water into the air providing water pressure to the shower head, don't know exactly how he's got it set up now, but it doesn't use electricity, that's for sure.

A few weeks back, Harry dropped over to my place, I was putting a fresh coat of wax on the Changfa Diesel I bought from Joel Koch. I could tell just by looking at Harry that it was love at first sight. Harry ran his hand across the flywheel and moved it slowly till it hit the compression stroke. I didn't wait for him to ask, I handed him the start handle and pointed out the compression release.

"Ok Harry, set that governor control down another quarter inch and lock her down, then wind her up as fast as you can and let go of the compression release". Harry wasted no time, as he turned it over I pointed out the "click, click, click" was the fuel injector firing. Harry let go of the compression release and the Changfa blew two big smoke rings and came to life with a steady idle. Harry stroked the gas tank and fondled the fuel line going down to the fuel filter, he finally looked up and said " I've got to have one of these".

As of this date, Harry has purchased both the Changfa and a Generator head for his own DIY extended run Generator. Since Harry's approach to living and problem solving is a little different, you might enjoy following his progress. Come back and visit, I'll post pictures of Harry's installation, maybe he'll have power in time to celebrate his 60th birthday?



Harry's new machine still has the Evap cooling in place, but it's ready for running at low speed for it's break in. The cooling system will provide hot water for the shower house.

May 10th 2002

After giving considerable thought to the placement of the generator set, Harry decided to remove an old homestead structure and use the poured concrete floor that was under all the rubble. There's some concern about fuel oil and lube oil getting into the spring so he decided to place a pan under the generator and to build the power house out of block and seal the floor and the bottom row of blocks.

Harry thinks the block house will hold the noise and be a trouble free fire retardant structure. It is also central to the cabin and the spring house where the majority of the electric power will be used.



Here's the location of the power house, look at the earlier picture and you can see that an old log structure has been cleared away so the concrete floor could be reused. Note the spring house to the right of the new powerhouse location.



Here's what's below the spring house, water runs at more than 20 gallons a minute year around from this spring, I don't know how much drop there is, but I would think this might spin a micro water turbine.



Here's a better view of the powerhouse floor.

December 7, 2002

Harry showed up at my place this week with a progress report on his generator house. He's planning to be ready any week now; I figure I need to go out and take a picture of what he's got done.

April 23, 2003

I dropped by Harry's place to see how he was doing on his generator shed. As a person might expect, if you have waited more than thirty years to install a power source, you can probably wait another year or so to do it the way you want, and the effort should never conflict with fishing, or any other thing you like to do. As I was driving up; Harry was just about to lift the canoe onto the car rack to go fishing. We talked about his progress, and the design of his generator shed. He shared his concern about rushing into things, and how he thought it was good that he had been proceeding slowly giving himself plenty of time to work out the design and details. Of greatest concern is the fuel oil and the need to protect his pristine water source that is down hill from the power shed. Harry has decided to place a pan under the engine and fuel system to catch anything that might drip. As a back up to that, he is planning to lay down some saw dust on the down hill side of the shed that would hold any diesel that might run off the slab. Harry said he knew he was behind schedule, but thought he'd be ready to place the engine and gen set by June... we'll see..





Picture above showing Harry's progress. He warns that the six inch block he's decided to work with are not working out the way he wanted, but it'll make a shed.

Stay tuned for the rest of the story.....

George B



June 13, 2002

As of this date, I have met only one person who is running a Changfa near continuous duty in North America. What's great is Andy is an outstanding mechanic and has been sharing his experience with me via email !

Andy is planning to get a digital camera and I'm hoping to do a story page on his installation and his findings.

Here's a taste of what's going on.

The setting is in the Mid West on a farm sized parcel of land. The Changfa hit it's break in at 174 hours of use; Andy's wife became alarmed when the generator took far less fuel than expected during a refueling around this time.

At 50 hours, the oil was changed and the strainer inspected, nothing was found in the strainer, not a spec of anything. Although Andy did find that his engine did NOT have Safety wire on the rod bolts; (they are set up to take it) Andy added the wire.

Andy's average loads appear to be heavy, I don't know all that he's carrying, be he thinks an average load is around 5000 to 6500 watts, but he has cautioned me that he isn't set up (YET) to provide a precise figure.

He has been shutting the genset down once every 24 hours, this has proved to be a good thing. Once shut off for a check, the Changfa failed to start. With a little investigation, it was discovered that the intake valve was leaking. Andy is not positive that adequate clearance was maintained in the valve train, but he did check for that once the problem was discovered and it seemed OK in it's cooler state. Andy didn't like the alignment of the rocker arm with the valve stem.

Andy said he was amazed how easy it was to pull the head and liked how sturdy everything looked. There was an area on the intake valve that lost it's seal, this problem grew worse with combustion gases till the problem was found during a routine shut down. It was also found that the hard water than Andy was using in the evap cooling had almost completely blocked some of the cooling passages. it is not known if this caused some vapor pockets that aggravated a problem or added enough temperature to use up the valve clearance.

After inspecting the valves, Andy decided to do a three angle valve job on the seats and the valve faces. He said both the valves and valve seats were VERY hard and it took more than the normal effort to lap them in. Andy felt this was a sign of an engine built to last a long time.

**I suggest that we check our engines for proper valve lash, and discard the evap cooling**

**if you're going to run the engine a bunch. After investigating the use of hard water in a hopper, it appears it has caused numerous problems in other cases. If you are going to keep your hopper cooling, I would set up a barrel to collect rain water or find another source of mineral free water for the hopper.**

I look forward to sharing more about Andy's experience with his direct drive Changfa195/ST generator. At this point, Andy thinks this is the best and most thrifty engine he has ever owned. Time will tell if he continues to think that way. come back for more on the "Andy Story".

**Andy's engine had another failure that took the oil pump out.** Andy was not able to catch it in time and the engine suffered severely from lack of oil. Andy put some effort into determining what exactly happened, but I'm not sure either of us know what happened first.

As of this entry, I have learned more about this design. Hardy Diesel probably has more experience with this design than anyone in North America. They have pointed out that the bearings on the counter balance shafts are well loaded and these bearings need to be of good quality and in good condition. If the bearing on the counter balance (oil pump end) fails, it will wear at the pump drive pin, eventually causing a failure. If you don't have an oil pressure shut down, you could lose the engine.

The issue of Chinese bearings verses others is complicated, but I think a bearing house said it best.... The Chinese make thousands of great bearings, and a few bad ones, due to quality control issues, you don't know if you received one of the few bad ones.

If you were to replace any bearing in this design, removing the side cover and replacing the bearing on the counter balance pump drive end should be the first one. After thinking about Andy's failure and all of what was going on, it is hard to say what caused trouble first. But I do think this bearing went out and is responsible for wearing down the pump drive pin till it could no longer turn.

At this time, I'd take Hardy Diesel's advice and note the loads placed on the counter balance shafts. If you're not going to put an oil pressure shut down or alarm on your unit, better think about changing the bearings out as an insurance policy.

As for Andy, he's a busy Man with a family and lots of chores around his farm to complete, if he attempts to run 7/24 again, I hope he contacts me so we can share more info.

IMHO, you'll need a closed system with a proper coolant to run 7/24, and you better have an oil pressure shut down or alarm.... anything less puts your engine at risk.

**I'll be looking for other 7/24 runs, email me if you try it.**

**As of May 10, 2003, I have not received a single report of a bearing failure in a Changfa. I think Changfa has made a big investment in QC and may be making one of the better engines to ocome out of China.**

**George B.**

Home

**Utterpower.com**

## Custom Direct Drive Adapter

There's a standard used in Asia where pulleys are fitted to engines using a three point pattern. The 185s, 195s, 1100s, and 1115s from different manufacturers have the same mounting pattern and accept the same pulleys (with exceptions here and there) See the [Changfa page](#) for examples of the direct drive.

If you look over an Asian engine; you'll notice there's only enough crank shaft hanging out of the engine to mount the flywheel. To make matters even more difficult, the flywheel is held on by a big nut that sticks out further than the face of the flywheel. This makes it a little harder to fashion an adapter for direct drives.



Here's the direct drive adapter that Randy Allmand and I came up with.

The raised center portion is designed to clear the flywheel fastener. The three holes in the lower flat area align with the Asian flywheel pulley mounting points. The recess in the top, and the four inner holes accept the L110 Style Love Joy Coupler that is so popular in North America. Although not shown, a serpentine (multi vee) pattern can be cut into the raised portion of the drive system to allow an alternator or multiple accessories to be driven efficiently.



**Above is the bottom side (flywheel side) of the adapter. The Asian system relies on the machined lip to 'center' the pulley or adapter onto the flywheel. This lip can be seen above.**



**Here's the completed 2nd generation adapter**



**Here's the bottom side, the raised center makes room for the flywheel fastener and the four bolt heads and lock washers. The bolts are set with lock tight to assure that they never back**

out.

The adapters are built one at a time to a high tolerance, you can order the adapter side as shown above for **\$159 dollars plus shipping and handling**. All prices subject to change without notice. The adapter weighs 9 pounds, worst case on shipping would be around \$18 UPS Ground as of 9/2002.

Love Joy coupler parts can be purchased throughout North America. Emerson Bearing and Applied Industrial are examples of the many suppliers that will provide you parts.

I have fitted our adapter to four different 195 style engines. One of the fly wheels fitted appears to have been made on a Monday morning, one bolt hole misses by a few thousandths, you could crank it in, but it's not the way I'd do it. Randy Allmand and I discussed opening up our tolerances, but decided we'd keep things tight and allow the customer to file out, or drill a mounting hole a size bigger if they find their pattern is a little off spec.

**12/11/02 Check out the new MJ McCarrol Drive Adapter!**

To order, send us some [email](#) and we'll get back to you.

[George B.](#)

[Home](#)





**?Why a direct drive you ask? Answer: To....Reduce the side thrust on your crank bearing to ZERO, do the job with fewer parts, less expense, and reduce the frictional losses allowing you to run more efficiently.**

**9/2003**

**Phil Podkanowicz of Illinois has done extensive drive testing to prove the difference between high end commonback vee belts and our direct drive system. Phil compared a vee belt system where the engine was run at rated speed, verses our direct drive system where the engine was run at a lower speed.**

**Due to less losses in the drive system, the generator actually made 200 plus watts more wiht the direct drive and did it at lower engine RPM! Thsi means more power, and less piston speed which should mean longer engine life. We should have an article about Phil' efforts soon.**

**The [MJ Direct Drive, for Asian Engines](#), the perfect solution for DIYers.**

**Do you own an Asian 185, 195, 1100, 1110, or 1115 ? The MJ drive is provided custom built for each of these engines to allow you to drive generator heads, pumps and other devices without belts, pulleys, tensioners, or bushings.**

**185s typically index on the outsides of the drive, all the others index on a ring cut into the back of the drive that matches the cut in the flywheel. 195s have smaller mounting holes than 1100s and larger engines. The 185 drive adapters require more machining.**



**We start with a quality purpose built alloy casting.**

Drive couplers are fitted with the L110 style Love Joy (six pin) half making it ready to bolt on and go. Simply select the proper L110 style coupler half, (Shaft size), and the inexpensive rubber spider and you're in business. One call to [Applied Industrial](#), and you'll have what you need for the generator side in the mail.

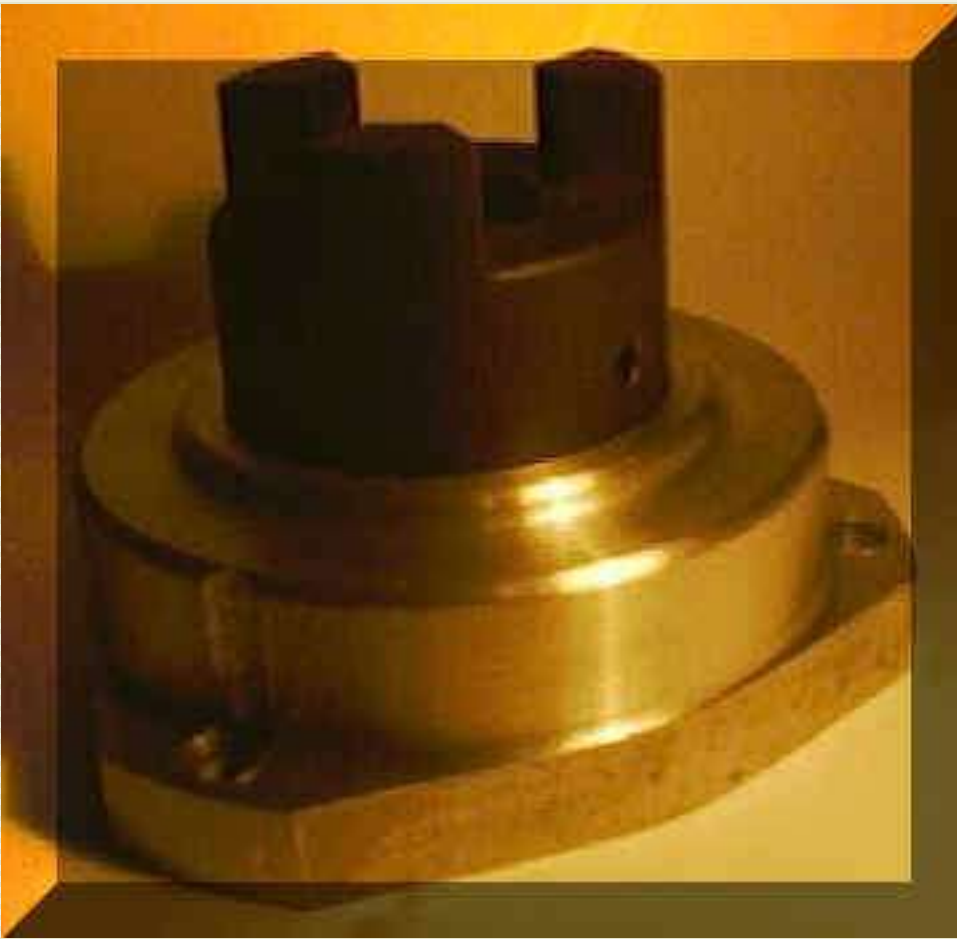

Picture above is the 185 drive, note the extra machining required. The unit is mounted with metric allen head "cap screws". As shown above, \$159.



Above is typical of the 195 thru 1115 engines . This assembly is **\$159**, the drive indexes on a machined ring on the bottom side of the drive. Your stock Metric fasteners will work with this assembly, you must specify your make and engine size.

If you think this is a bunch of money, you haven't priced common back belts, quality pulleys and bushings. If you go the pulley route, don't forget to calculate the extra frictional losses (**horse power loss**) and the need to adjust belts and eventually replace them. Also note the side load you are putting on your crank shaft. If you are making a generator that will be running often, this could be an important factor. Also be aware that it's a poor idea to use small diameter pulleys when you are above fractional horsepower. Keep in mind that small pulleys also require special belts (more expensive) to make that tight bend. [Consult an expert before you buy pulleys](#) , lots of us have had to buy them twice before we got the right stuff.

## Setting up the McCarrol drive.

There's pictures on the Changfa pages of engines and gen heads coupled with the love joy set up. The whole idea is to get as good and straight alignment as possible. This is quickly done with a short steel straight edge. Lay it along side the love joy halves on top and on the side for a perfect alignment, use shim stock to raise or lower till all is straight and then lock the engine/head down tight. The lovejoy halves are made of a 'sintered" material, it is highly probable that the half on the generator side will split in half if you experience a hypothetical 'train wreck', where the rotating mass comes to a sudden halt. If you don't understand the

concept, it's simply sacrificing the cheap an easily replaced part, so the expensive parts like the engine crankshaft doesn't take the abuse.

[George B.](#)

[Home](#)



### **Finding the right parts**

If you invest in fractional horse power pulleys to drive your alternator or generator head, you will most likely have trouble. Make sure you take the time to educate yourself or call someone who works with this stuff everyday.

If you don't know where to go for industrial grade pulleys, belts, bushings, couplers, etc, try calling **Mark, Jan or Kevin at 253-872-5398**. They work for **Applied Industrial**, who has outlets across North America. **All three individuals** do a great job of locating metric bushings, couplers, and other drive components you may need to put your DIY project together. This outfit is good at getting you the right part the first time.

[George B.](#)

[Home](#)



# The Listeroid Page

[Want to buy a Lister ?](#) Email [George B.](#)

## **A first look at the old Lister design.**

If you have interests in efficient off grid power production, you may have heard of the old Lister design. It's a heavy double flywheel stationary engine built from the ground up to be maintained and even rebuilt in place. This design was built by the British and was still being produced by Lister itself in 1987. The Indians started building parts for them and eventually assembled whole engines. The name Listeroid means 'copy', and some engines are close copies for sure. Amazing as it seems, this design still provides great fuel efficiency. I received an email from an Electrical Engineer who is very interested in Alternative fuels, and home power production. His personal tests revealed that our 6/1 produced a 14% improvement over the very efficient Asian 175 diesel he had been testing. This test was done with a brand new engine right out of the crate, it is likely that the efficiency gain will become even greater as the engine 'breaks in'.

There's another thing you need to know... this is NOT an engine full of washers, clips, spacers, shims, and all the little things that seem to jump out at you and roll across the floor into the darkest corner of your shop. In this design, things are purpose built, and there's darn few of them. I don't care how challenged you are, this is a simple engine, and easy to work on.

Your 85 year old Grandmother could rebuild this one if you put a chain fall right over the head so she can pull the cylinder without help. In fact... if you go down a few pictures on this page, you'll see the cylinder resting on a piece of plywood. The plywood is resting on top of the four massive engine studs, it makes a great work surface to hone the cylinder when fitting new rings, use a piece of plastic sheeting to provide that clean room approach.



Here's my 4 year old Pal 'Spencer', he's checking out the crated Lister 6/1. An added bonus is you can heat the shop for a day or two burning the crate.



This is the 12 HP 2 cylinder crate. Big enough for a camp... or at least that's what Spencer thinks.

Take a look at [Steve's Old Engine Shed](#) and check out a real LISTER, take time to load the wave file of the 10HP twin if you have the bandwidth and listen to the sweet music.

May 2, 2002

I found enough time to take the crate off the twin today. The cross bracing inside is unreal, they did a super job of making sure everything was secure. This is one massive piece of cast iron! The flywheels are far nicer castings than I expected. What is a disappointment are the fuel lines, there's a kink here and there on the low pressure side indicating the assembler didn't have the proper tool to bend the line. the manual covers different options with diagrams showing engines with tapered roller bearings, other ones with bushed bearings, engines with cylinder



liners, ones without, it will become apparent to you that these engines may all look similar from the outside, but can be quite different from engine to engine according to what you have ordered. Once you look over the manual, you'll note the difference between a 'bushed' main bearing housing and a 'tapered' main bearing housing. They have a different outward appearance, and either can be fitted to the same engine. The cylinder sleeves are wet, so you should be able to tell if the engine was equipped with a sleeve by pulling the door off and feeling for the end of the sleeve.



Above: This is a very nicely made cylinder with a WET sleeve, this end mounts downward on top of the crank case, if you open the door, and follow the rod upwards, you'll be able to feel the end of the sleeve and prove you have a sleeved engine without pulling the head.



Above is the top end of a cylinder, this particular one was fitted to P brand engine, it's a very nice casting with a fine finish on the inside.

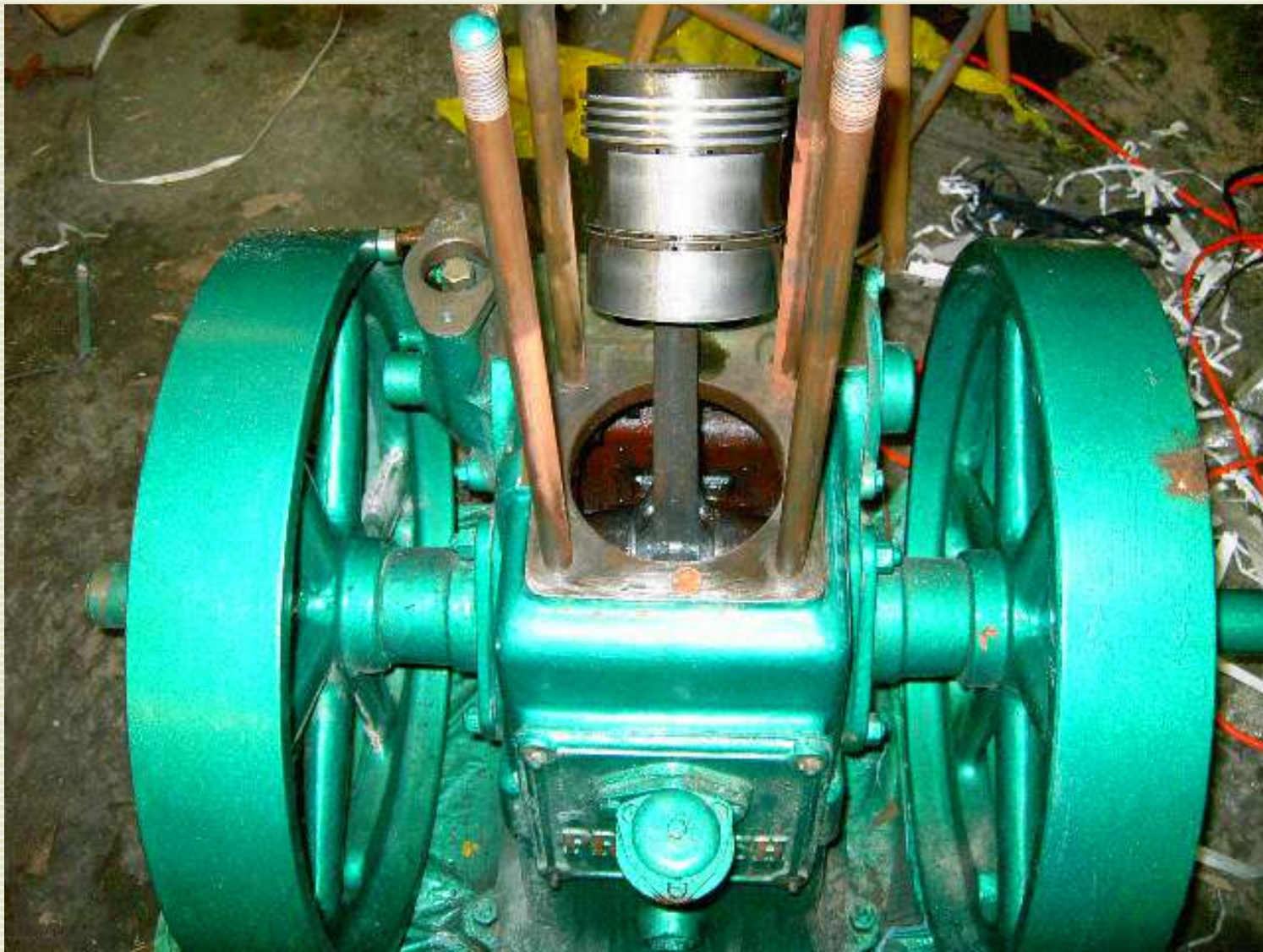

Above: Here's a 6/1 with the cylinder pulled. Once you've done this once, it's a five minute job to take the head and cylinder off. This is easier to work on than anything you've likely seen. These studs measure .715 thousands in diameter, that's a U.S. one cent piece on top of the deck.



Above: Here's a picture of square cut gears that drive the cam and governor. there's a small gear on the crank that drives this red 'idler gear', you can see the cam gear to the right. As you probably know, square cut gears are very strong and durable.



Here's a typical single, there must be a lot more of these made because there is a STANDARD Indian part for everything. The 12/2s are often fitted with the worst low pressure fuel lines I've seen, these are possibly made by beating the fuel lines between two rocks to form them. Easy enough for a DIYer to re-do, but some folks are expecting more. The engine above has Tapered Roller Bearings and splash only lubrication, which means there's no pump to fail. If you don't think this lube system is adequate, pull the dip stick while it's running. Water cooling inlet and outlets are standard NPT fittings. There's adequate room to re-tap the fitted connectors and move from 3/4 inch to one inch NPT threads. [fitting of choice](#)



Here's a twin with the covers off the heads, note the lube oil pump in the center of the engine, you can see the oil pickup coming off the sump. The oil pump can be replaced from the outside, the main bearing housings are external which allows the removal and replacement of main bearings from the outside of the engine. There's a large access portal in the side of the crank case that allows a person to gain access to internals. There's no need to unbolt this engine from it's mounting to completely rebuild it. It was designed from the ground up for quick parts replacement throughout the engine.

The lube oil system in a bushed type twin has a plunger type pump that supplies oil to pans that gravity feed oil onto bearings and lobes. I would not run a 12/2 without pulling the plug on the outlet side of the pump and making sure that it is pumping oil and primes quickly. I thought this metro had a little too much clearance between the pump piston and the bore, it does not prime well.

I ate lunch with a man who made his living flying all over Alaska servicing old slow speed Lister light plants far from the grid. He told me that rings, honing, and a valve job brought most of the Listers back on line. Lyndon said he'd seen a number of Listers that had been working hard for 10 years that had so little wear in the main bearings that there was no question about leaving them in place during the overhaul.



Here's a picture of the Mico (Indian Bosch) fuel pump. This unit is used in both engines and runs off a fuel pump cam on the cam shaft that operates the valves. The pump is activated by a cam follower, and all parts look well made.

The single is equipped with a dip stick, the twin has an oil level plug, pour it in till it flows out the fill level plug.

I poured five and one half quarts of oil into the single and got it up to the full mark on the dip stick. I put a gallon or two of diesel fuel in the tank and loosened the inlet fitting on the Mico pump. After some cranking with the compression release on, I got fuel through the pump and to the injector. Once I heard the injector 'clank', I prepared myself for a FIRST start.

One compression stroke and the engine was off and running. **This is it... you are instantly hooked on this sound**, the engine is really quiet, you hear some clatter from the valve train, and the pepper can silencer makes a bit of noise, but... to give you an idea how quiet it is, most of what you hear is the mechanical noise the injector makes as it fires 'clank'! This is enough in itself to amaze me. Unlike the noise of most engines, this is almost a welcome and soothing sound, kind of like a big OLE grandfather clock.

**The next step** is to fit the proper generator head for the Listeroids, a modern looking head would clash, and might take away some of the magic? you'd also have to run a 5.54 ratio to get a consumer 2 pole gen head to spin for 60 Hz. The ST 4 pole head will take a 2.77 ratio to get the 60hz, the Sheave will be far larger and create a more positive drive.

After reading a number of stories and accounts of Lister performance, I've decided to step up to a 5KW 4 pole head for the 6/1. Although this engine will most likely produce little more than 3KW ongoing, it should have the ability to produce far more for short periods, I feel it is better to have too much head than too little.

May 5, 2002

With a little spare time, I checked the threads and fasteners on this engine. To my liking, I found most are S.A.E. I hooked the hose to the engine for cooling and let it run for 1/2 hour, it is so quiet without a load, I'm not sure my neighbor knew I had anything running. Just like a big OLE Grandfather clock, tick tock, clickety clak, it's a noise I could fall asleep listening to.

I went down to Binford scrap metals and found myself a real heavy gauge box beam. The thought was to give the engine and generator head something really solid to set on. Once it's in the final resting place, I'll roto hammer some holes in the concrete slab and tie the base down with some anchors.



In the picture above you can see the base after it was primed and painted. The box is spaced to provide support all the way around the base of the engine. Studs were welded into the base allowing the engine to be lowered onto the studs. The thinking here is the engine isn't going to walk off if the nuts get loose. I didn't weigh the base, but it's probably fifty pounds or more.





Above is a picture of the engine secured to the base.

May 16th 2002

Check out the [thermostat installation](#)

June 11, 2002

I finally figured out what I wanted to try for a generator mount. Someone wrote in with the idea of trapping the generator head between two pieces of angle, and having the head slide back and forth in the 'track', then one could make adjustments without the belt tension causing the head to twist. It sounds like a great idea, so I thought I'd do something on that order here.

What I've decided to do is bolt a base to the generator head that has two angles hugging the inside and top of the frame rails, same idea, slightly different execution. Look at the picture below. These angles have just enough clearance to move the head back and forth for adjustment. A fresh coat of paint will really tighten things up.



The studs are welded in place, and match the generator's bolt pattern.

Following is some info that might help you with belt drive calculations. Go back and check out Dr. John Culp's drive set up for his 3600 RPM head.

Formula for computing pulley sizes:

$$D2 = D1 \times N1$$

---

$$N2$$

**D1= Diameter of pulley on engine**

**D2= Diameter of pulley on generator**

**N1= RPM of engine**

**N2= RPM of generator**

In the case of the Lister 6/1 AND a ST 1800 RPM head....

$$D1 = 23.25''$$

$$N1 = 650 \text{ (rated)}$$

$$(D1 \times N1) = 15112.5$$

$$N2 = 8.3958333''$$

**OR .... Where N1= 600**

$$N2 = 7.75''$$

**If we look at the generator speed of 1800 RPMs, we can see that the head spins 30 revolutions per second. Considering that this head has four poles, the output is two cycles per revolution or 60 HZ. If we look at the engine speed, we find it is turning 10.830 revolutions per second.**

I think the engine would be happy between 575>650 RPMs. Of course you'd have more power at the full rated 650 RPM speed. the slower speed might give slightly better fuel economy and longevity, I'm not sure. this engine was originally designed to run at 600 RPMs, not 650, and if we go back far enough we might find a slower running engine with the same bore and stroke... if you have done any research here, email me.

**NOTE: 10/2003 I have inserted the following as a warning. I have had several contacts with customers and owners of Listeroids that claim that their flywheels are 24 inches in diameter, All of the Listeroids I've**

had the opportunity to measure have been 23.5 inches. This small difference will have some effect on your drive ratio if you drive off the flywheel. If you had a 24 inch flywheel, you'd need an 8 inch pulley to get your 1800 RPMs at the generator at 600 RPMs engine speed.

I have discussed RPMs and the need to keep the Lister at rated RPM with a number of people in the old engine crowd. There is total agreement that you don't overspeed these engines just for the fun of it. You don't do it for liability reasons alone, but most folks have found the Listeroids to run happily at less RPMs than the rated speed.

I'd have not problem running my big flywheel Listeroid at any speed between 600-650 RPMs.

10/2003

#### Another Note on Lister 6/1s

Some folks have ordered a 2nd Lister and have noted differences in some of the components. I just talked to Hank in Florida who was a little surprised to find a plastic shut off valve on the bottom of the gas tank. I have a few brass valves that leak, I'm guessing the Indians adopted the plastic one because it doesn't leak. Another surprise for Hank was Metallic paint, it seems the Indians and many of their regular customers love this stuff, (Yuck). I find that Hunter Dark Green is just the right color for these engines, you'll want to do a little sanding and a little clean up on castings, etc, so I've given up on caring what color they come over in, I spray my own paint anyway. This note is a reminder that there are small differences from assembler to assembler, and that Indian Listers continue to change in small ways.

George B.

If you have personal experience with these engines, please consider emailing me.

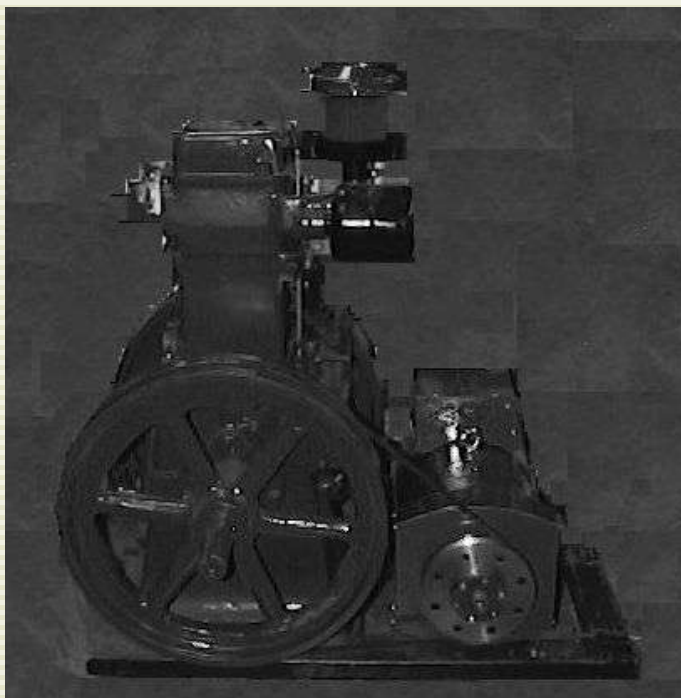

Above left is an old Lister light plant, above right is our Lister/ST generator.

**October 12, 2002** [A note on valve train lubrication.](#) **The Lister valve train relies on manual lube.** I asked an Indian about this set up, and he said the folks in his country found this system needs very little lube. In fact all of the grease type fittings you can see on the old Listers are a thing of the past on Indian Listers.

If you've done some reading about lubrication, you will note that Zinc is a super oil additive. But when it is used in the primary lubricating oil within the engine you can have too much Zinc. This additive can cause deposits to build up on valve faces, spark plugs and area of the combustion chamber. For an external application like the Lister valve train, larger amounts of Zinc will protect the valve train even when you forget to give it an occasional shot of oil.

There is a documented story of an automotive engineer showing up at a state fair booth where a guy was demonstrating an oil additive. they had a motor set up where two pieces of metal rubbed together and you could see the reduced friction when their product was added. The Engineer asked the guy running the booth if he would try 'his stuff', .... new pieces of metal were installed and this mystery concoction was added. To the amazement of the Booth Operator, he couldn't apply enough pressure to the disk to slow it down! The performance of this mystery stuff was off the chart, and clearly better than the stuff he was selling.

What was it?????... Head and Shoulders Shampoo.... right out of the bottle! Loaded with Zinc to control dandruff. Should you use Head and Shoulders to lube the valve train in the Lister design? Probably not, but it is a good case for finding something with high levels of Zinc in it. Since synthetics have much higher film strengths, it may make sense for a person to use it in this application as well.



Check out [our pulley](#), coupling a Lister to a generator head can be a complex, troublesome, and expensive , but not if you [incorporate our economical custom pulley](#), or our turnkey drive system.

**NEW** [What NOT to expect from a LISTEROID](#)

## Listeroid quality, what to expect

[Want to buy a Lister ?](#) Email [George B.](#)

[Jeff's super quiet Lister 6/1](#), you'll be amazed!

[Lister generators of Days Past](#)

[Customer's ListGen power plants](#), see what they've done....

[Lister 6/1](#)

[Lister 12/2](#)

[Lister Parts in North America](#)

[Building your own generator base](#)

[Listeroid Specs](#)

[Listeroid fuel consumption](#)

[Lister Stories](#), If you have first hand experience with this design, please email me an share your experience.

[First Run](#), If you bought a Listeroid, I'd recommend you read this before you do more than open the crate.

[Modifications](#)

[Cooling a Lister](#)

[Build a proper frame](#)

[Potential Problems](#)

[Tappets](#)

[Home](#)



## How do you keep a Lister at the proper temperature?

The Lister 6/1 likes to run at 180F and above, I have been running mine with 195 degree thermostats and think it's pretty close to the sweet spot for this engine, but it could be much higher.

**How important is the proper temperature in this engine and other water cooled designs? I think it's very important, I offer a story to expand on my experience, and more important, the experience of my friends. Manufacturers don't put thermostats in water cooled engines just to make the heater work!**

### George's big Lesson

Here's my approach to control the coolant temp in the Listeroid with a minimum investment. actual tests with radiators and cooling tanks proves the auto thermostat works great.



Here's a picture of the stock upper coolant port on the Lister. Note that stock fitting is 3/4 inch NPT.



Step one, use a die grinder and a stone or carbide cutter to port match to the gasket. You can see the pattern from the gasket around the port, I left some additional material. Some of these stock Indian coolant ports are barely open, I recommend you open them up before you put them to work.

Next, fit the thermostat into the head and assure that alignment with the flange is correct.



This picture shows a thermostat from a Plymouth Horizon slipped into the port. The first generation setup used a spacer plate and a stock flange, the spacer plate had a small recess cut into it for the lip of the thermostat, not shown.





Here's a picture of the NAPA 253 thermostat, you can invest a bunch of time sorting through thermostats to get the right size, but this one has proven to work well, some have a little hole in the valve to make it easier to chase the air out of the system, make the hole, especially if you will be draining the coolant and recharging it often.

I found the above flange in a Hardware store with a good plumbing section, the manufacturer is Northwest Cooper, and they call it a Waste Nut of all things. It's tapped with 1" NPT threads and ready for the pipe nipple you see screwed in. Put the assembled unit on the lathe, and turn in the recess for the thermostat as you see here. the hole pattern matches the Listeroids I have experience with, and it also works well with the hopper plate conversion for Chinese Horizontal singles. also note that this waste nut comes in 3/4" and 1/2" sizes, so it may be a solution elsewhere.

As for radiators and coolant tanks, a big electric water heater tank works great for a cooling tank, simply unscrew the heater elements, screw in an off the shelf nipple fitting, and elevate the tank above the engine where all hose connections move upwards with no dips. It's easy to find a solid tank in the salvage yard. Leave the insulation and sheet metal behind if you can. The tanks look nice when painted to match the engine.

Another great way to manage coolant temps is to use an old cast iron radiator that was used in a hot water system. Many houses and other buildings used these, and some older homes make use of them today. I have personally tested this set up with a 6/1 and found it to work real well with the same thermostat mentioned above. And of course, you can use a car radiator, if you do, use one that has upper and lower connections, don't use a cross flow for thermal siphon setups.

It helps to remember that you will not be shedding as many BTUs as a modern automobile, this may help you realize that you do not need the same efficiency in your coolant system. I have not seen a need or advantage for a water pump in my applications. Of course the key is to install a temp gauge at the upper coolant flange and then load the engine fully, let the gauge tell you if you have engineered the system properly. You can always add a fan if you need it.

If you could place a Lister lower than your living space, you could mount one of these old radiators up against a wall with a nice polished sheet of alloy or stainless behind it, this setup would radiate lots of heat into a living space when desirable.

[Back to Listeroids](#)

[Home](#)



## More lessons learned, one of them for a second or third time.

A compression test can identify a problem in an engine, but it can also give you false confidence that you have a good cylinder.

Sometimes I think it was my purpose in life to make mistakes so I could warn others NOT to do the same thing or come to the same conclusions.

I bought a 1990 GMC Sierra pickup from a Salesman at the local Kent Chevy Dealer. He told me it was his Father Inlaw's truck, it was absolutely flawless (show Room condition) with 46,000 miles on it.

After my purchase, (private sale), I realized I had an oil burner, it's just another used car Salesman story, pretty obvious that he was dumping his oil burner on me. I couldn't see anything coming out of the exhaust, so I thought I might as well drive it and see if it got better or worse (it was spilt milk at this point). The oil consumption was less of a problem for me, because I really don't drive that far or that often, with the exception of visits to our off grid locations, one being a 120 mile round trip, and the other being around 250 miles.

I'd use a quart round trip to Cowiche, and as the miles added up, pretty soon it was two quarts, then you couldn't pour it in often enough.

Then one day it was too much to ignore, I heard the engine ping under light acceleration, and saw a puff of black smoke with each ping. The ECU noted the ping via the knock detector, and retarded the timing...(great for good mileage) and the ping was canceled. Noting this, I found a place to really stomp on the truck and noted the steady stream of smoke out the exhaust. I got 50,000 miles out of my oil burner before it was time to pay the price for buying from a used car Salesman

that used too much Cologne. Looking back, I think he had a gold necklace and an open shirt, are these bad signs? I'm not sure... but I made the mistake of falling in love with a Truck.

Pulling the spark plugs at 95,000 miles revealed 7 plugs with great color, and a lone oil fouled plug in number one cylinder. This is where the story gets interesting (IMHO). The compression test showed all cylinders reading 175-180 pounds, with all plugs pulled and throttle plate open, I thought this was excellent news.

New plugs, New rotor, and rotor cap, (needed it anyway), still bad, added new spark plug wires... No help...

I dropped in to see Jerry Wright who I regard as an expert, he started rebuilding things at eight years old in his Dad's small engine shop. That's where he started... He's also built engines that won in their class at Daytona! He's a Mechanic's Mechanic. Jerry verified his thoughts regarding my problem with a GM mechanic friend and passes along the following. "We see GM 350s with valve seals bad, and burning excessive oil all the time, if it's not that, it's probably an intake manifold gasket defect allowing oil into the intake of number one cylinder, there's always a chance it's something else, but the odds are high, it's one of these".

With that info, I bought some valve stem seals from NAPA and thought about how I would change them. After looking at my SEARS screw in compression tester (VERY NICE), I noted that the quick coupler that connected the gauge to the hose that screws into the spark plug was the same as that on my shop air hose. A quick check revealed that I could use this to apply air to the cylinder from my compressor line and hold the valves closed under pressure. I then used a spring compressor to remove the keepers, springs and get to the valve seals. Sure enough, they were like little pieces of crumbly carbon. They came out in pieces.

Mike McCandless (owner of Auburn Auto Machine) warned me that DIYers often install the new seals wrong, they put them on the valve stem and then slide the compressed spring over the stem and push the seal from it's groove down the stem. I tried it this way and sure enough,

it's a bad idea. Trying to place the seal above the compressed spring is a pain, but it results in a correct installation. This causes me to wonder how many persons have installed these wrong and created an even bigger oil burner!

With the new seals installed in number one cylinder, I ran the truck around the block and found the same problems, maybe it was slightly better, but the ping and the smoke was still there.

I remembered Jerry's stories of stuck oil rings, usually caused by lack of oil changes, I used two cans of GM's top end cleaner, even poured some into #1 cylinder and let it set... NO immediate HELP.

At this point we have two possibilities, the intake manifold has a leak where oil is sucked into number one intake runner, or this cylinder is unable to control the oil. How does one determine which one?

We know the intake manifold is easy to pull compared to rebuilding the engine, but is there a way to prove what's going on for sure ??? Mike McCandless suggested I do a leak down test, "might try and identify a problem before you attempt to fix it." Derek Smail, (a mutual Friend and Motor Head) agreed to drop by with a quality test set up and provide his expertise.

Derek looked at number three cylinder and exclaimed "Shoot! this looks like a cylinder out of a custom engine! Text book perfect. Moving over to cylinder number one he found a major leak down through the pan! We pulled the dip stick and could feel the air across finger tips. This was NOT the news I was looking for.

DIYers need to take note, Mike's advice is something to keep in mind no matter how many times we re-learn it!.... **identify the real problem before you spend money trying to remedy the symptoms.**

And there were more lessons once the engine came apart.....

Intake gasket looked properly installed (no leaks)

Three cylinders and combustion chambers look real good, zero ridge at

95,000 miles.

Number one looks oil soaked, huge ridge in top of cylinder wearing at the bottom and front of the cylinder.

Build up of deposits are found on all cylinders on back side of valve and lower stem, this indicates the seals are no longer as effective. I would think that an investment in new valve seals should be made at 80,000 or greater miles on a Chev 350 of this Vintage.

I would also think water injection could help control these deposits, and that enabling the system when pulling hills or loads would be beneficial in other ways. If you choose to replace valve seals, investigate the new Teflon Seals and how to properly replace them. If you saw these deposits, you'd wonder how much air could flow at the higher RPMs, come to think of it, my truck is kind of a dog mid range and higher up.

This engine may have left the factory with a defect, But manufacturer's are pretty careful in this stage of assembly, and the folks doing it are usually skilled, so what happened ???

.40 over should clean up the wear in cylinder one, we'll see.

It was time to check in with Jerry Wright, compare notes, return his power steering pulley puller, and tell him the story. Jerry smiles, (there's not too many stories he hasn't heard). He tells me the story of a customer who brought in a car with 40 some thousand miles on it that was worn out. The cylinder wall taper was worse than some 300,000 mile motors. Jerry said had asked the owner.... "what had happened to the thermostat ?? the owner replied " I take them out of all my rigs, darned things cause nothing but trouble". Jerry looks upwards and shakes his head.... "What's really amazing is we also see high mileage engines with perfect cylinders, you can still see the cross hatch in the cylinders, this is why you change your oil, and you do it often".

With this story told, Jerry recalls my efforts to pass emissions at 60,000 miles or so.. "didn't you find it running cold ?" I thought back.... "Yes!" I remembered the gauge reading low and how I thought it was just a

gauge problem or something. I had put it off till I didn't pass emissions. (another lesson?) when I did take the thermostat out, I found it stuck open, I put a new one in and the gauge read as expected.

Considering that number one gets a shot of cold water out of the pump, it may be affected by the lack of a thermostat more than the others. If I pull the other head and find the front cylinder having more wear than the others, will this confirm this? Maybe it depends on who's expert you're talking to?

**The lesson for DIYers... even that ole Lister needs the proper operating temp. If you don't make up your own, order one of mine, and get that engine up to operating temp fast and keep it there!**

And now I wish to thank my friends, I have learned so much from them and life would be far harder without them. Not enough room to mention them all.

Jerry Wright owner (Mazda's only) Kent, WA 253-854-9601, simply the best mechanic I know.

Mike Mcandless owner (Auburn Auto Machine) Motorhead and custom engine builder, older American engines, and newer stuff too. Mike 253-735-5267.

Derek Smail, (he's Insane).... Mega Horsepower Custom Snowmobiles. Derek has experience with turbo two strokes and big (NA) cubic inch triples. Truly insane sleds for speed freaks. 253-640-2100, Covington, WA.

9/2003

A final Note, talked with Dale Green, (a well known NW engine builder), added some valuable insight into what happened to this engine. First he said We were probably right about the cold water taking out cylinder number one. This problem is often seen in 350 small block marine applications where temp control is NOT adequately maintained. Number one cylinder shows tremendous wear, others are OK.

He had more insight into what I'd call premature valve stem seal failure. Dale said these throttle body engines were run pretty lean, they run HOT and coke the seals. If you can get to the fuel mixture, you might correct this and increase the longevity of this engine. Another problem is the exhaust valves, they fail prematurely because of this lean condition.

I would imagine that GM had some Federal Government dictates to meet, and had no problem selling us a short lived engine to meet the specs.

I can't imagine how much crap goes into the Atmosphere once these valve seals go to hell, but I'd be tempted to say this engine could pollute far more in later life than if it was set up to run a little cooler (richer) from the very beginning.

It all has great entertainment value doesn't it? the FEDs tell the Auto Manufacturers how to paint cars, and the paint falls off. They tell them what the emissions will be, and you pay more and get half the mileage before you haul it off to the dump.

Water injection might be far more valuable than we know, this could lower temps during higher loads, and extend life. Of course, fixing the fuel mixture would be the proper fix, but it could also void the warranty of a newer vehicle, and maybe they could fine you out of your house?

All the best, always learning....

George B.



# Utterpower.com

Our serpentine pulleys allow the slow speed Listers (and other old open flywheel engines) to drive the 1800 RPM generator heads. These pulleys are nice enough to hang on the wall... and more important, they work great.





Above left is an inspirational picture of an old Lister light plant. Above right is the Listeroid fitted with the massive 5KW/ST generator head.

Inserted Note: As of 6/2003, I have build a number of Listeroid gen plants that use this drive system, and I have a good number of customers/friends that are using them as well. Take a look at [Steve Gray's beautiful Lister generator](#). This set up has made two big shows this year and draws a crowd. The ST head is the proper vintage to go well with the Lister. Readers might ask why Steve didn't go with some old belt system? I didn't really pin him down on that, but my research led me to believe it would be expensive and less reliable. Steve did tell me that the old engine crowd uses serpentine all the time. There's also a thin slice of Survivalist that runs through me that constantly reminds me of the advantages of the KISS principle and the rewards of using common components you can buy anywhere. The serpentine belt I use for the 6/1 is 91-92 inches long and is found in many years of Chevy V8s and V6s. Look under the hood and add up all the loads placed on that single belt! Air conditioning, power steering, Alternator, Water pump, and sometimes more. After the fourth time I was told my serpentine belt looked real bad on my Chev pickup, I bought a spare and put it under the driver's seat. I drove it for a few more years. After 12 plus years on the same belt, I was shamed into changing it, it was the wrong thing to do....I should have gone for the world's record...

If you're in the middle of nowhere, and you figure out how to tear up this belt, (**let me know how you did it**) a spare may be found in that upside down Chevy at the local bone yard. And if you're feeling like parting with a whole twenty some dollars, NAPA, or a host of other automotive suppliers will have just the one you're looking for brand new.

This is only half the story, the reason the Automotive world went to the serpentine belt was not to save you money on belt changes, it was a matter of efficiency, this system transfers energy from the prime mover to the loads with less loss resulting in better fuel economy.

After an exhausting search for a proper sized serpentine pulley to drive the 1800 RPM load, I decided it was time to invest in making it verses spend more time looking for it. You can only stand to wait so long!

Machinist Randy Allmand made himself and his machine shop available for prototyping the pulleys. Randy is a respected Hot Rodder and Fabricator, and has done lots of machine work for racers including the unlimited Hydro plane crowd. His personal lawn mower would make the 'tool man' jealous.



Here's Randy.....

When you're doing one off stuff, it takes time, and no matter how simple the part looks, it isn't (IMHO).



First frame, steps are taken to assure close tolerance, 2nd frame, setup to assure accurate taper to receive the standard SK style bushing. 3rd, SK bushing is test fit to assure proper engagement and depth.

**If you have no experience with 'bushed' pulleys or sheaves, the bushing can be ordered for the shaft diameter you are using. This means you can mount this pulley on any sized shaft that you can get the bushing in, or bore it to your own size. Metric sizes like**

32mm, 38mm, 42mm, 48mm, are readily available through vendors. Get the bushing mailed directly to you by calling **Applied Industrial**. Simply ask for an 'SK' style bushing in the size you need for your generator shaft.

**Inserted Note: It's KISS again, you can't get more common than the SK bushing, it allows you to move your pulley from one shaft size to another. If your pulley (Sheave) experience is limited to fractional horsepower stuff, you'll be amazed how the bushing locks the pulley in position and how you can move the three bolts from the locking position to the extracting position and back the bushing from the matching tapered bore in the pulley. Unlike the junk you find on consumer riding lawn mowers, bushed pulleys what designers use**



**Here's the result of a day in the machine shop. That raised part in the center is a standard SK bushing.**

This particular picture does not show off the fine machine work of this pulley. The Micro Vees have been cut with a precision machine tool. The pulley shown is set up for the more common 6 rib belt. This belt is less expensive and will do a fine job with the 6/1 Listeroid. If you want more, two additional VEEs are cut for the 8 rib belt. All the tooling necessary to locate holes, set hole depth, etc. , were made during the prototyping process, this should cut down on the labor to make the pulley. Also note the relationship between the gen head and the flywheel. Make sure there's adequate clearance behind the engine for maintenance, if you choose to increase the distance between the engine and head (where the engine and gen head are in different counties) , you could end up with some some belt whipping and a need to add an idler to cancel same. The short coupled system operates perfect!



As we know, belts like proper tension. This threaded rod passes through the end of the generator frame where spring pressure can be adjusted and tension maintained. **(Note added 4/2003), some folks are running without a tensioning device, and report all is well.**

**July 14, 2002**

Today we prepared the Listeroid 6/1 ST Generator for belt drive testing; when it first fired up, the belt was squeaking some, I applied a little tension and things got quiet and smooth. I placed a 100 watt Vapor light on the generator for a load, the engine's grandfather clock sound didn't change. The serpentine belt runs exactly dead true on the flywheel.

I stopped to recall how pleased John Culp is with his 6/1 serpentine drive, in his case, the pulley on the generator is a mere 4 inches in diameter and has carried 4600 watts! Our large diameter pulley has several times the area under the belt and should **NEVER** slip even with the fuel rack all the way open.

I took my two horse power chop saw down and put some hard wood under it, I pushed the blade into the wood and started it stalled. Those big ole flywheels are magic; it took a bit for the exhaust note to change, but the speed of that flywheel wants to remain constant. There is no better frequency and voltage control than a big ole flywheel and flyweight governor, an electronic device can't make up for a lack of flywheel mass which stores energy and smoothes out transitions in load. If you research old light plants, you will see that flywheel mass was

often **increased** when the engine was deployed as a light plant.

I am totally pleased with the serpentine drive system, this pulley is everything I hoped it would be and then some. Not only does it run true and grip well, it adds character to the gen set and looks like a well made, machined piece from the past. If you choose to drive off the crank, you are much further out on the crank. This lever effect increases the side load on your main bearing and will greatly increase the width of your gen set with the requirement to off set the head.

BTW, I received email from one of the experts on stationary engines... his comment regarding the use of serpentine belts...."**everybody uses them**", I didn't know the antique engine crowd used them to that extent, but I'm pleased to hear it, and now I know why. When you consider this system is far cheaper than two Vee pulleys, two bushings, and an expensive common back belt, you start to understand the value.



Above is a picture of the Listeroid 12/2 fitted with a 10KW ST Head.



Above is the 2002 batch of custom serpentine pulleys designed for the stock SK bushing. Note the Listeroid green color, it's a reserved, unpretentious color, and fits the character of a slow speed Listeriod perfectly. Look at the picture above this one to see the pulley mounted with the SK bushing in place.

**Pulleys are \$149 dollars plus a flat \$25 for shipping and handling in the Cont USA.** if you think this sounds expensive, you haven't priced out the alternative yet. [email](#) me with your requirements or questions.

[Home](#)

[George B.](#)



## What you should NOT expect from a Listeroid.

I've been thinking about the English Lister, we know this engine was in production all the way up to 1987, an incredible run for an engine that was designed so long ago. It is said that the reason they quit building it was because things changed in IRAN, and the market for the engine was altered enough to impact it's profitability.

Imagine what the English would be charging if they built this engine today?

\$4500, \$6500 USD ?

**Well, the fact is, they don't make them, and the folks that have originals are fond of them.**

For those of us that want to run the heck out of these engines, the only place we can turn is India, but there are some things we need to know.

Indians seem to like Metallic paint, I think they get aroused when they see it. This is not a bad thing but they seem to think that everyone likes this stuff! You can keep telling the Indians to send you plain ole green, but they can forget, is it possible this has something to do with eating curry?

These are work engines, the Indians don't hire artists to paint them. I would bet they don't even use a brush. The engine is fully assembled and then they rub paint over everything, even the nicely plated fittings on the high pressure fuel line. Yes! you get your monies worth in paint on a Listeroid, so expect to spend some time taking the paint off the stuff you don't want it on, and just be glad you didn't buy a car from the Indians.

As for the metal castings, these are work engines, they are finished well enough for a work engine, but these things don't look like a Honda casting.

Another thing that you should expect, **Indians might make the very worst gas tanks in the world.** The sheet metal is thin, and the gas caps come in three flavors. there's fair, poor, and bad, the fair one fits worse than anything you'd find on a quart paint thinner can. The brackets holding the tank on never fit quite right, and sometimes the valve at the bottom of the tank leaks and there's little you can do to stop it. One vendor of these engines uses a plastic valve on the gas tank... they probably got the idea from Briggs and Stratton and think we like it that way?

If you get a serviceable tank, great, but you should expect to do some rework in this area, and if you're not up to it, plan to pay someone to fit a quality gas tank. as I've mentioned elsewhere, I like to use plastic boat tanks when the vintage look is not important, and when it



is, I have no problem finding tanks off discarded stuff at the salvage yard.

The main reason to buy an Indian Listeroid, is to get an engine block, cylinder, head, crank, flywheels, injection pump, cam, push rods, piston, rings, and all the other parts that make up the Lister CS clone. Once you've got these, you can create a show piece with a little work.

As mentioned elsewhere, if it takes the Standard Lister type parts, you'll probably be able to order parts for the next fifty years or possibly longer. Just make sure it takes Standard parts.

George B.



## Listeroid Quality

### What to expect from a Listeroid

This is my experience, what you find may be different, I'll update this page as I learn more about these engines. There are some Metros that were imported that do not have TRBs or Sleeves, Following are engines I've looked at and how they were equipped.

### METRO Brand Engines

- 23.5 inch flywheel
- Tapered roller bearings
- Wet Sleeved cylinder
- Uses standard Mico Injection pump and injector (Indian Bosch)
- Gas tank has useful cap
- Nice low pressure fuel line, braided with banjo fittings.
- Fuel oil filter looks like standard clone, cast top, pressed sheet metal cup.
- Standard CS Clone High Pressure fuel line
- Uses standard CS Clone parts, pistons, cams, etc.
- Inferior tappets and tappet guides found in a number of engines, loss of tappet rotation found
- Good castings
- Engines have useable air cleaners
- Pepper can exhaust silencer good construction
- Average paint job
- Average finish on flywheels
- Some Metros slobbered oil, this will most likely clear up with running.
- Packed in crate, 'plastic lined', expect some surface rust here and there.
- **Basic tools included**

findings based on six inspections, and input from the field.

Update: Metro now builds a variant, I don't know how different it is from Standard, ask questions when you buy any Listeroid engine. If you have a tappet problem, see the tappet page for a fix, or order some standard tappets.

### Prakash Brand Engines

- 22.5 inch flywheel
- Wet Cylinder Sleeves
- tapered roller bearings
- Fuel oil filter looks like standard clone pressed sheet metal piece.
- Uses standard Mico Injection pump and injector (Indian Bosch)
- Poor to Bad gas tanks, bad fuel caps on fuel tank, funny plastic valve on bottom of tank.
- Uses standard CS Clone parts, pistons, cams etc.
- Excellent to fair castings (some minor flaws found near the mounting feet)
- Funny Plastic low pressure fuel line
- Standard CS Clone High Pressure fuel line
- Pepper Can silencer looks like it was made from a tin can
- Average paint job
- Tappets and Tappet guides look good.
- Engine started easily, and ran well
- No air cleaner provided
- Packed in crate, 'plastic lined', expect some surface rust here and there.
- Basic Tools included

Findings based on one tear down and two assessments performed by experienced owners.



Above: Prakash engine tear down, carbon on the piston top is from the test run and is typical . Notice the beautiful Metallic paint. Fuel filter on Left, cast iron top, pressed sheet metal cup. Note stock Indian studs, they are massive .715 thousands.

I was very impressed with the quality of this cylinder casting, it appears to use a higher technology than some of the previous brands I've tore down, if you shine a flash light down Through the coolant holes that align with the head, you'll see a very fine finish on the inside. You'll also enjoy seeing that this is a true 'WET' sleeved engine'. What this means is you don't have to worry about conductivity from the sleeve into the cast as you do a dry sleeve cylinder block, in this engine the sleeve itself is in direct contact with the coolant. The sleeve is sealed with two big 'O' rings of good quality. If you remove the fuel filter, you'll find letters BM in the casting.



Here's the head, note the standard Lister CS style Pre combustion chamber. carbon is typical of what I find in an engine that has been test run only. The head casting is also nicely made, they must use some pretty fine material on the inside to get this kind of finish. Note this goofy looking air intake (top), this engine is somewhat of a contradiction, it has really nice castings compared to most, but some of the exterior components are really low end parts, these are items I replace or discard anyway, so it's not that big of thing for me, but it might be for you.



It's simple to build a superior air cleaner setup, this unit was fabricated to bolt on an engine, and receive a standard round paper or foam element. If you have an air compressor, get one of those inexpensive die grinders and some three inch cut off blades, and you can make such an assembly in short order, having fancy equipment makes it go faster, but you can cut, grind, and weld some pretty nice looking stuff with basic tools and an arc welder. I thank Jim Wallace for the above example of his work..



Above: Now here's a vintage looking piece for you... a nice shiny yellow valve made of plastic. but look at that metallic paint! Bet that didn't pry your eyes off the fuel dripping off the line did it?



Above: Is the air inlet, standard bolt pattern and flange, you should plan to add your own filter, easy to do.





Above: Here's the standard MICO injector, never seen a bad one..



Shot of lower coolant inlet. I removed this lower coolant fitting and looked inside the cylinder, very well made casting.



Above: The flywheel, the finish on the wheels is pretty standard for Indian stuff... now worse, no better than usual, as they would tell you... this is a work engine, it wasn't assembled to show.

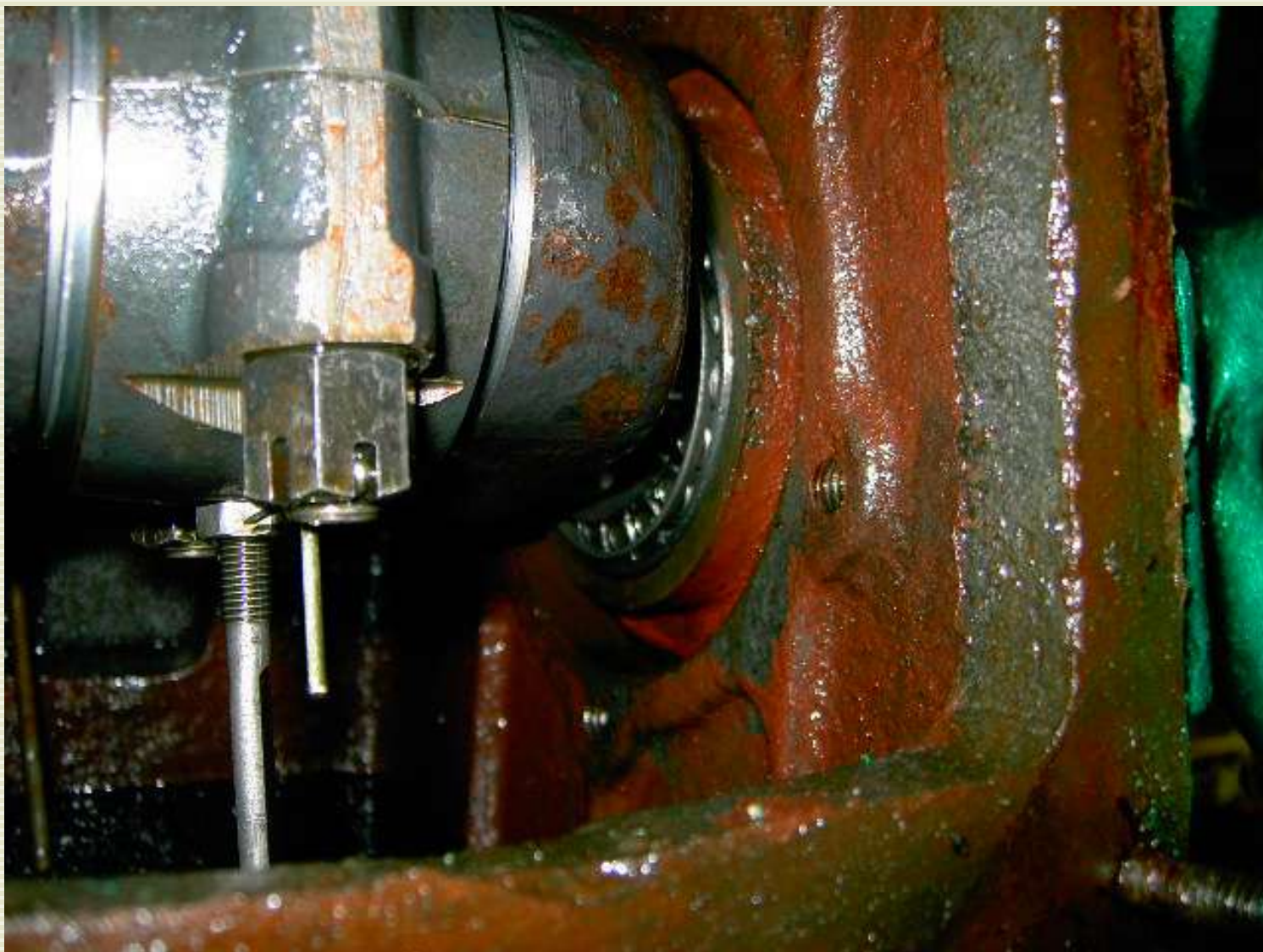

**Above: A view of the massive Standard crank, you can see the TRBs fitted.**

**After two days of looking the Prakash over, I'd say it has all the important stuff... a true wet sleeve design that should work real hard and get rid of the heat. Some of the nicest castings I've seen on an Indian Lister, and the worst gas tank, pepper can muffler, I've seen from anywhere on the planet. This looks to be a great engine to build a show piece on, but remember, I've only taken apart one of them. be prepared to repaint it, and to clean paint off stuff you didn't want painted, and remember, we found one rod/crank pin fit that was not proper. If you're not willing to check a few things, buy one that has been gone through or get a guarantee that all is ready to go. Note what appears to be a forging mark on the crank.**

**12/13/03**

**After tearing down an engine this far, I thought I would pull the valves, check the valve faces, intake and exhaust ports. The guides and valves feel excellent, valve faces and seats are very nice. The intake and exhaust ports are the best I've seen, there's nothing to grind, sand or blend. It would be a total waste of time (IMHO). This head is truly the best casting I've seen, it would be nice to have two or three more Prakash engines to look at and see if the quality of these parts are consistent.**

**End of Prakash pictures.**

I'll add more to this page as I learn the differences from one Brand to the next. Remember that the different brands make engines without sleeves, and without Tapered roller bearings, know what you are buying, ask questions.

I have quite a few spares at this time, if you bought a Metro engine, I encourage you to watch the rotation of your tappets, and address the problem if it does not rotate.

George B



## Listeroid , the non-rotating tappet

I have found a number of Metro Engines that have tappets that don't rotate, this drives me crazy. Some folks suggest a tappet can live a **very long** time without rotating when spring pressures are this low, especially with a mushroom tappet.

### **I don't care, I like mine to rotate and I've been experimenting....**

If you have a non rotating tappet, and you care about rotation, try this...

1. Pull the tappet guide, be careful to remove the paint on the top of the tappet before you try and force the guide up over all that paint. Always remember the tappet is sitting on the cam, don't hammer on these parts. If you find your tappets are difficult to get out, block the guide off the deck and carefully tap it out, always assure there's no chance of forcing the tappet into the cam.
2. With the guide removed, open the engine door and reach up and grab the tappet off the top of the cam. You may have to turn the crank to provide room for your hand.
3. If you have access to a lathe, chuck up the tappet and prove that the tappet face is cut at right angles to the stem. Also polish the face if you have the means.
4. I have found a number of tappet guides that have bores that are 'out of line'. I have been thinking about this situation for some time and think I have a solution that will work for most of us. Clean up the bore on the engine deck that the guide fits into, remove all signs of paint. Clean up the guide, use fine emery paper till you can rotate the guide in the bore, and rotate it fully with a strap wrench or other tool. Make sure you get rid of the gasket.
5. With the guide in it's bore, and a method to rotate it, use an inexpensive dial gauge (\$6.95 Harbor Freight) to indicate off the top and inside of the bore. Rotate the guide and check for run out. Paint a little mark at the two ends of the swing and then find the middle. File a little cut mark in the base where you can see it on the deck, rub a little white paint in the cut, and assure that this mark faces outward on the deck. If you're not following what we're doing, we are locating the guide in a position where the miss-aligned guide leans forward or aft on the cam lobe verses left or right. **This position 'nulls out' the deviation.**
6. Remove the guide, lube up the interior and the face of the tappet with molly assembly lube, put a **tiny** bit of sealer like silicone RTV under the seat where the gasket was. Place the tappet back on the cam lobe, push the guide back over the tappet. Be careful not to strike the tappet, remember it's sitting on the cam.
7. Another possibility is shimming the cam to assure the lobe remains off set as far as reasonable from the center line of the mushroom tappet. Thsi could be a factor. Take off the

left hand cam cover and push the end of the cam to the left as it's running, does this cause the cam to rotate?

8. Replace the guide keeper, replace the push rods, adjust valve clearance, test run engine and check for rotation. If the tappet face is at a right angle to the stem, and you follow these steps, you'll find rotation.

**A final helpful hint?, the bottom of the tappet should be concave. this will be barely perceptible, but you will see it if you place a machinist's steel rule, or similar straight edge across the face. If you are reworking a tappet, be careful not to remove this concave contour, this helps to rotate the tappet. One engine builder told me that tappet faces are often ground on an 81 inch radius! If true, that's not much of a dish in the end of that tappet is it?**

**11/2003 Interesting find ??? I have been bothered by the tappet guides and tappets I found in the Metro Engines...(obsessive disorder?) As you may recall, I tore down several engines and found some pretty poor workmanship in these parts. The issue was the bore of the tappet guides was not at right angles to the indexing surfaces that align the tappet face to meet the cam lobe. This can interfere with the proper rotation of the tappet.**

**I have had a chance to inspect parts from two major vendors of parts in India. When I compared Metro brand parts with the tappets and guides I found in the METRO engine, I was amazed how much nicer the parts in the box were verses what was found in the engine. The machining on the tappet guides (that came in the engine) looked like it had been done with a cutter that should have been thrown out about 2000 parts prior. The metal looks to have been moved off the part via friction verses cutting! The Metro spare parts looked far superior. I also looked over the another brand of parts, and I found the machining to be quite acceptable as well.**

**I can't find much else to complain about on the Metro, but I wouldn't run one unless I checked out the guides and tappets as mentioned above. I would go as far as pulling the tappets and inspecting the faces of the tappets. Why run it and take the chance of junking your cam?**

**At this point, I would not give Metro a high grade for Quality. Bad Tappet faces and just plain poor machining on the guides. It's hard to 'counterfeit' Pistons, and other parts, but the tappets and guides ARE something that a small shop could produce on worn out machinery and substitute for the real thing, maybe that's what happened in the two batches of Metro engines I inspected? If you bought one, don't worry, just check these parts, it's easy, they are not all poor, you just have to check and make sure yours isn't.**

**I am in the process of reviewing another brand of 'STANDARD' Lister, and I will share my findings. For the time being, my focus is on Listeroids that accept STANDARD parts that have been sold for sixty plus years. These engines have proved their efficiency, and parts will be made for decades to come... that is a comfort at this time. The newer designs will have to prove themselves, they may be good, but will you**

**find parts 30 years from now? It's my bet that the standard parts will still be on the shelf for your Great Grandchildren. You won't find them at NAPA, but they'll be all over the third world. Funny thing, I was watching National Geographic; a Special about a group of North African People who some how managed to exist in the middle of a very harsh landscape. They had a Listeroid 6/1 that powered their well pump, the engine was described as 'ancient'. Other than the Lister and Pump, it was Mud huts, and goats.**

I'm always looking for input on this subject, share your experience.

All the best!

George B.





## Jeff's Muffler Experiments

If Jeff can run a Listeroid in his neighborhood with his neighbor's blessing, so can you!

The following is a message from Jeff...

Hi, George!

I think I finally have my muffler design perfected! When you are outside with the garage door closed, all you can hear is the Lister ticking away; no audible exhaust noise at all. Once you get to the end of my driveway, you really can't hear anything at all. The final trick was to stiffen the top of the barrel with a disk of plywood over some acoustic paneling. A cloth strap holds everything tight. The trash can full of sand that the barrel is in helped, but there was still some noise from the top of the barrel flexing. The plywood cured that.

I ran a fuel test to see how much the fuel use was affected by the muffler. I did a single run at 1500W load, then extrapolated that to my previous runs. Fuel use increased by a few percent; I've attached some Excel graphs.

All in all, I think it works well. The noise is greatly reduced, with fuel economy hardly affected at all. I'm confident I could run it at all hours of the night and no one would complain.

--Jeff



Above is the corner of Jeff's two car garage, neighbors are close by.

Neither Jeff or George has obtained any kind of certification from anyone for a set up like this. If you do this, you become personally responsible to engineer for fire, carbon monoxide levels, and all the other related things.

I think this high temp flexible hose Jeff found is most interesting, a person wonders if the engine might scavenge better with a reed valve on the inlet of the barrel, and what the ideal size of the pipe might be from the outlet of the barrel to the muffler. As Jeff has mentioned, a more constant flow of exhaust gas verses the pulses of exhaust gas has a bearing on the overall noise level of the power plant.

As we look at what Jeff has done, it becomes obvious that there's room to 'tune' this design, and customize it for your environment.

If you are building a stationary power plant, weight is less of a concern, potential for experiments become endless.

Tom Miller of Olean, NY, was kind enough to send me a tape of old oil field engines running as they were installed in his area. Of great interest to me was some of the exhaust systems that ran underground some distance from the engine before the exhaust came to the surface, in some instances, water was fed into this exhaust system to 'muffle' the exhaust note.

Following are some thoughts that might be worth experimenting with. I would imagine all of these things have been done elsewhere and probably many years ago.

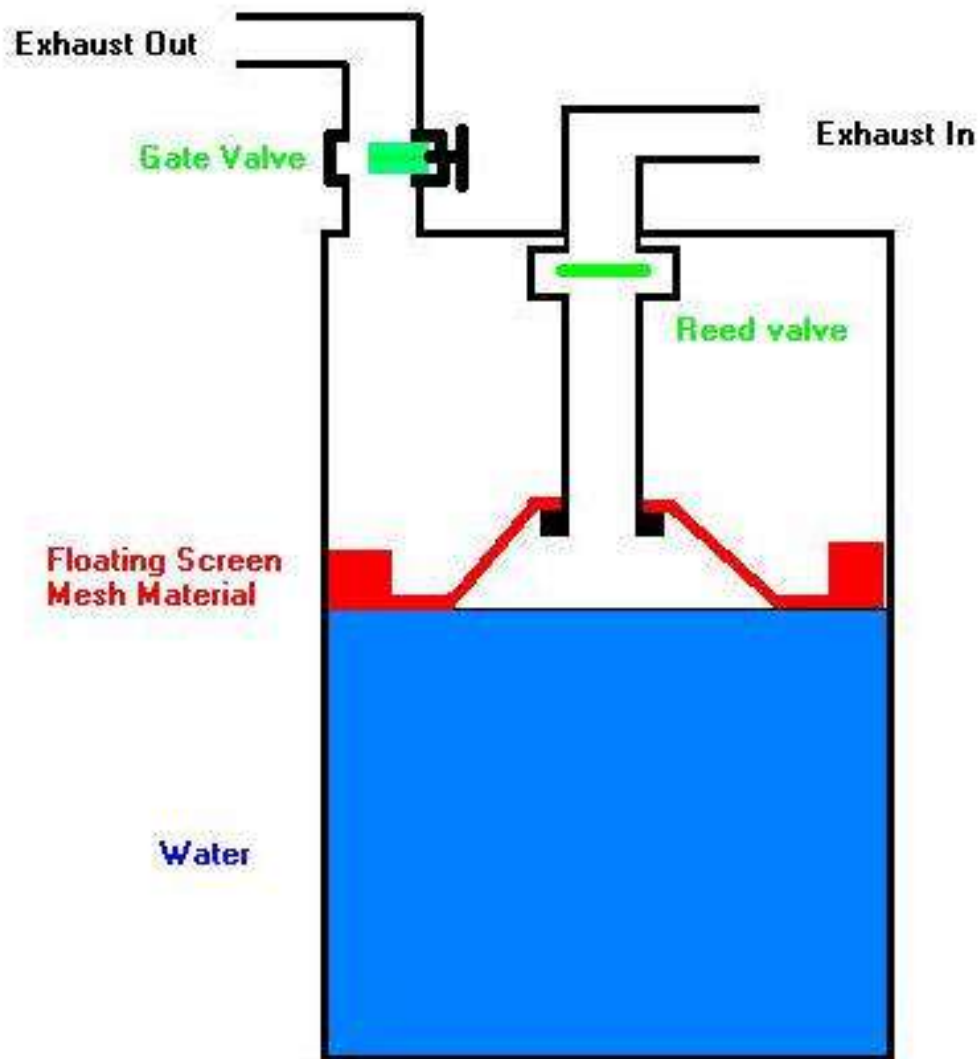

**If we were to:** Dig a hole in the ground, place a vapor barrier inside the hole, Insulate our barrel in rigid foam or other insulating material, and then fill the hole with pea gravel or ???. This should effectively de-couple the exhaust pulses from the surrounding ground/structures.

If we were to add some liquid soap and/or water wetting agents, would it become an more effective scrubber? What about those oil eating bacteria we read about? if we place a simple thermostat and valve between the condensing surfaces (condenser) and the sump, can we maintain some ideal temp and container for our bacteria to thrive? If the water in the muffler got real warm would the water vapor create an even more effective 'scrubbing' action' for our exhaust system?

If we run the exhaust upwards for some distance after the scrubber, would our vapor condense on the exhaust walls and allow us to gravity Feed the water back into the sump of the muffler?

Will the reed valve increase the scavenging efficiency of the engine and produce more power or efficiency?

In conjunction with the reed valve, can we now tune the gate valve to create a more constant stream of exhaust gases and cut down on any of the noise created by these pulses traveling through surrounding materials.

I mention these things to provide a spring board for your ideas,.... there will be lots of them, and few of them will be new...

Jeff... as always, thanks for sharing you work with the rest of us!

All the best,

George

## Customer's Installations

Joe Parker likes simple stuff that works when you need it.



He has a Friend that fabricated this beautiful free standing cooling tank for his ListerGenST5 set. Although it's not clearly shown, this gen head is the FuKing with features I like. Joe also makes use of the Allmand drive system, He likes the fact it works well and it's use creates a small foot print in your shed. Look closely, you'll see a rubber isolator under the I beam.

Following is John Essmeyer's ListerGenST5 on his off grid Estate. John spent a good portion of the summer working on his new place.

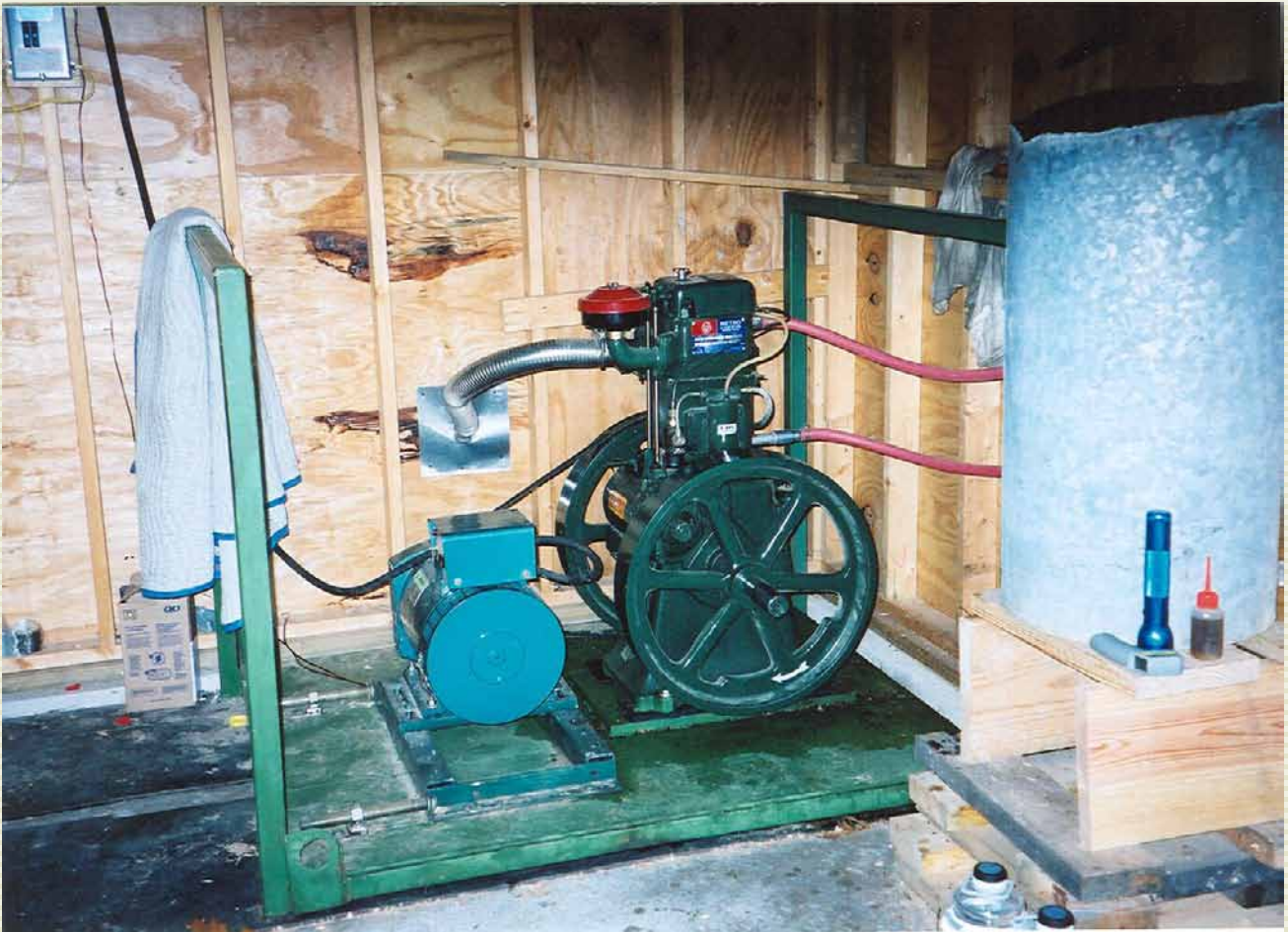

John's set up is a 'work in progress', this unit was used often during this summer to run an air compressor, Chop saws, skill saws, and more. Like lots of folks that experience the efficiency of these old designs for the first time, John was amazed to note that they used a total of five gallons of fuel for the entire summer! Fact is, much of this type of running is 'no load', if you have a very efficient drive like the Allmand drive used here, you'll spend a good deal of time checking the fuel till you get used to it. Although it's difficult to see, John and his Brother Mart have placed a thick rubber mat under the gen set, this has worked well for them. This unit will become the heart of John's off grid power generating outfit, John is presently struggling to rationalize the expense of expensive solar panels and maybe a wind turbine, when his gen set appears to make power for such a reasonable amount of fuel. It will be interesting to see what he finally comes up with.

Jeff Maier might have one of the more interesting ListerGenST3 setups. Jeff is a strong believer in efficient power that makes use of clean and renewable fuels. His personal research and experiments have proven that bio diesel is a MUCH cleaner and a more pleasant fuel to be around than Petrol based fuels. Jeff's setup is in the corner of his two car garage in the middle of the 'Burbs'. When Jeff first installed his Lister, the vibration was rattling the dishes in the home next door! The exhaust note was not exactly welcome in the neighborhood either. It didn't take long and Jeff engineered a few things into his design to totally eliminate these

problems.

[See Jeff's pages to get the rest of the story.](#)

All the best.





# Jeff's Listeroid 6/1 Experiments

By day, Jeff is an Electrical Engineer who works for a well known company, by night, he's an Experimenter/ Fabricator seeking Alternative Energy Solutions and efficiency.

Jeff Starts with one of our stock Listeroid 6/1s, the efficient Allmand Drive, and the ST3 head. This set up presently yields **.125** gallons of fuel per Kilowatt Hour, up considerably from Jeff's previous Prime Mover. Jeff has already produced formulas to predict fuel usage for a given load, and some nice graphs for the Lister 6/1 genset. It'll take a few days to get it all onto the Jeff pages, but it's on the way.

One of Jeff's early experiments will be to determine how detrimental the stock air cleaner is, will a newly designed air intake system produce more efficiency? Will it produce more output?

What about using a tiny bit of propane as a catalyst to more efficiently burn the Diesel fuel? Are there other generators out there that might boost the efficiency of the generating plant? These are all things we could learn from Jeff's experiments.

Lister 6/1 experiments, hard data, graphs, pictures.

A voltage regulator for the ST head

Why you should consider biodiesel

Running diesels in the Burbs.

The true and amazing story of Jeff Maier, .... experimenting with diesel power in the burbs.



Jeff and Angie's home in the great North West, that little stack on the left of the garage leads down to Jeff's "Experimenter's corner".

Following is snippet from email, a brief summary of Jeff's setup, and his plans.

## Hey, George

Here's a blurb about my setup along with some more pictures:

I've been interested in generating my own power and renewable energy for a long time. I believe that widespread, small scale generation is a good thing for a number of reasons. The power is used closer to where it's generated, reducing transmission losses. It's less visible; that is, fewer large power plants. It's less vulnerable to breakdowns, disasters, and terrorism. Plus, for someone like me, it's a whole lot of fun and very gratifying.

Here in the Pacific Northwest, it's cloudy a lot and, where I am, it isn't very windy. On top of that, what sun I do get is shaded for a good portion of the day, even in summer. Thus, solar power and wind are not real good options for me. For years, this relegated me to the sidelines. I could read about things and think that if only I lived in New Mexico and had a 5 acre plot, I could set up a solar farm that would generate more power than I could use.

Late last summer, I read about biodiesel, which I hadn't heard of until then. That got me to thinking; I don't live in the land of sunshine, and I have a small, suburban lot (See photo). What could I do with what I had? Biodiesel solved my renewables problem. In case you don't know what it is, here's basic biodiesel 101:

It's made from almost any kind of vegetable oil. Most of what you get in the US is made from virgin soybean oil. In Europe, it's made from rapeseed oil, which has a higher yield per acre. It can also be made from used fryer oil from restaurants, turning a waste disposal problem into a valuable resource. The oil is treated by a fairly simple process involving alcohol and lye, which removes the glycerin and leaves behind a fuel that can be used in most any unmodified diesel engine. Biodiesel has millions of vehicle miles on it, is EPA approved, and has been very thoroughly tested. It has no sulfur, a higher cetane number than petroleum diesel, a higher flashpoint, and fewer

emissions of all kinds. The fuel itself has almost no odor, unlike raw petroleum diesel. On burning, the smell has been described as like popcorn or French fries. Personally, I find it to smell like burnt veggie oil, but it is certainly far less noxious than petrol diesel fumes. It has maybe 10% less BTU's per gallon than petrol diesel, but that tends to be compensated for by the higher cetane number. To find out more, go to [www.biodiesel.org](http://www.biodiesel.org)

After reading about biodiesel, I started looking into diesel generators. My idea was (and still is) to use a bank of batteries and an inverter, just like you'd use with a solar array. When the batteries ran low, I would use the generator to charge them up again. I found a 3KW genset powered by a China diesel 175 engine, rated at 6HP and 2600 RPM. It worked well, but it was VERY noisy and vibrated a lot. I built a somewhat soundproof enclosure for it, which kept the noise down to 54dB as measured outside my garage. The vibration was still a problem, though. Bolts came loose, pipe fittings broke, and I could see it was going to be a high maintenance machine.

An added note from George; this 175 does not have counter balances like the 185s and up.

While looking on the web for fuel efficiency data on the China diesels, I came across George's web pages. I read about the Listers and was immediately fascinated by them. Well, it turns out that George lives about 45 minutes away from me, so I introduced myself and he invited me to come on down and have a look. Upon arriving, George offered me the starting crank for the Lister. When it fired up, I was immediately smitten. As I drove home I was really on the fence about it. After telling my wife about it, her comment was, "A quiet engine? I'll give you the money myself!" That tipped me over the edge. I got in touch with George and, a week or so later, with one truck rental and a forklift rental, I had a Listeroid 6/1 in my own garage. This was in mid-March, and I've been getting it setup and tweaking it ever since. As you can see in the photos, I've got it on a wooden base bolted into the concrete; these things like to walk around unless held down securely. I've got a big water barrel for thermosyphon cooling. I took the 3KW alternator from my China diesel genset and mounted it up with George's method, an automotive serpentine belt and custom pulley. On the wall, you can see my AC regulator circuit. This device senses the AC output voltage, compares it to a reference, and adjusts the field current to maintain a constant output voltage from no load to full load. It works quite nicely, and varies by maybe 3Vac from 0 load to a 3000W load. I've also run the exhaust through a car muffler and up a flu pipe through the roof (visible in the upper center of the photo of my house).

It is with this setup that I've made the fuel consumption measurements you see on these pages. Thus far, I haven't bought myself any batteries or an inverter yet. I want to make sure the genset is a really viable system before making that kind of investment. So far, things are looking good. I need to improve the muffling; at heavy loads, there is still some exhaust noise from outside. Also, my neighbor reports that his cabinets rattle a bit when the engine is running. The hard attachment to the concrete must

really transmit the low frequency vibration. I'll have to look into some kind of shock mount or other method of decoupling the vibration without having the engine bounce all over while running.

I've wired in a generator panel to my house. This is a breaker panel that has a dual main breaker. The two breakers are mechanically interlocked so only one of them can be on at any moment. Utility power feeds through one, generator power through the other. When the generator is running, just throw the breaker and the whole breaker panel is fed with generator power. This panel supplies all the overhead lighting in my house, plus a handful of outlets. When finished and in use regularly, I estimate that my power plant will supply 20% to 30% of the electricity I use.

So, this is very much a work in progress. I have a long ways to go, but so far, it's been a great journey.

Following is useful data on real tests done at an elevation below one thousand feet.

Load = 2500W Fuel = .125 Gal / KW-Hr. 10.46 KW-Hr in 4h 6m; 1.313 gal of fuel used.

Load = 1469W Fuel = .146 Gal / KW-Hr. 5.25 KW-Hr in 3h 33m; 0.766 gal of fuel used.

Load = 1100W Fuel = .169 Gal / KW-Hr. 4.96 KW-Hr in 4h 26m; 0.836 gal of fuel used.

Load = 291W Fuel = .436 Gal / KW-Hr. 1.72 KW-Hr in 5h 54m; 0.750 gal of fuel used.

Load = 0W (Field on; about 60W) 0.101 gal / hr. Run time = 5h 1m; 0.508 gal of fuel used.

And here's a formula Jeff came up with, keep in mind, this is for his specific setup, if you are using a different head or a less efficient drive system, you should expect a different result. Also keep in mind that there is a penalty for elevation, the higher you get, the less you should expect in output of any normally aspirated engine. Fuel Rate

$$(\text{Gallons / Hour}) = (\text{Load in KW}) * (.0918) + .101$$

Thanks Jeff!

Another note: Jeff is well aware that the massive concrete slab in his garage is an excellent transducer and will assure that low frequencies are well communicated to surrounding structures. Jeff is in the process of putting motor mounts under his generator frame. If you are going to engineer isolation into your gen set, do not put motor mounts under the engine alone, you must isolate the complete frame. Also note, if you were designing from scratch, you could 'box in' an area where your generator was going to set. This box would be formed of thick rubber strips and would effectively de-couple a few square feet from the rest of the slab. Properly done, this could mitigate the problem to a large degree.

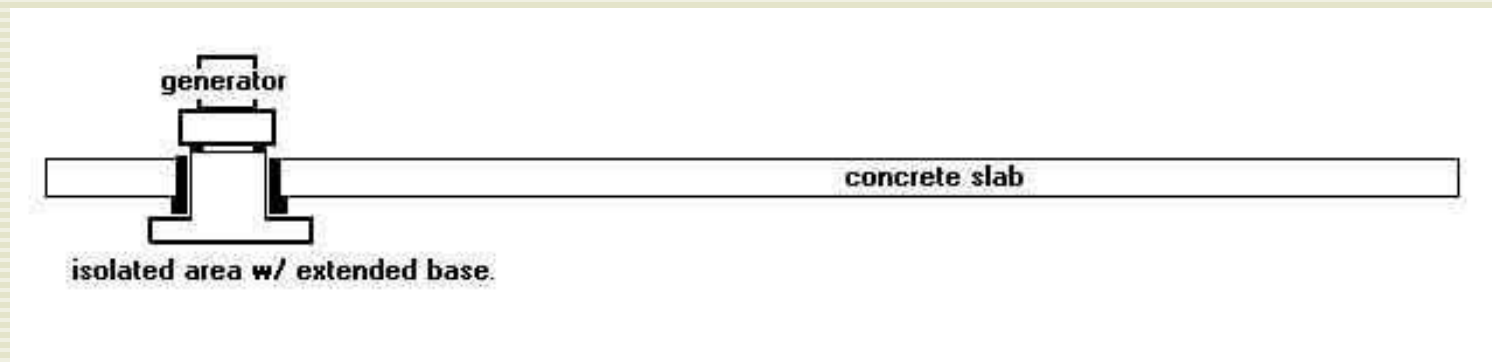

The above drawing shows a de-coupled area and the generator base on rubber shock mounts. This provides a double de-coupling that should do an excellent job. Easy to do when you have a clean sheet of paper...

George B.

## STOCK AIR CLEANER LOOKS LIKE A CHOKE

as I have mentioned elsewhere, the Indian oil bath air cleaners look like a joke, they look so restrictive that one would bet that modifying a stock filter could increase efficiency. since we all know that testing is the only way to prove anything, we gave a modified unit to Jeff for testing.

Hi, George!

I ran the test with your foam filter today. Here are the results:

Run Time: 2 Hr 50 min

Energy produced: 7.18 KW-Hr

Average load: 2534 Watts

Fuel used: 118 oz (0.922 gal)

Fuel rate: 0.325 gal / hr

Specific Fuel Consumption: 0.128 gal / KW-Hr

With the original air filter I got:

Fuel rate: 0.320 gal / hr

Specific Fuel Consumption: 0.125 gal / hr

The difference between the 2 is 2.4%; this is close enough that I'd call it within experimental error and that there is no substantial fuel economy difference between the two filters.

How shall I get your filter back to you? Maybe this would be a way to entice you up here to see my setup sometime.....

--Jeff

**So... there you have it! this is a lesson for some of us, and a reminder to others, just because an air cleaner looks to have been designed by Rube Goldberg, it doesn't mean you're going to pick up efficiency by trying to improve it. But... here we are with another question, it's one that you may have formulated while reading this.....**

**Will Jeff's unit carry more load with the less restrictive looking filter?**

12/2003 more from Jeff

**Jeff's Muffler Experiments**

## The Pulley (sheave) Page

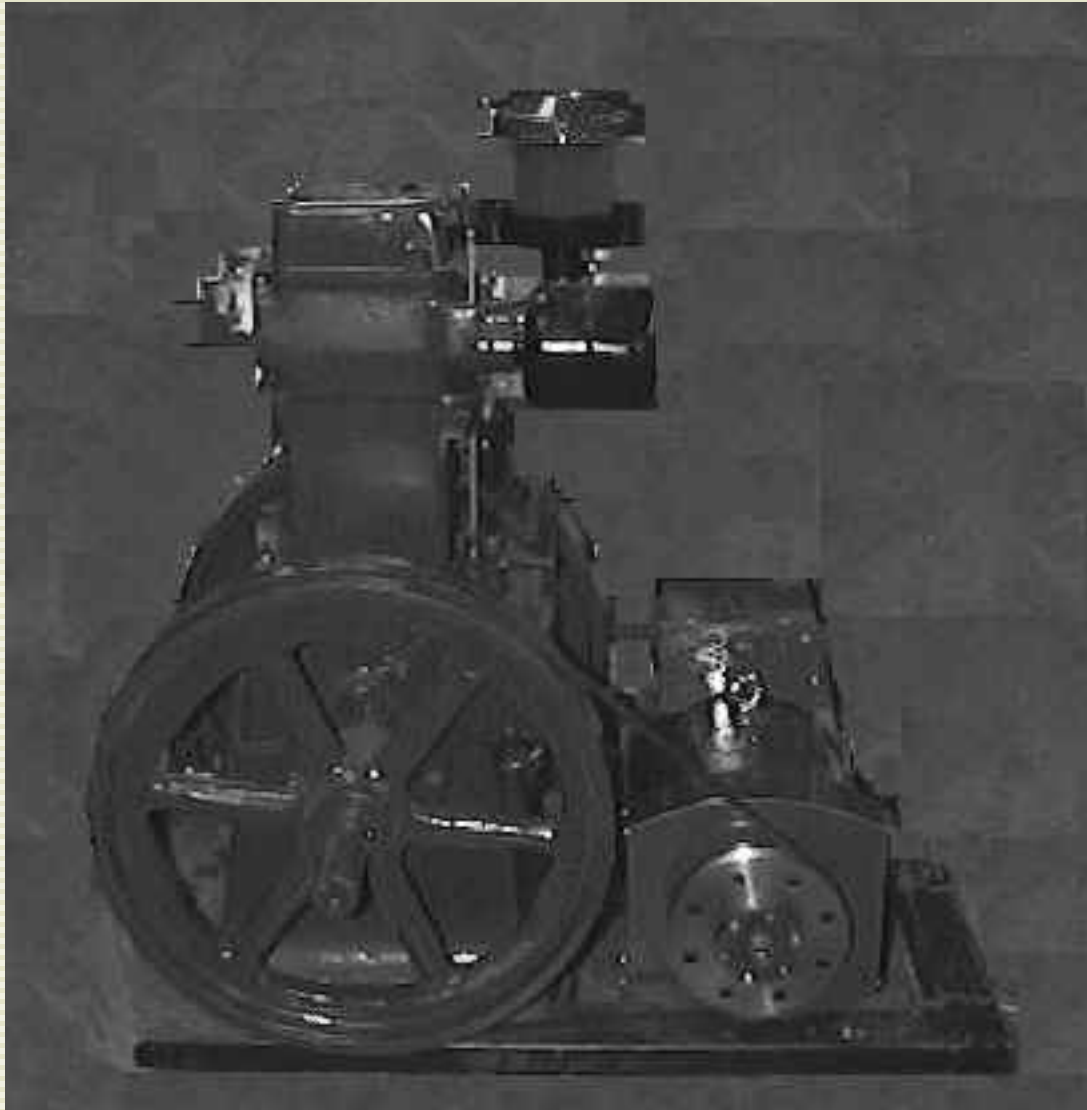

Above is a picture of a Lister clone, 'Listeroid' equipped with the trouble free and highly efficient Allmand drive



Above is a batch of custom made Pulleys for the Allmand drive system, these are pushing 20 pounds each..

If you are looking at buying an engine or a generator head... (or both), take the time to look into the drive system and determine the size of pulleys you'll need. It's important to learn how much power you can send through a single vee belt before it starts slipping. If you improperly size your belts and pulleys you'll set yourself up for an unpleasant experience where you buy the drive system twice. It's far better to call someone who knows their stuff and ask them to help you size the complete drive system.

Some folks have to learn the hard way, they quickly learn that those cheap little alloy pulleys are for fractional horsepower applications. I must admit I've learned some of these things the hard way too. I built a battery charger with an alloy pulley and vee belt, although I was only asking about 80 amps out of the set to charge a 12 volt battery string, the belt heated and literally turned over in the pulleys. The belt was a heavy duty piece that cost twice what a regular belt did and still couldn't handle it. I also learned that a VEE belt actually transfers less energy if you tighten it too much. If you have an infra red thermometer, you can learn a bunch about belts, and you can readily see your losses in excessive heat, and can best adjust the tension by watching the temp change.

If you must use VEE belts, learn about 'common back' vee belts and use high grade cast iron pulleys. Folks will tell you different, but you need to learn what a bushed pulley is verses a



lawn mower style pulley, and you need to use them. If you're going to build a generator you want it to work when you need it don't you?

Another thing you need to ask right now... **where did all those vee belts go on autos?** did the entire auto industry drop them just for the heck of it? The answer is they have been forced to make their stuff more efficient, and they have strong incentives to provide that efficiency. This was an area with huge payoffs for them, otherwise there would have been no change.

If you think using VEE belts is going to be cheap, wait till you order two quality pulleys of the correct size, and the bushings you need. Add a good common back belt and you're looking for a loan from the wife. Also note, using small pulleys in a system where you're well above fractional horsepower is a big problem. The smell of burning belts, seeing the frequency and voltage of your generator drop like a rock, it's all a pain, and then you need to go out and buy the right stuff all over again. Buy as big of VEE pulley (within reason) as you can afford, note that small pulleys often need special belts so proper engagement can be maintained around that pulley.

If you have an engine like the Lister, or a heavy flywheel engine like the Petter, you should give some thought to reducing the parts you must buy and reducing the losses in your drive system. Look at the **Allmand Drive System** for the Lister style engines, fuel savings will pay for the system alone.

This is proving to be an amazing system, it uses the flywheel itself for one pulley, and a custom bushed pulley that looks totally vintage for the generator or driven end. This pulley sets your generator head to run at 60hz when the engine is near it's full rated output. They are custom built for your application.

What's important to note is the only wearing part of the drive is a common serpentine belt that you can buy from any auto parts store. If they don't have this particular belt, they don't have much on their shelves. Designing around readily available wear parts is a golden rule here. sharing where to get it, and what exactly get is also part of our philosophy, we feel it is important to make you as independent as possible verses try and sell you our stuff, if you have a failure, or someone takes parts off your machine, you'll be able to replace it locally and make juice.

I got a call from John E. yesterday, He has a Listeroid 6/1 running at 650 RPMs as the prime mover on his off grid country estate. They're building the new House at this time and running big chop saws and an air compressor for nail guns etc. John says the Listeroid puffs a few smoke rings when the compressor starts at the same time the chop saw is loaded, but the power plant is doing the complete job. John has a good number of hours on his machine and is having a hard time believing how efficient the power plant is. He is now fully aware of the stored energy in those big flywheels and just how much work a six horsepower engine can do when equipped with them. There's added efficiency with the reduced losses of the drive system, but what is not obvious to some is the serpentine belt does NOT slip like a VEE belt When those hammerhead like loads hit the generator. this system transfers huge amounts of torque from the flywheel to the head to cover the load. It may take as many as three or four vee belts to transfer this peak torque load as effectively, and of course running that many vee belts would also create a large parasitic loss, ... 'kinda like giving giving Ted Kennedy a key

to your booze locker', the losses will be real, and noticeable.

*To summarize what I have learned to date.*

**Engines with big flywheels are like magic and can level peak loads with astounding results.** In order to experience this, **you must have a drive system that can handle the HUGE amounts of torque available and effectively transfer it to the generator head.** This is not easily done with VEE belts, and if you deploy a VEE set up that is sufficient to handle this peak torque load, the parasitic load will be great. This parasitic load will be felt when you try and manually start the generator set, and may prevent your wife or slightly built members of the household from starting the Gen set. Mating a 4 pole generator head to a Lister or large flywheel engine takes a pulley exactly twice as large as a 2 pole head, this means that the pulley on the 4 pole head has a massive contact area for the belt, and will transfer far more torque from the prime mover into the generator head. Two pole generator heads have their place, at present I'd say that's right next to your Brigg's and Stratton.

Here's one of the nicest Lister powered generator sets in North America (IMHO). Steve Gray is a Master Fabricator, and has one of the most impressive old engine websites ever. Note the quality of the picture below, **I stole it off his website**, please don't tell him! I'm still learning how to take a decent picture... click on Steve's website, but remember your way back, you could be there for a while.

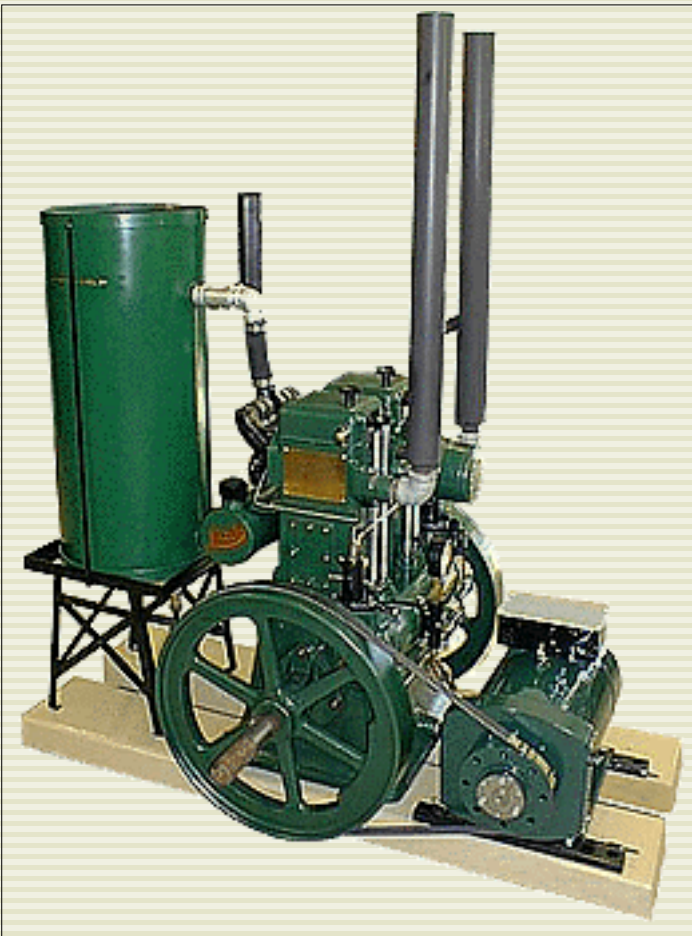

<http://www.oldengineshed.com/listgen.html>

**below,are other pages on this site that discuss the Allmand Drive, one of these days, I'll get all on one page.. don't hold your breath.**

[making.htm](#)

[Lister 6/1.htm](#)

[jeffm.htm](#)

[gen\\_base.htm](#)

You can order a complete drive system, let me know what you have, pulleys are custom made and take some time to have made when we don't have one in stock.

**Pulley shipped to your door (lower 48) \$169.95, ask about a bushing.**

[Email-George B.](#)

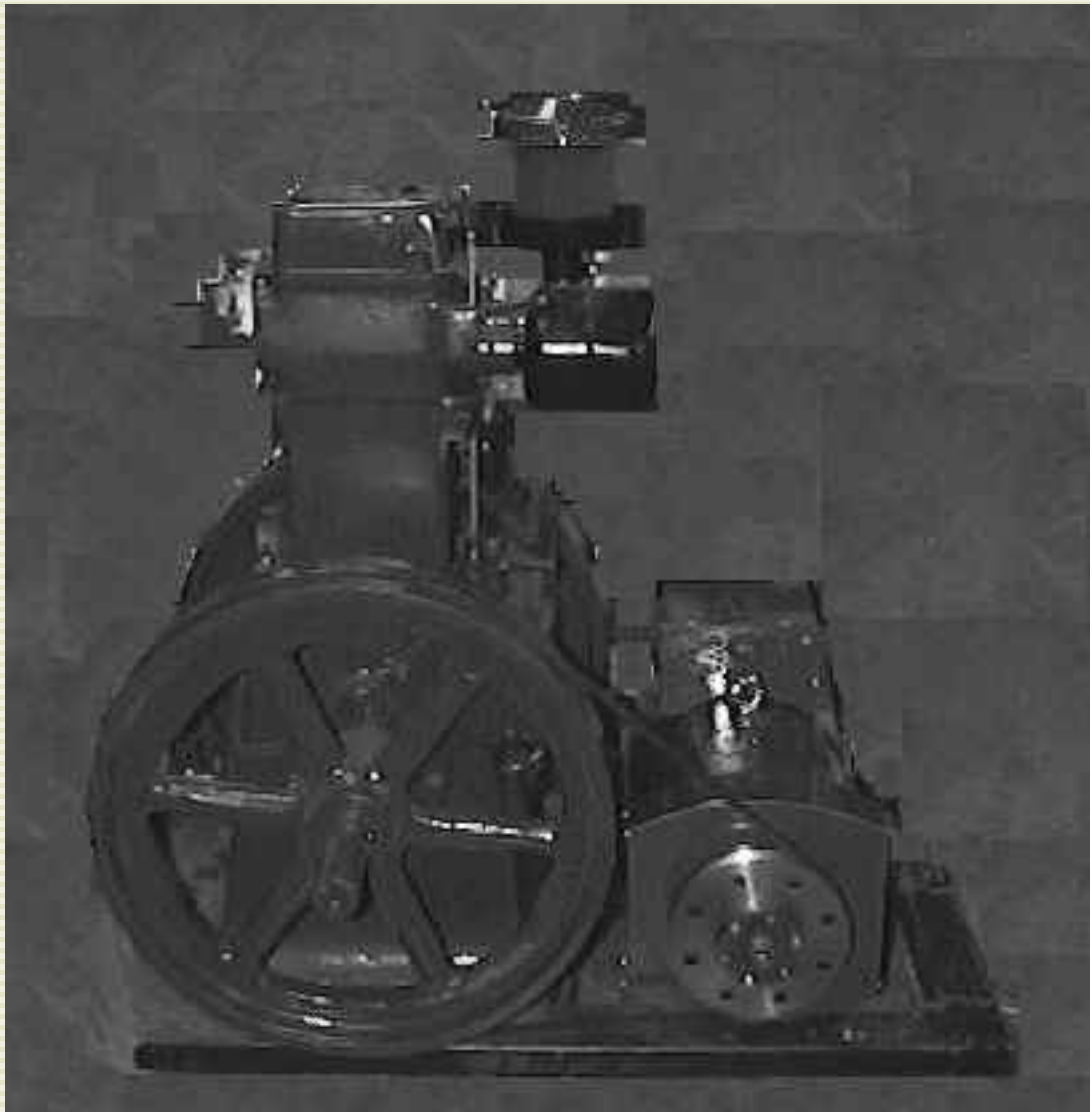

If you are new to Listers, take time to look over the '[Listeroid](#)' page. These are mighty work horses that could out live you in regular service. They are also known for their efficiency.

It has taken me several months to find the time to research and test a durable drive system for the Lister 6/1 and ST1800 RPM generator head. You could do it differently, perhaps you'd drive off the engine crank with a pulley, or try a different type of belt? I don't think you'll do any better than what we have done here, and it may take you a long time to discover why it's built the way it is.

Some folks note that small diameter pulleys are less money than the big ones. If you decide to drive with vee belts and two pulleys, you may be smoking belts when you try to load your generator. Over tightening VEE Belts to compensate for an under-sized pulley causes trouble. Pay the money to buy a bigger diameter pulley set if VEE belts become your choice.

Talk to your supplier, communicate your application and allow them to help with the selection. If you don't know where to start try <http://www.appliedindustrial.com> for sheaves, belts, couplers, bearings, etc. They have a number of outlets in the States and do a good job of getting you the right part.

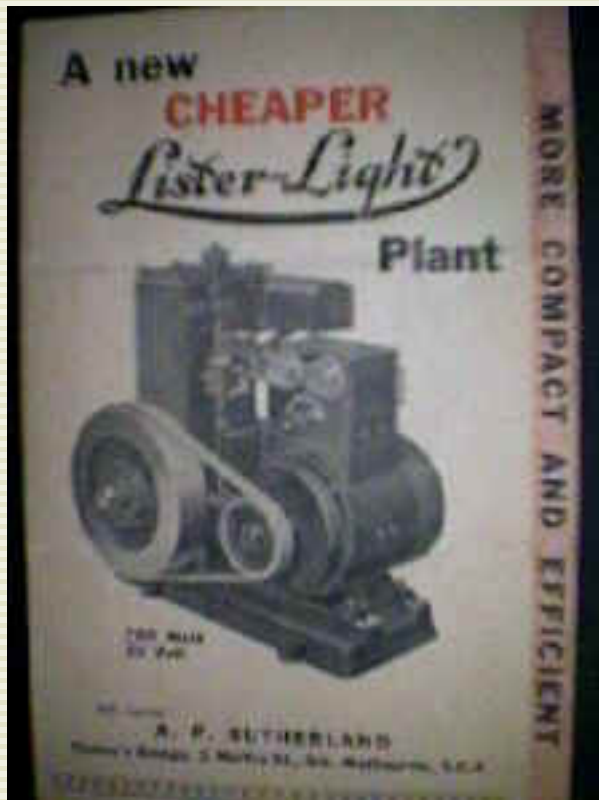

Above is a picture of an old Lister plant, notice how compact and simple the unit is? This became my goal.

The KISS principle? One belt, one Pulley, one Bushing. Less parts to buy, and the wear part is readily available at your nearest auto parts store. Maybe you've noticed that most all Autos now use the Micro VEE Poly belts often referred to as 'serpentes'. They come in both 6 rib and 8 rib belts and are strong enough to drive all the accessories off a single belt.

Our custom pulley forces the belt to track DEAD center on the flat flywheel. The Engine runs at it's rated speed while the 4 pole head maintains 60HZ at it's 1800 RPM speed. this is not a pressed steel pulley with rolled grooves, it's a precision machined piece of art work with a custom diameter.

**7/15/02** It was another day of testing, the generator set performed perfectly all day, there's been no attempt to check fuel usage yet, basically I'm trying to torture the drive system, checking the generator head, bearings, etc. the high flywheel mass is magic, I stalled the chop saw and waited to hear the exhaust note change, How different that is from the instant bog with the lights dimming with the consumer generators. I guess a person has to remember that this is a totally different kind of 6HP.

**7/23/02**

## Building a coolant system.

If you look at other pages on this site, you'll find that tanks are used for cooling verses radiators. Make sure you use a big enough tank. If you're like me, you will think of the amount of cooling required in terms of horsepower produced from the engine. If you're making 6 HP, you expect to have less heat to dissipate than a 100 hp engine. If you're using a thermostat, there's no penalty for running too big of tank.

For 6/1genset#1 we'll start with a radiator, but there is plenty of energy in this waste heat to do all of the domestic hot water for a house hold... even off a six horse power unit..so, I'll probably change over after experimenting.



Note the supports for the radiator frame. These are fabricated from pieces of pipe and scrap tubing found in the salvage yard. the rubber isolators are cut from a rubber mat with a hole saw and glued in place with rubber cement.



The key is to mount the unit high enough for proper thermal siphoning, make sure you purge all the air from the system, a burp tank is a good idea.

Once everything fits correctly, it's time to tear it down and paint it green.

### **August 7th, 2002**

The Lister 6/1 is presently fitted with a heat exchanger that allows antifreeze to be run in the engine block and the heat to be extracted and transferred to a tank and stored. After considerable testing, I am pleased with this set up, and have tossed the radiator into the scrap pile. Set the water pump at the spring, connect the hose to the cold water side, connect the hot water side to the shower a presto... hot water for a shower and dishes at no additional cost!

Today I ran the 6/1genset#1 for about 4 hours, I transferred the shop to the gen set and ran all my power tools, the FM receiver, chop saw, fridge, fan, fluorescent lighting, grinder, drill press, and more. It worked just like commercial power. I even made a few healthy cuts with the chop saw cutting some 3/8 steel plate.

I am still infatuated with this engine/generator combination, it was love at first sight and there's been nothing to change my mind. I was a little concerned about the lack of automatic oiling to the valve train. I even wrote to the manufacturer and asked about this; the reply... " no one uses the grease cups anymore, the shaft and arm materials are hard and require very little lube". Lets face it, at 600 RPMs, the requirements are reduced.

The bolt holding on the breather cover did fall out today. Although I caught it in short order, it did deposit a mist of oil on the valve cover and other parts of the engine. Seems to me, things must be getting oiled real well in the crank case if it can do this.... It is important to keep this breather in place, tighten that bolt because the little plate acts as a 'reed valve' and causes the lower end to operate in a vacuum. This keeps oil from being forced past the seals and keeps your engine clean and dry.

**Feb 11, 2003, load testing begins on 6/1genset#2, this engine is presently equipped with a cast iron radiator for cooling.**

I moved our first 6/1 to our cabin in the Cowiche Mountains. After some months, I have completed a second 6/1 generator using the 5KW ST5 gen head coupled with our custom pulley. After working on this engine for more than a year; I have come up with a list of modifications I like to make. This includes port matching on the intake and exhaust, some light polishing of the ports, hand lapping the valves, modifying the somewhat restrictive oil bath intake breather to accept a large replaceable foam filter. Blue printing the fuel linkage, creating the critical timing marks, and re-timing the engine if necessary.

I have come up with a frame configuration that meets all of my requirements, this incorporates the sub frames for the engine and head I mention elsewhere on this site. It also has mounting holes so it can be tied to a concrete slab or other foundation. Presently, it is bolted to the concrete floor in my shop.

Today I placed two 1500 watt space heaters on the set and ran it for about an hour at exactly 60 HZ. The engine didn't seem to be phased by this load at all, and I noticed that I could plug in my bench grinder and two horse chop saw and it ran as well as if it were plugged into the commercial power. I need to build a good load box for testing. Maybe I'll find more load this week.

**What will a Lister 6/1genset#2 carry ? Stay tuned.**

**Feb 12,** I went to Home Depot looking for components to make a load bank of sorts. I want to be able to load evenly, and in small increments. After looking at everything, I found a plastic flush mount light fixture rated at up to 250 watts for 91cents each... I bought 10 of them, but passed on the expensive light bulbs. On the way home, I slipped into the dollar store and found 200 watt bulbs for \$1, and 3 100 watt bulbs in package for a dollar. I wired this all up so it could be placed as a 240 volt or a 120 volt load.



Once things were hooked up, I cranked up the 6/1 and let it warm up on one 1500 watt space heater, then I switched in the other small space heater. The engine exhaust gets warmer as the load goes on, but it still seems to be loafing along, I then started switching in the light bulb load bank and adjusted for exactly 60 HZ... counting up the (stated) wattage, I was running 4200 watts and ran out of load to place on the set.

I did notice that the 6/1 started to smoke a little and the exhaust temp went from a cool 258 degrees to around 368 degrees when I added the 1200 watts of light bulbs.

With this load in place, I plugged in the 2HP chop saw and slammed through a few 2x 4s, it seemed to perform the same as it does plugged into commercial power.

Now here's a lesson for some readers, and some relief for others.....

Just because that light bulb says it's 100 watts doesn't mean it's consuming exactly that at the voltage you are providing, and just because that space heater says 1500 watts, it doesn't mean that's what it will consume under test.

Putting a clamp on amp meter on a cold heater showed it initially pulling close to the 1500 watts, but one rolled off to 900 when it got warmed up, and the other was pulling only 1200 when warm.

This head puts out 117 volts at 60HZ, and the real load I had on it constantly was 3200 watts. Unlike a small gas rig that wants to drop RPMs when it's overloaded, this 6/1 wants to carry more, running the 2HP chop saw on top of a full load is a testament to it's ability.

I don't know if there's a point to putting more constant load on this set, I think the 3KW continuous load is about right. the old Lister 6/1 power plants did 2800-3000 watts, this plant is doing slightly more, possibly due to the more efficient drive belt and pulley, and maybe that bigger air cleaner helps too?

I would bet this plant will start any load a 5KW consumer plant will start. I have a 125 foot well with a 1 1/2 HP 220 volt submersible pump at the bottom, if I wire the generator into my shop, I could open the breaker at the house and feed the well pump. That would mean There's 200 feet of wire between the 6/1ST5 and the pump.

Sounds like a good test to me, as you may have read elsewhere on my pages, the 6/1ST5 runs my buzz box welder without complaint, what more does a guy need in a small power plant?



This is 6/1#2, in the back, you can see a piece of flex pipe used as an exhaust, this sneaks under the door. The engine is fitted with a 190 degree thermostat (in the head), and a cast iron radiator. Yes... the set is bolted to the floor.

**July 2003...** I welded an exhaust flange of sorts to the front of the wood stove door, the flex pipe now goes into the wood stove and the flu is used as the exhaust system, believe it or not, it's fairly quiet, I think the fire brick and the heavier metal help to muffle things. The radiator spills some good heat... a problem in the summer, and most welcome in the winter. Of course the DIYer will have at least two solutions to this problem.



Here's the radiator, painted the same color as the Lister on the ends, and black everywhere else to help dissipate the heat. This particular cast iron radiator made a trip all the way from Calumet Minn., Thanks MJ! I ran the engine with a 2000 watt load for about three and 1/2 hours today, the heat from the engine block, radiator, and 2000 watts of light bulbs and heater kept the shop a comfortable temperature. Note the red tank in the background, this is a boat tank with quick connect, it's the best thing I've found for these engines.

If we figure **.150** gallons of fuel per KW hour, we might guess that the Lister would be dumping nearly 20,000 BTUs per hour into the coolant water when the engine is fully loaded. This waste heat might easily heat 400-600 square feet of insulated space when the power is

out. There should be an equal amount of heat that could be re-claimed from the exhaust.

Stay tuned, we'll see how this set starts the well pump.

**Here it is late July 2003, and I found time to test the 6/1\_ST5 for starting my well pump.**

**The pump is a typical 1HP pump at 125 feet with a bladder pressure tank with a pressure of 60 pounds. The wiring between the shop and the house is #6 or better and the overall distance is about 120 feet. To conduct this test, I opened the dual 60 amp breakers at the house that feeds the shop, then I hooked the generator into the shop service panel through a spare set of breakers, and 'back fed' the isolated circuit. If you do something like this, triple check everything, and take voltage readings before you through the breaker, and of course.. get approval from all possible authorities in your jurisdiction....**

**As expected, all this stored energy in the flywheels starts the pump like it was on commercial power. I even added the small loads in the shop and allowed the generator to power the well for an hour or so while the sprinkler was running... 6 horse power it is, but it starts induction motors like a typical 10 or 12 HP generator.**

**With this finding, I have scraped the idea of placing a bigger generator at our Easton location. the 6/1 will run the heck out of power tools, and take care of my hardest to start load..." the well pump". Some folks need more power, my thoughts are to use propane for all the big power sucking jobs.... dryer, water heater, and kitchen stove, if you have the well pump covered, you probably have most critical needs covered.**

**I am also pleased to report that the drive system is performing well. I still feel this is the ultimate set up for the Listers.**

**One more note, there are a number of folks that are concerned about voltage regulation, some of them read about voltage droop, and circuit breakers tripping and all that stuff. These problems are magnified when a modern engine (low fly wheel mass) is used.**

**The voltage of a typical generator head is related to the frequency (RPM of the engine), if you have a heavy flywheel like the Lister, your have some additional help in controlling droop (low voltage).**

**With all this said... remember that a Lister 6/1 doesn't like to carry more than about 3000 watts at sea level ongoing, maybe less if you choose to use vee belts verses our Allmand Drive Pulley. What this means is you must not load the engine down with other loads and try to start your well pump.**

Take a look [inside the 6/1](#)

Running a Lister for the first time. [First Run](#)

Please [email](#) me with your comments.





7/27/02

## **How do you take advantage of the waste heat from your generator? Build a junkyard heat exchanger!**

**Disclaimer: Modifying a pressure vessel of any type can be dangerous and could result in the loss of life, always fit proper pressure relief. If you cut or weld a tank, have it pressure tested and certified for your use. What you read here is for educational purposes only.**

I've been experimenting with the use of cooling tanks verses radiators for stationary use. My biggest concern with these tanks is the lack of rust protection and antifreeze in the engine block. Running an open system with hard water can be a real problem, If you're attempting to use the generator on a regular basis; proper coolant in the engine block is a nice thing to have.

Making an inexpensive heat exchanger, allows for the use of a proper coolant AND you can harness the energy to heat domestic water as well. There is a reasonably safe glycol based antifreeze that won't Poison you if your exchanger develops a leak (so they say). I guess a cautious person could add a generous amount of red dye to the coolant as an indicator as well.

There are basic rules for thermal siphon systems, the most basic, is have everything move upwards from the engine, any low spots in your coil or hoses could cause your setup to malfunction and damage your engine. A basic understanding of what is happening in a thermal siphon system will help a bunch. As water gets warmer, the molecules expand and it become less dense. This causes it to rise to the top of the system. Gravity acts on the heavier and cooler water forcing it to the lowest point in the system. If you were to accidentally create a lower point in your hoses between the engine and the tank, you'd have cooler water trying to migrate from both sides interrupting the flow. Picture a nice straight angle upwards from the engine to the tank on both runs. Maintain this, and keep the size of the hoses adequate and the thermal system will work.

If you plan to make use of such a system, make sure you place a temp gauge of some type in the block prior to the thermostat (if used) where you can see the real coolant temp. Thermostats are a concern for some of the Older than dirt folks that have been around cooling tanks, they explain that a sticking thermostat can cause overheating and may not be worth the risk of a failure. With this in mind, a person has to weigh the benefits verses the risks of a particular cooling system design. Personally, I think thermostats have proved themselves in Autos, and I make use of them.

I start my DIY project with a FREE water heater! I exploit the two standard one inch NPT (National Pipe Thread) holes in the side that were used to hold the heating elements. These become the lower and upper ends of the wound coil placed inside the tank. Most water heaters have been lined with a material to prevent the tank from rusting, it is important to try and preserve this barrier as much as possible.

the first thing I did was 'chuck up' a thin kerf cut off composite blade in my air tool. I cut a fraction below the weld on top of the tank. Watch your depth, you want to cut through one layer only, go all the way around and then find yourself an old screw driver or chisel point to use as a wedge, place it in the cut, and tap it in lightly all the way around to lift the top free.

If you do things right, you'll be able to lift off the tank top. Wipe it dry and take 200 grit (or so) sand paper and clean up the area you cut loose. Notice that the wedge you used broke the glass lining in a neat little crack.



If you look closely, you can see that there is a slip joint that fits inside of the one inch copper tubing. I found a copper piece that screwed into the pipe threads. I used a rat tail file to open up the hole just enough for this slip piece to pass through and then sweat soldered all the joints. Notice that everything moves upwards, even the last piece at the top moves slightly upwards as it exits out the side. Winding this coil; and soldering it in place will take a little patience, just keep pushing and prodding slowly till you have it. If you are going to be banging around your exchanger, consider making some support for the coil on the inside, I bonded the copper coil in several spots to the side of the tank with epoxy, if you try this, use the 200 grit sandpaper to scratch up the area you bond to.

Once you solder everything good, place the tank up right and fill it with water to test your work. If you like, use a rag and air hose to elevate the pressure in the coil and look for bubbles inside.



I screwed in these copper adapters TIGHT into the threads before soldering.

Once this work is complete, you can have the top refitted, and welded. The use of wire feed keeps the heat localized and does less damage to the glass lining.

**IT is very important that you fit the domestic water side with a proper pressure relief valve!**

If you wish to use it for a cooling tank only, leave the top off, fill it with water, and start your engine.





I removed the neck off a junk radiator and grafted it onto a one inch tee on the top end of the coil. this becomes the fill point and high point in the system. Use the same caution you use around an automobile when checking coolant, steam burns can be serious! Use a proper radiator pressure relief cap!



Here you can see the lower end of the coil, below that is the stock drain valve which I've fitted with an adapter to receive the male coupling of the hose for charging the tank.





Above is a picture of the shake down test site.



Here you can see the windshield washer bottle and modified mounting off a 74 Chev PU being used as an expansion tank for the engine side cooling loop.

**6/2003 Note, there are external heat exchangers that can be mounted to the side of the cooling tank externally. I highly recommend this approach. If you go to all the work of placing a coil inside the tank, and you end up with a leak, it would be a bunch of work to fix it. I will post such a set up time permitting.**

[Home](#)

[George B.](#)





### **What's inside the Indian Listeroid ?**

These engines beg to be taken apart, I don't know how you could get more basic, you'd have to work real hard at messing something up, **the perfect engine for the mechanically challenged to work on ?** I think so...

Maybe it's time for a bit of a warning, anytime you have an open flywheel, you have a hazard. Considering how Liberal things have gotten in the great OLE USA, this may be a real problem. When you see Attorneys litigate against McDonalds for not warning people that's American fries shouldn't be eaten at every meal, you know things are bad. With this said, it is my position that this is an engine for educational purposes only, you should never try and run one,.... you could hurt yourself or the ones you love. Also NOTE... If you haven't removed your lawn and replaced it with a non skid surface, you could loose everything with one slip of an unwanted solicitor. Personal responsibility may be a thing of the past.

**I'd bet that I could pull the head, and have both valves sitting on the bench in less than 5 minutes.**

Another nice thing is the tools you don't need, a Crescent Wrench, 3/4 inch breaker bar, 1 1/8 inch socket, and a screw driver will get most things done. Add to that a cylinder hone, and you might do a complete rebuild.

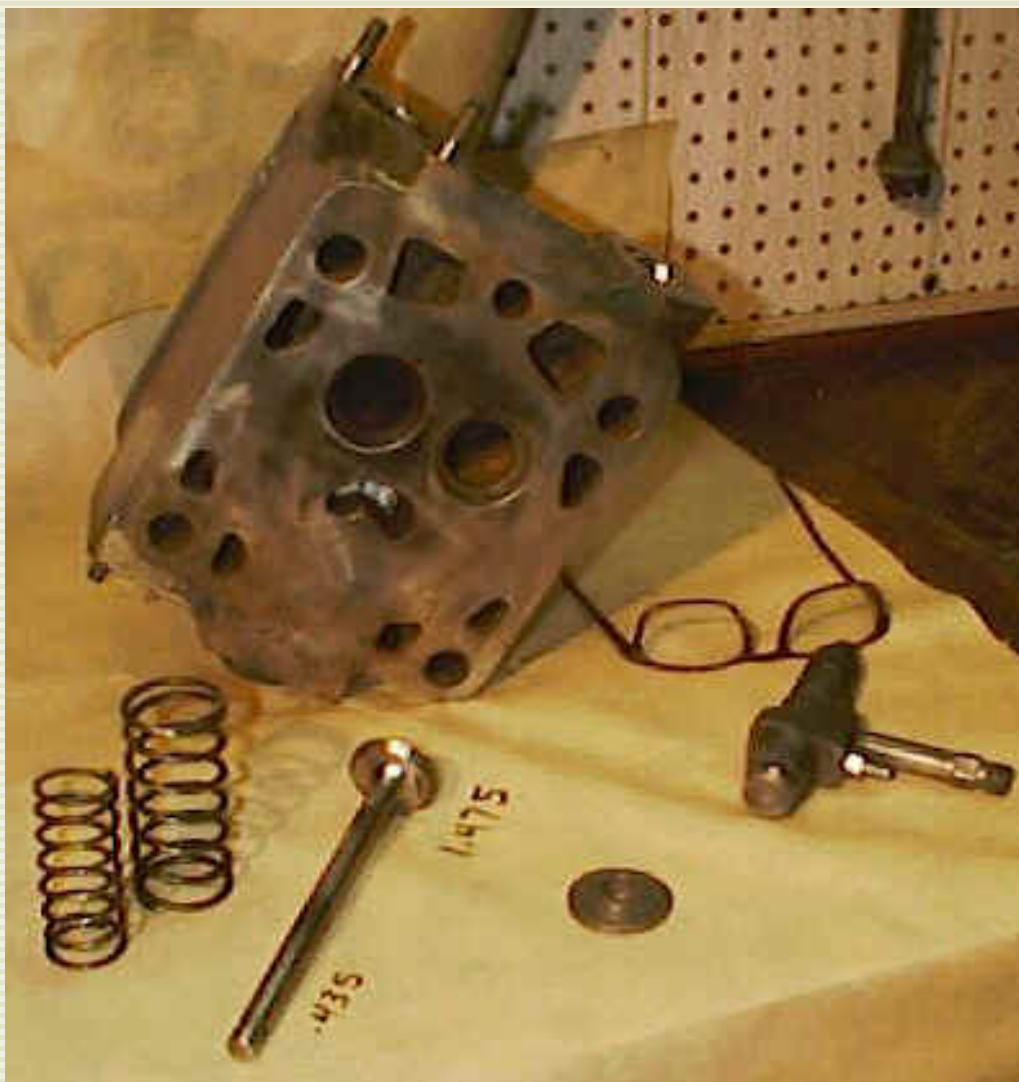

The Intake and exhaust use the same valve. The face measures 1.475 inches across, and the valve stem is a massive .435 inches! With spring pressures this low and valve guides this massive; they should never wear out.

See the little frown under the valves? That's the passage to the pre combustion chamber. In the earlier days, engines were fitted with the CS (cold start valve). According to some folks I've talked to, this option doesn't buy nearly as much as it did due to vastly improved injector nozzles and spray patterns. With the diminishing returns on investment, the Indians have decided to drop the option. This engine is equipped with a 'plug' that screws into the side of the head where the valve once was. I believe this opening has been retained to provide replacements for the older models AND to facilitate the forming of this pre-combustion chamber during the manufacturing process.

I would think that this plug could be modified to decrease the volume inside the pre combustion chamber, this might add efficiency if you were running this engine in the higher elevations where a higher compression would be an advantage.

The injection pump carries the MICO name which equates to Indian Bosh. I think this head is superior to some castings I've seen from India, the coolant passages and the inside of the head looks as good as anything GM was making in the 50s, and early 60s (their best years from a rebuilder's view point) with plenty of metal, and thick decks. Sorry about the outside... should

have taken pictures before I took my die grinder to it, but it may have been too dark to show well.

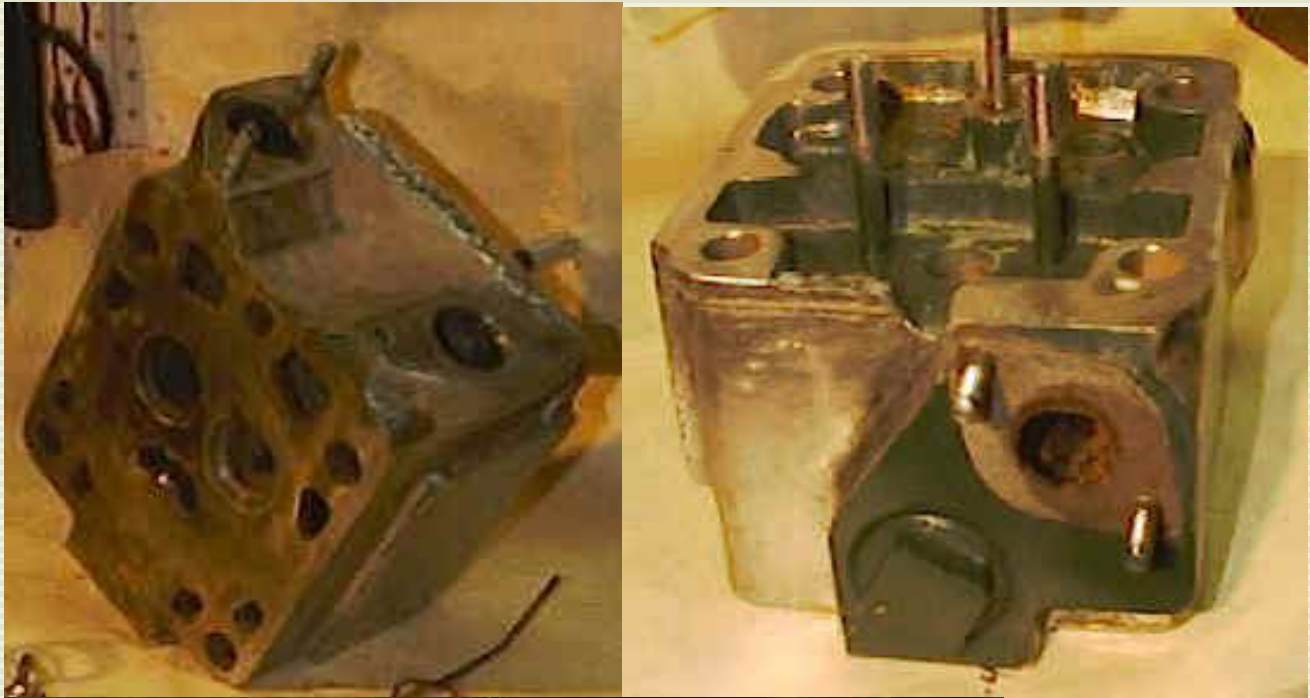

Above left, a view of the intake and exhaust layout. Middle picture shows the water coolant

passage. Note the slot to the left of the coolant outlet, this makes room for the injector. To the right we have the cylinder block which sits on top of the crank case. As you might be able to see in these pictures, the sleeved Listeroid engine looks to have been put together and machined with some care. The inside of the castings are very nice. Notice those studs, they are nearly 3/4 of an inch in diameter, torque the heads at 160-170 foot pounds!

This engine had been load tested after assembly, and from the looks of things, the engine had been run for at least 1/2 hour.

I invited Randy Allmand, (My machinist and Motor Head Friend) over to check out the valves, we looked at the valve face and the seats at 6X magnification and didn't find any problems, but since this engine is so fun to mess with , we hand lapped the valves.

I started the die grinder up and lightly cleaned up the intake and exhaust ports, the grinder is fun to use, next thing I knew; I was polishing the beams on the rocker arms, then it was the cam cover, the rocker shaft block. It's addictive, don't buy a die grinder unless you can control your urge to polish everything, you'll drive your Wife and your Dog nuts!

The cylinder sleeve has a nice hone job, I resisted the urge to pull the piston.

Another thing I will always check on these engines is the lifters, you can see the tops from the outside and can prove that they are rotating properly. If you find an engine that has a non rotating lifter, I'd make sure to pull the lifter and see if you can determine why, it's an easy thing to do.

Since this design uses external lube for the valve train, I looked it over pretty good. Several things to note, the rocker arm is bushed, both ends of the rocker assembly are replaceable, the valve runs a metal cap. If you NEVER lubed this assembly and managed to damage it, you could easily replace all wear parts. As I have mentioned elsewhere, the Indians have found that this arrangement survives with very little lubrication, they have abandoned the grease type rockers all together.

A noteworthy thing is the removable cylinder that sits on top of the crank case. The cylinder itself can be easily removed and taken to the bench where you could easily remove the sleeve from the bottom side. This design provides excellent access to everything, it's no wonder that this engine was still being produced in the UK through 1987. No doubt the amount of raw materials and the cost of shipping had something to do with Lister's decision to stop producing it.





This picture doesn't really convey the massiveness of the rod

[Here's The Cam and Governor assembly](#)

[George B.](#)

[The first run](#)

[Home](#)

# Governor/Cam

This page is dedicated to sharing information about the Standard Lister 6/1 Governor/Cam, since they live together we'll cover them together.



The first thing that's helpful is knowing how to pull this unit without breaking a sweat. As with most things on a lister, it's fast and easy, when you know how. Soem of you will assume there's no room to do this without pulling the

flywheel... wrong!

Face the front of the engine and note the two covers on each end of the engine. the cover on your left is called the cam shaft end cover, the cover on the right is the Cam shaft cover.

- Remove push rods, tappets and tappet guides. This can be harder the first time since they're buried in the ugly Indian paint job.
- Take the left hand cover off, note the Taper pin holding on the collar, if the small end of the pin is beaten over, cut it off flush to the collar with a die grinder and then use a drift just a tad smaller than the pin to drive it out. It will take a good wack or two, then you'll see it move, take it all the way out and remove the collar.
- Remove the linkage off the lever coming out of the cam cover.
- Now remove the cam cover on the right side.
- If your engine is equipped with studs for the cam cover, you may need to remove them BEFORE you are able to fully remove the cover, use vice grips if necessary to unscrew the studs.
- Pull the cam straight out till it clears the cam shaft end cover, then tilt the cam assembly and carefully rotate the flywheel to allow for clearance to tilt the cam downward and out till all is clear.

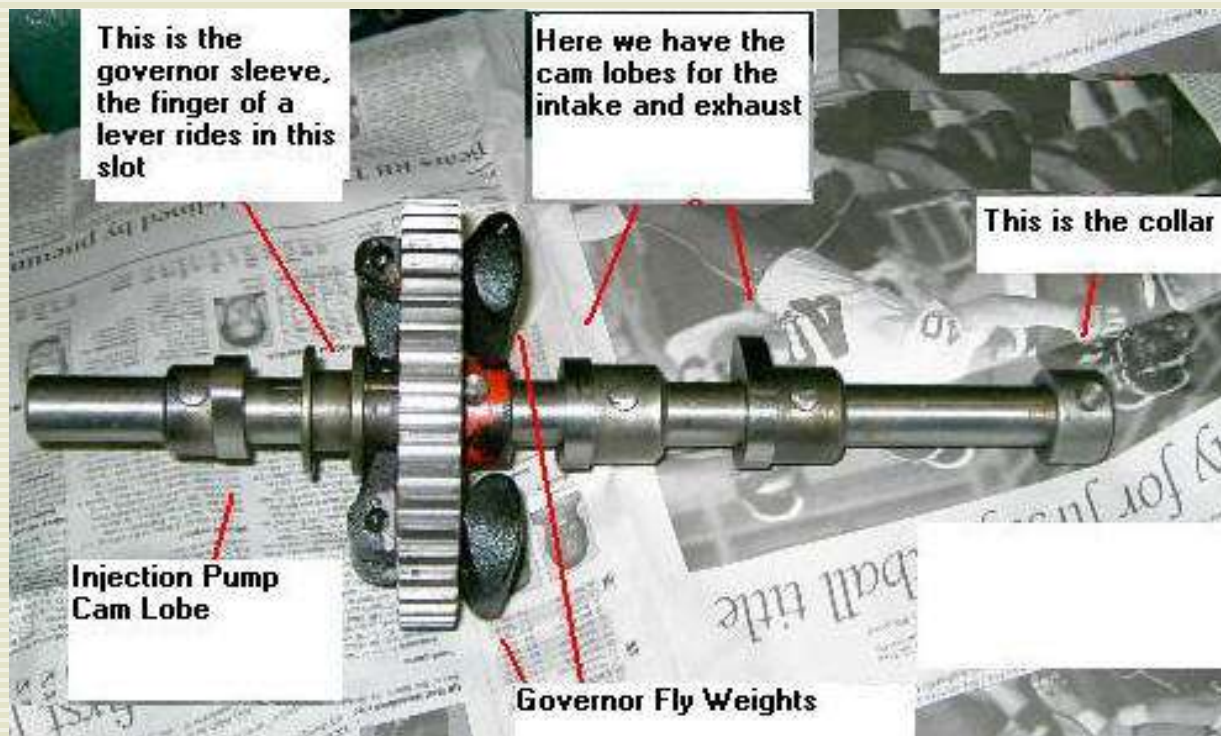

Above is a stock Lister 6/1 cam



Above is one of a pair of fly weights

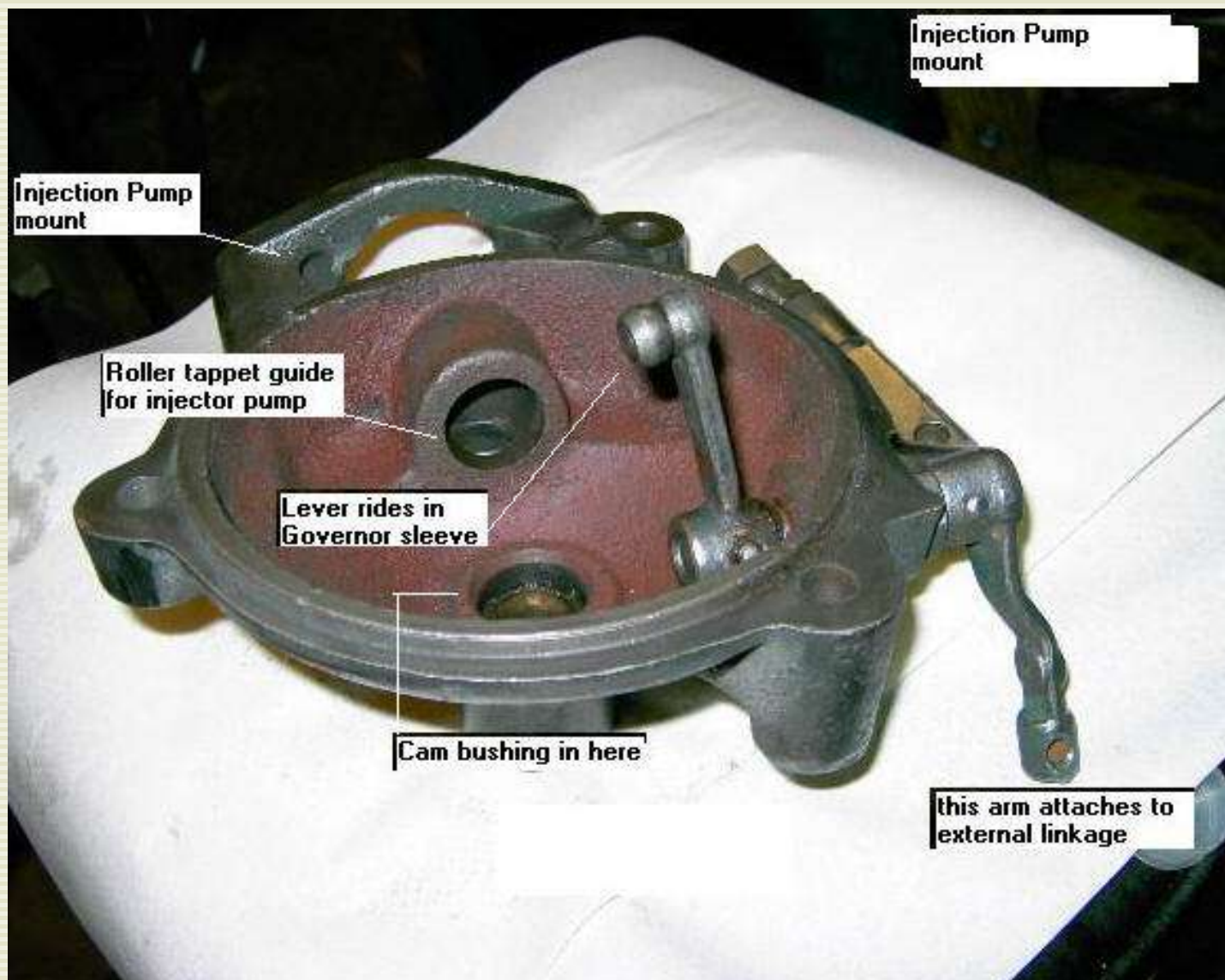

**Above: Go up two pictures and note that this roller tipped lever rides in the governor sleeve slot.**



**Here's the outside of the cam shaft cover mounted to the right side of the engine. As you can see, these castings (ugly as they are stock) clean up real nice with a die grinder and simple attachments. Experience has taught me that this casting will look like a piece of glass powder coated. I am sure it is some sort of compulsive disorder, but I can't take a piece off a Lister engine without cleaning it up, it just plain fun to see the transformation.**

**If you look at the roller tappet above, you'll see the upward side has a 'flat', the adjustment screw on the outside of this case makes contact with this flat to keep it from turning. The idea is to get this adjustment tight enough to keep it tracking, but not so tight it binds.**

**When you re-install the cam covers and the tappets, I recommend the use of RTV sealer over the stock gaskets. I also recommend that you remove any gasket you may have found under the tappet guide and use a very small amount of RTV sealer under the tappet guide indexing surface.**

**This is a pretty simple assembly. If there's something really wrong you're bound to see it. As I've mentioned elsewhere the governor has a problem covering from no load to heavy loads. One of our DIYer Brothers suggests that this is what a governor short on mass in the fly weights will do.**

**When one thinks about how this simple device works, you have a fly weight and a spring that are trying to reach some sort of equilibrium. When the engine refuses to pull the heaviest of loads, the spring tension is increased, the fuel rack opens, the heavy load is then picked up, and all is well till the load is removed, at that point, the engine goes into over speed at about 700 RPMs or more. Even though the RPM is greater, the fly weights do not have the force to counter the spring and move the fuel rack towards the closed position. I would say the theory that the flyweights are too light makes good sense, and we need to try it.**

**The Indian engine builders and those who buy these engines seem to tolerate minor things like this with ease. I think it's time to build a fixture and drill some holes from the inside of the flyweight. Once this is done soak the weight in a strong solvent, dry it off, and then bake it at 400 degrees in your wife's oven (when she's gone) for 30 minutes. Then it's time to find one of her old pans to melt lead in. Make sure you turn on the fan above the stove. Set your fly weights up so the lead won't spill onto her counter top and then onto Her floor and burn the pattern off. Once the fly weights are filled with lead, hide the pan in the bottom of the garbage can, and figure out a cover scent for the house. Maybe you have a Mexican entree in the icebox you could microwave for lunch??**

**If you try this fix, please share your results.**



## The first run.

**This page is a living document, it changes as we learn more about the Listers. If you haven't read it through for a while read it again.**

[It's new, you just broke it out of the crate and it's time to run it....](#)

Well... hold on a minute !

**Take that door off and inspect the sump, if you find metal shavings, sand, or curry, clean it out, and put a magnet in the sump to catch and hold what you don't get, right next to the drain plug is a good spot.**

**As with any engine built by hand, it's always a good idea to inspect things and measure clearances for yourself. Since these engines are all hand fitted, the work is only as good as the person doing it, Your engine could have been put together by the shop boy, while the main assembler was out for a bowl of curry.**

**It takes so little effort, and it's fun... take the time to look it over, and clean it up, at least check the big end of the rod for proper clearance, to this date, I've head from one person who has found a clearance problem. In his engine there was a sliver of metal caught between the rod and rod cap when assembled. Pull the rod cap noting how it came off, it only fits one way. Pull the bearing and inspect the crank pin and the bearing shells. if you have some .003 plasti gauge, you're in luck. Read the directions on the package, check this clearance, it should be .003 or less, some folks will say you can get away with a larger clearance, I'll stick with this as a max .**

**As for Oil, there are several lines of thought regarding the product you should use. Some suggest you use straight 30wt oil that meets the specs for diesel engines. There's a good deal of thinking that goes into this, but the primary motivation is the clearance of a splash oiled engine and the finish on bearing surfaces. If you have 'third world' finishes, it is best to stay away from low viscosity oils, or so the experts say.**

**Did you check the intake and exhaust valve settings? Set them cold, .017" Intake, .032" Exhaust.**

**Get your 1 1/8 socket out and torque those head bolts **160-170 foot pounds**... that's the four big ones... not that smaller one! 1 1/8 isn't a perfect fit, but it works fine, 28mm is probably the correct socket.**

Did you add oil to the crank case?

**[5/20/2003 Important note added:](#) The little oil dipper on the bottom of the big end of**

**the rod is threaded and may be adjusted differently from engine to engine. We also can not be sure that this part is always supplied by the same vendor and cut to the same length. Before you get carried away with adjustments, make sure you don't screw this thing in tight enough to mess up the rod bearing, you might even take off the rod cap to see how things meet each other before you make adjustments..**

**In one of my test engines, I have adjusted the oil to the level I think best for break in (dipper about 1/2 inch into the oil). At this level, there was nothing showing on the stock dip stick.. even when the dip stick was screwed in!**

**What does this mean?** It could mean that you will provide too much oil to the cylinder walls via the holes in the piston and overwhelm the main oil control ring and the ring above it that controls oil as well. If she slobbers oil, it's fairly certain that your dipper is picking up too much oil.

**What I'd consider doing is adjusting the dipper to correspond with the dip stick, to be safe, I'd adjust it to read correctly with the dip stick unscrewed verses screwed in. Be careful; error on the too much oil side verses too little.**

Take the door off and see if your dipper on the bottom of the rod cap is hitting the oil. Also make sure it's hitting the oil 'knife edge' NOT bluntly. We are finding these engines like a load like all diesels, if you run them with high oil levels in the pan, or you lightly load them, they will slobber oil. This will aggravate the problem and the cylinder can become so overwhelmed with oil that the rings may never seat... and the slobbering will continue. It is best to break in your engine with a low oil level, take off the door and verify that the dipper is making contact with the oil, but it's not way up on the dipper. Next put a reasonable load on the engine and let it run at 600 or so RPMs. Until I have a better understanding of this process, I recommend you avoid oils with extra zinc or other additives. Put a magnet in the pan, use regular oil, not some mystery stuff with PTFE or XYZ... (for break in at least). If an engine continues to slobber, run it some more, and keep the sump level at the low end, and keep a load on the engine. Once the rings seat properly, higher oil levels in the sump should be less of a problem, but as we know, all that oil follows the crank and looks like a big ole taffy pull. This can reduce your fuel efficiency and cause you to wonder why your machine isn't getting the outstanding fuel economy people brag about.

That little valve on the breather is important, make sure it's in place before you run it... it keeps a vacuum in the lower end and helps keep oil from going past seals. In my experience, it's easier to pull the door than mess with this check valve, it looks like the proper place to pour in more oil, but it's too easy to lose one of the screws, the spacer, or the 1/4 20 bolt. If Murphy's near, you'll screw up the reed valve too, best to take off the door, or get yourself a small funnel and pour it through the dip stick hole.

Did you lube the rocker arms? did you put a little oil in the push rod cups? how about some oil in the little well around the valve stems? Here's a place for your high Zinc oils, If you have some Arco Graphite hidden away, use it here, these additives won't contribute to deposits inside you combustion chamber when used here, it's a great place to add all this mystery stuff and say you tried it. and if you forget to lube things for a week of running , the stuff might actually do some good?



Do you still have that little squeeze bottle that came with your tool kit? With the main door off, suck up some oil out of the sump, put the piston/rod at the bottom of the stroke, note the holes on top of the big end of the rod; squirt some oil in the holes, if you can squirt some oil in the hole on the top end of the rod do it. Now squirt some oil into the TRBs, and squirt the cam lobes, tappet faces, and cylinder bore. We don't really know when this engine was run last, so might as well 'oil it up'. Take that plug out of the left side of the deck and squirt some oil straight down it, this plug lines up with the hole in the top of the camshaft bushing, this as well as the others is splash feed, but it doesn't hurt to prime things in an engine that has been setting for a long time. In fact, as quick as it is to take the door off, this pre lube will only make your engine happier.

Torque the two injector nuts to 38-40 ft pounds.

Did you oil your governor linkage with a light weight oil? You better look at the [article](#) on same before you run your engine.

It's water cooled, get a fitting at the local hardware store to connect your garden hose to the bottom cooling manifold. Hook another hose to the top for the overflow, adjust the water flow down low, a mere trickle to start. (This fitting comes in plastic 3/4 NPR to hose bib.) **Remember, this engine likes to run at 190f or even higher**, check my pages, a thermostat is easy to install and will allow the engine to come up to temp faster, this is a good thing. Running the engine at low temp will aggravate the oil slobber problem.

Are the flywheels clear of the ground?

Do you have the engine tied down so it won't walk around? Lister singles make lousy dance partners. If one of those flywheels tangles with the washer or dryer, you could be dipping into your hobby fund to replace it.

Remove the paint from the crank shaft where the start handle will go. The handle usually needs attention, remove the detent being careful to keep track of the cotter pin and spring. Use the wire wheel on your grinder, or a wire brush and clean up the stem on the detent. If you have some graphite, coat the detent with same, clean up the bore the detent fits into and coat the bore with more graphite and re-assemble. Check the inside of the ring that goes over the crank, it should be absolutely flat and smooth on it's face, if it has a casting break, or is rough, take a heavy file to it, or your bench grinder and make sure there is nothing for the gibb pin to grab if someone were to walk it onto the crank that far. Put some graphite on the inside of the ring and rub it in. These steps will make it far easier to get the handle off after a start.

#### **4/20/2003... (and inserted note) How to establish timing marks, and time the Lister**

The Indians didn't make it obvious where the timing mark was on these engines, It's a good idea to make your own now and 'spill time' the engine, this way you'll know where you are, and you'll have the proper marks for timing in the future. Take the head off, use a dial gauge, locate TDC, I choose to use a logical spot near the injector body to file my timing mark, after locating TDC, I then filed a mark in the fly wheel to align with the fixed mark. Now, it's just simple math to locate the mark where the injector pump stroke begins, my reference material

says 18-20 degrees BTDC (before top dead center). Simply do the math and realize that a single degree is going to be quite a distance on this big ole flywheel, this is vastly easier than almost anything most of us have seen before.

While you have the head off, clean up the head gasket, liberally paint acrylic floor wax on the inside of all water passages and all the way around the outside of the gasket, then wipe down the sealing surfaces. Use cheap Aluminum paint and mist on a thin coat on both clean sides and allow to dry. Before you put the head back on, run your fingers over all surfaces checking for any little bits. Make sure all is clean dry and free of dirt, also put it back in the same orientation you found it. Clean the top of the piston and combustion chamber while you're here, there may be some carbon due to the overload test at the factory.

Simply measure the distance around the flywheel with a good tape measure. Example: measure from the 12 inch mark and subtract 12 inches, this removes the error often found in the end of the tape. Once you have this measurement, divide it by 360 to get the distance per degree, and then multiply that by 20 to get the 20 degrees before TDC mark. Make sure you LEAD the TDC mark in the proper rotation, on the injection pump side of the engine! Simple for those of us who have been around engines, but this is a dandy beginners engine, so we'll be verbose. My example, I used the metric scale.... 1887MM circumference, divided by 360, then multiply that by 20 gave me about 10.5CM prior to TDC for my spill timing mark.

Once you've found your 20 degree mark, file it in, you might even rub some white paint into the file marks and label them.

Now for the timing, ..... run the engine, get all the air out, stop the engine, loosen the high pressure fuel line from the injector, place a tight fitting piece of clear plastic over the fuel line holding it straight up in the air, Note that some folks then fit a smaller plastic tube inside the first one to get a finer reading. now turn the engine over, compression release on, throttle rack open, and get fuel into the plastic, so you can see the fuel. Now slowly turn the engine and note the spot where the fuel just begins to pump. See the adjustment under the injector pump, raise or lower it depending on how far it's out. A warning to the wise, stick your finger under the injector, and there's a good chance you'll lose part of one when the flywheel is turned! keep your mitts out of the moving parts!

It'll smoke a little since it's cold and new, are you going to upset the **BOSS? Best do it when she's shopping .**

And now.. If no one ever told you... you can drive yourself mad if you don't understand how important it is to bleed out ALL the air between the fuel tank and the injector. Get some shop rags or paper towels, add some clean diesel fuel to the tank, make sure it's at least half full. Make sure the valve on the tank is open!

**Here's a method that may help you avoid an hour or two of messing around.**

Take the return hose loose from the injector so the air can easily escape and bleed from the fuel system.

Take a look on the inside of the injection pump body and you'll see a little bleed screw, open it slightly and allow the fuel to bubble out, place a rag under it and let it run till the bubbles quit coming out. Re-tighten the screw.

Now, take the high pressure line loose from the top of the Injection pump, Move the line to the side, where you can get a wrench on the top fitting and remove it from the injection pump... watch for the spring. Get a little bit of diesel and dribble it into the top of the injection pump, keep adding fuel oil till it over flows.

Set the decompressor under the intake valve

put the fuel delivery handle in the run position, **verify fuel rack is open** on the injector.

Crank the engine over with the start handle slowly, and watch the little bubbles fizz from the top of the injector. Once the little bubbles are no longer coming out, reassemble the top of the pump and hook up the high pressure line.

Loosen the high pressure line at the injector end.

Verify the fuel rack is fully open. Crank engine till fuel spills from the high pressure fuel line at the injector end, keep cranking and finger tighten the line to the injector, while you are still cranking slowly tighten the fitting with your wrench. As you crank, you should hear the injector fire with a CLINK! If you don't hear the 'clink', there's still massive amounts of air somewhere... or other problems.... backup... If you go the 'clink' proceed.

Put the handle back on and crank her up, with your free hand, move the decompressor out from under the tappet, and continue to crank, if it's above 40 degrees, it should fire first or second compression stroke. Once it fires... HOLD onto the handle! Don't let it go, and don't worry about a kick back, I haven't seen one yet. Once running walk the handle off the crank. If the engine doesn't stay running, you still have air in the system.

When you start this thing, run it up to 500 RPMs and let it oil well, it is far more important that things get lubed real well than it is to run at low RPMs. If you have an oil pump like on the 12/2s. Take the little plug out of the top of the pump and pour oil into it to pre lube the pump, forgetting this is a bad thing. Take the plug out and crank the engine over to prove it's pumping for each and every run till you become confident it will prime.... make sure you let it rest for a few days to see how it does after it's had time to drain back.

Run your Lister for at least 20 minutes first run, vary the speed, but run it mostly at 500 RPMs.

Watch the lifters at the bottom of the push rods, they should constantly rotate, if they don't, change the speed a little and see if they do. If you find a speed where rotation occurs, let it run there for a bit and see if they begin to rotate at other speeds. If not, inspect the tappet guides and tappets.

Watch for water leaks at the top and bottom of the cylinder, if you see any, try the torque wrench again. Also watch around the injector for leaks.

If the oil turns milky, don't panic, this happened to me, it takes a bit to drive the moisture out

of virgin cast iron, it should clear up after a few hours of run time.

Get a load for your engine, it is better to have a load than to run it with no load. Keep the loads medium for the first 20 hours. If you have a gen head for a load, shoot for 2200 to 2500 watts.

Think about taking the head off and lightly lapping the valves... this engine is made to take apart, it'll be fun, and you will learn more about your engine.

**Now you know the magic of a Lister, just like a big ole clock, tickety tock, a sound that could put you to sleep.**

[George B.](#)

[Home](#)

[Problems](#)

[Build a frame for your Lister Gen set](#)



**Lister Problems and Fixes, and some nice things to know about these engines. I have not found a site that talks to the little quirks of this design, and I am hoping that my experience and those of our readers will help us build some useful tips. This page will be added to as we learn more in our usual random wandering way. Remember that the following is for educational purposes only, open flywheel engines are dangerous and should never be run.**

**5/20/03 Oil slobbering, see first run Page**

April 2003,

I have found several tappets that do not turn freely, it's very easy to pull the tappets and guides and check the tappet face for finish, and see that it turns freely in the guide, these are checks I make on any new engines.

**Governor/Speed Jan 4, 2003**

There have been a few reports of poor governor performance in Lister power plants. I noted a problem in the first 6/1 ST combination where the power plant didn't seem to use all of the throttle rack, since the engine was carrying all the load I had expected and maybe more, I didn't pay too much attention the first time I saw this problem.

Then I got an email from Southern England asking if I had seen a problem with the Governor in Indian built machines? The writer went on to explain that they had seen this problem in a few of the British built machines. To shorten the story, the governor doesn't seem to respond when loads are dropped or increased. One can adjust spring pressure to cover light loads adequately, but if a big load comes along, the governor doesn't seem to be able to open the rack far enough to cover this load. Is it a lack of range in movement, or is it a lack of mass in the flywheel weights?

After checking a number of Indian Listers, I have noted a potential problem that manifests itself exactly as described above. Fortunately, an improvement may be had in about 5 minutes. This problem has been confirmed by me in two different machines, there's a chance you'll encounter it as well.

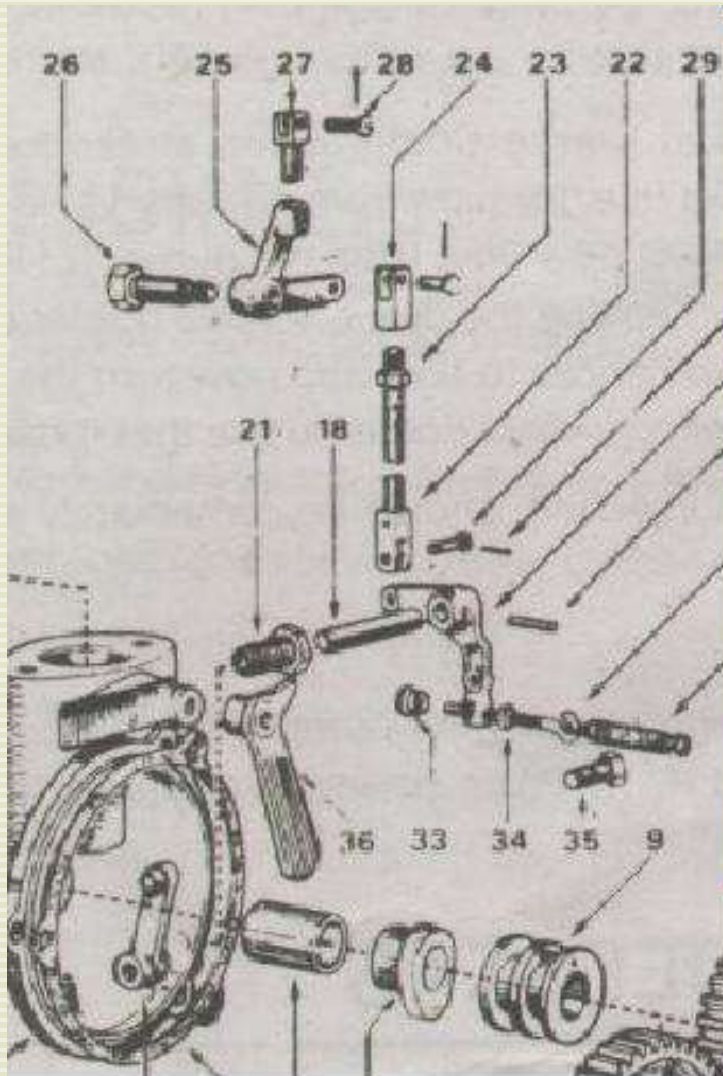

**Note items 25 (governor upper lever) and part 27 (eye end)**

Part 27 is attached via a pin to the fuel rack of the injection pump. It travels on the horizontal. Part number 25 travels in an arc causing part 25 to move downward as the fuel rack opens, and upward as the fuel rack closes.

**IF the hole drilled in part 25 is not properly chamfered at both ends**, parts 25 and 27 will bind causing the rack to freeze and not open or close all the way. **This will act exactly like a lazy governor.** You can check your linkage by removing it from the governor lever end and moving it up and down looking for any sign of binding, but it is possible you won't see the problem. The best way to look for it, is to remove parts 25 and 27 and run them back and forth in your hand putting a slight side load on part 25 as you go. You'll feel it bind... better yet, just chamfer the darned thing and polish up the pin on 25, grease it up and put it back on.

As an added measure, I would use molly grease or something slick and water proof.

**If you have an older machine, I would pull these pieces, clean them in solvent and re-apply a moly grease, or graphite, It is possible that dirt and grit could cause the same symptoms.**

**One last note, the Lister 12/2 has two of these, if they aren't chamfered, clean, and well lubed, the cylinders might not work together as planned.**

### **More on governor Linkage, Jan 5, 2003**

**Look at parts 22, 23, 24 this makes up a section of linkage that can contribute to binding. If one tightens the jam nut on the linkage with no regard for a proper alignment of the eyes, this part can act as a torsion bar and contribute to binding problems. Another noteworthy condition is the paint that is liberally applied**

to the linkage on Indian machines. It is my practice to remove the linkage from each machine and clean the paint from the entire linkage, apply some WD40 and refit it. Another potential problem is the long cotter pin that is found in part 28 connecting the injection pump to the linkage. It is possible that the tails are long enough to cause interference with the injector body. Take some side cutters and trim the tails off this cotter pin.

**Sluggish Throttle, Jan 6, 2003**, Steve Gray has experience with both singles and twins and suggests that people pay close attention to anything that might cause binding in the linkage. In addition, Steve has noted that too much or too heavy of lube on the racks themselves (inside the injection pump) will cause the throttling to be sluggish.

March 2003, It is now my opinion that Lister governors are just not as good as the German designed Asian diesels. The governors are far less complex, and far less sensitive. You can get good RPM control, but NOT from 'No Load' to 'Heavy Loads'.

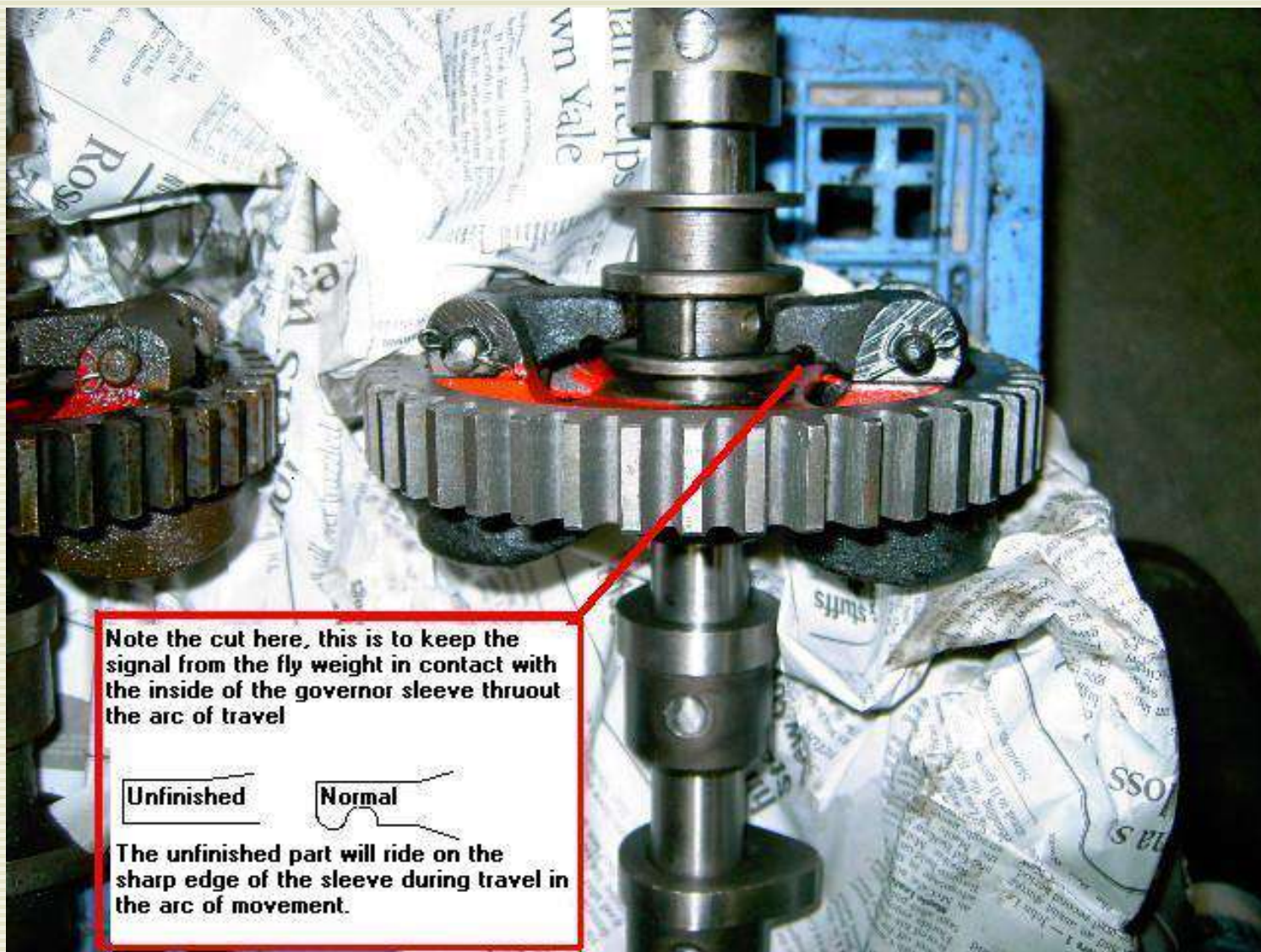

Picture above is the Lister 6/1 governor. Here you see an assembly with this extra machine work. I have seen two cams that have not been machined out in this area. The finger that fits into the sleeve is straight cut and the contact area changes from the inside to the rim of the sleeve as the flyweights travel thru the arc. Does this make any difference in operation? At this point I have no clue, but if the point of contact changes, is there some fulcrum effect that comes into play and modifies the intended relationship between spring and the force that the fly weights exert? At this time, there's only the question. And if you think it matters, one could easily dress the end of the finger with a chain saw file and sand paper to provide this feature.

A note on Cam removal. If you have the six spoke flywheel, you can remove the cam without removing the flywheel. This is most likely true of other flywheels, but if you don't have a hole large enough in the wheel, and enough area to tilt at an angle as you remove it, you're in trouble. On the standard CS 6/1 clones, you can have the complete cam/governor assembly out and on the bench in 10 minutes. This is a real nice feature, getting that gib pin out of the flywheel is a bigger challenge for people. For me, I would pass on any Listeroid variant, that required the flywheel to be pulled to service the cam.

[Here's some more on governor/cam assembly, and how to remove it.](#)

## Crank Handle

### Listers start easy and with little problems,

**But, if you are new to this engine it can be intimidating at first, try the following to build your confidence. Place your crank handle on the crank shaft, study the detent, spring, and keeper. Take it apart and clean, de-burr, and lube all pieces. Place the handle back on the crank and note the inward side. This face should be smooth and free of any casting marks. If it's not flat and smooth dress it on a grinder and make it that way. This will prevent the handle from hanging up on the gibb pin and whipping around after a start, .....sure you'd have to be drinking to push the handle that far inward, but it could be someone else that does it. Another note, don't let go of the handle after the engine starts unless there's some sort of resistance to your effort. Hold on to it and walk it off the crank, and start this process as soon as it fires. You must clean the inside of the ring and apply some graphite, rub it into the metal with a paper towel, this will make it slick and build your confidence that it's not going to bind or stick when you're walking it off the crank. Also, remove that paint off the starting side of the crank shaft and apply some more graphite. Once you've started a Lister 5 or six times, all your worries leave, but remember the importance of keeping the surfaces clean, and well lubed. It's an easy engine to start. but you don't do it with loose fitting clothing, or without a common sense approach.**

**The start handle is not designed to be fool proof, and the fit and finish of start handles I've seen puts them in the 'KIT' class. That is, you have all the parts necessary to build a proper start handle, but you need to take time to smooth down the critical dimensions and remove the ragged edges. As a final warning... I am surrounded by people who should NEVER start a Lister. They should never be allowed near a running open flywheel engine. Fact is, these are the same individuals that should never set foot on your property, because they have been raised victims and believe that they have no personal responsibility for their own safety, it is the rest of the world that is responsible for their welfare.**

Did you notice the **push rods are slightly difference sizes?** you will if you mix them up.

**A note on the head gasket.** Some folks like to take the head off and check the valves, lap them in, check for carbon deposits, etc. I know a few guys that buy cheap aluminum paint and use it to lightly coat both sides of gaskets like the ones found on this engine. they clean them up with soap and water first. One person claims he's reused the same gasket a number of times doing this. If you ruin a gasket, email me, I have a few gasket kits for these engines.

**2/23/2003 Leaking head gasket ?????** Lister 6/1#2 has been torqued and re-torqued (160 ft pounds) after running it for some hours with a load and a 190-195 degree water temp at the top of the head. **Several days later I noticed there were a few drops of coolant that squeezed out between the head and top of the cylinder on both sides of the head.** I have seen this before (different engine), and I'm fairly confident it is because of the composite nature of the head gasket. The gasket is made of an alloy sandwich with a material that looks something like asbestos sandwiched in between, maybe .060" or thicker.





The above head gasket is stamped 5/1, Rasik, I've pulled the alloy up away from the inner sandwich material so you can see, the alloy on the bottom is identical. Notice the distance from the coolant passages to the side of the block. If you were to buy one of these engines that was all painted up after it was put together, you MIGHT see blisters (under the paint) where the coolant was leaking through the composite material and think you had major trouble after a run or two. Note the fire ring around the cylinder hole in the gasket, this will stop all 'wicking' into the combustion chamber.

**For those of us that expect our engines to look like show pieces, this could be unacceptable.**

I have used acrylic floor wax for unconventional fixes before, and I thought I'd give it a try here. This stuff waterproofs material quite well, If you want to know how well, soak a shop rag in the stuff, ring it out and hang it up for a day or two, then try and wash it out. I took a dry gasket and peeled back the outer metal to expose the sandwich material. Next I poured an ounce of floor wax into a little bowl and used a small paint brush to apply it. This material acted exactly like an ink blotter and soaked up the floor wax like crazy! I think this is a good sign that we've identified the problem, but proof is in the testing.

**March 24, 2003**, after tearing down a test engine to examine the piston and rings, I fitted the engine with a new head gasket treated with the **acrylic floor wax**, it has now been run a number of times and it's been allowed to cool between runs. This made an amazing difference, the head gasket now performs like you would expect, no more weeping or wicking.

## **TAPPETS and TAPPET GUIDES**

I've mentioned elsewhere that I found a **tappet** that was not rotating properly in several Metro engines. It was the

intake tappet. Checking out **Listergen6/1#2**, I noted that the intake side tappet had stopped rotating after a few hours of running. I decided to pull the tappet and investigate. I had a second set of eyes check this out, and Randy Allmand decided to try polishing the face of the tappet and polishing the oiling cut where the tappet runs in the guide. Randy accomplished this work by chucking up the tappet in the lathe and working the face with various emery papers and some kind of diamond dust and wax stick.

After reinstalling the tappet (less than 5 minute job), it rotated just fine! At this time, I think it was the cut (oiling groove) that may have been a little rough, this might have caused some interference and prevented the tappet from rotating. Upon re-assembly, I painted a white dot on both tappets so I could quickly note that they were rotating properly.

I continue to learn more about [tappets and tappet guides](#), here's a page I've started.

## **OIL SLOBBERING**

If you have a new engine, make sure you keep the oil level low during the '**break in**' period. Take the door off, and check that the dipper (on the rod cap) is meeting the oil knife edge, try running the unit with the dipper one half inch into the oil. If you have doubts about effective oiling, take the dip stick out while it's running, if it blows oil all over your shop, you'll know there's plenty of oiling. High oil levels can overwhelm the new engine's ability to control all this oil till the rings seat. The high oil level may actually prevent the seating. Some of us who are researching this slobber problem believe that maintenance is often a hit and miss thing, and the manufacturer has marked dip sticks on the over full side to protect the engine. If you look at the dip stick, you might notice that there's plenty of reserve capacity below the very end of the dip stick even when it's screwed all the way in. I'm sure this allows the engine manufacturer to point the finger at the operator and ask how long he ran it with no oil on the stick? For those of us who are after efficiency, remember that high oil levels also consume energy. If you've ever seen pictures of what goes on in a crank case at engine speed, it looks like a huge taffy pull, where the oil is whipped around following the crankshaft. Running lower oil levels and checking your oil level more often can give you a higher fuel economy. This is just another test we need to conduct, if we run the engine at the very bottom of the stick verses the top mark, what will the difference in fuel consumption at a specified output be? I'd bet a cup of coffee there's a measurable difference in this engine, maybe even a significant difference. Once you have a 100 hours on your engine, try raising the oil level and monitor the slobber.

11/2003 I have a Lister 6/1 with gen head sitting out in a field in Easton, WA. The engine has went thru several heavy rain storms and squirts some water out of the muffler when I start it. The area in the top of the head also fills with water, this happens because the valve cover is not drip proof and actually channels water into this area. It is best to keep a cover over the Lister when it's not in use. Too bad some Indian hasn't seen the need to make a drip proof valve cover, seems it would be a fairly easy thing to do. For the time being, I put a square Tupperware basin over top of the valve cover to allow it to shed water... everything else on the engine seems to stand up to the elements, although I know it would be far happier under cover.

**I'm still in Love with Listers, a sound as sweet as country music.**

**George B.**

**Home**





## DIY Generator Base 'Frame Construction'. for the Listeroid\_ST\_Generator

**If you have never built anything and wished you had done it differently, this page is NOT for you. Thoughts appear in my usual random order. This page will be somewhat of a living document, reader feedback and experience will hopefully hone the content. This basic plan may allow you to build one generator frame verses several before you're happy with the result..**

**Building a generator as a project is more fun than some things because it won't take weeks and months to do. It's a perfect project to involve the young people in. Many of us wish we would have been involved in such a project in our young lives, we now understand what hands on experience does for building confidence..**

**The first** thing to think about is mobility, are you building a stationary plant, or do you wish to move this around from place to place?

If it's heavy (most of what we like is), make sure you 'design in' a lip or recess on one or more ends of the frame where you can get a fork lift under it, or the corner of a hand truck to lift it up and get a pipe roller or something else under it. an example of this is 'C' channel, you might ask yourself, should I put the 'C' inwards or outwards? If those lips are facing outwards, you have a lip to pry on, a fork lift driver can easily pick up your unit using the top of the 'C' to lift on. Of course, you may not want it moved, you may want to bolt it down and make it hard as possible to be moved....put the 'C' inwards, put the mounting bolts on the inside of the frame where it's hard to get at with the engine and head in place. BTW, you can move the world on a pipe roller if you have a flat surface, this can help you move an assembled unit to the corner of your shop.

Will this generator be on wheels? I once mounted my Lister 6/1\_gen in a small utility trailer and watched it dance all over. I've seen other 6/1s on small cast wheels that did fine. Don't take you set up for granted, maybe it needs a different orientation than your first idea. You might consider a mock up and a test run with tack welds and clamps before you fully weld anything.

If it's going to be stationary, maybe there's no reason to mount your radiator on the same frame? Maybe it will appreciate being mounted off a wall in your shed and away from any vibrations that may telegraph through adding to the total dB (noise) of the power plant? While you're at it, maybe you'll mount your breaker box, amp meter, volt meter and other stuff on the wall where it is at eye level as well? If you're going to have a free standing and separate fuel tank, and cooling tank, maybe there's room to build all this on a separate skid?

What I like to start with is two strong 'I' (eye) beams or C channel. rails boxed together in parallel. The generator has it's own sub mount which acts as a trolley allowing it to slide along the two beams for adjustment and positioning. The engine is located at one end of the eye beams assuring it's placement allows the end of the frame to strike a wall or other object before the flywheel or other parts of the engine do.

Don't drill mounting holes for the engine till you test fit everything...If you start here, you can move things around till you accommodate everything you forgot to allow for..., like a method to drain the oil, oil filters, radiator support, cooling tank mounts, aux. alternator for battery charging, fly wheel clearance, and a thousand other things.



Above is a picture of the sub assembly I like to fabricate for a pulley driven setup like the Lister 6/1 or 12/2. The angle rides on the outside or inside of the eye beams or channel that are used for the two main rails that support the engine and generator head. The box tubes align with the generator mounting holes. The location of the mounting holes in the box tube are determined after the engine is mounted, and a 'mock up' of the pulley and belt is performed. Keeping your pulley as far inward on the generator shaft will keep the side thrust on the bearing down and can make a difference in longevity.

The optional spring and rod arrangement is mounted on the shaft side of the generator and is used to maintain tension on the belt. On this design, a small piece of flat steel with a hole in it is placed on the bolt 'underside' that fastens the gen head down. This keeps the head from being lifted by the engine torque

April 2003

After building a number of frames for 6/1s and 12/2s, I believe this design is close to perfect for driving off the flywheel with the efficient special purpose utterpower pulley 'sheave'.

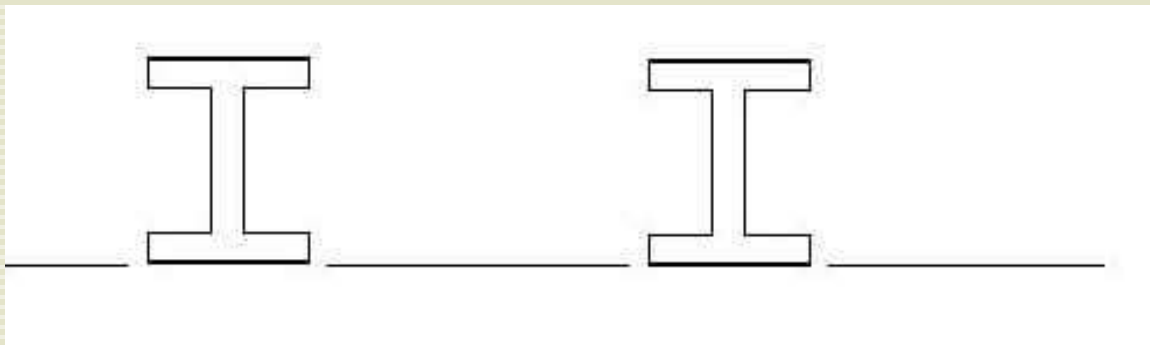

Start with two chunks of eye beam about 4 to six inches. Listers are beefy looking, and look better on beefy eye beams. 40 to 42 inch lengths works pretty well for me, you may want to mount more to your base than I do, so lay things out. Don't rule out wooden beams, they were used often in the old days. Consider sealing them up to keep them from being contaminated during oil changes, and fuel spills, etc.

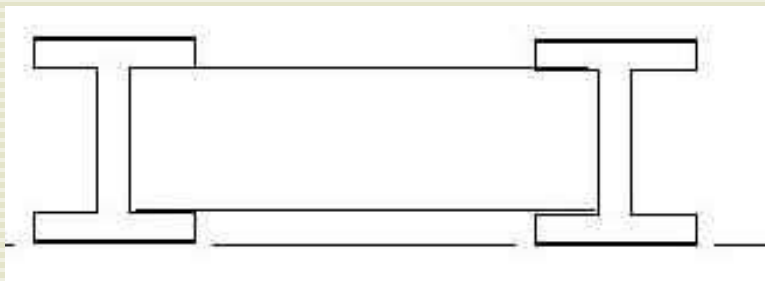

Measure your mounting holes on the bottom of your engine, set your eye beams up so the engine mount holes fall on the inside of the beam. Make sure you stay far enough away from the vertical of the eye so you have room for the NUT to clear. Find some stock and weld it across the ends to form a box. It's best to put a level across your work and assure all is flat, then put a clamp across each end and tack weld first. Do a weld at the top, then the bottom, once all is tack welded together, check alignment and then finish welding.

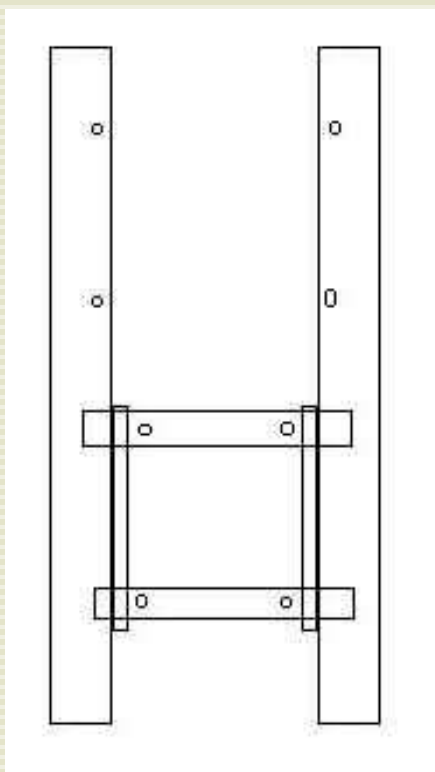

The above picture shows the sliding sub mount for the generator head. This allows the head to slide back and forth for adjustment, and maintenance. The mount can also be left on the generator for quick removal, and replacement. Note that the sub assembly uses the two eye beams as a sort of track. The head can not twist from alignment with the engine flywheel. I like "I" beams that are four inches wide across the top. The Listeroid mounting holes are about 13 inches wide, "side to side". The holes should fall half way between the edge and the center section, this gives you room for the nut and washer, and allows the base of the Lister to be well supported by the tops of the beams. If you are using 4 inch wide eye beams, the beams will come out 18.5 inches wide.

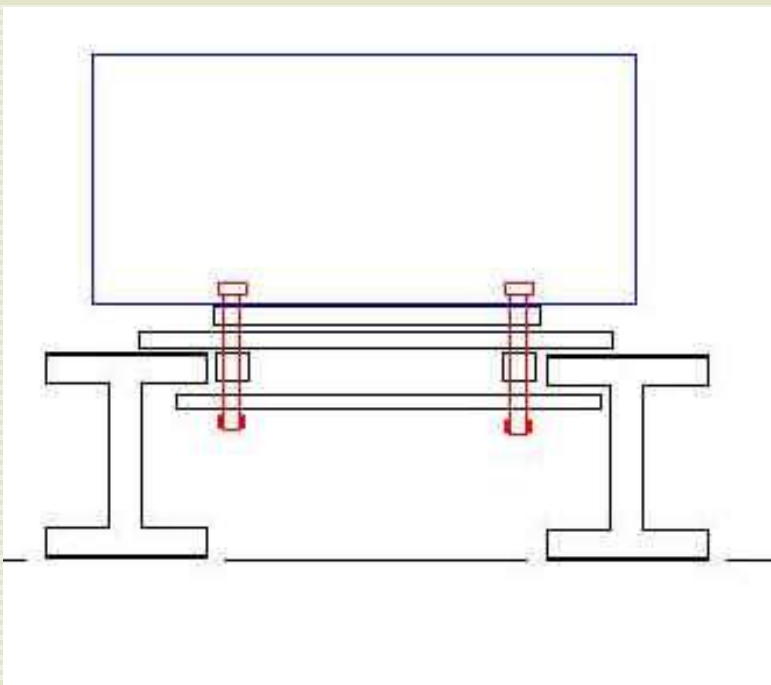

The above picture is a view from the generator end showing how the assembly is bolted together, gen head, sub assembly, and eye beams. I weld the top pieces to the side pieces, and bolt the bottom piece on with the same bolt that fastens the gen head to the base. Leave just enough clearance where the head can move back and forth. This will allow for adjustment, but keep the torque from lifting the head. You can use washers as shims to get it the way you want it. I have used masking tape along the top and inside of the eye beam. This allows me to lay out the generator sub assembly, weld the top to the inside track, and then pull the tape for clearance.

**NOTE:** The Allmand Serpentine pulley and standard SK bushing is placed on the generator shaft and placed inward as close as possible, this reduces the side thrust on the generator bearing. The pulley is then aligned with the flywheel and set to run in the center or inside of the flywheel. Once this 'mock up' has been completed, you can locate your holes for mounting the generator to the sub assembly.

## BELTS

I use the **NAPA Serp Belt part # 250060935** (six groove), note that the last three numbers are the size of the belt. (**93.5 inches**). this should be about right if you lay out your engine and gen head the way I do. Some folks ask about the 8 groove belt, for a 6/1, the only reason I've found (so far) to run the 8 groove belt is to make it look beefier. My recommendation is to call NAPA and check on the sizes they have, I've been told that the Automotive applications for the 8 groove belt are increasing, and more sizes **should** become available. At the time I write this, NAPA stocks a 25-080922 (92 3/4 inches) and a 25-080952 (95 3/4 inches). It's best you wrap a string around your flywheel and pulley, and measure the minimum length belt that would work for your layout. Goodyear claims to make superior belts, you might check them out too. Remember, there's lots of near new belts on those upside down junkers, seems people put new belts on them just before they get wrecked or junked out. I have found that many of the Chevy V8s and V6s have belts of the proper size, and who knows how many other makes will work. This supply of parts could be important in an emergency or in hard times, it embraces the philosophy of building with parts you can find when you need them most. And of course, you'll remember to keep that old belt off your car or truck and see if it fits, it could be a spare you can hang in your generator shed.

All that's left is a tension spring to keep the belt in tension. DIYers have reported good results with placing the belt in tension and locking the sub assembly down with a bolt and leaving the spring out. The effort to add the tension device assures a constant tension regardless of temp, load, etc. I'll stick with the spring for my stuff.

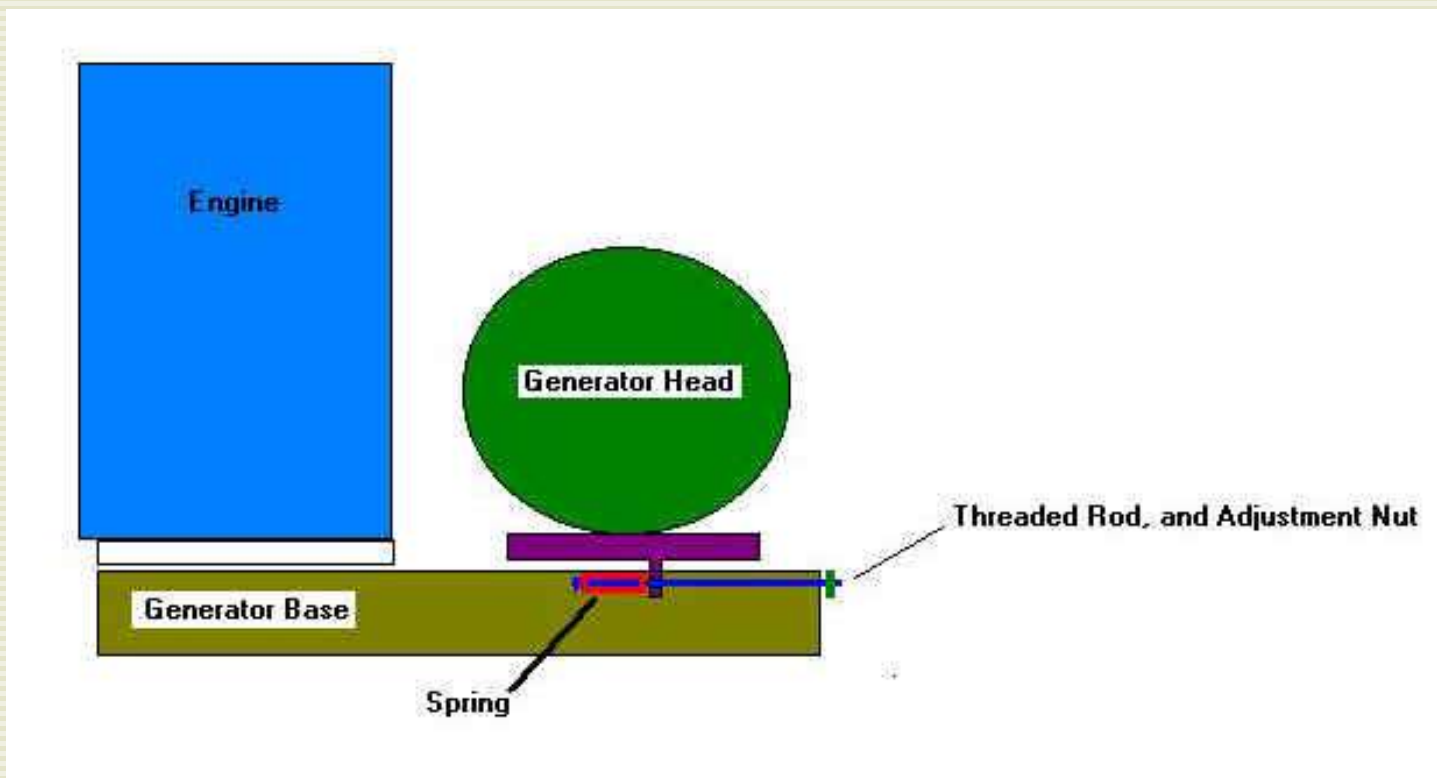

Above is an attempt to show the underside of the generator mount. There's a tab welded or bolted onto the bottom of the gen head track assembly. This has a hole drilled through it allowing a threaded rod to pass. A nut and large washer make up the end that carries a big diesel valve spring. The rod passes through a hole in the end of the gen base, or through another tab mounted or bolted to the frame. on the outside is an adjustment nut, "a drilled and tapped faucet handle works to allow adjustment without tools. the rod and adjustment nut puts the spring in compression, and forces the gen head away from the engine. put this rod as close as possible to being 'inline' with the belt, this assures an even and less binding tension system.

If you design it different, that's what it's all about. If you don't know where to start, the above design seems to work very well. The Lister looks at home on good sized 'T' Beams, one Frame I made has rails that just pick up the mounting holes on the 6/1 on the outside of the beam. In other words, the beams are narrower. the look is nowhere as appealing.

[Before you attempt to mount the engine, read this.](#)

Engine blocks will not appreciate being bolted to your generator base with grade 8 bolts. If you forget the basics here, you could crack the engine block, break off a mounting tab, or distort the block. Place the engine on the frame, align the flywheel and generator pulley using your belt to find the best engine position. Transfer your engine mounting holes to the frame, drill them, insert three soft (common hardware store 1/2 inch nuts and bolts), and snug them up with your fingers. Study the fourth hole and use feeler gauges to get an idea how much you need in the way of a shim to allow all four corners to rest on the frame. Shim your engine carefully to assure you're not distorting the block or breaking something when you tighten the mounting bolts.

If you start thinking you're going to take this concern one step further and put some big ole rubber mounts under the engine, remember the drive system will not like this, both the Engine and Generator need to be fixed in relation to one another to function properly.. If you want rubber mounts, put them under the common frame.

Keep in mind that open flywheel engines are dangerous, run them only after you build the proper guards and have them certified by the proper authorities. For legal reasons, we suggest you never start them.

[Adjusting the base](#)



A big ole Eye Beam frame is not a dainty thing. When you weld it up, things can move slightly. the tops of the eye beam might not be perfectly level, etc. All of this is of little concern to me, Remember to align your flywheel and pulley off one side of the eye beam, use the outside of the beam on the drive side as your guide. Make sure you're mounting holes are far enough away from the middle of the beam to allow for the nuts or fasteners to clear. AND most important.. if you don't like the way the engine and eye beam meets.. you can adjust this by smacking the top of the beam with a big ole sledge hammer! This is not anything like making a watch, it's totally appropriate to use a big ole hammer when mounting the engine to the frame.

George B.



## **Back Yard Engineer**

**We all have to learn, but some of us have to learn the same things more than once.**

I bought an old garden tractor years back, it was a Bolens 12HP Wisconsin powered, with a hydrostatic trans and a front loader. Even though it was light on HP, it could do some real work. It spent it's first twenty years at Weber's Nursery in Covington. I'm sure lots of kids used it and abused it.

When I bought it, I found all kinds of reasons to overload the bucket by twice the rated capacity and other foolish things. I'd lower the bucket and take runs at things that caused the whole machine to nearly hop off the ground when it hit... and still the little machine held up.

One day, I decided to overhaul the tired engine which cost \$600 dollars to have done. Then I stripped it, removed rust, did some sheet metal work and put it all back together. As I went through the boxes of parts, I noted how rusty and old the bolts looked. Going through my parts bin, I found a wide selection of beautifully plated grade 8 bolts with locking nuts. I figured these would look pretty cool on the ole tractor, so on they went.

The frame rails are tied together fore and aft with massive cast iron pieces that double as mountings for other parts like the heavy eye beam front end, and the hydraulic ram for the 2 point hitch aft.

All together it looked new again, gleaming, shiny paint, and those plated bolts and nuts... certainly a quality job I thought.

With a few hours of light work under it's belt, the engine started lugging down, sparks shot from underneath and I quickly shut it off. Upon inspection, I found the massive cast iron piece up forward broke in half which allowed part of the suspension to run up against the drive pulley. Upon further inspection, I found another crack in the massive cross tie aft!

**How could this be? Twenty plus years of abuse and no problems, then a light day of work breaks the tractor in half?**

Remember those old rusty bolts?... they were soft, weak, and stretchy, when you took a run at something, those ole bolts absorbed the shock and allowed the rails to move independent of the cast pieces. The shiny grade eight bolts I put on got snugged up tight. and being far stronger and less 'stretchy' transferred all that abuse into the cast parts that couldn't bend or flex enough... it just broke in half!

**Moral of the story?** Making something stronger is not always a good idea, you could understand the concept, but you've got to be paying attention as well!

The reason I take the time to share this story? Because I want you to give your designs some consideration. Take a drive coupler for instance, do you want to make it stronger than the crank shaft or generator shaft? If something needs to give, what should it be? The coupler?, the crank?, the generator shaft?

**I'm always learning.... sometimes, its the hard way.....**

**Read about [couplings](#)...** there's more to it than some of us understand.

George B.

[Home](#)



## **Coupler Design** written 3/2/2003

### **Why a coupler verses belts ?**

**Do you ever get tired of paying taxes? In the State of Washington, we're at 9% and people don't seem to mind at all.**

**If you look at Vee Belts as a means of moving energy from one place to another, you'll be taxed. Some of us don't care, but the fact is, you wouldn't have found this page, and you wouldn't have read this far if you were one of them.**

**My friend Phil P. took the time to build a Diesel generator driving an ST head. He took the time to set up a proper pulley and vee belt drive system with engine at full rated output of 2000 RPM. He then load tested the generator.**

**Next he took our MJ Drive coupler and drove the gen head directly at a reduced speed of 1800 RPMs to provide the 60hz frequency. Phil was able to carry more load with less horse power. Some of the added benefits will be engine longevity, less fuel used, no slipping belts, no belt replacement, no tensioners, no need to build or provide adjusters for belt tension. Small diesels like the 175 thru the 1115, do well with the MJ drive. Bigger engines may require bigger drive couplers. MJ himself has a 195 driving a 7.5kW head he uses for driving a digitally controlled welder. this unit runs up to 14 hours a day on the job site, and MJ has yet t replace the rubber spider. This is because he took the time to properly align the drive, it's easy to do but some people don't take the time.**

**When you buy a gallon of generator fuel, consider that you are being taxed around 6% if you are using a VEE BELT DRIVE.**

Before you go off and buy the coupler to mate your engine and generator together read this!

This page will be maintained in the usual 'random' manner you've grown to expect from me, I'll keep adding to the bottom of the page as we learn from personal experience.

Thanks to Mechanical Engineer Paul A. Bock of Buffalo, NY, and input from fellow DIYers, I am beginning to understand the dynamics of Coupler design.

What's amazing is I was first attracted to engines that seem to require less of a coupler due to their massive flywheels, and the actual learning came to play when DIYers wrote about their personal experience with couplers.

Engines are different, so are generator heads. If you look at the engines I've found interesting, you'll note they all have massive flywheels. This is most helpful in one or two cylinder engines where the power strokes are far spaced and you're trying to run a more constant speed through each revolution. the other thing I like is massive generator heads, this does factor into the selection of the coupler and does cause one to pay more attention to the design than lighter more compact generator heads. In a perfect world, you'd want lots of mass in the flywheel, and little or no mass in the head, this would leave the coupler with little or no challenge, but the electrical properties of the head would severely suffer.

Some of us DIYers are running into trouble when we try to mate up small 3 or 4 cylinder diesels with a gen head that has high mass. Some of these engines are light in the flywheel, (**maybe the worst are French Diesels**)...of course this is entirely another subject....

When the power stroke comes in, it can hammer an improperly designed coupler. Take the Love Joy 150, it's good for up to forty horsepower, but one of us found that the stock rubber spider will get hammered to pieces in minutes if there is insufficient flywheel mass. It stands to reason that the salient pole rotor is not going to appreciate this hammering either, so if one moves to a higher density spider in the coupler, you transfer even more beating along to the generator rotor.

What's a person to do? I think there's a good number of solutions, but I also think this is becoming a big enough stumbling block that we need to inventory the solutions and share them here. This may keep folks from spending money on solutions that are not satisfactory. For the time being, think of it this way.... mass in the flywheel is good, adding mass to anything on the crankshaft side is OK, adding mass to the rotating parts on the head side of the coupler is **BAD**, and will aggravate the problem.

There are other things that one can do to even out these lower speed power strokes that hammer couplings. One can look at Harmonic balancers and recognize that these devices null out, and in some designs store energy and return it back to the crank as the velocity of the power stroke falls off... This helps to maintain a more constant rotational speed and soaks up some of that energy that would otherwise hammer your coupler. doing the math, and designing such a coupler for a specific application is another thing.

**There are turn key solutions, (more expensive couplers) that are designed to take the beating and soak up the punishment, but they start at around \$400 dollars for an off the shelf solution. Look at the LOVEJOY site, they have engineers that can help select a coupling for you.**

**Until we get more info on this page, know that the stress on the coupler will be greatest at low speeds,** like starting and stopping the engine. Also note there are couplers that have some 'give' that helps with this problem, but as you'd expect they are more money. What you need to visualize is the low speed hammering that can occur at near idle speeds. Picture the power stroke of a diesel and the more violent power stroke verses the gas engine. You can hook an O scope to the generator output and see how uneven the rotational speeds are per revolution at low speeds, of course I'm talking speeds you won't run your generator at.

I'm thinking a harmonic balancer off a V8 or truck motor could be modified to make a flywheel mounted coupler. I also think Harmonic balancers could find their way onto our DIY projects to SMOOTH things out. **Of course, you do these things at your own risk...**

At this point, it should become apparent that slow speed engines have high mass flywheels to even out the speed and make them useful. Higher speed engines, and engines with more cylinders are going to be easier to work with if they have the same flywheel mass.

Let's take an example where a person is bound to get into trouble. You have a Pugeot diesel out of an automobile that was fitted with an automatic transmission. You take this engine and try and couple a generator head up to the flex plate and drive a high mass generator head. At idle, you'll be giving the coupler a severe pounding.

### **Added note 7/2003**

**Another item that is important to mention, some folks are racking up a good number of hours on the standard (inexpensive) Love Joy "L" style couplers with zero problems. Others complain that the rubber spiders eventually wear out and periodically need to be replaced. I've talked to the folks who have no problems and found that they took lots of care in the alignment. If one thinks about rolling clay into a ball in your hands, you'll note that this action is very similar to miss aligned shafts. Alignment problems are bound to eat spiders, and work couplers. It becomes obvious that one needs to spend some time with the alignment for trouble free operation.**

Stay tuned for the DIY solutions. . for the time.. let's all appreciate massive flywheels and know why they made em....

We have three DIYers who visit here that are building VW Diesels, and other small power plants, they all have slightly different design approaches, and will be sharing what worked, and what didn't in the way of direct drive couplings.

At this time, I wouldn't recommend using an L series six pin lovejoy for engines bigger than the 1115, and I'd limit the size of the head to 10KW, you might be OK with a 12KW, but less mass on the gen side is going to be easier on the coupler.

Remember... you can avoid all these problems by going to a belt drive, but you then have

another set of problems to engineer for... the world is full of trade offs...

More to follow.

George B.

## Air filter Listeroid 6/1 and 12/2

If you look over the stock air cleaner unit you may ask how the air finds its way in, and how effective the unit is at keeping dirt out?

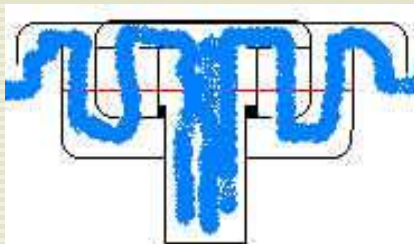

Above is the highly restrictive stock air cleaner, the red line represents the oil level.

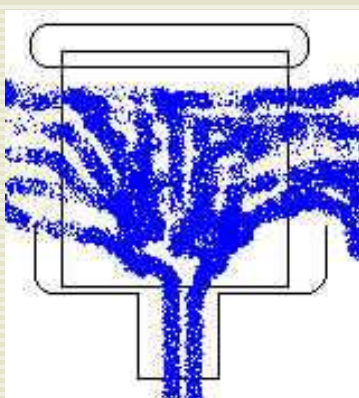

Sure, this engine is slow turning, but that big ole bore and long stroke really sucks, a less restrictive air cleaner might be a nice thing. Can a person make more power, or increase efficiency by modifying this unit? I would certainly think so, but a solid test is the only proof we should accept. One thing we know, a less restrictive unit can operate in a dusty environment longer before it impacts performance and demands cleaning. Anything we do to make it less restrictive will increase that interval.

We should ask ourselves; why oil bath systems aren't popular on modern equipment? Maybe it doesn't work as well as a modern paper filter element, or foam element, or foam/oil element? my guess would be that foam and oil is superior to most anything.

I modified the wimpy looking stock unit in about 5 minutes to take a standard filter element (see below). I placed it on the bottom of the stock cleaner bowl and found that the rubber end made a tight fit against the bottom. Looking at the top cover of the filter, I quickly realized that a piece of rubber cut from an inner tube, and cemented in place, or heavy friction tape would cover the holes in the top and make a sealing surface for the top of the element. This works excellent. To finish things off, add a small connector for the 1/4 20 threaded post, and added a section of threaded 1/4 20 threaded rod to extend the post so you can screw down the top again. It all looks stock when you're done.

To finish off your work, take a piece of metal fabric, I used aluminum with 1/8 inch holes, and rolled it to fit all the way to the outside of the air cleaner housing. IMHO, it looks far more British than the stock piece. Since I like British stuff, this makes me happy.

Next, I took a chain saw file and cleaned up all the little burrs in the filter inlet, I lightly shaped a few things to try and lower the turbulence that might be created by square edges by blending them.





Above is the filter element I found at Boeing Surplus, it has a nice foam sleeve that fits on the outside. I would think this could be blown out a good number of times before you'd needed to replace it.



Above left, the complete modified unit with the DIY outer guard in place. The complete stock unit is shown to the right.

One other item, save yourself some time, throw away the stock clamp that secures the air cleaner onto the intake pipe, get a stainless steel hose clamp, the Indian clamp is designed to torment you.

Look at the following pictures of Harold Polle's mod, and note the part number he shares....



This looks like a great fit, it has more filter area than my Surplus find. Note the metal fabric in it's construction. Thanks for sharing Ron!

Jeff Maier has agreed to test the modified air cleaner. If you look at a stock pipe, you'll notice a reduction in ID for the last inch prior to the air cleaner. A Motor Head would suspect the possibility that this step could cause eddies and problems beyond the choked down pipe itself. This reduction creates harsh transitions at the inlet itself, and again an inch or so into the inlet. I will modify an inlet pipe to remove this step, and to create a more conventional opening by increasing the diameter to max in the last inch of the inlet. This will help blend the transition from inlet pipe to the metal base of the air cleaner. If you look at the inside of the air cleaner itself, the air no longer has to make a 180 degree bend to find its way into the inlet, this is another area of concern for a Motor Head, the air in the modified air

cleaner does not have to make this sharp bend to find the air inlet tube. Again, the proof comes in testing, we'll see what Jeff finds.

## Adding a magnet to the sump

There's all kinds of really small and powerful magnets that can be dropped in the sump of an engine. This could be very beneficial in an engine with no oil filtration system. The hard metals could be trapped in the sump and you could easily check the magnet to see what's going on. There's an area right near the drain plug that looks perfect for such a magnet. A small neo often takes two hands to dislodge, if such a magnet is placed here, it's not likely to go anywhere. IMHO, this is worth the effort. I drop a magnet into the sump of all my engines. Start at [otherpower.com](http://otherpower.com), or [windstuffnow.com](http://windstuffnow.com) for magnets if you don't know where else to look.

## Lister 12/2, how to add an oil filter

The Lister 12/2 is fitted with a plunger type oil pump that works off it's own cam lobe and drives the pump piston directly. If you were to look at [Steve Gray's impressive 10/2](#), you'd see a neat gauge on top of the pump. The Indian units are usually fitted with a course threaded bolt at the top of the pump verses the pipe threads. Simply unscrew the top of the pump, remove the bolt, drill out with the proper drill, and re thread for 1/4 inch NPT. Now, screw in a tee, put a gauge on top, use the horizontal 1/4 NPT to receive a 1/8 NPT with a compression fitting for 1/4 OD tubing. I used a TP bypass filter from Gulf Coast filters, others are available. I screwed in a fitting at the filter end with a small valve so I could tune the restriction if necessary, this in theory would allow one to adjust a min gauge pressure. The return line from the Gulf Coast Filter is also 1/4 inch OD line. I chose to remove the governor spring post, drill out the hole slightly and re-tap for 1/8 NPT. the new fitting doubles as the oil return, and the spring post for the governor. What could be easier?





The above picture is genset UP12/2\_ST7.5\_#2, it took about two weeks to build and has lots of detail work and blueprinting. The head has been modified to 4 wire. LH picture shows filter plumed in plastic tubing, RH shows steel tubing which will receive a glossy black powder coating. This rig could have \$100 worth of brass fasteners on it!



As you can see above, the 1/8 inch NPT pipe doubles as the post for the governor spring and works well for the oil return.



Above: here are the stock inner and outer valves springs from a stock Listeroid. These arrived on the engine caked with that beautiful Metallic paint. Although it doesn't come across in the the picture, these are now wet glossy show quality parts powder coated with my \$79.00 powder coating kit, coating the cam covers, rocker arms, valve covers, access doors and a few other parts, makes the engine far more attractive. Paint the engine in dark hunter green, and you'll have a masterpiece. It doesn't cost much to make things nice, but time is a factor..

11/2003

At this time, I've come across several people who are running Listeroids 6 or more hours a day. One person replaced an idler gear in the cam drive, the other has had trouble free service for more than three years running. these are both off grid sites, and neither party regrets their selection of this old design.

Some folks are looking for ways to auto start old iron, if you look over my auto start battery charger, you'll see that this is possible if you take the time to experiment with the basic stamp microcontroller (do a search). I think the key is to make a decompressor that will latch or unlatch under orders of the controller, below is a crude drawing showing how you might approach this using a simple solenoid salvaged from ? Note the fulcrum and the advantage gained that help the solenoid force open the valve.

Some have adapted starter motor generators like those used on countless American garden tractors. Others are looking to fit an auto starter and auto ring gear to the crank shaft. Some will say this is too much messing around, others will have a great time adding features to this old design.

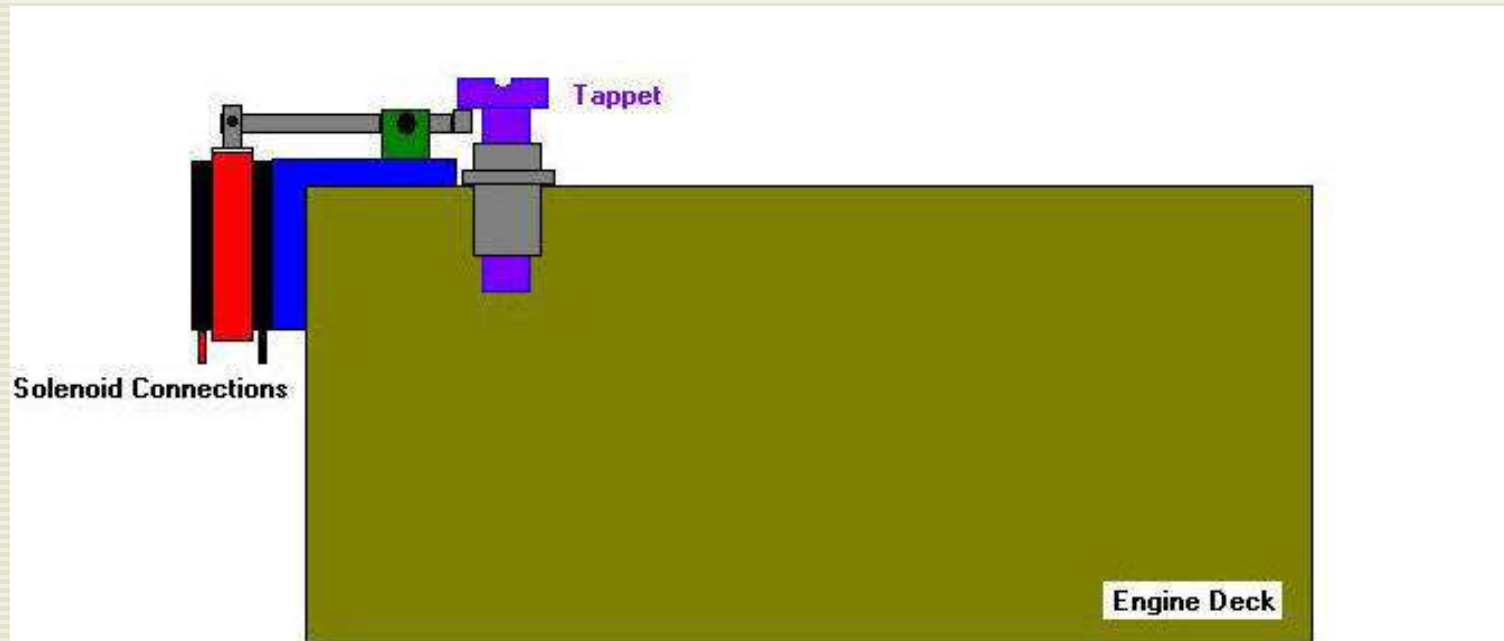

Once this is in place, you have one of the primary interfaces for the controller. In addition to the management of the starting process, this could be used for an emergency shut down. Also note, if you use a big American V8 starter and ring gear, there may be little need to use the decompressor at all.

12/2/2003 I just got word from DIYer Rich Gaarden that he has fitted a Chevy ring gear and starter to the Lister 6/1 and it starts in cold weather with about 10 seconds of cranking. This happens without a decompressor, and without any pre heat, ether or other starting aid. rich will take pictures and forward them, we'll share his setup when we get the pictures.

Have you noticed there's not timing marks on your Listeroid?

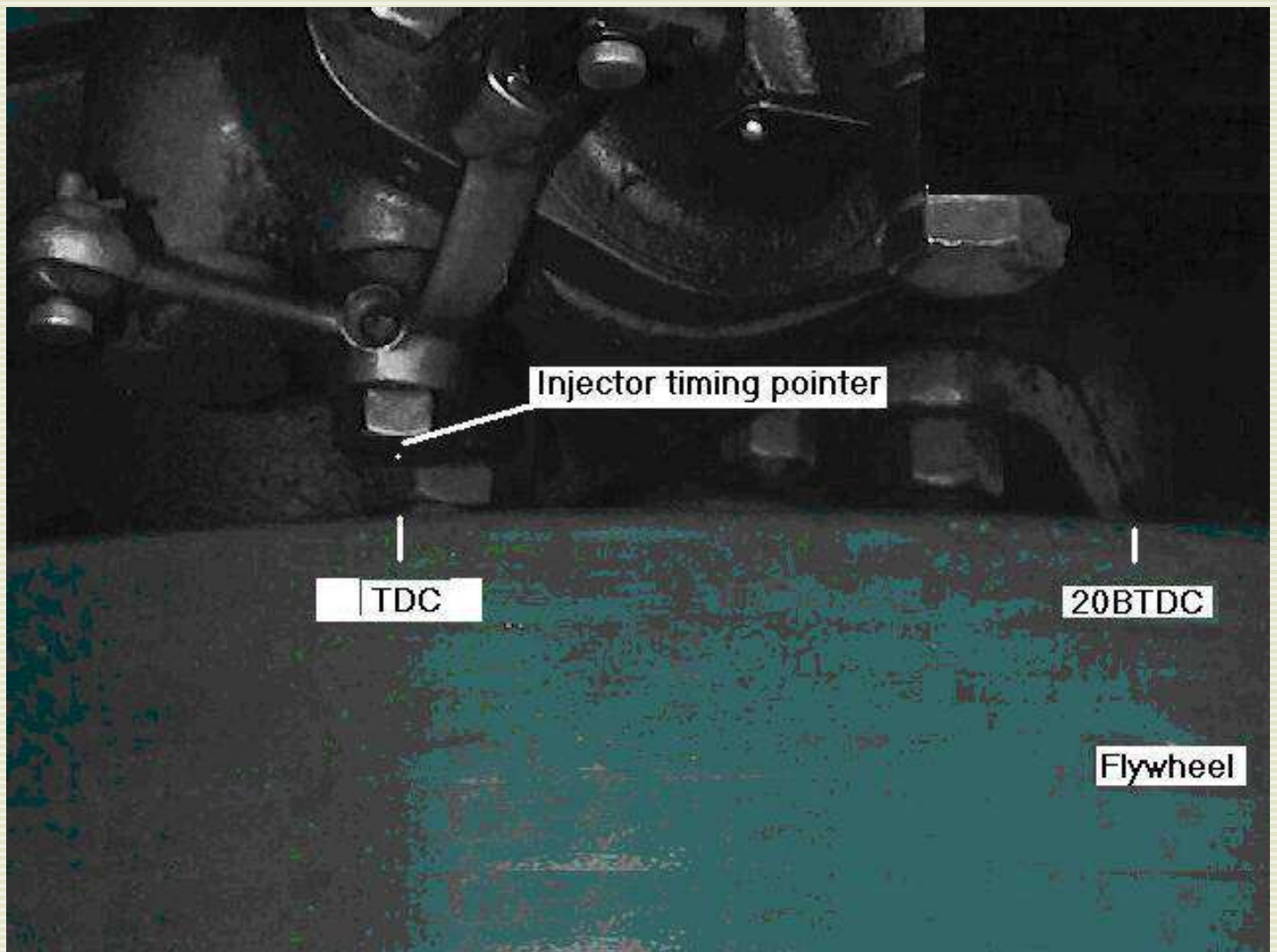

After looking things over for a long time, this appears to be the best pointer for a timing mark on the engine. These are big wheels, and you'll quickly learn that one degree is pretty wide. If you don't wish to take the head off to find top dead center, consider pulling the injector, and dropping a wire down the hole onto the top of the piston to use as an indicator for TDC.

[Ideas for a super quiet muffler, run your Lister in the suburbs !](#)



Above: Here's a Listeroid getting a coat of proper paint. This Metallic crap has to go. The easy way to paint one is to take the head off, and attach a home made lifting bar as you see here. This allows you to work standing, to have good light, and to clean up around the base.

Always more to add, stay tuned.

George B.





**The Lister 12/2 mates up well with either the ST7.5 or ST10 head. My designation for this combination is simply 12/2ST7.5 or 12/2ST10. Lister produced a generator based on the 12/2. My effort follows the same general layout making use of the stronger and more efficient micro Vee belts that are available at your nearest auto parts store. Expect 6KW continuous, and lots of capacity for short intervals to start motors like well pumps.**

**This is another page that will be added to and changed in my usual random order. At the bottom of this page is a link to the old Lister generator sets, they are beautiful!**

**7/16/02**

With the experience I am gaining with the 6/1, it is time to start putting the 12/2 together. Today I went down to Binford Scrap Metal and found some heavy six inch U channel. I gave about \$8 for all the metal required to make the base, I would imagine I would have paid \$80 to \$100 for new metal.

I spend a good part of the day cutting it and welding the base. The idea is to get support under the whole base of the engine, and have everything looking like it was made to go together.

I am very pleased with the basic set up on the 6/1, the idea of mounting the head on something that tracks between the rails works very well. With this set up, it's easy to fit a belt tension system and a anti twist adjustment to assure that the head is in alignment and stays there. I will refine the tension system just a little more when building this unit.

This frame will take two men and a boy to move around when I get done, but considering we're going to mount an engine that weighs 1432 pounds on it, who cares about a few extra pounds?

The goal will be to keep things compact, this engine has a lower base than the 6/1 and the flywheels hang lower than any part on the engine. The six inch channel 'up on end' raises the base high enough to keep the flywheels in the air.

**July 21, 2002**



The 12/2ST10 Listeroid is taking shape. The ST head got a new dog house that looks more the period and some green paint. This equipment looks like it belongs together. Notice the custom pulley, the drive is based on an 8 rib micro groove belt, verses the 6 groove used in the 6/1.

Engine 1432 pounds, generator head 305 pounds, base 100 pounds, generator carriage, 15 pounds, generator pulley 13 pounds. We're at 1865 pounds and have lots of stuff to add yet.

### Sept 2002

Other projects have kept me away from the 12/2. I made some time to check out the oil pump. there's a bolt in the top that can be removed to check for oil pressure. This one had next to no oil being pumped! I finally took the pump loose and disassembled it. It is of the plunger type and appears to be as simple as it gets, a check ball prior to the plunger, and a check ball after the plunger feeding the oil galley.

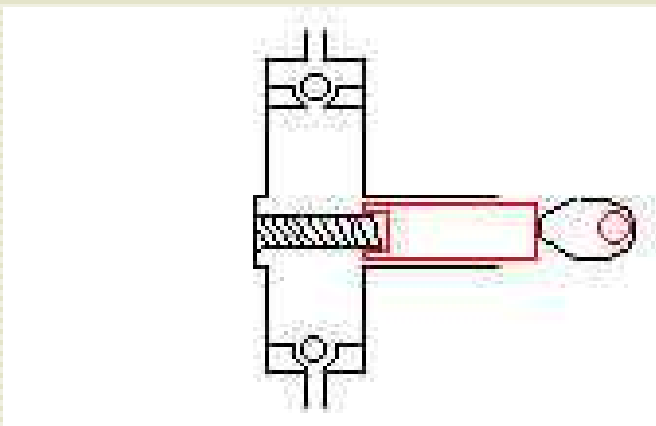

Above is a crude drawing of the plunger pump. Red is the plunger driven off the lobe on the cam shaft, two ball checks, some springs, and that's about it.

After cleaning up the pump, I noticed I could easily blow by the check valves! Looking at the seats, there was no mystery as to why. I think they may have missed the step of cutting one seat. I manufactured a tool to shape the seat and all seems to work well now. The volume of oil the pump delivers is low, if you have an engine like this, make sure the plunger pump is delivering oil before you run it!

After optimizing the operation of this pump, I allowed it to set for a week. With compression released in both cylinders, I removed the bolt at the top of the pump and turned the engine over many times without seeing oil at the output of the pump.

I have noted that many of the old Listers were fitted with a hand operated priming pump, I feel it would be an excellent idea to fit this engine with same. At the very least, I'd take this easily removed bolt out and pour some oil into the pump BEFORE I attempted to start this engine after it sat for more than a few days. If I get another Lister with this type of pump, I will see if it operates any better. Perhaps the ball checks will 'seat in' with some use and cure the problem?

[The first Run](#)

[Lister Generator plants of years past](#) <<<< **New**

[Home](#)

# Utterpower.com

## Lister Parts, we have them...



Above are some 'canned' solutions for parts :-)

In India you can buy standard lister parts in a can. There's standard canned rings, standard canned pistons, standard canned sleeves, and maybe you've never seen canned valves? The open can contains one set of standard valves. That can in the center really does say Lister 6/1 STD Piston ring set.

We stock a fair supply of parts for STANDARD clones here in the U.S.A., we give preference and discounts to our customers.

If someone is offering you an engine that takes parts other than standard, what are you getting in return? Is it cheaper? does it get better fuel economy? will the seller help you with the NON STANDARD parts? Before you buy is the time you ask these questions, it's never important till you need help, and it is always nice to consider that your investment is protected when you invest in

standards.

There are also some American made parts that interchange with Lister parts, if your engine will be doing real work, it's nice to know what you can substitute. Maybe NAPA has the parts you need on their shelf? Don't expect them to know what fits.

Let's take the Tapered roller bearings for instance, the **Timken part number is 32211M90KM1**. This will get you the race and the bearings, if you're going to use this stuff daily, getting parts from India, may not be reasonable solution.

## Parts discussion page

George B.



# Parts discussion Page

Here's where I'll try and share information about different parts on STANDARD engines. If you ask why the subject can be so verbose, know that the Listeroid design is a perfect 'test bed' for ideas, and know a good number of owners and readers experiment with parts modifications on these engines. It is my hope that information on this site will be groomed into a more logical format, so you can find things more easily, for the time being, expect less.

## Rocker Arms

For those of us who have been around modern machinery, the idea of having an open valve train just doesn't seem right. We look into the English Lister and note that the rockers were lubed with grease cups. We see that the standard Indian set up uses a rocker system with a counter sunk hole on top of the rocker to receive oil... why did the Indians move away from grease cups? Was it only a cost reduction, or did they find there to be little if any wear in these parts?

To add more to the conversation, some Indian rocker arms are bronze bushed and others are solid steel. If one considers that these run on steel shafts, your first thought is that someone is cutting corners on the steel unit without the bushing.

If you look into typical valve train wear in a bushed rocker/steel shaft assembly, you will note that it is common for the bushing to retain solid

particulate delivered by the oil. These particles become embedded in the bushed material and actually abrade the steel shaft, this is common in higher rpm engines with enclosed valve gear! could the steel on steel rocker system outlast the bushed system... probably by a long shot...

The Lister design has a number of advantages, and one obvious disadvantage when it comes to longevity of the valve train.

- Most engines will never idle as slow as a Lister runs flat out.
- Valve spring pressures are quite low due to this low RPM.

These are big advantages and greatly increase the life expectancy of the assembly as measured in hours of running. The disadvantage of the Lister design is having a rocker assembly out in the open where dust and dirt could contaminate the assembly.

At this point, we need to take a breath and note that Rocker arms, shafts and whole assemblies are readily available, the wear on these parts may be so slow that we won't need to worry about it during our life time.

For those of us wishing to experiment:

- How would a Teflon bushing perform with the low spring pressures and low cycle times in this design?
- Could we fit needle bearings between the rocker arm and the steel shaft, could we seal this up like a universal joint?

## Tappet Guides

Removing the guides from a virgin engine is a little bit of a problem. What we really need is a split collar that bolts to the top of the guide with two or more jacking bolts to force it off the deck. Before you remove tappet guides, paint a dot on the front of the guide body to indicate the original orientation and remember to place the guide back into it's original hole, more on this later.

**Make sure you remove the paint from the top of the lifters before you try and remove the tappet guide**, keep in mind you have a cam lobe under that tappet and don't hammer on things, it's best to keep blocking up the tappet guide to hold it off the cam should you need to drive the tappet from the

guide, (any interference will be caused by the paint). Very long jacking bolts could be real handy for pulling virgin (gobbered up with Indian paint) tappet guides, and tappets.

The top of the tappet guide is approx 1.335 inches in diameter



Above: A= a coarse threaded bolt that seals off a bore hole that goes through the top of the cam bearing, this is the splash fed hole for oiling this bearing. B= decompressor C= this part threads into the top of the tappet, it is removable to allow the tappet to be withdrawn from the guide. this is used to keep the valve slightly open for starting. D= this is the tappet guide retainer.



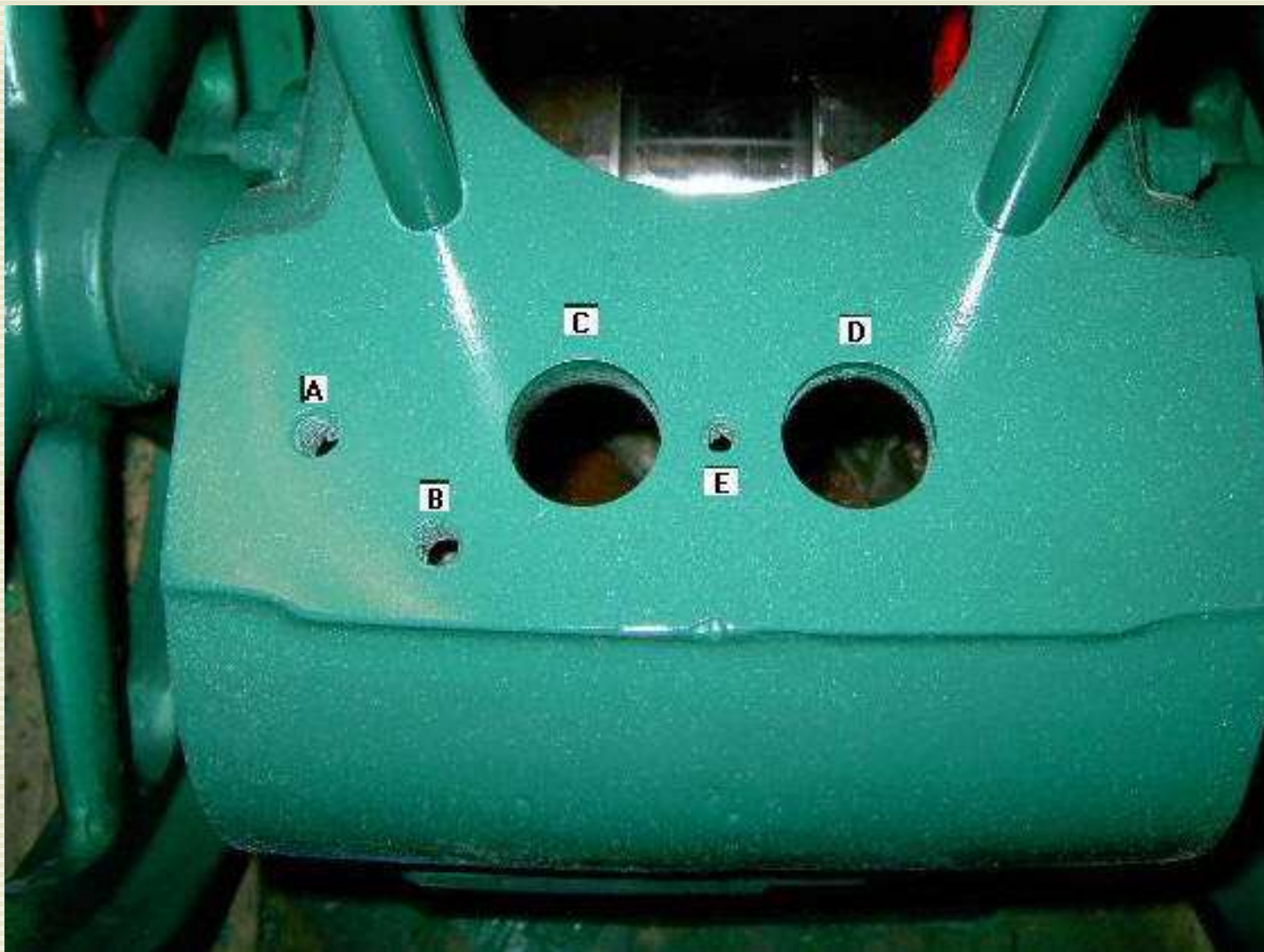

Above is the deck with parts removed. This particular crankcase is from Prakash; if you follow the contours at the very front of the deck, it becomes obvious that this crankcase comes from a different Foundry/different casting than the Metro engine above. Look at the size of those cylinder studs!

## Cams

Pulling a cam is quick and easy provided you have pulled the tappet guides and tappets once, and got rid of the surplus paint.

What you need to keep in mind is that cams have to be timed to the crank, I recommend you bring the engine to TDC, and grind some marks on the cam gear and the idler so you can be positive that it goes back together right. A good number of these engines do not have obvious marks for re-alignment. Expect more detailed info for timing the cam.

Following are steps for removal.

- Remove Lifters
- Remove tappet guide retainer
- remove tappet guide and tappets
- Pull injection pump, and linkage.
- Pull left and right cam covers, note that studs may have to be removed with vice grips to remove right hand cover.
- note orientation of cam gear and Idler gear.
- Remove pin from collar on left end of cam, use die grinder to remove peened over small end if necessary, drive the pin with a punch. It will take a good whack or two to get it to move.
- Remove collar
- Extract cam from right side, note that the manipulation of the flywheel and tilting the cam downwards will allow it's removal without taking the flywheel off.

## Pulling the Crank Shaft/ Flywheel

This may be the toughest job on the Lister, and some will say there's lots of tricks to make the job easier. This is a place to start, I am confident the old timers will read this, and help to tune the information.

The first question is knowing you really need to take the flywheel off... are you sure you need to do this ??

I am talking to a tool maker about building a 'Gib key puller', that will place the key in tension, I think this will make it far easier to remove. I imagine it to look like this:

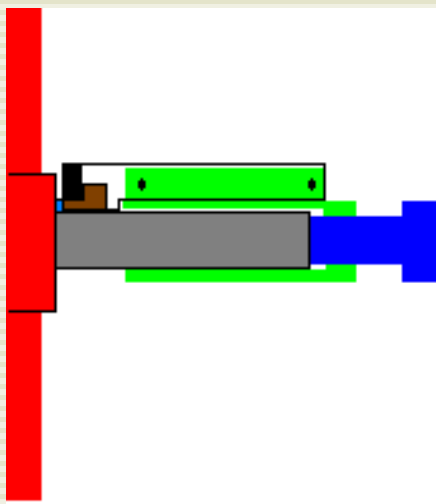

**Re= Flywheel**







**Brown= Gib Pin**

**Green= Body of puller made of a thick sleeve that goes around the shaft and two metal straps welded to the top of the sleeve that acts as a guide and anchor for the puller.**



**Black transparent= The puller itself, this is inserted in between the guides, and pinned in place with drill rod in as many holes as necessary to withstand the pulling force.**

**Blue= One large fine thread bolt used as an extractor.**

### Steps to removal

-  **Remove paint around the pin**
-  **Use WD40, Kerosene, or other penetrate to saturate the Gibb pin and areas in contact with it.**
-  **Use an pin extractor similar to the drawing above to place the key (pin) in tension without ripping it's head off.**
-  **Use a brass hammer, or use a brass or alloy piece of strapping placed between the flywheel hub and a steel hammer to take the blow, without damaging the flywheel.**
-  **Hit the flywheel hub, and then check the tension on the Gibb pin to see if there has been any movement.**
-  **Keep trying till you remove the pin**

**You will remove the flywheel to:**

-  **Replace main bearings**
-  **Pull the crank for replacement**
-  **Replace or 'true up' a flywheel.**

**If you have to do this more than once in a lifetime on your engine, old timers might call you unlucky. It is my thought we need a few kits that contain some specialty tools to make this task an others easier, possibly loan them out, and return them to a central place.**





**This page contains information on the *Standard* Listeroids, as I have mentioned elsewhere, there are now a number of variants that are lighter and in some cases need to turn higher RPMs. Make sure your engine is a 'STANDARD' clone modeled after the famous Lister CS 5/1\_6/1 before you make use of these specs.**

**Valve Adjustment when cold: Intake .017" Exhaust .032"**

Here's the torque specs used for utterpower Listeroids.

**Cylinder Head - 160 to 170 lb-ft(23 to 24kg-m)**

**Fuel Injector - 38 to 40 lb-ft(5 to 5.5Kg-m)**

**Connecting Rod - 50 to 60 lb-ft(7 to 8 Kg-m)**

**Housing for Main-Bearing 68 to 72 lb-ft(9.5 to 10kg-m)**

### **Clearances**

**Crank pin to Rod, (Big End) there seems to be some confusion regarding this figure, one of the better Indian references specifies a maximum of .003 for this clearance, and states no minimum.**

**Other's state the ideal clearance is .003", Max clearance is .005** A number of folks were consulted in the old time engine community. A figure as large as .007 was found in some Lister material, but modern day folks think these figures are where they need to be.

With all this said... *I'm going with the .003 and less figure*, and I have no clue how tight this gap can be and splash oil properly.

## General information

Head Bolt= 28mm or 1.1 Inches

Wrist pin diameter 1.250 inches

Cylinder bore 4.5 inches

## Following is general Indian descriptions of the CS clones, and some parts info.

Listeroid vertical slow speed diesel engines are rated for maximum load for continuous running. This power is obtained at any level of elevation up to 700 ft. above sea level, with fuel oil of not less than 18,000 B.T.H.U.per Ib. The engine will give satisfactory service from any grade of fuel oil but preferably the usage's of clean light diesel oil is recommended. The engines are of compression ignition type with direct fuel injection, four stroke, vertical water cooled.

### Construction Details

The cylinder head is made of high grade quality Cast Iron and is ensured in its design for effective running and minimum fuel consumption. The cylinder head cover is easily removable to give complete access to valve gear and atomiser. The cylinder is made of close grained Cast Iron and finally finished for exceptionally long life. Engines with replaceable cylinder liner can also be supplied if required. Piston is made of high quality Cast Iron and is ground to ensure good fit with the block with adequate clearance for satisfactory running.

It is fitted with four compressor rings and one oil ring. The valves are made of heat resistant high quality silicon steel and finished to ensure safe life. The crankshaft is made up of special EN steel ground to close tolerance. The main bearing are of bush type. The small end and the crankshaft bearings are of good quality white metal. Engines with crankshaft and taper roller bearings can also be supplied on demand.

The engine speed is controlled by spring loaded governor. The speed can also be adjusted while the engine is running. The governor controls the fuel pump with variable delivery and ensures that the required quality of fuel for any given condition of running is accurately maintained. The fuel injection pump delivery valve and the nozzle are the well renowned MICO (BOSCH) type. A large capacity fuel filter is fitted and is made of special fabric which is easily cleaned or replaced. The use of filter ensures long usage and trouble free functioning of the fuel injection system.

The engine is cooled by water circulation through the cylinder block and cylinder head with suitable inlet of outlet flanges provided in the sides. The engine is fitted with two well balanced cast iron fly wheels which keep the speed variation to the minimum under fluctuating load condition.

On every selected Listeroid diesel engine the best selected components are fitted for long life which are freely interchangeable with each other. Every engine is selected for fuel and load characteristics for varying load applications. They are specially painted and finished to have the best appearance and are supplied with the best packing fully lined inside the case. Each engine is supplied with fuel tank, starting handle, spanner set, oil can, screw driver, kept in a special tool box inside the case.

Model	H.P.	R.P.M.	Cylinder	Bore & Stoke	Compression Ratio	Fuel Consumption	Weight of Engine
PR-6	6	650	Single	114.3m.m x 139.7m.m	18:1	268 g/kwh 197.1 g/bhp./hr.	315 Kg.

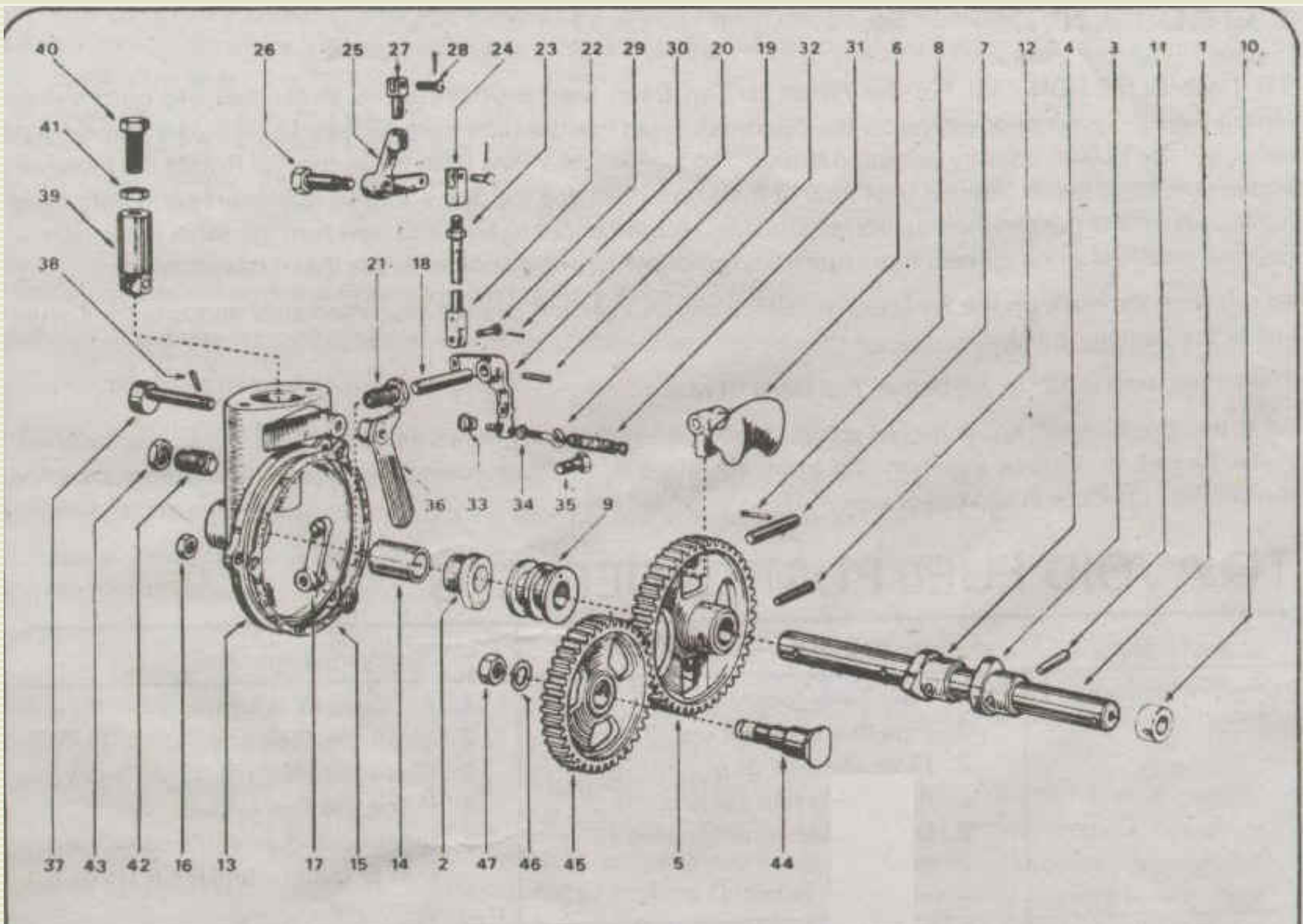

**SIDE COVER AND CAMSHAFT ASSEMBLY**

**PLATE - A**

Part	No. Required	Part	No. Required
------	--------------	------	--------------

No.	Description of Parts	6HT	BH	915	92	No.	Description of Parts	92
1.	Camshaft Bare	1	1	1	1	23.	Locknut for Governor Connecting Rod	1
2.	Fuel Pump cam	1	1	1	1	24.	Fork For Governor Connecting Rod	2
3.	Exhaust Valve cam	1	1	1	1	25.	Governor Upper Lever	1
4.	Inlet Valve cam	1	1	1	1	26.	Fulcrum Pin for Upper Lever	1
5.	Governor gear	1	1	1	1	27.	Eye end for Governor Upper Lever	1
6.	Governor Weight	2	2	2	2	28.	Joint Pin for Eye End	1
7.	Governor Weight spindle	2	2	2	2	29.	Joint Pin for Fork	2
8.	Governor Weight spindle split pin	4	4	4	4	30.	Split Pin	3
9.	Governor Sleeve	1	1	1	1	31.	Governor Spring	1
10.	Governor Collar	1	1	1	1	32.	Hook for Governor Spring	1
11.	Taper pin for cam	3	3	3	3	33.	Adjusting Nut for Hook	1
12.	Taper Pin for Gear Wheel	1	1	1	1	34.	Lock nut for Hook	1
<b>CAMSHAFT SIDE COVER</b>						35.	Anchor pin Governor Spring	1
13.	Camshaft Side Cover	1	1	1	1	36.	Cut-Off Hand Lever	1
14.	Bush for Camshaft cover	1	1	1	1	37.	Cut-Off Spindle with Eccentric	1
15.	Joint for Camshaft cover	1	1	1	1	38.	Taper Pin for Eccentric	1
16.	Nut for Camshaft cover	3	3	3	3	39.	Tappet for fuel pump	1
17.	Governor Inside Lever with Roller and Pin	1	1	1	1	40.	Adjusting screw for Tappet	1
18.	Spindle for Governor Inside Lever	1	1	1	1	41.	Lock Nut for Tappet	1
19.	Taper Pin for Governor Inside Lever Spindle	2	2	2	2	42.	Tappet fixing Screw	1
20.	Governor Bottom Lever	1	1	1	1	43.	Lock nut for Fixing Screw	1
21.	Bush for Bottom Lever	1	1	1	1	44.	Idler Spindle	1
22.	Governor Connecting Rod	1	1	1	1	45.	Idler Gear	1
						46.	Spring washer for Spindle	1
						47.	Nut for idler Spindle	1

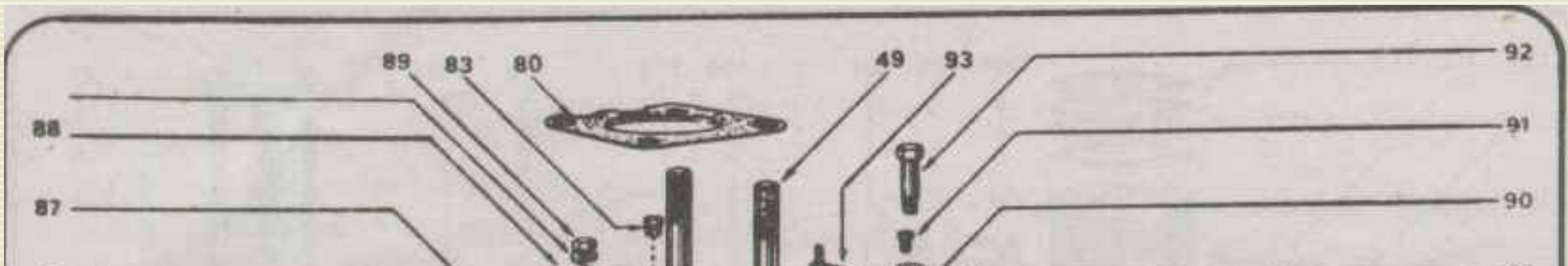



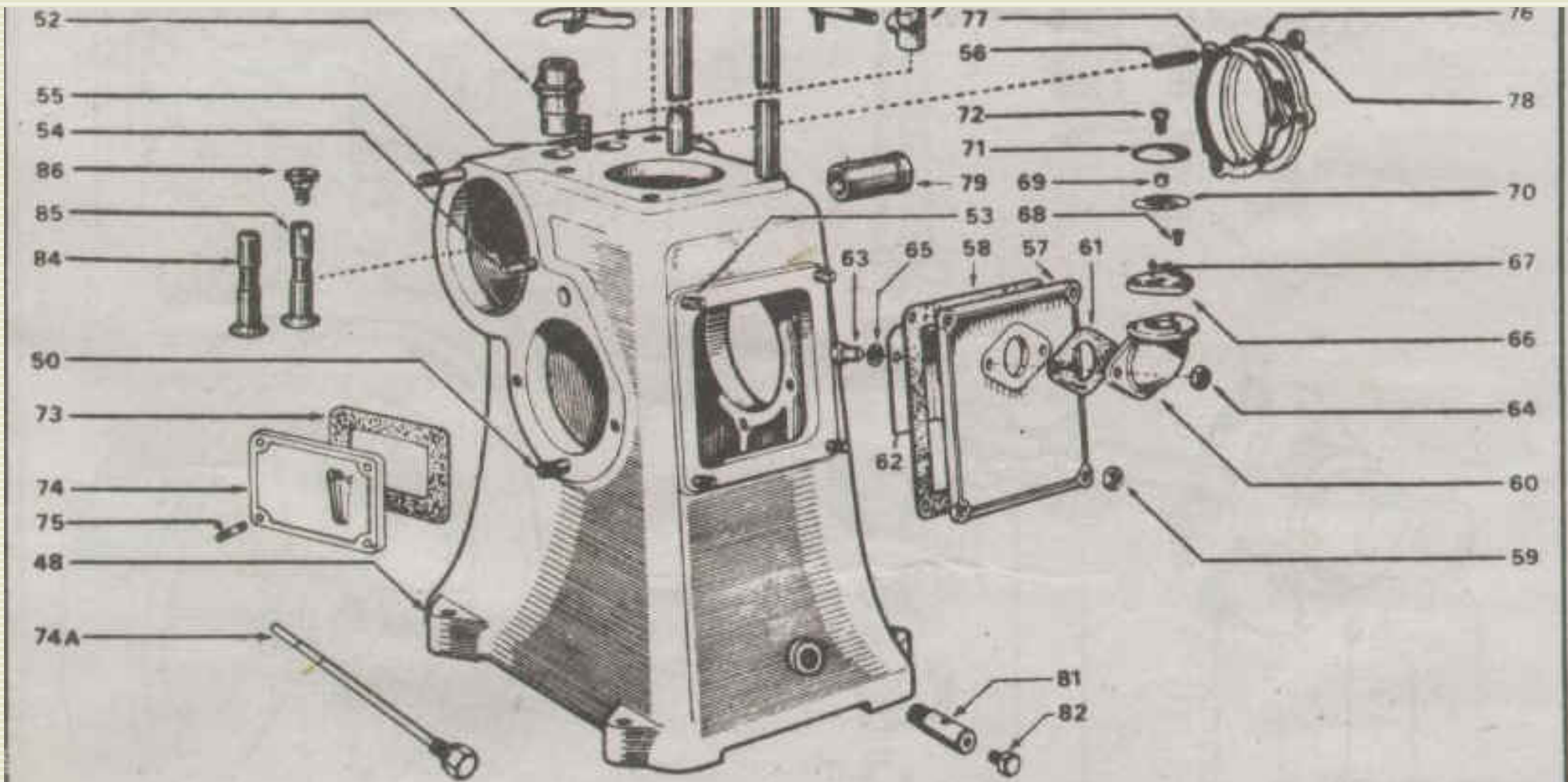

**(III) CRANKCASE ASSEMBLY**

**PLATE — B**

Part No.	Description of Parts	No. Required				Part No.	Description of Parts	No. Required			
		6 HP	8 HP	9.5 HP	10 HP			6 HP	8 HP	9.5 HP	10 HP
48	Crankcase	1	1	1	1	71	Breather Cover	1	1	1	1

49. Stud for Cylinder & Cylinder Head	4	4	4	4	72. Set Screw for Breather Cover	1	1	1	1
50. Stud for main Bearing Housing	7	7	7	8	73. Joint for Crankcase Small Door	1	1	1	1
51. Nut for Cylinder Head	4	4	4	4	74. Crankcase Small Door	1	1	1	1
52. Stud for Tappet Guide Clamp	1	1	1	1	74A. Oil Gauge	1	1	1	1
53. Stud for Crankcase Door	4	4	4	4	74B. Guide Nut for Oil Gauge	1	1	1	1
54. Stud for Camshaft side Cover Gear End	2	2	2	2	75. Stud for Crankcase Small Door	4	4	4	4
55. Stud for Camshaft Side Cover Gear End	1	1	1	1	76. Camshaft end Cover	1	1	1	1
56. Stud for Camshaft End Cover	3	3	3	3	77. Joint for Camshaft Cover	1	1	1	1
57. Crankcase Door	1	1	1	1	78. Nut for Camshaft Cover	3	3	3	3
58. Joint for Crankcase Door	1	1	1	1	79. Camshaft End Bearing	1	1	1	1
59. Nut for Crankcase Door	4	4	4	4	80. Joint Crankcase to Cylinder Block	3 to 5			
60. Breather Body	1	1	1	1	81. Drain Pipe	1	1	1	1
61. Joint for Breather Body	1	1	1	1	82. Drain Pipe Plug	1	1	1	1
62. Splash Guard for Door	1	1	1	1	83. Plug for Camshaft Oiling Hole	1	1	1	1
63. Bolt for Breather Elbow	2	2	2	2	84. Inlet Valve Tappet	1	1	1	1
64. Nut for Breather Elbow	2	2	2	2	85. Exhaust Valve Tappet	1	1	1	1
65. Washer for Breather Bolt	2	2	2	2	86. Tappet Head	1	1	1	1
66. Breather Plate	1	1	1	1	87. Tappet Guide	2	2	2	2
67. Dowel for Breather Plate	1	1	1	1	88. Tappet Guide Clamp	1	1	1	1
68. Screw for Breather Plate	3	3	3	3	89. Nut for Tappet Guide Clamp	1	1	1	1
69. Spacing Bush for Breather Plate	1	1	1	1	90. Valve Lifter	1	1	1	1
70. Breather Disc	1	1	1	1	91. Valve Lifter Pin	1	1	1	1
					92. Swivel Pin for Valve Lifter	1	1	1	1
					93. Operating Handle for Valve Lifter	1	1	1	1

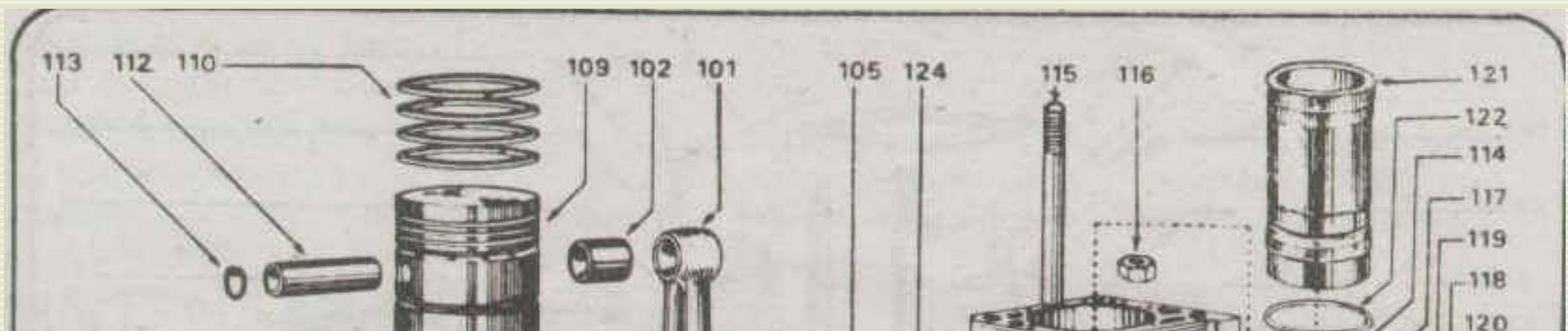

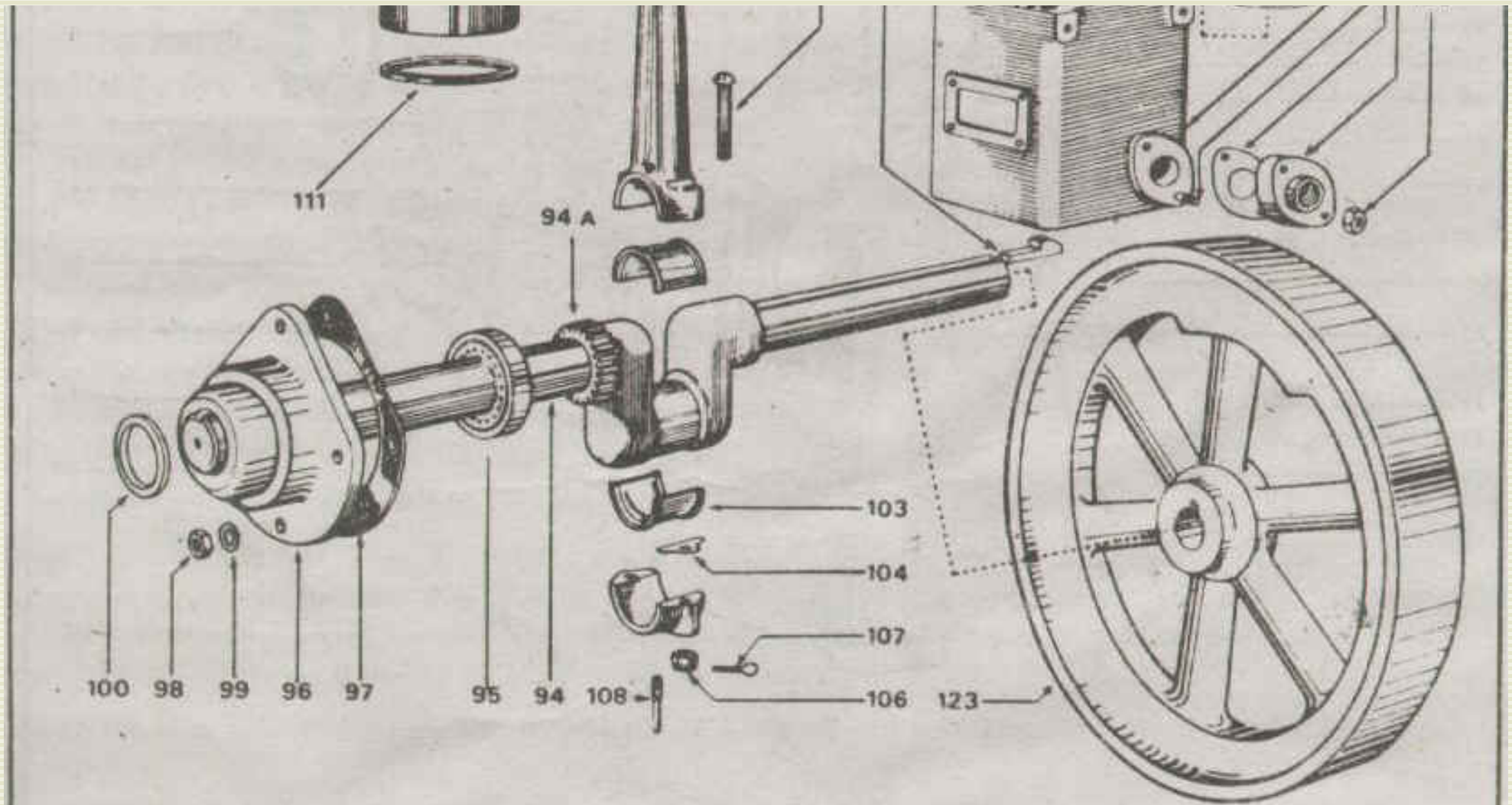

**(III) CRANKSHAFT, CONNECTING ROD, PISTON-CYLINDER & FLYWHEEL PLATE - C**

Part No.	Description of Parts	No. Required				Part No.	Description of Parts	No. Required			
		6HP	8HP	9.5HP	10HP			6HP	8HP	9.5HP	10HP
94	Crankshaft with Pinion	1	1	1	1	110	Compression Ring for Piston	4	4	3	3
95	Taper Roller Bearing with Cone	2	2	2	2	111	Oil Ring for Pistor	1	1	2	2
96	Housing for Taper Roller Bearing	2	2	2	2	112	Gudgeon Pin	1	1	1	1
97	Joints for Housing	4	4	4	4	113	Gudgeon Pin Circlip	2	2	2	2
98	Nut for Housing	7	7	7	8	114	Cylinder Block	1	1	1	1
99	Washer	7	7	7	8	115	Stud for Rocker Bracket	1	1	1	1
100	Oil Seal	2	2	2	2	116	Nut for Rocker Bracket	1	1	1	1
101	Connecting Rod with Cap	1	1	1	1	117	Stud for water Inlet Flange	2	2	2	2
102	Small End Bush for Connecting Rod	—	—	—	—	118	Water Inlet Flange	1	1	1	1
		1	1	1	1	119	Joint for water Inlet Flange	1	1	1	1
103	Connecting Rod Big End Bearing	1	1	1	1	120	Water Inlet Flange Nut	2	2	2	2
104	Shims for Connecting Rod Bearing	2	2	2	2	121	Cylinder Liner	1	1	1	1
105	Con. Rod Bolt	2	2	2	2	122	Liner Rubber Rings	2	2	2	2
106	Con. Rod Nut	2	2	2	2	123	Flywheel	2	2	2	2
107	Split pin	2	2	2	2	124	Flywheel Key	2	2	2	2
108	Con. Rod Dipper	1	1	1	1						
109	Piston Bare	1	1	1	1						

### How to spill time the engine

The Indians didn't make it obvious where the timing mark was on these engines, It's a good idea to make your own now and 'spill time' the engine, this way you'll know where you are, and you'll have the proper marks for timing in the future. Take the head off, use a dial gauge, locate TDC, I choose to use a logical spot near the injector body to file my timing mark, after locating TDC, I then filed a mark in the fly wheel to align with the fixed mark. Now, it's just simple math to locate the mark where the injector pump stroke begins, my reference material says 18-20 degree BTDC 'before top dead center is the spot. Simply do the math and realize that a single degree is going to be quite a distance on this big ole flywheel, this is vastly easier than almost anything most of us have seen before.

While you have the head off, clean up the head gasket, liberally paint acrylic floor wax on the inside of all water passages and all the way around the outside of the gasket, then wipe down the sealing surfaces. Use cheap Aluminum paint and mist on a thin coat on both clean sides and allow to dry. Before you put the head back on, run your fingers over all surfaces checking for any little bits. Make sure all is clean dry and free of dirt, also put in back in the same orientation you found it. Clean the top of the piston and combustion chamber while you're here, there may be some carbon due to the overload test at the factory.

Simply measure the distance around the flywheel with a good tape measure. Example: measure from the 12 inch mark and subtract 12 inches, this removes the error often found in the end of the tape. Once you have this measurement, divide it by 360 to get the distance per degree, and then multiply that by 20 to get the 20 degrees before TDC mark. Make sure you LEAD the TDC mark in the proper rotation, on the injection pump side of the engine! Simple for those of us who have been around engines, but this is a dandy beginners engine, so we'll be verbose. My example, I used the metric scale.... 1887MM circumference, divided by 360, then multiply that by 20 gave me about 10.5CM prior to TDC for my spill timing mark. Once you've found your 20 degree mark, file it in, you might even rub some white paint into the file marks and label them.

Now for the timing, ..... run the engine, get all the air out, stop the engine, loosen the high pressure fuel line from the injector, place a tight fitting piece of clear plastic over the fuel line holding it straight up in the air, Note that some folks then fit a smaller plastic tube inside the first one to get a finer reading. now turn the engine over, compression release on, throttle rack open, and get fuel into the plastic, so you can see the fuel. Now slowly turn the engine and note the spot where the fuel just begins to pump. See the adjustment under the injector pump, raise or lower it depending on how far it's out. A warning to the wise, stick your finger under the injector, and there's a good chance you'll loose part of one when the flywheel is turned! keep your mitts out of the moving parts!

## **Physical Dimensions** in inches

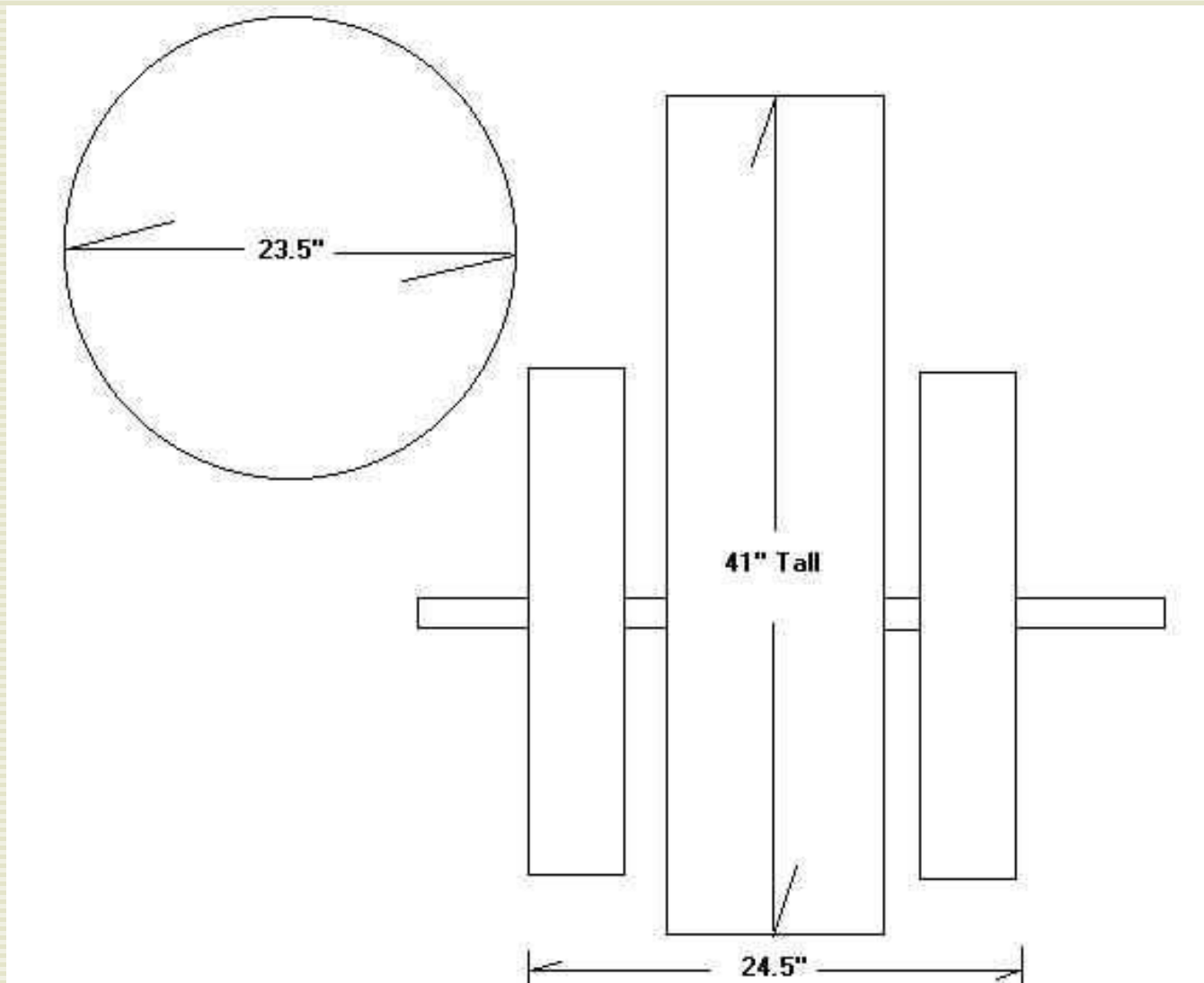

the crank shaft is approximately 3 feet long, fly wheels are clear of the ground on the model I am familiar with. Twelve two's on the other hand, have wheels that often hang lower than the base of the engine itself.

Shipping crates for six ones are 43" tall, 38" wide, 24" long. the crate itself will heat your shop for a full day if you have a wood stove. some of the wood is very dense and has a nice grain to it, you might save some of it for a wood working project.

**May 1, 2003**

**Fuel efficiency: Actual tests using the Listeroid 6/1, ST3 head, and the efficient Allmand drive system produced .125 gallons of biodiesel per KWH. We are working on a few simple MODS that could boost this REAL number even higher. Following is a formula from Jeff**

**Maier that will predict 6/1 fuel usage for this setup.**

**Fuel Usage Per Hour (Gallons/Hour) = (Load in KW) \* (0.0918) + .101**

[Home](#)



## Fuel economy, what's possible ? Another living page that will change as we collect data.

A generator is such a great thing, add a known load at a known RPM and you have a dyno. Jeff M. , an Electrical Engineer in the Seattle area is the first person I've come across that has done actual fuel tests on his Lister 6/1. Jeff is running a brand new engine with an ST3 head. He just spill timed the engine to 19-20 degrees BTDC and managed .125 gallons per Kilowatt hour on biodiesel ! I'd say that's pretty significant for a relic of the past. He is using the utterpower Allmand built pulley on the head and driving the generator off the flywheel, we think this is a very efficient belt drive and probably saves a few percentage points in losses over a Vee belt system. I've had MEs point out that the Long stroke and slow speed of the Lister design provides all the time necessary to 'wring out' more energy during the power stroke.

Biodiesel has around 118,000 BTU per gallon, Petrol Diesel has around 130,500, heavier Petrol oils have even more energy, and people do add cleaned up used motor oil to the diesel to stretch their fuel, Listers are known to burn straight motor oil, and the information that came with my 6/1 claimed it would burn any grade of diesel, but the light grades were preferred.

Jeff's (point one two five) .125 gallons per KWH was accomplished with a 2500 watt load. If we were to guess at the fuel economy on petrol diesel, it could be .1125 gallons per KWH with a 2500 watt load. Jeff points out that the cetane rating of bio is higher (better), and the lubricating properties are higher, so a 10% gain may not be realized.

As you may know, a diesel runs more efficiently with an 80% load than it does with a 20% load. so if we are loafing along with a 400 watt load using the genset to watch TV, the amount of fuel per KWH will be higher.

Jeff performed another test with a 1.1 KW load using biodiesel. This test produced .169 gallons per KWH. If we adjust this for Petrol diesel, we might expect .152 gallons per KWH.

With this data, you can see how it may be possible to run a small diesel for a good number of hours per day and not go broke if it's off road fuel. A Farmer friend was paying 95 cents a gallon for the stuff. You could run 7x24 at that price.

**At this point, you might be wondering exactly why Jeff is running Biodiesel for these tests? You might picture him in an off grid setting, forsaking city life and all that goes with it.**

Actually... Jeff lives pretty close in, with neighbors all around. 6000 sq ft lots are typical there. Biodiesel is a big plus in these settings, the smell we associate with diesels is not present! His previous diesel ran at 2600 RPMs, he had it in an insulated enclosure inside the attached garage. His wife Angie is very understanding and supportive, she didn't kill him the day the house filled with smoke. Jeff has a special flu installed to carry the exhaust out of the garage. The Lister is a more pleasant 650 RPMs, and Jeff is in the process of designing a muffler specifically for the 6/1. I think it's about time to add some Jeff pages so you can see his handiwork.

I swapped email with Jeff this AM, April 30, 2003, we talked a little about Biodiesel and Jeff's affection for it. Jeff explained that the area he lives in doesn't have an abundance of wind, or solar. Biodiesel is nothing more than liquid sunshine, and it allows a person to utilize alternative power where other means are not practical. Jeff also thinks watching the engine run is far more interesting than watching Solar Panels do their work. If one considers that biodiesel can also be made from waste products, it makes even better sense to put it to use. Making Bio diesel at home does not take rocket science, setting up a Lister to burn straight veggie matter is also possible, I've heard stories of Coconut Mills being powered by old Listers running straight Coconut oil. My brother was just telling me there's crops that could produce 500 gallons of oil per acre, I think that's amazing, maybe someday we could tell the Middle East we have far less need for their oil?

Jeff has more data coming, stay tuned for some Jeff pages, I have received some great graphs and more fuel data, the graph below was developed using Biodiesel, the ST head, utterpower drive, and the Lister 6/1.

Thanks Jeff!



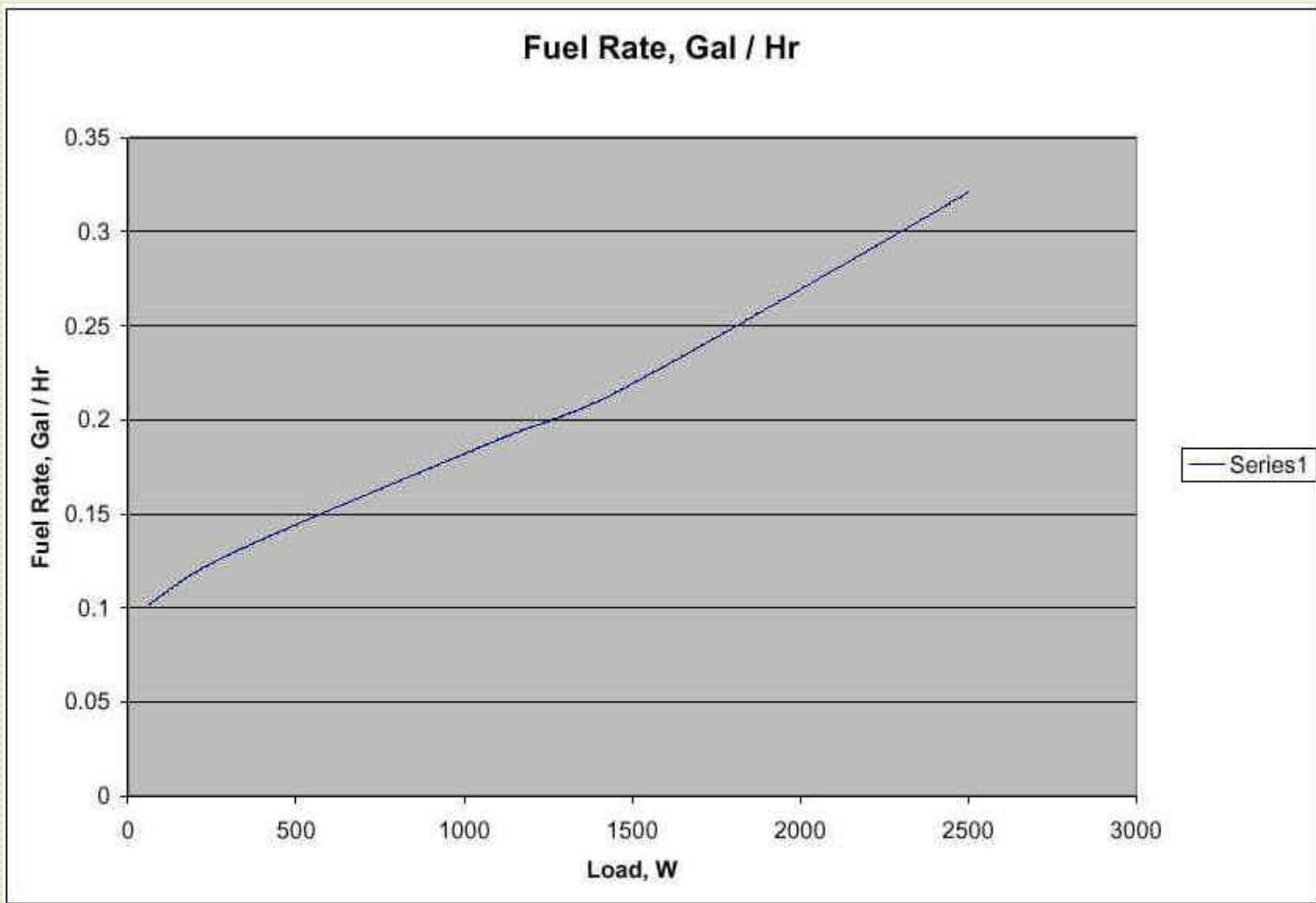

May 1, 2003

**Fuel efficiency:** Actual tests using the Listeroid 6/1, ST3 head, and the efficient Allmand drive system produced .125 gallons of biodiesel per KWH. We are working on a few simple MODS that could boost this REAL number even higher. Following is a formula from Jeff Maier that will predict 6/1 fuel usage for this setup.

**Fuel Usage Per Hour**      (Gallons/Hour) = (Load in KW) \* (0.0918) + .101

[More on Jeff](#)

Best Wishes,

[George B.](#)

[Home](#)





**If you spend hours on the WEB researching water cooled Lister singles and twins, you're bound to run across stories of Listers that have out lived their owners! If you have 'first hand' stories, I'd love to hear them, please write me. Below are some I've heard, or have been sent.**

**There's a collector who found a Lister CS 6/1 on the bottom of a scrap heap at the local dump. It was badly rusted and he had to soak it for a few months to get things apart. It runs well today with a rebuilt injector pump. The rest of the engine was salvaged including the rings!**

From V. Warner

As far as what it takes to kill one, I don't know about mine... but when I was a kid in the Netherlands in the sixties, we had a small weekend home next to a farm. The farmer ran a one-cylinder Lister. I loved the sound of that thing. I don't remember what the load was but this engine ran for days and days on end, for many years, sitting outside, pretty much unprotected in Dutch weather under a piece of corrugated metal and covered in rust, mud and other junk. And on and on it went. As horrible and unloved as the thing looked, they probably never changed the oil and just topped it off as needed. I also don't remember how it was cooled. Probably a tank.

From: Don Carson

George,

I saw your web page, and am familiar with the Lister C/S 6 and C/S8 single diesels. I was around these for many years in the Bahamas, and they are still quite common there in the out-island communities. Most of them are ancient ones imported direct from England as generators. I have worked on one which has been in continuous use for over 40 years, and has never had an overhaul. It still has the original rings and bearings in it! We figured it had over 100,000 hours on it, and is still running strong! Those engines are by far the finest diesel ever produced, and are truly bulletproof. After Hurricane Floyd devastated the island of Abaco, many of us went around helping to get the communities stabilized again. There was no power at many places, so we had to get gensets in and running quickly. In one community, we saw an old 8/1 generator tipped over inside a collapsed shed. My buddy Phil said, "lets try getting it going". So several of us tipped it back upright, hooked up a diesel drum and the water tank again, and it cranked right up!

It survived 200+ Mph winds, and still ran like a top. Needless to say the shelter there has had

power since! I am interested in your Petter diesel for my boat, what is the price of your small av1 style diesel engine?

Thanks,

Don Carson

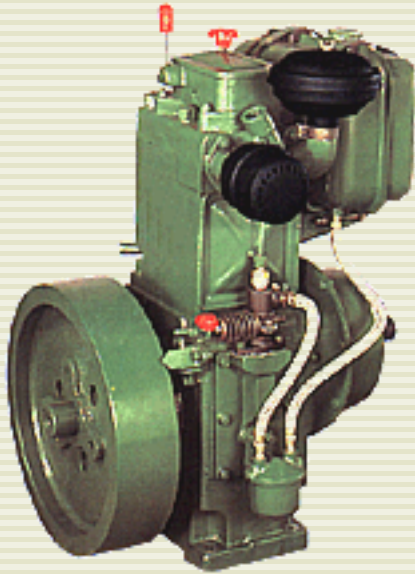

The first time I saw pictures of the **Petter Type Diesel**, I thought it was a handsome brute. The one I have in the shop has an enclosed rocker box and the typical heavy flywheel. It always starts on the first compression stroke and has a very British feel to it. The start handle engages in the same manner as the Listers, it takes a bit to remember to hold onto the handle and walk it off the cam shaft after it starts.,

This particular unit is designed to produce 8 HP at 1600 RPM. The flywheel diameter is 15 3/8 inches, width is 3 3/4 inches. The flywheel is flat (no crown).

According to the manufacturer, this engine can run safely at 1800 RPMs which would allow for a direct drive coupling to a 4 pole generator head.

We will be making a direct drive Petter powered generator this winter, I will document the build and share my findings.

I have some parts available for the Petter engines.

George B.



Products we offer for sale or think you should know about.



MJ Direct drive couplers for Asian Diesels and other engines with the Asian style flywheels. We make the only direct drive couplers we know of. Forget the belts and pulleys, direct drive your gen head.



Custom Drive pulleys for the Listers and other big flywheel engines, drive a generator head without the headaches. Get more for your money.

Drive Parts, Metric bushings, Industrial pulleys, belts and more.



Asian Diesel [Hopper conversion](#). get yourself a real cooling system!

[Capacitors](#), here's a source of High grade Start and Run caps for a hobby price.

A [propane injection](#) kit for your diesel.

A [Water Injection](#) kit for your auto

Parts for the Petters. [email George](#)

Complete gasket and seal kits for the Lister 6/1s and the 12/2s [email George](#)

Parts for the Changfa diesels, rings, rods, injector nozzles, etc. [email George](#)

Make real three phase power for your shop, buy a [rotary phase converter](#) for less.

[Generator heads](#) for sale.

[Engines](#) for sale [email](#) me for availability

## Radiator Cooling system for the Asian diesels

**Do you have an Asian Diesel with Hopper cooling?**



**Above is the manifold partially machined, more pictures soon.**

If you own a hopper cooled engine, you know the problems... work it hard and you'll be pouring water in it like crazy, use hard water and risk burning the engine up due to mineral build up in the coolant passages. Leave it outside with water in it, and risk freezing and breaking the block.

We sell a manifold that allows you to cool your engine with a thermostat, and radiator. When you're done, you'll have a proper system full of antifreeze. These engines thermo siphon well, which means you'll have no water pump to fail. Any small car radiator will do the job, and customers have had good luck with heater cores with built in fans as well.

The new manifold allows for several configurations including a standard Chevy goose neck and thermostat. The conversion cover ships with standard pipe thread fittings for 3/4 inch heater hose, and a place to screw in a temp gauge or other sensors. Below the manifold is a trick dip tube that assures a more positive and continuous flow of water through the radiator.

Since there are differences in hopper bolt patterns, it's best that you use easily made transfer pins to locate your own., or if you have an engine we sold, we'll know where to drill them.

I'll have pictures of an engine with manifold assembly installed.





Here's the very first production part. Top left is a the cold water return, This is a one inch National Pipe Thread 'NPT' hole, the barbed fitting works good with large heater hose, or small radiator hose. Left bottom is a 1/2" NPT hole for a temp sensor, or a manual temp gauge. In this example, the outlet is machined for a Chevy thermostat and goose neck. An optional fitting can be bolted over top of the thermostat to provide a one inch NPT female hole to accept a fitting like that on the inlet.

If you plan to regulate temp by other means, the hot water side can be tapped for a one inch pipe thread exactly like the cold water side.

There are a few parts that are not revealed on this page, they are included as part of the kit to assure a better thermal once the thermostat opens.

All of the Horizontal singles I have tested thermal well IF you stick to the basic rules. A list of these easy to follow rules is provided with the conversion kit.

Since people will order this in different configurations, here's pricing.

- Casting machined bottom flat \$38
- Tap holes NPT \$5 each
- Macine and tap for thermostat \$10
- finished cold side nipple and dip tube \$8
- Information sheet on successful thermal operation, dip tube construction \$included
- mounting holes, known pattern \$5, custom pattern \$10
- Shipping and handling \$10 (Cont USA)

Now for the good news, there's nothing you can't do yourself. The one inch TAP is a little spendy for a 'one off' operation, mine cost \$100 with tax, you can get a cheap one for \$30. The mounting holes can be located with transfer pins made on your grinder, and it assures an accurate line up.

All machine work done is high tolerance, the Machinist we use doesn't understand "good enough". He thinks in terms of ... "good enough for NASA".

[George B.](#)

[Home](#)

[George B.](#)

[Home](#)



# Quality capacitors! At discount prices!



Can a DIYer go thru life without discovering the value of high grade capacitors and their many uses? I think not.

It will take some time to build this page and share the many things they are good for, but one thing you might get excited about is using an ordinary induction motor as a generator, add a couple of caps across the input leads and presto, you have a generator. It's best to visit one of Greg's [pages for a simple tutorial](#). It's enough to make the gears turn in any DIYers head.

High grade capacitors are often so expensive you can't rationalize spending the money just to experiment and have fun. I just happen to know one of the major importers who is also a fellow DIYer and has agreed to discount capacitors to those in our ranks. so how come he is able to get such great deals on caps? He buys them by the container load. His regular customers buy thousands at a time.

Whether you want a truck load, or a hand full, it may not hurt to tell' em George B. sent you.

Send email to [engineer.com](mailto:engineer.com)

Following are sample prices for DIYers...

Capacitors are available in motor run and motor start configurations. Offered are surplus, new products at the best prices in the USA. Quantity discounts available. Guaranteed, we guarantee what we sell. Please note, capacitors can be used in parallel and/or in series combinations to fulfill most any requirement. These capacitors all have standard spade leads (lugs).

**Motor run:**

12 uF, GE, 200 VAC, Dielectrol filled	\$2.50 each.
15 uF, GE, 200 VAC, Dielectrol filled	4.00 each.
40 uF, 170VAC, Aerovox, oil filled	4.00 each
60 uF, 240 VAC, CSC, oil filled	7.00 each
100 uF, 370 VAC, ASC (Shuzuki) oil fill	18.00 each

**Motor start:**

189-227 uF (200), 165 VAC Aerovox      \$3.00 each

233-280 uF (250), 165 VAC Aerovox      5.00 each

We accept Bidpay and money orders; and cashiers, business, and personal checks are also all welcome. We reserve the right to hold a check until it clears.

For further information or to place an order, please contact [joe-cooke@engineer.com](mailto:joe-cooke@engineer.com)

**Home**



**For educational purposes only... I do not receive compensation for any kit sold, I share this only because it is of interest to me and my like minded friends and readers.**

## **Propane as a Diesel catalyst for the DIYer?**

**As we attempt to digest this, please note that propane has a far lower BTU value as a fuel per volume. Some explain that it acts as a catalyst and allows the diesel fuel to be burned more efficiently and will allow more fuel to be burned at higher efficiency when required. If this is true; why doesn't Detroit offer such a set up stock?**

**Why didn't they offer us a four valve head, serpentine belts, modern fuel injection, and other things? The only reason we got any of this neat stuff is because they were given incentives (forced) to provide them to us.**

**Read on, or go to the bottom of this page for ordering info.**

Joel Koch has an older 3/4 ton Chevy extended cab diesel pickup that gets an average of 22MPG with some of the driving at freeway speeds of 80MPH. these are averages over 200-300 miles between fill ups. Joel uses a modest amount of propane to accomplish this.

During a recent visit, I had a chance to drive this rig on the freeway. Going down the freeway in any of the turbo diesel rigs is pretty impressive, there's more torque than gas engines for sure, and it's not hard to pull the hills with traffic.

If you have one of Joel's kits hooked up, and turned on, it's quite another thing. The best way I can describe it is effortless power, it feels like the engine has an additional 175- 200 foot pounds of torque even down. It was a sensation like floating along on a cloud of power; there's just no need to anticipate a hill, you just put it in Overdrive, and drive it with the pedal. Going down the highway, I looked down and saw nearly 85MPH, didn't have a clue I was

going that fast.

Joel drives all over the Northwest, and since he makes lots of trips into Portland from the coast, it's pretty important to have a vehicle that can carry a load and still get decent fuel mileage. To have it blow down the Freeway like a Hot Rod is an added bonus.

When you get into Joel's rig, there's plenty of gauges to let you know what's happening, maybe the most important (IMHO) is the exhaust gas temp gauge. This will pretty much tell you what you need to know when you're messing with a diesel's fuel. If you're pulling a big long hill with your 39 foot 5th wheel loaded down, you'll know exactly what's going on. Pull a few hills with the propane off and watch the EGT, then pull a few more with the propane on. Joel's setup has a switch to enable the propane system, and a fine tuning adjustment so you can get it exactly the way you want it from the drivers seat.

It's a real pain making up your own kit, buying the parts is expensive, and the trial and error part can be time consuming. Joel's kit promises to make an easy job of it, and considering it has a money back guarantee, how can you go wrong?

Following are pictures of items included in the kits, there's several versions, so you may not get all the parts you see for your application.



NOTES  
THIS KIT REQUIRES IDENTIFICATION  
PIECE INCLUDED TO HELP WITH THE  
KIT UP, UNUSED, AND SEND IT BACK  
MONEY BY RETURNING SHIPPING. THE  
WE ARE AVAILABLE TO DO CUSTOM, OR  
IT, THROUGH IF YOU HAVE ANY IDEAS  
KIT FOR REWARDS!

FOR INJECTOR SEALER, WE LIKE A  
PSI, EVEN USING TIRE CEMENT, AND

THANKS, JOEL 800-801-9037 FAX 775



Power Solutions #PS 100

### Power Probe Professional Lighter



Complete Air bag Safe  
Resistance - 50 Meg Ohm  
Wire - 1/8" dia. 1/2" long  
Check Voltage  
Resistance Point  
Warranty  
Parts & Labor

Made in the USA  
Power Solutions  
3.600 225 Astoria, Oregon  
800 801 9037







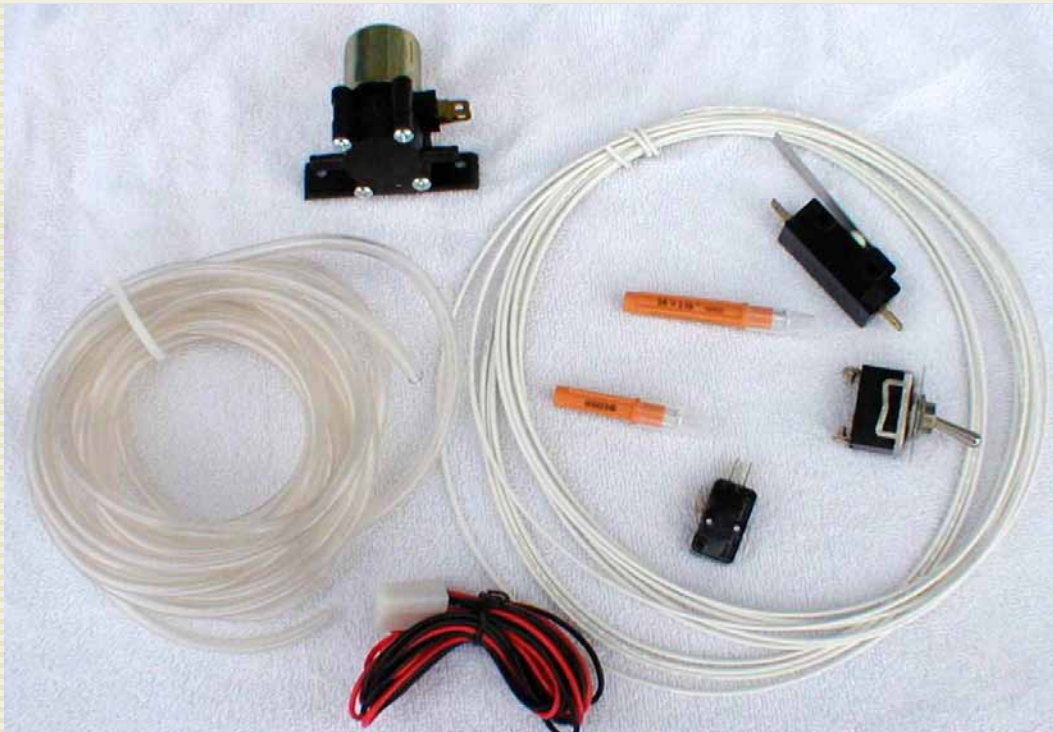

You can invest a lot of time and money making your own system, or you can **order the kit** and get a valuable information sheet with it. . In this kit are things like a Hobbs pressure switch that will assure your propane is not flowing when the engine is shut off. There's also an electric valve, an adjustable gas regulator with gauge, tubing , clamps, switches to tie into your throttle rack, manual switches, and a little delivery jet that can be installed in seconds. This kit has been for sale for some time, and it has evolved over time. Make sure you mention Propane injection when you send email.

### **Feedback #1**

I bought one of your kits from Joel about a month ago, and I just wanted to let you know how happy we are with it. We used it on a 1990 Chevy 1 ton 4 door 2x4 pickup, with a 6.2 **non-turbo diesel**. Before the propane, the truck had trouble making it up steep hills or maintaining speed while towing. We drive up to Breckenridge, CO every week, which is a 2 & 1/2 hour drive up the mountain. With no propane, we could only manage 30-40mph in 2nd gear. With your kit, we can do 65-75 in 3rd gear, and we use 25% less fuel while we're doing it. I'd also like to add how easy it was to install your kit. It took 2 of us 2 hours from start to finish, and we had no problems with any of the pieces that were included. So, thank you, have a great new year and keep up the outstanding work!

S.R. Powell

Corporal

United States Marine Corps

**Let's be real, this sounds like a paid advertisement, you'd find on one of those 'snake oil' sites. If this is real, why doesn't every diesel truck in the country have a propane bottle on it?**

PLEASE...send me your experience with propane injection, we need more feedback!

Thanks,

George B.

Home



## Water Injection

**Standard Kit \$74.95, includes shipping in the Continental USA. This page will be updated soon with mailing address, for the moment, email Erica, and mention the **water injection kit**, She will help process your order. Personal checks, Money Orders and Bidpay are accepted as payment. If you wish to use this system for turbo use, a higher pressure injection pump system is available for an additional \$10.**

Here's an interesting article on water injection from New Zealand.

Back in the fifties, comments from George B.

Following is some information from the kit developer. Now that some of us are retired, there's time to refine such devices.

NEW WATER INJECTION KIT, we're NOT able to do everything the others say theirs will, but here is what this one should do for you: greatly reduce or eliminate pre-ignition ping and detonation in a gasoline rig; increase power in diesel and gas engines, increase fuel mileage in diesel and gas engines; allow more timing advance (more power) in a gas engine, and more boost in diesel and gas engines. It will also clean carbon deposits out of an older engine.

How can water do this? Simply put, in the process of turning into a gas from a liquid, it absorbs huge amounts of heat, cooling the fuel/air mix to allow more power to be developed. Most all us "old-timers" (and many of the rest of you!) remember a particular cloudy, misty, cool day when your truck was able to pull further up a hill before we had to shift than normal. The water injection allows this to happen every day, even the hot, dry ones. ALL LARGE modern diesel engines use water injection or water/fuel mixes. PERIOD. And you can bet your last dollar there is a reason for it.

What this kit has is shown in the pictures (check valve included but not shown), and is designed to enable a 1600VW non-turbocharged diesel to use it just as well as a 454 "built" gasoline engine. You can set it up to come on only up the steep hills, or flow a tiny bit whenever you're on the throttle. All pre-settable and adjustable. We HIGHLY recommend diesel pickup and truck users have a boost gauge and pyrometer. If you are going to experiment, have the gauges to monitor the changes!!!

Please note, we include two separate inlet needles, as well as an adjustable brass needle valve. The larger inlet needle will allow flow rates of up to 1/3 gallon per MINUTE of water at only 10 psi or so pressure differential. This is about 20 gph!!! The smaller needle along with the brass needle valve can be adjusted to flow as little as a 1/2 pint or so per hour, so the end result is the ability to adjust almost infinitely as needed. I know of no other kit which allows this range.

I used water injection in Nevada for a long time, many years ago. My drive to work was 70 miles, one way. My objective was fuel economy AND power. The water injection did both, and I used my "home-built" kit using the engine vacuum, no pump, and a little brass needle valve I was able to adjust as I drove. Most days, 55 minutes to work, and this was with a 194 CID 4-cylinder engine!!

How is this kit different? By using a pump, (able to pump about 18 psi), you can control the flow much better. AND you can put a much larger bottle in the back! It also allows you to use a throttle switch (included) to control when it comes on. Then, use the included needle valve to further adjust flow, and a final included injection needle (two sizes) to control allowable injection. Slick, easy, and clean. You do NOT have to drill and risk contaminating an engine. If you have a turbo-charged engine, you may need a 2nd pump (\$10 extra, 10 psi more), or if your engine has more than 25 or so pounds turbo boost, you can get a much stronger RV diaphragm pump (and more \$\$!) and a 2nd pump to give around 40 psi total pressure. There is also a check valve included to stop possible pressurization from a turbocharger if you have guessed wrong on the boost. (See, you DO need a boost gauge!) Note, if your engine turbo develops more than 40 pounds boost, you may need to spend \$\$\$\$ and buy the "big boys" kit. Sorry...

Just a couple of warnings: You make modifications to your vehicle (install this kit) and have problems, it is your responsibility, NOT ours. You should ALWAYS wait until your engine is warmed up (at least 15-20 minutes) before turning the water on. The penalty for not doing so will be an exhaust system which is eaten up by corrosion in short order. You must NEVER inject water BEFORE a turbo, as it will erode (eat the the blades!!) Oh, if you already have a turbo boost gauge or propane injection, you can adapt off that inlet fitting, and won't need to use our nifty "injection needle".

We guarantee the parts to all work, but alas!, can not guarantee how well they will work in your particular application, for obvious reasons. Final notes: please only use clean, fresh water (steam water is best), and always use a filter on the end of the inlet hose. You will also need to provide you own water tank. I use a 5 gallon tank in the back of my Chev, and it lasts a LONG time!

Joel

Home



## Water Injection, does it work?

Back in the Fifties, my Uncle was a Commander of a US Navy Super Connie built by Lockheed. He would tell me stories about waiting for the air to cool to get his massive load of classified instruments and crew airborne. This aircraft needed every ounce of fuel they could carry to complete their mission, and often had to turn around when they had too much head wind. He flew out of Hawaii for years.

I remember the subject of water injection coming up, I was 10 or 11 years old and was amazed by the size of this huge and ugly hump back whale of an airplane. I asked him how water could do anything for the engines? His reply was...."We wouldn't get this aircraft off the ground without the water injection, we'd probably burn the engines up trying to develop the horsepower required to get it into the air before the end of the strip".

My Uncle was a pretty serious Guy back then, otherwise, I would have wondered if he was trying to pull my leg. Later on, I read about it, and know how important water injection is if you are attempting to get the most out of your engine.

Over the years I have read various accounts of water injection, with certain vendors claiming unbelievable things. After 40 years of reading, I am confident that water injection can do some great things for autos and generators, especially when the engine is carrying heavier loads. One thing I've noticed is water injection seems to do more for some engines and less for others, we can imagine the various ways to install such gear, and the number of people who may not have the skills or knowledge to tune it, and realize it's full potential.

I remember the first car I saw with water injection stock from the

factory, it was the 1963 Olds Jetfire, the little 215 cubic inch V8.

If water injection is so good, why don't more manufacturers put it on rigs? I'd answer that by saying.... these Engineers have hard data, they know a good portion of drivers don't even change their oil.. or check it for that matter. How are you going to get people to remember to add water once in a while?

Joel is getting 22MPG and drives his older 3/4 ton Chevy diesel extended cab at 80mph in open country. He covers a lot of ground and believes in manually tuning a combination of water injection and propane to get the best mileage. He says the propane and water goes a long ways, and it only takes a little propane to act as a catalyst for the diesel fuel, and a little water to help cool the incoming air.

If I were a snowbird pulling a 5th wheel any distance or pulling often, I'd have water injection whether it was a gas rig or diesel. The smallest amount of water can create a far denser fuel air charge, and give you more pulling power on hills with lower temps. Since these rigs are working hard just cutting the air on level ground, I'd expect to see some noteworthy advantages at cruise as well.

Here's a [story from New Zealand](#) regarding water injection

Due to the interest and demand, there's a [kit available](#) that has evolved over the years of testing.

All the Best,

[George B.](#)





## Making three phase power

Have you ever noticed how inexpensive 3 phase motors are? They can be had for scrap prices in most areas of the country. Many professional tools found at surplus stores have these motors; most all machine lathes and milling machines, use them. Three phase motors are more reliable, more efficient, and far less complex. They don't need caps, start windings, centrifugal switches or any of the things that cause failures and add expense to their single phase counter parts. Windstuffnow.com has an excellent page on [3 phase verses single phase](#).

You could buy 3phase equipment and change out the motor for a single phase unit, but the cost is usually prohibitive. You could also buy a little box... (a static converter) that will allow you to start the three phase motor and run it off single phase power in your shop, but the power will be way down. **This solution does nothing more than generate a voltage for the third phase long enough to get the motor up to speed and then the motor runs on two legs with a dead third leg at slightly less than two thirds power. This equates to having a two legged stool in your shop... "you can sit on it if you're careful, but don't ever try and stand on it."**

Or... you could buy a **rotary phase converter** box and build a proper setup. You'd have all the 3 phase power most home shops need, and you could run several three phase motors at the same time off the same set up if your service is large enough. Since the idler doesn't require much to run, start it in the morning and the three phase is there all day.

These units are assembled by an amazing 95 years young Gentleman that uses the moderate proceeds to subsidize his income. The converter panel is easy to hook up and is sold for \$20 per horse power. If you will be running a **5 HP-15 HP** worth of motors, you can usually get by on a 5HP panel which sells for **\$99.99**, if you wish to run motors that start with a big load on them such as an air compressor, you might consider the **10HP** panel at **\$198**. Although I have not yet installed a converter in my shop, I plan to. I have checked out the quality of construction of these boxes and have found the quality of wire crimping and materials to be first rate. Don't expect flashing lights, plastic, fancy logos or art work.... It's all housed in a plain, sturdy steel box with a steel cover. It's a manual unit, you push the button and hold it till the idler motor starts. Adam didn't think it needed anything past lead designations, hook up instructions, some basic theory, and a 1-800 number to call if you're having trouble making it work...

**Note...**this box isn't magic, if you run your shop on an extension cord you bought at Sears, it's not going to **MAKE** extra capacity. If you're having trouble running your table saw without the breaker tripping in your shop, **this is not the project for you!** Find a seasoned

DIYer to help you, or ask for the assistance of an electrician to assure you have an adequate service panel to run a rotary phase converter. And please don't ask what a proper panel is....we're not the proper authority, we're not licensed by your local jurisdiction; in fact we don't even know them... Another warning, some Electricians have never seen anything other than the Static Inverter, they may try and persuade you to install a static converter because they have a supply of them and profit by selling it to you along with the labor charge.

**Adam Packages and ships the RPC anywhere in the lower 48 for \$19.99. This makes the delivered price \$119.98 for the smaller panel. AS for Warranty, Adam tests all RPC boxes under load before he sends them out, Adam offers a money back guarantee, so you can buy with confidence. At this time, Adam doesn't have any desire to email, or be involved in the selling process, I take orders for him; and the 1-800 number goes to his Son who helps with any problems. Satisfaction, or you money back.**

**Prices are always subject to change...**

Best Wishes,

[Email George B.](#)



## Generator Heads

**On this page we'll post what we have for sale, and what we know is for sale else where. If you have a good used gen head, please consider sending me email, we'll see if we can match you up with a buyer. If you have questions email me as well.**

**Potential buyers should understand the difference between a center tapped and a full four wire head before making a purchase. There are vendors who make no effort to educate their customers prior to a sale; or inform them that they will be going all the way to China for Warranty help..... imagine that...**

**My advice... don't buy a head smaller than 10KW if it is center tapped, and understand the limitations. If you bought one already, see my pages on how to convert your head to a full four wire head.**

**See our rugged, **HEAVY** 1800 RPM, low tech, 4 pole AC Generators.**

**I have both a 15 and 20KW head for sale in Seattle, here's a chance to get same with no shipping charges!**



Misc for sale page

**email me for more info on anything you see.**

**New post!**

**near new.. WINCO 12KW PTO PN 6117-003, 120/240 Here's a unit on the East Coast, call Phil at 315-427-1560. Unit is in Utica, NY Zip 13490, asking price is \$1250.00**

**Send me email if you wish to buy a Lister or Chinese style diesel engine.**

See the new **direct drive coupler** and the conversion kit to convert from hopper cooling to **radiator cooling** for your Chinese single, scroll to the bottom of the Changfa page.

Here's a direct drive diesel unit put together by REX H. The engine is water cooled, with built in radiator and fan. It has a built in 7.5 amp alternator that can be used to power 12 volt lights or charge a battery. The engine is built by Changfa and makes 9HP at 2200 RPMs, the unit runs at a reduced 1800 RPMs and is fitted with a 5kw head, 120/240 volt. The set has been run long enough to Test, and is for sale. Rex plans on building several gen sets a year and put them up for sale.

Don't really know how much load this unit will carry, but the 3500 watt load we had on it, didn't seem to be the end of it. Since it's set up for reduced RPM and direct drive, it will probably last longer and live a trouble free life. The drive system is utterpower/Love\_Joy, the head is Yannan. Rex is asking \$1795, and will deliver in the Puget sound Area (SEATTLE), or REX will gladly mount it to a pallet and take it to your shipper for a small fee. Send him email if you're interested. REX H.

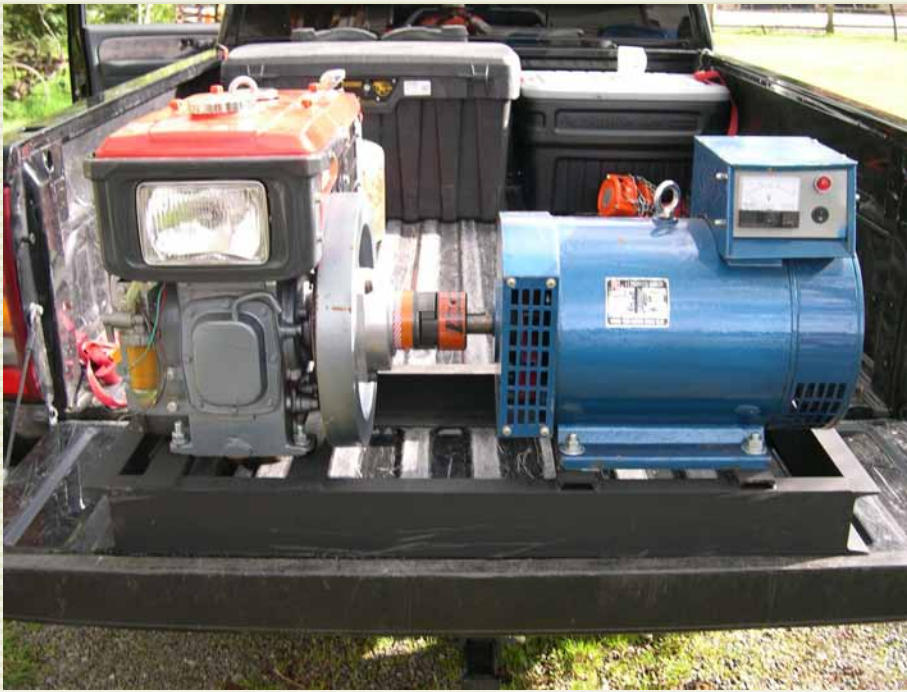

See our [Custom Pulley](#) for large open flywheel drives



## Motor Generator Set

I have several cont duty MG sets. These are powered by **24 volts DC** and crank out 115 volts AC at 3.5 amps. I have taken the covers off to inspect the slip rings, commutator side and brushes. They all look to have lived easy lives, brushes are long; slip rings are not grooved; etc. They are Military color, and certainly look like they were built at taxpayers expense. The wiring and other components appear in excellent condition.

These units have been run for several hours in my shop, they seem to draw very little with no load, but my good ampmeter has a blown fuse, so I don't have a figure to give you yet. The name plate appears to have the DC volts and amps transposed. It's interesting that these little units start my grinder fitted with 3/4 HP Induction motor. Once up to speed, it works very well. I also plugged in my 1 1/4 HP Sears Craftsman skill saw, I cut a two by four in half, but it was certainly down on power as one would expect. Tools like my JIG saw, 3/8 hand drill, and small hand grinder all seem to work as if they were plugged into the commercial power. I

plugged in my shop radio and tuned the AM band, not bad. Expect an output of around 400 watts, expect these to perform similar to the little Honda Gas generator 400 watt unit.

Unlike many inverters, these will be hard to kill and may survive an EMP. **\$65.00 each** plus shipping, guaranteed to work when you receive it.

### [Run three phase equipment at home, do it right!](#)

#### **Water pump, used, but works like new..**

Do you have a water supply somewhere below your cabin? Here's a nifty quality 100 GPH pump rated at 175 PSI ! I've tested it and all seems in good order, The motor is a 1725 RPM westinghouse 1/3 HP unit (single phase) 60 HZ. I've seen pumps in catalogs similiar to this one listed for \$275 without the motor. This small pump would lift water 300 or more feet from a spring or stream to your cabin. \$125 firm, includes shipping in the lower 48. High quality construction. Picture below.



[email George](#)





## Articles

[Low oil pressure, High Temp shut down, remote frequency adjustment](#)

[Hydrogen Power](#), [Drug abuse can help you appreciate the short term potential.](#)

[Coupler Design](#), if you're making your own generator, better read this.

[The pulley \(Sheave\) page](#)

DIY generator [frame](#) construction, for the Listeroid

[DIY generator frame for the 1115 ST10 genset](#)

A discussion on [center taped generator heads](#), and how to modify them.

What should we DIYers know [about oil and filters](#)?

George learns another lesson the hard way, [compression tests](#) can lead you to the wrong conclusion!

[Water Injection](#), it can make all the difference.

[Mistakes made in high mountain cabin building.](#) [What you should know before you build](#)

[What's this co-gen stuff all about?](#)

[What might you do with your generator?](#)

Wake up your diesel with [propane???](#)

[People](#) you'd enjoy meeting.

[Engine building, Joe Mondello](#), Thought provoking?

A lesson for the [Back Yard Engineer](#)

**New** [Panel Meters](#), learn why most of us don't need them.

[Things I hate](#)



[Engine Cooling Systems](#)

High on a Mountain, we have a [lab](#) of sorts

Do you have a basic plan for your off grid power? Here's our [plan](#)

The Spanski Brothers, if you saw their [reduction box](#), you'd say it was magic!

[Super coatings](#), could they work for us DIYers?

[Things that truly suck!](#)

[Salvage yard finds](#)

[Home](#)

## Controls

This Page is all about controls for your generator.

I remember the Navy days when we had the frequency control right at the control panel. The operator simply hit the switch one way or the other to raise or lower the RPM of the prime mover which raised or lowered the frequency.

DIYers can spend buckets of money buying commercial controls, but we may be able to emulate these controls for a small amount of money.

## Governor

A typical engine governor is nothing more than a 'fly weight' pulling against a spring, as the RPM of the engine increases, the centrifugal force on the weights causes it to apply more force on the linkage.



Above: Here's the Lister 6/1 Cam and governor assembly. Starting from the left, we see the cam lobe that runs the Injection pump, next is the governor sleeve that is connected to the Governor fly weights. As RPM is increased, the weights fly further out, and move the sleeve inwards towards the gear. A lever rides in the slot of this sleeve and moves in relation to the sleeve position. the force applied by the flyweights to the injection pump fuel rack will dictate the speed of the engine.

If we picture the flyweights pulling on the throttle from one direction, and an adjustable bias spring pulling it from the opposite direction, we complete the governor. If we increase the spring pressure, we increase RPM till the flyweights pull equally on the throttle and equilibrium is reached once again.

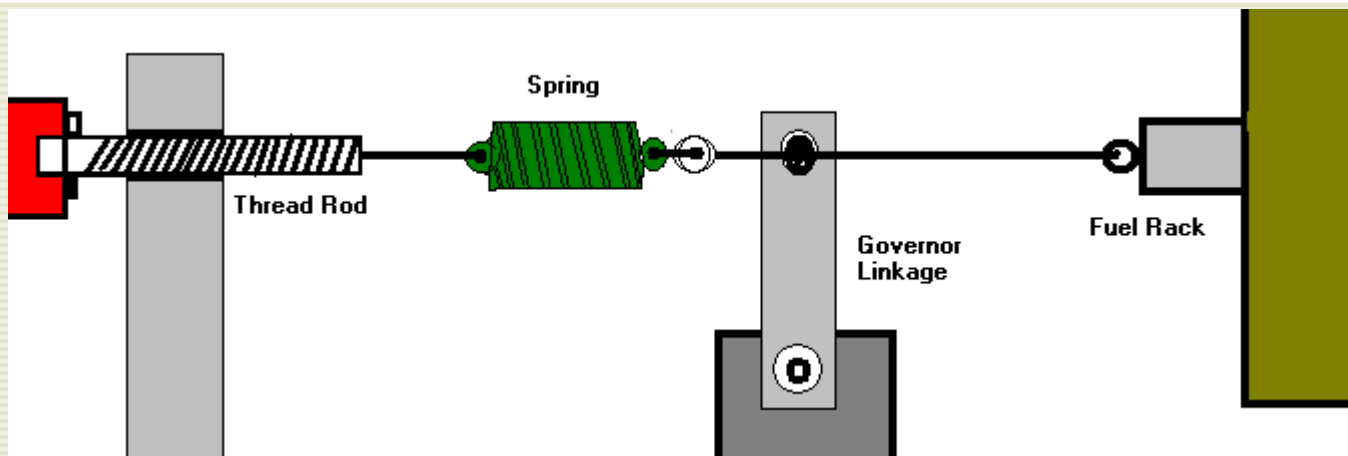

In the crude drawing above, we see the governor Lever coupled solid to the fuel rack, the further to the right the rack travels, the slower the engine turns till the fuel is shut off and the engine dies. If we disconnect the spring from the threaded rod at the left, the rack will close completely. If we turn the red knob to increase spring tension, the governor arm AND fuel rack will be moved to the left increasing the RPM. When RPMs increase, the fly weights pull against the spring and equilibrium is obtained once again, and the engine becomes governed at it's new speed. This green spring dictates the governing RPM of the engine.

Once you understand the simple workings of the governor, you can design your own Murphy switch (kill switch) or remote governor adjustment.

If you're at a yard sale, you might find an electric screwdriver for a dollar with a bad battery pack. If you were to join the screwdriver and the threaded rod above, you could finely adjust the frequency from your control panel, just like the big boys. You could power the electric screw driver with one of those cheap wall wart power supplies.

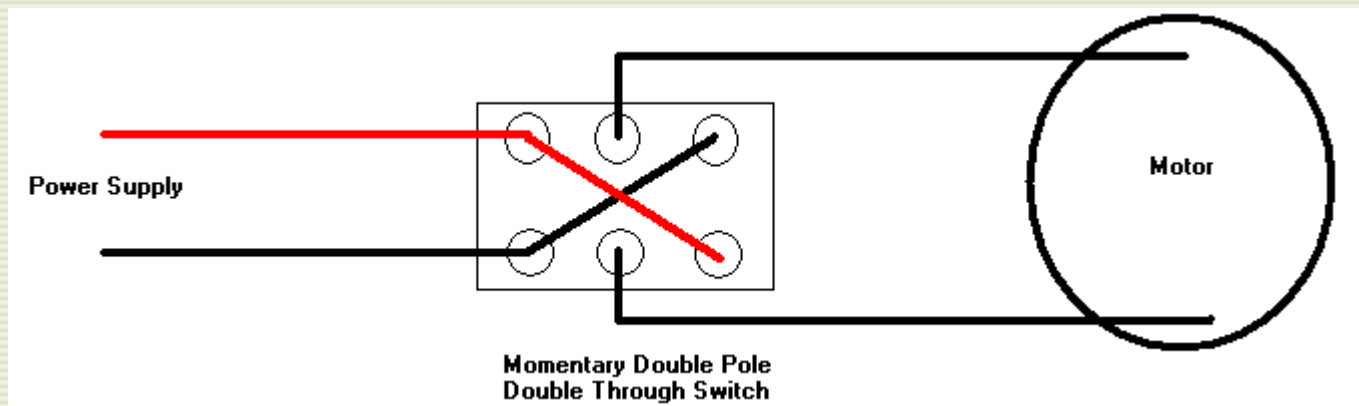

check out the switch above, this is all you need to control the motor, hold the switch to the left and the frequency drops, to the right, and the frequency goes up... simply let go of the switch when you have the frequency you want.

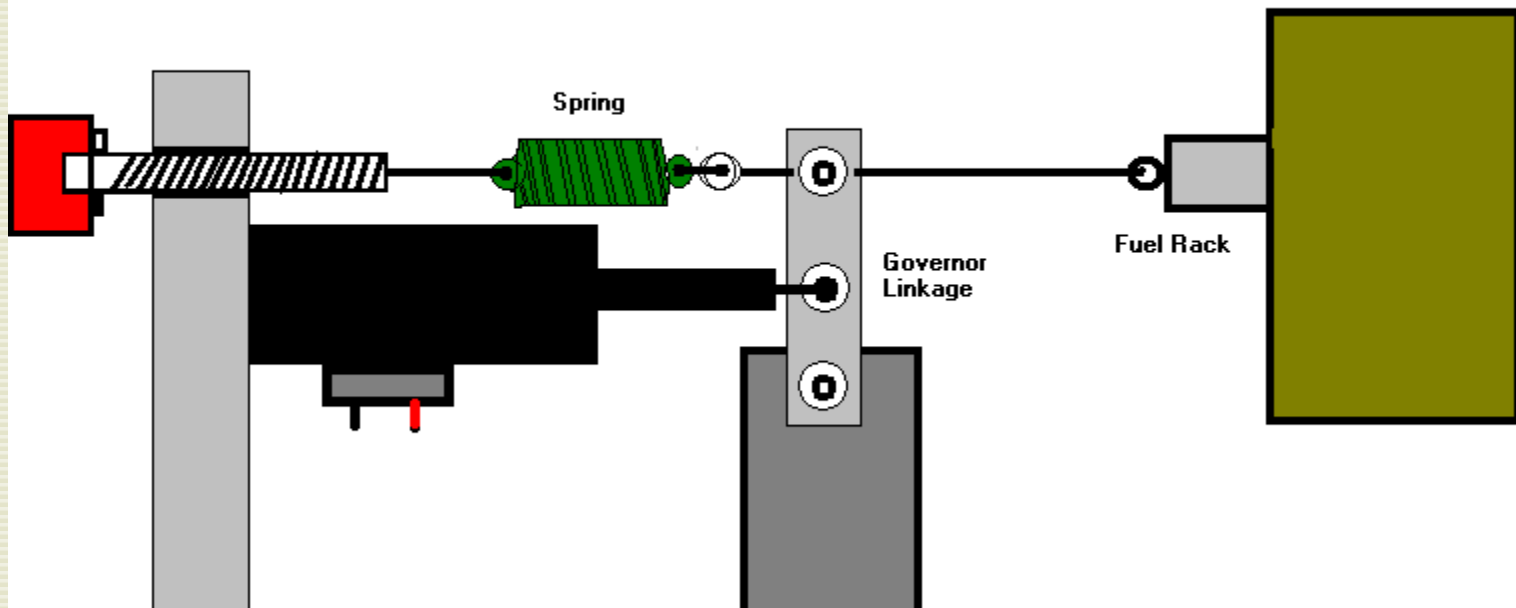

In the drawing above, we have added a solenoid. In its unpowered state, it does nothing, and offers no resistance to the movement of the governor linkage. When the electrical connections are made, the solenoid overpowers the spring and the fuel rack closes and kills the engine.

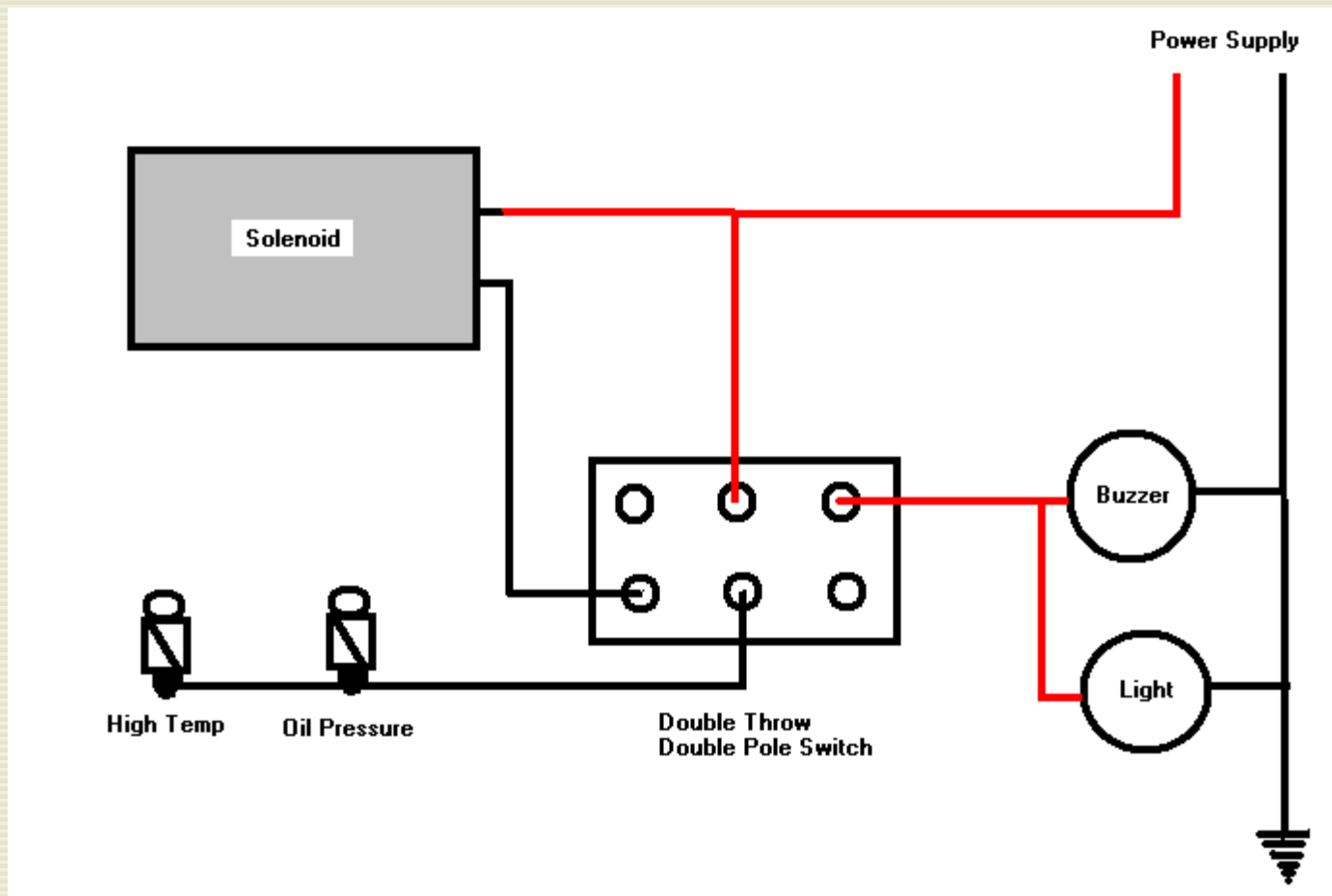

Here's one of many configurations you could have for a simple 'Murphy switch'. Again, we use a double pole double throw switch, but this time, it is not a momentary type. This switch can be flipped one way or the other and left there. When the engine is NOT running, the oil pressure sending unit provides a ground. When the generator is not running, the power supply is dead and provides no power to the solenoid, so it remains inactive. The switch can be flipped to the right to disable the Murphy switch, once the engine comes up to speed the generator head provides power to the input of the power supply, the buzzer and light is activated to warn that

the Murphy switch is disarmed. By this time the oil pressure is up, and the ground removed from the oil pressure sending unit. The operator can now move the switch to the armed position. The buzzer is silenced, the warning light goes out. A good sized capacitor across the power supply or a latching solenoid could assure that the gen set doesn't try and restart.

Of course there are other methods to kill the engine. You could build a spring loaded flap valve that sealed off the inlet side of the air cleaner denying air to the engine when a low oil pressure or high coolant temp is detected...

This page is nothing more than a place to start...



## The Hydrogen Page

**The most important rule DIYers can practice is to think in BTUs, NEVER lose sight of the BTU value, and what is given up in processing or conversion of an energy source. Enron type accounting is often used to express the great potential of hydrogen as a fuel. This page is here to provoke thought, if you are offended by the statements below, you are probably visiting the wrong WEB Site; consider moving on to freenergy.com or one of the many snake oil or propaganda sites that promise what you'd like to hear.**

**There are two major groups of people who are big on Hydrogen, One group is aware of the propaganda value of hydrogen power and wish to gain personal power by supporting it's development. The larger group is those who want to believe so badly that they will never question the claims. What is it they want to believe? Simply that powerful people are blocking the development of this technology for personal gain..... If it wasn't for them, we'd all be driving around in cars that get 400 miles per gallon, and hydrogen fuel would be close to free.**

**I dare you to do your own thinking; maybe you'll even consider why the current Administration is supporting the development of hydrogen? Are they stupid?**

You have a gallon of Gasoline that contains far more hydrogen than a gallon of liquid hydrogen. But you're going to pour this gasoline into a generator to make some hydrogen via electrolysis to burn in your scooter or something just as stupid. Oh.... maybe you're smarter than that? Maybe you've heard of a fuel processor, and you're going to use one of them for the conversion of a hydrocarbon to some nice clean hydrogen? What's the efficiency of the conversion? If you follow the BTUs and the conversion losses, it becomes a pretty insane thing to do; but they're doing it Europe right now, so it must be a good idea right? Bio diesel has FAR more energy than gasoline per volume and straight veggie oil has more than that! Like it or not, a diesel electric hybrid power plant has more promise than anything hydrogen until we master fusion power.

Current events SHOULD give us much to think about. Many of us understand that propaganda can be even more effective than the truth. Hollywood Actors step forward and present their expert opinions on what our Government should be doing... and people listen! No matter what you accept as truth, where are you going for your information?

Home Power magazine might be another example, there's some good information in this publication, but if you're going there to form your political opinions, you may be as lost as the guy who still believes in the carburetor that got 200 miles per gallon bolted to the stock engine in a 1954 Ford Pickup. Some of us might get a real kick out of their 'Power Politics'

column **Michael Welch** writes. After reading a few issues, I might find an article written by Michael Welch on what kind of Cannabis is best to smoke with a particular fortified wine more credible than anything to do with politics. But as a good Friend pointed out, his articles provide exactly what the **majority** of Home Power Readers want, more reason to hate the establishment, and all it stands for. This might be a greater draw for future magazine sales than an article on where to buy brand new fork lift batteries for \$2 each delivered!

**With all this said, I feel Don Lancaster is a good place to start learning about hydrogen**, there are people I trust to put politics aside when it comes to these matters, and Don is certainly one of them. Count the BTUs, and **do your own thinking**; don't be part of the propaganda.

<http://www.tinaja.com/h2gas01.asp>

Ok... if you've checked out Don's stuff and you still believe... why not check out <http://www.freeenergy.com/>, if you're going to dream, why not dream big? ...I hear there's a guy on the internet selling time machines, now that has some real possibilities!

George B.

Home

# 1115\_ST10\_Gen Construction

I started this gen set base with salvaged 5 inch by 2 inch Channel Iron. Five inch material is the minimum to allow clearance for the 1115 engine pan.

The engine arrives on two cast legs, if you stick with the design theory of eliminating all unnecessary parts, you'll quickly toss these items in your junk bin.



Above is one of the stock cast legs the engine is shipped on, get rid of them! eliminate them from your design.





Above you can see the engine setting on top of the channel, what you can't see is a piece of 3/8 strap that is placed between the engine and the top of the channel. this is used to align the coupling.

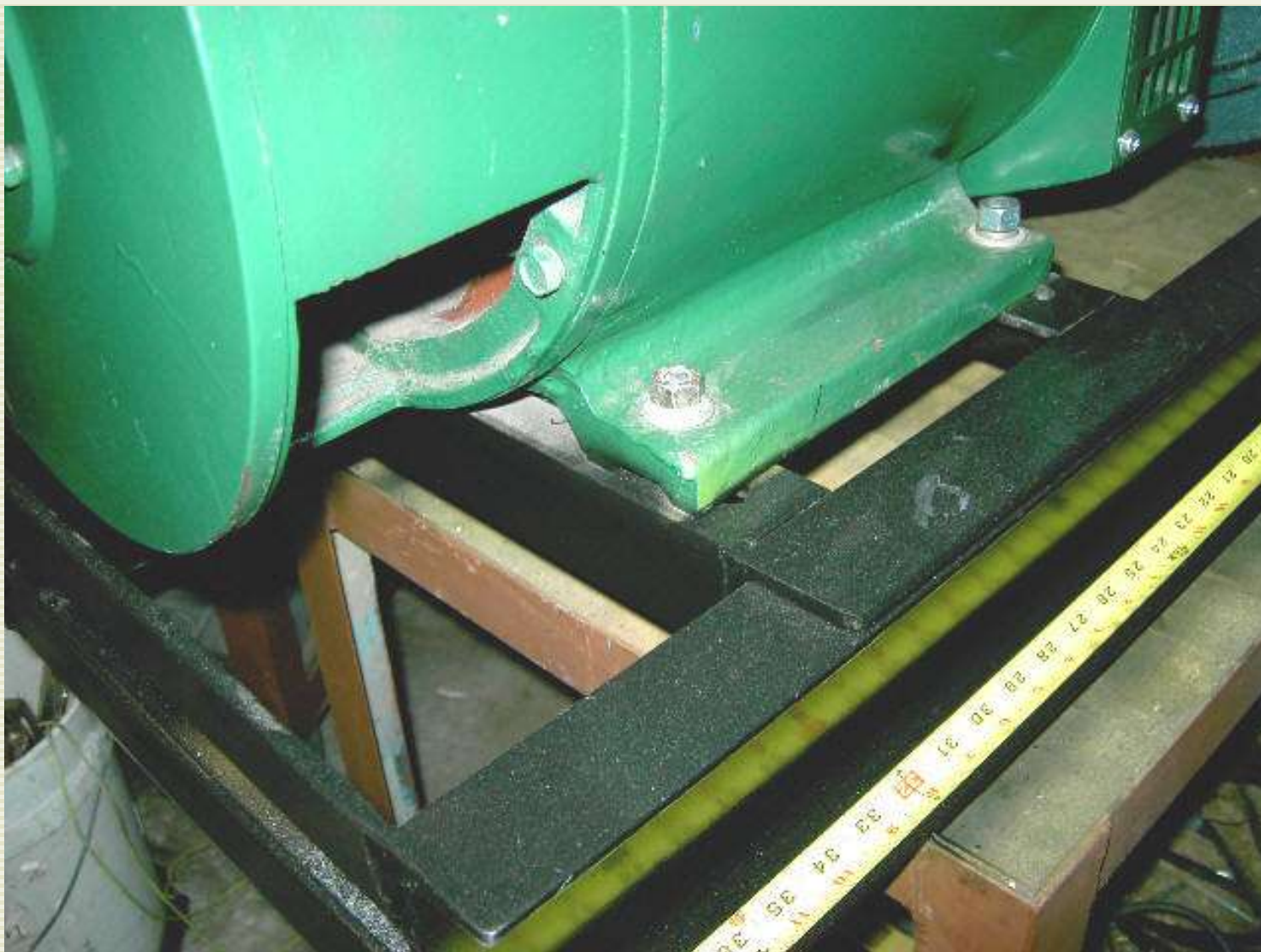

If you look closely, you can see that the sub frame for the generator is made of two pieces of angle iron that 'track' on top of the channel.. Cross pieces of angle run between these angles to support the generator and provide a rigid mount for the bolts. I used 6013 welding rod to weld up the frame. Note that the coupling needs to be aligned with some care, shim stock can be inserted between the angle and the top of the channel for a close alignment. side to side alignment can be achieved by slotting the generator mounting holes slightly. Once satisfactory alignment is achieved, vice grips or C clamps are used to hold the position while holes are drilled through the angle and channel to receive bolts and lock washers to 'lock in' the position. Should you have a need to service the coupling, remove these bolts, and slide the gen head back to open the coupling, replace the spider, or remove the head all together.

**My channel is 40 inches long, and the frame is 17.5 inches wide.**



Above: Here's how I chose to mount the engine, the corners of the channel and the corners of the engine base are flush. Here you can see the strap I used as a spacer to elevate the engine, and you can also see a cut in the top of the channel for ring gear clearance. Notice the arrow, here's where you insert the starting handle for manual starting, if you extend the frame too far, you'll wrap your knuckles on the frame!

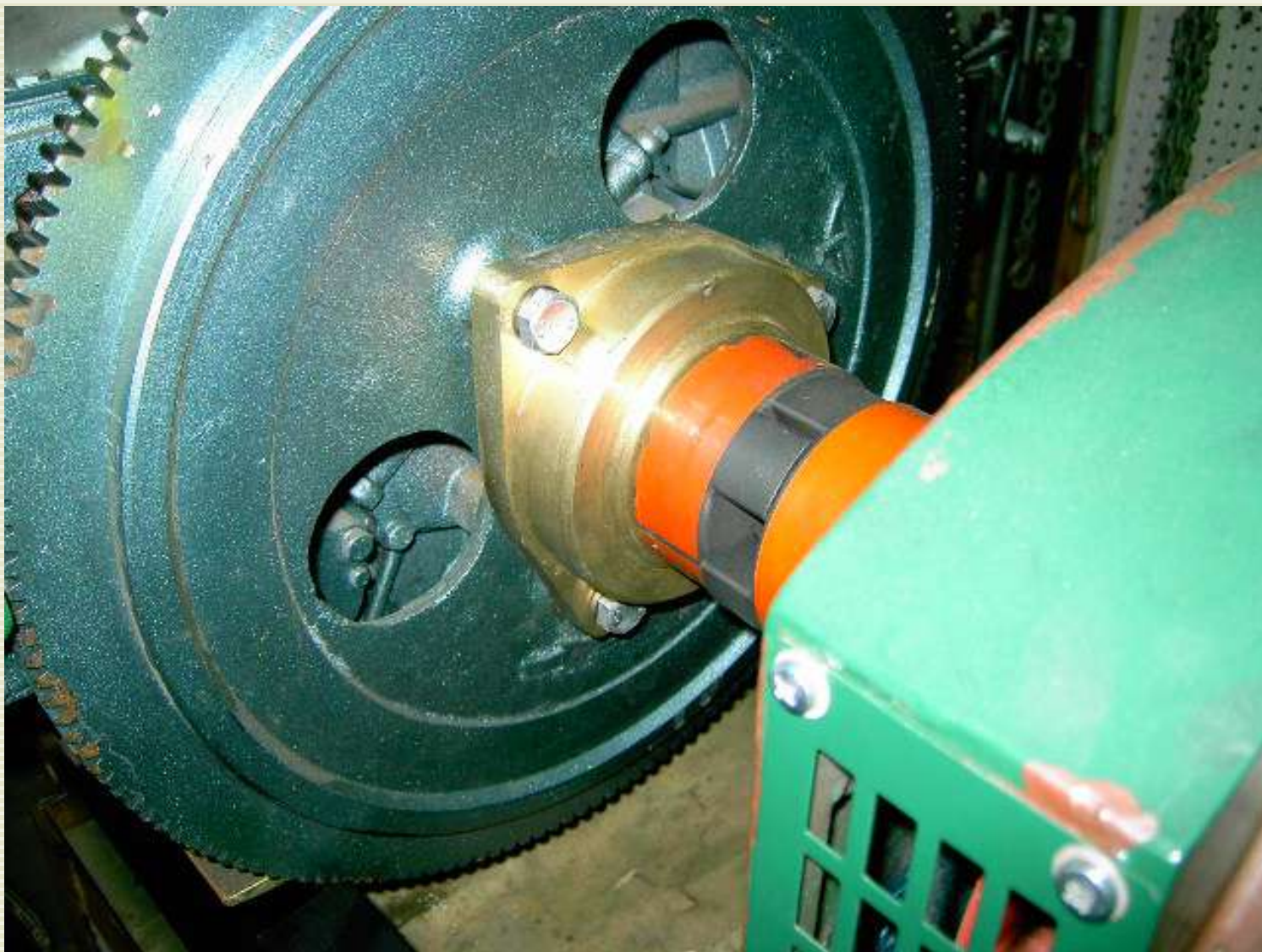

Here's the MJ drive adapter before the rubber spider is inserted, you'll note coupling is already pretty close.

I found some one inch thick rubber matt at Boeing surplus, it's great stuff to cut at the same diameter and place under your frame at four corners. It can make an amazing difference in noise reduction.

How you do it may be different, but this works well.





## The OIL and Filters Page

There are some interesting things going on in the Automotive industry, Mechanics are seeing more and more problems directly related to dirty or coked oil. I have personally seen a number of engines that had fewer than 50,000 miles on them that have been destroyed by lack of oil changes. Some car owners think oil changes are optional. The never ending challenge to produce higher mileage and fewer emissions is forcing change, not all of it is good when it comes to longevity.

**I offer the following as an example as to why you should consider installing a by pass filter and move to synthetics.**



The Hydraulic lifter above shares space with a dime. This little part has made it's way into lots of engines, a common Japanese V6 will have 24 of these. As you can imagine, the little oil passages within this lifter can get plugged up and cause it to fail. In addition, that little 'O' ring you see will eventually get hard and brittle and fail. These little units often sell for \$28 each at your dealer... do the math! Mechanics are busy changing out these little guys as I write. Adding a bypass filter and moving to synthetics never made more sense, you'll supply cleaner oil to your engine and lower the temp some, both will assure these (and other parts) live far longer lives.

---

At this point I am convinced that BYPASS FILTERS should be installed on anything you

plan on driving past 100,000 miles. Or continuous duty generator sets you wish to run verses work on.

I've read accounts of people mounting industrial type bypass filters on cars and driving 500,000 miles without an oil change, they claimed to have sent samples of their oil to a lab for testing and found that it was as clean as the stuff being sold as new oil. How can this be? What about acids, anti wear properties, oil molecules wearing out and all that stuff? Keep reading...

Then one of my friends that works for a well known rebuilder of massive (expensive) hydraulic pumps got interested in filters, He has been using the resources of his Company's lab and their oil analysis program. His conclusion is.... There are indeed oil filters that can filter down to one or two microns in the bypass mode. There is no need to change oil when you have the correct filters in place. The replacement oil during a filter change will keep the additive properties high enough to be effective, the removal of particles in the <20 micron range will indeed help extend the life of a vehicle. **He feels the proper name for a full flow filter should be "strainer", because that's all they do.**

If you look into this further, you'll find the government is big on **by pass filters** that use paper towel rolls. In fact, lots of Hummers and other military vehicles use these filters.

"My conclusion"; there are bypass filters that you could install on your generator set along with the regular filter that will greatly reduce particle size in the oil; can this be a bad thing?

There is no doubt (in my mind) that a good filter system could eliminate oil changes if proper filter change intervals are established.

Enter 'bypass filters' into your search engine, check out **Gulf Coast Filters**, be sure to check pricing before you buy. I have found prices double from vendor to vendor for the same filter system!

If you have an oil filter on a Chinese Horizontal, a Petter, or a Lister, consider sending me email and telling me about it, we need to share the best ways to add filtration for the lube oil.

An interesting note: Years ago; there was an oil filter called the 'Frantz Filter' , it used a roll of toilet paper as the filter element. Some people swore by them, the majority of folks knew it had to be a bad idea, and poo pood it.

Today, we have the Pentagon endorsing toilet paper and paper towel filters!, oil companies use toilet paper filters in their oil field pump engines. It's time to add a bypass to the things you love.

Here's an email I found on the net, I think this guy is right on target...

Subject: Franz Oil Cleaner

Date: Wed, 17 Dec 1997

From: Rod Leggett <tac@hia.net>

The information on your web page is not quite accurate or up-to-date concerning the Franz Oil Cleaner.

Back in the 60's the Franz Oil Cleaner was sold through individual distributors. Kind of like Tupperware. The filter was very controversial. A lot people thought the toilet paper would come apart and clog up the engine. The fact was, the filter was ingenious. It was designed on the premise that oil never wears out -- it just gets contaminated. It wasn't designed to replace the engine's oil filter.

The unit was mounted usually in a place under the hood that was easily accessible. Usually on one of the tire wells or firewall. It had a chrome cover the size of a roll of toilet paper. You placed a roll of toilet paper inside the cover and slid the cover over a metal tube about the size of the toilet paper core. It attached to a base using a ring-type clamp. It had a rubber o-ring gasket at the base, and when you set the clamp, you got an oil-tight seal. It had two small pipe-fitting connections on the bottom. Using the connectors that came with the unit, you would attach a rubber hose to the opening marked "inlet" on the Franz and the other end to a fitting on the engine that had oil pressure. It came with a fitting that would allow you to unscrew the oil pressure gauge fitting and install the Franz fitting, which had two outlets. You could then reinstall the oil pressure fitting and a fitting that would allow you to connect the Franz Oil Cleaner. The other opening on the Franz was discharge outlet. You usually punched a hole in the oil pan and screwed in a fitting that came with the unit. You then connected a hose back to the outlet on the unit.

The Franz didn't replace the oil filter that came on the car for two main reasons. First, you didn't want to void the car's warranty and second, you couldn't replace the filter, because a car's filter was designed not to restrict the oil pressure or flow to the engine parts. A cars oil filter doesn't clean oil, it just filters small microscopic metal parts from the oil.

Now this is where the Franz Cleaner was ingenious. About 10% of the car's oil would flow through the Franz. It went from the bottom and up through the tightly packed toilet paper into the center tube and back down in to the engine pan.

The toilet paper not only cleaned the oil, it removed water from it. You never had to change the oil, only the roll of toilet paper. One of the reasons I think it didn't catch on was that most of the cars at the time were using oils with additives. The additives would automatically under heat change the color of the oil from fresh clear-looking oil to black dirty-looking oil, even though it was as clean as the day you poured it out of the can. In conducting an experiment using oil without any additives, the oil never changed color. It remained as clear as the day it came out of the can.

The Franz had a metal wire that was in the cleaner top that was placed there before you inserted the toilet paper so when it came time to change, you unfastened the clip at the bottom, removed the top, then you could use the metal wire to pull the paper out of the holder. Yes, if you weren't real careful and didn't know what you were doing it could be messy. If you did know what you were doing, it was great.

Just think about it. When it came time to change the oil & filter all you did was pop the hood, replace the toilet paper in the Franz, add 1 quart of oil to the engine, and you were ready for another 3,000 or 5,000 miles. You never needed to change the car's regular oil filter because no sludge ever built up in the engine to clog it up. You didn't need to drain and change the car's engine oil because it remained clean and free from contaminants. Your cost for an oil and filter change? One quart of oil and one roll of toilet paper.

Franz cleaners were not only used to clean a car's engine oil, they also were used to keep the radiator water clean and the transmission fluid clean. They also made one that held 3 rolls of toilet paper and was used for large diesel trucks or or any large gasoline- or diesel-driven equipment or machinery.

I'm not real sure why the company didn't survive. It may have been its distribution process or the failure of the public to accept it, but one thing is for sure, it worked.

Very truly yours,

Rod Leggett



Bottom Line? keep an open mind, do your own research, but I think it's time for by pass filters, Allis Chalmers had them years ago, and you can still get the Yarn style by pass screw on element at NAPA.... now we just need to find an inexpensive bolt on mount for it.

Following is information sent by readers:

Hello,

I read your Utterpower site info about the Frantz. I just wanted to let you know that they are still for sale. A company called We Filter It markets it now. It is still called the Frantz Oil Cleaner/Filter. I personally have never used it but have read good stuff about it. The website is [www.wefilterit.com](http://www.wefilterit.com)

The prices for this type of filter all seem to run the same give or take 50 bucks. Other options for bypass filtration are the Gulf Coast Filter and the OilGuard

<http://www.gulfcoastfilters.com/> <http://www.oilguard.com/>

I hope that this information is helpful.

Take Care,

Joe

-----  
[Here's an email from David Miller regarding another bypass filter, thanks for writing Dave !](#)

Just a note to let you know there is another bypass oil filter available. Kleenoil Filtration. Was developed about the same time as the Frantz. The guy couldn't sell enough here in the states to make a living, so he took it to the UK. They bought it and have been using it ever since.

European petroleum products prices, which have been much higher than here, probably was a deciding factor. About 8 or 9 years ago, Richard Baxter (recently deceased) brought this product to the US market. I had the privilege of working with him for most of those years. It's slightly higher priced than the Frantz and some of the Amsoil units, but cartridge replacements are much cheaper than the Amsoil filters.

Filtering to 1 micron and removing all moisture, I have a majority of my over the road truck customers running 100,000 miles on a single oil

change. If you would like, you have my permission to put a link to my

website. [kleenoil.net](http://kleenoil.net)

Thanks, David L Miller 306 E.1150 N. Milford IN 46542

Best Wishes,

George B.

[Home](#)



## Building a cabin in a remote setting?



# MISTAKES

IT COULD BE THAT THE PURPOSE OF YOUR LIFE IS  
ONLY TO SERVE AS A WARNING TO OTHERS.

Back in the early 80s money was tight; every time we got a few dollars ahead; something would break and need replacing, or we'd take on a new bill like the Orthodontist for one of the kids. We wanted a cabin on our remote property; but we didn't have the money to have it built. Eventually we found the courage to build it with the help of our friends.





**Upper left, my Wife reflects, Lower right, children at play in Mt St Helen's ash, ..... remember that ?**

Over the years we have learned about Flickers, Porcupines, Red Squirrels, mice, bats, and opportunistic thieves. Had we known more about these vermin, we would have build it differently verses modify things along the way.

Here are some things I think are very important when building in the high country or in other remote places.

Flickers are close cousins of the wood pecker. They're smart enough to recognize that a cabin gable can provide a good shelter. They really like it if you extend the ridge pole through the gable end where they have a nice place to perch out of the weather. Often times they get bored just sitting there and decide to make a bunch of holes in your cabin.

One time, we had a flicker make a hole through the T-111 exterior, and then she pushed the insulation aside and pecked a big fat hole through the interior wall board. She had all winter to perch there looking out with her back side looking in. Having found a perfect home; she raised a family inside the wall. Her family grew up with an affection for cabins.. probably went on to raise their own families inside the walls of cabins.

My neighbor has a cabin sheathed in horizontal cedar siding, the Flickers love his place above all others. One gable end looks like Swiss cheese. Irving nails up metal fabric on the inside to discourage them.

Then there's Mr. Porcupine. I had no clue that T-111 siding was this guy's favorite snack. Some say it is the glue and resins used to hold the laminations together. Porky comes in the middle of the night and spends hours eating your cabin. He usually peels off the siding in layers chasing the delicious glue. You show up in the spring to a cabin that has big Pokka dot patterns in areas porky cared to chew. One night I woke up around 1:30 AM to hear this loud chewing noise and realized it was Porky, I ran down stairs, got my gun, and ran around the back side of the cabin to confront him. My wife was yelling don't shoot! don't shoot! Porky took off; I fired three shoots in the air, and followed up the assault by throwing a rock at Porky's back side. Porky's smarter now... if he hears me get up, he's off and running before I can get down stairs. Don't let anyone tell you Porcupines are stupid. I have been doping up the lower parts of the cabin with a mix of copper sulfata. Although this is nasty stuff, Porky is still snacking.



Our Pet Cheeks is a Golden Mantle Squirrel, he has the same marks as a chipmunk, Cheeks is a ground squirrel and has absolutely no thoughts about living in your cabin. He thinks he's smarter than you having his home deep in the ground where it's warm and where predators can't reach.

Red Squirrel on the other hand sees the world differently. Red makes a lot of noise, sometimes you'll be out walking and he'll think it's his job to tell every creature in the forest of your presence. He'll look down at you from a tree and scold you for being in his territory. When it comes to your cabin; Red thinks it's his, after all; he may spend far more time there than you do. Red often exploits holes started by Flicker, he can run up and down T-111 siding and reach a gable end in a split second. My wife sticks up for Red and often tells me I don't like him because we have similar personalities. I tell her we should be eating Red Squirrel stew three nights a week. Don't try and make friends with Red, don't encourage him to visit, unlike Cheeks he'll prove to be the friend from hell.

Red got into another cabin we have off grid... pretty soon he had holes in gable ends, through the bird blocks and places in between. He was making so much noise up in the ceiling, we could not sleep, a guest from hell for sure. I won't tell you how I got rid of Red; I think he's a protected animal here in Washington State. I'd love to drop off a truck load of Reds at the Governor's Mansion, we would soon see how protected they were.

Mice can be another problem, making your cabin tight is the first defense, plug holes, put sheet metal behind areas you suspect as entry places. Don't leave food where they can be attracted to it. No matter how much effort you put into your design, they could get in. If you plan to control mice with traps, good luck! In my experience, it is best to do all you can to keep them out, and then place d-Con in areas that children, cats, and critters like cheeks can't reach. When the few mice that get in snack on your d-Con, they leave in search of water, (according to users of this stuff).

Yellow Jackets enter your cabin for two main reasons, it's warmer, in there, or they are hunting for food. If your cabin is tight to the weather, they'll have less access, and you'll

have less of them in your cabin. I'll share a typical construction mistake you should avoid. Since we found a great deal on T-111 siding, I decided to put the face down and use it to sheath the roof. The idea was to create the illusion that we had done the roof in expensive tongue and groove decking. It worked great and we get a number of compliments as to how cool it looks, peeled poles, a log for the ridge pole, and that wood on the ceiling, it all adds up to a rustic look we wanted.

The problem you ask? every one of those little grooves cut to form the pattern in the T-111 hangs over the gable end and acts as an open door to bugs and hornets... I certainly didn't think about it, and after 20 years, I haven't made the time to fix it. Another note worthy mistake? I watch the Hornets in the fall, their food supply shrinks and the temperatures drop, they seem to be attracted to the metal roof and the heat it gives off. They crawl up near the ridge cover and discover easy access because I did not see the wisdom of laying a few layers of tar paper over the ridge. In fact, I thought the open ridge could have some advantages, a great way to allow your cabin to breath. Well... whatever those advantages might be, they are off set by hornets coming and going as they please. Hornets also find refuge in the cabin for the winter, in the spring they can fall from the overhead into your bedding and sting you! There have been a few years where we've opened the cabin and removed two dustpans full of dead or near lifeless hornets.

Bats are good things, I like them around and would go out of my way to make a home for them. If they find a place to live under the eave, that's great.. if they're in the cabin flying around desperate to find a way out, that is not good. The same efforts you use to keep mice, hornets, and flies out will keep Mr. Bat out too.

There's still a few lessons learned I haven't shared. I remember discussing the whereabouts of my cabin with Bob Meyers, a local who owned lots of high timber and grazing land above the south fork of Cowiche creek. He said... "OH... you mean the cabin on stilts?" His reply shook my confidence, I was asking myself if I had done the wrong thing? When it was first built, it sure looked like it was on stilts. I used post and pillar with plenty of triangulation to take the winter winds. There's nearly two feet of crawl space on one end and almost four on the other. After the skirting, and deck were added it looked far more appealing. Some of the cabins in the area were built with no access to the foundation, and there's no way to make adjustments for settling. This is something done right, if you create a place under you cabin you can't reach, this is where the foundation will fail....it's Murphy's law.

Another thing to remember, calculate your wall thickness with the siding in place! This has a real bearing on how your bird blocks are positioned. It also has a bearing on how the rafters are cut if you care enough to form a 'birds eye where the rafter meets the wall. You want things to meet flush, you don't want your bird blocks recessed, they should meet the siding flush or hang further out. If you have any kind of ledge, a flicker could hang on and roost there at night... of course he'll get bored sooner or later and start making holes just for entertainment sake.



Our ridge poles hanging out the gable ends became such a draw for wildlife, that I finally designed a sheet metal covering for them. It's steep and slick with no place to hang on. All the problems in that area ceased!

A final note when it comes to thieves. In the Cowiche area, the M.O. is always the same, they don't bring their own tools, if you have a weak spot, like a missing shutter, or a door that's easy to kick in, they'll make the effort. If it's too hard, they'll pass. When you consider that these folks are often too lazy to work, it stands to reason; it's got to be easy for them to steal your stuff. This spring, a thief broke in and took all the dinnerware that Upchurch had bought at the salvation Army, cracked, chipped, nothing matching.... they took it all! They even took a well worn pair of slippers he left at the cabin! Hell to pay for the fellow caught wearing them.

I once left a crow bar down by my spring, a thief found it and used it to pry open my door, ruin the lock, he then drug my \$20 barrel stove across the floor leaving deep scratches. It was two days work to fix the door.. and we were there with young children and no heat, not what we had planned to do for the three day weekend.

The golden rule... never leave tools around, or things like ladders that will allow thieves to gain access to high windows that may be less protected. Always remember that thieves rationalize everything... if things are neat and tidy, they may think you visit more often, they may note that you respect the place enough to leave it neat and clean and they may show your place more respect because of it. If you place shutters or an outer door on your cabin, use carriage bolts or signs that the things are bolted all the way through from the inside. Curt Chenoweth studied my cabin construction and came up with a superior idea for his own shutters. He bought some hardware that is often used for sliding barn doors, or garage doors. the track was bolted up under the eave across the front of the cabin above the door and windows. The shutters and outer door hang from this track. Shutters are framed in heavy angle and carry places for heavy padlocks. when they arrive, the shutters and outer door can be pushed aside, or even pushed off the track and stored! This is one of the best designs I've seen to date, it's just too much work for the common Thief to mess with.

Another major error folks make is laying out the floor plan with no consideration for the Chimney and snow loads. Snow and ice can do some amazing things, your chimney and the flashing around it can survive for a number of years... then one bad winter can bring the whole works right off the roof. If you are in snow country, it's best to avoid making valleys in the roof, keep things simple as possible and put your chimney right at the ridge. The further you move down from the ridge, the more problems you'll have with snow damage and down drafts that can fill your cabin with puffs of smoke. There's things you can do to reduce the problems, but nothing works better than a chimney located at the ridge.

Beware, the woman of the house is almost always the best space planner, she is the one who usually pays the biggest penalty when a living space is poorly planned. Only a fool would plan or design a cabin without the help of a woman. If you sit down together and plan the location of the wood stove, and assure the chimney exits straight up through the ridge, (or very close) you'll avoid all kinds of problems. If your wife misses the point of this, and insists that you need to place it elsewhere, ask her to sign an agreement that she will never complain about smoke in the cabin; or the fact that you spend some of your precious 3 day weekends on the roof repairing damage to the chimney created by snow and ice; then, make a copy of it; frame it, and screw it to the cabin wall.

I remember the very first time I went to Church, I think I was about 7, the Minister was giving the famous 'foundation sermon' I was in the second row and looked upward as he bellowed out the Bible's wisdom; "we must not build our house on sand". "We must take care to build a proper foundation or the whole house will fail". I never forgot that lesson, even at 7, I knew what he was trying to convey, but I spent most of the trip home looking at porches and other building parts that had settled, and looked neglected. Much of the lesson was taken literal.

But here I am talking about lessons I have learned and have carried for a life time. **How did I do on the cabin foundation?** Not very good; it's settled, and I need to get under it and square things up. It's one thing to learn the lesson, and yet another to practice it. I bet a whole bunch of those tilted and twisted porches were built by people that knew better too. The difference is; they were building for other people, **we build for ourselves, and we'll most likely be the ones doing it over if we decide to take short cuts.**

2003 Elk Hunt, more lessons learned. There's a big difference between a cabin wintering well, and a cabin functioning well during the winter. During the Elk hunt, we experienced a drop in temperature from 72 degrees down to nine degrees in a 24 hour period. We had snow, and an ice dam formed just above the gutter. I did not fully understand ice damming till I watched it this year, some folks live with this all the time, others have never seen it. For those with no first hand experience, the heat from the cabin causes the snow to melt and move down the roof, once it moves past the outside wall and onto the overhang, the water freezes and builds a dam just above the gutter. This dam holds water and that water can run up under the roofing material and do all kinds of weird things, it can even freeze and lift your roofing right off the roof. For me, it was a lesson to caulk the metal roofing at the seams so this dammed up water won't enter thru the seam and freeze between the roofing and the sheathing on the roof. 'Do it right, do it once', but if you don't know what right is, how do you do it right? Fact is, everything is more complicated when you build where temperatures swing and you have snow and ice.

More than a week in the cabin brings another thought, we are using d-Con to control mice, and other pests that get in. These critters can get in and make a huge mess of things in a hurry. d-Con does a great job for us, but is there a downside to using it? We have two cabins where d-Con is used, we have indeed eliminated mice, rats and other critters, but I

have noted that we have a higher fly population than other cabins. Upchurch's cabin (a mile away) was fly free this year, I swept out a dust pan of flies in ours, and noted new visitors each day till the temperatures plunged. I have thought about this long and hard, I think some of the mice that die do so inside the cabin, (maybe in the walls?), when they do, their little bodies may host fly larvae and create more guests. The hornets I've talked about may be finding the cabin a haven for more than one reason, it's out of the weather, but it may also be a good hunting ground for flies? Now a person has to make up his mind, do you want mice and the possibility of getting a virus spread by their droppings, or do you want to chase a few flies? Will your walls eventually become full of dead little mice, or should you allow the little critters to strip the insulation from the walls and drag it off to build their nests where they please? Not to mention the total destruction of any bedding, stuffed chairs, or mattresses. I think this whole issue should be a lesson to the cabin builder, maybe you throw in a little sheet metal in any area where you think the little critters are going to try and enter your cabin? maybe you get some of that green copper stuff.. and paint the wood so they won't chew in a possible point of entry. If you use siding similar to T-111, do keep your nail spacing short, maybe use some construction adhesive to keep things tight and seal off typical entry points. You can address these things as you build, or you can live with an ongoing problem later on.

You can read more about our building site here [Cowiche Project](#)

Expect more lessons to be added, I'm always learning what I should have done differently.

All the best,

George B.

[Home](#)



## *Cowiche Project*



High in the Washington Cascade Mountain Range sets our Cowiche area cabin site. It rests on top of a ridge at 4500 feet where Vultures soar and Deer and Elk browse and graze in the front yard. This mountain ridge separates the South Fork of the Cowiche, and Reynolds Creek.

You could spend weeks up here and not see another person; sometimes that's a good thing. It's also a great lab to prove 'off grid' concepts and appliances. It gets hot, it gets cold, the wind can howl; we've even had four feet of snow in a single night. If it works well here; it will probably work most places.

I enjoy being out on the front deck, with a fresh cup of coffee to greet the rising sun...

My goal is to place the Listeroid 6/1-ST generator underground where it will make quiet power even when there is ten feet of snow on the ground. At the same time, the spring will be set up to automatically charge a 1500-2000 gallon underground cistern to provide water through the dry season which starts in August and ends with the snow melt. I am hoping to get this project wrapped up before the snow flies this year. Imagine going in on snowmobiles and having all the creature comforts far from town.

Theft and vandalism are sometimes a problem in remote sites, with this in mind the entrance to the bunker will not be obvious. If they do get inside, they'll note how heavy this stuff is and look for something easier to drag off (I hope). I have several sets of auto wheel locks, and have even thought about using one of these here and there to make it more difficult to disassemble things.

The dirt work was completed August 17th, Carl Herke down on the Cowiche Mill road delivered

the bunker tank and did the dirt work an prep for the cistern. The bunker tank has been partially covered with one end sticking out of the hillside. The bank has been cut vertical near the tank end.

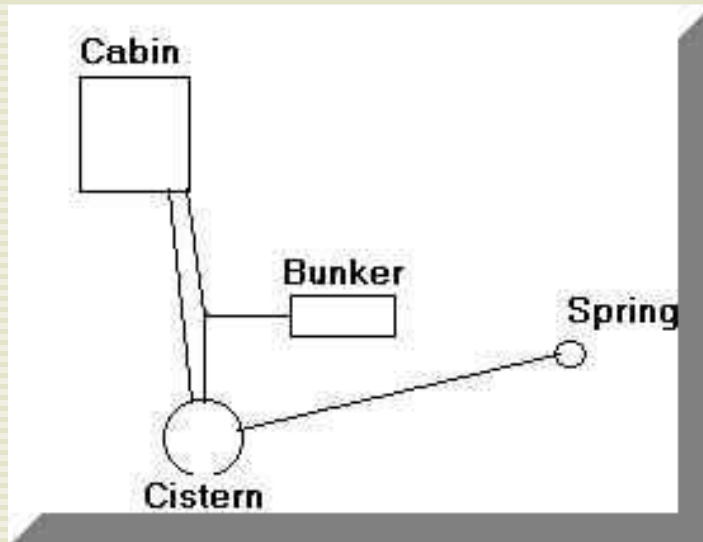

**8/21/02** The diagram above shows the basic layout of the first phase of the project. The cabin sits on the high ground, the bunker, spring and cistern are all on a hill side. The spring will be totally enclosed and will gravity feed the cistern via a buried pipe. When the cistern is full it will overflow, but not for long, the spring overflow is set high, in late spring the water level drops and shuts off the flow to the cistern. This helps maintain the natural water table, and impacts tree and plants less.

It will be more work to run conduit between the cabin and the bunker, but the idea is to have power with absolute silence. The enclosure is made from a 6 by 10 foot steel barrel laid level on it's side. Precautions will be taken to establish a poor fuel air mixture inside the barrel before any cutting is attempted. This will be done with a vacuum cleaner assuring an overly lean fuel air mixture by blowing air into the tank. The door opening will be cut with a skill saw and composite blade, the opening will be framed in angle iron and bolted or welded in place to add strength and a frame to swing a door on.

Next step is to fill the bottom of the barrel with gravel and fines to form the floor, The top three inches will be capped in concrete. It will be slightly sloped towards a drain which will allow any fuel or oil spilled to collect in an oil separator.

At this point, the Lister/ST 6/1 generator will be winched off it's trailer and pulled along timbers and pipe rollers to the opening of the Bunker. We think the engine will be happiest at the far end of the bunker with the starting flywheel to face the door opening. Space will be left on the end to allow the flywheels to be pulled, and for the engine to be rebuilt in place. The generator base will be firmly bolted to the concrete floor.

August 31, 2002, it's time for another week long trip to the cabin, here's a picture of the trailer loaded up, we'll pull out in the morning.



Here's the trailer ready to go for morning. The pieces of white pipe will be used in the spring to create a void around the culvert where water can collect.

**8/9/2002**

**The trip went well... but I did make some changes from the original plan.**



Here's the generator near the bunker opening. I used a snatch block, a 12 volt electric winch, pipe rollers, planks, and lots of time to get the engine off the trailer and down the hill side to the bunker. AS you might guess, it's top heavy and I'm pleased to say it stayed upright throughout the whole move. The Bunker is six feet high and ten feet long.

See that door opening... it took me nearly a day to cut it using a 4 1/2 inch Makita grinder and a composite cut off blade. What a person will do for the sake of having fun?



After struggling to lift the door off, I realized that this drum had a great deal of mass, The bottom of the drum felt much like concrete under foot. Maybe I didn't need to pour that concrete floor? Maybe I could get away with mounting the engine directly to the bottom of the drum?

I decided to weld in two heavy wall square steel tubes the same width as the generator frame to the floor as mounting points. I used 6011 rod to get some decent penetration into the thicker cooler material of the tank . Next, I moved the generator into position and bolted the frame to the mounts in all four corners. The engine sits length wise instead of cross wise as I had planned, this seems to provide plenty of room to do everything but pull the crank out. If this is ever required, I'd have to unbolt the engine and tilt it a few degrees. If you look closely, you can see the cooling tank in the back of the bunker, I welded in some brackets to support it with just a little clearance at the top of the tank. This provides the elevation required for a good thermal siphon. The coolant hose runs are kept short since the connections face the cooling tank.

It is important to note the manual method of cranking, this is done from the generator (head) end of the unit. you put the start handle over the RH side of the crank and wind her up. This feels pretty natural, but one has a tendency to slip the start handle inward to take advantage of the greater clearance between your hand and the side of the barrel. There is room for your hand to clear on the end of the shaft, but not a great deal.. In any case, I found that the inside of the crank handle was NOT smooth and hung on the gibb pin when it started, I quickly killed the engine and took a grinder to the inside of the handle making it flat and uniform, this removes any chance of hanging no matter where you decide to place the handle on the crank; all one has to do is remember to hold onto the handle after it starts! Then you simply let it walk off the end of the shaft. If your installation site is clean and dirt free, a little grease on the inside of the start handle could also be a good thing.

Next trip, the door will be hung, and the exhaust will be plumed. I will make a special exhaust adapter to allow the use of an automotive exhaust donut and pipe to tolerate some movement between the engine and the exhaust system.





Above is a picture of the spring after it was modified, this took the better part of four days to finish it to this stage. A felt like fabric was used to line the hole; the culvert was placed in the center (approx 6 feet or more in length). A ditch was dug into the lower side of the spring to allow a pipe to be fitted below the Average August 1 water level. Four inch diameter PVC pipe lengths were stood on end all around the culvert to create the water collection area, an over flow pipe was placed high to handle the heavy spring flow. Flag stones were placed on top of the PVC pipe; then fifteen wheel barrels of large pieces of basalt rock were used to fill the hole. on top of this is more felt, then a water barrier to keep surface water from entering the spring, then a layer of clay is used as a final seal. Above the spring is an interceptor ditch that diverts surface water around the spring as another measure to keep surface water out.



It's more than six feet to the bottom.



Here you can see the overflow tube on the left, and the tip of the pipe in the bottom of the ditch which will feed the cistern. The lower end of the spring was sealed up with a series of rock stacks and packed damp clay, once the pipe is laid in the ditch, the ditch will be filled with clay as well. This was a bunch of work, but if it provides good drinking water for the rest of my life, it will have been worth the effort.



If you look close you can see the cabin directly above the bunker. I would estimate it is 180 feet to the cabin. I'll use 6 gauge copper wire (from the salvage yard) to keep the losses low; I'll make three runs allowing for 220 volts should I decide there's a need in the future.



Above is a massive hole for the cistern, next trip, we'll dump in the the tank. That stump is massive, see the ladder in the back ground to get some idea how big the hole really is.



Here's a picture of 'cheeks' the ground squirrel; he likes to munch a few sun flower seeds as we drink our morning coffee on the cabin deck. He could scare a visitor to death... as he loves to come visit at full speed flinging himself into an open lap!

**9/27/02** As of this date, I've fabricated the exhaust system, built hinges, collected strapping and angle to go around the bunker door, and even found the 6 gauge wire down at Binford Salvage

Yard. I paid 33 dollars for a **new** 18 foot piece of 3/8 thick by 2 inch wide flat strap. This expense certainly is a reminder to identify needs and buy what you need at salvage yard prices when you see it there.

The exhaust system looks pretty decent, I fabricated a flange out of flat stock and welded a heavy wall piece of steel pipe to it. the ID is two inches and receives the 2 inch muffler pipe, pictures on this set up later.

Another milestone is getting the tank we'll use for the cistern ready, it's sitting on the ground waiting to be loaded on the trailer. I am in the process of planning the next trip up; hopefully I'll identify all the tools and things necessary to make things ready for winter and allow us to use the power at the cabin this winter.

**11/5/2002** It was a race to get things buttoned up for winter, the generator is snug in the bunker, the water tank in it's final resting place. This didn't happen any too soon; snow has fallen and temperatures remain low. No water, no wire run... it's a project on hold till spring.



The above tank must weigh 1000 pounds or more, the effort it took to get it down the hill side and into the hole was considerable. Had I planned better, the tank would have been placed with the back hoe; ... (another lesson learned). I owe much thanks to friends who gave up a day to rig, rope, and wrestle the tank into this hole. Kevin, Verne, Greg, Leslie, and Dennis, you saved the day! I could write a number of pages to describe my solo efforts.....the trials and tribulations of it's trip and placement, flat tires on the borrowed trailer, ropes breaking, tank rolling down the hill side, and more. Looking back..... it is the stuff cartoons are made of; possibly my next calling. "A stand in for Mutt or Jeff?"



Winter is here and it is time to put aside projects and enjoy the hunt and friendships forged over the years. In this case, it's 'Elk', one of the more tasty of North American Game. Above is Glen Phillips and Irving UpChurch; both land owners in these parts, seasoned Elk Hunters, Outdoorsmen, and Good Friends.

When spring arrives, I'll be at it again, with any luck, this will be the last year I haul water or closely manage battery power... how nice that will be.

### **May 2003, the snow is gone from the high country and it's time to return to the cabin.**

It was a nice trip in, the weather was perfect. We made the long trip in at an average speed of 12-15 miles an hour, I stopped at one of the hair Pin corners where wild asparagus grows and snapped off a big hand full to eat raw on the way in.

As we pulled down the long drive into our property, I was relieved to see that our picnic table was still in place, the shutters were undisturbed, and the Chimney looked as if it had taken on the snow loads just fine. After opening up the cabin, I ran down to the spring to see how things looked, I removed the cover and saw the water level was way above my plugged off overflow, this was great to see. I walked further down the ravine and noted the bunker was still bolted shut as I had left it, going down a little further, I came to the cistern that was still in it's hole. I think I had a few nightmares that the heavy spring run offs had floated it out of the hole and down the ravine, it was nice to see it sitting straight and level, and ready for the finishing touches.

I went back up to the spring and noted Fresh Elk tracks, I put the lid back in place and went back up to the cabin to help Sharon open up and get things unpacked. I pulled the two deep cycle batteries from the pickup and connected one to the heavy leads that feed the inverter, with this running, we had lights allowing us to take a closer survey of things inside, everything looked good.

I removed the garden hoses from underneath the cabin and set up a temporary pumping configuration from the spring to the pressure tank under the cabin. I set up a siphon from the spring down hill to the pump, from there, I laid out the hose back up to the cabin and into the inlet side of the pressure tank.

With the propane turned on, we had both hot and cold running water.

The next morning, I started in on the ditch that runs from the spring to the cistern, this is the overflow that charges the big cistern tank. With it half dug, I laid out the one inch black plastic and buried the first half, the other end went into the top of the cistern, the overflow was now being collected for use in the dry season!

During the week, I managed to move many yards of dirt with the help of my Son in Law. A box was constructed that provides access to the top fitting on the tank and provides room for the pump and filter underground. This should allow the water system to function during the fall and winter months. The plan is to operate with a drain back, the line between the cistern and the cabin will automatically drain back into the tank when a pump cycle completes, this will assure that water doesn't freeze in the pipes.

As I see it, I'll run 4 pair of wires (telephone cable), the water pipe, and 4 leads of 6 gauge wire between the cistern box, onto the generator bunker, and up to the cabin. They will all lay in the same ditch. The 6 gauge may be overkill from the bunker to the cistern box, but this is surplus stuff that I paid far less for, the pump will enjoy the low loss circuit between the generator and the pump. One pair of wires in the telephone cable will be used to communicate the pressure switch signal on the pressure tank (at the cabin) to the pump controller in the cistern box. when power is available, the pump will start, the drain back valve will close and water will be pumped up to the cabin thru a check valve. When the tank is full, the pressure switch will communicate an order to stop the pump and the drain back valve will be de-energised allowing all the water in the line to drain back into the cistern. This is simple enough, and if it works, it avoids digging thru solid rock to get the water lines below the freezing level.

At present, the cistern is nearly covered with dirt, the bank is being recontoured, once the native plants take over and other measures in place, a person may never discover the underground source of water.

Amazing.... Cheeks the Ground Squirrel, and Notchie the Chipmunk both wintered well. On the second day Cheeks was sitting in Sharon's lap, and allowing her to pet him! Ground Squirrels apparently do remember friends they've made from the previous year. Later in the week, I was enjoying a morning coffee on the deck, I had on shorts, and Cheeks came flying across the deck and started to run up my bare leg. It scared the heck out of me... my reaction scared Cheeks even more, he did at least a double flip and headed for his burrow near the generator bunker, he didn't get the courage to return till the afternoon.

[George B.](#)









## Co-gen

# Making Moon shine (motor fuel) with your Listeroid?

Do a WEB Search on 'co-Gen' or 'cogen' and you'll get the theme. I spend time thinking what a person can do with waste heat. It's pretty obvious if you have a living space or green house space to keep warm, but if it's plenty warm already, what do you do with this energy other than waste it like most people do already?

There are some processes that convert this heat into cooling through absorption, web searches using 'waste heat' and other related key words can fetch additional info.. Checking out how one of those ammonia refrigerators work can spark additional ideas.

Back in my 20s, I used to make Moonshine just because it was fun and illegal. I had a few friends that used to drop by and check out the latest batch, sometimes I'd trade a little 'motor fuel', for some good home made beer. If you think about the process of making alcohol from grains or starch (like potatoes), I think it may be a natural co-gen project, and it may be closely related to other processes you might think of.

Consider the Lauder Tun, this is an insulated container where the grains, potatoes, or other starchy foods are held at a temperature around 140-160 degrees F. The enzymes produced from sprouted, then roasted Barley is introduced into this 'mash' to break down the starches and convert them to simple sugars. The resulting mash is now ready for the fermentation process.

If we think of all this waste heat given off by our diesel via the coolant, and exhaust, it may be the perfect source of heat to keep the Lauder tun at the proper temp for the conversion period. If one considers that you could design the lauder tun with a simple thermostat to control the temperature via thermo siphon, this could be an easy and cost effective means of powering the lauder Tun.

Fermentation itself can be aided by a temperature increase, and by maintaining a constant temperature. Here's where you might have another thermal loop off the power plant with a simple thermostat for it's independent regulation.

Once we've fermented our motor fuel, it's time for the distillation process, here we try and maintain a temperature higher than the vapor point of Alcohol, and lower than the vapor point of the water in the mixture. Alcohol boils off at 140F, Water at 212F, so here we might

find a coolant temp to be perfect for the distilling process. There are many possibilities here, you could set it up as a pot still or more like a reflux still.

As for the final stage , we could use a water pump off the flywheel, or we can borrow some power from the generator end to push water through a condenser/radiator loop to condense this alcohol into our collection vessel.

Making Motor fuel would be legal, and most likely far less fun. Considering the effective Octane rating of Alcohol, it should be quite feasible to run a stock compression ratio in a Listeroid and run alcohol through it. One should be able to fit a spark plug right in the middle of that plug often fitted to the CS head, a bump on the flywheel could run the points, or maybe you remove the cam cover and fit the breaker points and a cam lobe there?

Imagine showing up at an old time engine show with a moon shine burner! , you could have an extra fitting coming off the tank to fill shot glasses when the boss isn't looken.

If the end of the world comes, you could be ready to power your mo-ped into town on home made motor fuel.

## Making use of waste heat

I'm always amazed at how efficiently a propane or natural gas water heater is. I have a forty gallon unit at one off grid location, I use a 5 gallon propane tank to fuel it, and it's pretty impressive how many showers one can take on this amount of fuel. I pump collected rain water and hauled in water via a solar powered pump, but we'll soon have the Lister working the well.

I was talking to a plumber who told me he has installed several heating systems where tandem gas hot water heaters are used for domestic water heating and act as the boiler(s) for a hot water heating system as well. this causes me to wonder about uses for a discarded unit? If you use one of these as a cooling tank, could you use a small blower to push the hot air up through the center and into your living space?

What would happen if you used the center of a gas water heater as a muffler for your diesel engine? Some might suggest it would get full of carbon and lose it's transfer efficiency, but maybe not?

Got a co-gen idea? write me...

All the best,

George B.



Alternative Energy and home made power is of interest to a wide variety of people, most of the folks found in these pages are doing interesting things with Alternative energy, When I met Jeff and discovered his projects, I had to change this introduction. One quickly learns, you don't have to be in the country to experiment with diesel power and AE.

[Jeff Maier](#) Experimenting in the Burbs, building a voltage regulator for the ST head. How to run a diesel without annoying your neighbor. Why I like biodiesel

[Harry Anderson](#) "My Dad taught me the value of a dollar, He'd always say, if you can live another three days without it, you probably don't need it".

[Brian](#) Fairsomething Maine is far away from the bright lights of the big city, it's a place where you can still go out in the back yard and shoot your rifle without the cops showing up. Brian is an avid shooter and re-loader, he enjoys the seventeen caliber among others. Brian lives in an area with few jobs, a place where it's warm in the summer and cold in the winter, where being self sufficient pays dividends. Brian has taught me a bunch, he's probably forgot more about reloading and shooting than I'll ever know, and although I've never been to Maine, I've learned how different it is from the temperate North West where I live. A quote from Brian... " I like it when it's well below freezing the best, no bugs and no mud to get stuck in". Follow the link to [Brian and Sue's story](#) it's about their quest for independence from the grid.

..[Bill \(Cougar\) White](#). "I'd never build a house up here in the open, I talk to the people in the timber over here and they don't even know it's windy in Easton!"

[Phil Podkanawicz](#) A true DIYer and diesel engine enthusiast from the Chicago area. Read about Phil and his quest to build a generator base with provisions to drive the head with belts and pulleys or the utterpower direct drive. Will this setup help Phil determine what he likes best? which set up will carry the largest KW load? follow along to the Podkanawicz pages. BTW, be warned... Phil likes green :-)



## Brian and Sue's BIG PROJECT, or our "Solar Saga"

This project started with an ice storm and power outage that Maine had a few years ago. We were without power for 5 days and I decided to do something about not having to go through that again. I looked into many ways to correct it, finally deciding on a small 500 watt inverter and 2 Trojan SCS 225 batteries. I'd keep the batteries on a charger in my shop and lug them into the house as needed. It worked for lighting. We ran extension cords as needed.

We purchased 2 PV panels and I figured that if they were needed for long term power outages, I'd lug them out and set them up to charge the batteries. I obtained some experience with a previous solar electrical system that keeps our electric start generator battery topped up. This system was what was planned and I have no clear recollection of when and where it changed....It may have just "evolved" rather than became a wholesale "changed idea". Yup, that's it. It may have also been because a friend was also considering "going solar", that may have contributed.

I decided that we needed a larger inverter, so bought a Trace 1512. This would allow us to have a transformer to convert 120 to 240 to drive our well pump. I'd feed the house through a 240v wall outlet, feeding both legs from the one inverter output. I built a special box that allowed this. It'd work as long as we never tried to run anything that required 240 volts. More on that in a bit. This 1500 watt inverter also needed more batteries, so another 2 SCS 225s were purchased. Then for long term outages, I tried to purchase another 2 PV panels. Does anyone see where this is going? I didn't at the time, but writing it down makes it all very plain.

For reasons I won't go into, the panels I had were no longer made, so to make the mount easier to fabricate, I sold them and bought 4 larger Kyocera 120 watt panels. Along about the same time I realized that the SCS 225 batteries really weren't going to do the job, so I started to shop for new batteries (non-gassing gel cells were the target). With all of this investment, I was going to do things right rather than hodgepodge (yah, right!). That meant a charge controller. I had in mind to get a duplicate of the ultra simple ProStar that I had on the generator batteries, but research quickly showed that the field was rapidly changing and I could get more from the PV panels with a SolarBoost controller. As I was trying to

figure out how to tap into the wiring to feed the well pump RV Power Products was working on making higher capacity SolarBoosts.

In a short time I realized that the transformer idea really was the pits for us. At some point I ran the idea past George and he quite strongly suggested that I make sure that I'd never be able to feed the house from two sources. Not liking sparks or explosions I felt it was good advice. Thanks George! Now, how to do it. It'd be easier to get two inverters, slave them together and get 240 volts that way and just tie into the existing house wiring. Some logical thought told me that 2 disconnects (we already had one) would insure that no double feeding of power would occur. Now it should be plain to everyone how this thing took on a life of it's own. :-)

At this point I'm talking a partial rewiring of our homes electrical entrance, 2 inverters, charge controller, 4 panels, 4 batteries, heck I Already had a substantial solar electrical system planned but was clueless to all of it. Looking at batteries told me that I'd need a mess of 'em, probably 14 or more, at least 1000# of batteries. (As I write this I'm chuckling) Where do I put my panels? I can't put them over there because of the ground work that will happen there in a few years, I don't want to put them over here because they'll be in the way when I plow snow. Heck, the best spot is behind our dwelling on a tower. Hmm, up there in the air they'll be subjected to pretty high winds. I didn't like commercially made mounts so had to learn to weld aluminum to fabricate my own over engineered but (I think) elegant mount, well three mounts, my buddy needed 2 mounts too. With the PV Panels being immoveable it only made sense to run conduit for the cable to get the juice into the controller. Since I was running conduit it only made sense to find a spot to have a power panel, the original idea of housing all the electronics inside a window seat was shelved. What to do? Where the heck will I put the electronics? A trip to the local solar outlet, found the batteries. Two 960 ah batteries at 520+ pounds each. Since they weren't non-gassing an airtight battery box would need to be built. I had one area that could house all of this stuff, but it got cold in the winter as it was unheated. Oh well, we haven't used this door in the mud room for years, so remove it and put a louvered panel in it's place to allow heat to get into the room to keep the batteries warm.

The original idea was 2 small batteries and an inverter to pump water and supply light during power outages so that I wouldn't have to run the Miller Bobcat generator/welder every outage. It grew to the finished project. It was started in the spring and over 6 months and I haven't a clue how many man-hours later (but it's a bunch of 'em), it's finished.

Much larger and much more expensive than the original vision. The end result is that when we replace our electric hot water heater, range, stove, and clothes dryer with propane fired units we'll be able to throw the switch on our utility company for more than 8 months of the year. The summer months we run A/C and the system isn't large enough for

that. For this Christmas the wife asked me what I wanted. Well, George and I have been talking Listers off and on for awhile, and I can hook it up to a generator head for when I do need to run a generator, and it'll last forever, and I don't need to run cable, I can tap into the Bobcat cable, and I can just add three walls and a floor and roof to the existing power shed.... So a Lister is on the way, I just hope the "solar" electrical generation project ends with that. I don't have possibility of hydro power, so I appear safe there.

Brian

### Pictures and Captions









- 1) This is the outside view of the first solar electric system. This is the outside of the generator shed with the Kyocera 40 watt panel showing. I left a one foot gap all around between the top of the exterior walls and the bottom of the roof for ventilation. During the summer months it still gets noticeably warmer in the shed when the generator/welder is running even with all that ventilation.
- 2) A view of the inside of the generator shed and the super simple Morningstar Prostar 30 charge controller for the two Trojan SCS 225 batteries that are connected in parallel at the base on the board the controller is mounted on. These batteries are the start batteries for the Miller Bobcat generator/welder as well as furnishing power to the shed. This arrangement insures that the batteries are always 100% charged as they are the only way to start the Bobcat. You'll recognize the batteries as being 1/2 of the proposed solar electrical system. The other two will be used for emergency lighting in the shop as it has no windows for prying eyes to spot things that they might lust after, hence no outside light gets in.
- 3) A view inside the generator shed looking toward the double Dutch door. Just above the opposite corner of the Bobcat can be seen the 500w inverter that supplies 120v for the use of small powered handtools without the need for starting

the Bobcat. It takes it's 12v supply from the Trojan batteries. It's the first inverter that supplied emergency lighting and was the original impetus for the solar saga. A 12v halogen light can be seen above the inverter, and a book that I document everything that happens with the Bobcat can be seen hanging from it's hook.

## Home PV System Captions







- 1) View from the road. The panels are to the north of our home. The door above the headlights of the Saturn opens into the mud room that houses the batteries and the PV power panel. The "space needle", actually a lightning rod, is clearly seen above the tower that the panels are mounted on. The generator shed is just out of the photo to the right of the car, approx 25' away from it. When the Lister arrives it'll be housed in an extension of the generator shed, and a retake of this photo would probably include at least a part of the shed addition.
- 2) A view from the other side. The 16' tower is clear. Lots of room to work up there on the platform. The ladder terminates 10' from the ground, so a separate ladder is still needed to get access to the panels.
- 3) Another view of the east side of the tower, panels and part of the mount assembly. We got snow during the night, so I waited an hour or so for the panels to clean themselves, with the sun's help of course.
- 4) Taken from the platform on the tower, this shows one of the 3 aluminum mounts we had to make. I kept one, a friend got the other 2. The top and bottom halves are welded together, each half was brought up separately, then pinned together. The struts that control the tilt angle are also pinned in place. They are shown at the winter angle. In the spring the top half will be lowered and the high hole seen in the upper portion of the strut will get the pin. There wasn't quite enough room inside the lower strut half to allow the optimum summer sun angle, a 3 piece strut would have allowed the proper angle, but what is lost by not having the best angle is made up for in hours of sunlight during the summer. The 2 piece strut was slightly easier to make and we felt it would be stronger. The panels are wired in series for approx 60 working volts yet is considered to be a "48 volt" system.





6

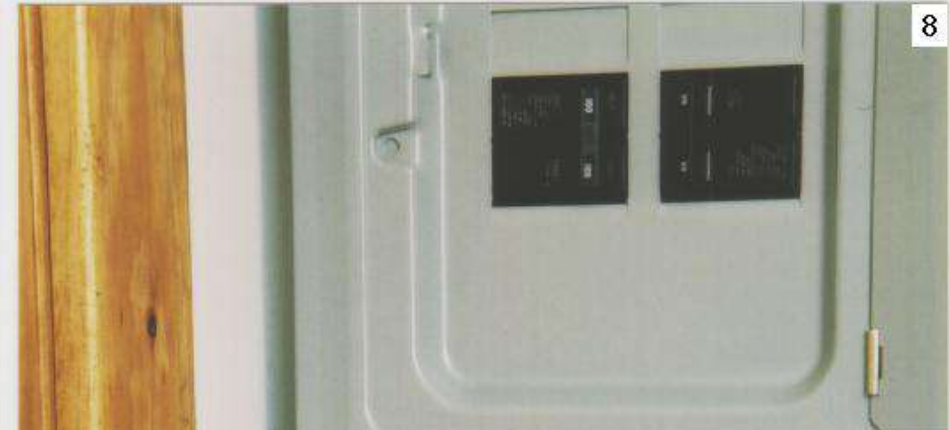

8



5) We just entered the mud room and here is the battery box at the lower right corner of the picture. Clockwise, still at the bottom, the grey box is the 100 amp breaker that acts as the disconnect from the outside 240v feed (outside feed being either mains or the generator) and has the 20 amp breakers that feed power from the inverters to the house. Continuing clockwise (we'll adhere to that) is the box that has the 60 amp breakers that feed power to inverters for battery charging and "pass through" for feeding the house, this allows charging batteries from any source connected to the outside disconnect. Above that the white Trace box houses the 250 amp DC breakers and (unseen) the breaker for the PV panels. The 4 large cables coming out of the bottom are 4/0 and go into the battery box, 2 cables for each inverter. The small white box with the black heatsink on the left is the SolarBoost charge controller.

The cables going into the bottom of the SolarBoost are #1 cables from the panels. This unit converts the 60 volt feed from the panels to 24volts with an increase in the current. To it's right, the grey box houses the GFCI for the PV panels and has a lightning arrester. The black box to it's right is the TriMetric meter. Below that are the two 1524 Trace

inverters slaved together to allow for 240v feed to the house.

6) Standing more or less in front of the power panel and looking into the airtight battery box. The red 4/0 cables can be seen, there are 2 black cables of the same size that can't be seen and some smaller wires leading to the battery temperature sensors, needed for controlling the charge voltage as the temperature of the batteries change. To the left is a louvered panel that allows the mud room and thereby the batteries to stay warm. As oriented in this photo, at the rear of the battery box can be seen the vent pipe that allows the H<sub>2</sub> to vent outside through the roof.

7) This is a close-up of the SolarBoost and TriMetric meter. The result of the SolarBoost can be seen. 4.6 amps is coming into the unit and the TriMetric is showing 10.7 amps being sent to the batteries. Since the panels are actually wired to be a 48v system one would expect that the amperage would be doubled when the SolarBoost finishes converting it to 24 volts. Obviously, not so. Part of the magic of the unit is that it uses ALL excess voltage sent to it, anything more than the voltage necessary to charge the batteries, and converts it to current. It samples what's needed every few seconds and adjusts depending on what the battery needs at that time. Due to this particular model of SolarBoost we saved some \$. By wiring the panels in series the amperage stayed at 7.1 amps and the voltage increased. This allowed the cable needed to be #4 cable instead of much larger cable. Since the SolarBoost likes voltage, for higher transmission efficiency we upped the cable to #1 gauge just to be sure. We still saved \$. If I ever want to increase the size of the PV array this controller will allow me to at least double the number of panels. I'll probably be able to use the existing cable, but might run another set "just to be sure" of low loss. :-)

8) A closeup of the lower panel is the important info in this photo. This saved us some \$. The 100 amp breaker in the bottom box has a little "rocker" that prevents both the 100 amp and the 20 amp breakers from being "on" at the same time. Both can be off at the same time, but only one at a time can be on, preventing feeding from the inverters at the same time as the mains are feeding the house. Shortly after George stressed this, "no double feed", a friend blew an inverter up by, you guessed it, doing what he always knew he'd never do; double feeding his home. It's cheap insurance. Lots less expensive than replacing two inverters.

Brian



After a long winter, we visited our off the grid cabin in Easton, Washington. Things looked great except for the deep cycle battery that provides both lights and water for the cabin. No matter what anyone tells you, a little 20 watt solar panel will boil a battery dry!

This trip I brought along a new .223 Savage Short Action Bull Barrel Varmint Rig. I've been hearing these things drive tacks right out of the box, so I finally ordered one. As I was driving towards the back gate of Easton Ranchettes, I saw Bill White hauling 14 foot long two by tens up a tall ladder onto the new barn he was building. The wind was blowing at least 15 miles an hour, and I decided to delay my shooting for a few minutes and give him a hand.

Bill greeted me with a big smile and took his glove off to shake my hand, he looked over at his hounds and told them to shut up... amazing, they went over and laid down and never made another noise while I was there. I looked over at the pile of two by tens, they were green Douglas Fir off Vic Monahan's mill, some of them probably weighed 65 pounds. I looked over at Bill.. "Don't you have any Friends in this town?" "You trying to kill yourself?" Bill adjusted his western hat and in his slow western accent replied " Most of us got jobs, those that don't are too darn old for this kind of stuff..... you got gloves?, if you don't I've got some in the truck". I accepted the offer and started shoving rafters up to Bill. Even though I paced myself, I could feel my heart pounding. Twenty minutes later, Bill came down off the roof and collected his gloves, "I think you just saved me a days work, let's go in the house and have a cup of coffee". I accepted and followed him to the door, "are you gonna show up for the pig roast?" I don't know I replied, we may go back up into the Cowiche Mountains again this year. "Well it was a bunch of fun last year, think about showing up". Bill poured two strong black coffees and pointed to some home made Jerky in a sack on the table. I grabbed a medium piece and started chewing..."darn good Bill".

**"Say... did I ever show you my latest Cougar hunting Tape?** Wait a second, I'll run upstairs and get you a copy of all three tapes, you can look at them when you have the time". I started thinking about the Jerky? Always thought it was impolite to ask what kind of meat you were being served, **darned good if it is Cougar I thought.** Shag Upchurch, another good Outdoorsman told me Cougar eating was a good as it gets...even better than a berry fed bear.

I finished my coffee, grabbed the tapes and reached into the sack for another jerked piece of Cougar? I told Bill I needed to let him get back to work, and thanked him for the treats.

I started down the gravel road, went through the back gate and over the canal. I got on a logging road and stopped about 100 feet below the snow line, the narrow mountain valley 1000 feet below, and snow covered Goat Peak lay above. It was nice and flat here. I walked down the road with a small bore 100 yard target. I posted it at two hundred yards and verified the distance with my range finder. I took an old piece of carpet and threw it down in the middle of the road. Laying prone in the road with the fore stock resting on a piece of rotten log, I slowly squeezed off three shots. I thought about Brian in Fairfeild, he's going to be shocked to learn I finally fired this Savage. I looked closely at the target, through the 10 power scope, I could see a group about five or six inches above the bull. I dialed in 24 clicks (down) and fired three more hand loads. I couldn't see the point of impact, so I left the rifle on the carpet and walked down to the target. Just to the lower right of the bull were three overlapping holes, maybe a .300 inch group! One adjustment after a bore sight and a group like this out of a brand new rifle.....my lucky day! the wind picked up, I fired a few more and they started stringing, I realized I could prove nothing with the wind blowing and packed up my stuff.

I looked down into the valley and saw my wife 'Sharon' walking our property, I looked at our windmill laying on the ground and thought how nice it will be to pour the footings and get the tower up this summer... one of a hundred projects that needs finishing.



When we got back home, I thought about Bill White, and remembered the VCR tapes he loaned me. I picked one at random and popped it into the machine in the family room. It wasn't a Hollywood Production, but I was surprised by the quality of the video, and how many cats he's recorded on tape! Many, if not most off these Cats are photographed and let go, some were hunted because they had become problems and they were harvested, (JERKED?) There's one hunt that takes place off Bill's 'Home Place', a Ranch in the Methow Valley, a beautiful sparsely populated area on the eastern side of our Cascade range. The Cougar hides in an old mine shaft and Bill and his party go in the mine with guns drawn and a single flashlight with not so good batteries. The whole event is insane, the big male cat makes a dash for it and runs over the top of two party members. This is truly insane. My thoughts turned to living here in the NW and NEVER seeing a Cougar in the wild. How many have stalked me and sized me up for dinner? Cougars have been dining on people more often here in the North West.

Looking over these videos, I find an email address [bswhite@eburg.com](mailto:bswhite@eburg.com), and a P.O. Box of 663, Easton WA 98925. Phone 509-656-2960. If you want some real excitement on tape, ask for the hunt that takes Bill and his party into the mine!



All the best,

George B.

[home](#)



Phil Podkanawicz shares his formula for a generator frame that will quickly convert from belt and pulley to direct drive, this is an experiment to see the pros and cons of each setup. His diesel is a German designed, Chinese made unit is very similar to our Changfa. The Gen Head is the ST10.

Phil has sent me his story and pictures, I'll do my best to compose it the way he has presented it to me. Any comments I make will be in blue, anything else is part of Phil's story.

How to assemble a belt or direct drive generator. The information that follows will show you how to build your own generator at home in the garage or shop. There are a few basic things you should know before starting a project like this. It requires about two horsepower for every kilowatt of power you generate. A kilowatt is 1000 watts. If you assemble a 5000 watt generator you will need at least a ten horsepower engine to turn your generator to full output. There are two pole generators that operate at 3600 rpm and four pole generators that operate at 1800 rpm to provide the same 60hz frequency. Things last longer when they turn slower so we choose to use the four pole generator. The next thing to consider is the type of engine you will use to turn your generator. I like diesel engines because they last longer and require no tune-ups and use less fuel than a gasoline engine. Most diesel engines operate at a slower rpm than gasoline engines. They also have more power at lower rpm's than a gas engine. I will be using single cylinder water cooled horizontal diesel engine for this project. It is a Chinese brand and is rated at 19.75 horsepower at 2200 rpm. It weighs about 450 pounds. When it is direct coupled to a generator it will turn at 1800 rpm and it may only produce 17 - 18 horsepower. It will be turning a 10,000 watt ST10 generator head. The ST10 head weighs in at about 265 pounds. The generator head can also be turned with a belt instead of coupled directly to the engine. This will allow the engine to turn at a higher rpm and produce more horsepower while the generator still turns at 1800 rpm when the proper size pulley is used on the generator. I have decided to build a generator set that can be belt driven or direct driven to see what works best and which one I like. Lets begin by taking a look at the engine and generator head I will be using. I'm a John Deere Fan and so my project will be painted John Deere green and yellow. The components for a belt drive and direct drive are also shown.



After we have chosen the engine and generator head we will use, its time to construct a rigid frame to support the head and engine. They are both heavy pieces and need a good sturdy platform to set on. The frame must be made of heavy enough material so that there is no twisting ,sag or distortion between the head and engine when it is operating This is critical when using a direct coupler. If using a small single cylinder diesel like mine and a 10 kw head the weight is already about 715 pounds, add the frame at about 130 pounds and now its 845 pounds. When completed

it will be nearly 1000 lbs. Use material heavy enough to support all this weight plus the twisting effect of the engine and vibrations. I will use four inch I beam and 3/8 x 2 inch flat bar stock for the frame. It will require about 12.5 feet of each for the frame which is about 45 X 20 inches. The frame I will be constructing will allow me to set the engine and head up for a belt or a direct couple. I will determine which way I will operate the generator set, belt drive or directly coupled to the engine. Yes it takes more time and work to construct a dual drive system but I will then know what works best. As you follow along you will notice in the pictures that the generator head has both a pulley and lovejoy coupler half attached to its shaft. Also notice that there are eight bolt holes and two notches in the frame, only four holes are needed to mount the engine. The other four holes are used when the engine is rotated. The small notches cut into the frame are for clearance of the flywheel starter ring gear. The slotted 3/8" flat bar stock for mounting the head have a 9/16" spacing between them to allow for 1/2" bolts to pass through and give a little wiggle room for adjustment. You will have to determine the measurements and spacing of your frame according to the specific engine and head you will use. I will be constructing the belt drive setup first.

A belt driven generator head will require that there be a way to adjust belt tension and pulley alignment. This means you should have a way to adjust the head in and out towards the engine and also left and right for proper alignment of the pulleys. Belt life will be severely shortened if the pulleys are not properly aligned. I will use 3/8 X 2 inch flat bar stock to make a pair of adjustable mounting brackets that will bolt to the generator head. They are made of two identical pieces of flat stock with five inch long bolts with the heads cut off and welded in between the the two pieces of flat stock. The bolts are 1/2 inch in diameter but spacing between the two pieces of flat stock is 9/16 inches. This 9/16 inch space between the two pieces of flat stock will allow 1/2 inch bolts to slide back and forth for adjustments. This is the same spacing between the flat stock pieces as was used on the frame. I had the flat stock laying around here so that is what I used, you may want to use something different.

[Here's some examples of Phil's DIY skills](#)



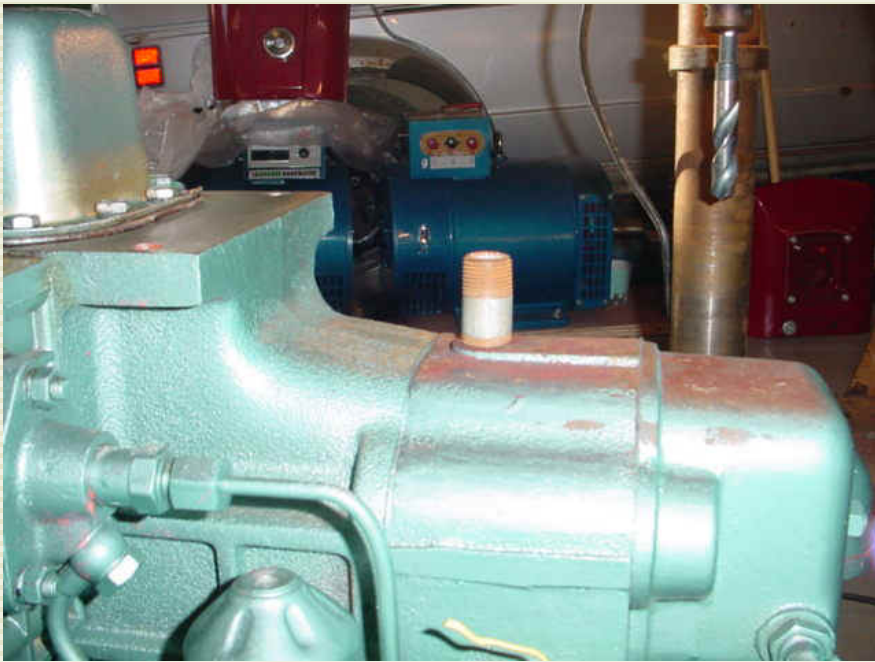

Here's a picture of Phil's engine being modified for thermal cooling, Phil has checked the casting and knows there is adequate room and material to drill out the drain hole, and re-tap for National Pipe Thread "NPT". This will allow Phil to make use of this fitting for thermal cooling.





The Asian standard for mounting pulley's has it's pros and cons, one thing that always pays off is taking the time to center your pulley. This allows the belts to run true and to have even tension. This step is often dismissed by DIYers. Dial indicators are inexpensive now, \$6.95 from Harbor Freight, but you can figure which way to move the pulley by creating a reference point close to the pulley and watching the gap grow and close through a revolution.

What an engine needs most.. ??

## Seal Your Engine for Winning Performance

by Joe Mondello Feb 2001

What an engine needs most.. ??

One of my Mechanical Engineer Friends often refers to Joe Mondello's thinking and findings. Since Mike McDonald has developed some pretty impressive equipment of his own, this gives me even more confidence in what Joe has to say. This article does talk about things I thought were 'snake oil' just a short time ago.

The article to the right was found on the net with old and broken links, I see no copy right, so here it is:

**Read, understand, and remember, this is what often makes a runner verses a dog in otherwise identical engines... A round hole !**

George B.



*Joe Mondello Feb. 2001 by Evey Roth*

Most engine builders and home enthusiasts take a new engine out of the box, hone the cylinders, install new rings, some use a torque plate and some don't and they wonder why the engines do not seal the rings and use a lot of oil. I am going to share with you my 40 plus years of engine building technologies I have applied to this unique 1 cylinder aluminum Briggs engine. A seasoned block is always better to start with after about 75 to 125 laps in your chassis karting or 15 to 25 laps in a junior dragster. We are using alternative and more successful ways to stabilize engine blocks and components before machining and final engine assembly. We are using cryogenics freezing and heating of the blocks and components, high frequency stress relief shaking to internally stress relief and align all molecules and porosity's in the material. This also relieves all stress areas where welding has been done. Also heating and cooling in an oven, hot water pressure washing systems will also work if cycled at hot to cold -- hot to cold at least 6 to 8 times. All block procedures, high frequency shaking, freezing, heating and cooling need to be done with a torque plate, side cover and bottom motor plate torqued with the same fasteners you are going to use for final assembly including the head gasket. The torque plate, motor plate and side cover need to be torqued 10 to 12 hours prior to any boring and honing operations. If you do not let the block normalize and stop moving for at least 10 to 12 hours before final sizing and honing of the cylinder bore is done it will change over .001 in diameter and will be out of round causing inadequate ring seal. Nearly every one including some engine builders install a torque plate, used head bolts and a used head gasket, torque the torque plate and hone the block. They remove the torque plate, clean and assemble and believe me this is when the problems start. If you then use a different set of head bolts and do not cycle them properly or use a different assembly lube on the bolts or use a

different head gasket the cylinder bore will change size. The size of the bore can change up to .0003 to .0005 just by using a different head gasket or head bolt.

The difference in bore size between just bolting on a torque plate or leaving the torque plate on for 10 to 12 hours is usually about .0009 to .0013. When cryogenically freeze the engine parts we see no change in size like we do when we shake them. We do find 1 to 3 points of a harder cylinder bore surface on the "C" scale on our Rockwell hardness tester but the lubricity factor is much better allowing rings and all bearing surfaces to have less friction and more longevity. We have increased piston and ring life over 400% by just freezing the piston and rings. When we shake the parts we do notice a size decrease especially in cylinder bore dimensions both height and width and side to side plus overall block height up to as much as .0035.

The cylinder bores will usually reduce their diameter up to .0006 to .0008. The largest decrease is the top and middle of the bore after high frequency stress relief shaking. I think by now a lot of you are wondering what does all this mean to me and the way my kart runs and performs.

Well it is hard for me to honestly tell you but I can tell you one thing for sure and that is that 75% or more of you out there do not have good sealing rings. I am going to try and advise you in the right direction to obtain and keep a good ring seal and of course good rings, pistons, piston ring grooves, cylinder bore finish plus piston, ring and cylinder block preparation is real critical. The last word on all this engine preparation is real simple: machine it round and straight, keep it round and straight. I realize a lot of you think cryo processes and high frequency stress relief shaking is smoke and mirror black magic voodoo, think again. I have been using cryo for over 15 years and stress relief shaking for over 10 years on every thing from chain saw and kart chains, transmissions, sprocket, gun barrels, cranks, valve springs, valves, heads, blocks, rods, even carbide cutters for porting heads and blocks and believe me this stuff all works.

Once you are comfortable with your seasoned, cryoed or stress relieved block then choose your head gasket, fasteners, (if they need to be cycled, do this before final torquing of Torque plate is done) always use the same assembly lube start to finish of your engine. Always have your cylinder bored within .002 to .003 of finished bore size using a Torque plate, side cover and engine mounting plate. Install Torque plate, new gasket, fasteners, side cover and gaskets plus engine mounting plate toque all fasteners to recommended torque and let stand for 10 to 12 hours, for roughing then go to a 300 to 320 grit stone for a semi-final and final honing procedure for the last .0003 to .0004 tenths removal is a 400 grit with about a 45 degree cross hatch.

When this final plateau honing is completed you should still be able to see the 320 grit below it. During all this honing operation do not ever allow your cylinder bore to ever get overheated especially on your final honing procedure.

I will guarantee you that your cylinder bore is round and will stay round. Always use a .0001 reading dial bore gauge while honing your cylinder bore for ultimate roundness and accuracy. The use of aluminum cylinder bores stock or coated or steel sleeves, all respond to these procedures. The rings we use and have tested Briggs and Stratton, Burris, Speed pro and Wisco, these are all



good rings if they are prepared properly. They must be end gapped correctly 90 degrees square to the bore. Always deburr sharp edges of the rings before installing in your freshly honed cylinder bores. I make an RS-100 1/2 round ring deburring stone and an RST-125 ring squaring and ring lapping combination tool, these are a must to do rings correctly. After you have end gapped your rings to your preferred specs I like .001 to .002 for Top .0015 to .002 for 2nd and .018 to .20 for oil rings.

Deburr all rings except sealing surface before engine assembly. Hand lap both sides of rings lightly with 600 wet and dry sandpaper and solvent on a flat plate or piece of heavy glass using RST-125 lapping tool.

For your piston installation we make an adjustable tapered piston-ring installation tool for all Briggs and other engines. Our Briggs part number for the 5 H.P. Briggs which covers 2.5625 bores to 2.625 is ARI-262. This tool eliminates ring breakage and scuffing. I recommend Marvel Mystery oil for ring land lubrication, use automatic transmission oil on the cylinder bore (any type is fine) and on the piston skirts, wrist pin and the rest of the engine use our 2115 engine assembly lube, do not use on piston rings. These are many engine secrets shared by no one, so take advantage of them; of course we teach you these and many more things at our Tech School.

We do cryogenic freezing, high frequency stress relief shaking, boring, honing and complete block preparation as mentioned in this article, we also sell complete prepared blocks with pistons and rings sryoed, fitted and rings deburred.

Do not be fooled by a lot of false advertising, all cryogenic freezers are basically the same but the way it is done is totally different. Find a person with a lot of experience that knows his metals for proper soak and cycle times. I have already figured this all out. If you would like me to put your parts through either the Cryogenic or Stress Relief Shake Processes please feel free to contact me.

I hope you have enjoyed this article which is one of many I will be doing on Briggs and Stratton motor parts, engines, oils, cams, complete assemblies, etc. We will be testing Cast-iron and Stainless Steel nickel coated cylinder liners from England in the near future.

NOTE: If you are going to re-ring your engine on a engine freshen up rebuild a fine 400 grit or finer ball hone is OK to use, WD40 works well as a lubricant when ball honing. Always use your Torque plate. Remember one of the biggest problems of ring seal is your engine oils and additives. More horsepower, sometimes means less ring seal, be careful. My next story Oils, Lubricants and Oil additives.

Always remember we make Horsepower, not promises! by Joe Mondello

**This page is reserved for stuff I really hate!**



We had a really good coffee pot, it made great coffee; but it was getting older and didn't look shiny and new anymore. One morning I walked in and found this **Kitchen Aid Pro 12**. It has an advanced display that tells you how long it's been since the Coffee was brewed, the Wife loves this feature because I can no longer lie to Her about when I made it. If the telltale says it was made 1 1/2 hours ago; it gets dumped when she makes her way into the kitchen.

Having a Coffee Pot 'RAT' on you is not the problem, having a coffee pot that has a defective valve on it is. Sharon took the first one back to the store for a replacement, but the second one is no better.

**But this is not the real problem.**

This coffee pot works like it was designed to spill or drip coffee from both the basket and the coffee pot itself! The problem is the connection between the glass pot and the piece of plastic that forms the rim and handle. As amazing as it seems, the rim is designed with small ribs that create a small air space between the glass pot and the rim. This routes the coffee between

the rim and glass; down the outside of the pot as effectively as if the designers intended it to work that way. If they had a product test team, I hope they hunt them down and shoot them all.

So here's my thought..... if you hate your Father-in-law, buy one of these for your Mother-in-law for Christmas, she'll be telling him to wipe off the kitchen counter and be asking him to chase spills all over the house till they both get smart and throw the damned thing away.

I'm left wondering..." who's coffee pot they have in the Boardroom of Kitchen Aid?" .... I bet it isn't a Kitchen Aid Pro12.

All the best,

George B.

## Engine Cooling Systems

There's a number of ways to implement a cooling system. This is the page where I will eventually pull this information together in one place. Always remember hot water and steam are dangerous, this information is for educational purposes only, never mess with any of this stuff.

### Hopper/condenser

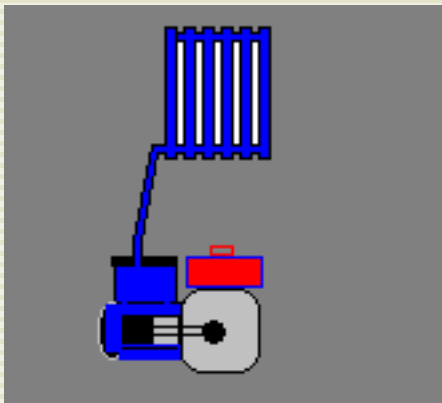

Above is a picture of a Chinese Horizontal, connected to a cast iron steam radiator out of an old house. You can buy these for so much a fin at salvage places, and recyclers of vintage building materials. There's a place in Seattle that charges about \$8 a fin for the plain Jane units, the more ornate they are, the more per fin you pay. You simply unbolt the top of the cast iron hopper; make a plate with a pipe fitting in the top, bolt it in place, and connect it to a condenser as shown. lots of other things can be used for the condenser. If you dare to be different, I would imagine one of those aluminum street light poles would work for a condenser.

Hopper systems have advantages and disadvantages. Hopper cooling systems remove the heat via steam. As an open system the steam rises into the air carrying off the excess heat. Open systems call for water to be added, there's usually a float or flag that indicates the hopper is low. The engine runs at a constant temp and if the elevation at which you are running is not too high, it will be near ideal for a hard working diesel engine. Hard water can rapidly deposit scale around the cylinder and impede the transfer of heat to the cooling medium; this can cause severe problems. I have heard of people using light acids to remove rust scale, and others suggest setting up a rain barrel to use as cooling water in an open hopper system. One of our readers reported a major build up of deposits in a few hundred hours of running a open hopper system on hard well water. Butch Philips in Cowiche asked that I build him a hopper cooled gen set, I delivered it to his Elk camp this year, he fired it up at 11F degrees and became concerned about the clouds of vapor coming out of the hopper, In real cold weather, it

looks like a cloud generator when you get a good load on it. If you haven't seen this, it's pretty cool.

Some readers have written to inform me that there were numerous hopper cooled **closed** condenser systems in use on the old work engines. These systems allowed the steam to rise and carry off the heat to a condenser (in the form of steam). The steam then condensed in an area remote from the hopper and the water trickled back down the same tube and back into the hopper. Looking at the old cast iron steam radiators used in houses, one might think a small water cooled diesel and one of these finned steam radiators could be put together to form a very effective heating and cooling system. In addition, one would only need to run one pipe (or high temp hose) to the steam radiator. of course it would be wise to assure that this pipe was slanted upwards to the condenser with no low spots in the middle, and that a proper relief valve was added. You'd also want this valve to be able to vent in a safe direction. What you'd be doing is capping the hopper with a plate, and running a single hose or pipe to the condenser. In effect, you'd be using your engine as a no/low pressure boiler.

I remember being in Ralph Akana's shop one visit; Ralph was born in Kauai and is one of the best wood workers and craftsman I've ever met. He lives in Northern California where fly fishing is good.



Above is one of my prized possessions; and an example of his skill; this net is all hand tied and the wood was bent in a piece of pipe laid across his stove. At the time Ralph was showing me his method of bending wood; I didn't fully understand what was happening.

Ralph would cut long pieces of wood and put them in a long piece of pipe with pipe threads

on each end. He added a certain amount of water and put the last cap on. One end was laid across his very hot shop stove, with the slightest of inclines going upwards to the other end. What he had created was a closed steam condensing circuit. Steam would form, run up towards the far end, condense and run back towards the stove. The process would make the wood very pliable, Ralph would pull the wood from the pipe and force it into a jig to cure.

You can use the same principle to cool your engine, leave out the wood, and make sure you have a large enough surface to condense the volume of steam you expect to create. It's always a good idea to engineer in a relief valve for safety. This is something Ralph did not do because he understood he had far more condensing surface than required for his application.

If you have a generous amount of surface area, you will not build pressure, the steam will hit the condenser and immediately condense on the cooler surfaces. Considering this, you could come up with some very interesting condensers that should work fine. And as long as your condenser is higher than your hopper, and the connecting tube between the two moves upwards with no dips. If it's vapor tight, you'll have no reason to add water. Add some rust preventative, but add antifreeze only after you study the effects of what it will do to the boiling point of your coolant, additives will modify the boiling point, which is the operating temp of your engine. If you are wondering how you calculate the operating temp of your coolant mixture, and elevation, put some in a pan, place it on the stove and put a thermometer in it! this will be your operating temp.

### **Thermal siphon cooling systems (no water pump)**

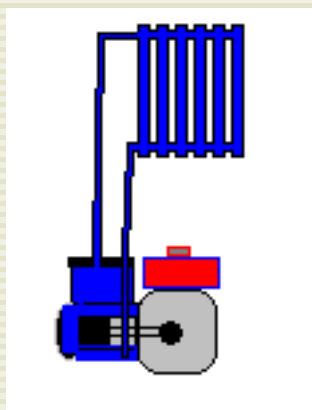

Above is a thermal cooled setup showing a cast iron 'hot water' radiator. You can quickly identify a hot water radiator from a steam unit by looking for the upper and lower fittings, steam (condenser units) have only the lower connections. This system works well with a thermostat just like that found in an automotive system.

Several readers have asked about thermal cooling systems, do they really work well ? If it is so good, why was there a need to put water pumps on engines? Some engine designs move water through jackets on the horizontal for a number of cylinders, This basic design relies on the coolant moving a little faster to carry away excess heat at high power output. You need to look at each engine design to see if it will cool properly without the pump.

**Thermal siphon systems** usually operate in a loop where hot water is allowed to rise from the highest point in the engine's cooling circuit upwards to a high point in the cooling tank or radiator. There's another connection made at the lower end of the tank or radiator that allows

the heavier (cooler water) to push it's way to the lowest part of the engine's cooling system. Naturally, this push is going to displace the lighter and hotter water that will be forced to move upwards thru the engine forcing circulation. It is **critical** that all connections between the engine and tank or radiator move upwards, with no dips or low spots that could allow for a 'deadhead' to impede the movement of the water.

There's a post on an old engine site I was reading that discussed the installation of a gate valve on the lower cooling connection on the engine. The author explained that when the engine is connected to an open tank, this valve was often closed to allow the system to operate as a hopper cooling system. If the operator wished, he could then open this valve to enable thermal cooling between the tank and the engine. Some operators actually tuned the cooling circuit to match the conditions and the type of work the engine was doing...leaving the valve closed operated in hopper mode, opening it, allowed the engine to run in thermal circulation mode which may have allowed the engine to run 10 or more degrees cooler depending on tank capacity and work being done.

If you make use of a car radiator for thermal siphon systems, make sure it's one with the plumbing on the top and bottom verses the cross flow type.

As of 5/2003, I have found that old House style cast iron 'hot water' radiators are excellent for the Lister 6/1. I would imagine they would do well on a converted Changfa as well. They are truly amazing, the hotter they get, the better they thermal, they can really pump some heat into the air, or your room. Some of the old ideas are still best today, the only down side is they weigh a bunch. On the 6/1s, I install a thermostat on the top connection, this allows for a far quicker warm up, it reduces emissions, and reduces wear on the engine. Studies have proven that maintaining an engine at the proper operating condition can greatly improve fuel economy. This is the single biggest gain you can achieve; one engines that are in good condition, with properly adjusted valves, and timing.

In closing, both hopper cooling and thermal cooling work on Listeroids and Chinese horizontals, hopper cooled Chinese engines can be quickly and cheaply converted to a closed system of your choice.

All the best

George B.

[home](#)







## **Our Cabin, how things evolve**

We've had a remote cabin for many years, it a great proving ground for AE (Alternative Energy) solutions. in the begininning, disposable propane bottles fed the cooking stove and the lantern. About 15 years ago, one of our friends bought us a refill adapter that allowed us to fill disposables from a 5 gallon propane bottle. What a significant savings this seemed to be at the time. Put the empty in the freezer for a bit and then screw it onto the adapter. Sometimes you got a complete refill in one shot, sometimes you needed to return the bottle to the freezer for an additional cool down. Some folks make a tool that allows them to open the safety valve for refills, I always thought this was too much trouble, it's a lot quicker to cool em off before filling. If you're smart, you'll weigh a full bottle and have some idea as to what you need to put back in. If you overfill one, it will vent via the pressure relief valve, if you have a bunch of overfilled bottles in the trunk, and you have a spark, you could blow yourself up. Building a simple balance scale could help you to fill at the proper weight. Placing a drop or two of oil into the valve will help you detect an improperly seated (leaking) valve. Sometimes you can plunge the head of a finish nail into a leaking valve and get a proper seat. Only takes a minute to check them. I carry them in our open utility trailer or in the back of the pickup for an added measure of safety. Done properly, it can save you money. You can get the refill adapter at Harbor Freight, and probably lots of other places. If you're not going to take precautions, spend the extra money and buy the bottles or get an adapter and run your stuff directly from the 5 gallon or larger bottles. We will probably use the smaller bottles for years; running the propane torch, using the lanterns outside for yard lights. Lighting in the out house. They have their place, and we have dozens of them.

Propane makes noise, some lanterns seem to make enough racket where they're hard to talk over. On top of this annoyance, they are a safety hazard. The longer you listen to them hiss, the more attractive electric lights get. Of course, you could try kerosene, we did, but it was difficult to get a good wick, good lamp and good fuel all at the same time. There were times I thought we'd be better off with smudge pots. I know some people get the hang of it, but we never did.

Sooner or later, you rediscover the electric light. I used to grab tail light bulbs out of junked cars, I'd collect them in a little plastic box for replacement bulbs and lighting solutions at one cabin or the other. You often start out with a Deep Cycle battery from Wall Mart and run 12 volt stuff. Some folks find a little black and white 12 volt TV and enjoy getting a little bit of the evening news. You can haul your battery back to your vehicle for a charge now and then, but as you would expect this gets old after you do it for a few years, or is it the fact that we get older?

The next step seems to be the modified sign wave inverter. Connect this with short heavy leads to your battery and you will do away with many of the problems found with the poor

man's 12 volt system mentioned above. With the inverter, you can power 120 Volt AC compact florescent fixtures and have bright lights with a lot less current draw off the batteries. I personally like the 13 watt twisted bulbs that are found in lots of stores across the country. You can power almost all the small household appliances off a decent inexpensive inverter, TV, Satellite receiver, blender, electric shaver, Computer, Water pump, and much more. If the Modified sine wave inverter was this cheap in 1980, I would have gone this way from the start. The inverter does use a little energy in the standby mode, but running 12 volts any distance creates more losses than a run of 120 volts AC.

After you start living with 120 volts AC off the grid, you start plugging in more things. You discover direct TV, and how easy it is to run your receiver and color TV off a small inverter. In fact, I found our 19 inch color TV, and DSS receiver ran very well off a \$40 inverter! Ahh, the cabin is getting very comfortable.. propane for heating water, you can take a hot shower, catch up on the news before bed and enjoy the peace and quiet when you want it. Pretty soon you're spending more time there and pushing your system to the limits. [Don and Patti Rowe](#) have the best deals on inexpensive inverters I could find, and I looked a long time, check them out.

You may have arrived at a point in life where it might be worthwhile (or at least fun) to know what the world has to offer in the way of off the grid solutions. There's good news for folks that enjoy working with their hands, lots of this stuff can be built at home for less money. If you have wind at your site, consider building your own wind machine, if you have lots of sun, buy some solar panels and build your own system. If you're forced to use an engine for your power source, maybe there's a way to harness more of that energy and put it to work heating water for the shower or washing dishes?

[George B.](#)



## How to make and manage power off grid.

No matter what you come up with, someone has probably already thought of it or done it. With that said, I don't claim any of this as original thinking, but it all makes perfect sense to me. The following is written in a **random** way and will be added to and changed as time goes on.

Some DIY people don't want anything to do with micro controllers. **NOTE**, if they are deployed properly, you have all the manual functionality remaining if they fail, you have little to lose and much to gain by building them into your design. Furthermore, some electronic stuff is junk, it casts a shadow on all electronic equipment when it fails. I know a guy who has replaced the controller for his gen set (motor home) twice already, that's because it's a junk design .... not because electronics is unreliable.

**I start** by assuming that there will be loads that are not economical to run off batteries, I also assume that the wind won't always blow, and the sun will not always shine, or at least that the associated equipment will not always be on line to make it. I offer arc welding as an example of an occasional load that doesn't make sense to run off batteries, but if one lives off grid, it's nice to have. There will also be times when you have company and the demands exceed all rational design parameters, **they'll come just to see what living off grid is all about!**

The main power source is the diesel generator, it is diesel for several reasons, one being the greater efficiency. The engine is water cooled providing a longer life, quieter running, and a noteworthy by product, hot water; which provides an effective means of storing otherwise wasted energy. The diesel used is simple to work on and has an advanced fuel and oil filter system that helps the engine live a longer and more trouble free life. Of course the controller has duties here as well, monitoring and alerting you to any abnormal conditions.

There are all types of diesels, the ones I'm interested in are heavy cast iron units with proven reliability and long lives. Their massive flywheels help provide a smooth constant speed. The stored energy within them allows a load to be added without the lights dimming like that of a hardware store generator. Many stationary diesels are designed to be repaired in the field, large access covers allow you to get at the guts of the machine in minutes if necessary. The down side, is the weight, some 6hp engines weigh 800 pounds! You won't ship one of these via UPS.

Other important factors are loading, pre lubing, and running the engine within design parameters. Diesels don't appreciate light loading long term, a controller can monitor for under loading and apply additional loads to assure the power plant is happy and running

efficiently.

The study of Marine diesels could provide some clues to longevity. Some suggest that the light weight diesels being sold to the boat building industry do not last any longer than a gas engine. They claim that time kills these new diesels as rapidly as their gas counterparts. Their examples include boats of the same class needing overhauls at the same time interval regardless of hours. We can wonder just how dry an engine gets after it has set for 3 months and is started without a pre lube system? How much damage is done? How much moisture lays in the crank case? How much moisture is brought into the engine during the heating and cooling cycle of a 24 hour day? Have you ever seen a water tight light fixture half full of water? One small pin hole leak will allow moist air to be sucked in during the night and condensed inside the fixture when the sun hits it. Sooner or later, it is filled with water. I am certain that a power plant left outside where the sun can shine directly on it will experience some of this, and it is noteworthy that this moisture can become acidic. Dissimilar metals within the engine can create a current flow and damage important metallic surfaces within the engine. Where you place your Generator Set, and even the color you paint it can have some bearing on it's operating life. any efforts to keep moisture out of fuel tanks and the crank case can pay big dividends.

I figure about 8kW peak will be enough to meet my needs. There are some small Diesels that really are efficient and long life. I once read about a big one cylinder diesel that made electricity for a small town. It was in service for SIXTY years with no bearing changes! The only reason they quit using it was power came to town and the Government subsidies made it way too attractive to ignore.

Some folks will say that we should be kinder to Mother Earth and not pollute the planet with a stinky diesel. My adopted reply.... "If Mr. Diesel were still alive, he might agree with you in part". His engine was designed to burn vegetable oil; a renewable resource and a **clean burning** one at that. If you wish to run your stationary diesel on veggie oil, it could work fine, and veggie oil has more energy per gallon than diesel. (There's info all over the WEB on this subject)...but the trick is making use of the cooling water to condition the veggie oil to pass through the injection pump and the injector, here's another place the controller comes to play, it could start the diesel on diesel fuel, and transfer to veggie when the temp is right. It can also transfer back to diesel and purge the lines of veggie before a shut down occurs. This is critical but easy to do with a controller.

Oh yes, **this system has batteries too**, the generator doesn't roll 24x7, wind power and solar power are Plug In options.

Imagine having the time to watch every gauge, and listen to every noise in your power shed. That's the controller's job, and she'll do it night and day with no pay and take appropriate action should anything go wrong.

### **The basic plan**

If you're going to deploy artificial intelligence, you need a way of communicating information and requests from one place to another. How about using a one wire bus between major appliances and the controller?, a relay would isolate the appliance from the

AC bus. Lets use a Fridge as an example, the resistance across the appliance side of the relay would be interpreted as a (request to run). The controller would receive this request and make a decision based on a number of factors.

Is the generator currently running? When is it scheduled to run next? What is the float voltage of the batteries? Could the Inverter handle this appliance? Depending on the current conditions and the set of rules given to the controller, the mission is carried out. And example might be... The current loads are being handled by the inverter running off batteries, that load might be a few compact fluorescent lights and the 19 inch TV running off the satellite dish.

This time, the controller decides it's worth running the generator, the controller prepares the diesel to start, it sets the compression release and engages the starter, once up to cranking speed, it dumps the compression release and monitors the set for a start. Once running, the starter is disengaged and the set is allowed to warm up at a reduced speed until it comes up to temp, (This is done to extend the life of the diesel and to cut down on emissions). Once the gen set has reached operating parameters, the controller sets the speed to 1800 RPMs and transfers all loads to the diesel except the satellite receiver. The controller pumps water, fills the cistern, recharges batteries, captures waste heat for domestic hot water as well as granting the fridge the RTR, (request to run). Once the controller thinks there's nothing left to be gained by running the generator, it transfers the loads back to the inverter and shuts down the diesel.

If you wish to add solar or wind power, their outputs feed the batteries. The controller factors these sources of energy and may choose to run more loads off the inverter automatically.

This system is being assembled and tested now. The engine under test is a Chinese made German designed 195 diesel. There is a documented case of this engine running for 50,000 hours before being overhauled, there are other engines like some of the Listers that ran 100,000 hours before they need an overhaul. Adding good filters, making sure that the fuel is high quality, operating your diesel at the right temp, and carrying loads only when the temp is optimum, is a necessity if you are trying for longevity like this.

The **controller** is being designed around the ATMEL Mega8 processor, it's loaded with built in goodies that will lower the parts count. There are lots of electronic equipment designs out there that are missing components that protect the circuits from over voltage and current. Equipment often operates for years without it, but when you're off grid, and you are depending on a controller to do a job, it should be well protected from the hostile world that it watches over. **Inputs should be idiot proof**, you should be able to hook up the battery and ground backwards without causing smoke.

One thing that is essential in any installation is a plan to handle **fault current and lightning**. Basically you want to create a path that routes the current away from, verses through you or your equipment. There are week long schools that address nothing but this subject. The one I attended was most interesting. One example of (interesting) is the inspection of grounding, bonding, and ground cable routing in communications centers. **Inspectors often find serious errors** that would have rendered the grounding plan far less effective or even dangerous. I have personally found a number of ground fault cables that pass through a short

piece of metal conduit cast into a concrete wall. Few of us would suspect that this piece of conduit would be a problem, in reality, it acts as a choke and makes it difficult for the fault current in a lightning strike to pass through the conductor. This could cause the lightning to find a better path through your controller, or worse yet... you!

## **Mechanicals**

Picture yourself snowed in, it's light an fluffy, and the trip to the main road via the snow mobile may not be possible for a few days. You have plenty of fire wood and there's 100 gallons of fuel in the generator tank. You can stay here till spring if you have to, and be comfortable doing it.... "if nothing breaks you can't fix".

Then it happens, the snow load on the roof pushes on your chimney pipe and the last joint is pushed apart; your cabin fills with smoke. You think about the summer days you spent looking up and wondering if you should re do that sloppy installation up there before winter; now you get to mess with it at a far less desirable time.

Your generator is no different; do it right and you'll have less trouble. The more things you anticipate the better, but all of them will cost you time, money, or both to address up front. where do you draw the line when it comes to prepping a gen set for an isolated off grid setting? I think it's a personal thing, but if you look at environments where reliability is a concern, you can get some ideas.

I think aircraft is a great place to pick up knowledge of how mechanical systems are made more reliable. In their world, they have scheduled inspections where potential problems can be found before they interfere with the operation of the aircraft. Safety wire is used everywhere, fasteners are literally wired in place. Parts that are 'certified for service' are used; you don't find a piece of bailing wire tying the throttle cable to the carb; or at least you shouldn't

I got an email from a good mechanic that just had a serious engine failure. I expect we'll exchange a number of emails in an attempt to figure how we could have prevented the problem from becoming as large as it was. It appears that something in (or around) the valve train broke off and found it's way to the sump. At this point we think it was sucked up through the inlet screen into the pump. Once this metallic piece entered the pump, it jammed the meshing gears and the drive tab sheared.

### **With no oil pressure, things went from bad to worse....**

I think this is a good example of a typical problem. Had he taken some preventative steps, this could have been found before it did the serious damage. He knows it, we all know it..."There's only so much time to deploy these things".

Here's a few ideas: Place a neo magnet in the pan where steel parts would cling before they could get to the inlet of the pump. Place a neo magnet in the oil return path of the rocker box to intercept and hold any loose steel pieces headed for the sump. Equip your diesel with an oil pressure switch and figure out how to shut down the set when the pressure goes away. This could be done with a solenoid, spring, and latch that would override the connection between the governor and fuel rack, and close the fuel rack when the oil pressure is not

present.

Modify the sump where it is deep around the pump pickup, where the suction action wouldn't suck up small metallic stuff in the sump. Make a bigger pickup, with a fine mesh screen.

**It's all easy stuff to do, but you have to do it before the need.**

**August 7, 2002 Putting more of your BTUs to work ????**

For the last few weeks, I've been thinking of all this waste heat rolling out of the diesel, the cooling tank does a fine job of storing it. The heat exchanger I'm building for the exhaust will capture even more. In the winter, I could find a use for all of it. In the summer it would be nice to use this waste energy to heat a refrigerant and to provide cooling... maybe to run an ice box or freezer?

I started thinking about an air dryer we had at work. It would run on one side, absorb water in a canister until it was no longer effective and then switch to the second canister. The wet side (off line) would be heated driving out the water; when dry, the canisters would be switched and the process would go back and forth. I discussed the idea with my neighbor and friend who works at Boeing. Use two canisters with coils in them to charge with a refrigerant, then heat it via a coil with hot water from waste heat. We talked about Ammonia, ether, and a number of potential refrigerants that might be compatible with the temperatures I thought we'd have to work with. Ether might do real work at 180 degrees, especially if you have an abundance of cooler water to cool down the canister after charging it with waste heat?

Using a micro controller, a few thermistors, a couple valves, a condenser, and two canisters with coils, you could put some more of this wasted energy to work off grid! Come to think of it, you might just conduct the waste heat off the exhaust system to run the heat pump section in a typical RV Ammonia fridge! There's no reason you couldn't put some distance between the heat driven pump section and the fridge itself!

About 3 days after Brian and I talked, he rushed across the street with the latest copy of the "Boeing Frontiers" magazine. He had it folded back to page 35, an article titled "Hot idea to cool down".

Here in the magazine is Craig Christy extracting the heat from a diesel exhaust and using it to potentially cool one of those refrigerated Vans without a compressor! [Scanned Article](#).

People can curse diesels, but if you could capture 75 percent of the BTUs in diesel fuel and put them to work, you'd have some mighty cheap utility bills, and it looks like Christy is going to show us how.

More to follow.



George B.



# Hot idea to cool down

Boeing engineer is getting national attention for his efforts to turn diesel exhaust into cooling agent

By Bob Howard

Imagine getting energy from the diesel exhaust of 18-wheelers, or an environment free of diesel or heat pollution. For most mortals, this would seem hard to fathom—but not for Craig Christy.

A Boeing engineer based at Huntington Beach, Calif., Christy spends his "free" time hot on the trail of a new way to cool things down.

Christy is working toward a new way to refrigerate the hundreds of thousands of truck trailers that carry food goods and other precious essentials, crisscrossing the world's highways day and night.

Christy recently won an award from the U.S. Department of Transportation for his efforts to capture diesel exhaust, run it through a passive, charcoal-adsorption compressor that would take out the heat and then provide refrigeration or air conditioning out the other end with no added emissions. (Adsorption refers to molecules accumulating on the surface of a solid or liquid; Absorption is to take in, or as if in, through pores.)

The idea has a number of other applications, from satellites to ship containers. Basically, wherever heat is generated, it can be reused to create cold air via a passive ammonia-adsorption system that requires no mechanical compressor, engine or fuel.

At Boeing, Christy is project lead engineer for Fluids Systems and Propulsion Systems for various spacecraft projects. He has received special recognition from NASA for his contributions on the X-43 Hyper-X program.

Christy is currently pursuing a Ph.D. in Engineering

and Applied Mathematics through a joint program between Claremont Graduate University and California State University Long Beach.

Christy's findings and research laboratory at California State University Long Beach have been the object of two federal grants, of \$50,000 each. His current research involves improving efficiency and sizing the units for truck trailers and containers. Already he has achieved constant cold air, flowing at 40 degrees Fahrenheit, from the lab version.

So how does it all work? The units would be built under a sub-floor inside 40-, 50- and 60-foot-long refrigerated truck trailers. This new vapor compression concept takes advantage of the ability of certain materials such as activated carbon, or charcoal, to soak up a relatively large quantity of ammonia refrigerant at a low temperature and low pressure.

The activated charcoal material would be stored in a canister or sorbent bed. A minimum of four sorbent beds allows a continuous flow of compressed refrigerant through the system. Of the four beds, one is always kept hot and one always cold; the other two are either becoming hot or becoming cold.

This temperature cycling replaces the work a mechanical compressor does. Like today's mechanical compressor, Christy's thermal compressor will create high-temperature, high-pressure gas.

That gas is acted on through another part of the system that releases the pressure, which drops the temperature and creates cold air.

"The technology has a unique potential for applications generating substantial waste heat," Christy says. "A modular sorption system would thrive on the plentiful high-temperature waste heat available from most transportation systems compared to the costly work input required of conventional mechanical air conditioning compressors.

"In hot and desert climates," Christy notes, "where cooling is most desired, this system is particularly attractive, because energy required for heating the refrigerant can be accomplished entirely by solar energy. The higher the intensity of solar heating, the more cooling can be made available."

Future experimental work on this system will include a detailed characterization of the adsorption beds, and optimization of temperature limits and cycle times. ■

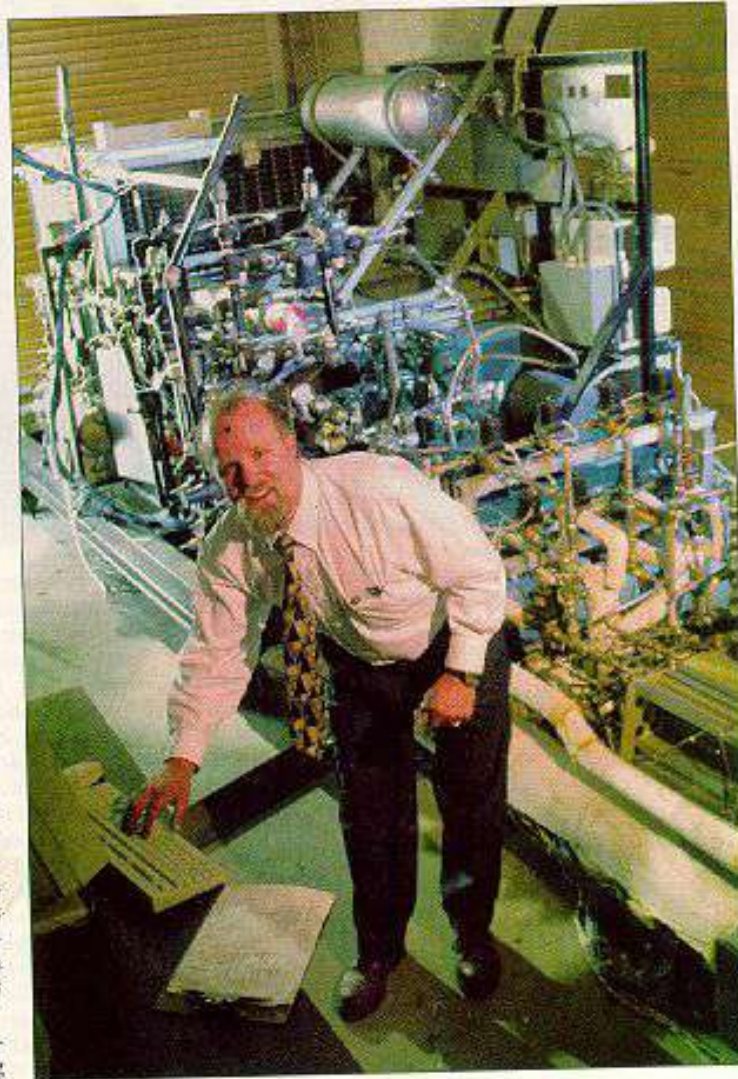

Craig Christy recently received an award from the U.S. Transportation Department for his cool ideas on diesel exhaust.

# Utterpower.com

**Epicyclic transmission ? So you think you've seen it all, and know about every mechanical gear box type ever created? Ever seen a high reduction gear box with one gear? You won't see the inside of their gear box here, but you may learn a few things.**



**Meet the Spanski Brothers, 'Stan and Howard'....how do you make a reduction box smooth, constant, reliable, long lasting and remarkably small? Stan and Howard know.**

Ever see a powered bicycle climb out of steep ravine that some folks refuse to walk up? The Spanski brother's bicycle will pull it with a 250 pound man on it, with a weed trimmer engine for power! A bike you can choose to pedal with no drag of the ultra light power train.

This is a serious gear box designed for the long haul, let your mind carry you along as you think of the endless possibilities! One day you'll find this reduction box in countless devices. Why am I so sure of that? Because it has fewer parts, it's stronger, it lasts longer, and it's cheaper to make...

<http://sbgearing.com/>

George B.



Coatings and Finishes, This is another living document, stuff may be changed or added in a random order.

Many DIYers take the time to research and de-bunk some of this stuff. I often turn to aircraft engines and associated documentation thinking that this may be a more reliable source of information.

Do you remember **Slick 50** ?, It was expensive, it was hype, and it didn't work.

Today there are even more coatings with suppliers claiming they do work, they offer evidence and suggest you and I can apply some of these things at home. Many of these products came out of the space program. Some of them are used in racing engines where piston skirts, piston tops, combustion chambers, and more are all treated. Some act as thermal insulators, others make the metal shed oil and return to the pan faster. It seems there's a coating that will accomplish most of what we DIYers would like to have, and these coatings are becoming cheaper and more available. Some claim dramatic horse power increases when they apply thermal barriers and dry lube coatings that get baked on at temperatures as low as 300 degrees. Does this stuff really work??

What is available to the DIYer? .... Is there a wonder substance that can be sprayed into a cylinder bore and bonded there to improve cylinder performance? As you may know, there's a number of Chrome finishes that have been used for many years in cylinder bores. Possibly the biggest benefit is the surface's ability to inhibit rust. This could be a worth while advantage if your engine is left setting for months at a time with no use. From the little research I've done, some of these old Chrome processes are less effective than modern finishes, and it appears they can have a down side over a good steel cylinder bore of the proper composition, so maybe we should do some research before we wish we had a chrome cylinder bore in our generator.

Manufacturers of slow speed diesels suggest you pull the head periodically and remove the carbon. Would some of these wonder coatings prevent the carbon build up? Several of the companies that make this stuff say it will. A small Changfa or Lister powered generator with a test load could tell the story in a hurry.

Here's two Links <http://www.performancecoatings.com>  
<http://www.microsurfacecorp.com/wear.htm> where you can get a flavor for what's going on if this subject is new to you.

Another worth while read is what has been applied to cylinder liners, and what is being used now. I offer these links to get you started. If you find something interesting, consider emailing me the link and a little about what you found.

[http://www.eci2fly.com/Tech\\_Ref/BreakInInstructions/bi5.htm](http://www.eci2fly.com/Tech_Ref/BreakInInstructions/bi5.htm)

<http://www.radialengines.com/faq.asp>

**Following are other links readers have mailed in, don't have a clue if this stuff is for real or not.**

<http://www.luboron.com>

<http://www.motorkote.com/mktech.html> This one is so special, they don't tell you what it is!

If you have first hand experience with any of this stuff, 'as it pertains to small engines', consider sending me an email.

George B.



## Salvage

Just a reminder that the best deals are at the salvage yard, and the best yards are those who are selling metals by the pound, that's where you get some decent deals. If you give them a dollar for something they would have sold for 3 cents in weight, you both come out ahead of the game. Pick up a coffee for the guy, don't get in their way, and make it worth their while to have you around, you'll be amazed at what people throw away.

I have an EZGo golf cart I picked up at the Salvage yard, the guy brought it down because it had a dent in the sheet metal in a corner. He backed his trailer up, pushed it out and left...I bought it from the Salvage owner for \$100, easy money for him, and a great deal for me since it is a very solid and reliable cart. I use it to pull my mower deck at Easton, it has a beer holder, a nice top to keep the sun out of your eyes, and far more comfort than a garden tractor.

Few things in life are more rewarding than finding that expensive part you were about to buy in salvage for pennies on the dollar. I found two 6309 ZZ bearings new in the box for \$2 a pound at Boeing surplus.. Thank goodness I remembered that these fit the slip ring end of the 10 and 12 KW STs.

Dropping by Binford scrap metals, I found a nice box beam for the Lister gen frame, \$4 beats the heck out of \$100 plus I'd pay for new metal.

## Monitoring temperature



Here's a trick that has paid dividends for years, See the display piece my wife leaves on top of the wood stove.



Moving this old toaster aside reveals some little metal disks I've pulled out of electric furnace heater relays, common electric water heater contactors etc. You find these in lots of junked out stuff.

Basically what they are is a bi-metal disk, two metals fused together have different expansion rates and change from concave to convex (in this case) with a 'snapping' sound when they do it.

When I light the stove, I know things are going well when I hear these little disks start snapping when they reach (their) critical temp, the toaster helps contain them since they will

eventually jump off the stove. I also know when the stove is running low on wood, and when to add more... If I forget, the disks snap and alert me.

These little disks can be used for lots of other things... I'll leave that up to your imagination.

George B



# Utterpower.com

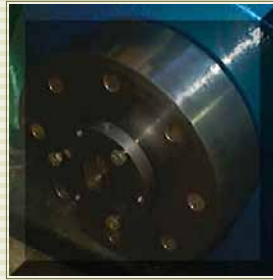

Custom Pulleys

(NEW)



Custom Direct Drives

(Newer)

Three phase power for the shop

Home Power with Harry Anderson

The ST Generator Head

The Plan!

DIY Automated Charger, 2 cylinder, 300cc with welding capability.

DIY Belt Driven Chinese 195 Generator Set.

DIY Belt Driven Lister 6/1 Generator

DIY Belt Driven Lister 12/2 Generator

Off Grid Water Supply

Fuel Storage for the Generator

DIY VW Pickup?

DIY Heat Exchanger Harness the waste heat from your diesel

Petter powered Diesel Generator (coming soon)

## Micro Hydro Turbine Generator

The Cowiche Project, developing an 'off grid' site with long life fuel efficient components.

[Should you add a bypass oil filter?](#)

[Home](#)



**We** built our high mountain cabin on ground covered with volcanic ash. At the time, my wife and I wondered how long it would take for nature to hide the evidence of the latest eruption of Mt St Helens. That was 1980 and our cabin has undergone many changes since then. Come to think of it, so have we. As we grow older; we seem to be attracted to some of the luxury items; like electric lights, an indoor shower; and although the satellite dish is not a must, it's nice to connect with the rest of the world from such a remote place. This all becomes possible with a modified sine wave inverter, I bought a unit from [donrowe.com](http://donrowe.com), it really runs everything we need at the cabin, and then some. And most important, it's quiet, why go where it's quiet only to make noise with a generator?

All these comfort items triggered the need for a better way to charge batteries. We have a little Coleman generator designed for light duty; with a 10 amp 12 volt charger built in; but one quickly learns that 10 amps isn't much for charging batteries if you're running a 19 inch TV, direct TV receiver, compact fluorescent lights, water pump, and other miscellaneous loads. Sure; you can buy a battery charger and power it via the AC outlet, but is there a better way?

While traveling the net, I came across <http://www.qsl.net/ns8o/welcome.html>. Greg has constructed all kinds of chargers out of used engines and junk yard treasures he's found; a great site to visit.

After thinking about Greg's hobby for a while, I decided to get a broken DC gas generator out of the corner of my shop and do something with it. The generator section was bad and I decided to order a rebuilt 100 amp GM auto alternator from a place on the net. I think it was around 50 some dollars delivered to my door, and to my surprise, it was nicely rebuilt.

After mounting a cheap aluminum 6 inch 'A' type pulley to the crank, I welded a bracket up for the alternator and found a small belt to fit the need. I hooked the unit to a junk battery and noted **75 amps** of charge rate. If my basic math holds up, that means I could deliver the same charge to the batteries in 4 minutes verses 30 minutes it would take with the Coleman charger, WOW, that's what I call noise reduction if nothing else. I made up some leads and decided to haul this charger up to the cabin next trip.

It was Elk hunting season, three of us packed up for a 10 day hunt out of the cabin. The Gen. set got thrown into the utility trailer and buried with supplies. When we arrived, we set up two deep cycle batteries outside and dropped the Gen. set a few feet from the batteries. One evening; we were watching a movie and **the inverter sounded it's alarm; "low voltage!", "feed me or I'm going to dump your programming!"**. I grabbed the flashlight and went out into the night to start the Gen. set. Where's the rope? I hadn't returned it to it's place, I shined the flashlight around looking everywhere. The wind was blowing about 25mph, and I could see snow flakes in the beam of light. I found the spare starter rope and wrapped it around the pulley, six pulls later the set was running and I bolted for the door. I quickly claimed the seat next to the wood stove and caught up with the movie. In the back of my mind, I was planning the next enhancements to the charger, "going out in the middle of the night to crank up a cold Gen. set is not my idea of fun".



In the photo above, you can see one of the added components, (a starter motor).

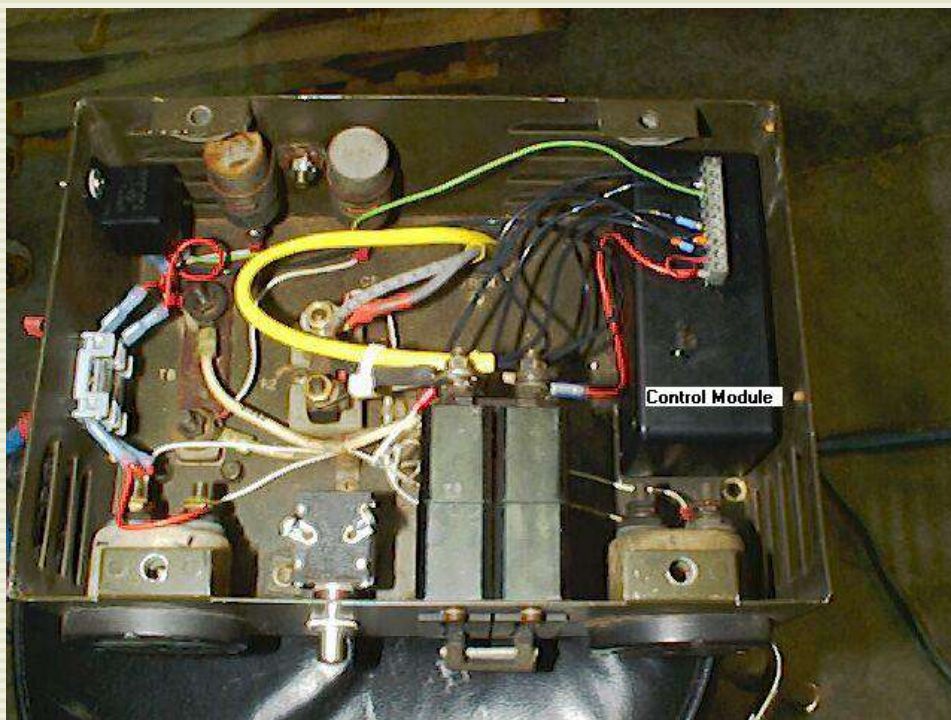

Just as important are the changes made in the stock circuit breaker and control cabinet. The black box stuffed in the corner houses the Stamp micro controller. When the batteries discharge to a threshold defined in software, the Gen. set comes to life, the 'Monitor' software module passes control to the 'Start' module, when it's completed the task of starting the engine; it passes control to the 'Run' module, etc. The processor gets most of it's data through two dedicated Analog/Digital Converters (ADCs). With these inputs, the software can do a fair job of monitoring the power plant. Other benefits of the controller are logged runtime totals, logging of battery readings, error logs, and other things that can help you keep track of maintenance requirements and the performance of your batteries. There is also extra I/O for adding features including a serial port that allows the controller to pass on status and data to other intelligent devices.

I have learned a great deal constructing this Gen set, first off, don't use cheap pulleys! Cast iron works well for an application of this type. Another thing I learned... **properly designed electronics are reliable**, getting the mechanicals right was the biggest problem for me. Take care in alignment of pulleys; designing good belt tension adjusters, and that sort of thing. As for software, how nice it is to write changes verses redoing hardware, and it's far easier than you might think.

The starter motor is a 12 volt permanent magnet design used in a city transit bus as a cooling fan motor. It is rated at 3/8 HP at 2800 rpms as a motor and delivers around 35 volts at governor speed in this application. I found the output could be used to arc weld; using Wall Mart 6013 5/64th rod; it does a great job on 1/8 steel, move to a smaller rod, and you can easily get enough penetration to weld much thicker material. Most important, it spins this engine to a start every time.

According to what I've read, car alternators are inefficient devices, a typical auto alternator is about 50% efficient. This isn't a big thing for this application, but if you were looking to get your monies worth out of a gallon of fuel, you would **NOT** build around a stock automotive alternator. There are better ways to get the job done, I am working on a small fully automated diesel charger with a highly efficient generator section, look for it on the '[projects page](#)'. Regarding auto alternators, check out [ELenz's project](#). You might look around at his 'other stuff' while you're there .

Following... pictures of the country around the cabin:



Tampico, WA. is the closest gas stop, although they only have one pump, they have a parade each spring and fall.

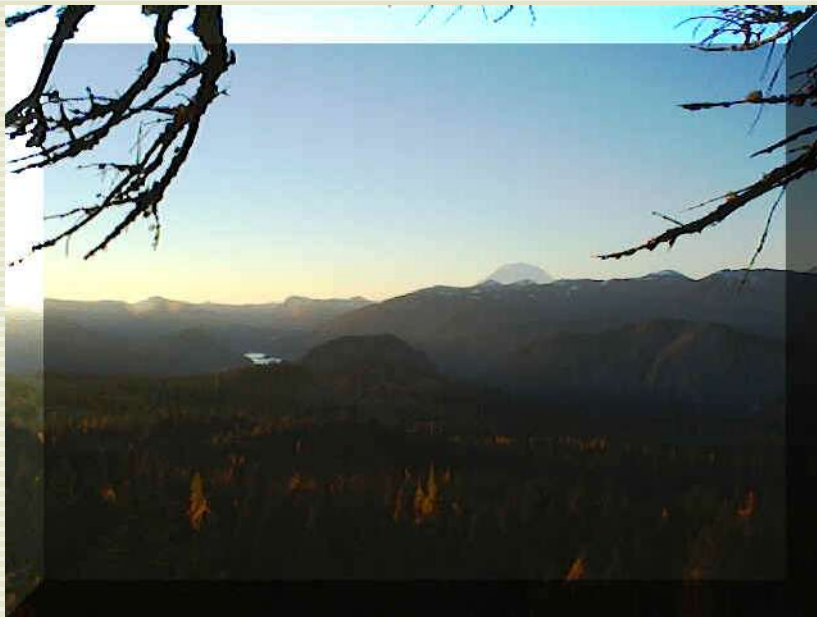

Louie Way Gap, 'not far from the cabin' ; that little bump in the back ground is one of our volcanos... Mt. Rainier, and that little puddle of water in Rimrock Lake.



Mountain Sky



The addition goes on.

**8/23/02 I'm planning an all out 'Off grid' power system for the Mountian Cabin, take a look.**

George B.







Over 20 years ago, Kathie Costanich discovered a plant growing about 100 paces from our high mountain cabin. She came over to the construction site (we were setting rafters on the cabin) and explained that there was a plant down there that was a known indicator of water close to the surface, "George.. you need to get a shovel and start digging". I remember telling Her that we had work to do, and I thought she was nuts. I pointed out the shovel and told Her to start digging!

Wouldn't you know, She dug down about 14 inches and hit water. This is dry country, plenty of pines, and an occasional spring, and Kathie finds it just down from the cabin. As you might guess, I ate crow for a few meals.

Since then, I have dug down about four feet and put a cover over the water supply. I remember one rare day when the temperature hit 100 degrees, the spring water was 40 degrees and the Pepsi and other refreshments submerged in the water felt so cool. In fact, sticking your hand in the spring was almost painful.

It seems like things evolve over the years, as I've said elsewhere, when you're younger, running up the hill with 5 gallon pails of water is no big deal. Then you get the idea to siphon water down hill to a shower, and finally you start thinking about pumping the water uphill to the cabin.

The first set up was a 12 volt shurflow pump. I'd charge up a 12volt deep cycle and lug it and the pump down to the spring, I'd hook up two garden hoses and pump water up hill to three 55 gallon plastic drums. then I'd reset the pump and battery at the barrels and pump the rest of the way to the cabin.

The next step was to add on to the cabin and have a real in door shower and a utility sink to wash dishes, wow! what an improvement.

The biggest problem I had with the shurflow and the garden hoses was leaks at the couplings and priming the darned thing. I should have bothered to place a foot valve but I never remembered to buy one and take it to the cabin. The Shurflow pump cost me about \$50, I think they are a good buy for the money. I was lucky enough to get a nice large pressure tank with an air bladder (for free) when a nearby house was moved and the well casing pulled. I used the Shurflow to pump about 40 gallons into this tank. You can wash plenty of dishes and take a number of showers before you need to supply power to the pump for recharging the tank.

As I've mentioned elsewhere, I'm planning to place a generator for the heavier loads and battery charging. I'll also use the inverter for the smaller loads and a home made controller to manage the system. With AC available, I will test a number of cost effective products to see what works well, and what doesn't.

To my surprise, the inexpensive inverter I purchased from donrowe.com has no problem starting an apartment sized fridge, and an intermediate sized sump pump. Is it possible that I have now found an inexpensive, compact water system that will run off a \$188 dollar Inverter?

Water supply gets a major upgrade in 2003, stay tuned for the story.

George B



## **Fuel Storage, A Living Document**

I've been looking for a fuel tank for one of our off grid locations for some time. What I wanted was something free standing, rugged, with a built in fuel gauge, and an area in the bottom designed to collect any moisture.

After looking at everything from a plastic barrel, to a paint can, I drove by the wrecking yard and noticed an old van body with an old Thermo King refer unit still attached. A large fuel tank (40>50 gallons?) was mounted under the trailer body. What was most interesting were the mounts. Two heavy gauge steel straps support the tank as part of the mount. The unit is suspended from two heavy angle iron pieces which bolt through the trailer rails.

Remove the unit, loosen the straps, rotate the tank within the straps 180 degrees and you have a free standing tank with feet and hole to bolt it down if you like. This tank could be mounted to your skid or left free standing outside your power shed.

Just think how many years thermo King has had to get it right? The bottom of the tank has a small square box build into it, and a plug to drain the water off the bottom of the tank. the fuel pick up comes off the top of the tank through a dip tube. There's a fitting for the return line from the injector(s) and a small vent tube. This could be the perfect tank for an off grid cabin. If you're staying the winter, I would imagine you could use a bigger tank.....

May 15, 2002, I cleaned the tank up and re- primered everything, next is a coat of white paint. I think white is the only color to paint a fuel tank... my thinking is based on heating and cooling and the fact that sucked in air contains water that could condense in the tank. White causes less heating and the lesser temp differential reduces the condensate.



Finding things that work without fabrication is the way to go.

**8/9/2002**



Here you can see the stand made from an old oil barrel stand cut down. Note the frame is Listeriod Green.



Here is the fuel filter and water trap. Note the primer button, this will work nice should I ever run out of fuel.

I plan on putting a canister full of silica beads inline with the air vent tube. What I've read so far has convinced me that water in the diesel fuel causes storage problems, and if you have no moisture in your fuel, you can keep diesel for years with no problem. Seems reasonable to take this step, especially if you find a great deal on the proper beads at the surplus store like I did. Here's a link to a page with a [Silica Bead FAQ](#). There's plenty of places to buy it. Here's another link to [How Stuff Works for Silica Beads](#)

1/16/03

I've been looking at those neat plastic tanks they sell for out boat motors. We have a 'G.I. JOES' near by that sells a six gallon tank for \$19.95, (larger sizes available) they have a neat carrying handle built in. I find it far better than a fixed gas tank on a gen set. If you set them up with the hose, connector, and squeeze bulb, you can easily prime everything right up to the injection pump with ease. Consider making a bracket for this tank, and leave yourself with the option of pulling the tank whenever you want.

[Home](#)

[George B.](#)

# Utterpower.com

How do you learn to do body work? I learn by doing...so here's my learning project. The reinvention of the Subaru Brat?

In any case, I start with a \$250 4 door Dasher (Diesel); If I totally screw up, the engine comes out and is put to work driving a generator head.



If you have a die grinder and a box of those little cutting disks, you can make a 4 door look like this in a few hours time.





Looks more like a pickup than a four door don't you think?



Here you can see what's left of the rear door. The inner section of the door is left unmolested and is welded shut. The outer skin is cut and sectioned.

One thing for sure, there's plenty of parts I'm flinging into the junk pile, and the weight reduction is starting to add up, sun roof, rear windows, window winders, rear seats, arm rests, and more, it all adds up to weight reduction that might improve mileage ???

11/28/02

As the weather changes, so do my projects , Randy Almand volunteered to come over a show me the basics of applying bondo.



On the left, you can see the application of all metal, on the right, the bondo.

[Home](#)



Welcome to the Limited Edition Generator Set page, I will be building one or two sets each year, these are show piece efforts and usually take a minimum of **10 days labor to build...**usually far longer. When I look at this set, I picture a crowd gathering to watch it run, the big flywheels turning, the gentle clatter of push rods, and lifters, the soothing sound of an old Lister. I think of a Latte Stand all light up in a tourist area where there is no power. I think of people pulling off the road just to watch the engine run, and deciding to buy something and watch. Pretty soon, people are pulling over to see what other people are looking at.

The one I've just completed is painted a Dark Hunter Green, this is a green with some blue in it,... reminds me of an antique color and looks just right to my eye on the old Lister. This unit is built on a heavy eye beam frame with my track system, and the custom built Allmand pulley which is a master piece of machine work itself. The eye beam frame and the sub assembly average two days to cut, weld, assemble, and paint. no two frames are exactly alike. I strive to find old eye beams with well know American steel company names in the beams. completed frames are primed and painted Dark Hunter Green to match the Engine and head. Frames are 200 pounds alone!

The generator head is a 3KW ST head **with two separate stator windings to allow for full 115 volt output as well as 115/230.** This unit is capable of point one two zero (.120) gallons per KWH at 2500 watts load! The head has an all brass slip ring cover with brass latch, built in Square D breaker box, breakers, etc. the head is also painted Dark Hunter green, the bottom of the fan housing is fitted with a mouse guard, screens on fan housing are custom pieces made of metal fabric and powder coated. All wiring sleeved, new high quality lugs, soldered, heat srinked, and more.

The rocker arms and many pieces have been re-worked, smoothed, and powder coated a rich glossy black that looks like baked on enamel from years past, they look like a piece of glass.

The engine has thermostat controlled cooling.

The head was removed, dial indicator used to identify exact TDC, timing marks located on fly wheel, engine precision timed. Tappet guides pulled and blue printed, Tappet faces polished, ports inspected, and blended when needed. Cam cover ground smooth and powder coated.

Air intake modified to receive superior and far less restrictive dry element.

Start handle, ground, powder coated and fitted with a custom turned cherry wood Handle built by a local Craftsman.

This set has an insane amount of work in it, it looks like a master piece from the past, I think

others will consider it a piece of ART. Few people would ever guess that this is new equipment. It comes with Listeroid tools, spare brushes for the slip rings, spare brush holders.

This particular unit is **\$3500** plus the cost to pallet ship, the unit is 42 inches long. Put it out in front of your business, you'll probably double sales, put it in the corner of your hardware store, and people would be coming in just to look at a design from the past that works great today.

Email me if you're interested, Pictures to be posted soon.

George B.



## Travel

During my Navy days (late 60s), there was a rumor that we had a shot at Australia as a liberty port, the crew was nearly manic at the mere possibility that we might visit there, unfortunately we didn't make it.

As the years have gone by, I have never spoke with an American that hasn't fallen in love with the People of OZ and their Country during a visit.

There have been times when I have marveled at mechanical master pieces only to find that they were conceived, designed, and built in Australia. There's a vast engineering talent down there to go along with all the other things you may know of.

If you're planning to leave the country for a vacation this year... why not visit Australia?

[George B](#)

[Home](#)



Visit Steve Gray's [oldengineshed](#), you'll be amazed!

[Greg Weinfurter](#) turns discarded stuff into useful power plants, learn about converting induction motors into generators and how to make gas powered battery chargers. It's a fun place to visit.



**Wanted:**

I'm looking for a nice used **4WD quad** in Washington State; 300cc and up machines are fine. If you are thinking of trading one in, please write me, I'll pay cash for a good machine. I also have several Lister singles and twin generator sets that could become part of a trade, they are works of ART with many hours invested. Send me an [email](#).

**Wanted:**

First Hand stories and experiences with the Lister Singles and Twins, we've heard you couldn't wear them out, we want to hear from more folks that used them or grew up with them. Please write me if you have a story to share.

Thanks in advance,

[George B.](#)

Thanks in advance,

[George B.](#)



One of the most helpful utilities I've found. **Convert** can help steer you towards reality when it comes to expectations, just drop it on your desktop where it's handy.. [download page](#)

Are you thinking of blending or making a fuel for your diesel? Try this Link..<http://www.biodiesलगear.com/documentation/index.htm>

Need a formula to figure pulley sizes ?

$$D2 = D1 \times N1$$

---

$$N2$$

D1= Diameter of pulley on engine  
D2= Diameter of pulley on generator  
N1= RPM of engine  
N2= RPM of generator