

Appendix



Nautilus Water Turbine Inc.

2131 Harmonyville Road
Pottstown PA 19465

voice: 610.469.1858
Fax: 610.469.1859
www.waterturbine.com



Importers and Distributors for



Appendix

Index

Water Turbines Explained.....	3
Site Evaluation-Head and Flow Measurement.....	12
Invoicing a Small Stream.....	12
Measuring Head.....	23
Measuring Flow.....	24
High Head-Low Flow Head Measurement.....	25
Estimated Flow From Pipes.....	26
Site Design Information.....	28
Flow in Flumes and Ditches.....	29
Improving Waterpower.....	30
Head Loss in Black PV C Pipe 1”-4”.....	32
Friction Loss of PVC Fittings.....	33
Friction Loss-Sched.40 PVC to 42”.....	34
Sluice Gate Calculations.....	37
Key Waterpower Formulas.....	39
Discharge Through Nozzles.....	41
Miscellaneous Formulas.....	43
Conversion Factors.....	44
Electrical Information and Formulas.....	45
DC Motor Wiring Diagrams.....	45
DC Motors and Circuits.....	46
Wire Size vs. Voltage Drop.....	48
Electrical Formula.....	49

Introduction to the Appendix

This appendix is made up of a number of articles on micro hydro and pertinent charts and tables. I have accumulated this information over a period of 25 years.

Many of the informative articles are reprints from hydro books published in the early part of the last century during the hydro hay days. Most are scanned in their original form. This may give a funky appearance, but the data included is still pertinent and often hard to find.

You'll see from the index that the appendix is broken down into sections. Site evaluation includes how to measure head and flow. These are two of the key factors that determine the power available.

You'll also find excellent data on the sizing of penstocks and canals. If this process is done incorrectly it will greatly impact the production of the site.

Sections on Key Waterpower Formulas and Electrical Formulas may be over the heads of some, but I recommend that one absorb as much as possible and use this practical information as a springboard to further research.

Please understand that while we have assembled this data and believe it to be accurate neither Nautilus Water Turbine Inc. nor its employees or dealers take responsibility for any loss of life, income, or capital that may occur with the incorrect use of the data included in this booklet. Use the information here at your own risk!

WATER TURBINES SIMPLY EXPLAINED

By Lord Wilson OBE, MA C Eng. Chartered Engineer

Waterwheels

Let us start with the waterwheel, the machine first used to obtain power from flowing streams and rivers.

Most of the very early waterwheels looked like this:—

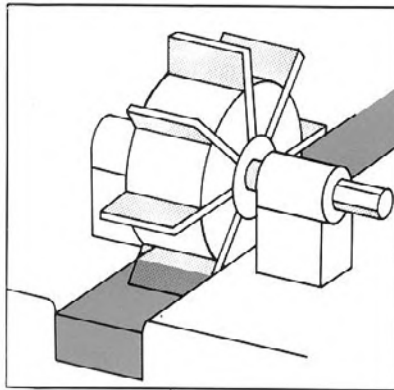

FIG 1 Primitive undershot wheel

They had flat paddles which dipped into a swiftly flowing stream of water. A huge volume of water, even if flowing swiftly, yielded only a very small amount of power at the shaft of the wheel. Then some Roman engineers had a brainwave and thought up a way of getting a greater "head" or "fall" of water to obtain more power from this wheel. Suppose we have a rapid or small waterfall on a river, preferably where there is a bend. We build a weir where there is a bend. We build a weir across the river, cut a channel across the bend and at some convenient point we concentrate the "fall" at the point where we are going to put our waterwheel. We now have the basic principle of the most modern hydro-electric plant. It looked like this:—

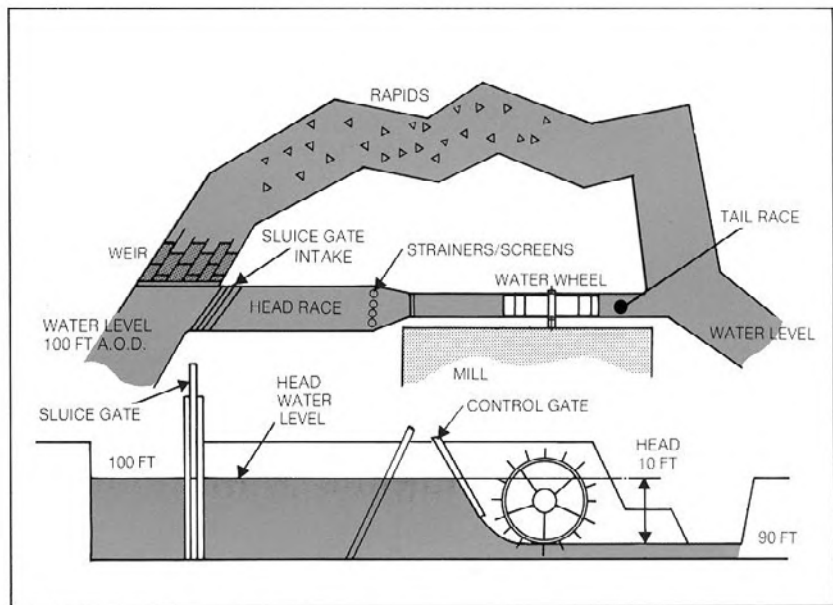

FIG 2 Typical mill with undershot waterwheel

The water is banked up behind the wheel and is admitted through a control gate at a fair velocity. We get far more power from this wheel than if it had only turned in the current of the river and a bunch of new terms – very easy to understand – crop up:—

Head

The drop in level of the water from above to below the wheel.

Weir

A low dam over which the river flows but when water is short it can all or nearly all be directed to the waterwheel.

Intake

Point where the water is taken out of the river to the wheel.

Sluice Gate

Usually arranged at the intake to shut off the water when necessary.

Headrace

Artificial channel, approximately level, leading the water to the wheel.

Strainers or Screens

A series of bars to stop wood and debris choking or damaging the wheel.

Control Gate

An adjustable gate which can vary the flow of water to the wheel.

Tail Race

Artificial channel carrying the water from the wheel back to the river.

This is all painfully obvious but remember the terms because we will use them again with turbines of all shapes and sizes.

The waterwheel described above is an undershot wheel of primitive design. The water shoots in a flat stream from below the control gate, strikes the paddles of the waterwheel and causes it to turn. This type of wheel was very inefficient. If "X" cubic feet of water per second falls through "Y" feet, the potential power (water horsepower or W.H.P.) is $X \times Y$. The maximum theoretical power obtainable from a wheel of this design is only $\frac{1}{2}X \times Y$ and the actual efficiency is about 25%. Clearly there was room for improvement and this was provided by

the "high breast" or "overshot" water wheel.

This also was designed by the Romans and in its most advanced form, in the 19th century industrial mills, it looked like this:—

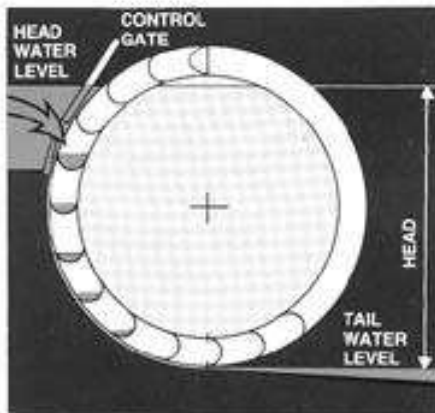

FIG 3 19th Century high breast waterwheel

With the high breast wheel the water was admitted to the curved buckets at the *maximum possible level*. The weight of water in the buckets carried the wheel round and the water was discharged as near as possible to the bottom centre line. These wheels were very efficient – up to 75% or even 80% – and were built to have outputs up to 250 B.H.P. and diameters of 75 ft.

I expect you are wondering why I am wasting all this time talking about waterwheels and not turbines. The answer is that although the two fulfil similar functions of converting the potential power of water falling through a given height into rotation power at quite a high efficiency, the waterwheel suffered from certain very grave disadvantages:—

1. Its speed of rotation was much too low for driving modern machinery.
2. Like all slow speed prime movers it was bulky, and expensive to build.
3. With powerful wheels the stresses were considerable and maintenance high.

4. When a high head and small quantity of water were to be used to develop power, the diameter of the wheel had to be nearly as great as the head. Wheels up to 75 ft. in diameter were built but this was the absolute limit.

5. Only wheels of the very best design had efficiencies of 70% to 80%. Many, particularly low head wheels with flat paddles, were very inefficient.

This is not an occasion to hold forth on the history of water turbines; suffice it to say that the first effective turbine was invented in 1827 in France and developments have been going on ever since. The waterwheel went out as the turbine came in, but I must stress the fact that they are not as different as all that, and in the U.S.A. the term "water wheel" is still sometimes applied to a turbine.

Pelton Wheels

The simplest type of turbine, like the simplest type of waterwheel, is the "Impulse Wheel", by far the best known being the "Pelton Wheel".* If a jet of water flows from a nozzle and strikes a flat plate, it is deviated through 90° and half its energy is lost even if the plate is moving at half the speed of the jet to give the maximum efficiency. If the plate is formed so that the jet can be turned through 180° and is moving at *half the speed of the jet, theoretically*, all the energy of the jet can be turned into useful power.

This is the reason for the odd, but now well-known shape of the Pelton wheel bucket.

The Pelton wheel was *not* the first type of water turbine to be used but because it is simple and demonstrates an important hydraulic principle it is the most popular with the vast majority of engineering laboratories. It can be used to demonstrate most of the essential features of water turbines.

Water under pressure is brought to the jet in a pipe. The pressure can be a

natural head from a mountain stream or dam, or can be provided by a pump. It issues from the pipe through a nozzle and all the pressure energy in the water in the pipe is converted to kinetic energy on passing through the nozzle. Put in simple language: a powerful high speed jet strikes the buckets and spins the wheel round. It gives up all (or nearly all) its energy to the wheel and drops into the tail pit below the wheel good for nothing but to run away to the tail race.

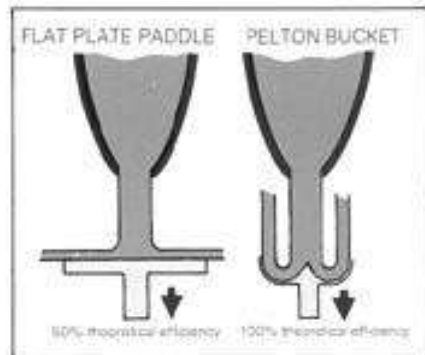
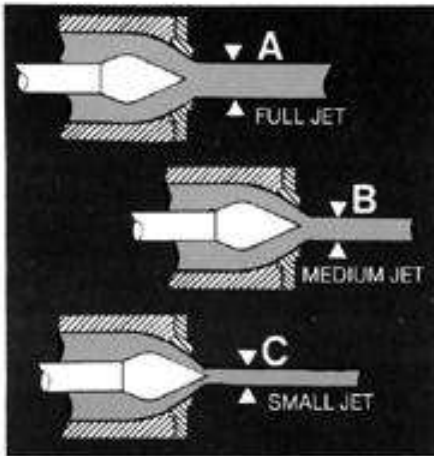

FIG 4 Effects of a jet striking a flat plate and a 'Pelton' bucket

If we always had enough water to keep full pressure at the nozzle and the Pelton wheel was always required to work at full load we could use a plain nozzle and no form of control. (This we do with Axia "fan" turbines.) Unfortunately the Lord has decreed that all too often there will not be enough water for full load, nor do we always want full load on any particular machine. Therefore we must find some convenient way of getting the best jet we can even when it is not the full jet. Here the "spear" or "needle" nozzle comes in. The diagram Fig. 5 shows how it works.



A — Full Jet
Spear gives maximum nozzle opening
B — Medium Jet
Spear entering nozzle
C — Small Jet
The spear and nozzle now only allow a small ring through which the water can pass but the water follows the contour of the spear and a "solid" jet is still formed.

FIG 5 How the spear nozzle works

In Fig. 6 we see the whole lot put together.

Up to now the going has, I hope, been fairly straightforward. Unfortunately the time has come when, if we are going to understand the basic principles of turbines, I must introduce some mathematics. For my sake as well as yours I will keep the thing as simple as possible but it really is important to flog through it carefully and try to get the gist of the business.

I have said already that the Pelton wheel bucket should, for maximum efficiency, rotate at approximately *half the speed of the jet*.

If H = Head in feet (i.e. pressure) immediately upstream of the jet,

V = Velocity of water emerging from the nozzle

and G = Acceleration due to gravity (our old chum)

then $V = \sqrt{2GH}$ (or, say, \sqrt{H})

This brings us to certain basic facts of turbine life.

1. The velocity of the jet depends only on "H", the head (or pressure). If the head is 400 ft. the velocity will be $8\sqrt{400} = 8 \times 20 = 160$ ft. per sec. This will apply equally to a Pelton wheel of 5 or 500 horsepower.

2. For maximum efficiency the buckets must rotate at approximately half the speed of the jet. This applies to the *mean diameter* of the buckets, i.e. twice the distance from the centre line of the shaft to the centre line of the jet. In this case the buckets must move at 80 ft. per second regardless of the mean diameter of the wheel.

3. We can only use a jet of a limited maximum diameter on a wheel of any particular size. This is known as the "runner/jet" ratio. A nominal runner/jet ratio for Pelton wheels can be taken as 10:1. Hence if the jet is 1 in. dia., the runner will be 10 in. mean dia. *

Now we are in a position to build a Pelton wheel knowing:—

Head = 400 ft.

Jet Velocity = 160 ft. per sec.

Mean bucket velocity = 80 ft. per sec.

Jet dia. = 1 inch

Mean runner dia. = 10 in.

$$= \frac{10}{12} \text{ ft.}$$

$$\text{Revolutions per sec.} = \frac{80}{\pi \times 10/12} = 30.5$$

$$\therefore \text{Revolutions per min.} = 30.5 \times 60 = 1830$$

If we now take a jet 2 in. dia., but still have 400 ft. head, on account of πr^2 and all that we will get four times the amount of water and hence 4 times the amount of power, but our runner must now be 20 in. mean dia. and our speed *must* drop to 915 R.P.M.

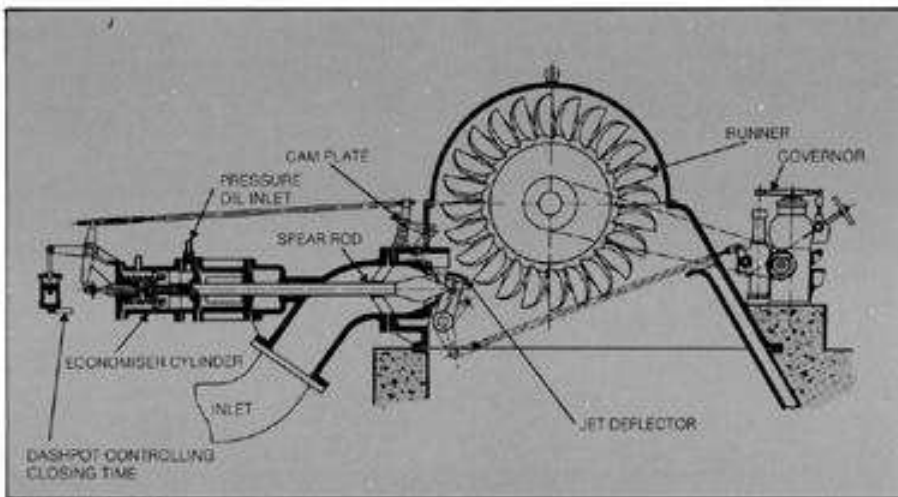

FIG 6 The Pelton Wheel.

Governing

A governor is a mechanism for keeping the speed of a prime mover constant when the load varies. With a steam or oil engine this can be done with quite a tiny centrifugal pendulum (the trade name for the flyballs) which only has to shut off the steam or oil supply if the load on the machine is reduced. With a water turbine we are faced with the problem of shutting off quickly a large volume of moving water. If you think what happens when you turn off a tap suddenly, you begin to get some idea of the difficulty. Hence the governor is a pretty complicated bag of tricks, and may cost nearly as much as the turbine.

On smaller output units an electrical load governor can be installed, which does not control the flow of water to the runner, but by-passes unwanted electrical output to an absorption system. Thus the unit runs at a constant speed and constant electrical load at the generator terminals.

Runaway Speed

This is regarded by the designers of electric generators to be driven by turbines as a dirty word which only about one in a hundred of them can understand. The rest regard it as a trick of the turbine makers to render their job nearly impossible.

Glance back at Figs. 1 and 2. Suppose the waterwheels are of very light construction and run in frictionless bearings and are doing no work. At what speed will the paddles move? Not being electrical designers, you have it

in one. *At the speed of the moving water.* They cannot move faster, or they would push the water along and become pumps. They may, and in fact do, move rather more slowly. Now look at the Pelton wheel in Fig. 6. Take off the load and let it rip. How fast will the buckets move? At a bit less than the speed of the jet (due to friction, windage, etc.), i.e. 'at a bit less than twice normal speed.

Therefore:—

"The Runaway Speed of a turbine is the speed at which it will rotate if all load is removed and the governor (if fitted) breaks down".

This can happen, and machinery, particularly electric generators, driven by water turbines, *must* be designed to run safely (at any rate for short periods) at runaway speed.

The runaway speed is usually about 80% above the normal speed.

Having reluctantly accepted this fact, the electrical boys say: "But why, with steam turbines and oil engines, do we only have to design for a maximum speed about 25% above normal?"

The answer is that if a steam turbine or oil engine really runs away, (i.e. main and emergency governors both fail) the result is disaster. The runaway speed is so high that unless the steam or fuel supply can be cut off, something will give pretty quickly, and few left alive to tell the coroner what really happened.

Reaction Turbines

Propellor and Kaplan

Propellor turbines can be supplied in a variety of configurations to suit specific needs. Although it is basically a fixed load turbine, considerable flexibility can be gained through the use of adjustable guide vanes. Full Kaplan turbines with adjustable blades and either fixed or adjustable guide vanes can also be furnished. The adjustable features and broad range of high efficiency enables the Kaplan to extract the maximum available energy under conditions of low flow and head. This feature also enables the Kaplan turbine to accommodate to large variations in load. The guide vanes and/or propellor blades can be manually adjusted, or controlled by a level control governor head.

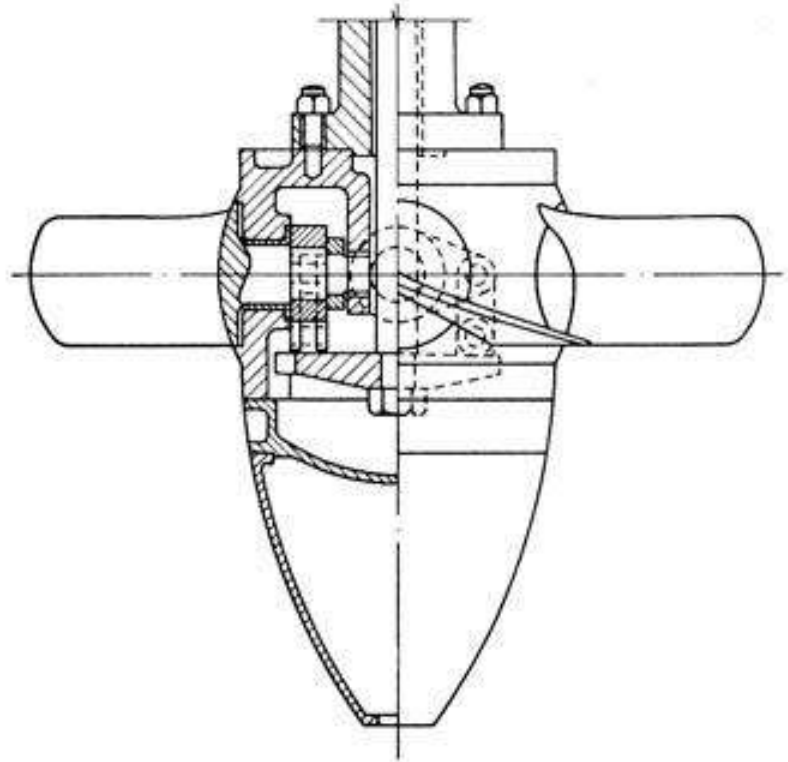

Francis

For conditions of equal power and head, the Francis turbine will often require less installation space than other types of turbine. It also has the advantage of very high peak efficiency which can be made to coincide with full load.

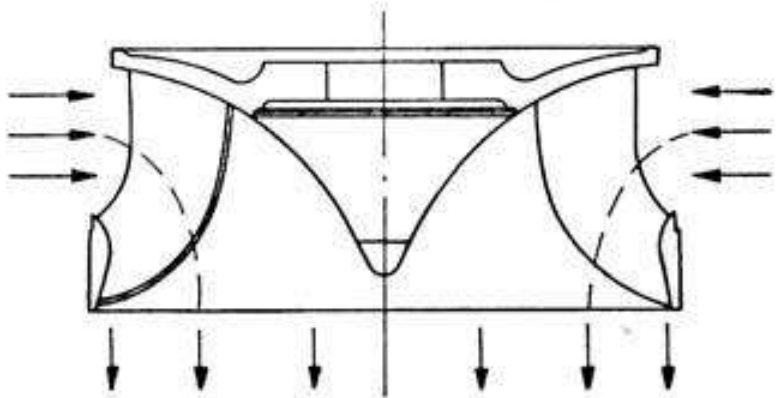

INVOICING A SMALL STREAM

THE strangeness of the problem doubtless is the one thing that has caused practically every man and woman owning a small stream power site to neglect investigating the practicability of using the stream for power, light, heat, and pumping water. Where can one begin to solve such a problem? It seems formidable because it is strange. But let us walk down to any small stream on any farm or near any town, anywhere, and find out

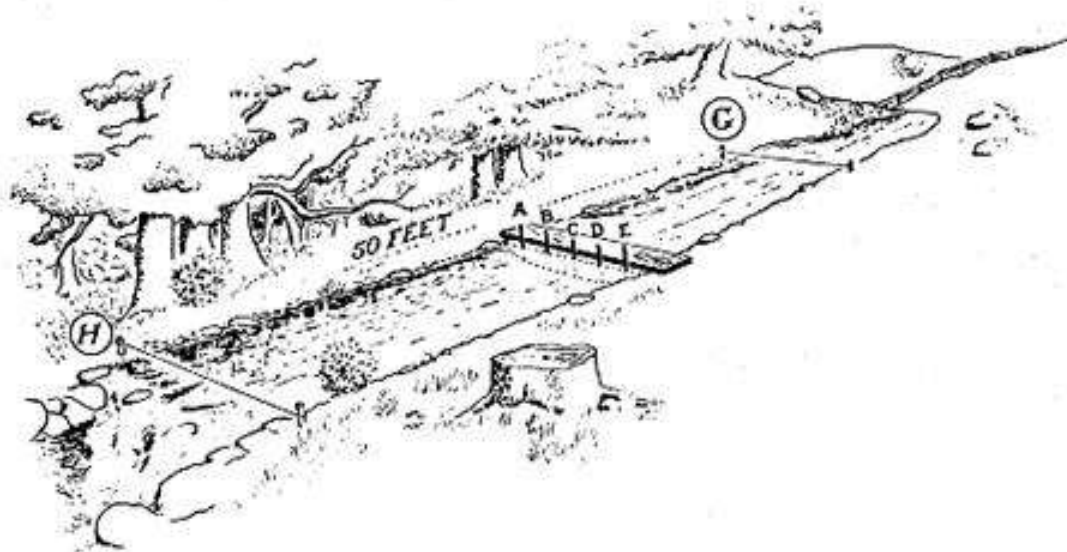

SHOWING A BROOK READY TO BE INVOICED BY USING A PLANK, SEVEN STAKES, FIVE CHIPS, AND THE MULTIPLICATION TABLE

quickly and accurately just what that stream is worth. What unused good has that brook or river in it for me, my home or my town?

Here is a fairly even stretch of the stream, as is pictured in the drawing on this page. Just above a little riffle, shown at the left of the picture, we drive a stake, H, and measure fifty feet directly upstream where we drive a stake, G. Now we drop a wooden block or chip about two inches square in the stream at G and time it as it floats that measured fifty feet to H. We drop a second block or chip and time it as it floats from G to H. One

after the other we drop three more chips and time them as they float the measured fifty feet from G to H. The first chip floats fifty feet from G to H in 10 seconds. The second chip floats the same distance in 8 seconds. The third chip requires 11 seconds to make the distance; the fourth chip, 9 seconds, and the fifth chip, 12 seconds. We are trying to learn how fast the brook flows in this 50-foot stretch we have measured off. So to get the average time of the five chips we add together the time made by each of them which equals 50. We divide 50 by 5, the number of chips, which gives us 10, therefore 10 seconds is the average time of the chips in floating that fifty feet, or 5 feet a second, 10 into 50 is 5.

But no stream flows evenly throughout its width. It is slower near the banks and bottom because there is friction between the water and the bottom and banks. The flow is swifter in the center just below the surface, where there is least friction. Consequently five feet a second, the average time of the five chips is too fast, so we deduct 20 per cent from this average speed or velocity by multiplying 5 by .80, which gives us 4 feet a second as the mean velocity of the stream in this 50-foot stretch. There we have the answer to one of the three simple questions we must answer to learn how much power is running to waste in the stream. We have found how fast the stream flows in a certain length or stretch and it does not make any difference where we measure off that stretch of the stream, the ultimate results will be the same.

Next we want to learn how much water is flowing down that 50-foot stretch, or in any other sector of the stream we have decided to use in invoicing the stream's possibilities. After that we will have to determine how much drop or fall we can get, since the farther the water falls from the dam to the wheel the greater the power developed. When we have answered these remaining two questions we will know all that is necessary to know about this stream in deciding how it can best be put to use.

To find out how much water is flowing in the stream, we lay a plank across the stream midway between stakes G and H, as shown in the drawing on page 26. Standing on this plank we drive the stake A, which is just a foot from the bank on the left-hand side of the brook, as shown in the drawing on page 26, but

given in a larger cross-section view lower down on this page. A foot farther out from stake A we drive stake B, and a foot farther still we drive stake C, then stakes D and E, at 1-foot intervals, indicated in the drawing on this page. The brook is only six feet wide. If it were wider, we would drive more stakes at 1-foot intervals. The plank is included merely as a convenience and may be omitted. Now we measure the depth of water at each stake.



CROSS SECTION OF STREAM

We find that it is 9 inches deep at stake A; 11 inches deep at stake B; 13 inches deep at stake C; 15 inches deep at stake D and 12 inches deep at stake E. To get the average depth we add together the depth of all five stakes, which gives us 60 inches, and divide by 5, which gives 12 inches as the average depth of that particular width of stream. This may seem rather simple arithmetic, but its purpose will all be clear in the next few lines.

Suppose the plank laid across the stream is a foot wide, then that part of the brook immediately beneath the plank would be a section of the stream the width of the plank, 1 foot, the length of the plank, 6 feet, and with an average depth of 1 foot. In other words, the part of the stream immediately beneath the plank would be a slice of the brook, 1 foot wide from the upstream edge of the plank to the downstream edge of the plank, 6 feet from bank to bank, and with an average depth of 1 foot. Well, how much water, what quantity of water, is in such a slice of the stream? We want the answer in cubic feet, so we multiply together those three dimensions of the slice of brook, $1 \times 6 \times 1$ equals 6, or 6 cubic feet, the quantity of water in the slice of brook we so carefully measured. A cubic foot of water is $7\frac{1}{2}$ gallons, so we have 45 gallons of water in that slice of brook, to express it in the more usual unit of measure. We have already determined that the brook flows 4 feet a second. That slice of brook we have measured flows just as fast as any of the rest of the water passing that point, so to get the rate of flow we multiply the speed, 4 feet

a second, by the quantity of water, 6 cubic feet, and find that the stream flows 24 cubic feet of water a second. At that rate it flows 1,440 cubic feet of water a minute, since there are 60 seconds in a minute and 60 multiplied by 24 equals 1,440. There we have the answer to the second question, how much water does the stream flow?

A horse power is 33,000 pounds dropping one foot in one minute. Thus, 33,000 pounds of water falling one foot in one minute will develop one horse power. Now we have 1,440 cubic feet of water a minute in the stream we are invoicing. Each cubic foot of water weighs $62\frac{1}{2}$ pounds, so the total weight of the water flowing down this stream each minute is equal to 1,440 cubic feet multiplied by $62\frac{1}{2}$, which is 90,000 pounds. If we drop 90,000 pounds of water one foot in one minute, how much horse power would the stream develop? Dividing 90,000 by 33,000, the result is 2.72 horse power.

However, we must remember that developing power under such low heads as one foot, or even two or three feet, is not the cheapest or the most practical method in small streams. It is better for us to have a 15-foot head, or fall, as Mr. Rowlands did. With a 15-foot head we saw that Mr. Rowlands's little 9-inch turbine wheel developed 5.72 horse power, and required only 246 cubic feet or 17,365 pounds of water a minute to do it. In fact, 246 cubic feet of water was all the water that particular type and size of wheel could use under a 15-foot head. No matter if the whole Mississippi River were surging about it, only 246 cubic feet of water would go through that wheel under a 15-foot fall. To get more power out of that size and type wheel the head or fall of the water must be increased, thus increasing the quantity of water the wheel could use. It is impossible to strain or to damage a water wheel by overloading. It can and will do just so much work, right up to its big 80 to 90 per cent efficiency, and there it stops. It is the mule of the entire world of machinery. If we propose to use all the 1,440 cubic feet of water a minute that flows in the stream we are invoicing we will have to employ a larger type of wheel than the one Mr. Rowlands uses. Even under 100-foot head his turbine wheel would use only 634 cubic feet of water a minute, but it would develop 99.60 horse power. We

would still have half of the water going to waste in using that type of 9-inch wheel, even if we cared to or were situated to install the heavier pipe or penstock construction to handle a fall or head of water of 100 feet.

Obviously if we want to use all the 1,440 cubic feet of water a minute in the brook, we must get a larger wheel. A 21-inch turbine wheel would use 1,435 cubic feet of water a minute under only a 12-foot head and would develop 26.74 horse power. That figure applies only to the New Pattern Hunt Francis Cylinder Gate Turbine Wheels. The same size Cylinder Gate Hunt McCormick Turbine Wheel would develop 32.9 horse power under a 12-foot head, but it would require 1,815 cubic feet of water a minute, which is more water than our "sample" stream averages. Or, a 24-inch Hunt Francis cylinder gate type would use 1,406 cubic feet of water a minute under only a 7-foot fall and would give 15.28 horse power in return, while the 24-inch Hunt McCormick cylinder gate type would use 1,831 cubic feet of water a minute under a 7-foot head and develop 19.4 horse power. The situation then, is that where there is a large quantity of water and a low fall available, there must be a larger wheel, or better, a pair or series of turbine wheels, to develop the water power plant fully. The stream to be utilized may be deep, or wide and flow slowly, through a flat country and it might be utterly impracticable to obtain even a 15-foot head of water within a reasonable distance. In such case a low head of water must be used and the type and size of turbine wheel that fits best in that particular development. There is a size and type of turbine wheel to fit any combination of quantity of water and fall of water to the very best advantage and fullest development of the plant under those specific conditions.

When a stream is very rapid or it is feasible to get a considerable drop or fall of water in a short distance, the development points to the use of a smaller size wheel. Perhaps the stream is only a tiny brook and hasn't enough water to run a large turbine wheel. Then, the thing to do is to let the small volume of water fall a greater distance to a small turbine water wheel and in that way develop as much power as the larger wheel that operates under a lower head, but with a greater volume of water. It seems

Well, I can guess a grade or drop of a stream pretty well, one man boasts.

Possibly he can, but the chances are 500 to 1 that he cannot. If ever you have seen young engineering students guessing at grades you will appreciate the truth of that. Let's not guess. We want everything in this procedure to be absolutely dependable. Nor need we call a surveyor out from town. That would cost money. Let us employ the simple tools and methods that Mr. Rowlands used, a 10-foot straight-edge, such as stone masons use, a carpenter's spirit level and a yard stick.

We want to get the greatest fall in the shortest distance along the stream that is possible. Let us pick out a stretch of the brook that seems to have the greatest fall in the shortest distance. Near the lower end of the riffle, where we think we may locate the turbine wheel, we place the straight-edge at the water's edge and parallel with the bank. The upstream end of the straight-edge rests on a pebble whose top is flush with the surface of the water. We place the spirit level on the center of the straight-edge and then with stones or a stake level up the lower end of the straight-edge until the spirit level shows that the straight-edge is exactly level. We then measure the distance of the lower end of the straight edge above the surface of the water and we find how far the water falls in this ten feet. If the downstream end of the straight-edge is one foot above the water, the fall in that 10-foot section of the stream is one foot. We move the straight-edge upstream exactly ten feet and repeat the measuring process, and continue to repeat the process through any length of the stream desired. If the fall in 100 feet is to be determined the 10-foot straight-edge will have to be moved and leveled up ten times. Any length of straight-edge may be used, just so the board is straight and true. Some streams with abrupt banks may make the application of this simple method a bit difficult, but it can be used in all cases by exercising a little common sense ingenuity.

There are all three of the water questions answered accurately. We have learned how fast the stream flows, how much water it delivers a minute and the head of water available. This method may be termed the "dry-foot" method, and it may be used in

THE WEIR METHOD OF MEASURING WATER

THE "dry foot" method of measuring a stream, as described in the previous chapter, is a quick and dependable way of measuring a large or small stream. For a brook or creek, there is another way that perhaps is easier, the weir method. Weir is only another name for dam. The weir method consists of putting



A WEIR FOR MEASURING THE FLOW OF A SMALL STREAM

a small board weir or dam across the stream, after having sawed a section out of the top and middle part of the weir so that all the water of the brook must flow through this sawed section. The depth of the water flowing through this sawed out section in the weir is measured and then by simply referring to the table of weirs on page 35 the capacity of the stream is shown instantly. The picture on this page shows such a weir for measuring a small stream. Should you employ an expert to measure your brook or creek, he probably would bring a current meter and a surveyor's transit or level and then would put in a weir, if the stream were not too

and the results he would obtain would be exactly the results you can obtain without cost.

Let us glance at the picture of a weir and then go down to the brook, put in a similar weir and determine immediately how much horse power is running to waste in that stream. The weir may be made of one large plank or of several pieces of old scrap lumber cleated together. An opening is sawed in the middle of the weir, as shown in the picture, and the weir is set across the stream and is carefully "plugged" with clay or sods to prevent water leaking underneath or at the sides of the weir. The opening is sawed on a slant, beveled, with the sharp edge of the bevel upstream. Say the opening is 30 inches wide and 10 inches deep, or any other width and depth, so long as all the water in the brook flows through the opening, there is no leakage at the bottom of sides, and at the same time the weir dams the brook sufficiently to form a little mill pond three or four feet above the weir. But to be definite, let's have the opening in our weir 30 inches wide and 10 inches deep. Now, two or three feet above the weir we drive a stake in the stream. The stake is marked 1 in the picture on the opposite page. We want the top of that stake just level with the surface of the water. Next we extend a yard stick, or a lath, from the top of the stake to the nearest edge of the opening in the weir. We get that yard stick or lath exactly level by using a spirit level and then we mark on the edge of the weir opening so that that mark is exactly level with the top of the stake. From that mark we measure straight down to the bottom edge of the opening in the weir and our work is done, except for the simple action of glancing across to the page opposite to the Table of Weirs printed there.

Let us say, to be specific, that the distance from the mark we made on the edge of the opening in the weir, to the bottom edge of the opening is $7\frac{3}{4}$ inches. On the Table of Weirs on the opposite page we notice five columns of figures. At the top of the first column is the word "inches;" at the top of the second column, the cipher, "0"; at the top of the third column, the fraction, " $\frac{1}{4}$ "; at the top of the fourth column, the fraction " $\frac{1}{2}$ ", and at the top of the fifth column, the fraction " $\frac{3}{4}$ ". We look down that first

column, under the word "inches," until we come to the figure 7, remembering that the distance we measured was $7\frac{3}{4}$. We run a finger across the table to the column that is headed " $\frac{3}{4}$ " and there we find the number 8.697, which is the key to determine the rate of flow in this stream. We recall now that the opening in the weir was 30 inches wide, so we multiply the key number, 8.697, by 30, which gives 260.91 and means that the stream flows at the rate of 260.91 cubic feet of water a minute. That is more than enough water under a 15-foot head to run Mr. Rowlands's little 9-inch turbine wheel and generate 5.72 horse power, since Mr. Rowlands's wheel requires only 246 cubic feet of water a minute. And yet this little stream flowing through an opening less than a yard wide; 30 inches wide, in fact; and less than a foot deep, only $7\frac{3}{4}$ inches deep, develops 5.72 horse power in the smallest turbine wheel.

TABLE OF WEIRS

Inches	0	$\frac{1}{4}$	$\frac{1}{2}$	$\frac{3}{4}$
1	0.403	0.563	0.740	0.966
2	1.141	1.360	1.593	1.838
3	2.094	2.361	2.639	2.927
4	3.225	3.531	3.848	4.173
5	4.506	4.849	5.200	5.558
6	5.925	6.298	6.681	7.071
7	7.465	7.869	8.280	8.697
8	9.121	9.552	9.990	10.427
9	10.884	11.340	11.804	12.272
10	12.747	13.228	13.716	14.208
11	14.707	15.211	15.721	16.236
12	16.757	17.283	17.816	18.352
13	18.895	19.445	19.996	20.558
14	21.116	21.684	22.258	22.835
15	23.418	24.007	24.600	25.195
16	25.800	26.406	27.019	27.634
17	28.256	28.881	29.512	30.145
18	30.785	31.429	32.075	32.733

This table is taken from "Electricity for the Farm," by Frederick Irving Anderson, The Macmillan Company. It is adapted from the co-efficients worked out in 1852 by Mr. James B. Francis of Lowell, Mass. This little table is as much a water classic in its way as is Tennyson's "Brook," and although studying a table of figures is not usually attractive, the understanding of the weir method of measuring stream flow is dollars and cents in the pocket of any man who dwells on a small stream. On page 161 we have placed

An adjustment whereby water power may be properly developed for the public good and without working toward monopolies is a vital legislative necessity for the Nation. However, there is no legislative restriction on the small stream power site owner who may put in a home, village or town plant. The conservation acts do not apply to him or his stream and in putting in a home or town plant he has the glad assurance that he is following the most beneficial conservation policy possible.

In this example of enough water flowing through an opening 30 inches wide and $7\frac{3}{4}$ inches deep to develop 5.72 horse power, we see now why Mr. Rowlands made a mistake in digging a mill race five feet wide and three feet deep. All he needed was a little wood pipe about a foot in diameter and placed below frost line where he could plow right over it without damaging it, or a small wooden or concrete flume. But like most of us he could not realize there is so much work or power in so little water. We base our vague notions of water power on the vague memories of old mills a generation ago that were run by water power. The railroads with cheap coal made possible the larger development of steam power plants and for awhile displaced to some extent the extensive development of water power. Then came a bigger realization of water power's real worth and with it a rapid growth and perfecting of giant plants for producing cheaper electricity and power. So successful was this period of development that a national conservation movement was born of a recognition of the colossal value of water power and of a fear that the country's water power resources might be monopolized by a few long-headed business men. Congress enacted laws to prevent monopoly, thereby doing some good, no doubt, in conserving this greatest national resource for the greatest good of the greatest number, but utterly failing to provide adequate ways of utilizing for the public's good this great resource that is running to waste while it is being so religiously conserved.

Measuring Head

The head is the height from the water surface in the forebay down to the level of the turbine. To measure this, use a tape measure and a clinometer or spirit level etc. A less accurate but useful alternative is to make your own level from a transparent tube half-filled with water. Attach this to the top of a 1m long stick and then point this horizontally at a point further up the slope as though it were a spirit level. By going to that point and repeating the process the total head can be measured – see the drawing below.

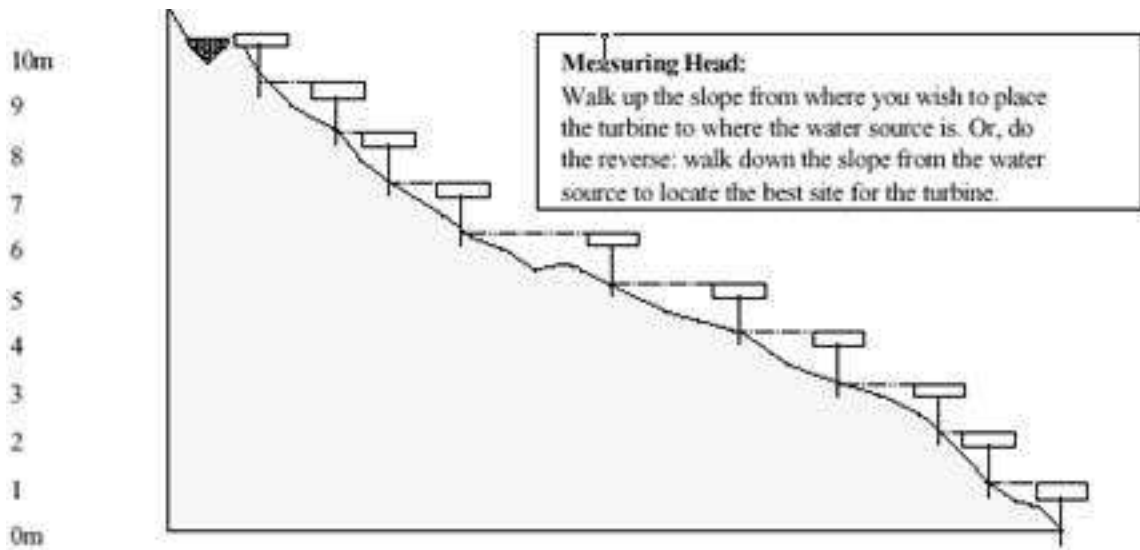

Another method is to use an accurate pressure gauge and a length of hose. Run a water-filled hose from the forebay to the turbine site and attach the pressure gauge to the bottom end. The pressure gauge shows 1.422 psi / meter of head e.g. 7.11 psi for a head of 5m to 15.64 psi for a head of 11m.

MEASURING THE FLOW OF WATER

There are several methods of measuring the flow of water. The choice of the method depends upon the

special conditions of the location. Here are described two of the more common ways to determine the flow.

The Weir Method

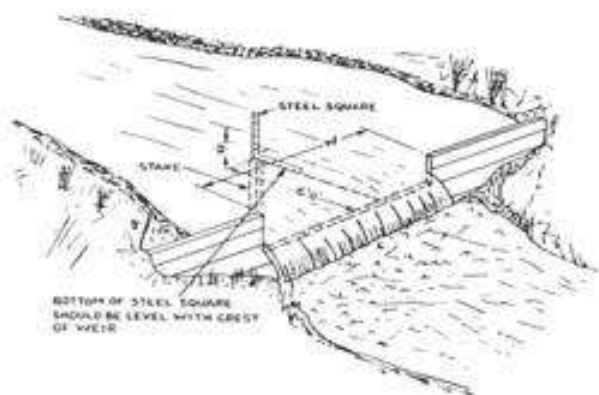

FIG. 1 — General View

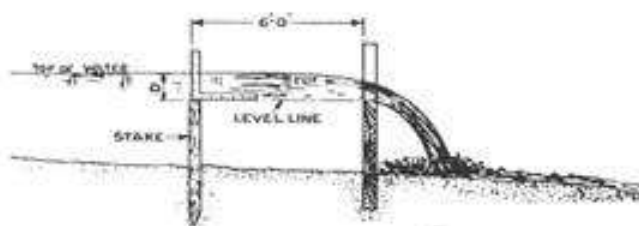

FIG. 2 — Cross Section

Used where stream is small and a comparatively slow-flowing stretch of water is available.

1. Select a suitable location where water flows slowly.
2. Place a notched plank across the stream as shown in Fig. No. 1, forming a weir dam.
3. The weir length W should be about 6 times the depth of water flowing over. The notch 1 ft. above the bed of stream, or earth filled in to make it tight.
4. Drive a stake in the bed of the stream at least 6 ft. upstream as shown in Fig. No. 2; the top of this stake must be exactly level with the crest of the weir.
5. When all leaks around the weir have been stopped, measure the depth of water above the stake.
6. The water flowing over the weir may be found from the table below which gives the flow in cubic feet per minute for each inch of weir length. The depths D vary from 0 to $11\frac{1}{8}$ in. by $\frac{1}{8}$ in. To get the total discharge over the weir, multiply the table reading by the length of the weir in inches.

TABLE III: WEIR METHOD								
Flow in cu. ft. per minute for each inch of weir length.								
Depth D in inches	Fractions of an inch							
	0	$\frac{1}{8}$	$\frac{1}{4}$	$\frac{3}{8}$	$\frac{1}{2}$	$\frac{5}{8}$	$\frac{3}{4}$	$\frac{7}{8}$
0	0.00	0.02	0.05	0.09	0.14	0.20	0.26	0.33
1	0.40	0.48	0.56	0.65	0.74	0.83	0.93	1.03
2	1.14	1.24	1.35	1.47	1.58	1.71	1.82	1.96
3	2.08	2.21	2.35	2.48	2.63	2.76	2.90	3.06
4	3.20	3.36	3.51	3.67	3.82	3.98	4.15	4.31
5	4.48	4.65	4.81	4.99	5.16	5.35	5.52	5.71
6	5.89	6.06	6.26	6.44	6.64	6.83	7.01	7.22
7	7.41	7.62	7.82	8.03	8.23	8.42	8.64	8.85
8	9.07	9.27	9.48	9.71	9.92	10.15	10.36	10.60
9	10.81	11.03	11.27	11.49	11.74	11.96	12.18	12.43
10	12.66	12.91	13.14	13.39	13.63	13.86	14.12	14.36
11	14.62	14.86	15.10	15.37	15.61	15.88	16.13	16.40

EXAMPLE

Assume weir length is 60 in., depth D over stake is $10\frac{1}{8}$ in. Table shows 12.91 cu. ft. per minute for each inch

Measuring Flow

Flow can be calculated approximately by knowing the water speed. This speed, multiplied by the cross-sectional area of the intake canal will give you an idea of the flow rate.

As a rule, say half a meter per second, or 5 meters in 10 seconds. Drop a leaf upstream and read the time it takes to travel the measured distance. Note that this method is only a guide and you will need a sufficient volume of water flowing at this rate to make the larger models work.

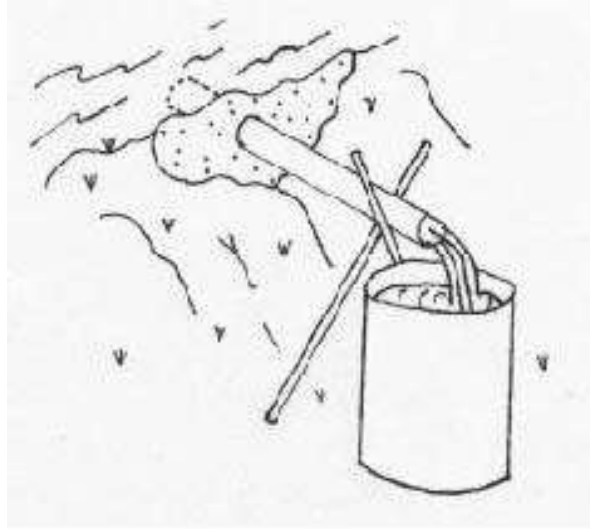

Measuring Flow:

$$\text{Flow} = \frac{\text{volume of bucket (litres)}}{\text{time to fill bucket (seconds)}}$$

The best way to measure the water flow is to take a piece of pipe the same diameter as the penstock, insert it in the stream or dam where the flow is expected to come from, and measure the flow from there.

In the diagram below, a short length of pipe (less than 1 meter) is buried into the side of a small 'dam' using mud or improvised sandbags. The top end of the pipe is completely submerged and part of the normal stream flow is diverted through the pipe. When this is flowing smoothly, a bucket of known volume is quickly placed to collect this flow and the time it takes to fill the bucket is recorded. The ideal bucket size would be 100 or 200 litres (half or a whole empty oil drum), but smaller buckets will work. Divide the volume of the bucket (in litres) by the time it takes to fill the bucket (in seconds) to get the approximate flow rate in litres per second.

Chart 10. ESTIMATED FLOWS FROM PIPES

PIPE MUST BE HORIZONTAL FOR BEST RESULTS
ALL QUANTITIES OBTAINED ARE APPROXIMATE

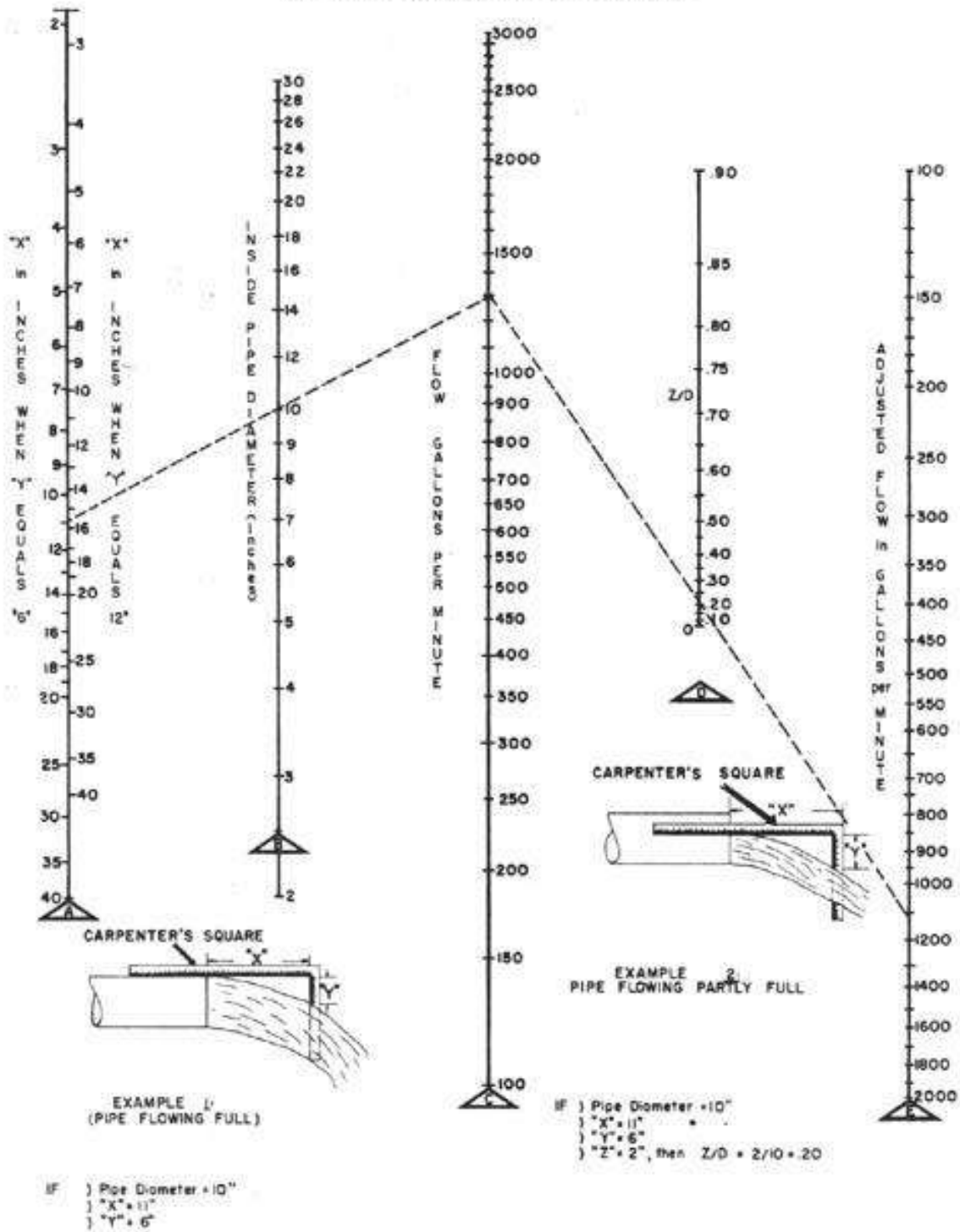

With a Straight Edge Connect 1" on Scale
 (Y = 6") With 10" on Scale and
 Read 1300 Gallons per Minute on Scale

Assume Pipe is Flowing Full and Proceed as
 in Example 1, Then With a Straight Edge
 Connect 1300 Gallons per Minute on Scale
 With 20 on Scale and Read
 1100 Gallons per Minute on Scale

FLOW OF WATER IN PIPES

CHART III: Flow of Water in Pipes 1 to 12 Inches Diameter

Based on the Hazen and Williams Formulae

$$V = 0.00276 Cd^{0.63}H^{0.54}$$

- Where V = velocity of flow in feet per second.
- C = pipe constant; assumed as 100 in chart.
- d = internal diameter in inches.
- H = fall or loss of head caused by friction per 1,000 feet length of pipe; length measured along slope.

Discharge of a Pipe Line in terms of diameter and velocity:

$$Q = \frac{\pi d^2 v}{576}$$

Where Q = discharge in cubic feet per second.

Discharge in terms of Friction Head and Diameter.

$$Q = 0.00001505 Cd^{2.63}H^{0.54}$$

$$q = 0.00675 Cd^{2.63}H^{0.54}$$

- Where Q = discharge in cubic feet per second.
- q = discharge in gallons per minute.

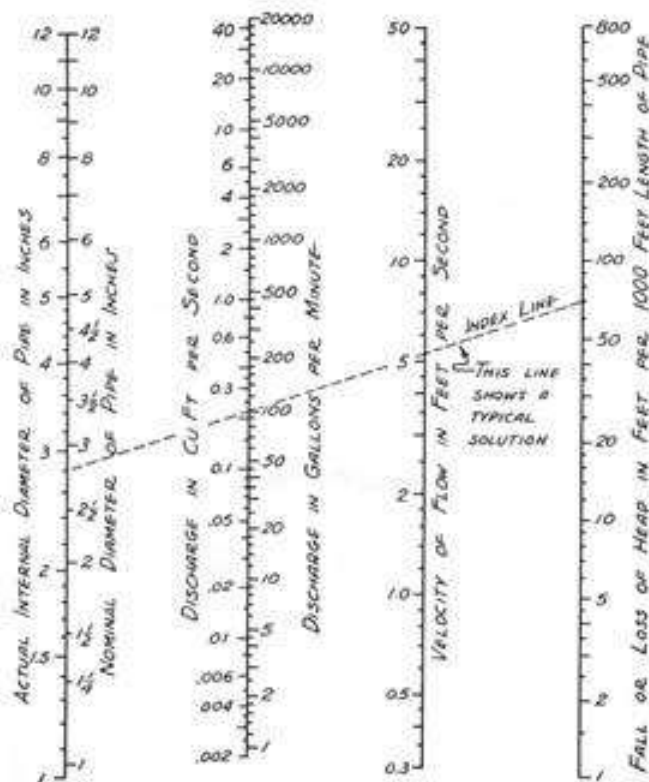

CHART IV: Flow of Water in Pipes 1 to 20 Feet Diameter

Based on the Hazen and Williams Formulae

$$V = 0.0132CD^{0.63}H^{0.54}$$

- V = velocity of flow in feet per second.
- C = pipe constant; assumed as 100 in chart.
- D = internal diameter in feet.
- H = fall or loss of head caused by friction per 1,000 feet length of pipe; length measured along slope.

Discharge of a Pipe Line in terms of diameter and velocity:

$$Q = \frac{\pi D^2 V}{4}$$

Where Q = discharge in cubic feet per second.

Discharge based on Friction Head and Diameter:

$$Q = 0.01037CD^{2.63}H^{0.54}$$

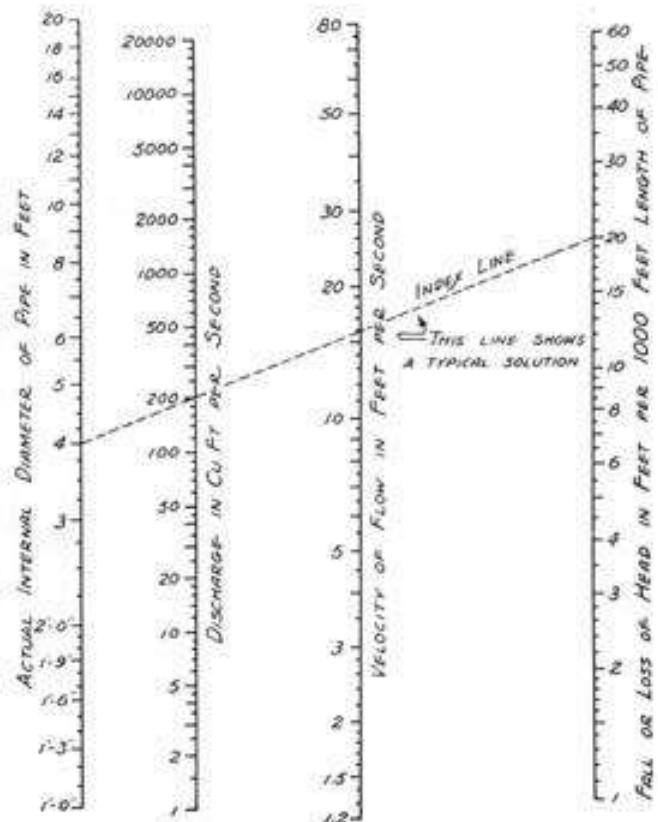

IMPROVING WATER POWER

In developing or improving a water power the first thing necessary is to know the amount of head that can be or is secured. The terms "head" and "fall," as commonly used, may be considered as synonymous, and either expresses the meaning intended, which is the vertical distance from the surface of the tail water to the surface of the head water. Where the works are already constructed this is easily found by careful measurement, but to ascertain the fall in an undeveloped stream a system of leveling will be necessary.

The working head, or that which exists when the Turbine is running, is all that is effectual, and it is this that should be measured, or a proper allowance made from the standing head.

Water has power according to the distance it falls, and the effect on a Turbine is that due to its weight in falling from a higher to a lower level.

Anything, therefore, that can be done to secure as much standing head as possible and to maintain the working head nearly at the same level is in the highest degree important. Two things are requisite for the latter purpose—a wide and deep head race and forebay to supply the water to the Turbine and a tail race of similar character that will not cause the water to back up against the Turbine, with plenty of clearance in the pit under the wheel.

THE HEAD RACE

It is important that the head race be constructed sufficiently deep and wide to give it capacity enough to prevent the loss of head after the Turbine has been running for some hours. This is especially necessary when the race is of considerable length and a large volume of water is to pass through.

Head water should not flow faster than 60 to 120 feet per minute. When iron or steel piping is used to convey the water to the Turbine, the receiving end of the supply pipe should be sufficiently below the surface of the head water to prevent any

possibility of drawing air. The velocity of the water through the supply pipe should not exceed 180 feet per minute in short lengths, and in long pipes of 250 feet or more the velocity should not be greater than 120 feet per minute.

SIZES OF WATER WAYS

To determine the sizes of the head and tail races, use the following rule:

Divide the number of cubic feet of water to be used by 85, and the quotient will be the area in square feet required in the cross section of the passages.

For example, one 48-inch C. M. C. Turbine under 12-foot head will discharge 4458 cubic feet of water per minute. This number divided by 85 gives a quotient of 52.4, so that the head race and other passages should be about 13 feet wide and 4 feet deep, or an equivalent cross-section in other proportions. If it is impractical to make a deep tail race the entire length, it is at least very essential that the pit under the Turbine complies with the given rules and that its depth should not be less than that shown in the table of measurements on page 25. The tail race should be lined with some material that will prevent washing or injury to foundations.

THE TAIL RACE

The correct construction of the tail race is equally as important as the proper construction of the head race.

The tail race should be made wide and its bed sufficiently below the surface of the stream into which it empties to permit three or four feet of dead water to stand in its entire length when the Turbine is not in operation. This will permit the water discharging into the tail race from the Turbine to pass away freely with very little rise in its surface.

Since the working head of the Turbine is decreased exactly by the amount of rise in the tail race, the importance of a tail race of sufficient capacity cannot be over emphasized.

Head loss in feet of pipe (PVC plastic pipe)

For head loss in feet, multiply PSI by 2.31. For instance, for 20 GPM and 1.5” diameter pipe, multiplying 1.34 PSI by 2.31, you get 3.1 feet. That is, for every 100 feet of 1.5” pipe with 20 GPM flowing through it, you will lose 3.1 feet of head due to friction.

Flow gpm	pipe diameter						
Column	1_	1.25_	1.5_	2_	2.5_	3_	4_
1_	0.05_	0.02_	0_	._	._	._	._
2_	0.14_	0.05_	0.02_	._	._	._	._
3_	0.32_	0.09_	0.05_	._	._	._	._
4_	0.53_	0.16_	0.09_	0.02_	._	._	._
5_	0.81_	0.25_	0.12_	0.05_	._	._	._
6_	1.13_	0.35_	0.18_	0.07_	0.02_	._	._
7_	1.52_	0.46_	0.23_	0.07_	0.02_	._	._
8_	1.94_	0.58_	0.3_	0.09_	0.05_	._	._
9_	2.42_	0.72_	0.37_	0.12_	0.05_	._	._
10_	2.93_	0.88_	0.46_	0.16_	0.07_	0.02_	._
12_	3.51_	1.04_	0.53_	0.18_	0.07_	0.02_	._
14_	4.11_	1.22_	0.65_	0.21_	0.09_	0.05_	._
16_	5.47_	1.64_	0.85_	0.28_	0.12_	0.05_	._
18_	7.02_	2.1_	1.09_	0.37_	0.14_	0.07_	._
20_	._	2.61_	1.34_	0.46_	0.18_	0.07_	0.02_
22_	._	3.16_	1.64_	0.55_	0.21_	0.09_	._
24_	._	3.79_	1.96_	0.67_	0.25_	0.09_	0.04_
26_	._	4.43_	2.31_	0.79_	0.3_	0.12_	0.05_
28_	._	5.15_	2.66_	0.9_	0.35_	0.14_	0.05_
30_	._	5.91_	3.05_	1.04_	0.42_	0.16_	0.11_
35_	._	._	3.46_	1.18_	0.46_	0.18_	0.12_
40_	._	._	4.62_	1.57_	0.62_	0.23_	0.13_
45_	._	._	._	1.99_	0.79_	0.3_	0.15_
50_	._	._	._	2.49_	0.79_	0.3_	0.2_
55_	._	._	._	3.03_	1.2_	0.46_	0.25_
60_	._	._	._	3.6_	1.43_	0.55_	0.3_
65_	._	._	._	._	1.66_	0.65_	0.35_
70_	._	._	._	._	1.94_	0.74_	0.4_
75_	._	._	._	._	2.22_	0.85_	0.45_
80_	._	._	._	._	2.52_	0.97_	0.5_
85_	._	._	._	._	2.84_	1.09_	0.6_
90_	._	._	._	._	3.19_	1.22_	._
100_	._	._	._	._	._	1.36_	0.8_
150_	._	._	._	._	._	1.5_	1.6_
200_	._	._	._	._	._	1.66_	2.7_
300_	._	._	._	._	._	._	5.8_

Friction Loss of Fittings

Size	Tee-Run	Tee-Branch	90°Ell	45°Ell
*	1.0	4.0	1.5	0.8
*	1.4	5.0	2.0	1.0
1	1.7	6.0	2.3	1.4
1*	2.3	7.0	4.0	1.8
1*	2.7	8.0	4.0	2.0
2	4.3	12.0	6.0	2.5
2*	5.1	15.0	8.0	3.0
3	6.3	16.0	8.0	4.0
3*	7.3	19.0	10.0	4.5
4	8.3	22.0	12.0	5.0

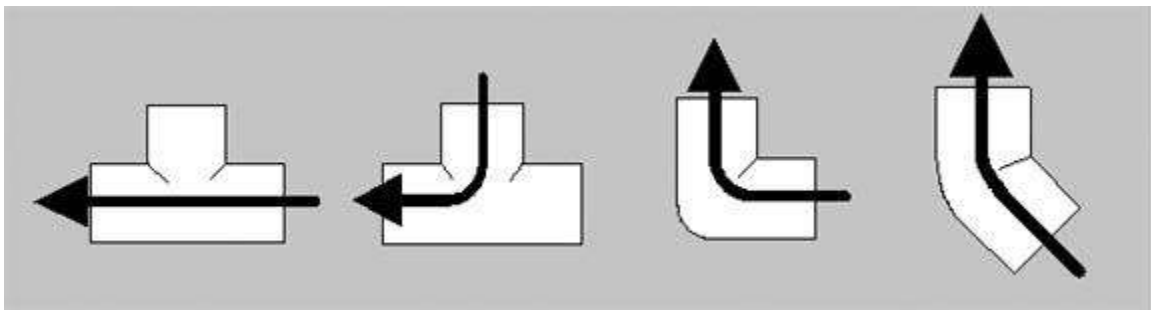

Shown in equivalent feet of pipe.

The pressure drop due to friction in PVC pipe and fittings has been studied by a number of authorities. Coefficient values established have always been in the range of 150-160 Hazen and Williams (or the equivalent in other head loss formulas).

This chart is based on a Hazen and Williams coefficient of 150. The values stated are bases on the equivalent schedule of pipe friction loss'. However, this information should be used for reference only, since variations may result from installations techniques, actual fitting geometry, and inside diameter of adjacent piping system.

US Gal per min	VEL		VEL		VEL		VEL		VEL		VEL		VEL		VEL		VEL	
	ft.	sec.	ft.	sec.	ft.	sec.	ft.	sec.	ft.	sec.	ft.	sec.	ft.	sec.	ft.	sec.	ft.	sec.
110	1.25	0.21	0.11															
120	1.33	0.23	0.12															
130	1.47	0.27	0.15															
140	1.56	0.30	0.16															
150	1.70	0.36	0.19															
160	1.78	0.39	0.21															
170	1.92	0.45	0.24															
180	2.00	0.48	0.26															
190	2.16	0.55	0.30															
200	2.22	0.58	0.32															
220	2.44	0.70	0.38															
240	2.67	0.82	0.44															
260	2.89	0.95	0.51															
280	3.11	1.09	0.59															
300	3.33	1.24	0.67															
320	3.56	1.39	0.75															
340	3.78	1.56	0.84															
360	4.00	1.73	0.93															
380	4.22	1.92	1.04															
400	4.44	2.11	1.14															
450	5.00	2.62	1.41															
500	5.56	3.19	1.72															
600	6.66	4.46	2.41															
650	7.22	5.17	2.79															
700	7.78	5.93	3.20															
750	8.34	6.74	3.64															
800	8.90	7.60	4.10															
850	9.45	8.50	4.59															
900	10.00	9.44	5.10															
950	10.50	10.20	5.51															
1000	11.10	11.90	6.21															
1100	12.20	13.70	7.40															
1200	13.30	15.10	8.69															
1300	14.40	18.60	10.04															
1400	15.60	21.40	11.56															
1500	16.70	24.90	13.12															
1600	17.80	27.40	14.80															
1800	20.00	34.10	18.41															
2000	22.20	41.40	22.36															

10"

12"

14"

16"

18"

20"

DETERMINING THE SIZE OF SLUICE GATES

Having decided upon the head available and the maximum quantity of water that must be handled, the size of the gate can be determined for the following three different cases:

CASE I— For Free Discharge:

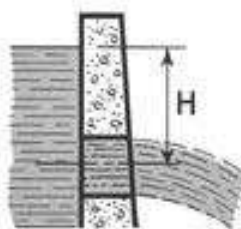

Fig. 1.

Where the water is to be discharged freely through a gate into the atmosphere as shown in Figure 1. Let H be the head or distance in feet from the surface of the water to the center of the gate opening. On Chart I connect the given values of "discharge" and "head" with a straight line. At the point where this straight line intersects the "area" scale, read the required area of gate opening.

Example. Suppose the discharge "Q" is to be 200 cubic feet per second and the head "H" to be 20 feet. By laying a straight edge as an index line on Chart I, we find that the area of gate opening required is 8.1 square feet. The solution of this problem is shown on Chart I.

CASE II— For Submerged Discharge:

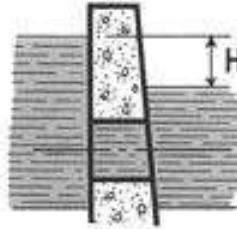

Fig. 2.

Where the water is to be discharged through what is called a submerged gate as shown in Figure 2. Here there is water on both sides of the opening, but the water on one side is " H " feet higher than on the other. The solution is identical with Case I, except that the head " H " to be used is the difference of water levels.

CASE III— Discharge through Pipes and Penstocks:

Where the water is to flow through a long penstock or pipe line as shown in Figure 3. The gate opening should provide a greater area than that of the pipe cross-section, and therefore the problem really becomes that of determining the diameter of pipe needed.

This case is more complicated than the two preceding cases and requires some knowledge of the hydraulics of pipe flow.

The factors that may be involved in pipe flow are acceleration head, loss of head at entrance, loss of head caused by friction in the pipe line, and the remaining pressure head at end of line. The total drop of the water from pond level to end of pipe line where pressure is measured is the sum of the four items named above. A discussion of each of these items follows.

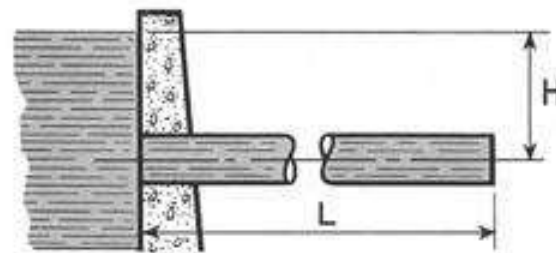

Fig. 3.

a: velocity head:

The velocity head is that part of the water drop used in speeding the water from rest up to its final velocity.

$$\text{Velocity head} = \frac{v^2}{2g} = \frac{v^2}{64.4}$$

where v = velocity of flow in pipe in feet per second and g = 32.2 feet per second per second.

b: loss of head at entrance:

There is generally a small loss of energy or head when water flows through a gate into a pipe line having a square edge at the entrance. This loss of head at entrance, as it is called, depends upon the square of the velocity and varies somewhat with different conditions. It is usually expressed as some fractional part of the value of $\frac{v^2}{2g}$. A safe factor to use is 0.5

$$\text{and therefore we can say that the loss of head at entrance} = 0.5 \frac{v^2}{2g} = \frac{v^2}{128.8}$$

This loss of head, however, is frequently avoided by using a curved entrance which is particularly feasible in the case of concrete headworks.

c: loss of head due to friction:

Another part of the water drop is used up in forcing the water over the rough surfaces of the pipe interior, and this loss of head is ordinarily termed "friction head." Many formulae have been derived to give the amount of this friction head and one of these formulae (see page 4), is arranged in chart form on Charts III and IV. Friction head per 1,000 feet length of pipe can be found, therefore, from Charts III or IV by connecting with a straight line (called index line) the values of "discharge" and "diameter" on the respective scales; the value for the friction head is at the intersection of index line with "friction head" or "fall or loss of head" scale.

d: remaining pressure head at end of pipe line:

A pressure gauge connected to the end of a penstock where it enters the turbine will record:

- a pressure equivalent to the vertical drop from the pond level to pressure gauge if the water is not flowing, or
- a value somewhat less than that in case (a) if the water is flowing. A little thought will show that this pressure is less than when the water is not flowing, because there are the three losses already enumerated as a, b, and c.

If the end of the uniform diameter pipe line discharges into the air, a pressure gauge attached at the end would read zero. The total fall here is the sum of items a, b, and c.

Where the Penstock Supplies Water to a Turbine:

Example. Suppose a head of 65 feet is available for a power development, that a discharge of 200 cubic feet per second is desired, and that the penstock is to be 600 feet long. What diameter of penstock should be selected?

There are many solutions to this problem; a small diameter penstock may be chosen necessitating a high velocity of flow with the consequent large losses of head used up in overcoming pipe friction. Or a large (and expensive) penstock may be decided upon with low velocity of flow and small friction loss. Between these two extremes there must be selected a size of penstock where the gain in efficiency is not overcome by the increased cost of the penstock.

Assume that we are willing to use up 12 feet of our 65 feet total head to overcome friction in pipe line; 12 feet loss in 600 feet length of pipe is the same as 20 feet loss in 1,000 feet length. This loss of head must be transferred to that for 1,000 feet length of pipe since the chart is designed on this basis. On Chart IV connect 20 feet "head" and 200 cubic feet per second "discharge" with a straight line, and read at intersections with other scales that a 4-foot internal diameter pipe is needed, and that the velocity of flow will be 15.9 feet per second. Notice that the velocity head need not be considered in this case because it is

effective in producing power. Knowing the velocity, we can calculate the

$$\text{entrance loss} = \frac{v^2}{128.8} = \frac{(15.9)^2}{128.8} = 1.96 \text{ feet.}$$

The losses of head total 12 feet friction loss (for 600 feet of pipe) plus 1.96 feet, or 14 feet approximately, leaving 65 less 14 feet or 51 feet head useful for power at end of pipe line.

If a greater useful head be desired, it would be necessary to repeat these computations assuming a lesser friction head. Let us limit the friction head to 5 feet per 1,000 feet length, keeping the discharge at 200 cubic feet per second. Using another straight line construction on Chart IV, we find that a 5 1/4 foot penstock will be needed and that the velocity now will be 9 feet per second.

$$\text{The loss at entrance is } \frac{v^2}{128.8} = 0.7 \text{ foot in this case.}$$

The friction loss in 600 feet is three-fifths of the loss per 1,000 feet or 3 feet. The total loss of head now is 3 plus 0.7 or 3.7 feet, leaving 65 less 3.7 or 61.3 feet head at end of line useful for power. By such "cut" and "trial" methods, an economical balance between penstock cost and power loss must be found. If the above diameter of 5 1/4 feet is satisfactory, then the area of gate opening ought to be at least that of a 5 1/4 foot diameter circle or 21.65 square feet. A convenient table of diameters and areas will be found on the inside front cover of this section.

In the solution above, as well as in the example to follow, we have assumed the penstock to be of such nature that its coefficient is 100, and thus have been able to use Charts III and IV without any correction factor. Reference to Table 1 on page 5 will show that the above solution will be correct for ordinary iron pipes 14 to 20 years old, for riveted steel pipe 10 years old, and for brick sewers. For other pipes and other conditions, a study should be made of Table I and explanation on page 5.

Where the Pipe Line Discharges Freely into the Atmosphere

Example. A somewhat different case is encountered in short pipe lines for water supply or irrigation. Suppose the drop from reservoir level to discharge end is 10 feet; that length of pipe necessary is 500 feet, and that a discharge of 1,000 gallons per minute is wanted. Determine the necessary size of pipe.

We need to know the approximate velocity of flow in order that velocity head and loss of head at entrance may be computed. Since there is no head reserved for power at end of such a supply line, we can assume for preliminary calculations that the friction head loss in 500 feet is the entire 10 feet head available; this 10 feet head per 500 feet length must be changed to 1,000 feet length in order to use the charts. Connecting on Chart III the 20 feet head and 1,000 gallons per minute values with a straight line, we find that an 8 3/4 inch pipe is required and the velocity of flow is 5.6 feet per second.

In cases where the ratio of length in feet to diameter is found to exceed 5,000, the above calculation for diameter will be sufficient and correct to within one per cent.

A Refinement in the Above Calculations for Short Lengths

For small ratios of length to diameter as in this problem, it is frequently advisable to consider entrance and velocity head losses. Assuming that the velocity is 5.6 feet per second found in the first part of this example, we calculate the velocity head to be

$$\frac{v^2}{64.4} = \frac{5.6^2}{64.4} = 0.487 \text{ feet from item a.}$$

The loss of head at entrance is

$$\frac{v^2}{128.8} = \frac{5.6^2}{128.8} = 0.243 \text{ feet from item b.}$$

Total loss is .487 plus .243 or .73 feet. Available head to overcome friction is 10 minus .73 or 9.27 feet in 500 feet length of pipe or 18.54 feet per 1,000 feet length. Using Chart III again, with a discharge of 1,000 gallons per minute and 18.5 foot fall or loss of head, we find that a diameter of 9 inches will be required. This completes the solution.

This last part of the computation is a refinement not usually needed in practical work. The effect of acceleration head and entrance loss can be offset by a slight increase in size of pipe over that obtained in the preliminary calculations. The selection of the nearest commercial size of pipe larger than the theoretical size usually takes care of this.

The Charts III and IV are for ordinary iron pipe 14 to 20 years old. For application to other pipes, study information in Table I and explanation following Chart IV found on page 5.

Chart I: Discharge of Gates and Sluices

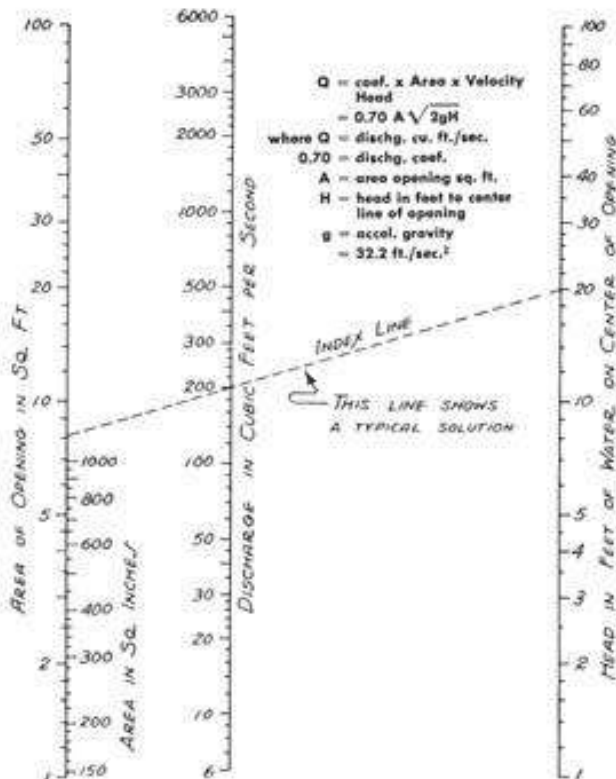
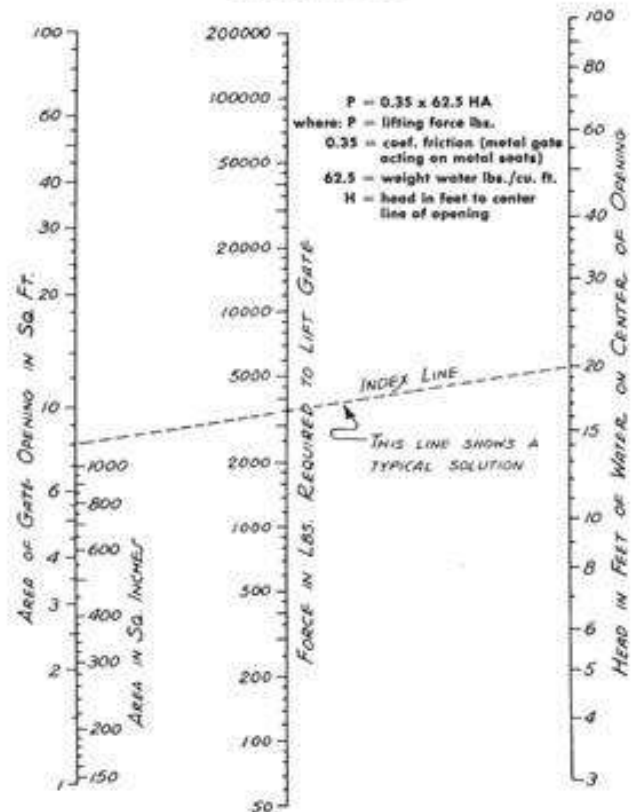

Chart II: Force Required to Overcome Friction in Sluice Gates



KEY WATERPOWER FORMULAS

A. Fundamental Water Power Formulae:

$$\text{HORSE POWER} = \frac{62.5 \times \text{Water (cu. ft. per sec.)} \times \text{Head (ft.)} \times \text{Efficiency (\%)}}{550}$$

$$\text{“ “} = \frac{\text{Water (cu. ft. per sec.)} \times \text{Head (ft.)} \times \text{Efficiency (\%)}}{8.815}$$

OR

$$\text{EFFICIENCY (\%)} = \frac{\text{Horse Power} \times 8.815}{\text{Cu. Ft. per Sec.} \times \text{Head (ft.)}}$$

OR

$$\text{CU. FT. PER SEC.} = \frac{\text{Horse Power} \times 8.815}{\text{Head} \times \text{Efficiency}}$$

B. Transformations For Various Heads:

1. Horse Power varies directly as the *Square Root* of the *Cube* of the Heads; that is, $\text{H.P.} = \text{h.p.} \times \left(\frac{H}{h}\right)^{3/2}$

Example. A 30-in. Wheel develops 48 H.P. under 8 ft. Head. What power will it develop under 16 ft. Head?

$$16 \text{ divided by } 8 = 2. \quad 2 \text{ cubed} = 8. \\ \text{Square root of } 8 = 2.82. \quad 2.82 \times 48 = 135 \text{ H.P.}$$

2. Speed or R.P.M. varies directly as the *Square Root* of the Heads; that is, $\text{R.P.M.} = \text{r.p.m.} \times \sqrt{\frac{H}{h}}$

Example. A 30-in. Wheel runs at 132 R.P.M. under 8 ft. Head. What speed should it run under 16 ft. Head?

$$16 \text{ divided by } 8 = 2. \quad \text{Square root of } 2 = 1.414. \\ 1.41 \times 132 = 187 \text{ r.p.m.}$$

3. Water Used varies directly as the *Square Root* of the Heads; that is, $\text{C.F.S.} = \text{c.f.s.} \times \sqrt{\frac{H}{h}}$

Example. A 30-in. Wheel uses 65 cu. ft. per sec. under 8 ft. Head. How much water will it use under 16 ft. Head?

$$16 \text{ divided by } 8 = 2. \quad \text{The square root of } 2 = 1.414. \\ 1.414 \times 65 = 92.0 \text{ cu. ft. per sec.}$$

IF THE SIZE WHEEL IS CHANGED TO DETERMINE THE H.P., CU. FT. PER SEC. AND R.P.M.

4. Horse Power varies directly as the *Square* of Diameters; that is, $\text{H.P.} = \left(\frac{D}{d}\right)^2 \times \text{h.p.}$

Example. A 30-in. Wheel develops 48 H.P. under 8 ft. Head. What H.P. will a 36-in. Wheel develop under 8 ft. Head?

$$36 \text{ divided by } 30 = 1.2. \quad 1.2 \text{ squared} = 1.44. \\ 1.44 \times 48 = 69.2 \text{ H.P.}$$

5. Speed or R.P.M. varies inversely as the *Diameters*; that is, $\text{R.P.M.} = \text{r.p.m.} \times \left(\frac{d}{D}\right)$

Example. A 30-in. Wheel runs at 132 R.P.M. under 8 ft. Head. What speed should a 36-in. Wheel run at under 8 ft. Head?

$$30 \text{ divided by } 36 = .833. \quad .833 \times 132 = 110.0 \text{ r.p.m.}$$

6. Water Used or C.F.S. varies directly as the *Square* of Diameters; that is, $\text{C.F.S.} = \text{c.f.s.} \times \left(\frac{D}{d}\right)^2$

Example. A 30-in. Wheel uses 65 cu. ft. per sec. under 8 ft. Head. How much water will a 36-in. Wheel under 8 ft. Head use?

$$36 \text{ divided by } 30 = 1.2. \quad 1.2 \text{ squared} = 1.44. \\ 1.44 \times 65 = 93.5 \text{ cu. ft. per sec.}$$

A term which has become very significant in water power engineering is *Specific Speed*. It is defined as the R.P.M. of a Wheel of the correct size to develop *ONE H.P.* under *ONE Ft. Head*. For any type of Wheel it may be determined as follows if the Three Quantities = H.P., R.P.M., and Head are known.

$$\text{SPECIFIC SPEED} = \frac{\text{R.P.M.}}{(\text{Head})^{5/4}} \sqrt{\text{H.P.}}$$

Example. A catalogue table shows a wheel develops 48 H.P. under 8 ft. Head at 132 R.P.M.

$$\text{SPECIFIC SPEED} = \frac{\text{R.P.M.} \times \sqrt{\text{H.P.}}}{\text{Head} \times \sqrt[5]{\text{Head}}}$$

$$\frac{132 \times 6.93}{8 \times 1.68} = 68.0$$

This term *Specific Speed*, N_s , is very useful in determining at a glance the characteristics of a wheel since it embodies a combination of the speed and power of a wheel under any given head.

Example. If it is required to develop 48 H.P. under 8 ft. Head at 150 R.P.M.

a solution of the expression, $N_s = \frac{150 \sqrt{48}}{8^{5/4}} = 77$ shows that only wheels having a specific speed of approximately 77 R.P.M. need be considered.

D. Permissible Velocity of Water in Raceways for Soils of Varying Character:

In determining the dimensions of a race for a given quantity of water, velocity must be considered and the flow should not be so rapid that the water will wash away the sides or bottom. The allowable velocity depends upon the character of the soil forming the sides. In sandy soil, the velocity should be less than in clayey soil.

On the other hand, if the water is carrying any considerable amount of silt or other matter in suspension,

the velocity should not be too slow or else the silt and mud will be deposited on the bottom of the raceway.

TABLE VI

Sand only	1.1 feet per second
Sandy soil, 15% clay	1.2 feet per second
Sandy loam, 40% clay	1.8 feet per second
Loamy soil, 65% clay	3.0 feet per second
Clay loam, 85% clay	4.8 feet per second
Agricultural soil, 95% clay	6.2 feet per second
Clay	7.3 feet per second

E. Pressure, Theoretical Velocity and Discharge Required per Horsepower for Different Heads of Water:

CHART VII

Head in feet	Pressure lbs. per sq. in.	Theoretical free discharge velocity ft. per sec.	Discharge for 1 H.P. in cu. ft. per min. at 80% eff.	Head in feet	Pressure lbs. per sq. in.	Theoretical free discharge velocity ft. per sec.	Discharge for 1 H.P. in cu. ft. per min. at 80% eff.
1	.433	8.02	661.8	36	15.59	48.12	18.38
2	.866	11.34	330.9	38	16.45	49.44	17.42
3	1.30	13.89	220.6	40	17.32	50.72	16.54
4	1.73	16.04	165.4	42	18.19	51.98	15.76
5	2.17	17.93	132.4	44	19.05	53.20	15.04
6	2.60	19.64	110.3	46	19.92	54.39	14.39
7	3.03	21.22	94.54	48	20.78	55.56	13.79
8	3.46	22.68	82.72	50	21.65	56.71	13.24
9	3.90	24.06	73.53	55	23.82	59.48	12.03
10	4.33	25.36	66.18	60	25.98	62.12	11.03
11	4.76	26.60	60.16	65	28.15	64.66	10.18
12	5.20	27.78	55.15	70	30.31	67.10	9.45
13	5.63	28.92	50.91	75	32.48	69.46	8.82
14	6.06	30.01	47.27	80	34.64	71.73	8.27
15	6.49	31.06	44.12	85	36.81	73.94	7.79
16	6.93	32.08	41.36	90	38.97	76.08	7.35
17	7.36	33.07	38.93	95	41.14	78.17	6.97
18	7.79	34.03	36.77	100	43.3	80.20	6.62
19	8.23	34.96	34.83	125	54.1	89.67	5.29
20	8.66	35.87	33.09	150	65.0	98.22	4.41
22	9.53	37.62	30.08	175	75.8	106.1	3.78
24	10.39	39.29	27.57	200	86.6	113.4	3.31
26	11.26	40.89	25.45	225	97.4	120.3	2.94
28	12.12	42.44	23.64	250	108.3	126.8	2.65
30	12.99	43.92	22.06	275	119.1	133.0	2.41
32	13.86	45.37	20.68	300	129.9	138.9	2.21
34	14.72	46.76	19.46				

THEORETICAL DISCHARGE OF NOZZLES IN U.S. GALLONS PER MINUTE AT VARIOUS HEADS AND PRESSURES
 Nozzle Sizes: 1/16" through 12"

HEAD IN FEET	1/16"	1/8"	3/16"	1/4"	3/8"	1/2"	5/8"	3/4"	7/8"	1"	1 1/8"	1 1/4"	1 1/2"	1 3/4"	2"	2 1/2"	3"	3 1/2"	4"	4 1/2"	5"	6"	7"	8"	9"	10"	11"	12"				
30	8.7	0.34	1.37	3.09	5.49	12.4	22.0	34.3	49.4	67.3	87.8	99.2	137	166	198	269	351	445	549	791	1076	1405	1779	2196	2196	3162	4304	5622	7115	8784	10629	12649
30	15.0	0.40	1.58	5.78	6.72	15.1	26.9	42.0	60.9	82.4	107.6	121.5	168	203	242	329	430	549	672	968	1316	1721	2179	2690	3673	5272	6885	8714	10758	13018	15492	
40	17.3	0.46	1.84	6.73	7.76	17.5	31.1	48.5	69.9	92.1	124.2	140.2	194	235	280	360	470	629	776	1116	1522	1988	2516	3106	4472	6087	7981	10293	12423	15032	17869	
50	21.7	0.56	2.17	8.28	9.48	19.2	34.7	54.3	78.1	104.3	138.9	156.8	217	263	313	428	566	703	868	1250	1701	2232	2813	3472	5000	6806	8889	11250	13899	16686	20000	
60	26.0	0.59	2.38	9.35	9.51	21.4	38.0	59.4	85.6	116.5	152.1	171.8	238	288	342	466	609	770	951	1369	1864	2434	3084	3804	5477	7455	9737	12324	15215	18410	21909	
70	30.3	0.64	2.57	9.78	10.27	23.1	41.1	64.2	92.4	125.0	164.3	185.3	257	311	370	503	657	832	1027	1479	2013	2629	3328	4108	5916	8053	10518	13311	16434	19885	23665	
80	34.6	0.69	2.75	9.78	10.98	24.7	43.9	68.6	98.6	134.5	175.1	198.3	275	332	395	528	703	889	1090	1481	2015	2639	3358	4592	6325	8609	11244	14231	17569	21099	25299	
90	39.0	0.73	2.91	6.35	11.65	26.2	46.6	72.8	104.8	142.3	186.4	210.4	291	352	419	571	745	943	1165	1617	2283	3083	3773	4659	6708	9131	11926	15094	18634	22547	26833	
100	43.0	0.77	3.07	6.91	12.28	27.6	49.1	76.7	110.5	150.4	196.4	221.7	307	371	442	602	786	994	1228	1768	2406	3143	3978	4911	7071	9625	12571	15910	19642	23767	28285	
110	47.6	0.80	3.22	7.24	12.88	29.0	51.9	80.5	115.9	157.7	206.0	232.6	322	389	464	631	824	1043	1288	1854	2524	3296	4172	5150	7416	10094	13185	16687	20601	24927	29665	
120	52.0	0.84	3.36	7.56	13.45	30.3	55.8	84.3	121.0	164.7	215.2	242.9	336	407	484	659	861	1089	1345	1937	2636	3443	4357	5379	7746	10543	13771	17429	21517	26036	30984	
130	56.3	0.87	3.50	7.87	14.00	31.5	59.0	87.5	126.0	171.5	224.0	250.8	350	425	504	686	896	1134	1400	2016	2743	3585	4555	5599	8062	10974	14355	18140	22396	27099	32550	
140	60.6	0.91	3.63	8.17	14.53	32.7	62.1	90.8	130.7	177.9	232.4	260.4	363	439	521	712	930	1177	1455	2092	2847	3719	4706	5810	8367	11388	14874	18829	23241	28122	33467	
150	65.0	0.94	3.76	8.46	15.04	33.8	65.1	94.0	135.3	184.2	240.6	271.6	376	455	541	737	962	1210	1504	2165	2947	3849	4871	6014	8660	11768	15396	19486	24057	29109	34442	
160	69.3	0.97	3.88	8.73	15.53	34.9	68.1	97.1	139.6	190.2	248.5	280.5	388	470	559	761	994	1258	1555	2236	3044	3975	5031	6211	8944	12174	15901	20125	24846	30365	35778	
170	73.6	1.00	4.00	9.00	16.01	36.0	70.4	100.0	144.1	196.1	256.1	289.1	400	484	576	784	1024	1297	1601	2305	3157	4098	5186	6403	9220	12549	16391	20744	25610	30988	36479	
180	77.9	1.03	4.12	9.26	16.47	37.1	73.1	102.9	148.2	201.8	263.5	297.5	412	498	593	807	1054	1334	1647	2372	3228	4216	5316	6588	9487	12915	16866	21346	26353	31887	37348	
190	82.3	1.06	4.23	9.52	16.92	38.1	76.1	105.8	152.3	207.3	270.7	305.7	423	512	609	829	1083	1371	1692	2437	3317	4332	5483	6769	9747	13267	17328	21931	27023	32761	38768	
200	86.5	1.09	4.34	9.77	17.36	39.1	79.1	108.5	156.3	212.7	277.8	315.6	434	525	625	851	1111	1406	1736	2500	3403	4445	5625	6945	10000	13611	17738	22500	27378	33612	40001	
300	129.9	1.33	5.32	11.96	21.26	47.8	85.1	132.0	191.4	260.5	340.2	384.1	532	643	765	1042	1361	1722	2126	3062	4168	5443	6889	8505	12248	16670	21774	27357	34021	41166	48991	
350	151.6	1.44	5.74	12.92	22.97	51.7	91.9	143.5	206.7	281.3	367.5	414.8	574	695	827	1125	1470	1860	2307	3307	4502	5880	7441	9107	13229	18006	23518	29765	36747	44464	52916	
400	173.2	1.53	6.14	13.81	24.59	55.2	98.2	153.5	221.0	300.8	392.8	443.5	614	743	884	1203	1571	1989	2455	3536	4812	6286	7955	9821	14142	19249	25142	31820	39284	47534	56570	
450	194.5	1.63	6.51	14.65	26.04	58.6	104.2	162.6	234.4	318.0	416.7	470.4	651	788	938	1276	1667	2109	2604	3730	5104	6657	8436	10417	15000	20417	26667	33751	41667	50418	60001	
500	216.5	1.72	6.86	15.44	27.45	61.8	109.8	171.6	247.1	336.5	439.2	495.8	686	830	988	1345	1757	2224	2745	3953	5380	7027	8894	10980	15812	21521	28110	35576	43921	53145	63247	
600	259.8	1.88	7.52	16.91	30.07	67.7	120.5	187.9	270.6	368.4	481.1	543.2	752	910	1083	1473	1925	2436	3007	4330	5894	7698	9743	12028	17321	23576	30795	38972	48113	58237	69283	
700	303.1	2.03	8.12	18.27	32.40	73.1	129.9	205.0	292.3	397.9	519.7	586.7	812	985	1169	1592	2079	2631	3248	4677	6366	8315	10524	12992	18709	25465	32260	40294	51968	62862	74934	
800	346.4	2.17	8.68	19.53	34.72	78.1	138.9	217.0	312.5	425.4	559.6	627.2	868	1050	1250	1701	2222	2815	3472	5026	6806	8889	11250	13809	20000	27223	35596	45001	55557	67223	80001	
900	389.7	2.30	9.21	20.72	36.83	82.9	147.3	230.2	331.5	451.2	589.3	665.2	921	1114	1326	1805	2357	2983	3683	5203	7219	9428	11935	14752	21214	28074	37113	47731	59227	71301	84854	
1000	433.0	2.43	9.71	21.84	38.82	87.3	155.5	242.6	349.4	475.6	621.1	701.2	971	1174	1398	1902	2485	3145	3882	5590	7609	9938	12578	15629	22361	30456	39753	50312	62114	75158	89444	
1100	476.5	2.54	10.18	22.90	40.72	91.6	162.9	254.5	368.4	498.8	651.5	735.4	1018	1232	1466	1995	2606	3296	4072	5863	7980	10423	13192	16286	23492	31921	41693	52748	65146	78820	93810	
1200	519.6	2.66	10.63	23.92	42.55	95.7	170.1	265.8	382.7	521.0	680.4	768.1	1063	1286	1531	2084	2722	3445	4253	6124	8335	10887	13779	17011	24495	33341	43347	53114	64043	76252	90981	
1300	562.9	2.77	11.07	24.90	44.26	99.6	177.1	276.6	398.4	542.2	708.2	799.5	1107	1339	1593	2169	2835	3585	4426	6374	8676	11331	14341	17705	24946	34702	45305	57365	70821	85631	101982	
1400	606.2	2.87	11.48	25.84	45.55	103.4	183.7	287.1	415.4	562.7	734.9	829.7	1148	1390	1654	2251	2940	3721	4593	6614	9003	11759	14883	18374	24936	34012	45036	56950	70498	86228	103832	
1500	649.5	2.97	11.89	26.74	47.25	107.0	190.2	297.2	427.9	582.4	760.7	858.8	1189	1438	1712	2330	3043	3851	4759	6847	9319	12312	15405	19018	25387	34276	44687	56620	70374	86349	104946	
1600	692.8	3.07	12.28	27.62	48.11	110.5	196.4	306.9	441.9	601.5	785.7	887.0	1228	1483	1768	2406	3143	3976	4911	7071	9625	12571	15910	19642	26285	34999	45284	56641	70569	86668	105339	
1700	736.1	3.16	12.65	28.47	50.02	113.9	202.5	316.4	455.6	620.0	809.9	914.3	1265	1531	1822	2480	3239	4100	5062	7269	9921	13268	16400	20347	29235	38684	51832	63949	80987	97994	116621	
1800	779.4	3.26	13.02	29.30	50.98	117.2	208.3	325.5	468.8	638.0	835.5	940.8	1302	1576	1876	2552	3333	4219	5208	7500	10209	13534	16875	20834	30001	40834	51701	63355	80003	100003	120002	
1900	822.7	3.34	13.38	30.10	51.91	120.4	214.0	334.4	481.6	655.5	856.2	966.6	1338	1619	1926	2632	3425	4334	5351	7706	10488	13899	17328	21405	28223	37193	47996	60351	75618	93598	113598	
2000	866.0	3.43	13.73	30.88	52.90	123.5	219.5	343.1	494.1	672.5	878.4	991.7	1373	1661	1976	2690	3514	4447	5490	7766	10761	14055	17885	21961	28723	37823	48543	62119	77153	97843	118290	

FLOW OF WATER

Flow of Water Through Nozzles in Cubic Feet per Second

Head in Ft at Nozzle	Pressure lbs. per Sq. In.	Theoretical Velocity Ft. per Second	Diameter of Nozzle, Inches							
			5	6	7	8	9	10	11	12
5	2.17	17.93	2.44	3.52	4.81	6.3	7.9	9.8	12.8	14.1
10	4.33	25.36	3.46	4.98	6.78	8.8	11.2	13.8	16.7	19.9
20	8.66	35.86	4.88	7.04	9.58	12.5	15.8	19.6	23.7	28.2
30	12.99	43.92	5.99	8.62	11.74	15.3	19.4	23.9	29.0	34.5
40	17.32	50.72	6.92	9.96	13.56	17.7	22.4	27.7	33.5	39.8
50	21.65	56.71	7.73	11.13	15.16	19.8	25.0	30.9	37.4	44.5
60	25.99	62.12	8.44	12.19	16.60	21.7	27.4	33.9	41.0	48.8
70	30.32	67.10	9.15	13.17	17.93	23.4	29.6	36.6	44.3	52.7
80	34.65	71.73	9.78	14.08	19.17	25.0	31.7	39.1	47.3	56.4
90	38.98	76.08	10.38	14.93	20.35	26.6	33.6	41.5	50.2	59.7
100	43.31	80.20	10.94	15.74	21.44	28.0	35.4	43.7	52.9	63.0
120	51.97	87.88	11.99	17.25	23.49	30.7	38.8	47.9	58.0	69.0
140	60.63	94.89	12.94	18.63	25.36	33.1	41.9	51.7	62.6	74.5
160	69.29	101.45	13.84	19.91	27.12	35.4	44.8	55.3	67.0	79.7
180	77.96	107.59	14.67	21.12	28.76	37.6	47.5	58.7	71.0	84.5
200	86.62	113.41	15.47	22.26	30.31	39.6	50.1	61.8	74.8	89.1
250	108.50	126.80	17.29	24.86	33.89	44.3	56.0	69.2	83.7	99.6
300	130.20	138.91	18.90	27.27	37.13	48.5	61.4	75.8	91.7	109.1
350	151.90	150.04	20.46	29.45	40.10	52.4	66.3	81.8	99.0	117.8
400	173.60	160.40	21.88	31.49	42.87	56.0	70.9	87.5	105.9	126.0
450	195.30	170.12	23.20	33.39	45.26	59.4	75.2	92.8	112.2	133.6
500	216.00	179.33	24.46	35.20	47.93	62.6	79.2	97.8	118.4	140.8

FLOW OF WATER

Flow of Water Through Nozzles in Cubic Feet per Second

Head in Feet at Nozzle	Pressure Pounds per Sq. Inch	Theoretical Velocity Ft. per Second	Diameter of Nozzle, Inches							
			1	1½	2	2½	3	3½	4	4½
5	2.17	17.93	0.10	0.22	0.39	0.61	0.88	1.20	1.56	2.04
10	4.33	25.36	0.14	0.31	0.55	0.86	1.24	1.69	2.21	2.87
20	8.66	35.86	0.19	0.44	0.78	1.22	1.76	2.39	3.13	4.07
30	12.99	43.92	0.24	0.54	0.96	1.50	2.16	2.93	3.83	4.98
40	17.32	50.72	0.28	0.62	1.10	1.73	2.49	3.39	4.43	5.75
50	21.65	56.71	0.31	0.70	1.24	1.93	2.78	3.79	4.95	6.43
60	25.99	62.12	0.34	0.76	1.35	2.12	3.05	4.15	5.42	7.04
70	30.32	67.10	0.37	0.82	1.46	2.29	3.29	4.48	5.86	7.61
80	34.65	71.73	0.39	0.88	1.56	2.44	3.52	4.79	6.26	8.13
90	38.98	76.08	0.42	0.94	1.66	2.59	3.73	5.08	6.64	8.63
100	43.31	80.20	0.44	0.99	1.75	2.73	3.94	5.38	7.00	9.09
120	51.97	87.88	0.49	1.08	1.87	3.00	4.31	5.87	7.67	9.96
140	60.63	94.89	0.52	1.17	2.07	3.23	4.66	6.35	8.28	10.76
160	69.29	101.45	0.56	1.25	2.21	3.46	4.98	6.78	8.86	11.50
180	77.96	107.59	0.55	1.32	2.34	3.67	5.28	7.19	9.39	12.20
200	86.62	113.41	0.62	1.39	2.47	3.87	5.57	7.57	9.90	12.86
250	108.50	126.80	0.70	1.56	2.76	4.32	6.22	8.47	11.07	14.38
300	130.20	138.91	0.76	1.71	3.03	4.74	6.82	9.27	12.13	15.75
350	151.90	150.04	0.82	1.84	3.27	5.12	7.37	10.02	13.10	17.01
400	173.60	160.40	0.88	1.97	3.50	5.47	7.87	10.71	14.00	18.19
450	195.30	170.12	0.93	2.09	3.71	5.80	8.35	11.36	14.85	19.39
500	216.00	179.33	0.99	2.21	3.91	6.11	8.80	11.98	15.65	20.34

MISCELLANEOUS FORMULA

$$\begin{aligned}
 1 \text{ horsepower} &= 33,000 \text{ foot-pounds/minute} \\
 &= 550 \text{ foot-pounds/second} \\
 1 \text{ horsepower} &= 746 \text{ watts} = .746 \text{ kilowatts} \\
 &= 76.04 \text{ kilogram meters/second} \\
 1 \text{ BTU} &= 778.3 \text{ ft. lbs.} = 0.0003927 \text{ H.P. hours} \\
 &= 0.0002928 \text{ KW hours}
 \end{aligned}$$

A. Alternating Current

$$\begin{aligned}
 \text{Single-Phase KW} &= \frac{EI \times \text{P.F.}}{1000} \\
 \text{Two-Phase KW} &= \frac{2EI \times \text{P.F.}}{1000} \\
 \text{Three-Phase KW} &= \frac{1.732EI \times \text{P.F.}}{1000}
 \end{aligned}$$

KW = kilowatts; E = average volts between line terminals

I = average line current; P.F. = power factor

$$\text{K.V.A.} = \frac{\text{Volts} \times \text{Amperes}}{1,000}$$

$$\text{KW} = \text{K.V.A.} \times \text{P.F.}$$

$$\text{Horsepower} = \frac{\text{KW} \times \text{Efficiency}}{746}$$

Amperes Per Phase

The current of A.C. apparatus is always given in amperes per phase and can be computed from the following formulae:

$$\text{Single-Phase Amp.} = \frac{1000 (\text{Kva})}{\text{Volts}}$$

$$\text{Two-Phase (4 wire) Amp.} = \frac{1000 (\text{Kva})}{2 \times \text{Volts}}$$

$$\text{Three-Phase (3 wire) Amp.} = \frac{1000 (\text{Kva})}{1.73 \times \text{Volts}}$$

Synchronous motors, as the name implies, run at synchronous speeds, regardless of the load. Squirrel-cage or wound-rotor induction motors lose speed as the load increases. The difference in speed between no load and full load is about 3 to 5%, rather

$$\text{General formula for AC synchronous motor speed} = \frac{120f}{p} \text{ where: } f = \text{frequency in cycles, } p = \text{no. poles of motor}$$

D. Short Method of Figuring Synchronous Speeds

For 60 Cycle current, speed equals 7,200 divided by number of poles
 For 50 Cycle current, speed equals 6,000 divided by number of poles
 For 40 Cycle current, speed equals 4,800 divided by number of poles
 For 25 Cycle current, speed equals 3,000 divided by number of poles

MISCELLANEOUS FORMULAE

$$\text{Circumference of circle} = 3.1416 \times \text{diameter.}$$

$$\text{Side of a square of equal area as that of a circle} = 0.8862 \times \text{diameter.}$$

$$\text{Diameter of a circle of equal area as that of a square} = 1.1284 \times \text{side of square.}$$

$$\text{Area of a circle} = 0.7854 \times \text{square of the diameter.}$$

$$\text{Surface area of a sphere} = 3.1416 \times \text{square of the diameter.}$$

$$\text{Volume of a sphere} = 0.5236 \times \text{cube of diameter.}$$

$$\begin{aligned}
 1 \text{ Kilowatt} &= 1,000 \text{ watts} \\
 1 \text{ Kilowatt} &= 1.341 \text{ horsepower} \\
 1 \text{ KW hour} &= 3412 \text{ BTU} \\
 1 \text{ HP hour} &= 2544 \text{ BTU} \\
 1 \text{ Ft. lb.} &= 0.001285 \text{ BTU}
 \end{aligned}$$

B. Direct Current

$$\text{Kilowatts} = \frac{\text{Volts} \times \text{Amperes}}{1,000}$$

$$\text{Horsepower} = \frac{\text{Volts} \times \text{Amperes} \times \text{Efficiency}}{746}$$

$$\text{Kilowatts} = \frac{\text{Horsepower} \times 746}{1,000 \times \text{Efficiency}}$$

C. Frequency and Speed

$$\text{Frequency (alternations per min.)} = \frac{\text{Speed (r.p.m.)} \times \text{number of poles}}{60}$$

$$\text{One cycle per second} = \frac{\text{Two alternations per second}}{2}$$

$$\text{One cycle per second} = \frac{120 \text{ alternations per minute}}{120}$$

$$\text{Number of cycles} = \frac{\text{Speed} \times \text{poles}}{120}$$

Capacity Required

In determining the capacity of units required, the power factor of the system should always be considered.

As A.C. generators are rated in kilo-volt-amperes (K.V.A.) on a non-inductive load (100% power factor) the proper capacity in true kilowatts should be determined at the proper power factor.

For 1,000 true kilowatts output at 80% power factor, the required capacity in kilo-volt-amperes would be $\frac{1,000}{0.8}$ or 1,250 K.V.A.

more for very small motors and less for very large motors.

In belt drive calculations, it is necessary to figure on the full load speed, which is the actual speed of the motor when running under normal conditions at full or nearly full capacity.

For circular conduits only:

$$\text{Velocity head} = h_v = \frac{V^2}{2g} = .0155V^2 = \frac{.00259 \text{ gpm}^2}{d^5}$$

$$\text{Velocity} = V = \frac{.4085 \text{ gpm}}{d^2}$$

Where: gpm = gallons per minute

d = inside diameter of conduit in inches

$$\text{Volume of cylinder or prism} = \text{area of base} \times \text{height.}$$

$$\text{Volume of cone or pyramid} = \frac{1}{3} \times \text{area of base} \times \text{height.}$$

$$\text{Volume of the frustum of a cone or pyramid} = \frac{1}{3} \times \text{height} \times (\text{area of upper base} + \text{area of lower base} + \sqrt{\text{area of upper base} \times \text{area of lower base}}).$$

Doubling the diameter of a pipe increases its volume four times; generalizing, increasing the diameter "n" times increases the volume "n³" or "n x n" times.

CONVERSION FACTORS

1 U. S. gallon = .8327 Imperial gallons
= 231.0 cu. inches
= .1337 cu. feet
= 8.34 lbs.
= 3.785 liters
= .00378 cubic meters

1 cu. ft. water = 7.48 U. S. gallons = 62.425 lbs.
1 cu. inch water = 0.0361 lbs.

1 cu. ft. water per sec = 448.83 U. S. gallons per minute
= 646,317 U. S. gallons per 24 hours

1 ψ /in² = 2.309 feet water @ 62°F
= 27.75 inches water
= .06804 atmospheres
= 2.042 inches mercury @ 62°F

1 atmosphere (standard conditions) = 14.69 ψ /in²
= 29.92 inches mercury
= 76 centimeters mercury
= 33.87 feet water

1 millimeter = 0.03937 inches = 0.003281 feet
1 centimeter = 0.3937 inches = 0.03281 feet
1 meter = 39.37 inches = 3.281 feet
1 kilometer = 3281 feet = 0.62137 miles

1 kilogram = 2.205 lbs.
1 pound = 0.4536 kilograms = 453.6 grams

1 liter = 1,000 grams (water) = 1,000 cu. centimeters
= 1.0567 quarts
= 0.2642 gallons
= 0.03531 cu. feet

1 inch = 25.4 millimeters
= 2.54 centimeters
= 0.0254 meters

1 foot = 0.3048 meters

1 mile = 1.609 kilometers
(statute)

1 ounce (avoir.) = 28.3495 grams

1 BTU = 252 calories

1 calorie = .003968 BTU

1 inch water = 0.03612 ψ /in²

1 foot water = 0.4334 ψ /in²

1 inch mercury = 0.4912 ψ /in²

π = 3.14159

$\frac{1}{\pi}$ = 0.31831

π^2 = 9.86960

$\sqrt{\pi}$ = 1.77245

$\log_{10} \pi$ = 0.49715

$\frac{180}{\pi}$ = no. degrees in 1 radian
= 57.296

$\frac{\pi}{180}$ = radians in 1°

= 0.01745

CONVERSION FACTORS

$$\begin{aligned}
 1 \text{ U. S. gallon} &= .8327 \text{ Imperial gallons} \\
 &= 231.0 \text{ cu. inches} \\
 &= .1337 \text{ cu. feet} \\
 &= 8.34 \text{ lbs.} \\
 &= 3.785 \text{ liters} \\
 &= .00378 \text{ cubic meters}
 \end{aligned}$$

$$\begin{aligned}
 1 \text{ liter} &= 1,000 \text{ grams (water)} = 1,000 \text{ cu. centimeters} \\
 &= 1.0567 \text{ quarts} \\
 &= 0.2642 \text{ gallons} \\
 &= 0.03531 \text{ cu. feet}
 \end{aligned}$$

$$\begin{aligned}
 1 \text{ cu. ft. water} &= 7.48 \text{ U. S. gallons} = 62.425 \text{ lbs.} \\
 1 \text{ cu. inch water} &= 0.0361 \text{ lbs.}
 \end{aligned}$$

$$\begin{aligned}
 1 \text{ inch} &= 25.4 \text{ millimeters} \\
 &= 2.54 \text{ centimeters} \\
 &= 0.0254 \text{ meters}
 \end{aligned}$$

$$\begin{aligned}
 1 \text{ cu. ft. water per sec} &= 448.83 \text{ U. S. gallons per minute} \\
 &= 646,317 \text{ U. S. gallons per 24 hours}
 \end{aligned}$$

$$1 \text{ foot} = 0.3048 \text{ meters}$$

$$1 \text{ mile} = 1.609 \text{ kilometers (statute)}$$

$$1 \text{ ounce (avoird.)} = 28.3495 \text{ grams}$$

$$1 \text{ BTU} = 252 \text{ calories}$$

$$1 \text{ calorie} = .003968 \text{ BTU}$$

$$\begin{aligned}
 1 \text{ } \phi/\text{in}^2 &= 2.309 \text{ feet water @ } 62^\circ\text{F} \\
 &= 27.75 \text{ inches water} \\
 &= .06804 \text{ atmospheres} \\
 &= 2.042 \text{ inches mercury @ } 62^\circ\text{F}
 \end{aligned}$$

$$1 \text{ inch water} = 0.03612 \text{ } \phi/\text{in}^2$$

$$1 \text{ foot water} = 0.4334 \text{ } \phi/\text{in}^2$$

$$1 \text{ inch mercury} = 0.4912 \text{ } \phi/\text{in}^2$$

$$\begin{aligned}
 1 \text{ atmosphere (standard conditions)} &= 14.69 \text{ } \phi/\text{in}^2 \\
 &= 29.92 \text{ inches mercury} \\
 &= 76 \text{ centimeters mercury} \\
 &= 33.87 \text{ feet water}
 \end{aligned}$$

$$\begin{aligned}
 1 \text{ millimeter} &= 0.03937 \text{ inches} = 0.003281 \text{ feet} \\
 1 \text{ centimeter} &= 0.3937 \text{ inches} = 0.03281 \text{ feet} \\
 1 \text{ meter} &= 39.37 \text{ inches} = 3.281 \text{ feet} \\
 1 \text{ kilometer} &= 3281 \text{ feet} = 0.62137 \text{ miles}
 \end{aligned}$$

$$\begin{aligned}
 \pi &= 3.14159 & \frac{180}{\pi} &= \text{no. degrees in 1 radian} \\
 \frac{1}{\pi} &= 0.31831 & &= 57.296
 \end{aligned}$$

$$\begin{aligned}
 \pi^2 &= 9.86960 & \frac{\pi}{180} &= \text{radians in } 1^\circ \\
 \sqrt{\pi} &= 1.77245 & &
 \end{aligned}$$

$$\log_{10} \pi = 0.49715 = 0.01745$$

$$\begin{aligned}
 1 \text{ kilogram} &= 2.205 \text{ lbs.} \\
 1 \text{ pound} &= 0.4536 \text{ kilograms} = 453.6 \text{ grams}
 \end{aligned}$$

TERMINAL MARKINGS & CONNECTIONS
D-C MOTORS

SERIES MOTOR

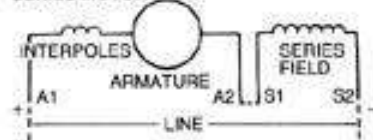

SHUNT MOTOR

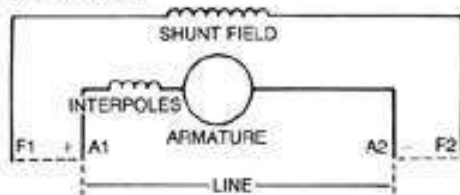

COMPOUND MOTOR

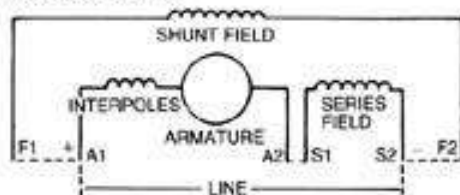

All connections are for counterclockwise rotation facing end opposite drive. For clockwise rotation, interchange A1 and A2.

Some manufacturers connect the interpole winding on the A2 side of armature.

When shunt field is separately excited, same polarities must be observed for a given rotation.

8

SHUNT GENERATOR

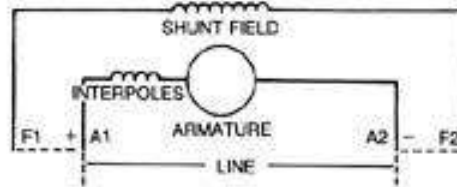

COMPOUND GENERATOR

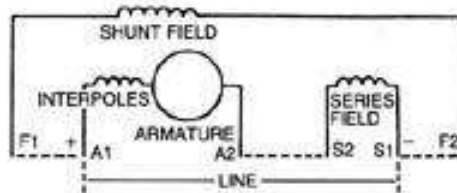

All connections are for counterclockwise rotation facing end opposite drive. For clockwise rotation, interchange A1 and A2.

Some manufacturers connect the interpole winding on the A2 side of armature.

For above generators, the shunt field may be either self-excited or separately excited. When self-excited, connections should be made as shown. When separately excited, the shunt field is isolated from the other windings. When separately excited same polarities must be observed for given rotation.

DC MOTORS AND CIRCUITS

1		2		3		4		5				6	
Size of motor		Motor overload protection Dual-element fuse				Switch 115% minimum or HP rated or fuse holder size	Minimum size of starter	Controller termination temperature rating				Minimum size of copper wire and trade conduit	
HP	Amp	Motor less than 40°C or greater than 1.15 SF (Max fuse 125%)	All other motors (Max fuse 115%)					60°C		75°C		Wire size (AWG or kcmil)	Conduit (inches)
90 V													
1/4	4.0	5	4 1/2	30	0	*	*	*	*	14	1/2		
1/3	5.2	6 1/4	5 6/10	30	0	*	*	*	*	14	1/2		
1/2	6.8	8	7.5	30	0	*	*	*	*	14	1/2		
3/4	9.6	12	10	30	0	*	*	*	*	14	1/2		
1	12.2	15	12	30	0	*	*	*	*	14	1/2		
120 V													
1/4	3.1	3 1/2	3 1/2	30	0	*	*	*	*	14	1/2		
1/3	4.1	5	4 1/2	30	0	*	*	*	*	14	1/2		
1/2	5.4	6 1/4	6	30	0	*	*	*	*	14	1/2		
3/4	7.6	9	8	30	0	*	*	*	*	14	1/2		
1	9.5	10	10	30	0	*	*	*	*	14	1/2		
1 1/2	13.2	15	15	30	1	*	*	*	*	14	1/2		
2	17	20	17 1/2	30	1	*	*	*	*	12	1/2		
5	40	50	45	60	2	* * *				6	3/4		
						* * *				8	3/4		
10	76	90	80	100	3	* * *				2	1		
						* * *				3	1		
180 V													
1/4	2	2 1/2	2 1/4	30	0	*	*	*	*	14	1/2		
1/3	2.6	3 2/10	2 8/10	30	0	*	*	*	*	14	1/2		
1/2	3.4	4	3 1/2	30	0	*	*	*	*	14	1/2		
3/4	4.8	6	5	30	0	*	*	*	*	14	1/2		

* Fuse reducers required.

WIRE SIZE vs VOLTAGE DROP

Voltage drop is the amount of voltage lost over the length of a piece of wire. Voltage drop changes as a function of the resistance of the wire and should be less than 2% if possible. If the drop is greater than 2%, efficiency of the appliance is severely decreased and life of the equipment will be decreased. As an example, if the voltage drop on an incandescent light bulb is 10%, the light output of the bulb decreases over 30%!

Voltage drop can be calculated using Ohm's Law, which is Voltage Drop = Current in amps x Resistance in ohms. For example, the voltage drop over a 200 foot long, 14 gauge power line supplying a 1000 watt floodlight is calculated as follows:

Current = 1000 watts / 120 volts = 8.4 amps
 Resistance of #14 wire = 2.58 ohms / 1000 feet @ 77°F
 Resistance of power line = 200 feet x 0.00258 ohms/foot
 = 0.516 ohms
 Voltage drop = 8.4 amps x 0.516 ohms = 4.33 volts
 Percent voltage drop = 4.33 volts / 120 volts = 3.6%

The 3.6% drop is over the maximum 2% so either the wattage of the bulbs must be decreased or the diameter of the wire must be increased (a decrease in wire gauge number). If #12 wire were used in the above example, the voltage drop would have only been 2.2%. The wire resistance values for various size wire are contained in the Copper Wire table on page 114.

An interesting corollary to the above example is that if the line voltage doubles (240 volts instead of 120 volts) the voltage drop decreases by 50%. That means that a line can carry the same power 2 times further! Higher voltage lines are more efficient.

A more commonly used method of calculating voltage drop is as follows:

$$\text{Voltage drop} = \frac{22 \times \text{Wire length in feet} \times \text{current in amps}}{\text{Circular Mils}}$$

Using the values in the Ohm's Law example at the top of this page, then Voltage drop = (22 x 200 x 8.4) / 4110 circ. mils = 9 volts = 7.5%.

Max Wire Feet @ 120 Volts, 1 Phase, 2% Max Voltage Drop						
Amps	Volt-Amps	#14	#12	#10	#8	#6
1	120	450	700	1100	1800	2800
5	600	90	140	225	360	575
10	1200	45	70	115	180	285
15	1800	30	47	75	120	190
20	2400	-	36	57	90	140
25	3000	-	-	45	72	115
30	3600	-	-	38	60	95
40	4800	-	-	-	45	72
50	6000	-	-	-	-	57
Amps	Volt-Amps	#4	#2	1/0	2/0	3/0
1	120	4500	7000	-	-	-
5	600	910	1400	2250	2800	-
10	1200	455	705	1100	1400	1800
15	1800	305	485	770	965	1200
20	2400	230	365	575	725	900
25	3000	180	290	480	580	720
30	3600	150	240	385	490	600
40	4800	115	175	290	360	440
50	6000	90	145	230	290	360
60	7200	78	120	190	240	305
70	8400	65	105	165	205	260
80	9600	-	90	144	180	230

Max Wire Feet @ 240 Volts, 1 Phase, 2% Max Voltage Drop						
Amps	Volt-Amps	#14	#12	#10	#8	#6
1	240	900	1400	2200	3600	5600
5	1200	180	285	455	720	1020
10	2400	90	140	225	360	525
15	3600	60	95	150	240	350
20	4800	-	70	110	180	265
25	6000	-	-	90	144	210
30	7200	-	-	75	120	175
40	9600	-	-	-	90	130
50	12000	-	-	-	-	105
Amps	Volt-Amps	#4	#2	1/0	2/0	3/0
1	240	9000	-	-	-	-
5	1200	1750	2800	4500	5600	7000
10	2400	910	1400	2200	2800	3600
15	3600	605	965	1500	1900	2400
20	4800	455	725	1100	1400	1800
25	6000	365	590	920	1100	1440
30	7200	300	485	770	970	1200
40	9600	230	360	575	725	880
50	12000	180	290	460	580	720
60	14400	150	240	385	485	600
70	16800	130	205	330	415	520
80	19200	-	180	290	365	440
100	24000	-	-	230	280	360
150	36000	-	-	185	190	240
200	48000	-	-	-	-	180

MISCELLANEOUS ELECTRICAL FORMULAS

OHMS LAW

Ohms = Volts/Amperes ($R = E/I$)
 Amperes = Volts/Ohms ($I = E/R$)
 Volts = Amperes × Ohms ($E = IR$)

POWER—A-C CIRCUITS

Efficiency = $\frac{746 \times \text{Output Horsepower}}{\text{Input Watts}}$

Three-Phase Kilowatts = $\frac{\text{Volts} \times \text{Amperes} \times \text{Power Factor} \times 1.732}{1000}$

Three-Phase Volt-Amperes = $\text{Volts} \times \text{Amperes} \times 1.732$

Three-Phase Amperes = $\frac{746 \times \text{Horsepower}}{1.732 \times \text{Volts} \times \text{Efficiency} \times \text{Power Factor}}$

Three-Phase Efficiency = $\frac{746 \times \text{Horsepower}}{\text{Volts} \times \text{Amperes} \times \text{Power Factor} \times 1.732}$

Three-Phase Power Factor = $\frac{\text{Input Watts}}{\text{Volts} \times \text{Amperes} \times 1.732}$

Single-Phase Kilowatts = $\frac{\text{Volts} \times \text{Amperes} \times \text{Power Factor}}{1000}$

Single-Phase Amperes = $\frac{746 \times \text{Horsepower}}{\text{Volts} \times \text{Efficiency} \times \text{Power Factor}}$

Single-Phase Efficiency = $\frac{746 \times \text{Horsepower}}{\text{Volts} \times \text{Amperes} \times \text{Power Factor}}$

Single-Phase Power Factor = $\frac{\text{Input Watts}}{\text{Volts} \times \text{Amperes}}$

Horsepower (3 Phase) = $\frac{\text{Volts} \times \text{Amperes} \times 1.732 \times \text{Efficiency} \times \text{Power Factor}}{746}$

Horsepower (1 Phase) = $\frac{\text{Volts} \times \text{Amperes} \times \text{Efficiency} \times \text{Power Factor}}{746}$

POWER—D-C CIRCUITS

Watts = Volts × Amperes ($W = EI$)

Amperes = $\frac{\text{Watts}}{\text{Volts}}$ ($I = W/E$)

Horsepower = $\frac{\text{Volts} \times \text{Amperes} \times \text{Efficiency}}{746}$

SPEED—A-C MACHINERY

Synchronous RPM = $\frac{\text{Hertz} \times 120}{\text{Poles}}$

Percent Slip = $\frac{\text{Synchronous RPM} - \text{Full-Load RPM}}{\text{Synchronous RPM}} \times 100$

MOTOR APPLICATION

Torque (lb.-ft.) = $\frac{\text{Horsepower} \times 5250}{\text{RPM}}$

Horsepower = $\frac{\text{Torque (lb.-ft.)} \times \text{RPM}}{5250}$

TIME FOR MOTOR TO REACH

OPERATING SPEED (seconds)

Seconds = $\frac{WK^2 \times \text{Speed Change}}{308 \times \text{Avg. Accelerating Torque}}$

$WK^2 = \text{Inertia of Rotor} + \text{Inertia of Load (lb.-ft.)}^2$

Average Accelerating Torque = $\frac{((\text{FLT} + \text{BDT})/2) + \text{BDT} + \text{LRT}}{3}$

FLT = Full-Load Torque BDT = Breakdown Torque
 LRT = Locked-Rotor Torque

Load WK^2 (at motor shaft) = $\frac{WK^2 (\text{Load}) \times \text{Load RPM}^2}{\text{Motor RPM}^2}$

SHAFT STRESS (P.S.I.) = $\frac{\text{HP} \times 321,000}{\text{RPM} \times \text{Shaft Diam.}^3}$

PUMP MOTOR APPLICATION

Horsepower = $\frac{\text{GPM} \times \text{Head in Feet} \times \text{Specific Gravity}}{3960 \times \text{Efficiency of Pump}}$

Head in Feet = 2.31 P.S.I.G.

FAN AND BLOWER MOTOR APPLICATION

Horsepower = $\frac{\text{CFM} \times \text{Pressure (lb./sq. ft.)}}{33000 \times \text{Efficiency}}$

VOLUME OF LIQUID IN A TANK

Gallons = $5.875 \times D^2 \times H$

D = Tank Diameter (ft.)

H = Height of Liquid (ft.)