

# KNOT KNOWLEDGE

## PHOTO-ILLUSTRATIONS

Twenty-three practical knots are presented with photographs of the steps involved in tying each knot. Every step is also described in text. It is not the function (yet) of Knot Knowledge to teach how to use these knots, so please do not use friction hitches for dangerous activities like climbing rope unless you have been properly trained. Knot Knowledge provides in its [lexicon](#) definitions of the few knot tying terms used in the text descriptions.

Clicking on a category shows all the knots within that category on one page. Clicking on the name of a knot shows just that knot.

- [Single Loop Knots Page](#) (272K)
  - [Bowline](#)
  - [Figure 8 Loop](#)
  - [In Line Figure 8 Loop](#)
  - [Butterfly Knot](#)
- [Double Loop Knots Page](#) (297K)
  - [Spanish Bowline](#)
  - ["A Rigid Double Splayed Loop in the Bight" \(ABoK #1100\)](#)
  - [Triple Crown Knot](#)

**Arrange the rope as shown, with a small loop in the standing part and the end going around the object the loop is to be tied around.**

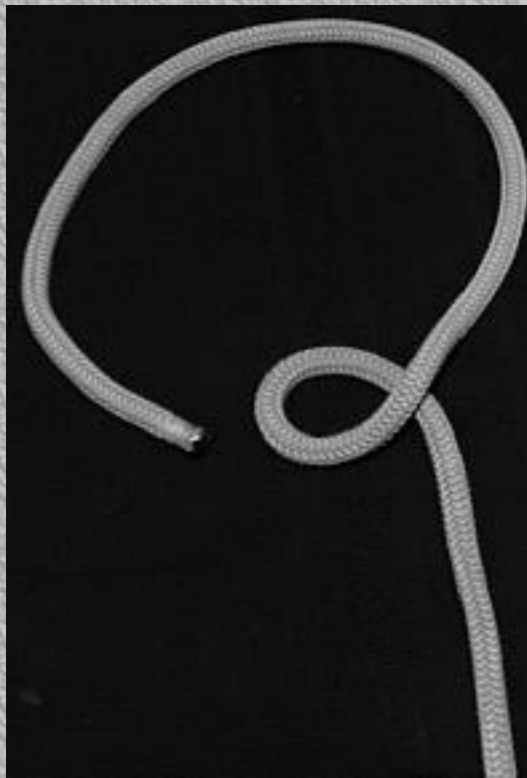

## *Step #2*

**Insert the end through the loop.**

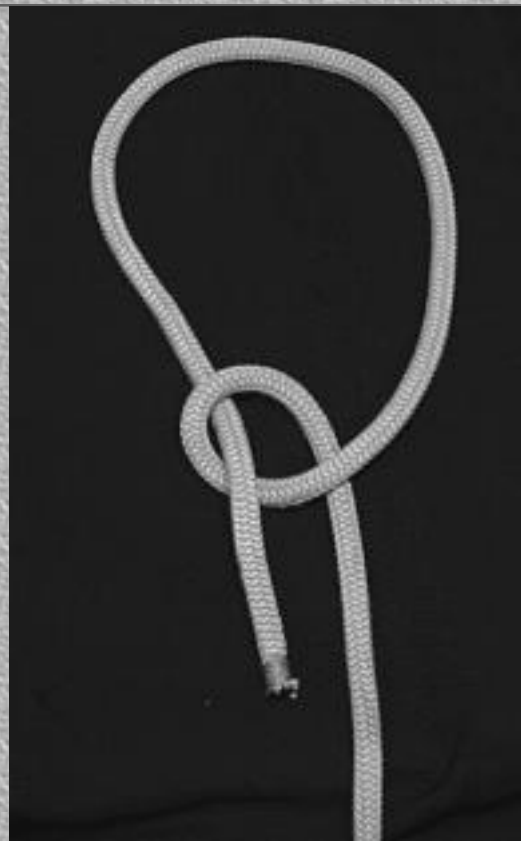

### *Step #3*

**Pull the end around and behind the standing part.**

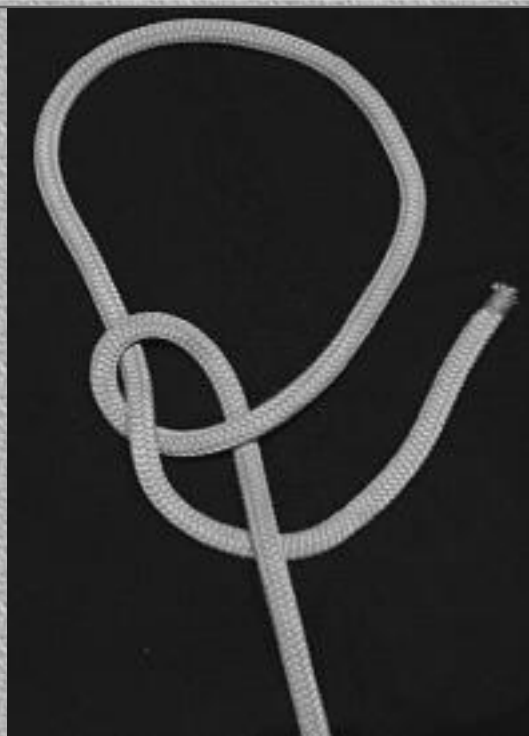

### *Step #4*

**Insert the end back through the loop.**

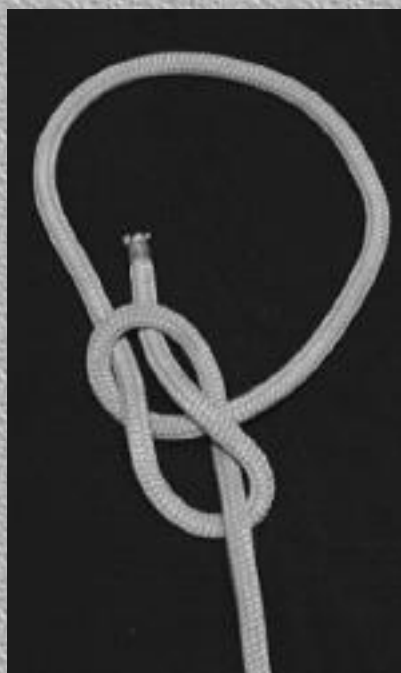

*Finished Bowline - Front View*

**Dress and set the knot.**

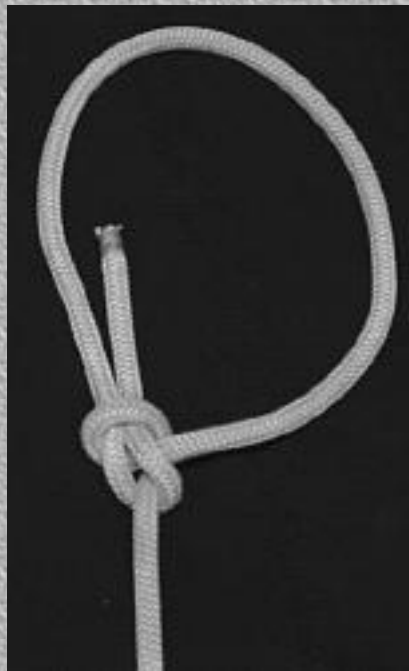

***Finished Bowline - Rear View***

**Dress and set the knot.**

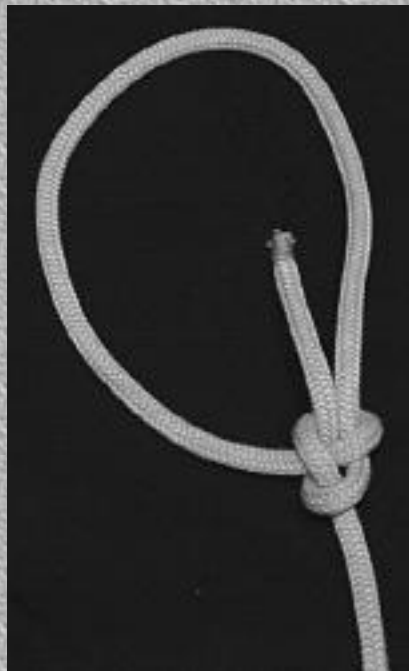

**Bowline - One Handed Twist Method**



**This is a fast and reliable method for making the loop in the standing part. This method can also be used to tie a [sheet bend](#). To use this method for a sheet bend, instead of twisting the end into a loop in its own standing part (as shown below), twist a loop very near the end of a second rope. Be sure that the end of the rope you have in your hand is pointing up and the end of the second rope (that you'll be twisting a loop into) is pointing down.**

### ***Bowline - One Handed Twist Method - Step #1***

**Grab the end of the rope and place it across the standing part. Place your thumb under the standing part.**



### ***Bowline - One Handed Twist Method - Step #2***

**Rotate your wrist clockwise, hooking the standing part with your thumb and bringing it around in a loop. Keep the end inside the big loop.**



### ***Bowline - One Handed Twist Method - Step #3***

**Continue rotating your wrist until the loop is formed in the standing part with the end threaded through it. Now you can just weave the end behind the standing part and back down through the loop, as described above (do this to complete the sheet bend, too).**



## Figure 8 Loop

The Figure 8 Loop is just a [Figure 8 Knot](#) tied in the bight.

### *Step #1*

**Start with a bight of rope and form a loop where the end is behind the standing part.**

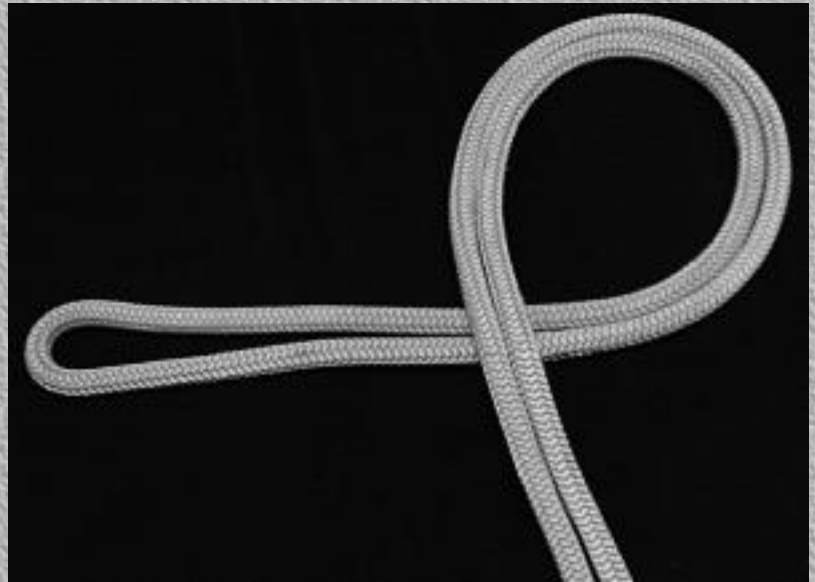

### *Step #2*

**Bring the end around and in front of the standing part.**



*Step #3*

**Insert the end back through the loop.**





## *Finished Figure 8 Loop*

**Dress and set the knot.**

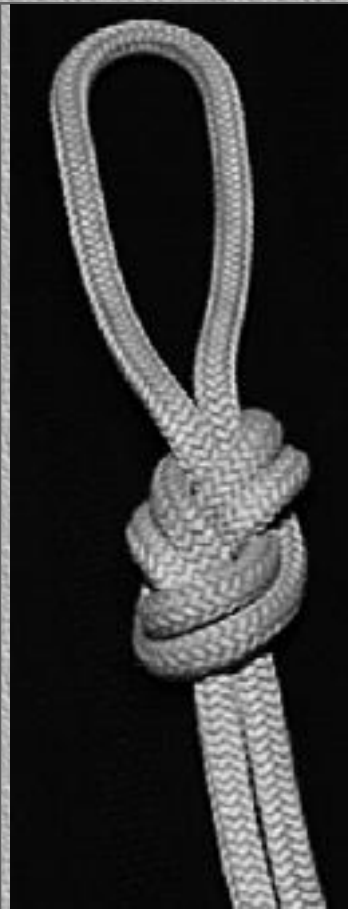

[\[Top of Page\]](#)

---

## **[In Line Figure 8 Loop](#)**

**The In Line Figure 8 Loop is used for a load that will be more or less parallel to the standing part. This loop knot can be pulled through a pulley easier than other loop knots.**

## *Step #1*

**Start with the standing part of the rope.**

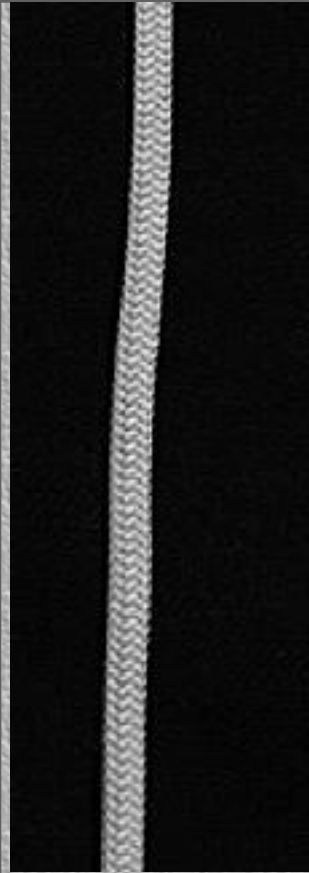

## *Step #2*

**Twist the standing part to create a loop, as shown.**



*Step #3*

**Bring the loop behind the standing part.**

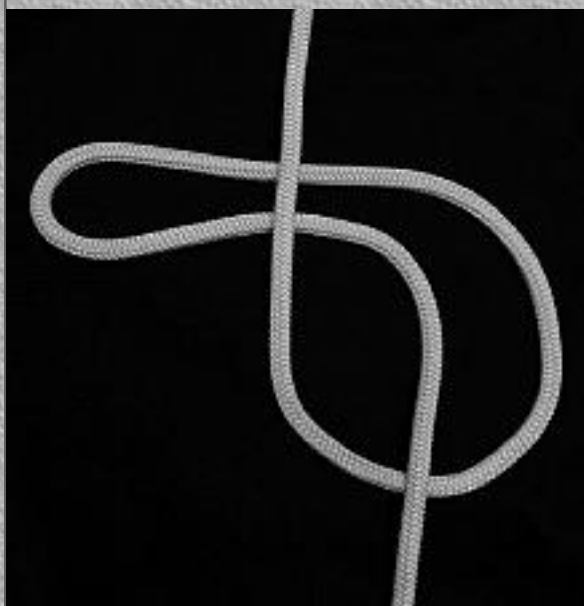

*Step #4*

**Wrap the loop back around the standing part.**

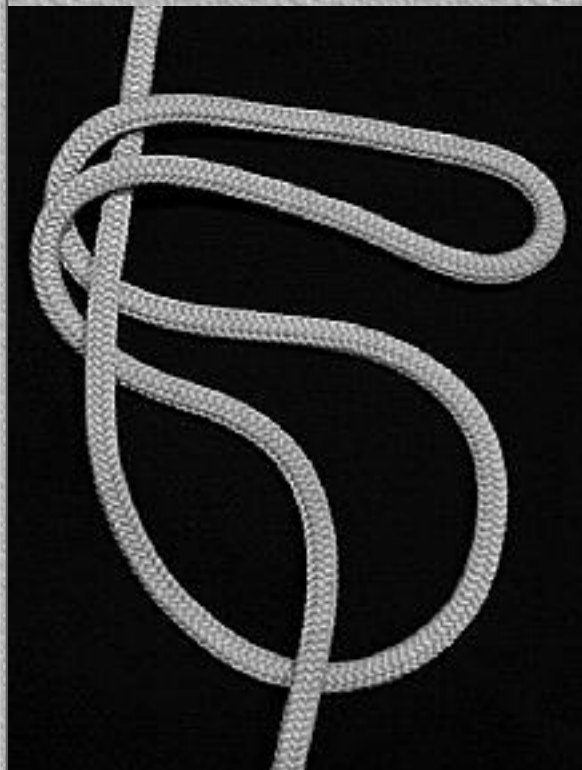

*Step #5*

**Insert the loop back through itself, to the side of the standing part that comes down out of the knot.**

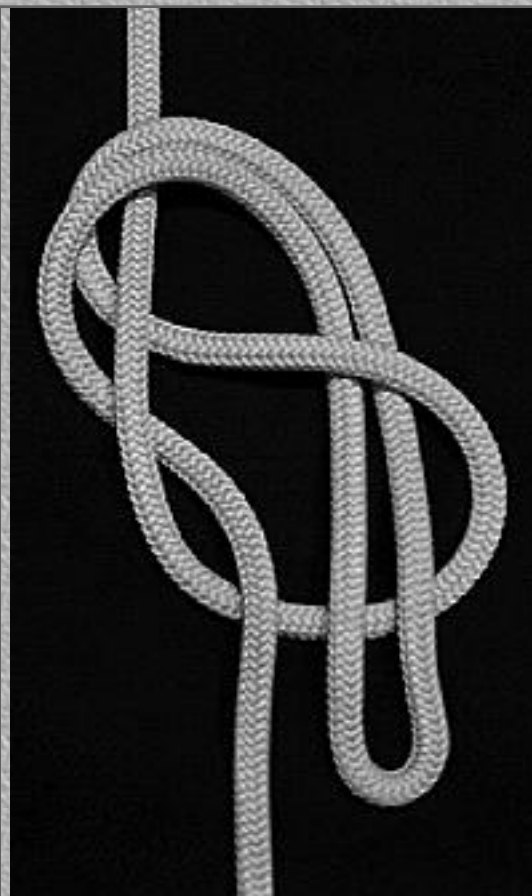

## *Finished In Line Figure 8 Loop - Front View*

**To dress the knot, pull the standing part coming out of the top of the knot. Then pull on the loop to set the knot.**

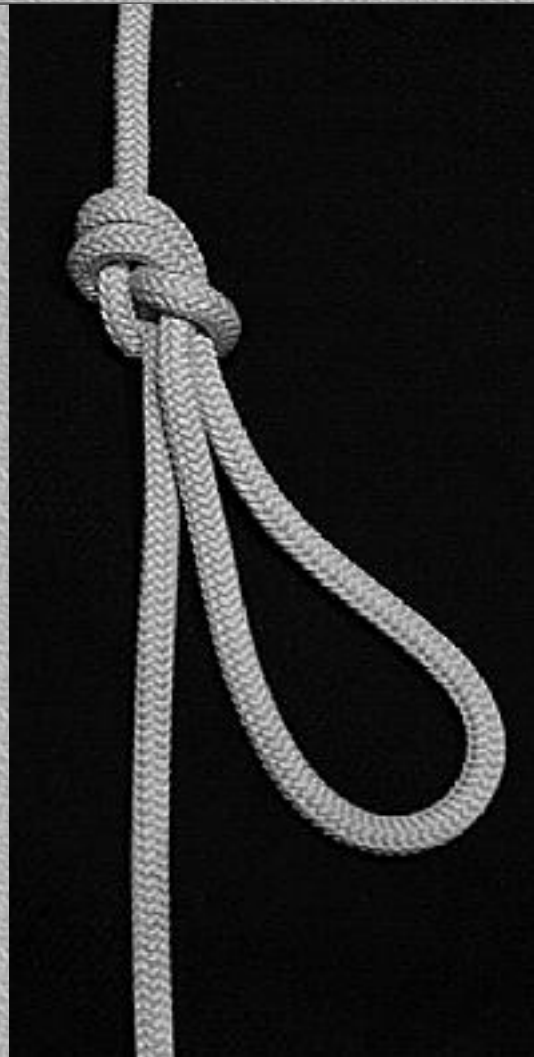

## *Finished In Line Figure 8 Loop - Opposite View*



**Opposite view.**

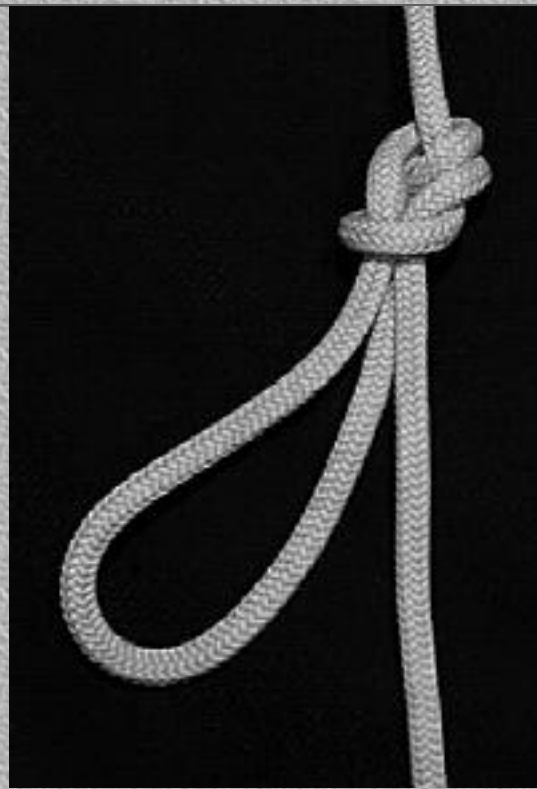

[\[Top of Page\]](#)

---

## **Butterfly Knot**

**The Butterfly knot is good to use when you need an attachment loop in the bight of a loaded rope, because the ends lead out of the knot perpendicular to the loop.**

*Step #1*

**Start with a bight of rope.**

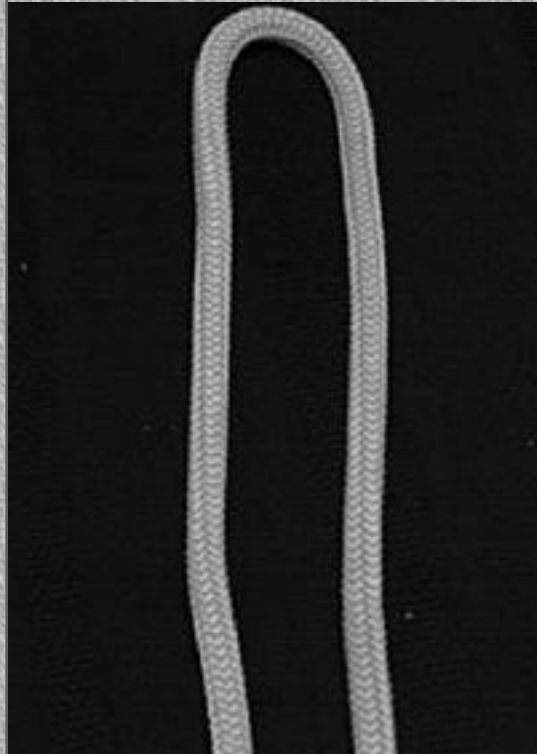

***Step #2***

**Twist the rope twice; that is, one full turn.**

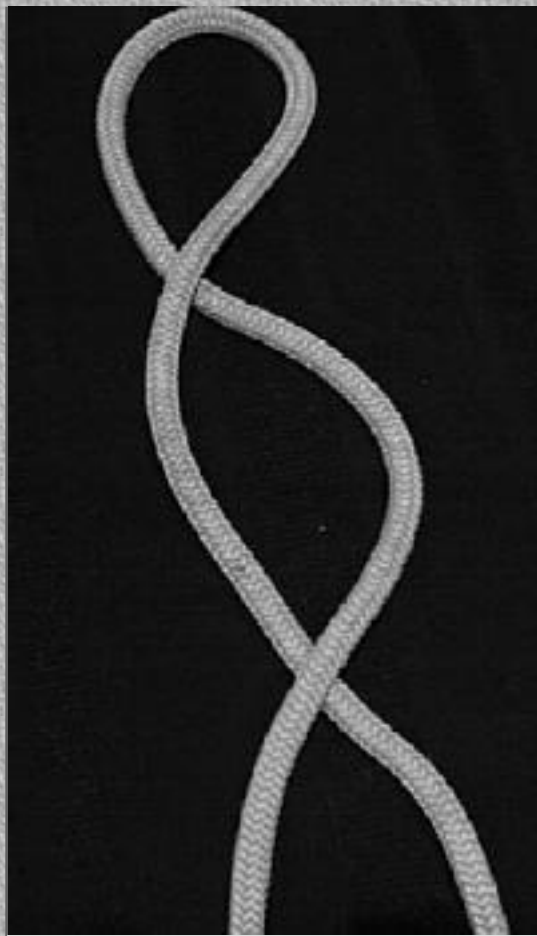

### *Step #3*

**Grasp the top of the bight and fold it down toward the ends.**

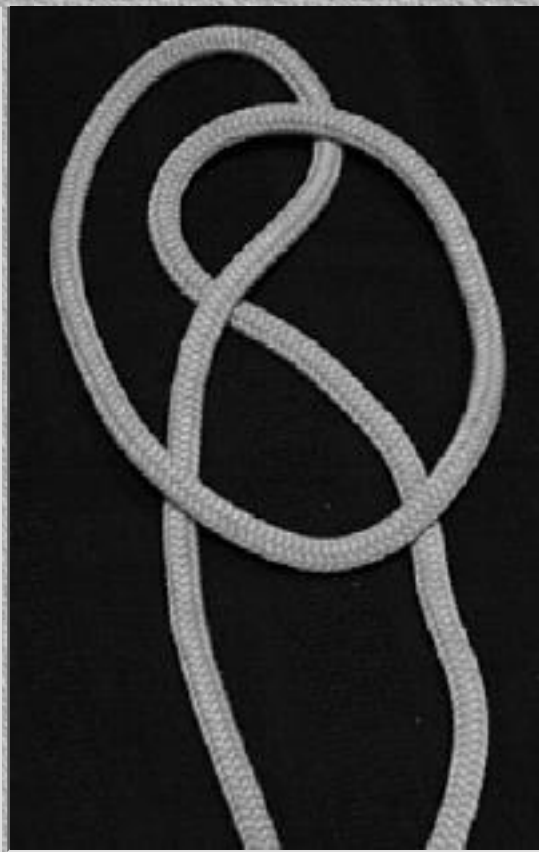

*Step #4*

**With your hand still on the top of the bight, pull it underneath and through the the "hole" that was just formed.**

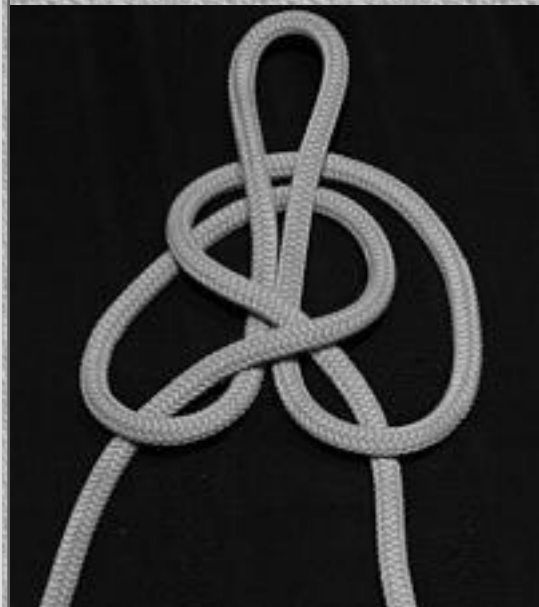

## *Finished Butterfly Knot - Front View*

**Dress and set the knot.**

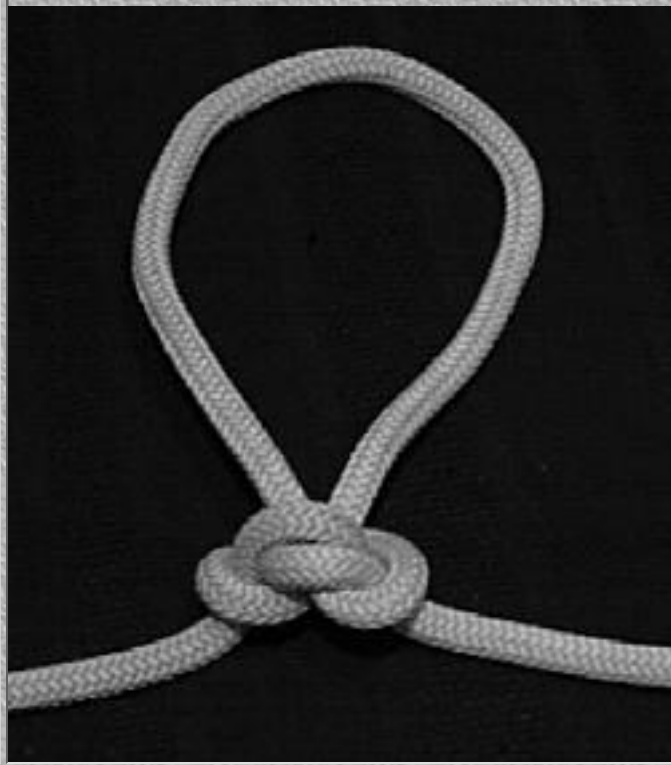

## *Finished Butterfly Knot - Rear View*

**Dress and set the knot.**



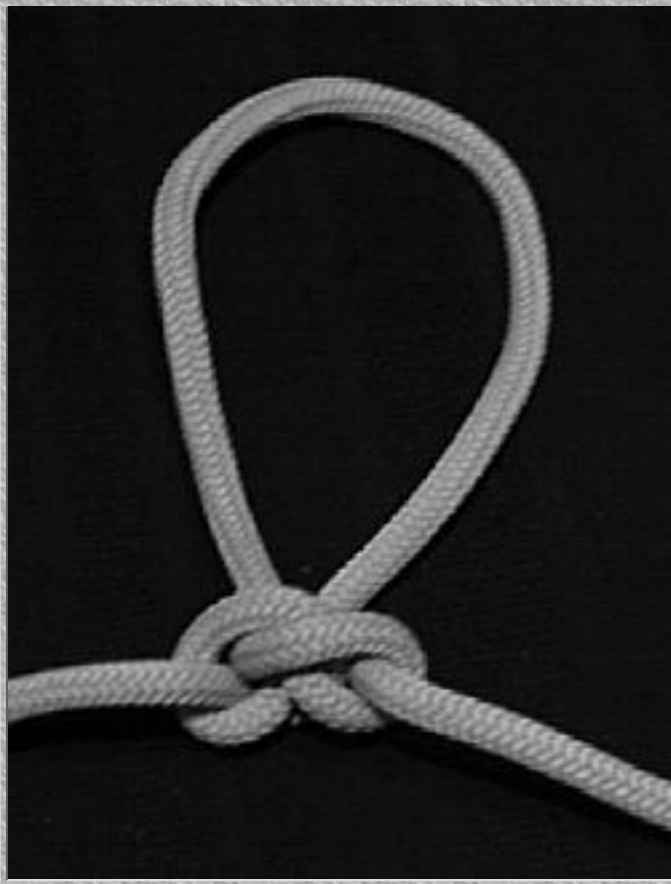

[\[Top of Page\]](#)

[Return to Index](#)

# KNOT KNOWLEDGE

## SINGLE LOOP KNOTS

### Bowline

There are several variations on tying the bowline, two of which are presented here. I start with one method of tying that is simple to photograph and then demonstrate the [one handed twist](#) method, which is an easy and reliable way of forming the loop in the standing part.

#### *Step #1*

Arrange the rope as shown, with a small loop in the standing part and the end going around the object the loop is to be tied around.

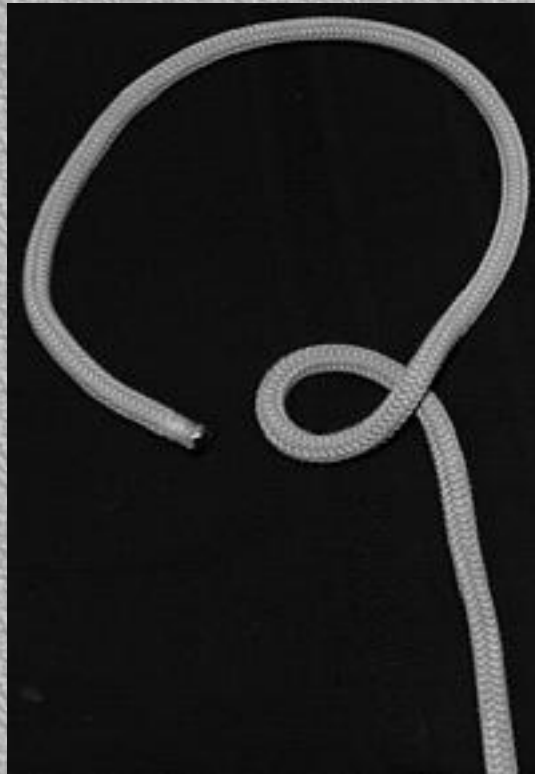

## *Step #2*

**Insert the end through the loop.**

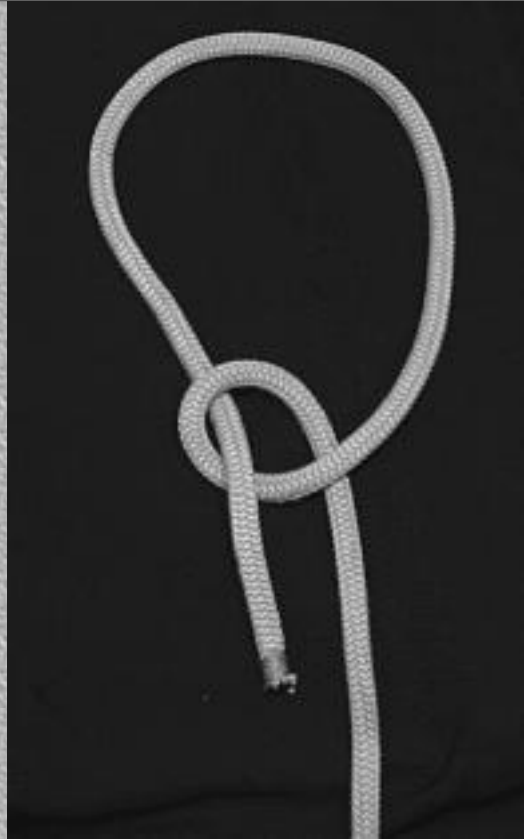

## *Step #3*

**Pull the end around and behind the standing part.**

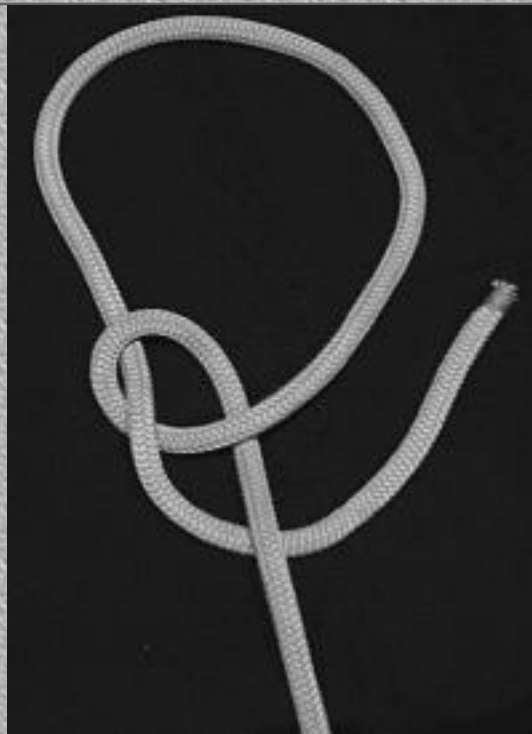

## *Step #4*

**Insert the end back through the loop.**

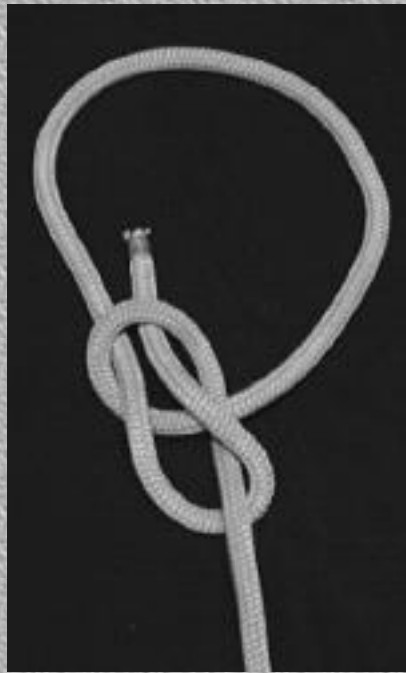

## *Finished Bowline - Front View*

**Dress and set the knot.**

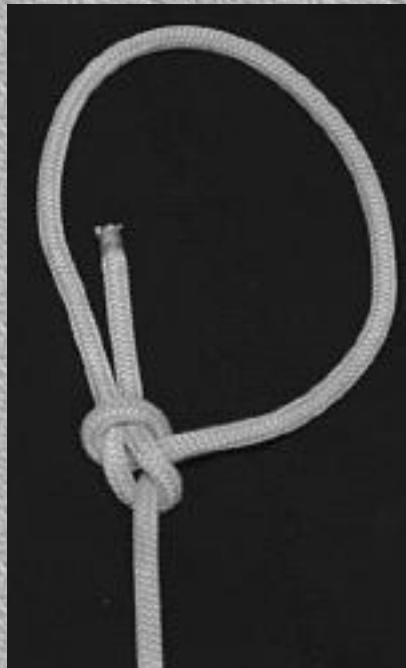

## *Finished Bowline - Rear View*

**Dress and set the knot.**

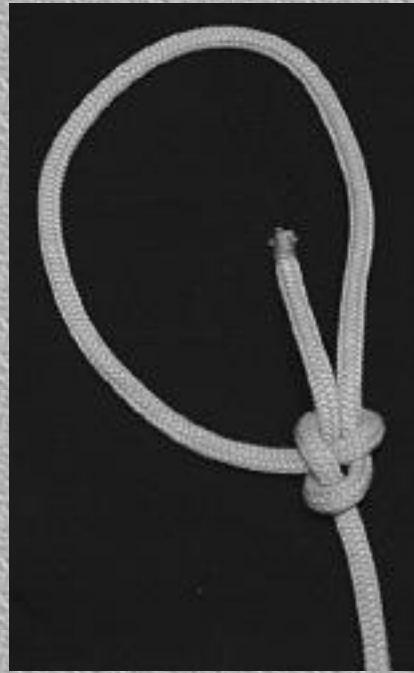

## **Bowline - One Handed Twist Method**

**This is a fast and reliable method for making the loop in the standing part. This method can also be used to tie a [sheet bend](#). To use this method for a sheet bend, instead of twisting the end into a loop in its own standing part (as shown below), twist a loop very near the end of a second rope. Be sure that the end of the rope you have in your hand is pointing up and the end of the second rope (that you'll be twisting a loop into) is pointing down.**

***Bowline - One Handed Twist Method - Step  
#1***



**Grab the end of the rope and place it across the standing part. Place your thumb under the standing part.**

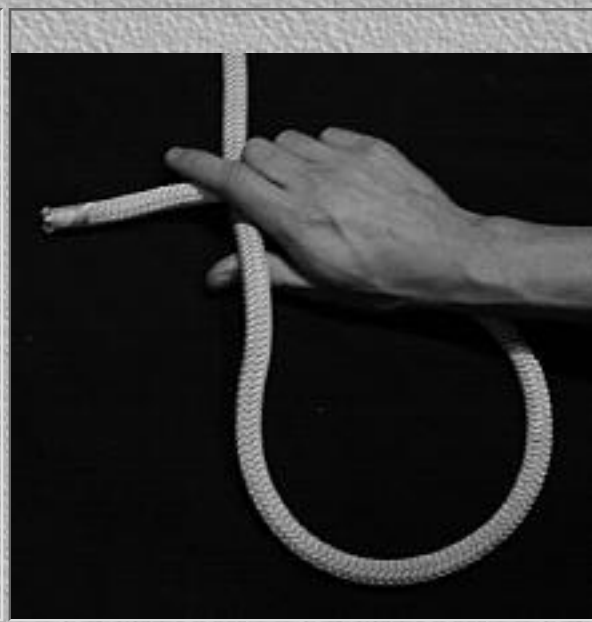

## ***Bowline - One Handed Twist Method - Step #2***

**Rotate your wrist clockwise, hooking the standing part with your thumb and bringing it around in a loop. Keep the end inside the big loop.**



## ***Bowline - One Handed Twist Method - Step #3***

**Continue rotating your wrist until the loop is formed in the standing part with the end threaded through it. Now you can just weave the end behind the standing part and back down through the loop, as described above (do this to complete the sheet bend, too).**



[\[Top of Page\]](#)

[Return to Index](#) [theCounter.com](http://www.theCounter.com)

# KNOT KNOWLEDGE

## SINGLE LOOP KNOTS

### Figure 8 Loop

The Figure 8 Loop is just a [Figure 8 Knot](#) tied in the bight.

#### *Step #1*

**Start with a bight of rope and form a loop where the end is behind the standing part.**

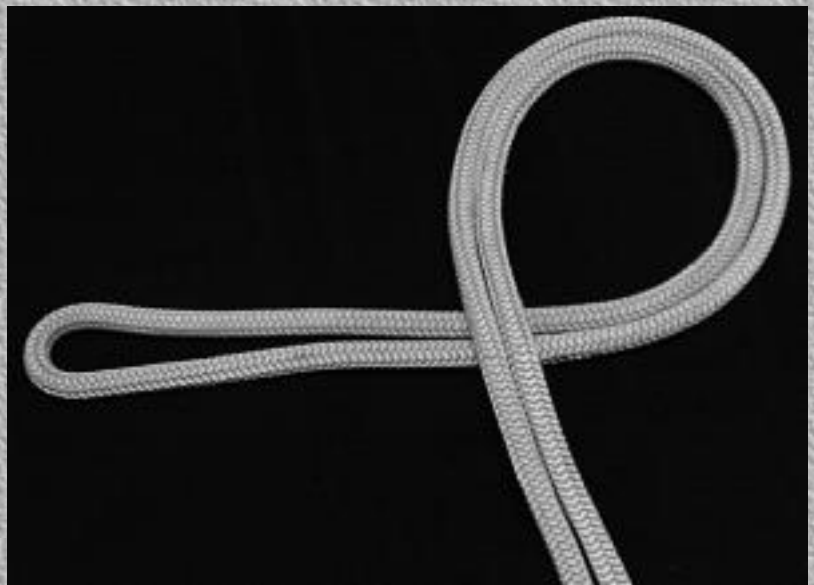

#### *Step #2*

**Bring the end around and in front of the standing part.**



***Step #3***

**Insert the end back through the loop.**



## *Finished Figure 8 Loop*

**Dress and set the knot.**

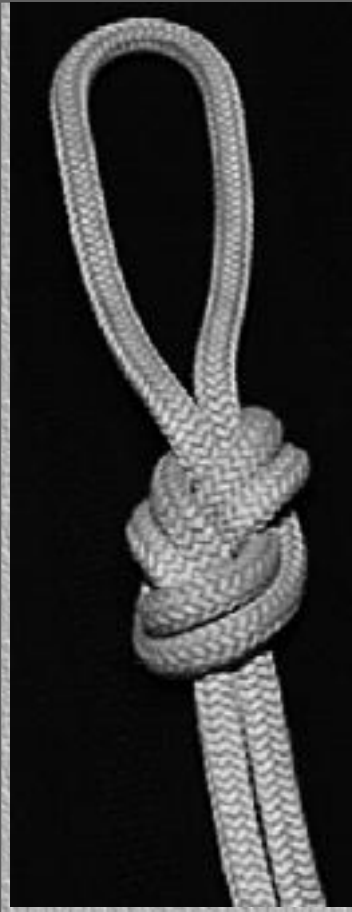

[\[Top of Page\]](#)

[Return to Index](#)



# KNOT KNOWLEDGE

## SINGLE LOOP KNOTS

### In Line Figure 8 Loop

**The In Line Figure 8 Loop is used for a load that will be more or less parallel to the standing part. This loop knot can be pulled through a pulley easier than other loop knots.**

#### *Step #1*

**Start with the standing part of the rope.**

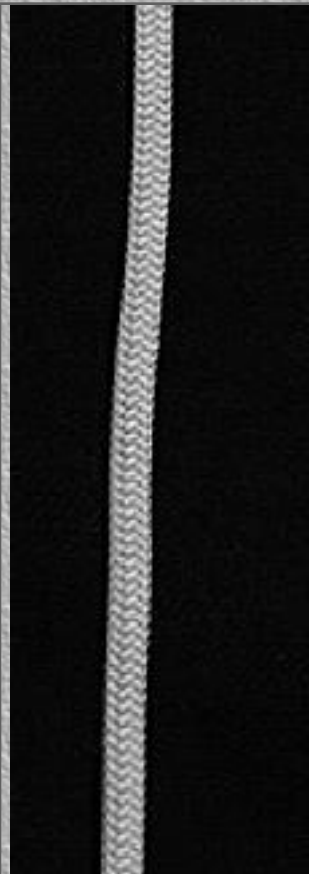

## *Step #2*

**Twist the standing part to create a loop, as shown.**

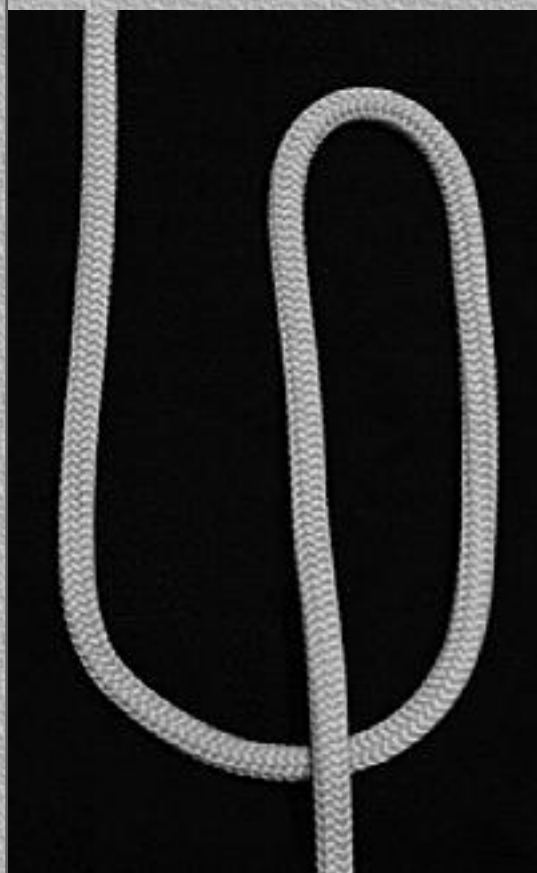

## *Step #3*

**Bring the loop behind the standing part.**

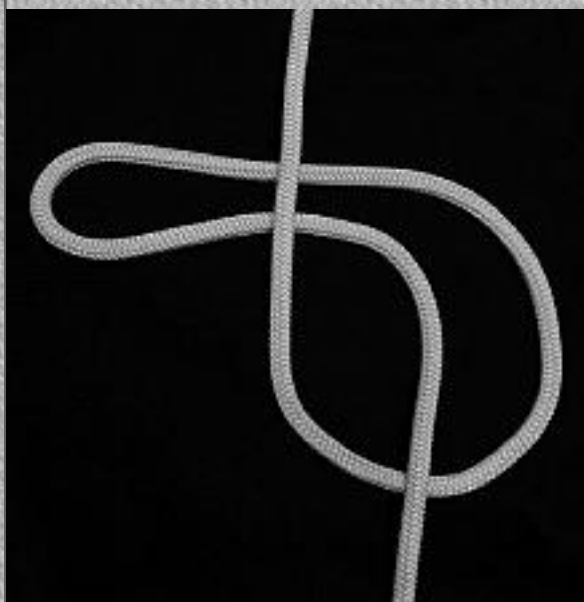

### *Step #4*

**Wrap the loop back around the standing part.**

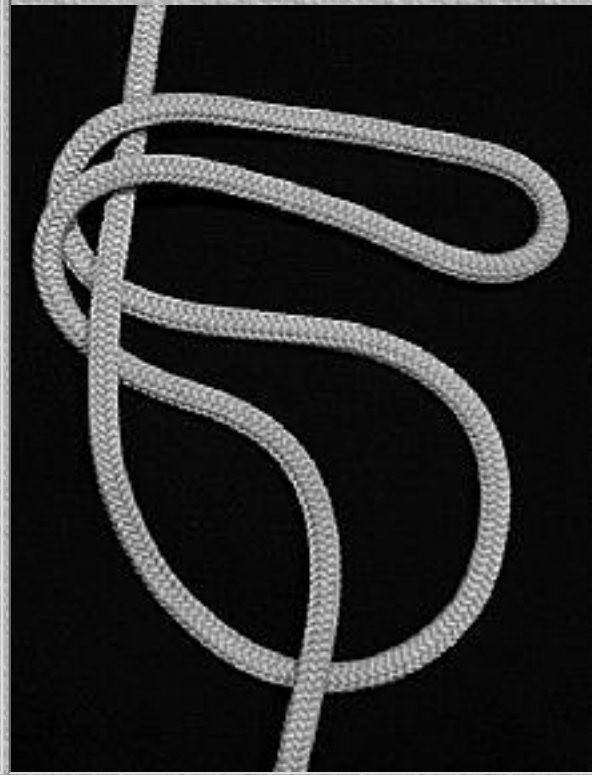

### *Step #5*

**Insert the loop back through itself, to the side of the standing part that comes down out of the knot.**

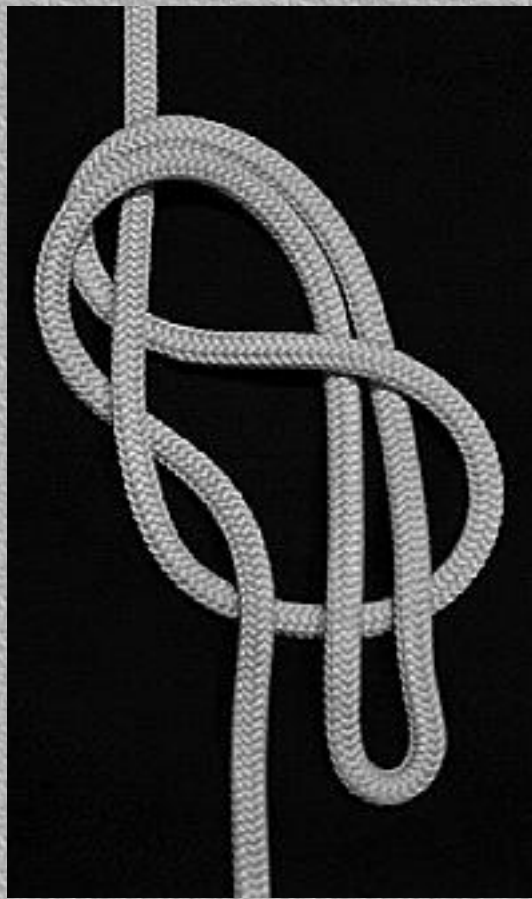

*Finished In Line Figure 8 Loop - Front View*

**To dress the knot, pull the standing part coming out of the top of the knot. Then pull on the loop to set the knot.**

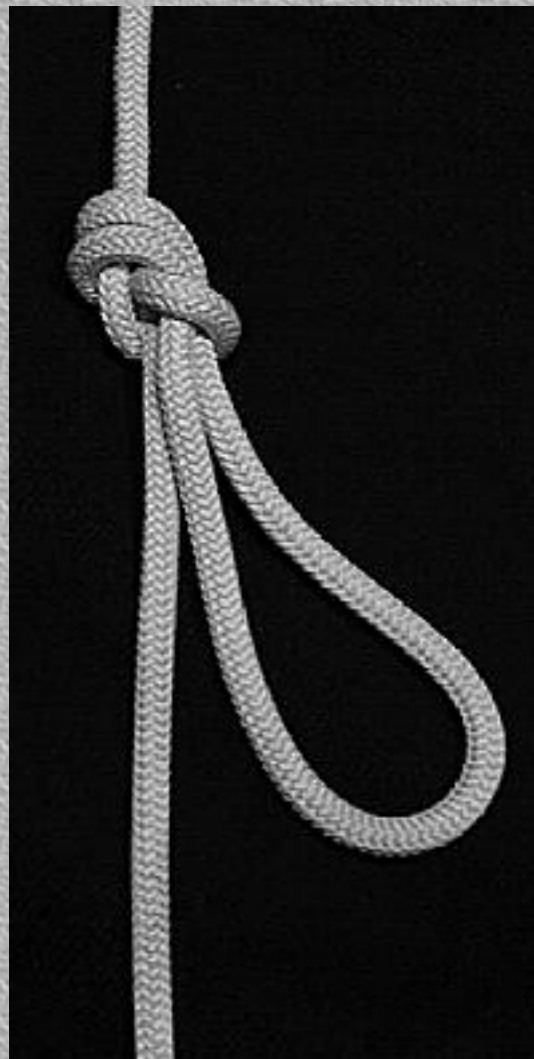

*Finished In Line Figure 8 Loop - Opposite View*

**Opposite view.**



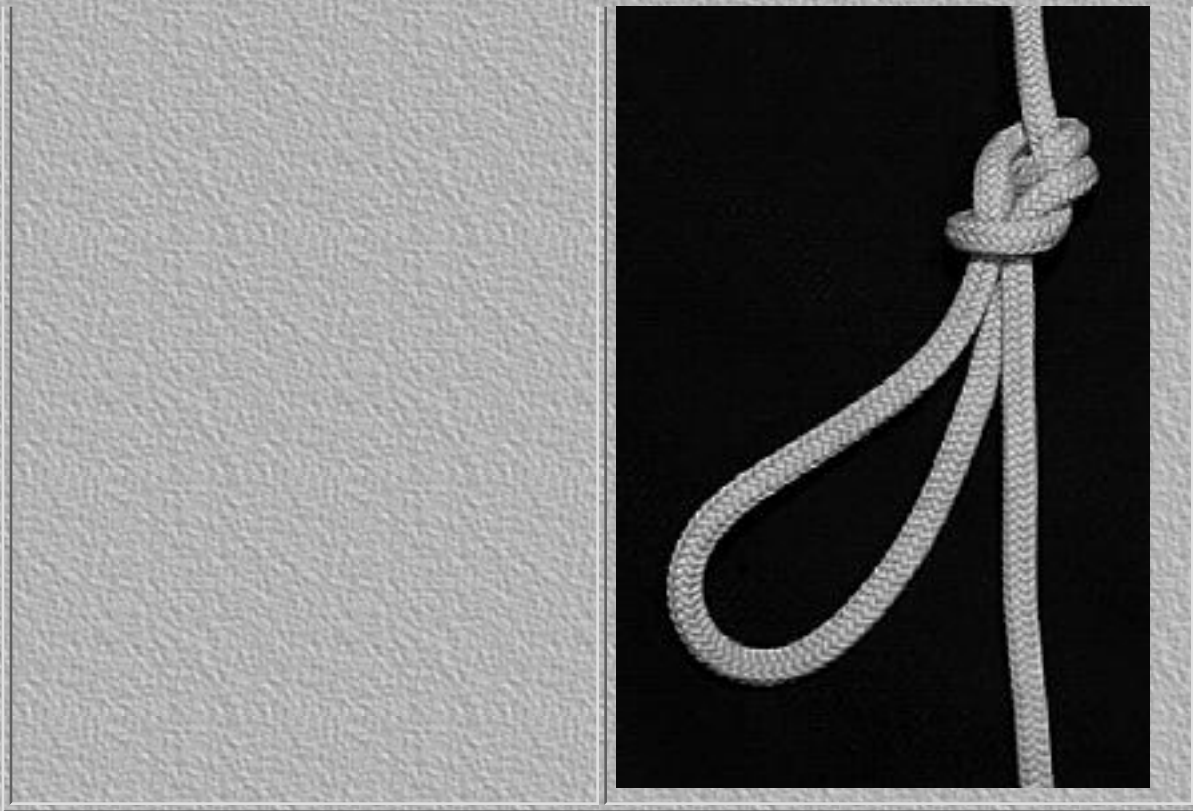

[\[Top of Page\]](#)

[Return to Index](#)

# KNOT KNOWLEDGE

## SINGLE LOOP KNOTS

### Butterfly Knot

The Butterfly knot is good to use when you need an attachment loop in the bight of a loaded rope, because the ends lead out of the knot perpendicular to the loop.

#### *Step #1*

**Start with a bight of rope.**

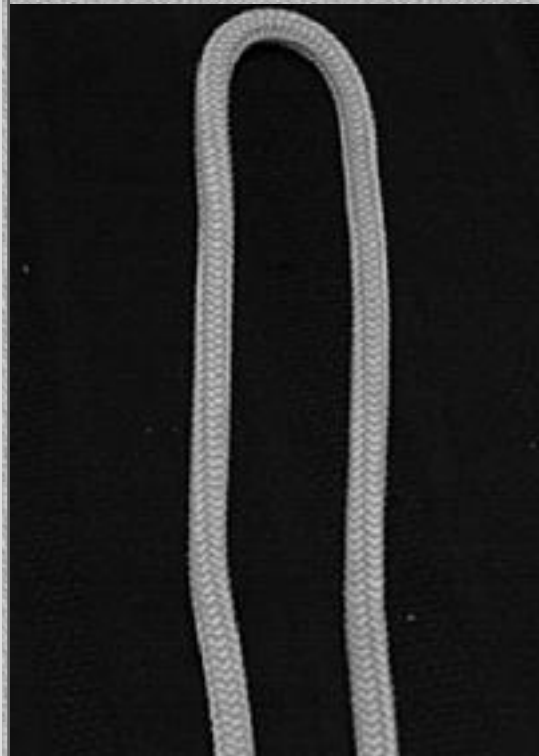

#### *Step #2*

**Twist the rope twice; that is, one full turn.**

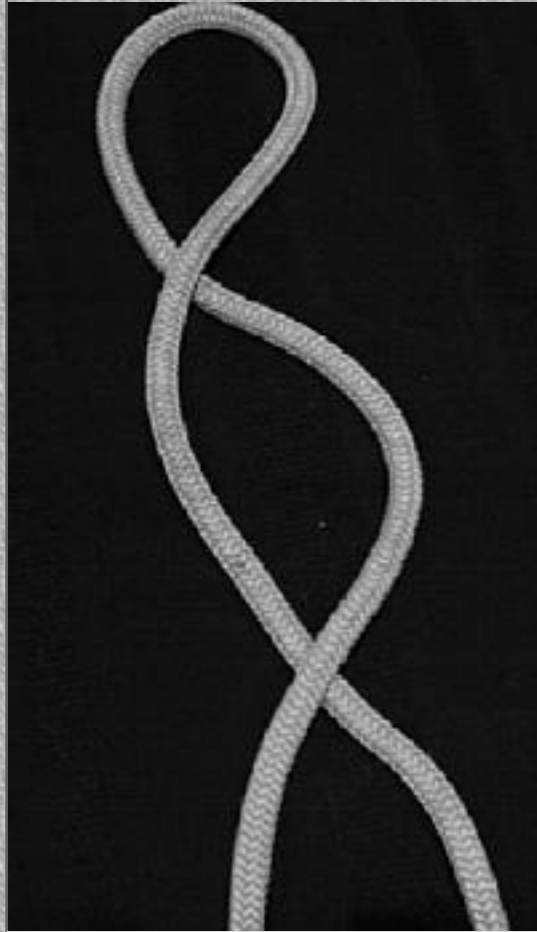

### *Step #3*

**Grasp the top of the bight and fold it down toward the ends.**

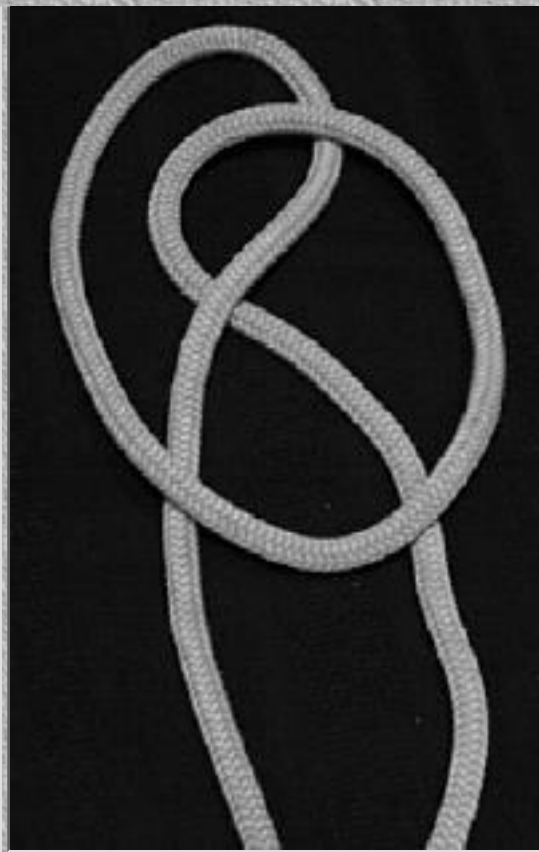

*Step #4*

**With your hand still on the top of the bight, pull it underneath and through the the "hole" that was just formed.**

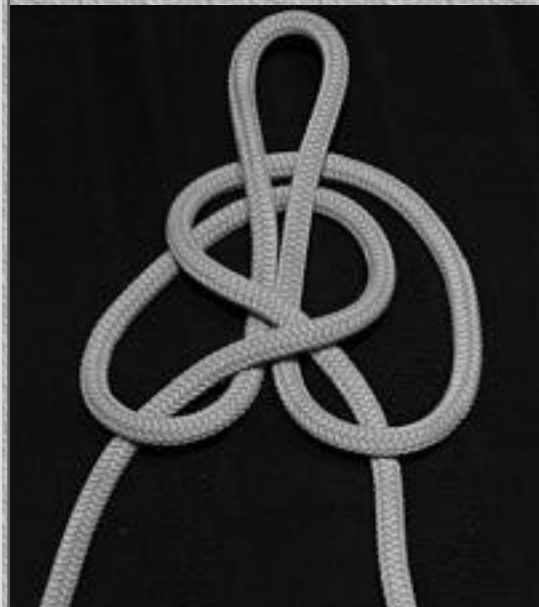

## *Finished Butterfly Knot - Front View*

**Dress and set the knot.**

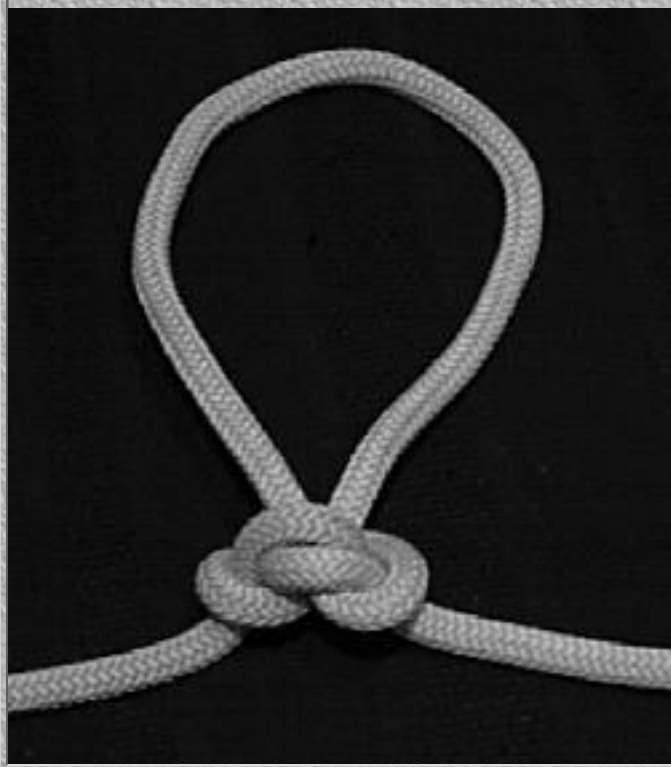

## *Finished Butterfly Knot - Rear View*

**Dress and set the knot.**



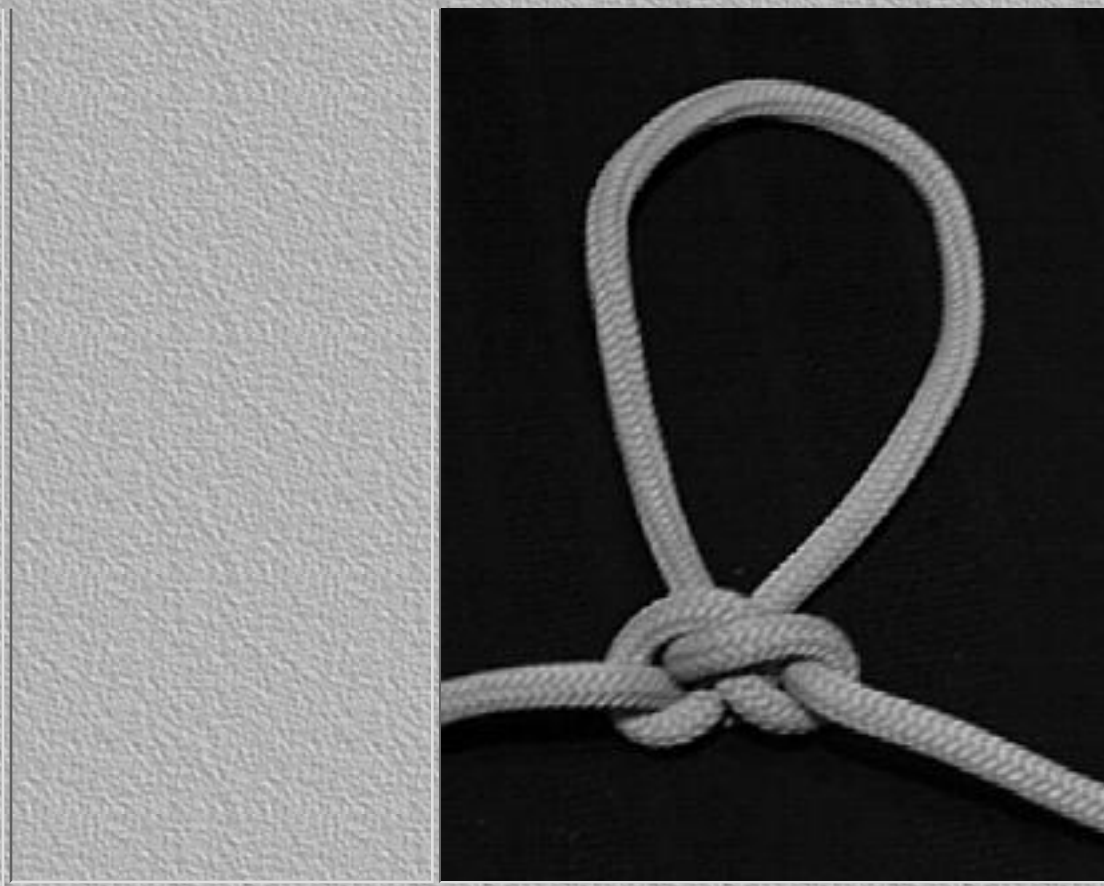

[\[Top of Page\]](#)

[Return to Index](#)

# KNOT KNOWLEDGE

## DOUBLE LOOP KNOTS

[\[Spanish Bowline\]](#)

[\["A Rigid Double Splayed Loop in the Bight"\]](#)

[\[Triple Crown Knot\]](#)

[\[Bowline on a Bight\]](#)

[\[Return to Index\]](#)

### Spanish Bowline

**The Spanish Bowline is a double splayed loop knot that is easy to adjust (before putting on a load) due to the fact that the rope communicates between the two loops. However, unless this knot is set very tightly, it is possible that the rope will slip when you have put it to use, which could be disastrous. When tied and set properly, it is an excellent utility knot.**

*Step #1*

**Make two loops.**

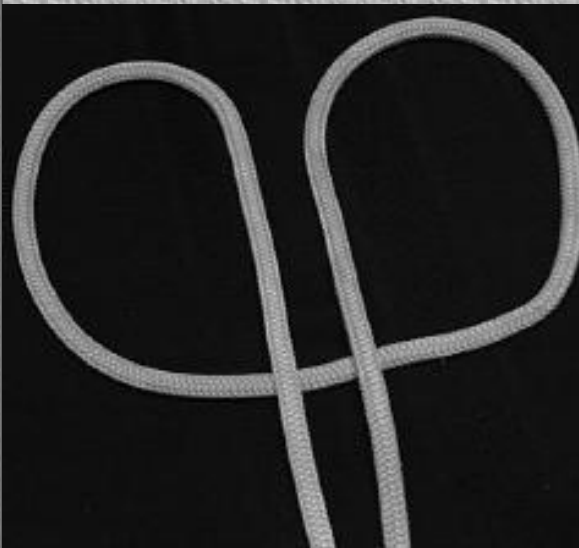

***Step #2***

**Put a half twist in each loop, turning the outside of each loop to the middle.**

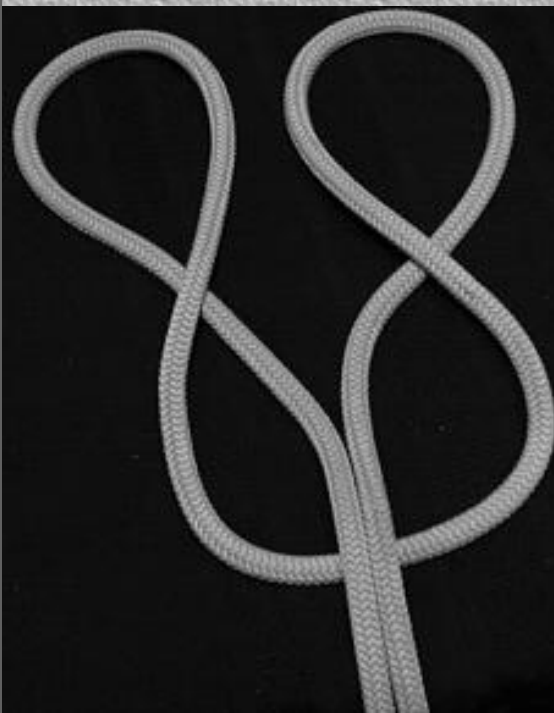

***Step #3***

**Take the left-twisted loop and insert it through the right-twisted loop.**

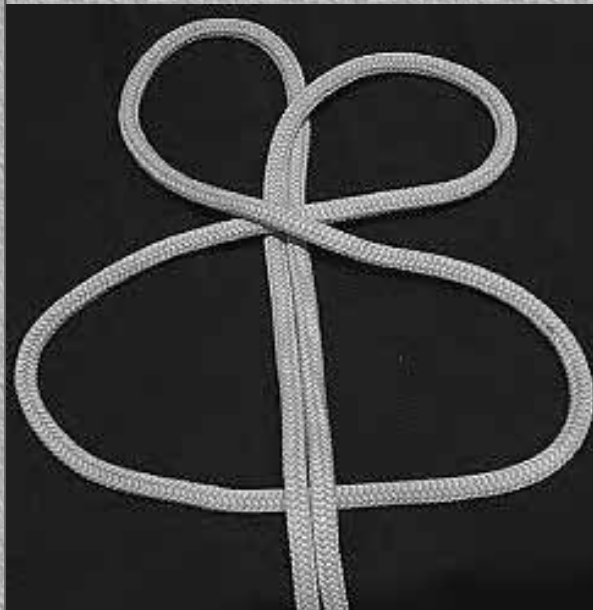

### *Step #4*

**Take the material from the bottom of the twisted loops and pull up bights through the top of the twisted loops.**

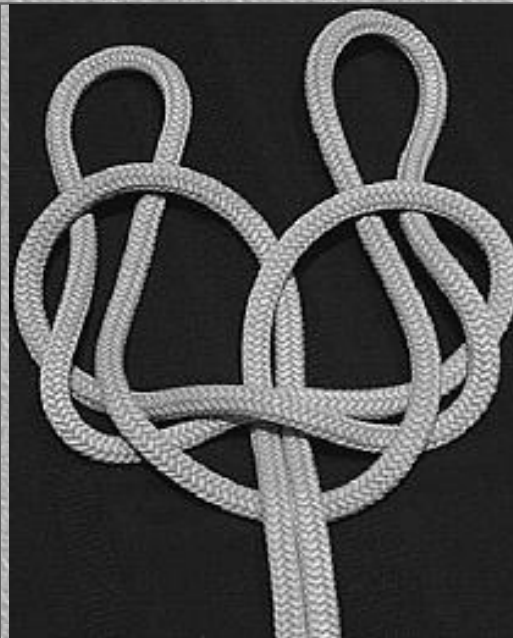

*Finished Spanish Bowline - Front View*



**Pull on the standing line to dress the knot. Pull on all parts to set the knot.**

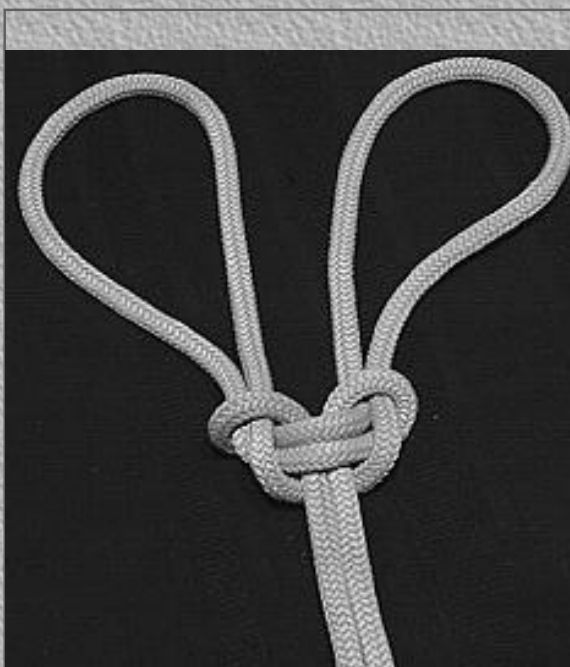

***Finished Spanish Bowline - Rear View***

**Pull on the standing line to dress the knot. Pull on all parts to set the knot.**

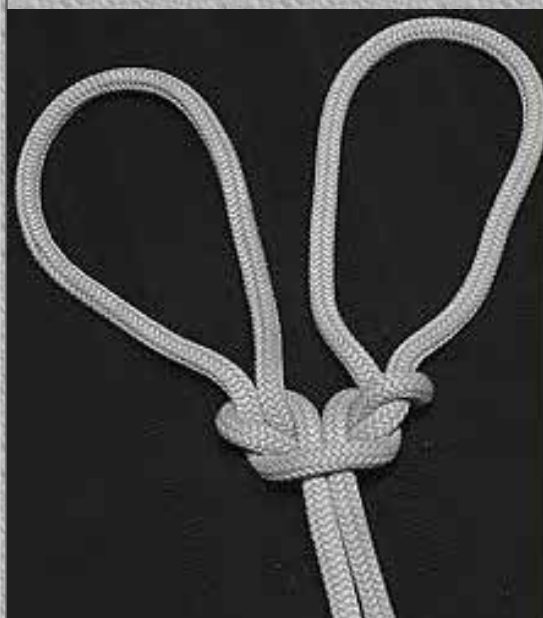

[\[Top of Page\]](#)

**"A Rigid Double Splayed Loop in the Bight" (ABoK #1100)**



**This knot is touted by Ashley as being "one of the firmest of the Double Loops since the two loops do not directly communicate with each other" (ABoK, p. 200). It seems to me that the loops still indirectly communicate, and I use that for initial adjustment. When the knot is properly set, it would be nearly impossible to get the rope to move between the loops.**

### *Step #1*

**To start this knot, begin with a [butterfly knot](#), but leave it loose as shown instead of drawing it up tight.**

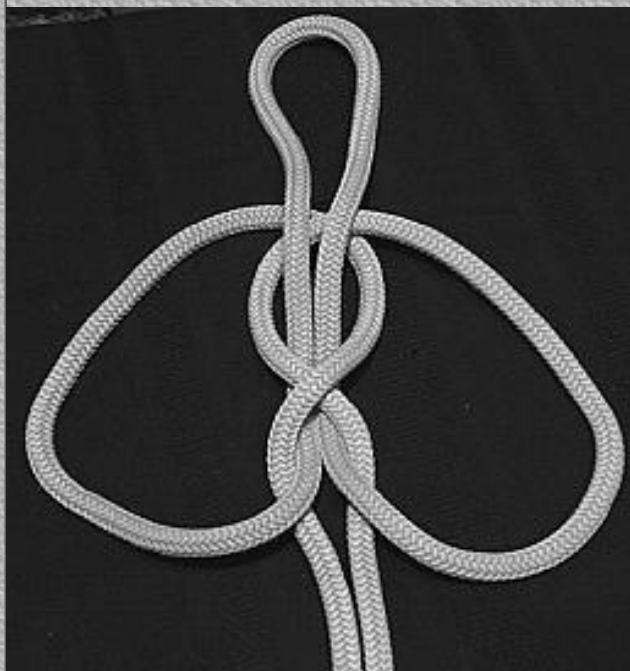

### *Step #2*

**Take the material from the lower two loops and pull bights through the upper loop.**

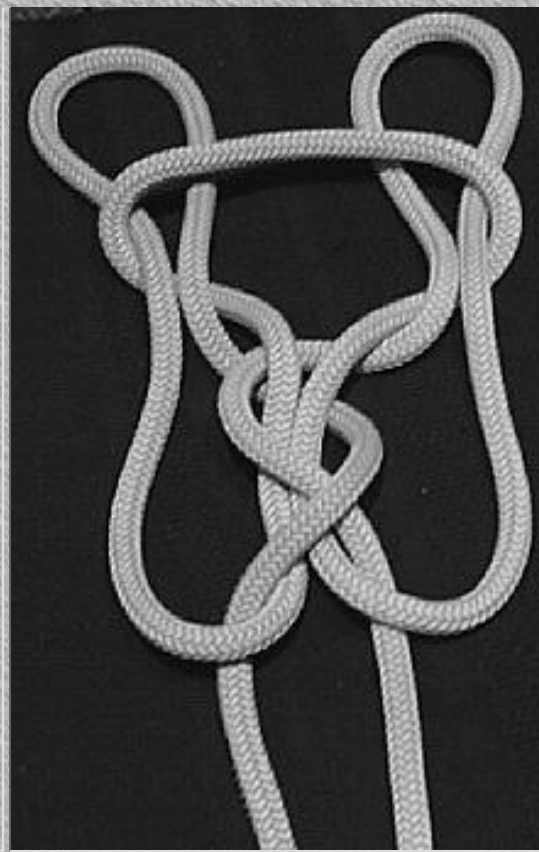

### *Step #3*

**Grasp the the top of the loop you just poked the bights through and bring it toward you and down so that it rests across the standing lines.**

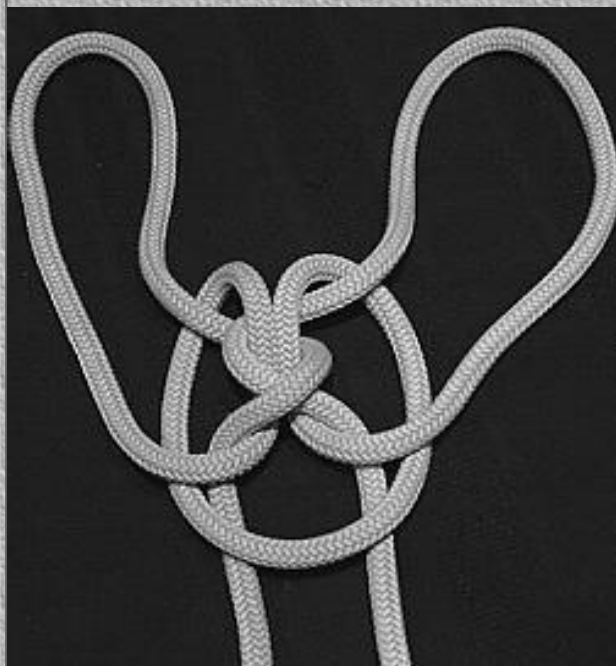

*Finished "Rigid Double Splayed Loop in a Bight"*

*Front View*

**Pull on the standing part to dress the knot. Pull on all parts to set the knot.**

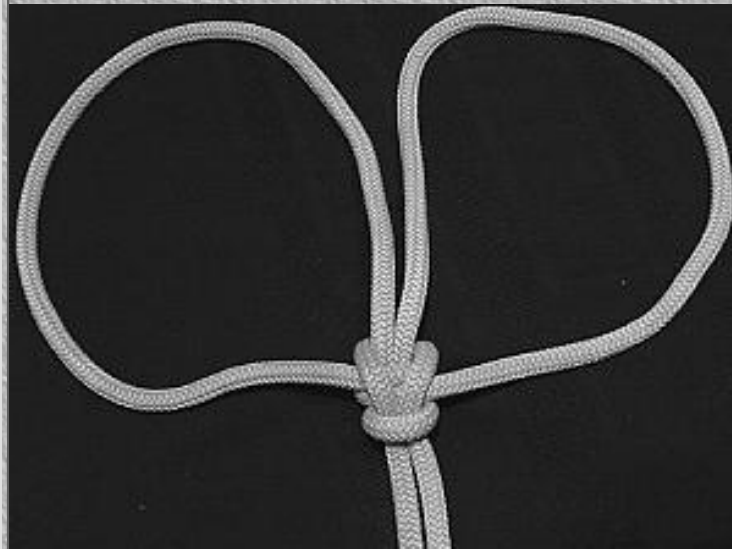

*Finished "Rigid Double Splayed Loop in a Bight"*

*Rear View*

**Pull on the standing part to dress the knot. Pull on all parts to set the knot.**

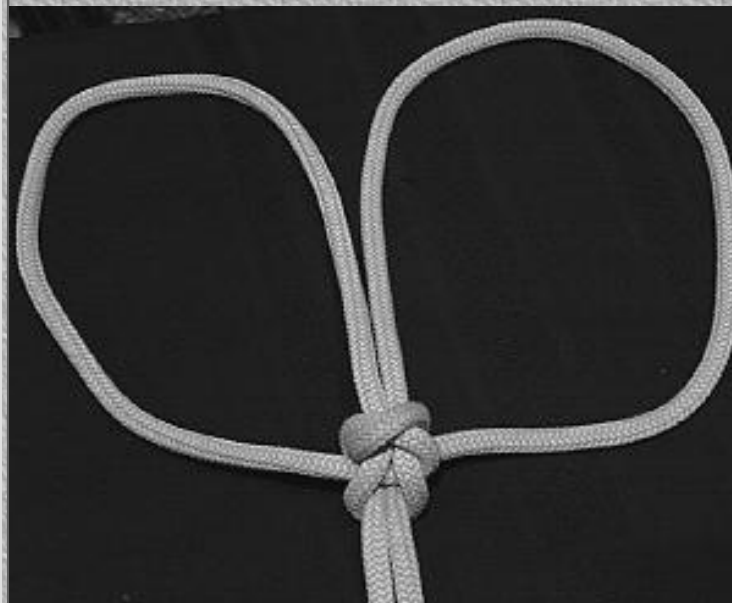

## Triple Crown Knot

The Triple Crown Knot is my favorite double splayed loop knot because it is easy to tie and the loops definitely don't communicate.

### *Step #1*

**Form two equal length bights in a bight.**

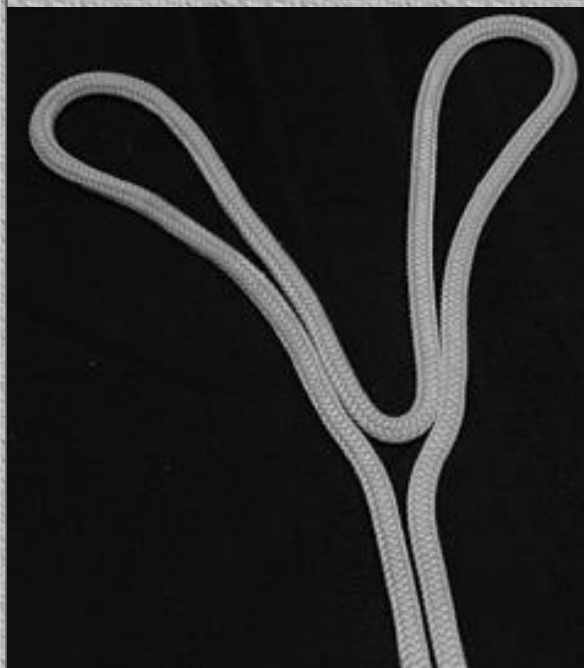

### *Step #2*

**Grasp the standing part and bring it up over and between the two bights, forming a small loop at the bottom**

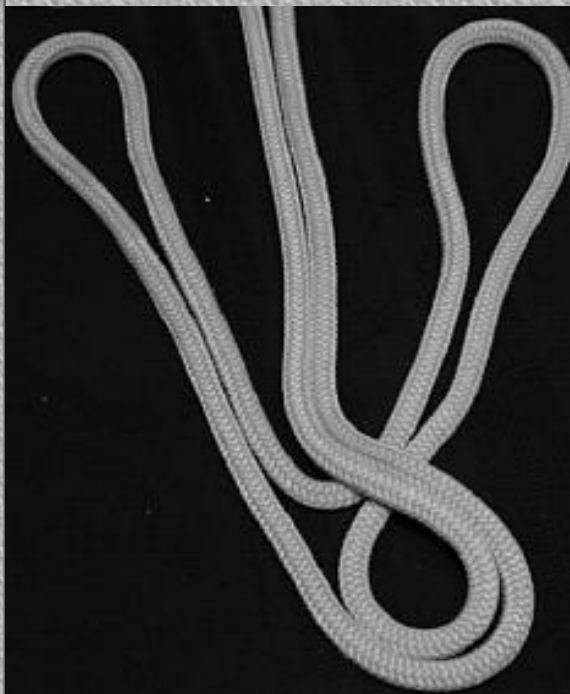

### *Step #3*

**Grasp the right hand bight and cross it over the standing part and the left hand bight.**

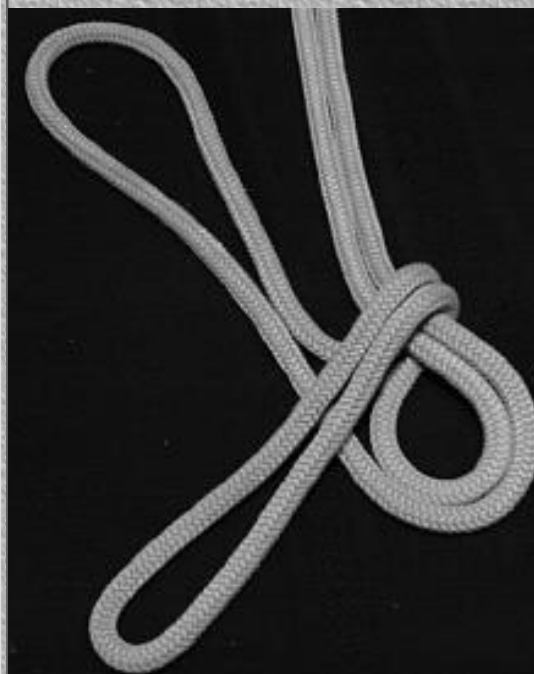

### *Step #4*



**Grasp the left hand bight and cross it over the right hand bight, inserting it through the small loop.**

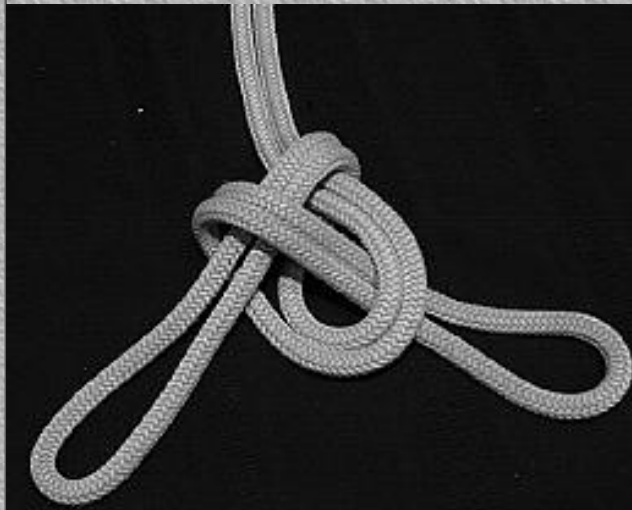

***Finished Triple Crown Knot - Front View***

**Pull on the standing part to dress the knot. Pull on all parts to set the knot.**

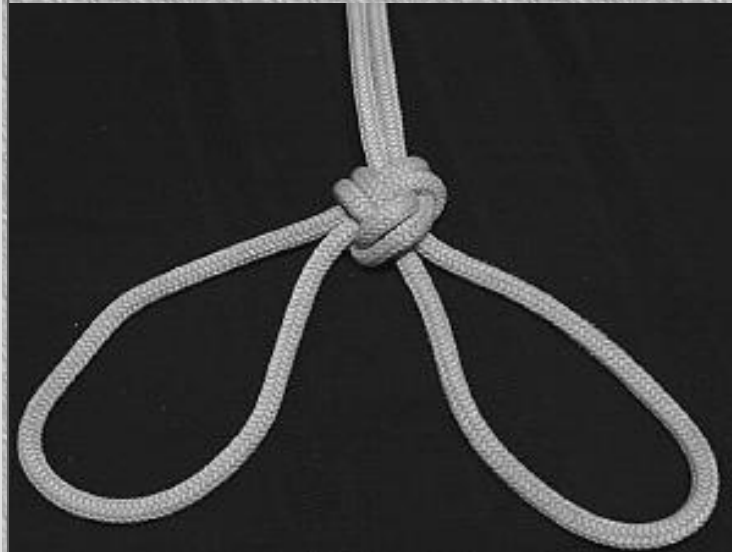

***Finished Triple Crown Knot - Rear View***

**Pull on the standing part to dress the knot. Pull on all parts to set the knot.**

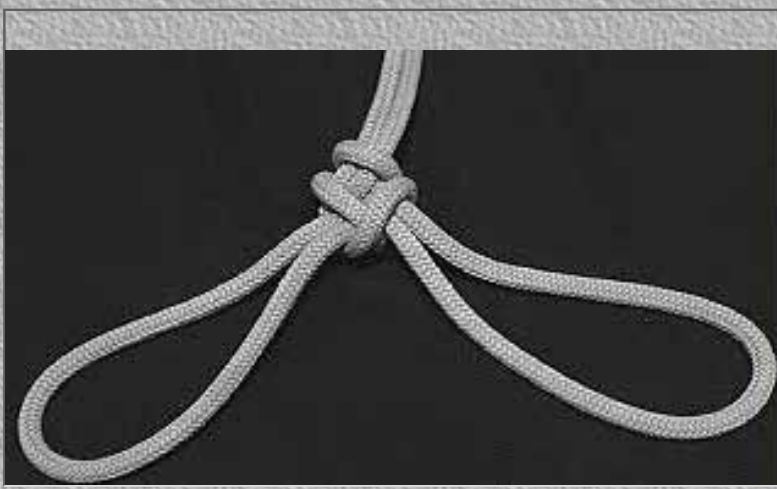

[\[Top of Page\]](#)

## **Bowline on a Bight**

**The Bowline on a Bight is good parallel loop knot to use when you need hand loops to tug on the rope to get it unstuck from a vine-choked branch. It is easy to tie and does not readily jam, so it is usually easy to untie after applying a load.**

### *Step #1*

**Start with a bight of rope.**



### *Step #2*

**Form a loop by bringing the end over the standing part.**

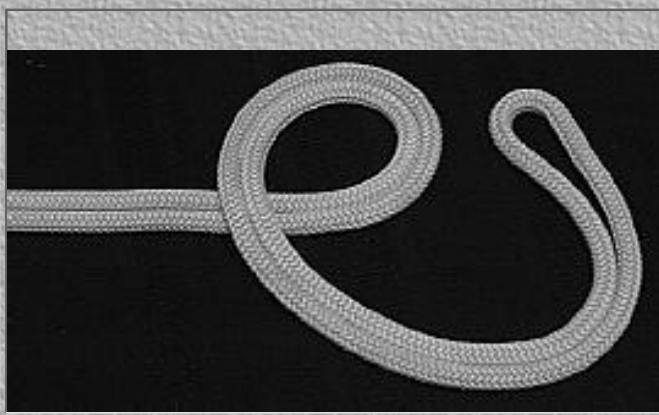

### *Step #3*

**Insert the end of the bight through the loop.**

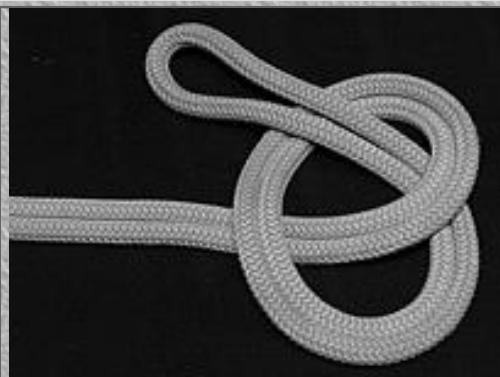

### *Step #4*

**Grasp the end of the bight and bring it toward you and down across the bottom of the loop.**

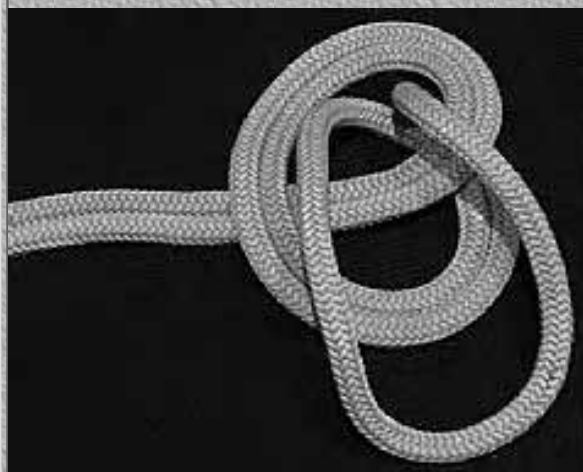

### *Step #5*

**With your hand still on the end of the bight, drag it beneath all the material that makes up the loop so that it ends up behind the standing part.**

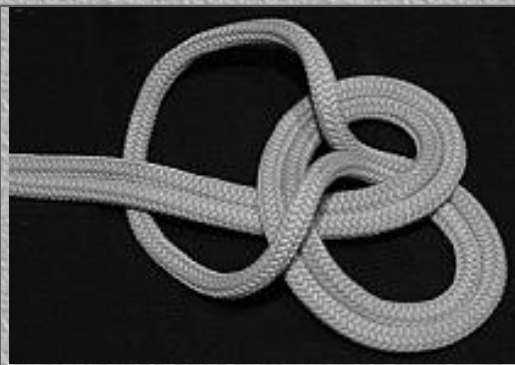

### ***Finished Bowline on a Bight - Front View***

**Pull on the lower loop to pull the end of the bight snug against the original loop. Pull on the standing part to set the knot**

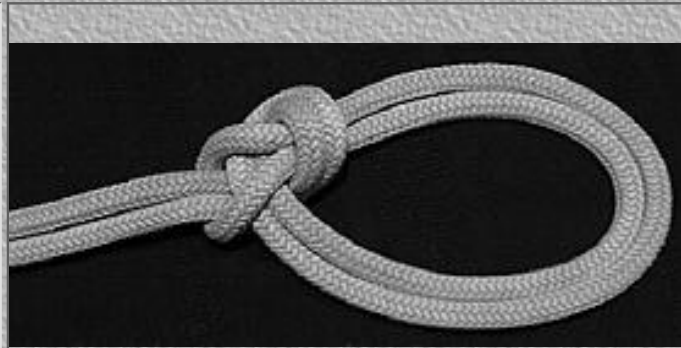

### ***Finished Bowline on a Bight - Rear View***

**Pull on the lower loop to pull the end of the bight snug against the original loop. Pull on the standing part to set the knot**



[\[Top of Page\]](#)

[Return to Index](#)



# KNOT KNOWLEDGE

## DOUBLE LOOP KNOTS

### Spanish Bowline

**The Spanish Bowline is a double splayed loop knot that is easy to adjust (before putting on a load) due to the fact that the rope communicates between the two loops. However, unless this knot is set very tightly, it is possible that the rope will slip when you have put it to use, which could be disastrous. When tied and set properly, it is an excellent utility knot.**

#### *Step #1*

**Make two loops.**

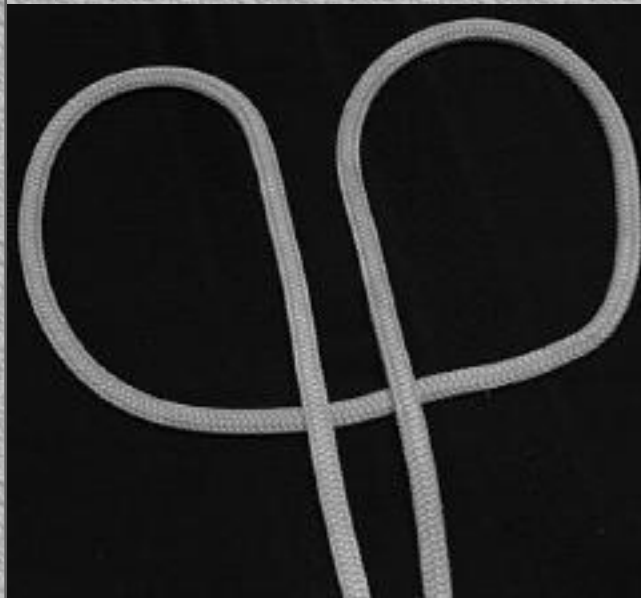

#### *Step #2*



**Put a half twist in each loop, turning the outside of each loop to the middle.**

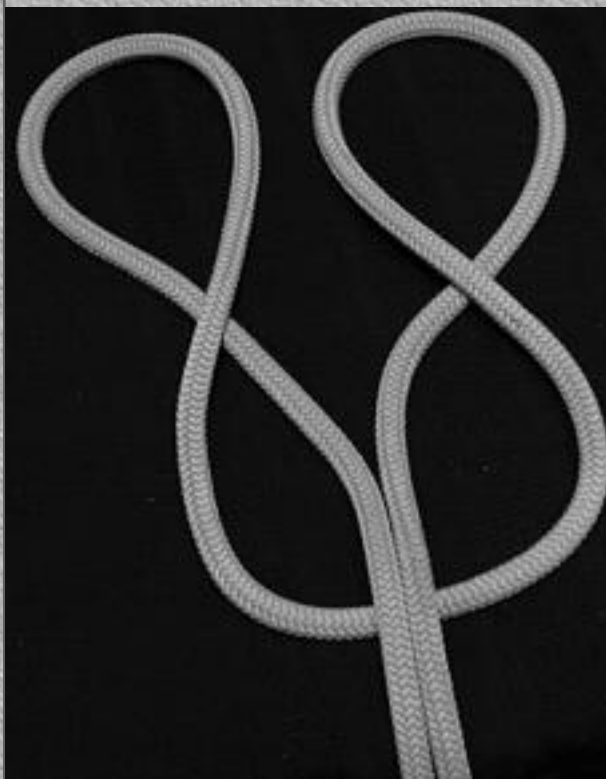

### *Step #3*

**Take the left-twisted loop and insert it through the right-twisted loop.**

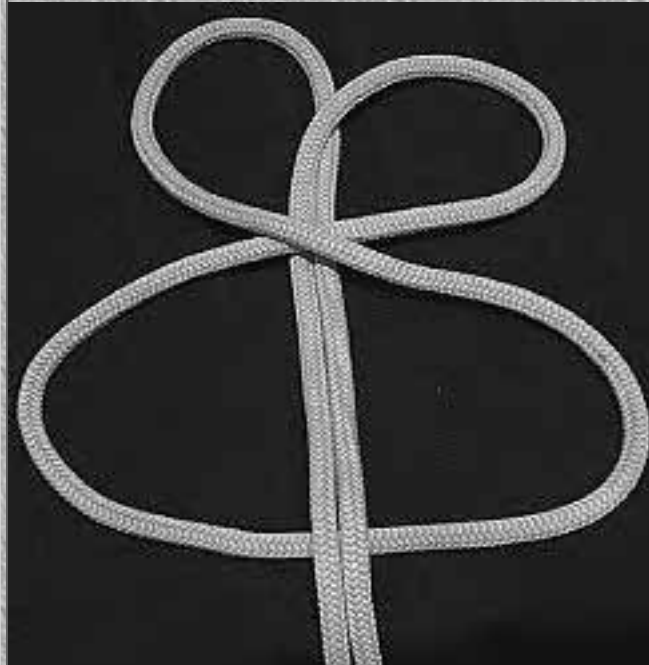

### *Step #4*

**Take the material from the bottom of the twisted loops and pull up bights through the top of the twisted loops.**

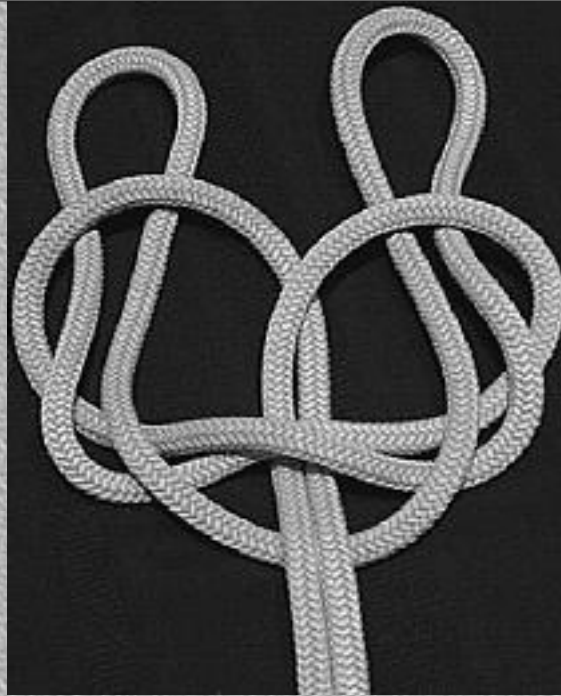

***Finished Spanish Bowline - Front View***

**Pull on the standing line to dress the knot. Pull on all parts to set the knot.**

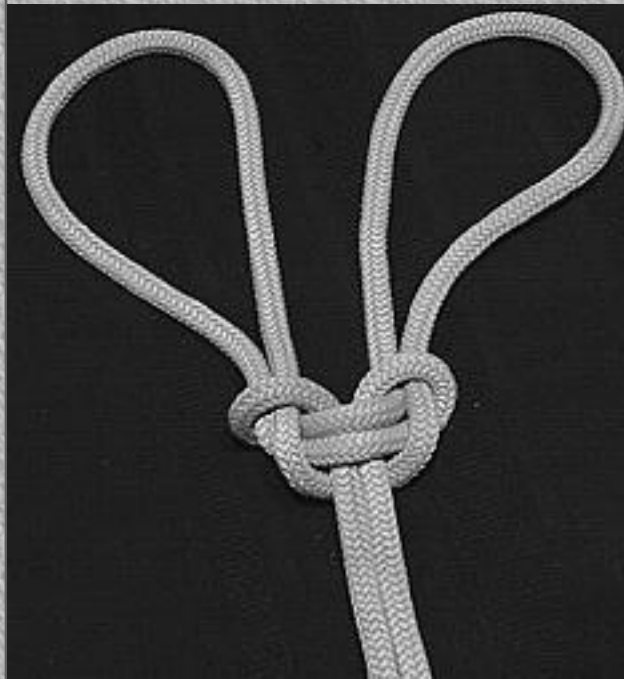

***Finished Spanish Bowline - Rear View***

**Pull on the standing line to dress the knot. Pull on all parts to set the knot.**

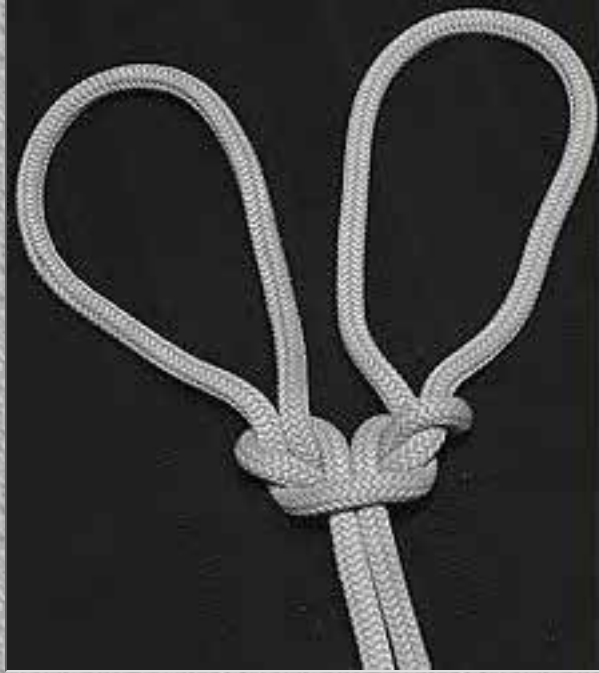

[\[Top of Page\]](#)

[Return to Index](#)

# KNOT KNOWLEDGE

## DOUBLE LOOP KNOTS

### "A Rigid Double Splayed Loop in the Bight" (ABoK #1100)

This knot is touted by Ashley as being "one of the firmest of the Double Loops since the two loops do not directly communicate with each other" (ABoK, p. 200). It seems to me that the loops still indirectly communicate, and I use that for initial adjustment. When the knot is properly set, it would be nearly impossible to get the rope to move between the loops.

#### *Step #1*

To start this knot, begin with a [butterfly knot](#), but leave it loose as shown instead of drawing it up tight.

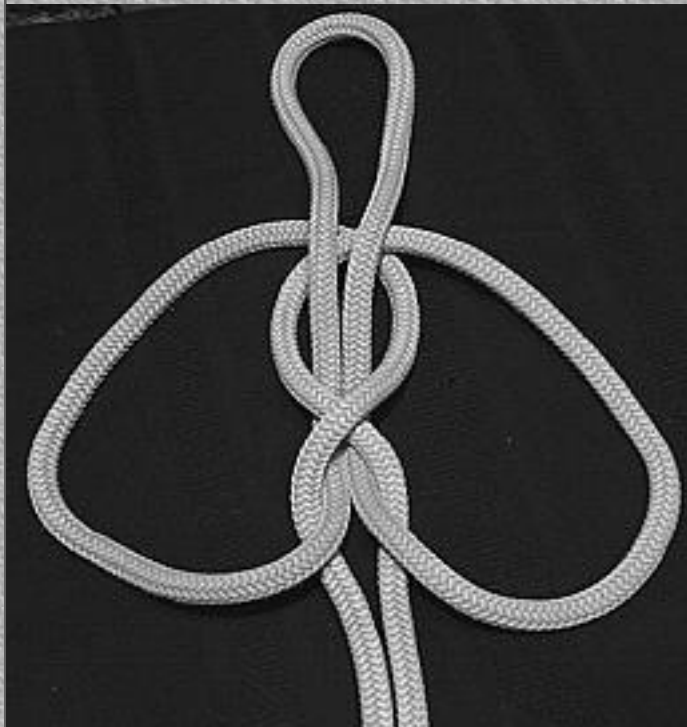



## *Step #2*

**Take the material from the lower two loops and pull bights through the upper loop.**

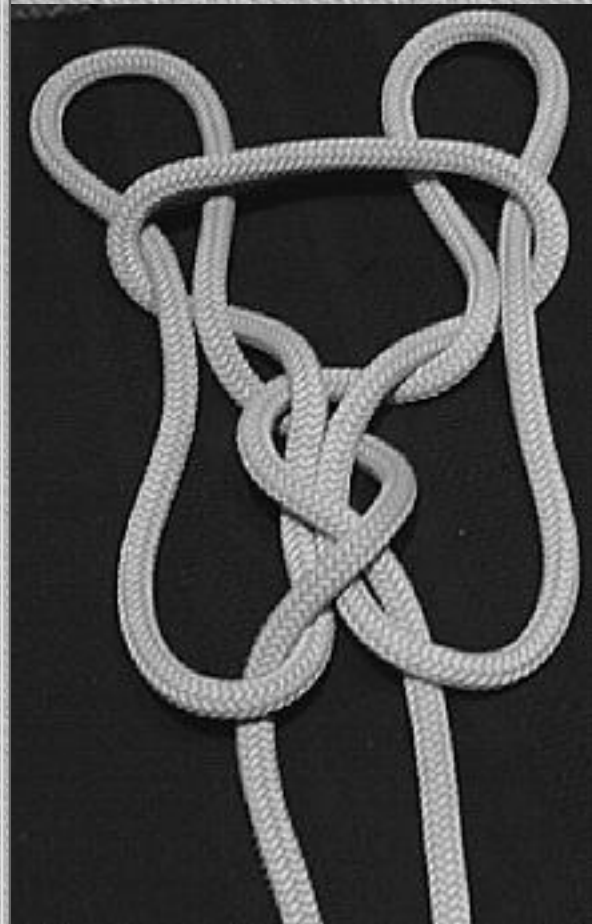

## *Step #3*

**Grasp the the top of the loop you just poked the bights through and bring it toward you and down so that it rests across the standing lines.**



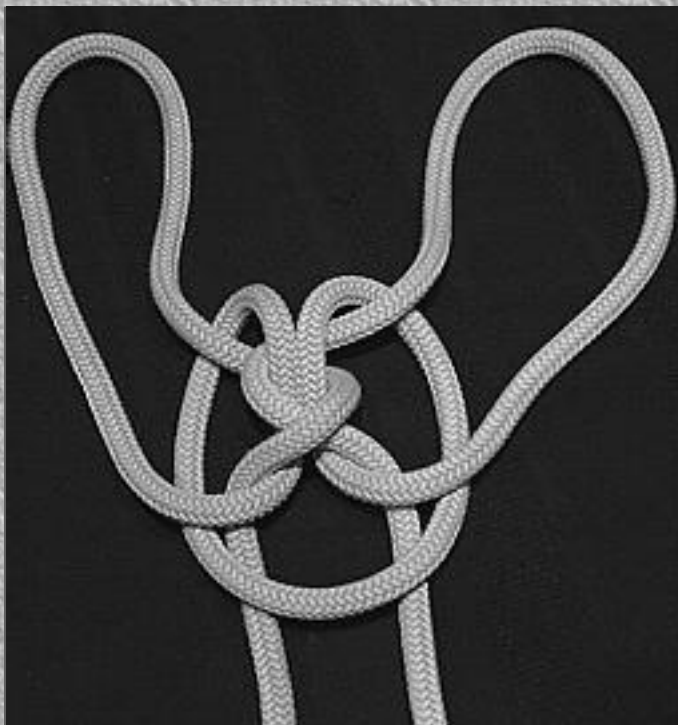

*Finished "Rigid Double Splayed Loop in a Bight"*

*Front View*

**Pull on the standing part to dress the knot. Pull on all parts to set the knot.**

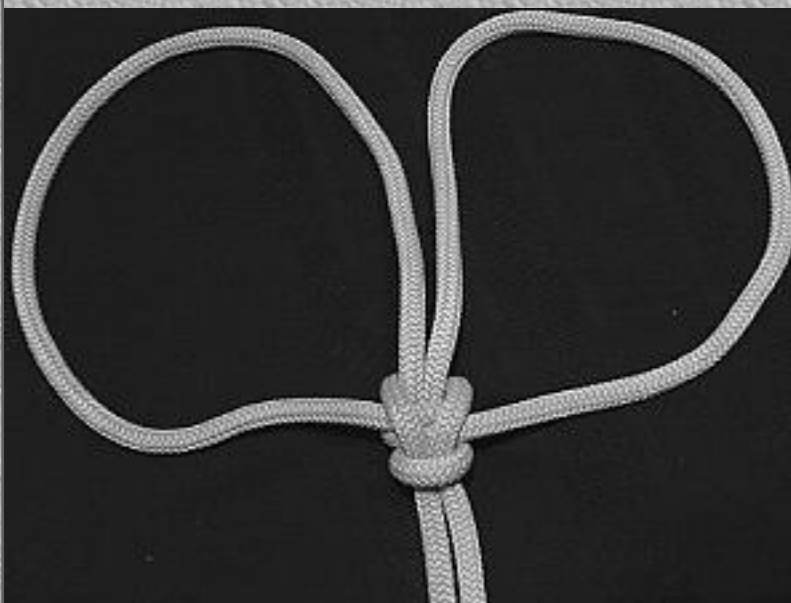

# *Finished "Rigid Double Splayed Loop in a Bight"*

## *Rear View*

**Pull on the standing part to dress the knot. Pull on all parts to set the knot.**

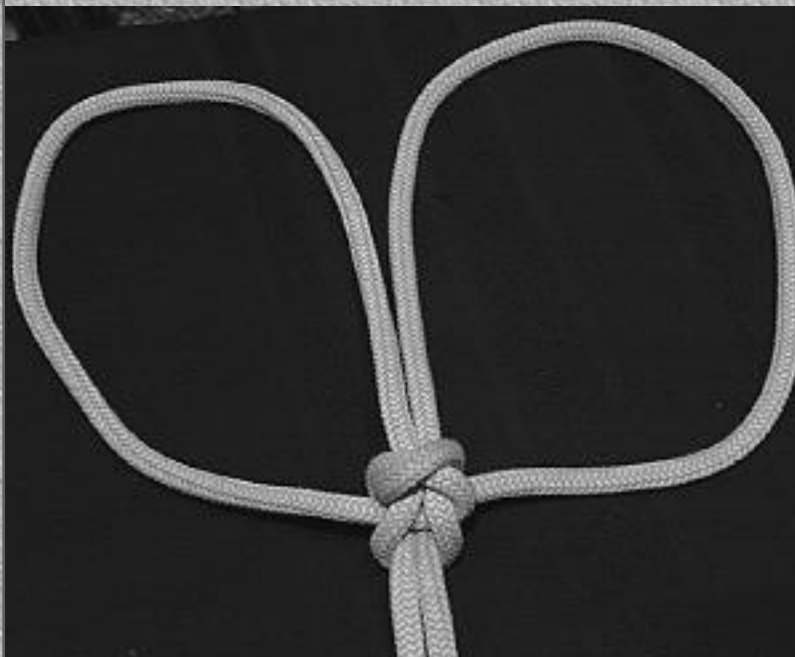

[\[Top of Page\]](#)

[Return to Index](#)

# KNOT KNOWLEDGE

## DOUBLE LOOP KNOTS

### Triple Crown Knot

**The Triple Crown Knot is my favorite double splayed loop knot because it is easy to tie and the loops definitely don't communicate.**

#### *Step #1*

**Form two equal length bights in a bight.**

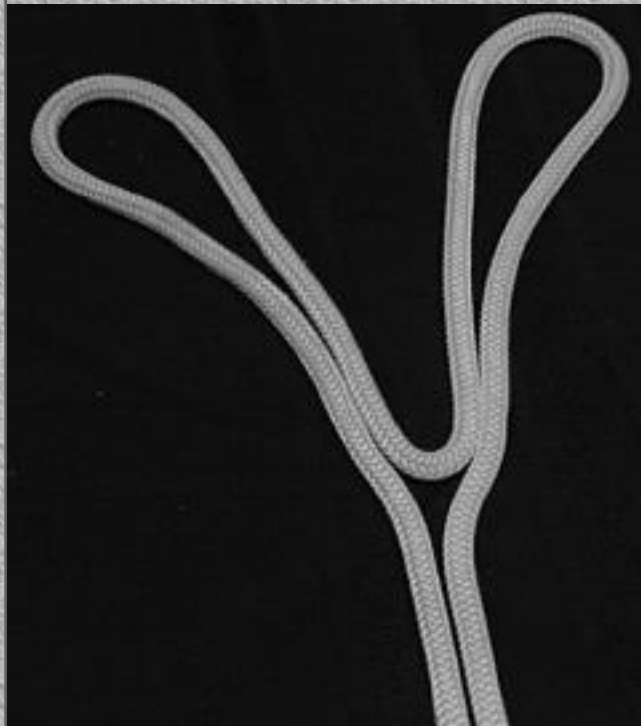

#### *Step #2*

**Grasp the standing part and bring it up over and between the two bights, forming a small loop at the bottom**

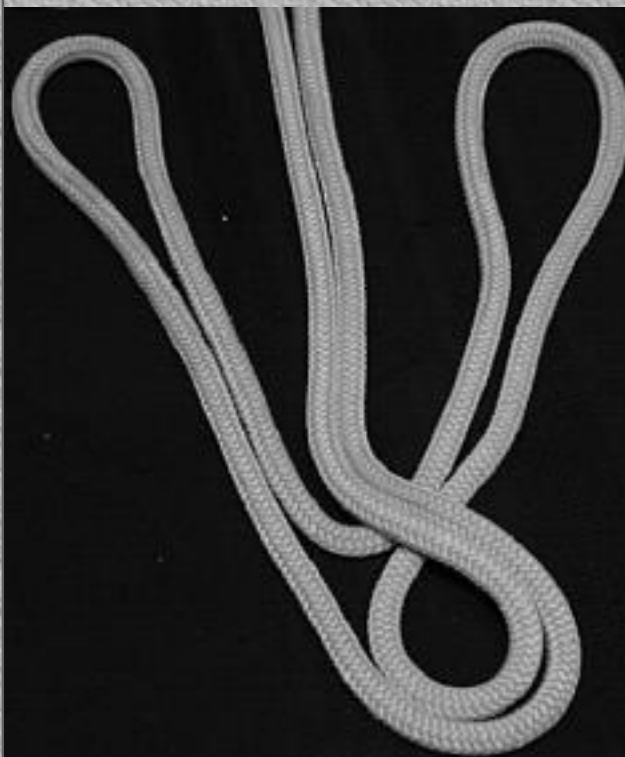

### *Step #3*

**Grasp the right hand bight and cross it over the standing part and the left hand bight.**

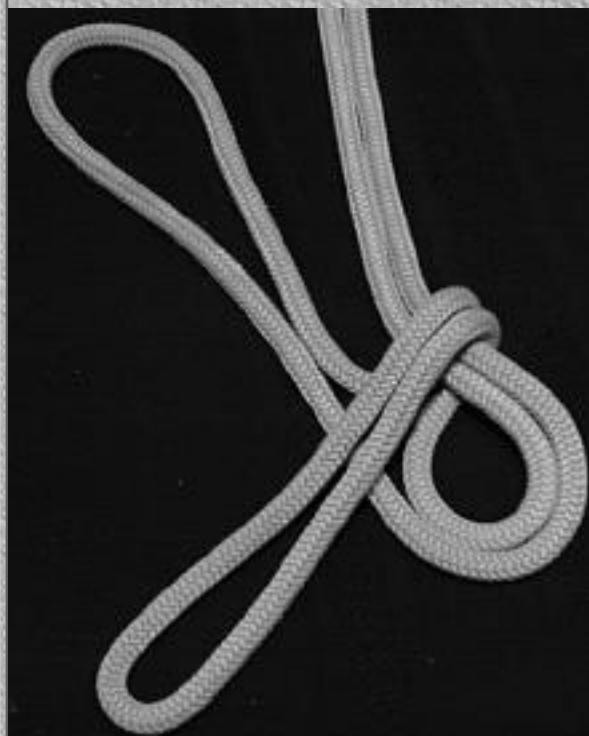

## *Step #4*

**Grasp the left hand bight and cross it over the right hand bight, inserting it through the small loop.**

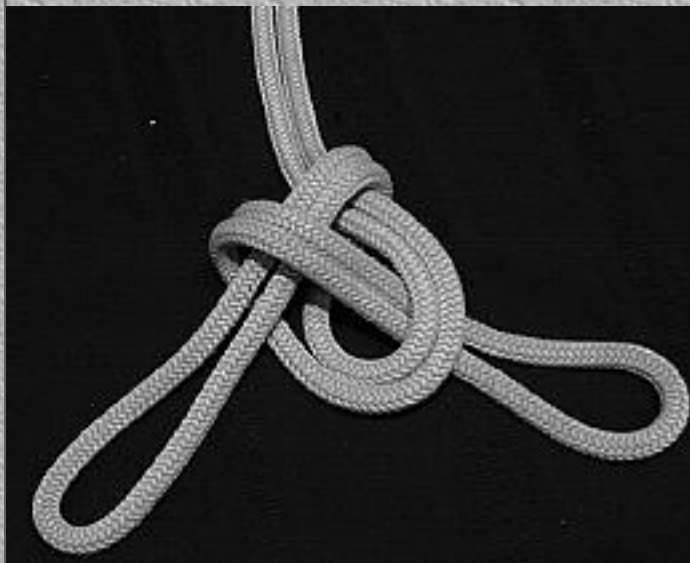

## *Finished Triple Crown Knot - Front View*

**Pull on the standing part to dress the knot. Pull on all parts to set the knot.**

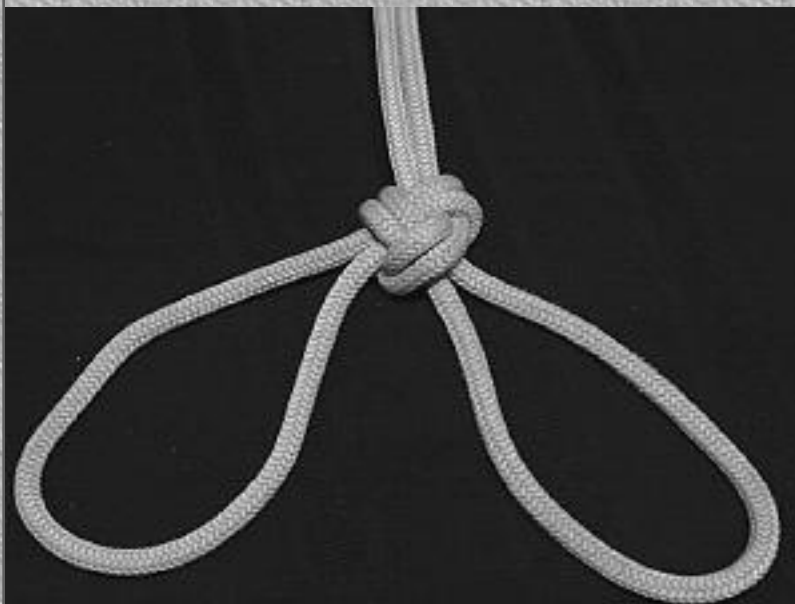

## *Finished Triple Crown Knot - Rear View*



**Pull on the standing part to dress the knot. Pull on all parts to set the knot.**

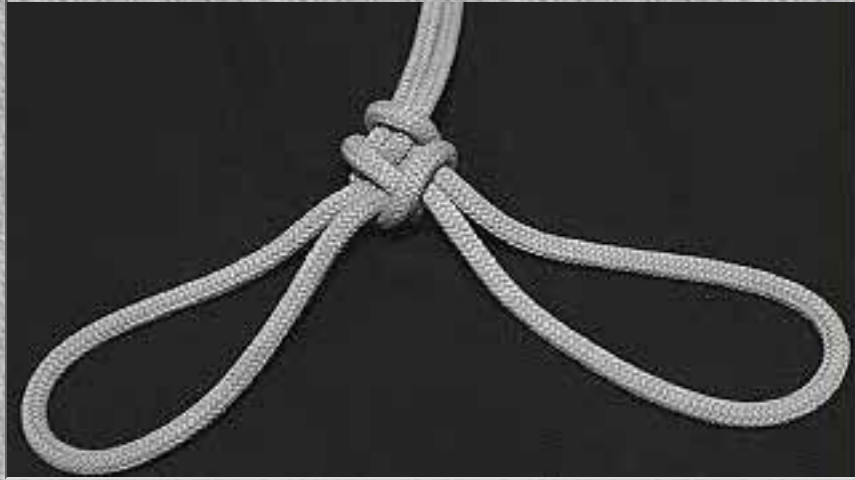

[\[Top of Page\]](#)

[Return to Index](#)

# KNOT KNOWLEDGE

## DOUBLE LOOP KNOTS

### Bowline on a Bight

The Bowline on a Bight is good parallel loop knot to use when you need hand loops to tug on the rope to get it unstuck from a vine-choked branch. It is easy to tie and does not readily jam, so it is usually easy to untie after applying a load.

#### *Step #1*

**Start with a bight of rope.**

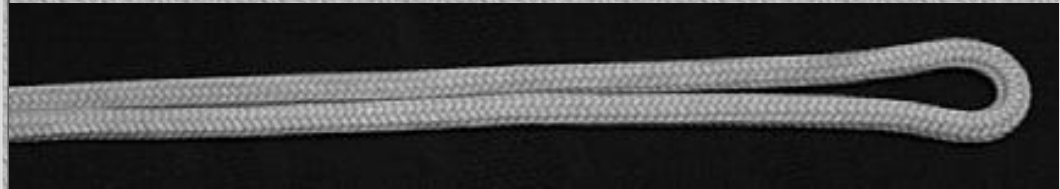

#### *Step #2*

**Form a loop by bringing the end over the standing part.**

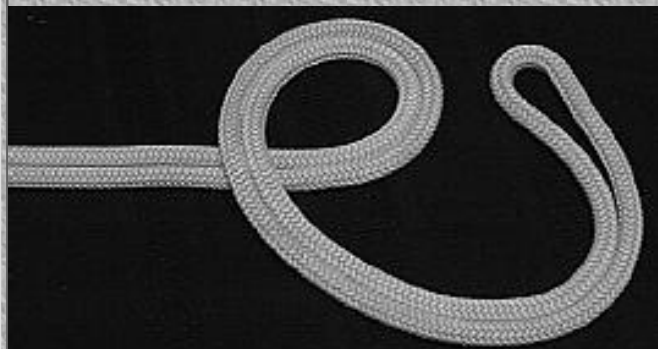

#### *Step #3*

**Insert the end of the bight through the loop.**

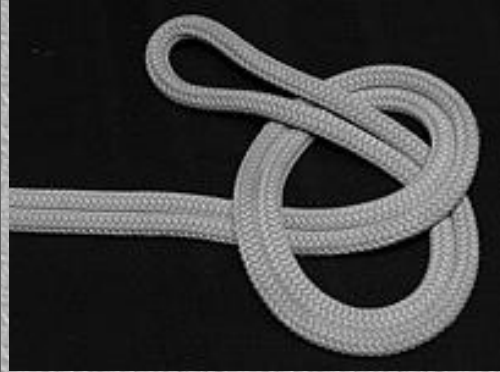

### *Step #4*

**Grasp the end of the bight and bring it toward you and down across the bottom of the loop.**

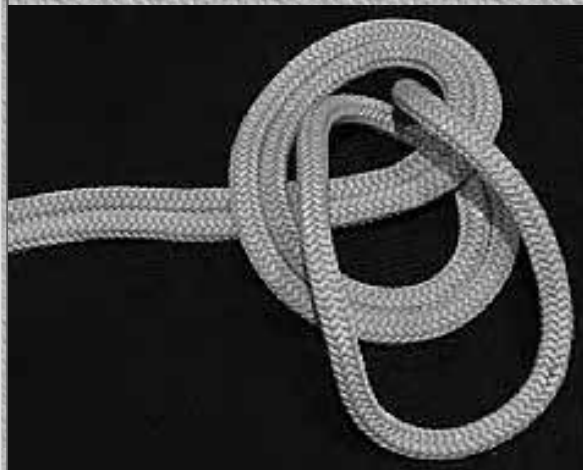

### *Step #5*

**With your hand still on the end of the bight, drag it beneath all the material that makes up the loop so that it ends up behind the standing part.**



***Finished Bowline on a Bight - Front View***

**Pull on the lower loop to pull the end of the bight snug against the original loop. Pull on the standing part to set the knot**

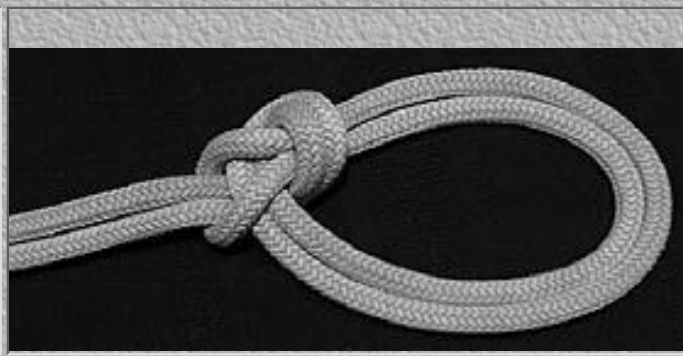

### *Finished Bowline on a Bight - Rear View*

**Pull on the lower loop to pull the end of the bight snug against the original loop. Pull on the standing part to set the knot**

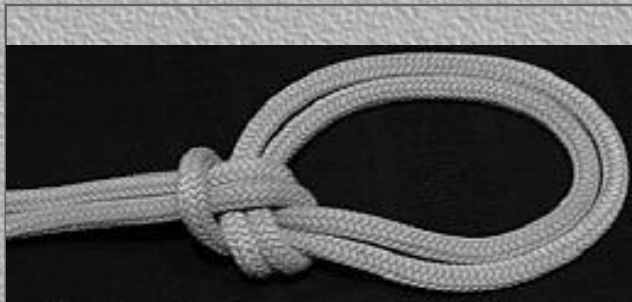

[\[Top of Page\]](#)

[Return to Index](#)



# KNOT KNOWLEDGE

## HITCHES

[\[Clove Hitch\]](#)

[\[Constrictor Hitch\]](#)

[\[Anchor Bend\]](#)

[\[Bunt Line Hitch\]](#)

[\[Highwayman's Hitch\]](#)

[\[Return to Index\]](#)

## Clove Hitch

**The clove hitch is a quick and easy knot to tie especially when you can pop it over the end of what you're tying on to. It's easy to untie even after a load has been applied.**

*Step #1*



**Make two loops,  
twisted in opposite  
directions.**

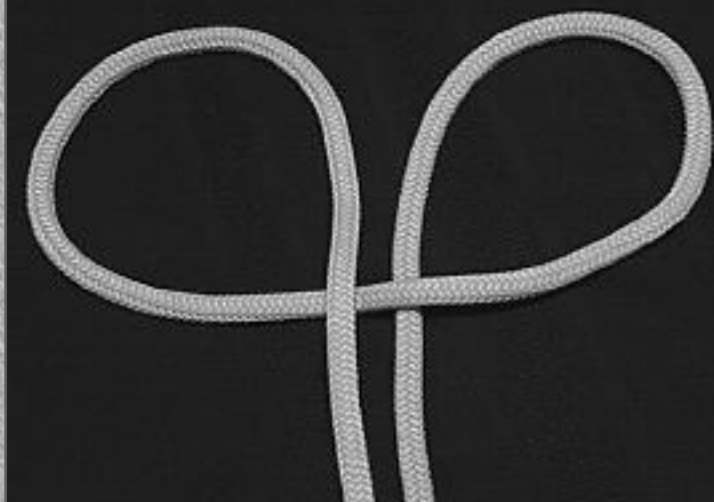

*Step #2*

**Place the left loop under  
the left part of the right  
loop, to form a hole.**

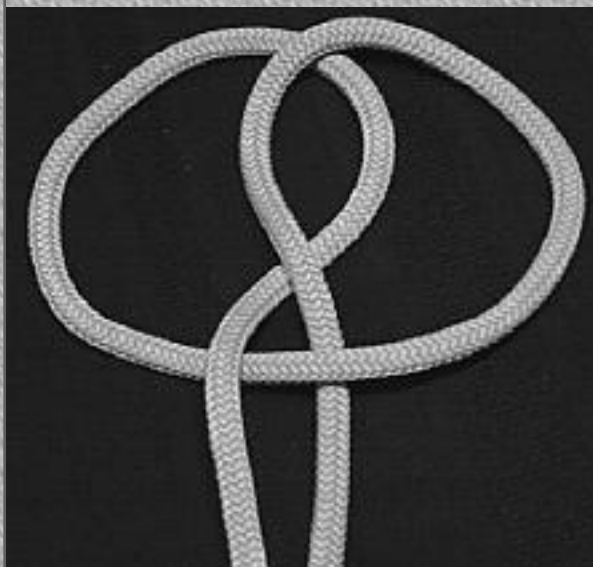

*Step #3*

**Pop the hole over the end of the object you're tying on to (in this case a barely-visible dowel rod).**

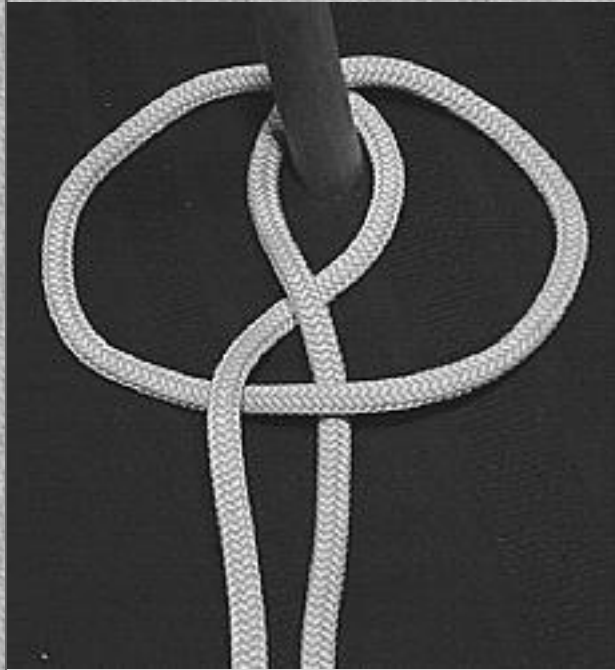

***Finished Clove Hitch - Front View***

**Dress and set the knot.**



***Finished Clove Hitch - Rear View***

**Dress and set the knot**

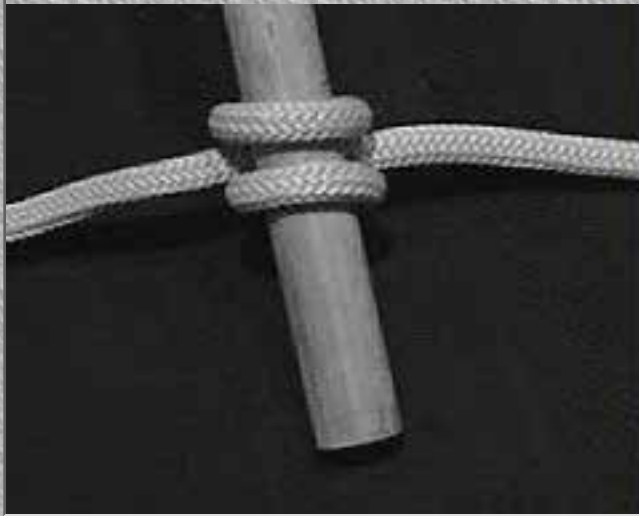

[\[Top of Page\]](#)

---

## Constrictor Hitch

**Use the Constrictor Hitch when you need to clamp a rope tightly around an object. It has a vice-like grip and is very hard to untie unless you slip the knot.**

### *Step #1*

**Place the end around and behind the item you're tying the rope to.**

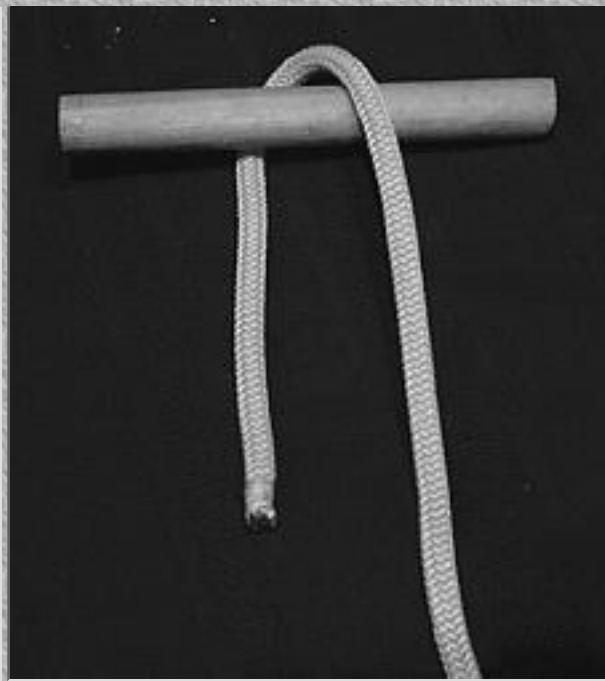

## *Step #2*

**Wrap the end around to the other side of the object, crossing the standing part.**

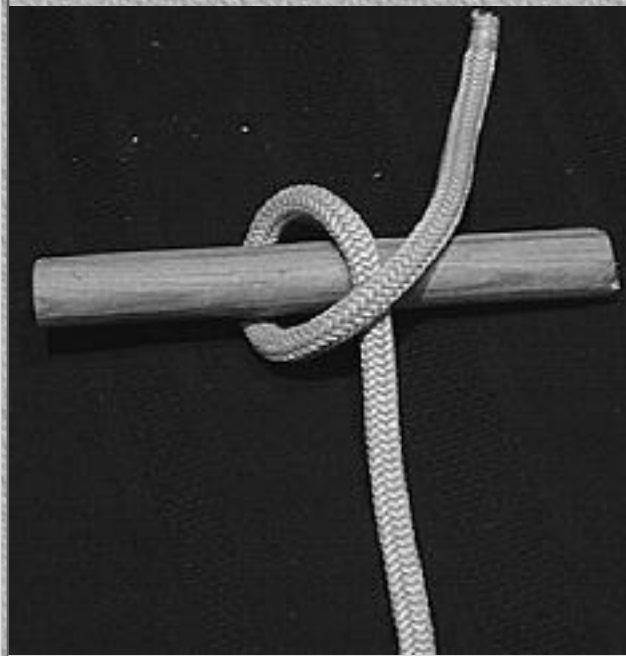

## *Step #3*

**Continue wrapping the end around the dowel so the end is parallel with the standing part.**

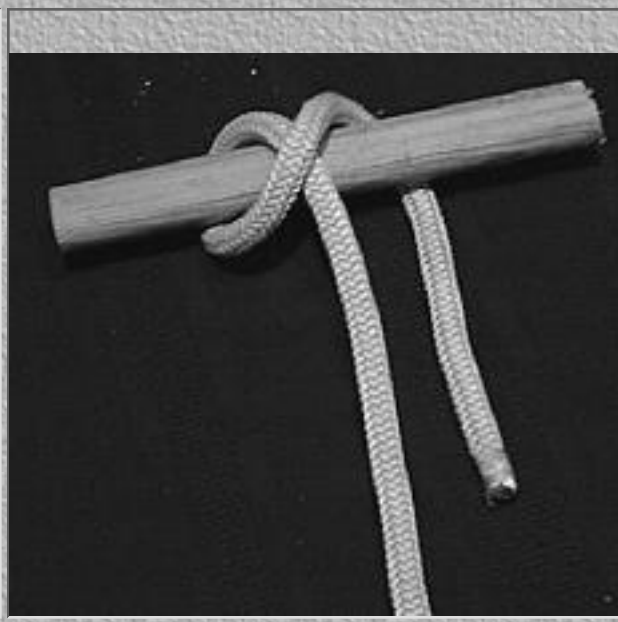

### *Step #4*

**Bring the end over the standing part and tuck it under and between the two loops.**

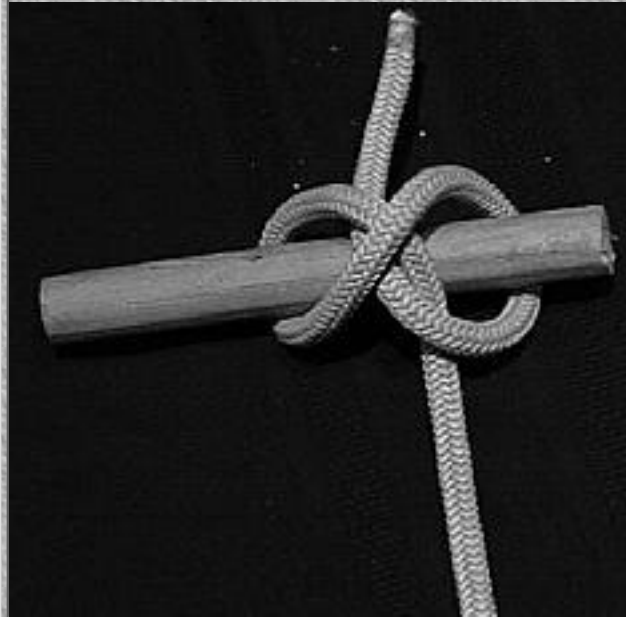

### *Finished Constrictor Hitch*



**Dress and set the knot.**

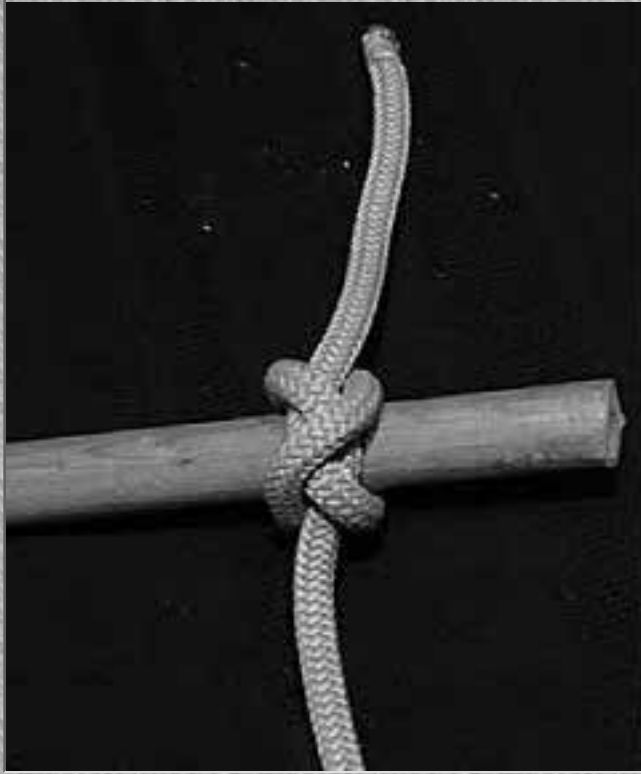

### *Slipped Constrictor Hitch*

**Since this knot cinches up so tightly, if you plan to untie it, stick a bight of rope through instead of the end. Yank on the end to disengage the knot from the object.**

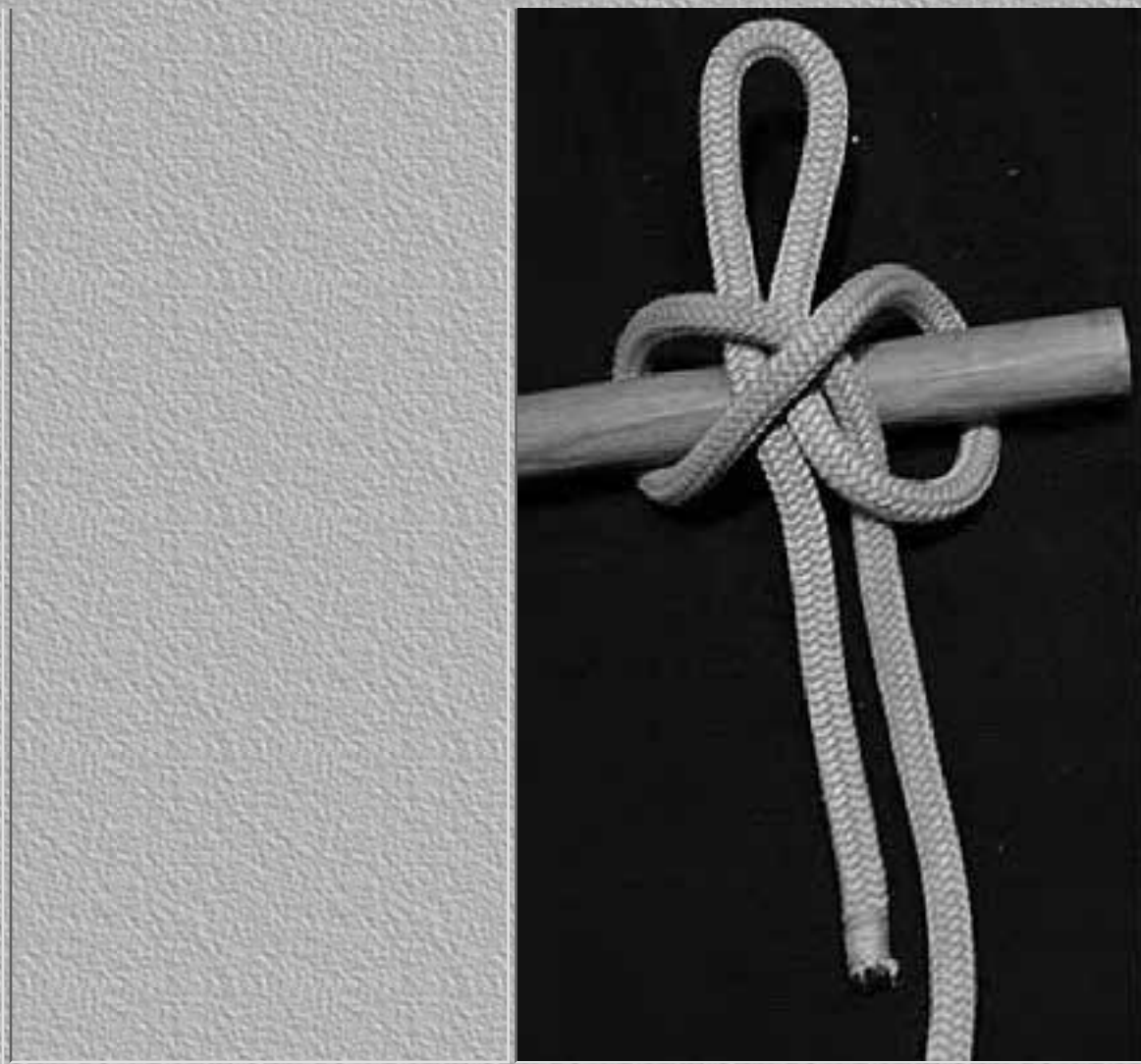

[\[Top of Page\]](#)

---

## Anchor Bend

**The Anchor Bend can be used to attach a rope to a carabiner or ring. The following shows two turns, and three or more can be used.**

*Step #1*

**Bring the end behind and then through the carabiner.**



## *Step #2*

**Loop the rope once around the carabiner.**



*Step #3*

**Bring the end behind the standing part.**

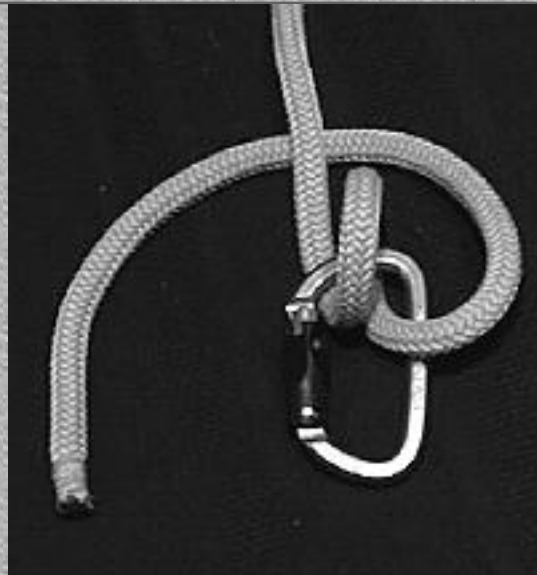

*Step #4*

**Bring the end through the two loops.**



### *Finished Anchor Bend*

**Dress and set the knot.**



[\[Top of Page\]](#)

---

## Bunt Line Hitch

**The Bunt Line Hitch is also a good attachment knot for a carabiner or a ring.**



## *Step #1*

**Bring the end in front and then through the carabiner.**



## *Step #2*

**Pull the end over and across the standing part.**



### *Step #3*

**Bring the end behind the loop.**



### *Step #4*

**Pull the end around the front of the loop, or below it, as pictured.**



### *Step #5*

**Insert the end through the loop.**



***Finished Buntline Hitch - Front View***

**Dress and set the knot, bringing the standing part snug against the carabiner.**



***Finished Buntline Hitch - Rear View***

**Dress and set the knot, bringing the standing part snug against the carabiner.**

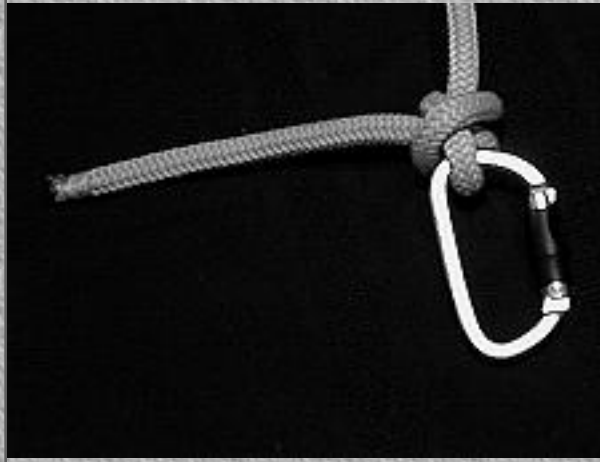

[\[Top of Page\]](#)

---

## Highwayman's Hitch

**The Highwayman's Hitch is ideal for tying a rope to an object when you need a quick release. Just yank on the end that is not supporting the load to untie and completely remove the rope from the object it was made fast to.**

### *Step #1*

**Pull a bight under the object you are tying on to. The left side is the standing part and the right side is the end. The standing part is**

**connected to the load.**

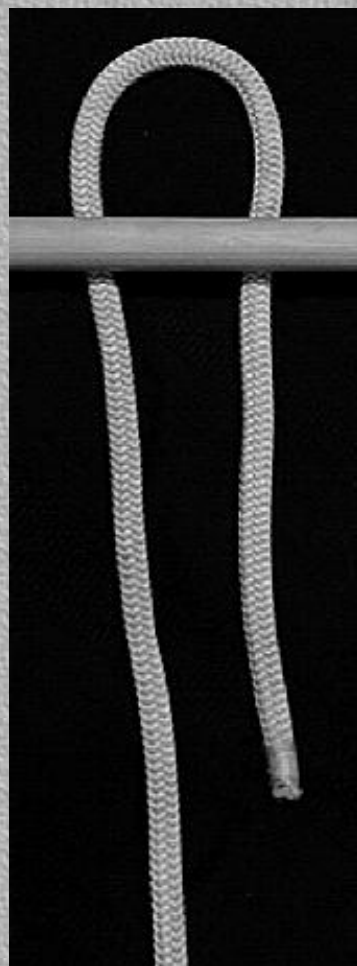

***Step #2***

**Form a bight in the standing part.**



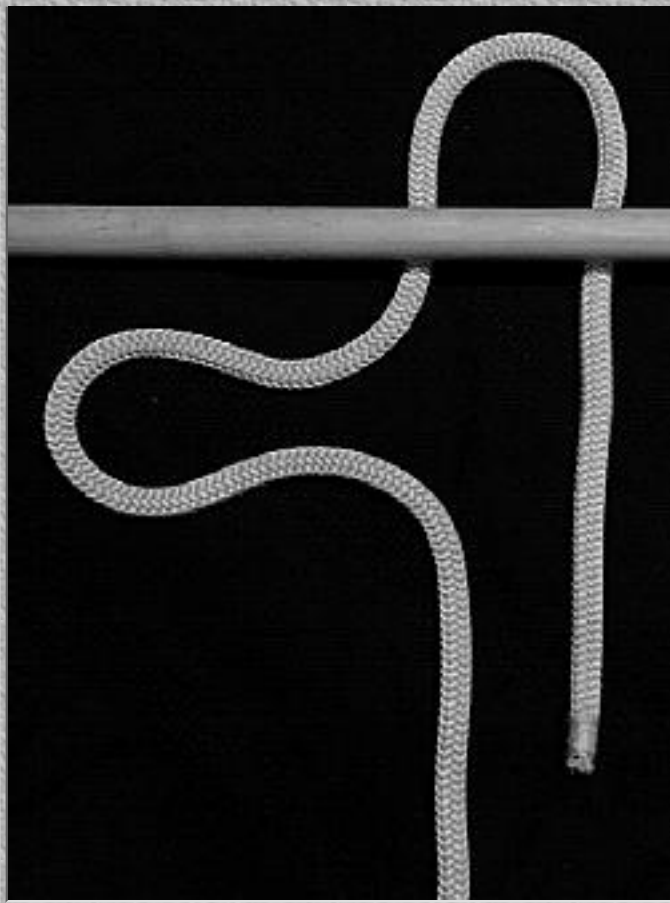

*Step #3*

**Pull the bight over the object and through the original bight.**



### *Step #4*

**Make a bight in the end.**

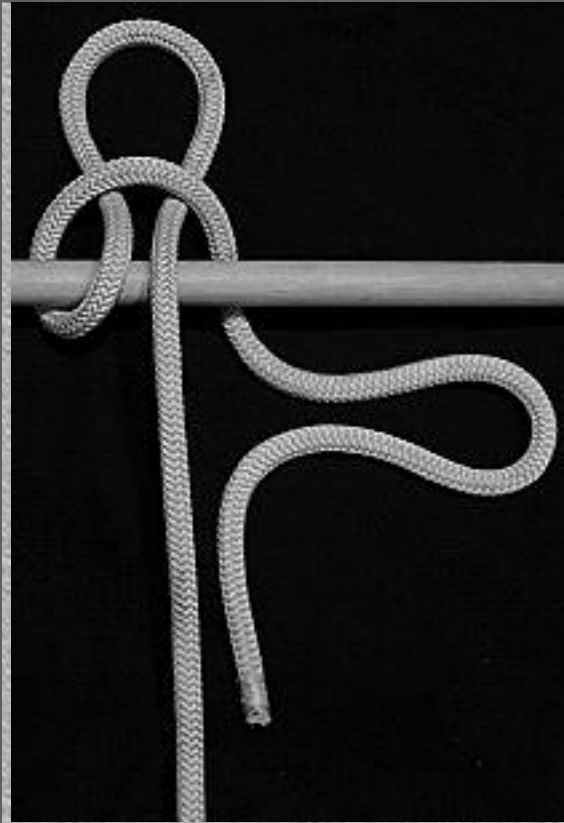

### *Step #5*

**Insert it through the previous bight.**

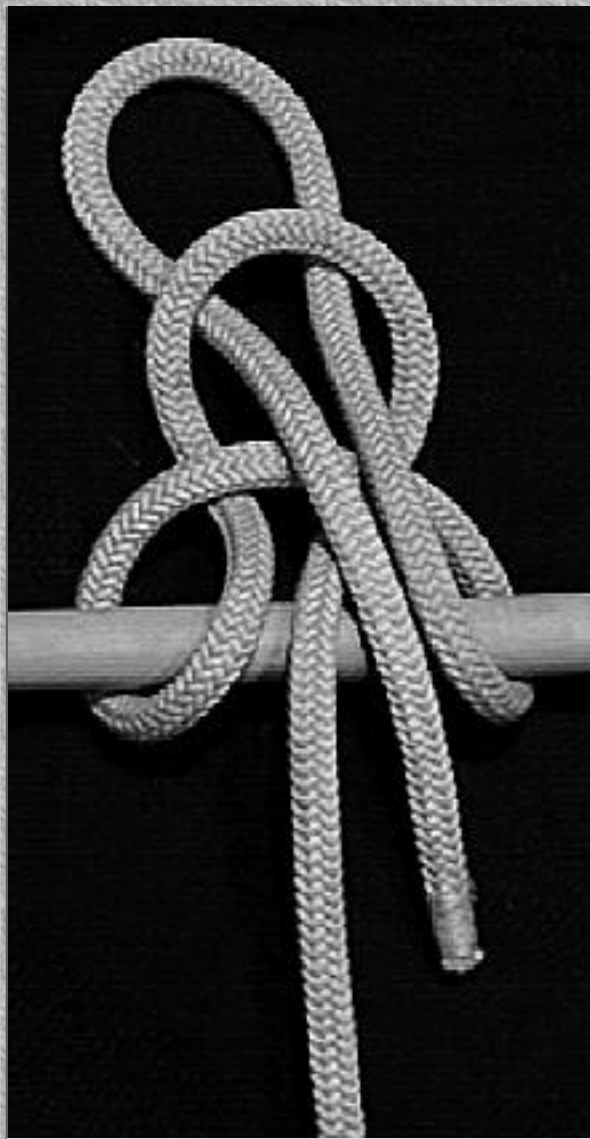

### *Step #6*

**Pull the standing part to dress the knot. Then set the knot by pulling on all parts. The end is yanked abruptly to disengage the knot.**

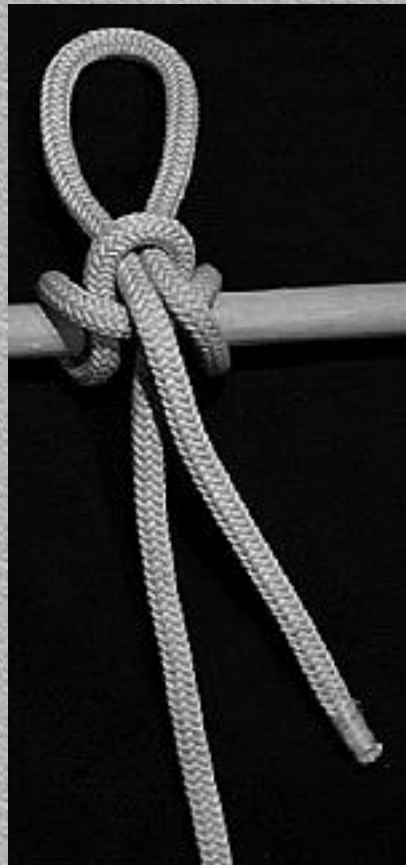

[\[Top of Page\]](#)

[Return to Index](#)

# KNOT KNOWLEDGE

## HITCHES

### Clove Hitch

**The clove hitch is a quick and easy knot to tie especially when you can pop it over the end of what you're tying on to. It's easy to untie even after a load has been applied.**

#### *Step #1*

**Make two loops,  
twisted in opposite  
directions.**

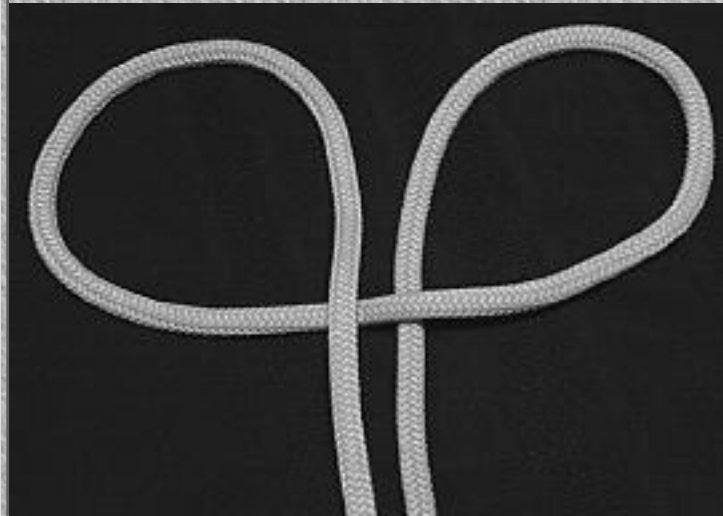

#### *Step #2*



**Place the left loop under the left part of the right loop, to form a hole.**

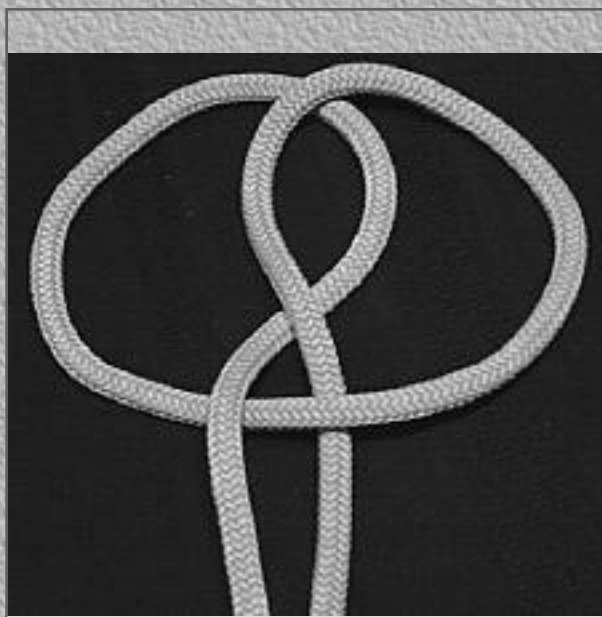

### *Step #3*

**Pop the hole over the end of the object you're tying on to (in this case a barely-visible dowel rod).**

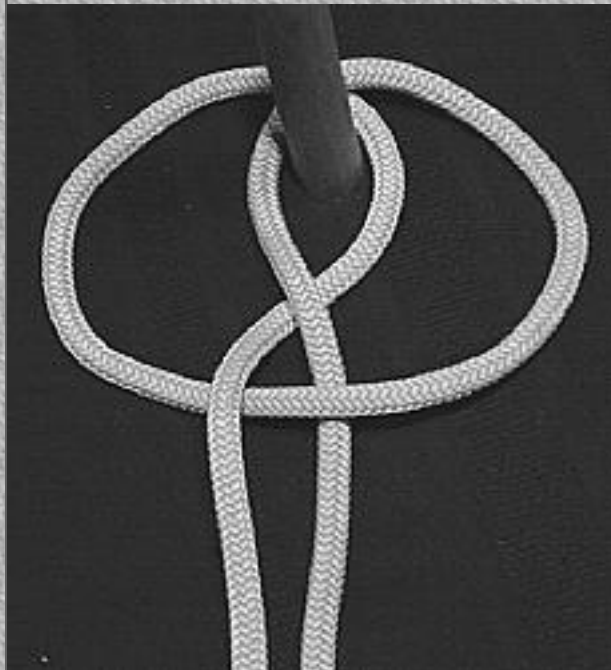

*Finished Clove Hitch - Front View*

**Dress and set the knot.**

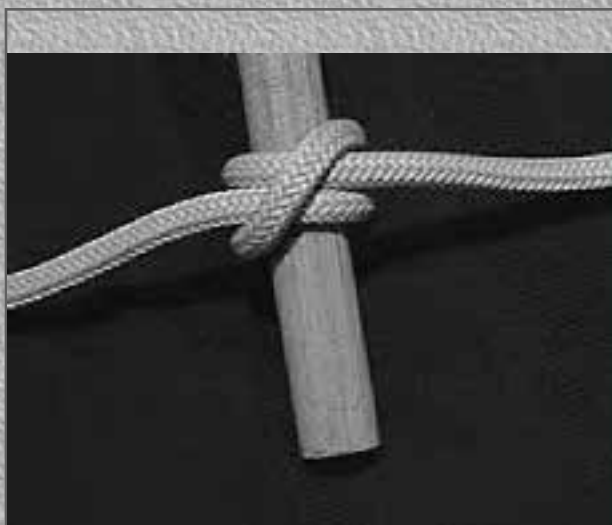

***Finished Clove Hitch - Rear View***

**Dress and set the knot**



[\[Top of Page\]](#)

[Return to Index](#)

# KNOT KNOWLEDGE

## HITCHES

### Constrictor Hitch

Use the **Constrictor Hitch** when you need to clamp a rope tightly around an object. It has a vice-like grip and is very hard to untie unless you slip the knot.

#### *Step #1*

**Place the end around and behind the item you're tying the rope to.**

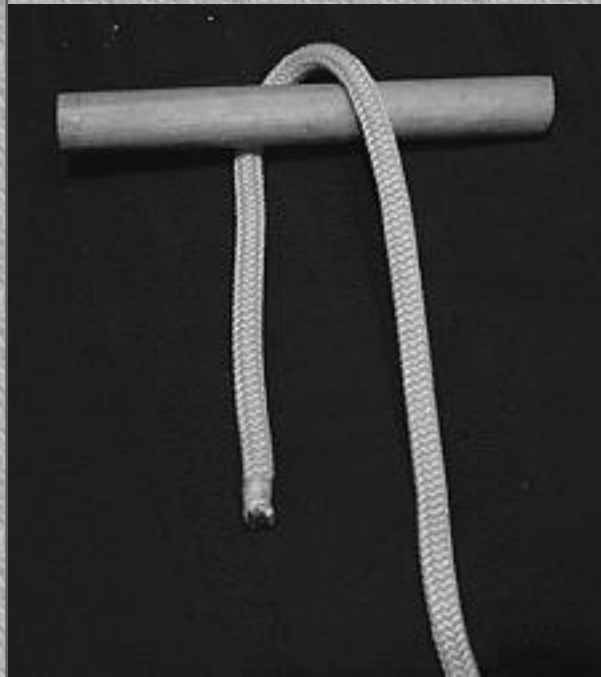

#### *Step #2*

**Wrap the end around to the other side of the object, crossing the standing part.**

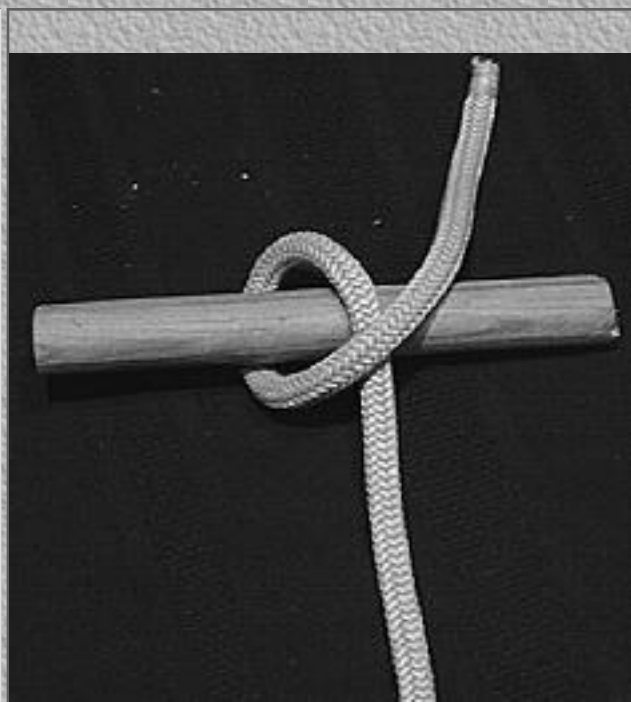

### *Step #3*

**Continue wrapping the end around the dowel so the end is parallel with the standing part.**



### *Step #4*

**Bring the end over the standing part and tuck it under and between the two loops.**

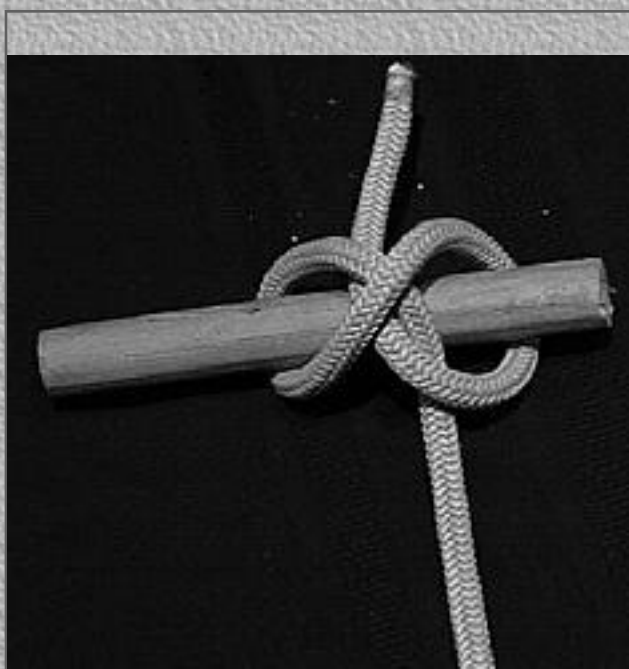

### *Finished Constrictor Hitch*

**Dress and set the knot.**

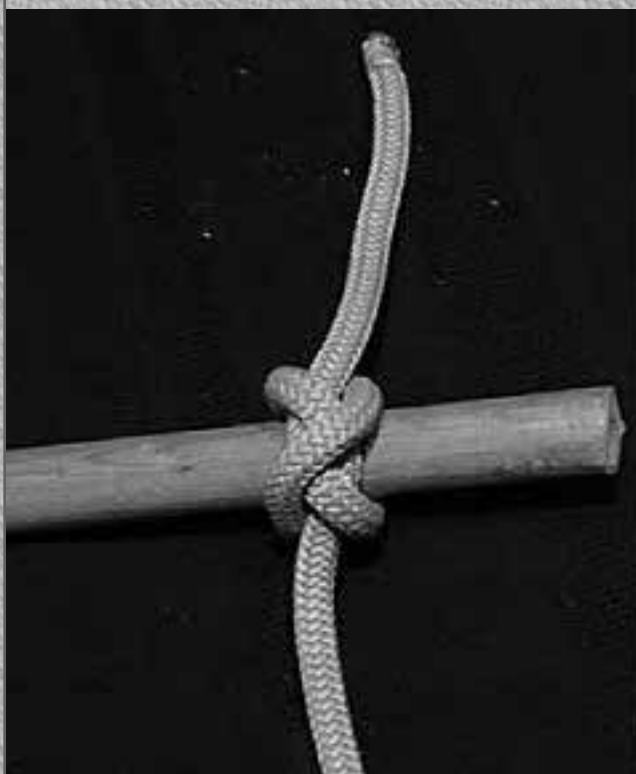

### *Slipped Constrictor Hitch*



**Since this knot cinches up so tightly, if you plan to untie it, stick a bight of rope through instead of the end. Yank on the end to disengage the knot from the object.**

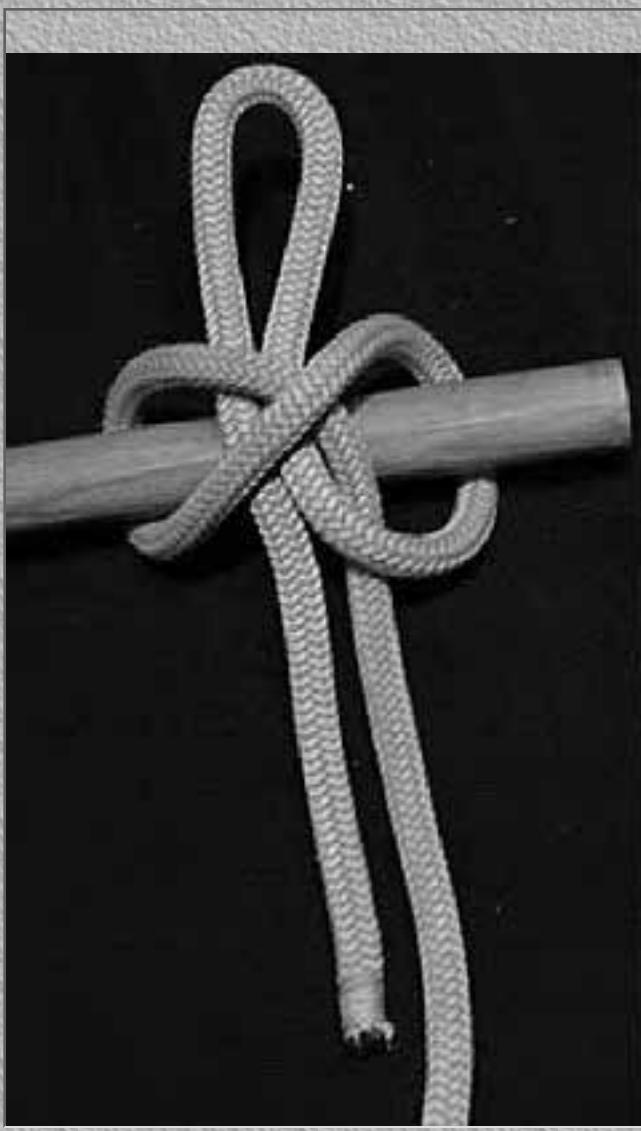

[\[Top of Page\]](#)

[Return to Index](#)

# KNOT KNOWLEDGE

## HITCHES

### Anchor Bend

The Anchor Bend can be used to attach a rope to a carabiner or ring. The following shows two turns, and three or more can be used.

#### *Step #1*

**Bring the end behind and then through the carabiner.**



#### *Step #2*

**Loop the rope once around the carabiner.**



### *Step #3*

**Bring the end behind the standing part.**

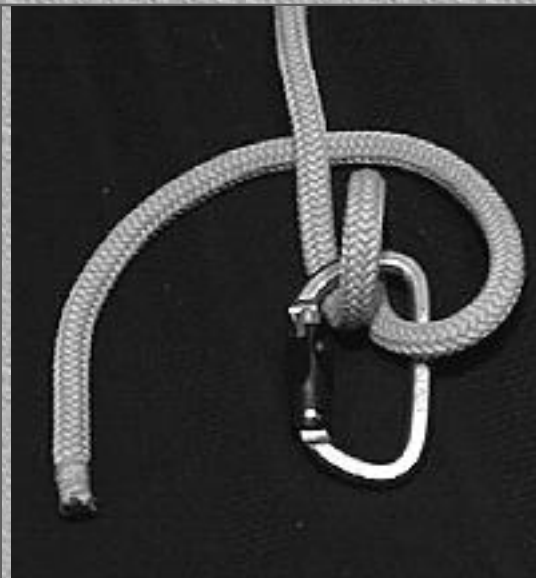

### *Step #4*

**Bring the end through  
the two loops.**



***Finished Anchor Bend***

**Dress and set the knot.**



[\[Top of Page\]](#)

[Return to Index](#)



# KNOT KNOWLEDGE

## HITCHES

### Bunt Line Hitch

The Bunt Line Hitch is also a good attachment knot for a carabiner or a ring.

#### *Step #1*

**Bring the end in front and then through the carabiner.**



#### *Step #2*



**Pull the end over and across the standing part.**



### *Step #3*

**Bring the end behind the loop.**



### *Step #4*

**Pull the end around the front of the loop, or below it, as pictured.**



***Step #5***

**Insert the end through the loop.**



***Finished Buntline Hitch - Front View***

**Dress and set the knot, bringing the standing part snug against the carabiner.**



***Finished Buntline Hitch - Rear View***

**Dress and set the knot, bringing the standing part snug against the carabiner.**

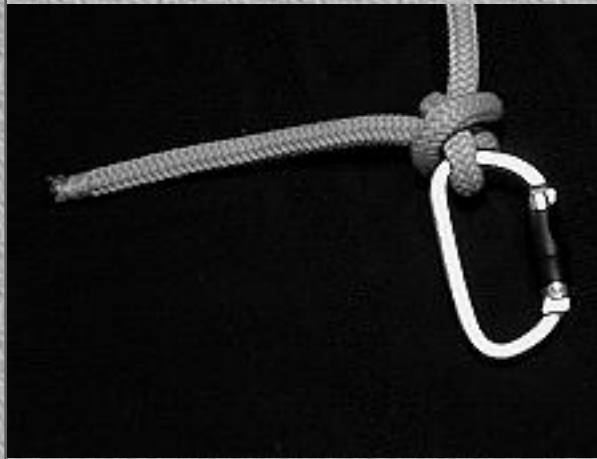

[\[Top of Page\]](#)

[Return to Index](#)

# KNOT KNOWLEDGE

## HITCHES

### Highwayman's Hitch

**The Highwayman's Hitch is ideal for tying a rope to an object when you need a quick release. Just yank on the end that is not supporting the load to untie and completely remove the rope from the object it was made fast to.**

#### *Step #1*

**Pull a bight under the object you are tying on to. The left side is the standing part and the right side is the end. The standing part is connected to the load.**

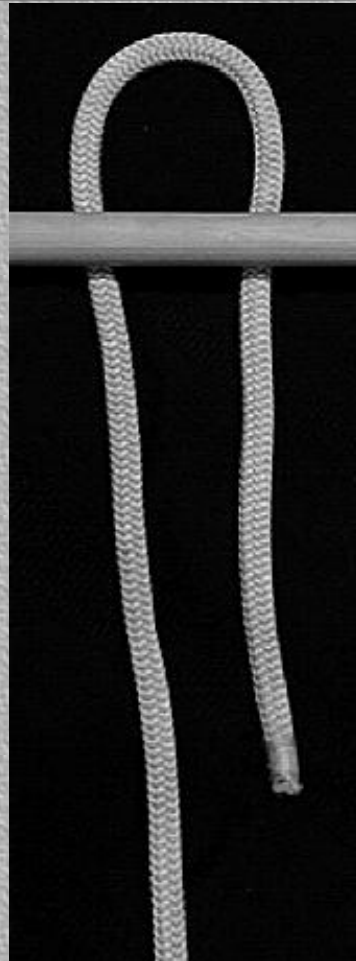



## *Step #2*

**Form a bight in the standing part.**

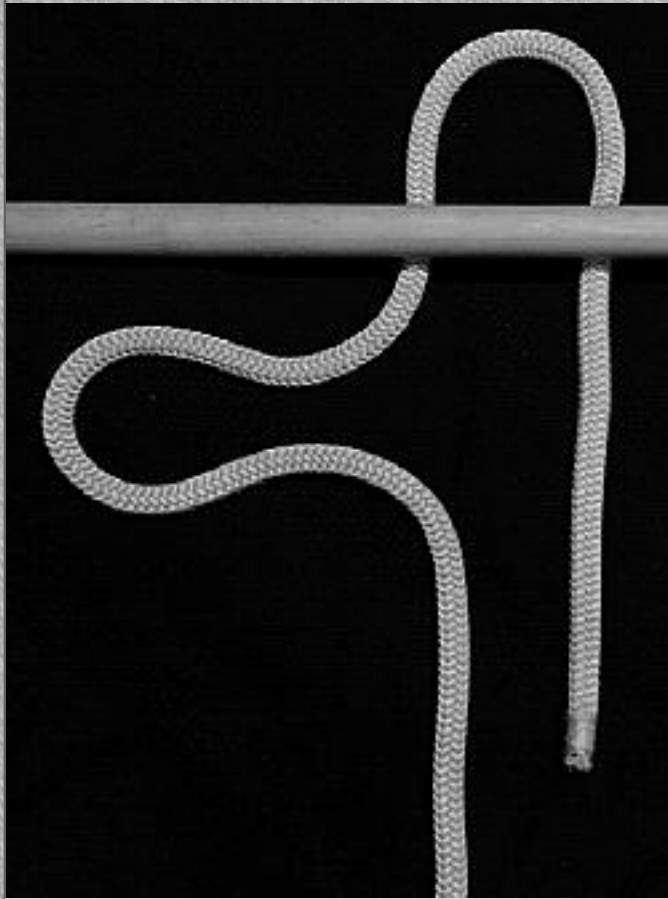

## *Step #3*

**Pull the bight over the object and through the original bight.**





*Step #4*

**Make a bight in the end.**

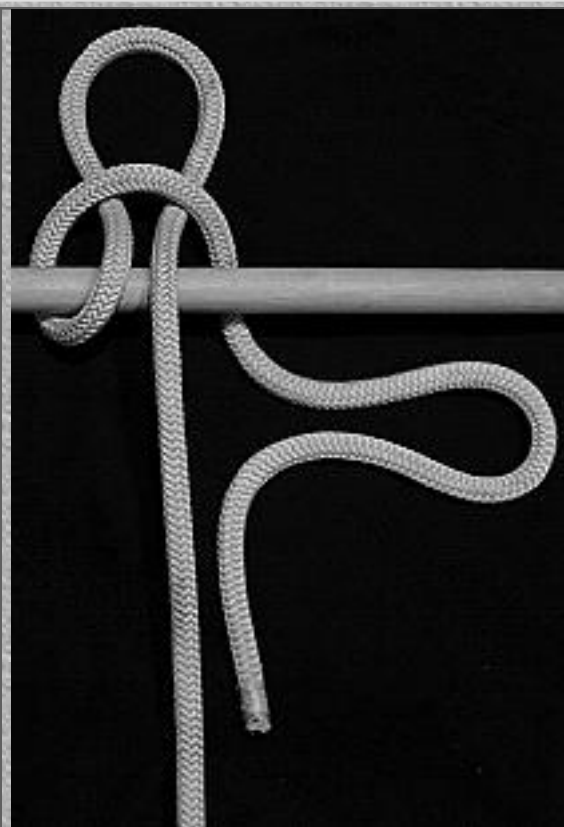

## *Step #5*

**Insert it through the previous bight.**



## *Step #6*

**Pull the standing part to dress the knot. Then set the knot by pulling on all parts. The end is yanked abruptly to disengage the knot.**

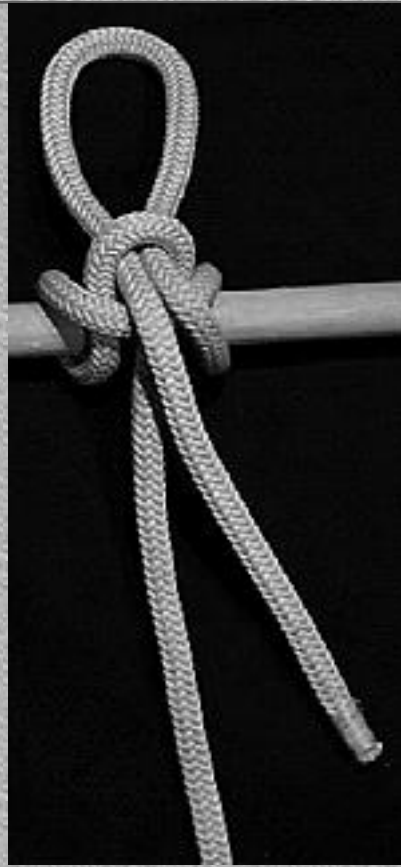

[\[Top of Page\]](#)

[Return to Index](#)

# KNOT KNOWLEDGE

## STOPPER KNOTS

[\[Figure 8\]](#)

[\[Heaving Line Knot\]](#)

[\[Double Overhand Knot\]](#)

[\[Return to Index\]](#)

### Figure 8

**The Figure 8 knot is made in the end of a rope. It is bulkier than an Overhand knot.**

*Step #1*

**Make a loop.**

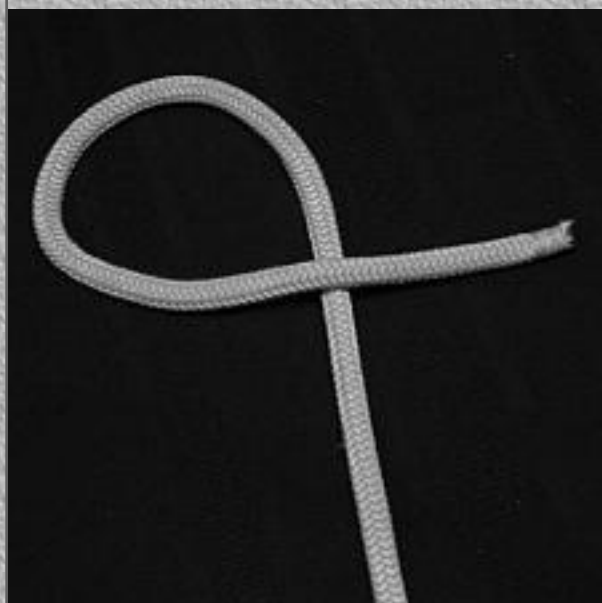

*Step #2*

**Bring the end around behind the standing part.**



*Step #3*



**Put the end through the loop.**

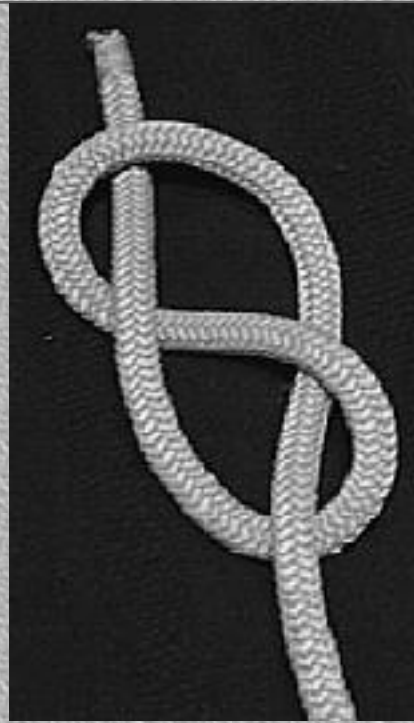

***Finished Figure 8***

**Dress and set the knot.**

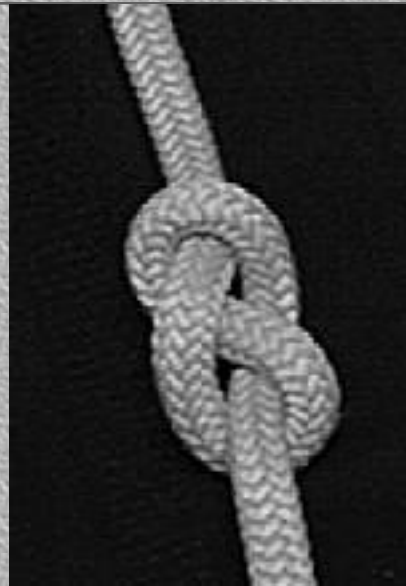

[\[Top of Page\]](#)

## Heaving Line Knot

**The Heaving line knot can be used to add weight to the end of the rope to give mass to it when you want to throw it.**

### *Step #1*

**Form a bight.**

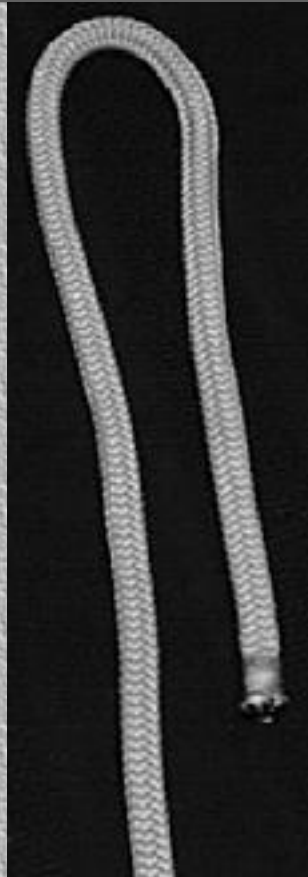

### *Step #2*

**Start making turns, taking the end behind the standing part and wrapping it around the bight.**

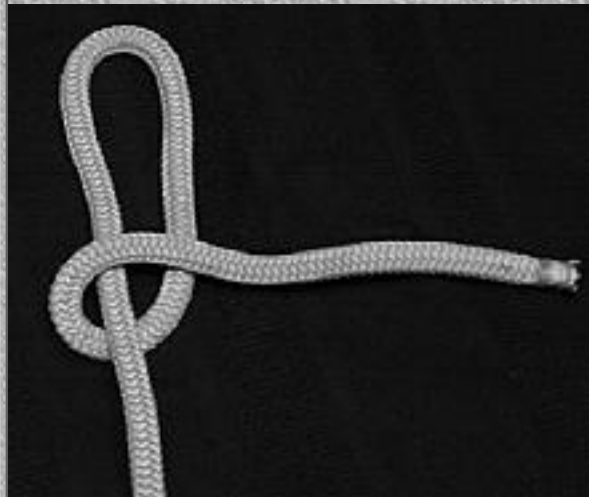

***Step #3***

**Make several turns.**



***Step #4***

**Insert the end through the loop.**



***Finished Heaving Line Knot***

**Pull on the standing part to tighten the knot.**

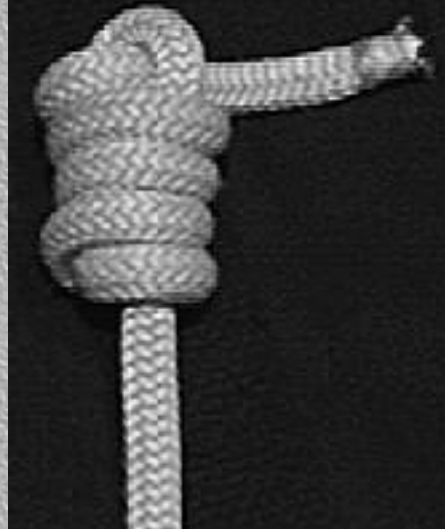

[\[Top of Page\]](#)



## Double Overhand Knot

**The Double Overhand is bulkier than the Figure 8 knot and is more difficult to untie.**

### *Step #1*

**Begin with an overhand knot.**



### *Step #2*

**Put the end back through the loop.**



### *Finished Double Overhand Knot*



**Yank firmly on both ends to snap this knot tight.**



[\[Top of Page\]](#)

[Return to Index](#)

# KNOT KNOWLEDGE

## STOPPER KNOTS

### Figure 8

**The Figure 8 knot is made in the end of a rope. It is bulkier than an Overhand knot.**

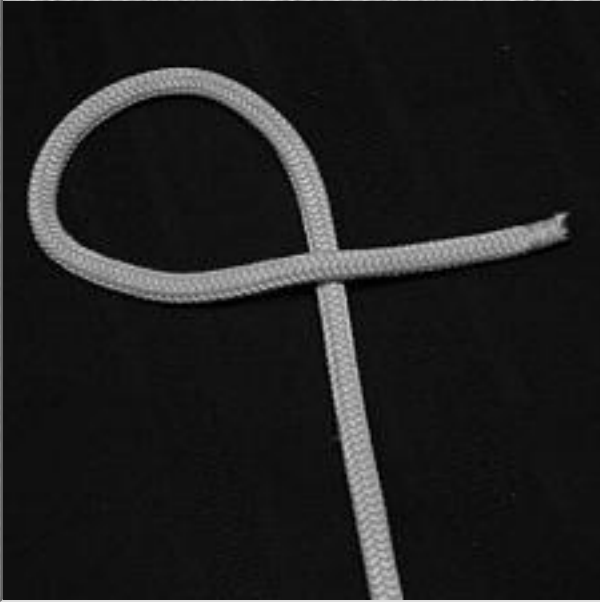
<i>Step #1</i>	
<b>Make a loop.</b>	

<i>Step #2</i>	

**Bring the end around  
behind the standing part.**



*Step #3*

**Put the end through the  
loop.**

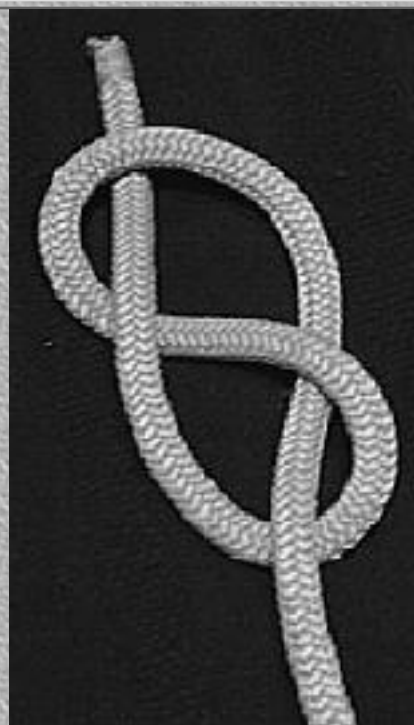

*Finished Figure 8*

**Dress and set the knot.**

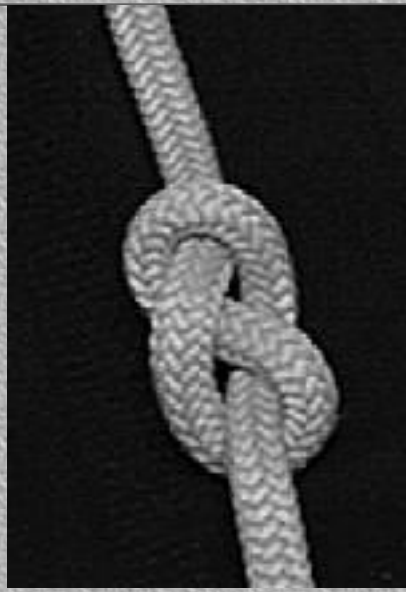

[\[Top of Page\]](#)

[Return to Index](#)

# KNOT KNOWLEDGE

## STOPPER KNOTS

### Heaving Line Knot

**The Heaving line knot can be used to add weight to the end of the rope to give mass to it when you want to throw it.**

#### *Step #1*

**Form a bight.**

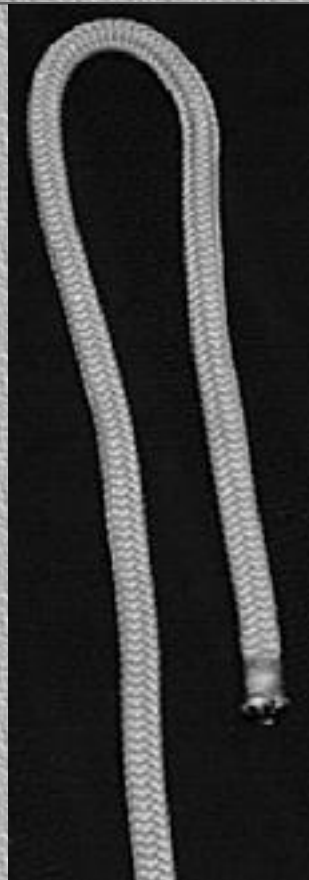

#### *Step #2*



**Start making turns, taking the end behind the standing part and wrapping it around the bight.**

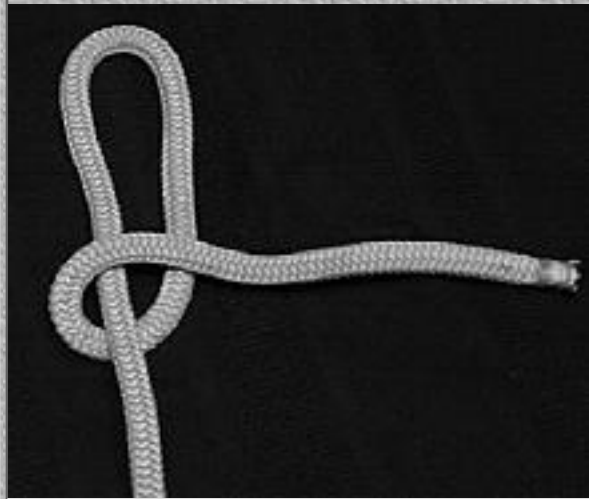

### *Step #3*

**Make several turns.**



### *Step #4*

**Insert the end through the loop.**



***Finished Heaving Line Knot***

**Pull on the standing part to tighten the knot.**

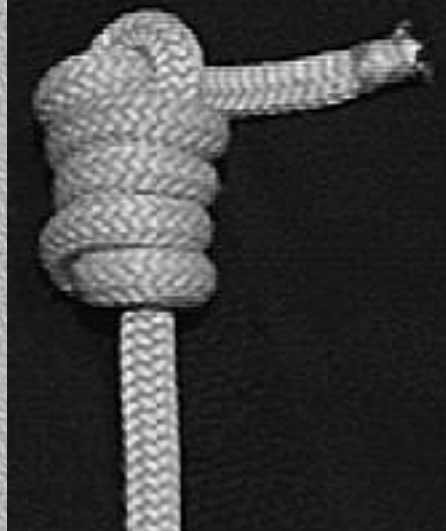

[\[Top of Page\]](#)

[Return to Index](#)

# KNOT KNOWLEDGE

## STOPPER KNOTS

### Double Overhand Knot

**The Double Overhand is bulkier than the Figure 8 knot and is more difficult to untie.**

#### *Step #1*

**Begin with an overhand knot.**



#### *Step #2*

**Put the end back through the loop.**



## *Finished Double Overhand Knot*

**Yank firmly on both ends to snap this knot tight.**

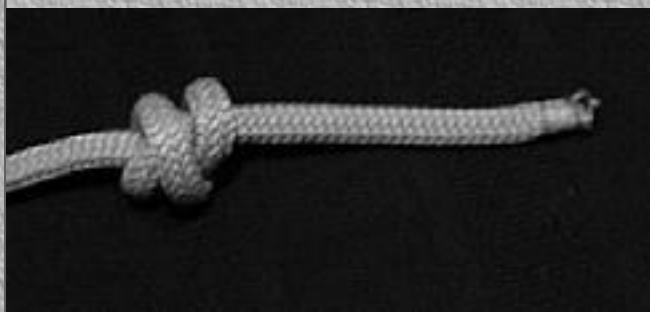

[\[Top of Page\]](#)

[Return to Index](#)



# KNOT KNOWLEDGE

## BENDS

[\[Sheet Bend\]](#)

[\[Full Carrick Bend\]](#)

[\[Return to Index\]](#)

### Sheet Bend

The sheet bend is very similar to the square knot, granny knot, thief knot, and particularly the bowline. In fact, the sheet bend can be tied using the [One Handed Twist Method](#) which is also used to tie the [bowline](#). The sheet bend is very fast to tie and when slipped, is one of the easiest bends to work with. It is also useful when joining two ropes of different diameters.

*Step #1*



**Form a bight  
(with the  
larger  
diameter  
rope).**

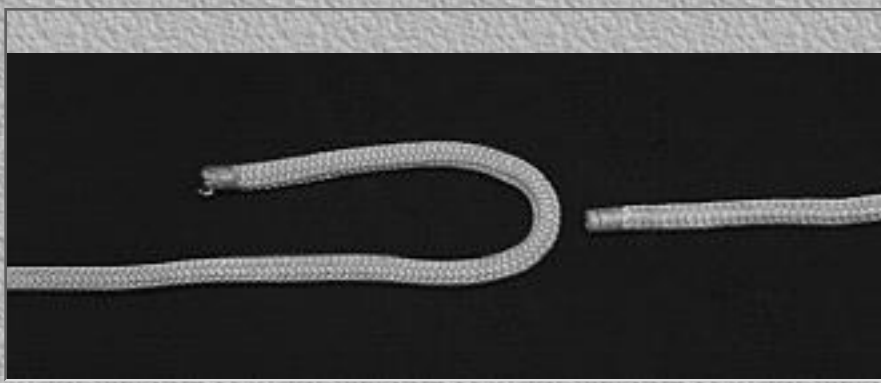

### *Step #2*

**Insert the second rope  
under and then over the  
end of the first rope.**



### *Step #3*

**Take the end of the second  
rope and bring it under the  
bight.**



### *Step #4*

**Bring the end over the bight, putting it under its own standing part.**

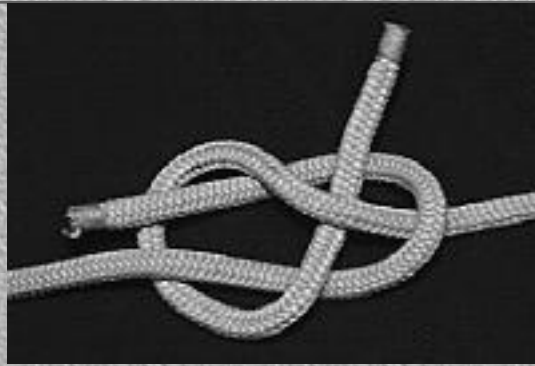

### *Finished Sheet Bend*

**Pull on both standing parts to set the knot.**

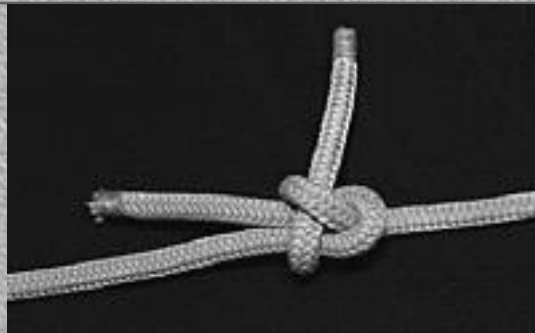

### *Double Sheet Bend*

**A double sheet bend is a more secure knot and can be tied by adding another wrap around the bight (that is, repeating steps 3 -4).**



### *Slipped Sheet Bend*

**To slip the sheet bend, stick a bight through instead of the end. Pull on the end to untie the knot.**

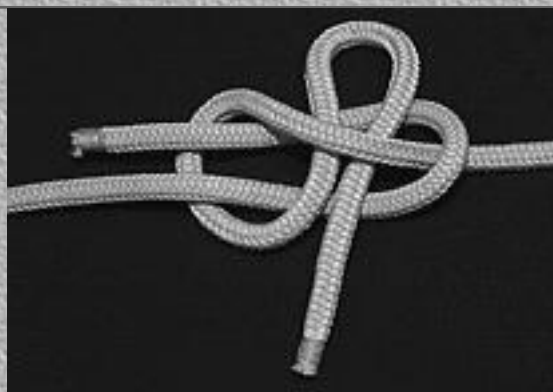

[\[Top of Page\]](#)

---

## Full Carrick Bend

**The Carrick Bend is a strong, secure knot that can be used to join two ropes of different construction.**

### *Step #1*

**Form a loop with the first rope, with the end behind the standing part.**

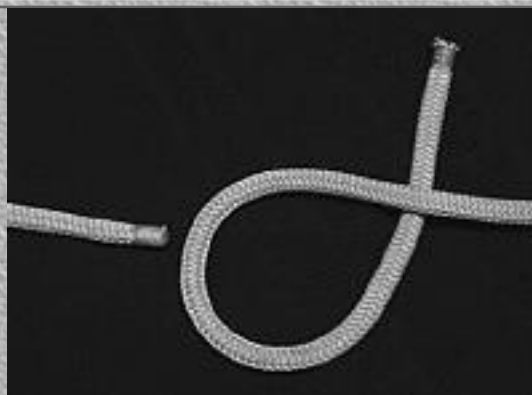

### *Step #2*

**Place the second rope under the loop.**



### *Step #3*

**Bring the end over the standing part of the first rope.**

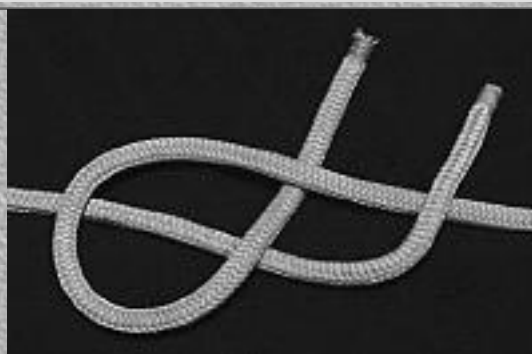

### *Step #4*

**Place the end of the second rope under the end of the first rope.**



### *Step #5*

**Place the end over the standing part of the first rope.**

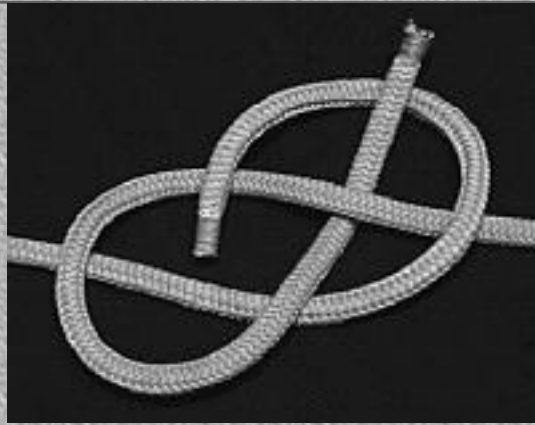

### *Step #6*

**Weave the end of the second rope under its own standing part.**



### *Step #7*

**Finally, pull the end over the first rope. The knot should be symmetric with the ends on opposite sides.**

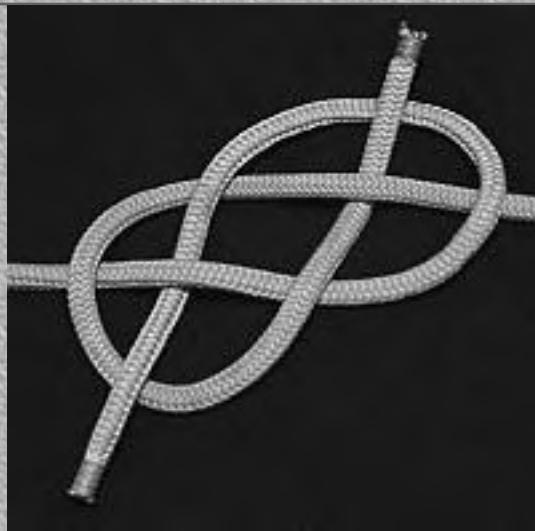



## *Finished Carrick Bend - Front View*

**Pull on both standing parts and then the ends to tighten the knot.**



## *Finished Carrick Bend - Rear View*

**Rear view.**



[\[Top of Page\]](#)

[Return to Index](#)

# KNOT KNOWLEDGE

## BENDS

### Sheet Bend

The sheet bend is very similar to the square knot, granny knot, thief knot, and particularly the bowline. In fact, the sheet bend can be tied using the [One Handed Twist Method](#) which is also used to tie the bowline. The sheet bend is very fast to tie and when slipped, is one of the easiest bends to work with. It is also useful when joining two ropes of different diameters.

#### *Step #1*

**Form a bight  
(with the  
larger  
diameter  
rope).**

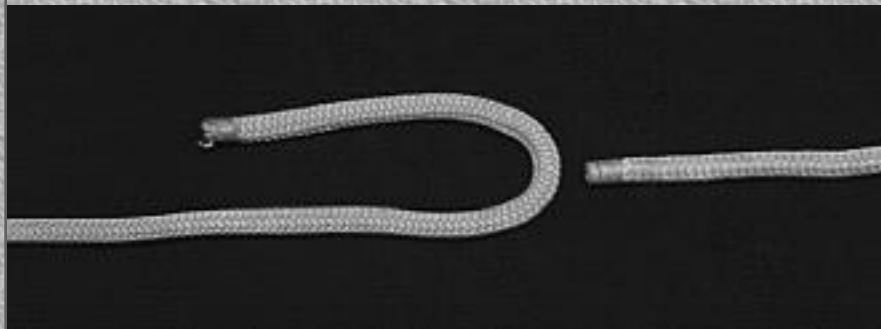

#### *Step #2*

**Insert the second rope under and then over the end of the first rope.**



### *Step #3*

**Take the end of the second rope and bring it under the bight.**



### *Step #4*

**Bring the end over the bight, putting it under its own standing part.**

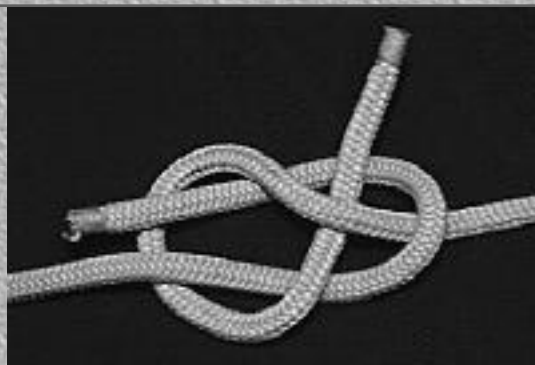

### *Finished Sheet Bend*

**Pull on both standing parts to set the knot.**

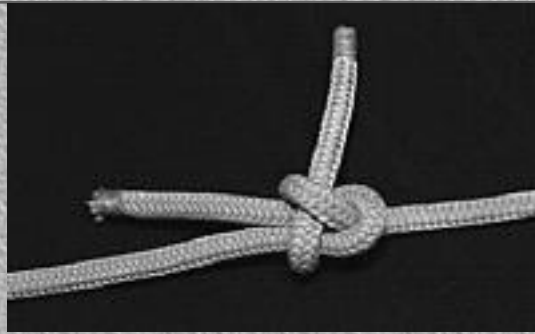

### *Double Sheet Bend*

**A double sheet bend is a more secure knot and can be tied by adding another wrap around the bight (that is, repeating steps 3 -4).**



### *Slipped Sheet Bend*

**To slip the sheet bend, stick a bight through instead of the end. Pull on the standing part to set the knot. Pull on the end to untie the knot.**

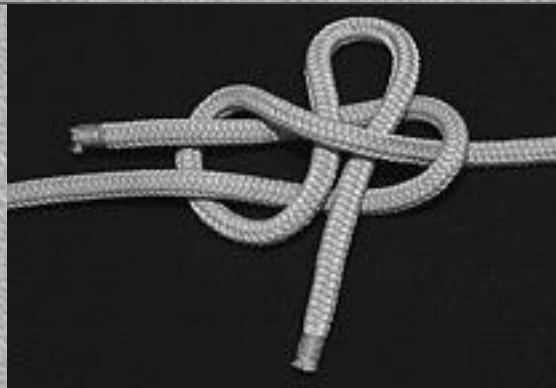

[\[Top of Page\]](#)

[Return to Index](#)



# KNOT KNOWLEDGE

## BENDS

### Full Carrick Bend

**The Carrick Bend is a strong, secure knot that can be used to join two ropes of different construction.**

#### *Step #1*

**Form a loop with the first rope, with the end behind the standing part.**

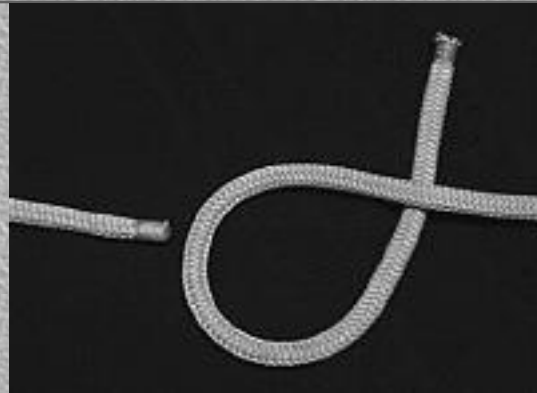

#### *Step #2*

**Place the second rope under the loop.**

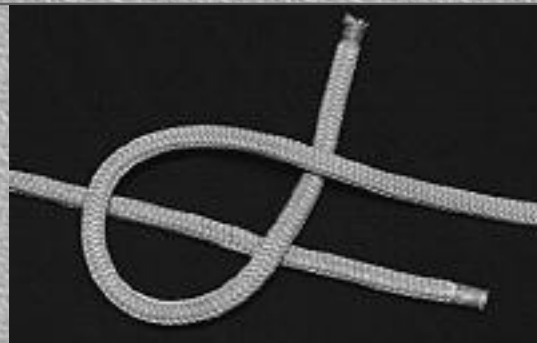



### *Step #3*

**Bring the end over the standing part of the first rope.**



### *Step #4*

**Place the end of the second rope under the end of the first rope.**



### *Step #5*

**Place the end over the standing part of the first rope.**

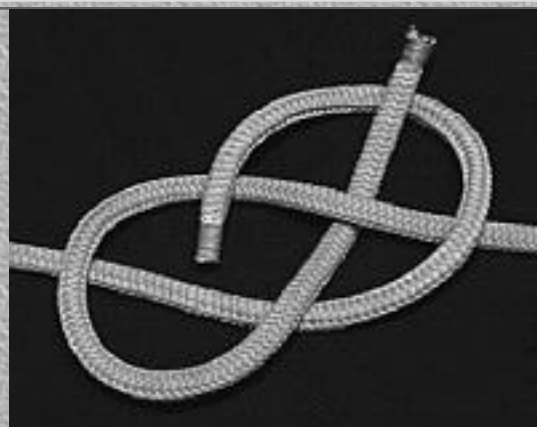

### *Step #6*

**Weave the end of the second rope under its own standing part.**

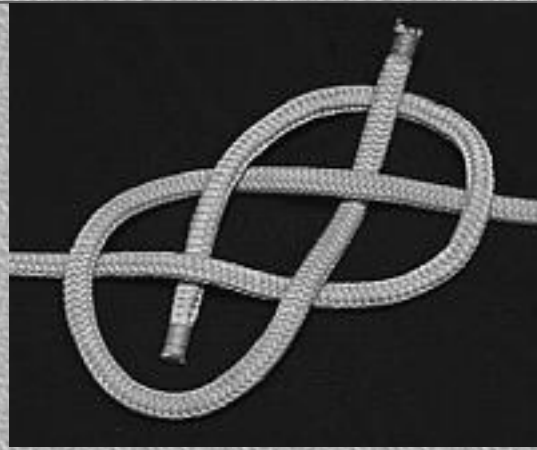

### *Step #7*

**Finally, pull the end over the first rope. The knot should be symmetric with the ends on opposite sides.**

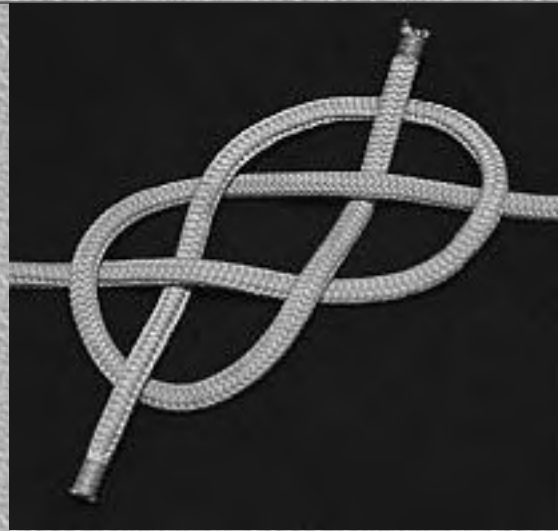

### *Finished Carrick Bend - Front View*

**Pull on both standing parts and then the ends to tighten the knot.**



### *Finished Carrick Bend - Rear View*

**Rear view.**



[\[Top of Page\]](#)

[Return to Index](#)

# KNOT KNOWLEDGE

## FRICTION HITCHES

[\[Blake's Hitch\]](#)

[\[Kreuzklem \(Hedden\)\]](#)

[\[Prusik\]](#)

[\[Kleimheist\]](#)

[\[Tautline Hitch/Rolling Hitch\]](#)

[\[Sliding Sheet Bend\]](#)

[\[Return to Index\]](#)

### Blake's Hitch

The Blake's Hitch is an ascending knot commonly used by arborists and tree climbers in general. It should only be used on arborist rope. Used for ascending, it is also used for descending as well.

*Step #1*

**In this picture, the black rope is what you tie the Blake's Hitch to (the standing part), and the white rope (the end) is what will be used to tie the Blake's Hitch. Place the end in front of the standing part.**

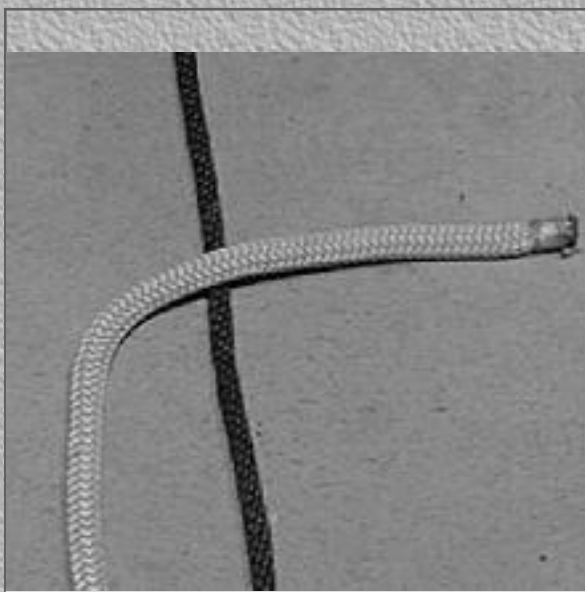

### *Step #2*

**Bring the end around behind the standing part.**

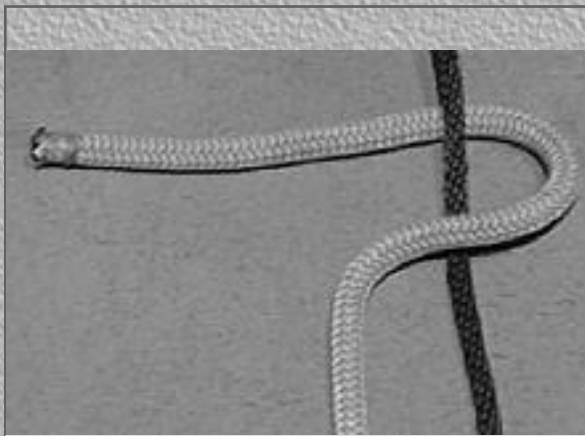

### *Step #3*

**Keep wrapping the end around the standing part.**

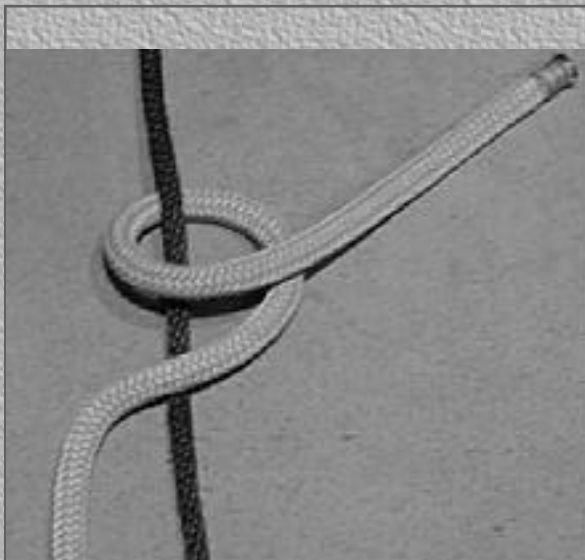



## *Step #4*

**Make more turns.**

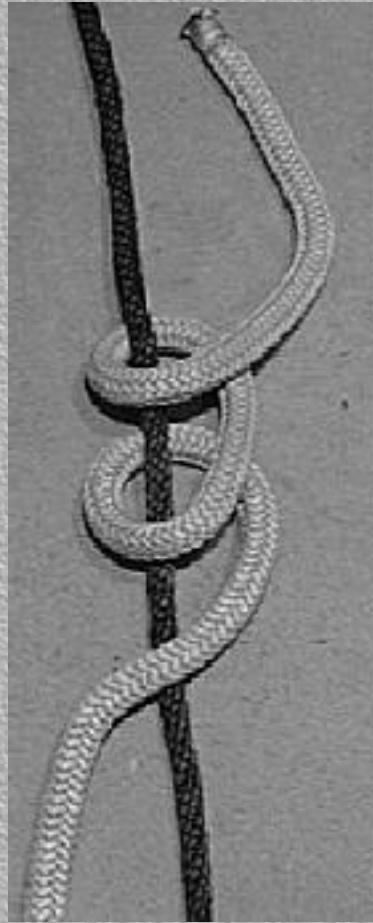

## *Step #5*

**Three turns are required.**

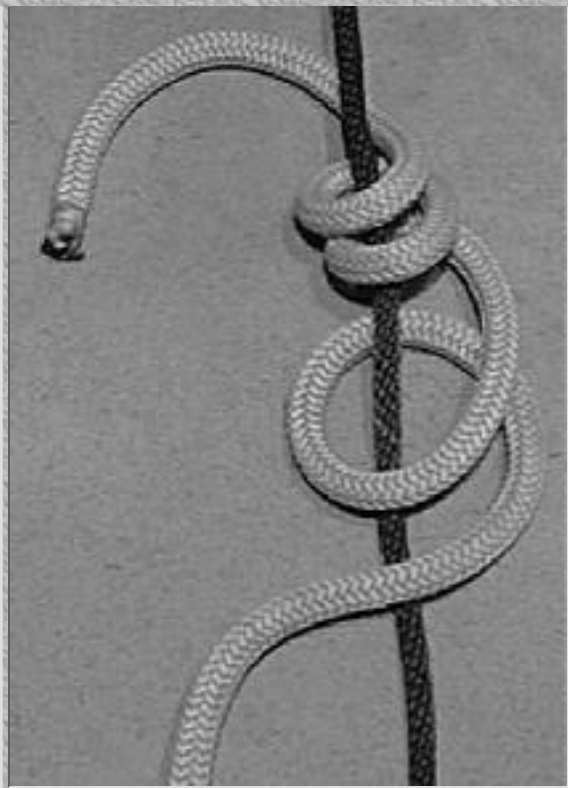

*Step #6*

**Bring the end down over itself...**

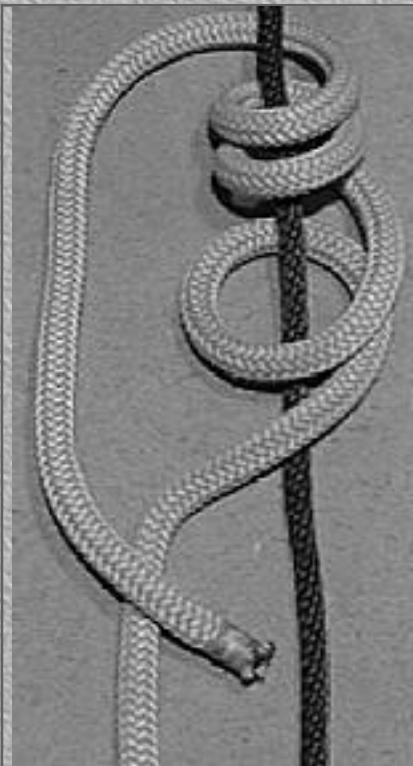

*Step #7*

**...and behind the standing part.**

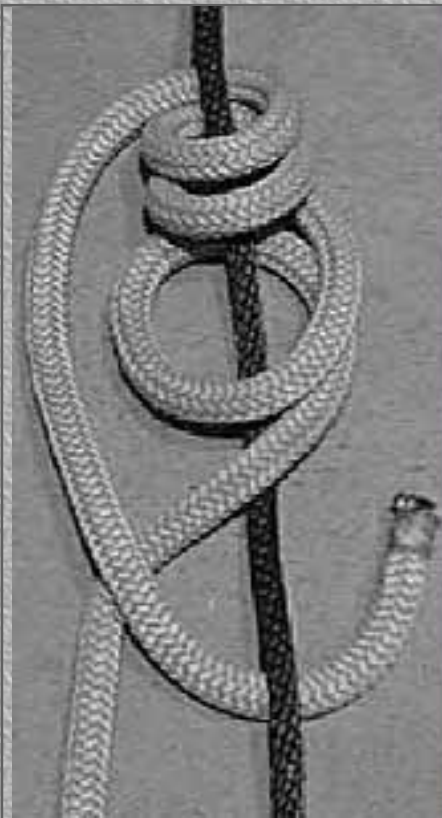

### *Step #8*

**Insert the end through the bottom two turns. When tying the knot it is helpful to wrap the bottom two turns around your thumb, so when you arrive at this step, you can remove your thumb and poke the end through the hole where your thumb was.**



***Finished Blake's Hitch - Front View***

Dress and set the knot, adding a [Figure 8](#) stopper knot in the tail for safety.

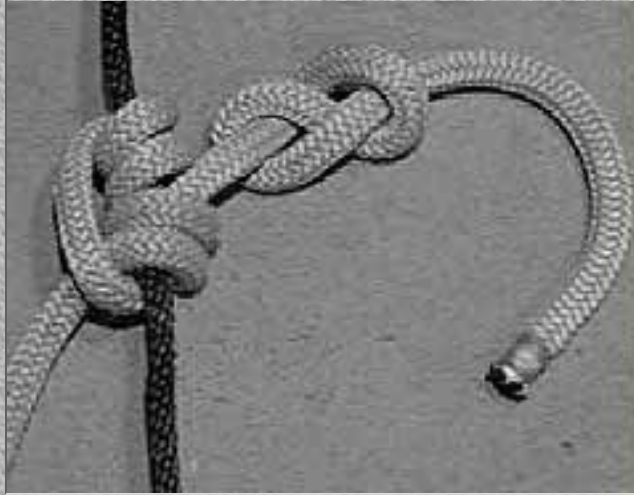

*Finished Blake's Hitch - Rear View*

Rear view.

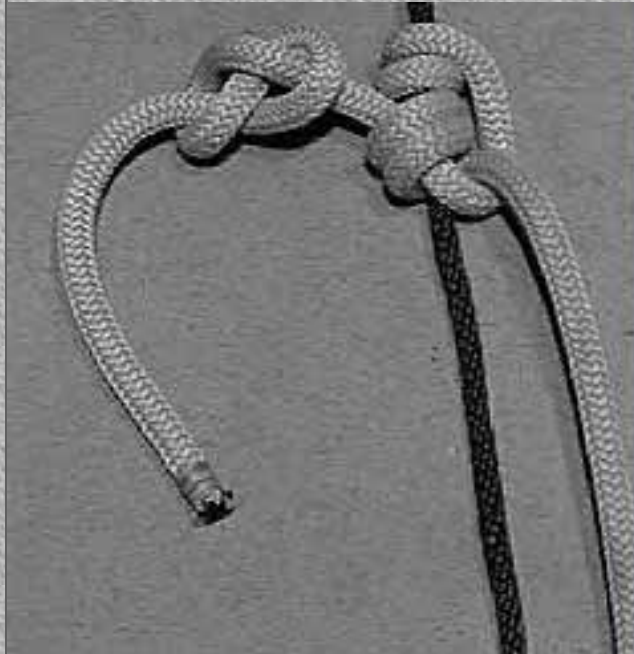

[\[Top of Page\]](#)

---

## [Kreuzklem \(Hedden\)](#)



**The Kreuzklem (or Hedden) is quick and simple to tie and untie. It is also easy to loosen the knot after applying a load, to advance it up the rope.**

*Step #1*

**Form a bight from the loop and place it behind the climbing rope.**

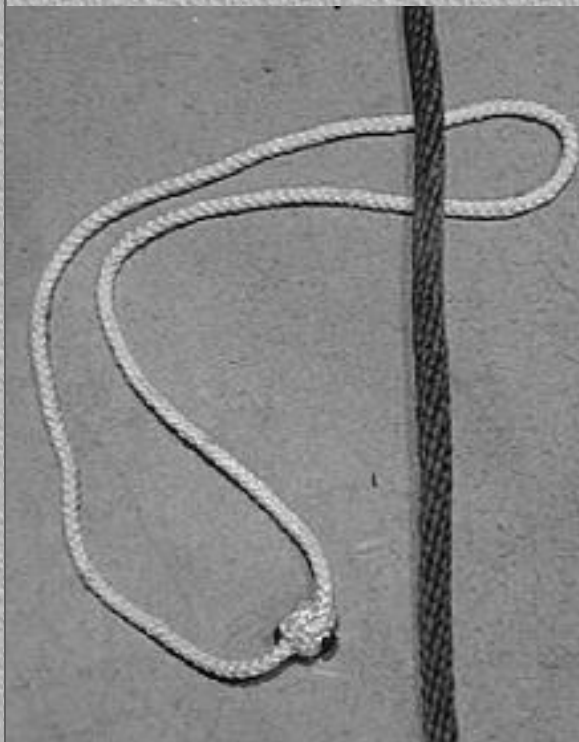

*Step #2*

**Wrap the loop across the climbing rope.**

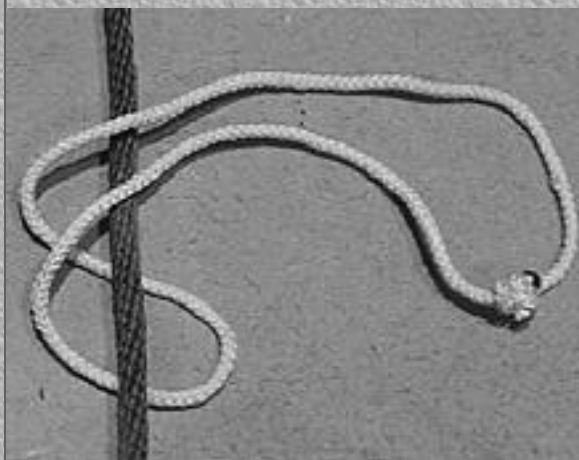



### *Step #3*

**Continue wrapping the loop around the climbing rope.**

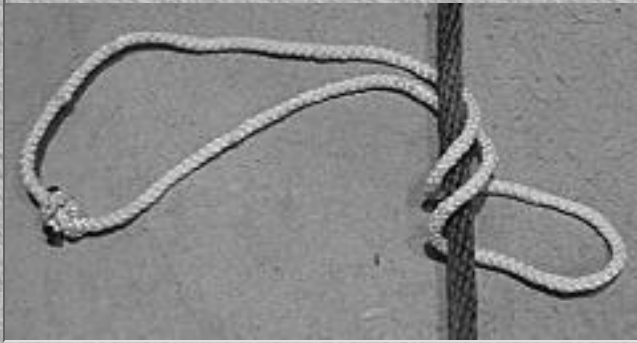

### *Step #4*

**Insert the loop through the bight.**

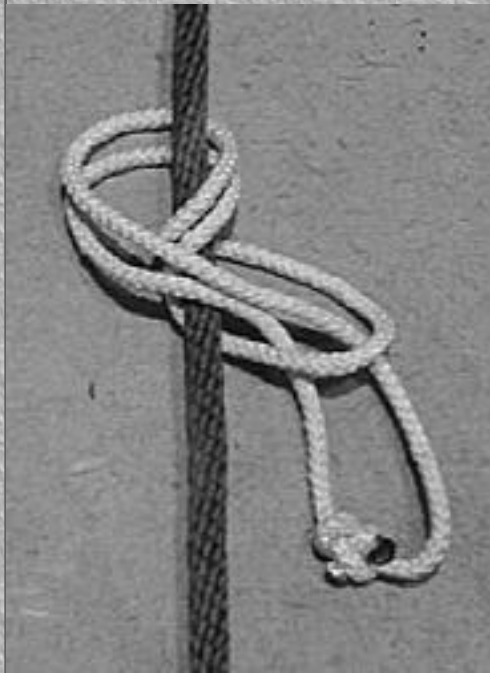

### *Finished Kreuzklem*

**Dress and set the knot.**

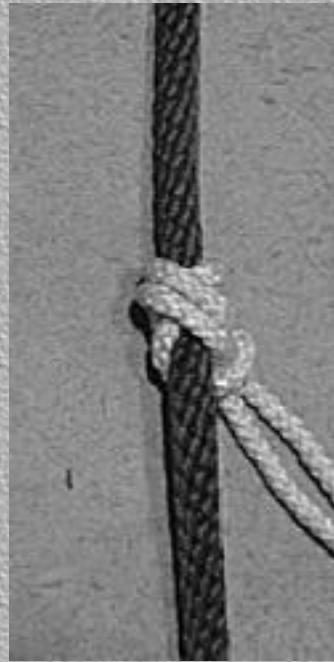

[\[Top of Page\]](#)

---

## **Prusik**

**The prusik is widely used as an ascending knot. The friction can be increased by adding a third turn. The prusik can cinch up tightly and the friction can be somewhat difficult to break after a load has been applied.**

*Step #1*

**Place a bight of the loop across the climbing rope.**

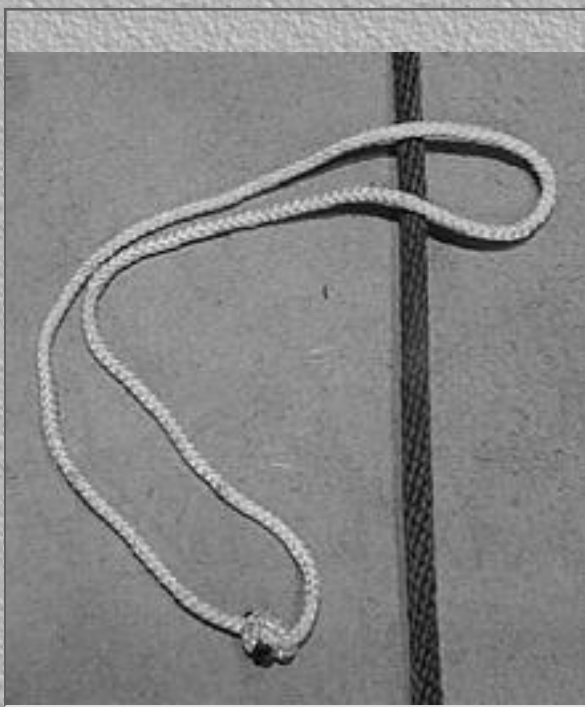

*Step #2*

**Wrap the loop behind the climbing rope and through the bight.**

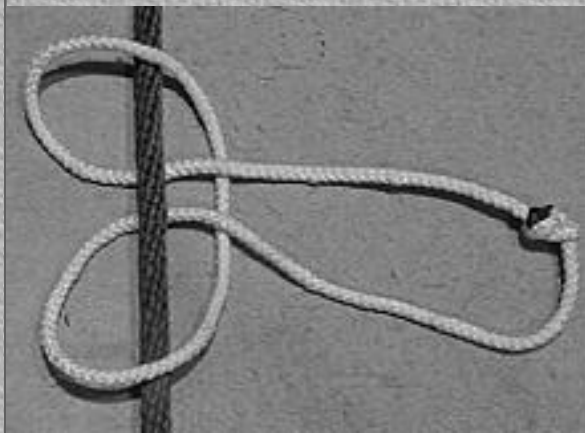

*Step #3*

**Continue wrapping the loop around the climbing rope.**

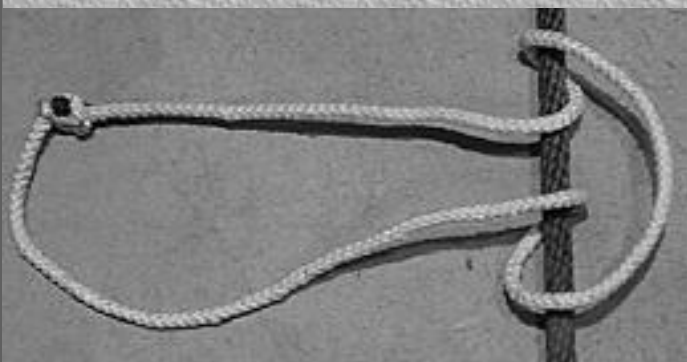

### *Step #4*

**Wrap it behind the climbing rope again and through the bight.**

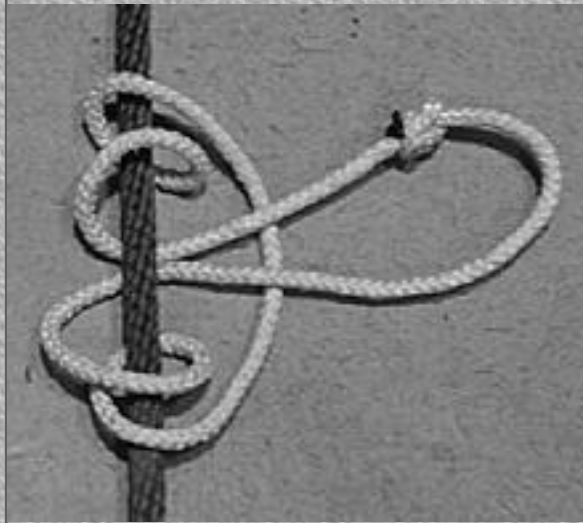

### *Finished Prusik*

**Dress and set the knot. It is important to keep this knot neat while tightening.**

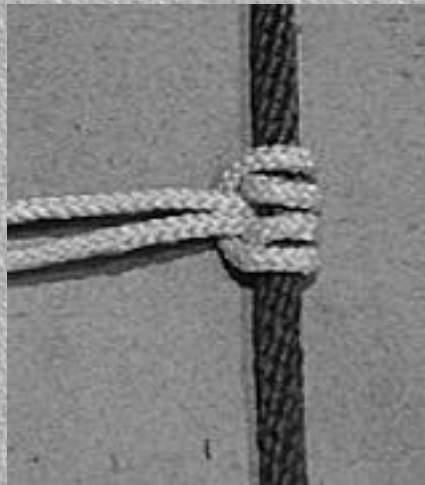

### *Finished Prusik - Opposite View*

**Opposite view.**

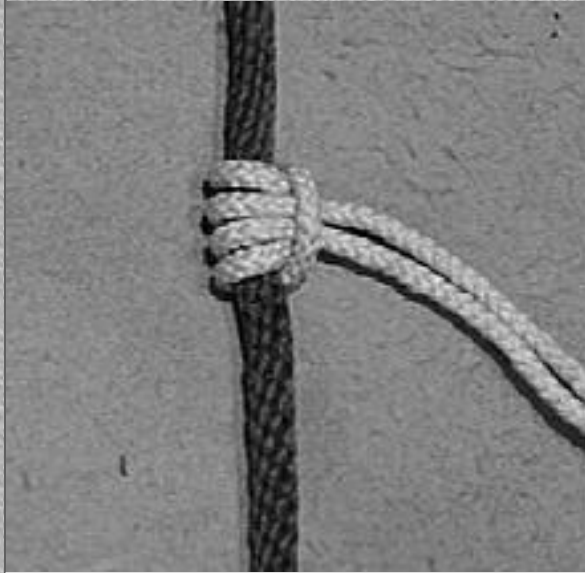

[\[Top of Page\]](#)

---

## **Kleimheist**

**The Kleimheist is easier to tie and untie than the prusik. It does not tend to cinch up as tightly as a prusik, so it is easier to break friction after releasing the load. You can add more turns to increase friction, as well.**

*Step #1*



**Place a bight of the loop behind the climbing rope.**

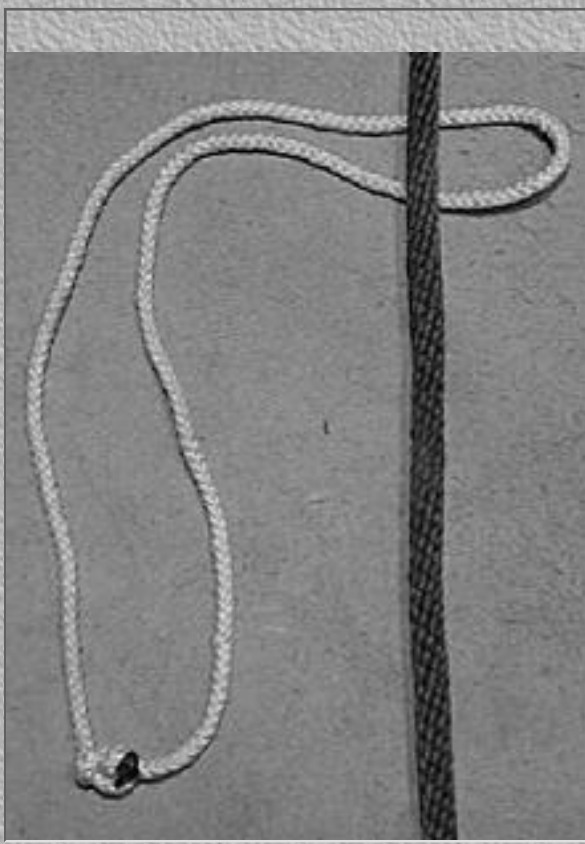

*Step #2*

**Wrap the loop across the climbing rope.**

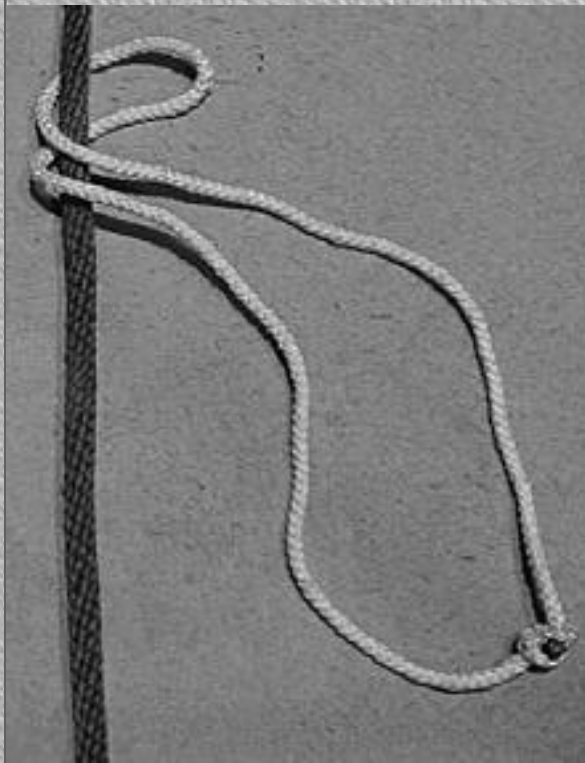

### *Step #3*

**Wrap the loop behind the climbing rope.**



### *Step #4*

**Repeat steps 2 - 3 two more times.**



### *Step #5*

**Insert the loop through the original bight**



***Finished Kleimheist***

**Pull the loop back down, bringing the bight down across the wraps. Tighten the knot.**

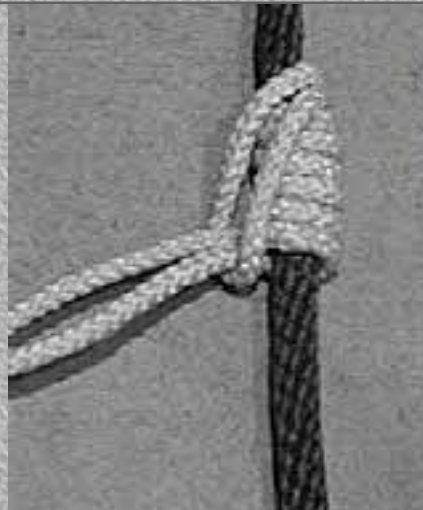

[\[Top of Page\]](#)

---

**Tautline Hitch (aka Rolling Hitch)**

**The Tautline Hitch is an adjustable knot that is commonly used for tensioning guy lines, such as on a tent. The knot can slide along the standing part. When the knot is released, the tension on the standing part tightens the coils in the knot, increasing the friction which keeps the knot in place under tension. Since the Tautline Hitch is tied to its own standing part, the rope must be able to slide around the object it is secured to for it to be adjustable. This knot is known as the Rolling Hitch when, instead of being tied around its standing part, it is tied around another rope, spar, or cylindrical object.**

### *Step 1*

**Pull the end around a secure object (The picture shows an empty thread spool.)**

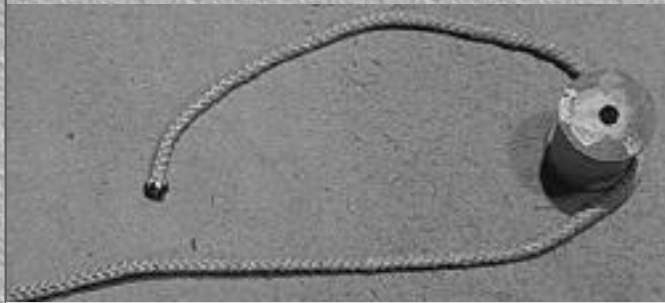

### *Step 2*

**Bring the end under the standing part.**





### *Step 3*

**Wrap the end around the standing part.**



### *Step 4*

**Wrap the end around the standing part a second time.**



### *Step 5*

**Now you add a half hitch above the turns. Bring the end over the standing part.**

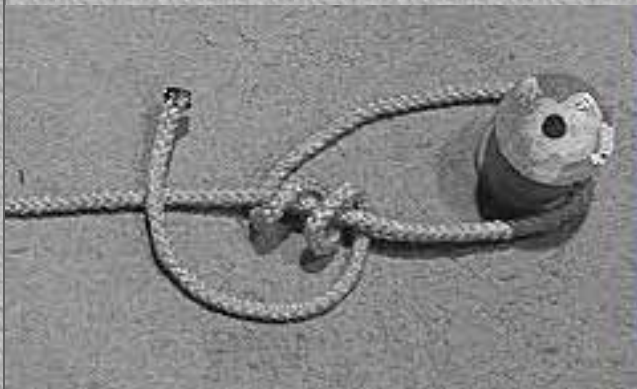

### *Step 6*



**Make a half hitch.**

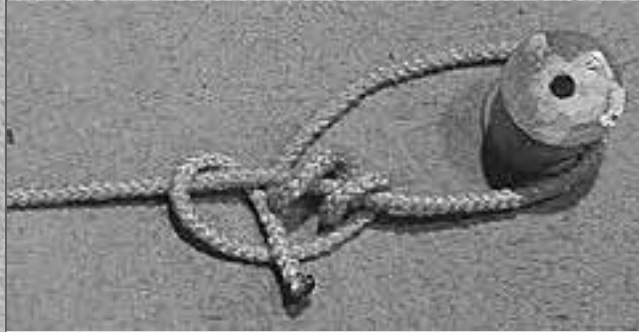

### *Finished Tautline Hitch*

**Tighten the loops. Be careful to keep the knot neat while doing this, and tighten it enough so that it will grip the standing part reliably, but not so tight that it can't easily slide.**

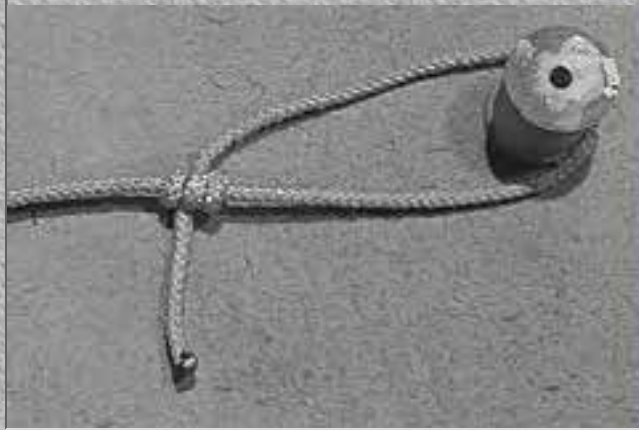

### *Finished Tautline Hitch - Opposite View*

**Opposite view.**

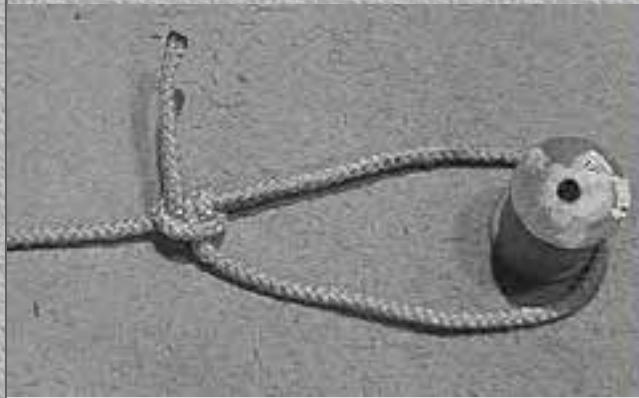

### *Finished Tautline Hitch*

**This picture shows the knot having been slid further up the standing part. Note that the rope had to move around the spool in order for this to occur.**

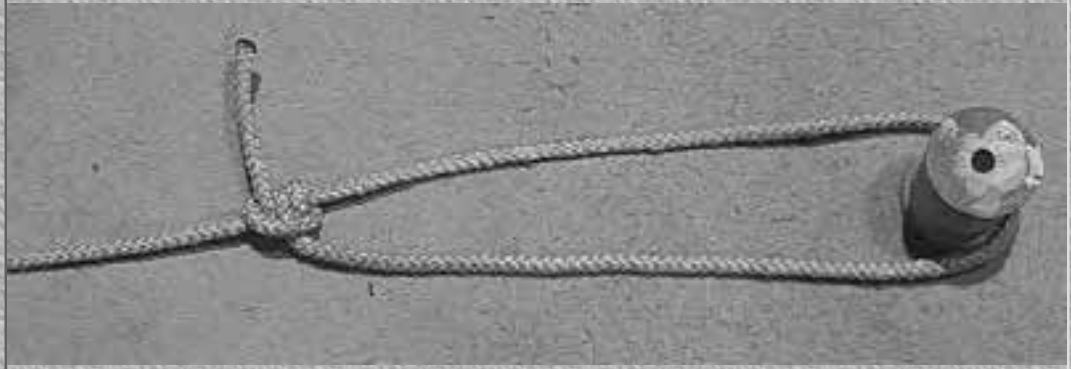

[\[Top of Page\]](#)

## Sliding Sheet Bend

The Sliding Sheet Bend is used for the same purpose as the [Tautline Hitch](#), but with a quick yank of the end, it is completely untied. This is a boon for those wearing gloves or who have cold, numb fingers. Moreover, unlike the Tautline Hitch, the Sliding Sheet Bend can be "locked" in place to prevent it sliding. It can also be unlocked to make it adjustable again. This is one of the most useful knots I know, and I gladly give credit and much appreciation to Peter Suber, who came up with this knot and shared it with the world. Visit [Dr. Suber's website](#) for more knots like this.

*Step 1*

**Wrap the end around the object it is to be secured to (a spool in this picture).**

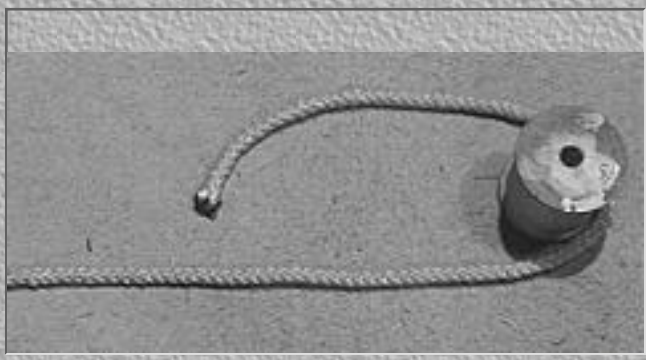

*Step 2*

**Form a bight in the standing part, pointing away from the spool.**

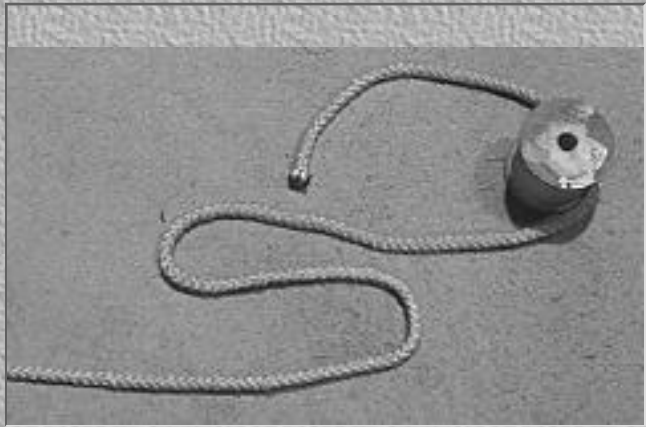

*Step 3*

**Pull the end under the bight.**



*Step 4*



**Bring the end over the bight...**

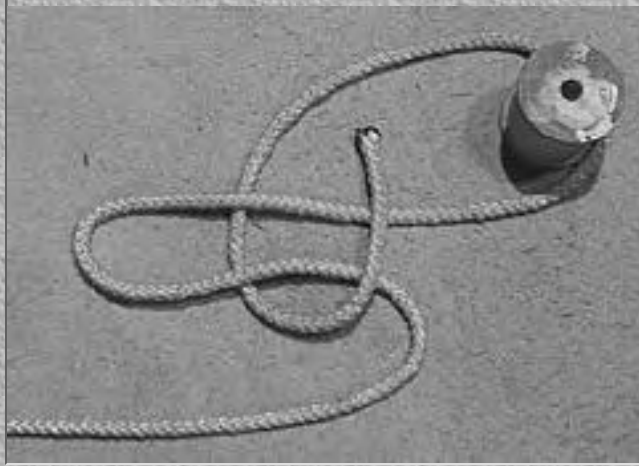

***Step 5***

**...and form a loop.**



***Step 6***

**Now, form a bight in the end and stick it through the bight in the standing part.**

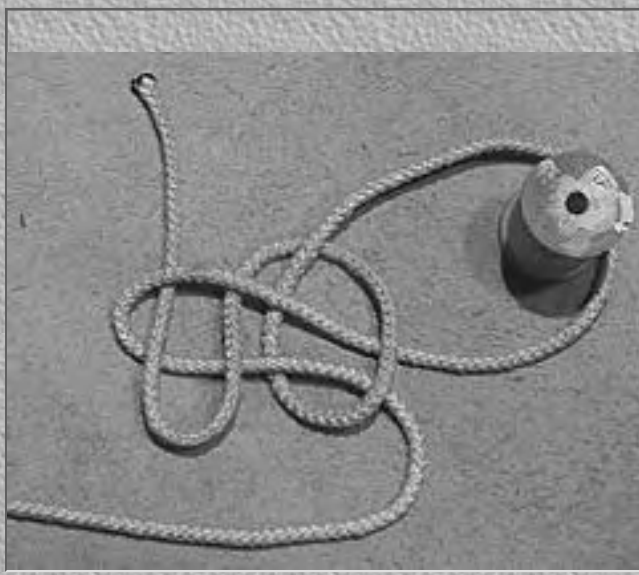

### *Step 7*

**If you are tying this knot flat as pictured, it helps at this point to slide the bight in the end so that it is over the loop formed earlier.**

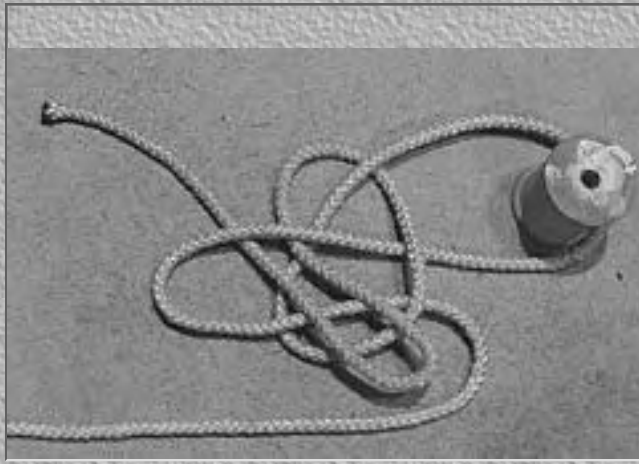

### *Step 8*

**Pull on both ends of the bight in the standing part, removing the bight, so the standing part is straight as pictured. Keep the knot neat while doing this!**

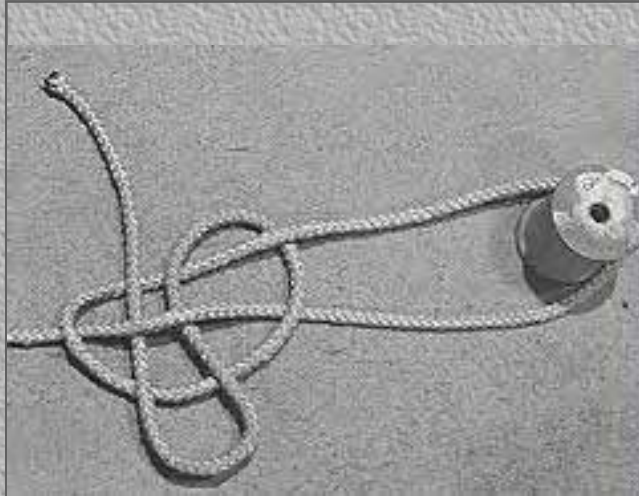



## *Finished Sliding Sheet Bend*

Tighten the knot, so that the standing part forms a "hump" as it passes over the bight in the end. This is what creates the friction, and the friction can be adjusted by increasing or decreasing the hump (by tightening and loosening the knot).

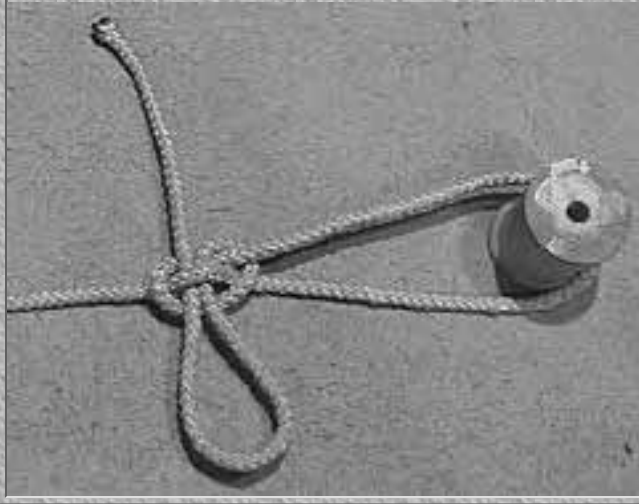

## *Finished Sliding Sheet Bend*

This picture shows the knot having been slid further up the standing part. Note that the rope had to move around the spool in order for this to occur (like the [Tautline Hitch](#)).

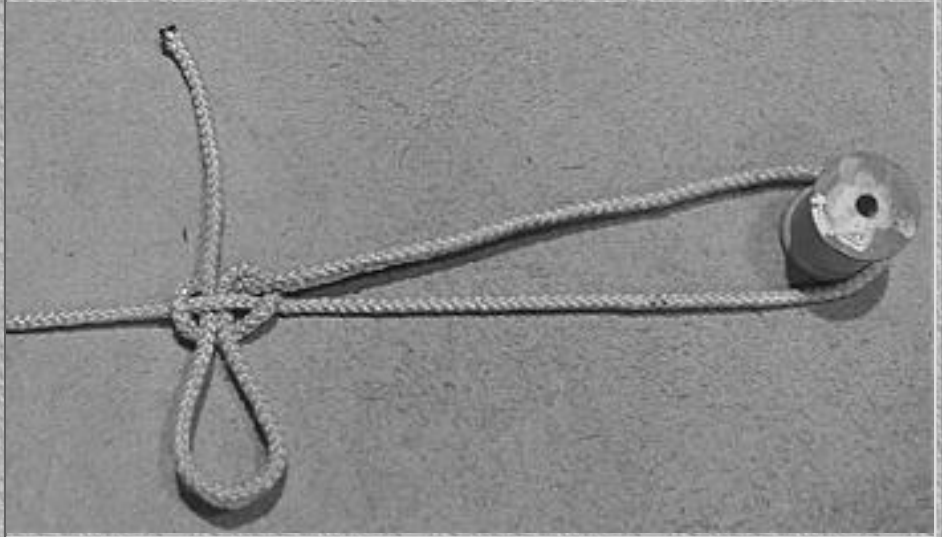

## *Locked Sliding Sheet Bend*

**Once you have adjusted the knot to your satisfaction, it can be locked by tightening the knot by pulling on the non-sliding parts of the knot. To unlock, loosen and flatten the knot, to reduce the hump. To untie, simply yank on the end.**

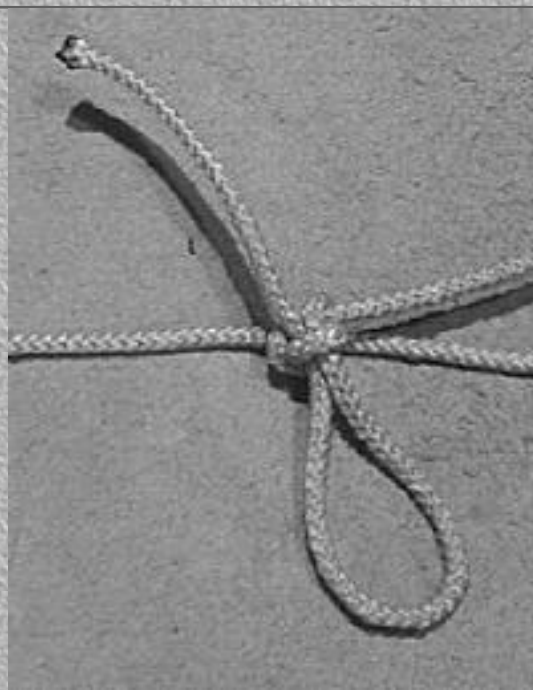

[\[Top of Page\]](#)

[Return to Index](#)

# KNOT KNOWLEDGE

## FRICTION HITCHES

### Blake's Hitch

**The Blake's Hitch is an ascending knot commonly used by arborists and tree climbers in general. It should only be used on arborist rope. Used for ascending, it is also used for descending as well.**

#### *Step #1*

**In this picture, the black rope is what you tie the Blake's Hitch to (the standing part), and the white rope (the end) is what will be used to tie the Blake's Hitch. Place the end in front of the standing part.**

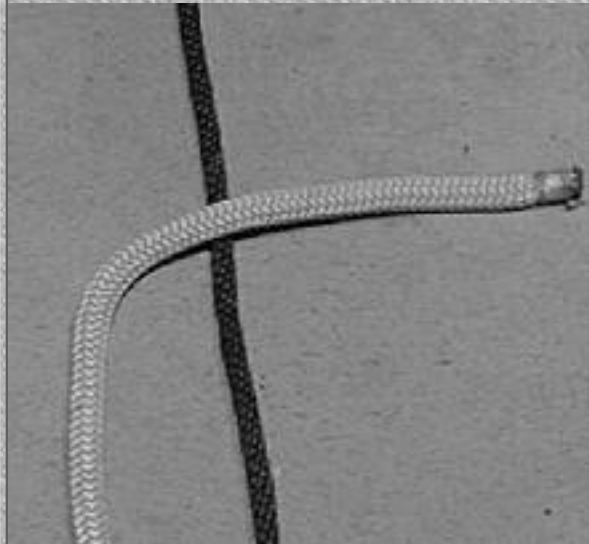

#### *Step #2*



**Bring the end around behind the standing part.**

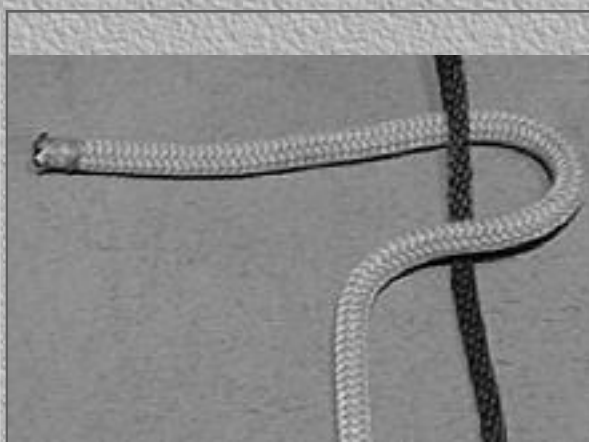

*Step #3*

**Keep wrapping the end around the standing part.**

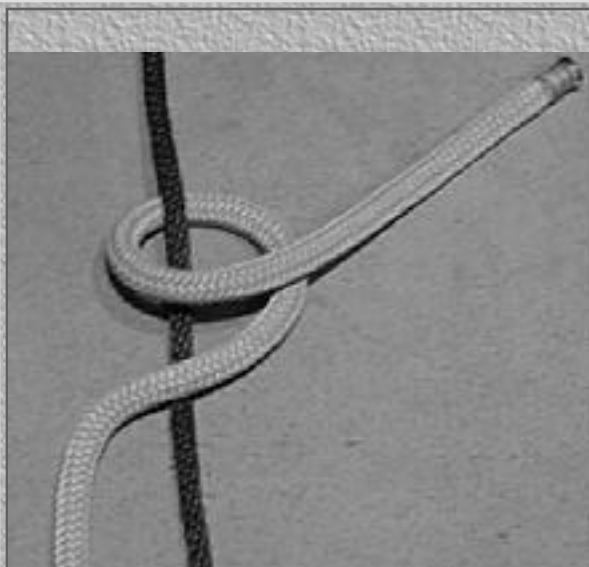

*Step #4*

**Make more turns.**

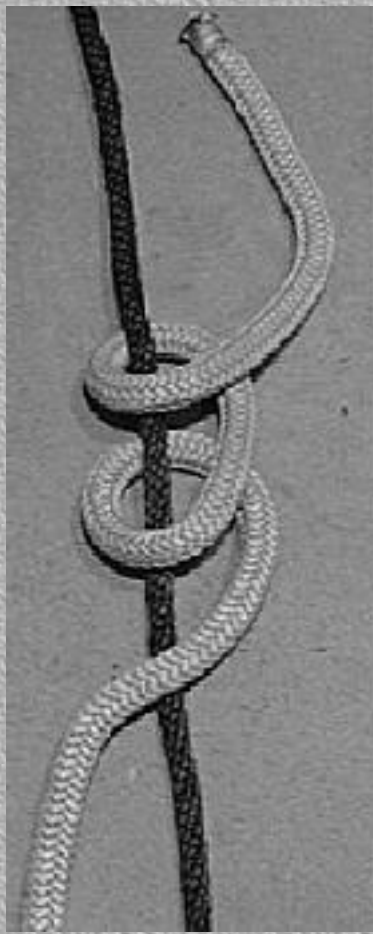

*Step #5*

**Three turns are required.**

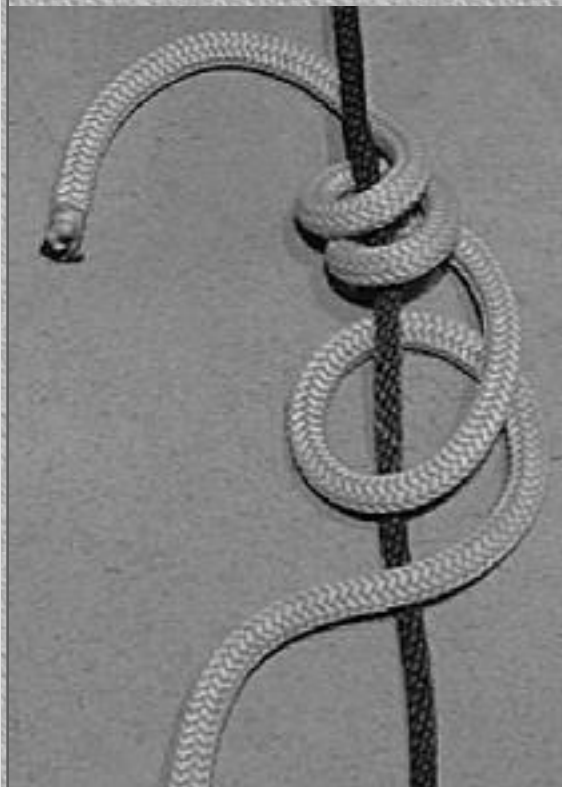



## *Step #6*

**Bring the end down over itself...**

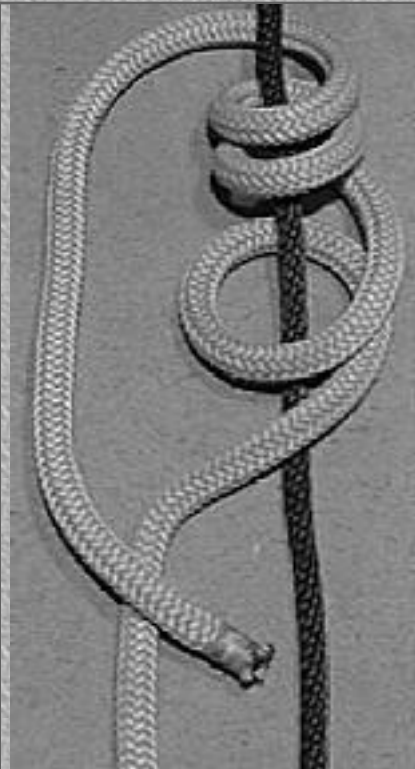

## *Step #7*

**...and behind the standing part.**

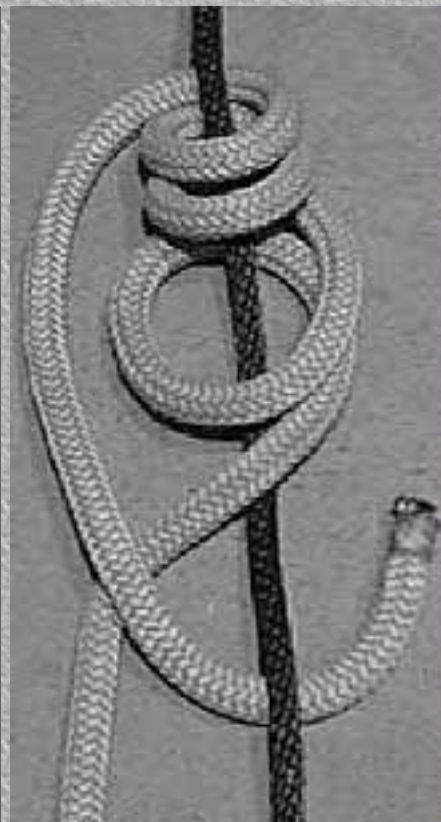

### *Step #8*

**Insert the end through the bottom two turns. When tying the knot it is helpful to wrap the bottom two turns around your thumb, so when you arrive at this step, you can remove your thumb and poke the end through the hole where your thumb was.**

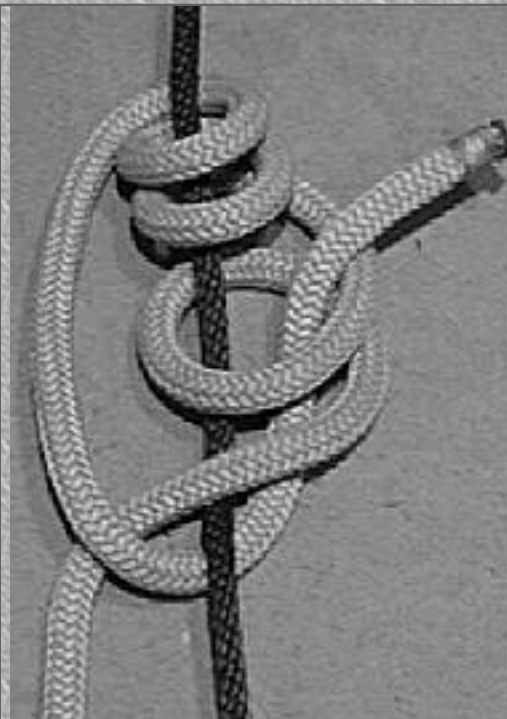

### *Finished Blake's Hitch - Front View*

Dress and set the knot, adding a [Figure 8](#) stopper knot in the tail for safety.

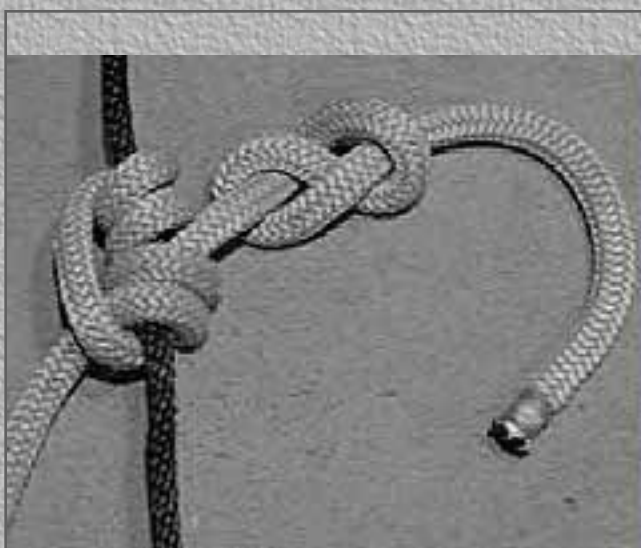

### *Finished Blake's Hitch - Rear View*

Rear view.

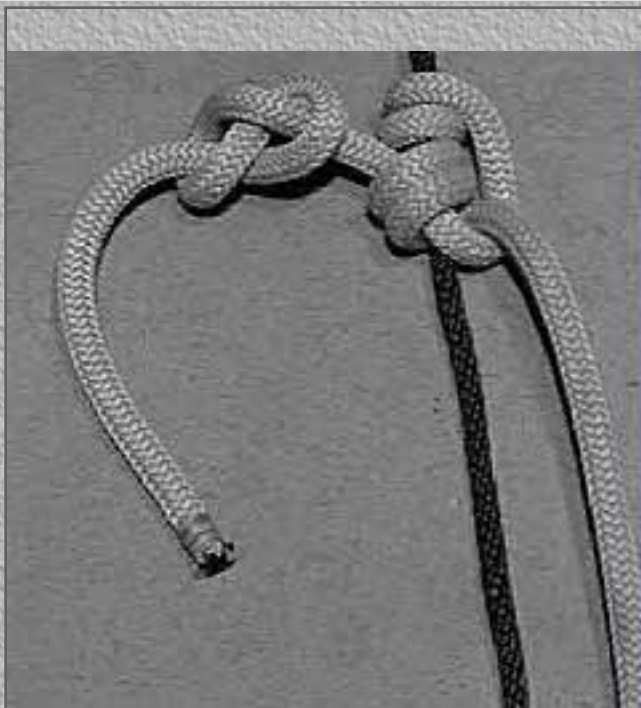

[\[Top of Page\]](#)

[Return to Index](#)



# KNOT KNOWLEDGE

## FRICTION HITCHES

### Kreuzklem (Hedden)

**The Kreuzklem (or Hedden) is quick and simple to tie and untie. It is also easy to loosen the knot after applying a load, to advance it up the rope.**

#### *Step #1*

**Form a bight from the loop and place it behind the climbing rope.**

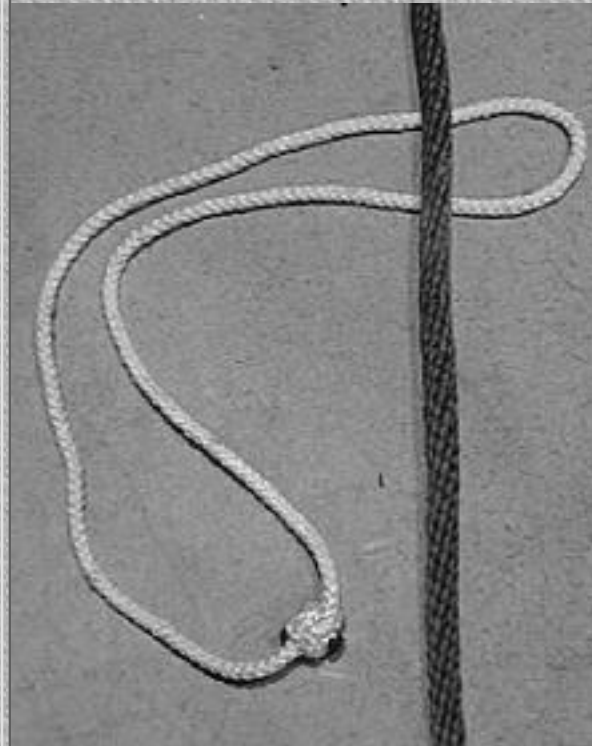

#### *Step #2*

**Wrap the loop across the climbing rope.**

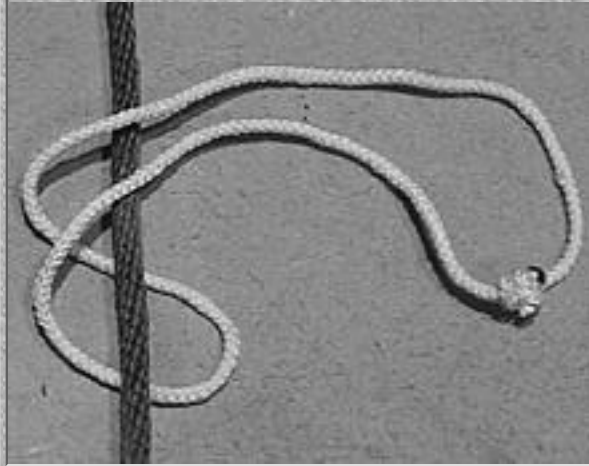

### *Step #3*

**Continue wrapping the loop around the climbing rope.**

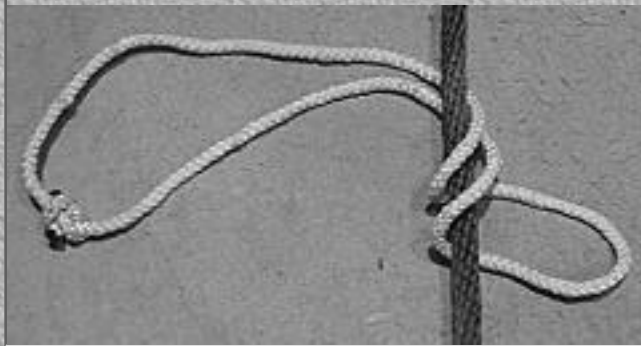

### *Step #4*

**Insert the loop through the bight.**



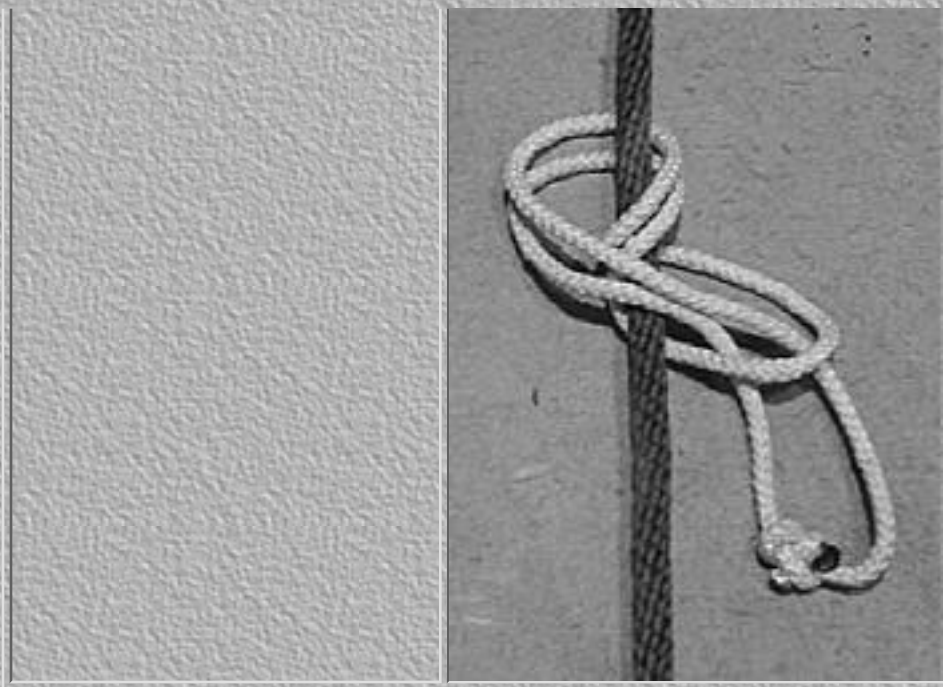

*Finished Kreuzklem*

**Dress and set the knot.**

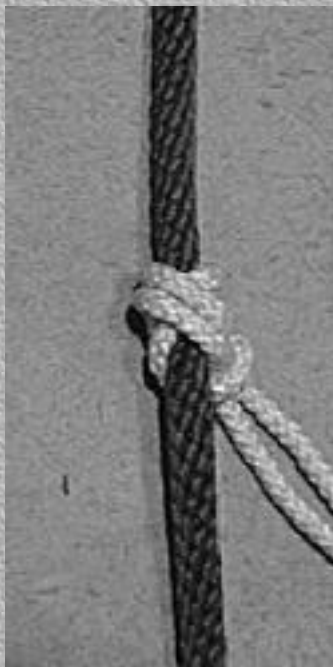

[\[Top of Page\]](#)

[Return to Index](#)

# KNOT KNOWLEDGE

## FRICTION HITCHES

### Prusik

**The prusik is widely used as an ascending knot. The friction can be increased by adding a third turn. The prusik can cinch up tightly and the friction can be somewhat difficult to break after a load has been applied.**

#### *Step #1*

**Place a bight of the loop across the climbing rope.**

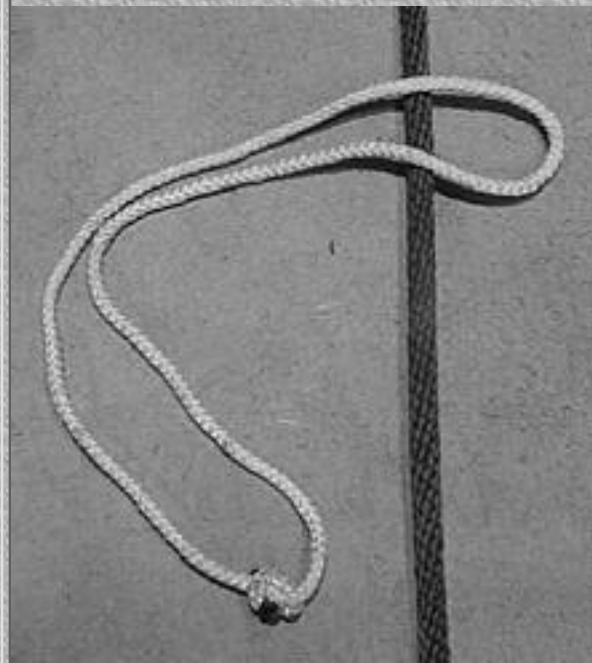

#### *Step #2*

**Wrap the loop behind the climbing rope and through the bight.**

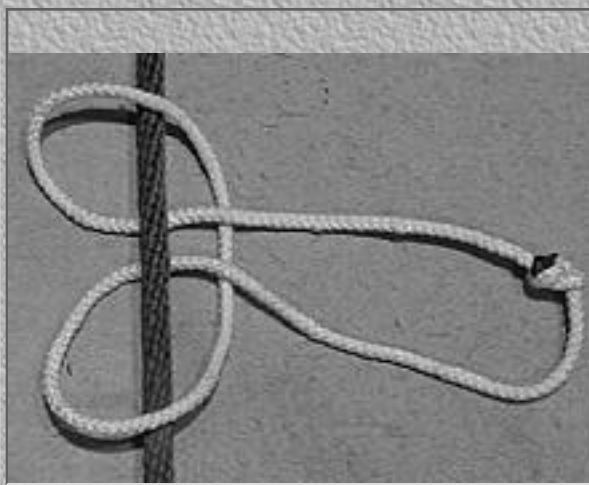

### *Step #3*

**Continue wrapping the loop around the climbing rope.**

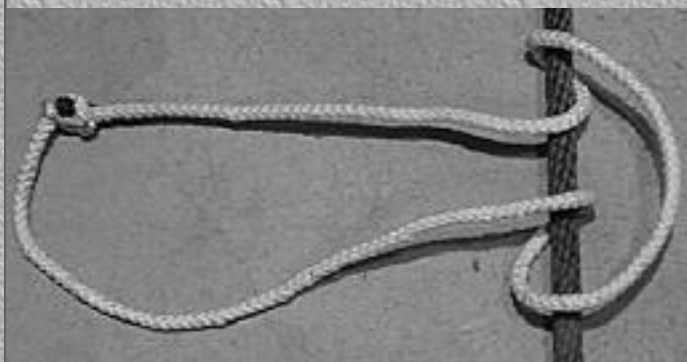

### *Step #4*

**Wrap it behind the climbing rope again and through the bight.**

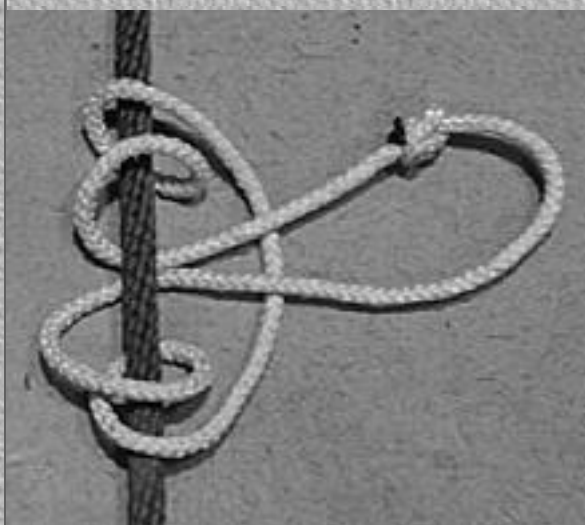

## *Finished Prusik*

**Dress and set the knot. It is important to keep this knot neat while tightening.**

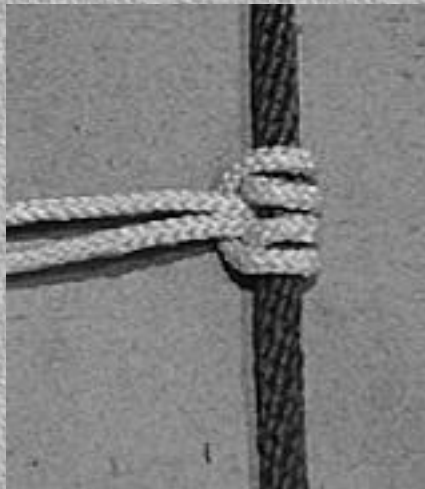

## *Finished Prusik - Opposite View*

**Opposite view.**

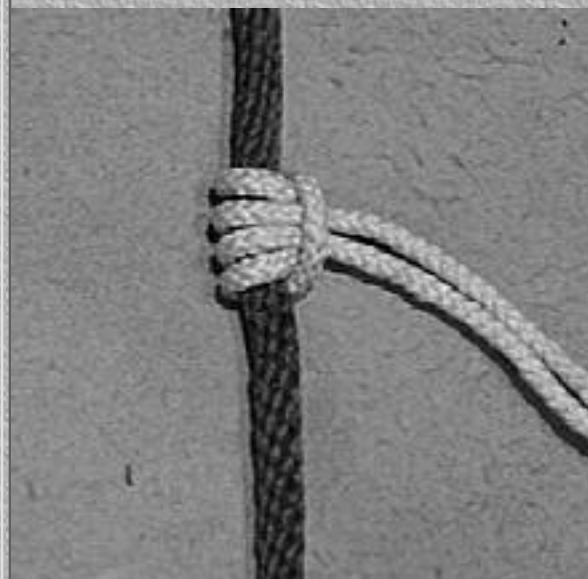

[\[Top of Page\]](#)



[Return to Index](#)



# KNOT KNOWLEDGE

## FRICTION HITCHES

### Kleimheist

**The Kleimheist is easier to tie and untie than the prusik. It does not tend to cinch up as tightly as a prusik, so it is easier to break friction after releasing the load. You can add more turns to increase friction, as well.**

#### *Step #1*

**Place a bight of the loop behind the climbing rope.**

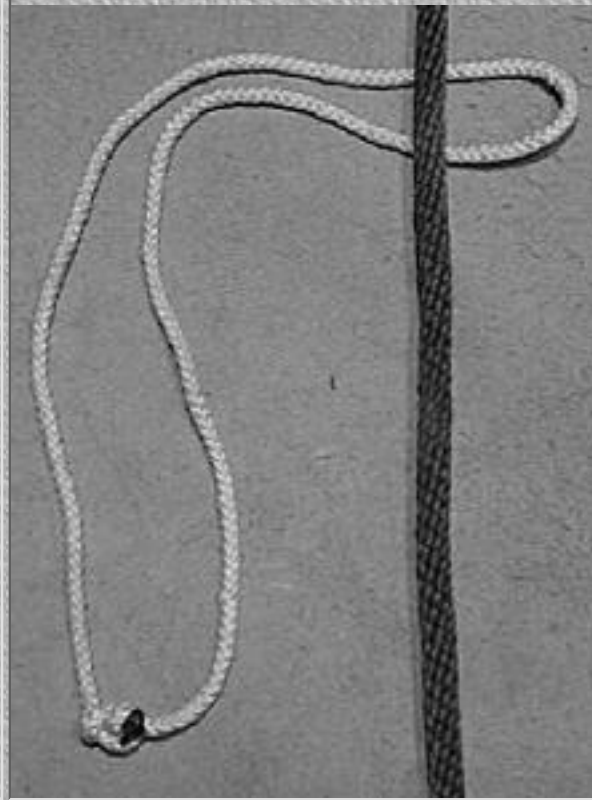

#### *Step #2*

**Wrap the loop across the climbing rope.**

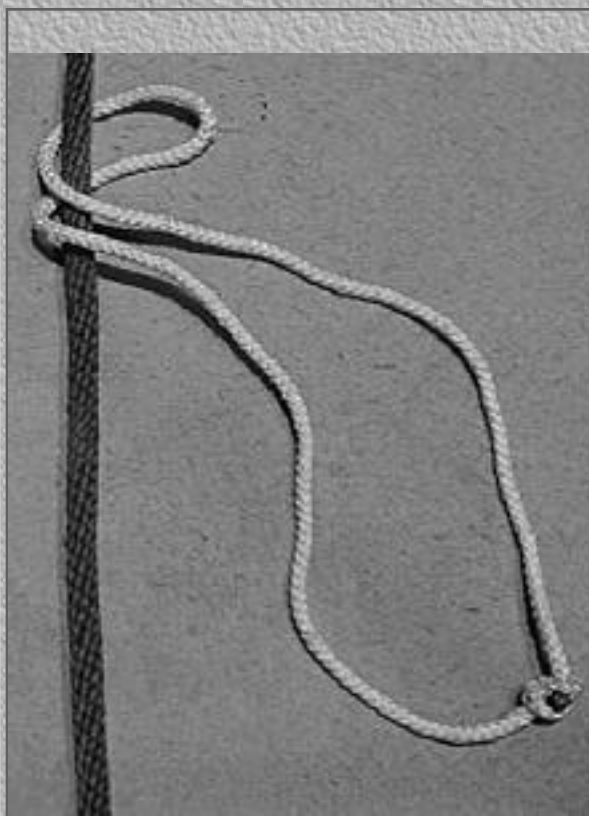

*Step #3*

**Wrap the loop behind the climbing rope.**

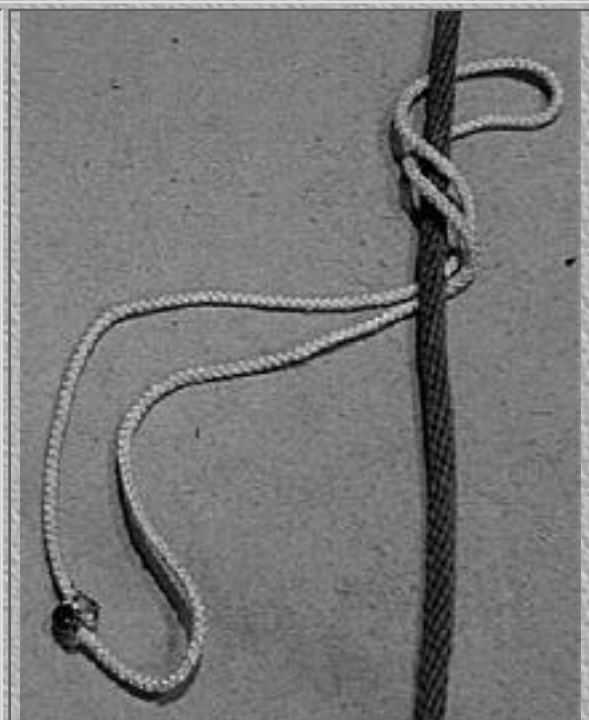

*Step #4*

**Repeat steps 2 - 3  
two more times.**

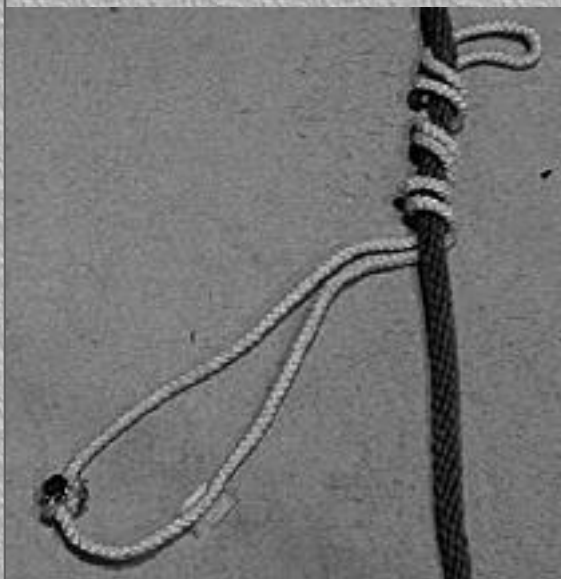

### *Step #5*

**Insert the loop through  
the original bight**



### *Finished Kleimheist*

**Pull the loop back down, bringing the bight down across the wraps. Tighten the knot.**

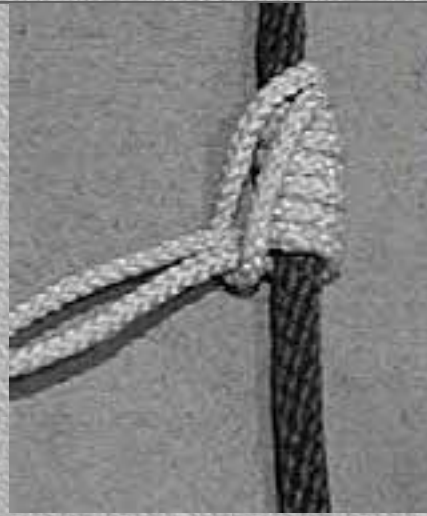

[\[Top of Page\]](#)

[Return to Index](#)



# KNOT KNOWLEDGE

## FRICTION HITCHES

### Tautline Hitch (aka Rolling Hitch)

The Tautline Hitch is an adjustable knot that is commonly used for tensioning guy lines, such as on a tent. The knot can slide along the standing part. When the knot is released, the tension on the standing part tightens the coils in the knot, increasing the friction which keeps the knot in place under tension. Since the Tautline Hitch is tied to its own standing part, the rope must be able to slide around the object it is secured to for it to be adjustable. This knot is known as the Rolling Hitch when, instead of being tied around its standing part, it is tied around another rope, spar, or cylindrical object.

#### *Step 1*

**Pull the end around a secure object (The picture shows an empty thread spool.)**

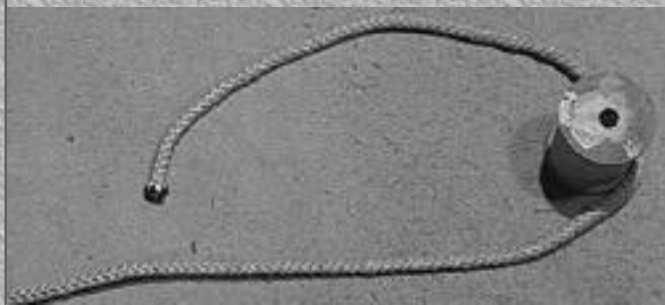

#### *Step 2*



**Bring the end under the standing part.**

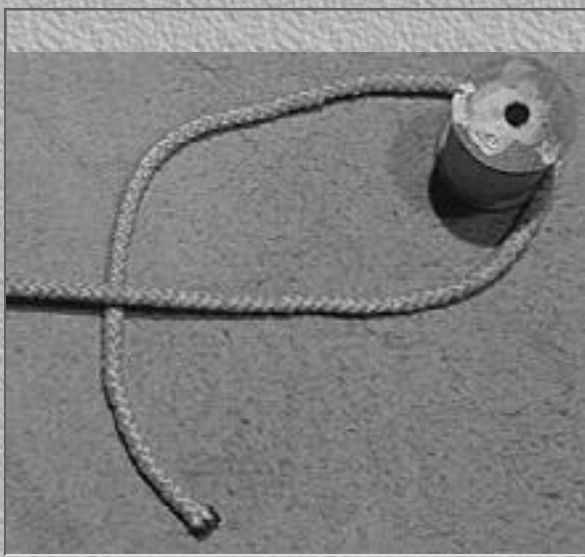

*Step 3*

**Wrap the end around the standing part.**



*Step 4*

**Wrap the end around the standing part a second time.**



### *Step 5*

**Now you add a half hitch above the turns. Bring the end over the standing part.**

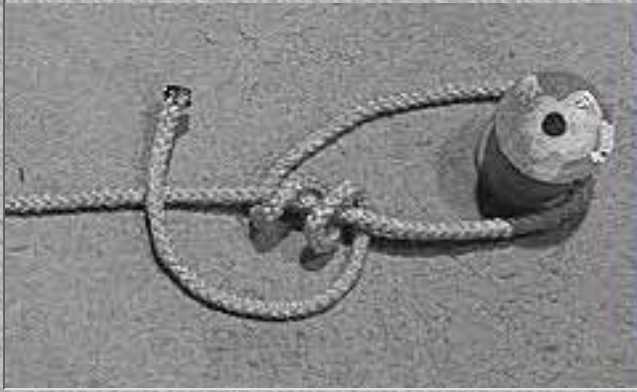

### *Step 6*

**Make a half hitch.**

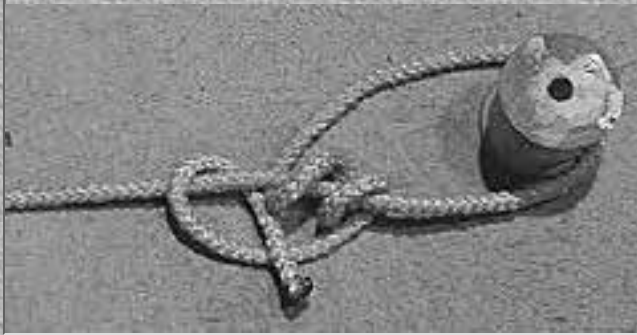

### *Finished Tautline Hitch*

**Tighten the loops. Be careful to keep the knot neat while doing this, and tighten it enough so that it will grip the standing part reliably, but not so tight that it can't easily slide.**



### *Finished Tautline Hitch - Opposite View*

**Opposite view.**

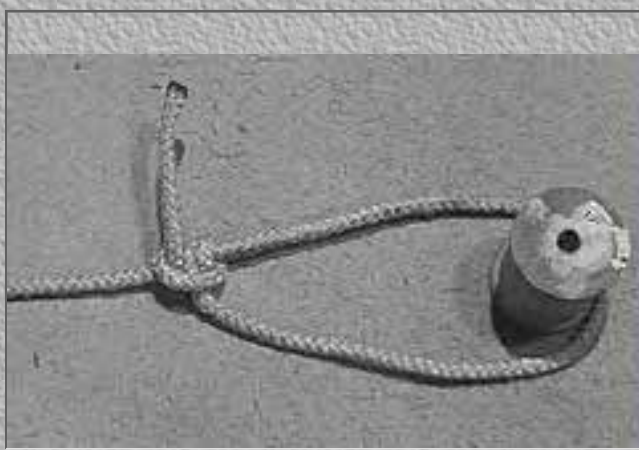

### *Finished Tautline Hitch*

**This picture shows the knot having been slid further up the standing part. Note that the rope had to move around the spool in order for this to occur.**

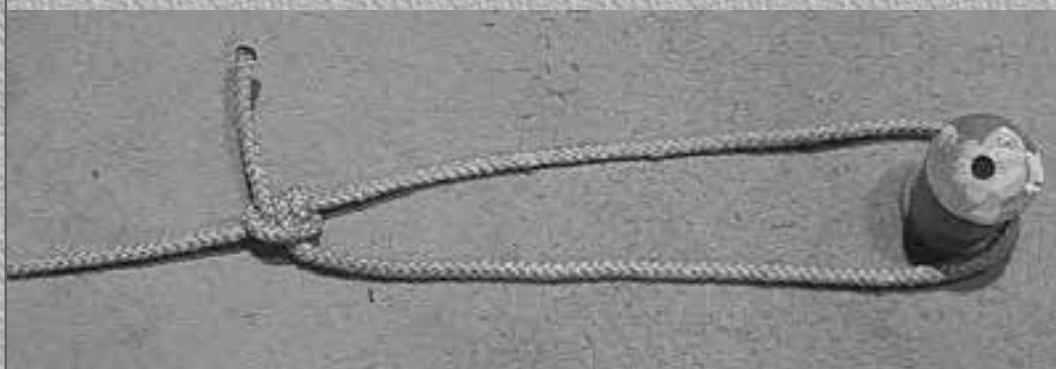

[\[Top of Page\]](#)

[Return to Index](#)



# KNOT KNOWLEDGE

## FRICTION HITCHES

### Sliding Sheet Bend

The Sliding Sheet Bend is used for the same purpose as the [Tautline Hitch](#), but with a quick yank of the end, it is completely untied. This is a boon for those wearing gloves or who have cold, numb fingers. Moreover, unlike the Tautline Hitch, the Sliding Sheet Bend can be "locked" in place to prevent it sliding. It can also be unlocked to make it adjustable again. For this clever knot, I gladly give credit and much appreciation to Dr. Peter Suber, who came up with this knot and posted it to the Web. I learned to tie this knot using his instructions, and you can [visit his website](#) for more knots like this.

#### *Step 1*

Wrap the end around the object it is to be secured to (a spool in this picture).

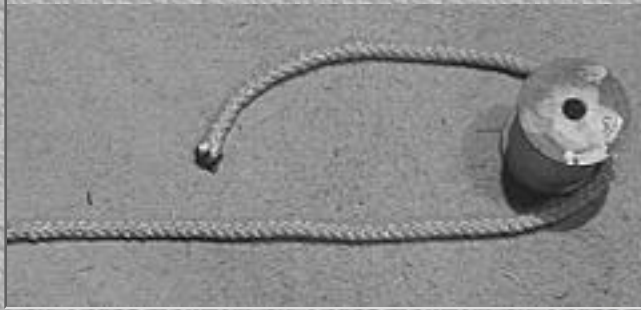

#### *Step 2*

**Form a bight in the standing part, pointing away from the spool.**

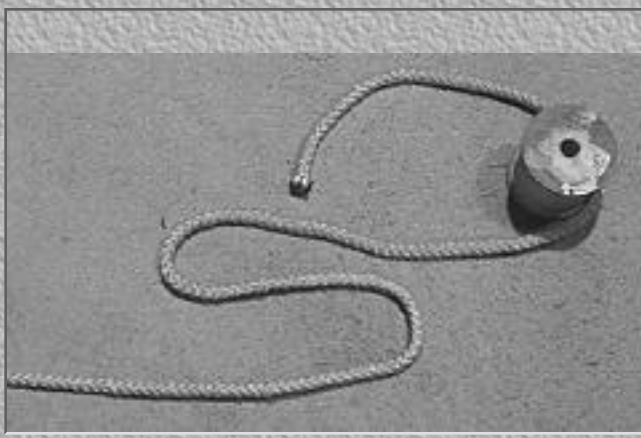

### *Step 3*

**Pull the end under the bight.**

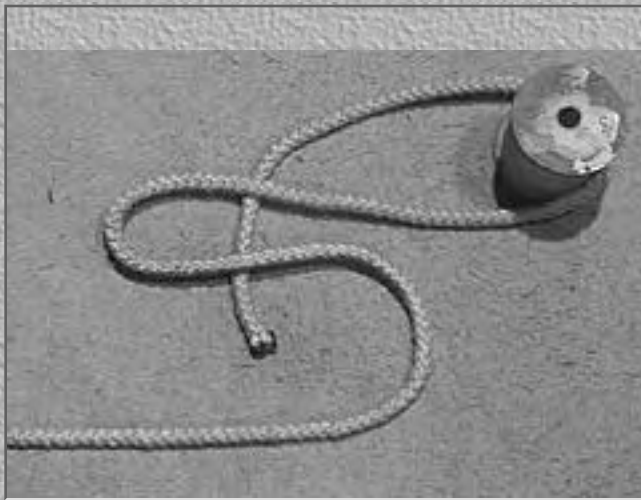

### *Step 4*

**Bring the end over the bight...**

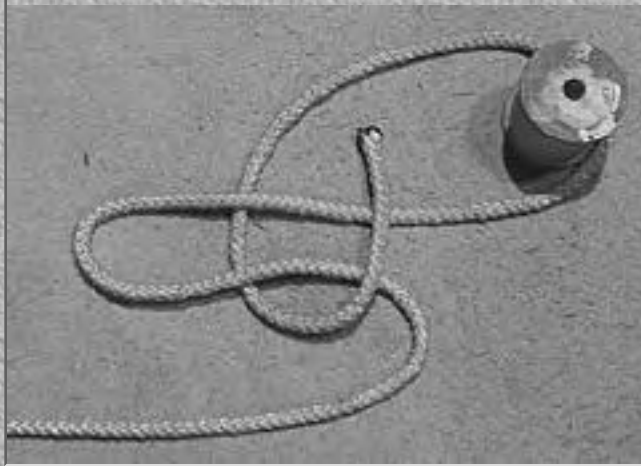



## *Step 5*

**...and form a loop.**



## *Step 6*

**Now, form a bight in the end and stick it through the bight in the standing part.**

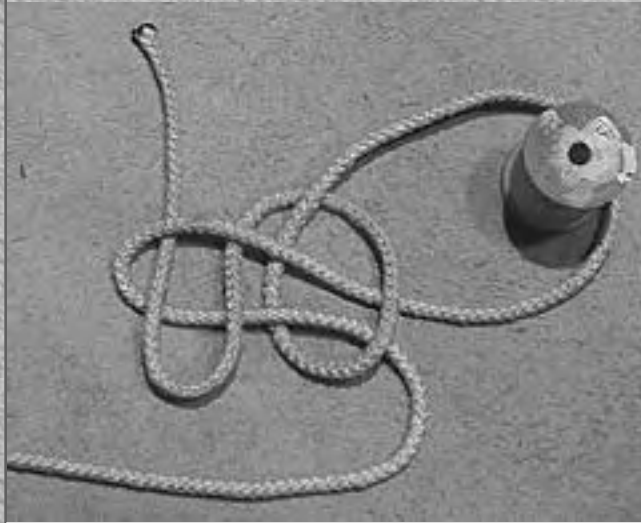

## *Step 7*

**If you are tying this knot flat as pictured, it helps at this point to slide the bight in the end so that it is over the loop formed earlier.**

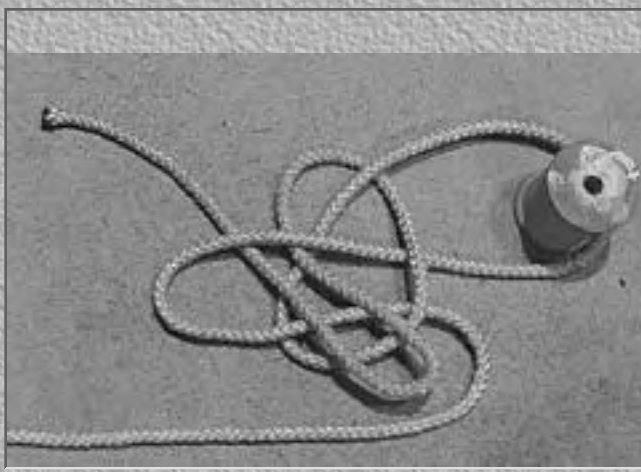

### *Step 8*

**Pull on both ends of the bight in the standing part, removing the bight, so the standing part is straight as pictured. Keep the knot neat while doing this!**

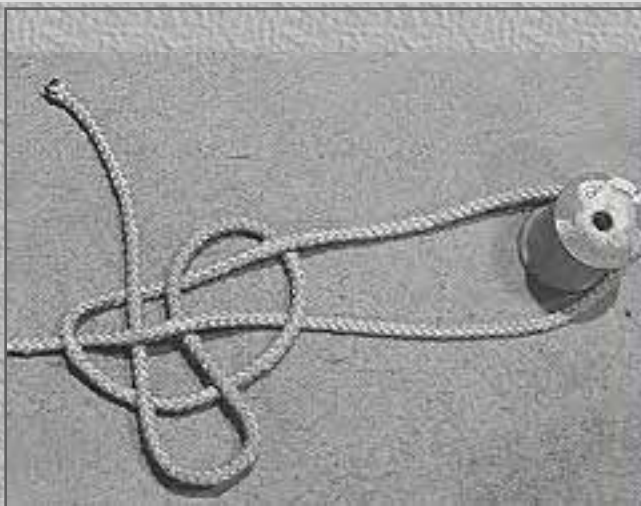

### *Finished Sliding Sheet Bend*

**Tighten the knot, so that the standing part forms a "hump" as it passes over the bight in the end. This is what creates the friction, and the friction can be adjusted by increasing or decreasing the hump (by tightening and loosening the knot).**

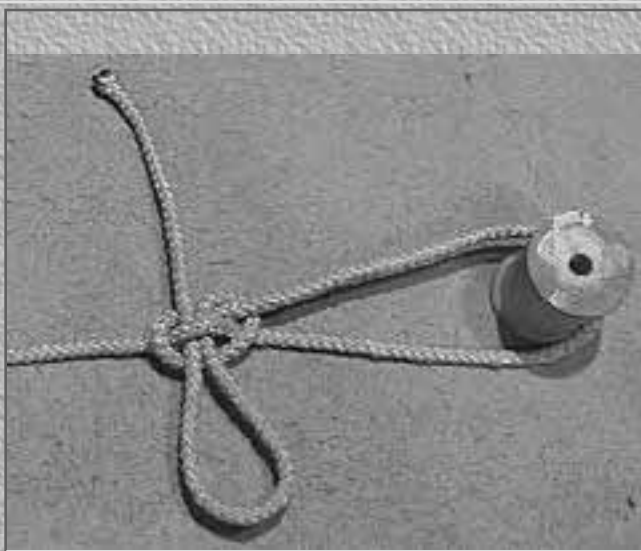

## *Finished Sliding Sheet Bend*

**This picture shows the knot having been slid further up the standing part. Note that the rope had to move around the spool in order for this to occur (like the [Tautline Hitch](#)).**

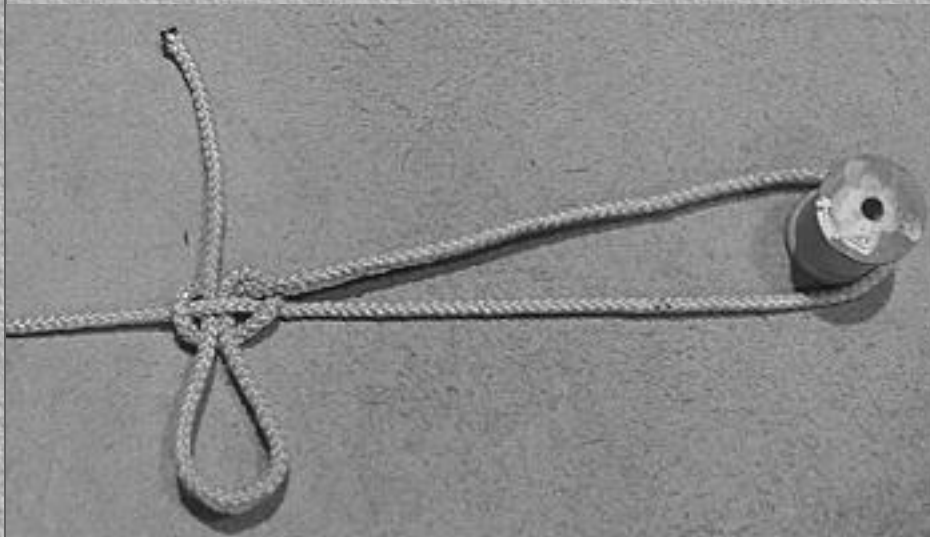

## *Locked Sliding Sheet Bend*

**Once you have adjusted the knot to your satisfaction, it can be locked by tightening the knot by pulling on the non-sliding parts of the knot. To unlock, loosen and flatten the knot, to reduce the hump. To untie, simply yank on the end.**

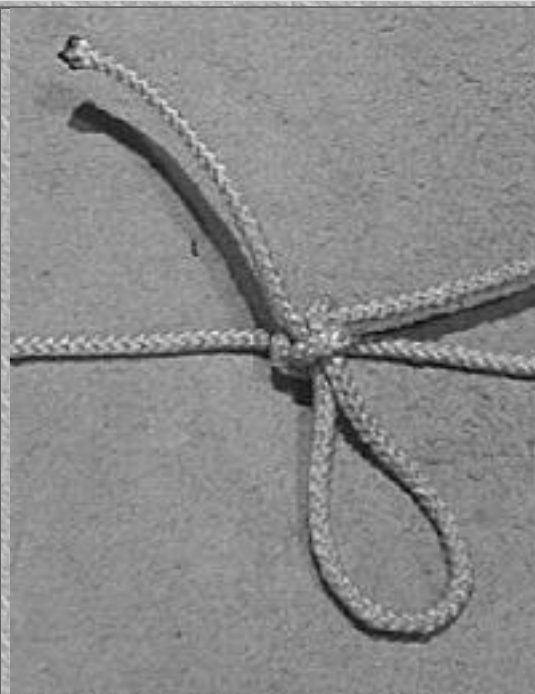

[\[Top of Page\]](#)



[Return to Index](#)

# KNOT KNOWLEDGE

## Contributions

### Lehman8

**This knot is Dan Lehman's creation. The sketch is his own handiwork. His design goal was to combine a "Figure 8 Loop's strong form and a Bowlinesque ease of untying". Notice the sketch labels the segments of the knots, and the scan of the knot is in the same orientation as the sketched knot.**

### *Lehman8*

#### **Dan's comments:**

**"The end (M-N) can be tucked out with the loopParts (F-G), which I think 'softens' the SPart's initial deflection (under the 'collar') and adds into the SPart's u-turn (A-B-C).**

**"NB: the end can here exit over-over-under-under-under (under E-F) (It's drawn over-over-under-under-over); and that version also allows a further**



tucking. But I think that then the end (M-N) provides less or no 'softening' at the point immediately after the 'collar'. That is, 'B' is hardly touching 'M-N', deflecting over 'D-E'."

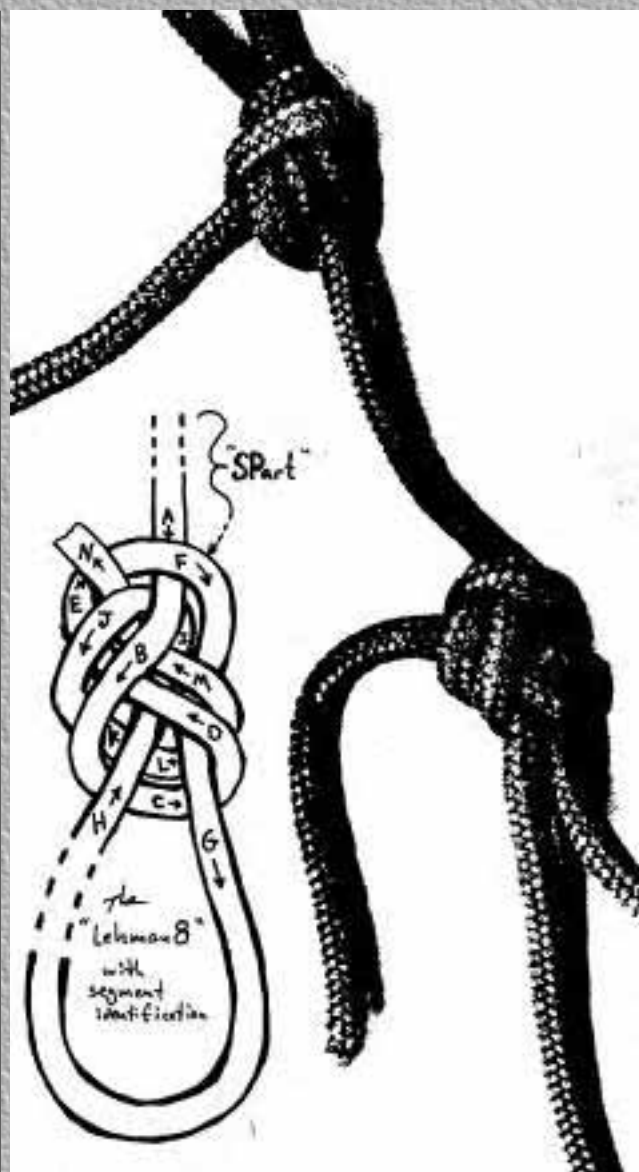

## Locktight Loop I

Dan Lehman shows how to tie version one of his Locktight Loop:

### *Locktight Loop I*

**Sketch by Dan Lehman, 1/1/2000.**

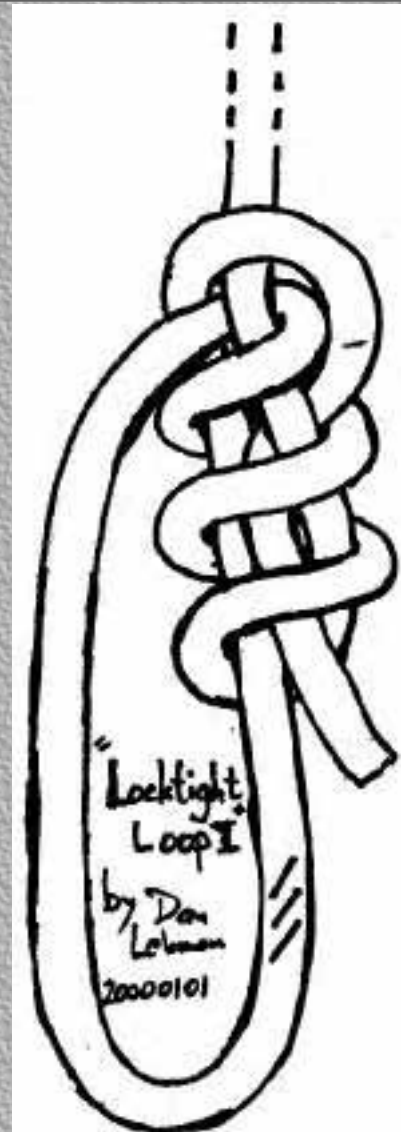

## **Locktight Loop II**

**Dan Lehman shows how to tie version two of his Locktight Loop:**

### *Locktight Loop II*

**Sketch by Dan Lehman, 1/11/2000.**

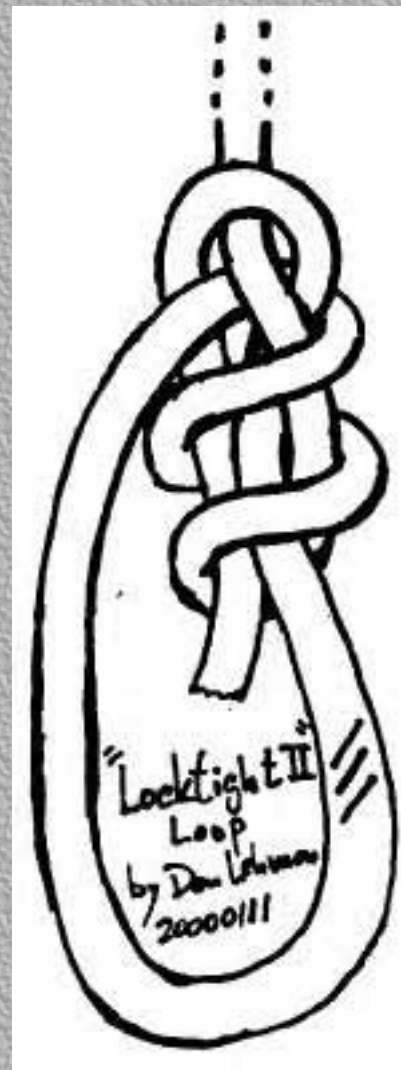

## **Single Bowline on the Bight**

**This is Dan Lehman's sketch of his Single Bowline in the Bight:**

*Single Bowline on the Bight*



**Sketch  
by Dan  
Lehman**

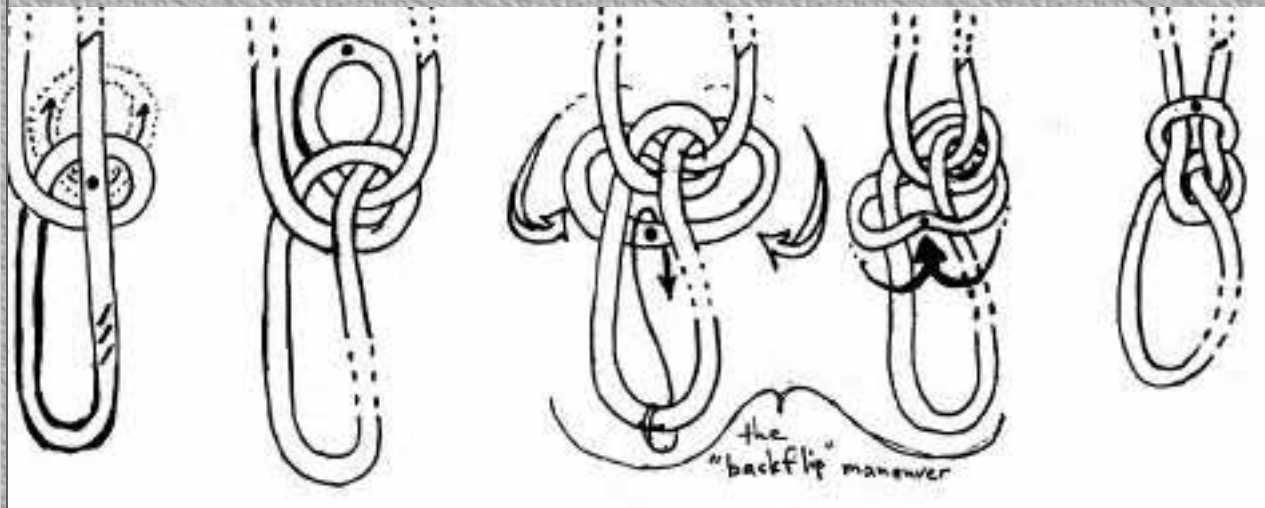

## **Figure 8 Loop, Strong Form**

**Dan Lehman shows the correct way to tie the Figure 8 Loop Knot:**

*Figure 8 Loop, Strong Form*

**Dan Lehman's comments:**

"I've labelled the segments so as to match - as closely as they do - the labels on the Lehman8 (hence, there is a 'collar' here labelled 'E-F', corresponding to that on the Lehman8-part of the Figure 8 component).

"One can see how 'padding' (of the SPART) section 'P-Q-R' of the Figure 8 above was modelled by 'J-K' in the Lehman 8."

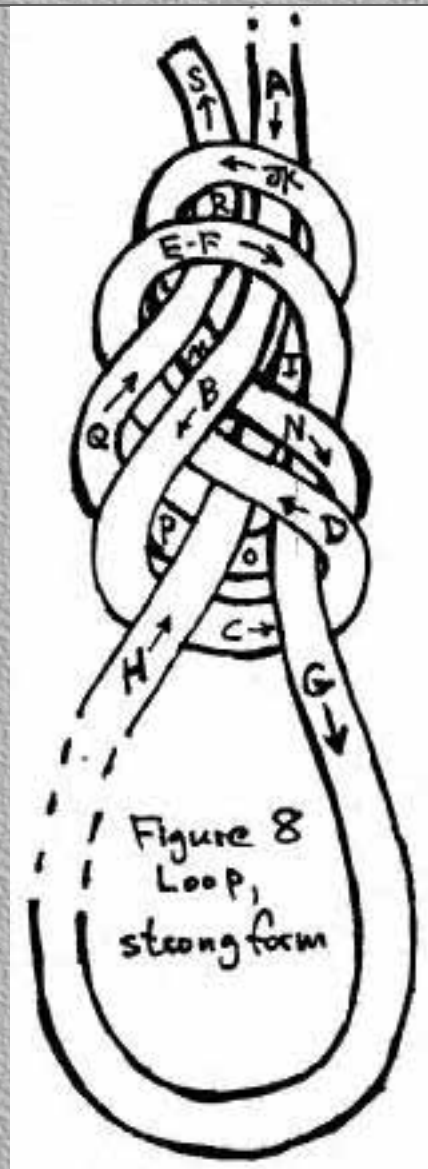

## Sailor's Hitches

These knots were sent to me by Kevin. They are his drawings, and the descriptive text is also his words. Thanks, Kevin, for contributing.

### *Sailor's Hitch*



**Draws up without working to form a strong, secure hitch that will not jam. It may be used as a way to tie a smaller rope to a very large rope. (The smaller rope should pull left when tied as shown here.) Push a bight through the final tuck to form a Slipped Sailor's Hitch.**

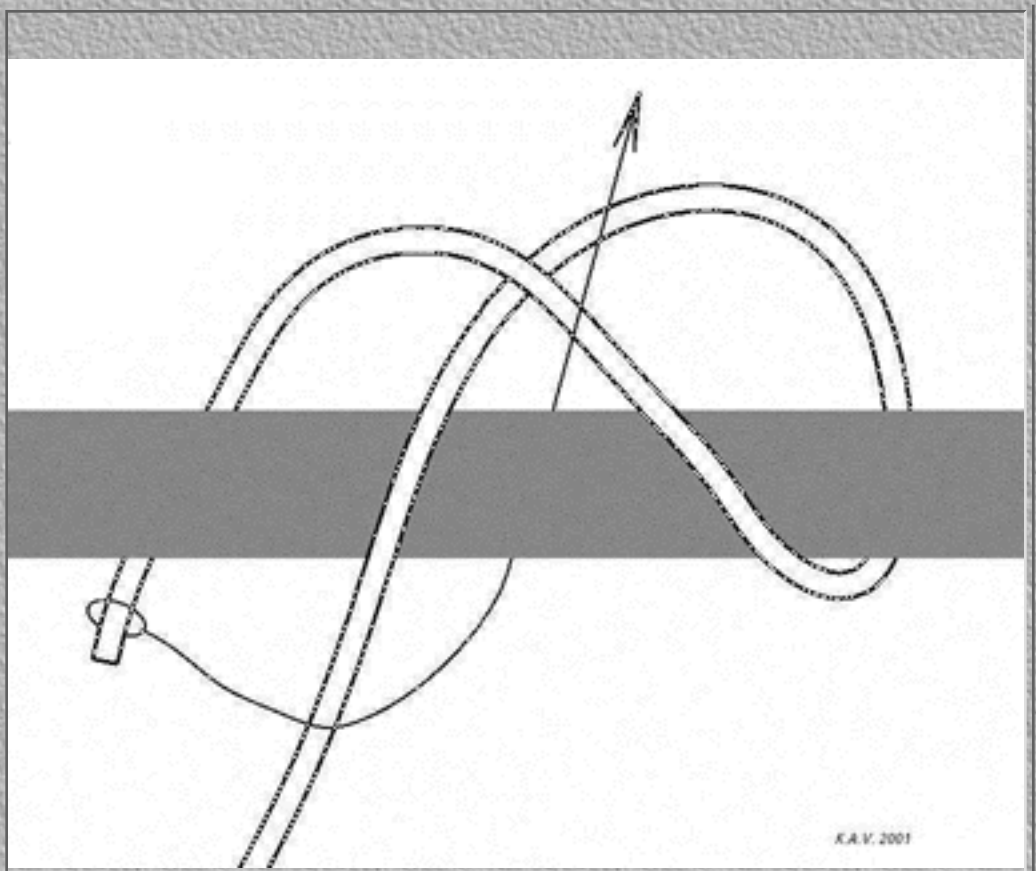

K.A.V. 2001

## *Gripping Sailor's Hitch*

**This hitch is a modification of the Sailor's Hitch that allows a lengthwise pull on smooth spar, even if tapered. This hitch even outperforms the Icicle Hitch in this regard. Ensure that the hitch is tight before applying the lengthwise pull. (The pull should be**

steady.)

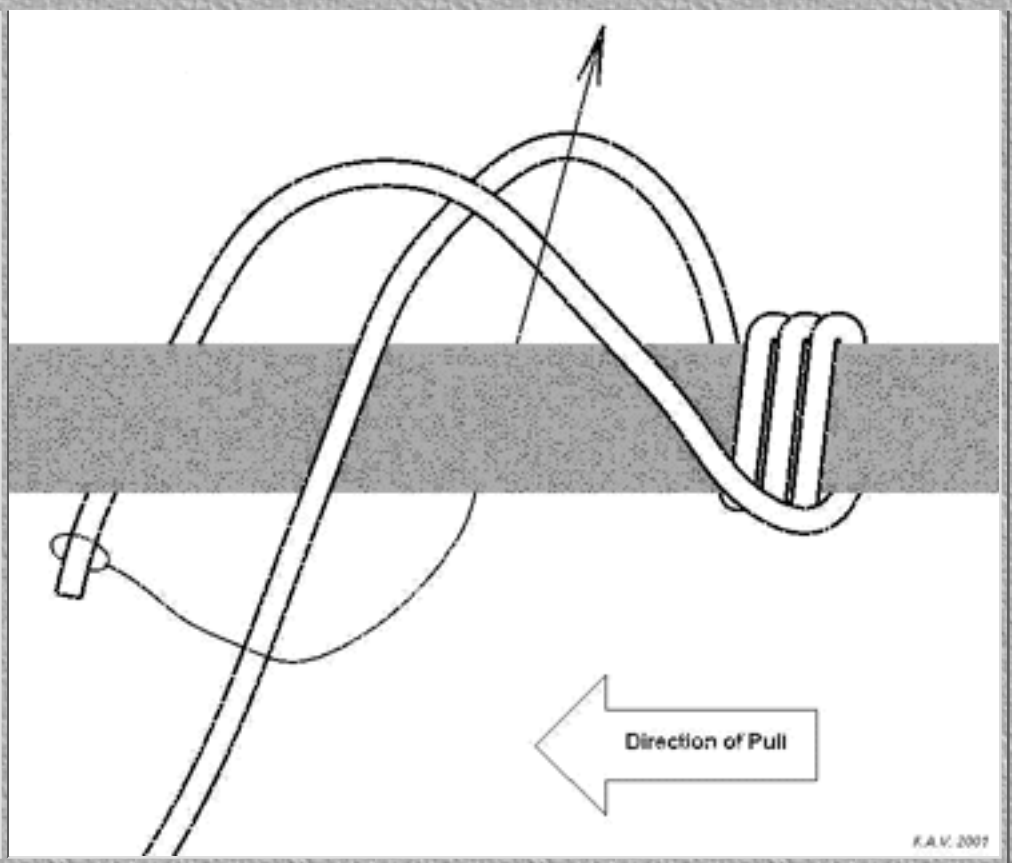

[\[Top of Page\]](#)

[Return to Index](#)

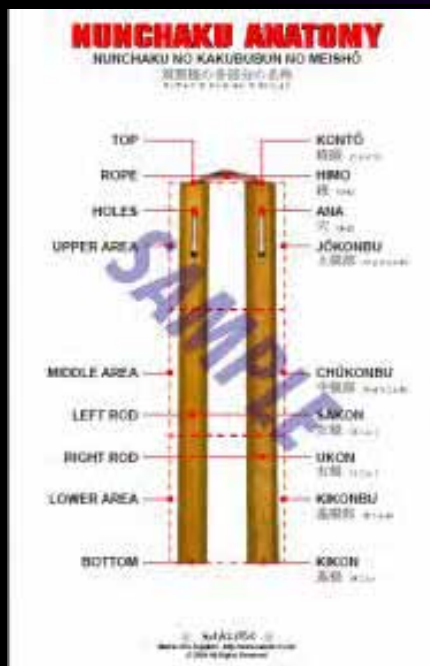
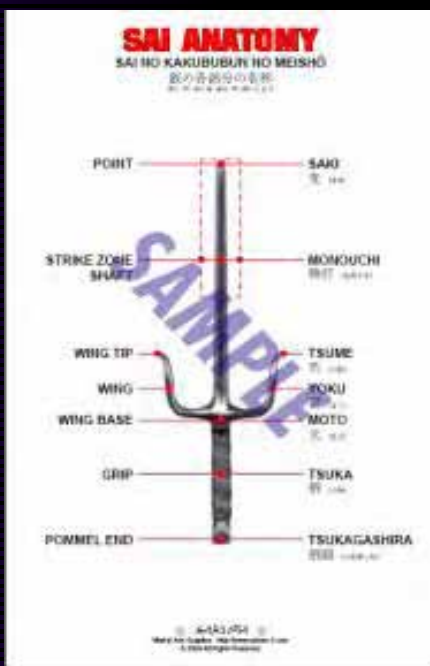

**WEAPONRY ANATOMY CHARTS FROM SAKURA MARTIAL ARTS SUPPLIES**

**Proper Weaponry Parts Names by the International Bukijutsu Federation.**

**PROPER WAY TO TIE NUNCHAKU**

[Home](#)  
[SEISHINKAN](#)  
[BATTLEGROUND](#)

**EMAIL**

- [SSK Information](#)
- [SSK Aikido](#)
- [SSK Goshin Jutsu](#)
- [SSK Iai Jutsu / Do](#)
- [SSK Jujutsu](#)
- [SSK Junior Sogo Budo](#)
- [SSK Karate](#)
- [SSK Culture](#)
- [SSK Programs](#)
- [SSK Schedules](#)
- [SSK Branches](#)
- [SSK Branch School](#)
- [SSK Staff](#)
- [John Viol Shihan](#)
- [SSK Omedeto Page](#)
- [SSK Student Pages](#)
- [SSK Kama Jutsu](#)
- [SSK Classical Weaponry](#)
- [SSK Suntetsu](#)
- [SSK Te no Uchi](#)
- [SSK Kakushi Buki Jutsu](#)
- [SSK Buki List](#)
- [SSK Buki Anatomy](#)
- [SSK Nunchaku Tying](#)
- [SSK Buki Jutsu](#)
- [SSK Jiu Jitsu Waza](#)
- [SSK Iai Kumitachi](#)
- [SSK Goshin Jutsu Waza](#)
- [SSK Power Karate](#)
- [SSK Instructional](#)
- [SSK No More Fear](#)
- [SSK Seminars](#)
- [SSK E Newsletter](#)
- [SSK Events](#)
- [SSK Interactive](#)
- [SSK Yogo - Counting 2](#)
- [SSK Yogo - Counting](#)
- [SSK Yogo - Anatomy](#)
- [SSK Yogo - Colors](#)
- [SSK Dojo Kun](#)
- [SSK Yogo - Greetings](#)
- [SSK Yogo - Commands](#)
- [SSK Dojo Yogo](#)

- [Site Map](#)
- [Site Search](#)
- [Guestbook](#)
- [SSK Message Board](#)
- [SSK Suggestion Box](#)

**Martial Arts WEB CAM**

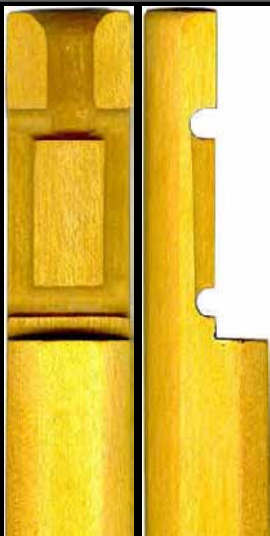

Cutaway views



Live and recorded Video of authentic Sogo Bujutsu / Budo

**Viol Shihan**



**Japan Photos**

**Japan Photos**

Visit the photo gallery of Sei Shin Kan Chief Instructor John Viol Shihan. Full color photos of his training, teaching and awards with his Instructors and friends in Japan.



Before tying, place candle wax on the points shown to ease tying and reduce friction during use.

**DO NOT USE OIL**



**1. Follow the diagram. Use a paper clip if needed**



**2. Push the end back up through the top.**





3. Pull cord tight here and make sure the loose ends are even



4. Start **B** the same way as **A**



5. Insert the other end as shown.

Adjust the distance between the heads of the Nunchaku now before tying the final knot. One fist width is the standard.



6. A standard double knot is more than sufficient. You can clip the ends and singe the tips to finish.

Pull the Nunchaku apart firmly to seat the rope and knot.



7. An alternate way to tuck and finish the ends. You can make another double knot on the other side.



Cutaway Nunchaku made by Master Craftsman and SSK Student **Norbert Jaeger**

**SAKURA'S BEST** - Top Quality Hand Made Nunchaku by Master Craftsman are available exclusively through **SAKURA Martial Arts Supply**



**SEI SHIN KAN WEAPONRY ANATOMY PAGE**

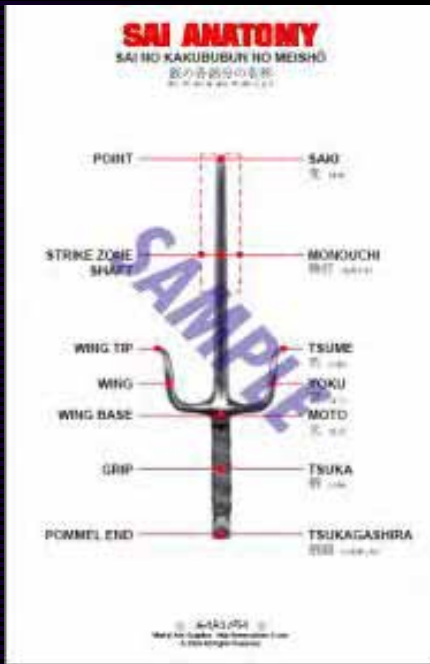
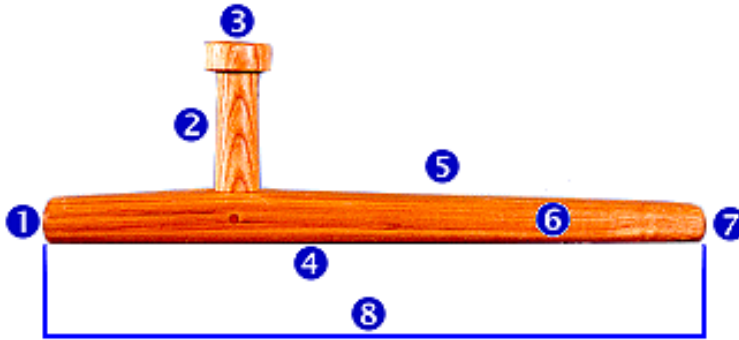

**WEAPONRY ANATOMY CHARTS FROM SAKURA MARTIAL ARTS SUPPLIES**

Proper Weaponry Parts Names by the International Bukijutsu Federation.

## SEI SHIN KAN BUKI JUTSU RELATED LINKS

### TANBO JUTSU



Short Staff Fighting

- [SSK WEAPONRY ANATOMY](#)
- [SSK KAKUSHI BUKI JUTSU](#)
- [SUNTETSU JUTSU](#)
- [TE NO UCHI JUTSU](#)
- [KAMA JUTSU](#)
- [NUNCHAKU TYING](#)

### S.S.K. CLASSICAL WEAPONRY TACTICS



KAMA TAI BO

[Top of Page](#)

43857

 <p><b>BID For Products</b></p>	<p>Name Your Price On Martial Arts Products! New, Used Or Clearance Items On The Sakura Bidding Board!</p>		<p><u>SAKURA FREE WARRIOR GREETING CARDS</u></p>
--	--	--	--

### TANBO JUTSU



Short Staff Fighting

[Check Out The Martial Arts WEB CAM Now! Click HERE.](#)



**SAKURA**  
Martial Arts Supply Co.  
Established in 1977

Call Toll Free!  
**1-888-SAKURA-0**  
Click [HERE](#) To  
Shop or Browse On-Line

[SEI SHIN KAN DOJO](#)

[BATTLEGROUNDS](#)

[SAKURA M/A SUPPLY](#)

Click [HERE](#) for contact information.

Send all E-MAIL to [webteam@seishinkan.com](mailto:webteam@seishinkan.com)

Copyright © 1998-2003 SEI SHIN KAN INC.

Last modified: April 28, 2004



Originally, this was published as:

Buck, Thomas (1993). **Tsuka-maki, The Art of Japanese Sword Restoration.** *Colorado Token Kai Quarterly*, v1, n1, pp. 3-8.

## The Art of Tsukamaki

written and illustrated by Thomas L. Buck

Ever since seeing my first Japanese sword, I have been captivated by the elegance and complexity of TSUKA-MAKI (the art of wrapping the tsuka). Although I will share with you a few of the tools, materials and techniques needed for tsuka-maki, I have learned, through the guidance of Takahashi-sensi, that patience, persistence and excellence are the true requirements for the application of this art.

### COMMON TERMS

In order to make this more understandable for both the novice, as well as the experienced wrapper, I shall start by defining a few of the common terms used in tsuka-maki.

FUCHI/KASHIRA	pommel caps
HA	cutting edge side
HISHIGAMI	paper wedges
ITO	cloth braid
MAKI	to wrap
MENUKI	hilt ornaments
MEKUGI	peg that secures hilt
MEKUGI ANA	holes in the hilt
MUNE	the side opposite cutting edge
NAKAGO	tang of sword
OMOTE	the side that faces out
TSUKA	hilt or sword handle
TSUKAITO	cloth braid covering tsuka
SAME	shark or ray skin
URA	the side that faces in

### TOOLS

For holding the *tsuka*: a [stand](#) that will hold the *tsuka* firmly in place for both wrapping and tightening, and will allow work to be done easily on both the *omote* and *ura* side.

For inserting the paper wedges, and adjusting the *ito*: [tweezers](#), a [pick \(any small pointed tool\)](#), and [any small hand held tool with a blunt wedge shaped tip](#). You can most likely find all of these in used dental tools.

### MATERIALS

Aside from the *tsuka* itself, the basic materials in tsukamaki are the *ito*, paper and glue.

The glue can either be purchased (such as Elmer's) or produced by boiling rice, working it into a past while still warm, and adding a small amount of water.

The paper can be of nearly anyweight, but ideally it should be relatively close to newsprint in weight and consistency.

During the wrapping, be sure to moisten the paper wedges before inserting them under the braid, this will allow the wedges to conform more readily to both the *tsukaito* and the *same*.

Although the *ito* is available in a wide range of colors, it is only manufactured using two different types of fibers (natural and synthetic). When trying to identify an unknown *ito*, a burn test is often helpful. The following chart gives tests for the principle natural fibers, and a few synthetics.

FIBER	FLAME	ODOR	RESIDUE
Cotton	Luminous, rapid	Burning paper	Fine, gray
Silk	Slow oran/yellow	Burning hair	Brittle bead
Wool, hair	Slow, blue	Burning feathers	Brittle bead
Rayon	Sparks, orange	Burnt paper	Black ash
Acetate	Rapid, sparks	Vinegarish	Hard bead
Nylon	Melts, no flame	Like celery	Hard bead

### SUGGESTED ITO LENGTHS

Although I have encounter several different ways to derive the required length of *ito*, ranging from special formulas and ratios, to wrapping the *tsuka* from end to end and half way back, I tend to follow the simple guidelines given me by Takahashi-sensi.

TANTO (4" tsuka)	6 feet of ito
WAKIZASHI (6" tsuka)	8 feet of ito
KATANA (10" tsuka)	12 feet of ito



For holding the *ito* in place: a [clamp](#) that can be worked around freely, will not allow the *ito* to shift, and goes on and comes off readily.



(page 1)

### PREPARING THE TSUKA

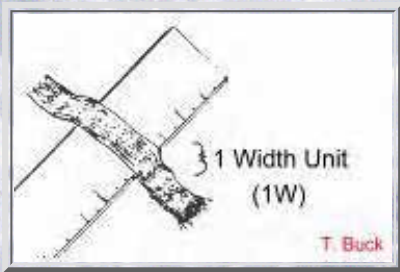

In preparing the *tsuka*, start by stretching a sample of the desired *ito* tight and measuring its width (1W).

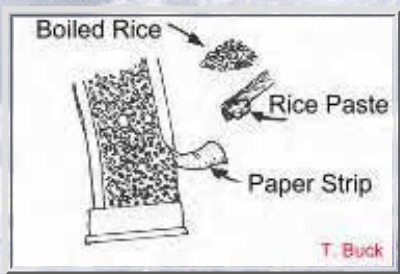

Using a small amount of rice paste glue, place thin paper strips along both the *ha* and *mune* sides of the *tsuka*. By layering the paper you will decide the finished shape of the *tsuka*, and also guard the *ito* from snaring on the surface of the same. Continue layering the paper until the *fuchi/kashira* will be flush with the edges of the *tsuka* (after the *ito* is in place).

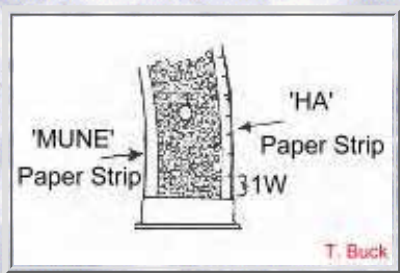

Measure and mark the *ha* and *mune* sides in *tsukaito* width segments (1W). The distance between the *fuchi* and *kashira* should measure an odd number of width units along both the *ha* and *mune*. If not, either the *tsuka* may have to be altered, or a different weight *ito* may have to be selected in order to fit within an odd number of spaces.

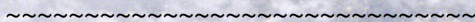

### HISHI-GAMI (THE PAPER WEDGES)

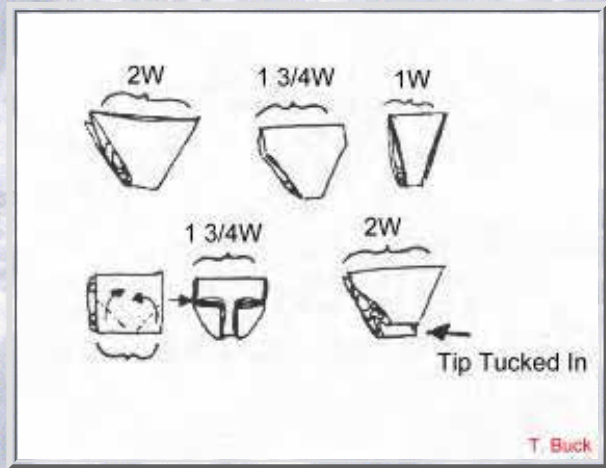

To give the *maki* a proper shape, the *tsukaito* is folded over various styles of *hishi-gami*, or small paper wedges. Here are a few of the many different styles used.

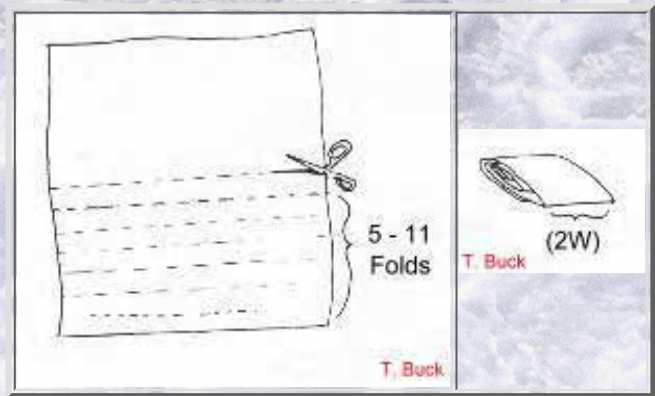

In making the wedges, begin by folding a sheet of newsprint, or standard weight paper 5-11 times. Cut off excess paper, then cut the folded paper into two width (2W) segments. Use these to make any of the wedge styles previously illustrated in this article.

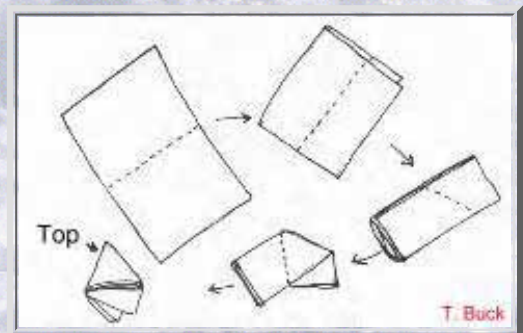

One alternative to the previously mentioned *hishi-gami*, is made from a piece of paper (1" X 1/2") folded as shown above.

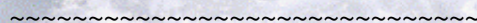

(page 2)



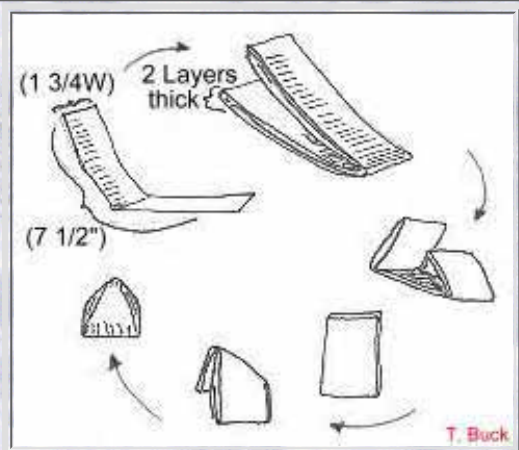

Another, fatter alternative wedge, can be made from a piece of paper (7 1/2" X 1 3/4W) folded as shown above.

### THE WRAPPING OF THE HANDLE

To begin with, it should be stated that both Japanese tradition, and personal observation, suggest that *tsukamaki* should be started and completed on the *omote*, or the side of the *tsuka* that faces outward when being worn. This is almost always true regardless of the style of wrap.

- Measure half the length of the *tsukaito*.
- Place the first two paper wedges on the *ura* (side opposite the *omote*), and align them with the marks on the paper strips.
- Make the first two *tsukaito* folds overlap the paper wedges.
- Bring the other half of the braid around and make the next two folds.
- Repeat with other length of *ito*.
- Continue this procedure on the other side, alternating the direction of the folds.

During the wrapping, tightness should be a primary concern. Each fold should be drawn or stretched so that there is no slackness or looseness.

Throughout the process, continually monitor and adjust the symmetry of the folds and open areas, and try to maintain a smooth surface appearance along the *ha* and *mune* edges of the *tsuka*. Ultimately, a quality *tsukamaki* maintains a consistent tightness and exactness.

### PLACING THE MENUKI

In both the *ito maki no katana*, as well as the *ito maki no tachi*, the *menuki* are usually

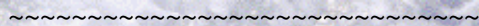

placed after the third set of folds from the *fuchi* on the *omote* side and three sets of folds from the knot on the *ura* side. In reference to *wakizashi* and *tanto*, the *menuki* are commonly placed after the second or third set of folds. In any event, the positioning of the may vary because of the *tsuka* size, *menuki* size, *ito* width, or placement of the *mekugi-ana*.

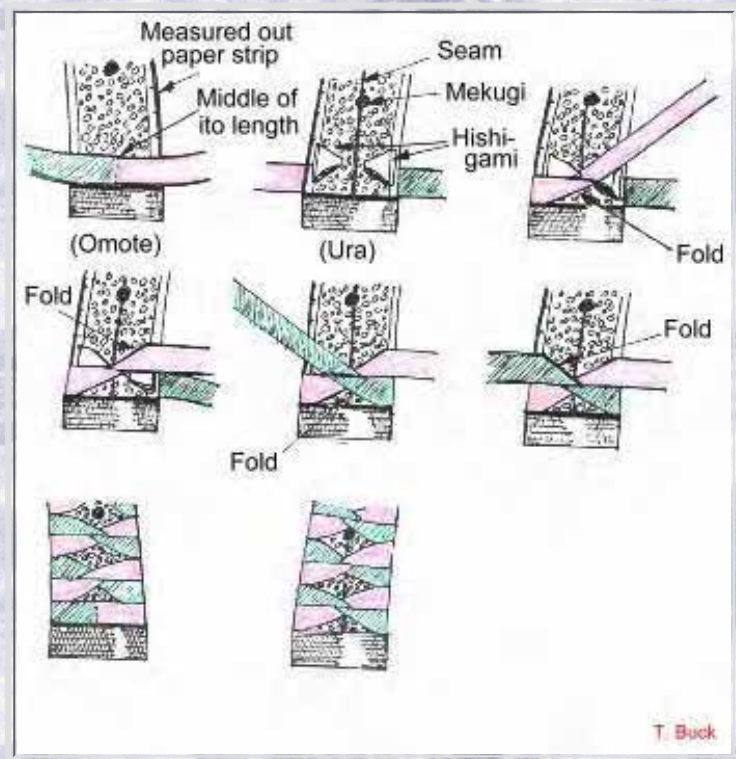

(Ito Maki no Katana)

### TYING THE URA SIDE KNOT

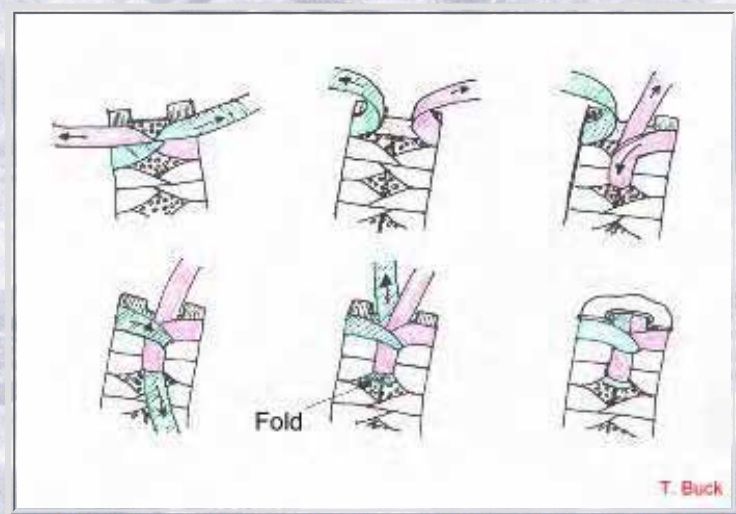

(Tying the Ura Knot)

At the end of the *tsuka*, on the *ura* side, pass the end of the *tsukaito*, coming from the *mune*, over and then under the preceding fold. Then, pass the end from the *ura* over the other end, and under the previous fold, making a loop. Bring it back again under the fold. Thread both ends through the *shitadome* (if present) and the *kashira* side-by-side.

### TYING THE OMOTE SIDE KNOT

To start the *omote* knot, pass the bottom end of the *tsukaito* under the top set of folds, pull the braid over the fold, cut off,



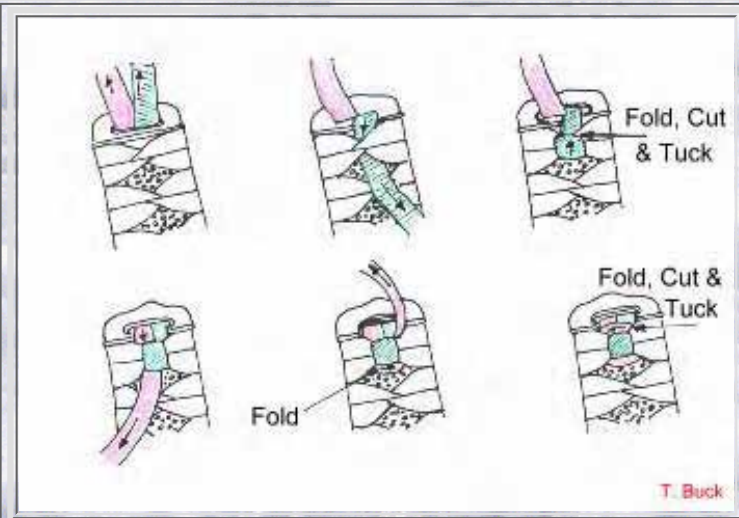

**(Tying the Omote Knot)**

apply rice paste glue, and tuck under. Take the top end of the tsukaito under the top set of flold, repeating the first part of the previous step. Then, make a loop by bringing it back again under the folds. At this point, insert a small wad of paper and fold the tsukaito over and tighten. Bring the top length around to the left and down again cut off, apply and paste glue and tuck under.

**ALTERNATIVE KNOTS**

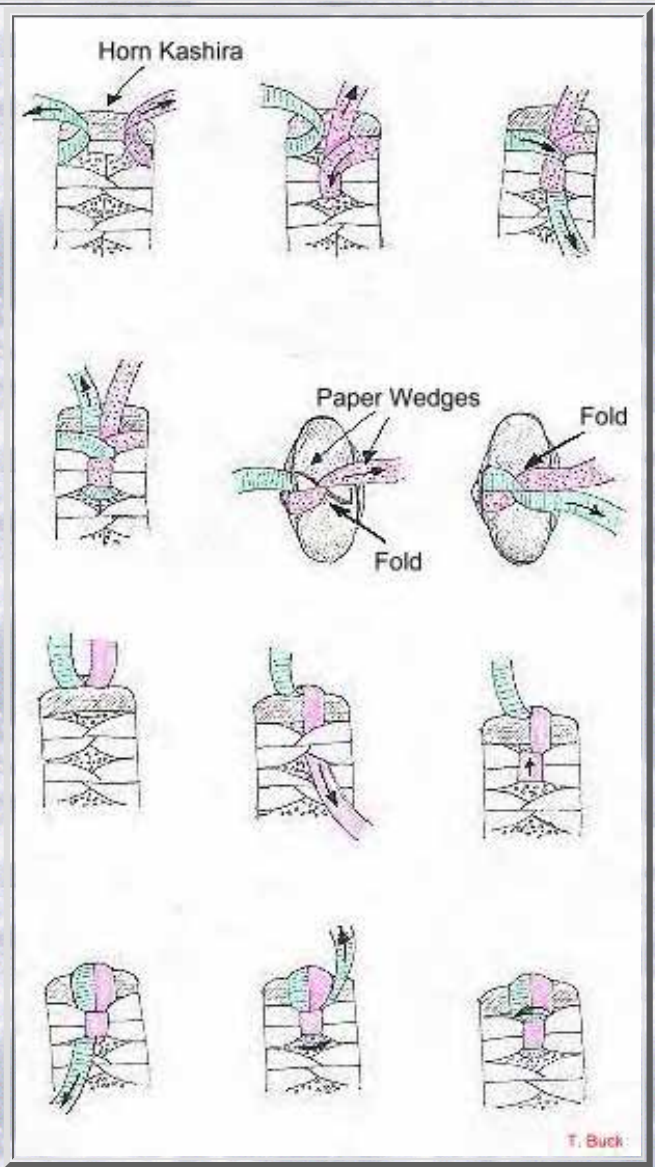
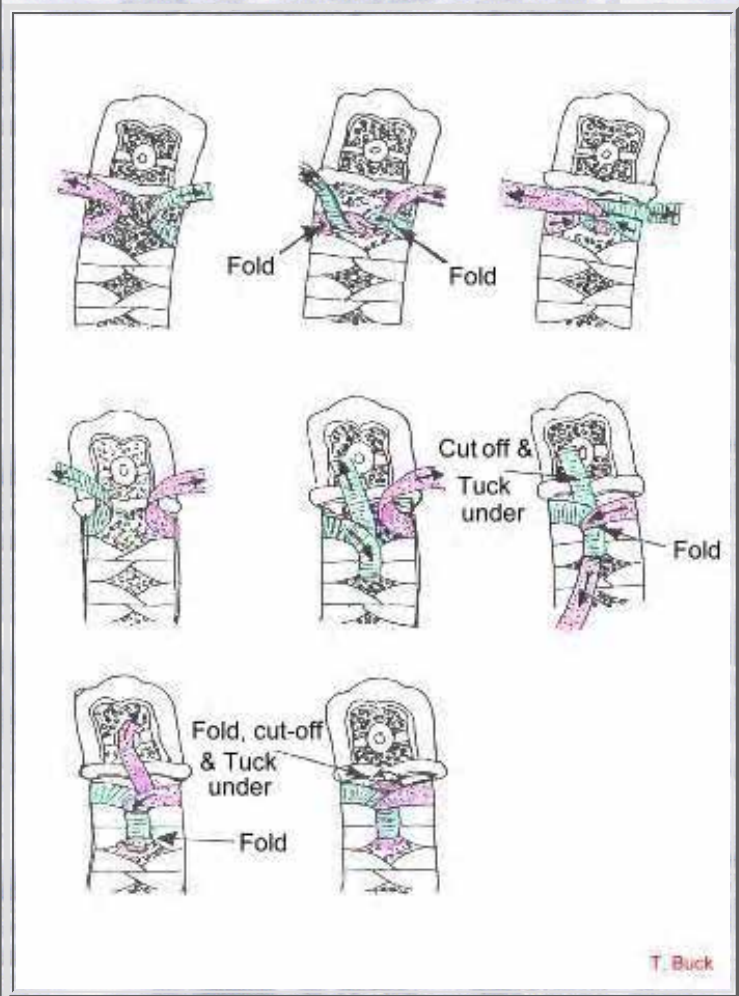

**(MAKIKAKE NO KASHIRA)**

**ALTERNATIVE TSUKAMAKI STYLES**

Of the more than forty styles of *tsuka-maki* that I am familiar with, here are five of the most common.





**(COMMON GUNTO KNOT)**

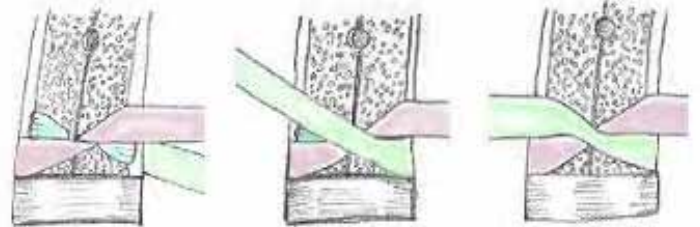

The folds for the first half of the cross-over are the same as those found in Maki no Katana.

For the second half, draw the ito across the lower folds...

...pinching the ito, and tucking the ito edges under at the center of the cross-over.

Cross-section of top ito in cross-over

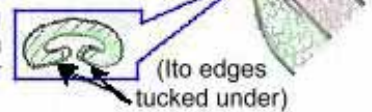

(Ito edges tucked under)

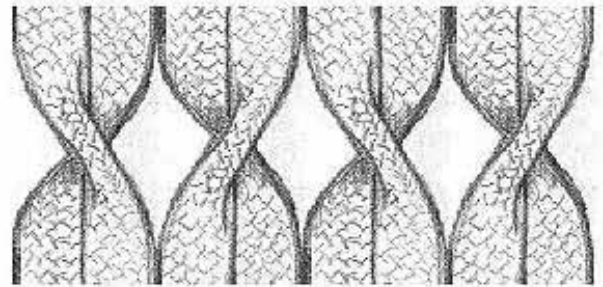

T. Buck

**(Tsumami maki)**



(page 4)



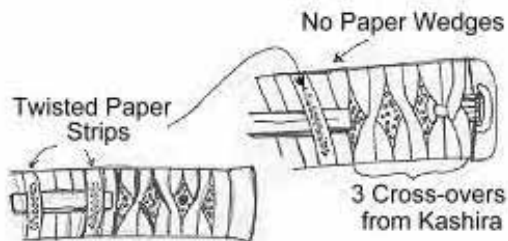
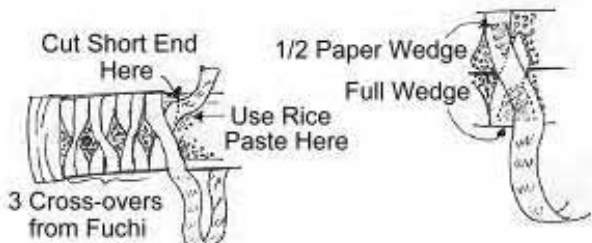
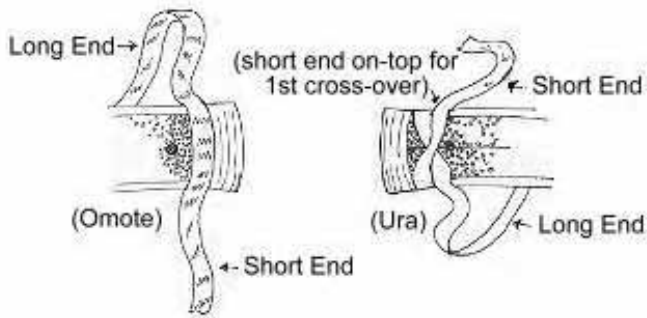

T. Buck

**(Katate maki)**

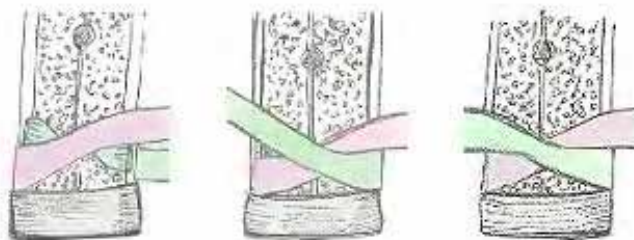

To begin the first cross-over, draw the first side of the ito loosely over the hishi-gami

For the second half, draw the ito flat across the lower strip...

...then, pull the ito tight, making sure the hishi-gami remain centered and completely covered.

Ito strips remain flat, with a nice even flow...

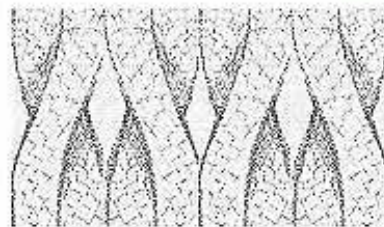

T. Buck

**(Tachi Tsukagashira Kake maki)**

(page 5)

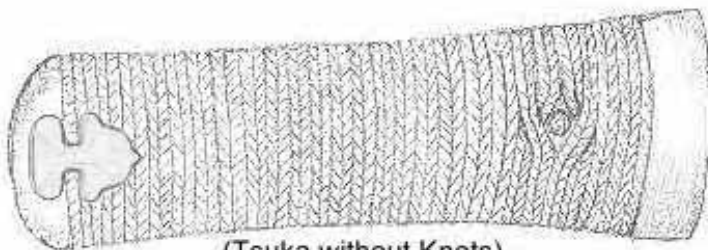

**(Tsuka without Knots)**

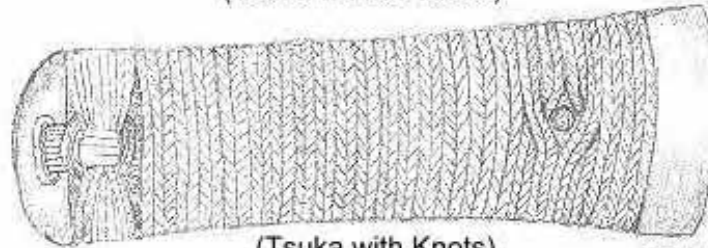

**(Tsuka with Knots)**

T. Buck

**(Two Variations of Kami Hira Maki zuka)**



**(Preparation:)**

(notch cut for string) (Ura Side) (Omote Side)

(Stitch stings in groups of two.)

**(The Wrap:)**

(Start wrap in notch on Ura side.)

(Same)

(To keep string from covering hole, over-lap string on itself alternating directions.)

to Kashira.

from Fuchi.

(For tsuka with knot, 12 string widths from kashira, begin three new groups of string)

(Ura side) (Ura side)

**(The Knots:)**

(Omote Knot) (Ura Knot) (Tsuka without Knots)

Follow the basic steps as for Ito Maki no Katana.

T. Buck

**(Kami Hira Maki zuka)**

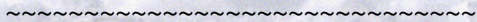

**Preparation:**

(Prepare Strings for 1st cross-over by stitching them together in groups of 2.)

'HA'

1W = 8 String/Cord widths

**The First Cross-over:**

Braid the Top Six Stings in Groups of 2

(close-up of 1st cross-over)

(Omote Side)

**The Twists -or- Folds:**

Twist strings in this direction

A. B. C. D.

Use the inner 6 Strings (A. & B.) for the 'folds' or twists to cover the hishi-gami (paper wedges).

Hishi-gami

After covering the paper wedges with the inner strings, loop the outer two remaining sets of strings (C. & D.) over the top of the twist.

Alternate C. & D. in looping.

**The Knots:**

(Cut & Tuck groups A. & B.)

(Ura Knot) (Omote Knot)

Follow the same basic steps as for Ito Maki no Katana

T. Buck

**(Hoso Jabaraito Kumiage zuka)**



~~~~~  
**VARIOUS SAGEO KNOTS**

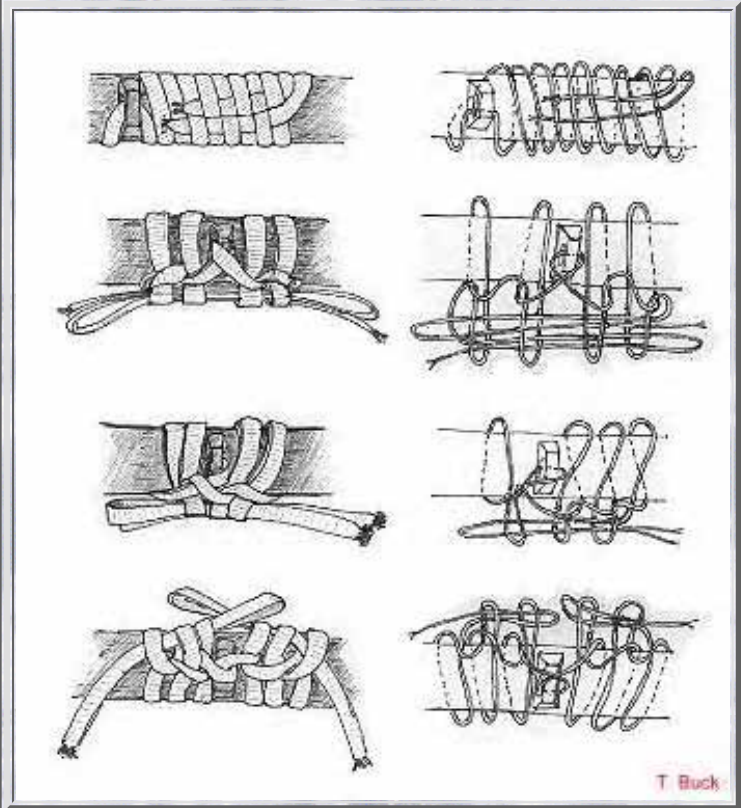

(Sageo Knots)

~~~~~  
(page 6)



[If you have any questions or comments, please e-mail me...](#)



[My Home Page](#)

How to tie a "figure 8" knot

This is one way to tie a "figure 8" knot.

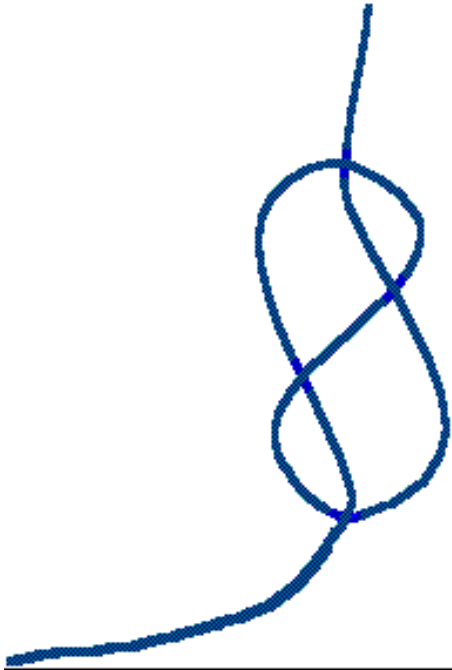



## Hand-crafted Knot Jewelry:

Decorative Marlingspike Seamanship rendered in precious metal.

[\[Home\]](#) [\[What's New\]](#) [\[FAQ \(Frequently Asked Questions\)\]](#)

[\[Links\]](#) [\[Tutorials\]](#) [\[Five-lead Rings\]](#) [\[Seven-lead Rings\]](#) [\[Pendants\]](#)

[\[Earrings\]](#) [\[Knotted Chain\]](#) [\[About Wire\]](#) [\[Knots\]](#) [\[Knot Components\]](#)

[\[Ring Size\]](#) [\[Technical\]](#) [\[How To Order\]](#) [\[Jewelry Order Forms\]](#) [\[Contact\]](#)

Bracelets: [\[Turk's Heads\]](#) [\[Sinnets\]](#) [\[Prolong\]](#) [\[Workshops/Shows\]](#) [\[Knotted Mail\]](#)

Price lists: Rings [\[Gold\]](#) [\[Platinum\]](#) Bracelets [\[Gold\]](#) [\[Platinum\]](#) Chains [\[All\]](#)

A recent question on Turk's Heads dealt with tying a five-lead knot in string. Here is a series of pictures illustrating the method for doing so. The resultant knot is a 5x4 (five-lead, four-bight) and is probably the most commonly found Turk's Head knot after the three-lead knots which are so simple that everyone already knows how to tie them. (Those are the ones you see people wearing on wrist or ankle when they come back from tropical vacations, usually tied in hemp and doubled or tripled.)



First the line goes around twice, with two crossings. Note that in this and the following illustrations there are no crossings hidden behind my hand, so as to avoid confusion.

On the third go-'round, a simple three-lead knot results, but we're not finished. Observe the placement of the line carefully, the next pass is critical.



It looks wrong, but that's because there is still one more line to go. Parallel the previous lead, but go over where it is under, and under where it is over.

Now it starts to look right again. Remember, there are no crossings behind the hand -- the running part will come around parallel to the original standing part to complete the knot and begin the "doubling" process.



After you've done this a couple of times, it starts making sense. It is possible to extend this method to make more complex knots, and I've put up [another page](#) that shows how to do a series of knots, starting with the 3x4, then the 5x6 and the 7x8, each larger knot containing the previous knot as a preliminary stage.

(This site last updated on 08-29-2004)

©1997-2003 Loren Damewood All Rights Reserved



[Powered by Syndicomm!](#)

Powered by [RingSurf!](#)

# The Better Bow

This simple knot will change your life.

The better bow stays tied all day long and unties with a simple tug. Learn it and you'll never again bend over to retie your shoes.



- 1 The better bow is very similar to the knot you already know. It starts the same way.



- 2 Make a single loop as you usually would, but don't tuck it in yet.







**3** Wrap the loop around your finger.

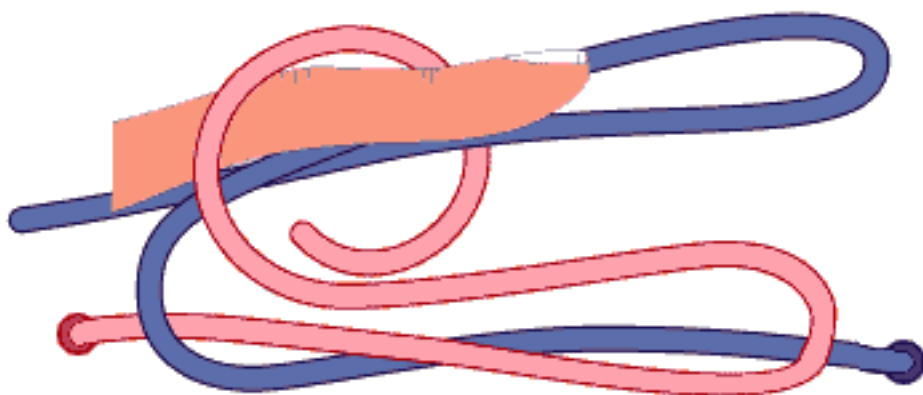

**4** Now here's the trick: make an extra turn around your finger. Prepare the second loop as usual (finger not shown).

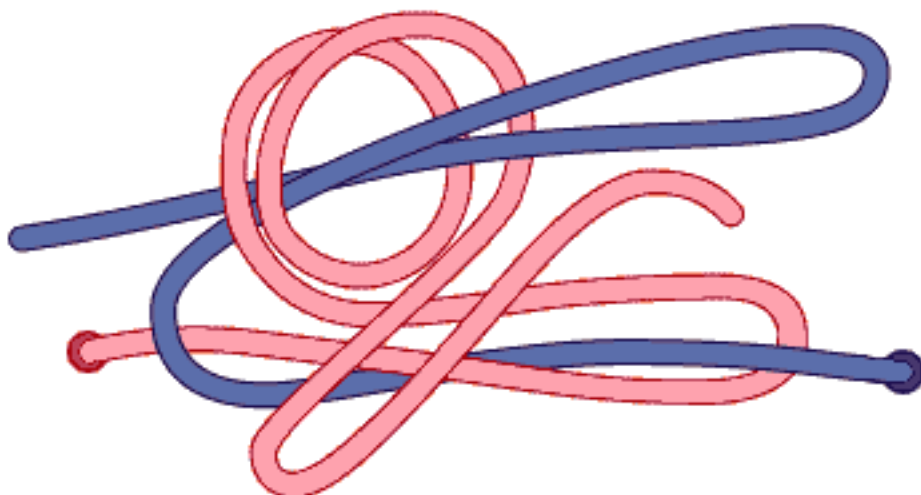

- 5 Simply withdraw your finger and tuck the second loop through the hole where your finger was.

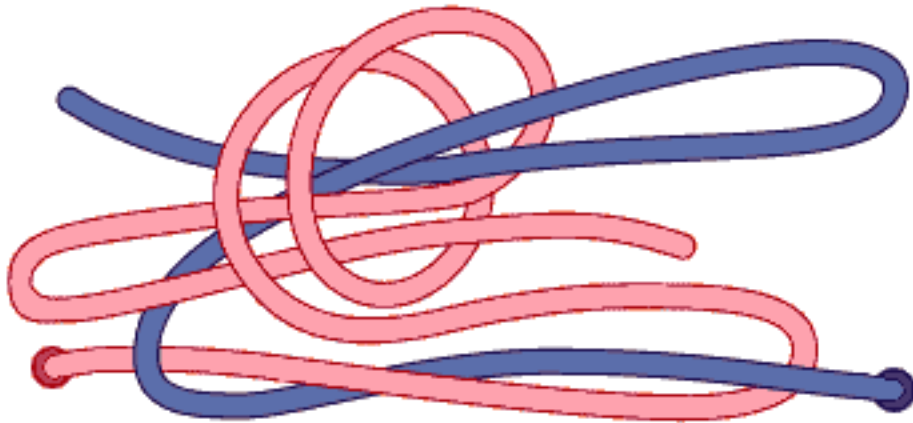

- 6 Pull it tight and—voila!—you have just tied the better bow.

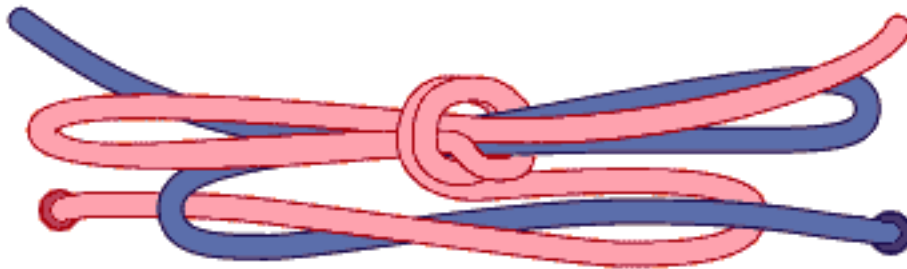

Hint: To untie, do not pull the blue free end. Pull the red one. This takes a little practice, but when you do it, the knot simply falls apart.



[Main Menu](#)



[Ian Fieggen's Site](#)



**Ian Knot**



*You have reached this page via an old hyperlink to the Ian Knot page.  
Please update your links to the new Shoelace Site address show below.*

## The Ian-Knot Page Has Moved!

*Stand by and you will be automatically trasferred to the new location.*

This page has moved to Ian's new expanded "Ian's Shoelace Site".

<http://www.fieggen.com/shoelace/ianknot.htm>

[CLICK HERE](#) to transfer manually to the new location.

[Previous Page](#)



[Top of Page](#)



[Next Page](#)



Copyright © 2004 by [Ian W. Fieggen](#). All rights reserved.



[Main Menu](#)[Ian's Shoelace Site](#)[Shoelace Knots](#)["Ian Knot"](#)[Flip Book](#)[Video](#)[Technical Info.](#)[History](#)[Testimonials](#)[Ian's Secure Knot +](#)[Standard Knot](#)[Two Loop Knot](#)[Surgeon's Knot](#)[FreedomKnot](#)[Slipping Knots? +](#)[Starting Knot](#)[Knot Variations](#)[Lacing Shoes +](#)[Web Polls +](#)[Aglet Repair](#)[F.A.Q.](#)[Links](#)[About Ian](#)[Contact Ian](#)[Ian Fieggen's Site +](#)[Fieggen Family Tree +](#)[Site Map](#)

*I tie my shoelaces with an "Ian Knot", the World's Fastest Shoelace Knot: Make a loop with both ends and simultaneously pull them through each other to form an almost instant knot.*

## How to tie an "Ian Knot", the World's Fastest Shoelace Knot.

*"One day, all shoelaces will be tied this way".*

### Step 1:

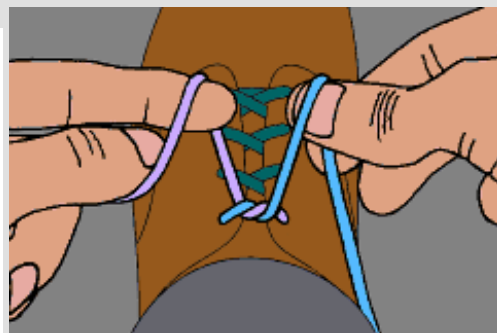
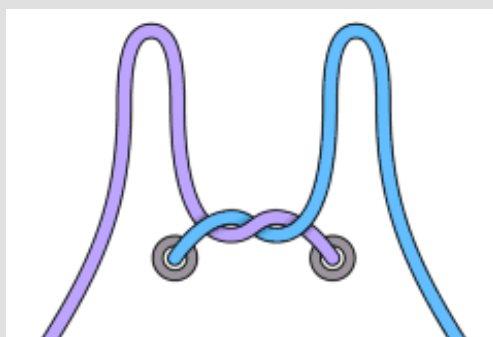

Tie a [Starting Knot](#) as shown, then hold the laces as pictured. The right (blue) lace is held *between* the right thumb and forefinger whilst the left (purple) lace is held *around* the left thumb and forefinger, using the other fingers of the left hand to hold the lace taut.

### Step 2:

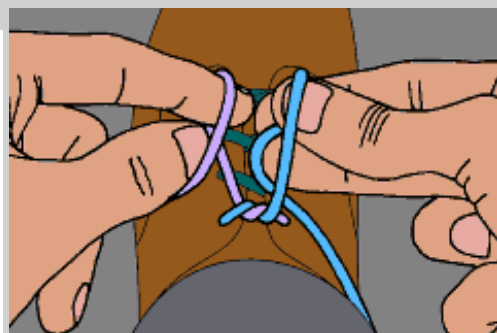
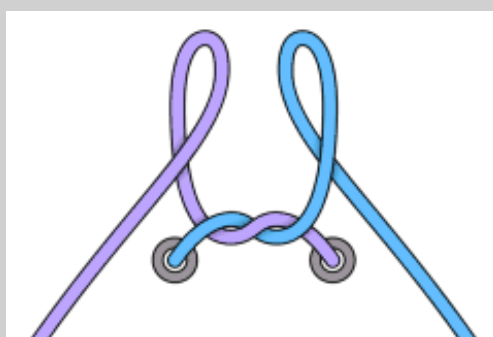

This move creates two loops, one with the loose end behind, the other with the loose end in front. Use the middle finger of the right hand to push the loose end of the right lace behind, whilst the left hand simply rotates forwards to swing its loop across to the right.

### Step 3:

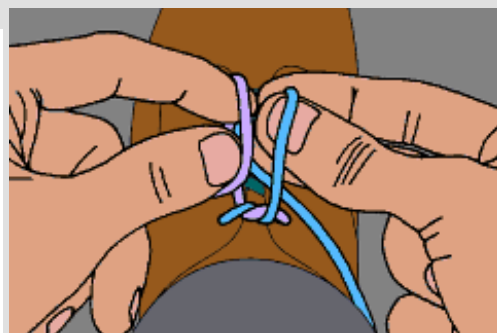
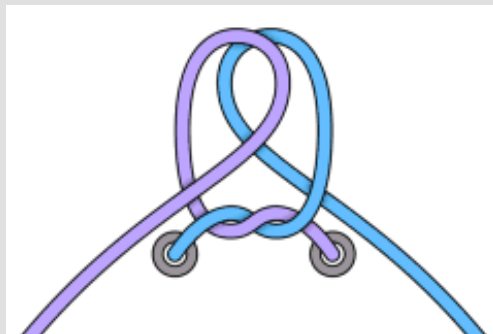

This next move crosses the two loops over each other. Use the left thumb to push its loose end over to the right, whilst the right middle finger continues to push its loose end all the way between the left thumb and forefinger to end up *inside* the left loop.

*Note that the diagram at left shows somewhat exaggerated crossed loops. They are really more "alongside" each other, which is difficult to illustrate.*

### Step 4:

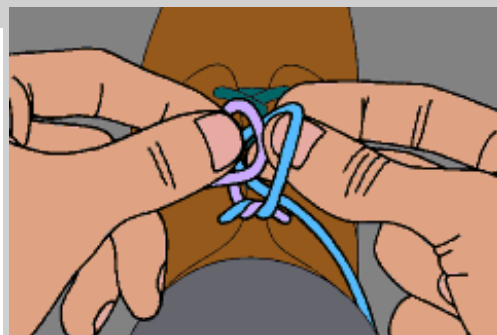
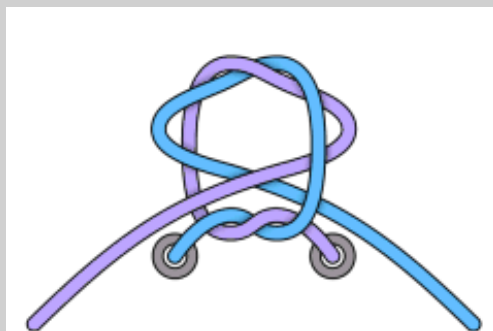

This tricky move requires each hand to use the two fingers inside its *own* loop to grab the loose end of the *other* hand's loop. Use the left thumb and forefinger to grab the loose right end, then the right thumb and middle finger can grab the loose left end.

### Step 5:

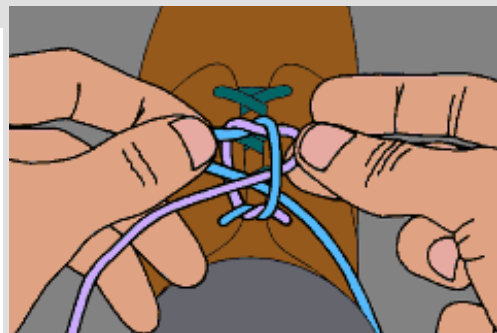
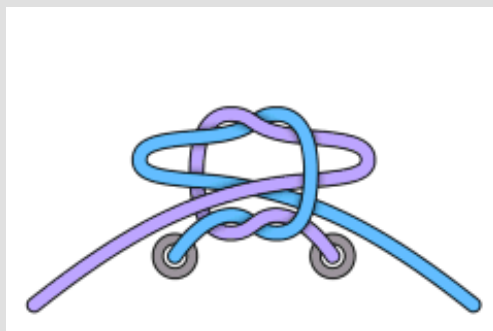

This move sees each hand releasing its own loop and pulling the loose end of the opposite loop through its own. Take care *not* to pull the ends all the way through, as this will form a "knot" instead of a "bow". In fact, this is a quick way to tie a starting knot (though the finger movements must be reversed left to right or else it forms a "[Slip Knot](#)").

## Step 6:

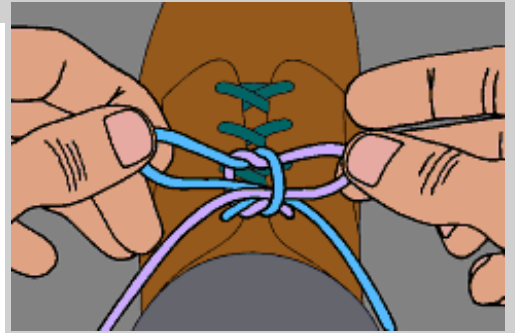
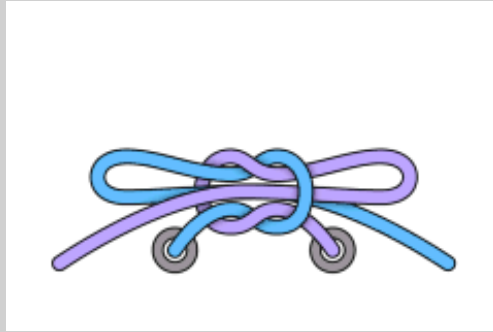

This final step simply completes the knot by pulling the loops tight. The result should be perfectly symmetrical; besides looking neat, this also means the laces wear more evenly and thus last longer. With practice, I can now tie my laces in about *one third* of the time of a conventional knot!

[Flip Book](#)

## Tell Ian how you went



Were you able to follow the instructions and successfully tie an Ian Knot? Use one of the buttons below to e-mail me and let me know how you went. Don't forget to type a quick "Hello" & where you're e-mailing from. I personally answer all e-mails (except spam!)

[Terrific,  
it works!](#)

[Interesting,  
but...](#)

[Couldn't  
do it](#)

[I want  
the book!](#)

[Previous Page](#)



[Top of Page](#)



[Next Page](#)



Copyright © 2004 by [Ian W. Fieggen](#). All rights reserved.



James Burdine's page

Home Page

Practical Slings

Directory of Related Links

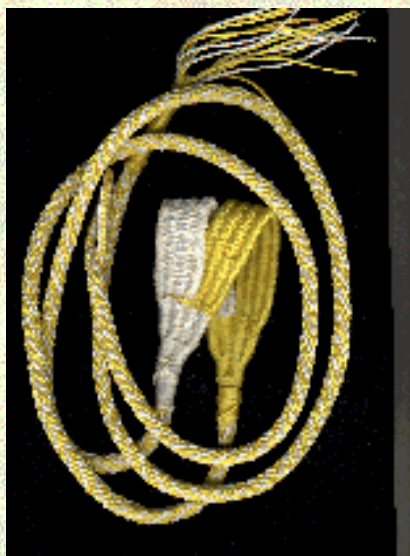

# The Sling Ancient Weapon

I've been fascinated with ancient weapons for most of my life. In my youth I read about David and Goliath and made my first sling. Not knowing the particulars of sling design, it was a poor thing but I did manage to get a rock out there occasionally. Later I picked up the only written text on the subject **The Sling for Sport and Survival** by Savage, and made a more sophisticated sling from a piece of suede and nylon rope. I also picked up a Macedonian Battle sling from a local manufacturer. Both of these slings lacked something. Later I learned about the fiber slings of various countries of the world and especially the Andean slings of the Inca civilization. I then picked up a copy of **Sling Braiding of the Andes** by Adele Cahlander. I tried to do the fist braiding as described in the book, but found it a bit complicated and slow. Also the method of making the sling pocket had me stumped. I started researching various methods of fiber working and researched local sources of sling information. I found an article (**American Antiquity** vol. 18, No. 2 October 1952 "A Prehistoric Sling from Lovelock Cave, Nevada; Heizer and Johnson) from University of Nv. In Reno that covered a sling fragment found in Lovelock cave, Nevada on the partially mummified body of a 6 y/o male dating from about 272-792 B.C. It was made from Apocynum cannabinum, aka Indian hemp. This was the first easy to understand method of making a sling pocket that I'd found. So I made my first sling. Compared to my current slings it was a poor thing with a narrow pocket. I learned to add more cords to widen the pockets, and made many of my own tools to do the knotted fabric weaving to make the pocket. Later I learned how to do a simple weave to do the Andean style pockets. Roderick Owen's book **Braids 250 Patterns From Japan, Peru, & Beyond** helped me further improve my sling making, especially the braids. I don't consider myself an expert, merely a journeyman, and am continually learning more things as I make each sling. The slings I make currently are mainly from #18 nylon seine twine. Since the color choices available in that material are limited, I generally dye the twine myself to achieve the color choices I currently have. Those choices are black, scarlet, yellow, navy blue, dark green, teal, cocoa brown, and white. Occasionally I can get gold, pink, and light green commercially. I may add tan at a later date. I also make slings from 48 pound test hemp twine, but do this only in natural color. If you want one from me write me for a brochure.





[HOME PAGE](#) | [PRACTICAL SLINGING](#) | [DIRECTORY OF RELATED LINKS](#)

**TO CONTACT ME  
WRITE, CALL OR EMAIL  
JAMES BURDINE  
THE FIBERWORKS ARMORY  
1006 KINGSVIEW CT.  
HENDERSON, NV. 89015  
PHONE: 702-564-9606  
[JBURDINE@PIPELINE.COM](mailto:JBURDINE@PIPELINE.COM)**



## Des noeuds en Jèrriais



un noeud



un pliat noeud

### Jèrriais

### Angliais

un pliat noeud

reef knot

un noeud couothant

slip knot

un pouais

slip knot

un noeud d'goulet d'boutelle

sling knot

un noeud en tchu d'poulain

granny knot

un noeud d'ridgage

shroud knot

un noeud d'têchiéthe

cow hitch

eune bliouque

bow

un noeud d'pendard

hangman's noose

un noeud d'bôlinne

bowline knot

un huit

figure of eight knot

eune clié

hitch

eune doubl'ye clié

two half-hitches

eune démié-clié

half-hitch

un tchu d'por

wall knot

un noeud d'ièrrîn

manrope knot

eune êpisseuse

splice



un noeud d'pendard



un noeud d'bôlinne

du fi patcheux

parcel string

d'la touinne

twine

d'la ficelle	string
du cordon	cord
d'la cord	rope
du filin	rope



eune bliouque



un noeud couthant

eune aussiéthe	hawser
lé câbl'ye	cable
un hîssas	halyard
les râîngues	bolt-ropes
les raquelinnes	ratlines
les haûbans	shrouds
l'êcoute d'eune vaile	sheet of a sail





un huit



un noeud d'têtchiéthe

nouer

to tie

nouachi

to tie badly

faïthe un noeud

to tie a knot

êpissi

to splice

haler ès noeuds

to draw lots



eune démié-clié

eune doubl'ye clié

lé cordgi

ropemaker

la cordéthie

rope walk



un tchu d'por

un noeud en tchu d'poulain

*Viyiz étout:*

- [Haler ès noeuds](#)
- [La mé en Jèrriais](#)



# Les Pages Jèrriaises

# How to amaze your friends in seven easy steps!

- 1) Get easily impressed friends.
- 2) This is a Trefoil Knot, and this is a Surgeon's Knot:

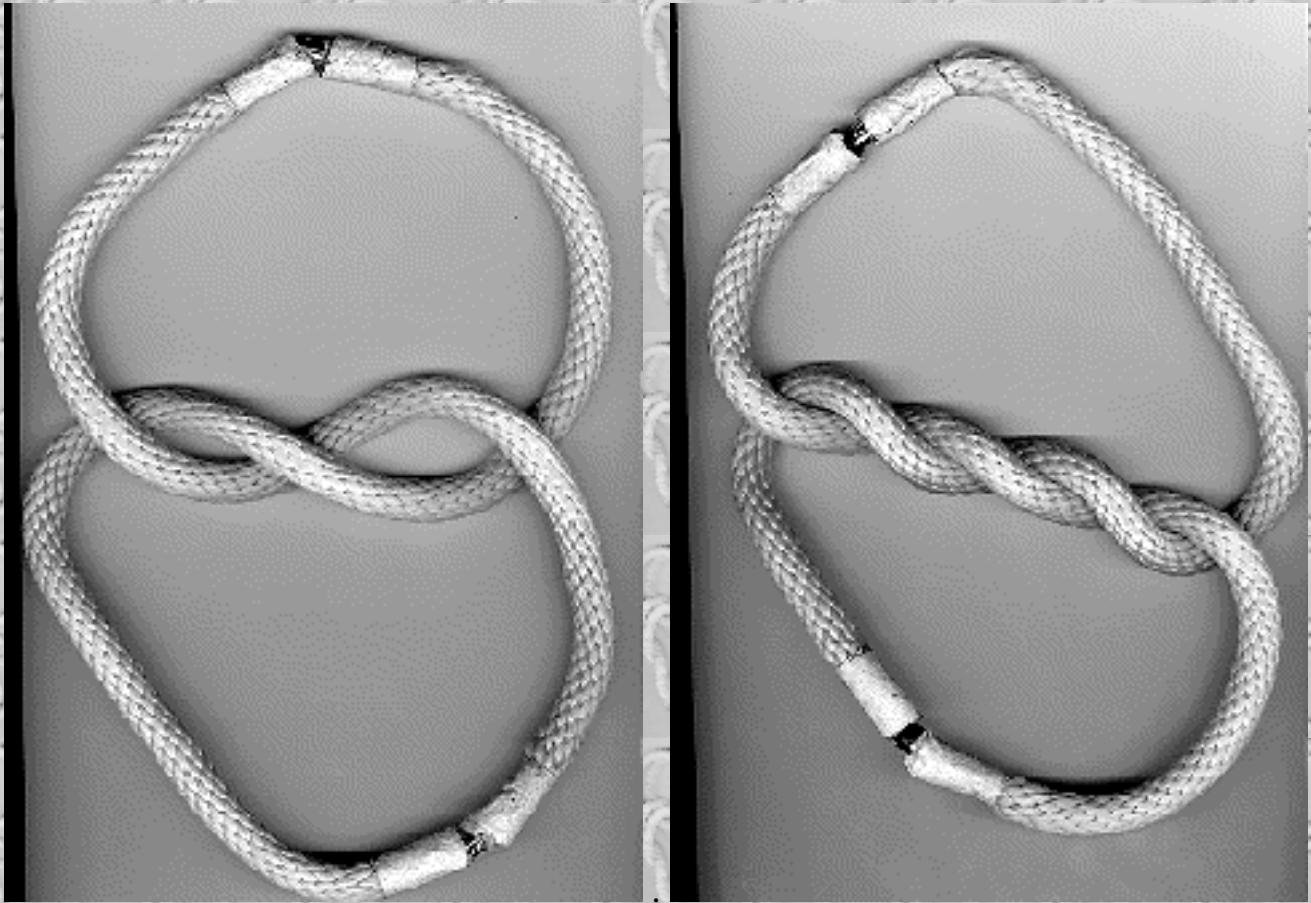

- 3) Splice the two knots together (note, of course, that the result is still knotted).
- 4) Gather four strands of the spliced together knots, as pictured:



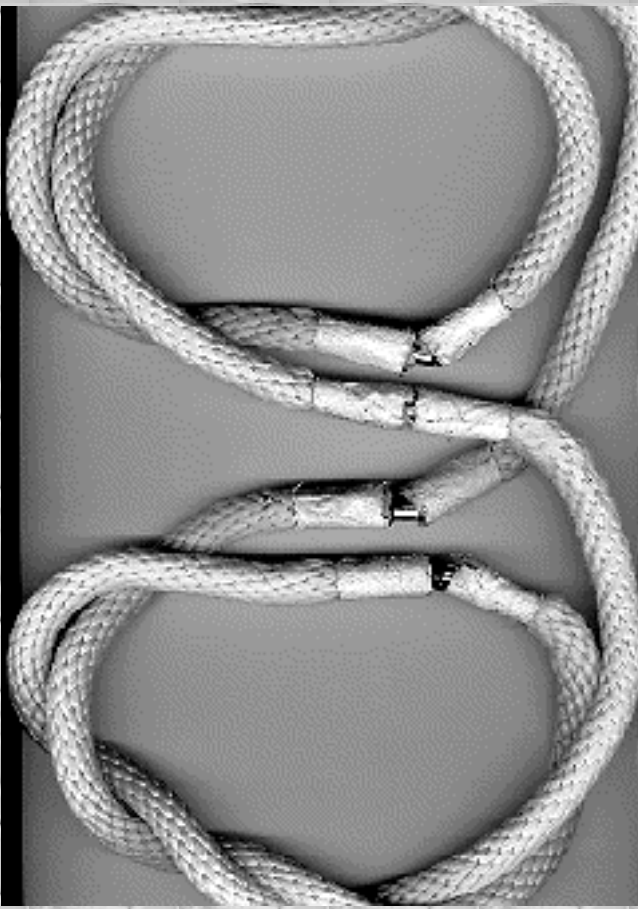

5) Break the strands!

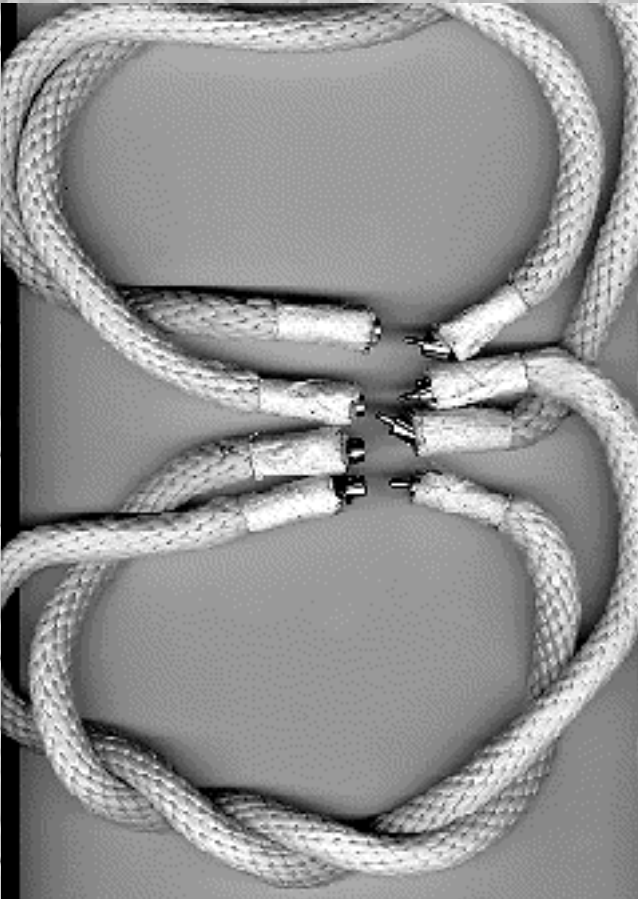

6) Give one full twist!!

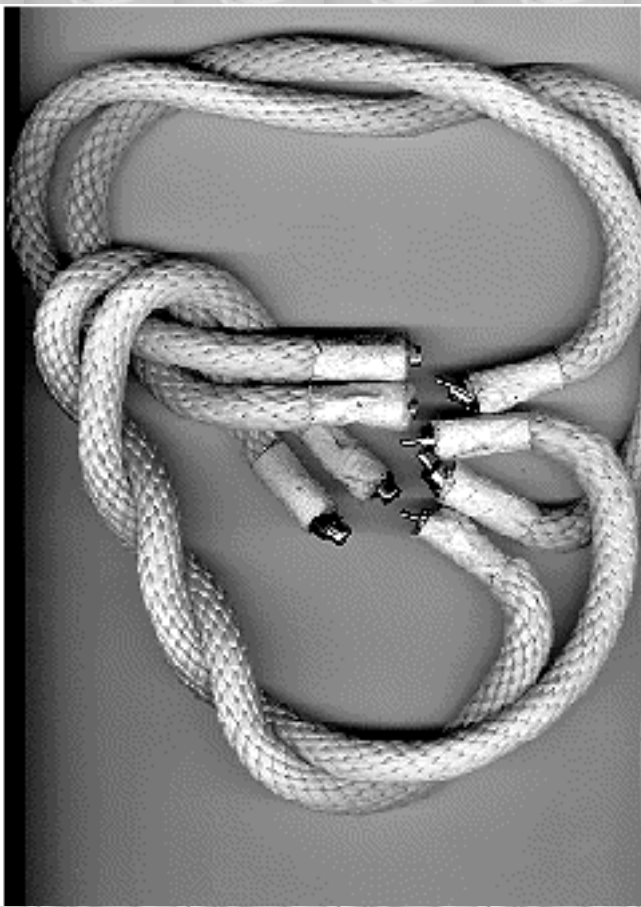

7) Reattach the strands and VOICI!

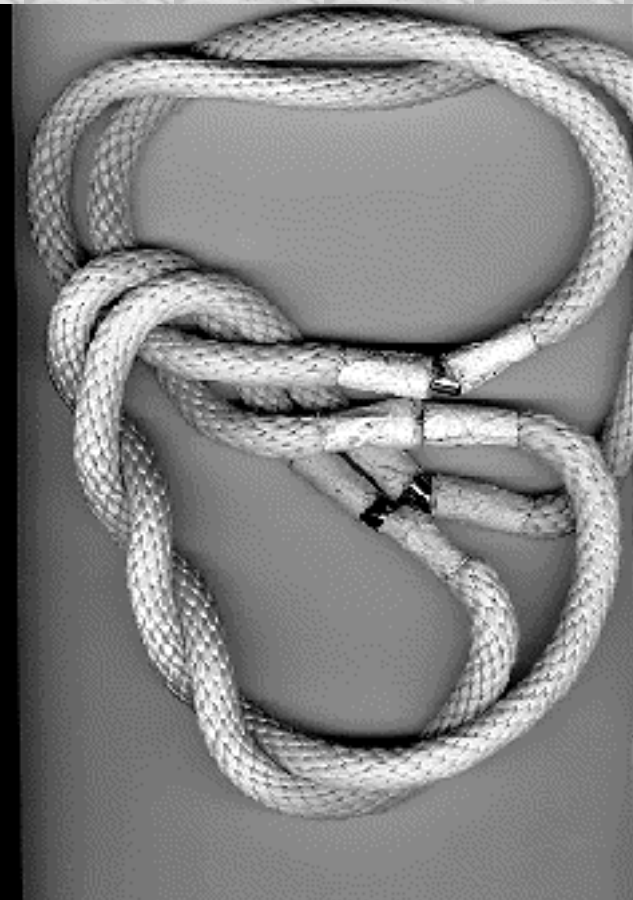

## It's Unknotted!

myriad examples (including some infinite collections of rope tricks), various theorems, and one conjecture, click for [my thesis](#). This example is due to K. Motegi.

---



[Chaim Goodman-Strauss](#)

Dept. Mathematics  
Univ. Arkansas  
Fayetteville, AR 72701  
[strauss@comp.uark.edu](mailto:strauss@comp.uark.edu)  
501-575-6332

# Fishing Knots

**A Grant's Guide By Herron Publications**

The average angler needs perhaps no more than three or four basic knots, but these knots relate directly to his mode of fishing. The game fisherman need have little interest in the knots used by the trout fisherman, who, in turn, uses knots that are not necessarily suitable for the bream fisherman.

Each knot dealt with in this book has its own definite and prescribed purpose. When properly tied, or formed, then worked or drawn up into shape, the knot can make all the difference between boating a big fish, or losing it.

I suggest that you select only those few knots that are of the greatest use to you, and practise, practise, practise tying them until they become second nature to you. It is most important that you use knots that can be tied in an easily remembered manner. There is little point using a knot that can only be tied by reference to a book - even this one. You'll be astonished how a few hours practice with a knot will make for perfection.

*Ern Grant, Author "Grant's Guide - Fishing Knots & Rigs"*

[Find out more about fishing knots and rigs....](#)

---

This fishing knot guide is brought to you by [Fishing Cairns](#) - *If You Can't Catch It In North Queensland, It's Probably Not Worth Catching.*



**International Angler Ring**  
**Current Global Rank #4**

[previous cast](#) | [random](#) | [poll](#) | [tackle](#) | [search](#) | [next cast](#)

IAR powered by [FishNation](#) [Join today](#)

<b>RANKED: 10</b>	<b>RANKED: 19</b>	<b>Fishing Top 100 Sites</b>	<b>RANKED #46</b>
-------------------	-------------------	------------------------------	-------------------

[Web Site By Port Douglas Internet Services](#)



# Barrell Knot



Start with a two ends pointing towards each other and overlap them ~ 1 foot. Pass the Right hand rope (the one pointing away from you) over the other and back under



Cross the same end over itself making an X

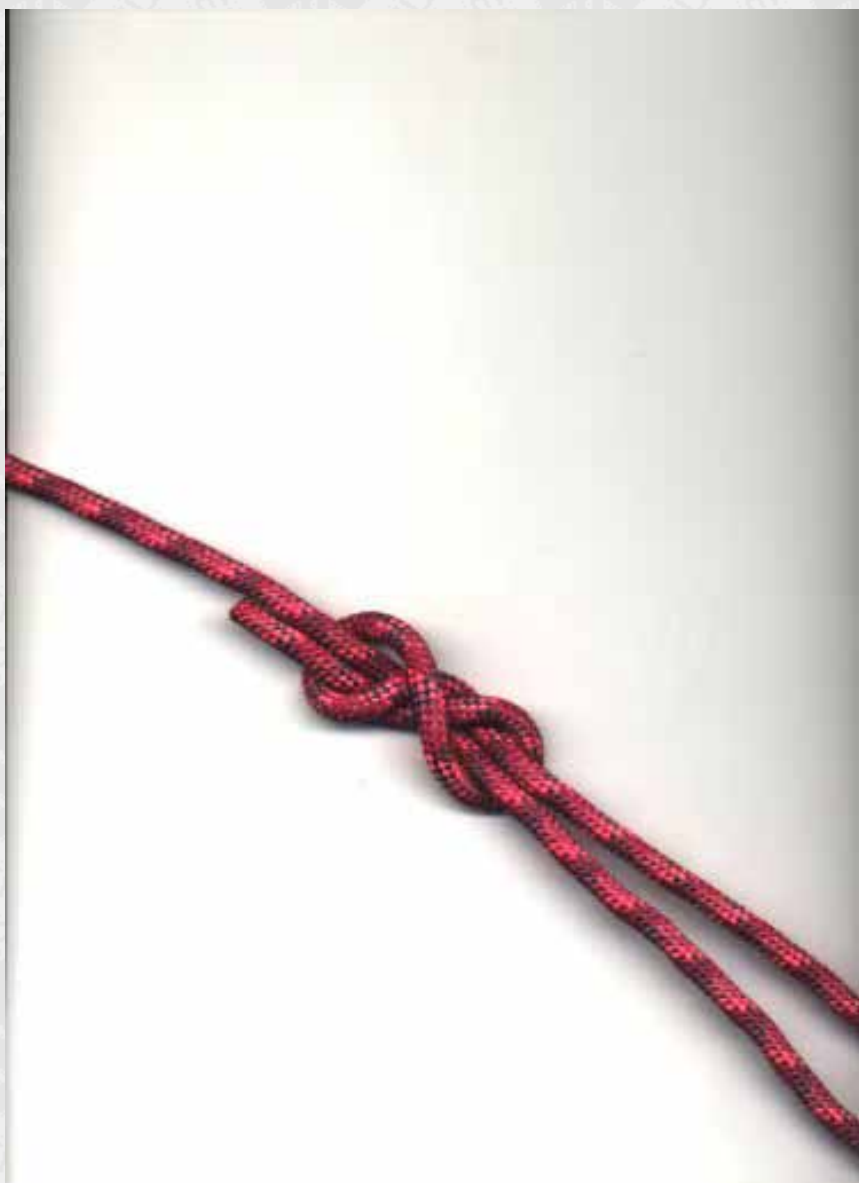

Pass the end UNDER the X and pull tight



Flip the entire works around and do the same thing on the other side. When you're done, you should have two sliding knots like these.





The finished knot.

Pull the outside ropes, and the two knots should slide together and the X's should mesh. If they don't the knot is wrong and you should start over.

[Back to Main Knot Page](#)

# Chinese Knotting: The Treasure Knot

[ [Generalities](#) ] [ [Nomenclature](#) ] [ [Similar Knots](#) ] [ [How To](#) ] [ [Home](#) ] [ [Books](#) ] [ [Links](#) ] [ [Supplies](#) ] [ [Glossary](#) ] [ [About](#) ]

## Generalities



I came by the instructions for this particular family of knots from a single [book](#), which is why I have classified them all together, despite there being what seems to be 2 distinct knot groups here. I may at some future date split this page, but until then... Only [Ashley's](#) #2463 bears any resemblance to any of this family of knots, so I have named the first one *bao* (a romanization of the Chinese name of the book in which I first found the instructions), the second type I am having great difficulty in executing (the instructions are quite sparse), but may end up being the *treasure knot* by default). In any case, it should be named by the time the instructions are completed.

The construction of the double bao knot is symmetrical in nature, so you will only be able to make knots with an even number of ears.

## Nomenclature

[The Treasure Knot](#): Double Bao (2), Triple Bao (3), Quadruple Bao (4), etc.

[Ashley's](#): #2463 (Two part Quadruple Bao, Bao4x2)

## Similar Knots

- [Flower Knot](#)
- Star Knot

## How To

Bao 2x: [4.](#)  [6.](#)  [8.](#)  [n.](#) 

## General Tips

- **be very clear on which loops are part of the central structure of the knot and which loops are ears as you are tightening the knot.** With the bao knot it is very easy to get confused and it's just a few tugs from finished construction to irretrievable mess, although, it is actually easier to distinguish ears from knot loops the larger (more ears) the knot.

## 2x4 Bao

The 2x4 bao is the smallest of the double bao knots. See the [detailed instructions](#) for construction information.



## 2x6 Bao

As previously mentioned, the construction method is symmetrical, so there are no odd numbered bao knots. The next larger bao knot after 2x4 is the [2x6 bao](#).



## *n* Bao

Tie the [2x4 bao knot](#), then tie the [2x6 bao knot](#). [The pattern](#) for making as large a double bao knot as desired (even as large as [12](#), [14](#) or more) should become clear.



---

[CLW](#)

Creation Date: Mon Sep 21 12:06:36 PDT 1998

Last Modified: *Friday, 14-Jul-2000 08:14:47 GMT*

Page accessed at local time: Friday, 03-Sep-2004 04:24:17 GMT



[Home](#)  
[E-Mail](#)

## KNOTBOARD OF THE MONTH

### RINGBOLT HITCHING:



#### Description ----

A series of interlocking lark's head knot that form a ridge around the outside of a ring or loop.

#### Use ----

To prevent chafing; as a decoration.

#### Comments ----

There are many forms of ringbolt hitching, the form shown here is one of the simplest and does not require the use of a needle as many other forms do. Ringbolt hitching was used to prevent chafing of ropes that were reeved through hand forged iron rings and to keep them from clanging against objects around them. In the present,

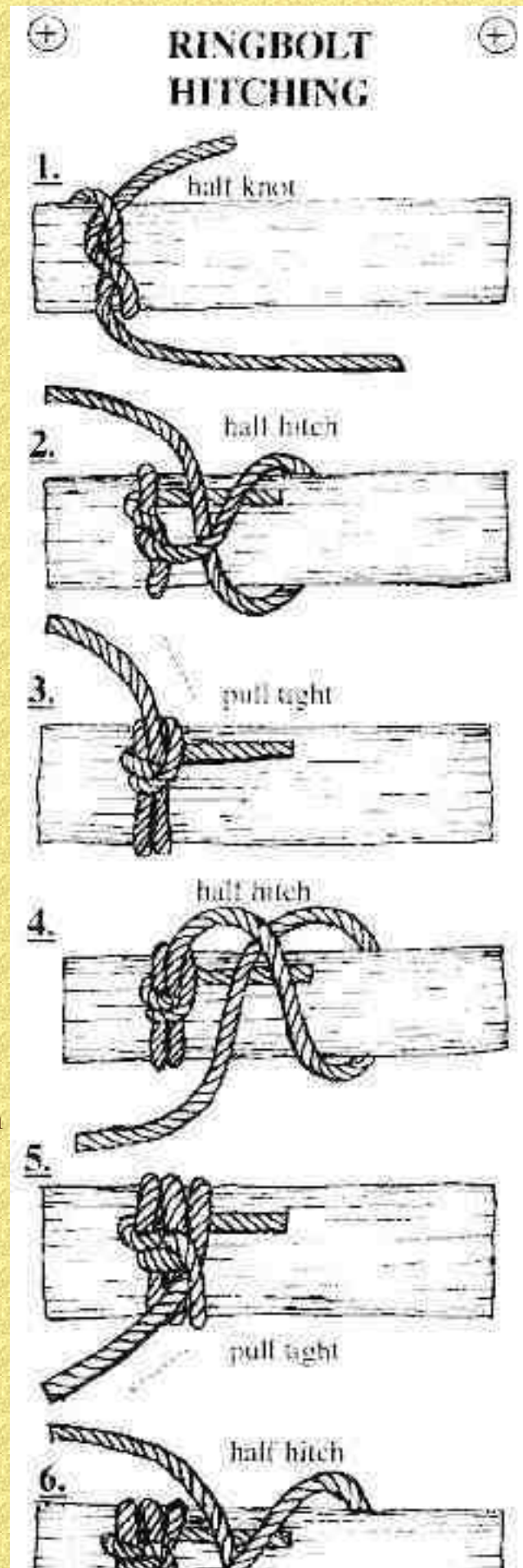



ringbolt hitching can be used to protect synthetic ropes that are easily chafed by applying a layer of material that is not easily chafed.

### Other Names ----

Platted Ring; Hog Backing; Cockscombing.

### Narration ----- (For Ringbolt Hitching knotboard.)

(1) Start the ringbolt hitching by tying a half knot around the object. (2) Tie a half hitch around the object so that the standing end is trapped under the half hitch. (3) pull the half hitch tight. (4) Tie the next half hitch in the opposite direction around the object. (5) Pull the half hitch tight. (6) Tie another half hitch in the opposite direction around the object; the same direction as the first half hitch. (7) Pull half hitch tight. (8) When the length of the ringbolt hitching is within 5 or 6 half hitches of being long enough; form a bight in the a short piece of twine so that the eye of the bight is toward the end of the work. (9) Continue to add half hitches until the ringbolt hitching is completed; reeve the running end through the eye of the bight. (10) Use the short piece of twine to pull the running end under the half hitches. (11) Cut off the end of the twine.

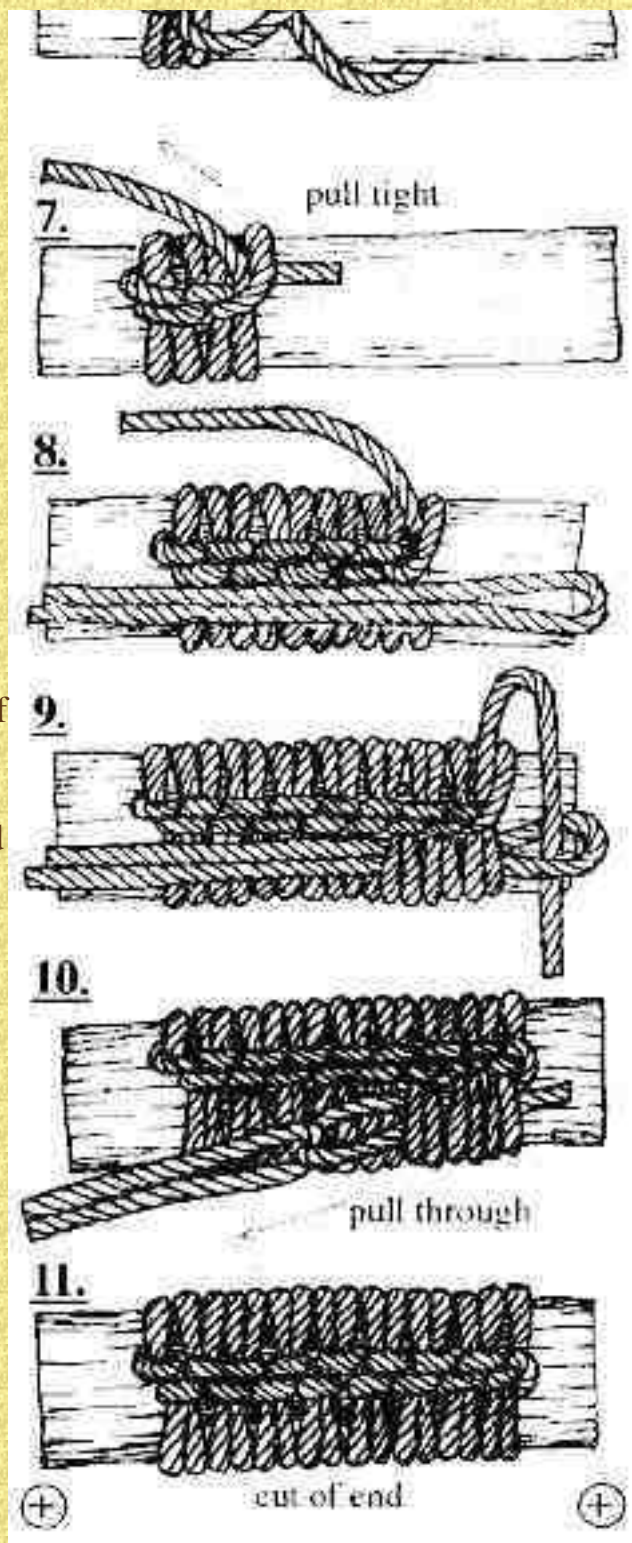



Home  
E-Mail

# BOATSWAIN'S WHISTLE KNOT

## RERUN ANIMATION

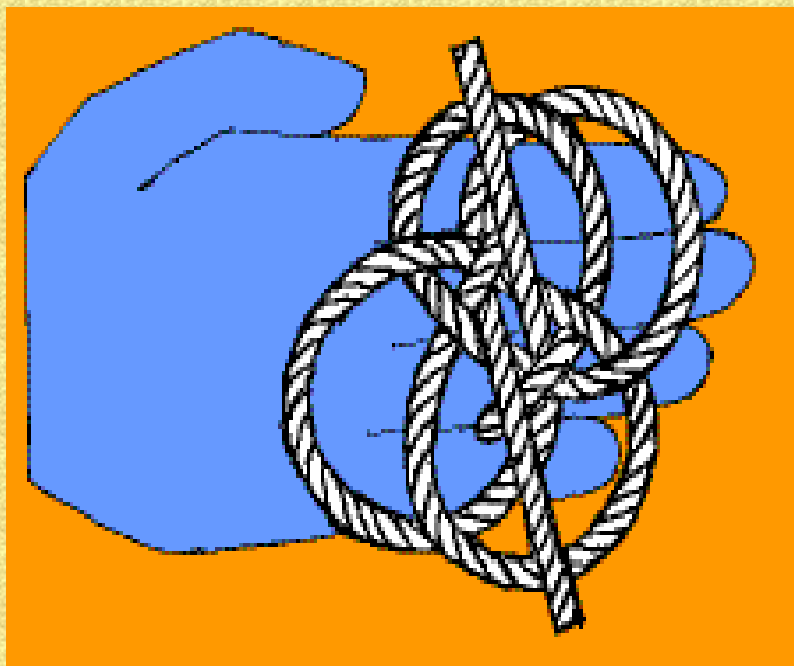

Home  
E-Mail

[Back To](#)[Standard copyrights and disclaimer.](#)[Back To](#)[Ropers Knot Page](#)

# Stoppers (🚫)

Knots on the end.

[Ropers Knot Page](#)

Knots on the end of a rope or yarn. There are a lot of situations where you need a knot like this.

Every application has its own special demands for knot properties. So you have to choose carefully. You can use a stopper to prevent a rope or yarn from unfolding, but please do that only in cheap rope/yarn. Use a proper whipping in all other cases.

## The Overhand Knot

### The Overhand Knot or Half Knot

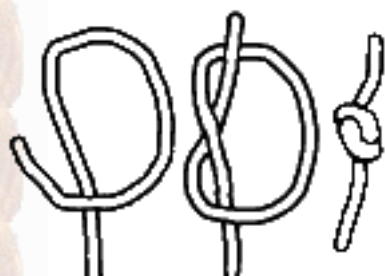

This is the simplest knot. Therefore probably the most used. The knot is very useful to support knots in yarns. The loose ends become a bit thicker. When this support makes the total bend too bulky you have to look for another bend. The overhand knot is not strong, so it is not used in situations where you might expect great force. It also reduces the strength of the rope or yarn by about 50%. But as an "anti-slip-knot" it does not have to withstand a lot.

[This knot on the WEB.](#)

## The Double Overhandknot

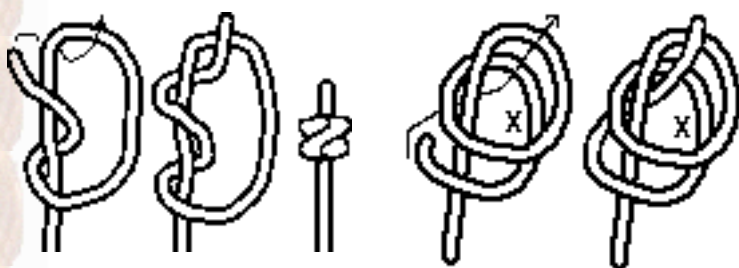

The double overhand knot is beautiful, thicker than the common overhand knot, but not any stronger. But use it with caution. The double overhand knot is also called the bloodknot when it is used at the end of a whip. This knot has several ways of tying and in principle two ways of working up.

Both ways of tying shown here also show both results. The bloodknot shown in the middle is the preferred way of working up the second way of tying marked with the crosses. The bloodknot is very hard to untie after it has been under stress. If you put an object through the cross-marked hole the knot will work up as the [strangleknot](#). It is usefull to practice this way.

[This knot on the WEB.](#)



# the Multifold-Overhand-knot



If you make more than two turns in the overhand knot it will be fatter. (But hardly stronger.) In twined rope it is important to work up the knot very carefully. (It will not only look neater, it wil prevent 'kinking' which will weaken the rope even more!)

[This knot on the WEB.](#)

## The (Flemish) Eight



This knot is larger, stronger and more easy to untie than the overhand knot. It does not harm your rope as much as the overhand knot does. So therefore sailors use this knot in most cases. (! not for bend support, where the smaller overhand is used, or in rope, a permanent small stopper)

[This knot on the WEB.](#)

Any comment, suggestions, anything mail me:  *qqqq*  
at *realknots.com* with subject "*question*"

All mail without thr right subject is flussed unred.  
automaticly.

I am sorry I had to remove the mail link. The mailgrabbers  
and spammers won. But.... I have a few hidden mail address  
for them to mail to each other after they grabbed it.



Because this is an non-comercial site I can and will not allow junk mail nor spam. Therefore comercial, non-personal and bulkmail will be charged with handling costs of \$100 per mail.

[Back To](#)



[Ropers Knot Page](#)

[Standard copyrights and disclaimer.](#)

[Forward To](#)



[The Bends](#)

# Bög



Kötélvég kibomlása ellen, más csomóknál a szabad végek kicsúszásának megakadályozására.

<< | [#eleje](#) | [index](#) | [levél](#) | [Dupla bög](#) >>

Utolsó módosítás: 2002.09.26 23:41:34 CEST

# Bowlin

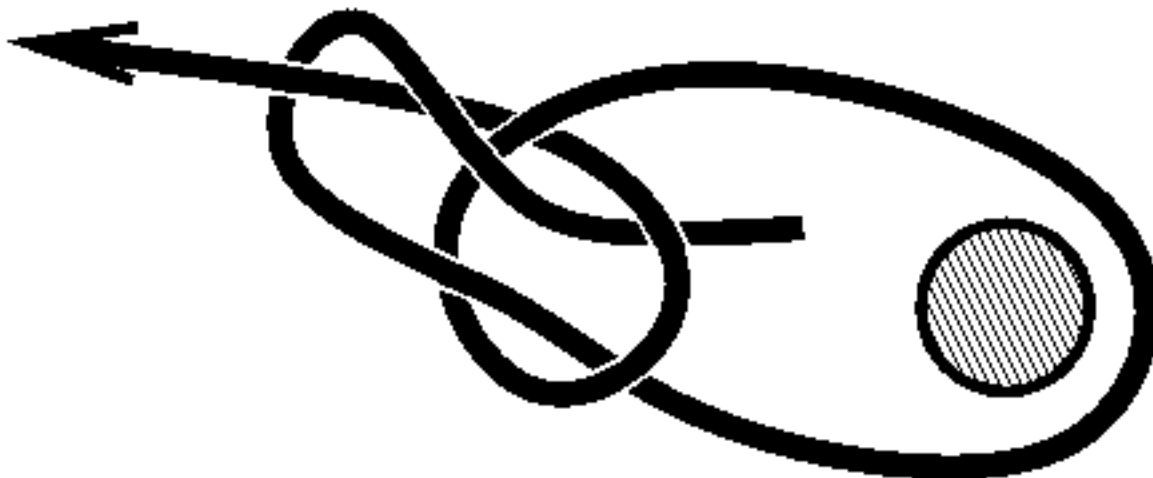

Állóhurok. Eleg jól tart. Még akkor is viszonylag egyszerű kibontani, ha megszorul és vizes. Ui. a szár körüli kis fül nem feszül meg. (Persze ha uszályt vontatsz vele, akkor úgymarad.) Más néven paalsteek. Le kell biztosítani a

kötélvéget.

[<< Zászló~](#) | [#eleje](#) | [index](#) | [levél](#) | [Dupla bowlin >>](#)

Utolsó módosítás: 2002.09.26 23:41:34 CEST

# Bowline



- A commonly used knot to tie a loop in the end of a rope. It has the advantage of not jamming, compared to some other loop forming knots (for example when using an overhand knot on a large bight to form a loop).
  - Form a small loop (the direction is important), and pass the free end of the knot up through the loop, around behind the standing part of the rope, and back down through the loop.
  - A chant used by many to remember this knot is "The rabbit comes out of the hole, round the tree, and back down the hole again", where the hole is the small loop, and the rabbit is the running end of the rope.
  - In the same way that a [Left Handed Sheet bend](#) is a [Sheet bend](#) that has the running end of the rope coming out of the wrong side of the knot, a cowboy bowline is a bowline that also has the running end of the rope coming out of the wrong side of the knot. It suffers the same problems as the left handed sheet bend.
- 
- Tip. Don't be afraid to use this knot to form a loop of any size in rope.
  - Tip. To quickly identify if you have tied the Bowline normal or left handed, check to see that the running end exits the knot on the inside of the loop.
  - Tip. For added security, finish the knot with a stop knot such as a [Figure of Eight](#) knot to remove any possibility of the Bowline slipping.
  - Tip. If you use this knot in a man carrying situation - perhaps a rescue where a harness is unavailable - then you **MUST** use a stop knot as mentioned above.



 [Return to Knot Menu](#)

---



*Copyright (C) Dick Ruck 1997*

[Ovingdean Saltdean Rottingdean Telscombe Cliffs Peacehaven Newhaven PC Computer Repair,  
Training and Virus Help](#)



[Home](#) [Sections](#) [Local Branches](#) [Events](#) [Resources](#) [Miscellaneous](#) [Whats's New](#) [Search](#)

## Campcraft Badge - Explorer Level - Knots and Lashings

[Round Turn and Two Half Hitches](#)

[Sheep Shank](#)

[Bowline](#)

[Diagonal Lashing](#)

[Figure of Eight Lashing](#)

[Whipping of your choice](#)

### 1. Round Turn and Two Half Hitches

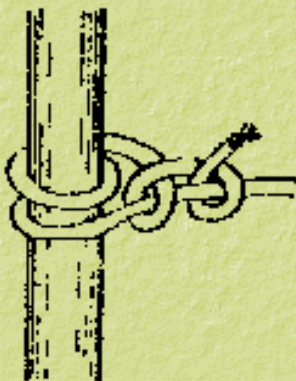

This knot is used to make fast a rope to an anchorage. It can be tied while the standing part is under strain. This is a good knot to attach your rope to an anchor for a flying fox or a bridge.



### 2. Sheep Shank

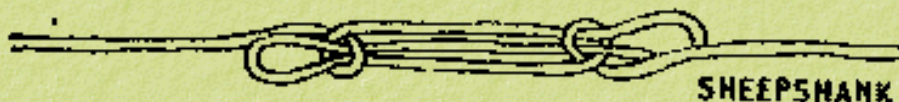

SHEEP SHANK

A knot tied in the bight for shortening a rope or taking up the slack, without cutting it. It can also be used to protect a weak damaged, or frayed section of the rope.



### 3. Bowline



The most useful and one of the simplest ways of putting a fixed loop in the end of a rope. It is easy to tie and untie, it never slips nor jams and has a high breaking strength.



#### 4. Diagonal Lashing

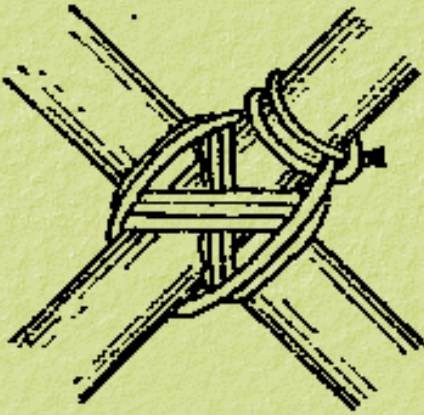

Used when two crossing spars tend to spring apart. Commonly used for the centre lashing on the diagonal braces of a trestle.

- Begin with a timber hitch.
- Do three diagonal turns across one way.
- Then three across the other way.
- Pull the lashing together with about three frapping turns
- Finish off with a clove hitch.



#### 5. Figure of Eight Lashing



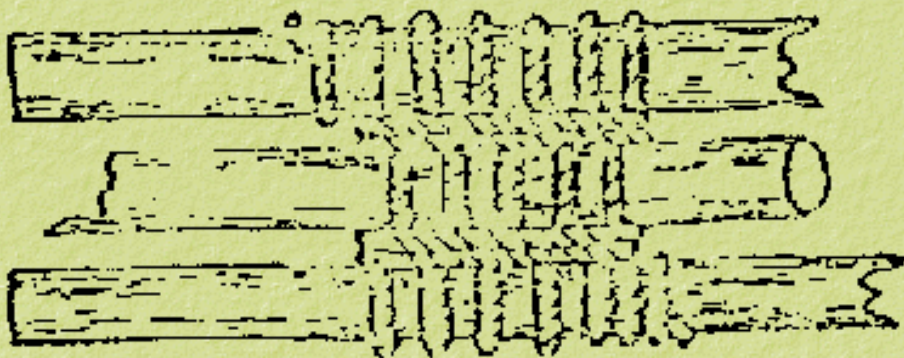

Used to make tripods. Lay spars with two running one way and the third in the other. Start with a clove hitch on one outer spar then take turns over and under. Make frappings between spars. End with a clove hitch on opposite spar to start.



## 6. Whipping of your choice

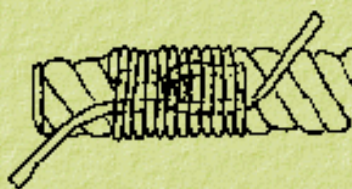
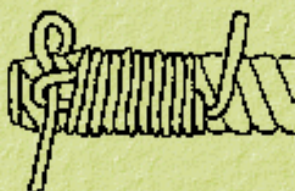

---

[Home](#) | [Sections](#) | [Local Branches](#) | [Events](#) | [Resources](#) | [Miscellaneous](#) | [What's New](#) | [Search](#)

---

[WebSpace Donated Courtesy of ARCON Web Services](#)





Gerald L. Findley, all rights reserved

## Knots

The use of rope in the workplace was common practice until the midpoint of this century. At that time, modern materials handling techniques started to be used and the use of ropes declined. Along with this decline in the use of ropes in the work place there was also a decline in the knowledge of how to use rope safely.

The more common uses of rope by the average person is the securing of a load to a personal vehicle or for recreational purposes. Both of these uses require a knowledge of how to choose and tie safe, secure knots. If this knowledge is not available, the consequences can be devastating, resulting in personal injury or the loss of personal equipment.

For the last 35 years I have been learning and teaching about rope. My experience in teaching about rope has shown me that most people must be shown how to tie a knot in small, sequential steps, and they must be shown many times before they can tie a knot with confidence.

In preparing this book I have attempted to design a set of teaching aids that present each selected knot, splice, or lashing in small, sequential steps. These teaching aids enable the learner to study each step and to duplicate it with a length of practice rope.

The knots, splices and lashings presented in this book were selected because of their use by the Boy Scouts of America and others who are interested in outdoor recreation.

The following knots and hitches are covered in :

# ROPE WORKS

- Whipping (3 methods)
- Service
- Grapevine Service
- Ringbolt Hitching
- Seizing
- Seizing With Racking Turns
- Figure Eight
- Figure Eight On A Bight
- Stevedore Knot
- Stopper Knot
- Square Knot
- Water Knot
- Sheet Bend
- Double Sheet Bend
- Sheet Bend (Short End)
- Bowline
- Bowline On A Bight

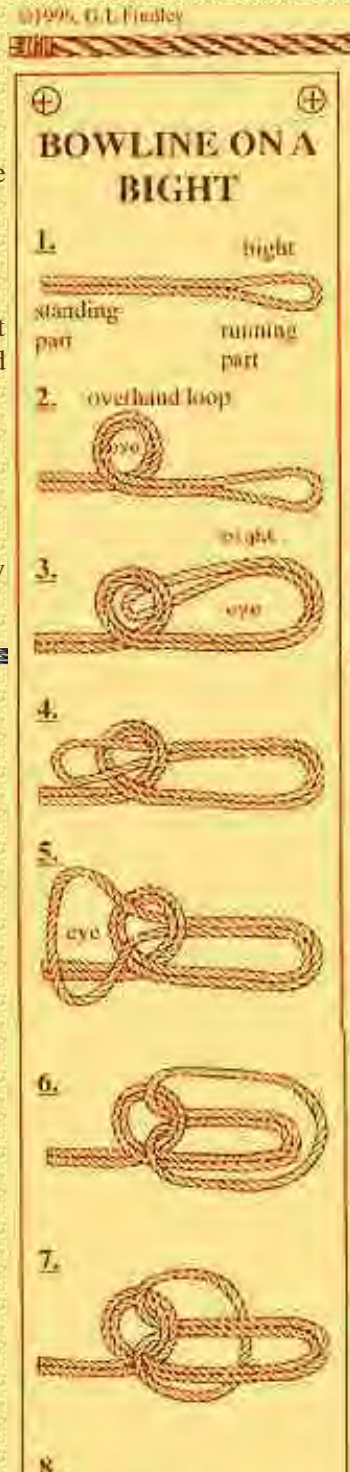

French Bowline  
Lineman's Loop  
Sheepshank  
Trumpet Knot  
Sheepshank (Quick)  
Clove Hitch  
Constrictor Knot  
Monkey's Paw  
Turk's Head  
Two Half Hitches  
Taut-line Hitch  
Timber Hitch  
Mooring Hitch  
Marlin Spike Hitch  
Marlin Spike Ladder  
Anchor Bend  
Belaying To A Cleat  
Jug Knot

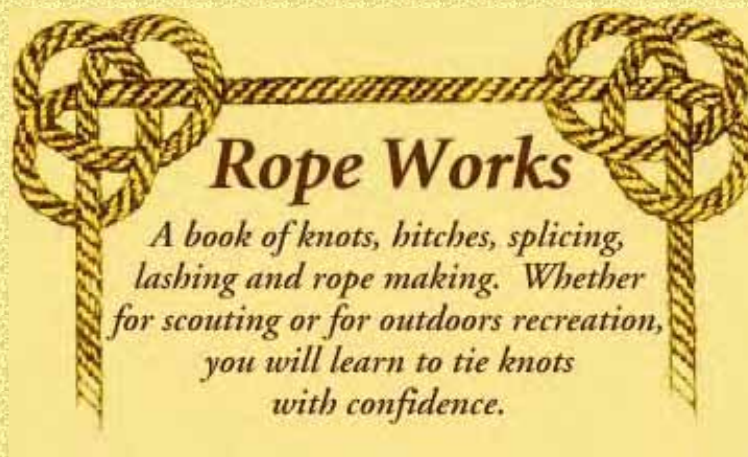
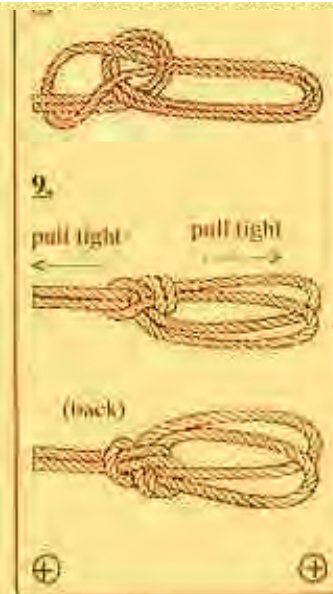

**Order a copy of RopeWorks now !**



**Home**  
**E-Mail**



Page has moved

[Click here...](#)

# [ScoutDB.org](http://ScoutDB.org) presents *"How To Tie A Tie"*

As a service to the more fashion challenged (like me) ScoutDB presents the following primer on how to tie a tie. And be sure to check out [what others are saying](#) about ScoutDB's H2TaT.

Note that all images below are mirror images. That is, it is what you would see when looking into the mirror.

---

## The Windsor Knot

Wide and triangular - for wide spread shirt collars



1. Start with wide end of the tie on your right and extending a foot below narrow end.
  2. Cross wide end over narrow and bring up through loop.
  3. Bring wide end down around behind narrow and up on your right.
  4. Then put down through loop and around across narrow as shown.
  5. Turn and pass up through loop and...
  6. Complete by slipping down through the knot in front. Tighten and draw up snug to collar.
- 

## The Half-Windsor Knot

Medium symmetrical triangle - for standard shirt collars



1. Start with wide end of the tie on your right and extending a foot below narrow end.
2. Cross wide end over narrow and turn back underneath.



3. Bring up and turn down through loop.
  4. Pass wide end around front from left to right.
  5. Then up through loop...
  6. And down through knot in front. Tighten carefully and draw up to collar.
- 

## The Four-In-Hand Knot

**Long and straight - to complement a standard shirt collar**



1. Start with wide end of the tie on your right and extending a foot below narrow end.
  2. Cross wide end over narrow and back underneath.
  3. Continue around passing wide end across front of narrow once more.
  4. Pass side end up through loop.
  5. Holding front of knot loose with index finger, pass wide end down through loop in front.
  6. Remove finger and tighten knot carefully. Draw up tight to collar by holding narrow end and sliding knot snug.
- 

## The Bow Tie

**For the man who dresses with a certain flair**



1. Start with end in left hand, extending 1.5 inch below that in right hand.
2. Cross longer end over shorter and pass up through loop.
3. Form front loop of bow by doubling up shorter end (hanging) end placing across collar points.
4. Hold this front loop with thumb and forefinger of left hand. Drop long end down over front.

5. Place right forefinger pointing up on bottom half of hanging part. Pass up behind front loop and...
6. Poke resulting loop through knot behind front loop (see illustration). Even ends and tighten.

---

[Bob Baggerman](#)

[bob.public@mindspring.com](mailto:bob.public@mindspring.com)



[ScoutDB Home](#)

6/21/2003

<http://www.scoutdb.org/h2tat/>

[Standard copyrights and disclaimer.](#)

[Back To](#)  [The](#)  
[Stoppers](#)

## Bends ( )

To 'unite' two ropes.

[Back To](#)   
[Ropers Knot Page](#)

### The reef-knot



The reef-knot is only useful in simple applications. Ashley says "it is a true Binder Knot, for which it is admirable, but under no circumstances should it be used as a bend." It is easy tied and will not jam, so it is always easy to untie. It is used to tie packages, and as a base for the shoe-bow. Sailors used it for binding rolled sails or better reefed sails. And that is where it got its English name from. Americans call it the square knot. Probably because it looks square, or because it was much used on square-rigged-ships, but that is a total guess of me. Its relatives, the granny, the thief-knot and the what-knot all have their purposes, but not as a trustful knot.

For more information on the reef-knot-family you may visit the [Reef-knot Family](#).

### The Sheet Bend

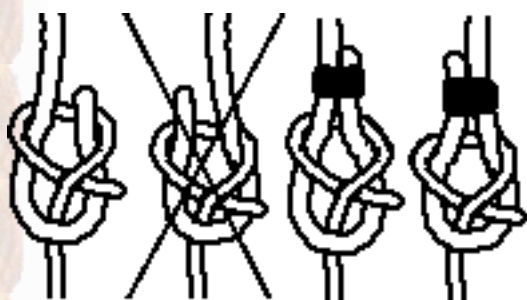

The sheet bend is my favorite bend. Be careful. With the loose end on the wrong side you have an other, weaker knot (Left-hand sheetbend). If the knot is well seized it does not matter if it is tied right or left handed

For more information on the reef-knot-family you may visit the [Sheetbend Family](#).

### The Carrick Bend / The Josephine Knot





Also known as Full carrick Bend, Sailor's Knot and Anchor Bend. Beware! There are not many knots with so much wrong drawings as this bend. The ends have to be on opposite sites and the crossings always are alternating up/down/up/down... The Carrick Bend is one of the best knots. Ashley states it is possible the nearest thing we have to a perfect bend.

It does not easily slip, not even if the rope is wet. And it is always easy to untie, also after a heavy load. If used as a Hawser bend in heavy material it is always seized and parceled to save wear.

### The Josephine Knot

In the Macrame this knot is called the Josephine Knot. It is self evident the Josephine knot is not seized nor pulled tight.

## The True Lovers or Fishermans's Knot



The True Lovers, or Fisherman's Knot may be laid in two different ways. Which of both the is the stronger, I do not know.

With two equal [overhandknots](#) it is symmetrical. This is probably the most used variant.



With two different overhand knots you get the most beautiful version (always work it up neatly!)

Only ... The double eight is stronger, easier to untie after use and as decorative from all sides as the true lovers at best.

## The Weavers-Eight

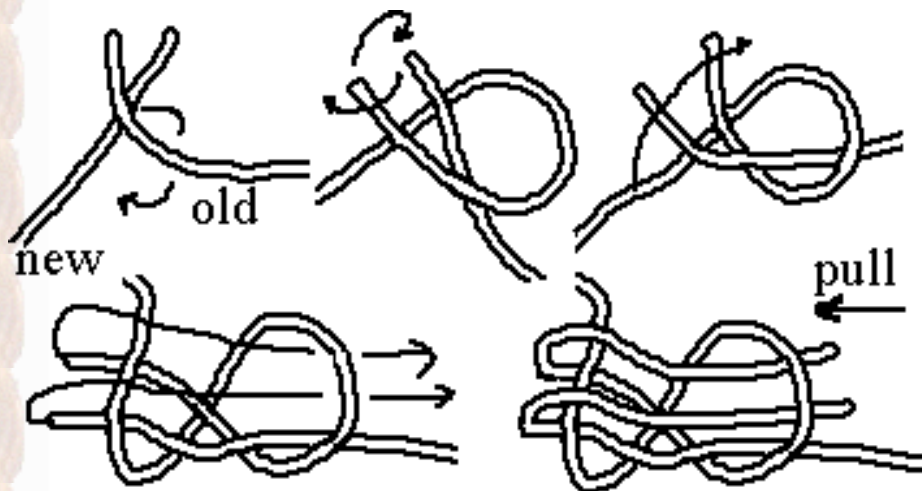

This is the best weaver knot I know. Although it looks difficult to tie, it is actually very easy. Fast to tie with small material, and reliable for wool, linen and most other weaver materials. Because both loose ends fall back over the standing part, it has an almost perfect lead.

Hold both threads together on the crossing between your thumb and finger. (first drawing)

Twist both threads together while you hold the cross in two simple movements. (first/Second



drawing)

Now, you pull over the standing part of the line you tie on, (third drawing)

And put both loose ends over the line you tie on through the loop you just created.

Now let loose the cross and hold the loose ends fixed to the standing part of the line you tie with and pull the knot tight.

This knot is related with [The \(Flemish\) Eight](#). You can observe this by removing the thread you tied the knot with, leaving the thread you tied the knot on unchanged. If you have difficulties in learning this knot, you can start by practicing the flemish eight in the thread you want to tie on, using an imaginary thread to tie with.

**For the other direction**

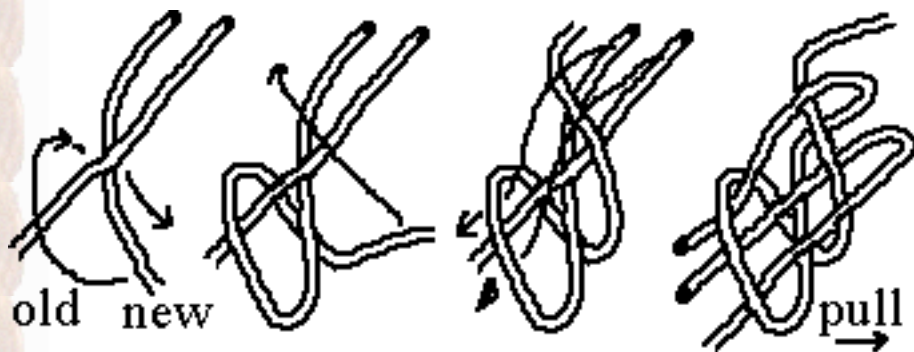

A weaver on a traditional weaving loom never knows in advance in what direction the next line has to be tied. Therefore he has to know two ways of tying the weaver knot. One for each direction. This is the same Weavers-Eight but tied different. Tied this way the knot points to the other direction.

Any comment, suggestions, anything mail me:  *qqqq*  
at [realknots.com](http://realknots.com) with subject "question"

All mail without the right subject is flushed unread automatically.

I am sorry I had to remove the mail link. The mailgrabbers and spammers won. But... I have a few hidden mail addresses for them to mail to each other after they grabbed it.

.....

Because this is a non-commercial site I can and will not allow junk mail nor spam. Therefore commercial, non-personal and bulkmail will be charged with handling costs of \$100 per mail.

[Back To Ropers Knot Page](#)



[Standard copyrights and disclaimer.](#)

[Forward To Hitches](#)

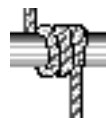



# Home ARCHIVE

## KNOTBOARD OF THE MONTH

Each month there will be new knotboard and descriptive text displayed on this page.

THIS MONTH'S IS THE :

### BELAYING TO A CLEAT:

Use ----

To secure a flag lanyard, to moor a boat to a dock.

Comments ----

Belaying to a cleat is a fast non-jamming method of securing a rope anywhere along its length without reeving any part of the rope through or around anything.

Narration ----- ( For Belaying to a CleatKnotboard.)

(1) Take a turn around the cleat and pull the line tight. (2) Complete a round turn around the cleat . (3) Place the line across the cleat. (4) Take a bight around one horn of the cleat. (5) Place the line across the cleat a second time. (6) Take a bight around the other horn of the cleat to form a figure eight around the horns of the cleat. (7) Repeat steps 3 through 6. (8) Form an underhand loop. (9) Place the eye of the underhand loop over the horn of the cleat. (10) Pull the underhand loop tight to form a half hitch around the horn of the cleat, this locks the rope in place.

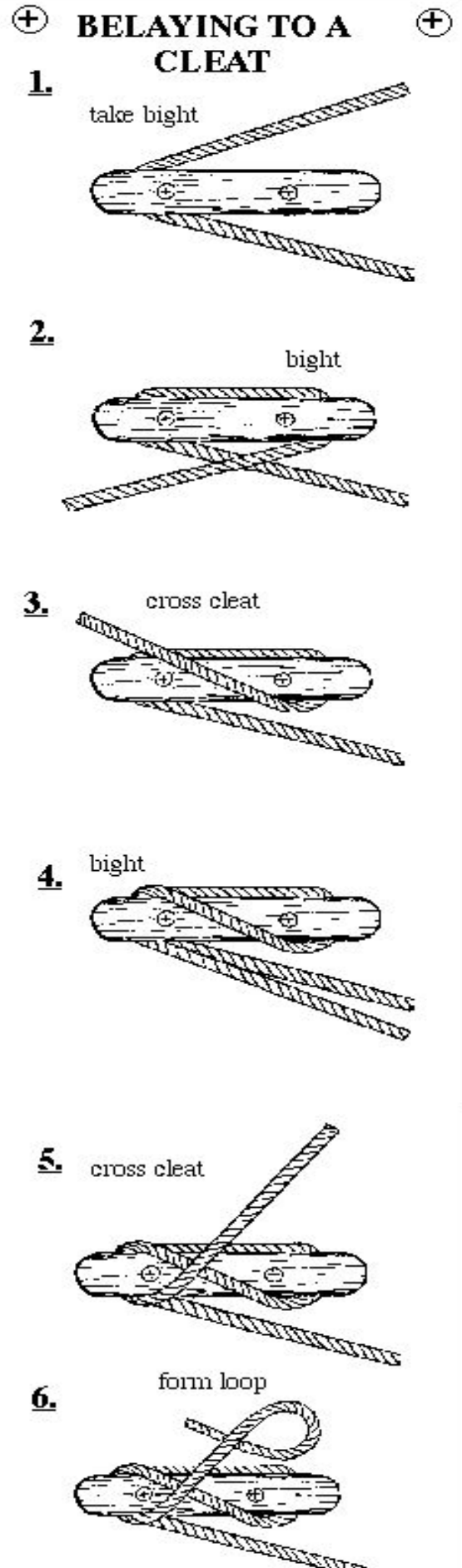

## ANIMATED KNOT



## BELAYING TO A CLEAT

---

## KNOTBOARD OF THE MONTH ARCHIVE

---

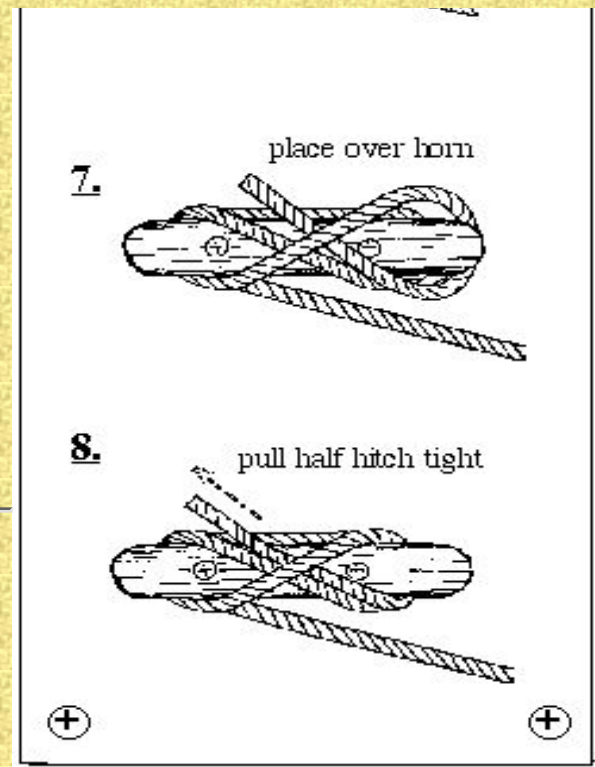

Home  
E-Mail



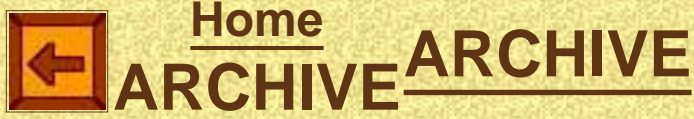

## KNOTBOARD OF THE MONTH

Each month there will be new knotboard and descriptive text displayed on this page.

**THIS MONTH'S IS THE :**

### FLOOR LASHING:

Use ----

to lash a series of poles to a set of stringers to form a flat surface such as a deck, a table top, or a road way.

Comments ----

When using a floor lashing, both ends of the decking poles must be lashed at the same time to insure a firm even surface.

When placing the decking poles on the stringers, lay the decking poles so that their butt end are in alternating direction. Alternating the butt ends of the decking poles will compensate for the natural taper of the poles so that the length of the decking along each stringer will be equal.

Narrative ---- (For floor lashing knotboard)

(1) Tie a clove hitch around each stringer. (2) Secure the short end of the rope by wrapping it around the running end (wrap with the lay of the rope ). (3) Place the decking poles on the stringers and take a bight around the first pole. (4) Next, on the inside of the stringer, pull a bight up between the first decking pole and the next decking pole. (5) Place the eye of

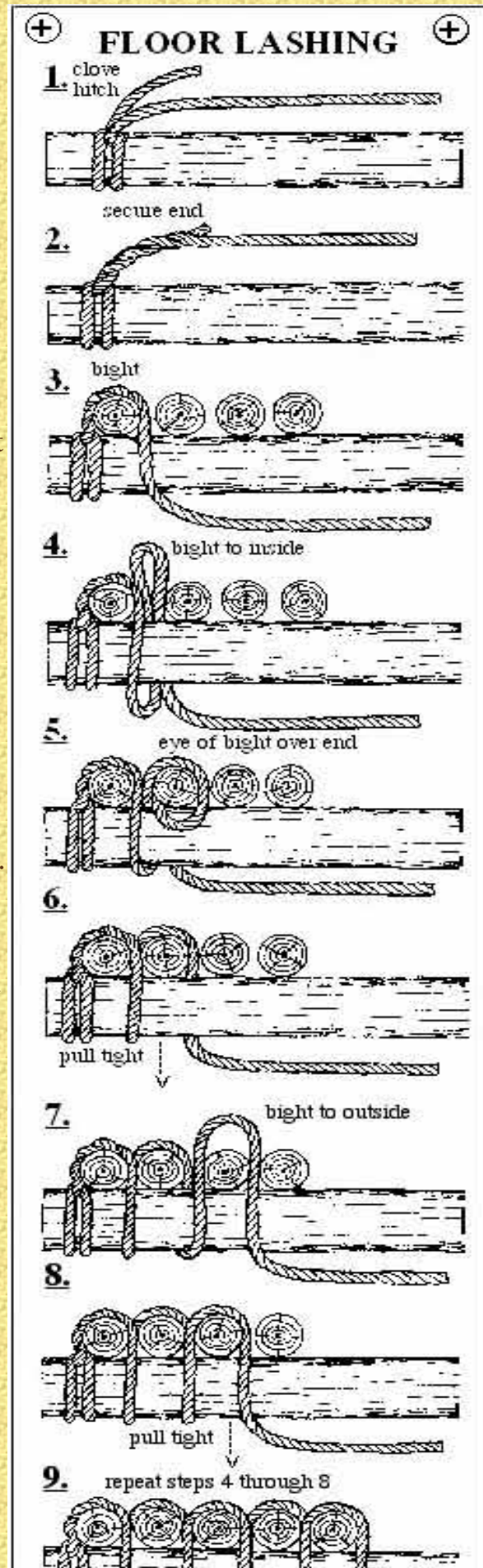



# The Friendship Knot

The knot frequently referred to as the Friendship Knot is illustrated below. This illustration is modified from The Ashley Book of Knots by Clifford W. Ashley (p. 141 # 787). It is in the category of Two Strand Lanyard Knots. It is often given as token of friendship or recognition by Scouts and Scouters to be worn from the shirt pocket button.

It is also known as the Sailor's Knife Lanyard Knot, Marlingspike Lanyard Knot, Single Strand Diamond Knot, Two Strand Diamond Knot, and Bosun's Whistle Knot.

The version used as a friendship knot can be tied in about 9 inches of small cord about the first two fingers of the left hand. Start with a longer piece to work out the concept using the whole hand as a tying fixture.

The following sequence illustrates the steps.

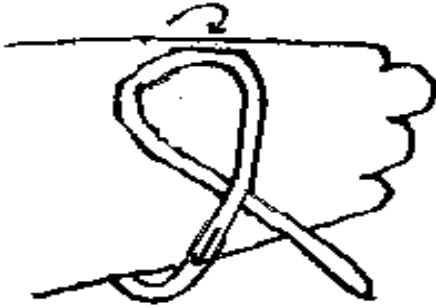

I - underhand loop in palm

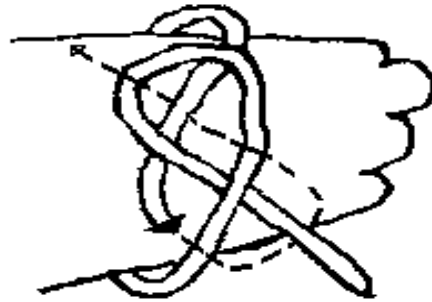

II- bring end around back hand and under first loop as shown. Dash line shows next step.

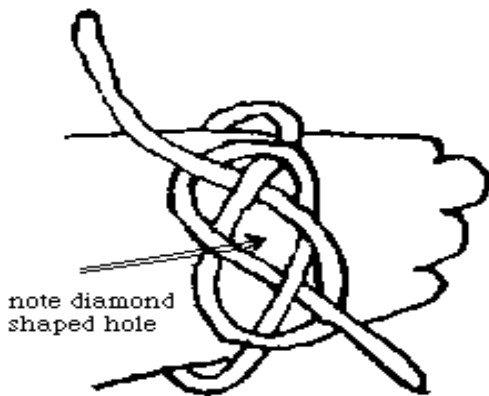

note diamond shaped hole

III - work end through as shown and you will have a full Carrick Bend with a diamond hole in the middle

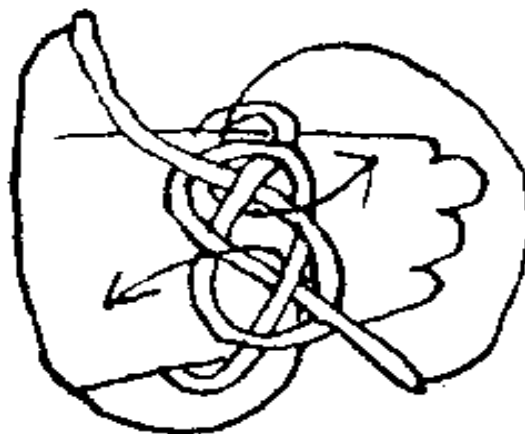

IV- this is the trick getting the ends in the right hole ( the diamond)

After completing this sequence remove the knot from the fingers or hand and grasp the open loop left by the cord from around the fingers with one hand and using the other hand gently tighten the knot by a slight pull on the two loose ends. Slack within the knot can be worked through to improve the uniformity of the knot.

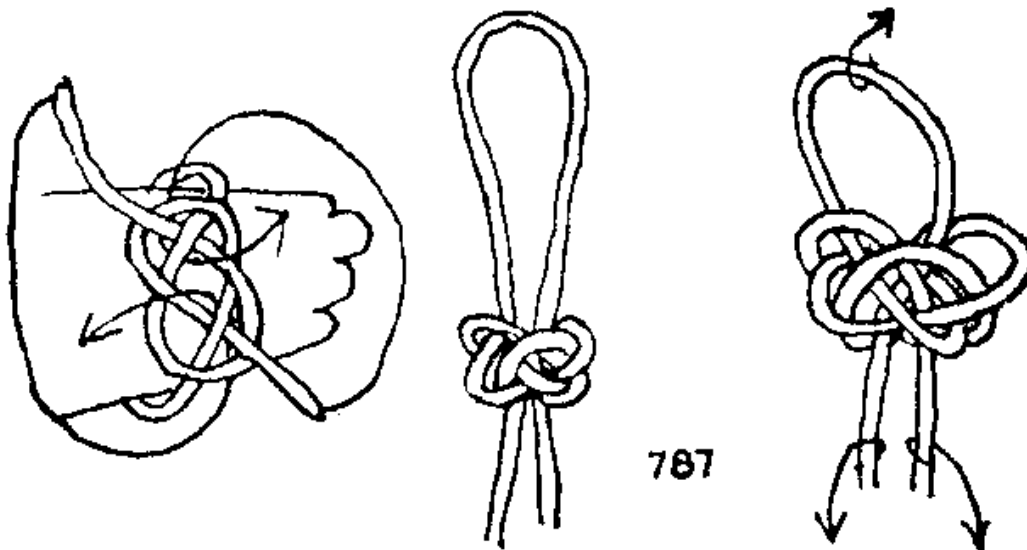

787



jk95



## Home ARCHIVE

# KNOTBOARD OF THE MONTH

Each month there will be new knotboard and descriptive text displayed on this page.

**THIS MONTH'S IS THE :**

## JUG KNOT:

**Use ----**

- to provide a convenient carrying handle for jug or bottle ---- to attach a tool, such as a hammer to a security line to prevent accidental dropping --- to add a wrist loop to a walking staff --- to attach a safety line to a canoe paddle ..... use your imagination, but be sure that you keep safety in mind.

**Other Names ----**

Jar knot, moonshiner's knot, hackamore, bridle knot..

**Comments ----**

The most common use is to provide a loop handle attached to the neck of a bottle. The loop handle makes it easy to carry several bottles with one hand. If a toggle or a two strand button knot such as boatswain whistle knot is added to the free end of the rope, The loop of the jug knot can be use to toggle the bottle to a belt so that the bottle can be use as a canteen.

Plastic bottles with screw-on lids such as soda, sport drink, and mineral water bottles make strong,

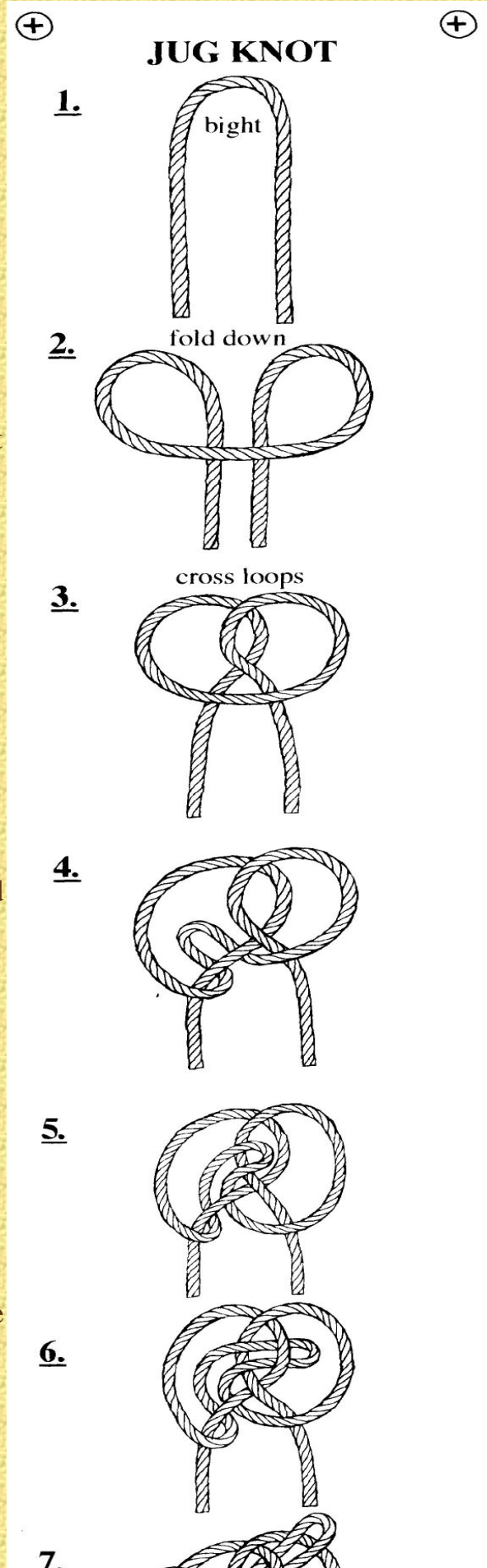

lightweight containers for carrying water on hikes and camp outs. 2 and 3 liter soda bottles are large enough to use as water containers around the camp kitchen. Smaller bottles (8 to 16 oz.) can be used as personal water bottles or canteens. These bottles can be made even more convenient by using a jug knot to attach a loop handle.

To help keep your water cool and refreshing in hot weather, place a sock over the bottle, wet the sock when you fill the bottle, evaporation will do the rest.

In cold weather, carry your water bottle under your coat. A dry sock placed over the bottle will help keep the water from freezing. In cold weather, carry your water bottle under your coat. A dry sock placed over the bottle will help keep the water from freezing.

In cold weather, carry your water bottle under your coat. A dry sock placed over the bottle will help keep the water from freezing.

#### **Narration ----- (For Jug Knot Knotboard.)**

Narrative ---- (For jug knot knotboard) (1) Form a bight in the middle of a 24 to 30 inch long by 3/16 inch diameter rope. (2) Fold the bight down over the standing ends to form two loops. (3) Place the right loop over the side of the left loop. (4) Weave the middle of the bight under the standing end; then over the left edge of the right loop; (6) next go under the right edge of the left loop; (7) finally pass the bight over the right side of the left loop. ( 8) Turn the tops of the original loops down over the knot. ( 9) Place the knot over the neck of a bottle and work the knot tight so that the bight forms a 4 to 5 inch loop handle and the loose ends are even.

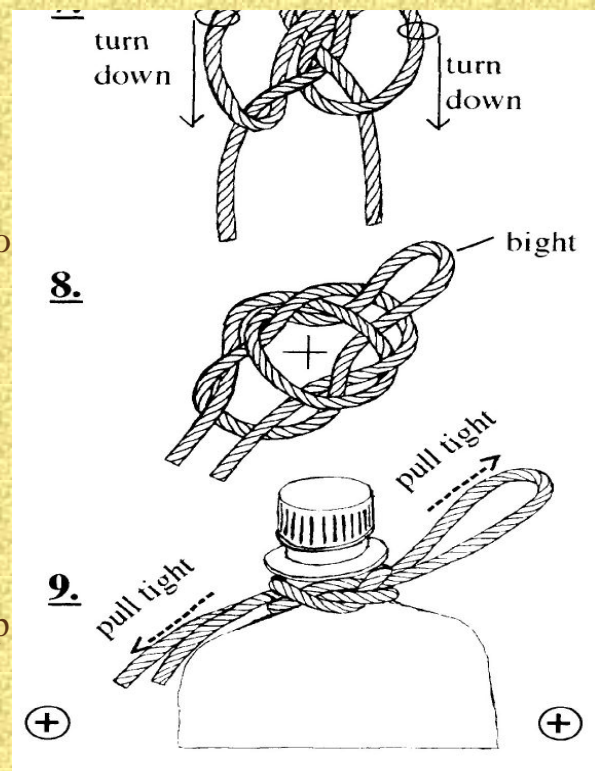

---

## KNOTBOARD OF THE MONTH

# ARCHIVE

---





Home  
E-Mail

[Back To](#)



[The Bends](#)

[Standard copyrights and disclaimer.](#)

# The Sheetbend Family (🇳🇱)

[Back To](#)



[Ropers Knot Page](#)



The sheetbend is a bend. There is a page on [bends](#).



[The Sheet Bend, general.](#)

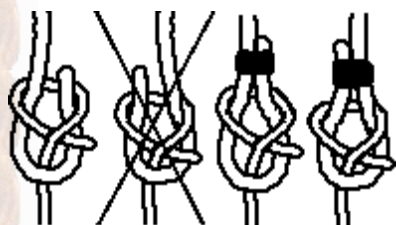

The sheet bend is my favorite bend. Be carefull. With the loose end on the wrong side you have an other, weaker knot (Left-hand sheetbend). If the knot is well seized it does not matter if it is tied right or left handed

[The sheetbend on the WEB.](#)

## The Sheet Bend



This way of tying is for connecting equally sized ropes to each other. When the ends are connected you have the [Bowline Knot](#). You have to try to take the first 'steps' as one simple clockwise turn of your wrist. So practice...

## The wever\_sheetbend



If you want to tie two thin yarns to each other you use a wever-knot. The one shown here is the same as the Sheet Bend. If the yarn is slippery use an [Overhandknot](#) on the ends before tying this knot. If this ends up into a to bulky knot you need an other wever\_knot.

## Sheet Bend for a (to) short end.



With the simplest noose you can catch an end and capsiz the knot to a sheed bend. Be careful. without practicing you have a 50% change of catching it wrong. Also, (as always) working up the knot properly is important.

## The Lap-Knot

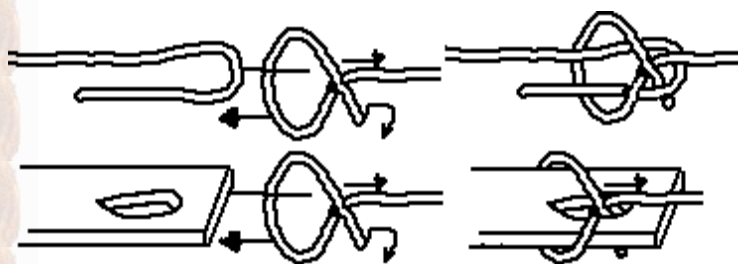

The Lap Knot sometimes is called the false sheetbend. But false knots do not exist. The Lap knot has been in use for ages by many civilisations. I use the name Lap knot because that is the name Robert Pont used in his description of this knot. He found it was used in Lapland in a lot of applications. Especially in lether, it is very suitable, just as secure as the sheetbend, but even more easy to untie. That is important, especially when your fingers are cold.

The Lap Knot is the knot to tie a rope to a strap. If the strap is hard to bend and the rope is slippery,

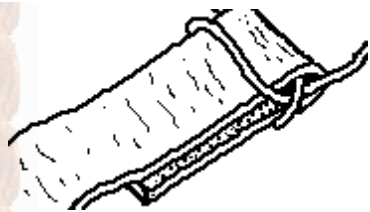

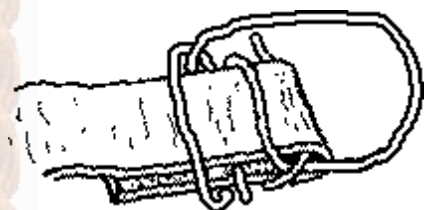

it is advisable to add an overhand knot at the end. Robert Pont thinks it is the best solution for this special situation. He tested it with a many heavy loads under hard conditions. Every time with the same strap, and the same rope. It did not slip a bit, in rain,sun, and snow during several months.

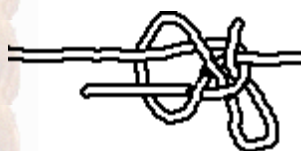

If the Lap Knot is the knot for tying a rope to a strap it is certainly the knot to make a rope loop at the end of a strap. With a bit of practice, you can enjoy its usefulness.



Ever needed a slipped knot which holds secure and releases instantly when pulled? tie the slipped version of the Lap-knot. You will be surprised. I saw this knot for the first time observing a man who hung sausages on a line. He knitted the line into a small noose and shifted the slipped loop over it making a slipped Lap knot. When he needed a sausage he simply grabbed an end and pulled. No scissors, no tools.

 The sheetbend is a bend. There is a page on [bends](#) 

Any comment, suggestions, anything mail me:  [qqqq](mailto:qqqq@realknots.com)  
at [realknots.com](http://realknots.com) with subject "*question*"



All mail without thr right subject is flussed unred. automaticly.



I am sorry I had to remove the mail link. The mailgrabbers and spammers won. But.... I have a few hidden mail address for them to mail to each other after they grabbed it.

.....

Because this is an non-comercial site I can and will not allow junk mail nor spam. Therefore comercial, non personal and bulkmail will be charged with handling costs of \$100 per mail.

[Back To](#)



[Ropers Knot Page](#)

[Standard copyrights and disclaimer.](#)

[Back To](#)



[The Bends](#)

# Lark's Head

(Cow Hitch, Lanyard Hitch)



- The Lark's Head knot is used to loosely attach a rope to a spar or ring. The knot has two redeeming features, it is easy to tie, and it does not jam. However, it will slip fairly easily along the spar, and may slip undone when tied using man made fibre ropes.
- Tip. This is a knot to be avoided when a secure attachment is required. The [Round turn and two half hitches](#), and the [Clove hitch](#) are far more secure.

 [Return to Knot Menu](#)



*Copyright (C) Dick Ruck 1997*

[Ovingdean Saltdean Rottingdean Telscombe Cliffs Peacehaven Newhaven PC Computer Repair, Training and Virus Help](#)





## Home ARCHIVE

# KNOTBOARD OF THE MONTH

Each month there will be new knotboard and descriptive text displayed on this page.

**THIS MONTH'S IS THE :**

## MASTHEAD KNOT:

### Description ----

A multiple loop knot formed by reeving the loosely made loops of two over hand knots through each other and then securing the knot to a mast (pole).

### Use ----

On board ship, a masthead knot was used to rig a temporary mast if the mast was lost in battle or during a storm. On land a masthead knot can be used to rig a gin pole or a flag pole.

### Comments ----

There are several forms of the Masthead Knot. This form of the Masthead Knot was chosen for its symmetry and the ease of transition to the running half hitches used to secure it to the pole.

### Other Names ----

Jury mast knot, pitcher knot.

### Narrative ---- (For masthead knot knotboard.)

(1) Loosely tie two over hand knots. (2) Place the loop of one overhand knot on top of the loop of the loop of the other over hand knot. (3&4) Reeve the

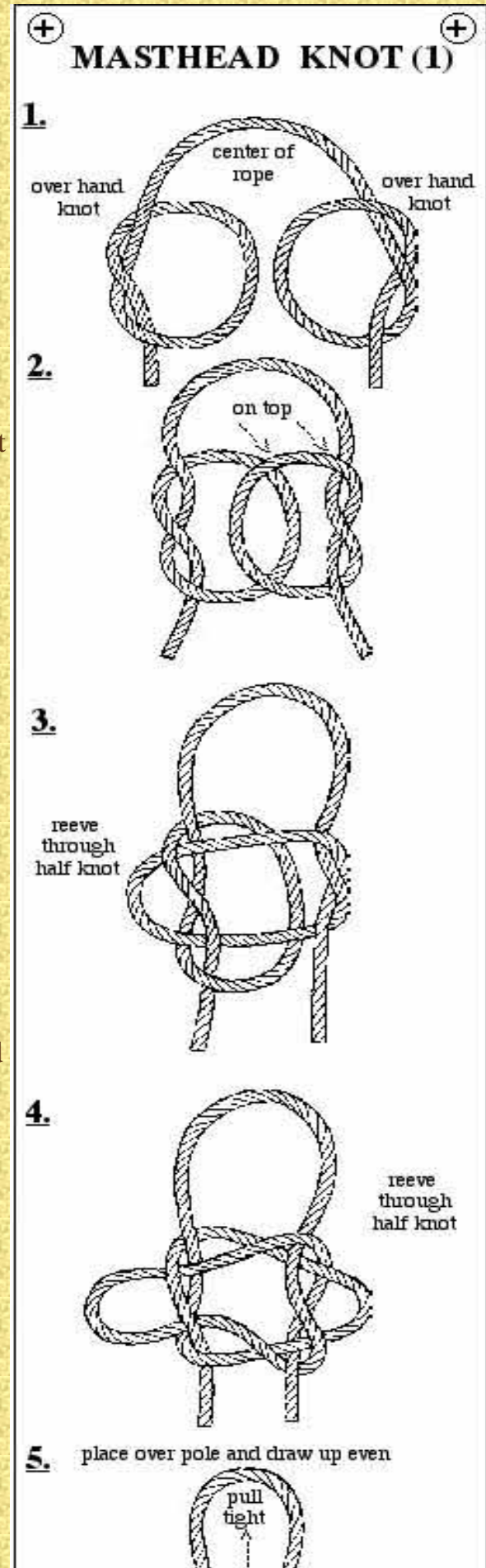

loops of the overhand knot through the half knot part of the opposite overhand knot. (5) Place over a pole and draw the three loops up even. (6) Secure to the pole with a series of running half hitches above and below the mast head knot.

**[NOTE]**

A fourth loop may be formed by tying or splicing the ends together. If a fourth loop is made, nail a cleat to the pole to prevent the mast head knot from slipping.

**[NOTE]**

Attach the guy lines to the loops with becket hitches.

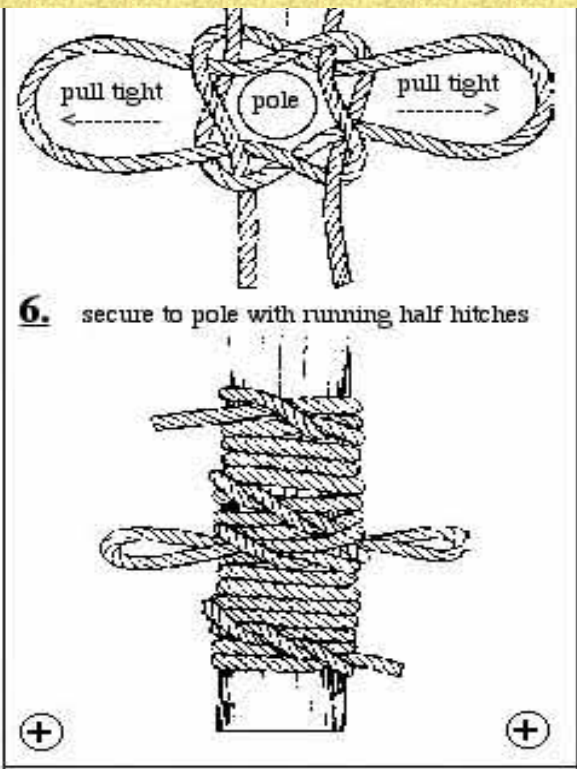
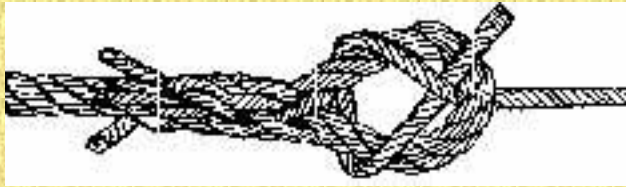

---

**KNOTBOARD OF THE MONTH**  
**ARCHIVE**

---



**Home**  
**E-Mail**



## ARTICLE OF THE MONTH

Each month there will be article on this page.

**THIS MONTH'S IS THE :**

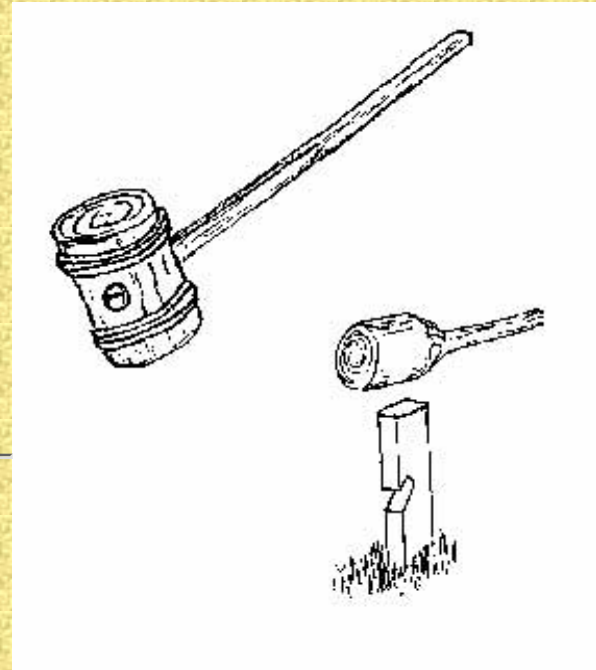

## MAULS:

A maul is a wooden club or hammer that is used for driving stakes or wedges and for safety reasons should be used instead of an ax.

Using an ax instead of a maul exposes the user to the danger of being cut by its sharp edge. Even if the edge is covered by a sheath, a glancing blow can cause the sheath to be ripped off or to be cut through.

The pole of an ax serves as a counterweight to the blade. This counterweight adds to the balance of the ax head and helps to control and increase the force of momentum delivered to the bit. The ax head is shaped in such a way that the momentum of the ax head is delivered through the thin walls of the eye. However, when an ax is being used as a hammer, this same shape causes the eye of the ax head to spread and the handle to loosen.

The flat surface and angular edges of an ax pole makes it difficult to strike a stake squarely. This difficulty in striking a square blow results in most blows delivering some there force sideways, causing the end of the wooden stake to flare and split very quickly. In addition, when the pole of an ax contacts a stake, the metal surface of the pole lacks the ability absorb any of the force of the impact this contributes to the destruction of the stake. A wooden maul, on the other hand, absorbs some of the impact of the initial contact and a maul has no angular edges. Therefore, more of the force of the maul is used to do useful work and less of the force is used up in deforming or splitting the stake.

**FOR MORE INFORMATION GO TO "MAULS"**





"MAULS"

---

**ARTICLE OF THE MONTH**  
**ARCHIVE**

---



Home  
E-Mail



[Back To](#)[The Noose](#)[Standard copyrights and disclaimer.](#)

# FAK

frequently Asked Knots.

[Back To](#)[Ropers Knot Page](#)

Following knots were asked for very often last year. For frequently asked questions on knots also try: [rec.crafts.knots FAQ](#)

This page is more or less made to publish these "FAQ-knots" so I can add them in the knot index.

## The Monkey Fist

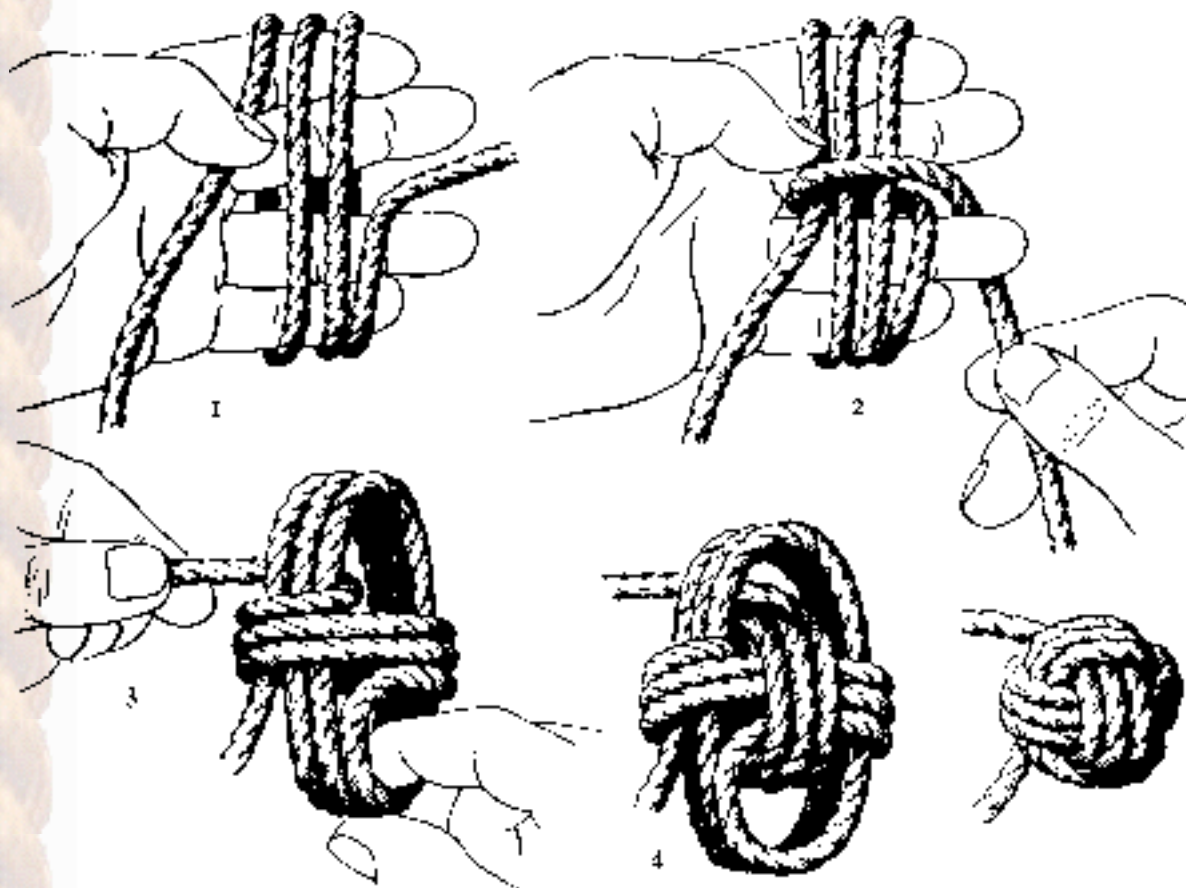

The Monkey Fist is used as an end knot for a heaving line. A heaving line is a line used for throwing from one location to another. This enables a larger line that could not be thrown over the distance to be pulled over. The most common use of a heaving line is at sea, to pull a cable to shore from a ship. A cable is not easily thrown over a distance of 10m [

ft] or more, so instead one throws a heaving line. The line is tied to the cable and when it has been received the cable can then be pulled over. To make it easier to throw one needs to connect a weight on the end of the line - usually a stone, lead-ball or a small bag of sand is connected to the end. Better still a small rope ball is tied on the end. It is neat, it will endure many tosses last long and it is easily thrown. That is what the monkey fist is was originally used for. Now it is also used as fancy knot for key-rings, necklaces and so on. The knot can be done with or without a central

core (i.e. a round stone or ball bearing) to add extra weight but it is recommended to use extra loops depending on the size of the object.

The instruction drawing is made by Hervey Garrett Smith and copied from the dutch translation of his book "[The Marlinespike Sailor](#)". I got permission of "International Marine/Ragged Mountain Press" to use the instruction drawing on my site.

(I got 3 to 5 requests a week for this knot. That is why I am sure it is most wanted.)

## The Dolly

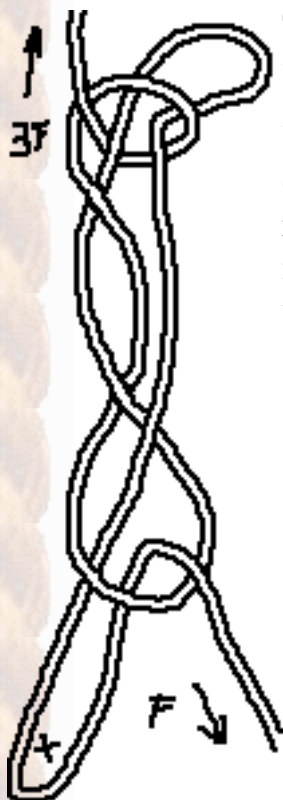

This is probably the most famous truckers knot. I never realized it was so wanted. I got 2 to 4 requests per month for it.

You need to hook in the cross marked place. The force  $F$  you apply at the loose end is multiplied by (almost) 3 on the standing part. You may say it is only a rope tackle. Beware, it wears out your precious rope fast, so if you use it often it is wise to use a form of protection in the bight where the loose end is pulled through. A folded paper will do, a smooth piece of leather is much better.

I do not have experience with this knot myself. But I have been told it will hold as long as the force is applied. And because that is also the case with its closest relative, the sheep shank, I think it will.

Any comment, suggestions, anything mail me:  *qqqq*  
at [realknots.com](mailto:realknots.com) with subject "*question*"

All mail without thr right subject is flussed unred.  
automaticly.

I am sorry I had to remove the mail link. The mailgrabbers  
and spammers won. But.... I have a few hidden mail address  
for them to mail to each other after they grabbed it.

.....

Because this is an non-comercial site I can and will not allow junk mail nor spam. Therfore commercial, non-personal and bulkmail will be charged with a handling cost of \$100 per mail.



[Home](#)  
[E-Mail](#)

## KNOTBOARD OF THE MONTH

### MONKIE'S PAW:

#### Description ----

Two forms of the monkey's paw are shown here the first is formed from four interlocking loops: a four crown turk's head; the second is constructed from three interlocking coils.

#### Use ----

The core determines what the monkey's paw can be used for. When tied over a stone or heavy ball, the monkey's paw can be used to add weight to a heaving line. If tied over a cork ball with small cord the monkey's paw makes a good float for boat keys or other small items used around a water front. Tied over a ball of twine or other soft material, the monkey's paw can be used as weight on the end of a rope for the game jump the shot. A Monkey's Paw can also be used as a toggle..

#### Comments ----

Neither form of the Monkey's Paw has an advantage over the other. Which one you choose to use is a matter of personal preference.

#### Core Size -----

The diameter of the core should be between three and four diameters of the rope being used..

#### Narration ----- (For Monkey's Paw Turk's Head knotboard.)

(1) Form an overhand loop (2) Form a second

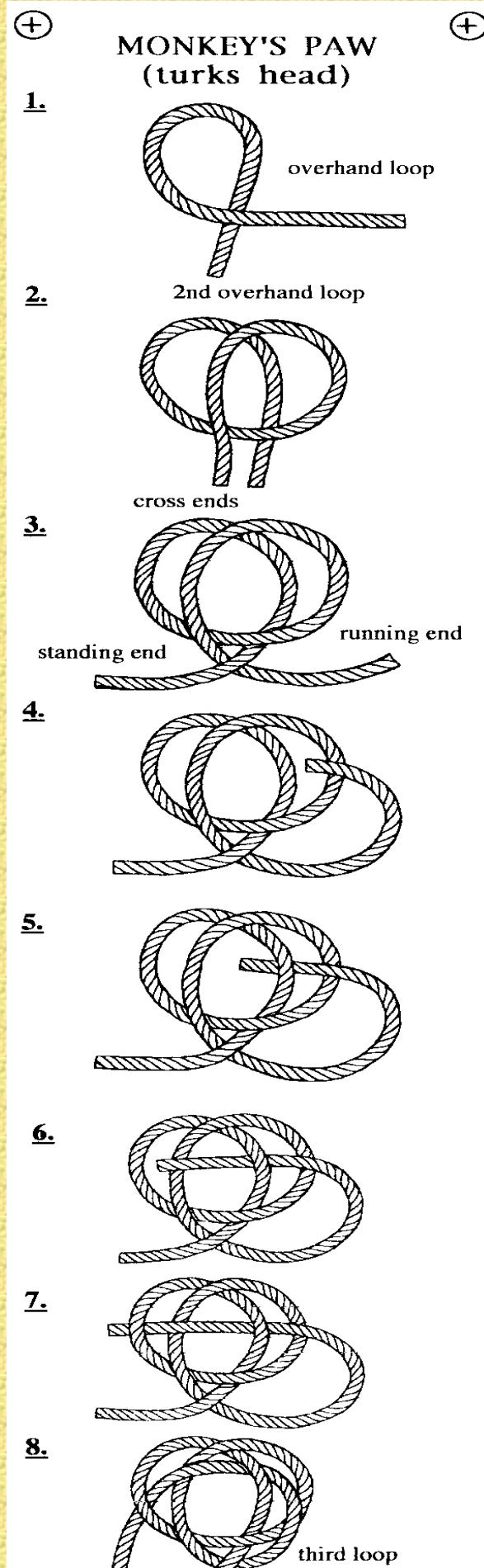



overhand loop over the left edge of the first overhand loop . (3) Cross the standing end over the running end. (4) Weave the running end across the loops by placing the running end over the right side of the top loop (5) then under the right side of the bottom loop (6) next, over the left side of the top loop (7) and finally under the left side of the of the bottom loop. (8) Pull the running end through until a third loop equal in size to the first two loops. (9) Add the fourth loop by placing the running end parallel to the standing end. (10) Chase the original pattern 2 to 3 times. (11) Work tight over the core.

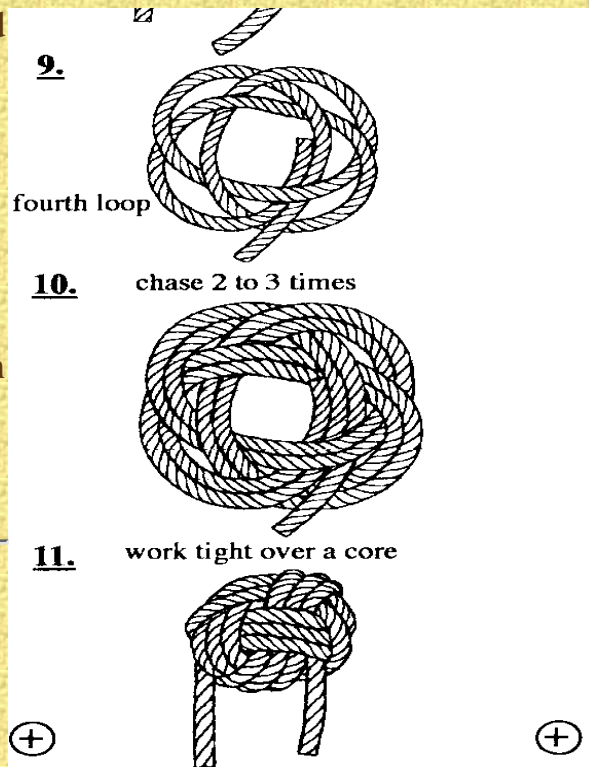

[Home](#)  
[E-Mail](#)





## Home ARCHIVE

# KNOTBOARD OF THE MONTH

Each month there will be new knotboard and descriptive text displayed on this page.

**THIS MONTH'S IS THE :**

## MOORING HITCH:

### Description ----

An underhand loop toggled to the standing part with a bight made in the running end.

### Use ----

To securely tie off a rope so that it can be quickly untied, especially a small boat to a dock or piling.

### Comments ----

A secure knot that is easily tied or untied in wet or dry rope; when properly tied a non closing loop is formed, this allows the hitch to move up or down a piling as the water level changes.

### Narration ----- (For Mooring Hitch Knotboard.)

(1) Take a bight around an object. (2) Form an underhand loop in the running part. (3) Place the eye of the underhand loop over the standing part. (4) Pull a bight of the standing part through the eye of the underhand loop. (5) Pull the underhand loop tight around the bight. (6) Place the running part under the eye of the bight that was pulled through the underhand loop. (7) Pull a bight of the running part through the eye of the standing part bight. (8) Pull on

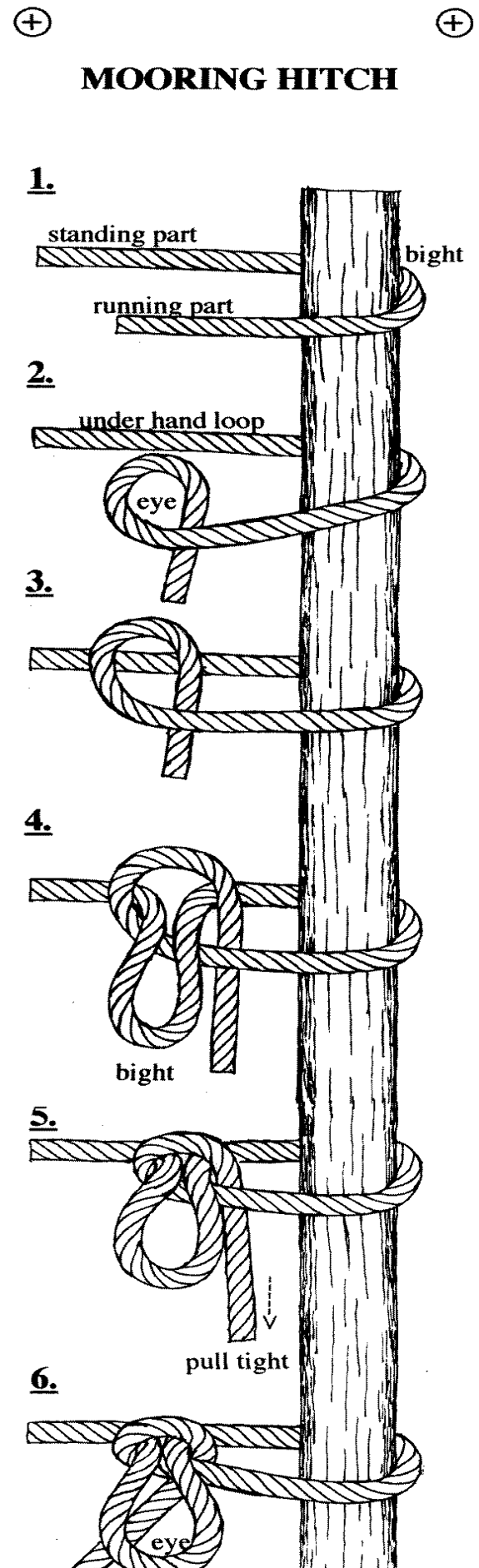

the standing part to tighten the standing part bight around the running part bight.

## ANIMATED KNOT



## MOORING HITCH

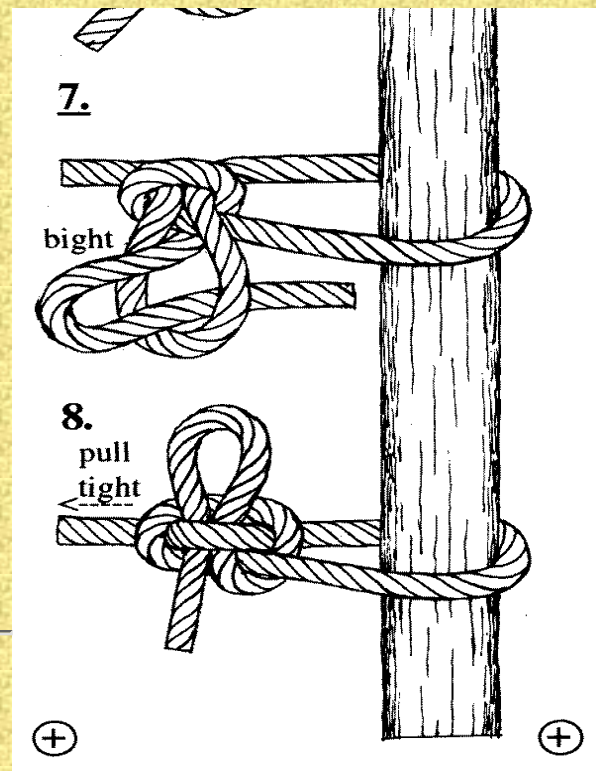

---

## KNOTBOARD OF THE MONTH

## ARCHIVE

---



Home  
E-Mail



## Home ARCHIVE

# KNOTBOARD OF THE MONTH

Each month there will be new knotboard and descriptive text displayed on this page.

**THIS MONTH'S IS THE :**

## TRIPOD LASHING:

### Description ----

A shear lashing around 3 poles.

### Use ----

To bind three poles together, for the construction of a tripod. ---- To bind three poles together that contact at the same point in a structure

### Comments ----

The tripod lashing is a shear lashing that binds three poles together at the same point. ---- The tripod lashing gets its name from the fact that its most common use is the construction of a tripod. ---- The tripod lashing can be used just about anywhere in a structure that three poles cross each other at the same point and the same time in the sequence of construction. ---- Tripod lashing takes two main forms; with racked wrapping turns (the rope is woven between the poles) and with plain wrapping turns (the rope is wrapped around the poles without weaving the rope between the poles). When the lashing is made with racked turns the rope contacts each pole around its entire circumference; this

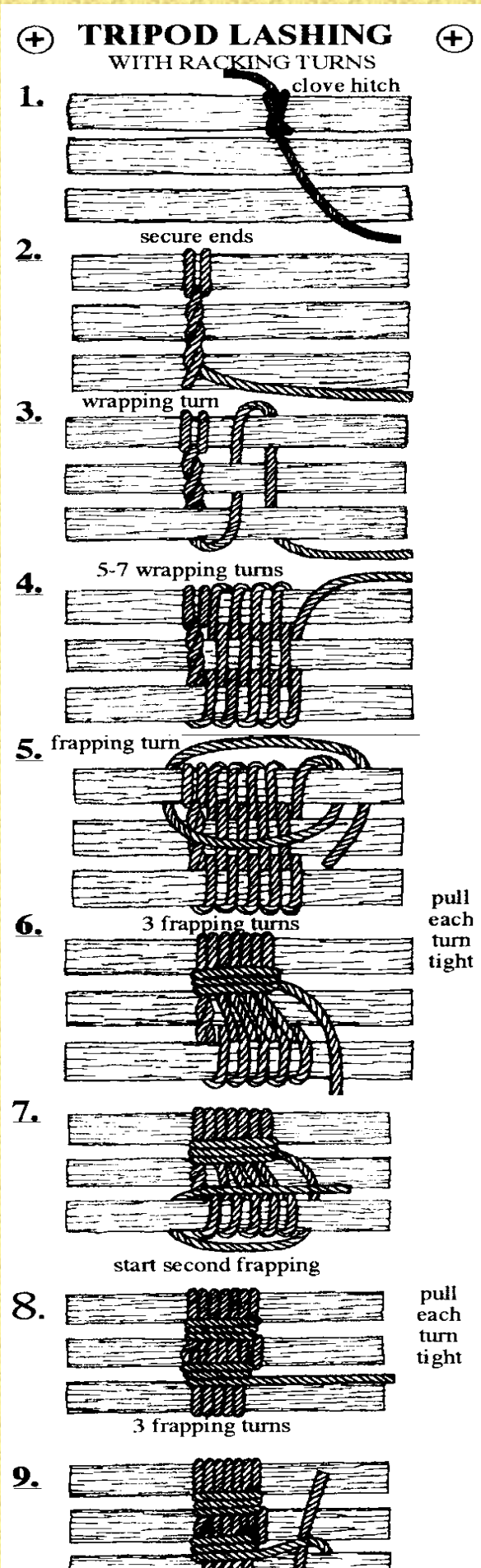



contact makes the tripod lashing with racking turns the most secure form of tripod lashing: therefore tripod lashing with racking turns should be used when safety is important. However, for light structures where there would be no danger if the lashing slipped, the faster to tie tripod lashing with plain wrapping turns may be used.

### Laying Out The Poles ----

For most tripod lashings, lay the pole side by side with the butt ends aligned. The alignment of the butts of the pole insures that the tripod legs are the desired length.

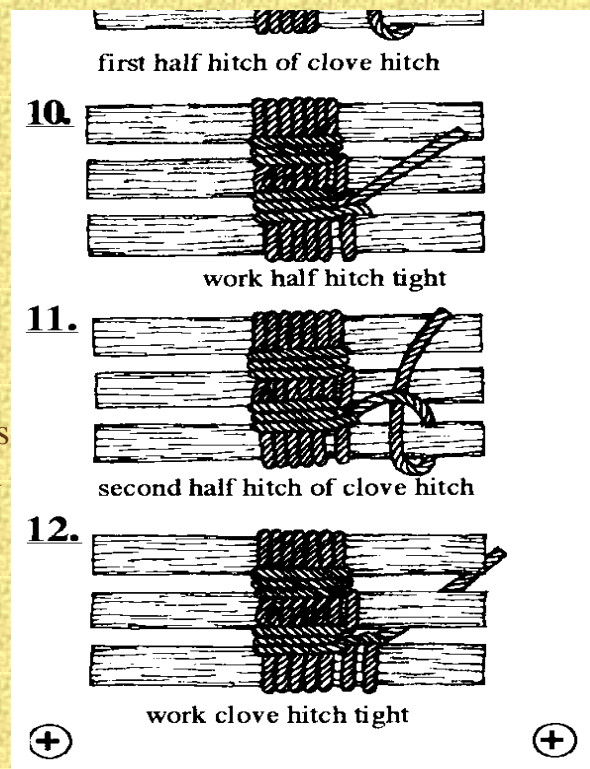
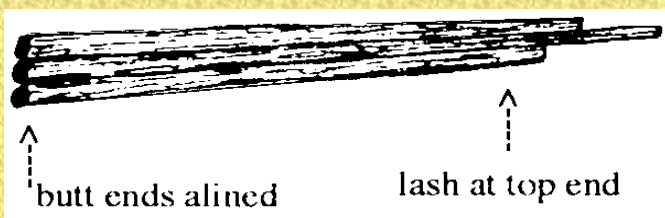

### [NOTE]

The practice of laying the center pole in the opposite direction to the outside poles creates several problems. When the poles are laid in opposite directions the wrappings must be put on loosely so that when the center pole is rotated to its proper position the lashing is tightened around the poles. If the wrappings are put on too tight, the rope is stretched causing damage to the rope fibers, therefore weakening the lashing. On the other hand, if the rope is wrapped too loosely, the lashing will not tighten enough when the center pole is rotated and the lashing will be able to slip along the length of the pole. Either way, the rope too loose or the rope too tight, a dangerous situation is created.

### Setting Up A Tripod -----

Set up the tripod by crossing the outside poles so that the cross point of the poles is under the center pole. Crossing the outside poles under the center pole causes part of the load that is placed on the tripod to be taken up by the wood to wood contact of the poles.

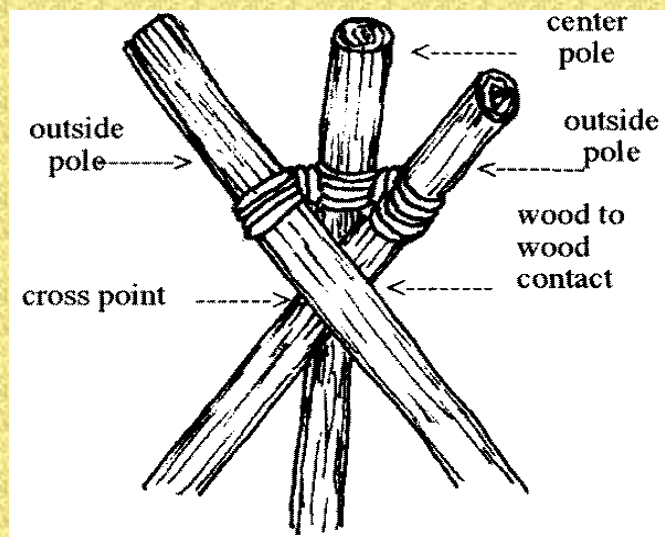

### Narration ----- ( For Tripod Lashing Knotboard.)



(1) Tie a clove hitch around one of the outside poles. (2) Secure the standing part by wrapping it around the running part. [NOTE] Wrapping the standing part around the running part prevents the clove hitch from slipping around the pole. If the clove hitch slips the lashing will loosen up from the inside. (3) Start the racked wrapping turns by weaving the rope between the poles. (4) Take a total of 5 to 7 wrapping turns. Pull each wrapping turn tight as it is made. [NOTE] The stiffness of the tripod lashing depends on the number and tightness of the wrapping turns. As the tightness of the wrapping turns or the number of wrapping turns increases, the stiffness of the tripod will increase. (5) Take the first frapping turn by taking the rope around the pole that the clove hitch was tied to, then between the outside pole and the center pole. (6) Take 3 frapping turns. Pull each frapping turn tight as it is made. (7) Start the second set of frapping turns by taking the rope across the center pole and reeving it between the second outside pole and the center pole. Take the second set of frapping turns in the opposite direction to the first set of frapping turns. [NOTE] Taking the second set of frapping turns in the opposite direction to the first set of frapping turns prevents the rope from crossing the wrappings at a diagonal. Unnecessary crossing of the rope increases friction between the strands of the rope making it difficult to tighten the lashing properly. (8) Take a total of 3 frapping turns. Pull each turn tight. (9) Take the first half hitch of the ending clove hitch around the second outside pole by taking the rope past the pole and then around the pole. (10) Work the half hitch tight so that it is locked against the lashing. [NOTE] See the narration for square lashing for instructions on working the half hitch tight. (11) Take the second half hitch of the ending clove hitch. (12) Work the half hitch tight to complete the ending clove hitch. [NOTE] If the clove hitch is not worked tight so that it is locked against the lashing the clove hitch will slip around the pole allowing the lashing to loosen. [NOTE] If very smooth rope is being used, a 3rd half hitch should be added to the clove hitch to insure that the lashing will stay in place.

---

## KNOTBOARD OF THE MONTH

# ARCHIVE

---



[Home](#)  
[E-Mail](#)



[Home](#)  
[E-Mail](#)

## KNOTBOARD OF THE MONTH

### TURK'S HEAD:

#### Description ----

Three strand braid worked in a continuous circle.

#### Use ----

- (1) As a decorative knot around a staff or railing.
- (2) Worked tight around a checked or cracked tool handle or canoe paddle to reinforce them.
- (3) As a neckerchief slide or wogal.

#### Comments ----

The form of Turks head shown here is a five crown Turk's head, this is only one of a group of knots that go by the name Turk's heads. The crown number is determined by counting the number of bights at the edge of the knot. To make a larger loop the, increase the size of the wraps made in steps 1 - 4 and then, at step 7 use three strand braiding to increase the number of crowns. The number of crowns can be increased by increments of three; so that the number of crowns in a larger loop can be 8, 11, 14, etc..The size of the finished Turk's head depends on the size of the rope used and the number of times the strand is chased.

#### Other Names ----

Three lead by five bight Turk's head, ordinary Turk's head.

#### Narration ----- (For Turk's head knotboard.)

- (1) Start at the center of the line, by taking a

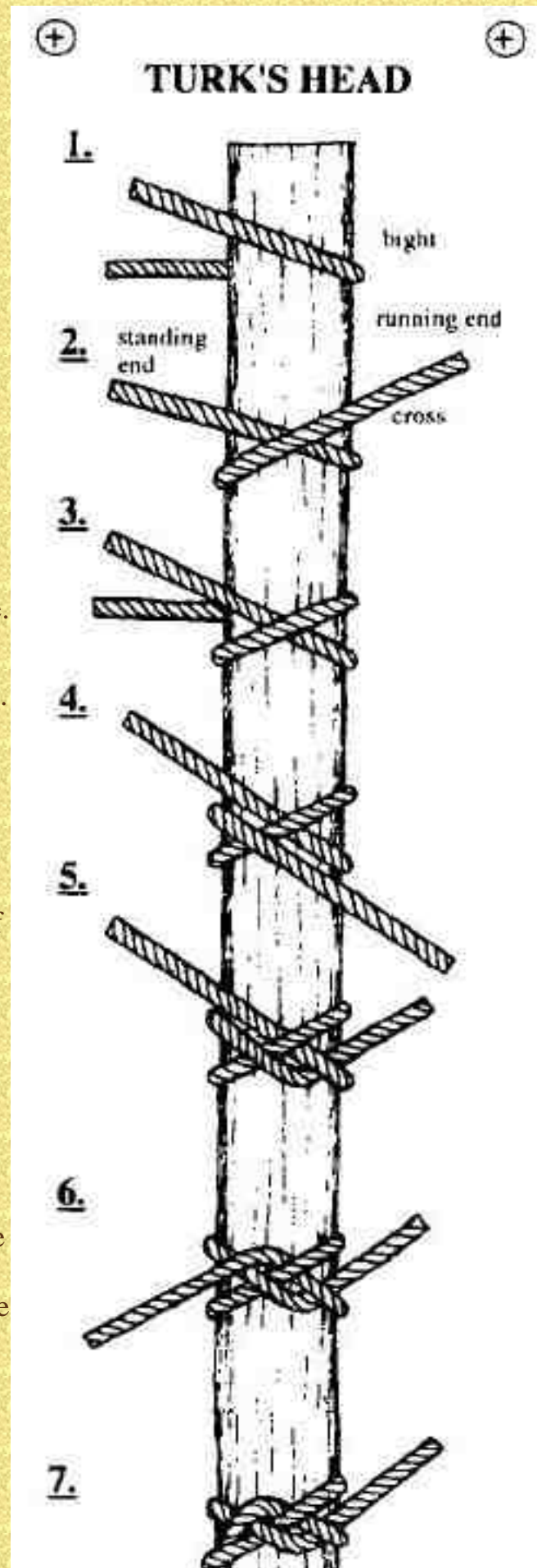



bight around an object (the fingers of the left hand work well) (2) Complete the round turn and cross the running end over the standing end. (3) Take a second bight around the object so that the running end is between the standing end and the first wrap. (4) Lay the running end across the first wrap then (5) tuck the running end under the standing end. (6) lay the standing end across the second wrap and (7) tuck it under the first wrap. (8) rotate the knot around the object so that you are looking at the opposite side. (9) Cross the second wrap over the first wrap. (10) Reeve the standing end through the eye formed between the two wraps. (11) Reeve the running end through the eye between the two wraps so that the ends are in opposite directions. (12) Chase, follow, the strand of the knot two or three times. Cut off and secure the ends.

[NOTE] To determine the length of line to use, wrap the line around the object four times for a single strand knot. Add three and one half wraps for each time you intend to chase the original strand.

## ANIMATED KNOT



## TURK'S HEAD KNOT

