

How to Efficiently Power LEDs in a Primitive Environment

The over all goal is to build the most energy efficient long lasting lighting for “primitive environment use” from commonly available items. Properly driven or powered LEDs are well suited for this purpose.

Given some proper size resistors, x-mass tree bulbs, or LM317 integrated circuits and white or colored LEDs highly efficient primitive task lighting can me made.

Simple Current Control Methods for Driving LEDs

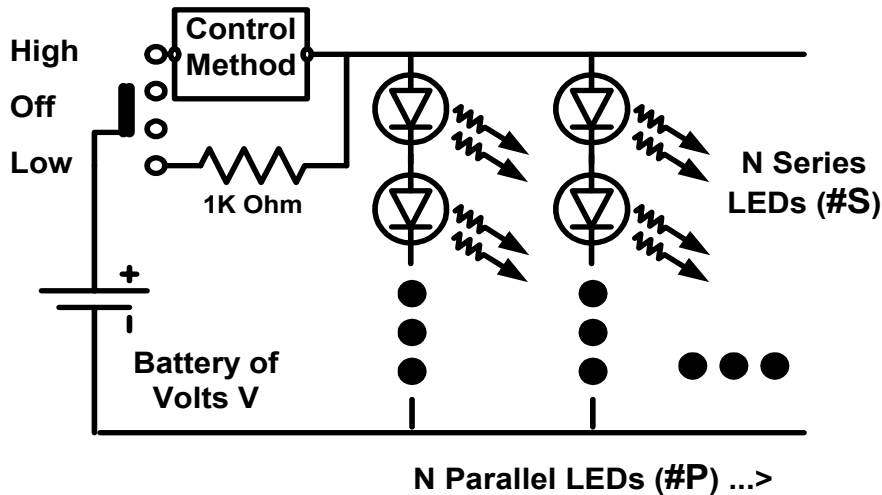

Control Methods

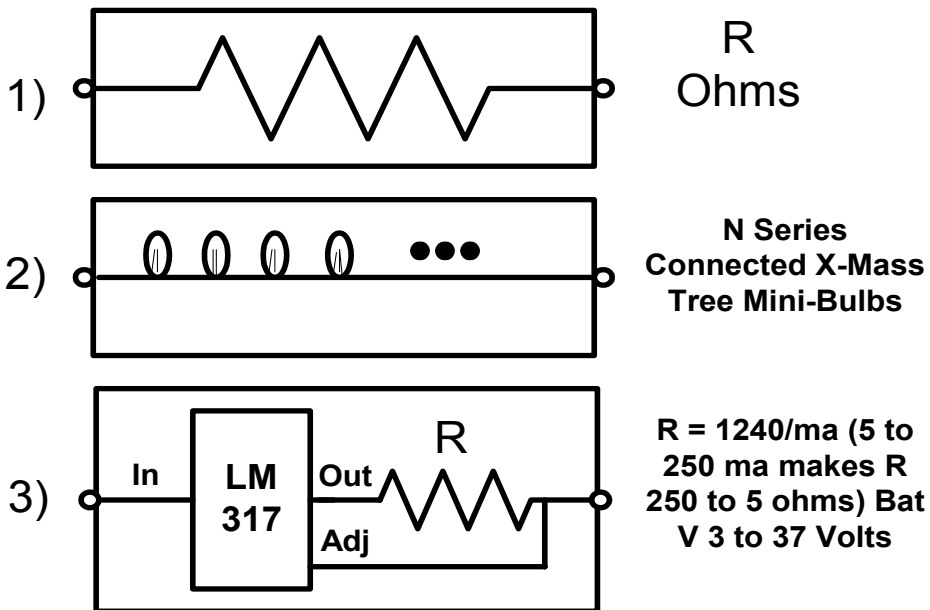

How to Efficiently Power LEDs in a Primitive Environment

At the top of the above diagram shows a generalized but simplified circuit of how to drive (or power) LEDs. On the lower half of page is an explanation of 3 simple methods that can be used.

The first is to use a proper size resistor in series with the LEDs. The resistance value is chosen to limit the flow through the LED at maximum voltages the battery will operate at (usually during charging). The second is to use the proper number of series connect x-mass tree bulbs as a varistor (change in resistance with increase in voltage). The positive increase in resistance with increase in current is used to advantage and this method is more efficient at producing light than a simple resistor.

The third method of driving LEDs is by use a LM 317 integrated circuit chip in series with a resistor that limits current to given value over a wide range of input voltages. This method works best when input voltage is expected to vary over a wide range. The following shows the resulting current for different values of R.

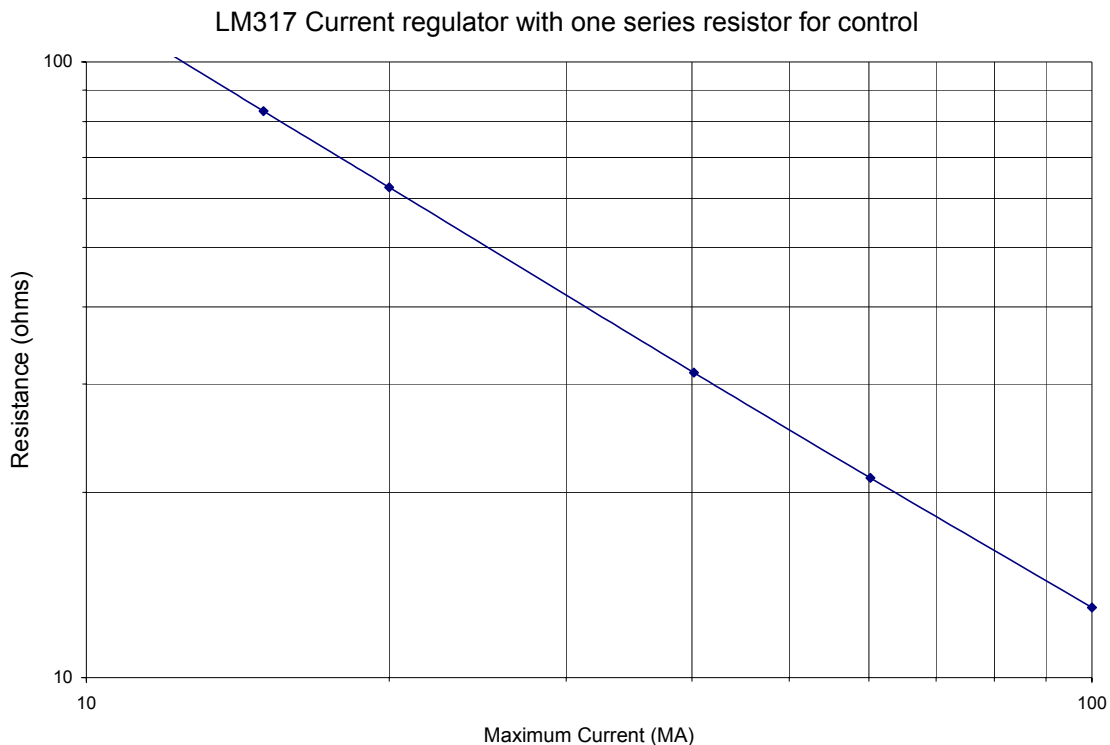

How to Efficiently Power LEDs in a Primitive Environment

The lifetime of the currently available white LEDs is not anything near the 100,000 hours of mono color LEDs. More typically it is about 5,000 to 30,000 hours at 20ma. The lifetime is related to how hot the junction gets during operation. As a result it is highly recommended that one design for half current or 10 ma to gain a significantly longer lifetime.

Optimum design for a number of different input voltages was chosen based on limiting the LED current for the highest voltages that could occur during operation. The following table gives the different battery configurations chosen.

“AA” is assumed to be a typical fully charged Ni-Cad or Ni-MH cell or a typical alkaline cell that averages in operation about 1.2 volts. It is assumed the cells are not being charged while the unit is in operation. A high of 15 volts for the typical 12 volt lead acid battery is assumed to be maximum charging voltage. In this case it is assumed that charging occurs during operation of the lighting. The following shows the assumed voltages for design purposes.

	Volt for each cell	Volt for 4-AA cells	Volt for 8-AA cells	Volt for 12 volt bat
Low	1	4	8	11.5
Average	1.2	4.8	9.6	12.5
High	1.6	6.4	12.8	15

Optimum design for a number of different LED configurations and average battery voltages is given in the following table. The last column gives the resistance values needed in the circuit for the approach chosen.

How to Efficiently Power LEDs in a Primitive Environment

Graph	Circuit		# of	Average		Circuit
Name	Name	Type Driver	Cells	Battery Voltage	# Of LEDs	Resistor R ohms
F1	1S-1P-6W-20	6 W-20 X-mass bulbs	4-AA	4.8	1	53.0
F1	1S-1P-CC15	Const current 15 ma	4-AA	4.8	1	82.0
F1	1S-1P-R160	Series Resistor	4-AA	4.8	1	160.0
F2	2S-1P-6-W-20	6 W-20 X-mass bulbs	8-AA	9.6	2	53.0
F2	2S-1P-CC15	Const current 15 ma	8-AA	9.6	2	82.0
F2	2S-1P-R320	Series Resistor	8-AA	9.6	2	320.0
F3	3S-1P-10W-20	10 W-20 X-mass bulbs	6-Lead	12.5	3	85.7
F3	3S-1P-CC15	Const current 15 ma	6-Lead	12.5	3	82.0
F3	3S-1P-R270	Series Resistor	6-Lead	12.5	3	270.0
F3a	3S-2P-12-D-35	12 D-35 X-mass bulbs	6-Lead	12.5	6	76.0
F3a	3S-2P-2-W-20	2 W-20 X-mass bulbs	6-Lead	12.5	6	18.4
F3a	3S-2P-3-W-20	3 W-20 X-mass bulbs	6-Lead	12.5	6	25.7
F3a	3S-2P-CC20	Const current 20 ma	6-Lead	12.5	6	62.0
F3a	3S-2P-CC30	Const current 30 ma	6-Lead	12.5	6	41.4
F3a	3S-2P-R130	Series R=130	6-Lead	12.5	6	130.0
F3b	3S-4P-3-D-35	3 D-35 X-mass bulbs	6-Lead	12.5	12	17.8
F3b	3S-4P-4-T-50	4 T-50 X-mass bulbs	6-Lead	12.5	12	11.0
F3b	3S-4P-CC40	Const current 40 ma	6-Lead	12.5	12	31.0
F3b	3S-4P-CC60	Const current 60 ma	6-Lead	12.5	12	21.0
F3b	3S-4P-R67	Series Resistor	6-Lead	12.5	12	67.3
F3c	3S-6P-4-W-35	4 W-35 X-mass bulbs	6-Lead	12.5	18	16.0
F3c	3S-6P-5-W-50w	5 W-50w X-mass bulbs	6-Lead	12.5	18	8.7
F3c	3S-6P-CC60	Const current 60 ma	6-Lead	12.5	18	20.5
F3c	3S-6P-CC90	Const current 90 ma	6-Lead	12.5	18	13.7
F3c	3S-6P-R44.7	Series Resistor	6-Lead	12.5	18	44.7
F3d	3S-7P-3-W-35	3 W-35 X-mass bulbs	6-Lead	12.5	21	7.2
F3d	3S-7P-4-W-35	4 W-35 X-mass bulbs	6-Lead	12.5	21	12.6
F3d	3S-7P-CC84	Const current 84 ma	6-Lead	12.5	21	15.2
F3d	3S-7P-R39.9	Series Resistor	6-Lead	12.5	21	39.9
F4	4S-1P-3W-20	3 W-20 X-mass bulbs	6-Lead	12.5	4	24.3
F4	4S-1P-4W-20	4 W-20 X-mass bulbs	6-Lead	12.5	4	33.7
F4	4S-1P-5W-20	5 W-20 X-mass bulbs	6-Lead	12.5	4	44.7
F4	4S-1P-CC15	Const current 15 ma	6-Lead	12.5	4	82.0
F4	4S-1P-R110	Series Resistor	6-Lead	12.5	4	110.0
F4a	4S-2P-1-W-20	1 W-20 X-mass bulbs	6-Lead	12.5	8	8.1
F4a	4S-2P-4-G-50	4 G-50 X-mass bulbs	6-Lead	12.5	8	17.2
F4a	4S-2P-8-G-50	8 G-50 X-mass bulbs	6-Lead	12.5	8	31.0
F4a	4S-2P-CC30	Const current 15 ma	6-Lead	12.5	8	41.0
F4a	4S-2P-R56	Series Resistor	6-Lead	12.5	8	56.0
F4b	4S-4P-2-D-35	2 D-35 X-mass bulbs	6-Lead	12.5	16	33.0
F4b	4S-4P-2-G-50	2 G-50 X-mass bulbs	6-Lead	12.5	16	7.5
F4b	4S-4P-2-T-50	2 T-50 X-mass bulbs	6-Lead	12.5	16	5.3
F4b	4S-4P-3-T-50	3 T-50 X-mass bulbs	6-Lead	12.5	16	8.0
F4b	4S-4P-R40	Series Resistor	6-Lead	12.5	16	40.0

How to Efficiently Power LEDs in a Primitive Environment

“4S-4P” in the above table stands for 4 LEDs are connected in Series and there are 4 parallel connected sets of the 4 series LEDs. This results in a total of 16 LEDs. “2-W-20” stands for a quantity of 2 of the W-20 type X-mass tree bulbs. “W” stands for Wal-Mart and “20” is the number of bulbs in the original string. See table at end for more definition.

The following graphs show the voltage versus current for the different LED driver circuit configurations. Note the current available to the LED for the given operating voltage range.

F1

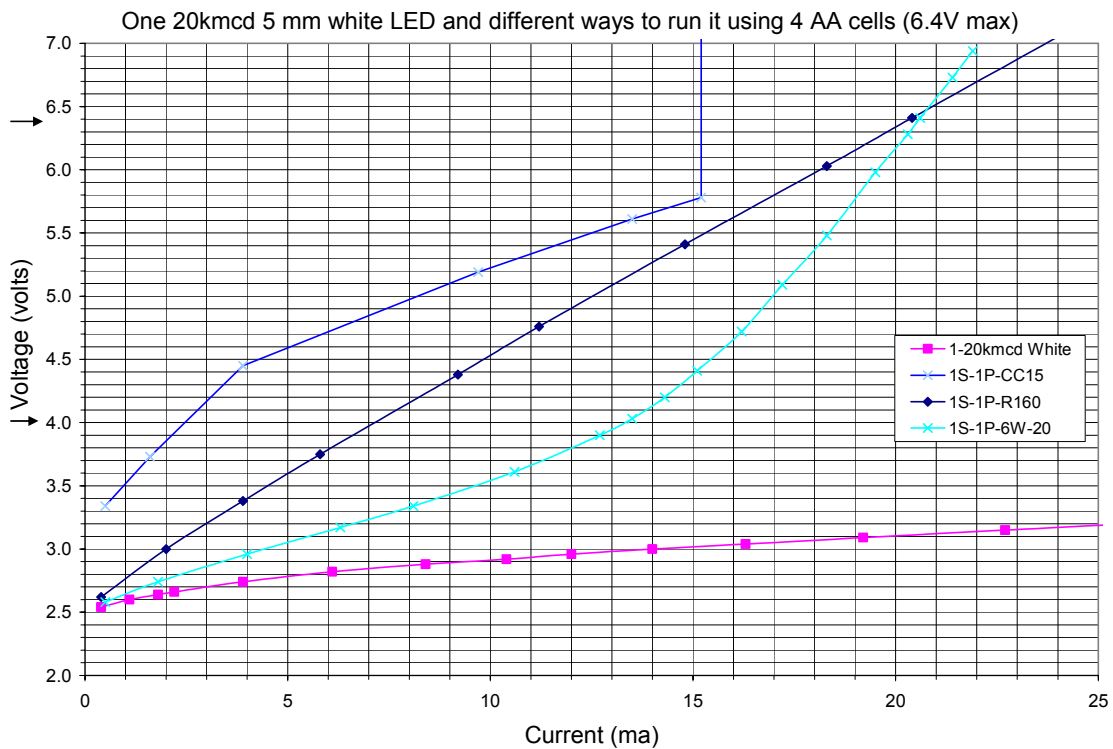

How to Efficiently Power LEDs in a Primitive Environment

F1a

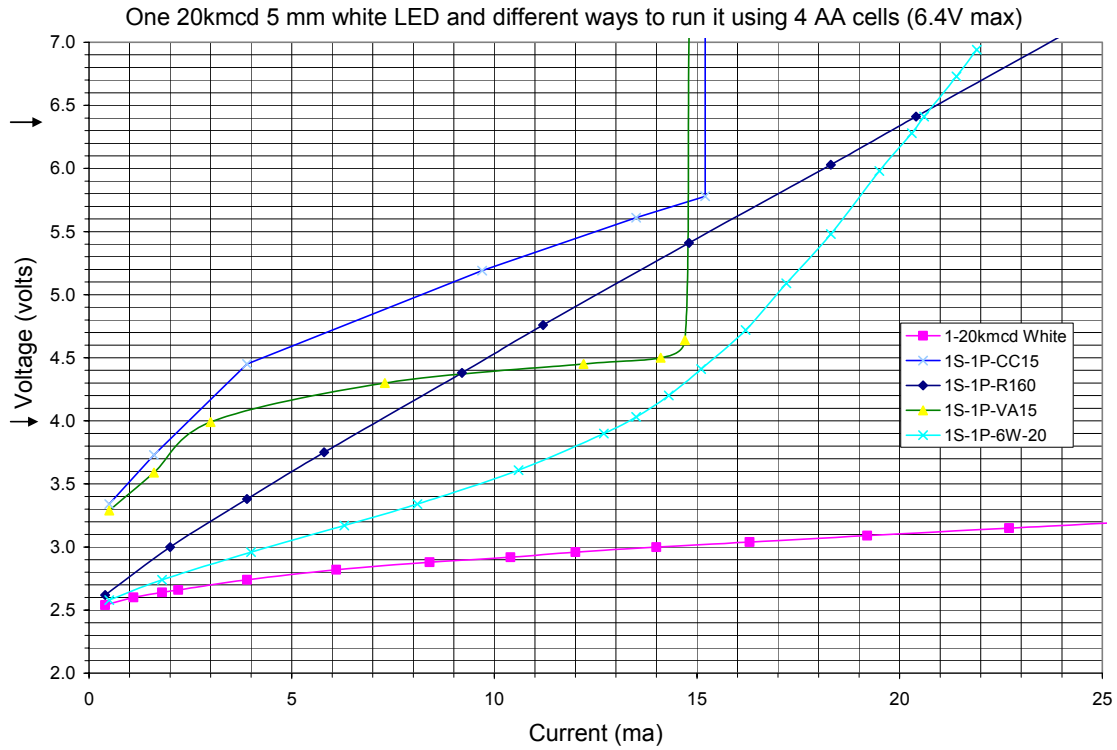

F2

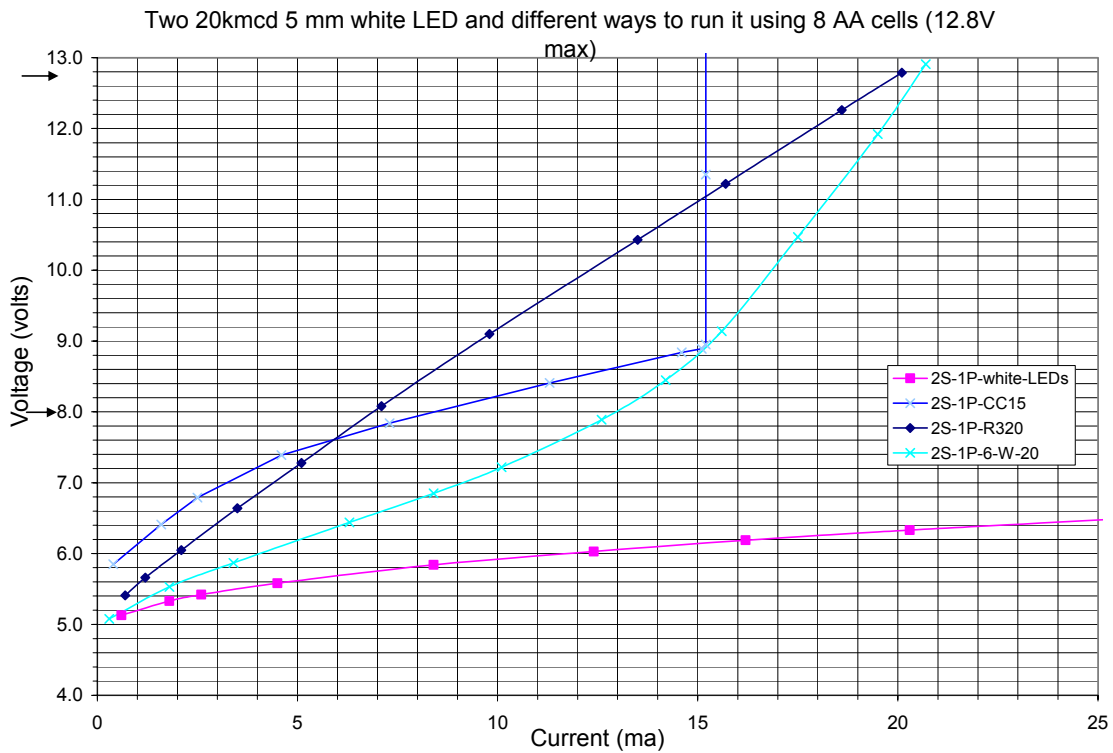

How to Efficiently Power LEDs in a Primitive Environment

F3

Three 20kmcid 5 mm white LEDs in series and different ways to run it using 12 v battery

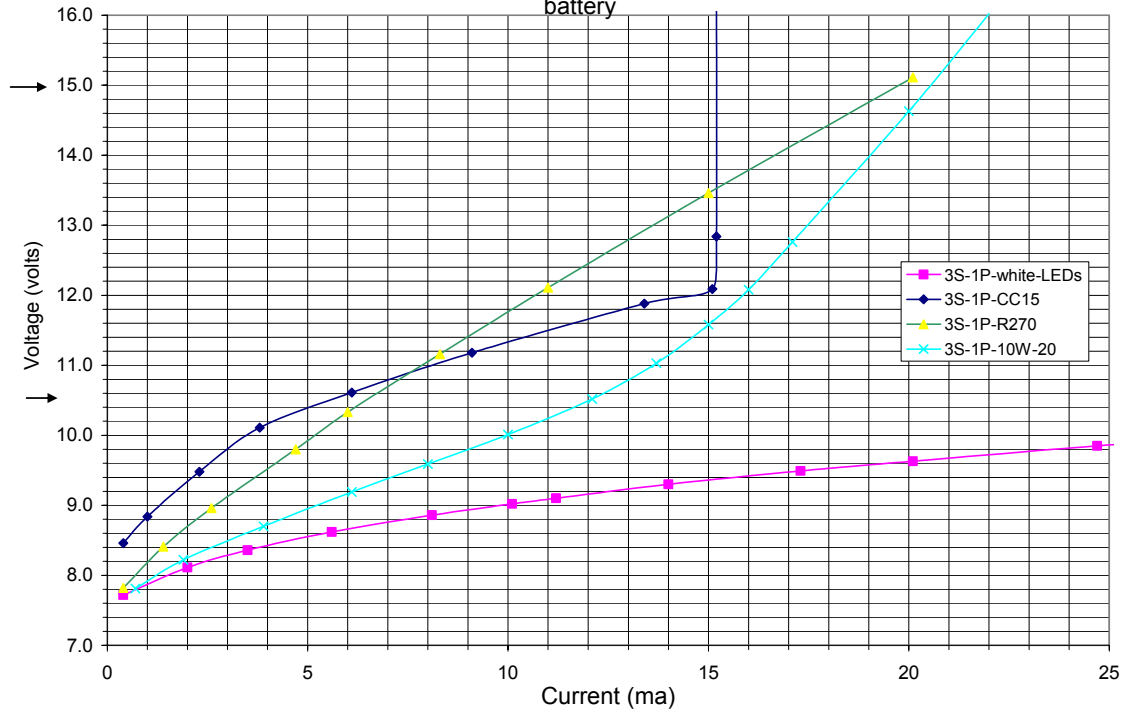

F3a

2 Parallel connected sets of 3 series white LEDs powered in different ways using a 12 v battery source

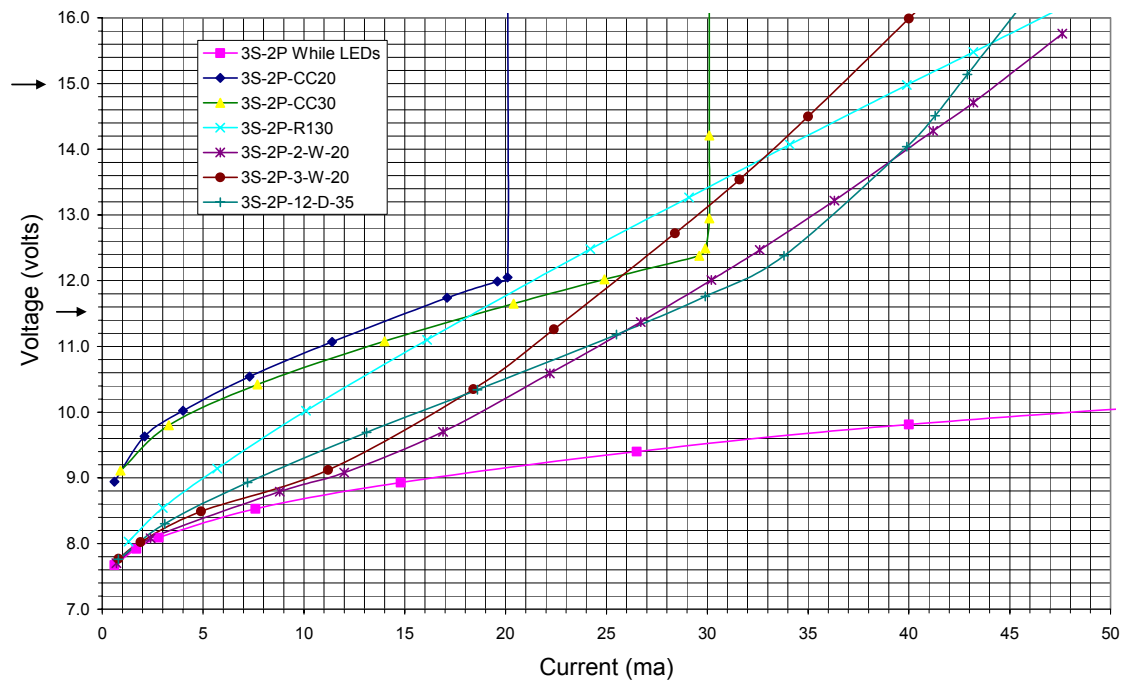

How to Efficiently Power LEDs in a Primitive Environment

F3b

4 Parallel connected sets of 3 series white LEDs
powered in different ways using a 12 v battery source

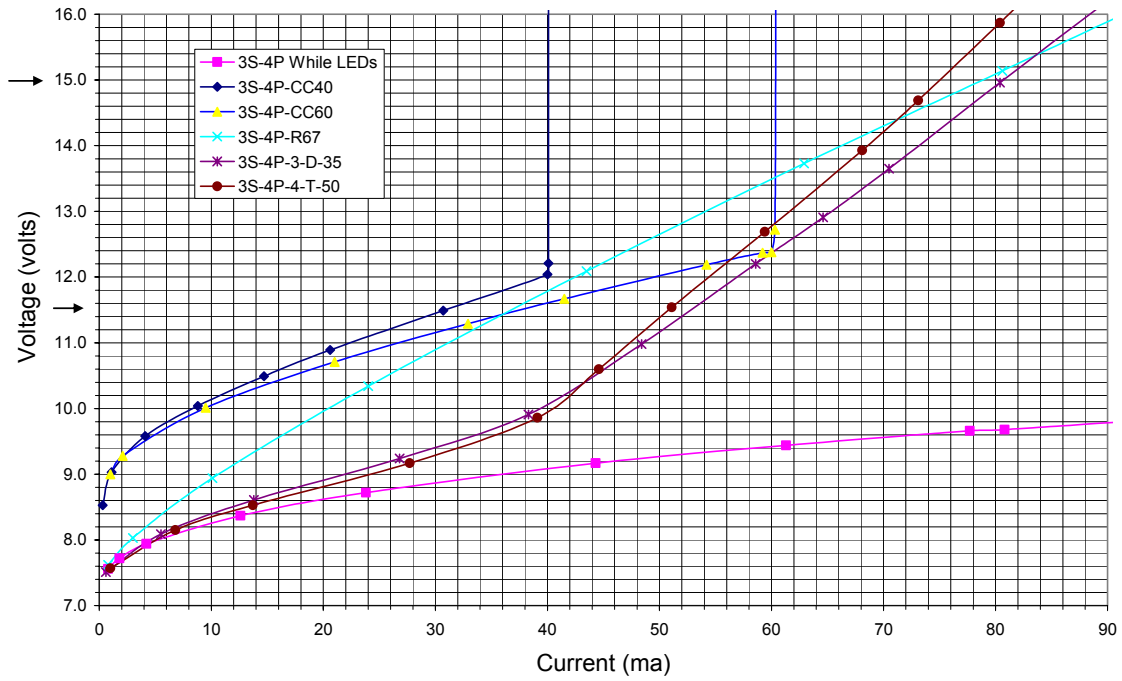

F3c

6 Parallel connected sets of 3 series white LEDs
powered in different ways using a 12 v battery source

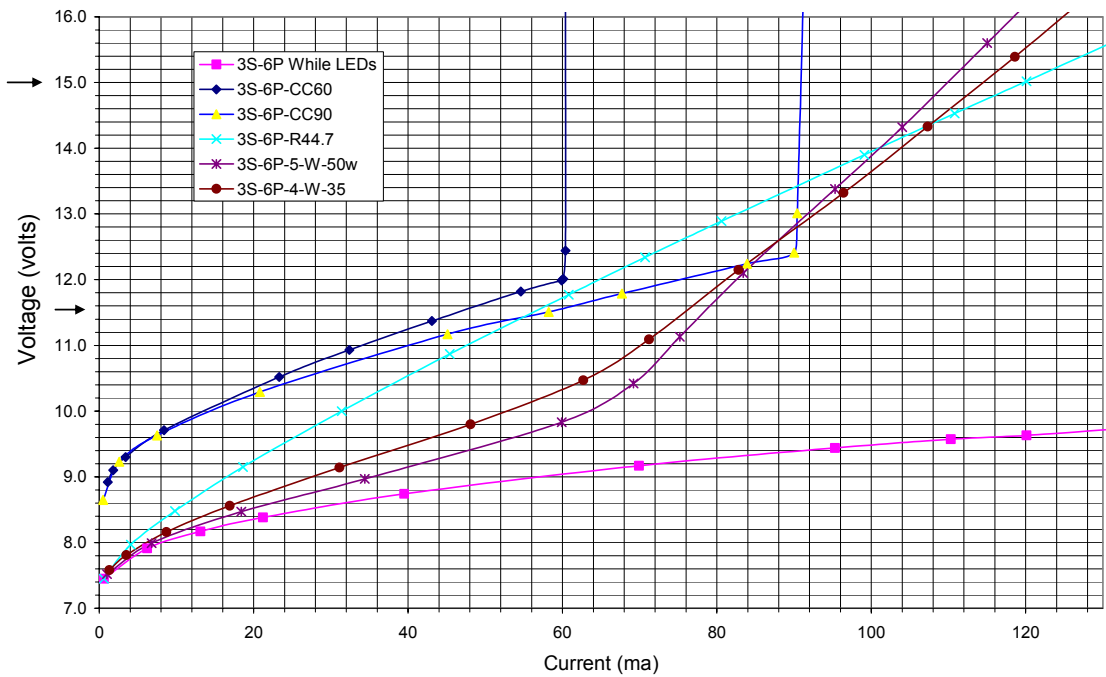

How to Efficiently Power LEDs in a Primitive Environment

F3d

7 Parallel connected sets of 3 series white LEDs powered in different ways using a 12 v battery source

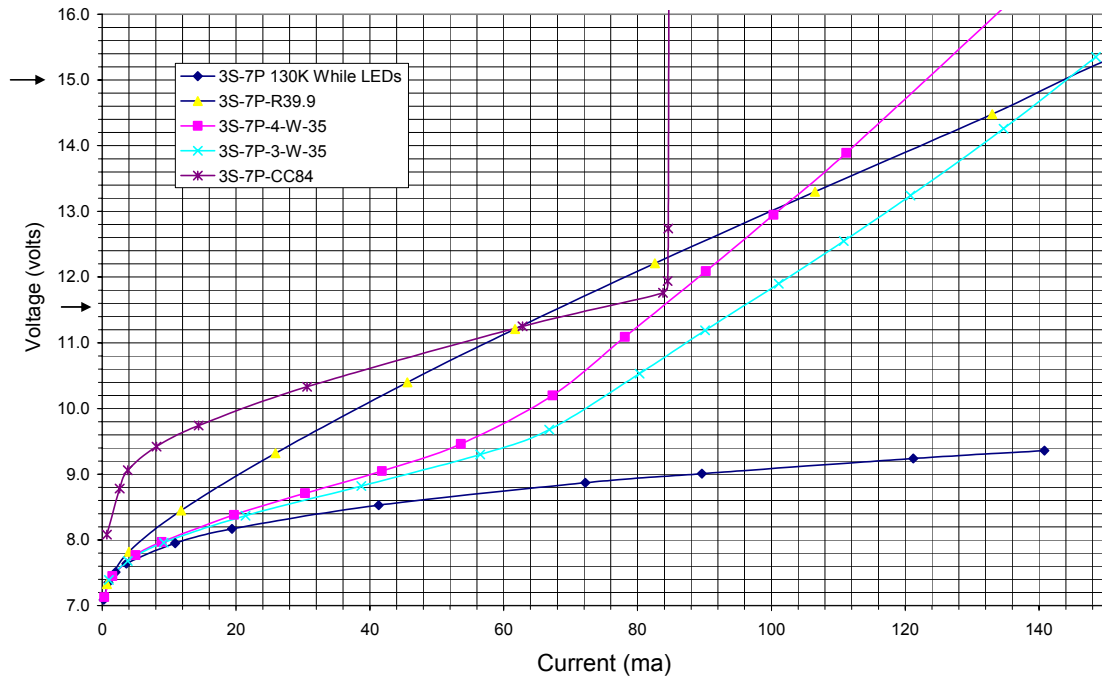

F4

Four 20kmcd 5 mm white LEDs in series and different ways to run it using 12 v battery

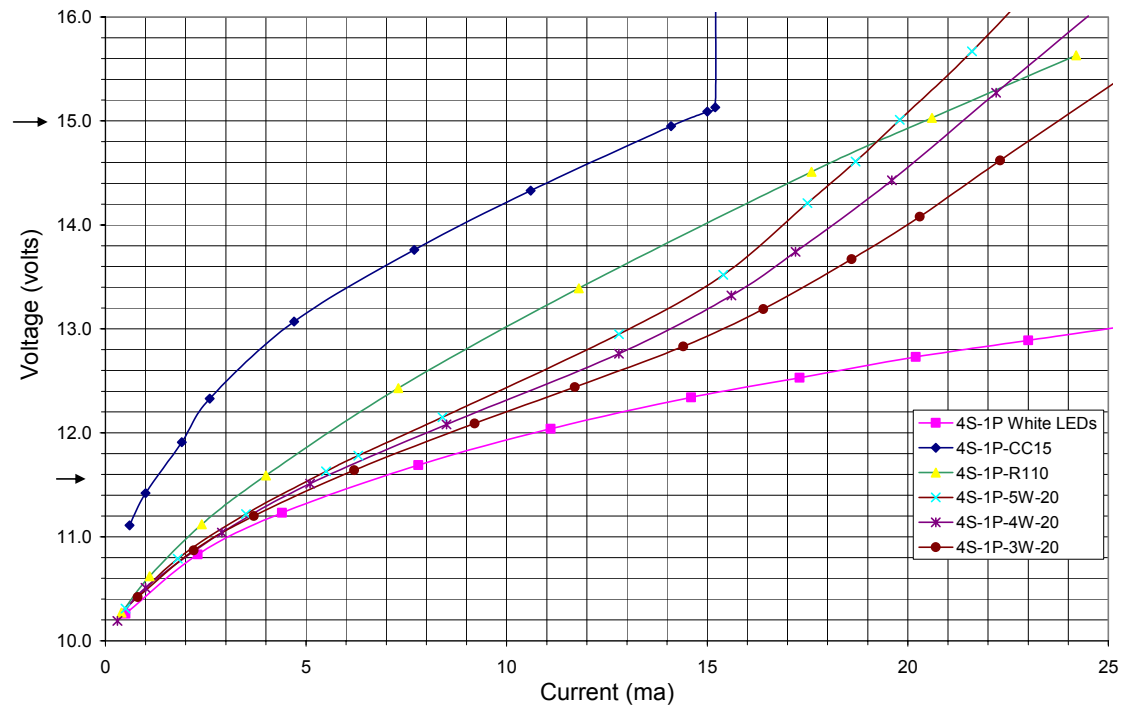

How to Efficiently Power LEDs in a Primitive Environment

F4a

2 Parallel connected sets of 4 series white LEDs
powered in different ways using a 12 v battery source

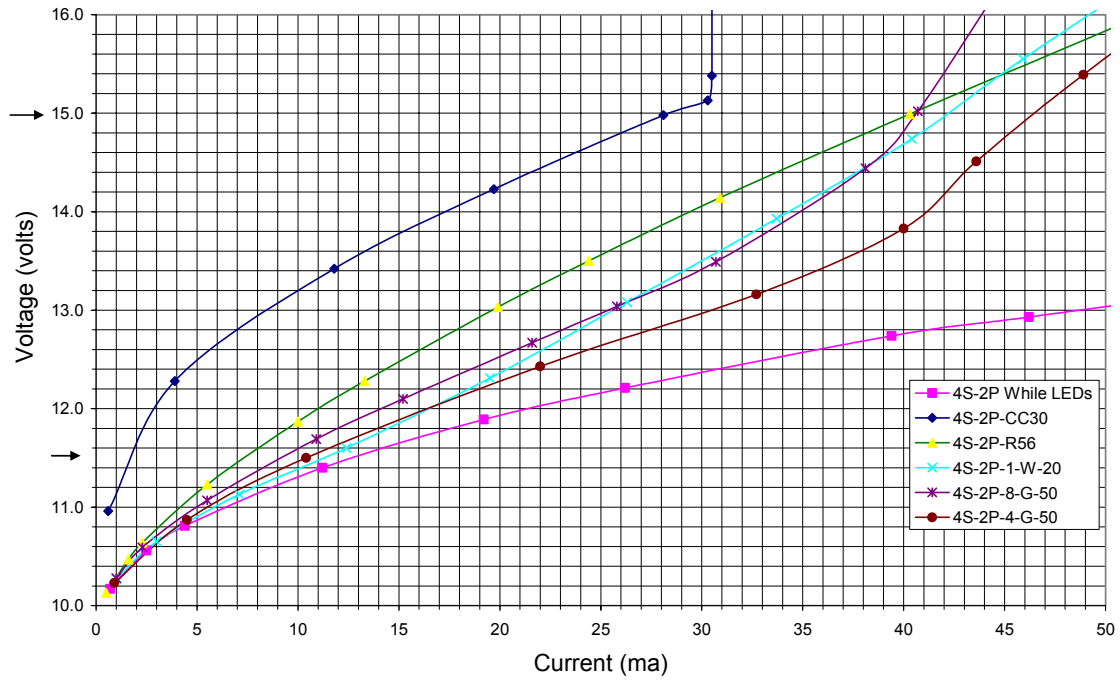

F4b

4 Parallel connected sets of 4 series white LEDs
powered in different ways using a 12 v battery source

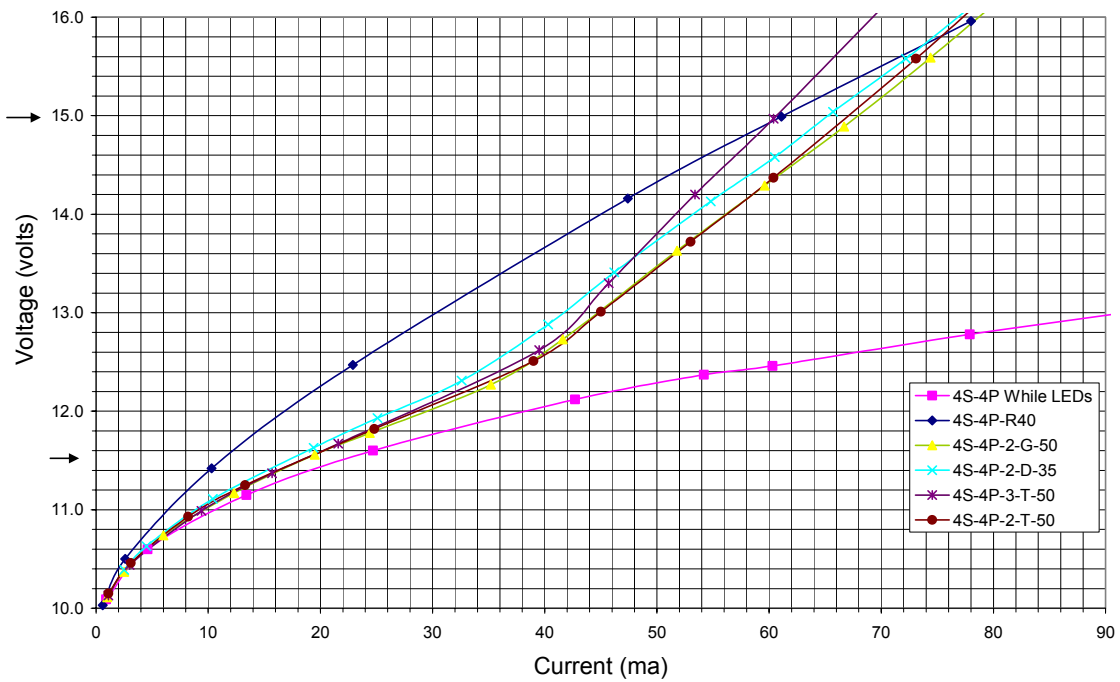

How to Efficiently Power LEDs in a Primitive Environment

The following wiring diagram is typical for x-mass tree bulbs. It can be used to help determine how many parallel combinations of N bulbs are in each string.

X-MASS TREE BULB STRING WIRING DIAGRAMS

Three wires twisted together indicates 2 or more parallel connected N bulb series connected strings

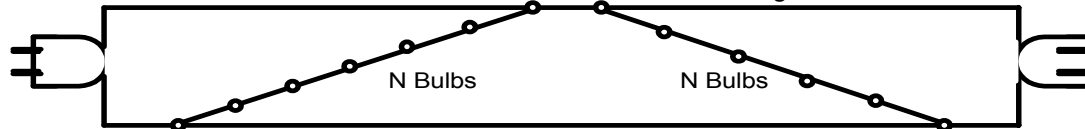

Total bulbs in string = 1,2,3,4 or more times N.
Voltage of each bulb = $120/N$

One or two wire is one series connected string

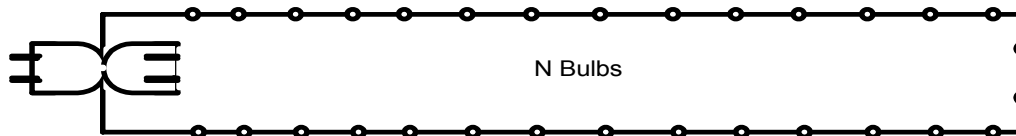

Total bulbs in string = N.
Voltage of each bulb = $120/N$

The number of bulbs hooked across 120 volts AC determines the operating voltage for the bulb. This then is the maximum this bulb should operate at. Reducing the voltage to 82% of the original will increase the lifetime by 10 times. Reducing the voltage to 68% of the original will increase the lifetime by 100 times.

# of Bulbs per 120 volts	Volts per bulb
20	6.0
35	3.4
50	2.4
100	1.2

The following table lists the characteristics of the typical miniature x-mass tree bulb. The current for the bend in the curve gives the point of best operating point for these bulbs. This bend in the curve current should be chosen to be between half and $\frac{3}{4}$ the intended operating current for the LED.

How to Efficiently Power LEDs in a Primitive Environment

X-mass tree bulb type and cost	Bulb ID	Color of light	Lux per bulb	Watts full string	Max Amps per bulb	Max Volts per bulb	Ohm Cold	Ohm Hot	Amps at bend in curve
Holiday Time from Wal-mart 100 CT mini light set (white wire) \$1.98	W-50w	white	2450	36.0	0.164	2.420	1.8	16	0.066
Targets 100 mini light set (green wire) \$1.99	T-50	white	1740	18.0	0.101	2.420	2.8	26	0.039
Wal-Mart 20 light set (green wire) \$.97	W-20	white	4300	6.5	0.073	6.050	8.4	101	0.016
Wal-Mart 70 mini light set (green wire) colored light \$4.46	W-35	multi color	680	46.0	0.210	3.457	2.3	18	0.060
Wal-Mart 100 mini light set (green wire) white light \$1.98	W-50g	white	2830	38.0	0.155	2.420	1.7	16	0.064
CVS Pharmacy "Merry Midget" 100 white light green wire miniature set \$1.99	C-50	white	2160	36.5	0.155	2.420	1.7	16	0.064
99 Cent store "Santa's Finest" 35 clear color	D-35	white	2450	12.0	0.118	3.457	3.5	33	0.040
Walgreen's \$1.99 50 light clear set 12 ft	G-50	white	2360	9.0	0.109	2.420	3.3	28	0.035
Alan Party Supply Co "Deco Lights" Walgreen's \$2.99 20 light clear set 8 ft	A-20	white	4480	13.0	0.125	6.050	5.4	55	0.028
Holiday Tradition 35 bulb miniature set \$.99	H-35	white	2820	12.0	0.109	3.457	3.7	35	0.034

The following graphs show the typical curves for voltage and current for miniature x-mass tree bulbs.

How to Efficiently Power LEDs in a Primitive Environment

A11-20

6.05V at 72-125ma for 20 bulb X-miss mini bulb strings

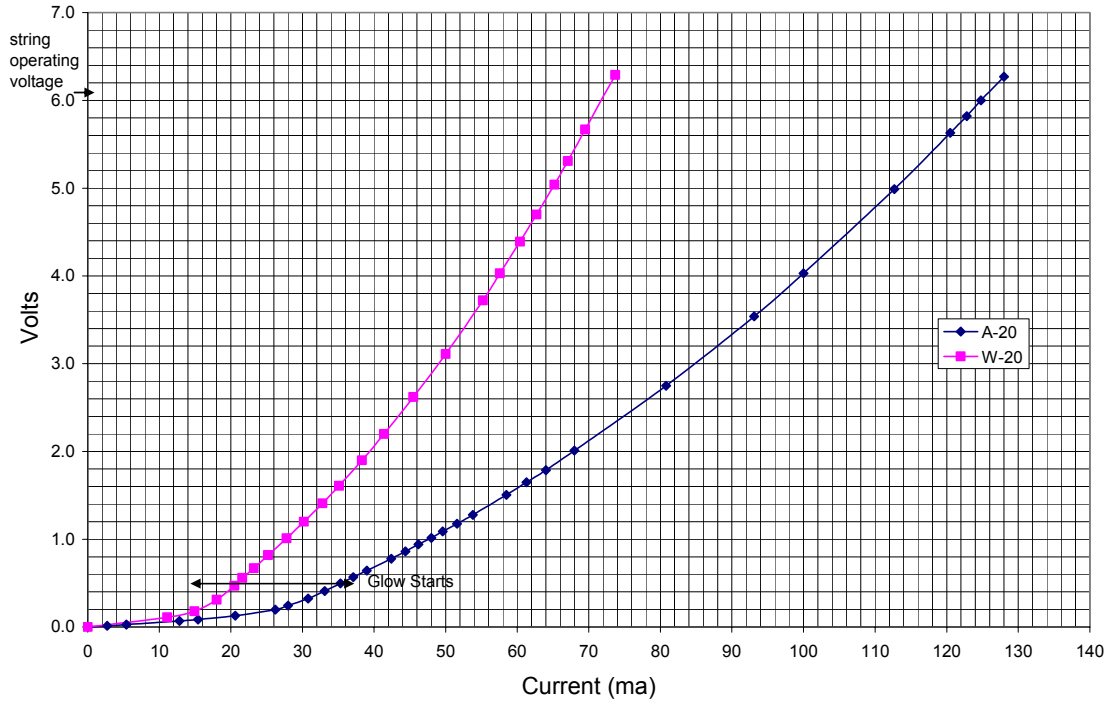

A11-35

3.46V at 119-210 ma for 35 or 2x35=70 X-miss mini bulb strings

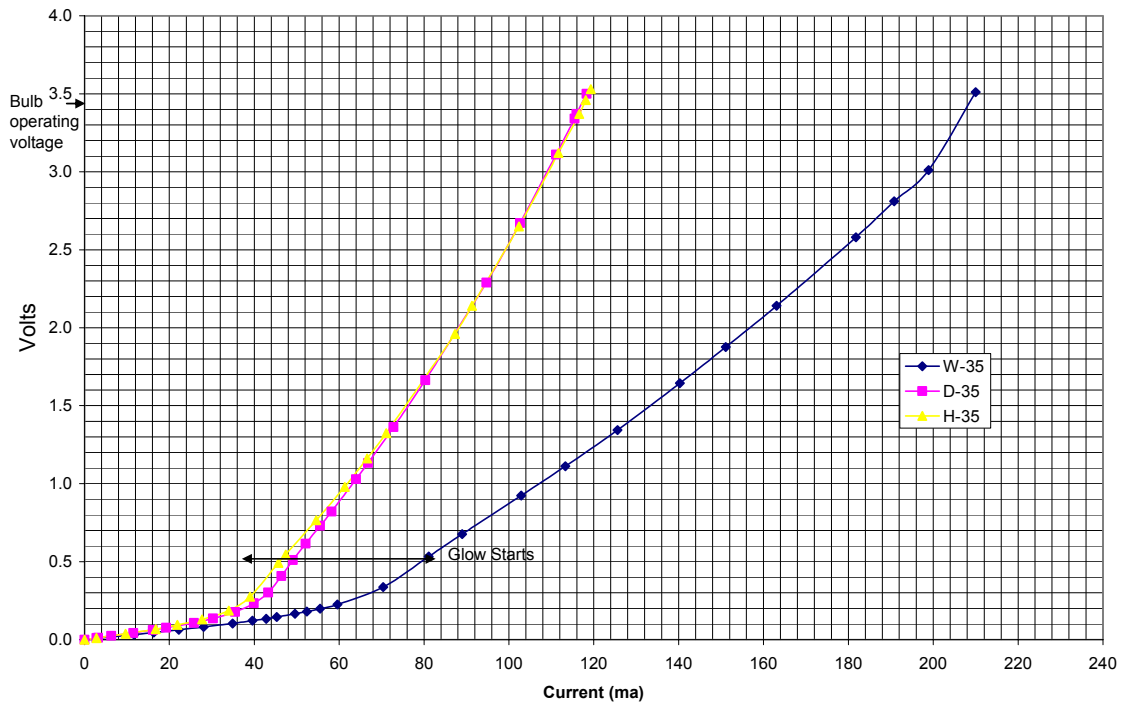

How to Efficiently Power LEDs in a Primitive Environment

All-50

2.42V at 92-162ma for 50 or 2x50=100 X-miss mini bulb strings

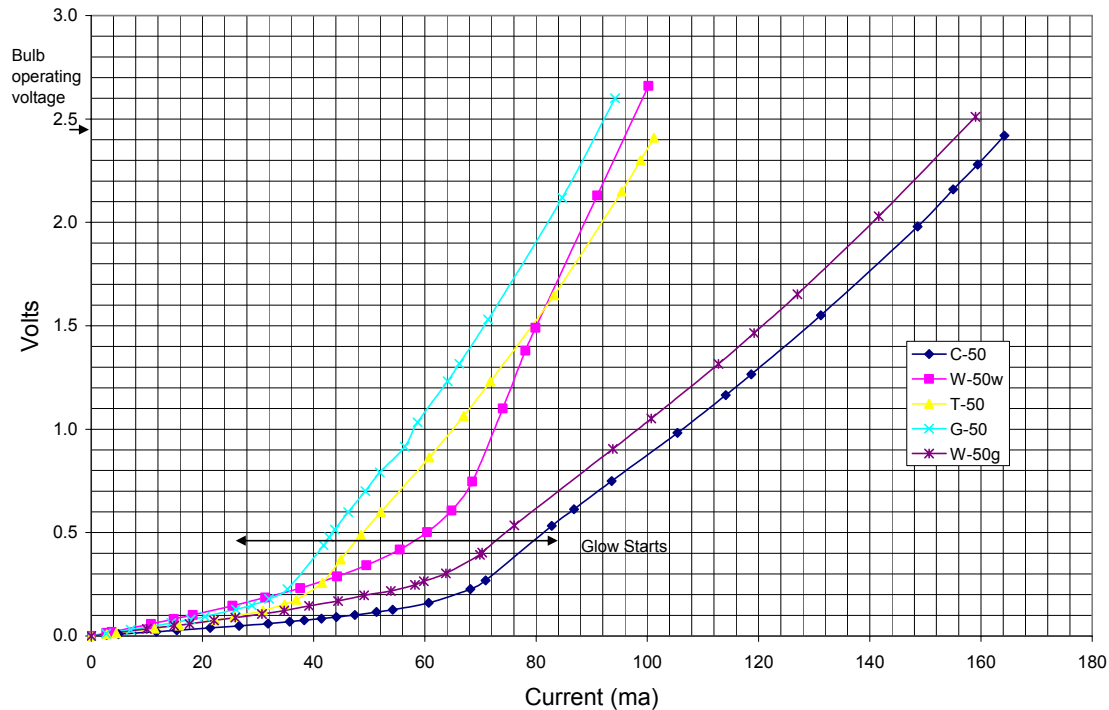

Results and Summary:

A series resistor to limit LED current has the following advantages and disadvantages.

Advantages:

- 1) Given the right size resistor it is simple to implement.
- 2) Is relatively small and non-breakable.
- 3) Can be used safely when operating current does not need to be controlled over a broad range.

Disadvantage:

- 1) Straight line characteristics make for energy inefficient current protection.
- 2) Should not be used when “design to” voltages are over a broad range. Has the least protection for the high current end of all of the 3 driver methods tested. Because primitive environments need to operate in broad voltage and current ranges this approach becomes the least workable one.

How to Efficiently Power LEDs in a Primitive Environment

X-mass miniature tree bulbs used as variable resistor to limit LED current have the following advantages and disadvantages.

Advantages:

- 1) Is the most energy efficient method of driving an LED to produce light. Allows more light in usable current range while protecting a bit better than a resistor at the high end.
- 2) Is more likely to be available after a PS than resistors.
- 3) Will last a long time at reduced currents before burn out.

Disadvantages:

- 1) More prone to developing corrosion at the socket to bulb mechanical connection. Recommend soldering when one can do this. They do need special cleaning if soldered.
- 2) One needs to match typical current flow to be greater than bend in resistance curve. Takes a bit of trial and error.
- 3) The bulbs are fragile and can break if not protected.
- 4) Current surge when cold is more than a resistor and may in the long run slightly shorten LED lifetime.

The use of an LM-317 integrated circuit in a constant current circuit configuration driven by a wide ranging voltage values as a driver circuit for LEDs has the following advantages and disadvantages.

Advantages:

- 1) Will work up to voltages of 37 volts and still hold the current to a given maximum depending the value of the control resistor.
- 2) Low cost and easy to implement. Provided some chips are purchased and stored before the PS.
- 3) This is by far the safest most protected way to drive LEDs. Keep the current below a given value for all input voltages.

Disadvantages:

- 1) They use a bit of energy taking in about 2.3 volts of overhead. This is the minimum drop across the unit that is needed to control current. Thus they are not the most energy efficient way of driving LEDs.
- 2) They would not be readily available after a PS. Would need to purchase them before.

How to Efficiently Power LEDs in a Primitive Environment

Availability:

LM317LZ (small size no heat sink) Jameco# 23552 cost \$.23/each

LM317T (bigger with heat sink) Jameco# 23579 cost \$.45/each

Go to <http://www.jameco.com/> and type in the part number.

Resistors can be ordered from:

<http://www.digikey.com/scripts/DkSearch/dksus.dll?Criteria?Ref=17978&Site=US&Cat=34341471>

As examples:

82 ohm 82H-ND cost \$1.89/100

160 ohm 160H-ND cost \$1.89/100

110 ohm 110H-ND cost \$1.89/100

LEDs can be ordered from <http://www.ebay.com/>

Search for “white led mcd 100” or whatever color you want. Some of the Highest MCD are the newest or the narrowest beam angle. These are not necessary the longest lasting. To determine lifetime one needs to ask detailed questions to the seller. Even then it is not that easy. Good luck.

MikeL