

AT MICROFICHE
REFERENCE
LIBRARY

A project of Volunteers in Asia

Low Cost Physiotherapy Aids

by Don Caston

Published by:

Appropriate Health Resources and Technologies
Action Group (AHRTAG)
85 Marylebone High Street
London W1M3DE
UNITED KINGDOM

Available from:

same as above

Reproduced by permission.

Reproduction of this microfiche document in any
form is subject to the same restrictions as those
of the original document.

LOW COST PHYSIOTHERAPY AIDS



BY DON CASTON

ILLUSTRATED BY JOAN THOMPSON

Appropriate Health Resources and
Technologies Action Group Ltd.

LOW COST PHYSIOTHERAPY AIDS

Designed by Don Caston
Illustrated by Joan Thompson
Physiotherapy adviser Sarah Holloway

**For AHRTAG
85, Marylebone High Street, London W1M 3DE, U.K.**

The development and publication of this book was made possible by a grant from the Swedish International Development Authority (SIDA).

We would like to acknowledge the help of Miss Meenakshi Zaveri, Miss Chhanda Das and Mr Gautam Chaudhury.

Published by the Appropriate Health Resources and Technologies Action Group Ltd.

Copyright © 1982 AHRTAG

AHRTAG will gladly consider any request for permission to reproduce or translate part or all of this publication.

ISBN (AHRTAG) 0 907320 06 6

Printed and bound in England by

Bourne Offset Ltd.

2, The Ridgeway,

Iver, Bucks.

INTRODUCTION

This book shows how to make simple aids for exercising different parts of the body. The aids can be used in hospital or at home. A person must continue with the exercises after he has left hospital.

It is important that whoever chooses the aid understands the right treatment for each medical condition. The maker must work closely with a medical adviser so that they can adapt exercises to suit each person.

USING THE AIDS

- Make each aid the correct size for the user. If the aid is too large or too small the exercise will not help. You can see the correct measurement for each aid by looking at the pictures.
- Make sure the person will not fall over and injure himself when he does the exercises.
- The aid must not rub or press on the skin. You must be very careful with people who have no feeling in their skin, as with leprosy.
- Make sure the aid is comfortable to use.
- Smooth all rough surfaces and remove all corners and sharp edges.
- Make sure that ropes and ties do not cut into the skin.

HINTS ON MAKING THE AIDS

- You can make all the aids in the book using local materials and skills. All you need is wood or bamboo, with nails, string and cloth.
- Handicapped people can make these aids. You can make foot and hand vices to help them hold the wood in place while they work (see page two).
- You can make a weight by filling a piece of cloth with sand, clay or stones. This is shown on page 17.
- You can adjust hand or finger exercises to suit the strength of the person who will use them. The thicker the wood, the more strength the person will need to do the exercise. You can make the wood easy to bend by thinning it.
- When you make the exercisers which need a material that will stretch, you can use pieces of old rubber inner tube cut from a car or bicycle tyre.

TOOLS

- You can make all the aids with a saw, chisel, hammer and a drill.
- You can make your own wooden hammer and bow drill. You can make chisel and drill bits with nails.

TOOLS USED TO MAKE AIDS

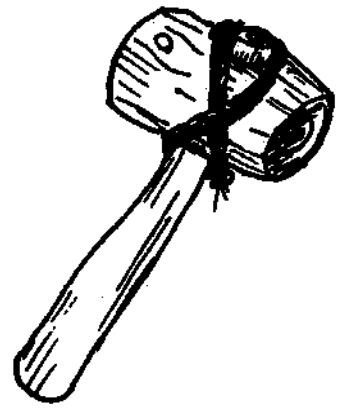
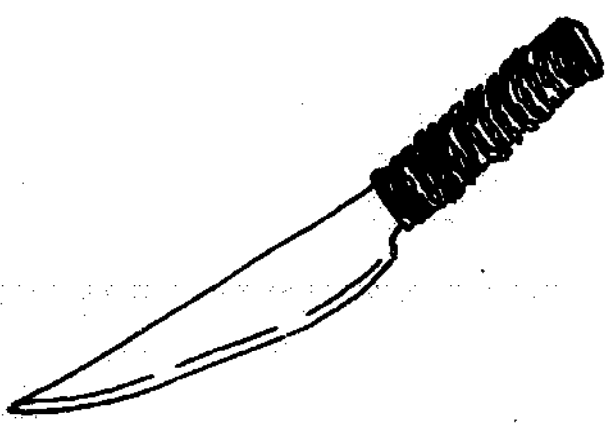
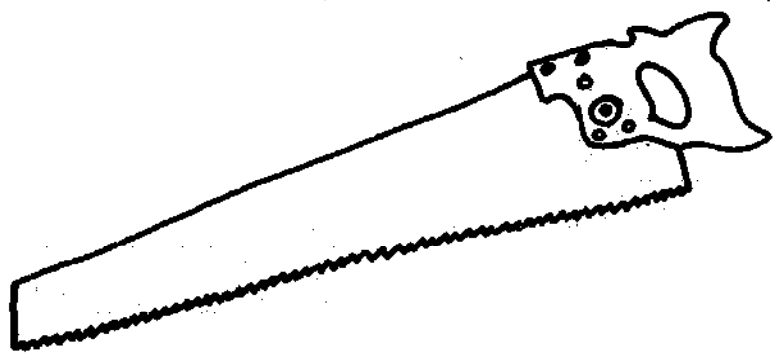
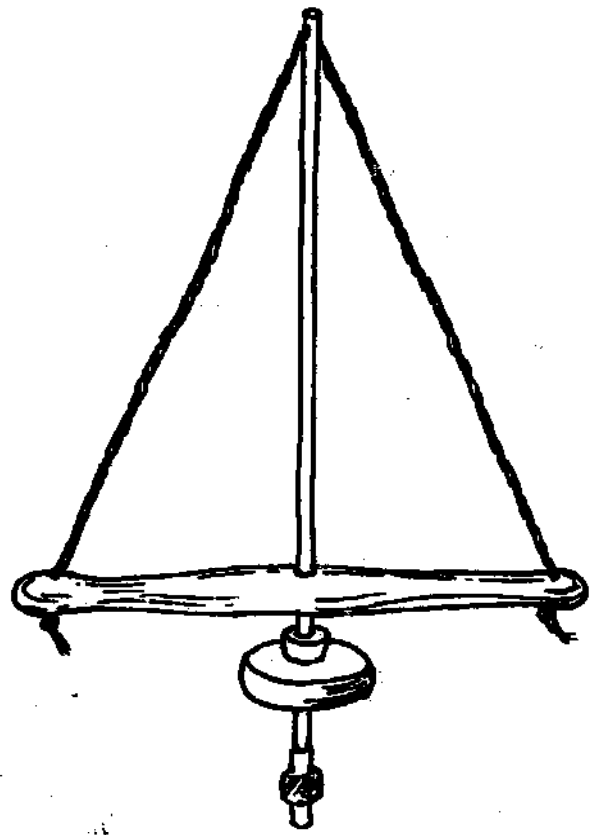
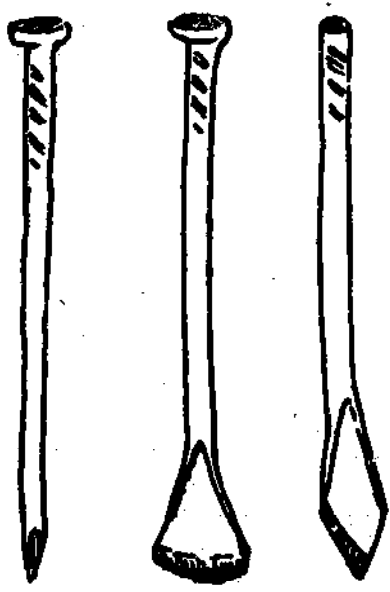

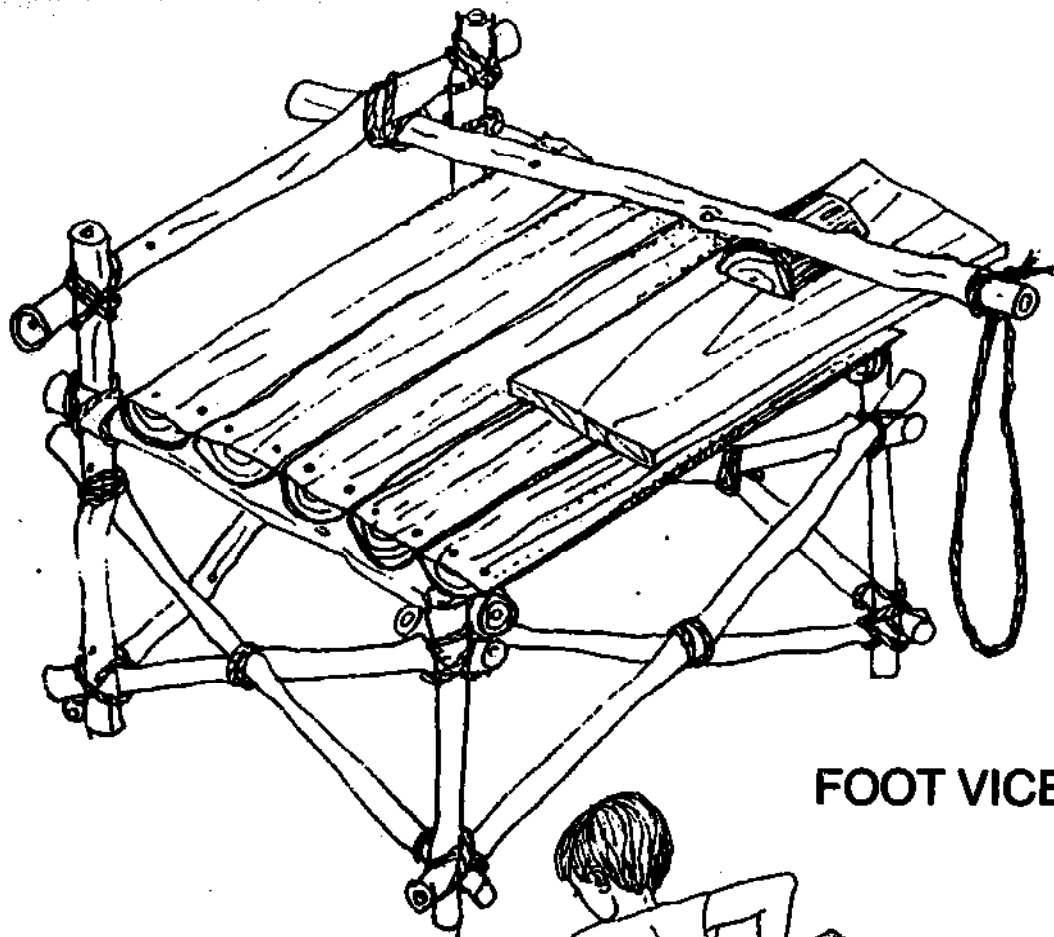

FOOT VICE

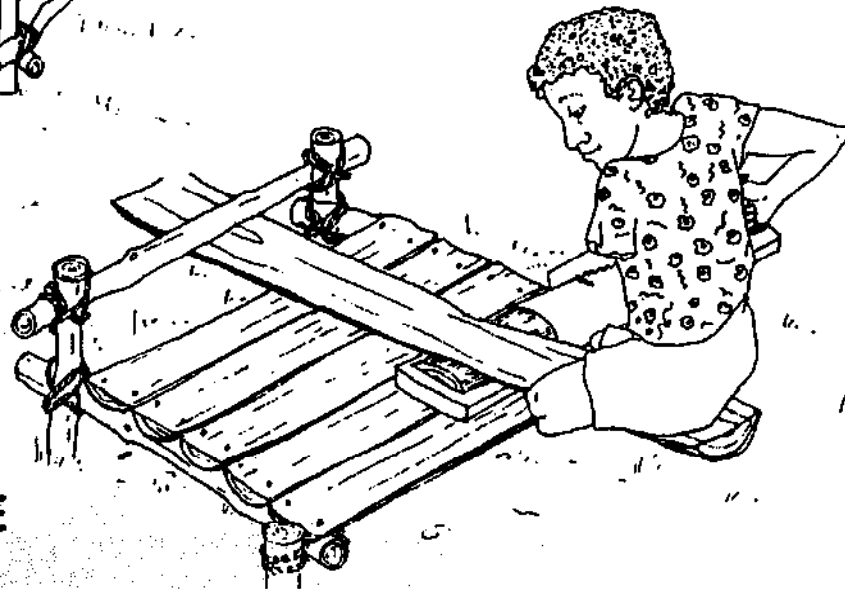
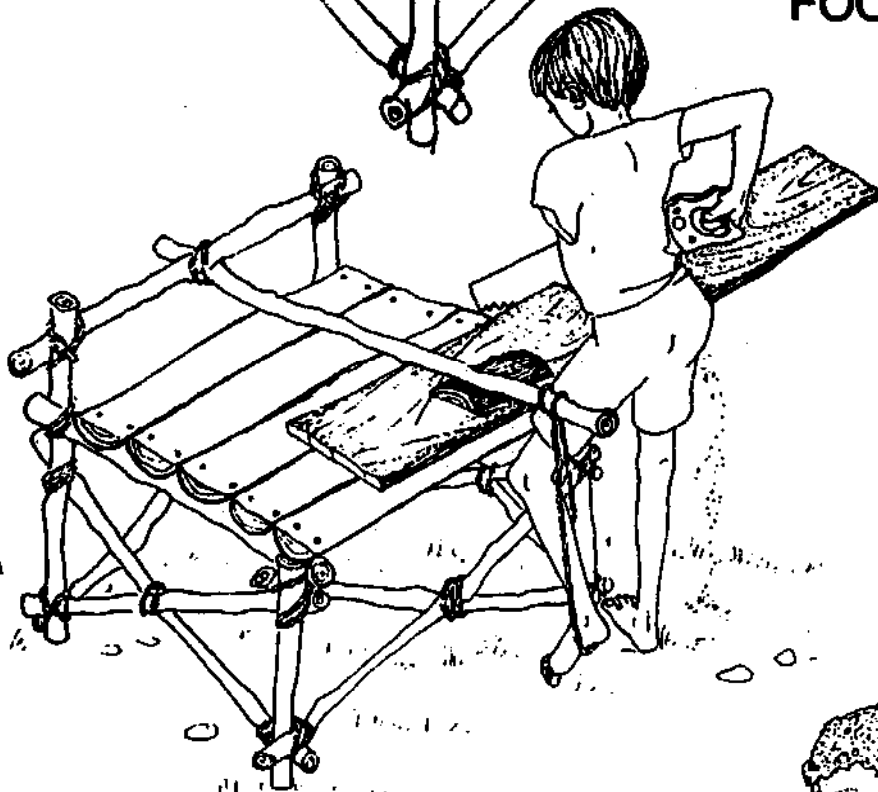

SITTING VICE

FINGER EXERCISER

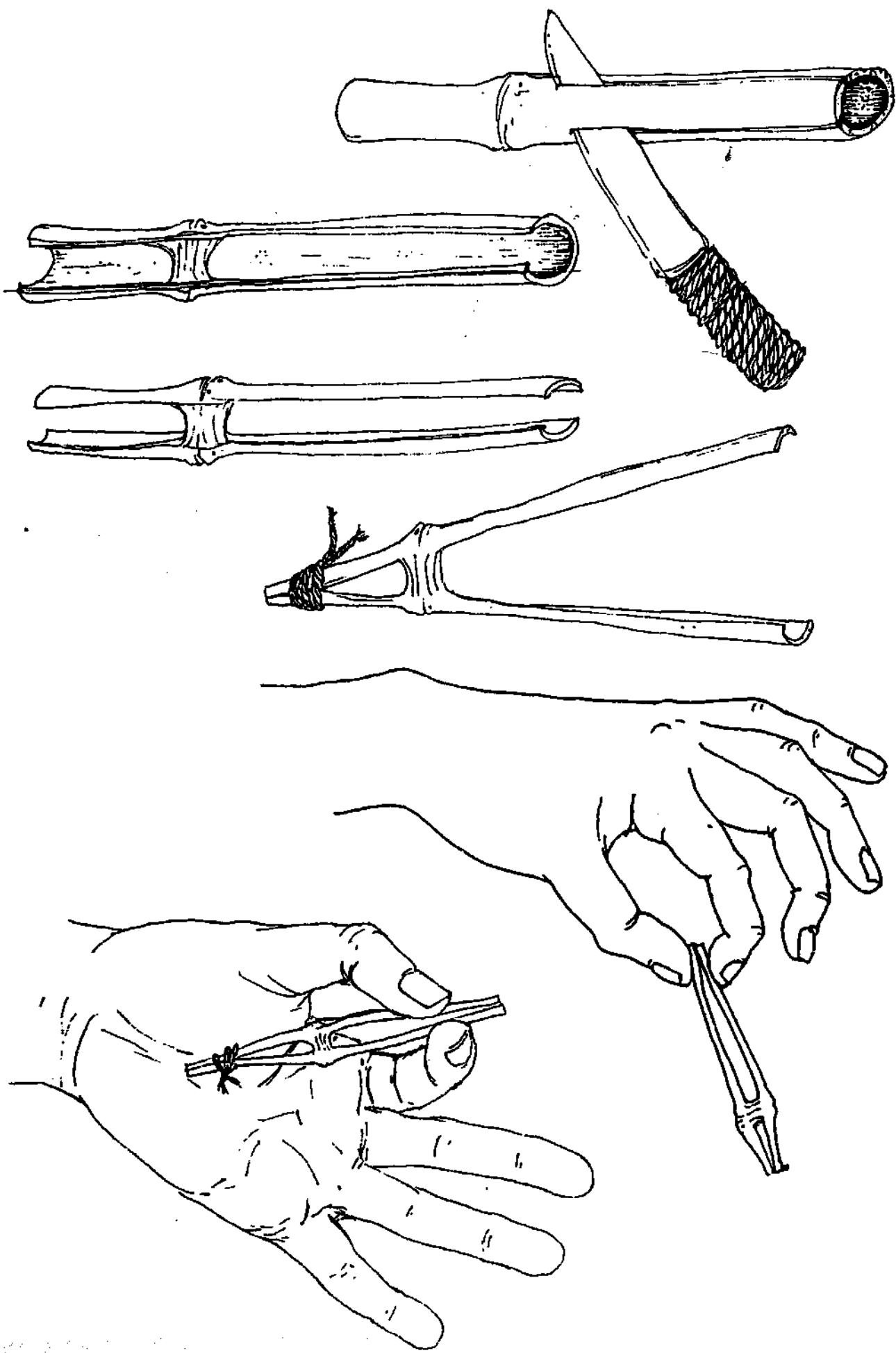

FINGER EXERCISER

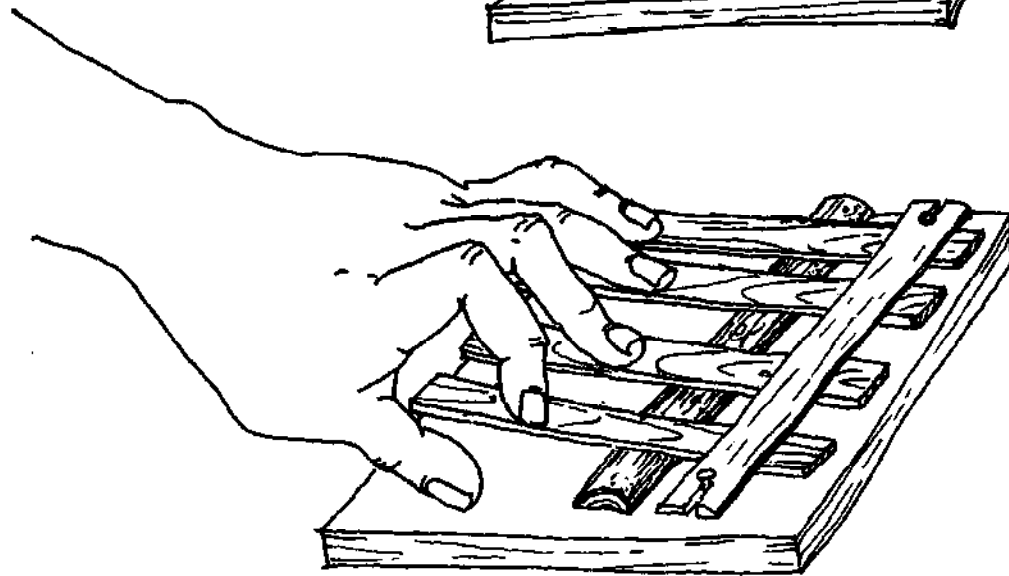
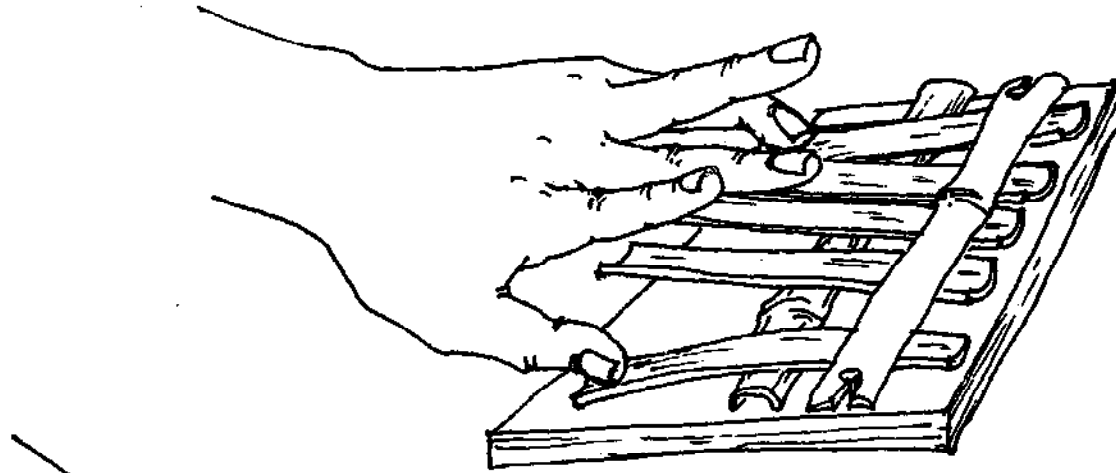
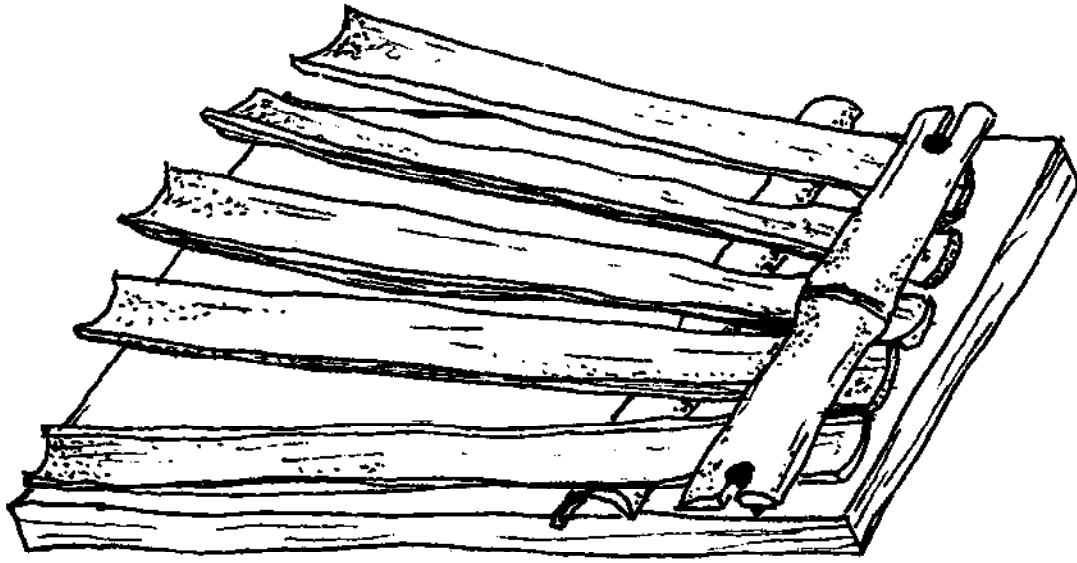

FINGER EXERCISER

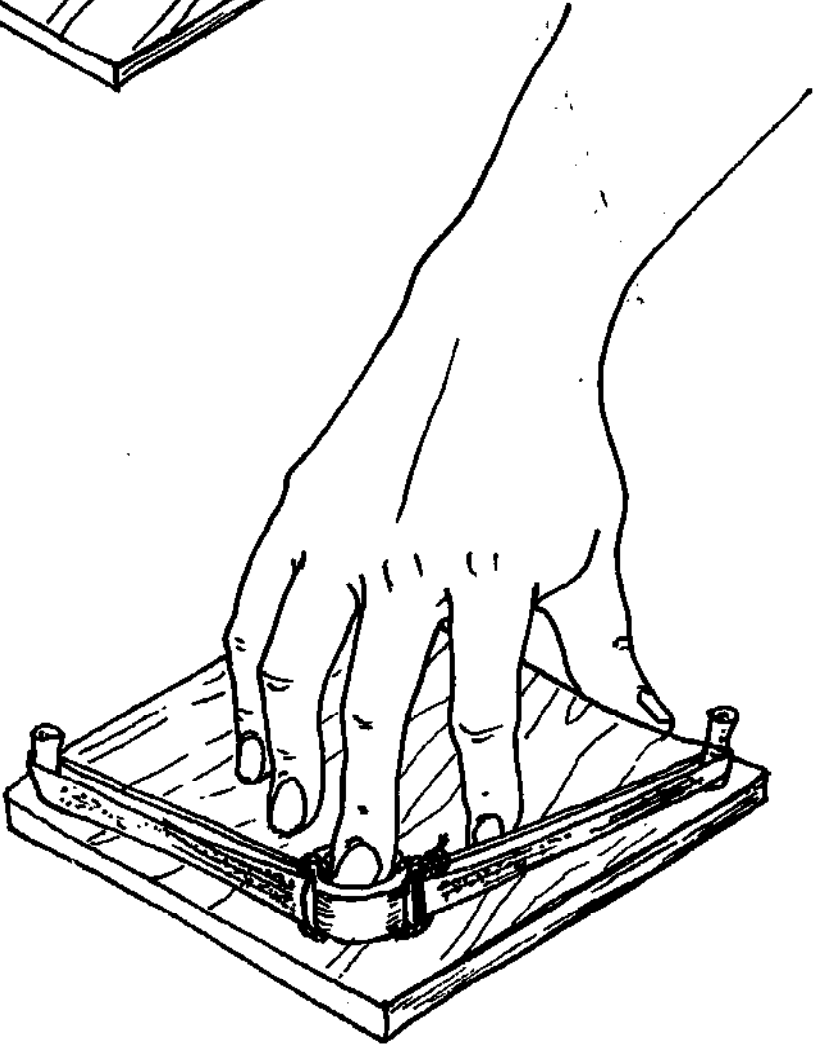
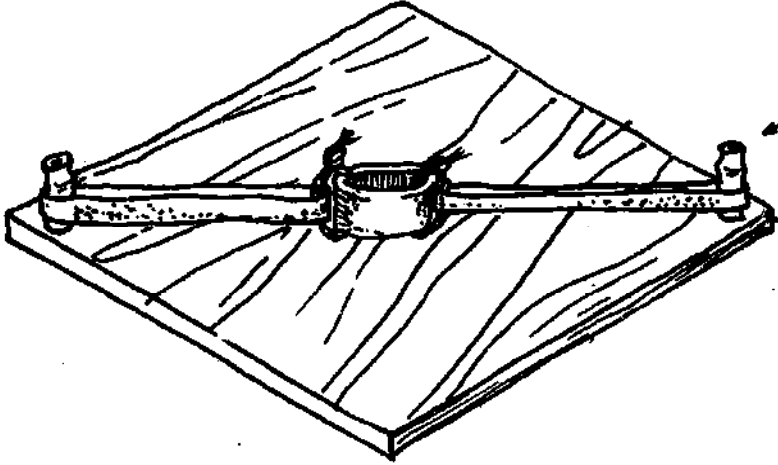
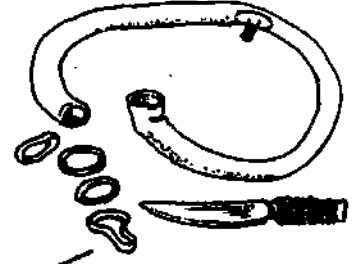
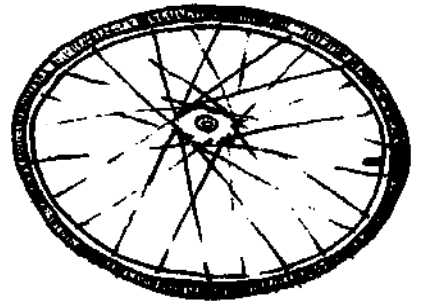

FINGER EXERCISER

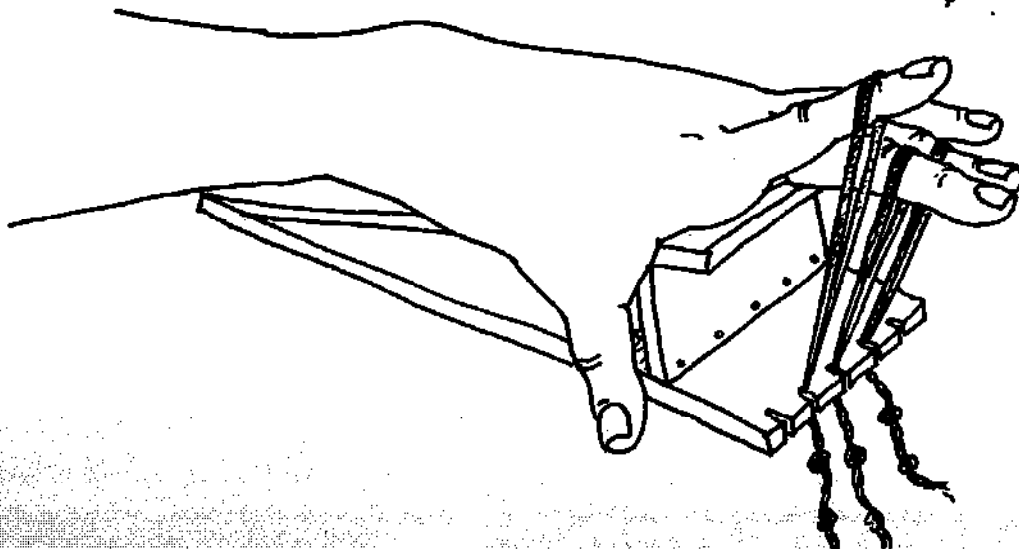
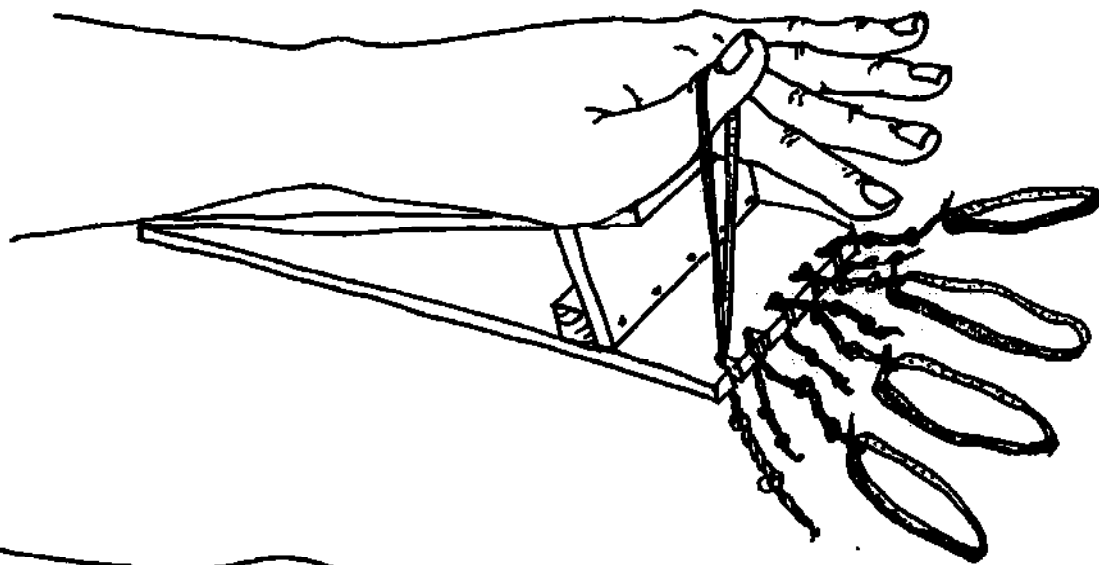
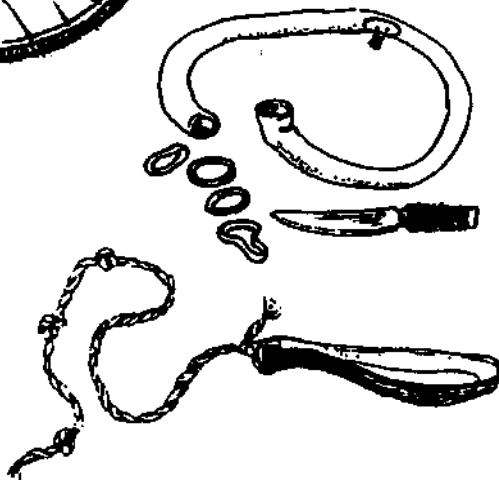
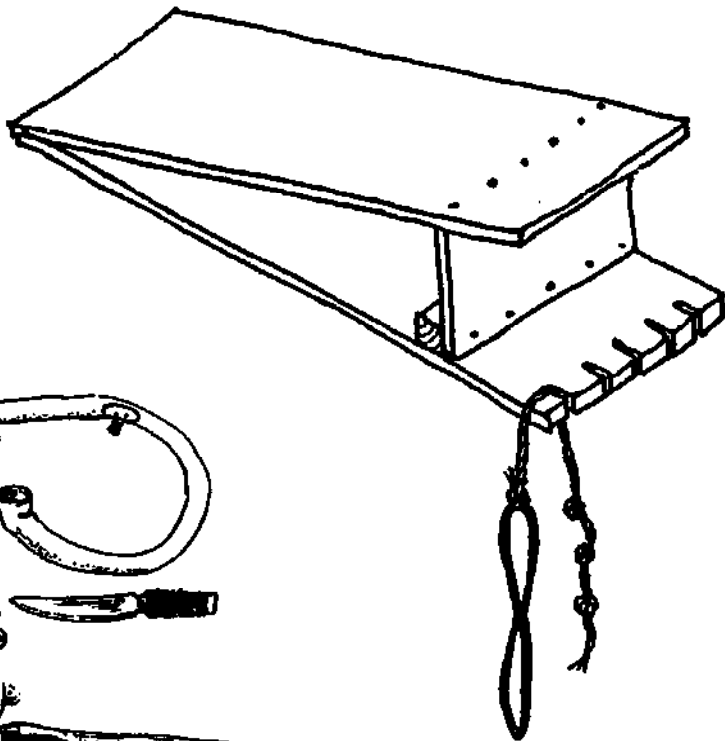
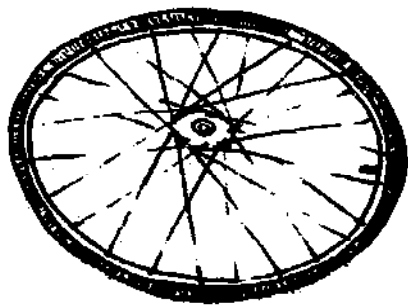

FINGER EXERCISER

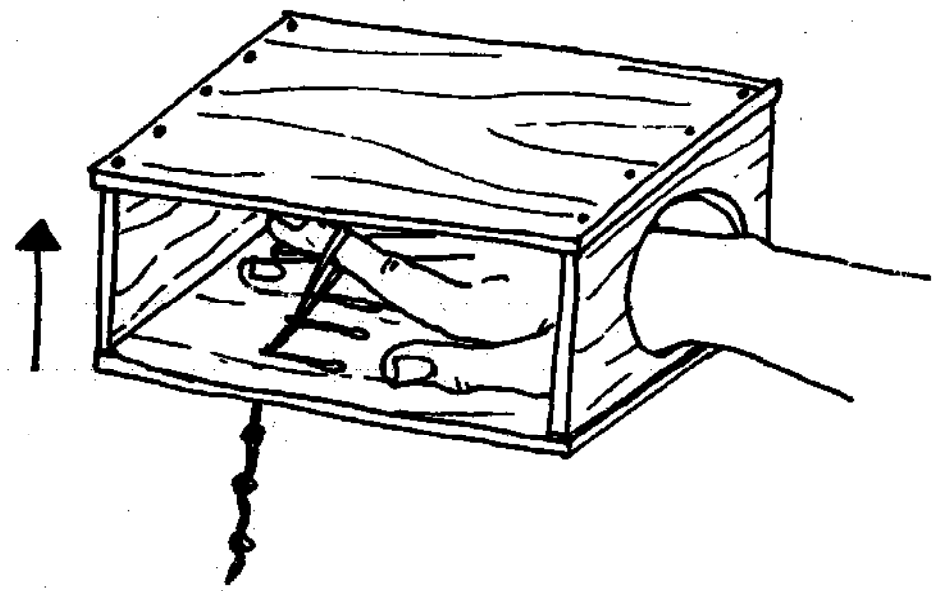
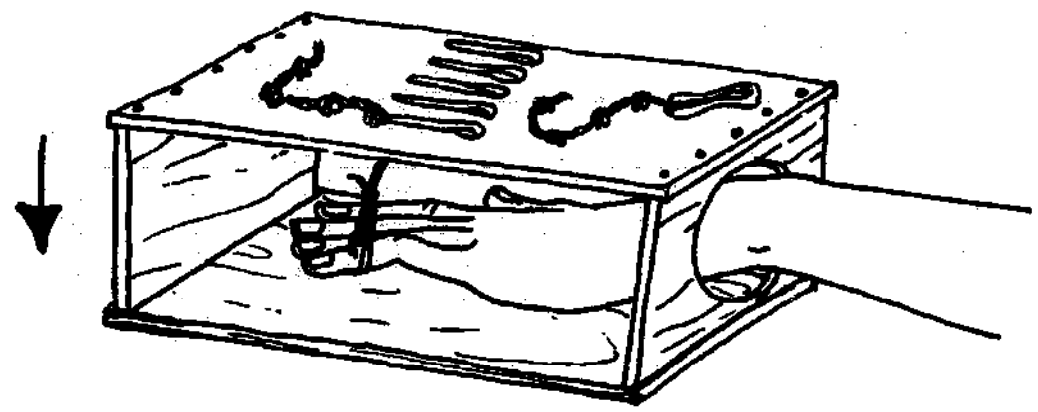
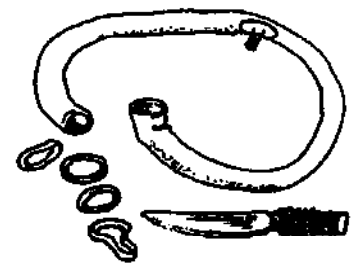
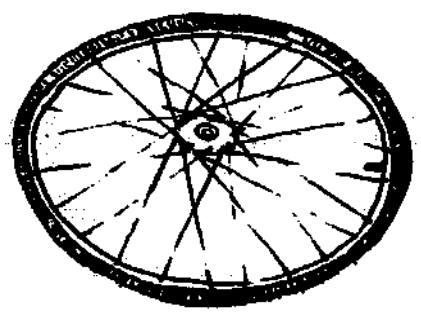

HAND AND FINGER EXERCISER

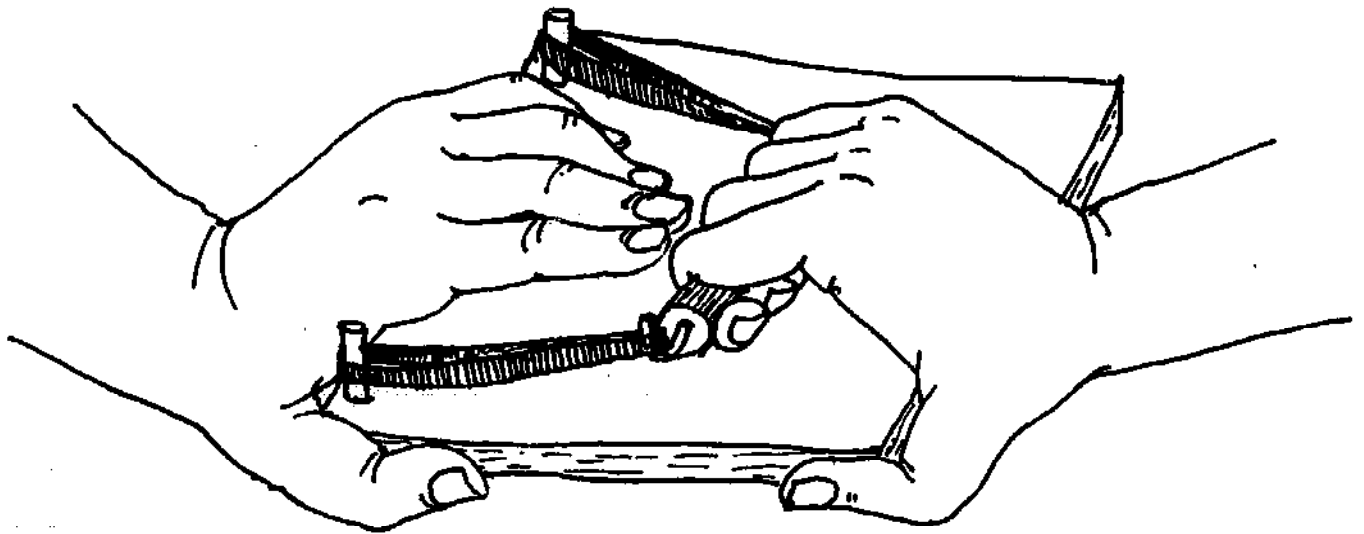
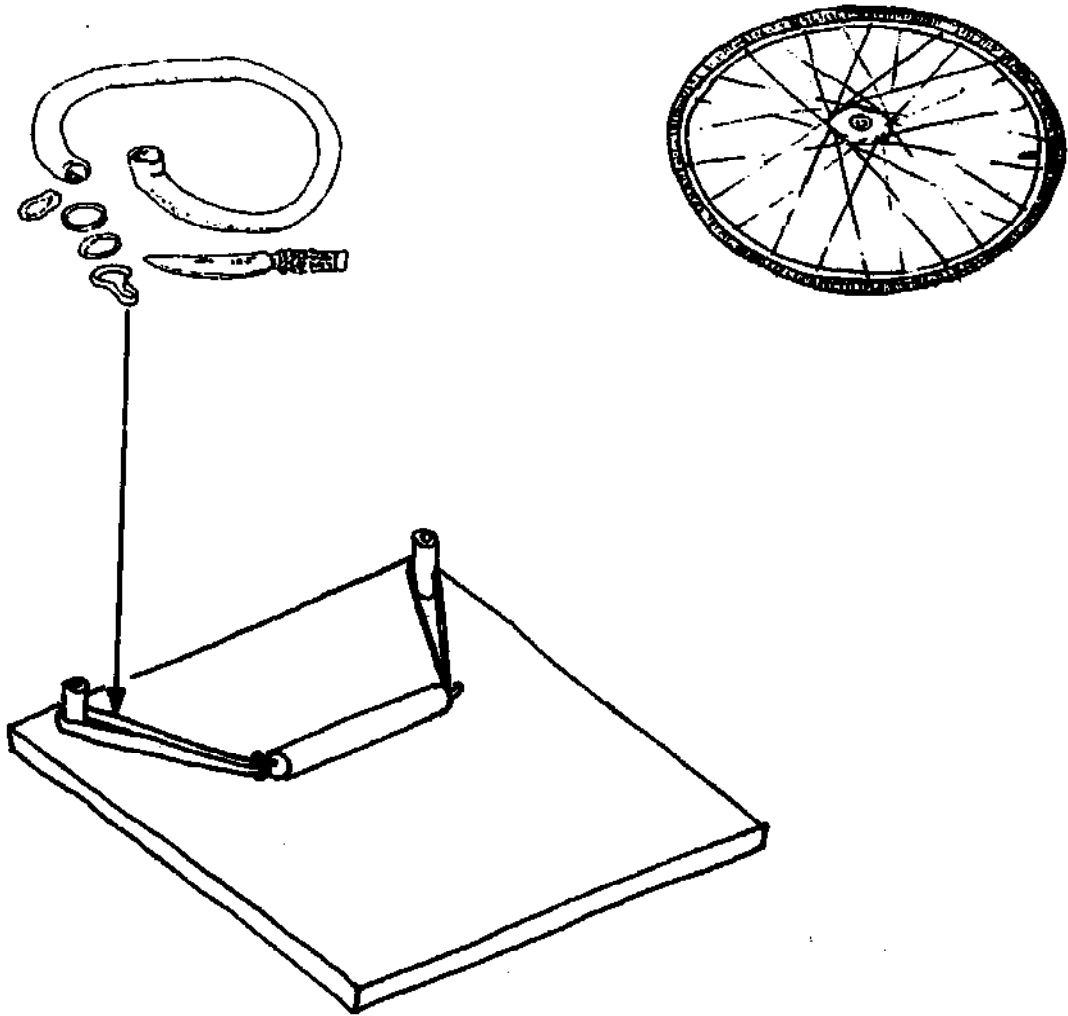

CLAY HAND EXERCISER

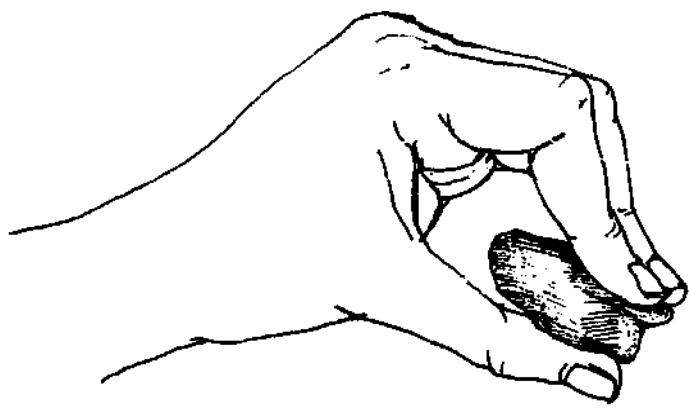
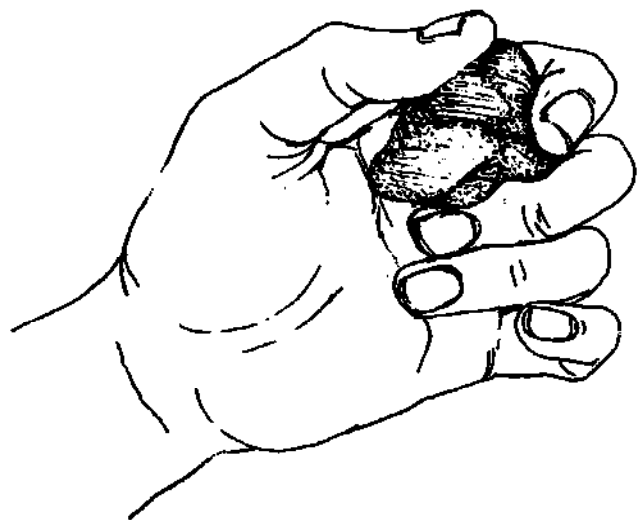

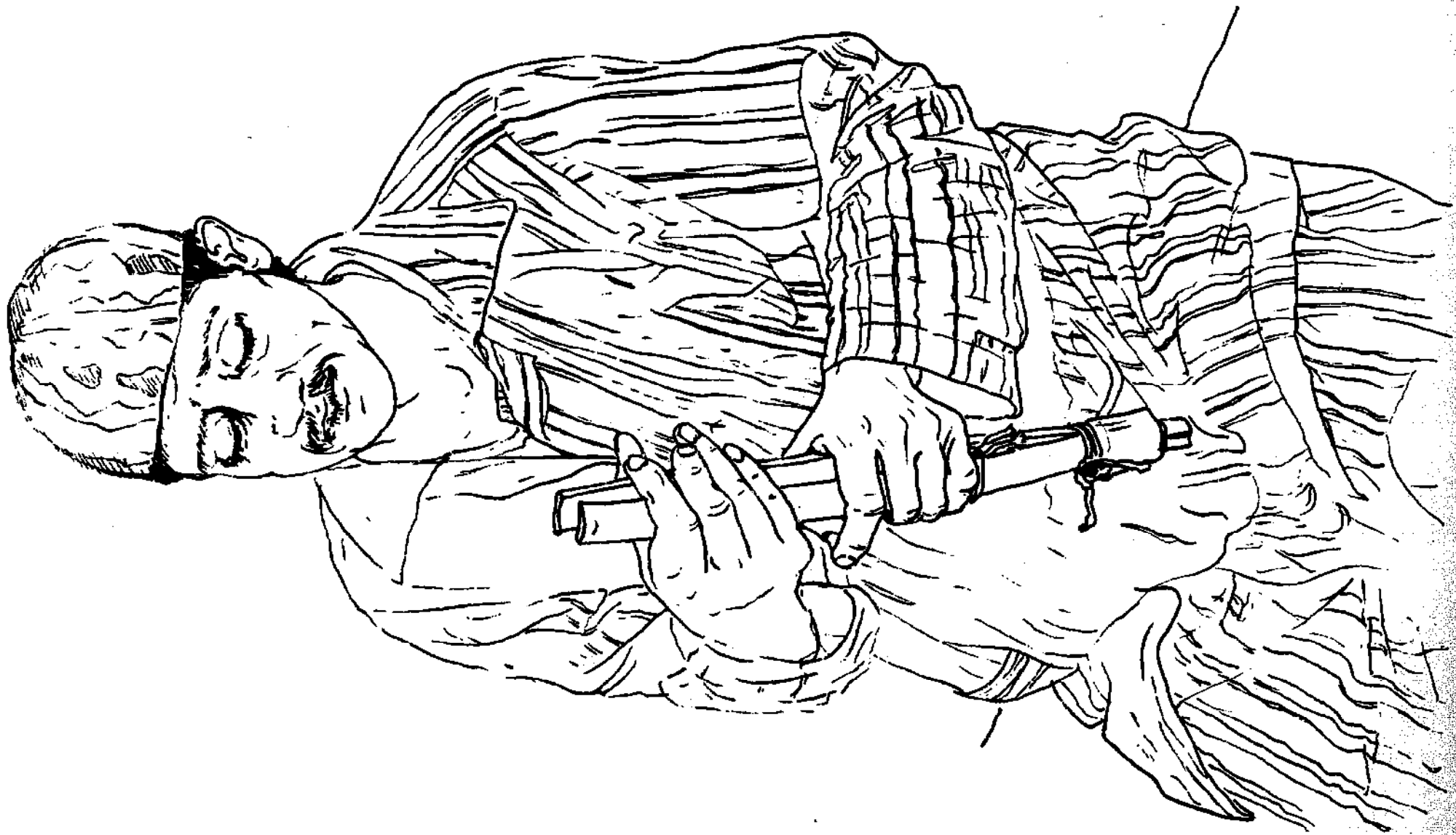

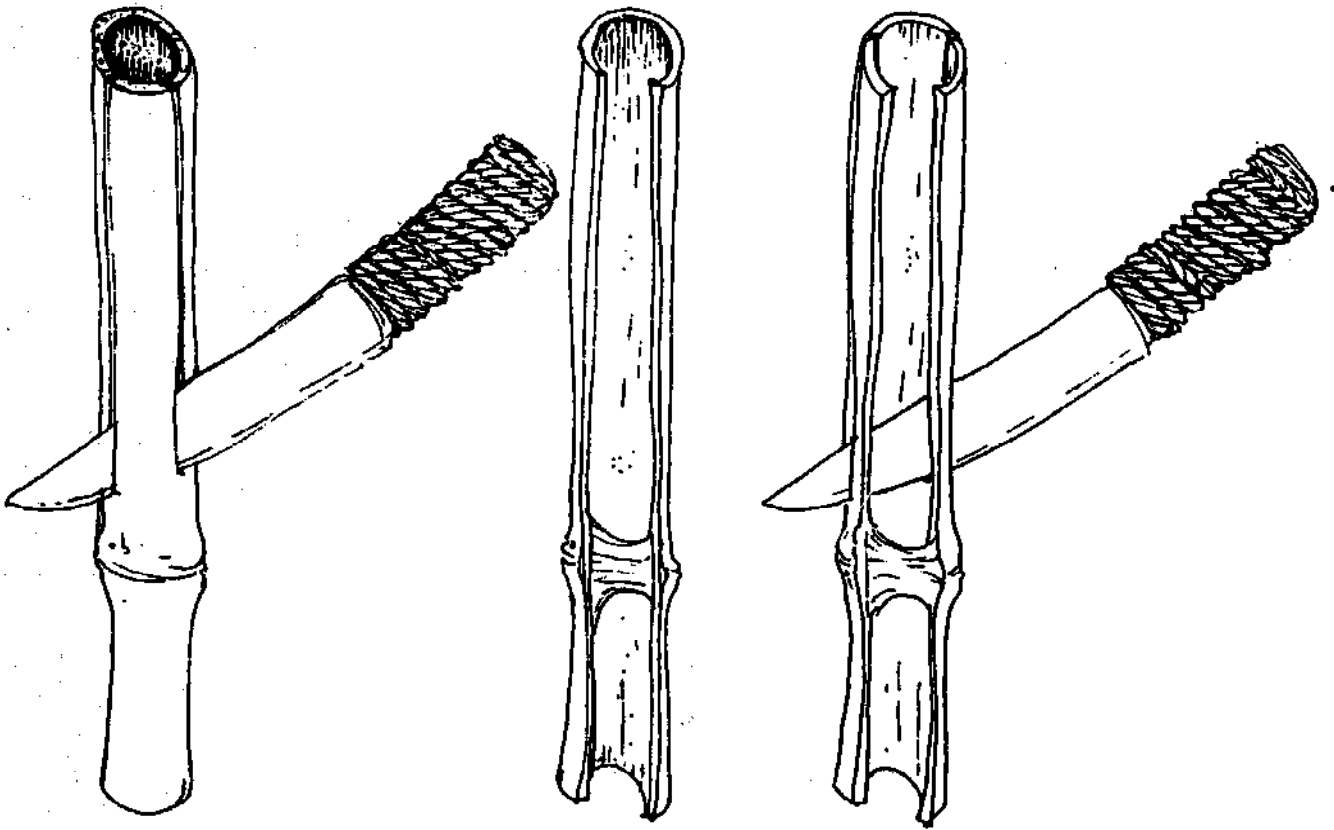

HAND EXERCISER

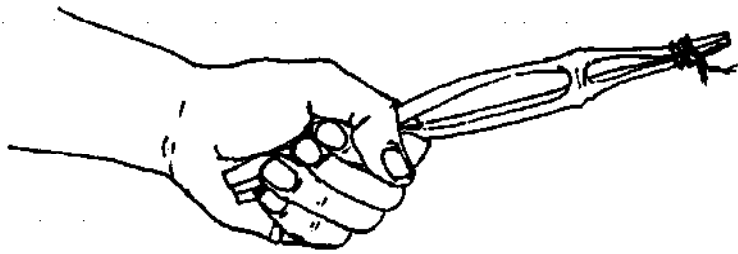
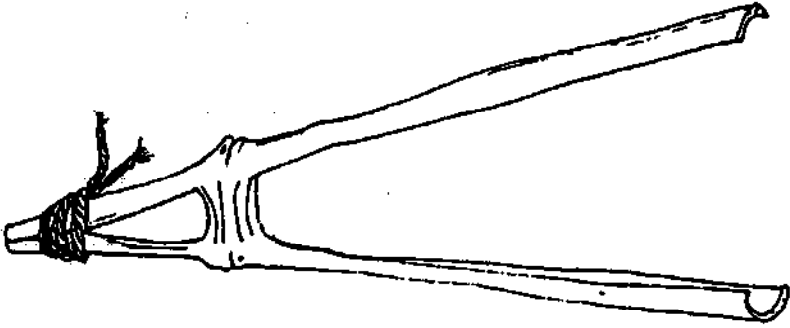
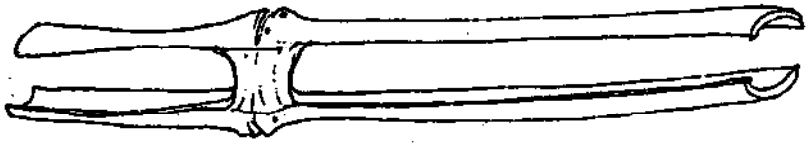

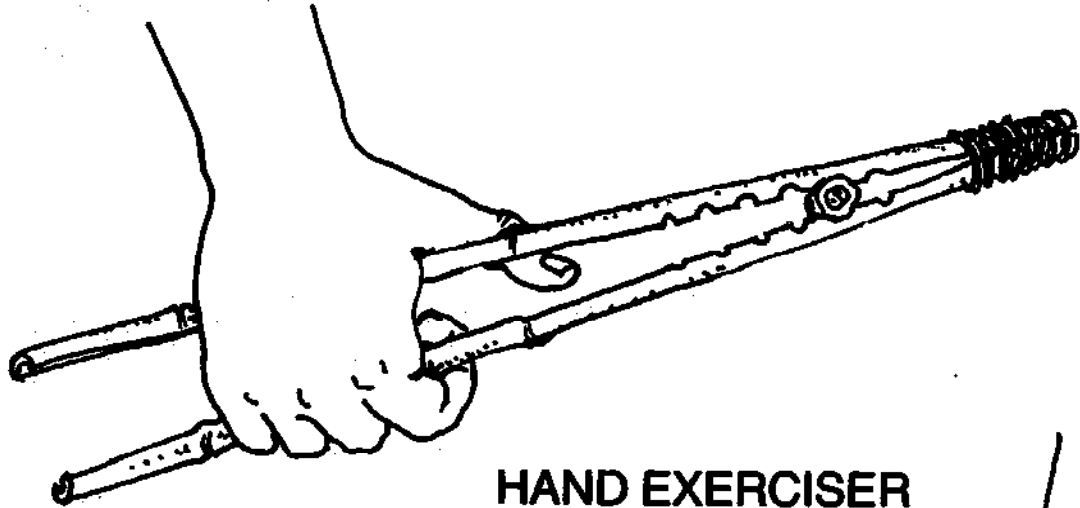

HAND EXERCISER

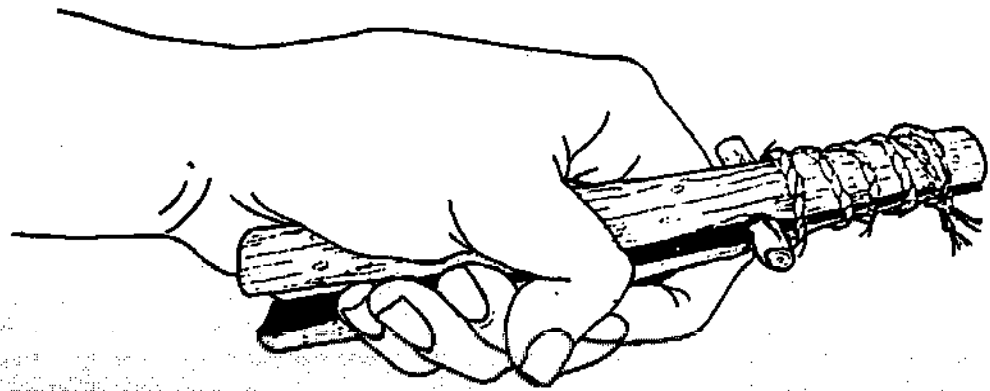
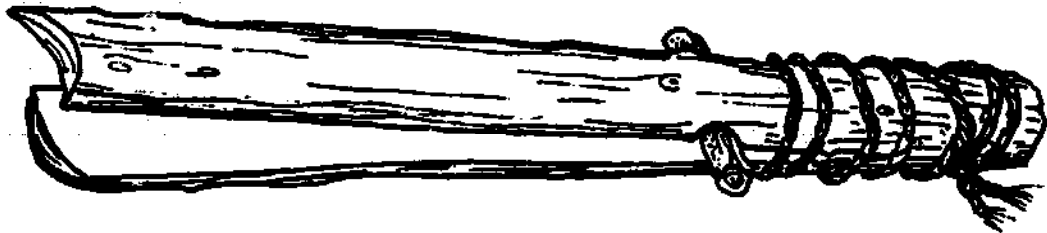
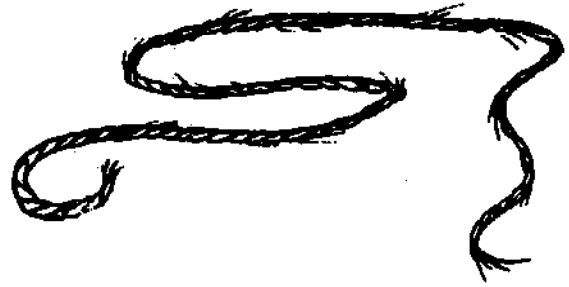
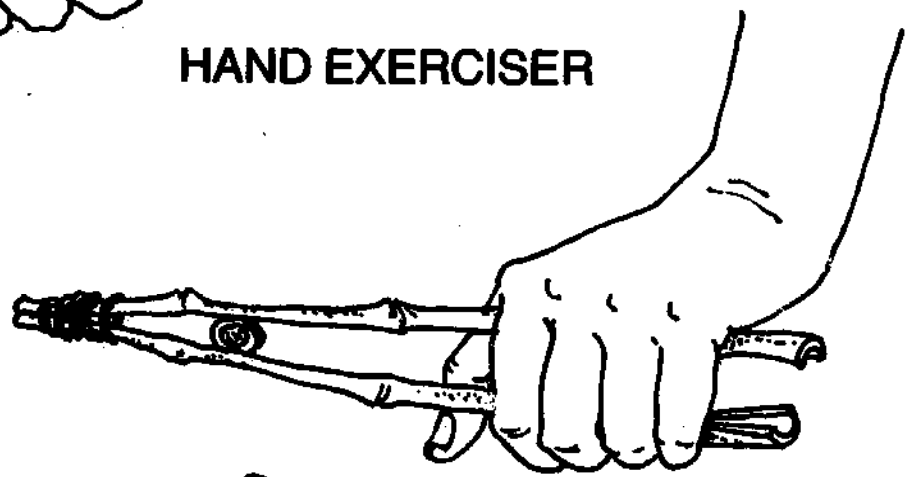

HAND EXERCISER

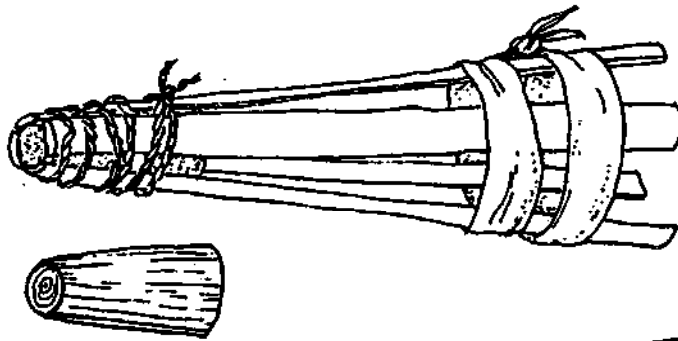
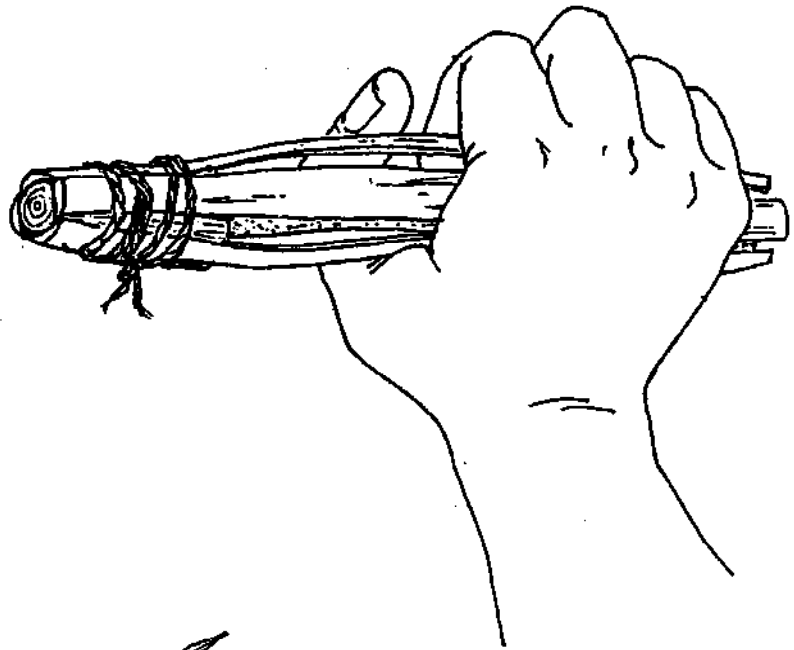
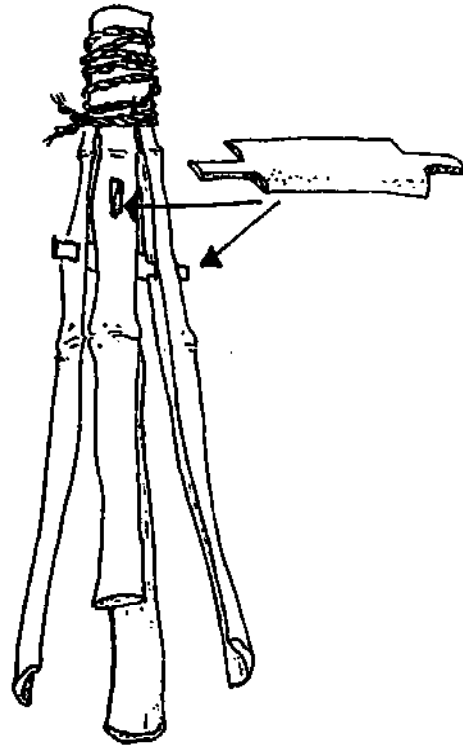

HAND EXERCISER

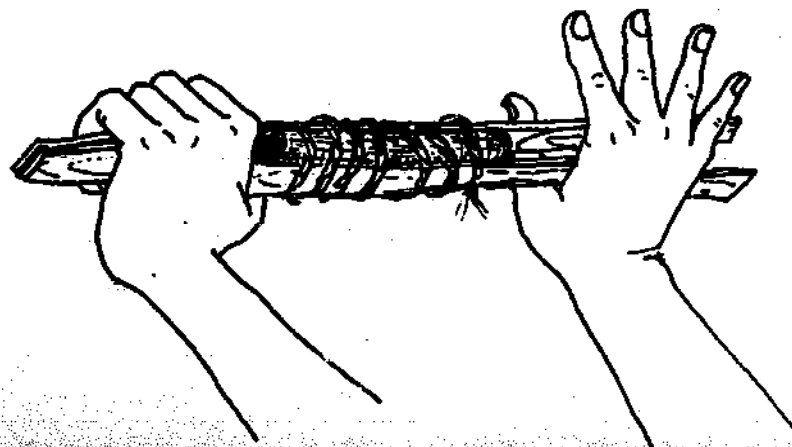
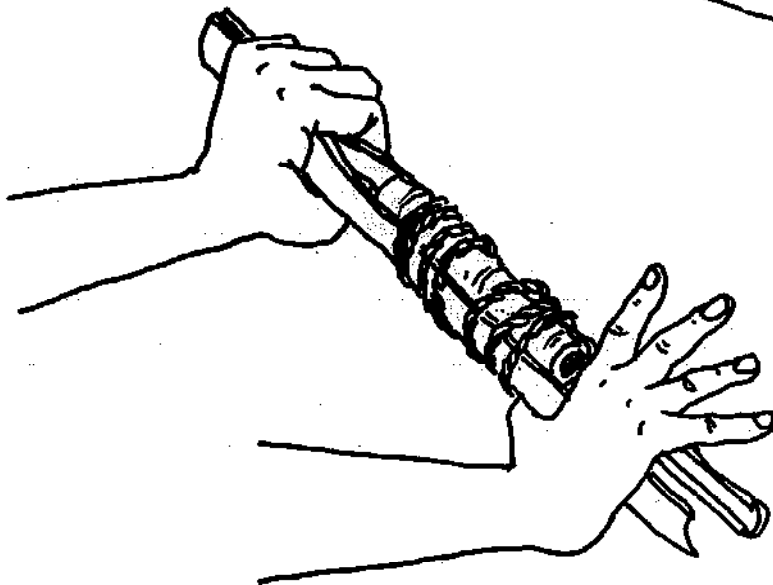
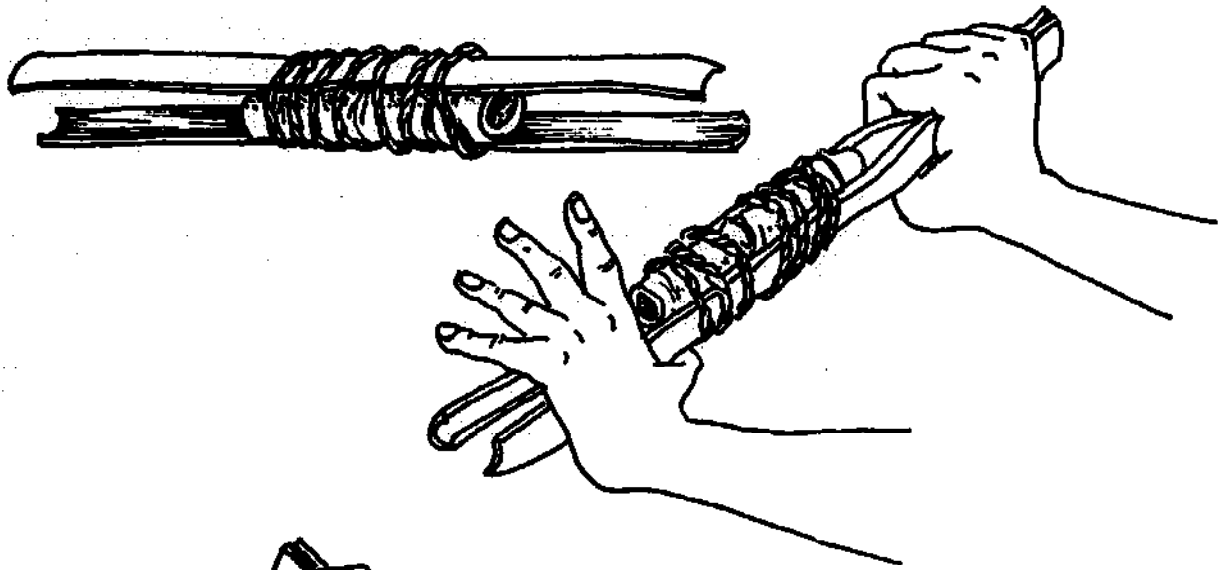

LONG REACHER (TONGS)

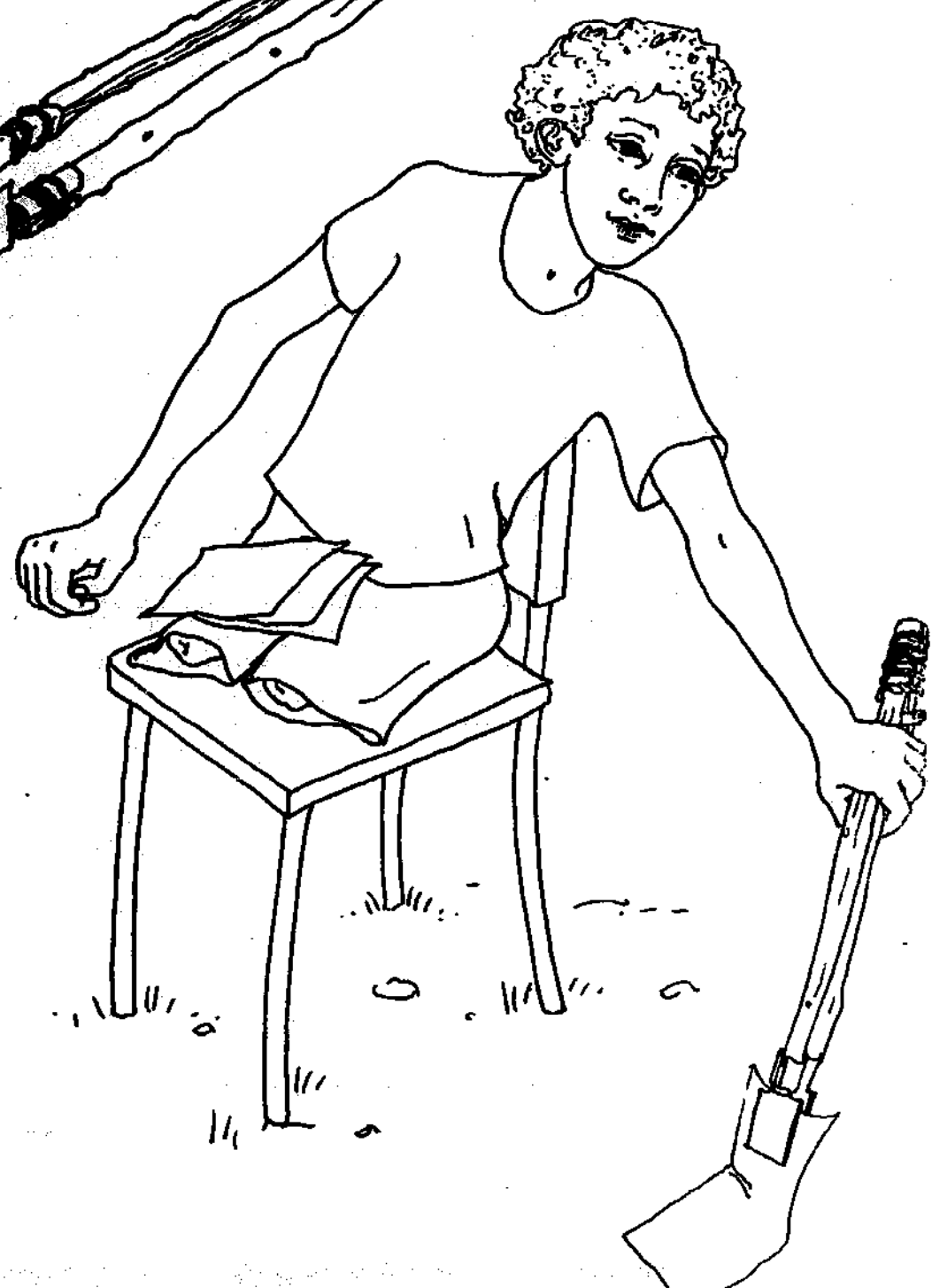

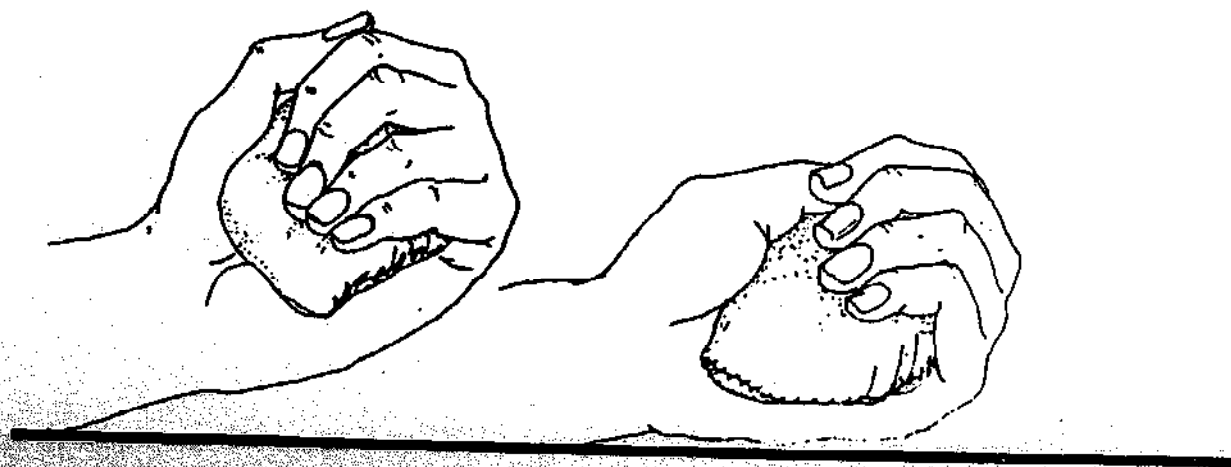
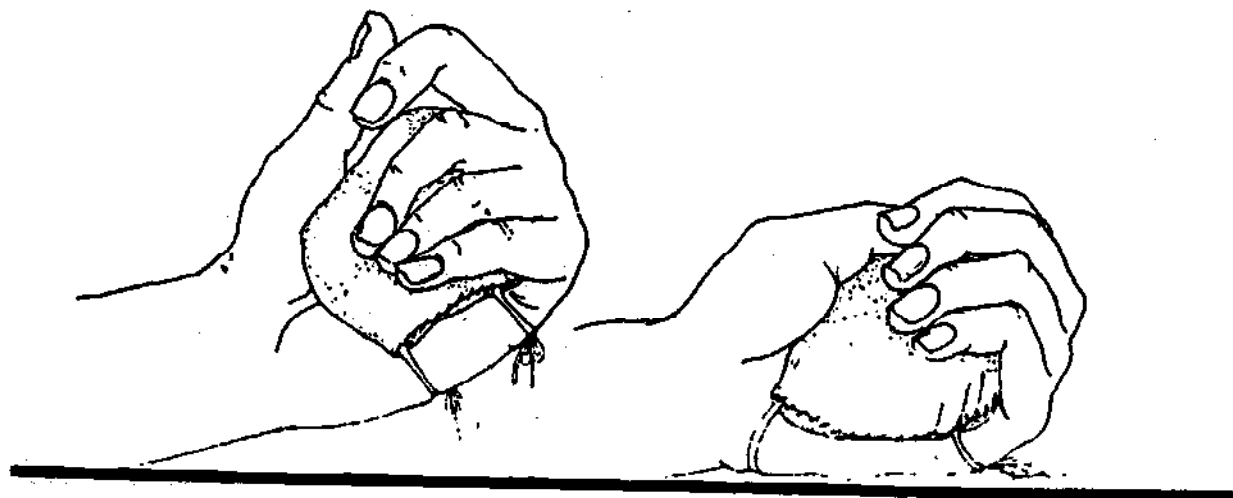
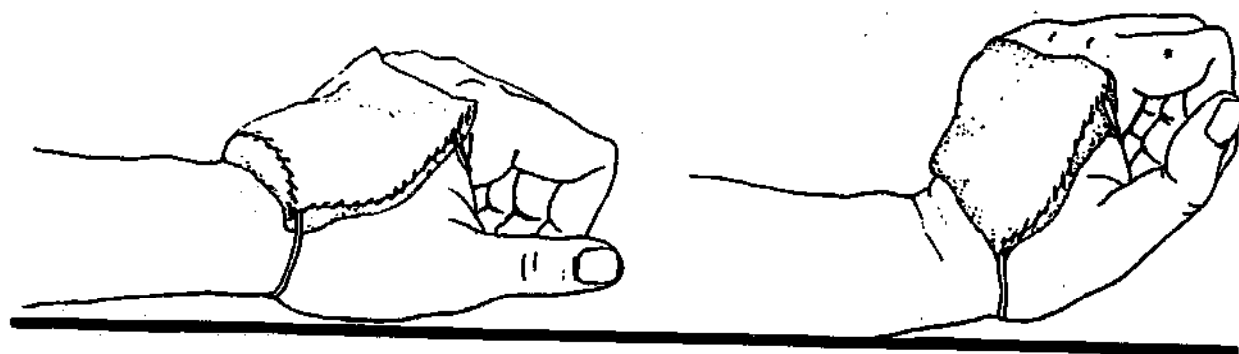
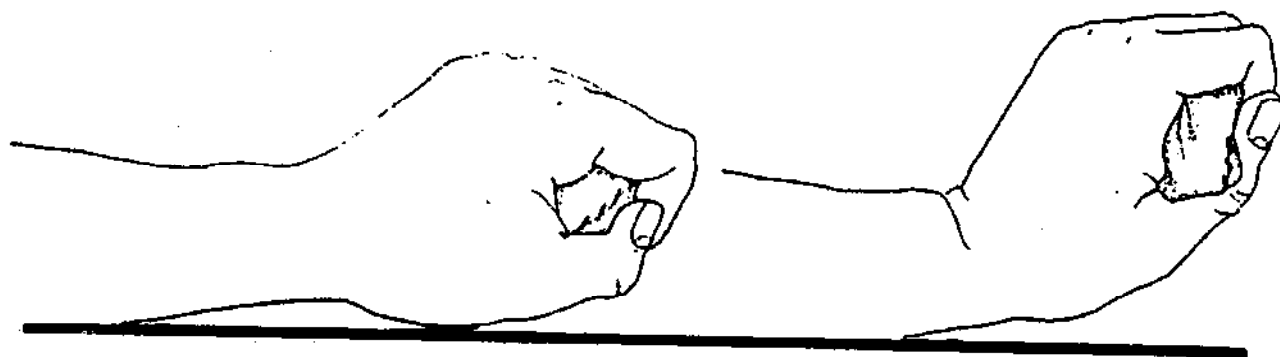

WRIST AND ARM EXERCISER

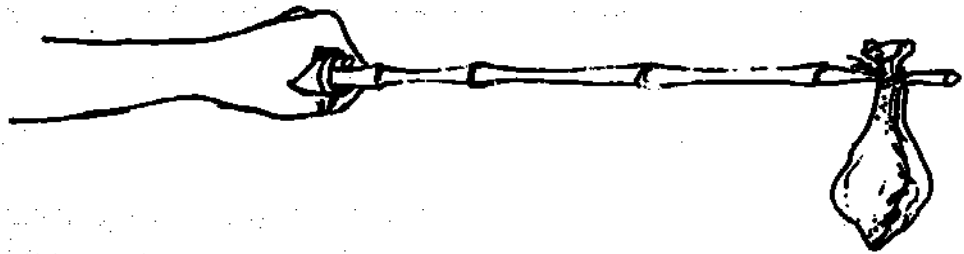
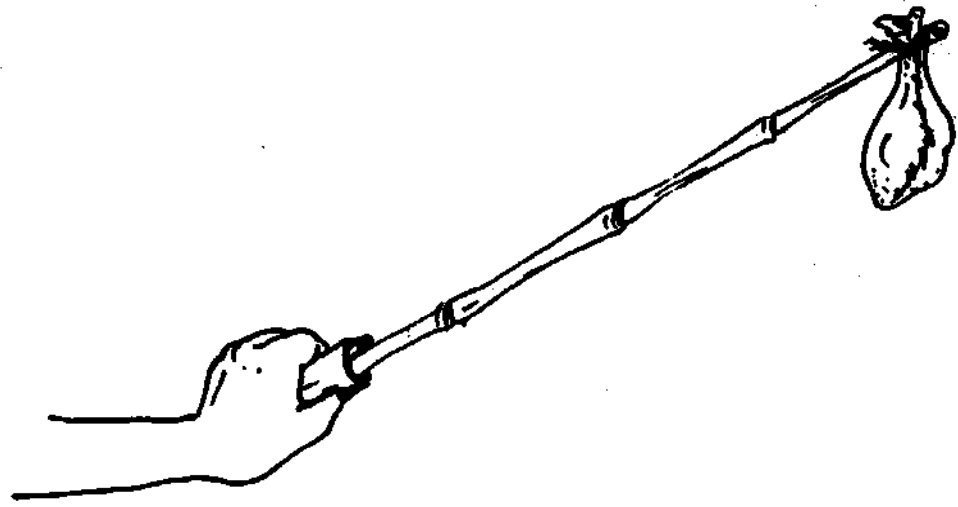
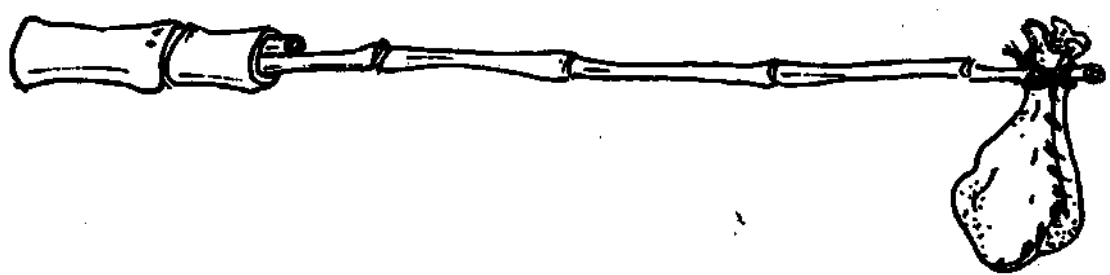
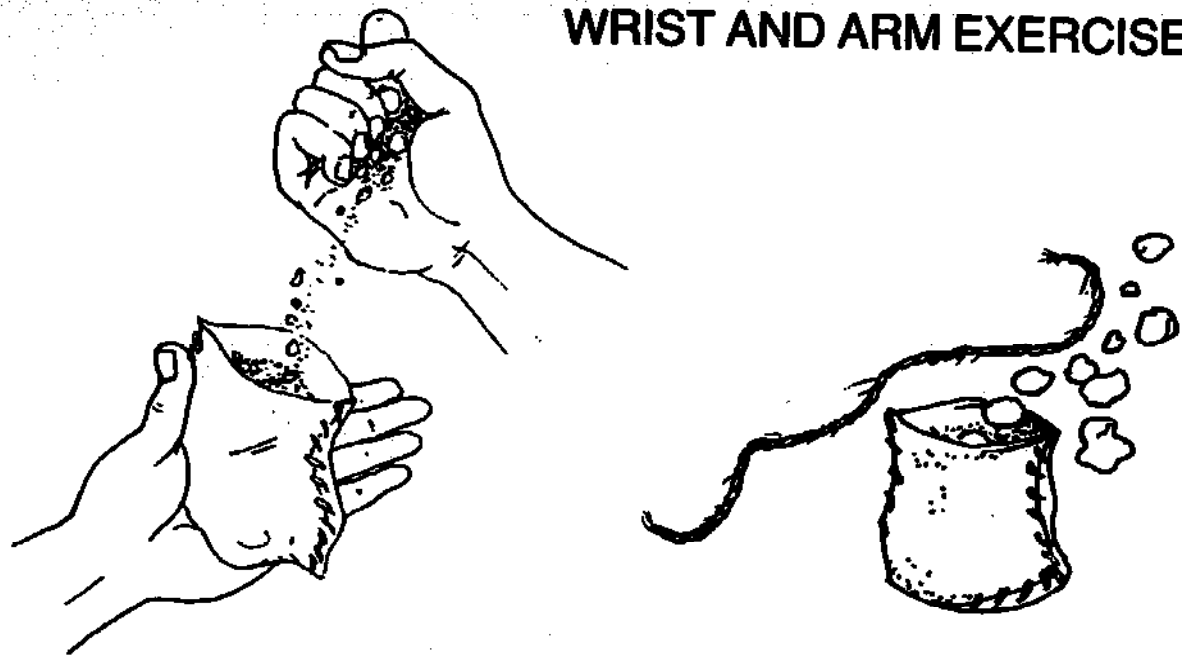

WEIGHTED ARM EXERCISER

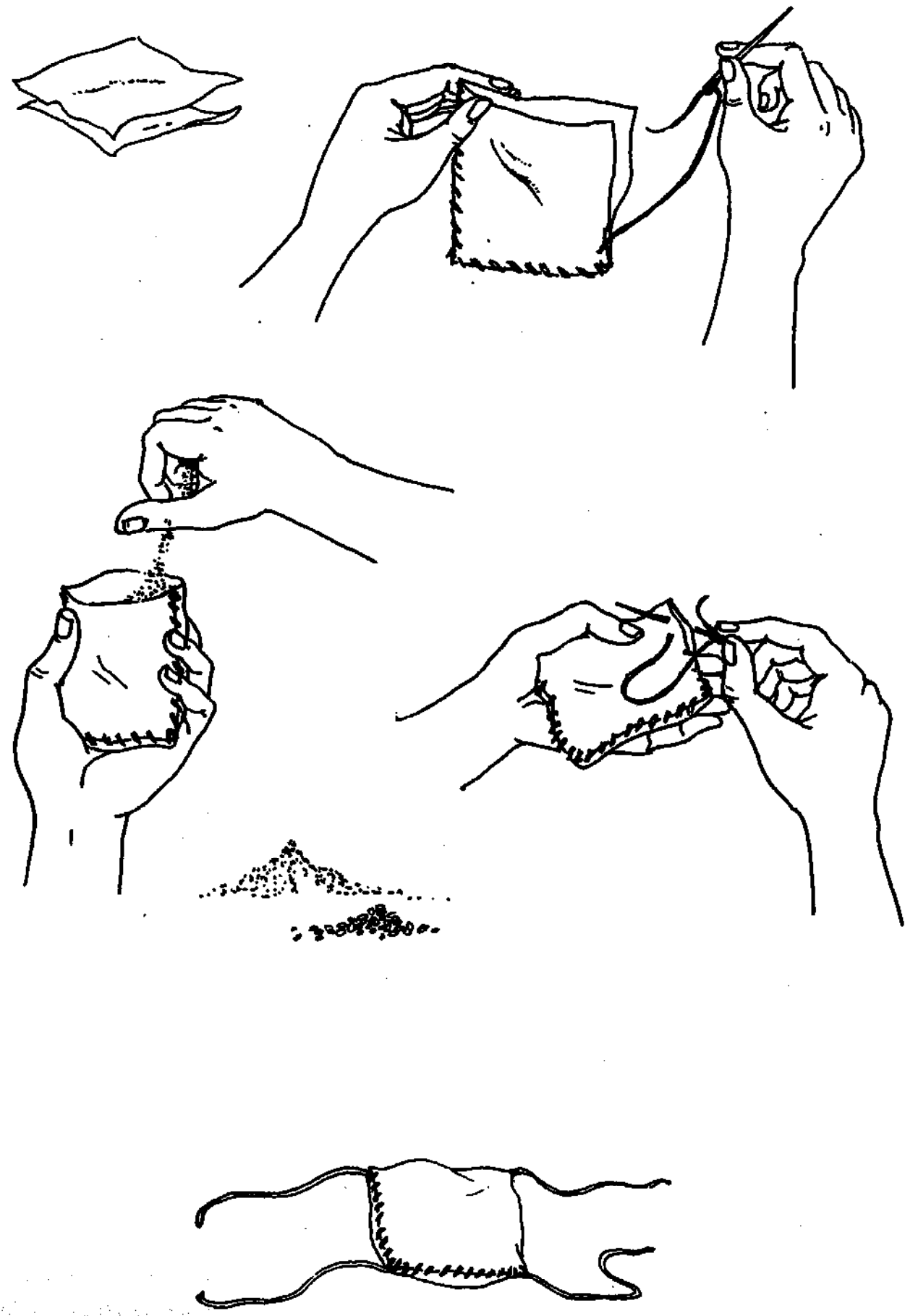

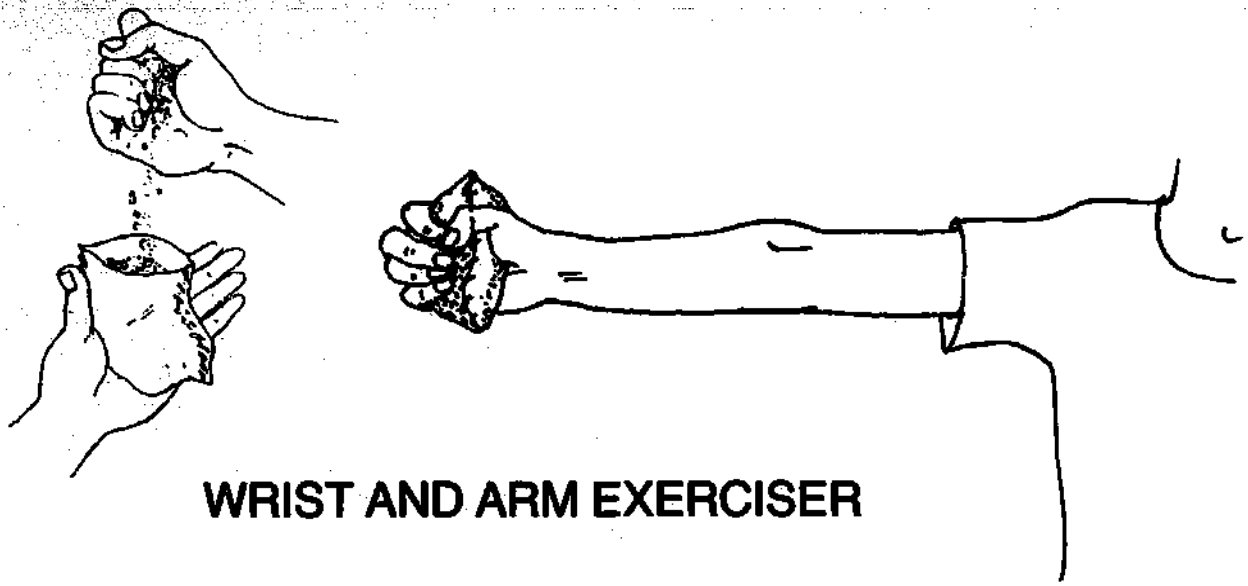

WRIST AND ARM EXERCISER

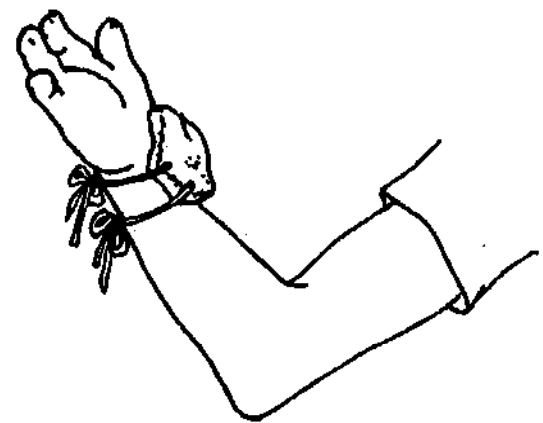
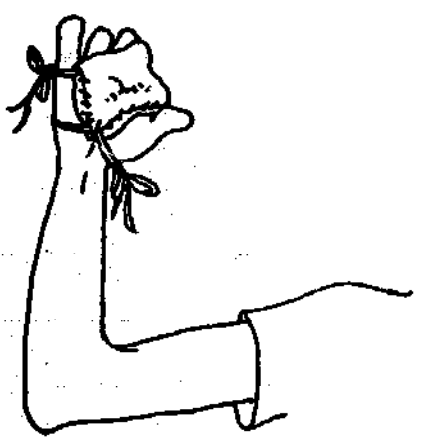
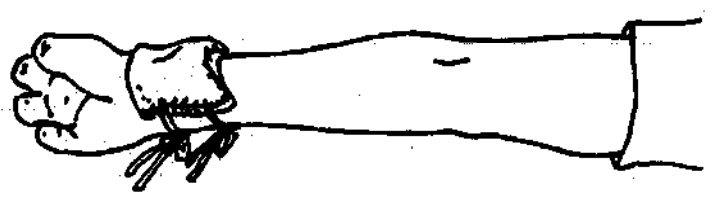
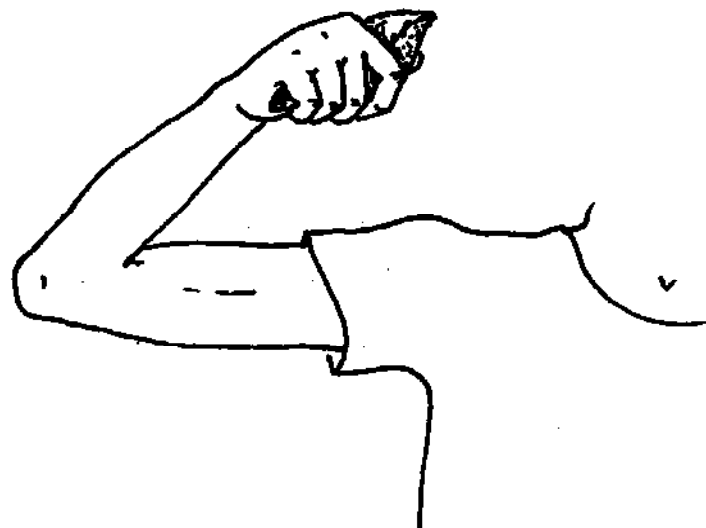

WEIGHTED ARM EXERCISER

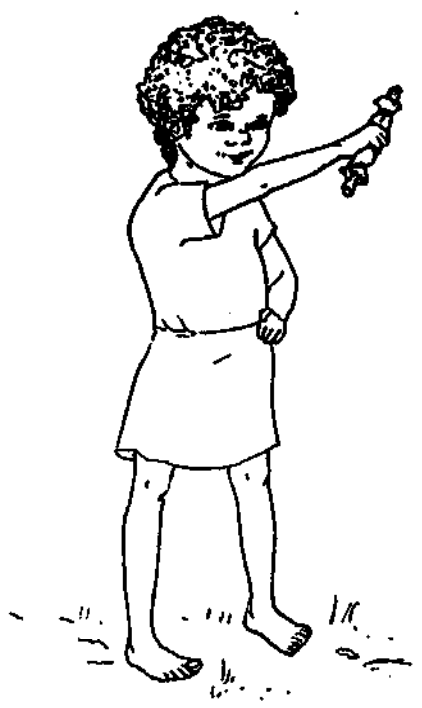
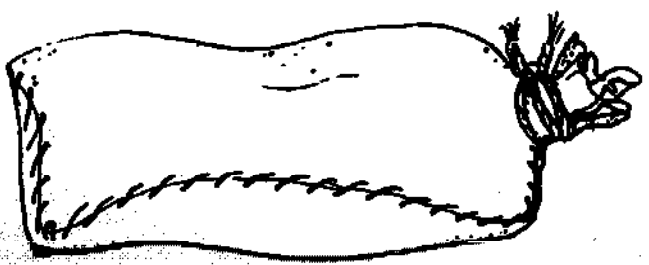
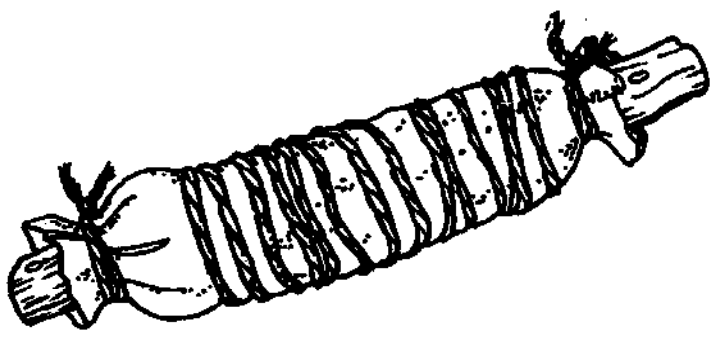
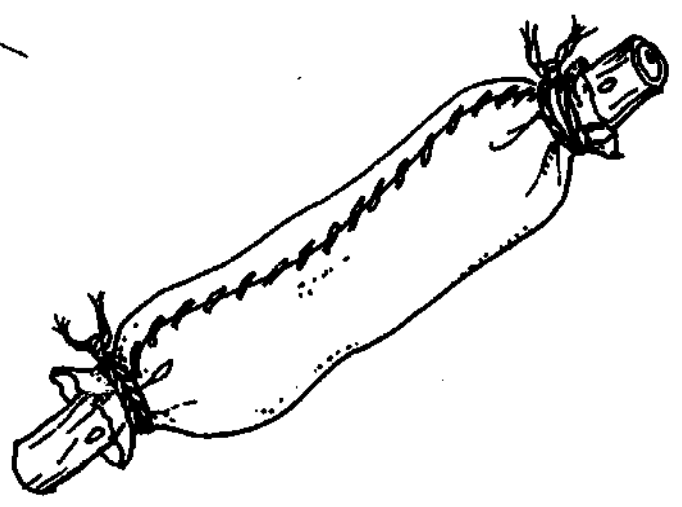
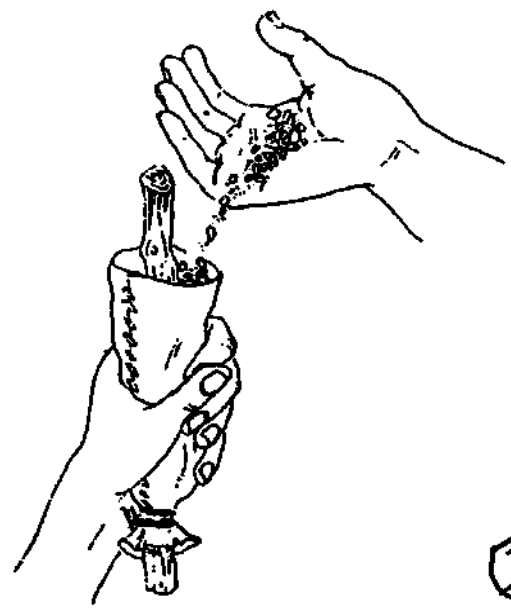
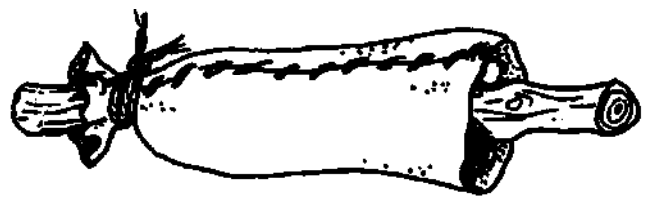
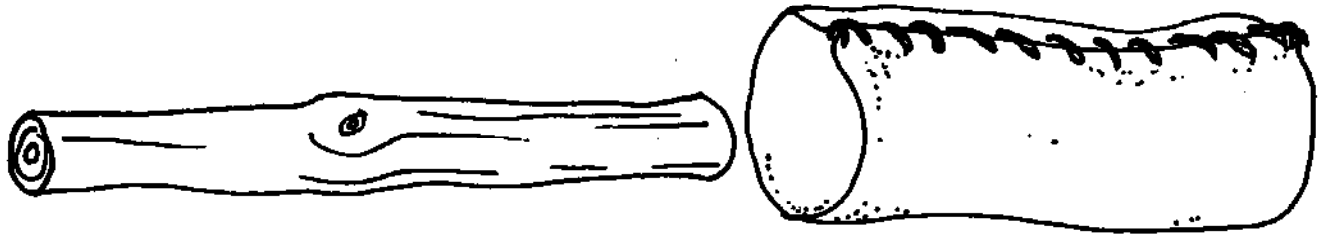

WEIGHTED ARM EXERCISER

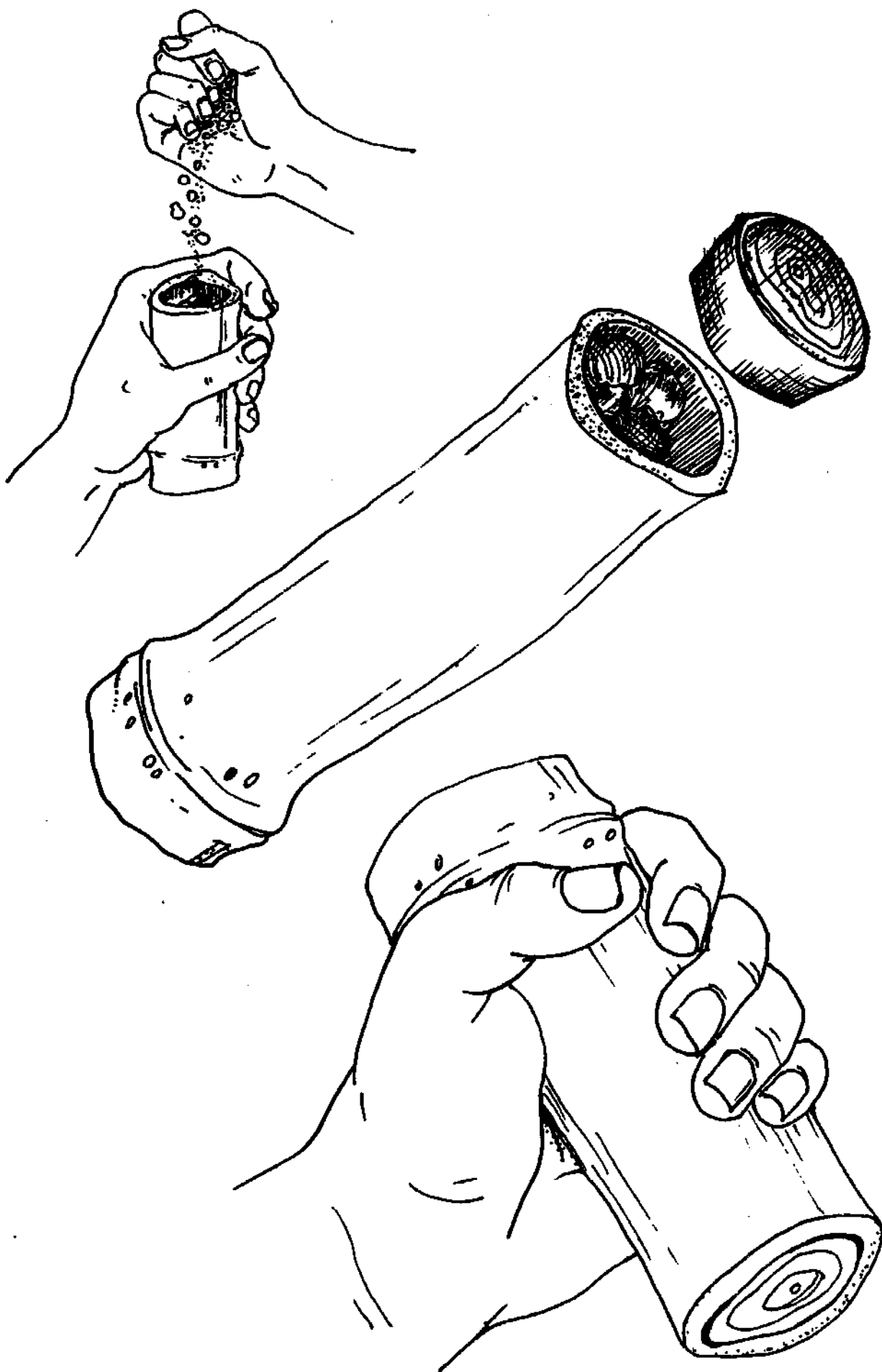

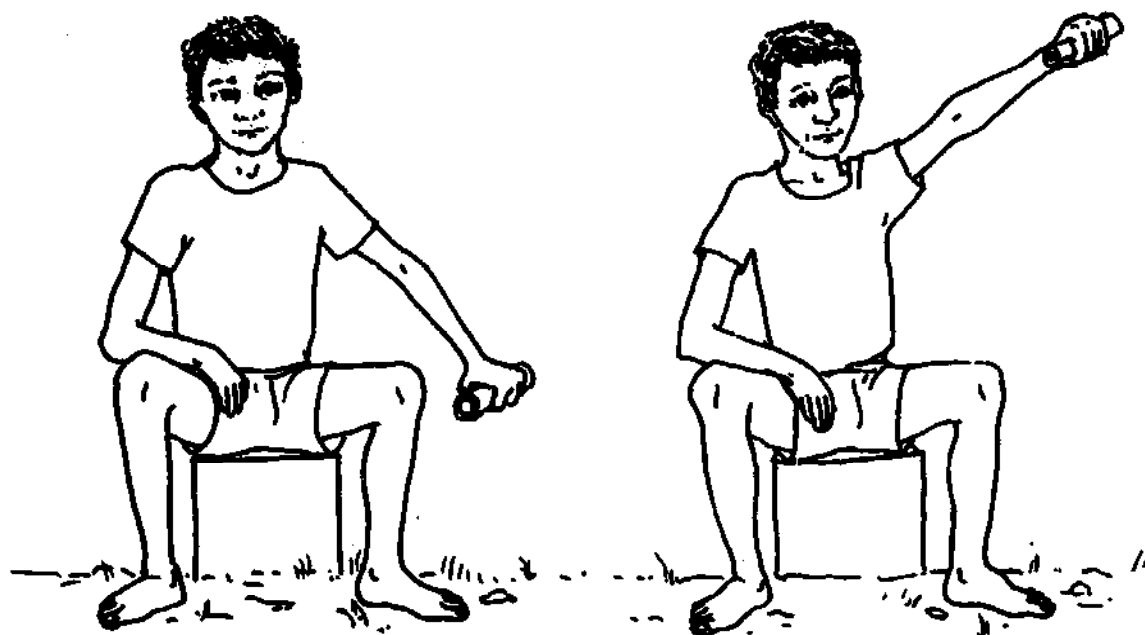

ARM EXERCISER

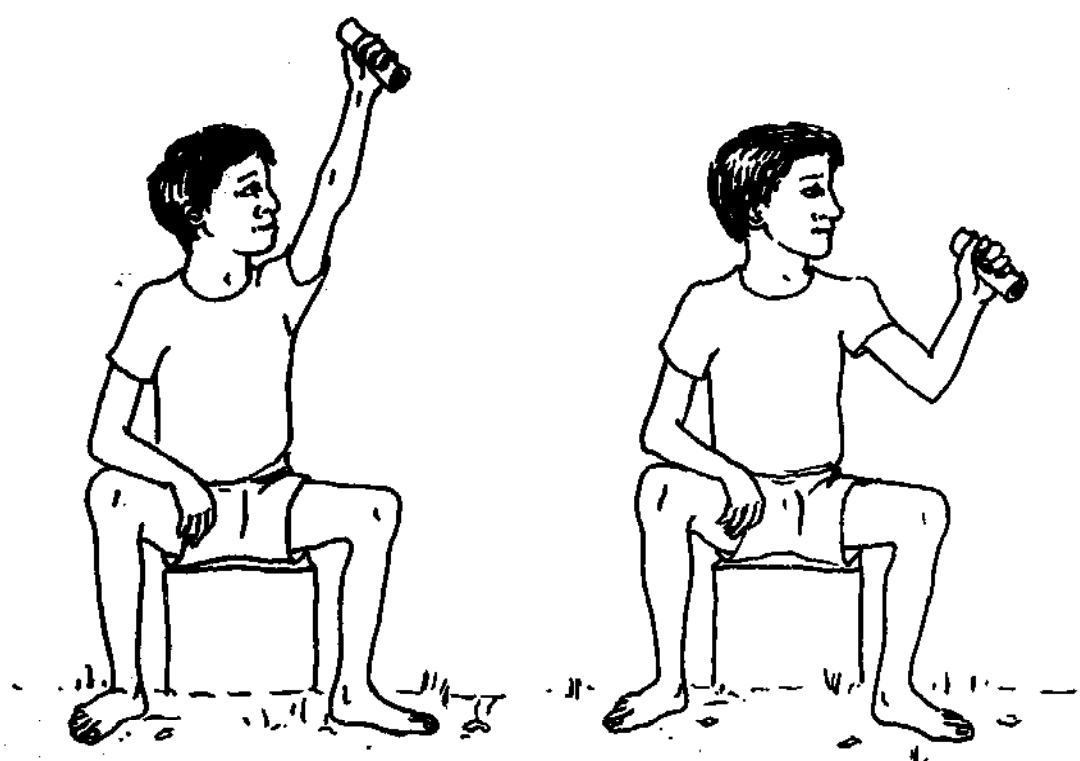

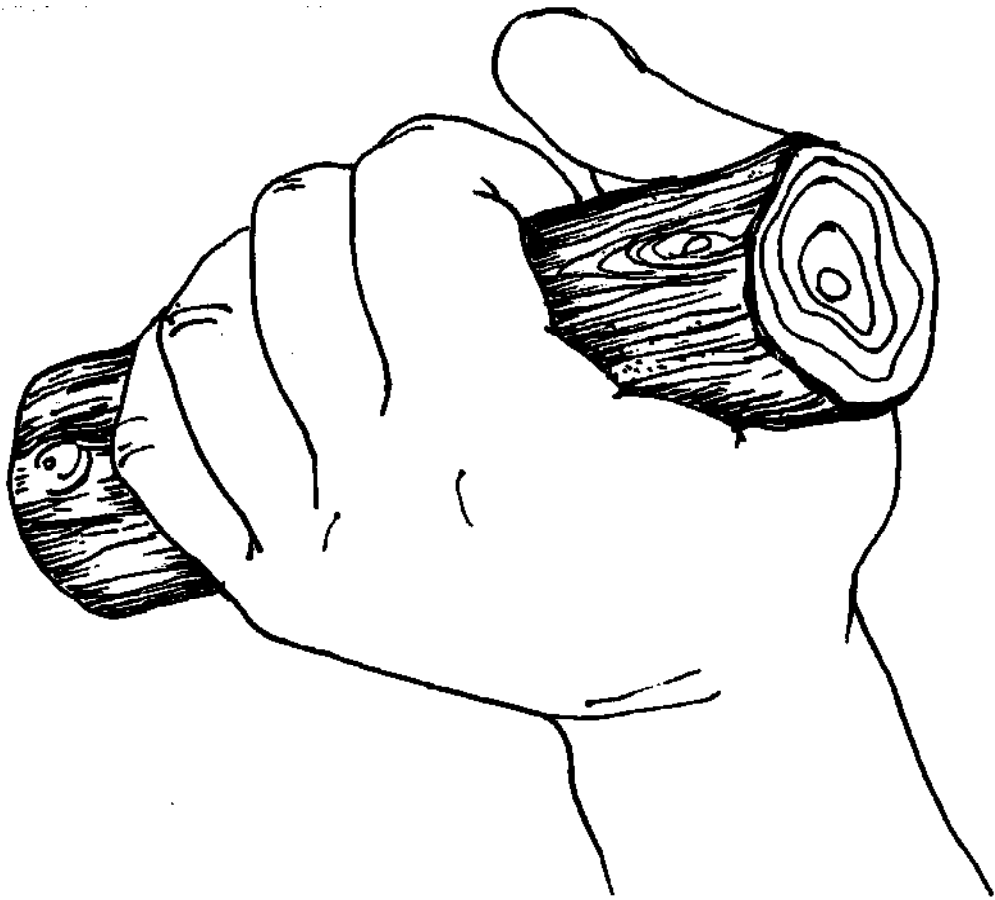

WRIST AND ARM EXERCISER

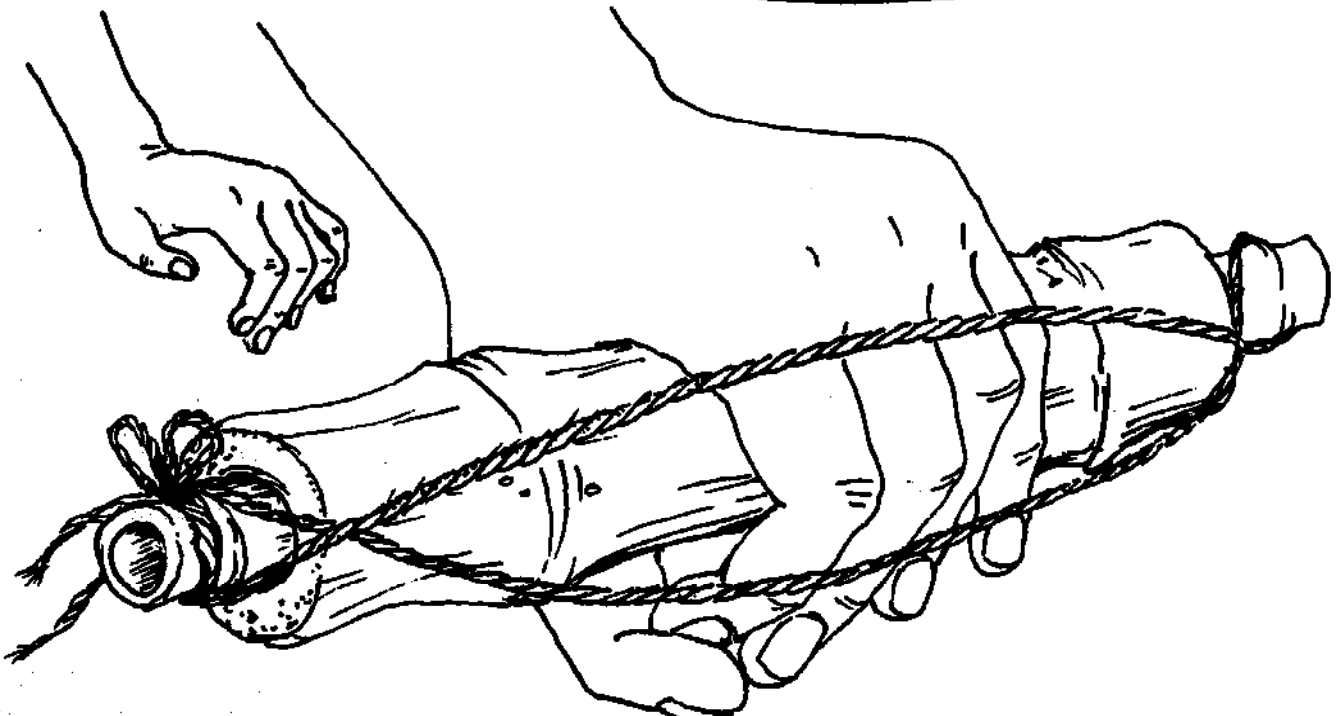
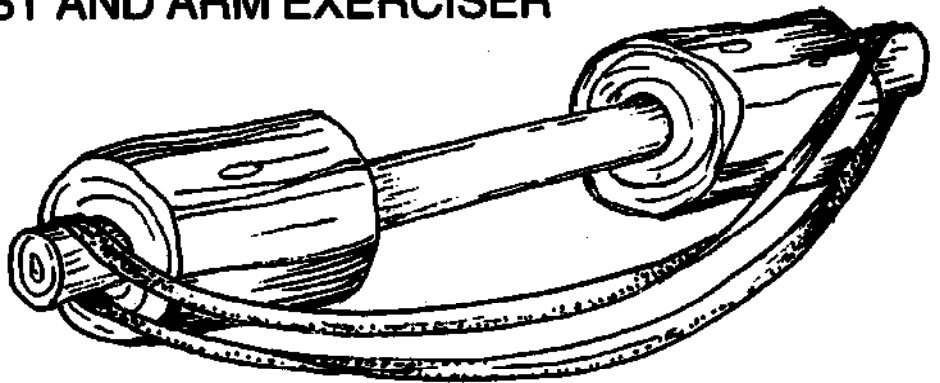
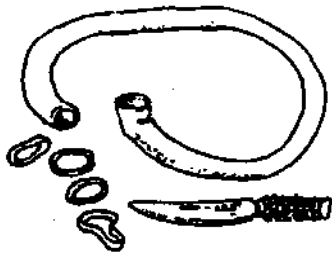

TWISTER

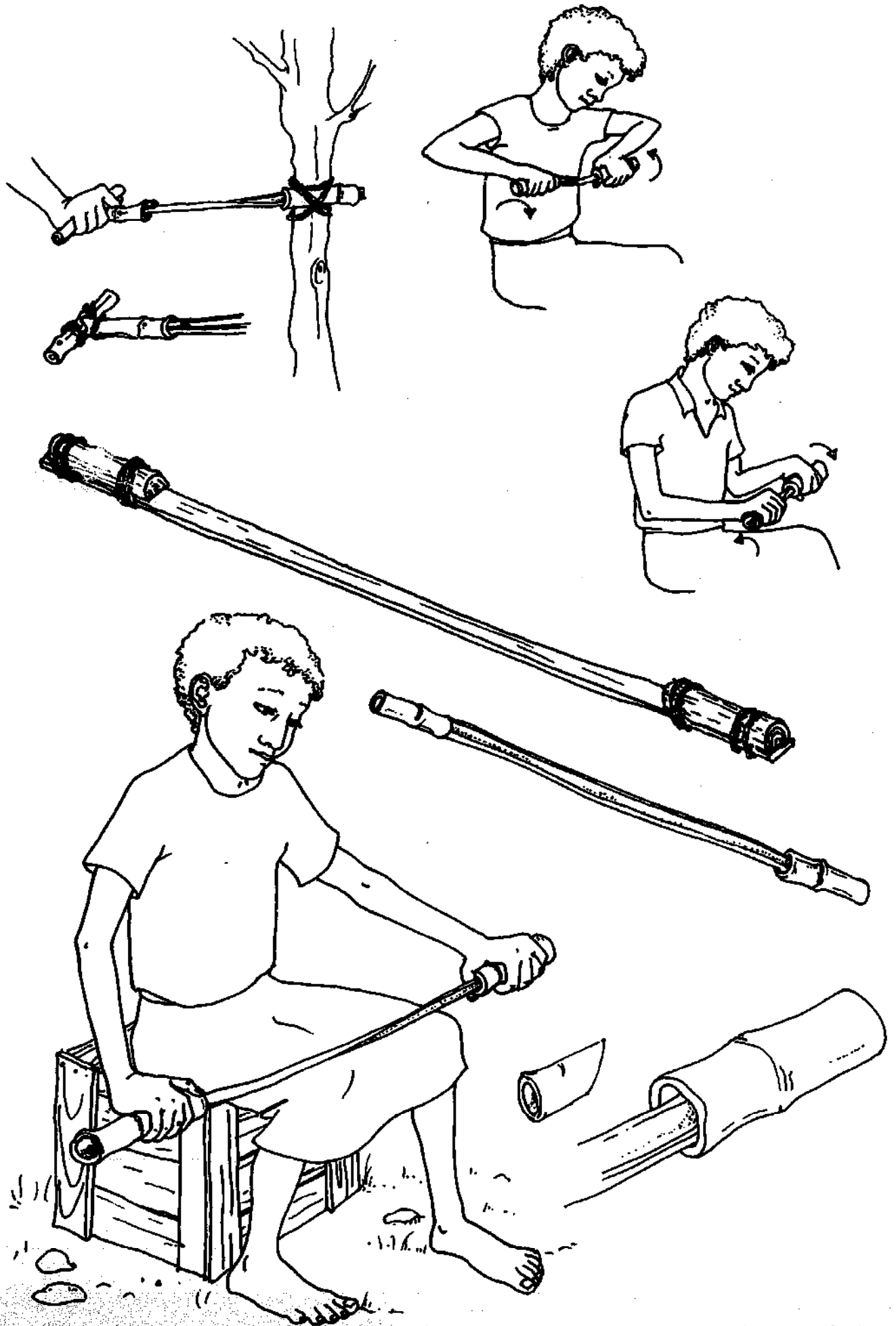

TWISTER

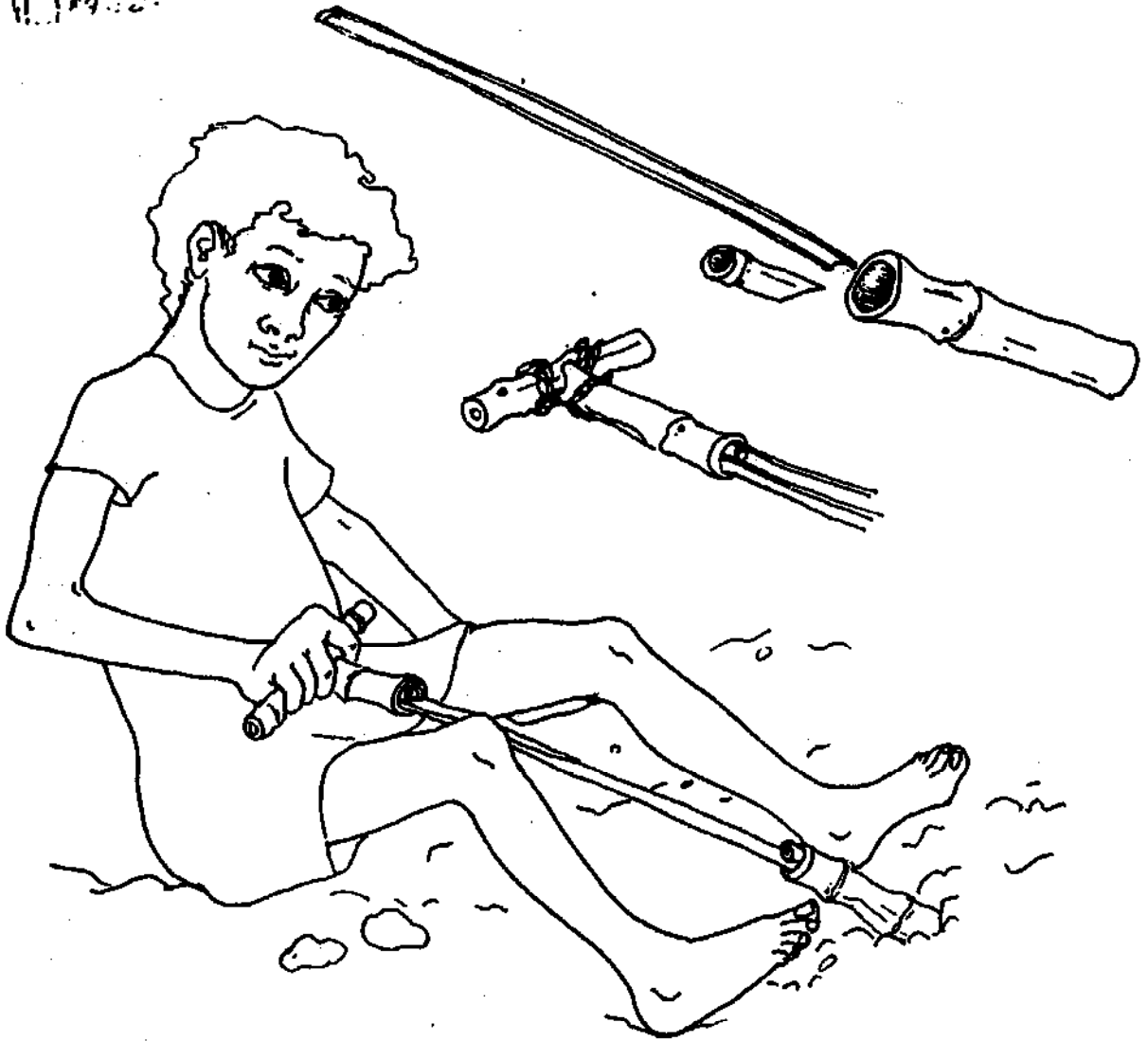
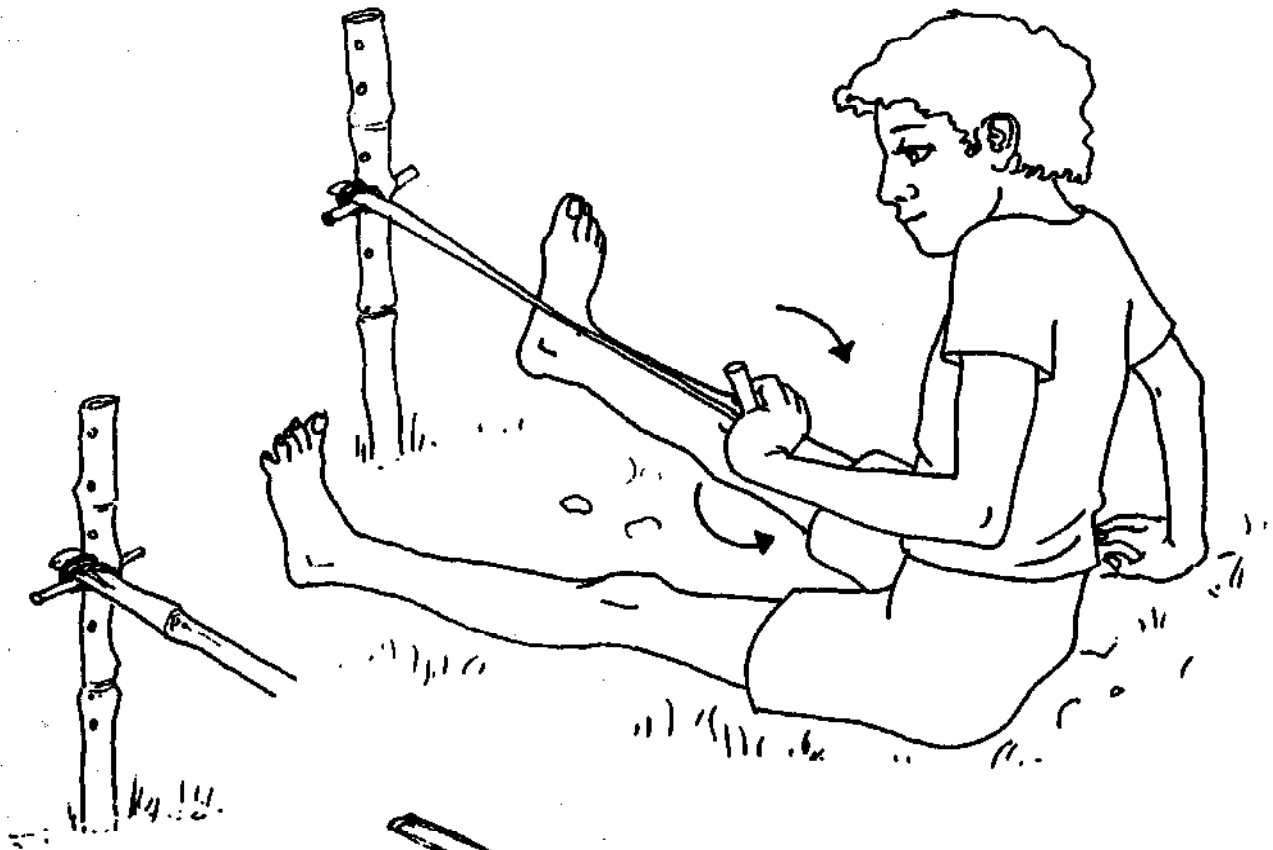

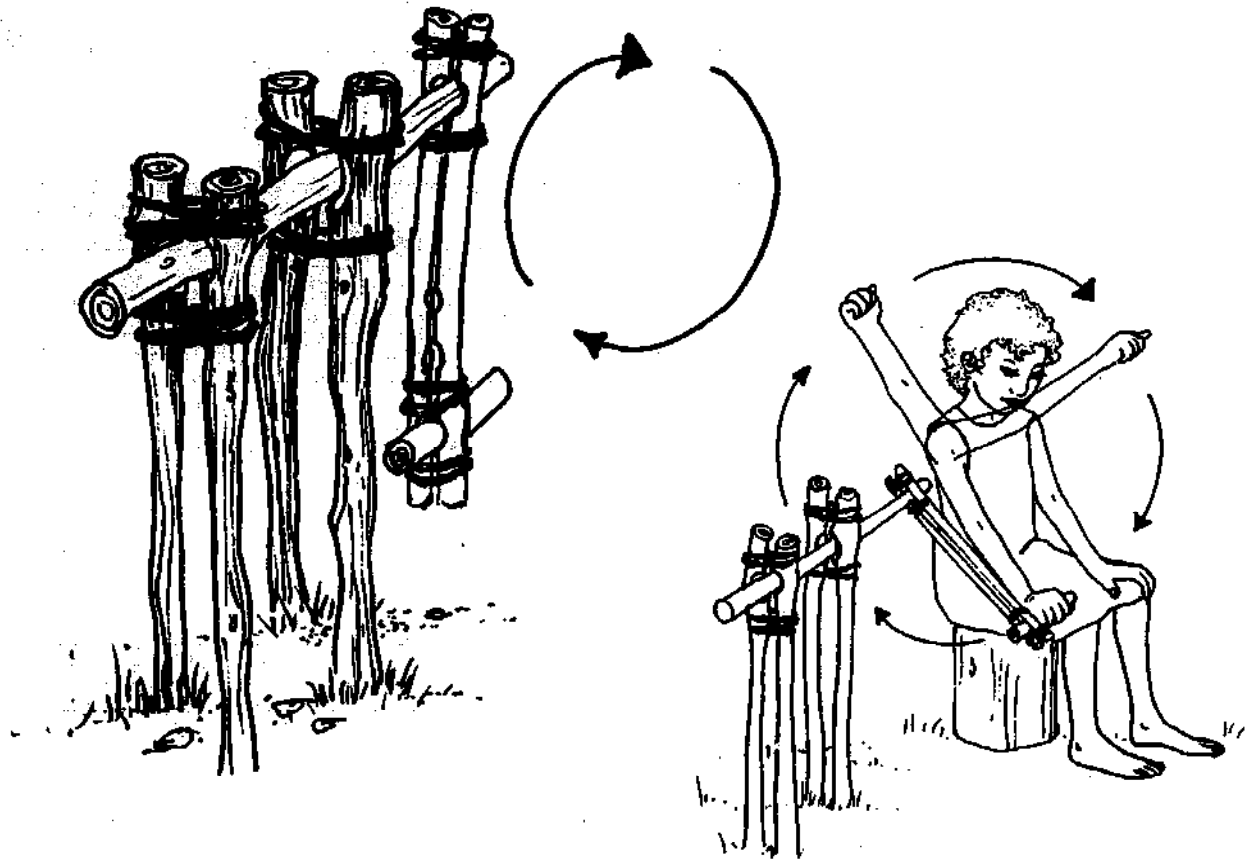

ARM AND SHOULDER EXERCISER



ARM EXERCISER

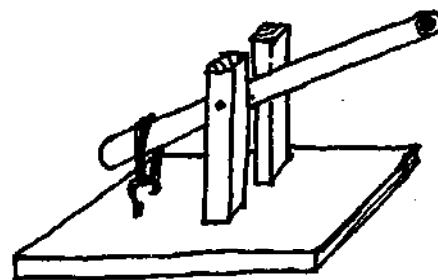
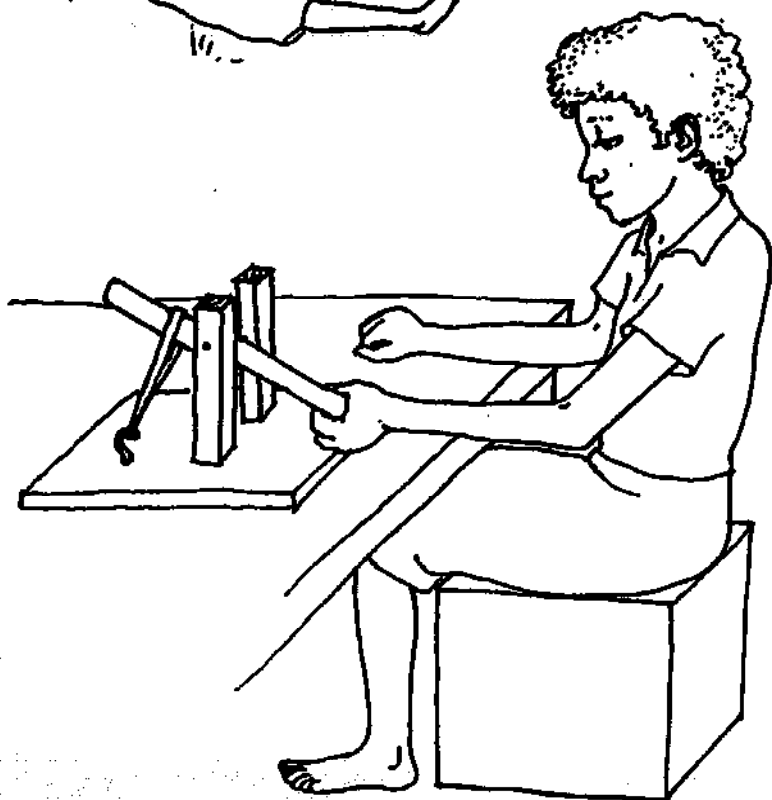
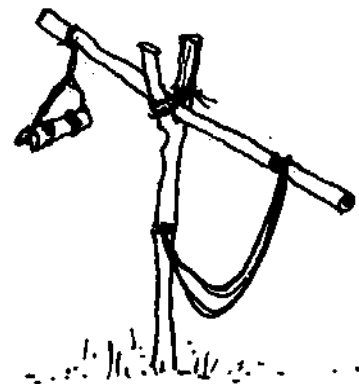
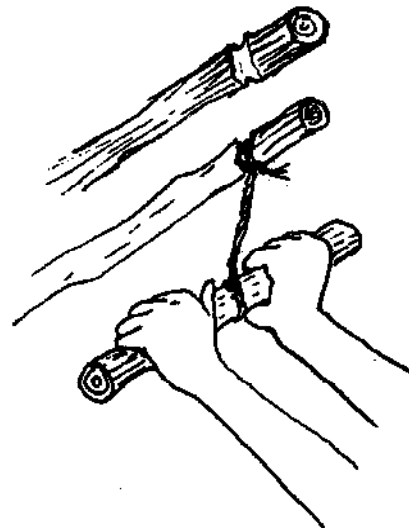
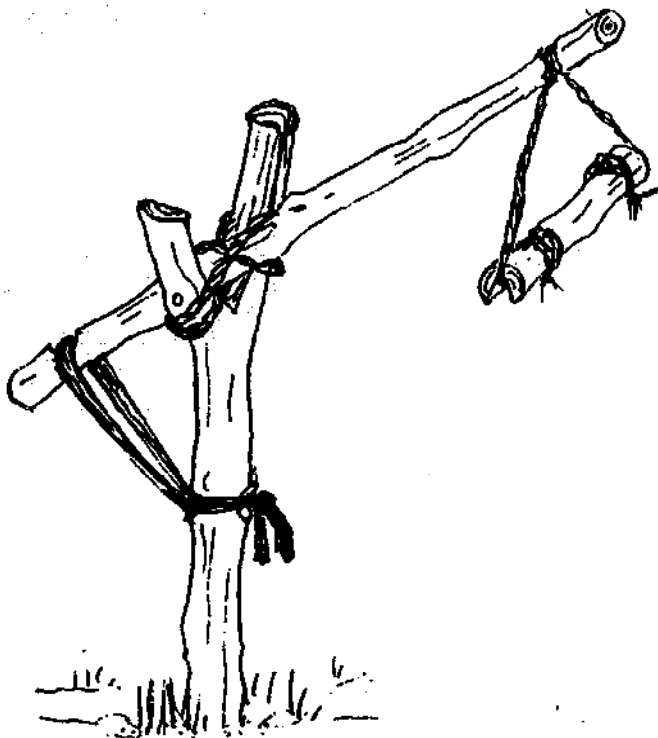

ARM AND LEG EXERCISER

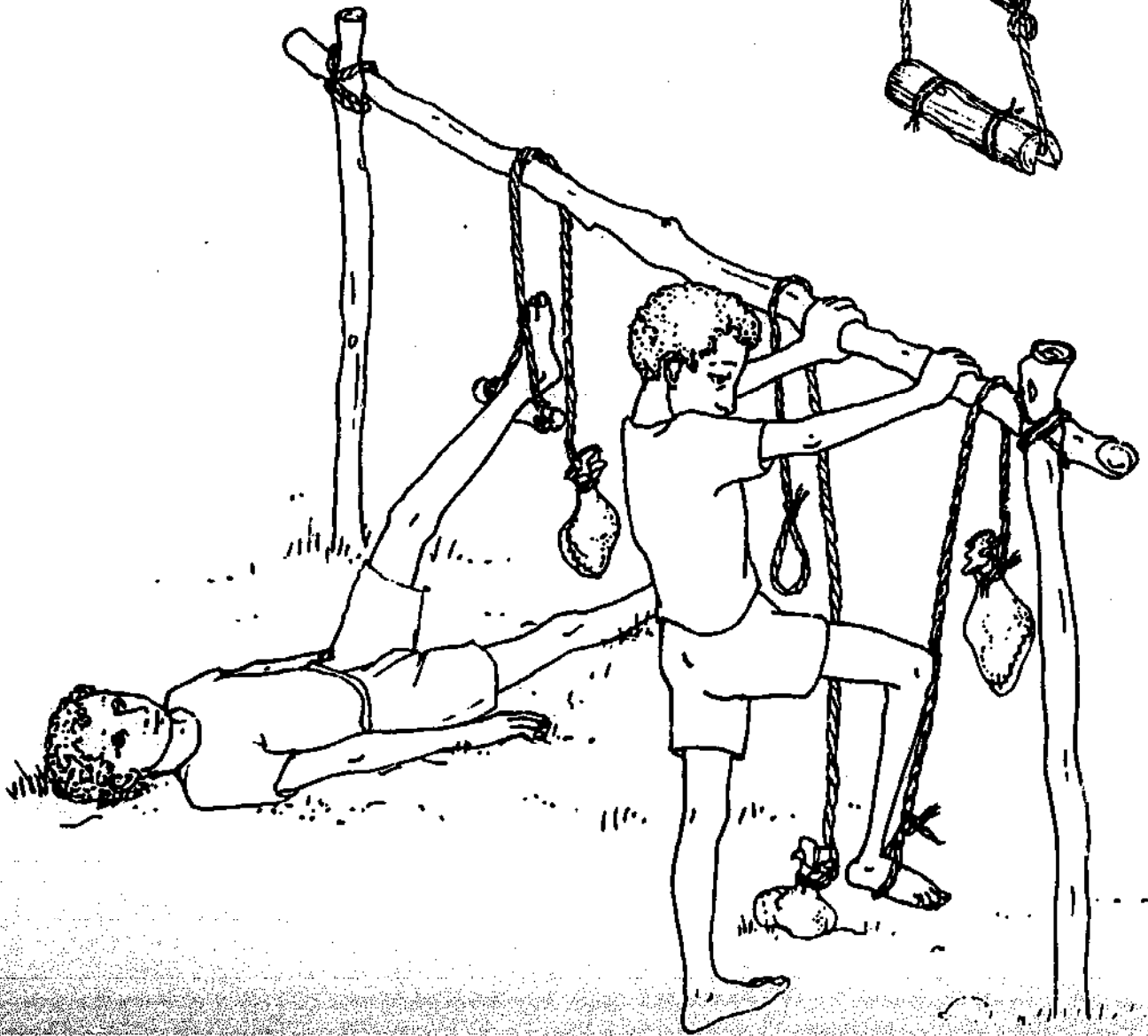
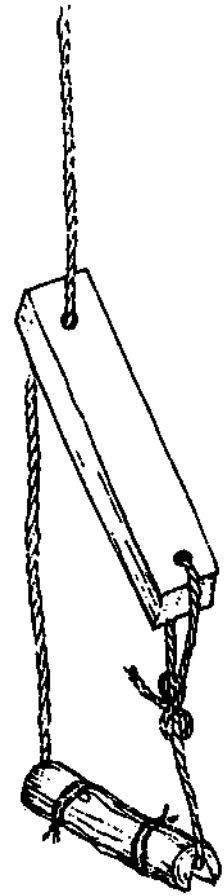
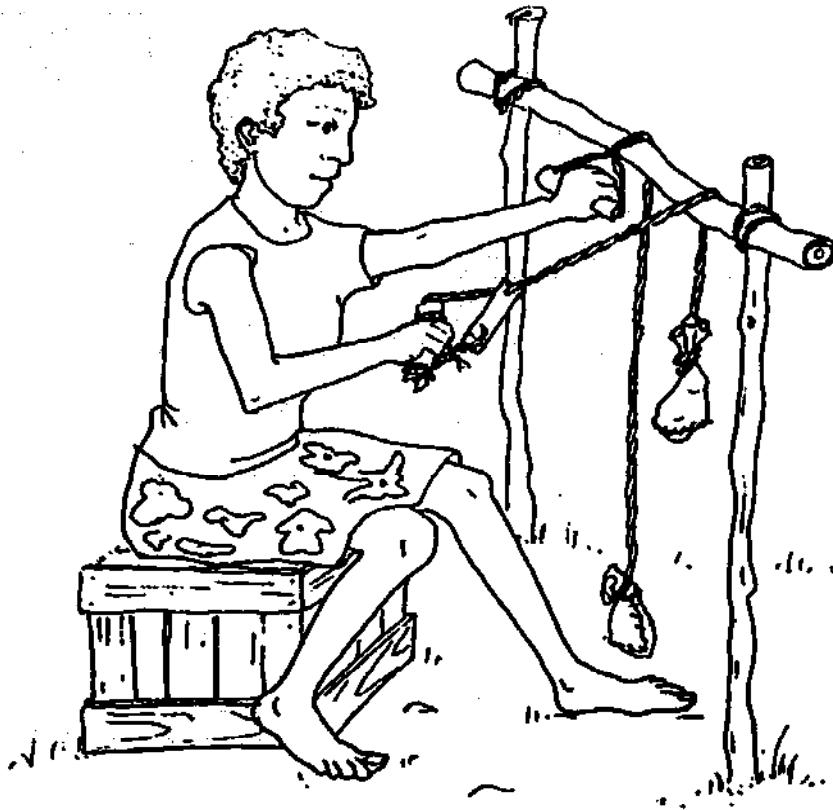

ARM AND LEG EXERCISER

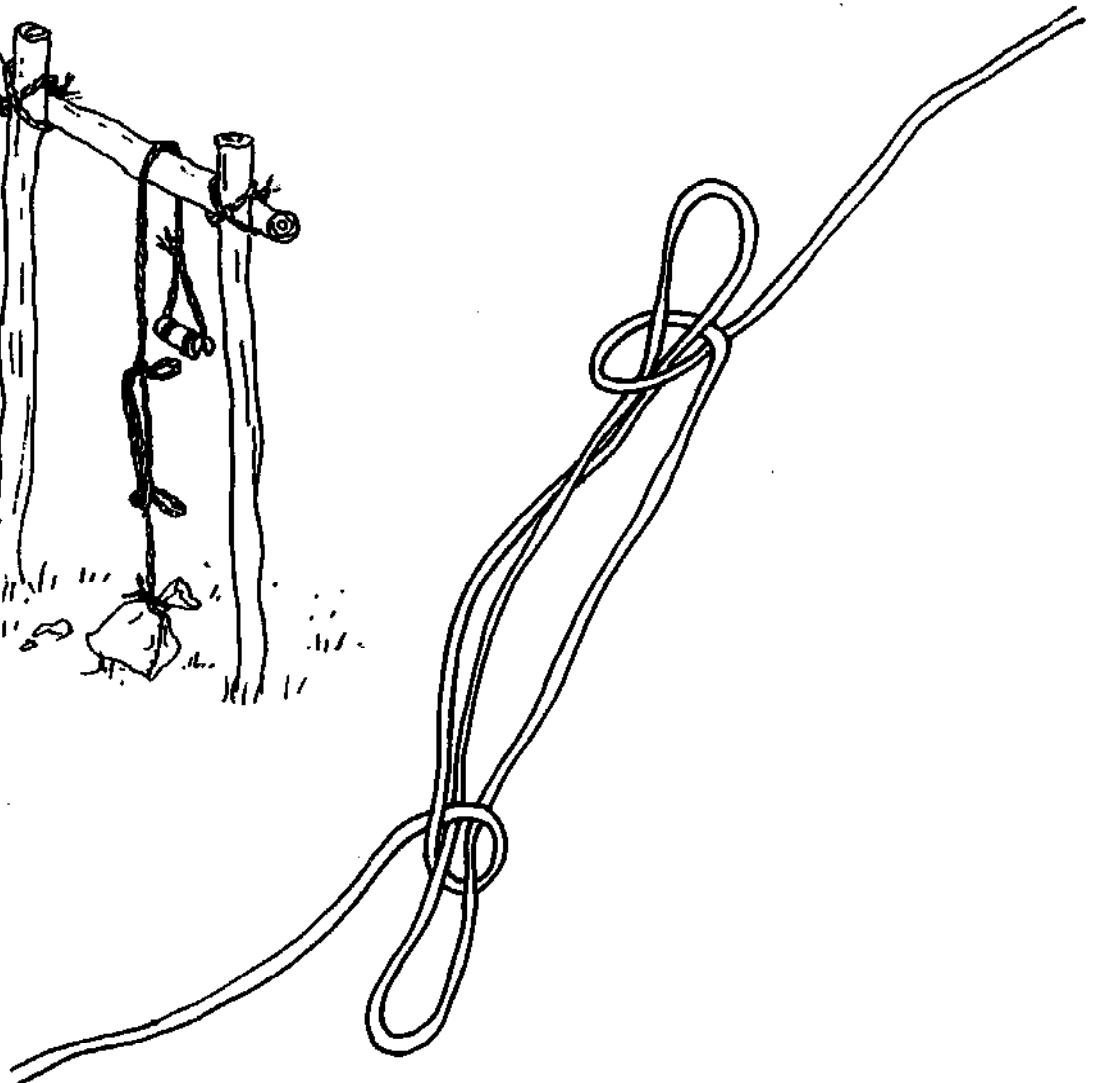
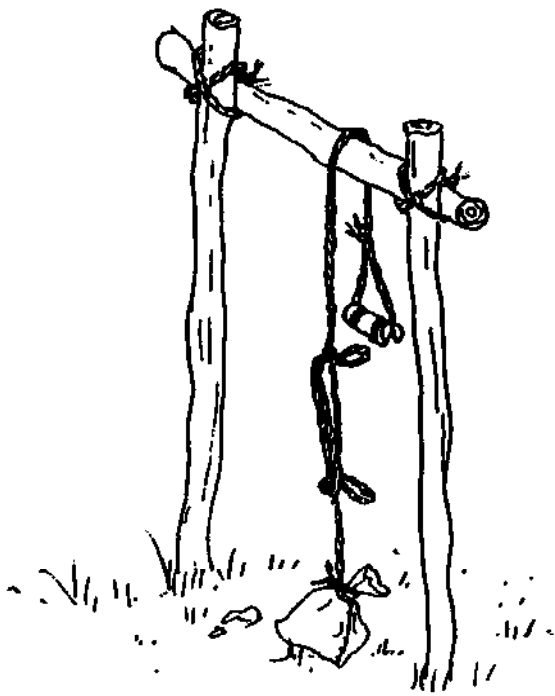
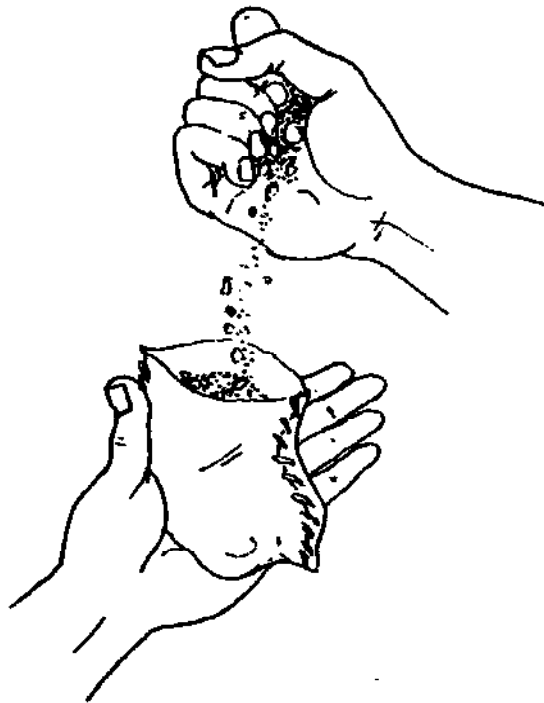

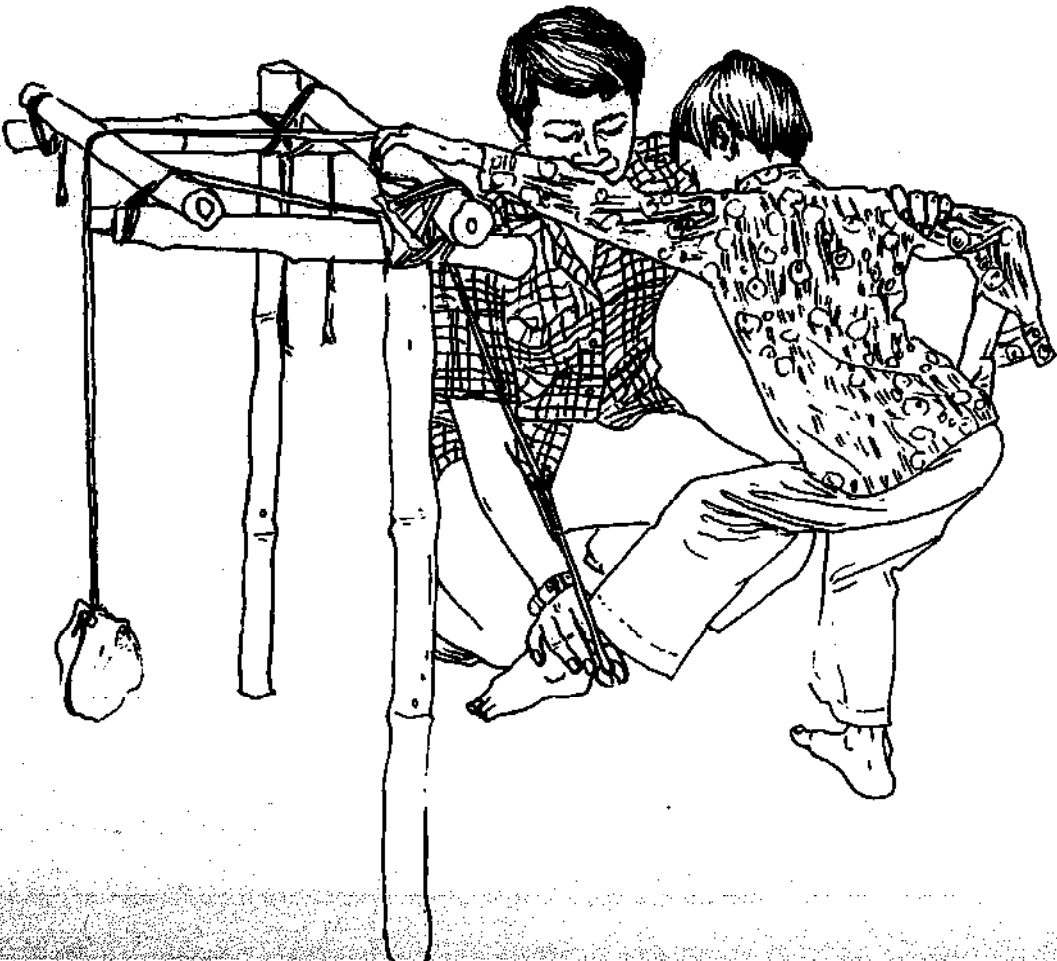
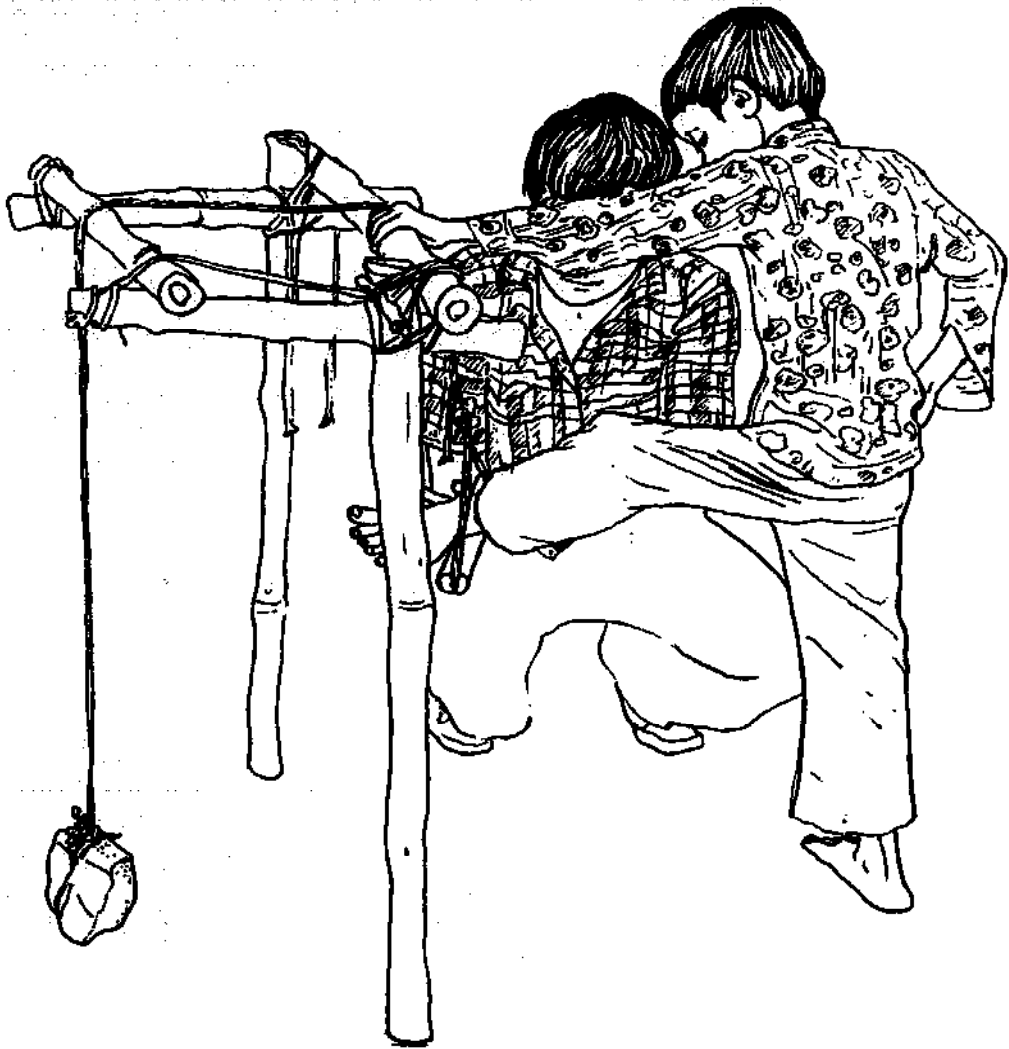

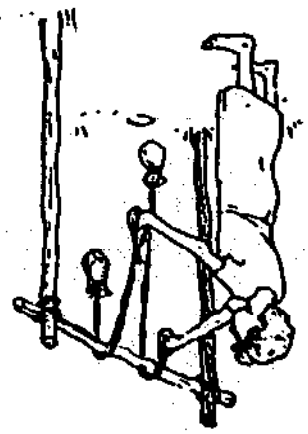
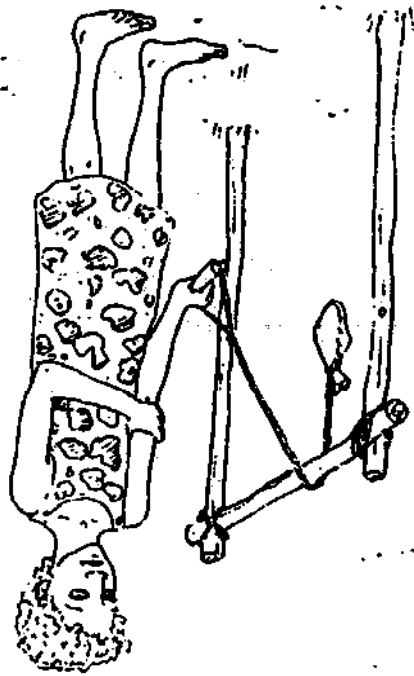
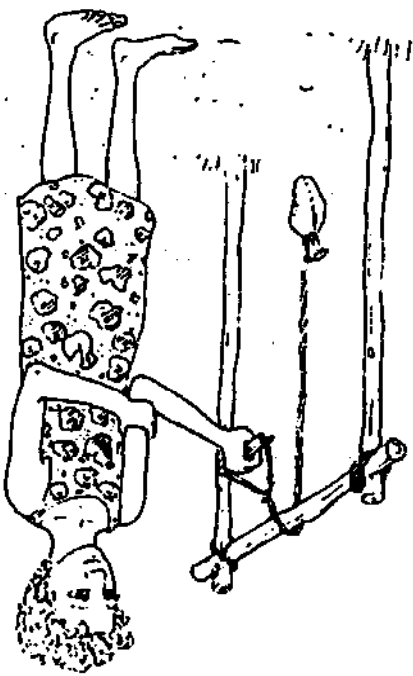
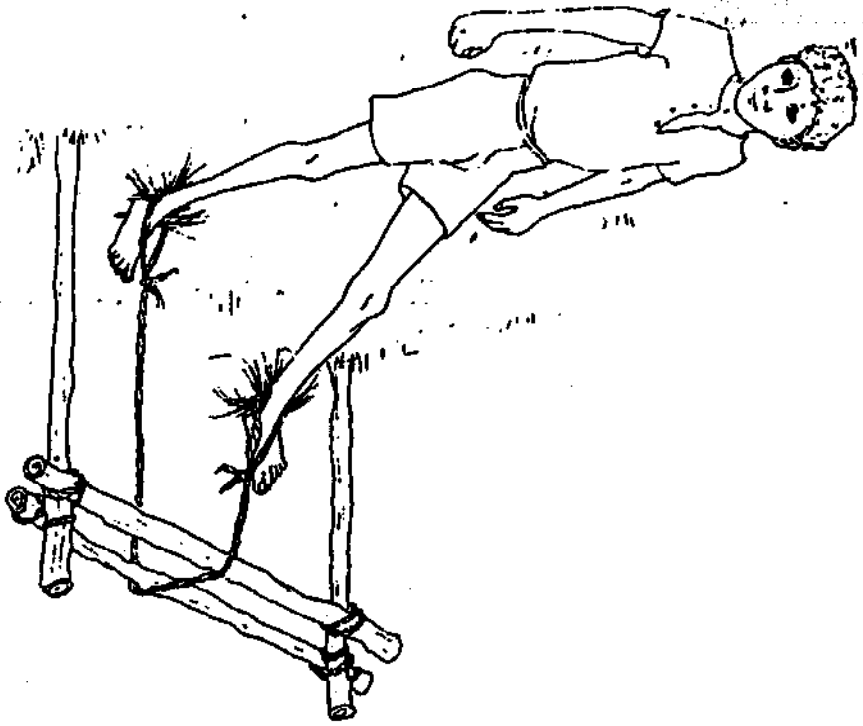

ARM AND LEG EXERCISER

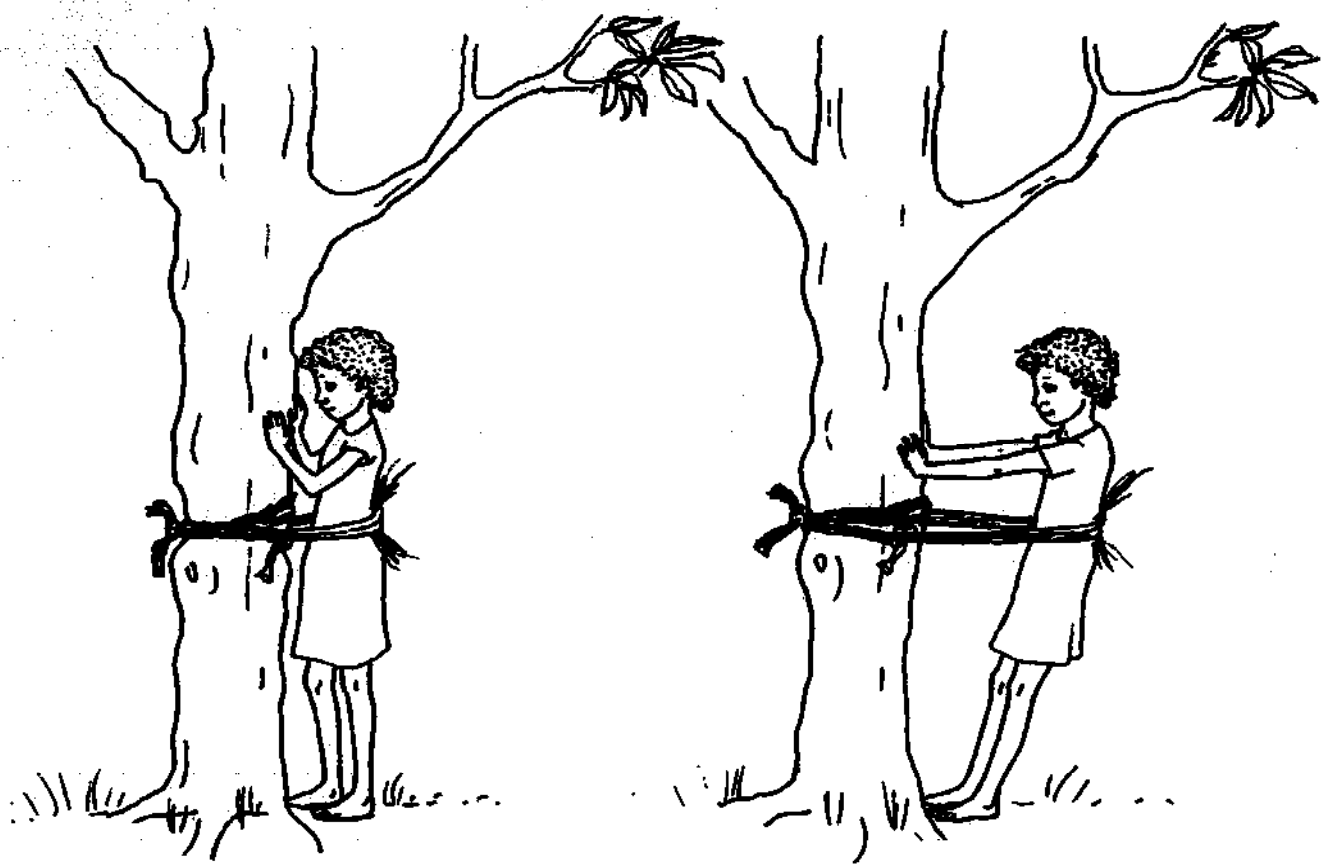

ARM EXERCISER

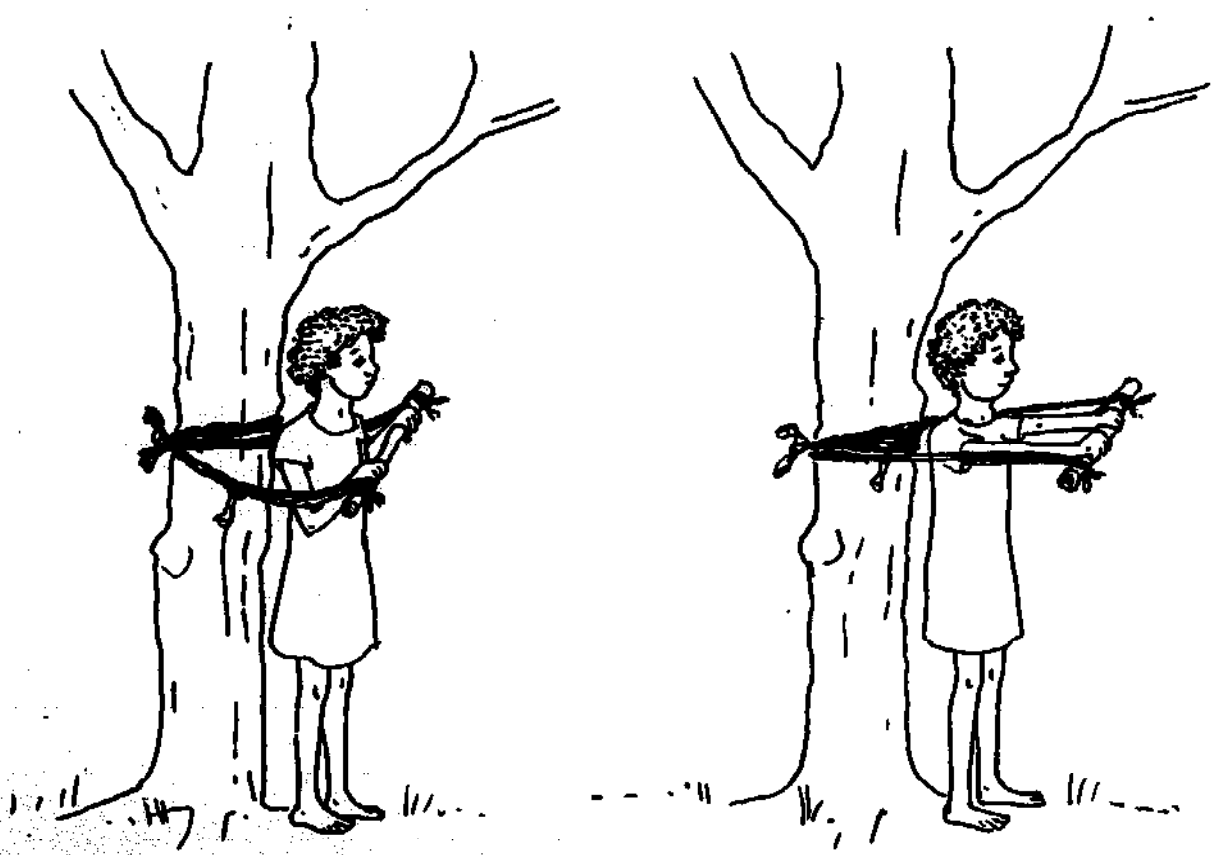

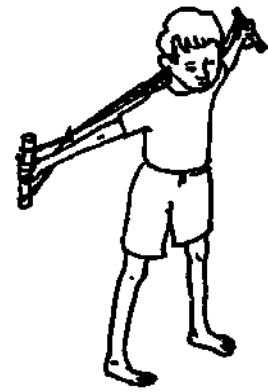
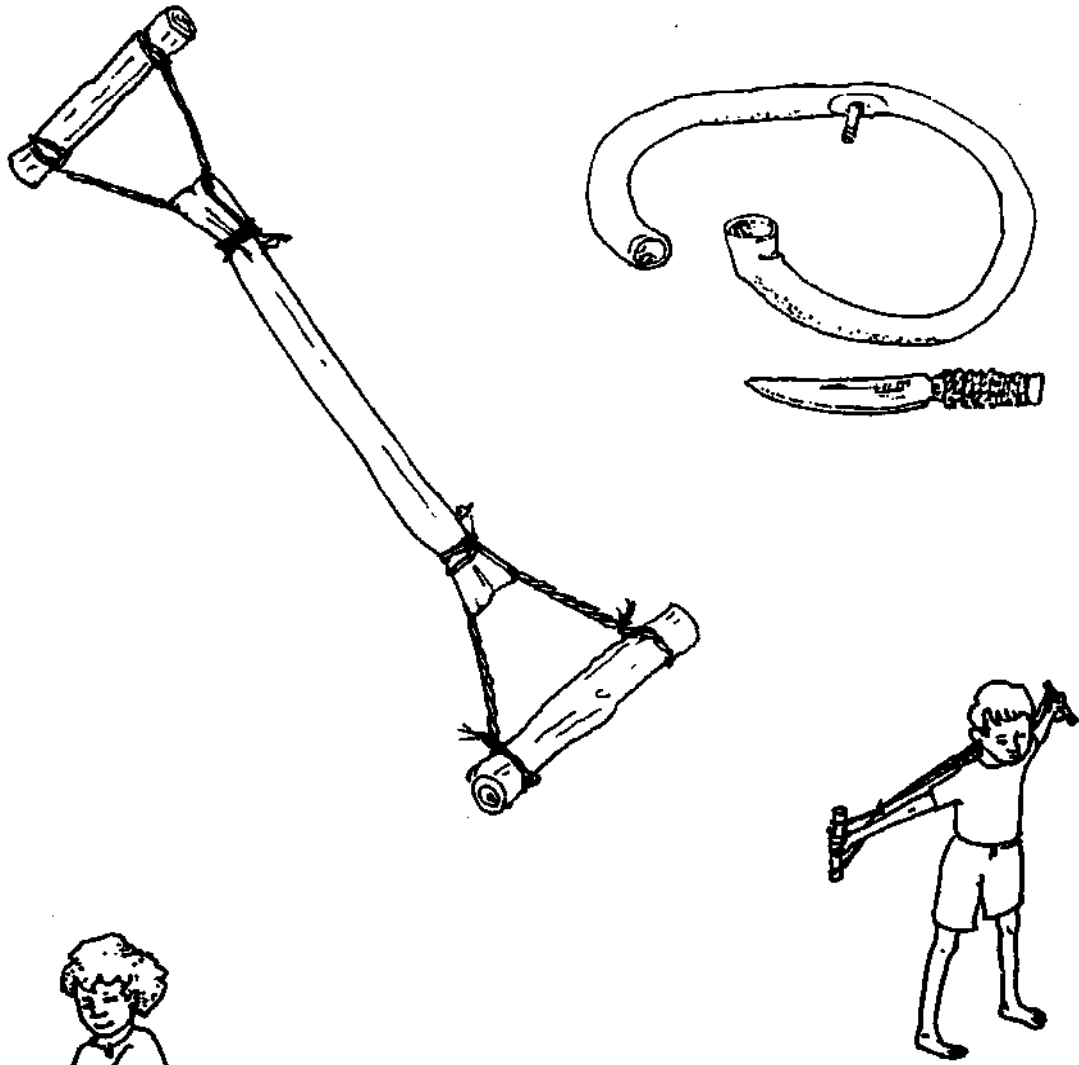

ARM AND LEG EXERCISER

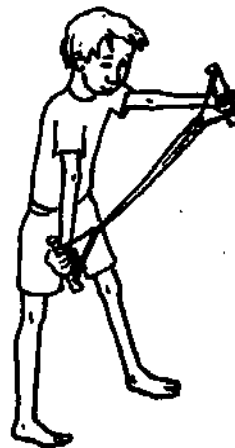

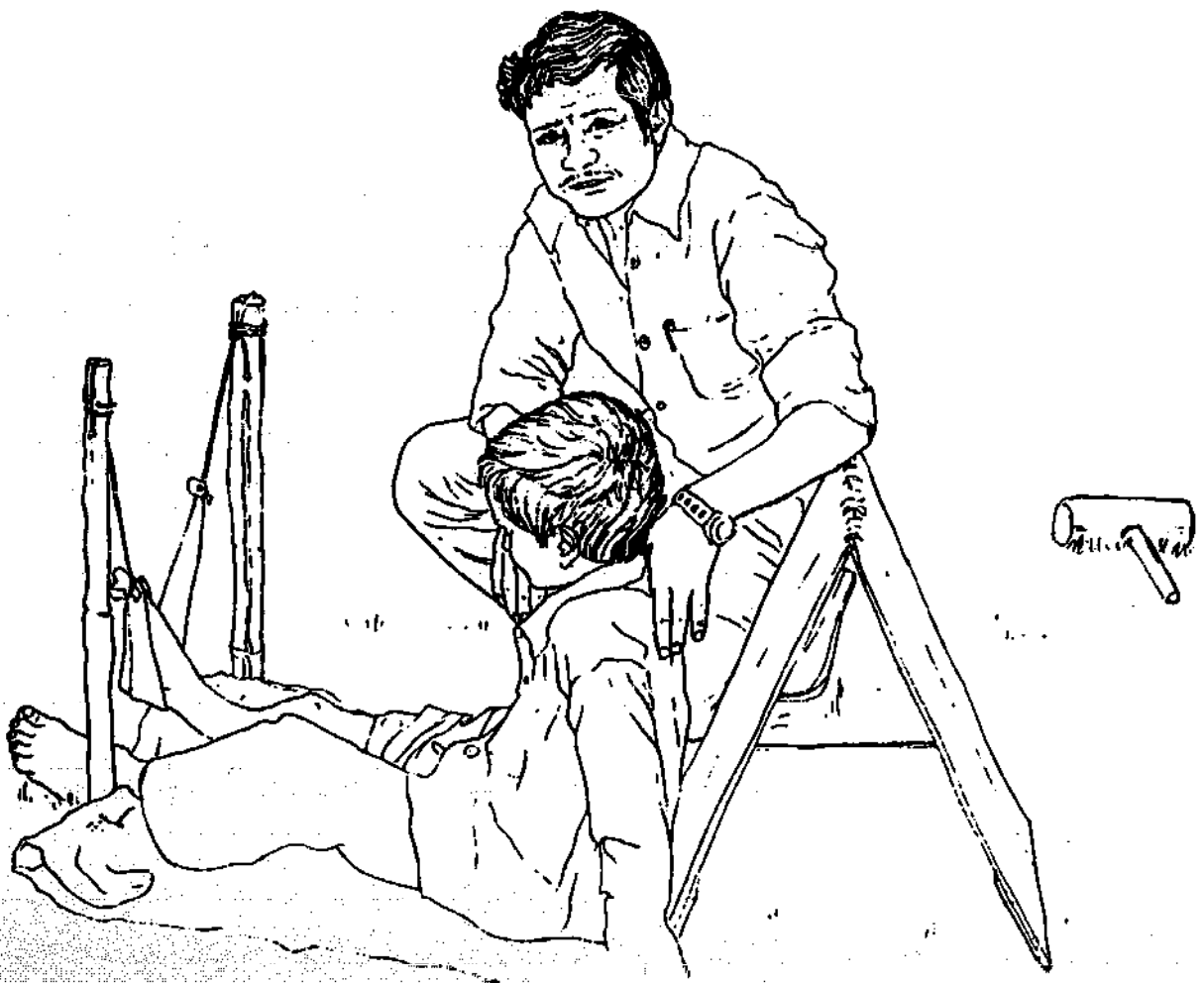
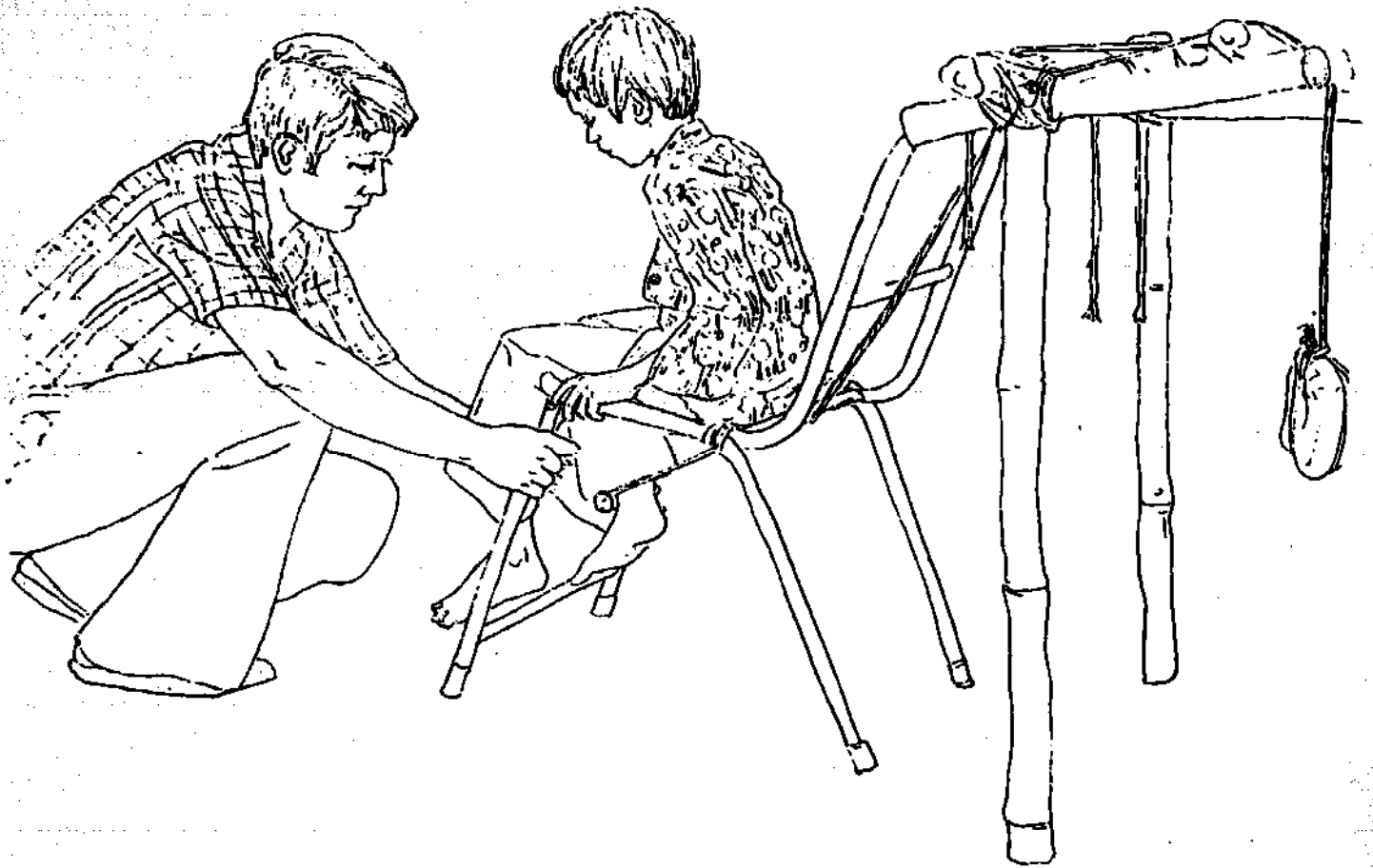

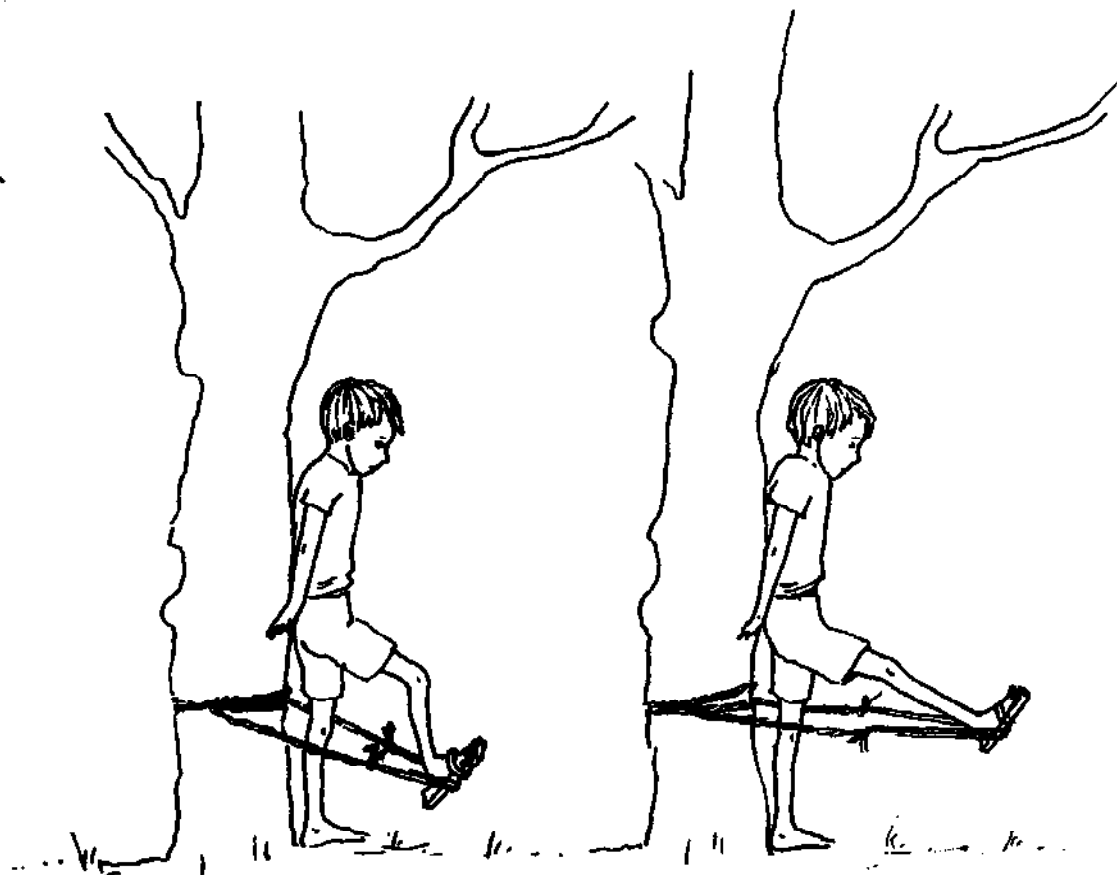

LEG EXERCISER

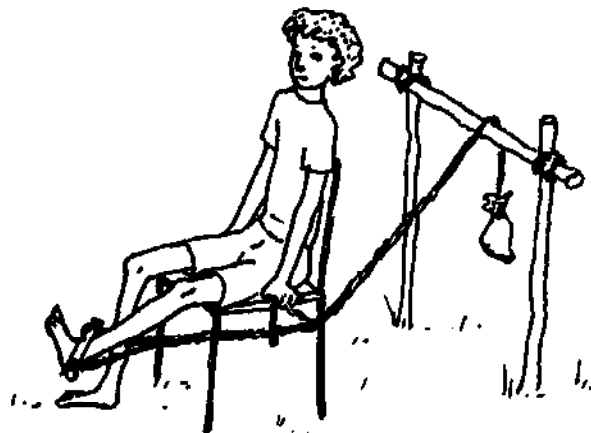
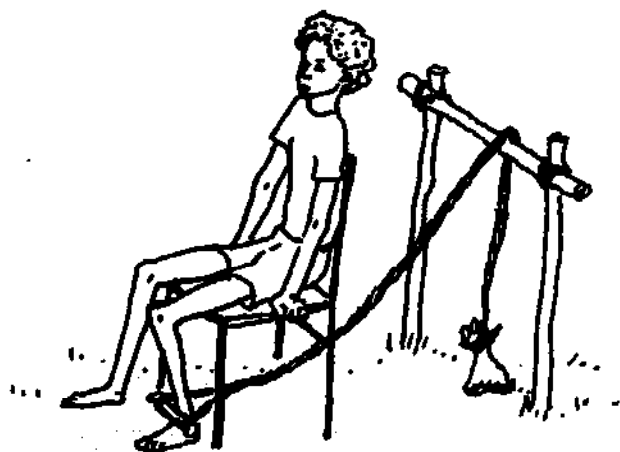
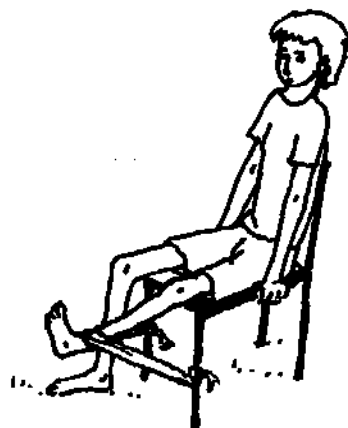
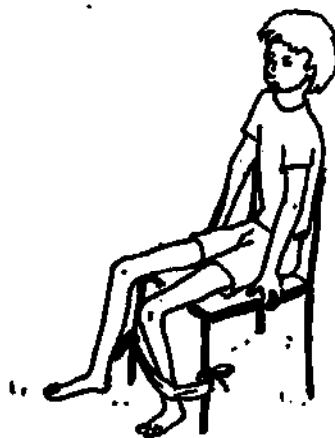
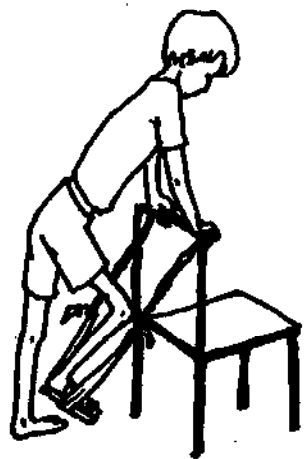

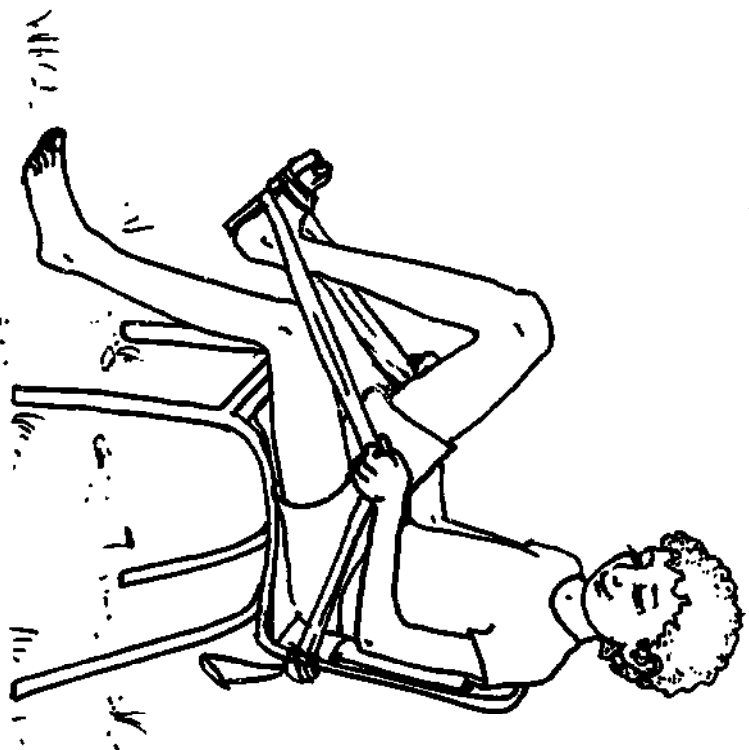
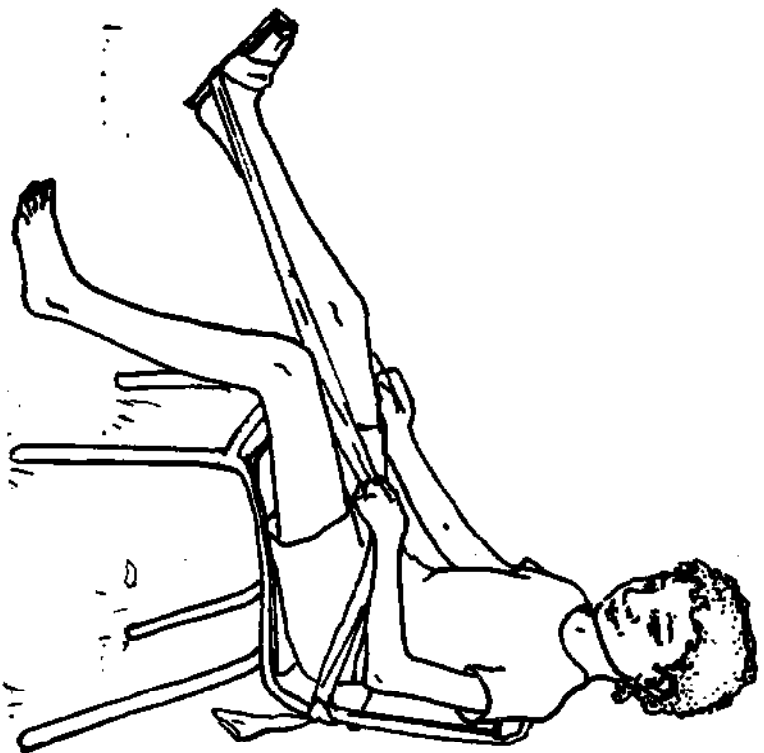

LEG EXERCISER

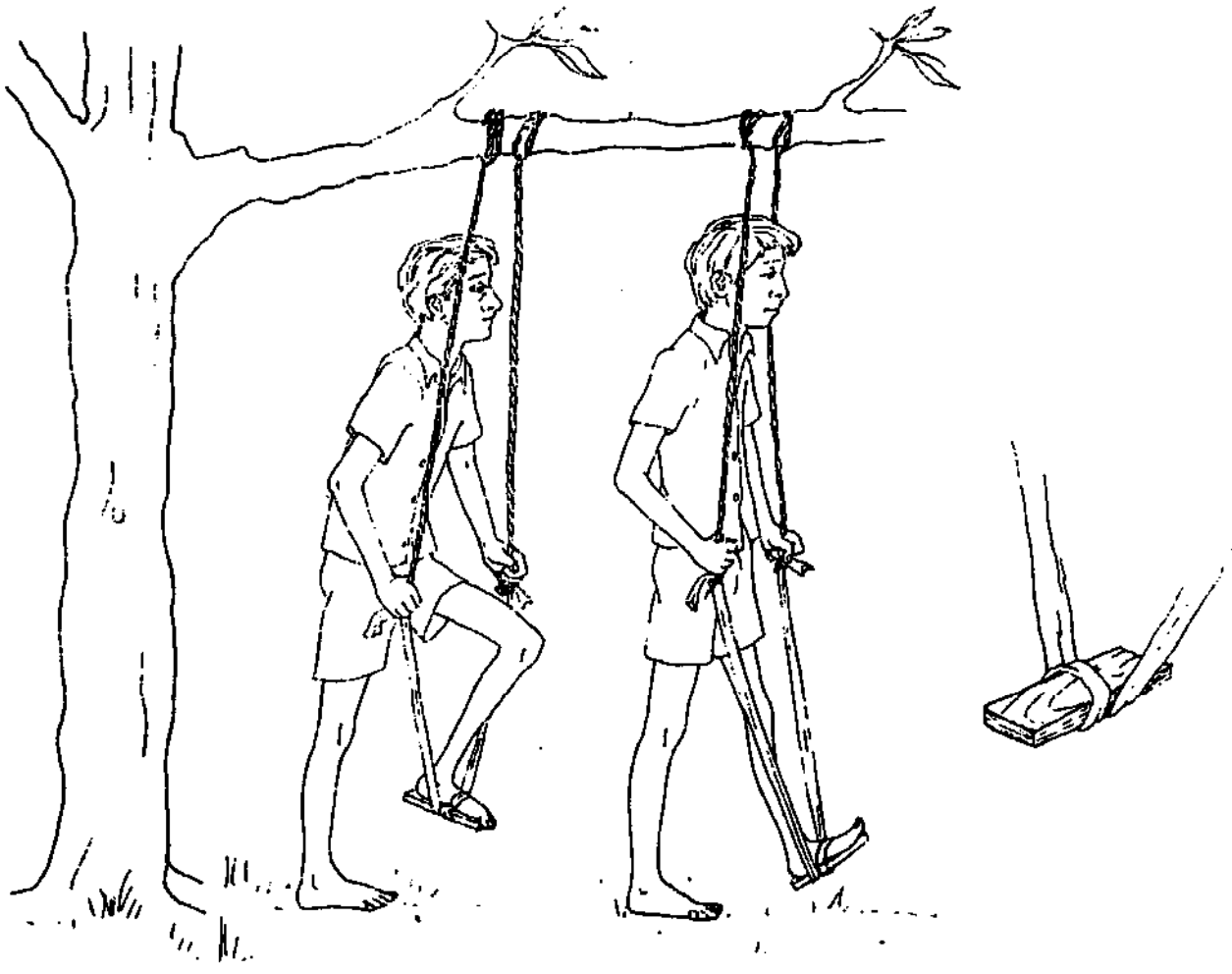
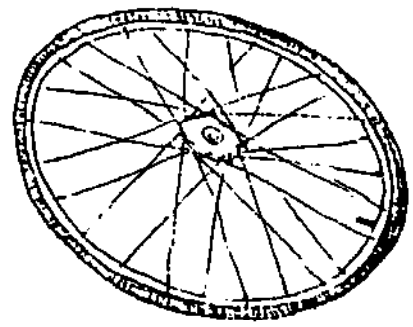
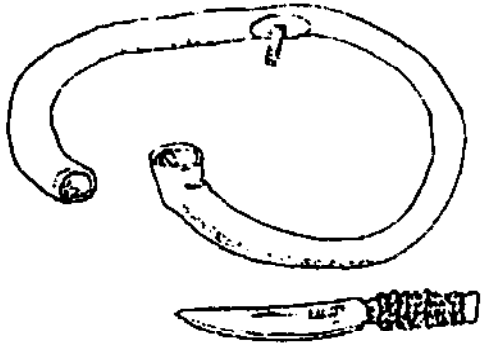

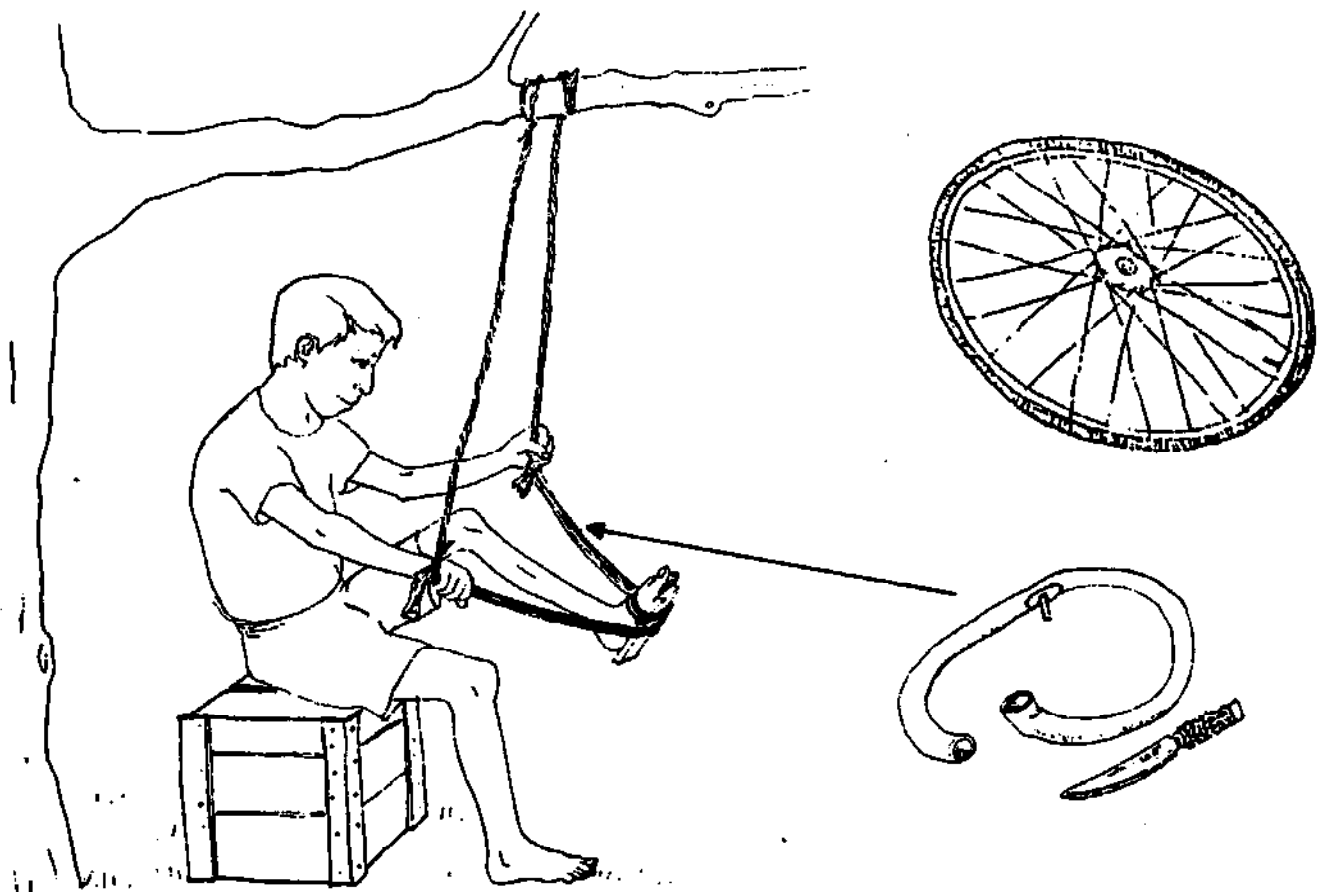

LEG EXERCISER

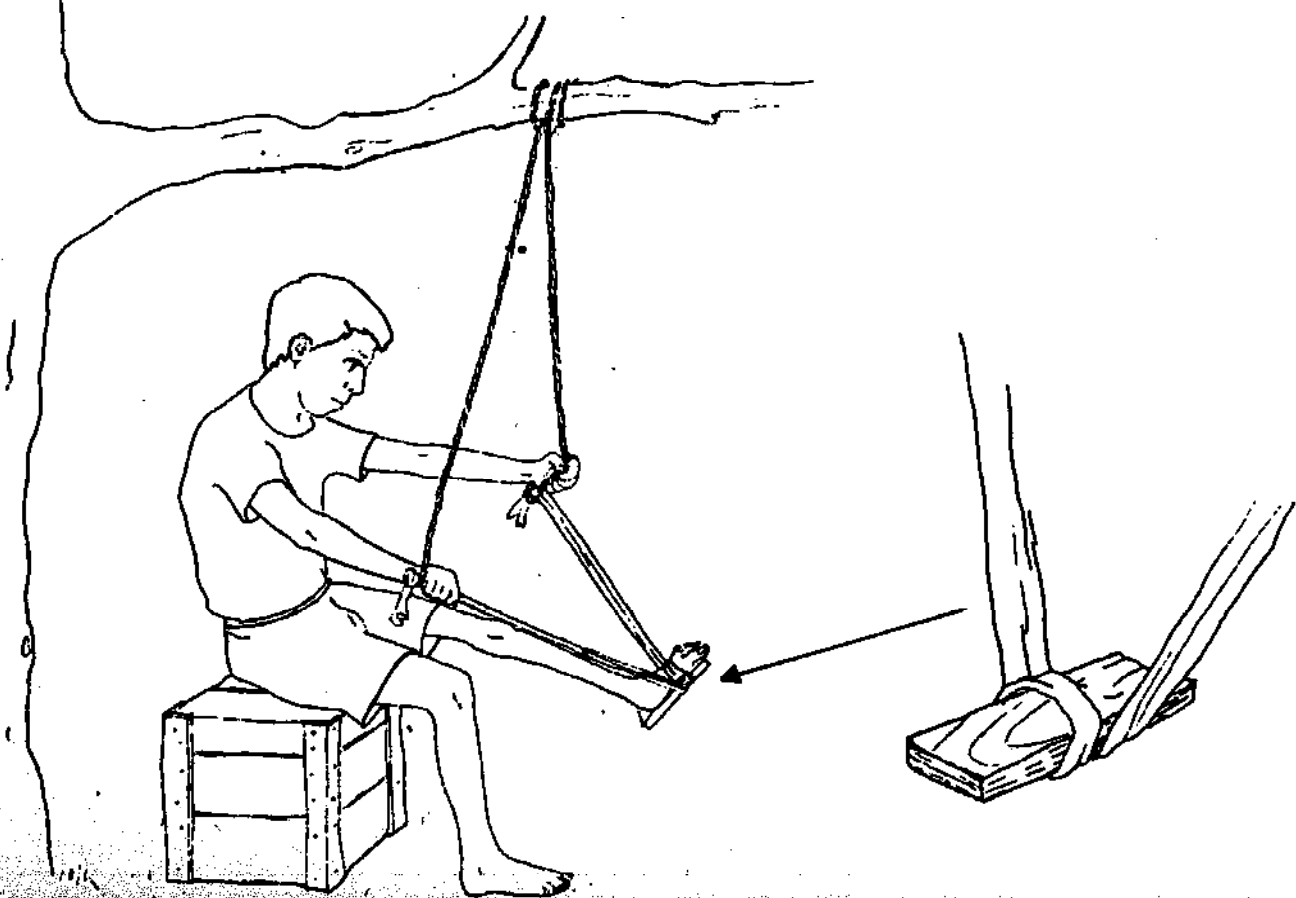

LEG EXERCISER

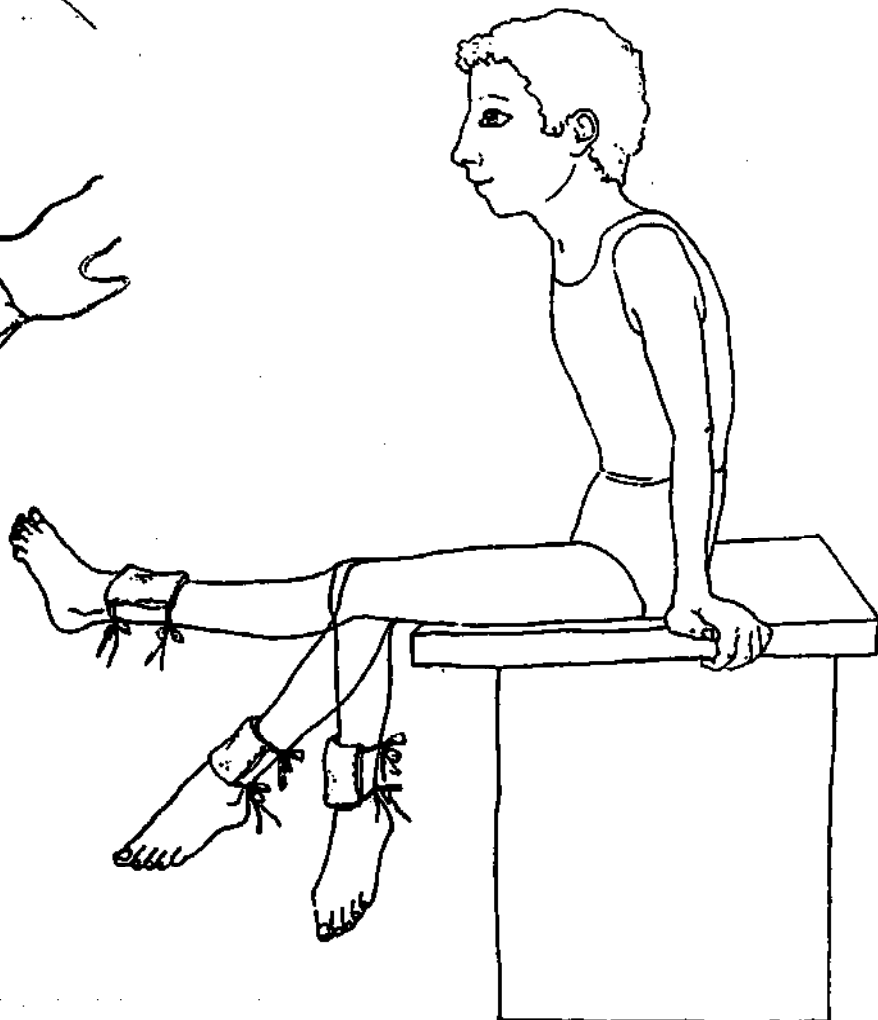
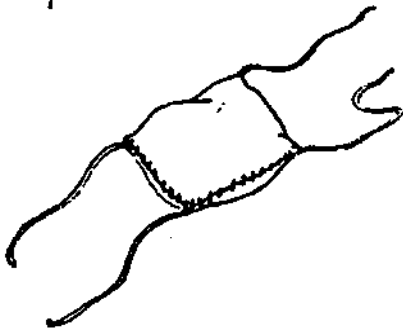
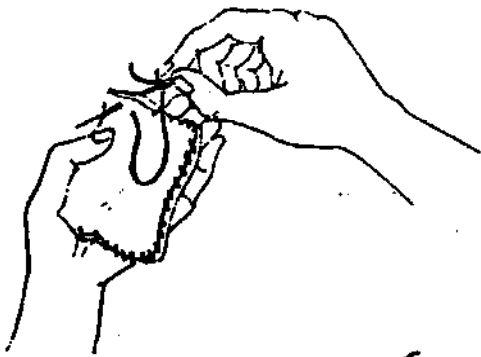
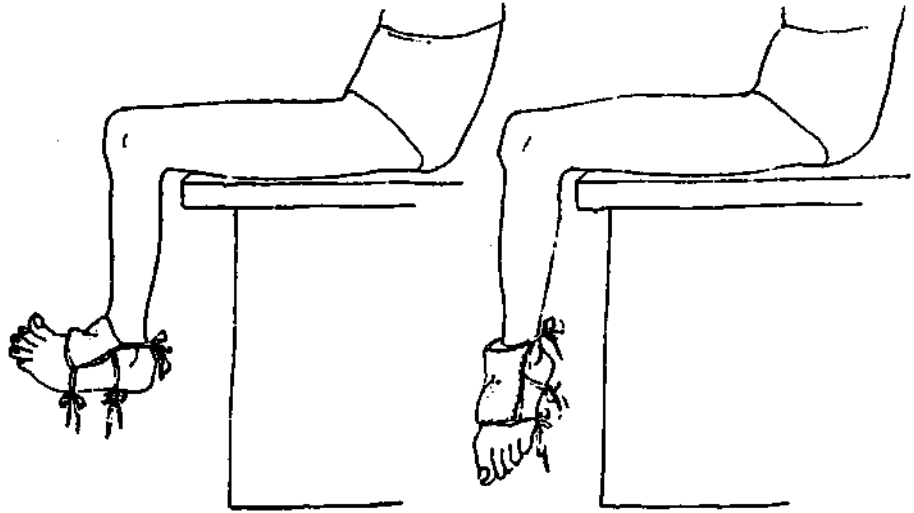
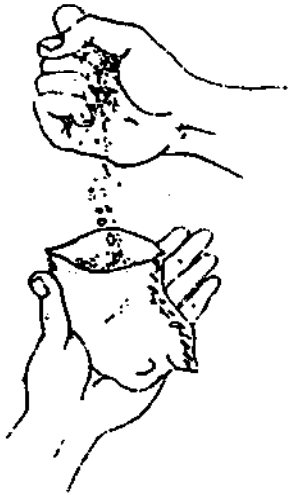

FOOT EXERCISER

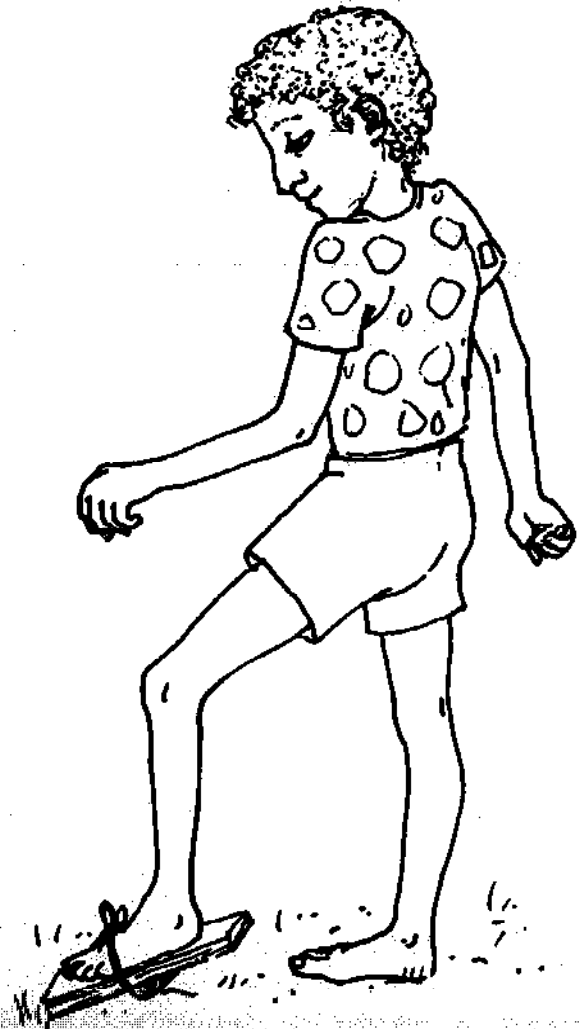
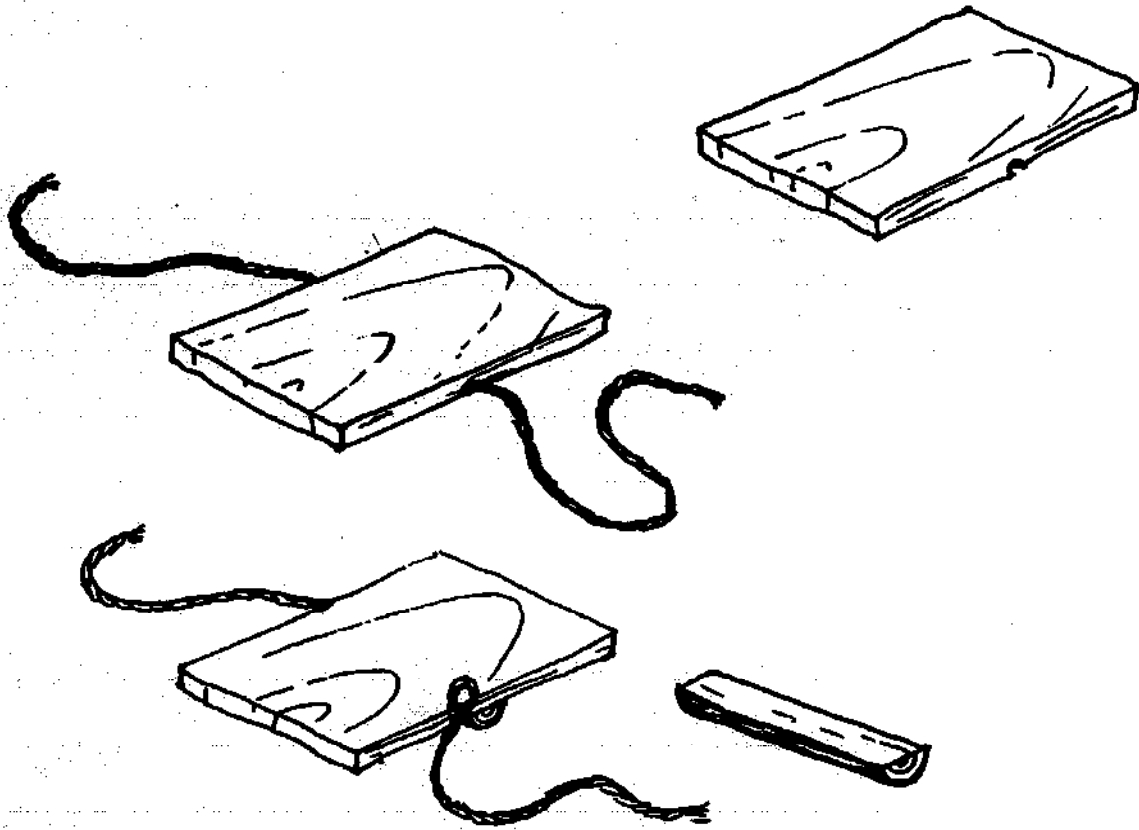

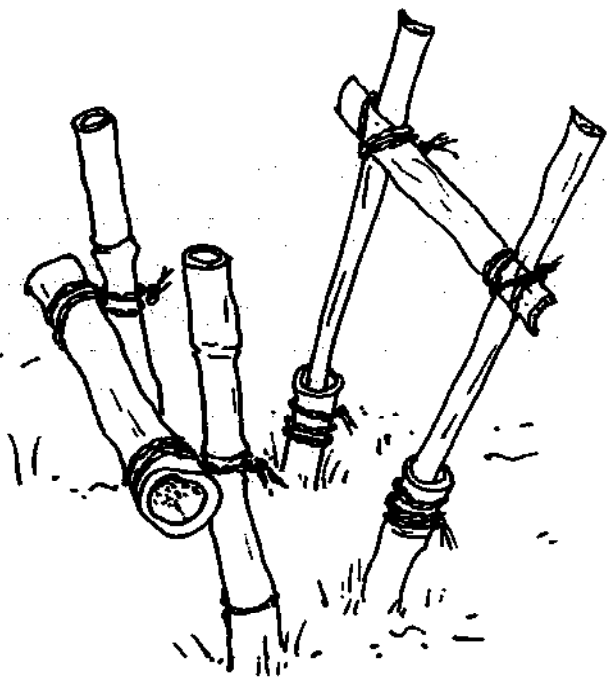

FOOT EXERCISER

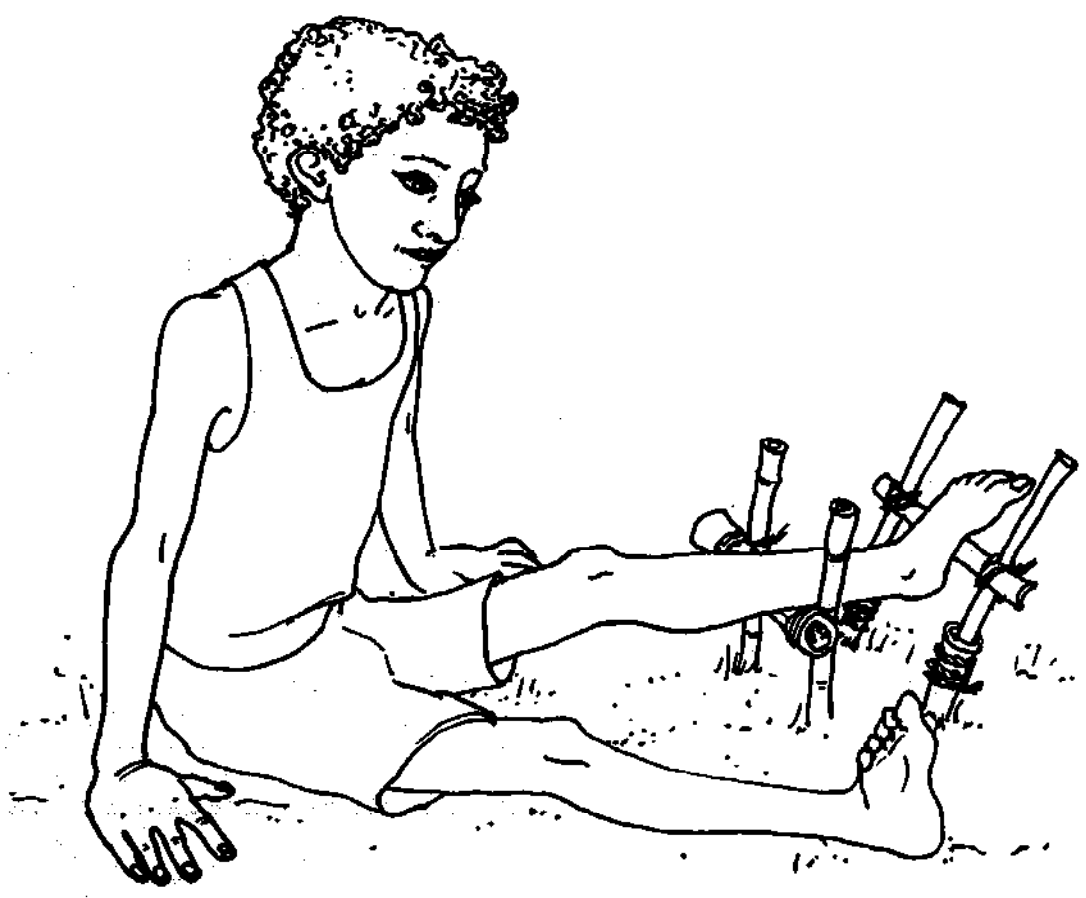

BODY RAISING EXERCISER

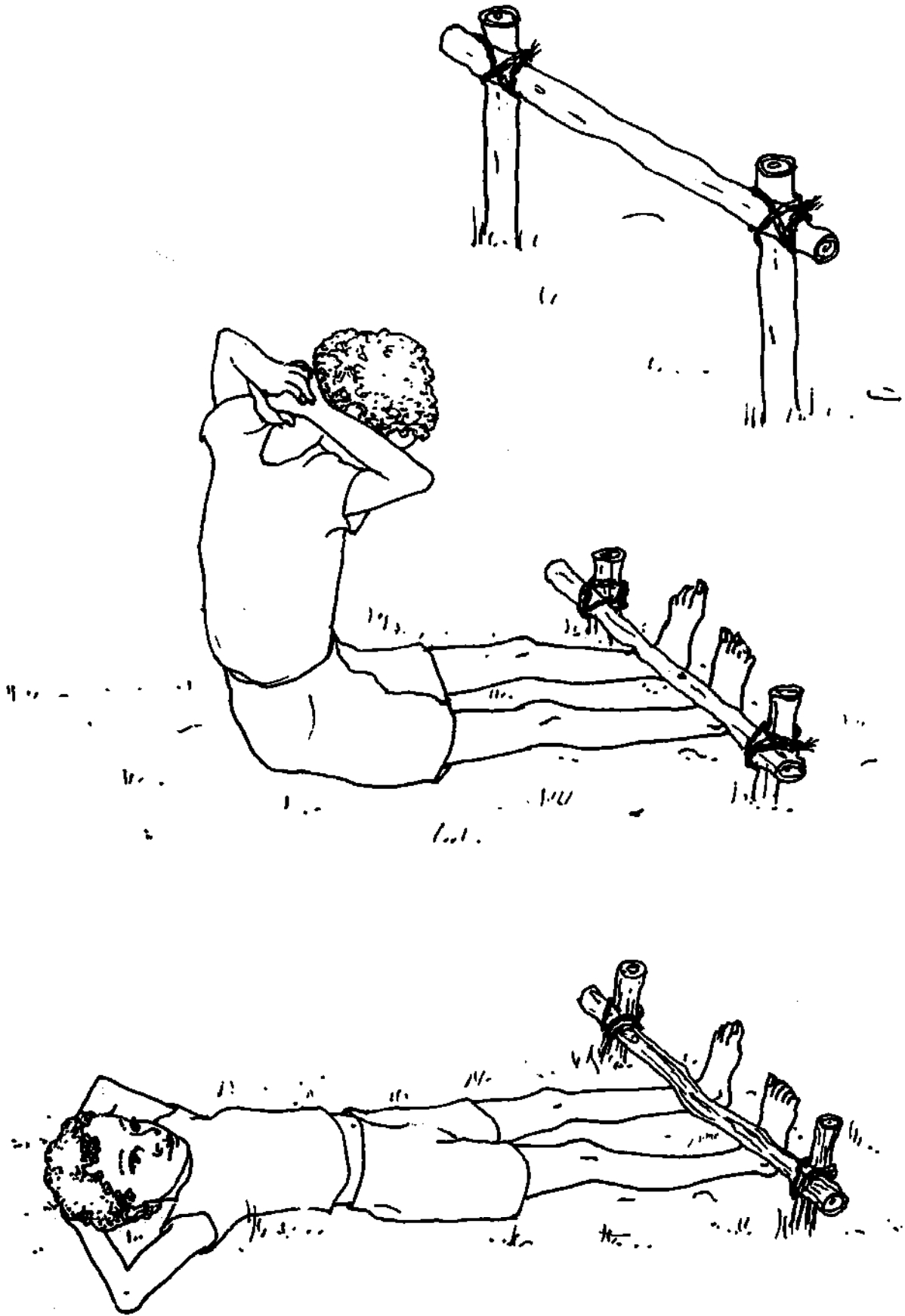

BODY RAISING EXERCISER

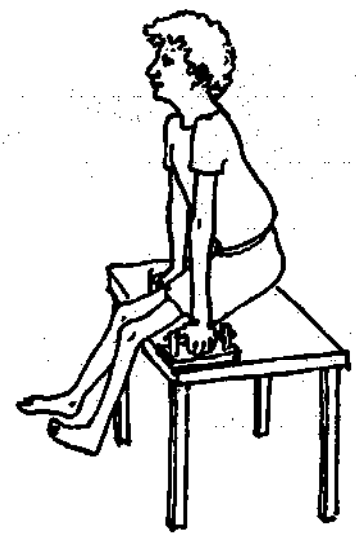
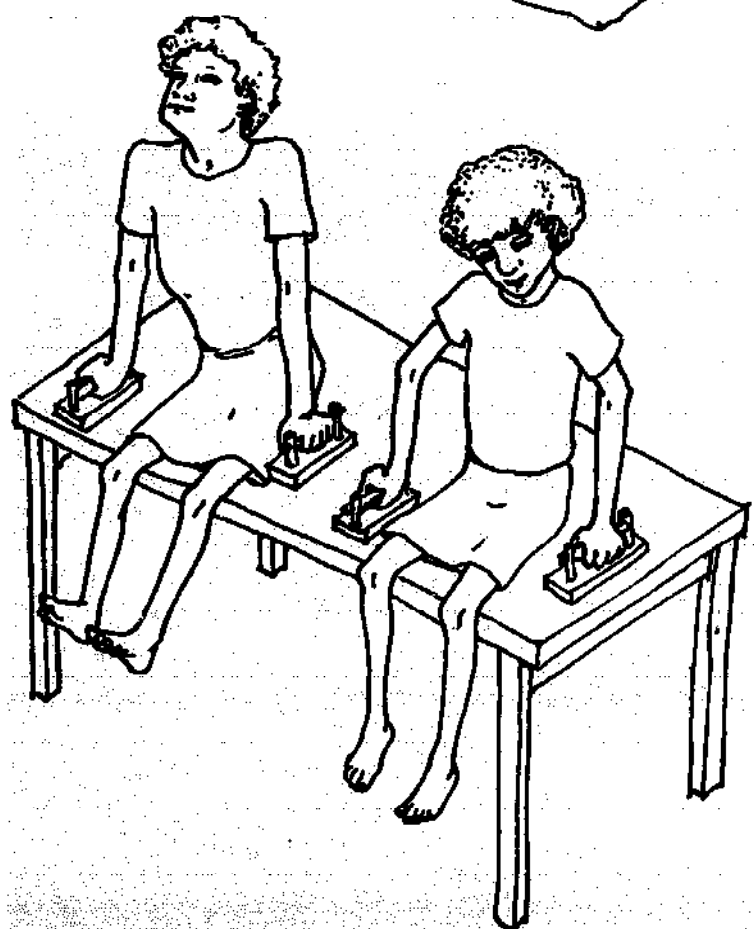
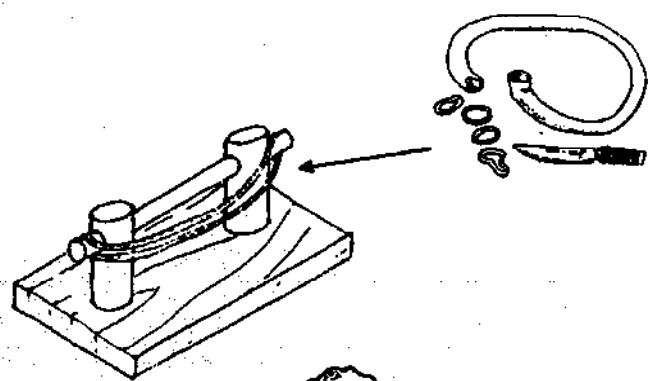
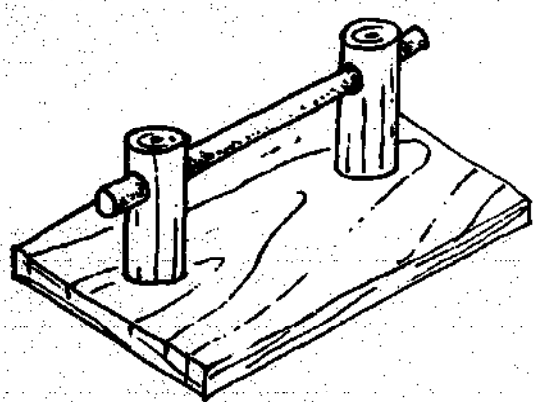

BODY RAISING EXERCISER

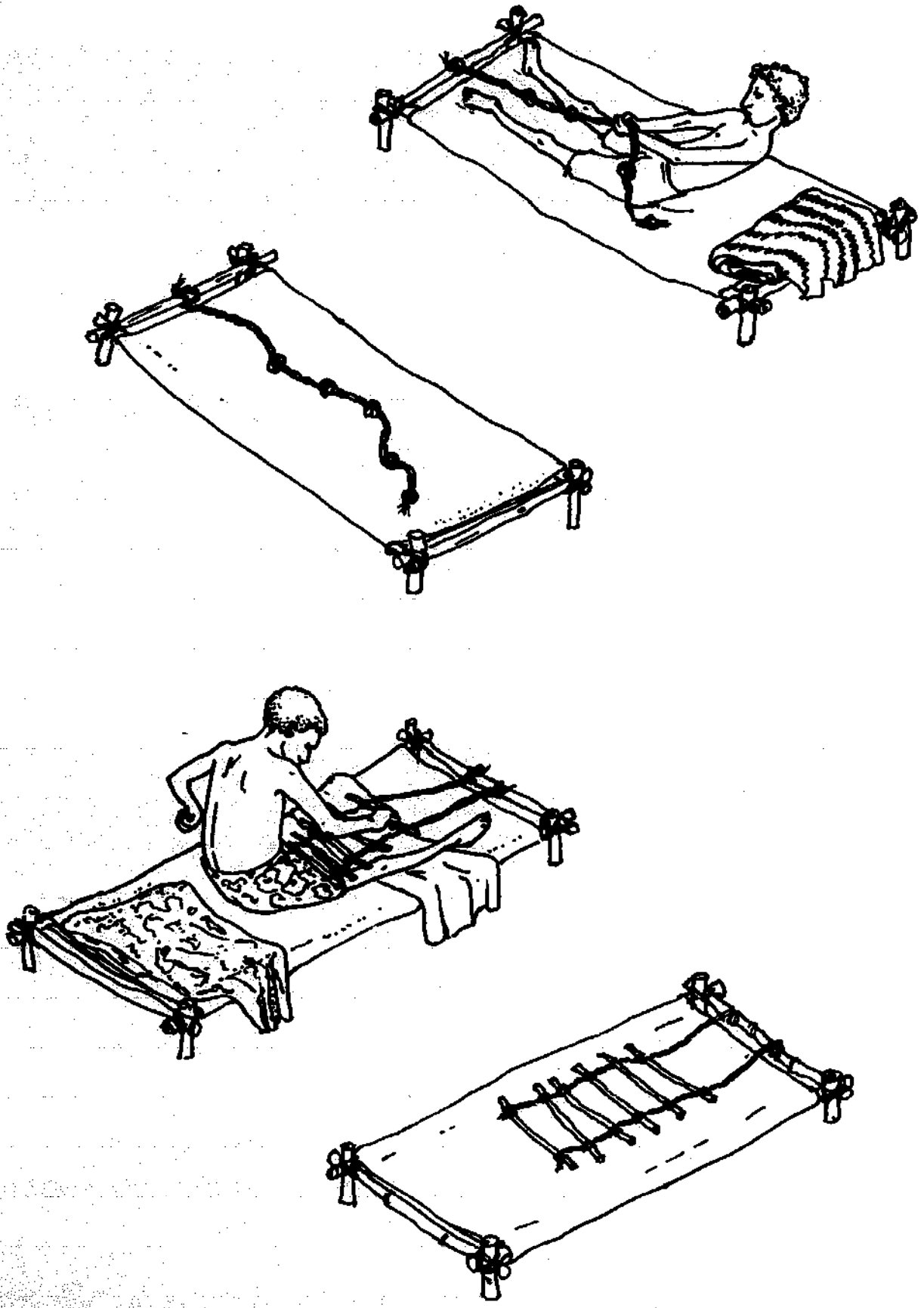

CLIMBING FRAME

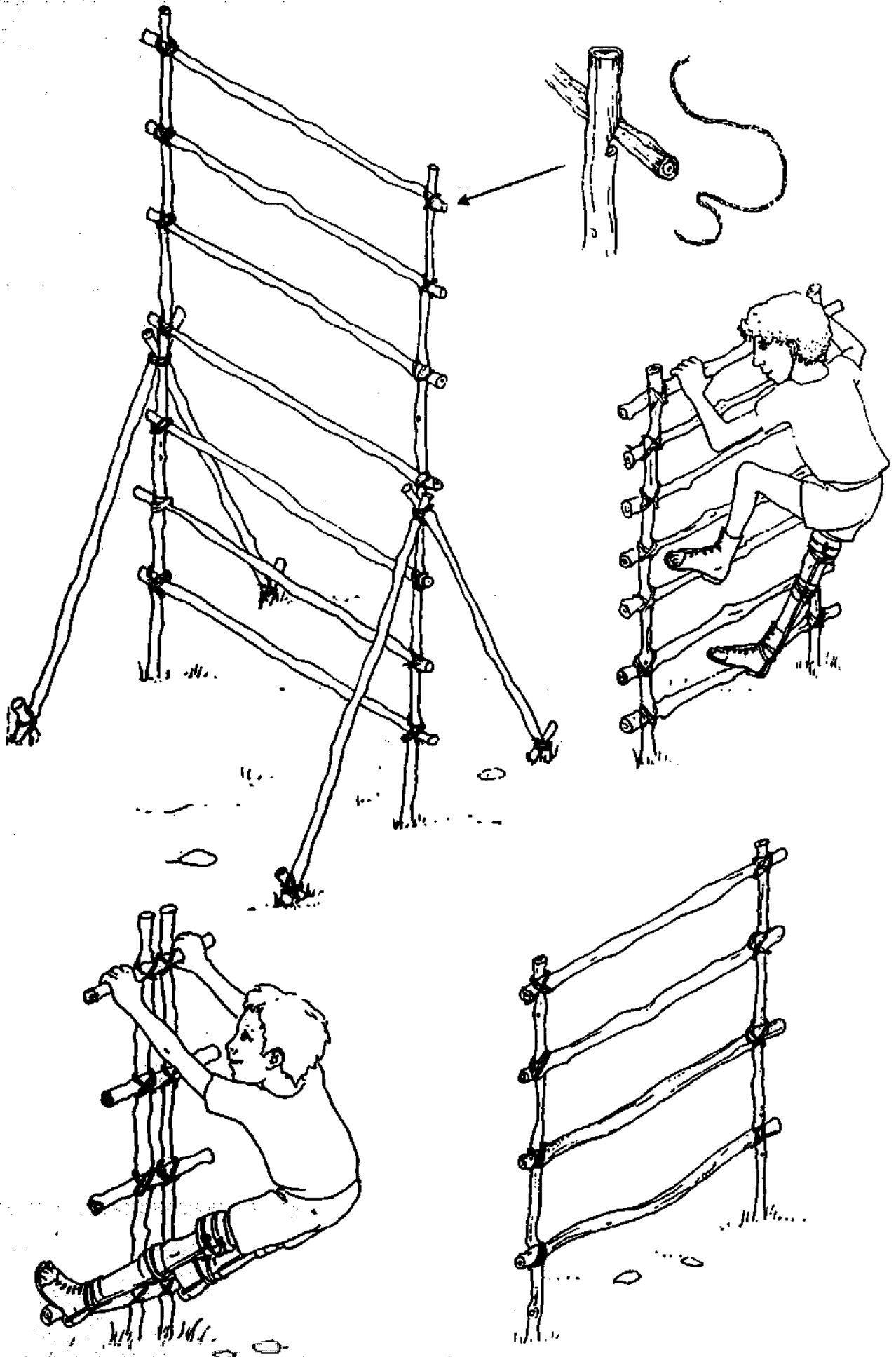

The Appropriate Health Resources and Technologies Action Group Ltd.

AHRTAG is concerned with the development of equipment and techniques for health care at community level. It also provides an information service on appropriate technology for health.

Special areas of interest include:

- the cold chain
- dental health
- disability prevention and rehabilitation
- diarrhoeal diseases

Since it began in 1977, AHRTAG has been in touch with overseas groups with similar interests and is part of an informal world network linking people interested in primary health care.

Other publications:

- 'Playing together' (1981) — aids for disabled children — a set of 8 'pop-up' illustrations plus instruction sheet. (Don Caston & Joan Thompson)
- 'Low cost aids' (1982) — a book showing a wide range of aids for disabled children. The text has been kept to a minimum and there are 53 pages of drawings. (Don Caston & Joan Thompson)
- 'How to look after a refrigerator' by Jonathan Elford, 1980.
- 'Auxiliaries in primary health care — an annotated bibliography' edited by Katherine Elliott, 1979.
- 'Assisting dental education and dental public health in developing countries: a symposium', 1981.

For details of prices and postage write to AHRTAG, 85 Marylebone High Street, London W1M 3DE, United Kingdom.

Free publications:

- 'How to make hand grips' (1981) — a poster showing ways in which clay, plaster and epoxy resin putty can be used to make hand grips to allow disabled people to hold tools, spoons and brushes, etc. (Don Caston & Joan Thompson)
- 'How to make an illuminator' (1982) — simple design for an illuminator which can be used with an oil or candle lamp, battery power, mains electricity or even sunlight. Light behind a drawing makes it easier to see and holds everybody's attention. (Don Caston & Joan Thompson)
- Diarrhoea Dialogue — a quarterly newsletter on all aspects of diarrhoeal disease control. Also available in French and Spanish.
- The AHRTAG baby length measurer (1982) — a working drawing showing how to make a baby length measuring device.

2

3

4

5

6

7

8

9

10

11

12

13

14

15

16

17

18

19

20

21

22

23

24

25

26

27

28

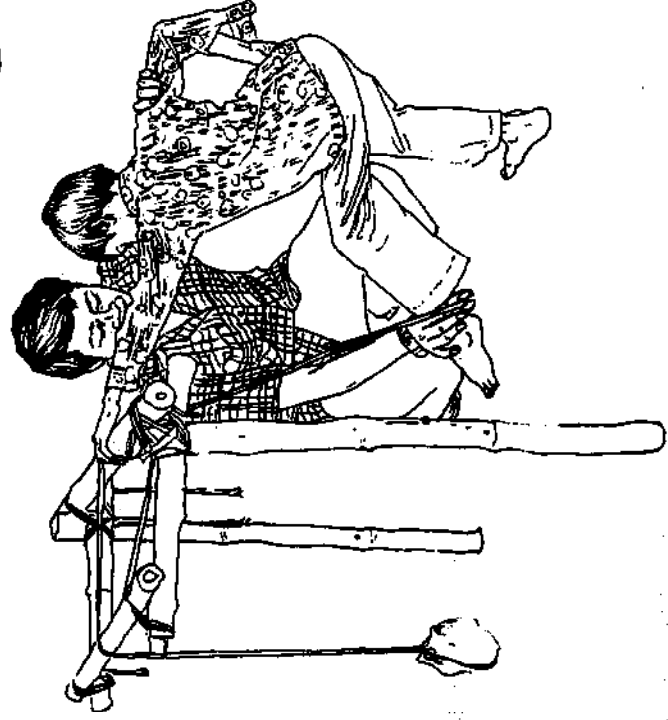
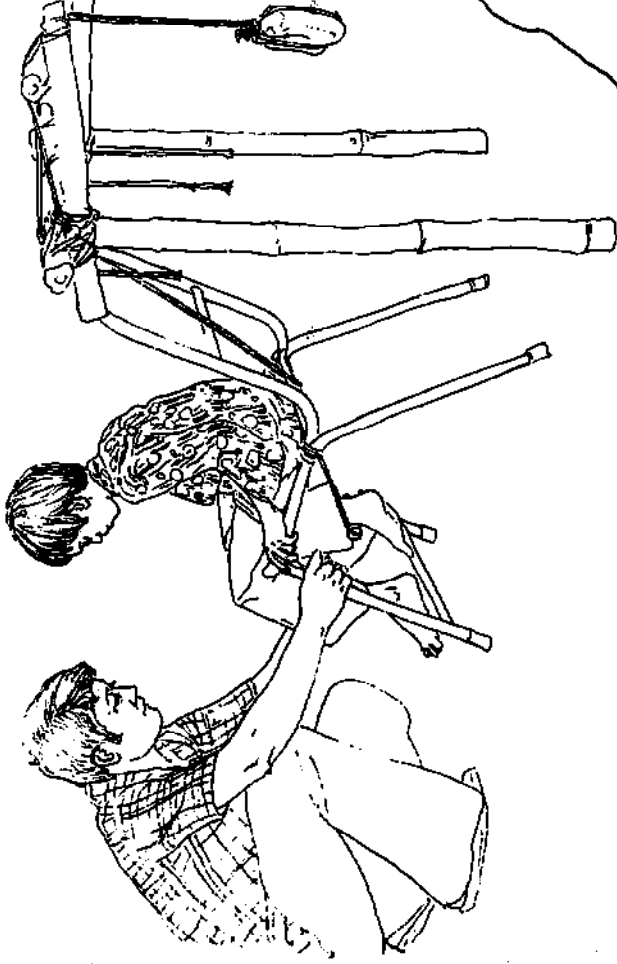
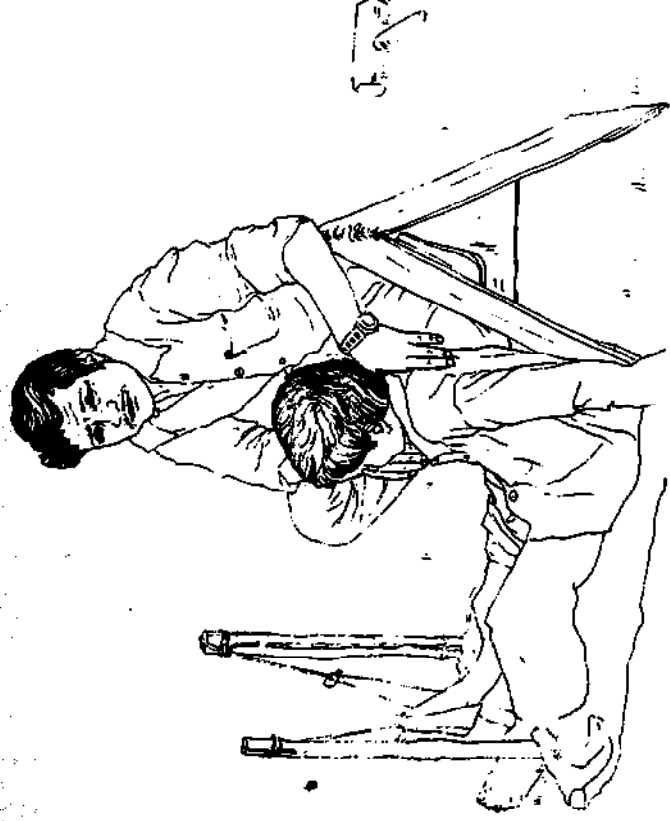
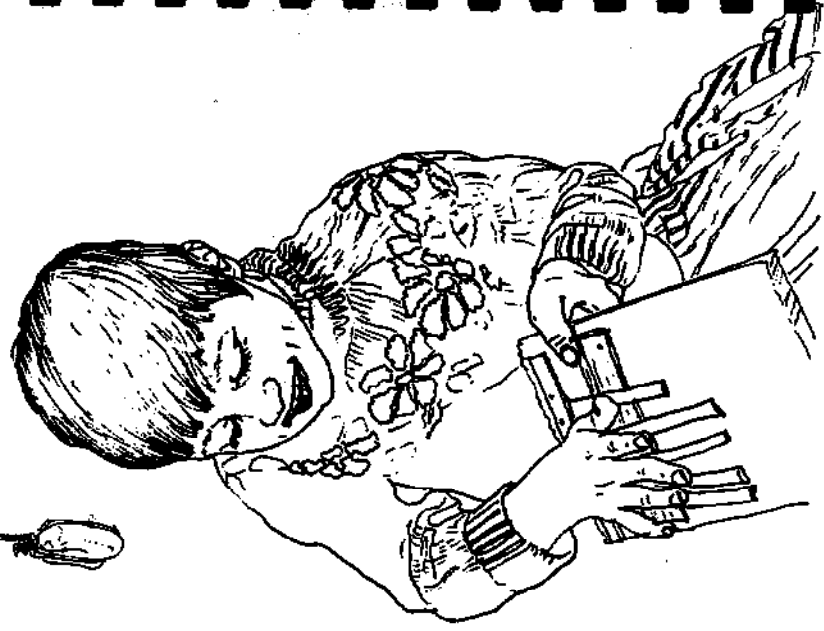
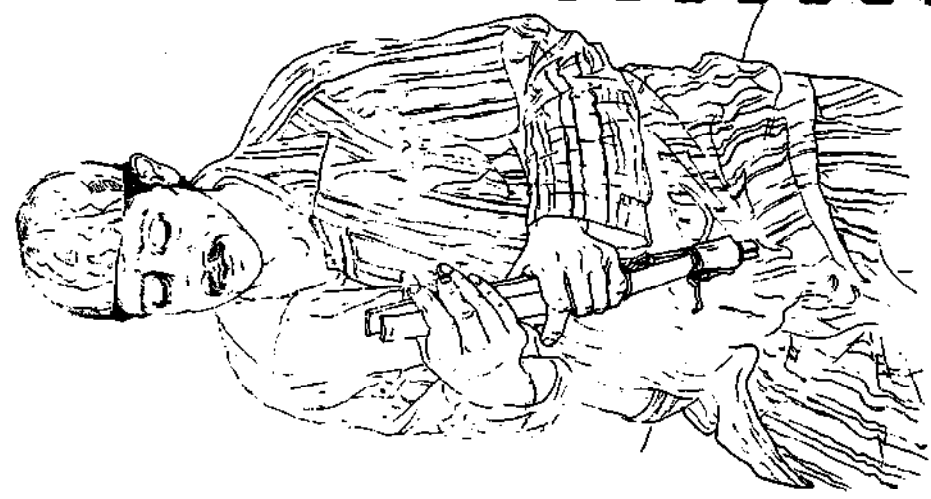

Appropriate Health Resources and
Technologies Action Group Ltd.
85 Marylebone High Street,
London W1M 3DE, UK