

DC Motor Calculations, part 1

by Theodore Wildi

Electrical Machines, Drives, and Power Systems, Fourth Edition, Prentice Hall PTR

[Back to Document](#)

Now that we have a good understanding of dc generators, we can begin our study of dc motors. Direct-current motors transform electrical energy into mechanical energy. They drive devices such as hoists, fans, pumps, calendars, punch-presses, and cars. These devices may have a definite torque-speed characteristic (such as a pump or fan) or a highly variable one (such as a hoist or automobile). The torque-speed characteristic of the motor must be adapted to the type of the load it has to drive, and this requirement has given rise to three basic types of motors:

1. Shunt motors
2. Series motors
3. Compound motors

Direct-current motors are seldom used in ordinary industrial applications because all electric utility systems furnish alternating current. However, for special applications such as in steel mills, mines, and electric trains, it is sometimes advantageous to transform the alternating current into direct current in order to use dc motors. The reason is that the torque-speed characteristics of dc motors can be varied over a wide range while retaining high efficiency.

Today, this general statement can be challenged because the availability of sophisticated electronic drives has made it possible to use alternating current motors for variable speed applications. Nevertheless, there are millions of dc motors still in service and thousands more are being produced every year.

Table of Contents:

- Counter-electromotive force (cemf)
- Acceleration of the motor
- Mechanical power and torque
- Speed of rotation
- Armature speed control

Counter-electromotive force (cemf)

Direct-current motors are built the same way as generators are; consequently, a dc machine can operate either as a motor or as a generator. To illustrate, consider a dc generator in which the armature, initially at rest, is connected to a dc source E_s by means of a switch (Fig. 5.1). The armature has a resistance R , and the magnetic field is created by a set of permanent magnets.

As soon as the switch is closed, a large current flows in the armature because its resistance is very low. The individual armature conductors are immediately subjected to a force because they are immersed in the magnetic field created by the permanent magnets. These forces add up to produce a powerful torque, causing the armature to rotate.

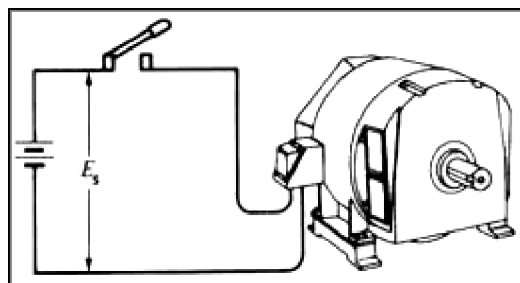

Figure 5.1 Starting a dc motor across the line.

On the other hand, as soon as the armature begins to turn, a second phenomenon takes place: the generator effect. We know that a voltage E_o is induced in the armature conductors as soon as they cut a magnetic field (Fig. 5.2). This is always true, *no matter what causes the rotation*. The value and polarity of the induced voltage are the same as those obtained

when the machine operates as a generator. The induced voltage E_o is therefore proportional to the speed of rotation n of the motor and to the flux F per pole, as previously given by Eq. 4.1:

$$E_o = ZnF/60 \quad (4.1)$$

As in the case of a generator, Z is a constant that depends upon the number of turns on the armature and the type of winding. For lap windings Z is equal to the number of armature conductors.

In the case of a motor, the induced voltage E_o is called *counter-electromotive force (cemf)* because its polarity always acts *against* the source voltage E_s . It acts against the voltage in the sense that the net voltage acting in the series circuit of Fig. 5.2 is equal to $(E_s - E_o)$ volts and not $(E_s + E_o)$ volts.

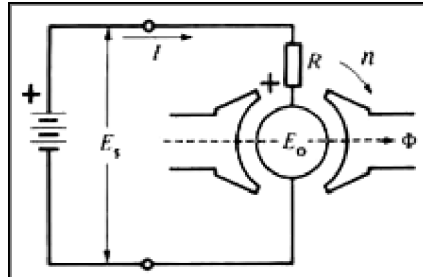

Figure 5.2 Counter-electromotive force (cemf) in a dc motor.

Acceleration of the motor

The net voltage acting in the armature circuit in Fig. 5.2 is $(E_s - E_o)$ volts. The resulting armature current I is limited only by the armature resistance R , and so

$$I = (E_s - E_o)/R \quad (5.1)$$

When the motor is at rest, the induced voltage $E_o = 0$, and so the starting current is

$$I = E_s/R$$

The starting current may be 20 to 30 times greater than the nominal full-load current of the motor. In practice, this would cause the fuses to blow or the circuit-breakers to trip. However, if they are absent, the large forces acting on the armature conductors produce a powerful starting torque and a consequent rapid acceleration of the armature.

As the speed increases, the counter-emf E_o increases, with the result that the value of $(E_s - E_o)$ diminishes. It follows from Eq. 5.1 that the armature current I drops progressively as the speed increases.

Although the armature current decreases, the motor continues to accelerate until it reaches a definite, maximum speed. At no-load this speed produces a counter-emf E_o slightly less than the source voltage E_s . In effect, if E_o were equal to E_s the net voltage $(E_s - E_o)$ would become zero and so, too, would the current I . The driving forces would cease to act on the armature conductors, and the mechanical drag imposed by the fan and the bearings would immediately cause the motor to slow down. As the speed decreases the net voltage $(E_s - E_o)$ increases and so does the current I . The speed will cease to fall as soon as the torque developed by the armature current is equal to the load torque. Thus, when a motor runs at no-load, the counter-emf must be slightly less than E_s so as to enable a small current to flow, sufficient to produce the required torque.

Example 5-1

The armature of a permanent-magnet dc generator has a resistance of 1 Ω and generates a voltage of 50 V when the speed is 500 r/min. If the armature is connected to a source of 150 V, calculate the following:

- The starting current
- The counter-emf when the motor runs at 1000 r/min. At 1460 r/min.
- The armature current at 1000 r/min. At 1460 r/min.

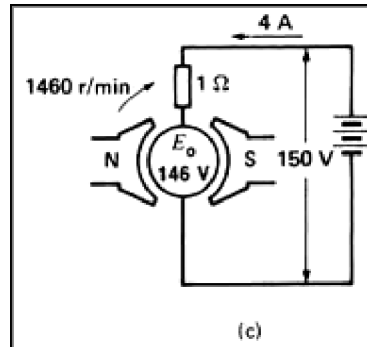
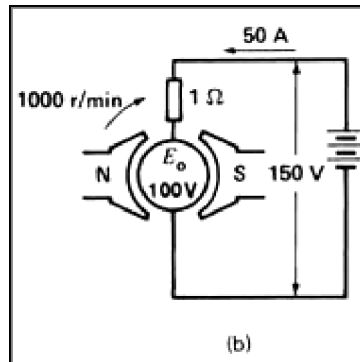
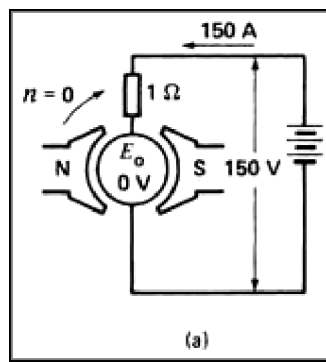

Figure 5.3 See Example 5.1.

Solution

a. At the moment of start-up, the armature is stationary, so $E_o = 0 \text{ V}$ (Fig. 5.3a). The starting current is limited only by the armature resistance:

$$I = E_s/R = 150 \text{ V}/1 \text{ } \Omega = 150 \text{ A}$$

b. Because the generator voltage is 50 V at 500 r/min, the cemf of the motor will be 100 V at 1000 r/min and 146 V at 1460 r/min.

c. The net voltage in the armature circuit at 1000 r/min is

$$E_s - E_o = 150 - 100 = 50 \text{ V}$$

The corresponding armature current is

$$\begin{aligned} I &= (E_s - E_o)/R \\ &= 50/1 = 50 \text{ A (Fig.5.3b)} \end{aligned}$$

When the motor speed reaches 1460 r/min, the cemf will be 146 V, almost equal to the source voltage. Under these conditions, the armature current is only

$$\begin{aligned} I &= (E_s - E_o)/R = (150 - 146)/1 \\ &= 4 \text{ A} \end{aligned}$$

and the corresponding motor torque is much smaller than before (Fig. 5.3c).

Mechanical power and torque

The power and torque of a dc motor are two of its most important properties. We now derive two simple equations that enable us to calculate them.

1. According to Eq. 4.1 the cemf induced in a lap-wound armature is given by

$$E_o = Z\eta F/60 \quad (4.1)$$

Referring to Fig. 5.2, the electrical power P_a supplied to the armature is equal to the supply voltage E_s multiplied by the armature current I :

$$P_a = E_s I \quad (5.2)$$

However, E_s is equal to the sum of E_o plus the IR drop in the armature:

$$E_s = E_o + IR \quad (5.3)$$

It follows that

$$\begin{aligned} P_a &= E_s I \\ &= (E_o + IR)I \\ &= E_o I + I_2 R \quad (5.4) \end{aligned}$$

The $I_2 R$ term represents heat dissipated in the armature, but the very important term $E_o I$ is the electrical power that is converted into mechanical power. The mechanical power of the motor is therefore exactly equal to the product of the cemf multiplied by the armature current

$$P = E_o I \quad (5.5)$$

where

P = mechanical power developed by the motor [W]

E_o = induced voltage in the armature (cemf) [V]

I = total current supplied to the armature [A]

2. Turning our attention to torque T , we know that the mechanical power P is given by the expression

$$P = nT/9.55 \quad (3.5)$$

where n is the speed of rotation.

Combining Eqs. 3.5, 4.1, and 5.5, we obtain

$$\begin{aligned} nT/9.55 &= E_o I \\ &= ZnFI/60 \end{aligned}$$

and so

$$T = ZFI/6.28$$

The torque developed by a lap-wound motor is therefore given by the expression

$$T = ZFI/6.28 \quad (5.6)$$

where

T = torque [N×m]

Z = number of conductors on the armature

F = effective flux per pole [Wb]*

I = armature current [A]

6.28 = constant, to take care of units
 [exact value = 2π]

Eq. 5.6 shows that we can raise the torque of a motor either by raising the armature current or by raising the flux created by the poles.

Example 5-2

The following details are given on a 225 kW (» 300 hp), 250 V, 1200 r/min dc motor (see Figs. 5.4 and 5.5):

armature coils 243

turns per coil 1

type of winding lap

armature slots 81

commutator segments 243

field poles 6

diameter of armature 559 mm

axial length of armature 235 mm

* The effective flux is given by $F = 60 E_o/Zn$.

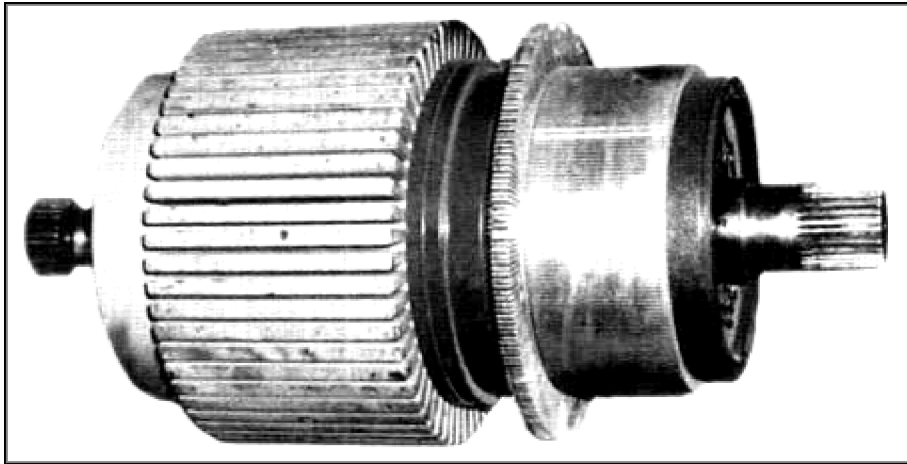

Figure 5.4 Bare armature and commutator of a dc motor rated 225 kW, 250 V, 1200 r/min. The armature core has a diameter of 559 mm and an axial length of 235 mm. It is composed of 400 stacked laminations 0.56 mm thick. The armature has 81 slots and the commutator has 243 bars. (H. Roberge)

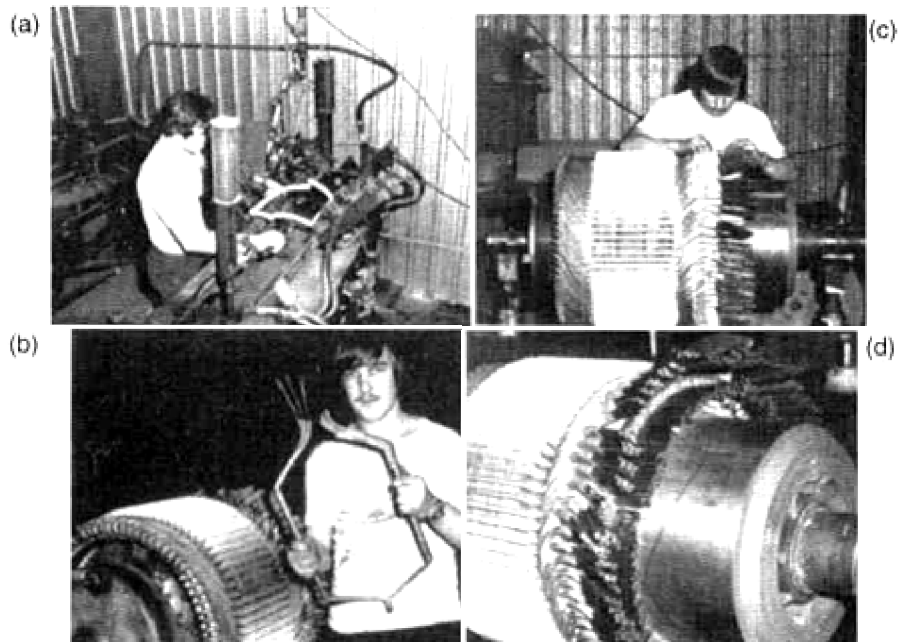

Figure 5.5

- Armature of Fig 5.4 in the process of being wound, coil-forming machine gives the coils the desired shape.
- One of the 81 coils ready to be placed in the slots
- Connecting the coil ends to the commutator bars.
- Commutator connections ready for brazing (H Roberge)

Calculate

- The rated armature current
- The number of conductors per slot
- The flux per pole

Solution

a. We can assume that the induced voltage E_o is nearly equal to the applied voltage (250 V).

The rated armature current is

$$I = P/E_o = 225\,000/250 \\ = 900A$$

b. Each coil is made up of 2 conductors, so altogether there are $243 \times 2 = 486$ conductors on the armature.

Conductors per slot = $486/81 = 6$

Coil sides per slot = 6

c. The motor torque is

$$\begin{aligned} T &= 9.55 P/n \\ &= 9.55 \times 225\,000/1200 \\ &= 1791 \text{ N}\cdot\text{m} \end{aligned}$$

The flux per pole is

$$\begin{aligned} F &= 6.28 T/ZI \\ &= (6.28 \times 1790)/(486 \times 900) \\ &= 25.7 \text{ mWb} \end{aligned}$$

Speed of rotation

When a dc motor drives a load between no-load and full-load, the IR drop due to armature resistance is always small compared to the supply voltage E_s . This means that the counter-emf E_o is very nearly equal to E_s .

On the other hand, we have already seen that E_o may be expressed by the equation

$$E_o = ZnF/60 \quad (4.1)$$

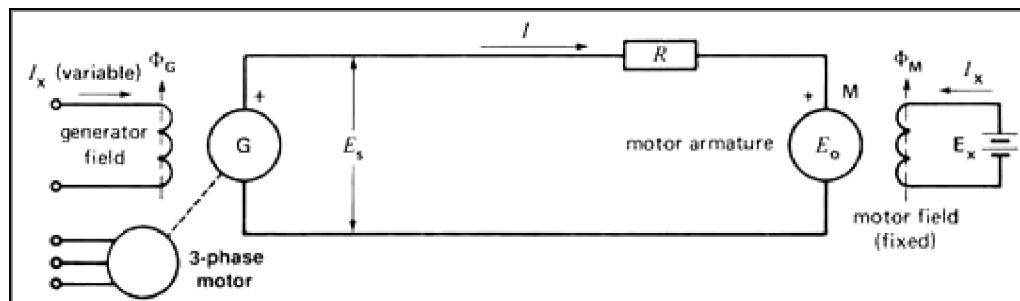

Figure 5.6 Ward-Leonard speed control system.

Replacing E_o by E_s we obtain

$$E_s = ZnF/60$$

That is,

$$n = \frac{60E_s}{Z\Phi} \text{ (approx)}$$

where

n = speed of rotation [r/min]

E_s = armature voltage [V]

Z = total number of armature conductors

This important equation shows that the speed of the motor is directly proportional to the armature supply voltage and inversely proportional to the flux per pole. We will now study how this equation is applied.

Armature speed control

According to Eq. 5.7, if the flux per pole F is kept constant (permanent magnet field or field with fixed excitation), the speed depends only upon the armature voltage E_s . By raising or lowering E_s the motor speed will rise and fall in proportion.

In practice, we can vary E_s by connecting the motor armature M to a separately excited variable-voltage dc generator G (Fig. 5.6). The field excitation of the motor is kept constant, but the generator excitation I_x can be varied from zero to maximum and even reversed. The generator output voltage E_s can therefore be varied from zero to maximum, with either positive or negative polarity. Consequently, the motor speed can be varied from zero to maximum in either direction. Note that the generator is driven by an ac motor connected to a 3-phase line. This method of speed control, known as the Ward-Leonard system, is found in steel mills, high-rise elevators, mines, and paper mills.

In modern installations the generator is often replaced by a high-power electronic converter that changes the ac power of the electrical utility to dc, by electronic means.

The Ward-Leonard system is more than just a simple way of applying a variable dc voltage to the armature of a dc motor. It

can actually force the motor to develop the torque and speed required by the load. For example, suppose E_s is adjusted to be slightly higher than the cemf E_o of the motor. Current will then flow in the direction shown in Fig. 5.6, and the motor develops a positive torque. The armature of the motor absorbs power because I flows into the positive terminal.

Now, suppose we reduce E_s by reducing the generator excitation F_G . As soon as E_s becomes less than E_o , current/reverses. As a result, (1) the motor torque reverses and (2) the armature of the motor *delivers* power to generator G. In effect, the dc motor suddenly becomes a generator and generator G suddenly becomes a motor. The electric power that the dc motor now delivers to G is derived at the expense of the kinetic energy of the rapidly decelerating armature and its connected mechanical load. Thus, by reducing E_s , the motor is suddenly forced to slow down.

What happens to the dc power received by generator G? When G receives electric power, it operates as a motor, driving its own ac motor as an asynchronous generator!* As a result, ac power is fed back into the line that normally feeds the ac motor. The fact that power can be recovered this way makes the Ward-Leonard system very efficient, and constitutes another of its advantages.

* The asynchronous generator is explained in Chapter 14.

Example 5-3

A 2000 kW, 500 V, variable-speed motor is driven by a 2500 kW generator, using a Ward-Leonard control system shown in Fig. 5.6. The total resistance of the motor and generator armature circuit is 10 mΩ. The motor turns at a nominal speed of 300 r/min, when E_o is 500 V.

Calculate

a. The motor torque and speed when

$$E_s = 400 \text{ V and } E_o = 380 \text{ V}$$

b. The motor torque and speed when

$$E_s = 350 \text{ V and } E_o = 380 \text{ V}$$

Solution

a. The armature current is

$$I = (E_s - E_o)/R = (400 - 380)/0.01 \\ = 2000 \text{ A}$$

The power to the motor armature is

$$P = E_o I = 380 \times 2000 = 760 \text{ kW}$$

The motor speed is

$$n = (380 \text{ V}/500 \text{ V}) \times 300 = 228 \text{ r/min}$$

The motor torque is

$$T = 9.55P/n \\ = (9.55 \times 760\,000)/228 \\ = 31.8 \text{ kN}\cdot\text{m}$$

b. Because $E_o = 380 \text{ V}$, the motor speed is still 228 r/min.

The armature current is

$$I = (E_s - E_o)/R = (350 - 380)/0.01 \\ = -3000 \text{ A}$$

The current is negative and so it flows in reverse; consequently, the motor torque also reverses.

Power returned by the motor to the generator and the 10 mΩ resistance:

$$P = E_o I = 380 \times 3000 = 1140 \text{ kW}$$

Braking torque developed by the motor:

$$T = 9.55P/n \\ = (9.55 \times 1\,140\,000)/228 \\ = 47.8 \text{ kN}\cdot\text{m}$$

The speed of the motor and its connected mechanical load will rapidly drop under the influence of this electromechanical braking torque.

Rheostat Speed Control

Another way to control the speed of a dc motor is to place a rheostat in series with the armature (Fig. 5.7). The current in the rheostat produces a voltage drop which subtracts from the fixed source voltage E_s , yielding a smaller supply voltage across the armature. This method enables us to *reduce* the speed below its nominal speed. It is only recommended for small motors because a lot of power and heat is wasted in the rheostat, and the overall efficiency is low. Furthermore, the speed regulation is poor, even for a fixed setting of the rheostat. In effect, the IR drop across the rheostat increases as the armature current increases. This produces a substantial drop in speed with increasing mechanical load.

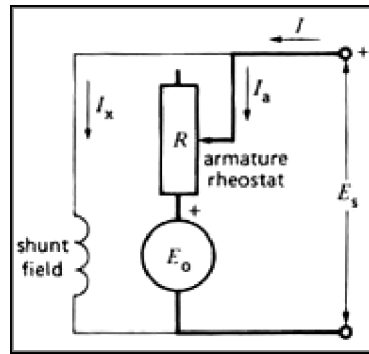

Figure 5.7 Armature speed control using a rheostat.

Related Links:

[DC Motor Calculations, part 2](#)

[DC Motor Calculations, part 3](#)

[DC Motor Calculations, part 4](#)

Excerpt from the book published by Prentice Hall PTR. Copyright 2000. Available for purchase online in association with Amazon.com. (Also available for purchase in association with Amazon.co.uk and Amazon.co.de.)

DC Motor Calculations, part 2

by Theodore Wildi
 Electrical Machines, Drives, and Power Systems, Fourth Edition, Prentice Hall PTR

[Back to Document](#)

Table of Contents:

- [Field speed control](#)
- [Shunt motor under load](#)
- [Series motor](#)
- [Series motor speed control](#)
- [Applications of the series motor](#)

Field speed control

According to Eq. 5.7 we can also vary the speed of a dc motor by varying the field flux F . Let us now keep the armature voltage E_s constant so that the numerator in Eq. 5.7 is constant. Consequently, the motor speed now changes in inverse proportion to the flux F if we increase the flux the speed will drop, and vice versa.

This method of speed control is frequently used when the motor has to run above its rated speed, called *base speed*. To control the flux (and hence, the speed), we connect a rheostat R_f in series with the field (Fig 5 8a).

To understand this method of speed control, suppose that the motor in Fig 5 8a is initially running at constant speed. The counter-emf E_o is slightly less than the armature supply voltage E_s due to the IR drop in the armature. If we suddenly increase the resistance of the rheostat, both the exciting current I_x and the flux F will diminish. This immediately reduces the cemf E_o , causing the armature current I to jump to a much higher value. The current changes dramatically because its value depends upon the very small *difference* between E_s and E_o . Despite the weaker field, the motor develops a greater torque than before. It will accelerate until E_o is again almost equal to E_s .

Clearly, to develop the same E_o with a weaker flux, the motor must turn faster. We can therefore raise the motor speed above its nominal value by introducing a resistance in series with the field. For shunt-wound motors, this method of speed control enables high-speed/base-speed ratios as high as 3 to 1. Broader speed ranges tend to produce instability and poor commutation.

Under certain abnormal conditions, the flux may drop to dangerously low values. For example, if the exciting current of a shunt motor is interrupted accidentally, the only flux remaining is that due to the remanent magnetism in the poles. * This flux is so small that the motor has to rotate at a dangerously high speed to induce the required cemf. Safety devices are introduced to prevent such runaway conditions.

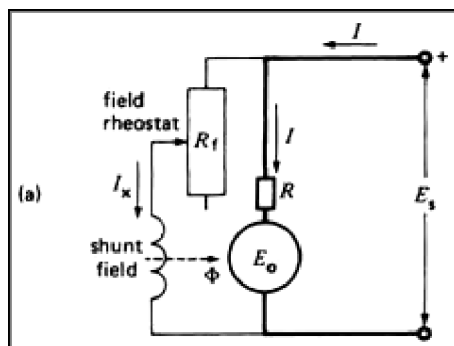

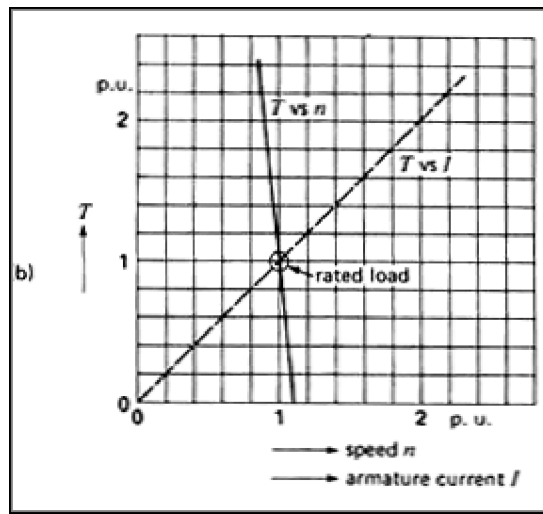

Figure 5.8a. Schematic diagram of a shunt motor including the field rheostat
b. Torque-speed and torque-current characteristic of a shunt motor.

Shunt motor under load

Consider a dc motor running at no-load. If a mechanical load is suddenly applied to the shaft, the small no-load current does not produce enough torque to carry the load and the motor begins to slow down. This causes the cemf to diminish, resulting in a higher current and a corresponding higher torque. When the torque developed by the motor is *exactly* equal to the torque imposed by the mechanical load, then, and only then, will the speed remain constant (see Section 311). To sum up, as the mechanical load increases, the armature current rises and the speed drops.

The speed of a shunt motor stays relatively constant from no-load to full-load. In small motors, it only drops by 10 to 15 percent when full-load is applied. In big machines, the drop is even less, due in part, to the very low armature resistance. By adjusting the field rheostat, the speed can, of course, be kept absolutely constant as the load changes.

* The term *residual* magnetism is also used. However, the *IEEE Standard Dictionary of Electrical and Electronics Terms* states: "If there are no air gaps in the magnetic circuit the remanent induction will equal the residual induction; if there are air gaps the remanent induction will be less than the residual induction."

Typical torque-speed and torque-current characteristics of a shunt motor are shown in Fig. 5.8b. The speed, torque and current are given in per-unit values. The torque is directly proportional to the armature current. Furthermore, the speed changes only from 1.1 pu to 0.9 pu as the torque increases from 0 pu to 2 pu.

Example 5-4

A shunt motor rotating at 1500 r/min is fed by a 120 V source (Fig. 5.9a). The line current is 51 A and the shunt-field resistance is 120 Ω . If the armature resistance is 0.1 Ω , calculate the following;

- The current in the armature
- The counter-emf
- The mechanical power developed by the motor

Solution:

- The field current (Fig. 5.9b) is

$$I_x = 120\text{V}/120\ \Omega = 1\text{A}$$

The armature current is

$$I = 51 - 1 = 50\text{A}$$

- The voltage across the armature is

$$E = 120\text{V}$$

Voltage drop due to armature resistance is

$$IR = 50 \times 0.1 = 5\text{V}$$

The cemf generated by the armature is

$$E_o = 120 - 5 = 115\text{V}$$

- The total power supplied to the motor is

$$P_i = EI = 120 \times 51 = 6120\text{W}$$

Power absorbed by the armature is

$$P_a = EI = 120 \times 50 = 6000 \text{ W}$$

Power dissipated in the armature is

$$P = IR^2 = 50^2 \times 0.1 = 250 \text{ W}$$

Mechanical power developed by the armature is

$$P = 6000 - 250 = 5750 \text{ W}$$

(equivalent to $5750/746 = 7.7 \text{ hp}$)

The actual mechanical output is slightly less than 5750 W because some of the mechanical power is dissipated in bearing friction losses, in windage losses, and in armature iron losses.

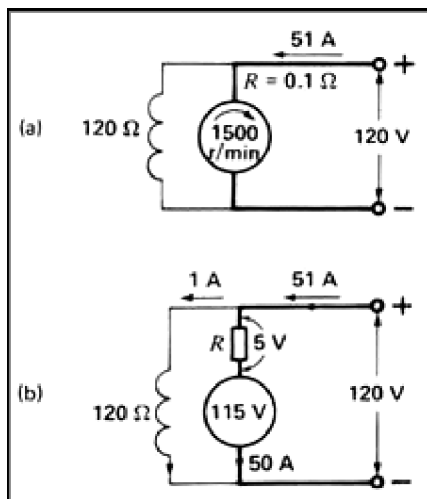

Figure 5.9 See Example 5.4.

Series motor

A series motor is identical in construction to a shunt motor except for the field. The field is connected in series with the armature and must, therefore, carry the full armature current (Fig. 5.10a). This *series field* is composed of a few turns of wire having a cross section sufficiently large to carry the current.

Although the construction is similar, the properties of a series motor are completely different from those of a shunt motor. In a shunt motor, the flux F per pole is constant at all loads because the shunt field is connected to the line. But in a series motor the flux per pole depends upon the armature current and, hence, upon the load. When the current is large, the flux is large and vice versa. Despite these differences, the same basic principles and equations apply to both machines.

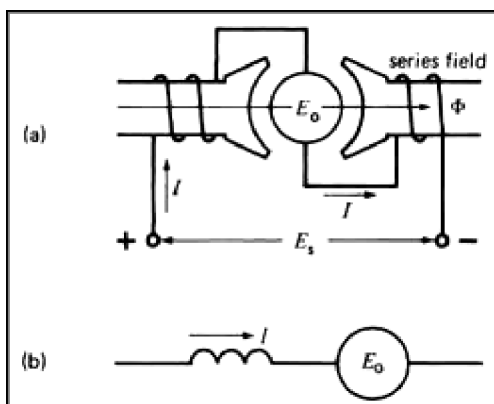

Figure 5.10a. Series motor connection diagram b. Schematic diagram of a series motor

When a series motor operates at full-load, the flux per pole is the same as that of a shunt motor of identical power and speed. However, when the series motor starts up, the armature current is higher than normal, with the result that the flux per pole is also greater than normal. It follows that the starting torque of a series motor is considerably greater than that of a shunt motor. This can be seen by comparing the T versus I curves of Figs 5. 8 and 5.11.

On the other hand, if the motor operates at less than full-load, the armature current and the flux per pole are smaller than normal. The weaker field causes the speed to rise in the same way as it would for a shunt motor with a weak shunt field. For example, if the load current of a series motor drops to half its normal value, the flux diminishes by half and so the speed doubles. Obviously, if the load is small, the speed may rise to dangerously high values. For this reason we never permit a series motor to operate at no-load. It tends to run away, and the resulting centrifugal forces could tear the windings out of

the armature and destroy the machine

Series motor speed control

When a series motor carries a load, its speed may have to be adjusted slightly. Thus, the speed can be increased by placing a low resistance in parallel with the series field. The field current is then smaller than before, which produces a drop in flux and an increase in speed.

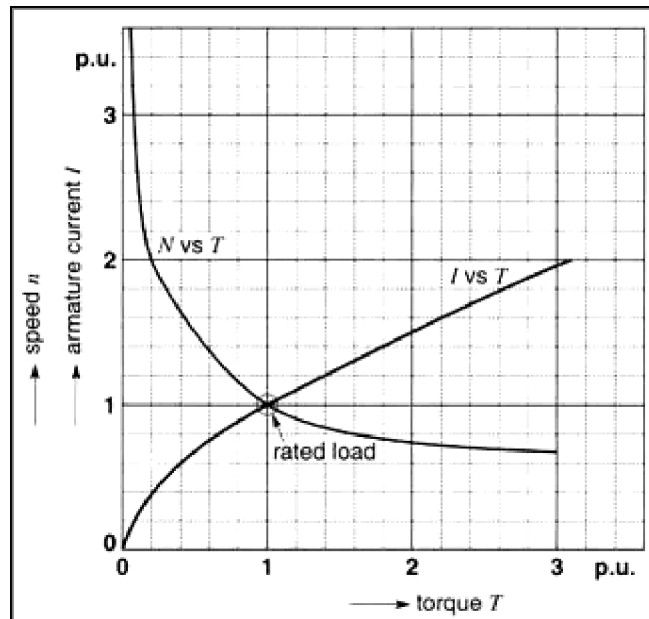

Figure 5.11 Typical speed-torque and current-torque characteristic of a series motor.

Conversely, the speed may be lowered by connecting an external resistor in series with the armature and the field. The total IR drop across the resistor and field reduces the armature supply voltage, and so the speed must fall.

Typical torque-speed and torque-current characteristics are shown in Fig. 5.11. They are quite different from the shunt motor characteristics given in Fig. 5.8b.

Example 5-5

A 15 hp, 240 V, 1780 r/min dc series motor has a full-load rated current of 54 A. Its operating characteristics are given by the per-unit curves of Fig. 5.11.

Calculate

- The current and speed when the load torque is 24 N·m
- The efficiency under these conditions

Solution

a. We first establish the base power, base speed, and base current of the motor. They correspond to the full-load ratings as follows:

$$P_B = 15 \text{ hp} = 15 \times 746 = 11\,190 \text{ W}$$

$$n_B = 1780 \text{ r/min}$$

$$I_B = 54 \text{ A}$$

The base torque is, therefore,

$$\begin{aligned} T_B &= \frac{9.55 P_B}{n_B} = 9.55 \times 11\,190 / 1\,780 \\ &= 60 \text{ N}\cdot\text{m} \end{aligned}$$

A load torque of 24 N·m corresponds to a per-unit torque of

$$T(\text{pu}) = 24/60 = 0.4$$

Referring to Fig. 5.11, a torque of 0.4 pu is attained at a speed of 1.4 pu. Thus, the speed is

$$n = n(\text{pu}) \times n_B = 1.4 \times 1780 \\ = 2492 \text{ r/min}$$

From the T vs I curve, a torque of 0.4 pu requires a current of 0.6 pu. Consequently, the load current is

$$I = I(\text{pu}) \times I_B = 0.6 \times 54 = 32.4 \text{ A}$$

b. To calculate the efficiency, we have to know P_o and P_i .

$$P_i = EI = 240 \times 32.4 = 7776 \text{ W}$$

$$P_o = nT/9.55 = 2492 \times 24/9.55$$

$$= 6263 \text{ W}$$

$$h = P_o/P_i = 6263/7776 = 0.805 \text{ or } 80.5\%$$

Applications of the series motor

Series motors are used on equipment requiring a high starting torque. They are also used to drive devices which must run at high speed at light loads. The series motor is particularly well adapted for traction purposes, such as in electric trains. Acceleration is rapid because the torque is high at low speeds. Furthermore, the series motor automatically slows down as the train goes up a grade yet turns at top speed on flat ground. The power of a series motor tends to be constant, because high torque is accompanied by low speed and vice versa. Series motors are also used in electric cranes and hoists: light loads are lifted quickly and heavy loads more slowly.

Related Links:

[DC Motor Calculations, part 1](#)

[DC Motor Calculations, part 3](#)

[DC Motor Calculations, part 4](#)

Excerpt from the book published by Prentice Hall PTR. Copyright 2000. Available for purchase online in association with Amazon.com. (Also available for purchase in association with Amazon.co.uk and Amazon.co.de.)

DC Motor Calculations, part 3

by Theodore Wildi
 Electrical Machines, Drives, and Power Systems, Fourth Edition, Prentice Hall PTR

[Back to Document](#)

Table of Contents:

- [Compound Motor](#)
- [Reversing the direction of rotation](#)
- [Starting a shunt motor](#)
- [Face-plate starter](#)
- [Stopping a motor](#)
- [Dynamic braking](#)

Compound Motor

A compound dc motor carries both a series field and a shunt field. In a *cumulative compound motor*, the mmf of the two fields add. The shunt field is always stronger than the series field.

Fig. 5.12 shows the connection and schematic diagrams of a compound motor. When the motor runs at no-load, the armature current I in the series winding is low and the mmf of the series field is negligible. However, the shunt field is fully excited by current I_x and so the motor behaves like a shunt machine: it does not tend to run away at no-load.

As the load increases, the mmf of the series field increases but the mmf of the shunt field remains constant. The total mmf (and the resulting flux per pole) is therefore greater under load than at no-load. The motor speed falls with increasing load and the speed drop from no-load to full-load is generally between 10 percent and 30 percent.

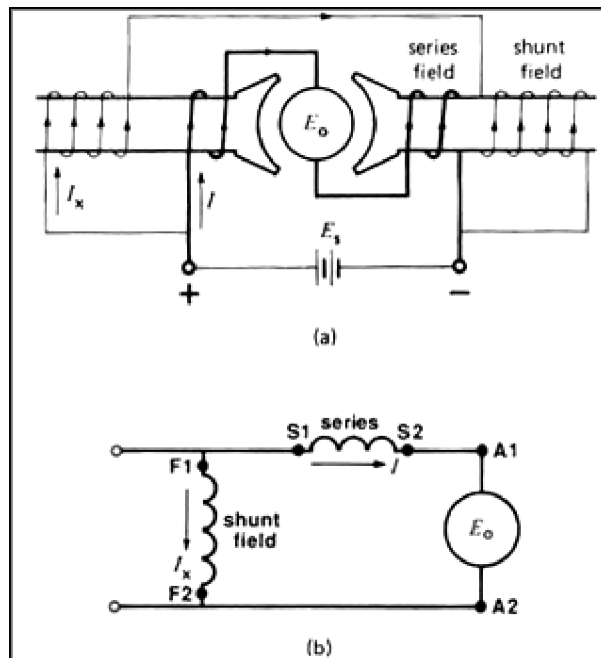

Figure 5.12 a. Connection diagram of a dc compound motor.
 b. Schematic diagram of the motor.

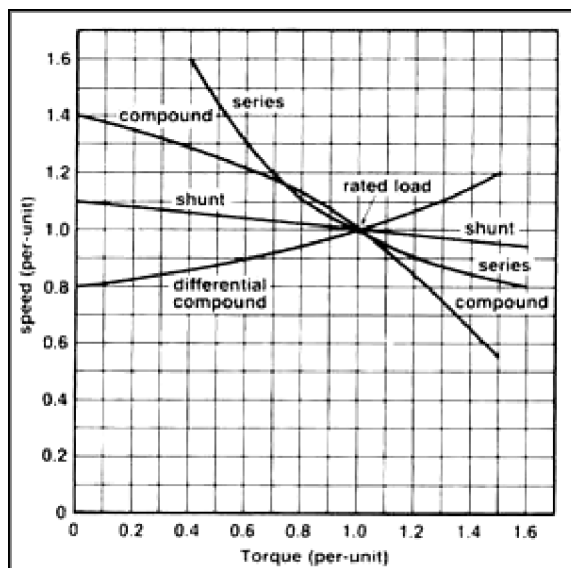

Figure 5.13 Typical speed versus torque characteristics of various dc motors.

If the series field is connected so that it opposes the shunt field, we obtain a *differential compound motor*. In such a motor, the total mmf decreases with increasing load. The speed rises as the load increases, and this may lead to instability. The differential compound motor has very few applications.

Fig. 5.13 shows the typical torque-speed curves of shunt, compound and series motors on a per-unit basis. Fig. 5.14 shows a typical application of dc motors in a steel mill.

Reversing the direction of rotation

To reverse the direction of rotation of a dc motor, we must reverse either (1) the armature connections or (2) both the shunt and series field connections. The interpoles are considered to form part of the armature. The change in connections is shown in Fig. 5.15.



Figure 5.14 Hot strip finishing mill composed of 6 stands, each driven by a 2500 kW dc motor. The wide steel strip is delivered to the runout table (left foreground) driven by 161 dc motors, each rated 3 kW. (Courtesy of General Electric)

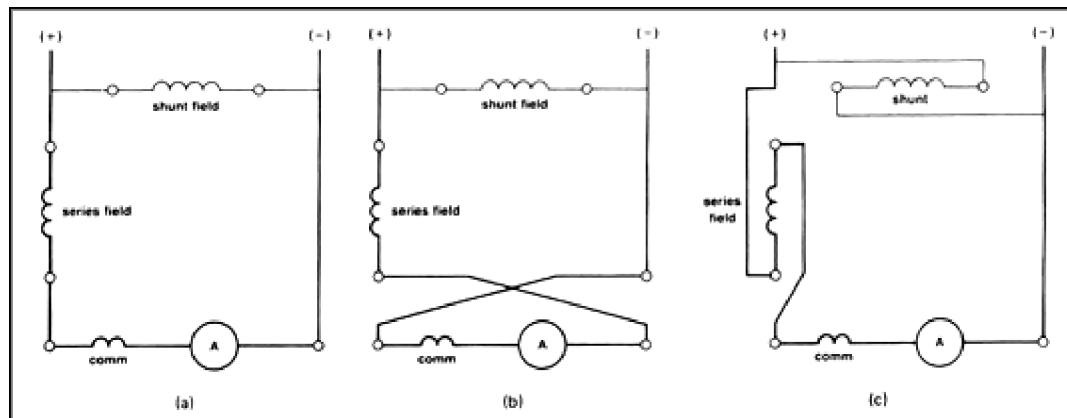

Figure 5.15

- Original connections of a compound motor.
- Reversing the armature connections to reverse the direction of rotation.
- Reversing the field connections to reverse the direction of rotation.

Starting a shunt motor

If we apply full voltage to a stationary shunt motor, the starting current in the armature will be very high and we run the risk of

- Burning out the armature;
- Damaging the commutator and brushes, due to heavy sparking;
- Overloading the feeder;
- Snapping off the shaft due to mechanical shock;
- Damaging the driven equipment because of the sudden mechanical hammerblow.

All dc motors must, therefore, be provided with a means to limit the starting current to reasonable values, usually between 1.5 and twice full-load current. One solution is to connect a rheostat in series with the armature. The resistance is gradually reduced as the motor accelerates and is eventually eliminated entirely, when the machine has attained full speed.

Today, electronic methods are often used to limit the starting current and to provide speed control.

Face-plate starter

Fig. 5.16 shows the schematic diagram of a manual face-plate starter for a shunt motor. Bare copper contacts are connected to current-limiting resistors R_1 , R_2 , R_3 , and R_4 . Conducting arm 1 sweeps across the contacts when it is pulled to the right by means of insulated handle 2. In the position shown, the arm touches dead copper contact M and the motor circuit is open. As we draw the handle to the right, the conducting arm first touches fixed contact N.

The supply voltage E_s immediately causes full field current I_x to flow, but the armature current I is limited by the four resistors in the starter box. The motor begins to turn and, as the cemf E_o builds up, the armature current gradually falls. When the motor speed ceases to rise any more, the arm is pulled to the next contact, thereby removing resistor R_1 from the armature circuit. The current immediately jumps to a higher value and the motor quickly accelerates to the next higher speed. When the speed again levels off, we move to the next contact, and so forth, until the arm finally touches the last contact. The arm is magnetically held in this position by a small electromagnet 4, which is in series with the shunt field.

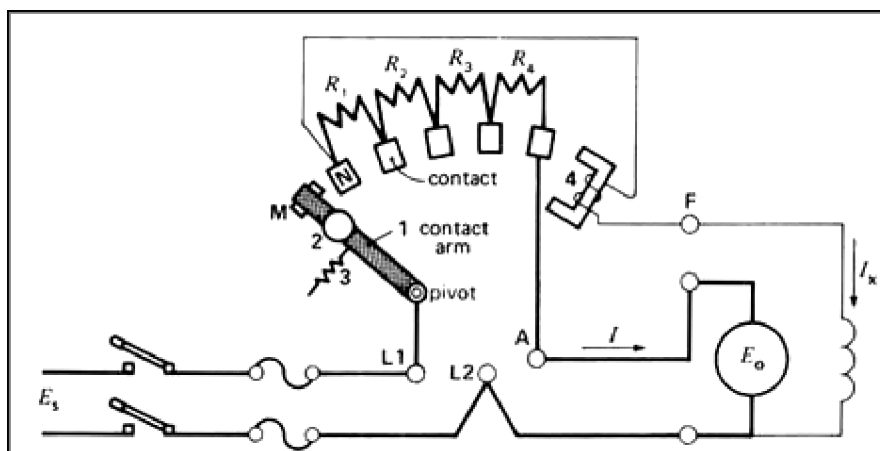

Figure 5.16 Manual face-plate starter for a shunt motor.

If the supply voltage is suddenly interrupted, or if the field excitation should accidentally be cut, the electromagnet releases the arm, allowing it to return to its dead position, under the pull of spring 3. This safety feature prevents the motor from restarting unexpectedly when the supply voltage is reestablished.

Stopping a motor

One is inclined to believe that stopping a dc motor is a simple, almost trivial, operation. Unfortunately, this is not always true. When a large dc motor is coupled to a heavy inertia load, it may take an hour or more for the system to come to a halt. For many reasons such a lengthy deceleration time is often unacceptable and, under these circumstances, we must apply a braking torque to ensure a rapid stop. One way to brake the motor is by simple mechanical friction, in the same way we stop a car. A more elegant method consists of circulating a reverse current in the armature, so as to brake the motor electrically. Two methods are employed to create such an electromechanical brake (1) dynamic braking and (2) plugging.

Dynamic braking

Consider a shunt motor whose field is directly connected to a source E_s , and whose armature is connected to the same source by means of a double-throw switch. The switch connects the armature to either the line or to an external resistor R (Fig. 5.17).

When the motor is running normally, the direction of the armature current I_1 and the polarity of the cemf E_o are as shown in Fig. 5.17a. Neglecting the armature IR drop, E_o is equal to E_s .

If we suddenly open the switch (Fig 5.17b), the motor continues to turn, but its speed will gradually drop due to friction and windage losses. On the other hand, because the shunt field is still excited, induced voltage E_o continues to exist, falling at the same rate as the speed. In essence, the motor is now a generator whose armature is on open-circuit.

Let us close the switch on the second set of contacts so that the armature is suddenly connected to the external resistor (Fig. 5.17c). Voltage E_o will immediately produce an armature current I_2 . However, this current flows in the *opposite* direction to the original current I_1 . It follows that a reverse torque is developed whose magnitude depends upon I_2 . The reverse torque brings the machine to a rapid, but very smooth stop.

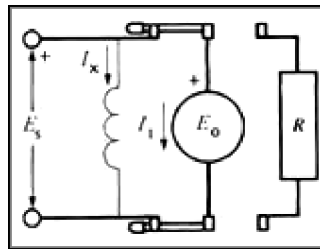

Figure 5.17a Armature connected to a dc source E_s .

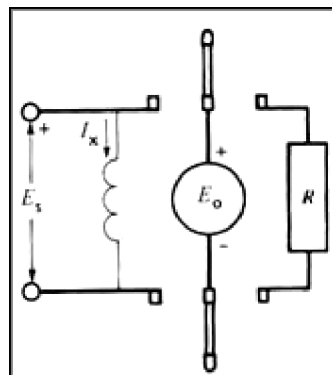

Figure 5.17b Armature on open circuit generating a voltage E_o .

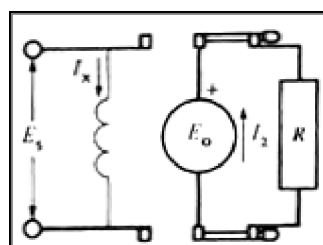

Figure 5.17c Dynamic braking.

In practice, resistor R is chosen so that the initial braking current is about twice the rated motor current. The initial braking torque is then twice the normal torque of the motor.

As the motor slows down, the gradual decrease in E_o produces a corresponding decrease in I_2 . Consequently, the braking torque becomes smaller and smaller, finally becoming zero when the armature ceases to turn. The speed drops quickly at first and then more slowly, as the armature comes to a halt. The speed decreases exponentially, somewhat like the voltage across a discharging capacitor. Consequently, the speed decreases by half in equal intervals of time T_o . To illustrate the usefulness of dynamic braking. Fig. 5.18 compares the speed-time curves for a motor equipped with dynamic braking and one that simply coasts to a stop.

Related Links:

[DC Motor Calculations, part two](#)

[DC Motor Calculations, part 1](#)

[DC Motor Calculations, part 2](#)

[DC Motor Calculations, part 4](#)

Excerpt from the book published by Prentice Hall PTR. Copyright 2000. Available for purchase online in association with Amazon.com. (Also available for purchase in association with Amazon.co.uk and Amazon.co.de.)

DC Motor Calculations, part 4

by Theodore Wildi

Electrical Machines, Drives, and Power Systems, Fourth Edition, Prentice Hall PTR

[Back to Document](#)

Table of Contents:

- [Plugging](#)
- [Dynamic braking and mechanical time constant](#)
- [Armature reaction](#)
- [Flux distortion due to armature reaction](#)
- [Commuting poles](#)
- [Compensating winding](#)
- [Basics of variable speed control](#)
- [Permanent magnet motors](#)

Plugging

We can stop the motor even more rapidly by using a method called *plugging*. It consists of suddenly reversing the armature current by reversing the terminals of the source (Fig. 5.19a).

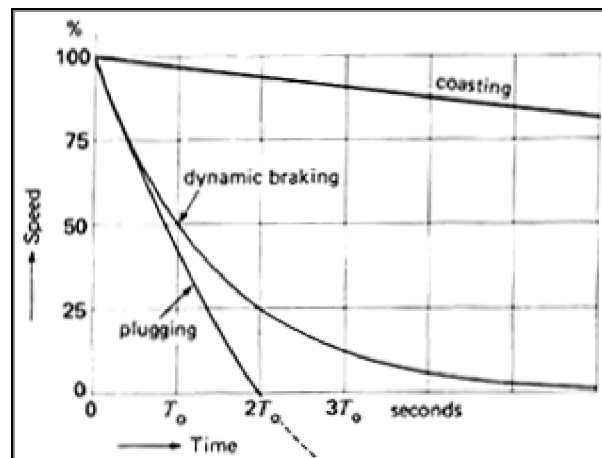

Figure 5.18 Speed versus time curves for various braking methods.

Under normal motor conditions, armature current I_1 is given by

$$I_1 = (E_s - E_o) / R$$

where R_o is the armature resistance. If we suddenly reverse the terminals of the source, the net voltage acting on the armature circuit becomes $(E_o + E_s)$. The so-called counter-emf E_o of the armature is no longer counter to anything but actually *adds* to the supply voltage E_s . This net voltage would produce an enormous reverse current, perhaps 50 times greater than the full-load armature current. This current would initiate an arc around the commutator, destroying segments, brushes, and supports, even before the line circuit breakers could open.

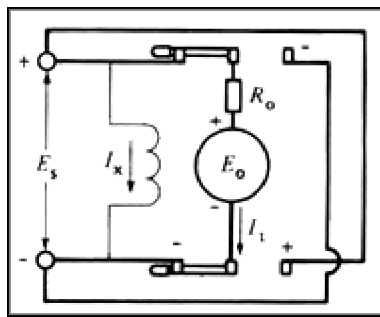

Figure 5.19a Armature connected to dc source E_s .

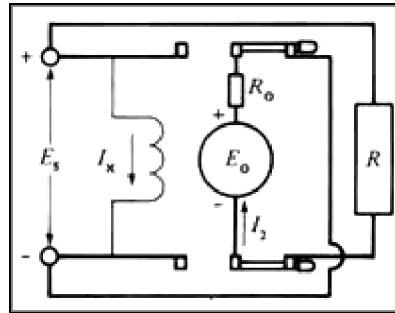

Figure 5.19b Plugging.

To prevent such a catastrophe, we must limit the reverse current by introducing a resistor R in series with the reversing circuit (Fig. 5.19b). As in dynamic braking, the resistor is designed to limit the initial braking current I_2 to about twice full-load current. With this plugging circuit, a reverse torque is developed even when the armature has come to a stop. In effect, at zero speed, $E_o = 0$, but $I_2 = E_s/R$, which is about one-half its initial value. As soon as the motor stops, we must immediately open the armature circuit, otherwise it will begin to run in reverse. Circuit interruption is usually controlled by an automatic null-speed device mounted on the motor shaft.

The curves of Fig. 5.18 enable us to compare plugging and dynamic braking for the same initial braking current. Note that plugging stops the motor completely after an interval $2T_o$. On the other hand, if dynamic braking is used, the speed is still 25 percent of its original value at this time. Nevertheless, the comparative simplicity of dynamic braking renders it more popular in most applications.

Dynamic braking and mechanical time constant

We mentioned that the speed decreases exponentially with time when a dc motor is stopped by dynamic braking. We can therefore speak of a mechanical time constant T in much the same way we speak of the electrical time constant of a capacitor that discharges into a resistor.

In essence, T is the time it takes for the speed of the motor to fall to 36.8 percent of its initial value. However, it is much easier to draw the speed-time curves by defining a new time constant T_o which is the time for the speed to decrease to 50 percent of its original value. There is a direct mathematical relationship between the conventional time constant T and the half-time constant T_o . It is given by

$$T_o = 0.693T \quad (5.8)$$

We can prove that this mechanical time constant is given by

$$T_o = \frac{Jn_1^2}{131.5 P_1} \quad (5.9)$$

where

T_o = time for the motor speed to fall to one-half its previous value [s]

J = moment of inertia of the rotating parts, referred to the motor shaft [kgxm]

n_1 = initial speed of the motor when braking starts [r/min]

P_1 = initial power delivered by the motor to the braking resistor [W]

131.5 = a constant [exact value = $(30/p)^2 \log_e 2$]

0.693 = a constant [exact value = $\log_e 2$]

This equation is based upon the assumption that the braking effect is entirely due to the energy dissipated in the braking resistor. In general, the motor is subjected to an extra braking torque due to windage and friction, and so the braking time will be less than that given by Eq. 5.9.

Example 5-6

A 225 kW (»300 hp), 250 V, 1280 r/min dc motor has windage, friction, and iron losses of 8 kW. It drives a large flywheel and the total moment of inertia of the flywheel and armature is 177 kg·m². The motor is connected to a 210 V dc source, and its speed is 1280 r/min just before the armature is switched across a braking resistor of 0.2 Ω.

Calculate

- The mechanical time constant T_o of the braking system
- The time for the motor speed to drop to 20 r/min
- The time for the speed to drop to 20 r/min if the only braking force is that due to the windage, friction, and iron losses

Solution

a. We note that the armature voltage is 210 V and the speed is 1280 r/min.

When the armature is switched to the braking resistor, the induced voltage is still very close to 210 V. The initial power delivered to the resistor is

$$P_1 = E^2/R = 210^2/0.2 = 220\,500 \text{ W}$$

The time constant T_o is

$$\begin{aligned} T_o &= Jn_1^2/(131.5 P_1) \quad (5.9) \\ &= \frac{177 \times 1280^2}{131.5 \times 220\,500} \\ &= 10 \text{ s} \end{aligned}$$

b. The motor speed drops by 50 percent every 10 s. The speed versus time curve follows the sequence given below:

speed (r/min)	time(s)
1280	0
640	10
320	20
160	30
80	40
40	50
20	60

The speed of the motor drops to 20 r/min after an interval of 60 s.

c. The initial windage, friction, and iron losses are 8 kW. These losses do not vary with speed in exactly the same way as do the losses in a braking resistor. However, the behavior is comparable, which enables us to make a rough estimate of the braking time. We have

$$n_1 = 1280 \quad P_1 = 8000$$

The new time constant is

$$\begin{aligned} T_o &= Jn_1^2/(131.5 P_1) \\ &= (177 \times 1280^2)/(131.5 \times 8000) \\ &= 276 \text{ s} = 4.6 \text{ min} \end{aligned}$$

The stopping time increases in proportion to the time constant. Consequently, the time to reach 20 r/min is approximately

$$\begin{aligned} t &= (276/10) \times 60 = 1656 \text{ s} \\ &= 28 \text{ min} \end{aligned}$$

This braking time is 28 times longer than when dynamic braking is used.

Theoretically, a motor which is dynamically braked never comes to a complete stop. In practice, however, we can assume that the machine stops after an interval equal to 5 T_o seconds.

If the motor is plugged, the stopping time has a definite value given by

$$t_s = 2T_o \quad (5.10)$$

where

t_s = stopping time using plugging [s]

T_o = time constant as given in Eq. 5.9 [s]

Example 5-7

The motor in Example 5-6 is plugged, and the braking resistor is increased to 0.4 Ω , so that the initial braking current is the same as before.

Calculate

- a. The initial braking current and braking power
- b. The stopping time

Solution

The net voltage acting across the resistor is

$$E = E_o + E_s = 210 + 210 = 420 \text{ V}$$

The initial braking current is

$$I_1 = E/R = 420/0.4 = 1050 \text{ A}$$

The initial braking power is

$$P_1 = E_o I_1 = 210 \times 1050 = 220.5 \text{ kW}$$

According to Eq. 5.9, T_o has the same value as before:

$$T_o = 10 \text{ s}$$

The time to come to a complete stop is

$$t_s = 2T_o = 20 \text{ s}$$

Armature reaction

Until now we have assumed that the only mmf acting in a dc motor is that due to the field. However, the current flowing in the armature conductors also creates a magnetomotive force that distorts and weakens the flux coming from the poles. This distortion and field weakening takes place in motors as well as in generators. We recall that the magnetic action of the armature mmf is called *armature reaction*.

Flux distortion due to armature reaction

When a motor runs at no-load, the small current flowing in the armature does not appreciably affect the flux Φ_1 coming from the poles (Fig. 5.20). But when the armature carries its normal current, it produces a strong magnetomotive force which, if it acted alone, would create a flux Φ_2 (Fig. 5.21). By superimposing Φ_1 and Φ_2 , we obtain the resulting flux Φ_3 (Fig. 5.22). In our example the flux density increases under the left half of the pole and it decreases under the right half. This unequal distribution produces two important effects. First the neutral zone shifts toward the left (against the direction of rotation). The result is poor commutation with sparking at the brushes. Second, due to the higher flux density in pole tip A, saturation sets in. Consequently, the increase of flux under the left-hand side of the pole is less than the decrease under the right-hand side. Flux Φ_3 at full-load is therefore slightly less than flux Φ_1 at no-load. For large machines the decrease in flux may be as much as 10 percent and it causes the speed to increase with load. Such a condition tends to be unstable; to eliminate the problem, we sometimes add a series field of one or two turns to increase the flux under load. Such motors are said to have a *stabilized-shunt winding*.

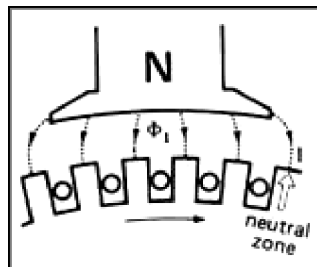

Figure 5.20 Flux distribution in a motor running at no-load.

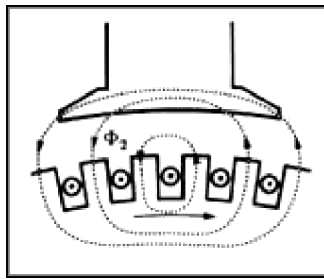

Figure 5.21 Flux created by the full-load armature current.

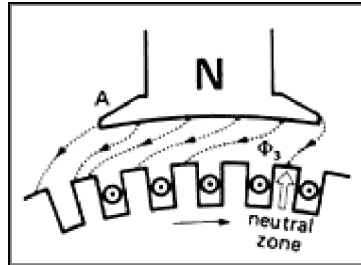

Figure 5.22 Resulting flux distribution in a motor running at full-load.

Commutating poles

To counter the effect of armature reaction and thereby improve commutation, we always place a set of *commutating poles* between the main poles of medium- and large-power dc motors (Fig. 5.23). As in the case of a dc generator, these narrow poles develop a magnetomotive force equal and opposite to the mmf of the armature so that the respective magnetomotive forces rise and fall together as the load current varies. In practice, the mmf of the commutating poles is made slightly greater than that of the armature. Consequently, a small flux subsists in the region of the commutating poles. The flux is designed to induce in the coil undergoing commutation a voltage that is equal and opposite to the self-induction voltage mentioned in Section 4.28. As a result, commutation is greatly improved and takes place roughly as described in Section 4.27.

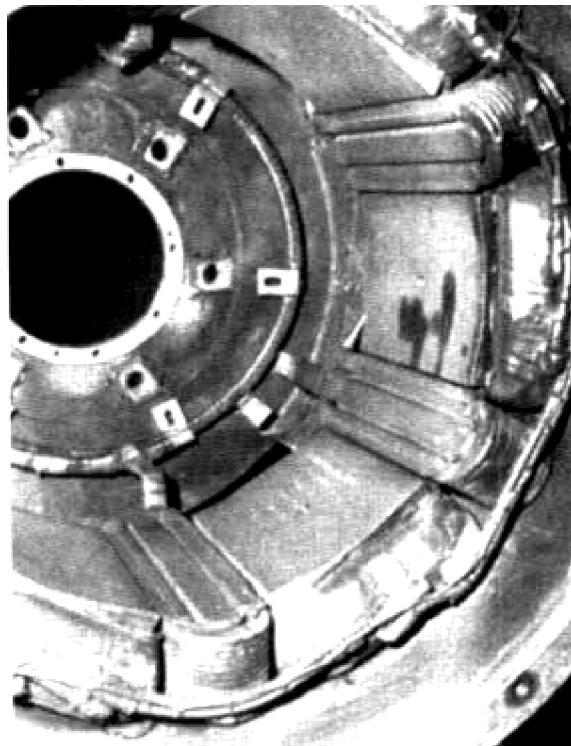

Figure 5.23 The narrow commutating poles are placed between the main poles of this 6-pole motor.

The neutralization of the armature mmf is restricted to the narrow zone covered by the commutating poles, where commutation takes place. The flux distribution under the main poles unfortunately remains distorted. This creates no problem for motors driving ordinary loads. But in special cases it is necessary to add a compensating winding, a feature we will now describe.

Compensating winding

Some dc motors in the 100 kW to 10 MW (»134 hp to 13 400 hp) range employed in steel mills perform a series of rapid,

heavy-duty operations. They accelerate, decelerate, stop, and reverse, all in a matter of seconds. The corresponding armature current increases, decreases, reverses in stepwise fashion, producing very sudden changes in armature reaction.

For such motors the commutating poles and series stabilizing windings do not adequately neutralize the armature mmf. Torque and speed control is difficult under such transient conditions and flash-overs may occur across the commutator. To eliminate this problem, special *compensating windings* are connected in series with the armature. They are distributed in slots, cut into the pole faces of the main field poles (Fig. 5.24). Like commutating poles, these windings produce a mmf equal and opposite to the mmf of the armature. However, because the windings are distributed across the pole faces, the armature mmf is bucked from point to point, which eliminates the field distortion shown in Fig 5.22. With compensating windings, the field distribution remains essentially undisturbed from no-load to full-load, retaining the general shape shown in Fig. 5.20.

The addition of compensating windings has a profound effect on the design and performance of a dc motor:

1. A shorter air gap can be used because we no longer have to worry about the demagnetizing effect of the armature. A shorter gap means that the shunt field strength can be reduced and hence the coils are smaller.
2. The inductance of the armature circuit is reduced by a factor of 4 or 5; consequently, the armature current can change more quickly and the motor gives a much better response. This is particularly true in big machines.
3. A motor equipped with compensating windings can briefly develop 3 to 4 times its rated torque. The peak torque of an uncompensated motor is much lower when the armature current is large. The reason is that the effective flux in the air gap falls off rapidly with increasing current because of armature reaction.

We conclude that compensating windings are essential in large motors subjected to severe duty cycles.

Basics of variable speed control

The most important outputs of a dc motor are its speed and torque. It is useful to determine (the limits of each as the speed is increased from zero to above base speed. In so doing, the rated values of armature current, armature voltage, and field flux must not be exceeded, although lesser values may be used.

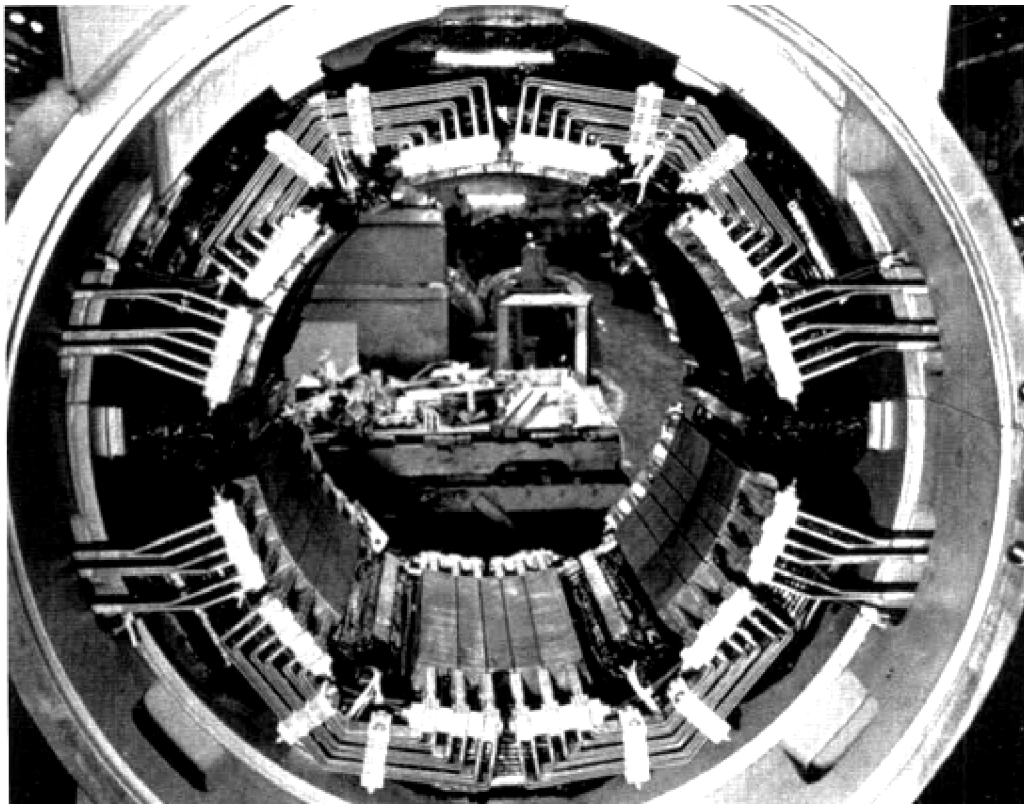

Figure 5.24 Six-pole dc motor having a compensating winding distributed in slots in the main poles. The machine also has 6 commutating poles. (Courtesy of General Electric Company)

In making our analysis, we assume an ideal separately excited shunt motor in which the armature resistance is negligible (Fig. 5.25). The armature voltage E_a , the armature current I_a , the flux Φ_f , the exciting current I_f and the speed n are all expressed in per-unit values. Thus, if the rated armature voltage E_a happens to be 240 V and the rated armature current I_a is 600 A, they are both given a per-unit value of 1. Similarly, the rated shunt field flux Φ_f has a per-unit value of 1. The advantage of the per-unit approach is that it renders the torque-speed curve universal.

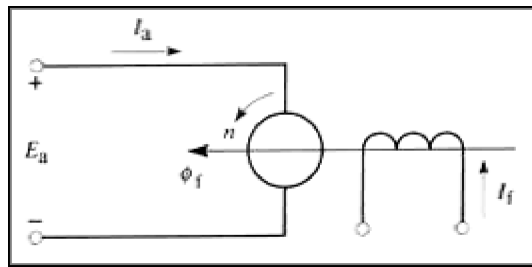

Figure 5.25 Per-unit circuit diagram

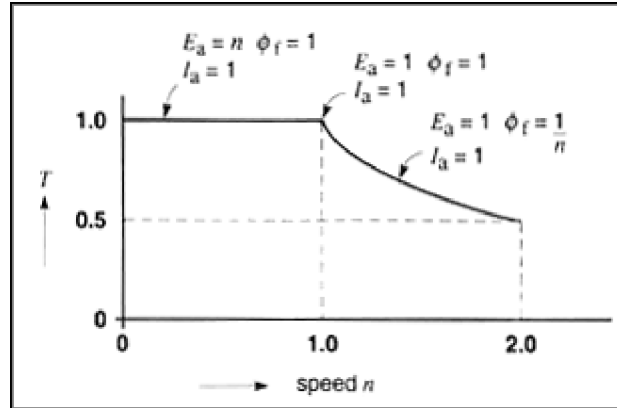

Figure 5.26

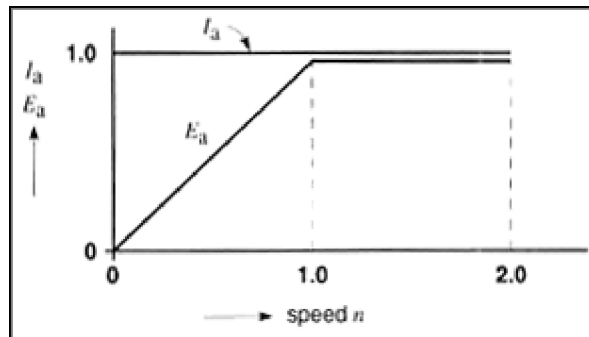

Figure 5.27

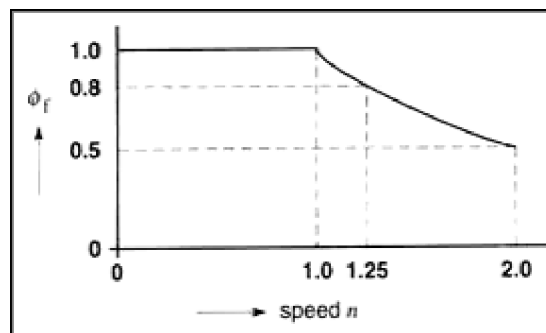

Figure 5.28

Thus, the per-unit torque T is given by the per-unit flux Φ_f times the per-unit armature current I_a

$$T = \Phi_f I_a \quad (5.11)$$

By the same reasoning, the per-unit armature voltage E_a is equal to the per-unit speed n times the per-unit flux Φ_f

$$E_a = n \Phi_f \quad (5.12)$$

The logical starting point of the torque-speed curve (Fig. 5.26), is the condition where the motor develops rated torque ($T = 1$) at rated speed ($n = 1$). The rated speed is often called *base speed*.

In order to reduce the speed below base speed, we gradually reduce the armature voltage to zero, while keeping the rated values of I_a and Φ_f constant at their per-unit value of 1. Applying Eq. (5.11), the corresponding per-unit torque $T = 1 \times 1 = 1$. Furthermore, according to Eq. (5.12), the per-unit voltage $E_a = n \times 1 = n$. Figures 5.27 and 5.28 show the state of E_a , I_a and Φ_f during this phase of motor operation, known as the *constant torque mode*.

Next, to raise the speed above base speed, we realize that the armature voltage cannot be increased anymore because it is already at its rated level of 1. The only solution is to keep E_a at its rated level of 1 and reduce the flux. Referring to Eq. (5.12), this means that $n\Phi_f = 1$, and so $\Phi_f = 1/n$. Thus, above base speed, the per-unit flux is equal to the reciprocal of the per-unit speed. During this operating mode, the armature current can be kept at its rated level of 1. Recalling Eq. (5.11), it follows that $T = \Phi_f I_a = (1/n) \times 1 = 1/n$. Consequently, above base speed, the per-unit torque decreases as the reciprocal of the per-unit speed. It is clear that since the per-unit armature current and armature voltage are both equal to 1 during this phase, the power input to the motor is equal to 1. Having assumed an ideal machine, the per-unit mechanical power output is also equal to 1, which corresponds to rated power. That is why the region above base speed is named the *constant horsepower mode*.

We conclude that the ideal dc shunt motor can operate anywhere within the limits of the torque-speed curve depicted in Fig. 5.26.

In practice, the actual torque-speed curve may differ considerably from that shown in Fig. 5.26. The curve indicates an upper speed limit of 2 but some machines can be pushed to limits of 3 and even 4, by reducing the flux accordingly. However, when the speed is raised above base speed, commutation problems develop and centrifugal forces may become dangerous. When the motor runs below base speed, the ventilation becomes poorer and the temperature tends to rise above its rated value. Consequently, the armature current must be reduced, which reduces the torque. Eventually, when the speed is zero, all forced ventilation ceases and even the field current must be reduced to prevent overheating of the shunt field coils. As a result, the permissible stalled torque may only have a per-unit value of 0.25. The resulting practical torque-speed curve is shown in Fig. 5.29.

The drastic fall-off in torque as the speed diminishes can be largely overcome by using an external blower to cool the motor. It delivers a constant stream of air, no matter what the speed of the motor happens to be. Under these conditions, the torque-speed curve approaches that shown in Fig. 5.26.

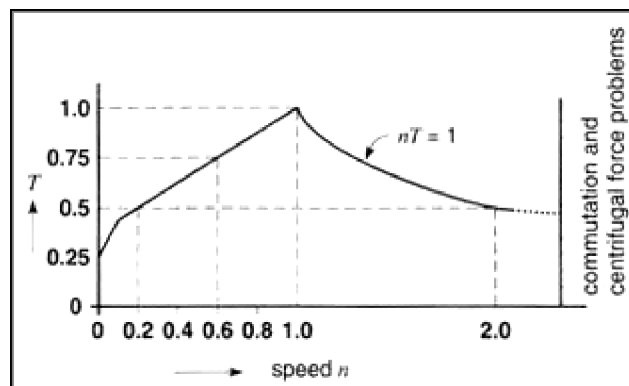

Figure 5.29 Torque-speed curve of a typical dc motor.

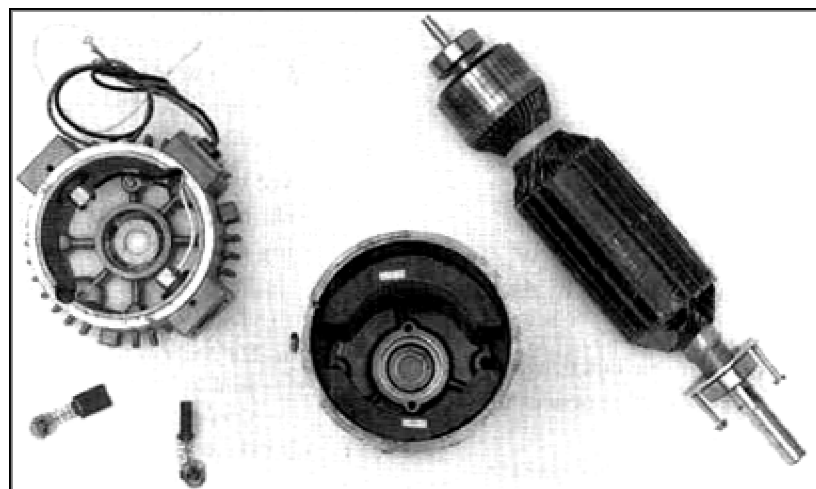

Figure 5.30 Permanent magnet motor rated 1.5 hp, 90 V, 2900 r/min, 14.5 A. Armature diameter: 73 mm; armature length: 115 mm; slots 20; commutator bars: 40; turns per coil; 5; conductor size: No. 17 AWG, lap winding. Armature resistance at 20°C: 0.34 W. (Courtesy of Baldor Electric Company)

Permanent magnet motors

We have seen that shunt-field motors require coils and a field current to produce the flux. The energy consumed, the heat produced, and the relatively large space taken up by the field poles are disadvantages of a dc motor. By using permanent magnets instead of field coils, these disadvantages are overcome. The result is a smaller motor having a higher efficiency

with the added benefit of never risking run-away due to field failure.

A further advantage of using permanent magnets is that the effective air gap is increased many times. The reason is that the magnets have a permeability that is nearly equal to that of air. As a result, the armature mmf cannot create the intense field that is possible when soft-iron pole pieces are employed. Consequently, the field created by the magnets does not become distorted, as shown in Fig. 5.22. Thus, the armature reaction is reduced and commutation is improved, as well as the overload capacity of the motor. A further advantage is that the long air gap reduces the inductance of the armature and hence it responds much more quickly to changes in armature current.

Permanent magnet motors are particularly advantageous in capacities below about 5 hp. The magnets are ceramic or rare-earth/cobalt alloys. Fig. 5.30 shows the construction of a 1.5 hp, 90 V, 2900 r/min PM motor. Its elongated armature ensures low inertia and fast response when used in servo applications.

The only drawback of PM motors is the relatively high cost of the magnets and the inability to obtain higher speeds by field weakening.

Related Links:

[DC Motor Calculations, part 2](#)

[DC Motor Calculations, part 3](#)

[DC Motor Calculations, part 1](#)

Excerpt from the book published by Prentice Hall PTR. Copyright 2000. Available for purchase online in association with Amazon.com. (Also available for purchase in association with Amazon.co.uk and Amazon.co.de.)