

I have a little shadow that
goes in and out with me,
And what can be the use of
him is more than I can
see....
- [My Shadow](#), Robert Louis
Stevenson

Sandburg Center for Sky Awareness
A Fairfax County Public Schools Planetarium

Me and My Shadow

Making the Sun-Earth Connection

 *Me and My Shadow*
- Mills Brothers



Use a [sundial](#) to measure [Solar Time](#). Get the current [Standard Time](#) from [The Official U.S. Time](#) Web page.

Most days, [Solar Time](#) is slightly different from [Standard Time](#) (up to [16 min. fast](#) or [14 min. slow](#)). This time difference is known as the [Equation of Time](#).

Are You Clock-wise?

Ever wonder [why is Clockwise clockwise](#)? As it turns out, for objects in the Northern Hemisphere, shadows cast by the Sun [move in a clockwise direction](#). In fact, the word *hour* means "the day" or "Sun's path." For details, see the [How Sundials Work](#) Web page.

Every day, shadows...

...are shortest at noon, and longest at sunrise & sunset. On June 21, noon shadows

On a sunny day, drive a stake into the ground and observe how its shadow changes throughout the day or year--a simple yet profound way to demonstrate the interconnection between the Sun and Earth! The following Web resources may help you to more fully comprehend the deeper meaning of these simple observations.

The Analemma

Ever notice the odd-looking [figure eight](#) that appears on many [globes](#)? It's called an [analemma](#). Visit the [Analemma](#) Web site to learn more about, well, analemmas, including an explanation of how the analemma is derived from the stake you drove into the ground.

See Dennis di Cicco's award-winning [time lapse photograph](#) of the Sun (showing the analemma). See also [Building an Analemma Curve](#), courtesy the [Analemma Society](#). Construct an [indoor analemma](#); construct an [outdoor analemma](#). [Calculate & chart](#) an analemma for any location at any time of day.

A graph of the analemma for [Washington, D.C.](#) shows the [Equation of Time](#) (Offset of the Sun) corrected for the [eight-minute solar time difference](#) between Washington, D.C. (77°W) and 75°W--the [Standard Time Meridian](#) for the Eastern [Time Zone](#). Can you tell when the maximum & minimum [altitude](#) of the midday Sun occurs during the year?

Close examination of an almanac reveals that the latest sunrise and earliest sunset *do not* occur--as one would expect--on the [December Solstice](#) (on average, 21 DEC), the day with the fewest hours of daylight in the Northern Hemisphere. As it turns out, the earliest sunsets occur in early December and the latest sunrises occur in early January. [A similar situation occurs before/after the [June Solstice](#) (on average, 21 JUN).] A puzzling mystery easily solved by the analemma! For details, see [Why the earliest sunset, latest sunrise, and shortest day of the year occur on different dates](#).

Sun Calculators

Explore the daily and annual cycles of change in the apparent path of the Sun across the sky. Great Circle Studio's [Solar Calculator](#) will calculate the Sun's [altitude](#) and [azimuth](#) for a user-specified location, date & time, and data interval. A variety of output modes are available. Use this

are the shortest of any day during the year (for northern mid-latitude locations), and vice-versa on December 21 (see [solstice/equinox diagram](#)).

Due to the [geometry of equatorial sundials](#), the [gnomon](#) shadow is the same length for the entire day (although its length varies from day-to-day according to the annual cycle of change in the [declination of the Sun](#)).

Longitude is...

...equivalent to time, and vice versa. If you know the time difference between two locations, then you can use the rate of the Earth's rotation (15°/hr or 1°/4 min) to calculate the difference in longitude between the two places.

For example, [Solar Noon](#) occurs eight minutes *later* in Washington, D.C. than it does on the [Standard Time Meridian](#) for the Eastern Time Zone (75°W); how many degrees of longitude separate the two locations?

$$8 \text{ min} \times 1^\circ/4 \text{ min} = 2^\circ$$

Therefore, the longitude of Washington, D.C. is 77°W. Simple, huh? Well, it wasn't always so easy! Read [The Illustrated Longitude](#), the story of clockmaker [John Harrison](#), who solved the problem that Newton and Galileo failed to conquer--how to determine longitude at sea. See also, [Lost at Sea--the Search for Longitude](#) from PBS/NOVA Online.

Long story short, sundials must be [corrected for longitude](#) (as well as the [Equation of Time](#)) so that

information to predict how the length of your shadow would change daily and annually (at the same time each day). Verify your predictions using the [SCSA Shadow Length Calculator](#).

How can you determine the height of objects too tall to measure directly? Using shadows, of course! Use the [SCSA Object Height Calculator](#) to calculate the height of tall shadow-casters, e.g., buildings, flagpoles, utility poles, trees, etc.

Using user-specified times of sunrise and sunset, the [SCSA Daylight Calculator](#) calculates the number of hours of daylight, also known as the Duration of Insolation ([Incoming Solar Radiation](#)).

The [Solar Noon Calendar](#) calculates tables showing either the exact time of **Solar Noon** for your location for each day of the year, or the **Standard Time Correction** (the amount you have to add to, or to subtract from, solar time on your sundial to get the time shown on your wristwatch).

The NASA [J-Track](#) Web page shows where on Earth the Sun is currently directly overhead (see small Sun icon, correctly oriented with respect to latitude and longitude).

You Can Make a Sundial!

Tell time using shadows! As its name suggests, the [You Can Make a Sundial!](#) Web site generates sundials for a user-specified location.

Several types of sundials are available in a variety of output formats (GIF, PDF, and EPS). Start by making a customized [horizontal sundial](#) similar to the "**Sandburg Sundial**," a ready-to-use horizontal sundial available for downloading in two file formats (some assembly required):

- **Lower Resolution** - [dial.gif](#) (16k) plus [gnomon.gif](#) (7k)
- **Higher Resolution** - [sandburg_sundial.pdf](#) (54k)
[Download free [Adobe Acrobat Reader](#).]
- [Enhanced Sandburg Sundial](#) (29k) - featuring arcs showing apparent solar [altitude](#) from 10-70 degrees above the horizon, courtesy sundialist Robert "[Shadow Master](#)" Hough [Note: The "dot" that appears along the upper edge of the [gnomon](#) (technically known as the [style](#)) is called the [nodus](#). Determine the solar altitude by observing where the nodus shadow falls among the arcs on the dial face (mnemonic: notice the nodus).]

Print sundial templates using [cover stock](#). For directions regarding set-up and use, visit the [How to Set Up & Use a Horizontal Sundial](#) Web page. For reference, visit the [North American Sundial Society Horizontal Sundial Glossary](#).

Experiment with several other interesting types of sundials (designed for 39°N latitude):

- [Combination Analemmatic-Horizontal Sundial](#) - Unlike other types

Solar Time reads the same as **Standard Time**.

Did You Know...

...that Earth is eight light-minutes from the Sun? Huh? That's right. At the speed of light (186,000 miles per second, or 300,000 km/sec), it takes nearly eight minutes for sunlight to reach the Earth. The Earth is connected to the Sun, but it is a long-distance connection!

30 JUL 2002

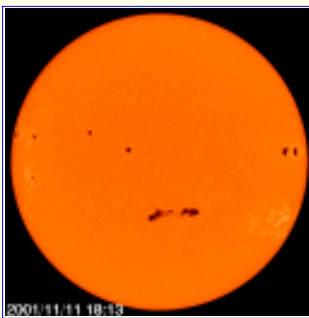

Today's sunspot number is
304 /

Sunspot No. Trend (past 24 hours)	
/	Increasing
--	Steady
\	Decreasing

Credits: Real-time image courtesy [SOHO](#); sunspot number courtesy [NOAA](#).

Updated: 29 JUL 2002
[ARCHIVES](#)

Today's Predicted UV Index is

8

Valid for Wash., DC during the Solar Noon hour on

30 JUL 2002

[UV Index](#) courtesy [NOAA](#).

of sundials that must be carefully oriented before they will work properly, the combination analemmatic-horizontal sundial is self-orienting. **How it works:** Assemble the horizontal sundial (lower dial). Place the combination sundial on a horizontal surface. Using the analemmatic sundial (upper dial), stick a vertical pin in today's date along the date scale (vertical line, center of dial). [Note that pin placement is more precise on the first day of each month (and the [equinoxes](#)).] Keep the paper horizontal and turn it until the two sundials display the same time--both sundials are now properly oriented and the compass rose indicates true direction. That's cool--a combination sundial-Sun compass! **Why it works:** The analemmatic sundial measures time with respect to the [azimuth](#) of the Sun; the horizontal sundial measures time with respect to the distance of the Sun from the [meridian](#).

- [Analemmatic Sundial](#) - A relatively uncommon type of sundial (derived from the [equatorial sundial](#)), the [analemmatic sundial](#) features a [gnomon](#) that moves throughout the year. See the [Analemmatic Sundials](#) Web page for numerous examples of analemmatic sundials located around the world.
- [Equatorial Sundial](#) (assembly [instructions](#)) - The foundation of all gnomonics, the art and science of sundials. From an educator's point of view, the [equatorial sundial](#) is by far the best type of sundial for teaching a wide range of fundamental concepts in astronomy, geography, and mathematics. See the [SCSA Educator's Guide to Equatorial Sundials](#) for background information and suggested teaching strategies.

You Can Construct a Sundial!

The [preceding section](#) features a variety of ready-made, ready-to-assemble sundials--little if any prerequisite knowledge is necessary to begin sundialing. Sooner or later, you'll want to know what makes a sundial tick (pun intended)--at that point in time, you are ready to construct a sundial from scratch. The following information resources should help to get you started.



Two highly recommended books from Dover Publications, Inc.: [Sundials: Their Construction and Use](#), by R. Newton Mayall, Margaret W. Mayall, ©2000; and [Sundials: Their Theory and Construction](#),



by Albert Edmund Waugh, ©1973. Similar content; complementary coverage. Both books use the graphic (or geometric) method of sundial construction--a simple, non-mathematical approach to constructing sundials. In a word, these two books are a "must-have" for the novice sundialist.

The first step in designing a sundial is to determine your exact location (latitude and longitude):

- Use a relatively inexpensive Global Positioning System (GPS)

Today's Observed
UV Index is

7.3

Sandburg Planetarium
19 MAY 2002, 01:05 p.m.
Partly Cloudy
(Sun [Transit](#): 01:05 p.m.)

[UV Index Solarmeter](#)
courtesy [EPA](#)
[SunWise School Program](#)

I'm Being Followed...

...by a moonshadow.
- [Moonshadow](#), [Cat Stevens](#)

The Moon, especially the Full Moon, is bright enough to cast shadows at night. So, how bright does an astronomical object have to be to cast shadows? Good question! In fact, the question may be impossible to answer, since there are so many factors involved. However it is possible to quantify the brightness or [magnitude](#) of a light source. Oddly, negative magnitudes are brighter than positive ones. The [Sky & Telescope magnitude](#) Web page lists the following magnitudes for the Sun, Moon, brightest planet, and brightest star (in the night sky):

- Sun = -26.7m
- Full Moon = -12.5m
- Venus = -4.4m
- Sirius = -1.5m

"Night is a shadow world. The only shadows we see at night are cast by the moonlight, or by artificial light, but night itself is a shadow."
- [Soul of the Sky](#), an essay by Diane Ackerman

The "Morning Chorus"

receiver, such as the [Garmin 12](#), [eMap](#), or [eTrex Vista](#).

- U.S. Naval Observatory [Complete Sun and Moon Data for One Day](#) Web page: Use Form A - U.S. Cities or Towns; select State or Territory; enter City or Town Name; click "Get data"; among other useful information (especially the time of "Sun [transit](#)"), the database returns the location name and its longitude & latitude.

Start simple. Your first homemade sundial should be either a horizontal sundial or an equatorial sundial. [Before you start](#) [tips from the North American Sundial Society (NASS)]....

- I. [Horizontal Sundial](#) - Four methods for determining the hour lines on the dial face, including the graphic method of horizontal sundial construction, as well as three methods for calculating the hour lines (in order of difficulty):
 - . Graphic (or Geometric) Method of Construction: [Make Your Own Horizontal Sundial](#), courtesy Paul R. Field, member, NASS.
[Note: The horizontal sundial is derived from the equatorial sundial. See Figures 4-6.]
 - B. [Horizontal Sundial Hour Line Calculator](#): Calculates hour, half-hour, and quarter-hour lines for a user-specified latitude. Special thanks to Peter Daykin, *Derbyshire Sundials*, for this time-saving calculator! Use a NASS utility to [convert from deg/min/sec to decimal degrees or vice-versa](#).
 - C. Microsoft® Excel Spreadsheet: [Horizontal Dial.xls](#), courtesy Dr. Robert L. Kellogg, Treasurer, NASS. Enter your latitude & longitude. In order to calculate the longitudinal offset of your location from the [Standard Time Meridian](#) (STM) in your [time zone](#), enter the longitude of the STM and your longitude (again). Enter "yes/no" in response to query, "Correct for longitude?" Enter size of dial (radius, in centimeters). Note results in columns labeled "Time (hh.mm)" and "Dial Angle (degrees)."
 - D. Mathematical Calculation (of Hour Lines): [Five simple sundial projects for you to make](#), courtesy *Sundials on the Internet*. See [Project 2 - A horizontal sundial](#). Check your answers using either the [hour line calculator](#) or [horizontal dial spreadsheet](#). See also [Basic Trigonometry](#), courtesy NASS.
[Note: [Project 3](#) provides further proof that the horizontal sundial is derived from the equatorial sundial. See Steps 3 & 6.]
- II. [Equatorial Sundial](#) - The thickness of the gnomon determines the way in which the hour lines are drawn on the two dial faces: hour lines are spaced exactly 15 degrees apart and radiate from either the exact center of the dial face or tangentially from a small inner

During the pre-dawn twilight, have you ever noticed that birds wake up and sing all at once? Ornithologists call this phenomenon the "Morning Chorus." Plan to wake up early tomorrow to see the [sunrise](#) and listen to the symphony of nature--a delightful way to feel more connected to the natural world!



circle representing the diameter of the gnomon (for details, see [Telling Time Using Shadows](#), *Educator's Guide to Equatorial Sundials*). Use the [SCSA Equatorial Sundial Gnomon Length Calculator](#) to calculate the length of the upper & lower segment of the gnomon.

Horizontal Sundials and the Earth's Rotation

The [rotation](#) of the Earth around its [axis](#) causes a daily cycle in the Sun's apparent path across the sky that can be observed indirectly using a horizontal sundial.



In the northern mid-latitudes, the Sun rises in an easterly direction, arches across the southern sky, and sets in a westerly direction. Facing south, the Sun rises on your left and sets on your right. Sun shadows fall in the opposite direction as the Sun. Therefore, morning times are located

on the right (or western) side of the dial plate of a horizontal sundial (shown upper left); afternoon times are located on the left (or eastern) side. Because the Earth rotates counterclockwise (as viewed from above the Northern Hemisphere), shadows cast by the Sun [move in a clockwise direction](#). See a six-hour time lapse movie that shows the clockwise motion of the gnomon shadow around the dial face of a horizontal sundial from roughly 6 a.m. to 12 noon: [sundial.avi](#) (1.02 MB); [sundial.mov](#) (1.01 MB). [Time-lapse movie courtesy [Film & Video Stock Shots](#).]

Equatorial Sundials and the Earth's Revolution

Although horizontal sundials are more familiar to most people (due to the fact that horizontal sundials are by far the [most common type of sundial](#)), experience has shown that an [equatorial sundial](#) is better suited for making the connection between the Earth's [rotation](#) and solar time-keeping (see [Are You Clock-wise?](#) sidebar, left), as well as the connection between the Earth's [revolution](#) around the Sun and the [annual cycle of change](#) in the [Sun's apparent path across the sky](#).

The **subsolar point** is the point on the Earth's surface at which the Sun is at the [zenith](#) at local solar noon. On any given day, the subsolar point moves east-west along a single line of latitude as the Earth rotates counterclockwise. The latitude of the subsolar point varies between zero degrees (0°) at the [equinoxes](#) and $\pm 23.5^\circ$ at the [solstices](#). The latitude of the subsolar point varies directly with the [declination of the Sun](#). The [analemma](#)--the odd-looking [figure eight](#) that appears on many [globes](#)--neatly traces the annual north-south migration of the subsolar point (caused by the tilt of the Earth's [axis](#) of [rotation](#) and the [revolution](#) of the [Earth around the Sun](#)).

Theoretically, the [gnomon](#) (or [style](#)) of a [properly oriented equatorial](#)

[sundial](#) will not cast a shadow on the [dial plate](#) during the [equinoxes](#). Because the dial plate of an equatorial sundial is [parallel to the Earth's Equator](#), the Sun is directly over the edge of the dial plate on the equinoxes, when the subsolar point moves east-west along the Equator. From the March Equinox to the September Equinox, when the subsolar point is located in the Northern Hemisphere (between 0° and 23.5°N latitude), the gnomon shadow falls on the [upper dial face](#); from the September Equinox to the March Equinox, when the subsolar point is located in the Southern Hemisphere (between 0° and 23.5°S latitude), the gnomon shadow falls on the [lower dial face](#) (see [example](#)).

Put a little theory into practice--assemble a simple [equatorial sundial](#) [courtesy [StarDate Online](#) and the University of Texas McDonald Observatory/[SCOPE](#) (Southwestern Consortium of Observatories for Public Education)] and empirically observe where the gnomon shadow falls as the seasons change. Gain valuable insight by checking the NASA [J-Track](#) Web page to see where on Earth the Sun is currently directly overhead (see small Sun icon, which is correctly oriented with respect to latitude and longitude). Related activity: [calculate & chart](#) a projection of the analemma.

Light & Shadow - Suggested Activities for Grade K-12

- [Just Me and My Shadow](#) - Kids create crazy creatures with shadows and a little sunshine. From *Sesame Street Parents*.
- Smithsonian Astrophysical Observatory *Everyday Classroom Tools*, featuring K-2, 2-4, and 4-6 threads for each activity:
 - . [Hello, Sun!](#)
 - B. [You Light Up My Life](#)
 - C. [Me and My Shadow](#)
 - D. [This is a Stickup!](#) (sundials)
- From the [National Science Teachers Association](#), [Astronomy with a Stick](#) - Daytime Astronomy for Elementary and Middle School Students
- [SCSA Educator's Guide to Equatorial Sundials](#) - Background information and suggested teaching strategies, including the [SCSA Equatorial Sundial Activity](#):
 1. The [Sandburg Planetarium Equatorial Sundial template](#) (print using [cover stock](#)) - Designed for use with a pencil-sized gnomon, approximately 1/4" (7 mm) in diameter.
 2. [Assembly instructions](#) (courtesy John Hoy)
 3. [Equatorial Sundial Activity Questions](#) - Provide differentiated instruction by assigning multiple choice questions only, as appropriate. [Teacher's Answer Key available upon [request](#).]
- From NASA *Liftoff to Space Exploration*, a set of sundial Web pages

(upper elementary, middle school):

- . [Sundials](#)
- B. [How Sundials Work](#)
- C. [Building a Simple \[Equatorial\] Sundial](#)
- D. [Pondering Sundials](#)
- From [StarDate Online](#) and the University of Texas McDonald Observatory/[SCOPE](#) (Southwestern Consortium of Observatories for Public Education), the [SCOPE solar poster educational activities and resources](#), including:
 - . Equatorial Sundial Activity, two versions: [HTML](#); [PDF](#)
 - B. [Dial Face Template](#) (print using [cover stock](#))
- Bill Nye the Science Guy [Earth's Seasons](#) video, Disney Educational Productions, No. 68A93VL00 - Entertaining demonstrations showing the reasons for the seasons. The program includes a brief segment (entitled "Try This") featuring a home-made horizontal sundial--the "Cardboard Sundial of Science"--that provides a fast-paced introduction to several fundamental concepts in sundialing, including the clockwise rotation of the [gnomon](#) shadow, [style angle](#) versus latitude (the style should be parallel to the Earth's axis), the noon line, and [hour lines](#). The segment ends with a broadbrush introduction to the [Equation of Time](#) (EoT).
[Editorial Commentary: The program script does not refer to the phenomenon as the EoT, rather it simply points out the observed difference between Solar Time and Standard Time ("noon won't quite stay noon; 9 in the morning won't quite stay 9 in the morning"). The program fails to mention the fact that the time difference could be caused, in part, by a difference in longitude between the location of the observer and the Standard Time Meridian. The complex topic of correcting Solar Time for Standard Time is perhaps better covered by the classroom teacher rather than Bill Nye's "MTV" presentation style.]
- Tracing the Analemma
 - . [SCSA Calculate and Chart the Analemma](#) - A year-long projection of the Sun's image on a horizontal surface. (See also [Related Resources](#).)
 - B. From the Smithsonian Institution, [Eyes on the Sky, Feet on the Ground](#) - Hands-On Astronomy Activities for Kids. See [Chapter Two - The Earth's Orbit](#), Activity 2-4: The Analemma (constructing a ceiling analemma).
 - C. Two interrelated activities from *Paper Plate Education*: [Sub-Solar Cup](#); and [Analemma Project](#).

Me and My Shadow - A Rule-of-Thumb for Safe Sun Exposure

The [Sun](#) is a [star](#) that radiates energy at all wavelengths of the [electromagnetic spectrum](#); some wavelengths of solar radiation are hazardous to plants and animals. Visit the EPA [Stay Healthy in the Sun](#) Web site for information about the health risks posed by ultraviolet (UV)

radiation, as well as the steps people can take to protect themselves from overexposure to the Sun.

An easy way to tell how much ultraviolet (UV) radiation exposure you are getting is to **look for your shadow**:

- If your shadow is taller than you are (in the early morning and late afternoon), then your UV exposure is likely to be low.
- If your shadow is shorter than you are (around midday), then you are being exposed to high levels of UV radiation. Seek shade and protect your skin and eyes.

[The Ultraviolet Index](#) (UV Index) overview includes a link to EPA's new [SunWise School Program](#) regarding Sun safety. The National Oceanic and Atmospheric Administration (NOAA) produces a daily [UV Index](#) U.S. map (showing predicted exposure levels).

Sunspots and the Solar Cycle

What is "The Solar Cycle?" In a regular cycle, the Sun undergoes a period of great activity called the "solar maximum" (predicted to occur during 2000-2001), followed by a period of quiet called the "solar minimum." One way scientists track solar activity is by observing sunspots. Sunspots are relatively cool areas that appear as dark blemishes on the face of the Sun. During solar maximum there are many sunspots; during solar minimum there are few. See sidebar (left) for [today's sunspot number](#).

For more information about sunspots, Solar Maximum, and the Sun-Earth Connection, visit the [SCSA Themes](#) Web page. For classroom teachers, a couple of suggested sunspot-related activities...

- [Happy Birthday Sunspot Plot](#) - Sunspots and the Solar Cycle (Grade Level 4-8) [Teacher's Answer Key available upon [request](#).]
 - [Estimating the Size of Sunspots](#) - Use the Internet to *safely* observe & measure sunspots [Teacher's Answer Key available upon [request](#).]
-

Sun-Earth Day, Astronomy Week/Day, Sky Awareness Week, and Space Day

Plan to celebrate [Sun-Earth Day](#)--a national celebration of the Sun, the space around the Earth (geospace), and how all of it affects life on our planet--on **20 March 2002**. Its theme is: "Celebrate the Equinox and the Seasons." Celebrate [Astronomy Week/Day](#): Astronomy Week is April 15-21, 2002; Astronomy Day is Saturday, April 20th. Celebrate [National Sky Awareness Week](#) (NSAW), April 21-27,



2002. Its theme is: "THE SKY - Where Meteorology Meets the Heavens and the Earth."

Locally, the **Sandburg Planetarium** will host two special events:

- "[Astronomy Day at Huntley Meadows Park](#)," **Saturday, 20 April 2002.** (Rain Date: Sunday, 28 April 2002.)
- "[Sun-Earth-Moon Day](#)" on **Mon., 06 May 2002**, from **8:30 a.m. 'til 2:40 p.m.** (Rain Date: Tue., 07 May.) The event is timed to coincide as closely as possible with [Space Day](#) (Thu., 02 May) and the [Last Quarter Moon](#) (Sat., 04 May). Amateur astronomers from the Maryland Sidewalk Astronomers (MSA), [National Capital Astronomers](#) (NCA), [Northern Virginia Astronomy Club](#) (NOVAC), and [Shenandoah Astronomical Society](#) (SAS) have volunteered to be our guides for a day of sundialing, [safe sunspot observing](#), and [Moon-watching](#).

© Copyright 2002-2004 [Walter Sanford](#). All rights reserved.

[Sun-Earth-Moon Day 2002](#) | [S-E-M Day 2001](#) | [Sun "Block Party" 2000](#) | [SCSA Home](#)

My Shadow

by Robert Louis Stevenson

I have a little shadow that goes in and out with me,

And what can be the use of him is more than I can see.

He is very, very like me from the heels up to the head;

And I see him jump before me, when I jump into my bed.

The funniest thing about him is the way he likes to grow--

Not at all like proper children, which is always very slow;

For he sometimes shoots up taller like an india-rubber ball,

And he sometimes goes so little that there's none of him at all.

He hasn't got a notion of how children ought to play,

And can only make a fool of me in every sort of way.

He stays so close behind me, he's a coward you can see;

I'd think shame to stick to nursie as that shadow

sticks to me!

**One morning, very early, before the Sun was up,
I rose and found the shining dew on every
buttercup;**

**But my lazy little shadow, like an arrant
sleepy-head,**

**Had stayed at home behind me and was fast
asleep in bed.**

Sundials on the Internet



"Sundials on the Internet" is the leading world internet site for information about all aspects of sundials, including:

- [projects](#) you can do
- [books](#) you can get
- national [societies](#) to
- [pictures](#) you can see
- [sundials](#) you can [commission](#) or [buy](#)
- [sundial trails](#) all over the world
- including the most recent ones on the sundials of the [Camino de Santiago](#) in northern Spain, and the sundials of the [city of Oxford, England](#)

All sundial enthusiasts around the world are invited to join in the British Sundial Society's [international conference in Oxford](#) from 16-18 April 2004. Oxford is rich in sundials - see our new [Oxford sundial trail](#)



Our [traffic statistics](#) show [counter](#) visitors to our home page since 19 May 2000.-
Please bookmark us - and come again!

See our new [Solar Noon Calculator](#) giving the exact time of local solar noon for you



Practical information	Introduction Set up a dial Finding your latitude and longitude Mottoes Frequent questions 5 projects to do	Mass dials Bevezetés a Napórákhoz (HU) Come preparare una meridiana (I) Faire un cadran solaire (F)	Types of sundials Types de cadrans solaires(F) Tipos de relógios solares(P) Types Zonnewijzers (NL)
Other languages	 Czech deutsch français magyar italiano nederlands portugues español Index of foreign language pages Can youhelp translate some more pages?		
Sundial pictures	New sundials Links to pictures of sundials		
Sundials to buy	The Sunfair gives detailed information about most of the leading world sundial makes, including OutdoorDecor.com Spot-On Sundials Connoisseur Sundials		
Commission a special sundial?	Harriet James David Harber Sundials		
Technical information	Equation of Time Computer programs Declination of a wall Nature of time	Az időkiegyenlítés (HU) L'equazione del tempo (I) La Ecuación del Tiempo (SP)	A fal tájolásának meghatározása (HU) De Tijdsvereffening(NL) Tijdsystemen(NL)
NEW full-text search	Search complete site!	Find:	
Information sources	Sundial books Bücher(DE) Boeken(NL) BSS Bulletin Book Reviews NASS Publications Tijdschriften (NL) Sundial mailing list		

Sundial makers	The Sundial Fair List of makers worldwide Include your details? Arthur Wilbur Co Connoisseur Sundials Harriet James		
 Sponsored by the British Sundial Society	BSS Home Page What we do Join us! BSS Bulletin "Make A Sundial" Advertising BSS Conference 2003		
Other societies	Full world list Netherlands Austria Österreich (A) N. America		
Sundial trails: in S. England	The City of London sundial trail The London Thames trail Chipping Camden Cotswolds trail Cambridgeshire Hampshire seaports Horniman (London) East Sussex Test Valley (Hampshire)		
rest of UK	Derbyshire County Down, N. Ireland Leicester Time Trail Oxfordshire S. Norfolk Suffolk Winchester Isle of Guernsey		
France:	Central Paris Brianconnais Finistère Pays de Buech Queyras (F) Queyras		
rest of Europe & Middle East	Austria : Österreich (A) Austria Belgium : Rupelmonde , Flanders Germany: Gorlitz Israel : Israel sundial trail Italy: Milan/Bergamo Milano/Bergamo(I) Malta Netherlands Poland Spain : Barcelona The Camino de Santiago NEW Complete world list		
the Americas	Seattle Toronto Kentucky Ottawa Ecuador Ecuador (SP) NEW		
in Australia	Sydney Tasmania		
Let's hear from you	Comments Feedback page Personals page		
"Clocks" magazine articles by N. Ta'Bois.	Adjusting for Longitude The Analemma Calculating hour lines Disc dials Equinoctial dials Gnomon or style	Greenwich meridian Hours and hours Latitude & sundials Meantime dials Minor adjustments	The Noon Mark Pillar dials Ring dials Significant dials "Sun time & clock time"
Links	Other interesting sundial sites Wemaster's choice - a miscellany of links to other sites which we have found useful or interesting or both How to set up a reciprocal link This site is listed in the BBC Education Web Guide which brings you the newest and best websites for learning.		

Please bookmark Sundials on the Internet so we can see you again!

<http://www.sundials.co.uk/index.html>

This home page was completely redesigned in March 2000. If you would like to see our previous home pages, they are kept posted for your interest (though without links) at [home99.htm](#), [home98.htm](#) and [home97.htm](#). We have come quite a long way since then!

Flags courtesy of [ITA's Flags of All Countries](#).

This site is one of the community websites maintained by [Internetworks Ltd](#) who are interested in developing similar successful website for other communities. Please visit our websites on the [Camino de Santiago](#), the [Inca Trail](#) in Peru, the [High Atlas](#), and a list of our [other websites](#). We would be happy to build a website for you too!

Entire contents Copyright © Internetworks Ltd 1997/2001 last revised

Comments/ suggestions/ problems, please get in touch by [E-mail](#)

Equatorial Sundials

What is an Equatorial Sundial?



An equatorial sundial (see a 360° view [animated GIF](#)) consists of a [dial plate](#), and a [gnomon](#) (or [style](#)) that is perpendicular to the dial plate. The dial plate has an upper dial face (see [example](#)) and a lower dial face (see [example](#)), both of which are marked off in hours (every hour is exactly [15 degrees wide](#)). The gnomon is a pole (or rod) that passes through the [center](#) of the dial plate, extending above the upper face of the dial plate, and extending below the lower dial face. The shadow of the gnomon (or style), cast among the [hour lines](#) on one of the two dial faces, [shows the time](#).

An equatorial sundial is actually a reduced model of the Earth, similar to a globe with its upper and lower halves removed: the dial plate represents the [plane](#) of the Earth's [Equator](#); the gnomon represents the Earth's [axis](#) of [rotation](#). The upper dial face represents the [Northern Hemisphere](#); the lower dial face represents the [Southern Hemisphere](#).

For more information, visit [The Equatorial Sundial](#) Web page.

Setting the Sundial

Analogous to setting the correct time on a clock or wristwatch (by moving the hands of the timepiece into proper position), properly orienting an equatorial sundial will move the gnomon (or style) shadow into position so that the dial face displays the correct time.

- The gnomon should be [parallel to the Earth's axis](#), inclined at an angle equal to the [latitude of the observer](#) (ϕ , phi). See [A Tale of Two Sundials](#).
- The dial plate should be [parallel to the plane of the Earth's Equator](#) (perpendicular to the gnomon), inclined at an angle equal to the [complement of the observer's latitude](#)--the angle that when added to the angle of the observer's latitude equals a right angle in measure (90°). This angle is also known as the [colatitude](#). See [A Tale of Two Sundials](#).
- Place the sundial on a horizontal surface; the top of the gnomon should point toward the [Celestial North Pole](#) (i.e., Polaris, the North

Star). More simply, align the upper dial face so that 12 noon points toward [geographic north](#) and the 12 noon [hour line](#) is aligned with your local [meridian](#).

The sundial may be used to align itself with your local meridian. Obtain the exact time of "Sun transit" from the U.S. Naval Observatory [Complete Sun and Moon Data for One Day](#) Web page. Set your wristwatch for the exact [time of day](#).¹ At the precise moment of Sun [transit](#), align the sundial so that it reads exactly 12 noon (regardless of the time shown by your wristwatch); the sundial is now aligned with your local meridian. A slightly more complicated but more accurate procedure would be to use the shadow cast by a [plumb bob](#) to strike a north-south line at the time of Sun transit. For example, a tripod, nylon cord, and boat anchor were used to [find the local meridian](#) (see shadow of cord) during [SUNdays in September](#), Huntley Meadows Park, Fairfax County, VA.

Disclaimer: *The preceding statements regarding the proper alignment of an equatorial sundial are based upon the assumption that the sundial does not feature a [built-in correction](#) for longitudinal offset from the Standard Time Meridian (see the following section, "Solar Time Versus Standard Time").*

¹ Determine the exact time of day by using either a radio-controlled atomic clock (such as the [ExactSet" RM806](#) from [Oregon Scientific, Inc.](#)), or a relatively inexpensive Global Positioning System receiver (such as the [Garmin GPS 12](#)) that displays both the exact time (precise to the nearest second) and location (latitude & longitude) of the sundial.

Solar Time Versus Standard Time

Solar Time, technically known as [Local Apparent Time](#) (L.A.T.), is sundial time--when the Sun crosses your [line of longitude](#) (is due south of the observer for northern mid-latitude locations), it is [solar noon](#). In contrast, when the Sun crosses the [Standard Time Meridian](#) for your time zone, it is 12 noon Standard Time (regardless of the Sun's position relative to your meridian).

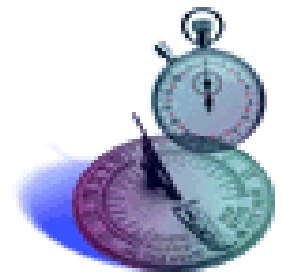

Standard Time or wristwatch time is the worldwide time-keeping standard based upon [Mean Solar Time](#) for [selected lines of longitude](#) (located in the middle of each time zone) known as [Standard Time Meridians](#). Around the world, there are [24](#) Standard Time Meridians, beginning with the Prime Meridian (0° longitude). In the continental United States, the Standard Time Meridians are 75°W, 90°W, 105°W, and 120°W for the [Eastern, Central, Mountain, and Pacific Time Zones](#), respectively.

Nominally, each time zone is one hour wide (15 degrees of longitude), extending 30 minutes (7.5 degrees of longitude) to the east and west of the Standard Time Meridian. Unless you live along a Standard Time

Meridian, Solar Time (sundial time) is different from Standard Time (wristwatch time) by as much as 30 minutes (earlier or later). In the real world, the location of a given time zone boundary is determined by geopolitics as well as geography. The net result is that some time zones are wider than one hour, therefore the difference between Solar Time and Standard Time is greater than the theoretical 30-minute maximum.

To correct **Solar Time** (sundial time) for **Standard Time** (wristwatch time), one must compensate for both the difference in longitude (between the location of the observer and the Standard Time Meridian) and the [Equation of Time](#). The [Solar Noon Calendar](#) calculates tables showing either the exact time of **Solar Noon** for your location for each day of the year, or the **Standard Time Correction**--the amount you have to add to, or to subtract from, the Solar Time shown on your sundial to get the Standard Time shown on your wristwatch. Add one hour for [Daylight Saving Time](#).

Telling Time Using Shadows

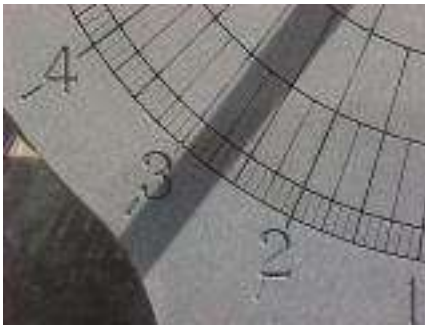

The [gnomon](#) is the part of a sundial that casts the shadow used to tell time. For equatorial sundials, the gnomon is a pole (or rod) of varying thickness. Some equatorial sundials are designed so that time is told by estimating the center of the gnomon shadow (see [example](#)); for others, time is told by reading one edge of the gnomon shadow,

technically known as the "[style](#) shadow." For example, in the close-up photograph of an equatorial sundial dial face (shown left), time is told by reading the upper-left edge of the gnomon shadow. The thickness of the gnomon determines the way in which the hour lines are drawn on the two dial faces, and how time is told from either the gnomon shadow or the style shadow.

"If the [gnomon] is less than 1/8" (3.175 mm) in diameter or if the rod tapers to a point at the top, [then] all of the hour lines will be drawn from the center...." [Quote courtesy [Sundials: Their Construction and Use](#), Mayall & Mayall, Dover Publications, Inc., ©2000, p. 98.] For example, look closely at the [StarDate Equatorial Sundial](#) template; notice that the hour lines radiate from the exact center of the dial face. A thin gnomon should be used with this type of dial face design, otherwise time is told by estimating the center of the gnomon shadow.

In contrast, the [Sandburg Planetarium Equatorial Sundial](#) is designed for use with a slightly thicker gnomon, e.g., a pencil approximately 1/4" (7 mm) in diameter. Notice that the hour lines radiate tangentially from a small inner circle representing the diameter of the gnomon. A similar

design is used by both the [St. Petersburg, FL Equatorial Sundial](#) and the [Boulder, CO Equatorial Sundial](#). Tell time by reading the style shadow on the dial face--the time-telling edge of the gnomon shadow should be parallel to one of the hour lines (see [dial face close-up](#), upper left).

Making the Sun-Earth Connection

"The fundamental units of time are set by the cycles in the sky, and people have been measuring them since prehistoric time. ... The sundial is a link between the sky and our need to measure time, and it's actually a model of the apparent movement of the Sun. The [equatorial] sundial charts the progress of the Sun across the sky during the day [as well as throughout the year]." [Quote courtesy [Griffith Observatory](#).] Two motions--the [rotation](#) of the Earth around its axis, and the [revolution](#) of the Earth around the Sun--cause daily and annual cycles in the Sun's apparent path across the sky that can be observed indirectly using an equatorial sundial.

Earth's Rotation and Solar Time-Keeping

Planet Earth is a magnificent timepiece! The Earth [rotates](#) counterclockwise once every 24 hours. One complete rotation equals 360 degrees. The rate of the Earth's rotation equals 15 degrees per hour:



$$360^\circ/24 \text{ hr} = 15^\circ/\text{hr} \text{ or } 15^\circ/60 \text{ min, which reduces to } 1^\circ/4 \text{ min}$$

Therefore, all of the [hour lines](#) on the dial face of an equatorial sundial are spaced exactly [15 degrees apart](#). Similarly, there are [24 time zones](#) around the world; each time zone is one hour or 15 degrees of longitude wide.

Sun shadows fall in the opposite direction as the Sun. Because the Earth rotates counterclockwise (as viewed from above the Northern Hemisphere), shadows cast by the Sun [move in a clockwise direction](#). Therefore, morning times are located on the right side of the [upper dial face](#); afternoon times are on the left. The reverse is true for the Southern Hemisphere, which is modeled by the [lower dial face](#).

Earth's Revolution Around the Sun and the Annual Cycle of Change in the Sun's Apparent Path Across the Sky

Long-term investigation using an equatorial sundial (also known as an "[equinoctial sundial](#)") enables one to indirectly observe the [annual cycle of change](#) in the [Sun's apparent path across the sky](#) (caused by the tilt of the Earth's [axis](#) of [rotation](#) and the [revolution](#) of the [Earth around the Sun](#)).

The [Celestial Equator](#) is an imaginary semi-circular line arching across the sky: one endpoint is due east; the other endpoint is due west. At its highest point in the sky, the Celestial Equator intersects the [meridian](#) at an [altitude](#) equal to the [colatitude](#) (e.g., an altitude of 51° for a latitude of 39°). Simply stated, the Celestial Equator is the projection of Earth's [Equator](#) onto the sky. Analogous to latitude on Earth, [declination](#) is position north or south of the Celestial Equator. The Sun crosses the Celestial Equator two times per year: the [Sun's apparent path across the sky](#) is north of the Celestial Equator for one-half of the year (MAR-SEP); south of the Celestial Equator the other half of the year (SEP-MAR). The [declination of the Sun](#) varies between zero degrees (0°) at the [equinoxes](#) and $\pm 23.5^\circ$ at the [solstices](#). To determine the maximum [altitude](#) of the Sun (at local solar noon), take the [colatitude](#) of the observer and add or subtract the [Sun's declination](#) (as per the sign). For example, at 39°N latitude, the Sun's maximum altitude is 74.5° on June 21st ($51 + 23.5$); 27.5° on December 21st ($51 - 23.5$).

On the day of the [equinoxes](#), the declination of the Sun equals zero degrees (0°) and the [Sun's apparent path across the sky](#) follows the Celestial Equator. Since the dial plate of an equatorial sundial represents the plane of the Earth's Equator, the Sun is directly over the edge of the dial plate on the [March](#) and [September](#) Equinoxes, therefore the gnomon (or style) of a [properly oriented equatorial sundial](#) will not cast a shadow on the dial plate. From the March Equinox to the September Equinox (when the [declination of the Sun](#) is positive), the gnomon shadow falls on the [upper dial face](#); from the September Equinox to the March Equinox (when the [declination of the Sun](#) is negative), the gnomon shadow falls on the [lower dial face](#) (see [example](#)).

Assemble a simple [equatorial sundial](#) (courtesy [StarDate Online](#) and the University of Texas McDonald Observatory/[SCOPE](#)) and empirically observe where the gnomon shadow falls as the seasons change. Gain valuable insight by checking the NASA [J-Track](#) Web page to see where on Earth the Sun is currently directly overhead (see small Sun icon, correctly oriented with respect to latitude and longitude).

Time for Learning

The equatorial sundial is *by far* the best type of sundial for teaching a wide range of fundamental concepts in [astronomy](#), [geography](#), and [mathematics](#). Most upper-elementary students are somewhat aware of the Sun's apparent daily motion across the sky; fewer students realize that the Sun's apparent path across the sky changes in a predictable annual cycle. Experience working with equatorial sundials will increase

students' awareness of *both* the Sun's daily and annual motions caused by the Earth's rotation around its axis and revolution around the Sun.

In education as in life, timing is everything! Ideal times to work with equatorial sundials include a week-or-so before and after the [equinoxes](#) (SEP & MAR) so that students have the opportunity to indirectly observe the Sun crossing the [Celestial Equator](#)--one of the real [reasons for the seasons](#). Also, there are four days during the year when the [Equation of Time](#) equals zero (0 minutes): on average SEP 02; DEC 25; APR 15; and JUN 14. On these four days, [Solar Time](#) is coincident with [Standard Time](#) (after correcting for the difference in longitude between the location of the observer and the Standard Time Meridian). From an educator's point of view, April 15 appears to be the best of the four dates with respect to the school calendar (SEP 02 is too early in the school year, JUN 14 too late, and DEC 25 is a holiday).

The **SCSA** recommends the following instructional resources, appropriate for use with upper elementary, middle, and high school students:

- . From NASA *Liftoff to Space Exploration*, a set of sundial Web pages:
 1. [Sundials](#)
 2. [How Sundials Work](#) - **Editorial Commentary:** *Be aware of a fundamental factual error on this Web page: "...the base plate is titled [sic] at an angle equal to the latitude." The dial plate of an equatorial sundial should be inclined (tilted) at an angle equal to the [complement of the observer's latitude](#) (also known as the [colatitude](#)).*
 3. [Building a Simple \[Equatorial\] Sundial](#) - **Editorial Commentary:** *From the March Equinox to the September Equinox, use the [Northern Hemisphere](#) equatorial sundial template. From the September Equinox to the March Equinox, use the [Southern Hemisphere](#) template. Be sure to fold the Southern Hemisphere template so that the dial face and gnomon point downward rather than upward (as directed). Also, be aware that the Southern Hemisphere dial face is misnumbered.*
 4. [Pondering Sundials](#)
- B. From [StarDate Online](#) and the University of Texas McDonald Observatory/[SCOPE](#) (Southwestern Consortium of Observatories for Public Education), the [SCOPE solar poster educational activities and resources](#), including:
 1. Equatorial Sundial Activity, two versions: [HTML](#); [PDF](#)
 2. [Dial Face Template](#)
- C. The **SCSA Equatorial Sundial Activity**
 1. The [Sandburg Planetarium Equatorial Sundial template](#) (print using [cover stock](#)) - Designed for use with a pencil-sized

gnomon, approximately 1/4" (7 mm) in diameter.

2. [Assembly instructions](#) (courtesy John Hoy)
3. [Equatorial Sundial Activity Questions](#) - Provide differentiated instruction by assigning multiple choice questions only, as appropriate. [Teacher's Answer Key available upon [request](#).]

D. Among many good [geography lesson plans](#) from [George F. Cram Company, Inc.](#), **SCSA** specifically recommends the following sundial-related lessons (for use with the [Horizon Ring Globe](#)): [Lesson 11 - Rotation of the Earth](#); [Lesson 12 - Global Time](#); [Lesson 14 - Earth and Sun](#); [Lesson 15 - The Changing Seasons](#); and [Lesson 16 - Daylight Hours](#) (see section re: the analemma).

Related Resources

- [A Tale of Two Sundials](#) (featuring the [St. Petersburg, FL Equatorial Sundial](#) and the [Boulder, CO Equatorial Sundial](#))
- [Equatorial Sundials and the Sun's Apparent Path Across the Sky](#) (including [Table of the Declination of the Sun](#))
- [Table of the Equation of Time](#)
- **SCSA** [Equatorial Sundial Gnomon Length Calculator](#)
- [Time Conversion Table](#) (UTC/EST/EDT)
- The [Aurora, CO Equatorial Sundial](#)
- The [Brighton, CO Equatorial Sundial](#)
- The [Denver, CO Equatorial Sundial](#)
- The [Englewood, CO Equatorial Sundial](#)
- The [Littleton, CO Equatorial Sundial](#)
- The [Frankenmuth, MI Equatorial Sundial](#)
- The [Bloomington, MN Equatorial Sundial](#)
- The [Port Arthur, TX Equatorial Sundial](#)
- The [Medicine Hat Equatorial Sundial](#), Alberta Province, Canada
- The [Carroll Moore Memorial Sundial](#), Nebraska Wesleyan University, Lincoln, NE
- The [Seattle, WA Equatorial Sundial](#), Webster Park
- The [Henry Moore Sundial Sculpture](#), [Sundial Plaza](#), Adler Planetarium & Astronomy Museum, Chicago, IL - art and science converge to create an elegantly beautiful "**bowstring equatorial sundial**"
- The [Larkin Memorial Sundial](#), Claremont, CA (a bowstring equatorial sundial)

- The [Lyman Briggs Sundial](#), Gaithersburg, MD (a [polar sundial](#))
- Other varieties of the [equatorial sundial](#)

© Copyright 2002-2004 [Walter Sanford](#). All rights reserved.

[Me and My Shadow - Making the Sun-Earth Connection](#) | [SCSA Home](#)

The Official U.S. Time

Please click a time zone

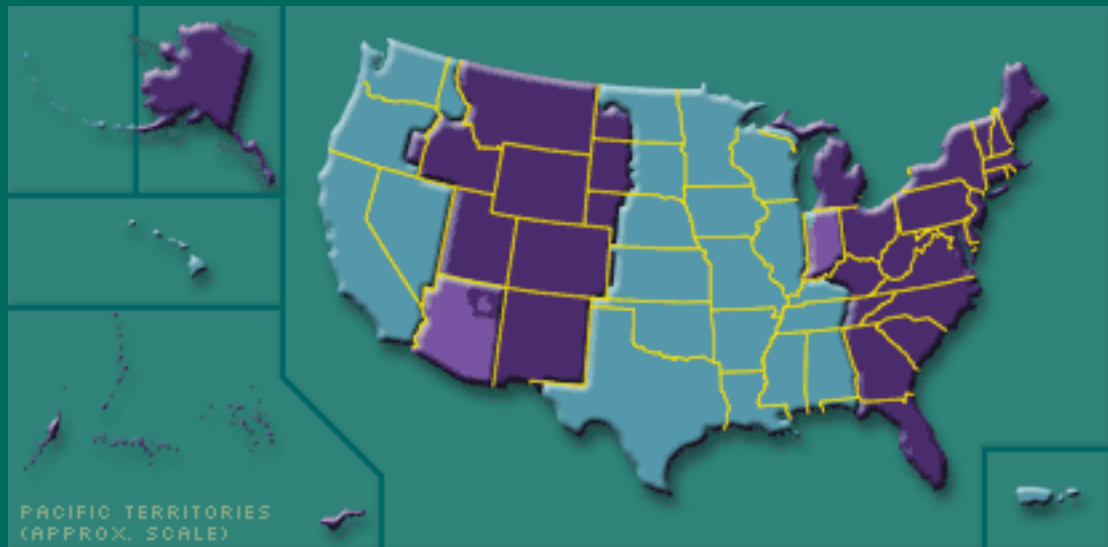

[Samoa](#) | [Hawaii-Aleutian](#) | [Alaska](#) | [Pacific](#) | [Mountain](#) | [Central](#) | [Eastern](#) | [Atlantic](#) | [UTC](#)

[Time exhibits](#)

[About this service](#)

[PRIVACY POLICY & SECURITY NOTICE](#)

Table of Mean Value of the Equation of Time, in Minutes (at true Noon)*To correct Solar Time for Standard Time:**Add Equation of Time when Sun "slow," i.e., sign is positive (+); subtract when Sun "fast," i.e., sign is negative (-).*

Day	JAN	FEB	MAR	APR	MAY	JUN	JUL	AUG	SEP	OCT	NOV	DEC
1	+3.4	+13.6	+12.5	+4.1	-2.8	-2.3	+3.6	+6.3	+0.2	-10.1	-16.3	-11.2
2	3.9	13.7	12.3	3.8	3.0	2.2	3.8	6.2	0.1	10.4	16.4	10.8
3	4.3	13.8	12.1	3.5	3.1	2.0	4.0	6.2	0.5	10.8	16.4	10.4
4	4.8	13.9	11.9	3.2	3.2	1.9	4.2	6.1	0.7	11.1	16.4	10.0
5	5.2	14.0	11.7	2.9	3.3	1.7	4.4	6.0	1.1	11.4	16.4	9.6
6	5.7	14.1	11.5	2.6	3.4	1.5	4.6	5.9	1.5	11.7	16.3	9.2
7	+6.1	+14.2	+11.2	+2.3	-3.4	-1.3	+4.7	+5.8	-1.8	-12.0	-16.3	-8.8
8	6.5	14.2	11.0	2.1	3.5	1.2	4.9	5.7	2.1	12.3	16.3	8.3
9	6.9	14.3	10.7	1.8	3.6	1.0	5.0	5.5	2.5	12.6	16.2	7.9
10	7.3	14.3	10.5	1.5	3.6	0.8	5.2	5.4	2.8	12.8	16.1	7.5
Day	JAN	FEB	MAR	APR	MAY	JUN	JUL	AUG	SEP	OCT	NOV	DEC
11	7.8	14.3	10.2	1.2	3.7	0.6	5.3	5.2	3.2	13.1	16.0	7.0
12	8.2	14.3	10.0	0.9	3.7	0.4	5.4	5.1	3.5	13.4	15.9	6.5
13	+8.5	+14.3	+9.7	+0.7	-3.7	-0.2	+5.6	+4.9	-3.9	-13.6	-15.8	-6.1
14	8.9	14.3	9.4	0.4	3.7	0.0	5.7	4.7	4.2	13.8	15.6	5.6
15	9.3	14.2	9.1	+0.2	3.7	+0.2	5.8	4.5	4.6	14.1	15.5	5.1
16	9.6	14.2	8.9	-0.1	3.7	0.4	5.9	4.3	5.0	14.3	15.3	4.6
17	9.9	14.1	8.6	0.2	3.7	0.7	6.0	4.1	5.3	14.5	15.1	4.1
18	10.3	14.0	8.3	0.5	3.7	0.9	6.1	3.9	5.5	14.7	14.9	3.6
19	+10.6	+13.9	+8.0	-0.7	-3.6	+1.1	+6.2	+3.7	-6.0	-14.9	-14.7	-3.2
20	10.9	13.8	7.7	0.9	3.6	1.3	6.2	3.5	6.4	15.1	14.5	2.7
Day	JAN	FEB	MAR	APR	MAY	JUN	JUL	AUG	SEP	OCT	NOV	DEC
21	11.2	13.7	7.4	1.2	3.5	1.5	6.3	3.2	6.7	15.2	14.3	2.2
22	11.5	13.6	7.1	1.4	3.5	1.7	6.3	3.0	7.1	15.4	14.0	1.7
23	11.8	13.5	6.8	1.6	3.4	2.0	6.4	2.8	7.4	15.6	13.7	1.2
24	12.0	13.4	6.5	1.8	3.3	2.2	6.4	2.5	7.8	15.7	13.4	0.7
25	+12.3	+13.2	+6.2	-1.9	-3.2	+2.4	+6.4	+2.2	-8.1	-15.8	-13.1	-0.2
26	12.5	13.1	5.9	2.1	3.1	2.6	6.4	1.9	8.4	15.9	12.9	0.3
27	12.7	12.9	5.6	2.3	3.0	2.8	6.4	1.7	8.8	16.0	12.5	0.8
28	12.9	12.7	5.3	2.4	2.9	3.0	6.4	1.4	9.1	16.1	12.2	1.3
29	13.1		5.0	2.6	2.8	3.2	6.4	1.1	9.5	16.2	11.9	1.8

Table of Equation of Time

30	13.3		4.7	2.7	2.6	3.4	6.4	0.8	9.8	16.3	11.5	2.3
31	+13.4		+4.4		-2.5		+6.3	+0.5		-16.3		+2.8

Sundials on the Internet

For a full overview [click here](#)

The Equation of Time

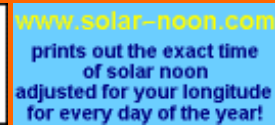

"Sun time" and "clock time"

Sundials tell "sun time". Clocks and watches tell "clock time". Neither kind of time is intrinsically "better" than the other - they are both useful and interesting for their separate purposes.

"Sun time" is anchored around the idea that when the sun reaches its highest point (when it crosses the meridian), it is **noon** and, next day, when the sun again crosses the meridian, it will be noon again. The time which has elapsed between successive noons is sometimes more and sometimes less than 24 hours of clock time. In the middle months of the year, the length of the day is quite close to 24 hours, but around 15 September the days are only some 23 hours, 59 minutes and 40 seconds long while around Christmas, the days are 24 hours and 20 seconds long.

"Clock time" is anchored around the idea that each day is exactly 24 hours long. This is not actually true, but it is obviously much more convenient to have a "mean sun" which takes exactly 24 hours for each day, since it means that mechanical clocks and watches, and, more recently, electronic ones can be made to measure these exactly equal time intervals.

Obviously, these small differences in the lengths of "sun days" and "mean days" build up to produce larger differences between "sun time" and "clock time". These differences reach a peak of just over 14 minutes in mid-February (when "sun time" is slow relative to "clock time") and just over 16 minutes at the beginning of November (when "sun time" is fast relative to "clock time"). There are also two minor peaks in mid-May (when "sun time" is nearly 4 minutes fast) and in late July (when sun time is just over 6 minutes slow) (These minor peaks have the fortunate effect, in the Northern hemisphere, that the differences are relatively minor during most of the months when there is a reasonable amount of sunshine).

The differences do not cumulate across the years, because "clock time" has been arranged so that, over the course of a four year cycle including a leap year, the two kinds of time very nearly come back to the same time they started. (The "very nearly" is because "clock time" still has to be adjusted by not having a leap year at the turn of each century, except when the year is exactly divisible by 400, so 1900 was not a leap year, but 2000 will be). Even with this correction, we had an extra second added to "clock time" recently.

The reasons for these differences are discussed below, followed by some information on what the differences are at given times of year.

Why the days are of different lengths

These differences arise from two quite separate causes. The first is that the plane of the Equator is not the same as the plane of the Earth's orbit around the sun, but is offset from it by the **angle of obliquity**.

The second is that the orbit of the Earth around the sun is an ellipse and not a circle, and the apparent motion of the sun is thus not exactly equal throughout the year. The sun appears to be moving fastest when the Earth is closest to the sun.

These two effects are explained in more detail in a leaflet of the [Royal Greenwich Observatory](#) and in [Art Carlson's excellent article](#) on the subject at the end of this page.

The sum of the two effects is the Equation of Time, which is the red curve with its characteristic twin peaks shown below. (Many thanks to Patrick Powers for providing this graph from his own [sundial page](#)).

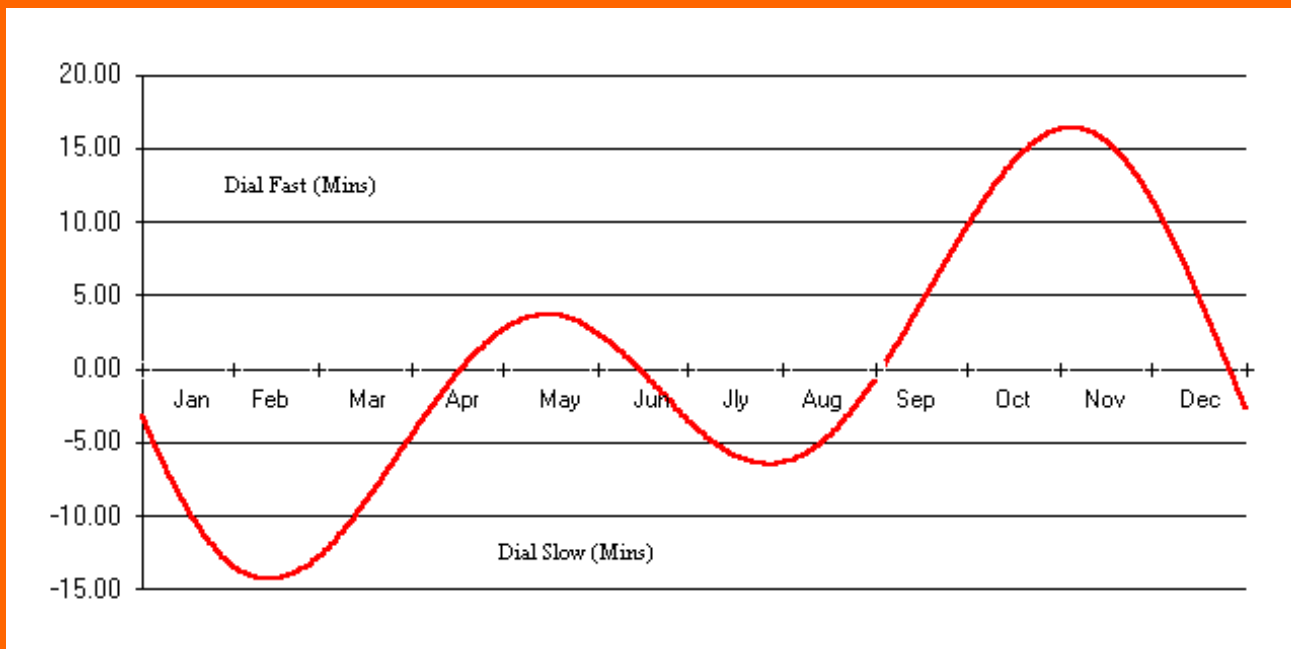

Some people like such information presented in tables rather than in graphs, so two tables are presented for your information below. These are both handy summary tables, which will give you a different view of the Equation of Time, and may help you to remember some key features, for example, that between the end of March and mid-September the sun is never more than 6 minutes away from "clock time", and for the whole of February it is 13 or 14 minutes slow! If you want to know the Equation of Time for every day of the year, there is a table in Appendix A of the [book](#) by Waugh.

Table showing the dates when "Sun Time" is (nearly) exactly a given number of minutes fast or slow on "Clock Time"

Minutes Fast

16	Nov 11	Oct 27
15	Nov 17	Oct 20
14	Nov 22	Oct 15
13	Nov 25	Oct 11
12	Nov 28	Oct 7
11	Dec 1	Oct 4
10	Dec 4	Oct 1
9	Dec 6	Sep 28
8	Dec 9	Sep 25
7	Dec 11	Sep 22
6	Dec 13	Sep 19
5	Dec 15	Sep 16
4	Dec 17	Sep 13
3	Dec 19	May 4
		May 27
		Sep 11

2	Dec 21	Apr 25	Jun 4	Sep 8
1	Dec 23	Apr 21	Jun 9	Sep 5

The Four Days Watches tell Sun Time - exactly right!

0	Dec 25	Apr 15	Jun 14	Sep 2
---	--------	--------	--------	-------

Minutes Slow

1	Dec 28	Apr 12	Jun 19	Aug 29
2	Dec 30	Apr 8	Jun 23	Aug 26
3	Jan 1	Apr 5	Jun 29	Aug 22
4	Jan 3	Apr 1	Jul 4	Aug 18
5	Jan 5	Mar 29	Jul 9	Aug 12
6	Jan 7	Mar 26	Jul 18	Aug 4
7	Jan 9	Mar 22		
8	Jan 12	Mar 19		
9	Jan 15	Mar 16		
10	Jan 18	Mar 12		
11	Jan 21	Mar 8		
12	Jan 24	Mar 4		
13	Jan 29	Feb 27		
14	Feb 5	Feb 19		

Table showing the Equation of Time on the 5th, 15th and 25th of each month, together with the average daily change in seconds (given in minutes and second, + = "Sun time" is fast on "clock time")

Eq.of time on the:	5th	15th	25th	Av. change (secs)
January	-5m03	-9m10	-12m12	20
February	-14m01	-14m16	-13m18	5
March	-11m45	-9m13	-6m16	16
April	-2m57	+0m14	+1m56	18

May	+3m18	+3m44	+3m16	4
June	+1m46	-0m10	-2m20	16
July	-4m19	-5m46	-6m24	20
August	-5m59	-4m33	-2m14	11
September	+1m05	+4m32	+8m04	20
October	+11m20	+14m01	+15m47	13
November	+16m22	+15m28	+13m11	10
December	+9m38	+5m09	+0m13	27

The equation of time

Written by [Art Carlson](#). October, 1995 .

The rotation of the Earth makes a good clock because it is, for all practical purposes, constant. Of course, scientists are not practical and care about the fact that the length of the day increases by one second every 40 000yrs. For the rest of us, it's just a matter of finding a convenient way to determine which way the Earth is pointing. Stars would be good, but they are too dim (and too many) at night and go away during the day. A useful aid is the Sun, which is out and about when we are and hard to overlook.

Unfortunately, the apparent position of the sun is determined not just by the rotation of the Earth about its axis, but also by the revolution of the Earth around the Sun. I would like to explain exactly how this complication works, and what you can do about it.

The diameter of the Sun as seen from the Earth is 1/2 degree, so it moves by its own radius every minute.

$$\begin{array}{r}
 24\text{hrs} \quad 60\text{min} \quad 1 \\
 \text{-----} \times \text{-----} \times \text{-deg} = 1\text{min} \\
 360\text{deg} \quad 1\text{hr} \quad 4
 \end{array}$$

That means it will be hard to read a sundial to better than the nearest minute, but then, we don't bother to set our clocks much more accurately than that either. Unfortunately, if we define the second to be constant (say, the fraction 1/31 556 925.974 7 of the year 1900, the "ephemeris second"), then we find that some days (from high noon to high noon) have more than 86,400 seconds, and some have less. The solar Christmas day, for example, is 86,430 seconds long. The discrepancy between "apparent time" and "mean time" can add up to +/- 15min. How does it come about?

The inclination of the ecliptic

First note that the Earth rotates on its axis not once in 24hrs but once in 23hrs 56min 4sec. It's just that in the course of a 365dy year, the Earth must turn an extra time to make up for its orbit about the sun.

$$\begin{array}{r}
 1\text{day} \quad 24\text{hrs} \quad 60\text{min} \\
 \text{---} \times \text{-----} \times \text{-----} = 3\text{min } 56\text{sec} \\
 366 \quad 1\text{dy} \quad 1\text{hr}
 \end{array}$$

The trouble comes in because this 3min 56sec is only an average value. Think of an observer sitting at the north pole on a platform which rotates once every 23hrs 56min 4sec. She will see the stars as stationary and the sun as moving in a circle. The plane of this circle is called the "ecliptic" and is tilted by 23.45deg relative to the equatorial plane. The observer will see the sun move from the horizon, up to 23.45deg, then back down to the horizon. The sun will move at a constant speed (I'm lying, but wait till later) along its circle, but the shadow cast by the North Pole (the one with the red and white candy stripes) will *not* move at a constant rate. When the sun is near the horizon, it must climb at a 23.45deg angle, so that it has to move 1.09deg before the shadow moves 1deg.

$$\begin{array}{r}
 1\text{deg} \\
 \text{-----} = 1.0900\text{deg} \\
 \cos(23.45\text{deg})
 \end{array}$$

On the other hand, in the middle of summer, the sun is high in the sky taking a short cut, so it must move only 1deg along its circle to cause the shadow to move 1.09deg. This effect generalizes to more temperate climates, so that in spring and fall the 3min 56sec is reduced by the factor 1.09 to 3min 37sec, whereas in summer and winter it is correspondingly increased to 4min 17sec. Thus a sundial can gain or lose up to 20sec/dy due to the inclination of the ecliptic, depending on the time of year. If it is accurate on one day, six weeks later it will have accumulated the maximum error of 10min.

$$\begin{array}{r}
 20\text{sec} \quad 2 \quad 1\text{min} \\
 \text{-----} \times 45\text{dys} \times \text{--} \times \text{-----} = 10\text{min} \\
 1\text{dy} \quad \text{pi} \quad 60\text{sec}
 \end{array}$$

The seasonal correction is known as the "equation of time" and must obviously be taken into account if we want our sundial to be exact to the minute.

If the gnomon (the shadow casting object) is not an edge but a point (e.g., a hole in a plate), the shadow (or spot of light) will trace out a curve during the course of a day. If the shadow is cast on a plane surface, this curve will (usually) be a hyperbola, since the circle of the sun's motion together with the gnomon point define a cone, and a plane intersects a cone in a conic section (hyperbola, parabola, ellipse, or circle). At the spring and fall equinox, the cone degenerates to a plane and the hyperbola to a line. With a different hyperbola for each day, hour marks can be put on each hyperbola which include any necessary corrections. Unfortunately, each hyperbola corresponds to two different days, one in the first half and one in the second half of the year, and these two days

will require different corrections. A convenient compromise is to draw the line for the "mean time" and add a curve showing the exact position of the shadow points at noon during the course of the year. This curve will take the form of a figure eight and is known as an "analemma". By comparing the analemma to the mean noon line, the amount of correction to be applied generally on that day can be determined. At the equinox, we found that the solar day is closer to the sidereal day than average, that is, it is shorter, so the sundial is running fast. That means in fall and spring the correct time will be earlier than the shadow indicates, by an amount given by the curve. In summer and winter the correct time will be later than indicated.

The eccentricity of the Earth's orbit

If you look at such a figure eight calculated correctly, you will see that the fall and winter loop is actually somewhat larger than the spring and summer loop. This is due to the lie I told above. The Earth does not actually orbit at a constant speed around the sun. On January 2, the Earth is 1.7% closer to the Sun than average and thus the angular velocity is 3.4% larger (conservation of angular momentum). This makes the solar day longer than the sidereal day by about 8sec more than average,

$$\begin{array}{r} 3\text{min } 56\text{sec} \\ \text{-----} \times 0.034 = 8.0\text{sec/dy} \\ 1\text{dy} \end{array}$$

and in the course of 3 months a sundial accumulates an error of 8min due to the eccentricity of the Earth's orbit.

$$\begin{array}{r} 8.0\text{sec} \qquad \qquad 2 \qquad 1\text{min} \\ \text{-----} \times 91\text{dys} \times \text{--} \times \text{-----} = 8\text{min} \\ 1\text{dy} \qquad \qquad \pi \qquad 60\text{sec} \end{array}$$

Thus the correct time will be later than the shadow indicates at the spring equinox and earlier at the fall equinox. This shifts the dates at which the sundial is exactly right from the equinoxes into the summer, making the summer loop of the figure eight smaller.

The 20sec/dy error due to the inclination of the ecliptic and the 8sec/dy error due to the eccentricity work in the same direction around Christmas time and add up exactly (well, almost) to the 30sec/dy mentioned earlier. The accumulated errors of 10min and 8min due to these two effects don't add up quite so neatly, so the maximum accumulated error turns out to be somewhat less than 18min. If you calculate everything correctly, you find that during the course of a year a sundial will be up to 16min 23sec fast (on November 3) and up to 14min 20sec slow (on February 12).

Suppose in October you start a 15min coffee break at 10:45 by the wall clock. If you believe the sundial outside, without accounting for the equation of time, you will already be late for the 11:00 session as soon as you step out the door.

Other pages on the Internet which are concerned with the Equation of Time are from the Royal Greenwich Observatory
<http://www.ast.cam.ac.uk/pubinfo/leaflets/equation/equation.html>,

and from a number of individual pages, including

http://ourworld.compuserve.com/homepages/patrick_powers/sundials.htm, from

<http://cpcug.org/user/jaubert/sundial.html> (this link now changed or superseded)

<http://www.ipp.mpg.de/~awc/sundial.html>

We would appreciate an [E-mail](#) from you if you know of any others. Thank you

For a full overview of Sundials on the Internet [click here](#)

This site designed and maintained by [Internetworks](#) Ltd of [Epsom](#), England
first posted 1996 last revision
Comments/ suggestions/ problems, please get in touch with the [Webmaster](#)

Workshop Hints

Why is clockwise Clockwise?

© [Donn Haven Lathrop](#) 1996

is a question which was once answered to my satisfaction by that paragon of authority-my elementary school teacher, who firmly stated; "Because the hands on a clock turn in a certain direction, and we call that direction clockwise." Shortly after this revelation, I learned that the opposite of clockwise was, by default, counter-clockwise. Many years later, in working with clocks and in writing of their development and of their makers, I found I wanted to know WHY clockwise became clockwise. This time, I wasn't going to be fobbed off with another "Because that's the way it is." answer. I also had a sneaking suspicion that there were other reasons for this seemingly arbitrary choice of direction, and that other words were used to describe this left to right motion, before the first clock ever ticked.

Delving about in various books brought up a number of possible reasons for this evidently arbitrary choice of direction - left to right - for the hands of clocks, as well as the likely reasons behind many other rites and rituals which require this left to right motion. Examples of these are the insistence of the ancient Sumerians, Babylonians, Chaldeans, and Egyptians on left to right movement in their religious ceremonies and the Irish warriors who wordlessly declared their hostile intentions by circling their enemies from right to left - counter-clockwise. There is also the record of the circumambulation of Jericho before its walls fell - although we don't know whether the Israelites walked clockwise or counter-clockwise.

Clockwise and counterclockwise as we now know them seem to have derived from an accident of - as the real estate dealer said - location, location, location. In the Northern Hemisphere (in what is now Iraq), where the cradle of our civilization was rocked and the first written records were kept some 4,000 years ago, the early thinkers and teachers noted that their own shadows moved from left to right, as does the shadow of a stick or a sundial move from left to right during the course of the sun across the heavens. It seems to be a peculiarity of our human nature that if we are watching the movement of a stick's shadow, that we face north to do so. If we want to see our own shadows, we have to face north. Otherwise we would either be standing on the 'dials' of our 'sun-clocks', or spending a lot of time looking over our shoulders just to see our own shadows. The hemicyclium (a very early sundial), by its very design demanded that someone checking the time had to face north to do so, as did vertical dials that were placed on the south walls of buildings. When horizontal sundials came along, the numbers were placed on the north edge of the dial, because they were then easier to read; the Sun was to the south, and the dial lines radiate from south to north. That meant that one had to face north to most easily read the dial, and the shadow moved from left to right.

In that same Northern Hemisphere, however, if you want to check the path of the sun across the heavens, you have to face south, and the sun moves from your left to your right. And these are the reasons why the hands of a clock turn from left to right - clockwise. Therefore, our modern 'clockwise' seems to be an accident of the development of civilization in the Northern Hemisphere and human nature. If our ancestors had decided to develop civilization in southern Africa, or the Antipodes, clockwise would have been counter-clockwise, simply because everything is reversed south of the Equator. A sundial designed for North Dakota will work in New Zealand, but the numbers will be backwards.

This left-to-right, or clockwise, movement, became so ingrained in the culture patterns of different peoples that their ancient rituals made 'good' magic by moving from left to right. The North orientation is also tied in with this direction of movement - it was believed that making the 'sacred circuit' from left to right would keep the constellation of the Great Bear (Ursa Major) from getting stuck in one position, or even turning backwards. This constellation, before Stonehenge or the invention of any other calendrical device, was a celestial clock to early Man. These many hundreds

of centuries later, it still marks the seasons of the year - clockwise. The bear's 'tail' points eastward in spring, to the south in summer, to the west in autumn, and northward in winter. Before clocks were invented and the words 'clockwise' and 'counter-clockwise' were derived from the motion of the hand(s), the clockwise movement was called 'sunwise'. Sunwise is a term found in the descriptions of various rituals in ancient manuscripts, and sunwise applied whether the ritual was employed by people who were desperately praying for rain or who were disporting themselves in a fertility frolic.

This sunwise direction has been a ritualistic requirement since earliest history, and has been found all over the world; from the dawn of the Sumerians and their written records, amongst the very early clans of the Scottish Highlands, in the sand-paintings of the Navajo in our own Southwest, to the prayer wheel of the modern Tibetan. In what may be a deliberate rejection of this pagan ritualistic requirement the Stations of the Cross in Roman Catholic and Anglican churches are visited counterclockwise.

The antonym of sunwise is widdershins, and this anti-sunwise, or backwards motion was required by some rituals - particularly in the ancient 'undoing ceremony' - the 'ceremony of riddance.' For instance, there is a record that Welsh children suffering from internal disorders were 'dipped into a sacred well against the sun', and were then dragged three times around the well on the grass in the same direction. Note the wordless declaration by Irish warriors of their intent to 'undo' their enemies. Right to left motion was also considered to be evil, or a method of summoning the Devil, and therefore became common in 'black' magic.

However, don't ask me why the Muslim faithful in Mecca circle the Ka'aba seven times counter-clockwise, why people lost in the wilderness tend to drift to the left as they wander, nor why Douglas 'Wrong Way' Corrigan flew widdershins in 1938 when he flew from Brooklyn to Dublin after filing a flight plan to Los Angeles, nor why baseball base-runners and racers; whether horse, automobile, or human - even the great roller derby stars - always travel counterclockwise, regardless of the hemisphere in which the race is located. And please! don't ask me why it is that from the clock's point of view - its own hands are travelling counterclockwise!

I will leave you with two thoughts: Perhaps the nameless American baseball baserunner who ran to third base - clockwise - instead of first, was attempting to undo the 'evil' that was making his team lose; and on some serious reflection on all of the above, it might be a good idea to get rid that cute little backwards quartz clock hanging over the bar in your basement recreation room. One never knows!

[Index of the Hints and tips](#) [Home Page](#)

Page address <http://www.bhi.co.uk/hints/clckwse.htm>

Last Updated 26th June 2000

© 1999 British Horological Institute.

We welcome your comments and suggestions. [Please contact us at:](#)

British Horological Institute, Upton Hall, Upton, Newark, Notts. UK. NG23 5TE

Telephone (01636) 813795. Fax (01636) 812258. E-Mail info@bhi.co.uk

Reproduction of part or all of the contents of any of these pages is prohibited except to the extent permitted below. These pages may be downloaded onto a hard disk or printed for your personal use without alterations. This copyright notice must appear on each copy. These pages may not be included in any other work or publication, or be distributed or copied for any commercial purpose except as stated above.



How Sundials Work

As the earth turns on its axis, the sun appears to move across our sky. The shadows cast by the sun move in a clockwise (hence the definition of clockwise) direction for objects in the northern hemisphere.

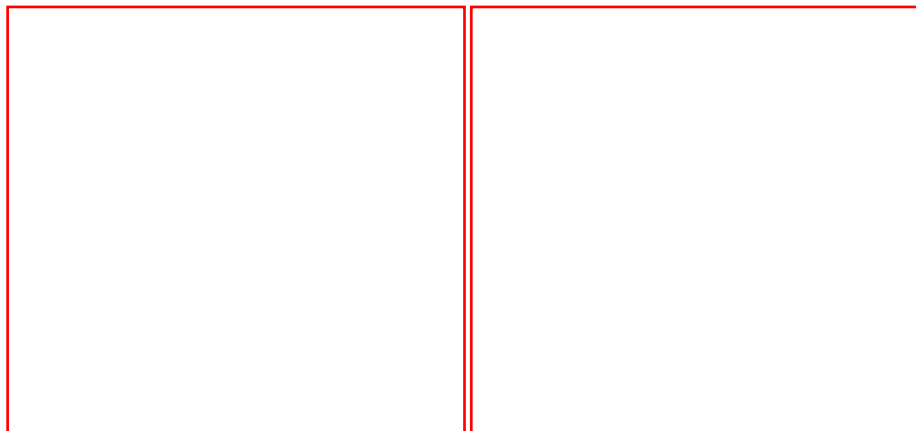

Read More At:

[Types of Sundials](#)

by the British Sundial Society

[The Physics of a Sundial](#)

by the Univ. of Washington

Shadow sticks or obelisks are simple sundials. If the sun rose and set at the same time and spot on the horizon every day, they would be fairly accurate clocks. However, the sun's path through the sky changes every day because the earth's axis is tilted. On earth's yearly trip around the sun the North Pole is tilted toward the sun half of the time and away from the sun the other half. This means the shadows cast by the sun change from day to day.

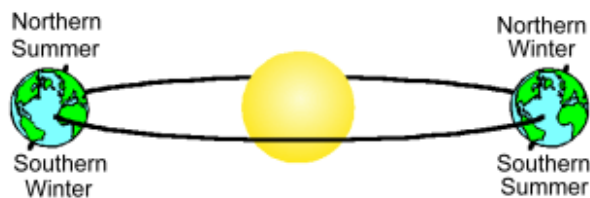

Glossary:

[axis](#)
[sphere](#)
[obelisk](#)

In addition, because the earth's surface is curved, the ground at the base of the shadow stick or obelisk is not at the same angle to the sun's rays as at the equator. This means that the shadow does not move at a uniform rate during the day. That is, if you mark the shadow at sunrise and sunset, you cannot evenly divide the space between for the individual hours. Try changing the latitude in the applet to the right and see how the hour marks change.

There are several ways to overcome these problems. One is to build a *horizontal* sundial, where the base plate is level, and the "stick," called the style, is angled so it is parallel to the earth's axis. The hour marks can then be drawn by trigonometric calculations, correcting for the sundial's latitude.

Another solution is an *equatorial* sundial, where the base plate is titled at an angle equal to the latitude, and the style is perpendicular to the base, which will align it with the earth's axis. The base can then be marked with regularly-spaced hour marks.

Hour

Our word *hour*, and the Greek and Latin *hora* come from the Ancient Egyptian *har* or *hor*, meaning "the day" or "sun's path." The Egyptians worshipped the god *Horus*, son of Osiris and Isis, as the god of dawn. Horus was represented in hieroglyphics as a hawk-headed man, and the sparrow-hawk was sacred to him.



The Seasons

The tilt of the earth's axis is the reason for our seasons. Try aiming a flashlight straight down at the floor and notice the size of the light beam. Now tilt the flashlight (the earth is tilted 23° 27') and notice how the light beam is spread out over a larger area. In the same way, heat from the sun is spread out over a larger area in the winter.

How do we know to tilt a sundial by our latitude?

next 

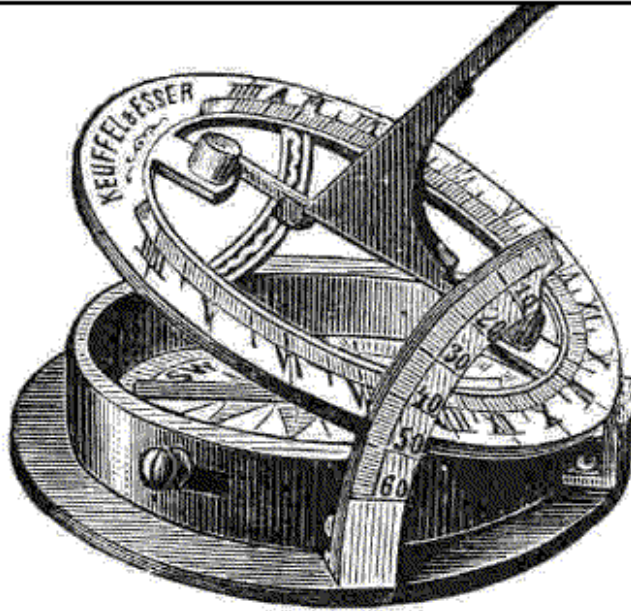

Time Zones

There are currently 24 time zones, right? Well, not quite. There are several nations that have established time zones that are 30 minutes different from the "standard" zones. So there are actually 29 zones!

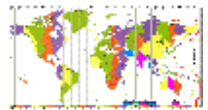

How do we know to tilt a sundial by our latitude?

next 

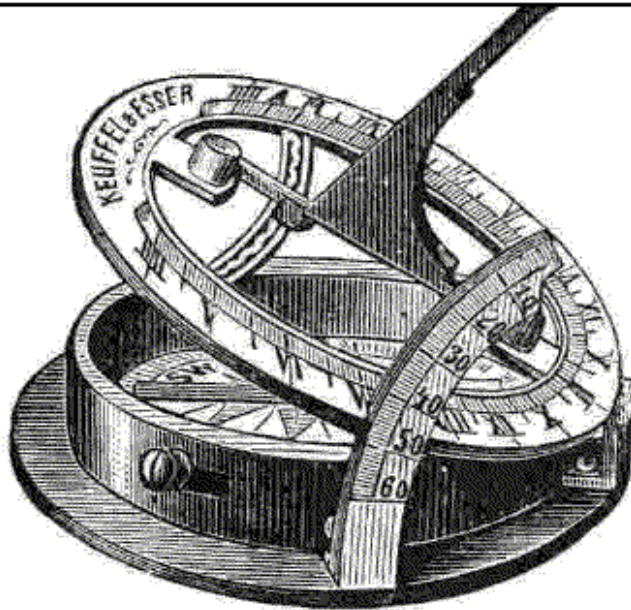

Oh, yes, there's one more problem. Sundials only measure *local solar time*. If a friend had a sundial 5 degrees longitude to the west of your sundial, his sundial would read a different time than yours. This is a simple calculation: the earth turns 360 degrees in about 24 hours, therefore the sun's apparent position moves $360/24 = 15$ degrees each hour. So your friend's sundial would read 20 minutes different (earlier) than yours. This difference is only affected by longitude, not latitude. To standardize things, the earth was divided into 24 time zones in the 1840's, each to be one hour different from the next.

[Next: Build a Simple Sundial](#)
[Previous: What is a Sundial](#)

Updated February 10, 1999 . [Contacts](#)

ANALEMMA

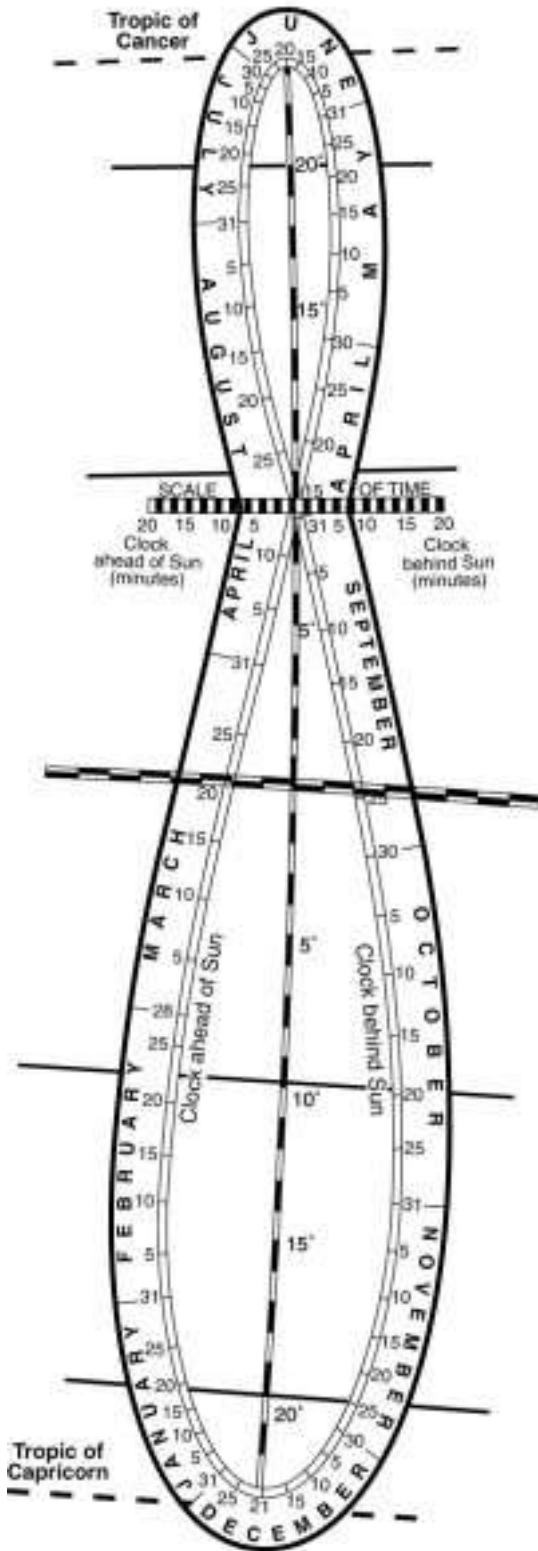





ANALEMMA

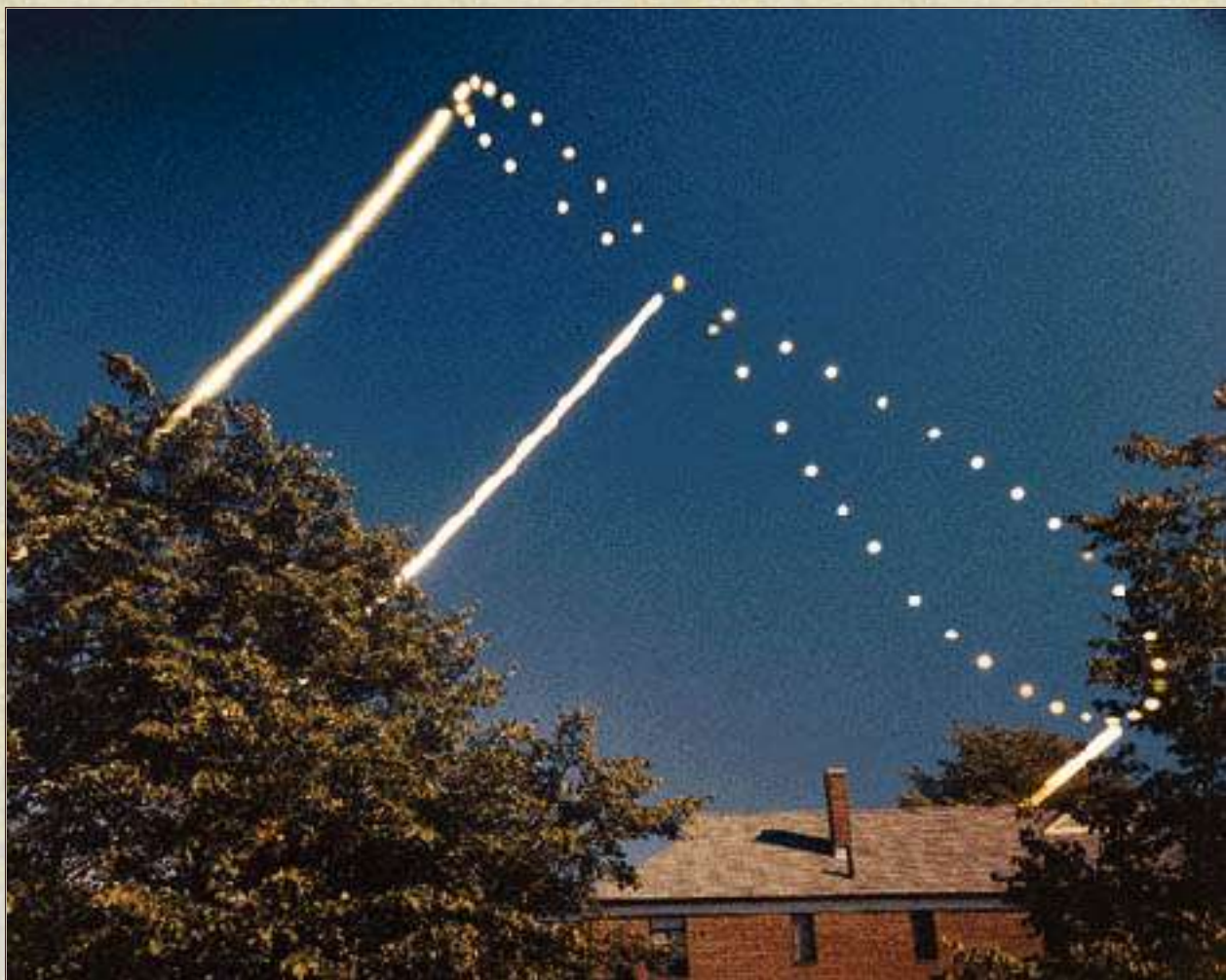

Time lapse photograph of the sun taken at 8:30 AM over a one-year period.

Photo by Dennis di Cicco

© [Sky & Telescope](#). Used with permission.



The Analemma Society

Great Falls Virginia

Analemma Society construction class

Building an analemma curve

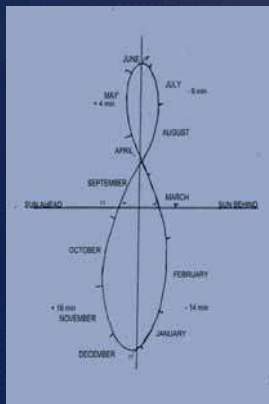

Figure #1, 19th Cent. Analemma

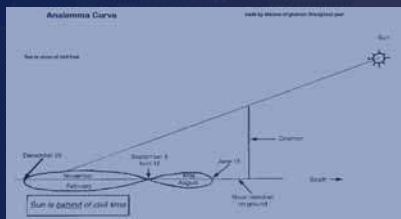

Figure #2, Building an analemma curve

1. Draw a perpendicular to a line proportional to the gnomon.
2. Determine length of equinoctial shadow.
3. Mark off this length on gnomon. (For "Observatory Park" latitude the equinoctial shadow for a 20' gnomon is 15' 6".)
4. From the point of intersection of gnomon and line, make a mark to the right on the line and on the gnomon the length of the equinoctial shadow.
5. Connect, with straight line, top of gnomon to mark on line; this is equinoctial shadow of gnomon.
6. Construct a circle from top of gnomon using length of gnomon as radius; this is the meridian.
7. Construct a straight line through circle parallel to line using length of gnomon as distance; this is known as the horizon.
8. Calculate $1/15$ of circumference.
9. Using this length as radius, make two marks on circle on intersection of equinoctial shadow line and circle.
10. Draw lines from top of gnomon through two points of intersection of the two circles. Line on right is winter solstice sun-ray; line on left is summer solstice sun-ray.
11. From these two points of intersection, draw two lines to opposite side of circle parallel to the equinoctial shadow line; these are called winter and summer diameters.
12. Divide these two lines in half.
13. Construct two semicircles using these points on the outside of the lines. Semicircle on right represents

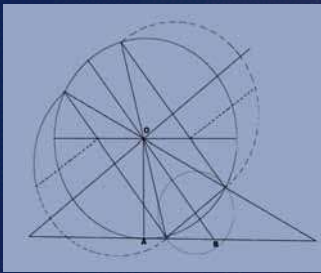

Figure #3, Greek analemma, drawn for a 20' gnomon, Greek hours, 90; projection not shown

OA - Length of gnomon

AB - Length of equinox shadow

summer hours; semicircle on left represents winter hours.

14. Extend summer and winter solstice shadow lines to opposite side of circle.
15. Construct straight line through circle connecting centers of the two semicircles; this is the axis.
16. From the intersections of summer and winter diameters, construct line parallel to axis to semicircles.
17. Construct parallel line connecting the points of intersection of the two circles.
18. Using intersection of this line with the equinoctial line as center, describe a circle that passes through intersections of the meridian circle with the summer and winter solstice lines.

[Support the Observatory Park project](#)

[Contact us](#)

[Join the Analemma Society](#)

[Home](#) / [Roll-top Project](#) / [Support Roll-to Project](#) / [Mission](#) / [By-laws](#) / [Park](#) / [History](#) / [Park project](#) / [Reference](#) / [Dark skies](#) / [Telescopes](#) /

[Educational adults](#) / [Educational students](#) / [Community](#) / [Events](#)

[FEBRUARY 21TH :](#)

[Attend our benefit luncheon and help developping astronomy activities in the Observatory Park of Great Falls](#)

[*Our sky tonight](#)

[*Roll-Top Observatory Project](#)

[Support the roll-top observatory project](#)

[Observatory Park Calendar of events](#)

[*Mission](#)

[*By-Laws](#)

[*Existing buildings and future plans](#)

[*History of the site](#)

[*The Analemma Society Park project](#)

[*Reference:Pascal](#)

[Moon Easter](#)

[*Great Falls dark skies](#)

[*Telescopes](#)

[*Educational program adults](#)

[*Educational program students](#)

[*Related Web Sites](#)

[The President's Pen:](#)

[*THE ANALEMMA, origin and definition](#)

[Construction class](#)

:

Analemma Society

Observatory Park Great Falls, Virginia

Latitude N 38° 59' 40", Longitude W 77° 18' 45"

A park to learn science as it developed through astronomy

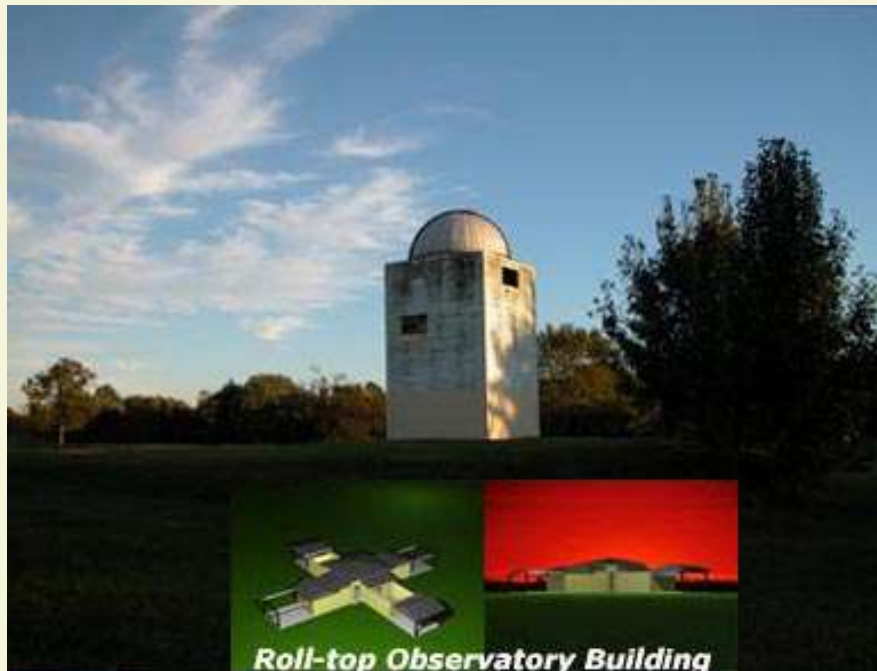

The Analemma Society, formed in 1998, is developing an astronomy park where students can learn about the origin and nature of science as well as experience first hand the wonders of the Universe.

This is a great opportunity for Northern Virginia Schools and the community to observe the day and night sky.

Support our project and get involved by becoming a member. Use this web site for details on membership, send your support using this web site.

Copyright © 2000-2003, Analemma Society. All rights reserved.

[Contact us](#)

[VIEWING :](#)

Park is open to the public for viewing every Friday night from 7:30 pm weather permitting (Check by clicking [HERE](#) the weather forecast for Great Falls and [HERE for detailed sky](#) and temperature information). To check special openings see our [calendar](#) or contact [Charles Olin](#)

[DIRECTIONS](#)

Park is located in Great Falls, VA, at the corner of Springvale Road and Georgetown Pike (Rt.#193). Please click [HERE](#) for detailed map of Observatory Park access and parking)

The 2004 bond referendum is now being finalized. For the Observatory Park to be added to the referendum list we need you to show as soon as possible your

[*THE GREEK ANALEMMA](#)

Weather forecast :



interest and support.
[BOND REFERENDUM SUPPORT](#)

[Click here and view the Observatory Park interactive master plan](#)

***Support / Join**

[*Become a member](#)
[*Support our project](#)
[*Tell us what you think about this project](#)

[News from NASA](#) : The Space Calendar covers space-related activities and anniversaries for the coming year. Included are over 1,000 links to related home pages. This Calendar is compiled and maintained by Ron Baalke

[Monthly Calendar](#)

Pages From a Dialist's Notebook

An Indoor Annalemma

In the fall of 1995 I moved to a new home where I placed my office in a room high in the north east corner of the building. The room has a large east-facing window through which the sun came - suddenly and brightly - each morning at about 7:30. At first I found this annoying, but then I realized I could take advantage of the situation and project an 8:00am analemma which would demonstrate the **Equation of Time**. Preliminary observations indicated that the analemma would wind its path across the walls, furniture and floor on the west side of the room.

I mounted a cardboard arrow high on the east window for a gnomon, and each morning at 8:00 I placed a small Avery dot where its shadow fell at **Standard Time**. My first dot was placed on the 1995 winter solstice. During the winter the analemma snaked its way across the north wall, through a bookcase, and onto a filing cabinet on the west wall.

A GNOMON'S EYE VIEW of its own ANALEMMA
It made it! - this depiction 12-21-1996, the winter solstice

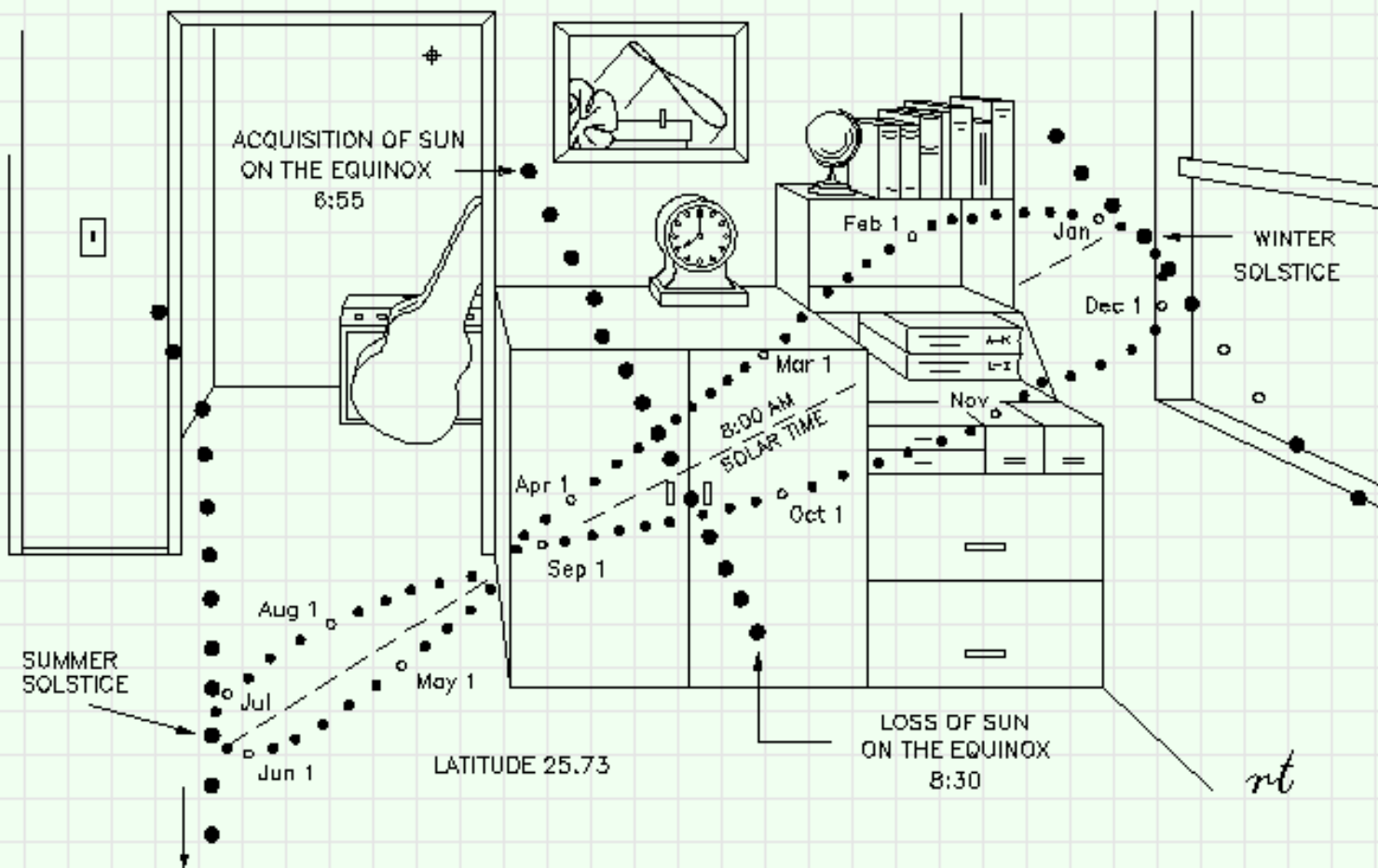

[Click in the drawing to see a color version.](#)

The morning of the vernal equinox was clear and sunny. I placed dots at 5 minute intervals following the path of the shadow as long as the sun entered the room.

I realized from the Loss Of Sun on the equinox that I was in for some damage control. An eave overhanging the window was going to block the sun during high summer. Also, the point where the loops of the analemma crossed was going to come right where the shadow dropped off the filing cabinet and into the closet.

I decided to plot the smaller, summer loop with a second gnomon 10 inches below the first. This had the effect of moving the loop out into the room where it makes an interesting conversation piece. The effect of lowering the gnomon is not obvious in the drawing.

On the morning of the summer solstice, I again traced the path of the shadow, this time into and out of the closet, then across the floor. Here is a [photograph of the small loop](#) taken a few days after the summer solstice. The photo also shows a portion of the path of the summer solstice shadow as it moved across the floor.

The journey through the autumnal equinox and back across the filing cabinets was uneventful, and eventually the shadow crept up onto the north wall.

Although the morning of the winter solstice was cloudy I had already placed enough dots to indicate that analemma had found its home, and the year-long project was successfully completed.

The timing for the placement of the dots was provided by [The Dialist's Companion](#), a program written by Fred Sawyer and myself recently published by [The North American Sundial Society](#).

Analemma started 12-21-1995. Drawing started and put on line 6-22-1996. Updated 7-6, 8-21, 9-24, 10-16, 10-30, 11-10, 11-23, 11-30, 12-9, 12-21 of 1996

[Return to The](#)



[Dialist's Notebook](#)

The M&M Millennial Analemma



The children are working on our *analemma*, marking the position of the sun, as shown by a shadow, on their playground.

Every week or two for two years, we have run outside at *exactly* the same time and used a black permanent marker to outline the shadow cast by a ring of metal. We use a small, battery-powered, radio-controlled clock, linked to the atomic clock in Denver, CO, to get the exact time, so that we can mark the shadow at precisely the middle of the day.

This is 12:00 noon Central Standard Time and 1:00 PM during Daylight Saving Time.

We set a small alarm clock to go off five minutes before 12:00. When the alarm goes off, the kids scream "Analemma" and go into action. One grabs the RC Clock, another gets a black permanent marker, and two more begin to sweep off the spot where we will mark the shadow.

This has been one of our most successful astronomy activities. The children love it. They watch the shadow of the sun, and say things like "Look how fast it's moving!" Each child in her own way now understands that the sun is low in the wintertime and high in the summertime.

Definition of Analemma

An analemma is a plot of the declination of the sun versus the Equation of Time. The declination of the sun, loosely speaking, is how "high" it is in the sky; the Equation of Time is how far the sun time is ahead of or behind time shown by an accurate clock.

If you are over the age of 40, you may remember seeing an elongated figure 8 printed on any world globe.

For a more complete definition and explanation of the analemma, go to <http://www.analemma.com>.

[Return to Astronomy with Children](#)



Calculate and Chart the Analemma

Finding the Analemma by Computation. Given the [latitude](#) & [longitude](#) of the observer, the Sun's [altitude](#) & [azimuth](#) (**A** & **az**) at [exactly](#) 12:00 noon Standard Time, and the height of an [aperture](#) through which the Sun's image is cast (**d**), the x,y [coordinates](#) for points along the [analemma](#) may be calculated using the following formulas (after Waugh, [Sundials: Their Theory and Construction](#), pp. 21-28):

$$\begin{aligned} (1) \quad VS &= d \cdot \text{COT}(A) \\ (2) \quad BV &= VS \cdot \text{COS}(a) \\ (3) \quad BS &= BV \cdot \text{TAN}(a) \end{aligned}$$

Where:

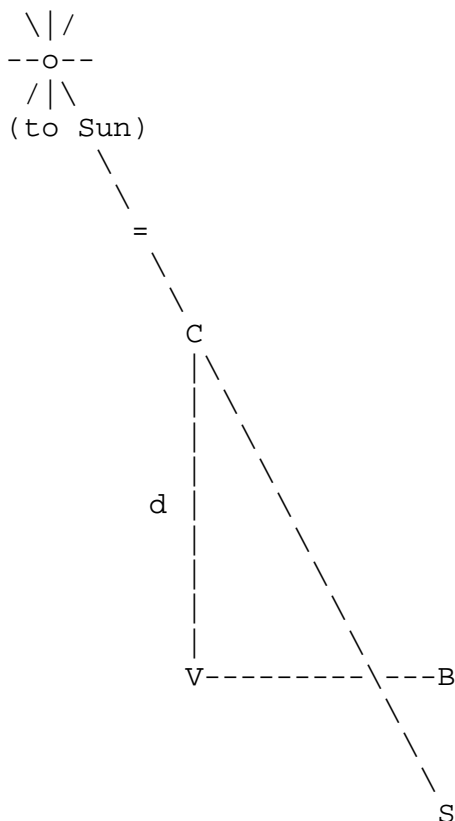

C = Sun aperture (a hole ~1/4 in. diameter)
d = 48 in. (given height of Sun aperture)
V = the base, i.e., the point on the floor (or ground) vertically below aperture
BV = the meridian
CS = beam of sunlight passing through aperture
S = Sun's image ("spot" on the floor)
 $\angle A$ = CSV (**A**litude of Sun)
 $\angle a$ = BVS (**a**zimuth of Sun or angle from the south)

Note: Solar altitude & azimuth data are obtained from the USNO [Altitude and Azimuth of the Sun or Moon During One Day](#) Web page. The values for **COT(A)**, **COS(a)**, and **TAN(a)** are obtained from [Table 1](#).

Any point along the analemma can be located on the Cartesian Plane by an [ordered pair](#) of numbers (x,y), called the coordinates. The [origin](#) represents **Point V**, and in this case, also represents the center of a [compass rose](#). The y-axis represents the [meridian](#) (**BV**): north is toward the top of the y-axis; south is toward the bottom. East is

toward the right end of the x-axis; west is toward the left. Construct a [graph](#) of the approximate shape of an analemma (as projected on a horizontal surface) using the values for "x" & "y" in [Table 2](#) (see orange columns). The shortest and longest and distances from the base (**Point V**) are inferred from the values of **BV** for JUN 21 and DEC 21 respectively.

Washington, D.C., ~39°N (38°53'N), ~77°W (77°02'W)

Table 1. Altitude & Azimuth of the Sun (at 12:00 noon EST)

Month	Day	Altitude (A)	$\angle VCS = 90 - A$	$COT(A) = \text{TAN}(\angle VCS)$	Azimuth (az)	$a = az - 180$	COS(a)	TAN(a)
JAN	1	28.1	61.9	1.8728	177.0	-3.0	0.9986	-0.0524
	15	29.9	60.1	1.739	175.3	-4.7	0.997	-0.082
FEB	1	33.8	56.2	1.4937	173.8	-6.2	0.9941	-0.1086
	15	38.2	51.8	1.271	173.1	-6.9	0.993	-0.121
MAR	1	43.3	46.7	1.0611	173.0	-7.0	0.9925	-0.1227
	15	48.8	41.2	0.875	173.5	-6.5	0.994	-0.114
	21	51.2	38.8	0.804	173.9	-6.1	0.994	-0.107
APR	1	55.6	34.4	0.6847	174.7	-5.3	0.9957	-0.0927
	15	60.9	29.1	0.557	175.8	-4.2	0.9973	-0.0734
MAY	1	66.2	23.8	0.4411	176.9	-3.1	0.9985	-0.0542
	15	70.0	20.0	0.36397	176.9	-3.1	0.9985	-0.0542
JUN	1	73.1	16.9	0.3038	175.3	-4.7	0.9966	-0.0822
	15	74.3	15.7	0.281	172.7	-7.3	0.992	-0.128
	21	74.5	15.5	0.2773	171.6	-8.4	0.9892	-0.1476
Month	Day	Altitude (A)	$\angle VCS = 90 - A$	$COT(A) = \text{TAN}(\angle VCS)$	Azimuth (az)	$a = az - 180$	COS(a)	TAN(a)
JUL	1	74.0	16.0	0.2867	170.0	-10.0	0.9848	-0.1763
	15	72.4	17.6	0.317	169.2	-10.8	0.982	-0.191
AUG	1	68.9	21.1	0.3858	170.4	-9.6	0.9859	-0.1691
	15	65.0	25.0	0.466	172.7	-7.3	0.992	-0.128
SEP	1	59.3	30.7	0.5937	176.0	-4.0	0.9975	-0.0699
	15	54.1	35.9	0.724	178.6	-1.4	0.9997	-0.024
	23	51.0	39.0	0.810	179.8	-0.2	0.9999	-0.003
OCT	1	47.9	42.1	0.9035	180.8	+0.8	0.9999	0.0139
	15	42.6	47.4	1.087	182.0	+2.0	0.999	0.035
NOV	1	36.6	53.4	1.3465	182.5	+2.5	0.9990	0.0436
	15	32.6	57.4	1.564	182.1	+2.1	0.999	0.037
DEC	1	29.3	60.7	1.7819	180.8	+0.8	0.9999	0.0139
	15	27.9	62.1	1.8887	179.2	-0.8	0.9999	-0.01396
	21	27.7	63.3	1.905	178.4	-1.6	0.9996	-0.028

Washington, D.C., ~39°N (38°53'N), ~77°W (77°02'W)

Table 2. Sample Values of the Analemma (at 12:00 noon EST)

Month	Day	VS (in.)	y (in.) = BV	x (in.) = BS
JAN	1	89.904	89.814	-4.670

	15	83.472	83.222	-6.824
FEB	1	71.712	71.282	-7.7697
	15	61.008	60.581	-7.330
MAR	1	50.928	50.572	-6.220
	15	42.000	41.748	-4.759
	21	38.592	38.360	-4.105
APR	1	32.880	32.748	-3.045
	15	26.736	26.664	-1.957
MAY	1	21.173	21.141	-1.146
	15	17.471	17.445	-0.946
JUN	1	14.592	14.548	-1.193
	15	13.488	13.380	-1.713
	21	13.296	13.1497	-1.946
Month	Day	VS (in.)	y (in.) = BV	x (in.) = BS
JUL	1	13.776	13.569	-2.388
	15	15.216	14.942	-2.854
AUG	1	18.528	18.269	-3.087
	15	22.368	22.189	-2.840
SEP	1	28.512	28.455	-1.992
	15	34.752	34.742	-0.834
	23	38.880	38.876	-0.117
OCT	1	43.392	43.349	+0.607
	15	52.176	52.124	+1.824
NOV	1	64.656	64.591	+2.842
	15	75.072	74.997	+2.775
DEC	1	85.536	85.450	+1.196
	15	90.658	90.649	-1.265
	21	91.440	91.403	-2.559

Figure 1.0 Approximate shape of an analemma projected on a horizontal surface. The analemma shows the Sun's annual north-south and east-west migration caused by changes in the Sun's [declination](#) (see reference [table](#)) and [Equation of Time](#) (see reference [table](#)) respectively.

The actual shape and orientation of the analemma depends upon the time of day as well as the time difference between the location of the observer and

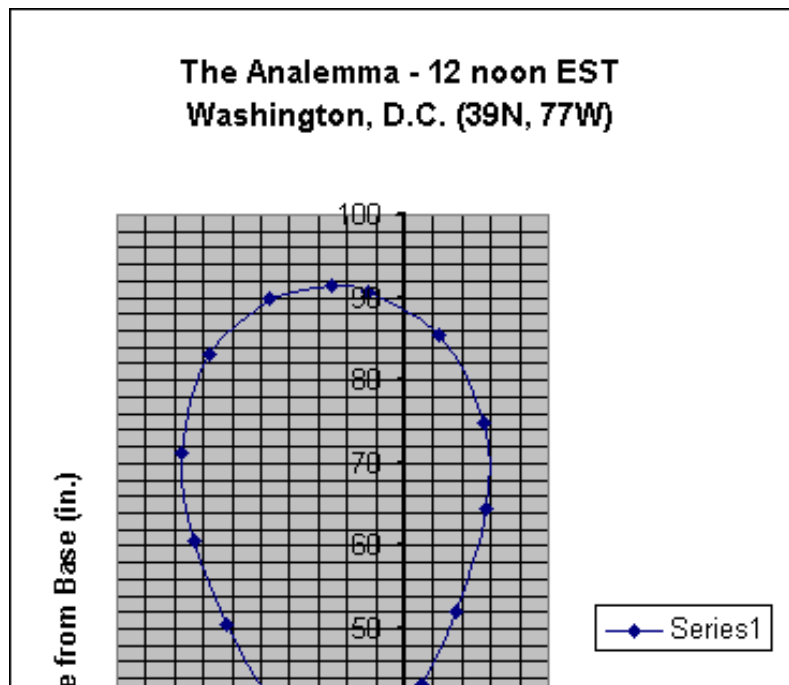

the [Standard Time Meridian \(STM\)](#):

▶ See a side-by-side comparison of the analemma for the same location at two different times: Washington, D.C. at [10 a.m. & 12 noon](#).

▶ For locations east of the STM, the figure eight is offset to the right of the y-axis; for locations west of the STM, the offset is to the left. For example,

Washington, D.C. (77°W) is located two degrees west of the STM for the Eastern [Time Zone](#) (75°W), therefore the noon analemma for D.C. (shown right) is offset to the left of the y-axis (meridian). Contrast the shape and orientation of the D.C. analemma with the analemma for the [ETZ STM](#) (at the same latitude and time). See a side-by-side comparison of the analemmas for the same latitude (39°N) at two different longitudes: [75 \$^{\circ}\text{W}\$ and 77 \$^{\circ}\text{W}\$](#) (at 12 noon).

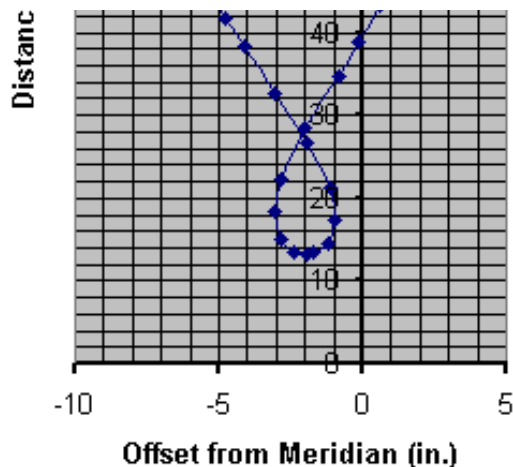

Experiment with analemmas for other locations (both real-sky and projected) as well as the Equation of Time using [SunAnalemma.xls](#), the Microsoft® Excel workbook by Dr. Robert L. Kellogg, Treasurer, [North American Sundial Society](#). Download and open the workbook. At the following external prompt, click the "Enable Macros" button:

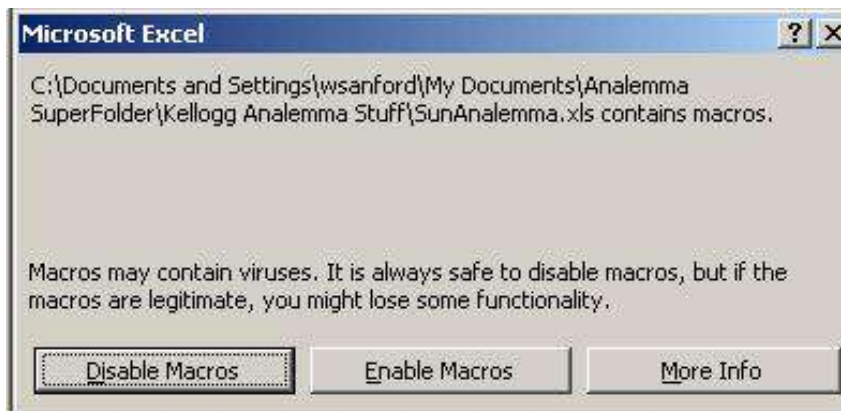

[Note: If you launch Microsoft Excel from within Microsoft Internet Explorer, the following prompt appears in an external dialog box:

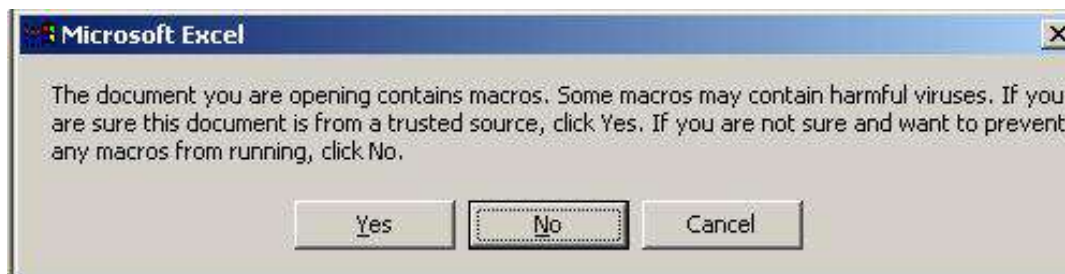

The [Sandburg Center for Sky Awareness](#) is a trusted source; click the "Yes" button.] ENTER the "Longitude of [Standard Time] Meridian" and "Longitude of Concern" (e.g., your longitude). Voila!

Related Resources

- [Charting an Indoor Analemma](#), honoring the work of the late Dr. James R. Griffith, Ph.D., [U.S. Naval](#)

[Research Laboratory](#), Washington, D.C.

- [An Indoor Analemma](#) projection by Robert Terwilliger, Coconut Grove (Miami), Florida (Webmaster, [North American Sundial Society](#))
- [The M&M Millennial Analemma](#), an outdoor analemma projection by Michael Kauper, Minneapolis, Minnesota (See also *Astronomy with Children: Our Backyard Analemma Project*, [Sky & Telescope](#) magazine, March 2003, pp. 77-81.)
- Determine the exact time of day by using a radio-controlled atomic clock, such as the [ExactSet" RM806](#) from [Oregon Scientific, Inc.](#)

© Copyright 2003-2004 [Walter Sanford](#). All rights reserved.

[Me and My Shadow - Making the Sun-Earth Connection](#) | [SCSA Home](#)

Position of the Sun at Noon Washington, DC

Click on the image to view a full-resolution PDF file (only 11 kB).

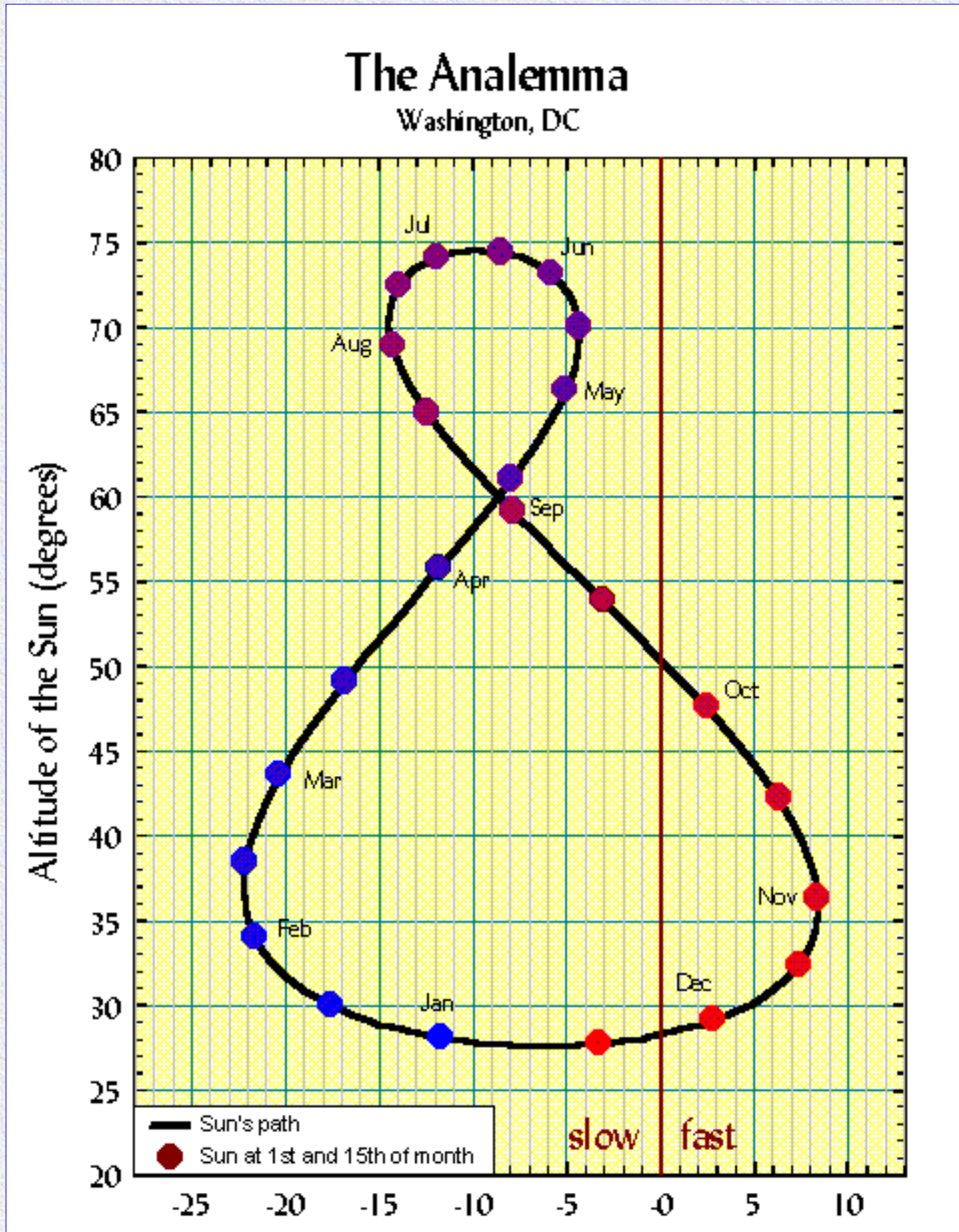

Offset of the Sun (minutes)

For a very nice web site with information about analemmas, see <http://www.analemma.com/>

[Marc A. Murison](#) *Astronomical Applications Dept.*

U.S. Naval Observatory

19 November 1996

The globe shows
24 standard meridians

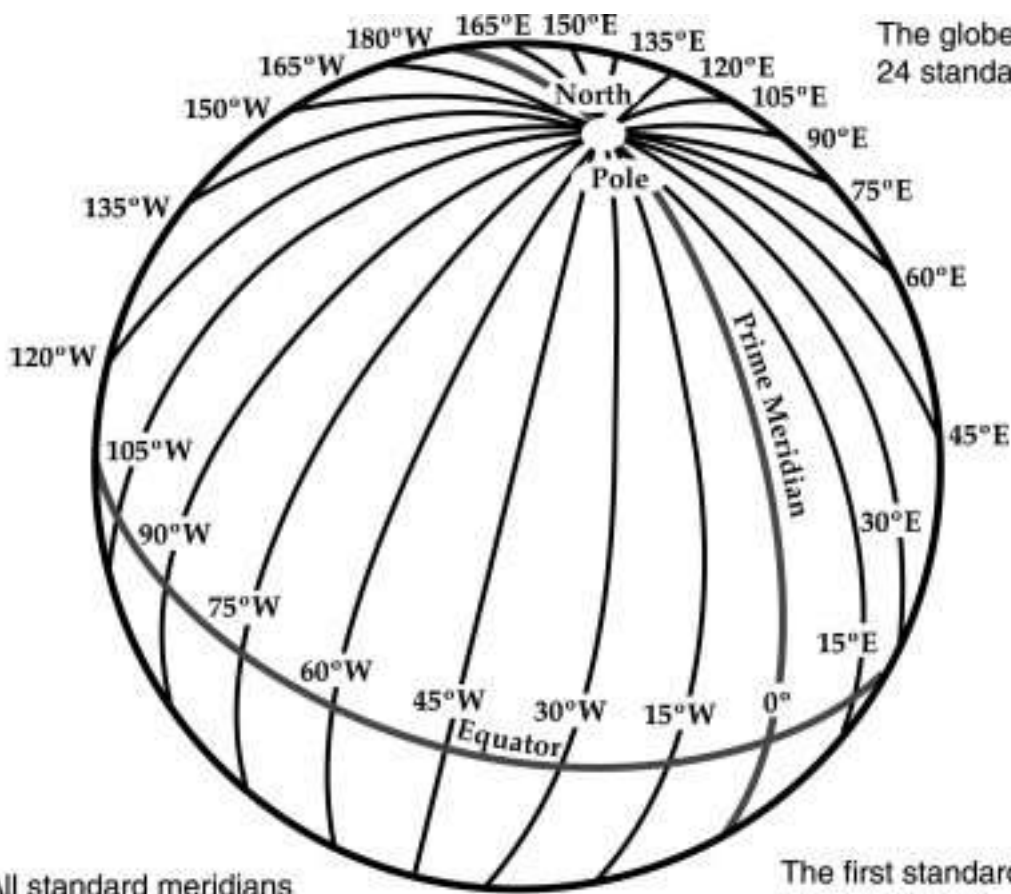

All standard meridians
are 15° apart

The first standard
meridian is the
Prime Meridian

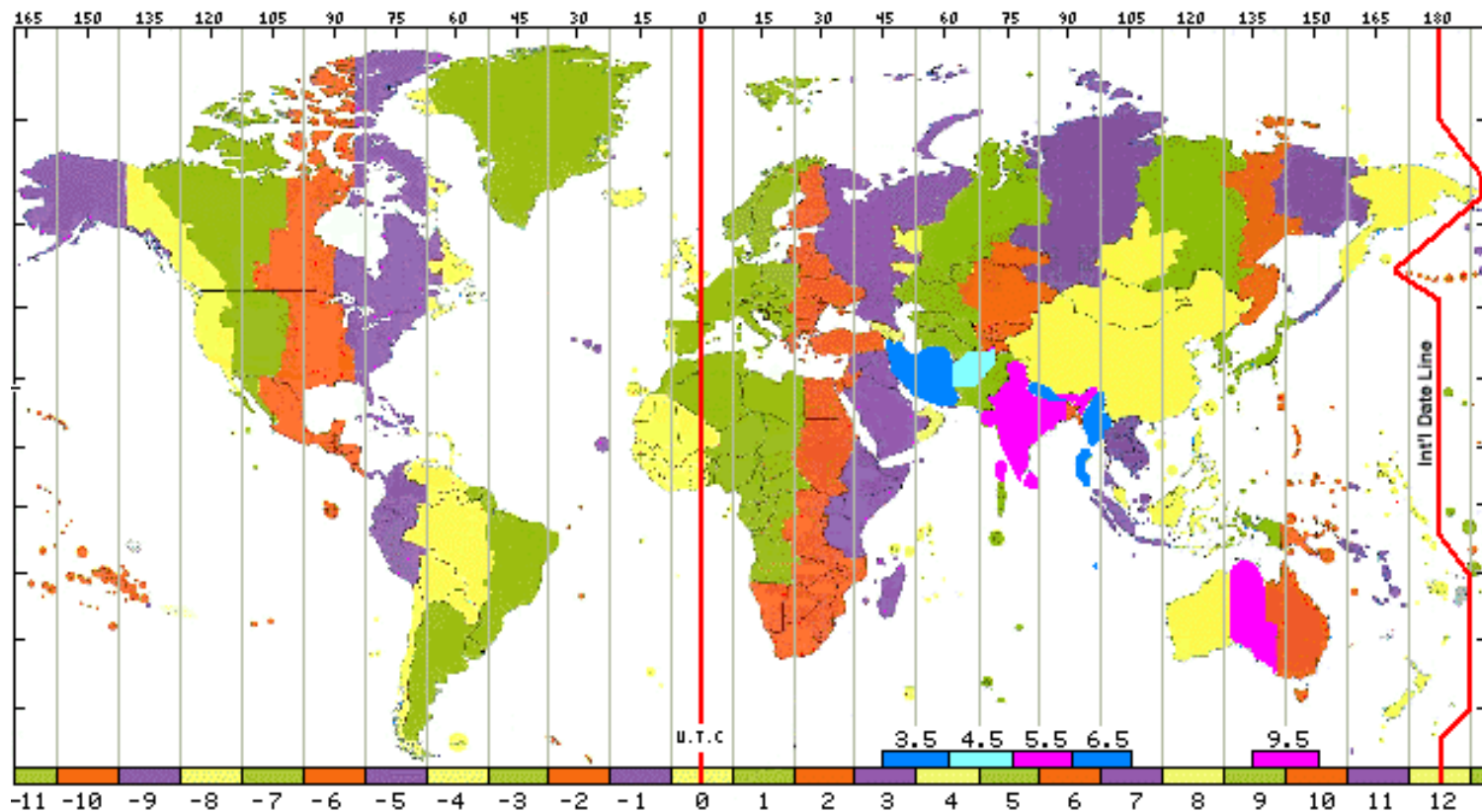

ALTITUDE

Height above the surface of a planet, measured as an angle between 0 degrees at the [horizon](#) and 90 degrees at the [zenith](#).

[scsa home](#) | [mission & goals](#) | [scheduling](#) | [site visits](#) | [curriculum](#) | [planetarium visits](#)
[what's up?](#) | [sos](#) | [com](#) | [special events](#) | [resources](#) | [wow!](#) | [what's new?](#) | [contact us](#) | [credits](#)

"Ye stars! Which are the
poetry of heaven!"
- Lord Byron (1788-1824)

"To see the world in a grain
of sand,
And heaven in a wildflower;
Hold the universe in the
palm of your hand,
And eternity in an hour."
- William Blake

Visit the [Sandburg Sky Poetry](#) Web page, including CSMS student-authored sky poems.

Sandburg Center for Sky Awareness
A Fairfax County Public Schools Planetarium
['00-01 Special Events](#) | ['99-00 Special Events](#) | ['98-99 Special Events](#)

Special Events for 2001-2002

(Events sorted in reverse chronological order, ending SEP 2001.)

NEW

The Dog Days of Summer

Ever heard the expression, "the dog days of summer?" "*Dog Days* is the name for the most sultry period of summer, from about July 3 to Aug. 11. Named in early times by observers in countries bordering the Mediterranean, the period was reckoned as extending from 20 days before to 20 days after the [conjunction](#) of Sirius (the dog star) and the Sun." *Source: Columbia Encyclopedia*

Sirius is much like a Greek word meaning "scorcher." The "Dog Days of Summer" refers to the time period during the summer when Sirius--the brightest star in the night sky--is high in the daytime sky, supposedly adding to the heat of the summer Sun (Sirius is searing us).

NEW

Safe Solar Observing

 There's more than meets the eye to the little yellow ball in the sky! See what you're missing--plan to attend the Smithsonian National Air and Space Museum Albert Einstein Planetarium **FREE** Monthly Star Lecture: [Safe Solar Observing](#) on **Saturday 27 July 2002** at **6:00 p.m.**

Earth at Aphelion

The shape of the Earth's orbit around the Sun is an [ellipse](#) (although it is almost perfectly circular); the point at which the Earth is farthest from the Sun is known as *aphelion*. The Earth reaches aphelion on **06 July 2002 (04h UT)**--at a distance of 94,507,300 miles, the Earth is now 3,101,000 miles farther from Sun than at [perihelion](#) on 02 January 2002. Food for thought: if the Earth is farthest from the Sun, then why is it summer in the northern mid-latitudes? The answer lies in the annual cycle of change in the apparent path of the Sun across the sky (refer to [June Solstice](#) below).

Earliest Sunrise/Latest Sunset

Washington, D.C. - From June 10-18, the Sun rises at 5:42 a.m. EDT, the earliest time of sunrise all year. From June 20 to July 5, the Sun sets at

8:37 p.m. EDT, the latest time of sunset all year.

Event	Date(s)	Time (EST)
Earliest Sunrise	06/10/02 - 06/18/02	05:42 p.m.
Latest Sunset	06/20/02 - 07/05/02	08:37 a.m.

June Solstice



The Summer Solstice occurs at 9:24 a.m. EDT on **21 June 2002**. On this date, the Sun reaches the northernmost line of latitude (the Tropic of Cancer, 23.5°N) where the midday Sun is at the zenith (the imaginary point directly overhead). At northern mid-latitude locations, the midday Sun reaches its maximum altitude (annually) and the duration of insolation (number of hours of daylight) is greatest. For example, in Washington, D.C. the midday Sun will reach an altitude of 74.5 degrees above the horizon and there will be nearly 15 hours of daylight (14h54m). Also, the Sun rises farthest to the north of east (to the far left of the Washington Monument in the accompanying photograph) and sets farthest to the north of west than at any other time of year.

It's interesting to note that the apparent paths of the Sun and Moon across the sky are exactly opposite at the solstices: near the time of the June Solstice, the Full Moon follows the path of the Sun during the December Solstice; near the time of the December Solstice, the Full Moon follows the path of the Sun during the June Solstice. For more information, see [Yin and Yang - Dynamic Equilibrium in the Universe](#).

By jimminy, it's time to say, "Bye, Gemini!"



Ever heard the old expression, "by jimminy?" Originally, the phrase meant something like, "with any luck," derived from the [mythological association](#) between the Gemini Twins and good luck. By the [middle of June](#), your luck has run out as the constellation Gemini (No. 3, [FCPS Starfinder](#)) slips below the western horizon shortly after 9 p.m.

National Hurricane Awareness Week

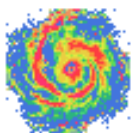

The National Weather Service has declared **May 19-25, 2002** as **National Hurricane Awareness Week**. Each day of the week will have a special emphasis:

SUN : History
 M-W : Hurricane Hazards
 THU : Forecast
 FRI : Prepare
 SAT : Take Action

"The goal of [Hurricane Awareness Week](#) is to educate you about the hazards of Hurricanes and provide you with knowledge which can be used to help protect you, your family, and your property." [Quote courtesy the NOAA/NWS [Tropical Prediction Center](#) (TPC), formerly known as the National Hurricane Center (NHC).]

Sandburg Sun-Earth-Moon Day 2002



Weather permitting, the Sandburg Planetarium will host "[Sun-Earth-Moon Day](#)" on **Mon., 06 May 2002**, from **8:30 a.m. 'til 2:40 p.m.** (Rain Date: Tue., 07 May.) The event is timed to coincide as closely as possible with [Space Day](#) (Thu., 02 May) and the [Last Quarter Moon](#) (Sat., 04 May). Amateur astronomers from the Maryland Sidewalk Astronomers (MSA), [National Capital Astronomers](#) (NCA), [Northern Virginia Astronomy Club](#) (NOVAC), and [Shenandoah Astronomical Society](#) (SAS) have volunteered to be our guides for a day of [sundialing](#), [safe sunspot observing](#), and [Moon-watching](#).

***Editor's Note:** Good friends and good conditions combined for a great day for firsthand observation of the real sky: fair weather prevailed for most of the day (relatively clear skies and comfortable temperatures); and the daily sunspot number was high (317). In a word, S-E-M Day 2002 was another smashing success! For details, read [Sandburg "Sun-Earth-Moon Day 2002"](#) - a special report highlighting Sandburg Planetarium's local celebration of Space Day.*

Astronomy Day at Huntley Meadows Park

Due to inclement weather, AD@HMP has been rescheduled for Sunday, 28 April, 3-9 p.m.

Weather permitting, join [Planetarium Teachers](#) from Fairfax County Public Schools (Sandburg, Edison, & TJHSST), volunteers from the [Northern Virginia Astronomy Club](#) (NOVAC), and Fairfax County Park Authority Naturalists for a local celebration of [National Astronomy Day 2002](#) on **Saturday, 20 April 2002**, at [Huntley Meadows Park](#), Fairfax County, VA.



 A variety of activities are planned. From **3:00 'til 9:00 p.m.**, astronomy experts will be on-hand to provide guidance and answer questions. Planetarium Teachers will provide a guided tour of the evening sky, featuring all five of the [visible planets](#) as well as [prominent stars & constellations](#) visible with the unaided eye. Binoculars and

telescopes will be available for public observation of day and night sky phenomena, including sunspots (3:00 - 6:00 p.m.), the First Quarter Moon (day & night), planets, especially Jupiter and Saturn (beginning at twilight), and other night sky targets such as binary stars, star clusters, and galaxies.

Two formal workshops (reservations required) will be held at the Huntley Meadows Park Visitor Center:

- **4:00 - 6:00 p.m. - Making & Using an Equatorial Sundial/Real-Sky Solar Observation;** and
- **6:30 - 9:00 p.m. - Making & Using a Starfinder/Night Sky Observation**

Workshops are open to adults and families with children nine (9) years and older. Space may be infinite, but in this case, space is limited! For more information or to make reservations, contact Kitty Keller, FCPA Naturalist, at 703-768-2525.

Rain Date: Sunday, 28 April 2002

[Astronomy Day@HMP is part of the program, "Bringing Astronomy to the People"--the Sandburg Planetarium public outreach initiative for 2001-2002.]

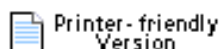

***Editor's Note:** During a three-hour window of opportunity between morning and evening rain events, approximately 50-70 people participated in AD@HMP. See photographs of the [special event](#) as well as the [park](#), courtesy Phil Wherry.*

A Gathering of Planets

During late-April and early-May, all five planets visible with the unaided eye can be seen in the western sky during twilight. For more information, including graphics illustrating where to look for the planets from 20 April 'til 03 June 2002, visit [A Gathering of Five Planets](#), courtesy the Henry Buhl, Jr. Planetarium and Observatory, Carnegie Science Center. For additional narrative and graphics, see either [Planets Gather in Evening Sky](#), a 15 March 2002 press release from Griffith Observatory, or [Spring's Dancing Planets](#), courtesy Astronomy.com.

First 90-Degree Day

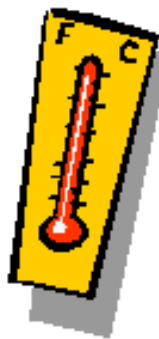

Tuesday, 16 April 2002 the high temperature at Reagan National Airport (DCA) exceeded 90°F--the first 90-degree day for the year 2002 (May 19 is the average date of the first 90-degree day at DCA; September 12 the last).

Spring Forward...



At 2:00 a.m. on **Sunday, 07 April 2002** set your clocks forward one hour to begin "[Daylight Saving Time](#)" (EDT). Something of a misnomer, we merely shift the increasing daylight hours from morning to evening. Daylight Saving Time begins on the first Sunday in April (spring forward...) and ends on the last Sunday in October (...fall back).

April is National Poetry Month

Celebrate [National Poetry Month](#) and increase your sky awareness by reading some of [Carl Sandburg's sky-related poetry](#), or by reading Carl Sandburg Middle School [student-authored sky-related poetry](#).

Comet Ikeya-Zhang

A simple comet-watching [mnemonic](#): I C IC C I-Z? (I see icy Comet Ikeya-Zhang?) Maybe. "A newly discovered comet, now approaching the Sun and Earth, could develop into a relatively bright naked-eye object in coming weeks, researchers say. The best views of the comet may be reserved for those under dark skies far from bright lights, but even city dwellers should be able to spot it. ... Ikeya-Zhang's expected path across the sky in the coming weeks will greatly favor Northern Hemisphere observers. During **most of March on into early April**, the comet will be visible near to the north-northwest horizon about an hour after sundown. Bright moonlight may hinder observations during the last week of March." [Source: [Comet makes its celestial entrance](#), courtesy MSNBC.]



As of 15 February, Ikeya-Zhang's [apparent magnitude](#) was +6.8m. For reference, +6.0 is the naked-eye limit at a dark site; +9.0 is the limiting magnitude of 50mm binoculars. Comet Ikeya-Zhang is expected to peak somewhere between +3.5 and +3.0. "The 1986 appearance of Halley's Comet, considered disappointing by many, also peaked at around magnitude 3.0. In contrast, Comet Hale-Bopp, which put on a memorable show in April 1997, attained a brightness close to magnitude -1, or about 60 times brighter than Halley." [Source: *ibidem*, MSNBC]

For more information (including graphics showing where to look in the sky for the comet), read [Comet Ikeya-Zhang](#) (updated 01 MAR '02), an

article featured at *Sky & Telescope* online.

Ikeya-Zhang Updates:

- [Finder Charts for 13-19 March 2002](#)
- [Finder Charts for 20-26 March 2002](#)
- [Finder Charts for 27 March - 02 April 2002](#)

March Equinox



The March Equinox occurs at 19:16 UTC (2:16 p.m. EST) on **20 March 2002**. The word equinox literally means "equal nights," referring to either of two times of the year when the Sun crosses the plane of the Earth's Equator and day and night are of nearly equal length, that is, about March 21 and September 21. The Sun rises exactly due east (just to the right of the Washington Monument in the accompanying photograph) and sets due west. The March Equinox is the beginning of astronomical spring in the Northern Hemisphere and autumn in the Southern Hemisphere (in the Northern Hemisphere, *meteorological* spring is MAR, APR, and MAY).

[Celebrate the Equinox and the Seasons](#) by participating in a local observance of **NASA Sun-Earth Day**, Wednesday, **20 March 2002**. [Teachers: See the [SCSA/Themes/Sun-Earth Connection](#) Web page for theme-related information resources and suggested teaching strategies.]

***Sundials & Equinoxes:** Theoretically, the [gnomon](#) (or [style](#)) of a properly oriented [equatorial sundial](#) will not cast a shadow on the [dial plate](#) during the [equinoxes](#). Because the dial plate of an equatorial sundial is [parallel to the Earth's Equator](#), the Sun is directly over the edge of the dial plate on the equinoxes, when the Sun is at the [zenith](#) along the Equator. From the March Equinox to the September Equinox, when the Sun is at the zenith in the Northern Hemisphere (between 0° and 23.5°N lat.), the gnomon shadow falls on the [upper dial face](#); from the September Equinox to the March Equinox, when the Sun is at the zenith in the Southern Hemisphere (between 0° and 23.5°S lat.), the gnomon shadow falls on the [lower dial face](#).*

March: In Like a Lion; Out Like a Lamb.



You've probably heard the old saying, "March comes in like a [lion](#) and goes out like a [lamb](#)."



Usually, this saying is used to describe typical March weather: in the beginning of March, the weather is often wild; by the end of March, the weather is usually mild. But this modern weather proverb actually originates from astronomy: in the [late-February/early-March](#) night skies, [Leo, the Lion](#) (No. 5, [FCPS Starfinder](#)) is rising in the east ("coming in") at the same time that [Aries, the Ram](#) (lamb) is setting in the west ("going out").

Perigee & the Full Moon; the Moon Illusion

27 February 2002, the closest perigee of the year coincides with the Full Moon (see the [Lunar Perigee and Apogee Calculator](#)). Huh?



The Moon's [orbit](#) around the Earth is an [ellipse](#) (not a perfect circle), therefore the Earth-Moon distance varies: [perigee](#) is when the Moon is closest to the Earth; [apogee](#) is when the Moon is farthest. Does the Earth-Moon distance vary enough to affect the apparent size of the Moon? In a word, yes (see [Inconstant Moon - The Moon at Perigee and Apogee](#) or [Big Moonshine](#)), although the difference may be imperceptible to all but the most careful observers.

Read about the "Moon Illusion," an unrelated phenomenon wherein some people perceive that the Moon appears to be larger when it is near the horizon than when it is higher in the sky:

- [Explaining The Moon Illusion](#) - why the Moon looks larger close to the horizon (by Lloyd Kaufman and James Kaufman for the Proceedings of the National Academy of Sciences) [reference: USNO Data Services [FAQ](#)]
- [Scientists Offer Answer to Baffling Lunar Illusion](#)

Moon Occults Saturn

[Webster's Dictionary](#) defines *occult* (transitive verb) as "to shut off from view or exposure, to cover, or eclipse." On **20 February 2002**, the [Moon occults Saturn](#). Slightly past First Quarter, the Moon is 55% illuminated (right side). In Washington, D.C., Saturn disappears behind the Moon's dark limb (upper left side) at 7:17 p.m. EST; it reappears on the bright limb (slightly above center, right side) at 8:39 p.m. The Moon's limb takes approximately two minutes to cover/uncover Saturn from ring tip to ring tip. The occultation may be seen with either the unaided eye or binoculars, however magnification of at least 30x is required to resolve the rings of Saturn (a small, "department store" telescope should be satisfactory).

18 February 2002 - Pluto Anniversary

Pluto was discovered 72 years ago today by [Clyde W. Tombaugh](#), February 18, 1930.

02 February 2002 - Groundhog Day

According to legend, if the groundhog sees his shadow on February 2nd, then there will be six more weeks of winter weather; if he doesn't see his shadow, then there will be an early spring. [Hogtivities](#) provides a list of activities for celebrating **Groundhog Day** with younger students.

Editor's Note: Punxsutawney Phil saw his shadow, and we know what

that means.... Sigh!

Cold Facts to Warm Your Heart!

At last, winter's icy grip may be slipping! **Tuesday, 29 January**, the daily average temperature in Washington, D.C. begins increasing--yippee!!!

Latest Sunrise/Earliest Sunset

The date(s) of latest sunrise occurs at the end of December/beginning of January; the date(s) of earliest sunset occurs in early December:

Event	Date(s)	Time (EST)
Latest Sunrise	12/31/01 - 01/10/02	07:27 a.m.
Earliest Sunset	12/02/01 - 12/12/01	04:46 p.m.

Earth at Perihelion

The shape of the Earth's orbit around the Sun is an [ellipse](#) (although its orbit is almost perfectly circular); the point at which the Earth is closest to the Sun is known as *perihelion*. The Earth reaches perihelion on **02 January 2002 (14h UT)**. Food for thought: if the Earth is closest to the Sun, then why is it winter in the northern mid-latitudes? The answer lies in the annual cycle of change in the apparent path of the Sun across the sky (refer to [December Solstice](#) below).

December Solstice - Happy Solar New Year!



The Sun reaches the December Solstice at **19:21 UTC (02:21 p.m.) on 21 DEC 2001**, marking the beginning of astronomical winter in the Northern Hemisphere and summer in the Southern Hemisphere (in the Northern

Hemisphere, *meteorological* winter is DEC, JAN, and FEB). On this date, the Sun reaches the southernmost line of latitude (the Tropic of Capricorn, 23.5°S) where the midday Sun is at the zenith (the imaginary point directly overhead). At northern mid-latitude locations, the midday Sun reaches its minimum altitude (annually) and the duration of insolation (number of hours of daylight) is least. For example, in Washington, D.C. the midday Sun will reach an altitude of 26.5 degrees above the horizon and there will be 9h26m of daylight. Also, the Sun rises farthest south of east (to the far right of the Washington Monument in the accompanying photograph) and sets farthest south of west than at any other time of year.

It's interesting to note that the apparent paths of the Sun and Moon across the sky are exactly opposite at the solstices: near the time of the December Solstice, the Full Moon follows the path of the Sun during the June Solstice; near the time of the June Solstice, the Full Moon follows the path of the Sun during the December Solstice. For more information,

see [Yin and Yang - Dynamic Equilibrium in the Universe](#).

December's Gems/Boardwalk Astronomy



The Geminid meteor shower peaks on the night/morning of **December 13/14**.

Under ideal conditions, as many as 120 meteors per hour might be seen. This year, the New Moon will not be a source of light pollution. To find Gemini (the shower radiant), refer to the [December FCPS Starfinder](#) which shows the 9 p.m. mid-December sky; Gemini is constellation No. 3, rising above the eastern horizon [to the upper-left of Orion, the Hunter (No. 1)]. For more information, visit [SKY Online's Meteor Page](#).



Weather permitting, join the **Sandburg Planetarium Teacher**, volunteers from the [Northern Virginia Astronomy Club](#), and Fairfax County Park Authority Naturalists for an informal night of meteor- and skywatching at [Huntley Meadows Park](#). Binoculars and telescopes will be available for public observation. Dress warmly! Bring a blanket &/or a lawn chair. Plan to meet at the Visitor Center around 9-ish on 13 DEC; as a group, we will venture out to the boardwalk/wetland trail in the middle of the park. For more information or to make reservations (required), contact Kitty Keller, FCPA Naturalist, at 703-768-2525. [Part of the program, "Bringing Astronomy to the People"--the Sandburg Planetarium public outreach initiative for 2001-2002.]

***Editor's Note:** More than 70 people registered to participate in the "Boardwalk Astronomy" event (many more folks were wait-listed); regrettably the event was cancelled due to inclement weather. Thanks for your interest!*

Earliest Sunset/Latest Sunrise

The date(s) of earliest sunset is near the beginning of December; the date(s) of latest sunrise follows a couple of weeks later:

Event	Date(s)	Time (EST)
Earliest Sunset	12/02/01 - 12/12/01	04:46 p.m.
Latest Sunrise	12/31/01 - 01/10/02	07:27 a.m.

Hurricane Season Ends

Hurricane Season in the Tropical Atlantic Ocean ends **November 30th**. The 2001 hurricane season was relatively inactive.

Once in a Blue Moon

During November 2001, there are two Full Moons: the first Full Moon occurs on NOV 1; the second Full Moon is on NOV 30. When two Full Moons occur in the same



month, the second is referred to as a *Blue Moon*. Well, that's the most widely used modern definition of a Blue Moon. Visit the [Blue Moon Folklore](#) Web page for a comprehensive review of past usage of the term.

On average, Blue Moons occur once every three years (33 mo.). The next Blue Moon occurs in July 2004 (Full Moons on 02 & 31 July). The [Blue Moon](#) Web page includes a nice FAQ list, as well as a hyperlink to the [Blue Moon Calculator](#).

Music sets the mood! From the audio CD, [Classic Doo Wop: Best of The Marceles](#), listen to Track 1, *Blue Moon* (2:21).

Leonids Meteor Shower

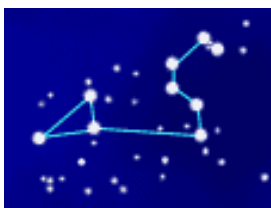

The annual [Leonids meteor shower](#) should occur on the night/morning of **November 17th/18th**, peaking on Sunday, 18 NOV around 5 a.m. EST (Washington, D.C.). Plan to watch anytime after 11 p.m.-to-12 midnight when the constellation Leo, the Lion rises above the eastern horizon--meteors will appear radiate outward from Leo. To find Leo, refer to the [January FCPS Starfinder](#) (the 9 p.m. January sky is the same as the 1 a.m. November sky); note the bright star Regulus, the heart of the lion (Letter "M") rising above the eastern horizon. For more information, visit [The Sky is Falling!](#), Astronomy.com's guide to meteors and how to watch them (also, [Heads up: Here come the Leonids](#)), or visit [SKY Online's Meteor Page](#).

Next month, December's GEMs (the Geminids meteor shower)....

***Editor's Note:** Under less than ideal conditions (urban light pollution, haze, and toward sunrise, thin fog) between 4 and 6 a.m., Sunday, 18 NOV 2001, I saw dozens of meteors, possibly more than a hundred total. In contrast, a good friend reported that, "Conditions were very, very good on Skyline Drive; we easily saw thousands [of meteors] over a period of maybe three hours. There were times when four or five were visible at once, though it was more typical to see one every second or two." Incredible!*

Beginning of Ramadan - 17 November 2001

"The Islamic calendar is based on lunar months, which begin when the thin Crescent Moon is actually sighted in the western sky after sunset within a day or so after New Moon." **Ramadan** is the name for one of the 12 months of the Islamic calendar. The New Moon occurs on 15 November 2001; the first day of Ramadan is **17 November 2001**. "The Islamic date begins at sunset on the previous evening [16 NOV] and ends at sunset on the [17th]." For details, see the U.S. Naval Observatory article, [Crescent Moon Visibility and the Islamic](#)



[Calendar](#) (source of preceding quotes).

Halloween - 31 October

The name *All Hallows E'en* means "hallowed" or "holy evening," the eve before All Saints' Day. Before that it was an old Druid festival that began at midnight and lasted throughout the following day. The festival was in honor of Crone Hecate the Destroyer who brought death to all vegetation, returning the seed of life to sleep [a simple explanation for the change of seasons from summer to fall to winter]. To honor Pomona, the goddess of fruits and seed, people shared apples and nuts.

Archeoastronomers theorize that the [Harvest Moon](#) and **Halloween** pumpkins may be related. When tilted to the left just after rising, the Full Moon's markings (the "man in the Moon") look like an orange-colored jack-o-lantern's face and it is possible that the Moon, as it appears to harvesters working into the evening during early fall, suggested the idea for the Halloween pumpkin.



Daylight Saving Time Ends



Remember the mnemonic: *Spring forward; fall back?* On the last Sunday in October (**2 a.m., Sunday, 28 October 2001**), clocks are set back one hour to return to Standard Time.

Notice how much earlier sunset seems to be! Sure sign that winter is coming: the number of daylight hours is decreasing. By the time of the December Solstice (21 DEC 2001), there will be only nine hours and 27 minutes (9h27m) of daylight--the fewest hours of daylight all year!

First Frost

On average, the first frost occurs during late October or early November for much of the Washington, D.C. metropolitan region. Tuesday morning, 09 October (a little ahead of schedule!) we observed the first widespread frost at the Sandburg Center for Sky Awareness.

A few frosty facts for Washington, D.C. (Reagan National Airport):

- Earliest occurrence of 32°F or lower in the autumn:
10 October 1895
- Latest occurrence of 32°F or lower in the autumn:
14 December 1980
- Average date of first occurrence of 32°F or lower in the autumn:
November 8th

With the onset of frosty cold temperatures, it won't be long 'til the first snowfall! In the meantime, make artificial snow by visiting [Snowflake Designer](#), a very cool (pun intended) [Shockwave multimedia](#) Web site.

October Sky

According to the NOAA [National Climatic Data Center](#), **October** is the least cloudy month for the mid-Atlantic United States. Remember, climate is "average" weather (as well as weather extremes), so expect some clouds and precipitation during the month of October. But on average, you can expect many good skygazing opportunities during the Fall. Plan your skywatching sessions by visiting the SCSA Web page, [What's up?](#)

On a related note, if the sky is overcast then you may want to spend the evening indoors reading [October Sky](#), the best-selling book by Homer Hickam (which inspired the movie of the same name). *October Sky* is the inspirational, loosely autobiographical story of a young boy from a small coal mining town in West Virginia who grew up to be a NASA engineer.

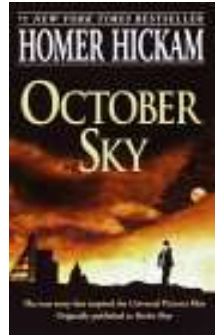

"Shine on, Shine on Harvest Moon..."

The **Harvest Moon**, named for the Full Moon occurring closest to the [September Equinox](#) (22 SEP '01), occurs on **02 October 2001**, rising in the east approximately a half-hour (29 minutes) after the Sun sets in the west. The additional light late into the evening allows farmers time to harvest their crops after sunset.

The Harvest Moon usually occurs in September, but occasionally falls in October, as it does this year.

Sidewalk Astronomy/Sandburg MS BTSN

Weather permitting, Monday evening, **24 September 2001** [before the Sandburg MS Back-to-School Night (BTSN)], join the **Sandburg Planetarium Teacher** for a quick guided tour of the evening sky, featuring real-sky observation of sunspots (before sunset), the First Quarter Moon, as well as a variety of other night sky targets including the planet Mars, prominent stars & constellations, etc. Binoculars and telescopes will be available for public observation. Volunteers from the [Northern Virginia Astronomy Club](#) will be on-hand to provide guidance and answer questions. Look for us on your way to the BTSN meeting.



Editor's Note: Regrettably, the "Sidewalk Astronomy" event was cancelled due to inclement weather.

September Equinox



The equinox occurs on **22 September 2001 at 7:04 p.m. EDT**, marking the beginning of astronomical autumn in the Northern Hemisphere and the start of astronomical spring in the Southern Hemisphere.

The Sun rises exactly due east (just to the right of the Washington Monument in the accompanying photograph) and sets due west, and day and night are approximately equal in duration. *Note: meteorological fall (SEP, OCT, NOV) begins 01 SEP.*

Sundials & Equinoxes: *On the equinoxes, the gnomon of a properly oriented equatorial sundial will not cast a shadow on the dial plate. Because the dial plate of an equatorial sundial is parallel to the Earth's Equator, the Sun is directly over the edge of the dial plate on the equinoxes (when the Sun is at the zenith along the Equator). From the March Equinox to the September Equinox, the gnomon shadow falls on the upper dial face; from the September Equinox to the March Equinox, the gnomon shadow falls on the lower dial face.*

NOVAC Star Gaze 2001

 Interested in astronomy? Not sure how to get started? Plan to attend the [NOVAC Star Gaze 2001](#), **22 September 2001**, 4:00 p.m. 'til 12 midnight, at Franklin Park in Loudoun County, VA. Sponsored by the [Northern Virginia Astronomy Club](#), a wide variety of activities (day and night) are planned.

Editor's Note: *I'm pleased to report that it was my good fortune to be able to attend my first NOVAC Star Gaze, but it won't be my last! The event was attended by several hundred NOVAC members--knowledgeable men and women who enthusiastically invited anyone who passed by to have a look at the night sky as seen through a wide variety of binoculars and telescopes. Thanks to everyone who graciously allowed me to use their equipment--good show!*

Say Goodbye to the 90s...

On average, September 12th is the last 90-degree day at Washington Reagan National Airport (DCA). For more information about fall weather in the Washington, D.C. area, visit the [WeatherNet4 Washington Fall Statistics](#) Web page. With the onset of cooler temperatures, it won't be long 'til our [first freeze](#) which, in part, triggers [leaf color to change](#).

Hurricane Season

Mid-September (specifically, 09 SEP) is the climatological peak of Tropical Atlantic hurricane season.



Why the earliest sunset, latest sunrise, and shortest day of the year occur on different dates

by John Holtz



If the first day of winter for us Northern Hemisphere dwellers is around December 21st, and this is the shortest day of the year (shortest amount of sunlight), then why does the earliest sunset occur around December 7th? Why does the latest sunrise occur around January 4th?

Winter Sunrise/Sunset Times for 79° 48.8' W, 40° 37.6' N

Date	Time of Sunrise (EST)	Time of Sunset (EST)	Length of Daylight (hh:mm)
2001 Nov 23	7:15 am	4:56 pm	9:41
2001 Dec 7 earliest sunset	7:30 am	4:52 pm	9:22
2001 Dec 21 shortest day	7:40 am	4:55 pm	9:15
2002 Jan 04 latest sunrise	7:43 am	5:05 pm	9:22
2002 Jan 18	7:40 am	5:20 pm	9:40

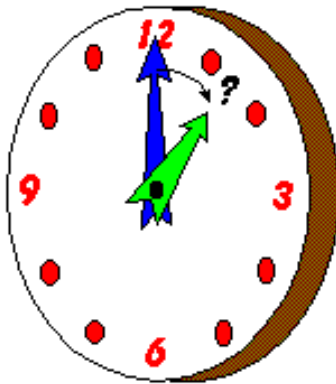

To answer this difficult astronomical puzzle, try solving this everyday puzzle first.

Puzzle: At 12 noon (12:00:00) and midnight, the hour and minute hands of a clock are perfectly aligned. (You remember those old fashion clocks with hands, correct?) At what time are the hands aligned again?

Answer: 1:05:27.2727 ([View this page for the solution](#))

Now imagine that the hour and minute hands are not connected together as they are in a real clock. Let the minute hand make one rotation in exactly 60 minutes, but let the time required for the hour hand to make one rotation vary by a few minutes. For a given period of the hour hand, you can calculate how long until the hands align again, just like you solved the real puzzle above. (You did solve the above puzzle, right?)

Surprise! The "hands of the clock" and the rotation periods that I was referring to in the clock puzzle can be replaced by the daily rotational period of the Earth (23 hours 56 minutes 4 seconds) and the revolution period of the Earth around the sun (365.25 days). If the Earth did not revolve around the Sun, then the day would be 23 hours 56 minutes long from high noon to high noon. But during the time it takes the Earth to rotate, it moves a small distance in its orbit around the Sun. Thus, the time from noon to noon is slightly longer than 23 hours 56 minutes (23:56).

Although the *average* time from noon to noon is 24 hours, the actual time varies from day to day because of two different effects. One effect that causes the variation is the Earth's orbit around the Sun — it is elliptical, not circular

(eccentricity = 0.0167). Based on Kepler's Second Law of Planetary Motion, a planet travels fastest when closest to the Sun and slowest when farthest from the Sun. The Earth is closest to the Sun around January 4th, and therefore travels farther in one day than when the Earth is farthest from the Sun around July 3rd. So, the revolution speed of the Earth around the Sun varies from day to day. (The rotational period about the Earth's axis is fixed at 23:56:04.) In the clock puzzle, this would be like changing the speed of the hour hand throughout the year, leading to a different solution.

Earth's Orbit around the Sun and the Effect on the Length of Day

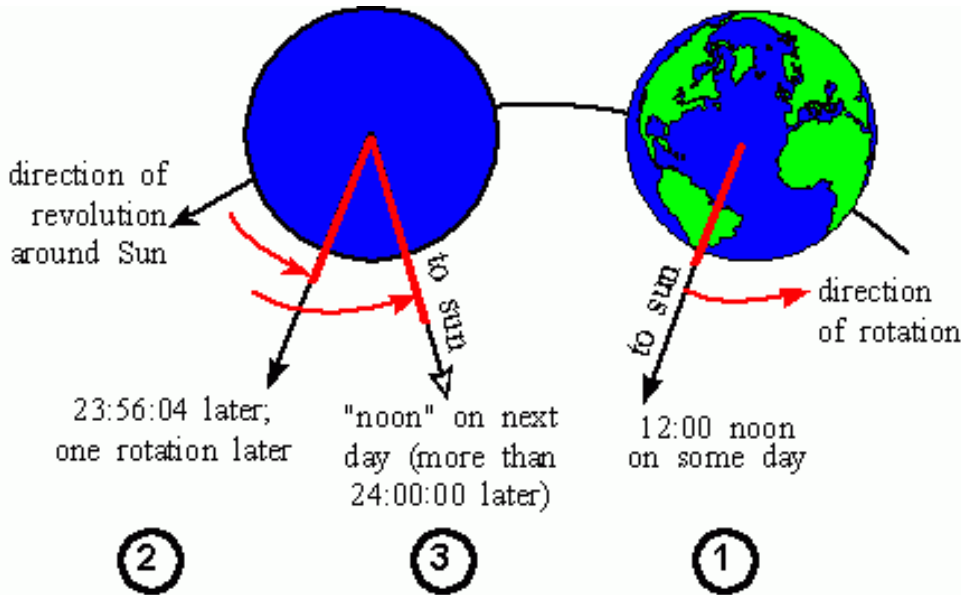

Perihelion. The Earth is closest to the Sun around January 4th. Consequently, the orbital velocity is highest on this date. As a result, the length of the day, the period from noon to noon for example, is longer than the average of 24 hours. (The additional motion of the Earth in its revolution around the Sun during the 4 minutes between steps 2 and 3 is not shown.)

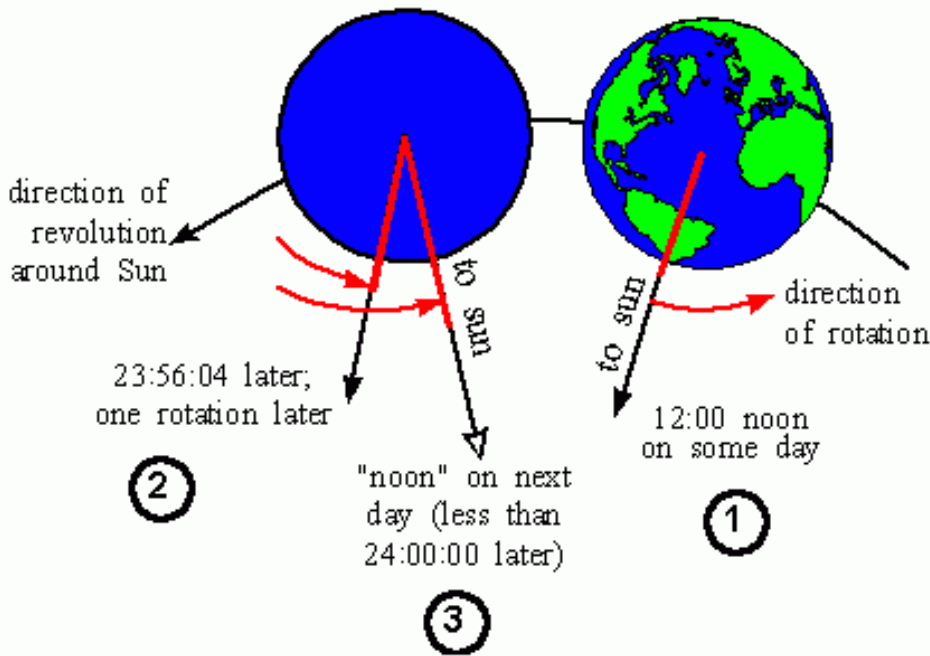

Aphelion. The Earth is farthest from the Sun around July 3rd. Because the orbital speed is slowest at this time of year, the length of the day is shorter than the average of 24 hours. (The angle between the arrows in steps 2 and 3 is smaller in this figure than between steps 2 and 3 in the perihelion figure.)

The second effect that varies the length of time from noon to noon is due to the tilt of the Earth's axis (known as the obliquity) with respect to the Earth's orbit. You are well aware of this fact but perhaps did not realize the manifestation in the sky. The obliquity causes the sun to be highest in the sky on the first day of summer (around June 21st) and lowest in the sky on the first day of winter (around December 21st).

Earth's Tilt and the Effect on the Sun's Height

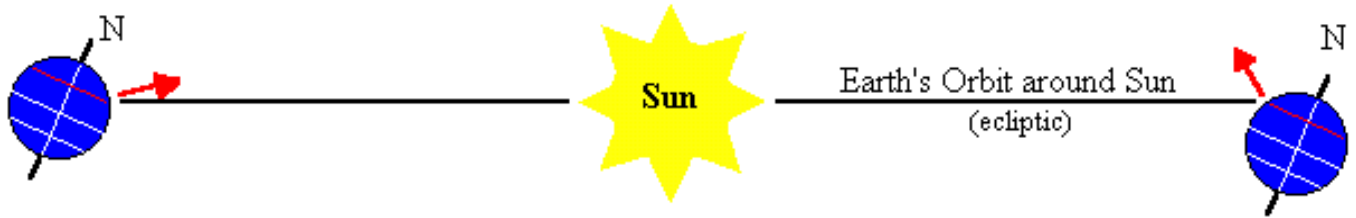

Summer. The north pole is tipped 23.5 degrees toward the Sun. The Sun appears high in the sky (straight overhead shown by red arrow).

Winter. The north pole is tipped 23.5 degrees away from the Sun. The Sun appears low in the sky (straight overhead shown by red arrow).

In reality, the Earth moves around the Sun. But for discussion purposes, it may help to imagine that the Earth is stationary while it rotates and that the Sun is moving around the Earth. To further simplify the discussion, imagine that the Sun appears to move at a *uniform rate*. The Sun moves along a path called the ecliptic, and as shown below, and it is tipped by the same 23.5 degrees to the Earth's axis. The consequence of the tilt is that the Sun appears to move at a non-uniform rate around the Earth's equator. As with the Earth's eccentricity, the varying speed results in the length of a day that is sometimes longer than 24 hours and sometimes shorter than 24 hours.

Earth's Obliquity and the Effect on the Length of Day

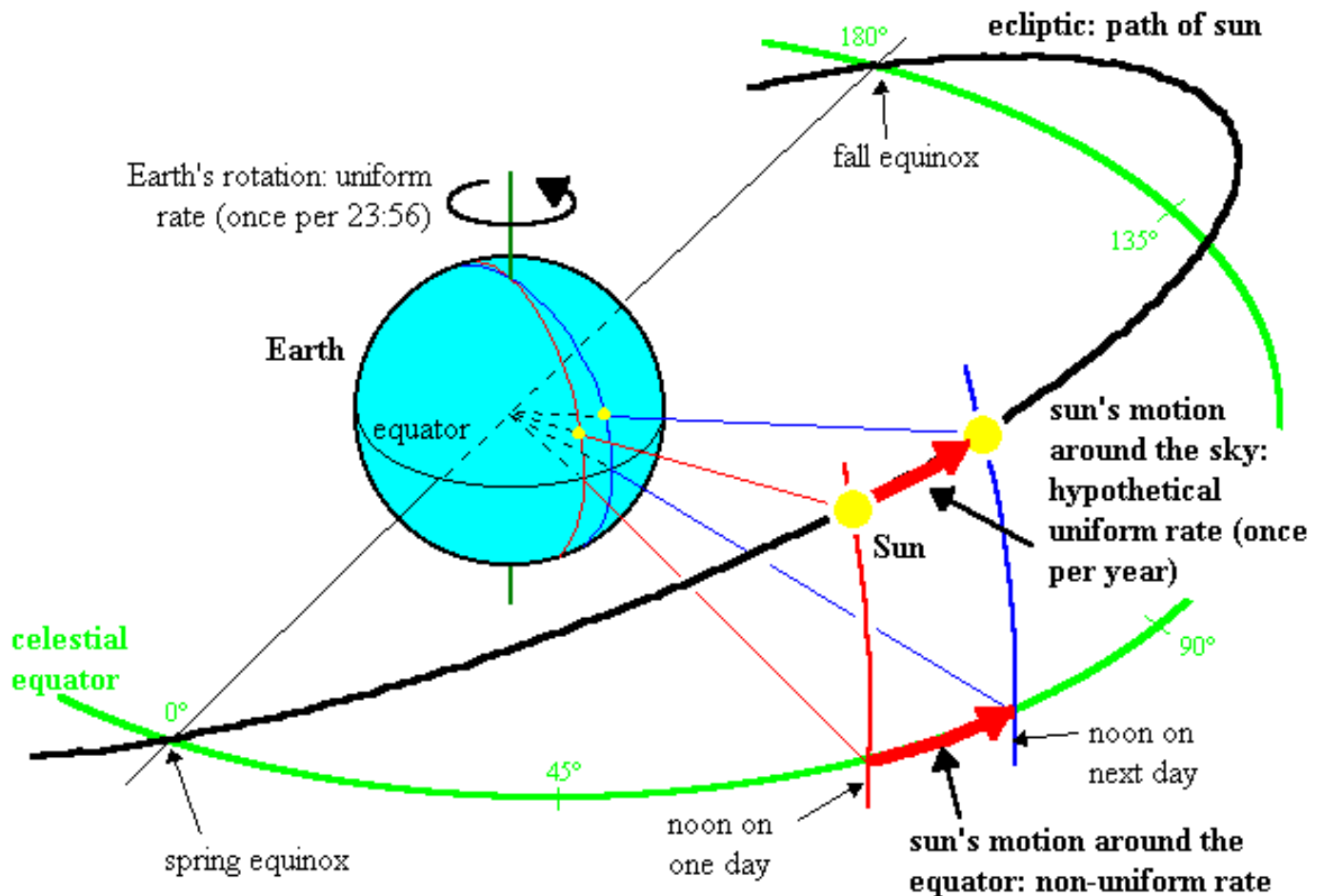

Even if the Sun were to follow the ecliptic (black arc) at a uniform rate, the time from noon to noon, when the Sun is on the meridian, would vary. Due to the tilt of the Earth's axis with respect to the ecliptic, the Sun's apparent speed along the celestial equator (green arc) is non-uniform; that is, the right ascension of the sun changes at a non-uniform speed. The speed along the equator depends on where the Sun is relative to the equinoxes because the position changes the angle α between the speed along the ecliptic and the speed along the equator (see figure at right). The speed along the equator is slowest near the equinoxes (when α is the largest) and fastest halfway between: at the solstices (α is near 0).

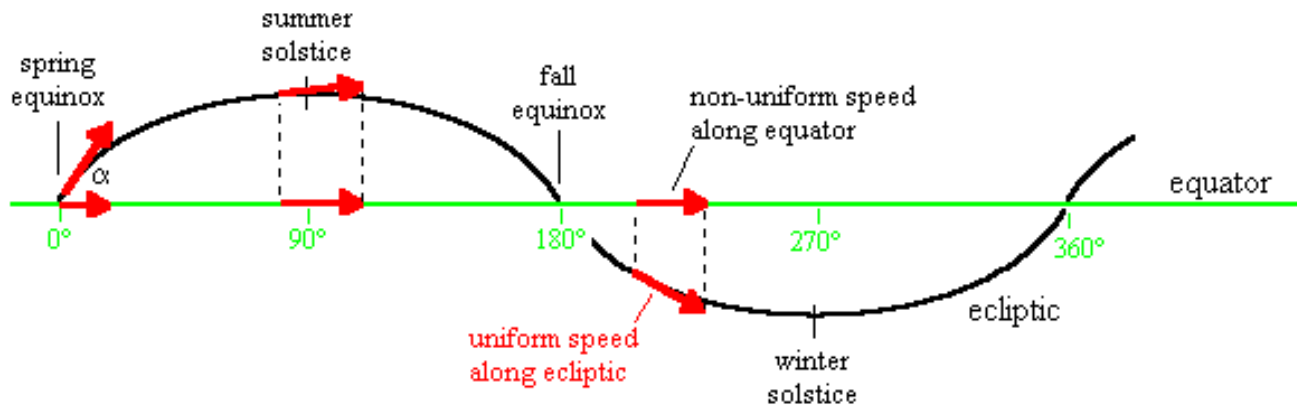
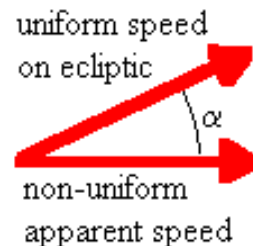

These two factors — the Earth's elliptical orbit around the Sun and tilt of the Earth's axis — cause the Sun to be at a slightly different position in the sky from day to day when viewed at a particular time of the day.

If you were to note the Sun's position, say at 12 noon, for an entire year, you'd discover that it traces a figure-eight. This pattern is the analemma, and an approximate representation is shown at right. (Some globes plot the analemma, usually in the Pacific Ocean.)

The Earth's elliptical orbit and tilt of the axis causes the Sun to be at a different position horizontally each day, while the tilt of the Earth's axis causes the Sun to be at a different position vertically. (To explore the relative importance of each effect on the horizontal width of the analemma, [view this page](#).)

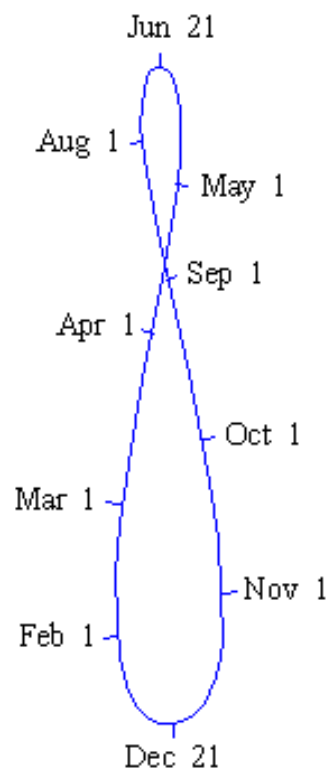

Okay, we are now ready to answer the original problem: why the earliest sunset, latest sunrise, and shortest day of the year occur on different dates. Imagine the figure-eight analemma rising, crossing the sky, and setting. This simply shows where the sun is at any given time of day, on any day of the year. From northern latitudes, the analemma slants upward and to the left at "sunrise" and upward and to the right at "sunset". (The analemma is vertical at local noon.) The shortest day of the year (first day of winter) occurs when the sun is at the bottom of the analemma; thus, the sun spends the least amount of time above the horizon. The longest day of the year (first day of summer) occurs when the sun is at the top of the analemma so that the sun spends the greatest amount of time above the horizon.

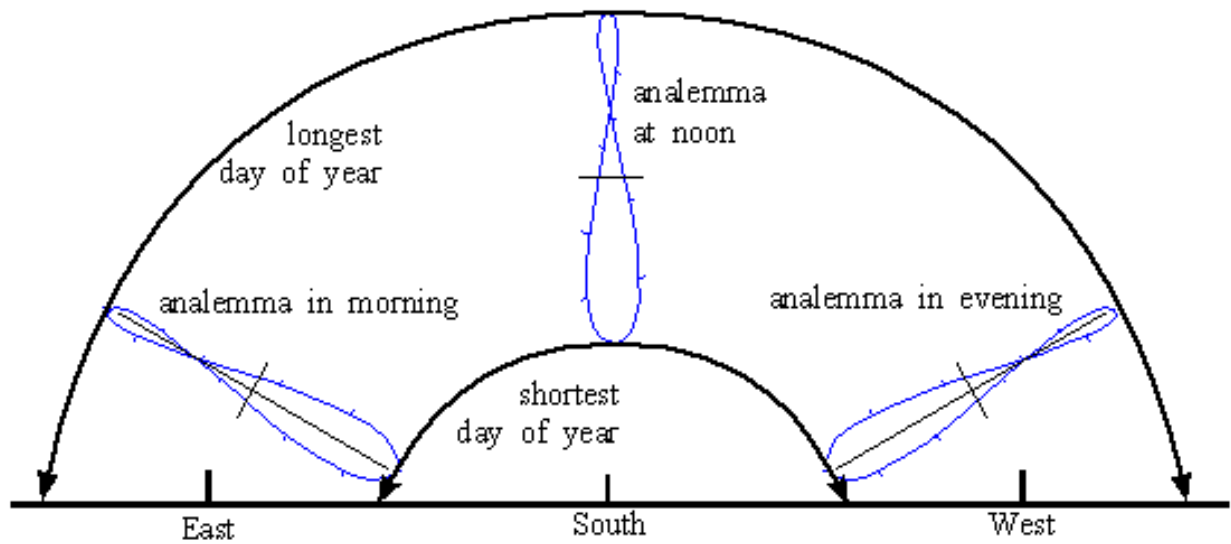

However, if you've drawn your figure-eight with the correct slant, you'll notice that the latest sunrise occurs when the last part of the analemma rises. This does not occur with the sun "at the bottom" of the analemma (December 21st) but a few days later (January 4th). Likewise, the earliest sunset occurs when the first part of the analemma sets below the western horizon. Again, this occurs a few days (December 7th) before the sun reaches "the bottom" of the analemma (December 21st).

Highly Magnified View of Analemma Rising and Setting

for 79° 48.8' W, 40° 37.6' N

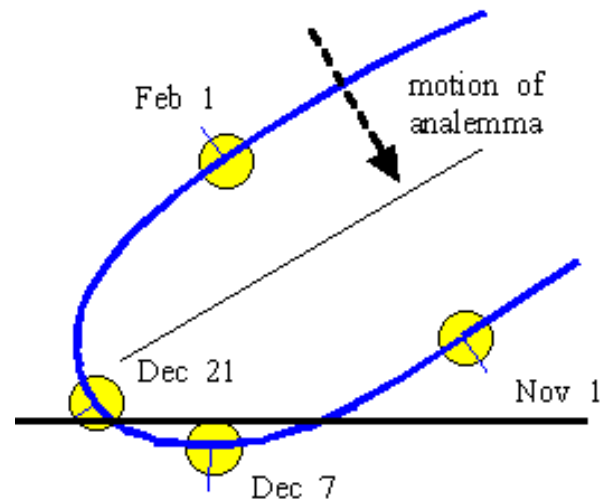
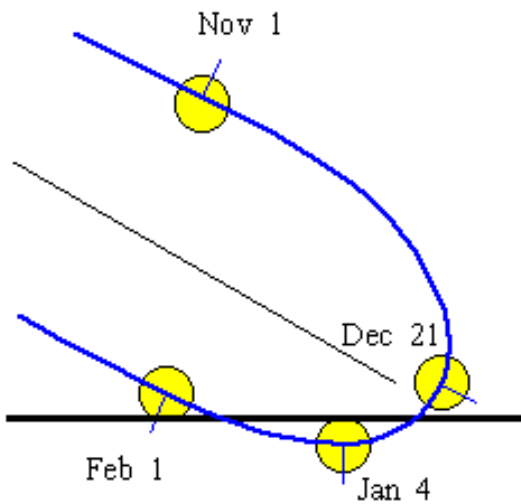

Rising. The analemma at 7:43 am EST for every day of the year. If the date is January 4th, then the Sun is at the "lowest" position of the analemma, and sunrise is just occurring. The Sun has already risen at any other position on the analemma; that is, on any other date. Thus, January 4th is the date of the latest sunrise.

Setting. The analemma at 4:52 pm EST for every day of the year. If the date is December 7th, then the Sun is at the "lowest" position of the analemma, and sunset is just occurring. The Sun has not yet set at any other position on the analemma; that is, on any other date. Thus, December 7th is the date of the earliest sunset.

The same process can be used to see why the dates differ in the summer. However, the two effects causing the width of the analemma — the Earth's elliptical orbit and tilt — combine in the winter and partially cancel each other during the summer. Thus, the top of the analemma is very narrow. So, the effect is not as drastic in the summer as in the winter..

Summer Sunrise/Sunset Times

for 79° 48.8' W, 40° 37.6' N

Date	Time of Sunrise (EDT)	Time of Sunset (EDT)	Length of Daylight (hh:mm)
2001 June 07	5:49 am	8:48 pm	14:59
2001 Jun 14 earliest sunrise	5:48 am	8:51 pm	15:03
2001 Jun 21 longest day	5:49 am	8:54 pm	15:05
2001 Jun 27 latest sunset	5:50 am	8:54 pm	15:04
2001 Jul 04	5:54 am	8:53 pm	14:59

Many thanks to Larry Denenberg for pointing out that *both* the eccentricity *and* obliquity have a significant effect on the horizontal width of the analemma. For an interesting article on the other planets, refer to "The Analemmas of the Planets" in the March 1982 *Sky & Telescope*, pages 237-239.

| Return to John Holtz' [Home Page](#) |

Page created and maintained by [John Holtz](#). Comments are welcomed.

Last modified 2003 Dec 21. added effects of obliquity

Great Circle Studio's Solar Calculator

Read Solar Calculator [usage information](#).
Form defaults are for [Pacific Grove, Calif. USA](#).

Local Latitude ° ' " N S
Local Longitude ° ' " E W
Time Zone Offset h m
Data Interval d h m
Altitude Mask °

Starting Date & Time

Ending Date & Time

<u>Output Mode</u>	Horizontal Coords. (HTML)	Ecliptic/Equatorial Coords. (HTML)
	Horizontal Coords. (TEXT)	Ecliptic/Equatorial Coords. (TEXT)
	Enable Header Info (HTML/TEXT)	Disable Header Info (HTML/TEXT)
	Altitude vs Azimuth 2D-Plot	Altitude vs Azimuth 3D-Plot

Click ONCE on buttons for selection.

[Email Feedback.](#)



As of Stardate 38047.6737
There have been **nineteen thousand seventyfive** accesses.

Last Update: **March 2001**
© 2001 Great Circle Studio
LJ Coletti

AZIMUTH

The angular distance clockwise around the [horizon](#) from the northern direction, usually expressed in angular measure from 0 degrees for an object in the northern direction, to 180 degrees for an object in the southern direction, around to 360 degrees.

Note that sundialists measure [azimuth](#) from the southern direction.

Equatorial Sundials and the Sun's Apparent Path Across the Sky

You can learn a lot more than the time of day by looking at an equatorial sundial!

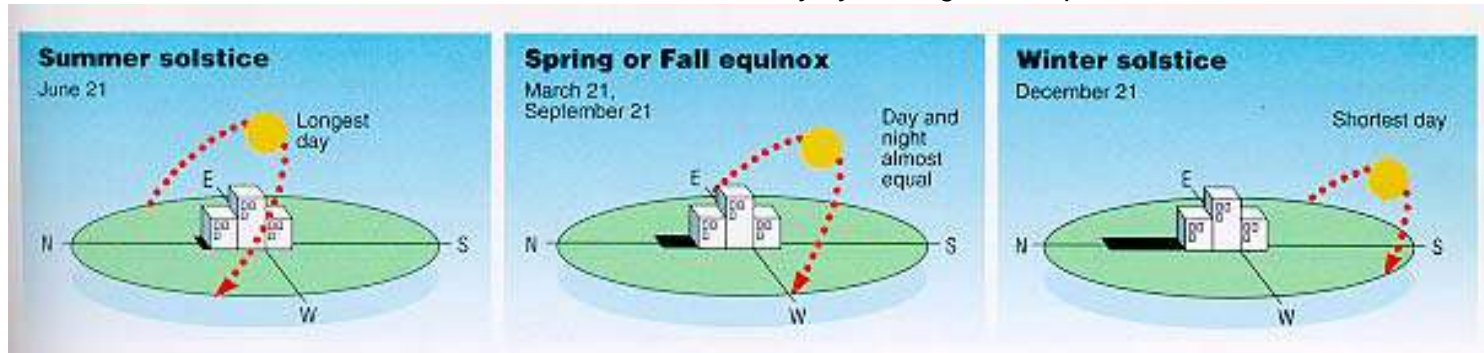

Graphic courtesy [The CoVis Project](#) and [The USA Today Weather Book](#) by Jack Williams.

Summer Solstice

An [equatorial sundial](#) is actually a reduced model of the Earth, similar to a globe with its upper and lower halves removed: the [dial plate](#) represents the [plane](#) of the Earth's [Equator](#); the [gnomon](#) represents the Earth's [axis](#) of [rotation](#). The upper dial face represents the [Northern Hemisphere](#); the lower dial face represents the [Southern Hemisphere](#). From the Spring Equinox to the Fall Equinox, when the Sun's apparent path across the sky is north of the [Celestial Equator](#), the gnomon (or [style](#)) shadow falls on the upper dial face (as shown by the picture to the right, taken 23 June 2002).



Every day, shadows are shortest at noon, and longest at sunrise & sunset. On June 21, noon shadows are the shortest of any day during the year (for northern mid-latitude locations), and vice-versa on December 21 (see [solstice/equinox diagram](#)). Due to the [geometry](#) of equatorial sundials, the gnomon shadow is the same length for the entire day (although its length varies from day-to-day according to the annual cycle of change in the [declination of the Sun](#)).

Note that it is incorrect to say that the [Summer Solstice](#) is the "longest day" of the year. The fact of the matter is that the day is still 24 hours long--no longer than any other day of the year! However, it is correct to say that the number of hours of daylight is greatest (notice that the red dashed line is longest on the [Summer Solstice diagram](#)). Further, it is more correct to refer to the "Summer Solstice" as the "June Solstice," since the seasons are reversed in the Northern and Southern Hemispheres.

Spring or Fall Equinox

On the day of the [equinoxes](#), the Sun's apparent path across the sky (shown by the red dashed line on the [Spring or Fall Equinox diagram](#)) follows the [Celestial Equator](#). Since the Celestial Equator is simply the projection of Earth's Equator onto the sky, you may also visualize the [red dashed line](#) as a segment of the outer edge of the dial plate of a very large equatorial sundial. The Sun is directly over the edge of the dial plate on the [Spring](#) or

[Fall](#) Equinoxes (more correctly referred to as the March or September Equinoxes), therefore the gnomon (or style) of a [properly oriented equatorial sundial](#) will not cast a shadow on the dial plate.

Winter Solstice

From the Fall Equinox to the Spring Equinox, when the Sun's apparent path across the sky is south of the [Celestial Equator](#), the gnomon (or style) shadow falls on the lower dial face.

Note that it is incorrect to say that the [Winter Solstice](#) (more correctly referred to as the December Solstice) is the "shortest day" of the year. It is correct to say that the number of hours of daylight is least (notice that the red dashed line is shortest on the [Winter Solstice diagram](#)).

© Copyright 2002-2004 [Walter Sanford](#). All rights reserved.

[Me and My Shadow - Making the Sun-Earth Connection](#) | [SCSA Home](#)

Sundial Geometry

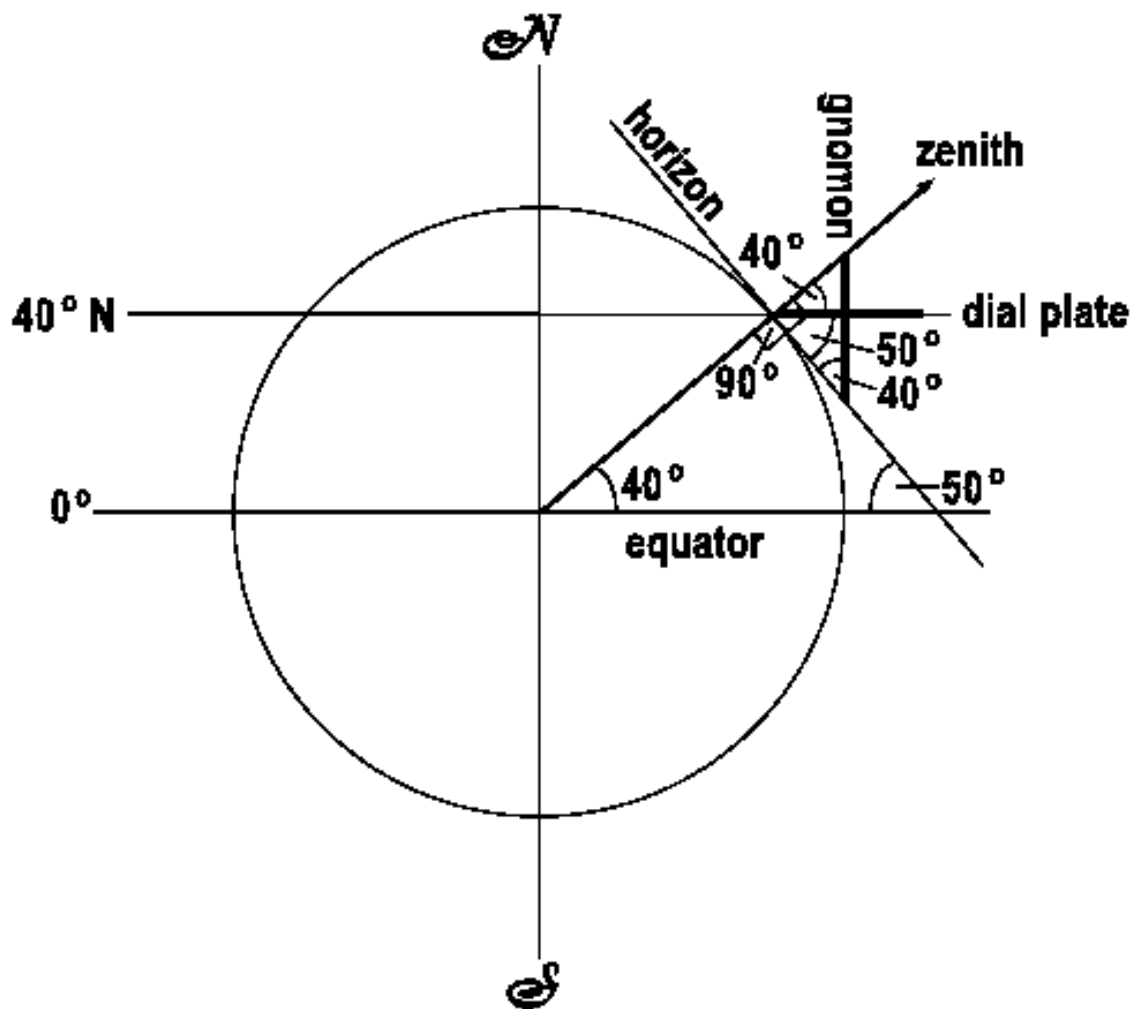

[sundial_geometry.pdf](#)

© Copyright 2002-2004 [Walter Sanford](#). All rights reserved.

[Me and My Shadow - Making the Sun-Earth Connection](#) | [SCSA Home](#)

Horizontal Sundial Nomenclature (Northern Hemisphere Version)

N.B. In the Southern Hemisphere the numerals run anti-clockwise around the dial plate.

Click on the [blue](#) text for the definition

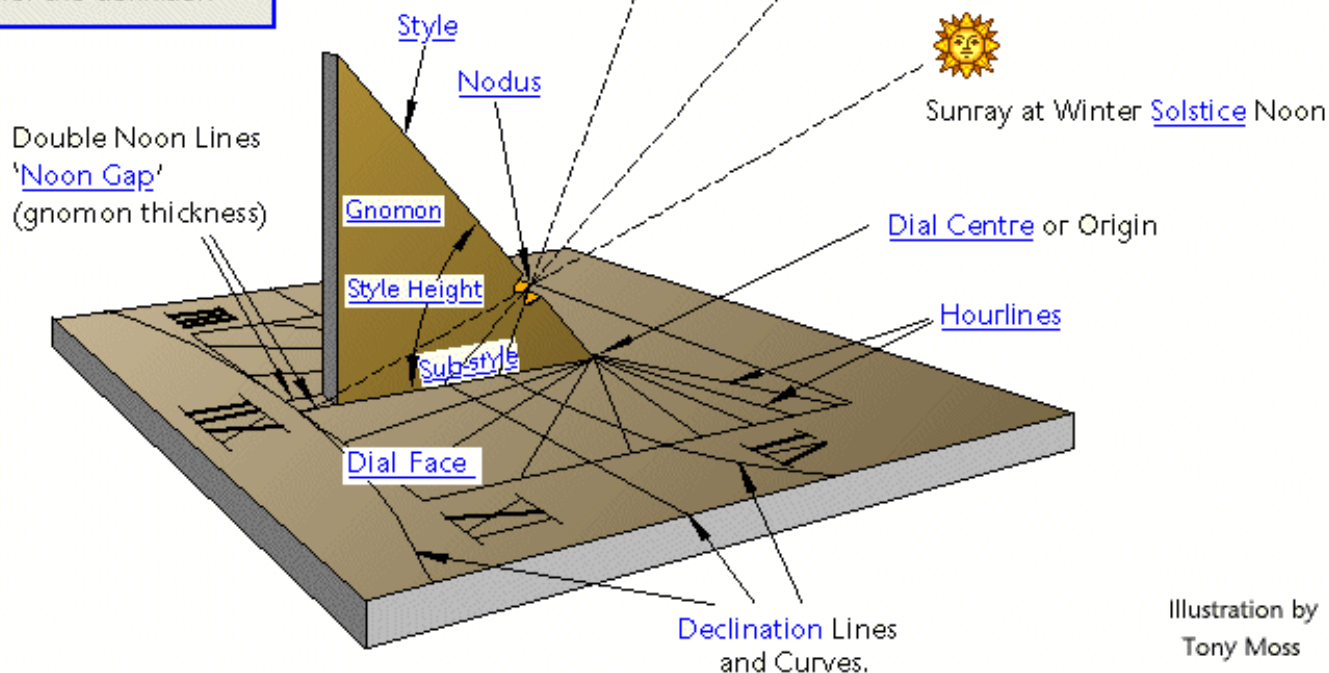

This illustration and abbreviated glossary are excerpted from that of the **British Sundial Society**, written by **John Davis**. Used with permission. You are encouraged to explore the [complete glossary](#).

altitude (of the sun): the angular distance of the (centre of) the sun's disk above the observer's horizon.

altitude dial: any dial which uses the sun's [altitude](#), rather than its [azimuth](#), for indicating the time. Usually does not need to be aligned N-S. Examples are analemmatic dials, ring dials, and shepherds' dials.

axis (of the Earth's rotation) or polar axis: the line running through the true North and South [poles](#) about which the Earth rotates.

azimuth (of the sun): the angle of the sun, measured in the horizontal plane and from true [south](#). Angles to the west are positive, those to the east, negative. Thus due west is 90° , north is $\pm 180^\circ$, east -90° .

centre (of a dial): the point where all the [hour lines](#), and a polar-pointing [style](#), meet. In simple [horizontal](#) or [vertical dials](#), this point coincides with the root of a (thin) [gnomon](#). In the case of a thick gnomon having two styles, there are two centres to the dial.

declination (of the sun): the angular distance of the Sun above or below the [celestial equator](#). Its value follows an annual sine wave like curve, varying between 0° at the [equinoxes](#) and $\pm 23.4^\circ$ (approx.) at the [solstices](#). It has positive values when the Sun is above the celestial equator (summer in the Northern hemisphere) and negative when below.

dial face (or dial plate): the physical surface on which the [hour lines](#) and [furniture](#) lie. It (usually) supports the [gnomon](#).

ecliptic (plane): (pron. e-clip-tic) the plane that the Earth's [orbit](#) traces during a year. The orbits of the Moon and the planets are

also close to this plane. It is a great circle on the [celestial sphere](#).

Equation of Time: the time difference between [Local Apparent Time](#) (apparent solar time) and [mean solar time](#) at the same location. Its value varies between extremes of about +14 minutes in February and –16 minutes in October. It arises because of the elliptical [orbit](#) of the Earth, and the tilt of the Earth's [axis](#) to the [ecliptic](#). The preferred usage by diallists is:

$$\text{mean solar time} = \text{apparent solar time} + \text{EoT}$$

but this sign convention is by no means universal and the opposite sign is used in modern almanacs. Irrespective of the sign convention adopted, sundials will always appear slow compared to mean time in February, and fast in October/November.

equator: the great circle of the Earth (or other celestial body) which is equidistant from the [poles](#). It has, by definition, a [latitude](#) of 0°.

equator, celestial: the intersection of the extended plane of the Earth's equator with the [celestial sphere](#).

equatorial plane: the plane through the Earth defined by the [equator](#).

equinoxes: (vernal or spring, autumnal or fall) literally "equal nights" i.e. equal amounts of daylight and night-time. The Sun's [declination](#) at the equinoxes is 0°. The vernal equinox is around 20-21 March, the autumnal equinox is around 22-23 September.

furniture: all features on a [dial face](#) other than the [hour lines](#) and their numerals are referred to as dial furniture. This may include [declination](#) lines and curves, a compass rose, [Equation of Time](#) graphs or tables, mottoes etc. Other common furniture includes: date, maker's and/or benefactor's name, coats of arms, and [latitude](#) and (rarer) [longitude](#).

gnomon: (pron. no-mon) the physical structure of a sundial which casts the shadow (from the Greek for "indicator"). The gnomon today is most-often [polar](#) pointing (sometimes described as an "axial gnomon"), although it may also be horizontal or vertical. The distinction between gnomon and [style](#) made (and encouraged in this Glossary) in modern dialling literature is not the one used in early works, and the two words are still sometimes used interchangeably.

horizontal dial: the common or garden sundial with a horizontal [dial face](#) and polar-pointing [gnomon](#).

hour angle: [Local Apparent Time](#) expressed as the angular position of the Sun in its daily track. Measured from [noon](#), it increases by 15° per hour with increasing time (i.e., morning hours are negative). Beware, this convention is not universal.

hour line: the line on a [dial face](#) indicating the shadow position at a particular time (includes fractional as well as whole hours).

latitude: The angular position of a place north or south of the equator. Positive values in the Northern hemisphere, negative in the South (i.e., the South Pole = -90°).

Local Apparent Time: [solar time](#), as derived from the real Sun at any particular location. It is the [hour angle](#) of the Sun + 12 hours. Some authors (non-UK) may refer to it a Local True Time.

longitude: the angular location of a place on the Earth's surface measured east or west of the Prime meridian though Greenwich, England. Longitudes W are positive, E are negative.

Mean Solar Time: the authoritative (by the National Physical Laboratory) definition is: a measure of time based conceptually on the diurnal motion of the fictitious mean Sun, under the assumption that the Earth's rate of rotation is constant.

nodus: a point which casts a shadow to indicate the time and/or (more often) the date on a [dial face](#). It may take the form of a small sphere or a notch on a polar-pointing [gnomon](#), or it may be the tip of a gnomon with an arbitrary (usually horizontal or vertical) orientation.

noon, solar : the time when the sun is due south of the observer's location. At solar noon the sun is at it's highest altitude, or angular distance above the observer's horizon. Not to be confused with 12:00 standard time.

noon gap (or **gnomon gap** or **split noon**): the gap in the hour scale of a dial to account for the finite thickness of the [gnomon](#). It is positioned on the dial face where the Sun is in the same plane as the gnomon, i.e. at [noon](#) for horizontal or direct S dials.

orbit (of the Earth): the path of the Earth around the sun. For dialling purposes, this is taken as elliptical, with a very small eccentricity, i.e., it ignores the small perturbations due to the effects of the Moon and other planets.

poles (N and S of the Earth): the locations on the Earth's sphere with [latitudes](#) of +90° (N) and –90° (S).

pole, celestial: the points where the Earth's [axis](#) meet the [celestial sphere](#). The stars appear to rotate around these poles.

solar time: the same as [Local Apparent Time](#).

solstices: (Summer, Winter) literally, "Sun stands still". In the Northern hemisphere, they represent the beginning of summer (on or around 21 June) and the beginning of winter (on or around 21 December). They are the days with the shortest and longest night-times and correspond to the extreme values of [declination](#).

sphere, celestial: an imaginary sphere, arbitrarily large and co-centred with the Earth, on which all the stars appear to be fixed.

style {stile}: the line in space which generates the shadow edge used to indicate the time on the [dial face](#). Note that a [gnomon](#) with finite thickness will have two styles (one along each of the upper edges) which will each be operational for parts of every day. If the gnomon is in the form of a long rod, the style will be the virtual line running along the centre of the rod and the dial is read by estimating the centre of the shadow.

style height: of a polar style is the [angle](#) that the style makes with the [sub-style](#) line. Note that this is an unusual use of the word "height", and **style angle** could be regarded as a better term.

sub-style (line): the line lying in the dial plane which is perpendicularly below (or behind for a vertical dial) the [style](#).

vertical dial: any dial in which the [dial face](#) is vertical.



Table of the Declination of the Sun
Mean Value for the Four Years of a Leap-Year Cycle

Positive sign (+) Sun north of Celestial Equator; negative sign (-) Sun south of Celestial Equator.

Day	JAN	FEB	MAR	APR	MAY	JUN	JUL	AUG	SEP	OCT	NOV	DEC
1	-23°04'	-17°20'	-7°49'	+4°18'	+14°54'	+21°58'	+23°09'	+18°10'	+8°30'	-2°57'	-14°14'	-21°43'
2	-22°59'	-17°03'	-7°26'	+4°42'	+15°12'	+22°06'	+23°05'	+17°55'	+8°09'	-3°20'	-14°34'	-21°52'
3	-22°54'	-16°46'	-7°03'	+5°05'	+15°30'	+22°14'	+23°01'	+17°40'	+7°47'	-3°44'	-14°53'	-22°01'
4	-22°48'	-16°28'	-6°40'	+5°28'	+15°47'	+22°22'	+22°56'	+17°24'	+7°25'	-4°07'	-15°11'	-22°10'
5	-22°42'	-16°10'	-6°17'	+5°51'	+16°05'	+22°29'	+22°51'	+17°08'	+7°03'	-4°30'	-15°30'	-22°18'
6	-22°36'	-15°52'	-5°54'	+6°13'	+16°22'	+22°35'	+22°45'	+16°52'	+6°40'	-4°53'	-15°48'	-22°25'
7	-22°28'	-15°34'	-5°30'	+6°36'	+16°39'	+22°42'	+22°39'	+16°36'	+6°18'	-5°16'	-16°06'	-22°32'
8	-22°21'	-15°15'	-5°07'	+6°59'	+16°55'	+22°47'	+22°33'	+16°19'	+5°56'	-5°39'	-16°24'	-22°39'
9	-22°13'	-14°56'	-4°44'	+7°21'	+17°12'	+22°53'	+22°26'	+16°02'	+5°33'	-6°02'	-16°41'	-22°46'
10	-22°05'	-14°37'	-4°20'	+7°43'	+17°27'	+22°58'	+22°19'	+15°45'	+5°10'	-6°25'	-16°58'	-22°52'
Day	JAN	FEB	MAR	APR	MAY	JUN	JUL	AUG	SEP	OCT	NOV	DEC
11	-21°56'	-14°18'	-3°57'	+8°07'	+17°43'	+23°02'	+22°11'	+15°27'	+4°48'	-6°48'	-17°15'	-22°57'
12	-21°47'	-13°58'	-3°33'	+8°28'	+17°59'	+23°07'	+22°04'	+15°10'	+4°25'	-7°10'	-17°32'	-23°02'
13	-21°37'	-13°38'	-3°10'	+8°50'	+18°14'	+23°11'	+21°55'	+14°52'	+4°02'	-7°32'	-17°48'	-23°07'
14	-21°27'	-13°18'	-2°46'	+9°11'	+18°29'	+23°14'	+21°46'	+14°33'	+3°39'	-7°55'	-18°04'	-23°11'
15	-21°16'	-12°58'	-2°22'	+9°33'	+18°43'	+23°17'	+21°37'	+14°15'	+3°16'	-8°18'	-18°20'	-23°14'
16	-21°06'	-12°37'	-1°59'	+9°54'	+18°58'	+23°20'	+21°28'	+13°56'	+2°53'	-8°40'	-18°35'	-23°17'
17	-20°54'	-12°16'	-1°35'	+10°16'	+19°11'	+23°22'	+21°18'	+13°37'	+2°30'	-9°02'	-18°50'	-23°20'
18	-20°42'	-11°55'	-1°11'	+10°37'	+19°25'	+23°24'	+21°08'	+13°18'	+2°06'	-9°24'	-19°05'	-23°22'
19	-20°30'	-11°34'	-0°48'	+10°58'	+19°38'	+23°25'	+20°58'	+12°59'	+1°43'	-9°45'	-19°19'	-23°24'
20	-20°18'	-11°13'	-0°24'	+11°19'	+19°51'	+23°26'	+20°47'	+12°39'	+1°20'	-10°07'	-19°33'	-23°25'
Day	JAN	FEB	MAR	APR	MAY	JUN	JUL	AUG	SEP	OCT	NOV	DEC
21	-20°05'	-10°52'	0°00'	+11°39'	+20°04'	+23°26'	+20°36'	+12°19'	+0°57'	-10°29'	-19°47'	-23°26'
22	-19°52'	-10°30'	+0°24'	+12°00'	+20°16'	+23°26'	+20°24'	+11°59'	+0°33'	-10°50'	-20°00'	-23°26'
23	-19°38'	-10°08'	+0°47'	+12°20'	+20°28'	+23°26'	+20°12'	+11°39'	+0°10'	-11°12'	-20°13'	-23°26'
24	-19°24'	-9°46'	+1°11'	+12°40'	+20°39'	+23°25'	+20°00'	+11°19'	-0°14'	-11°33'	-20°26'	-23°26'
25	-19°10'	-9°24'	+1°35'	+13°00'	+20°50'	+23°24'	+19°47'	+10°58'	-0°37'	-11°54'	-20°38'	-23°25'
26	-18°55'	-9°02'	+1°58'	+13°19'	+21°01'	+23°23'	+19°34'	+10°38'	-1°00'	-12°14'	-20°50'	-23°23'
27	-18°40'	-8°39'	+2°22'	+13°38'	+21°12'	+23°21'	+19°21'	+10°17'	-1°24'	-12°35'	-21°01'	-23°21'
28	-18°25'	-8°17'	+2°45'	+13°58'	+21°22'	+23°19'	+19°08'	+9°56'	-1°47'	-12°55'	-21°12'	-23°19'
29	-18°09'	-8°03'	+3°09'	+14°16'	+21°31'	+23°16'	+18°54'	+9°35'	-2°10'	-13°15'	-21°23'	-23°16'
30	-17°53'		+3°32'	+14°35'	+21°41'	+23°13'	+18°40'	+9°13'	-2°34'	-13°35'	-21°33'	-23°12'
31	-17°37'		+3°55'		+21°50'		+18°25'	+8°52'		-13°55'		-23°08'

A Walk through Time



[Ancient Calendars](#)



[Early Clocks](#)



[A Revolution in Timekeeping](#)



[The "Atomic" Age](#)

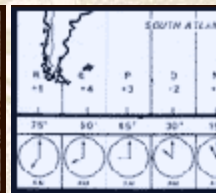

[World Time Scales and Time Zones](#)



[NIST Time Services](#)



[Bibliography](#)

World Time Scales

In the 1840s a railway standard time for all of England, Scotland, and Wales evolved, replacing several "local time" systems. The Royal Observatory in Greenwich began transmitting time telegraphically in 1852 and by 1855 most of Britain used Greenwich time. Greenwich Mean Time (GMT) subsequently evolved as an important and well-recognized time reference for the world.

In 1830, the U.S. Navy established a depot, later to become the U.S. Naval Observatory (USNO), with the initial responsibility to serve as a storage site for marine chronometers and other navigation instruments and to "rate" (calibrate) the chronometers to assure accuracy for their use in celestial navigation. For accurate "rating," the depot had to make regular astronomical observations. It was not until December of 1854 that the Secretary of the Navy officially designated this growing institution as the "United States Naval Observatory and Hydrographic Office." Through all of the ensuing years, the USNO has retained timekeeping as one of its key functions.

With the advent of highly accurate atomic clocks, scientists and technologists recognized the inadequacy of timekeeping based on the motion of the Earth, which fluctuates in rate by a few thousandths of a second a day. The redefinition of the second in 1967 had provided an excellent reference for more accurate measurement of time intervals, but attempts to couple GMT (based on the Earth's motion) and this new definition proved to be highly unsatisfactory. A compromise time scale was eventually devised, and on January 1, 1972, the new Coordinated Universal Time (UTC) became effective internationally.

UTC runs at the rate of the atomic clocks, but when the difference between this atomic time and one based on the Earth approaches one second, a one second adjustment (a "leap second") is made in UTC. NIST's clock systems and other atomic clocks located at the USNO and in more than 25 other countries now contribute data to the international UTC scale coordinated in Paris by the International Bureau of Weights and Measures (BIPM). As atomic timekeeping has grown in importance, the world's standards laboratories have become more involved with the process, and in the United States today, NIST and USNO cooperate to provide official U.S. time for the nation. You can see a clock synchronized to the official U.S. government time provided by NIST and USNO at <http://www.time.gov>.

The World's Time Zones

In the latter part of the nineteenth century, a variety of meridians were used for longitudinal reference by various countries. For a number of reasons, the Greenwich meridian was the most popular of these. At least one factor in this popularity was the reputation for reliability and correctness of the Greenwich Observatory's publications of navigational data. It became clear that shipping would benefit substantially from the establishment of a single "prime" meridian, and the subject was finally resolved in 1884 at a conference held in Washington, where the meridian passing through Greenwich was adopted as the initial or prime meridian for longitude and timekeeping. Given a 24 hour day and 360 degrees of longitude around the earth, it is obvious that the world's 24 time zones have to be 15 degrees wide, on average. The individual zone boundaries are not straight, however, because they have been adjusted for the convenience and desires of local populations.

Interestingly, the standard timekeeping system related to this arrangement



World Time Scales

of time zones was made official in the United States by an Act of Congress in March 1918, some 34 years following the agreement reached at the international conference. In an earlier decision prompted by their own interests and by pressures for a standard timekeeping system from the scientific community — meteorologists, geophysicists and astronomers — the U.S. railroad industry anticipated the international accord when they implemented a "Standard Railway Time System" on November 18, 1883. This Standard Railway Time, adopted by most cities, was the subject of much local controversy for nearly a decade following its inception.

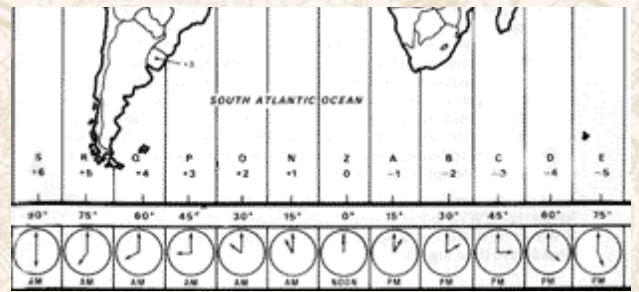



Shop in Health & Personal Care (Beta) What is this?

amazon.com



VIEW CART

WISH LIST

YOUR ACCOUNT

HELP



Your Gold Box

WELCOME

YOUR STORE

BOOKS

APPAREL & ACCESSORIES

ELECTRONICS

TOYS & GAMES

DVD

SOFTWARE

SEE MORE STORES

Search

Browse Subjects

Bestsellers

Magazines

Corporate Accounts

e-books & docs

Bargain Books

Used Books

Eddie Bauer

FREE SHIPPING

when you spend \$50 or more at Eddie Bauer on Amazon.com

Shop Now

Shop Eddie Bauer at Amazon.com

Search Inside the Book™

SEARCH

WEB SEARCH

Powered by Google

BOOK INFORMATION

- [buying info](#)
- [editorial reviews](#)
- [customer reviews](#)
- [look inside](#)
- [Amazon.com articles](#)

RATE THIS BOOK

I dislike it I love it!

1 2 3 4 5

[Edit your ratings](#)

Favorite Magazines!



Explore our new [Magazine Subscriptions](#) store.

The Illustrated Longitude
by [Dava Sobel](#), [William J. H. Andrewes](#)

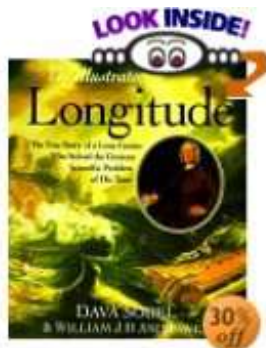

[Look inside this book](#)

List Price: ~~\$35.00~~
Price: **\$24.50**

READY TO BUY?

or [Sign in](#) to turn on 1-Click ordering.
eligible for **MORE BUYING CHOICES**

FREE Super Saver Shipping on orders over \$25.
Don't have one? We'll set one up for you.

33 used & new from \$19.00
[See details.](#)

You Save: \$10.50 (30%)

Availability: Usually ships within 24 hours

33 used & new from \$19.00

Edition: Hardcover

Other Editions:	List Price:	Our Price:	Other Offers:
Paperback (Reprint)	\$22.95	\$16.07	4 used & new from \$15.51

[See more product details](#)

Better Together

Buy this book with [Longitude](#) by Dava Sobel today!



+



Total List Price: \$46.95
Buy Together Today: **\$34.06**

Customers who bought this book also bought:

- [The Riddle of the Compass: The Invention That Changed the World](#) by Amir D. Aczel (Author)
- [Galileo's Daughter: A Historical Memoir of Science, Faith, and Love](#) by Dava Sobel

Visit the [DVD Store](#)



[Longitude](#) DVD

- [The Map That Changed the World : William Smith and the Birth of Modern Geology](#) by Simon Winchester (Author)
- [The Professor and the Madman: A Tale of Murder, Insanity, and the Making of The Oxford English Dictionary](#) by Simon Winchester (Author)
- [Time's Pendulum: From Sundials to Atomic Clocks, the Fascinating History of Timekeeping and How Our Discoveries Changed the World](#) by Jo Ellen Barnett

► [Explore Similar Items](#): [20 in Books](#), [20 in DVD](#), and [5 in Music](#)

So You'd Like to...

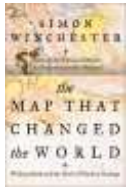

[Be A Library](#)

[Patron/Benefactor...](#): A guide by agnostictrick..., Santa Claus to the LHHS Library

► [Create your guide](#)

Product Details

- **Hardcover:** 216 pages ; Dimensions (in inches): 0.84 x 10.20 x 9.22
- **Publisher:** Walker & Co; Illustrated edition (November 1998)
- **ISBN:** 0802713440
- **In-Print Editions:** [Paperback](#) (Reprint) | [All Editions](#)
- **Average Customer Review:** ★★★★★ Based on 24 reviews. [Write a review.](#)
- **Amazon.com Sales Rank:** 59,490 (Publishers and authors: [improve your sales](#))

Look Inside This Book

You can [view sample pages](#) from this book.

The Standard Deviants



It's like jumper cables for your brain! Learning has never been so much fun, in our [Standard Deviants store](#).

Our Customers' Advice

See what customers recommend in addition to, or instead of, the product on this page.

► [Recommend an item!](#)

- **1 person recommended** [Galileo's Daughter: A Historical Memoir of Science, Faith, and Love](#) in addition to The Illustrated Longitude

► [See more customer buying advice](#)

Editorial Reviews

Amazon.com

Dava Sobel's [Longitude](#) tells the story of how 18th-century scientist and clockmaker William Harrison solved one of the most perplexing problems of history--determining east-west location at sea. This lush, colorfully illustrated edition adds lots of pictures to the story, giving readers a more satisfying sense of the times, the players, and the puzzle. This was no obscure, curious difficulty--without longitude, ships often found themselves so far off course that sailors would starve or die of scurvy before they could reach port. When a nationally-sponsored contest offered a hefty cash prize to the person who could develop a method to accurately determine longitude, the race was on. In the end, the battle of accuracy--and wills--fought between Harrison and arch-rival Maskelyne was ruthless and dramatic, worthy of a Hollywood feature film. *Longitude's* story is surprising and fascinating, offering a window into the past, before Global Positioning Satellites made it look easy. --*Therese Littleton*

From Library Journal

Sobel's 1995 volume attracted a large audience, an unusual feat for a historical science title. Her text describes John Harrison's development of the chronometer, an instrument that measured time exactly while at sea and allowed mariners to calculate longitude for the first time and accurately navigate. This handsome edition is profusely illustrated with numerous annotated photos and paintings of the players and the machinery that led to the chronometer's creation. Copyright 1999 Reed Business... [▶read more](#)

Book Description

When Dava Sobel's *Longitude* was published to universal acclaim in 1995, readers voiced only one regret: that it was not illustrated. Now, William Andrewes, the man who organized and hosted the *Longitude* Symposium that inspired her book, has joined Dava Sobel to create a richly illustrated version of her classic story.

The *Illustrated Longitude* recounts in words and images the epic quest to solve the thorniest scientific problem of the seventeenth and eighteenth centuries. Throughout the great age of exploration, sailors attempted to navigate the oceans without any means of measuring their longitude: All too often, voyages ended in total disaster when both crew and cargo were captured or lost upon the rocks of an unexpected landfall. Thousands of lives and the fortunes of seafaring nations hung on a resolution.

To encourage a solution, governments established major prizes for anyone whose method or device proved successful. The largest reward of £20,000—truly a king's ransom—was offered by the British Parliament in 1714. The scientific establishment—from Galileo to Sir Isaac Newton—had been certain that a celestial answer would be found and invested untold effort in this pursuit. In stark contrast, one man, John Harrison, imagined and built the unimaginable: a clock that solved the problem by keeping precise time at sea, called today the chronometer. His trials and tribulations to win the prize throughout a forty-year obsession are the culmination of this remarkable story.

The *Illustrated Longitude* contains the entire original narrative of *Longitude*, redesigned to accompany 178 images chosen by Will Andrewes: from portraits of every important figure in the story to maps, diagrams, and photographs of scientific instruments, especially John Harrison's remarkable clocks. Andrewes's elegant captions emphasize the scientific and historical events surrounding the images, and they tell their own dramatic story of longitude, paralleling and illuminating Dava Sobel's memorable tale. --*This text refers to the [Paperback](#) edition.*

[▶ See all editorial reviews...](#)

Spotlight Reviews ([What's this?](#))

[Write an online review](#) and share your thoughts with other customers.

13 of 13 people found the following review helpful:

★★★★☆ Highly Recommended!, June 17, 2001

Reviewer: [Darren Clipston \(see more about me\)](#) from Greenwich, Connecticut USA

"The Illustrated Longitude" is an excellent, worthwhile historical account of John Harrison's progression as an instrument maker and legitimate finder of a practical solution to the problem of determining Longitude at Sea.

If you are at all interested in the antecedents of today's accurate timekeeping devices this book is a must. The print quality is very high and the illustrations a wonderful aid to feeling the story unfold. The book does not contain detailed plans of Mr Harrison's chronometers or description of the techniques of celestial navigation, but rather is a brisk, engagingly written account of the origin of the Longitude problem, Mr Harrison's solution and those of his rivals and the political intrigues which delayed full acknowledgement of the merit of the H-1 to H-4 devices.

I bought this book some months after visiting the Old Royal Observatory in Greenwich, England. The ingenious mechanisms at work can keep an observer enthralled for hours. They are also very beautiful. "The Illustrated Longitude" really fills out the significance of the Longitude problem in that era and the career details and challenges overcome by a very clever and self made man.

Was this review helpful to you?

19 of 20 people found the following review helpful:

★★★★★ A classic, now beautifully illustrated, June 6, 2000

TOP 100 Reviewer: [J Scott Morrison \(see more about me\)](#)
Reviewer from Kansas City

I originally read a library copy of "Longitude" back when it was published in 1995. But I hankered for a copy of my own. Recently I discovered this new illustrated version of the original and must say that it's a real find. The pictures really do help one understand better the magnitude of William Harrison's breakthrough discovery about how to use a very accurate timepiece (now called a "chronometer") to determine longitude and help ships avoid the tragedy of becoming lost with potentially tragic consequences. The text is not so technical to put off a non-expert. I'm sure one could learn more about the workings of the chronometer, but I suspect a more detailed explanation might have put it beyond the comprehension of many of us.

Was this review helpful to you?

All Customer Reviews

Average Customer Review: ★★★★★

[Write an online review](#) and share your thoughts with other customers.

1 of 6 people found the following review helpful:

★★★★☆ Could have been much better, February 9, 2003
Reviewer: Navid Tahamtani from Sao Paulo, SP Brazil

You just can't put some irrelevant illustrations and a hard back on an already excellent book and expect it to get better.

I purchased this version for my daughter as a gift and was very

disappointed to find that it didn't really illustrate anything further than the original. In fact, if anything, this book is worse, since it is hard to carry and read. Better save US\$10 and buy the paper back. However the "illustrations", (photos and reproduction of old drawings), are all excellent, as far as printing quality is concerned and will do a wonderful job of adorning your coffee table for the visitors.

Was this review helpful to you?

2 of 3 people found the following review helpful:

★★★★★ Excellent illustrations, informative narrative,
November 1, 2002

Reviewer: A reader from GOODRICH, MICHIGAN United States

I found the book an excellent history/biography lesson that takes only a day or so to finish reading. It is written in a mostly non-technical style and the pictures and illustrations definitely support the saying "A picture is worth a thousand words". Since I use the Global Positioning System in my daily work, it was refreshing to read a book that dealt with the history of positioning and timing on the face of the earth in a straight forward way. I also enjoyed the emphasis on the personalities involved and their motivations.

Was this review helpful to you?

0 of 4 people found the following review helpful:

★★★★★ Beautiful Book, July 11, 2002

Reviewer: [scojam \(see more about me\)](#) from Sarasota, Florida USA

Nice photographs and high quality paper. Ideal for display on a coffee table, or library/den. I've only read some of the book, but it looks very informative and useful. I'm glad I paid the extra few bucks for this book, compared to the cheaper paperback versions I've seen.

This was recommended to me by a friend who is an avid reader, but I waited until now to buy it. The illustrations gave me a nice excuse to buy it now.

Was this review helpful to you?

0 of 1 people found the following review helpful:

★★★★★ The perfect gift for mariners, February 14, 2002

Reviewer: A reader from Mahwah, NJ USA

This book is a beautiful coffee-table edition of the original book published in 1995. It's a historical account of the quest to solve the toughest scientific problem of the 17th and 18th centuries. It presents the story of John Harrison, who solved the problem by creating a timepiece that could keep precise time at sea - today known as the chronometer.

This 1998 edition contains reproductions of a large number of historical documents, charts, and portraits and includes an incredible collection of photos of timekeeping and navigational instruments. Together with a 4-video set of an expertly produced program by

A&E, starring Jeremy Irons, this is a fabulous addition to any maritime books collections.

Was this review helpful to you?

[▶ See all 24 customer reviews...](#)

Customers who bought titles by Dava Sobel also bought titles by these authors:

- [Simon Winchester](#)
- [Ross King](#)
- [Amir D. Aczel](#)
- [Peter Sis](#)
- [Jason Theodosakis](#)

[▶ Explore similar authors](#)

Auctions and zShops sellers and our other stores recommend:

- [New Womens Classic Square Nugget Quartz Gold Tone Watch ~ DUTCH ~ ohexpress \(Current bid: \\$26.95\)](#)
- [New Mens Heavy Classic Nugget Quartz Gold Tone Watch ~ ohexpress \(Price: \\$30.95\)](#)

So You'd Like To...

- [See My X-Mas List : DVDs Part II \[TV Series Revisited\]](#): by [sapphire27](#), Expert Couch Potato
- [Be A Library Patron/Benefactor on \\$50 A Month](#): by [agnostictrickster](#), Santa Claus to the LHHS Library

Listmania!

- [Book Club Reading](#): A list by [Kirk Nelson](#), Member of the club.....
- [Some books of late...](#): A list by [mr_gkyc](#), Me. Moi.
- [About Science and Scientists Wish List](#): A list by [uber geek1970](#), Avid Reader

Look for similar books by subject:

Browse for [books](#) in:

- [Subjects](#) > [Science](#) > [Earth Sciences](#) > [Geography](#)
- [Subjects](#) > [Science](#) > [Experiments, Instruments & Measurement](#) > [Scientific Instruments](#)
- [Subjects](#) > [Science](#) > [History & Philosophy](#) > [History of Science](#)

Search for books by subject:

[Longitude](#)
[Measurement](#)
[History](#)
[Chronometers](#)
[Harrison, John,](#)
[Practical And Spherical Astronomy](#)
[Science](#)

Turn your past books purchases into \$\$\$
[Learn more](#) about selling at Amazon.com today!

[Top of Page](#)

[Books Search](#) | [Browse Subjects](#) | [Bestsellers](#) | [Magazines](#) | [Corporate Accounts](#)
[e-Books & Docs](#) | [Bargain Books](#) | [Used Books](#)

[Amazon.com Home](#) | [Directory of All Stores](#)

Our International Sites: [Canada](#) | [United Kingdom](#) | [Germany](#) | [Japan](#) | [France](#)

[Contact Us](#) | [Help](#) | [Shopping Cart](#) | [Your Account](#) | [Sell Items](#) | [1-Click Settings](#)

[Investor Relations](#) | [Press Releases](#) | [Join Our Staff](#)

Bottom of the Page™ Deals for March 02

Amazon.com = low prices. Save up to 50% on these 24-hour deals, updated every day at noon (central time).

	Our Price	You Save
Dove Plush Bath Robe, White You'll look simply marvelous, darling, in this 100% plush white cotton robe!	\$29.00	\$11.00 (28%)
Panasonic SQT555W601 Automatic Power-Failure Light Next time the power goes off, don't get left in the dark.	\$26.99	\$13.00 (33%)
Canon BCI-3e Multipack Ink Tanks (4 Pack) Keep the cartridge, replace the ink, save money.	\$33.99	\$16.00 (32%)
Smoke Away Stop Smoking Support Program 1 ea Discover a happier and healthier lifestyle with Smoke Away.	\$24.99	\$15.00 (38%)
Snuggle Fabric Softener Dryer Sheets, Fresh Rain 120 count 6 boxes Eliminate static cling and leave your clothes soft and fresh smelling.	\$19.99	\$20.00 (50%)
Neutrogena Moisture Rich Shower and Bath Gel, 35 Ounces (2 Bottles) Pamper skin and senses with this refreshing shower and bath gel.	\$29.99	\$28.00 (48%)
Revival Soy Protein Bar, Chocolate Temptation Bar 15 ea You won't have to feel guilty about giving in to this Chocolate Temptation.	\$27.99	\$4.96 (15%)
Starbucks Decaffeinated House Blend Universal Ground Coffee, 6 12-Ounce FlavorLock Bags (72 ounces total) Savor a true coffee classic without the jitters.	\$28.99	\$4.00 (12%)
Schick Silk Effects Plus Refill Blades with Aloe - 10 ea Exclusive microfine wires make getting a close shave easier on your skin.	\$11.49	\$1.00 (8%)

 **FREE Super Saver Shipping on orders over \$25.** [See details.](#)

Amazon.com now offers bargains on brand-name essentials, all priced so low they've sunk to the bottom of the page! We take up to 50% off standard retail prices and deliver right to your door--no club fees, no hassle, no parking lot. Check back every day at noon (central time) for all-new Bottom of the Page™ Deals.

You are here: [NMM Home](#) / [What's on](#) / [Exhibitions](#) / Royal Observatory

[Go back one level](#)

[National Maritime Museum](#)

[Royal Observatory](#)

[Queen's House](#)

John Harrison and the Longitude problem

The Longitude problem

Whereas, in order to the finding out of the longitude of places for perfecting navigation and astronomy, we have resolved to build a small observatory within Our Park at Greenwich...

Charles II



The Royal Observatory, Greenwich

[Repro ID PU8920](#) © NMM London For every 15° that one travels eastward, the local time moves one hour ahead. Similarly, travelling West, the local time moves back one hour for every 15° of longitude.

Therefore, if we know the local times at two points on Earth, we can use the difference between them to calculate how far apart those places are in longitude, east or west.

This idea was very important to sailors and navigators in the 17th century. They could measure the local time, wherever they were, by observing the Sun, but navigation required that they also know the time at some reference point, e.g. Greenwich, in order to calculate their longitude. Although accurate pendulum clocks existed in the 17th century, the motions of a ship and changes in humidity and temperature would prevent such a clock from keeping accurate time at sea.

King Charles II founded the Royal Observatory in 1675 to solve the problem of finding longitude at sea. If an accurate catalogue of the positions of the stars could be made, and the position of the Moon then measured accurately relative to the stars, the Moon's motion could be used as a natural clock to calculate Greenwich Time. Sailors at sea could measure the Moon's position relative to bright stars and use tables of the Moon's position, compiled at the Royal Observatory, to calculate the time at Greenwich. This means of finding Longitude was known as the 'Lunar Distance Method'.

In 1714, the British Government offered, by Act of Parliament, £20,000 for a solution which could provide longitude to within half-a-degree (2

Page index

1. The Longitude problem
2. [John Harrison \(1693-1776\)](#)
3. [H1 \(1730-1735\)](#)
4. [H2 & H3 \(1737-1759\)](#)
5. [H4 \(1755-1759\)](#)
6. [Winning the Longitude Prize](#)
7. [Rupert Gould](#)

Related websites

- ∴ [The Harrison initiative](#)
- ∴ [The Worshipful Company of Clockmakers](#)
- ∴ [English attack on the Longitude problem](#)
- ∴ [How a pendulum clock works](#)
- ∴ [Celestial navigation](#)
- ∴ [British Horological Institute](#)
- ∴ [A walk through time](#)
- ∴ [Collections online](#)

Useful tools

-  [Single page](#)
-  [PDF version](#)
-  [Find similar](#)
-  [Email this document](#)
-  [Print this page](#)

minutes of time). The methods would be tested on a ship, sailing

...over the ocean, from Great Britain to any such Port in the West Indies as those Commissioners Choose... without losing their Longitude beyond the limits before mentioned

and should prove to be

...tried and found Practicable and Useful at Sea.

A body known as the Board of Longitude was set up to administer and judge the longitude prize. They received more than a few weird and wonderful suggestions. Like squaring the circle or inventing a perpetual motion machine, the phrase 'finding the longitude' became a sort of catchphrase for the pursuits of fools and lunatics. Many people believed that the problem simply could not be solved.

1 | [2](#) | [3](#) | [4](#) | [5](#) | [6](#) | [7](#) | [Next >](#)

See also:

- [Time telling](#)

© NMM London

Â



Home of the Prime Meridian of the World
Longitude 0° 0' 0", Latitude 51° 28' 38"

Inland Revenue Exempt Charity (No X92488). [Find out how to support the Museum's work.](#)

© National Maritime Museum, Greenwich, LONDON SE10 9NF
Tel: +44 (0)20 8858 4422, Recorded Information Line +44 (0)20 8312 6565

Â Â [Low graphics version](#) Â | Â [Site map](#) Â | Â [About us](#) Â | Â [Contact us](#) Â

NOVA
ONLINE[NOVA Home](#) | [NOVA Site Map](#) | [E-mail](#)Lost at Sea—The Search for
Longitude

Welcome to the companion Web site to "[Lost at Sea: The Search for Longitude](#)," originally broadcast on October 6, 1998. Based on the bestselling book *Longitude* by Dava Sobel, the program tells the story of how an unknown genius, John Harrison, discovered the key to navigating on the open seas and thus solved one of the thorniest problems of the 1700s.

[Text Longitude Home](#) | [Great Challenge](#) | [GPS](#)
[Find Your Longitude](#) | [Ancient Navigators](#) | [Resources](#)
[Teacher's Guide](#) | [Transcript](#) | [Site Map](#)

[NOVA Online](#) | [Editor's Picks](#) | [Previous Sites](#) | [Join Us/E-mail](#) | [TV/Web Schedule](#)
[About NOVA](#) | [Teachers](#) | [Site Map](#) | [Shop](#) | [Jobs](#) | [Search](#) | [To print](#)



NOVA Online is produced for PBS by the WGBH Science Unit
 Major funding for NOVA® is provided by the Park Foundation,
 The Northwestern Mutual Foundation, and Sprint.

© | created October 1998

Shadow Length Calculator

Use the **SCSA Shadow Length Calculator** to calculate the length of your shadow:

1. Measure your height.
2. For a specific date and time, determine the apparent [Altitude of the Sun](#). [Set "Tabular Interval" to one (1) minute.] **NEVER** look directly at the Sun--blindness may result! Altitude/Azimuth Table courtesy U.S. Naval Observatory.

Note: Input fractions as decimals. For example, input 4 ½ as 4.50.

Your Height: (unit-independent)

Apparent Altitude of the Sun: (0-90 degrees)

Your shadow should extend units from the mid-point of your [footsteps](#).

© Copyright 2002-2004 [Walter Sanford](#). All rights reserved.

[Me and My Shadow - Making the Sun-Earth Connection](#) | [SCSA Home](#)

Object Height Calculator

Use the **SCSA Object Height Calculator** to calculate the height of tall shadow-casters, e.g., buildings, flagpoles, utility poles, trees, etc.:

1. Measure the distance from the base of an object to the tip of its shadow.
2. For a specific date and time, determine the apparent [Altitude of the Sun](#). [Set "Tabular Interval" to one (1) minute.] **NEVER** look directly at the Sun--blindness may result! Altitude/Azimuth Table courtesy U.S. Naval Observatory.

Note: Input fractions as decimals. For example, input $4\frac{1}{2}$ as 4.50.

Object Shadow Length: (unit-independent)

Apparent Altitude of the Sun: (0-90 degrees)

Height of Object is units.

© Copyright 2002-2004 [Walter Sanford](#). All rights reserved.

[Me and My Shadow - Making the Sun-Earth Connection](#) | [SCSA Home](#)

Daylight Calculator

Use the **SCSA Daylight Calculator** to calculate the number of hours of daylight--also known as the Duration of Insolation (Incoming Solar Radiation)--by subtracting the time of sunrise from the time of sunset. Input times should be expressed in 24-hour format: A.M. times are in 24-hour format already; convert P.M. times by adding 12 hours. For example, 5:16 p.m. is equivalent to 17:16 hours.

Obtain the times of sunrise and sunset for your location by visiting one of the following U.S. Naval Observatory Web pages:

- [Complete Sun and Moon Data for One Day](#)
- [Table of Sunrise/Sunset, Moonrise/Moonset, or Twilight Times for an Entire Year](#)

Sunrise time (hh:mm, 24-hour format):

Sunset time (hh:mm, 24-hour format):

© Copyright 2002-2004 [Walter Sanford](#) & [Phillip Wherry](#). All rights reserved.

[Me and My Shadow - Making the Sun-Earth Connection](#) | [SCSA Home](#)

Print Your Solar Noon Calendar

for your exact longitude wherever you are in the world

Message from our sponsors

design of unparalleled accuracy. Please visit our [website](#) or click on the images for more details!

This facility was devised for purchasers of Spot-On Sundials, an innovative modern

Spot-On Sundial in brass

New! Polar Spot-On Sundial in brass

Spot-On Sundial in stainless steel



The innovation is the split gnomon which produces a "line of light" at solar noon. To set up a Spot-On Sundial to true north, all you need is the exact time of solar noon at your longitude - you can then rotate the dial till you get the line of light, lock it down, and it is then "spot on" to true North. Design copyright © Piers Nicholson 2001

The time of solar noon depends on the Equation of Time and on the difference in longitude between your location and the standard meridian of the time zone you are in. It is slightly different for every day of the year. Our unique Solar Noon Calculator will provide you with a table showing the exact time of solar noon for your location for each day of the year.

If you prefer, you can print out the values of the Standard Time Correction, which gives you the amount to add to, or subtract from, the time on your sundial to obtain the time shown by your watch. The Standard Time correction is the sum of the [Equation of Time](#), and the longitude correction; the longitude correction is the time the sun takes to travel between your longitude and the longitude of your standard meridian

Our [latitude and longitude](#) page from our sister site, [Spot-On Sundials](#), will help you to find the input data you need for our unique Solar Noon Calculator

Note that our calculator requires that your latitude and longitude be in decimal format. If your co-ordinates are in Degrees, Minutes, Seconds please click [here](#).

	Example	Your Details	Comments
Location	Epsom		<i>this information is displayed across the top of your calendar, it is not included in any calculations</i>
Latitude	51.33250 N		<i>optional - enter your latitude if you want your latitude/longitude co-ordinates to be displayed on your calendar</i>
Longitude	0.26722 W		<i>required - Longitude is used in the calculations</i>
Time Zone			<i>required - select your time zone from the drop-down list</i>

Type of Calendar	Solar Noon Standard Time Correction	<i>Solar Noon displays the exact time of solar noon each day.</i> <i>Standard Time Correction is the amount you have to add to, or to subtract from, solar time on your sundial to get the time shown on your watch (see note above)</i>
------------------	--	---

If your area has daylight saving time in the summer, we recommend that you highlight or draw a box round the relevant time, and write "Add one hour for daylight saving time" at the foot of the relevant months.

We have welcomed visitors here since 3 May 2001

This site developed and maintained by [Inter~~net~~works](#) of Epsom, England
Webpage copyright © internetworks Ltd, 2001 last updated February 2003
In case of problems, please contact the [webmaster](#)

Tracking				Sighting		Other		
J-Track	J-Track 3D	Station	Shuttle	J-Pass	J-Pass E-Mail	J-Sky	FAQ	Links

Groups: [Spacecraft](#) | [Amateur](#) | [Weather](#) | [Search](#)

If you don't have Java, here are some of the most popular satellites for tracking that you can view (no Java required!):

- [Int'l Space Station](#)
- [Shuttle](#)
- [Hubble Space Telescope](#)
- [Chandra X-Ray Observatory](#)
- [NOAA 12](#), [NOAA 14](#), [NOAA 15](#)

Click on craft Change orbital data in lower right [Weather lay](#)

Ctrl+Click on craft Toggles on/off ground trace

Shift+Click on craft Goes to web page about craft

Click+hold on map Display first visible at longitude



Updated April 22, 2003. [Contacts](#)



IS ATKINS RIGHT FOR YOU?
FIND OUT NOW WITH A **FREE DIET PROFILE.**

ATKINS
LOSE 10lbs
IN 5 WEEKS

Height: 5 ft. 7 in. Weight:



[the You Can Make a Sundial! page.](#) | [What's Your Latitude?](#)

Customize Your Horizontal Sundial

Your latitude, choice of motto, and more.

Input your latitude in degrees (like 45) or degrees and minutes (like 45 32) or degrees, minutes and seconds (like 45 30 54). *Don't use decimal fractions.* If you're in the southern hemisphere use a minus sign.

Your latitude?

Everything below here can be left as is.

Motto

If you have a one line motto put it in the second line of the form. If you want more than two lines you can do it if you're feeling bold. To put more than one line on one line of the form use `)` to separate the lines, e.g. `Roses are red)(Violets are blue)(I know I like sundials)(I hope you do too.` Also, below, you'll probably want to choose to not include the graph of the equation of time.

Enter the name of your location:

Input your longitude. Leave it blank if you don't want longitude "correction".

If you entered your longitude above then enter the longitude of the standard meridian of your time zone, probably a multiple of

15. *Don't make it blank.* If you don't know what it is then you'd better not enter your longitude above.

Do you want to include a graph of the equation of time?

Yes No

Do you want your dial to show daylight saving time?

No Yes

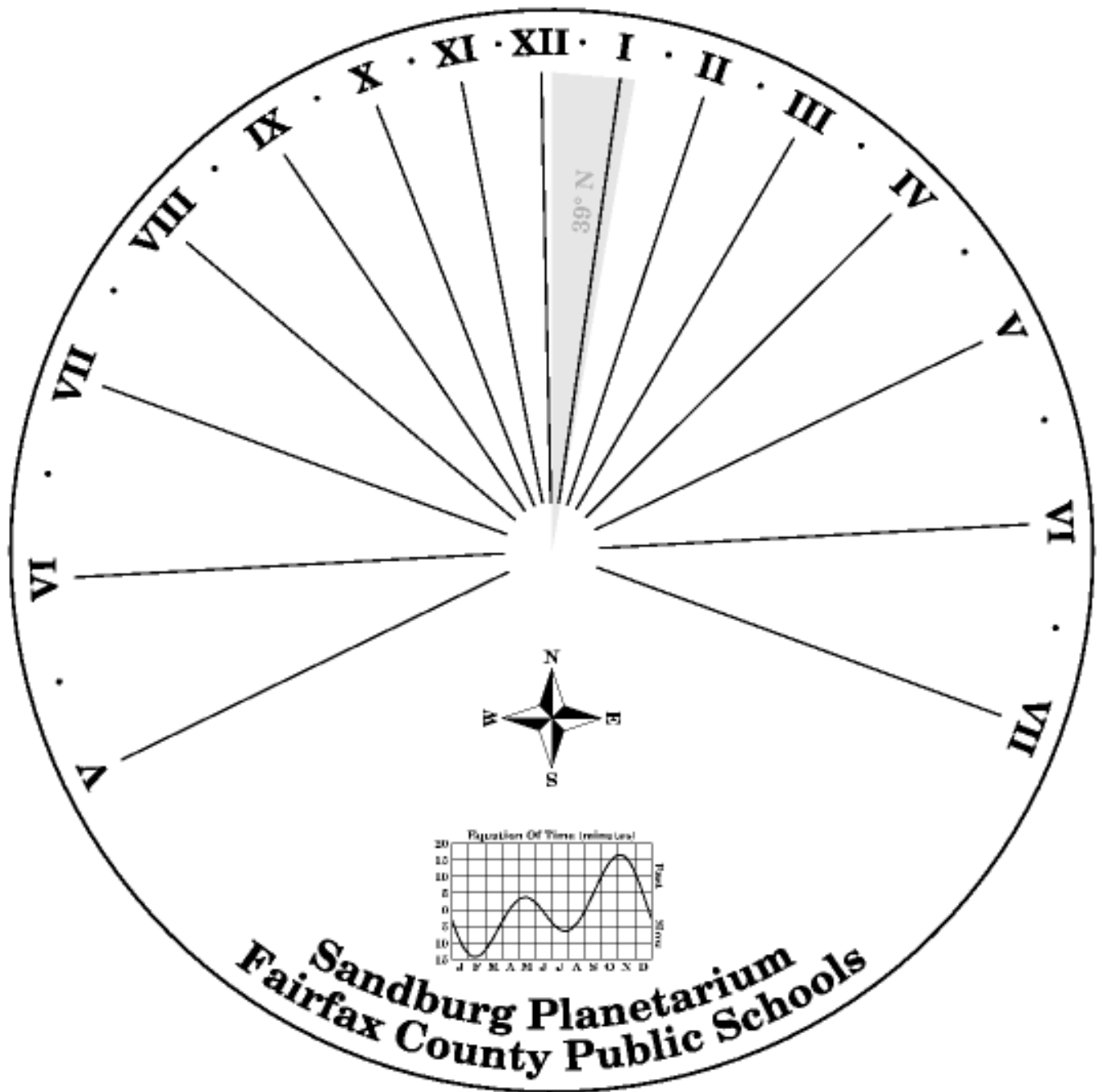

39° N 77° W (Alexandria, VA)
(Add one hour for Daylight Savings Time)

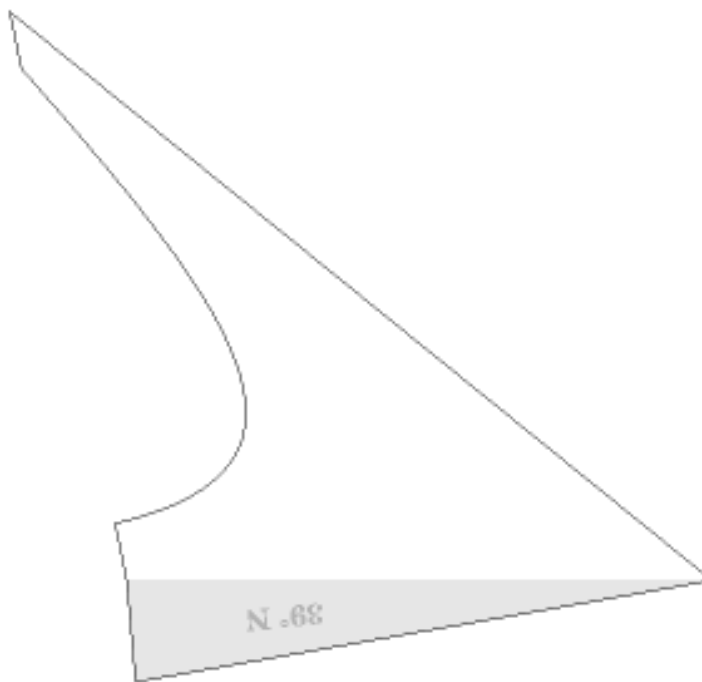

Gnomon for latitude 39° N

(Cut along solid lines, score along dashed line, fold into shape, and glue to dial. You may prefer to use this as a template for cutting a gnomon out of stiffer material.)

For further information on sundial construction, see <http://www.sundials.co.uk/projects.htm>

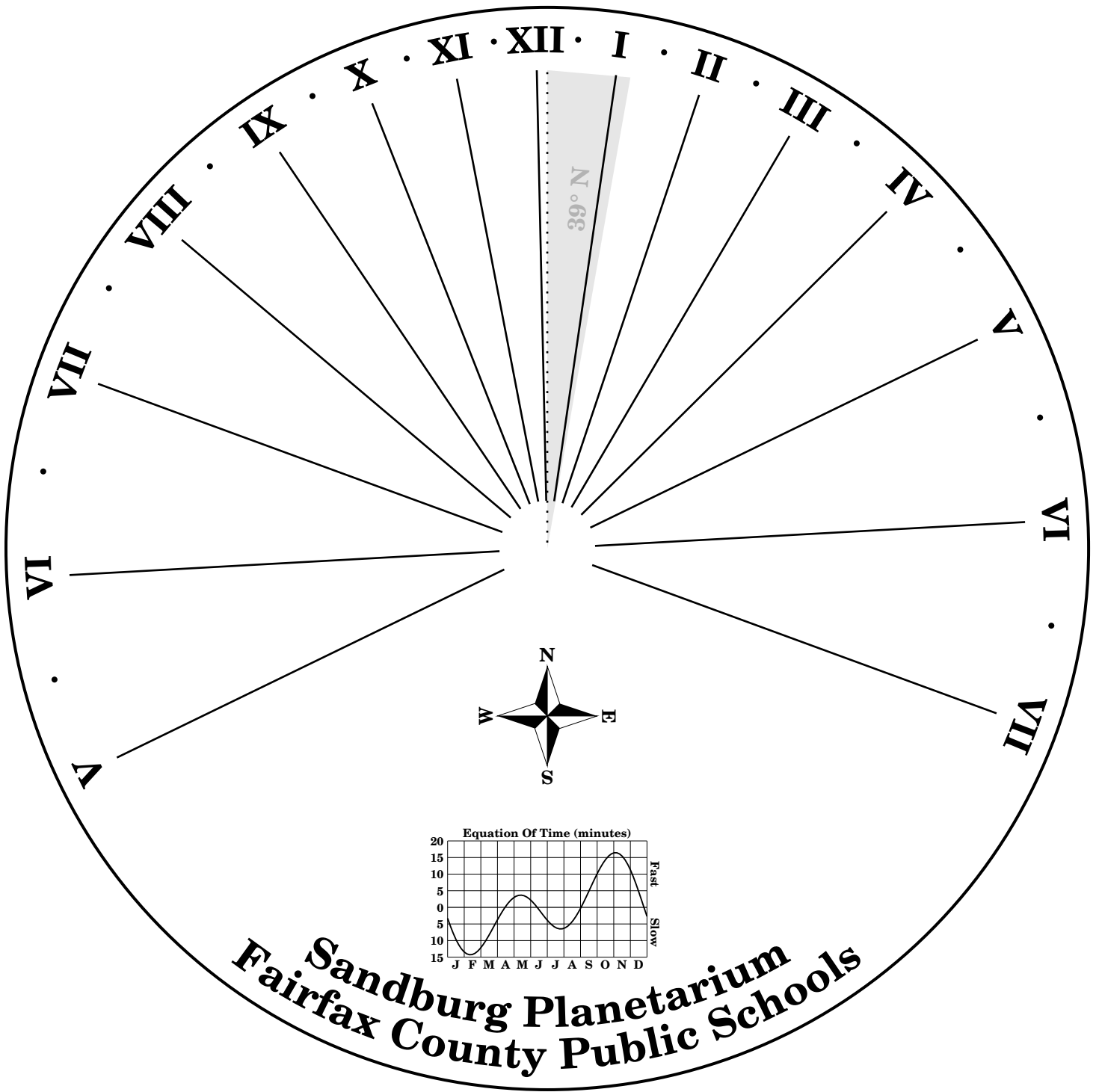

39° N 77° W (Alexandria, VA)
(Add one hour for Daylight Savings Time)

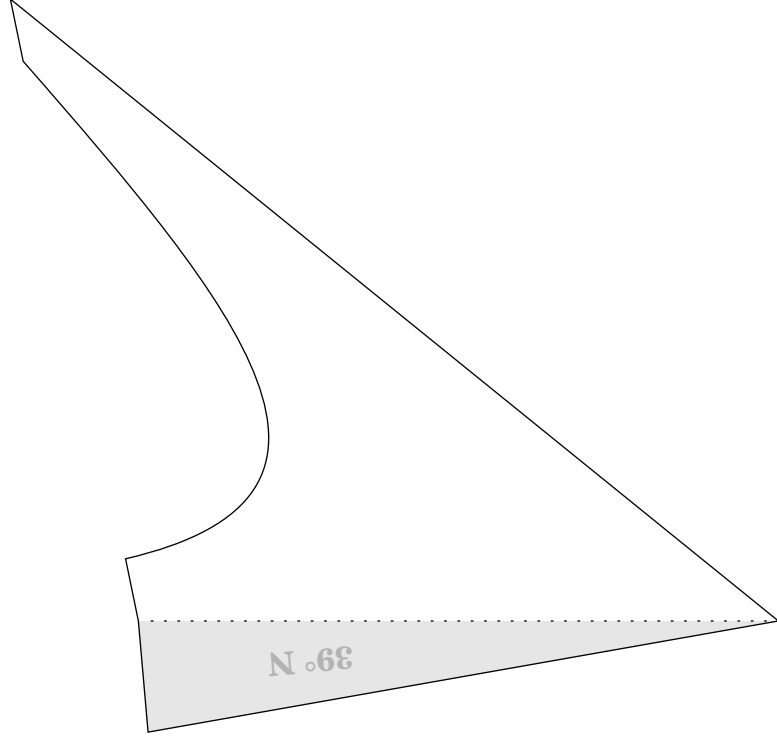

Gnomon for latitude 39° N

(Cut along solid lines, score along dashed line, fold into shape, and glue to dial. You may prefer to use this as a template for cutting a gnomon out of stiffer material.)

For further information on sundial construction, see <http://www.sundials.co.uk/projects.htm>



Using Adobe Acrobat to View PDF Files

(Print this page out for reference.)

Documents that contain graphics, photos, and specialized formatting such as multiple columns are not easily converted to HTML, the programming language of the web. FCPS web curators use Adobe Acrobat to prepare documents that contain more than text for the web site. Acrobat converts documents to PDF images. PDF documents appear on the web in an identical format and appearance to printed documents. The current version of Acrobat is version 6.0. If you are unable to view certain charts or graphs, and you are using earlier version of Acrobat, please follow these instructions to upgrade your software to enable you to view these images.

Web users need to have the free Acrobat Reader program installed and linked to their web browsers to view PDF images. Instructions and [system requirements](#) for downloading and attaching the viewer for both PC and Apple platforms follow:

- Go to the Adobe Acrobat Reader free download page:
<http://www.adobe.com/products/acrobat/readstep2.html>.
- Choose your language, platform, and connection speed on Step 1 of 2. Your selection will determine the version of software that you will download.
- As soon as you choose your language, platform, and connection speed on Step 1, Step 2 of 2 will be displayed.
- By default, you will download the full version using Adobe Download Manager. The full version allows you to:
 - Search PDF files
 - Activate accessibility features built into PDF files
 - View Photoshop® Album slide shows and electronic cards, extract pictures, and order prints
 - Play back embedded movies, animation, and sound
 - View, organize, and purchase eBooks

If you don't need the full version, uncheck the first check box where it says, "Download the full version." If you don't want to use the Adobe Download Manager, check the second check box where it says, "Do not use Adobe Download Manager."

- Click the "download" button. Make note of where the downloaded file is being saved on your computer.

- After the download is complete, some computers will start to install automatically. If your computer doesn't start to install the software, double-click the newly downloaded file and follow the instructions on your screen. If there is a failure at any point during the installation of Acrobat Reader, the installer performs a complete uninstall. For this reason, it is important not to close the installer application by clicking its close box in the upper right corner of the background window after clicking the "Thank You" dialog box that appears at the end of the installation. If you wait for a second or two, the installer will automatically close the background windows after the installation is complete. The installation procedure will ask you to read and accept the Electronic End-User License Agreement.
- Now you are ready to view PDF files. To view a file, simply click on the link on any web page. Acrobat reader will automatically be called up to allow you to view (and print) the file.
- Special note to FCPS employees: All FCPS computers should be equipped with the Acrobat Reader program. Employees with Internet connections who do not have Acrobat Reader should follow the instructions for downloading and installing the program. Employees responsible for equipping new computers for Internet access are asked to make the Acrobat viewer part of the standard installation package.



Last update: September 9, 2003
Curator: Jill Kurtz, jill.kurtz@fcps.edu

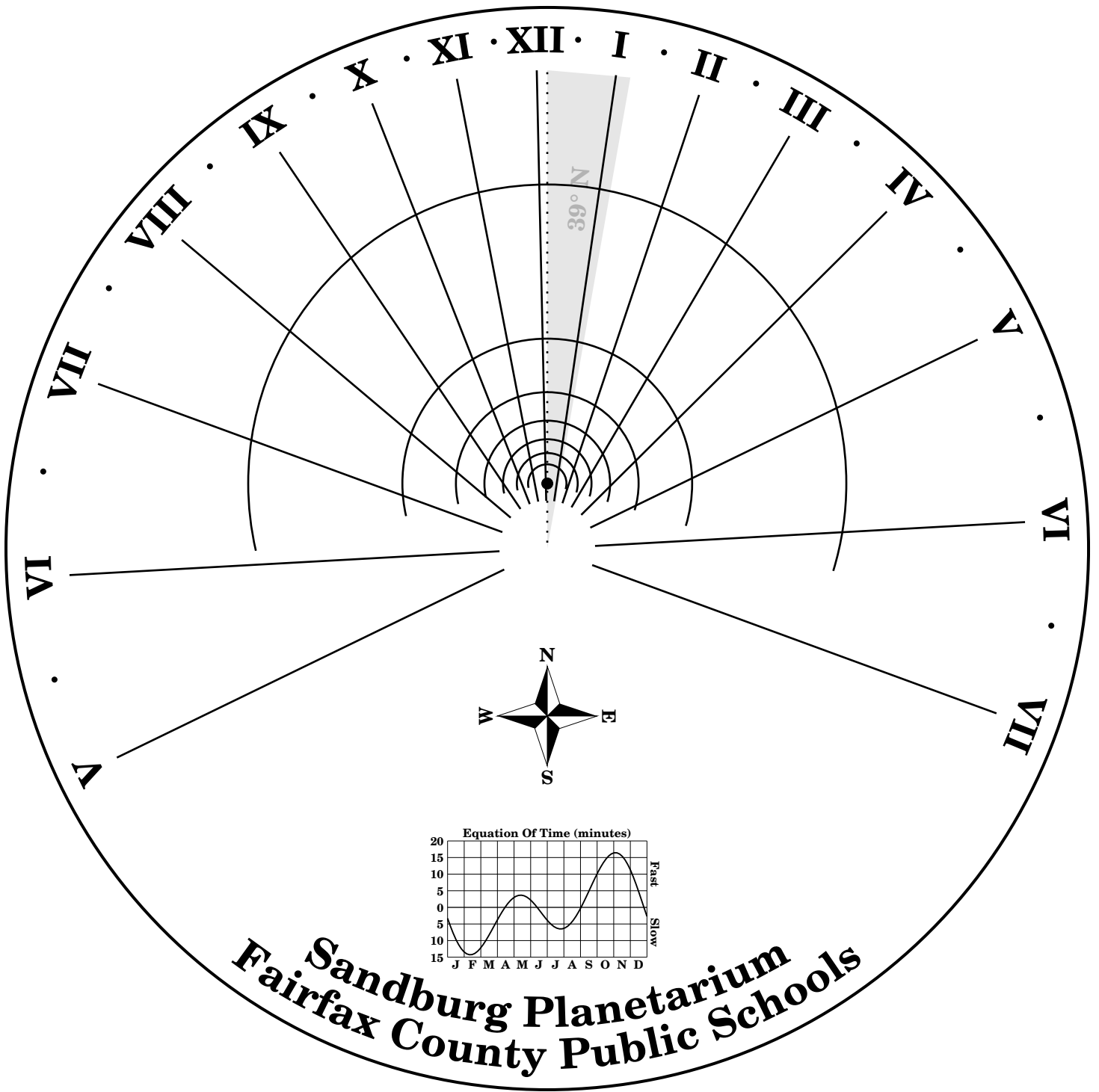

39° N 77° W (Alexandria, VA)
(Add one hour for Daylight Savings Time)

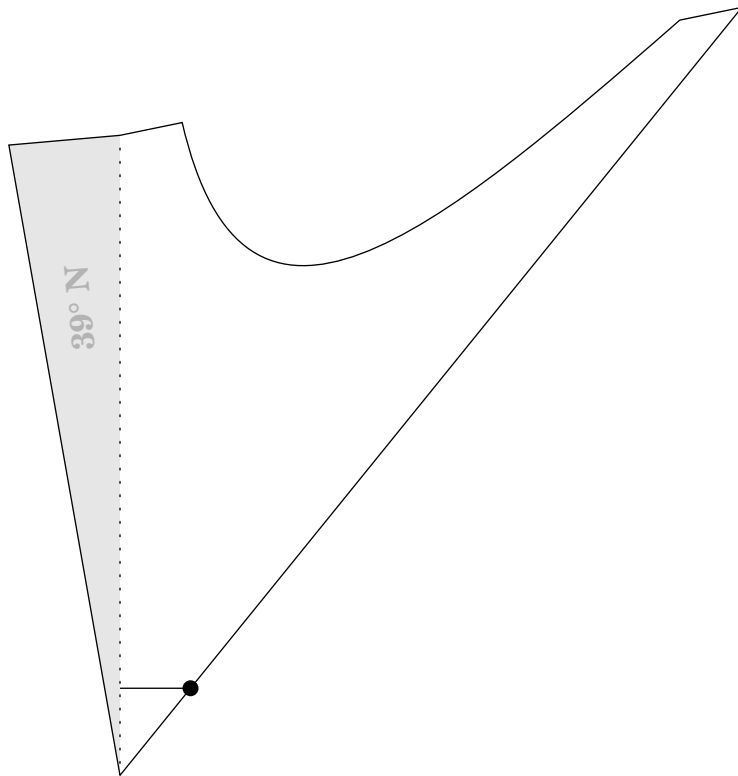

Gnomon for latitude 39° N

(Cut along solid lines, score along dashed line, fold into shape, and glue to dial. You may prefer to use this as a template for cutting a gnomon out of stiffer material.)

For further information on sundial construction, see <http://www.sundials.co.uk/projects.htm>

Search Tools

 Search by Brand 

Find Printer Supplies

Find a Store

Shopping Tools

 0 Item(s) in Cart
 Subtotal: \$0.00

[Add \\$50.00 more
for FREE shipping*](#)
 [View Cart](#)
 [Check Out](#)

 Order by Item # 

 Order Tracking 

 My Account 

 My Shopping Lists 

 Request a Catalog 

 Apply for Credit Card 
[Home](#) > [Office Supplies](#) > [Paper, Forms, Envelopes](#) > [Paper](#) > [Cover & Card Stock](#) > [Wausau Astrobrights® Bright Color Cover Stock](#)

Green paper shown.

Wausau Astrobrights® Bright Color Cover Stock

This firm, yet flexible heavyweight (65 lb) cover stock has a bright, clean surface for more true color reproduction. A smooth, lint-free surface ensures clear printing without problems. This cover stock is especially good for mailers, menus, brochures, announcements and more. The recycled papers (Gamma Green, Lunar Blue and Re-Entry Red) contain 30% postconsumer material.



Item Number	List Price	Our Price	Units	Availability	Compare
919500	\$22.95	\$10.64	pack	In Stock	

 BUY MORE
and SAVE!

Buy 3+

\$9.50

pack

[Wausau Astrobrights® Bright Color Cover Stock, 8 1/2" x 11", 65 Lb., Cosmic Orange, Pack Of 250 Sheets](#)
Quantity

Item Number	List Price	Our Price	Units	Availability	Compare
255842	\$22.95	\$10.64	pack	In Stock	

 BUY MORE
and SAVE!

Buy 3+

\$9.50

pack

[Wausau Astrobrights® Recycled Bright Color Cover Stock, 8 1/2" x 11", 65 Lb., Gamma Green, Pack Of 250 Sheets](#)
Quantity

Item Number	List Price	Our Price	Units	Availability	Compare
424152	\$22.95	\$10.64	each	In Stock	

 BUY MORE
and SAVE!

Buy 3+

\$9.50

each

[Wausau Astrobrights® Recycled Bright Color Cover Stock, 8 1/2" x 11", 65 Lb., Lunar Blue, Pack Of 250 Sheets](#)
Quantity

Item Number	List Price	Our Price	Units	Availability	Compare
-------------	------------	-----------	-------	--------------	---------

What's free, easy...
and gives you up to
10% back?
Office DEPOT
ADVANTAGE
A new Standard in
Customer Reward Programs
[Details](#) 

HP Technology
Savings Week!
Save
up to
\$250
by Mail!

[Details](#) 

	424241	\$22.95	\$10.64	each	In Stock
	BUY MORE and SAVE! Buy 3+		\$9.50	each	
Wausau Astrobrights® Recycled Bright Color Cover Stock, 8 1/2" x 11", 65 Lb., Re-Entry Red, Pack Of 250 Sheets					
Quantity					

	Item Number	List Price	Our Price	Units	Availability	Compare
	424367	\$22.95	\$10.64	each	In Stock	
BUY MORE and SAVE! Buy 3+		\$9.50	each			
Wausau Astrobrights® Bright Color Cover Stock, 8 1/2" x 11", 65 Lb., Solar Yellow, Pack Of 250 Sheets						
Quantity						

Site Info:	Other Depots:	Customer Service:	Company Info:	Specials:
Site Map	Janitation Depot	Contact Us	Affiliate Program	Super Values
Terms of Use	Tech Depot	Delivery	Career Opportunities	Rebate Center
Privacy Policy	Office Depot en Español	Find a Store	International	Advertised Specials
		Catalog Request	Government Programs More	

Prices shown are in U.S. Dollars. Please login for country specific pricing.
Prices are subject to change based on your location.

Copyright ©2004 by Office Depot, Inc. All rights reserved.

**Sandburg Center for Sky Awareness
A Fairfax County Public Schools Planetarium**

How to Set Up & Use a Horizontal Sundial

A horizontal sundial consists of the dial plate, marked off in hours, and the gnomon (including the style) that sits on the meridian (noon hour line) and sticks up from the dial plate at a right angle relative to the plane of the dial face. Place the sundial on a horizontal surface (hence the name, "horizontal sundial") and align the gnomon with [true north](#) (on the dial face, 12 noon should point north).

Finding the Direction of True North

1. Use a compass (compensate for [magnetic declination](#)).
2. Align with Polaris, the North Star.

For more information, visit the [How to set up a horizontal sundial](#) Web page:
<http://www.sundials.co.uk/setup.htm>

Visit the SCSA [Equatorial Sundials](#) Web page for an explanation of how the sundial may be used to align itself with your local meridian:

http://www.wsanford.com/~wsanford/exo/sundials/equatorial_sundials.html#setting-the-dial

Find your meridian by using a self-orienting [Combination Analemmatic-Horizontal Sundial](#):

<http://www.wsanford.com/~wsanford/exo/sundials/shadows.html#combo-sundial>

Telling Time Using the Sundial

Morning times appear on the dial face to the left side of the meridian; afternoon times to the right. Most days, **Solar Time** and **Standard Time** are slightly different (by as much as 16 minutes). This time difference is known as the [Equation of Time](#). Add or subtract the Equation of Time as appropriate (see reference table showing daily [Equation of Time](#)).

The **Sandburg Sundial** features a correction for longitude (note that the gnomon is offset slightly from the meridian) so that Solar Time will coincide with Standard Time (after adding/subtracting Equation of Time). Add one hour for [Daylight Saving Time](#).

http://www.wsanford.com/~wsanford/exo/sundials/horizontal_sundial_setup.html

[About NASS](#)

[Publications](#)

[Join NASS](#)

[Current
Data](#)

[Message
Board](#)

[Sundial
Register](#)

[Links](#)

[F.A.Q](#)

[Conference
News](#)

[Contacts](#)

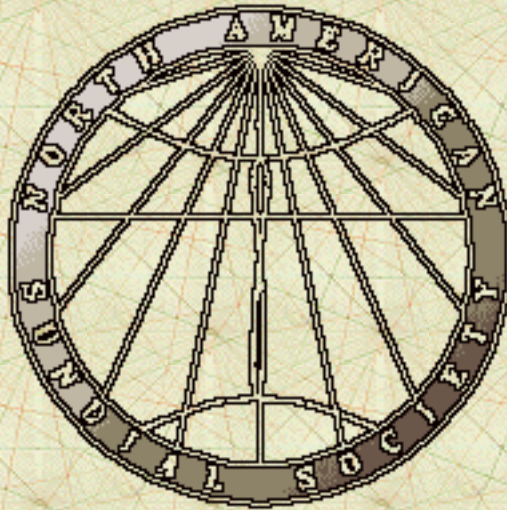

NASS on the Net

The Home page of the North American Sundial Society

NEW! The 400+ dials in the NASS Register of North American Sundials include 274 photos. Now you can browse these photos via thumbnail indexes.

Click on **Sundial Register** in the left frame, then **Photo Index**

Copyright © The North American Sundial Society
[Webmasters - link to this site](#)

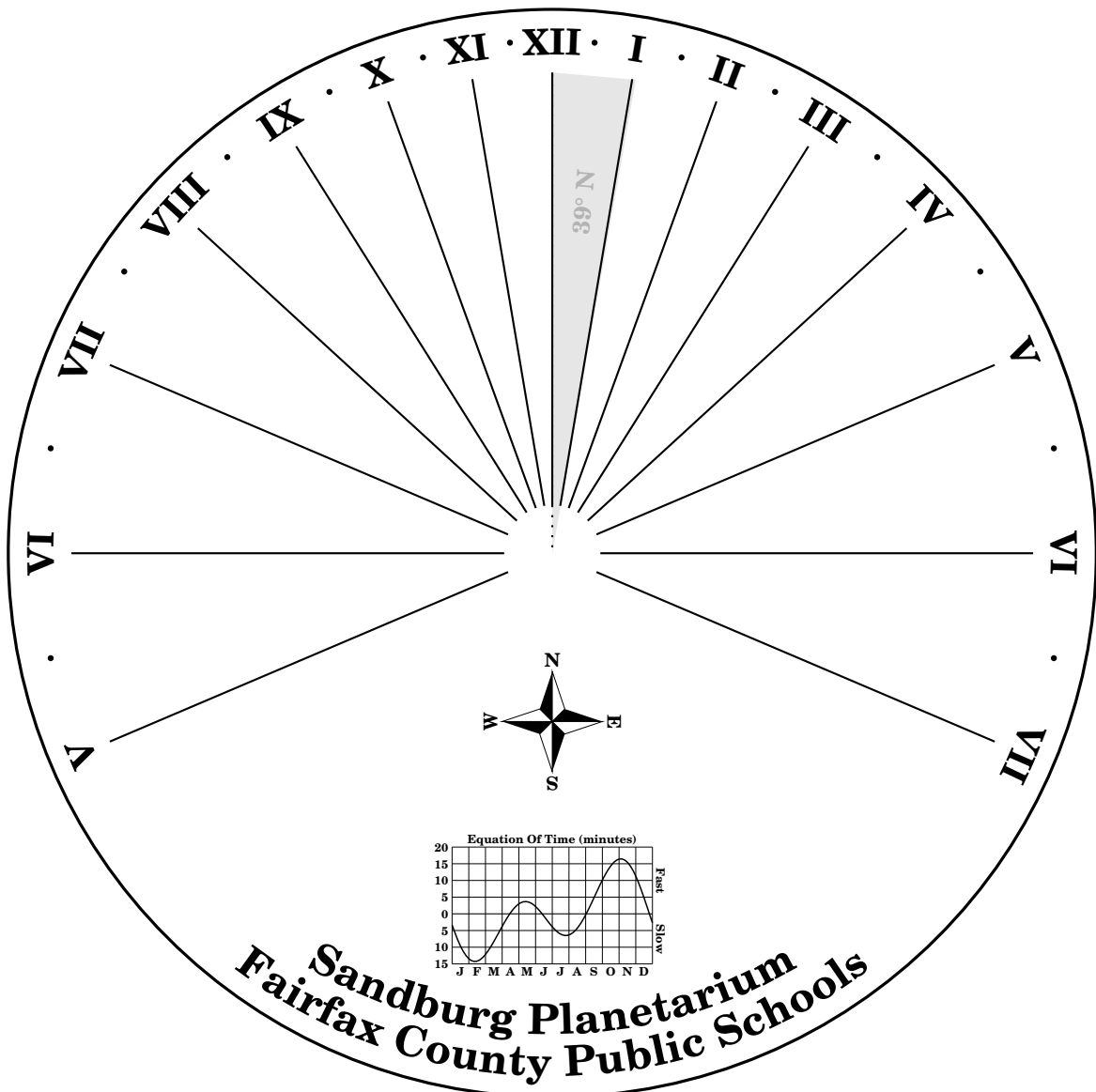
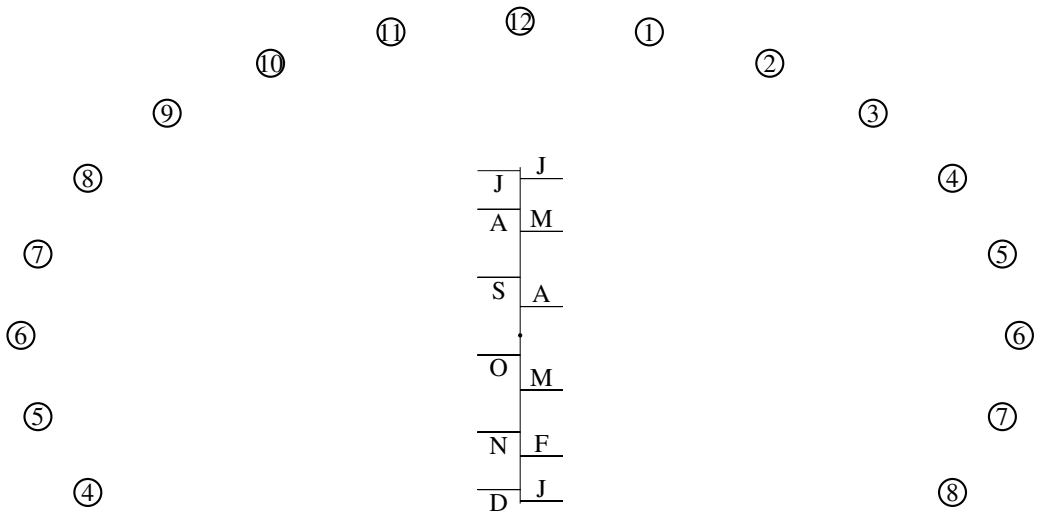

39° N (Alexandria, VA)
(Add one hour for Daylight Savings Time)

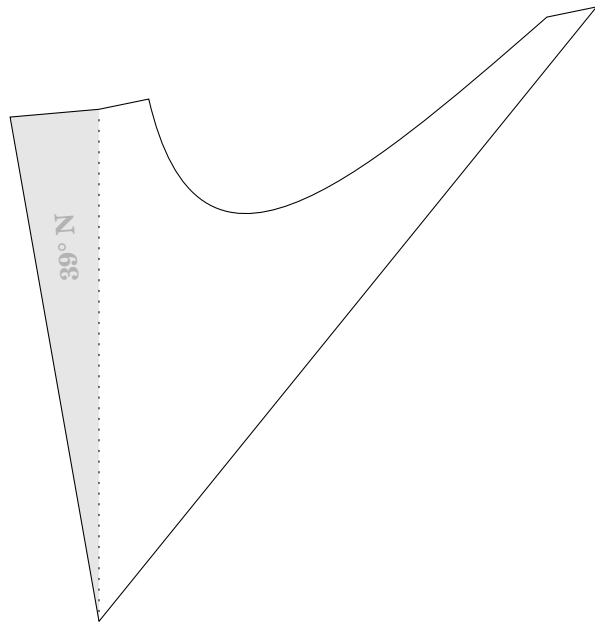

Gnomon for latitude 39° N

(Cut along solid lines, score along dashed line, fold into shape, and glue to dial. You may prefer to use this as a template for cutting a gnomon out of stiffer material.)

For further information on sundial construction, see <http://www.sundials.co.uk/projects.htm>



The very latest SOHO images

[Search Tool for Near Real Time Data](#)

[About these images](#)

THE VERY LATEST SOHO IMAGES

EIT 171

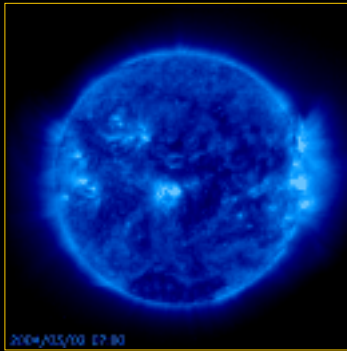

[More EIT 171](#)

[256 × 256](#)

[512 × 512](#)

[1024 × 1024](#)

EIT 195

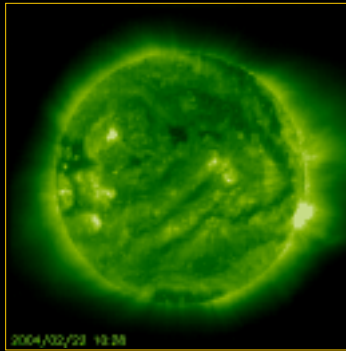

[More EIT 195](#)

[256 × 256](#)

[512 × 512](#)

[1024 × 1024](#)

EIT 284

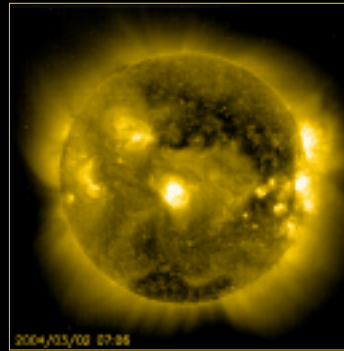

[More EIT 284](#)

[256 × 256](#)

[512 × 512](#)

[1024 × 1024](#)

EIT 304

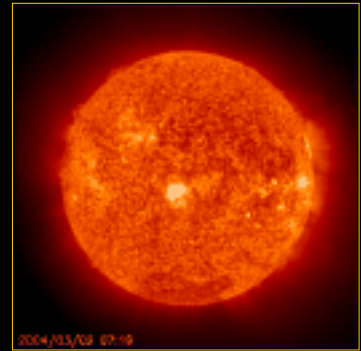

[More EIT 304](#)

[256 × 256](#)

[512 × 512](#)

[1024 × 1024](#)

MDI Continuum



[More MDI Continuum](#)

[256 × 256](#)

[512 × 512](#)

[1024 × 1024](#)

MDI Magnetogram

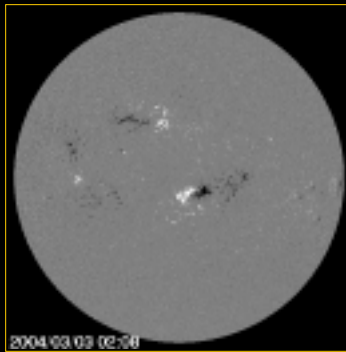

[More MDI Magnetogram](#)

[256 × 256](#)

[512 × 512](#)

[1024 × 1024](#)

LASCO C2

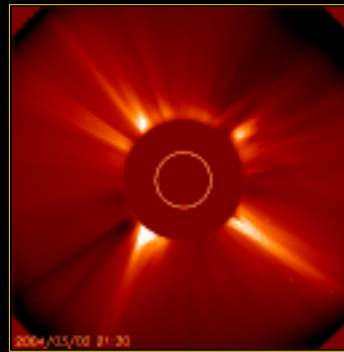

[More LASCO C2](#)

[256 × 256](#)

[512 × 512](#)

[1024 × 1024](#)

LASCO C3

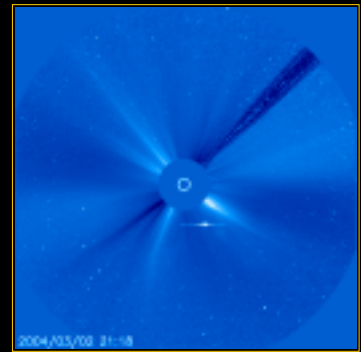

[More LASCO C3](#)

[256 × 256](#)

[512 × 512](#)

[1024 × 1024](#)

[Click here to see only the images in a new window](#)

[Click here for the old \(six images\) version](#)

REAL TIME MOVIES

Java Movie Player

[MPEG](#)

[Animated GIFs](#)

[See also the latest CDS rasters](#)

For details on comets or planets, [visit the sungrazer pages](#)

Last modification: March 03, 2004 00:06 EST

Feedback and comments about this site, please direct to the [SOHO Webmaster](#).

Questions about our mission, the spacecraft and science, please direct to: [Dr. SOHO](#).



SOHO Explore

The Education and Public Outreach Page of the Solar and Heliospheric Observatory (SOHO)

THE SUN 101

- An introduction to "[Our Star the Sun](#)" with cool images and videos.

SOHO GLOSSARY

- [Terms, concepts, & definitions](#) of words used on the SOHO web pages.

SUN FUN ACTIVITIES

- Fun [activities](#) using the same real sun data that scientists use!

SOHO LESSON PLANS

- Examine our [Lesson Plans](#)! Your students can use **real SOHO data** !!!

ASK Dr. SOHO

- Have a question about SOHO or the Sun?
Check out our [Frequently Asked Questions List](#) and our [Not so Frequently Asked Questions List](#)!
If you can't find the answers there [Ask Dr. SOHO](#).

EDUCATIONAL MATERIALS

- [Educational CDs, posters, portfolio, and much much more.](#)

THE BEST LINKS UNDER THE SUN

- [Links](#) to sites about the Sun, Educational Resources
other missions and much much more...

UPCOMING EVENTS

- Solar Physics and Space Science [Programs/Events](#) near you as well as on TV and live on the Internet.

Last modification: October 02, 2002

Feedback and comments about this site, please direct to the [SOHO Webmaster](#).

Questions about our mission, the spacecraft and science, please check: [Dr. SOHO](#).

[Click here to escape from frames](#)



National Oceanic and Atmospheric Administration

Wed March 03 2004

[Home](#)

[Contacts](#)

[Media](#)

[Disclaimer](#)

[Search](#)

[People Locator](#)

Site Index

[Site Map](#)

(includes pull-down menu text)

Today's Weather

Your Local Forecast by City, State



[Current Watches/Warnings](#)

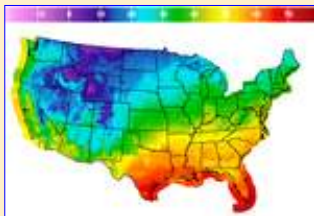

[Graphical Weather Map: Get High and Low Temperatures and More](#)

STORM WATCH



[Image of the Day](#)

About NOAA

Top Story

NOAA SHIP LOCATES WRECK OF BOW MARINER Agency Brings Scientific Assets to Environmental Assessment and Search Missions

The NOAA ship Rude found the wreckage of Bow Mariner, a 570-foot tanker that sank 50 nautical miles east of Chincoteague, Va., on Feb. 28, 2004. The ship sank in about 250 feet of water. Rude (pronounced Rudy) is a hydrographic survey ship that supports NOAA's nautical charting mission; it was part of a NOAA team dispatched to the scene to provide scientific and environmental support in the aftermath of the disaster at the request of the U.S. Coast Guard. Rude used side-scan sonar to locate the sunken ship. Because of its expertise in surveying the ocean floor for production of the nation's nautical charts, Rude has been called upon before by the U.S. Coast Guard to assist with disaster response. Rude found the wreckage of TWA 800 in 1996 and John F. Kennedy Jr.'s aircraft in 1999.

[Full Story Inside](#)



Other News



NOAA RELEASES NEW MANUAL ON COASTAL HABITAT RESTORATION MONITORING

For the first time, NOAA compiled key restoration monitoring information applicable to coastal habitats nationwide. "Science-Based Restoration Monitoring of Coastal Habitats, Volume One: A Framework for Monitoring Plans Under the Estuaries and Clean Waters Act of 2000 (Public Law 160-457)" provides useful tools for developing and carrying out monitoring of coastal restoration efforts.

EARTH OBSERVATION SYSTEM MOVES FORWARD WITH WORKING GROUP MEETING IN SOUTH AFRICA

The intergovernmental Group on Earth Observations (GEO) will hold its working meeting this week in Cape Town, South Africa, to continue development of a ten-year plan for an Earth Observation System. Retired Navy Vice Adm. Conrad C. Lautenbacher, Ph.D., undersecretary of commerce for oceans and atmosphere and NOAA administrator, will lead the U.S. delegation.



NOAA SEEKS COMMENT ON PROPOSAL TO LESSEN FISHING IMPACTS ON SEA TURTLES & REOPEN GRAND BANKS TO U.S. PELAGIC LONGLINE FLEET

The conclusion of a three-year experiment in the Grand Banks and recent estimates of sea turtle bycatch (unintentional catch) in the Atlantic pelagic longline fishery have prompted NOAA Fisheries to propose mandatory changes in fishing practice for the fleet.



[News Story Archive](#) -

Home page stories 1999 - Present



[NOAA Magazine](#) - The

stories behind the headlines.



[AccessNOAA](#) - NOAA

Employees Make a Difference

- ["Meet the NOAA Administrator](#)
- ["NOAA Administrator's Speeches](#)
- ["NOAA Leadership](#)
- ["NOAA Strategic Planning](#)
- ["Annual Guidance Memo](#)
- ["FOIA](#)
- ["NOAA History](#)
- ["Information Quality](#)
- ["Privacy Policy](#)

Opportunities

- ["Contracting](#)
- ["Employment](#)
- ["Diversity](#)
- ["Grants](#)
- ["NOAA Rotational Assignment Program](#)

Organizations

- ["NOAA National Weather Service](#)
- ["NOAA Satellites and Information](#)
- ["NOAA Fisheries](#)
- ["NOAA Ocean Service](#)
- ["NOAA Research](#)
- ["NOAA Marine & Aviation Operations](#)
- ["CIO/HPCC](#)
- ["Education Resources](#)
- ["Education and Sustainable Development](#)
- ["Finance & Administration](#)
- ["General Counsel](#)
- ["International Affairs](#)
- ["IT Security](#)
- ["Legislative Affairs](#)

- ["NOAA Library](#)
- ["NOAA in Your State](#)
- ["Science Advisory Board](#)
- ["Employee Worklife Center](#)

Public Affairs

Media Advisories



[NOAA Launches Redeveloped Web Site on U.S. Marine Protected Areas](#)

Science, Service, and Stewardship

 <p>Weather Watches, warnings, floods, hurricanes, Weather Radio...</p>	 <p>Ocean Coral reefs, tides, currents, buoys, marine sanctuaries, estuaries, diving, spills</p>	 <p>Satellites Real-time imagery, environmental, geostationary and polar satellites</p>	 <p>Fisheries Protecting marine mammals, sea turtles, habitats, statistics, economics, enforcement</p>
 <p>Climate El Niño & La Niña, global warming, drought, climate prediction, archived weather data, paleoclimatology</p>	 <p>Research Environmental labs, air quality, atmospheric processes, climate and human interactions</p>	 <p>Coasts Coastal services, products, Great Lakes, coastal zone management</p>	 <p>Charting & Navigation Nautical & navigational charts, mapping, remote sensing, safe navigation</p>



Question of the Month

What are coastal wetlands and where are they Located?

NOAA Answers Your Questions

A new Web site to help you find NOAA information.

In the Spotlight

- " [Name NOAA's New Ship](#) Contest Closed, Entries Being Evaluated
- " [NOAA Issues Draft Policy to Update Fair Weather Partnerships](#) Public Comments Requested
- " [Economic Statistics for NOAA \(PDF\)](#)
- " [NOAA 2005 Budget Request](#) "Blue Book" Online
- " [Coastal Zone Management Act Consistency Appeals](#)
- " [NOAA Climate Data at a Glance](#) - Find 108 years of weather data for the U.S.
- " [NOAA Ocean Explorer](#) - Ocean exploration without getting wet!



[Visit the World's only undersea laboratory - NOAA's AQUARIUS habitat.](#)

Anchored off the coast of Florida, AQUARIUS provides divers with a place to work and live.

- "[Media Contacts](#)
- "[News Releases](#)
- "[NOAA Background Info](#)
- "[Public Affairs](#)
- "[External Affairs](#)
- "[Story Ideas for Reporters](#)
- "[Webcasts](#)



[Drifting Iceberg](#)



Visit the [NOAA Photo Library](#) and view more than 30,000 images.



- " [Search & Rescue Satellite-aided Tracking/Emergency Beacon registration](#)
- See how NOAA's SARSAT helps to save mariners, aviators and other people in distress.
- " [NOAA Posts Images Online of Northeast Blackout](#)
- " [NOAA Aircraft Takes Dramatic Photos of North Carolina Coast after Hurricane Isabel Unleashed Her Fury](#)
- " [Dept. Of Commerce Millennium Pipeline Company Decision \(40-page PDF File\)](#)



Now Playing

-  [Want to Know About NOAA?](#) You'll need *RealPlayer* to view this streaming video clip. [Click here](#) for video text.
-  [NOAA Launches the First of Four Planned NOAA Fisheries Survey Vessels](#) You'll need *RealPlayer* to view this streaming video clip. [Read the story.](#)

Sunspot Archives

3 Mar 2004



Today's sunspot
number is

50

Courtesy National Oceanic and
Atmospheric Administration
Updated: 02 Mar 2004

[What is the Sunspot
Number?](#)

For more information on
current solar conditions visit
[The Space Weather
Bureau](#)

Sunspot Plotter (Java support required)

The Java applet below allows you to plot 11 years worth of sunspot number centered on any date between 1755 and the present. Using the pull-down menus enter the date of interest, and hit "Refresh". Click [here](#) for a plot of all monthly-averaged sunspot numbers from the year 1749 through the present.

MORE DATA

[Greenwich Sunspot Data](#)

See also: Monthly averages of sunspot numbers from 1749 through the present (updated monthly):

[\(25 kb GIF image\)](#)

[\(37 kb postscript file\)](#)

[\(62 kb text file\)](#)

What is the Sunspot Number? The Space Environment Services Center (SESC) sunspot number for the indicated date is from the daily Solar Region Summary issued by SESC. The SESC sunspot number is computed according to the Wolf Sunspot Number $R=k(10g+s)$, where g is the number of sunspot groups (regions), s is the total number of individual spots in all the groups, and k is a variable scaling factor (usually <1) that indicates the combined effects of observing conditions, telescope, and bias of the solar observers. A sunspot number of zero indicates there were no visible sunspots on that date; a blank indicates that no observations were taken. The sunspot region information used to compute the daily sunspot number incorporates reports from as many as six observatories. These reports are used to form a composite picture of each individual region, including sunspot number, area and classification, taking into account such factors as the time of observation and the quality of seeing. This composite information is the daily average obtained from the reporting observatories and may not represent the latest data. It is reported daily in the Solar Region Summary and listed in the Region Summary section of the Weekly.

(Note: there are actually two "official" sunspot numbers reported. The International Sunspot Number is compiled by the [Sunspot Index Data Center](#) in Belgium. The NOAA, or American, sunspot number is compiled by the US [National Oceanic and Atmospheric Administration](#).)

[Back to Sunspots and The Solar Cycle](#)

Copyright © 1998 **[Bishop Web Works](#)**
All rights reserved.



Earth's Seasons Equinoxes, Solstices, Perihelion, and Aphelion 1992-2020

Note: In the tables, **d, h, m** indicate day, hour, minute, respectively, of [Universal Time](#).

Universal Time

		d	h			d	h	m			d	h	m
1992				1992									
Perihelion	Jan	3	15	Equinoxes	Mar	20	08	48	Sept	22	18	43	
Aphelion	July	3	12	Solstices	June	21	03	14	Dec	21	14	43	
1993				1993									
Perihelion	Jan	4	03	Equinoxes	Mar	20	14	41	Sept	23	00	22	
Aphelion	July	4	22	Solstices	June	21	09	00	Dec	21	20	26	
1994				1994									
Perihelion	Jan	2	06	Equinoxes	Mar	20	20	28	Sept	23	06	19	
Aphelion	July	5	19	Solstices	June	21	14	48	Dec	22	02	23	
1995				1995									
Perihelion	Jan	4	11	Equinoxes	Mar	21	02	14	Sept	23	12	13	
Aphelion	July	4	02	Solstices	June	21	20	34	Dec	22	08	17	
1996				1996									
Perihelion	Jan	4	07	Equinoxes	Mar	20	08	03	Sept	22	18	00	
Aphelion	July	5	18	Solstices	June	21	02	24	Dec	21	14	06	
1997				1997									
Perihelion	Jan	2	00	Equinoxes	Mar	20	13	55	Sept	22	23	56	
Aphelion	July	4	19	Solstices	June	21	08	20	Dec	21	20	07	
1998				1998									

Earth's Seasons, etc. 1992-2020

Perihelion	Jan	4 21	Equinoxes	Mar	20 19 55	Sept	23 05 37
Aphelion	July	4 00	Solstices	June	21 14 03	Dec	22 01 56
1999		1999					
Perihelion	Jan	3 13	Equinoxes	Mar	21 01 46	Sept	23 11 31
Aphelion	July	6 22	Solstices	June	21 19 49	Dec	22 07 44
2000		2000					
Perihelion	Jan	3 05	Equinoxes	Mar	20 07 35	Sept	22 17 27
Aphelion	July	4 00	Solstices	June	21 01 48	Dec	21 13 37
2001		2001					
Perihelion	Jan	4 09	Equinoxes	Mar	20 13 31	Sept	22 23 04
Aphelion	July	4 14	Solstices	June	21 07 38	Dec	21 19 21
2002		2002					
Perihelion	Jan	2 14	Equinoxes	Mar	20 19 16	Sept	23 04 55
Aphelion	July	6 04	Solstices	June	21 13 24	Dec	22 01 14
2003		2003					
Perihelion	Jan	4 05	Equinoxes	Mar	21 01 00	Sept	23 10 47
Aphelion	July	4 06	Solstices	June	21 19 10	Dec	22 07 04
2004		2004					
Perihelion	Jan	4 18	Equinoxes	Mar	20 06 49	Sept	22 16 30
Aphelion	July	5 11	Solstices	June	21 00 57	Dec	21 12 42
2005		2005					
Perihelion	Jan	2 01	Equinoxes	Mar	20 12 33	Sept	22 22 23
Aphelion	July	5 05	Solstices	June	21 06 46	Dec	21 18 35
2006		2006					
Perihelion	Jan	4 15	Equinoxes	Mar	20 18 26	Sept	23 04 03
Aphelion	July	3 23	Solstices	June	21 12 26	Dec	22 00 22
2007		2007					
Perihelion	Jan	3 20	Equinoxes	Mar	21 00 07	Sept	23 09 51
Aphelion	July	7 00	Solstices	June	21 18 06	Dec	22 06 08
2008		2008					
Perihelion	Jan	3 00	Equinoxes	Mar	20 05 48	Sept	22 15 44
Aphelion	July	4 08	Solstices	June	20 23 59	Dec	21 12 04
2009		2009					
Perihelion	Jan	4 15	Equinoxes	Mar	20 11 44	Sept	22 21 18
Aphelion	July	4 02	Solstices	June	21 05 45	Dec	21 17 47
2010		2010					
Perihelion	Jan	3 00	Equinoxes	Mar	20 17 32	Sept	23 03 09
Aphelion	July	6 11	Solstices	June	21 11 28	Dec	21 23 38
2011		2011					

Perihelion	Jan	3 19	Equinoxes	Mar	20 23 21	Sept	23 09 04
Aphelion	July	4 15	Solstices	June	21 17 16	Dec	22 05 30
2012				2012			
Perihelion	Jan	5 00	Equinoxes	Mar	20 05 14	Sept	22 14 49
Aphelion	July	5 03	Solstices	June	20 23 09	Dec	21 11 11
2013				2013			
Perihelion	Jan	2 05	Equinoxes	Mar	20 11 02	Sept	22 20 44
Aphelion	July	5 15	Solstices	June	21 05 04	Dec	21 17 11
2014				2014			
Perihelion	Jan	4 12	Equinoxes	Mar	20 16 57	Sept	23 02 29
Aphelion	July	4 00	Solstices	June	21 10 51	Dec	21 23 03
2015				2015			
Perihelion	Jan	4 07	Equinoxes	Mar	20 22 45	Sept	23 08 20
Aphelion	July	6 19	Solstices	June	21 16 38	Dec	22 04 48
2016				2016			
Perihelion	Jan	2 23	Equinoxes	Mar	20 04 30	Sept	22 14 21
Aphelion	July	4 16	Solstices	June	20 22 34	Dec	21 10 44
2017				2017			
Perihelion	Jan	4 14	Equinoxes	Mar	20 10 28	Sept	22 20 02
Aphelion	July	3 20	Solstices	June	21 04 24	Dec	21 16 28
2018				2018			
Perihelion	Jan	3 06	Equinoxes	Mar	20 16 15	Sept	23 01 54
Aphelion	July	6 17	Solstices	June	21 10 07	Dec	21 22 22
2019				2019			
Perihelion	Jan	3 05	Equinoxes	Mar	20 21 58	Sept	23 07 50
Aphelion	July	4 22	Solstices	June	21 15 54	Dec	22 04 19
2020				2020			
Perihelion	Jan	5 08	Equinoxes	Mar	20 03 49	Sept	22 13 30
Aphelion	July	4 12	Solstices	June	20 21 43	Dec	21 10 02

A portion of the data in this table was taken from *Planetary and Lunar Coordinates 2001-2020* ([US edition](#)/[UK edition](#)). Used with permission.

[[Publications](#) | [Data Services](#) | [Software](#) | [FAQ](#) | [Research](#) | [About AA](#)]
 [[News](#) | [Site Map](#) | [Index](#) | [Home](#)]

[Need help?](#)

MERIDIAN

The great circle on the [celestial sphere](#) that passes through the celestial poles and the observer's zenith. More simply, a line of longitude (either on the Earth's surface or projected into space).

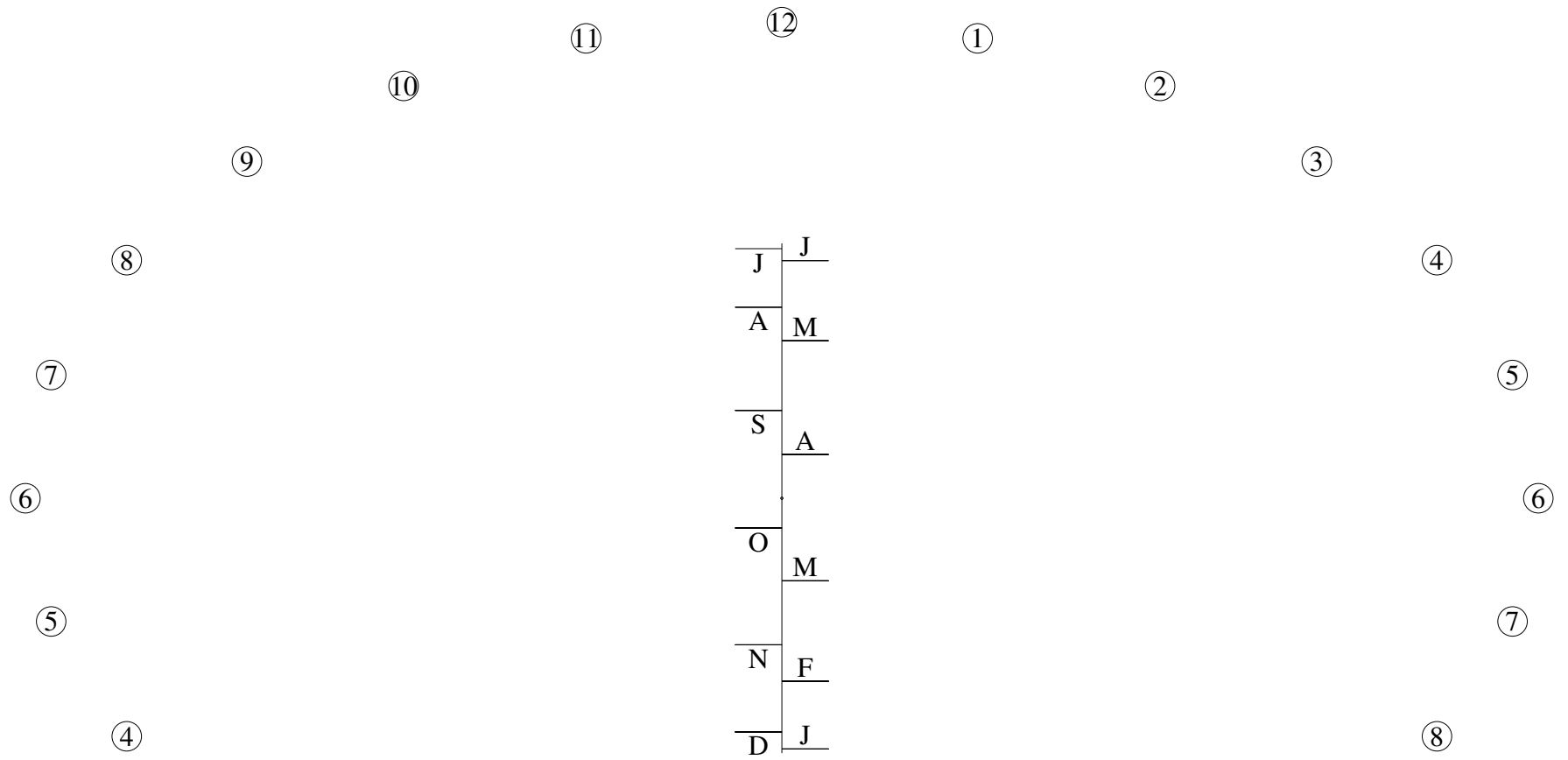

Sandburg Planetarium Analemmatic Sundial

Analemmatic dials



This page discusses the following subjects:

- [The principle of the analemmatic dial](#)
- [The shape at different latitudes](#)
- [The human scale](#)
- [No analemma around the date line!](#)
- [Variations in design](#)
- [Circumference of an ellipse](#)
- [Websites on analemmatic dials](#)



The principle of the analemmatic dial

We'll start by considering an equatorial dial of the armillary type, such as [Genk-1](#). Choose a certain time, for instance 11 o'clock (local time). At 11 o'clock on different days the shadow of the pole-style always hits the 11 o'clock mark on the hour ring. Which point of the pole-style causes this shadow?

We can find out by drawing a ray of sunlight 'through' the pole-style to the 11 o'clock mark. On the summer solstice (June 21) the sun is high in the sky, and it is the green ray that causes the shadow. On the equinox (March 21 or September 23) the sun is lower and gives the yellow ray. (The hour ring in the picture is closed, so that the front part would block the sun. Just imagine the front is open.) On the winter solstice (December 21) the sun is low and it is the purple ray that causes the shadow on the hour mark.

In this way a date scale could be constructed along the pole-style, which would run from the green dot (June 21) to the purple dot (December 21) and back again to June 21.

Now project the hour ring vertically onto the ground. The projection is an ellipse, with the major axis running east-west and

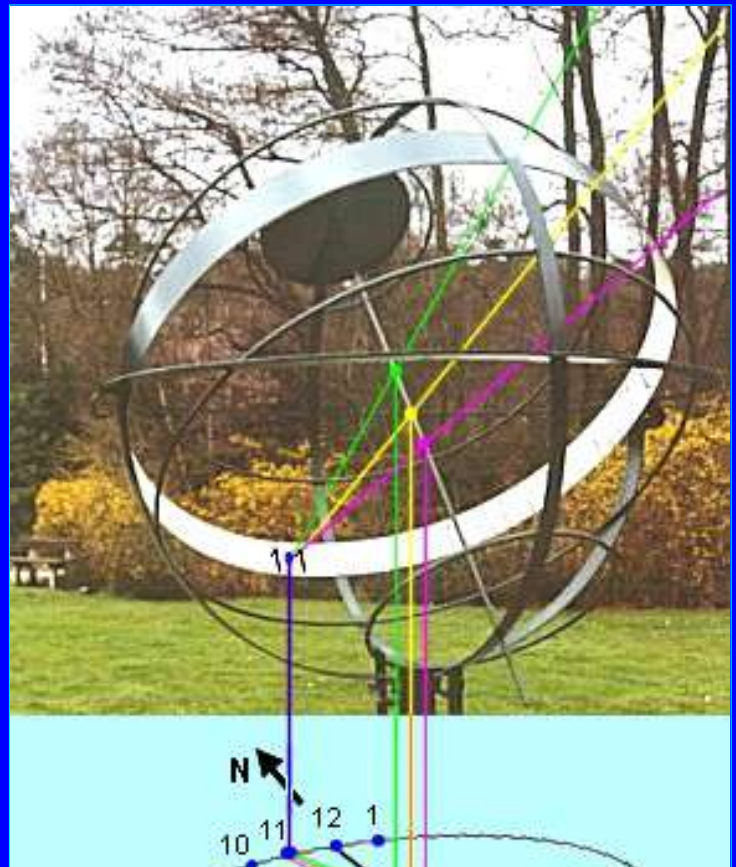

the minor axis running north-south. The projections of the hour marks are on the ellipse; some are indicated by blue dots. The point for local noon is at the north side, on the minor axis.



Also project the date scale that we constructed along the pole-style, vertically on the ground. And imagine that the vertical green, yellow and purple lines are real rods. On June 21 the shadow of the vertical green rod will just hit the 11 o'clock mark on the ellipse. Likewise, on March 21 and September 23 the 11 o'clock mark will be hit by the shadow of the yellow vertical rod, and on December 21 by the shadow of the purple rod.

Now for the final step: replace the row of vertical rods by a single, movable rod, yourself for instance. When you set yourself at 11 o'clock on the correct point of the date scale, your shadow will hit the 11 o'clock mark on the ellipse.

This figure makes also clear that the hour marks may be extended vertically, as the gnomon is also vertical. That has been done, for instance, at [Genk-6](#). For the same reason the date line may be elevated, so as to elongate your shadow. An example can be found in [Leoben](#).



The shape at different latitudes

It follows from the [principle](#) of the analemmatic dial explained above that the shape of the dial depends on latitude. On the equator the ellipse is compressed into an east-west line, with a long north-south date line. Moving to the poles, the date line shrinks and the minor axis of the ellipse increases. On the tropics the two are equal. On the poles, the ellipse would be grown into a circle and the date line shrunk into a point: the equatorial dial is back.

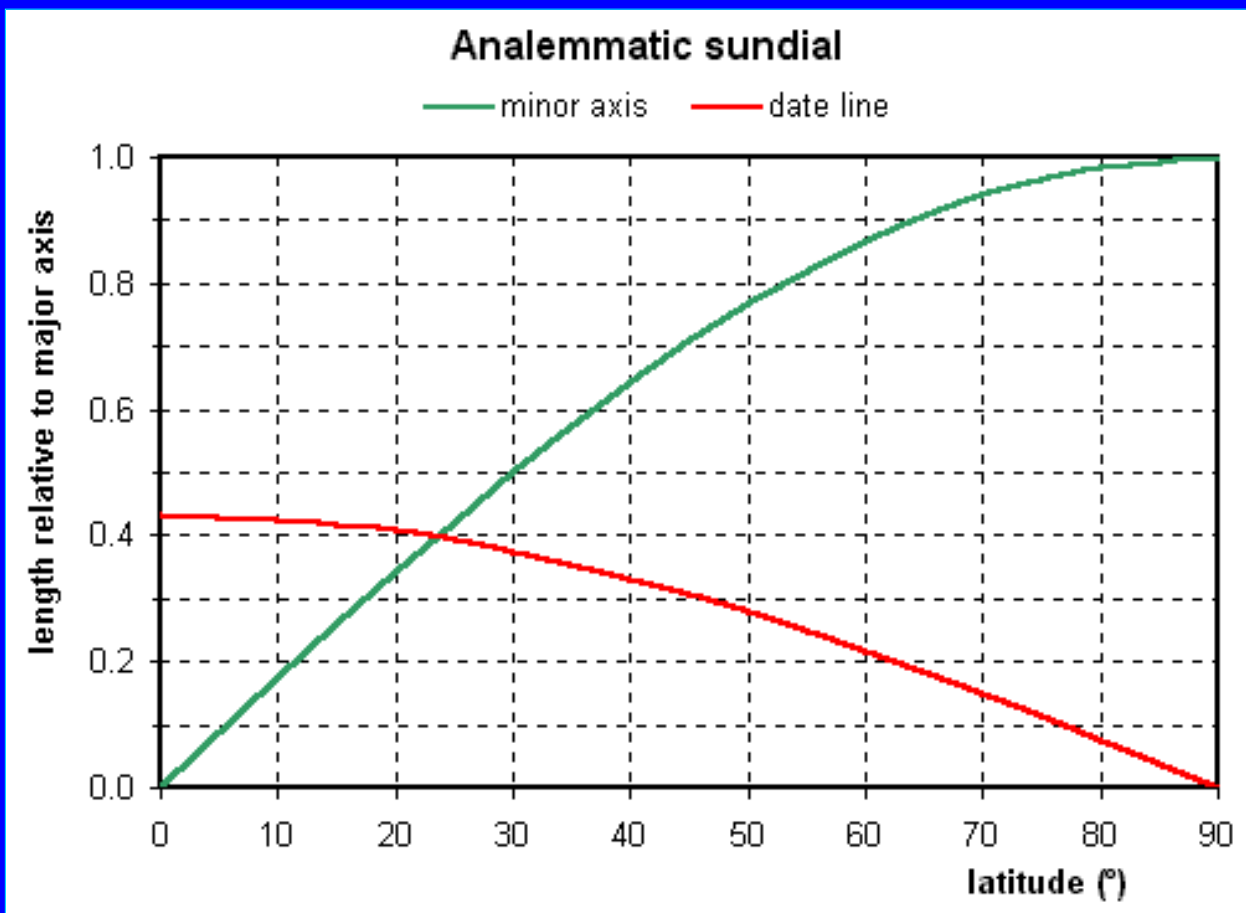

The graph above depicts the length of the minor axis (green) and the date line (red), relative to the major axis, as a function of latitude. The examples below show how the shape comes out at various latitudes. They are constructed for the Northern hemisphere. Local noon is at the top. The 'functional' hour points are filled with red, the others with blue. The date line is divided into the zodiacal months for clarity. The diamond-shaped points are the foci of the ellipse.

north / noord

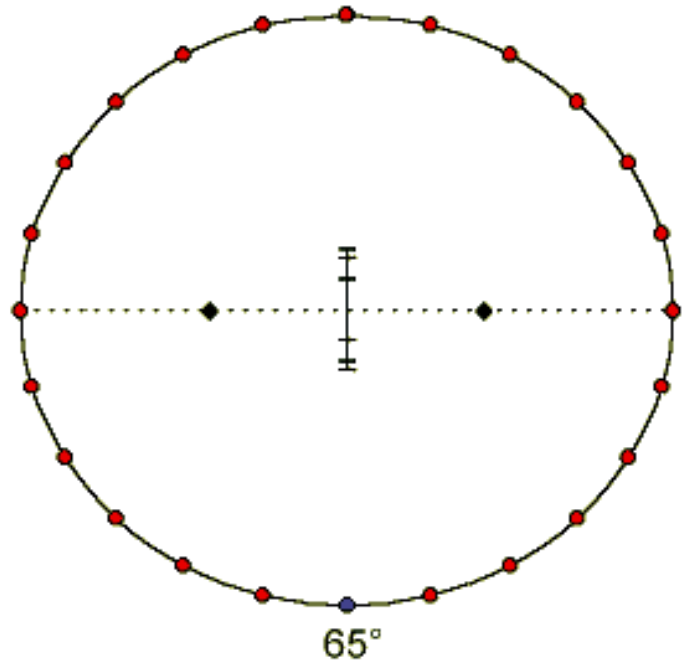
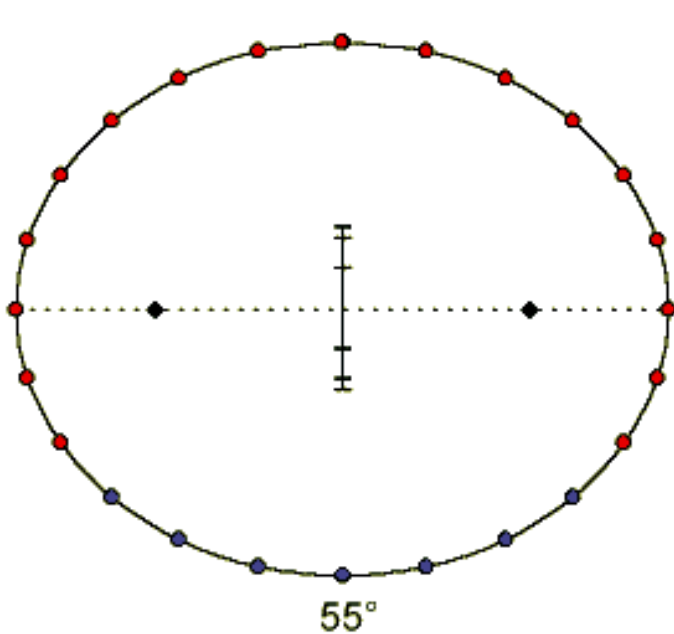
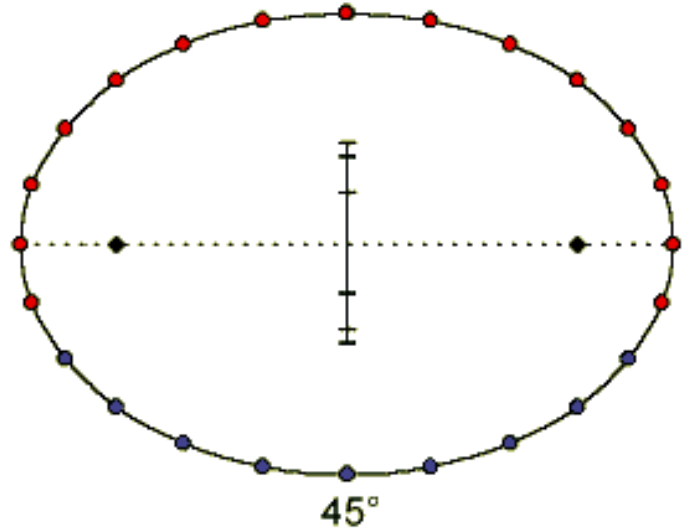
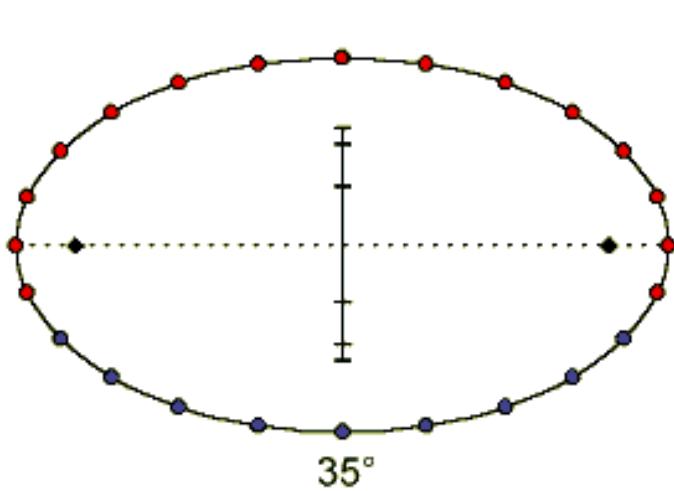
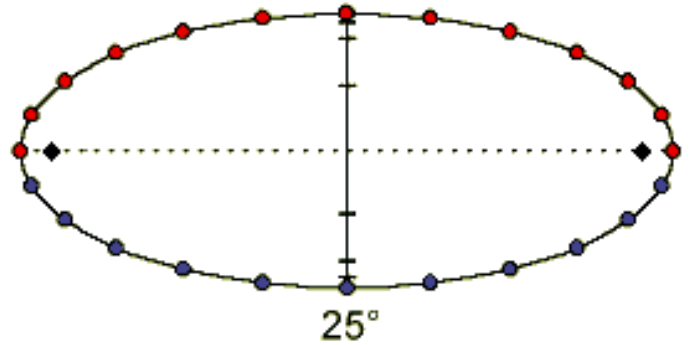
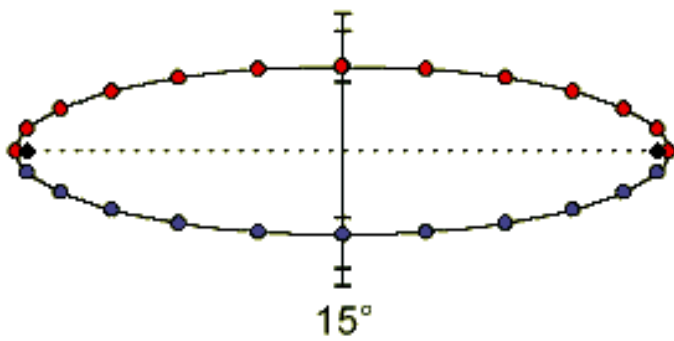

Below 30° your shadow may be quite small. In addition, in summer you have to stand almost on the ellipse. This makes reading the dial very inaccurate. Above 60° the date line is so short that you hardly need a movable gnomon. Hence, the analemmatic dial is most attractive between, say, 35° and 55°. The ca. 50 specimens at [this site](#) are all located

between 30° and 54°, with the exception of the one in [Torreón](#) (ca. 25°).



The human scale

In this section, we consider a human gnomon for the analemmatic dial. How far does his/her shadow reach, extended if necessary by pressing the hands together above the head? How does that turn out at different dates and times and different latitudes?

One may consider the top of the head (or the finger tips) as the index of a nodal dial. During the day, its shadow follows the path usually found in a horizontal nodal dial (see for instance [Genk-2](#)). Such a path is usually called a 'date line'. As this phrase means something different in analemmatic dials, let's call it a 'date arc'...

At different dates, the human gnomon stands at different points on the date line, which causes the date arcs to be shifted with respect to each other. How much they shift depends on the length of the date line, which in turn is determined by the size of the dial and by the latitude. We'll have to do some calculations to see how this works out in practice. A spreadsheet program can easily do that.

Let us assume that the gnomon height (top of head or finger tips) is 2 meter (6½ ft). I will compare two values for the major axis, 6 and 10 meter (20 and 33 ft). I chose three latitudes in the most attractive range (see [above](#)): 35°, 45° and 55°, and calculated the date arcs per zodiacal month (30° steps along the ecliptic). This is how it looks:

Analemmatic dials - date arcs for gnomon length = 2 m (6.5 ft)

major axis = 6 m (20 ft)

major axis = 10 m (33 ft)

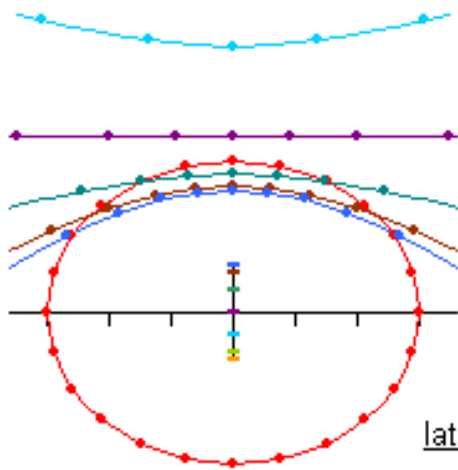

latitude = 55°

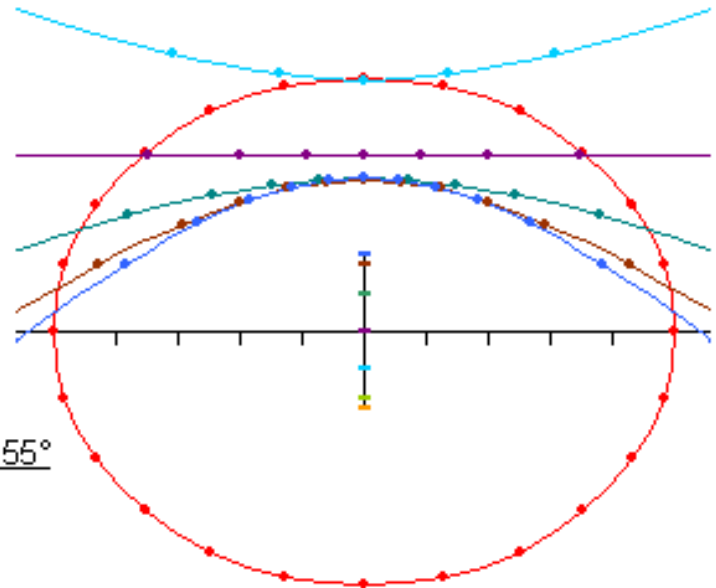

Dec 21

Jan 20

Feb 18

Mar 20

Apr 20

May 21

Jun 21

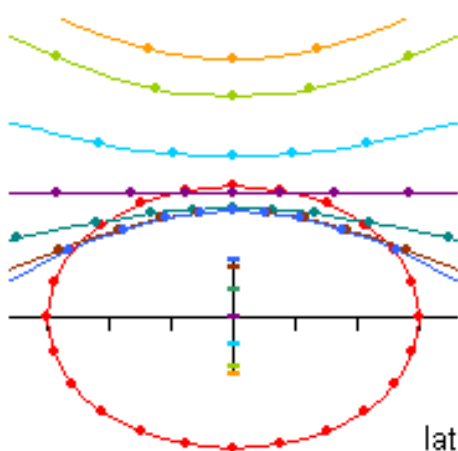

latitude = 45°

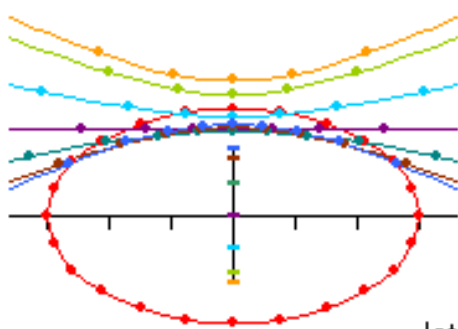
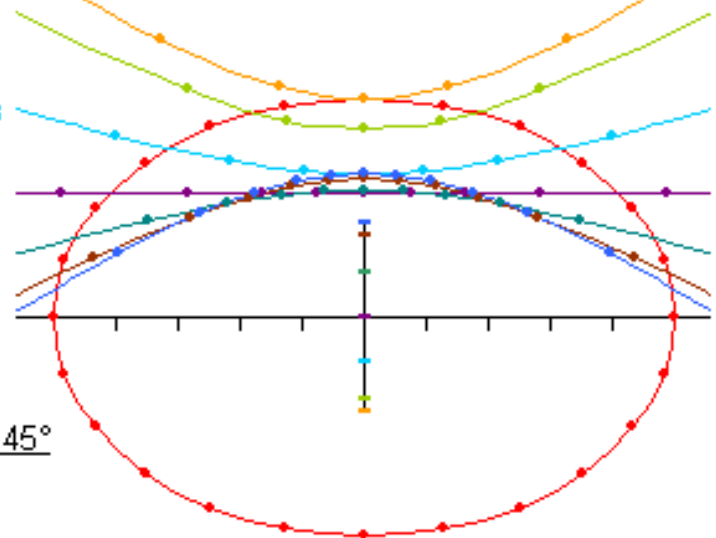

latitude = 35°

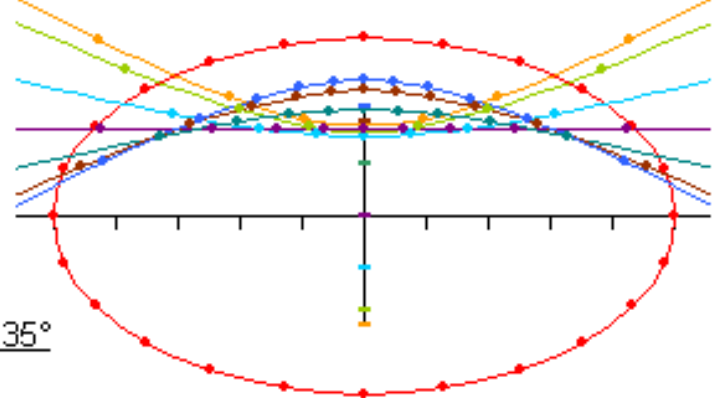

Note that the shadow does not even reach the small ellipse during most of the day in summer. It does not even get halfway in the large ellipse. Of course it's no problem to

extend the shadow line, but not too far. The accuracy would decrease, and one would have difficulties reading the hour marks. It would be interesting to investigate how much extension is being tolerated in practice...

In winter the shadow mostly reaches beyond the edge of the ellipse. Then it may be a disadvantage that the shadow is too wide for accurate reading.

Note also that the pattern of date arcs may show interesting variations. In many cases the date arches intersect, so that the shadow has to be extended most on other dates than June 21.

In conclusion, 6 meter (20 ft) is a suitable size, keeping in mind that an analemmatic dial is mostly visited in summer. When the dial is especially intended for use by kids, the size should be reduced accordingly.



No analemma around the date line!

One needs to know the value for the equation of time (EoT) when converting the local time shown by a dial to civil time. Sometimes it is provided as a table or a graph. In an analemmatic dial, it is tempting to take care of the correction by standing aside of the date line when the sun is fast or slow.

This may be the idea behind the analemma that is found around the date line in a quarter of the dials at [this site](#). However, the correction may be right around noon, but then it will be incorrect at other times. The deviations introduced in this way may well exceed the corrections aimed at.



One should therefore always stand on the date line and not on the analemma, even if that is locally suggested by signs or folders. One may use the analemma to estimate the correction for a given date by measuring the distance to the date line off the noon mark along the ellipse. That is to say, if the designer used that scale, which for instance does not seem to be the case in [Brou](#).

The origin of this popular misconception may be the [Brou](#) dial, in which the analemma has been added during the 1902 restoration. That was accomplished by the contractor, a sundial amateur. [Mayall & Mayall](#), the authoritative US sundial book, mentioned the alleged function of the analemma without comment (p. 223 in the 2000 edition), including a picture. That may be the reason why this disease is particularly widespread in North America



and Australia.

Two exceptions should be mentioned: The analemma around the date line of [Marinus Hagen's dial](#) was provided with a minute scale perpendicular to the date line, from

which the correction could be read. In this case the date line doubled as the X-axis for an EoT graph.

The other exception is the dial in [Longwood Gardens](#). The ellipse is split in two halves at the local noon point. Each half has its own figure-8 curve. These do not have the usual analemma shape, but were especially calculated to enable reading of standard time, with an error of one or two minutes.

In general, the analemmatic dial is a typical summer attraction. On the Northern hemisphere, the equation of time is 6 minutes at the most in summer. Hence, in this part of the world the analemmas are completely redundant anyway!



Variations in design

The design of the analemmatic dial can be varied in many ways. Some aspects also refer to other dial types, others only apply to this special type. This is going to be quite a list, then.

Hour points

- local time (noon point on the minor axis)
 - standard time
 - daylight saving time ([Peize](#), [Lattrop](#), [Hélécine](#))
 - standard time including EoT correction ([Longwood](#))
 - astronomical or Julian time ([Besançon](#))
- subdivisions per half-hour ([Ootmarsum](#), [Vienne](#), [Avignon](#)) or quarter ([Brou](#), [Besançon](#))
- Arabic or Roman numbers
- only the 'functional' points
 - all 24 hour points, numbered ([Brou](#), [Dijon](#), [Besançon](#), [Gray](#))
 - all 24 hour points, only functional points numbered ([Murcia](#))
- times of earliest sunrise and latest sunset ([Slijk-Ewijk](#))
- applied to vertical elements ([Genk-6](#), [Hélécine](#), [Mount Annan](#), [Wellington](#))
- raised, to be used as seat ([Kalamazoo](#))

Date line

- divided per calendar month or zodiacal month
- subdivisions per 1/3 month ([Ootmarsum](#), [Vienne](#))
- only present for summer half-year ([Lattrop](#))
- raised, to extend shadow ([Leoben](#), [Penticton](#))
- instructions of how to stand ([Hasselt](#), [Augusta](#))

Gnomon

- tripod instead of human ([Brou](#), [St.-Luc](#), [Longwood](#))

Dial face

- truncated ([Tel Aviv](#))
- decorated ([Ronse](#), [Gray](#), [Lancaster](#), [Sabadell](#), [Torquay](#))
- raised, to be used as seat ([Lafayette](#))
- foci of ellipse indicated ([Ootmarsum](#), [Utrecht](#), [Gray](#))
- Lambert circles added ([Ootmarsum](#))

Other aspects

- table/graph for EoT correction, sometimes including correction for time zone ([Hagen](#), [Ootmarsum](#), [Gray](#), [Meylan](#), [Vienne](#))
- instructions for use ([Ootmarsum](#), [Meylan](#))
- geographic coordinates given
- nodal dial for reading the date ([Ootmarsum](#))
- circle that has the ellipse as its horizontal projection ([Genk-6](#))



Circumference of an ellipse

When one is going to construct an analemmatic dial, one has to know how many bricks, tiles etc. to order. So one needs to know the area and the circumference of the elliptic dial face.

For the area of an ellipse there is a simple equation:

$$A = \pi \cdot a \cdot b ,$$

in which a and b are the semi-major and semi-minor axis, resp. This is a natural generalization of the equation for the area of a circle:

$$A = \pi \cdot r \cdot r ,$$

in which r is the radius of the circle.

The circumference is quite another story. For the circle it simply is:

$$C = 2 \cdot \pi \cdot r ,$$

but for the ellipse there is no simple equation. If one tries to derive it, one gets stuck with an unsolvable integral. In fact, the elliptic integrals constitute an important chapter of calculus. Which is not of much help in the building materials store...

Of course, the circumference can be approximated by numerical methods. The graph below presents the circumference as a function of the minor/major axis ratio and is expressed relative to the circumference of the circumscribed circle (radius a).

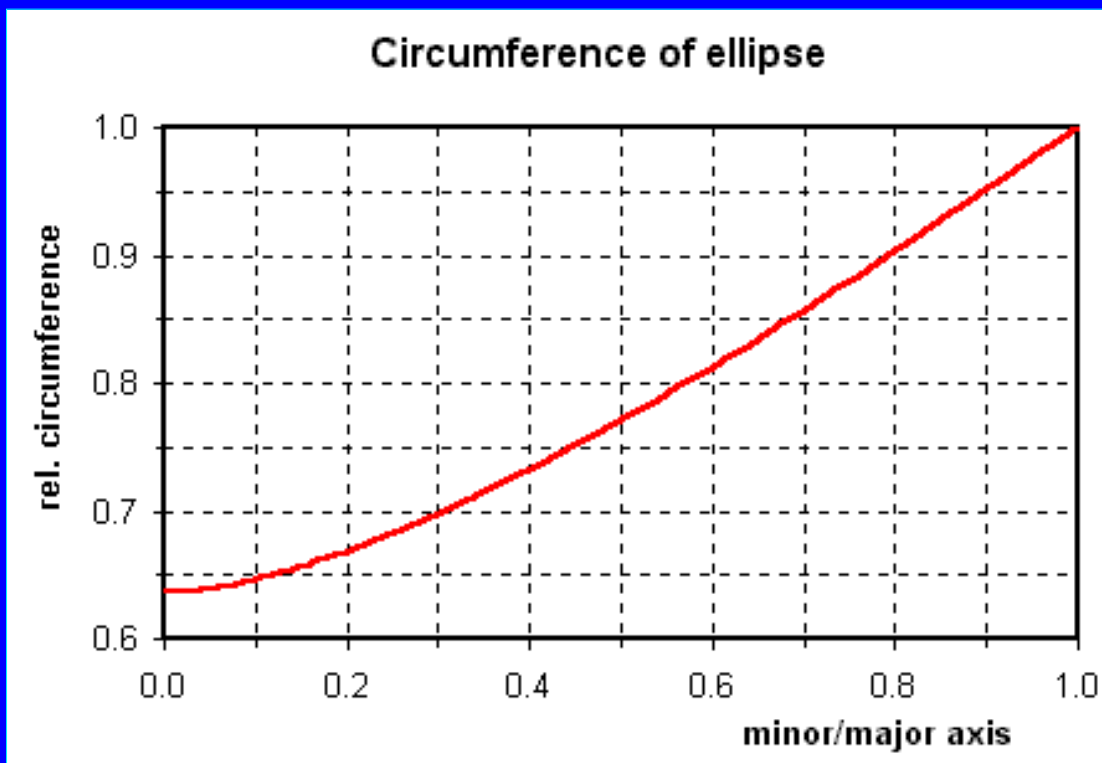

A close approximation (within 0.5%) is obtained by the equation:

$$C = \pi [3(a+b) - \sqrt{(a+3b)(3a+b)}] ,$$

originating from the Indian mathematician Ramanujan (1914). ($\sqrt{\quad}$ denotes the square root.)
Read a moving [biographical sketch](#) of this genius.



Websites on analemmatic dials

A number of sites address the analemmatic dial:

- [Chris Budd & Chris Sangwin](#), *Analemmatic sundials: how to build one and why they work*. An extensive, evocative story, in the on-line mathematics journal *Plus*, June 2000.
- [John Hoy](#), *Make an analemmatic garden sundial*. Simple, easy-to-follow tutorial.
- [Frederick W. Sawyer](#), *Of analemmas, mean time, and the analemmatic sundial*. The story about the sundial in [Longwood Gardens](#), with lots of background info.
- [Needham Science Center Schoolyard Sundial](#). The design for your schoolyard dial, for just a couple of \$.
- [Modern Sunclocks](#) (Douglas Hunt), your own analemmatic dial on order! See the specimen in [Lafayette](#) (Louisiana, USA).



Analemmatic dials



The analemmatic dial consists of a horizontal dial face with an elliptic perimeter, on which the hour points are located. Several examples of this still uncommon type are shown below. The major axis of the ellipse runs east-west. A date line is set along the minor (north-south) axis. A vertical gnomon, preferably you yourself, is placed on the correct date. The time is read from the point where your shadow (or its extension) intersects with the ellipse.



The size of the dial face should fit a human gnomon. Some dials are much too large; an occasional dial is too small. The matter of the human scale is discussed in some detail on the Selected Topics page.

The French astronomer Joseph de la Lande wrote in 1757 that the theory and construction of the analemmatic dial is "one of the most complicated problems in all of gnomonics". In fact the principle is easily derived from the equatorial dial.

Why this dial type is called 'analemmatic', is unclear. It has nothing to do with the 'analemma', the figure-eight loop that depicts the equation of time versus declination. Other names for this dial type have been proposed, but without much success. So we'll stick to what we have...

The oldest existing specimen is found in front of the church in Brou, near Bourg-en-Bresse (France). It dates from the 16th or 17th century. And it remained a French affair for years on end: Dijon (1827), Besançon (1902), Montpellier (1927), Avignon (1931) and Vienne (1937). The first one abroad was constructed in 1939, in Longwood Gardens (USA).

The first Dutch dial of this type was laid out in 1974 by Marinus Hagen, one of the founders of the Dutch Sundial Society, in his garden. By now, about 15 'stationary' analemmatic dials are found in the Netherlands, and short-lived dials are sometimes made at public events.

The shape of the analemmatic dial depends on the latitude. On the equator, the ellipse is pinched into a straight line, with a long date line at right angles. Moving away from the equator, the date line shrinks and the minor axis of the ellipse grows. At the poles, the ellipse would become a circle, and the equatorial dial is back again.

Mayall & Mayall as well as Zenkert hold the view that the analemmatic dial is more difficult to construct than a pole-style dial. Plain nonsense! In fact it is quite easily

designed and laid out, using for instance stones in the lawn, or concrete paint in a schoolyard or square. Compare that to the craftsmanship required for the construction of an armillary sphere, or the painting of a durable vertical dial face!

In putting this section together, I was struck by the variation among analemmatic dials. The piece on [variations](#) lists some of those.

In several of the dials depicted below the date line has been adorned by an analemma. The idea seems to be that this enables civil time to be read. This is INCORRECT! See the piece [No analemma around the date line!](#), which also mentions the two exceptions.

Of course I am extra keen on analemmatic dials. Therefore I also collect the specimens which I find on the Internet. In addition, several sites giving information about analemmatic dials have been published; see the special listing of [links](#).

The page on Selected Topics discusses the following subjects:

- [The principle of the analemmatic dial](#)
- [The shape at different latitudes](#)
- [The human scale](#)
- [No analemma around the date line!](#)
- [Variations in design](#)
- [Circumference of an ellipse](#)
- [Websites on analemmatic dials](#)

Netherlands



Our garden
Peize



M. Hagen
Oosterhuizen







St. Janskerkhof
Utrecht



National Heritage
Museum, Arnhem

			
Oostwal Ootmarsum	Cosmos Observatory Lattrop	Lido Slijk-Ewijk	Merlet College Cuijk
			
Leidsche Hout Park Leyden	Private garden, Makkum	Planet trail Rijswijk	Elementary school Grijpskerk
			
Hooijenga garden Heemskerk (direct link)			

Belgium

			
Sundial Park Genk (Belgium)	Municipal Museum Hasselt (Belgium)	Provincial Domain Hélécine (Belgium)	Church Square Peer (Belgium)
			
Municipal Library Ronse (Belgium)			

France

			
Brou Bourg-en-Bresse (France)	Dijon (France)	Vienne (France)	Avignon (France)



Observatory
Besançon
(France)



Montpellier
(France)



Gray
(France)



Meylan
(France)

Rest of Europe



Leoben
(Austria)



Williamson Park
Lancaster
(England)



Barcelona
(Spain)



Sabadell
(Spain)



Murcia
(Spain)



St.-Luc
(Switzerland)

Internet - North America



Longwood Gardens
Kennett Square
(Pennsylv., USA)



4-H Children's
Garden
East Lansing
(Michigan, USA)



Science Museum
Kalamazoo
(Michigan, USA)



Highland Park
(Illinois, USA)



Riverwalk
Augusta
(Georgia, USA)



Callaway Gardens
Pine Mountain
(Georgia, USA)



Schoolyard
Lafayette
(Louisiana, USA)

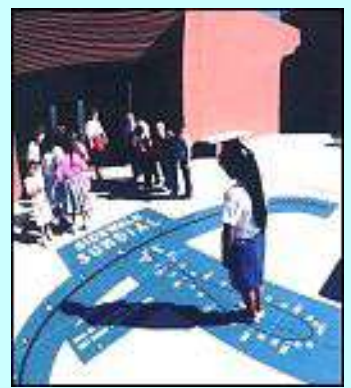

Flandrau Science
Center, Tucson
(Arizona, USA)



Millennium Garden
Thunder Bay
(Ont., Canada)



Skaha Beach
Penticton
(B.C., Canada)



Steve Irvine
Warton (Canada)
(direct link)



Torréon (Mexico)
(direct link)

Internet - Australia & New Zealand



Botanical Garden
Mount Annan
(NSW, Australia)



Maria Creek
Kingston
(S.A., Australia)



Esplanade
Torquay
(Vict., Australia)

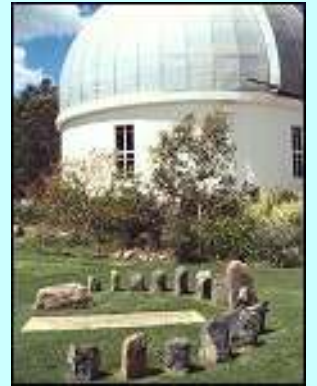

Mount Stromlo
Observatory
Canberra
(Australia)



Carter
Observatory
Wellington
(New Zealand)

Rest of the World



Tel Aviv
(Israel)



Rasht
(Iran)



Aoyama
(Japan)



Higashi Harima
Caravan Park
Akashi (Japan)



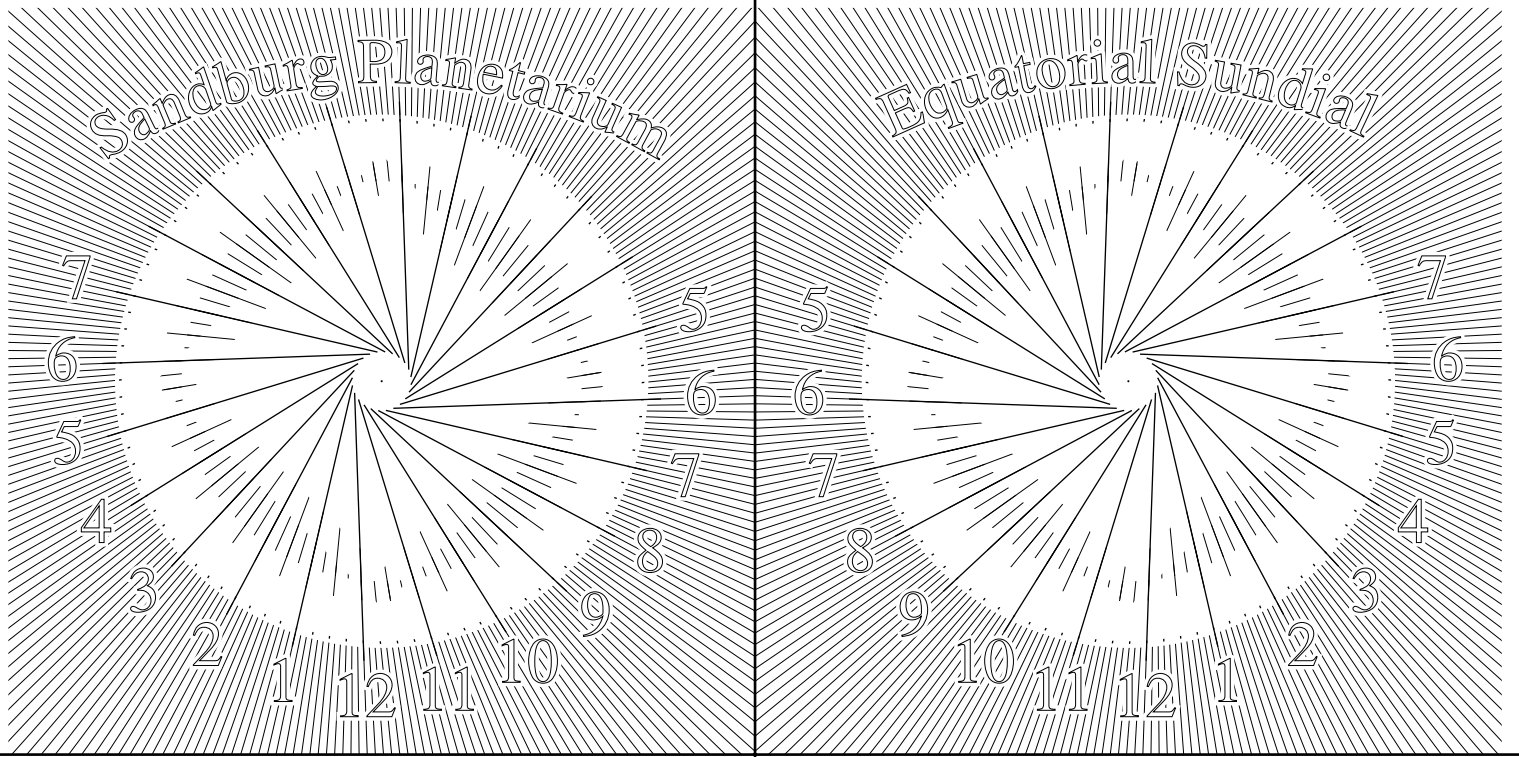

EQUATORIAL SUNDIAL

For assembly instructions please see
<http://www.cyberspace.org/~jh/dial/eqinst.html>

Copyright 1999 jh (ver. 2.0)

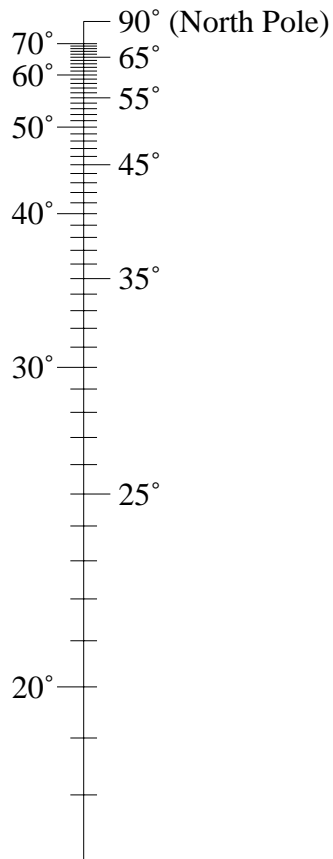

Shop in **Jewelry & Watches**
(Beta-What is this?)

amazon.com



VIEW CART

WISH LIST

YOUR ACCOUNT

HELP



Your Gold Box

WELCOME

YOUR STORE

BOOKS

APPAREL & ACCESSORIES

ELECTRONICS

TOYS & GAMES

DVD

SOFTWARE



SEE MORE STORES

Search

Browse Subjects

Bestsellers

Magazines

Corporate Accounts

e-books & docs

Bargain Books

Used Books

Eddie Bauer

FREE SHIPPING

when you spend \$50 or more at Eddie Bauer on Amazon.com

Shop Now

Shop Eddie Bauer at Amazon.com

Search Inside the Book™

SEARCH

WEB SEARCH

Powered by Google

BOOK INFORMATION

[buying info](#)

[customer reviews](#)

[look inside](#)

RECENTLY VIEWED

[The Illustrated Longitude](#) by Dava Sobel, William J. H. Andrewes

▶ [See more in the Page You Made](#)

Featured Item:

[God's Equation](#) by Amir D. Aczel (Author)

RATE THIS BOOK

Sundials : Their Construction and Use [UNABRIDGED]

by [R. Newton Mayall](#) (Author), [Margaret W. Mayall](#) (Author)

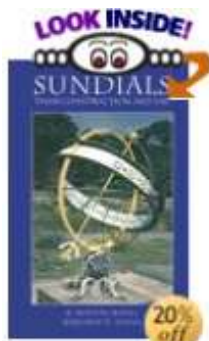

[Look inside this book](#)

List Price: \$12.95

Price: ~~\$10.36~~ &

eligible

for **12 used & new** from \$5.75

FREE

Super one to sell?

[Sell yours here](#)

Saver Shipping

on orders over \$25.

[See details.](#)

Don't have one?

We'll set one up for you.



You Save: \$2.59

(20%)

Availability: Usually ships within 24 hours
Only 4 left in stock--order soon (more on the way).

Want it delivered Thursday, March 4? Choose **One-Day Shipping** at checkout. [See details.](#)

12 used & new from \$5.75

Edition: Paperback

▶ [See more product details](#)

Better Together

Buy this book with [Sundials](#) by Rene R.J. Rohr (Author) today!



+



Total List Price: \$26.90

Buy Together Today: \$21.52

Customers who bought this book also bought:

- [Making a Clock-Accurate Sundial Customized to Your Location \(for the Northern Hemisphere\)](#) by Sam Muller
- [Easy-to-Make Wooden Sundials](#) by Milton Stoneman (Author)
- [Latitude Hooks and Azimuth Rings: How to Build and Use 18](#)

I dislike it I love it!

1 2 3 4 5

[Edit your ratings](#)

Favorite Magazines!



Explore our new
[Magazine Subscriptions](#)
store.

[Traditional Navigational Instruments](#) by Dennis Fisher

- [The Complete On-Board Celestial Navigator : Includes 2003-2007 Nautical Almanac](#) by George G. Bennett
- [The Sextant Handbook](#) by Bruce Bauer

► [Explore Similar Items: 13 in Books](#)

Customers interested in this title may also be interested in:

Sponsored Links ([What's this?](#)) [Feedback](#)

- [Construction Bookstore](#)
Large selection - discount prices Hard-to-find books in stock now
[www.bookmarki.com](#)
- [Premium Garden Products](#)
Fountains, Statuary, Decor & More. [ABirdsWorld.com](#)
[www.ABirdsWorld.com](#)
- [Sundials & Pedestals](#)
Equitorial, Armillary, **and** Garden **Sundials** - Fast Shipping.
[www.aaronsoutdoors.com](#)

Product Details

- **Paperback:** 320 pages ; Dimensions (in inches): 0.70 x 8.46 x 5.38
- **Publisher:** Dover Pubns; Unabridged edition (June 20, 2000)
- **ISBN:** 048641146X | [All Editions](#)
- **Average Customer Review:** ★★★★★ Based on 1 review.
[Write a review.](#)
- **Amazon.com Sales Rank:** 98,146
(Publishers and authors: [improve your sales](#))

Look Inside This Book

You can [view sample pages](#) from this book.

What's Your Advice?

Is there an book you'd recommend instead of or in addition to this one? Let the world know! Enter the book's ASIN ([what's an ASIN?](#)) in the box below, select advice type, then click Submit.

I recommend: in addition to this book
 instead of this book

Editorial Reviews

Book Description

Clearly written, easy-to-follow instructions for constructing a sundial on almost any surface and in virtually any position, with information on selecting appropriate materials, making Standard Time dials, and laying out hour lines. Dial furniture, portable sundials, constructing a heliochronometer (a highly precise solar timekeeper) and other subjects also covered. Over 60 illustrations provide examples of scale models and actual dials from around the world.

All Customer Reviews

Average Customer Review: ★★★★★

[Write an online review](#) and share your thoughts with other customers.

4 of 4 people found the following review helpful:

★★★★☆ If you want to know how to make a sundial...,
January 6, 2002

Reviewer: [Dan Lamb \(see more about me\)](#) from Calgary, Canada

This is a great book to learn about the various types of sundials & how to make them. It is a little weak on the 'how it works' side of things, but is great on the 'how to do it' side. It thoroughly describes how to construct each of the main types of dials, including how to make a verier for more accurate measurement of the shadow's position on the dial. This, together with Albert Waugh & Rene Rohr's book's can give you a good understanding of both the theory and practice of sundial construction. (There is overlap in each of the books, but this book pre-dates the other two somewhat.) I would recommend this book as a worthwhile purchase for anyone interested in understanding and/or construction of sundials.

Was this review helpful to you?

Customers who bought titles by R. Newton Mayall also bought titles by these authors:

- [Albert Waugh](#)
- [Rene R.J. Rohr](#)
- [Sam Muller](#)
- [Milton Stoneman](#)
- [Dennis G. Fisher](#)

▶ [Explore similar authors](#)

Look for similar books by subject:

Browse for [books](#) in:

- [Subjects](#) > [Science](#) > [General](#)
- [Subjects](#) > [Science](#) > [Reference](#) > [Engineering](#)

Search for books by subject:

[Sundials](#)
[Technology & Industrial Arts](#)
[Technology](#)
[Technical & Manufacturing Trades](#)
[Reference](#)

i.e., each book must be in subject 1 AND subject 2 AND ...

Feedback

- I have read this book, and I want to [review](#) it.
- [E-mail a friend about this book.](#)
- [Write a So You'd Like to... guide.](#)

- Is there a specific product you'd like us to sell?
[Tell us](#) about it.



Suggestion Box

Your comments can help make our site better for everyone. If you've found something incorrect, broken, or frustrating on this page, let us know so that we can improve it. Please note that we are unable to respond directly to suggestions made via this form.

If you need help with an order, please [contact Customer Service](#).

Please mark as many of the following boxes that apply:

Product information is missing important details.

Product information is incorrect. Propose corrections using our [Online Catalog Update Form](#).

The page contains typographical errors.

The page takes too long to load.

The page has a software bug in it.

Content violates [Amazon.com's policy on offensive language](#).

Product offered violates [Amazon.com's policy](#) on items that can be listed for sale.

Comments or Examples:

Examples: Missing information such as dimensions and model number, typos, inaccuracies, etc.

Where's My Stuff?

- Track your [recent orders](#).
- View or change your orders in [Your Account](#).

Shipping & Returns

- See our [shipping rates & policies](#).
- [Return](#) an item (here's our [Returns Policy](#)).

Need Help?

- Forgot your password? [Click here](#).
- [Redeem](#) or [buy](#) a gift certificate.
- [Visit our Help department](#).

Search

for

Your Recent History

[Learn More](#)

Recently Viewed Products

 [The Illustrated Longitude](#) by Dava Sobel, William J. H. Andrewes

Customers who bought items in your Recent History also bought:



 [Longitude](#)
by Dava Sobel



 [The Riddle of the Compass](#)
by Amir D. Aczel (Author)

[▶ Visit the Page You Made](#)

Turn your past books purchases into \$\$\$
Learn more about selling at Amazon.com today!

[Top of Page](#)

[Books Search](#) | [Browse Subjects](#) | [Bestsellers](#) | [Magazines](#) | [Corporate Accounts](#)
[e-Books & Docs](#) | [Bargain Books](#) | [Used Books](#)

[Amazon.com Home](#) | [Directory of All Stores](#)

Our International Sites: [Canada](#) | [United Kingdom](#) | [Germany](#) | [Japan](#) | [France](#)

[Contact Us](#) | [Help](#) | [Shopping Cart](#) | [Your Account](#) | [Sell Items](#) | [1-Click Settings](#)

[Investor Relations](#) | [Press Releases](#) | [Join Our Staff](#)

Bottom of the Page™ Deals for March 02

Amazon.com = low prices. Save up to **50%** on these **24-hour** deals, updated every day at noon (central time).

	Our Price	You Save
Dove Plush Bath Robe, White You'll look simply marvelous, darling, in this 100% plush white cotton robe!	\$29.00	\$11.00 (28%)
Panasonic SQT555W601 Automatic Power-Failure Light Next time the power goes off, don't get left in the dark.	\$26.99	\$13.00 (33%)
Canon BCI-3e Multipack Ink Tanks (4 Pack) Keep the cartridge, replace the ink, save money.	\$33.99	\$16.00 (32%)
Smoke Away Stop Smoking Support Program 1 ea Discover a happier and healthier lifestyle with Smoke Away.	\$24.99	\$15.00 (38%)
Snuggle Fabric Softener Dryer Sheets, Fresh Rain 120 count 6 boxes Eliminate static cling and leave your clothes soft and fresh smelling.	\$19.99	\$20.00 (50%)
Neutrogena Moisture Rich Shower and Bath Gel, 35 Ounces (2 Bottles) Pamper skin and senses with this refreshing shower and bath gel.	\$29.99	\$28.00 (48%)
Revival Soy Protein Bar, Chocolate Temptation Bar 15 ea You won't have to feel guilty about giving in to this Chocolate Temptation.	\$27.99	\$4.96 (15%)
Starbucks Decaffeinated House Blend Universal Ground Coffee, 6 12-Ounce FlavorLock Bags (72 ounces total) Savor a true coffee classic without the jitters.	\$28.99	\$4.00 (12%)

[Schick Silk Effects Plus Refill Blades with Aloe - 10 ea](#)

Exclusive microfine wires make getting a close shave easier on your skin.

\$11.49

\$1.00
(8%)

 **FREE Super Saver Shipping on orders over \$25.** [See details.](#)

Amazon.com now offers bargains on brand-name essentials, all priced so low they've sunk to the bottom of the page! We take up to 50% off standard retail prices and deliver right to your door--no club fees, no hassle, no parking lot. Check back every day at noon (central time) for all-new Bottom of the Page™ Deals.

[Conditions of Use](#) | [Privacy Notice](#) © 1996-2004, Amazon.com, Inc. or its affiliates



Free Shipping from 70+ Sellers



Shop now

Spring into savings for the whole family

Search Inside the Book™
SEARCH

WEB SEARCH
Powered by Google

Sundials, Their Theory and Construction

by [Albert Waugh](#) (Author)

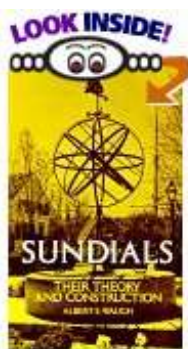

[Look inside this book](#)

READY TO BUY?

or

List Price: \$8.95 [Sign in](#) to turn on 1-Click

Price: **\$8.95** & ordering.

eligible

for

MORE BUYING CHOICES

FREE [used & new](#) from \$2.35

Super

Saver

Have one to sell?

[Sell yours here](#)

Shipping

on orders

over \$25.

[See](#)

[details.](#)

Don't have one?



We'll set one up for you.

BOOK INFORMATION

[buying info](#)

[customer reviews](#)

[look inside](#)

Availability: Usually ships within 24 hours

Only 4 left in stock--order soon (more on the way).

Want it delivered Thursday, March 4? Choose **One-Day Shipping** at checkout. [See details.](#)

RECENTLY VIEWED

[Sundials : Their Construction and Use](#) by R. Newton Mayall (Author), Margaret W. Mayall (Author)

[The Illustrated Longitude](#) by Dava Sobel, William J. H. Andrewes

▶ [See more in the Page You Made](#)

Featured Item:

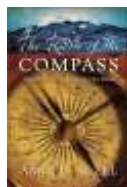

[The Riddle of the Compass](#) by Amir D. Aczel (Author)

[76 used & new](#) from \$2.35

Edition: Paperback

Other Editions:	List Price:	Our Price:	Other Offers:
Hardcover	\$25.50	\$25.50	2 used & new from \$23.50

▶ [See more product details](#)

Better Together

Buy this book with [Sundials](#) by R. Newton Mayall (Author), Margaret W. Mayall (Author) today!



Buy Together Today: \$19.31

Customers who bought this book also bought:

- [Easy-to-Make Wooden Sundials](#) by Milton Stoneman (Author)
- [Sundials : History, Theory, and Practice](#) by Rene R.J. Rohr

RATE THIS BOOK

I dislike it I love it!
1 2 3 4 5

[Edit your ratings](#)

Favorite Magazines!



Explore our new [Magazine Subscriptions](#) store.

(Author)

- [Making a Clock-Accurate Sundial Customized to Your Location \(for the Northern Hemisphere\)](#) by Sam Muller
- [Latitude Hooks and Azimuth Rings: How to Build and Use 18 Traditional Navigational Instruments](#) by Dennis Fisher
- [Time's Pendulum: From Sundials to Atomic Clocks, the Fascinating History of Timekeeping and How Our Discoveries Changed the World](#) by Jo Ellen Barnett

▶ [Explore Similar Items: 20 in Books](#)

Customers interested in Sundials, Their Theory and Construction may also be interested in:

Sponsored Links ([What's this?](#)) [Feedback](#)

- [Premium Garden Products](#)
Fountains, Statuary, Decor & More. ABirdsWorld.com
www.ABirdsWorld.com
- [Sundials & Pedestals](#)
Equitorial, Armillary, **and** Garden **Sundials** - Fast Shipping.
www.aaronsoutdoors.com
- [70+ Garden Sundials](#)
Krupps.com has a great selection of garden **sundials and** statuary!
www.krupps.com

Product Details

- **Paperback:** 230 pages ; Dimensions (in inches): 0.52 x 8.58 x 5.48
- **Publisher:** Dover Pubns; (June 1, 1973)
- **ISBN:** 0486229475
- **In-Print Editions:** [Hardcover](#) | [All Editions](#)
- **Average Customer Review:** ★★★★★ Based on 5 reviews.
[Write a review.](#)
- **Amazon.com Sales Rank:** 52,525
(Publishers and authors: [improve your sales](#))

Look Inside This Book

You can [view sample pages](#) from this book.

What's Your Advice?

Is there an book you'd recommend instead of or in addition to this one? Let the world know! Enter the book's ASIN ([what's an ASIN?](#)) in the box below, select advice type, then click Submit.

I recommend: in addition to this book
 instead of this book

Editorial Reviews

Book Description

Fascinating approach to sundials. On one hand, it is a rigorous appraisal of the science of sundials including mathematical treatment

and pertinent astronomical background. On the other hand, it provides a nontechnical treatment simple enough so that several of the dials can be built by children. 106 illustrations.

All Customer Reviews

Average Customer Review: ★★★★★

[Write an online review](#) and share your thoughts with other customers.

7 of 7 people found the following review helpful:

★★★★☆ Overall the best available sundial text., March 18, 2002

Reviewer: [Alex \(see more about me\)](#) from Melbourne Australia

I have read and viewed the major English language texts on Sundials. These being 1. Waugh, 2. Mayall & Mayall, and 3. Rohr.

The Waugh text has good, mostly clear, instructions and gives both graphical and equation based methods of constructions. Mayall and Mayall perhaps has better graphical constructions but Waugh excels in the variety of tables in the appendix. Waugh also has the clearest explanation of determining the declination of a wall. This is very important as many buildings are aligned along magnetic north (& south & east & west) rather than true north (south etc...).

A shortcoming of the almost every book including Waugh, is the lack of clear instruction on how to draw other types of hours. Most importantly of these interesting alternatives types of hours are babylonian and Italian hours. These hours are still useful today. So far I've only found the Rohr text to have any attempt of explaining how to draw these lines. However the Rohr text simply doesn't match the clarity and breadth of Waugh and Mayall and Wayall.

Waugh (and Mayall and Mayall) both could do with an update on trigonometry. With the easy availability of scientific calculators, the need for log versions of equations and the use of things like "cot" functions is not needed and simply makes the calculations clumsy to perform on a key pad.

The book by Cousins is an excellent highly detailed text if you can get it, but it seems to be out of print. It is useful if you really want to get into the maths of spherical geometry and it wouldn't be the best book you'd want to read first. It makes you appreciate the wonderful elegance of the graphical solutions but it may convince you that it is all too hard when it actually isn't in a practical sense. Just about anyone can make a simple sundial.

The text by Rohr also has a good section on how to do hour lines on just about any shaped surface (bowl, sphere, plane etc..) if you have a rod for a gnomon. This is about the only strength of this text over the others.

So to conclude Waugh would be the best first text, very closely followed by Mayall and Mayall, then Rohr. The text by Cousins is excellent but at a much higher level that isn't needed for the construction for the standard types of dials.

Was this review helpful to you?

3 of 3 people found the following review helpful:

★★★★☆ Definitely a classic..., January 6, 2002

Reviewer: [Dan Lamb \(see more about me\)](#) from Calgary, Canada

I agree with the other reviewers...This is a very clear and concise treatment of the theory and practice of sundial construction. It is a very easy read, (anyone over the age of around 12-13 should have no difficulty with it at all,) and entertaining to boot! It has a few items that some of the other 'classics' on sundials do not. (Rene Rohr,s book "Sundials:History, Theory and Practice" and Mayall & Mayall's "Sundial's:Their Construction and Use".) The only thing this book really misses, (and the same holds true for virtually every book on sundials!) is the link between sundials telling time, and their potential use for navigation. Apart from that, this is a great book, and I highly recommend it.

Was this review helpful to you?

6 of 6 people found the following review helpful:

★★★★★ Best book on sundials I've ever seen, August 29, 1998

Reviewer: smckee@dol.net from Rising Sun, MD

This book not only covers everything from time itself to noon marks to fancy sundials, it is well written and fun to read - a rare combination in a "technical" book.

Was this review helpful to you?

15 of 15 people found the following review helpful:

★★★★★ The all-time classic work on dialing., July 24, 1998

Reviewer: An Amazon.com Customer

Albert Waugh's "Sundials: Their Theory and Construction" is a veritable treasure-house of information on the ancient science of gnomonics. As a dedicated dialist of several years, I never could have achieved such wonderful results without Waugh's classic book. The work presents the art of building sundials from two perspectives: for the advanced dialist, Waugh's book approaches the theory from a highly complex, mathematical viewpoint, including some aspects of celestial mechanics; for the average "do-it-yourself-er", Waugh presents several projects that are simple and well-explained. Accompanying this fine work is a collection of solar tables, astronomical information, and various data of inestimable value that would alone justify the purchase price of the book. So whether your purpose is to further your technical interest in the fascinating science of gnomonics, or merely to build an attractive sundial for your garden over the weekend, "Sundial! s: Their Theory and Construction" should be in your collection. It is considered the very "bible" of dialmaking. I couldn't brag about it more had I written it myself!

Was this review helpful to you?

▶ [See all 5 customer reviews...](#)

Customers who bought titles by Albert Waugh also bought titles by these authors:

- [R. Newton Mayall](#)
- [Milton Stoneman](#)
- [Rene R.J. Rohr](#)
- [Sam Muller](#)
- [Dennis G. Fisher](#)

▶ [Explore similar authors](#)

Auctions and zShops sellers and our other stores recommend:

- [Marshall, Roy K. : Sundials - hardcover \(Current bid: \\$18.94\)](#)
- [Marshall, Roy K. : Sundials - hardcover \(Price: \\$18.95\)](#)

Look for similar books by subject:

Browse for [books](#) in:

- [Subjects](#) > [Science](#) > [Physics](#) > [Time](#)
- [Subjects](#) > [Home & Garden](#) > [Crafts & Hobbies](#) > [General](#)

Search for books by subject:

[Sundials](#)

[Crafts / Hobbies](#)

[Science](#)

[Time](#)

i.e., each book must be in subject 1 AND subject 2 AND ...

Feedback

- **I have read this book, and I want to [review](#) it.**
- [E-mail a friend about this book.](#)
- [Write a So You'd Like to... guide.](#)
- Is there a specific product you'd like us to sell?
[Tell us](#) about it.



Suggestion Box

Your comments can help make our site better for everyone. If you've found something incorrect, broken, or frustrating on this page, let us know so that we can improve it. Please note that we are unable to respond directly to suggestions made via this form.

If you need help with an order, please [contact Customer Service](#).

Please mark as many of the following boxes that apply:

Product information is missing important details.

Product information is incorrect. Propose corrections using our [Online Catalog Update Form](#).

The page contains typographical errors.

The page takes too long to load.







The page has a software bug in it.

Content violates [Amazon.com's policy on offensive language](#).

Product offered violates [Amazon.com's policy](#) on items that can be listed for sale.

Comments or Examples:

Examples: Missing information such as dimensions and model number, typos, inaccuracies, etc.

Where's My Stuff? <ul style="list-style-type: none">Track your recent orders.View or change your orders in Your Account.	Shipping & Returns <ul style="list-style-type: none">See our shipping rates & policies.Return an item (here's our Returns Policy).	Need Help? <ul style="list-style-type: none">Forgot your password? Click here.Redeem or buy a gift certificate.Visit our Help department.
Search <input type="text"/> for <input type="text"/>		
Your Recent History Learn More		
Recently Viewed Products <ul style="list-style-type: none"> Sundials by R. Newton Mayall (Author), Margaret W. Mayall (Author) The Illustrated Longitude by Dava Sobel, William J. H. Andrewes	Customers who bought items in your Recent History also bought: <ul style="list-style-type: none">  Longitude by Dava Sobel  The Riddle of the Compass by Amir D. Aczel (Author)	
▶ Visit the Page You Made		

Turn your past books purchases into \$\$\$
[Learn more](#) about selling at Amazon.com today!

[Top of Page](#)

[Books Search](#) | [Browse Subjects](#) | [Bestsellers](#) | [Magazines](#) | [Corporate Accounts](#)
[e-Books & Docs](#) | [Bargain Books](#) | [Used Books](#)

[Amazon.com Home](#) | [Directory of All Stores](#)

Our International Sites: [Canada](#) | [United Kingdom](#) | [Germany](#) | [Japan](#) | [France](#)

[Contact Us](#) | [Help](#) | [Shopping Cart](#) | [Your Account](#) | [Sell Items](#) | [1-Click Settings](#)

[Investor Relations](#) | [Press Releases](#) | [Join Our Staff](#)

Bottom of the Page™ Deals for March 02

Amazon.com = low prices. Save up to 50% on these 24-hour deals, updated every day at noon (central time).

	Our Price	You Save
Dove Plush Bath Robe, White You'll look simply marvelous, darling, in this 100% plush white cotton robe!	\$29.00	\$11.00 (28%)
Panasonic SQT555W601 Automatic Power-Failure Light Next time the power goes off, don't get left in the dark.	\$26.99	\$13.00 (33%)
Canon BCI-3e Multipack Ink Tanks (4 Pack) Keep the cartridge, replace the ink, save money.	\$33.99	\$16.00 (32%)
Smoke Away Stop Smoking Support Program 1 ea Discover a happier and healthier lifestyle with Smoke Away.	\$24.99	\$15.00 (38%)
Snuggle Fabric Softener Dryer Sheets, Fresh Rain 120 count 6 boxes Eliminate static cling and leave your clothes soft and fresh smelling.	\$19.99	\$20.00 (50%)
Neutrogena Moisture Rich Shower and Bath Gel, 35 Ounces (2 Bottles) Pamper skin and senses with this refreshing shower and bath gel.	\$29.99	\$28.00 (48%)
Revival Soy Protein Bar, Chocolate Temptation Bar 15 ea You won't have to feel guilty about giving in to this Chocolate Temptation.	\$27.99	\$4.96 (15%)
Starbucks Decaffeinated House Blend Universal Ground Coffee, 6 12-Ounce FlavorLock Bags (72 ounces total) Savor a true coffee classic without the jitters.	\$28.99	\$4.00 (12%)
Schick Silk Effects Plus Refill Blades with Aloe - 10 ea Exclusive microfine wires make getting a close shave easier on your skin.	\$11.49	\$1.00 (8%)

 **FREE Super Saver Shipping on orders over \$25.** [See details.](#)

Amazon.com now offers bargains on brand-name essentials, all priced so low they've sunk to the bottom of the page! We take up to 50% off standard retail prices and deliver right to your door--no club fees, no hassle, no parking lot. Check back every day at noon (central time) for all-new Bottom of the Page™ Deals.

[Conditions of Use](#) | [Privacy Notice](#) © 1996-2004, Amazon.com, Inc. or its affiliates

[FAQs](#)
[News & Features](#)
[Image Gallery](#)
[Solar System Guide](#)
[Explorations](#)
[Constellation Guide](#)
[Star Guide](#)
[Galaxy Guide](#)
[Astroglossary](#)
[Resource List](#)
[Keywords](#)
[Site search](#)

AstroGlossary

[A](#) [B](#) [C](#) [D](#) [E](#) [F](#) [G](#) [H](#) [I](#) [J](#) [K](#) [L](#) [M](#) [N](#) [O](#) [P](#) [Q](#) [R](#) [S](#) [T](#) [U](#) [V](#) [W](#) [X](#) [Y](#) [Z](#)

- T -

telescope

An optical instrument that gathers and focuses [light](#) into a camera, CCD, [spectrograph](#), or an astronomer's eye. Two major types of telescopes dominate astronomy: reflectors and refractors.

reflectors

A primary mirror gathers and focuses [light](#) to the focal point. These [telescopes](#) are most common in astronomical observatories.

Aperture ranges from a few centimeters to several meters. Mirror diameter is limited by the flexible nature of glass, mirror weight, and design of the telescope. Some telescopes overcome these problems with a segmented primary mirror.

refractors

An objective lens gathers and focuses light to the focal point. Aperture size is limited by the purity and weight of the glass lens. Several of the most magnificent telescopes are refractors. Yerkes Observatory's 40-inch refractor is the largest. Not only are the instruments mechanically and aesthetically beautiful, but they are also responsible for pioneering astronomical research that paves the road for present-day discoveries.

Astronomy demands precise clockwork motion of a telescope. In order to track stars and faint objects in the sky for long hours, the telescope must turn opposite the direction of the Earth. A telescope mount solves this problem. Two axis divide the motion of the telescope into two orthogonal (right angle) directions. The [right ascension](#) axis and the [declination](#).

temperature

Astronomers refer to a star's [photosphere](#) temperature, called the effective temperature, since this temperature influences the appearance of the star's [spectrum](#). The temperature of a [star](#) is dependent on several variables like [mass](#), pressure, [density](#), and radius. Imagine a long thermometer, the length of the Sun's radius. In the core, temperature is highest around 15 million degrees. As you pull the thermometer out of the Sun, the temperature falls. Halfway out, the temperature is about 5 million degrees. At the photosphere, where almost all [photons](#) escape, the temperature is 6000 degrees -- the effective temperature of the Sun.

terminator

A hard, shadow edge marking the boundary between the night and day side of a moon or planet. Along this jagged boundary on the Moon, you can clearly see another dimension to mountains and [crater](#). Sometimes, towering crater rings still catch a bit of sunlight as they slip behind the terminator.

terrestrial planets

The four inner planets of our solar system: Mercury, Venus, Earth and Mars. They consist mainly of rocky material: iron, sulfur, magnesium, silicon, nickel. No H nor He exists in the atmospheres of these planets. Daytime temperatures range from 600 K (621 F) on Mercury to 300 K (81 F) on Mars. In addition, the most striking difference between the terrestrial planets and outer solar system planets lies in average [density](#).

Mercury: 5430 kg/cubic meter

Venus: 5250 kg/cubic meter

Earth: 5520 kg/cubic meter

Mars: 3950 kg/cubic meter

Jupiter: 1330 kg/cubic meter

Saturn: 660 kg/cubic meter

Uranus: 1290 kg/cubic meter

Neptune: 1640 kg/cubic meter

Pluto: 2030 kg/cubic meter

But the outer planets dominate in size, ranging from Jupiter (11.21 Earth diameters) to Neptune (3.88 Earth diameters). Pluto is the smallest planet in our solar system, 0.18 the Earth's diameter and even labeling Pluto a planet has recently been debated.

thermonuclear fusion

A star's [light](#) or [photon](#) engine. Every [star](#) on the [main sequence](#) converts [mass](#) into energy through thermonuclear fusion. The process demands high temperature and pressure in order to fuse the hydrogen into helium, due to powerful electromagnetic forces separating neighboring H atoms.

tidal force

The difference between gravitational forces on opposite sides of an object, like a planet or moon. [Gravity](#) is a force that depends on both the involved [masses](#) and distance between the masses. The Moon-Earth gravitational interaction results in sea tides on Earth. Elsewhere in the solar system, the magnitude of gravitational force on Jupiter's moon, Io, is greatest on the Jupiter side of Io, and least on the backside. The difference between the two forces compresses and stretches Io, which in turn heats up Io's interior. As a result, Io is the most geologically active body in the solar system.

total solar eclipse

Results from the Moon completely blocking out the Sun in the sky (see [eclipse](#)). The Moon's shadow narrowly projects onto the Earth, making this a rare experience.

transit

The time at which a celestial object is highest in the sky. This is the best time to view the object. At transit, the object's light travels through the thinnest possible layer of Earth's atmosphere, which can distort an object's appearance. At times of rise and set, when an object is nearest the horizon, its light travels through the most atmosphere.

See also

[right ascension](#)

[declination](#)

[A](#) [B](#) [C](#) [D](#) [E](#) [F](#) [G](#) [H](#) [I](#) [J](#) [K](#) [L](#) [M](#) [N](#) [O](#) [P](#) [Q](#) [R](#) [S](#) [T](#) [U](#) [V](#) [W](#) [X](#) [Y](#) [Z](#)

[Home](#) [Site Map](#) [Privacy](#) [Copyright](#)
[Observatory](#)

[McDonald](#)



[Información en español](#)



[Home](#)

[Products](#)

[FAQ's](#)

[Distributors](#)

[Contact Us](#)

[Links](#)

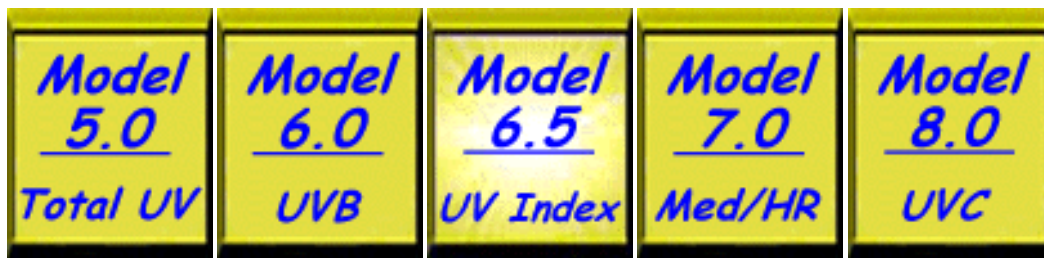

Model 6.5

Specifications

Sensor

Silicon Carbide (SiC) Photodiode packaged on gold plated header via gold wire bonding under UV glass window cap, hermetically sealed.

Radiometer

Peak sunlight response bandwidth: 297-310nm
 Total solar response: 290-400nm, Diffey
 Display: 3 ½ digit LCD
 Resolution: 0.1 UVI
 Power Source: 9V DC battery
 Accuracy: +5% ref NIST (NBS) standards



**Model 6.5 Price:
\$179.00**

If you cannot find this meter at a local [distributor](#), you can [order direct](#).

Proper usage of Solarmeter Ultraviolet Radiometer for Outdoor UV Index Measurement



The instrumentation used to measure UV index for the U.S. E.P.A./NWS program is directed toward the sky in a global normal (perpendicular to level ground) inclination. Therefore the Solarmeter® is designed to operate in the same fashion. Solar irradiance measured this way includes direct (reduced by cosine law depending on solar zenith angle) plus global (diffused by the atmosphere).

This verticle reading represents an average intensity value your body will experience while being active on a tennis or volleyball court, or lying flat on a blanket on the grass. If however, you are reclined in a lounge chair facing the sun perpendicular to the sun angle, you will experience a higher UV intensity, as represented by pointing the Solarmeter® directly at the sun. This value will typically exceed the UV index number.

To

obtain the UV index instantaneous value, the following instructions will provide the most consistent, accurate results:

- Stand clear of buildings, trees, etc. to avoid absorption, diffusion effects of surroundings.
- Face the sun direction and hold meter vertically in front of you (Figure 1)
- Press and hold button on front of meter case. Note reading on LCD. This value represents the instantaneous UV index.
- If planning to sunbathe in a lounge chair facing the sun, or if sitting in a stadium facing the sun, tilt meter directly toward sun to obtain direct reading. Take extra precaution under these conditions to reduce sun damage.

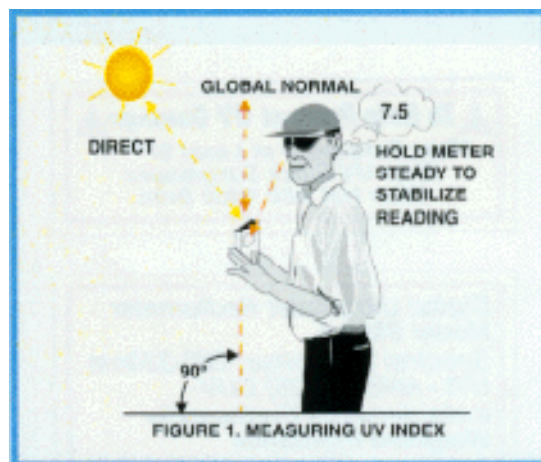

Note that various cloud conditions reduce UV index. When partly cloudy, take readings often and average clear with cloudy readings to correlate with UV index.

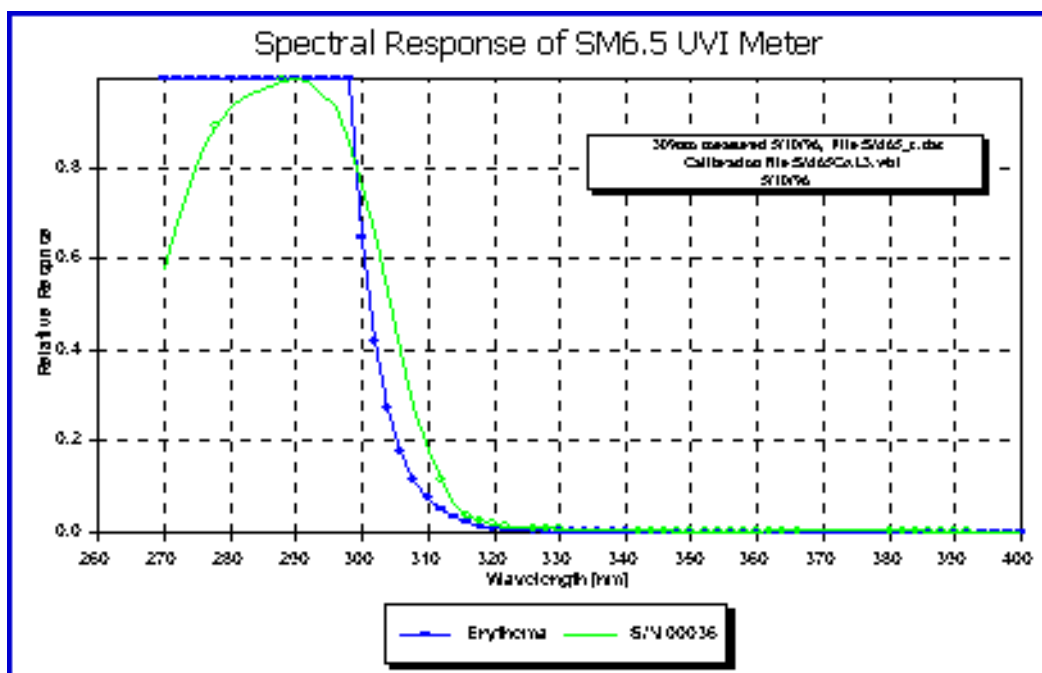

Interpretation of UV index Relative to Proper Precautions

U.S. EPA publication #430-F-94-016 dated January 1995 provides an excellent overview describing exposure levels and precautions. Also, the sunscreen manufacturer industry may offer SPF values proportional to the UV index. However, the best source of precautionary information should be your own medical physician relative to your skin type, family history and other variables.

Detailed UV index reports from the EPA #430-F-94-017 and 019 equate the index values to skin type and

RANGE BETWEEN MOST SENSITIVE AND LEAST SENSITIVE

minutes to burn according to the graph to the right.

There are five skin types ranging from Type I (always burns/never tans) to Type V (always tans/rarely burns). This chart indicates the range from most sensitive to least sensitive skin. Since minutes to burn for previously unexposed Types I and II are so short, these types should follow all of the following precautions regardless of the UV index values. Consult your physician to verify your skin type.

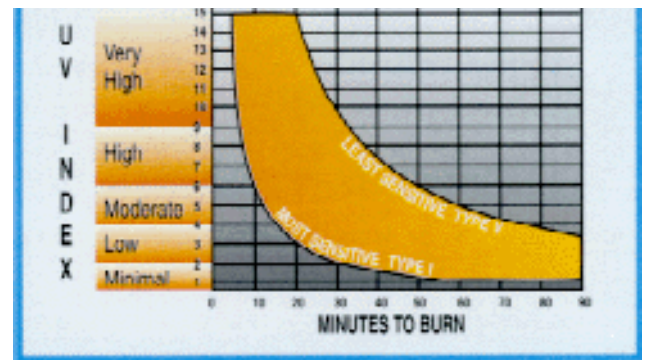

Precautions Outdoors

To reduce the chance of sunburn, skin cancer, and eye damage:

- Minimize sun exposure at midday (10:00 a.m. to 4:00 p.m.)
- Apply sunscreen with SPF-15 or higher to all exposed areas of the body.
- Reapply sunscreen every two hours, even on cloudy days, especially after swimming or perspiring.
- Be aware of reflective surfaces (water, sand, snow) which increase UV exposure.
- Wear clothing that covers the body and shades the face.
- Protect children by keeping them from excessive sun and applying sunscreen frequently to children older than 6 months of age.
- Wear sunglasses that absorb 99-100% of the full UV spectrum when outdoors in bright sun.

Remember, the most important UV damage prevention is to avoid sunburn!

The Solarmeter® model SM6.5 is not a medical instrument, but rather an affordable scientific instrument designed to help you avoid sunburn by providing an instantaneous UV index value.

Among the outdoor variables affecting UV intensity are:

- Seasonality/Sun Zenith Angle
- Location/Latitude/Geography
- Reflective Surroundings
- Altitude
- Weather conditions
- Ozone Layer Thickness

By regularly using the Solarmeter® you will become very informed of damaging UV levels in many and varied conditions. This knowledge, along with following the outdoor precautions mentioned above, should help enable you to avoid sun damage.



<i>Model</i> <u>5.0</u> <i>Total UV</i>	<i>Model</i> <u>6.0</u> <i>UVB</i>	<i>Model</i> <u>6.5</u> <i>UV Index</i>	<i>Model</i> <u>7.0</u> <i>Med/HR</i>	<i>Model</i> <u>8.0</u> <i>UVC</i>
--	---	--	--	---

Solartech, Inc. UV Meters

Welcome to Solartech, Inc., the UV meter specialists. We supply the best value high quality hand-held UV measurement devices in the industry.

- [Home](#)
- [Products](#)
- [FAQ's](#)
- [Distributors](#)
- [Contact Us](#)
- [Links](#)



*Now with
genuine leather
carrying case!*

Click [HERE](#) to go to Japanese (‘‘ú–{Œê) Page.

U.S. Environmental Protection Agency



Protecting human health, safeguarding the natural environment

[Recent Additions](#) | [Contact Us](#) | [Print Version](#) Search: [Advanced Search](#)

- [EPA Newsroom](#)
- [Browse EPA Topics](#)
- [Laws, Regulations & Dockets](#)
- [Where You Live](#)
- [Information Sources](#)
- [Educational Resources](#)
- [About EPA](#)
- [Programs](#)
- [Business Opportunities](#)
- [Jobs](#)
- [Recursos en Español](#)

Special Features

- [Clear Skies](#)
- [Winter Wise Tips](#)
- [Budget, Goals and Performance](#)
- [Ongoing 9/11 response](#)



Mike Leavitt
[Administrator's Web site](#)

Top Stories

EPA and nation s counties announce energy efficiency challenge Mar. 1 - The National Association of Counties, representing more than 1,500 county officials, joined EPA in challenging counties to protect the environment, save energy and cut operating costs by improving the energy efficiency of county courthouses and office buildings.

[News release](#) | [comunicado de prensa](#) | [ENERGY STAR](#)

Expert panel to study World Trade Center health Mar. 1 - EPA is convening an expert technical review panel to obtain greater input on ongoing efforts to monitor health effects for workers and residents impacted by the collapse of the World Trade Center. The panel will characterize any remaining exposures and risks, identify unmet public health needs, and recommend any steps to further minimize the risks associated with the aftermath of the World Trade Center attacks.

[News release](#) | [World Trade Center Expert Technical Review Panel](#)



EPA and Department of Energy sign agreement to link supercomputers Feb. 19 - Under a

Key Topics

- [Air](#)
- [Cleanup](#)
- [Compliance & Enforcement](#)
- [Economics](#)
- [Ecosystems](#)
- [Emergencies](#)
- [Environmental Management](#)
- [Environmental Technology](#)
- [Human Health](#)
- [Industry](#)
- [International Cooperation](#)
- [Pesticides](#)
- [Pollutants / Toxics](#)
- [Pollution Prevention](#)





memorandum of understanding, this agreement will

strengthen the scientific foundation for environmental, energy and public health issues.

[News release](#) | [comunicado de prensa](#)

39 new facilities join Performance Track program

Feb. 11 - Performance Track rewards facilities that voluntarily exceed regulatory requirements and set goals to continuously improve their environmental performance.

[News release](#) | [comunicado de prensa](#) | [Performance Track](#)

Smartway Transport announces 50+ partners

Feb. 9 - Voluntary freight industry program promotes fuel efficiency and reduction of greenhouse gas and pollutant emissions. More than 50 shippers and carriers have signed partnership agreements.

[News release](#) | [comunicado de prensa](#) | [SmartWay Transport Partnership](#)

[\[More from the EPA Newsroom and News Around the Nation\]](#)

[Radiation](#)

[Research](#)

[Treatment & Control](#)

[Wastes](#)

[Water](#)

[\[Browse EPA Topics\]](#)

[EPA Home](#) | [Accessibility](#) | [Privacy and Security Notice](#) | [FOIA](#) | [Civil Rights Statistics](#) | [Contact Us](#)



U.S. Environmental Protection Agency

SunWise School Program

[Recent Additions](#) | [Contact Us](#) | [Print Version](#) Search:

[EPA Home](#) > SunWise

[Overview](#)

[Ozone Layer](#)

[UV Index](#)

[Action Steps](#)

[Publications](#)

[Glossary](#)

[Links](#)

[FAQs](#)

[Recognition Program](#)

[Recursos en Español](#)



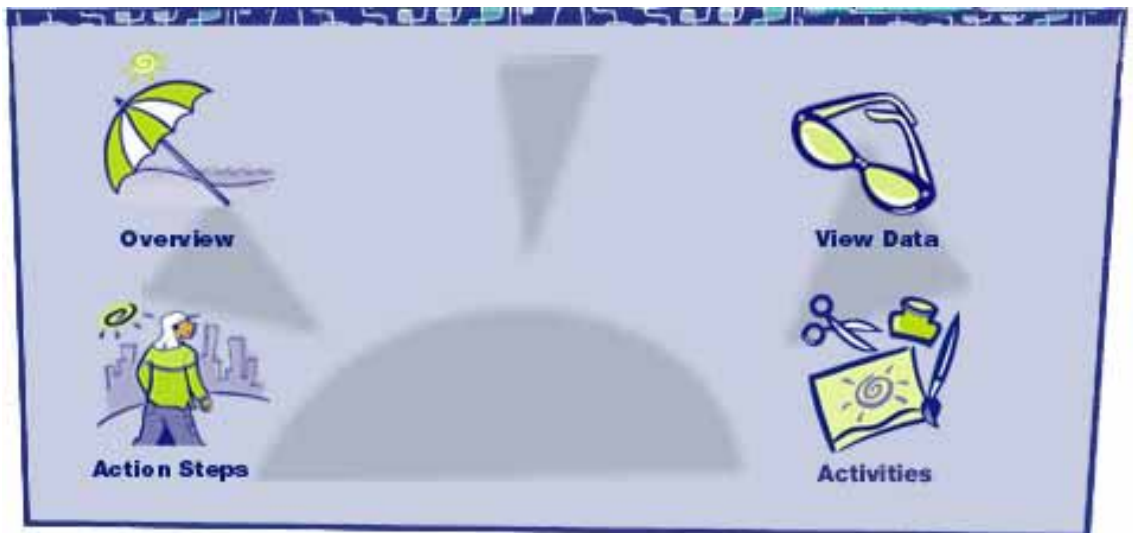
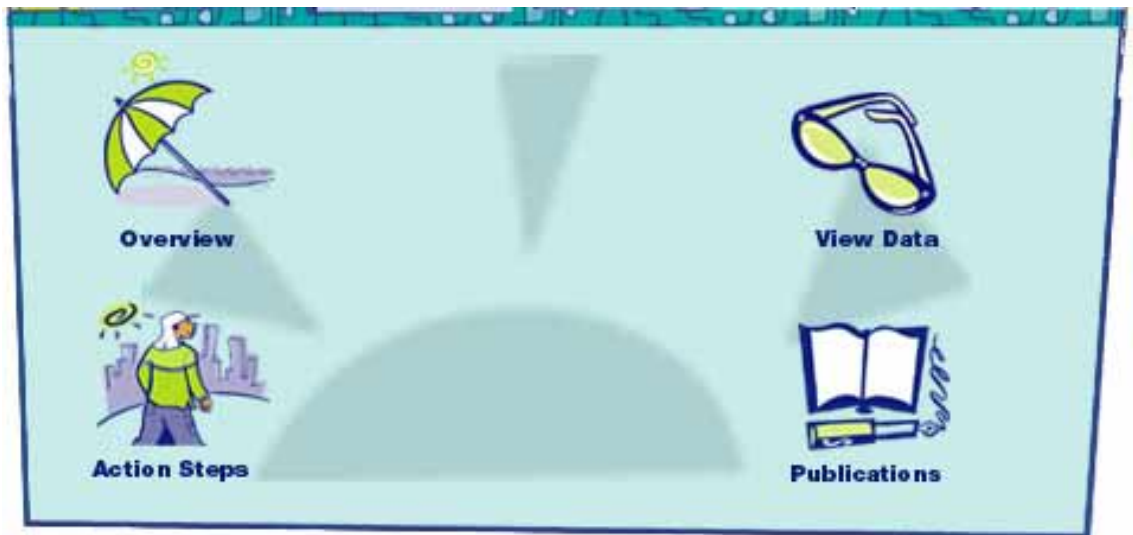



SEARCH

BROWSE

- [Music](#)
- [DVD](#)
- [Video](#)

Hello. Sign in to get [personalized recommendations](#). New customer? [Start here](#).

Top Sellers in Music**Feels Like Home**

Norah Jones blew everybody away with her jazzy, country-tinged,

Grammy-winning debut CD, [Come Away With Me](#). On this recording, Jones doesn't mess with her trademark formula. Under Arif Mardin's cozy... [Read more](#)

More Top Sellers:

[Leslie Sansone - Walk Away the Pounds 3 Pack \(includes weight set\)](#) VHS ~ Leslie Sansone

[Stargate SG-1 Season 6 Boxed Set](#) DVD ~ Richard Anderson

New and Future Releases**Memorex 2.4x DVD+RW (25 Pack Spindle)**

disc is single sided and can store

Amazon.com Product Description

The DVD+RW rewritable

SAVE AN ADDITIONAL
20% OR MORE!
AT THE
CDNOW PREFERRED
BUYER'S CLUB

START SAVING NOW! >>

FREE SHIPPING

WHEN YOU SPEND \$25
OR MORE! AT THE CDNOW
PREFERRED BUYER'S CLUB

[SEE DETAILS](#)

GET THE NEW NORAH JONES



Buy it Now!

Michael Buble

BUY IT NOW
>>> \$7.99



>>>> BUY IT NOW \$7.99

up to 4.7 GB of data and 2 hours of video. Each disc is designated as RW to avoid user confusion. The disc was developed for new DVD+RW drives,... [Read more](#)

 [3rd Degree](#) by James

Patterson, Andrew Gross

 [Apple 15 GB iPod](#)

[M9460LL/A](#) by Apple Computer

 [Lost In Translation](#)

(Widescreen Edition) **DVD** ~

Scarlett Johansson

 [Ocean Wonders Aquarium](#)

by Fisher-Price

Listmania! ([What is this?](#))



[My Favorite Albums of 2003 in No Particular Order](#)

(25 item list)



[Must own NEW music](#)
(10 item list)

- [Best Music Ever\(in no order\)](#)
- [My favorite music](#)
- [Albums On My Newest CD Rack](#)

Top Sellers



Music

[Feels Like Home](#)

[The Passion of the Christ \(Score\)](#)

▶ [More Music bestsellers](#)



DVD

[Stargate SG-1 Season 6 Boxed Set](#)

[Lost In Translation \(Widescreen Edition\)](#)

▶ [More DVD bestsellers](#)



Video

[Leslie Sansone - Walk Away the Pounds 3 Pack \(includes weight set\)](#)
[Winged Migration](#)

▶ [More Video bestsellers](#)

[About the CDNOW/Amazon.com Alliance](#)

[About the CDNOW Preferred Buyer's Club](#)

[Your Privacy](#)

Where's My Stuff?

- Track your [recent orders](#).
- View or change your orders in [Your Account](#).

Shipping & Returns

- See our [shipping rates & policies](#).
- [Return](#) an item (here's our [Returns Policy](#)).

Need Help?

- Forgot your password? [Click here](#).
- [Redeem](#) or [buy](#) a gift certificate.
- [Visit our Help department](#).

Search**for**

Turn your past purchases into \$\$\$
[Learn more](#) about selling at Amazon.com today!

[Top of Page](#)[Directory of Amazon.com Stores](#)[Help](#) | [Shopping Cart](#) | [Your Account](#) | [Sell Items](#) | [1-Click Settings](#) | [Join Advantage](#)[Conditions of Use](#) | [Privacy Notice](#) © 1996-2004, Amazon.com, Inc. or its affiliates



Imagine the Universe! Dictionary

Please allow the whole page to load before you start searching for an entry. Otherwise, errors will occur.

[[A](#) [B](#) [C](#) [D](#) [E](#) [F](#) [G](#) [H](#) [I](#) [J](#) [K](#) [L](#) [M](#) [N](#) [O](#) [P](#) [Q](#) [R](#) [S](#) [T](#) [U](#) [V](#) [W](#) [X](#) [Y](#) [Z](#)]

(Note - Greek letters are written out by name - alpha, beta etc.)

A

accretion

Accumulation of dust and gas onto larger bodies such as stars, planets and moons.

accretion disk

A relatively flat sheet of gas and dust surrounding a newborn star, a black hole, or any massive object growing in size by attracting material.

active galactic nuclei (AGN)

A class of galaxies which spew massive amounts of energy from their centers, far more than ordinary galaxies. Many astronomers believe supermassive black holes may lie at the center of these galaxies and power their explosive energy output.

★ [Tell me about AGN!](#)

★ [Tell me more about AGN!](#)

angstrom

A unit of length equal to 0.00000001 centimeters. This may also be written as 1×10^{-8} cm (see [scientific notation](#)).

angular momentum

A quantity obtained by multiplying the mass of an orbiting body by its velocity and the radius of its orbit. According to the conservation laws of physics, the angular momentum of any orbiting body must remain constant at all points in the orbit, i.e., it cannot be created or destroyed. If the orbit is elliptical the radius will vary. Since the mass is constant, the velocity changes. Thus planets in elliptical orbits travel faster at [perihelion](#) and more slowly at [aphelion](#). A spinning body also possesses spin angular momentum.

apastron

The point of greatest separation between two stars which are in orbit around each other. See [binary stars](#). Opposite of [periastron](#).

aphelion

The point in its orbit where a planet is farthest from the Sun. Opposite of [perihelion](#).

apoapsis

The point in an orbit when the two objects are farthest apart. Special names are given to this orbital point for commonly used systems: see [apastron](#), [aphelion](#), and [apogee](#).

apogee

The point in its orbit where an Earth satellite is farthest from the Earth. Opposite of [perigee](#).

Ariel V

A UK X-ray mission, also known as UK-5

★ [Tell me more about Ariel V](#)

ASCA

The Japanese Asuka spacecraft (formerly Astro-D), an X-ray mission

★ [Tell me more about ASCA](#)

ASM

All Sky Monitor. An instrument designed to observe large areas of the sky for interesting astronomical phenomena. An ASM measures the intensity of many sources across the sky and looks for new sources. Many high-energy satellites have carried ASM detectors, including the ASM on [Vela 5B](#), [Ariel V](#), and the [Rossi X-ray Timing Explorer](#).

Astro E

A X-ray/gamma-ray mission built jointly by the United States and Japan. Astro E was destroyed in February 2000, when a Japanese M-5 rocket failed to lift the instrument into orbit. A replacement mission, Astro-E2, is planned for 2005.

★ [Tell me more about Astro E](#)

astronomical unit (AU)

149,597,870 km; the average distance from the Earth to the Sun.

astronomy

The scientific study of matter in outer space, especially the positions, dimensions, distribution, motion, composition, energy, and evolution of celestial bodies and phenomena.

astrophysics

The part of astronomy that deals principally with the physics of the universe, including luminosity, density, temperature, and the chemical composition of stars, galaxies, and the interstellar medium.

atmosphere

The gas that surrounds a planet or star. The Earth's atmosphere is made up of mostly nitrogen, while the Sun's atmosphere consists of mostly hydrogen.

AXAF

The Advanced X-ray Astrophysics Facility. AXAF was renamed Chandra X-ray Observatory, [CXO](#), and launched in July 1999.

★ [Tell me more about AXAF](#)

B

Balmer lines (J. Balmer)

Emission or absorption lines in the [spectrum](#) of hydrogen that arise from transitions between the second (or first excited) state and higher energy states of the hydrogen atom. They were discovered by Swiss physicist J. J. Balmer.

baryon

Any of the subatomic particles which interact via the strong nuclear force. Most commonly, these are protons and neutrons. Their presence in the universe is determined through their gravitational and electromagnetic interactions.

BATSE

BATSE (Burst and Transient Source Experiment) was an instrument aboard the [Compton Gamma Ray Observatory](#) that detected and located [gamma-ray bursts](#) in the sky.

BBXRT

The Broad Band X-Ray Telescope, which was flown on the Astro-1 space shuttle flight (Dec. 1990)

★ [Tell me more about BBXRT](#)

Big Bang

A theory of [cosmology](#) in which the expansion of the universe is presumed to have begun with a primeval explosion (referred to as the "Big Bang").

binary stars

Binary stars are two stars that orbit around a common center of mass. An X-ray binary is a special case where one of the stars is a collapsed object such as a [white dwarf](#), [neutron star](#), or black hole, and the separation between the stars is small enough so that matter is transferred from the normal star to the compact star star, producing X-rays in the process.

★ [Tell me about X-ray binary stars](#)

★ [Tell me more about X-ray binary stars](#)

black dwarf

A non-radiating ball of gas resulting from either a [white dwarf](#) that has radiated all its energy or gas which has contracted but contains too little mass to begin nuclear [fusion](#).

black hole

An object whose gravity is so strong that not even light can escape from it.

★ [Tell me about X-rays from black holes](#)

★ [Tell me about gamma rays from black holes and neutron stars](#)

★ [Tell me more about black holes](#)

black-hole dynamic laws; laws of black-hole dynamics

1. First law of black hole dynamics:

For interactions between black holes and normal matter, the conservation laws of mass-energy, electric charge, linear momentum, and [angular momentum](#), hold. This is analogous to the first law of thermodynamics.

2. Second law of black hole dynamics:

With black-hole interactions, or interactions between black holes and normal matter, the sum of the surface areas of all black holes involved can never decrease. This is analogous to the second law of thermodynamics, with the surface areas of the black holes being a measure of the entropy of the system.

blackbody radiation

Blackbody radiation is produced by an object which is a perfect absorber of heat. Perfect absorbers must also be perfect radiators. For a blackbody at a temperature T , the intensity of radiation emitted I at a particular energy E is given by Planck's law:

$$I(E,T) = 2 E^3 [h^2 c^2 (e^{E/kT} - 1)]^{-1}$$

where h is [Planck's constant](#), k is [Boltzmann's constant](#), and c is the [the speed of light](#).

blackbody temperature

The temperature of an object if it is re-radiating all the thermal energy that has been added to it; if an object is not a blackbody radiator, it will not re-radiate all the excess heat and the leftover will go toward increasing its temperature.

blueshift

An apparent shift toward shorter [wavelengths](#) of [spectral lines](#) in the radiation emitted by an object caused by motion between the object and the observer which decreases the distance between them. See also [Doppler effect](#).

bolometric luminosity

The total energy radiated by an object at all [wavelengths](#), usually given in joules per second (identical to watts).

Boltzmann constant; k (L. Boltzmann)

A constant which describes the relationship between temperature and kinetic energy for molecules in an ideal gas. It is equal to 1.380622×10^{-23} J/K (see [scientific notation](#)).

Brahe, Tycho (1546 - 1601)

(a.k.a Tyge Ottesen) Danish astronomer whose accurate astronomical observations of Mars in the last quarter of the 16th century formed the basis for [Johannes Kepler's laws of planetary motion](#). Brahe lost his nose in a duel in 1566 with Manderup Parsberg (a fellow student and nobleman) at Rostock over who was the better mathematician. He died in 1601, not of a burst bladder as legend suggests, but from high levels of mercury in his blood (which he may have taken as medication after falling ill from

the infamous meal). [Show me a picture of Tycho Brahe !](#)

bremsstrahlung

"braking radiation", the main way very fast charged particles lose energy when traveling through matter. Radiation is emitted when charged particles are accelerated. In this case, the acceleration is caused by the electromagnetic fields of the atomic nuclei of the medium.

C

calibration

A process for translating the signals produced by a measuring instrument (such as a telescope) into something that is scientifically useful. This procedure removes most of the errors caused by environmental and instrumental instabilities.

Cataclysmic Variable (CV)

[Binary star](#) systems with one [white dwarf](#) star and one normal star, in close orbit about each other. Material from the normal star falls onto the white dwarf, creating a burst of X-rays.

★ [Tell me more about Cataclysmic Variables](#)

Cepheid Variable

A type of variable star which exhibits a regular pattern of changing brightness as a function of time. The period of the pulsation pattern is directly related to the star's intrinsic brightness. Thus, Cepheid variables are a powerful tool for determining distances in modern astronomy.

★ [Tell me more about Cepheid Variables](#)

CGRO

The Compton Gamma Ray Observatory

★ [Tell me more about CGRO](#)

Chandra X-ray Observatory (CXO)

One of NASA's Great Observatories in Earth orbit, launched in July 1999, and named after [S. Chandrasekhar](#). It was previously named the Advanced X-ray Astrophysics Facility ([AXAF](#)).

Chandrasekhar, S. (1910 - 1995)

Indian astrophysicist renowned for creating theoretical models of white dwarf stars, among other achievements. His equations explained the underlying physics behind the creation of white dwarfs, neutron stars and other compact objects.

Chandrasekhar limit

A limit which mandates that no [white dwarf](#) (a collapsed, degenerate star) can be more massive than about 1.4 [solar masses](#). Any degenerate object more massive must inevitably collapse into a [neutron star](#).

cluster of galaxies

A system of galaxies containing from a few to a few thousand member galaxies which are all [gravitationally bound](#) to each other.

collecting area

The amount of area a telescope has that is capable of collecting electromagnetic radiation. Collecting

area is important for a telescope's [sensitivity](#): the more radiation it can collect (that is, the larger its collecting area), the more likely it is to detect dim objects.

Compton effect (A.H. Compton; 1923)

An effect that demonstrates that photons (the quantum of electromagnetic radiation) have momentum. A photon fired at a stationary particle, such as an electron, will impart momentum to the electron and, since its energy has been decreased, will experience a corresponding decrease in [frequency](#).

★ [Tell me more about Dr. Compton and the Compton Effect](#)

★ [Tell me how gamma-ray astronomers use the Compton effect](#)

Copernicus

NASA ultraviolet/X-ray mission, also known as OAO-3

★ [Tell me more about the Copernicus mission](#)

Copernicus, Nicolaus (1473 - 1543)

Polish astronomer who advanced the theory that the Earth and other planets revolve around the Sun (the "heliocentric" theory). This was highly controversial at the time, since the prevailing [Ptolemaic](#) model held that the Earth was the center of the universe, and all objects, including the sun, circle it. The Ptolemaic model had been widely accepted in Europe for 1000 years when Copernicus proposed his model. (It should be noted, however, that the heliocentric idea was first put forth by Aristarcus of Samos in the 3rd century B.C., a fact known to Copernicus but long ignored by others prior to him.)
[Show me a picture of Nicholas Copernicus !](#)

corona (plural: coronae)

The uppermost level of a star's atmosphere. In the sun, the corona is characterized by low densities and high temperatures (> 1,000,000 degrees K).

★ [Tell me about X-rays from the Sun's corona](#)

★ [Tell me about X-rays from other stellar coronae](#)

COS-B

A satellite launched in August 1975 to study extraterrestrial sources of gamma-ray emission.

★ [Tell me more about COS-B](#)

cosmic background radiation; primal glow

The background of radiation mostly in the [frequency](#) range 3×10^8 to 3×10^{11} Hz (see [scientific notation](#)) discovered in space in 1965. It is believed to be the [cosmologically redshifted](#) radiation released by the [Big Bang](#) itself.

cosmic rays

Atomic nuclei (mostly protons) and electrons that are observed to strike the Earth's atmosphere with exceedingly high energies.

cosmological constant; Lambda

A constant term (labeled Lambda) which Einstein added to his general theory of relativity in the mistaken belief that the Universe was neither expanding nor contracting. The cosmological constant was found to be unnecessary once observations indicated the Universe was expanding. Had Einstein believed what his equations were telling him, he could have claimed the expansion of the Universe as perhaps the greatest and most convincing prediction of [general relativity](#); he called this the "greatest

blunder of my life".

cosmological distance

A distance far beyond the boundaries of our Galaxy. When viewing objects at cosmological distances, the curved nature of spacetime could become apparent. Possible cosmological effects include [time dilation](#) and [redshift](#).

cosmological redshift

An effect where light emitted from a distant source appears [redshifted](#) because of the expansion of spacetime itself. Compare [Doppler effect](#).

cosmology

The astrophysical study of the history, structure, and dynamics of the universe.

CXO

The Chandra X-ray Observatory. CXO was launched by the Space Shuttle in July 1999, and named for [S. Chandrasekhar](#).



[Tell me more about CXO](#)

D

Dark Matter

Name given to the amount of mass whose existence is deduced from the analysis of galaxy rotation curves but which until now, has escaped all detections. There are many theories on what dark matter could be. Not one, at the moment is convincing enough and the question is still a mystery.

de Broglie wavelength (L. de Broglie; 1924)

The quantum mechanical "wavelength" associated with a particle, named after the scientist who discovered it. In quantum mechanics, all particles also have wave characteristics, where the [wavelength](#) of a particle is inversely proportional to its momentum and the constant of proportionality is the [Planck constant](#).

Declination

A coordinate which, along with [Right Ascension](#), may be used to locate any position in the sky. Declination is analogous to latitude for locating positions on the Earth, and ranges from +90 degrees to -90 degrees.

deconvolution

An image processing technique that removes features in an image that are caused by the telescope itself rather than from actual light coming from the sky. For example, the optical analog would be to remove the spikes and halos which often appear on images of bright stars because of light scattered by the telescope's internal supports.

density

The ratio between the mass of an object and its volume. In the metric system, density is measured in grams per cubic centimeter (or kilograms per liter); the density of water is 1.0 gm/cm³; iron is 7.9gm/cm³; lead is 11.3.gm/cm³

disk

(a) A flattened, circular region of gas, dust, and/or stars. It may refer to material surrounding a

newly-formed star; material accreting onto a black hole or [neutron star](#); or the large region of a spiral galaxy containing the spiral arms. (b) The apparent circular shape of the Sun, a planet, or the moon when seen in the sky or through a telescope.

Doppler effect (C.J. Doppler)

The apparent change in [wavelength](#) of sound or light caused by the motion of the source, observer or both. Waves emitted by a moving object as received by an observer will be [blueshifted](#) (compressed) if approaching, [redshifted](#) (elongated) if receding. It occurs both in sound and light. How much the [frequency](#) changes depends on how fast the object is moving toward or away from the receiver.

Compare [cosmological redshift](#).

dust

Not the dust one finds around the house (which is typically fine bits of fabric, dirt, and dead skin cells). Rather, irregularly shaped grains of carbon and/or silicates measuring a fraction of a micron across which are found between the stars. Dust is most evident by its absorption, causing large dark patches in regions of our Milky Way Galaxy and dark bands across other galaxies.

E

eccentric

Non-circular; elliptical (applied to an orbit).

eccentricity

A value that defines the shape of an [ellipse](#) or planetary orbit. The eccentricity of an ellipse (planetary orbit) is the ratio of the distance between the foci and the major axis. Equivalently the eccentricity is $(r_a - r_p)/(r_a + r_p)$ where r_a is the [apoapsis](#) distance and r_p is the [periapsis](#) distance.

eclipse

The passage of one celestial body in front of another, cutting off the light from the second body (e.g. an eclipse of the sun by the moon, or one star in a binary system eclipsing the other). It may also be the passage of all or part of one body through the shadow of another (e.g. a lunar eclipse in which the moon passes through the Earth's shadow).

ecliptic

The plane of Earth's orbit about the Sun.

Eddington limit (Sir A. Eddington)

The theoretical limit at which the [photon](#) pressure would exceed the gravitational attraction of a light-emitting body. That is, a body emitting radiation at greater than the Eddington limit would break up from its own photon pressure.

Einstein, Albert (1879 - 1955)

German-American physicist; developed the Special and General Theories of [Relativity](#) which along with Quantum Mechanics is the foundation of modern physics. [Show me a picture of Albert Einstein !](#)

Einstein Observatory,

The first fully imaging x-ray telescope in space, launched by NASA in 1978. Originally named "HEAO-2" (High Energy Astrophysics Observatory 2), it was renamed for Albert Einstein upon launch. Also see [HEAO](#).



[Tell me more about HEAO-2 \(Einstein Observatory\)](#)

ejecta

Material that is ejected. Used mostly to describe the content of a massive star that is propelled outward in a [supernova explosion](#). Also used to describe the material that is blown radially outward in a meteor impact on the surface of a planet or moon.

electromagnetic spectrum

The full range of [frequencies](#), from radio waves to gamma rays, that characterizes light.



[Introduce me to the electromagnetic spectrum](#)



[Tell me more about the electromagnetic spectrum](#)

electromagnetic waves (radiation)

Another term for light. Light waves are fluctuations of electric and [magnetic fields](#) in space.

electron

A negatively charged particle commonly found in the outer layers of atoms. The electron has only 0.0005 the mass of the [proton](#).

electron volt

The change of potential energy experienced by an [electron](#) moving from a place where the potential has a value of V to a place where it has a value of (V+1 volt). This is a convenient energy unit when dealing with the motions of electrons and [ions](#) in electric fields; the unit is also the one used to describe the energy of X-rays and gamma rays. A **keV** (or **kiloelectron volt**) is equal to 1000 electron volts. An **MeV** is equal to one million electron volts. A **GeV** is equal to one billion (10^9) electron volts. A **TeV** is equal to a million million (10^{12}) electron volts.

elements

The fundamental kinds of atoms that make up the building blocks of matter, which are each shown on the periodic table of the elements. The most abundant elements in the universe are hydrogen and helium. These two elements make up about 80 and 20 % of all the matter in the universe respectively. Despite comprising only a very small fraction of the universe, the remaining *heavy elements* can greatly influence astronomical phenomena. About 2 % of the Milky Way's disk is comprised of heavy elements.

ellipse

Oval. That the orbits of the planets are ellipses, not circles, was first discovered by Johannes [Johannes Kepler](#) the careful observations by [Tycho Brahe](#)

erg/sec

A form of the metric unit for power. It is equal to 10^{-10} kilowatts (see [scientific notation](#)).

event horizon

The distance from a black hole within which nothing can escape. In addition, nothing can prevent a particle from hitting the [singularity](#) in a very short amount of proper time once it has entered the horizon. In this sense, the event horizon is a "point of no return". See [Schwarzschild radius](#).

evolved star

A star near the end of its lifetime when most of its fuel has been used up. This period of the star's life is characterized by loss of mass from its surface in the form of a [stellar wind](#).

EXOSAT

European Space Agency's X-ray Observatory



[Tell me more about EXOSAT](#)

extragalactic

Outside of, or beyond, our own galaxy.

F

Fast Fourier Transformation (FFT)

A Fourier Transform is the mathematical operation that takes measurements made with a radio interferometer and transforms them into an image of the radio sky. The Fast Fourier Transform is a technique used by computer programs that allows the Fourier Transform to be computed very quickly.

Fermi acceleration

In order to explain the origins of [cosmic rays](#), Enrico Fermi (1949) introduced a mechanism of particle acceleration, whereby charged particles bounce off moving interstellar [magnetic fields](#) and either gain or lose energy, depending on whether the "magnetic mirror" is approaching or receding. In a typical environment, he argued, the probability of a head-on collision is greater than a head-tail collision, so particles would be accelerated on average. This random process is now called 2nd order Fermi acceleration, because the mean energy gain per "bounce" is dependent on the "mirror" velocity squared.

Bell (1978) and Blandford and Ostriker (1978) independently showed that Fermi acceleration by supernova remnant (SNR) shocks is particularly efficient, because the motions are not random. A charged particle ahead of the shock front can pass through the shock and then be scattered by magnetic inhomogeneities behind the shock. The particle gains energy from this "bounce" and flies back across the shock, where it can be scattered by magnetic inhomogeneities ahead of the shock. This enables the particle to bounce back and forth again and again, gaining energy each time. This process is now called 1st order Fermi acceleration, because the mean energy gain is dependent on the shock velocity only to the first power.

flux

A measure of the amount of energy given off by an astronomical object over a fixed amount of time and area. Because the energy is measured per time and area, flux measurements make it easy for astronomers to compare the relative energy output of objects with very different sizes or ages.

frequency

A property of a wave that describes how many wave patterns or cycles pass by in a period of time. Frequency is often measured in [Hertz](#) (Hz), where a wave with a frequency of 1 Hz will pass by at 1 cycle per second.

FTOOLS

A suite of software tools developed at NASA's Goddard Space Flight Center for analyzing high-energy astronomy data.

FTP

File Transfer Protocol -- A widely available method for transferring files over the Internet.

fusion

The process in which atomic nuclei collide so fast that they stick together and emit a large amount of energy. In the center of most stars, hydrogen fuses into helium. The energy emitted by fusion supports the star's enormous mass from collapsing in on itself, and causes the star to glow.

G

galactic halo

A spherical region surrounding the center of a galaxy. This region may extend beyond the luminous boundaries of the galaxy and contain a significant fraction of the galaxy's mass. Compared to [cosmological distances](#), objects in the halo of our galaxy would be very nearby.

galaxy

A component of our universe made up of gas and a large number (usually more than a million) of stars held together by gravity. When capitalized, Galaxy refers to our own Milky Way Galaxy.

Galilei, Galileo (1564 - 1642)

An Italian scientist, Galileo was renowned for his epoch making contribution to physics, astronomy, and scientific philosophy. He is regarded as the chief founder of modern science. He developed the telescope, with which he found craters on the Moon and discovered the largest moons of Jupiter. Galileo was condemned by the Catholic Church for his view of the cosmos based on the theory of [Copernicus](#). [Show me a picture of Galileo !](#)

gamma ray

The highest energy, shortest [wavelength electromagnetic](#) radiations. Usually, they are thought of as any [photons](#) having energies greater than about 100 keV. (It's "gamma-ray" when used as an adjective.)

Gamma-Ray Burst (GRB)

Plural is GRBs. A burst of gamma rays from space lasting from a fraction of a second to many minutes. There is no clear scientific consensus as to their cause. Recently, their distances were determined to be large, placing the origins of the bursts in other galaxies.

★ [Tell me about Gamma-Ray Bursts](#)

★ [Tell me more about Gamma-Ray Bursts](#)

Gamma-ray Large Area Space Telescope (GLAST)

An international mission planned for launch in 2006, GLAST will study the universe in the energy range 10 keV - 300 GeV.

★ [Tell me more about GLAST](#)

Gamma Ray Imaging Platform (GRIP)

A balloon-borne gamma-ray telescope made by a group at the California Institute of Technology. It has had many successful flights.

Gamma Ray Imaging Spectrometer (GRIS)

A balloon-borne instrument which uses germanium detectors for high resolution gamma-ray [spectroscopy](#).

★ [Tell me more about GRIS](#)

general relativity

The geometric theory of gravitation developed by [Albert Einstein](#), incorporating and extending the theory of [special relativity](#) to accelerated frames of reference and introducing the principle that gravitational and inertial forces are equivalent. The theory has consequences for the bending of light by massive objects, the nature of black holes, and the fabric of space and time.

Giant Molecular Cloud (GMC)

Massive clouds of gas in interstellar space composed primarily of hydrogen molecules (two hydrogen atoms bound together), though also containing other molecules observable by radio telescopes. These clouds can contain enough mass to make several million stars like our Sun and are often the sites of star formation.

Ginga

The third Japanese X-ray mission, also known as Astro-C.

★ [Tell me more about Ginga](#)

globular cluster

A spherically symmetric collection of stars which shared a common origin. The cluster may contain up to millions of stars spanning up to 50 [parsecs](#).

gravitational collapse

When a massive body collapses under its own weight. (For example, interstellar clouds collapse to become stars until the onset of [nuclear fusion](#) stops the collapse.)

gravitational radius

See [event horizon](#).

gravitationally bound

Objects held in orbit about each other by their gravitational attraction. For example, satellites in orbit around the earth are gravitationally bound to Earth since they can't escape Earth's gravity. By contrast, the Voyager spacecraft, which explored the outer solar system, was launched with enough energy to escape Earth's gravity altogether, and hence it is not gravitationally bound.

gravity

A mutual physical force attracting two bodies.

GSFC

Goddard Space Flight Center, one of the centers operated by NASA.

guest star

The ancient Chinese term for a star that newly appears in the night sky, and then later disappears. Later, the Europeans called this a [nova](#).

H

Hawking radiation (S.W. Hawking; 1973)

A theory first proposed by British physicist Stephen Hawking, that due to a combination of properties of quantum mechanics and gravity, under certain conditions black holes can seem to emit radiation.

Hawking temperature

The temperature inferred for a black hole based on the [Hawking radiation](#) detected from it.

HEAO

The High Energy Astrophysical Observatory satellite series

★ [Tell me more about HEAO-1](#)

★ [Tell me more about HEAO-2 \(Einstein Observatory\)](#)

★ [Tell me more about HEAO-3](#)

HEASARC

High Energy Astrophysics Science Archive Research Center, located at NASA's Goddard Space Flight Center. The HEASARC creates and maintains archives of data from ultraviolet, x-ray and gamma-ray satellites for use by astronomers around the world.

helium

The second lightest and second most abundant element. The typical helium atom consists of a nucleus of two protons and two neutrons surrounded by two electrons. Helium was first discovered in our Sun. Roughly 25 percent of our Sun is helium.

Herschel, Sir William (1738 - 1822)

Sir William Herschel was a renowned astronomer who first detected the [infrared](#) region of the [electromagnetic spectrum](#) in 1800.

Hertz, Heinrich (1857 - 1894)

A German physics professor who did the first experiments with generating and receiving [electromagnetic waves](#), in particular radio waves. In his honor, the units associated with measuring the cycles per second of the waves (or the number of times the tip-tops of the waves pass a fixed point in space in 1 second of time) is called the hertz.

hertz; Hz (after H. Hertz, 1857 - 1894)

The derived [SI](#) unit of [frequency](#), defined as a frequency of 1 cycle per [second](#).

HST

Hubble Space Telescope

Hubble, Edwin P. (1889 - 1953)

American astronomer whose observations proved that galaxies are "island universes", not [nebulae](#) inside our own galaxy. His greatest discovery, called "Hubble's Law", was the linear relationship between a galaxy's distance and the speed with which it is moving. The Hubble Space Telescope is named in his honor. [Show me a picture of Edwin Hubble !](#)

Hubble constant; H_0 (E.P. Hubble; 1925)

The constant which determines the relationship between the distance to a galaxy and its velocity of recession due to the expansion of the Universe. After many years in which the Hubble constant was only known to be somewhere between 50 and 100 km/s/[Mpc](#), it has been determined to be 70 km/s/Mpc \pm 7 km/s/Mpc by the Hubble Space Telescope's Key Project team. (Advances in [cosmology](#) have shown that since the Universe is self gravitating, H_0 is not truly constant. Astronomers thus seek its present value.)

Hubble's law (E.P. Hubble; 1925)

A relationship between a galaxy's distance from us and its velocity through space. The farther away a galaxy is from us, the faster it is receding from us. The constant of proportionality is the Hubble

constant, H_0 , named after Edwin P. Hubble who discovered the relationship. Hubble's Law is interpreted as evidence that the Universe is expanding.

Huygens, Christiaan (1629 - 1695)

A Dutch physicist who was the leading proponent of the wave theory of light. He also made important contributions to mechanics, stating that in a collision between bodies, neither loses nor gains "motion" (his term for momentum). In astronomy, he discovered Titan (Saturn's largest moon) and was the first to correctly identify the observed elongation of Saturn as the presence of Saturn's rings. [Show me a picture of Christian Huygens !](#)

hydrogen

The lightest and most abundant element. A hydrogen atom consists of one proton and one electron. Hydrogen composes about 75 percent of the Sun, but only a tiny fraction of the Earth.

I

IKI

The Space Research Institute in Russia. It is the equivalent of NASA in the U.S.

implosion

A violent inward collapse. An inward explosion.

infrared

[Electromagnetic](#) radiation at [wavelengths](#) longer than the red end of visible light and shorter than microwaves (roughly between 1 and 100 microns). Almost none of the infrared portion of the [electromagnetic spectrum](#) can reach the surface of the Earth, although some portions can be observed by high-altitude aircraft (such as the Kuiper Observatory) or telescopes on high mountaintops (such as the peak of Mauna Kea in Hawaii).

inclination

The inclination of a planet's orbit is the angle between the plane of its orbit and the [ecliptic](#); the inclination of a moon's orbit is the angle between the plane of its orbit and the plane of its primary's equator.

image

In astronomy, a picture of the sky.

★ [Tell me about how astronomers use images](#)

interstellar medium

The gas and dust between [stars](#), which fills the plane of the Galaxy much like air fills the world we live in. For centuries, scientists believed that the space between the stars was empty. It wasn't until the eighteenth century, when [William Herschel](#) observed nebulous patches of sky through his telescope, that serious consideration was given to the notion that interstellar space was something to study. It was only in the last century that observations of interstellar material suggested that it was not even uniformly distributed through space, but that it had a unique structure.

ions

An atom with one or more electrons stripped off, giving it a net positive charge.

ionic (or ionized) gas

Gas whose atoms have lost or gained electrons, causing them to be electrically charged. In astronomy, this term is most often used to describe the gas around hot stars where the high temperature causes atoms to lose electrons.

IUE

International Ultraviolet Explorer, an [ultraviolet](#) space observatory launch in 1978. Originally designed for a 3 year mission, IUE exceeded all expectations and functioned for over 18 years, finally ceasing operation in September 1996.

 [Tell me more about IUE](#)

J

jets

Beams of particles, usually coming from [an active galactic nucleus](#) or [a pulsar](#). Unlike a jet airplane, when the stream of gas is in one direction, astrophysical jets come in pairs with each jet aiming in opposite directions.

K

kelvin (after Lord Kelvin, 1824 - 1907)

The fundamental [SI](#) unit of thermodynamic temperature defined as 1/273.16 of the thermodynamic temperature of the triple point of water. More practically speaking, the Kelvin temperature scale measures an object's temperature above absolute zero, the theoretical coldest possible temperature. On the Kelvin scale the freezing point of water is 273 ($= 0^{\circ}\text{C} = 32^{\circ}\text{F}$) [$\text{K} = 273 + \text{C} = 273 + 5/9 * (\text{F}-32)$]. The Kelvin temperature scale is often used in sciences such as astronomy.

Kepler, Johannes (1571 - 1630)

German astronomer and mathematician. Considered a founder of modern astronomy, he formulated the famous three laws of planetary motion. They comprise a quantitative formulation of [Copernicus's](#) theory that the planets revolve around the Sun. [Show me a picture of Johannes Kepler !](#)

Kepler's laws (J. Kepler)

Kepler's first law

A planet orbits the Sun in an [ellipse](#) with the Sun at one focus.

Kepler's second law

A line directed from the Sun to a planet sweeps out equal areas in equal times as the planet orbits the Sun.

Kepler's third law

The square of the period of a planet's orbit is proportional to the cube of that planet's semimajor axis; the constant of proportionality is the same for all planets.

kilogram (kg)

The fundamental [SI](#) unit of mass. The kilogram is the only SI unit still maintained by a physical artifact (a platinum-iridium bar) kept in the International Bureau of Weights and Measures at Sevres, France. One kilogram is equivalent to 1,000 grams or about 2.2 pounds; the mass of a liter of water.

kinematics

Refers to the calculation or description of the underlying mechanics of motion of an astronomical object. For example, in radioastronomy, [spectral line](#) graphs are used to determine the kinematics or relative motions of material at the center of a galaxy or surrounding a star as it is born.

Kirchhoff's law of radiation (G.R. Kirchhoff)

The emissivity of a body is equal to its absorbance at the same temperature.

Kirchhoff's laws (G.R. Kirchhoff)

Kirchhoff's first law

An incandescent solid or gas under high pressure will produce a continuous spectrum.

Kirchhoff's second law

A low-density gas will radiate an emission-line spectrum with an underlying emission continuum.

Kirchhoff's third law

Continuous radiation viewed through a low-density gas will produce an absorption-line spectrum.

L

L₀

A representation of the [luminosity](#) of an object in terms of Solar luminosity. The average luminosity of the Sun is about 4×10^{33} [erg/sec](#). Astronomers often express units for other objects in terms of solar units, which makes the resulting numbers smaller and easier to deal with.

Lagrange, Joseph (1736 - 1813)

A French mathematician of the eighteenth century. His work *Mecanique Analytique* (Analytical Mechanics; 1788) was a mathematical masterpiece. It contained clear, symmetrical notation and covered almost every area of pure mathematics. Lagrange developed the calculus of variations, established the theory of differential equations, and provided many new solutions and theorems in number theory. His classic *Theorie des fonctions analytiques* laid some of the foundations of group theory. Lagrange also invented the method of solving differential equations known as variation of parameters. [Show me a picture of Joseph Lagrange !](#)

Lagrange points

Points in the vicinity of two massive bodies (such as the Earth and the Moon) where each others' respective gravities balance. There are five, labeled L1 through L5. L1, L2, and L3 lie along the centerline between the centers of mass between the two masses; L1 is on the inward side of the secondary, L2 is on the outward side of the secondary; and L3 is on the outward side of the primary. L4 and L5, the so-called Trojan points, lie along the orbit of the secondary around the primary, sixty degrees ahead and behind of the secondary.

L1 through L3 are points of unstable equilibrium; any disturbance will move a test particle there out of the Lagrange point. L4 and L5 are points of stable equilibrium, provided that the mass of the secondary is less than about 1/25.96 the mass of the primary. These points are stable because centrifugal pseudo-forces work against gravity to cancel it out.

laser

Laser is an acronym for Light Amplification by Stimulated Emission of Radiation. It's a device that produces a coherent beam of optical radiation by stimulating electronic, ionic, or molecular transitions to higher levels so that when they return to lower energy levels they emit energy.

LHEA

Laboratory for High Energy Astrophysics, located at NASA's Goddard Space Flight Center. The scientists, programmers and technicians working here study the astrophysics of objects which emit cosmic ray, x-ray and gamma-ray radiation.

light

The common term for [electromagnetic](#) radiation, usually referring to that portion visible to the human eye. However, other bands of the e-m [spectrum](#) are also often referred to as different forms of light.

light curve

A graph showing how the radiation from an object varies over time.

★ [Tell me about light curves](#)

light year

A unit of length used in astronomy which equals the distance light travels in a year. At the rate of 300,000 kilometers per second (671 million miles per hour), 1 light-year is equivalent to 9.46053×10^{12} km, 5,880,000,000,000 miles or 63,240 [AU](#) (see [scientific notation](#)).

limb

The outer edge of the apparent [disk of a celestial body](#).

luminosity

The rate at which a star or other object emits energy, usually in the form of [electromagnetic](#) radiation.

M

M_0

A representation of the mass of an object in terms of [Solar mass](#). The average mass of the Sun is about 2×10^{33} grams. Astronomers often express units for other objects in terms of solar units, since it makes the resulting numbers smaller and easier to deal with.

magnetic field

A description of the strength of the magnetic force exerted by an object. Bar magnets have "di-polar" fields, as the force is exerted from the two ends of the bar. In simple terms, the earth, the sun, stars, [pulsars](#) all have dipolar magnetic fields.

magnetic pole

Either of two limited regions in a magnet at which the magnet's field is most intense. The two regions have opposing polarities, which we label "north" and "south", after the two poles on the Earth.

magnetosphere

The region of space in which the [magnetic field](#) of an object (*e.g.*, a star or planet) dominates the radiation pressure of the [stellar wind](#) to which it is exposed.

magnetotail

The portion of a planetary [magnetosphere](#) which is pushed in the direction of the solar wind.

magnitude

The degree of brightness of a celestial body designated on a numerical scale, on which the brightest star has magnitude -1.4 and the faintest visible star has magnitude 6, with the scale rule such that a

decrease of one unit represents an increase in apparent brightness by a factor of 2.512; also called apparent magnitude.

mass

A measure of the total amount of material in a body, defined either by the inertial properties of the body or by its gravitational influence on other bodies.

matter

A word used for any kind of stuff which contains [mass](#).

mega-ton

A unit of energy used to describe nuclear warheads. The same amount energy as 1 million tons of TNT.

$$1 \text{ mega-ton} = 4 \times 10^{22} \text{ ergs} = 4 \times 10^{15} \text{ joules.}$$

Messier, Charles (1730 - 1817)

The 18th century French astronomer who compiled a list of approximately 100 fuzzy, diffuse looking objects which appeared at fixed positions in the sky. Being a comet-hunter, Messier compiled this list of objects which he knew were not comets. His list is now well known to professional and amateur astronomers as containing the brightest and most striking [nebulae](#), [star clusters](#), and galaxies in the sky.

meter; m

The fundamental [SI](#) unit of length, defined as the length of the path traveled by light in vacuum during a period of $1/299\,792\,458$ s. A unit of length equal to about 39 inches. A **kilometer** is equal to 1000 meters.

metric system

See [SI](#).

microquasar

Microquasars are stellar mass black holes, that display characteristics of the supermassive black holes found at the centers of some galaxies. For instance, they have radio jets - something not every black hole has.

microwave

[Electromagnetic](#) radiation which has a longer [wavelength](#) (between 1 mm and 30 cm) than visible light. Microwaves can be used to study the Universe, communicate with satellites in Earth orbit, and cook popcorn.

N

NASA

The National Aeronautics and Space Administration, founded in 1958 as the successor to the National Advisory Committee for Aeronautics.

nebula (pl. nebulae)

A diffuse mass of interstellar dust and gas. A **reflection nebula** shines by light reflected from nearby stars. An **emission nebula** shines by emitting light as electrons recombine with protons to form hydrogen. The electrons were made free by the ultraviolet light of a nearby star shining on a cloud of

hydrogen gas. A [planetary nebula](#) results from the explosion of a solar-like type star.

neutrino

A fundamental particle produced in massive numbers by the nuclear reactions in stars; they are very hard to detect because the vast majority of them pass completely through the Earth without interacting.

neutron

A particle with approximately the mass of a [proton](#), but zero charge, commonly found in the nucleus of atoms .

neutron star

The imploded core of a massive star produced by a [supernova explosion](#). (typical mass of 1.4 times the mass of the Sun, radius of about 5 miles, [density](#) of a [neutron](#).) According to astronomer and author Frank Shu, "A sugar cube of neutron-star stuff on Earth would weigh as much as all of humanity!" Neutron stars can be observed as [pulsars](#).

★ [Tell me about X-rays from neutron stars](#)

★ [Tell me about gamma rays from black holes and neutron stars](#)

Newton, Isaac 1642 - 1727

English cleric and scientist; discovered the classical laws of motion and gravity; the bit with the apple is probably apocryphal. [Show me a picture of Isaac Newton !](#)

Newton's law of universal gravitation (Sir I. Newton)

Two bodies attract each other with equal and opposite forces; the [magnitude](#) of this force is proportional to the product of the two masses and is also proportional to the inverse square of the distance between the centers of mass of the two bodies.

Newton's laws of motion (Sir I. Newton)

Newton's first law of motion

A body continues in its state of constant velocity (which may be zero) unless it is acted upon by an external force.

Newton's second law of motion

For an unbalanced force acting on a body, the acceleration produced is proportional to the force impressed; the constant of proportionality is the inertial mass of the body.

Newton's third law of motion

In a system where no external forces are present, every action force is always opposed by an equal and opposite reaction

noise

The random fluctuations that are always associated with a measurement that is repeated many times over. Noise appears in astronomical images as fluctuations in the image background. These fluctuations do not represent any real sources of light in the sky, but rather are caused by the imperfections of the telescope. If the noise is too high, it may obscure the dimmest objects within the field of view.

nova (plural: novae)

A star that experiences a sudden outburst of radiant energy, temporarily increasing its [luminosity](#) by hundreds to thousands of times before fading back to its original luminosity.

nuclear fusion

A nuclear process whereby several small nuclei are combined to make a larger one whose mass is slightly smaller than the sum of the small ones. The difference in mass is converted to energy by Einstein's famous equivalence "Energy = Mass times the Speed of Light squared". This is the source of the Sun's energy.

O

occultation

The blockage of light by the intervention of another object; a planet can occult (block) the light from a distant star.

opacity

A property of matter that prevents light from passing through it. The opacity or opaqueness of something depends on the frequency of the light. For instance, the atmosphere of Venus is transparent to ultraviolet light, but is opaque to visible light.

orbit

The path of an object that is moving around a second object or point.

OSO 3

Orbiting Solar Observatory 3

★ [Tell me more about OSO 3](#)

OSO 8

Orbiting Solar Observatory 8

★ [Tell me more about OSO 8](#)

P

pair production

The physical process whereby a gamma-ray photon, usually through an interaction with the electromagnetic field of a nucleus, produces an electron and an anti-electron (positron). The original photon no longer exists, its energy having gone to the two resulting particles. The inverse process, pair annihilation, creates two gamma-ray photons from the mutual destruction of an electron/positron pair.

★ [Tell me how astronomers use pair production](#)

parallax

The apparent motion of a relatively close object compared to a more distant background as the location of the observer changes. Astronomically, it is half the angle which a star appears to move as the earth moves from one side of the sun to the other.

parsec

The distance to an object which has a parallax of one arc second. It is equal to 3.26 light years, or 3.1×10^{18} cm (see scientific notation). A **kiloparsec (kpc)** is equal to 1000 parsecs. A **megaparsec (Mpc)** is equal to a million (10^6) parsecs.

periapsis

The point in an orbit when two objects are closest together. Special names are given to this point for commonly used systems: see [periastron](#), [perihelion](#), and [perigee](#). The opposite of [apoapsis](#).

periastron

The point of closest approach of two stars, as in a [binary star](#) orbit. Opposite of [apastron](#).

perigee

The point in its orbit where an Earth satellite is closest to the Earth. Opposite of [apogee](#).

perihelion

The point in its orbit where a planet is closest to the Sun. Opposite of [aphelion](#).

photon

The smallest (quantum) unit of light/electromagnetic energy. Photons are generally regarded as particles with zero mass and no electric charge.

photoelectric effect

An effect explained by A. Einstein which demonstrates that light seems to be made up of particles, or photons. Light can excite electrons (called photoelectrons in this context) to be ejected from a metal. Light with a [frequency](#) below a certain threshold, at any intensity, will not cause any photoelectrons to be emitted from the metal. Above that frequency, photoelectrons are emitted in proportion to the intensity of incident light.

The reason is that a photon has energy in proportion to its wavelength, and the constant of proportionality is the Planck constant. Below a certain frequency -- and thus below a certain energy -- the incident photons do not have enough energy to knock the photoelectrons out of the metal. Above that threshold energy, called the work function, photons will knock the photoelectrons out of the metal, in proportion to the number of photons (the intensity of the light). At higher frequencies and energies, the photoelectrons ejected obtain a kinetic energy corresponding to the difference between the photon's energy and the work function.

pi

The constant equal to the ratio of the circumference of a circle to its diameter, which is approximately 3.141593.

Planck constant; h

The fundamental constant equal to the ratio of the energy of a quantum of energy to its [frequency](#). It is the quantum of action. It has the value 6.626196×10^{-34} J s (see [scientific notation](#)).

Planck equation

The quantum mechanical equation relating the energy of a photon E to its [frequency](#) nu:

$$E = h \times \nu$$

planetary nebula

A shell of gas ejected from stars like our Sun at the end of their lifetime. This gas continues to expand out from the remaining [white dwarf](#).

plasma

A low-[density](#) gas in which the individual atoms are ionized (and therefore charged), even though the total number of positive and negative charges is equal, maintaining an overall electrical neutrality.

pointing

The direction in the sky to which the telescope is pointed. Pointing also describes how accurately a telescope can be pointed toward a particular direction in the sky.

polarization

A special property of light; light has three properties, brightness, color and polarization. Polarization is a condition in which the planes of vibration of the various rays in a light beam are at least partially aligned.

positron

The antiparticle to the [electron](#). The positron has most of the same characteristics as an electron except it is positively charged.

proton

A particle with a positive charge commonly found in the nucleus of atoms.

protostar

Very dense regions (or cores) of molecular clouds where stars are in the process of forming.

Ptolemy (ca. 100-ca. 170)

A.k.a. Claudius Ptolemaeus. Ptolemy believed the planets and Sun to orbit the Earth in the order Mercury, Venus, Sun, Mars, Jupiter, Saturn. This system became known as the Ptolemaic system and predicted the positions of the planets accurately enough for naked-eye observations (although it made some ridiculous predictions, such as that the distance to the moon should vary by a factor of two over its orbit). He authored a book called Mathematical Syntaxis (widely known as the Almagest). The Almagest included a star catalog containing 48 constellations, using the names we still use today.

[Show me a picture of Ptolemy !](#)

pulsar

A rotating [neutron star](#) which generates regular pulses of radiation. Pulsars were discovered by observations at radio [wavelengths](#) but have since been observed at optical, X-ray, and gamma-ray energies.

★ [Tell me about pulsars!](#)

★ [Tell me more about pulsars!](#)

PVO

Pioneer Venus Orbiter

★ [Tell me more about PVO](#)

Q

quasar

An enormously bright object at the edge of our universe which emits massive amounts of energy. In an optical telescope, they appear point-like, similar to stars, from which they derive their name (quasar = [quasi-stellar](#)). Current theories hold that quasars are one type of [AGN](#).

quasi-stellar source (QSS)

Sometimes also called quasi-stellar object (QSO); A stellar-appearing object of very large [redshift](#) that is a strong source of radio waves; presumed to be [extragalactic](#) and highly luminous.

R

radial velocity

The speed at which an object is moving away or toward an observer. By observing [spectral lines](#), astronomers can determine how fast objects are moving away from or toward us; however, these spectral lines cannot be used to measure how fast the objects are moving across the sky.

radian; rad

The supplementary [SI](#) unit of angular measure, defined as the central angle of a circle whose subtended arc is equal to the radius of the circle. One radian is approximately 57° .

radiation

Energy emitted in the form of waves (light) or particles (photons).

radiation belt

Regions of charged particles in a [magnetosphere](#).

radio

[Electromagnetic](#) radiation which has the lowest [frequency](#), the longest [wavelength](#), and is produced by charged particles moving back and forth; the atmosphere of the Earth is transparent to radio waves with wavelengths from a few millimeters to about twenty meters.

Rayleigh criterion; resolving power

A criterion for how finely a set of optics may be able to distinguish the location of objects which are near each other. It begins with the assumption that the central ring of one image should fall on the first dark ring of another image; for an objective lens with diameter d and employing light with a [wavelength](#) λ (usually taken to be 560 nm), the resolving power is approximately given by

$$1.22 \times \lambda/d$$

Rayleigh-Taylor instabilities

Rayleigh-Taylor instabilities occur when a heavy (more dense) fluid is pushed against a light fluid -- like trying to balance water on top of air by filling a glass 1/2 full and carefully turning it over. Rayleigh-Taylor instabilities are important in many astronomical objects, because the two fluids trade places by sticking "fingers" into each other. These "fingers" can drag the [magnetic field](#) lines along with them, thus both enhancing and aligning the magnetic field. This result is evident in the example of a [supernova remnant](#) in the diagram below, from Chevalier (1977):

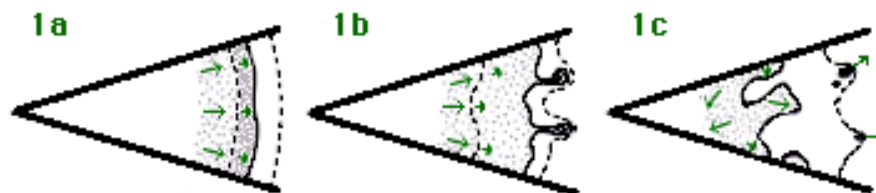

red giant

A star that has low surface temperature and a diameter that is large relative to the Sun.

redshift

An apparent shift toward longer [wavelengths](#) of [spectral lines](#) in the radiation emitted by an object caused by the emitting object moving away from the observer. See also [Doppler effect](#).

reflection law

For a wavefront intersecting a reflecting surface, the angle of incidence is equal to the angle of reflection, in the same plane defined by the ray of incidence and the normal.

relativity principle

The principle, employed by Einstein's [relativity](#) theories, that the laws of physics are the same, at least locally, in all coordinate frames. This principle, along with the principle of the constancy of the [speed of light](#), constitutes the founding principles of [special relativity](#).

relativity, theory of

Theories of motion developed by [Albert Einstein](#), for which he is justifiably famous. Relativity More accurately describes the motions of bodies in strong gravitational fields or at near the [speed of light](#) than [Newtonian](#) mechanics. All experiments done to date agree with relativity's predictions to a high degree of accuracy. (Curiously, Einstein received the Nobel prize in 1921 not for Relativity but rather for his 1905 work on the photoelectric effect.)

resolution (spatial)

In astronomy, the ability of a telescope to differentiate between two objects in the sky which are separated by a small angular distance. The closer two objects can be while still allowing the telescope to see them as two distinct objects, the higher the resolution of the telescope.

resolution (spectral or frequency)

Similar to [spatial resolution](#) except that it applies to [frequency](#), spectral resolution is the ability of the telescope to differentiate two light signals which differ in frequency by a small amount. The closer the two signals are in frequency while still allowing the telescope to separate them as two distinct components, the higher the spectral resolution of the telescope.

resonance

A relationship in which the orbital period of one body is related to that of another by a simple integer fraction, such as 1/2, 2/3, 3/5.

retrograde

The rotation or orbital motion of an object in a clockwise direction when viewed from the north pole of the [ecliptic](#); moving in the opposite sense from the great majority of solar system bodies.

revolution

The movement of one celestial body which is in orbit around another. It is often measured as the "orbital period."

Right Ascension

A coordinate which, along with [declination](#), may be used to locate any position in the sky. Right ascension is analogous to longitude for locating positions on the Earth.

Ritter, Johann Wilhelm (1776 - 1810)

Ritter is credited with discovering and investigating the ultraviolet region of the [electromagnetic spectrum](#).

Roche limit

The smallest distance from a planet or other body at which purely gravitational forces can hold together a satellite or secondary body of the same mean [density](#) as the primary. At less than this distance the tidal forces of the larger object would break up the smaller object.

Roche lobe

The volume around a star in a binary system in which, if you were to release a particle, it would fall back onto the surface of that star. A particle released above the Roche lobe of either star will, in general, occupy the 'circumbinary' region that surrounds both stars. The point at which the Roche lobes of the two stars touch is called the inner [Lagrangian or L1 point](#). If a star in a close binary system evolves to the point at which it 'fills' its Roche lobe, theoretical calculations predict that material from this star will overflow both onto the companion star (via the L1 point) and into the environment around the binary system.

Röntgen, Wilhelm Conrad (1845 - 1923)

A German scientist who fortuitously discovered X-rays in 1895.

★ [Tell me more about Wilhelm Röntgen](#)

ROSAT

Röntgen Satellite

★ [Tell me more about ROSAT](#)

rotation

The spin of a celestial body on its own axis. In high energy astronomy, this is often measured as the "spin period."

S

SAS-2

The second Small Astronomy Satellite: a NASA satellite launched November 1972 with a mission dedicated to gamma-ray astronomy.

★ [Tell me more about SAS-2](#)

SAS-3

The third Small Astronomy Satellite: a NASA satellite launched May 1975 to determine the location of bright X-ray sources and search for X-ray [novae](#) and other transient phenomena.

★ [Tell me more about SAS-3](#)

satellite

A body that revolves around a larger body. For example, the moon is a satellite of the earth.

Schwarzschild black hole

A black hole described by solutions to Einstein's equations of [general relativity](#) worked out by Karl Schwarzschild in 1916. The solutions assume the black hole is not rotating, and that the size of its [event horizon](#) is determined solely by its mass.

Schwarzschild radius

The radius r of the [event horizon](#) for a [Schwarzschild black hole](#).

scientific notation

A compact format for writing very large or very small numbers, most often used in scientific fields. The notation separates a number into two parts: a decimal fraction, usually between 1 and 10, and a power of ten. Thus 1.23×10^4 means 1.23 times 10 to the fourth power or 12,300; 5.67×10^{-8} means

5.67 divided by 10 to the eighth power or 0.0000000567.

second; s

The fundamental **SI** unit of time, defined as the period of time equal to the duration of 9,192,631,770 periods of the radiation corresponding to the transition between two hyperfine levels of the ground state of the cesium-133 atom. A **nanosecond** is equal to one-billionth (10^{-9}) of a second.

semimajor axis

The semimajor axis of an **ellipse** (e.g. a planetary orbit) is half the length of the major axis, which is the line segment passing through the foci of the ellipse with endpoints on the ellipse itself. The semimajor axis of a planetary orbit is also the average distance from the planet to its primary. The **periapsis** and **apoapsis** distances can be calculated from the semimajor axis and the **eccentricity** by

$$r_p = a(1-e) \text{ and } r_a = a(1+e).$$

sensitivity

A measure of how bright objects need to be in order for that telescope to detect these objects. A highly sensitive telescope can detect dim objects, while a telescope with low sensitivity can detect only bright ones.

Seyfert galaxy

A spiral galaxy whose nucleus shows bright emission lines; one of a class of galaxies first described by C. Seyfert.

shock wave

A strong compression wave where there is a sudden change in gas velocity, **density**, pressure and temperature.

singularity

The center of a black hole, where the curvature of spacetime is maximal. At the singularity, the gravitational tides diverge; no solid object can even theoretically survive hitting the singularity. Although singularities generally predict inconsistencies in theory, singularities within black holes do not necessarily imply that **general relativity** is incomplete so long as singularities are always surrounded by **event horizons**.

A proper formulation of quantum gravity may well avoid the classical singularity at the centers of black holes.

solar flares

Violent eruptions of gas on the Sun's surface.

solar mass

A unit of mass equivalent to the mass of the Sun. 1 solar mass = $1 M_{\text{sun}} = 2 \times 10^{33}$ grams.

special relativity

The physical theory of space and time developed by Albert Einstein, based on the postulates that all the laws of physics are equally valid in all frames of reference moving at a uniform velocity and that the **speed of light** from a uniformly moving source is always the same, regardless of how fast or slow the source or its observer is moving. The theory has as consequences the relativistic mass increase of rapidly moving objects, **time dilatation**, and the principle of mass-energy equivalence. See also **general relativity**.

spectral line

Light given off at a specific [frequency](#) by an atom or molecule. Every different type of atom or molecule gives off light at its own unique set of frequencies; thus, astronomers can look for gas containing a particular atom or molecule by tuning the telescope to one of the gas's characteristic frequencies. For example, carbon monoxide (CO) has a spectral line at 115 Gigahertz (or a [wavelength](#) of 2.7 mm).

spectrometer

The instrument connected to a telescope that separates the light signals into different [frequencies](#), producing a [spectrum](#).

A **Dispersive Spectrometer** is like a prism. It scatters light of different energies to different places. We measure the energy by noting where the X-rays go. A **Non-Dispersive Spectrometer** measures the energy directly.

spectroscopy

The study of [spectral lines](#) from different atoms and molecules. Spectroscopy is an important part of studying the chemistry that goes on in stars and in interstellar clouds.

spectrum (plural: spectra)

A plot of the intensity of light at different [frequencies](#). Or the distribution of [wavelengths](#) and frequencies.



[Tell me more about spectra](#)

speed of light (in vacuum)

The speed at which [electromagnetic](#) radiation propagates in a vacuum; it is defined as 299 792 458 m/s (186,212 miles/second). Einstein's [Theory of Relativity](#) implies that nothing can go faster than the speed of light.

star

A large ball of gas that creates and emits its own radiation.

star cluster

A bunch of stars (ranging in number from a few to hundreds of thousands) which are bound to each other by their mutual gravitational attraction.

Stefan-Boltzmann constant; sigma (Stefan, L. Boltzmann)

The constant of proportionality present in the Stefan-Boltzmann law. It is equal to 5.6697×10^{-8} Watts per square meter per degree [Kelvin](#) to the fourth power (see [scientific notation](#)).

Stefan-Boltzmann law (Stefan, L. Boltzmann)

The radiated power P (rate of emission of [electromagnetic](#) energy) of a hot body is proportional to the radiating surface area, A , and the fourth power of the thermodynamic temperature, T . The constant of proportionality is the Stefan-Boltzmann constant.

stellar classification

Stars are given a designation consisting of a letter and a number according to the nature of their [spectral lines](#) which corresponds roughly to surface temperature. The classes are: O, B, A, F, G, K, and M; O stars are the hottest; M the coolest. The numbers are simply subdivisions of the major classes. The classes are oddly sequenced because they were assigned long ago before we understood their relationship to temperature. O and B stars are rare but very bright; M stars are numerous but dim. The

Sun is designated G2.

stellar wind

The ejection of gas off the surface of a star. Many different types of stars, including our Sun, have stellar winds; however, a star's wind is strongest near the end of its life when it has consumed most of its fuel.

steradian; sr

The supplementary **SI** unit of solid angle defined as the solid central angle of a sphere that encloses a surface on the sphere equal to the square of the sphere's radius.

supernova (plural: supernovae)

The death explosion of a massive star, resulting in a sharp increase in brightness followed by a gradual fading. At peak light output, supernova explosions can outshine a galaxy. The outer layers of the exploding star are blasted out in a radioactive cloud. This expanding cloud, visible long after the initial explosion fades from view, forms a supernova remnant (SNR).

★ [Tell me about X-rays from supernovae and their remnants](#)

★ [Tell me about gamma rays from supernovae](#)

★ [Tell me more about supernovae](#)

★ [Tell me more about supernova remnants](#)

sunspots

Cooler (and thus darker) regions on the sun where the [magnetic field](#) loops up out of the solar surface.

SXG

The Spectrum X-Gamma mission

★ [Tell me more about SXG](#)

Swift

Swift is a NASA mid-sized mission whose primary goal is to study gamma-ray bursts and address the mysteries surrounding their nature, origin, and causes. Swift is expected to launch in 2003.

★ [Tell me more about Swift](#)

synchronous rotation

Said of a satellite if the period of its rotation about its axis is the same as the period of its orbit around its primary. This implies that the satellite always keeps the same hemisphere facing its primary (e.g. the Moon). It also implies that one hemisphere (the leading hemisphere) always faces in the direction of the satellite's motion while the other (trailing) one always faces backward.

synchrotron radiation

[Electromagnetic](#) radiation given off when very high energy electrons encounter [magnetic fields](#).

Système Internationale d'Unités (SI)

The coherent and rationalized system of units, derived from the MKS system (which itself is derived from the metric system), in common use in physics today. The fundamental SI unit of length is the [meter](#), of time is the [second](#), and of mass is the [kilogram](#).

T

Tenma

The second Japanese X-ray mission, also known as Astro-B.



[Tell me more about Tenma](#)

Thomson, William 1824 - 1907

Also known as Lord Kelvin, the British physicist who developed the [Kelvin temperature scale](#) and who supervised the laying of a trans-Atlantic cable. [Show me a picture of Lord Kelvin!](#)

time dilation

The increase in the time between two events as measured by an observer who is outside of the reference frame in which the events take place. The effect occurs in both [special](#) and [general relativity](#), and is quite pronounced for speeds approaching the [speed of light](#), and in regions of high gravity.

U

Uhuru

NASA's first Small Astronomy Satellite, also known as SAS-1. Uhuru was launched from Kenya on 12 December, 1970; The seventh anniversary of Kenya's independence. The satellite was named "Uhuru" (Swahili for "freedom") in honor of its launch date.



[Tell me more about Uhuru](#)

ultraviolet

[Electromagnetic](#) radiation at [wavelengths](#) shorter than the violet end of visible light; the atmosphere of the Earth effectively blocks the transmission of most ultraviolet light.

universal constant of gravitation; G

The constant of proportionality in [Newton's law of universal gravitation](#) and which plays an analogous role in A. Einstein's [general relativity](#). It is equal to $6.664 \times 10^{-11} \text{ m}^3 / \text{kg}\text{-sec}^2$ (see [scientific notation](#)).

Universe

Everything that exists, including the Earth, planets, stars, galaxies, and all that they contain; the entire cosmos.

V

Vela 5B

US Atomic Energy Commission (now the Department of Energy) satellite with an all-sky X-ray monitor



[Tell me more about Vela 5B](#)

The Venera satellite series

The Venera satellites were a series of probes (fly-bys and landers) sent by the Soviet Union to the planet Venus. Several Venera satellites carried high-energy astrophysics detectors.



[Tell me more about Venera 11 & 12](#)



[Tell me more about Venera 13 & 14](#)

visible

Electromagnetic radiation at **wavelengths** which the human eye can see. We perceive this radiation as colors ranging from red (longer wavelengths; ~ 700 nanometers) to violet (shorter wavelengths; ~400 nanometers.)

W

wave-particle duality

The principle of quantum mechanics which implies that light (and, indeed, all other subatomic particles) sometimes act like a wave, and sometimes act like a particle, depending on the experiment you are performing. For instance, low **frequency electromagnetic** radiation tends to act more like a wave than a particle; high frequency electromagnetic radiation tends to act more like a particle than a wave.

wavelength

The distance between adjacent peaks in a series of periodic waves. Also see [electromagnetic spectrum](#).

white dwarf

A star that has exhausted most or all of its nuclear fuel and has collapsed to a very small size. Typically, a white dwarf has a radius equal to about 0.01 times that of the Sun, but it has a mass roughly equal to the Sun's. This gives a white dwarf a **density** about 1 million times that of water!



[Tell me more about white dwarfs](#)

Wien's displacement law

For a blackbody, the product of the **wavelength** corresponding to the maximum radiancy and the thermodynamic temperature is a constant. As a result, as the temperature rises, the maximum of the radiant energy shifts toward the shorter wavelength (higher **frequency** and energy) end of the **spectrum**.

WWW

The World Wide Web -- a loose linkage of Internet sites which provide data and other services from around the world.

X

X-ray

Electromagnetic radiation of very short **wavelength** and very high-energy; X-rays have shorter wavelengths than ultraviolet light but longer wavelengths than gamma rays.

XSELECT

A software tools used by astrophysicists in conjunction with the **FTOOLS** software to analyze certain types of astronomical data.

XTE

X-ray Timing Explorer, also known as the Rossi X-ray Timing Explorer (RXTE)



[Tell me more about RXTE](#)

Y

Z

Z

The ratio of the observed change in wavelength of light emitted by a moving object to the rest wavelength of the emitted light. See [Doppler Effect](#). This ratio is related to the velocity of the object. In general, with v = velocity of the object, c is the speed of light, λ is the rest wavelength, and $\Delta\lambda$ is the observed change in the wavelength, z is given by

$$z = (\Delta\lambda)/\lambda = (\sqrt{1+v/c} / \sqrt{1-v/c}) - 1.$$

If the velocity of the object is small compared to the speed of light, then

$$z = (\Delta\lambda)/\lambda = v/c$$

Objects at the furthest reaches of the known universe have values of $z = 5$ or slightly greater.

[\[A B C D E F G H I J K L M N O P Q R S T U V W X Y Z \]](#)

[Home](#)

[Imagine Science](#)

[Special Exhibit](#)

[Satellites and Data](#)

[Dictionary](#)

[Resources](#)

[Teacher's Corner](#)

[Feedback](#)

[Ask a High Energy Astronomer](#)

[Show me a printable version of this page.](#)

Imagine the Universe is a service of the High Energy Astrophysics Science Archive Research Center ([HEASARC](#)), Dr. Nicholas White (Director), within the [Laboratory for High Energy Astrophysics](#) at NASA's [Goddard Space Flight Center](#).

[The Imagine Team](#)

Project Leader: [Dr. Jim Lochner](#)

Curator: [Meredith Bene Ihnat](#)

Responsible NASA Official: [Phil Newman](#)

All material on this site has been created and updated between 1997-2004.

[Useful plugins](#)

[NASA's privacy statement](#)

Do you have a question, problem or comment about this web site? Please [let us know](#).

External links contain material that we found to be relevant. However they're not maintained by us and the content may have changed. If you find any external links that contain inappropriate material, [please let us know!](#)



SkyandTelescope.com

[close window](#)

The Stellar Magnitude System

By Alan M. MacRobert



Sky & Telescope illustration

Most ways of counting and measuring things work logically. When the thing you're measuring increases, the number gets bigger. When you gain weight, the scale doesn't tell you a *smaller* number of kilograms or pounds. But things are not so sensible in astronomy — at least not when it comes to the brightnesses of stars.

Ancient Origins

Star magnitudes do count backward, the result of an ancient fluke that seemed like a good idea at the time. The story begins around 129 B.C., when the Greek astronomer [Hipparchus](#) produced the first well-known star catalog. Hipparchus ranked his stars in a simple way. He called the brightest ones "of the first magnitude," simply meaning "the biggest." Stars not so bright he called "of the second magnitude," or second biggest. The faintest stars he could see he called "of the sixth magnitude." Around A.D. 140 [Claudius Ptolemy](#) copied this system in his own star list. Sometimes Ptolemy added the words "greater" or "smaller" to distinguish between stars within a magnitude class. Ptolemy's works remained the basic astronomy texts for the next 1,400 years, so everyone used the system of first to sixth magnitudes. It worked just fine.

[Galileo](#) forced the first change. On turning his newly made telescopes to the sky, Galileo discovered that stars existed that were fainter than Ptolemy's sixth magnitude. "Indeed, with

the glass you will detect below stars of the sixth magnitude such a crowd of others that escape natural sight that it is hardly believable," he exulted in his 1610 tract, *Sidereus Nuncius*. "The largest of these . . . we may designate as of the seventh magnitude." Thus did a new term enter the astronomical language, and the magnitude scale became open-ended. There could be no turning back.

As telescopes got bigger and better, astronomers kept adding more magnitudes to the bottom of the scale. Today a pair of 50-millimeter binoculars will show stars of about 9th magnitude, a 6-inch amateur telescope will reach to 13th magnitude, and the [Hubble Space Telescope](#) has seen [objects as faint as 30th magnitude](#).

By the middle of the 19th century astronomers realized there was a pressing need to define the entire magnitude scale more precisely than by eyeball judgment. They had already determined that a 1st-magnitude star shines with about 100 times the light of a 6th-magnitude star. Accordingly, in 1856 the Oxford astronomer Norman R. Pogson proposed that a difference of five magnitudes be defined as a brightness ratio of exactly 100 to 1. This convenient rule was quickly adopted. One magnitude thus corresponds to a brightness difference of exactly the fifth root of 100, or very close to 2.512 — a value known as the Pogson ratio.

The Meaning of Magnitudes	
This difference in magnitude...	...means this ratio in brightness
0	1 to 1
0.1	1.1 to 1
0.2	1.2 to 1
0.3	1.3 to 1
0.4	1.4 to 1
0.5	1.6 to 1
1.0	2.5 to 1
2	6.3 to 1
3	16 to 1

4	40 to 1
5	100 to 1
10	10,000 to 1
20	100,000,000 to 1

The resulting magnitude scale is logarithmic, in neat agreement with the 1850s belief that all human senses are logarithmic in their response to stimuli. The decibel scale for rating loudness was likewise made logarithmic. (Alas, it's not quite so, not for brightness, sound, or anything else. Our perceptions of the world follow power-law curves, not logarithmic ones. Thus a star of magnitude 3.0 does not in fact look exactly halfway in brightness between 2.0 and 4.0. It looks a little fainter than that. The star that *looks* halfway between 2.0 and 4.0 will be about magnitude 2.8. The wider the magnitude gap, the greater this discrepancy. Accordingly, *Sky & Telescope's* computer-drawn sky maps use star dots that are sized according to a power-law relation. But the scientific world in the 1850s was gaga for logarithms, so now they are locked into the magnitude system as firmly as Hipparchus's backward numbering.)

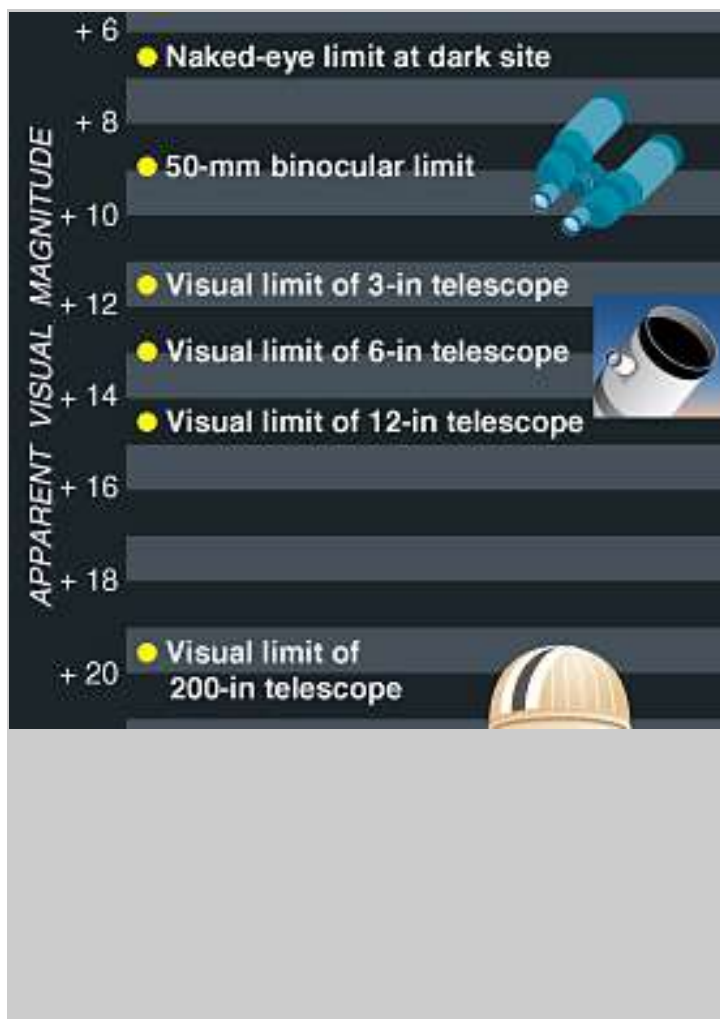

Now that star magnitudes were ranked on a precise mathematical scale, however ill-fitting, another problem became unavoidable. Some "1st-magnitude" stars were a whole lot brighter than others. Astronomers had no choice but to extend the scale out to brighter values as well as faint ones. Thus Rigel, Capella, Arcturus, and Vega are magnitude 0 — an awkward statement that suggests they have no brightness at all! But it was too late to start over. The magnitude scale extends farther down into negative numbers: Sirius shines at magnitude -1.5 , Venus reaches -4.4 , the full Moon is about -12.5 , and the Sun blazes at magnitude -26.7 .

Fifty-seven magnitudes of apparent brightness encompass the things that astronomers study, from the glaring Sun to the faintest objects detected with the Hubble Space Telescope. This range is equivalent to a brightness ratio of nearly 100 billion trillion. Sky & Telescope illustration

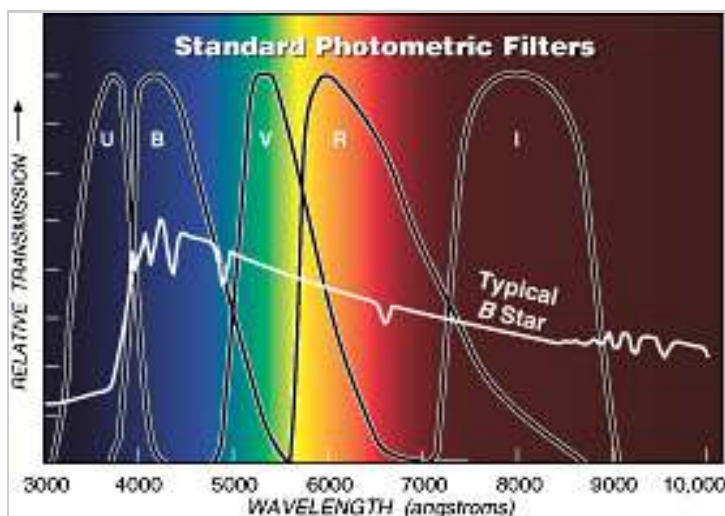

The bandpasses of the standard UBVRI color filters, along with the spectrum of a typical blue-white star. Sky & Telescope illustration.

Other Colors, Other Magnitudes

By the late 19th century astronomers were using photography to record the sky and measure star brightnesses, and a new problem cropped up. Some stars having the same brightness to the eye showed different brightnesses on film, and vice versa. Compared to the eye, photographic emulsions were more sensitive to blue light and less so to red light. Accordingly, two separate scales were devised. *Visual magnitude*, or m_{vis} , described how a star looked to the eye. *Photographic magnitude*, or m_{pg} , referred to star images on blue-sensitive

black-and-white film. These are now abbreviated m_v and m_p , respectively.

This complication turned out to be a blessing in disguise. The difference between photographic and visual magnitudes was a convenient measure of a star's color. The difference between the two kinds of magnitude was named the "color index." Its value is increasingly positive for yellow, orange, and red stars, and negative for blue ones.

But different photographic emulsions have different spectral responses! And people's eyes differ too. For one thing, your eye lenses turn yellow with age; old people see the world through yellow filters. Magnitude systems designed for different wavelength ranges had to be more firmly grounded than this.

Today, precise magnitudes are specified by what a standard photoelectric photometer sees through standard color filters. Several photometric systems have been devised; the most familiar is called UBV after the three filters most commonly used. U encompasses the near-ultraviolet, B is blue, and V corresponds fairly closely to the old visual magnitude; its wide peak is in the yellow-green band, where the eye is most sensitive.

Color index is now defined as the B magnitude minus the V magnitude. A pure white star has a B-V of about 0.2, our yellow Sun is 0.63, orange-red Betelgeuse is 1.85, and the bluest star

believed possible is -0.4 — pale blue-white.

So successful was the UBV system that it was extended redward with R and I filters to define standard red and near-infrared magnitudes. Hence it is sometimes called UBVRI. [Infrared astronomers](#) have carried it to still longer wavelengths, picking up alphabetically after I to define the J, K, L, M, N, and Q bands. These were chosen to match the wavelengths of infrared "windows" in the atmosphere — wavelengths at which water vapor does not entirely absorb starlight.

In all wavebands, the bright star Vega has been chosen (quite arbitrarily) to define magnitude 0.0. Since Vega is dimmer at infrared wavelengths than in visible light, infrared magnitudes are, by definition and quite artificially, brighter than their visual counterparts.

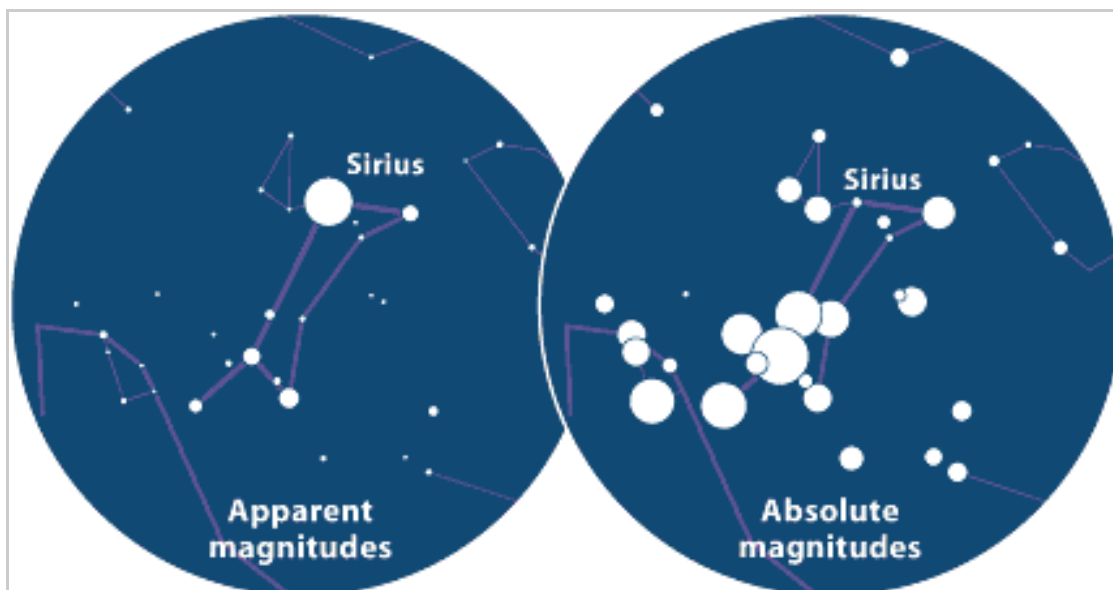

The left-hand map of Canis Major uses dot size to indicate *apparent magnitude*, while the right-hand one indicates *absolute magnitude* — a measure of intrinsic stellar luminosity. Which chart better matches your own eyeball impressions? Sky & Telescope illustration

Appearance and Reality

What, then, is an object's *real* brightness? How much total energy is it sending to us at all wavelengths combined, visible and invisible? The answer is called the *bolometric magnitude*, m_{bol} , because total radiation was once measured with a device called a bolometer. The bolometric magnitude has been called the God's-eye view of an object's true luster. Astrophysicists value it as the true measure of an object's total energy emission as seen from Earth. The *bolometric correction* tells how much brighter the bolometric magnitude is than the V magnitude. Its value is always negative because any star or object emits at least some radiation outside the visual portion of the electromagnetic spectrum.

Up to now we've been dealing only with *apparent* magnitudes — how bright things look from Earth. We don't know how intrinsically bright an object is until we also take its distance

into account. Thus astronomers created the *absolute magnitude* scale. An object's absolute magnitude is simply how bright it would appear if placed at a standard distance of 10 parsecs (32.6 light-years). Seen from this distance, the Sun would shine at an unimpressive visual magnitude 4.85. Rigel would blaze at a dazzling -8 , nearly as bright as the quarter Moon. The red dwarf Proxima Centauri, the closest star to the solar system, would appear to be magnitude 15.6, the tiniest little glimmer visible in a 16-inch telescope! Knowing absolute magnitudes makes plain how vastly diverse are the objects that we casually lump together under the single word "star."

Absolute magnitudes are always written with a capital M , apparent magnitudes with a lower-case m . Any type of apparent magnitude — photographic, bolometric, or whatever — can be converted to an absolute magnitude.

Beware: for comets and asteroids a very different "absolute magnitude" is used. It tells how bright they would appear to an observer standing on the Sun if the object were one astronomical unit away.

Alan MacRobert is a senior editor of Sky & Telescope magazine and an avid backyard astronomer.



new spring sandals for women & men Shop Now **NORDSTROM**

Shop Nordstrom at Amazon.com

Search Inside the Book™

SEARCH

WEB SEARCH

Powered by Google

BOOK INFORMATION

[buying info](#)

[editorial reviews](#)

[customer reviews](#)

[look inside](#)

RECENTLY VIEWED

- [Sundials, Their Theory and Construction](#) by Albert Waugh (Author)
- [Sundials : Their Construction and Use](#) by R. Newton Mayall (Author), Margaret W. Mayall (Author)
- [The Illustrated Longitude](#) by Dava Sobel, William J. H. Andrewes

▶ [See more in the Page You Made](#)

Featured Item:

Soul of the Sky: Exploring the Human Side of Weather

by [Dave Thurlow](#) (Editor), [C. Ralph Adler](#) (Editor), [Paul M. Breeden](#) (Illustrator)



[Look inside this book](#)

List Price: \$12.95

Price: ~~\$12.95~~ &

eligible for **used & new** from \$0.44 for

FREE one to sell?

Super

Saver

Shipping

on orders

over \$25.

[See](#)

[details.](#)



READY TO BUY?

or

[Sign in](#) to turn on 1-Click ordering.

MORE BUYING CHOICES

[Sell yours here](#)

Don't have one? We'll set one up for you.

Availability: Usually ships within 1 to 3 weeks

39 used & new from \$0.44

Edition: Paperback

▶ [See more product details](#)

Customers interested in this title may also be interested in:

Sponsored Links ([What's this?](#)) [Feedback](#)

- [Ph.D. examines human soul](#)
Do humans possess an immortal **soul**? Is death the end?
Evidence examined
www.apologeticspress.org

Product Details

- **Paperback:** 149 pages ; Dimensions (in inches): 0.50 x 10.00 x 7.25
- **Publisher:** Mt Washington Observatory; (February 2000)
- **ISBN:** 0931134994
- **Average Customer Review:** ★★★★★ Based on 2 reviews.



[The Sextant Handbook](#)
by Bruce Bauer

[Write a review.](#)

- **Amazon.com Sales Rank:** 337,825
(Publishers and authors: [improve your sales](#))

Look Inside This Book

You can [view sample pages](#) from this book.

RATE THIS BOOK

I dislike it I love it!

1 2 3 4 5

[Edit your ratings](#)

What's Your Advice?

Is there an book you'd recommend instead of or in addition to this one? Let the world know! Enter the book's ASIN ([what's an ASIN?](#)) in the box below, select advice type, then click Submit.

I recommend: _____ in addition to this book
 _____ instead of this book

Favorite Magazines!

Explore our new
[Magazine Subscriptions](#)
store.

Editorial Reviews***Weatherwise Magazine, November/December, 1999***

"There are stories of tornadoes, floods, hurricanes, fog, ice storms, and lightning to name a few. In these, the unruly atmosphere not only provokes a memorable event, but also serves as a backdrop while the human drama plays out. Often, the storms retold in Soul of the Sky damage property and take lives, but that is not all. Weather, however adverse, can bring communities and families together and cause us to reassess what's most valuable in our lives. You cannot read these stories without recalling your own experiences with weather. Be it wind, lashing rain, the threat of hurricane or tornado, a muggy day we have all been there, measuring it with the instrument we know best: ourselves."

The Orlando Sentinel, October 3, 1999

"This anthology's contributors take weather personally, writing about everything from drought in Georgia to snow storms in New England and how climate changes affect their lives. Annie Dillard evokes Tinker Creek in flood; Robert Henson recalls the tornadoes of his Oklahoma upbringing; Diane Ackerman reminds us how to watch the sky."

Book Description

Soul of the Sky is a collection of essays that illustrates how the weather can inspire and terrify, connect us and urge us on to new adventures, and invite us to gain a deeper appreciation of how weather and climate affect our everyday lives. Contributors include Diane Ackerman, Catherine Buni, David Clark, Jan DeBlieu, Jerry Dennis, Annie Dillard, Gretel Ehrlich, Robert Henson, Sebastian Junger, David Laskin, John Hanson Mitchell, Chet Raymo, and others.

▶ [See all editorial reviews...](#)

All Customer Reviews

Average Customer Review: ★★★★★

[Write an online review](#) and share your thoughts with other customers.

1 of 1 people found the following review helpful:

★★★★☆ Fresh Rain, January 17, 2002

Reviewer: Susan Strom from Arizona

"Soul of the Sky" is fresh rain amidst the usual smorgasbord of weather textbooks and technical guides. Exploring the personal side of the weather, "Soul of the Sky" is a compilation of well written stories of human interaction with the weather. As a stormchaser myself, I particularly enjoyed "Only a Storm", an essay by Robert Henson about life under the moody skies of Tornado Alley.

Was this review helpful to you?

1 of 1 people found the following review helpful:

★★★★☆ Soul of the Sky, May 8, 2000

Reviewer: barb_tn from Washington, DC

The stories in this book will bring back memories of storms you have weathered throughout your life. And if you've never experienced some of nature's harshest weather, you'll get a real feel for it after reading this book. It was quite a fascinating read.

Was this review helpful to you?

Auctions and zShops sellers and our other stores recommend:

- [Thurlo, Dave, Ed.: Soul of the Sky: Exploring the Human Side of Weather \(Price: \\$7.50\)](#)

Look for similar books by subject:

Browse for [books](#) in:

- [Subjects](#) > [Literature & Fiction](#) > [Essays](#) > [General](#)
- [Subjects](#) > [Science](#) > [Earth Sciences](#) > [Meteorology](#)
- [Subjects](#) > [Outdoors & Nature](#) > [Environment](#) > [Weather](#)

Search for books by subject:

[Weather](#)
[Social aspects](#)
[Storms](#)
[Nature / Field Guide Books](#)
[Nature](#)
[Meteorology](#)
[Essays](#)
[Literary Criticism & Collections](#)

i.e., each book must be in subject 1 AND subject 2 AND ...

Feedback

- **I have read this book, and I want to [review](#) it.**
- [E-mail a friend about this book.](#)
- [Write a So You'd Like to... guide.](#)

- Is there a specific product you'd like us to sell? [Tell us](#) about it.



Suggestion Box

Your comments can help make our site better for everyone. If you've found something incorrect, broken, or frustrating on this page, let us know so that we can improve it. Please note that we are unable to respond directly to suggestions made via this form.

If you need help with an order, please [contact Customer Service](#).

Please mark as many of the following boxes that apply:

Product information is missing important details.

Product information is incorrect. Propose corrections using our [Online Catalog Update Form](#).

The page contains typographical errors.

The page takes too long to load.

The page has a software bug in it.

Content violates [Amazon.com's policy on offensive language](#).

Product offered violates [Amazon.com's policy](#) on items that can be listed for sale.

Comments or Examples:

Examples: Missing information such as dimensions and model number, typos, inaccuracies, etc.

Where's My Stuff? <ul style="list-style-type: none">• Track your recent orders.• View or change your orders in Your Account.	Shipping & Returns <ul style="list-style-type: none">• See our shipping rates & policies.• Return an item (here's our Returns Policy).	Need Help? <ul style="list-style-type: none">• Forgot your password? Click here.• Redeem or buy a gift certificate.• Visit our Help department.
Search <input type="text"/> for		
Your Recent History Learn More		
Recently Viewed Products <ul style="list-style-type: none"> Sundials, Their Theory and Construction by Albert Waugh (Author) Sundials by R. Newton Mayall (Author), Margaret W. Mayall (Author) The Illustrated Longitude by Dava Sobel, William J. H. Andrewes	Customers who bought items in your Recent History also bought: <ul style="list-style-type: none">  Longitude by Dava Sobel  The Riddle of the Compass by Amir D. Aczel (Author)	

[Visit the Page You Made](#)

Turn your past books purchases into \$\$\$
[Learn more](#) about selling at Amazon.com today!

[Top of Page](#)

[Books Search](#) | [Browse Subjects](#) | [Bestsellers](#) | [Magazines](#) | [Corporate Accounts](#)
[e-Books & Docs](#) | [Bargain Books](#) | [Used Books](#)

[Amazon.com Home](#) | [Directory of All Stores](#)

Our International Sites: [Canada](#) | [United Kingdom](#) | [Germany](#) | [Japan](#) | [France](#)

[Contact Us](#) | [Help](#) | [Shopping Cart](#) | [Your Account](#) | [Sell Items](#) | [1-Click Settings](#)

[Investor Relations](#) | [Press Releases](#) | [Join Our Staff](#)

Bottom of the Page™ Deals for March 02

Amazon.com = low prices. Save up to 50% on these 24-hour deals, updated every day at noon (central time).

	Our Price	You Save
Dove Plush Bath Robe, White You'll look simply marvelous, darling, in this 100% plush white cotton robe!	\$29.00	\$11.00 (28%)
Panasonic SQT555W601 Automatic Power-Failure Light Next time the power goes off, don't get left in the dark.	\$26.99	\$13.00 (33%)
Canon BCI-3e Multipack Ink Tanks (4 Pack) Keep the cartridge, replace the ink, save money.	\$33.99	\$16.00 (32%)
Smoke Away Stop Smoking Support Program 1 ea Discover a happier and healthier lifestyle with Smoke Away.	\$24.99	\$15.00 (38%)
Snuggle Fabric Softener Dryer Sheets, Fresh Rain 120 count 6 boxes Eliminate static cling and leave your clothes soft and fresh smelling.	\$19.99	\$20.00 (50%)
Neutrogena Moisture Rich Shower and Bath Gel, 35 Ounces (2 Bottles) Pamper skin and senses with this refreshing shower and bath gel.	\$29.99	\$28.00 (48%)
Revival Soy Protein Bar, Chocolate Temptation Bar 15 ea You won't have to feel guilty about giving in to this Chocolate Temptation.	\$27.99	\$4.96 (15%)
Starbucks Decaffeinated House Blend Universal Ground Coffee, 6 12-Ounce FlavorLock Bags (72 ounces total) Savor a true coffee classic without the jitters.	\$28.99	\$4.00 (12%)
Schick Silk Effects Plus Refill Blades with Aloe - 10 ea Exclusive microfine wires make getting a close shave easier on your skin.	\$11.49	\$1.00 (8%)

 **FREE Super Saver Shipping on orders over \$25.** [See details.](#)

Amazon.com now offers bargains on brand-name essentials, all priced so low they've sunk to the bottom of the page! We take up to 50% off standard retail prices and deliver right to your door--no club fees, no hassle, no parking lot. Check back every day at noon (central time) for all-new Bottom of the Page™ Deals.

[Conditions of Use](#) | [Privacy Notice](#) © 1996-2004, Amazon.com, Inc. or its affiliates

Search:

QuickLinks

- [About Garmin](#)
- [About GPS](#)
- [Investor Relations](#)
- [Virtual Pressroom](#)
- [Employment](#)
- [Customer Support](#)
- [Software Updates](#)
- [Product Registration](#)
- [FAQs](#)
- [Dealer Locator](#)
- [MapSource® Unlock](#)
- [Aviation Databases](#)

Welcome to Garmin

World Leader in Navigation and Communication

Garmin® is a leader in Global Positioning System (GPS) technology and an innovator in consumer electronics. We serve both the aviation and consumer markets. Our products are used in flying, boating, driving, hiking, and many other activities. We're customer focused and committed to producing quality products that improve people's everyday lives.

Aviation	Panel-Mount GPS
AVIONICS	Portable GPS
Consumer	Remote/Sensors
MARINE	Chartplotters
OUTDOOR	GPS Sounders
MOBILE ELECTRONICS	Fishfinders
CARTOGRAPHY	Basic GPS
OEM/SENSORS	GPS Mapping
	Automotive GPS
	PDA/GPS
	MapSource
	BlueChart®
	Engines
	TracPaks

[Dealers Only](#)

► Garmin News Flash

- [StreetPilot 2620](#): Pre-loaded map data!
 - [Forerunner™ 101](#): Entry-level trainer
 - [GPSMAP® 76C / GPSMAP 76CS](#): Exciting new marine handhelds with autorouting
 - [GPSMAP 276C](#): Chartplotter/car navigator
 - [Foretrex™ 201](#): Hands-free GPS
 - [Rino 130®](#): Our newest handheld radio
 - [GPSMAP 172C / GPSMAP 178C](#)
- Sounder:**
- Next-generation chartplotter/sounder
 - [Fishfinder 250 / Fishfinder 250C](#): Fishing excitement at affordable prices!
 - [Garmin Joins the NASDAQ-100 Index®](#)
 - [GPSMAP 60C / GPSMAP 60CS](#): Heavy-duty color GPS for marine/outdoor
 - [iQue™ 3600](#): Handheld Palm OS® and GPS



Outdoor

GPS 12

[Specifications](#)
[Testimonials](#)
[Accessories](#)
[Manuals](#)
[Software Updates](#)
[FAQs](#)
[Home](#) > [Outdoor](#) >
[Products](#) > GPS 12

Search:

GPS 12



Package includes:

- GPS 12 receiver with built-in antenna
- Wrist strap
- Owner's manual
- Quick reference guide

The

▶ Interactive Demo

360° Product View (180K)

The interactive demo requires Macromedia Flash 4 plug-in.

[Download now](#)

▶ Video Overview

[Hi-res Overview](#) 26.5MB mpeg

[Lo-res Overview](#) 9.95MB mpeg

Garmin® GPS 12 Personal Navigator®: an affordable 12 parallel channel handheld for outdoor adventurers who want a basic, hard-working 12-channel GPS, but who don't want to spend a bundle. Based on the popular GPS 12XL, the GPS 12 offers outdoor enthusiasts an entry-level way to gain the power and performance of a 12-channel receiver with fast satellite acquisition in the toughest conditions—even in heavy tree cover.

The GPS 12's rugged, waterproof case features military-tough construction, and its rocker keypad design provides true one-hand operation that keeps you on the move—day or night, rain or shine. It also features 500 available waypoints and 1024 track log points, nine proximity waypoints to mark and steer clear of dangerous areas, and Garmin's innovative TracBack® function—a feature that turns your track log into an instant breadcrumb trail and allows you to reverse your route in order to quickly navigate back home. As an added bonus, the GPS 12 also boasts a position averaging feature which diminishes the effects of Selective Availability (SA) upon position error and displays a value that reflects the estimated accuracy of the averaged position.

Include a host of advanced navigation features like enhanced moving map graphics, average and maximum speed data, and trip timers, and you have all the things that make the GPS 12 a purebred Garmin—innovation, performance, and value.

Outdoor

[Product Comparison](#)



[TOP](#)

Copyright 1996-2004 Garmin Ltd. or its subsidiaries
[Privacy Statement/Terms of Use](#)

Mobile Electronics

eMap

[Specifications](#)[Screen Examples](#)[Testimonials](#)[Accessories](#)[Manuals](#)[Software Updates](#)[FAQs](#)
[Home](#) > [Mobile Electronics](#) > eMap

Search:

eMap

Discontinued



Package Includes:

- eMap®
- Basemap: [Americas Highway](#) or [Atlantic Highway](#)
- Wrist strap
- User's manual

MapSource Compatibility

Garmin Recommends:

* denotes [limitations](#)

Product Training Video



Produced by Garmin

[Buy Now](#)Available from local dealers or our online store. [More Info](#)>

Interactive Demo

360° Product View (164K)

The interactive demo requires Macromedia Flash 4 plug-in. [Download now](#)

Video Overview

[Hi-res Overview](#) 11.3MB mpeg

[Lo-res Overview](#) 4.61MB mpeg

Here's another reason to toss out those paper maps: the eMap. It's the size of a small, flat calculator, contains a 12 parallel channel GPS receiver, and weighs a mere six ounces. Even with its compact style, the eMap boasts an extra-large display for showing even more map data and the same power you've come to expect from Garmin handhelds—even while operating for up to 12 hours on just two AA batteries.

The eMap features an internal basemap containing information on North and South America including state and country boundaries, lakes, rivers, streams, airports, cities, towns, coastlines, and U.S., state, and interstate highways. In addition, the eMap provides exit information for the federal interstate highway system. With the eMap, you will know when you are near services such as food, lodging, and service stations.

The eMap is compatible with Garmin's complete line of downloadable [MapSource®](#) CD-ROMs including U.S. Roads and Recreation, WorldMap, U.S. Topo, and MetroGuide® U.S.A. When paired with the MetroGuide U.S.A. CD-ROM, the eMap has the ability to look up address and telephone number information for nearby services and points of interest. The eMAP will store eight or 16 megabytes of downloaded CD-ROM information at a time depending on the size of the cartridge you use in the unit.

Designed with everyone in mind, this unit will take you from the car, to the hiking trail, to the beach without missing a beat.

Product Comparison



Copyright 1996-2004 Garmin Ltd. or its subsidiaries
[Privacy Statement/Terms of Use](#)

Outdoor

eTrex Vista

[Specifications](#)
[Testimonials](#)
[Accessories](#)
[Manuals](#)
[Software Updates](#)
[FAQs](#)

eTrex Vista

[Enlarge image](#)

Package includes:

- eTrex Vista®
- Database: [Marine Point Database](#)
- Basemap: [Americas Highway](#) or [Atlantic Highway](#) or [Pacific Highway](#)
- PC interface cable
- Wrist strap
- User's guide
- Quick reference guide



The eTrex Vista combines a basemap of North and South America, with a barometric altimeter and electronic compass. The compass provides bearing information while you're standing still and the altimeter determines your precise altitude. The Vista is also designed to provide precise GPS positioning using correction data obtained from the Wide Area Augmentation System (WAAS). This product will provide position accuracy to less than three meters when receiving WAAS corrections.

The eTrex Vista also boasts an internal memory capacity of 24 megabytes, which allows it to accept downloaded mapping data from Garmin's [MapSource®](#) CD-ROMs, including [Fishing Hot Spots®](#). A silver case gives this unit a high-tech look. New to the product design, Garmin will include marine aids to navigation in addition to the basemap. These navigational aids will be pre-loaded into each unit from the factory.

Suggested Retail Price:
\$321.41 U.S.D. (for domestic US market only)

Product Comparison

MapSource Compatibility

Garmin Recommends:

* denotes [limitations](#)

eTrex Family Quick Links

[eTrex®](#) [Camo](#) [Summit](#) [Venture](#) [Legend](#)

[eTrex Family Comparison Chart](#)

eTrex Product Showcase

Which eTrex is right for YOU?

Check out and compare the entire eTrex product line.

[Click Here](#)

The interactive demo requires Flash 5 plug-in. [Download now](#)

Product Training Video



Produced by Garmin
[Buy Now](#)

Available from local dealers or our online store. [More Info>](#)

Video Overview

[Hi-res Overview](#) 20.3MB mpeg
[Lo-res Overview](#) 7.64MB mpeg

[TOP](#)

Copyright 1996-2004 Garmin Ltd. or its subsidiaries
[Privacy Statement/Terms of Use](#)



Complete Sun and Moon Data for One Day

You can obtain the times of sunrise, sunset, moonrise, moonset, transits of the Sun and Moon, and the beginning and end of civil twilight, along with information on the Moon's phase by specifying the date and location in one of the two forms below and clicking on the "Get data" button at the end of the form.

Use [Form A](#) for cities or towns in the U.S. or its territories. Use [Form B](#) for all other locations. Both forms are immediately below.

Be sure to check [Notes section](#), located after the two forms.

Form A - U.S. Cities or Towns

Year: **Month:** **Day:**

State or Territory:

City or Town Name:

The place name you enter above must be a city or town in the U.S. The place's location will be retrieved from a file with over 22,000 places listed. Either upper- or lower-case letters or a combination can be used. Spell out place name prefixes, as in "East Orange", "Fort Lauderdale", "Mount Vernon", etc. The only exception is "St.", which is entered as an abbreviation with a period, as in "St. Louis". You need only enter as many characters as will unambiguously identify the place.

Form B - Locations Worldwide

Year: **Month:** **Day:**

Longitude: east west degrees minutes

Latitude: north south degrees minutes

Time Zone: hours east of Greenwich west of Greenwich

Place Name:

The place name you enter above is used only in the table header; you can enter any identifier, or none (avoid using punctuation characters).

Need coordinates? Try NIMA's [GEOnet Names Server](#).

Need a time zone? Try the [time zone map](#).

Notes



For information on the definitions of terms used, see [Rise, Set, and Twilight Definitions](#) or [Phases of the Moon and Percent of the Moon Illuminated](#) in **FAQ**.

If you need rise/set or twilight times for a series of dates for a U.S. location, use our [rise/set table program](#), which computes a one-page table covering an entire year.

For U.S. cities or towns (Form A), the output times will be on a 12-hour clock (with "a.m." or "p.m." listed); for worldwide locations (Form B) the output times will be on a 24-hour clock.

For U.S. cities or towns (Form A), the times of the phenomena are presented in the standard time of the place requested, using the *current* time zone of the place. Standard time in [time zones](#) was introduced in the U.S. in 1883, but the time zone boundaries have evolved considerably since then, with places shifting from one zone to another. There is no attempt here to track such changes.

[Daylight time](#) is implemented only for U.S. cities or towns (Form A) and only for years 1967 and later, in accordance with the Uniform Time Act of 1966 and subsequent legislation. Daylight time is not used for places currently exempt from it.

At the bottom of the output page for U.S. cities or towns there is a link to the [map-generating service of the U.S. Census Bureau](#). Clicking on this link will provide a map of the area surrounding the location for which astronomical data have been given. The large red dot in the middle of the map indicates the location for which the data were computed. The width of the map is 0.25 degrees of longitude, equivalent to 1 minute of time in rise/set phenomena. Except for some critical cases in Alaska, the map roughly indicates the area within which the computed astronomical data are valid.

For worldwide locations (Form B) that require it, the time zone can be entered in hours and a fraction. For example, for locations in India, the time zone may be entered as 5.5 hours east of Greenwich. The time zone field can accommodate up to five characters.

If you are having trouble seeing the date fields on this page, try the [version without JavaScript](#).

Sunset photo by Lu Rarogiewicz from Mt. Wilson, California.

Need other kinds of astronomical information? Start at our [home page](#).

Back to . . . [top](#) [Form A](#) [Form B](#)

[[Publications](#) | [Data Services](#) | [Software](#) | [FAQ](#) | [Research](#) | [About AA](#)]
[[News](#) | [Site Map](#) | [Index](#) | [Home](#)]

[Need help?](#)

Before You Start

Latitude and Longitude

You will need to know your latitude - and if you wish to include a longitude correction (time zone offset) - you will need to know your longitude. If you don't know them they can be found from [Internet sources](#).

IMPORTANT Some sites will indicate longitudes **west** of Greenwich (i.e. in North America) as **negative**. Most methods of sundial construction require west longitudes entered as **positive**.

If you live in the western hemisphere, do not use the minus sign when considering your longitude

Correcting for your position in your Time Zone

When solar time became inadequate for railway timekeeping, a system of time zones was initiated creating 24 time zones, each 15° wide - within which all clocks would tell the same time. (Basic arithmetic: The earth's 360° circumference was divided into 24 one hour segments, and the result was 24 time zones each 15° wide.)

However, the sun moves across each artificial time zone at its own pace.

If you wish your sundial to compensate for its position in its 15° time zone and approach **Standard (clock) Time**, you will need to apply a **longitude correction**.

This correction is determined by the relationship between the longitude of your sundial and the longitude of the central meridian of your time zone. The central meridians of all 24 time zones can be found in the table below.

If you are setting up a commercial sundial, the longitude correction will not be built into the dial, but it will be a constant amount which you must apply at each reading. If your longitude is west of your central meridian, add four minutes to the time on the dial for each degree. If you are east of your central meridian, subtract. This correction can be built into your dial if you are making one.

Even after the **longitude correction** is applied, your dial will not consistently tell **Standard Time** due to [The Equation of Time](#) which varies throughout the year. See below.

Time Zone	Number (offset)	Central Meridian	Locations

GMT-11hrs	11	165	Midway, Samoa
GMT-10hrs	10	150	Hawaii, Society Is.
NORTH AMERICA			
GMT-9hrs	9	135	Alaska, Pitcairn Island
US Pacific	8	120	Whitehorse, Seattle, Los Angeles
US Mountain	7	105	Yellow Knife, Denver, Phoenix, W. Mexico
US Central	6	90	Churchill, Chicago, New Orleans, E. Mexico
US Eastern	5	75	Montreal, New York, Columbia, Peru
Atlantic	4	60	Nova Scotia, Venezuela, (Newfoundland -30m)
GMT-3hrs	3	45	Greenland, E. Brazil, Argentina
GMT-2hrs	2	30	Georgia & S. Sandwich Islands
GMT-1hrs	1	15	Cape Verdes, Azores
Greenwich	0	0	WET, British Isles, Iceland, W. Africa
Middle Europe	-1	-15	MET, Europe, Scandinavia, C. Africa
Eastern Europe	-2	-30	EET, OEZ, Europe, Mid East, E.C. Africa
GMT+3hrs	-3	-45	Mos, Moscow, E. Africa
GMT+4hrs	-4	-60	Gorki, Oman, Mauritius
GMT+5hrs	-5	-75	Pakistan, (India +30m)
GMT+6hrs	-6	-90	Bangladesh, Burma

GMT+7hrs	-7	-105	S.E. Asia, Sumatra
GMT+8hrs	-8	-120	China, Philippines, W. Australia
GMT+9hrs	-9	-135	Korea, Japan, (C. Australia +30m)
GMT+10hrs	-10	-150	P. New Guinea, Guam, E. Australia
GMT+11hrs	-11	-165	Sakhalin Peninsula, Solomon Islands
GMT+12hrs	-12	-180	New Zealand, Wake, Marshall Islands

The Equation of Time

Even if your dial includes the **longitude correction**, its timekeeping will vary throughout the year due to a phenomenon called The Equation of Time. Simply put, the **apparent** motion of the sun will cause your dial to be as much as 16 minutes fast or slow at various times of the year. The Equation is caused by the earth's elliptical orbit, and the 23.44° tilt of its axis from the plane of its orbit.

The chart below shows the amount your dial will vary from clock time through the year. Download it, print it out, and keep it close to your dial. There are dials which compensate for the Equation of Time, but they are complicated.

The Equation of Time

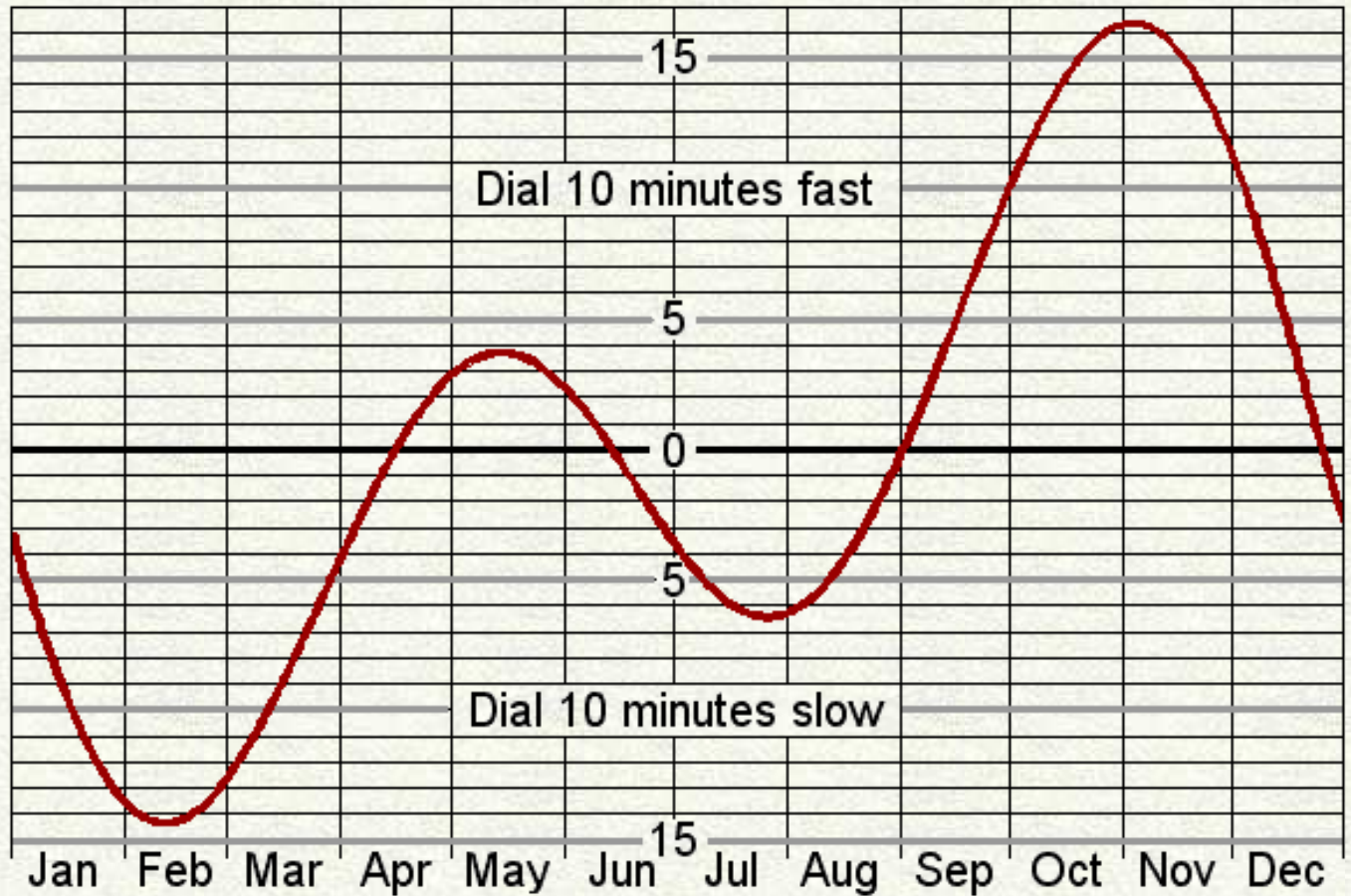

Right-click in the graph, then "Save As"

Make your own Horizontal sundial:

Materials required: A pencil, protractor, compass and a straight edge.

Draw a vertical line, now draw a line perpendicular (AB) to the vertical line. (Fig. #1)

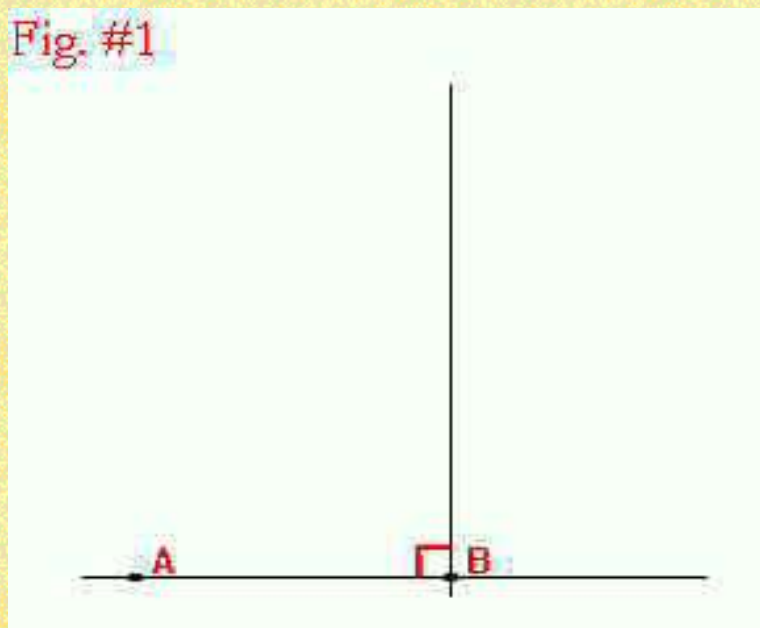

Now draw a line from A through the vertical line so that angle B'AB is equal to the latitude of the place where the dial is to be used. Remember this angle for making the gnomon. (Fig. #2)

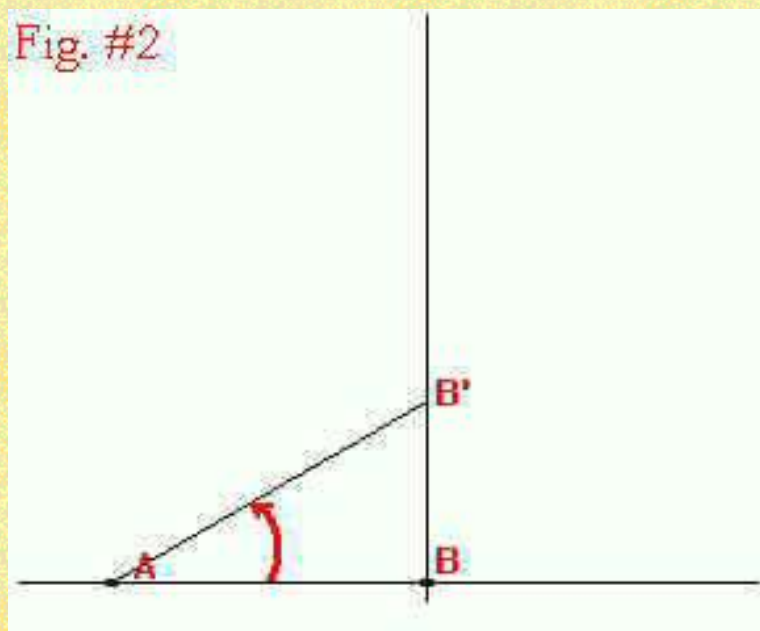

Draw a line perpendicular to line AB' that intersects line AB at point B. (Fig. #3)

Fig. #3

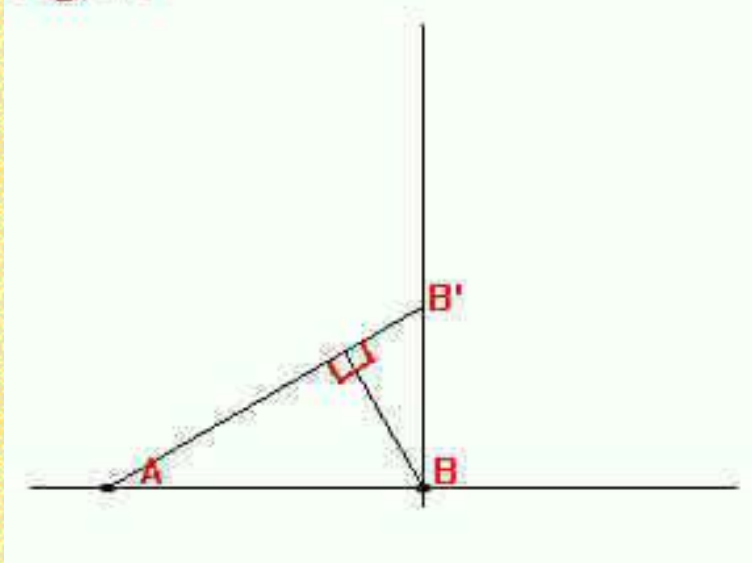

Now use the distance A'B to find C (use the compass), draw a semi-circle centered at C and divide it into 15 degree pieces (use the protractor). (Fig. #4)

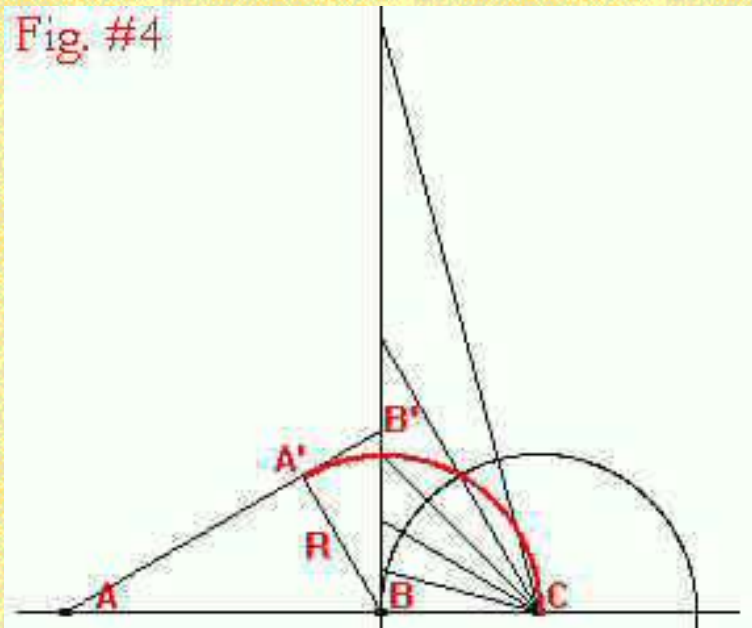

Why 15 degrees? One day is 24 hours, or the amount of time it take for "the sun to go around the earth". So in 24 hours the sun "moves" through 360 degrees (recall that there are 360 degrees in a circle). Therefore to find how many degrees are in 1 hour we divide 360 by 24. $360/24=15$ degrees, this is called the hour angle of the sun.

Connect the 15 degree points along line BB' to point A. These are the hour lines for your sundial. Draw a line through A and parallel to line BB', this is the 6:00 hour line. (Fig. #5)

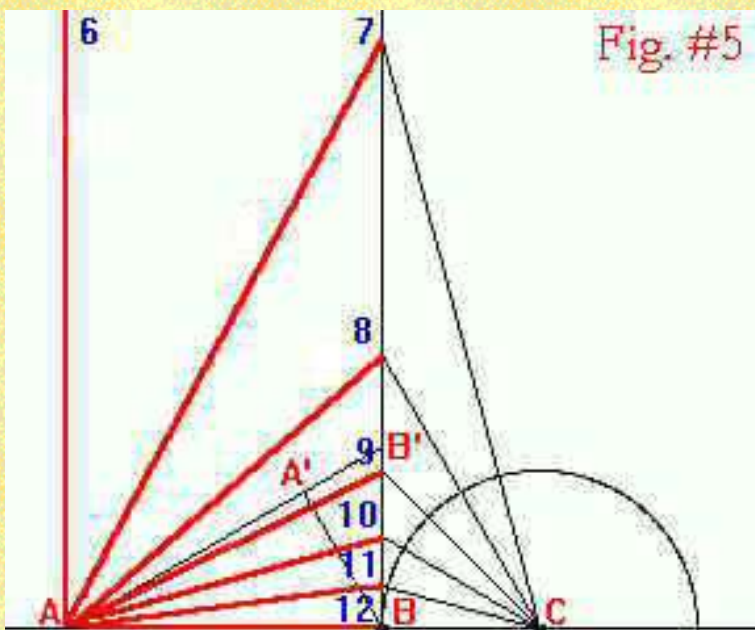

To find the morning hour line "flip" the afternoon hour lines over the 6 hour line. In other words angle B-A-11 is equal to angle B-A-1, likewise angle B-A-10 is equal to angle B-A-2 etc. (Fig. #6)

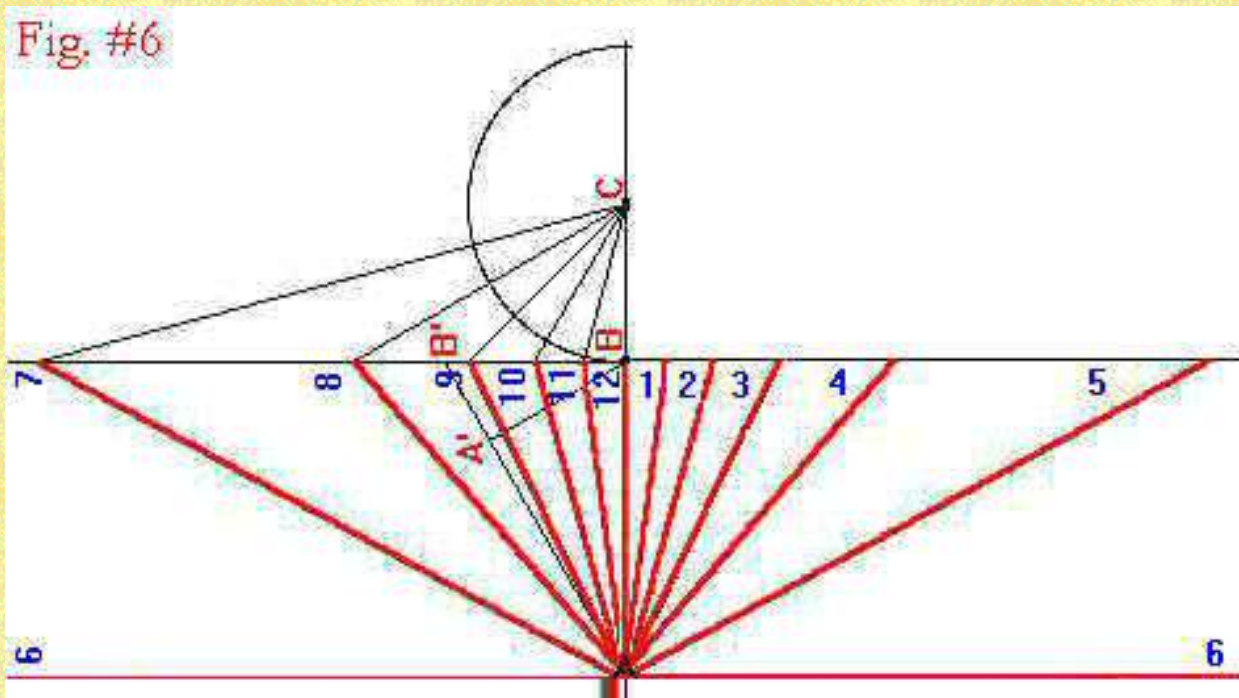

All that is left is to add the gnomon and set the dial in the sun. The gnomon is a triangular piece that has one angle equal to the latitude of the place where the dial is to be used. See the diagram below on how to affix the gnomon to the dial.

It's now time to take the dial outside and start to tell time. Orient your dial so that the 12:00 hour line and gnomon (which lies along the 12:00 line) are pointing toward TRUE NORTH.

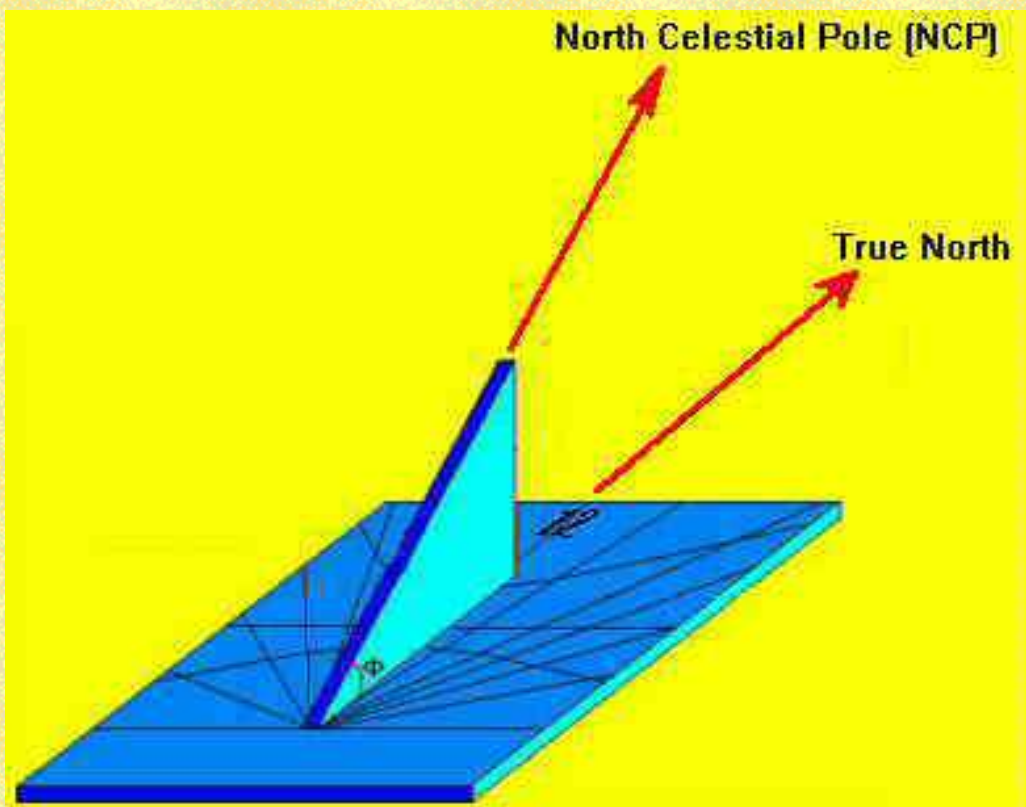

Point of interest: The above procedure for graphically making a horizontal sundial was used by James Madison. He designed a dial using this same formula while an undergraduate at Princeton circa 1769. The image below is the actual work done by James Madison.

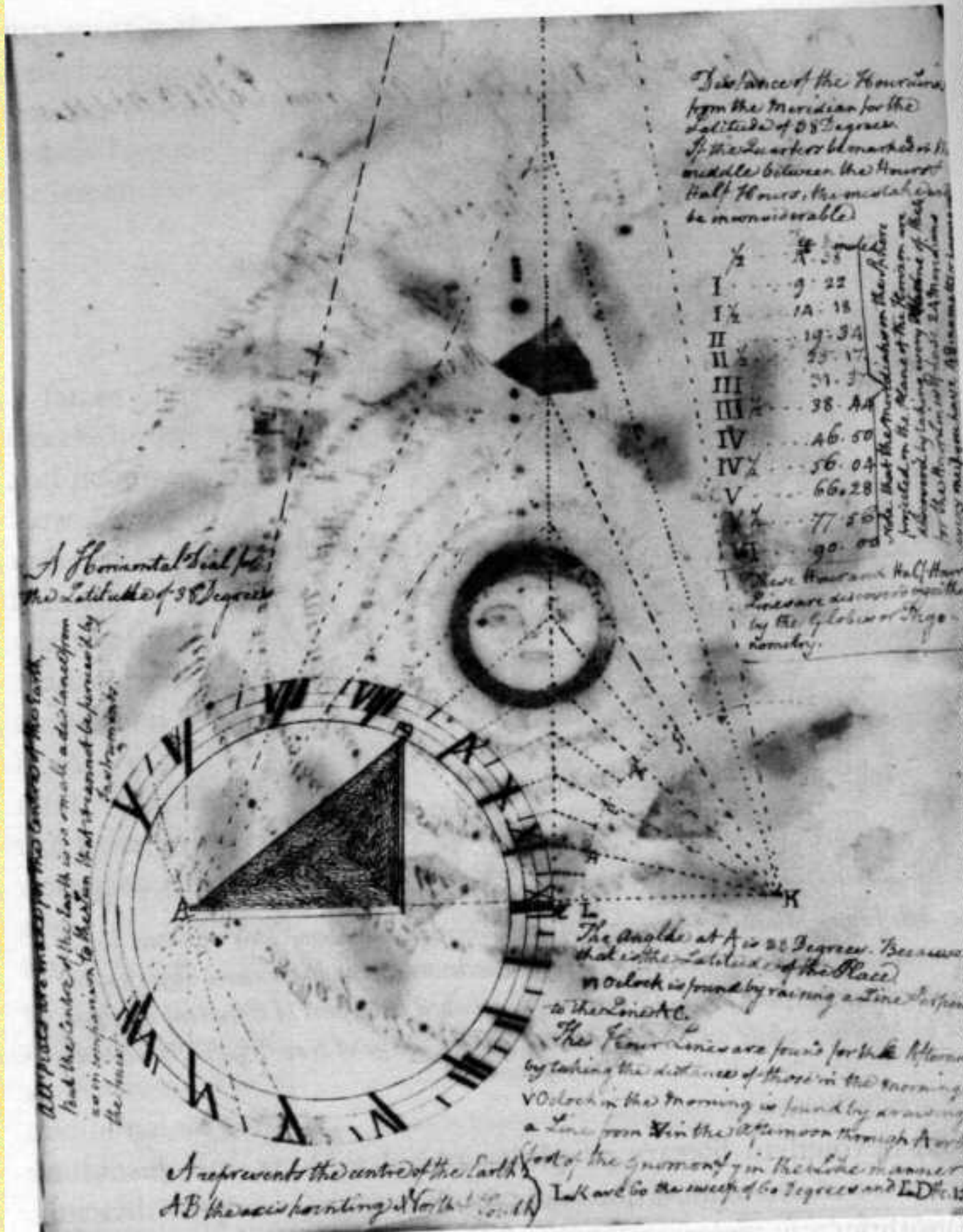

Distance of the Hours from the Meridian for the Latitude of 38 Degrees. If the Quarters be marked in the middle between the Hours & Half Hours, the mistake will be inconsiderable.

Hour	Distance in Miles
I	9.22
I 1/2	14.18
II	19.34
II 1/2	25.17
III	31.3
III 1/2	38.44
IV	46.50
IV 1/2	56.04
V	66.28
V 1/2	77.50
VI	90.00

A Horizontal Dial for the Latitude of 38 Degrees

All pieces were made for the Centre of the Earth, and the Centre of the Earth is so small a distance from us in comparison to the Sun that it cannot be perceived by the Instruments.

These Hours and Half Hours Lines are discovered by the Globes of Geography.

The angle at A is 38 Degrees. Because that is the Latitude of the Place. Noon is found by raising a line perpendicular to the Line AC.

The Hour Lines are found for the Morning by taking the distance of those in the evening. Noon in the morning is found by drawing a line from H in the afternoon through A with feet of the gnomon in the line manner. LK will be the sweep of 60 Degrees and LD the 15.

A represents the centre of the Earth, AB the axis pointing North & South.

NOTE: The faint image of the Sun at the center of the document and the faint concentric circles are Madison's notes about the Copernican System which are on the other side of the sundial calculation page.

If you live in the Northern hemisphere finding true north is as easy as finding the North star and setting your dial to point at it, also if you measure the angle of the North star (Polaris) above the horizon you will have your latitude. DO NOT use a compass to find north, a compass shows magnetic north NOT true north.

Another way to find true north is to watch the shadow of a vertical rod, when the shadow is at its shortest length it is pointing true North/South.

Make your own [Equatorial Sundial](#).

Make your own [Vertical Sundial](#).



This page accessed 18310 times.

Page created by: abraxas2@ix.netcom.com

Changes last made on: *October 22, 2002*

Copyright (c)2002 I/O Asso.

DERBYSHIRE SUNDIALS

HORIZONTAL SUNDIAL SHADOW ANGLE CALCULATOR

DERBYSHIRE SUNDIALS

[Ashover](#)[Bakewell](#)[Baslow](#)[Brassington](#)[Carsington](#)[Chapel-en-le-Frith](#)[Darley Dale](#)[Eyam](#)[Hartington](#)[Kedleston](#)[Over Haddon](#)[Ripley](#)[More sundials](#)including
scratch dials[Home page](#)

To find the Horizontal Sundial shadow hour angles for your locality you need to know your latitude. In the UK the latitude can be found by reference to an Ordnance Survey map. This will give your latitude in units of degrees and minutes. Convert this angle to decimal degrees before typing in to the first box below, i.e. if your latitude is 53° 30', type it in as 53.5 Then click the calculate button to see the results...

Sundial time = 12 Noon

Sundial time = 11:45 am and 12:15 pm

Sundial time = 11:30 am and 12:30 pm

Sundial time = 11:15 am and 12:45 pm

Sundial time = 11:00 am and 1:00 pm

Sundial time = 10:45 am and 1:15 pm

Sundial time = 10:30 am and 1:30 pm

Sundial time = 10:15 am and 1:45 pm

Sundial time = 10:00 am and 2:00 pm

Sundial time = 9:45 am and 2:15 pm

Sundial time = 9:30 am and 2:30 pm

Sundial time = 9:15 am and 2:45 pm

Sundial time = 9:00 am and 3:00 pm

Sundial time = 8:45 am and 3:15 pm

Sundial time = 8:30 am and 3:30 pm

Sundial time = 8:15 am and 3:45 pm

Sundial time = 8:00 am and 4:00 pm

Sundial time = 7:45 am and 4:15 pm

Sundial time = 7:30 am and 4:30 pm

[Calculator](#)

For horizontal dials

[Calculator](#)

For vertical dials

[Email](#)[Links Page..](#)

Sundial time = 7:15 am and 4:45 pm

Sundial time = 7:00 am and 5:00 pm

Sundial time = 6:45 am and 5:15 pm

Sundial time = 6:30 am and 5:30 pm

Sundial time = 6:15 am and 5:45 pm

Sundial time = 6:00 am and 6:00 pm

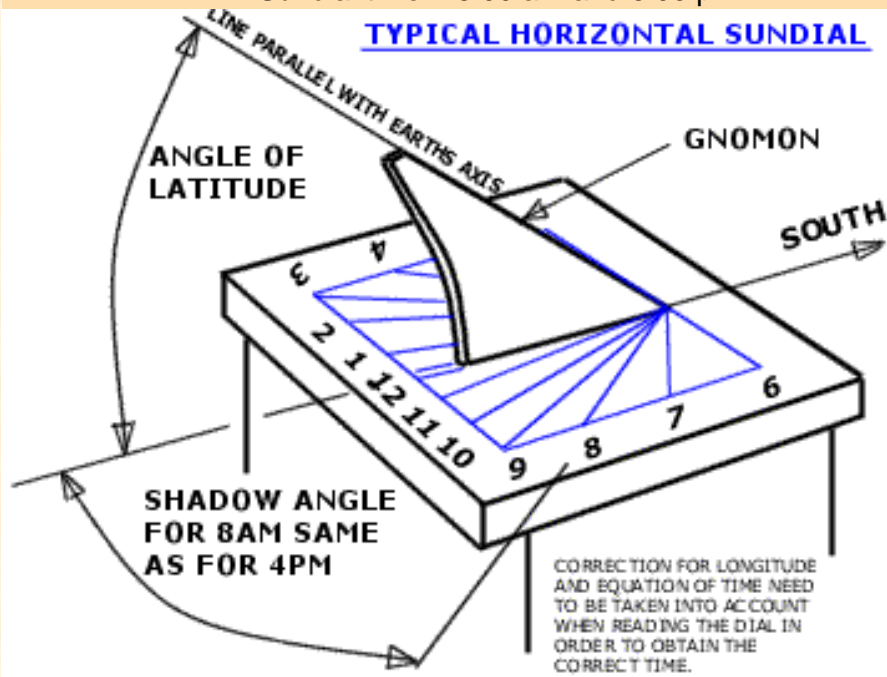

**DERBYSHIRE
SUNDIALS**

^^^ [Back to the top](#) 2000 This revision 13 November 2002

Convert Degrees Minutes Seconds to Decimal Degrees

You must enter all three values
separated by spaces.

Latitude:

Longitude:

Convert Decimal Degrees to Degrees Minutes Seconds

Latitude:

Longitude:

Sundials on the Internet

For a full overview [click here](#)

Five simple sundial projects for you to make



Here are five sundial projects which will demonstrate the principles of a sundial and ensure that you end up with a sundial which tells accurate sun time. The projects are:

[an equatorial sundial](#)

[a horizontal sundial](#)

[another horizontal sundial](#) (with a link to the original in French) and copiously illustrated

[a diptych dial](#)

[an equiangular dial](#) **NEW**

You can find some other projects for sundials and other sun-related phenomena on the [Event Inventor's page](#)



visitors have come to this page since 1 June 2001 - we hope you enjoy them too.

Project One - An Equatorial Sundial

This project is summarised from "[Make a Sundial](#)" project no.3, by kind permission of the [British Sundial Society](#)

For this project, you will need:

- a piece of card slightly wider than the protractor and say 25cm (10 in.) long
- a drinking straw or knitting needle
- a protractor

1. Draw lines across the card dividing the length into sections of 1, 10, 14, and 1 cm. (The length of 14 is alright for latitudes of 50 deg. or more, but if you live at a lower latitude, you will need to make this length longer) We'll call these lines A, B, and C. Mark the centre point O of line A, and the centre point P of line C. Draw a line OP connecting the two centre points.
2. Place the centre of the protractor on O and draw round it. Make a pin hole through O, turn the card over, and place the centre of the protractor on the pin hole. Draw round the protractor again so you have two semicircles back to back
3. Mark 15 degree intervals and number the hours as shown, on both semi-circles.
4. Score and fold the card along the lines A, B, and C
5. Enlarge the pin hole at O and push the straw through. Make sure the straw is at 90 deg. to the card around O.
6. Move the bottom end of the straw along the line OP until the angle it makes with the horizontal is the same as the latitude of the place where you are (this is about 30 deg. for Perth and for New Orleans, 45 deg for Bordeaux and for Minneapolis, 51.5 deg. for London, and 55 deg for Edinburgh)

You may find it easier to calculate the correct angle, and mark off the correct length along the straw. The correct length is $10 \times (\cotangent \text{ of the latitude})$. In the examples above, the correct lengths would be 17.3 cm. for Perth or for New Orleans, 10 cm for Bordeaux and for Minneapolis, 8 cm for London, and 6.9 cm for Edinburgh

7. When you've found the correct location for the bottom end of the straw, bend up a tab as shown in the diagram, or put a pin through from the other side to hold the straw in the right place
8. The straw forms the gnomon. The shadow of the gnomon will fall on the hour lines on the top of the dial in summer, and on the underside in winter.
9. You can colour your dial and write a motto such as "AIM HIGHER THAN THE MARK" underneath.

You now have a working [equatorial](#) sundial. The dial plate, with the 15 degree angles marked on it, is parallel to the equator, and the straw forming the gnomon is parallel to the earth's axis. The sun appears to revolve round the earth's axis at 360 deg. every day, which is 15 deg. every hour (which is why you marked out your hour lines at 15 deg. intervals)

You can also see from your model how a horizontal sundial is constructed. Wait till the shadow is exactly on one of your hour lines, and mark a line where the shadow of the base of your straw falls on the horizontal piece of your card, and mark the hour alongside.

When you have marked out a number of lines in this way, you will see that the angles are not a regular 15 deg. on the horizontal surface. You will also see that the shadow line along the "equator" surface meets the shadow line along the horizontal surface, along the line of the fold B. The hour lines on the horizontal surface are, in fact, the projection, on the horizontal surface, of the 15 deg. lines on the equatorial surface. This forms the basis of the graphical method of determining the hour lines for horizontal sundials, which of course are different for each latitude.

["Make a Sundial"](#) contains lots of other interesting sundial projects, so why not order a copy today, and support the British Sundial Society who wrote this page for you and helped to sponsor [Sundials on the Internet](#).

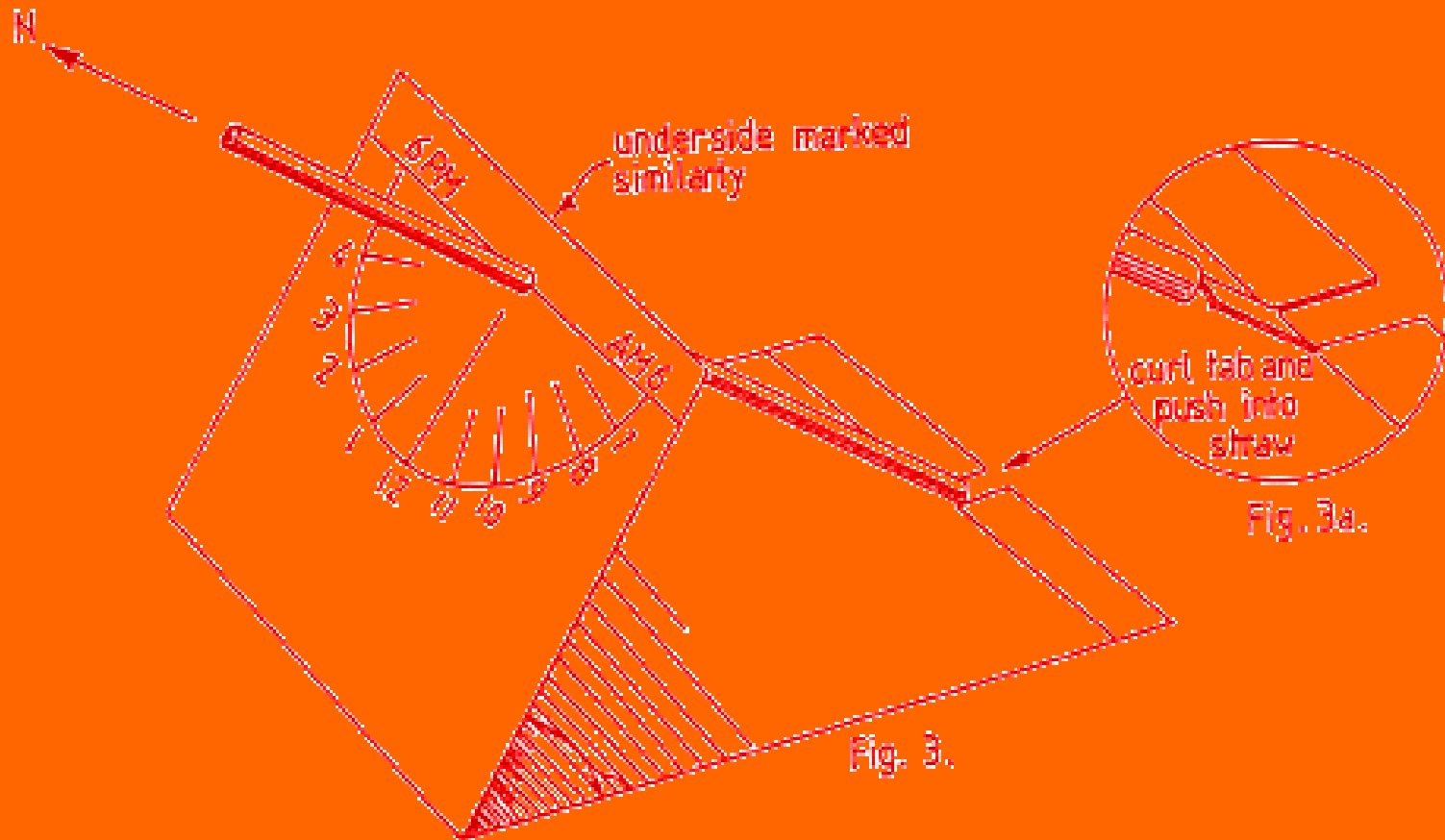

Project 2 - A horizontal sundial

This project was devised and written by Tony Helyar, and is one of a number of interesting pages on his site at <http://freepages.pavilion.net/users/aghelyar>

To Construct a Horizontal Sundial

The first step is to mark out the hour angles. A base line with a centrally rising perpendicular gives the noon, 6am and 6pm lines as follows:-

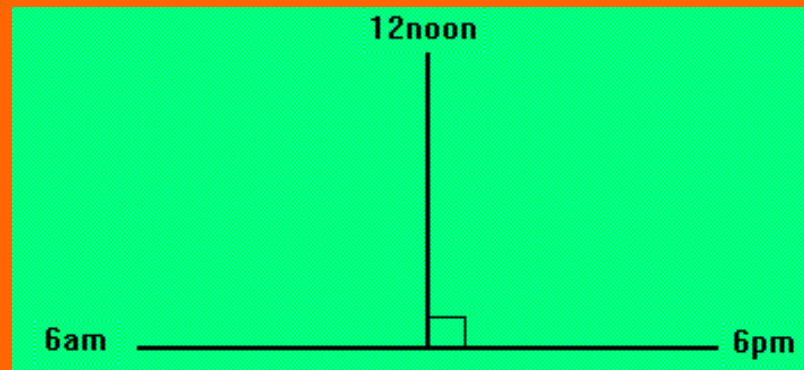

Various methods exist for generating the remaining hour angles, we will use the computational method. The formula for calculating the angles quoted in many works on the subject is:

$$\log \tan D = \log \tan t + \log \sin \emptyset$$

and was used in this form to save the need for long multiplication of fractions. However in these days of pocket calculators we can use the more straightforward:

$$\tan D = (\tan t)(\sin \emptyset)$$

In both these formula D is the angle which the hour line makes with the noon line, t is the time measured from noon in degrees and minutes of arc [the earth completes the 360° round the sun in 24 hours so 1 hour = 15° and 1 minute = 15' of arc], and \emptyset is the latitude of the place where the dial is to be positioned. Each angle calculated for times before noon also gives the angle for the equivalent times after noon:-

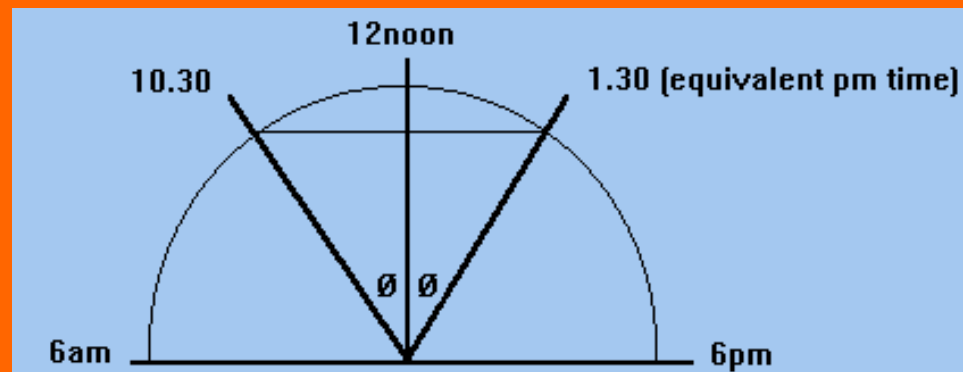

It's best to draw up a table:

time	t	tan t	sin Ø	tan D	D
9.30 (2.30)	37°30'	0.7673	0.7749	0.5945	30.73°

I have put in one set of figures assuming a latitude of $50^{\circ}48'$ ($\text{Ø} = 50.8$). Of course this is an obvious spreadsheet application. Having plotted all the hour angles required, normally hours and half hours, the shadow casting component, known as a gnomon or style, can be fitted along the noon line as shown below. The angle or height of the style is equal to the latitude of the dial location.

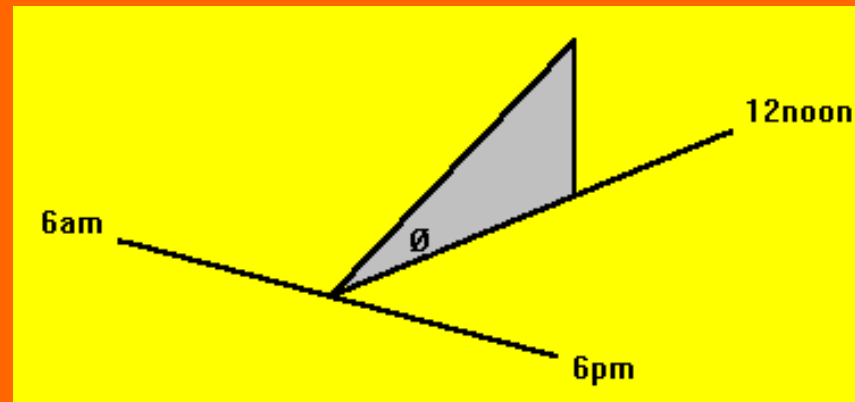

It is a good idea to draw the whole thing out on a large sheet of paper fixed to a board and make a style out of thin card. This will check the design before committing it to a more permanent medium. The sundial should be positioned where it will be in the sun for the maximum length of time with the dial plate perfectly level and with the noon line pointing directly north.

Project 3 - How to make a sundial by Andre E. Bouchard

Ce projet [en français](#)

(Andre E. Bouchard is the chairman of Communications ABC inc., a communications research company, and is Secretary General of the Commission des Cadrons Solaires du Quebec)

One might imagine that we could measure time simply by setting up a vertical pole on level ground. After a few days, it would become clear that this idea does not work. The shadow of a vertical object does not fall in the same direction nor extend to the same distance at the same time on successive days. This is because the Sun passes across the sky each day on a path which rises and falls with the changing seasons.

This difficulty is overcome by observing the shadow cast by a fixed object set up so that its straight edge, known as the style, is parallel to the Earth's polar axis. This is achieved by elevating it at the same angle from the northern horizon as the latitude of the intended location of the sundial.

Of course, our sundial will indicate Sun Time, which may differ from the time told by a watch. For one thing, the apparent circular motion of the Sun varies in speed with the time of year, so that a day may last for slightly more, or slightly less, than the annual average of 24 hours. At certain times of year, this causes Sundial Time and Clock Time to differ by as much as 16 minutes.

1. Choose your materials for the style and dial face on the basis of appearance, durability and ease of working.

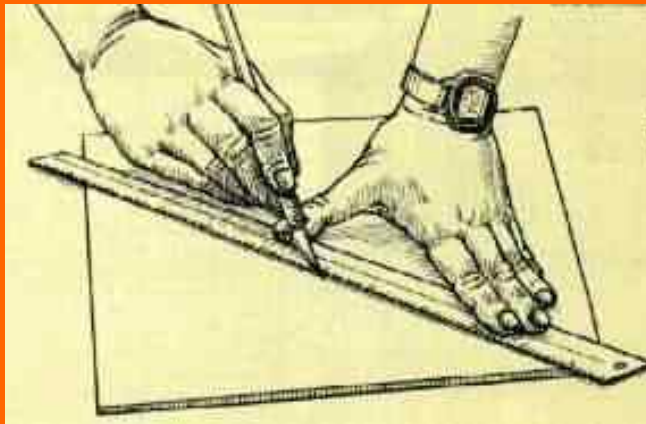

2. Cut out the style as shown and cut a straight rod, slightly longer than the sloping upper edge. The style angle (at the point that is to be fixed at the centre of the dial) must equal the latitude of the place where it will stand, as shown on a map of your country. .

3. Draw a semi-circle on the lower half of a piece of stiff paper, marking out angles of 15 degrees with a protractor. Fold back the upper half of the paper.

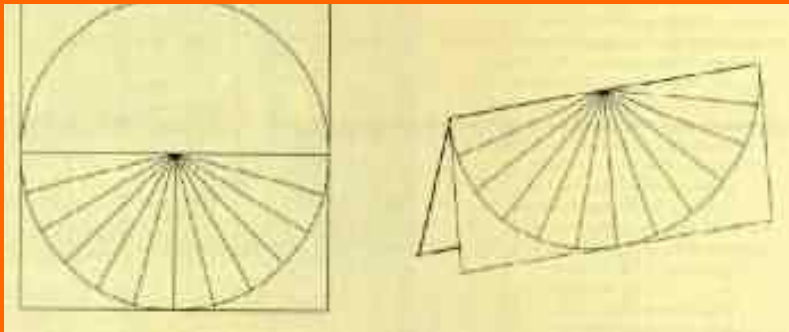

4. Attach the style to the dial face.

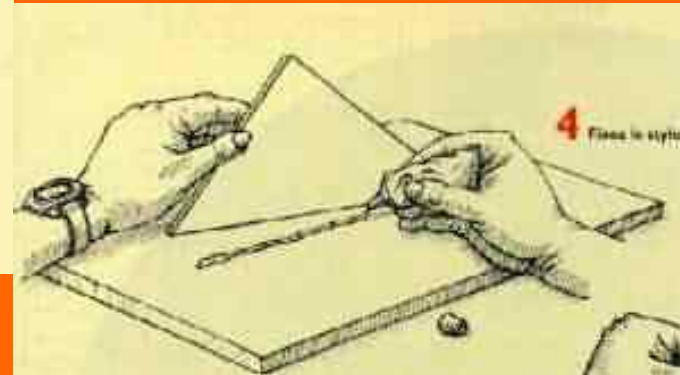

5. Fasten the rod along the sloping edge of the style..

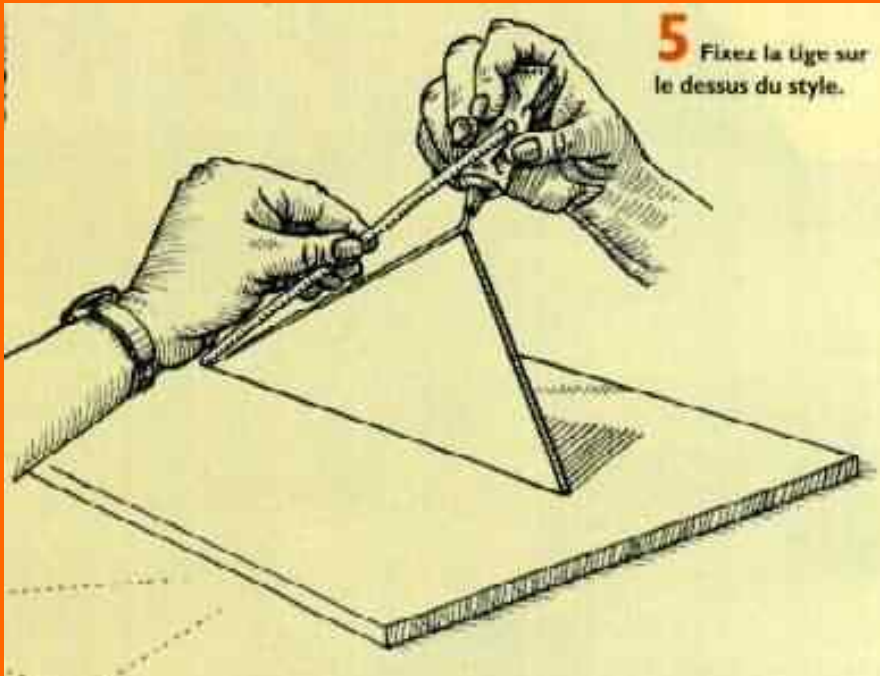

6. Fit the paper semi-circle so that it rests against the end of the style plate opposite to the measured angle and fits closely around the sloping rod. Attach one end of a length of cord around the rod and, but stretching it in line with each 15 degree line, mark out point to left and right across the dial face. Temporary extensions to left and right of the dial face will be needed, where points can be added in line with the wider angles. Remove the paper protractor and with a straight ruler, draw in the hour lines of the sundial, joining the marked points to the point of emergence of the sloping style..

7. Use a magnetic compass to orientate the sundial, so that the base of the style is in line with the North/South axis. Remember that the compass indicates magnetic north, and all for the magnetic declination.

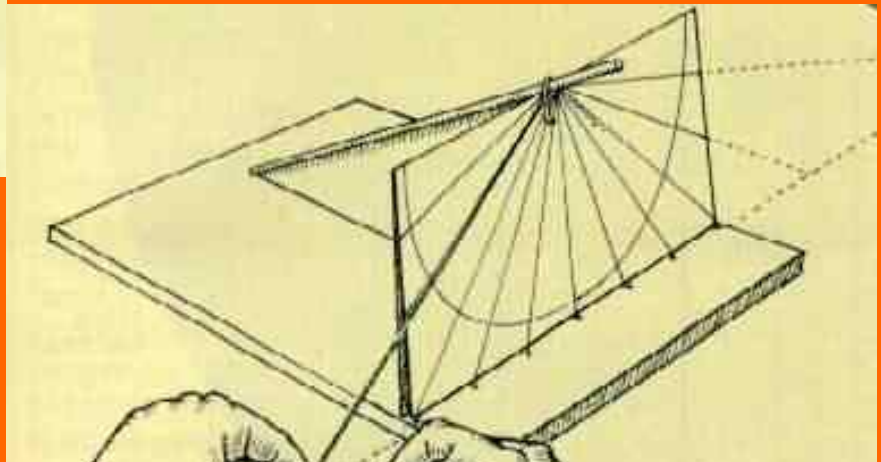

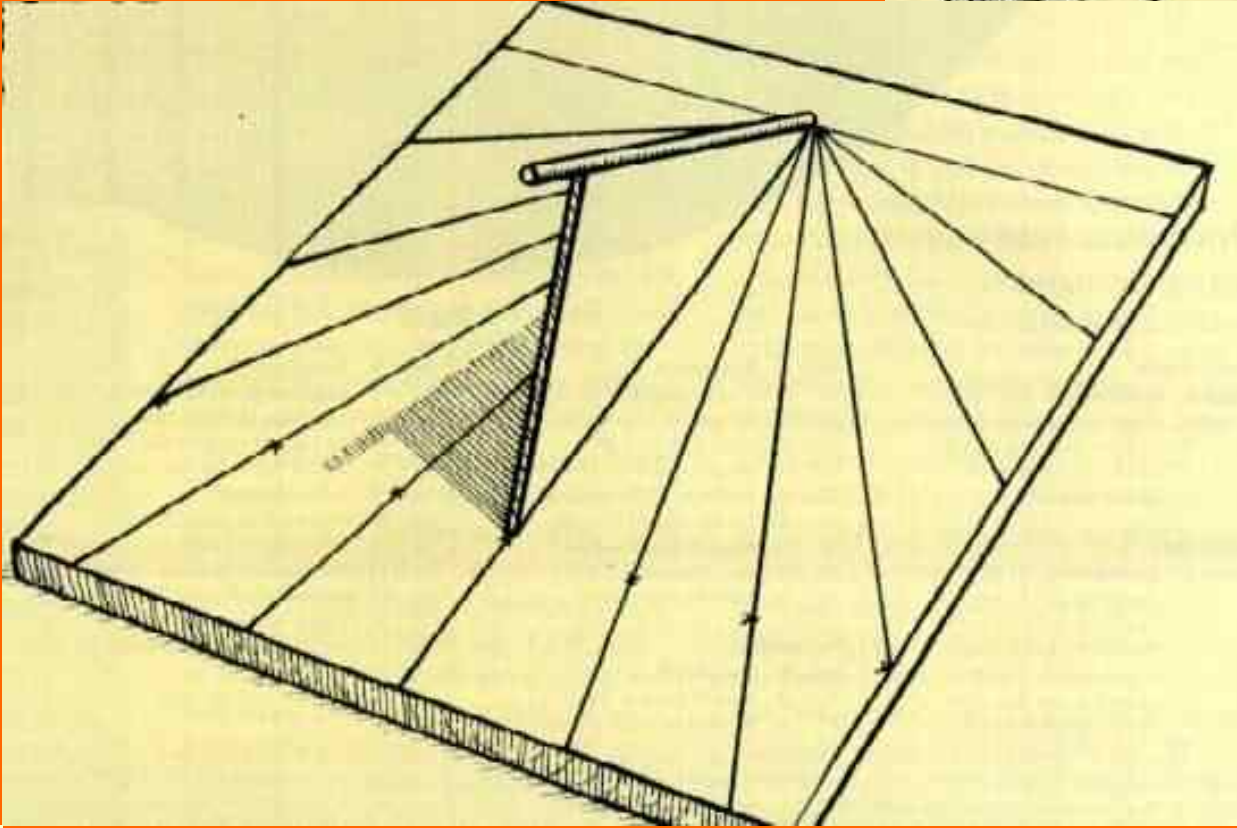

Project 4 - The diptych dial

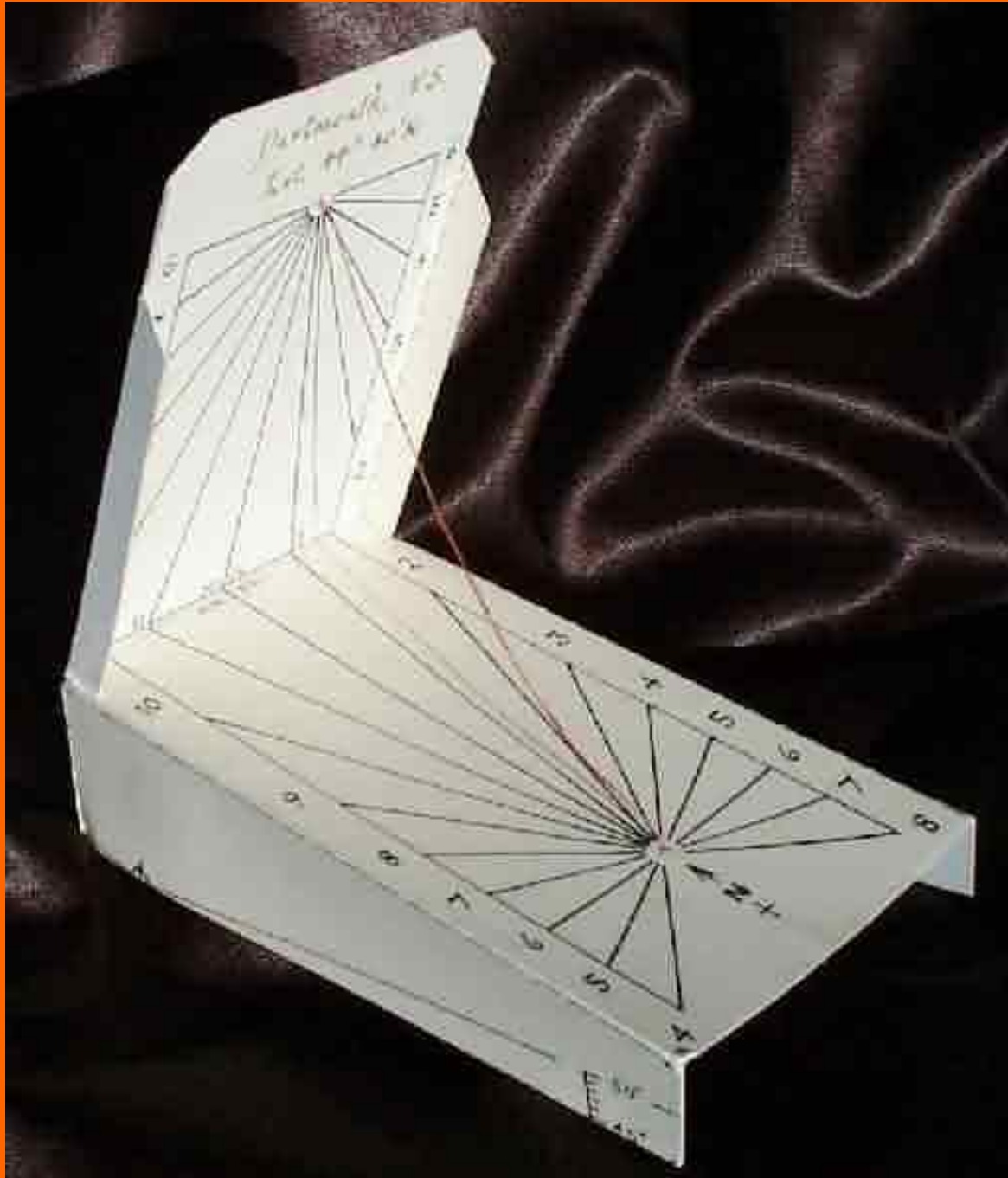

DIRECTIONS FOR DIPTYCH DIAL ASSEMBLY

The folding sundial you are about to make is called a diptych dial. Such dials have been made for four or five centuries and were traditionally made of ivory or boxwood. The diptych dial provided here was designed by Dr. Allan Mills, Astronomy Group, Leicester University, UK . The scanned images and text have been prepared by Dr. Randall Brooks, National Museum of Science and Technology, Ottawa, Canada

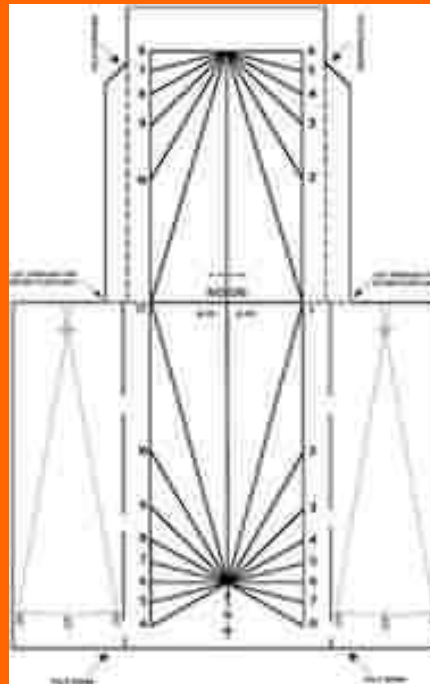

Step 1: Print the template dial (provided as JPEG graphics to download) on a piece of A4 or letter sized paper. The downloaded files may be resized if desirable. Paste the paper dial onto a piece of bristol board or heavy card making sure that glue is spread evenly over the entire surface. To download the full size template (55kb) [click here](#)

Step 2: Trim along the outside lines on the template diagram.

Step 3: To provide accurate time, the sundial must be orientated properly. The first step is to determine the latitude of the site using an atlas. On the right and left of the lower half of the dial (the base), you will see two scales marked 35° - 55° . Once you have determined the required latitude, mark the latitude angle off on both scales drawing lines through each of the X symbols at the top. Cut the flaps off along these lines.

At the top you may want to write the location and latitude and/or perhaps your name, i.e. "Sam Smith, Fecit" (Fecit is Latin for "maker" and often appears on early instruments).

NB: If your site is outside the 35° - 55° latitude range, you can move the position of the "X" until you get the required tilt to the dial's base.

Step 4: Note the dashed lines; two of these are marked "score on back, fold forward" and two marked "score on front, fold down". Folds must be made along these lines and if you score these lines lightly with a sharp craft knife, the folds will be sharper and the sundial will stand better and look more finished. However, in making these scores, do not cut all the way through the card backing! After scoring, make the necessary folds in the direction indicated.

Step 5: Along the line with "Noon" above and "a.m. p.m." below, make another score line on the back and fold the upper section forward so that the two panels make a right angle.

Step 6: To finish the dial attach a string (preferably elastic string) through holes at the top and bottom at the points where all the hour lines converge. The easiest way to accomplish this is to use a thick needle and thread the string through tying knots on each end so that the string is taught when the dial is folded and ready for use. This string is the gnomon (pronounced no-mon) and casts the shadow to indicate the time.

Step 7: You may wish to embellish the back of your dial with an old-style graphic from a book on sundials, a drawing of your pet or whatever appeals to you. This is where you can individualize your diptych dial!

Positioning your sundial:

The sundial must be orientated with the gnomon pointing north/south and, of course, the dial must be located where a shadow will be cast by the gnomon most of the day (though one can move the dial from window to window as the day progresses if necessary).

Method 1: (The Purist's Method) To determine the orientation without reference to other mechanical devices, North can be found by observing Polaris, the North Star, at night. In orientating the sundial, the gnomon is actually being pointed to the North Celestial Pole which is within 1° of the North Star. Thus, if you can find Polaris at the end of the Little Dipper, line up your dial by pointing the gnomon towards Polaris. You might want to record the orientation for your dial by making light pencil marks on a window sill for future reference. Those in southern latitudes will not be able to use this method as there is no bright star near the South Celestial Pole.

Method 2: (The Practical Method) A magnetic compass may be used to determine the north/south line, but, because of the difference between magnetic north and true north, the dial reading could be out by an hour or more depending on the local difference between magnetic and true north (or south if in southern latitudes).

Method 3: (The Lazy Person's Method) To a first approximation, the orientation can be found by finding the orientation at any time from a clock or watch and orientating the dial so the shadow shows the correct time. However, if left in this position, there could be an error of up to 30 minutes over the year as a result of what is known as the "equation of time". Because of the Earth's orbital motion around the Sun, the solar day (apx. 24 hours) is not exactly the same length from day to day varying by up to ± 16 minutes a day. However, if the orientation is carried out on April 15, June 10, Sept. 1 or Dec. 20, this error will be negligible and any orientation made between April 15 and 1 Sept. will be in error by, at most, a few minutes (but don't forget the effect of daylight savings time).

Happy dialling!

Project 5 - The equiangular dial

For a full size version of this image, click on the image

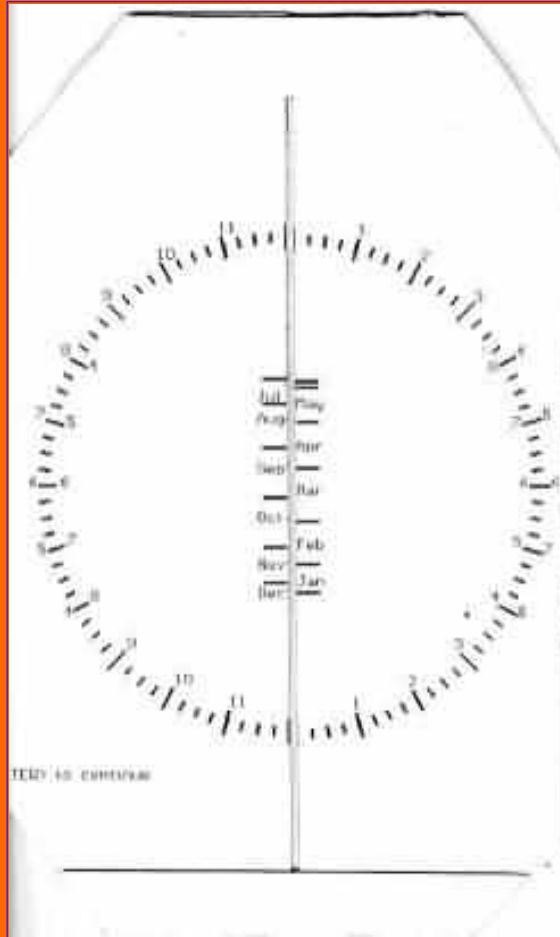

This dial is of a rather unusual and not very well-known type. It was invented by **Samuel Foster** in the seventeenth century and has been forgotten and re-discovered more than once since then. The version described below is based on a description by **F.W. Sawyer** of the [North American Sundial Society](#).

Unlike a common vertical or horizontal dial with a fixed gnomon, this one has its hour lines equafly spaced on the circumference of a circle, and no calculations involving latitude are required. The positioning of the dial does not depend on a prior knowledge of the North- South meridian and it can be used as a sun compass.

DIRECTIONS FOR EQUIANGULAR DIAL ASSEMBLY

Step 1. Take the page of patterns and paste it to a piece of card at least 1.3 mm thick. Suitable material can be obtained from a good stationer or artists' supplier.

Step 2. Using a sharp knife or scalpel, cut out the two rectangular pieces with the hour scales: also the gnomon, taking particular care with the shadow-casting edges, a and b. The angle C is 51.50, the latitude of London. If the dial is to be used at a different latitude, the angle should be altered accordingly, but sides a and b must always be at right angles to each other.. (Do you need help in [finding your latitude](#)?)

Step 3. Join the two rectangular pieces, using pasted strips of card applied along the dotted lines. A gap should be left, just sufficient to admit the gnomon.

Step 4. The slotted squares help to maintain the gnomon vertical and the hour-plate at right angles to it.

HOW TO USE THE EQUIANGULAR DIAL

Slide the hour-plate to a position where the V of the gnomon coincides with the appropriate date on the month scale. With the base on a horizontal surface, rotate the assembly until the indicated times are the same for each shadow. The upper shadow is to be read on the clockwise scale, the lower on the anti-clockwise one. The indicated time is then the correct Solar Time, and the gnomon is in the North-South plane. The dial functions best at times one or two hours before or after midday. Around noon precise settings are rather difficult.

For a full size print of this image, click on the image.

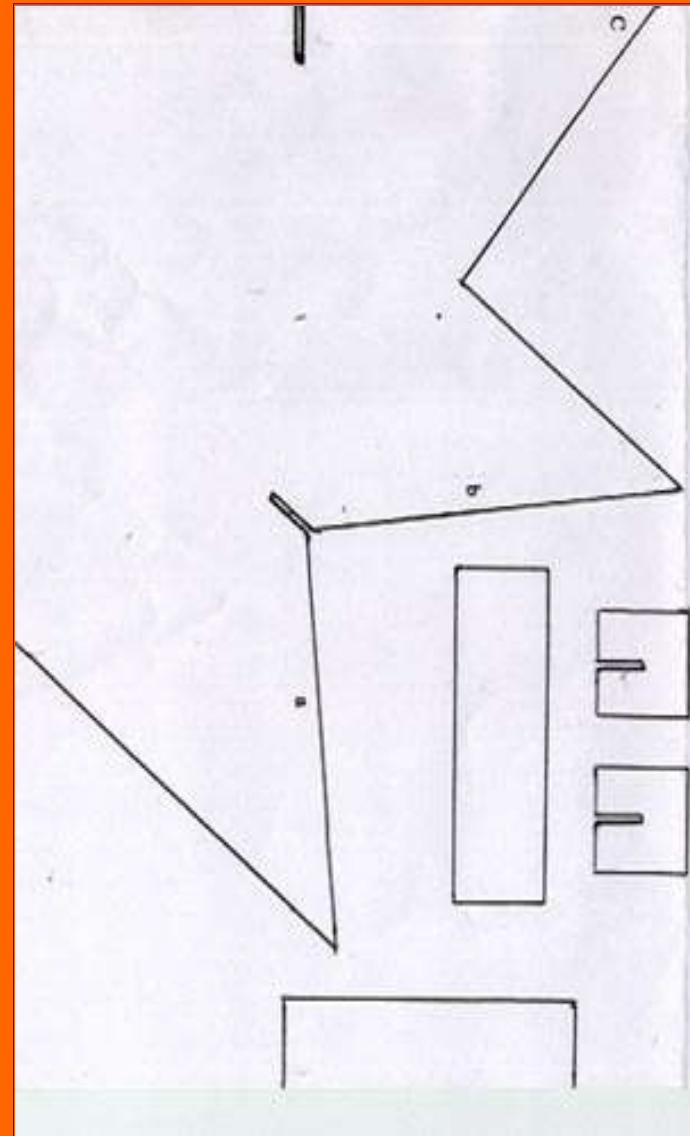

For a full overview of Sundials on the Internet [click here](#)
This site designed and maintained by [Internetworks](#) Ltd of [Epsom](#), England
last revision

Comments/ suggestions/ problems, please get in touch with the [Webmaster](#)

Basic Trigonometry

The formula for calculating the hourlines on a horizontal sundial is:

$$\tan X = (\tan h)(\sin \text{lat})$$

Where:

X = the result, the angle the hour line makes with the 12 o'clock line.

h = the time (hour angle) measured from noon in degrees. The earth rotates 360 degrees in 24 hours, or 15 degrees in 1 hour

lat = the latitude of the dial.

Here is the framework for a BASIC program for computing the angles for the hourlines from 6 AM to 6 PM on a horizontal dial located at 35°. The program will not work as-is because most BASICs require angles to be computed in radians.

Use the format to build your own programs; or for a calculator or spreadsheet.

```

1 CLS
2 lat = 35
3 FOR h = -90 to 90 STEP 15
4 X = ATN((TAN(h)*SIN(lat)))
5 PRINT X
6 NEXT
7 END

```

You can apply the longitude correction (time zone offset) by changing line 3. For instance, if your longitude is 4.56 degrees **east** of your central meridian, you would **add** 4.56 to the value for h, and line 3 would be:

```

3 FOR h = -90 + 4.56 to 90 + 4.56 STEP 15

```

But let's do the arithmetic, and while we're at it, let's change the STEP value to produce half-hours.

```

3 FOR h = -85.44 to 94.56 STEP 7.5

```

SOS-5**Sunrise, Sunset, & Twilight****May 2002**[APR](#) | [MAY](#) | [JUN](#)

Date	Begin Civil Twilight	Sunrise	Sunset	End Civil Twilight
1	05:42 a.m.	06:10 a.m.	08:01 p.m.	08:29 p.m.
5	05:37 a.m.	06:06 a.m.	08:04 p.m.	08:34 p.m.
10	05:31 a.m.	06:00 a.m.	08:09 p.m.	08:39 p.m.
15	05:26 a.m.	05:56 a.m.	08:14 p.m.	08:44 p.m.
20	05:21 a.m.	05:52 a.m.	08:18 p.m.	08:49 p.m.
25	05:17 a.m.	05:48 a.m.	08:22 p.m.	08:53 p.m.
30	05:14 a.m.	05:46 a.m.	08:26 p.m.	08:57 p.m.

Note: All times are EDT for Washington, D.C.

(This page should display for 30 seconds before advancing automatically to the next page. If the slideshow stops, then click on your Web browser's "Reload" or "Refresh" button to resume the presentation.)

Griffith Observatory presents the Star Awards



The **Griffith Observatory Star Awards** were established to recognize excellence in web sites that promote public awareness of astronomy. These are the best astronomy sites on the World Wide Web, and they present useful, thorough, and accurate information in a well-organized and attractive way, making the sky more accessible.

The exclusive Star Award is presented once each week to a deserving site.

- Feb. 29 - Mar. 6 [Tranquility Base Today](#)
The Apollo 11 landing site as it exists today.
- Feb. 22 - 28 [Solar System Collisions](#)
Simulate the collision of an asteroid or a comet with any planet in Solar System
- Feb. 15 - 21 [Kuiper Belt](#)
About "trans-Neptunian" objects - the source of comets.
- Feb. 8 - 14 [Lunar Picture of the Day](#)
An engaging photo of the moon each day.
- Feb. 1 - 7 [Space Science Education Resource Directory](#)
NASA space science products for use in classrooms, science museums, etc.
- Jan. 25 - 31 [The Soviet Exploration of Venus](#)
Details of 30 Soviet Venus missions, 1961- 1984.
- Jan. 18 - 24 [Venus Transit 2004](#)
Resources to understand, enjoy, and participate in the transit.
- Jan. 11 - 17 [Curious About Astronomy? Ask an Astronomer](#)
Astronomy questions answered by Cornell astronomers.
- Jan. 4 - 10 [Explore Mars Now](#)
Walk through and explore an interactive Mars habitat.

Dec. 28 - Jan. 3, 2004 [Exploratorium's Journey to Mars](#)
Images, webcasts, and information from the Mars landers.

2004 above
2003 below

- Dec. 21 - 27 [Map of the Universe](#)
Display of range of astronomical scales from the Earth's neighborhood to the cosmic microwave background.
- Dec. 14 - 20 [Mt. Wilson Observatory](#)
History and current research at historic Mt. Wilson.
- Dec. 7 - 13 [Paul Carlisle's Earth Viewer and Moon Calendar](#)
Earth illumination for any day + moon phases for any month.
- Nov. 30 - Dec. 6 [Sky Router](#)
Portal to astronomy links with news and sky events.
- Nov. 23 - 29 [Myths and Tales Associated with the Constellations](#)
Sky maps, constellation mythology, space news.
- Nov. 16 - 22 [Deep Sky Database](#)
Online observing list generator for deep sky objects.
- Nov. 9 - 15 [Starizona Guide to CCD Imaging](#)
Guidance on taking and processing CCD images.
- Nov. 2 - 8 [Geological Lunar Research Group](#)
Resources for observers interested in geology of the moon.
- Oct. 26 - Nov. 1 [Astronomy Programs](#)
Links to about 200 freeware, shareware, and commercial astronomy programs.
- Oct. 19 - 25 [View of Our Universe](#)
A view of our universe as it is at this minute.
- Oct. 12 - 18 [Astrotips](#)
"All and only about astronomy software."
- Oct. 5 - 11 [Stanford Solar Center](#)
A collection of fun educational activities based on the sun.
- Sept. 28 - Oct. 4 [Digital Lunar Orbiter Photographic Atlas of the Moon](#)
The definitive searchable on-line moon atlas.
- Sept. 21 - 27 [Astrogeology Research Program](#)
News, images, missions, technology, and research on the solar system.

- Sept. 14 - 20 [David Ratledge's Virtual Home](#)
Deep sky, CCD imaging, telescope making.
- Sept. 7 - 13 [Me and My Shadow - Making the Sun-Earth Connection](#)
Sun-related resources and activities demonstrate sundials, sun calculators, and the analemma.
- Aug. 31 - Sept. 6 [AstroViewer](#)
Online planisphere for any time and place on Earth.
- Aug. 24 - 30 [Al Kelly's CCD Astrophotography Page](#)
Instructions on taking CCD images.
- Aug. 17 - 23 [Cyprus Astronomical Society](#)
Sky events, meteor showers, asteroids, astrophotography.
- Aug. 10 - 16 [Open Directory Project for Astronomy](#)
3,000 astronomy links by category.
- Aug. 3 - 9 [Transit of Venus, June 8 2004](#)
All about the next transit of Venus across the sun.
- July 27 - Aug 2 [MarsQuest Online](#)
Tour Mars by airplane and rover.
- July 20 - 26 [Glossary and Lexicon of Astronomical Terms](#)
Astronomical dictionary; part of a Caltech knowledgebase.
- July 13 - 19 [Einstein Archives Online](#)
900 documents and 3,000 photographs of Albert Einstein.
- July 6 - 12 [Space Biology: An Educator's Resource](#)
Online resource for educators and their students.
- June 29 - July 5 [Light From Space](#)
Spectacular space images with detailed interpretations.
- June 22 - 28 [StarrySkies.com](#)
Excellent general astro resource for teachers and students.
- June 15 - 21 [California and Carnegie Planet Search](#)
Planets beyond our solar system.
- June 8 - 14 [Light From Space](#)
Breathtaking views of space with detailed captions.
- June 1 - 7 [The Electric Sky](#)
Articles from minor craters on the moon to galaxies.

- May 25 - 31 [The Two Micron All Sky Survey at IPAC](#)
Gallery of images from the Two Micron sky survey.
- May 18 - 24 [Arkansas Sky Observatory](#)
Many hints, guides, and tools for telescopes and observing.
- May 11 - 17 [Great Debates in Astronomy](#)
Resources on astronomy's four great debates.
- May 4 - 10 [Astronomy.com](#)
Astronomy and science news, stories, pictures.
- April 27 - May 3 [Your Sky](#)
Create detailed sky maps for any place, date, and time.
- April 20 - 26 [Catastrophism](#)
Meteorite & comet impacts and the consequences.
- April 13 - 19 [Meteorite Studies](#)
Systematic classification of meteorites through photographs.
- April 6 - 12 [Analemma](#)
Explanation of the analemma and the earth's path around the sun.
- March 30 - April 5 [Earth & Sky](#)
On-line radio program features tonight's sky.
- March 23 - 29 [Citizens for Responsible Lighting \(CRL\)](#)
Non-profit organization helps preserve the quality of the night sky.
- Mar. 16 - 22 [Jodrell Bank Observatory](#)
Observatory tour and history plus night sky hints and astronomical almanac.
- Mar. 9 - 15 [Apollo Lunar Surface Journal](#)
Transcripts and photos of the Apollo missions.
- Mar. 2 - 8 [Hermit Eclipse](#)
Upcoming lunar and solar eclipses.
- Feb. 23 - Mar. 1 [Worcester Park Observatory Amateur Spectroscopy - UK](#)
Home of practical amateur spectroscopy.
- Feb. 16 - 22 [Keeping an Eye on Space Rocks](#)
Asteroid animations from Jet Propulsion Laboratory.
- Feb. 9 - 15 [Handbook Of Space Astronomy and Astrophysics](#)
Contents of reference handbook on-line with links.

- Feb. 2 - 8 [Isaac Newton Group of Telescopes](#)
The Observatory and its research and publications.
- Jan. 26 - Feb. 1 [Northern Lights](#)
Aurora science, photography, and auroral activity from Norway.
- Jan. 19 - 25 [Buying a Star FAQ](#)
The truth about buying or naming a star [no longer exists].
- Jan. 12 - 18 [Quarks to Quasars](#)
A "Powers of 10" style visualization of scale.
- Jan. 5 - 11 [New Views of the Universe](#)
Online companion to Hubble Space Telescope traveling exhibit.

2003 (above)

- Dec. 29 - Jan. 4, 2003 [The Astronomical League](#)
The world's largest federation of amateur astronomers.
- Dec. 22 - 28 [American Meteor Society](#)
Amateur and professional meteor observing and research.
- Dec. 15 - 21 [WebExhibits](#)
Hundreds of interesting exhibits on the web.
- Dec. 8 - 14 [The Dome of the Sky](#)
Astronomy news, sky views, data, and more.
- Dec. 1 - 7 [Astromart](#)
Astronomy equipment classifieds, vendors, and links.
- Nov. 24 - 30 [GeoAstro Applet Collection](#)
Java Applets for detailed solar and lunar data.
- Nov. 17 - 23 [Sky & Telescope's Interactive Sky Chart](#)
Sky chart from any location, date, and time from 1600 to 2400 AD.
- Nov. 10 - 16 [Cambridge Cosmology](#)
Cosmology, Big Bang, cosmic strings, dark matter, etc.
- Nov. 3 - 9 [Light and Matter Astronomy Area](#)
Planet Finder, BinoSky, Variable Star Calendar, and links.
- Oct. 27 - Nov. 2 [Atlas of the Universe](#)
Series of maps give feeling for size of universe.
- Oct. 20 - 26 [Guide to CCD Imaging](#)
Online source for information about CCD imaging and processing techniques.

- Oct. 13 - 19 [Let's Talk Stars](#)
Weekly astronomy talk radio program hosted by David H. Levy.
- Oct. 6 - 12 [The Clear Sky Clock Home page](#)
Two-day weather predictions for amateur astronomers.
- Sept. 29 - Oct. 5 [The Telescope Review Web Site](#)
Detailed reviews of over 100 telescopes and accessories.
- Sept. 22 - 28 [astronomylinks.com](#)
Astronomy and space related links from around the world.
- Sept 15 - 21 [Weird Telescopes](#)
A variety of solutions by individuals in search of the perfect image.
- Sept. 8 - 14 [AstronomyDaily.com](#)
Observing information customized for your viewing location.
- Sept. 1 - 7 [The Salopian Web](#)
Astronomy resources with current events, star maps, planet visibility, etc.
- Aug. 25 - 31 [Planet Quest](#)
The search for another earth (Jet Propulsion Laboratory).
- Aug. 18 - 24 [Imagine the Universe](#)
Black holes, dark matter, and quasars, from High Energy Astrophysics Science Archive Research Center.
- Aug. 11 - 17 [NASA Astrophysics Data System Browse Service](#)
Archive of many new and historical astronomical journals.
- Aug. 4 - 10 [Planet Mars in Popular Culture](#)
How Mars has inspired the human imagination.
- July 28 - Aug. 3 [SETI@home](#) [Search for ExtraTerrestrial Intelligence]
Use YOUR computer in Search for ExtraTerrestrial Intelligence.
- July 21 -27 [Earthrise](#)
Searchable collection of 116,100 earth images from NASA flights.
- July 14 - 20 [Constellations: Stories and a Deepsky Atlas](#)
Sky atlas with photographs and mythology by Hawaiian Astronomical Society.
- July 7 - 13 [DarkSky - A Web Tool for Stargazing](#)
Find the most suitable sites for enjoying the nighttime sky.
- June 30 - July 6 [Sky View Cafe](#)
Program displays sky map, generates tables, shows eclipses, and much more.

- June 23 - 29 [Nick Stroble's Astronomy Notes](#)
Illustrated notes for introductory astronomy course.
- June 16 - 22 [IPAC Education and Outreach](#)
Infrared Processing & Analysis Center images, tutorials, & activities.
- June 9 - 15 [Great Debates in Astronomy](#)
Proceedings of four great debates plus background material.
- June 2 - 8 [Local Times Around the World](#)
The current time anywhere.
- May 26 - June 1 [Multiwavelength Astronomy](#)
Overview of astronomy at all wavelengths.
- May 19 - 25 [NASA Planetary Data System MAP-A-PLANET](#)
Detailed maps of several planets and moons (including our moon).
- May 12 - 18 [The World's Largest Optical Telescopes](#)
Links to all the world's largest telescopes.
- May 5 - 11 [The Blue Marble](#)
The most detailed (1 km) true-color image of the Earth ever created.
- April 28 - May 4 [Mars Explorer for the Armchair Astronaut](#)
Mars maps of any area at a variety of zoom factors, image sizes, and projections.
- April 21 - 27 [The Constellations](#)
Data and maps of the constellations and their stars.
- April 14 - 20 [Missions Currently Planned](#)
Links to sites of future (and some recent) space missions.
- April 7 - 13 [Elizabeth Roettger's Homepage](#)
Hands-on astronomy activities and Astronomy Education Notebook
- March 31 - April 6 [Astrodigital Explore Mars](#)
Articles and data tables about the planet Mars.
- March 24 - 30 [Atmospheric Optics](#)
Learn about and simulate rainbows, halos, glories, coronas and more.
- March 17 - 23 [AstroVenture](#)
Kids search for and design a habitable planet.
- March 10 - 16 [From Stargazers to Starships](#)
High-school level book-on-the-web emphasizes gravity and spaceflight.

- March 3 - 9 [ABC Space Science](#)
Space-related news.
- Feb. 24 - March 2 [Mars Society](#)
"New Mars" magazine and news about Mars.
- Feb. 17 - 23 [SpaceDaily](#)
The latest news in space exploration and technology.
- Feb. 10 - 16 [Exploring Mars](#)
CNN's Mars site includes news, 3D models, and background info.
- Feb. 3 - 9 [Regional Planetary Image Facility](#)
Reference library of over 300,000 images of planets and their satellites.
- Jan. 27 - Feb. 2 [Inconstant Moon](#)
Explore the moon with maps, photos, explanations, animations and more.
- Jan. 20 -26 [SCT Site for Beginners](#)
For users of Schmidt-Cassegrain Telescopes and scopes in general.
- Jan. 13 - 19 [The Belmont Society](#)
Dedicated to the beginning amateur astronomer.
- Jan. 6 - 12 [Educational Resources in Astronomy and Planetary Sciences](#)
Projects and activities for school use.

2002 (above)

- Dec. 30 - Jan. 5, 2002 [Mars Exploration](#)
NASA's Jet Propulsion Laboratory site for Mars exploration.
- Dec. 23 - 29 [Ken's Eyepiece Corner](#)
"One-stop shopping" for questions about telescope eyepieces.
- Dec. 16 - 22 [StarDate Online](#)
Radio programs and a bimonthly astronomy magazine.
- Dec. 9 - 15 [Center for Backyard Astrophysics](#)
Global network of small telescopes studying cataclysmic variable stars.
- Dec. 2 - 8 [QuickCam and Unconventional Imaging Astronomy Group](#)
Astronomical images with unconventional electronic imaging devices.
- Nov. 25 - Dec. 1 [Terrestrial Impact Craters and Their Environmental Effects](#)
The environmental and biological consequences of cratering.
- Nov. 18 - 24 [Exploratorium Observatory](#)
Astronomy exhibits, facts, and resources.

- Nov. 11 - 17 [Imagine the Universe](#)
Mysteries of the universe for ages 14 and above.
- Nov. 4 - 10 [Earthview](#)
Information about the history, science, and observation of eclipses.
- Oct. 28 - Nov. 3 [Light Pollution Awareness Website \(LiPAW\)](#)
Reference site for the problem that affects all astronomers.
- Oct. 21 - 27 [Paper Plate Education](#)
Hands-on science activities using paper plates.
- Oct. 14 - 20 [Astronomy in Japan](#)
Science, history, and culture (in English).
- Oct. 7 - 13 [Astronomy Outreach Network](#)
Astronomy resources and personalities.
- Sept. 30 - Oct. 6 [Cometography.com](#)
News of current comets and details of comets of the past.
- Sept. 23 - 29 [Great Images in NASA](#)
Over a thousand high-resolution NASA images of significant historical interest.
- Sept. 16 - 22 [The Night Sky in the World](#)
Satellite monitoring of the artificial night sky brightness.
- Sept. 9 - 15 [European Southern Observatory](#)
News and press releases from the observatories in Chile.
- Sept. 2 - 8 [Spaceflight NOW](#)
News of spacecraft and space missions.
- Aug. 26 - Sept. 1 [Ned Wright's Cosmology Tutorial](#)
UCLA cosmology class plus latest cosmology news.
- Aug. 19 - 25 [Sloan Digital Sky Survey](#)
The most comprehensive and fully digital map of the sky.
- Aug. 12 - 18 [NASA's Solar System Exploration](#)
NASA's site for solar system news and missions.
- Aug. 5 - 11 [Epact](#)
Photographs and descriptions of 520 ancient scientific instruments.
- July 29 - Aug. 4 [ICQ International Comet Quarterly](#)
World's primary web site for information on observing comets.

- July 22 - 28 [Kepler Mission](#)
Proposed mission to detect earth-sized planets around other stars.
- July 15 - 21 [Sundials on the Internet](#)
Information about all aspects of sundials.
- July 8 - 14 [History of Apollo Lunar Exploration](#)
Text of the book "Where No Man Has Gone Before" by William Compton.
- July 1 - 7 [Astronomy Workshop](#)
Astronomy programs, simulators, and viewers for amateurs and students.
- June 24 - 30 [Exploring Planets in the Classroom](#)
More than 25 detailed astronomy classroom-ready activities.
- June 17 - 23 [Messier45.com](#)
On-line resource and list-generator for deep-sky observers.
- June 10 - 16 [Auroras](#) - paintings in the sky
How auroras are created and what they look like.
- June 3 - 9 [Yohkoh Public Outreach Project](#)
Images of the sun as seen by an X-ray satellite telescope, and activities.
- May 27 - June 2 [Center for Orbital and Reentry Debris Studies](#)
All about space debris, collision avoidance, and reentry breakup.
- May 20 - 26 [Arty the Part-time Astronaut](#)
A children's interactive adventure through the solar system.
- May 13 - 19 [Canadians in Space](#)
Lesson plans and assessment tools for teachers on the topic of humans in space.
- May 6 - 12 [Astronet](#)
Information and news about astronomy, spaceflight, and earth science.
- April 29 - May 5 [2001 Mars Odyssey](#)
Info on the spacecraft headed to Mars and background on the red planet.
- April 22 - 28 [Auroras 2000.com](#)
Your guide to the northern and southern lights with forecasts.
- April 15 - 21 [Amazing Space](#)
A set of web-based activities primarily designed for classroom use.
- April 8 - 14 [Solar Max](#)
Your guide to the year of the active sun.

- April 1 - 7 [Zoom Astronomy](#)
Comprehensive introduction to astronomy for people of all ages.
- March 25 - 31 [High Altitude Observatory Education Pages](#)
Solar and solar-terrestrial physics education for teachers and students.
- March 18 - 24 [Malin Space Science Systems](#)
Library of 57,000+ images from Mars Global Surveyor.
- March 11 - 17 [Que Tal](#)
An earth-in-space monthly astronomy newsletter.
- March 4 - 10 [Mars Millennium Project](#)
Challenges students to design a community for the planet Mars.
- Feb. 25 - Mar. 3 [Palomar Observatory Public Site](#)
Information about the history and programs of the Palomar Observatory.
- Feb. 18 - 24 [NASA Kids](#)
News, projects, games, and a teacher's corner.
- Feb. 11 - 17 [Space & Astronomy for Kids](#)
News, chat, questions, features, etc. for older kids
- Feb. 4 - 10 [Astronomynow](#)
Web site for Britain's leading astronomy magazine.
- Jan. 28 - Feb. 3 What's Out Tonight
[No longer available]
- Jan. 21 - 27 [NASA](#)
NASA's home page.
- Jan. 14 - 20 [Treasure Troves of Astronomy](#)
Astronomy resource for students and educators.
- Jan. 7 - 13 [Cosmic Voyage](#)
On-line resource for amateur astronomers.

2001 (above)

- Dec. 31 - Jan. 6, 2001 [Spaceguard UK](#)
UK site for studies of threats by collisions with asteroids and comets.
- Dec. 24 - 30 [Dark-Sky Observing Site Directory](#)
A national dark-sky observing site directory.
- Dec. 17 - 23 [Data Base of Terrestrial Impact Structures](#)
Detailed catalog of meteorite craters around the earth.

- Dec. 10 - 16 [The Deep Sky Database](#)
On-line resource for building customized observing lists from over 10,000 deep sky objects.
- Dec. 3 - 9 [Spaceref.com](#)
Your space reference to current news, missions, & various topics regarding space science.
- Nov. 26 - Dec. 2 [Building a Dobsonian Telescope](#)
Plans for building your own small or large Dobsonian telescope.
- Nov. 19 - 25 [NASA's Space Science Education Resource Directory](#)
Directory of NASA space science products for use in classrooms, science museums, planetariums, etc.
- Nov. 12 - 18 [Dave's Astronomy Magazine](#)
Solar observation, comet info, star charts, and more.
- Nov. 5 - 11 [Catching the Light Astrophotography](#)
Deep-sky astronomical photography, tips & techniques etc.
- Oct. 29 - Nov. 4 [The NASA Astrophysics Data System](#)
Search and read thousands of abstracts and articles from major astronomy journals.
- Oct. 22 - 28 [Calendar Studies](#)
Calendars - their histories and conversions.
- Oct. 15 - 21 [The SETI League, Inc.](#)
Grassroots organization Searching for Extra-Terrestrial Intelligence with radio telescopes
- Oct. 8 - 14 [Moonsighting with Astronomy](#)
Where the earliest new moon sighting is possible, plus Gregorian-Islamic calendar conversion.
- Oct. 1 - 7 [Shuttle Countdown Information Center](#)
Space Shuttle launches, countdown and status.
- Sept. 24 - 30 [Eric's Corner of the Universe](#)
In-depth practical information for the amateur astronomer.
- Sept. 17 - 23 [SpaceScience.com](#)
Daily news about science at NASA to "Inform, Inspire, and Involve."
- Sept. 10 - 16 [Science Behind the Extraterrestrial Phenomenon](#)
Science behind SETI, attempts at contacting ETs, and life on other worlds.
- Sept. 3 - 9 [Liftoff to Space Exploration](#)
NASA updates, satellite visibility, tutorials, and more.
- Aug. 27 - Sept. 2 [KidsAstronomy.com](#)
Dynamic children's website with free astronomy class.

- Aug. 20 - 26 [Astroweb](#)
Collection of pointers to astronomically relevant Internet resources maintained by the AstroWeb Consortium.
- Aug. 13 - 19 [Exoscience Astronomy News](#)
Science and Technology News.
- Aug. 6 - 12 [North American Skies](#)
Astronomy information, articles and sky events for North America.
- July 30 - Aug. 5 [Skeptic's Dictionary](#)
Authoritative information on UFOs, the "moon effect," and more.
- July 23 - 29 [Multiwavelength Messier Museum](#)
Views of well-known objects in many wavelengths, with a tutorial.
- July 16 - 22 [NASA Watch](#)
News of NASA and its activities (unauthorized).
- July 9 - 15 [SpaceWeather.com](#)
Science news and information about the sun-earth environment.
- July 2 - 8 [The Hipparcos Space Astrometry Mission](#)
Online access to the Hipparcos and Tycho Catalogues plus up-to-date preprint and journal papers.
- June 25 - July 1 [Radio-Sky Publishing](#)
Resources to help you begin your investigations of the radio universe.
- June 18 - 24 [From Stargazers to Starships](#)
High-school level astronomy "book-on-the-web" tutorial.
- June 11 - 17 [Chandra X-ray Observatory Center](#)
Breaking news and images from the Chandra X-ray satellite.
- June 4 - 10 [Dale Ireland's Astronomy Page](#)
Photographs, diagrams, charts, fabrications ...
- May 28 - June 3 [High Moon](#)
Klipsi's highly personalized site for eclipses and other astronomical events.
- May 21 - 27 [CelesTrak](#)
Full service satellite tracking site.
- May 14 - 20 [Astronomical Images by David Malin](#)
200 astrophotos by David Malin at the Anglo-Australian Observatory.
- May 7 - 13 [Astrobiology Web](#)
Latest field research, articles, and links on life elsewhere.

- April 30 - May 6 [Evening Sky Map](#)
A ready-to-use all-sky map for both northern and southern hemispheres.
- April 23 - 29 [Stig's Sky Calendar](#)
Customizable sky observing information for your location.
- April 16 - 22 [Mars Mission Project](#)
Simulation of the colonization of the Red Planet for students.
- April 9 - 15 [Celestial Observer](#)
"The most complete astronomical observation and information on-line calculator on this globe"
- April 2 - 8 [P.E.R.M.A.N.E.N.T.](#)
"Projects to Employ Resources of the Moon and Asteroids Near Earth in the Near Term"
- March 26 - April 1 [The Antique Telescope Society](#)
Interested in antique telescopes, binoculars, books and related items?
- March 19 - 25 [Thursday's Classroom](#)
Connection between NASA's latest research and the classroom.
- March 12 - 18 [Introduction to Green Flashes](#)
All about this interesting but misunderstood sunset phenomenon.
- March 5 - 11 [History of Astronomy](#)
Comprehensive resource for the history of astronomy.
- Feb. 27 - March 4 [Explorezone.com](#)
Lots of science news, including space and astronomy.
- Feb. 20 - 26 [Near Earth Asteroid Rendezvous Mission](#)
Follow the encounter with asteroid Eros.
- Feb. 13 - 19 [The High Altitude Satellite Observers Home Page](#)
Information for observers of high altitude satellites.
- Feb. 6 - 12 [Aurora's Northern Nights](#)
Images of the aurora and many links; also lists of unusual astronomical events.
- Jan. 30 - Feb. 5 [CASS Astronomy Tutorial](#)
Introductory astronomy course for liberal arts majors.
- Jan. 23 - 29 [Astrobiology](#)
A site devoted to the study of the origin, evolution, distribution, and destiny of life in the universe.
- Jan. 16 - 22 [Space.Com](#)
Ultimate site for space news, information, education, and entertainment.

Jan. 9 - 15 [Universe Today](#)
Space exploration news from around the Internet.

2000: Jan. 2 - 8 [Heavens Above](#)
Full information (times & charts) to observe satellites including International Space Station, and Hubble.

1997 (below)

1997: January 1 - 4 [Nine Planets](#)
A complete guide to the solar system

January 5 - 11 [Best of the Hubble Space Telescope](#)
Images and descriptions of the best HST images

January 12 - 18 [Cosmic Mirror](#)
Astronomy news from across the universe

January 19 - 25 [Views of the Solar System](#)
Selected images of the planets and their moons

January 26 - Feb. 1 [History of Astronomy](#)
Includes astronomers biographies and many historical links.

February 2 - 8 [Comet Observation Home Page](#)
The latest information on current comets

February 9 - 15 [Mike Boschat's Astronomy Page](#)
A huge alphabetical directory of astronomy sites.

February 16 - 22 [The Comet's Tale](#)
An activity that teaches the composition of comets.

Feb. 23 - March 1 [The Constellations](#)
Astronomy and mythology of all 88 constellations.

March 2 - 8 [Extrasolar Visions](#)
All about the planetary systems around other stars.

March 9 - 15 [NASA's Observatorium](#)
A huge site that takes you to images, games, tutorials, and more.

March 16 - 22 [Solar System Live](#)
An interactive orrery lets you view the solar system for any date or orientation.

March 23 - 29 [The Case for Mars](#)
Why we should return to Mars.

March 30 - April 5 [Astronomical Applications Department of the US Naval Observatory](#)
Calculate all sorts of things about astronomical objects with precision.

- April 6 - 12 [Eclipse Home Page](#)
All you could want to know about upcoming eclipses.
- April 13 - 19 [Astronomy Cafe](#)
"The Web Site for the Astronomically Challenged."
- April 20 - 26 [Astronomical Society of the Pacific](#)
Astronomy education and articles for the whole world.
- April 27 - May 3 [Welcome to the Planets](#)
The Jet Propulsion Laboratory's planets page.
- May 4 - 10 [Project Galileo](#)
Images, activities, latest news, and more about Jupiter.
- May 11 - 17 [The Basics of Space Flight](#)
A slick introduction into the basics of space flight.
- May 18 - 24 [Astronomy Picture of the Day](#)
Each day a different image or photograph of our fascinating universe is featured.
- May 25 - 31 [Space Day](#)
Space exploration resource includes space trivia and games and educational resources for teachers and students.
- June 1 - 7 [Space Telescope Science Institute](#)
All about the Hubble Space Telescope, its operation, and pictures.
- June 8 - 14 [The Search for Extraterrestrial Intelligence](#)
SETI Institute home page – Are we alone in the universe?
- June 15 - 21 [Calendar Zone](#)
Everything you want to know about calendars around the world.
- June 22 - 28 [Planetarium Software](#)
List of selected astronomy computer software with links.
- June 28 - July 5 [FAQ on Telescope Buying and Usage](#)
Good advice on selecting telescopes and related equipment.
- July 6 - 12 [Leonid Home Page](#)
All about November's annual shower.
- July 13 - 19 [Informal Science Education Resource](#)
Educational resources for the Hubble Space Telescope with photos and activities.
- July 20 - 26 [Extrasolar Planets Encyclopedia](#)
Detailed information about planets around other stars.

- July 27 - Aug. 2 [Careers in Astronomy](#)
Learn how to pursue the goal of becoming an astronomer.
- Aug. 3 - 9 [Windows to the Universe](#)
Exhaustive graphical astronomy tutorial and encyclopedia
- Aug. 10 - 16 [National Geographic's Star Journey](#)
Exciting site with lots to explore for all ages.
- Aug. 17 - 23 [Solar System 3D: Planets and Satellites](#)
Stereo atlas of the solar system (red-blue or red-green glasses required).
- Aug. 24 - 30 [Earth and Moon Viewer](#)
Various maps of the earth or moon with named features, lighting conditions, etc.
- Aug. 31 - Sept. 6 [SKY Online](#)
Sky & Telescope's home page: observing information, software, news, reviews, etc.
- Sept. 7 - 13 [Cosmos in a Computer](#)
Immense multimedia guide to the cosmos from National Center for Supercomputing Applications, University of Illinois.
- Sept. 14 - 20 [Mars Global Surveyor](#)
NASA's homepage for the Mars orbiter
- Sept. 21 - 27 [Cassini: Voyage to Saturn](#)
NASA's homepage for the Cassini mission to Saturn and its moons
- Sept. 28 - Oct. 4 [The Constellations and their Stars](#)
All about the constellations.
- Oct. 5 - 11 [The Mars Meteorite Home page](#)
All about SNC (also called "Snicks") Mars meteorites.
- Oct. 12- 18 [NASA Origins Program](#)
The Origins program– astrobiology, the search for extrasolar planets.
- Oct. 19 - 25 [NASA Spacelink](#)
The aeronautics and space resource for educators.
- Oct. 26 - Nov. 1 [The USGS Flagstaff Space Mission Support Page](#)
The home page for the USGS Astrogeology Branch; emphasizes planetary cartography.
- Nov. 2 - 8 [Black Holes and Neutron Stars](#)
The laypersons guide to black holes and neutron stars.
- Nov. 9 - 15 [National Space Science Data Center](#)
Astrophysics, space physics, solar physics, lunar and planetary data from NASA space flight missions

- Nov. 16 - 22 [Life in the Universe](#)
Web site to accompany Stephen Hawking's CD-ROM of the same name.
- Nov. 23 - 29 [Berit's Best Astronomy Sites for Children](#)
Selected astronomy web sites for children.
- Nov. 30 - Dec. 6 [Messier Catalog](#)
The popular Messier Catalog in information and pictures.
- Dec. 7 - 13 [Solar System Simulator](#)
Renders planets and satellites from any point in space looking in any direction.
- Dec. 14 - 20 [Comets and Meteor Showers](#)
Background on historic, present, and future comets and meteor showers.
- Dec. 21 - 27 [Mission to Mars](#)
Interactive educational site lets you design your own Mars mission.

1998 (below)

- Dec. 28 - Jan. 3 [Space Educators' Handbook](#)
An immense assortment of space-related educational resources including *Spinoff* magazine.
- 1998: Jan. 4 - 10 [National Solar Observatory / Sacramento Peak](#)
Information on many aspects of astronomy from the sun and planetary alignments to colliding galaxies and bad astronomy reporting.
- Jan. 11 - 17 [Universe at Your Desktop](#)
Hundreds of famous and obscure astronomy catalogs
- Jan. 18 - 24 [The Galileo Project](#)
Galileo, his discoveries, times, instruments, and contemporaries.
- Jan. 25 - 31 [Stanford Solar Center](#)
Providing Solar On-Line Activity Resources for the joy of solar science exploration.
- Feb. 1 - 7 [Other Worlds, Distant Suns](#)
Yet another cool extrasolar planets page. For full effect, it requires a VRML plug-in.
- Feb. 8- 14 [Maps of the Solar System](#)
Global image mosaics of large bodies in the solar system, most from spacecraft observations.
- Feb. 15 - 21 [Introduction to Cosmology](#)
Basic concepts of modern astronomy and the Microwave Anisotropy Probe
- Feb. 22 - 28 [Space Calendar](#)
Space-related activities and anniversaries for the coming year.
- Mar. 1 - 7 [The Space, Planetary, and Astronomical Cyber-Experience](#)
Enter "CyberSpace" and discover the wonders of the online universe.

- Mar. 8 - 14 [Lunar Prospector](#)
Information about the Lunar Prospector Mission as well as lunar history and mythology.
- Mar. 15 - 21 [Center for Mars Exploration](#)
Headquarters for the exploration of the Red Planet.
- Mar. 21 - 27 [Mount Wilson Observatory](#)
Take a virtual tour of America's historical observatory and create your own star charts.
- March 28 - Apr. 3 [Skyview Virtual Observatory](#)
Generate images of the sky in a variety of wavelengths with this virtual observatory.
- Apr. 4 - 10 [Sea and Sky](#)
Explore the sky through pictures, games, and links.
- Apr. 11 - 17 [revoked]
- Apr. 18 - 24 [Izzy's Skylog](#)
Backyard Astronomy for the beginner. Great horizon maps!
- Apr. 25 - May 1 [Visual Satellite Observers Home Page](#)
Spot Mir, HST and others crossing the night sky.
- May 2 - 8 [NASA's Planetary Photojournal](#)
Easy access to the publicly released images from the many solar system exploration programs.
- May 9 - 15 [Exploring the Moon](#)
Everything you wanted to know about the lunar exploration efforts of the U.S. and Soviet Union.
- May 16 - 22 [Windows to the Universe](#)
A fun and different Web site about the earth and space sciences.
- May 23 - 29 [NASA Human Spaceflight](#)
Shuttle and Space Station news and links.
- May 30 - June 5 [StarTimes OnLine](#)
Daily astronomy and space headlines with links; keep informed.
- June 6 - 13 [Telescopes In Education](#)
Operate a remotely controlled 24-inch telescope and CCD camera on Mt. Wilson.
- June 14 - 20 [Astronomical Imaging by Brad Wallis and Robert Provin](#)
Advanced amateur astrophotography page.
- June 21 - 27 [Skywatcher's Diary](#)
A day-to-day description of what to watch for in the sky this month.
- June 28 - July 4 [The Basics of Radio Astronomy](#)
The title says it all.

- July 5 - 11 [Eclipse Chaser](#)
Guide to recent and future solar eclipses with photos, maps, travel tips, observing hints, and more.
- July 12 - 18 [Mysteries of Deep Space](#)
Astronomy information and activities, by PBS Online
- July 19 - 25 [Volcanoes of Other Worlds](#)
Volcanoes around the solar system
- July 26 - Aug 1 [JPL Solar System Dynamics](#)
Provides detailed information related to all known bodies orbiting the sun.
- Aug. 2 - 8 [Eyes on the Sky Robotic Solar Observatory](#)
Robotic solar viewing telescope and BBS
- Aug. 9 - 15 [The Space Place](#)
JPL's new educational (primarily K-12) web site.
- Aug. 16 - 22 [Near-Earth Asteroid Tracking Home Page](#)
Keep up to date on "Near-Earth" asteroid discoveries.
- Aug. 23 - 29 [Astronomy Now Breaking News](#)
Daily astronomy news from Britain's *Astronomy Now* magazine.
- Aug. 30 - Sept. 5 [Spacezone](#)
A well-rounded page of space history, news, and education.
- Sept. 6 - 12 [Backyard Astronomy](#)
Tips on observing the universe from *Sky & Telescope* magazine.
- Sept. 13 - 19 [Infrared Astronomy](#)
All about infrared astronomy from NASA's IR center.
- Sept. 20 - 26 [Cyberhole Online Astronomy](#)
Complete astronomy site with links, news, software, etc.
- Sept. 27 - Oct. 3 [Mission and Spacecraft Library](#)
Comprehensive spacecraft, facts, pics and more.
- Oct. 4 - 10 [Today at NASA](#)
NASA news stories, press releases, and links.
- Oct. 11 - 17 [StarChild](#)
Learning center for young astronomers.
- Oct. 18 - 24 [Planetarium Web Sites](#)
Planetarium Websites around the world.

- Oct. 25 - 31 [The Hitchhikers Guide to the Moon](#)
Lunar observing at its best.
- Nov. 1- 7 [Sonoma State University Favorite Astronomy Links](#)
Links for everyone.
- Nov.8 - 14 [Cosmobrain Astronomy and Astrophysics](#)
Excellent list of selected astronomy web sites.
- Nov. 15 - 21 [Forum for Amateur AstroSpectroscopy](#)
For the amateur interested in learning about and doing astronomical spectroscopy.
- Nov. 22 - 28 [Big Bear Solar Observatory](#)
Amazing views of our nearest star.
- Nov. 29 - Dec. 5 [Space Team Online](#)
Join the men and women who work on NASA's Space Shuttle and the International Space Station.
- Dec. 6 - 12 [Structure and Evolution of the Universe](#)
Explain, explore, and examine our evolving universe.
- Dec. 13 - 19 [Munich Astro Archive](#)
Astronomy information and catalogs (in English).
- Dec. 20 - 26 [CERES Astronomy Education](#)
20 astronomy classroom lessons for K-12 teachers and students.

1999 (below)

- Dec. 27 - Jan. 2, 1999 [From Stargazers to Starships](#)
High-school level tutorial on astronomy, Newtonian mechanics, and spaceflight.
- Jan. 3 - 9 [Planetary Society](#)
Your connection to the exploration of the cosmos and the search for extraterrestrial life and intelligence.
- Jan. 10 - 16 SkyTour
[No longer available.]
- Jan. 17 - 23 [Itty Bitty Scienceguides](#)
Neat to know, cool science stuff!
- Jan. 24 - 30 [Ned Wright's Cosmology Tutorial](#)
Cosmology resources including news and a tutorial.
- Jan. 31 - Feb. 6 [Hubble Heritage Archive](#)
Selected HST images and descriptions.
- Feb. 7 - 13 [The Lunascan Project](#)
Moon maps and moon images galore.

- Feb. 14 - 20 [Deep Space 1](#)
Information on new technologies currently being "validated" on this mission for future space flights.
- Feb. 21 - 27 [The Electronic Universe Project](#)
A smorgasboard of astronomy images and good information to go with them.
- Feb. 28 - March 6 [International Supernovae Network](#)
Supernova hunting for the advanced amateur.
- March 7 - 13 [Astronomy Notes](#)
College-level astronomy textbook (a great reference).
- March 14 - 20 [Star of the Week](#)
A site dedicated to showing that the stars are not all the same.
- March 21 - 27 [The Arcturus Observatory](#)
CCD images courtesy of The Arcturus Observatory.
- March 28 - Apr. 3 [Peoria Astronomical Society](#)
Astronomical Handbook, three-D star map and more.
- April 4 - 10 [Students for the Exploration and Development of Space](#)
Comprehensive site with tons of useful astronomy information.
- April 11 - 17 [Aboriginal Star Knowledge](#)
Astronomical info developed principally by the Lakota Indians over many generations.
- April 18 - 24 [Encyclopedia Astronautica](#)
All about the many space programs through history.
- April 25 - May 1 [Space Connection](#)
News of space for teachers, parents, and students.
- May 2 - 8 [Astronomy for Kids](#)
Explore the sky through facts, puzzles, and maps.
- May 9 - 15 [Astronomical Image Library](#)
Comprehensive and ambitious image bank of deep-space objects.
- May 16 - 22 [Association of Universities for Research in Astronomy](#)
Interesting projects from the operators of major telescopes worldwide.
- May 23 - 29 [Tom's Astronomy Web](#)
Good links to lots of astronomy web sites.
- May 30 - June 5 [Feltz Field Guide to the Night Sky](#)
A detailed on-line "field guide" to the night sky.

- June 6 - 12 [Meteorite Central](#)
Meteorites, facts, chat and more.
- June 13 - 19 [Space Online](#)
Keep up to date with all the news from and about space.
- June 20 - 26 [Hubble Constant dot Com](#)
Information on the Hubble Constant, cosmology, and the size and age of the universe.
- June 27 - July 3 [Astronomy Now Breaking News](#)
Daily news from the UK's leading astronomy magazine.
- July 4 - 10 [Regulus](#)
The astronomy newsletter for amateurs of all levels.
- July 11 - 17 [Astronomy Homework Help](#)
User friendly resource page for high school and undergraduate college students.
- July 18 - 24 [The Solar and Heliospheric Observatory \(SOHO\)](#)
Views of the sun, SOHO real-time web watch.
- July 25 - 31 [Adventures in Deep Space](#)
Challenging observing projects for amateur astronomers.
- Aug. 1 - 7 [Aurora Web](#)
Aurora facts and resources, including forecasts.
- Aug. 8 - 14 [Near-Earth Object Program](#)
Information on asteroids that may strike the earth.
- Aug. 15 - 21 [NASA Space Science News](#)
Astronomy and space science news presented by the Marshall Space Flight Center.
- Aug. 22 - 28 [Space & Astronomy For Kids](#)
An astronomy guide for children, with many links.
- Aug. 29 - Sept. 4 [Bad Astronomy](#)
If it's bad and it's on TV or the in the movies, this explains how it really works.
- Sept. 5 - 11 [Your Sky](#)
View a map of the sky from any place on earth at any time.
- Sept. 12 - 18 [International Occultation Timing Association](#)
Master index and information site for lunar occultations and grazes.
- Sept. 19 - 25 [Kuiper Belt Page](#)
Clearinghouse for information on cometary bodies that orbit beyond Pluto.

- Sept. 26 - Oct. 2 [Association of Lunar and Planetary Observers](#)
Detailed information on observing solar system objects and phenomena from the sun to meteors.
- Oct. 3 - 9 [International Meteor Organization](#)
Promotes international coordination of amateur meteor observations.
- Oct. 10 - 16 [American Lunar Society](#)
Moon equipment, books, youth education, and observing projects.
- Oct. 17 - 23 [Amateur Astrophotography and CCD Image Links](#)
Very attractive, slick, and helpful page with a great raison d'etre.
- Oct. 24 - 30 [Planetary Nebulae Observer's Home Page](#)
A site devoted to the astronomical objects known as planetary nebulae.
- Oct. 31 - Nov. 6 [The Virtual Observatory - List Generator](#)
Generate custom object lists with this great resource!
- Nov. 7 - 13 [Central Bureau for Astronomical Telegrams \(CBAT\)](#)
Clearinghouse for announcements on new and transient astronomical events.
- Nov. 14 - 20 [Sunspots and the Solar Cycle](#)
Facts, daily pictures, history, tutorials, and predictions.
- Nov. 21 - 27 [MarsNews.com](#)
Stay informed with with the Mars Society with news about the Red Planet.
- Nov. 28 - Dec. 4 [The Astronomy Guide](#)
A search engine for everything in astronomy.
- Dec. 5 - 11 [The NGC/IC Project](#)
A comprehensive, and growing, database of the original NGC and IC deep space objects.
- Dec. 12 - 18 [Star Trails](#)
An initiative by the Goddard Space Flight Center to involve amateurs in scientific research.
- Dec. 19 - 25 [Solar Terrestrial Dispatch](#)
Space Weather, Solar & Geophysical Support Services.
- Dec. 26 - Jan. 1, 2000 [STSPLUS](#)
Excellent resource for past/current shuttle missions, satellite tracking, and related software.



Search Website

contact: info@GriffithObs

Equatorial Sundial Gnomon Length Calculator



An [equatorial sundial](#) consists of a [dial plate](#), and a [gnomon](#) (or [style](#)) that is perpendicular to the dial plate. The dial plate has an upper dial face and a lower dial face, both of which are marked off in hours. The gnomon is a pole (or rod) that passes through the [center](#) of the dial plate, extending above the upper face of the dial plate, and extending below the lower dial face.

Use the following rule-of-thumb to determine the length of the **upper segment** of the gnomon: "If the shadow of the gnomon is to reach the circle of hour numbers at the times of the solstices, the gnomon must be about half as long as the radius of that circle. (The theoretical value is 0.44 times the radius.)" Quote courtesy [Sundials: Their Theory and Construction](#), Albert E. Waugh, Dover Publications, Inc., ©1973, p. 32.

Input the radius of the dial plate (one-half the diameter) and your [latitude](#) to calculate the length of the **lower segment** of the gnomon required to [properly orient your equatorial sundial](#).

Note: Input fractions as decimals. For example, input $4\frac{1}{2}$ as 4.50.

Radius of dial plate (including height of "foot"): (unit-independent)

Latitude: (0-90 degrees)

The gnomon should extend units from the center of the lower dial face to a horizontal surface.

**For 0° latitude (the Equator), the gnomon lower segment is theoretically infinite in length.
 Note that the computer is unable to display infinity (∞) properly.**

© Copyright 2002-2004 [Walter Sanford](#). All rights reserved.

[Me and My Shadow - Making the Sun-Earth Connection](#) | [SCSA Home](#)

ROTATION

The turning of a body around an imaginary axis running through it. As viewed from above the North Pole, the Earth rotates counterclockwise once every 24 hours (one day), causing day and night.

Film & Video STOCK SHOTS



[Home](#)

NEW FEATURE: Film & Video Stock Shots

[Featured Footage Gallery](#)

Current Feature:

- Home
- About Us
- Rate Sheet
- Client List
- Categories
- Sample Footage
- We Rep Footage
- Order a Demo
- Contact Us

- On this site you will find the **[premiere stock footage provider](#)**, and the tools to secure that footage for your project(s).

- Use of provided media for commercial purposes without the express written consent of **Film & Video Stock Shots** is strictly prohibited.

Register Facts

1. Numbers of Dials by County or Region - UPDATED (09/07/2001)

The numbers of dials (above zero!) that are currently known in different parts of the UK & Eire are listed below:

Gloucestershire	310	Powys	28
Cornwall	197	Borders Region	27
Devon	193	Sussex (W)	27
Wiltshire	174	Nottinghamshire	25
Yorkshire (N)	158	Central Region	24
Cumbria	157	Hertfordshire	24
Oxfordshire	150	West Midlands	23
Hampshire	135	Manchester (Greater)	22
Kent	128	Yorkshire (ER)	22
Suffolk	125	Clwyd Area	21
London (Greater)	121	Yorkshire (S)	20
Cheshire	115	Highland Region	18
Somerset	110	Antrim & Belfast	16
Dorset	96	Bedfordshire	14
Cambridgeshire	95	Isle of Wight	13
Hereford & Worcester	92	Tyne & Wear	10
Northumberland	92	Isle of Man	9
Northamptonshire	91	Dyfed Area	8
Lothian Region	84	Overseas Dials	8
Tayside Region	78	Down	7
Strathclyde Region	73	Dublin	5
Warwickshire	72	Glamorgan (South)	5
Sussex (E)	66	Gwent Area	4
Essex	63	Bristol	3
Derbyshire	61	Glamorgan (West)	3
Shropshire	59	Armagh	2
Lancashire	58	Cork	2
Leics & Rutland	58	Kildare	2

Grampian Region	53	Louth	2
Yorkshire (W)	50	Galway	1
Dumfries & Galloway	47	Glamorgan (Mid)	1
Lincolnshire	44	Isles of Scilly	1
Staffordshire	42	Offaly	1
Durham	41	Tipperary	1
Surrey	41	Tyrone	1
Fife	38	Western Isles	1
Norfolk	37	Wexford	1
Berkshire	36	Wicklow	1
Gwynedd Area	34		
Merseyside	32		
Buckinghamshire	31		
Channel Isles	30		

Info from P Powers

2. Numbers of Dials by Type

The numbers of dials by type are as follows:

Horizontal	1257		
Vertical (S)	1192		
Vertical (D)	796		
Equatorial	206		
Mult Cube	147		
Multiple	142		
Mult Facet Head	68		
Vertical (W)	45		
Analematic	37		
Other	34		
Vertical (E)	33		
Mult Obelisk Complete	30		
Mult Cube Market Cross	21		
Polar	20		
Azimuth	18		
Mult Lectern with Star	18		

Multi Lectern no Star	16		
Multi Diptych	15		
Multi Obelisk Partial	15		
Noon mark	15		
Scaphe	12		
Spherical	12		
Multi Composite Facet Head	7		
Incl/Recl	6		
Vertical (N)	4		
Equiangular	1		
Altitude	1		

Info from P Powers

REVOLUTION

The motion of one body around another. The Earth revolves counterclockwise around the Sun once every 365 days (one year). *Orbit* is a synonym for revolution. (Remember that *synonyms are two words which have the same meaning.*)

Sun and Moon Data for Washington, D.C.

Azimuth (0-360°) of Sunrise/Sunset & Moonrise/Moonset During Full Moon

Year	2001					2002							
Month	SEP	OCT	NOV		DEC	JAN	FEB	MAR	APR	MAY	JUN	JUL	AUG
Day	02	02	01	30	30	28	27	28	27	26	24	24	22
SR/SS	80/280	94/265	108/251	118/242	120/240	113/247	100/260	86/275	72/289	62/298	59/301	64/296	74/285
MR/MS	105/252	89/268	72/285	64/294	59/301	63/299	78/285	91/274	111/254	119/244	123/237	119/239	111/246

N=0, NE=45, E=90, SE=135, S=180, SW=225, W=270, NW=335

Maximum Altitude (0-90°) of Sun & Moon During Full Moon

Year	2001					2002							
Month	SEP	OCT	NOV	DEC	JAN	FEB	MAR	APR	MAY	JUN	JUL	AUG	
Day	02	02	01	30	30	28	27	28	27	26	24	24	22
Sun	59	47	37	29	28	33	43	54	65	72	75	71	63
Moon	39	52	63	67	75	74	64	55	39	31	26	27	35

[Horizon](#)=0, [Zenith](#)=90

Duration of Sunlight & Moonlight During Full Moon

Date	Sunrise	Sunset	Duration	Moonrise	Moonset	Duration
09/02/01	06:39 a.m.	07:37 p.m.	12h58m	07:28 p.m.	06:08 a.m.	10h40m
10/02/01	07:06 a.m.	06:49 p.m.	11h43m	06:53 p.m.	06:55 a.m.	12h02m
11/01/30	06:36 a.m.	05:08 p.m.	10h32m	05:13 p.m.	06:47 a.m.	13h34m
11/30/01	07:07 a.m.	04:47 p.m.	09h40m	04:14 p.m.	06:42 a.m.	14h28m
12/30/01	07:27 a.m.	04:56 p.m.	09h29m	04:16 p.m.	07:40 a.m.	15h24m
01/28/02	07:18 a.m.	05:25 p.m.	10h07m	03:59 p.m.	07:16 a.m.	15h17m
02/27/02	06:44 a.m.	05:59 p.m.	11h15m	05:13 p.m.	07:14 a.m.	14h01m
03/28/02	05:59 a.m.	06:28 p.m.	12h09m	05:17 p.m.	06:15 a.m.	12h58m
04/27/02	06:16 a.m.	07:57 p.m.	13h41m	07:35 p.m.	06:46 a.m.	11h11m
05/26/02	05:48 a.m.	08:24 p.m.	14h36m	07:40 p.m.	05:54 a.m.	10h14m
06/24/02	05:44 a.m.	08:38 p.m.	14h54m	07:42 p.m.	05:16 a.m.	09h36m
07/24/02	06:03 a.m.	08:27 p.m.	14h24m	08:24 p.m.	05:58 a.m.	09h34m
08/22/02	06:28 a.m.	07:54 p.m.	13h26m	07:43 p.m.	05:53 a.m.	10h10m

Related Web Sites

- [Yin and Yang](#) - Dynamic Equilibrium in the Universe
- United States Naval Observatory (USNO) [Phases of the Moon](#)
- USNO [Complete Sun and Moon Data for One Day](#)
- USNO [Sun or Moon - Altitude/Azimuth Table for One Day](#)

ZENITH

The imaginary point in the sky directly overhead an observer. Everyone has their own personal zenith, and it follows you everywhere you go!

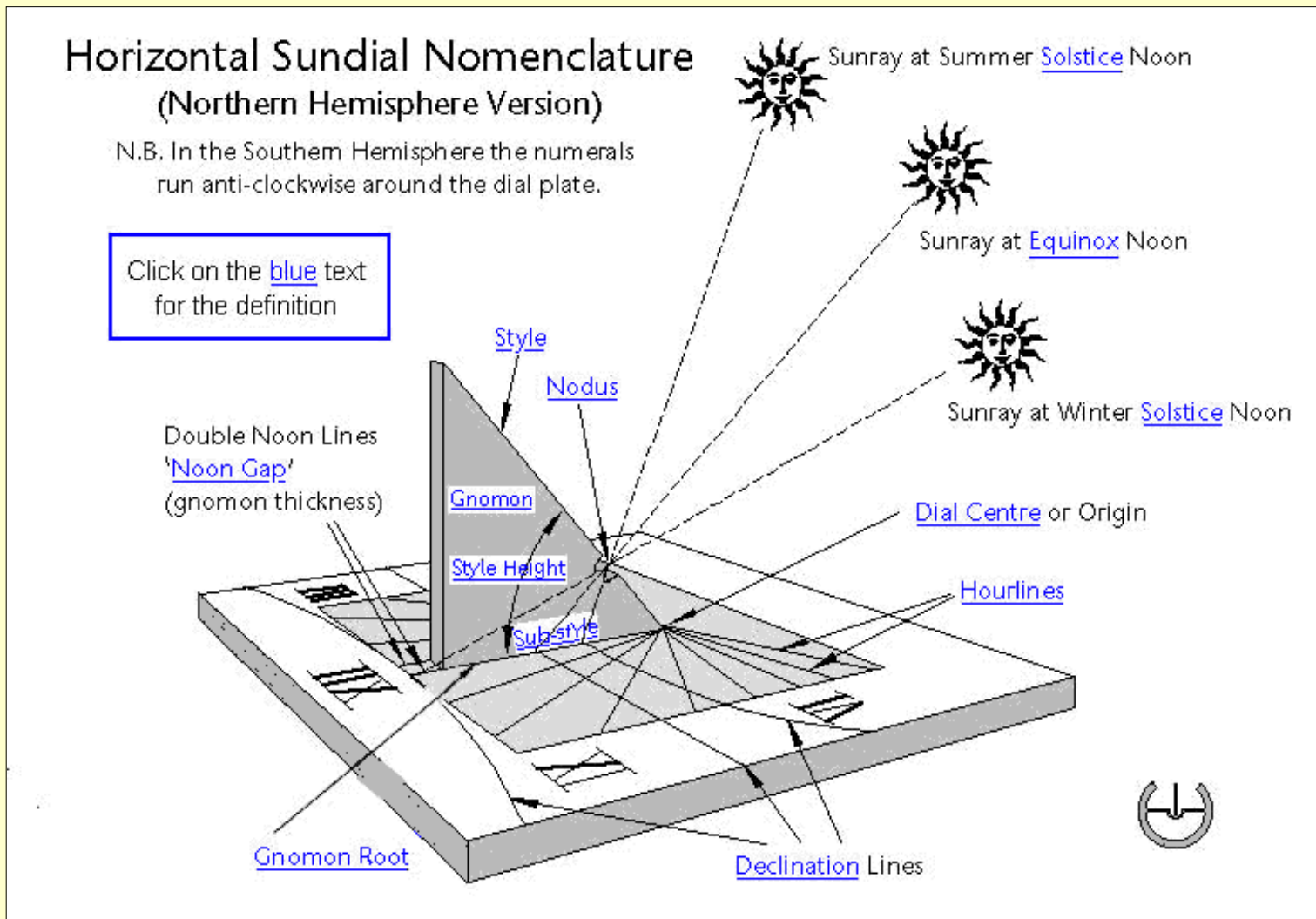
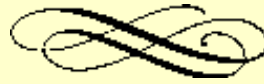

Figure 1. Basic sundial nomenclature.

A

aberration (of light): the effect by which the apparent direction of distant astronomical bodies is altered by the velocity of the Earth and the finite speed of light. Discovered by James Bradley, it has a value of 20.47 arc-sec and is thus totally insignificant to dialling.

accuracy (of a dial): a measure of how closely the time indicators (lines or points) of a dial indicate the true time. Contrast with [resolution](#). See also [precision](#).

Act of 1751: {1752} refers to an act of the British parliament in that year which finally adopted the [Gregorian calendar](#) and set the beginning of the (English) year to 1 January, rather than 25 March. As a result, there can be some confusion about the year, prior to 1752, for dates between January and March. Scotland's New Year's Day had already been set to 1 January since 1600. Dates in the Julian calendar are usually denoted "Old Style", with those in the Gregorian "New Style".

British dials made before 1752 and which have [EoT](#) or [sunrise/sunset](#) tables show dates 11 days earlier than the current ones, e.g. the [vernal equinox](#) is on 10 March instead of 21 March, and the EoT will be shown as zero on 5 April, 3 June, 23 August and 15

December. Note that the Act was passed in 1751 but did not come into operation until the following year, hence the alternative dates sometimes seen.

acute angle: an angle of less than 90°.

age of the moon: see [phase of the moon](#).

almanac: an annual calendar of months and days, with astronomical and other data. They usually include an [ephemeris](#) of the Sun and some other celestial bodies, the [equation of time](#), the [Sun's declination](#) etc. Almanacs are sometimes inscribed on, or accompany, C16-18 dials.

The annual Nautical Almanac, produced by the Royal Greenwich Observatory, derives from the version first published by Astronomer Royal Nevil Maskelyne in 1767.

almucantar: (pron. al-moo-can-tar) a circle of equal [altitude](#) on the [celestial sphere](#). It is a [small circle](#) on the celestial sphere, parallel to the [horizon](#).

alidade: the revolving arm of an astrolabe through which sightings of the stars are made. Sometimes used on sundials where a pinhole at one end of the ~ forms an image of the Sun on a plate at the other end carrying an [analemma](#).

altazimuth: {alt-azimuth} a mounting system for an astronomical instrument that allows it to be set in [altitude](#) and [azimuth](#). The term is also used to describe the horizon [co-ordinate system](#) which uses these two parameters.

altitude (of the sun): {elevation} [α , **ALT**] the angular distance of the (centre of) the sun's disk above the observer's [horizon](#) (negative values indicate that the Sun is below the horizon). It is measured along the [principal plane](#) to the sun's centre, and is the complement to the [zenith distance](#). It is part of the [horizon co-ordinate system](#). See [Equations](#). Note that aviators and others use the term altitude to measure a height (distance) above the ground.

anaphoric (clock): a clock with a dial face like an [astrolabe](#), showing [seasonal hours](#).

ante meridiem (a.m.): before [noon](#).

analemma: (pron. ana-lem-a) in modern usage it is a graphical plot with the [Equation of Time](#) on one axis and the sun's [declination](#) on the other. In appearance, a tall thin figure of eight. The dates of various points around the curve are often shown. The shadow of a point falling onto an arbitrary plane at the same [clock time](#) each day will trace out an [analemma](#) over the course of a year. Normally seen on the [noon line](#) of a dial, but can be on any [hour line](#). The exact appearance of the analemma will depend on the plane upon which it is projected.

[Figure 2.](#) The components of the analemma

The word analemma has had several other meanings in the history of astronomy and dialling. In the first century BC, the Roman engineer Vitruvius used the word to refer to a graphical construction, equivalent to today's [orthographic](#) projection. In the second century AD Ptolemy used analemma to mean an instrument acting as a nomograph for defining the angles of a dial. The use of a modern analemma on a dial dates to around 1640, and the first treatment in English was by Samuel Foster in 1654.

angle: (units of measurement) may be decimal [degrees](#); degrees, [arc-minutes](#) and [arc-seconds](#); [radians](#) (2π radians = 360°); or (seldom, military equipment) [mils](#) (6400 mils = 360°); or (very rare) [grade](#) (1/100th of a right angle). Preferred notations are: [dd.dd° or dd° mm' ss"]. Note that trigonometric functions in computer spreadsheets (e.g. Excel™) are always defined in radians. The mathematical convention is that positive angles are measured counter-clockwise, usually with the zero angle position in the 3 o'clock direction or along the x-axis (see [cartesian co-ordinates](#)). In dialling, it is

more common to measure angles counter-clockwise from the [noon line](#), although some authors measure from the [sub-style](#) line.

Antarctic Circle: the parallel of [latitude](#) at 66° 34' S. Note that this defines the northern limit of the region around the S pole having at least one day a year with no night.

antisolar point: the point on the [celestial sphere](#) directly opposite the sun's position.

aperture: a small transparent hole in an opaque surface, designed to let a small beam of [sunlight](#) through to fall on a [dial plate](#) or [alidade](#) e.g. for [noon dials](#), [ring dials](#) and [heliometers](#).

aphelion: (pron. ap-heel-eon) the point where the Earth's [orbit](#) takes it furthest from the sun. It occurs during the first week of July.

apogee: (pron. apo-gee) the point in the Moon's (or other satellite's) orbit when it is furthest from the Earth.

arc: a curve which is part of the circumference of a circle.

arc-minutes {or **minutes of arc**}: an angular measure equal to 1/60th of a [degree](#). Preferred notation [' or arcmin].

arc-seconds {or **seconds of arc**}: an angular measure equal to 1/60th of an [arc-minute](#). Preferred notation [" or arcsec].

Arctic Circle: parallel of [latitude](#) at 66° 34' N. Note that this defines the southern limit of the region around the N pole having at least one day a year with no night.

Aries (first point of): see [equinoxes](#).

armillary sphere: a skeleton model of the celestial sphere with rings representing the equator, tropics etc. Often finely made in brass, but versions in wood with paper scales were common in 19th century France. It is also the basis of a form of dial - see [armillary](#), dial (types of).

ascendant: rising towards the [zenith](#). Note: astrologers have a different definition.

astro compass: see [solar compass](#).

astroid: (pron. as-troy-d) a mathematical curve which is formed by the envelope of a series of straight lines, and has the equation: $x^{2/3} + y^{2/3} = 1$. In dialling, it is the shape of a vertical gnomon used in the latitude-independent [astroid](#) dial. The astroid curve is also one branch of the shape which is traced out by a point on the circumference of a circle as it rolls inside a circle of four times the radius.

astrolabe: an early astronomical instrument in the form of a heavy disk (the [mater](#)) which was suspended vertically and had an angular scale marked around it (the [limb](#)). A coplanar [klimata](#) and an [alidade](#) rotated about its centre. A fretted [rete](#) gave the positions of the brightest fixed stars. The various components were held on the central pivot (the pin or axis) by a small wedge or horse; sometimes dog.

The **planispheric** ~ represents the [celestial sphere](#) by a two-dimensional [stereographic projection](#), showing the position of the sun and major stars at different times and dates, as well as different latitudes. A separate plate is required for each latitude. It was probably a Greek invention of the 2nd century BC, but it was developed extensively by the Islamic cultures from the 9th century AD. It fell out of use in the late 17th century in the west.

The **universal** ~ uses modified projections of the celestial sphere so that they are latitude-independent. The Gemma Frisius type (developed in the west in the early 16th century) retains the stereographic projection but moves the centre to the [First](#)

[point of Aries](#). The Rojas type (by J. de Rojas of Sarmiento, 1550) uses an [orthographic projection](#) with a projection point at infinity. The La Hire type (late 17th century) moved the projection point in an attempt to make it easier to read.

The **mariner's ~** is a much-simplified instrument designed to measure the sun's altitude, using an open frame and weighted at the bottom to make it more stable onboard ship; it is a precursor to the sextant.

See [Appendix X](#) for further astrolabe terminology.

astronomical triangle: the spherical triangle on the [celestial sphere](#) whose vertices are the observer's [zenith](#), the elevated [celestial pole](#), and the position of the Sun (or other celestial body).

atmospheric refraction: see [refraction](#).

autumnal {or fall} equinox: see [equinoxes](#).

axis (of the Earth's rotation) or polar axis: the line running through the true North and South [poles](#) about which the Earth rotates.

azimuth (of the sun): [**A**, **AZ**] the angle of the sun, measured in the horizontal plane and from true [south](#). Angles to the west are positive, those to the east, negative. Thus due west is 90°, north is ±180°, east -90°. It is part of the [horizon co-ordinate system](#). See [Equations](#). Note that navigators (and some astronomers, but not [Meeus](#)) measure azimuth or bearings clockwise from the north.

B

back-staff: an old instrument for measuring the [altitude](#) of the Sun while facing away from it. The **Davis quadrant**, designed by the English captain John Davis, is actually a form of back-staff.

bay (or bay en imy wenut): literally a "palm rib of the observer of the hours". It was an ancient Egyptian instrument or sighting device, used in conjunction with a [merkhet](#) to observe and time [transits](#).

Beltane {Beltaine}: an ancient Celtic festival held on the 1st of May, when bonfires were lit. It is one of the [cross-quarter days](#)

bissextile: a [leap-year](#) (from bis sextus dies, or doubled 24 February).

blue moon: there are at least two possible meanings. It can mean a second full moon in a given calendar month. It seems that this "meaning" was accidentally invented by Sky and Telescope magazine in 1946, but it has passed into wide usage. Alternatively, it may mean that the Moon actually has a blue coloration, due to smoke or other aerosols in the atmosphere. Both phenomena are rare (the second more so), hence the expression "once in a blue moon".

brachiolus: (pron. brak-e-o-lus) from the Latin for "little arm" it is a movable arm which acts as a suspension point for a cord on a [card dial](#).

break of day: see [daybreak](#).

British Summer Time [BST]: see [time \(types of\)](#).

C

Candlemas: the festival of the purification of the Virgin Mary, on 2nd February. It also corresponds to the Celtic festival of [Imbolc](#), and is a [cross-quarter day](#).

calendar: a system for counting days and defining the [date](#).

Campbell-Stokes: see [sunshine recorder](#).

Cancer: see [tropics](#).

canting out: see [wedging out](#).

Capricorn: see [tropics](#).

cardinal point (of the compass): North, South, East or West [N, S, E or W]. These points are the intersections of the celestial meridian (N, S) and the prime vertical (E, W) with the [horizon](#). Note that the Latin terms are Septentrio, Meridies, Oriens and Occidens, so that a compass rose on a mediaeval dial simply identifying "S" is ambiguous.

cartesian co-ordinates: see [co-ordinates](#).

celestial equator: the intersection of the extended plane of the Earth's [equator](#) with the [celestial sphere](#).

celestial latitude: see [ecliptic latitude](#).

celestial longitude: see [ecliptic longitude](#).

celestial pole: the points on the [celestial sphere](#) where it meets the Earth's [axis](#). The stars appear to rotate around these poles.

celestial sphere: an imaginary sphere, arbitrarily large and co-centred with the Earth, on which all the stars appear to be fixed.

centre (of a dial): the point where all the [hour lines](#), and a polar-pointing [style](#), meet. This point does not always exist (e.g. on [polar dial](#) and [direct E or W dials](#), the lines meet at infinity). In simple [horizontal](#) or [vertical dials](#), this point coincides with the root of a (thin) [gnomon](#). In the case of a thick gnomon having two styles, there are two centres to the dial. The centre is often, but not necessarily, the [origin](#) of the co-ordinate system used to describe the dial. See [Figure 1](#).

chapter ring: the ring on a dial face carrying the hour numerals. The term is more widely used for clocks, but it also finds use, for example, on dials with several separate rings for different locations.

chilindrum: see [Dial \(types of\); cylinder ~](#).

civil time: see [Time \(types of\) civil~](#).

clinometer: an instrument for measuring the [inclination](#) or slope of a surface. Also called an [inclinometer](#).

cloisonné: a term sometimes used to describe the technique of making metal dials by deeply etching the lines and numerals and then filling them with coloured material. It derives from the jewellery method of separating enamels into shallow compartments with metal edges.

co-latitude: equals $90^\circ - \text{latitude}$.

compass bowl: a bowl sunk into the [dial plate](#) of a (portable) [horizontal dial](#) to house a magnetic compass.

compass rose: a drawing of the compass directions, showing as a bare minimum the [cardinal points](#), but more usually eight, sixteen or thirty-two points.

compendium: normally used to describe a collection of scientific instruments in one

case. Also, **Compendium**: the journal of the NASS.

conic section: any of the range of geometric curves produced by the intersection of plane with a cone (i.e. circles, [ellipses](#), [parabolas](#) and [hyperbolas](#)).

co-ordinates: a system of measurements used to describe any point in two or three dimensions.

Co-ordinate Systems:

Cartesian ~ [x,y,z] in which the axes are mutually perpendicular, are normally used for positions of points within a dial. For simple [horizontal dials](#) the preferred axes have x increasing to the E of the [dial plane](#), y increasing to the N of the dial plane and z (in 3-D only) increasing perpendicularly to the dial plane (upwards). For vertical and other plane dials, x increases to the left, y increases downwards, and z perpendicular to the plane in the direction towards the observer. The [origin](#) of the system must be defined explicitly. Note that these definitions produce a conventional right-handed co-ordinate system, and are also those used by the [Zonwvlak](#) programs.

ecliptic ~: {celestial ~} [β , λ_e] or [ELAT, ELON] the system of ecliptic (or celestial) [latitude](#) and [longitude](#), defined with respect to the [ecliptic](#) and the [celestial poles](#). Ecliptic co-ordinates predominated in Western astronomy until the Renaissance but, with the advent of national nautical [almanacs](#), the [equatorial system](#), more suited to observation and navigation, gained ascendancy.

Figure 3. Celestial co-ordinates seen by an observer in mid-northern latitudes.

equatorial ~: [α , δ] or [RA, DEC] is the most common astronomical co-ordinate system and is defined by the [celestial equator](#) and [poles](#). The [right ascension](#) and [declination](#) are directly analogous to terrestrial [latitude](#) and [longitude](#).

Figure 4. The equatorial system of celestial co-ordinates, showing the right ascension (RA) and declination (dec) of a star.

galactic ~: is used for studying the structure of the galaxy. It is unlikely to be encountered in dialling.

geographic ~: (or terrestrial ~) [ϕ , λ] or [Lat, LON] the standard method of determining any location on the Earth's globe, using [latitude](#) and [longitude](#).

horizon ~ system: {or [altazimuth](#) system} [a,A] or [ALT,AZ] the simplest celestial co-ordinate system, it is based on [altitude](#) and [azimuth](#). It is fundamental in navigation as well as in terrestrial surveying. However, for specifying the position of the Sun or other celestial bodies, other co-ordinate systems fixed with respect to the [celestial sphere](#) are far more suitable.

Ordnance Survey co-ordinates: (also referred to as the British National Grid, BNG) the system of Eastings and Northings used to define locations in the UK. They are [cartesian co-ordinates](#) with a basic grid consisting of 100km squares, each of which has a unique two-letter code (e.g. SZ). See [Appendix XI](#) for a map of the grid squares. The full OS grid reference comprises these two letters followed by a three-digit easting and a three digit northing, eg SZeeennn. This

gives a resolution of 100m in both directions. Higher resolution ("6-figure" or BNG) references usually replace the letter code with their numerical values, eg eeeee nnnnn, giving a 1m resolution. Here, the first two digits of the easting (northing) are the distance in 10 km increments east (north) of the datum point at the bottom left of the map. Note that the OS maps on which the co-ordinates are based use the transverse [Mercator](#) projection, with a projection origin at 49° N; 2° W.

polar ~ : $[r, \theta]$ an angle-based co-ordinate system sometimes used for defining points on a dial plane, where r is the distance from the origin and θ is measured anti-clockwise from the S. Note: navigators also make use of polar co-ordinates and usually define them as (θ, r) .

Ptolemaic co-ordinates [[hec, hor](#)]: an angular co-ordinate system loosely based on the geometry of [Ptolemy](#).

terrestrial : see [geographic](#) ~.

End of Co-ordinate systems

cross: for a discussion of the cross sometimes seen on the noon line of a dial, see [noon cross](#) and [cross patty](#).

cross-quarter days: days which are (approximately) midway between the [Quarter days](#), hence dividing the year into eight parts. They are occasionally used instead of the [zodiac](#) signs for [declination lines](#) on dials, and have become adopted as modern celebrations or holidays. See Appendix XII for their names and dates.

cross patty {c. pattée or c. formée}: an heraldic term for a form of square cross shape (☩) sometimes seen instead of XII on the [noon line](#) of dials. It is perhaps the most common of the [noon crosses](#).

cross-staff: a simple instrument for determining the [altitude](#) of a celestial body. A cross piece or [transom](#) is moved along a staff, calibrated with a cotangent scale, and sighted by eye against the body and the [horizon](#). Old illustrations often show a ~ with three transoms fitted but, in use, only one would be used at a time. Also called a **fore-staff** or **Jacob's staff**.

culmination (of the sun): to lie on the [meridian](#) or, in more general language, to reach its highest point. Equivalent to the [superior transit](#). From the Latin "culmen", meaning summit.

cursor: a part of a mathematical instrument which slides backwards and forwards over a scale.

cusp: (mathematical) a sharp point where two curves meet e.g. the "horns" of the Moon (strictly, where the second derivative of a curve changes sign).

(astrological) the initial point of an astrological [house](#) or [sign](#).

cycloid: (pron. si-cloy-d) a geometric curve which is traced out by a point on the circumference of a circular disk rolling (without slipping) along a straight line.

D

daeg mael: one of the Anglo-Saxon [tides](#), it may also have been the word for a dial in the early Anglo-Saxon period.

dagsmork: an Icelandic term ('daymarks') referring to landmarks in the countryside which, when viewed from a fixed location, indicated the direction of the Sun at fixed times of the day.

date: a single day in a chosen [calendar](#) system. Note that the agreed international date system (and British Standard 4795) specify "year, month, day" - for example 1951 August 10. Common UK usage is the reverse of this - beware the illogical American usage of month, day, year, especially in all-numeric forms.

Date Line see [International Date Line](#).

dawn: the first light of day, taken as the onset of morning [twilight](#).

day: the period for one rotation of the Earth. **Solar** ~ : measured between successive [transits](#) of the sun: **Mean solar** ~ : measured between successive [transits](#) of the fictitious mean sun. Equal to 24 hours, it is the usual meaning of ~ unless it is further qualified. **Sidereal** ~ : measured between successive transits of the [First point of Aries](#) (or, in everyday language, any 'fixed' star). A sidereal day is 23 hours 56 minutes 4.1 seconds. Beware the possible confusion between day and [daytime](#).

daybreak (or **break of day**): an old term for first light, usually taken as the onset of astronomical [twilight](#).

daytime: that period of a day between sunrise and sunset.

Daylight Saving Time: see [time \(types of\)](#).

declination (of a wall) {sometimes called the **declining angle** or the **deviation**, to avoid confusion with the *sun's* [declination](#)}: [**d**, **DEC**] the angle, measured in a horizontal plane, that a wall's perpendicular makes with due south (i.e. a wall facing S has $d = 0^\circ$). Walls declining westward have positive declinations, those eastward, negative. Beware – this is not a universal convention and some authors define the angle with respect to the nearest [cardinal point](#) of the compass.

declination (of the sun): [**d**, **DELTA**, **DEC**] the angular distance of the Sun above or below the [celestial equator](#). Its value follows an annual sine wave like curve, varying between 0° at the [equinoxes](#) and $\pm 23.4^\circ$ (approx.) at the [solstices](#). It has positive values when the Sun is above the celestial equator (summer in the Northern hemisphere) and negative when below. The same system is used as part of the [equatorial co-ordinate system](#) (together with [right ascension](#)) to locate other celestial bodies. See [Figure 1](#) and [Equations](#).

declination lines: lines on a dial showing the sun's declination on a particular date. They are read by observing the shadow of a [nodus](#).

degree: [$^\circ$ or deg] an angle equal to 1/360 of a complete circle.

descendant: falling from the [zenith](#). Note: astrologers have a different definition.

diagonal scale: a device for interpolating between scale divisions, pre-dating the [vernier](#) scale. It is constructed by drawing diagonals between individual divisions across a wide band, with a series of equi-spaced arcs parallel to the main scale crossing them. It is read by noting the position of the [fiducial line](#) with one of these arcs. Most usually found on astronomical instruments, a similar design was used by Sir Christopher Wren for indicating the minutes on his famous vertical dial on All Souls' College, Oxford.

dial: a Middle English word, apparently deriving from the Latin 'dies' though the medieval Latin 'dialis', used for what is now called a [sundial](#). It later became used for many types of indicators, hence the necessity (from 1599) for the qualifying 'sun' prefix. The word ~ in modern English has now become common again as a shortened version of sundial. Hence **dialling** {dialing}, the art and science of designing and constructing

dials; **diallist** {dialist}, one who designs or makes dials.

Dial types:

Ahaz (Dial of Ahaz): supposed [refraction dial](#), from the Bible story (Kings 20 v8-11) which may allude to a dial showing time running backwards.

altitude ~: {or elevation ~} any dial which uses the sun's [altitude](#), rather than its [azimuth](#), for indicating the time. Usually does not need to be aligned N-S. Examples are [ring dials](#), [flag dials](#), and [shepherds' dials](#). Altitude dials were also often incorporated in [quadrants](#) and folding rules.

analemmatic ~: (pron. ana-lem-mat-ic) dials consisting of [hour points](#), (rather than lines) laid round an [ellipse](#), and a movable [gnomon](#) perpendicular to the [dial plane](#). It may be on any plane, but the most usual form is horizontal. In the horizontal version of the dial, gnomon position lies on the straight N-S minor axis, at a point determined by the [sun's declination](#) (i.e., the date). Most usually found set in the ground in parks, where the observer acts as the gnomon. Note that some of these dials show an [analemma](#) drawn about the gnomon positioning line. This is a method of indicating the [EoT](#) for the appropriate date, but it must be remembered that the gnomon is not positioned on the analemma. The analemmatic dial may be regarded as a projection of the [universal equatorial ring dial](#). Analemmatic dials were once common paired with a horizontal ~ in a self-orienting portable [compendium](#).

analemmic ~: this term has sometimes been used to describe dials which have an [analemma](#)-shaped [gnomon](#), or analemmas on the [hour lines](#), enabling them to read [mean time](#). Note, the dials have no direct link to [analemmatic](#) ones.

Anglo-Saxon ~ {sometimes just **Saxon ~**}: a sundial from the Anglo-Saxon period (c 650 – 1050 AD); designed to show [unequal hours](#), or the basic [tides](#), with a horizontal [gnomon](#). Similar to the [mass dials](#) which superseded it, a Saxon ~ shows much higher levels of craftsmanship and is often finely decorated. Also, it is invariably engraved in a separate (circular or rectangular) stone, not into a pre-existing wall. Saxon dials are often taken to be the precursors to the later [scientific](#) dials. In the early part of the period the semicircle was divided by five lines into four segments. During the latter part of the period it was subdivided into eight or twelve segments and the dial sometimes carried an inscription in Old English. Throughout the period the principal lines had a cross bar near the perimeter giving the appearance of Latin crosses. See [Appendix II](#) for the basic time periods shown on the dial.

antiboreum: an ancient form of dial in which a partial-sphere is hollowed into a stone, and a ray of sunlight enters the partial-sphere through a south-facing pinhole through the stone.

armillary: (pron. ar-mil-ar-y) (or armillary dial; some authors also use the term [armillary sphere](#)) a form of [equinoctial](#) sundial which comprises, as a minimum, two circular bands plus a rod through the poles representing the Earth's [axis](#) and acting as the [gnomon](#). One band represents the [equator](#) (carrying the hour scale) and the other the local [meridian](#). Usually, other [great circles](#) are added representing the [Prime meridian](#) and the [ecliptic plane](#), sometimes together with small circles for the [tropics](#) and [arctic circles](#). These add artistically, but detract from its clarity as a dial. The gnomon sometimes carries a [nodus](#) at the centre of the sphere; this may be used for indicating the date.

astroid ~: a ~ which uses the [sun's declination](#), [altitude](#) and [azimuth](#) to give the [hour angle](#). It is latitude-independent, and is named after the geometric [shape](#) which forms its gnomon.

auxiliary ~: a small [equatorial dial](#) used as a mechanical aid to constructing dials on other planes (particularly [vertical decliners](#)) by co-mounting on a common [gnomon](#) and projecting the [hour lines](#). Often used with a [trigon](#).

azimuthal ~ (or **azimuth** ~): any dial which uses the sun's [azimuth](#) for indicating the time. It usually needs to be aligned N-S, and has a vertical style (if it has no dependence on altitude).

Berosos ~: another term for a [hemispherium](#), named after its inventor Berossus Chaldaeus, a Babylonian astronomer who flourished on the Greek island of Cos around 270 B.C.

bifilar ~: invented in 1922 by Hugo Michnik in its horizontal form, although it can be on any plane. The time is indicated by the intersection on the dial plate, of the shadows of two wires (or other lines in space) stretched above and parallel to it. The wires often run E-W and N-S, with their (different) heights above the plane being a function of the location of the dial. It may have equiangular hour markings, and hence can be delineated to show many kinds of hours.

Bloud ~ : a portable, *magnetic* [azimuth](#) ~ made mostly in Dieppe by makers such as Charles Bloud.

book ~ {**open book** ~}: a modification of the [polar](#) ~, with the [dial plate](#) consisting of two planes set in a vee, with their intersection line lying parallel to the Earth's [axis](#). A polar [gnomon](#) can be placed bisecting the angle of the two planes. Alternatively it may be arranged so that the outer edge of each plane acts as the [gnomon](#) for the other. The term book ~ can also be applied to [diptych dials](#) which are designed to look like a book when closed.

Butterfield ~: a pocket sundial by, or in the style of, Michael Butterfield (Paris, 17th century). Typically it consists of an octagonal silver [horizontal dial](#) with a [gnomon](#) of adjustable angle, often with a bird's head pointer, with several rings of [hour lines](#) for cities of different [latitudes](#). A magnetic compass is fitted in the same case.

cannon ~: see [noon gun](#).

Capuchin ~ {or **Capucine** ~}: a latitude-specific [card dial](#), related to the [Regiomontanus dial](#). So-called because the outline of the hour-lines is said to resemble a hooded Capuchin monk.

card ~: a class of [portable dials](#) built on a single plane, e.g. a card which is suspended in the vertical plane. They usually have a sun sighting device along one edge, and a cord with a bead which hangs vertically below a movable suspension point.

ceiling ~ {also known as a **mirror** ~ or **reflected** ~}: a dial marked on a ceiling where the time and date are indicated by a beam of sunlight reflected from a small horizontal mirror placed on a windowsill.

chalice ~ (or **cup**, **bowl** etc.): a form of [refraction](#) ~ where the hourlines are drawn on the inside of a drinking vessel. Early examples, often in precious metals are rare and valuable.

Chinese ~: a wide range of dials have been used in China, from the vertical gnomon of the mythical astronomer Xi, through [equiangular](#) ~ with sun-pointers and 100-segment time scales from the 1st - 2nd centuries BC, [equatorial dials](#) for

equal hours in the Ming dynasty (1368 to 1664), to conventional horizontal dials in the 19th century.

compass ~: a [portable](#) horizontal dial with an accompanying compass to allow it to be correctly oriented. The compass is often below the pierced dial plate, and the gnomon is hinged for packing. Beware: the term compass dial is often used to mean a [magnetic dial](#).

complementary ~: a (hypothetical) horizontal ~ used as an aid to designing a vertical declining and/or reclining dial. Its [gnomon](#) and [hour lines](#) are calculated not for the site of the proposed (real) dial, but for the location where the Earth's surface is parallel to the [dial plate](#) of the proposed dial. For a simple [direct south](#) dial, the complementary dial would be located at the [co-latitude](#).

cone ~: a term used to describe several entirely different types of dial. (a) a class of dials where the [dial plate](#) is an inverted, truncated cone, giving dials similar to a [scaphe dial](#) or a [hemicyclium](#), or (b) a class of modern dials which use a cone lying on its side as the [gnomon](#). Many varieties, including [sidereal](#), exist.

cross ~: (or cruciform ~ or crucifix ~) a dial in the form of a cross, usually of stone, with the "front" surface of the cross parallel to the [equatorial plane](#), and the top pointing south. The side surfaces of the cross can each form a [dial plane](#), with its [gnomon](#) being a corresponding edge of the cross itself. Usually found as churchyard memorials. Rare. [Portable](#) cross dials have the long arm parallel to the polar [axis](#) and the short arm E-W.

cube ~: a (set of) dials on the surfaces of a cube. There may be up to 6 dials, but more often 5 e.g. direct N, S, E, and W, together with a [horizontal](#) on the top surface. Alternatively, it is possible to set the cube so that its top surface is parallel to the equatorial plane, i.e. the base makes an angle equal to the [co-latitude](#) with the horizontal. Both portable (usually adjustable) and monumental versions are known.

cycloid (polar) ~: a variation of the standard [polar dial](#) in which the gnomon has a [cycloid](#) shape, with the result that the [hour lines](#) are equally spaced.

cylinder ~ (also known as a **shepherd's** ~ or **pillar** ~): a [portable](#), [altitude dial](#) in which hour lines for different dates are delineated around the surface of a cylinder, which is allowed to hang or stand vertically. A horizontal [gnomon](#) projects radially from the top of the cylinder, and is adjusted to the appropriate date around its periphery. Sometimes two gnomon are supplied; a long one for winter and a short one for summer. The dial is held with the gnomon facing the Sun so that the shadow falls vertically. Latitude specific. This was the **chilindrum** of Chaucer's monk.

declining ~: a [vertical dial](#) which does not face any of the [cardinal](#) points of the compass. The [sub-style](#) will be displaced from the [noon line](#), although the latter will still lie vertically below the [dial centre](#).

diametral ~: one of the [equatorial projection dials](#), first described by Samuel Foster of Gresham College in the 17th century, it is a horizontal dial with a moveable [style](#) and hour points which lie along a straight line lying E-W.

diffraction ~: a dial invented in 1999 by M. Catamo & C. Lucarini. It has no [gnomon](#), but the [dial plate](#) consists of a circular [diffraction](#) pattern, which forms a bright, multicoloured diametrical line pointing at the Sun when viewed perpendicularly to the centre of the dial plate. Horizontal, altitude and equinoctial versions are possible. The dial plate is usually made from a CD (compact disc), hence "**CD dial**".

digital ~: an ingenious 20th century dial. The "gnomon" consists of a rectangular sandwich of shadow masks set parallel to the [polar axis](#). This gnomon casts a shadow in which digits representing the time are sunlit. Patented, and requires great precision in manufacture.

diptych ~: (pron. dip-tich or dip-tic) a [portable](#) (pocket) dial in which a [vertical](#) and [horizontal](#) dial are hinged together, and a common cord [gnomon](#) running between them also ensures that they open to a right angle. Latitude specific. This term is, confusingly, sometimes also used to describe a monumental [open book](#) dial.

direct ~: a [vertical dial](#) which directly faces one of the [cardinal points](#) of the compass e.g. direct S.

double horizontal ~: a horizontal dial with (usually) a combined polar pointing [gnomon](#) and a vertical one showing the time/date on a [stereographic](#) projection of the sky onto the horizontal plate. Capable of self orientating, although normally fixed in position. Usually attributed to William Oughtred in the early 17th century, early hand-engraved versions are very fine.

Egyptian ~: a range of sundials from ancient Egypt (portable and fixed) exists, the earliest being from the time of Tuthmosis III (1479-1425 BC). The portable devices appear as a long, thin 3-D letter "L", laid with the long shaft horizontal along the sun's [azimuth](#), with the upturned foot casting a shadow onto the shaft. It is very similar to the [merkheth](#) but has a dedicated hour scale

equant ~: (pron. ek-want) a modified [horizontal](#) ~ in which the [hour-lines](#) are replaced by [hour points](#). These points are arranged round a geometric curve chosen so that the points are equally spaced, allowing the use of a [vernier](#) scale and more accurate interpolation of times. Not related to [Ptolemy's equant point](#).

equatorial ~: a dial in which the [dial plate](#) is set parallel to the [equatorial plane](#) and the polar-pointing [gnomon](#) is perpendicular to it. The dial has [hour lines](#) equally spaced at 15° intervals around the gnomon, and hence the dial plate may be rotated to account for [EoT](#), [longitude](#) and [BST/DST](#) corrections. Sunlight falls on the underside of the dial plate from the [autumnal equinox](#) until the vernal equinox. For this period, the gnomon must project below the dial plate, which is delineated on both sides. An alternative form replaces the dial plate by a narrow hour ring (or half-ring) allowing the scale, inscribed on its inner circumference, to be read throughout the year. With this form, special analemma-shaped gnomons can be used to show [mean time](#). Note: some authorities insist that this dial should be called an [equinoctial](#) ~.

equiangular ~: a term used for dial types where the [hour points](#) are placed at equal angles (15°) around a circle (or part of). If the [dial plane](#) is not parallel to the [equatorial plane](#), the mounting of the gnomon, (which does not need to be polar) must be movable to accommodate this.

equatorial projection ~: a class of dials obtained by projecting a [universal equatorial ring dial](#) onto any plane. Members of the class include [analemmatic](#), [diametral](#), [Foster-Lambert](#) and [Parent](#) dials.

equinoctial ~: (pron. ec-we-noc-te-al) another (historical) name for an [equatorial](#) ~, preferred by some authors.

flag ~: an [altitude](#) ~, formed by "unwrapping" the scale of a [shepherd's](#) ~ into a flat plane which can be shaped like a flag or pennant and is positioned perpendicular to the sun.

Foster-Lambert ~: a form of [equatorial projection dial](#), with the projection arranged to produce a circular ring of equiangular [hour points](#). A good example is the large reclining dial (now back at Herstmonceux Castle after a period at Cambridge) designed in 1975 by Gordon Taylor for the Royal Greenwich Observatory.

geographical ~: a dial in which the dial plate shows a map of the world, with curved hour lines allowing the time at any location to be indicated.

globe ~ (or **spherical** ~): a class of dial in which the "*dial plate*" is a [globe](#) or sphere, usually set with its axis parallel to the Earth's polar [axis](#) and often with the observer's position at the top. The gnomon is in the form of a thin semi-circular vane which can swivel around the globe about its axis. In use, the vane is rotated until the shadow is minimised and the time read from an equiangular scale around the [equator](#). It indicates the [meridian](#) of [longitude](#) where it is currently [noon](#). An alternative type of globe dial (a [terrella](#)) simply uses the globe itself to form the shadow, and the time is indicated by the [terminator](#). Transparent globe ~ are also possible (the Wenger ~). where the shadow of a movable point on the surface is made to fall on the centre of the globe.

Graeco-Roman ~: a general class of dial from about the 3rd century BC (Greek) to the 4th century AD (Roman). Made of stone, they include the [hemispherium](#), the [hemicyclium](#), and some conical dials.

great decliner: usually indicates a [declining dial](#) which nearly, but not quite, faces E or W. The [centre](#) of the dial falls off the [dial plate](#) and, as a consequence, it does not show a noon line.

hâfir dial: an Islamic dial with [unequal](#) hours, vertical [gnomon](#) and equiangular date scale of 12 segments.

halazûn dial: an Islamic dial with [unequal](#) hours, vertical gnomon and a date scale of 6 segments (each representing two signs of the zodiac).

hat ~: an [altitude dial](#) comprising a circular disk mounted concentrically on top of a vertical cylinder. The dial is read by the maximum vertical length of the disk's shadow on the outside of the cylinder.

heliochronometer: a [precision](#) sundial which incorporates some means to allow it to read [civil](#) (or [mean](#)) time. This is usually achieved by incorporating an [EoT](#) cam (as in the Pilkington and Gibbs heliochronometers), or by projecting a spot of light onto an [analemma](#). Note: some authors use this term to describe [any](#) precision sundial.

hemispherium: an ancient dial with the [dial surface](#) formed by a hemisphere hollowed into a horizontal (or occasionally vertical) stone face. The [gnomon](#) is a vertical spike (length equal to the radius of the sphere) set in the bottom of the hemisphere. It is essentially a horizontal [altitude dial](#), with a shaped dial plate which prevents [sunrise and sunset](#) being at infinite distances.

hemicyclium: similar to the [hemispherium](#), but with the south-facing part of the hemisphere cut away, and with the [gnomon](#) now projecting horizontally from the N edge.

horizontal ~: the common or garden sundial with a horizontal [dial plate](#) and polar-pointing [gnomon](#). Latitude specific.

inclining ~: usually applied to [portable dials](#) in which a [horizontal dial](#), designed for a high [latitude](#), typically 60°, may be inclined by raising its southern edge (in

the N hemisphere) so that it may be used at locations with lower latitudes. The opposite arrangement is also sometimes found. The term is also sometimes confusingly used for near-vertical dials where the top leans away from the observer.

Islamic ~: a ~ with [unequal hours](#) and showing the Islamic prayer times.

Lambert ~: see [Foster-Lambert ~](#).

Little Ship of Venice {or **Navicula**}. A portable dial in the shape of a Venetian ship with a central mast. Based on the [Regiomontanus dial](#), the few early examples are valuable.

magnetic ~ {or **magnetic compass ~**} : a small [portable ~](#) in which a complete [horizontal ~](#) is mounted on a compass card, and hence is self-orienting. In principle, the magnetic variation of the place and date where it will be used can be accommodated by rotating the dial from the magnetic N-S line of the compass. Beware: this type of dial is sometimes described as just a [compass dial](#).

magnetic azimuth ~: a [portable ~](#), usually in [diptych](#) form. There is no [string gnomon](#) but instead the lid is lined up to fall exactly on the base, the time being read from the compass needle on a [chapter ring](#). The chapter ring position is moved in a N-S direction from a calendar [volvelle](#) on the under side.

mass ~ (or **mass clock**. Also known as a **scratch ~**): a rather basic dial from the medieval period scratched or engraved into the south-facing stonework of a church or similar building, often near the main door or the priest's door. Although later than [Anglo-Saxon](#) dials, they are generally less well executed. Usually circular or semicircular in form, with a hole in the centre to accommodate a horizontal [gnomon](#) rod (invariably missing). Delineated, probably empirically, to show some form of [unequal hours](#), there is a huge variety of design types. Some are event markers rather than true sundials.

mechanical universal equinoctial ~ (sometimes **minute ~**): a ~ that uses gearing to show accurate time on a clock face, i.e. a [solar clock](#).

mirror ~: a ~ having no gnomon, but using a small, appropriately angled mirror to reflect a small spot of sunlight onto the dial face. The dial may be on a vertical wall facing N or within a building. See also [ceiling dial](#) or [reflecting dial](#) (separate definitions).

monofilar ~: a ~ in which time is marked by the point where the shadow of a thread (or other thin [gnomon](#)) held between the dial face and the Sun intersects a set of date lines.

moon ~: a sundial calibrated in some way so that it can tell the time by [moonlight](#). No change to the basic dial is required, but a correction factor for the time is required which accounts for the age or [phase of the Moon](#). Never very accurate because of the complex nature of the Moon's orbit, they generally require a nearly full Moon to be able to be read clearly. Purpose-built moon dials have either spiral hour lines or a table of moon phases (as in the famous Queens' College, Cambridge, dial).

multiple ~: simply more than one dial physically incorporated into the same dial structure.

multiple gnomon ~: a ~ in which there is a separate shadow casting element (gnomon) for each [hour line](#). The elements can be points, lines or planes.

navicula de Venitiis: see Dial Types ([Little Ship of Venice](#))

noon (or meridian) dial or line: a dial which has only one [hour line](#), for [noon](#). It has a [nodus](#) rather than a full [gnomon](#). This may be in the form of a small ball on the end of a shaft or, more usually, an aperture in a plate or window opening into a building. Very long, accurately-levelled meridian lines (running N-S) built into cathedrals were intended for the accurate determination of the [equinoxes](#), [solstices](#) and other solar parameters. A **noon dial** (as opposed to noon line) is usually taken to mean a complete noon [analemma](#), possibly including dates.

noon gun: a small cannon mounted such that focussed sunlight from an appropriately angled lens falls on the touch-hole and fires the gun at [noon](#). A novelty rather than an accurate time indicator.

noon mark: a stone, or line marked on a stone, set to receive the noon shadow of a building or other feature. The term is, however, often used interchangeably with a [noon](#) ~.

Nuremberg ~: a loose collective term used for the [diptych dials](#) made around Nuremberg, Germany, during the 16th and 17th centuries. The majority were made of ivory, featured a compass bowl in the lower leaf and had a [string gnomon](#).

Oughtred ~: another name for a [double horizontal](#) dial.

Parent ~: a form of [analemmatic](#) ~, with the [dial plane](#) parallel to the Earth's axis so that the ellipse of hour points becomes a segment. First designed by Parent in 1701.

pelekinon ~: a form of ~ attributed to the Greeks around 100 BC. In appearance, the dial resembles a butterfly or double-headed axe, and was delineated to show [unequal hours](#).

pillar ~: see [cylinder](#) ~. Sometimes also confusingly used to describe monumental dials mounted on tall pillars.

poke ~: an old term for a pocket or [portable](#) dial.

polar ~: a ~ in which the [dial plate](#) is set along the E-W direction and reclines so that it is parallel to the [polar axis](#). The standard polar-pointing [gnomon](#) is thus also parallel to the dial plate. Simple to construct, but the hour lines disappear to infinity when the Sun is in the plane of the dial. For a south-facing polar dial, the theoretical limits at the summer solstice are 6am to 6pm.

polarised light ~: a gnomon-less dial which detects the orientation of the [polarised](#) skylight. Its polariser/analyser system is best arranged to view a region of the sky near the N [celestial pole](#) (S in the southern hemisphere), allowing the [hour lines](#) to follow a standard 15° per hour scale. Although not particularly accurate, it has the advantage that it does not require direct [sunlight](#) to work as long as there is clear sky towards the N celestial pole. Thought to have been invented by Sir Charles Wheatstone in 1848.

polyhedron ~: a multiple dial in the form of a solid polyhedron, with a separate dial on each face. Usually each dial is some form of [decliner/recliner](#), but may include [scaphe](#) and [polar dials](#) as well. Particularly common as the monumental Scottish stone lectern and obelisk dials.

portable ~: simply a dial meant to be moved from place to place, either as a pocket dial or simply being transportable. In most forms, some means of orienting the dial is included, and they are often either [universal](#) or capable of being read at a number of fixed [latitudes](#).

prism ~: a term occasionally used to describe a [multiple dial](#) with two or three dial faces set on the sides of a triangular prism.

proclining ~: a term sometimes used to describe a dial which is approximately upright but which leans forward towards the observer. A dial which leans forward by 10° will have an [inclination](#) of $+100^\circ$. They are sometimes also called [inclining](#) dials, although that term is best reserved for dials derived from a horizontal ~.

reclining ~: strictly, an approximately [vertical dial](#) which leans backwards away from the observer. However, often used as a catch-all term for any non-vertical dial. The angle is defined from the horizontal towards the observer, so a dial which leans backwards by 10° from the vertical has an [inclination](#) $+80^\circ$.

reflecting ~: these dials have no [gnomon](#), but reflect [sunlight](#) by means of a semi-cylindrical mirror, set with the axis of the mirror parallel to the *polar axis*. The mirror reflects the light to form a caustic curve amongst the [hour points](#). For the special case of the mirror having a [cycloid](#) shape, the hour points are equally spaced. Note that the term reflecting dial may also be used for [ceiling dials](#).

refraction ~: dials which use a clear liquid in a solid cup to compress the hour lines. Sometimes drawn on the inside of a drinking cup - a [chalice dial](#) - (see [Dial of Ahaz](#)) or on the bottom of a fountain basin or swimming pool. A second form uses a cylindrical lens to focus sunlight onto a [curved dial plate](#).

Regiomontanus ~: a universal form of [card dial](#), usually with the suspension point of the cord movable in two dimensions in the card plane. It is the basis for many other variants of dial.

ring ~: a [portable](#), [altitude dial](#) in the form of a ring, with a small [aperture](#) in its circumference. The ring is suspended in a vertical place such that the aperture faces the sun. The time is then indicated on a time/date scale on the inside of the dial. The suspension point may be adjustable on the circumference to allow for [latitude](#) changes. Not very accurate, due to their usually small size and the fact that a very compressed date scale is needed to prevent the ring becoming too wide. These dials were known by Vitruvius in the first century BC. Beware: this term is also sometimes loosely used to describe a [universal equinoctial ring dial](#).

Saxon ~: see [Anglo-Saxon](#) ~.

scaphe ~: (pron. sk-af-e) {skafe, scaphion} a dial in which the dial plate is a shallow dish in any plane (usually a horizontal or, rarer, vertical one). The name comes from the Greek word for boat, and the dial itself is thought to have developed from the [hemispherium](#). Normally with a vertical [gnomon](#).

scientific ~: a term usually taken to mean a dial which is designed to show [equal hours](#), or at least in which the effect of latitude been mathematically accounted for. Thus any dial with a polar-pointing [gnomon](#) is scientific, but, for example a [mass dial](#) is not. Mostly, they date from the 16th century onwards.

scratch ~: see [mass dials](#).

self-orienting ~: any dial which, when correctly adjusted for the latitude and/or date, can be used to find the direction of south. Sometimes also called "self-southing".

shadow plane ~: a class of dial in which the [gnomon](#) is movable and is set by the observer so that it, and its shadow, lie in the sun's [hour plane](#). The gnomon may be a plane, line or point. The [dial plate](#) can, if required, be any surface. A

globe dial with a movable vane is an example of a shadow plane ~.

shepherd's ~: see [cylinder dial](#) for the usual meaning. A second type of shepherd's dial is a set of marks cut in the turf, so that the shepherd's crook could be used as a vertical gnomon – see Shakespeare's Henry VI part 3, act 2, scene 5.

sidereal ~: (pron. sy-deer-e-al) a ~ designed to show [sidereal time](#) by means of introducing a variable offset to the time shown by the solar shadow on an [equiangular dial](#). The dials are rare, with no known public dial in the UK(?)

solar clock (or solar chronometer): an instrument in which a sighting of the sun, through a movable telescope or open sights, is made to display the time on a clock face by a set of gears. A famous example by Sir Charles Wheatstone is in the Science Museum. Note: this term is often used as a synonym for [heliometer](#), but is best reserved for the definition given here.

spherical ~: see [globe dial](#).

spoon ~: a rare form of [scaphe](#) ~ delineated in the bowl of a spoon.

stained glass ~: a (generally vertical) dial in which the [dial face](#) is of stained glass, and is viewed from the back, i.e. through the glass from inside the building. The gnomon remains on the outside of the building, and frequently causes cracking of the glass if supported directly from it. Typically, they were incorporated into church windows in the 17th century, although most are now in museums and there are some notable modern examples.

standing ring ~: a form of [universal equinoctial ring dial](#) mounted on a stand, usually including a compass.

Star of David ~: a monumental dial similar in concept to the [cross dial](#), except that the six-pointed star with 60° angles gives opportunities for numerous dials.

sun clock: see [solar chronometer](#), dial (types of).

tidal ~: a dial delineated to give the times of the marine tides. Based on some form of [equiangular dial](#) (e.g. an [equatorial dial](#)). It bears the compass points in a circle with the names of various ports written against them. The '[establishment of a port](#)' is given as a compass point and, together with the hour markers, indicate the interval of time between the passage of the Moon over the meridian of the port and its high tide. Not to be confused with dials showing the Anglo-Saxon [tides](#).

universal ~: any [portable dial](#) with a means of allowing it to work at, or be adjusted for, any [latitude](#). Note: sometimes the range of usage is limited to one [hemisphere](#). The term is also sometimes applied, with qualifications, to dials which operate over a more limited range of latitudes, e.g. dials with, say, 30°-60°N scales.

universal equatorial ring ~ (or - equinoctial -): a portable dial which looks similar to a folding version of an [armillary dial](#), but with a movable suspension point to provide latitude adjustment. A stylised version of the hour ring and [gnomon](#) forms the BSS logo. In some versions, an [aperture](#) gnomon mounted on the central axis is used, the position of the aperture being adjusted to suit the [sun's declination](#). This form is self-orienting. Large well-made versions are accurate and valuable.

vertical ~: any dial in which the [dial plate](#) is vertical.

window ~: (or projecting ~) a ~ in which the [hour lines](#) are marked on a window in such a way that their shadows fall across a single reading point inside the

room. The lines, as drawn on the window, form an inverted, mirror-imaged [vertical dial](#). This form is related to [stained glass](#) and [mirror \(or ceiling\)](#) ~.

- End of Dial types -

dialling scales: ruler-like (or rule-like) scales designed to help in the geometrical layout of dial. Their non-linear scales are effectively analogue computers for solving dialling equations. Standard scales, following George Serle's original version of 1657, and themselves developed from Samuel Foster's 1638 work, have separate scales for : hours, latitude (prime) and latitude (meridian).

dial plane: the plane in which the dial plate, and the hour indicators, lie.

dial plate (or ~ face): the physical plate on which the [hour lines](#) and [furniture](#) lie. It (usually) supports the [gnomon](#).

diffraction grating: a plate with a set of closely spaced slits (usually parallel and equi-distant) which disperses incoming light into its constituent wavelengths (i.e. colours). The surface of a CD acts as a circular reflection diffraction grating.

dioptra {dioptra}: a form of [alidade](#), used as the index of a volvelle (and also sometimes of a [quadrant](#) or an [astrolabe](#)), rotating against an angle scale.

dip (of the horizon): the angle of the observed [horizon](#) (due to the curve of the Earth's surface and the height of the observer, but neglecting [refraction](#)) below the true or astronomical horizon. It is given by:

$$\text{dip (arc-minutes)} = 1.811 \times \sqrt{\text{height (metres)}}.$$

dip (magnetic): the angle that the Earth's magnetic field makes with the horizontal. It varies with geographical location and (slowly) with the date. See [Appendix IX](#) for values. It is measured with an [inclinometer](#).

dipleidoscope: (pron. dip-ly-do-skop) from the Greek words for "double image viewer". Devised by James Bloxham and patented by Edward Dent in 1843. It is an instrument for observing the [transit](#) of the Sun to an accuracy of a few seconds. Essentially, it comprises a hollow equilateral prism, with the front, semi-reflecting face facing south and parallel to the polar axis. At noon, the reflection of the Sun from this surface exactly coincides with a second image doubly reflected from the other two faces.

diptych: literally, two leaves or pages. See [dial types, diptych](#) .

diurnal: daily, or occupying one day. Can also mean of the daytime (as opposed to nocturnal: of the nighttime).

domifying circles: (from the Latin Domus Coelestris - celestial house.) Circles on the [celestial sphere](#) which show the hourly position of the Sun in the six [Regiomontanus \(astrological\) houses](#) that are above the horizon. On a [vertical](#) south dial, they are represented by straight lines emanating from the intersection of the [noon line](#) and the horizon line (i.e. the horizontal line on the [dial plate](#) perpendicular to the [nodus](#)). The domifying lines are angled similarly to the [hour lines](#), but are numbered in the reverse direction as DOM. VII (horizontal, E), DOM.VIII, DOM.IX, DOM.X (along the noon line), DOM.XI, DOM.XII and DOM.I (horizontal, W). On a [horizontal dial](#), these lines all lie parallel to the [noon line](#). See [Appendix V](#).

Dominical cycle: a letter-cycle originating in the Roman period, when each day of the year was allocated the letters A,B,C,D,E,F and G in a repeating sequence. In a given year, every weekday (e.g. Monday) has the same letter, and the cycle repeats with the 28-year Julian [leapyear](#) cycle. The Dominical letter (for Sundays) is often found on

[portable dials](#), and is used with the [Golden Number](#) to find [Easter](#).

dusk: the evening [twilight](#) period.

E

earthshine: the illumination resulting from sunlight reflected from the Earth, particularly when providing low-level illumination of the "dark" portion of the Moon.

East: the point on the horizon 90° (measured clockwise) from the North. The Sun appears to rise from the East point on the [equinoxes](#).

Easter: the requirement to set the date of this Christian festival drove much of the early astronomy and calendar reforms. The standard astronomical algorithm for the date is now "the first Sunday after the full moon ([paschal moon](#)) that occurs upon, or next after, the [vernal equinox](#)". However, because the rules were set by the Christian clergy before the dates of the equinoxes could be defined accurately, the vernal equinox for this calculation is always taken as 21 March. See [Meeus](#) or [Duncan](#) in Sources for a full algorithm. The extreme dates of Easter are 22 March and 25 April

eccentricity (of the Earth's orbit): [e_c , **EC**] a measure of the relative sizes of the major and minor axes of the Earth's elliptical [orbit](#). $e_c = 0.01671\dots$ in the year 2000 and is slowly decreasing. $e_c = 0$ would imply a circular orbit. The earliest accurate value was found by John Flamsteed, the first Astronomer Royal, in about 1700 (most of his results were only published after his death in 1707).

eclipse (of the Moon or the Sun): the phenomenon which occurs when the Earth (or at least the observer's location), Sun and Moon lie on a straight line. If the Moon lies in the [ecliptic plane](#) between the Sun and the Earth, a solar eclipse occurs (either full, partial or annular, depending on the relative distances). If the Earth lies between the Sun and the Moon (i.e. at a full moon) a lunar eclipse is seen.

ecliptic (plane): (pron. e-clip-tic) the plane that the Earth's [orbit](#) traces during a year. The orbits of the Moon and the planets are also close to this plane. It is the plane in which [eclipses](#) occur since, by definition, the Sun is always on the ecliptic. It is a [great circle](#) on the [celestial sphere](#).

ecliptic latitude: {celestial latitude} [δ , **ELAT**] is the position of a body on the [celestial sphere](#), measured along the [great circle](#) from the [ecliptic](#). Positive to the north, negative to the south, range -90° to $+90^\circ$. It is part of the [ecliptic co-ordinate system](#).

ecliptic longitude: {celestial longitude} [λ , λ_c , **ELON**] is the position of a body on the [celestial sphere](#) measured around the ecliptic from the [vernal equinox](#) positive to the east. Range 0° to 360° . It is part of the [ecliptic co-ordinate system](#).

elevation: see [altitude](#).

ellipse: a [conic section](#) and the path the Earth follows during a year (neglecting only the small perturbations caused by the moon and the other planets). It is defined by two foci, and by a major and a minor axis. A circle is a special case of an ellipse with the two foci coincident, and the major and minor axes equalling the diameter. The elongation of an ellipse is characterised by its [eccentricity](#). Also, the outline shape of an [analemmatic dial](#).

ellipsoid: a closed geometric surface obtained by rotating an [ellipse](#) around its major or minor axis.

elongation (of the Moon): the angle of the Moon relative to the Sun, as viewed from an observer on the Earth. The term may also be applied to the planets. An elongation of

180° implies a full Moon.

epact (number): the number of days past the full moon on the 1st January of any year in a 19-year [metonic](#) cycle (the period before the Sun and the Moon are again in the same relative positions in the constellations). Epact tables are found on old dials, particularly [portable](#) ones, in conjunction with lunar [volvelles](#) and [calendars](#). In conjunction with an [almanac](#), they can be used to predict the date of [Easter](#).

ephemeris: (pron. ef-em-er-is) a table of predicted positions of celestial objects as a function of time. Astronomical [almanacs](#) invariably include an ephemeris for the Sun.

ephemeris second: an obsolete definition of a second used between 1955 and 1965, based on the Earth's speed of rotation. Now replaced – see [second \(of time\)](#).

epicycle: a small circle whose centre moves around the circumference of a larger one. It was proposed as the shape of the orbit of some of the planets by [Ptolemy](#).

epoch: a particular fixed instant used as a reference point on a time scale for astronomical calculations, e.g. J2000.0 or noon 1 Jan 2000 (2451545.0 JD). The word epoch also occurs on some dials, for example, in tables for calculating Easter.

Equation of Time: [E, EoT] the time difference between [Local Apparent Time](#) (apparent solar time) and [mean solar time](#) at the same location. Its value varies between extremes of about +14 minutes in February and –16 minutes in October. It arises because of the elliptical [orbit](#) of the Earth, and the tilt of the Earth's [axis](#) to the [ecliptic](#). The preferred usage by diallists is:

$$\text{mean solar time} = \text{apparent solar time} + \text{EoT}$$

but this sign convention is by no means universal and the opposite sign is used in modern almanacs. Irrespective of the sign convention adopted, sundials will always appear slow compared to mean time in February, and fast in October/November. See [Equations](#).

Figure 5. The Equation of Time and its components.

EoT varies continuously, but is usually tabulated for [noon](#) each day at a particular location. Hence values for America (e.g. as printed in the NASS Compendium) can be a few seconds different from those in Europe. The noon EoT on a particular day varies slightly over the [leap year](#) cycles (4, 100, 400 years), and more significantly over millennia.

The first published tabulation of the EoT was by Christiaan Huygens in 1665, but the knowledge of its existence probably goes back to [Ptolemy](#). The first Astronomer Royal, John Flamsteed (1646-1719) produced the first English tables in 1672.

EoT can also be expressed as an equivalent [hour angle](#)

equant point [E_a,EOTA]: a point in [Ptolemy's](#) model of the solar system around which the Sun and the planets rotate.

equator: the [great circle](#) of the Earth (or other celestial body) which is equidistant from the [poles](#). It has, by definition, a [latitude](#) of 0°.

equatorial mount: a mount for an instrument (e.g. a telescope) which has one axis parallel to the polar [axis](#) and another at 90° to this (the declination axis). The [diurnal](#) motion of a celestial body can be followed by rotation about the polar axis alone. A polar-pointing gnomon could act as the axle for such a mount.

equatorial plane: the plane through the Earth defined by the [equator](#).

equinoctial plane: the plane of the [equator](#) extended to the [celestial sphere](#), i.e. defined

by the [celestial equator](#).

equinoctial line (on a dial): is the line followed by the shadow of a [nodus](#) on the [equinoxes](#). For a plane dial, it is a straight line perpendicular to the [sub-style](#).

equinoxes: (vernal or spring ~, autumnal or fall ~) literally "equal nights" i.e. equal amounts of daylight and night-time. Astronomically, the points where the plane of the [ecliptic](#) cuts the [celestial equator](#), or the moments when the Sun is at these positions. The vernal ~, around 20-21 March, is also called the **First point of Aries** and represents the zero of [ecliptic longitude](#) and [right ascension](#). Thus the Sun has an ecliptic longitude of 0° or 180° at the ~. Day numbers of the Earth's orbit are usually counted from this point. The autumnal equinox is around 22-23 September, and has a right ascension of 12h. The Sun's [declination](#) at the equinoxes is 0°. See [Figure 1](#).

establishment (of a port): the interval between the time of the moon passing the [meridian](#) and high tide at the port. It is indicated on some [equiangular dials](#) which can indicate the times of the tides ([tidal dials](#)).

F

fiducial line (or ~ edge): (pron. fid-oo-shal) the edge of an index plate or pointer against which a scale is read.

filem: an old term for a plumbline, particularly on a [card dial](#), to show the vertical.

First point of Aries: see the definition for [equinoxes](#). Note that, because of the [precession](#) of the equinoxes, this point currently lies in the constellation of Pisces.

fleur-de-lis {fleur-de-lys}: an heraldic symbol of a stylised Madonna Lily, composed of three petals bound together near their bases. Often used on dials to denote the half-hour lines.

furniture: all features on a [dial plate](#) other than the [hour lines](#) and their numerals are referred to as dial ~. This may include [declination lines](#), [compass rose](#), [EoT](#) graphs or tables, [mottoes](#) etc. Other common furniture includes: date, maker's and/or benefactor's name, coats of arms, and [latitude](#) and (rarer) [longitude](#). See [Figure 1](#).

G

Geographic Position (GP): the point on the Earth's surface directly beneath a celestial body (i.e. where a line to the body from the centre of the Earth intersects the surface).

geoid: the Earth's shape, formed by the mean sea level and its supposed extension under the land masses. It cannot sensibly be represented mathematically, and is often approximated by one of many ellipsoids. Those most likely to be encountered are the Airy 1836 ellipsoid, used to define [Ordnance Survey](#) maps, and the WGS 84 ellipsoid, used in the [GPS](#) system.

globe: a spherical chart of the Earth. Note that although the Earth's [geoid](#) is actually a flattened ellipsoid (i.e. slightly melon-shaped with an equatorial radius of 6378 km, and a polar radius of 6357 km) the spherical representation is used for all dialling activities with the exception, for example, of the model used by the [GPS](#) system.

gnomon: (pron. no-mon) the physical structure of a sundial which casts the shadow (from the Greek for "indicator"). The gnomon today is most-often [polar](#) pointing (sometimes described as an "axial gnomon"), although it may also be horizontal or vertical. The special properties of a polar pointing gnomon were known to the Moorish astronomer Abdul Hassan Ali in the first half of the 13th century, but its first use may be earlier. The distinction between gnomon and [style](#) made (and encouraged in this

Glossary) in modern dialling literature is not the one used in early works, and the two words are still sometimes used interchangeably. Originally (in English from 1546), gnomon meant a [vertical](#) pillar or rod which cast a time-indicating shadow. See [Figure 1](#).

Hence **gnomonics**: the science of sundialling and **gnomonist** (seldom used): a person who practices gnomonics.

Golden Number: a number sequence (1-19) used to describe the year number in the [metonic cycle](#). It was used, together with the [Dominical letters](#), to find [Easter](#), and is often found on [portable dials](#).

grade (or **grada** or **gons** (obsolete)): [grad] a unit of angular measurement, equal to 1/100th of a right angle, or $\pi/200$ radians. Used particularly in France in the 18th and 19th centuries.

great circle: a circle on the surface of a sphere whose diameter is equal to the diameter of that sphere. Thus the circle has the same centre as the sphere. The shortest route between two points on the surface of a (solid) sphere lies on the circumference of the great circle connecting them.

GPS (Global Positioning System): a system of polar-orbiting satellites, run by the US Dept. of Defense, which allows hand-held radio receivers to provide accurate 3-D location information anywhere on (or near) the Earth's surface. It also provides a highly accurate clock, based on [UTC](#). The system uses the WGS84 [co-ordinate system](#) and description of the Earth's [geoid](#).

grazing incidence: a term used to describe illumination in which the [rays](#) are parallel to the receiving surface. The shadow of a point above the surface falls at infinity.

green flash: an atmospheric phenomenon occasionally observed during the final phase of [sunset](#), when the upper [limb](#) of the Sun shows as a green flash due to the complex wavelength-dependence of [atmospheric refraction](#).

Greenwich Mean Time (GMT): see [GMT](#), *time (types of)*

Greenwich Meridian: the line of [longitude](#) (or half a [great circle](#)) passing through the centre of the Airy transit circle at the old Royal Greenwich Observatory in London, and which defines the origin of Longitude ($^{\circ} = 0^{\circ}$). It is now designated the [Prime Meridian](#). Note: prior to 1884, there was no single fixed prime meridian, and hence early sundials sometimes refer to different origins, notably Paris.

Gregorian calendar: the calendar first introduced by Pope Gregory XIII in 1582 AD and now the accepted calendar throughout the vast majority of the world. It introduced the modern system of [leap years](#) which results in an error of only 3 days in 10,000 years. Note that adoption of this calendar throughout Europe took an extended period. Its introduction in Britain in [1752](#) produced a step change of 11 days which can be seen in the difference between [EoT](#) tables on dials earlier than this and those on later ones.

H

halcyon days: (pron. hal-ce-on) originally, 14 days about the winter solstice. Now taken as simply calm, peaceful.

Hallomas (Halloween in USA): All Saints' day on 1st of November. It is one of the [cross-quarter days](#).

hctemoros angle: [*hec*] (pron. hec-tem-or-os) the angle from the western horizon to the sun's position, measured around the *hctemoros* circle. Part of the [ptolemaic co-ordinate](#) system, and related to the [seasonal hours](#).

hectemoros circle: the [great circle](#) that passes through the E-W points on the [horizon](#) and through the sun's position.

heliacal rising: (pron. he-le-ac-l) the instant of the earliest visibility of a star in the East at dawn. The heliacal rising of the star [Sirius](#) was used by the ancient Egyptians to predict the coming of the annual Nile flood. Since their year had 365 days, this occurrence had a variable date.

height (of a style): see [style height](#).

heliocentric: an adjective to describe a model of the solar system which places a stationary Sun in the centre, with the planets revolving around it.

heliograph: has two distinct meanings: (i) a device for transmitting morse signals over extended distances by using an accurately aligned mirror to send flashes of sunlight to the receiving station. For long messages, the ~ has a mechanism for tracking the sun's motion. (ii) an astronomical instrument for studying sunspots, as built by George Airy at Kew in 1873.

heliometer: a telescope which produces two images of the Sun which can be manipulated to determine its angular size accurately. Invented in 1754 by John Dollond of London, it is also used to measure angular distances between stars.

heliostat: a scientific instrument which holds an image of the Sun stationary, allowing extended observation (e.g. for solar spectrometry).

hemisphere (northern ~ and southern ~): one half of the Earth's globe, either north of or south of the [equator](#). Note that a sundial at a particular [latitude](#) in one hemisphere must be reversed for use at the reciprocal latitude in the other hemisphere.

horarius circle: (pron. hor-ar-e-us) the [great circle](#) that passes through the N-S points on the [horizon](#) and through the sun's position.

horarius angle: [*hor*] the angle from the southern horizon to the sun's position, measured around the *horarius* circle. One of the [ptolemaic co-ordinates](#).

horizon: the line of intersection between the sky and the Earth. For normal astronomical purposes, the observer's horizon is taken to be the [great circle](#) on the [celestial sphere](#) on which every point is 90° from the observer's [zenith](#). The **observed horizon** (accounting for the curve of the earth and the height of the observer above its surface, but excluding [refraction](#)) is below the astronomical horizon by an angle called the [dip](#). This can have a significant affect on the times of [sunrise/sunset](#).

horologia: the collective Latin name for dials, water-clocks and sand-glasses, used in the Middle Ages.

horologium: a name used to describe medieval manuscripts listing shadow lengths, deriving from the Latin name for timepieces. Modern versions have also been produced. In modern astronomy, it is also the name of a faint southern constellation ("the Clock").

hour: usually means 1/24th of a [mean solar day](#), unless otherwise stated. Scientifically, it is defined as 3600 standard [seconds](#). See [Hour \(types of\)](#) for other definitions. The word derives from the Latin "hora", which was synonymous with prayer.

hour angle: [*h*, *HA*] the angle corresponding to the sun's position around its daily (apparent) [orbit](#). Measured westward from local [noon](#), it increases at a rate of 15° per hour. Thus 3pm (Local Apparent Time) is 45° and 9 am is -45°.

hour circle: a [great circle](#) on the [celestial sphere](#) that passes through the [celestial poles](#). It is orthogonal to the [celestial equator](#).

hour line: the line on a [dial plate](#) indicating the shadow position at a particular time

(includes fractional as well as whole hours). See [Figure 1](#).

hour line angle: [X, HLA] the angle that an [hour line](#) on a [dial plate](#) makes with the [noon line](#). The angle increases with time (i.e. positive for the p.m. hours). Thus, for a horizontal dial, the angle increases clockwise (hence the origin of the term) whereas for a vertical south-facing dial, it increases counter-clockwise. Beware, this convention is not used by all authors, and some define the angle with respect to the [sub-style](#) line.

hour point: a point on the [dial plane](#) indicating the crossing of the [gnomon](#)'s shadow at a particular time. Hour points replace [hour lines](#) on dials where the shadow edge does not pass through the dial [centre](#).

hour plane: the plane which, at any instant, contains the sun, the observer and the [N celestial pole](#). The [style](#) and the appropriate [hour line](#) lie in the hour plane.

Hours (types of):

antique ~: same as [unequal hours](#) or seasonal hours.

Babylonian ~: number of hours elapsed since [sunrise](#), with 24 equal hours per day. The origin of the term is unclear, but may be related to the fact that the ancient Babylonians originated the base-60 counting system for angles etc. They are sometimes written as "horae ab ortu solis" or H. AB ORT." on dials. See [Equations](#) for conversion from equal hours to Babylonian hours.

biblical ~: same as [unequal hours](#) or seasonal hours.

Bohemian ~: same as [Babylonian](#) ~.

Canonical ~: the seven times of the day (as opposed to time periods) used to define the services or divine offices in the medieval church. These offices were based on the sixth century Rule of St. Benedict. See [Appendix IV](#) for details.

An alternative definition of the term canonical hours, sometimes applied to lines on early Italian dials, is the system of putting equi-angular hour lines around the base of a horizontal gnomon on a vertical south dial.

common ~: the standard 2 x 12 equal hour system, also called German or French ~. In Latin "horae communes", they are often labelled "kleine uhr" (small hours) on [Nuremberg dials](#).

decimal ~: an hour system with ten equal hours per day (as sometimes used by the Chinese and ancient Egyptians, and during the French Revolution).

equal ~: any hour system where the length of an hour is independent of the date, and the same during [daytime](#) and night-time.

French ~: an early name for the equal hour system with 2 x 12 hours per day, beginning at midday and midnight. Sometimes written "Oltromontane".

French revolution ~: the equal hours according to [French Revolution time](#).

Great ~: a term for any of the [unequal hour](#) systems. Often labelled "grosse uhr" on [Nuremberg dials](#).

Greek ~: same as [Babylonian](#) ~.

Italian ~: {sometimes Italic ~} the number of hours that have elapsed since the most recent [sunset](#) (hour 0), with 24 equal hours per day. They were used in

many European countries during the period 1200 to 1800. They are sometimes written "horae ab occasu solis" or "H. AB OCC." on dials. The two terms (Italian and Italic) are often used synonymously in modern works but there is some evidence in older works that Italian hours were counted from 30 minutes after sunset. See [Equations](#) for conversion from equal hours to Italian hours.

modern ~: the equal hours as used in modern time systems. They may occasionally be referred to as common, European, French, German or vulgar hours.

Nuremberg ~: a hybrid [equal hour](#) system. The daylight hours were measured using the [Babylonian](#) ~ system, starting with 1 at sunrise, while the night hours started with 1 at sunset and used the [Italian](#) ~ system. In Latin, "horae norimbergenses".

octaval ~: a time system with the period of daylight divided into eight hours. Probably introduced by the Romans, circa 250AD. See [Appendix III](#) for the names of the daylight periods.

planetary ~: a planetary hour is the time needed for 15° of the [celestial equator](#) to rise above the [horizon](#), counting from [sunrise](#). As there is always 180° of the celestial equator above the horizon, there are 12 planetary hours from sunrise to sunset but they are unequal not only from day to day but also from hour to hour. Note: this definition is based on the writings of Sacrobosco, but some authors use planetary hours simply as another form of seasonal hours, with the hours associated with the "planets". See [Appendix VIII](#) for the symbols of the planets and this association. The [Zonwvlak](#) program uses the definition of the German scholar Joseph Drecker (1925) who defines a planetary hour as the time for 15° of the [ecliptic](#) to rise above the horizon (counting from sunrise) and are hence very irregular.

seasonal ~: a form of [unequal hours](#), usually with 12 daytime and 12 night-time hours. Named from the fact that the length of an hour varies with the [seasons](#).

temporal ~ or **temporary** ~: an [unequal](#) hour system with 12 hours from sunrise to sunset, and 12 hours (of a different duration) from sunset to sunrise.

unequal ~: an hour system where the duration of an hour depends on the date and is different from day-time to night (except at the [equinoxes](#)). The number of hours during day-time is usually 12, but may be 8 and just possibly 10 (e.g. on some mass dials). Counting of the daytime hours begins at sunrise.

Welsch ~: i.e. foreign. Same as [Italian](#) ~.

End of Hours (types of)

house: (astrological) a segment of the [celestial sphere](#). Several methods of dividing the sphere into segments exist, the most common of which produce the signs of the [zodiac](#), and the [Regiomontanus houses](#).

hyperbola: a [conic section](#), its most common use in dialling is the shape of the [declination lines](#) on a dial.

I

Imbolic: an ancient Celtic festival held on the 2st of February, celebrating fertility. It is one of the [cross- quarter days](#)

inclination: [*i*, **I**] the angle between the back of the [dial plane](#) and the horizontal for [inclining](#) or [reclining](#) dials. Equivalently, it is the angle between the [zenith](#) and the positive *z* [co-ordinate](#) of the dial. $i = 0^\circ$ implies a [horizontal](#) dial. For an inclining dial, $0 < i < \phi$ (the latitude of the place). For a reclining dial leaning away from the observer, $i < 90^\circ$; whilst $i > 90^\circ$ implies a proclining dial leaning forward towards the observer. Beware: this convention is not followed by all authors.

inclinometer (or **clinometer**): an instrument for measuring the [inclination](#) or slope of a surface. Two types are common: simple devices with a plumb-line hanging across a protractor, or precision ones where a sensitive spirit level is moved to the horizontal position against an accurate scale. Note: the term inclinometer is also used to describe an instrument - also called a [dip circle](#) - for measuring the vertical component of the Earth's magnetic field.

index: besides its normal meaning of an alphabetical list, an ~ is a pointer on a scientific instrument, indicating a point on a graduated scale. The **index arm** of a sextant is the movable arm carrying the index mirror and the [fiducial line](#).

inferior: refers to an event on the [celestial sphere](#) below the [horizon](#). Opposite of [superior](#).

inhiraf: the angle which the [qibla line](#) makes with the north ray of the meridian at any location.

International Date Line: the line from the N to S [poles](#), approximately following the 180° line of [longitude](#), through which the date alters by one day (positively if travelling from W to E). Variations from the 180° meridian are made to avoid political and geographic boundaries.

Islamic prayer lines: the lines on Islamic dials where the shadow of the [nodus](#) falls at the times when Muslims must pray. The times of the three most common lines are determined by a linear relationship to the [noon](#) shadow length of a vertical [gnomon](#):

zuhr: noon shadow + 0.25 x gnomon height

asr-awwal: noon shadow + gnomon height

asr-tâni: noon shadow + 2 x gnomon height

isogonals: lines of equal [magnetic deviation](#) plotted on some navigational charts.

J

Jaipur: (pron. Ji-poor) a famous early 18th century solar astronomical centre in India, constructed by the Maharaja Jai Singh around 1724. It includes many monumental sundials, including a famous [equatorial](#) one with a gnomon 27 metres high.

Julian calendar: the [calendar](#) system introduced by Emperor Julius Caesar and devised

by the Greek philosopher (and court astronomer of Egypt) Sosigenes. Widely used from 45BC to 1582AD. By this date, it was in error (compared to the Earth's orbit) by 10 days due to the imperfect use of [leap years](#) (i.e. it assumed the length of a year was 365.25 days).

Julian Day {sometimes **Julian Ephemeris Day**}: [**JD**] the astronomer's scale of date and time. Used in dialling, for example, for the accurate calculation of the [EoT](#) and [sun's declination](#). Measured continuously in decimal days since noon GMT 1 Jan, 4713BC. By tradition, since midnight is difficult to define without an accurate clock, the JD begins at Greenwich Mean noon, that is, 12:00 UT. As an example, 9:36 GMT on 26 April 1977 is JD2,443,259.9. See Sources: [Meeus](#) for a full algorithm for converting modern date/time to JD. The Julian Day count was defined by John Herschel in 1849, based on the 4713 BC epoch used in 1583 by Joseph Scaliger (France). It is commonly stated (probably erroneously) that Scaliger named the system after his father.

K

kamál: an early Arabic navigational instrument for determining the Sun's [altitude](#) by means of a transom and a knotted cord.

Kepler's Laws (of planetary motion): three laws which describe the motion of the planets around the Sun, after Johannes Kepler (1571-1630). They are:

1. Planets travel in elliptical (rather than circular or epicyclic) orbits, with the Sun at one of the foci.
2. The line joining the Sun and the planet sweeps out equal areas of space in equal time intervals (so that the planet moves faster when it is nearer the Sun, and establishing the Sun as the main controller of the planets)
3. The link between the size of the planet's orbit and its period of rotation is described mathematically.

klimata: (pron. clim-arta) part of an [astrolabe](#), it is a disk rotating on the [mater](#) with the north [celestial pole](#) in the centre and showing [almucantar](#) lines for the design location. After the Ancient Greek meaning "angle of the Sun's rays", and hence the modern word "climate".

L

Lambert's circles: circles of construction used when drawing sets of nested [ellipses](#) to represent [analemmatic dials](#) for different [latitudes](#), these dials using a common scale for the (vertical) [gnomon](#) position. Such sets of dials are particularly useful for a [solar compass](#), e.g. the Cole sun compass used in N. Africa during the Second World War. After the mathematician Lambert (b. 1728, Alsace).

Lammas (or Lammas Day): one of the [cross-quarter days](#). It is on 1st August, and was formerly observed as the harvest festival.

latitude (geographical, of a place): [ϕ , **PHI**, **Lat**] Note: avoid LAT, since it implies local apparent time. It is the angular position of a place north or south of the [equator](#). Positive values in the Northern [hemisphere](#), negative in the South (i.e., the South Pole has $\phi = -90^\circ$). Part of the [geographic co-ordinate system](#), the term comes from the Greek "latus" (breadth).

leap second: an extra [second](#) inserted into [UTC](#) at the end of some years between 24:00:00 Dec 31 and 00:00:00 Jan 1 to ensure that UTC remains in step with the Earth's [diurnal](#) rotation. It may also be added at the end of June. The addition is not predictable as it depends on many factors, such as the increased atmospheric drag on the Earth in El Niño years. The actual addition is performed by the Bureau International des Poids et

Mesures near Paris. Leap seconds are gradually becoming more common as the rate of the Earth's rotation slows due to energy dissipation by the tides.

leap year: years in which an extra day (February 29) is introduced so that the ([Gregorian](#)) calendar keeps step with the Earth's [orbit](#). The rule for leap years is that a year is a leap year if and only if the year number: is divisible by 4, except years divisible by 100 which are not leap years unless they are also divisible by 400. This corresponds to the length of the year being 365.2425 [mean solar days](#). This can be compared to the 365.25 days in the earlier [Julian calendar](#). (The Julian leap year doubled February 24.) The leap year system causes the [EoT](#) (and [Sun's declination](#)) on a particular day of the year to exhibit a small periodic variation.

lemniscate (curve): the term used in Latin countries for the [analemma](#). From lemniscus, meaning ribbon. In English, the ~ is a mathematical curve which is similar to a spiral and is sometimes used in road design; it also looks similar to one lobe of the analemma.

libration (of the Moon): the periodic oscillation of the Moon from 'side to side' (and 'up and down') which allows an observer on the Earth to see somewhat more than half its surface.

limation: (rare) a term used by Flamsteed to mean the correction of a calculation or observation, having originally (1612) had the meaning 'filing or polishing'.

limb: part of an [astrolabe](#), it is the circular ring with a scale of hours and degrees. Its first recorded English use was in 1593.

limb (of the Sun): the outer circumferential region of the Sun (or other celestial body). The term **limb darkening** indicates that the disk of the Sun does not have uniform brightness but is dimmer around the "edges" due to increased optical absorption by the [photosphere](#).

local apparent time: [**L.A.T.**] solar time see [LAT \(types of\)](#). Hence **local apparent noon**, at the Sun's [superior transit](#).

local hour angle (or just **hour angle**): [**h, HA**] [Local Apparent Time](#) expressed as the angular position of the Sun in its daily track. Measured from [noon](#), it increases by 15° per hour with increasing time (i.e., morning hours are negative). Beware, this convention is not universal.

lodestone: a naturally occurring oxide of iron, mounted with two iron poles in a non-magnetic frame. Used for magnetising compass needles, small ones were made specially for [portable dials](#).

longest day: a term in common parlance, defined as the day of the year with the greatest (astronomical) [sunrise](#) to sunset period. It is normally used synonymously with the summer [solstice](#) although, strictly, it can vary by a day depending on the exact time of the solstice and the relationship between the rate of change of the [EoT](#) and that of the local sunset/sunrise.

longitude (or geographic ~ to distinguish it from the ecliptic ~): [**λ, λ_g, LON**] the angular location of a place on the Earth's surface measured east or west of the [Prime meridian](#) though Greenwich. Longitudes W are positive, E are negative. Part of the [geographic co-ordinate system](#), the term comes from the Greek "longus" (length). See also [Prime Meridian](#).

Longitude Act: a 1715 act of the British parliament which established a Board of Longitude to manage a prize of £20,000 for a practical method of finding longitude at sea.

longitude correction: the correction required to [local apparent time](#) to translate it to the

L.A.T. for the central meridian of that [time zone](#). The correction is +4.0 minutes for every 1° longitude W of the time zone [meridian](#) (and −4.0 minutes for E). Sometimes, this correction is built into the [hour lines](#) by calculating the local [hour angle](#) for times at the zone meridian.

lunar angle: the difference between the [right ascensions](#) of the Sun and the Moon. On a standard sundial used as a [moon dial](#), the [L.A.T.](#) equals the time shown by the lunar shadow plus the lunar angle expressed in hours.

lunation: the time interval between successive New Moons. The [mean](#) interval is 29 days 12 hours 44 minutes 3 seconds (the [synodic month](#)) but, because of the perturbing action of the sun, the difference between the shortest and longest lunations in the 20th century is 5 hours 19 minutes.

M

Mach bands: (pron. mak) subjective light and dark bands which an observer sees when looking at a black-white edge. They are produced by the brain's visual processing (i.e. they are not real) and have the effect of sharpening up edges. First described by the German physicist Ernst Mach (1838-1916).

magnetic variation {magnetic declination, magnetic deviation}: Note, the use of the term magnetic declination is best avoided because of confusion with the other types of declination. It is the angle between the true N [pole](#) and the magnetic N pole. At present in the UK, the magnetic pole is very approximately 3° W of true north, and decreasing by about 12' annually. See [Appendix IX](#) for more detailed and historical values. There can be large local variations to the general values, some of which can be found mapped on navigational charts. The use of a magnetic compass for aligning a permanent dial is not recommended, even if due corrections are made, as the presence of steel or magnetic rocks will cause very local variations.

manaeus: (pron. man-ay-us) the circle of months which formed part of the ancient [orthographic](#) spherical projection used by late Middle age diallists. It establishes the [sun's declination](#).

maquette: a sculptor's small preliminary model. The term is used to describe small mock-ups of three-dimensional dials.

Martinmas: St Martin's day, on 11th November. It is one of the [cross-quarter days](#).

mass dial: see Dial types ([mass dial](#)).

mater: the heavy disk which forms the base of an [astrolabe](#).

mean solar day: the time between successive [transits](#) of the fictitious mean Sun (i.e. an imaginary sun which appears to circle around the [celestial equator](#) at a constant rate equal to the average rate of the Earth's real rotation). The basis of [civil](#) time keeping.

mean time: see [Time \(types of\)](#).

mean local time (or local mean time) : [see Time \(types of\)](#).

Mercator projection: the most common projection used to produce a 2-D map of the [globe](#). Developed by Gerardus Mercator in Belgium, 1586. It has straight meridians and parallels of latitude that intersect them at right angles. Scale is true at the equator or at two standard parallels equidistant from the equator. The **Transverse Mercator** projection is obtained by projecting the sphere onto an enclosing cylinder tangent to a central meridian. This is the projection used for [Ordnance Survey](#) maps of the UK.

merkhet: a [transit](#) instrument from ancient Egypt, consisting of a horizontal "L" shaped stone with a plumb-bob supported from the short vertical arm. It was used in

conjunction with a [bay](#).

meridian: the [great circle](#) (or, more usually, half of a great circle) passing through the N and S [poles](#). The same as a line of [longitude](#). The term is sometimes used to mean the meridian line passing through the observer's location, or its representation on the [dial face](#).

meridional: south-facing (e.g. a [direct-south dial](#)). In more general usage, it generally means of, or from, the south.

meridian line: see [Dial Types \(noon line\)](#) for the lines inscribed in the floors of Renaissance cathedrals, etc.

metonic cycle: a cycle of 19 years (or 235 lunar months) over which the Sun and the Moon return to the same relative positions amongst the constellations. It was discovered by the Greek astronomer Meton c.433 BC and determines the [epact](#) number and the [Golden Number](#). Actually, the moon runs 1½ hours slow over this period, or one day over 312.7 years. This fact has to be included in the calculations for [Easter](#).

midnight: strictly, the time when the Sun achieves its most negative [altitude](#) (or, equivalently, when its [azimuth](#) is $\pm 180^\circ$). More loosely defined as half-way between [sunset and sunrise](#) or, with even less accuracy, 12 hours after local [noon](#).

midsummer, midwinter (~ day): the same as summer or winter [solstice](#). Note that **Midsummer** (with capital M) is a legal term for the [Quarter Day](#) on June 24.

mil: unit of angular measurement used in some military equipment, e.g. rangefinders, theodolites. 6400 mils = 360° . Beware possible confusion with use as a linear measurement of 1/1000 inch used by engineers (particularly in the USA).

mileways: an obsolete term for an [hour angle](#) of 5° , equivalent to 20 minutes of time. So called because this is the approximate time that it takes to walk one mile.

minute of arc: see [arc minute](#).

minute (of time): is now defined as 60 [seconds](#). Historically, the definition was 1/60th hour, where the [hour](#) was derived from the rotational period of the Earth.

month: an interval of time related to one revolution of the Moon around the Earth (a "moonth"). The calendar month derives from the **synodic month** (full-moon to full-moon) which averages 29.53 days. The **anomalistic month** ([perigee](#) to perigee) averages 27.53 days.

Moon: the natural satellite of the Earth. It has a mean distance from the Earth of 384.4×10^3 km and a semi-diameter at mean distance of $15' 33''$. The inclination of its orbit to the ecliptic is $5^\circ 8' 43''$. Note: "moon", without an initial capital letter, is sometimes used to refer to moons of planets other than the Earth.

moondial: see [Dials \(types of\)](#).

moonlight: rays of light which reach the observer directly from the Moon, having originally been [sunlight](#) reflected by the Moon's surface. There is usually sufficient light to cast a shadow only between the 1st and 3rd quarters of the Moon. Since the angular size of the Moon is approximately the same as that of the sun, the ratio of [umbra](#) to [penumbra](#) of a moon shadow is also the same as for a sun shadow.

motto: a sentence, phrase or verse inscribed on a dial expressing an appropriate sentiment. Mottoes started appearing on dials in the late 16th century but were particularly popular in the 19th century.

N

nadir: the point on the [celestial sphere](#) that is diametrically opposite the observer's [zenith](#).

nautical mile: a distance (6080 feet or 1853 metres) determined as 1 arc-minute of [longitude](#) at the [equator](#).

night (or night-time): the period of darkness between [sunset and sunrise](#).

nocturnal: (noun) a fixed or, more usually, portable instrument used to tell time by the apparent revolution of the stars on the [celestial sphere](#). The stars most often used on these instruments are either the "guards" of the Little Bear (Ursa Minor) or the "pointers" of the Great Bear or Plough (Ursa Major). These are known as the Little Dipper and Big Dipper, respectively, in the USA. Most nocturnals have inscriptions "GB" and "LB" on their scales. The term ~ can also be used as an adjective, meaning "of the night".

nodus: a point which casts a shadow to indicate the time and/or date on a [dial face](#). It may take the form of a small sphere or a notch on a polar-pointing [gnomon](#), or it may be the tip of a gnomon with an arbitrary (usually horizontal or vertical) orientation. See [Figure 1](#).

nodus height: [N, NH] the height (distance) of a [nodus](#) perpendicular to the [dial plane](#). It is also the same as a vertical style height.

nomogram (sometimes nomograph): a system of graphs showing relationships between three or more variables. From the Greek "nomos" (law).

nonius: a device similar to a [vernier](#) for interpolating readings on an angular scale, but using a large number of concentric scales rather than a single movable one. Named after the 16th century Portuguese mathematician Pedro Nōnes.

noon: the time of the sun's [transit](#) each day. Equivalently, the time that the Sun reaches its largest [altitude](#) for that day. Note that noon is specific to the observer's location, unlike 12:00 o'clock with which it is often confused.

The word ~ originates from the Latin 'nonus' or ninth, indicating the ninth hour of the day counting from sunrise. By 1420 it meant the hour or ecclesiastical office of Nones, so noon gradually became associated with the beginning of this office.

noon cross: a cross shape often seen instead of XII on the [noon line](#) of dials. It can have many forms, many of which look like an Iron or Maltese cross. The nearest heraldic term is the [cross patty](#).

noon gap (or gnomon gap or split noon): the gap in the hour scale of a dial to account for the finite thickness of the [gnomon](#). It is positioned on the dial plate where the Sun is in the same plane as the gnomon, i.e. at [noon](#) for horizontal or direct S dials. A gnomon gap is occasionally seen on the [sub-style](#) of a [declining](#) dial. See [Figure 1](#).

noon line (on a dial): simply the [hour line](#) corresponding to noon, it is the most important line from which the others are usually calculated. It is the line which most often carries an [analemma](#).

noon marker: a single mark or stone in the ground (or on a wall) set to show noon when crossed by the shadow of a convenient vertical; for example, a stick or edge of a wall. Sometimes also called a [shepherd's dial](#).

North: the intersection of the local [meridian](#) with the [horizon](#), in the direction of the north [celestial pole](#).

North Pole: the point on the Earth's surface and its [axis](#) with a latitude of +90°. It lies in the direction of the **North celestial pole**, from which the Earth is seen to rotate anti-clockwise.

numerals: The numerals on dials are usually either [Arabic](#) (the usual 0-9 used in English) or, especially on older dials, [Roman](#) numerals (I, II,..XII etc.). Note that it is common to find IIII in place of the later IV on some dials. A convention sometimes used on dials with more than one hour ring is to use Roman numerals [for Local Apparent Time](#), and Arabic ones for [civil time](#) (often [BST](#) etc.). Many other forms of numerals (e.g. Chinese, Turkish) are used world-wide.

nutation: a small periodic (principal time constant of 18 years 220 days) oscillation of the rotational [axis](#) of the Earth about its mean position. Discovered by James Bradley (1693-1762), the third Astronomer Royal, in 1748. The disturbance of the idealised orbit of the Earth (as a two-body system) is due to the gravitational attraction of the Moon and, to a lesser extent, the other planets. Nutation introduces small changes, typically 7 arcseconds annually, to the [precession](#) of the [equinoxes](#).

O

obelisk: a tall tapering shaft of stone, usually monolithic with a square or rectangular section ending with a pyramidal apex. Prominent in Ancient Egypt as a solar symbol, often at the entrance to tombs or as a cult object in shrines to the sun.

obliquity (of the ecliptic): {sometimes the **slant**} [**ε** , **EPS**] is the angle between the Earth's [equatorial plane](#) and the [ecliptic](#). The current mean value of the obliquity (i.e. ignoring its [nutations](#)) is 23° 26' 21", decreasing by 23" over the next 50 years. Note that this figure sets the position of the [tropics](#).

obtuse angle: an angle of greater than 90° and less than 180°.

occidental: west-facing (e.g. a [direct-west dial](#)). In more general usage, it generally means of, or from, the west.

orbit (of the Earth): the path of the Earth around the sun. For dialling purposes, this is taken as elliptical, with a very small [eccentricity](#), i.e., it ignores the small perturbations due to the effects of the Moon and other planets.

origin: the (0,0) point (or (0,0,0) in three dimensions) of a co-ordinate system used to describe a [dial plane](#). It is usual to place this point at the [centre](#) of the dial (if it exists), but it is sometimes placed at the [sub-nodus](#) point.

oriental: east-facing (e.g. a [direct-east dial](#)). In more general usage, it generally means of, or from, the east.

orrery (pron. or-rer-re): (sometimes called a **planetarium**): a physical model of the solar system, used for demonstration purposes. Named after Charles Boyle, 4th Earl of Orrery, who had an early example built by John Rowley in 1712. Sometimes powered by clockwork to provide the correct relative orbital periods of the planets. Early examples are very valuable. See also [tellurian](#).

orthography: the art of drawing anything without perspective, as though viewed from infinity. In dialling, the sphere so drawn consists of circles, straight lines and [ellipses](#). Hence orthographic (or orthogonal) projection, which is used in the universal astrolabe.

ortho-style: a style which is perpendicular to the dial plate. It was used in many ancient dials.

P

parabola: a mathematical term for the [conic section](#) obtained by cutting a cone with a plane parallel to its generator (or "edge"). A **parabolic** surface, obtained by rotating a parabola about its own axis, is much used for mirrors as it has the property of focusing parallel rays of light to a point focus.

parallactic angle: [π] the angle of the polar triangle between the directions to the [pole](#) and to the [zenith](#) at the celestial object. Hence it is the angle between the vertical and the [hour circle](#), of use in calculating the effects of astronomical [refraction](#).

parallax: the effect whereby the apparent position or direction of an object changes with the observation point. See [solar parallax](#) for its affect on solar parameters. The effect can affect the accuracy of reading scales.

paschal moon: (pron. pas-kal) the first full moon following the Spring [equinox](#). Important for the determination of Easter.

patina: Coloured, metallic compounds (usually oxides and sulphides) which form on metal surfaces left exposed to the atmosphere. The actual colour depends principally on the metal, but also on the impurities in the atmosphere resulting from pollution or proximity to the sea. Typically, copper-containing alloys develop a greenish colour.

pedestal: the supporting structure for a dial, particularly horizontals. Usually of stone, it may comprise several different pieces and brings the dial to a convenient viewing position. See [Appendix VII](#) for more details of architectural terms.

pelorus: an instrument for finding the solar [azimuth](#), consisting of a magnetic compass and an [alidade](#), with some means (e.g. mirrors, prisms, shades) of viewing the Sun and the compass needle.

penumbra: the area of partial shadow surrounding the central [umbra](#). It is due to the finite size of the sun. An observer standing in the penumbra would observe only part of the sun's disk.

perigee: (pron. pe-ri-gee) the point in the Moon's (or other satellite's) orbit when it comes closest to the Earth.

perihelion: (pron. perry-he-le-on) the point in the Earth's [orbit](#) when it comes closest to the sun. It occurs during the first week of January.

perpetual calendar: a device, usually in the form of a circular plate with one or two rotating engraved disks, for finding the day of the week for any date (over a wide range of years). They are often combined with [portable dials](#) as part of a [compendium](#). More sophisticated versions have extra tables for Saint's Days and similar data.

phase (or age) of the Moon: the approximately monthly variation of the angular separation of the Sun and the Moon, leading to the sequence of new, waxing, full and waning moons. The **age** (as seen, for example, in tables associated with [moon dials](#)) is measured in days since the last new moon. Astronomically, the phase of the Moon is defined as the angle between the Sun and the Moon measured from the Earth (the [lunar angle](#)). The mean length of the [synodic](#) (i.e., lunar) month is 29.53059 days (usually approximated to 29½ days in the lunar mechanisms of clocks).

photosphere: the outer envelope of the Sun which produces the visible light by which it is seen.

pinnules: sighting pinholes (usually in pairs) in an alignment device, e.g. an [alidade](#).

planet: astronomically, a celestial body in orbit around a star. The five planets of the solar system known to the ancients were Mercury, Venus, Mars, Jupiter and Saturn. In addition, they often counted the Sun and the Moon as planets; for example, in the [planetary hours](#) system. See [Appendix VIII](#) for symbols.

planetarium: see [orrery](#).

planisphere: a map of part of the [celestial sphere](#), formed by a [stereographic projection](#) of the sphere onto a flat plane and showing (or adjustable for) the positions of the stars at a particular time and location.

plinth: the base part of a [pedestal](#), normally resting on the ground. Note that some authors use ~ to refer to the whole of the pedestal. See [Appendix VII](#) for more details of architectural terms.

plumb-line: a freely suspended line with a weight (or plumb-bob) at its lower end, used for defining the vertical.

plummet: the form of [plumb-line](#) incorporated in a portable dial and used for levelling it. It usually consisting of a solid elongated cylinder suspended, by a joint with free movement in the horizontal axes, above a datum point.

pobble: the bead on the [plumb-line](#) of a [card dial](#).

polar axis: see [axis](#).

polar co-ordinates: see [co-ordinates](#).

polar distance: the distance (as an angle) of the Sun from the elevated [celestial pole](#); the complement of the [declination](#).

polarised light: light in which the electromagnetic waves have a single plane of vibration in a direction perpendicular to the direction of propagation. Polarising filters allow the transmission of light rays with only a selected plane of polarisation. Discovered by Christiaan Huygens (1635-1703). [Sunlight](#) is randomly polarised, but [skylight](#) is partially plane polarised, with the direction of polarisation at any point in the sky being perpendicular to the plane containing the point, the Sun and the observer. The proportion of the skylight which is polarised is a maximum in the [principal plane](#) and at 90° to the sun. The proportion is always less than 75%, and substantially less in slightly hazy conditions.

Polaris (or Pole Star): actually α Ursae Minoris, it is the star which appears quite close to the N [celestial pole](#) and is frequently used for finding north by navigators. It currently appears to rotate daily around a circle of radius 1°, so it requires some knowledge if it is to be used for aligning a sundial. The size of this circle varies over the centuries with the [precession](#) of the equinoxes.

polar plane: any plane which is parallel to the Earth's [axis](#).

polar triangle: the [spherical triangle](#) on the [celestial sphere](#) whose vertices are at the [pole](#), the [zenith](#), and a celestial body, with respective angles of the [hour angle](#), the [azimuth](#), and the [parallactic angle](#). The arcs joining these are the [co-latitude](#), the north polar distance ($90^\circ - \delta$) and the [zenith distance](#). The polar triangle is fundamental to the operation of most types of sundial, whose function it is to derive the hour angle, and hence the time, given any three of the other quantities.

poles (N and S of the Earth): the locations on the Earth's sphere with [latitudes](#) of $+90^\circ$ (N) and -90° (S).

polos: an old term for a polar-pointing [style](#).

post meridiem (p.m.): the portion of the day between [noon](#) and [midnight](#).

precession (of the equinoxes): the slow westward progression of the [equinoxes](#) on the [ecliptic](#). It is caused by the drift of the Earth's [axis](#) in space, as in a precessing spinning top. The position of [Polaris](#) turns around the pole of the [celestial pole](#) once in about

26,000 years. As a consequence, the vernal equinox regresses by about 50 arcseconds per year along the ecliptic. It is caused predominantly by the gravitational force of the Sun and the Moon on the Earth's equatorial bulge. Secondary effects, due to the other planets, give a rotation of the ecliptic plane of 47 arc-seconds per century.

The first measurement of precession was made by Hipparchus in 129 BC.

precision (of a dial): a combination of the [resolution](#) and [accuracy](#) of a dial, it gives a measure of how exactly (and correctly) it indicates [any](#) time.

Prime meridian: the [meridian line](#) defined as the origin for [longitudes](#). Now synonymous with the [Greenwich meridian](#), before 1884 various countries defined their own origin. The early Greeks used Rhodes or Alexandria. [Ptolemy](#) used the Fortunate Islands, assumed to be Ferro in the Canary Islands by scholars in the Renaissance. [Nuremberg](#) was common for dials made there, and in relatively modern times many maritime nations had their own locations; Paris in particular continued to be used even post-1884. Note that the 0° longitude line used by the [GPS](#) system is actually a mean value, periodically recalculated to allow for tectonic drift etc. and currently lies approximately 38 m (80 feet) east of the Greenwich line.

Prime vertical: the vertical circle perpendicular to the [meridian](#). It passes through the E and W points.

Primum Mobile: (pron. pree-mum mo-be-lay) an old term for the supposed crystal sphere carrying the stars in their orbits around the earth.

principal plane {or vertical plane}: the plane obtained by varying the Sun's [altitude](#) whilst its [azimuth](#) is constant. Perpendicular to the [almucantar](#).

prosthaphaeretical arc: a term introduced by Samuel Foster to describe an arc on the surface of the earth between the location of an [inclining/declining](#) dial and the position where it would be identical to a horizontal dial (i.e. the [complementary](#) dial). In astronomy, prosthaphaerisis is the adding of a small amount to an observed value.

Ptolemy's rulers: an interconnected set of three linear scales used to measure the angular positions of stars, used particularly by Regiomontanus and the Nuremberg group in the 1460s.

Q

Qibla line: sometimes found on Arabic dials, it is an [azimuth](#) line on the [dial plate](#) starting at the [centre](#) and pointing to Mecca.

quadrant: a term used for a large genus of astronomical and navigational instruments. In the form of a quarter-circle, it incorporates a sun or star sighting device along one of its radial edges and a plumb-bob hanging from the centre of the circle. The old **quadrans vetus** was originally an Islamic invention which provides [seasonal hours](#) but is only truly accurate for an observer on the equator. The **quadrans novus**, invented by Profatius in 1288) was more accurate, incorporating the circular scale of the [astrolabe](#) folded into a quadrant but it was difficult to read. The 1438 **horary quadrant** of von Gmunden was one of several attempts to improve on this. The **Gunter** ~ (after Edward Gunter, Gresham College, 1623) is latitude dependent and employs a [stereographic](#) projection. The **navigational** ~ is actually an octant (eighth of a circle) with two reflecting mirrors replacing the plumb-bob. For the **Davis** ~, see [back-staff](#).

Quarter days: the first or last days of each quarter of the year on which rent or interest is due. These dates are occasionally used instead of the [zodiac](#) signs for [declination lines](#) on dials. See Appendix XII for their names and dates.

quincunx: five dots arranged as on dice. It sometimes appears on [mass dials](#) at [noon](#) or

service times.

R

radian: [rad] the primary unit of angular measurement, it is the central angle subtended by an arc of a circle equal in length to its radius. 2π radians = 360° or $1 \text{ rad} \approx 57.3^\circ$.

ray: a single line or narrow beam of light.

reclination: a term sometimes used for the angle by which a [reclining dial](#) leans away from the observer (i.e. the complement of the [inclination](#)). It is more consistent, however, to translate this into the equivalent [inclination](#).

rectificatory: an old term for a right-angled triangle where the other two angles are the [latitude](#) and [co-latitude](#). Used particularly in the graphical construction of dials.

reflex angle: an angle of greater than 180° .

refraction: the "bending" of light at the interface of two materials of different refractive indices. It accounts for the focusing action of lenses. In dialling, use is made of ~ in dials which use a clear liquid in a solid cup to compress the hour lines, or which use a cylindrical lens to focus [sunlight](#) onto a curved [dial plate](#). **Atmospheric refraction** (due to the curve of the Earth's surface and the variation of atmospheric density with height, in turn dependent on meteorological conditions) is the effect which makes the Sun (or other celestial body) look slightly higher in the sky than its true astronomical position. It is only significant when the Sun is within a few degrees of the [horizon](#). At 0° altitude, the bending is equivalent to approximately 34 arc-minutes, so that it is possible to see the Sun when it has actually just sunk below the horizon. See [Equations](#). This effect is not generally included in normal sundials but it must be allowed for when calculating solar parameters from observations using [meridian lines](#).

The **refractive index** [μ , MU] of a medium (or its index of refraction), needed to calculate these effects, is defined as the ratio of the speed of light in a vacuum to its speed in the medium.

Regiomontanus houses: an astrological division of the [celestial sphere](#) into 12 segments or houses. The division is performed in equal segments around the [celestial equator](#), rather than around the [ecliptic](#) as is done for the normal signs of the [zodiac](#). The houses are numbered I to XII, beginning at the east point of the horizon and are, confusingly, associated with the standard zodiac signs with I corresponding to Aries. Only the last 6 of the signs appear above the horizon. They are shown as [domifying circles](#) on some old dials.

resolution (of a dial): the smallest time increment to which the scale on a dial can be read. Contrast with [accuracy](#). See also [precision](#).

rete: {or net or spider} (usually pron. ree-tee) part of an [astrolabe](#), it is the fretted disc containing a number of star pointers, and which can be turned on the [limb](#) until the star's pointer crosses the altitude circle on the [stereographic](#) projection, allowing the time to be read off (assuming the date is known). The term ~ has sometimes (first reference in 1677) been used as a graduated scale fixed to an astronomical telescope.

reticule: fine lines or scales on an optical element in a sighting device (e.g. a telescope) to aid in alignment or measurement of an object.

revolve: (astronomical) to orbit around another body, e.g. the Earth revolves around the Sun. Contrast to [rotate](#).

right ascension: [α , RA] a co-ordinate used by astronomers, as part of the [equatorial co-ordinate system](#), (together with [declination](#)) to define the position of a celestial body.

It is the angular distance measured along the [celestial equator](#) (positive to the east) from [the vernal equinox](#) to the intersection of the celestial equator to with the [hour circle](#) through the point in question. Usually measured from 0 to 24 hours, but sometimes 0° to 360°.

root (of a gnomon): The fixing between the [gnomon](#) and the [dial plate](#). See [Figure 1](#)

rotate: (astronomical) to spin on its own axis, e.g. the Earth rotates on its polar [axis](#). Contrast to [revolve](#).

S

Samhain: an ancient Celtic festival held on the 1st of November. It is one of the [cross-quarter days](#).

saros cycle: a cycle of 18 years 11 days 8 hours (223 [lunations](#)) between repetitions of [eclipses](#).

scales: see [dialling scales](#).

sciagraphy: {**skiagraphy**} the art or science of shading and shadows. From sciaterics or scioterics - the name for gnomonics in ancient Greece.

seasons: the seasons are defined astronomically as follows:

Spring: from the vernal [equinox](#) to the summer [solstice](#)

Summer: from the summer solstice to the autumnal equinox

Autumn: from the autumnal equinox to the winter solstice

Winter: from the winter solstice to the vernal equinox

In popular parlance, the seasons of the northern hemisphere comprise the following months:

Spring March, April, May

Summer June, July, August

Autumn September, October, November

Winter December, January, February

The signs of the [zodiac](#) for the seasons are given in [Appendix I](#).

second (of angle): see [arc-second](#).

second (of time): the fundamental unit of time. The accepted scientific definition of the second is now 9,192,631,770 periods of radiation corresponding to the transition between the two hyperfine levels in the ground state of caesium 133. This definition was adopted in 1967, and replaced the earlier (since 1955) [ephemeris second](#) which was defined in terms of a fraction of the mean tropical year in 1900. The above frequency was chosen because it gives a close approximation to the number of seconds in a day (86,400). Fluctuations in the Earth's rotational rate since about 1969 have been such that the day is between 1 and 3 ms longer than this number of seconds. These variations are totally insignificant to even the best sundial. The word ~ derives from the Latin "secunda minuta" or second minute.

semidiameter (of the sun): [**s**, **S**] half the angular size of the Sun (or, more correctly, its

photosphere). As the distance from the Earth to the Sun varies during its [orbit](#), the semi-diameter varies from 15.76 arc-minutes in July to 16.29 arc-minutes in January. In dialling, it is usual to take the sun's full diameter as $\frac{1}{2}^\circ$.

septentrional: a term now rarely used for "of the north" and sometimes applied to north-facing dials.

shadow sharpener: any of the various devices for sharpening the edge of a shadow, allowing more accurate time readings to be made. Usually a physical addition to the [gnomon](#) or [nodus](#), it casts a secondary shadow, with its own [penumbra](#), in which the primary shadow can be located more accurately (although it may have less contrast). The term is sometimes also used to refer to a movable lens which produces an image of the shadow edge.

shadow square: a square (or rectangular) scale often found on [quadrants](#) and [astrolabes](#) which allows the tangent or cotangent of the [altitude](#) of a celestial body to be found.

shortest day: a term in common parlance, defined as the day of the year with the least (astronomical) [sunrise](#) to sunset period. It is normally used synonymously with the winter [solstice](#) although, strictly, it can vary by a day depending on the exact time of the solstice and the relationship between the rate of change of the [EoT](#) and that of the local sunset/sunrise.

sidereal time, sidereal day: see [time](#) (types of).

signs of the zodiac: see [Zodiac](#).

Sirius: (the Dog star) the brightest star in the night sky, used by the Egyptians as a means of determining the beginning of the Nile floods. See [heliacal](#) rising.

skylight: light which reaches the observer from the general (blue) sky. It is [sunlight](#) which has undergone multiple scattering events with the molecules of the Earth's atmosphere (i.e. Rayleigh scattering) or with clouds or other aerosols in the atmosphere. High levels of skylight reduce the contrast of a shadow. It also tends to be [polarised](#).

slant: see [obliquity](#).

small circle: a circle on the surface of a sphere whose centre does not coincide with that of the sphere (and hence it must always have a smaller diameter).

solarium: Latin for sundial. Beware, it can also be interpreted as "sunning place".

solar compass: an instrument for direction finding which uses dialling principles. The most common are modified versions on an [analemmatic dial](#) with a vertical [gnomon](#). Sometimes called an **astro-compass**, although these latter more properly use sightings of the fixed stars.

solar longitude: the [ecliptic longitude](#) of the Sun, it varies from 0° (at the vernal [equinox](#)) to 360° during the year. By [Kepler's Second Law](#), the rate of change of the solar longitude is such that the Earth sweeps out equal areas on the ecliptic plane in equal times.

solar parallax: the difference between the Sun's [altitude](#) as observed from the Earth's surface and its true astronomical value from the centre of the Earth./

solar time: see [time\(types of\)](#).

solstices: (Summer ~, Winter ~) literally, "Sun stands still". In the Northern hemisphere, they represent the beginning of summer (on or around 21 June) and the beginning of winter (on or around 21 December). They are (usually) the same as the [longest](#) and [shortest](#) days, respectively. Astronomically, they are the occasions when the Sun's [ecliptic longitude](#) is 90° or 270° , respectively, and correspond to the extreme values of

declination. See [Figure 1](#).

South: one of the [cardinal points](#) of the compass, it is the direction opposite north, in the direction of the south celestial pole. It is also the direction of the Sun at local [noon](#) (in the northern hemisphere).

southing: another term for a southern [transit](#).

South Pole: the location on the Earth's surface where it intersects the [axis](#), and opposite the [North Pole](#). It has a [latitude](#) of -90° .

spherical angle: the angle whose vertex is at the intersection of two [great circles](#) of the [celestial sphere](#). Spherical trigonometry deals with spherical angles and triangles.

spherical triangle: the figure formed on the surface of a sphere by three intersecting [great circles](#). The **fundamental** (or **nautical**) triangle is the special case of a spherical triangle on the [celestial sphere](#) with vertices at the [zenith](#), [North celestial pole](#) and the [Sun](#).

split noon: see [noon gap](#).

standard time zone: [TZ] a geographical region which uses the same [civil time](#). These are approximately regions between two lines of [longitude](#), set 15° apart, and hence with 1 hour time difference between adjacent zones. The standard time for each zone is the [mean solar time](#) at the central or standard meridian for the zone. For the UK, which is in Zone 0, the standard meridian is the [Prime Meridian](#) at Greenwich, and the zone nominally extends from $7\frac{1}{2}^\circ$ W to $7\frac{1}{2}^\circ$ E. For political reasons, other time zones have their boundaries adjusted to follow country borders or other features. The zones were defined at the same international conference in 1884 that set Greenwich as the Prime meridian.

steradian: (pron. ster-ade-e-on) unit of solid angle. It is the central solid angle of a sphere subtended by a surface area equal to the square of its radius. The whole sphere supports an angle of 4π steradians around its centre.

stereography: (hence stereographic projection) a drawing method in which a sphere is projected from a point on its surface to a plane which is tangent to it. Its main property is that circles on the celestial sphere are projected as circles or straight lines on the plane. It is fundamental to the construction of [planispheres](#) and [astrolabes](#) as the [rete](#) is a stereographic projection. Its use is difficult in the construction of sundials due to the vast length of some of the radii required (although this can be overcome by calculating in [cartesian coordinates](#) and then converting). Its use was advocated by 17th century diallists.

string gnomon: a [gnomon](#) in the form of a flexible cord which is pulled tight when the dial, typically in [diptych](#) form, is opened.

style {stile}: the line in space which generates the shadow edge used to indicate the time on the [dial plate](#). Note that a [gnomon](#) with finite thickness will have two styles (one along each of the upper edges) which will each be operational for parts of every day. If the gnomon is in the form of a long rod, the style will be the virtual line running along the centre of the rod and the dial is read by estimating the centre of the shadow. Note: this modern distinction between gnomon and style is not the one found in earlier literature where (from 1577) the word style was used to indicate a polar-pointing gnomon (a [polos](#)) or, more rarely, a [nodus](#). Hence **stylar**: pertaining to the style or gnomon of a dial (first used 1688). See [Figure 1](#).

style height: [SH] of a polar style is the [angle](#) that the style makes with the [sub-style](#) line. Note that this is an unusual use of the word "height", and **style angle** could be regarded as a better term. For a style which is perpendicular to the [dial plane](#), style

height is simply the distance from its top to the foot. See [Figure 1](#).

sub-nodus (point): the point on the [dial plane](#) that lies perpendicularly below (or behind for a vertical dial) a [nodus](#). The distance from this point to the nodus is sometimes called the **ortho-style distance**.

sub-style angle: [SD] the angle that the sub-style makes with the noon line, measured positively clockwise (towards the p.m. hours for a south-facing vertical dial).

sub-style (line): the line lying in the dial plane which is perpendicularly below (or behind for a vertical dial) the [style](#). See [Figure 1](#).

sub-style triangle: the right angled triangle formed with the polar [style](#) as the hypotenuse, with the other sides lying along the [sub-style](#) and the [ortho-style distance](#).

summer solstice; see [solstices](#).

Sun: the star at the centre of our solar system. The mean distance to the Earth (designated the Astronomical Unit or AU) is 149.6×10^6 km. It has a surface temperature of about 5800° K. The solar spectral irradiance reaching the Earth's surface (at AM1 - air mass 1 - i.e. looking through a standard atmosphere with the Sun at the [zenith](#)) ranges from about 250 nm to 2000 nm, with the main peak at 490 nm. See [semi-diameter](#) for the apparent size of the Sun.

sun clock: see [Dial types](#).

sun compass: see [solar compass](#)

sundial: an instrument for telling the time and/or date from the position of the Sun. More generally, it can give any function of the Sun's co-ordinates. See [dial](#) for the origins of the term, and [Dial \(types of\)](#) for types.

sunlight: light reaching the observer [directly](#) from the Sun. Contrast with [skylight](#). Note that the Sun's rays reaching the Earth are always taken as parallel, but coming from an extended source (see [semi-diameter](#)).

sunrise, sunset: the first (last) appearance of the Sun above the [horizon](#) each day. This occurs when the sun's [altitude](#) reaches $-0^\circ 50'$. Note that astronomers define the rising of an object as an altitude of 0° . The difference is due to the combined effects of the Sun's mean [semi-diameter](#) (16 arcmin) and [atmospheric refraction](#) (34 arcmin). See [Equations](#) for expressions to calculate sunrise and sunset.

sunshine recorder: a meteorological instrument for recording the hours in which the Sun shines. The most interesting type is the **Campbell-Stokes** ~, which uses a spherical lens to focus bright sunlight onto a paper chart, burning a track along it.

superior: refers to an event on the [celestial sphere](#) above the [horizon](#). Opposite of [inferior](#).

synodic: pertaining to the successive conjunctions of a planet (or moon) with the Sun.

T

tellurian: a demonstration model, similar to an [orrery](#), but showing the Earth-Sun system, or the Earth-Sun-Moon system. This latter is sometimes referred to as a **lunarium**. Note: the tellurian is sometimes called a [tellurium](#) but this term is best avoided as it is the name of the 52nd element in the periodic table.

terminator: the edge of the shadow cast by a self-shadowing object, such as the edge of the illuminated part of the Moon.

terrella: from the Latin for "little globe". See [globe dials](#).

tide(s): the divisions of a day used in the Anglo-Saxon period. The time from [sunrise to sunset](#) was divided into four tides or time periods. See [Appendix II](#) for the names of the tides. Lines showing the tides are found on [Anglo-Saxon](#) and some [mass](#) dials. Some dials also have lines denoting the half-tide. Note that this use of the word has no connection with the marine tides.

Time, (types of):

Apparent solar ~: the measure of time based on the diurnal motion of the true sun.

British Summer Time: [BST] [civil time](#) in the UK during the "summer", one hour ahead of [GMT](#). Invented by William Willett and first introduced in 1916. A sundial showing BST in Petts Wood, near Chislehurst, Kent, is his memorial. BST usually begins on the last Sunday in March, and ends on the last Sunday in October. These dates are now co-ordinated with Summer Time in the rest of the EU.

civil ~: the legally-accepted time scale in a particular country or region. It is based on the [standard time](#) for that [standard time zone](#), but may have fixed differences (eg [BST](#)). Measured in [modern hours](#) from the most recent [midnight](#), with either a 24 hour or 2 x 12 hour format.

clock ~: simply the times shown by a clock, usually [civil](#) time. Hence the appendage "o'clock" to some times.

Daylight Saving Time: [DST] [civil time](#) during the summer in much of the USA (and some other countries) obtained by advancing clock time one hour from local standard time. Equivalent to [BST](#) in the UK.

dynamical ~: [or Terrestrial Dynamical Time, TDT] "scientific time" – it superseded [ephemeris](#) time in 1984, and is based on a uniform scale of time derived from atomic clocks (i.e. not subject to fluctuations in the Earth's rate of rotation). Now usually called **international atomic time (TAI)**.

ephemeris ~: [ET] "scientific time" - used between 1960 and 1983, this uniform timescale was based on the [ephemeris second](#), itself derived from the period of rotation of the Earth at a particular date. It was succeeded by [dynamical](#) time when the [second](#) was redefined in 1984.

French revolution ~: a decimal timescale (10 equal hours or decadays per day) devised in 1790 by the French Academy after the French Revolution. Each hour was divided into 100 millidays (of 86.4 seconds) and each milliday into 1000 microdays (0.0864 seconds each). The decimal timescale, which had been used previously in ancient Egypt and China, was never fully implemented and was quickly dropped, with the result that sundials so calibrated are extremely rare.

Greenwich Mean Time: [GMT] the basis for [civil time](#) standards worldwide, it is the time at Greenwich as given by the fictitious mean sun. It is derived from [UT](#), but GMT is measured from [midnight](#).

Local Apparent Time: [L.A.T. - the use of the full-stops is encouraged to avoid confusion with the common contraction of "latitude"] this is [solar time](#), as derived from the real Sun at any particular location. It is the [hour angle](#) of the Sun + 12 hours. Some authors (non-UK) may refer to it a Local True Time.

local mean ~ {**mean** ~}: [**LMT**] this is [solar time](#) which has been corrected for the [EoT](#) but not for [longitude](#), so it is still location specific. English towns used this form of time prior to the coming of national railways and the telegraph, e.g. Oxford time.

Mean Solar Time: the authoritative (by the National Physical Laboratory) definition is: a measure of time based conceptually on the diurnal motion of the fictitious mean Sun, under the assumption that the Earth's rate of rotation is constant.

railway ~: (or **London time**) a colloquial term used for Greenwich time as it began to replace local time with the introduction, in the mid-1800s, of railways and the resulting need for unified timetables.

sidereal ~: [**T**, **SDT**] "astronomical or star time". This is timekeeping based on the [sidereal day](#), and hence it runs ahead significantly with respect to solar-based time. **Local sidereal time** is equal to the [hour angle](#) of the first point of Aries and is, to a first approximation, sidereal time with a [longitude correction](#).

solar ~: the same as [Local Apparent Time](#).

Summer time: a generic term for [BST](#), [DST](#) etc.

standard ~: [**ST**] is [mean solar time](#) at the central meridian of a given [time zone](#).

universal ~ :[**UT or UTC**] this is the basis for terrestrial and civil timekeeping, and was adopted in January 1972. It is tied to the rotation of the Earth, and hence has to be periodically adjusted by the addition of [leap seconds](#) to account for the gradual slowing of the Earth, and the vagaries of its rotation. UT is by definition measured from the [superior transit](#) of the fictitious [mean sun](#) (i.e. mean [noon](#) at Greenwich), and hence is 12 hours behind [GMT](#) (although this difference only tends to be recognised by astronomical calculations). UT measurement is based on standard [seconds](#). The version referred to as **UTC (Universal Time, Co-ordinated)** simply means the value averaged over a number of atomic clocks world-wide. In aviation, it is referred to as Z or zulu.

zonal solar time: sometimes used to denote solar time at a [time zone](#) meridian. Thus it is [local apparent time](#) with a longitude correction but without EoT. In the UK, it would be denoted **Greenwich Solar Time**.

- End of Time (types of) -

time zone: see [standard time zone](#).

torquetum: (pron. tor-kwet-um) an early (known to be before 1326 AD) astronomical instrument capable of fixing star positions and producing conversions between equatorial and ecliptical co-ordinates. Some forms may have been used to help delineate dials, and torquetum-style dials for solar and [sidereal](#) time were made in the late 17th century. Most famously, it features amongst the instruments in Holbein's 1533 painting "The Ambassadors" (National Gallery).

transit: the meridian passage of a celestial body. For the sun, this occurs when it is directly south of the observer. It can also refer to the time of this occurrence. Transits may be either [superior](#) or [inferior](#).

transom: a crosspiece of fixed length, as on a [cross-staff](#). Sometimes called a **vane**.

triangle (fundamental or nautical): [see spherical triangle](#).

triens: an extended quadrant, with a 120° arc. It can usually tell the time in both [equal](#) and [unequal](#) hours.

trigon: in dialling, a mechanical aid to drawing lines of [declination](#) on [dial plates](#). It consists of an instrument which is fitted to, and can swivel around, the [nodus](#) on a polar-pointing [gnomon](#), and can be set at an angle equal to the sun's declination angle to the gnomon. Often used with an associated [auxiliary](#) dial. Trigon is also an archaic term for a triangle. From the Greek "trigonon" or three-cornered.

tritych: (pron. trip-tich) literally "three leaves", it refers to a set or [compendium](#) of three instruments, including at least one dial. Other instruments often include a compass and perpetual calendar.

tropical year: see [year](#).

tropics: geographical bands of the Earth's surface, extending from the equator to latitude 23° 26' N (tropic of **Cancer**) or to 23° 26' S (tropic of **Capricorn**). The terms are also used to refer to these specific latitudes. Note that they represent the extremes of the region where the Sun can reach the [zenith](#) when the sun's [declination](#) is at its extreme values.

twilight: the interval after [sunset](#) or before [sunrise](#) when the Sun illuminates the upper atmosphere and hence it is not completely dark. It is determined by the sun's [altitude](#) falling within a given range, as follows:

civil twilight: -0° 50' and -6°

nautical twilight: -6° and -12°

astronomical twilight: -12° and -18°

These values reflect the need for decreasing light levels for various activities.

U

umbra: the central, darkest portion of a shadow, i.e. the region which does not receive direct rays from any part of a distributed light source (e.g. the Sun).

umbra recta: Latin for "upright shadow", it is the label often found on the cotangent scale of [altitudes](#) < 45° on a [shadow square](#).

umbra versa: Latin for "reverse shadow", it is the label often found on the tangent scale of [altitudes](#) > 45° on a [shadow square](#).

Universal Time (UT): see [time \(types of\)](#).

V

vernal {spring} equinox: see [equinoxes](#).

verdigris: (pron. ver-de-gree) the green [patination](#) found on weathered brass and copper.

vernier: a small moveable scale for obtaining fractional parts of the subdivisions of a fixed scale. Invented by Pierre Vernier in 1631 (published Brussels, 1638). For circular scales, a Type A vernier has a central zero. After about 1780, sextants commonly had a Type B vernier with the zero on the right of the scale. European instruments often have the very similar [nonius](#).

vertical angle: the angle from the [zenith](#) to the [horarius circle](#) passing through the sun,

measured along the [prime vertical](#) (the E-W vertical circle). It is one of the [ptolematic co-ordinates](#).

vertical plane: see [principal plane](#).

volvelle: (pron. vol-vel) an old device consisting of one or more movable circles surrounded by other graduated or figured circles. It is used for showing the rising and setting times of the Sun and Moon, the state of the (marine) tides etc. A ~ has sometimes been included around the rod-gnomon of [equiangular](#) dials.

W

wedging out: (or **canting out**) placing wedges between a dial plate and its mounting surface. (a) for a [horizontal dial](#): to compensate for moving a dial to a different [latitude](#) from the one it was designed for, (b) for a [vertical dial](#): to ensure that it faces a [cardinal point](#) of the compass (usually S).

West: the point on the [horizon](#) 90° (measured anti-clockwise) from the [north](#) point. The Sun appears to set at the west point at the [equinoxes](#).

winter solstice: see [solstices](#).

X

Y

year: the time that it takes the Earth to make one orbit of the sun. The **tropical year** is the interval in which the [mean ecliptic longitude](#) of the Sun increases by 360°. This is the version of the year used in normal calendars and has a length of 365.24219 days. Other versions of a year (e.g. the sidereal, anomalistic and Julian years) have differences of about a hundredth of a day to this figure.

Yule: an ancient Celtic festival held on or around the 21st of December, celebrating the winter solstice. It is one of the [cross-quarter days](#), and has now become synonymous with Christmas.

Z

zenith: (astronomical) the point on the [celestial sphere](#) vertically above the observer. In everyday parlance, ~ usually implies the highest point. This gives rise to confusion as the mid-day Sun is often described as its ~, irrespective of the [latitude](#).

zenith distance (or **zenith angle**): [z] the complement of the [altitude](#) i.e. $(90^\circ - a)$

zodiac: an imaginary band, centred on the [ecliptic](#), across the [celestial sphere](#) and about 16° wide, in which the Sun, Moon and the planets Mercury, Venus, Mars, Jupiter and Saturn are always located. The band is divided in 12 intervals of 30°, each named (the **Signs of the Zodiac**) after the constellation of stars which it contains. The sun's [ecliptic longitude](#) may be measured against this scale. The names (and/or signs) of the constellations are given in [Appendix I](#) and are often used in sundials, instead of the date, to specify [declination](#) lines etc. Because of the effects of [precession](#) over the period of 2,300 years since the constellations were first named, the signs of the zodiac have slipped by a whole sign, i.e. at the [vernal equinox](#) (defined as the first point of [Aries](#)), the Sun is actually in the constellation of Pisces.

Zonwvlak: a major suite of computer programs for calculating sundial lines. Written by Fer de Vries (Netherlands) it is available at www/iaehv.nl/users/ferdv. The name is short for zonnewijzer (sundial) vlak (plane).

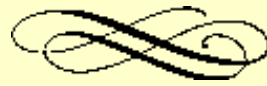

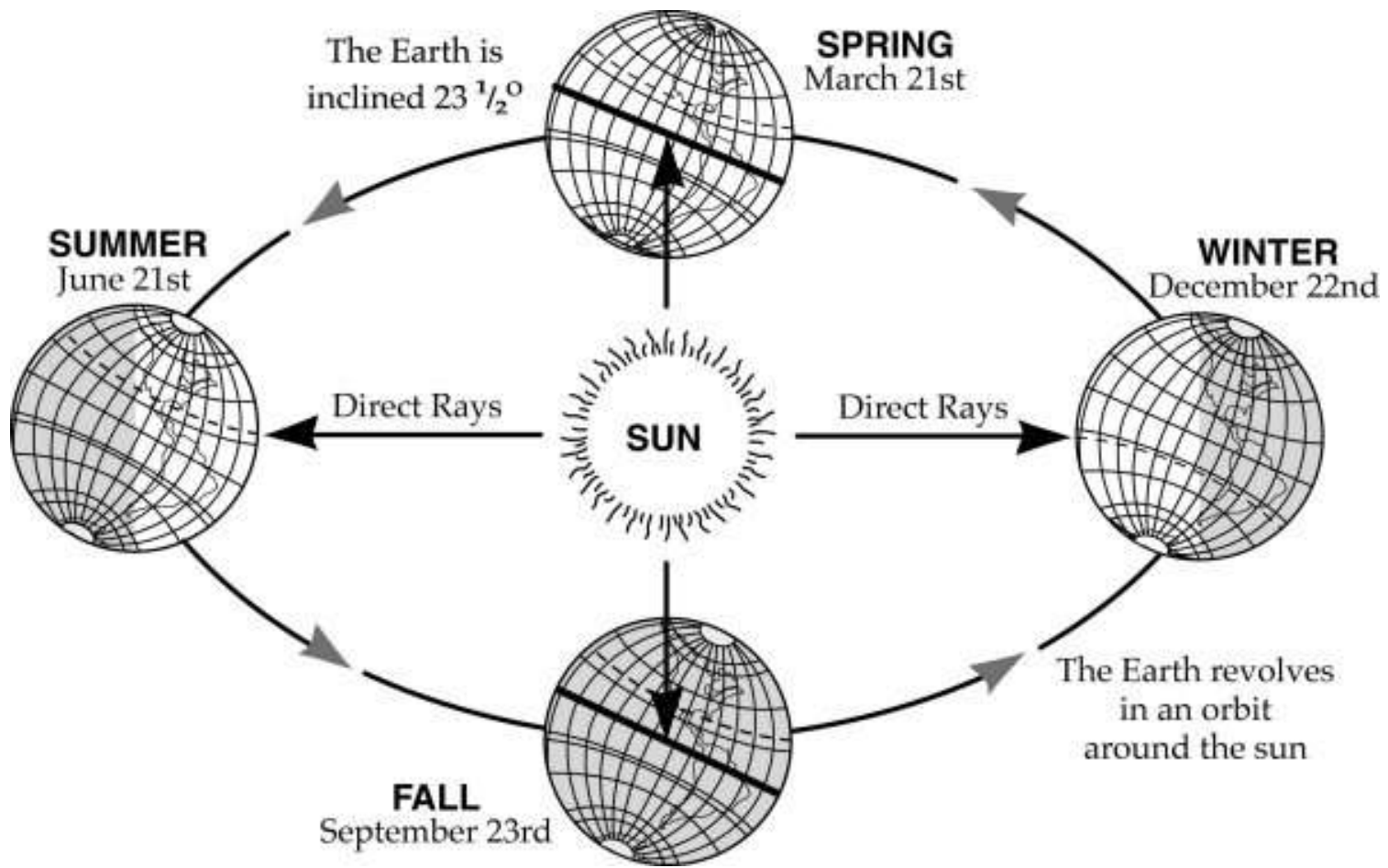





DIAL FACE TEMPLATE

LATITUDE STRIP

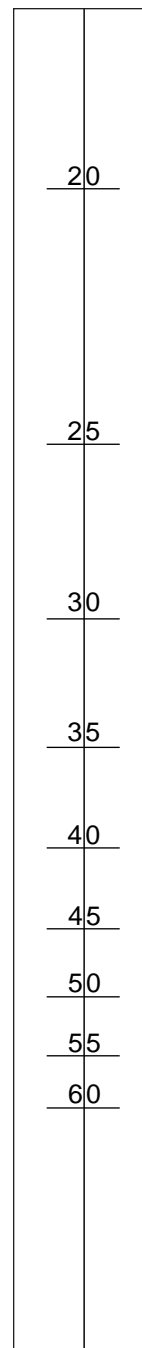
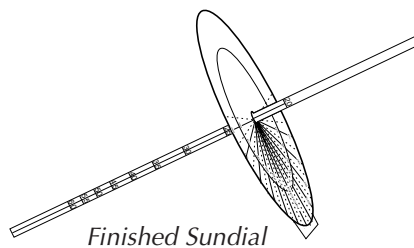
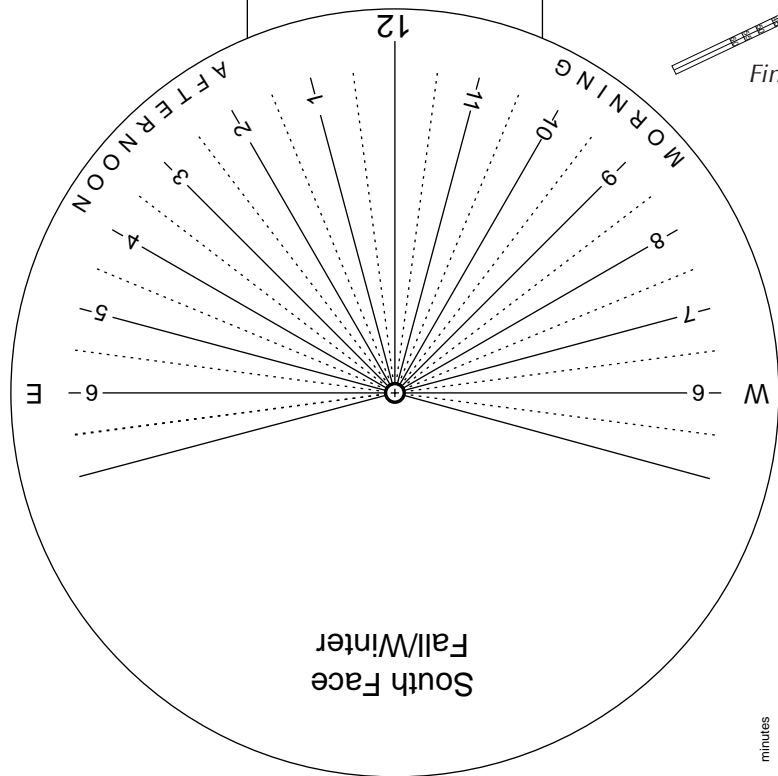
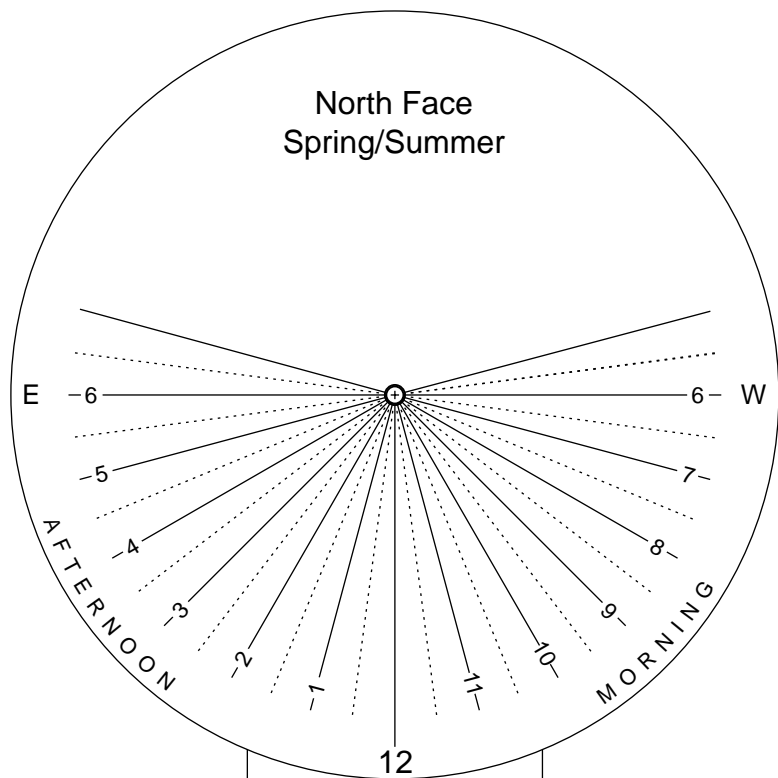

Bottom

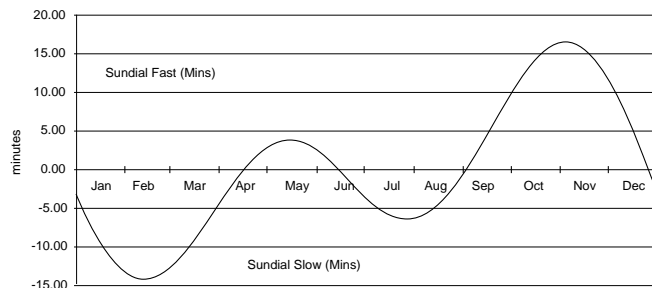

Correction for the "Equation of Time"

[FAQs](#)
[News & Features](#)
[Image Gallery](#)
[Solar System Guide](#)
[Explorations](#)
[Constellation Guide](#)
[Star Guide](#)
[Galaxy Guide](#)
[Astroglossary](#)
[Resource List](#)
[Keywords](#)
[Site search](#)
[Teacher Guide](#)

Equatorial Sundial

One of astronomy's first tools to measure the flow of time, a sundial is simply a stick that casts a shadow on a face marked with units of time. As Earth spins, the stick's shadow sweeps across the face. The face of the sundial represents the plane of Earth's equator, and the stick represents Earth's spin axis.

Preparation

First, find your latitude and longitude and an outdoor observing site in a clear area (away from the shadows of buildings or trees). Determine north from a map, or by finding the north star at night and marking its location. Assemble the equipment as described below. Use a flashlight to demonstrate how to position and read the sundial indoors before going out.

Materials and Construction

- Download and print the template and latitude strip (see below).
- Mark a drinking straw using the latitude strip as a guide. First mark the bottom of the scale at one end, then mark each of the latitudes.
- Fold and glue the template. Make sure the dial faces are lined up.
- Cut out the center hole.
- Place the straw in the hole with the top face lined up with your latitude. The straw should fit snugly. Make sure the stick and face are perpendicular. Tape it in place if necessary. The bottom end goes on the ground.

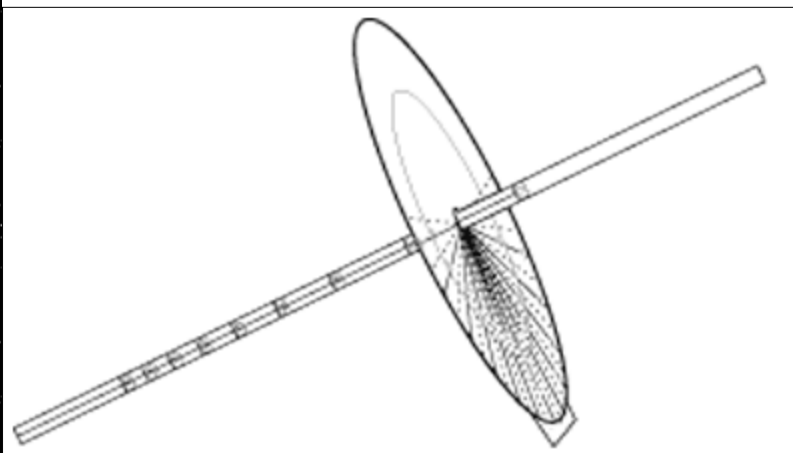

Download the dial face template and latitude strip ([29K pdf](#)).

Experiment

On a sunny day, take the sundial outside and aim the pointed end north. Record the time on the sundial at least four times in one day. Each time, also record the "clock" time for your date and location. Try this

[Activities](#)
[StarDate in the Classroom](#)
[National Science Education](#)
[Standards](#)
[Links](#)

Printable version

[78K pdf](#)

Free [Adobe Acrobat software](#) is required to view the document.

NSES Standards

- Content Standard in 5-8 Earth and Space Science (Earth in the solar system)
- Content Standard in 5-8 Science as Inquiry (Abilities necessary to do scientific inquiry)

experiment during different months.

Analysis

1. Why does this sundial have front and back dial faces?

Answers

1. The north face is for use from about March 21 to September 21, and the south face is for use from about September 21 to March 21. The Sun is north of the celestial equator during the first period (spring and summer) and south of the celestial equator during the second (fall and winter).

[Home](#) [Site Map](#) [Privacy](#) [Copyright](#)
[Observatory](#)

[McDonald](#)  UTOPIA

 [Información en español](#)



SCOPE

Southwestern Consortium of Observatories for Public Education

Observatories of the Southwest

Interstate 10 is the Highway to the Stars. Almost all of the largest optical telescopes in the continental United States, as well as the world's most powerful radio telescope, lie within two or three-hours of the highway.

The optical telescopes all stand on mountaintops, which provide clear views of the sky. These remote outposts also offer spectacular views of both Earth and sky for the hundreds of thousands of visitors who drop in each year.

All of the major southwestern observatories offer special programs for visitors, including museums, tours, and star parties. Each is worth a side trip from the Interstate.



[Apache Point Observatory](#)



[Kitt Peak National Observatory](#)



[McDonald Observatory](#)



[National Radio Astronomy Observatory](#)



[National Solar Observatory](#)



[Whipple Observatory](#)



[SCOPE solar poster educational activities and resources.](#)



We are Southwestern Research Observatories working together to inspire public awareness of astronomy through access and education.

For more information on SCOPE and to make suggestions and comments, please contact [Robert Wilson](#) at Kitt Peak National Observatory.

Hello, Sun!



In this Thread, we will examine the passage of time by watching the world change outside of our classroom. The Sun will seem to

move across the sky in a steady manner throughout the day. This will allow us to begin thinking about the movement of either the Sun or the Earth as well as the shape of the Earth so that the motions make sense. The National Science Education Standards call for students to become comfortable with objects' properties of size and movement, an example being the Sun. Students should learn that the Sun appears to move around the Earth, but in fact it is the Earth spinning around on its axis while the Sun remains stationary. This Investigation allows students to explore what the NSES refers to as "technological design". The vocabulary that can be integrated into this Thread are words such as Sun, Earth, day, night, spin, axis, arc, model, angle, sphere, and degree. For a new approach to learning some of these vocabulary words, visit Word Lore, an appendix dedicated to exploring the history of words pertaining to this curriculum.



The easiest way to see time passing is with a clock, but what made us aware of passing time before clocks? The motion of the Sun is the key here, and most students do not know what that motion looks like.

We know that we are a small planet shaped like a ball in orbit around a huge star 93 million miles away. This star we call the Sun, and it is an enormous ball of very hot gas. This star is so large, that even from this far away, its light can reach our planet. Sunlight is radiated from the Sun in all directions, and we are only a tiny planet in the way of a tiny bit of that sunlight. Therefore, we get light from what appears in the sky as a small disc in a certain direction. If we were very close to the Sun, that orb would seem larger. Why do we feel warmth all over the land during the day? Well, that is because we have a lovely atmosphere to keep us warm like a blanket. Why then do we feel cold in the winter? That will be explored in a later Thread.

You will need chalk or wipe board and chalk/markers, easel, roll paper for easel, pencils, journals, crayons, adhesive yellow dots or BINGO markers.

The class will initially need a sunny day for this and will need to repeat measurements from the earliest time possible in the morning until school lets out in the afternoon, at one hour intervals. You will need to locate the direction South outside in the yard. In the classroom, you may want to spend several class periods spanned over a week thinking about the data you've collected. There are few tools required, so materials gathering for the investigation is minimal.

In some respects, it appears that the Sun circles the Earth. Greek philosophers speculated about our world and its geometry and decided that it is the Earth which is turning on its own, making things appear to swing past it, outside of it. This is similar to being on a carousel and watching your family rush around you, even though it is you who are moving. To prepare ourselves to model the Sun, it would be good to first explore some alternative approaches to looking at the world around

us. This requires thinking flexibly. Now would be a good time to introduce puzzles, riddles and optical illusions, to help us think about the importance of opening up our minds to different ways of seeing the same thing.

The movement of our Earth is very uniform, making the Sun rise, arc overhead, and set at the same speed everyday. This speed is our spin time, or day, of 24 hours. For students, the term "day" is more like the daylight time. Confusion between "days getting longer" but "days are always 24 hours long" can happen. Begin to refer to these times as daylight time and spin time, to ease communication among your students. In fact, perhaps we should consider inventing our own terminology for these two concepts in class.

As part of the ECT curriculum, we offer some lessons about how ancient and historical cultures used observations similar to those the students will make in the Threads. For Hello, Sun!, We've included background information and classroom activities in the Appendix relating to how Scandinavians one thousand years ago used the Sun to tell time. We call it Telling Time Without a Clock. [Note: The Daymarks project is also relevant for the Thread called This is a Stickup!]



Kindergarten through Second Grade

Developmental Issues

The purpose of this Thread for this age group is to emphasize the joys of wondering about our world and learning to look for change and patterns carefully. It introduces the skills of question asking, communicating ideas in speech and drawings, and manipulating objects. Students will learn about the Sun as our light and heat source and about our world as having a regular time pattern, which can be observed from the simple motion of the Sun.

This Thread is not intended to impose on students of this age the model of a turning spherical

Earth past a distant steady Sun. Research shows that the average five year old is just learning how to envision images in his or her mind and to manipulate those images (for instance, thinking about how to walk to school and then reversing the route in one's mind). However, constructing images that require shifts that the child has never experienced, thinking about positions of objects in the future (beyond yesterday, today, tomorrow), and holding a dynamic model in one's head to reason about it, is challenging for students of this age.

It is important to realize that experience with models and analogies helps children learn to understand them. Teachers should not shy entirely away from presenting concepts that are slightly beyond the developmental level of their students, but that they should support the students' developing understanding with other paths to grasping the concept.

Inquiry Introduction

What is a day? Why is it that we know when a day has passed, or what time of the day it is? What are the things we look for to tell us about the time of day? Or when we are tired? Hungry? Cold? Are there things which always happen at a certain time of the day? Students may want to draw a day (allow yourself time to write a brief narration for each drawing based on their verbal description.) Are they thinking only about daylight time? Do any of them describe a day as more related to the spin time perspective?

Is there any way we can think of to tell that a day is passing? Many students will suggest the clock. Tell them this is the modern way, but what about when people didn't have clocks or watches? Does anything change during the daytime which isn't a clock? If no one suggests the Sun, lead them to think about the world outside the classroom. When it is day, what does it look like? This question will seem odd to the students without a contrasting frame of reference. Ask them what the night looks like, then return to thinking about the day. The Sun will enter the discussion now, if it had not already. You should now ask again what happens during the day to make it become night. Can we see that happen? What would we need to do first? Go outside!

Inquiry Investigation

Outside, you should bring an easel with paper and a marker. Without mentioning the direction South, you need to make everyone face South (or North if you are in the Southern Hemisphere). This is important for the observations. While you are doing this, you might want to talk about why it is important that everyone face the same direction (without talking about South) when you are all observing the same object. Facing south is important because in the continental United States, the Sun is in the south at all times. You should not mention this fact at this time. What is important is that everyone should be able to talk about the same viewpoint. Otherwise, imagine trying to talk

about a pillow on your bed if everyone else is looking at your door. It will be hard to do unless you have everyone looking at your bed first.

You should then draw the view ahead of you on the paper on the easel. Ask everyone if the details are correct. If not, what should be changed or added? It is the morning during this first observation, and the Sun will be over everyone's left shoulder. Our shadows will be to the right of our bodies. Just noticing that they have a shadow is fun for this age group. Later Threads will provide more time for your students to explore this further.

Ask the students some questions. Where is the Sun? How high is it in the sky? Can everyone think about tree heights or house heights? How about where the Sun should be in the picture? Could we tell from other clues? Some will feel the Sun on their left cheek, and say that is a clue. Few may make the connection between the shadow on their right and the Sun on their left. (This is a great connection which will be explored deeply in later Threads.) Draw the Sun on the easel.

We could, out here in the warmth, talk about our Sun and the heat and light it gives us. How far away do we think it is? What is it made of? How big is it? We don't need to know the real answers for this. We should just be thinking about this great Sun of ours and how much it can affect our world down here.

Return with the easel to the classroom and try to ask where they think the Sun might be in an hour. There will be wild guesses, and that is part of the fun of asking questions in a wondering scientific spirit! They could mark their guesses with mini sticky notes or dots, if you wish.

Return with them every hour to make another drawing. Maybe they can take turns helping you draw the Sun into the easel drawing. How did the guesses turn out? Does anyone have a theory about the movement? Where is the Sun going? What happened to the shadows?

After a few more observations, a definite shape is appearing in the movement of the Sun. This shape is known as an arc, but for the purposes of this younger age group, you can call it whatever you wish. In fact, it would be a good time to compare this shape to other shapes around their world. Some classes in the past called this shape a rainbow, a frown, a big belly, and a bridge. What do they see in this shape? Could they take this shape and draw it in their journals? What do they see? What else can they make from that shape?

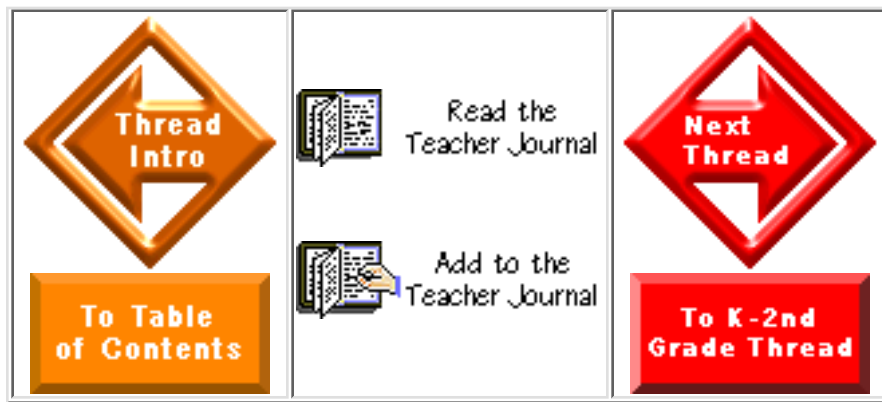

Second Grade through Fourth Grade

Developmental Issues

Second to fourth-grade age children are better able to reason more time-related concepts, consider two or more variables in thinking about a problem, and begin to plan things for the future. Their skills in dynamic imagery are developing as well as their ability to hold more information in their heads. This makes it possible for them to hold and manipulate the position of images in their minds. This is key to concepts such as predicting from observation or thinking about the movement of two objects, the Earth and the Sun. This Thread will focus on these ideas as directed by our observations. Since students at this age are able and enthusiastic when it comes to reading and writing, an emphasis will be placed on recording data and sharing it with others. On a social level, this age group is typically interested in teams and other social groupings. You may want to consider allowing for this in the investigation, creating teams of illustrators, time keepers, or instructors. It may help students become comfortable with the atmosphere of inquiry-based learning.

Experience with models and analogies helps children learn to understand them. Teachers of students at this level should introduce them and should not shy entirely away from presenting concepts that are slightly beyond the developmental level of their students. Look for ways to support the students' developing understanding with a number of alternative paths to grasping the concept as well.

Inquiry Introduction

Where does the Sun go in the evening? Why does it seem to rise in the morning? What is happening? What is a day for us? We should think more about the outside world and how it knows about a day. Without a clock, what could we look at to know about a day? How could you plan such an experiment? What are the important things to plan when you are about to observe something? How long would it take to get a good idea about what was happening? How would we keep a record of what we saw outside?

Inquiry Investigation

Outside, you should bring an easel with paper and a fresh marker. You also may want students to bring journals. Without mentioning the direction South, you need to make everyone face South (if you are in the continental United States). This is important for the observations. While you are doing this, you might want to talk about why it is important that everyone face the same direction (without talking about South) when you are all observing the same object. Facing South is important because in the continental United States, the Sun is in the south at all times. You should not mention this fact at this time. Children at this age should be comfortable with left and right, and can use these words to think about the direction of the Sun. What is important is that everyone should be able to talk about the same viewpoint. Otherwise, imagine trying to talk about a pillow on your bed if everyone else is looking at your door. It will be hard to do unless you have everyone looking at your bed first.

What needs to be drawn on the paper? Why should we be so careful about getting our view on the paper? We should think about the fact that we are all about to have an experience outside, and if we want to share it with other people, we should really make sure we've got a good recording of our experience.

Should we look at the Sun directly? No, this will harm our eyes. Even glances are not very healthy. How else could we describe where the Sun is? Some will feel the Sun on their left cheek, and say that is a clue. Others might make the connection between the shadow on their right and the Sun on their left. (This is a great connection which will be explored deeply in later Threads.) Where is it with respect to our bodies? To the school? To that tree over there? How does it feel on our faces or arms?

Now, let us leap into another arena of thinking and ask where on the two-dimensional drawing of our view would we put the Sun? We need to make the connections between the representation of objects on the drawing and the actual objects themselves which are outside in the world. Does everyone have a thought about this, and can they explain it to others? Draw the Sun where everyone agrees it should appear in the picture. Drawing in journals also might be a good idea. Return to the classroom.

In the classroom, talking about what a model is would be a good way to link these two experiences. In the real world, we saw a Sun with respect to our position out in the world, and with respect to the positions of other things out in the same world. The drawing, however, contains our viewpoint, without us in the picture. It is a model of the world around us, and we are not in it because it is what we saw around us. What is the shape of this model compared to the shape of our world? Is it still an OK picture of what we saw? When we were outside, it sure looked like our view. How is our drawing different from the real view? Think about the three dimensions of the world around us and how paper limits us.

What will happen in one hour? Anything? What will our view look like? Will we need to draw a different picture of the school yard? If not, what will be different in the picture, if anything? Perhaps here the class could break into brainstorming teams to think about where the Sun might be in one hour and why. They should prepare an explanation for the other teams.



Return with them every hour to make another drawing. Maybe here is where teams might help keep records and draw the Sun on the easel view. How did their predictions turn out? Does anyone have a theory about the movement? Where is the Sun going? What happened to their shadows? Can those same teams back in the classroom think some more about the movement they have now seen and how it might be reinterpreted?

After a few more observations, a definite shape is appearing in the movement of the Sun. This shape is known as an arc, but you can call it whatever you wish. Children at this age are really broadening their creative skills, and having them think up their own name for this shape would be fun for them. Some classes in the past called this shape a rainbow, a frown, a big belly, and a bridge. What do your students see in this shape? Could they take this shape and draw it in their journals? What shapes can be made from it, half-circles, circles?

What reasons can we think of to explain why the Sun is making this shape? Do we think that the Sun is really moving around the Earth? Many will come to your class already having been told about the spinning of the Earth, but they will not be able to explain it well. Ask them if they could explain the movement of the Sun with a spinning Earth. Is it important right now that everyone believe the Earth is spinning? No, not really. It is important only that they have had this day-long observation and been able to model it in the classroom on paper. You could ask them to try to get up with a group and recreate their observations in a play, where one person (the Sun) walks around another (the Earth) during the day and also where the Sun person is still and the Earth person slowly spins.

So, where does the Sun go in the evening? Could we draw it or write about it somewhere? Could we interview other classrooms who have not had the same experiences as us and see what they think? What about classes who have had the same experiences as we did outside? What do they think? Many will say the Sun goes to the other side of the world. Ask them then what it is like for people on the other side of the world when it is day for us? Can anyone point to a place on the globe which is having night right now? The Internet has a database of live cameras set around the world. Finding the country your students chose and looking at a "live" picture will help solidify their theory and strengthen their resolve. See the resources page for a list of good Internet sites with live cameras.

Another way of enforcing this experience is to make a Noon Line in your school: either in your own classroom, if we face South, or in a friend's classroom across the hall. For instructions, please see the Appendix for Time Keeping without a Clock.

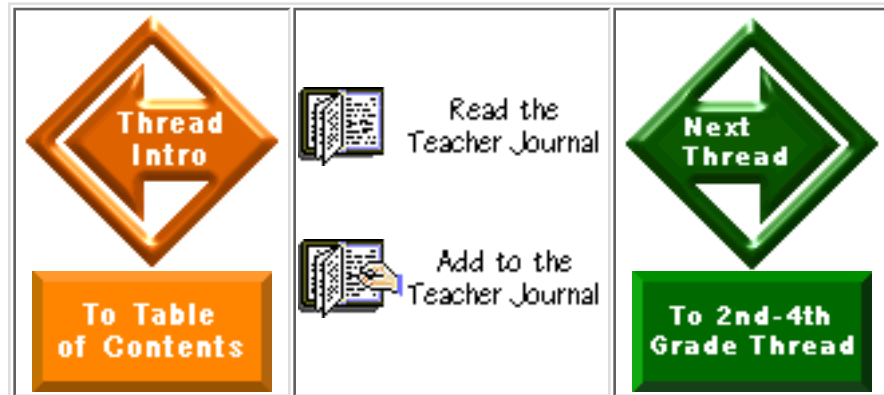

Fourth Grade through Sixth Grade

Developmental Issues

Fourth through sixth graders are increasingly able to abstract, reflect, and put one's self into another situation. They are able to reason about time more flexibly. They can manipulate images in their minds and can coordinate the dynamics of more than one image. They also can entertain the possibility of future events and think about hypothetical outcomes. These students are also making connections between what they are experiencing and how it affects their lives; how situations in general can affect lives in general. They also can consider different scenarios and envision whether these fit with their observations. This combination allows us now to explore the passing of the day with respect to objects in motion in a three-dimensional world outside of planet Earth and also to think about experiences happening for people in different places. Also, the level of math acquired by this age lets us talk about our experiences in another language, the language of geometry and numbers. This Thread will present the two theories of the Sun's motion debated by the geocentricists (who believe in an Earth centered Solar System) and heliocentricists (who believe in a Sun centered Solar System). Using the different positions of the Sun during the day as they relate to different positions in time and space, we will probe the data for theories and make models of what we have postulated.

Inquiry Introduction

The passing of a day has long been known and measured to be what? 24 hours. But what does 24 hours represent? How could we watch that happen without a clock? What is happening outside which plots the length of day and night?

Inquiry Investigation

Outside, you should bring an easel with paper and a marker. Students should bring their journals. Also bring a navigational compass (or enough compasses for the whole class). What time of day is it?

Without having already known it was morning, are there any clues around you that might tell you the same thing? How far around the world can we see with our eyes without turning our head?

Ask the students some questions. Which way is North? How could we find out for sure? If a certain direction is North, which way is East? We always learn East is to the right of North. If everyone faces North, East will be on our right hand. This will help ease the perspective problem. The question is, how easily can we see the Sun when facing the North? Have everyone face the South. Which way is South? Is it easier to see the Sun in our view now? OK. We will face South, then. Could we draw that view? Having everyone bring out their journals is a good exercise here. They can all draw what they are seeing. Ask them what they have done by drawing the world. Is our drawing truly the real world? It is a flat model. How does it compare to the world around us? Is it a good representation of the world? Would someone from another school be able to recognize trees and houses as such in our drawing? Also, draw this view on the easel paper.

Should we look at the Sun directly? No, this will harm our eyes. Glances are not even very healthy. How else could we describe where the Sun is? Some will feel the Sun on their left cheek, and say that is a clue. Others might make the connection between the shadow on their right and the Sun on their left. (This is a great connection which will be deeply explored in later Threads.) Where is the Sun with respect to our bodies? To the school? To that tree over there? How does it feel on our faces or arms?

How high is the Sun? How could we measure that? With a ruler? There is a very easy technique called "fist measuring" which can help us without having to use anything but our own bodies. All you need to know is that 90° is the angle difference between holding your arm straight out to the side and straight out in front of you. All you need to do is stand still and put your arm out in front of you at eye level, with your hand in a fist. Close one eye. Carefully begin moving your arm stiffly, watching and counting how many fists you can line up side by side until your arm is 90° away from where you started, or straight out to your side. Use things around the yard as guides to help you count those imaginary fists. The figure helps you see what we are describing. Dividing 90° by the number of fists you counted will give you how many degrees your fist covers! (Hint: In case you are not sure of your answer, an average fist covers 10° on the sky. Your value should be close to this.) Similarly, you can try to calibrate your finger! Try this outside (your finger held at arm's length will cover 1° on the sky.)

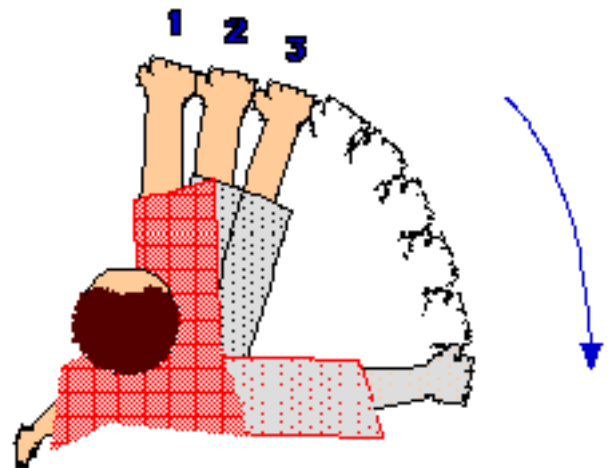

Now, let us imagine where on the two-dimensional drawing of our view would we put the Sun?

We need to make the connections between the representation of objects on the drawing and the actual objects themselves which are outside in the world. Does everyone have an idea, and can they explain it to others? Draw the Sun where everyone agrees it should appear in the picture. Use the first measurement tool to relate the Sun's position to the horizon, to nearby buildings and trees, and perhaps to due south. Return to the classroom.

How would we go about making some good observations of the Sun to understand what is happening in a day? Most students will tell you to go out every so often and check. Why? What might change? Does our world change? How has it changed since spring? How will it change in four months? How will it change in five hours? How have we changed in a year? The changing world means we need to keep an eye on it. What is the scale for watching the Sun move in a day? If no one else does, suggest that observations be made every hour. Have the students devise a plan for carrying the easel and markers and making sure journals get collected for observing outside. Does anyone have a clue about where the Sun might be next? Let's all make some predictions with accompanying reasons in our journals.

Return with them every hour to make another observation and drawing. Where is the Sun now? Is it noticeably different? How many fists up in the sky is it? Maybe they can help you draw the Sun in. How did their predictions turn out? Does anyone have a theory about the movement? Where is the Sun going? What happened to their shadows? Many will come to your class already able to tell you that the Earth spins, but they will not be able to explain it well. Ask them if they could explain the apparent movement of the Sun with a spinning Earth. Is it important right now that everyone believe the Earth is spinning? No, not really. It is important only that they have had this day-long observation and been able to model it in the classroom on paper and then later on the board as a geometrical model. We can then talk about our experiences back in the classroom and think of some good explanations for what we saw.

So, where does the Sun go in the evening? We could interview other classrooms who have not had the same experiences as us and see what they think. What about classes who have had the same experiences as we did outside? What do they think? Many will say the Sun goes to the other side of the world. What is it like for people on the other side of the world when it is day for us? Can anyone point to a place on the globe which is having night right now? The Internet has a database of live cameras set around the world. If you are able, access a site and find the country your students chose. Looking at a real picture "live" from that place will help solidify their theory and strengthen their resolve. See page 61 for a list of Internet sites with live cameras.

After a few more observations, a definite shape is appearing in the movement of the Sun, if you use each Sun plot as a dot in an outlined shape. What shape is emerging to describe the movement of the Sun? This shape is known as an arc. How might we extend this shape into a bigger shape? Draw this arc

high on the board, leaving room on the sides and the bottom for thoughts about the larger shape of this arc. Ask them if this is the shape they saw the Sun moving in. Students will see a semi-circle and a full circle, some may even be silly and make some squiggle. Perhaps they should put their bigger shape in their journals and give it a name.

Can anyone think of a reason why the Sun is making this shape? Is the Sun moving? Do we think the Sun is moving around the Earth in this shape? Where in our drawing on the board is the Earth? If this is too hard to think about, where then were we in the picture? If the shape were a semi-circle, what would happen to us? Would the Sun go right through us? What about the other side of the Earth. Do people live there? What would happen to their day if the Sun just went zipping past in a straight line like that? Do they think this is probable? What might be a more likely shape for this situation? A circle!

What do we know that is special about a circle? How many degrees are in a circle? How many hours are there in a day? Could we figure out some things about where the Sun might be shining in one hour? What about in five hours? Where will the Sun be? On a globe, we could try to guess this place and look on the Internet. (The Thread, Time Warp, begins some thoughts on Time Zones.) England is five hours from Eastern Standard Time, and there is a great Internet site for Cambridge, England, where a live camera takes a wide angle shot of the University there every few minutes. This visual proof can be turned around in such a way: Thinking about a circle seems very mathematical and not related to our world very much. However, if we recall that we made a circle from the motion of the Sun in our experience, then it must be said that what can be predicted from a circle can be applied to the apparent motion of the Sun.

Does that circle mean that the Sun is moving around the Earth? Could there be another way of seeing the Sun do what we've just seen it do? Here is the challenge of perspective, and this will be the most difficult of all. Imagine you were born and lived on a spinning carousel.

You've never known the ground. What would your view be like? All around you the world would be spinning past, but the things on the carousel would stay in place. How easy it would be to believe that you are standing still and everything else is moving, if you've never been off of the carousel.

Place a bright light source or even a student at the front of the room. Have the students stand such that their left shoulders are pointing to the light source in the same way their shoulders had pointed to the Sun. Ask the students to then say where in their vision does the light source lie. Give them a blank piece of paper. They should say or even draw the light at the very left of their view or paper. Just drawing where the light source is in their view might be superior to drawing the room and the light









source. The reason for this is, as they are spinning about past the light source, the room is also appearing to spin. Thus, the idea of the light source appearing to move becomes moot, because the entire room will appear to move. This is not what we saw when we watched the Sun all day long. We saw the Sun appear to move past the scenery. So, perhaps saying that they should draw where the light source is instead of what they are seeing will help them develop a better mental model of what is happening.

Ask them to turn counter-clockwise until they are facing the light source. Have them again say or draw where the light is in their field of vision. The view will be that there is a room with a light source in the middle. Then ask them to turn again so that the light source is on their right shoulder. Have them tell you about or draw this final view. This time, the room should appear to be filling their view except for the very right side, where there is a light source. They may want to glue or staple the drawings into their journals later.

Putting the pictures in the order of their movement, does anyone see a pattern? Put the easel and its drawing in the front of the room. Does anyone see a connection? What two types of motion do we now know can cause the pattern we have observed? If the light source were the Sun, what time of day would the first drawing represent? Where is mid-day? What would happen if we spin around past the point where the light source was at our right shoulder? Our backs would be to the light source. Is this what happens at night? Ask the students if everyone on the Earth gets sunlight sometime. This will lead into the question of what kind of spinning shape allows that to happen.

Now the big challenge is to find out what the students think this motion means. The light source "Sun" was always at the front of the room, but on the drawing of our turning, we saw it move across our field of view. Is it possible then that the Earth might be the thing that is moving while the Sun actually stands still?

At some point, it would be good to discuss with your students why you had them face South when they were outside. What would happen if we all had faced the other way? Could we go out and see that? We could explore the school's Daymarks by using the Appendix, Telling Time Without a Clock. What objects around the school could help us to keep track of time without a watch?

 	 <p>Read the Teacher Journal</p>  <p>Add to the Teacher Journal</p>	 
---	---	---

You Light Up My Life



Purpose

Next, we want to determine the behavior of sunlight from observations outside and inside the classroom. We will learn about how light travels by using mirrors, prisms, and shadow makers.

The National Science Education Standards state that the nature of light is an important topic to be learned in this age group, and the manipulation of tools is crucial. The vocabulary which can be introduced to help talk about our experiences are light, shadow, shade, opaque, transparent, translucent, waves, colors, mirror, rainbow, spectrum, and ray. For a new approach to learning some of these vocabulary words, visit Word Lore, an appendix dedicated to exploring the history of words pertaining to this curriculum.



Teacher Background

Light is a very odd thing, but a very special thing. It travels faster than everything else in the Universe. It defines how we measure everything we do, for it travels around, hitting objects and bouncing their images to our eyes. When the images of objects reach us, they allow us to judge the positions of those objects. In that way it is our only good means of determining time. If something moves from one minute to the next, we are most likely to notice this if we can see its image. We can only see its image, if light is bouncing around. Therefore, light can tell us about the world and its changes.

Our current scientific knowledge suggests that light can act in ways that are wave-like and ways that are particle-like. That light acts as a wave means it bounces off things or interacts with other lights similar to the way that waves in water do. That light acts as a particle means that when it bounces off things, it carries with it energy that can be transferred to the things it hits. An example of this is a sunburn, where sunlight has hit and been absorbed into the skin, burning the cells.

This wave particle thing called light travels in a very straight way, in rays, from its source. Anything in the path of the light ray will block the ray to some degree. If the object is very dense and dark, preventing the light from passing beyond it, it is called opaque. Beyond this object, then, on the side farthest from the light source, is what is know as a shadow - where there is an absence of the bright light. You can usually still see things in the shadow because there is other light scattered or bounced about the room or yard hitting that area indirectly. Some transparent objects like glass even let light travel almost completely through them. Objects which may allow only a little light to pass through, like colored plastics, are called translucent. However, the translucent

You will need white paper and masking tape, pencils, crayons, mirrors, prisms, objects of differing transparency, garden hose or spray bottle, flashlights, overhead projector, water and clipboards.

A few sunny days would be good for experiencing this topic. Students will be developing theories about light and need a few chances to test them in the outdoors. Only a few periods of class time are required. (This Thread leads to another Thread about shadows which will take longer to explore fully but supports the same developing understandings.) Gathering materials will take time, as equipment may need to be reserved or ordered.

materials often distort the light they let through. This is because light is a strange thing itself.

White light, or the common light from the Sun, is a tight tangle of all visible colors of light. The colors travel together all mixed up in a way that makes our eyes see the combination as bright whiteness. This combination can be untangled out if you somehow crack open that tight mixture with a light bending tool. Thick clear things like glass and water are very good at this, but plain glass or water is not enough. They have to be in a shape which makes it tough for the tight light package to get through without breaking apart.

A prism is a piece of glass shaped like a triangular solid, or a triangle stretched upwards to make a three-dimensional shape. The light travels into the triangle from a face of the triangle at a certain angle. Whenever light goes from one medium (air) to another (glass) the different colors of light bend slightly differently. The pencil in the glass of water trick is an example of this. Usually, through a flat medium like a pane of glass, the light enters, colors bend by a specific amount, and then bend back into one another going out the other flat side. But the prism, because it is not flat but triangular, doesn't allow the colors to bend back into one another. Instead, it encourages more bending by the angle it has on its other side. So, the white light enters the glass and the colors bend and take different paths through the prism. When they reach the other side, instead of meeting up again with each other passing back into air, each color splits even more from the pack by the same angle again and takes a slightly different path out of the prism. We see the colors break open in the beam. A spray of water will also make this happen as the little droplet shapes of water work like miniature prisms. You get a misty rainbow in the droplets as the white light package gets ripped open in the spray -- exactly as it happens in the sky with real rainbows.

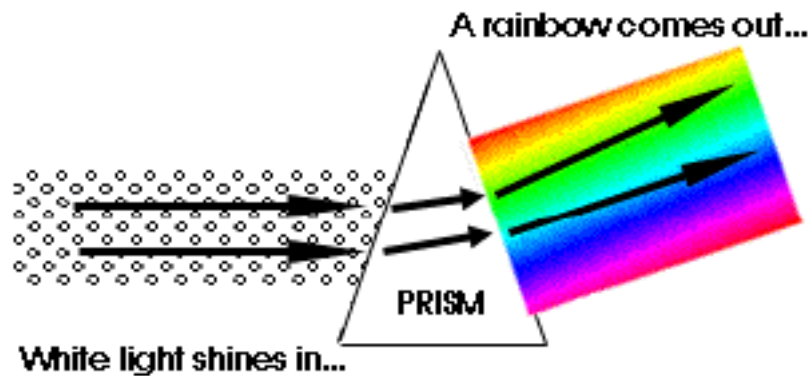



Kindergarten through Second Grade

Developmental Issues

This Thread will focus our experiences of shadows on what light is doing. The students will explore the direction of light and how it always makes a shadow behind an object. We will make it into a game called Sun/Blocker/Shadow which hopefully will root important scientific concepts in a fun game. Five- to eight-year-olds are not very adept at grasping the nature of light. Most undergraduate physics students have difficulty with the concept! However, being comfortable with the way light works is crucial for understanding shadows. Make sure that children understand that when someone says "there is no light" that it's different from how we talk about dark in everyday language. If a room is slightly darkened but they can still see, it is because there is light available! Providing the concrete experiences offered in this Thread helps children develop a strong base for the complete concepts they will learn when they're older.

Inquiry Introduction

What are shadows? Where do they come from? How do you make one? What things do you need to make a shadow? Could we make a shadow outside? Inside? In a dark room or at night? Under water?

Inquiry Investigation

Outside, the Sun lights up the world. But what happens when things get in the way of the sunlight? Does everything make a shadow? Where are our shadows? Can I walk up to someone and step on her shadow? Playing a game of shadow tag would be fun here.

After the energy is released from play, gather the students around again.

Let's face the Sun and try to find our shadows. Are they in front of us? They are behind us. Let's face our shadows. Where is the Sun? It is behind us now. So, where are shadows going to be when

the Sun is over there (point to the left)? Let's face that way. Our shadows would be behind us again, on the other side. So, where do shadows form? On the side of us away from the Sun. Is this true for any light? Can both the Sun and shadow ever be on the same side of us? Could we face the Sun and face our shadows at the same time? Why or why not? What is it about the Sun's light that is not making that happen?

The overhead projector in the classroom gives off a nice light. Turn it on and ask someone to stand in front of it with his eyes covered (otherwise it will hurt). Where is his shadow? He can't see it, but the class can see it behind him. Where should he move to see his own shadow? He turns around and there it is.

What is the Sun? What is the light? Are there things in our classroom which give off light? What are they? Could we think about the sunlight as we do the classroom light? Are there such things as portable lights? Could we use them to think more about light and blockers of light?

What about with flashlights? Could we shine a flashlight on something and make a shadow behind it? In pairs in the classroom, have students shine a flashlight on objects they have in front of them. You could give them wooden shapes and other things. Where are the shadows? Can they change the shape of the shadow or the size?

There seems to be some kind of lining up that has to happen: Sun, blocker of Sun, and the shadow. Could we find a tree and see if it works with a tree? Find a nearby tree and see if the same is true. What about a car or the school? Where is the Sun? Where is the shadow?

Emphasize "Sun/Blocker/Shadow" while pointing to each of these elements in the set-up. Move the flashlight to another spot and show again the different pieces of the Sun/Blocker/Shadow. Let them quiz each other with teams at their own desks. For the youngest grades this may require supervision. You may just want them to play with the flashlights, see if they can tell someone else one special thing they found out about the light and shadows.

A short assessment handout is included that you could use tomorrow to see how many have experienced this fact of light: Light travels in straight lines, so that shadows are directly away from the light source. This handout was created by a first grade teacher as part of the Everyday Classroom Tools curriculum. She had great success with it, and used it repeatedly to reinforce the ideas.

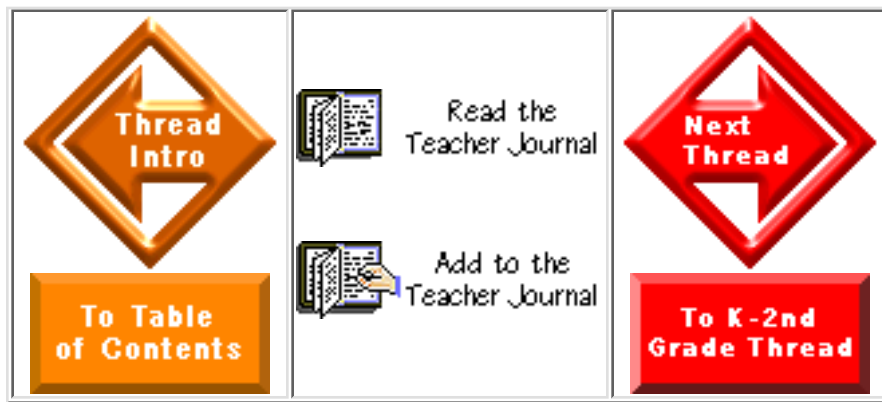

Second Grade through Fourth Grade

Developmental Issues

This Thread allows teachers to direct questions towards the nature of light through repeated experiences with it and objects which block it. These students can juggle ideas such as the seen and the unseen. This will help us to get a firm enough grasp of what light is doing that we will be able to predict some things about both it and shadows. Try getting them to notice the world around them, especially things that don't seem to make sense. Encourage them to take the next step in problem solving by coming up with the kinds of questions they would ask to solve the mysteries. Be aware: they will come up with questions that they may not be able to completely answer! Encourage your students to write their questions down in a journal where they could call upon them as they gain further understandings.

Inquiry Introduction

What are shadows? What is shade? Are they the same? What is light? Where does it come from? How is it made? Let's go outside and think more about this. Grab stuff you want to see shadows of and maybe some paper if you want to draw shadows to show people later. Does anybody think there is something which does not make a shadow? Bring it along.

Inquiry Investigation

Outside, find a place where there is space to spread out clipboards and people without overlapping shadows. It may be better to do this closer to mid-day when the shadows are shorter. Have everyone place their test objects on the paper. What do we see? Which objects make really good shadows? Which make weirdly colored shadows? Why might this be so?







In all of this, where is the Sun? Look again at the shadows. Which way do they point in relation to the Sun? Is there anything we could do to change that? Trace the shadow there right now. Then try to find some way to make the shadow look different on the paper. Some will move the object, some will move their position on the ground,



others will twist their paper a bit. Draw the shadow again. Whose shadow looks different? Why? What happens when you move the object itself? How did the shadow change? Is it pointing in a different direction? Where is the Sun? What about when you move to a different place? Where and how did you move? How might that have affected the way your shadow looks? Where is the Sun? What about those of you who twisted the paper? Where is your new shadow? Is it still pointing away from the Sun? But where is it on the paper? The paper moved and not the Sun, right?

Why are shadows always pointing away from the Sun? How is light working to do that? How does the Sun know the wooden block is there? Light is somehow hitting the block and making that shadow. What is that area behind the block and away from the Sun? Is there light in there? Not as much as there is around it. So, when light hit the block, did it go through the block? A shadow must be the area behind an object facing the Sun which can get no direct light.

Why is it cooler in the shade? Is the Sun warm? What happens in the shade? It is not getting the light and so is not as warm. Cool. Exactly.

 	 <p>Read the Teacher Journal</p>  <p>Add to the Teacher Journal</p>	 
--	--	--

Fourth Grade through Sixth Grade

Developmental Issues

This Thread offers fourth through sixth grades the opportunity to tackle the theory of light through different and more serious experiences outdoors. They are ready to ask and be asked some deep questions which will hopefully open their analytical minds to the possibilities of even deeper questions for real understanding. Providing them with tools and time is all we need for them to create a fairly good theory of the nature of light. Even if they don't come up with the same theory that scientists currently hold, they are learning about theory generation, how we come up with the best explanations that we can until we learn something new to help us generate a better explanation.

Inquiry Introduction

Why can we see the world around us? What outside conditions cause us to see worse or better? Students will mention the weather and amount of light. Why does the weather affect our view? It will become obvious that the weather can block light, such as on a cloudy or rainy day. So, really, the only factor is light. What is this light stuff? Where does it come from? Does it only come from the Sun? What other things give off light? Fire and friction are good examples, friction being what causes light bulb filaments to glow. (This may be new to this age group. If so, it would be useful to have all of the class rub their hands together and tell you what happens to the temperature. Can they think of other familiar objects that produce heat in this way?) Phosphorescence is another way of making light, but a very confusing way at that. How does that little sky spot of the Sun make the whole town light up? What is light doing? How might we figure out more about it?

Have the class make strategies for learning more about the Sun. Brainstorm about ways to test theories. For example, one hypothesis might be that the sunlight glows in the air. How could we test that? Is there a way? One way might be to get a clear container of air and shine a light in it, then turn the lights off. If the air is still glowing inside, that could be interpreted as evidence for the theory. What other thoughts might they have about how light works? Now might be good time to talk about reflection.

Inquiry Investigation

Bring outside (on flat ground or pavement with paper) all of the things they might need to discover properties of light. We suggest you bring mirrors, objects of varying opacity, closed boxes, flashlights, paper, tape, etc. (Please note: It is an unfortunate fact that children outside with mirrors often will try to aim the bright sunlight into the faces of others. You should







consider using mirrors indoors with flashlights, which are weaker, or mentioning that mirrors will be taken away if students cannot behave properly with them.) Encourage your class to build devices for trapping or analyzing light.

Why are shadows on only one side of an object outside? Do they ever move? Why or why not? Most will say that the Sun is shining and hitting the object on one side of it, and the shadow forms because the light can't get through to the other side of the object, so there's no light there. Trace the shadow on the paper. Twist the paper. Where is the shadow on the paper? Where is the Sun? Is the shadow still pointing away from the Sun? But where is it on the paper? Did the Sun move? But the shadow changed because what we were measuring it on moved. Keep this in mind when we do the Sun stick measurements.



Why can you still see the pavement in that shadow? Surely there must be some light coming from somewhere? What is happening? What happened to the light that hit the block? Did it get sucked into the block? Did it bounce off the block? How can light bounce? What other things can bounce like that? Many will say playground balls or something like that. Is light made of little balls of bright stuff? If so, what could we do to test that? Here is where the mirrors come in.

It is hard to see the light bouncing from the block, but easy to detect light which is being bounced from a mirror. Can we bounce light around the yard? How far can we get before it is difficult to catch the beam of light? If light can bounce so well off mirrors, might it not bounce around off other things, but not as well? Probably. That is why it still gets around the whole yard, even the pavement inside a shadow, when the Sun is in one place in the sky. This is why it gets bright out in the morning even before the Sun rises, and that it is still light just after the Sun sets. Light indeed travels in very straight lines, but light itself can bounce though it still travels in straight lines from object to object.

 	 <p>Read the Teacher Journal</p>  <p>Add to the Teacher Journal</p>	 
--	--	--

Me and My Shadow



Purpose

In this Thread, we will become familiar with the orientation of shadows, their size in relation to the object casting them, and how the alignment of the Sun, the object, and the shadow tells us much about how shadows work. The National Science Education Standards stress that geometry and light should be integrated into curricula as tools for learning about three dimensional objects. Vocabulary words which can be used to help talk about our experiences are alignment, casting, angle, and light source.



Teacher Background

The height of a tilted light source (in other words, the angle between the light source and the ground) and the size of the object it is illuminating determine the length of the shadow that the object casts. The object blocks the light coming from the source so that nothing behind the object gets any direct light. The length of the shadow is a result of how high above or below the top of the object the light source is. Imagine if the light source were directly above the top of the object. Would there be a shadow? No, not one that would be visible around the object. Twist the light source a little down from the top, and a shadow appears behind the object, but is very short. This is because as the light source moves down, the shadow is being created by the small area of the object blocking the light. Imagine straight lines coming down from the light and hitting the object. The higher the light, the less light lines get blocked by the object and hence the less shadow. Thus, the lower the light source is aimed at the object, the more the object blocks the lines, or rays, of light.

You will need enough pebbles, coins, marbles or counting blocks for the entire class, a box of chalk, chalk/wipe board and markers, overhead projector or lamp.

This requires one class session outside in the sunlight. Another class session or two inside is enough time to really think about our outdoor experiences. Materials gathering is quite minimal.

The key to understanding shadows is to realize that the light source and object must be lined up in order to make a shadow appear. In fact, if the object is placed anywhere along that line, it will produce a shadow of the same length behind the object. It is only when you change the orientation of the light source that the shadow changes. That makes sense in one order: light hits an object and casts a shadow. But experiencing the connection of these fundamentals in a different arrangement is good for rooting our experiences more firmly. In other words, trying to predict where to place an object to cast a shadow at a specific location: essentially trying to locate the path of the light.

We've made a brief page about [solar eclipses](#). Solar eclipses are excellent examples of light and shadow.

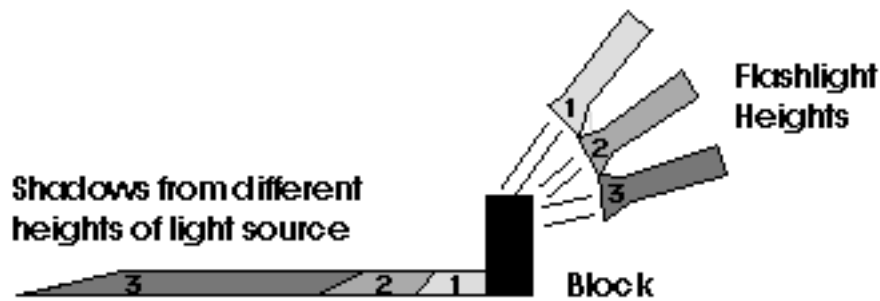

	<p> Download</p> <p> Internet Resources</p> <p>Children's Books </p> <p> Folklore & Mythology Connections</p>	<p>To K-2nd Grade Thread</p> <p>To 2nd-4th Grade Thread</p> <p>To 4th-6th Grade Thread</p>
--	---	---

Kindergarten through Second Grade

Developmental Issues

This Thread invites Kindergartners through second graders to continue to think about light and shadow while using their bodies to make observations. This roots our experiences by relating them to ourselves, which is fitting for this age group. It engages students in manipulating objects with a focus in mind as well as exercising balance and movement skills which are good for this age group. Teachers of second graders should consider using the grade 2-4 version of this Thread.

Inquiry Introduction

Remember the game Sun/Blocker/Shadow? Why does it work? What other game could we devise to play with the way light works? Everyone grab a marble or cube. (Don't call the cubes "blocks" or it will confuse the game.)

Inquiry Investigation







Together, let's go outside and find a place to spread out on an area of asphalt or concrete, etc. Where are our shadows? Can everyone find his or her own shadow? Where is it? Is everyone's shadow visible? Can the teacher come and step on someone's shadow? Does it hurt to step on a shadow? How far away from the person is the teacher who is stepping on the shadow? Is it hard to reach the person from where the teacher is standing? Why are shadows so far away from their makers?

Play Shadow Tag again, this time with some questions afterward. Was it hard to play this game? We had to be careful to watch our shadows and the person who was "It" very carefully. When was it hardest to be careful: when running towards the Sun or away from it? Why? How are shadows made, then?

Now it is time to reverse our thinking. Everyone, drop your cube somewhere. Where is your shadow? Can you move your shadow so that the shadow of your hand can cover the little cube on the ground? This will at first seem quite difficult, but soon they will begin to cry out that they have done it. Helping is definitely OK.

How did you know where to put your fingers? They will begin to vocalize in their own ways an important fact: that the sunlight is in straight lines to their hands and they need only line themselves up with the Sun and the cube to cast a shadow on it. In this way, they have figured out that one can determine the position of the light source from the angle of a shadow they can cast. Can anyone think of a way to play this game in the classroom?



 	 <p>Read the Teacher Journal</p>  <p>Add to the Teacher Journal</p>	 
--	--	--

Second Grade through Fourth Grade

Developmental Issues

This Thread will examine the orientation of the Sun, ourselves, and shadows from the reverse way around. It will seem like a tricky game, but once the idea of the linear nature of light travel is experienced, we can talk more about light in the next Thread. To do so, again we will exploit this age group's fascination with mystery, team learning, and the ability to string two or more variables together into a model. Second grade teachers should consider choosing this version of the Thread over the version intended for younger (K-2) students.

Inquiry Introduction

What has to happen before we can see a shadow of ourselves? There must be light. There is light and us, but there is something else we need to actually see the shadow. We need something for the shadow to land on. So, three things are required for shadows: a light, an object, and a surface. Is there any guideline for where the shadow should land when we are standing in the light? Does it matter where we put the light? What about in outer space?

Inquiry Investigation

Everyone should grab one small shiny object like a new penny or an interlocking math cube, a pink eraser or a marble. Let's go outside. Find an asphalt or concrete area with a lot of space, enough that the entire class can spread out and be bathed in sunlight. Is there enough room for their shadows? You might consider timing this for between 11 a.m. and 1 p.m., when the shadows are shorter but not so short as to make this impossible.

Everyone should spread out enough that they can twirl in place and not hit anyone. Next, everyone should drop their shiny object somewhere about 4-5 feet from them in any direction. Now find your own shadows and stick your arms out. Make an OK sign with your fingers, so that your shadows show a little ring or circle for your hands. Can you, without squatting, move your shadow ring so that it encircles the shiny object on the ground?

They will mock this as easy at first, until they find it is very difficult. There is some kind of trick to doing this, and it will be fun watching them catch on. What has to happen before the shadow can line up with the object? What else is needed to make a shadow besides the surface (shiny object) and the thing making the shadow? The Sun. See how many can incorporate this into their struggle. There has to be an alignment of the three crucial items needed in making a shadow happen.



Soon, (it takes about 3-4 minutes), they will begin crying out that they have figured it out, one by one. Ask them what they did, and they will try to explain they made things line up or they looked back to where the Sun was. It is the lining up of these objects which is so crucial to learning about how light and shadows work. If someone has managed to ring the object by luck, ask about the positions of the things needed to make a shadow. Is there any pattern? Can we shuffle from side to side and still make the shadow happen on the object? Can we shuffle forward and backward and still make the shadow happen on the object? How? Where must the Sun be in order for this to work? Directly behind our hand. Where must the object be in order for this to work? Directly in front of our hand.

Where is the Sun? Where is our shadow? Have them face the Sun. Where is our shadow? Turn to the left. Where is the Sun? Where is our shadow? Is there a pattern here? What if the Sun were over there (point to the left)? Where would our shadows be? What is true then about shadows and the Sun? Shadows point away from the Sun. Do shadows point away from a lamp as well? We can play with this back in the classroom.

They will want to play more with this trick once they all have caught on. You can ask them if they can get two people to circle the object at once from different positions. Break into teams of shadow makers. Can anyone make other shapes with your body to circle the object? Does everyone have to stand at the same distance from the object to ring it? How many people can you line up who are casting a shadow around the object but are standing apart from each other?

Back in the classroom, let's pool what we've seen. We saw that we had to line our hand up with the Sun to make a shadow, but we also had to line that shadow up with the shiny object. We had to move our entire bodies so that the Sun was at our back to get the OK sign over the object. We found that we could also move towards it and away from it and still keep the OK ring around the object by moving our hand only slightly.

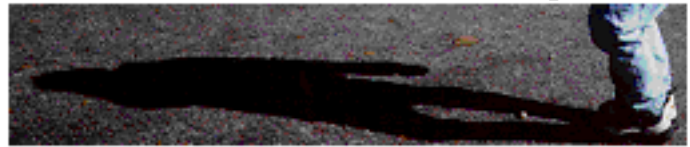

Draw on the board a Sun, a person with her hand out, and the object, but do not line them up in the proper way for the person's shadow to hit the object. Will this person's shadow hit the object? Why or why not? Students should gather in the same teams that they were in outside. They should think about the question on the board and then come up with an answer. Ask the teams in turn what they think. They will hopefully mostly say no, this cannot happen. Why not? They will talk about things not being lined up. You could prod them some more by asking them if they mean you can't draw a straight line which connects them all.

Draw a line that connects the three items, first asking what the order is. Sun, object, shadow...It should be a terrible looking line, with connections between points not meeting at a 180 degree

angle. In other words, not a straight line. Where would I need to put the person to make the line straight? Teams can confer and answer you in rotation. Have them come up to the board and place an X where they think the person's hand should be. Different colored chalk would work well for different teams, otherwise numbers will suffice. Does everyone agree? If not, more examples like this could be done.

Is this what we experienced outside? We had to line up everything to make it work! Why? What must be true about sunlight or any other light source? It travels in straight lines.

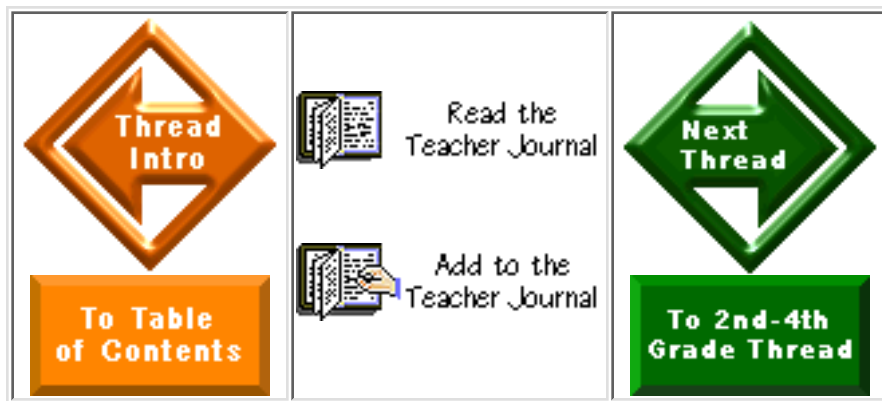

Fourth Grade through Sixth Grade

**Developmental
Issues**

For this age group, this Thread involves a quick investigation outside to

exercise our powers of perception. Although this is probably a little easy for them, it is still a good idea for them to be familiar with every aspect of the shadow making process.

Inquiry Introduction

What makes a shadow? Most will know that shadows are caused by the Sun or other light hitting an object and blocking the path of light behind the object. This is easy, right? You can make a shadow fairly easily and determine where the light source is from just looking carefully at a shadow. But can you aim a shadow at an object? Huh?

Inquiry Investigation

Everyone should grab one small shiny object like a new penny, interlocking math cube, a pink eraser or a marble. Let's go

outside. Find an asphalt or concrete area with a lot of space, enough that the entire class can spread out and be bathed in sunlight. Is there enough room for their shadows? (You might consider timing this for 11 a.m. or 1 p.m., when the shadows are shorter.)







Everyone should spread out enough that they can twirl in place and not hit anyone. Next, everyone should drop their shiny object somewhere about 4-5 feet from them in any direction. Now find your own shadows. Make an OK sign with your fingers, so that your shadows show a little ring or circle for your hands. Can you, without squatting, move your shadow ring so that it encircles the shiny object on the ground?

They will mock this as easy at first, until they find it is difficult. There is a trick to doing this, and it will be fun watching them catch on. What has to happen before the shadow can line up with the object? What else is needed to make a shadow besides the surface (shiny object) and the thing making the shadow? The Sun. See how many can incorporate this into their struggle. There has to be an alignment of the three crucial items needed in making a shadow happen.

Soon, (it takes about 1-2 minutes), they will begin calling out that they have figured it out, one by one. Ask them what they did, and they will try to explain they made things line up or they looked back to where the Sun was. It is the lining up of these objects which is so crucial to learning about how light and shadows work. If someone has managed to ring the object by luck, ask about the positions of the things needed to make a shadow. Is there any pattern? Can we shuffle from side to side and still make the shadow happen on the object? Can we shuffle forward and backward and still make the shadow happen on the object?



How? Where must the Sun be in order for this to work? Directly behind our hand. Where must the object be in order for this to work? Directly in front of our hand.

 	 Read the Teacher Journal  Add to the Teacher Journal	 
--	--	--

This is a Stickup!



Purpose

In this Thread, we are continuing to examine the passage of time from observations we can make about the outside world. In Hello, Sun!, we saw that the Sun appears to

jog across the sky during the school day. It looks like a nice and smooth motion. By using the shadow of the Sun during the day, we may make safe and accurate measurements of that motion. The National Standards require that students be learning what causes light, heat and shadow, and how time passes, how to use rulers and other measuring tools. The vocabulary words which can be introduced to help us talk about our experiences are line, length, angle, sphere, straight, and model.



Teacher

Background

We have already explored the way the Sun moves in the sky during the day.

The next step is to try and see that motion from another perspective.

Some classes may have been able to determine the height of the Sun in fists and found that the Sun first gets higher then lower in the sky. Did students also notice that their shadows got shorter and then longer again? Do they have a record of that? As we saw from the Thread, **Me and My Shadow**, the height of a light source changes the lengths and orientations of shadows. Using a standard stick with careful measurements can give us a better record of the changing shadow lengths outside in the Sun and also good data for exploring deeper.

If we measure shadow lengths during the day using a standard stick, the shadow pattern will look like a fan of lines, first long, then shorter, then long again. This fan will begin with its first shadow line on the left of the stick, if you are looking from South of the stick. This fan pattern will then proceed with lines moving ever more to the right and at steeper angles to the edge of the paper. This is because the Sun rises in the East, or to the right of the stick. A light source on the right will cast a shadow of an object to the left. The angle of the Sun above the horizon determines the length of the shadows it causes behind objects. The higher the Sun is, the shorter the shadow. This is why the fan gets shorter at mid-day. In fact, if the Earth did not tilt on its axis 23.5° as it does, then the Sun's height at mid-day would be the same every day of the year. The Thread called **Latitudes and Attitudes** will let us explore this further.

At one point in the investigation, you will talk about the relationship between angles and sides of a



You will need pencils, construction paper flags, flashlights, paper, and either a 12-inch stick/ruler or half-meter stick; 2-4 additional; chalk or wipe board, chalk/markers, big roll white paper, coffee can filled with sand, tape, flashlights/toothpicks/clay/paper enough for half the class number; 4-6 additional; easel, protractors, yarn or string, a calculator with trigonometry functions (tangent/cotangent).

The class will initially need a sunny day for this with repeated measurements throughout the day every hour, starting with the earliest hour in the school day. You will need to have previously located South in the school yard. Materials gathering time is minimal since most of the materials are common in the classroom.

In the classroom, you will want to spend several class periods over a week or more exploring your data and what it means. The older your grade level, the more time you will want to spend. There is a lot of good math which can be introduced in this Thread and taught simultaneously. The procedure described in the Investigation portion of this Thread should be repeated at least three more times during the year.

right triangle. A right triangle is one which has a 90° angle in it. In such a triangle, the tangent of an angle is defined as the length of the side opposite the angle divided by the length of the side next to the angle. The hypotenuse, or longest side, is not used in finding the tangent. In the sunstick investigation, the tangent of the angles use the "sides" made by the length of the stick and the length of the shadow. So, depending on which angle you are trying to find, you will divide one by the other. In a calculator or using a table of tangents, you can find the angle. In the upper grades, you will use a protractor and some string to measure the angles directly as well as finding them with the tangent.

If you are interested in making sundials with your class, please check out this pattern for [a simple design for a sundial](#).



Kindergarten through Second Grade

Developmental Issues

This age group cannot yet manage the precision required for the Investigation in this Thread. They will not be able to make good measurements nor understand their importance. What we want them to learn from this adventure is that as it moves across the sky, the Sun's light changes the stick's shadow, something which they should remember from Me and My Shadow. However, we can emphasize using the Sun as a clock in this Thread. It is suggested that instead of employing the measuring stick and paper that you instead use a sapling or pole in the school yard and bright marking objects or flags. This way we can express the same basic concept in a very big and personal way, using first our bodies to mark where the shadows are and then special flags we place to make semi-permanent records of the shadows. Decorating personal flags would be a fine integration of art into this Thread for this age group.

Inquiry Introduction

What is happening to the Sun outside during the day? Is it staying in one place? Does it seem to move? What happens to our shadows if the light moves? Do you think our sunlight shadows could move, too? What if we move? Do our shadows move with us? Does the Sun/Blocker/Shadow game work if we move? How could we try it out? How long would it take before we noticed any movement? Can we actually see the Sun moving? How long did it take in **Hello, Sun!** before we noticed the motion?

Inquiry Investigation

Arrange ahead of time for your observation place to be undisturbed by students during the day and recess. Perhaps alerting your principal about the activity will help. Outside, let's pick a short tree or pole (or use a standard stick) on which the school's shadow does not fall anytime during the day. It would be best if this object were near the place where we all did **Hello, Sun!** so similar horizon landmarks are around us. This will help us understand what is going on.

What time is it? Where is the shadow of our tree? Can we all go run to the shadow and stand on it? How long is the shadow? Could someone go stand at the very end of the shadow? Place a little class flag there with the time written on it. Who thinks the shadow will be somewhere else in an hour? Where? Stand on the spot you think it will be. With our names on our own flags (of a different color than the class flag), let's each place a flag down where each of us thinks the shadow will be in one hour. Pick random students' flags and ask them why they chose that spot. Could they relate their decision to the Sun at all? Where do we think the Sun will be in one hour?

In one hour, go outside again. Where is the end of the shadow? Mark this with another class flag. Who was closest? Which way did the shadow move? What is changing? Where is the Sun? Did the tree shrink or grow? Let's retrieve our personal flags. Where might the shadow be next hour? This time students may begin to see that a pattern might be forming, and many will put their flag to the right of the second class flag. Again, ask them why and if they can relate it to the Sun.

By the third hour out, it should be clear what is happening to the pattern of the shadow. It is moving to the right. The length of the shadow is not going to make much sense to them, since it involves the height of the Sun; pointing out the correlation will be difficult. However, with flashlights inside, repeating the You Light Up my Life investigation may allow more modeling of the situation. Consider this if you feel your students might gain insight. Otherwise, it is not crucial at this age group. These are understandings they can build as they get older.

Which way did the Sun go today? Which way did the shadow go? Did the tree move at all during the day? No ... so what happened? Play the Sun/Blocker/Shadow game again

inside with a flashlight, some object, and paper. Model the experience from outside with everyone. Ask them every step of the way if this is where the Sun was and this is where the tree or pole was. Which way did the shadow go? Is the Sun going that way? Does it happen like that for everyone in the whole world?

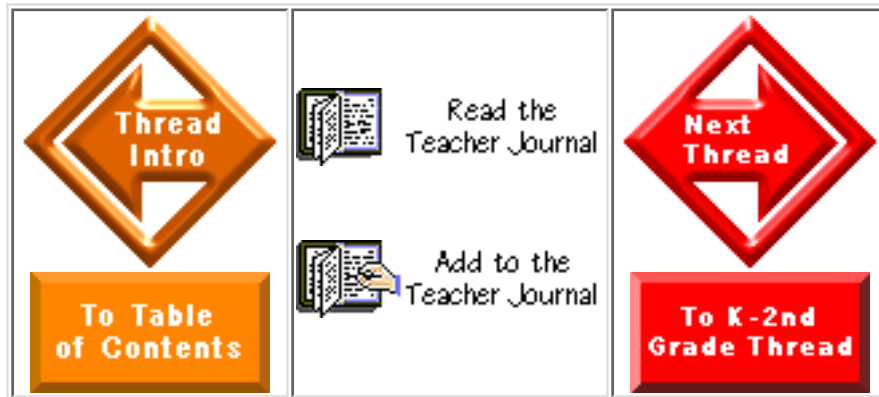

Second Grade through Fourth Grade

Developmental Issues

This is a good Thread for this age group. They are beginning to learn about numbers and how to use measuring tools. At this age they are extra keen not to make mistakes, since they are desperate to fit in and avoid looking stupid. And they want to be given real tasks to do. These characteristics make a subset of this Thread perfect for your students. We will not delve into this situation's geometry with these students, but we will let them participate in some serious observing, building, and modeling in a way which we hope will satisfy their intellectual desires.

Inquiry Introduction

How does the Sun seem to move during the day? From where to where? Recall the **Hello, Sun!** blackboard drawings? Could anyone draw them on the board? So, since we were facing South, the Sun moved from left to right. What happens to shadows made by the Sun during the day, then? How could we observe them and be able to take them inside to look at? Can we take somebody else's shadows inside? How could we do this? Gather suggestions from them. Many will recall that we were able to take the Hello, Sun! data indoors because we made a record of it. How could we make a record of the shadows? They will suggest putting paper on the ground, perhaps, or taking pictures. Will one picture be able to show us all of the shadows from a whole day? No. A piece of paper would work, if it had all of the shadows on it. How big a piece of paper? How long are shadows? And what should we use as a shadow maker?

Look around the room and find a standard stick. How could we keep this stick from falling over? A can with junk in it to keep the stick still is a good idea: things like clay and rocks, a Styrofoam plant basket block and stones, or a coffee can filled with sand are good ideas. Paper from a big roll and masking tape will be good for the record keeping. And a nice new marker.

Inquiry Investigation

Time the observations to coincide with the times we all went out for Hello, Sun! Bring all of the materials outside. Find the location from **Hello, Sun!** and put your equipment down there. Pull out a large sheet (about four feet long and as wide as the paper itself) and lay it down with one corner pointing towards south. (Human symmetry ideals would want you to put it square with a side facing south. Don't give in. Since the shadows at morning will be longer than those in mid-day, you will need to account for this in the orientation of your paper.) Tape the paper very firmly down. You may want to mark where the edges of the paper are in case it blows out of position. Put the can down in the corner. Make a careful circle around the bottom of the can so that you always know where it is supposed to go.

So that we don't all crowd the paper with our shadows, let's stand on the north side of the paper. (There is no need to call things north and south with this age group. They will get all fuddled up with the vocabulary. You might say, "Let's stand at the top of the paper.")

What time is it? Someone look at a watch. Where is the shadow here? Trace the shadow line carefully with a dark marker. Write the time at the shadow's end. (Do this for every shadow observation today. Putting the date down near the bottom of the paper is probably a good idea.) The shadow is to our right. Where is the Sun? It is to our left. How long is this shadow? Where do we think the shadow will be in one hour? Does anyone recall Hello, Sun! and what we learned about how the Sun moved in the course of one hour? What might that do to the shadow? Will the Sun be higher in the sky? What might that do to the shadow? The students may want to place stones on the paper marking where they think the next shadow will be. If they think the shadow might change size, they should place their stone where they think the end of the shadow will be.

Back outside again in one hour ... where did the shadow move? How many things outside in our set-up could be changing? Let them decide if the stick could have changed size. Could the paper have changed size? What else is changing? Where is the Sun? (Remember not to look at directly at the Sun, as that may cause permanent damage to the eye's retina.) Is



there a connection? How long is the shadow? Where in the sky is the Sun?



Back in the classroom, retrieve the Hello, Sun! easel drawing. Leave it in view during this day as a reference guide for students. What time did we make this last observation? Can anyone find it on the Hello, Sun! drawing? How high is the Sun now as compared to one hour ago? Did anything happen to the shadow during this last hour? What might be the link? They may or may not see the height and length relationship right away, so encourage more thinking until they propose the idea. When they do, ask them when they think the shadow might be the shortest today, or when it will be the longest. If they do not see the connection yet, revisit this line of questioning after each observation outside until they do.

After a completed sun stick record has been made (i.e. at the end of the day) tape the record up in the classroom. Tomorrow we will be thinking more about this day and building our own models of it.

The next day, set aside a table for the flashlight/toothpick/clay/paper materials and begin talking with the class about our experiences from the previous day. What did we do yesterday and what do we think we have discovered? We think we discovered that as the Sun moved across the sky and up and down in the sky, the shadows moved across the paper and got longer or shorter. How could we try to model that inside the classroom? We would need a Sun, right? What if we wanted everyone to have his own Sun? What could we use instead of a Sun? What is the Sun anyway? They should hopefully recall their experiences with You Light Up My Life well enough to know that light is light, whatever its source, and that objects in the path of flashlights will cast shadows just as they do in the path of sunlight. What else do we need? We need some kind of little stick stuck into something. A toothpick in clay works well. And we need paper and markers. No problem.

In teams of two, have them gather one set of materials and bring them to a desk or table. Can they recreate what happened outside? Give them plenty of time to fiddle with the materials. They will want desperately to play with the flashlights at first, but not as badly as they did in You Light Up My Life. Ask them to focus on recreating the events of yesterday. What must they do with the flashlight to get their toothpick shadows looking like those on yesterday's record taped to the wall? Have them tell you why they built their model the way they did and how they constructed it. Perhaps teams could later come to the front and explain their models to the rest of the class.

What can we see here? Grab someone's flashlight and aim it down from above the very top of the toothpick. What kinds of things would happen to the

shadows if we did this? There would be no shadow. Does this happen on the Earth anywhere? What about if we really lowered the flashlight (aim it at the side of the toothpick and very low). The shadows would be very long. Does this ever happen on the Earth? Gather their suggestions. Ask that they write up their experiences from the past few days, especially what they think they learned and what more they might want to learn about how shadows work on the Earth.

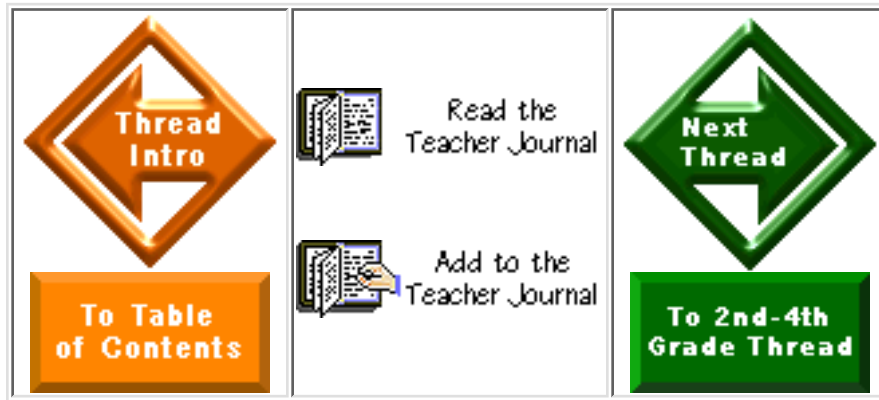

Fourth Grade through Sixth Grade

Developmental Issues

These students are ready to make some serious observations about their world. This age group is able to record data and comprehend the need for careful observation. They are responsible and eager to master skills. The onset of puberty often hampers a child's desire to take risks. The simplicity of the observations and the obvious results as they come in provide a student with a comfortable experience in which to make some important predictions. The journal keeping is a very personal thing and can be a safe, private place also to record their ideas. Modeling our investigation in this Thread will help make some connections between the math we are doing and what it shows about the world around us. At this age group, most curricula are introducing basic geometry: triangles, circles, and some simple concepts associated with them. This Thread uses degrees, fractions, angles and triangles to explore the spin speed of the Earth, the height of the Sun, and later in the year, the tilt of the Earth. It is fairly important that the students be familiar with the protractor before this Investigation. By the time protractors are used in this Investigation, you and your class will be involved in some serious thinking and connection building. It will distract from the cognitive process to stop and learn about the protractor in the middle of the thread.

Inquiry Introduction

When the Sun moves across the sky, how could we really record its exact position? It is extremely dangerous to look directly at the Sun. How else

could we possibly try to record the motion? Let's hope they are thinking about the Sun as a light source and that they know an awful lot about the characteristics of light sources now. If not, ask them if the Sun is a light. What do they know about light sources? What can lights do? What results occur when we put something in the way of the light? Is there anything important about the light we can learn from what happens to the shadow of the object in its way? We can tell how bright it is, sometimes, by the darkness of the shadow if the object is very opaque. What about the height of the light? If light travels in straight lines, what happens to a shadow if the light comes from up here? Aim a pretend flashlight up high above someone's head. This may not be obvious to everyone. Good. That means it is time to go outside and experience this all for ourselves.

Let's bring something outside which we know a lot about. Here's a piece of wood (the 12 inch dowel rod or ruler, or the half-meter stick). How long is it? How could we know for sure? Have them suggest and implement the act of measuring it with a ruler. OK, so we know it is a foot long. Let's stick this outside and watch its shadows all day and measure them as well. If they did this kind of thing last year, they may pipe up and say so. Ask them if they ever measured the shadows they made then or if they discovered the speed of the Sun's movement? Well, no. OK, then. Time to roll.

Inquiry Investigation

Bring the easel and paper out again. Outside, with the materials set up in a good sunny spot, have them carefully pin down the paper somewhere safe where it won't be trampled. You might ask them which way is South. Suggest they point a corner of the big paper to the South and put the can with the upright dowel near that corner. What happens if the can slips? What could we do to make sure we always know where the can goes? What happens if the paper slips? What could we do to make sure we know where the corners of the paper were? Taping the corners down and chalking the outline of the paper seems to work well. Outline the can on the paper itself. If it is windy, weights on the corners of the paper should be used.

What time is it? Where is the shadow? Have someone trace the shadow with dark marker very very carefully. Why so carefully? When we measure, we need to have a good record. Mark the time of the traced shadow at the top of the traced line. We might all make some guesses as to where we think the shadow might be next time we come out to check our set-up by placing rocks or sticks on the paper.

Where is the Sun? Have a team draw the horizon on the easel as seen from the spot in front of the stick (i.e. the sky's southern hemisphere). In that case, what might we want to know about where we are standing with the

easel? Have them make some mark on the ground so that they can stand in the same place again after one hour. Ask them to draw the Sun in, using the "fists" technique from Hello, Sun! Where will the Sun be in an hour? They will point to some spot on the paper. Let's keep this drawing going along with the sun stick record. So, where might the shadow be after the Sun has moved for an hour? And the length of the shadow? Longer, shorter, or the same? Why? Gather ideas but don't encourage any one over another. We'll soon see in an hour!

In one hour, revisit the set-up. Before we trace the shadow, what might we want to do? Check that everything is in its place. Then have someone trace the shadow carefully, marking the time at the top of the shadow line again. So, what happened here? Tell me about how the new shadow is changed from the last one. Someone will tell you that it moved and that it got shorter. Why did it do this? Did the stick move or get shorter? What is the only thing that can change the shadow? The light. So, the light moved in some way. Where is the Sun now? Have the Sun keepers stand in their spot and draw the Sun in on the easel. Is there a connection? If no one sees that when the Sun moves to the right, the shadow moves to the left, that is fine. We can just keep saying these things. Also, how many "fists" high is the Sun? How long is the shadow? What is happening here?

Each successive visit outside will become less interesting to them until past midday (when the Sun reached its highest point in the sky) when the shadows get longer again. Why is this happening? Do we now make the connection? How could we model that inside the classroom? They should think about this for tomorrow, for we will be building our own models then and discovering some things about the world from them. For homework, you may have them write in their journals what they think happens during the day to shadows and the Earth and Sun. Can they imagine what shadows would be like somewhere else on the Earth? Before they arrive for the next day, tape the easel drawings to the wall above the sun stick drawing (in the diamond orientation).

The next day, ask them what happened yesterday and what they think they now know. Show them that you put up the drawings we made so that they are just like they were when we saw them on the ground. Have them think about (but not call out) the two positions the drawings have been in.

Break the students into teams of four people, hand out the sets of sun-stick models (flashlight/toothpick/clay/paper) and have the teams rebuild the set-ups. How can we recreate the scene with flashlights? Where did the Sun come up this morning? Where did it go and how high? When were the shadows the longest? The shortest? What is the real connection? Have them tell you what they think is happening. They will say things like, "When the Sun is highest, the

shadows are shortest." Ask them why. Does it have to do with the nature of light? Can anyone draw what is happening in their model or outside on the board?

Help by drawing the stick in the middle and put the Sun on the far left. Ask someone to come up and draw how the light is coming to the stick. Ask the class where the shadow is. They will want to come up and point or draw it in. Extend the sunlight lines past the very tip top of the stick line (if they are not past it already) so that they reach beyond and mark the end of the shadow. Ask them about shadows again and what they learned from You Light Up my Life if they wonder why you are asking that. Flashbacks are no problem, and are always encouraged. When everyone understands, draw the Sun higher and over more to the right. Have someone else come up and draw how the light is coming to the stick. Where is the shadow now? And so on.

Tape to the board next to the chalk drawings (but higher up) the easel drawing of the Sun. Underneath this, tape the sun stick drawings for comparison. Is this what we saw? Yes. What has happened is that we have experienced something and set it aside. We then modeled it and thought about it in lines and direction, and set this next to our first experience. What was true for one is true for the other, and vice versa. Since these two experiences support each other, each view is as valid as the other. The next step is taking a trip to the third realm of experience: the mathematical one. How could we communicate our experience in terms of mathematical models?

Isolate one section of the chalk drawing on the board (by either erasing the rest or re-drawing the key parts) so that it looks like a little triangle formed from the sunlight line zooming past the top of the stick, the sun stick itself, and the line marking where the shadow was cast. What shape is this? A triangle. What do you know about triangles? What does the word itself say to you? Tri = Three, angle = some height measured in degrees. Point back to the drawing on the board. Which angle opens up and points to the Sun's position?

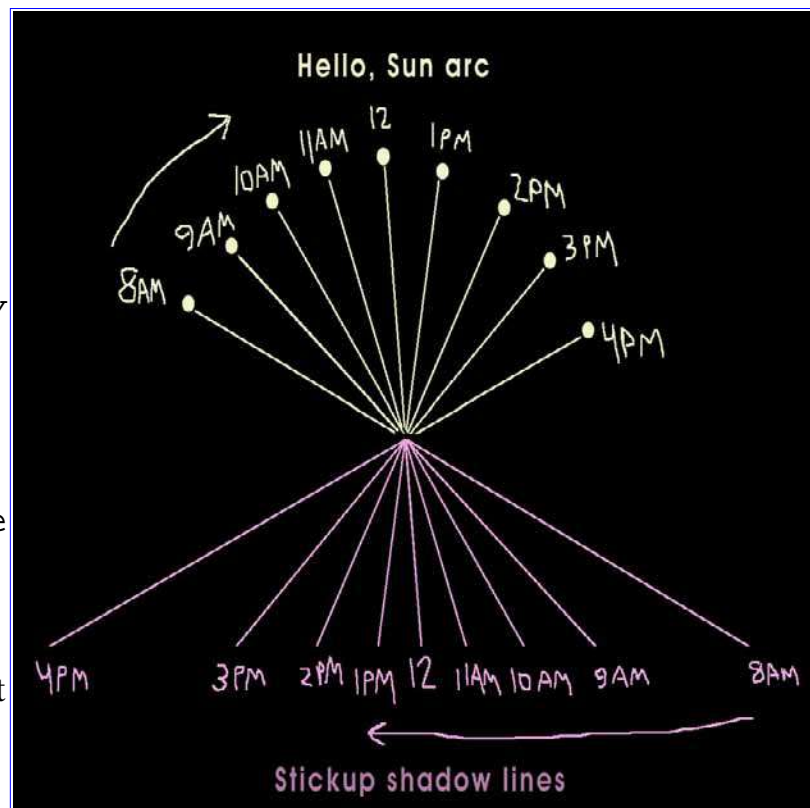

Draw a Sun high on the board. Ask some class members where the stick's shadow would be on their model if this Sun could give off light? How could we test this? Hopefully, they will use the flashlight in

their hands and move them so that they are in line with the Sun mark without leaving their desks. So, how high is the flashlight or the Sun mark above the paper in degrees? Trace the line from the Sun to the end of the shadow--but with what?

It would be good to trace the length of the shadow with a pencil first. Then, have one person hold the flashlight while another holds a string to the flashlight near the lens. A third person should pull the string until the other free end reaches the tip of the shadow drawn on the paper. What is the shape made by the string, the toothpick, and the paper shadow outline? The fourth person should be able to see this shape by viewing the whole construction from the side. What does the string represent? It points to the Sun. It follows that an angle formed at the corner by the string and the paper "ground", represents the "Sun's" angle above the ground. Can the fourth person see how this is possible by tracing with his or her eye the line made by the string up to the "Sun"? Can she explain it to everyone else in the group?

Have the fourth person in each group take a protractor and measure the height of the Sun (or the string line, in this case) in degrees. How high is our Sun in degrees above the paper? How long was the shadow? Let's record these numbers on the bottom of the paper somewhere. Erase the first Sun and draw another significantly lower on the board and redo this entire procedure for that new height. What does this triangle look like? How is it different from the first one? What is the height of our Sun? What is the length of the shadow?

What is happening here? There must be some relationship between the height of the Sun and the length of shadow it makes, but we knew this from our experiences outside. There also seems to be some mathematical relation between that angle of the triangle and the length of the triangle's bottom side. Did the size of the toothpick ever change? No. This makes a steady length for one side of the triangle. Maybe we could think about that some more. Is there a fraction we could think about that might change as the small angle changes? How about the toothpick length divided by the shadow length? What is the number? Is it greater than one here (for the first set of numbers, write them on the easel as a fraction.) How big was the angle? And what about for the other set? Write them on the easel also (if there is any room left, that is!). How big was its angle? We seem to find that the bigger the angle, the bigger the fraction. Cool. Do we have any other data we can check? Let's gather all of our data in one place so we can look for patterns, if there are any!

Start a table on a new sheet on the easel. The table should have room enough for 7 columns, with **Time** and **Length of Shadow** and **Length of Stick** as headers for columns 1-3. Obviously, the third column will not change! Let's think about how we have gotten data so far. The first column we know because we were careful to write down the time each time we took a measurement. The second column we had to measure ourselves with a ruler. The third column we knew already, because we had measured the stick. What else have we been talking about that we can figure out about this system of three lines, stick, shadow, and ray of sunlight? They should continue thinking about the idea of the triangle and that

fraction.

How might we really find the angles we want to know about? Does anyone suggest using the string idea on the real setup? Set up the stick and paper on the floor. Let students use string to connect the top of the stick to the end of the first shadow. Someone can then measure the angle made at the paper with the string and write this into a **measured angle** column. They should do this for all of the shadow lengths.

Look only at the sun stick drawings, not the Hello, Sun! set. How long was our stick? It was one foot, or 12 inches, or if you used a half-meter stick, it was 50 centimeters. What are the lengths of these shadows? A group should measure the lines and record the lengths in the table (using centimeters is just as valid as using feet or inches). Can they make a fifth column for the **fraction** and fill it in? If not, you might consider using a calculator and giving them fractional values for the numbers they call out. Is there a pattern? Could we make some guesses based on the sizes of the fractions as to what the angles might have been for those times?

We are so close to being able to find an angle from this information, even though we have one we think we measured correctly. If this relationship is so simple, is there a table somewhere?

Producing a table of tangents might be cool. It is not possible to expect these students to read the table very well, nor is it reasonable to expect them to understand radians of a circle. So, it is suggested that you instead tell them the calculator has the table built in. Yes, really. And for each fraction we find, we can find the angle that goes with it. Do this for each tangent fraction and write the **calculated angle** in on the easel in a sixth column.



The trick here is, if they have not suggested it already, is that the Hello, Sun! drawing has fists drawn in to indicate height. Since a fist is about 10 degrees, we can see how the angles match. If someone can call out the fist measurement, the rest should be able to tell you the degrees. Write **fist degrees** into the seventh and final column. The two last columns will not be perfectly matched, but they will be close. Ask them which measurement do they think is the less accurate and why? The fists, obviously, because the variables are the measurer's accuracy and hand size. Those who recorded the Hello, Sun! drawing should not be made fun of at this

point, but should be reminded that if their eyesight was as perfect as the math, they would be in the Guinness Book of World Records! Human error is a fact of life. How could we have made mistakes in the math? The way we typed data into the calculator, the way we measured the shadow length, or the wiggling of the sun stick outside in the first place.

What are we looking to find out from this work, anyway? Probe the class for what ideas they might be having about why we are doing this today. Some may think about the height of the Sun changing, because they can see from the **Hello, Sun!** data that it is. Some may think we are trying to learn more about triangles and angles. Others may think this is a load of malarkey. OK, two out of three isn't bad. The gist is to see if we can use three different means of finding the same answer, to prove that if the logic is correct, the method is irrelevant in finding the answer. So many times we discourage children from using their own problem solving techniques because we ourselves have not internalized their method enough to comprehend if it is sound. Hopefully, after this investigation, students will see that a few minutes of thought can create three separate means of finding the same value for the Sun's angle.

Encourage your class to think about how each method was different in terms of accuracy, levels of math and observation, and simplicity.

The last thing to think about with this single data set is the time it took for the Sun to zip across the sky or the shadows to zip across the paper during the day. The pattern of shadows makes a big fan on the paper. How would you use the protractors to find out things about the pattern? Are there any places where you would want to measure angles? Let them measure for a while. Then ask what the is biggest angle they can find. It will be the angle between the first and last shadows. What is this angle? What does it represent about the Sun itself? How long did it take the Sun to travel that far? Subtracting the times listed on the shadows, it is (if you measured from, say, 9 a.m until 2 p.m.) five hours. So, the Sun moved so many degrees (ends up being 75) in five hours.

How many degrees is it around the Earth? It is 360 degrees, because the Earth is a ball. So how far around the Earth did the Sun appear to scoot in five hours? (Of course, it is the Earth spinning around like a top past a steady Sun.) Give them time to puzzle with this. Some will ignore the 360 degrees and use the 5 instead, knowing a day is twenty-four hours. They can divide 24 hours by 5 hours and discover that 5 hours goes into 24 hours almost 5 times. So, the Earth almost went one-fifth of the way around on its axis past the Sun. Others will divide the degrees traveled in five hours into the degrees around the Earth and also give you a fraction of almost one fifth. Are both answers right? Of course they are.

How could we find out how many miles of Earth spun past the Sun in five hours? We'd need to

know how many miles around the Earth is. Is there any way to find that out without looking it up? No, not yet. We need another measurement from Latitudes and Attitudes.

Measure again around the time of the winter solstice (about December 22), recreating the steps they did for the autumn equinox. After they have also observed and measured the spring equinox (about March 21) shadow lines, begin the discussions for the end of the coming Thread **Tilt-A-World**.

A note about the autumn equinox (about September 22): Since you are likely to have read this entire package ahead of time, here's a note for you. If your class has not reached this Investigation before the autumn equinox, please attempt to build and make your own record of the sun stick shadows on that day. If there are other teachers in your school who are participating in this curriculum, they could help you keep up the observations or at least watch your classroom while you run out to make these records on the equinox. You should try to measure the fist height of the Sun each time you go out, just as the kids will do. No need to measure your lines; they can do that themselves when they do the others. Curious students will want to know what you are doing, and you can tell them that soon they will be doing it as well. If it is really impossible for you to get autumn equinox data, then what is there to do? You will have two sets of data to use and not three for the next Thread.

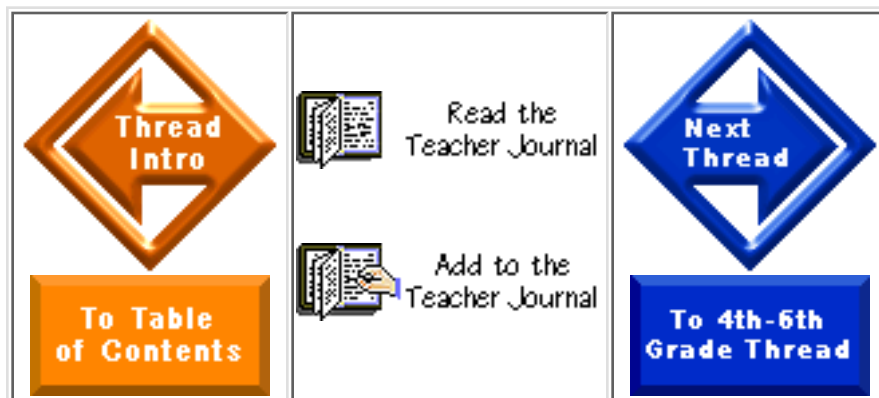

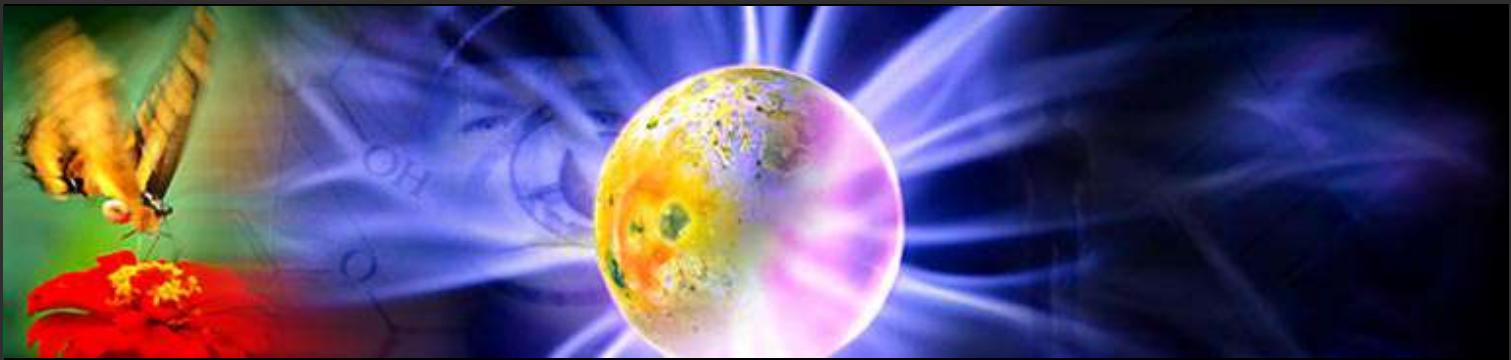

- [aboutNSTA](#) ▶
- [yourMembership](#) ▶
- [teacherResources](#) ▶
- [professionalInfo](#) ▶
- [NSTAConventions](#) ▶
- [NSTACommunity](#) ▶
- [otherVisitors](#) ▶

scienceStore



If ever a subject could benefit from a strong dose of perspective, it's evolution.

[\[more\]](#)

NSTA member price: \$12.76
Nonmember price: \$15.95

siteSearch

[advanced search](#)

Your Classroom

Info focused on you and your teaching environment



Elementary
School



Middle
School



High
School



College

NSTAPresents

News

[NASA: Liquid Water Once on Mars](#)

CNN.com

[Top NASA Advisor Joins National Science Teachers Association](#)

NSTA

[Asteroid Theory of Dinosaur Extinction Questioned](#)

Yahoo/Reuters

[More News](#)

Today in science history

On March 3 in 1845, German mathematician Georg Cantor is born to a prosperous merchant and an artistic mother in St. Petersburg, Russia. He is credited with founding set theory (the basis of today's "new mathematics") and with introducing transfinite numbers. Vehement opposition to his views strained him greatly; Cantor suffered recurrent breakdowns and depressions, and eventually died in an asylum. [from *The Illustrated Almanac of Science, Technology, and Invention*]

Calendar

03/04/2004 -

[Satellite Broadcasts Take Students Along as Scientists Track Habitat Change](#)

03/05/2004 - 06/11/2004

["TLC Elementary School" Cablecast To Feature Earth's Changing Surface](#)

03/06/2004 - 09/10/2005

[BRAIN—The World Inside Your Head, a Traveling Exhibit](#)

[More Events](#)

[contact us](#) • [site map](#) • [faq](#) • [legal notice](#) • [site credits](#)
copyright © 2004 NSTA

Expand Your Professional Horizons at NSTA's 52nd National Convention!



Atlanta, Georgia
April 1-4, 2004

Convention strands:
Maintaining the Professional Edge;
Science Beyond the Printed Word;
Hooking Kids on Science; Integrating Technology. [\[more\]](#)

... and **this**:

New! Convention

Personal Scheduler:

Plan your professional development itinerary, whether or not you're registered yet.

Virtual Exhibitor

Workshops

NSTANewsletters

If you are **not** a member of NSTA and would like to receive our free electronic newsletters - *Science Class* (monthly) and *NSTA Express* (weekly) - enter your e-mail address and location below and click submit.

E-mail:

State/province:

NSTA members: you will receive these newsletters (unless you have opted out). To check the e-mail

address we have on file for
you, click [here](#).

[Newsletter archives](#)

[NSTAHome](#)
[Astronomy Home](#)
[Tracking a Moving Shadow](#)
[The Rise and Fall of Daylight Hours](#)
[Making and Using Models](#)
[Register your class!](#)
[Participants](#)
[Kenichi Kishishita's Report from Japan](#)
[Read a student journal from Margaret Jackson's class.](#)
[Workshops](#)

ASTRONOMY Astronomy With A Stick

[Unit 1: Tracking a Moving Shadow](#)

[Unit 2: The Rise and Fall of Daylight Hours](#)

[Unit 3: Making and Using Models](#)

Daytime Astronomy for Elementary and Middle School Students

by SYLVIA K. SHUGRUE

Changes in the length of daylight hours profoundly affect the daily and annual rhythms of our lives. Yet studies have shown that even college graduates fail to understand the relationships between the Sun and the Earth that cause these changes (Sadler and Schneps 1988). Students who learn by rote in a classroom do not fully understand or retain these important concepts. Astronomy skills properly introduced in elementary school will produce adults who understand the Earth's place in the universe.

You can help your upper elementary students experience these relationships through indirect observations of the Sun on the school playground and with models built in the classroom. These activities provide a continuous exercise in critical thinking and combine well with practice in the use of mathematics and language skills.



Students from Garrison Elementary in Washington, D.C., prepare a circle on the ground in order to place a gnomon to indirectly observe the Sun's movement in the sky. [photo by W.T. Webb.]

The science information and skills gained in the activities form a foundation for future studies in astronomy and geography.

The over-arching question addressed by the following activities is "Why do daylight hours vary in length where we live?" The following activities have been arranged for convenience into three interchangeable units. It is best to begin the observations in September and continue at intervals throughout the school year. [Unit 1](#) requires sunny weather to make observations, although some of the calculations are done later in the classroom. The [unit 2](#) graphing activities, and [unit 3](#) modeling activities can be done throughout the year and on overcast or rainy days.

We are currently registering classes worldwide to participate in AWS. Registered classes will be able to share data, different ways they are using AWS in their classrooms, stories and myths about the sky overhead, and other information. Join today.

SYLVIA K. SHUGRUE, now retired, was a science teacher in the Washington, D.C., public schools for many years. She is a past president of the National Science Teachers Association. These activities were developed with the help of the students of the Gage-Eckington Elementary School in Washington, D.C. The Reverend Francis J. Heyden, former chief astronomer at the Manila Observatory and, before that, chief astronomer at the Georgetown University Observatory, offered suggestions, guidance, and support throughout the 4 years during which these units were developed and tested. Stephen Berr, Director of the Colonial School District Planetarium, Norristown, Pennsylvania, reviewed this article. Reprinted from Science Activities, Published by HELDREF PUBLICATIONS, 1319 Eighteenth Street, NW, Washington, D.C. 20026-1802.

[Join Now! Click Here!](#)

See also the companion site [Day Into Night](#) >>

National Science Teachers Association
1840 Wilson Blvd
Arlington, Virginia 22201-3000
(703) 243-7100
www.nsta.org

Questions? Contact astronomy@nsta.org

If you have the old version you should download the new and improved version now! Find it in both PostScript and PDF (and several other dials) at [my sundial page](#).

Assembly

Fold the paper lengthwise along the printed centerline. If you are careful you can get the crease right on the line. I hold it up to a light and make sure the dial faces on the two sides are lined up before I crease it. You may find it helpful to score the fold lines. An empty ball point pen and a straight edge work great. If you are using a dot matrix printer the compression from the pins helps the paper fold nicely.

Next fold the paper on the other line. If you are in the northern hemisphere you'll fold it so the latitude scale is on the outside.

Take an ordinary sharpened pencil and poke it through the paper in the center of the dial. This is the most difficult part of assembly. If you take your time and work at it you can get the pencil right through the center. You can cut away the excess paper to make the hole neater if you wish.

Poke a thumbtack through the latitude scale at [your latitude](#). Slide the paper along the pencil until they form a right angle and then stick the eraser onto the thumbtack. For greatest accuracy use a pencil with a new eraser and carefully put the tack into the eraser right at the edge. If you wish you can put tape or glue at the hole where the pencil passes through. This is especially helpful if the hole gets enlarged through wear.

Telling Time

You are now ready to tell time. Place the sundial somewhere in the sunshine so that it is facing north. That is, the pencil should be pointing north (really the pencil should point almost directly at Polaris, the "North Star.") Be sure the paper is perpendicular to the pencil. Read the time.

Find other sundial's at [my sundial page](#).

**Sandburg Center for Sky Awareness
A Fairfax County Public Schools Planetarium**

Equatorial Sundial Activity Questions

Teacher's Answer Key available upon [request](#).

Multiple Choice (circle correct answer within brackets):

1. The *gnomon* (or *style*) of an equatorial sundial represents the Earth's [**axis, Equator**] of rotation.
2. The *dial plate* of an equatorial sundial represents the plane of the Earth's [**axis, Equator**].
3. The *upper dial face* of an equatorial sundial represents the [**Northern Hemisphere, Southern Hemisphere**].
4. The *lower dial face* of an equatorial sundial represents the [**Northern Hemisphere, Southern Hemisphere**].
5. The *12 o'clock hour line* (also known as the meridian line) that divides the dial face in half represents your [**line of latitude, line of longitude**].
6. Relative to a horizontal surface, the *gnomon* of an equatorial sundial should be inclined at an angle equal to your [**latitude, longitude**].
7. Relative to a horizontal surface, the *dial plate* of an equatorial sundial should be inclined at an angle equal to the [**complement, supplement**] of your latitude.
8. [**Complementary, Supplementary**] angles are two angles for which the sum of their degree measurements equals 90 degrees.
9. As viewed from above the North Pole, the Earth appears to [rotate](#) [**clockwise, counterclockwise**].
10. As viewed from above the South Pole, the Earth appears to [rotate](#) [**clockwise, counterclockwise**]. (If necessary, experiment with a globe *before* answering this question.)
11. Sun shadows fall in the [**same, opposite**] direction as the Sun.
12. During the day, the gnomon shadow appears to move [**clockwise, counterclockwise**] around the [**upper, lower**] dial face.
13. The Earth's [[rotation, revolution](#)] causes the gnomon shadow to appear to move around the dial face.
14. The Earth's [[rotation, revolution](#)] causes the gnomon shadow to move from the upper dial face to the lower dial face, and vice versa.
15. When [Daylight Saving Time](#) is in effect, Solar Time (sundial time) is [**earlier, later**] than Standard Time (wristwatch time). **Hint:** Remember the mnemonic, "Spring forward; fall back."

Short Answer (be clear and concise):

1. When doesn't an equatorial sundial work?
2. On the day of the equinoxes (MAR 20, SEP 22), the gnomon (or style) of a [properly oriented equatorial sundial](#) will not cast a shadow on the dial plate. Explain.
3. The Earth rotates once every 24 hours (approximately). How many degrees does the Sun appear

to move across the sky in one hour? **Hint:** One complete [rotation](#) of the Earth is 360 degrees. Verify your answer by using a protractor to measure the angle formed by the sundial center and two adjacent hour lines on the dial face.

4. Why do time zones generally run north-south instead of east-west? Why are time zones 15 degrees of longitude in width?
5. The Sun and Earth are parts of an interconnected system. Use the words "[rotation](#)" and "[revolution](#)" to summarize your short-term (day-long) and long-term (year-long) observations of the equatorial sundial.

For Further Thought:

1. Are you [clock-wise](#)? Why is "clockwise" clockwise?
2. Why is it incorrect to say that 12 noon is 12 p.m.?
3. [Longitude](#) is equivalent to time (and vice versa). Explain. What would be the difference in longitude between two sundials separated by a 12-minute time difference? **Hint:** Reduce the rate of the Earth's rotation from degrees/hour to degrees/minute.
4. Would your sundial read the same time as another sundial 100 miles directly north of you? Would the shadows be the same length?
5. Does an equatorial sundial work the same north and south of the Equator? Would an equatorial sundial work at the North and South Poles?

Bonus Question:

Explain three reasons that Solar Time (sundial time) may be different from Standard Time (wristwatch time).

© Copyright 2002-2004 Walter Sanford. All rights reserved.



Sundials

The earliest and simplest form of sundial is the shadow stick. The time of day is judged by the length and position of the stick's shadow. Some nomadic peoples still use this method for timekeeping. The technical name for a shadow stick is a *gnomon*. As the sun moves through the sky from sunrise to sunset, the shadow of the gnomon rotates "clockwise." The shadow is shortest when the sun is directly in the south, defining local noon.

As early as 3500 B.C. the Egyptians began building slender, tapering, four-sided obelisks which served as timepieces. The moving shadow of the obelisk formed a type of sundial, and markers arranged about the base separated the day into divisions as well as indicating the longest and shortest days of the year.

However, because of the earth's tilt, the sun's path through the sky changes slightly from day to day, so the shadow cast by the gnomon is not the same every day. Many sundials overcome this problem by angling the gnomon and aiming it north. This type of gnomon is called a *style*. Because its alignment compensates for the Earth's tilt, the hour marks remain the same all year round.



In the quest for accuracy, many types of sundials evolved, including some very complex portable sundials. In about 30 B.C.

Marcus Vitruvius, a Roman architect, described 13 different sundial designs used in Greece, Asia Minor, and Italy. The invention of more accurate mechanical clocks and



Egyptian
Obelisk

Marcus Vitruvius

A 1st century B.C. Roman architect who authored a famous 10-volume treatise named "De Architectura". The books dealt with city planning and architecture; temple construction; public and private buildings; clocks; hydraulics and civil and military devices.

De Architectura was a classic text book from Roman times to the Renaissance.

Read More

At:

[The North American Sundial Society](#)

[Sundials on the Internet](#)

by The British Sundial Society

[Sundial Mottos](#)

by The British Sundial Society

Glossary:

[gnomon](#)

[style](#)

[obelisk](#)

the standardization of time using time zones made sundials obsolete. Now sundials are used mostly for ornamental purposes.

[Next: How a Sundial Works](#)

Updated August 24, 1998. [Contacts](#)



Building a Simple Sundial

1 one

Determine your latitude. Using a map for your area, estimate your latitude (most road maps indicate latitude and longitude). Your latitude will be the number of degrees north if you live in the northern hemisphere, or south if you live in the southern hemisphere.

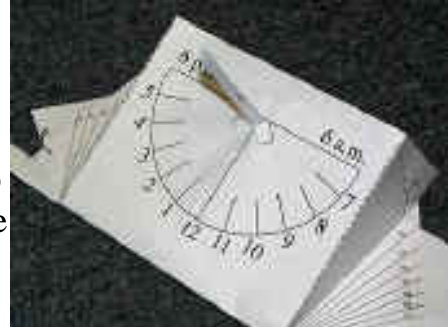

Or, you can locate your latitude using the internet at one of these sites:

- [U.S. Census Bureau](#) (U.S. Only).
- [International](#) (Confusing Interface).

2 two

Print the sundial construction template. Choose a template based on your hemisphere (e.g. if you live above the equator, choose Northern Hemisphere). You will need [Acrobat](#) to print these files.

- [Northern Hemisphere](#) (PDF)
- [Southern Hemisphere](#) (PDF)

3 three

Construct the sundial. You will need scissors and some tape. The more carefully you make the folds, the more accurate your sundial will be. This [set of pictures](#) illustrates the construction at various stages.

Finding North

A compass points to magnetic north, which is not the same as true north. For the best accuracy, a sundial's style should point to true north.

To find true north, find a level spot of ground and place a straight stick upright in the ground. Mark the end of the shadow every 15 minutes through the middle part of the day. Notice where the shadow is the shortest. That is true north.

Read More At:

[Make a Sunclock](#)

by the Exploratorium

[Sundial Builder](#)

by Washington University

[Make a Complex Sundial](#)

by Indiana University

Glossary:

[latitude](#)
[hemisphere](#)

4 four

Align the sundial. Take your sundial outside, place it on a level surface, and aim the style due North. You now have a working sundial! When you read the time, remember to take Daylight Savings Time into account (during Daylight Savings Time, the sundial will be an hour behind your clock).

Now that you have a sundial, here are [some questions](#) to ponder.

[Next: Some Questions to Ponder](#)

[Previous: How Sundials Work](#)

Updated February 10, 1999 . [Contacts](#)



Pondering Sundials

Now that your sundial is working, here are some things to think about.

1. When doesn't a sundial work?
2. Does your sundial match your watch time? Why?
3. If the earth rotates every 24 hours (approximately), how many degrees does the sun appear to move in one hour? In four minutes? (Hint: one full rotation of the earth is 360 degrees).
4. The sun's diameter in the sky is about 0.5 degree. About how long does it take for the sun to appear to move its own diameter across the sky?
5. Why don't we use local solar time instead of time zones in our everyday lives? Would it be easy to know what time your favorite TV program starts?
6. Why do time zones generally run north-south instead of east-west?
7. Does a sundial work the same north and south of the equator?
8. What would be different about a sundial at the North Pole? The South Pole?
9. Why didn't the ancient Egyptians use watches instead of sundials and obelisks?
10. Would your sundial read the same time as another sundial 100 miles directly north of you? Would the shadows be the same length?

[Back to: Building a Sundial](#)

Updated September 3, 1998. [Contacts](#)



SCOPE

Southwestern Consortium of Observatories for Public Education



[Apache Point Observatory](#)



[Kitt Peak National Observatory](#)



[McDonald Observatory](#)



[National Radio Astronomy Observatory](#)



The activities and resources on the back of this poster are downloadable in Acrobat Reader format (PDF):



(click here to download the free [Adobe Acrobat Reader](#))

SCOPE solar programs: (English) (Spanish)	Shadow Play Activity (English) (Spanish)	Reflective Solar Cooker Activity (English) (Spanish)	Sunspots Activity (English) (Spanish)
Print References	Equatorial Sundial Activity (English) (Spanish)	Sundial Template (English) (Spanish)	Frequently asked sun questions (English) (Spanish)



[National Solar Observatory](#)



[Whipple Observatory](#)



Please take a moment to fill out our [Poster Activity Evaluation Form](#) after you have tried any of the above activities. We will use your input to improve the next set of activities.



Links:

- ["Our Star, the Sun,"](#) by Mary Kay Hemenway, Science and Children (National Science Teachers Association) , September 2000 pgs. 48-51.
- [Project SunSHINE](#), 250 general sun-related web sites
- [Ask Mr. Sunspot](#)
- [McDonald Observatory - StarDate's Guide to the Solar System: The Sun](#)
- [NOAO Resource List about the Sun](#)
- [Exploratorium: Making a Sun Clock](#)
- [NASA Kids: Sundials](#)
- [You Can Make a Sundial](#)
- [Sundials on the Internet](#)
- [Knowledge Hound: Solar Cooking and Food Preparation](#)
- [Solar Cooking Archive](#)

Equatorial Sundial

Construction: 15 minutes. Activity: Spread over the course of several hours.

Sundials were one of astronomers' first tools to measure the flow of time. This instrument is simply a stick that casts a shadow on a face marked with units of time. As Earth spins, the stick's shadow sweeps along the face. Civilizations around the world, from Anazazi, Babylonian, to Chinese, constructed a variety of similar mechanisms.

ACTIVITY

This sundial allows you to read the solar time of day. The face of the sundial is the plane of Earth's equator, whereas the stick represents Earth's axis pointing to the North Celestial Pole.

Preparation

First, find your latitude and longitude and an outdoor observing site in a clear (no shadows) area. Determine the direction north (from a map, or by finding the north star at night and marking its location). Assemble the equipment as described below. Use lamps to demonstrate how to position and read the sundial indoors before going out.

Experiment

On a sunny day, take the sundial outside and direct the pointed end toward north. Record the time on the sundial at least four times in one day. Each time, also record the "clock" time for your date and location. Try this experiment during different months of the year.

Materials and Construction

1. Photocopy the template and one latitude strip.
2. Attach the latitude strip to a stick, such as a 7-inch (18-cm) pencil or straw. Thinner sticks cast thinner shadows.
3. Fold and glue the template. Make sure the dial faces are lined up.
4. Cut out the center hole.
5. Place the stick in the hole with the top face lined up with your latitude. The stick should fit snugly. Make sure the stick and face are perpendicular. Tape it in place if necessary. The bottom end goes on the ground.

Analysis

1. For your data, when is the stick's shadow shortest? Can you predict what time of day it would be the shortest? Can you predict the times of sunrise/sunset from your data? (Confirm with your local newspaper.)
2. If the sundial time did not match clock time, explain why.
3. Why does this sundial have front and back dial faces?

Answers

1. The shadow is shortest at local noon.
2. For each 1 degree east or west of the center of your time zone (your longitude difference from the center), there is a correction of 4 minutes of time. Also, the Sun's orbit in the sky changes with the seasons, and a correction of up to about 15 minutes for the "Equation of Time" must be made. Read the correction from the graph below. Daylight Savings Time changes results by one hour.
3. The north face is for use from March 21 to September 21, and the south face is for use from September 21 to March 21. The Sun is north of the celestial equator during the first period (spring and summer) and south of the celestial equator during the second (fall and winter).

National Science Education Standards:

Earth and Space Science (5-8): The sundial helps tie together concepts of the Earth and Sun system; Earth's rotation and orbit.

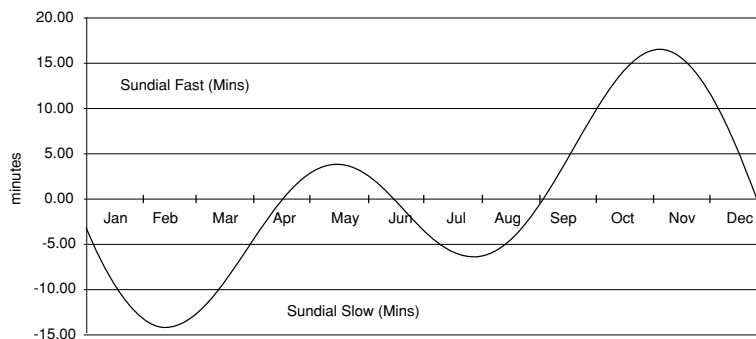

Correction for the "Equation of Time"

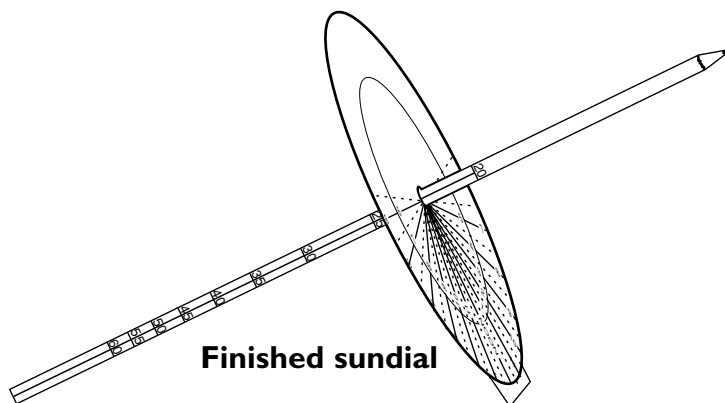

Finished sundial



Teacher's Store >

[In The Spotlight](#)

[Online Specials](#)

[Order Policies](#)

[Contact Sales Rep](#)



[More options >](#)



Recommended

1. [Bill Nye the Science Guy Complete Series](#)
2. [Going Wild! With Jeff Corwin Complete Series](#)
3. [Bill Nye Make Your Own Curriculum Set](#)
4. [Animated Science Collection](#)
5. [Biome Curriculum Set: Rain Forest](#)

Top Picks

1. [Ring of Endless Light](#)
2. [Bill Nye the Science Guy Complete Series](#)
3. [Going Wild! With Jeff Corwin Complete Series](#)
4. [Simply Seasons with Winnie the Pooh](#)
5. [Beyond the Page Complete Series](#)

[MORE >](#)

Order Now

Earth's Seasons

Part of [Bill Nye the Science Guy Complete Series](#)

Price: \$39.95

Subject Area: Science & Nature

Grade Level: Primary, Intermediate, Junior High, High School

Product ID: 68A93VL00

Bill Nye the Science Guy goes full tilt to give the reasons for the seasons. His worldly perspective shows why when it's winter in America, it's summer in Australia.

Edition Details

Release Date: 1995
 Running Time: 26 minutes
 Format: Video (Closed captioned)
 Additional Features: Marc Record Available





Welcome to our collection of children's online astronomy activities. In the following six chapters are hundreds of fun explorations into astronomy as a classroom tool for learning how to theorize, experiment, and analyze data. The activities are fully illustrated and contain detailed, step-by-step instructions as well as suggested discussion topics. This book is lots of fun for teachers and students alike.

This site contains the complete text and graphics of the collection along with related links, a table of contents, an explanation of how to use this book, and email links to the authors. We do hope you enjoy these adventures in astronomy as much as we enjoyed designing them.

[Table of Contents](#) | [Everyday Classroom Tools](#)



Selected as a Valued Internet Site
for the Discovery Channel Online



This site is best viewed with Netscape Communicator. Download
Netscape Now!

CHOOSE

Copyright © 1996 Smithsonian Institution
These pages designed by Tania Ruiz. Last updated September 9, 1998.

CHAPTER TWO

THE EARTH'S ORBIT

While the Earth rotates once a day about its axis between the north and south poles, it revolves about the Sun in its orbit but once a year. The seasons are caused by the simple fact that the Earth's axis of rotation is not perpendicular to the plane of its orbit. Rather, the Earth's axis is tilted some $23^{\circ}.5$ away from the perpendicular, as shown in the figure (which is NOT to scale).

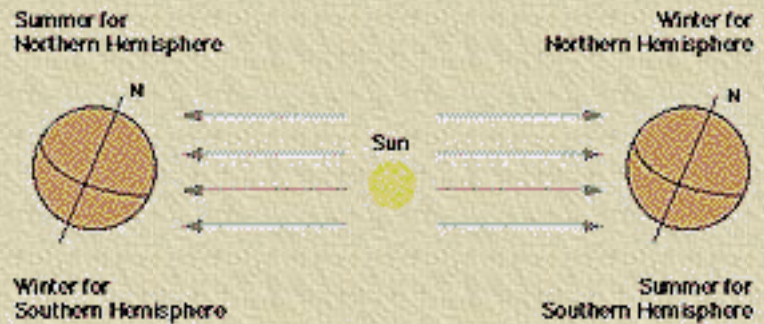

As the Earth orbits the Sun, the orientation of its rotational axis is held fixed, so that if we imagine it extended into space, it is always pointing towards Polaris, the pole star. As the Earth orbits around the Sun, for a portion of the year the Sun is in the same direction as the tilt happens to be. In other words, the Earth is in a part of its orbit where its tilt direction is towards the direction of the Sun. This means that the Northern Hemisphere will have warmer temperatures and hence summer. For the other portion of the year, the Earth has moved around the Sun, putting the Sun not in the direction in which the tilt happens to be. In other words, the tilt direction is off into space behind the Earth (towards the outer planets). With the top of the Earth now tilted away from the Sun, the Southern Hemisphere can enjoy summer. There are, of course, times in between as the Earth is orbiting when it has the Sun neither towards or away from the direction of the tilt. These times are when no hemisphere is experiencing any greater amount of sunlight than another, and so this is Spring or Fall for the hemispheres.

This chapter investigates both the causes and the effects of the changing of the seasons. We start simply by trying to quantify the observation "it's colder

in the winter" and end by measuring the tilt of the Earth itself!

Topic 1: Observations of The Seasons

If you ask students what a particular season means to them, they'll probably mention the weather usually associated with it. Summer is hot. Winter is cold. Spring and Fall are in between. (For those of us living close enough to the poles, winter means snow, too!) A common misconception (even among a disturbingly large number of college graduates) is that the Earth is closer to the Sun during the summer, causing summer's warmer temperatures. This model, of course, is inconsistent with the fact that while the Northern Hemisphere has summer, the Southern Hemisphere has winter. Furthermore, while it's summer for the Northern Hemisphere, the Earth is actually slightly farther away from the Sun than during the winter.

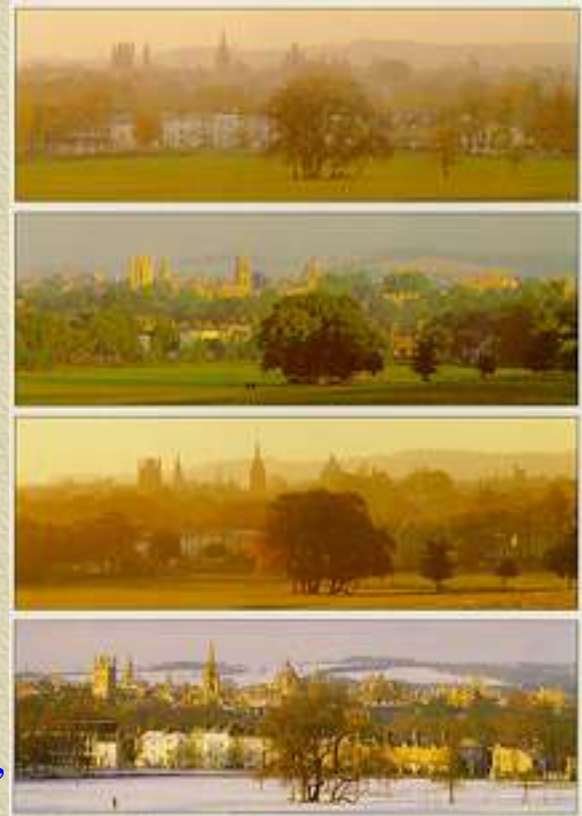

As we know, during the Northern summer, the North Pole is tilted towards the Sun. During the winter, it is tilted away. This tilt causes the Sun to appear higher in the sky during the summer than during the winter. The higher Sun causes more hours of daylight and more intense, direct sunlight, or hotter conditions on the surface of the Earth. Questions to ask the class include: How is summer different from winter? What changes as winter gives way to spring? What changes are there as summer becomes fall? What about when winter approaches?

Activity 2-1: The Sun's Changing Path

The shadow stick measurements (Topic 2, "Sun Shadows") and measurements of the Sun's path on a dome (Topic 3, "Tracking the Sun Path in the Sky") from the previous chapter can be continued from week to week and month to month to show seasonal changes. Both will illustrate that the Sun follows a higher arc through the sky in the summer than in the winter. A comparison of shadow lengths all measured at midday will show that the shadow lengths increase as winter approaches becoming longest about December 21 (the shortest day) and then decrease again until June 21 (the longest day).

One way to keep track of the shadow lengths is to draw a graph by hand or on the computer. The plot should have midday shadow length (on the vertical axis) versus the date of the observation (on the horizontal axis). Each week, make a new measurement and update the graph. The measurements on the dome require more time, but provide a much better record of the Sun's path through the sky during more of the day rather than just at midday. Repeating the dome measurements each month (perhaps using the same plastic dome with different colored markers) will very clearly record the changes in the Sun's path through the sky during the year.

Activity 2-2: Recording Daily Temperatures

Weather is the result of an almost incalculable number of events. As such, it would be folly to attempt to predict a given city's temperature for a given date, far into the future. It would be equally foolish to point to an exceptionally cold day in June and declare "Winter's coming!" There are just too many variables for such a simplistic view. However, hidden among the randomness are trends which can be measured, and from which conclusions like "winter's coming" can be made.

The class can measure the outside temperature at a particular time each day,

perhaps noon or lunch time. From newspapers or broadcast newscasts, the class can collect local high and low temperature readings for each day. These can be plotted on a graph or entered into a data base. For younger students, a classroom chart with cartoon thermometers with daily temperature marks can be made. The exact form of this activity is not important. One should emphasize the importance of recording data in an appropriate way. Sometimes making a simple graph can explain pages and pages of numbers. Simplicity is the key. With clear presentation of data, it is much easier to move forward and, for example, correlate the temperature measurements with the shadow stick and dome measurements.

Activity 2-3: Tracking Sunrise and Sunset Times

The tilt of the Earth in its orbit about the Sun affects not only the intensity of the solar radiation at a given location, but also the number of daylight hours. These two effects combine to create the weather we usually associate with each season.

In the Northern Hemisphere, the Summer Solstice (longest day, shortest night) occurs around June 21. From June 21 to December 21, the days grow shorter and the nights longer. There are two equinoxes, during which the hours of daylight and night are equal: the Vernal Equinox (around March 21) and the Autumnal Equinox (around September 22). One can observe these changes by recording the times of sunrise and sunset and measuring the length of the day. Changes in these times are large enough (about a minute a day) to be seen on a graph. The figure below shows such a graph made from sunrise and sunset times at the National Optical Astronomical Observatory located on Kitt Peak near Tucson, Arizona for September to December. If begun in September and continued through the Winter Solstice (about December 22), the graph should show the gradual decrease in the number of daylight hours (in the Northern hemisphere) with the minimum at the Winter Solstice. It would be interesting to include either of the equinoxes on the graph as well.

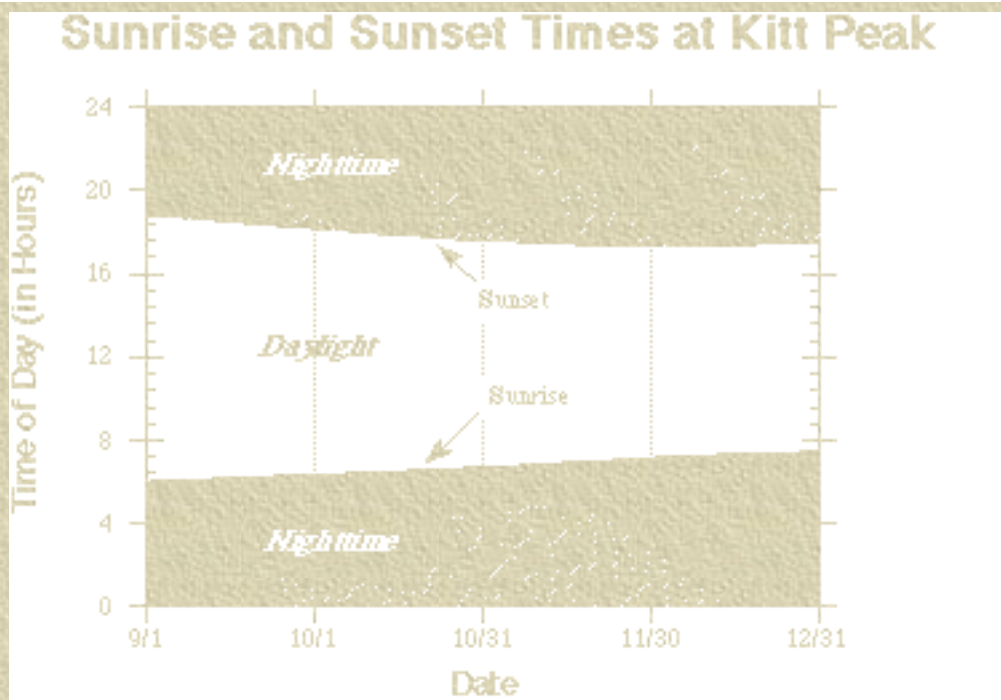

Materials: Large paper from roll (3'X6'); markers; yardstick; pencil; circle labels; paints; adhesive dots; daily local newspaper.

- 1. On a large sheet of paper, make a grid on which to plot the sunrise and sunset times. The time of day should run along the vertical axis, leaving about one inch for every hour. The date of the observation will be recorded along the horizontal axis.
- 2. Look up the times of sunrise and sunset in a daily newspaper. Plot these times on the graph, marking the points with adhesive dots. After plotting for several weeks, connect the dots with a line.
- 3. Optional: These coordinates can be stored and plotted with a computer spreadsheet like AppleWorks.

Discussion

The figure below shows a plot of sunrise and sunset times taken once a week from September through December. Notice that the shortest day occurs around December 21, as expected. In order to reinforce the connection between the number of daylight hours and average daily temperature, try making a wall-sized chart combining sunrise-sunset data with the daily temperature, as collected in the previous activity. While daily fluctuations in the temperature will be apparent, it is the general trends which we seek. How

does the length of the day change with season? Does the daily temperature match this trend also?

Activity 2-4: The Analemma

This simple, long-term activity provides an easy way to record the changes of the Sun's apparent motion. We already know that the Earth's tilt causes the Sun's path to be higher in the sky during the summer than in the winter. Because the Earth's orbit around the Sun is not perfectly circular, the Sun's position at a specific time (as given by the clock) changes Eastwardly and Westerwardly as well. By reflecting sunlight onto the classroom ceiling and marking the Sun's position at the same time every week, we can record the change of the Sun's apparent motion, and after a year should notice a figure-eight-like figure known as an analemma.



Be sure to remind students that looking at the Sun can cause permanent eye damage—Never look directly at the Sun!

Materials: Southern window with direct sunlight; small mirror; masking tape; adhesive dots (optional)

- 1. Choose a Southern window with direct sunlight which will remain unblocked throughout the year.
- 2. Place a very small mirror on the window sill and adjust so the sunlight shines on a clear area of the ceiling (without lights, mobiles, etc.). A mirror only an inch across is adequate. It is best to be able to tape the mirror there permanently, but at the very least, mark the mirror's position with masking tape. (If

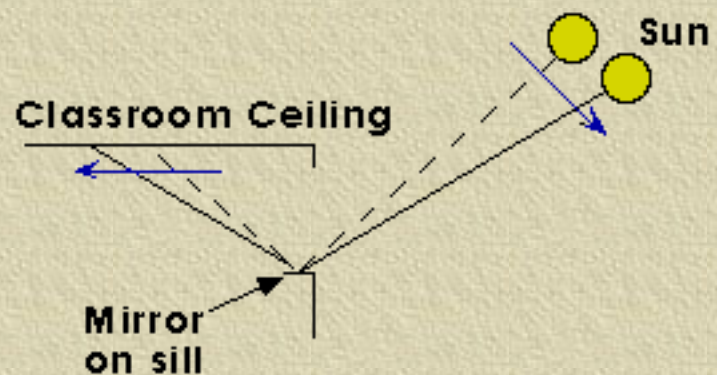

the reflection from a permanently-mounted mirror becomes distracting during the rest of the day, simply cover it with a sheet of paper).

- 3. Once or twice a week, at exactly the same time by the clock, mark the location of the Sun's reflection on the ceiling with an adhesive dot or a piece of masking tape (watch out for Daylight Savings Time changes- adjust the time so that you always make measurements in the same time reference, Standard Time).
- 4. Record the date and time of the observation on the marker.

Discussion

Where would the spot of sunshine be if the Sun were lower in the sky? Higher? more Easterly? more Westerly? How much does the Sun appear to move each week? Is this change constant throughout the year? After we have measured for a year, could we use the previous year's analemma as a rough calendar? Would it work for every day or are there some periods of ambiguity? When are they?

The analemma is longer in one direction than in the other. This longer variation is caused by the seasonal motion of the Sun's path. The other variation (east-west) is the drift of solar time to the average solar time due to the eccentricity of the Earth's orbit around the Sun. (Eccentricity, while precisely defined, can be thought of as an ellipse's lack of circularity- for more information on planetary orbits, see Chapter 4 on The Solar System) If the Earth's orbit were perfectly circular, there would be no east-west drift, and the analemma would be reduced to a line, corresponding to the longer axis of the observed analemma!

Topic 2: Summer and Winter Sunlight

It is important to note

To this person, the sun looks lower

that even without the tilt of the Earth, there would still be variations in temperature from one location to another, caused mainly by the curvature of the earth. Locations closer to the equator would still, on the average, be warmer than locations closer to the poles. Light and heat (radiation) from the Sun would still strike polar regions at more of an angle than nearer the Equator. This angle tends to "spread out" the same amount of energy over a larger area, thereby decreasing its intensity and the amount of heat it brings to the Earth. The activities in this topic demonstrate and test this assertion.

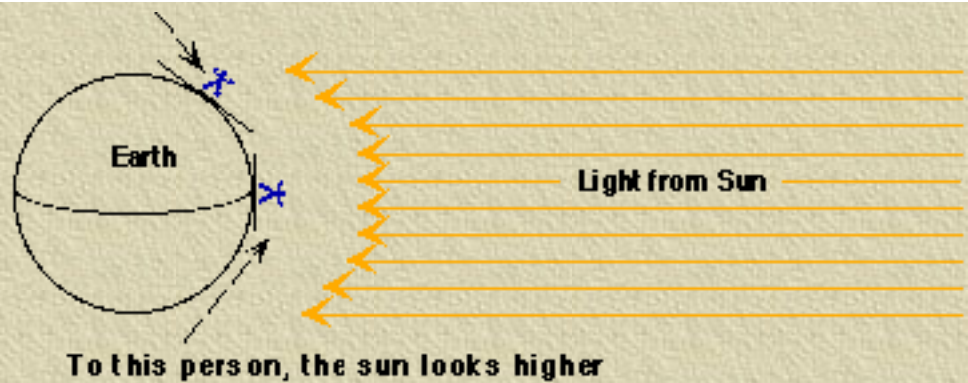

Activity 2-5: Energy from the Sun

Solar radiation is emitted in various forms which travel at the speed of light. Light travels through space as waves of different lengths. Our eyes can only see radiation as visible light, but radiation also occurs as radio waves, infrared rays, ultraviolet rays, X-rays and gamma rays. Together these waves make up the electromagnetic spectrum. Most of the radiation is "visible" - no coincidence!

Questions to ask: How can we measure the warmth from the Sun? Is it possible to find a way to measure it outside? What could we use and how could we show differences in temperature? How long would we have to wait until we take a comparative reading? Can we predict the variations? What might influence fluctuations in warmth? What experiences have students had which help in these predications? Will soil be warmer or colder than air temperature? Does this change during the day?

Materials: Thermometers; soil; sunlight; cardboard; stick; glue; pencils; flashlight; paper

- 1. Students (in small groups) predict the time of day and comparison

reading times with most pronounced variables in temperature. They choose an appropriate spot to insert a thermometer(s) in the earth. They make and place a sign signifying experiment areas.

- 2. They return at various intervals to read and record the time and temperature.
- 3. Students compare their predictions and the actual readings.
- 4. They read and record the temperature of the air at the same time as the recordings of the earth temperature and compare these.
- 5. These experiments may be repeated in a few months. This data may then be recorded and compared to earlier readings.

Discussion

Students discuss results of these experiments. What caused the highest or hottest temperature? Was this related to the time of day? What were students able to discover from their measurements? How accurate were their predictions? What factors helped them to predict well? What conclusions can they make about the effect of the Sun's rays on the Earth? If done at intervals over a period of time, did earlier experiments help their predictions?

Students may make a graph using this information either on graph paper or on the Bank Street Filer or on the database of AppleWorks. What other elements could students use to measure temperature? How could we devise an experiment to predict and record the temperature of water or sand in the sunlight? Student may predict and then test the model, record date and compare the results.

Activity 2-6: How Angle Spreads a Flashlight Beam

This activity requires a darkened room. You may want to do this as a large

group activity for younger students. Older students should try it in small groups and compare their results.

Does the illuminated spot on the graph paper always remain the same size? When is it larger? smaller? Is the spot always the same brightness? When is it brighter? fainter?

Materials: Graph paper; cardboard or plywood; masking tape; flashlight; markers.

- 1. Attach a sheet of graph paper to the cardboard or plywood with the masking tape. Hold the board perpendicular to the floor and shine the flashlight directly onto the graph paper from the side, about two feet away. Be sure the flashlight is parallel to the floor, and, therefore, perpendicular to the paper. You might try placing the flashlight on a pile of books.

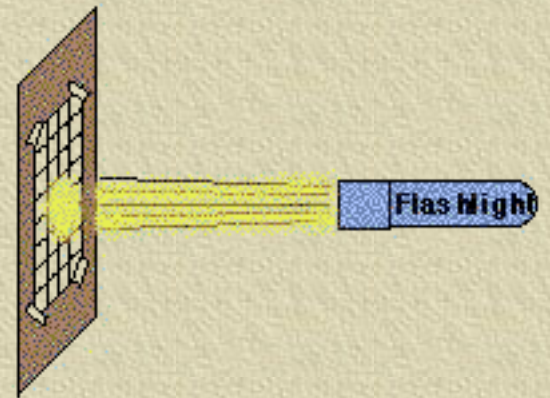

- 2. Trace the outline of the flashlight's beam on the graph paper.
- 3. Keeping the same distance from the paper to the flashlight, try rocking the board towards and then away from the flashlight. Does the area of the beam on the paper increase or decrease? Tilt the board at a large angle like 45° or 60° and trace the new outline of the beam with a different color. Try a couple of other angles, marking the outlines with different colors.
- 4. By counting the squares on the graph paper enclosed or partially enclosed by the circle of light, you can quantify the observation that more area is covered by the beam when the board is tilted at larger angles.

Discussion

No matter how the board is tilted, nothing changes the amount of light which the flashlight produces. When the board is tilted, and the flashlight illuminates a larger area of the graph paper, the same amount of light energy

must be spread over a larger area. The lighting is then less intense. Is there any difference between tilting the board and tilting the flashlight? What if we were using a larger, hotter light source, like a halogen lamp, or a star? Wouldn't the heat carried also be less intense when the board is tilted at larger angles? The next activity explores just this question using the closest star, the Sun.

Activity 2-7: How Angle Spreads Sunlight

This activity requires a sunny day and direct sunlight.



Be sure to remind students that looking at the Sun can cause permanent eye damage- Never look directly at the Sun!

This activity is similar to the previous activity in that it shows how light falling upon a tilted surface is less intense than if it were falling directly. With light comes the energy to heat. This activity examines this "spreading out" of light by measuring how quickly and how much sunlight can warm two sheets of paper, one tilted, one not.

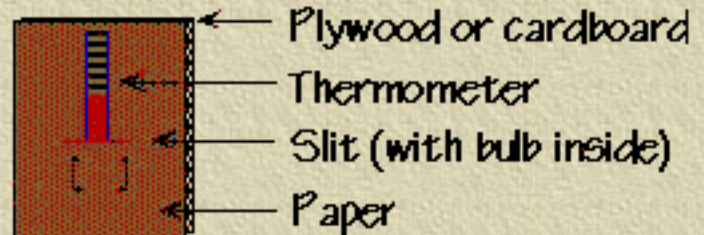

Materials: Two sheets of black construction paper; two pieces of cardboard or plywood; bricks or blocks to prop up board; masking tape; two thermometers.

- 1. Cut an inch-wide slit in the middle of each piece of construction paper. Tape one sheet of black construction paper to each of the cardboard or plywood boards. Place a thermometer into each slit such that the bulb is between the board and the paper, and the scale can be

read without removing the thermometer. Tape the thermometers in place. Leave the assembled thermometers in the shade long enough so that they read the same outside temperature.

- 2. Tilt one board so that it faces the Sun and the Sun's rays fall nearly perpendicular to the board. The other should be flat on the ground, or even tilted slightly backwards from the Sun if the Sun is especially high in the sky.
- 3. Periodically (every minute or so) record the temperature on each thermometer until the temperatures level off and stop climbing. Let the thermometers sit for a few minutes. Record their final temperatures.

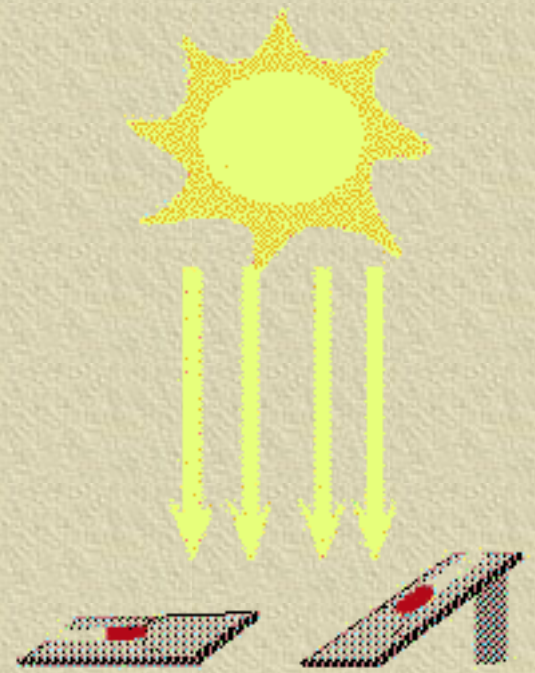

Paper is
perpendicular to
light rays

Paper is NOT
perpendicular to
light rays

Discussion

Which paper was heated more quickly? Which got warmer? You might want to try different angles. Beware the effects of clouds and wind, as well as the shadows of over-anxious students! What do the results of this experiment tell you about the changes in temperature from Activity 2-5? What was the angle of the Sun when the temperature dropped? When the temperature was the highest?

Activity 2-8: Sunlight on a Curved Surface

This activity requires a darkened room.

We have already seen how the angle at which light strikes a surface affects its intensity. This activity will demonstrate that light shining on a curved surface may be more intense in one place than in others. If we shine a light

on a uniformly colored ball, like a dodge ball or kick ball, the area experiencing more intense illumination will appear brighter than those receiving less intense light.

Materials: Slide or overhead projector or other source of directed light such as a bright flashlight; large, uniformly colored dodge or kick ball; books to lift light source to desired height

- 1. Place the ball on a table. Aim the light source such that it shines directly on the center of the ball, but be sure the beam is wide enough to illuminate the entire ball at once.
- 2. Examine the brightness of the light across the surface of the ball. Rotate the ball. What happens to the bright spot? Does it follow the ball's rotation, or does it always face the light source?
- 3. Experiment with changing the orientation of the ball, the light, or both. Can you provide even illumination of the ball? Why not?

Discussion

Where on the ball was the light the brightest? Where was it the faintest? If you changed the orientation of the ball, what parts would be brightest? Which would be faintest? What if you moved the light source?

Activity 2-9: Sunlight on the Curved Earth

This activity duplicates the previous activity using a globe of the Earth instead of a plain ball. It, too, requires a darkened room.

The previous activity demonstrated that the curvature of an object can cause different areas of the surface to receive light of differing intensities. This activity shows that the Earth is subject to this effect as well. We have seen in our earlier thermometer experiment that less intense light cannot heat a surface as quickly or as completely as intense, direct light. Therefore, we can predict that there should be areas of the Earth where the sunlight is more intense than at others. These areas should be warmer than other areas. This is

why locations near the Equator are generally warmer than those closer to the Poles.

Our observations show that the Sun is higher in the sky during the summer than during the winter. Summer approaches for a given hemisphere (North or South) when the Earth moves to a place in its orbit in which that hemisphere's Pole (North or South) is tilted towards the Sun. This causes the Sun to be higher in the sky and its light to be more intense (less spread out). This more intense summer sunlight is better able to heat the land, air, and water. This warming is certainly consistent with our observations of the seasons.

Materials: Slide or overhead projector or other source of directed light such as a bright flashlight; large globe of the Earth; books to lift light source to desired height

- 1. Place the globe on a table with the North Pole upward. Aim the light source such that it shines directly on the center of the globe, but be sure the beam is wide enough to illuminate the entire globe at once.
- 2. Notice that the light appears brighter towards the equator of the Earth. This configuration, with neither Pole tipped towards the Sun corresponds to the equinoxes (strictly speaking, the Earth's axis is still tilted by $23^{\circ}.5$ with respect to its orbit but on an equinox, that tilt is sideways with respect to the Sun, and not towards or away from it).
- 3. Try tilting the North Pole by about $23^{\circ}.5$ towards and away from the light source (the angular distance between noon and one o'clock on a clock's face is 30° , so don't exceed this angle).
- 4. The previous chapter's activity "Day and Night on the Spinning Globe" could be repeated with a tilted Earth, to measure the variation of sunrise and sunset times with season angle.

Discussion

Does the bright area move across the face of the Earth? How should the globe be positioned to show winter? summer? spring? fall?

Topic 3: The Tilt of the Earth

We have built a model of the seasons which agrees with our observations, but there is one important loose end; we accepted the tilt of the Earth as 23.5° . The next activity will allow us to measure this value! The final activity summarizes and demonstrates our model for the class.

Activity 2-10: Measuring the Earth's Tilt

This activity is suitable for grades 3 through 6.

While the effects of the tilted Earth model are consistent with observation, might it not be possible to measure the Earth's tilt directly? Using observations with a simple shadow stick, we can measure the Sun's angular height in the sky over the course of weeks and months. As we've seen, it is the tilt of the Earth's axis which causes the height of the Sun's path to change. In this activity, we will measure this change to infer the amount of the Earth's tilt. shows that as the height of the Sun changes, it casts different length shadows at midday. By recording these midday shadow lengths and the height of the shadow stick, we can "reconstruct" the situations from these days and measure the angular height directly. The difference of the angular heights of the Sun between an equinox (September 21 or March 21) and a solstice (December 21 or June 21) is equal to the tilt of the Earth's axis, 23.5° .

Materials: Shadow stick from Chapter 1; observations of the midday shadow lengths; large sheet of paper; colored markers; protractor.

- 1. Obtain midday shadow lengths for convenient equinoxes or solstices

(September 21, December 21, March 21, June 21) as described in the activity "Sun Shadows" of the previous chapter. Also make sure to keep a record of the height of the shadow stick.

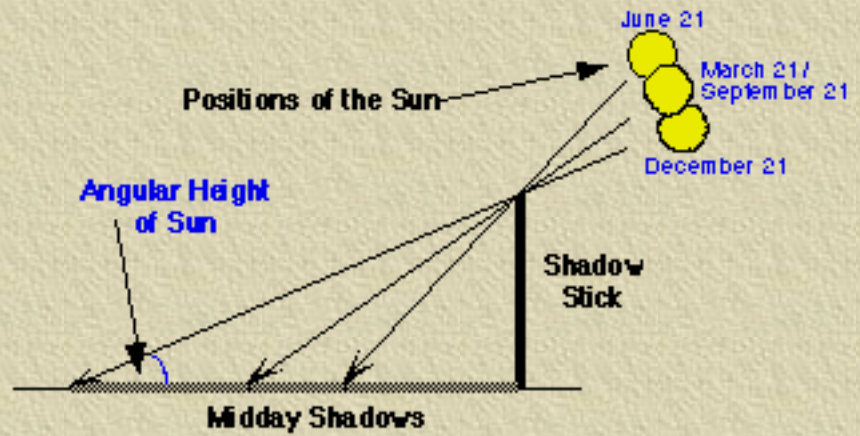

- 2. On a large sheet of paper, draw a line the same length as the shadow stick. To reconstruct the angle of the Sun's height for each equinox and solstice in your data, start at the bottom of the shadow stick and draw a line perpendicular to the shadow stick the same length as the midday shadow for each solstice and equinox in your data. Try using different color markers for each day. Your drawing should resemble the figure above.
- 3. Have the class measure the angular height of the Sun on the paper with a protractor for each equinox and solstice. The difference of the angular height between subsequent equinoxes and solstices should be about 23.5° . The difference in angular height between the two equinoxes or the two solstices should be twice that, or 47° .

Analysis Option

Mathematically, since the shadow stick and its shadows form right triangles, the shadow stick height and the shadow lengths are all that is needed to compute the Sun's angular height; it is simply the arctangent of the ratio between the shadow stick height and the shadow length. While such trigonometric functions are certainly beyond the scope of the elementary school classroom, this fact can be used to verify the students' results.

Discussion

When are the midday shadows the longest? Why? When are they the shortest? Why? What causes the shadow lengths to change? Can you relate your measurements to our model of the seasons?

Activity 2-11: Demonstrating the Tilted Earth

This activity is suitable for students in grades 3-6.

This activity demonstrates the model of the seasons we have been developing- that of an Earth whose axis of rotation is tilted by 23.5° degrees with respect to the plane of its orbit around the Sun. By aligning the Earth's axis with a stationary point in space (the location of Polaris), it is easy to demonstrate the tilt of the Earth's axis during the course of an orbit about the Sun (i.e. a year).

Materials: Globe of the earth; sign to mark North; and masking tape. A student can act the part of the Sun and another student can hold the globe.

- 1. Place the Sun student in the middle of the room. Place the Earth student about six feet away. Mark one corner of the room "North". If we could extend this corner much higher, the North Star would be at its top.
- 2. Tilt the globe so that the North Pole tilts towards the ceiling at the corner marked North. The student holding the globe must be careful to preserve this alignment.
- 3. Walk the Earth around the Sun making sure to keep the North Pole properly aligned. When the North Pole points away from the Sun, this is winter for the Northern Hemisphere. When it points towards the Sun, it is summer for the Northern Hemisphere.
- 4. Walk the Earth around the Sun again, and watch the changes in the Southern Hemisphere. When it is summer in the Southern Hemisphere, what is it in the Northern?
- 5. After all of the students understand this example, try this experiment with the Earth turned such that its axis is perpendicular to the plane of its orbit about the Sun. If the Earth had this orientation, there would be no seasons.

Discussion

What differences in climates and seasons can you determine from the observations in these experiments? How would seasonal changes appear to you if you were on the equator or at the north or south poles? What is the pattern of sunlight at the equator? At the North Pole? At the South Pole? What were the differences in how the light was hitting the Northern Hemisphere as you carried the globe around the Sun?

Related Sites

Comments?

[Contents](#) |  [Back to Top](#) |     | [Home](#)

Paper Plate Education

"Serving the Universe on a Paper Plate"

Activity: Sub-Solar Cup



[Note: A version of this activity is included in the [Paper Plate Astronomy video](#). We recommend you see [video excerpts](#) for more detailed activity instructions and pictures.]

Throughout the year, this simple device will indicate where on the Earth the sun is currently overhead. See the [Analemma](#) activity to plot a figure-8 analemma on a globe using the Sub-Solar Cup.

Drill a small hole out of the bottom of a dark plastic cup. On the top of the cup secure two pieces of thread to make a set of cross hairs. Cut out a viewing window on the side of the cup.



Secure the globe on its side so that a figure standing at the observer's location is upright on the globe. That is, a tangent at the observer's location is parallel to the ground. Align the figure's line of longitude on the globe with your north-south meridian.



Position the cup upside down on the globe so that sunlight goes through the small hole and is centered over the cross hairs. That location is the current sub-solar point.



View the location of the sun at local noon throughout the year to track the [sun's annual migration](#) between the tropics.



This activity, contributed with original reference by Gary Tomlinson, is an adaptation of an activity written by Robert Mitchell. See The Physics Teacher, May 1991, pp. 318-319.

GLPA Proceedings, 1999, pp. 36-36.

[Note: This activity is [detailed](#) in the [Paper Plate Astronomy video](#).]

[Home](#)

[Up](#)

[Site Map](#)

[What's New?](#)

[Upcoming Events](#)

The contents of this site may be reproduced for non-profit educational purposes only. Please cite the contributing author in credits.

All other uses require the express written permission of the respective contributors.

Copyright ©2003 [Chuck Bueter](#). All rights reserved.

Paper Plate Education

"Serving the Universe on a Paper Plate"

Activity: Analemma Project



With the Sub-Solar Cup activity you can determine the position on the earth where an observer would see the sun directly overhead. Plotting the sub-solar point at the same time each day should yield an analemma, the figure-eight shape on a globe that expresses the sun's declination and the equation of time.

In this ongoing project, we hope to track the sub-solar point for one year, provided the weather and personal commitments permit regular observations at noon. See the Analemma Project (same name, different project) for multiple exposure photographs that produce terrific visual image of analemmas. Paper Plate Education, being a very casual pursuit, will likely undertake this Sub-Solar Cup endeavor with less exactness. Enjoy.

The results are in and appear at the bottom of this page...



From the Sun Clock home page at <http://www.mapmaker.com/sunclock.htm> see the Sun Path diagram for depictions of analemmas. It is a nice addition to this activity.



For continuity, we secure our globe in a base so our location (see

figurine at left) is atop the globe. Then we align our globe base with cracks in a driveway that are nearly north-south. Any minor offset from north-south will cause a slanted figure-eight.



Another way to check the north-south alignment is to track the path of the sun through several hours. If the globe is properly aligned, the sun should move along one latitude for the entire day.

At the end of 12 months we will mark the globe to clarify the path of the analemma.



December 25, 2002
Noon (Standard Time)

The sun appears just slightly above the Tropic of Cancer two days after the December solstice. Please recognize the sub-solar image is an approximate position, dependent on the accuracy of the globe's alignment relative to the real earth.



January 6, 2003
Noon

For the first image, the base was wobbly on ice. The zoomed image is with the base steady. Weather is mostly cloudy.



**January 9, 2003
Noon**



**January 12, 2003
Noon**



**January 22, 2003
Noon**

Hands shaky from bitter cold. Intermittent snow, windy, temperature 10 degrees F.





January 30, 2003
Noon



February 11, 2003
Noon



February 27, 2003
Noon



Lesson learned: Do not align globe with intersection of four slabs of concrete running along cardinal points, for when the slabs heave in the winter the globe is not automatically level anymore.



**March 13, 2003
12:10 p.m.**



**March 21, 2003
12:10 p.m.**



**March 30, 2003
Noon**



**April 15, 2003
Noon (Standard Time)**



**April 24, 2003
Noon**

An upside not to move the clock forward to daylight time (DT):
the time remains noon, Standard Time (ST).



**April 29, 2003
Noon**



**May 21, 2003
Noon**



**June 17, 2003
Noon**

Has been a large gap since last observation.



June 22, 2003

By tracking the summer solstice sun across the length of the day, we can see the globe is slightly skewed from ideal. In the morning the sub-solar point is slightly under the globe's Tropic of Cancer line; in the afternoon the solar dot is well above the line.



June 24, 2003
approx. noon



July 9, 2003
Noon



July 16, 2003
Noon



July 25, 2003
Noon



August 12, 2003
Noon



August 19, 2003
12:05 p.m.



August 28, 2003
Noon

Meanwhile, Mars at opposition is making its closest approach to earth in nearly 60,000 years.



September 10, 2003
Noon



September 15, 2003
Noon



September 23, 2003
Noon

September Equinox. The sun's position just above the equator hints that the globe is slightly out of alignment. As long as that error is kept nearly constant, we should still be able to plot a figure-8 (albeit misaligned) onto the globe at the end of one year.

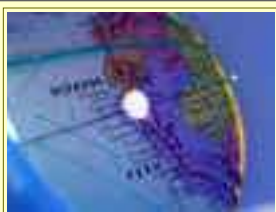

October 12, 2003
Noon



October 27, 2003
11:55 a.m. EST



November 6, 2003
12:05 p.m. EST



November 26, 2003
Noon



Meanwhile, the big sunspot groups of 2003 come round again--a bonus while tracking the sun.

Image courtesy of [SOHO \(ESA & NASA\)](#).



December 2, 2003
Noon



December 21, 2003
Noon



We're done! We have tracked the sun for 12 months. Now we just have to plot the points on the globe. To be more scientific about this, we could continue tracking the sub-solar point to see if its path is repeatable. You may notice that the sun does not exactly coincide with the tropic of Capricorn. In the past year, the globe has settled into the padded base and repeated handling has affected the

THE OUTCOME

The results are in, with mixed success. We first plotted the sub-solar point with yellow circles on the Tropic of Capricorn and moved up to the Tropic of Cancer. From there the red circles descend back to the Tropic of Capricorn. If the three points immediately after the vernal equinox were better positioned, then the figure-8 of the analemma would be more apparent. Again, the globe was repositioned after each observation, so plenty of error is introduced.



globe-plot.jpg (286

KB)



globe-plot2.jpg (50 K

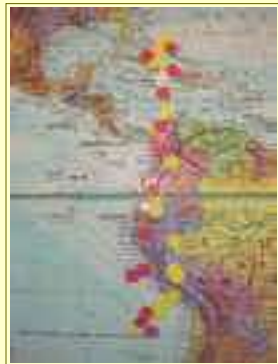

globe-plotzoom.jpg

(275 KB)



globe-plotzoom2.jpg (34 KB)

[Note: The [Sub-Solar Cup activity](#) is [detailed](#) in the [Paper Plate Astronomy video](#).]

[Home](#)
[Up](#)
[Site Map](#)
[What's New?](#)
[Upcoming Events](#)

The contents of this site may be reproduced for non-profit educational purposes only. Please cite the contributing author in credits.

All other uses require the express written permission of the respective contributors.

Copyright ©2003 [Chuck Bueter](#). All rights reserved.

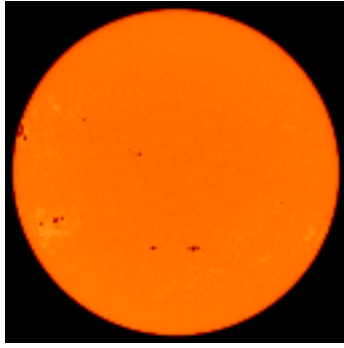

Sunspots and the Solar Cycle

What is "The Solar Cycle?" In a regular cycle, the Sun undergoes a period of great activity called the "solar maximum," followed by a period of quiet called the "solar minimum." One way scientists track solar activity is by observing sunspots. Sunspots are relatively cool areas that appear as dark blemishes on the face of the Sun. During solar maximum there are many sunspots; during solar minimum there are few. On average, solar maximum occurs once every 11 years; the next solar maximum occurs in 2000-2001.

Sunspot activity is monitored using an index called the "sunspot number." The sunspot number varies from day-to-day. As a rule of thumb, if you divide the official sunspot number by 15, then you'll get the approximate number of individual sunspots visible on the solar disk if you look at the Sun by projecting its image on a white screen with a small telescope. The real-time satellite image (upper left) shows some of the larger sunspots currently visible on the disk of the Sun. **Caution: *NEVER* look directly at the Sun (especially through optical instruments such as telescopes) -- blindness may result!**

(This page should display for 30 seconds before advancing automatically to the next page. If the slideshow stops, then click on your Web browser's "Reload" or "Refresh" button to resume the presentation.)

STAR

A self-luminous ball of gas that shines or has shone because of nuclear reaction (fusion) in its interior.

Electromagnetic Spectrum

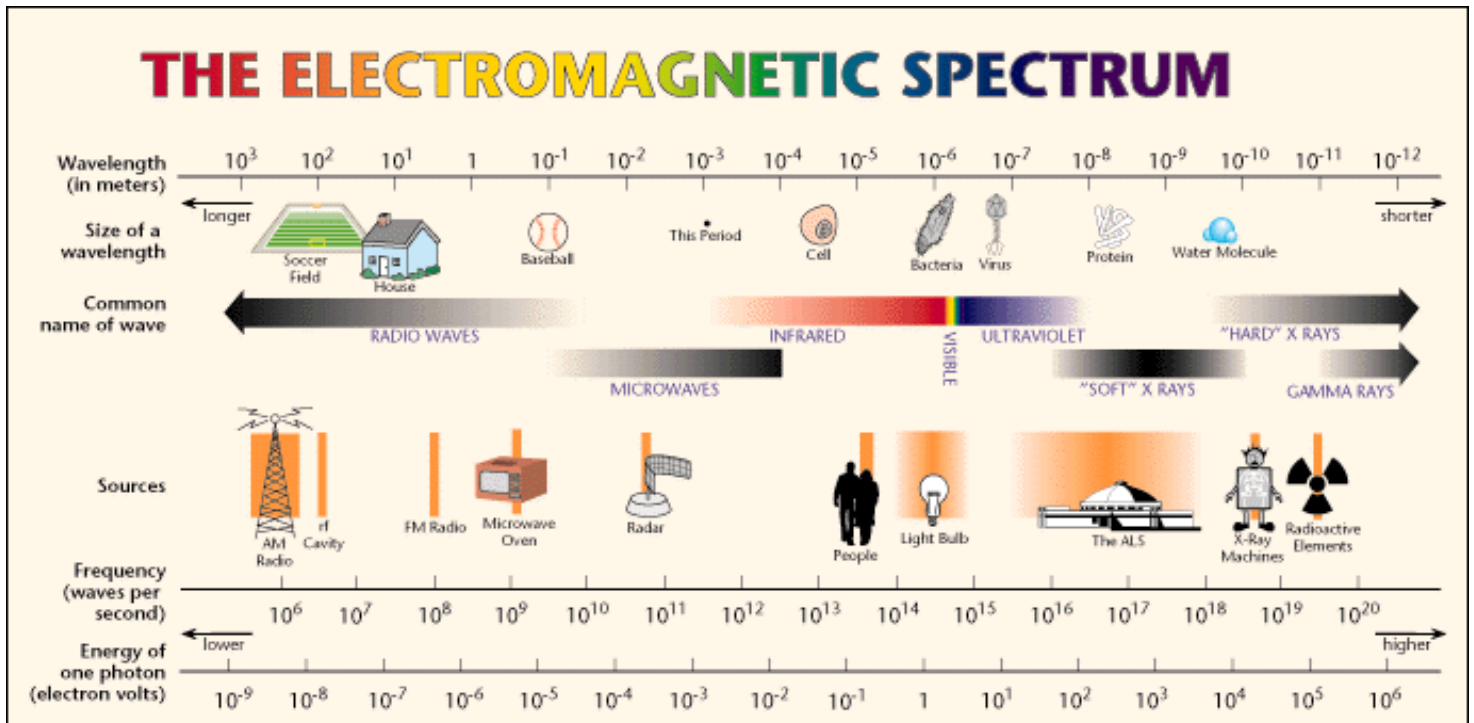

The electromagnetic spectrum covers a wide range of wavelengths and photon energies. Light used to "see" an object must have a wavelength about the same size as or smaller than the object. The ALS generates light in the far ultraviolet and soft x-ray regions, which span the wavelengths suited to studying molecules and atoms.

Look at the picture of the electromagnetic spectrum. See if you can find answers to these questions:

1. What kind of electromagnetic radiation has the shortest wavelength? The longest?
2. What kind of electromagnetic radiation could be used to "see" molecules? A cold virus?
3. Why can't you use visible light to "see" molecules?
4. Some insects, like bees, can see light of shorter wavelengths than humans can see. What kind of radiation do you think a bee sees?

[Return to "Electromagnetic Radiation"](#)

[Return to "The Advanced Light Source: A Tool for Solving the Mysteries of Materials."](#)

[MicroWorlds Contents](#) | [Registration & Comments](#)

[Questions and Support](#)
[Privacy and Security Notice](#)

"We have always a resource in the skies. They are constantly turning a new page to view. The wind sets the types in this blue ground, and the inquiring may always read a new truth."

- Henry David Thoreau (1817-1862)

"My heart leaps up when I behold

A rainbow in the sky."

- *The Rainbow*, William Wordsworth

"Night is a shadow world. The only shadows we see at night are cast by the moonlight, or by artificial light, but night itself is a shadow."

- *Soul of the Sky*, Diane Ackerman

Visit the [Sandburg Sky Poetry](#) Web page, including CSMS student-authored sky poems.

Day & Night

The line which divides day & night is called the terminator. As the Earth rotates counterclockwise, the terminator appears to move from east to west.



(Graphic produced using [Xearth.](#))

Sandburg Center for Sky Awareness A Fairfax County Public Schools Planetarium

[Sky Awareness](#) | [Sun-Earth Connection](#) | [Rays Awareness](#) | [Tracking Satellites](#) | [GPS 00-01 Themes](#)

Themes for 2001-2002

Increasing Your Sky Awareness

- [Top 10 Reasons to Look Up!](#)
- [Basic Tools of the Skywatcher/Amateur Astronomer](#)



Are you aware that the sky is on the air?

Huh? Look, listen (with [RealPlayer](#)), and enjoy the online version of the following sky awareness radio programs:

- [The Weather Notebook](#), A Radio Show about Weather and Everyday Life from the Mount Washington Observatory (home of the world's worst weather).
- [StarDate](#) radio--the longest-running science feature in the country--is the daily astronomy-related radio program produced by the McDonald Observatory, University of Texas.
- [Earth & Sky @World of Science](#) includes a link to "Tonight's Sky," featuring a sky chart generated by *Starry Night Deluxe*.
- Do you remember how the sky looked this morning? How does it look now? Visit the [WeatherNet4 CityCam](#) Web site to see the current skyscape in Washington, D.C. You can also access the last three (3) hours of archived images, captured every 15 minutes (Netscape 4.x required).
- The Sandburg Center for Sky Awareness proudly presents the [State of Sky Kiosk](#)--an online automated "slideshow" presenting a series of sky-related Web pages, featuring the current sky (day & night) as well as some of the sky's greatest hits. In a little more than 10 minutes, the kiosk provides a fairly comprehensive picture of, well, the current state of the sky. For some "slides," the content is "randomized," meaning that a slightly different Web page will appear during subsequent cycles through the slideshow. Just point your Web browser to the [kiosk "splash" page](#), sit back, and enjoy!
- [Test Your Sky-Q](#) (astronomy-related)
- [Look Up! Quiz and Sky Awareness Activities](#) (weather-related)
-

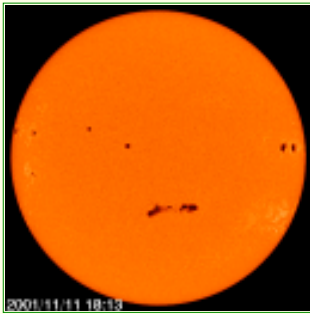
30 JUL 2002

Today's sunspot
number is
304 /

**Sunspot No. Trend
(past 24 hours)**

/	Increasing
--	Steady
\	Decreasing

Credits: Real-time image courtesy [SOHO](#); sunspot number courtesy [NOAA](#).

Updated: 29 JUL 2002
[ARCHIVES](#)

Today's Predicted
UV Index is

8

Valid for Wash., DC during
the Solar Noon hour on

30 JUL 2002

UV Index courtesy [NOAA](#).

Today's Observed
UV Index is

7.3

[Sandburg Planetarium](#)
19 MAY 2002, 01:05 p.m.
Partly Cloudy
(Sun [Transit](#): 01:05 p.m.)

[UV Index Solarmeter](#)
courtesy [EPA](#)
[SunWise School Program](#)

Plan to celebrate [National Sky Awareness Week](#) (NSAW), **April 21-27, 2002**. Its theme is: "THE SKY - Where Meteorology Meets the Heavens and the Earth."



This year, [Astronomy Week/Day](#) precedes NSAW:

Astronomy Week is **April 15-21, 2002**;

Astronomy Day is **April 20th**. Astronomy Day has a special theme: "Sun-Earth Day." The NASA Sun-Earth Connection Education Forum has set up a special [Web site](#) providing Astronomy Day theme-related resources.

- Clouds, clouds, and more clouds! And even more clouds!
 - [Skywatcher's Cloud Chart](#) - online, interactive version of the popular cloud chart from The Weather Channel & [For Spacious Skies](#), a national effort to increase sky awareness and concern.
 - Intellicast - Dr. Dewpoint Weather 101: [All About Clouds](#)
 - [All about clouds](#) (popular title, huh?) from USA TODAY Weather
 - [Australian Weather Photography](#). Also visit Harald Edens' Netherlands [Weather Photography](#) Web site, which features cloud, lightning, atmospheric optical phenomena, and astronomy photographs.
 - Ever imagine that you see shapes in the clouds (technically known as *nephelococcygia*)? You're not alone! Visit [Cool Clouds for "Kids" of All Ages](#) to see the "Energizer Bunny" and other interesting shapes in the clouds. Also visit [CloudE Momma's](#) Web site to see a unique cloud "E"-clipse!
- [Weatherwise](#) magazine Annual Photo Contest Winners: [1999](#); [2000](#); [2001](#); [2002](#); [2003](#)
- Assuming the sky is cloud-free, approximately how many stars are visible in the night sky? Well, as you can see from a [Light Pollution Map of the Washington, D.C. Area](#), that depends upon where you live. Fact of the matter is, in the most light-polluted areas of the region, only the 25-or-so brightest stars are visible! See what you're missing: **visit your local planetarium.**
- [Snowflakes - A Thematic Approach](#) provides K-12 teachers with a flurry of ideas for using snow to deliver interesting and exciting interdisciplinary instruction perfect for the winter season.
- Annotated links to a variety of other [sky awareness resources](#)

Sun-Earth Connection

- [Me & My Shadow - Making the Sun-Earth Connection](#) - an SCSA Web page of theme-related resources and classroom-ready activities.
- The NASA [Sun-Earth Connection Education Forum Solar Events](#) Web page, featuring hyperlinks to *Solar Webcast*, [Sun-Earth Day](#), [Solar Week](#), and *The Space Weather Center Exhibit*.

Today's Moon



(Graphic courtesy US Naval Observatory.)

New Moon:	Jul 10
First Quarter:	Jul 17
Full Moon:	Jul 24
Last Quarter:	Aug 01
New Moon:	Aug 08

- The NASA [Sun-Earth Connection Education Forum](#), including information and resources related to **Sun-Earth Day, 20 March 2002**.
- [Sun-Earth Connection Tutorial](#)
- [Sunspots and the Solar Cycle](#) (including today's sunspot number, *What is "The Solar Cycle?"*, and many other interesting features)
- From NASA and the Exploratorium, two *great* Web sites: [Solar Max 2000, Your Guide to the Year of the Active Sun](#); and [Auroras 2000, Your Guide to the Northern and Southern Lights](#).
- From the Space Environment Center, the [NOAA Space Weather Scales](#) were introduced in November 1999 as a way to communicate to the general public the current and future space weather conditions and their possible effects on people and systems. Analogous to hurricanes, tornadoes, and earthquakes, the Space Weather Scales have numbered levels that convey severity.
- [Ask Mr. Sunspot](#) - This is one of those frames sites where you'll have to navigate to the resource. Click on "Mr. Sunspot" in the "Sections" menu (left column).
- [The Space Weather Bureau](#)
- [Auroras - Paintings in the Sky](#)

Rays Awareness™

- [Rays Awareness™](#) - *Don't get burned by too much of a good thing.™* "Rays Awareness is The Weather Channel's national campaign designed to educate people about the dangers of overexposure to the sun, while enabling them to enjoy the outdoors in a safe and healthy manner."
- What is ultraviolet (UV) radiation? Part of the [Electromagnetic Spectrum](#).
- [The Ultraviolet Index](#) (UV Index) overview, including a link to EPA's new [SunWise School Program](#) regarding Sun safety; National Oceanic and Atmospheric Administration (NOAA) [UV Index](#) map.
- [Ozone Depletion and UV Radiation](#); [EPA's Ozone Depletion Home Page](#); [Sunburn Cam](#), courtesy Discovery Channel Online.

Tracking Satellites: Natural & Man-made

Natural Satellites



The Moon is planet Earth's only natural satellite, revolving around the Earth once a month. Get to know some of its prominent surface features using the [space.com Skywatcher's Guide to the Moon](#) (including a [Printable Moon Map](#)).



Teacher Tips: Students discover the month-long cycle of Moon phases (see sidebar, left) in the interactive online activity, [Birthday Moons - It's Just a Phase You're Going Through...](#) (recommended for Grade 3 and higher). For activity extension

&/or enrichment, visit the [Related Internet information resources](#) Web page, featuring annotated links to a few selected Moon phase-related World Wide Web sites.

Man-made Satellites

 Be they faint streaks or brilliant flares, [satellite observing](#) is like watching man-made "shooting stars!" Track the [International Space Station](#) (ISS) in real-time. The NASA *Liftoff to Space Exploration* [Tracking](#) Web page makes it easy to locate some of the larger man-made objects in space, including the ISS, Space Shuttle (when in orbit), Hubble Space Telescope, or NOAA polar-orbiting weather satellites. Or use [J-Pass Version 2.5](#) beta to calculate the next visible pass of these man-made [satellites](#) (your Web browser must support Java applets). 

A highly recommended non-NASA satellite tracking Web site, [Heavens-Above](#) provides daily predictions for all satellites brighter than a user-specified limiting [magnitude](#) (use 3.5 for light-polluted urban areas), as well as detailed star charts showing the satellite's track through the heavens. All *Heavens-Above* Web pages, including the graphics, are generated in real-time and customized for the user's location and time zone. "Anonymous users" will need to specify their location (once per session), otherwise it is unnecessary to become a registered user.

Editor's Note: Under light-polluted urban skies, it is difficult if not impossible to see most man-made satellites. But at an apparent magnitude of -1, the International Space Station (ISS) is as bright as some of the visible planets--I have seen the ISS every time I looked for it!

GPS - The New North Star



[Location-Finding Using Global Positioning System \(GPS\)](#), including annotated links to a variety of [GPS-related resources](#).

- The [Degree Confluence Project](#) - where *geography* and *GPS technology* intersect. Visit virtually all of the points where a line of latitude and longitude meet (integer degree intersections), or trek to locate the [point of confluence](#) nearest you!
- [Geocaching](#) - the high-tech sport where *you* are the search engine! A handheld **GPS receiver** and a hunger for adventure are all you need to play this 21st century version of hide-&-seek.



[Geoscience-Related Information Servers](#) | [Geosystems in FCPS](#)

Happy Birthday Sunspot Plot - Sunspots and the Solar Cycle

Acknowledgements: Adapted from [Happy Birthday Sunspot Plot](#), a NASA [Thursday's Classroom](#) activity. Background information includes excerpts from [Sunspots and the Solar Cycle](#), sponsored by [Science@NASA](#).

OBJECTIVES & UNDERSTANDINGS

After completing this activity, you should be able to:

- Construct and interpret a bar graph of the annual sunspot number from 1986-1999.
- Infer the period of the solar cycle (by interpreting the graph).

MATERIALS

Each student will need a copy of the [activity sheet](#) and a pencil (to complete the graph).

BACKGROUND

What is "The Solar Cycle?" In a regular cycle, the Sun undergoes a period of great activity called the "solar maximum," followed by a period of quiet called the "solar minimum." One way scientists track solar activity is by observing sunspots. Sunspots are relatively cool areas that appear as dark blemishes on the face of the Sun. During solar maximum there are many sunspots; during solar minimum there are few.

Sunspot activity is monitored using an index called the "sunspot number." The sunspot number varies from day-to-day; daily sunspot numbers are averaged to derive an annual sunspot number. In this activity, you will explore the long-term cycle of solar activity by graphing the past 14 years of annual sunspot numbers.

Note: As a rule of thumb, if you divide the official sunspot number by 15, then you'll get the approximate number of individual sunspots visible on the solar disk if you look at the Sun by projecting its image on a white screen with a small telescope. [**Caution:** *Never* look directly at the Sun (especially through optical instruments such as telescopes) -- blindness may result!]

PROCEDURE

1. Using the materials provided by your teacher, construct a bar graph of the annual sunspot number from 1986-1999.
2. Answer the following activity questions.

ACTIVITY QUESTIONS

1. Calculate the mean "average sunspot number" (annual sunspot number) for the past 14 years. How does this number compare with [today's sunspot number](http://www.wsanford.com/~wsanford/exo/n-m_themes.html) (http://www.wsanford.com/~wsanford/exo/n-m_themes.html)?
2. When (which year) was the last solar maximum? What was the annual sunspot number? Is the solar maximum a brief event, or does it tend to last for a period of months to years?
3. When (which year) was the last solar minimum? What was the annual sunspot number?
4. Assuming that the year 2000 turns out to be a solar maximum, how many years passed from the last solar maximum to the next (current) solar maximum? From such a relatively small data set, can the period of the solar cycle be determined with certainty?
5. When (which year) were you born? Were you born during a solar maximum, solar minimum, or sometime in between? If the year 2000 turns out to be a solar maximum, then predict how old you will be during the next solar maximum.

Safely Estimating the Size of Sunspots

PURPOSE

There's more than meets the eye to the little yellow ball in the sky! Sunspots are relatively cool areas that appear as dark blemishes on the face of the Sun. Looking at solar telescope imagery, it's difficult to get a sense of the actual size of sunspots. In this activity, you will estimate the actual size of these features.

MATERIALS

1. Internet access via Web browser, e.g., Netscape Communicator or Microsoft Internet Explorer
2. Pencil, metric ruler, and hardcopy of near-real-time solar telescope imagery (showing sunspots)
3. Scientific calculator

PROCEDURE

1. Use a Web browser to access [The very latest SOHO images](#) Web page. Download/print the latest **MDI Continuum** solar image.
2. In the following data table, record the image date and time. [Note Date/Time format: Date = yy/mm/dd; Time = UTC. Refer to a [Time Conversion Chart](#) to convert UTC to EST/EDT.]
3. Using a metric ruler and the hardcopy solar image, carefully measure the diameter of the Sun (mm) and the width (mm) of the largest sunspot (along major axis); record these data in the data table (below). Circle and label the largest sunspot (e.g., "largest").
4. Answer the Activity Questions.

DATA

Date (mm/dd/yy)	Time (EST/EDT)

Feature	Scale Model Size (mm)	Actual Size (km)
Diameter of Sun		
Largest Sunspot		
Sunspot No. 2		
Sunspot No. 3		

ACTIVITY QUESTIONS

1. Use a proportion (two equivalent ratios) to solve for the actual size of the largest sunspot. Show your work (below); record your answer in the data table (above).

$$\frac{s}{d} = \frac{S}{D}$$

Where:

s = Scale Model Size of Sunspot

d = Scale Model Diameter of Sun
 S = Actual Size of Sunspot
 D = Actual Diameter of the Sun (1,400,000 km)

Substitute, cross-multiply, do dimensional analysis, solve for "S":

$$\frac{s \text{ (mm)}}{d \text{ (mm)}} = \frac{S \text{ (km)}}{1,400,000 \text{ km}}$$

$$S \text{ (km)} = \frac{s \text{ (mm)} \times 1,400,000 \text{ km}}{d \text{ (mm)}}$$

- Compare/contrast the size of the largest sunspot with the diameter of the Earth (12,735 km). Approximately how many Earth diameters would fit inside the Sun's diameter? Show your work; circle your answer.
- The hardcopy **MDI Continuum** solar image is really a *scale model* of the Sun. Use the Sun's scale model diameter and actual diameter to determine the scale of the image (you may need to refer to a brief [tutorial on determining fractional scale](#)). Show your work; circle your answer. Use the image scale to estimate the size of two other sunspots; record the estimated size of these sunspots in the data table (above). Circle and label the two sunspots (e.g., "No. 2," "No. 3").

APPENDICES

- . **The very latest SOHO images**
<http://sohowww.nascom.nasa.gov/data/realtime-images.html>
- B. **Time Conversion Chart**
<http://www.wsanford.com/~wsanford/activities/timeconv.html>
- C. **Determining the Fractional Scale of a Map or Scale Model**
<http://www.wsanford.com/~wsanford/activities/scale.html>
- D. **Converting Metric Units** - Use the following list of metric units to count the number of units **change**, then move the decimal point (in the **same** direction in which you were counting) one place for each unit of change:

(largest) km hm dam m dm cm mm (smallest)
 2--1--0
 <-----

For example, convert 1,100 cm to m by moving the decimal point 2 places to the left: 1,100 cm = 11 m (approximately 36 feet).



- [For Students](#)
- [For Educators](#)
- [For Museums](#)
- [For Scientists](#)
- [For Amateur Astronomers](#)
- [Observing the Transit](#)
- [Venus Transit Story](#)
- [Television and Live Webcasts](#)
- [What's Happening In Your Area](#)
- [Cross-Cultural Connections](#)
- [Multimedia Resources](#)
- [Student Observation Network \(SON\)](#)
- [Venus Transit Bookmark, Banner, and Wallpaper](#)

Some materials require the Flash 6 plug-in



LEARN MORE about NASA's support of this year's ESTME Week! Engage young people in the joys and rewards of discovery throughout the year.



On June 8th, 2004 a celestial event of historical scientific importance will occur when the silhouette of the planet Venus once again crosses the face of the Sun as seen from the Earth. This event or transit of Venus last occurred in [1882](#), so no one alive today has ever witnessed the transit of Venus



The Venus Transit Animation begins at the surface of Venus where heat ripples distort the scene in a shimmering heat bath. As we leave Venus and move off into space, we arrive at Earth and watch as Venus falls behind us and finally passes across the face of the Sun.

Sun-Earth Day 2004 has selected the transit of Venus as this year's theme. Opportunities are available to prepare for the viewing of the event. This website has been developed to provide the necessary resources and opportunities for participation in our fourth Sun-Earth Day. This year's program will continue to offer new and exciting space science content that will cross all of space sciences, offering activities and resources for every classroom and museums event. The goal is to involve as much of the student population and the public in this event as possible and to help them understand the immense importance and excitement surrounding this and previous transits.

Through engaging activities focused on US and world history, music, technology, math, and astronomy, classrooms and museums can create their own event or participate in one of the opportunities we make available. Comparisons of Venus with Earth and Mars, calculations of the distances to nearby stars, and the use of transits to identify extra-solar planets will all add to the excitement of this cosmic occurrence.

While visiting this site don't forget to register for your free educational packet!

Click below for this year's Sun-Earth Day flyer.

- [Sun-Earth Day Flyer PDF file \(188 K\)](#)



SkyandTelescope.com

close window

Astronomy Day: Bringing Astronomy to the People



Visitors to the Charles Hayden Planetarium at Boston's Museum of Science were treated to views of the Sun through a filtered 6-inch refractor during the Astronomy Day celebration in April 2001. S&T photo by Edwin L. Aguirre.

One day each year, astronomy clubs, planetariums, and other groups of sky lovers band together to expose the general public to the wonders and excitement of astronomy. Officially, Astronomy Day is celebrated "to promote the forerunner of all scientific endeavors and to provide information, resources, and encouragement in all facets of astronomy." But showing that astronomy is *fun* is really what it's all about.

Doug Berger, former president of the Astronomical Association of Northern California, founded this annual event in 1973 as a high-profile way of drawing public attention to the science and the hobby through exhibits and activities at urban centers. Since then the celebration has mushroomed in size and scope. Hundreds of astronomy clubs, observatories, museums, colleges, and planetariums worldwide now host special family-oriented Astronomy Day events and festivities. Some organizations extend their activities over an entire week.

Schedule

Astronomy Day is usually celebrated between mid-April and mid-May, on the Saturday closest to the first-quarter Moon. In 2003 Astronomy Day was May 10th, and Astronomy Week was May 5–11. In 2004 Astronomy Day falls on April 24th. However, local organizers often host events on dates that best suit their needs, or to accommodate a special event like an eclipse, planetary alignment, or bright comet.

Why Participate?

This event is a great way for your club to gain visibility in your community. Having the public look through telescopes and at your displays spreads interest in astronomy throughout the general public and might even attract new members to your club. It provides a platform for discussing light pollution — an issue that should concern everyone. Perhaps most important, Astronomy Day is great morale-booster for you and your fellow club members. It brings people together for a day of sharing their love of the sky with others.

If you don't belong to an astronomy club and want to find a local club or planetarium that might be hosting an Astronomy Day celebration, check out our [directory](#) of clubs, observatories, planetariums, and science museums in North America, Europe, and Australia/New Zealand.

More Information

To assist organizations and individuals in planning Astronomy Day programs, the Astronomical League and *Sky & Telescope* have prepared a fact-filled *Astronomy Day Handbook*. Written by David H. Levy, the 66-page guide offer time-tested suggestions for conducting large and small endeavors. It also includes the rules and entry forms for the [Sky & Telescope Astronomy Day Awards](#), prizes given annually to the groups whose programs do the best job of "Bringing Astronomy to the People."

You can obtain a free printed copy of the handbook by sending a request to:

Astronomy Day Information
Sky Publishing Corporation
49 Bay State Road
Cambridge, MA 02138
e-mail: kwilliams@SkyandTelescope.com

The Astronomical League maintains the official [Astronomy Day Web page](#), which describes the event's background and where to find an Astronomy Day activity in your area.

Finally, check out our free [Getting Started in Astronomy flyer](#), which is available in Adobe PDF format. It includes an article on how to take your first steps in the hobby, six bimonthly star charts with simple instructions, and a Moon map. This free black-and-white publication is suitable for printing, photocopying, and distributing at Astronomy Day exhibits, at star parties, in classrooms, at scout-troup meetings, and at any other gathering of the astronomy-interested public.



The 13th Annual **Sky Awareness Week** (SAW) celebration will be held April 20-26, 2003. Its theme will be ...

"THE SKY- Where Meteorology Meets the Heavens and the Earth!"

Since 1991, more than 40 states and the District of Columbia have issued proclamations in support of this growing celebration. **The National Weather Service, The National Weather Association, The National Science Teachers Association, the National Science Foundation,** and [The Weather Channel](#) are among the many organizations that have collaborated with us in this effort!

SAW 2003 (our 13th annual event) will provide opportunities galore for teachers, students, parents, home schoolers, senior care centers, nature center staff, meteorologists and others to look toward the sky. In doing so, they can...

1. learn how to read the sky (first by learning cloud types and their weather, and then by forecasting from them)
2. understand sky processes (water cycle, sky color, rainbows).
3. appreciate the sky's natural beauty.
4. protect the sky as a natural resource (it's the only one we have).
5. see how meteorology, astronomy, geology, oceanography, and hydrology blend with other sciences to create our environment

Also, **SAW 2003** falls during the same time of year as [National Science and Technology Week](#), **National Mathematics Awareness Week**, and **Earth Day, Astronomy Day, and National Parks Day**. To foster these linkages, dozens of schools across the United States and internationally will share sky data across the **Internet**. In 1997, NOAA launched a new geostationary weather satellite during **SAW**.

SAW encourages people across the nation and around the world to notice the myriad of cloud types, ranging from fair weather cumulus puffs to high-flying cirrus streamers. Late spring is a time when most places experience their most dramatics and changeable skies.



In addition to making their own weather forecasts, just as farmers and explorers used to do, people will notice that the sky is not the same color blue every day. These changes, albeit subtle are often tied to the movement of weather systems and accumulations and transport of atmospheric pollutants. The list of "things" in the sky also includes birds, airplanes, hot air balloons, and the sun, moon and stars. We can appreciate all of these and gain an upbeat feeling by **LOOKING UP!** For more ideas about "looking up," and to learn more about **SAW 2002** check out the links below:

- to learn [how you can participate](#),
- to find out about [schools which are participating already](#)
- to obtain data from [schools which are participating already](#)
- to explore "[cloud and sky windows](#)"
- to discover what [nephelococcygia](#) means
- to learn the real difference between "[partly cloudy](#)" and [partly sunny](#)"
- to test your sky awareness, try a new **SKY QUIZ** that will be posted shortly. **NEW**
- to vote for your favorite cloud in the [COOL CLOUD](#) poll.

You can also contact us via:

snail mail	e-mail	telephone
Barbara G. Levine or H. Michael Mogil HOW THE WEATHERWORKS 301 Creek Valley Lane Rockville, MD 20850	skyweek@weatherworks.com	301-527-9339 1-800-8CLOUD9 (1-800-825-6839) FAX = 301-990-9324

A comprehensive sky study guide, two different cloud charts, cloud postcards, and other low-cost sky-related materials are available for [purchase](#).

This page was last updated on March 20, 2003.



[Top](#)

Astronomy Day at Huntley Meadows Park

Due to inclement weather, AD@HMP has been rescheduled for Sunday, 28 April, 3-9 p.m.

Weather permitting, join [Planetarium Teachers](#) from Fairfax County Public Schools (Sandburg, Hayfield, Edison, & TJHSST), volunteers from the [Northern Virginia Astronomy Club](#) (NOVAC), and Fairfax County Park Authority Naturalists for a local celebration of [National Astronomy Day 2002](#) on **Saturday, 20 April 2002**, at [Huntley Meadows Park](#), Fairfax County, VA.



 A variety of activities are planned. From **3:00 'til 9:00 p.m.**, astronomy experts will be on-hand to provide guidance and answer questions. Planetarium Teachers will provide a guided tour of the evening sky, featuring all five of the [visible planets](#) as well as [prominent stars & constellations](#) visible with the unaided eye. Binoculars and telescopes will be available for public observation of day and night sky phenomena, including sunspots (3:00 - 6:00 p.m.), the First Quarter Moon (day & night), planets, especially Jupiter and Saturn (beginning at twilight), and other night sky targets such as binary stars, star clusters, and galaxies.

Two formal workshops (reservations required) will be held at the Huntley Meadows Park Visitor Center:

- **4:00 - 6:00 p.m. - Making & Using an Equatorial Sundial/Real-Sky Solar Observation;** and
- **6:30 - 9:00 p.m. - Making & Using a Starfinder/Night Sky Observation**

Workshops are open to adults and families with children nine (9) years and older. Space may be infinite, but in this case, space is limited! For more information or to make reservations, contact Kitty Keller, FCPA Naturalist, at 703-768-2525.

Rain Date: Sunday, 28 April 2002

[Astronomy Day@HMP is part of the program, "Bringing Astronomy to the People"--the [Sandburg Planetarium](#) public outreach initiative for 2001-2002.]

Sandburg "Sun-Earth-Moon Day 2001"

In celebration of National Sky Awareness Week and Astronomy Week/Day,¹ the [Sandburg Planetarium](#) hosted "**Sun-Earth-Moon Day - Making the Sun-Earth Connection.**"²

On **Tuesday, 17 April 2001**, Charles Olin, President of the [Analemma Society](#), visited Carl Sandburg MS (CSMS) Grade Level 8 Science classes; he showed several types of sundials and explained how they work. The following day, students prepared for Sun-Earth-Moon Day by assembling the [Sandburg Sundial](#) (54k [PDF](#)), a customized ready-to-use horizontal sundial.³ On **Thursday, 19 April**, amateur astronomers from the [National Capital Astronomers](#) (NCA) and [Northern Virginia Astronomy Club](#) (NOVAC) visited Sandburg MS for a day of *safe* sunspot observing,⁴ sundialing, and Moon-watching. *Sincere* thanks to Andrew Seacord (NCA), John Avellone (NOVAC), and Charles Olin--at CSMS, we appreciate your spirit of volunteerism and willingness to share your expertise and enthusiasm for observational astronomy! And of course, thanks to the following Sandburg science teachers for allowing their classes to participate in the special event: Mr. Daugherty, Ms. Hayward, Ms. Long, Ms. Williams, and Ms. Wallace.

¹ [National Sky Awareness Week](#) (NSAW) was **April 22-28, 2001**; its theme was: "THE SKY - Where Meteorology Meets the Heavens and the Earth." This year, [Astronomy Week/Day](#) (AW/D) coincided with NSAW: **Astronomy Week** was **April 23-29, 2001**; **Astronomy Day** was **April 28th**. For the first time, Astronomy Day had a special theme: "Sun-Earth Day."

² The [Sandburg Center for Sky Awareness](#) prepared a special Web page of theme-related suggested teaching strategies, including pointers to electronic resources and classroom-ready activities: [Me and My Shadow - Making the Sun-Earth Connection](#).

³ **Editor's Note:** Experience has shown that an [equatorial sundial](#) is better suited for making connections between the Earth's rotation and solar time-keeping, as well as the Earth's revolution around the Sun and the annual cycle of change in the Sun's apparent path across the sky.

⁴ **Disclaimer:** ***NEVER*** look directly at the Sun, especially when using an optical device such as a camera, binoculars, or telescope--blindness may result! With the exception of the "Solar ProjectorScope" (which allows indirect viewing of the Sun's image), every telescope used during this event was equipped with a solar filter which permits only about 1/1000 of 1% of the incoming solar radiation to enter the telescope! Safely view near-real-time solar imagery (including sunspot imagery) by visiting the [SOHO Images](#) Web site ([SOlar and Heliospheric Observatory](#)).

(Storyboard reads left-to-right, top-to-bottom. Click on thumbnailed images for larger view.)



Andrew Seacord's large-aperture telescope (an 8-inch [Celestron](#) Schmidt-Cassegrain telescope equipped with a solar filter from [Orion Telescopes & Binoculars](#)) reveals spectacular detail in one of six large sunspots which were visible on S-E-M Day.



Students look through John Avellone's long-focus refractor telescope equipped with a metal-on-glass solar filter from [Orion Telescopes & Binoculars](#).

S-E-M Day Sidebar Activities

Students were reminded that the [Sun](#) is a [star](#) which radiates energy at all wavelengths of the [electromagnetic spectrum](#); some wavelengths of solar radiation, e.g., ultraviolet radiation, are hazardous to plants and animals. Students were introduced to the [UV Index](#) as a measure of the risk of overexposure to the Sun.

To help students get a better sense of the actual size of sunspots, they completed the sidebar activity, [Safely Estimating the Size of Sunspots](#). Many students were surprised to discover that the largest sunspot (visible during S-E-M Day) was approximately four-to-five times larger than the Earth's diameter!

The Waning Crescent Moon (16% illuminated) should have been visible in the day sky, but was invisible in the glare of the Sun (as the Moon wanes, the lighted portion of the Moon appears to grow smaller; it also appears to get closer to the Sun with each passing day until it is invisible during the New Moon phase). 8th grade students study [Moon phases](#) during the 4th quarter.



Mr. Avellone demonstrates the proper use of the "Solar ProjectorScope" which he built for the Sandburg Planetarium. This ingenious homemade telescope projects a 5-inch diameter image of the Sun inside a "dark box" enabling completely safe sunspot viewing. It works *very* well--many thanks, John!



Sandburg Planetarium Teacher Walter Sanford explains how to set up and use a horizontal sundial. Step 1 - Place the sundial on a horizontal surface and align it with [true north](#). Mr. Sanford focuses student attention upon his shadow...



...then he does the [hokey-pokey](#)... But seriously, folks! Mr. Sanford demonstrates the idea that if the Sun is rising in the east (right hand pointing toward Sun), casting shadows toward the west (left), then north must be generally in the direction in which he's facing (toward the building in the background).



Mr. Sanford guides a pair of students in the use of a compass...



...to more closely approximate the direction of true north (after compensating for [magnetic declination](#)). A properly aligned sundial shows **Standard Time** (after correcting for the longitudinal offset from the Standard Time Meridian, the [Equation of Time](#), and [Daylight Saving Time](#)).

Photographs courtesy Judy Kramer, Sandburg MS Enrichment Specialist.
Thumbnail images prepared using photoweb v1.2 by [Phil Wherry](#).

[More 2001 Photos](#) | [Sun "Block Party" 2000](#) | [Me and My Shadow](#) | [SCSA Home](#)

Space Day



[About](#)
[Contact](#)
[Home](#)

[Partners](#)

[News & Events](#)

[Students](#)

[Teachers/Event Planners](#)

The next Space Day is Thursday, May 6, 2004.

Founded by

LOCKHEED MARTIN 

[HOME](#)

[Telescope Making](#)

[Open Telescope Nights](#)

[Info](#)

[Star Dust Archive](#)

[Links](#)

National Capital Astronomers

[Our Mission Statement and Membership Application](#)

Serving science and society since 1937. The National Capital Astronomers (NCA) is a non-profit, membership supported, volunteer run, public service corporation dedicated to advancing space technology, astronomy, and related sciences through information, participation, and inspiration, via research, lectures and presentations, publications, expeditions, tours, public interpretation, and education. NCA is the astronomy affiliate of the Washington Academy of Sciences.



NCA has for many years published a monthly newsletter called *Star Dust* that is available for members. Besides announcement of coming NCA meetings and a calendar of monthly events *Star Dust* contains reviews of past meeting and articles on current astronomical events.

Monthly Meetings with Educational Presentations are Open to the Public with No Admission Charge

Next Meeting Date is Saturday, March 6, 2004

7:30 to 9:30 pm E.S.T. at the [University of Maryland Astronomical Observatory](#) in College Park, Md.

Our Special Guest for March Will Be Albert Holm, Ph.D. of the Computer Sciences Corporation

Speaking on The American Association of Variable Star Observers: A Bridge Between Amateurs and Professionals

About the Topic: Since its founding at the Harvard College Observatory in 1911, the AAVSO has provided a channel to deliver observations by amateur astronomers to their professional colleagues and to publicize data requests made by the professionals. This talk describes how the AAVSO provides these services and more today. It also discusses how recent technological advances - orbiting astronomical telescopes, digital computers, the Internet, automated sky surveys - have provided the AAVSO with both opportunities and challenges.

About Our Guest: After completing his Ph.D. at the University of Wisconsin with an analysis of the condensations in planetary nebulae, Albert Holm joined the Wisconsin team in running the Orbiting Astronomical Observatory-2 in 1970. He became a founding member of the operations team for the International Ultraviolet Explorer in 1977. In 1983 he transferred to the Space Telescope Science Institute, where he is now responsible for data processing operations. His research interests include white dwarfs and subdwarfs, dwarf novae, R CrB-type variables, and ultraviolet calibration and photometry. He was a member of the AAVSO Council from 1991 to 1999, and served as its president from 1995 to 1997.

Join Us for Dinner Before the Meeting

Join our special guest and club members for dinner at 5:30 p.m. in the Garden Restaurant in the [Inn and Conference Center University of Maryland University College](#) at University Blvd. and Campus Dr.

The restaurant is in the [West Wing Lobby Level](#).

About Our Meetings

Public transportation: contact [Elizabeth](#) if you need a ride from the Metro to dinner or to the Observatory.

Inclement weather: In case of severe weather (tornado/snow/impassable roads), a notice will be placed on the [UMCP Website](#) on the day of the meeting. (Be sure to shift-ctrl-reload to force your browser to reload.)

[Dining Establishments Near the UMCP Observatory](#)

NCA has regular monthly meetings September through June on the first Saturday of the month. (unless it is a holiday weekend). We do not have a monthly meeting in July or August.

[Some Past Meetings, by no means even most.](#)

NCA Members Open Telescope nights.

On some clear Friday and Saturday nights, members may observe with NCA's Celestron 14" SCT Telescope by appointment only. Contact member [Mike McNeal](#), 5410 Grove St, Chevy Chase, Near Friendship Heights Metro station. Must be willing to help with the setup. Call Mike McNeal 301.907.9449.

Telescope-Making and Mirror-Grinding Class

New: Telescope-making and mirror-making classes with Guy Brandenburg at the Chevy Chase Community Center, at the intersection of McKinley Street and Connecticut Avenue, NW, a few blocks inside the DC boundary, on the northeast corner of the intersection, in the basement (woodshop), on Fridays, from 6:30 to 9:30 PM. For information: To contact Guy, use this phone #: 202-262-4274 or gfbranden@earthlink.net.

For NCA information by E-mail or phone

- [Jay H. Miller](#), NCA President 301-530-7942 home, jhmiller@os2bbs.com
- [Jeffrey Guerber](#), NCA vice-president 301-614-5915 GSFC, 703-281-4980 home. jeff.guerber@gsfc.nasa.gov
- [Nancy Grace Roman](#), NCA secretary, 301-656-6092 home, ngroman@erols.com
- [Jeffrey Norman](#), NCA treasurer, [202]-966-0739 (home), jbnorman2@aol.com
- [Harold Williams](#), NCA web master, 301-650-1463 planetarium, 301-565-3709 home, Harold.Williams@montgomerycollege.edu.
- [Elliott Fein](#), NCA *Star Dust Editor* 301-762-6261 home, elliott.fein@erols.com.
- [Andrew W. Seacord, II](#), Trustee and former NCA President, [301]-805-9741 home.
- Wayne H. Warren, NCA Trustee and former NCA President w.h.warrenjr@att.net
- Gary Joaquin, NCA Trustee and former NCA vice-president [703]-750-1636,
- Glaydis Fuller, NCA Trustee
- [uaqa](#) understanding articulation quality assurance home of National Capital Astronomers web page. Check out their web publishing services and the other people and organizations using uaqa.com., also home to Astrolabes.org and Mestaffunion.org .

[HOME](#)

[Telescope Making](#)

[Open Telescope Nights](#)

[Info](#)

[Star Dust Archive](#)

[Links](#)

*Last modified 12:18PM EST 18 February 2004 by [Harold Williams](#)
before that by [John Settle](#) His personal website is [Urban Astro Images](#)*

Valid HTML
4.01!

Novac.com

The Northern Virginia Astronomy Club



Features



Real-Time Astronomy News

The Best of Novac

[Equipment Reviews](#)

[Nebula Filters](#)

[Astrophotography](#)

[Amateur Telescope Making \(ATM\)](#)

[Area Light Pollution Maps](#)

[Novac's Roboscope](#)

[More](#)

Welcome

[What's New?](#)

[About Novac](#)

[Meetings](#)

[Observing Sites](#)

[Public Viewing](#)

[Resources](#)

[Newsletters](#)

[Photos](#)

[Officers](#)

[Join](#)

[Contact](#)

[Member Login](#)



[Click for info](#)

Welcome to



Shenandoah Astronomical Society Middletown, Va

[Newsletter](#)

[Guest Book](#)

[Links](#)

[Photos](#)

[Admin](#)

[Home](#)

[Members](#)

[About](#)

[Calendar](#)

[Join](#)

[Contact](#)



Shenandoah Astronomical Society

The image at left is of Bill Cheng's new "TCT Telescope" A Tilted Component Telescope is the subject of Bill article in February's SAS Newsletter... Click on the Newsletter link below. The next regular meeting will be on Monday March 1st. Our own Dr. Barry Morrison, will present a program titled "The Eye as an Optical Instrument" Program begins at 7.30 PM THE SHENANDOAH ASTRONOMICAL SOCIETY meets at Lord Fairfax Community College, located on US RT. 11, in Middletown, Virginia

Highlights

- [....March Newsletter \(html\)](#)
- [....March Newsletter \(pdf file - better for printing\)](#)
- [....Mars Rovers! Spirit and Opportunity](#)
- [..SAS Clear Sky Clock!](#)
- [.Lord Fairfax Directions](#)
- [Local Astro Club Newsletters.](#)
- [Membership Application](#)
- [More Member Photos](#)
- [S & T News Briefs](#)
- [S & T Week's at a Glance](#)
- [SAS 's Favorite Web Pages](#)

You are visitor

190

Sandburg "Sun-Earth-Moon Day 2002"

In celebration of [Space Day](#), the [Sandburg Planetarium](#) hosted "Sun-Earth-Moon Day - [Making the Sun-Earth Connection.](#)"¹

On **Monday, 06 May**, amateur astronomers from the Maryland Sidewalk Astronomers (MSA), [National Capital Astronomers](#) (NCA), [Northern Virginia Astronomy Club](#) (NOVAC), and [Shenandoah Astronomical Society](#) (SAS) visited Sandburg MS for a day of *safe* solar observation,² sundialing, and Moon-watching. *Sincere* thanks to Neil Feldman (MSA), Andrew Seacord (NCA), John Avellone (NOVAC), and Bill Devlin (SAS)--at CSMS, we appreciate your spirit of volunteerism and willingness to share your expertise and enthusiasm for observational astronomy! And of course, thanks to the following Sandburg Grade 8 Physical Science teachers for allowing their classes to participate in the special event: Mr. Daugherty, Ms. Hayes, Ms. Hayward, Ms. Smetana, and Ms. Wallace.

¹ The [Sandburg Center for Sky Awareness \(SCSA\)](#) prepared a special Web page of theme-related suggested teaching strategies, including pointers to electronic resources and classroom-ready activities: [Me and My Shadow - Making the Sun-Earth Connection.](#)

² **Disclaimer:** *NEVER* look directly at the Sun, especially when using an optical device such as a camera, binoculars, or telescope--blindness may result! With the exception of the "Solar ProjectorScope" (that enables indirect viewing of the Sun's image), every telescope used during this event was equipped with a solar filter that permits only about 1/1000 of 1% of the incoming solar radiation to enter the telescope! Safely view near-real-time solar imagery (including sunspot imagery) by visiting the [SOHO Images](#) Web site ([SOlar and Heliospheric Observatory](#)).

³ **Editor's Note:** Experience has shown that an [equatorial sundial](#) is better suited for making the connection between the Earth's rotation and solar time-keeping, as well as the Earth's revolution around the Sun and the [annual cycle of change](#) in the Sun's apparent path across the sky.

(Storyboard reads left-to-right, top-to-bottom. Click on thumbnailed images for larger view.)



Mr. Sanford, Sandburg Planetarium Teacher, welcomes Sandburg MS Grade 8 Science students to Sun-Earth-Moon Day (S-E-M Day), introduces our guests, and reviews guidelines for safe solar observation and safe Sun exposure, warning students of the risk of blindness and overexposure to UV radiation.



John Avellone (left) and Andrew Seacord (right) make last-minute preparations while awaiting the arrival of the first classes....

Students visit with Bill Devlin, sundial enthusiast from Front Royal, VA. Our sincere thanks to Bill for travelling so far to share his expertise with FCPS students! Bill used a vast array of sundial stuff (covering two tables) to conduct demonstrations that helped to make abstract sundial theory more concrete and understandable--good show, Bill! For details, see [Sundialing with Bill Devlin](#).



Mid-morning, Sandburg students were joined by special guests from the [Stratford Landing ES \(SLES\)](#) Gifted & Talented Center. To prepare students for participation in S-E-M Day, Mr. Sanford visited Ms. Waller (upper left, center) and Ms. White's (upper left, right) team-taught Grade Level 6 class on Friday, 03 May. Students were introduced to basic sundial theory, and assembled two types of sundials: the [Sandburg Sundial](#) (54k [PDF](#)), a customized ready-to-use horizontal sundial; as well as an [equatorial sundial](#),³ courtesy NASA *Liftoff to Space Exploration*.

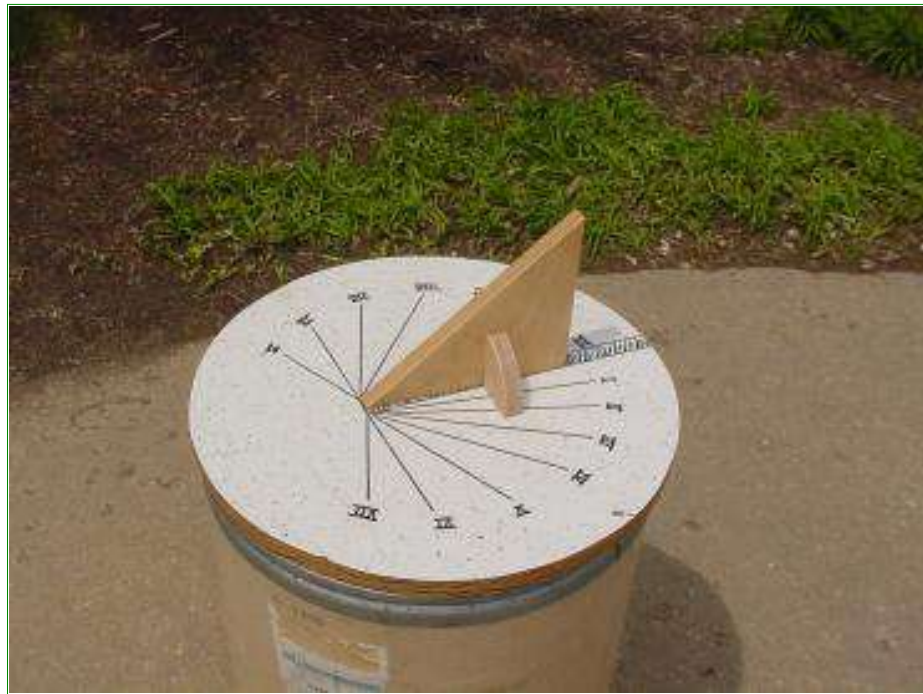

Mr. Devlin demonstrates how horizontal sundials actually work (above left & right). The [dial plate](#) must be horizontal (hence the name, "horizontal sundial"), and the [gnomon](#) (shadow caster) must form an angle equal to the latitude of the observer so that the [style](#) (top edge of the gnomon) is parallel to the Earth's axis. A properly aligned sundial shows **Standard Time**, after correcting for the longitudinal offset from the [Standard Time Meridian](#), the [Equation of Time](#), and [Daylight Saving Time](#).

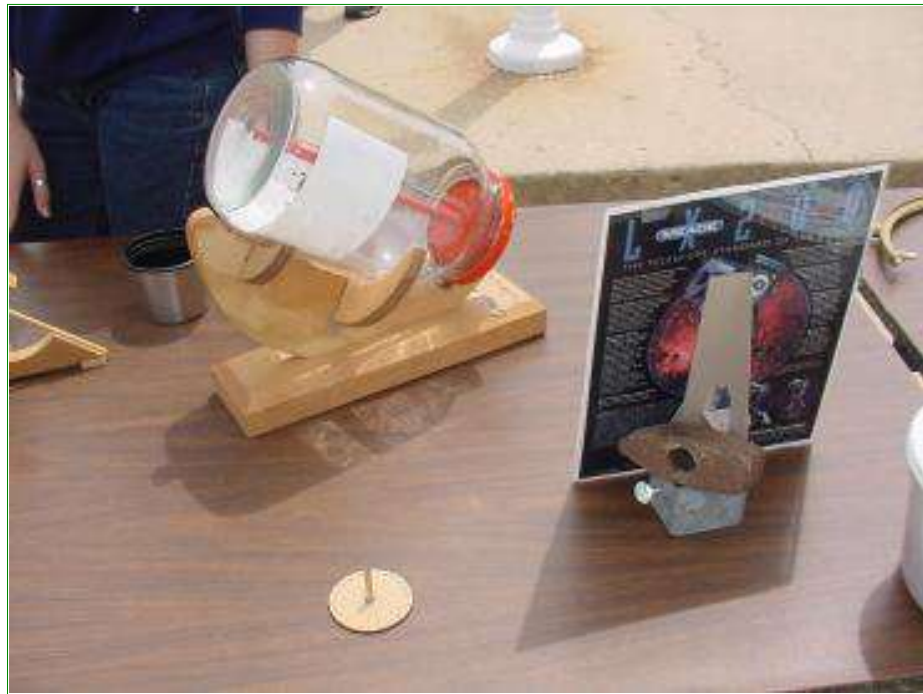

Bill demonstrates how a "pickle jar bowstring equatorial sundial" works (above left & right). The bowstring equatorial sundial is a close relative of the [equatorial sundial template](#) that SLES students assembled (see photos below). See firsthand a four-foot diameter bronze [bowstring equatorial sundial](#) by visiting the Garden of Time at Fairfax Memorial Park on Braddock Road, one mile east of George Mason University, Fairfax, VA.



With careful guidance from Bill & Eva Devlin (upper left), students put a little theory into practice by experimenting with the sundials they assembled....

Sidebar Activities



Hmmm, what's wrong with this picture? [Look Sun](#) is a [star](#) that radiates energy at [all wavelengths of the electromagnetic spectrum](#); some wavelengths of solar radiation, e.g., ultraviolet radiation, are hazardous to plants and animals. Students were introduced to the [UV Index](#) as a measure of the risk of overexposure to the Sun. A UV Index [Solarmeter](#) (courtesy [EPA SunWise School Program](#)) was used to measure the UV Index periodically during the day.

Hmmm, what's wrong with this picture? [Look Sun](#) is a [star](#) that radiates energy at [all wavelengths of the electromagnetic spectrum](#); some wavelengths of solar radiation, e.g., ultraviolet radiation, are hazardous to plants and animals. Students were introduced to the [UV Index](#) as a measure of the risk of overexposure to the Sun. A UV Index [Solarmeter](#) (courtesy [EPA SunWise School Program](#)) was used to measure the UV Index periodically during the day.

second, notice that the dial face itself is incorrectly numbered--Houston, we have a problem! [Please notify the responsible [NASA Webmaster](#).] That said, if the equatorial sundial upper dial face were properly numbered (as it is on the [Northern Hemisphere](#) template), with 6 a.m. on the right side of the dial face, 6 p.m. on left, and the correct numbers shown between 6 a.m. and 12 noon, then the time would read approximately 10 a.m.--about the same time shown by the horizontal sundial!

All students were reminded that the [Sun](#) is a [star](#) that radiates energy at [all wavelengths of the electromagnetic spectrum](#); some wavelengths of solar radiation, e.g., ultraviolet radiation, are hazardous to plants and animals. Students were introduced to the [UV Index](#) as a measure of the risk of overexposure to the Sun. A UV Index [Solarmeter](#) (courtesy [EPA SunWise School Program](#)) was used to measure the UV Index periodically during the day.

SLES students used a tape measure and the [SCSA Object Height Calculator](#) to calculate the height of the tallest flagpole in front of Sandburg MS.





Andrew Seacord's large-aperture telescope (upper left), an 8-inch [Celestron](#) Schmidt-Cassegrain telescope equipped with a solar filter from [Orion Telescopes & Binoculars](#), reveals spectacular detail in the many large sunspots that were visible on S-E-M Day (the daily sunspot number was 317!). Interested students have a blast (my apologies, I couldn't resist!) learning about solar science from Mr. Seacord, a semi-retired professional astronomer.

Avid telescope builder John Avellone does double-duty, manning two telescopes: NOVAC's 70mm f/10 equatorial-mounted motor-driven refractor telescope fitted with the [Coronado Instruments](#) "SolarMax" Hydrogen alpha (H alpha) filter for safely viewing the Sun's chromosphere and solar prominences (black & gold telescope shown right, left side of picture); and a homemade 6" f/8 solar telescope (based upon John Dobson's original solar telescope design) that enables completely safe viewing of the entire solar disc and all visible sunspots (right, center).



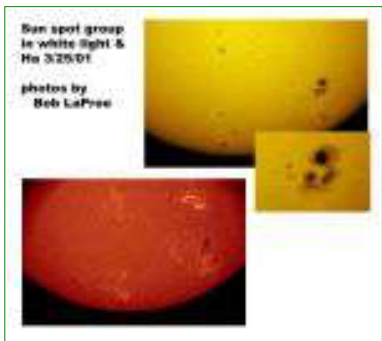

John Avellone adjusts a solar telescope equipped with a [Coronado Instruments](#) H alpha filter, enabling students to observe spectacular views of solar prominences similar to the ones shown in the photographs above (images courtesy [Coronado Instruments](#) Image Gallery).

The H alpha filter isolates a one-Angstrom (0.1 Micron) region of the optical spectrum, centered on a wavelength of 6563 Angstroms (deep red). By looking only at this wavelength of light, contrast with the sky (which does not emit H alpha light) is maximized. Hence, the glowing hydrogen gas prominences streaming out from the solar limb are visible. Further, because of the narrow spectral passband of the filter (slightly less than 1 Angstrom), features generated by the motions of hydrogen gas in the photosphere, the outer layer of the Sun, also can be seen. See near-real-time H-alpha imagery by visiting the [Latest Images](#) Web page, courtesy [Big Bear Solar Observatory](#).



Upper left (two pictures): A group of Ms. Wallace's students listen intently as Mr. Sanford explains how the ingeniously simple design of the Dobsonian solar telescope enables safe solar observation. Sunlight enters the telescope through a two-way mirror (most of the incoming sunlight reflects off the surface of the mirror before entering the telescope) and travels the length of the telescope before it "reflects" off the surface of a large, unsilvered mirror at the bottom of the tube. Light then travels back up the length of the telescope and is redirected into a low power eyepiece (near the top of the tube) after passing through a No. 10 welder's glass. Simple. Inexpensive. Completely safe!

Upper right: A young woman looks through the Dobsonian solar telescope (center) while Mr. Neil Feldman shares his enthusiasm for firsthand observation of astronomical phenomena such as sunspots. Meanwhile, Mr. Sanford (far right) realigns the "Solar ProjectorScope" for the next group of observers. This ingenious homemade telescope, designed & built by John Avellone for the **Sandburg Planetarium**, uses a repurposed "department store" telescope to project a 5-inch diameter image of the Sun inside a "dark box" enabling completely safe sunspot viewing.



Mr. Feldman realigns the Dobsonian solar telescope with the Sun. Because the Earth rotates, manual telescopes must be realigned frequently to keep the observing target within the telescope's field of view.

Our sincere thanks to Mr. Feldman for generously donating to the **Sandburg Center for Sky Awareness** the Dobsonian solar telescope (shown left, center), actually constructed by John Dobson, reknowned amateur astronomer and founder of the San Francisco Sidewalk Astronomers.



The experts agree, your first telescope should be a good pair of binoculars! Students take turns using an inexpensive pair of Tasco 10x50 binoculars, tripod-mounted for stability, to observe the Waning Crescent Moon (28% of the Moon's visible disk illuminated). In the glare of the Sun, the Moon showed very little contrast, making it difficult to see otherwise obvious lunar surface features such as prominent craters. By midday, Moon-watching was a washout! Grade Level 8 Science students study astronomy and Moon phases during the 4th quarter.

For more information regarding observational astronomy, visit the **SCSA** Basic Tools of the Skywatcher/Amateur Astronomer Web page.

Photographs courtesy Judy Kramer, Sandburg MS Enrichment Specialist,
and Petra Pair, Sandburg School-Based Technology Specialist.
Thumbnail images prepared using photoweb v1.2 by [Phil Wherry](#).

[All 2002 Photos](#) | [Sundialing...](#) | [S-E-M Day 2001](#) | [Sun "Block Party" 2000](#) | [SCSA Home](#)

*Sandburg Center for Sky Awareness
A Fairfax County Public Schools Planetarium*

* * * **Sun-Earth-Moon Day 2001** * * *
Sandburg Sun "Block Party" 2000

On **Wednesday, 03 May 2000**, amateur astronomers from the [National Capital Astronomers](#) (NCA) and [Northern Virginia Astronomy Club](#) (NOVAC) visited Carl Sandburg MS for a day of *safe* sunspot observing through a variety of telescopes. [Originally planned as part of the SCSA's [local observance of National Sky Awareness Week](#) (April 23-29, 2000), inclement weather forced us to reschedule the event several times.] Special thanks to Andrew Seacord and Ed Witkowski, Outreach Coordinators for NCA and NOVAC (respectively), and NOVAC members John Avellone and Bob Kwartin--at CSMS, we *sincerely* appreciate your spirit of volunteerism and willingness to share your expertise and enthusiasm for observational astronomy!

Students prepared for the day of sunspot observing by completing an in-class activity, [Happy Birthday Sunspot Plot - Sunspots and the Solar Cycle](#), a NASA [Thursday's Classroom](#) activity adapted by Walter Sanford, SCSA Director. By graphing the past 14 years of annual sunspot numbers, students discovered the 11-year solar cycle which peaks in 2000-2001.

Disclaimer: ***NEVER*** look directly at the Sun, especially when using an optical device such as a camera, binoculars, or telescope--blindness may result! With the exception of the "ProjectorScope" (which allows indirect viewing of the Sun's image), every telescope used during this event was equipped with a solar filter which permits only about 1/1000 of 1% of the incoming solar radiation to enter the telescope! Safely view near-real-time solar imagery (including sunspot imagery) by visiting the [SOHO Images](#) Web site ([Solar and Heliospheric Observatory](#)).

(Storyboard reads left-to-right, top-to-bottom. Click on thumbnailed images for larger view.)



CSMS Principal Donna Pasteur and SCSA Director Walter Sanford welcome members of NCA and NOVAC. Shown left-to-right: Ed Witkowski, John Avellone, Donna Pasteur, Bob Kwartin, Walter Sanford, and Andrew Seacord.



In preparation for a full day of sunspot observing, NCA President Andrew Seacord sets up and tests his equipment (including an 8-inch [Celestron](#) Schmidt-Cassegrain telescope equipped with a solar filter from [Orion Telescopes & Binoculars](#)).



Further preparation as Ed Witkowski checks out his [Televue Pronto](#) 70mm refractor telescope (equipped with a [Solarscreen](#) solar filter)...



...while Bob Kwartin manually aligns his [Celestron C90](#) hybrid spotting scope/telescope (equipped with a [Thousand Oaks](#) form-fitting glass solar filter).



Before making introductions and handing-off to the guest speakers, event coordinator Walter Sanford greets Ms. Long's class (one of five Grade Level 8 science teachers whose classes participated in the event), providing an overview of the lesson plan, discussing *safe* solar observation...



...as well as the [UV Index](#) and the risk of overexposure to [ultraviolet radiation](#) from the Sun. Thanks to Mr. Daugherty, Ms. Hayward, Ms. Long, Ms. Williams, and Ms. Wallace for allowing their classes to participate in the event!



John Avellone shows students several devices which may be used for safe solar observation, such as a No. 14 welder's glass (left hand), [Eclipse Shades®](#), or special telescope solar filters. Next, Mr. Avellone provided a clear, concise explanation of telescope design...



...then the group moved to the telescopes for direct observation of sunspots.



Telescope builder John Avellone aligns his ingenious homemade "Solar Projector Telescope" (built around a "department store" 50mm refractor telescope) which projects a small image of the Sun inside a "dark box" enabling...



...completely safe sunspot viewing by small groups of students. The 5-inch diameter image of the Sun is magnified 43 times.

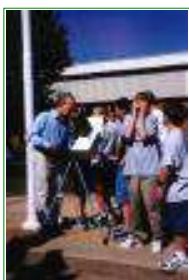

Another group of students look at the "Solar Projector Telescope" while a young man tests a pair of Mr. Avellone's [Eclipse Shades®](#). Don't be fooled by their similar appearance--these glasses are not simply mirrored sunglasses!



Ms. Pasteur looking radiant as she looks at the Sun through a pair of [Eclipse Shades®](#).



Mr. Sanford and Bob Kwartin watch as a student peers through Bob's telescope (foreground) while Ms. Pasteur learns about the cycle of solar activity from retired professional astronomer Andrew Seacord (background).



Mr. Seacord's large-aperture telescope reveals spectacular detail in an especially large cluster of [sunspots](#) near the solar limb (the edge of the disk of the Sun). The daily sunspot number for 03 May '00 was 76.



Groups of students patiently wait their turn...



...to look through each telescope...



...as Ms. Pasteur makes the rounds of all of the telescopes too.



Ms. Long watches as one of her students discovers the lesson learned by all participants: there's more than meets the eye to the little yellow ball in the sky!

Photographs courtesy Judy Kramer, Sandburg MS Enrichment Specialist.
Thumbnail images prepared using photoweb v1.2 by [Phil Wherry](#).

[Sun-Earth-Moon Day 2001](#) | [SCSA Home](#) | www.wsanford.com

"The stars are too many to count.
The stars make sixes and sevens.
The stars tell nothing--and everything.
The stars look scattered.
Stars are so far away they never speak when spoken to."

- *Stars*, Carl Sandburg

Visit the [Sandburg Sky Poetry](#) Web page, including CSMS student-authored sky poems.

Themes for 2001-2002

- [Increasing Your Sky Awareness](#)
- [Sun-Earth Connection](#)
- [Rays Awareness™](#)
- [Tracking Satellites](#)
- [GPS - The New North Star](#)



Use a [sundial](#) to measure Solar Time. Get the current Standard Time from [The Official U.S. Time](#) Web page.

Learn more about [sundials](#)...



Sandburg Center for Sky Awareness



A Fairfax County Public Schools Planetarium [Walter Sanford](#), Director

[Carl Sandburg Middle School](#)

[8428 Fort Hunt Road, Alexandria, VA 22308](#)

[38.7257° N, 077.0643° W](#)

Phone: 703-799-6169

FAX: 703-799-6197

[Scheduling](#) | [Site Visits](#) | [Planetarium Visits](#)

SCSA Impacted by FCPS FY2003 Budget Cuts

As a result of external budget cuts by Fairfax County Public Schools and internal staffing decisions by the Sandburg MS Principal, the Sandburg Planetarium will be open part-time (afternoons only) during the 2002-2003 school year. After-school and evening programs, including programs for community groups (private schools, PTAs, civic associations, boy & girl scout troops, etc.), have been discontinued. The **Sandburg Center for Sky Awareness** Web site is forced to go into a "dormant state," effective 25 July 2002 until further notice. Our Web presence isn't going away, however what you see is what you get--the SCSA Web site cannot be updated regularly unless full-funding is restored for the FCPS Planetarium Program. The SCSA Director regrets any inconvenience these actions may cause.

"SUNday in September" - Huntley Meadows Park



Sunday, 29 September 2002, the Sandburg Planetarium Teacher and volunteers from the Northern Virginia Astronomy Club ([NOVAC](#)) collaborated to host "SUNday in September," a day of informal day-sky observation (including safe solar observation and sundialing). Special thanks to the following NOVAC members for generously volunteering to share their expertise and enthusiasm for observational astronomy: John Avellone, Rob Garrett, Mike Lewis, Alex Lim, Rob McKinney, and Gary Shell. See [photos](#) highlighting this special event, courtesy Phil Wherry, NOVAC. [Note: Scheduled long before FCPS's short-sighted decision to cut its planetarium program by half, "SUNday in SEP" was the SCSA's last official public outreach event until full-funding for the program is restored.]

NASA Sun-Earth Day - 20 March 2002 *Celebrate the Equinox and the Seasons*

[Me and My Shadow - Making the Sun-Earth Connection](#) - an SCSA Web page of theme-related resources and classroom-ready activities

Sandburg ["Sun-Earth-Moon Day 2002"](#) - a special report highlighting Sandburg Planetarium's local celebration of National Sky Awareness Week and Astronomy Week/Day

[The Year in Review](#) - A Special Report

Highlighting the Activities of the Sandburg Center for Sky Awareness for 2001-2002

Sandburg ["Sun-Earth-Moon Day 2002"](#) - A Special Report Highlighting Sandburg Planetarium's local celebration of Space Day

["Wildcats" Spotted Scopin' Sunspots!](#) - Highlights of Woodlawn ES Grade Level 4 visits to the Sandburg Planetarium

["Explorers" Explore Exploration](#) - A Special Report Highlighting the educational outreach initiative between the Explorers Club Washington Group and Sandburg MS

And the [survey](#) says...

The Sandburg Center for Sky Awareness cross-curricular sky poetry unit was featured in the **12 April 2000** episode of "Meet the Author" on [Fairfax Network](#) (special thanks to producer Sandra Brennan!). For more information about this innovative unit, read ["The Sky Touches Everyone,"](#) an article that appeared in the May 1998 issue of ["Apple,"](#) the FCPS professional magazine.



[Meet the Author](#)
QuickTime movie
(6.9 MB)



Last [updated](#) 25 Jul 2002





**For more information:
Click Here!**

Observed at: Washington, DC

[Click For Forecast!](#)

Updated at 51 minutes past the hour. Click "Reload" for the most up-to-date information.



Sundials on the Internet

For a full overview [click here](#)

Books on Sundials

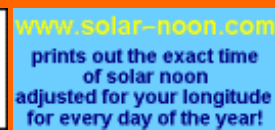

<p>Search:</p> <p>Keywords:</p> 	<p>You can order many of these books online using the links in the list below with amazon.com and amazon.co.uk. Other books on sundials, together with books on any other subject, CDs and music can be ordered using the links at the head of this page. Every book you order this way helps us build "Sundials on the Internet" to serve you even better!</p>
---	---

Search for books etc on: [Astrolabes](#) • [Equinox](#) • [Solstice](#) • [Time](#) • [Ancient Civilizations](#)

Sundial books in print - English

These books are likely to be in print. The prices given may be out of date and do not include postage. We will be updating this information so it is easy for you to order these books if you want them. Additions or corrections to this list are welcome. Please [E-mail](#) us.

Recent additions to the list are indicated with **NEW**

Please mention "Sundials on the Internet" if you make contact with any of these sundial publishers.

Sundials by C St J H Daniel

(Shire Album no. 176), Shire Publications, Princes Risborough, HP17 9AJ, UK, 1986, 32pp with 50 illustrations and 3 diagrams. A very good general introduction to sundials. £1.75(?) [Order this book today!](#)

Sundials - History Theory and Practice by Rene' RJ Rohr

(translated by Gabriel Godin from "Les Cadrans Solaires") Dover Publications, 31 E 2nd. St., Mineola, NY 11501, USA, 176 pp, \$11.95 plus 20% for postage/ packing.

[Order this book today! \(USA\)](#) [Order this book today! \(UK\)](#)

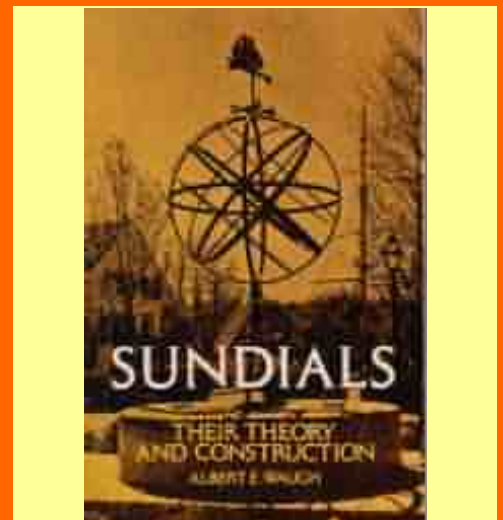
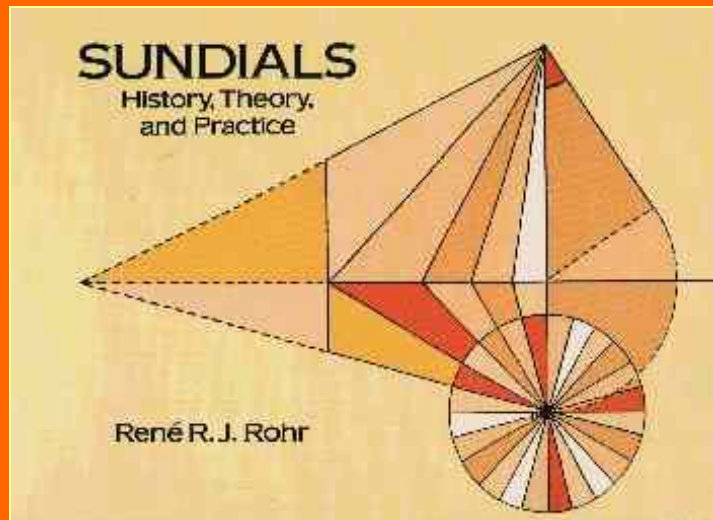

Sundials - Their Theory and Construction, by Albert E Waugh

Dover Books, London/ NY, 228pp, ISBN 0 486 22947 5, £5.95. A very comprehensive guide to all aspects of dialling
[Order this book today \(USA\)](#) [Order this book today! \(UK\)](#)

Easy-to-make Wooden Sundials by Milton Stoneman

Dover Publications, 31 E 2nd. St., Mineola, NY 11501, USA, 64 pp, \$3.95 plus 20% for postage/ packing.
[Order this book today! \(USA\)](#) [Order this book today! \(UK\)](#)

A Hand Guide to Astronomical Observatory of Jaipur

Piyush International, 366 Indira Bazar, Jaipur, India, 1997 (2nd edition), 40 pp with 22 coloured photographs.
Comprehensive description of all the instruments on this very interesting sundial site and of its construction by Maharaja Sawai Jai Singh in between 1727 and 1743.

The Art of Sundial Construction by Peter Drinkwater

P. Drinkwater, 56 Church Street, Shipston-on-Stour, Warwick, UK, 1985. A geometrical approach to the calculation of many kinds of dials. 84pp. ISBN 0 946643 09 1

Astronomical Observatory of Jaipur, India by Daulat Singh

Delta Publications, "Die Festung", Jai Ambay Nagar, Tonk Road, Jaipur, 1981. Describes the extensive collection of sundials and other instruments laid out as a huge outdoor observatory by Sawai Jai Singh in the early 18th century, including the Samrat Yantra (king of all instruments) constructed of masonry with a gnomon 90 feet high, which enables the local time to be determined to within 2 seconds. 34pp.

A Celebration of Cornish Sundials by Carolyn Martin

Dyllansow Truran, Trewolsta, Trewirgie, Cornwall, UK, 1994. Includes a list of Cornish sundials and a map of where to find them, and chapters on history, and types of sundials and the mathematics. Many line drawings. 48pp. ISBN 1 85022 071 9
[Order this book today!](#)

Cambridge Sundials by Alexis Brookes and Margaret Stanier.

Pendragon Press, Papworth Everard, Cambridge. Colour photographs and full descriptions of 19 sundials in the city of Cambridge and 4 nearby. 56 pp

A Dozen Dials by PH Ransom NEW

PH Ransom, 29 Rufus Close, Southampton SO16 8LR, 1998. A book about sundials connected with mathematics and its history. 56pp. with illustrations. £7 incl. postage and packing.

Hampshire Sundials

POBox 292, Epsom, Surrey KT17 4YP, UK, 1996, 16pp with 32 A5 colour photographs plus map showing location of the dials £13.00 (incl p&p Europe) add £3 for other countries.

The Inequalities of Sundial Time by Dr. Eilon Soroka NEW

Dr. Eilon Soroka, 36 Bilu Street, Rishon LeZion 75321, Israel. 1st edition, 1999, Rishon LeZion, ISRAEL 294pp, 55 tables, 37 graphs, 28 b/w figures, 32 b/w illus., \$95 + P & P

Make a Sundial by Jane Walker et al.

British Sundial Publications, 55 Sevenacres, Somerton, Somerset, UK, 1991, 70pp, £5. Written for schools, but is also a very good practical introduction for a novice wishing to make sundials, and to understand their making.

Making a Clock-Accurate Sundial customized to your location, by Sam Muller NEW

Naturegraph Publishers Inc. 3543 Indian Creek Road, Happy Camp, CA 96039, 58 pp, 1997. A practical guide for making your first sundial, with step-by-step instructions and clear diagrams (See [review](#)) [Order this book today! \(UK\)](#)

Maltese Sundials by Paul I. Micallef

Sapiensam Bookshop, Republic Street, Malta, 1994. A complete survey of the designers of Maltese sundials and 60 black-and-white photographs with text of sundials in Malta. 125pp.

Oxford Sundials by Margaret Stanier

Somerville College, Oxford. Colour photographs of 15 sundials with full descriptions. 36pp

SUNCLOCKS - Paper Sundials to Make and Use.

JVT Publications, 5549 Camus Rd, Carson City, NV 89701, USA, ISBN 1-893812-51-0, \$12.95 A very useful introduction to sundials with 8 cut-out projects to make a sundial for different latitudes in the USA (See [review](#))

Suffolk Sundials by John Davis

POBox 292, Epsom, Surrey KT17 4YP, UK, 1997, A4, 20pp with 32 colour photographs plus map showing location of the dials £15.00 (incl p&p Europe) add £3 for other countries.

Sundials by Frank W Cousins

Pica Press, New York City, 1970. A very comprehensive work on gnomics, giving the history, theory and lay-outs of all types of sun dials, including dialling scales, moon dials, self-compensating dials, Wheatstone dials, etc.

Sundials by R N and M W Mayall

Sky Publishing Corp, Cambridge, Mass, 1989, 250pp, £10. Comprehensive, and with a rather different approach to Waugh

Sundials Australia, by Margaret Folkard and John Ward

Sundials Australia, 3, Bedford Street, Kensington Park, South Australia 5068, 1996, 113 pages, A4 size, 90 black and white photographs and 100 line drawings. This authoritative book includes relevant facts about the Earth, Sun and stars, and the various types of sundial, and the relationship between sun and clock time. Formulae for calculating hour lines are clearly listed. The blackness and sharpness of shadows is discussed. There is also a collection of mottoes, a dictionary of sundial terms, and a list of references. Price \$A20 plus \$A9 overseas postage. (This book is also available from the British Sundial Society)

Sundials and Timedials, by Jenkins and Bear

Tarquin Publications, 1987, 15pp with 8 models ISBN 0 906212 59 6 [Order this book today! \(UK\)](#)

Sundials of East Sussex by Michael Lowne

POBox 292, Epsom, Surrey KT17 4YP, UK, 1997, A4, 16pp with 19 colour photographs plus map showing location of the dials £15.00 (incl p&p Europe) add £3 for other countries.

Time and the Sundial by Carole Vincent, 1988

Philips and Co, High Street, Crediton, Devon, UK, 24pp, 99p. A simple and clear exposition of the different types of sundials, of sun time and clock time, and of how to set up a horizontal sundial. Also a description of the Armada dial in Plymouth - the biggest horizontal dial in Britain.

Search for other books etc on: [Sundials](#)

Search for books etc on: [Astrolabes](#) [Equinox](#) [Solstice](#) [Time](#) [Ancient Civilizations](#)

Please mention "Sundials on the Internet" if you make contact with any of these sundial publishers.

Sundial books - French

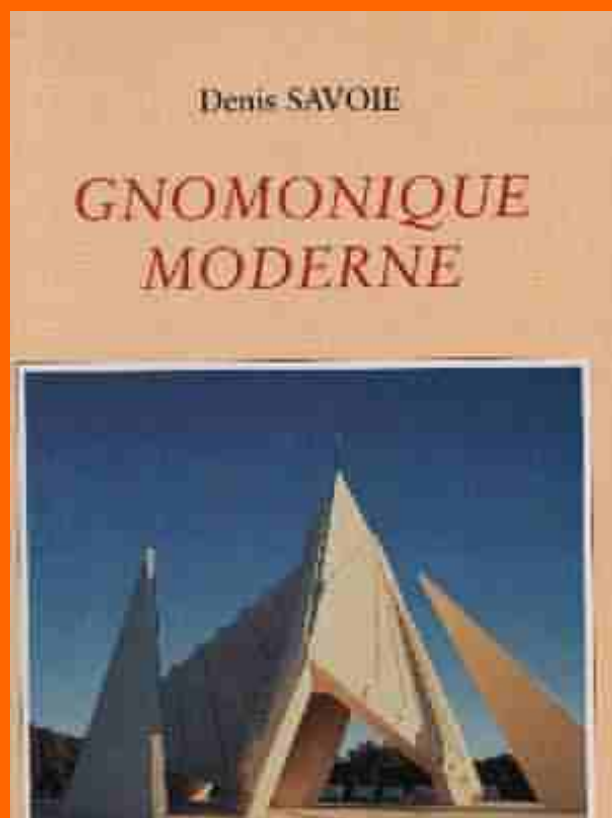

Cadran Solaires de la Sarthe par Paul Deciron NEW

Petit Patrimoine Sarthois, 2 rue des Maillets, 72072 Le Mans, France, 1996. A5, 75pp including many black-and-white photographs. This book gives a lot of background on sundials, together with a list of some 100 sundials in the departement of the Sarthe centred on Le Mans.

Cadran Solaires de Paris by Andrée Gotteland & Georges Camus NEW

CNRS Editions, 15 rue Mallebranche 75005 Paris, France, 224 pages, ISBN 2-271-05533-4, Lists 190 sundials in Paris classified by district, together with much other sundial information.

Cadran Solaires des Alpes by Pierre Putelat and Paul Gagnaire

P. Putelat, Molines-en-Queyras, 05350 France. ISBN 2-9505792-5-6

Calcul astronomique pour amateurs by S.Bouiges NEW

(Masson, 1982) ISBN 2-225-78265-2. It contains a very useful section : calcul d'un cadran solaire plan.

Gnomonique Moderne par Denis Savoie NEW

Societe Astronomique de France, 3 rue Beethoven, 75016 Paris France. ISBN 2-901730-05-1, 252 pp., 1997 This book is addressed to all those interested in sundials. It deals with the mathematical calculation of sundials with numerous worked examples. It presents the complete theory of sundials including some aspects ignored in the classical texts. There is also a complete bibliography of sundial articles and books in French.



Les cadrans solaires Vaudois par Christophe Galluz **NEW**

Payot, Lausanne, 1987. ISBN 2-601-03035-6. 31 pages of text and 80 pages of photographs (some in colour) of sundials from the canton Vaud (centred on Lausanne in Switzerland).

L'heure au soleil - Cadrans solaire de Franche Comté by F.Suagher, P.

Perroud, JP Marchand **NEW**

Librarie CETRE, 17 Grand Rue, F-25000 Besancon, 1991. ISBN 2-901040-95-8 128 pages FF220+37 postage 100 coloured photographs and drawing of sundials in Eastern France near Besançon. Historical patrimony, curiosities, popular art and location of 230 sundials.

Sundial books - German

Literaturhinweise (deutschsprachig)

Deutsche Gesellschaft für Chronometrie : 'Sonnenuhren - Handbuch',

Manuskriptform, 218 Seiten, DIN A4, Bezug : DGC, Ziererweg 8, D-71254 Ditzingen.

Groh-Karten Bibliothek, 'Sonnenuhren',

18 arbeitspostkarten mit einem Vorwort von Jutta Metz, Fotokunst-Verlag Groh, Wörthsee bei München

Philipp/Roth/Bachmann : 'Sonnenuhren - Deutschland und Schweiz', Katalog der ortsfesten Sonnenuhren,

Herausgeber : Deutsche Gesellschaft für Chronometrie, 750 Seiten, 16,5 x 24 cm, Bezug : DGC, Ziererweg 8, D-71254 Ditzingen.

Rohr René R. J. : 'Die Sonnenuhr', Geschichte, Theorie, Funktion.

Verlag Callwey München, 1982, 215 Seiten, 26 x 29 cm, ISBN 3-7667-0610-1

Schaldach Karlheinz : 'Römische Sonnenuhren', Einführung in die antike Gnomonik,

Verlag Harri Deutsch Thun und Frankfurt am Main, 123 Seiten, 15 x 21 cm, ISBN 3-8171-1537-7

Schilt Heinz : 'Ebene Sonnenuhren', Sonnenuhren verstehen und planen - berechnen und bauen.

1985. 128 Seiten, 15 x 21 cm, Bezug : Heinz Schilt, Dorfstr. 24, CH-3506 Grosshöchstetten/BE/Schweiz.

Schumacher Heinz : 'Sonnenuhren 1', Gestaltung, Konstruktion, Ausführung.

Verlag Callwey München, 3. Auflage 1984, 173 Seiten, 21 x 26,5 cm, ISBN 3-7667-0725-6

Schwarzinger Karl, 'Katalog der ortsfesten Sonnenuhren in Österreich',

Herausgeber : Österreichischer Astronomischer Verein, Wien 1993, 144 Seiten, 23,5 x 16,5 cm, Bezug : Karl Schwarzinger, Tiglsweg 76a, A-6073 Sistrans/österreich, Tel u. Fax : 0043 / 512 / 378868, Email : k.schwarzinger@tirol.com.

Zenkert Arnold : 'Faszination Sonnenuhr',

Verlag Harri Deutsch Thun und Frankfurt am Main, 2. Auflage 1995, 167 Seiten, 21 x 24 cm, ISBN 3-8171-1386-2

Sundial books - Italian

La Meridiana di Piazza Vecchia in Bergamo **NEW**

Text Gianfranco Alessandretti, Photography Domenico Luchetti, Editore Lucchetti - Bergamo - Italy. 47 pp with colour photographs. Full historical, technical and gnomonical treatment; The history of the word "Analemma"; The measurement of time. Price: Lit 8,000

Meridiane - le tecniche. **NEW**

Ed Demetria Srl, via del lavoro 52 - loc Ferlina, 37012 Bussolengo (Vr), Italy. Linda Perina e Renzo Zanoni et al. 95 pp with colour photographs. Excellent "How-to" treatment, with 20 articles on the history of sundials and the nature of time plus 11

articles on the practicalities of constructing a Sundial. Price: Lit 13,000

Meridiane e Orologi Solari di Bologna e Provincia

G. Paltrinieri, via Giuseppe Dozza n. 3, 40139 Bologna, Italy.

Meridiane e Orologi Solari d'Italia

G. Paltrinieri, via Giuseppe Dozza n. 3, 40139 Bologna, Italy. 275 pp with colour photographs. Full historical, technical and gnomonical treatment. Price: Lit 120,000 (about USD \$70). Orders by mail only

Meridiane in Provincia di Asti

Amministrazione Provinciale di Asti, 1992 (57 pp)(out of print)

Orologi solari - Trattato completo di gnomonica by Girolamo Fantoni

Technimedia, Rome 1988 (ISBN not listed).

Orologi Solari a Taggia

Mario Arnaldi, Viale Leonardo 82, 48029 Lido Adriano, RA, Italy, Lit15,000

"Segnali di tempo - Meridiane in Provincia di Cuneo" by Davide Dutto e [Lucio Maria Morra](#) **NEW**

(Via Craveri, 45 - 12045 Fossano (CN) - Italy) L'Arciere-Blu Edizioni, Cuneo 1996 (144 pp, Lit.84,000).



Sundial books - Spanish



"Relojes de sol.Historia,Funcionamiento,Construcción"ISBN:84-315-2070-1 by Gian Carlo Pavanello & Aldo Trincherro

NEW

Precio: 2.890 pts. 189 paginas Editorial De Vecchi, S. A. 1998 Balmes,247. 08006 BARCELONA

Diseño y Construcción de Relojes de Sol y de Luna by Rafael Soler **NEW**

Colegio de Ingenieros de Caminos, Canales y Puertos, Carrer Convent de Sant Francesc 10-1er, 07001 Ciutat de Mallorca, Spain, Ptas 6,300 + 1,231 postage in Europe

Relojes de Piedra en Galicia

JL Basanta Campos

We would [welcome additions](#) to these book lists, particularly books in German, French, Spanish, and other languages

For a full overview of Sundials on the Internet [click here](#)
This site designed and maintained by [Internetworks](#) Ltd of [Epsom](#), England
first posted 1996 last revision
Comments/ suggestions/ problems, please get in touch with the [Webmaster](#)

Sundials on the Internet

For a full overview [click here](#)

How to join your national sundial society

List of national sundial societies

Austria -

[Arbeitsgruppe Sonnenuhren](#) - (Gnomonicae Societas Austriaca) - [Austrian Sundial Society](#)

Sonnenstrasse 24, A-6800 Feldkirch, Austria

Belgium - [Zonnewijzerkring Vlaanderen](#) - Belgian Sundial Society

Oeverstraat 12, B-9150 Rupelmonde, Belgium

[British Sundial Society](#)

4 New Wokingham Road, Crowthorne, Berkshire, RG45 7NR Tel 01 344 772 303 douglas.bateman@btinternet.com

Catalonia, Spain - [Societat Catalana de Gnomonica](#) - Catalan Sundial Society

Centre d'Estudis del Rellotge de Sol, Atenes 3, 08006 Barcelona, Catalunya, Spain.

France - [Commission des cadrans solaires](#) of the Société Astronomique de France

3, rue Beethoven, 75016 Paris, France

Hungary - Hungarian Sundial Society

Contact details not known

Italy - [Guppo Milanese Quadranti Solari - GQMS](#) - The Milan Sundials Group

Netherlands - [De Zonnewijzerkring](#) - Dutch Sundial Society

van Gorkumlaan 39, 5641 WN Eindhoven, Netherlands

North America - [North American Sundial Society \(NASS\)](#)

8 Sachem Drive, Glastonbury, CT 06033 USA

Quebec - [Commission des cadrans solaires du Quebec](#)

42 av. de la Brunante, Outremont (Montreal), Quebec H3T 1R4 Canada

Spain - [Asociacion Española de Amigos del los Relojos de Sol](#) - Spanish Sundial Society

M. Lombardero, Isaac Peral 48, 28040 Madrid, Spain

Switzerland - [Sonnenuhrenfreunde der Region Basel \(SFB\)](#) - Basel Sundial Society

F. Muhlemann, Leberning 4, CH-4107 Ettingen, Switzerland

Zonnewijzerkring Vlaanderen

- Belgian Sundial Society

The objectives of the Belgian Sundial society are:

to promote interest in sundials and to encourage and assist in the design and making of sundials

to locate and catalogue existing sundials in Flanders and, where necessary, to assist in their restoration

to offer special events, publications, and other activities related to sundials

British Sundial Society

[The British Sundial Society](#) is the largest in the world, with many overseas members. We publish our [Bulletin](#) three times a year, and publish an excellent guide for schools or novices [Make a Sundial](#). We welcome new members; you can [join us](#) very easily by filling in your application form on [bssjoin.htm](#). We have specialist sub-groups on mass dials and on restoration. Each year, we have an annual meeting with many interesting speakers (the last one was held in Cumbria in April 1997), and a number of other meetings and workshops. We have sponsored a Sundial Award scheme in order to promote awareness of sundials and to encourage good design.

Societat Catalana de Gnomonica

Catalan Sundial Society

The Society publishes a journal "La Busca de Paper" (The Gnomon of Paper) which is biligual (Catalan and Spanish). It is issued 3 times a year and has 24 A4 pages about all aspects of sundials.

Guppo Milanese Quadranti Solari - GQMS

The Milan Sundials Group

The Milan Sundials Group is charged with relations with foreign sundial associations by the Unione Astrofili Italiana.

De Zonnewijzerkring

(The Dutch Sundial Society)

Aims of De Zonnewijzerkring:

1. - study of GNOMONICS
2. - register the Sundials in the Netherlands
3. - restoration of existing dials
4. - publishing about
GNOMONICS

The membership:

Anybody can join DE ZONNEWIJZERKRING.
The yearly contribution is f 45.- + an entrance fee of f 15.-.
To become a member send an [E-mail](#) to the secretary.

The Bulletin:

The bulletin with articles by the members is published three times a year.

Two regular subjects are:

- - literature
- - Sundials in the Netherlands

Meetings and Excursion

Three times a year (on a Saturday afternoon a meeting is held.
Once a year an excursion is made to a part of the country with interesting sundials.

Address of the secretary:

Van Gorkumlaan 39
5641 WN Eindhoven

[E-mail](#)

[Homepage van Fer J. de Vries](#)

North American Sundial Society

The North American Sundial Society is an association of people from a wide variety of disciplines who are interested in the study, development, history, and preservation of sundials and the art of dialling throughout the continent. We now have our own website at www.sundials.org

The North American Sundial Society is an association (convened in 1994) for those who view the sundial as something more than a simple garden decoration. There was a time, not that long ago, when an appreciation of dials in all their various forms was an integral part of the scientific and mathematical training of any well-educated person.

NASS hearkens back to such a time and offers sundial enthusiasts at all levels of expertise an opportunity to learn, to interact, and to exchange ideas and information.

As essayist Hilaire Belloc once noted:

"Civilisation loses its treasures by an unconscious process. It has lost them before it has appreciated that they were in the way of being lost: and when I say 'its treasures' I mean the special discoveries and crafts of mankind."

Dialling is fast becoming a lost art and a forgotten science. By participating in NASS you can slow this unconscious process and even help to regain and advance the forgotten science.

The Society was convened in February 1994 by Ross McCluney, Fred Sawyer and Bob Terwilliger in the hope of fostering communication and coordination among dialists. Recognizing that many of its members are already associated with one or more of its European counterparts, the Society has adopted a role which complements the work already being done by other organizations.

The Society produces a quarterly journal in both print and digital formats. The digital edition is produced using Neobook Pro (TM). Requirements for the digital edition include an IBM compatible computer with 640K RAM, VGA color, MS-DOS 3.1 and a hard disk. A Logitech or Microsoft compatible mouse is also recommended.

We also hold an annual convention to which all of our more than 250 members are invited. Our first meeting was in 1995 at the Smithsonian Institute in Washington DC. Our next meeting is on 27-28 September 1996 at Victoria College in the University of Toronto, Ontario, Canada.

Join now! Participate! Discover new concepts; share your favourite ideas, techniques and sources. Whether you design, construct, study, collect, or simply enjoy dials, it all comes together in the North American Sundial Society !

For more information, please contact Frederick W. Sawyer III, 8 Sachem Drive, Glastonbury, CT 06033 USA (fax: 203-275 5295 email: 71541.1662@compuserve.com)

Commission des cadrans solaires du Quebec

The society was founded on 18 June, 1994. There are now around 50 members. We are publishing a Newsletter: Bulletin de liaison - LE GNOMONISTE. We are also working on a repertoire of sundials in Quebec, and have 224 listed so far. We have one meeting a year; the meeting last year was on 15 June 1996 at Laval University, Quebec City.

To join (there is no fee) please contact the Secetaire General, Andre Bouchard, 42, av. de la Brunante, Outremont (Montreal), Quebec, H3T 1R4, Canada tel: 514-341-3997, fax: 514-341-3997, E-mail: 600009@ican.net mentioning "Sundials on the Internet".

Please visit our Internet site at http://cadrans_solaires.scg.ulaval.ca which is illustrated with many sundials.

- Asociacion Española de Amigos del los Relojos de Sol (Spanish Sundial Society)

The aim of the Society is the development of the historical, geographical and mathematical research related to sundials.

A meeting is held in Madrid every Thursday. The Society issues the quarterly bulletin "ANALEMMA" in Spanish with short abstracts in English.

Membership is free. However, to receive "ANALEMMA" a subscription is necessary. The subscriptions are on a calendar year basis. For foreign members, the fee is \$35 (including shipping and mailing expenses). The recommended way of sending the fees is to mail a check payable to "Asociacion Española de Amigos del los Relojos de Sol" drawn on any Spanish bank. Please send your application to the Secretary, M. Lombardero, Isaac Peral 48, 28040 Madrid, Spain

For a full overview of Sundials on the Internet [click here](#)

This site designed and maintained by [Internetworks](#) Ltd of [Epsom](#), England
last revision

Comments/ suggestions/ problems, please get in touch with the [Webmaster](#)

Sundials on the Internet

For a full overview [click here](#)

Links to pictures of sundials on the internet

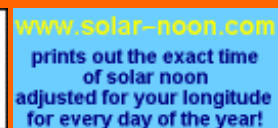

If you know of any other links to pictures of sundials, please send us an [E-mail](#) Your help would be appreciated.

Section 1 - Pictures on "Sundials on the Internet"

These are some of the pages on "Sundials on the Internet" which have pictures of sundials on them.

[connois.htm](#) - Sundials for the Connoisseur by Silas Higgon

[Hand-carved stone sundials by Harriet James](#)

[~cantab.htm](#) - The Cambridgeshire sundial trail

[~esussex.htm](#) - My favourite sundials in East Sussex

[~polska.htm](#) - My favourite sundials in Poland

[~toronto.htm](#) - My favourite sundials in Toronto

[~thames.htm](#) - The London Thames sundial trail

[~cotswolds.htm](#) - The Cotswold sundial trail

[massdial.htm](#) - Mass Dials

[projects.htm](#) - Four simple sundial projects

plus most of the newer sundial trails listed on our [Index to sundial trails](#) page

Banners can be very effective
[click here for the many ways we can help you advertise on this site!](#)
Internetworks Ltd, POBox292, Epsom, Surrey, KT17 4YP, England sundiweb@aol.com

Section 2 - Sites with images of many sundials

Many of these links have been reported as broken - so we have taken out the link so our link checker doesn't get overworked, but we leave the link in as plain text in the hope that you can find out what the correct link is and kindly [let us know](#)

[Sundials of the Czech republic](#) - **NEW** http://www.astrohk.cz/slunecni_hodiny.html

[Catalogue of sundials in Hungary](#) **NEW**
<http://www.mek.iif.hu/porta/szint/termesz/csillag/naporak/html/budapest.htm>

[Sundials in Canada](#) **NEW**

[Sundials In Murcia \(SW Spain\)](#) **NEW**

Many thumbnail images of sundials in the province - each is a link to a larger photograph and a description of the dial.

[Sundials In Austria](#)

The home page of Karl Schwarzinger with pages in both English and German
Sundials in Brittany, France

<http://perso.club-internet.fr/printant/astro/bcadran.html>

[Sundials in Berlin, Germany - English version](#)

<http://www.in-berlin.de/User/jd/sundials/index.html>

[Sundials in Germany](#)

<http://home.nexgo.de/peter.lindner/sundials.htm>

[Some sundials in Italy](#)

<http://www.geocities.com/vgs96>

[Frans' sundial site](#) **NEW**

A large website with many pictures of public and other sundials in the Netherlands and elsewhere in the world, classified according to the type of sundial. - www.biol.rug.nl/maes/sundials/

[Sundials in the Netherlands](#)

<http://www.iaehv.nl/users/ferdv/fotos.htm>

[The new millennium sundial in New Zealand](#) - www.eastland.tourism.co.nz/Sundial/index.htm

[Some pretty pictures of portable sundials](#)

<http://www.bo.astro.it/dip/Museum/english/Gnomons-and-Sundials.html>

[antique pocket sun dials](#) <http://freespace.virgin.net/robert.young10/index2.htm>

Some [plans for sundials](#) and other sun and star instruments

<http://www.lockes.co.uk>

A listing of UK sundials

which have recently been stolen - <http://calligrafix.co.uk/salvo/stolen-sundials.html>

http://cadrans_solaires.scg.ulaval.ca

which has individual pages for many makers of sundials in Quebec, and of the sundials they have made.

[A list of sundials near Leeds, England](#)

including a number of images - http://www.dsellers.demon.co.uk/sundials/sun_ch3.htm

[Piers Nicholson's personal web page](#)

with images of some painted sundials, and also a large public sundial near Lincoln, England -

<http://members.aol.com/piersn>

[Ye Sundial Booke](#)

An expanding picture library including horizontal dials, vertical dials, pillar dials, polyhedral dials, and Saxon dials - <http://www.exford.co.uk/sundials/>

[Phil Walker's personal web pages](#)

A selection of sundial photographs

[Francois Blateyron's personal page](#)

offers a lot of sundial pictures, from Paris and Besançon. This site is bilingual French and English

[Carlo G Croce's personal page](#)

with a number of sundial pictures and lots of related information This site is bilingual English and Italian.

[a page of sundial pictures](#)

that I hold in Galaxy Picture Library for use by publishers. -

<http://www.galaxypix.freemove.co.uk/history/sundials.htm> **NEW**

[Some sundial pictures](#) taken by Julian Holland **NEW**

Section 3 - Sites with image(s) of a single sundial (in order of country)

Many of these links have been reported as broken - so we have taken out the link so our link checker doesn't get overworked, but we leave the link in as plain text in the hope that you can find out what the correct link is and kindly [let us know](#).

[sundial at Heinrich Harrer Museum in Hüttenberg](#)

Austria - <http://www.quake.net/~xdclab/wn/images/har.gif>

[sundial in Fellows' Garden, Merton College, Oxford](#)

England - <http://users.ox.ac.uk:80/~mertinfo/time-ceremony.html>

[Sundial with a "live" sundial image and automatic time readout](#)

at Pembroke College, Cambridge, **England** - www.uk.research.att.com/sundial/

[The six sundials on the Gate of Honour](#)

at Gonville and Caius College, Cambridge, **England**- <http://www.cai.cam.ac.uk/pics/clock.jpg>

[The famous sundial at Queens' College](#)

Cambridge, **England** - <http://www.quns.cam.ac.uk/Queens/images/sundial.html>

[The Lumbutts Sundial](#) in West Yorkshire, **England**

German Sundial seen in the Deutsches Museum in Munich, **Germany**

This sundial has a odd-shaped gnomon that completely compensates for the equation of time. The gnomon must be changed twice a year after (I think) the solstices. Each sundial is individually made for any given location to within 300 meters, and is accurate to (nearly) the minute. The website (in German) at

<http://www.hasler.net/sonne.htm> says where some such dials are, but does not have any more information.

[sundial at the public observatory in Mainz](#)

Germany (page in German) - <http://iphcip1.physik.uni-mainz.de/~astro/pop/VSW.html>

[new large horizontal sundial with an over 50 ft gnomon](#) **NEW**

built 1998 in Bad Bevensen, **Germany**, : <http://www.bad-bevensen-info.de/sonnenuhr>

[Sundial at Hong Kong University](#)

Hong Kong - <http://www.ust.hk/~webetc/PhotoCat/L36.html>

The sundials at Jaipur, **India**

<http://www.photonetal.com/stock.indiantms>

also lots of information about the sundial and Jaipur Observatory at

<http://www.jiva.org/observe/jaipur/life3.html>

[The sundial of Sheikh Bahai](#)

at Isfahan, **Iran** - <http://www.anglia.ac.uk/~trochford/masimam/bahai.html>

[An ancient sundial at Knowth](#), one of the ancient monuments of **Ireland** **NEW**

[New public sundial erected at the seaside resort of Blackrock](#) Dundalk, **Ireland**, to mark the millennium - **NEW**

year http://www.louthonline.com/Regional_News/Blackrock/Blackrock_Sundial/blackrock_sundial.html

A sundial invented in 1437

Korea - <http://203.254.53.1/Explore/Pictures/9i.html>

Sundial at the National Planetarium

Malaysia - <http://mastic.gov.my/kstas/baksathe.htm>

Sundial in Middelburg, Zeeland

Netherlands, <http://pd19.eb.ele.tue.nl/middelburg.html>

Sundial at Patensie, Cape Province, South Africa (33,8° S 24,8° E)

The dial is 37m in diameter, and said to be the largest in South Africa. The gnomon is made out of a wooden pole and the dial is made of concrete blocks. It was erected by Mr. D Schellinghout in 1988.

sundial at Pajala, Sweden, said by the Guinness book of records to be the largest in the world

Sweden - <http://www.pajala.se/narliv/ftgreg/elcs/elcs.htm>

there is also a website at <http://www.pajala.se/welcome/tourism/soltorg.html>

[A short-lived sundial in San Rafael, California](#)

USA The Barker family made this beautiful sundial for a 2-day street festival in June 1998, and it lives on in their attractive web site at <http://user.aol.com/graphicon1/sund.html>

[Sundial at the Team Disney Building](#)

at Walt Disney World, Florida, **USA** <http://www.fsec.ucf.edu/~at/disndial.htm>

Photographs of this building and dial can be found at <http://www.sunpath-designs.com/disimage.htm> and a

drawing of the markings is at <http://www.sunpath-designs.com/dismaps.htm>

Finally, a large file (1400 KB), with a copy of the cover illustration featuring this dial of the April 1991 issue of Progressive Architecture can be found at <http://www.sunpath-designs.com/sunpath9.htm>

Sundial adjacent to Maxwell Hall

at the University of Indiana, **USA** - <http://www.indiana.edu/~summer/sumthem/dial.html>

Treble clef sundial at The School of Music

at Ann Arbor, Michigan, **USA** - <http://calypso.sils.umich.edu/AnnArbor/Music.html>

[Morehead Planetarium sundial](#)

on the campus of the University of North Carolina at Chapel Hill **USA** (3 pictures) -

<http://ils.unc.edu/TOCH/planet.html>

[Barnwell sundial](#)

at Barnwell, South Carolina, **USA** - <http://www.sccsi.com/sc/thoroughbred/sundial.gif> -

Physics/ Astronomy building sundial

at the Physics/ Astronomy building of the University of Washington, Seattle, **USA** This sundial is included in the [Seattle sundial trail](#)

[The Richard Swenson sundial, University of Wisconsin, USA](#)

Probably the largest vertical sundial in existence

Section 4 - Sites with sundials we have not yet had time to classify **NEW**

Thanks to Steven Woodbury!

sundial at University of Limerick <http://www.ul.ie/~childsp/Elements/issue1/samways.html>

vertical dial on church in Cornwall <http://www.compulink.co.uk/~abouttime/sun.htm>

vertical dials at Palladio's Villa Barbaro at Maser Italy <http://www.chem.vt.edu/chem-dept/field/palladio.htm>

Phhil Walker sundial photos <http://www.sundial.pwp.blueyonder.co.ukr/sundial1.htm>

sundial at Justice Center, Hunterdon County NJ <http://www.co.hunterdon.nj.us/depts/c%26h/newsltr.htm#gift>

sundials: Beijing; Jaipur; Tirol <http://192.106.166.8/mclink/astro/gallery/osl/index.htm>

sun tower at Gullett Elementary School, Austin, TX <http://marple.as.utexas.edu/~ideas>

sundial for Pennsic (an annual gathering of the Society for Creative Anacronism)

<http://www.radix.net/~dglenn/events/pennsic/sundial.html>

The C.M. Huffer Memorial Sundial, Mt. Laguna Observatory <http://mintaka.sdsu.edu/tour/sundial.html>

Picture of Barnwell SC dial (free-standing vertical cast-iron dial) <http://www.sccsi.com/sc/thoroughbred/sundial.gif>

and another picture of Barnwell SC dial, with county courthouse <http://barnwellweb.com/index.htm> and brief description of Barnwell SC dial (#17) <http://www.barnwellweb.com/chamber/points.htm>

We would appreciate an [E-mail](#) from you if you know of any others.

**If you are able to put a reciprocal link saying
For general information about sundials, we recommend [Sundials on the Internet](#)
this would be much appreciated too. Thank you.**

**For a full overview of Sundials on the Internet [click here](#)
This site designed and maintained by [Internetworks](#) Ltd of [Epsom](#), England
first posted 1997 last revision
Comments/ suggestions/ problems, please get in touch with the [Webmaster](#)**

Sundials on the Internet

For a full overview [click here](#)

The Sundial Fair

Our [traffic statistics](#) show counter visitors to this page since 19 November 2000.
Please bookmark us - and come again!

Have your own entry? - you can now order [your own Sundial fair entry](#) on a secure server through Epsom Internet Services.

Our sundial maker of the month is

[Westwood Dials, UK](#)

Directory of the Sundial Fair

- [Accurate Sundials, USA](#) NEW
- [Arthur Wilbur Co/ OutdoorDecor.com, USA](#)
- [Brookbrae Ltd, UK](#)
- [David Brown Sundials, UK](#)
- [The Carving Studio, UK](#) NEW
- [Charlestown Forge, UK](#) NEW
- [Connoisseur Sundials, UK](#)
- [Courtyard Sundials, UK](#)
- [Flowton Dials, UK](#) NEW
- [GSD - Gunning Sundials, UK](#)
- [David Harber Sundials, UK](#)
- [Sally Hersh, UK](#)
- [Harriet James, UK](#)
- [Merlin Designs, UK](#)
- [Modern Sunclocks, UK](#)
- [Precision Sundials LLC](#) NEW
- [SON Manufacturing Co, USA](#) NEW
- [Spot-On Sundials, UK](#)
- [Sundials Et Cetera, UK](#)
- [Sundial Sculptures, USA](#)
- [Warwick Sundials, South Africa](#)
- [Westwood Dials, UK](#)

Please mention "Sundials on the Internet" when you make contact with any of

these sundial makers.

Flowton Dials

Dr John Davis, Orchard View, Tye Lane, Flowton, Ipswich, UK, IP8 4LD

Telephone: (+44) 473 658646 (01473 658646 from UK)

Email: john.davis@btinternet.com

Website: <http://www.flowton-dials.co.uk/>



Flowton Dials make high quality sundials and reproduction scientific instruments. We work in a range of materials and formats but specialise in making replicas of historic bronze horizontal sundials, especially when the original is corroded or has been stolen. All dials are individually commissioned and fully researched. We also produce a range of pocket sundials and can undertake design, consultancy or restoration projects. See our website for a full range of past work which includes sundials incorporated into sculptures and large tower dials.

GSD - Gunning Sundials

The Heliochronometer Specialists

Wych Elm Cottage, Sussex Road, Petersfield, Hampshire GU31 4JZ

Tel: +44 (0) 1730 262010. Fax: +44 (0) 1730 266640

Email: gunsun@btinternet.com Website: <http://www.draysonebeckett.co.uk/gunning.sundials/>

We are manufacturers who specialise in the manufacture of Heliochronometers. Long considered the acme of sundials, a heliochronometer is an instrument truly worthy of the Millennium. It is only the heliochronometer that gives a direct and accurate reading of Standard Time throughout the sunlit year. It is a precision timepiece determining time exactly - literally to the minute. Used earlier this century to set the time of civic clocks and to standardise time on railway networks, it essentially became redundant, in 1913, with the introduction of Radio Time Signals.

Now, however, after a gap of eighty years and with rather more emphasis on it being both a precision timepiece and an attractive garden ornament, Gunning Sundials have produced the latest variant in an historical but rare line of heliochronometers. The new model combines modern brass manufacturing methods with age old techniques in order to ensure the accurate conversion of solar time to standard (watch) time. Levelling screws ensure perpendicularity and accurate alignment is achieved by making adjustments to cater for latitude, longitude and Summer Time. The result is a handsome, precise instrument certain to be a constant source of admiration and conversation in the garden.

For full details, photographs and to place an order please see our website at <http://www.dbweb.com/gunning.sundials/>

David Harber Sundials
Valley Farm, Bix, Henley-on-Thames, Oxon, RG9 6BW, England
Tel: (+44) 1 491 576 956 Fax: (+44) 1 491 413 524
Website: www.davidharbersundials.co.uk Email: sales@davidharbersundials.co.uk

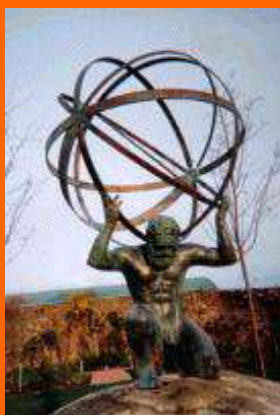

We make highly unusual as well as very classical sundials. Our dials have been described as "The Rolls Royce of Sundials" in an article in 'The Times' of London.

We are mainly known for our armillary spheres. The spheres can be made of brass, mirror polished stainless steel or bronze and can range in size from 50cm to 4 metres diameter. We also make a wide range of other sundials and sundial sculptures and David delights in producing dials to suit the tastes and requirements of every client using materials as diverse as mirror glass, gold, copper, oxidized steel, marble and slate.

Whether you want a vertical dial for your home or a stunning mirror-glass obelisk sundial for your office we will make you a sundial that will be a talking-piece for centuries to come. Each sundial is made to commission, and to ensure their accuracy they are made for the exact longitude and latitude of their resting-place. The dial is personalized with details such as a sundial motto, the name of the house, children's initials and dates of birth, a commemorative message, etc. We also can engrave the distance and direction from the sundial's resting-place to anywhere you have connections with.

David has produced and installed various dials for clients ranging from Chicago banks to Oxford Colleges as well as private gardens in Britain, Europe and the United States. Public Sundials completed in 1999 include:

- Magdalen College, Oxford
- The Putney Society in London
- Stonehenge dial for an Oxfordshire village
- Stevenage Town Centre
- ESRI, Berkeley, California, USA.
- Citoroen Headquarters, UK

We would be delighted to send you our brochure.

Sally Hersh - Sundial Maker
and Sculptor

Sycamores Studio, School Lane, Lodsworth, Petworth, West Sussex GU28 9DH UK

Tel: 01798 861 248 Fax: 01798 861 355

Website: www.sallyhersh.com Email: info@sallyhersh.com

Winner of the British Sundial Society 2nd National Award "BSS Award 2000" in the Professional Class for her
Equatorial Dial
and

Winner of the British Sundial Society's 1st National Sundial Award 1995
for her Wall Dial at West Dean College.



SALLY HERSH is an Award Winning Sundial Maker who specialises in beautiful Wall Dials that are hand cut into slate and stone.

As her Sundials are made to commission, she is mindful of the immediately surrounding landscape and architecture when planning a design as this can influence the shape or even content of a Sundial. Where appropriate, she likes to incorporate clients' personal references such as logos or monograms (which she can design too) or a chosen motto. Each Sundial can be as simple or complex as required and is mathematically accurate for its location.

As a craftswoman, sculptor and much experienced letter cutter each Sundial incorporates elegant, calligraphic lettering of the very highest standards, which can be gilded if required.

SALLY HERSH also offers bronze and stone Equatorial and Horizontal Dials with hand carved or engraved inscriptions.

Her clients, both private and corporate, are located in Europe, the USA and throughout Britain

All her Sundials are beautifully made and clients can expect excellent service with unusually high attention to achieving the very best results.

Please view Website: www.sallyhersh.com

Hand-carved stone sundials by Harriet James
Wood Villa, 26 Staverton, N. Trowbridge, Wilts, BA14 6PB, UK
Telephone: +44 1225 782561
Email: sunnydials@compuserve.com Website: www.harrietjames.sundials.co.uk

Unique carved stone dials · Beautiful to look at
Accurate time-keepers · Brass or iron gnomons
Durable and weatherproof · Gilded and painted decoration
Excellent corporate or personal gifts
Suitable for gardens & parks, new buildings, schools & churches

Click on any of these thumbnails for an enlarged version, or [click here](#) for Harriet James' home page with all the pictures enlarged.

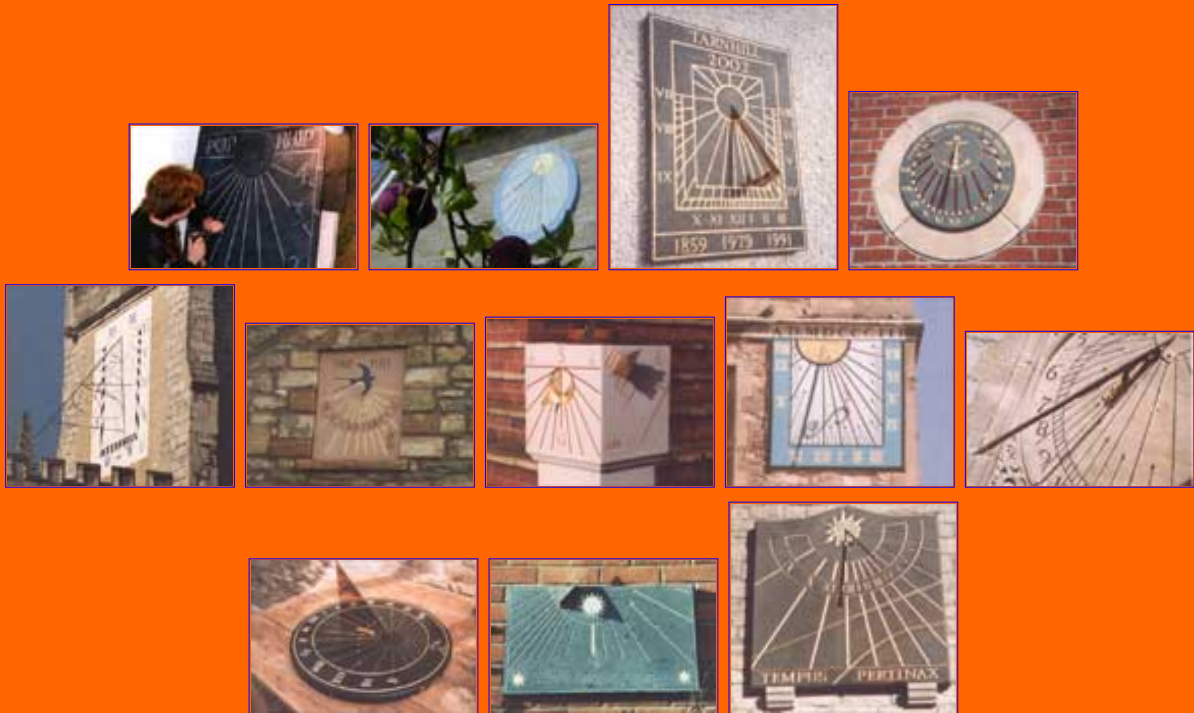

Please visit our main Web page at www.harrietjames.sundials.co.uk

Merlin Design
The Nook, Rudgeway Park, Rudgeway, Bristol, BS35 3RU
Tel: +44 1454 615036
Email: keithb@easynet.co.uk Website: <http://easyweb.easynet.co.uk/~keithb/index2.html>

We are etchers in brass and specialise in designing and making customised, accurate and site specific brass sundials. We have made dials for all regions of the U.K. as well as for many clients in France and the U.S.A.

- horizontal brass sundials in both traditional and contemporary styles.
- produced to commission only.
- site specific.
- complete design service from calculations and artwork through to fabrication and installation
- many options within any one design including dedications, mottoes, anniversaries, crests or logos as well as pictorial images.
- very fine detail through acid etching.
- bright or patinated finish.

- baseplates made from high quality sheet brass .
- gnomons cut from plate brass and accurately profiled to the required latitude.



For further details please contact Keith Bunting at Merlin Design, or visit our web site at <http://easyweb.easynet.co.uk/~keithb/index2.html>

Modern Sunclocks

1 Love Street, Kilwinning, Ayrshire, Scotland KA13 7LQ, UK
Tel and Fax: 01 294552 250 International Tel & Fax: +44 1 294 552 250

Email: ModernSunclocks@digitalmail.com Website: <http://www.argonet.co.uk/education/sunclocks/>

Modern Sunclocks

Human Sundials which use YOUR OWN SHADOW to tell correct time.



As well as the novelty, of being a part of your own sundial, consider the following *advantages* of our 'SUNCLOCKS':

- Essentially both "theft-proof" and "damage-proof", they are perfect for public spaces (children's play areas, etc) and are now becoming popular as Millennium-markers.
- It can be made from almost any material (stone, wood, concrete, mosaic) - or just PAINTED onto the ground, which is the method normally used by Junior Schools.
- Set *into* a lawn, it will not interfere with grass-cutting. It automatically caters for both Standard and Daylight-Saving Time - so you never need to adjust your layout.

- You will have a maintenance-free conversation-piece, that is UNIQUE - no two 'Sunclocks' are identical, as each layout is specific to its own Latitude & Longitude.
- All you need is any *level* area, 6 metres (20 feet) across.

"Modern Sunclocks" supply a PERSONALISED set of Plans - containing all measurements, plus setting- out instructions, uniquely calculated and printed for whatever address you specify anywhere in the world. These plans cost £25 (UK), or the equivalent of £35 for overseas orders (which includes airmailing cost). In Britain, complete kits (concrete, wood, brick, etc) are now available - please ask for details of sources. All Email enquiries should be addressed to: ModernSunclocks@digitalmail.com Please see our new website at <http://www.argonet.co.uk/education/sunclocks/>

Precision Sundials LLC
100 Overlake Park, Burlington, VT 05401 USA
(802) 864-3714 voice (802) 862-6597 fax
Email: bill@precisionsundials.com Website: www.precisionsundials.com

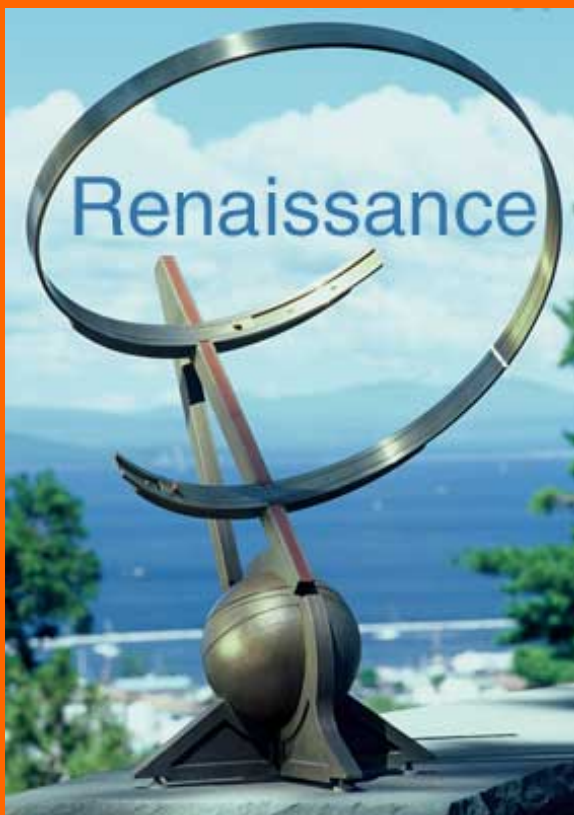

These custom sundials by Bill Gottesman read civil (watch) time with nearly 1 minute accuracy all year long. They adjust for Daylight Savings and the date. The Renaissance Sundial (patented) illuminates the time with a crisply focused beam of light, rather than casting a fuzzy shadow. It is made of bronze and naval brass, and is nearly four feet tall.

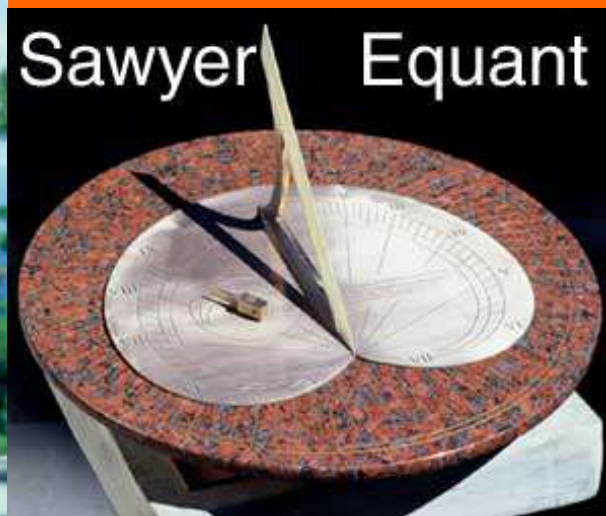

The Sawyer Equant Sundial is 16 inches across. It reads solar time on its bronze plate, and civil time on its granite plate. Both sundials adjust for latitude using a precise patented wedge mechanism. These

modern sundials are accurate, bold, fun to use, and cannot be found anywhere else. Visit us at www.precisionsundials.com

SON Manufacturing Company
P O Box 126 , Cherry Valley, New York, NY 13320 USA
Tel : 607-264-3291
Email: sonmfg@iag.net Website: www.sundialcompass.com



SON Manufacturing Company, designer and manufacturer of the 1.75-inch diameter hand-polished, solid brass pocket 1750 Sundial Compass, an 18th century reproduction, sells WHOLESALE to Retail Store and Corporate Gift Buyers, and RETAIL Online.

We ENGRAVE corporate and organization logos, graphics, and text to personalize on compass lid for Corporate Gifts, every Recognition or Graduate program, Schools, Military, Maritime, Organizations, Tournament (Tennis, etc.) Awards.

The museum quality craftsmanship of this functional instrument makes a beautiful presentation in its custom gift box. Cherry Desk Display available.

Info/Pricing: 607-264-3291 or 800-795-2270 Celebrating 25 years of Excellence in Quality and Service - 1978-2003.
Thank You!

Spot-On Sundials
PO Box 292, Epsom,KT17 4YP England
Tel: 01 372 725 742 Mobile: 07 909 747 335
Website: www.spot-on-sundials.co.uk
Email: info@spot-on-sundials.co.uk

Spot On Sundial

A new concept
in garden sundials

designed by Piers Nicholson



The Spot-On Sundial is a new concept in horizontal sundials. Its unique feature is the split gnomon which casts the shadow. Every day at noon a line of light shines between the 2 plates for around 5 minutes. This feature also permits the sundial to be set up precisely, so that it will tell you the right "time by the sun" for years to come. This scientific sundial is available at £105 delivered mainland UK. The Spot-On Sundial comes with complete set-up instructions. For more details, [see www.spot-on-sundials.co.uk](http://www.spot-on-sundials.co.uk)

Two stunning new models!

The Spot-On Stainless Steel Dial (right)

For public spaces and larger gardens - 14 x 18 ins.

The Spot-On Polar Dial (below)

solid brass, 12½ x 5½ ins.



Sundials Et Cetera

The Pottery, 2 High Road, Everthorpe, Brough, East Yorkshire, HU15 2AP, England.

Tel: +44(0)1430 422088 Fax: +44(0)1430 422089

Email: susie@sundials-etc.co.uk Website: www.sundials-etc.co.uk

We design and handmake stoneware ceramic sundials, water features and accessories for the garden and conservatory.

We have a range of standard sundials for walls and plinths, which are usually made for latitude 55 degrees (suitable for the British Isles).

However, most of our work is individually designed for each client and can be adapted for any latitude and for walls facing in any direction - so they can be made for any location in the world!

We can include names, dates, quotations etc.

View our web site to see some examples: www.sundials-etc.co.uk

Sundial Sculptures by John L. Carmichael
925 E. Foothills Dr., Tucson Arizona 85718, USA
Tel: 520-696-1709

Email: johncarmichael@mindspring.com Website: www.sundialsculptures.com

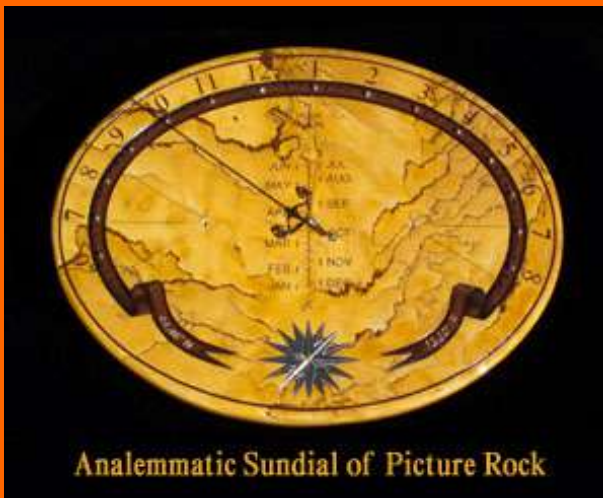

Sculptor, John Carmichael makes exquisite hand-carved stone sundials with inlaid brass, beautiful artwork, and multiple scientific functions. Unique copywrited brass cable gnomon is held taught by heavy counterweight. These precise timekeeping instruments are available in 25" and 40" diameter sizes and larger. I also design large monumental public sundials. All sundials are custom-made to order, using the latitude and longitude of the sundial's location and each customer's particular tastes and requirements. (sundial type, shape, size, artwork, etc.). Very informative Sundial Owner's Manual included. See pictures on website. Will ship anywhere. Catalog mailed upon request. (Please indicate CD or paper version).

Warwick Sundials
South Africa

Tel: +27 31 7675998 Fax: +27 31 7675997

Email: kwarwick@mweb.co.za

We handcraft accurate sundials in solid gunmetal bronze and brass. The Equatorial dial is cast in gunmetal bronze weighing 5 Kg. and is adjustable for latitude. Both our armillary sphere and horizontal dials are made from solid brass plate and rod.

The very favourable exchange rate of the South African rand with other currencies ensures very affordable prices.

Westwood Dials

White House Farm, New Hall Lane, Mundon, Nr. Maldon, Essex CM9 6PJ, England

Tel: 01 621 740 599 Fax: 01 621 740 599

Email: westwood.dials@virgin.net Website: www.westwooddials.com

We offer a fine range of beautifully made armillary sphere sundials in brass, copper, bronze or steel.

A wide choice of sizes and prices. Styles for small and large gardens and public places

Easy to purchase. Delivered UK and worldwide

[Contact us](#) for brochure or for more information

Accurate Sundials

W59 N358 Hilbert Avenue, Cedarburg, Wisconsin 53012, USA

Tel: 262-387-9992 Fax: 262-387-9992

Email: sales@accuratesundials.com Website: www.accuratesundials.com

**A sundial that tells real clock time!
Have you ever seen one before?**

We custom design, engineer and machine elegant and accurate sundials for your specific latitude, longitude and time zone (which we find from your street address). Attractive dials available in solid brass, copper and aluminum.

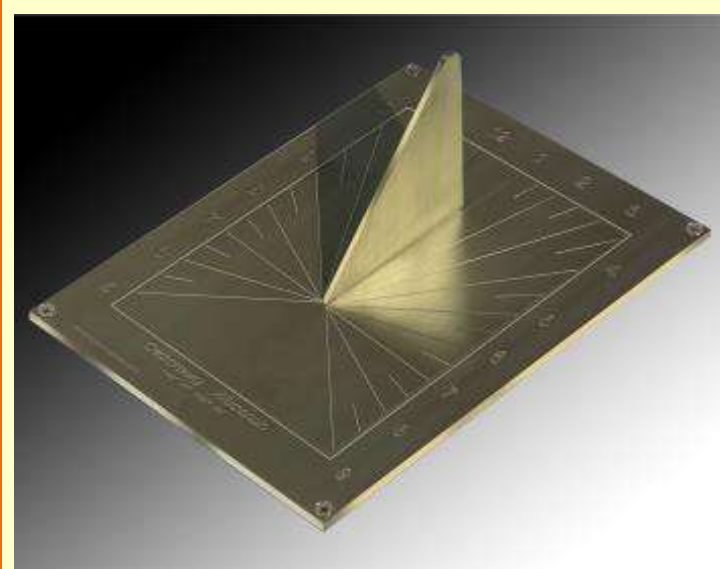

Here's what our customers say:

"...I'm impressed. It has an elegant look, but still seems like an instrument rather than decoration... The weight and feel is also nice. I'm happy with my purchase."

Ervan D. Fremont, California

"It's gorgeous!"

Karen C. West Lake, Ohio

"(The sundial) is great! The information included is fascinating and useful. We're very happy with it!"

Rick J. Milwaukee, Wisconsin

"I received a beautiful brass sundial as a gift. It's beautiful and it tells real clock time. What a great idea and a great gift!"

Debbie M. Mequon, Wisconsin

See for yourself at <http://www.accuratesundials.com/>

Arthur Wilbur Co /OutdoorDecor.com
PO Box 3089, Tuscaloosa AL 35403, USA
Tel: 888-651-0113, or Fax: 205-333-3264



The Arthur Wilbur Company is an online retailer of sundials and home and garden products. Our sundials are of good quality, made of materials such as brass, copper, cast iron, and aluminum. The sundials are made for both indoor and outdoor use, and are also great for gifts. In general, the sundials are made for use for latitudes around 40 degrees. We currently offer sundials in the following styles:

- Armillary
- Garden
- Sundial-Birdbaths

In addition to the sundials, we offer quality pedestals to place the sundials on, as well as other products for the garden, including custom house signs, weathervanes, birdfeeders, and other outdoor products.

Please visit our [website](#) , email us at sales@outdoordecor.com, or call us at 888-651-0113 or 205-333-7802, or Fax: 205-333-3264. We are happy to answer questions about our products, as well as visit with companies which would like us to carry their products.



Brookbrae Ltd
7 Cranleigh Gardens, Kingston-upon-Thames, Surrey, KT2 5TX, England
Tel: +44 (0) 20 8546 2110 Fax: +44 (0) 20 8546 2990
Website: <http://www.brookbrae.com> Email: olivergero@brookbrae.com

Brookbrae design and make artistic focal features for the built environment. We are particularly known for our innovative and excellently crafted sundials, armillary spheres and feature clocks. Most of our commissions are in the public and corporate sectors and for over 25 years we have provided successful solutions for city and town spaces . To see examples of our work please visit our website www.brookbrae.com

s We work closely with architects, landscape architects and clients to develop site specific, admired and accurate time features. From initial enquiry, through to design, making and commissioning you will find us a friendly and efficient company to work with.

For further information please contact Oliver Gero. Telephone +44 (0) 208 546 2110
Fax +44 (O) 208 546 2990. e-mail: olivergero@brookbrae.com

David Brown Sundials .
Gibbs Orchard, Sutton Road, Somerton, Somerset, TA11 6QP, UK
Tel: +44 (0)1458 274841
E-mail DMBSundial@aol.com Website: www.davidbrownsundials.com

David Brown makes sundials in slate and other stone, tailor made for individual clients. They can include anniversary date lines, decorative carvings and commemorative features. Inscriptions are all v-cut by hand; gold leaf and enamel paints are used for highlighting and decoration.

David makes horizontal, vertical, analemmatic and polyhedral dials, the latter maybe his speciality: his prizewinning polyhedral dial at Christ Church, Oxford, has 11 dials and 24 gnomons and a wealth of historical detail incorporated into the design and carving.

Recent commissions in the UK have included a 1.4m diameter vertical dial for Queen Margaret's School, York, an analemmatic dial (7 metre diameter) at Wisborough Green, Sussex, and a horizontal garden sundial with musical features.

Prices start at £800. Pictures and more information on www.davidbrownsundials.com Please write, phone or e-mail for a brochure or to discuss your requirements .

The Carving Studio
2 West Alley, Hitchin, Herts, SG51EG, England
tel/fax. 01462 459266.
Email: info@thecarvingstudio.co.uk Website: www.thecarvingstudio.co.uk



- Unique carved sundials.
- Every piece hand carved into the finest selection of british stone.
- Vertical, and horizontal
- Designed and calculated for each individual site.
- Beautiful and intriguing to look at
- Brilliant gifts or commissions for birthdays, anniversaries weddings etc.
- Designed calligraphy lettering, and personalized inscriptions produces individuality in every dial.
- You can also visit THE CARVING STUDIO and watch the work in progress.

Charlestown Forge
9 Mount Charles Road, St Austell, Cornwall, PL25 3Lb
Tel: 01 726 63325

Email: charlestownforge@btopenworld.com Website: www.charlestownforge.com



CHARLESTOWN FORGE OFFERS A COMPREHENSIVE SELECTION OF READY MADE OR SPECIALLY COMMISSIONED SUNDIALS ALL OF WHICH ARE DESIGNED AND MADE BY CORNWALLS PREMIERE BLACKSMITH/METAL SCULPTOR, BRAD DILLON.

CHOOSE FROM ARMILLARY SPHERES, HORIZONTAL GARDEN DIALS, WALL DIALS OR BOWSTRING DIALS. MATERIALS INCLUDE BRASS, BRONZE, COPPER, STEEL, STAINLESS STEEL OR CAST IRON. SENSIBLY PRICED WITH ADDITIONAL DETAIL ON REQUEST.

PREVIOUS CONTRACTS INCLUDE, WALL DIAL FOR HELP THE AGED GARDEN AT CHELSEA FLOWER SHOW, HER MAJESTY THE QUEENS VISIT TO TRELISSICK GARDENS AND THE EDEN PROJECT (EDEN ARTIST)

PRICES FOR BASIC GARDEN SUNDIAL START AT £165 .



Connoisseur Sundials
Lane's End, Strefford, Craven Arms, Salop SY7 8DE, England
Tel: (+44) 1 588 672 126
Email: sundials@ouvip.com Website: <http://www.sun-dials.net>

We design and make a large variety of accurate working dials in brass or bronze and in a range of sizes.

They include horizontal, vertical, polar and equatorial dials, as well as armillary spheres. The vertical dials can be made for walls facing in any direction (including north!)

Each dial is crafted by hand and given a polished finish. Bronze dials may be patinated as an optional extra.

Full setting instructions are given.

In addition to the outdoor dials, small decorative indoor models are available. These include equatorial, pillar and flag dials. These are especially suitable as corporate gifts.

A colour brochure and price list are available on request. Please contact Silas Higgon on (+44) 1 588 672 126

Please visit our main Web page at www.sun-dials.net

Courtyard Sundials
Richard White
1 The Courtyard, 2 High St, WIVELISCOMBE, Somerset TA4 2JZ
Tel: +44 (0) 1 984 624 644
Email: richard@courtyardsundials.co.uk Website: <http://www.courtyardsundials.co.uk/>



The first solar timepiece being marketed by Courtyard Sundials is an Armillary Sphere, cast in naval brass, with the hours embossed on the equator band. The shaft of an arrow acts as the gnomon, which casts the shadow. The dial weighs 12 lbs (5.5 kg), is approximately 20 ins (51 cm) high, with a diameter of just under 17 ins (43cm).

Hand-crafted in England from naval brass, the armillary dial makes a stunning focal point and feature in any garden. For that individual touch, each sundial can be personalised with an engraved brass dedication plaque.

The armillary sundial can be mounted on any stone pedestal and Courtyard Sundials has a selection for your choice. This armillary design is exclusively available direct from Courtyard Sundials and a number of carefully selected outlets - contact us for your nearest stockist.

For a full overview of Sundials on the Internet [click here](#)
This site designed and maintained by [Internetworks](#) Ltd of [Epsom](#), England
www.sundials.co.uk/sunfair.htm first posted 1997
last revision
Comments/ suggestions/ problems, please get in touch with the [Webmaster](#)

Sundials on the Internet

For a full overview [click here](#)

Index to our sundial trails worldwide

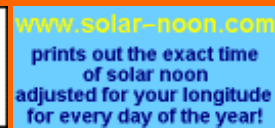

STOP PRESS

Our [competition](#) for new sundial trails closed on 21 October 2001. There were 9 entries indicated by **NEW** below. There is [a further competition](#) for new sundial trails submitted to us before 21st October 2002. are:

This page gives the complete list with hot links to all the locations covered by our pages of sundial trails and lists of favourite sundials. They have all been compiled by people who know the area, and would organise a tour for any friend coming to the area who might be interested in sundials. We hope you will find them helpful and interesting.

[Austria](#) also in [German](#)

Australia

- [Sydney](#)
- [Tasmania](#)

Belgium

- [Rupelmonde](#) also available in Dutch and French **NEW**

France

- [Central Paris](#)
- [Finistère](#)
- [Queyras](#)
- [Pays de Buech](#)
- and the [the Briançonnais](#) in the Hautes Alpes

Germany

- [Gorlitz](#) also available in [Spanish](#) **NEW**

Israel

- [The Israel trail](#) **NEW**

Italy

- [Milan/Bergamo](#)
- [Milan/Bergamo \(en italiano\)](#)

[Malta](#)

[Netherlands](#)

North America

- [Seattle, USA](#)
- [the Kentucky veterans memorial, USA](#)

- [Ottawa, Canada.](#)
- [Toronto, Canada.](#)

South America

- [sundials of Ecuador](#)

Poland

- [sundials in Poland](#) including the Muzeum Przytkowskich Wjedrzejowie

Spain

- [Barcelona](#)

[United Kingdom](#)

- [The Hampshire seaports sundial trail](#) **NEW**
- [The Leicester Time Trail](#) **NEW**
- [County Down, Northern Ireland](#) **NEW**
- [The City of London sundial trail](#) **NEW**
- [Chipping Camden, England](#) **NEW**
- [Derbyshire, England](#) **NEW**
- [the Test Valley sundial trail in Hampshire, England](#) **NEW**
- [the Cotswold sundial trail in Western England](#)
- [the Thames sundial trail in London](#)
- [East Sussex](#)
- [the Horniman Museum sundial trail in London](#)
- [Suffolk.](#)
- [South Norfolk](#)
- [Winchester](#)
- [Cambridgeshire](#)
- [Oxfordshshire](#)
- [the sundial trail for Guernsey in the Channel Islands](#)

NEW

COMPETITION

NEW

Competition 2002 for new sundial trails

The [competition](#) we held in 2001 and [previously](#) in the year 2000 were so successful that Internetworks Ltd has decided to offer a further prize of \$100 for the best new sundial trail written for us before 21 October 2002. There is also a \$50 prize for entries from people under 20 on that date. **All you have to do** is to imagine you are giving directions to a visitor who wants to see a few good sundials in your area, and write a trail which gives some information about each dial on the trail, together with very clear directions for how to get from one to the other.

All shortlisted entries will be posted on Sundials on the Internet with full acknowledgments to their author as soon as possible after we receive them. If you want a picture on your entry, please post the picture as a .jpg image on your own website (or get a friend to do it) and send us the link address.

You can write your entry **in any language**; please provide an English translation if you can

Please refer to our [competition](#) page for detailed guidance on the preparation of sundial trails, and for the entry regulations.

The trail can be on foot, like [Sydney](#) or [Winchester](#), by bicycle like [Ottawa](#), by car like [South Norfolk](#), by public transport like [Barcelona](#) or a mixture of different kinds of transport like the [London Thameside trail](#)

The main criteria in assessing the sundial trails submitted are:

- 1. Are the sundials on the trail interesting, and does the trail itself look interesting?
- 2. Are the directions clear, so that the dials are easy to find without fear of getting lost.

The winner of our 2000 competition, the [Guernsey sundial trail](#), is a useful model to follow.

5 sundial trails gets over 100 visitors a week: [London Thameside](#) [Cambridge](#) [East Sussex](#) [Toronto](#) and [Poland](#) Most of [the others](#) get more than 50. Sundial trails are a good way to introduce people to the fascinating world of sundials

Entries should be sent to [Sundials on the Internet](#) to arrive before midday on 21 October 2001. The trails must be written in HTML so that they can be accessed through Internet Explorer without any further work by us. We will put the standard "Sundials on the Internet" header and footer on the page (or you can do this if you prefer).

The shortlisted entries will be posted on Sundials on the Internet shortly afterwards, and will be judged by a panel of independent people well-versed in sundials. The decision of the judges will be final; no correspondence will be entered into. We will welcome your entries

For a full overview of Sundials on the Internet [click here](#)

This site designed and maintained by [Internetworks](#) Ltd of [Epsom](#), England

last revision

Comments/ suggestions/ problems, please get in touch with the [Webmaster](#)

Sundials on the Internet

For a full overview [click here](#)

The Sundials of the Camino of Santiago

The Camino Francés is the main section of the [Camino de Santiago](#), and runs from St. Jean-Pied-du-Port in south-western France near Biarritz to Santiago in northwest Spain. It has four main feeder routes from Paris, Vezelay, Le Puy and Nimes. There are also a number of other pilgrimage routes in Spain converging on Santiago. This page is concerned solely with the sundials on or near the Camino Francés. If you want more information about the Camino, we recommend www.santiago-compostela.net which has over 800 pictures of it, and the [Confraternity of St. James](#) which is the British society devoted to helping people doing this interesting pilgrimage route.

It is never possible to be certain that we have included all the sundials there are; if you come across any others, please send us an [email](#), if possible with a picture. with the main places with sundials in this talk marked in red



These are the two towers of the cathedral in Pamplona, with a clock on the left-hand tower and a sundial on the right-hand tower. You will see that the gnomon (which casts the shadow, is not centred, but substantially slewed to the right. This indicates that the face of the tower is facing west of south, and therefore that the sun will only shine onto the dial from 11 o'clock in the morning onwards. All vertical sundials cast the shadow vertically downwards at noon, when the sun is due south. A dial facing west of south, like this one, has to have the gnomon slewed to the east, and this in turn means that the morning hours will be much more widely spaced out than the afternoon hours. If you come across any other vertical sundial, you can use this to tell which way it is facing.

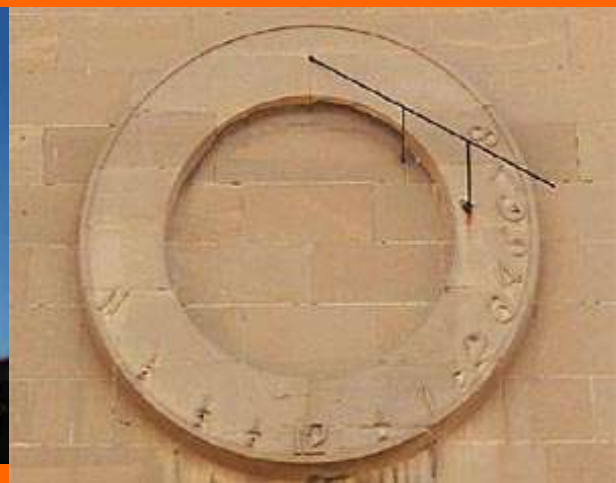

This sundial is over a baker's shop in the calle San Nicolas in Pamplona, just behind the church and, of course,

the large sundial on the right hand tower of your lovely Cathedral There is also an interesting modern sundial in the Bartolomé de Carranza suburb in south-west Pamplona ; you can see the large gnomon which casts the shadow here, and paving squares like these indicates the hours.



This sundial is on the south-east face of the tower of the church of San Francisco Javier which was built in 1952. It too has a clock and a sundial. You will see from the detail photograph that the sundial gives a time of around 7.15 whereas the clock is indicating 8.35. This illustrates a major difficulty for sundials in Spain, which keeps Central European Time, even though most of Spain is west of the Greenwich meridian. This means that there is always a difference of at least one hour between sundials and clocks in Spain, and in summer time, a difference of more than 2 hours. This sundial should have a difference of around 2 hours and 15 minutes, since Pamplona is nearly 4 degrees West of Greenwich, but it does not appear to have been laid out quite correctly.



This is an ancient sundial on the church at Torres del Rio. You will notice that it is angled out from the wall. This is because sundials are much easier to construct if they are pointing exactly to due south.

And a little further along the road is the sundial on the church of Santa Maria in Viana . This is a close-up of the sundial, which shows that it is now in very poor condition



Logroño, the capital of La Rioja, does not appear to have any sundials, though there is a [sculpture](#) on a roundabout which looks as if it ought to be a sundial, but it is just a sculpture. (You can tell from a distance that it is not a sundial because the gnomon would be around 44 degrees to the horizontal, which is the same as the latitude for Logroño; this is a much steeper angle, so it cannot be a sundial)

About 40 km. to the south of the Camino is the monastery of Yuso, which has a very old library. The Yuso monastery is the cradle of both the Spanish and the Basque languages - the earliest written words in both languages are marginal notes in Latin manuscripts in this library. The Yuso monastery also has a sundial in the courtyard. This sundial is also angled out from the wall to ensure the sundial is pointing due south.

Halfway between Yuso and the camino is the nunnery at Cañas; this is a very interesting building with a good museum and some ancient tombs including this one of the first abbess. The nunnery also has a sundial in the courtyard.



Between Cañas and Yuso is a small village with a sundial high up on the wall at a cross-roads; this too is in poor condition. Back on the Camino, the little church at Azofre has one of the best preserved sundials on the whole Camino.



The cathedral at Leon has two interesting sundials. The left-hand picture shows the multiple dial at the south-east corner of the cathedral; the stone is angled from the wall, so that the central dial points exactly south, and has the usual angled gnomon. To the left hand side, there is a west facing dial, which has only part of its gnomon. And there is a third sundial to the right (31). This one faces due East, and again has part of its gnomon missing. There is another sundial further along this wall of Leon cathedral (32). This one is in quite good condition, and it is not angled out from the wall, so you will see that the gnomon is not vertical on the centre line, but is displaced to the left so that it will still tell the correct time by the sun.



There is then a long section of the Camino, with apparently no sundials at all. In Santiago de Compostela, there are at least eight sundials, and six of them are very easy to see. These pictures show the three sundials in the cloister of the cathedral, which is accessible through the museum. The fourth picture is the east face of the rather worn sundial, also from 1601, which stands on a stone wall to the left of the Hostal dos Reyes Catolicos in Obradoiro Square. There are two other sundials on the south and west faces of this large block of stone, but these two are much more worn.



Many people travelling to or from the Camino pass through San Sebastian, which has a striking modern sundial in an eastern suburb

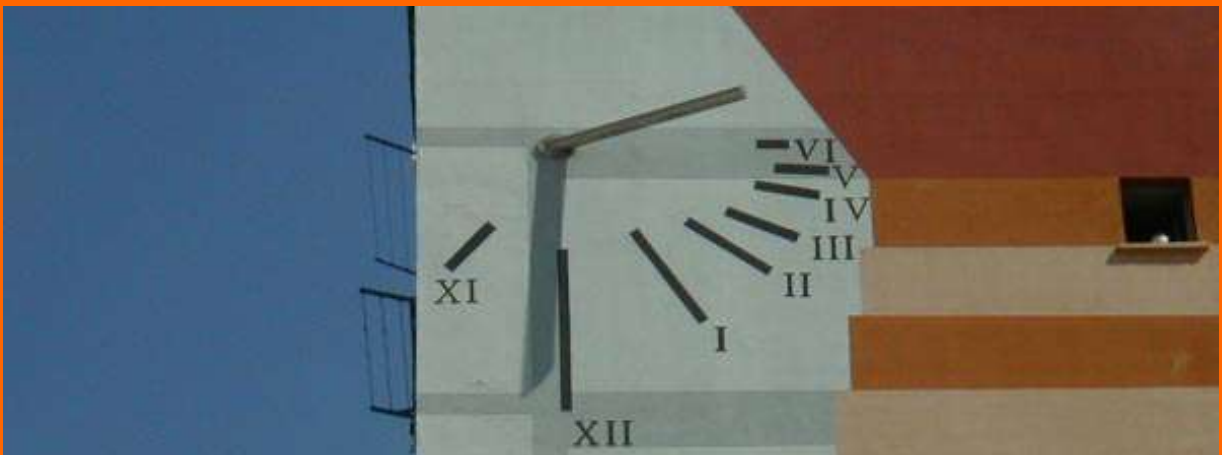

And, in Biarritz just over the border in France, there are two human gnomon or analemmatic sundials in marvellous locations overlooking the great sweep of the bay with its Atlantic waves. These sundials are especially popular with children; you stand on a spot marked for the month of the year, and your shadow indicates the approximate time.



For a full overview of Sundials on the Internet [click here](#)

This site designed and maintained by [Internetworks](#) Ltd of [Epsom](#), England

first posted July 1997 last revision

Comments/ suggestions/ problems, please get in touch with the [Webmaster](#)

Sundials on the Internet

For a full overview [click here](#)

The City of Oxford sundial trail

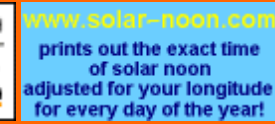

Oxford has a collection of magnificent sundials. Most of them are inside colleges, which normally restrict visitors to a short period in the afternoons, typically 2 to 4 pm. They will sometimes let you in at other times if you explain that you are specially interested in their sundial at the Porter's Lodge.

There is an excellent book "Oxford Sundials" by Margaret Stanier which gives more details of many of the sundials listed here, and some others. It can be obtained from the [British Sundial Society](#)

Before starting this Oxford sundial trail, you will find it helpful to print out this [street map](#) of the City. You may also find it useful to look at [another map](#) which indicates the main colleges and other places of interest and has other information about Oxford. On this page, walking directions are given in *italics*

The trail starts at the top left hand corner of the map. Green College is on the Woodstock Road, which is the left hand fork of the two main roads at the top of St. Giles. The second sundial is in the small graveyard garden of St. Giles Church, which is at the top of St. Giles, between the Woodstock and Banbury Roads.



This vertical declining mean time noon mark at Green College was designed by C. St. J Daniel in 1994 and made by Martin Jennings. It works by projecting a spot of light through the gilded sun shape above and to the left of the dial. When the spot of light falls exactly on the "figure-of-eight" or analemma, the time is exactly 12 noon GMT (or 1 pm BST when summer time is in operation). When the spot falls on the vertical gold line through the centre of the analemma, it is solar noon in Greenwich, and when it falls on the vertical white line just to the right of this, it is the time of solar noon in



Oxford. An explanation of the differences between GMT (the time on our watches) and solar time, please visit our [Equation of Time](#) page

The armillary sphere in the garden of St Giles Church has the gnomon (which casts the shadow) slanting up at the same angle as the latitude; the shadow falls on the curved plate marked in Roman numerals. This sundial was placed as a memorial and has a small inscription plaque on the pedestal

Now walk south down St. Giles to the end, passing St. Johns College on your left and the Ashmolean Museum on your right. Leave St. Giles by taking the short road to the left of the church (St. Mary Magdalen) Leave the church of St. Mary Magdalen on your right at the end of St. Giles, following the very short Magdalen Street, and then turn left into Broad Street. Here you have colleges to left and shops on the right. Walk to the end, where just before the Sheldonian Theatre you have the Museum of the History of Science on the right, with its large collection of scientific instruments including sundials. This museum is open most afternoons. At the end, continue straight on down Holywell Street, until you come to the entrance of New College on your right.

Here there is a most interesting new sundial which was made in the summer of 1999 by the noted stonecarver and diallist Harriet James. It measures 15 by 17 feet, and is carved directly into the stone of the tower. More details of this dial are given on our [New Dials](#) page

From the gate of New College, turn right to the end of Holywell Street. At this point, you can turn left up St. Cross Street to see the dial on St. Cross Church restored by Harriet James in 1999 and pictured below, or you can continue down Longwall 9see below)

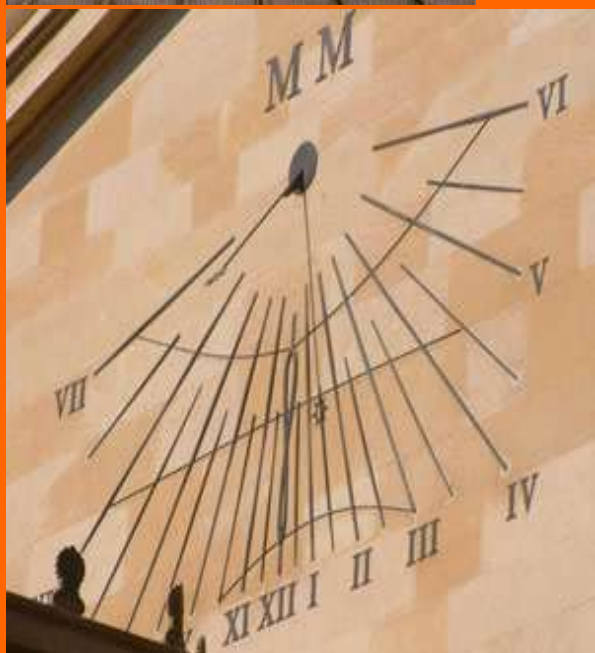
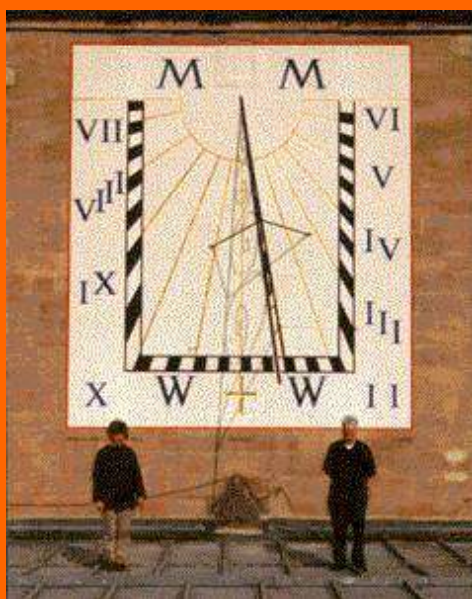

(If you have visited St. Cross, retrace your steps to Holywell Street, and) continue down Longwall which curves round to the right. Halfway along Longwall, on the left-hand side, is the back gate of Magdalen College. If it is open, you will be able to go a few paces inside, and find the octagonal tower at the end of the new Longwall quad facing you. On the gable end above the tower is the large vertical dial by David Harber erected in the year 2000.

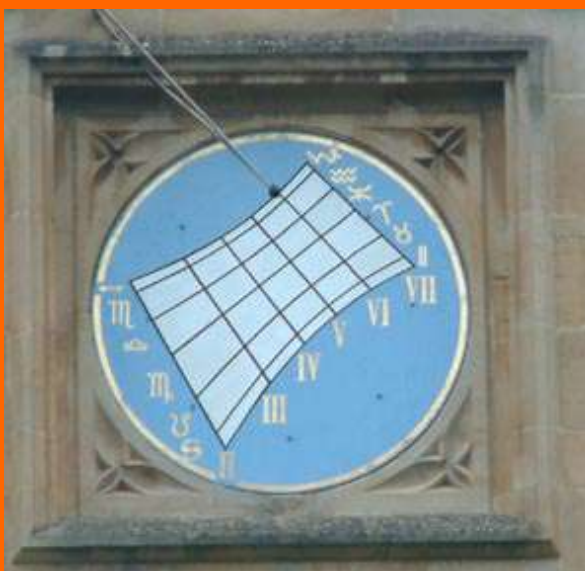

Continue down Longwall to the traffic lights at the High Street, cross over the High Street and turn right. Then turn left into Merton Street, just after the Eastgate Hotel. Continue along Merton Street when it takes a sharp turn to the right. Further on, on your left is the entrance to Merton College

Merton College has two interesting sundials. The first is on a buttress of the chapel, just inside the main gate and to the right. It is east-facing, and only shows the hours from 6am to 9 am. It dates back to 1629. It has three sets of lines, the gold lines slanting upwards to the right with the 7, 8, and 9 marks at their foot to indicate the hours, the gently slanting black lines, with figures indicating the number of hours since sunrise, and the vertical black lines indicating the azimuth (direction of the sun) from 10 deg. S of E, by 10 deg increments to 20 deg. N of E. In addition there are 9 black lines slanting steeply down to the right which are lines of constant solar declination of no interest to the observer, but used for the construction of the time lines.

The second dial is high up on the wall of the quad. It is a west-facing dial, and indicates the time from 2pm to 7 pm. This dial also has declination lines running across the dial, with the relevant signs of the zodiac indicating the month of the year

Turn left out of the gate of Merton and continue along Merton Street. The next college on your left is Corpus Christi which has the famous Pelican dial standing on its pillar just inside the front entrance. This dial by Charles Turnbull was erected in 1581, and has had a number of restorations since. It is a multiple dial, with one major south-facing dial on the curved surface of the pillar shown in the right-hand photo, and four smaller sundials on the square section above it on each face of the pillar, facing respectively south, west, north and east. There are four more reclining dials on the next level up, and the whole is crowned with a magnificent pelican. This is a "tour de force" of sundial construction, and has been the unchallenged king of all the Oxford sundials for more than 400 years.



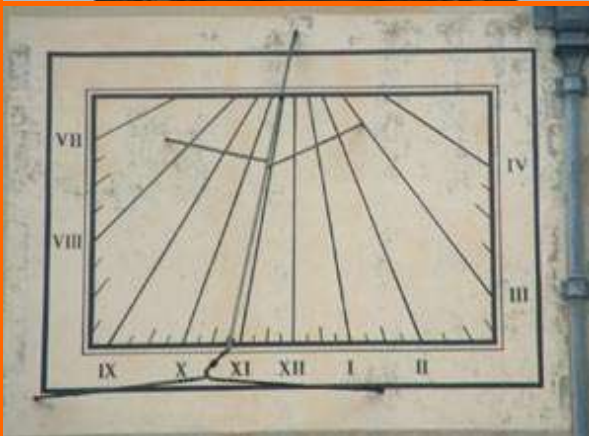

Turn right out of the gate of Corpus Christi (back towards Merton), and right again into Merton Grove. This will take you out onto a gravel path with playing fields on your left and Christ Church on your right. When you get to the gravel path (Broad Walk) across the wide expanse of Christ Church Meadow turn right and continue until you get to the visitors' entrances to Christ Church. Oxford Cathedral is within the college, and visitors to the Cathedral are admitted free of charge. Follow the signs to the cathedral, and when you reach it, continue straight on for fifty feet or so. This sundial is facing you on the side of the Kilcanon building.

Leave Christ Church by the same entrance, turn right through a garden to emerge on St. Aldates, the main road from the south. Turn right towards the centre of the city, until you get to the main crossroads called Carfax. Here you turn right along the High Street, walking for 300 yards or so until you reach the gates of All Soul's College on the left

This magnificent sundial is at the far side of the second quadrangle; it was made in 1659, and the motton translates as "The hours pass away and are set down to our charge". It shows the hours from 6 am to 5 pm in minutes.





From the gate of All Souls, turn right a short way back up the High Street, and take the first right again into Radcliffe Square. Brasenose Lane is across the square to your left, and you walk down this fifty yards or so to the gate of Brasenose College on your right. This marvellous sundial is in the first quad.

It was made in 1719, and faces 6 degrees east of South. The half hour lines have fleur-de-lys at their ends, and are further divided in four.

This ends the Oxford sundial trail, but if you have time, it is well worth taking the guided tour round the Bodleian Library, which has its entrance on Radcliffe Square. The tour includes a visit to the Convocation House, which has two stained glass sundials set in the south and west windows in an upper room. They are very difficult to see from the ground. The dials no longer have gnomons, but they are very interesting examples of their kind.

There is another stained glass sundial in a window of the Museum of the History of Science, which is just behind the Bodleian Library, and which you passed earlier in your tour. It is halfway up the stairs, and again lacks a gnomon. The motto translates "The evening is uncertain, - come now! - delay is harmful - tomorrow is nothing" It was made around 1611.

Pictures of these stained glass sundials are included in "Oxford Sundials" by Margaret Stanier which can be obtained from the [British Sundial Society](#)

For a full overview of Sundials on the Internet [click here](#)

This site designed and maintained by [Internetworks](#) Ltd of [Epsom](#), England
last revision

Comments/ suggestions/ problems, please get in touch with the [Webmaster](#)

Sundials on the Internet

For a full overview [click here](#)

British Sundial Society



The British Sundial Society - International Conference

Oxford, 16-18 April 2004

All sundial enthusiasts from around the world are invited to join the Society in the lovely setting of St Anne's College, Oxford. Our usual two-day conference is being extended to be earlier on the Friday and conclude on the Sunday afternoon with a guided walking tour of some of Oxford's famous dials. In addition to the lectures and banquet, delegates have been invited to a private reception and tour of the world famous collections in the Museum of History of Science. In addition there is a choice of coach tours - one is to Blenheim Palace, the home of the 11th Duke of Marlborough and the birthplace of Winston Churchill. In the Italian garden there is a fine horizontal dial by John Rowley, dated 1710. The other tour is to the workshops of David Harber and to see Joanna Migdal's studio. Both have national and international reputations. The conference fees are from £220 to £250 and include all the accommodation, meals, lectures and any admission charges. It is not necessary to be a member of the British society to attend the conferences.

Highlights of the conference will include:

- A full lecture programme including the Andrew Somerville Memorial Lecture given this year by Dr. Ken Mackay on Scottish dials, and other speakers from the UK, USA and Austria.
- A visit to the fine collects of sundials in the Museum of the History of Science
- Coach tours to Blenheim Palace or to the workshop of David Harber, the well-known sundial maker.
- A walking tour of 10 of the sundials in Oxford colleges. (see also the [Oxford sundial trail](#))

If you would like more information, please write, telephone, or e-mail to Douglas Bateman, Secretary, British Sundial Society, 4 New Wokingham Road, Crowthorne, Berkshire, RG45 7NR, United Kingdom. Tel: +44 1344 772303. E-mail: douglas.bateman@btinternet.com

For a full overview of Sundials on the Internet [click here](#)

This site designed and maintained by [Internetworks](#) Ltd of [Epsom](#), England

last revision

Comments/ suggestions/ problems, please get in touch with the [Webmaster](#)

[Shop Our Catalog](#)

[Privacy](#)

[Customer Service](#)



Bringing the world of home and garden furnishings to your fingertips ©...

[Security](#) [About Us](#) [Affiliates](#) [Corporate](#)

© 2001 The Arthur Wilbur Co., Inc. / OutdoorDecor.com

HOME PAGE	HORIZONTAL DIALS	ARMILLARY SPHERES		VERTICAL DIALS	EQUATORIAL DIALS	ANALEMMATIC DIALS
POLAR DIALS	WHAT'S NEW	<i>Sundials for the Connoisseur</i>			CORPORATE GIFTS	PRICE LIST

HORIZONTAL DIALS		VERTICAL DIALS	
ARMILLARY SPHERES		EQUATORIAL DIALS	
POLAR DIALS		ANALEMMATIC DIALS	
WHAT'S NEW?		CORPORATE GIFTS	

Connoisseur Sundials
 Lane's End, Strefford
 Craven Arms, Shropshire SY7 8DE

Tel/Fax: +44 (0)1588 672126

Email sundials@ouvip.com

Sun-dials - horizontal dials,sundials,vertical dials,equatorial dials,polar dials.

Sundials on the Internet

For a full overview [click here](#)

Page Access Statistics - June to September 2001



This page shows the number of page accesses to each page on our site, with a link to that page so you can see it for yourself! The page accesses relate to the period 1 June 2001 to 1 October 2001 (a period of 122 days, one third of a year)

The total number of pages requested in this period were 184,193 (1,507 pages per day) and the number of distinct hosts served was 35,264

Comparative figures for previous periods (with links to those pages if you want to see the detail) were:

	May-Sept 2000	Oct 2000 - Jan 2001	Feb-May 2001	June-Sept 2001
Total page accesses	146,381	163,373	202,466	184,193
Page accesses/day	1,212	1,353	1,663	1,507
Distinct hosts served	26,455	35,251	41,905	35,264
	View page	View page	View page	Detail below

Pages in order of page accesses per month

Pages in order of page accesses per month

20485 [index.htm](#)
 10018 [projects.htm](#)
 9879 [home3.htm](#)
 6910 [setup.htm](#)
 6674 [pix.htm](#)
 5430 [equation.htm](#)
 4636 [index.htm](#)
 4431 [sunfair.htm](#)
 4220 [newdials.htm](#)
 4212 [connois.htm](#)
 3560 [intro.htm](#)
 3266 [types.htm](#)

Pages in alphabetical order with page accesses per month

584 [~barceln.htm](#)
 394 [~briancn.htm](#)
 337 [~buech.htm](#)
 1486 [~cantab.htm](#)
 892 [~cotswolds.htm](#)
 368 [~ecuador.htm](#)
 353 [~ecuadorsp.htm](#)
 1326 [~esussex.htm](#)
 375 [~finistere.htm](#)
 550 [~guernsey.htm](#)
 524 [~hornimn.htm](#)
 510 [~KY.htm](#)

2786	makers.htm	355	~leicester.htm
2782	comprogs.htm	364	~malta.htm
2538	books.htm	503	~milan.htm
2245	bssbooks.htm	492	~milanit.htm
1901	faq.htm	362	~nederla.htm
1867	hj.htm	166	~netherl.htm
1865	soti.htm	162	~newtrails.htm
1486	~cantab.htm	350	~norfolks.htm
1429	~thames.htm	571	~ottawa.htm
1369	mottoes.htm	437	~oxon.htm
1326	~esussex.htm	557	~paris.htm
1320	indexsp.htm	1300	~polska.htm
1300	~polska.htm	441	~queyfr.htm
1244	bsshome.htm	398	~queyras.htm
1238	~toronto.htm	696	~seattle.htm
1234	natsocs.htm	1075	~suffolk.htm
1202	declin.htm	741	~sydney.htm
1163	tbsun.htm	393	~tasmania.htm
1130	tbc.al.htm	355	~testvalley.htm
1128	massdial.htm	1429	~thames.htm
1118	future.htm	1238	~toronto.htm
1114	tbana.htm	26	~wilts.htm
1083	articles.htm	481	~winton.htm
1080	indexit.htm	423	1sundial.htm
1075	~suffolk.htm	235	2sundial.htm
1032	indexfr.htm	343	3sundial.htm
992	sunlist.htm	437	4sundial.htm
977	deutsch/indexde.htm	273	5sundial.htm
894	otherint.htm	143	8sundial.htm
892	~cotswolds.htm	157	9sundial.htm
871	tblat.htm	229	addedval.htm
816	mottoesp.htm	1083	articles.htm
789	tbgno.htm	437	articlnl.htm
782	tbadj.htm	402	awards.htm
761	typesfr.htm	2538	books.htm
756	ecuasp.htm	384	booksnl.htm
749	time.htm	321	bssadv.htm
748	nasscomp.htm	189	bssadv2.htm
746	français.htm	2245	bssbooks.htm
741	~sydney.htm	371	bssgen.htm
723	setupit.htm	1244	bsshome.htm
710	tbdis.htm	150	bssjform.htm
710	tydsysnl.htm	362	bssjoin.htm
699	typesnl.htm	213	bulorder.htm
696	~seattle.htm	522	choice.htm
693	tbmer.htm	287	comments.htm
690	dutch.htm	304	competition.htm

665 [tbequ.htm](#)
648 [tbrin.htm](#)
620 [feedback.htm](#)
620 [tbsig.htm](#)
607 [tbhou.htm](#)
605 [projefr.htm](#)
604 [tbnoo.htm](#)
584 [~barceln.htm](#)
577 [nasshome.htm](#)
572 [indexpor.htm](#)
571 [~ottawa.htm](#)
557 [~paris.htm](#)
552 [deutsch.htm](#)
550 [~guernsey.htm](#)
544 [reviews.htm](#)
543 [tbpil.htm](#)
540 [typespo.htm](#)
537 [equanl.htm](#)
524 [~hornimn.htm](#)
522 [choice.htm](#)
510 [~KY.htm](#)
506 [deutsch/booksde.htm](#)
505 [makerapp.htm](#)
503 [~milan.htm](#)
494 [deutsch/katade.htm](#)
492 [~milanit.htm](#)
491 [equatit.htm](#)
490 [dhs.htm](#)
484 [hjames.htm](#)
481 [~winton.htm](#)
469 [sustrans.htm](#)
447 [tbmea.htm](#)
441 [~queyfr.htm](#)
441 [indexcz.htm](#)
437 [~oxon.htm](#)
437 [4sundial.htm](#)
437 [articlnl.htm](#)
437 [index5.htm](#)
425 [tbmin.htm](#)
423 [1sundial.htm](#)
414 [index3.htm](#)
414 [typesit.htm](#)
402 [awards.htm](#)
401 [italiano/indexit.htm](#)
400 [mailist.htm](#)
400 [personal.htm](#)

2782 [comprogs.htm](#)
270 [conference2000.htm](#)
34 [conference2001.htm](#)
4212 [connois.htm](#)
1202 [declin.htm](#)
245 [declinhu.htm](#)
162 [declnl.htm](#)
552 [deutsch.htm](#)
506 [deutsch/booksde.htm](#)
322 [deutsch/gnomonde.htm](#)
322 [deutsch/gsa.htm](#)
375 [deutsch/gsade.htm](#)
977 [deutsch/indexde.htm](#)
105 [deutsch/introde.htm](#)
398 [deutsch/kata.htm](#)
494 [deutsch/katade.htm](#)
490 [dhs.htm](#)
690 [dutch.htm](#)
320 [dutchsoc.htm](#)
756 [ecuasp.htm](#)
237 [eothu.htm](#)
537 [equanl.htm](#)
5430 [equation.htm](#)
491 [equatit.htm](#)
336 [espanol.htm](#)
1901 [faq.htm](#)
177 [faqnl.htm](#)
278 [favritfr.htm](#)
205 [favritna.htm](#)
246 [favritnl.htm](#)
379 [favrituk.htm](#)
620 [feedback.htm](#)
746 [francais.htm](#)
1118 [future.htm](#)
142 [glosnl.htm](#)
228 [gsa.htm](#)
203 [gsade.htm](#)
1867 [hj.htm](#)
484 [hjames.htm](#)
9879 [home3.htm](#)
360 [home4.htm](#)
193 [home97.htm](#)
292 [home98.htm](#)
20485 [index.htm](#)
4636 [index.htm](#)
11 [index.htm?module=DB_File&readme=1](#)

398 [~queyras.htm](#)
398 [deutsch/kata.htm](#)
394 [~briancn.htm](#)
393 [~tasmania.htm](#)
384 [booksnl.htm](#)
379 [favrituk.htm](#)
375 [~finistere.htm](#)
375 [deutsch/gside.htm](#)
371 [bssgen.htm](#)
371 [links.htm](#)
368 [~ecuador.htm](#)
364 [~malta.htm](#)
364 [stats.htm](#)
362 [~nederla.htm](#)
362 [bssjoin.htm](#)
362 [tb.htm](#)
360 [home4.htm](#)
355 [~leicester.htm](#)
355 [~testvalley.htm](#)
354 [translate.htm](#)
353 [~ecuadorsp.htm](#)
350 [~norfolks.htm](#)
346 [indexhu.htm](#)
343 [3sundial.htm](#)
337 [~buech.htm](#)
336 [espanol.htm](#)
322 [deutsch/gnomonde.htm](#)
322 [deutsch/gsa.htm](#)
321 [bssadv.htm](#)
320 [dutchsoc.htm](#)
312 [italiano/introit.htm](#)
310 [italiano/setupit.htm](#)
304 [competition.htm](#)
292 [home98.htm](#)
287 [comments.htm](#)
285 [introhu.htm](#)
278 [favritfr.htm](#)
275 [sponsor.htm](#)
273 [5sundial.htm](#)
270 [conference2000.htm](#)
266 [setupnl.htm](#)
246 [favritnl.htm](#)
245 [declinhu.htm](#)
243 [sunapp.htm](#)
237 [eothu.htm](#)
235 [2sundial.htm](#)
235 [translat.htm](#)

79 [index2.htm](#)
22 [index2001.html](#)
414 [index3.htm](#)
437 [index5.htm](#)
441 [indexcz.htm](#)
1032 [indexfr.htm](#)
346 [indexhu.htm](#)
1080 [indexit.htm](#)
572 [indexpor.htm](#)
1320 [indexsp.htm](#)
3560 [intro.htm](#)
285 [introhu.htm](#)
212 [intronl.htm](#)
154 [inw.htm](#)
401 [italiano/indexit.htm](#)
312 [italiano/introit.htm](#)
310 [italiano/setupit.htm](#)
21 [italiano/typesit.htm](#)
206 [joinissi.htm](#)
141 [joinnl.htm](#)
371 [links.htm](#)
400 [mailist.htm](#)
505 [makerapp.htm](#)
2786 [makers.htm](#)
204 [makersnl.htm](#)
1128 [massdial.htm](#)
1369 [mottoes.htm](#)
816 [mottoesp.htm](#)
147 [mottonl.htm](#)
748 [nasscomp.htm](#)
577 [nasshome.htm](#)
197 [nassjoin.htm](#)
189 [natsocnl.htm](#)
1234 [natsocs.htm](#)
4220 [newdials.htm](#)
894 [otherint.htm](#)
181 [othersun.htm](#)
400 [personal.htm](#)
181 [personapp.htm](#)
6674 [pix.htm](#)
170 [pixnl.htm](#)
129 [progress.htm](#)
10018 [projects.htm](#)
605 [projefr.htm](#)
544 [reviews.htm](#)
6910 [setup.htm](#)
187 [setupcz.htm](#)

229 [addedval.htm](#)
228 [gsa.htm](#)
213 [bulorder.htm](#)
212 [intronl.htm](#)
206 [joinissi.htm](#)
205 [favritna.htm](#)
204 [makersnl.htm](#)
203 [gsade.htm](#)
197 [nassjoin.htm](#)
193 [home97.htm](#)
193 [sitindex.htm](#)
189 [bssadv2.htm](#)
189 [natsoenl.htm](#)
187 [setupcz.htm](#)
181 [othersun.htm](#)
181 [personapp.htm](#)
177 [faqnl.htm](#)
170 [pixnl.htm](#)
166 [~netherl.htm](#)
162 [~newtrails.htm](#)
162 [declnl.htm](#)
157 [9sundial.htm](#)
154 [inw.htm](#)
150 [bssjform.htm](#)
147 [mottonl.htm](#)
143 [8sundial.htm](#)
142 [glosnl.htm](#)
141 [joinnl.htm](#)
140 [stylenl.htm](#)
139 [timenl.htm](#)
139 [writenl.htm](#)
132 [transnl.htm](#)
129 [progress.htm](#)
118 [stats2000c.htm](#)
105 [deutsch/introde.htm](#)
79 [index2.htm](#)
45 [sunfairtem.htm](#)
34 [conference2001.htm](#)
26 [~wilts.htm](#)
22 [index2001.html](#)
22 [sunfair2001.htm](#)
21 [italiano/typesit.htm](#)
11 [index.htm?module=DB_File&readme=1](#)

723 [setupit.htm](#)
266 [setupnl.htm](#)
193 [sitindex.htm](#)
1865 [soti.htm](#)
275 [sponsor.htm](#)
364 [stats.htm](#)
118 [stats2000c.htm](#)
140 [stylenl.htm](#)
243 [sunapp.htm](#)
4431 [sunfair.htm](#)
22 [sunfair2001.htm](#)
45 [sunfairtem.htm](#)
992 [sunlist.htm](#)
469 [sustrans.htm](#)
362 [tb.htm](#)
782 [tbadj.htm](#)
1114 [tbana.htm](#)
1130 [tbcnl.htm](#)
710 [tbdis.htm](#)
665 [tbequ.htm](#)
789 [tbgno.htm](#)
607 [tbhou.htm](#)
871 [tblat.htm](#)
447 [tbmea.htm](#)
693 [tbmer.htm](#)
425 [tbmin.htm](#)
604 [tbnoo.htm](#)
543 [tbpil.htm](#)
648 [tbrin.htm](#)
620 [tbsig.htm](#)
1163 [tbsun.htm](#)
749 [time.htm](#)
139 [timenl.htm](#)
235 [translat.htm](#)
354 [translate.htm](#)
132 [transnl.htm](#)
710 [tydsysnl.htm](#)
3266 [types.htm](#)
761 [typesfr.htm](#)
414 [typesit.htm](#)
699 [typesnl.htm](#)
540 [typespo.htm](#)
139 [writenl.htm](#)

[This page written and maintained by Internetworks Ltd](#)



The Spot-on Sundial - a new concept in sundials

The new **Spot-On Sundial** combines modern functional design with unrivalled accuracy.

3 models of **Spot-On Sundial** to suit all situations from small urban gardens to large open spaces and public areas

All models can have an engraved message on the side of the gnomon to give a unique gift for an anniversary, birthday, wedding, or special event.



Spot-On Sundial in brass

The main feature of the Spot-On Sundial is the divided gnomon* constructed of two parallel plates with a small air gap. This permits a ray of sunshine to pass through for a few minutes at solar noon, [more...](#)



The Unique Line of Light

Spot-on Sundial in Stainless Steel

An interesting dial which gives excellent reflections in the mirror-finished stainless steel, and, with the contrasting matt circle on which the hour lines are shown, gives the appearance of "floating on air"

[more...](#)

These stainless steel dials are individually designed for their precise location and incorporate engraving text, logos, or drawings agreed with the client.



These elegant and robust dials incorporate the split gnomon, so that every day at solar noon a line of light will shine through the gnomon along the noon line.



When you have decided which sundial you want, you can now buy it in our new [online store!](#)

What is local noon?

Noon is when the sun is at its highest in the sky. Watches are based on the assumption that all days in the year are exactly 24 hours long. Sundials are based on the idea of measuring time before and after noon, days vary in length, true noon rarely coincides with clock noon, [more...](#)

Use the [Spot-On Sundials Solar Noon Calculator](#) to print out a table showing the exact time of solar noon throughout the world at any location worldwide.



The Spot-On Sundial is easy to read

The shadow of the top slanting edge of the gnomon travels round the sundial in a clockwise direction (for our Northern Hemisphere models). This shows the shadow falling exactly on an hour line. The time is 8 am winter time (indicated by the VIII Roman numerals) or 9 am in Summer Time/Daylight Saving Time, [more...](#)

Plinths and stockists



Click [here](#) for names and addresses and more pictures.

- [Reading your sundial](#)
- [Setting up your sundial](#)
- [Equation of Time](#)
- [Longitude and Latitude](#)
- [Solar noon calculator](#)
- [Looking after your sundial](#)
- [How to order your sundial](#)
- [Choosing the right model](#)
- [A note from the Designer](#)
- [Engraving](#)
- [Delivery times](#)
- [Sundials on the Internet](#)
- [Shop](#)

Choosing the correct model for your location

Horizontal sundials need to have the angle between the gnomon (which casts the shadow) and the dialplate appropriate to the latitude where they are to be used. The Spot-On Sundial is made in seven models - use [this page](#) to help you decided which is the correct model for you.

*Gnomon

The gnomon is the upright part of the sundial which casts the shadow. It is derived from the Greek word meaing indicator; the g is silent, so it is pronounced "no-mon" with the first o long.

Ordering a Sundial

First, choose the right [model](#) for your latitude. Then decide whether or not you want an [engraving](#). Then go to our [shop](#) (if you want to pay by credit card on the Internet) or use our [reservation form](#) (if you are paying by cheque or by inter-bank transfer). For [despatch dates click here](#)., or use our reservation form (if you are paying by cheque or by inter-bank transfer)

Setting up

Detailed instructions are provided for [brass](#) and [stainless steel](#) sundials, [advanced](#) set up for super accuracy, [indoor](#) set up.



Note from the Designer

People often ask what is so special about the Spot-On Sundial and how it came to be designed. If you too are interested in this, here is the full [story!](#)

Piers Nicholson

New! Polar Spot-On Sundial in brass



An unusual sundial echoing the 3 Millennium sundials designed by Piers Nicholson for the Tylers and Brickayers company of the City of London, [more...](#)

The gnomon* is made from two brass plates with a narrow airgap, which produces a "line of light" like the other dials in the range.

The dialplate is in the same plane as the gnomon, so the shadow is a straight line which moves gradually from left to right over the dialplate.

NEW! A Spot-On Sundial for Schools

We will shortly be introducing a new model of Spot-On Sundial designed specially for use in schools to demonstrate the way sundials work.

The dialplate and gnomon are made of acrylic, and the baseplate from styrene. The gnomon consists of two plates with a narrow air-gap, and thus gives the "line of light" which is the hallmark of this innovative design.

The sundial is 7 ins. square, and the markings of the dialplate are closely similar to those of the brass model. The target price for these sundials is around £20 (€30, \$30) each

Spot-On Sundials POBox 292, Epsom, KT17 4YP, England
Tel: 01372 747767 (International +44 1372 747767) info@spot-on-sundials.co.uk

www.spot-on-sundials.co.uk designed and maintained by [Internetworks Ltd](#) of Epsom, England.
Copyright © Spot-on Sundials 1999-2003

Sundials on the Internet

For a full overview [click here](#)

Introduction to Sundials

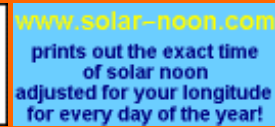

When we were planning **Sundials on the Internet**, in 1996, I met someone socially for the first time. They were very glad to meet someone interested in sundials. "I have been working for some time on a sundial, but I can't get it to tell the time consistently." He explained that he had a vertical post in his garden, and wanted to make a sundial with it. I thought back to how my own interest in sundials started, when I put a stout baulk of timber vertically in the ground to support one end of a bench, and then thought I might use it for a sundial. So I cast some paving stones with the numbers 9, 10, 11 and so on which I laid around it where the shadow fell. I was so cross when it became more and more inaccurate as the days went by. And it must have been five years later that I came across a [book](#) by AP Herbert about sundials which clarified why it hadn't worked. After that, I started making some sundials which did work, and once you start getting interested in sundials, it is very difficult to stop!

These two experiences are a microcosm of the story of sundials from time immemorial. Everyone has noticed shadows moving round during the day. Someone unknown in the past found out that if the shadow was cast by a sloping object pointing to the celestial pole, it would cast a consistent shadow which would be in the same place at the same time every day. Though it has been suggested that this may have been 2000 years ago, it is more likely that it would have been around 500 years ago; before the development of clocks, it would have been difficult to determine what "the same time each day" meant, and anyone such an innovation would probably have been dismissed as impractical and useless.

Practically everybody knows what a sundial is. Most people have a residual idea that, if they had to, they could make one. But most people's practical knowledge of sundials is confined to having seen some standard brass horizontal dials on plinths in gardens. They may even have one in their own garden, or perhaps in their garden shed because they don't know how to set it up.

And there is a widespread - though totally wrong - general impression that sundials are not very good at telling the time. This has been well put by Hilaire Belloc who produced a number of sundial [mottos](#) including:

I am a sundial, and I make a botch
Of what is done far better by a watch.

The poor reputation of sundials is ill-deserved, and has arisen mostly because we have all accepted "watch time" as an absolute standard, without devoting any thought to the nature of the time it is measuring.

Sundials measure time as it is. Noon is when the sun is highest in the sky (when it crosses the meridian). Watches measure time as we would like it to be, with noon tomorrow exactly 24 hours, 0 minutes and 0 seconds away from noon today. But noon on 26 December is actually 24 hours, 0 minutes and 29 seconds away from noon on Christmas Day. And noon on 15th September is only 23 hours, 59 minutes and 39 seconds away from noon on the following day.

Mechanical watches obviously cannot be made to run in this way. (Electronic watches could be made to do so, though the manufacturers would probably not find a very large market for them). So Mean Time was invented, an artificial construct in which all days are assumed to be exactly 24 hours long.

The sundials seen above church doors are a reminder of a time when sundials were the standard. Until about 200 years ago, public clocks could not be made sufficiently accurate to run for more than a few days without being reset, and the only way of resetting them was from a sundial.

Until the railways came, there was no particular reason why people in, say, Bristol should keep the same time as people in London. And, of course, at that time there was no practical way of communicating information about time over a distance. When the telegraph made such communication possible, it became necessary for people living in one area to agree that they would not keep their own local time, but would all keep a time based on the local standard meridian. Bristol is at 2°35'W of Greenwich, so noon there is just over 10 minutes later than in London. There is still a relic of this change - the clock over the old Corn Exchange in



Bristol has two minute hands. One shows Greenwich Mean Time like all the other clocks in England, and the other shows Bristol time!

Later on, another artificial change was made with Summer Time, which arbitrarily adds one hour to all clock times during the summer.

So, in the summer, there are 3 good reasons why your watch will be telling a different time from the sundial. They may be up to 15 minutes different because your watch is assuming that all days are equal in length. Then it will be 4 minutes different for every 1° you are east or west of your standard meridian. (This can be quite substantial; Vigo in Spain, for example is 8°44'W of Greenwich, but is on Central European Time, for which the standard meridian is 15°E of Greenwich, so the correction for longitude in Vigo will be 1 hour 34 minutes and 56 seconds). Lastly, it will be exactly 60 minutes

different because your watch, if you live in England, has been arbitrarily altered to tell the time in Prague for the duration of the summer!

With all these artificial difficulties to contend with, it is quite a surprise that interest in sundials continues at all. But interest is in fact growing. [Sundial societies](#) exist in Britain and many other countries, and their membership is expanding. You are very welcome to join too.

We hope that **Sundials on the Internet** will give you some idea of the world of sundials - its complexity and its fascination. Sundials are unique in that Science (in the form of accurate calculations), Art (in the form of pleasing design) and Craft (in the form of good workmanship in the making) all have to come together to create a good sundial. Getting all of these right is quite a challenge! Good luck.

(This page is based on an article "Is that really the time?" by Piers Nicholson which appeared in "The Valuer" of August/September 1992)

For a full overview of Sundials on the Internet [click here](#)

This site designed and maintained by [Internetworks](#) Ltd of [Epsom](#), England

first posted April 1997 last revision

Comments/ suggestions/ problems, please get in touch with the [Webmaster](#)

Sundials on the Internet

For a full overview [click here](#)

How to set up a horizontal sundial

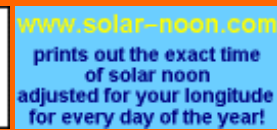

A horizontal sundial consists of the dial plate, marked off in hours, and the gnomon which sits on the noon line and projects out from the dial plate.

In order to tell the correct [local time](#) the gnomon must be parallel with the earth's axis, or, in other words, that it should point towards the celestial pole. In the northern hemisphere, this means, for practical purposes, that the gnomon should point at the Pole Star. One should first [check](#) whether or not the sundial is correctly made for the place at which it is to be set up. If it is not, the base plate of the dial must be [corrected](#) so that the gnomon is pointing correctly true north, towards the celestial pole.

Finding the direction of true North

Various methods are suggested in the literature, and are summarised here, with references to published sources if you need them

1. ● **Use a compass.** This is not very accurate, but it will do for a small garden sundial. **Remember** that the compass points to magnetic north, and a correction must be made for magnetic deviation. (Magnetic deviation at Greenwich in the UK was 3°58 W, and decreasing by 0°08 annually, but in some areas of the world it is much higher, and there are also much more local variations)
2. **Mark a shadow at the exact time of local noon** The shadow must be cast by a true vertical object. You can use a plumb line, a pole aligned vertically with a spirit level, or a vertical corner of a building. You may need to experiment to get a good shadow, and to find a reliable method of marking the shadow at the instant of local noon.

Remember that the sun travels 15° westwards in one hour, and thus travels 1° westwards every four minutes. (In the latitude of London, this is equivalent to 950 feet per second). The time on your watch must be corrected for this. For example, at Lowestoft (which is the easternmost point of England at 1°45E, local noon is exactly 7 minutes earlier than noon in Greenwich. Penzance in the far West of England is at 5°33W, and local noon there is 22 minutes and 12 seconds later than at Greenwich.

Remember too that the sun appears to be fast or slow compared to watches by an amount discussed under the [Equation of Time](#). The sun is "fast" between 16 April and 14 June, and again between 2 September and Christmas and "slow" at other times of year. "Fast" means that, if you are on the standard meridian for your time zone, the sun will be directly overhead ("sun noon") not at 12:00:00 by your watch, but a few minutes earlier. When you are setting up your horizontal sundial, you want to know the time the sun is directly overhead. So you mentally add the Equation of Time to your watch time, or advance your watch by the amount of the Equation of Time so that, at the instant when your watch says 12:00:00, everyone else's watches will be saying it is actually a few minutes earlier than that, and it will indeed be "sun noon". The same thing, of course, applies if you are not on the standard meridian for your time zone, but you have already taken account of this with the calculation in the preceding paragraph.

3. **Use the method of equal altitudes** This requires a reliably sunny day, and an accurately level board with a true vertical nail or stick. In one variation, concentric circles are drawn around the base of the vertical stick. The position of the tip of the shadow is noted whenever it just touches each of the circles in the morning hours and in the evening hours. If one is lucky there will be two marks on the same circle. Join them with a line. Bisect this line, and draw a line from the bisection point to the base of the stick - this will be a true North-South line.

An alternative is to mark out points on the track of the tip of the shadow first, and then to connect them with a line. Then draw a circle to give the greatest possible distance between the two intersection points, and as before bisect the line, and draw a line from the bisection point to the base of the stick - this will be a true North-South line.

Checking the angle of the gnomon

Since horizontal sundials are often mass-produced, they have to be made for just one latitude. Many are made in Birmingham, where the latitude is around $52\frac{1}{2}$ deg.N, so the angle between the gnomon and the dial plate is also $52\frac{1}{2}$. Quite often, people bring back a sundial when they have been on holiday, so the angle may be very different. For example, a sundial made for the south of Spain will have an angle around 37 deg. and will not tell the correct time if it is set up with the dial plate horizontal in Southern England where the latitude is 51 deg. Fortunately, this can be compensated for.

First, measure the angle of the gnomon with a protractor.

Second, you can if you wish cross-check this measurement and check that the hour lines have been laid out correctly, by "back-calculating the gnomon angle from the angles of the hour lines. (The [book](#) by Waugh gives an example of this calculation on p.48, and also a table showing the correct angles of the hour lines for each degree of latitude. For example, the angle of the 9am and 3pm hour lines from the noon line is $26^{\circ}24'$ at 30°N , $29^{\circ}50'$ at 35°N , $32^{\circ}44'$ at 40°N , $35^{\circ}16'$ at 45°N , $37^{\circ}27'$ at 50°N , and $39^{\circ}20'$ at 55°N .)

Compensating for an incorrect gnomon angle

Third, provide a wedge to bring the gnomon parallel to the earth's axis. For example, the holiday sundial brought back from Spain (lat 37°N) to be set up in Southern England (lat 51°N) would have to be wedged up by 14° , so that the gnomon is at 51° to the horizontal. You can either measure this angle with a protractor, or you can calculate the height of the wedge by multiplying the length of the dial plate by the sine of the correction angle. In this case, the wedge required for a square sundial with a side of 10 cm would be 2.4 cm.

For a full overview of Sundials on the Internet [click here](#)

This site designed and maintained by [Internetworks](#) Ltd of [Epsom](#), England

first posted 1997 last revision

Comments/ suggestions/ problems, please get in touch with the [Webmaster](#)



The Spot-on Sundial - a new concept in sundials

[Home](#)

Sundials

[Brass Style](#)[Stainless Steel](#)[Polar](#)

Buying a Sundial

[Choosing the right model](#)[Engraving](#)[How to order](#)[Delivery times](#)[Shop](#)

Setting up

[Brass Sundial](#)[Stainless Steel Sundial](#)[Indoor set-up](#)[Advanced Setup](#)[Looking after your dial](#)[Reading your sundial](#)[The time of solar noon](#)[Latitude and longitude](#)[Solar Noon Calculator](#)[Equation of Time](#)[Plinths and stockists](#)[Designer's note](#)[Press Pictures](#)[Sundials on the Internet](#)[Nicholson Sundials](#)

Finding your latitude and longitude

You need to know your latitude before you [order](#) your Spot-On Sundial - the angle of the gnomon (which casts the shadow) has to be the right one for your location, as described on the [models](#) page.

You also need to know your longitude later on when you come to [set up](#) your Spot-On Sundial, so it is worth writing it down for later.

In the United Kingdom

We recommend www.streetmap.co.uk (which is very useful for many other things apart from finding your latitude and longitude). You can bring up a map of any locality in the UK by keying in its postcode, street name (in London), place name, telephone dialing code, OS grid reference, Landranger grid or latitude and longitude. Each map has grid squares of 500m., and gives the latitude and longitude under the map.

Click on any of the links below; you will find a search box for your location under the map. Note particularly that the latitude and longitude is given in degrees, minutes, and seconds - you may need to convert the minutes and seconds to decimals of degrees if you are going to use them in a calculation.

For example, the map for the [Tylers and Bricklayers sundial at Blackfriars](#) has an arrow pointing at the position of the sundial and states "The location is at 532025m 180818m (N51:30:37 W0:05:50). The latitude is the figure preceded by N, and the longitude is preceded by W for West (or E for East)"

Other examples are the Tylers and Bricklayers sundial at [Greenwich](#) which states "The location is at 539746m 179666m (N51:29:53 E0:00:48)" and an example outside London is the Sustrans sundial at [Lincoln](#) which states "The location is at 499685m 370945m (N53:13:33 W0:30:24)"

In the United States

In the United States, the form below will find the latitude and longitude by typing in the place name or the zip code. For example, typing in the name of our sister community, Epsom NH, produces

Epsom NH
Location: 43.22238N; 71.33562W

together with links to a map which you can customise to your particular needs and census data.

City: _____ and state:

or zip code:

For all other countries



A very good source is the location database of Heavens Above at <http://www.heavens-above.com/countries.asp>

This excellent site will also give you star maps, satellite maps, and lots more, all customised to your particular location

Other sites you can try are <http://gnnpswww.nima.mil/geonames/GNS/> and <http://www.mapblast.com>

Links to other sites giving latitude and longitude are given in the excellent [What's Your Latitude](#) page which we recommend for further reading.



Spot-On Sundials POBox 292, Epsom, KT17 4YP, England
Tel: 01372 747767 (International +44 1372 747767) info@spot-on-sundials.co.uk

www.spot-on-sundials.co.uk designed and maintained by [Internetworks Ltd](#) of Epsom, England.
Copyright © Spot-on Sundials 1999-2003

Sundials on the Internet

For a full overview [click here](#)

Mottoes on sundials - a minor art form in themselves

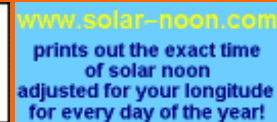

Mottoes on sundials are a minor art form in themselves. Many of them perhaps look on the more pessimistic side of life, but there are plenty of others to suit every temperament. This list - in no particular order - is given for your information and amusement; you are encouraged to send an [E-mail](#) if you would like to add others. Please give some indication of the source if at all possible.

Among those sent in recently are

20 April 2001 (Rachel Sarda)

"Light and shadow by turns, but love always"

7 July 1999 (Kathleen M Broadhead)

Time and Tide Wait For No Man

10 June 1999 (Piers Nicholson)

Aim Higher than the Mark (on the new sundial at [Ashby](#))

5 May 1999 (Pete Bliss)

The shadow of my finger cast
Divides the future from the past;
Before it stands the unborn hour
In darkness and beyond thy power;
Behind its unreturning line
The vanished hour no longer thine;
One hour alone is in thy hand,
The now on which the shadow stands.

28 April 1999 (Sandy Brown)

Slow comes the hour
Its passing speed how great

The assortment following is from a collection of more than 2000 mottoes collected by sundial maker James Stewart, who worked in Invercargill, New Zealand up until his death in 1933. (James Stewart was the great great grandfather of Bruce Christie, of the Plant Science Department, Massey University, Palmerston North, New Zealand. (Phone 64-6-3504253 Fax 64-6-3505614) who kindly supplied this collection.

1. A day may prime thee, improve this hour.
2. Moved by the light.
3. A stick in time saves mine.
4. On this moment hangs eternity.
5. To thee that mourn the hours are slow
But with joyful swiftly go.
6. The gliding hour flies on its fitful wings.
7. Come boys now's the hour.
8. Learn ze, years pass by like running water.

9. Snatch the present hour, fear the last.
10. As a shadow such is life.
11. Look at me and pass on.
12. By the shadow shall I mark time.
13. Be thankful, watch, pray and work.
14. The sun who guides the heavenly bodies produces the shade.
15. Come light visit me.
16. Count all the hours lost which are not accompanied by some worthy deed.
17. With the shadow nothing, without the shadow nothing.
18. To God alone be the glory.
19. Learn to live and die well.
20. The Lord is my light.
21. Perhaps the last.
22. Go your way into His courts with thanksgiving.
23. Let the slight shadow teach thee wisdom
24. Evil be to him who thinks evil thereof.
25. I count bright hours only.
26. I tell only sunny hours.
27. I am a shadow, so art thou,
I mark the time, dost thou?
28. Amidst the flowers I tell the hours.
29. The clock the time may wrongly tell,
I never if the sun shines well.
30. Time flies, eternity draws near.
31. Lead kindly light.
32. Let not the sun go down on your wrath.
33. Let others tell of storms and showers,
I tell only sunny hours.
34. Light is the shadow of God.
35. Night comes when no man can work.
36. Like a true fireman, I am always ready.
37. He hath made his choice aright,
who counted but the hours of light.
38. Till the day dawn and the shadows flee away.
39. My time is in thy hand.
40. Man wants but little here below,
nor wants that little wrong.
41. Only as I abide in the light of heaven
do I fulfil the will of my maker.
42. They pass by and are scorned.
43. So passes the glory of the world.
44. The sun guides me the shadows gone.
45. Tak tent o'time, ere time be tint.
46. Time passes as a shadow.
47. Time flies, death urges, knells call, heaven invites.
48. With warning hand I mark times rapid flight,
From life's glad morning to its solemn night.
Yet through the dear God's love, I also show,
There's light above me by the shade below.
49. When thou dost look upon my face,

To learn the time of day:
Think how my shadow keeps its pace,
As thy life flies away.
Take, mortal this advice from me
And so resolve to spend
They life on earth, that heaven shall be
Thy home when time shall end.

50. I stand amid the summer flowers
To tell the passage of the hours.
When winter steals the flowers away
I tell the passing of their day.
Man whose flesh is but as grass
Like summer flowers thy life shall pass
While time is thine lay up in store
And thou shalt live for evermore.

To end up in the wrong direction, these verses by Hilaire Belloc have probably not been used on actual sundials, but express some of the problems and indeed pathos of the sundials!

- *In soft deluding lies let fools delight.
A shadow marks our days, which end in Night*
- *How slow the Shadow creeps; but when 'tis past
How fast the Shadows fall. How fast! How fast!*
- *Loss and Possession, Death and Life are one.
There falls no shadow where there shines no sun.*
- *Stealthy the silent hours advance, and still;
And each may wound you, and the last shall kill.*
- *Here in a lonely glade, forgotten, I
Mark the tremendous process of the sky.
So does your inmost soul, forgotten, mark
The Dawn, the Noon, the coming of the Dark.*
- *I that sitll point to one enduring star
Abandoned am, as all the Constant are.*
- *Save on the rare occasions when the Sun
Is shining, I am only here for fun*
- *I am a sundial, and I make a botch
Of what is done far better by a watch.*
- *I am a sundial, turned the wrong way round.
I cost my foolish mistress fifty pounds*

For a full overview of Sundials on the Internet [click here](#)

This site designed and maintained by [Internetworks](#) Ltd of [Epsom](#), England

last revision

Comments/ suggestions/ problems, please get in touch with the [Webmaster](#)

Sundials on the Internet

For a full overview [click here](#)

Frequently Asked Questions

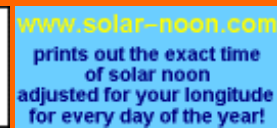

We welcome queries on sundials - if we cannot answer them ourselves, we can usually suggest someone else who can. We've grouped together some of the queries we have received and the answers we gave then - maybe some of them may be relevant to your question too.

Q42 - 26 Jan 2001 - I just want to ask you the size of the biggest sundial in the world

The big sundials I know about are:

Pajala in northern Sweden - there is I think a link from Sundials on the Internet - use the search facility on the home page

Jaipur in India - ditto and I think there is a web page

There was also a plan to construct a very large sundial in the easternmost point of New Zealand but I don't know if it got built

Q41 - 5 Jan 2001 - HELP - My 8yo has a project to do a sundial. The problem is ,in the northwest Puget Sound area it rains alot and it is difficult to do one without the sun. Any suggestions?

Under Nicholson's law, the areas of the world with most sun have fewest sundials, eg Arizona, Mexico, Southern Spain, Greece) and the areas with the highest rain/snowfall have most (eg England, French and Swiss Alps, northern Spain)

Q40 - 13 Dec 2000 - Hi, I'm a 16th C re-enactor and would love to get my boyfriend an authentic timepiece (until he acquires the money for a subdermal watch implant !?!) I can't seem to find out if either equinoctial sundials, or 'peasents' ring' sundials were in England in the 1500s, as I understand it shepherds' sundials were. I'd be grateful for any help you could offer.

Cylinder dials go back a long way - there is one mentioned by Chaucer and quoted in the book by Waugh. Mrs. Gatty's book says they go back to the 13th cent. (probably also based on Chaucer).

As far as I can remember they got really common in the 18th century, when modern notions of time were beginning to creep in, but the technology for measuring it was (?mercifully) much less sophisticated than it is today.

The people who could give you more information are at the Museum of the History of Science in Oxford.

Q39 - 14 Oct 2000 - 30 09 several of your items on the FAQ page ask about human sundials for schools. I refer you to the Needham Science Center in Needham, Massachusetts, USA. They can provide (for a small fee of \$5.00) appropriate measurements for the layout of a sundial in the schoolyard where the children act as the gnomon. Their address is: http://www.i_need_science@mail.needham.mec.edu

Q38 - Please can you tell me where I can get some information? Everything I find is for the northern hemisphere!

Yes, it's true, but there are only two important differences, that the gnomon points at the south celestial pole, and that the hour numbers go round the dial in the opposite direction to the Northern hemisphere. But everything else is exactly the same. For example, the gnomon's angle and the angles of the hour lines are related to the latitude in exactly the same way as in the northern hemisphere. Some [computer programmes](#) will print out for the southern hemisphere as well as the northern. A very good [book](#) on sundials, written specifically for the Southern Hemisphere, is available.

Q38 - 3 September - I have seen every sundial website there is, but I want to know what materials I need to make a horizontal sundial. My school is building a sundial in the front of our school. This is a project that is very important to our school besides our aviary, green house, butterfly garden, and waterfall. We all would really appreciate it if you would send us some information. Thanks from the kids at West Hernando Middle School

Lovley to hear from you, but the answer is to look round the website first! We try to answer all Emails but usually cannot do so immediately, so it is worth having a good look for what you want (in this case, our [projects page](#))

Q37 - 10 Dec How do you set up an equatorial dial

Setting up an equatorial dial is essentially the same as setting up a horizontal dial (see our [setup.htm](#) page, with the one additional step that you need first to set the angle between the gnomon and the horizontal at the same angle as the latitude of the place you are.

Q36 - 01 Aug I am stuck on a question for a quiz, is there any chance you could tell me what the indicator which casts a shadow

on a sundial is called?

The gnomon. Strictly, the gnomon is the indicator and the edge of it which casts the shadow is the style.

Q35 - 29 July Can you please tell me the name for the art of making sundials?

A35 - The art is gnomonics and the people who do it are gnomonists according the dictionary, but it is a mouthful to say, so many people prefer dialing and dialists.

Q34a - 30 July - Are the E.O.T timing figures the same for the southern hemisphere. Thanks in advance.

Q34b - 26 July - I have made a sundial but it does not appear to be particularly accurate. Do I need to make any adjustment to the equation of time because I live in the Southern Hemisphere?

A34 - No - the sun is so far from the earth that the Equation of Time corrections are, for all practical purposes, exactly the same wherever you are on earth. The correction does change slightly on any given date from one year to another because of leap years, so the values given in books are usually the average of the four year cycle. Computer programmes such as the NASS Dialist programme give accurate values for every second of every day for a century or more!

Q33 - 29 July 1999 I will be teaching a carpentry class starting in September. We are studying the Colonial America. I am interested in finding plans and instructions on making a sundial that would be similar to one that would have been used by the early colonies of America. Can you please direct me to a source that could help me? Thank you for your time. Cris

A33 - The early colonists would have brought over with them some sundials, mainly horizontal ones, being made in Europe at the time. There are a number of these in museums in North America, see, for example, the [Ottawa sundial trail](#). They would also have brought knowledge of vertical sundials, and there are a number of examples of these too, for example on the Sisters of Charity Convent in Ottawa and also in Quebec and other colonial centres.

Q32 - 7 July 1999 My question is similar to Question 24 in the FAQ. I am interested in creating a human sundial as part of a schoolground naturalization project in Calgary, Canada (latitude 52). I realize I cannot make a horizontal sundial with a vertical gnomon (person) because it will be inaccurate over the seasons. Your web page made reference to analemmatic sundials being used on lawns in a similar way such that the human gnomon would stand in a slightly different position each month to make the correction. Could you tell me where I could get the information on how to make such a sundial? Olympic Heights Elementary School Calgary, Canada P.S. Great Website!

*A32 - The books by both Rohr and Waugh have ten pages or so on how to construct an analemmatic dial. You can order both of these straight off our books page. The easy way is to buy a kit of instructions from [Modern Sunlocks](#) who will work it all out for your exact location for a quite modest fee Hope this helps
PS Thanks for your kind PS!*

Q31 - 23 May I was wondering whether anybody would be able to tell me where the largest Sundial in Australia is? If you could help me as soon as possible I would be most grateful. My e-mail address is: grimus@eisa.net.au

A31 - Sorry, we just don't know but we would like to, and could even start a largest sundials page! This would include the one at Jaipur in India and at Pajala in Finland.

Q30 - 1 June 1999- we live in Stamford, Connecticut USA and have been debating the difference between northern and southern latitudes sundials. Are the 15 degree hour markers equal but opposite in the southern hemisphere? Clockwise v. counterclockwise and can you explain the answer

Q29 - 22 May 1999 I received a sundial as a gift. I see that the numbers go LOWER as you go clockwise around the dial. Does that mean it was designed for use in the southern hemisphere? Don't know why they would sell that in New York if it's true. But your project on how to construct a horizontal sundial shows the numbers going in the clockwise direction. If the sun goes from east to west by way of the south, as in the northern hemisphere, does it not follow that the shadow cast by anything, a tree, a person, etc., will progress in a clockwise direction as the day progresses? What am I missing?

A29 - All the sundial books we know concentrate on the northern hemisphere. The only thing different about the southern hemisphere is that the gnomon points to the southern celestial pole rather than the northern one. The direction of the rotation of the earth is in the same direction in both hemispheres. So you are quite right that a horizontal sundial with the numbers increasing in an anti-clockwise direction will have been designed for the southern hemisphere. In the northern hemisphere, the numbers on a horizontal sundial increase in a clockwise direction (just like a clock!) A very good [book on sundials](#), written specifically for the Southern Hemisphere, is available.

Q28 - 19 May 1999 What is the art of making sundials called?

A28 - According to the Oxford English dictionary, the art is called gnomonics and the person skilled in the art is called a gnomonist. However they are both such mouthfuls that most people try and avoid using them! (Incidentally, the word gnomon was first recorded in the 1600s, and was also used to describe a carpenter's square as well as the shadow-edge of a sundial)

Q27 - 14 May 1999 I received a sundial as a gift. It's a horizontal type. The numbers descend as you go around clockwise. I am no expert on sundials but how can that be? Time goes backward as the sun progresses through its path. Any suggestions or help? Thanks.

Q26 - 10 May - I teach 8th grade science at Sage Ridge School in Reno, Nevada. I am interested in creating a sundial using an

analemma. I am interested in knowing how to calculate the curvature of the analemma for this latitude. I would like to have students create one of these sundials out of plywood next year. Thank you. David Roberts

A26 - The theory of central projection analemmatic sundials is explained in a comprehensive paper originally published in the NASS Compendium by Yvon Masse, and available at <http://www.union-fin.fr/usr/ymasse/cpaprc.htm>. If you just want the answers, [Modern Sunlocks](#) will provide a set of plans for an analemmatic dial for your precise location.

Q25 - 1 May Dear Friends, what a fantastic website. One Q though: why does the gnomon have to be at one's latitude's angle? In Q19 you explain the HOW but not the WHY. Why does a vertical gnomon turn incorrect after a few years? Thanks for your help. Heiner Thiessen

A25 - Think first of the day of the equinox. The sun's apparent path from earth is exactly above the equator, and rotating at 15 deg. an hour with respect to the earth's axis. If you make an equatorial dial with the gnomon parallel to the earth's axis and the dial plate parallel to the equator, the shadow will move round the dial plate at exactly 15 degrees an hour. Now move forward to the summer solstice. The sun's path is now 23.5 degrees above the equator. But the plane of its orbit is still parallel to the equator, so the shadow will still move round it at 15 degrees an hour. But now consider both cases when the gnomon is at, say, 45 deg to the earth's axis. The shadow will move round this gnomon at a variable number of degrees an hour, not at a constant 15 degrees every hour. The number of degrees in any particular hour will be different at the solstice (and indeed at every other day of the year) from what it was at the equinox. So any mark you make on a dial plate to indicate the "clock" hour will not be true after even a few days. I hope this helps. If you want a practical demonstration, put a vertical pole in the ground, and mark where the shadow is at any time other than noon - then mark the same time at intervals over the next few weeks. You will see it for yourself. (You will find a fuller explanation on [equation.htm](#) under the Inclination of the Ecliptic.

Q24 - 30 April - I am a Landscape Architect in Omaha, Nebraska. I have designed a human sundial to be installed in a public park but am having problems finding the correct settings. Can you help me find someone to do that?

Q23 - 26 April 1999 I am a sculptor working on a proposal to build a 26 foot high marble and stainless steel column which would function as a sundial. I am not sure what the best method for laying out the hour marks is. I would appreciate any information that you could give me.

A23 - Very tall sundials have problems all their own, partly because the gnomon may not be straight due to self-weight, and partly because the shadow gets fuzzy if it is a long way away from the hour lines. So you need to do a bit of experimenting. You can see a picture of one I did at Lincoln linked from my entry on/personal.htm This was only 5 m. high. You also need to understand quite a bit about the theory of sundials, and for this you need 2 or 3 of the books listed on/books.htm You can get most of them through amazon.com

Q22 - 14 April 1999 Can you tell me, can I construct and arrange a vertical sundial facing due north the same way as a sundial facing due south as illustrated within these pages. I live in the southern hemisphere and I wish to make a vertical sundial but our aspect faces due north. Any assistance will be welcome

A22 - I always get slightly muddled about the southern hemisphere, but the essence of it is that the gnomon has to be parallel with the earth's axis. In the northern hemisphere, that means it points at the pole star. In the southern, it points at the southern celestial pole, and the sun appears to go round it at 15 deg per hour just as everywhere else in the world

Q21. 15 Dec 1998. I have read your "[How to set up a horizontal sundial](#)" page with interest. Surely, if one's sundial's gnomon is correct for one's latitude and the clock time correction for one's actual longitude (with respect to the time zone longitude) has been calculated, it is a simple matter to let the sundial do it for you. Simply set the sundial so that it shows the local sun time, taking into account the equation of time. There is no need to rely on noon. This could be done in the morning and checked at intervals during the day. I all is OK the sundial's noon line should point to the celestial pole.

A21 - Yes, you are quite correct. Why we do not recommend doing it this way is that most horizontal dials are not sufficiently accurate to do it this way, because the gnomon does not have a square edge, the lines are too wide, and/or the gnomon not quite straight. It is also quite rare to find a "garden-centre" sundial which is correctly set for its latitude. So we thought it preferable to set the thing out right to start with, and let the minor inaccuracies sort themselves out.

Q20. 3 Dec 1998 I live in Israel which is approximately 32 degrees north. I have made a sundial according to my latitude. What I would like to know is whether the graphs for correcting the discrepancy of a sundial are the same all the world over, or change from place to place. (I have a copy of a graph from Enland - would it be valid here?) Also, how do I adjust for differences in longitude within the same time zone? I hope you can help me or guide me to the right source on the web. Thanks in advance, Jonathan

A20 - Thanks for your message. The Equation of Time is universal. The distance to the Sun is so much greater than any distances on earth. If you want your sundial to show the time at your prime meridian, you work out the time difference at 60 minutes of time equals 15 degrees of rotation. So, Lowestoft is at 1 deg 20 East, so the correction is 5 mins 20 secs. The sun reaches Greenwich after it reaches Lowestoft, so if I want the Lowestoft dial to read Greenwich time, I must calculate the hour lines for 12.05.20, 1.05.20, 2.05.20 and so on. I hope this will help you. If it does, let me know, and I will post it on our FAQ page to help others.

Q19. I have a couple questions about the gnomon on a sundial. How long should it be, and is it's angle calculated from the

latitude, or is it taken directly from latitude (my lat is 33.6, should the angle be 33.6 degrees)?

A19 - The gnomon always has to point at the celestial pole. if you are at the North (or South) pole, it therefore points straight up if you are at the equator it is horizontal. as you move north (or south) from the equator, the gnomon angle lifts up from the horizontal and the latitude also increases. So, If it is a horizontal sundial, the angle between the gnomon and the horizontal is equal to the latitude If it is a vertical dial, the angle between the gnomon and the vertical is equal to the co-latitude (or 90 degrees less the latitude)

As to how long it should be, you can calculate it, because the sun's orbit dips 23.5 deg below the equator in winter and 23.5 above it in summer. You want to make sure that the shadow falls all the way across the dial plate when the sun is highest - on midsummer day. Get your maths teacher to help you out with how to calculate it if you cant work it out for yourself. Hope this helps

Q18 - 16 Oct 1998 - I am looking for information on setting up an armillary sundial. I have taken it apart and restored it. On setting it up I need the longitudinal and latitudal figures. I can't find the information of the internet. Please help me.

A18 - Please refer to our page on "[Setting up a horizontal sundial](#)". Setting up an armillary is essentially the same - the axis (gnomon) has to point to the celestial pole, which means that the angle it makes with the horizontal has to be equal to the latitude of the place, and the projection of the gnomon on the horizontal has to be pointing to true north, ie along the local meridian.

Q17. Dear Mr Sundial, I have a sundial with a gnomon set at 52 degrees, which is obviously an incorrect setting for is location which is 39 degrees 35 minutes South, and 174 degrees 16 minutes East. Could you please advise me of the correct setting given that New Zealand Standard time is G.M.T. plus 12 hours. Thanking you in anticipation. Could you also enclose your "snail mail" address so I can send you a 1999 New Zealand calendar in appreciation. Frank Lacy,

A17. Thanks for your message, You too should refer to/[setup.htm](#). For horizontal sundials, setting in the southern hemisphere is essentially the same as setting in the northern hemisphere, except that the gnomon is pointing to the south celestial pole. So you need to wedge up the sundial in such a way that it thinks it is at 52 deg. South. Your sundial is certainly manufactured for a place exactly on a standard meridian, and you cannot adjust for this (see next Q). You just have to remember to add or subtract the appropriate amount (4 mins for every degree you are away from your standard meridian). If you want to convert exactly to "clock time", you will also have to add or subtract the Equation of Time (see/[equation.htm](#)). I would certainly appreciate a calendar. Thank you. Would you also like to write a sundial trail for your neighbourhood (see/[sunlist.htm](#))

Q16. we live in Langhorne, Pennsylvania, and we are affected by the daylight savings time. we put a sundial in our backyard, and my father and I had several long talks regarding adjusting or not adjusting the sun dial for the daylight savings time. please put us out of our misery, by answering this strange question.

thank you, heather and kenneth pyle

A16. Please refer to www.sundials.co.uk/setup.htm for a full answer. The short answer is that it's best to set it for your local noon, and then to remember when you read it that you need to adjust it by XX minutes to get the time at your standard meridian, and a further hour if it's in the summer.

The reason for this is that the angular difference between successive hours is not uniform. So rotating the dial will lead to inaccuracies. This may not matter too much if the gnomon of your sundial doesnt have a square edge, or if the hour lines are engraved too wide as many mass-produced dials are.

You should also check what latitude the sundial you have is designed for, and if necessary make the adjustments in/[setup.htm](#)

Q15. I have recently moved to NSW Australia and whilst touring the local area spotted a sign at 'Singleton', which states 'Worlds Largest Sundial', having visited the 'Observatory' at Jaipur, India a few years earlier who had the same claim, I realised that one of them must be wrong. Both were of a similar design, but certainly the one in India was considerably larger. Perhaps you would like to list them, but as to which is the 'Worlds largest', I will leave to you!

I would like to try and get details of the size of the one in Jaipur, and if it is larger I will show this to the local tourist information centre! Any ideas where I might find this information? Do you know which is the Worlds largest sundial, perhaps neither of those I have mentioned. I am finding the general 'Sundial' information fascinating.

Thank you Sue Spence

A15. The large instrument - a mammoth structure - is called Brihat Samarat Yantra and the main part is a right angle triangle with a base of 44 metres and a gnomon angle of 27 degrees, so the height is 27 meters. The semicircular quadrants have a radius of 15 meters. There is a link to it on the [pix.htm](#) page. There is another big one at Pajala in Sweden written up in the penultimate issue of the British Sundial Society Bulletin no 97.3. It has a diameter of 39 metres, so I guess that is not the biggest! (Paul Fischer has kindly given us its URL: <http://www.pajala.se/narliv/ftgreg/elcs/elcs.htm> and there is a description of it at <http://www.pajala.se/welcome/tourism/soltorg.html>

Q14. I am a member of the British Sundial Society and have built dials but I am still a beginner and one question remains in my mind that I can not seem to find the answer for. There seems to be a bit of a clue in question 1 in the F.A.Q. document but it is still not clear to me.

If the angle of the earth changes from Summer to Winter then why is the axis of the earth always quoted as pointing to the pole star?

A14. The answer to your question is in what the angle is changing relative to. The angle of the earth's axis relative to the far distant stars doesn't change at all as the earth goes round the sun. But the angle relative to the sun does. In midsummer the axis is tilted 23.5 degrees towards the Sun, and in midwinter, it is tilted the same amount away from the sun.

Q13. Dear Society, What I would like to know is how Sundials work throughout the seasons. I mean the noon shadow falls in one place in Summer and a totally other place in Winter. Could some one explain this very rudimentary fact to me? I have just purchased my first sundial and would like to set it up correctly. Thank you so much for your help. Susan

A13. Dear Susan Thanks for your message. Try looking at [setup.htm](#) on www.sundials.co.uk Essentially, at a given time of day in winter, the sun is lower in the sky and at a different angle relative to south compared with the same time of day in the summer. The slope on the gnomon, which is equal to the latitude, compensates for this, so that the shadow, taken from the lower part of the gnomon in winter and a higher part in summer, falls in the same place at the same hour. Let me know if this helps you. If so, I will put it up on the FAQ to help others.

Q12. Do any of your visitors ever tell you if they got useful information from it?

A12. Yes, occasionally. It's obviously only a very small fraction of those who visit Sundials on the Internet, and it's a great pleasure to get E-mails like this example:

Q11. I think this page is really great. When I got the project of making a sundial I didn't know where to start until I found your web site explaining how to make a sundial. I found that it was really easy to make and I hope now to get a good make for my project.

Thank-you Jennifer (one very happy person!)

A11. Thanks a million. It's so nice to get a letter like yours - it makes the whole thing worth while. So I'm another very happy person! Webmaster - Sundials on the Internet

Q10a. We are doing a schools project on sundials and would like some help

Q10b. we are doing an assignment for school and wish to construct a sundial our latitude is 38deg 23' how do we plot the hour lines ?

Q10c. I'm a student at a high school and want to know alot about sundials. This information is needed for a science final and would be greatly appreciated if you could send it immediately.

A10. There are details of a suitable project on www.sundials.co.uk/projects.htm if you have to get started immediately. If you have more time, we would suggest obtaining "Make a Sundial" from the British Sundial Society which has a number of projects. It was produced specifically for schools, but is equally suitable for anyone seeking to gain understanding of sundials and experience in making simple models before venturing on to larger projects. It can be [ordered](#) directly from them

Q9. I want to give my daughter some help on a project on the history of sundials, but can't find anything in my public library

A9. Sundials - History Theory and Practice by [Rene RJ Rohr](#) has a very good section on the history of sundials.

Q8. My son is doing a science fair project on sundials. We are unable to locate a list of most famous sundials, and their location so that we can pinpoint them on a world map. Any help would be appreciated.

A8. There is no comprehensive or easy way of finding out this kind of information. Some of the [books](#) give lists of sundials in particular areas. Our own pages on favourite sundials in [North America](#), in [the United Kingdom](#), in [France](#), and in [the Netherlands](#) will also be helpful. And there are links to pictures of other sundials on the Internet on [pix.htm](#). We are building these lists up gradually - if you find them helpful, please help us by adding any information you have!

Q7a. I am keen to make a sundial but know very little about it.

Q7b. I don't know if you can help me, but I want to construct a vertical sundial similar to some I saw in the U.K. I am particularly interested in a sundial that tracks the four seasons. Any construction details, geometry, and advice (pictures of vertical sundial faces?) would be greatly appreciated. My house faces south and I have the perfect location for such a sundial. Can you help?

A7. If you want a few small practical projects to do before you get involved with your first big individual project, your best course is to get "Make a Sundial" (see question 1 above). This will give you a good basic grounding. Or you could start off with the projects on [...../projects.htm](#)

If you want to dive straight in to a big project, the books I have found most useful are Sundials - Their Theory and Construction, by Albert E [Waugh](#) and the book by [Rene RJ Rohr](#) mentioned above.

Q6. I acquired a Shepherd's watch but don't know exactly how to use it. Can you be of any help? Thanks, Ann

A6. There is a very good sundial mailing list which is the best way of getting quick and definitive answers to detailed technical questions like this. You can find out how to post a question (and how to subscribe to the list if you want) on www.sundials.co.uk/maillist.htm. Please start your enquiry along the lines "I found out about the mailing list from the FAQ page on Sundials on the Internet"

Q5. Are there any internet sites on the theory and/or construction of sundials? if so, where? How does their construction differ from the northern to southern hemispheres?

A5. Try the sites listed on equation.htm. But you will probably find you are better off with one of the books listed above or on books.htm. A very good [book](#) on sundials, written specifically for the Southern Hemisphere, is available.

Q4. I am a student in Singapore and I would require instructions to make a sundial for latitudes of 0 degrees, please email me immediately.

A4. Most of the literature about sundials is written by people in medium or high latitudes. There, the gnomon (which has to point to the celestial pole) makes a large angle (some 50 deg in England) with the horizontal. At low latitudes, the gnomon makes a very small angle with the horizontal, and on the Equator, the gnomon has to be parallel with the dial plate. If you go to the botanic gardens in Singapore, they have a really nice sundial there and you could copy that using simple materials. Essentially you have a flat plate projecting p cm. from a horizontal surface with the hour lines. The hour lines are placed at $y = p \times \tan h$ where h is the hour angle which is 15 deg for 11 am and 1 pm, 30 deg for 10 am and 2pm etc. It could last a lot longer than 30 days.

He replied: I have made the sundial and it is quite accurate. Another victory for Sundials on the Internet!

Q3. Where and Which is the largest sundial on this planet? Where is the oldest sundial still in tact? Curious is the cat!

A3. I should think the one at [Jaipur](#) India is probably the largest. This is another of the questions worth posting on the sundial mailing list. See question 5. above

Q2. Please could you send me details about where I can buy a sundial. I know this is a bit cheeky, but I am having great problems finding a stockist. I would be very grateful if you could help me in this matter.

A2. The easiest place to buy a sundial is at a garden centre, or from a mail order catalogue like the one from the Science Museum in London. But you should read [How to set up a horizontal sundial](#) first so that you know how to check the gnomon angle, and how to correct for it if it is not right for your location. The accuracy of these dials is often very poor because the gnomon is not straight or the hour lines are wrongly marked out. For a more accurate sundial, you should go to one of the sundial makers listed on our [sundial makers and designers](#) page

Q1. I am a reference librarian at the Flagstaff, Arizona Public Library. A patron has requested information about the Dial of Almaraz. This is supposedly a 15th Century European sundial (in Almaraz, Spain?) which uses a room and a window or a portion of a building as the mechanism of the sundial. We have consulted many different sources, but have been unable to locate any references.

A1. See question 6. above

For a full overview of Sundials on the Internet [click here](#)

This site designed and maintained by [Internetworks](#) Ltd of [Epsom](#), England

first posted 1996 last revision

Comments/ suggestions/ problems, please get in touch with the [Webmaster](#)

Sundials on the Internet

For a full overview [click here](#)

Mass Dials



Mass dials (scratch dials) are medieval (1100 - 1600) dials found on the south walls of churches.

They were usually near the main door or the priest door at about four to five feet above the ground.

About 8 or 9 inches across and rather roughly cut, they come in a wide variety of designs, from semi-circles of dots to complete circles with associated radii. Their chronology is difficult to determine but simple versions with only four or five lines are early whilst those with numbers round the edge (rare) are late.

Frequently, several appear on one church but no regional variation in design has been established. Their boundaries of occurrence are slowly appearing. Some counties (e.g. Lancashire and the West Riding of Yorkshire) have few dials whereas others (e.g.

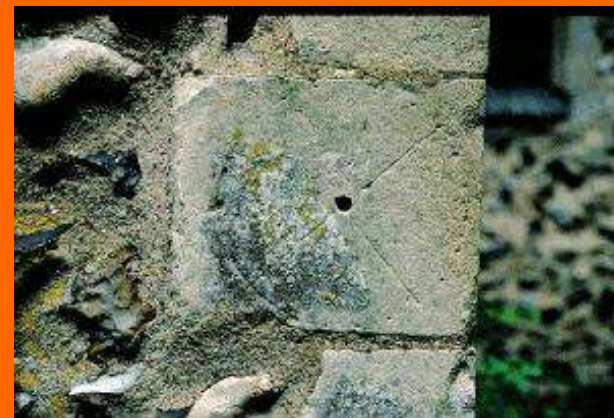

Gloucestershire, Lincolnshire and Kent) have many.

The gnomon, invariably missing, pointed straight out horizontally and so the dial would not record the same hours at all times of the year. The mass dial is in any case usually regarded as an event marker for the church services rather than a time piece.



Due to rebuilding, mass dials can end up almost anywhere on a church, even the north wall. They are frequently found inside a later added porch over the south door.

The [British Sundial Society](#) has a separate Mass Dial Group who are compiling a Register of the 3000 or so dials so far recorded. For further details, contact: Tony Wood, 5 Leacey Court, Churchdown, Gloucester, GL3 1LA Tel: 01452 712953 e-mail: bssaow@joymail.com

For a full overview of Sundials on the Internet [click here](#)

This site designed and maintained by [Internetworks](#) Ltd of [Epsom](#), England

last revision

Comments/ suggestions/ problems, please get in touch with the [Webmaster](#)

Sandburg Center for Sky Awareness
A Fairfax County Public Schools Planetarium

The St. Petersburg, FL Equatorial Sundial
War Veterans' Memorial Park
27.8°N latitude, 82.7°W longitude

Note: Using Microsoft Internet Explorer, [photo descriptors](#) appear on mouse roll-over.



Related Resources

- Pinellas County Parks - [War Veterans' Memorial Park Sundial Facts](#)
- The [Boulder, CO Equatorial Sundial](#), University of Colorado
- [Erickson Memorial Company](#), Sundial Division
- [SCSA Educator's Guide to Equatorial Sundials](#)

© Copyright 2002-2004 [Walter Sanford](#). All rights reserved.

*Photographs courtesy Alan J. Peche, Flight & Space Director,
[Saunders Planetarium, Museum of Science & Industry](#), Tampa, FL.
Thumbnail images prepared using photoweb v1.2 by [Phil Wherry](#).*

[Me and My Shadow - Making the Sun-Earth Connection](#) | [SCSA Home](#)



Sundial

[A](#) | [B](#) | [C](#) | [D](#) | [E](#) | [F](#) | [G](#) | [H](#) | [I](#) | [J](#) | [K](#) | [L](#) | [M](#) | [N](#) | [O](#) | [P](#) | [Q](#) | [R](#) | [S](#) | [T](#) | [U](#) | [V](#) | [W](#) | [X](#) | [Y](#) | [Z](#)



Latitude N 40°00.502'

Longitude W 105°16.211'

Determined by [GPS device](#) courtesy of Mark Haury.

For information about sundials:

- [British Sundial Society](#)
- [North American Sundial Society](#)
- [Sandburg Center for Sky Awareness](#)
and [Sanford's photos of the Tippet Sundial](#)
- [Sundials on the Internet](#)

For more UCB campus information:

- [Body & Soul: Architectural Style at UCB](#)
- [Historic District Tour](#)
- [Norlin Quad -- QT panoramic image.](#)
[Requires free QuickTime plug-in](#)
- [Norlin's Quotes](#)
- [UCB Commencement Webpages](#)

The John Garrey Tippit Memorial Sundial is located outside Norlin Library's east entrance. It is a gift of the John H. Tippit family -- strong supporters of the University and the Libraries -- as a memorial to John Garrey Tippit, a 1969 UCB graduate who died in a 1970 accident. He was 24 years old.

John had just graduated from UCB and was looking forward to commencing studies in the fall at the University of Denver Law School. He was working on a construction project, building a dam in Wyoming during the summer. It was supposed to be his day off, but John was working for a friend when a methane explosion tragically ended his life.

Since his death, the family had been looking for a project that would provide a useful and lasting addition to the Boulder campus.

Dedication and groundbreaking took place on 12 May 1995.

[George Norlin](#) would have appreciated the addition of this sundial. He greatly appreciated the beauty of the Boulder campus:

"To the best of my ability I have stood for the things of the spirit. Yet, I have felt that the physical beauty of the campus -- a campus worthy of the splendid setting with which nature has endowed it, a campus worthy to be the outward frame of the University's soul, would be an educational force enhancing the morale and spirit of all who come into and go forth from its halls."

The John Garrey Tippit Memorial Sundial is an [equatorial sundial](#) located at [40.00825°N latitude](#), [105.26997°W longitude](#) as approximated by NGS

topographic map. The 10,000 pound, rose granite sundial stands five feet high, six feet in diameter and 6.375 inches in thickness. The gnomon shaft is steel, extending from the ground through the dial plate and outward another two feet. It is designed to be read from the upper surface in Spring/Summer, and from the lower surface in Fall/Winter. Radiating lines with Arabic numerals. Graduated in half-hours with 5 minute marks.



After commencement exercises, graduates, families and friends gather around the sundial at the Norlin Library east entrance.

Thanks to the [Sandburg Center for Sky Awareness](#) and the [North American Sundial Society](#) for information about sundials.

**CHINOOK
ONLINE CATALOG**

**LIBRARIES
INFO**

**UCB
HOMEPAGE**

**LIBRARIES
HOMEPAGE**

This page last modified 9 December 2003 by the [Libraries Webmaster](#).

[Top of page.](#)

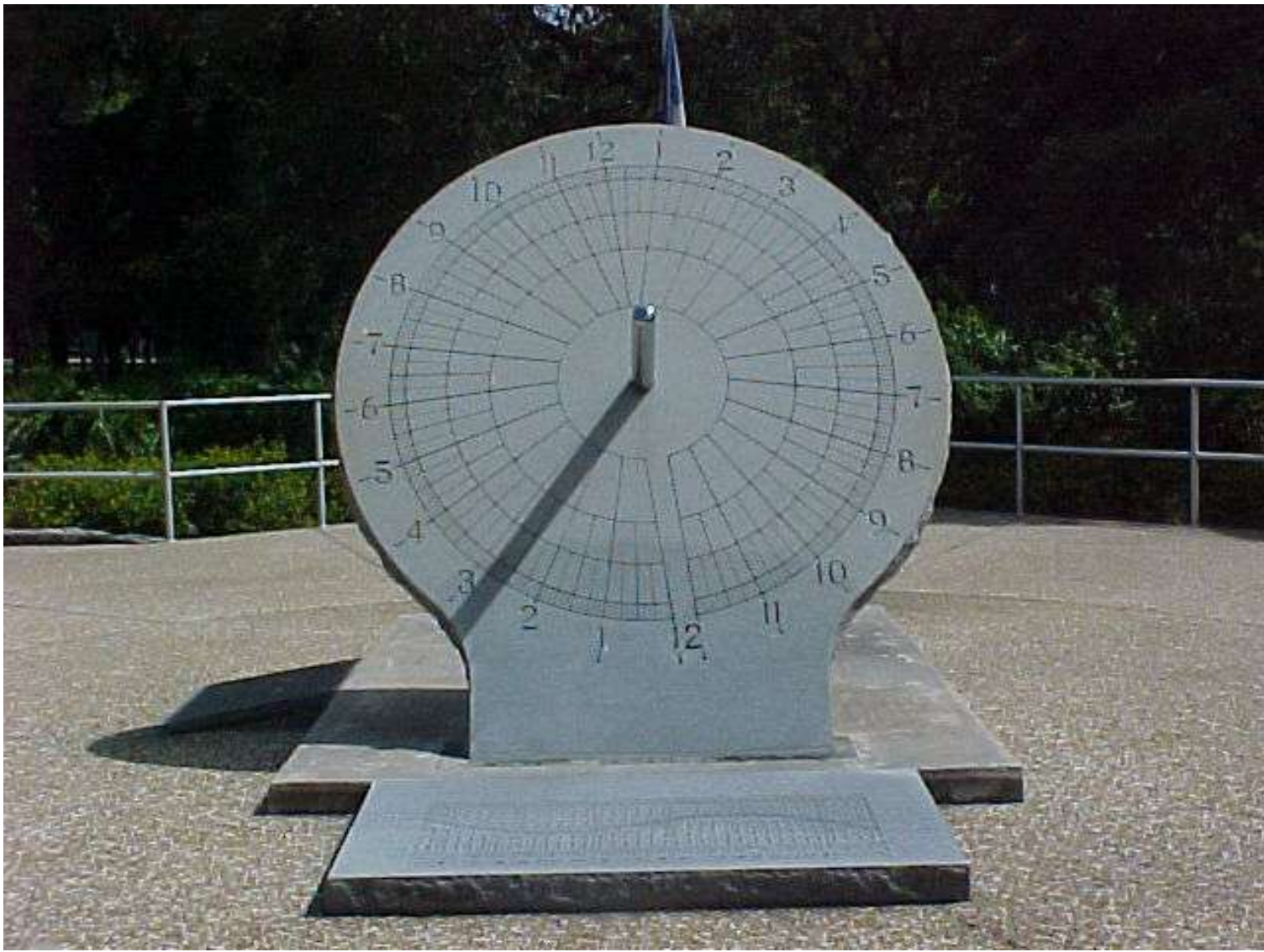

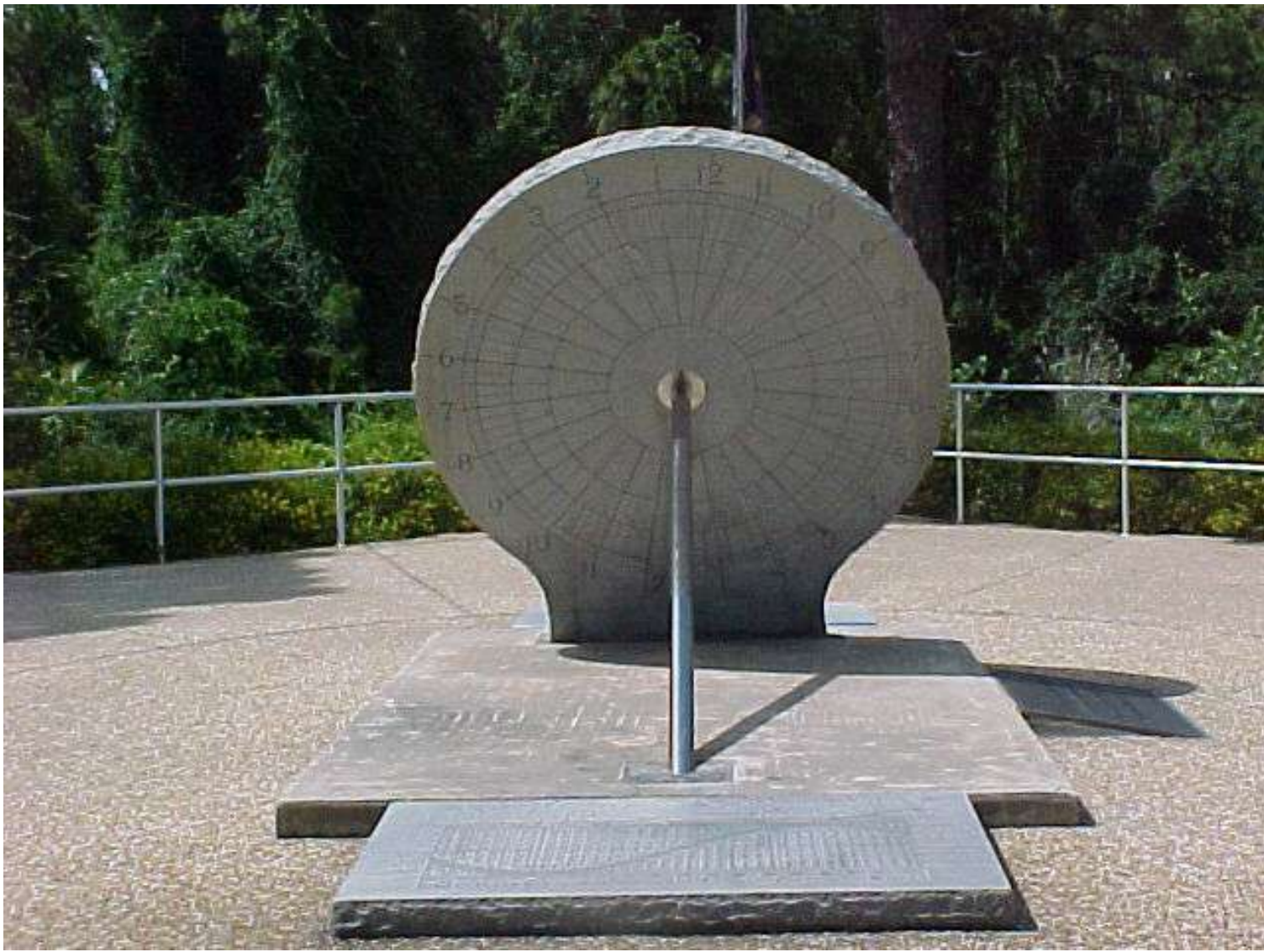

Attention ! le site a été transféré !

Veillez désormais utiliser l'adresse :

www.cadrams-solaires.org

Merci de mettre à jour vos favoris et les éventuels liens sur vos pages web.
Vous allez être redirigé vers cette adresse dans 10 secondes.

Warning! this site has been transferred!

Please use now the following address:

www.cadrams-solaires.org

Please update your bookmarks and links on your web pages.
You will be redirected to the new address in 10 seconds.

www.cadrans-solaires.org

[in English](#)

[en Français](#)

A Tale of Two Sundials

"It was the best of times; it was the worst of times."
- *A Tale of Two Cities*, by Charles Dickens

A tale of two cities; two [equatorial sundials](#). Same manufacturer ([Erickson Memorial Co.](#)); virtually the same design. So what's the most important difference between the two sundials? Look closely at the following photographs...



St. Petersburg, FL



Boulder, CO

In both pictures, observe that the [gnomon](#) (or style) is a pole (or rod) that is perpendicular to the [dial plate](#). However, notice that the two gnomons (and therefore the dial plates) are inclined at different angles relative to a horizontal surface. Why? Like the old saying from real estate sales, it's all about "location, location, location!"

Latitude. Remember the first two (of three) criteria for [setting an equatorial sundial](#)?

- The gnomon should be [parallel to the Earth's axis](#), inclined at an angle equal to the [latitude of the observer](#) (ϕ , phi).
- The dial plate should be [parallel to the plane of the Earth's Equator](#) (perpendicular to the gnomon), inclined at an angle equal to the [complement of the observer's latitude](#). This angle is also known as the [colatitude](#).

St. Petersburg, FL is located at 27.8°N latitude, therefore the gnomon of the [St. Petersburg sundial](#) is inclined at an angle of 27.8 degrees and the dial plate is inclined at a 62.2 degree complementary angle.

In contrast, Boulder, CO is located at 40.0°N latitude, therefore the gnomon of the [Boulder sundial](#) is inclined at an angle of 40.0 degrees and the dial plate is inclined at a 50.0 degree complementary angle.

Longitude. The [Standard Time Meridian](#) for the Mountain Time Zone is [105°W longitude](#). By coincidence, Boulder, CO is located at 105.3°W longitude, therefore [Solar Time](#) (sundial time) is virtually the same as [Standard Time](#) (wristwatch time), ignoring the [Equation of Time](#) and [Daylight Saving Time](#).

The Standard Time Meridian for the Eastern Time Zone is [75°W longitude](#); St. Petersburg, FL is located at 82.7°W. In contrast to Boulder, St. Petersburg, FL is located near the extreme western limit of the Eastern Time Zone, therefore the difference between Solar Time and Standard Time is approximately 30 minutes. For this reason, the [St. Petersburg sundial](#) features a [built-in correction](#) for longitude. In the following photographs, look closely at the orientation of the 12 noon [hour line](#) (or [noon gap](#))...

St. Petersburg, FL



12 noon offset by ~30 min.

Boulder, CO



12 noon not offset.

The [meridian](#) line of an equatorial sundial is an imaginary vertical line passing through the [center](#) of the [dial face](#)--when the Sun crosses the meridian line, it is local [solar noon](#). Notice that the 12 noon hour line of the St. Petersburg sundial is offset slightly from the meridian line because 12 noon Eastern Standard Time occurs ~30 minutes *earlier* than local solar noon in St. Petersburg, FL. In contrast, notice that the 12 noon hour line of the Boulder sundial is almost perfectly aligned with the meridian line because the times of local solar noon and 12 noon Mountain Standard Time are virtually coincident in Boulder, CO.

Note: For both sundials, correct [Solar Time](#) (sundial time) for [Standard Time](#) (wristwatch time) by adding or subtracting the [Equation of Time](#) as appropriate (using graphs that appear on plaques accompanying the sundials) and adding one hour for [Daylight Saving Time](#) (when in effect).

© Copyright 2002-2004 [Walter Sanford](#). All rights reserved.

[Me and My Shadow - Making the Sun-Earth Connection](#) | [SCSA Home](#)

Check your dial, and align it to True North

If you are setting up a commercial dial, you can check it to see if it has been constructed to be a timekeeper and not just a garden ornament. .

If you have an [armillary or bowstring equatorial dial](#), the dial must be positioned so it is level east to west, and the gnomon (usually an arrow), is vertically directly above 12:00. Skip to [finding north](#)

If you have a [horizontal dial](#) proceed to **1.**

For the terms used below, you may wish to refer to the [glossary](#).

- **1.** The high end of the gnomon should point directly to 12:00 on the dial face. If it doesn't, your [commercial dial](#) is incorrect.

If you have a [custom made](#) dial, it may include a longitude correction, in which case the gnomon will not point precisely to 12:00. Unless it is designed for your location, setting it up is beyond the scope of this FAQ.

- **2.** If the dial includes 6:00 AM and 6:00 PM, they should be at the ends of a single straight line, which is at a right angle to the sub-style - the line where the gnomon meets the dial face.
-

- **3.** Since the gnomon must have a finite width, the indication for 12:00 must have an equivalent width.
-

A [sketch of a dial](#) that meets conditions **1** through **3**

- **4.** If you want to test further . . .

Measure the style height - the vertical angle the gnomon makes with the dial face.

Measure the angle on the dial face between the sub-style and the 3:00 or 9:00 hourline. (These two angles should be the same.)

The sine of the style height should equal the tangent of the 3:00 hourline.

This trick can also be used to determine the style height, and hence the original latitude, for a dial that is missing its gnomon.

Although there are exceptions, most common dials must be oriented with regards to north.

The high end of the gnomon on an ordinary flat dial must be aligned to **True North**. (In the southern hemisphere to **True South**.) i.e. The style, or shadow casting edge of the gnomon must be parallel to the earth's axis.

Using the Shadow of a Vertical Object at Solar Noon

Perhaps the most accurate method. The shadow of a vertical object at Solar Noon will point to True North. A string with a weight on the end suspended from a tripod will make a true vertical object.

You can find the time of Solar Noon at your location on the page below. To use this page, do not use the pull-down list of cities. To get the precise time you should use your exact latitude and longitude.

If you need to convert from decimal degrees to deg/min/sec or vice-versa, [go here](#).

You will also need to enter your offset to UTC (EST = 5, PST = 8) and indicate if it is currently Daylight Saving Time.

- [NOAA Sunrise/Sunset and Solar Noon Calculator](#)

Another method of finding Solar Noon, and much, much, more about your dial and how it operates is to download *The Dialist's Companion*. It is a DOS program, published by NASS, which calculates a wide range of data elements of interest to dialists and others who are concerned with phenomena associated with solar time.

- [The Dialist's Companion](#)

Using a Compass

Using a compass is not recommended as a compass needle points to **Magnetic North**, and it is also difficult to get accurate readings with a compass. If you do use a compass, be sure to compensate for the **magnetic declination** of your

location.

To find the magnetic declination for your location, go to the link below and enter your latitude, longitude, and altitude (approximate). If you fill in only your Zip code and click [Get Location], your latitude and longitude will be filled in automatically, and accurately enough - then scroll down the page and click [Compute!]. Your **magnetic declination** will be D the value in the first field of the table:

```
D(+ East)
(deg)
-5d  26m
```

The negative value in the example above indicates that **True North** lies 5 degrees 26 minutes **clockwise** from the compass needle.

- [Compute Values of Earth's Magnetic Field](#)

A Graphical Method Using Shadows

Draw a diagram with concentric circles as shown below. Place a vertical object (a nail?) at **C**, and place the diagram on a level surface where it will receive sunlight all day.

Note where the shadow of the object touches one of the circles in the morning, and again in the afternoon as at **A** and **B**. Draw a line from **A** to **B** and bisect it at **D**. A line connecting **C** to **D** will point to True North.

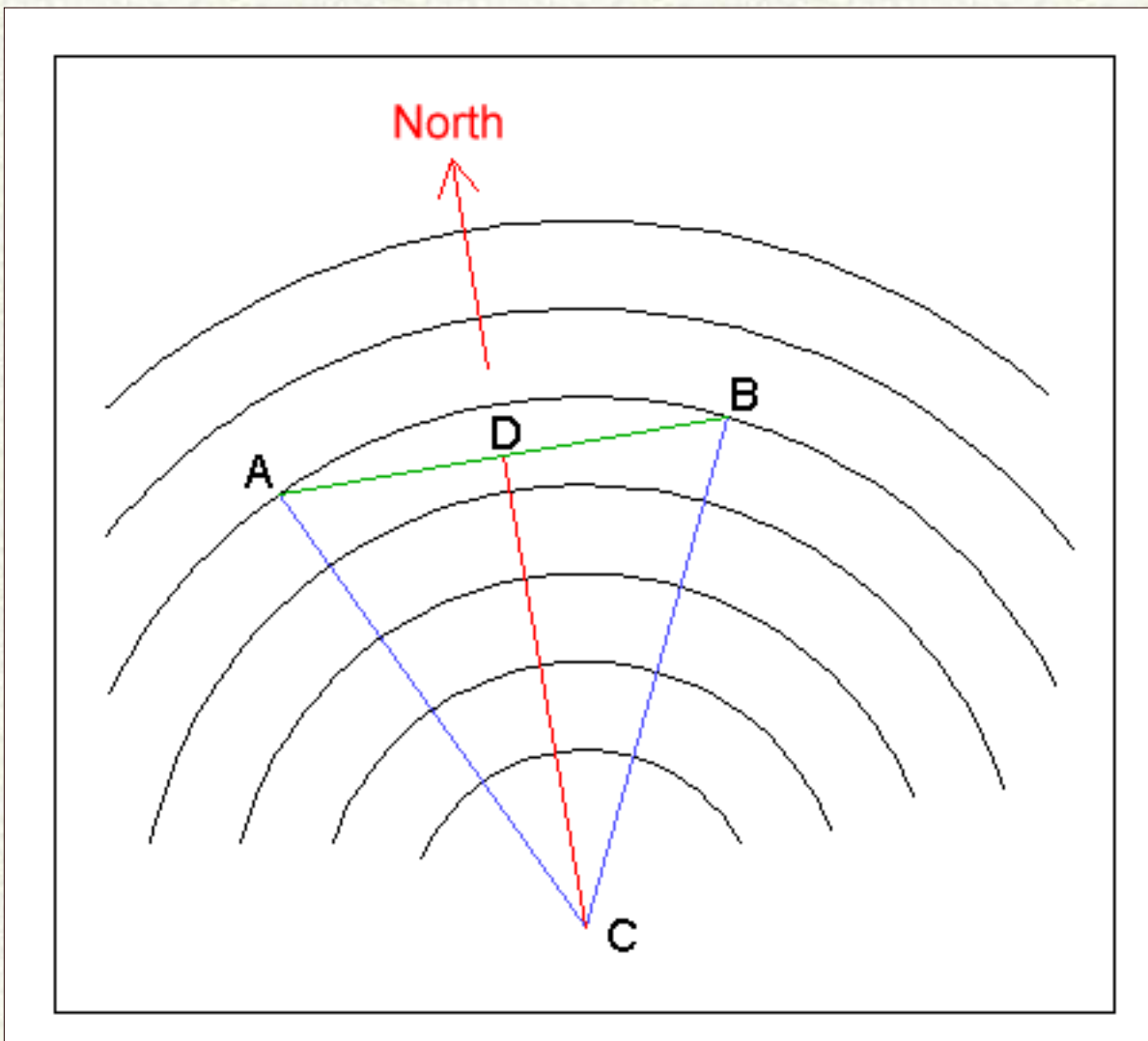

Using Polaris, the North Star

If you can get a good view of Polaris, it is always within a degree of True North.

When you have determined True North, proceed to:
[Correcting a commercial dial to your latitude](#)



[Department of the Navy](#)

[U.S. Naval Observatory](#)

Time Service Department

Features

- [What Time is it?](#)
- [USNO Master Clock](#)
- [How Many Clocks?](#)
- [BIPM Circular T](#)
- [Cesium Fountain](#)
- [Linear Ion Trap](#)
- [GPS](#)
- [Satellite Time Transfer](#)
- [Network Time Service](#)
- [Telephone Time](#)
- [Loran-C Timing](#)
- [US Time Zones](#)
- [Systems of Time](#)
- [Leap Seconds](#)

Highlights

- [Daily GPS Constellation Status](#)
- [PTTI Systems & Apps Meeting](#)

Popular Links

- [NEOS](#)
- [NIST](#)
- [USNO Home](#)
- [ntp.org](#)
- [Contact the USNO](#)
- [The Sky This Week](#)
- [Sun Rise/Set](#)

[Time](#)

[GPS](#)

[TWSTT](#)

[NTP](#)

[Loran-C](#)



- [Tour Info](#)
- [Travel Directions](#)

The Official Source of Time for the Department of Defense (DoD) and the Global Positioning System (GPS), and a Standard of Time for the United States

Please read this [Privacy and Security Notice](#) and this [Disclaimer for External Links](#). For Freedom of Information Act / Privacy Act questions, contact our [FOIA Program Office](#). Our [DoD Resource Locator](#) registration number is 46042.

Send comments on this page to webmaster@www.usno.navy.mil **Visitors since 22 Jul 2003:**

760352

This is an Official U.S. Navy Web Site

[Need Help?](#)

[Product & Services](#)
[Listing for Interior Design & Home Furnishings](#)
Blindsgalore®, Owens Corning, Owens Corning, Smith+Noble, Thomas J. MacDonald

[Product & Services](#)
[Listing for Plumbing](#)
Kinetico, Sanitary For All, TOTO USA

[Sponsored Links](#)

SMARTBUYS [View All >](#)

plumb bob found in 250 Shop. 5 items shown.

1. [Contractor Transit with Laser Plumb, Outfit](#) \$709.99 > [View product details @ Sears.com!](#)
2. [Contractor Transit with Laser Plumb, Outfit](#) \$709.99 > [View product details @ Sears.com!](#)
3. [22X Laser **Plumb** Transit, 300 ft. Range, Contractors](#) \$649.99 > [View product details @ Sears.com!](#)
4. [22X Laser **Plumb** Transit, 300 ft. Range, Contractors](#) \$649.99 > [View product details @ Sears.com!](#)
5. [8 oz. **Plumb** Bob, Steel](#) \$3.99 > [View product details @ Sears.com!](#)

[View All Shop Results >](#)

Tips Found [View All >](#)

plumb bob found in 6 Tips. 6 items shown.

1. [Using a **Plumb** Bob](#)
2. [Plumb Posts](#)
3. [Door Hanging](#)
4. [Choosing a Level](#)
5. [Hanging Kitchen Cabinets](#)

[View All Tip Results >](#)

Videos Found [View All >](#)

plumb bob found in 250 Videos. 5 items shown.

1. [Wall Stenciling Continued](#)
2. [Bookcase Construction](#)
3. [Starting the Second Floor](#)
4. [Door Installation](#)
5. [First Floor Framing](#)

[View All Video Results >](#)

[BobVila.com](#) > **Search** > You searched for "**plumb bob**"

Search

Narrow your search by selecting a section: [Articles](#) (775), [BBS](#) (4950), [FixIts](#) (1), [Glossary](#) (15), [Shop](#) (838), [Tips](#) (6), [Videos](#) (1096), [All Sections](#) (7682)

BBS Note: The Bulletin Board messages express the views of the author of the message, not necessarily the views of BobVila.com, Bob Vila or the Bulletin Board. If you feel that a posted message is objectionable, you are encouraged to contact us immediately by email. [For more details click here.](#)

Shop Note: In some instances, prices shown may not reflect the current price available at a particular store. Be sure to check both the price and availability when viewing the product at the store.

[About](#) | [FAQ](#) | [Contact](#) | [Sitemap](#) | [Terms of Use](#) | [Help](#)

© 2003 BVWebTies LLC. All Rights Reserved.







2002-09-29-solar-observing

Photo Index



[\[med\]](#) | [\[big\]](#) | [\[info\]](#)



[\[med\]](#) | [\[big\]](#) | [\[info\]](#)



[\[med\]](#) | [\[big\]](#) | [\[info\]](#)



[\[med\]](#) | [\[big\]](#) | [\[info\]](#)



[\[med\]](#) | [\[big\]](#) | [\[info\]](#)



[\[med\]](#) | [\[big\]](#) | [\[info\]](#)



[med](#) | [big](#) | [info](#)

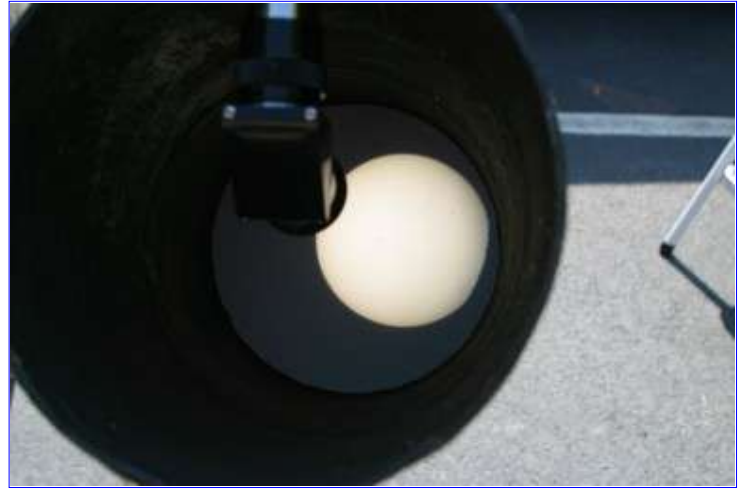

[med](#) | [big](#) | [info](#)



[med](#) | [big](#) | [info](#)



[med](#) | [big](#) | [info](#)



[med](#) | [big](#) | [info](#)



[med](#) | [big](#) | [info](#)



[med](#) | [big](#) | [info](#)



[med](#) | [big](#) | [info](#)



[med](#) | [big](#) | [info](#)



[med](#) | [big](#) | [info](#)



[med](#) | [big](#) | [info](#)



[med](#) | [big](#) | [info](#)



[med](#) | [big](#) | [info](#)



[med](#) | [big](#) | [info](#)



[med](#) | [big](#) | [info](#)



[med](#) | [big](#) | [info](#)



[med](#) | [big](#) | [info](#)



[med](#) | [big](#) | [info](#)



[med](#) | [big](#) | [info](#)



[med](#) | [big](#) | [info](#)



[med](#) | [big](#) | [info](#)



[med](#) | [big](#) | [info](#)



[\[med\]](#) | [\[big\]](#) | [\[info\]](#)



[\[med\]](#) | [\[big\]](#) | [\[info\]](#)



[\[med\]](#) | [\[big\]](#) | [\[info\]](#)



[\[med\]](#) | [\[big\]](#) | [\[info\]](#)



[\[med\]](#) | [\[big\]](#) | [\[info\]](#)



[\[med\]](#) | [\[big\]](#) | [\[info\]](#)



[\[med\]](#) | [\[big\]](#) | [\[info\]](#)



[\[med\]](#) | [\[big\]](#) | [\[info\]](#)



[\[med\]](#) | [\[big\]](#) | [\[info\]](#)



[\[med\]](#) | [\[big\]](#) | [\[info\]](#)



[\[med\]](#) | [\[big\]](#) | [\[info\]](#)

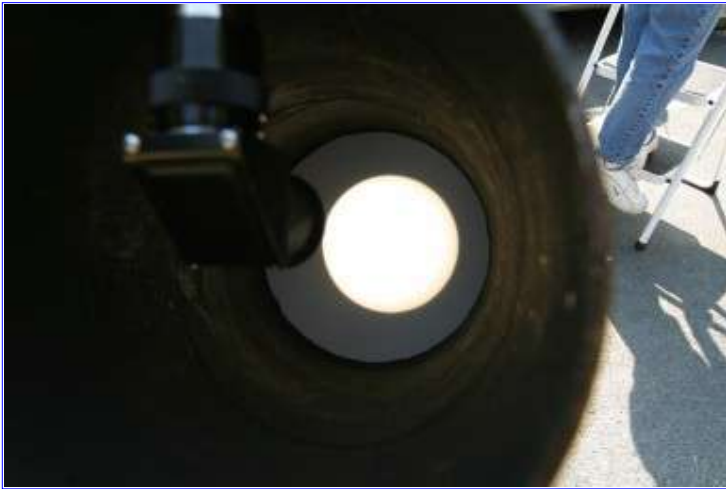

[\[med\]](#) | [\[big\]](#) | [\[info\]](#)

[\[med\]](#) | [\[big\]](#) | [\[info\]](#)



[\[med\]](#) | [\[big\]](#) | [\[info\]](#)



[\[med\]](#) | [\[big\]](#) | [\[info\]](#)



[\[med\]](#) | [\[big\]](#) | [\[info\]](#)



[med](#) | [big](#) | [info](#)



[med](#) | [big](#) | [info](#)



[med](#) | [big](#) | [info](#)



[med](#) | [big](#) | [info](#)



[med](#) | [big](#) | [info](#)



[med](#) | [big](#) | [info](#)



[med](#) | [big](#) | [info](#)



[med](#) | [big](#) | [info](#)



[\[med\]](#) | [\[big\]](#) | [\[info\]](#)



[\[med\]](#) | [\[big\]](#) | [\[info\]](#)



[\[med\]](#) | [\[big\]](#) | [\[info\]](#)



[\[med\]](#) | [\[big\]](#) | [\[info\]](#)



[\[med\]](#) | [\[big\]](#) | [\[info\]](#)



[\[med\]](#) | [\[big\]](#) | [\[info\]](#)



[\[med\]](#) | [\[big\]](#) | [\[info\]](#)



[\[med\]](#) | [\[big\]](#) | [\[info\]](#)



[med](#) | [big](#) | [info](#)



[med](#) | [big](#) | [info](#)



[med](#) | [big](#) | [info](#)



[med](#) | [big](#) | [info](#)



[\[med\]](#) | [\[big\]](#) | [\[info\]](#)



[\[med\]](#) | [\[big\]](#) | [\[info\]](#)



[\[med\]](#) | [\[big\]](#) | [\[info\]](#)



[\[med\]](#) | [\[big\]](#) | [\[info\]](#)



[\[med\]](#) | [\[big\]](#) | [\[info\]](#)



[med](#) | [big](#) | [info](#)



[med](#) | [big](#) | [info](#)



[med](#) | [big](#) | [info](#)



[\[med\]](#) | [\[big\]](#) | [\[info\]](#)



[\[med\]](#) | [\[big\]](#) | [\[info\]](#)



[\[med\]](#) | [\[big\]](#) | [\[info\]](#)



[\[med\]](#) | [\[big\]](#) | [\[info\]](#)



[\[med\]](#) | [\[big\]](#) | [\[info\]](#)



[\[med\]](#) | [\[big\]](#) | [\[info\]](#)



[\[med\]](#) | [\[big\]](#) | [\[info\]](#)



[\[med\]](#) | [\[big\]](#) | [\[info\]](#)



[med](#) | [big](#) | [info](#)



[med](#) | [big](#) | [info](#)



[med](#) | [big](#) | [info](#)



[med](#) | [big](#) | [info](#)



[med](#) | [big](#) | [info](#)



[\[med\]](#) | [\[big\]](#) | [\[info\]](#)



[\[med\]](#) | [\[big\]](#) | [\[info\]](#)



[\[med\]](#) | [\[big\]](#) | [\[info\]](#)



[med](#) | [big](#) | [info](#)



[med](#) | [big](#) | [info](#)



[med](#) | [big](#) | [info](#)

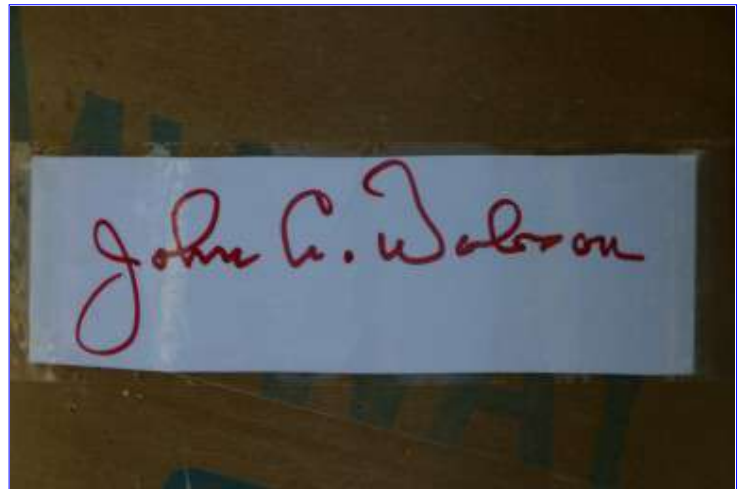

[med](#) | [big](#) | [info](#)



[med](#) | [big](#) | [info](#)



[med](#) | [big](#) | [info](#)



[med](#) | [big](#) | [info](#)



[med](#) | [big](#) | [info](#)



[med](#) | [big](#) | [info](#)



[med](#) | [big](#) | [info](#)



[med](#) | [big](#) | [info](#)



[med](#) | [big](#) | [info](#)



[\[med\]](#) | [\[big\]](#) | [\[info\]](#)



[\[med\]](#) | [\[big\]](#) | [\[info\]](#)



[\[med\]](#) | [\[big\]](#) | [\[info\]](#)



[\[med\]](#) | [\[big\]](#) | [\[info\]](#)



[\[med\]](#) | [\[big\]](#) | [\[info\]](#)



[\[med\]](#) | [\[big\]](#) | [\[info\]](#)



[\[med\]](#) | [\[big\]](#) | [\[info\]](#)



[\[med\]](#) | [\[big\]](#) | [\[info\]](#)



[\[med\]](#) | [\[big\]](#) | [\[info\]](#)



[\[med\]](#) | [\[big\]](#) | [\[info\]](#)



[med](#) | [big](#) | [info](#)



[med](#) | [big](#) | [info](#)



[med](#) | [big](#) | [info](#)



[med](#) | [big](#) | [info](#)



[\[med\]](#) | [\[big\]](#) | [\[info\]](#)

[photoweb](#)



Up to the minute piece of mind.

Emergency Alert Systems



[MORE INFO](#)



S+ARCK
WITH OREGON SCIENTIFIC
Time & Weather Collection

[MORE INFO](#)



The Ferrari Collection

[MORE INFO](#)

Oregon Scientific is a proud sponsor of the US Sailing Team.



[MORE INFO](#)

[PRIVACY STATEMENT & LEGAL](#)

[SITE MAP](#)

[CONTACT US](#)

March 3 2004

[TIME](#)

[WEATHER](#)

[FITNESS](#)

[COMMUNICATION](#)

[EDUCATIONAL LEARNING](#)

[FERRARI](#)

[STARCK](#)

[TIME](#)

[WEATHER](#)

[FITNESS](#)

[COMMUNICATION](#)

[EDUCATIONAL LEARNING](#)

[FERRARI](#)

[STARCK](#)

[ATOMIC PROJECTION CLOCKS](#)
[ATOMIC CLOCKS](#)

QUARTZ CLOCKS
TRAVEL CLOCKS

MULTI-CHANNEL WEATHER FORECASTERS
WEATHER STATIONS
LONG RANGE
THERMOMETERS & HYGROMETERS
WIRED WEATHER FORECASTERS
EMERGENCY ALERT SYSTEMS
SENSORS & ACCESSORIES

ALTIMETER WATCHES
HEART RATE MONITORS
PEDOMETERS & PULSE METERS
BLOOD PRESSURE MONITORS
WEIGHT & BODY FAT MONITORS

DIGITAL CAMERAS
VOICE RECORDERS

ACCELERATOR
FLYING RHINO
MORE WAYS TO LEARN!

AERODYNAMIC LINE
SPEEDOMETER LINE
SENSORS

SMALL
MEDIUM
LARGE
SENSORS

➤ HOME

➤ ABOUT US

➤ LATEST NEWS

➤ CUSTOMER SERVICE

➤ WHERE TO BUY

➤ ABOUT US

➤ LATEST NEWS

➤ CUSTOMER SERVICE

➤ WHERE TO BUY

CORPORATE PROFILES
CAREERS
AWARDS

FAQ'S
SOFTWARE DOWNLOADS
INSTRUCTION MANUAL DOWNLOADS
ONLINE PRODUCT REGISTRATION
PRODUCT TECHNOLOGY
TROUBLESHOOTING



When Does Daylight Time Begin and End?

Daylight time begins in the United States on the first Sunday in April and ends on the last Sunday in October. On the first Sunday in April, clocks are set ahead one hour at 2:00 a.m. local standard time, which becomes 3:00 a.m. local daylight time. On the last Sunday in October, clocks are set back one hour at 2:00 a.m. local daylight time, which becomes 1:00 a.m. local standard time.

Not all places in the U.S. observe daylight time. In particular, Arizona, Hawaii, and most of Indiana do not use it.

In 2003, daylight time begins on April 6 and ends on October 26.

In 2004, daylight time begins on April 4 and ends on October 31.

In 2005, daylight time begins on April 3 and ends on October 30.

Many other countries observe some form of "summer time", but they do not necessarily change their clocks on the same dates as the U.S.

Daylight time and time zones in the U.S. are defined in the U.S. Code, Title 15, Chapter 6, Subchapter IX - [Standard Time](#).

History of Daylight Time in the U.S.

Although standard time in [time zones](#) was instituted in the U.S. and Canada by the railroads in 1883, it was not established in U.S. law until the Act of March 19, 1918, sometimes called the Standard Time Act. The act also established daylight saving time, a contentious idea then. Daylight saving time was repealed in 1919, but standard time in time zones remained in law. Daylight time became a local matter. It was re-established nationally early in World War II, and was continuously observed from 9 February 1942 to 20 September 1945. After the war its use varied among states and localities. The Uniform Time Act of 1966 provided standardization in the dates of beginning and end of daylight time in the U.S. but allowed for local exemptions from its observance. The act provided that daylight time begin on the last Sunday in April and end on the last Sunday in October, with the changeover to occur at 2 a.m. local time.

During the "energy crisis" years, Congress enacted earlier starting dates for daylight time. In 1974, daylight time began on 6 January and in 1975 it began on 23 February. After those two years the starting date reverted back to the last Sunday in April. In 1986, a law was passed permanently shifting the starting date of daylight time to the first Sunday in April, beginning in 1987. The ending date of daylight time has not been subject to such changes, and has remained the last Sunday in October.

For a very readable account of the history of standard and daylight time in the U.S., see

Ian R. Bartky and Elizabeth Harrison: "Standard and Daylight-saving Time", *Scientific American*, May 1979 (Vol. 240, No. 5), pp. 46-53.

[\[Publications\]](#) | [\[Data Services\]](#) | [\[Software\]](#) | [\[FAQ\]](#) | [\[Research\]](#) | [\[About AA\]](#)
[\[News\]](#) | [\[Site Map\]](#) | [\[Index\]](#) | [\[Home\]](#)

[Need help?](#)

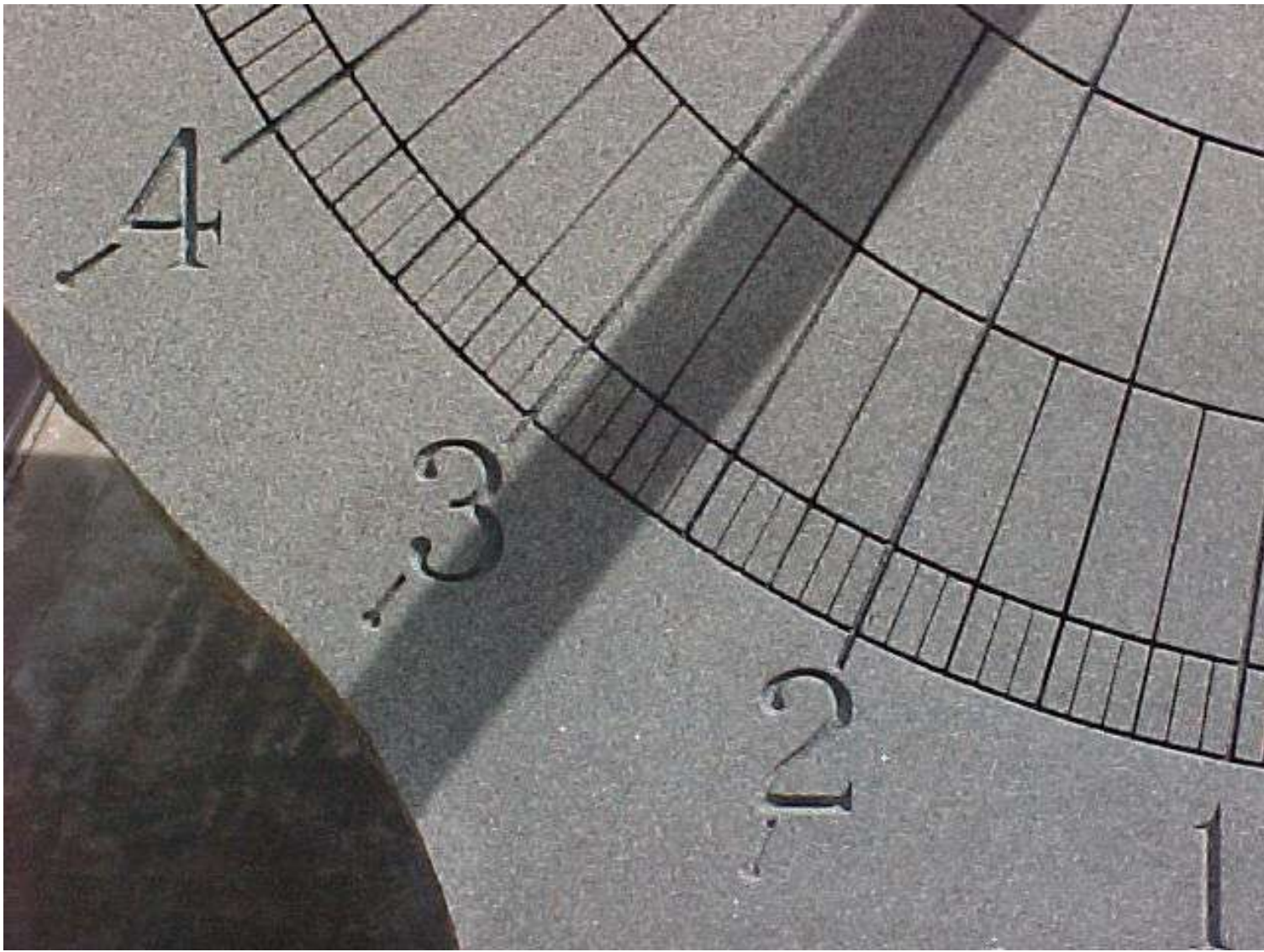

*Sandburg Center for Sky Awareness
A Fairfax County Public Schools Planetarium*

**The Carroll Moore Memorial Equatorial Sundial
Nebraska Wesleyan University, Lincoln, NE
40.8°N latitude; 96.7°W longitude**

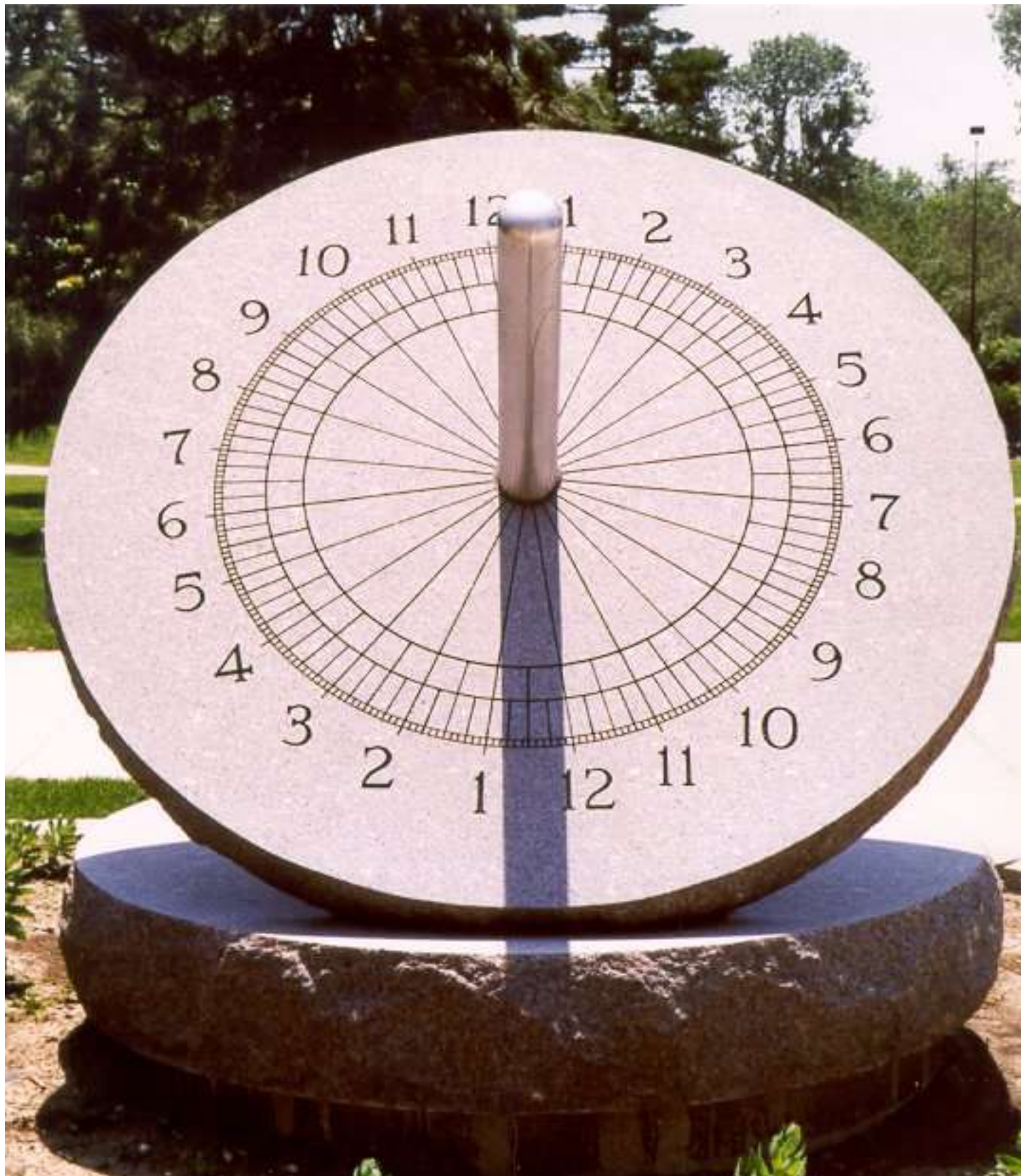



© Copyright 2003-2004 [Walter Sanford](#). All rights reserved.

Photograph courtesy Erik Hubl, Chairman, [Hyde Memorial Observatory](#)

[Me and My Shadow - Making the Sun-Earth Connection](#) | [SCSA Home](#)

Sandburg Center for Sky Awareness
A Fairfax County Public Schools Planetarium

The Boulder, CO Equatorial Sundial
John Garrey Tippit Memorial Sundial, University of Colorado
40.0°N latitude, 105.3°W longitude

Note: Using Microsoft Internet Explorer, [photo descriptors](#) appear on mouse roll-over.



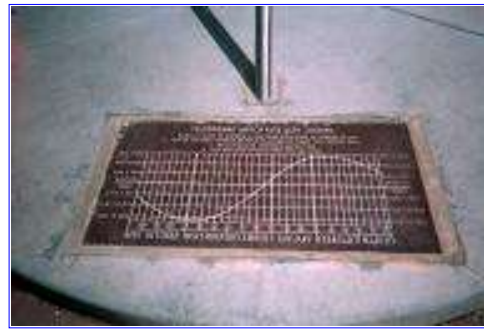

Related Resources

- The [John Garrey Tippit Memorial Sundial](#), University of Colorado
- [The Errors of an Equatorial Sundial](#), by R.H. Garstang, JILA, University of Colorado (657 KB PDF)
- The [St. Petersburg, FL Equatorial Sundial](#), War Veterans' Memorial Park
- [Erickson Memorial Company](#), Sundial Division
- [SCSA Educator's Guide to Equatorial Sundials](#)

© Copyright 2002-2004 [Walter Sanford](#). All rights reserved.

*Photographs courtesy [Walter Sanford](#), Director, [Sandburg Planetarium](#).
Thumbnail images prepared using photoweb v1.2 by [Phil Wherry](#).*

[Me and My Shadow - Making the Sun-Earth Connection](#) | [SCSA Home](#)



Tour of Griffith Observatory

The Griffith Observatory is closed to the public for renovation. This page, from 2001, is presented as a souvenir. The Observatory will reopen with new exhibits in 2005.

The Griffith Observatory has been a major Los Angeles landmark since 1935. It is visited by nearly two million people each year, which is almost half the annual attendance of Grand Canyon or Yellowstone National Parks. The Observatory ranks seventh on the list of major tourist attractions of Southern California. It sits on the southern slope of Mount Hollywood, where it commands a stunning view of the Los Angeles basin below. Thousands of people enjoy the view from its balconies, especially at night.

Take a [virtual tour](#) of the Observatory as it existed in late 2001.

High resolution [publicity photographs](#) of the Observatory are posted on a separate page.

A [history of the directors of the Observatory](#) and "[A History of Griffith Observatory](#)" are now on-line.

[lawn](#) | [Hall of Science](#) | [planetarium theater](#) | [telescopes](#)

The Lawn



As you look at the Observatory, you'll see three large copper domes. The one on the right (west) houses the triple-beam [solar telescope](#); the one on the left (east) houses the 12-inch [Zeiss Refracting Telescope](#); the largest dome (at center) houses the planetarium theater. The cupola (front center) holds the pendulum over the Main Rotunda.

Access to the roof and the Refracting Telescope is by way of the stairway on either side of the building. Note the romantic art deco style of architecture of the building, which was constructed in 1933-1935.

On the west edge of the lawn is a memorial to James Dean in the form of a bronze bust. Major segments of *Rebel Without a Cause* were filmed at the Observatory, as have been many motion pictures since.



The



Astronomers Monument honors six of the greatest astronomers of all time. They are [Hipparchus](#) (?-125 B.C.), [Copernicus](#) (1473-1543), [Galileo](#) (1564-1642), [Kepler](#) (1571-1630), [Newton](#) (1642-1727), and [Herschel](#) (1738-1822). Click here for a [detailed tour](#) of the Monument.

Near the Monument a radio antenna receives signals from weather satellites for display in the museum.



At the base of the Monument is the sundial (left). The fundamental units of time are set by the cycles in the sky, and people have been measuring them since prehistoric time. An Egyptian sundial from 1500 B.C. still exists. The sundial is a link between the sky and our need to measure time, and it's actually a model of the apparent movement of the sun. The sundial charts the progress of the sun across the sky during the day.

The sundial's thick round bar represents the celestial equator, which is the projection of the earth's equator into space. The main axis, a metal rod, lies parallel to the earth's axis of rotation. The sun is south of the celestial equator between September 22 and March 21, and during those six months the shadow falls on the north part of the time indicator.

Note that the sundial doesn't work on the first days of spring or autumn. As our sun crosses the celestial equator, the shadow of the thick bar falls on and hides the time scale. Click [sundials](#) for more information.

The Observatory lawn is the best place to view the famous [Hollywood Sign](#).

Hall of Science

There is no charge for admission to the Hall of Science - the astronomy museum - or to the telescope.

Main Rotunda

Upon entering the building your attention goes first to the [Foucault Pendulum](#). The pendulum demonstrates that the earth rotates. The 240-lb brass ball, which hangs by a wire 40 feet long, swings in a constant direction while the earth turns beneath it. The pendulum is supported by a bearing that doesn't turn the pendulum as the building rotates with the earth. A ring magnet at the bearing gives a little tug on each swing of the pendulum to keep the pendulum in motion. It is set up by the staff each morning and runs all day. It slowly comes to a stop after the power is turned off at night.



Look up to see the famous [Hugo Ballin Murals](#),

completed in 1934. Medieval cathedrals told stories in stone,

and these murals tell the story of science in paint. On the ceiling are Atlas, the four winds, and the signs of the zodiac. Other figures include the planets as mythological gods and a comet. The eight rectangular panels show highlights of

astronomy, aeronautics, navigation, civil engineering, metallurgy and electricity, time, geology and biology, and mathematics and physics (left to right, starting with the panel opposite the main entrance).

South Gallery

The South Gallery is between the Main Rotunda and the entrance to the planetarium theater. The general theme is planets.

You'll notice the Gravity Well first. Its parabolic shape reproduces the gravitational effect the sun has on the planets (or a planet on its moons). The well has a steeper curvature ("stronger gravity") near the center, and this causes objects to speed up as they approach the center. We might say they move faster near the center because the gravity is stronger there. Einstein would say they move faster because space has a greater curvature. In the gravity well, friction with the surface causes the steel balls to slow down and eventually to fall in; in space there is so little friction that the planets do not move significantly closer to the sun during the lifetime of the solar system. A satellite in low earth orbit feels friction with the upper atmosphere and eventually spirals to the ground, as

Skylab did in 1979.

An Orrery sits on the floor to the left (north) of the Gravity Well. An orrery is a device that shows the planets in motion around the sun. This one includes the moon. Notice that the earth's inclination is shown as well, so you can see that the moon generally passes above or below the sun, as seen from earth, rather than directly in front of it. This is a mechanical orrery; a projection orrery is often used in planetarium shows.

The Astroscreen is a large rear-projection screen with a video projector behind it. It promotes the current public [planetarium show](#).

Large color transparencies surround the Astroscreen. They are some of the most spectacular photographs ever taken of the planets and their satellites, and most were taken by spacecraft.



Planet scales are behind the Gravity Well. They show your weight on the earth, moon, Mars, and Jupiter. Although an old exhibit, it remains popular. Notice -- and this is a hard concept -- that your weight depends not only upon the mass of the planet on which you are standing, but also on its size. On small worlds, you stand closer to the center of mass. That's why the sun, with 333,000 times the mass of the earth, has only 28 times the surface gravity. If you compressed the sun's mass into a sphere the size of the earth and stood on it, you would weigh 333,000 times as much as you do here.

Scale models of the planets lie opposite the Astroscreen. You might be surprised at how small the earth is. Jupiter is larger than all the other planets put together. The edge of the sun is shown at the same scale (the sun's diameter is 13 feet).

East Hall

If you turn at the pendulum and go towards the large Earth Globe, you will be heading down the East Hall and toward the East Rotunda. The exhibits are described in approximately the order you'll come to them.

The Moon Alcove has transparencies of highlights of the Apollo missions to the moon (1969 -1972) on the side walls. When do you think astronauts will return to the moon? A device on the ceiling simulates the phases of the moon (view it from the center of the room). The model shows the change in the moon's appearance 20,000 times faster than it really occurs.

The next alcove interprets the earth from space. At the front of the alcove is the Geochron, a clock that shows the current time everywhere on earth as well as the sunrise and sunset lines. It bears close study. The caption is somewhat technical but it tells you how much information is contained in the Geochron. On the back wall is a display showing current weather pictures of the earth and comparing this with cloud patterns on Venus and Mars.



The Moon Globe is directly across the corridor. The six-foot model shows the entire surface of the moon. If you stand just behind the railing you see the moon as if you were 2,000 miles above its surface. The scale is 30 miles to the inch (20 km per cm). At the same scale, Los Angeles would fit in the palm of your hand. Notice how many craters are a lot more than an inch across! The older part of the moon's surface was saturated with craters about four billion years ago. Each new impact overlapped older craters as it created new ones until

it resembled a World War I battlefield. Between four and three billion years ago lava flooded lowlands with dark lava seas. Relatively few craters have formed since, but they look fresher than the others. The mountains are really the curved rims of the largest craters. There is essentially no erosion because there is no air.

The museum now opens into the main east exhibit area. Most of these exhibits are temporary. Here you will find a 1/5 scale model of the Hubble Space Telescope surrounded by many of the spectacular photographs it has taken. (For Hubble photographs on the Web, visit [Best of the Hubble Space Telescope](#) or [Space Telescope Science Institute](#)).



Two "Planet Odyssey" exhibits let you tour the solar system on your own path and view the best pictures and videos of the planets.

Paintings by Chesley Bonestell -- the most famous space artist of all -- are in two cases against the north wall. Two web sites, <http://www.bonestell.com> and <http://www.bonestell.org> will give you background information on Bonestell and his work.

Among the permanent exhibits is the Camera Obscura (to your immediate left). Camera obscura is Latin for "dark chamber." A large convex lens focuses light from outside the building onto the viewing screen. The image would be upside down, but an overhead mirror turns it right-side-up again. It demonstrates how a lens focuses light to make an image. Renaissance artists used similar devices to make accurate sketches of distant scenes. The camera obscura doesn't admit enough light to work very well at night.

Nearby is "Stargazer," a pair of computers that lets you look at the sky for the dates you select.

You might choose to see the sky at the time of your birth, for example, or to preview the next eclipse or planetary conjunction. You can run forward or backward through time through thousands of years. They are based on a program by the same name from Carina Software for Macintosh computers.



To the right and in front of the large raised Earth Globe is the Seismograph. There are actually two seismographs--one in the basement and one on display. The display seismograph, which is visible in the glass case, records vibrations from the floor and displays them on the left drum inside the glass case; it is for demonstration only, and it lets you create your own earthquakes by jumping on the floor. The seismograph in the basement (not accessible to the public) detects long-period waves (the equivalent of low notes) and displays them on the center drum and short-period waves ("high notes"), which are displayed on

the drum at right. Low notes travel farther than high notes (which is why ships' fog-horns have such a low pitch). High notes carry more information about things that are close. The three drums turn once every 15 minutes, and the tick marks are one minute apart, so each sheet records for 24 hours. Records of several famous earthquakes are displayed nearby along with interpretative material. In front sits a small cutaway globe showing the earth's interior and the paths of seismic waves. Go to [Recent Earthquakes in California](#) for maps and listings of recent local earthquake activity.

East Rotunda

The East Rotunda contains the 6-foot Earth Globe and Meteorite Exhibit.

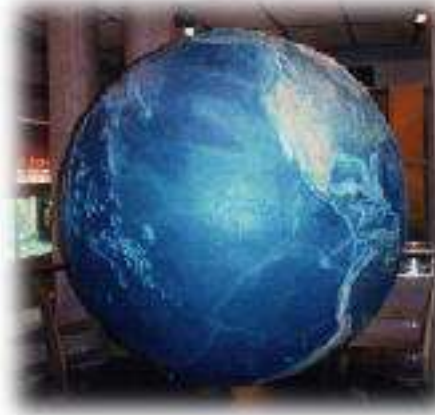

The Earth Globe is the centerpiece. The earth is one planet of nine in the solar system, and this globe shows its physical topography, especially of the ocean floor. We've recently begun to learn about the topography of Venus and Mars, and we've found that each planet is different, but with similarities. The ridges running through the oceans (especially the Atlantic Ocean) are indicative of continental drift and are one type of boundary between crustal plates. In contrast, Venus has two "continents," but little or no continental drift; apparently its crust is too thick. Mars shows the beginnings of crustal motion with one huge canyon, but the motion didn't get very far. This globe is

especially useful for looking at the distribution of mountain ranges, ocean ridges, and trenches. Unlike flat maps, in which Greenland looks as big as South America, the globe shows the true relative sizes of the earth's features.

The globe is hand-painted to show the continents with maximum summer vegetation for both hemispheres. The scale is 106 miles to the inch (70 km/cm) with a variable vertical exaggeration of about 12 times. The globe is tilted so that its axis of rotation is aligned with the true axis of the earth. (This means you see the northern hemisphere best from the north side, and the southern

from the south.)

The Meteorite Exhibit can be read from either direction because each case treats a separate topic. Meteorites are important because, moon rocks aside, they are our only samples of material from beyond the earth. They are fragments of minor planets that formed and then shattered in mutual collisions millions or billions of years ago. A few contain pieces of the original material out of which the planets formed. Some (the iron meteorites) came from the interiors of small planets, while others (the stony) are the mantles and crusts of others. A very few (including one in our collection that is on display in the Mars Alcove at the far end of the exhibit hall) came from Mars! Others on display came from the surface of the asteroid Vesta. Note especially the collection of California meteorites. The origin of glassy tektites is linked to meteorite impacts on earth. Large impacts have shaped the surfaces of the moon and inner planets. Notice two large meteorites weighing several hundred pounds each on the floor. Meteorites are the oldest objects you will ever touch.



West Hall

Return to the Pendulum in the Main Rotunda, and continue on to the Tesla Coil. The coil is demonstrated at regular intervals by the Guides. Ask at the Information Booth for the time of the next demonstration.

The [Observatory's Tesla Coil](#) is a transformer that increases the electrical voltage up to about half a million volts. It is the high voltage that causes the electricity to jump so far. The sparks are like short lightning bolts and the sound is like miniature thunder. The coil's high frequency (35,000 cycles, versus 60 for household current) prevents the electric current from penetrating objects, and the electricity moves along their surfaces. That is why you can take an enormous charge from this coil without damaging your skin.

The [Tesla Coil](#) was invented by the eccentric genius [Nikola Tesla](#) (b. 1856 - d. 1943), who displayed his first model in 1891. It emitted five-inch sparks. His largest coil, in 1899, was 200 feet high and sent sparks as thick as your arm flying 135 feet. It burned out the power company's main generator. That coil lit up incandescent lamps 26 miles away (where it sounded like thunder), but Tesla's idea of transmitting electricity without wires never caught on. Tesla invented much of the equipment used today in transmitting electrical power and radio signals. The [Observatory's Tesla Coil](#) was built in the 1920s, reportedly for vaudeville, and donated to the Observatory in 1937. You can purchase your own Tesla Coil from



[Tesla Technology Research](#) and read about making Tesla coils at this [Electronics Technology Listings](#) page.

The Nature of Light alcove is opposite the Tesla Coil. The back wall contains samples of most of the natural elements and their ores in a recently renovated exhibit. The display at right explains the nature of light. Everything that exists (at least on the planets) is made of the same fundamental elements, and all that we know about the stars comes from analyses of their light. The left wall explains how the chemical elements were created in the Big Bang and in stars.

The next alcove houses a new exhibit on the planet Mars that features a large Mars globe, a 20-foot Pathfinder panorama, and an actual [Mars rock](#). The Mars rock is a piece of basaltic lava that flowed and then cooled on the surface of Mars 1.3 billion years ago. It was knocked into space by a meteorite impact 180 million years ago, and fell to earth as a meteorite in 1962.

The opposite alcove contains the Galaxies exhibit. Galaxies are fundamental building blocks of the universe, and they come in a variety of shapes and sizes. The alcove will familiarize you with their importance and with the general shape of our own Milky Way.

Adjacent to the Galaxies alcove is the Radio Astronomy exhibit. Radio telescopes allow us to see what the universe would look like if our eyes were sensitive to radio waves. Until about World War II, all we knew about the universe came from what we could see with our eyes, and all the information we had arrived in the form of visible light. Since then, astronomers have devised ways of seeing the universe in infrared light, gamma rays, X-rays, and other exotic wavelengths, and the study of the universe at these wavelengths is a vital part of modern astronomy. Just as the world would look plain if you could only see things that are green, so the universe looks plain if you can see only those things that radiate visible light. Radio (and other) waves let us see things that would otherwise be invisible (like clouds of warm hydrogen), and give us new perspectives on the familiar. (Notice the unusual appearance of the sun at different wavelengths in the solar exhibit farther down the hall.)

An exhibit within the Radio Astronomy alcove explains pulsars, rapidly spinning neutron stars that send pulses of radio energy earthward. They also send much weaker pulses of visible light. Pulsars were discovered with radio telescopes.

The Cosmic Ray exhibit lies opposite the Radio Astronomy area. Cosmic rays are extremely energetic subatomic particles, often from exploded stars, that strike the earth's upper atmosphere. They smash the air molecules and send a shower of debris down towards the ground. We don't see the cosmic rays themselves, but we do detect the debris they create. The electroscope (left rear) demonstrates that particles are constantly hitting it and causing it to lose its charge. In this demonstration, additional particles are generated by a radioactive substance.

If cosmic rays can go through the Observatory roof, they can go through your body, too, and they do. We're constantly bombarded by cosmic ray debris, and they are a minor source of genetic mutation.

Sharing the Cosmic Ray Alcove are two astronomical computers that allow you to run three programs: "Hangman," "Birthdates on the Planets," and "Professor Astro." "Hangman" asks you to guess astronomical words and terms, and you hang if you don't guess them before running out of

chances. "Birthdates" calculates your age on each planet and the date of your next birthday in terms of that planet's years. If you are 11 years old on earth, you are about 46 on Mercury, for example. "Professor Astro" tests your knowledge of the universe and gives interesting information about things you may not have known. It takes about a half-hour to run all three programs.

West Rotunda

The West Rotunda is devoted mainly to the sun - the only star that we see from up close.



A "triple-beam coelostat," actually three solar telescopes on one mounting, sends three beams of sunlight down from the roof and into three instruments that give us three different views of the sun. A short video shows how the telescopes are mounted in the dome on the roof (this is the dome to the right as you face the Observatory from the lawn) and how they work. The telescopes operate only when the sun is shining! Nighttime visitors have to be content with the transparencies and video.

The first of three views of the sun that you will see (during the daytime only) is a bright "white-light" image on the front side of the coelostat column. It shows the sun as you would see it with your eyes alone (and the proper filters). You will often notice sunspots. Notice the earth and moon to scale below; 1 inch equals 40,000 miles.

The second solar telescope sends its beam through a slit on a table at right and into a pit 20 feet below the floor, where it falls on a diffraction grating, which acts like a prism to break the light into a continuous band of colors called the spectrum. Transparencies above explain the importance of the solar spectrum. The dark lines are produced by gases in the sun's atmosphere. Look into the eyepiece and see if you can identify any of the dark lines from the chart at upper right.

The third solar telescope uses a filter that absorbs all the light except that which comes from hydrogen, and it shows what the sun would look like if you could see only hydrogen at a certain temperature and pressure. The image is too small to see sunspots well, but you will often notice prominences--huge streamers of hydrogen that arch high above the sun's surface.

A World War II vintage periscope nearby is very popular with kids of all ages. This periscope, which was donated by the U. S. Navy, was used to sink over 40,000 tons of Japanese shipping at the end of the war. Now you can use it to sink houses and buildings in Hollywood. The periscope extends through the ceiling and projects 22 feet above the roof (you can see the top part of it from the roof).



On the other side of the rotunda you'll see a model of the 200-inch Hale Telescope on Palomar Mountain, part of the [Palomar Observatory](#), near San Diego, and the central plug from its mirror.

The model demonstrates how the 500-ton telescope and 2,000-ton dome turn to point to different parts of the sky. The mounting is designed to allow the telescope to track the stars by turning in one direction only. The large mirror to the left of the model is an unusual historic relic. It was originally the central plug of the 200-inch mirror that was removed after grinding, and it is now on loan to Griffith Observatory. It shows how thick this large telescope mirror is. The 200-inch telescope, completed in 1948, was the largest useful telescope in the world until the construction of new telescopes with thin multiple mirrors. The first of these was the twin 400-inch Keck Telescopes in Hawaii, operated jointly by the University of California and by the California Institute of Technology, and which began operation in 1991.



Telescopes

Climb to the roof by the stairs on either side of the building. (You have to go outside to get to the roof.) Most people climb to the roof for the view, but there are interesting things up there. The dome at the west end of the building houses the [solar telescopes](#). This dome is not open to the public. Note the top part of the periscope protruding through the roof [the periscope was removed in June, 2002].



The large main dome houses the planetarium theater. The octagonal cupola opposite it covers the main rotunda and holds the pendulum.



To the east is the [12-inch Zeiss Telescope](#). Although the lights of Los Angeles brighten the sky and make it almost impossible to see faint objects like galaxies and nebulae, the telescope gives wonderful views of the moon and planets. The Telescope Demonstrators are exceptionally helpful at explaining what you are looking at and in answering any astronomy questions you might have. The Sky Report, (323) 663-8171, is a

recorded message that gives current information on what's happening in the sky; it's updated weekly. The Galileo Project has an excellent illustrated [history of the telescope](#).



[General Info](#) | [Tour of Observatory](#) | [Planetarium](#) | [Special Events](#) | [Renovation](#) | [Sky Info](#)
[Star Awards](#) | [Griffith Observer](#) | [Calif. Astro. Clubs](#) | [Bookshop](#) | [FOTO](#) | [IPS Journal](#)

Search Website

contact: info@GriffithObs

HORIZON

The imaginary line where the sky *appears* to meet the earth. The horizon can be divided into 360 degrees of [azimuth](#).

SUNDIAL EQUATIONS

"All this information is secured by means of instruments suitable for these purposes, and by tables and by canons.... For everything works through innate forces shown by lines, angles and figures" *Opus Majus*, Roger Bacon (1220-1292)

Sundial equations are published in many of the standard sources. Those reproduced here use the preferred symbols and definitions of the various parameters as described in the glossary. They are also self-consistent, and follow the sign conventions of the glossary, i.e. if the correct signs of the angles are input, and proper note is taken of the signs of the trigonometrical functions, the outputs will also have the correct signs.

Notes. In the equations for the hour line angle X , the equations are for $-90^\circ < h < 90^\circ$, i.e. between 6 a.m. and 6 p.m. L.A.T. For other times, the true hour line angle is given by:

$$X' = X \pm 180^\circ$$

The hour angle, h , in degrees, is given by

$$h = (T_{24} - 12) \times 15^\circ$$

where T_{24} is the time in 24-hour clock notation (hours after midnight) in decimal hours.

1. Horizontal dial ($i = 0^\circ$)

Style height:

$$SH = \phi$$

Hour line angles:

$$X = \arctan \{ \sin \phi \cdot \tan(h) \}$$

2. Vertical direct S dial ($i = 90^\circ$)

Style height:

$$SH = 90^\circ - \phi$$

Hour line angles:

$$X = \arctan \{ \cos \phi \cdot \tan(h) \}$$

3. Declining dial ($i = 90^\circ$)

Style height:

$$SH = \arcsin \{ \cos d \cdot \cos \phi \}$$

Sub-style angle:

$$SD = \arctan \left\{ \frac{\sin d}{\tan \phi} \right\}$$

Hour line angles:

$$X = \arctan \left\{ \frac{\cos \phi \cdot \tan(h)}{\cos d + \sin d \cdot \sin \phi \cdot \tan(h)} \right\}$$

4. Declining-reclining dial

The case considered here is for $i > \phi$ and $d < d_{crit}$

$$d_{crit} = \arccos \left\{ \frac{\tan \phi}{\tan i} \right\}$$

where

i.e. the common case of a roughly south-facing dial reclining slightly from the vertical. Then:

Noon line angle (with respect to the line of greatest slope):

$$v = \arctan \{ \tan d \cdot \cos i \}$$

Style height:

$$SH = \arcsin \{ \cos \phi \cdot \sin i \cdot \cos d - \sin \phi \cdot \cos i \}$$

Sub-style angle:

$$SD = \arctan \left\{ \sin i \sin d \times \frac{\sin i \cdot \cos d - \tan \phi \cdot \cos i}{\cos i + \tan \phi \cdot \cos d \cdot \sin i} \right\}$$

Hour line angles (with respect to the noon line):

$$X = \arctan \left\{ \frac{(\cos \phi \sin i - \sin \phi \cos i \cos d) \tan(h) + \cos i \sin d}{\cos d + \sin d \cdot \sin \phi \cdot \tan(h)} \right\} - v$$

5. Sun's azimuth

$$A = \arctan \left(\frac{\sin(h)}{\sin \phi \cos(h) - \cos \phi \tan \delta} \right)$$

6. Sun's altitude

$$a = \arcsin \{ \sin \phi \sin \delta + \cos \phi \cos \delta \cos(h) \}$$

7. Sunrise/sunset

The time (hour angle) of sunrise/sunset is given by:

$$h_{sr,ss} = \mp \arccos(-\tan \phi \cdot \tan \delta)$$

The azimuth of the rising/setting sun is given by:

$$A_{sr,ss} = \mp \arccos \left(-\frac{\sin \delta}{\cos \phi} \right)$$

Note that these times and azimuths are for astronomical sunrise/sunset, i.e. when the centre of the sun is on the true horizon, neglecting atmospheric refraction. For other definitions of sunrise/sunset, the corresponding altitudes should be used in the equations of (5) and (6)

8. EoT (best fit equations)

A full calculation of the EoT for any time in any epoch is complex and the reader is referred to Meeus (see [Sources](#)), an Astronomical Almanac, or the NASS [Dialist's Companion](#) computer program, or use the on-line solar calculator at www.gcstudio.com/suncalc.html. Mean daily values of the EoT (over the period 2000 - 2099) are available from: <http://www.chabot.demon.nl/sundials/sunmeangmt.htm>. For many practical purposes, the fourier transform approximation given below, which has a worst-case error of 0.0025 radians (35 seconds of time), will be sufficient.

$$E_a = -0.0000075 - 0.001868 \cos w + 0.032077 \sin w + 0.014615 \cos 2w + 0.040849 \sin 2w$$

where E_a is in radians at 12:00 UT and w is calculated from day number n_d (ranging from 1 on 1 January to 365 on 31 December) by:

$$w = 2\pi n_d / 365$$

To convert to the EoT in seconds (of time), multiply E_a by $43200/\pi$.

For detailed values of the EoT (and many other solar parameters) on any particular day, use the NASS Diallers' Companion program.

9. Declination (best fit equations)

The comments made above for the EoT also apply to the Sun's declination. The fourier transform approximation below yields a maximum error of 0.0006 radians (less than 3 arcminutes) or, if the final two terms are omitted, 0.0035 radians (12 arcminutes):

$$\delta = 0.006918 - 0.399912 \cos w + 0.070257 \sin w - 0.006758 \cos 2w + 0.000907 \sin 2w \\ - 0.002697 \cos 3w + 0.001480 \sin 3w$$

where δ is in radians and w is as defined for the EoT above.

10. Sun's refraction

$$R_o = \frac{1}{\tan \left[\alpha + 7.31 / (\alpha + 4.4) \right]}$$

R_o is the refraction in arcmins for a temperature of 10°C and an atmospheric pressure of 1010 mb. For other conditions, a multiplying factor of $0.28P/T$ is required, where P is the pressure in mb and T is the temperature in kelvins (= temp in °C + 273).

11. Babylonian and Italian Hours

The Babylonian hour t_B and Italian hour t_I (in hours) are given by:

$$t_B = \{24 + (h + \zeta) / 15\} \bmod 24$$

and

$$t_I = \{24 + (h - \zeta)/15\} \bmod 24$$

where h is in degrees and

$$\cos \zeta = -\tan \phi \cdot \tan \delta$$

12. Seasonal or Temporal Hours

The temporal hour t_T (in hours) is given by:

If $h < -\zeta$:

$$t_T = \frac{6 \times (360 + h - \zeta)}{(180 - \zeta)}$$

If $\geq \zeta$:

$$t_T = \frac{6 \times (h - \zeta)}{(180 - \zeta)}$$

Otherwise:

$$t_T = \frac{6 \times (h + \zeta)}{\zeta}$$

where all angles are in degrees and ζ is as defined for Babylonian hours above.

Figure 5

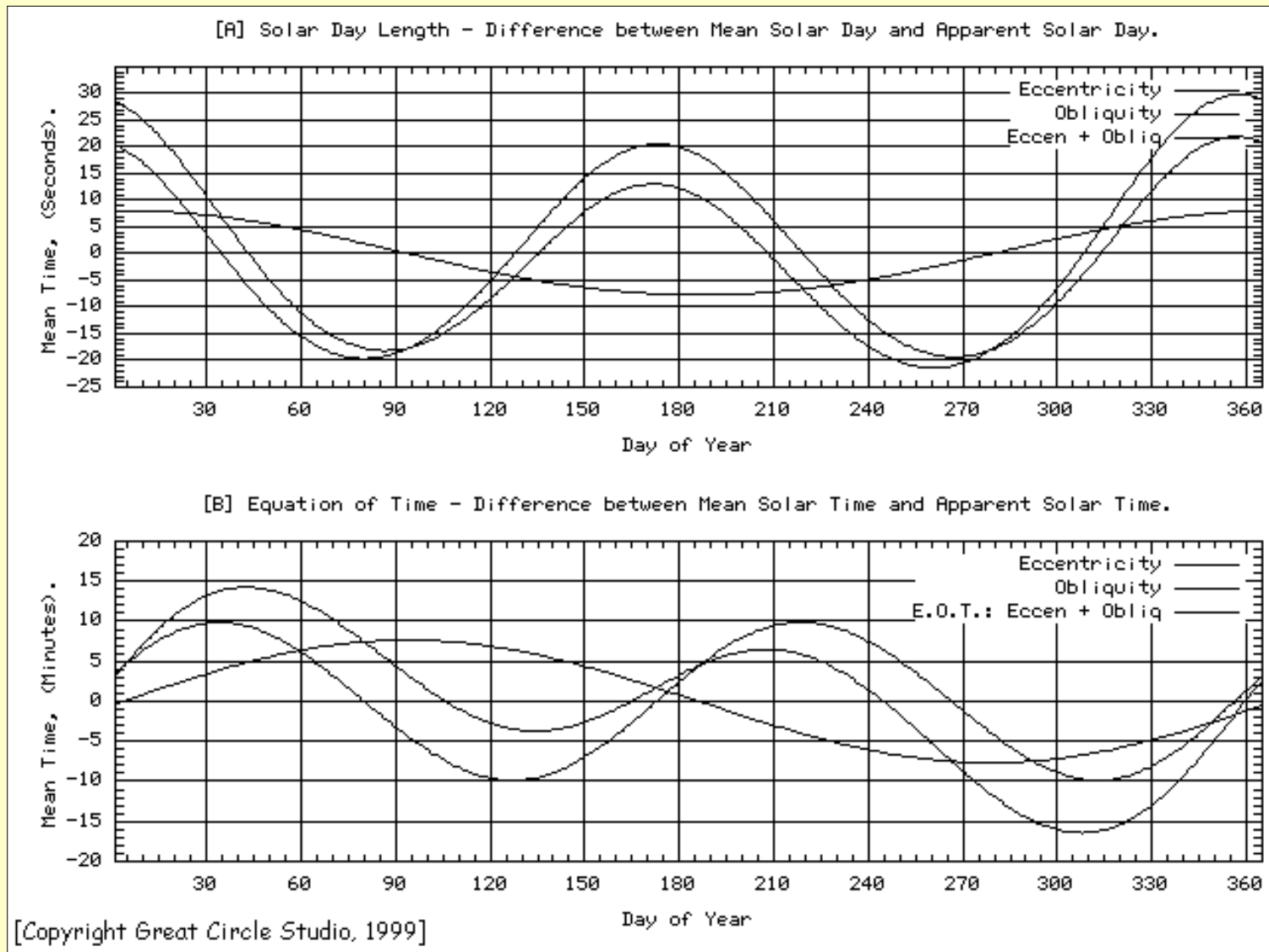

Figure 5. The Equation of Time and its components.

[A](#) [B](#) [C](#) [D](#) [E](#) [F](#) [G](#) [H](#) [I](#) [J](#) [K](#) [L](#) [M](#) [N](#) [O](#) [P](#) [Q](#) [R](#) [S](#) [T](#) [U](#) [V](#) [W](#) [X](#) [Y](#) [Z](#)

[Introduction](#) [Dial types](#) [Hours \(types of\)](#) [Time \(types of\)](#) [Illustration](#)
[Symbols](#) [Equations](#) [Chronology](#) [Sources](#) [Appendices](#)

The BSS Sundial Glossary



Several letters to the BSS Bulletin in 1999 suggested that a sundialing glossary would be useful in furthering the society's aims. It is hoped that this resulting glossary will fulfil two objectives. The first of these is to provide newcomers to dialling with a reference document which will explain the many strange terms or unusual usages of common words which they will come across in the dialling literature.

The second objective is to try to produce definitive meanings of the terms which diallists sometimes use rather loosely, and which can therefore lead to some confusion. Thus when several words have the same meaning, the preferred use is described here. Likewise, an attempt has been made to produce a standardised set of symbols for the most widely used terms in dialling equations.

Choices between different meanings have been made on the basis of adopting the most common modern usage found in the literature (particularly those items shown in the [Sources](#) section) as long as this does not produce confusion. Alternative usages, spellings or conventions which may be met, particularly in early dialling works, have been given where possible, but it is hoped that future authors will adopt the preferred definitions given here.

As English is used in countries other than the UK, there may be alternative definitions overseas. However, this glossary has been assembled with collaboration from the [North American Sundial Society](#) and, via the medium of the internet, diallists worldwide, so it is not expected that there will be major differences in terminology throughout the majority of the English-speaking world. The alphabetical section of the glossary consists of over 190kb, please watch the status bar of your browser and wait for the entire document to load.

John Davis - BSS Glossary Editor

UPDATES TO THE EDITOR

It is proposed to update this glossary periodically, so that it will develop along with the science of dialling. If you have any comments, corrections or additions, please inform the editor at john.davis@btinternet.com or at the address below.

John Davis
Orchard View, Tye Lane
Flowton,
Ipswich IP8 4LD
UK

May 2000

SCOPE

The glossary contains mainly terms which are directly related to dials and dialling. Additionally, excursions into the fields of astronomy, horology, optics and solar sciences have been made where it seems useful. Some comments on the history of dialling are made, but there are no direct entries for famous diallists, except where something is named after them.

NOTATION

Words [thus](#) are links to entries in this glossary or other internal references.

Bold text indicates a definition.

~ indicates a repeat of the entry word.

Symbols in square brackets [**x**, **X**] give the preferred symbol and abbreviation. See section on [Symbols](#) for a full list.

Alternative spellings or terms to the preferred ones are shown in brackets thus: {dialing}.

Pronunciation of unusual words is shown with a simplified phonetic scheme thus: **gnomon** (pron. no-mon). If no pronunciation is given for an entry, it is pronounced as it is written (following normal Oxford Dictionary rules for English pronunciation).

A note on the Southern Hemisphere. This glossary has been written primarily for the Northern Hemisphere, since this is where the majority (but not all) of the BSS membership resides. Gnomons in the Southern Hemisphere generally point to the S celestial pole, and the hour numbers on a horizontal dial run anti-clockwise rather than clockwise. The notation and equations used in the glossary are consistent as long as the sign conventions are followed, but the reader must mentally change N to S in the text.

PRINTED VERSION

This Glossary is also published by the British Sundial Society as a printed book which is now available.

ACKNOWLEDGEMENTS

I would like to thank the numerous members of the BSS and the NASS who helped with the definitions of terms, and who provided encouragement to the project. These include, in no particular order, Margaret Stanier, David Young, Patrick Powers, John Carmichael, Harvey Frey, Tony Wood, John Ingram, Doug Bateman, Frank and Rosie Evans, David Scott, Fer de Vries, Gianni Ferrari, Tony Baigent, Chris Lusby Taylor, Mac Oglesby, Vit Planocka, Daniel Wenger, Gordon Taylor, Michael Lowne, Sara Schechner, Robert van Gent, Tony Moss, Allan Mills, Thibaud Taudin-Chabot, Gerald Stancey, Mike Cowham, Gloria Clifton.

WEB DESIGNER

Conversion of the printed version for this website has been a complex and demanding task, undertaken by BSS member Robert Terwilliger who is also the Webmaster for the [North American Sundial Society](#).

Glossary: a list with explanations of abstruse, antiquated, dialectal or technical terms.

